



**HAL**  
open science

# Caractérisation du bois de Mûrier blanc (*Morus alba* L.) en référence à son utilisation dans les luths Iraniens

Aida Se Golpayegani

## ► To cite this version:

Aida Se Golpayegani. Caractérisation du bois de Mûrier blanc (*Morus alba* L.) en référence à son utilisation dans les luths Iraniens. Mécanique des matériaux [physics.class-ph]. Université Montpellier II - Sciences et Techniques du Languedoc, 2011. Français. NNT: . tel-00804975

**HAL Id: tel-00804975**

**<https://theses.hal.science/tel-00804975>**

Submitted on 26 Mar 2013

**HAL** is a multi-disciplinary open access archive for the deposit and dissemination of scientific research documents, whether they are published or not. The documents may come from teaching and research institutions in France or abroad, or from public or private research centers.

L'archive ouverte pluridisciplinaire **HAL**, est destinée au dépôt et à la diffusion de documents scientifiques de niveau recherche, publiés ou non, émanant des établissements d'enseignement et de recherche français ou étrangers, des laboratoires publics ou privés.



UNIVERSITÉ MONTPELLIER 2  
-Sciences et Technique du Languedoc-



## THÈSE

Pour obtenir le grade de  
DOCTEUR DE L'UNIVERSITE MONTPELLIER II  
Spécialité : Mécanique et Génie Civil  
Ecole Doctorale : Information, Structures, Systèmes

---

### **Caractérisation du bois du Mûrier blanc (*Morus alba* L.) en référence à son utilisation dans les luths Iraniens**

---

Par

**Aida SE GOLPAYEGANI**

Soutenue publiquement le 18 Novembre 2011

#### **JURY**

Jean Michel GÉNEVAUX	(Université du Mans)	Rapporteur
Bertrand CHARRIER	(Université de Pau et des Pays l'Adour)	Rapporteur
Iris BRÉMAUD	(EMPA, Zürich, CH)	Examineur
Fabien CHERBLANC	(Université de Montpellier 2)	Examineur
Sandie LECONTE	(Musée de la musique)	Examineur
Joseph GRIL	(CNRS, Université de Montpellier2)	Directeur de Thèse
Marie-France THEVENON	(CIRAD, Montpellier)	Codirectrice de Thèse
Kambiz POURTAHMASI	(Université de Téhéran, IR)	Codirecteur de Thèse



*To Ehsan,*

*Reza and Shazi*

*And of course, to the memory of Ali*

*“You’re built from dry wood, dry skin and dry strings*

*Then where does this lively sound come from?”*

*Old Persian poem (talking about a Tar)*





# Acknowledgements

This study was done during a three years stay in Montpellier, in which I worked in “Mécanique de l’Arbre et Bois (MAB)” team in LMGC and “Production et Valorisation des Bois Tropicaux et Méditerranéens” Research Unit of CIRAD. There were also collaborations and contributions of other teams and laboratories which helped me on enriching this experience. Therefore, here, I would like to thank the people that not only contributed to my scientific experience, but also to the quality of my life.

I would like to address my most sincere thanks to Jean Gérard and Joseph Gril for accepting me into their teams. In both teams I’ve been encountered with a great quality of scientific discussions and human contacts that were heartwarming.

My deepest thanks are also addressed to Jean-Michel Genevoux and Bertrand Charrier for accepting to judge my work. The discussion I had with M. Genevoux before and during the defense was eye opening and made me to look at the data through yet another eye. The remarks of M. Charrier were also enlightening through new and possible approaches for the possible continuation of this work.

I would like to thank Fabien Cherblanc for accepting to be the president of my jury. I am also grateful to Sandie Le conte, not only for taking the time to read my thesis and be a member of the jury, but also for her availability and valuable remarks on the ongoing work during our encounters at cité de la musique.

I am in great debt towards my three advisors: Joseph Gril, Marie-France Thévenon and Kambiz Pourtahmasi.

Kambiz was (and still is) my mentor from the time I stepped in Tehran university. His kindness, his availability and his sharp eye for catching new and controversial subjects, has given me the courage necessary to start this research and to be able to hang in there until the very end. Without his support, the possibility of studying abroad could be still a vague image.

Marie-France was practically my first contact in France. From the time we started exchanging mails to prepare my arrival in France, until the time when I was overwhelmed with her limitless kindness and hospitality (and of course that of her family and her two magnificent girls) upon my arrival, and during the whole three years of my time in Montpellier; she could always surprise me with her consideration, her understanding and her presence in tough situations. I have learnt so much from her scientifically, but my utmost gratitude is going to her for her humanity and her never fading smile.

Joseph is one of the persons from whom I have learnt a great deal (possibly the most I have ever learnt). His detail oriented way of thinking and his ability to discuss and consider different approaches to acquire correct answers, have shaped my mind. Along with scientific conversations, his attentive behavior towards the quality of my life in France and his attempts to introduce cultural facts to me, made me feel comfortable and welcomed in my new life. My special thank is going to him for his availability, regardless of his very busy schedule, and his patience on doing the last corrections towards the very end of thesis.

Joseph, Marie-France and Kambiz, this portion of my life is marked with your kindness and support; thank you all for that.

A big part of this work was not possible without suggestions, remarks and discussions with Iris Brémaud. Being involved in the project from the very beginning, she selflessly offered her time and her knowledge to enhance this research. I would like also to thank her for taking the time to read the final manuscript and participate in my jury.

Iris, I am addressing my gratitude to you not just as a colleague, but also as a friend. Your attention to details, your profound regard to the data, along with your good humor and your everlasting energy had put great souvenirs in my heart.

\*\*\*

I have passed three years working simultaneously amongst colleagues in LMGC and CIRAD. The efforts made by the members of both teams made me feel welcomed and at home.

In CIRAD, I would like to thank Daniel Guibal, Patrik Langbour and Luïc Brancheriau. I had invaluable talks with Luïc during the tests and at the time of analysis. I will also always remember the early morning talks with Daniel drinking a cup of coffee.

Throughout this study, I had heard different words describing my samples (e.g. match sticks!), mostly referring to their unusually small dimensions. Indeed, I had some abnormal samples, and their preparation was not possible but with the help of Sylvan Lotte and Claude Daigremont .

An enormous portion of this work is done thanks to Christine Baudassé and Nicolas Leménager. I have spent great times with them, during all three years, but especially during the last three months working beside them. The fun I had working and talking with them every day (while doing the serious work!) was incredible. I managed to make a name for myself by behaving so attentively to termites, and made Nicolas thinking of making a new carrier for himself out of fixing the broken machines!

Christine and Nicolas, thanks for every single moment of pure happiness and joy!

My great thanks are also going to Luc Martin and Gill Chaix for making the time for either the tests or the discussions on the analysis.

Isabelle Châlon, not only made the complicated paper work looks like a piece of cake, but offered her special moral support in time of difficulty. Thank you Isabelle!

\*\*\*

In LMGC, where I spent almost every day of the last year of the thesis, the spirit of team work along with the every one's willingness for offering help, made my time there scientifically rewarding and spiritually interesting.

I would like to thank Delphine Julien, Bruno Clair, Tancrede Almeras and Bernard Thibaut. In different occasion I had the opportunity to appreciate their kindness, their moral and scientific support and more than anything their presence.

Olivier Arnould has offered his knowledge, his attentiveness and his good heart in countless times to this work. My deepest thanks go to him for his availability and patience.

The heart of the team, Chantal Romano, has made me feel amongst family every time we talked. I specially want to thank her for her invaluable help for the preparation of ceremony after my defense.

\*\*\*

During these three years, I had the opportunity of working, participating and having the help of other individuals or laboratories to enrich this study:

Samad Zareh: The Iranian master in instrument making who prepared us with his know-how as well as the raw material.

Pr. Claude Andary: I was honored with his presence in my thesis committees as well as during my defense.

Eric Masson: The chemical analysis was done thanks to him. I want to thank him particularly for his notes and comments on the GC-Mass spectra.

Gille Valette, who kindly prepared us with the first chemical analysis.

Loïc Bertrand, with whom I had enlightening conversation during Soleil training school.

And many others that might slipped my mind, but I am thankful towards all of them.

\*\*\*

I feel lucky to have an amazing family. To Ehsan, my love and soul mate, who tolerated my absence for three years, who supported me through it all, and to whom I cannot even begin to express my affection and gratitude; and to my parents, who stood by me through thick and thin, who supported me through each apparently unreasonable choice, and whose presence is a blessing: Thank you, although “thank” is not a good enough word...

And of course to my friends, those in Iran and those in France: my greatest thanks and appreciations for your presence, for the support, the laughs, the conflicts and the reconciliations.

\*\*\*

Three years away from a known world and being shipped to the unknown, was a unique experience. Sometimes it feels like I spent a life time away, other times it seems like only seconds passed from the time I first stepped in France. I feel like a different person, and I certainly hope that the changes are for the better. Aside from the scientific experience, the combination of encounters, new culture and unexpected challenges made me a new person. I am finishing this study, not only with new findings and fresh results, but with a new “me”; a more optimistic, decisive and motivated “me”. And “this” happened, indeed, thanks to all of you...



---

**Titre:** Caractérisation du bois de Mûrier blanc (*Morus alba* L.) en référence à son utilisation dans les luths Iraniens

---

## RESUME

L'objectif est de mieux connaître les diverses propriétés (physico-mécaniques, biologiques et chimiques) du bois de Mûrier blanc (*Morus alba* L.), en tant que matériau éminemment utilisé dans la fabrication de luths Iraniens. La différence de caractéristiques vibratoires de cette espèce a été mesurée en fonction de la présence d'extractibles, mais aussi pour trois traitements artisanaux qui ont été adaptés à l'échelle du laboratoire.

Le bois Mûrier blanc est caractérisé par un module spécifique modéré, un amortissement plus bas que prévu et une anisotropie faible entre ses trois axes. Il est précisé que cette espèce ne peut pas être classifiée avec les mêmes normes que les autres bois utilisés pour les instruments classiques Européens.

En utilisant les deux extractions indépendantes et successives, il est révélé que l'amortissement est régi par deux types d'extraits, certains l'abaissent et certains l'augmentent. Ces composés ne sont pas tous extractibles par les mêmes solvants.

L'immersion de longue durée dans une eau à température ambiante ne modifie pas les propriétés mécaniques de l'espèce, toutefois, elle peut laisser le bois avec des défauts irréversibles. Un court traitement à l'eau chaude (70°C) entraîne l'augmentation de l'amortissement et la diminution du module spécifique. Dans ce dernier cas, des modifications sont presque progressives avec le temps.

Le bois de Mûrier blanc semble être « très durable » par rapport à une attaque fongique, même dans des conditions extrêmes. Le délavage dans l'eau n'a pas d'effets sur la résistance de cette espèce contre basidiomycètes. Ce bois est classé « moyennement durable » contre l'attaque des termites et devient sensible après le délavage. Ses extractibles ont donc des effets toxique sur les termites.

Les phénols, acides gras, stérols, hydrocarbures supérieurs, et composés aromatiques sont les composés présents dans les extraits de cette espèce. Le résorcinol, composé prédominant trouvé dans l'espèce, a été récemment rapporté comme la cause de plusieurs problèmes de santé, ce qui est aujourd'hui observé chez les artisans Iraniens.

**MOTS-CLEFS:** Mûrier blanc, Propriétés physico-mécaniques, Instrument musique, Extraction, Traitement hygrothermique, Durabilité naturelle, Composés chimiques

---

**Title:** Characterization of white Mulberry (*Morus alba* L.), considering its usage in Iranian lutes

---

## **ABSTRACT**

This work aims at studying the several divers properties (Physico-mechanical, biological and chemical) of white Mulberry (*Morus alba* L.), as the leading material used in fabrication of Iranian lutes. The vibrational characteristic of this species is measured in relation with secondary metabolites (extractives) as well as three artisanal hygro-thermal treatments adapted to laboratory scale.

White Mulberry wood is characterized with a moderate specific modulus, less than expected damping and a low anisotropy between three directions. It is specified that this species cannot be described with the same standards as other woods used in European classical instruments.

Using independent and successive extractions reveal that two types of extraneous compounds govern the damping in this wood, some raising it, when the rest have a decreasing effect. These compounds are not all extractable by the same solvents.

Long time immersion in water at ambient temperature hardly changes mechanical properties of the species, however, it can leave wood with irreversible defects. Hot water treatment at 70°C results for damping and moduli to be increased and decreased respectively. These changes are time related. Several mild desorption and adsorption cycles, seem to reduce damping without greatly endangering the moduli.

White Mulberry wood is found to be very durable towards fungi, even in extreme conditions. Water leaching seems to be affectless on this species resistance towards basidiomycetes. This wood is rated moderately durable towards termites and becomes sensible after water leaching. Extractives seem to play important role in this wood natural resistance, as they are found to have toxic effect on termites.

Resorcinol, a phenol, is the leading compound in the extractives of white Mulberry. Fatty acids, sterols, higher hydrocarbons, and aromatic compounds are also found as the constituents of secondary metabolites. Resorcinol is documented to cause irritations close to what is normally experienced by the fabricants working with white Mulberry for a long time.

**KEYWORDS:** White Mulberry, Physico-mechanical properties, Musical instruments, Extraction, Hygro-thermal treatments, Natural durability, Chemical compounds

## **Laboratoires où a été préparée la thèse:**

---

Laboratoire de Mécanique et Génie Civil (LMGC), CNRS UMR 5508, Université Montpellier II, pl. E. Bataillon, 34095 Montpellier Cedex 5. France.

---

Laboratoire de préservation des bois, CIRAD PERSYST - UPR 40, TA B-40/16, 73, rue Jean François Breton, 34398 Montpellier. France.

---

# Table of contents

Acknowledgements.....	5
Table of contents.....	11
0. Résumé approfondi.....	13
0-1-Introduction.....	13
0-2- Matériaux.....	14
0-3- Méthodologie de recherche.....	14
0-4- Les propriétés physico-mécaniques du mûrier blanc à l'état natif.....	16
0-5- Les effets des extractions.....	18
0-6- Effets des traitements traditionnels sur les propriétés physico-mécaniques.....	22
0-7- Etude de la durabilité naturelle.....	25
0-8- Identifications des composées chimiques des extraits du bois de Mûrier blanc.....	28
0-9- Conclusion générale.....	29
Notations.....	32
1. Introduction.....	34
1-1- Wood and music: a history of myths.....	34
1-2- The beginning.....	35
1-3- Objectives of the current study.....	36
1-4- The plan of presentation.....	36
2. Basic definitions and bibliography.....	38
2-1- Introduction.....	38
2-2- Wood as a multifunctional material.....	38
2-3- Wood microstructure: a window to its final properties.....	39
2-4- Vibrational properties.....	45
2-5- Natural durability of wood.....	55
2-6- Introduction to White Mulberry ( <i>Morus alba</i> L.).....	56
2-7- Musical instruments.....	64
2-8- Conclusion.....	69
3. Material and methods.....	71
3-1-Material.....	71
3-2- Methods.....	81
4. Physico-mechanical properties of untreated white Mulberry.....	108
4-1- Presentation of raw data and correlations.....	109
4-2- Specific gravity, rigidity, and damping.....	111
4-3- EMC and vibrational properties.....	117
4-4- Different partial swellings in three batches:.....	120
4-5- Conclusion on the differences between the 3 batches.....	122
4-6- Anisotropic properties of white Mulberry in its native state.....	123
4-7- Conclusion.....	126
5. Effect of hygro-thermal treatments.....	129



5-1- Hygro-thermal treatment at laboratory scale.....	130
5-2- Physico-mechanical modifications caused by hygro-thermal treatments .....	132
5-3- Cyclic drying and stabilization .....	148
5-4- Conclusion.....	151
6. Effect of extraction .....	153
6-1- Procedure of extractions.....	153
6-2- Modification of properties due to extractions .....	161
6-3- Conclusion.....	185
7. Natural durability of white Mulberry .....	187
7-1- Natural durability of solid wood .....	187
7-2- Investigating extractives toxicity in reaction to the termites.....	196
7-3- Conclusion.....	201
8. Identification of extractive compounds in white Mulberry's wood.....	203
8-1- Reminder of the analyzed material.....	204
8-2- Methods.....	204
8-3- Results of compounds indentification .....	208
8-4- Discussion on the compounds present in the extractives of white Mulberry.....	230
8-5- Conclusion.....	232
9. Overall conclusion and perspectives.....	235
9-1- Quick return to the study.....	235
9-2- Conclusion in relation with the objectives .....	236
9-3- Perspectives.....	237
References.....	239
Table of figures .....	253
Table of tables.....	262
Annex A. Iranian lutes: an intro to <i>Târ</i> .....	264
A-1- Music history in Iran until the appearance of lutes .....	264
A-2- Lutes .....	266
A-3- References for Annex A.....	271
Annex B. Details on the solvents used for extraction.....	274
Annex C. Differences in 2 series of specimens submitted to successive extractions .....	276
C-1- Origin of the problem .....	276
C-2- Common trends between both series .....	277
C-3- Differences between two series .....	280
C-4- Summary of arguments.....	284
Annex D. Criteria of natural durability standards.....	286

## 0. Résumé approfondi

---

### 0-1-Introduction

Le bois, matériau biologique, a été exploité depuis la naissance de l'humanité pour des utilisations telles que l'habitat, l'énergie, le chauffage, la fabrication d'outil et d'objets, etc. Il peut aussi être source de médicaments et matières actives, et, a été dès les temps les plus anciens utilisé pour la facture d'instruments de musique.

L'usage du bois, en tant que matériau vibratoire dans les instruments de musique, est imprégné de nombreux mythes, cultures, rites et traditions. Chaque artisan a une idée précise de la sélection d'un bois de qualité instrumentale. Toutefois, bien que les chercheurs essaient de dessiner un pont entre le savoir-faire traditionnel et les connaissances scientifiques, ces dernières restent encore parcellaires. De plus, les études académiques dans ce domaine sont bien souvent limitées aux instruments les plus connus. Il existe des recherches approfondies sur les violons, les guitares et en général les instruments de musique classique Européenne, mais les connaissances documentées sur ceux des autres continents sont rares.

Le mûrier blanc est, traditionnellement, la seule source pour la fabrication des trois luths (*Târ*, *Sétâr* et *Kamâncheh*) en Iran. Toutefois, cette espèce ligneuse indispensable à la réalisation des luths n'a jamais été étudiée pour ses propriétés physiques, ni acoustiques.

Alors que le bois vert n'est jamais utilisé dans la fabrication des luths, le "vieux" bois est préféré par les artisans, indépendamment de leur culture. De plus, la grande majorité des artisans ont leurs propres prétraitements avant de commencer à travailler sur le matériau. Ces prétraitements consistent en des trempages de durée variable dans l'eau à des températures variables elles aussi, et sont censés aboutir à des caractères améliorés en terme d'acoustique. Ces traitements artisanaux ont pour inconvénient majeur d'entraîner des désordres de santé (dermatoses, problèmes respiratoires,...) chez les opérateurs qui les réalisent.

Aussi, afin de comprendre les mécanismes en jeu et de rationaliser et/ou d'optimiser ces pratiques artisanales, les objectifs de cette étude sont:

- La caractérisation acoustique du mûrier blanc en tant que matière première pour la fabrication de l'instrument
- L'étude du rôle des extractibles sur les propriétés physiques et acoustiques du matériau
- L'étude de l'efficacité des prétraitements traditionnels : trois traitements artisanaux sont choisis et effectués à l'échelle du laboratoire
- La détermination de la durabilité naturelle du murier vis-à-vis d'organismes lignivores
- L'identification et la catégorisation des composés extractibles

## 0-2- Matériaux

Deux arbres ont été sélectionnés en Iran par un luthier professionnel, chaque arbre ayant les caractéristiques nécessaires à la fabrication d'un instrument parfait.

Après abattage et débit, plusieurs baguettes de  $50 \times 5 \times 5 \text{ cm}^3$  (L,R,T) ont été préparées et expédiées au laboratoire du CIRAD en France. Pendant l'expédition, des barres ont été conservées dans des sacs isothermes pour éviter le changement de degré d'humidité du matériau. Ces baguettes ont été séchées à basse température dans un séchoir à air ventilé pendant 2 semaines, puis ont été transférées à la chambre climatique ( $20 \text{ °C} \pm 2 \text{ °C}$  et  $65\% \pm 5\% \text{ HR}$ ) dans laquelle elles ont été conservées trois semaines.

A partir des baguettes, 5 types d'échantillons ont été préparés :

- Des échantillons sous forme de poudre (taille de particules  $< 0,5 \text{ }\mu\text{m}$ )
- Des échantillons carrés ( $20 \times 20 \times 5 \text{ mm}^3$ , RTL)
- Des échantillons vibratoires ( $150 \times 15 \times 2 \text{ mm}^3$ , LRT)
- Des échantillons pour analyse mécanique dynamique (ADM) ( $42-50 \times 4 \times 3 \text{ mm}^3$ , Directions ortho-tropiques variant selon l'échantillon).
- Des échantillons pour essais biologiques ( $50 \times 25 \times 15 \text{ mm}^3$ , LRT)

Le même processus de conditionnement a été appliqué à tous les échantillons utilisés pour les différentes expérimentations (sauf pour les échantillons biologiques) : un séchage quasi-anhydre (48 h,  $60 \text{ °C}$ ) et trois semaines de stabilisation ( $20 \text{ °C}$ ,  $65\% \text{ HR}$ )

Ces séchages et reconditionnements ont été répétés avant et après chaque manipulation (ou traitement), ainsi qu'entre les étapes si nécessaire (e.g. extractions successives).

### Définition de l'état natif

L'état natif, dans tous les cas, se réfère à l'état des échantillons (bois massif ou poudre) sur lesquels n'a été appliqué aucun traitement chimique, ni hygrothermique. Les échantillons natifs ont tous passé par les étapes de conditionnements selon le protocole général. Toutes les propriétés mesurées dans cet état seront considérées comme la ligne de base pour comparer et calculer les différences. Les changements entre état natif et traitements seront exprimés selon formule ci-dessous :

$$Diff (\%) = \left( \frac{Traité}{Natif} - 1 \right) \times 100 \quad (0-1)$$

## 0-3- Méthodologie de recherche

Plusieurs paramètres physiques ont été mesurés durant cette étude : la densité ( $\rho \text{ (g/cm}^3\text{)}$ ), la masse (g), les dimensions ( $\text{mm}^3$ ) et la teneur en eau (MC%).

Dans cette partie, seules les méthodes de vibration et ADM vont être abordées. Les traitements chimiques et hygrothermiques, les essais de la durabilité naturelle ainsi que ceux concernant l'identification des composants seront présentés ultérieurement.

### **0-3-1- Les Méthodes de vibrations**

Deux méthodes vibratoires ont été utilisées dans cette étude. Chacune de ces méthodes présente des avantages et inconvénients concernant la répétabilité, la base du facteur d'amortissement obtenu et les erreurs absolues et systématiques. Comme il sera explicité en détail plus loin, l'un des facteurs d'amortissement de la vibration forcée (expérimentation réalisée au LMGC) est comparable à celui acquis par la vibration libre (expérimentation réalisée au Cirad). Par conséquent, toutes les comparaisons concernant les propriétés d'amortissement après les traitements sont basées sur cette constatation.

#### **0-3-1.a. Vibration forcée sans contact sur poutres libre-libre très élancées (LMGC)**

Dans cette méthode, l'échantillon est suspendu sur deux supports élastiques très minces. À une extrémité de l'échantillon est collée une très petite pièce rectangulaire en métal en face d'un aimant électronique, lequel engendre la vibration. Les vibrations des échantillons sont mesurées au moyen d'un capteur de déplacement sans contact.

Le  $E'/\rho$  (GPa) est calculé à partir de la fréquence de la résonance selon la méthode de Bernoulli. Le facteur d'amortissement ( $\tan\delta$ ) est déterminé par le décrément logarithmique de l'amplitude des vibrations, après l'arrêt de l'excitation. Pendant ce temps, dans le domaine fréquentiel, le facteur de qualité (Q) est mesuré par la largeur de la bande à demi-puissance (-3 db). Ces deux facteurs ( $\tan\delta$  par décrément logarithmique et Q par la largeur de la bande) devront théoriquement être les mêmes. Cependant, la mesure de chacun d'eux étant liée à différents types d'erreurs, il en résultera qu'ils ne seront pas exactement identiques (Brémaud 2006).

#### **0-3-1.b. Vibrations libres sur poutres flottantes (Bing ®)**

L'échantillon est mis sur deux supports élastiques permettant ainsi la propagation libre de la vibration. Une percussion simple à une extrémité se traduira par une vibration qui sera enregistrée par un microphone fixé au dessus de l'autre extrémité de l'échantillon. Dans ce cas, le premier mode de fréquence est choisi manuellement. Ces vibrations enregistrées seront transmises via un filtre anti repliement à une carte d'acquisition, laquelle à son tour transformera l'analogique et numérique et offrira à l'ordinateur le signal numérisé.

La transformée de Fourier Rapide (FFT) est utilisée pour traiter et interpréter les informations dans le domaine fréquentiel. Le facteur d'amortissement ( $\tan\delta$ ) est déterminé selon le premier mode de fréquence par un logiciel basé sur MATLAB ® (David, 1999), tandis qu' $E'_L$  (module d'élasticité longitudinal) est également calculé en utilisant les dimensions géométriques et la masse de chacun des échantillons.

#### **0-3-1.c. Analyse dynamique mécanique (ADM)**

Le bois est un matériau anisotrope, ce qui signifie que ses propriétés varient selon ses trois directions principales (LRT). Il est important de souligner que les caractéristiques acoustiques des instruments de musique sont souvent fortement liées à l'anisotropie du bois.

Le comportement viscoélastique du mûrier blanc a été mesuré en utilisant une ADM de la marque BOSE ® ELF320 équipée de poignées de fatigue en traction/compression, d'une

cellule de charge de 22 N et d'un capteur de déplacement de haute résolution. Les échantillons ont été fixés entre deux pinces avec une distance de travail de 35 mm et testés dans selon leur direction axiale. Les manipulations ont été réalisées avec des alternances de traction/compression et un chargement contrôlé en déplacement (amplitude de  $\pm 0,0175$  mm). En utilisant des logiciels d'analyse de BOSE ® WINTEST,  $E^*$  (module complexe),  $E'$  (module de stockage),  $E''$  (module de perte) et  $\tan\delta$  ont été calculés. Les modules ont été corrigés pour la rigidité de l'ensemble de l'appareil, le facteur correctif étant mesuré en utilisant une éprouvette en acier. Un balayage de fréquence de 0,1 à 10 Hz a été exécuté, avec trois répétitions pour chaque échantillon (natif puis traité).

#### 0-4- Les propriétés physico-mécaniques du mûrier blanc à l'état natif

Les résultats obtenus nous ont permis d'évaluer certaines propriétés du bois dans son état natif, et, de tracer une ligne de base permettant la comparaison des effets de traitements. De plus, cette étude basée sur trois lots de bois (lot 1 et 2 issus de l'arbre 1, lot 3 issu de l'arbre 2), a permis d'évaluer la variabilité inhérente au matériau.

Les densités moyennes de trois lots de bois utilisés dans cette étude sont comparées sur la figure 0.1. La valeur moyenne des échantillons au cours d'une étude précédente est également incluse (Se Golpayegani, 2007, Thèse de master)

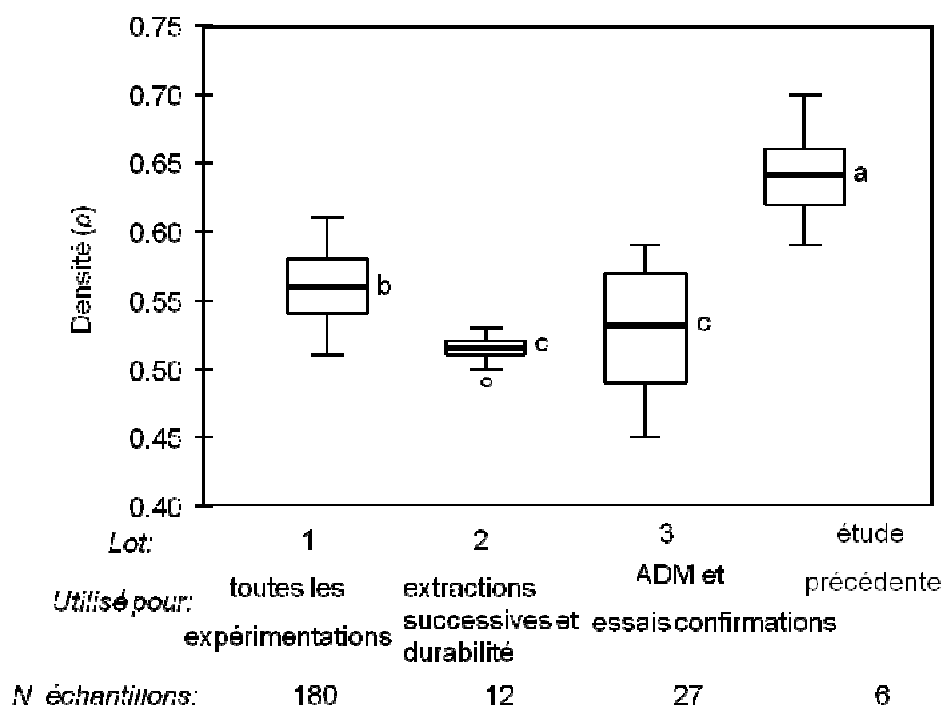

Fig.0.1. Densités moyennes des trois lots utilisés dans cette étude, les données d'une étude précédente (Se Golpayegani 2007) sont aussi incluses. (a, b, c) les groupes significativement différentes (ANOVA à un facteur)

Bien qu'étant issus du même arbre, les densités moyennes des lots 1 et 2 diffèrent significativement. En revanche, les lots 1 et 3 ont une gamme de densités proches, même en venant d'arbres différents ( $\approx 0,55$  et  $0,53 \text{ g/cm}^3$  densité moyenne pour les lots 1 et 3

respectivement). Le lot 3 avec une gamme de densité de 0,45 à 0,59g/cm<sup>3</sup>, s'attribue la plus faible densité moyenne.

Les densités moyennes mesurées pour les 3 lots restent toutefois dans une gamme étroite. En outre, ces différences de densité n'ont pas d'effet significatif sur les propriétés vibratoires. (Fig.0.2).

La figure 0.2 montre la relation entre  $\tan\delta$  et  $E'/\rho$  pour tous les échantillons vibratoires mesurés dans notre étude. On peut apercevoir que les mesures pour la majorité des échantillons de mûrier restent en dessous de la courbe de référence établie par Ono & Norimoto (1983, 1984).

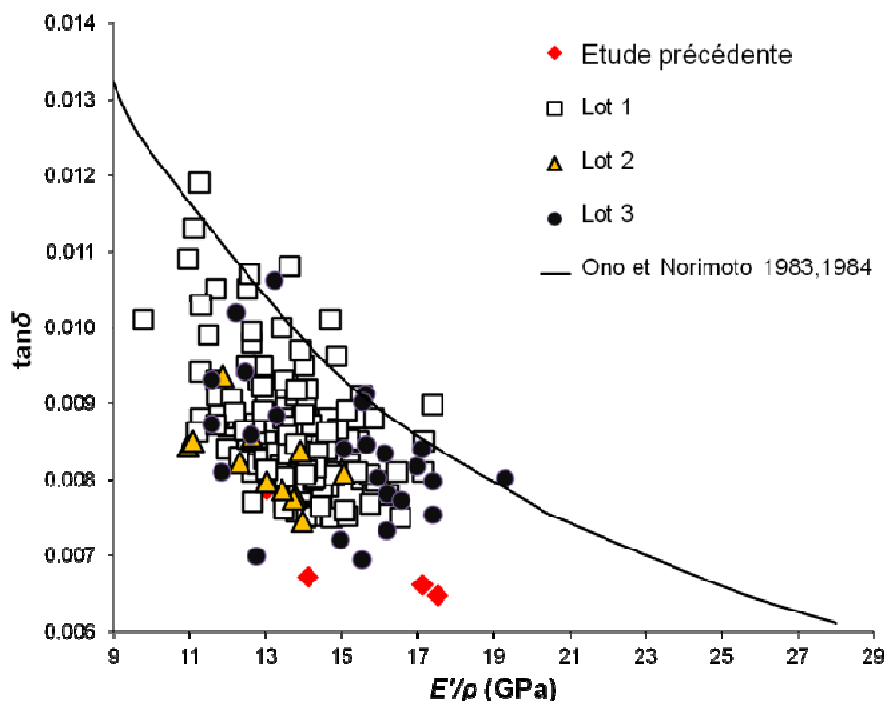

Fig. 0.2. La relation entre  $\tan\delta$  (le facteur d'amortissement par largeur de bande en demi puissance retirés de la vibration forcées) et  $E'/\rho$  pour le bois natif (N°:207). Les données d'une étude précédente (Se Golpayegani 2007) ont également été incluses. La courbe standard a été ajoutée à partir de (Ono et Norimoto, 1983, 1984).

En conclusion, malgré quelques variations dans leurs propriétés physiques, nos trois lots ont montré des valeurs assez similaires concernant leurs caractéristiques vibratoires. Donc, il est acceptable de considérer les trois lots comme non significativement différents. Afin d'enlever toute ambiguïté sur les différences possibles entre les lots et d'engendrer d'éventuelles erreurs au niveau des résultats, les échantillons de chaque lot ont été séparément exposés aux traitements/manipulations et n'ont jamais été mélangés.

Les propriétés viscoélastiques du bois du Mûrier blanc, mesurées par ADM, ont été évaluées exclusivement sur des échantillons issus du lot 3.

L'ordre de grandeur des valeurs de  $\tan\delta$  et  $E'$  dans les trois directions est en accord avec la littérature :  $\tan\delta_T > \tan\delta_R > \tan\delta_L$  et  $E'_L \gg E'_R \geq E'_T$  (Ono et Norimoto 1985; Guitard et El Amri 1987; Narine 2007).

La fig. 0.3 montre les ratios d'anisotropie de  $\tan\delta$  entre les trois directions L,R,T. On peut constater que ces ratios entre les trois directions sont petits : L/R et T/R  $\approx 1,3$  et T/L  $\approx 1$ .

En outre, les ratios d'anisotropie du module d'élasticité ont des valeurs réelles (L/R  $\approx 4$ , L/T  $\approx 8$  et R/T  $\approx 1,9$ ) également inférieures à ce qui est rapporté dans la littérature (Guitard et El Amri 1987; Nairn 2007).

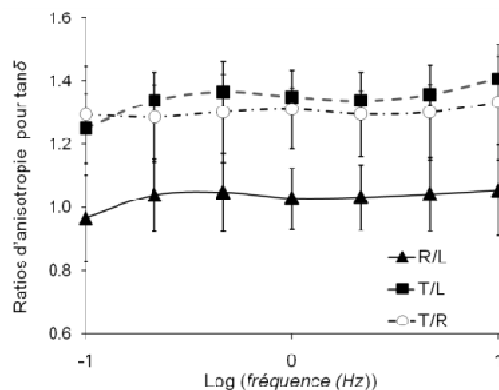

Fig.0.3. les ratios d'anisotropies de  $\tan\delta$  entre les trois axes d'orthotropie. N° : 14 pour chaque direction.

Enfin, nous pouvons formuler les observations suivantes sur les propriétés physico-mécaniques du mûrier blanc :

- La densité moyenne du mûrier blanc est 0,55. Cette densité modérée, e plaçant ainsi parmi les espèces de plus faibles densité utilisées pour la fabrication de tables d'harmonie des instruments européens (Wegst 2006).
- Une relation négative existe entre  $E'/\rho$  et  $\tan\delta$ . Néanmoins, les valeurs étaient de 6% à 11% inférieures à celles de la courbe standard (Fig.0.2).
- Le module spécifique de nos échantillons est faible et variable (11-18 GPa). Ceci s'est accompagné d'un amortissement plus faible que prévu.
- Le classement (l'ordre de grandeur) de  $E'$  et  $\tan\delta$  pour les 3 axes suit la tendance déjà vérifiée. En revanche, les anisotropies de ces deux paramètres étaient faibles.
- Les trois dernières remarques situent le mûrier blanc plus proche de l'érable que de l'épicéa (utilisé pour les plaques supérieures dans certains instruments de musique) (Jansson 2002 ; Brémaud et al 2010).

## 0-5- Les effets des extractions

### 0-5-1- Le choix des solvants et les procédures des extractions

Cinq solvants ont été choisis (présenté dans l'ordre croissant de polarité): Hexane (H), Dichlorométhane (D), Acétone (AC), Méthanol (ME) et l'eau chaude (EC). Les extractions ont été réalisées avec des Soxhlets.

Deux méthodes d'extraction ont été réalisées :

- extraction indépendante : cette méthode est basée sur l'utilisation d'un unique solvant sur un jeu indépendant de spécimens (N° : 12). Les propriétés vibratoires et physiques

des échantillons sont mesurées avant et après extraction. Par conséquent, toute modification observée sera provoquée par le solvant utilisé.

- Extractions successives : un ensemble d'échantillons (N° : 12) est soumis à des extractions successives du solvant le plus apolaire (H) au plus polaire. Le processus sera suivi en utilisant de l'AC, le ME, et éventuellement de l'EC. Entre les étapes, les échantillons sont séchés et stabilisés selon le protocole général.

Les deux méthodes sont appliquées pour la poudre, les échantillons massifs carrés et ceux de vibrations. Les échantillons d'ADM ne subiront que des extractions indépendantes au méthanol (ME) et à l'eau.

### 0-5-2- Modifications des caractéristiques physico-mécaniques des échantillons exposés aux extractions

Toutes les propriétés physiques et vibratoires ont été modifiées par les extractions. A l'issue des extractions successives, les densités et les modules spécifiques ( $E/\rho$ ) des échantillons ont diminués, alors que simultanément les EMC et  $\tan\delta$  ont augmentés.

#### 0-5-2.a. Les rendements d'extraction

Dans le cas des poudres, la quantité d'extraits cumulée lors des extractions indépendantes est sensiblement identique à celle trouvée pour les extractions successives. En revanche, pour le bois massif, les pertes de masses cumulées diffèrent entre les deux procédures d'extraction, suggérant un effet structural sur l'accessibilité aux divers solvants (Fig.0.4). Ceci a été confirmé par les différents taux d'extraction des échantillons orientés en radial ou tangentiel testés par DMA: 9, 14 et 18% respectivement pour le ME.

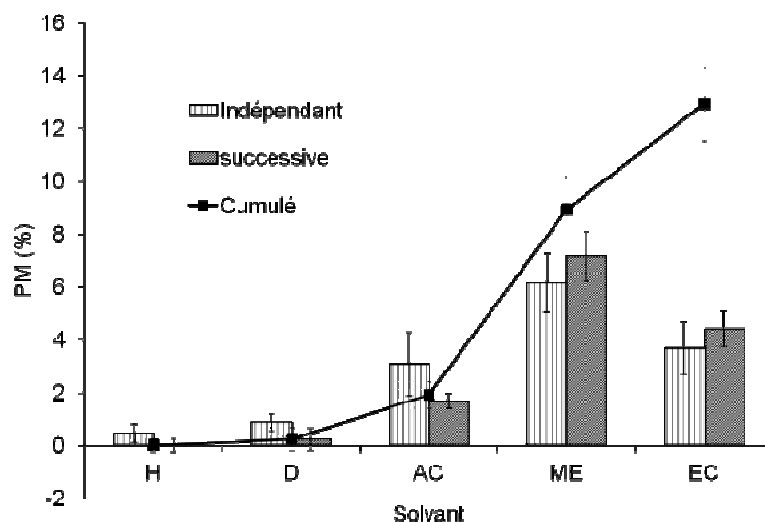

Fig.0.4. Pertes de masse moyenne (moyenne de 12 échantillons exposés à chaque solvant), après l'extraction indépendante, successive (relative : par rapport la phase précédant) et cumulée (par rapport à la phase native) dans le bois solide.

Lorsqu'ils sont utilisés séparément sur les poudres, les solvants les moins polaires, H et D, ne pénètrent qu'au niveau du lumen et enlèvent de petites quantités d'extraits (1,6% et 1,7%). Les rendements d'extraction de ces solvants ont été beaucoup plus faibles pour le bois massif. Dans le cas des bois massifs, lorsque D est utilisé après H, son rendement



d'extraction est très faible, ce qui suggère qu'H avait déjà enlevé la plupart des extraits accessibles aux solvants apolaires. De même, AC a présenté un rendement d'extraction plus faible lorsqu'il a été utilisé après H et D, indiquant qu'il permet aussi d'enlever la matière dans le lumen des cellules. Bien que AC et ME soient connus pour pouvoir accéder à des composés similaires, ME a engendré le plus grand rendement d'extraction du bois massif (6,2%) lors de l'extraction indépendante. Son efficacité a été encore accrue lors de son utilisation après AC (7,14%).

Au contraire, dans le cas des poudres, EC a montré le rendement le plus élevé (8,31%, extraction indépendante), alors que le rendement d'extraction était beaucoup plus faible sur le bois solide. Cela montre qu'au niveau du bois massif, les extraits polaires sont plus facilement éliminés par ME que par EC.

### 0-5-2.b. Variation du $E'/\rho$ et $\tan\delta$

$E'/\rho$  a progressivement diminué au cours de l'extraction. Les solvants H, D, AC, ME EC ont modifiés  $E'/\rho$  de 0,2%, -0,6%, -5%, -11% et -1,8% respectivement, après les extractions indépendantes. Les modifications cumulées (c'est-à-dire par rapport à l'état natif) de  $E'/\rho$  après les extractions successives ont suivi une tendance similaire, mais de plus grande amplitude. La diminution de  $E'/\rho$  est apparue proportionnelle aux pertes de masses dues aux différents solvants.

La figure 0.4 montre les changements relatifs de  $\tan\delta$  après chaque extraction indépendante et successive. Les solvants apolaires (H et D) ont retiré de petites quantités (environ 1%) des composés, probablement issus du lumen, induisant de petits changements dans le  $\tan\delta$ . Cependant, dans le cas des extractions successives, D a augmenté le  $\tan\delta$  de 14%, ce qui pourrait être lié à l'exposition précédente au H.

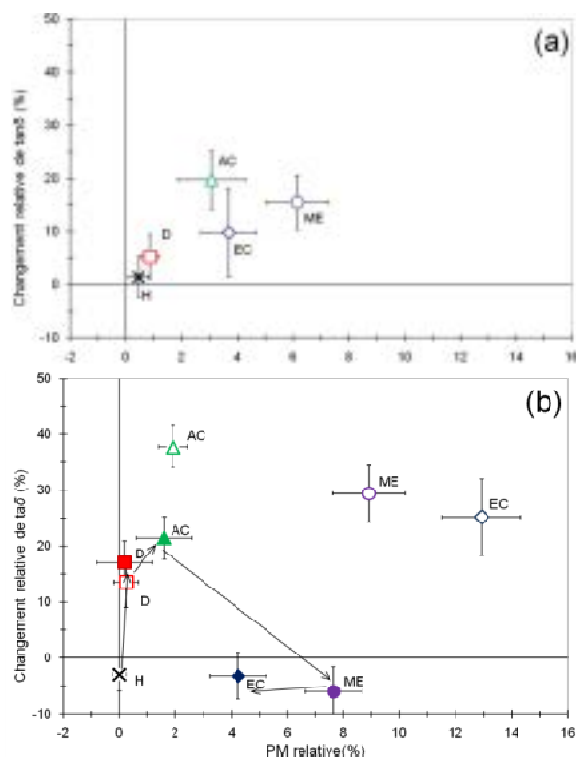

Fig.0.5. Changements relatifs (%) de  $\tan\delta$  en fonction des pertes de masses (%) (a) indépendante (b) successive. Les symboles vides: les changements relatifs à l'état initial des échantillons natifs (indépendants et successives-cumulés) ; les symboles pleins : des changements relatifs à la phase précédente. Les flèches: l'ordre des extractions successives. Les valeurs de  $\tan\delta$  des extractions indépendantes ont été corrigées pour les témoins.

Le plus grand changement dans  $\tan\delta$  est apporté par l'extraction à AC ( $\approx 20\%$  de manière indépendante ou utilisé après le D,  $\approx 38\%$  pour les cumulés), même si sa perte de masse correspondante était modérée. Le ME et EC, malgré leur rendement d'extraction supérieur, ont moins d'effets sur  $\tan\delta$ . Lorsque ME est utilisé après AC, les  $\tan\delta$  à une valeur inférieure à celui de l'état précédent.

Pour justifier ces effets on peut proposer l'hypothèse ci-dessous:

Deux types de composés chimiques coexistent dans les parois cellulaires, certains diminuent et d'autres augmentent  $\tan\delta$ . Les premiers sont extractibles par ME mais aussi par AC et EC. Par conséquent, l'extraction indépendante par ces solvants abouti toujours à une augmentation de  $\tan\delta$ . Ces derniers composés (ceux qui augmentent  $\tan\delta$ ), étant probablement hydrophiles, ne sont pas extractibles par H, D ou AC. Ainsi, une extraction successive en utilisant ME puis EC a réduit  $\tan\delta$ , car les "abaissant- $\tan\delta$ " avaient déjà été retirés par les solvants précédents et il n'était resté que les composants "augmentant- $\tan\delta$ ".

Ces méthodes, en mettant en jeu deux extractions indépendantes et successives, pourraient servir à identifier des comportements similaires dans d'autres espèces.

#### **0-5-2.c. Modifications des propriétés viscoélastiques**

La figure 0.6 illustre les variations de  $E'/\rho$  et de  $\tan\delta$  dans les trois directions principales du bois après extraction par ME et EC ou deux cycles de séchage (témoins). Les variations de  $E'/\rho$ , après l'extraction au ME ont été similaires dans les trois directions : -18% à -20%, bien que les pertes de masses soient différentes (9%, 14% et 18% pour L, R et T respectivement). EC a causé, à la fois, les pertes de masses les plus faibles (6-8% pour L, R et T), et les moindres diminutions de  $E'/\rho$  dans les directions L et R, alors qu'elle a causé les mêmes effets que ME en T. Concernant  $\tan\delta$ , il y avait une grande incertitude dans les résultats de la direction L, car le bois avait pu être écrasé dans le sens transverse du fait de l'expérimentation. Cependant, après l'extraction par ME, le changement de  $\tan\delta$  dans le sens radial était au moins deux fois plus importante que dans les sens L ou T.

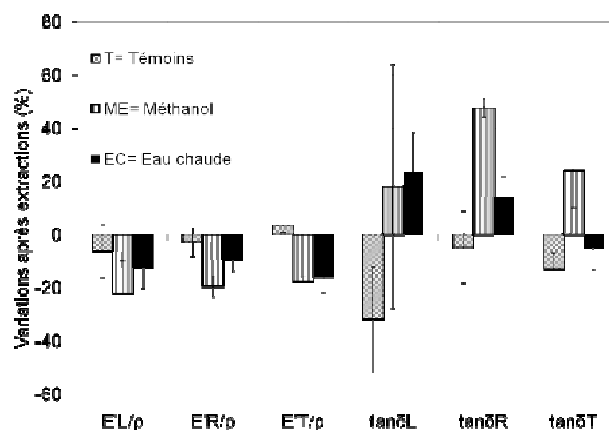

Fig.0.6. Variations des propriétés mécaniques après extractions mesurées par ADM à 10 Hz. Les valeurs pour les témoins n'ont pas été déduites de celles traitées.

## 0-6- Effets des traitements traditionnels sur les propriétés physico-mécaniques

Deux types de traitements hygrothermiques ont été réalisés :

- Une immersion dans l'eau de longue durée (température ambiante  $\approx 20^{\circ}\text{C}$ - $25^{\circ}\text{C}$ ) avec pas de 1 mois. La manipulation a été suivie jusqu'à 4 mois.
- Le traitement dans l'eau chaude à courte durée ( $70^{\circ}\text{C}$ ) avec des pas de 2 heures. La manipulation a duré jusqu'à 12 heures.

Ces deux traitements ont été effectués uniquement pour les échantillons vibratoires.

En plus de ces deux traitements, un autre, basé sur l'exposition du bois à un cycle de désorption/adsorption, a été ajouté au cours de cette étude.

### 0-6-1- Modifications des propriétés physico-mécaniques par traitements hydro-thermiques

La plus grande perte de masse a été observée après 4 mois de traitement dans l'eau ( $3,48\% \pm 1,83$ ). D'autres groupes d'échantillons montrent des pertes de masses assez proches, variant de  $1,57 \pm 0,44\%$  pour le deuxième mois (minimum) à  $2,44\% \pm 0,73$  (maximum) pour le premier mois d'immersion. Toutefois, les résultats ne sont pas statistiquement différents, ce qui montre que la prolongation du traitement n'a eu aucun effet sur l'amplitude d'extraction des composés du bois.

Les échantillons immergés ont montré des traces de déformations et des fissures. Ces fissures, probables effondrements, pourraient être le signe de modifications microscopiques, lesquelles ont éventuellement entraîné des changements irréguliers des  $\tan\delta$ .

$\tan\delta$  a montré des changements insignifiants au cours des mois d'immersion dans l'eau. Les échantillons qui ont été immergés pendant trois et quatre mois, montrent de légères diminutions de leurs  $\tan\delta$  moyen. A l'inverse, les témoins et les échantillons immergés pendant deux mois, présentent un amortissement augmenté de  $\approx 2\%$  (Fig.0.7).

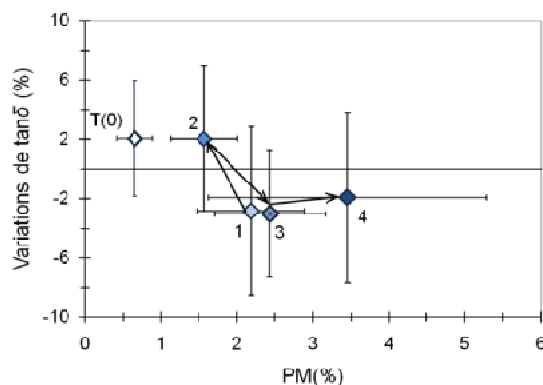

Fig.0.7. Variations relatives des pertes de masse (% PM) et  $\tan\delta$  (%) pour quatre groupes d'échantillons soumis à différentes durées d'immersion dans l'eau. T (0) : Témoins, 1, 2, 3 et 4 : nombre de mois d'immersion. Les flèches indiquent la continuité dans le temps.

Au niveau du module spécifique, les échantillons soumis au traitement pour un et trois mois montrent les changements les plus importants dans leurs  $\Delta\rho \approx -6,19\% \pm 1,65$  et  $-7,17\% \pm 2,35$ ; respectivement, et, par conséquent, leurs modules spécifiques ont varié plus que pour les autres échantillons ( $\approx -7\%$  et  $-6\%$ ). Cependant, la dispersion entre les échantillons d'un groupe étant importante (en particulier dans les échantillons du deuxième mois), il est difficile de conclure.

### 0-6-2- Modifications des propriétés physico-mécaniques par traitement à l'eau chaude de court durée

Pour les échantillons soumis au traitement à l'eau chaude ( $70^\circ\text{C}$ ) de courte durée, une certaine extraction s'est produite indépendamment du temps de traitement. Cette extraction s'est manifestée par la perte de masse (PM) des échantillons (Fig.0.8). Les PM sont similaires aux valeurs observées pour les échantillons immergés dans l'eau à température ambiante ( $\approx 4,27\%$  et  $\approx 4,52\%$ , PM maximum observées après le traitement à l'eau chaude et à température ambiante, respectivement). Cela pourrait être indiquer que les extraits hydro-solubles du mûrier blanc, ne sont pas sensibles à la température (dans la gamme étudiée ici) et peuvent être enlevées avec l'utilisation de l'eau à température ambiante. D'autre part, le temps reste le facteur de différenciation entre les deux méthodes. La PM maximale est atteinte après seulement 10 heures de traitement avec à l'eau à  $70^\circ\text{C}$  ( $\approx 3,34\% \pm 0,79$  / moyenne de 5 échantillons), alors qu'il faut quatre mois complets d'immersion dans l'eau à température ambiante pour un résultat semblable ( $\approx 3,46\% \pm 1,83$  / moyenne de 12 échantillons).

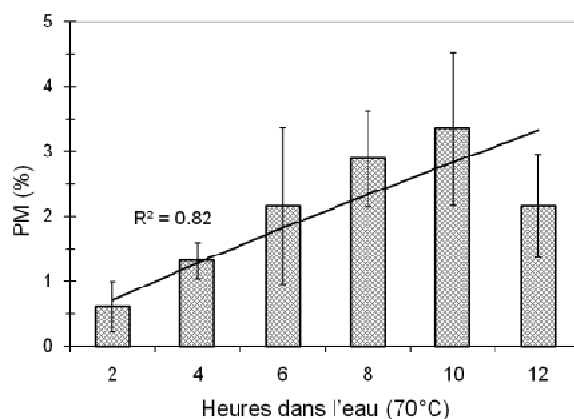

Fig.0.8. Pertes de masse (PM%) des échantillons soumis à des traitements à l'eau chaude (70 °C). N °: 5 pour chaque intervalle de temps: 5 × 6 = 30 au total.

Contrairement à ce qui a été observé pour les échantillons soumis à une immersion de longue durée à l'eau (où il n'y avait aucun lien apparent entre la durée et les variations de  $\tan\delta$ ), le traitement à l'eau chaude a montré un impact sur la relation temps- $\Delta\tan\delta$ . La fig.0.9, illustre les variations de PM (%) et  $\tan\delta$ (%) pour six groupes d'échantillons soumis à des durées différentes du traitement à l'eau chaude (70°C).

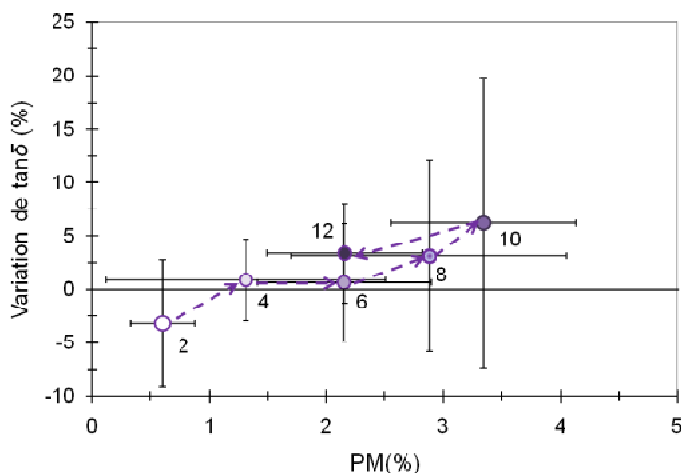

Fig.0.9. Variation relative des pertes de masse (PM%) et  $\tan\delta$  (%) pour six groupes d'échantillons soumis à des durées différentes du traitement dans l'eau (70°C). Les flèches sont indicatives de la continuité dans le temps.

$E'/\rho$  a été réduit par le traitement à l'eau chaude, l'amplitude en revanche, n'a pas suivi une tendance claire. Les plus fortes baisses, observées après 4 et 12 heures de traitement, ne semblent pas être liées au temps de traitement.

### 0-6-3- Le séchage et les stabilisations Cycliques

Un groupe d'échantillons (N°:17) a été exposé à cinq cycles de séchage et de stabilisation selon le protocole général (48 heures séchage à 60°C et 3 semaines de stabilisation à 20°C et 65% HR).

Avant et après chaque cycle, les échantillons ont été testés pour déterminer leurs propriétés physiques et vibratoires.

En exposant les échantillons à des faibles cycles de désorption-absorption, l'amortissement a été modifié plus que tout autre paramètre. Étant déjà dans la gamme basse par rapport à la courbe standard (courbe rouge sur la figure. 0.10), après quatre cycles, le  $\tan\delta$  moyen de nos échantillons a été réduit de  $\approx 11\%$ . Cependant, cela a été compensé après un cinquième séchage et  $\tan\delta$  a atteint à peu près sa valeur initiale, en restant toutefois  $\approx 6\%$  inférieur à la valeur d'origine.

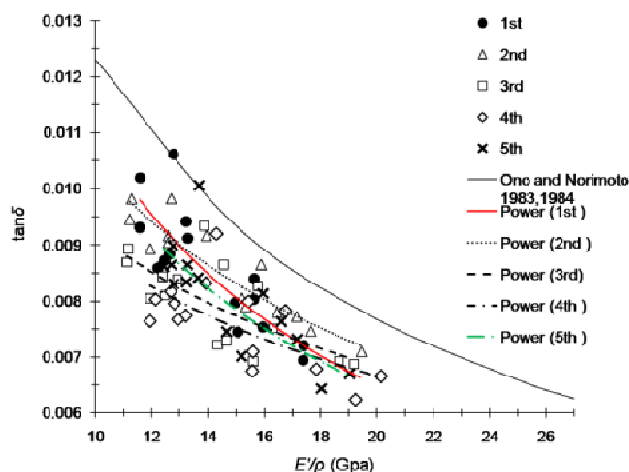

Fig.0.10.  $\tan\delta$  en relation avec  $E'\rho$  après 5 fois de séchage et stabilisation. La courbe de référence a été ajoutée à partir de Ono et Norimoto (1983, 1984 ).

Dans une perspective plus générale, on peut mettre en rapport les résultats présentés dans cette étude avec la méthode traditionnelle de la fabrication de l'instrument, où le bois est exposé à l'air pour une durée beaucoup plus longue que celle de notre étude. Cette petite diminution de l'amortissement pourrait être la raison cachée pour laquelle les bois secs à l'air sont normalement jugés plus pratiques pour la fabrication des instruments.

## 0-7- Etude de la durabilité naturelle

L'étude sur la durabilité naturelle du bois massif a été effectuée selon les directives de norme XP CEN/TS 15083-1 (2006) pour la détermination de la durabilité contre les champignons, et selon EN117 (2005) pour les termites. Pour comprendre si le lessivage dans l'eau a un effet sur le comportement de l'espèce contre les organismes lignivores, les échantillons ont été immergés dans l'eau selon EN84 (1997).

Les différents types de champignons, ainsi que les conditions des tests, se trouvent dans le tableau 0.1.

Tableau 0.1. Les champignons et les conditions des tests contre les basidiomycètes

Champignons	Type	N° d'échantillons	Condition
<i>Coriolus versicolor</i>	Pourriture brune/souche CTB 863-A	30 délavé+ 30 non-délavé	22°C, 65% HR
<i>Coniophora puteana</i>	Pourriture blanche/souche BAM Ebw.15	30 délavé+ 30 non-délavé	
<i>Gloeophyllum trabeum</i>	Pourriture blanche/souche BAM Ebw.109	10 délavé+ 10 non-délavé	
<i>Poria placenta</i>	Pourriture blanche/souche PRL 280	10 délavé+ 10 non-délavé	
<i>Pycnoporus sanguineus</i>	Pourriture brune/souche CTFT 27 O	10 délavé+ 10 non-délavé	27°C, 70% HR (Conditions tropicaux)
<i>Antrodia sp</i>	Pourriture blanche/souche CTFT 57 A	10 délavé+ 10 non-délavé	

Selon les indications de XP CEN/TS 15083-1, la perte des masses des échantillons testés étaient inférieures à 5%, par conséquent le mûrier blanc pourra être classé comme « très durable ». Les échantillons non-délavés ont été classés comme très durable, même lorsqu'ils ont été testés avec des souches très agressives (tropicaux) (médiane de la PM ≈ 3% contre *Antrodia*) (Fig.0.11).

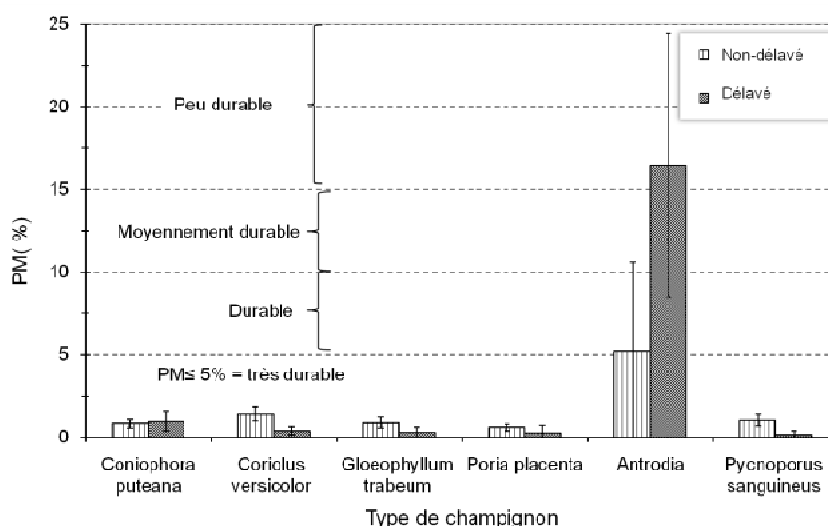

Fig.0.11. Comparaison entre les pertes de masse des échantillons délavés et non délavés testés contre des champignons basidiomycètes.

Les pertes de masses des échantillons délavés ont été moins élevées que celle des non-délavés, devant la majorité des champignons (Fig.0.11). Cela pourrait indiquer que les extraits enlevés par le lessivage, sont sans effet sur la durabilité du bois du mûrier face aux basidiomycètes. L'autre hypothèse concernant les résultats pourra être basée sur la durée et/ou les conditions du délavage dans l'eau. Autrement dit, un lessivage de quatorze jours dans l'eau à température ambiante, a peu d'effet (ou probablement pas d'effet) sur l'extraction des métabolites secondaires.

L'hypothèse ci-dessus est vraie, sauf pour *Antrodia*. Lorsque les échantillons délavés ont été exposés à ce champignon, les composés retirés semblaient jouer un rôle important dans la durabilité, car la catégorie a changé de la classe « durable » (même « très

« durable » compte tenu le fait que la PM est sur la limite) à « peu durables » (la PM  $\approx$ 16 %). Il est possible que l'on soit passé en deça d'un seuil critique pour la résistance vis-à-vis d'Antrodia.

La durabilité contre les termites *Reticulitermes santonensis* a été évaluée selon les directives de la norme EN 117 (2005) pour 10 échantillons non-délavés et délavés.

Les échantillons de mûrier non-délavés pouvaient être classés comme « moyennement durable ». Le classement pour les échantillons lessivés était « non durable ». Comme dans le cas des basidiomycètes, la perte de masses des échantillons délavés était moins importante que celle des non-délavés.

Tableau 0.2. Résistance des échantillons de *Morus alba* contre les termites

Echantillons	Taux de survie des ouvriers %	Cotation visuelle	Perte de masse%	
			Moyenne $\pm$ écart type	Médiane
Non-délavés N = 2 échantillons N = 8 échantillons	0	1 2	2,20 $\pm$ 0,30	2,05
Délavés N = 10 échantillons	0	3	0,91 $\pm$ 0,33	0,83
Control virulence N=10 échantillons	>60	4	12,42 $\pm$ 0,97	12,30

D'autre part, les résultats de la cotation visuelle ne peuvent pas être reliés à ceux de la perte de masse. La cotation des échantillons délavés est supérieure à celle des non-délavés, ce qui signifie que, visuellement, les échantillons délavés ont été plus consommés par les termites. Même si les résultats de la PM et la cotation visuelle (critère normatif du résultat d'essai dans la norme EN117) semblent contradictoires, nous devons remarquer deux points : la frontière entre les classements 2 et 3 est très subtile. En outre, la différence observée entre la limite inférieure de la perte de masse des échantillons non-délavés (1,9% de la masse sèche) et la limite supérieure de la perte de masse des échantillons des délavés (1,24% de la masse sèche) est tellement petite que soulèvent des doutes réels sur l'importance de ces variations. La seconde remarque porte sur l'efficacité le calcul de la PM pour de tels tests. Généralement, pour la résistance aux termites, la PM n'est pas calculée, et le classement visuel est considéré suffisant pour exprimer les résultats. Dans notre cas, les deux ont été faites, mais les résultats n'ont pu être corrélés.

Pour conclure, nous pouvons affirmer que le mûrier blanc brut a été trouvé moyennement durable contre les termites, et sensible suite au délavage. Les extraits étaient toxiques (mais pas répulsifs), car les termites ont dû manger au moins une partie du bois pour finalement mourir. Les classifications en fonction de la cotation visuelle et de la perte de masse ont été différentes pour les échantillons délavés. Néanmoins, la proximité des valeurs moyennes observées pour les échantillons délavés et non-délavés, avec leurs petites PM comparé à celui des témoins de virulence (2,20% et 0,91% par rapport à 12,42% pour les témoins), fait douter que le calcul la perte de masse soit un outil approprié pour exprimer les résultats de ce test.



## 0-8- Identifications des composés chimiques des extraits du bois de Mûrier blanc

Les essais d'identification ont été réalisés sur les extraits cumulés après les extractions indépendantes et successives (§0.5).

Deux méthodes ont été appliquées :

- La chromatographie en phase liquide à haute performance (CLHP ou en son abréviation anglais: HPLC)
- La chromatographie en phase gazeuse couplée à la spectrométrie de masse (GC-MS)

HPLC-MS n'a pas pu donner des résultats sur les extraits enlevés par les solvants polaires (c'est-à-dire, AC, ME et EC). Probablement en raison d'incompatibilité du solvant utilisé et/ou le réglage des appareils (qui n'a pas été ajusté pour travailler sur le bois), les pics étaient compliqués à interpréter. Par conséquent, nous avons eu recours à la GC-MS, comme une nouvelle méthode pour l'identification des extraits du mûrier blanc.

La GC-MS a été réalisée deux fois sur tous les extraits cumulés. Le premier GC-MS n'a permis d'identifier que les composés enlevés par des solvants polaires (AC, ME et EC) et non pas ceux des solvants apolaires (H et D). Finalement, une dernière série de GC-MS, en utilisant deux extraits bruts et leurs dérivations Sylan (avec N, O-bis-(trimethylsilyl) trifluoroacetamide ou BSTFA), nous a donné une vision plus claire des composés enlevés.

Le tableau 0.3, montre les classements des composés identifiés par GC-Mass dans l'ensemble des extraits bruts et dérivés.

Tableau 0.3. Classement des composés identifiés dans les extraits du mûrier blanc.

Catégorie	Compound
Hydrocarbures saturés	Une variété d'Undecan au Squalene
Phénols	Resorcinol
	2,4-bis(1,1-dimethylethyl)- Phenol
	2, 6, Dimethoxy phenol
	3,4,5,Trimethoxy phenol
	Bis(trimethylsilyl)isovanillate
Acides gras et leurs esters	Une variété de l'acide Butanedioic à l'acid Tricosanoic
Composés aromatiques	Benzaldehyde
	Umbelliferone
Stérols	$\beta$ -Sitosterol
	Campesterol trimethylsilyl ether

Les extraits du mûrier blanc contenaient des hydrocarbures saturés, des phénols, des acides gras, des composés aromatiques et des stérols. Les hydrocarbures saturés et acides gras sont les plus variés, tandis que les quantités les plus élevées sont attribuées aux phénols. Des composés aromatiques et des stérols existent en proportions minimes et ils sont moins diversifiés que les autres composés.

Le résorcinol (le composé le plus souvent trouvé), est connu comme un antifongique et son effet protecteur contre les basidiomycètes avait déjà été rapporté (Adikaram et al. 2010). Par ailleurs, le résorcinol a été répertorié comme «dangereux si digéré», «irritant pour la peau et les yeux » et « dangereux pour les organismes aquatiques » par l'INRS

(2000). Les difficultés respiratoires (toux, souffle court) ont également été observées chez les travailleurs généralement exposés au résorcinol.

Les problèmes de santé mentionnés ci-dessus sont similaires à ceux qui ont été rapportés par les fabricants des instruments iraniens. Les phénols ont été signalés pour être absorbés par la peau ainsi que par inhalation. Donc, il est probable que le fort impact du marteau et de jauge (les outils habituels des artisans), permettent de libérer de petites particules, chargées des métabolites secondaires dans l'air et causer des problèmes allergiques.

## **0-9- Conclusion générale**

Le mûrier blanc a été observé pour avoir une densité modérée ( $\approx 0,55 \text{ g/cm}^3$ ), un module spécifique faible ( $E'/\rho \approx 13 \text{ GPa}$ ), un amortissement plus bas que supposé ( $\tan\delta \approx 0,85\%$ ) et des petits ratios d'anisotropie entre les trois axes.

Notre approche vers une compréhension de relation entre les métabolites secondaires et les caractères vibratoires, permet de trouver deux types d'extractibles qui altèrent l'amortissement différemment. En utilisant des extractions indépendantes et en série, il a été révélé que  $\tan\delta$  est régi par deux types de substances, certaines l'abaissant (extractibles par l'acétone et le méthanol) et certaines l'augmentant (extractibles uniquement par le méthanol et l'eau chaude). Le module spécifique a été diminué graduellement au cours des traitements. Les ratios d'anisotropie de  $\tan\delta$  ont été modifiés par les extractions, mais pas ceux des modules spécifiques.

La durée de traitement à l'eau à température ambiante, ne pouvait pas modifier l'un des déterminants des facteurs physico-mécaniques. Un court traitement à l'eau chaude ( $70^\circ\text{C}$ ) a entraîné l'augmentation de l'amortissement et la baisse du module spécifique. Dans ce dernier cas, des modifications ont été presque progressives avec le temps. Des cycles identiques de séchages et de stabilisations, ont diminué l'amortissement à 8% par rapport à sa valeur initiale sans modifier significativement les modules.

Le bois du mûrier blanc a été classé comme « très durable » contre les champignons. Le délavage dans l'eau n'a pas pu changer la durabilité, sauf pour une condition d'attaque extrême. Non délavé, cette essence est « moyennement durable » contre l'attaque des termites.

Les différents types de phénols, d'hydrocarbures, d'acides gras et de stérols ont été identifiés dans les extraits. Le résorcinol, le composé prédominant trouvé, est largement connu comme étant la cause de plusieurs problèmes de santé, tout comme ce qui a été observé chez les artisans iraniens.

Enfin, il faut noter que d'après les données rapportées dans l'étude actuelle et ceux des précédentes, le mûrier blanc, dans son rôle en tant qu'un bois musicalement important, ne pouvait être considéré avec le même « standard » que les instruments classiques européens. Si nous insistons pour avoir un faible amortissement et un module élevé comme les exigences pour le choix d'un bois de haute qualité, le mûrier blanc (comme certains d'autres feuillus utilisés dans les instruments asiatiques) aurait été qualifié comme « faible ». Ce n'est bien sûr pas le cas, comme ces instruments sont fabriqués et largement joués dans leurs régions. Une telle incompatibilité peut être attribuée à des goûts

différents pour les sons musicaux. En fait, le type du son produit par un instrument asiatique peut être très différent et peu souhaitable pour un instrument européen (et vice versa). Par conséquent, une vue complète de l'instrument ne pourra pas être atteinte sans prendre en compte sa structure et son mode de fabrication, ainsi que les facteurs d'influence sociale et régionale.



# Notations

Remark: The conditioning has been always done in  $20^{\circ}\text{C} \pm 2^{\circ}\text{C}$  and  $65\% \pm 5\%$  RH. Unless stated otherwise, the tolerances have stayed the same for all the tests.

The list below is describing the most used factors in this study, for the other ones, short descriptions are given in the text whenever necessary.

Category	Notation	Description
Basic wood properties	MC, EMC	Moisture content, equilibrium moisture content
	$\rho$	Specific gravity
	L	Longitudinal direction
	R	Radial direction
	T	Tangential direction
Mechano-vibrational properties	E	Modulus (stands for Young's modulus/modulus of elasticity)
	E'	Storage or real modulus
	E''	Loss or imaginary modulus
	E*	Complex modulus
	$E/\rho, E'/\rho, E''/\rho$	Specific moduli
	$\tan\delta$	Internal friction, loss tangent, damping
Dynamic mechanical methods	DMA	Dynamic mechanical analyzer
	Bing®	Free vibration of the floating bar method, located in Cirad
	LMGC (vibration) method	Free-free bar forced vibration method, located in LMGC
Extraction Materials and terms	WL	Weight loss
	EC	Extractive content
	H	Hexane
	D	Dichloromethane
	AC	Acetone
	ME	Methanol
	HW	Hot water ( $70^{\circ}\text{C}$ or $100^{\circ}\text{C}$ depending on the test)



# 1. Introduction

---

## **1-1- Wood and music: a history of myths**

Wood is a material with historical use in versatile domains. Being an organic product available for the ancient human, it served as shelter, fuel, sometimes medicine and a communicating tool. The later, was then turned into first musical instruments. Even now, and with the appearance of new electronic sound generators and synthesizers, the common notion of musical instrument is referred to those with wooden parts (i.e., guitars, violins, lutes, pianos, etc). The good sonority of wood is also a known fact. “Tapping”, in order to acquire some sort of vibration in form of the sound, is still one of the first ways that people interact with a piece of wood. This of course, is beside its aesthetic character that provokes a warm, “cozy” feeling in a spectator.

Wood, in its role as a vibrator membrane in musical instruments, is covered with myths, cultures, rituals, and traditions. The ancient history of its application in musical domains, has allowed the entrance of experiences, errors and cultural criteria to the secret personal “recipes” of each instrument maker. Notwithstanding the fact that every artisan has already a specific idea on selecting a wood of superior quality for instrument fabrication, the scientific knowledge on the matter is comparatively recent. Researchers have tried to draw a bridge between the traditional know-how and scientific reasons hiding behind craftsmen decisions.

The academic studies on the matter are not only fairly recent (compared to some centuries old instruments), but also limited to the most known ones. There are extensive researches done on the violins, guitars, and in general classical European musical culture. The documented knowledge on those of other continents is scarce. It is important to know, that contrary to the common belief, what is learned for western instruments cannot (always) be extrapolated to those of other countries and/or cultures. Dissimilar available wood in form of raw material (production of different climates due to geographical distances), not to mention different life styles, resulted in different instruments fabricated sometimes for a completely different musical “taste”. Hence, there is still a wide uncrossed field of Asian musical instruments left to be researched and documented to give a comprehensive idea on the history of world’s music evolution.

The criteria why a wood is picked by an artisan to make a musical instrument and why other ones are left behind can be related to some intrinsic features of each species. Certainly, the visual appearance also plays a quite important role in the process of wood selection.

The origin of differences in woods is coming from their various structures and chemical constituents. The extraneous components, though present in minute amounts compared to wood primary elements, is in strong relation with the vibrational character of a specific wood.

Green wood has been almost never used for instrument fabrication. “Old” wood is preferable amongst artisans of different cultures. The word “old” does not really refer to an “aged” tree, but to one that has been cut and air-dried for a long time. In Iran, some superior lutes are fabricated from old doors, which wood was in use for several decades. This air-drying, although a natural step in a wood life, could also be considered as pre-treatment of the raw material. Along with that, a relatively large number of craftsmen have their own special pre-treatments before starting to work on the material. These steps, covered with the same myths as the process of wood selection, are often followed to the smallest details, by generation of fabricants, believing that the final product would consequently exhibit improved characteristics. This supposedly enhanced feature (whether it is a better sounded instrument or a more stable one) could also be subjected to scientific investigation, hoping to reveal (if any) the actual mechanism of improvement.

## **1-2- The beginning**

The preliminary steps of the present study started in 2005 at the wood and paper department of university of Tehran. Iranian lutes, highly respected and at the same time un-researched subjects, draw the attention of Dr. Kambiz Pourtahmasi. In the frame of a master thesis, under his direction, I run some initial tests on white Mulberry, the leading material for fabrication of three different lutes in Iran. Extensive anatomical tests, fairly vast chemical ones, and rather limited vibrational experiments were carried out. Working closely with professional artisans, we got first ideas on the actual problems, unfamiliarity, and demands. Once the project was completed, even though a large amount of data was gathered, it was obvious that we were still far from conclusive results.

Based on the vibrational tests of the previous project made in the laboratory of “Mécanique de l’Arbre et Bois (MAB)” team in LMGC (Montpellier, France) by Dr. Kambiz Pourtahmasi, during a scientific visit in the spring of 2007, an extended new project on the subject was accepted, with the present PhD program started November 2008. As the objectives of the new project met the interests of “Production et Valorisation des Bois Tropicaux et Méditerranéens” Research Unit of CIRAD (Montpellier, France), a collaboration was organized between the two teams, with the extractions and natural durability tests performed in CIRAD and the vibrational experiments in LMGC. During the study, some of the experiments regarding the identification of the compounds present in the secondary metabolites were done in chemical laboratory of the *Critt Bois* in Epinal, France.

This project was financially supported mostly by a French government scholarship (BGF). However, it was also integrated into a wider Franco-Iranian Gundishapur project, that involved Iranian instrument makers and players, Tehran university academics as well as representatives of LMGC, CIRAD and Cité de la Musique in Paris.



### **1-3- Objectives of the current study**

The Objectives of the following study are as follow:

- i. Characterizing white Mulberry as a raw material for instrument fabrication: to our knowledge, until this day there is no documented research focusing on the acoustical features of white Mulberry from Iran. Doing this research, we could not only develop a concrete idea on how white Mulberry is classified compared to other common species for soundboards, but the data would be also used to draw a base line for reaching the second and third objectives.
- ii. Investigation on the efficiency of traditional pre-treatments: three artisanal treatments are selected and performed at laboratory scale. The goal is to find out if those treatments are really effective regarding wood sonority and/or stability.
- iii. Studying extractives as the origin of differences: Assuming secondary metabolites as one of the possible source of variations in vibrational characteristics, we aim to clarify the matter in white Mulberry.
- iv. Determining natural durability of the species: as reliable literature on the white Mulberry decay resistance are rare and contradictory, one of the goals of this research is to give a clear statement on the matter. These tests would also be useful for the following objective.
- v. An initial identification and categorization of the extractive compounds. The problem of allergy to wood flour had been already identified during the previous study: even though no documented report exists on the matter, artisans complain of hard coughs happening during fabrication process. Noting that this disturbance is limited to the wood in fabrication and not to the completed instrument, one assumption is the repulsiveness of the secondary metabolites. Running a real toxicity test is not planned within this study, but two indirect tests can give us the basic information necessary for further research: (i) identification of chemical components present in the extracted material; (ii) examining the possible repulsive/toxic effect of extractives on the decay agents. The first would result in an inclusive list of the constituent components, and the later could be regarded as a preliminary statement on the toxicological nature of the extractives.

The five points mentioned will be combined to reach a global objective, a multi directional view of a less studied species with an important and rather “exotic” field of use.

### **1-4- The plan of presentation**

This manuscript is designed so that subjects of interest can be easily selected. Following this introduction, a general part (chapter 2) gives basic definitions and references to previous research related to the present study: in relation to the different objectives covered in this thesis, articles from chemical, mechanical and biological domains are reviewed. Chapter 3 describes the material choice, conditioning and cutting, followed by a description of mechanical methods used in this research; other specific methods are left to corresponding chapters. The results of physical and mechanical tests are presented in chapters 4 to 6: chapter 4 presents the native wood properties, chapter 5 the effect of

laboratory-scaled artisanal treatments, and chapter 6 the effect of various extraction. Chapter 7 presents the results of natural durability tests and evokes the probable toxicity effect of extractives, and chapter 8 addresses the identification of extractive compounds. General conclusions and perspectives are finally proposed in chapter 9, the list of bibliographical references is followed by annexes giving background information on Iranian lutes and some methodological details.

## 2. Basic definitions and bibliography

### 2-1- Introduction

As it is apparent from the list of objectives, this study covers a variety of domains and for each of them some basic or bibliographical information is needed. This chapter will contain some remarks on wood anatomy, a wider range of researches on natural durability, some on chemical properties and extractives, and an extensive presentation on wood vibrational characteristics. This will be naturally completed by a description of *Morus alb* L. and a brief review on its use in musical domain.

### 2-2- Wood as a multifunctional material

In all its different applications, wood has always been considered as an essential part of human's life. From ancient times, being the main material for shelters, and for fuel during centuries, its significance has never faded away. Its application varied according to the region and culture, and throughout the years, new and modern utilizations have come along. Its outstanding mechanical features – when specific gravity is taken into account - (Table 2.1) along with easier handling process has made of wood a competitive material in house-making industry. Furthermore, the warm and comfortable feeling initiated by using wood-based materials - parquets, wall cover veneers, porches and decks and thousands of other objects- has always captivated people's minds.

Table 2.1. basic physical and mechanical properties of some construction materials (From: SP guide to composites, Lines (2002)).

Material	$E^a$ (GPa)	$\rho^a$	$E/\rho^{a,b}$	$E^{1/2}/\rho^c$
Steel	210	7.8	26	1.85
Titanium	120	4.5	26	2.43
Aluminum	73	2.8	26	3.05
Glass	73	2.4	30	3.50
Concrete	15	2.5	6	1.54
Aluminum oxide	380	4.0	95	4.87
Carbone fiber composites	400	2.0	100	10
Wood	14	0.5	28	7.48

- a.  $E$ : (elastic) modulus,  $\rho$ : specific gravity,  $E/\rho$ : specific modulus
- b. Important conditions for rods in tension
- c. For beams in bending

Along with lumber, wood-based composites have also entered into the course. From various types of particle or fiberboards to pulp and paper, wood in all shapes and forms answers the increasing demand of world growing population.

Talking about wood as a multi-application material would be indeed incomplete without mentioning its vast use in musical instruments. Having carved it easily by basic tools, the premier instruments out of wood served for sending signs as well as showing gestures of

different feelings. During the years, different kinds of lutes, wind instruments, xylophones, or violins were fabricated out of special wood species. Although sometimes attempts were made for replacing wood with other (sometimes synthetic) materials, eventually in most of the cases, wood remained the desirable material for instrument making.

This multi- functionality of wood is coming from its intrinsic features. A combination of anatomical (percentage of vessels/parenchyma/fibers), structural (how wood elements are organized) and chemical (what are the constituents forming those elements) properties make the wood worthy of being used in versatile domains. Some of these characters are determined in the first basic steps of wood formation. For that, we will first take a quick look to the process in which primary wood elements are formed.

## **2-3- Wood microstructure: a window to its final properties**

### **2-3-1- Cell wall formation**

Xylogenesis represents an example of cell differentiation in an exceptionally complex form. This process is controlled by a wide variety of factors both exogenous (photoperiod and temperature) and endogenous (phyto-hormones), along with interaction between them. It is driven by numerous structural genes that are involved in cell origination, differentiation, programmed cell death, and heartwood formation (Chaffey 2002).

Wood (secondary xylem) is manufactured by a succession of five major steps: cell division, cell expansion (elongation and radial enlargement), cell wall thickening (involving cellulose, hemicelluloses, cell wall proteins, and lignin biosynthesis and “deposition”), programmed cell death, and heartwood formation. Second and third steps contribute mostly to the final structure of the wood, while the fourth and fifth participate both to the structure (by forming cell wall) and constitution (by forming chemical compounds) (Savidge 2000, Chaffey 2002).

After the expansion reaches its final stage, the formation of cell wall begins. Through this stage, four major compounds are created and assembled: polysaccharides (cellulose, hemicelluloses), lignin, cell wall proteins, and other minor compounds (Flavonoids, tannins, terpenoids, pectin...) (Plomion et al. 2001, Déjardin et al. 2010).

The cell wall is described as the non-living (in heartwood), largely carbohydrate matrix that provides the mechanical support necessary for the plant. The empty portion of cell structure (after the programmed cell death) is referred to as the lumen. In most wood studies, a wood cell occupies only two domains: lumen and cell wall (Fig.2.1). The cell wall has 2 principal layers. The primary cell wall is the initial layer, formed during or following cell division and later modification during the post-cambial differentiation of the cell. The secondary layer is the portion formed after cell enlargement is completed (Butterfield and Meylan 1980).

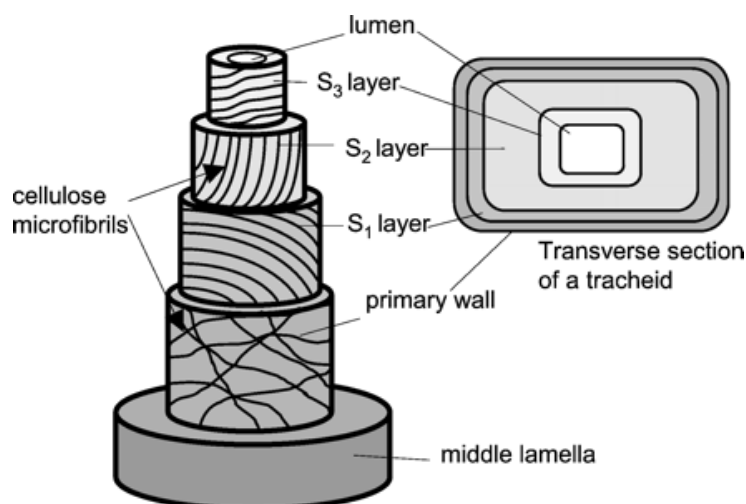

Fig.2.1. Basic wood cell structure, showing the layers of the cell wall (Plomion et al. 2001).

The lumen consists of nothing except for some secondary metabolic (extractives in the heartwood or transition wood cells) - and is often considered a “void space”. The cell wall, with a highly regular structure, is almost constant between species, contributes mostly for wood features. Density of the wood species however, is determined by both cell wall and lumen characteristics.

Cell wall is composed of microfibrils (MF), which are bundles of cellulose polymer chains united in highly ordered crystalline regions, with amorphous regions in between. In the secondary cell wall, cellulose provides a reinforcing structure. The MFs are embedded in a matrix composed of hemicelluloses and lamellar lignin sheets bound together through chemical bonds (Barnett and Bonham 2004).

This secondary layer of cell wall consists from three distinct sublayers: S<sub>1</sub>, S<sub>2</sub> and S<sub>3</sub>. The main differences between these layers are their microfibrillar angle (MFA). In S<sub>1</sub> MFA is 50°-70° to cell axis, in S<sub>2</sub>, it is 10°-20°, while in S<sub>3</sub>, it turns to 60°-90° (Fig.2.1). The thickest one is S<sub>2</sub>: it has the greatest effect on the mechanical behavior of wood (Salmén 2004). MFA had also been recognized as the primary factor affecting axial vibrational properties (Norimoto et al. 1986, Obataya et al. 2000, Brémaud et al. 2010b). However, primary and secondary constituents also play significant roles in defining this material behavior. In the following we will concisely introduce them.

### 2-3-2- Wood constituents

Between 40 to 50% of wood consists of cellulose which constitutes the MF. Thanks to a precise association and interaction of hydrogen bonds, microfibrillar cellulose is mainly crystalline.

Cellulose is a linear chain of several hundred to over ten thousand  $\beta$  (1 $\rightarrow$ 4) linked D-glucose units. The water-insoluble cellulose MF are associated with mixtures of soluble non-cellulosic polysaccharides, the hemicelluloses, which account for about 25% of the dry weight of wood. In contrast to cellulose, hemicelluloses are made of several sugars in addition to glucose: xylose, mannose, galactose, rhamnose, and arabinose. Hemicelluloses

are different from cellulose in their molecular weight and conformation (Fig.2.2) (Rowell 1984).

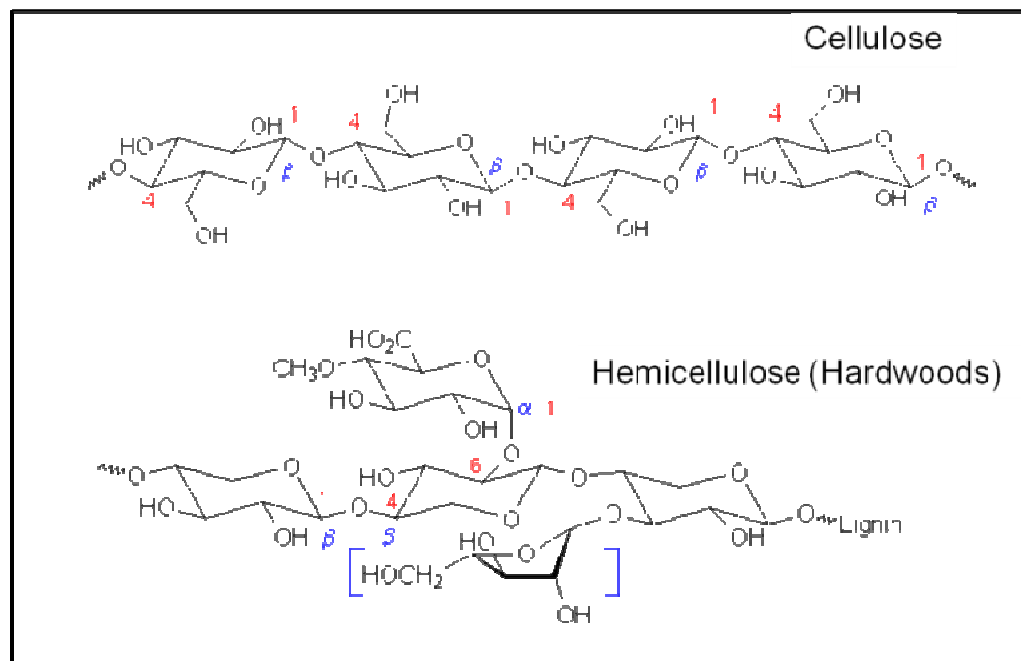

Fig.2.2. Partial structure of cellulose and hemicelluloses (From online website of University of Maine, Orono, USA)

The third major component of wood (25- 35%) is lignin. It is a phenolic polymer derived from three hydroxycinnamyl alcohols: p-coumaryl alcohol, coniferyl alcohol, and sinapyl alcohol (Fig.2.3). The basic role of lignin is the embedding of polysaccharide network to ensure tissues rigidity and cohesiveness. It also provides the hydrophobic surface needed for the transport of water. In general, lignin structure is much more complex than that of cellulose and hemicelluloses as it is a cross-linked macromolecule with molecular masses exceeding 10,000 units (Sjöström 1981).

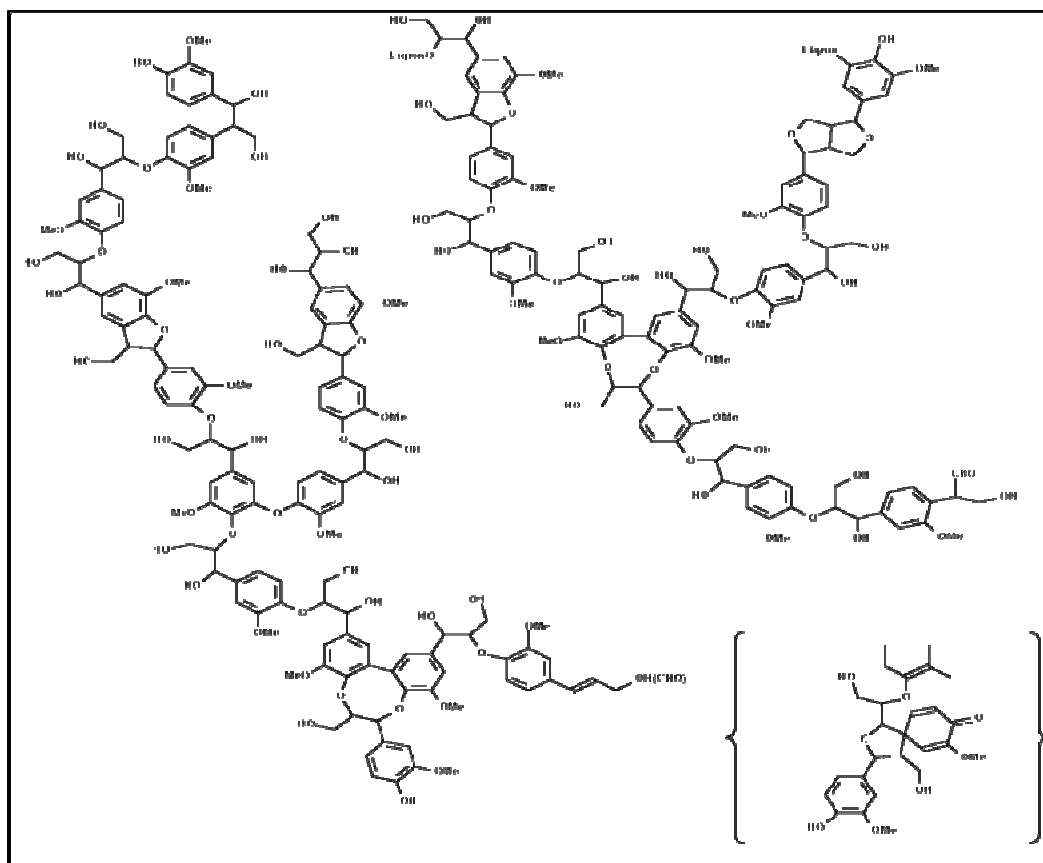

Fig.2.3. Partial structure of lignin (From online website of University of Maine, Orono, USA)

Though cellulose, hemicelluloses, and lignin are always known as the main structural components of wood, yet other components existing in small quantities, depending on their quantity, localization, and nature, play an important role in variation of wood properties. These “secondary constituents” can include very different components: fats, waxes, alkaloids flavonoids, tannins, sugars, etc. (Rowell 1984).

As these components are mostly extractable by water and/or other solvents, the name “extractives” is universally chosen for them. Extractives are known to determine wood color, odor, and natural durability. They may also influence mechanical properties (Yano et al. 1994 and 1995, Matsunaga et al. 2010).

As it was mentioned in the general introduction, studying the nature, localization and possible effect of extractives on white Mulberry properties (acoustical in particular) is one of the main focuses of this research. Let quickly examine some of the most common extractives in wood species.

#### ➤ Wood extractives: Origin and variety

Extractives are described as the wood constituents that can be removed using solvents. The amount of extractives are reportedly small (5- 10%) in woods of temperate zones, but in the species of tropical regions sometimes increases up to 30% (Hillis 1986). However, there are also tropical trees with smaller amounts of secondary metabolites. For instance, the wood of Bongossi (*Lophira alata* Banks ex Gaertn. f) has less than 2% acetone soluble extractives (Klick and Niemz 2010).

Dissimilar compounds could be found in extractives of different woods. Teak (*Tectona grandis*) is known to contain latex and quinines (Rudman 1960). Eucalyptus has lipophilic extractives including mostly sterol and fatty acids as well as hydrocarbons (Gutiérrez et al. 1999). Tropolone, an aromatic compound, was widely found in western red cedar (Mah 1987). Different kinds of sugars forming the syrup (e.g. sucrose and arabinogalactan) are reported in sugar maple (*Saccharum Marsh*) (Rowe and Conner 1979). For more information about compounds actually found in the extractives of different species, see Hillis (1962) and Rowe and Conner (1979).

Chemical compounds of extractives can vary extremely from one species to another. This feature gives wood species a signature of extractive maps and is used in chemotaxonomy (Hillis 1986, Otto and Wilde 2001)

The type and quantity of extractives can also be different in trees of the same species, and even in the different parts of the wood of one tree. Many phenolic compounds are cumulated in heartwood while only small amounts can be found in corresponding sapwood. The lack or presence of extractives can affect wood pulping, drying, hygroscopicity and mechanical or acoustical properties. These compounds are also responsible for the special fragrance and color of each wood (Johansson et al. 2000, Grabner et al. 2005).

Regarding removal of extractives, no single solvent could remove all the extraneous compounds in one wood. Ether is relatively non-polar and extracts fats, resins, oils, sterols, and terpenes. Ethanol/ benzene combination form a powerful polar mix and extracts most of the ether-soluble plus most of the organic materials insoluble in water. Hot water extracts some inorganic salts and low molecular weight polysaccharides including gums and starches. Water also removes some hemicelluloses such as arabinogalactan gum present in larch wood (Pettersen 1984).

Wood powder solubility in ethanol/ benzene in a 1:2 volume ratio used to be employed as the basic method for approximate measure of wood extractive content (Tappi standard T204 cm-07, ASTM standard D1107- 96(2007) and European standard NF B51-014-1987). However, as in recent years Benzene has been announced as carcinogen, toluene is used as its replacement.

Along with wood ultrastructural characters (cell-wall structure and chemical constitution), there are other factors which influence wood mechano-vibrational behavior. In the following, we will discuss two important ones, moisture content, and anisotropy, also affected by the quantity and quality of extractives.

### **2-3-3- Wood moisture content**

Wood is a hygroscopic material. The quantity and location of water molecules in wood are always changing according to the ambient humidity moisture content of wood (MC) is defined as the weight of water in wood expressed as a fraction, usually a percentage, of the weight of oven dry wood (Formula 2-1).



$$MC = \frac{W_{\text{water}}}{W_0} = \frac{W - W_0}{W_0} \quad (2-1)$$

where  $W$  is the weight of wood specimen in a given humidity and  $W_0$  is the anhydrous weight.

Moisture can exist in wood as liquid water (free water) or water vapor in cell lumens and cavities and as water held chemically (bound water) within cell walls (Skaar 1972). Green wood is often defined as the condition in which the cell walls are saturated in water. Nevertheless, green wood also contains additional amount of water in the lumens. The MC at which both the cell lumens and cell walls are completely saturated with water is the maximum possible MC. The  $MC_{\text{max}}$  can be deduced from specific gravity ( $\rho$ ) and had been reported to vary from 267% ( $\rho \approx 0.3$ ) to 44% ( $\rho \approx 0.9$ ) (Simpson and TenWolde 1999). A MC at which the wood is neither gaining nor losing moisture is called equilibrium moisture content (EMC).

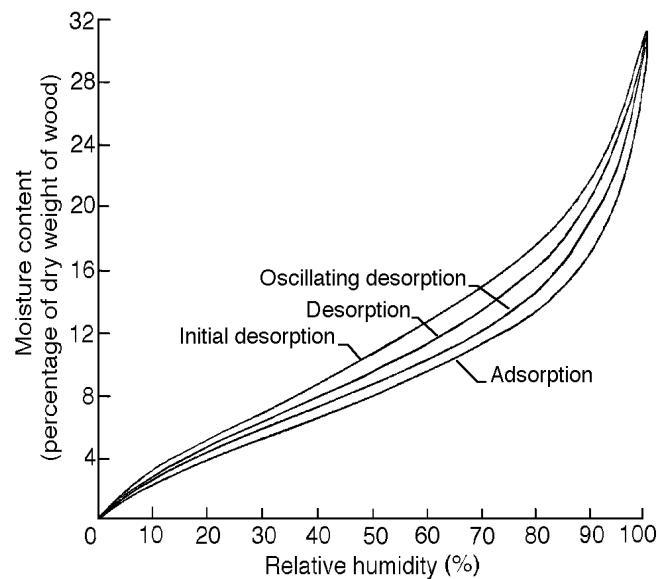

Fig.2.4. Moisture content–relative humidity relationship for wood under adsorption and various desorption conditions (Wood Handbook 2010).

The MC at which only the cell walls are completely saturated (all bound water) but no water exists in cell lumen is called the fiber saturation point (FSP). FSP is considered the point above which wood's physical and mechanical properties do not change as a function of MC. The average FSP moisture content is 30%, but it could vary for several percentages between species and within the different parts of the same wood.

Conceptually, FSP distinguishes very clearly between free and bound water. Water removal from the cell wall is expressed by shrinkage of macroscopic dimensions, while obtaining water molecules causes swelling. In reality, however, the borderline is vague

and the transition is gradual between free and bound water near FSP. Even within a single cell, the cell wall may begin to dry before all water has left the lumen.

The relationship between EMC and relative humidity at constant temperature is referred to as a sorption isotherm. A desorption is measured by bringing wood from the initially humid state to a dry one. On the contrary, adsorption is measured from an initial dry state to a humid one (Fig.2.4).

Wood EMC is affected by extractives (Nearn 1955, Wangaard and Granados 1967, Chafe 1987, Hernández 1989 and 2007, Choong and Alchemadi 1991, Mantanis et al. 1995, Sehlstedt- Persson 2001, Nzokou and Kamdem 2006, Kilic and Niemz 2010). Two of those works focused exclusively on tropical species (Wangaard and Granados 1967, Choong and Alchemadi 1991) and stated that the extracted wood exhibited a higher EMC than the samples that still had a hold of their accessory compounds. The lower FSP in particular species was associated with the fact that extractives seem to occupy the places filled with water in other ones (Nearn 1955). Extractives' bulking is also reported to change wood hygroscopicity at higher humidity (Chafe 1987 for Eucalyptus, Choong and Alchemadi 1991 for tropical species). In general, the presence of extractives decreases wood EMC. However, this is species related, and in rare cases extractives has an increasing effect on the EMC (Cooper 1974 for black walnut, Krutul 1983 for spruce).

## **2-4- Vibrational properties**

Ross and Pellerin (1994) state that “nondestructive materials evaluation is the science of identifying physical and mechanical properties of material without altering its end-use capabilities”. Acoustical properties can be used for non-destructive testing of wood, by getting a fast estimation of the elastic and damping properties. Acoustics have been used extensively to determine elastic properties in wood species: Jayne (1959) used transverse vibration technique to assess the dynamic stiffness of Sitka spruce. Haines et al. (1996) compared the static and dynamic moduli obtained for several softwoods using resonance flexure method. Different kinds of wave propagation are used to determine elastic moduli of woods in use (Cai et al. 1997, Wang et al. 2001). Other examples of use of vibrational tests to determine mechanical properties can be found in (Ilic 2001, Kubojima et al. 2006, Cironei et al. 2009, Zhao et al. 2010, Yoshihara 2011).

### **2-4-1- Elasticity and anisotropy**

The material elasticity can be described by the relation between stress and strain. In the linear elastic range, stress  $\sigma$  and strain  $\varepsilon$  are related through Hooke's law:

$$\sigma = E\varepsilon \quad (2-2)$$

where  $E$  is the elastic modulus.

➤ **Anisotropy**

Wood has very different properties along its three principal directions. This anisotropy, observable in physical and mechanical characteristics, results from its fabrication steps causing basic wood elements to have dissimilar orientation.

Wood has three orthotropical axes: Longitudinal (L), Radial (R) and Tangential (T) (Fig.2.5).

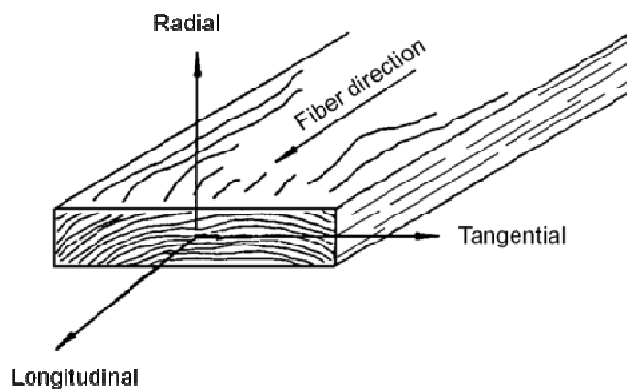

Fig.2.5. Three orthotropical directions in a timber (Wood Handbook 2010)

In this system of axes, elasticity law is described using nine elastic constants (Bodig and Jayne 1982):

- Three elastic moduli:  $E_L$ ,  $E_R$  and  $E_T$
- Three shear moduli:  $G_{TL}$ ,  $G_{LR}$ ,  $G_{RT}$
- Six Poisson ratios (could be reduced to 3):  $\nu_{RT}$ ,  $\nu_{TR}$ ,  $\nu_{TL}$ ,  $\nu_{LT}$ ,  $\nu_{LR}$ ,  $\nu_{RL}$

The constants are related to the compliances in the following matrix (Bucur 2006):

$$\begin{bmatrix} \varepsilon_{LL} \\ \varepsilon_{RR} \\ \varepsilon_{TT} \\ 2\varepsilon_{RT} \\ 2\varepsilon_{TL} \\ 2\varepsilon_{LR} \end{bmatrix} = \begin{bmatrix} \frac{1}{E_L} & -\frac{\nu_{LR}}{E_R} & -\frac{\nu_{LT}}{E_T} & 0 & 0 & 0 \\ -\frac{\nu_{RL}}{E_L} & \frac{1}{E_R} & -\frac{\nu_{RT}}{E_T} & 0 & 0 & 0 \\ -\frac{\nu_{TL}}{E_L} & -\frac{\nu_{TR}}{E_R} & \frac{1}{E_T} & 0 & 0 & 0 \\ 0 & 0 & 0 & \frac{1}{G_{RT}} & 0 & 0 \\ 0 & 0 & 0 & 0 & \frac{1}{G_{LT}} & 0 \\ 0 & 0 & 0 & 0 & 0 & \frac{1}{G_{LR}} \end{bmatrix} \quad (2-3)$$

The elastic modulus is much higher in L direction than in R and T:  $E_L \gg E_R > E_T$  (Guitard et El Amri 1987, Narin 2007, Katz et al. 2008).

Most of the present work deals with the measurement of axial properties in the L direction. Therefore, unless explicitly indicated by the index R, T or L, the symbol  $E$  will refer to the elastic modulus in the L direction.

➤ **Elastic modulus and resonance frequency**

$E$  is related to the sound velocity  $V$  according to the one-dimensional wave equation:

$$E = V^2 \rho \quad (2-4)$$

Where  $V$  is the sound velocity and  $\rho$  is the density ( $\text{Kg/m}^3$ ). This wave equation was developed for idealized long slender rods in longitudinal direction, when the ratio of length to the thickness is big (Bucur 2006, Meyers 1994). The application of this equation in wooden materials is influenced by internal characteristics of the specimens – knots, grain angle-, moisture content, temperature as well as materials dimensions and geometric form.

The resonance frequency of an object is directly related to the sound velocity  $V$ ; it depends also on its geometry and the imposed boundary conditions. In the following, we will mainly consider the case of flexural vibration of a regular and homogeneous wooden beam with rectangular cross-section and “free-free” boundary conditions (Bordonné 1989, Brancheriau 2002). According to Bernoulli (1784), the frequency of the  $n^{\text{th}}$  mode of resonance of such a beam is related to  $E/\rho$  by:

$$f_n = \frac{m_n^2}{2\pi} \times \sqrt{\frac{I}{SL^2}} \times \sqrt{\frac{E}{\rho}} \quad (2-5)$$

where  $S$  is the specimen cross-section ( $\text{m}^2$ ),  $L$  its length (m),  $I$  the moment of inertia (calculated according to  $bh^3/12$  for a rectangular beam of width  $b$  and height  $h$ ),  $m_1=4.730$ ;  $m_2=7.853$ ;  $m_3=10.996$ ....

This formula is only valid when the ratio  $L/h$  is big enough to neglect the contribution of shear. However, in reality, the modulus calculated this way is not constant, it decreases with the frequency especially when the slenderness of the specimen is low.

If one wants for  $E$  to be completely independent from the frequency, then the effect of shear and rotational inertia should also be considered (Bordonné 1989). Details on the matter will be presented in chapter 3 when both vibrational methods are discussed in details.

### **2-4-2- Damping**

➤ **A damped system**

Let consider a sinus waveform generated by a system characterized by a simple harmonic motion. An ideal system creating this kind of motion loses no energy. Such waveform can also be called a continuous waveform as it continues forever without eventually vanishing. Fig.2.6 (up) illustrates such an ideal system where the wave continues forever.

Real systems are never ideal: they always lose energy in the form of heat, both internally (because of heat loss during physical deformation) (David 1999, Brancheriau 2002) and externally (because of friction with air). Such energy loss in an oscillating system is known as damping and a damped wave form (Fig.2.6-down) is also called a non continuous wave form.

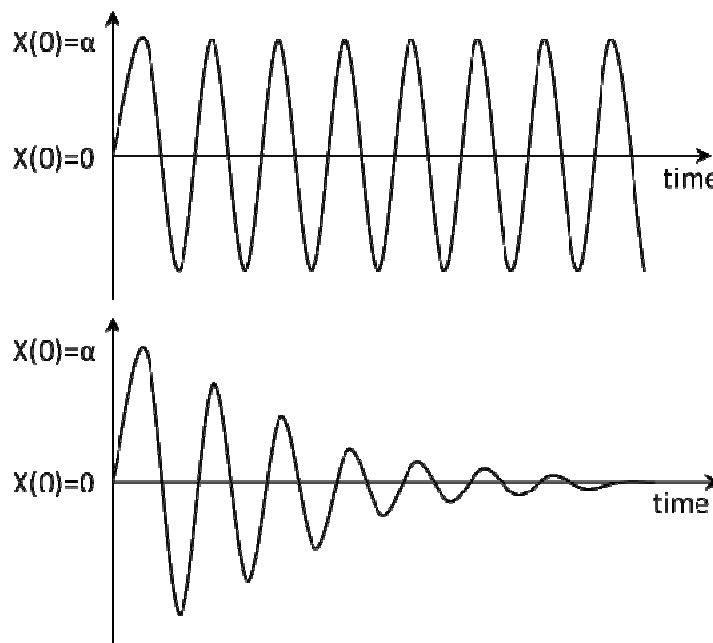

Fig.2.6. Non-damped (up) and damped wave form (down)

A source of damping in a wooden object is the viscoelastic behavior of the material (Gril 1987, Bardet 2001). Wood, as a polymeric material, is not really elastic. Even at low strain levels, it is viscoelastic.

➤ **Complex modulus**

For a linear viscoelastic material, when imposing a small sinusoidal vibration at a given frequency  $f$ , the response would be also sinusoidal in the same frequency shifted by an angle of  $\delta$ . Let consider the case of a vibration test where the deformation ( $\epsilon$ ) is imposed (Bardet 2001, Brémaud 2006):

$$\epsilon(t) = \epsilon_0 \cos(\omega t) \quad (2-6)$$

where  $\epsilon_0$  is the amplitude of the applied strain and  $\omega$  the angular frequency ( $\omega = 2\pi f$ )  
Then after a period of adaptation the steady-state stress response would be:

$$\sigma(t) = \sigma_0 \cos(\omega t + \delta) \quad (2-7)$$

Let define the complex strain  $\epsilon^*$  and stress  $\sigma^*$ , so that  $\epsilon(t)$  and  $\sigma(t)$  are the real part of  $\epsilon^*$  and  $\sigma^*$ , respectively:

$$\varepsilon^* = \varepsilon_0 e^{i\omega t} \text{ and } \sigma^* = \sigma_0 e^{(i\omega t + \delta)} \quad (2-8)$$

$\varepsilon^*$  and  $\sigma^*$  are related by a complex modulus ( $E^*$ ) defined as:

$$E^*(\omega) = \frac{\sigma^*}{\varepsilon^*} = E' + iE'' = E'(1 + i \tan \delta) \quad (2-9)$$

where  $E'$ , the real part of  $E^*$  is called “storage modulus” its imaginary part  $E''$  is the “loss modulus”. The ratio  $\tan \delta = E''/E'$  is called “damping ratio”, “loss tangent” or “loss factor”. In the case of air-dry wood, we have always  $E'' \ll E'$  so that  $\tan \delta \ll 1$ . In that case,  $E'$  is close to the amplitude of  $E^*$  and to the elastic modulus of wood  $E$ , measured in a quasi-static test. For simplicity, from now on we will use the following simplified denominations:

- “**modulus**” for the storage modulus  $E'$
- “**specific modulus**” for  $E'/\rho'$
- “**damping**” for  $\tan \delta$

### **2-4-3- Damping description**

Different methods are used to calculate damping in wood. They can be divided into these major groups:

- Vibration decay measurement (time domain),
- Bandwidth determination of measured model resonance (Frequency domain),
- Steady- state measurement of input and stored energy.

The last one is based on the energy balance of vibrationally-excited structures.

The complete dynamic behavior of a structure can be described by its individual modes (harmonics) of vibration. The so-called modal parameters characterize the modes in a given frequency range (Gade and Herlufsen 1994). The modal parameters are:

- The resonance or modal frequency,
- The damping of the resonance – the modal damping,
- The mode shape.

Damping can be described by many factors, which are all interrelated; for example, loss factor, damping ratio, quality factor, reverberation time, and logarithmic decrement. Detailed description of the two most common ones, logarithmic decrement and quality factor will be described below.

#### **➤ Logarithmic decrement**

The logarithmic decrement is a variable describing how quickly a motion decays. It therefore belongs to the time domain measurements. It is important to point out that the logarithmic decay curve displays the whole frequency spectrum, therefore logarithmic decrement measurements give accurate results when only one resonance is present (Gade and Herlufsen 1994).

Logarithmic decrement,  $\lambda$ , is used to find the damping ratio of a damped system in the **time domain**. The logarithmic decrement is the natural log of the amplitudes of any two successive peaks:

$$\tan \delta = \frac{\lambda}{\pi} = \frac{1}{\pi n} \left| \ln \frac{x_1}{x_{n+1}} \right| \quad (2-10)$$

where  $x_1$  is the greater of the two amplitudes and  $x_n$  is the amplitude of a peak  $n$  periods away (Fig.2.7).

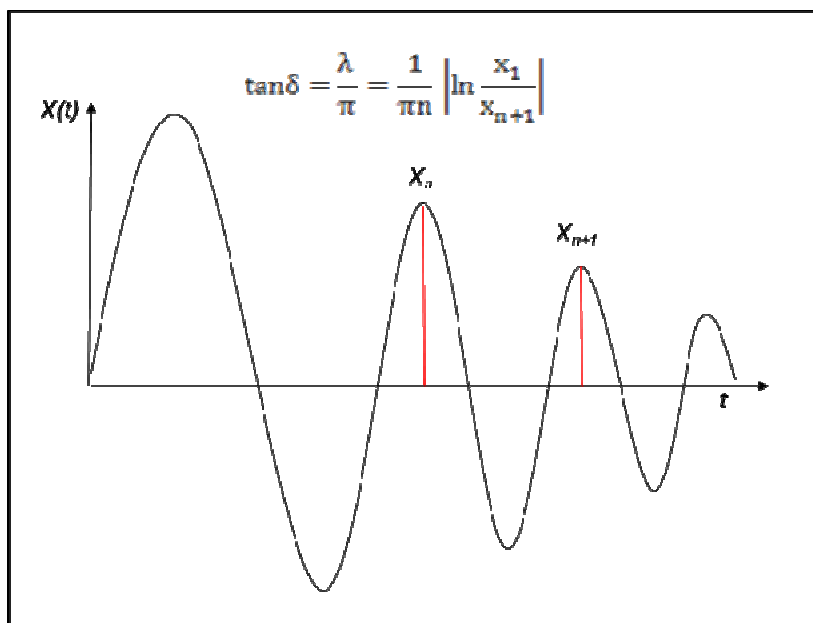

Fig.2.7. Illustration of the loss factor ( $\tan \delta$ ) in the time domain via logarithmic decrement

### ➤ Q factor

The inverse of the quality factor or  $1/Q$  is a dimensionless parameter describing that how damped an oscillator or resonator is, or equivalently, characterizes a resonator's bandwidth relative to its center frequency. In other words  $Q$  factor is an indicator of the “quality” of the resonant system.

Resonant systems respond to frequencies that are close to their natural frequency much more strongly than they respond to other frequencies. The  $Q$  factor measures the sharpness of the resonance peak, as displayed in a frequency response function (FRF) spectrum or by fast Fourier transform (FFT), and therefore this method belongs to the frequency domain category. Systems with a high  $Q$  factor resonate with greater amplitude at the resonant frequency compared with systems with a low  $Q$  factor. Damping within the system decreases the  $Q$  factor. The  $Q$  factor is defined as the resonant frequency (frequency of the peak)  $f_0$  or  $f_c$  divided by the bandwidth between the half power point values. When the Y-axis is converted to a decibel scale, the half power points are located on either side of the peak where the amplitude is lower than the peak by 3 dB (Fig.2.8). Decibel is the standard unit in acoustics for measuring the level or level difference.

The  $Q$  factor can be calculated as:

$$Q = \frac{f_c}{f_2 - f_1} = \frac{f_c}{\Delta f} \quad (2-11)$$

where:

Q: Q factor,  $f_2$ : the upper,  $f_1$ : Lower half power frequency,  $\Delta f$ :  $f_2 - f_1$  and  $f_c$ : Frequency of the peak

The higher the Q, the narrower and “sharper” the peak is.

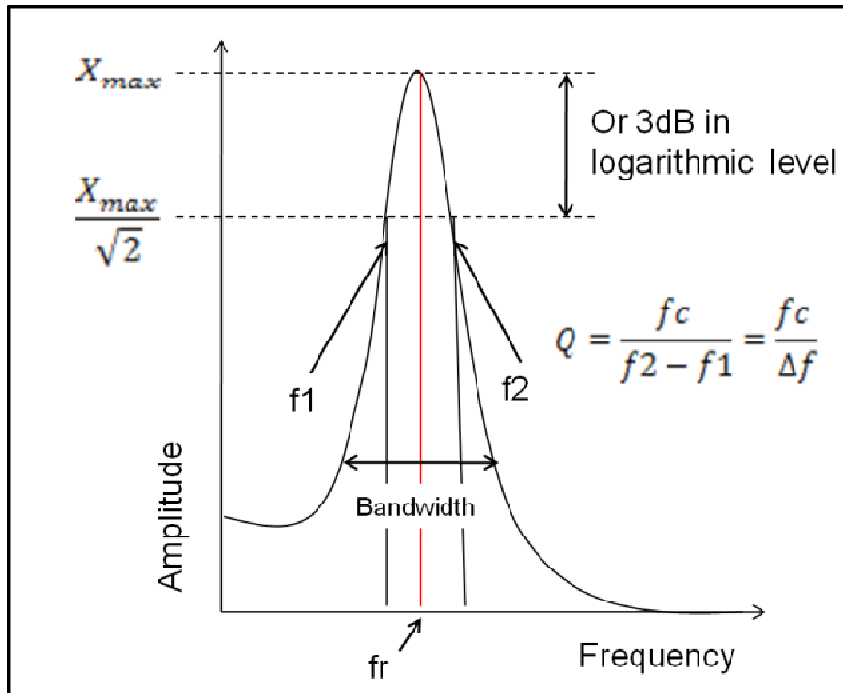

Fig.2.8. Illustration of the loss factor ( $\tan\delta$ ) in the frequency domain via bandwidth at the half power (Q or quality factor).

The accuracy of the frequency measurements is determined by the frequency resolution of the measurement. The accuracy can be increased by reducing the frequency range of the baseband, or making a zoom measurement around the frequency range of interest. This automated function is very useful especially in terms of time efficiency. However, it is also possible to calculate the Q factor on subsequent harmonics.

The quality factor is directly related to damping when  $\tan\delta < 0.2$  (Bucur 2006):

$$\tan \delta = \frac{1}{Q} \quad (2-12)$$

#### 2-4-4- Factors influencing vibrational characteristics

Damping depends on humidity, temperature, imposed frequency, and grain angle, as well as on intrinsic features varying within and between species (MFA, anatomy, extractives ...).



#### 2-4-4.a. $\tan\delta$ and frequency

$\tan\delta$  is dependent on the frequency (even in the audible range) (James 1975, Nakao et al. 1985, Torgovnik 1993, Afzal et al. 2003). Afzal (2003) and his co-workers have found that  $\tan\delta$  increases almost constantly in the frequency range of 500MHz to 2.5 GHz in two studied softwoods. However, they state that the increase slope is dependent on the wood species. This was also previously stated by Ono and Kataoka (1975) and Nakao et al. (1985), who relate this phenomenon to the raising effect of shear and rotation inertia due to the vibration in bending – in small transition zones (Fig.2.9)-.

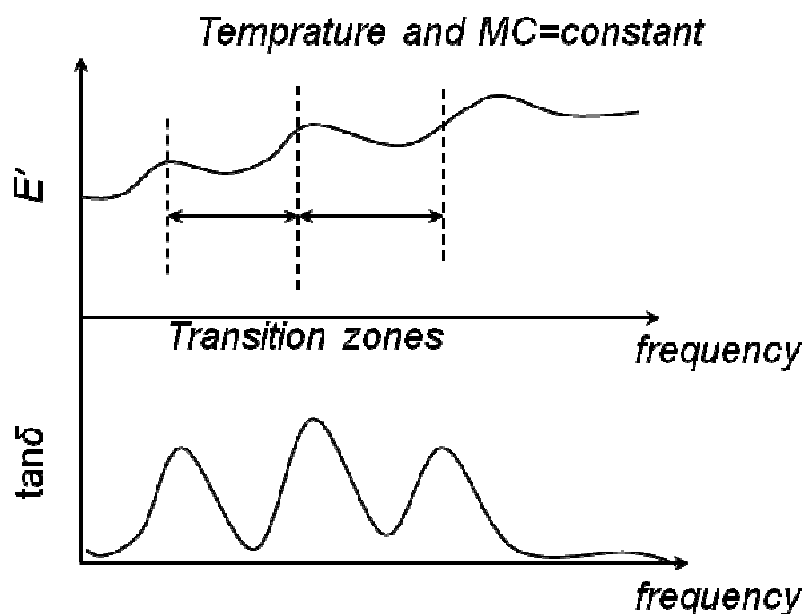

Fig.2.9. Illustration transition zones for modulus and  $\tan\delta$  in a constant moisture content (MC) and temperature conditions.

#### 2-4-4.b. Vibrational properties and humidity

Vibrational characteristics (almost always represented with  $\tan\delta$  and  $E'/\rho$  for musical instruments), are strongly dependent on the hygroscopic conditions. A constantly played instrument may not be exposed to extreme changes of hygroscopic conditions, but it will most certainly face mild changes in the form of adsorption/desorption cycles.

$\tan\delta$  increase and  $E'/\rho$  decrease when humidity is raised (Akitsu et al. 1993, Obataya et al. 1998, Hu 2008). In 1961, Kadita and his co-workers studied the effect of moisture content on dynamic modulus of wood. The results indicate that the maximum value of dynamic modulus is observed at 4-5% moisture content in L direction, but not in the R direction.

Bucur in her book has cited Suzuki and Sasaki (1980 and 1988) who studied the effect of MC on damping at room temperature. They observe that  $\tan\delta$  increases from  $5.5$  to  $18.5 \times 10^{-3}$  when moisture content increases from 5 to 35%.

Facing to gradually increasing RH,  $\tan\delta$  of the *Picea glehnii*, a softwood, experiences an augmentation while  $E'/\rho$  subsequently decreases (Akitsu et al. 1993). However Obataya et al. (1998) show that the increase in  $\tan\delta$  relative to raising humidity is not linear, as a minimum damping is observed at 6-7% MC. The effect of conditioning on the mechanical moduli had also been investigated in the R direction of hinoki (*Chamaecyparis obtuse*)

(Ishimura et al. 2001). They found out that both MOR (Modulus of rupture) and  $E$  increase significantly in the late stages of conditioning in adsorption, even though the MC had hardly changed. The same conditioning in desorption had also enhanced the moduli, but in the early stages. They interpreted these results in relation with an instability occurring due to the present MC being different from that of actual EMC.

Finally, several studies have reported that the lowest  $\tan\delta$  and the highest  $E'/\rho$  are observed at 8% MC in softwoods (James 1961, 1964, Bradley and Carr 1976, Akitsu et al. 1993). Changes in these factors in oven-dried state are explained by the probability of molecular chains in the amorphous regions of the cell wall to be unnaturally distorted. The other reason would be the presence of micro voids between the chains of molecules. As the moisture content increases, the water molecules would be placed in these micro voids and the previously deformed molecule chain would get back to the natural state.

#### **2-4-4.c. Vibrational properties and temperature**

Temperature can be a modifier of vibrational properties in relation with water. Several researchers studied the effect of high temperature on vibrational properties in presence or absence of water (Kollmann 1960, James 1961, Dunlop 1978, Gerdhard 1980, Kubojima et al. 2005, Jiang and Lu 2009). Gerhard (1980), summarizing several of these studies, concludes that temperature tend to have greater effects in the presence of higher MC (regarding mechanical moduli). He also mentions that this trend is more observable at cold temperature than at the high one. Talking about  $\tan\delta$  specifically, Kubojima et al. (2001) report that damping shows a minimum values in both cooling and heating systems, while its change is more remarkable in the range of 150°C-200°C. In the same study, they also state that  $E'$  decreases constantly with the increasing temperature.

The modifying effect of temperature in the presence of water has been also investigated by Kubojima et al. (2005). They compare the effect of high temperatures (115-150°C) in the presence of high RH (75%-98%) on the  $E'/\rho$  and  $\tan\delta$  of the Sitka spruce. Using non-humidified samples as controls, they show that both vibrational factors exhibited their extreme values (biggest for  $\tan\delta$  and smallest for  $E'/\rho$ ) in the water-present heating. They conclude that wood becomes significantly softer in face of high temperature and humidity.

More recently, Jiang and Lu (2009) have studied the dynamic viscoelastic behavior of wood in reaction to heating treatments.  $\tan\delta$  increases in freezing-treated specimens (-120°C). At higher temperature however, the change of  $\tan\delta$  is related to the temperature range as well as the species. Change in damping with temperature variation is related to the freezing of molecular motions in amorphous lignin at low temperatures and the rearrangement and dislocation of molecules under the softening effect of high temperature (Bucur 2006; Ping 2008).

In another study, Placet et al. (2007) demonstrate the changes in green wood viscoelastic behavior in a range of 0 to 95°C. Although the same standard changes in wood rheological behavior is observed –i.e., increase in  $\tan\delta$  and decrease in  $E'$  with raising temperature-, it is stated that for a complete interpretation, wood anatomical features (cell wall structure, MFA, grain angle) should also be taken in to account. Changes in

viscoelastic properties are also related to the depolymerization of hemicelluloses happening at high temperatures ( $\geq 135^{\circ}\text{C}$ ) (Assor et al. 2009).

Finally, changes in wood damping under the influence of temperature are strongly related to MC. At low temperatures (below zero); the raise in wood MC up to FSP would cause a phase transition close to “glass transition point for absorbed water”. Then as the temperature gets close to zero,  $\tan\delta$  decreases (Bucur 2006). At high temperatures, the increasing effect of rising temperature on  $\tan\delta$  still exist, though it is strictly related to structural and chemical condition of wood cell wall. This means the more cell wall contains materials to be softened by augmenting temperature, the more  $\tan\delta$  is going to increase.

#### **2-4-4.d. Vibrational properties and extractives**

Variations of physico-mechanical of wood depend on several parameters. Arrangement of grain angle, MFA in the cell wall, the primary wood matrix constituent, as well as the secondary ones are found to affect final wood’s mechanical properties (Ono and Norimoto 1983 and 1984, Obataya et al. 2000, Brancheriau et al. 2002, Noda et al. 2002, Kojima and Yamamoto 2004, Bucur 2006, Brémaud et al. 2010a, Minato et al. 2010). Measuring damping properties in wood different directions, Salmén (1984) states that the values are independent of shape and structural arrangements of wood constituents. Although in lower quantities, extractives have a considerable effect on wood mechanical properties and are able to alter its damping. For musical instruments in particular, extractives are somehow responsible for low damping in some cases: Matsunaga et al. (1996, 1998, 1999) report that Pernambuco (*Caesalpinia echinata*), a tropical hardwood used for making violin bows, have a lower  $\tan\delta$  than the reference given by (Ono and Norimoto 1983, 1984). They attribute this exceptionally low damping to the large quantity of extractives in the species. Although they confirm the possible effect of MFA, the effect of extractives is the predominant one (on lowering damping) as far as Pernambuco is concerned. In another case (Yano et al. 1994), vibrational properties of red cedar (*Thuja plicata*) are changed after methanol extraction. On the other hand, there are researches stating the contrary, introducing the extractives (sugar type ones) responsible for the high damping of Cane (*Arundo donax* L.) (Obataya et al. 1999). This is emphasizing the importance of nature of the extractives rather than only their crude abundance.

Extractives impact can be studied either through correlations between their amounts and vibrational properties variation resulting from their removal, or by the re-injection of extracts into a “neutral” wood. Methanol extraction increases the  $\tan\delta$  of heartwood by 15 to 37% in red cedar and up to 60% in African Padauk (*Pterocarpus soyauxii*), while  $E'/\rho$  slightly decreases (Yano 1994, Brémaud et al. 2011). Impregnation of water-soluble extractives of pernambuco into spruce (*Picea abies*) decreases  $\tan\delta$  by a half (Matsunaga et al. 1999). The formation of hydrogen bonds between extractives and cell-wall matrix has been proposed as a possible cause of  $\tan\delta$  reduction (Matsunaga et al. 2000). Impregnation of Sitka spruce (*Picea sitchensis* Carr.), with isolated key chemical compounds from muirapiranga (*Brosimum rubescens*), a Moraceae as is Mulberry, decreases  $\tan\delta$  by up to 25%, both in axial and radial directions. This is explained by

motion restriction of matrix macromolecules due to extractives entering (Minato et al. 2010). Sitka spruce used for piano soundboards has been impregnated with simple and natural phenolics to investigate changes in its physico-vibrational properties:  $\tan\delta$  decreases linearly in function of the weight gain in the L direction. Simultaneously  $E'/\rho$  had decreased during the process (Fig. 2.10, Sakai et al. 1999). Amongst the impregnated compounds is Resorcinol, a simple phenolic that is found abundantly in Iranian white Mulberry's wood (Se Golpayegani 2007, Sadeghifar et al. 2011).

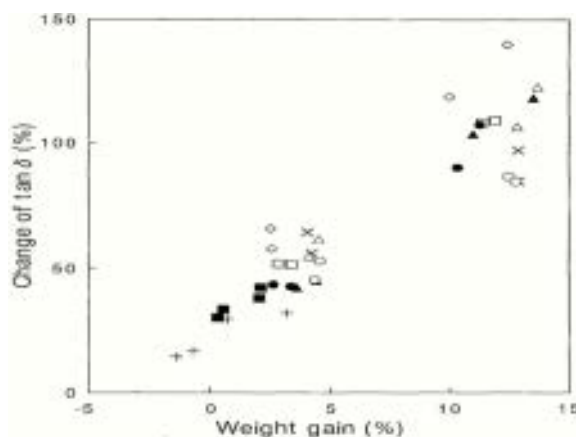

Fig. 2.10. Changes in  $\tan\delta_L$  in Sitka spruce in function of impregnation of simple phenolic. The crosses are indicators of specimens treated with Resorcinol (from Sakai et al. 1999).

In the end, as far as literature review is concerned, extractives can certainly influence both  $\tan\delta$  and  $E'/\rho$ . Nevertheless, the direction of these changes vary in between the species, and is extremely dependent on the origin and location of extractives.

## 2-5- Natural durability of wood

Along with modifying wood mechanical properties, extractives are responsible for the high natural durability of particular species. Here again, the nature of accessory substances is the determining factor on how resistant a wood would be towards decay organisms. Here we look at the basis of wood natural durability as well as its relation with the extractive contents.

Natural durability of wood is of interest only for heartwood. The decay agents normally degrade more easily sapwood, still living and containing more sugar. The heartwood of some trees has a different color from that of their sapwood, indicating the presence of higher amounts of complementary substances.

Extractives have been always considered as one of the primary reasons for high natural durabilities of several species. Some tropical woods, having high yields of extractives, show high resistance rates (Scheffer and Morell 1998). Natural durability is not the same between different species, and is variable at intra-tree and inter-tree levels within one species.

Besides extractives, other factors can severely alter the natural durability of a given species, such as local anatomical defaults (e.g., knots and cracks that allow an easier

access through the wood) or the presence of humidity that allows the fungi to grow more rapidly on a trunk.

Here we are going to concentrate on the extractives and natural durability correlations, and other factors are not going to be discussed. For more information on the natural durability in general as well as in function with extractive contents, we can refer to (Fortin and Poliquin 1976, Highley 1995, Scheffer and Morell 1998, Taylor et al. 2002, Amusant et al. 2004 and 2007, Faraji et al. 2004, Evans et al. 2008).

Woods that are durable towards fungi or insects may become decay sensitive when their extractives are removed (Scheffer and Cowling 1966, Smith et al. 1989). Scheffer and Morell (1998) made a comprehensive review of different species' natural disabilities towards decay agents. They stated that high classes of natural durability are often assigned to species with high extractives yields. Windeisen and Wegener (2002) found that the amounts of extractives are different in the outer and inner heartwood of cultivated Larch trees. They observed a close relationship between the mass loss due to the decay and the yield of extraction. Natural durability of teak (*Tectona grandis* L.), a tropical species, was also investigated in relation with the composition of its extractives (Haupt et al. 2003): a specific compound (*tectoquinone*) having a direct effect on decay resistance of teakwood was identified.

Extractives are not always correlated to high natural durability (Hillis 1987). Moreover, often the heartwood does not contain very toxic compounds, but individual components of low toxicity, which interaction makes the wood durable (Shultz and Nicholas 2002).

## **2-6- Introduction to White Mulberry (*Morus alba* L.)**

### **2-6-1- General description of the species**

*Morus alba* L. (white Mulberry) is generally described as a perennial tree or shrub. It has been reported to be a short-lived, fast growing, small to medium size tree, which grows 10-20 meters tall (USDA, ARS, National Genetic Resources Program 2011).

The fruits are edible, with a sweet but bland taste, unlike the more intense flavor of red Mulberry and black Mulberry. It is 1-2 cm long; in species in wild presents in deep purple color, but in cultivated plants varies from white to pink (Fig.2.11).

The greatest bloom is usually observed in early spring, with fruit and seed production starting in the spring and continuing until summer. The White Mulberry has a moderate life span relative to most other plant species and a moderate growth rate, normally getting to 15 meters height at 10 years (USDA plant profile 2011).



Fig.2.11. White Mulberry's tree (left), its fruit (right-up) and different shapes of its leaves (right-down).

In the plant kingdom *Morus alba* is a member of *Moraceae* family along with Texas, black and red mulberries. In the most recent classification (APG classification, Bremer et al. 2009), *Moraceae*, *Barbyaceae*, *cannabaceae*, *cercropiaceae*, *ulmaceae* and *urticaceae* are classified under *Rosals*.

### 2-6-2- Cultivation, distribution and traditional use

White Mulberry succeeds in variety in soils, though prefers a warm well drained loamy one in sunny position. The plant is fairly wind resistant but the branches are often killed back when growing in strong maritime exposure. white Mulberry's cultivation became widespread trough out the world as a feeding source for silk worms. It has begun over four thousand years ago in china and became a fast grown industry in recent years. In 2002, 6.260 Km<sup>2</sup> of land were devoted to the species in China (Huo 2002).

Other than china (which is often considered the origin of the species), white Mulberry had also been planted as well as being widely naturalized in warm temperate regions of the world. It has been grown vastly in India, through Afghanistan and Iran and then extended to southern Europe over a thousand years ago (Fig.2.12). More recently, it has become extremely naturalized in urban areas of eastern North America, where it hybridizes readily with a locally native red Mulberry (*Morus rubra*). Since then, serious concerns has been raised regarding long- term viability of red Mulberry because of extensive hybridization in some areas. Consequently, it has been listed as an invasive plant in parts of North America (Hoffman and Kearns 1997).



Fig.2.12. Plan of white Mulberry's distribution (natural and cultivated) in Asia, Europe and North America

Besides the major use of Mulberry's leaves for silkworm feeding, there are still different other fields of uses for the species. White Mulberry has a long history of medicinal use in Chinese medicine; almost all parts of the plant are used in one way or another. The leaves are antibacterial, astringent, diaphoretic, hypoglycemic, odontalgic, and ophthalmic. They are taken internally in the treatment of colds, influenza, eye infections, and nosebleeds. The stems are anti-rheumatic, antispasmodic, diuretic, hypertensive and pectoral. They also were used in traditional medicine to reduce high blood pressure. Other than leaves and stems, they are reports of using root- bark, branches and fruits extensively to treat several of health problems (insomnia, diabetes...) (Chen and Li 2007).

Medicine apart, Mulberry's fiber, and stem-bark has been used conventionally for making clothes and papers in China and ancient Europe. The wood of the Mulberry is a potential source of ethanol, with yields of up to 6% from sawdust treated with acid and then given four days incubation (Duke 1983). Due to its elasticity and flexibility when steamed, it is valued for making sports equipment such as tennis rackets and cricket bats. It is also used for boat building, furniture, agricultural implements etc. It furnishes a medium grade fuel wood (Singh et al. 1976, Duke 1983, Vines 1987).

### **2-6-3- Some general points on white Mulberry's wood**

White Mulberry's tree yields a medium-weight hardwood with a density of 0.45 - 0.80 g/cm<sup>3</sup>. Heartwood is yellow or yellowish brown, darkening to golden or red-brown upon exposure and is sharply demarcated from up to 4 cm wide. It has white or pale yellow sapwood with a normally straight grain and a moderately coarse texture (Orwa et al. 2009).

Anatomically, white Mulberry is a semi porous wood, with multiple vessels organized as clustered (in the early wood) and as diagonal groups (in the latewood) (Fig.2.13). The average diameter of vessel elements is 253 μm, while fibers are extended to 1098 μm of height in the form of nonseptate libriform fibers. Axial parenchyma are rare, however,



paratracheal axial parenchyma (in vasicentric form) are observed in the species (Karami et al. 2010).

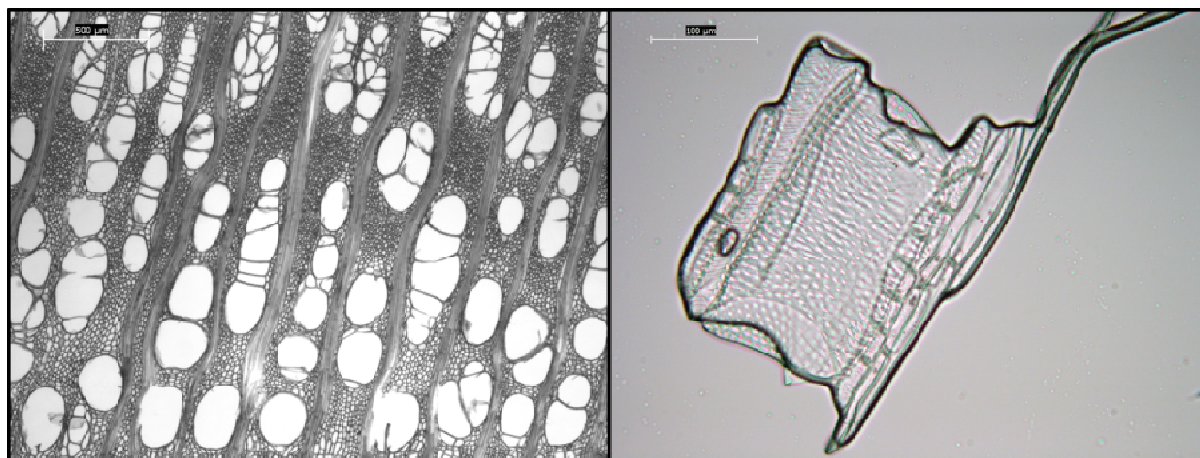

Fig.2.13. Microscopic cross-section (left) and a separated vessel along with its paratracheal parenchyma of white Mulberry from Iran. Courtesy of the photos: Dr. Kambiz Pourtahmasi

The first interest of white Mulberry's cultivation being the feeding resource of the silk worms, the wood had rarely got the attention necessary for studying its mechanical properties. Nevertheless, there are still some reports on the physico-mechanical features of white Mulberry native to china, or those of India and Malaysia (Table 2.2).

Table 2.2. Physico- mechanical properties of white Mulberry<sup>a</sup>

Property/test	green	dry
Specific gravity	0.55	0.6
Radial shrinkage (%)	3	-
Tangential shrinkage (%)	8	-
Volumetric shrinkage (%)	12	-
Bending strength (Kg/cm <sup>2</sup> )	546	888
Crushing strength (Kg/cm <sup>2</sup> )	52	90
Hardness (Kg)		824
Impact strength (cm)	137	119
Max Crushing strength (Kg/cm <sup>2</sup> )	278	491
Shearing strength (Kg/cm <sup>2</sup> )	-	169
Work to maximum load (cm-Kg/cm <sup>2</sup> )	1.05	1.40
Static bending (Kg/cm <sup>2</sup> )	285	470
Stiffness (1000 Kg/cm <sup>2</sup> )	76	107

a. (Limaye 1957, Banks et al. 1977, Little 1980)

#### 2-6-4- Extractives of white Mulberry

In the general introduction to the species, it was mentioned that apart being the "traditional" feeding source for silk worms, leaves and root bark of the white Mulberry were of great importance regarding their roles in forming healing mixtures. This was the case in china's ancient society. However, this tradition had also made its way to the modern pharmaceutical investigations and consequently several studies were done on identifying and determining the components presents in both leaves and root barks.



Reports were published on the antioxidant and anti-diabetic activities of the leaves and root- bark extracts of white Mulberry and other species of the family (Chen and Li 2007, Yatsunami et al. 2008, Nakamura et al. 2009, Zheng et al. 2010). Piao et al. (2009) had isolated several new types of stilbenes and flavonoids from the leaves of white Mulberry. Crystal structure of Moracin M (a stilbenoid found in the stem bark of *Milicia excels/Moraceae*) had also been isolated (Kapche et al. 2007). The same compound (Moracin M) could also be observed in the wood extracts of *Bagassa guianensis* Aubl., another species from the family (Royer et al. 2010).

Besides what was identified in non- woody parts of the white Mulberry, the extractives of wooden part had rarely been investigated. Venkataraman (1972), had investigated six *Artocarpus* and five *Morus* (both from the Moraceae family), trying to define new chemotaxonomy markers. It was stated that until then it was the phenolic wood extracts which were considered as the potential chemotaxonomy markers, however, remembering the existence of several stilbenes in the extraneous compounds, they could probably replace (or at least work beside) phenols for a better distinguish in between species. It was concluded that great taxonomy markers could be created using flavonoids, stilbenoids and terpenoids all together in the species.

In their review, Row and Conner (1979) had gathered the published data on the wood extractives of three species from Moraceae family, *Maclura pomifera* (Osage orange), *Morus rubra* L. (Red Mulberry) and *Morus alba* L. (White Mulberry). They reported phenolics, falvonoids and stilbenes as the three most isolated extractives' categories from the family.

Table 2.3 is showing the list of compounds extracted from *Morus alba* and *Morus rubra* (results of several studies gathered in Row and Conner 1979).

Table 2.3. Heartwood extractives of *Morus alba* and *Morus rubra* (Row and Conner 1979).

Category	Compound	<i>Morus alba</i>	<i>Morus rubra</i>
Simple phenolics	Resorcinol	+	+
	B- Resorcyaldehyde	+	+
	Photocatechualdehyde	+	
Benzophenones	Malcurin	+	
	2,4,4',6-Tetrahydroxy-benzophenone	+	
Stilbenes	Resveratrol	+	
	Oxyresveratrol	+	+
	Dihydroxyreserveratrol	+	
	3,3',4,5'-Tetrahydroxy- stilbene ("piceatannol")		+
Flavonoids	Kaempferol		+
	Dihydrokaempferol	+	+
	Noratocarpanone	+	+
	Morin	+	+
	Dihydromorin	+	+
	Quercetin	+	+
	Dihydroquercetin (taxifolin)	+	
Other	Albactalol	+	

They also reported that  $\beta$ - Sitosterol could be isolated from the bark of white Mulberry (Kulkani et al. 1970 cited in Row and Conner 1979). Other compounds related to cyclomulberrochromene had also been reported in the bark of white Mulberry (Nomura et al. 1976).

In an attempt to assess the effect of extractives on the natural resistance of wood to decay, the extraneous compounds of several hardwoods were isolated and identified (Déon et al. 1980). Difou (*Morus mesozygata*) was amongst the species studied. Morin, extracted only by methanol, and dihydroxy morin, extractable by variety of solvents of different polarities, both belonging to the flavonoied, have been identified in this Moraceae.

Oxyresveratrol and resveratrol (from stilbenoids) along with Morin and afzelechin (from flavonoids) were isolated and identified by Mass and NMR (Nuclear magnetic resonance) spectroscopic analysis in *Morus bombycis* (Lee et al. 2000). Extraction was done using ethylacetate and the results confirmed the flavoinds/phenolics as the most occurred components in the wood extractives of the Moraceae family.

Recently another study had used secondary metabolites in the wood of a bagass (*bagassa guianensis* Aubl.) to investigate the chemotaxonomy in the Moraceae family (Royer et al. 2010). Different kinds of Morins (Morin M, Morin N, and Morin O), previously identified stilbenoids (i.e. Albactalol and resveratrol) and three flavonoids were isolated and identified. Their study has determined that *B. guianensis* is closely related to *Morus* sp. in phylogeny and should be included in the Moraceae family.

Studies on the wood extractives of white Mulberry from Iran are limited to two: Se Golpayegani (2007) had studied quantity and nature of the extractive compounds present in the white Mulberry from four different sites in Iran. The extraction was done using ethanol/benzene and identification was carried out by a GC-Mass apparatus. Phenols, carboxylic acids and heavy hydrocarbons had turned out to be able to classify most of the identified components. Table 2.4 is showing a list from the compounds found in the white Mulberry from Iran.

Table 2.4. Identified compounds in the benezen/ethanol extracts of white Mulberry wood from Iran (Se Golpayegani 2007).

Compound category	Compound name
Carboxylic acids ( free or ester or diversion with silyl)	2 - Methyl - 1H - indole - 3 - propanoic acid
	Hexa-decanoic acid
	2- heptanoic acid
	2- pentanoic acid
	9,12-octa decanoic acid
	1,2- benzene dy carboxylic acid
	Propanoic acid
	Botanoic acid
	Acetic acid
	Exovaleric acid
	Ribonic acid
	Phetalic acid( butyl aceter)
	Pantandyoic acid
	Otanamic acid
	Sisilic acid
Arsenos acid	
Synamic acid	
Sugars	Sorbitol hexa acetate

Phenols and alcohols	Hexil resorcinol
Ketons and aldehyds	4-bromo-1 butanol
	n- butanal
	1-2h-naftalenon
	2-butanone-4,4-dimethoxy
Hormones and steroids	androsta
	δ-sitostrol
	Stigma strol-22,23-dyhydro3-α- phenyl
	Kelest-5-n
	17-17r-methylen cistrol
Alkane hydrocarbons	Eicosan
	Tetracosan
	heneicosan
	Pentadecan
	Heptadecan
	octadecan

Finally, very recently, a research was done focusing only on the heart wood extractives of Iranian white Mulberry (Sadeghifar et al. 2011). They reported various alcohols, aldehydes, carboxylic acids and phenolic compounds to be found in the in the extraneous materials. They have also identified resorcinol (a phenol) to be the most abundant component (>90%) amongst others.

Resuming all the references cited in this section, it could be said that white Mulberry's extractive contain a mixture of flavonoids, stilbenes and sterols. Even though common compounds might not be present in all family species (and they may even be different within the same species from different regions), the reoccurrence of compounds belonging to at least one of the mentioned categories in all species from the Moraceae family, could confirm such statement.

Following a brief description of each of these predominant categories is presented.

#### ✓ *Flavonoids*

Falvonoids (bioflavonoids) also known as vitamin P or citrine, are a class of plant secondary metabolites or yellow pigments having a structure similar to that of flavones. Over 4,000 flavonoids have been identified, many of which occur in fruits, vegetables and beverages (tea, coffee, beer, wine and fruit drinks). They are responsible for colors in the verity of plants and are reported to have small inhibitory activity against organisms that cause plant diseases (Galeotti et al. 2008).

Most importantly, flavonoids are known for their strong antioxidant properties. To put it the simplest words, anti oxidants are compounds that protect cells against the damaging effects of reactive oxygen species. The capacity of flavonoids to act as antioxidants depends upon their molecular structure. Quercetin, the most abundant dietary flavonol, is a potent antioxidant because it has all the right structural features for free radical scavenging activity (Fig.2.14).

Regarding their structure, flavonoids are water-soluble polyphenolic molecules containing 15 carbon atoms (Fig.2.14).

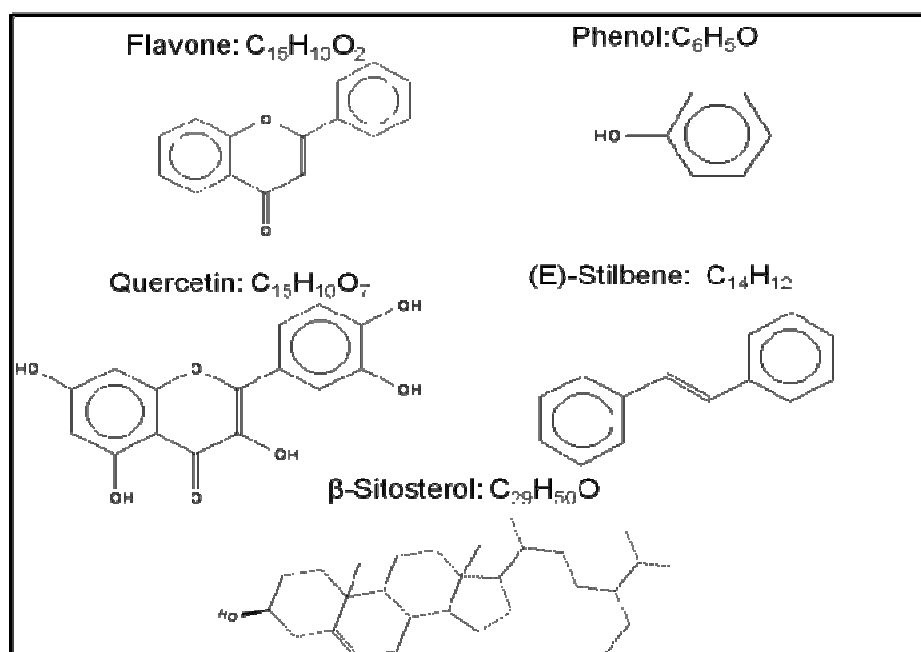

Fig.2.14. Open chemical structure of the representative compounds of the main categories found in the wood extractives of *Moraceae* family.

#### ✓ *Phenols*

Phenol is also known as carbolic acid (C<sub>6</sub>H<sub>5</sub> OH) and consists of a phenyl (-C<sub>6</sub>H<sub>5</sub>) group bonded to a hydroxyl (-OH) group. Phenols are soluble in water, with about 8.3 g dissolving in 100 ml (0.88 molar concentrations).

It is slightly acidic: the phenol molecule has weak tendencies to lose the H<sup>+</sup> ion from the hydroxyl group, resulting in the highly water-soluble phenolate anion C<sub>6</sub>H<sub>5</sub>O<sup>-</sup> (also called phenoxide) (Smith and March 2007). They are widely distributed throughout plant kingdom, acknowledged to be able to preserve the plant against oxidative damage. The same feature had caused them to be served as anti-cancers and anti strokes in the modern pharmacology (Michalak 2006).

#### ✓ *Stilbenes*

Before, the term stilbene referred to compound possessing the 1,2- diphenylethene structure, but recently discovering new compounds which composed of C<sub>6</sub>-C<sub>2</sub>-C<sub>6</sub> skeleton and referring them to being in the same group has expanded the stilbenes. Other than *Moraceae*, Stilbenes occur in *Betulaceae*, *Leguminasae* and some other species.

Resveratrol and pinosylvin (both naturally occur in plants) are formed from elimination of one carbon atom in the process of crystallization. Pinosylvin monomethyl ether – present in the heart wood of *Pinus* spp., - is known to effect natural durability.

#### ✓ *Steroids*

A steroid is a type of organic compound that contains a specific arrangement of four cycloalkane rings that are joined to each other.

Sterols are a subgroup of the steroids. They occur naturally in plants, animals, and fungi, with the most familiar type of animal sterol being cholesterol. They are identified as

white powders with mild, characteristic odor, which have applications in cosmetics and medicine as well as in wood additives.

$\beta$ -Sitosterol (or sitosterol) is widely distributed in the plant kingdom (Fig.2.14).  $\alpha$ - and  $\beta$ -Ecdysones isolated from silk worm (*Bombyx mori*) have steroid skeletons, and are well known as molting hormones. Compounds with similar structure to the ecdysones were isolated from plants (e.g., *Podocarpus* and *Taxus* spp.), and are referred to as phytoecdysones.

### **2-6-5- Natural durability of white Mulberry**

Natural durability of white Mulberry had been the subject of a few studies. On the other hand, the results are not indicating to a clear statement on the decay resistance of the species. In a study of comparing tropical and European wood resistance towards fouling and boring marine organisms, white Mulberry from Europe has been categorized as moderately durable and the authors stated the necessity of using the preservatives in case of its utilization in harbors or boats (Sen and Sivrikaya 2009). Supporting more or less the same results, white Mulberry from Asia and Australia, has been cited as non resistant towards termites and marine borers based on its 31 months of average life in field when the most resistant species in the same study- *Acacia catechu*- had an average life of 422 months (Tewary 1979 via Scheffer and Morell 1998).

To contradict the statements above, white Mulberry from India (penjab in particular), had found to be very resistant towards *Microcerotermes championi*. In all cases of the study, the consumption percentage remained below 5% of the original dry mass of the species (Zamir 2008). Although there is no trace of white Mulberry in the species classified based on natural durability in the last edition of Wood Handbook (2010), Red Mulberry and Osage orange (both *Moraceae*) are listed as very resistant. It has also been stated that white Mulberry from Iran has a high durability as a results of its extractives and the act of removal would decrease its durability to the half (Kazemi et al. 2006).

Looking at the contradictory reports on the natural durability of white Mulberry, it seems probable that natural durability of this species would be different between trees of different regions which variations could be related to different quantity/ composition of their extractives.

### **2-7- Musical instruments**

Even before the time that human beings acquire the ability to communicate via speaking, music (in the form of simple sounds generated from preliminary instruments) had been used to make the connections (Cross 2001). The initial forms of musical instruments included bones and ivory-carved flutes (Conard 2004), which later evaluated to extremely variable instruments, from drums to lutes and from pianos to clarinets. Each musical instrument carries a history of cultures, beliefs and experiments, which lead it to reach its present structure. Notwithstanding the fact that today there are several new materials available (i.e., Synthetic polymers), wood is still the most preferable raw material for fabrication a considerable number of instruments. Not only that, but also it is interesting to know that specific species that were traditionally used for each instrument, are still

exclusively being used by the artisans. The historical/experimental knowledge probably resulted from errors and trials, is still carefully followed by the craftsmen, however the scientific explanation on the matter is scarce. This is partly due to the extensive regional and cultural verity of the musical instruments that sometime each require a separate detailed study. Nevertheless, there are common factors between existing instruments that could help in a classification. These factors could be related to the resonance part (which part is vibrating? Which one is not? Which one is used as the resonant “accelerator”? Which one is “damping” the sound?) or to their key acoustical descriptor factors being in the same range ( $\rho$ ,  $E'/\rho$ ,  $\tan\delta$ . See the following). Musical instruments could also be classified based on their regional distribution (which country/ continent). Another possible categorization would be based on the type of woods utilized in their fabrications (softwoods/hardwoods, tropical/temperate woods). Each classification could be useful for a certain aim, while they are all a step closer towards understanding the diversity of the instruments.

### 2-7-1- Key descriptor factors for the musical instruments

To be able to describe an instrument acoustically, one would normally rely on the mechanical properties of the part which is producing the greatest amount of vibration. The properties which are determining how “well” an instrument would perform include its specific gravity ( $\rho$ ), its elastic modulus ( $E'$ ), the loss coefficient ( $\tan\delta$ ) and of course its structure. They determine the speed of sound in a material and the intensity of the radiated sound (Bucur 2006, Wegst 2006, Yoshikawa 2007). These factors have been discussed in details in the previous section, when talking about wood’s vibrational properties. Nevertheless, there are some additional descriptors (resulting from these three factors), which are commonly used when selecting a wood for a musical instrument is concerned (they could also be called “material performance index” (Brémaud 2011)):

c: Speed of sound 
$$c = \sqrt{\frac{E'}{\rho}} \quad (2-13)$$

z: Impedance 
$$z = c\rho = \sqrt{E'\rho} \quad (2-14)$$

R: Sound radiation coefficient 
$$R = \frac{c}{\rho} = \sqrt{\frac{E'}{\rho^3}} \quad (2-15)$$

Speed of sound is related to a wood’s elastic modulus and its specific gravity. It is roughly independent of wood species, but varies with the grain direction (Bucur 2006, Wood Handbook 2010).

Sound impedance is also related to both  $\rho$  and  $E'$ . Its quantity is reported to be important when the vibration is transmitted between two membranes of different impedances (Fletcher and Rossing 1998, Wegst 2006). The impedance is also related to the form and structure of the soundboards.

Sound radiation coefficient is showing how much a vibration in a body is damped due to sound radiation. If we like to produce a loud sound, a large sound radiation coefficient of the material is desirable.

In the wood-related studies on the musical instruments, a combination of the above factors is used to give an understanding to a wood-based performing part.

### **2-7-2- Classification of musical instruments**

Musicologists classified ancient and current instruments in families: (von Hornbostel and Sachs (1914))

- Idiophones: Instruments that making sounds essentially by vibrating themselves, without using a string (e.g. Xylophones)
- Membranophones: Instruments that use a stretch membrane for making the sound (e.g. Drums)
- Chordophones: Instruments that rely on a stretched string (e.g. Pianos, violins, guitars). Iranian lutes (*Tar* and *Setar*) correspond to this class.
- Aerophones: Instruments that use air column for creating sound (e.g. Flutes).
- Electrophones: Instruments that produce sound by electronic means (e.g. Keyboard synthesizers).

The first four categories were initially established, while the fifth one was added later on.

Both western string musical instruments (on which the majority of wood-made instruments research has focused) and Iranian lutes (which are addressed by this study), belong to the third class (chordophones). Hence, we skip a detailed description of other classes, and limit our introduction to that of wood-made chordophones. For other wood-made instruments in other classes (specially xylophones) see: (Holz 1996, Yano et al. 1997, Fletcher 1999, Rossing et al. 2004, Rujinirun et al. 2005, Brancheriau et al. 2006, Bucur 2006, Aramaki et al. 2007, Brémaud et al. 2011, Sedik et al. 2010).

#### **➤ Wood related Chordophones**

The sound created by the impact of the pluck on the string is usually hardly audible. This is because a vibrating string moves a small quantity of air. Thus, there should be a resonator coupled with air, that transmits the vibratory energy and radiates the sound. In violin, for example, the string is combined with the top plate (usually a softwood with the fibers parallel to the grain) via a bridge. The sound will then travel through sound posts and ribs to back plate, which also radiates it.

In chordophones the shape, structure and material of the resonator is of great importance. In violins, *f*-holes are not only transmitting the sound, but also contribute to pass a quantity of air which itself is necessary for sound creation (Wegst 2006).

In Iranian *Setar* (Fig.2.16-left), the same mechanism is pursued, as the strings are coupled through a bridge to a top plate, which in turn is connected to several carefully bent strips of white Mulberry. In *Tar*, however, the similarity of the mechanism is not so certain, as the strings are coupled with a stretched membrane (sheepskin), which in turn is used for transmitting the sound to a whole carved structure of white Mulberry (Fig.2.16-middle).

Therefore, the stretched membrane could also contribute to vibration radiation. Furthermore, the uneven internal structure of the lute, representing the traces of gauge's impacts (which is resulted in dissimilar internal diameters in the bowl part), could influence the produced vibration.

Wegst (2006) illustrated the relationships between descriptor factors for soundboard woods, and had compared it to materials used for other vibrating members (strings, violin bows, xylophone bows, xylophones) (Fig.2.15).

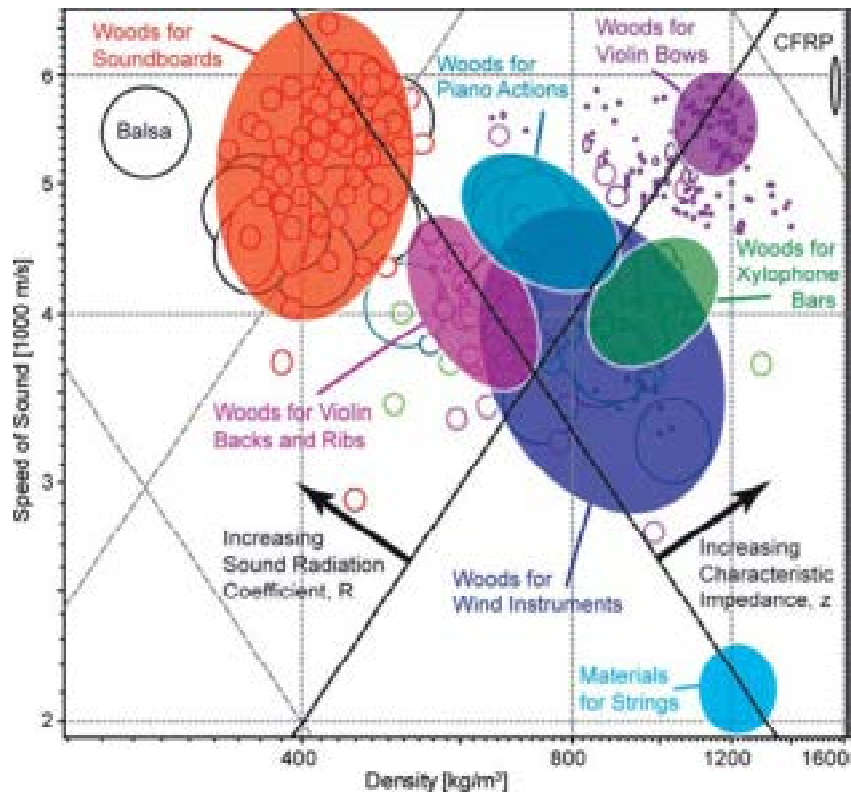

Fig.2.15. Material property chart for wood used for different vibratory parts of musical instrument (Wegst 2004 in Wegst 2006). The x-axis is specific gravity ( $\rho$ ), y-axis is  $c$  (1000 m/s). Specimens belonging to soundboards are marked in an orange oval.

She stated that soundboard woods are the best radiators amongst the others, and also they have a low impedance which is beneficial for transmitting the sound into the air. This fact was also re-emphasized by Yoshikawa (2007), where he tried to propose a new classification for the soundboard (top plate) and the frames (back plates and ribs). He stated that this high sound radiation capability is the reason why softwoods are usually chosen for the soundboards. Nevertheless, hardwoods, dense and hard to vibrate, are used in frames and back plates, moreover, they are good transmitters of wave vibration (Yoshikawa 2007).

In a leading wood source for western instruments soundboards (*Picea abies* or European spruce), a low  $\tan\delta$  and high  $E'/\rho$  which are negatively related indicate superior material for fabrication (Yano 1994, Haines 2000, Bucur 2006). The high  $E'/\rho$  and low  $\tan\delta$  are associated to low MFA but unrelated to extractive content (Obataya et al. 2000). In general, low  $\rho$  and  $\tan\delta$ , and high  $E'/\rho$  and axial-to-shear anisotropy are required for the



soundboard of a classical western instruments (Yano et al. 1994, Obataya et al. 2000, Wegst 2006, Brémaud 2011).

Regarding species used in the soundboards of extra-European musical instruments, the criteria could not be as clear-cut as that. One of the basic problems on the matter is that, compared to classical western ones, sound boards of other continents have been rarely thoroughly studied. Brémaud (2011), had brought together data from 82 extra-European wood species (Middle-Eastern, Asian and Latin-American) commonly used in soundboards. Investigating similarities and differences between the species, she observed that, except for a lower-than-average specific gravity ( $\rho \approx 0.7$ ), other characteristics cover the broad range known for wood. She concluded that the instrument structure and integrated culture play an important role regarding the “good sonority” of soundboards of these areas, thus the criteria considered as “standard” for western soundboards cannot be used for those of other continents.

### 2-7-3- White Mulberry in musical instruments: existing reports

The research on white Mulberry as a fabrication material for instruments is limited to those of Japan and Iran. In Japan, the local white Mulberry is used in “Satsuma Biwa”, a traditional lute (Fig.2.16-right). Yoshikawa (2007) measured the key descriptor factors in medium and high quality white Mulberry. He observed that the acoustical properties stay far from the “standard” quality criteria of the western soundboards. In fact, compared to them, white Mulberry would be classified vibrationally “poor”, as it has a very high value of anti-vibration parameter and a very low value of transmission parameter. However, he stated that the non-standard acoustical properties of white Mulberry used in Biwa is compensated for with both the instrument structure and the way it is played. In Biwa (unlike violin for example), all parts (soundboards, back plate) is fabricated from white Mulberry. Moreover, the instrument is played by strongly striking a large wooden plectrum to the stings. This way of playing (contrary to the mild plucking by a small pick in guitar) results in a very distinguished impact tone.



Fig.2.16. Iranian lutes *Setar* (left) and *Tar* (middle) beside Japanese lute *Biwa* (right).

White Mulberry in Iran is used in the bowl parts of traditional lutes (*Setar*, *Tar* and *Kamancheh*). While in *Setar*, comparatively thin bended strips are glued together to form

the soundboard, in *Tar*, the wood is directly carved to eventually yield the desired shape. Furthermore, in *Tar* the importance of its unusual structure and an additional vibrating membrane makes one wonder if the same considerable effect of the structure as for Biwa also exists in that Iranian lute.

Pourtahmasi and Se Golpayegani (2008) made some preliminary tests to acquire the vibrational properties of white Mulberry from two different sites in Iran. Both sites are famous amongst artisans as yielding acoustically desirable woods. Although no strong striking mechanism as that of Biwa exists for Iranian lutes, the wood still showed lower  $\tan\delta$  and a moderate  $E'/\rho$  slightly higher than that of the white Mulberry of the higher quality Biwa. Table 2.5 shows the data obtained for the Iranian white Mulberry by two vibrational methods (i.e., Contact analysis and free-free flexural bars).

Table 2.5. Vibrational properties measured for Iranian white Mulberry of two sites (Data from Pourtahmasi and Se Golpayegani 2008)

sites	$\rho$	$c_L^a$ (m/s)	$c_R$ (m/s)	$c_T$ (m/s)	$E'_L{}^b$ (GPa)	$E'_R$ (GPa)	$E'_T$ (GPa)	$\tan\delta^c$ (%)
1 (average of 6 specimens)	$\approx 0.58$	$\approx 4800$	$\approx 2519$	$\approx 1839$	$\approx 12.85$	$\approx 3.5$	$\approx 1.85$	$\approx 0.76$
2 (average of 5 specimens)	$\approx 0.65$	$\approx 5137$	$\approx 2915$	$\approx 1957$	$\approx 17.33$	$\approx 3.8$	$\approx 2.5$	$\approx 0.61$

a.  $c$ : sound speed (m/s)

b.  $E'$ : modulus (GPa),

c.  $\tan\delta$  obtained based on the average of three samples

For more information on the Iranian lutes, see Annex A.

## 2-8- Conclusion

This general and introductory part had two objects. The first one was to give basic definitions and ground rules of what is going to come afterwards, in order to make our approach towards choosing the methods and experiments reasonable and facilitate the process of interpretation of the results. This chapter could give us a few points on this object:

- Wood, being a hygroscopic, anisotropic, multifunctional material, yielded from a living organism, cannot be studied without considering its inter-specific properties. Each characteristic is not only related to the history of micro-cellular formation, but it is also in close interaction with both environmental and intrinsic factors.
- Vibrational features are affected by both factors mentioned above. MC and temperature (examples of the first one), and extractives (example of the second one) had been reported as the influential factors on this character.
- Natural durability of wood, also an important descriptor of the species, is related to the quantity and nature of the secondary components.
- The second object of this review was more specified and limited to the subject of present research. We wanted to emphasise the importance of carrying out a study on white Mulberry from Iran. Taking a quick look at the last parts, it could be stated that:

- White Mulberry, being a feeding source, has worldwide cultivation importance. Its wood however had been rarely studied, partly due to unknown field of use.
- Contradicting the last statement above, the wood was traditionally a source for lutes fabrication in Middle and Far East. In both places, the rituals for wood selection are well known to the artisans, but a mystery for researchers.
- In a more general point of view, considering white Mulberry a part of hardwoods, used in Asian musical instruments – on which the scientific familiarity is scarce-, the importance of obtaining more crud data on the matter was brought into the light.
- White Mulberry's extractives, used in pharmaceutical domains, should be interesting to be investigated in connection with physico- mechanical characters.

## 3. Material and methods

---

### 3-1-Material

#### ➤ General view of the material selection

One of the important steps in any study on wood is the way the raw material is collected. Considering the objectives detailed in §1.3, the following points played a role in our choice of material:

- Mulberry wood will be investigated for its acoustical properties in relation to its role as raw material for fabrication of lutes.
- Not any white Mulberry tree is convenient for making a musical instrument. Even though scientific knowledge is scarce to non-existent on this case, instrument makers seem to have implicit ideas on whether or not a tree/wood makes a fairly good/excellent instrument.
- Sampling should be done in close collaboration with a professional artisan so the instrument-making quality of wood would be assured.
- Although the basic material came from Iran, all the tests would be done in France.

Remarks above can draw us a guideline on how the material should be selected:

- It is difficult to select many trees that produce appropriate raw material for instrument making, therefore, one or two trees (based on the material need) would be enough.
- The selected tree(s) should meet all the criteria necessary for making a musical instrument. This calls for an instrument maker presence at the time of the sampling.
- In addition, as comparing traditional treatments on laboratory scale is also included in the plan, it was only reasonable to do the test on the same selected material that would be normally used in studios artisans.

#### 3-1-1- Origin of material and sample cutting

##### 3-1-1.a. Choice of material

Taking into account the preceding remarks, two trees (one in the beginning and the other one-half way through the study) were chosen by a professional instrument maker<sup>1</sup>. According to him, the selected wood met all the criteria necessary for manufacturing a perfect instrument.

The tree was cut from a forest near Kordan (Karaj department in Iran), where the growing season runs from mid-March to September. In November (at which time the material was bought), the min and max of the temperature were -5 °C and +26°C, with an average RH

---

<sup>1</sup>.This study was done in a close collaboration with M. Zareh, a professional Iranian instrument maker, experienced in manufacturing *Tar* and *Setar*, by whom the trees were chosen and confirmed.

of 55%. These conditions keep wood MC over FSP, even if it has been cut for a few months. The cutting was done at chest height, and upper parts as well as all branches were removed. Trunks were cut and air-dried for one month before being trimmed to transportable dimensions.

### **3-1-1.b. First cuttings**

In a real cutting plan to get the raw material for *Tar*, a 1 m long trunk is first cut into its length to 50cm pieces (as 50 cm is the least height necessary for carving the bowl part of a *Tar*). Then it will be cut in two symmetrical halves serving as fabrication material for one instrument. Throughout the carving, pith and bark – and all the area around them to the extent of several centimeters- are cut off by gauge. Although the wood has little sapwood, this trimming will ensure to avoid the presence of sapwood and juvenile wood.

The same cutting plan was followed in general steps. However, in order to be able to transport the material in a simple way, small pieces were prepared. One further cutting was added to get several rods.

Eventually several ( $L=50 \times R=5 \times T=5\text{cm}^3$ ) rods were prepared (Fig. 3.1) and shipped to CIRAD laboratory in France. During the shipment, the rods were kept in sealed bags to avoid losing too much moisture.

### **3-1-1.c. Drying and stabilization before cutting**

Once in place, rods were first kiln dried for 2 weeks in a commercial Cathild kiln. Temperature for starting the drying process was calculated by adding 5°C to the actual temperature of the environment. At the time, 15 December 2008, the actual temperature in Montpellier was 7°C. Drying was started at 12°C with a humidifier installed inside the kiln while temperature was increased gradually up to 35°C. The process was ended after 2 weeks.

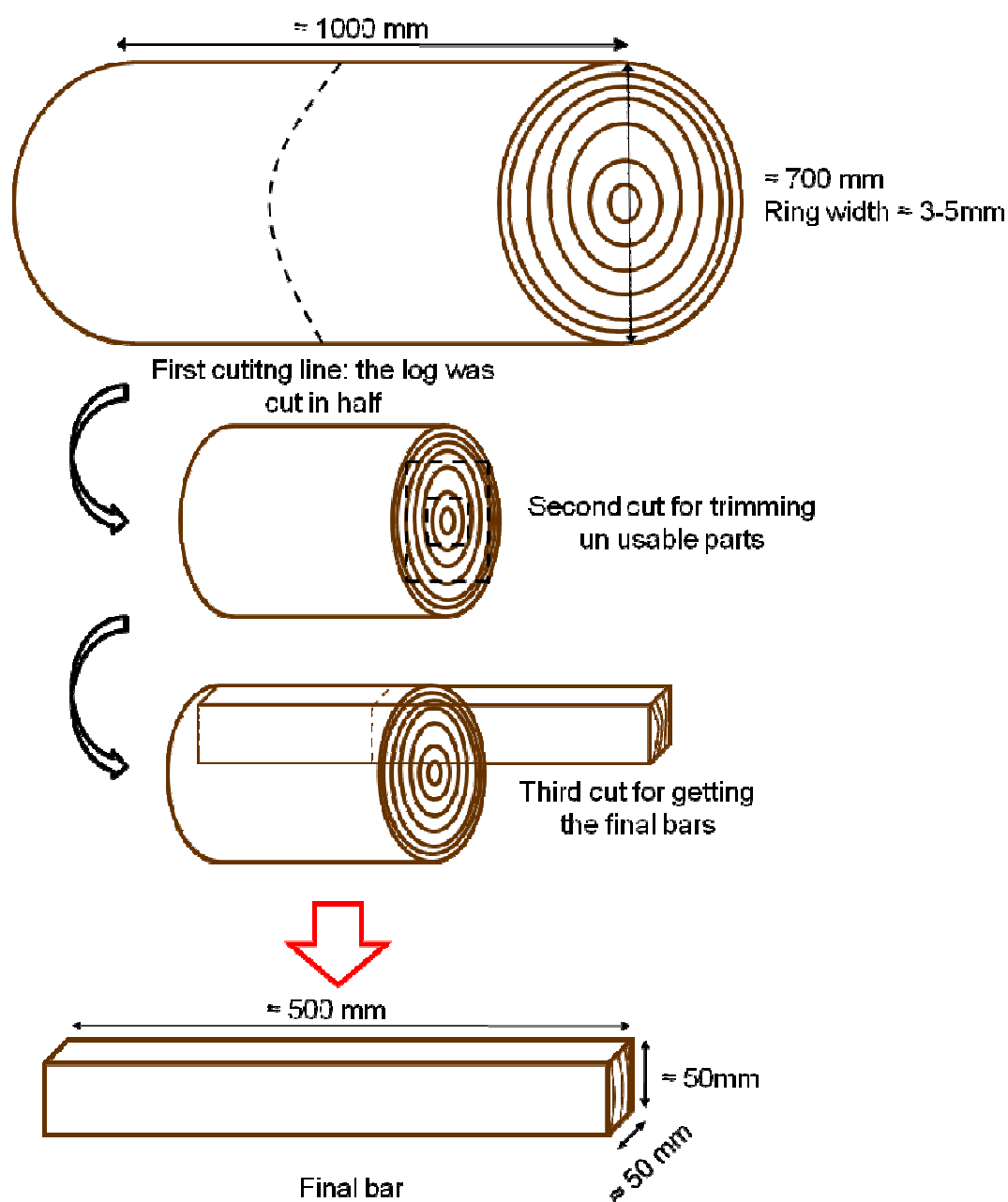

Fig.3.1. Schematic of cutting wood bars from original log in Iran

Bars were then moved to the climatic chamber in which they were stabilized at  $20^{\circ}\text{C} \pm 2^{\circ}\text{C}$  and  $65\% \pm 5\% \text{RH}$  for 3 weeks. They were then ready to be either cut into test specimens or ground into powder.

### 3-1-1.d. Powder preparation

Fine powder was prepared from wood rods and used for extractions.

Powder was prepared using a Retsh rotating-knife grinder (SM 100). First powder with particle size <4mm was produced. Final powder with particle size <0.5 mm was then made following second grinding by a Retsh ultra-centrifugal mill (ZM 200).

### 3-1-1.e. Shrinkage specimens

A total number of 126 specimens were cut to dimensions:  $[L=5 \times R=20 \times T=20 \text{mm}^3]$  and went through the same extraction protocols as vibrational ones. Before and after each extraction, specimens were dried at 60°C for 48 hrs and their dimensions were noted to calculate shrinkage and swelling due to each treatment.

### 3-1-1.f. Specimens for vibrational tests

First tests of both acoustic tests were planned (and performed) along the grain for all specimens. A special care was taken to have the axial specimen direction parallel to the fiber direction (always keeping at least two or three growth rings in one specimen), as any deviation from that direction would affect profoundly the obtained factors (especially damping).

The dimensions of damping specimen were:  $(L=150 \pm 0.04 \times R=15 \pm 0.03 \times T=2 \pm 0.01 \text{mm}^3)$ . The dispersion of the three dimensions in specimens, shown in Fig.3.2, was small thanks to careful cutting.

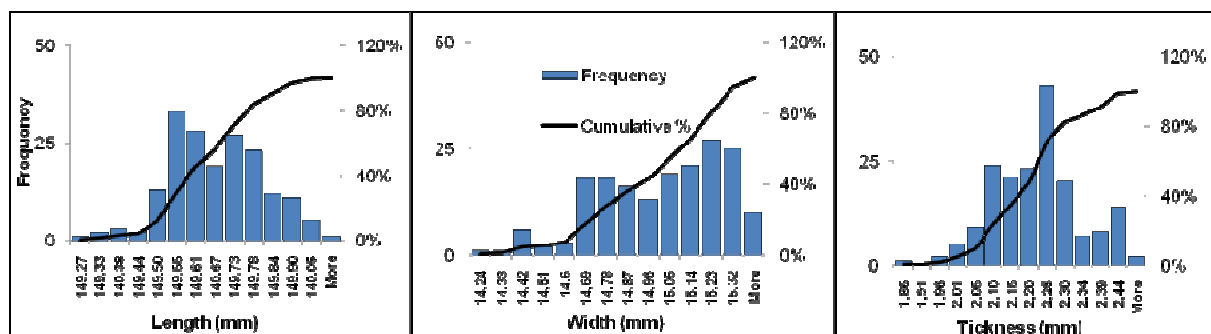

Fig. 3.2. distributions of three dimensions measured in 180 specimens

The especially thin thickness was demanded to improve damping measurement precision by forced vibration. According to Brémaud (2006), although the nominal thickness of the specimens is secondary (as long as it does not increased the stiffness too much), its homogeneity is of much significance for attaining an accurate damping.

Wood bars were first smoothed using a planer (Mark: LUREM) and then cut to the practical specimens by a panel saw (LUREM, blade thickness: 3.5 mm). Followed cutting plan to get the vibrational specimens is shown in Fig. 3.3.

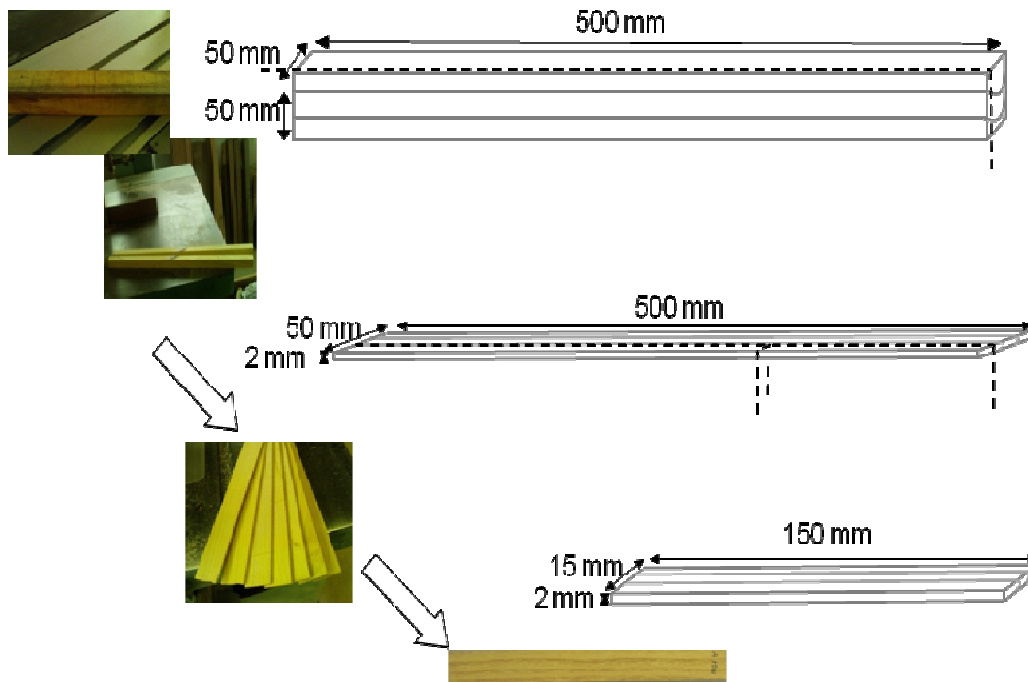

Fig.3.3. Detailed cutting plan for vibrational specimens

### 3-1-1.g. Specimens for DMA test

All the wooden rods were pre-cut to nominal dimensions of  $(L=500 \times R=50 \times T=50 \text{ mm}^3)$ . Unfortunately, due to sawing errors, R and T varied from 42 to 50 mm and less than 40% of the bars were cut exactly parallel to the directions (for R and T directions). Fig.3.4 shows the cutting plan from a well-oriented bar.

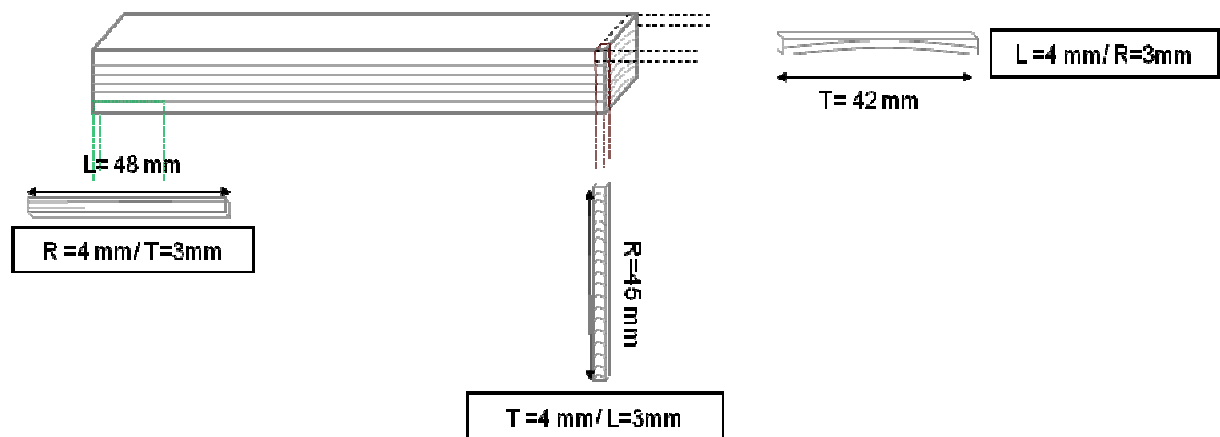





Fig.3.4. Cutting plan of specimens for DMA from a perfectly oriented bar

More than 150 ( $\approx 50$  in each direction) specimens were originally cut from several rods. After filtering for problems in orientations, sawing errors and other imperfections (local cracks ...) eventually 34 to 38 specimens in each direction remained. One further selection was done to reduce the number of specimens for test. Thus, in the end 14 specimens from each orthotropic direction were tested in their native state.



### 3-1-1.h. Specimens for determining natural durability

Specimens were all cut from the second batch of wood rods (§3-1-3, Fig.3.8). Standard requirements recalled in fig 3.5 exclude a ring orientation parallel to the width. Specimens ( $L=50\pm 0.5 \times R=25\pm 0.5 \times T=15\pm 0.5 \text{ mm}^3$ ) were cut from original rods, from which 120 were selected for testing the durability against termites and basidiomycetes. The theoretical volume should be  $18.75 \text{ cm}^3$ , but the exact volume of each specimen was calculated and recorded.

Dimensions in mm	XP CEN/TS 15083-1 (fungi resistance) EN113 (dimension and orientation)			EN117		
	L	R	T	L	R	T
	50	25	15	50	25	15
Annual ring angle	No requirements except that annual ring cannot be parallel to the width			Angle > 10°		
						

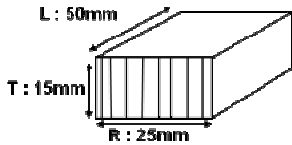

L : 50mm  
R : 25mm  
T : 15mm



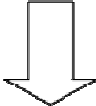

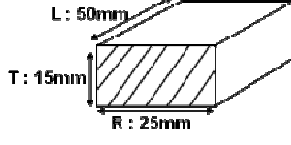
L : 50mm  
R : 25mm  
T : 15mm

Fig.3.5. Requirements of standards for specimens cutting and annual ring angle for biological tests.

The standard conditioning of two weeks in 20°C and 65% RH was applied to all specimens as well as controls, prior to any accelerated ageing and/or biological test

### 3-1-2- Conditioning

#### 3-1-2.a. Some general rules about conditioning

All along this study, several general rules were defined for all tests and specimens and followed as much as possible.

- Similarity of the condition of each test: For our mechanical (vibrational) tests to be not only repeatable but also verifiable and comparable, all the conditions applied during all the tests should be the same. This meant performing the tests on the same machine or testing instruments, with the same settings and in the same environmental conditions, as many tests as possible were performed in a climatic chamber.
- Same conditioning protocol: To minimize the variations, especially in damping properties, resulting from different environmental conditions, all specimens were dried and stabilized in identical conditions before testing (48h at 60°C then in a climatic room/chamber for at least 3 weeks).

Despite the fact that all the “rules” above were established and closely followed to maintain similar and repeatable conditions for our tests, changes in conditions and/or specimens did happen. In these cases, complementary tests were added to insure the reliability of the obtained results. Whenever it was the case, detailed information about the reason why the change in conditions happened will be explained fully for each individual test/method in following parts (§3-2-3).

### 3-1-2.b. Hygro-thermal conditioning of the specimens

The same conditioning process was applied to all specimens: every vibrational and physical measurement was performed after an established process of drying and stabilization.

The anhydrous state of wood is commonly obtained after 48 hours in an oven at 103°C. This procedure induces small modifications in wood structure, possibly reversible, although the humidification necessary for reversing the modifications, according to Brémaud (2006), is not possible for this kind of study. The risk of thermal damage was particularly critical in the case of successive treatments applied on the same specimens (see chapter 6). Therefore, a temperature of 60°C for 48 h was applied instead for oven drying to prevent any irreversible modification. In the course of the treatments, the specimens were exposed to that mild oven drying and once the tests were over, they were all dried at 103°C. Fig. 3.6 shows the residual MC calculated by comparing MC after 48 hrs at 60°C to that at 103°C, applied after completion of the test for 130 treated specimens. Residual MC (based on the anhydrous weight) varied between 0.14% and 3.26% with an average of 1.61% ± 0.61 (water-treated specimens included). This residual MC did not appear to depend on specific gravity.

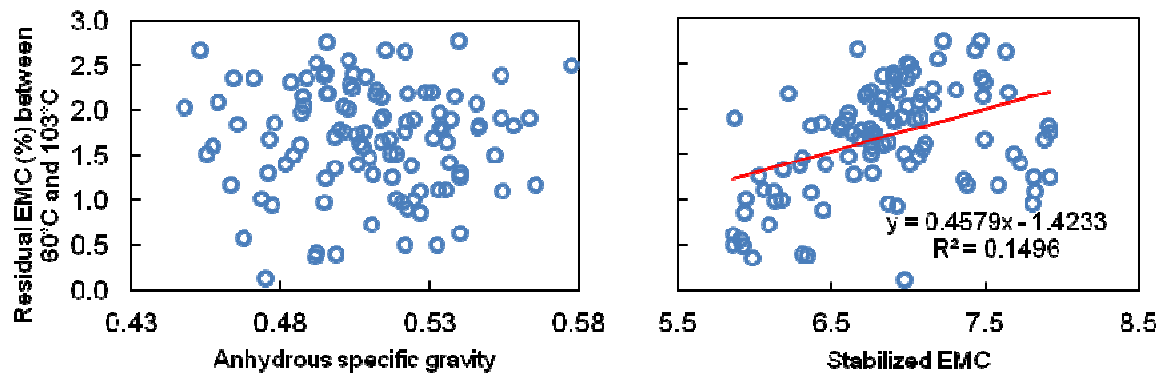

Fig. 3.6: Residual MC (%) (Between MC after 48 hrs in 60°C and MC obtained after 48hrs in 103°C) against anhydrous specific gravity and stabilized EMC (air dried %).

Once oven dried as described above, the specimens were kept in the climatic chamber for 3 weeks. This protocol was carefully repeated before and after each test or extraction/treatment. It should be said that even this mild drying, when used several times on the same series (specimens of successive extractions and their respective controls), caused small defaults in the form of light bending or micro cracks.

Powders were also stabilized in the same conditions mentioned, however the time of resting in the climatic chamber were fairly shorter.

### 3-1-2.c. The real conditions of tests

Due to localization of test machines, not all tests could be actually performed in the same conditioning rooms. Table 3.1 shows the specifications concerning localization and conditions of each test.

Table 3.1. Specifications on the location and conditions of the humidity sensible tests/measurements.

Test/measurement	location	Condition
First physical measurements (mass and dimensions)	CIRAD	Controlled
Biological tests	CIRAD	Controlled
Bing	CIRAD	Controlled
Free- free flexural vibration	LMGC	Uncontrolled
DMA	LMGC	Uncontrolled

The climatic chamber, where the specimens were kept during their stabilization period, was situated in CIRAD. Between CIRAD and LMGC ( $\approx 45$  min travel time), specimens were kept in PE bags, to reduce moisture change to minimum. Not only the transportation was done as fast as possible, also the pick temperature hours were avoided.

When conditioned, the specimens were organized separately (with enough space between each two) to allow the maximum air movement in between them. Packing in PE bags, each specimen was sealed in an independent place, separated from the rest, therefore during the test, bringing out each specimen from the bag would not expose others to the change of humidity.

To observe the change during the time that the specimen spent out of PE bag for testing, each specimen was weighted twice: directly out of the bag before going through the test, and after the end of test before being returned to its proper bag. The exact time (using the computer chronometer) spent out of the bag was also noted. By using the formula (3-1), the variation of MC during the test was calculated:

$$\frac{\Delta MC}{MC} = \frac{m_2 - m_1}{m_{stab} - m_0} \times 100 \quad (3-1)$$

where;

$m_0$ = anhydrous weight  $m_1$ = weight before the test,  $m_2$ = weight at the end of the test and  $m_{stab}$ = stabilized weight measured in CIRAD's climatic chamber

Taking all the steps above, we tried to make sure that the MC variations in specimens remained small. The variation observed during the test at LMGC was  $-0.26 \pm 0.19$  %/% (Confidence interval 95%). Fig.3.7 shows the relative variation of MC (cf. formula (3-1)) in relation with the timed passed for each measurement.

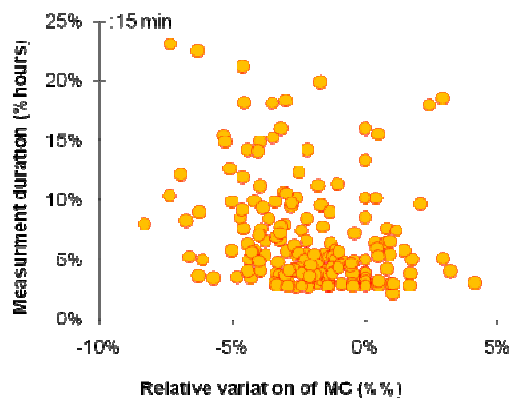

Fig.3.7. Relative MC variation during the free-free flexural test in LMGC in relation with the duration of each measurement -3 repetitions for each specimen- (Nb: 180).

Fig.3.7 shows the variations in MC during the time specimens spent out of PE bags. As the testing time increased (e.g. some specimens needed more than 3 tries/repetitions to get consistent results), the changes in MC got higher. In any case, the  $\Delta MC\%$  remained small ( $\leq 5\%$ ). Furthermore these variations did not seem to alter  $\tan\delta$  severely, as the uncertainty between the repetitions remained low (§3.2.2.a.calculated error and repeatability for LMGC method).

### 3-1-3- Complementary information about the material

#### 3-1-3.a. Different batches, same properties

The raw materials of this study belonged to three batches of two trees. The first batch was brought to France in the beginning of the study: the wood was still in its green state. The second batch (from the same tree as the first one) was kept outdoors ( $\approx$  air dried) for 6 months before being shipped to France.

Approximately one and a half year into the study, the third batch of wood was sent. The need for verification tests and DMA as a newly added test, called for more specimens. For selecting the second tree, the same selection and filtering criteria were used: same consultant instrument maker and even the same wood market. Specimens from second tree (third batch) were never mixed with those of the first tree (first and second batches) and were tried to be used, as far as possible, for completely independent tests. Results presented in chapter 4 could confirm the proximity of the batches. Test specimens coming from each batch are categorized in Fig.3.8 (for more details on differences between batches see chapter 4).

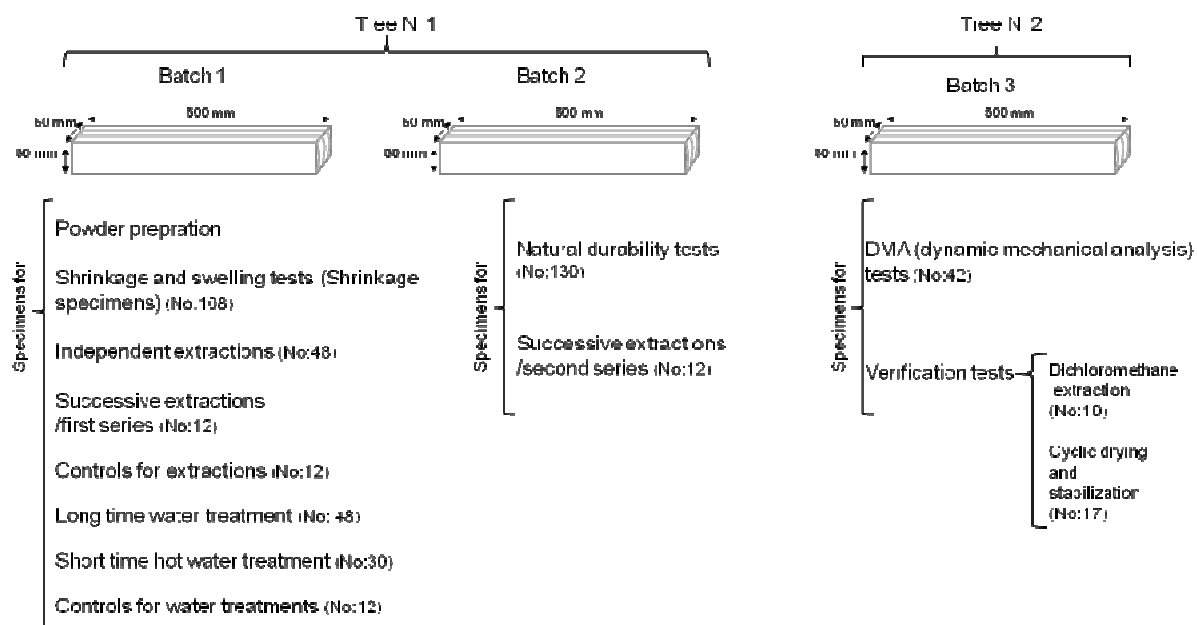

Fig.3.8. Specifying the test specimens coming from each batch. First and second batch are only different by their air drying duration.

### 3-1-3.b. Native state: Definition and use as a reference

From this point, in several parts of this study, the term “native state” is going to be used for describing specific specimen conditions. Native state in all cases refers to the specimens (solid wood or powder) that have never been treated chemically or hygro-thermally. Native-state specimens all went through one time of drying and stabilization according to the general protocol. All measured properties in that state would be considered as the reference for comparing and calculating any difference. To calculate changes in properties due to a treatment, native and treated states of each factor would be used as in below:

$$\text{Diff} (\%) = [(\text{Treated}/\text{Native}) - 1] \times 100 \quad (3-2)$$

However this formula would be useful when just one treatment is imposed on the specimens and consequently there is only one treated state. Yet, in case of successive extractions sometimes, 5 consecutive solvents were applied on the same samples, meaning that each sample has five treated stages instead of one. This time two types of differences were calculated:

$$\text{Diff}_{\text{relative}} (\%) = [(\text{Treated}/\text{Previous}) - 1] \times 100 \quad (3-3)$$

and;

$$\text{Diff}_{\text{cumulated}} (\%) = [(\text{Treated}/\text{Native}) - 1] \times 100 \quad (3-4)$$

$\text{Diff}_{\text{relative}}$ : Relative difference (%) between treated state and previous state of that particular treatment

$\text{Diff}_{\text{cumulated}}$ : Cumulated difference (%) between the treated state and the very first native state of the specimens

Using both differences have particular advantages: when relative differences are being used, the changes occurred due to the each treatment is measured, whilst when accumulative differences are presented, the additional effects of all preceding treatments are concerned. The first value ( $\text{Diff}_{\text{relative}}$ ) is helping to look at each solvent/ treatment individually and to investigate the possible influences it has on the specimens. The second value ( $\text{Diff}_{\text{cumulated}}$ ) is giving an overall view from each solvent in relation with all the others. Measuring it, one could be looking for the strongest/weakest treatments and investigate if there are any imposed treatment masking or strengthening the effects of others.

Depending on the type of treatment,  $\text{Diff}_{\text{relative}}$  and/or  $\text{Diff}_{\text{cumulated}}$  may be used to present the results.

## **3-2- Methods**

### **➤ General view of the methods**

In this sub-chapter, physical and vibrational devices, measurements and their corresponding errors will be presented and discussed in details. We chose to present these methods separately, as they were repeated for several groups of specimens going through different treatments. Moreover, considering that several corrections had to be made on the data, a part will be added to list and describe them.

Specifications on the treatments (extractions and hygro-thermal ones), compound identification methods and testing natural durability, will be discussed individually in each corresponding chapter.

### **3-2-1- Physical measurements:**

#### **3-2-1.a. Mass**

Measuring mass is one of important physical evaluation concerning wood. Determination of specimen weight in different stages of treatments not only allows one to calculate moisture content and extractive percentage but also help to clarify the test conditions. The accuracy of mass measurement is of great importance, especially in our study where some specimens were light in weight (DMA specimens weight range: 0.24-0.37 g) and the weight changes due to some of treatments was hard to detect (range of weight loss due to hexane extraction in acoustic specimens: 0.003-0.17% of initial oven dry weight or in another words 0.06mg weight loss detectable by Sartorus balance in Cirad).

#### **➤ Balances**

Three balances were used in this study (Fig.3.9) based on the machine/test locations and the importance of checking specimens weight in situ. Table 3.2 shows their specifications.

Table 3.2. Characteristics and specifications of the balances and mass measurements.

Balance	LOC	Resolution (g)	Min/Max/average weighted (g)	Estimated absolute error (g)	Relative error for Min/Max/average
Mettler (PM100)	CIRAD	0.01	[0.24] <sup>1</sup> , [11.44], [3.02] <sup>a</sup>	0.02	[8.3%], [0.1%], [0.6%]
Sartorius (LC-6205)	CIRAD	0.001	[2.04], [7.95], [5.92] <sup>b</sup>	0.002	[0.09%], [0.02%], [0.03%]
Mettler (PM100)	LMGC	0.01	[0.24], [3.26], [2.54] <sup>c</sup>	0.02	[8.3%], [0.6%], [0.7%]

LOC: Location

- a. Min and max weights are those of DMA and biological specimens, respectively
- b. Min and max weights are those of separated powder and powder in its cartridge for extraction, respectively
- c. Min and max: DMA and vibrational specimens, respectively

The first Mettler balance (CIRAD) is checked every 3 months by internal quality staff as well as once a year by an exterior professional for its precision and accuracy. It was used for measuring oven-dried and stabilized weights of all four kinds of specimens (vibrational, shrinkage, DMA and biological samples). Oven-dried specimens were kept in desiccators for at least 5 min (never more than 10 min) before being weighted. The weight change due to time passing between oven/desiccators and scale is negligible.

The Sartorius balance (CIRAD) was specifically used for determination of weight of extracted powder as well as its initial dry weight.

The second Mettler balance (LMGC) was used for all in situ weight measurements at LMGC, when weight should be determined before and after each test (e.g. during free-free bar flexural test or DMA test).

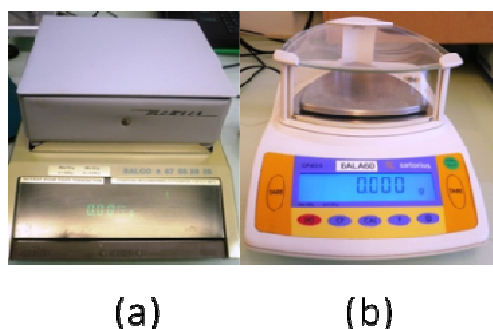

Fig.3.9. Balances used in this study: (a): Mettler balance (CIRAD and LMGC) and (b): Sartorius balance (CIRAD).

### 3-2-1.b. Moisture content percentage (MC %)

Moisture content of the specimens has been evaluated based on both their stabilized weight and their oven-dried weight. Although the predicted MC for stabilized specimens

<sup>1</sup>. The lightest specimens (DMA) were also measured with the second balance (Sartorius) simultaneously, in order to confirm the validity of the measurements.

in our applied conditions (20°C and 65% RH) is 12%, concerning our species, the observed MC is always lower in native state, and also changes drastically due to treatments (§4-3).

The percentage of moisture content is calculated according to:

$$MC(\%) = \frac{M_1 - M_0}{M_0} \times 100 \quad (3-5)$$

where:

$M_1$  = stabilized weight (weight measured after at least 3 weeks in 20°C±2°C and 65% ±5% RH)

$M_0$  = oven-dried weight (weight measured after 48 hr in 60°C)

➤ **Systematic error of cyclic 60°C drying**

Considering that a complete drying (at 103°C) was never applied on the test specimens, it is clear that a complete anhydrous state has been never reached, which implies an error of MC measurements. This is acceptable though, as the aim of study is comparative and the similarity of the imposed hygroscopic situation is of greater importance. Once the tests were completed, nearly all the available specimens were dried at 103°C so that the residual MC can be calculated and used whenever necessary.

**3-2-1.c. Dimensional measurements**

In case of solid specimens, determination of dimensions is important for a better understanding of how a treatment affects the wood. As wood is an anisotropic material, dimension change in each direction (L, R or T), whether caused by change in MC or by removing specific contents (extractives), gives an idea about the approximate place of extracted compounds.

Depending on the specimen, two different devices were used for measuring dimensions (Fig.3.10). Like in the case of weight, both oven-dried and stabilized dimensions are evaluated (Table 3.3).

Table 3.3. characteristics and specifications of the devices used for dimensional measurements

Device	Mark	Equipped	Min-Max measurable (mm)	Absolute error (mm)	Min/Max/Average measured	Relative errors for Min/Max/Average
Vernier scale	DIGIMATIC ABSolu	Data transfer system	0.01- 300	±0. 02	[1.84],[150.01],[55.48] <sup>a</sup>	[1%],[0.01%],[0.03%]
Digital comparator stand	Mitutoyo (ID-H0560)	Data transfer system	0-60.96	± 0.002	[2.60],[50.50],[24.61] <sup>b</sup>	[0.07%],[0.0003%],[0.0003 %]

a. Min and max belong to the thickness and length of vibrational specimens.

b. Min and max belong to DMA and biological samples respectively.



The vernier scale was used specifically for vibrational specimens. The length was measured from end to end of each specimen, while the width and thickness were assessed based on middle points of relevant direction.

The comparator stand was used for measuring DMA, shrinkage and biological specimens. It imposed a force inferior to 2.5 N. The three dimensions were measured at middle point for each direction.

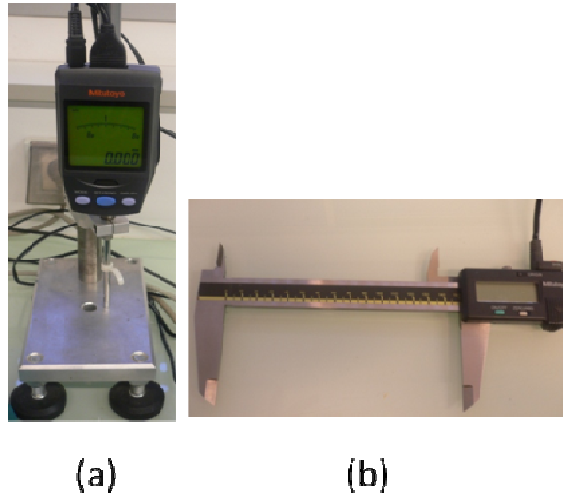

Fig.3.10. Devices for measuring dimensions: (a): Digital comparator stand and (b): Vernier scale.

#### 4-1-4- Specific gravity

Wood specific gravity is used for expressing the quantity of the material. It also serves indirectly to deduce modulus ( $E'$ ) from specific modulus ( $E'/\rho$ ). It is defined as the mass of wood per unit volume and is calculated according to:

$$\rho = \frac{m_{\text{stab}}}{V_{\text{stab}}} \quad (3-6)$$

where:

$\rho$  = stabilized specific gravity

$m_{\text{stab}}$  = stabilized weight of specimens (measured after 3 weeks in 20°C and 65%RH)

$V_{\text{stab}}$  = stabilized volume of specimen

Calculation of wood specific gravity is essential, as it enters in the determination of  $E'$  in free-free bar flexural tests.

The calculated  $\rho$  is subject to error, as it cumulates those of dimensions and mass previously discussed. Irregularity in the shape of specimens – coming from cutting defaults- imposes an additional error on  $\rho$ .

In any case, we tried to lower the errors coming from irregularity in specimen geometry by removing the specimens with severely inordinate shapes. As for other part (sum of the mass/dimensions errors), an estimated error based on each factor's relative errors will be calculated.

➤ **Relative error of specific gravity for vibrational specimens**

The relative errors (i.e. estimated absolute error divided by the measured value) for the vibrational specimens are estimated as 0.92%, 0.13% and 0.01% for thickness (T), width (R) and length (L), respectively. These errors are calculated based on average values of 180 native state specimens measured with vernier device in CIRAD, assuming measurements done to nearest 0.01mm resulting in an absolute error of 0.02mm. In previous section, the relative error for mass (average of 180 specimens for first scale in CIRAD) was 0.1%. This gives a total of  $\approx 1.16\%$  of relative error, and an average  $\rho$  of vibrational specimens of  $0.56 \pm 0.03$ .

➤ **Relative error of specific gravity for DMA specimens**

The relative errors for DMA specimens are 0.06%, 0.04% and 0.004% for thickness, width and length, respectively. These errors are calculated based on the measurement of 130 DMA specimens by digital comparator in CIRAD, assuming measurements done to closest 0.001mm, hence an absolute error of 0.002. Relative error of mass value is higher in case of DMA specimens as they were considerably smaller and lighter in weight (Relative error for first scale in CIRAD for 130 specimens: 0.62%). The relative error for the  $\rho$  was  $\approx 0.72\%$ , resulting in an average  $\rho$  of  $0.53 \pm 0.03$ .

➤ **Partial shrinkage/swelling**

Wood is a hygroscopic material, thus studying its deformation under applied conditions is of great importance to give an idea about its stability under environmentally changing conditions. But also it is a useful indicator to clarify the relationship between wood constituents and removed extractives.

Partial shrinkage/swelling can be calculated either between a higher MC state and oven-dried state, or between two different MC states based on oven-dried state.

Partial shrinkage/swelling for each dimension can be calculated as:

$$S = \frac{\Delta L}{L_0} = \frac{L_x - L_0}{L_0} \quad (3-7)$$

where S: partial shrinkage/swelling,  $L_x$ : concerned dimension in MC of x and  $L_0$ : is the same dimension in anhydrous condition.

While looking for the hygroscopic deformation between at different MC the formula below will be used for calculations:

$$S = \frac{L_{x2} - L_{x1}}{L_0} \quad (3-8)$$

$L_{x1}$  and  $L_{x2}$  are the two measurement of the same dimensional factor at two different moisture contents.

In our study, 3 conditions were applied to all specimens. The two already explained conditions throughout the tests: drying at 60°C (quasi-anhydride), and stabilizing at 20°C and 65% HR. An additional one – 27°C and 75% HR for one month- was also applied later on to put the specimens in “incomplete” adsorption conditions.

According to the definition, the partial shrinkage depends on both MC (which is different for specimens after each treatment) and on the shrinkage/swelling coefficient ( $\alpha$ ) which can be calculated as:

$$\alpha = \frac{\lambda}{\Delta MC} \quad (3-9)$$

where  $\lambda$  is any relative dimensional change divided by the percentage of MC change.

### 3-2-2- Vibrational tests

Two vibrational methods are used in this study. Each of these methods has its own advantages and weak points regarding the repeatability of the tests, the way to obtain the damping factor and the absolute and systematic errors. As will be detailed later, the damping obtained from force vibration in LMGC is comparable with that acquired from free vibration in CIRAD, the comparison of damping properties after treatments will be based on that. It should be noted that all tests were done in ambient temperature.

The two methods developed below establish a relationship between vibration frequencies and mechanical properties. Both underlying models are based on the assumption of a homogeneous material. They differ by the accounting or not for shear in the cross-section.

#### ➤ Bernoulli equation

Bernoulli method (first developed in 1748) is based on the hypothesis that if the ratio of length<sup>1</sup> to width of a beam is very high, the beam can be considered as a thin line and the shear (as well as transverse deformations) can be ignored. The effect of elastic support is also ignored (Brancheriau 2002).

Based on Bernoulli equation (first mentioned in chapter 2 for calculating n<sup>th</sup> mode frequency §equation 2-4),  $E_x$  (Elastic modulus in longitudinal direction) can be calculated as follows:

$$E_x = 4\pi^2 \frac{\rho AL^4 f_n^2}{I_{GZ} P_n} \quad (3-10)$$

where;

$E_x$  = Elastic modulus

$f_n$  = resonance frequency for the n<sup>th</sup> mode of vibration

$P_n$  = solution of Bernoulli equation:  $\sqrt[4]{P_n} = (2n+1) \frac{\pi}{2}$

$A$  = cross sectional area

$L$  = specimen length

$I$  = cross sectional inertia

---

<sup>1</sup> Here, the length is the static length, in other words it is the ratio of vibration wavelength to the thickness that is being considered.

➤ **Timoshenko equation**

Bernoulli's model does not take into account the shear between the cross sections, in other the cross sections of the beam remain perpendicular to its neutral line. Timoshenko's model takes into account a shear angle that reflects the fact that cross sections do not remain perpendicular to the neutral line.

Timoshenko's beam theory constitutes an improvement over Euler-Bernoulli theory, in that it incorporates shear and rotational inertia effects. This is one of the few cases in which a more refined modeling approach leads to an analytical solution. The reason for this is that Timoshenko's theory gives rise to a *hyperbolic* system, unlike the Euler-Bernoulli system, for which propagation velocity is unbounded.

The basic formula for an unsoliciated homogenous orthotropic beam in bending would be (Brancheriau et al 2002):

$$E_x I_{GZ} \frac{\partial^4 v}{\partial x^4} - \rho I_{GZ} \left( 1 + \frac{E_x}{K G_{xy}} \right) \frac{\partial^4 v}{\partial x^2 \partial t^2} + \frac{\rho I_{GZ} \partial^4 v}{K G_{xy} \partial t^4} + \rho S \frac{\partial^4 v}{\partial t^2} = 0 \quad (3-11)$$

where:

$E_x$  = Longitudinal Elastic modulus

$I_{GZ}$  = cross sectional inertia

$\rho$  = specific gravity

$K$  = Timoshenko shear factor dependent on the specimen geometry, equal to 5/6 for a rectangular cross section.

$G_{xy}$  = shear Modulus

$S$  = cross sectional area

$v$  = transversal displacement

The original Timoshenko equation had ignored the effect of elastic supports.

In the following parts the basis of both methods as well as practical steps to run them is described. More information on the methodology and their theoretical origin can be found in Bordonné (1989), David (1999), Brancheriau (2002) and Brémaud (2006).

**3-2-2.a. Free-free bending vibration test (LMGC method)**

This was the test initially planned to be the only vibrational test carried out on the specimens. The use of thin specimens ( $L/h \cong 75$ ) allows not only the study of local variations in properties, but also an almost complete extraction, yet the specimens would be still testable (after the treatments) as they remain structurally stable.

The method was already fully set and ready to be used at LMGC. More explicit details can be found in the Thesis of Brémaud (2006). From now on, it will be called LMGC method.

➤ **General view**

In this method, the specimen is suspended on two very thin elastic supports. At one end, a small rectangular shape metal piece is glued facing an electronic magnet, which imposes the vibration. The specimen movement is measured using a contactless displacement sensor.

$E'/\rho$  is calculated by the frequency resonance according to Bernoulli method (equation 3-10). Damping factor ( $\tan\delta$ ) is determined by the logarithmic decrement of the amplitude of vibration after stopping the excitement. Meanwhile, in frequency domain, quality factor (Q) is measured by bandwidth at the half power (-3dB). The two factors,  $\tan\delta$  calculated from logarithmic decrement and  $1/Q$  from bandwidth, are theoretically the same, but each of them is subjected to errors of different kinds which would eventually cause them not to be exactly similar.

➤ **Specimen preparation**

Specimens were prepared in following dimensions: ( $L=150 \times R=15 \times T=2 \text{ mm}^3$ ) with all efforts towards having a LR orientation. However, it was quite impossible to have the same clear, well-oriented cut for all specimens and it caused an error in the measurements, which we tried to minimize by increasing the number of test-specimens as well as repetitions.

For attaching the metal piece (thickness  $\approx 0.2 \text{ mm}$ , weight  $\approx 0.03 \text{ g}$ ), a small drop of cyanoacrylate glue (super glue) is used, enough to cover the whole width of the specimen and not too much to excess the edges. Even though the glue drop is small, it adds approximately  $0.03 \text{ g}$  to the net weight of the specimens and the result will need to be corrected later (see § 3-2-3.b). The specimens were all stabilized in a climatic chamber and then transferred (in hypothermic bags) to LMGC laboratory for testing.

➤ **Principles of the test**

When starting with the test, the resonance frequencies of the specimens are unknown (as they have never been tested with this method). For that reason, the first test begins with default setting of the program: 10 s frequency sweep (0.1 Hz resolution): scan between 150 and 750 Hz (which covers  $E'/\rho$  of 3 to 43 GPa) (Fig.3.11).

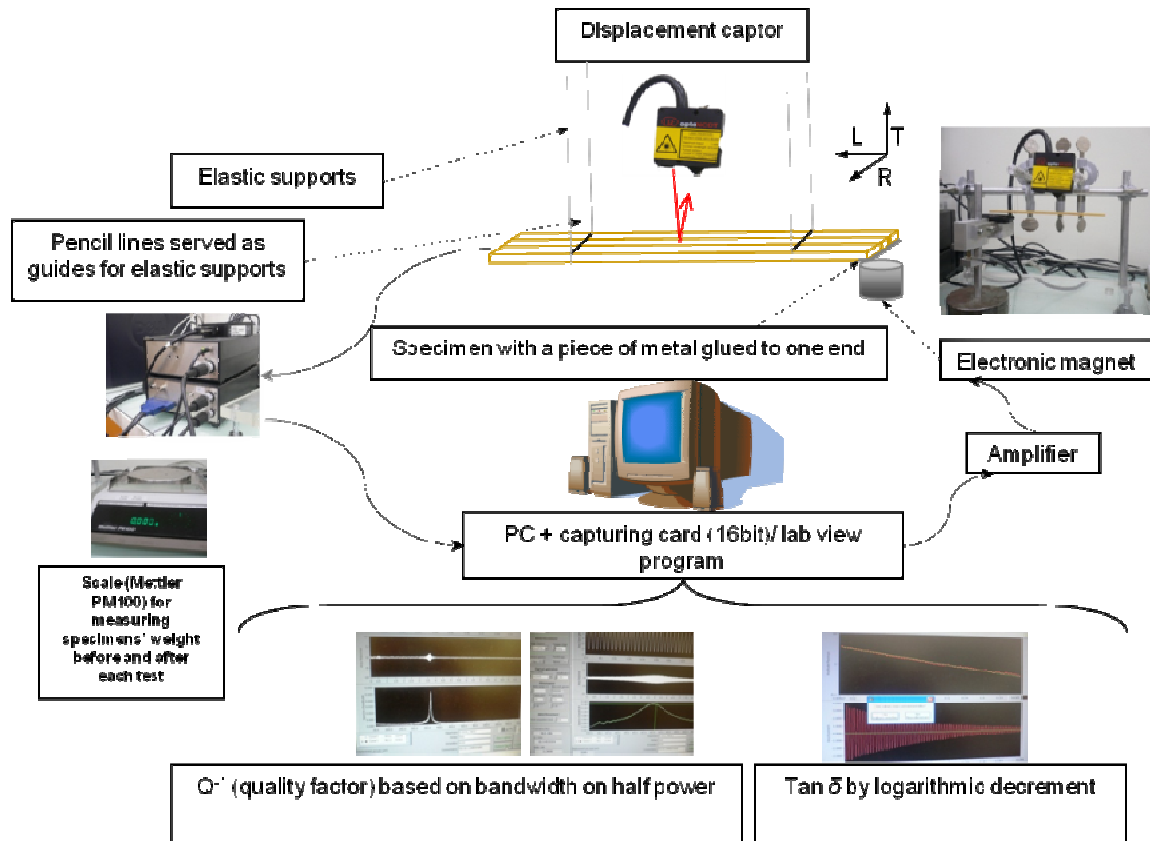

Fig.3.11. Schematic plan of the vibration test in LMGC

➤ **Quality factor ( $Q^{-1}$ ) by bandwidth**

From the detected resonance frequency, band width at half power (-3dB) is measured. According to Brémaud (2006), the uncertainty of  $Q^{-1}$  depends either on bandwidth or on resonance frequency (Fig.3.12).

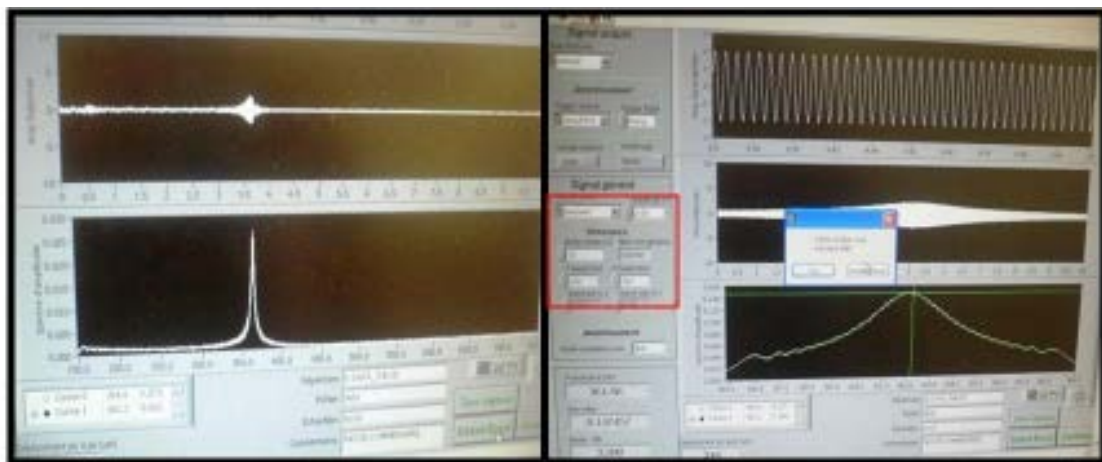

Fig.3.12. the visualization of detected resonance frequency which would result in calculating  $Q^{-1}$  based on bandwidth of half power. In second photo the red window shows the place for changing the setting of parameters.

In the end of this step, the resonance frequency, bandwidth and quality factor are registered in the previously determined file.

➤ **Tan $\delta$  by logarithmic decrement**

The specimen is then excited at the resonance frequency determined in the previous step. After some seconds enough for vibration to be stabilized (less than 10 seconds), it is stopped manually. A signal is produced and appears on the screen (Fig.3.13-left), if the signal is not completely regular (due to unevenness of the surface or other problems), one can re-do the excitation and get another one. If the signal seems correct, the biggest regular part is chosen and the lateral parts – which represent the weak frequencies-, are avoided.

From there, an exponential curve is produced, its regularity is determined by a coefficient ( $R^2$ ) recorded along with  $\tan\delta$ .

If all factors obtained seems reasonable:  $Q^{-1}$  and  $\tan\delta$  - which theoretically should be the same- sufficiently close and high  $R^2$ , the results are recorded and the program is ready for a new measurement.

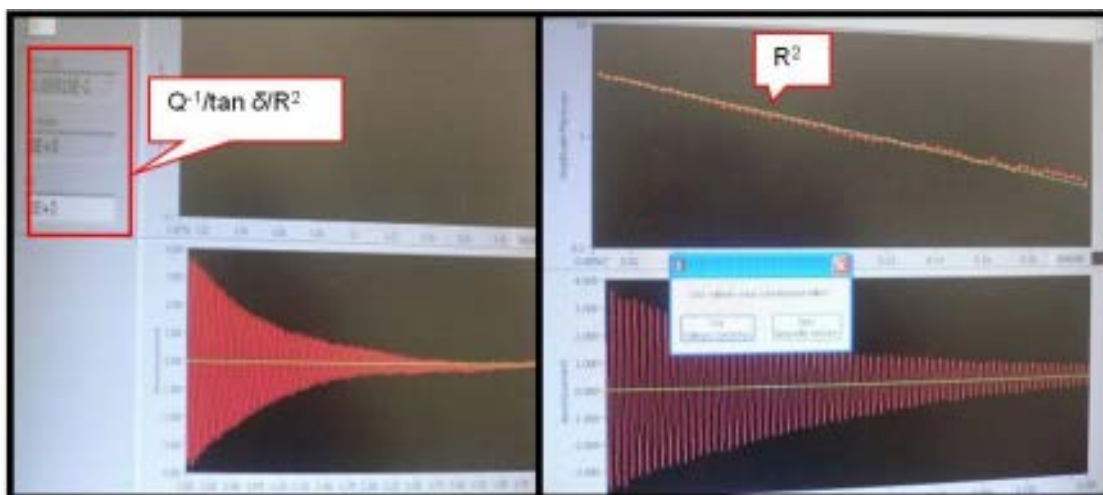

Fig.3.13. Visualization of a regular signal (left) and selection of a major part with a strong  $R^2$  (right, down and up respectively) which eventually results in  $\tan\delta$  from logarithmic decrement

➤ **Calculated error and repeatability**

The absolute error has already been calculated for several factors obtained in this method. According to Brémaud (2006), the absolute error for resonance frequency is around 0.1 Hz. For this study' specimens, the relative error can be calculated between 0.02% and 0.03%.

As for the amplitude, the influential factors are the resolution of the laser as well as the surface conditions of the specimen. Surface condition means the unevenness of the contact spot between laser beam and specimen, which causes the laser beam not to remain on the surface and adds an absorption effect. The resolution of the laser was already calculated as 0.01mm while the effect of unevenness was found negligible (Brémaud 2006). However, in case of Mulberry specimens, surface condition played sometimes a quite important role in altering the results of  $\tan\delta$  by logarithmic decrement, causing them

to vary abnormally between the repetitions. As a result, in further steps of testing, small modifications have been applied for avoiding the laser absorption on the surface.

The maximum uncertainty for  $E'$  and  $E'/\rho$  is calculated around 10% and 7%, respectively.  $E'/\rho$  is calculated using resonance frequency and geometrical dimensions of the specimen (and thus those both factors' errors would be applied when calculating  $E'/\rho$  error).

For calculating errors of measuring damping properties,  $Q^{-1}$  and  $\tan\delta$ , one specimen was tested 30 times, while in-between the repetitions, the specimen was taken off and on elastic supports. Note that, the dimensional errors are not interfering with damping measurements, as this factor is given directly by the apparatus. The relative error for  $Q^{-1}$  was 6% while for  $\tan\delta$  by logarithmic decrement, it was approximately 18% (Fig.3.14).

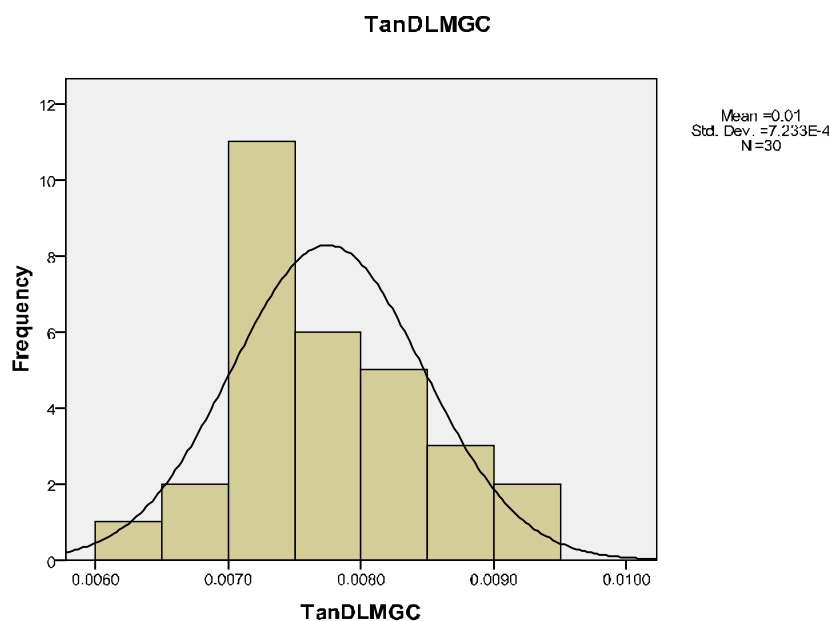

Fig.3.14. Distribution of obtained values for  $\tan\delta$  of 30 repetitions on one clear specimen using LMG method

➤ **Modification of LMG method:**

As mentioned above, the specimen surface condition, usually of negligible effect, has caused some alteration in the results of  $\tan\delta$  by logarithmic decrement. White Mulberry has a semi ring porous distribution of vessel elements as well as fairly big pore diameters (192  $\mu\text{m}$  in early wood and 63  $\mu\text{m}$  in late wood) (Karami et al. 2010). Furthermore, no more than 1 or 2 growth rings were included in each specimen. These two factors increased the possibility of laser beam being absorbed by vessel elements. The problem rose in the later stages of the tests (when the primary tests had already been carried out). From then on, to avoid the  $\tan\delta$  variations between repetitions and to obtain a more regular and clear signal, a small piece of paper (“post-it” type) was attached on specimen surface, at the exact contact point of laser beam and specimen. The weight added to specimen by paper was negligible while on the other hand, this small modification has later on reduced the relative error from 18% to 7%.



### **3-2-2.b. Free vibration of floating beam (BING®)**

#### **➤ General view**

The free vibration of floating beam (from now on referred to as BING method), is based on studying the induced vibration in a piece of wood. The ratio of the modulus to  $\rho$  of the material, called specific modulus, is equal to the square of the propagation speed of a signal in the material (Bucur 2006). This relationship indicates the existing connection between mechanical properties and vibratory behavior. By analyzing the spectral vibration in different directions, the natural frequencies of beam from its responses to the excitation pulse can be identified.

This method was developed by Bordonné (1989) and has been used in CIRAD to expand the database by experimenting  $E'$  of different woods. It calculates mechanical properties ( $E'$  and  $\tan\delta$ ) by using two different models relating vibrational and mechanical properties. By recording the audio signal and the obtained frequencies and then analyzing them in the software written in Matlab® (David 1999), eventually the mechanical factors would be achieved. Generally the first signal mode of frequency (which is the highest one and is called the fundamental mode/frequency) is used for the calculations.

#### **➤ Specimen preparation**

The dimensions of the specimens for this test can vary, but the length to height and width ratio should be enough to bear the impact causing the vibration. Specimens of ( $L=360 \times R=20 \times T=20 \text{ mm}^3$ ) have already been successfully tested for their  $E'/\rho$  with same method but bigger dimensions are also being used in CIRAD. However, BING test were now carried out on much thinner specimens, and the method had to be modified to fit the new test dimensions (see the following). The reason for this was for us to be able to compare both methods. As specimens were cut according to the requirements of LMGC method, it was only reasonable to carry the second one (BING) on the same specimens. Therefore, the same ( $L=150 \times R=15 \times T=2 \text{ mm}^3$ ) specimen dimensions were used for BING test. The conditioning process was also exactly the same as it was described earlier (§3-1-2).

#### **➤ Method for obtaining the damping**

The specimen is put on two elastic supports to allow the free propagation of the vibration (Fig.3.15).

A simple percussion at one end causes a vibration recorded by a microphone placed at the other end. In this case, the first mode of frequency is manually chosen.

These recorded vibrations is transmitted via an anti-aliasing filter to an acquisition card which in turn converts the analog signal and provides the computer with digitized signal.

Fast Fourier Transform (FFT) is used for processing and interpreting the information in frequency domain.

$\tan\delta$  is determined according to first mode of frequency by a software written in Matlab® (David 1999), while  $E$  is also calculated using each specimen geometrical dimensions as well as its weight.

Data for each repetition for each specimen is automatically recorded to a Notepad file, as well as all the frequency signals.

Three repetitions are done for each specimen.

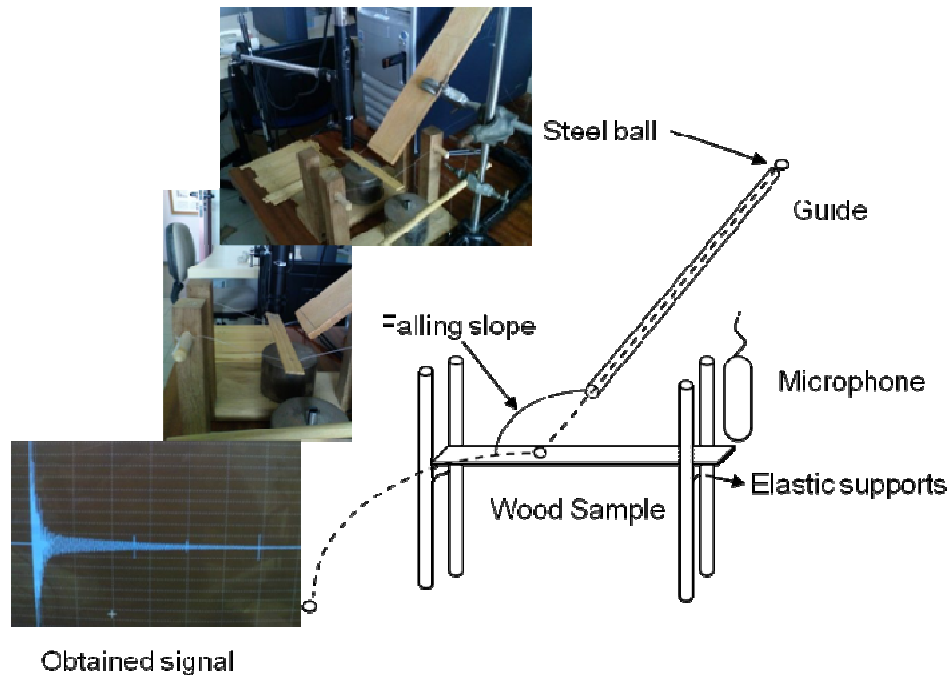

Fig.3.15. Schematic description of BING® method

➤ **Calculated error and repeatability**

The uncertainty of the measurement has been reported<sup>1</sup> to be 4% for  $E'$  (Brancheriau 2002).

For determining the uncertainty of  $\tan\delta$ , a test of repeatability was carried out. One perfectly oriented sample was tested for 30 times without changing any setting in the machine (Fig.3.16). In-between the repetitions, the sample was taken off and on the elastic supports. Eventually the uncertainty of measurement for  $\tan\delta$  from BING has been calculated as 11%.

<sup>1</sup>. Uncertainty for the tests performed using a wooden hammer.

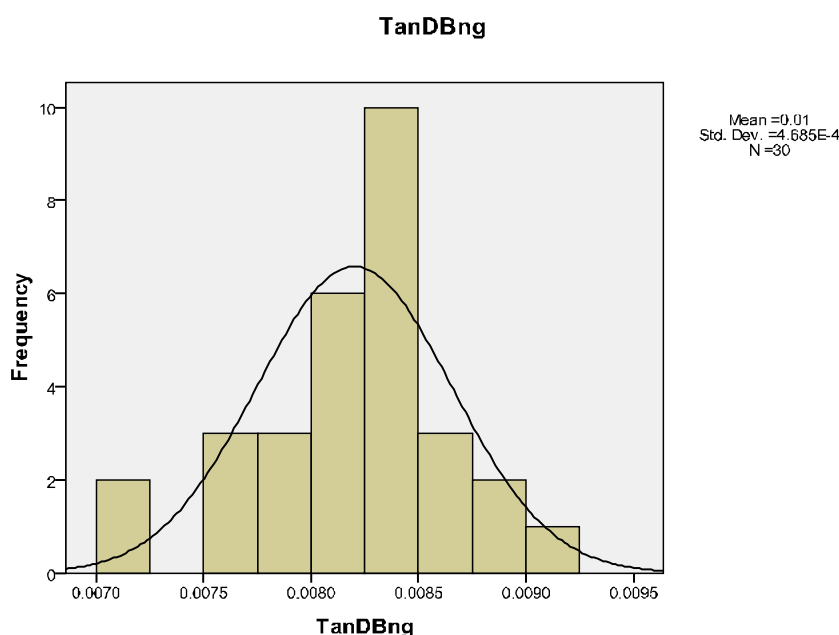

Fig.3.16. Distribution of obtained values for  $\tan\delta$  by 30 repetitions on one clear specimen using BING method

#### ➤ **Modification of BING®**

Normally for specimens of bigger dimensions the percussion is created by tapping one end of the specimens using a metal stick with wooden ball head. The firm impact is generally making enough vibration for a microphone to record. Considering the dimensions of our specimens, that kind of impact could probably cause the sample to jump out of place. Even if we tried striking very carefully, the stability of the specimen on the elastic support would be greatly endangered and no reliable data could be obtained. To solve this problem, we decided to let a very small metal ball drop – with a constant slip of  $45^\circ$  – on the middle point of the specimen to initiate the vibration. The weight of the metal ball is 0.4 g and it has a diameter of 4.75 mm. The ball dropping is done using a secure path so the slip and direction remain constant during the repetitions. Furthermore, the area around the specimens and elastic support are all covered with tissue in order to avoid any unwanted additional vibrations that could be generated by the metal ball hitting the surface after the first contact with the specimen.

#### **3-2-2.c. Comparison of two vibrational methods: forced and free vibration**

When analyzing the results, most often we are going to use the values of  $\tan\delta$  by bandwidth ( $Q^{-1}$ ) of forced vibration (LMGC method). This was the factor that was measured for all the specimens (unlike the one from BING) and had relatively the least experimental error. Occasionally however,  $\tan\delta$  by BING will have to be used as the descriptor of damping after particular treatments. This requires a quick presentation on how damping factors of the two methods relate together. In the case of  $\tan\delta$ , it seems reasonable to relate the damping of same origins. This means relating  $\tan\delta$  by bandwidth from forced vibration to the  $\tan\delta$  of free vibration, as they are both based on frequency

domains. On the contrary,  $\tan\delta$  by logarithmic decrement being based on time domain, is not going to be compared to the damping obtained from free vibration.

The vibrational tests were carried out in the course of two years during which time the instrument for testing vibration of the floating beams (BING) has been modified. These modifications (calculating additional results, replacing microphone with a laser beam...) have most definitely played a role in relating the two methods. Furthermore, the more we got experienced on how to test with fewer errors, the results from either method became more relevant.

It should be also noted that the specimens were cut and prepared based on the requirements of forced vibration method (LMGC), while the free vibration method (BING) was demanding bigger specimens to deliver a trustworthy result. Having said that, the relationship between  $\tan\delta$  of two methods seemed reliable when comparing the results obtained for bigger samples by two methods (Brémaud 2006, El Mouridi 2007).

Fig.3.17 shows the relationship between two specific moduli as well as  $\tan\delta$  s obtained by free and forced vibration. Measurements were done on 80 specimens in their native state in the first year of the study. As can be seen in Fig.3.17.b,  $\tan\delta$  shows large dispersion especially in the mid range. Moreover, the error bars show large variations between repetitions in both vibration measurements, which could be caused by different reasons (lack of stability of specimen on the elastic holders, disoriented specimen, inexperienced technician...). Specific modulus, on the other hand (Fig.3.17.a), although showing more or less the same dispersion, exhibits a better relationship between two methods ( $R^2=0.72$ ).

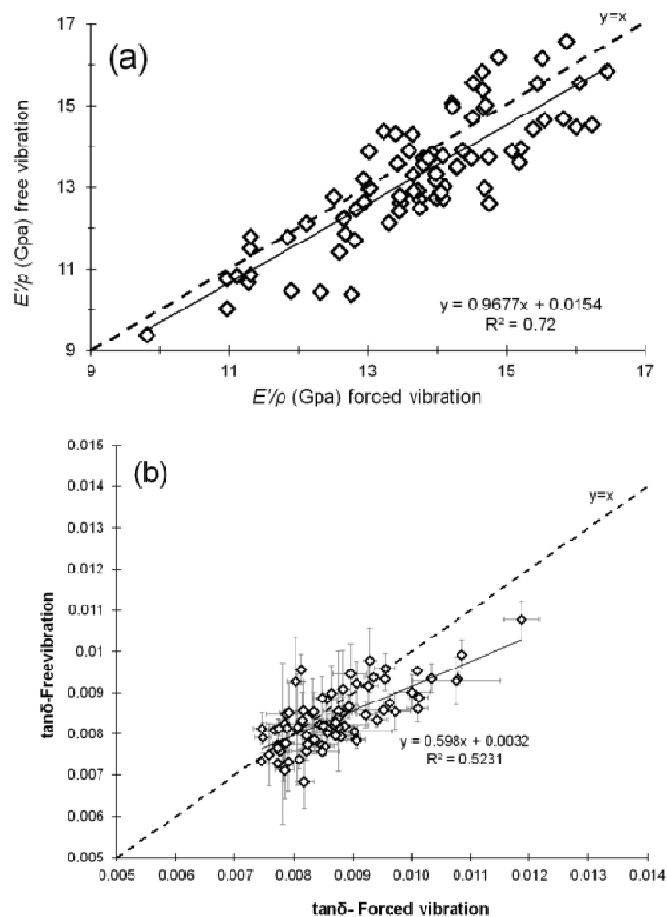
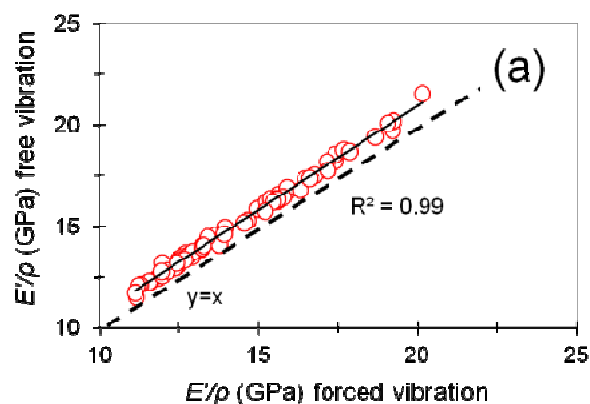

Fig.3.17. Relationship between specific modulus ( $E'/\rho$ ) (a) and  $\tan\delta$  (b) obtained by forced and free vibration. The error bars in 1b are calculated based on three repetitions of measurements done on the same specimen. Nb: 80.

Fig.3.18 shows the same factors for 62 measurements done on the same vibrational test machines in the second year of the study.

A stronger relation between two two methods is clearly evidenced.  $E'/\rho$  values are related significantly together ( $R^2=0.99$ ) and  $\tan\delta$  values even though still dispersed in low and middle range, are better related to one another ( $R^2=0.68$ ).



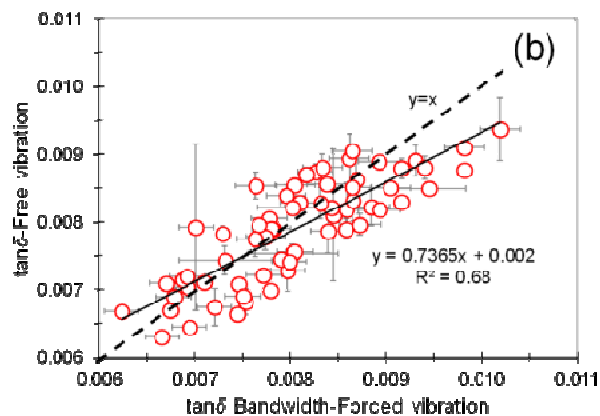

Fig.3.18. Relationship between specific modulus ( $E/\rho$ ) (a) and  $\tan\delta$  (b) obtained by forced and free vibration. The error bars in 2b are calculated based on three repetitions of measurements done on the same specimen. Nb: 62. (both values are collected from running the tests in same range of frequency- i.e. 360 Hz in average).

The improved relation found between the values obtained from two vibrational methods can be explained by several factors:

- We got more experienced (more aware of error origins on a particular instrument).
- The microphone was replaced with a laser beam in free vibration (which caused a more precise registration of the vibration).
- Changes in the specimens themselves: coming from another tree (batch 3), not only they were slightly different in properties (higher specific modulus and lower  $\tan\delta$ ) but also easier to measure (less repetitions before acquiring a correct result) which might have reduced the errors (For more details on the differences between three batches, see chapter 4).

Smaller error bars of the forced vibration in Fig.3.18.b (with the exception of two samples) confirm the above statement : tests of second year-either caused by better sampling / less personal error / better equipped instrument- were more repeatable.

In the end, considering the above results, and still noting that the specimens size were not “suitable” for BING method, the correlation between the two methods seems correct.

### **3-2-2.d. Dynamic mechanical analysis**

Up to now, all vibrational tests described are performed along the grain. Consequently, all the observed modifications caused by imposed treatments (whether natural or artificial), will only be valid in one orthotropic direction. Although these observations are of great value towards the final aim, they are certainly not enough.

Wood is an anisotropic material, meaning that its properties vary according to the direction (L, R, T, or intermediate). Moreover, essential features of musical instruments is sometimes strongly conditioned by wood anisotropy (§2-4-2). Thus, the results of vibrational tests along the grain (either by LMGC or BING method) need to be complemented by measuring the same factors in other directions. For that, we will use a DMA (dynamic mechanical analyzer) (Fig.3.19).

The test is done along the three material directions (L, R and T) in both treated and native state. Treatments are limited to the most effective ones decided after a first set of treatments (see chapter 5).

➤ **General view**

The viscoelastic behavior of specimens is measured using a BOSE® ELF320 DMA equipped with tension/compression fatigue grips, a 22 N ( $\pm 0.17\%$  maximum error) load cell and a high-resolution displacement sensor (1 mm range with  $\pm 0.26\%$  maximum error). The specimens are fixed between two clamps with a working distance of 35 mm and tested in tension along their longest direction. The tests are done in purely alternative tension/compression loading controlled in displacement with an amplitude of  $\pm 0.0175$  mm corresponding to a maximum tension/compression strain of  $\pm 0.02\%$  (i.e., within the linear viscoelasticity domain but well below the bulking limit). Using BOSE WinTest® analysis software,  $E^*$  (complex modulus),  $E'$  (storage modulus),  $E''$  (loss modulus) and  $\tan\delta$  are calculated. Moduli are corrected for the rigidity of the whole apparatus, measured using a stiff steel specimen. Frequency sweeps from 0.1 to 10 Hz are run, in triplicate for each specimen, native and then treated.

➤ **Specimens preparation for DMA**

Specimens were cut from the third batch of wood, thus come from a different tree than what was used for vibrational tests along the grain- but the obtained results can be considered valid based on following justifications:

There is no significant difference between the mean values obtained from three batches. In addition, the same normal distribution is observed for all three source materials (see chapter 4).

As the sampling was dimensionally limited for R and T specimens due the pre-cut stock, a new set of L-oriented specimens with same dimensions as the other two has been prepared. As a result, the comparison of anisotropy between 3 directions will be possible based on the values retained from the specimens coming from the same tree/batch and tested with the same machine (DMA).

The cutting plan for DMA specimens has already been presented in §3-1-1.g.

➤ **Principals of DMA test: a step by step measurement**

- Samples are brought in PE bags to the test chamber, each sample is taken out carefully and its weight and dimensions<sup>1</sup> are measured.
- Before installing the sample between the clamps several steps should be taken to get the DMA ready for the test:
- Attaching the load cell to the DMA (load cell of 22 N in our case)
- Setting the limitation for apparatus used (i.e. load cell, displacement transducer, etc) (Fig.3.19.b). Normally the limits are already showing in a table. However, it is be

---

<sup>1</sup> Specimen weight and dimensions are already recorded in the original climatic chamber. Here weight is re-measured to monitor its change in relation with the changing humidity. Dimensions are also re-noted as they are required by Wintest® program for modulus calculations and we wanted to enter the exact dimensions of each sample.

- better to adjust the limits depending on the material type/load cell/desired displacement.
- Selecting the channels on the oscilloscope: only the necessary factors should be chosen (force, displacement in this case).
  - Now the specimen can be installed into the machine. The distance between two clamps is adjusted to the length of the specimens (35 mm for a specimen 42-48 mm long). While fixing the specimen, close care should be taken that it stays as closely as possible to the center points, and that the dimensions of upper and lower parts gripping into the clamps are the same. Once the specimen is directionally well fixed, the clamps are tightly screwed using a small screwdriver (first the lower screw then the upper to avoid changes in verticality). The specimens should be closely gripped by clamps, not too tight to cause wood crushing and not too loose to induce specimen shaking during the test.
  - Putting the load cell to the automatically adjusted zero. For displacement, first a manual adjustment is done, then the small remaining value is electronically set out.
  - Tuning the instrument to the specimen: using tunnel Q Waveform at the Wintest ® program, the upper level of the force which is likely to be imposed is selected. During the test, DMA performs a frequency sweep to regulate the motor with mechanical characteristics of the specimen. This takes several minutes and results are shown as “successful/not successful”.
  - Ramp test for determining sample rigidity: the inserting level should be high enough to obtain the maximum calculated desired deformation and the representative rate (N/sec)<sup>1</sup>.
  - Entering the practical requirements of the test: the most important ones here are force and frequency range. A condition file is produced and it is possible to eventually check all the features entered manually and/or the calculated ones.
  - Entering specimens dimensions (height, width<sub>1</sub> and width<sub>2</sub>, all in mm). Note that what is here regarded as height is not the specimen length, but is the distance between the clamps.
  - Running the test
  - A FFT analysis is performed and the results are shown in a separate window.
  - The results consist of:
    - A graph showing the signals of the displacement changing with time (mm/Sec)
    - A second graph demonstrating the relation between amplitude and frequency (dB/Hz)
  - The values of: frequency (Hz),  $\tan\delta$ , phase angle (°) and stiffness (N/mm)
  - Exporting the data: in a separate window, we can choose what values to export (depending on the running test) amongst what has been proposed (temperature, hysteresis, E and  $\tan\delta$ ).

---

<sup>1</sup>.The ramp test should be re-done every time the specimen type (in another words: its rigidity) is changing. In the present case, it is when samples with different orientation are tested (L, R and T).



- $E^*$  (complex modulus),  $E'$  (Storage modulus),  $E''$  (Loss modulus) and  $\tan\delta$  (tangent of  $\delta: \frac{E''}{E'}$ ) are exported to an Excel.csv file.

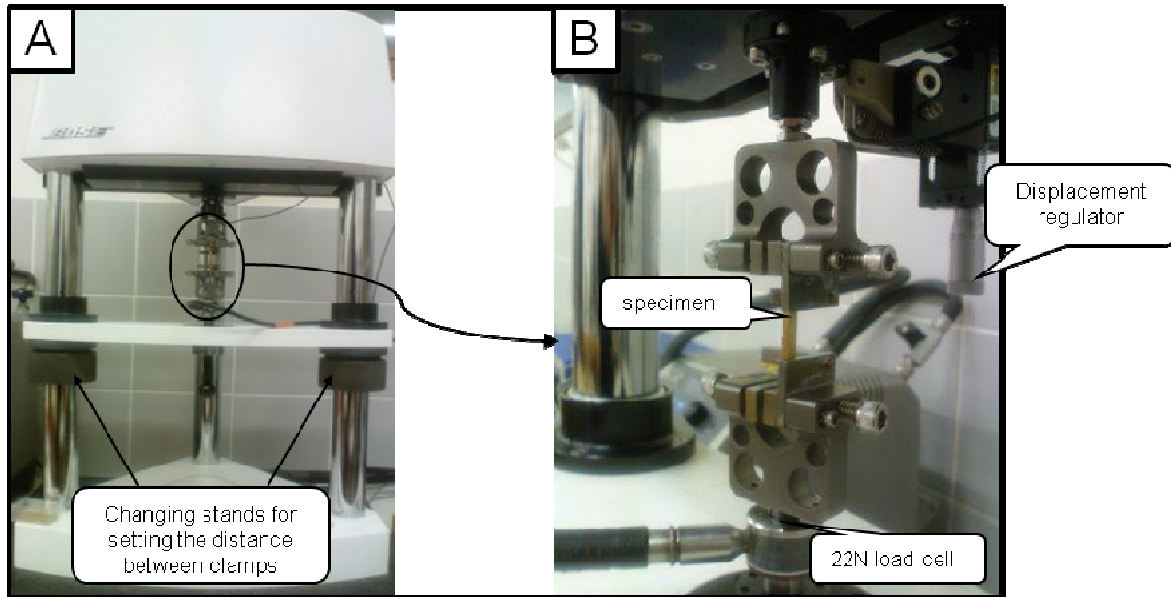

Fig.3.19. DMA machine (A ) and a close look to the fixation of the specimen between the clamps (B).

➤ **Correcting  $E$  and  $\tan\delta$  for rigidity of the instrument**

When using DMA machine in tension for rather rigid specimens (especially L specimens in our case), it is unavoidable that a part of the clamps is pulled along with the sample, meaning that some movement is allowed by the flexibility of the machine. For that, both  $E$  and  $\tan\delta$  must be corrected for the machine rigidity.

Strain/stress relationship for the material is explained more conveniently using the complex compliance  $J^*=1/E^*$ :

$$\varepsilon^*=J^*\sigma^* \quad (3-12)$$

The complex modulus is written:

$$E^* = E' + iE'' = E'(1 + i \tan \delta) \quad (3-13),$$

where:

$$\tan \delta = \frac{E''}{E'} \quad (3-14)$$

so that we have:

$$J^* = \frac{1}{E^*} = \frac{1}{E' + iE''} = \frac{E' - iE''}{E'^2 + iE''^2} = \frac{E'}{E''} \left( \frac{1 - i \tan \delta}{1 + i \tan^2 \delta} \right) \quad (3-15)$$

and  $J^*$  can be written as:  $J^* = J' - iJ''$  where:

$$J' = \frac{1}{E'} \times \left( \frac{1}{1 + \tan^2 \delta} \right) \quad (3-16)$$

$$J'' = \frac{\tan \delta}{E'} \times \left( \frac{1}{1 + \tan^2 \delta} \right) \quad (3-17)$$

$$\frac{J''}{J'} = \tan \delta \quad (3-18)$$

When we measure vibration properties on the machine, we in fact measure an apparent compliance:  $J_a^*$ . Let  $J_0^* = J_0$  be the compliance of the machine, assumed elastic. As it is placed in series with the material.

$$J_a^* = J^* + J_0 \quad (3-19)$$

so that

$$J^* = J_a^* - J_0 \leftrightarrow \begin{bmatrix} J' = J'_a - J_0 \\ J'' = J''_a \end{bmatrix} \quad (3-20)$$

For the modulus we have:

$$\frac{1}{E'} = \frac{1}{E'_a} - \frac{1}{E_0} = \frac{E_0 - E'_a}{E'_a E_0} \quad (3-21)$$

Using the equations (3-23), we can rewrite  $\tan \delta$  as below:

$$\tan \delta = \frac{J''}{J'} = \frac{J''_a}{J'_a - J_0} = \frac{J''_a}{J'_a} \times \frac{1}{1 - \frac{J_0}{J'_a}} = \frac{J''_a}{J'_a} \times \frac{J'_a}{J_0} \times \frac{1}{\frac{J'_a}{J_0} - 1} \quad (3-22)$$

Then, using  $J_0 = \frac{1}{E_0}$ ,  $J'_a = \frac{1}{E'_a}$ ,  $\tan \delta_a = \frac{J''_a}{J'_a}$ , we obtain:

$$E' = E'_a \times \left( \frac{E_0}{E_0 - E'_a} \right) \quad (3-23)$$

$$\tan \delta = \tan \delta_a \times \frac{1}{1 - \frac{E'_a}{E_0} \times (1 + \tan^2 \delta_a)} \quad (3-24)$$

$E_0$  can be calculated as:

$$E_0 = \frac{KL}{S} \quad (3-25)$$

where

$K$ : rigidity of the apparatus (1785 N/mm<sup>2</sup> for the rigidity imposed by the load cell of 22N, the rigidity of the whole machine is not taken in to account as it is much greater than that of the sample and the load cell)

$L$ : length of the specimen (mm)

$S$ : transverse section of the specimen (mm<sup>2</sup>)

Once corrected, it appears that  $\tan\delta_L$  was underrated  $\approx 1.5$  times less than the actual value (in other words:  $\tan\delta_L = \tan\delta_{L(\text{apparent})} \times 1.5$ ). The ratio was 1.2 for  $\tan\delta_R$  and  $\tan\delta_T$ .  $E^*$  and  $E'$  were both underrated by 2.8~3.6 GPa. This value was 29-59 MPa for  $E''$ .

### 3-2-3- Corrections

Two types of corrections are applied to the raw data:

- Recognized errors: these errors are already known when the tests are performed.
- Those figured out once tests are done, e.g. by encountering unreasonable or out-of-range values: a source of error is identified and consequently corrected.

While the first type of corrections is easy to be made – as the source of error is already known and the corrections are generally clear-, the second ones are difficult to figure out. They originate from a wide range of factors, from remaining water due to imperfect drying, residual solvent and even the effect of additional glue. In the following part, the source of errors and their respective applied correction is explained in details.

The corrections must be applied to the data obtained in native and treated states.

#### 3-2-3.a. Corrections for removed extractives

Throughout the extractions, the anhydrous mass of the specimens is reduced. As a result, both EMC and  $E'/\rho$  of the treated specimens is miscalculated: the amplitude of error depends directly on the removed extractives percentage and to a lesser degree to their place in cell wall/lumen. Therefore, both values will be corrected to be transformed into actual values:

For specific modulus:

$$\frac{E'}{\rho_c} = \frac{E'}{\rho_{NC}} \times \left[ \frac{D}{D_M} \right] \quad (3-26)$$

where:

$\frac{E'}{\rho_c}$  = Corrected value for specific modulus (GPa)

$\frac{E'}{\rho_{NC}}$  = Calculated value for specific modulus based on uncorrected specific gravity (GPa)

$D$  = Specific gravity of the specimen

$D_M$  = specific gravity of the specimens after the most effective extraction\*

For correcting EMC for specimens in their native state (before extraction):

$$MC_{\text{nat/corrected}} = MC_{\text{nat}}(1 - ex_m) \quad (3-27)$$

The correction of EMC after each extraction was done according to the equation (3-28):

$$MC_{\text{ext/corrected}} = MC_{\text{ext}}[1 - (ex_m - ex_{sa})] \quad (3-28)$$

where;

$MC_{\text{nat}}$  = MC in native state

$MC_{\text{ext}}$  = MC after extraction

$ex_m$  = amount of extractives removed by the most effective solvent\*

$ex_{sa}$  = weight loss of the concerned sample due to extraction

\* The most effective solvent-considering its yield of extraction- in this study was Methanol.

For traditional treatments (chapter 5), the results of most efficient duration of treatment was used.

### **3-2-3.b. Un predetermined corrections: EMC, remaining solvent, glue**

This part consists of corrections that we did not first think of. Incoherent results, bizarre data points, or unjustifiable changes, all pointed to unknown problems.

Tracing these problems was a bit more complicated than the first ones. As the error source or its nature was unknown, the correction was based on a hypothesis about what could have an effect on that specific “seeming-to-be-wrong” value and continued from there. By re-doing some of the tests, introducing new specimens for old treatments and several new additional experiments, it was eventually possible to either calculate fixed correction factors or re-calculate values to get to corrected ones.

#### **➤ Correcting the weight for quasi-anhydrous drying**

The general protocol of our tests consisted of submitting the specimens to a quasi-anhydrous drying at 60°C. This was specially done in favor of specimens submitted to successive extractions, as a repeated 103°C drying could put some risks on the testability of specimens by the vibrational method.

The correction was done, by re-drying all the control samples (both vibrational and shrinkage) once again for 48 hrs in 60°C, one year after finishing all the tests. Note that, during the passing year, all specimens were kept in a climatic chamber and consequently were fully stabilized. By measuring weight and dimensions of these re-dried samples and by comparing them to the last year's obtained values a correction factor was calculated. The idea was that during the time, those samples went through cyclic dryings and stabilizations, either because of the inadequacy of stabilization time and/or quasi-complete drying, the residual water have contributed to specimen's weight gain. Therefore, the apparent weight loss/gain of treated specimens should be corrected for that.

$$C_{mc} (\%) = \frac{W_{fd} - W_{pyd}}{W_{pyd}} \times 100 \quad (3-29)$$

$C_{mc}$ : correction factor for MC

$W_{fd}$ : weight (g) after final quasi-complete drying (60°C/48 hrs, one year after ending the tests)

$W_{pyd}$ : weight (g) after last drying in the past year (60°C/48 hrs).

After comparing mean values of shrinkage and vibrational specimens,  $C_{mc}$  was calculated as [0.03%± 0.01%], by which, the apparent measured weight is corrected as below:

$$W_{corrected} = W_{apparent} \times (1 - 0.0003) \quad (3-30)$$

Note that as the weight was measured to two decimal significance, this correction did not bring important changes to the measured values.

➤ **Correction for the stuck (remaining) solvent (cases of D and AC)**

After each extraction specimens were carefully dried according to the protocol. The time/duration of this drying should theoretically be enough to evaporate all the solvents. Especially in the cases of solvents with high evaporation potentials (i.e. Acetone), the probability of solvent's presence after sufficient amount of time is really small. That being said, Mulberry's specimens proved to behave differently in this matter.

❖ **Dichloromethane**

Considering the specimens treated by D, a weight gain was observed in all the specimens (vibrational and shrinkage) after the extraction. The actual presence of removed extracts (even though in little amounts) put even more doubts on the weight gain. This led us to perform an additional test\* which could confirm the presence of a remaining solvent causing the weight gain.

✓ ***Rinsing under pressure***

Rinsing was done strictly on vibrational specimens treated independently (only) with D.

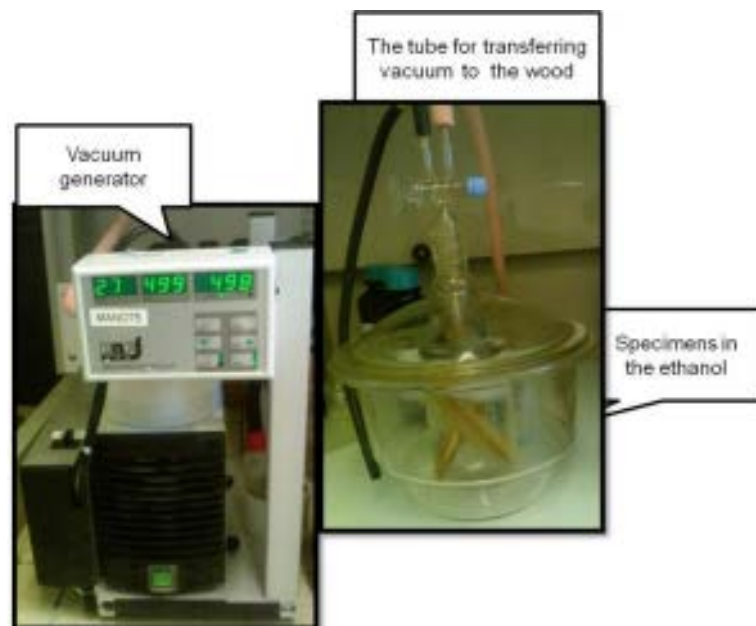

Fig.3.20. The equipments for rinsing the specimens

✓ *treatment protocol*

Putting the samples in cold ethanol (technical grade) for 30 minutes.

Transferring the saturated samples under vacuum (50 -15KPa) for 30 minutes. (As under the vacuum, ethanol's boiling point would be reduced, reducing the pressure down to less than 10 KPa should be avoided).

At least two repetitions of the previous phase, with ethanol changed at the end of each vacuum.

Doing the same rinsing as above, this time with water, for at least 3 times. (50-5 KPa).

Drying the samples: first in humid papers, then for 3-5 days in a climatic chamber and finally 48 hrs in 60°C in an oven.

✓ *Calculation*

Having the basic dried mass of the specimens before any extraction and the mass after extraction and rinsing treatment, it was possible to calculate the actual mass loss of dichloromethane treated samples:

$$WL_{act} (\%) = \frac{W_{rins} - W_0}{W_0} \times 100 \quad (3-31)$$

Note that the apparent weight loss ( $WL_{apparent}$ ) was based on the dried weight after the treatment without any rinsing.

Rinsing with ethanol and water helped removing any small amount of solvent remaining in the voids or not completely evaporated by first drying.

❖ Acetone

One set of vibrational specimens treated with acetone showed an abnormally small WL which was not compatible with what had been observed on the powder and shrinkage specimens. One year after the first drying, a second drying in the same conditions (60°C/48 hrs) was done on the controversial samples. The aim was that to see if WL after one year of stabilization is different from WL measured instantly after the extraction. This way, the possible remains could finally come out and the actual WL after acetone treatment was calculated.

After the second drying the average WL of vibrational specimens after acetone was corrected as:

$$WL_{app}: 0.03\% \rightarrow WL_{act}: 3.07\%$$

➤ **Correction for systematic additional weight of the glue**

The problem with glue rose once the results of the controls were analysed. Considering the fact that controls were never treated for anything, their weight could not be abruptly changing. The small variations in weight are expected (and accepted) as signs of humidity alterations, which after a while should come back to normal. However, a systematic weight gain was observed in the control specimens of vibrational tests, which sometimes reached 2% of their dry weight. As similar weight gain was not observed in shrinkage specimens, and as the effect was limited to vibrational ones, the cause should be coming from an additional factor that was strictly used in the second ones.

Looking at the protocol of free-free flexural vibration test, the addition of cyanoacrylate glue to the specimens was specified as one of the primary steps for sample preparation. This additional glue would add a negligible amount to the sample's original weight. However, in the case of controls, the specimens were dried, stabilized and tested 6 times. This means 6 times of the small glue drops on the same specimens, which eventually could not be neglected anymore.

For estimating how much of the additional weight of specimens comes from the glue, a new set of controls in course of drying have been tested. The specimens were already tested twice for their vibrational properties. The glue on the specimens is carefully scraped using a scalpel, avoiding cautiously not to remove fibers from the surface of the specimen. They are then re-dried based on the protocol and re-measured for their weight. Percentage of weight gain due to the glue is calculated as:

$$WG_g (\%) = \frac{W_g - W_{scr}}{W_g} \times 100 \quad (3-32)$$

$WG_g$ = weight gain coming from the glue (%)<sup>1</sup>,  $W_g$ = dry weight of specimen without scraping the glue (g),  $W_{scr}$ = dry weight of specimen after scraping the glue (g)

---

<sup>1</sup> The calculated weight gain came from two-times glue additions.  $WG_g$  was divided by two for reaching the weight gain of one-time glue addition. The number of vibrational tests the specimens went through was multiplied by the correction factor to correct their corresponding weight.

### **3-2-4- Missing data**

Two situations made data unavailable:

Specimens submitted to long time water treatments were not tested by BING method. The decision of using BING as a comparative method was made after specimens were put in the water-filled containers. Controls, however, were tested by BING method, as they were just submitted to physical conditioning.

The BING test was also missed between dichloromethane (D) and acetone treatments (AC) for first set of specimens going through successive extraction. As missing test was discovered after the specimens were already treated by acetone, the situation could not be reversed. Nevertheless, another set of specimens have been selected and added to go through the same treatment/tests (see Annex C).



## 4. Physico-mechanical properties of untreated white Mulberry

---

### ➤ General view

In this part, we will mainly discuss about properties measured on specimens in their native state in order to reach two main objectives:

- Reporting the values of several physico-mechanical factors of un-treated white Mulberry.
- Investigating if relations between different factors, already reported for other timbers (e.g. that reported between  $\tan\delta$  and  $E'/\rho$  by Ono and Norimoto 1983, 1984), also apply to white Mulberry.
- The correlations between EMC, specific gravity, damping and specific modulus will serve not only as reference for later treatments but also to define the characters of wood in its native state. Furthermore, before starting the treatments, specimens should be classified in equivalent groups based on the distribution of those descriptive properties. This is necessary for insuring that homogenous subsets are going to be submitted to each treatment. This requires for the first results of vibrational tests to be thoroughly analyzed.

In addition to the points mentioned, this study was based on raw material of 3 batches (from 2 trees), which were supposed to have the same properties. Having said that, being of different origins and exposed to different stabilizing durations, some of the properties varied from batch to batch. For that, differences and similarities between specimens of 3 batches are also going to be presented. For a better comparison, some results of a previous study (Se Golpayegani 2007, Pourtahmasi and Se Golpayegani 2008) on white Mulberry from different regions in Iran have also been included.

## 4-1- Presentation of raw data and correlations

As a first approach, physical and vibrational properties measured for vibrational specimens are presented in Table 4.1. The data presented belong only to vibrational specimens: those from DMA or shrinkage specimens are not included.

Table 4.1. Raw values for physical and vibrational properties of vibrational specimens.

Batch/property	Batch 1 (N: 180)	Batch 2 (N: 12)	Batch 3 (N: 27)	All batches (N: 219)
$\rho_{\text{stab}}$	0.56 ± 0.03	0.51 ± 0.01	0.53 ± 0.05	0.55 ± 0.03
MC (%)	6.61 ± 0.48	5.42 ± 0.11	6.73 ± 0.54	6.56 ± 0.56
tan $\delta$ bandwidth (%)	0.86 ± 0.08	0.82 ± 0.05	0.84 ± 0.09	0.85 ± 0.08
tan $\delta$ decrement (%)	0.82 ± 0.10	0.71 ± 0.08	0.83 ± 0.10	0.82 ± 0.10
tan $\delta$ Bing (%)	0.84 ± 0.12	0.83 ± 0.09	0.78 ± 0.09	0.83 ± 0.12
$E'$ (GPa)	7.69 ± 0.98	6.69 ± 0.72	8.18 ± 1.70	7.69 ± 1.11
$E'/\rho$ (GPa)	13.71 ± 1.34	13.12 ± 1.25	15.17 ± 2.09	13.85 ± 1.52
$E'/\rho_{\text{Bing}}$ (GPa)	13.52 ± 1.66	11.94 ± 1.22	15.93 ± 2.86	13.62 ± 1.96
$E''/\rho$ (GPa)	0.12 ± 0.01	0.11 ± 0.01	0.12 ± 0.01	0.12 ± 0.01
$S_{\text{Vol}}$ (%)	3.63 ± 0.81	2.19 ± 0.50	5.32 ± 1.55	3.76 ± 1.14
$\alpha_{\text{Vol}}$ (%/%)	0.55 ± 0.12	0.40 ± 0.09	0.80 ± 0.26	0.57 ± 0.17

Note.  $\rho_{\text{stab}}$ : stabilized specific gravity at 20°C ± 2 and 65% ± 5 RH, MC: moisture content,  $E'$ : modulus,  $E'/\rho$ : specific modulus,  $E''/\rho$ : specific loss modulus,  $S_{\text{Vol}}$ : volumetric swelling (between anhydrous and stabilized) and  $\alpha_{\text{Vol}}$ :  $S_{\text{Vol}}/\text{MC}$ , coefficient of volumetric swelling. The results are presented as average ± standard deviation.

These values, though descriptive elements themselves, do not give a thorough understanding of the species. Moreover, it is not clear whether or not the differences between batches are significant, and if yes, whether those variations affect the way different factors interact in each batch.

It is known that mechanical properties of wood are linked with several physical features including specific gravity, moisture content, and partial shrinkage/swelling (Haines 2000, Bucur 2006, Gachet and Guitard 2006). The existence (or absence) of strong relations between these factors can help for a better comprehension of the raw material.

The correlations between several physical and mechanical (including vibrational) properties are presented in Table 4.2. Note that physical measurements were done on none-normalized samples, and thus lacked accuracy, but this was indispensable to relate vibrational and physical properties of the same sample.

Table 4.2. the correlations between the physical and vibrational properties (Native state/all batches), indicators are as in Table 4.1. \*: significant at  $\alpha$ : 0.05, \*\*: significant at  $\alpha$ : 0.01.

N:219	$\rho_{stab}$	$E'$ (GPa)	$E'/\rho$ (GPa)	$\tan\delta$	$E''/\rho$	MC(%)	$S_L$ (%)	$S_{Vol}$ (%)	$\alpha_L$ (%/%)	$\alpha_{Vol}$ (%/%)
$\rho_{stab}$	1	0.75**	0.42**	0	0.44**	0.47**	-0.1	-0.01	-0.06	-0.11
$E'$ (Gpa)		1	0.91**	-0.34**	0.57**	0.28**	-0.14*	0.11	-0.05	0.05
$E'/\rho$ (Gpa)			1	-0.49**	0.56**	0.19**	-0.14*	0.12	-0.05	0.08
$\tan\delta$				1	0.4**	0.1	0.15*	0.04	-0.02	0.02
$E''/\rho$					1	0.26**	-0.03	0.15*	-0.06	0.09
MC(%)						1	0.13	0.35**	-0.01	0.13
$S_L$ (%)							1	0.19**	0.31**	0.18*
$S_{Vol}$ (%)								1	0.2**	0.96**
$\alpha_L$ (%/%)									1	0.22**
$\alpha_{Vol}$ (%/%)										1

Table 4.2 suggests that several properties are related. Some of those correlations are expected ( $\rho_{stab}$  with  $E'$  and  $E'/\rho$ ,  $\tan\delta$  with  $E'/\rho$ ). Surprisingly,  $\rho_{stab}$  and  $S_{Vol}$ , known to have a significant correlation are showing none. As our specimens were a mix of 3 batches (and 2 trees), one might suspect that the differences between batches affect the general correlations.

Table 4.3. The correlations between the physical and vibrational properties (Native state/ Batch 1).

N: 180	$\rho_{stab}$	$E'$ (Gpa)	$E'/\rho$ (Gpa)	$\tan\delta$	$E''/\rho$	MC(%)	$S_L$ (%)	$S_{Vol}$ (%)	$\alpha_L$ (%/%)	$\alpha_{Vol}$ (%/%)
$\rho_{stab}$	1	0.72**	0.43**	0.10	0.50**	0.45**	0.03	0.26**	0.05	0.17*
$E'$ (GPa)		1	0.93**	-0.28**	0.60**	0.20**	-0.05	0.18*	0.03	0.14
$E'/\rho$ (GPa)			1	-0.44**	0.52**	0.04	-0.07	0.11	0.02	0.09
$\tan\delta$				1	0.49**	0.14	0.08	-0.00	-0.04	-0.03
$E''/\rho$					1	0.16*	-0.01	0.07	-0.04	0.03
MC(%)						1	0.18*	0.41**	0.04	0.14
$S_L$ (%)							1	0.10	0.29**	0.06
$S_{Vol}$ (%)								1	0.09	0.92**
$\alpha_L$ (%/%)									1	0.09
$\alpha_{Vol}$ (%/%)										1

Table 4.3 shows the correlations of only batch 1, with the highest number of vibrational specimens (180), a few factors become significantly correlated:  $\rho_{stab}$  and  $S_{Vol}$ ,  $\rho_{stab}$  and  $\alpha_{Vol}$ . Notwithstanding the appearance of these new correlations, the already established ones have not got stronger by limiting the specimens to just one batch.

These two tables of correlations show that although the three batches exhibit the same range of vibrational properties, they differ in at least one physical property that affects the obtained correlations for the whole data set. A simple analysis of variance (one-way

ANOVA) between the average values of different factors from three batches evidences the presence of significant differences between three batches (Table 4.4).

Table 4.4. Analysis of variance between the mean values of different physical and vibrational factors obtained from three batches. \* significant at  $\alpha$ : 0.01.

N : 219 Between 3 batches	Sum of Squares	df	Mean Square	F	Sig.*
$\rho_{stab}$	0.033	2	0.017	17.175	0.000
$E'$ (GPa)	12.635	2	6.317	5.971	0.003
$E'/\rho$ (GPa)	52.913	2	26.457	12.662	0.000
$\tan\delta$	0.000	2	0.000	1.643	0.196
$E''/\rho$	.003	2	0.001	9.379	0.000
MC(%)	16.188	2	8.094	35.743	0.000
$S_L$ (%)	0.005	2	0.003	.533	0.588
$S_{Vol}$ (%)	92.498	2	46.249	54.389	0.000
$\alpha_L$ (%/%)	1.706	2	0.853	42.211	0.000
$\alpha_{Vol}$ (%/%)	1.706	2	0.853	42.211	0.000

As already speculated from the correlation tables, the differences between the values of three batches are significant in the majority of cases. To look more deeply to these differences and to determine whether or not these variations are related, in the following parts each factor will be studied in association with other related ones, first in an overall view of all specimens and then by differentiating the batches. When available, data from a previous study on white Mulberry (Se Golpayegani 2007) will be also included.

## 4-2- Specific gravity, rigidity, and damping

### 4-2-1- Variations in specific gravity between the batches

Specific gravities of the specimens of different batches are shown in Fig.4.1.

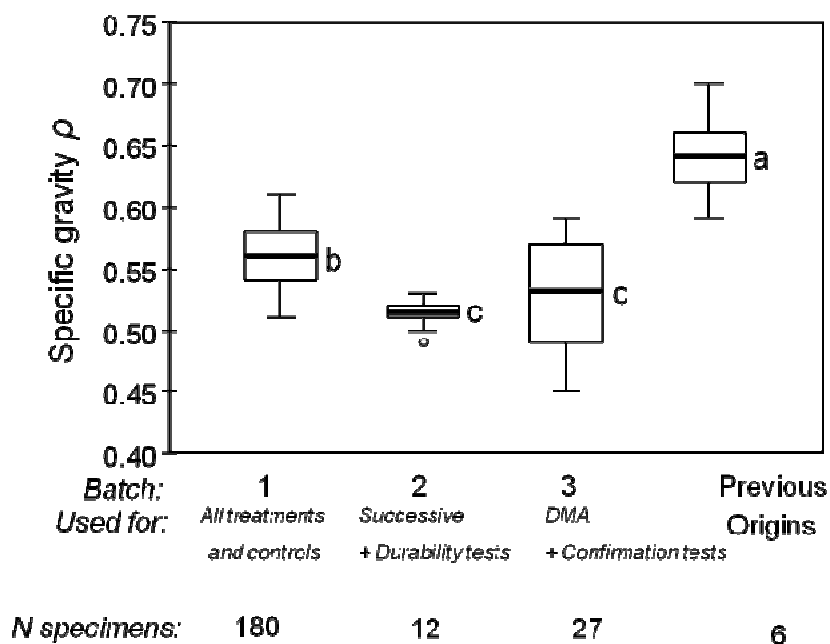

Fig.4.1. Average specific gravity of specimens of the 3 batches used in this study, Data from a previous study (Se Golpayegani 2007) are also included. (a, b, c): significantly different groups based on one-way ANOVA.

The average  $\rho$  of specimens from previous origins is higher than that of present study. This difference can be ascribed to two things: one is that only 6 specimens were studied and secondly, that the used timbers came from two different regions. It should also be noted that only one test (no repetition) was done on each specimen of previous origins.

Between three batches, batch 1 and batch 3 have closer range of specific gravities, even though they come from different trees ( $\approx 0.55$  and  $0.53$  average  $\rho$  for batches 1 and 3 respectively). Batch 3 exhibits a range of  $0.45$  to  $0.59$   $\text{g/cm}^3$  in its  $\rho$  and includes the lowest value. Average specific gravity of batch 2, although from the same tree as batch 1, is significantly lower.

Although the different batches exhibit different average  $\rho$ , they stay in a close range. Moreover, these differences do not have a real effect on vibrational properties. (§4-2-2).

#### 4-2-2- Relationship between damping and specific modulus

The relationship between damping ( $\tan\delta$ ) and specific modulus ( $E'/\rho$ ) can be used to describe wood ability for musical purposes. As  $E'/\rho$  can be easily measured in different species, and by considering a fact that a reference relation has already been established between  $\tan\delta$  and  $E'/\rho$  (Ono and Norimoto 1983, 1984), their relationship has been commonly used in different studies (Brémaud 2006, 2010b, 2011).

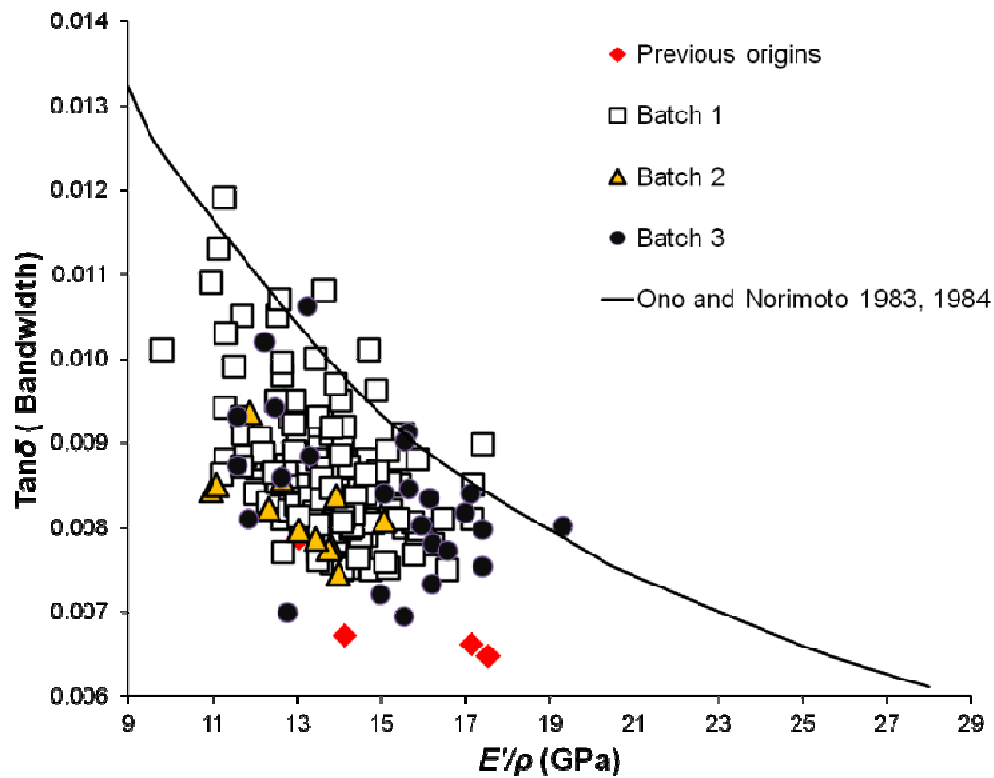

Fig.4.2. the relationship between  $\tan\delta$  (damping factor by bandwidth from forced vibration/LMGC method) and  $E'/\rho$  for native wood (N°:207), data from previous study (Se Golpayegani 2007) is also included. Standard curve is added from (Ono and Norimoto 1983, 1984).

Fig.4.2 shows the relationship between damping factor and  $E'/\rho$  for all the vibrational specimens measured in this study (outliers were excluded). With a first brief look at the figure, it is clear that apart from a few one, Mulberry specimens stay below the reference curve and even in some cases (batches 2/3 and the specimens from previous origins); they occupy the lowest range below the curve.

Specimens from previous origins (Se Golpayegani 2007) have a low damping, which is quite distinctive even by comparing to the generally low damping of other specimens. In any case, even those specimens still stay within the same low damping range as the currently tested samples.

Specific moduli measured by BING (calculated by Timoshenko method) are higher than those calculated by Bernoulli method (Fig.4.3.a and b), this however does not change the trend in  $\tan\delta$  and  $E'/\rho$  relationship and it still stays in the lower range.

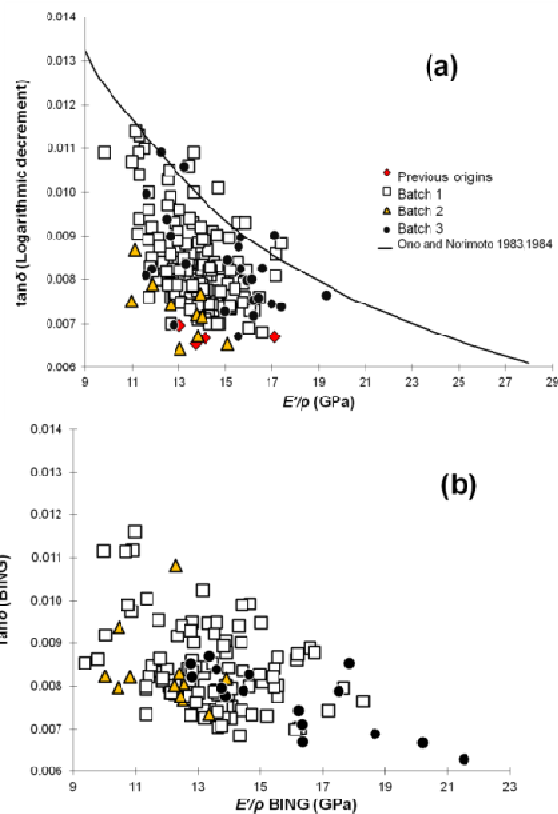

Fig.4.3. relationship between  $\tan\delta$  by logarithmic decrement (a) and  $\tan\delta$  by BING (b) method and their corresponding  $E'/\rho$ , note that BING test was not done for all the specimens and thus, the number of specimens is lower ( $N^\circ$ : 143).

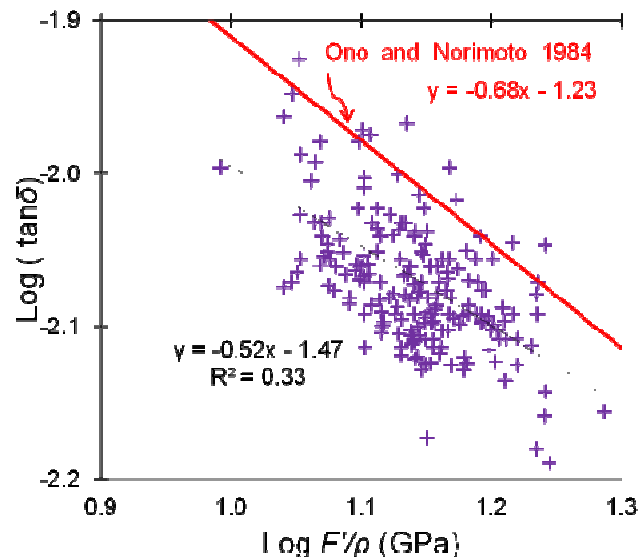

Fig.4.4. Relationship between logarithm of ratio of  $\tan\delta/E'/\rho$  and logarithm of  $E'/\rho$  for ensemble the specimens ( $N^\circ= 207$ ). The curve in red is added from Ono and Norimoto (1984).

The relationship between  $\tan\delta$  and  $E'/\rho$  for all the Mulberry specimens can be described as:  $\log(\tan\delta) = -0.52(\log E'/\rho) + 3.64$  (where  $E'/\rho$  is in  $\text{GPa}^1$ ). This result is compatible with what was reported by Ono and Norimoto (1984) where they reported:  $\log(\tan\delta) = -$

<sup>1</sup>. The values for maximum and minimum slopes are -0.41 and -0.62 respectively.

$0.68 (\log E'/\rho) + 4.86$  for 30 hardwoods. Brémaud in 2006 has also reported  $\log (\tan\delta) = -0.68 (\log E'/\rho) + 4.89$  for 30 hardwood (temperate and tropical).

Using the logarithmic relationship decreases the dispersion (Fig.4.4) and exposes a strong linear relationship between the two factors. For comparing the effect of treatments, however, the natural values will be used, as they would help highlighting the variations resulted from the treatments.

#### 4-2-3- Specific loss modulus ( $E''/\rho$ )

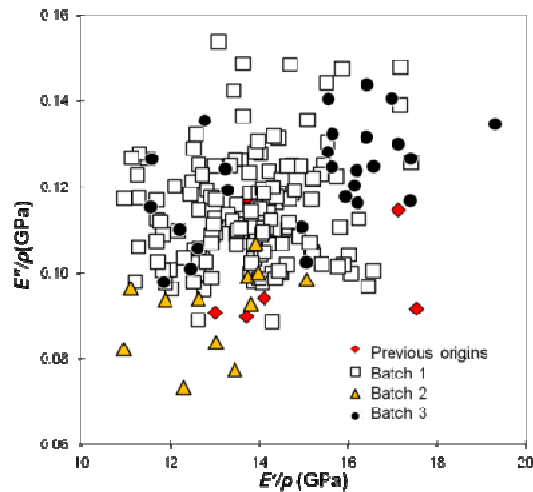

Fig.4.5.  $E''/\rho$  (Specific loss modulus) and  $E'/\rho$  (specific modulus) relationship for all the specimens, different batches are separated by colors and shapes.

Fig.4.5 shows the relation between the imaginary part ( $E''/\rho$ ) and the real part ( $E'/\rho$ ) of the modulus, for all specimens, distinguishing the batches.  $E'/\rho$  and  $E''/\rho$  do not exhibit a strong correlation. Generally,  $E'/\rho$  can be considered as an indicator of element orientation (MFA for example) in wood while  $E''/\rho$  relate more to the constituents of wood cell wall, primary as well as secondary (Knowles et al. 2004, Donaldson 2008, Lachenbruch et al. 2010). The high dispersion along with a weak regression ratio ( $R^2=0.13$ ) may point to the fact that vibrational properties are more governed by chemical constituents of the cell wall (extractives maybe?) than microfibrillar orientation.

However, as will be analyzed later, the variations in secondary constituents (extractives in particular as a focusing point in this study) were rare to nonexistent between three batches<sup>1</sup>. This was a desirable fact for us, as we wanted our specimens' properties from three batches to be as identical as possible, but at the same time, it made it rather difficult to draw a sharp conclusion from Fig.4.5. Consequently, this information can only be a probable indicator of white Mulberry vibrational properties being controlled by cell wall chemical composition.

<sup>1</sup>See Chapter 6, on the extraction yield of specimens. Specimens for independent extractions (from batch 1), those submitted to successive extractions (from batch 2) and specimens of DMA (from batch 3); all had approximately the same yield of extraction.



#### 4-2-4- Rigidity and specific gravity

Fig.4.6 and 4.7 presents the relationship between  $E'$  and  $E'/\rho$ , respectively, and  $\rho_{stab}$ .

Looking at Fig.4.6, it can be seen that all three batches (and specimens from previous origins) show a reliable correlation between their  $\rho$  and their  $E'$ .

One could estimate that having different specific gravities as shown in §4-2-1, our three batches would behave differently regarding their moduli.  $E'/\rho$  is known to be quite independent from specific gravity and to be dependent basically on  $E'$  (Armstrong et al. 1977, Green et al. 1999). Agreeing with the precedent statement, globally a weak relation between  $E'/\rho$  and  $\rho_{stab}$  is evidenced in Fig.4.7. On the other hand, when different batches are separated, apart from batch 2, they show apparent correlations.

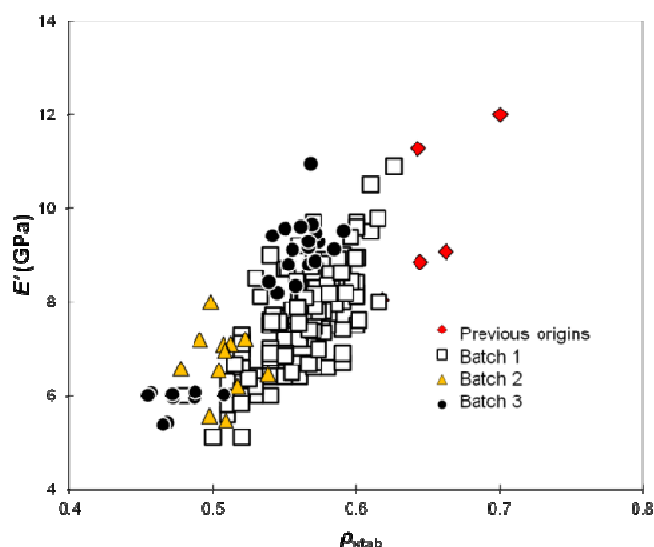

Fig.4.6. Modulus ( $E'$ ) and stabilized specific gravity ( $\rho$ ) for 3 batches of this study, specimens from previous study are also included.

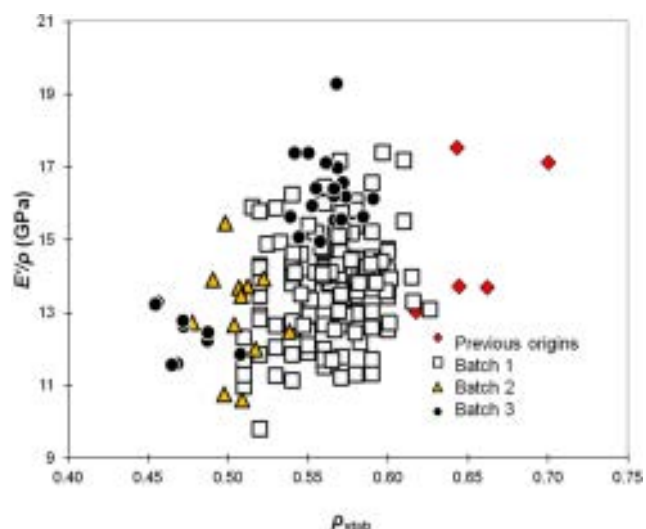

Fig.4.7. Relationship between specific modulus ( $E'/\rho$ ) and  $\rho_{stab}$  (stabilized specific gravity measured after 3 weeks at  $20^{\circ}\text{C} \pm 2$  and  $65\% \text{ HR} \pm 5$ ) for all the specimens ( $N^{\circ}$ : 207).

There are several points which could be drawn out of Fig.4.6 and 4.7:

- Specimens from previous study, having greater specific gravities than current batches ( $\rho_{\text{stab}}=0.64$  in average), are also showing greater  $E'$  and  $E'/\rho$ , which are completely parted from the current batches in case of  $E'$  (Fig.4.6).
- Specimens belonged to the batch 3, are obviously showing two separate groups of  $\rho$  (0.47 and 0.54 g/cm<sup>3</sup> in average for the lower and higher ranges respectively). These two types of  $\rho$  have also their effects on altering  $E'$  and  $E'/\rho$  - lower specific gravities are associated with lower  $E'$  and  $E'/\rho$  and vice versa<sup>1</sup>.
- Second batch, most of its specimens having almost the same  $\rho$  (0.51± 0.01 in average), is not showing any clear trend by relating  $\rho$  and obtained moduli.

In conclusion, even though the dispersion is still high in all the batches, and discard specimens of the batch 2 (which show different  $E'$  while having the same specific gravities), the majority of Mulberry specimens are showing a gradual increasing relationship between their specific gravity and its respective  $E'$ .

### 4-3- EMC and vibrational properties

Several researchers (Akitsu et al. 1993, Obayata et al. 1998, Oliveira et al. 2005, Rowell 2005) previously reported the importance of moisture content of wood in relation with its vibrational properties. Variations in different woods moisture contents can be the cause for dissimilar damping properties. Here, we are going to briefly talk about i) whether or not there is a difference in stabilized MC between different batches and ii) if those possible different MC have any role in varying other physical-vibrational factors obtained from batches.

It should be mentioned that as the specimens are all coming from the same species, and by considering the fact that the hygro-thermal conditioning were always the same, our specimens show almost the same stabilized MC. Where MC is different between the batches, it is due to the intrinsic characters of each batch and not because of any MC-altering imposed condition.

Fig.4.8 presents the general view of MC and  $E'/\rho$  relations in three batches along with the specimens of a previous study.

---

<sup>1</sup>. Differences in some specimens of batch 3 were expected. When sampling for the second time of cyclic drying and stabilization (as a confirmation for the first time) deliberately two visually different kinds of specimens were chosen. Although the specimens were coming from the same batch/tree, some of the specimens had narrower growth rings than the others. As the purpose for that test was to compare the before/after values and not the actual ones, two kinds of specimens were submitted to the treatment: 9 within wider range of growth rings and 8 of narrower ones. Those of narrower growth rings had lower densities and specific moduli while exhibiting higher damping factors. Therefore, what is here manifested as two individual groups inside the batch 3 is natural according the criteria for its corresponding test (for more details § chapter 5- cyclic drying and stabilization).

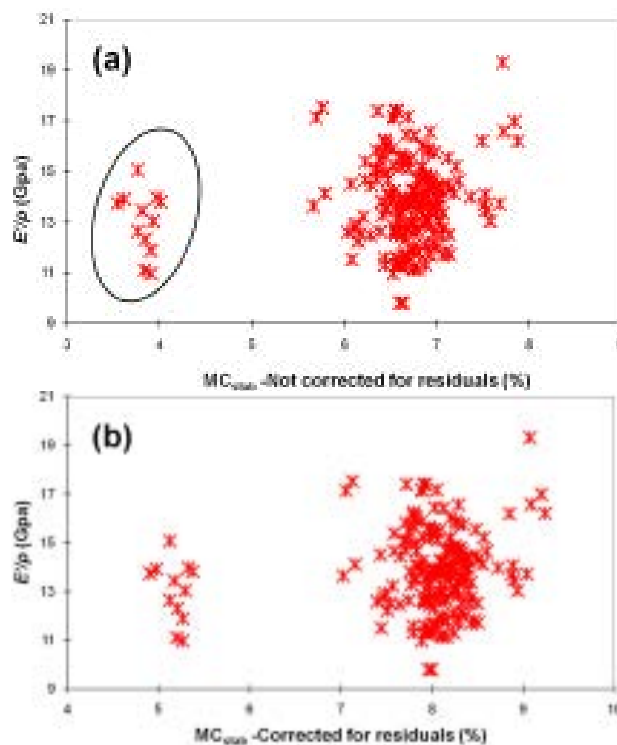

Fig.4.8. Stabilized moisture content ( $MC_{stab}$ ) and specific modulus ( $E'/\rho$ ) relation for all the specimens (N°:207). MC (at 60°C) is not corrected for the residual MC (at 103°C) and (b) MC (at 60°C) is corrected for the residual MC (103°C). The black circle is focusing on abnormal data.

The presented MC in Fig.4.9 is the stabilized one (see chapter 3). Looking at the figures, it is clear that even though the expected nominal MC in the imposed conditions is 12%, our specimens never reach that value. However, it should be noted that stabilized MC is strongly related to each species character and according to CIRAD database species rarely exhibit an exactly 12% MC in those conditions.

This is partly of course due to the quasi-anhydrous drying in 60°C that resulted in lower calculated MC and it is correctable using the correcting factor calculated based on a second perfect drying at 103°C. Then again, even by correcting for the residuals, specimens MC stay below 10% (Fig.4.8.b). Looking again at Fig.4.8.a, a few specimens are clearly parting from the others. These abnormally low amounts of MC are those of the specimens belonged to the batch 2 (Fig.4.9).

As far as the relationship between  $E'/\rho$  and stabilized MC is concerned, our specimens do not show any clear correlation. Even in relation with  $\tan\delta$  (which is known to have more direct connection with MC (Obataya et al. 2001, Havimo 2009), no clear trend could be traced (Fig.4.9).

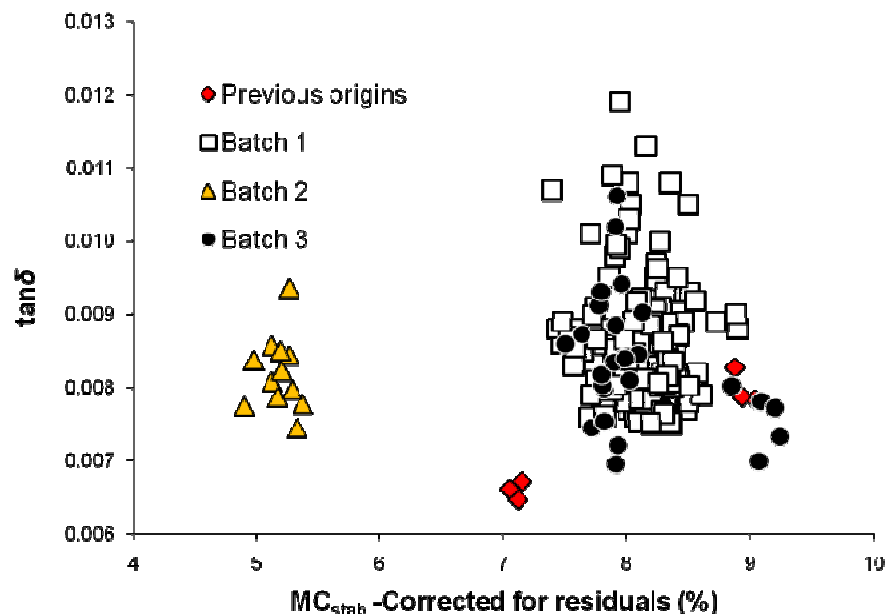

Fig.4.9.  $MC_{stab}$  and  $\tan\delta$  relationship for specimens in their native state (batches separated). MC (60°C) is corrected for the residual MC (103°C).

Majority of the specimens (excluding the specimens from previous origins, batch 2 and 12 outliers: 189 remaining samples to be exact) are exhibiting an average  $MC_{stab}$  of  $6.74\% \pm 0.32$ . The lack of variation in MC is maybe the reason why there is no trend found on  $\tan\delta$  and MC relationship. Having said that, even when few specimens show lower stabilized MC (second batch for example), their corresponding  $\tan\delta$  do not clearly differ from others. This is different in the case of specimens from previous origins (Se Golpayegani 2007). Each group of three specimens, coming from an individual origin, has specifically different  $MC_{stab}$ , which is in direct relationship with their corresponding  $\tan\delta$  (Fig.4.10).

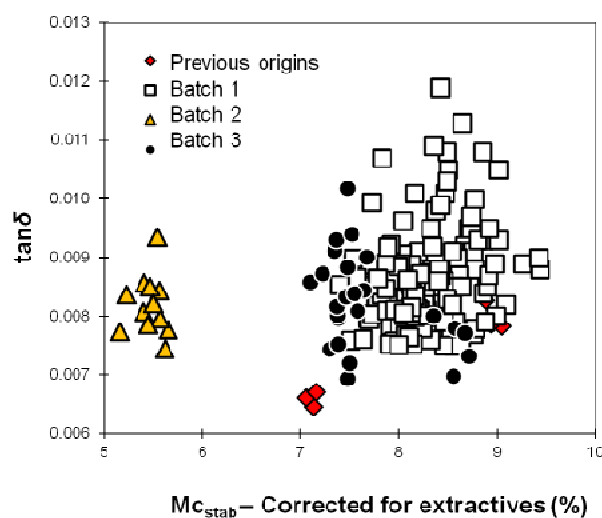

Fig.4.10.  $MC_{stab}$  and  $\tan\delta$  relationship;  $MC_{stab}$  is corrected for the contribution of the extractives.

Several researchers (Demaree and Erickson 1976, Mantanis et al. 1995, Brémaud et al. 2010a) have already reported the effect of extractives on the MC. Depending on their nature and their place in wood matrix, extractives can modify the observed MC. It was reported that the swelling of extracted wood takes place much faster than the un-extracted one (Mantanis et al. 1995), which means that these secondary constituents are contributing to a lower MC in wood.

MC calculation is based on the anhydrous mass, supposing the cell wall is composed only of primary wood constituents, whereas in fact it can be a combination of both primary and secondary (i.e. extractives) ones. If that is the case, then the  $MC_{stab}$  is just the apparent MC (native) and should be corrected for the contribution of extractives (according to equation 3-27, §3-2-3.a).

Once corrected (Fig.4.10), even though  $MC_{stab}$  is increased and the  $\tan\delta/MC$  relation for the first batch becomes slightly stronger, in general the dispersion does not change.

#### 4-4- Different partial swellings in three batches:

When explaining the specific gravity and moduli relationships in the previous part (§4-2-4), one could expect that the difference in  $\rho$  between three batches could result in various swelling coefficients. Moreover, as by limiting the general correlation table (Table 4.2) to the internal relations of the batch 1 (Table 4.3), a connection between  $S_{vol}$  and  $\rho_{stab}$  appears. Thus, the possibility of the batch 3 exhibiting an out-of-range volumetric swelling would be reasonable.

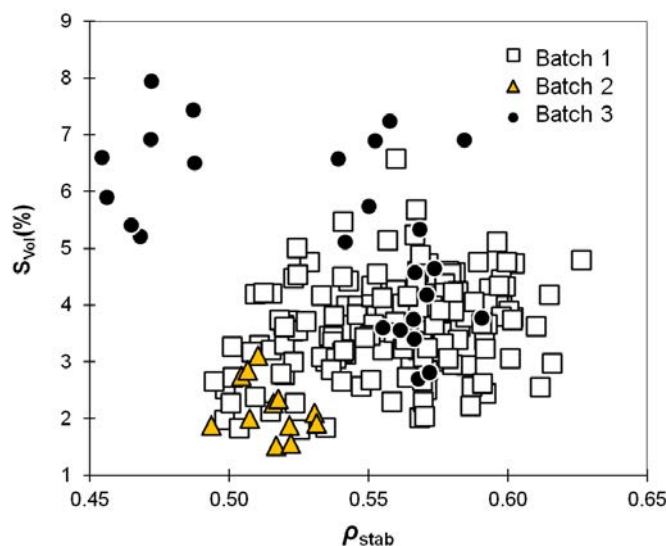

Fig.4.11. Volumetric swelling ( $S_{vol}$ ) and stabilized specific gravity ( $\rho_{stab}$ ) for all the specimens measured in three batches.

By calculating the average volumetric swelling (between anhydrous state and air dried) for all the specimens (N:209, all batches mixed) we come to the value of  $3.76 \pm 1.14$  %. Looking at the Fig.4.11 though, it is clear that there are several specimens which showing an outranged  $S_{vol}$  and therefore, cause a big variation from average. Those values are (as

expected) from 8 specimens of batch 3 with lower specific gravities. If we look at the average  $S_{vol}$  of the batches separately:

Batch 1: [3.63%± 0.81], batch 2: [2.19%±0.50] and batch 3: [5.32%± 1.51],

One can note:

- The average  $S_{vol}$  of all specimens is more representative of the first batch, while the standard deviation is clearly large due to the highest values of batch 3.
- Specimens of the batch 2 are exhibiting the lowest values of  $S_{vol}$ , even so, they still remain in the same range as specimens of first batch (similar for their vibrational properties, §4-2-2).
- Majority of specimens of batch 3 stay in the average range of  $S_{vol}$ , though some are exhibiting the highest values while not having different densities.

Remembering the MC variations between batches (§4-3), it is only reasonable to look again on volumetric swelling, this time by subtracting the effect of different MC. Fig.4.13, shows the relationship between  $\rho_{stab}$  and volumetric swelling coefficient ( $\alpha_{vol} = S_{vol}/MC$  %/%)

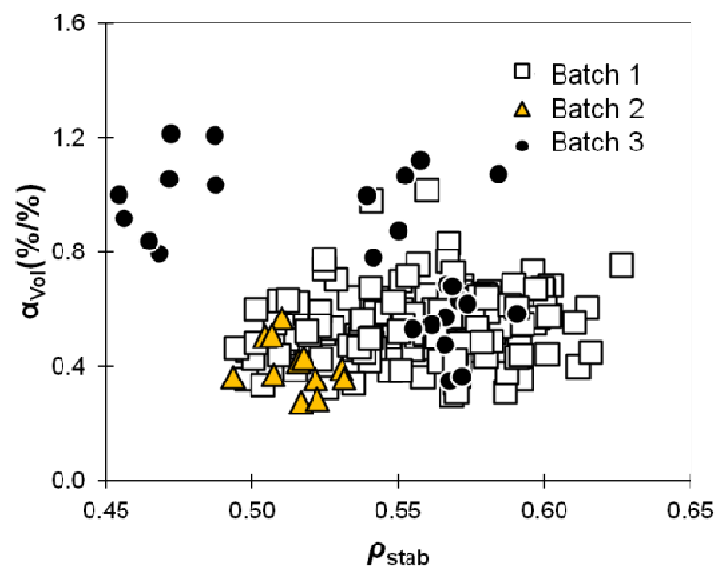

Fig.4.12. Volumetric swelling coefficient ( $\alpha_{vol} = S_{vol}/MC$  %/%) and  $\rho_{stab}$  relationship for three batches.

Once the effect of MC is omitted from the volumetric swellings, specimens from batch 1 and 2 are becoming quite uniform. Specimens of the batch 3 are still far from the other two. It appears that despite being low in MC (Fig.4.9), specimens of batch 2, when exposed to higher humidity, are re-acting the same as those of first one. In the same manner, specimens of the batch 3, having the same MC as those of the first one, exhibit different swelling coefficients. In conclusion, MC variations do not seem to be the reason why our specimens react similarly or differently when swelled.

There are also other factors that play important roles on how a wood would react on its swelling behavior; for instance Micro fibril angle (MFA), amount of primary constituents and percentage of extractives (Skaar 1988). It has been reported that an important MFA would cause a higher shrinkage/swelling in axial direction and simultaneously a lower one in transversal direction (Cave 1972, Armstrong et al. 1977, Cave and Walker 1994). Looking at the values in Table 4.1, the variation in MFA is less plausible, especially when the similarity of moduli between three batches comes to mind. Primary and secondary constituents on the other hand, could be the source of variations in swelling coefficients. A lower specific gravity along with narrower growth rings, which has no apparent effect on EMC and  $E'/\rho$  and only increases the volumetric swelling, could be coming from different quantity and/or quality of constituents. While another chemical treatment was not done on controversial specimens (reminder: specimens for confirming the cyclic drying and stabilization), the other measured aspects indicate no other probable reason for such a result.

#### **4-5- Conclusion on the differences between the 3 batches**

The unexpected additional tests and the unavailability of the raw material left us with no choice other than using three slightly different batches. When the first and second batches were only different for the air-dry duration, the third came from a different tree. Even though close attention was paid to use specimens of each batch for a particular independent test, the results of different batches had to be compared simultaneously. This led us to one question: Could the results of tests- particularly vibration ones- be compared? Even though they may come from testing the specimens that are originated from different batches?

The results gained by testing vibrational specimens can allow us to draw the following conclusion:

- Specific gravities of three batches were different. Batches from different trees were more alike than those of the same one. Differences in  $\rho$  did not seem to be affective when vibrational factors were concerned.
- All three batches stayed in the lower range compared to “reference curve” (Ono and Norimoto 1983, 1984) in  $\tan\delta$  and  $E'/\rho$  relationships. The variations between  $\tan\delta$  of three batches were not significant.
- The positive relationship between  $\rho$  and  $E'$  had been observed in majority of specimens (with the exception of batch 2). Two different ranges of  $\rho$  in the specimens of third batch were related to higher or lower  $E'$ .
- Specimens of batches 1 and 3 exhibited an average MC of  $6.74\% \pm 0.32$  while the 12 specimens of batch 2 showed a lower one. This MC variation had no apparent effect on vibrational or physical properties of the batch 2.
- While the volumetric swelling ( $S_{Vol} \%$ ) for first, second and half of the specimens of the third batch stayed in a close range, the less dense specimens of batch 3 had higher  $S_{Vol}$ . The same phenomenon was also observed in a few other specimens of the batch 3 with in-ranged  $\rho$ .

- As MC variations were not correlated to those of  $S_{Vol}$ , possible variations in secondary constituents could be considered as the reason to this behavior.

In conclusion, despite a few variations in their physical properties, our three batches exhibited quite similar values concerning their vibrational features. As those physical variations could not clearly be correlated to measured acoustical properties, it is acceptable for three batches to be considered the same. To remove any doubts on possible differences between three batches (which could probably alter the results), specimens of each batch were used for individual treatments and they were never mixed. Moreover, having the raw vibrational values of all three batches in one close range, the average value based on all specimens can be used as descriptors for white Mulberry in its native state.

#### 4-6- Anisotropic properties of white Mulberry in its native state

Anisotropy of wood vibrational properties is an important feature for its role in musical instruments. Specimens for DMA test came from the third batch and their dimensions were much smaller than those of vibrational ones.

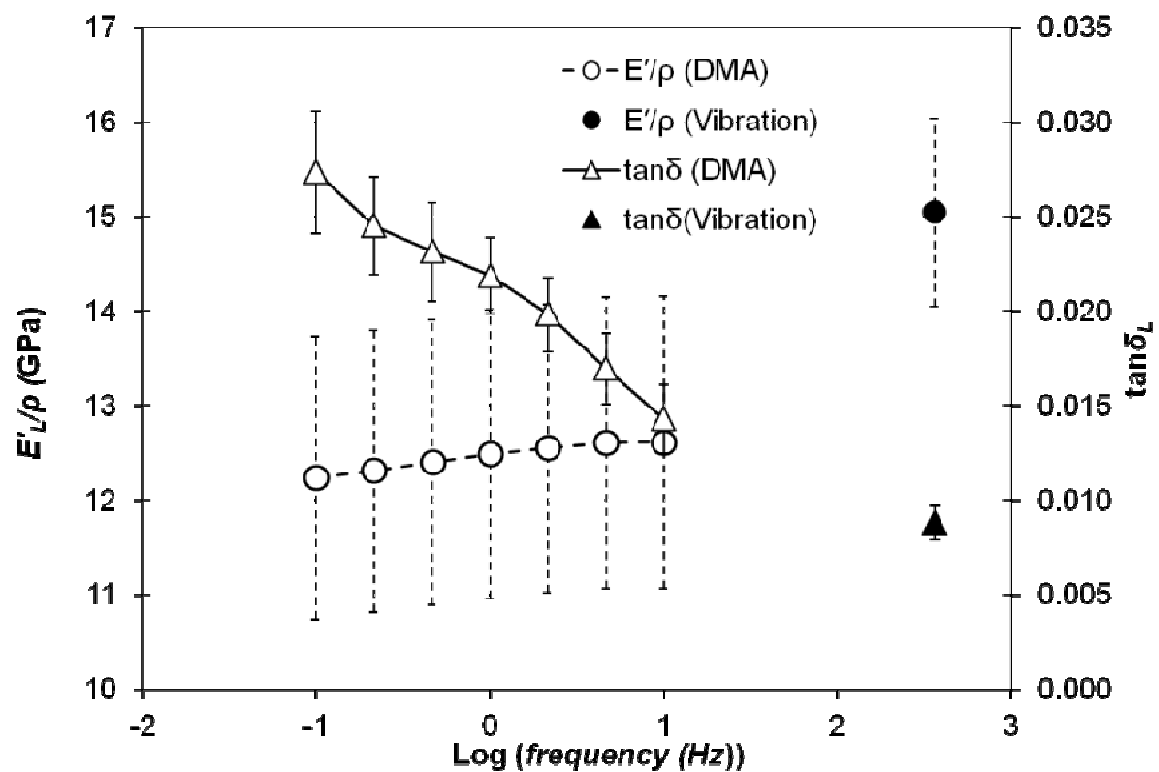

Fig.4.13. Longitudinal  $\tan\delta$  and specific modulus obtained by LMGC vibration method and DMA. For DMA, each point is the average of 14 longitudinally oriented specimens tested 3 times. For vibration, each point represents the average of 27 specimens tested three times. All specimens came from batch 3.

Fig.4.13 is comparing the  $\tan\delta_{L}$  and  $E'_{L}/\rho$  obtained from DMA and LMGC vibration method in function of log frequency. The range of frequency induced in DMA is much lower than that of vibration (0.1 to 10 Hz compared to 360 Hz in vibration). When the



influence of frequency is taken into account and extrapolated to the higher frequency of the vibration test, a good consistency is observed, especially for  $\tan\delta$ .

This range of frequency, even though has little effects on the  $E'$  and  $E''$ , is most definitely negatively related to the obtained  $\tan\delta$ . It is being said that  $\tan\delta$  has its minimum and maximum values in different ranges of frequency (Torgovnikov 1993). James (1975), measured the changes in axial  $\tan\delta$  of two softwoods, when different frequencies, RH and temperature conditions were imposed. He stated that in a stable condition, and in the lower ranges of frequency (lower than 400 Hz),  $\tan\delta$  decreases with the increasing frequency. However, in the higher ranges (more than 1 KHz), the raise in frequency has an increasing effect on the damping. The imposed frequency in our study stays in the lower ranges compared to what was done in the mentioned research, and the results are compatible.

In DMA frequency range, while the same decreasing trend exist between  $\tan\delta_R$  and  $\tan\delta_T$  and imposed frequencies, the ratios are slightly differed.  $\tan\delta_L$  is decreased to its half between the lowest and highest frequencies (0.1 and 10 Hz). The ratios are 1.83 and 1.66 for  $\tan\delta_R$  and  $\tan\delta_T$  respectively (Fig.4.14).

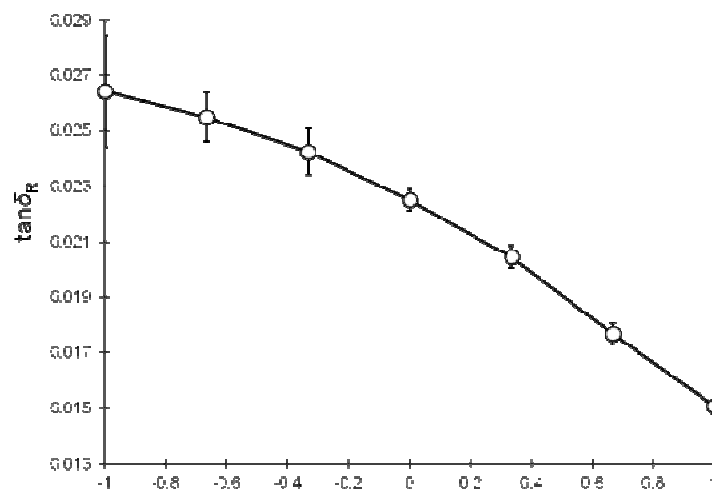

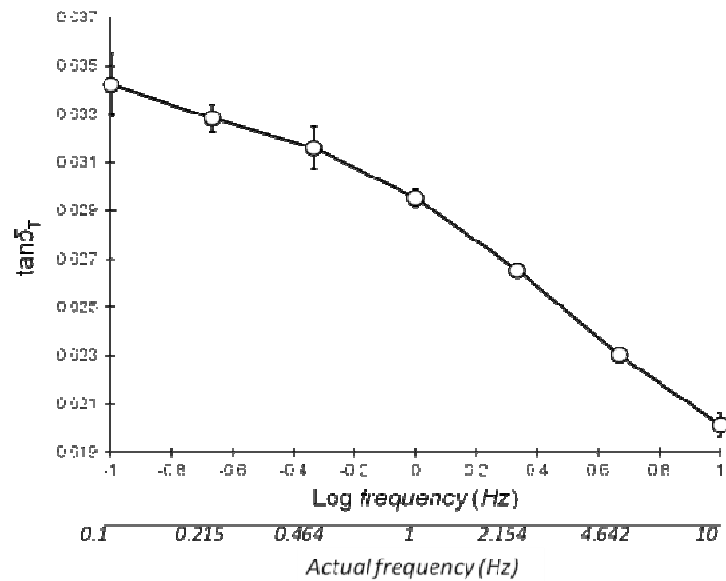

Fig.4.14.Changes in  $\tan\delta_R$  and  $\tan\delta_T$  in function of the frequency. Results of DMA method for 14 samples.

This range of frequency will not be problem when later on effects of treatments are going to be discussed. As far as the moduli are concerned, the change of frequency has little effects, and for the case of  $\tan\delta$ , only the values of same frequencies are going to be compared.

Table 4.5 shows the raw values obtained by DMA method. Both  $\tan\delta$  and the moduli (10 Hz frequency) are corrected for the rigidity of the clamps according to equations §3-26 and 3-27.

Table 4.5. Raw values for factors measured by DMA.  $E^*$ : complex modulus,  $E'$ : Storage modulus,  $E''$ : Loss modulus. All values are those of 10 Hz frequency.  $N^\circ$ : 14 in each direction of orthotropy.

Direction of ortotropy	$E^*$ (GPa)	$E'$ (GPa)	$E''$ (GPa)	$\tan\delta (10^{-3})$
L	7.15± 0.21	7.15± 0.21	0.06± 0.01	1.43±0.18
R	1.72± 0.005*	1.72± 0.005	0.02± 0.005	1.51± 0.07
T	0.92± 0.005	0.92± 0.005	0.02± 0.005	2.01± 0.05

\*The 0.0005 standard deviation is added in case of moduli, as the values were stable through out repetitions.

Ordering of both  $\tan\delta$  and  $E'$  for three principal directions are compatible with what could be found in the literature:  $\tan\delta_T > \tan\delta_R > \tan\delta_L$  and  $E'_L \gg E'_R \geq E'_T$  (Ono and Norimoto 1985, Guitard and El Amri 1987, Narin 2007).

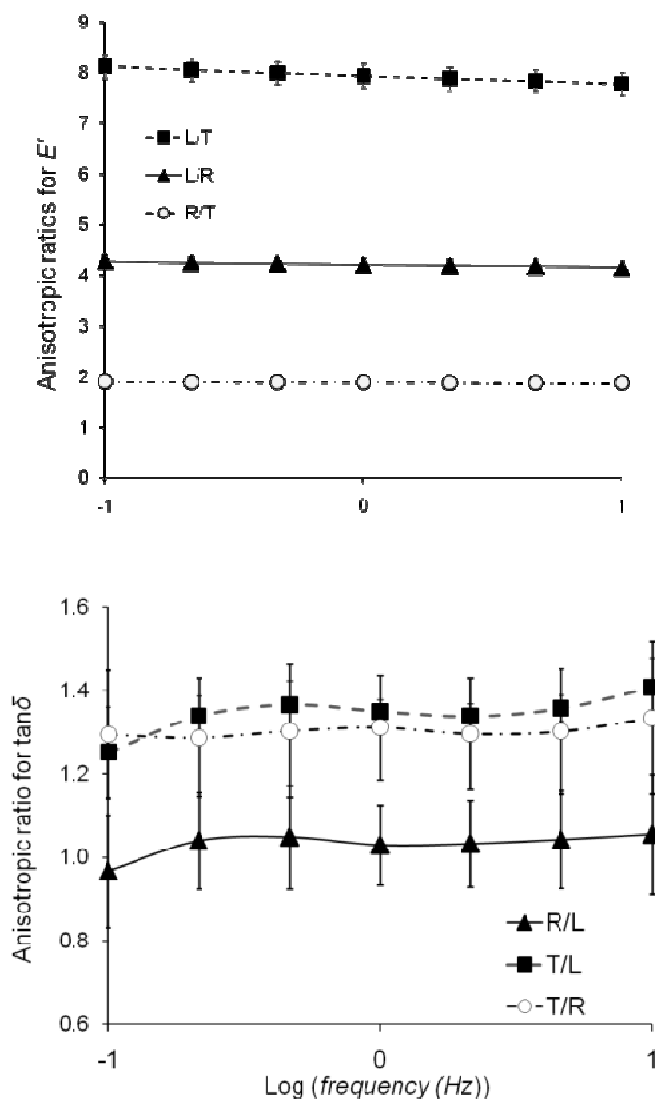

Fig.4.15. anisotropic ratios for  $E'$  (storage modulus (up)) and  $\tan\delta$  (down) between three axes of orthotropy, N°: 14 L, R and T samples (42 in total).

Fig.4.15 shows the anisotropic ratios for  $E'$  and  $\tan\delta$  between three principal axes of orthotropy. Looking at the anisotropic ratios, it can be seen that damping anisotropies between the three main directions are small: R/L and T/R  $\approx$  1.3 and T/L  $\approx$  1 (Fig.4.15 down). These values are lower than those collected from several studies by Brémaud et al. (2010c), in which the average ratios were of 2.7 (R/L), 2.9 (T/L) and 1.14 (T/R) for hardwoods.

Talking about anisotropies of modulus, actual values (L/R  $\approx$  4, L/T  $\approx$  8 and R/T  $\approx$  1.9) are also in the lower range of anisotropy compared with literature reviews (e.g., Guitard and El Amri 1987, Nairn 2007).

## 4-7- Conclusion

To talk about the probable effects of treatments on a wood, one should first be able to describe the non-treated natural specimen (i.e. native state). In these last pages, several physical, as well as vibrational, properties were presented, compared, and discussed. Even

when the three batches were concerned, the changes of values were limited to a small range. As a consequence, we could consider the average value for three batches (Table 4.1) or the average value of the majority of specimens (for  $S_{vol}$  and MC % for example), as the representatives of specific factors for a native white Mulberry wood.

The remarks on the physical and dynamic mechanical properties of white Mulberry could be resumed as below:

- Average specific gravity of white Mulberry (0.55), indicates its moderate  $\rho$ , which is in the lower range of the species known to be used in fabrication of soundboards in European instruments (Wegst 2006).
- The non-corrected MC showed a value of  $\approx 6.6\%$ , and when it was corrected for the contribution of extractives, had reached  $\approx 8\%$ .
- The partial swelling indicated (according to majority of specimens), a moderately stable wood. This however proved to be connected greatly to the stabilized specific gravity, as in those few having lower-in-the-range  $\rho$ , partial swelling was sometimes multiplied by four.
- The standard negative relationship exists between  $E'/\rho$  and  $\tan\delta$  in white Mulberry. Nevertheless, the  $\tan\delta$  values stood 6%-11% lower than the standard curve –for the average frequency of 360 Hz- (Fig.4.2).
- $E'/\rho$  of our specimens was rather low and variable (11-18 GPa). This was accompanied by a lower than expected damping.
- The ordering of  $E'$  and  $\tan\delta$  between three axes followed the already verified trend. On the other hand, the anisotropies of two factors were low.

The last three remarks are putting white Mulberry closer to maple (used for back or sides of western musical instruments) than the resonance spruce (used for top plates) (Jansson 2002).



## 5. Effect of hygro-thermal treatments

---

➤ Hygro- thermal treatments: re-creating the traditional pre-treatments

Treatment in water, for different time spans and temperatures, is one of the very common pre-fabrication processes for instrument makers in Iran. This is due to the simplicity and availability of the original material (water). Working with water is easy and most of the time is backed by years of experience, whereas treating with chemicals is always looked with suspicion by artisans who find water a less risky choice. Using chemicals is also more expensive. Two important factors, time and temperature of water treatment, on the other hand, remain utterly dependant on the idea of the artisans. Based on their personal experience, water pre-treatment could either result in an acoustically improved instrument or (sometimes and) in an easier fabrication process.

The choice of treatments was started by consulting the instrument makers. Although the treatments were sometimes unclear and unprecisely explained, we could finally come up with two more common water-based ones.

Again, it also worth mentioning that, considering the fair number of reports on water/humidity effect on damping/vibrational properties (see chapter 2) these treatments can be seen not only as the reproduction of real treatments at laboratory scale, but also as a study on water-wood relationship.

Two kinds of hygro-thermal treatments were carried out<sup>1</sup>: long time immersion in water at ambient temperature during 1 to 4 months; short time hot water treatment during 2 to 12 hrs. Both treatments were applied to vibrational specimens only.

Corresponding values for specimens which were exposed to HW (70°C) for 8 hrs will be also regarded as independent water extraction when comparing independent extraction to successive one (§6-2-1).

In addition to these two pre-planned treatments, another one, based on exposing wood to mild desorption/adsorption conditions was added later on. This “cyclic drying and stabilization”, although not being designed beforehand, resulted in interesting findings.

In the upcoming chapter, the experimental phases and requirements for performing each treatment will be explained and interpreted.

---

<sup>1</sup>. Treatments were varied slightly from the traditional ones. Long time immersion in water have been rarely carried out up to 4 months and normally two months duration time is considered to be enough. Short time 70°C water treatment is always performed for 8 hours and less and has never been extended to 12 hours. The longer time duration have been added for the sake of better comparison.

## **5-1- Hygro-thermal treatment at laboratory scale**

### **5-1-1- Long time immersion in water (at ambient temperature)**

The specimens were dried and stabilized in climatic chambers. Their oven-dried and stabilized dimensions/weights were noted and MC was calculated. Distilled water was added to samples in proportion of 5 to 1 (wood volumetric value). They were kept in closed plastic containers, glass sinkers were used to prevent them from floating.

Treatment was continued for 4 months with 4 monthly intervals and the tests were done at ambient temperature (20~25°C).

As the time necessary for conditioning was long, using only one set of samples to be exposed to all 4 months of water immersion was not reasonable. Consequently, we decided to use 4 independent sets of 12 specimens for each time/treatment.

At the end of each month, the corresponding set of 12 specimens was brought out of water. Drying was first done using humid tissue in which they were kept several days to avoid any crack occurrence. Glass sinkers were also used to impose additional weight on specimens during this phase. Once specimens were dried enough for bending risk to be negligible, they were transferred to the oven to be dried, measured and stabilized according to the procedure described in §3-1-2.b, before being tested for their vibrational properties.

One set of controls (for all time durations) was assigned particularly to this treatment. Control specimens were dried and stabilized simultaneously to each group of treated samples and tested at the same time as them (Fig.5.1).

### **5-1-2- Short time hot water treatment (70°C)**

All the first steps are as described in case of long time water treatments (Conditioning, volume calculation, volume water/wood ratio). The duration of 12 hrs was decided for this treatments, 2 hours intervals were applied and the specimens were independent (Fig.5.1).

5 specimens were chosen for each time/treatment. Again, specimens were put in a long beaker, filled with distilled water, according to wood volume.

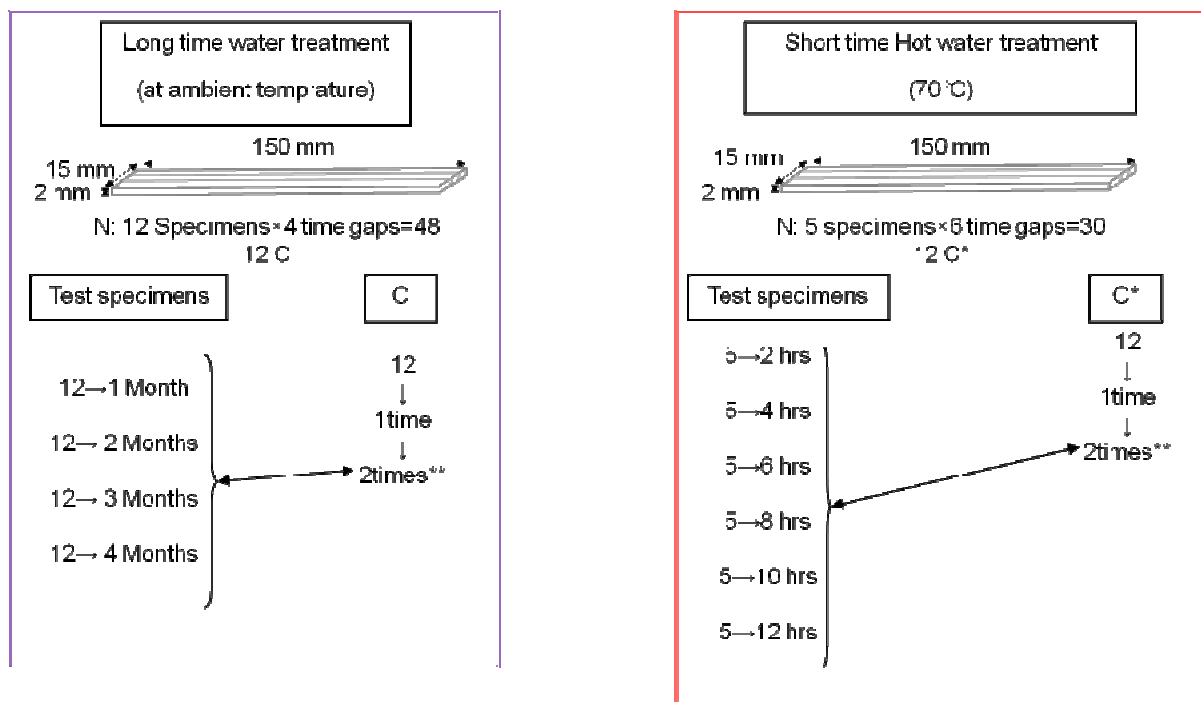

Fig.5.1. General protocol for hygro- thermal treatments

C: Controls

\* Controls for short time water treatments were the same as those for independent extractions.

\*\* As specimens' set were independent for both cases, only two conditioning periods were necessary, once before and once after the treatment.

A heater was used to increase water temperature to 70°C before introducing the samples. During the process, we used a thermometer to make sure that water temperature is completely stable at 70°C. At the end of each two hours gaps, the respective specimens were carefully brought out and were dried and stabilized as in case of previous treatment (drying in tissues, oven drying, stabilizing in climatic chambers).

One control group was assigned for this treatment and independent extraction (§ chapter6).

As the set were independent for both cases, only two conditioning periods were necessary, once before and once after the treatment.

### 5-1-3- Hygroscopic cycles: a non-predesigned treatment

When discussing a plan for re-creating the actual pretreatments at laboratory scale with craftsmen, a drying-based treatment was not at all considered. However, they always mentioned that a long-time air-dried white Mulberry is most convenient for instrument fabrication. The air-drying (which sometimes exceeds four years) is done in out-door conditions, which means that wood has to go through series of desorption-adsorption cycles (sever microclimatic change being carefully avoided).



Performing the successive extractions (see chapter 6), an independent series of specimens used as controls went through 6 conditioning cycles<sup>1</sup> (48 hrs oven drying at 60°C and 3 weeks of stabilisation at 20°C and 65% RH). This was originally designed to work as reference for extraction specimens, but as they were all tested with the same vibrational method, we decided to analyse them separately. It appeared that the simple act of drying and stabilizing has a significant effect on damping, without modifying other important factors (e.g.  $\Delta V_0$ ). However, the results were not sufficiently clear. Consequently two years into the study, a second set of specimens (N° 17) from batch 3 (2<sup>nd</sup> tree, see chapter 4) were introduced to go through 5 times of physical conditioning cycles, to confirm the results of extraction controls.

For the second try, 2 separate groups were selected: 8 specimens with narrow (1.5-1.8 mm) and 7 with wider (3.75-5 mm) growth rings. We wanted to study how two kinds of specimens (coming from the same tree) react to continuous physical conditioning. The analysis will show that both series, despite their different initial damping and specific moduli, reacted similarly in terms of relative change.

## 5-2- Physico-mechanical modifications caused by hygro-thermal treatments

### ➤ Our approach for the analysis

Considering the fact that the hygro-thermal treatments were performed according to instrument makers protocols and were aimed to verify their possible effect on the final vibrational properties, it was reasonable to look first at any possible alteration in  $\tan\delta$  and  $E/\rho$ . However and in addition to the acoustical modifications, we tried to look at the data with two slightly different viewpoints:

- Water (at ambient or higher temperature) is a known extractant for wood. We also used boiling water (100°C) as the latest phase in successive order of solvents (see chapter 6). Tappi standard N° T207cm-08 is strictly talking about the standard procedure of using water at ambient, as well as at boiling temperature, for extracting substances from wood matrix. It is a fact that, as we were limited to the protocol described by craftsmen, the imposed conditions varied from those of standards. This included differences in test duration and applied temperature. However, we can always suspect that an incomplete extraction happened. For that, and to investigate if really any compound removal occurred, we simply looked and compared the weight losses due to each time/treatment. This was more essential in the case of short time hot water treatment, as the 70°C temperature could probably be more effective to remove extraneous compounds.
- The long time immersion in cold water was similar to what has been done by other researchers to observe the effect of wetting or re-wetting on swelling or MC of the

---

<sup>1</sup>.Six was the number of times that the successively extracted specimens had to be conditioned.

specimens (Ishimaru et al. 2001a and b, Almeida and Hernandez 2007). The case was the same for hot water (Kubojima et al. 1998 and 2000, Obataya et al. 2000). Again, our applied process was not exactly identical, not to mention the problem of assigning different groups of specimens to various time/treatments that caused a lack of continuity in the obtained data. Nevertheless, we looked at the changes in MC and volume as well as on how treated specimens reacted compared to untreated ones when exposed to higher RH. This was also in the interest for the global aim of this study, as a treatment ineffective for vibrational features, could be improving wood stability.

To sum up, the following results could be looked to from two viewpoints: one is that of an artisan, for whom the effect of treatment on the final product is of the greatest importance. The second is a research aspect, with water and wood matrix relationship presented and discussed.

### 5-2-1- Effect of long-time water immersion at ambient temperature

#### 5-2-1.a. Presentation of all values

Table 5.1 presents the variation of some physical and vibrational properties in the specimens submitted to different months of immersion in water. Although this treatment is not considered as an “extraction”, a rather significant weight loss happened due to the immersion. Therefore both EMC and  $E'/\rho$  are corrected for the contribution of extractives, according to formula (3-26, 3-27 and 3-28). Here the most exhaustive extraction (based on WL) is observed in the fourth month.

Table 5.1. variation in some representative values due to water immersion.

Months in the water	EMC <sup>c</sup> (%)		$\rho$		$E'/\rho$ (GPa)		$\tan\delta(10^{-3})$	
	Native	Treated	Native	Treated	Native	Treated	Native	Treated
Control	7.87± 0.21	8.88± 0.11**	0.57± 0.02	0.55± 0.02	14.28± 1.38	14.64±2.21	0.85± 0.06	0.87± 0.07
	8.07± 0.21	8.68± 0.10			14.01± 0.96	13.68± 1.62		
	(c)							
1	8.00± 0.14	8.86± 0.26**	0.56± 0.03	0.53± 0.02	13.68± 1.72	12.74± 2.00	0.83± 0.06	0.80± 0.06
	8.18± 0.14	9.08± 0.25			13.60± 1.25	12.54± 1.75		
	(d)							
2	8.06± 0.23	8.46± 0.18**	0.57± 0.02	0.54± 0.02	14.00± 1.12	13.49± 2.08	0.82± 0.06	0.83± 0.05
	8.26± 0.24	8.25± 0.17			13.74± 1.10	12.86± 1.72		
	(b)							
3	7.95± 0.24	7.57± 0.16**	0.57± 0.02	0.53± 0.02	14.48± 0.79	13.72± 1.40	0.82± 0.05	0.79± 0.06
	8.15± 0.25	7.39± 0.16			14.27± 0.81	13.51± 1.17		
	(a)							
4	7.82± 0.66	7.66± 0.30**	0.57± 0.01	0.55± 0.02	14.47± 1.16	14.24± 1.55	0.83± 0.05	0.82± 0.06
	8.01± 0.68	7.48± 0.29			14.23± 0.84	13.38± 0.95		
	(a)							

EMC: equilibrium moisture content (%),  $\rho$ : specific gravity,  $E'/\rho$ : specific modulus (GPa)

\*\* Significant at  $\alpha$ : 0.01.

a, b and c. inhomogeneous subsets

e. EMC relative to 103°C oven-drying. “Apparent” are measured values, “Corrected” is based on calculated oven-dry mass after the most efficient (4<sup>th</sup> month) removal of extractives (§3-2-3.a)

Correcting  $E'/\rho$  for the amount of removed extractives, it appears that the apparent value underestimates it by 0.2-1 GPa. Statistically speaking, and as it can be clearly seen on the

table, with the exception of EMC, other recorded values are not significantly different between the different groups as well as compared to controls.

Using the same statistical analysis (One way-ANOVA combined by Duncan post-hoc in SPSS ®), it is confirmed that the modified values of each group are also not different from native (untreated) ones.

### **5-2-1.b. Effect of water immersion on physical properties**

#### **➤ Weight loss due to treatment**

Tappi standard T207cm-08 describes cold-water extraction as a way for bringing out inorganic compounds, tannins, gums, sugars and coloring matters from wood matrix. Despite our testing conditions being different from the standard extraction guideline, the WL gives a good indication of any substance removal during the treatment.

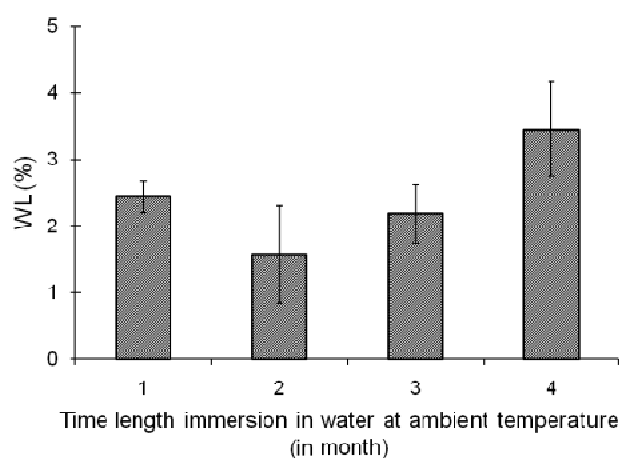

Fig.5.2. Oven dried weight loss (%) for specimens submitted to different months of water immersion. N°: 12 for each time interval. The values in each case are calculated based on the initial dry weight of each group of specimens submitted to that particular month.

Fig.5.2 presents the average WL per group of specimens for different times of water immersion. The highest WL appears after 4 months of water treatment (3.48 %± 1.83). Other groups show rather close WL (from 1.57%± 0.44 for the second month (min) to 2.44%± 0.73 (max) for the first month). In any case, the results are not statistically different, showing that the time extension has no effect on the amplitude of substance removal. On the other hand, the simple presence of WL is confirming the fact that the imposed treatment also worked as an extraction. Se Golpayegani (2007) reported cold-water extraneous materials for white Mulberry wood of four different sites in Iran as 6.84% ± 2.13. However, that study was performed using the powder phase of a material that had significantly more extractives of the one in current study, not to mention the fact that powder is more accessible to extractive agents than solid wood. Furthermore, all the standard (Tappi) requirements were met in that study, suggesting that most probably it resulted in a quasi-complete extraction.

#### **➤ Variations in MC and oven- dried volume**

Swelling effect of water had been the theme of several studies (Mantanis 1994a, 1995, Mantanis and Young 1997, Yamamoto et al. 2001, Hernandez 2007). The mechanism by which water reaches the cell-wall structure is shown schematically in Fig.5.3. During this

process, water first fills the lumens and cavities and then reaches the empty spots in the cell-wall matrix. The swelling, which happens due to the second part (cell-wall expansion), is the one actually visible at macroscopic level.

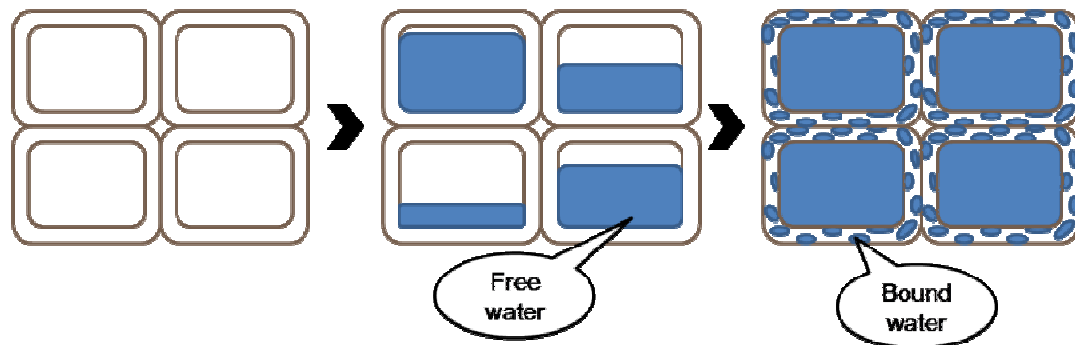

Fig.5.3. Scheme of water reaching in the cell wall structure.

In our treatment, however, even though water fills all the cavities, it eventually evaporates by oven drying. On the other hand, it is interesting to look at the variation of  $\Delta V_0$  (%), first to see if any irreversible changes in volume happened due to treatment and secondly, to investigate whether the small WL, mentioned in previous part, could be related to any macroscopic dimensional change. Variations in MC are also closely related to volume variations (Smith 1955, Simpson 1993, Rowell 2005).

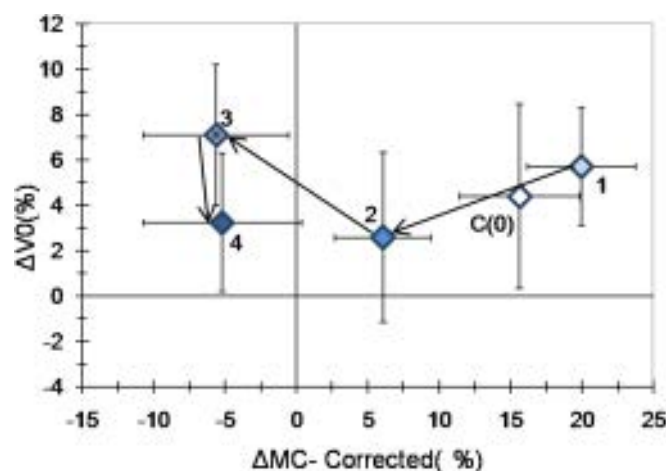

Fig.5.4. Variations in corrected moisture content ( $\Delta MC$  (%)-Corrected for the contribution of extractives) and oven-dry volume change ( $\Delta V_0$  -60° (%)) for four groups of specimens submitted to different durations of immersion in water. C (0): controls, 1, 2, 3 and 4: number of immersion months. The arrows are indicative of the time continuity. The values in each case are calculated based on the initial dry weight of each group of specimens submitted to that particular month. Presented values of controls are those of one cycle of drying and stabilization (see the explanation below).

Fig.5.4 shows positive modifications in  $\Delta V_0$  (%) (Controls included). Specimens of first and third months show a slightly higher  $\Delta V_0$ :  $5.72\% \pm 2.60$  and  $7.11\% \pm 3.09$  respectively, with 3<sup>rd</sup> month being the maximum amongst all four.

The increase of oven-dried volume however, is associated with inconsistent variations in MC. Specimens of First and second month show an increase in treated MC compared to

the native ones, while starting from third month, a stable 5% decrease is observed for both 3<sup>rd</sup> and 4<sup>th</sup> months.

The behavior of the control samples can give a key to explain the results shown in Fig.5.4. The  $\Delta MC$  variation in function of  $\Delta V_0$ , for the controls (C (0) on the Fig.5.4), is in fact the values recorded after drying and stabilizing twice the samples (one cycle). This value cannot be considered as the corresponding value to each month (because it was not measured at the same time of second, third and fourth months). However, it is the closest to what each group is gone through physically. The raising/lowering trend in  $\Delta MC$  could result from the historical effect of previous drying and conditioning. Two times of drying and conditioning have apparently a shocking effect on the specimens causing their MC to increase by  $\approx 15\%$  (controls), and  $\approx 20\%$  (first month). The immersion in water can not cover for the sudden change of MC when it only lasted for one month, while with the extended time, it starts to make the MC more stabilized.

### 5-2-1.c. Effect of water immersion on vibrational properties

Fig.5.5 presents the relationship between the variations in  $\tan\delta$  caused by different months of water immersion and their corresponding WL. Values of controls (which are gone through 2 cycles of physical condition as the treated specimens) are also presented on the figure.

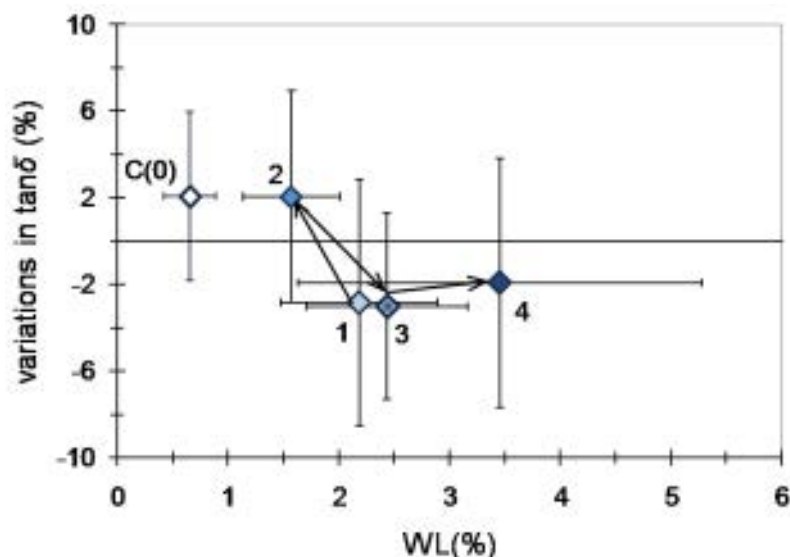

Fig.5.5. Relative variation in weight losses (WL %) and  $\tan\delta$  (%) for four groups of specimens submitted to different months of immersion in water. C (0): controls, 1, 2, 3 and 4: number of immersion months. The arrows are indicative of the time continuity. The values in each case are calculated based on the initial dry weight of each group of specimens submitted to that particular month.

$\tan\delta$  shows insignificant changes due to different months of water immersion. Specimens that have 3 and 4 months of immersion show small decreases in their average  $\tan\delta$ , while controls and those immersed for 2 months show  $\approx 2\%$  increases. Large error bars for every point underline the wide dispersion between the specimens of each group. This variation could be due to the fact that even though all cares were taken for the specimens to dry with as few problems as possible, eventually some bending happened. Measuring

getting a precise  $\tan\delta$  was particularly difficult for these specimens, and it sometimes needed up to 10 repetitions for one specimen to get an exploitable value ( high measurement uncertainty). However, a final visual rating was done on the treated samples, and those that exhibited severe bending or visually non-negligible problems were not included in the final results.

Fig.5.6 shows one group of specimens submitted to 2 months water immersion. While some deformations are obvious, there are also small (perpendicularly oriented to length) cracks, which are still visible to eye. These cracks, showing probable collapse, could be the signs of microscopic modifications that possibly resulted in inconsistent changes of  $\tan\delta$ .

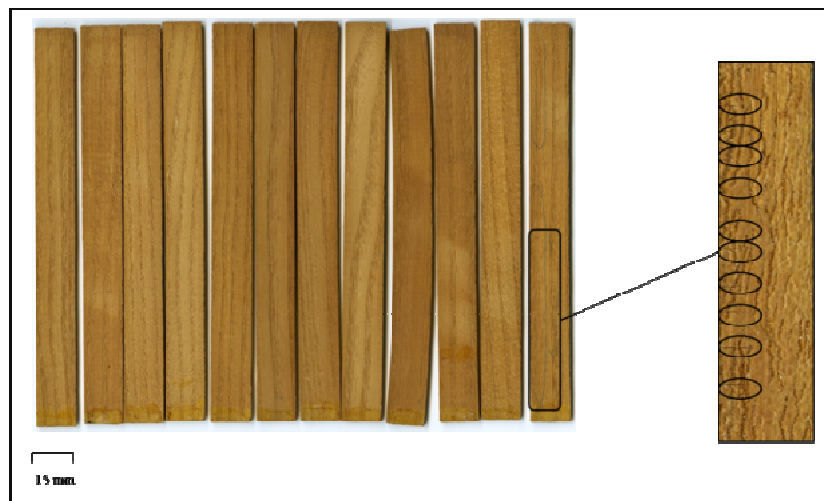

Fig.5.6 Specimens submitted to two months water immersion (left) and the magnified view of one specimen with cracks—marked with black ovals— appeared after the treatment (right). Note that the specimens of two months were scanned as an example and same defects were observed in the specimens submitted to all four months.

Fig.5.7 (a and b), illustrates the variation in  $\tan\delta$  in relation with the immersion time. In Fig.5.7.a, the values are presented beside the one from controls, while in the Fig.5.7.b, the effect of one cycle of drying and stabilization is deduced from each month's recorded  $\tan\delta$ . In an overall look, and even by considering the minimum and maximum values, it appears that the time factor of water immersion has no effect on the modification of  $\tan\delta$ . Although the time of the treatment was extended to 4 months, the amplitude of variations is almost the same for the specimens of 3rd and 4th months ( $\Delta\tan\delta\approx-3\%$  and  $-2\%$ , respectively<sup>1</sup>).

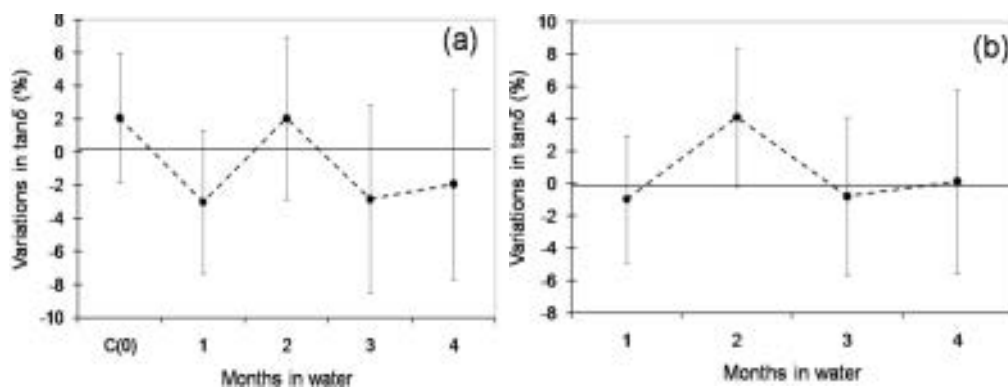

Fig.5.7. Variations in  $\tan\delta$  in relation with different time of water immersion where in (a): controls are presented separately and (b): values of controls were subtracted from  $\tan\delta$  of different months.

To sum up, it can be stated that the long time treatment of wood with water at ambient temperature does not apparently change the damping properties. However, some important modifications (eventual bending, cracks, other microscopic changes...), could result from the treatment that can change other factors. Those factors include  $\Delta\rho$  and  $E'/\rho$ . Fig.5.8. exhibits the variations in  $\rho$  and  $E'/\rho$  for 4 groups of specimens submitted to different periods in water.

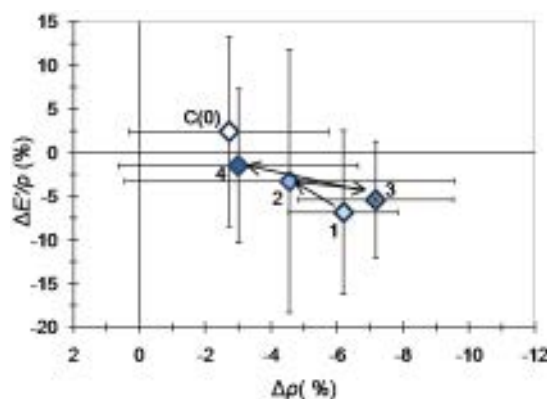

Fig.5.8. Variations in  $\Delta E'/\rho$  and  $\Delta\rho$  for four groups of specimens submitted to different months of immersion in water. Indicators are as in before.

Here, expectedly, the bigger variations in  $\Delta\rho$  are associated with greater modifications of  $\Delta E'/\rho$ . Specimens submitted to 1 and 3 months of water dipping, show then most important changes in  $\Delta\rho$  by  $\approx -6.19\%\pm 1.65$  and  $-7.17\%\pm 2.35$  respectively, and their  $E'/\rho$

<sup>1</sup> Variation between the treated and native state. Controls are not taken into account.

are consequently modified more than the others ( $\approx -7\%$  and  $-6\%$ ). Still, the dispersion between the specimens of one group is large (especially in the specimens of second month), which makes it difficult to draw a conclusion. As a general trend, water immersion has a slight decreasing effect on  $E'/\rho$ . However, the time factor (like for  $\tan\delta$ ) does not seem to play a significant role on how  $E'/\rho$  is modified.

#### **5-2-1.d. Effect on dimensional stability**

Once the treatments were finished, the long time water immersion specimens were exposed to 2 more extreme desorption and adsorption conditions (Fig.5.9):

- A complete drying ( $103^\circ\text{C}$  for 48 hrs), performed one year after the end of the original treatments.
- A mild humidification – to put the specimens into an incomplete adsorption- of the treated specimens performed 6 months after the end of the original treatments (6 months in the climatic chamber as in the above cases). During the humidification, specimens were kept for 1 month in a chamber with controlled conditions of  $27\pm 2^\circ\text{C}$  and  $75\%\pm 5\%$  RH.

At the end of each phase, the change in volume was calculated based on the following formula:

$$\Delta V_0 \% = \frac{V_1 - V_0}{V_0} \times 100 \quad (5-1)$$

where  $V_1$  is the specimen volume after each drying/adsorption condition and  $V_0$  the oven dry volume ( $60^\circ\text{C}/48$  hrs). As a reminder, the anhydrous drying ( $103^\circ\text{C}$ ) was done the very last to avoid any possible irreversible change in cell-wall voids that might affect the process of adsorption.

In adsorption, specimens react approximately the same as the controls (Reminder: Controls submitted to two cycles of drying and conditioning). Apparently simply putting the wood in the water, when followed by a careful drying, is not endangering the stability of dimension at higher humidity.



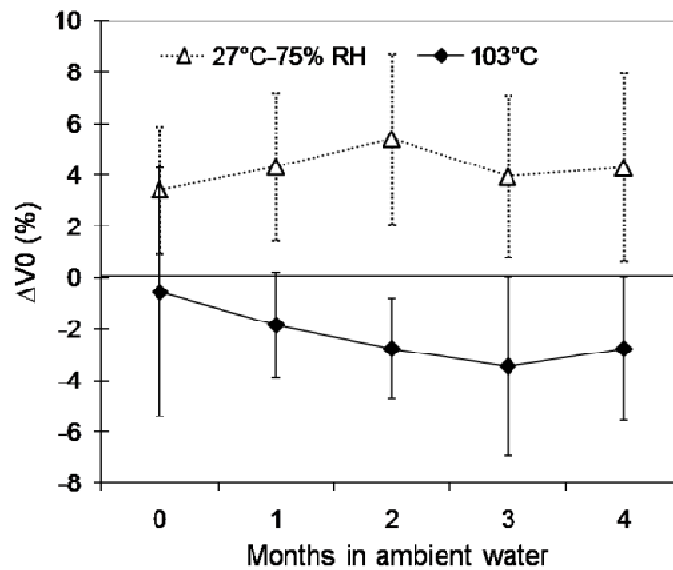

Fig.5.9 Changes in oven- dried volume ( $\Delta V_0$  %) for long- time water treatment specimens, after perfect drying (103°C) and one month in 27°C and 75% RH. N°:12 each×5=60 total.

In a total desorption, on the other hand, a gradual decreasing trend can be observed.  $\Delta V_0$ (%) are  $\approx$  -0.5%, -2%, -3%, -3.5% and -3% for controls, specimens of 1st, 2nd, 3rd and 4th months, respectively. While there is no significant difference between how the specimens of 3rd and 4th month reacted in complete desorption, shorter times of ambient water treatment (from 2 month until not treated at all) seem to be less touched by the extreme drying.

## 5-2-2- Effect of short-time hot water treatment

### 5-2-2.a. Presentation of all values

Table 5.2 gives native and treated values of some physical and vibrational factors for the specimens submitted to increasing time to hot water (70°C) treatment. The correction was done on both EMC and  $E'/\rho$  for the same reasons presented in part 5-2-1.a.

Table 5.2. Variation of properties due to hot water treatment.

Hours of treatment	EMC <sup>d</sup> (%)		$\rho$		$E'/\rho$ (GPa)		tan $\delta$ (10 <sup>-3</sup> )	
	Native	Corrected Apparent	Native	Treated	Native	Corrected Apparent	Native	Treated
Control <sup>e</sup>	8.39±0.45	8.00±0.15**	0.55±0.03	0.52±0.04	15.75±2.33	14.50±3.43	0.86±0.03**	0.79± 0.05
	8.13±0.44	7.74±0.16						
2	8.51± 0.22 8.24± 0.21	8.53± 0.13**	0.57± 0.01	0.52± 0.01	16.38± 0.16	13.89± 0.97	0.80±0.06**	0.78± 0.02
		8.21± 0.11						
4	8.32± 0.24 8.07± 0.23	8.73±0.38**	0.59± 0.02	0.51±0.02	18.88± 1.50	15.22± 1.11	0.77± 0.02**	0.78± 0.03
		8.37±0.38						
6	8.34± 0.24 8.08± 0.25	8.68± 0.14	0.57± 0.02	0.51± 0.01	16.76± 1.74	15.88± 0.46	0.79± 0.03**	0.79± 0.04
		8.27± 0.13						
8	8.42± 0.36 8.16± 0.35	8.70± 0.17**	0.56± 0.01	0.49± 0.03	15.51± 1.47	13.22± 1.22	0.84± 0.04**	0.86± 0.06
		8.25± 0.12						
10	8.37± 0.24 8.11± 0.23	8.81± 0.12**	0.56± 0.01	0.51± 0.02	17.14± 1.62	15.58± 2.39	0.80± 0.03**	0.85± 0.12
		8.29± 0.18						
12	8.20± 0.23 7.94± 0.22	8.56± 0.17**	0.55± 0.02	0.49± 0.03	15.95± 1.64	13.07± 1.20	0.80± 0.02**	0.83± 0.03
		8.06± 0.15						

\*\* Significant at  $\alpha$ : 0.01

EMC: equilibrium moisture content (%),  $\rho$ : specific gravity,  $E'/\rho$ : specific modulus (GPa)

a, b and c. in homogenous subsets

d. EMC relative to 103°C oven-drying. “Apparent” are measured values, “Corrected” is based on calculated oven-dry mass after the most efficient (10 hrs) removal of extractives (see Hernandez 2007).

e. Treated state for controls stands for values measured after one time of drying and stabilization.

The apparent  $E'/\rho$  underestimate  $E'/\rho$  by 1.81-3.22 GPa in native state, and by 0.58 -1.04 in treated state.

A general look, even without paying attention to the statistical analysis, shows that in all six groups,  $\rho$  and  $E'/\rho$  are decreased and tan $\delta$  is increased. EMC slightly rises due to treatment, though its amplitude of change stays far below that of vibrational factors.

Once statistically analyzed, it appears that with the exception of corrected EMC and untreated tan $\delta$ , the observed changes are not significant. In both those significant cases, the differences are important between the controls and treated groups, and not in between the different duration of hot water treatment.

**5-2-2.b. Effect of short time hot water treatment on physical properties****➤ Weight loss due to treatment**

As higher temperature is imposed than for the cold water treatment, the conditions were closer to what is normally done in a standard extraction (Tappi. T207cm-08). However, due to bigger size of the specimens, extraction might not be complete and it is interesting to see how much the amount of extracted substance is related with the duration of treatment.

Fig.5.10. shows that the extraction happened whatever the extraction time. Surprisingly, the WL due to hot water treatment is about the same as that recorded in specimens immersed in water at ambient temperature ( $\approx 4.27\%$  and  $\approx 4.52\%$ , respectively). This suggests that water soluble secondary material in white Mulberry are not susceptible to higher temperature and could be removed with the use of water at lower temperatures. On the other hand, the time effect remains the differentiating factor between the two methods. When the maximum WL is reached after only 10 hours of treatment with  $70^{\circ}\text{C}$  water ( $\approx 3.34\% \pm 0.79$ / average of 5 specimens), reaching the approximate same value in ambient conditions, has required four full months of complete water immersion ( $\approx 3.46\% \pm 1.83$ / average of 12 specimens).

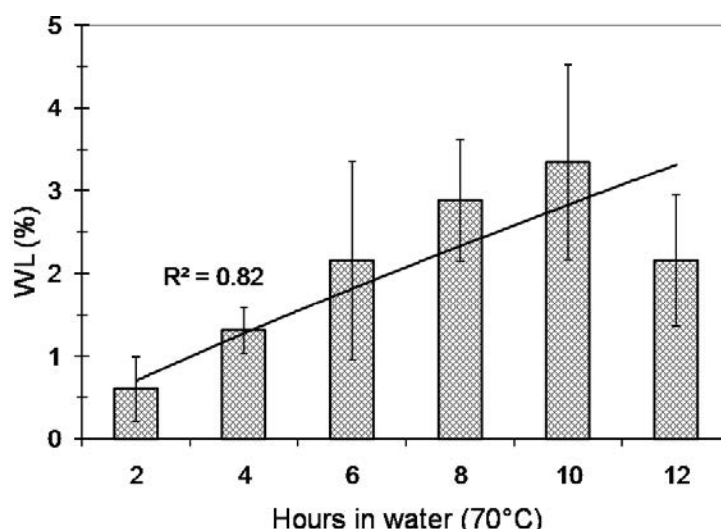

Fig.5.10. Oven dried weight loss (WL %) for specimens submitted to different hours of  $70^{\circ}\text{C}$  water. N°: 5 for each time gap:  $5 \times 6 = 30$ .

WL of specimens in hot water treatment seems to be directly related to the duration of the treatment, except for the abnormal drop at 12 hrs. A possible explanation for that drop could be some microscopic alterations at cell-wall level, which might even block some of the “could-be-easily-removed” substances. Depolymerization of hygroscopic hemicelluloses and modifications in carbohydrates and other wood constituents happen after high temperature thermal treatments either in presence of water (steam) (Kubojima et al. 2005) or its absence (Mitchell et al. 1953, Stamm 1964, Obataya et al. 2000 and 2006). Nevertheless, the high temperature imposed in those studies (minimum  $120^{\circ}\text{C}$ ) which would be enough for the degradation does not exist in our situation. However, small degrees of degradations can happen at lower temperatures for longer heating times (Jiang et al. 2009). Thus, the observed event could be a combination of extractives

degradation with small modifications in cell-wall structure as well as its components, which have their pick at 10hrs and stabilize at longer heating times. This, however, needs to be confirmed with the results of other physico-mechanical properties.

➤ **Variations in MC and oven dry volume**

Fig.5.11. illustrates the variations in oven dry volume ( $\Delta V_0$  %) and moisture content (MC %). Apart from 2hrs that barely changes MC ( $\approx 0.28\% \pm 1.28$ ), other durations increase MC in the same range ( $\approx 5.3\%$ , average of  $\Delta MC$  for 4 to 12 hours). Changes in oven-dried volume ( $\Delta V_0\%$ ) following a similar pattern. For the specimens of 2 to 12 hrs (with the exception of 4hrs),  $\Delta V_0$  is very close ( $\approx 8.30\%$ ). Although the small  $\Delta MC$  for 2hrs is consistent with a low WL, the high  $\Delta V_0$  for 4hrs is not associated with a high WL. In fact, in the case of 4hrs, 2 out of 5 specimens exhibited non-negligible defects (crack indicating probable collapse, surface marks...). These observations justify ignoring  $\Delta V_0$  value for 4 hrs.

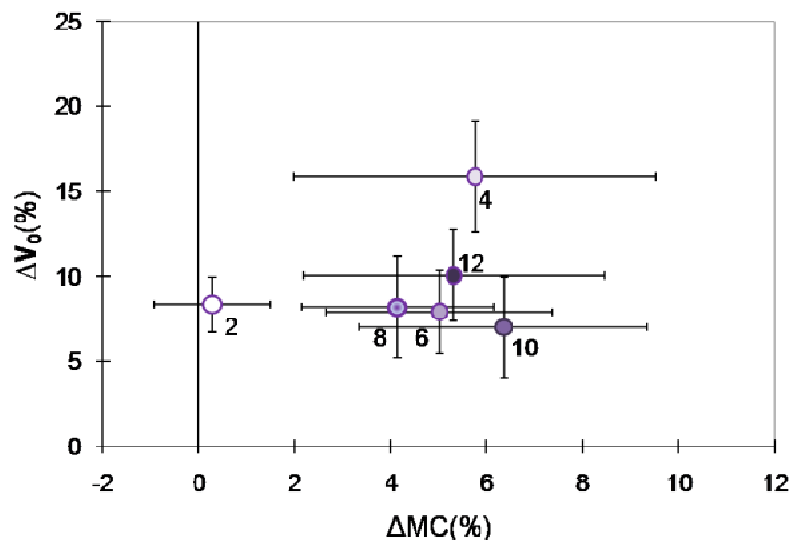

Fig.5.11. Variations in corrected moisture content ( $\Delta MC$  (%)-Corrected for the contribution of extractives) and oven- dry volume change ( $\Delta V_0$  -60° (%)) for six groups of specimens submitted to different hours of 70°C water treatment. 2-12: hours of treatments.

Heat treatment increases wood hygroscopicity (Obataya et al. 2002, Obataya et al. 2006). Thermal degradation is accelerated in steaming at temperature above 90°C, although small degradations already happen at 60°C (Obataya et al. 2006). The latter case is close to the current treatment imposed in this study. One could assume that the 70°C heating, when done for a long time, causes small degradations that increase hygroscopicity. Although 2hrs does not induce a change of hygroscopicity, but the change happens independently from treatment time above 4 hours.

**5-2-2.c. Modifications in vibrational properties due to short time hot water treatment**

➤ **Modifications in  $\tan\delta$**

Fig.5.12 shows that unlike cold water, for hot water treatment a consistent trend is observed for  $\Delta \tan\delta$  and WL.

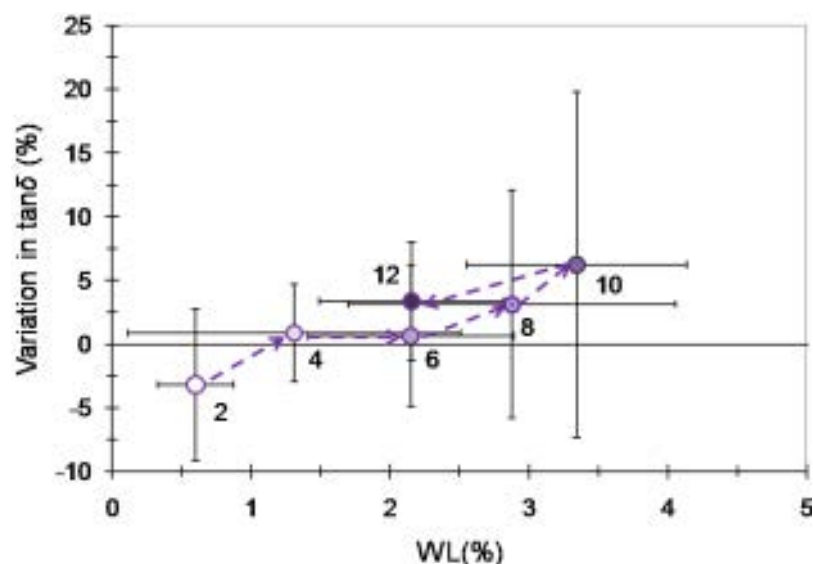

Fig.5.12. Relative variation in weight losses (WL %) and  $\tan\delta$  (%) for six groups of specimens submitted to different hours of 70°C water. The arrows are indicative of the time continuity. The other indicators are as in before.

The duration of 2 hr is not sufficient to induce an effect on  $\tan\delta$ , contrarily to the full standard water extraction at 100°C (§6-2-3.b). The insignificant decrease of damping might be more the result of drying than the actual water treatment. Not much difference in  $\tan\delta$  is observed between 4 and 6 hr, despite the increasing WL. For 8 and 10 hr, both WL and  $\tan\delta$  increase, with, however, large variations between the specimens obliging to some caution. 12 hr data, in consistency with  $\Delta MC$ ,  $\Delta V_0$  and WL, exhibit less modification for  $\tan\delta$ . Most important changes happen between 8 and 10 hr of treatment.

Water-soluble extractives have contradictory effect on  $\tan\delta$ , either to decrease (Matsunaga et al. 1999, Minato et al. 2010) or increase it (Obataya et al. 1999). If we assume that, following WL, decomposition and removal of the secondary substances have happened in our case, modification in  $\tan\delta$  is compatible with the WL for 2, 8, 10 and 12 hr, where the higher amount of removed extractives causes greater modifications. Nevertheless, this pattern is not justifiable for 4hr and especially 6hr treatments, where despite the WL,  $\tan\delta$  remains unchanged. Obataya and co-workers (2006) suggested that the small WL in heat/steam treated specimens at 60°C is not indicating the absence of decomposition of cell-wall polymers, but rather the inability of materials to leave. If this is the case in this treatment, and the treatment not only decomposed the extractives, but also degraded small amount of cell-wall constituents, then the combination of these two effects could cause stable- apparently -unchanged  $\tan\delta$ . In other words, the 8hr WL could also happened at 6hr, but due the insufficient treatment time, the components could not leave the cell-wall matrix. The presence of bulked material (though being detached enough to increase absorption sites and hence hygroscopicity), caused damping to stay stable. Whereas at 8 and 10 hr of treatment, enough time was passed for the degraded substances to be removed and for  $\tan\delta$  to be modified. Here, again, 2 additional hours of treatment (12 hrs) seems to bring less important modifications to the  $\tan\delta$  and the pick of change stays (like for WL) at 10 hr.

➤ **Modifications in  $E'/\rho$**

According to the literature (Luxford 1931, Minato et al. 1997), extractives can have different (sometimes minor) effects on  $E'/\rho$  depending on their types. For white Mulberry, apparently their presence has a mechanically reinforcing effect on cell-wall matrix (§6-2-3.a). Of course, as extractive also contribute to the  $\rho$ , a complete judgment on their pure effect on  $E'/\rho$  is not possible. However, in our study (even if it is not presented), the change in  $E'$ , is in the same direction (and mostly the same amplitude) as  $E'/\rho$ , which make the direct effect of complementary substances on this species strength more probable. That being said, whether the gradual increase in time has an effect on the amplitude of reduction, is still to be confirmed.

The variation in  $E'/\rho$  by hot water treatment is illustrated in Fig.5.13. Looking at the circles (changes in  $E'/\rho$  based on the values of forced vibration/LMGC), it can be seen that  $E'/\rho$  is reduced for all the time treatments, the amplitude on the other hand, is not following a clear trend. The highest decreases, observed after 4 and 12 hrs of treatment, though pretty assuring by the reasonable variations between their specimens compare to others, do not seem to be related to time of treatment. To confirm that there is actually a reduction in  $E'/\rho$  after the treatment, and that is not significantly related to the test duration, results of the  $\Delta E'/\rho$  by free vibration (BING method) are also been added to Fig.5.13. Here, even though the amplitudes of change are far smaller than those of former method, still a stable decrease that is not time related is observed. Again, one can assume that the different modifications in  $E'/\rho$  in different hours in LMGC method, could come from the proper properties of specimens of each group (more presented by the LMGC method than in the Bing) and they are not related to the time of treatment.

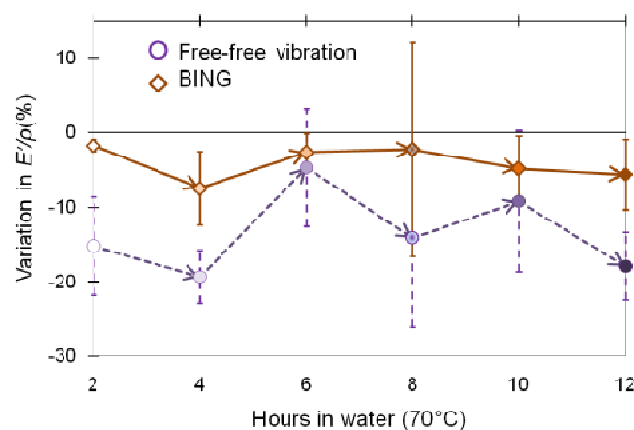

Fig.5.13. variations in  $E'/\rho$  after different hours of 70°C water treatment as measured by two acoustical methods. Arrows are indicative of time continuity.

Heat treatment are found to have mostly an increasing effect on  $E'/\rho$  (Kubojima et al. 1998, 2000). Recrystallization of cellulose along with the decrease of absorption sites – in the absence of water- were assumed to be the reasons for such phenomenon. However,

contradictory reports have also been found. Obataya et al. (2000) reported the degrading effect of heat treatment on the modulus. They connected this event with the degradation of cell-wall constituent. The same event (reduction of  $E'$  by increasing temperature) was related to the loss of crystallinity in cellulose (Kuboijima et al. 2001). In our study, the treatment is done in complete water immersion, which reduces the shear effect of moderate heating and replaced it with a combination of water/ heating. As the decrease in absorption sites does not happen (considering the increase in hygroscopicity) and the temperature is not high enough for any sever modification on cellulose (which could alter rigidity), the stable time – independent decrease of  $E'/\rho$  by hot water treatment could be related to decomposition of extractives/cell wall constituents.

To conclude, we will look at the last three presented factors ( $\Delta MC$ ,  $\Delta \tan \delta$  and  $\Delta E'/\rho$ ) modified by the short time 70°C water treatment (Fig.5.14).

The increasing trend in MC and  $\tan \delta$  are almost perfectly synchronized with each other. This is in harmony with the literature on the MC/ $\tan \delta$  relationship. It was reported that not only a higher  $\tan \delta$  is observed in conditions with higher RH (and thus with higher moisture contents), but also that any treatment that increases MC, can eventually – and even in an indirect way – cause an augmentation in  $\tan \delta$  (Akitsu et al. 1993, Obataya et al. 1998). On the other hand, the amplitudes of change stay small in our case (Max  $\Delta MC$  and  $\Delta \tan \delta \approx 6\%$ ).

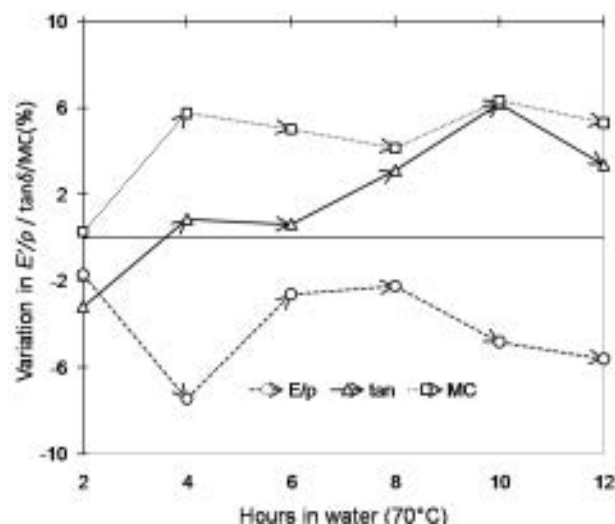

Fig.5.14. Variations in  $E'/\rho$ ,  $\tan \delta$  and MC in relation to different hours of 70°C water treatment, values of  $E'/\rho$  are from free vibration (Bing) method.

The values of  $E'/\rho$  (From free vibration method) show a synchronizing vice versa form of that of  $\Delta MC$ . One could even go further and say, despite similarly insignificant amplitude of change, modification in  $E'/\rho$  are compatible with that of  $\Delta MC$  (as for example the highest 6% increase of MC resulted in lowest  $\approx 7.5\%$  decrease in  $E'/\rho$ ). The inverse relationship of in  $E'/\rho$  and MC have been previously reported by several reporters (Gerhards 1982, Wood Handbook 2010, Obataya et al. 2001). Remembering the fact that an increasing removal of the extractives also happened due to the treatment, and referring to the literature, that have already correlated the slight changes in specific modulus to

secondary substances, one could also assume that the modifications in  $E'/\rho$  are coming from extractives leaving the cell-wall matrix. That is correct indeed, if we remember that the observed variations in vibrational properties could be caused by a combination of the WL (due to extraction), change in MC (due to the extractives removal/ decomposition of cell-wall constituents), and change in MC (due to the water- wood interaction at the time of the treatment).

#### 5-2-2.d. Change in volumetric stability due to treatment

Finally, like for the previous specimens –treated with water at ambient temperature-, the specimens of short 70°C water treatment are exposed to a desorption/adsorption condition for us to study their volumetric stability in the face of changing conditions. Fig.5.15 is presenting the changes in oven-dried volume in the specimens of this treatment when exposed to two different conditions. The detailed conditions (Temperature, RH) are the same to those used for the previous samples (§5-2-1.d)

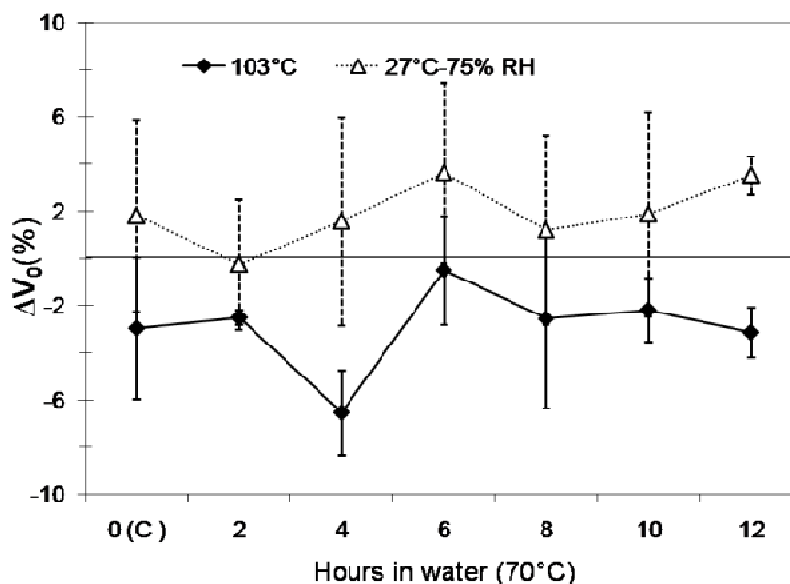

Fig.5.15. Changes in oven- dried volume ( $\Delta V_0$  %) for short time hot water (70°C) treatment specimens, after complete drying and one month in 27°C and 75% RH. N°:5each×6=30 plus 12 controls.

To briefly go through the changes in desorption, we can state that with the exception of the 4hrs specimens, the others show a  $\Delta V_0$  (%) almost near to the controls ( $\approx -3\%$ ). Remember that the 4hrs treated specimens, are the ones having the lowest visual ratings. Apparently the water treatment, although not improving the stability in desorption, do not either negatively affected it.

In adsorption, however, the results are less varied. While all the treated groups show around the same variations as controls ( $\Delta V_0 \approx 2\%$ ), 2 hrs treated one, is showing a less modified  $\Delta V_0$ . The same thing can be seen for the 2hrs specimens in desorption. Although it may seem like that the 6 hrs treated ones in desorption have the least modified  $\Delta V_0$ , but the important dispersion between specimens (which does not exist for the 2hrs  $\approx -2.51\% \pm 0.31$  compared to  $\approx -0.49\% \pm 2.30$  for 6 hrs), make the results of 2hrs more trustworthy.



Dimensional stability of wood was improved by heat treatments at high temperatures (Edvardsen and Sandland 1999, Bekhta and Niemz 2003). A 4 hours treatment at 220°C is reported to result in a decrease in moisture performance and an improvement in dimensional stability (Li et al. 2011). While commercially accepted heat treatments are done at higher temperatures (between 180°C and 220°C) in order to improve the stability, the lower temperatures are reported to cause less important modification<sup>1</sup> (Hill 2006).

For us, the 70°C water involved treatment, could be included the latter category, where though not having particularly negative effect, does not either cause dramatic changes in dimensional stability.

In the end, it could be carefully noted, that although no definitive improving or degrading effect considering dimensional stability can be retained from time limited 70°C water treatments, a two hrs treatment seems to be slightly improving to volumetric stability in adsorption.

### 5-3- Cyclic drying and stabilization

#### 5-3-1- Variation of properties

Table 5.3 contains the values recorded after five times of drying and stabilization.

Table 5.3. Recorded values for EMC (%), specific gravity  $\rho$ , specific modulus  $E'/\rho$  (GPa) and  $\tan\delta$  (%) for specimens submitted to 5 times of drying and stabilization

Cycle N°	EMC <sup>c</sup> (%)	$\rho$	$E'/\rho$ (GPa)	$\tan\delta$ (10 <sup>-3</sup> )
1	7.81± 0.14 (ab)	0.51± 0.04	14.07± 1.98	0.85± 0.10* (a)
2	7.68± 0.15 (ab)	0.54± 0.05	14.56± 2.38	0.87± 0.10* (a)
3	7.19± 0.20* (a)	0.53± 0.05	14.42± 2.37	0.79± 0.08 (ab)
4	8.76± 0.11 (ab)	0.53± 0.05	15.07± 2.46	0.76± 0.07* (b)
5	8.11± 0.29* (b)	0.54± 0.04	14.70± 2.16	0.80± 0.09 (ab)

\*.significant at  $\alpha$ : 0.05.

a, b and c: inhomogenous subsets.

c. EMC relative to 103°C oven-drying.

Statistically speaking, there is no significant differences observed between  $\rho$  and  $E'/\rho$  measured after each cycle.  $\tan\delta$  and EMC, on the other hand, are changed significantly (most notably damping between 2<sup>nd</sup> and 4<sup>th</sup> cycles).

To get a better understanding on  $\tan\delta$  changes through the drying cycle, the following part presents the  $\tan\delta$ - $E'/\rho$  relationship in forms of curves and their place compared to the reference curve.

<sup>1</sup>.Close care should be taken when comparing with heat- based treatments, as commercial heating is normally done with the interference of other factors (under vacuum, in the presence of N<sub>2</sub>...).

### 5-3-1- Evolution of the $E'/\rho$ - $\tan\delta$ relationship

Fig.5.16 shows the relationship between  $\tan\delta$  and  $E'/\rho$  for the specimens submitted to drying and stabilization, distinguishing the two sub-groups with different growth rings width:

Specimens with narrow growth rings have a low  $E'/\rho$  ( $12.48 \pm 0.65$  GPa), high  $\tan\delta$  ( $0.94\% \pm 0.07$ ) and lower specific gravity ( $\rho_{narrow} = 0.47 \pm 0.01$ ).

Specimens with wide growth rings, show an average higher  $E'/\rho$  and lower  $\tan\delta$  ( $E'/\rho \approx 16.11 \pm 1.00$  GPa /  $\tan\delta \approx 76\% \pm 0.05$ ). Their specific gravity is higher than the former type ( $\rho_{wide} = 0.55 \pm 0.01$ ).

While the values of the latter specimens is more representative of the majority of tested specimens in this study (§4-2), despite their seemingly different values, specimens with narrow rings still stay in the average range of vibrational properties of white Mulberry.

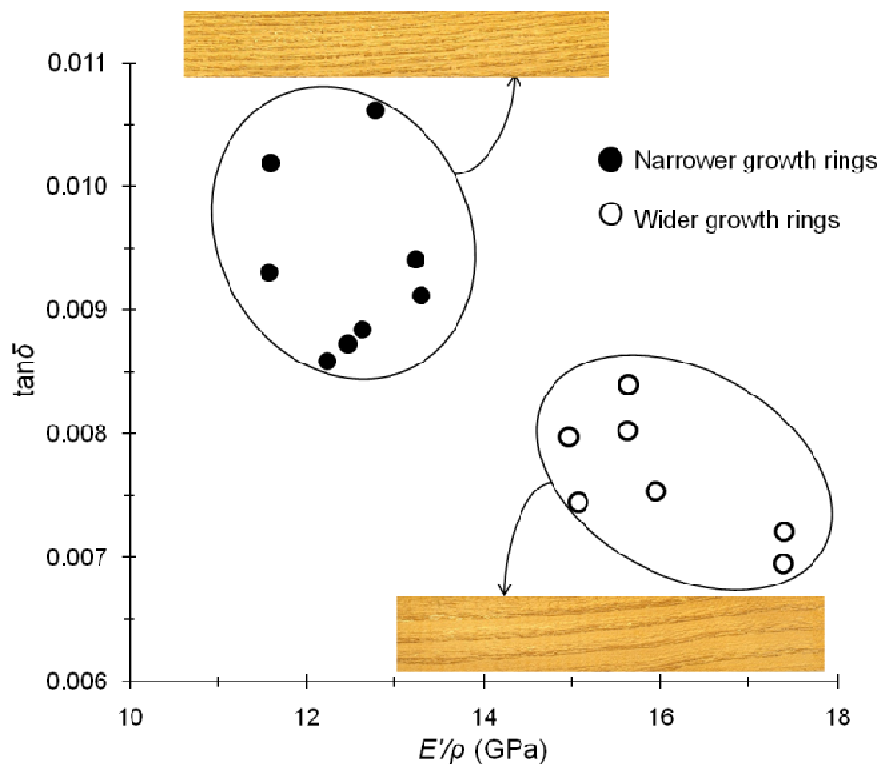

Fig.5.16.  $\tan\delta$  and  $E'/\rho$  relationship for specimens submitted to cyclic drying and stabilization. N°:15. Two specimens considered statistically as outliers are excluded.

Other recorded physical properties stay closely in the same range for both types (EMC,  $\Delta V_0$  %...). Furthermore, differences in vibrational properties between specimens had not an effect on how they reacted in face of drying and stabilization (Fig.5.17).

Subjecting the specimens to weak cycles of desorption-absorption could, more than anything else, modifies damping. Being already in the lower range (Red curve in Fig.5.17), after 4 conditioning cycles,  $\tan\delta$  dropped by  $\approx 11\%$  of its original value. This however is partly recovered after 5<sup>th</sup> cycle, to  $\approx 6\%$  lower than the initial.

The amplitude of changes may seem small, but two points should be kept in mind:

- Even when exposed to more severe treatments,  $\tan\delta$  change stayed small: for cold and hot water treatments,  $\Delta\tan\delta$  never exceeded 3% and 7%, respectively.
- More generally, and linking the presented results to what could be seen in an in-situ traditional wood preparation for instrument, wood would be left to air-drying for a much longer time than that of this study. Probably the observed reduction in damping would tend to stability when facing longer cycles. This slow decrease in damping could be the hidden reason why long-time air dried wood is preferred for instrument making.

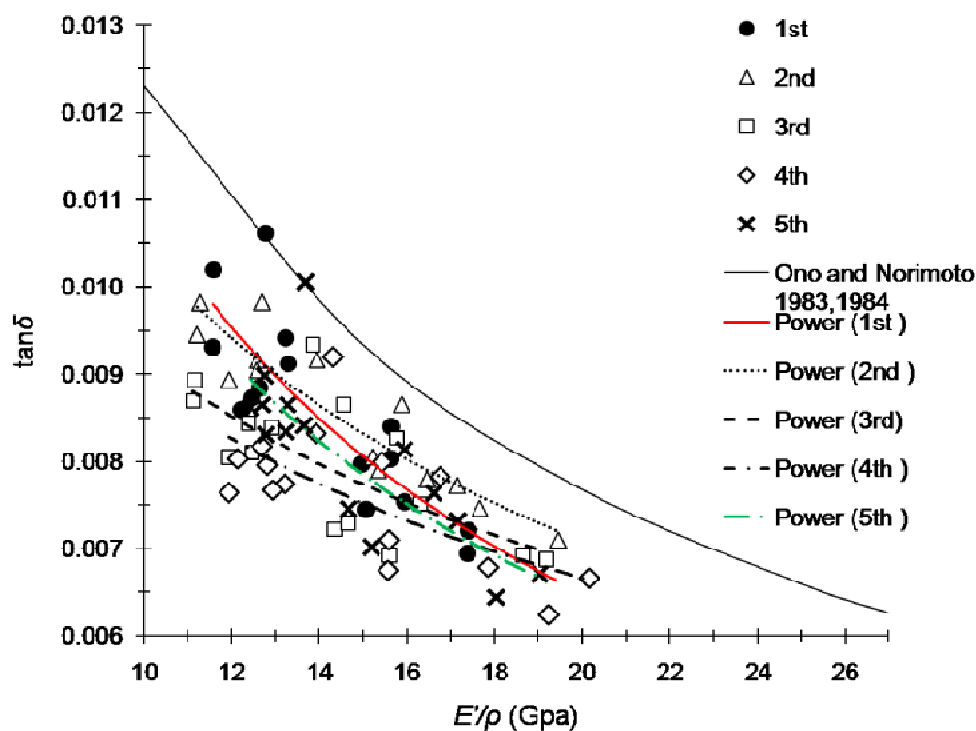

Fig.5.17.  $\tan\delta$  and  $E/\rho$  relationship after 5 times of drying and stabilization. Reference curve is added from Ono and Norimoto 1983, 1984).

As already mentioned, the musician and the artisans prefer aged wood for the fabrication of musical instruments. The term “aged” refers here to a wood that was air-dried for a long time, sometimes it happens naturally: wood is cut and used for other applications – e.g. doors or furniture- for several decades before being re-used for instrument fabrication; other times it is cut and left to be air-dried for several years by the instrument maker himself, hoping to create a more stabilized raw material. Recently Noguchi et al. (2011) compared a 300 old Akamatsu (*Pinus densiflora*) wood with a recently cut one, for its vibrational and mechanical properties. They found that the aged wood has lower  $\tan\delta$  and higher  $E/\rho$  than newly cut wood. They also stated that despite the fact that heat treatment is sometimes considered as an accelerated method of aging, natural aging happens in presence of a moderate RH (30%-80%) that is not normally allowed in heating treatment. The cyclic conditioning described above could be considered as a preliminary procedure to simulate real in-situ aging process. Stability of wood also can be improved

by drying, as the very hygroscopic hemicellulose is degraded at high temperature (Hillis and Rozsa 1985, Edvardsen and Sandland 1999). Here, however, we used this group as controls to check the volumetric stability of other treated ones. The negligible changes in  $\Delta V_0$  between the phases (+1.03%, +0.21%, -0.49% and +0.72% /relative differences between five dryings) suggests that the dimensions throughout years of repetitive desorption/adsorption cycles would remain stable.

## **5-4- Conclusion**

Three kinds of treatments involving only water, quasi-anhydrous drying and stabilization were performed on different groups of specimens. The two water treatments were the reproduction of actual in-situ pretreatments traditionally performed by the artisans, while the last drying/ stabilization involved process can be regarded as the early phase of natural aging.

Long time immersion in water in ambient condition does not bring any significant change in damping, specific modulus, or volumetric stability in adsorption. While small decreases were observed in both  $\tan\delta$  and  $E'/\rho$ , no effect of time relation was observed. Immersion in water, on the other hand, caused visible defects (from irreversible bending to small cracks due to probable collapse) on vibrational specimens.

Short time hot water treatment causes  $\tan\delta$  to increase and specific modulus to drop. The modifications in  $\tan\delta$  are time related, and in most cases proportional to the amount of removed extractives.  $\Delta E'/\rho$ , contrary to the last case, shows a stable time-independent reduction by the treatment. Both vibrational factors are related to  $\Delta MC$ , as a gradual increase in MC affected directly and inversely  $\tan\delta$  and  $E'/\rho$ . The modifications are explained by the combination of extractives removal and early decomposition of cell-wall constituents. Volumetric stability in both adsorption and desorption is mostly unaffected by the treatment.

Cyclic drying and stabilization, first designed to be used only as controls for other treatments, is able to decrease damping without negatively affecting other properties. As it is an approved fact amongst artisans that a long time air dried/aged wood has great preferences in instrument fabrication, this test could be considered to roughly simulate the leading to a wood with lower damping and higher rigidity.



## 6. Effect of extraction

---

### ➤ On extractions: multi-aim chemical treatments

Chemical extractions are not, like hygro-thermal treatments (chapter 5), designed to simulate techniques used by artisans. The reported strong relationship between extractives (regarding both their quantity and their nature) and vibrational properties, as well as the effect of their location in wood matrix on the amplitude of modification, are sufficient reasons to consider multi solvent extraction as an informative method. Water will be now considered as one of the possible extractive agents, and will be included to study the role of water-soluble compounds.

In this chapter, a detailed explanation on the protocol of extraction is followed by the results obtained with two extraction methods on powder, shrinkage, vibrational and DMA specimens. The vibrational methods are the same as those presented in chapter 3 (§3-2-2).

### 6-1- Procedure of extractions

#### 6-1-1- Choice of solvents

The choice of solvents is done according to two criteria: they should (i) differ in polarity and (ii) leave specimens in perfectly testable conditions (not endanger any structural characteristics).

Based on literature review, the most commonly used solvents for wood were identified. Water was an inevitable choice and then other solvents were chosen based on their specific features (polarity, boiling point and ability to extract from wood without destructing the structure). The chosen solvents are, by increasing polarity:

Hexane (H) → Dichloromethane (D) → Acetone (AC) → Methanol (ME) → Hot water (HW)

Hexane (H), as the least polar agent in the list, is expected to reach heavy hydrocarbons deposited in the lumen. Dichloromethane (D) is able to solubilize fatty acids, resins, and different oil type compounds. Acetone (AC) can remove fatty acids, resin acids, fatty alcohols, sterols, di- and triglycerides, steryl esters and waxes. Methanol (ME) extracts a selection of alcohols, phenols, ketones, esters, ethers, aldehydes, carboxylic acids, and furans from wood structure. Water can probably reach different compounds such as polysaccharides and carbonic acids. A degradation of hemicelluloses can also happen when water is used at high temperatures (Assor et al. 2009), which was not the case in this study.

More details on the technical features of each solvent can be found in Annex B.

### 6-1-2- Extraction protocole

Extraction is done in all cases using a soxhlet system (Fig.6.1). Specimens (powder or solid wood) are put in cellulose cartouches, and extracted by a cyclic solvent rinsing. Time and temperature of extraction depend on the specimens' type and used solvents (see below, §6-1-4). Once the extraction is completed, the solvent is evaporated using a rotavapor system and specimens are oven-dried at 60°C for 48 hrs. In case of vibrational specimens, the stabilization phase of two weeks in climatic chamber follows.



Fig.6.1. Soxhlet system of powder extraction: The color change by methanol can be seen in the picture on the right.

#### ➤ Evaporation of solvents/ getting the crude extracts

Evaporation of solvents is performed (i) to get an approximate measurement of extractive contents and (ii) to remove, isolate and gather extractives for a through compound identification using Gas chromatography spectrometry mass (GC-Mass).

Evaporation was done using a soxhlet based Rotavapor RE-120 (Fig.6.2). The balloon, filled with solvent and removed compounds, is connected to the machine while floating in a pot of hot water at controlled temperature. Water temperature is set according to each solvent boiling temperature. Imposing a speedy rotary movement to the balloon placed in a bain marie, along with applied vacuum, causes the solvent to be evaporated and re-condensed in another container while the solid extracts remains in the original one. The rotary speed is manually controlled to avoid imposing a sudden vacuum to the entire solvent.

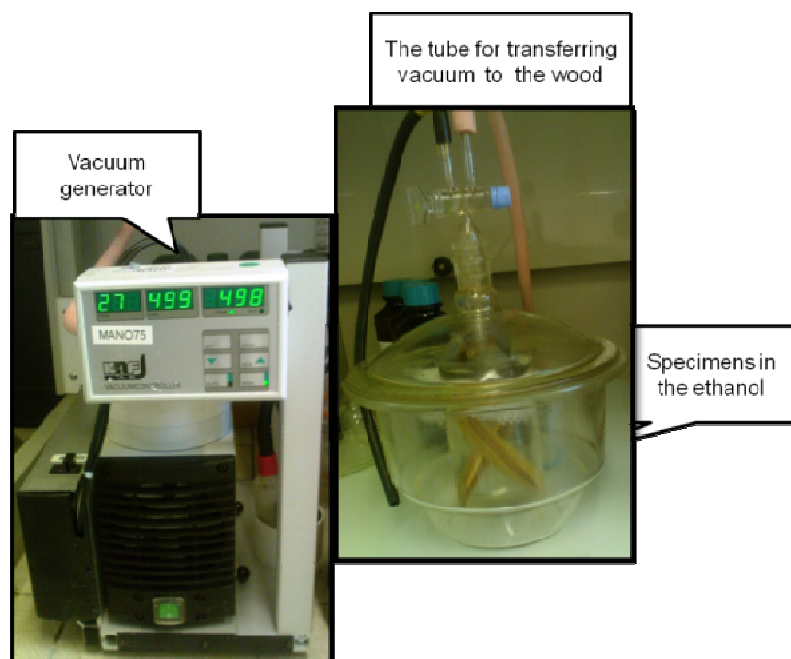

Fig.6.2 the assembly of rotavapor for solvent evaporation

### 6-1-3- Methods of extraction

For each solvent, its affinity and reaction with wood matrix must be considered. This means studying solvent-wood reaction in a mutual relationship. We decided to use each solvent once individually (independently/in a parallel way) and once in relation with others (successively/serially). Each of these methods has its own advantages:

Studying the yield of extraction corresponding to each solvent and the probable localization of removed extracts gives a better understanding of the individual effect of each extractive agent. “Which are the solvents that act the same? What solvent is the most/least effective regarding its yield/modification of vibrational properties?” These are the questions that would be answered by using each solvent independently.

A deeper perception of extractives can be reached by using solvents one after another in a successive way. Thus, the cumulative effect of two or more successive solvents on one set of specimens can be studied. This method can help to answer the following questions: “what is the relation of each solvent with others regarding their relative activity? Can two similar solvents – polarity-wise – mask each other’s effect when used simultaneously? What are the reasons for a solvent being ineffective and/or effective when used individually/successively?” ...

Different specimens were submitted to both methods (Fig.6.3).





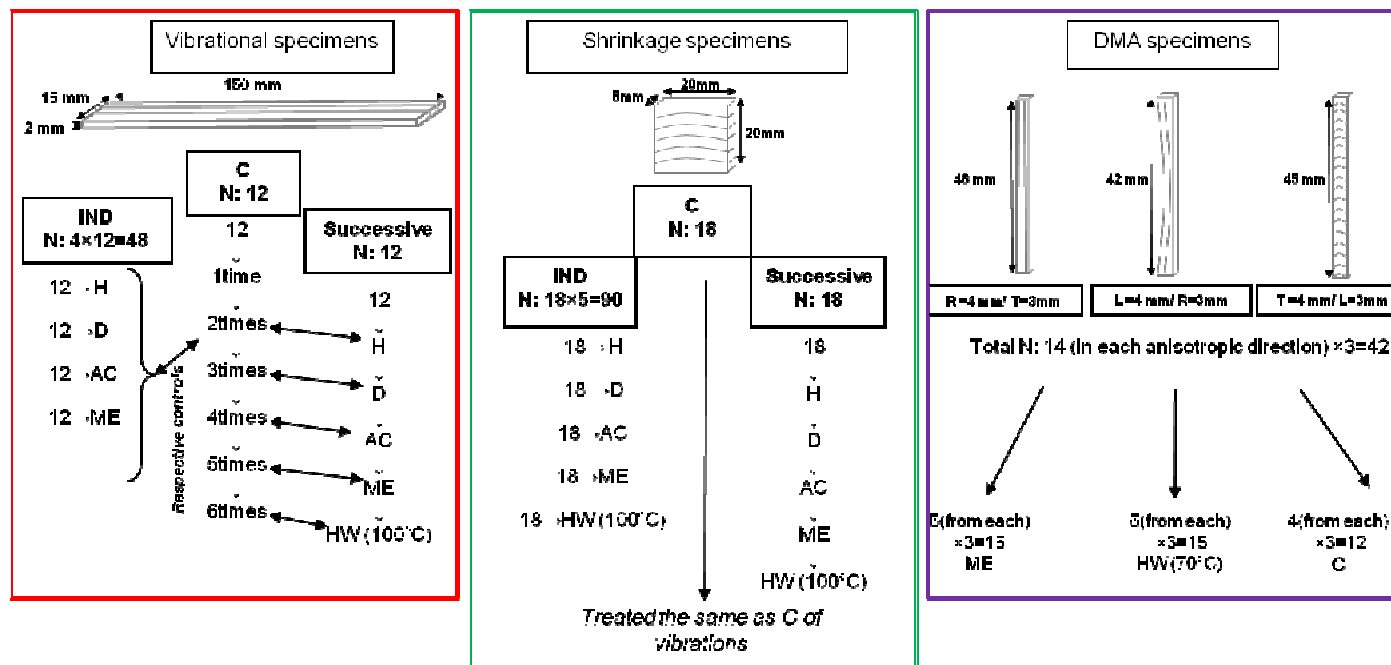

Fig.6.3. General extraction protocols for solid specimens.

- IND: Independent method of extraction, C: controls, H: Hexane, D: Dichloromethane, AC: Acetone, ME: Methanol, HW: Hot water (Temperature is precised in each case).
- Protocol for controls: oven drying (48 hrs, 60°C) + 3 weeks in 20°C±2°C and 65%±5%RH.
- All specimens have undergone the same conditioning protocol as Controls, before and after treatments as well as in between steps in case of successive treatments.
- Treatments for DMA specimens were independent, their controls were conditioned twice.



### **6-1-3.a. Independent extraction**

This method consists in using each solvent separately on one independent set of specimens. This means that one set of specimens (N: 12) is exposed to one solvent. Their vibrational properties, or any other property, are measured before and after the treatment. Consequently, the observed alteration is only caused by that particular solvent.

### **6-1-3.b. Successive extraction**

This method starts with the solvent of lowest polarity (H in this case) on one set of specimens (N: 12), and continues with the following extractive agents by increasing polarity: D, AC, ME, HW. In between the steps, specimens are subjected to the conditioning cycle and measured. Two different sets of controls (one for independent and one for successive extractions) are prepared using specimens of the same shape and dimensions (and from the same batch, see chapter 5). Controls are measured at the same time/conditions but without having to go through extractions.

## **6-1-4- Details on the extractions of different types of samples**

### **6-1-4.a. Extraction from powder**

Powder extraction is the most exhaustive one: when using fine powder, solvent access to the sites is increased for extracting agents. Extraction time, however, has always been a matter of discussion. When the extraction would be finished? Are all extractable compounds removed at the time of stopping the process? Answering to these questions has always been challenging. For some tropical woods, where extraneous compounds are highly associated with colors, the solvent is colored as long as there is any material to remove and when this is not the case anymore it may indicate complete extraction.

In our case, however, color-associated extractives are not quantitatively important. Some weak color change happens in cases of AC and ME extractions, in a hardly detectable way in HW, but never in H and D. This made us to decide on an optimum time of extraction based on standards (Tappi standards T204cm-07 and T207cm-08) and 8 hours exhaustive extraction was assumed enough. Once the first independent extractions were completed, the obtained WL and extractive contents were compared with available literature and the choice of extraction time was confirmed.

Powder is prepared as described earlier (§3-1-1.d). Extractions are done using a Soxhlet (Fig.6.1). 3 g of oven-dried powder is put in a cellulose cartridge. Drying is done as usual at 60°C for 48 hrs. Although this condition does not allow reaching anhydrous condition, it is necessary to avoid any decomposition of temperature sensitive compounds. Furthermore, as drying after extraction is also done in the same conditions, comparison of the results is possible.

Specimen weight is measured with its corresponding cartridge. However, in some cases a little piece of cotton must be put on the powder to avoid possible particle floating. In those cases, the weight is measured again after adding the cotton.

For each solvents triplicate tests are carried out. Once the extraction is over, the cartridge is brought out carefully and oven-dried (60°C, 48 hrs). Before measuring final dry weight, and after bringing out of oven, the specimen is left in a desiccator for at least 10 minutes.

The weight loss of powder is calculated as:

$$WL_p(\%) = \frac{W_{0\text{before}} - W_{0\text{after}}}{W_{0\text{before}}} \times 100 \quad (6-1)$$

where:

$WL_p$ : powder weight loss (%)

$W_{0\text{after}}$ : oven-dry weight of powder + cartridge + cotton (when used) after extraction

$W_{0\text{before}}$ : oven-dry weight of powder + cartridge + cotton (when used) before extraction

In addition to  $WL_p$ , the crude extracts amount is also calculated. For that matter, the weight of glass balloons used for extractions is noted before starting the process. Once it is over, the solvent is evaporated and the balloons are re-weighed to obtain the weight of remaining extracts. This data is used as a comparator to  $WL$ , to see if the actual removed substance is in relation with the observed lost weight. But as a complete drying of balloons is not done before and after extractions, the data are not as direct as  $WL$  and are just used to compare the trend (§6-2-2.a).

The crude extractive contents is calculated according to:

$$EC(\%) = \frac{W_{b\text{before}} - W_{b\text{after}}}{W_{b\text{before}}} \times 100 \quad (6-2)$$

where:

$EC(\%)$ : crude extractive contents

$W_{b\text{after}}$ : weight of balloon + remaining extractives after solvent evaporation

$W_{b\text{before}}$ : weight of empty balloon before extraction

#### **6-1-4.b. Protocol for extraction of solid wood (shrinkage, vibration and DMA specimens)**

##### **➤ Extraction duration/ arrangement of specimens**

The extraction protocol for solid wood is based on two basic requirements: (i) to extract as much as possible (duration of extraction) and (ii) to make the process as non-destructive as possible (number of specimens in each cartridge, their adjustment, drying method...).

The first aim is important because extraction of solid wood cannot be as exhaustive and complete as for powder. The big dimension of specimens (especially vibrational ones) limits solvent access. Even though the completeness of powder extraction may never be reached, it can be approached by extending the treatment duration.

The second aim is essential regarding different aspects. In case of shrinkage specimens, other sources of dimension alterations than solvents (high temperature, bad sample adjustment...)

should be avoided. The importance of a non-destructive extraction is even more crucial for vibrational specimens that must preserve their original straight shapes. As  $\tan\delta$  by logarithmic decrement proved to be dependent on surface condition of the specimen, the least surface change is desirable. Micro and macro cracks, bending, and collapse must be avoided. For DMA specimens, surface condition is not the top priority but keeping a straight, not-bent conformation is essential: when specimens are fixed in the clamps, any alteration from straightness may induce errors.

By taking into account all aspects mentioned above, and by comparing available data, 12 hrs of soxhlet extraction is considered as enough for a complete removal of extractives. There are some reports of 18 hrs to 36 hrs of intensive extractions (Demirbaş 1991, Baptista et al. 2006, Brémaud 2006), but considering the moderate extractive yield of white Mulberry (reported 12% after ethanol/ benzene by Se Golpayegani 2007), this time duration seems to be enough. The good correlations of powder and solid extraction will confirm this choice (§6-2-2.b).

For shrinkage, vibrational and DMA samples, the numbers of specimens in one cartridge is 6, 6 and 12, respectively. Specimens are placed to fit the bottom of the cartridge. If in any case specimens must be put on top of each other, it is done in a way that not only a solvent flow is ensured but also that the specimens are subjected to the least pressure/dimension change.

In case of vibrational samples, the specimens are fastened to each other using a thin cotton thread extended to the exterior of soxhlet, in order to keep them from floating. Long cartridges are used to match the length of the specimens.

Both vibration tests (LMGC/BING) are carried out in between extraction phases, as well as twice in the beginning and in the end. In successive method, contrary to the independent one, any measured property would be the cumulative result of the previously used solvents. Nevertheless, by using the values of previous phase, it is also possible to calculate the independent effect of each solvent.

## **6-2- Modification of properties due to extractions**

### **6-2-1- Overview of data for solid wood**

Before starting to analyze the modifications observed after each solvent/ method, Tables 6.1 and 6.2<sup>15</sup> present the raw values, as well as the homogenous subsets obtained by ANOVA and t-test paired samples, for solid specimens subjected to independent (Table 6.1) and to successive use of solvents (Table 6.2). The raw values of EMC,  $\rho$ ,  $E'/\rho$  and  $\tan\delta$  are presented for each group of specimens exposed to one (or a series in case of Table 6.2) solvents.

---

<sup>1</sup>.As the same group of controls used for independent extraction and short time hot water treatment, the control results are the same as what was presented in Table 5.2.

Table 6.1. Properties for groups submitted to independent extractions.

Treatment	EMC (%) <sup>d</sup>		Specific gravity		$E'_L/\rho$		$\tan\delta_L (10^{-3})$	
	Native	Treated	Native	Treated	Native	Treated	Native	Treated <sup>f</sup>
Control <sup>e</sup>	9.2±0.5	9.2±0.2 <i>ns</i>	0.556±0.027	0.553±0.030 <i>ns</i>	15.0±2.2	15.2±2.4 <i>ns</i>	8.6±0.3	7.9±0.5 **
	8.2±0.4 (a)	8.2±0.2 (ab)	(a)	(ab)	14.0±1.6 (b)	14.2±1.6 (a)	(a)	(a)
Extracted								
H	9.1±0.2	8.9±0.4 <i>ns</i>	0.570±0.031	0.566±0.030 **	13.5±2.0	13.7±2.0 **	10.2±0.6	9.6±0.6 **
	8.1±0.2 (a)	7.9±0.4 (a)	(a)	(b)	12.3±1.4 (a)	12.5±1.4 (a)	(b)	(bc)
D	9.0±0.3	9.6±0.4 **	0.560±0.031	0.557±0.031 **	14.3±2.2	14.3±2.2 <i>ns</i>	9.6±1.0	9.3±0.8 *
	8.0±0.3 (a)	8.6±0.3 (c)	(a)	(b)	13.2±1.6 (ab)	13.3±1.6 (a)	(b)	(bc)
AC	9.1±0.4	9.4±0.4 *	0.567±0.026	0.550±0.025 **	14.6±1.6	13.9±1.6 **	8.7±0.4	9.8±0.6 **
	8.1±0.3 (a)	8.6±0.3 (c)	(a)	(ab)	13.3±1.1 (ab)	13.2±1.1 (a)	(a)	(c)
ME	9.2±0.4	8.7±0.2 **	0.554±0.026	0.520±0.025 **	14.4±2.2	12.9±2.0**	8.9±0.5	9.5±0.5 **
	8.2±0.4 (a)	8.3±0.3 (bc)	(a)	(a)	13.5±1.4 (ab)	12.9±1.4 (a)	(a)	(bc)
HW	9.2±0.3	9.0±0.2 <i>ns</i>	0.550±0.015	0.530±0.017 **	14.1±1.7	14.0±1.9 <i>ns</i>	8.5±0.5	8.6±0.6 <i>ns</i>
	8.2±0.3 (a)	8.3±0.1 (bc)	(a)	(ab)	13.3±1.3 (ab)	13.7±1.7 (a)	(a)	(ab)

H: Hexane, D: Dichloromethane, AC: Acetone, ME, Methanol, HW: Hot water

“Apparent” stands for measured values, “Corrected” take into account the contribution of extractives to weight (for EMC) and specific gravity (for  $E'_L/\rho$ ).

(a, b, c): homogenous subsets in one-way ANOVA at a level  $\alpha:0.05$  (=comparison between groups in a given column, based on measured values)

(*ns*, \*, \*\*): differences between untreated and treated properties of a given group (based on corrected values whenever applicable) in *t*-test for paired samples, \*\*: significant at  $\alpha: 0.01$ , \*:  $\alpha: 0.05$ , *ns*: not significant.

d) EMC relative to 103°C oven-drying. “Apparent” are measured values, “Corrected” is calculated by taking into account the total extractive content (cumulated % on powder) from batch 1 (see Hernandez 2007).

e) “Treated” state for controls stands for values measured after one cycle of oven-drying followed by air-dry re-stabilization.

f)  $\tan\delta$  are raw values, whereas  $\tan\delta$  variations in Fig.6.17 are corrected for controls.

Table 6.2. Measured values for the group of specimens submitted to successive extraction.

Treatment	EMC (%) <sup>a</sup> Corrected Apparent	Specific gravity $\rho$	$E'_1/\rho$ Corrected (GPa) Apparent (GPa)	$\tan\delta_L (10^{-3})$
Untreated	7.0± 0.3 6.1± 0.3	0.515± 0.011	13.72± 1.47 12.99± 1.25	8.2± 0.5
H	7.1± 0.3 ns 6.2± 0.2	0.512± 0.016 ns	13.46± 1.68 ns 12.82± 1.35	7.9± 0.4 **
D	9.2± 0.2 ** 8.0± 0.2	0.515± 0.012 ns	13.51± 1.26 ns 12.78± 1.07	9.3± 0.6 **
AC	9.0± 0.4 ns 8.0± 0.3	0.515± 0.016 ns	13.53± 1.64 ns 12.79± 1.30	11.3± 0.8 **
ME	8.6± 0.1 ** 8.2± 0.1	0.505± 0.014 **	12.69± 1.38 ** 12.24± 1.13	10.6± 0.6 **
HW	8.8± 0.1 ** 8.8± 0.1	0.488± 0.011 **	11.85± 1.23 ** 11.84± 1.05	10.2± 0.5 *

a. EMC relative to 103°C oven-drying. “Apparent” are measured values, “Corrected” is based on calculated oven-dry mass after the most efficient (ME) removal of extractives (see Hernandez 2007)

\*\* : significant for  $\alpha$ : 0.01 for each successive treated state in relation to the previous phase of extraction

In the tables, both “native” and “treated” values are presented. In two cases (EMC and  $E'/\rho$ ), the values are corrected for the contribution of extractives. Corrected  $E'/\rho$ , which is more representative of an extractive-free cell-wall is 0.01 to 1.2 GPa higher than the apparent one (Tables 6.1 and 6.2).

Table 6.2 shows that as specimens go through further serial extraction, their  $\rho$  and  $E'/\rho$  decrease, while their EMC and  $\tan\delta$  increase. The same is observed for independent extraction (Table 6.1), but less clearly. Remember that six different sets of specimens are submitted to each individual treatment (solvent) in case of independent extraction, therefore, intrinsic characters of each group/specimens prevents the observation of the same net trend of the serial extraction.

Although these tables are informative on the modifications, a number of results cannot be simply derived from them. Questions like: “which is the most efficient treatment amongst all five (yield wise)?”, “Do some properties change together under the effect of one solvent?” or “What did we get from applying solvents both serially and individually”, remain unanswered. For that, the variations must be analysed.

## 6-2-2- Effect of extraction on physical properties

### 6-2-2.a. Weight loss and extractive content relationship in powder extraction

The amount of removed extracts is always lower for solid wood than powder as complete extraction is never assured in the former. Fig.6.4 compares EC (%) and WL (%) obtained by both methods of extractions, independent and successive. The differences between WL by two methods will be fully discussed later on. Here we focus on the EC-WL relationship. The same order of amplitude is obtained. Except HW as the last solvent used after a series of four other agents, with its EC falling below its WL (Fig.6.4.b), in all other cases EC stays over WL and sometimes the ratio is twofold.



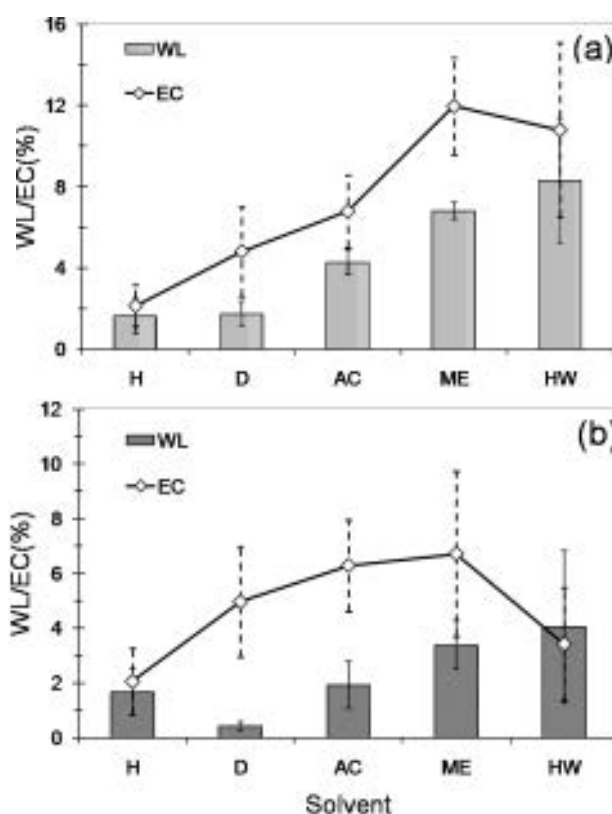

Fig.6.4. Comparison of weight loss (WL %) and extractive contents (EC %) of powder specimens using an independent method (a) and successive method of extractions (b), N: 6 each for independent: 6×5: 30 and 6 for successive.

There are several explanations for the higher EC compared to WL. The extracts are never oven-dried and EC is calculated based on the weight of residuals remained at the bottom of balloon after solvent evaporation. This exposition is limited to the time necessary to evaporate all of the solvent volume ( $\approx 300\text{ml}$ ), residual extracts possibly contain some moisture resulting in overestimating their weight. On the other hand, small losses (onto the cell cartridge or very limitedly when transferring the solvent from one glass balloon to another), may have the opposite effect but in general EC stays higher than WL.

Notwithstanding the fact that individual EC values cannot be fully trusted, their trend is in complete harmony with that of WL both methods and thus, they can be used as verification for WL. The case of HW in successive extraction seems to fall out of the trend, but considering the evaporation temperature for water ( $100^{\circ}\text{C}$ ), the residual extracts were almost “dried” compared to the preceding ones and the  $\text{EC}_{\text{HW}}$  could be in fact considered as correct.

### **6-2-2.b. Weight loss of powder, shrinkage, and vibrational specimens**

Both methods of extractions are carried out on all three kinds of samples (i.e. powder, shrinkage, and vibrational specimens). Even though the final aim for which various types of specimens are exposed to treatments are different, they are all measured for their WL, which can be compared for checking and discussing differences. Fig.6.5, showing WL from solid wood as a function of powder WL, confirms that powder extraction is more exhaustive than that from solid wood. The mean values obtained by solid wood are all below those of powder. They are, however rather close except for HW that was half less efficient on solid wood. The figure allows also to compare WL of different types of solid wood specimens.

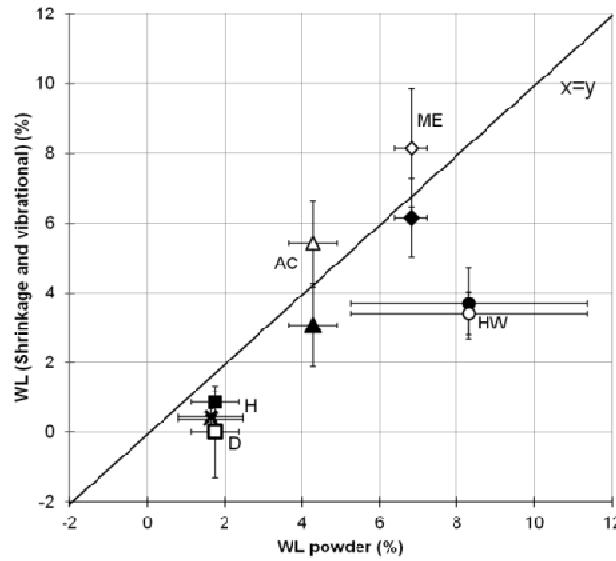
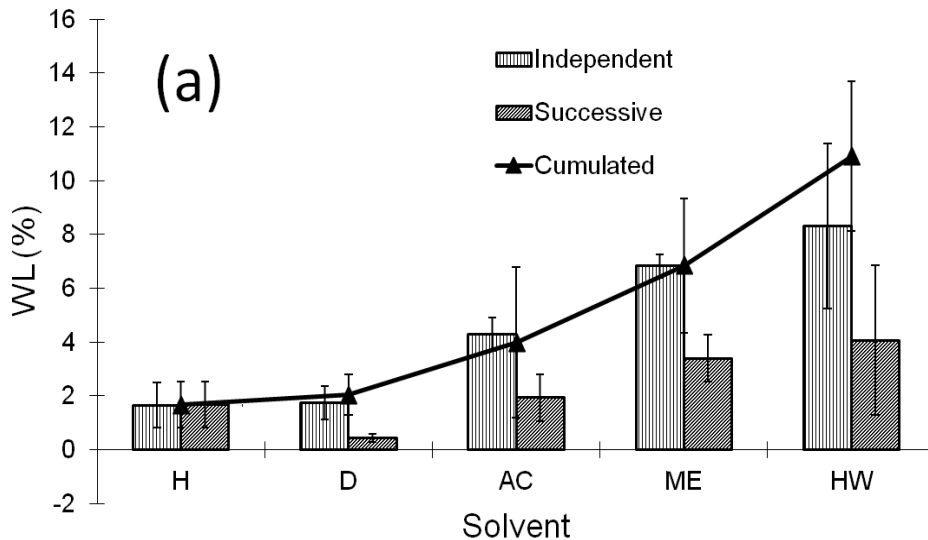

Fig.6.5. Weight loss (WL %) due to extraction on shrinkage (filled symbols) and vibrational (empty symbols) specimens, as a function of powder WL.

Fig.6.6 details the WL by both extraction procedures for powder, shrinkage, and vibrational specimens. Concerning powder extraction (Fig.6.6.a), HW is the most effective solvent, followed closely by ME. AC is intermediate and stays close to ME. Less polar solvents (H and D) remove approximately the same amount of extracts when used individually, but when used in a serial way D removes almost a third of the independent amount. Successive extraction of AC, ME and HW drop to half of the independent value. For H the independent and successive extractions are equivalent because it is the first of the serial extractions. The ordering of WL due to five solvents is compatible with their polarities: the more polar the solvent, the higher the WL.



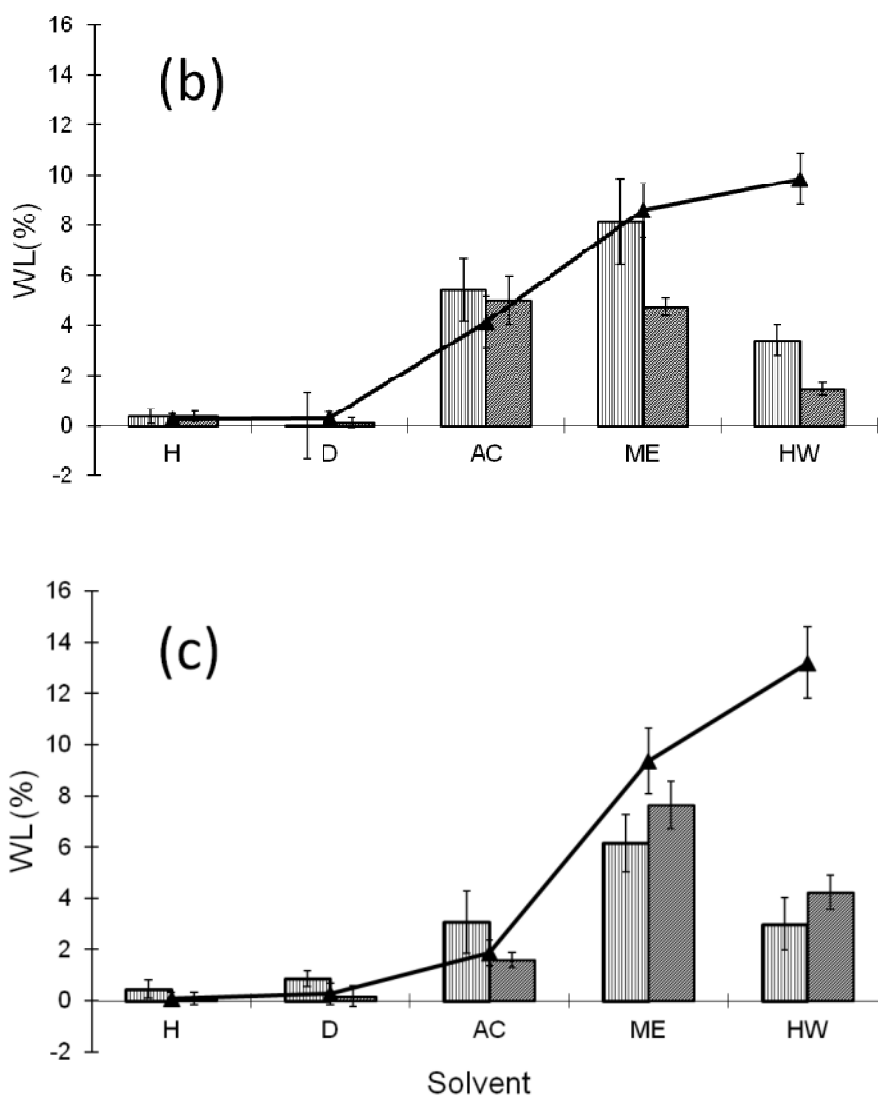

Fig.6.6. Weight loss (WL %) for (a) powder, (b) shrinkage and (c) vibrational specimens. “Successive” weight losses are relative to the previous step, “independent” and “successive-cumulated” are relative to native oven-dry weight. H: Hexane, D: Dichloromethane, AC: Acetone, ME: Methanol and HW: Hot water.

Focusing this time on the shrinkage specimens as a first form of solid samples, Fig.6.6.b shows the same removal order as in powder. However, here the apolar solvents cannot reach as thoroughly as they did in powder. Thus, the yield of extraction for successive use of AC nearly reaches the amount of its individual use ( $WL_{AC}$ : 5.5% and 5% for independent and successive methods respectively). This means as H and D cannot entirely empty the lumen (where they are supposed to be the most effective), AC does not only extract from cell walls, but also covers for whatever remained in the lumens. For shrinkage specimens highest yield of extraction is that of ME with 8.14% and 4.75% for independent and successive extraction.

In specimens of greater dimensions, the accessibility of the extracts plays a more important role. In vibrational specimens (Fig.6.6.c), the apolar solvents<sup>16</sup> still remove much less extracts

<sup>1</sup>Here, as it can be seen in the Fig.6.6.c, contrary to powder and shrinkage specimens, the weight losses are not the same for the first treatments (H). This means that the series which were used for independent extraction by H was not used for following serial extractions. This is indeed correct, as the exhibited results (as well as all the results

than in the powder, even though they are more effective than in case of shrinkage specimens (Fig.6.6.b). AC here, not being as intrusive as in shrinkage specimens, only removes  $\approx 3\%$  of extracts. Once solvent are used in a serial way on the vibrational specimens the results become slightly different from the last two cases. When D is used after H, its yield is very low, suggesting that H has already removed most of extractives accessible to apolar solvents. Similarly, AC has a smaller yield when used after H and D, suggesting that when used independently, it also removed compounds from lumens. Although AC and ME are thought to be able to solubilize similar types of compounds, ME causes the most exhaustive extraction from solid wood: 6.2% when used independently. Its efficiency even increases when used after AC (7.14% from vibrational specimens). Here, contrary to the last two cases, successive yield of extraction exceeds the independent yield in ME and HW. This can be partly due to the inefficiency of AC after H and D, which left more compounds to be removed by the following solvents.

Comparing WL of 3 kinds of specimens shows that the efficiency of solvents is in relation with their polarity as well as volume/dimension of the specimens and accessibility of the extractives. In powder, this order is respected completely. In solid wood however, HW is not as efficient as in powder and AC and ME remove the extracts more easily. This is verified by the fact that the cumulated yields were however the same between powder and solid.

#### **6-2-2.c. Weight loss and volume change: vibrational and shrinkage specimens**

Even though WL gives a pretty good idea on the quantity of the extractives present in the wood structure, their localization cannot be deduced from a simple extraction yield. According to the classification by Stamm and Loughborough (1942), extractives are divided into 2 subgroups: (i) those in the coarse capillary structure (lumen) and (ii) those in the cell wall structure. Theoretically, although type (i) affects the relationship between  $\rho$  and swelling (Mantanis et al. 1995), only type (ii) can definitely dimensional changes. Moreover, when vibrational properties are concerned, only cell-wall modifications can be counted as effective. Consequently, dimensional changes due to extractions give a first idea about the location of removed extractives.

However, these general principles do not apply easily to our specimens. Fig.6.7.a shows the relationship between WL and the corresponding volume variation ( $\Delta V_0$  %) for vibrational specimens after independent extractions. Even though all specimens swell due to treatments (maximum for HW  $\approx 10\%$  after independent extraction), once they are corrected for the values of controls, shrinkage is observed in the majority of extractions (Fig.6.7.b). This result, however, is not convincing enough, as  $\Delta V_0$  data are inconsistent with WL. D, although not removing much compound, displays a corrected  $\Delta V_0$  of -5.6%.

These values are obtained based on the formula (3-3). As the dry state (from which the values of  $\Delta V_0$  were calculated) is actually a quasi-anhydrous condition of 60°C drying, the complete

---

on the successive method which are going to be presented from now on) are those of second series of specimens which were extracted successively. For a detailed explanation on the differences between first and second series, and the justifications for choosing the second series as the representative of successive extractions, look at Annex C.

swelling compares to a real anhydrous state cannot be calculated. The conditioning protocol despite being necessary for the vibrational measurements, can impose a serious error on the dimensional certainty.  $\Delta V_0$  values of controls ( $+ 6.53\% \pm 5.22/$  average for a group of 12 specimens), the large amplitude along with high variation between specimens is putting even more doubts on the results.

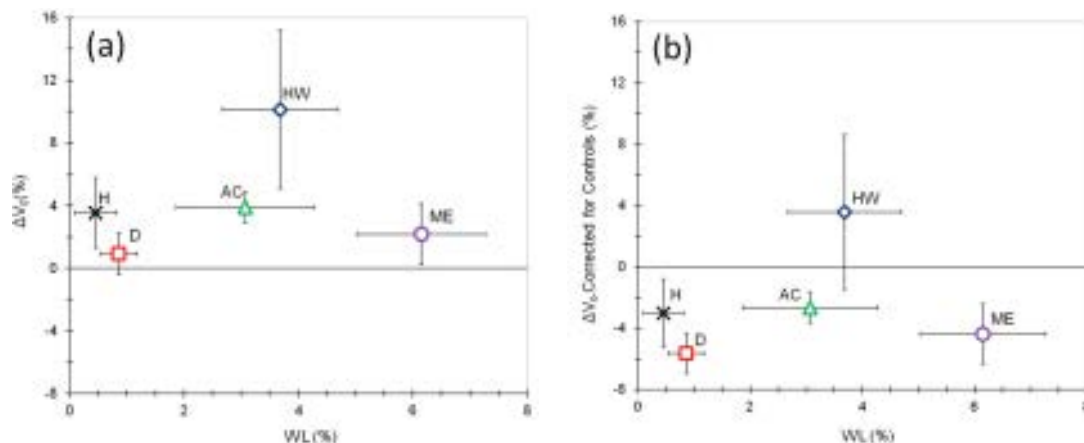

Fig.6.7. Variations in oven dry volume ( $\Delta V_0\%$ ) and weight loss (WL %) after independent extractions in vibrational specimens. (a) uncorrected, (b) corrected for control.

$V_0$  is calculated by multiplying the R, T and L dimensions. However, from those three, T, being the smallest ( $\approx 2\text{mm}$ ), exhibits large variations and its modifications cannot be trusted. Indeed, when T dimension is not taken into account (Fig.6.8), and a  $\Delta S_0$  (changes in RL surface in anhydrous conditions) is used instead of  $\Delta V_0$ , amplitudes of changes are much less important than in Fig.6.7. This time  $\Delta S_0$  of the controls ( $0.20\% \pm 0.31$ ) is also deduced from the actual values. In Fig.6.8, vibrational specimens extracted by H, D and ME, are showing small to negligible changes in their surface (some ME- extracted showing shrinkage but still less than 1%), while AC and HW extracted samples are swollen. For AC the swelling is small, but for HW-extracted specimens a maximum of  $\approx 3.5\%$  is observed.

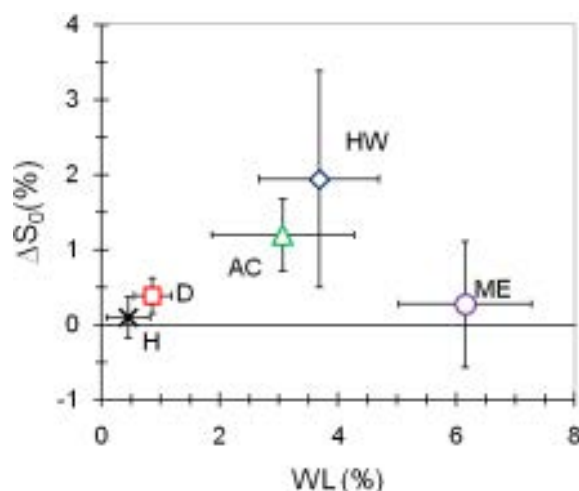

Fig.6.8. Variation in oven dry surface ( $\Delta S_0\%$ ) and weight loss (WL%) after independent extraction in vibrational specimens. Data is corrected for the corresponding controls.

Fig.6.8, does not point to any WL compatible modifications. HW causes a swelling in surface, larger than the others, while, ME, having the highest extraction yield, does not greatly modify any macroscopic dimensions.

Shrinkage specimens are gone through the same extraction protocol as vibrational ones (except not having to be stabilized after each drying). Here controls exhibit an average  $\Delta V_0$  of  $0.04\% \pm 0.16$  (average value for a group of 18 specimens), which confirms the validity of the measurements on the extracted samples.

Fig.6.9 presents WL (%) and  $\Delta V_0$  (%) for shrinkage specimens submitted to both independent and successive extractions. Here, like in vibrational specimens, the maximum swelling happens after HW extraction (9.73% and 6.76% independently and successively, respectively). Specimens extracted by polar solvents, still having high extractive yields, exhibit the lowest  $\Delta V_0$ :  $\approx 1\%$  and  $0.5\%$  for AC and ME (values of independent extraction). D on the other hand, when used as an individual extractive agent, shows a swelling capability close to water ( $\approx 9\%$ ). Successive  $\Delta V_0$  values for shrinkage specimens (shown in Fig.6.9.b) indicate that AC and ME induce shrinkage when used after other solvents, but the amplitudes remain small ( $\approx -0.55\%$  and  $-1.25\%$  for AC and ME respectively). Using H as an extractive agent before D (H+2 times of drying), seems to significantly decrease the swelling amplitude of D, as  $\Delta V_0$  displays values of  $0.42\%$  and  $1.87\%$  (successive and cumulated-successive) after D extraction.

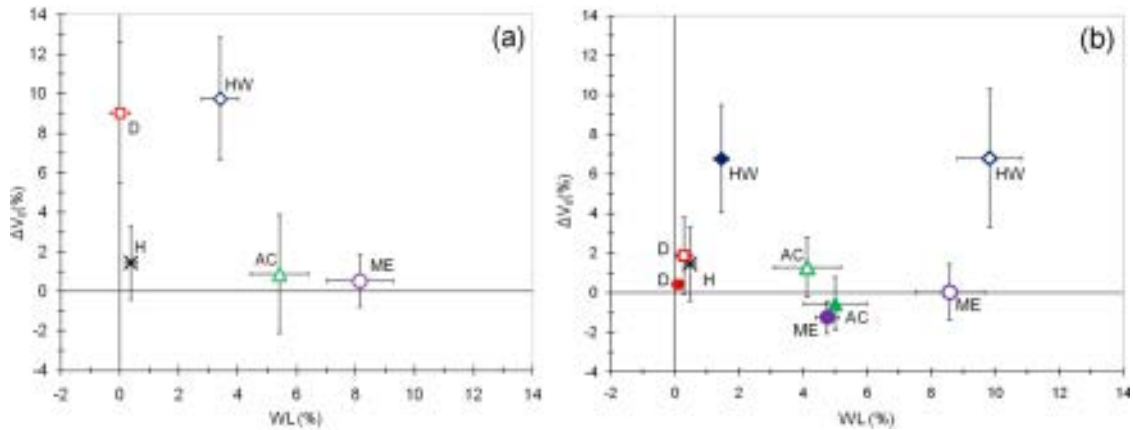

Fig.6.9. Variations in oven dry volume ( $\Delta V_0\%$ ) and weight loss (WL %) after independent (a) and successive (b) extractions in shrinkage specimens. Open marks are changes relative to native state (Independent and cumulated-successive), filled marks are relative to previous phase (successive).

Following the same reasoning as for vibrational specimens, Fig.6.10 shows the modifications in  $\Delta S_0$ , this time not taking into account the small L dimension ( $\approx 5\text{mm}$ ) of shrinkage specimens. Here, the contribution of the uncertain dimension (L) was not as severe as before, therefore the amplitude is not that modified. D and HW – extracted specimens are still showing the highest swelling, while ME- extracted ones present small ( $\approx 1\%$ ) shrinkage in their macroscopic surface. Dimensional modification (in surface) confirms the observations with vibrational specimens for H, HW and ME (Fig.6.8), but not for D and AC.

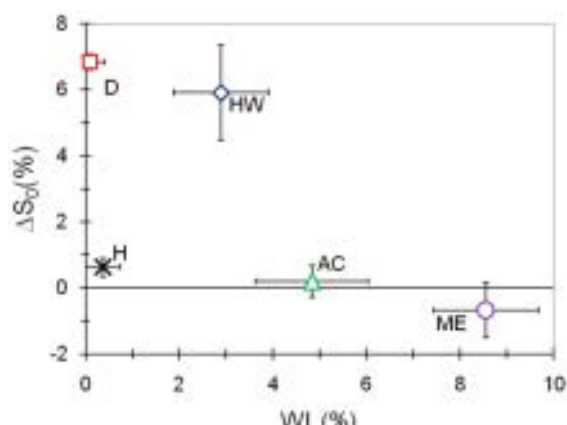

Fig.6.10. Variation in oven dry surface ( $\Delta S_0$ %) and weight loss (WL%) after independent extraction in shrinkage specimens.

To remove any existing doubts about the origins of swelling, and to show whether or not the quasi-anhydrous drying protocol interferes with obtained swellings, changes in  $\Delta S_0$  (%) based on a final 103°C drying of independently extracted shrinkage specimens is presented in Fig.6.11. This complete drying is performed one year after finishing the extraction process on the shrinkage specimens during which time they were kept in climatic chamber. It should be noted that the  $\Delta S_0$  value after H extraction is that of 60°C drying as the specimens were not available for 103°C drying (specimens were previously submitted to successive extraction). The results are almost identical. D and HW still show a surface swelling close to each other and much above the others. AC and ME, after being dried at 103°C, exhibited a bit more shrinkage.

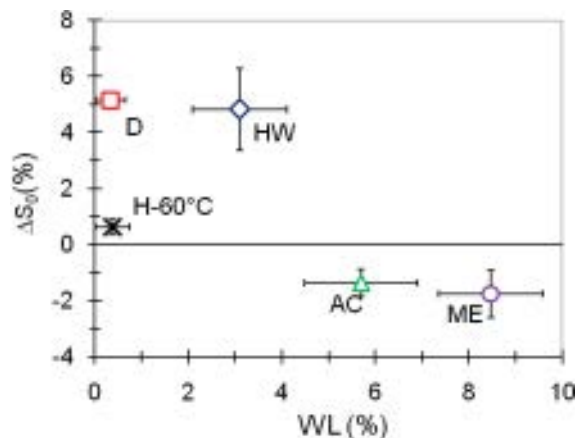

Fig.6.11. Variations in oven dry  $\Delta S_0$  (%) – based on 103°C drying- and weight loss (WL%) for shrinkage specimens submitted to independent extractions. value for H is that of 60°C drying.

It is commonly believed that extractives leaving the cell wall have an effect on macroscopic dimensions of wood (Mantanis et al. 1995, Brémaud 2006, Hernandez 2006). In the context of this study, those components are expected to be responsible for change in vibrational properties. Each solvent's ability for compounds removal is in direct relation with its own molecular volume, polarity, and capability of creating hydrogen bonds (Stamm and Loughborough 1942). The WL is expected to be at least partially related to  $\Delta V_0$ , especially in those cases where compounds are removed from the cell wall. Our results however were different in this respect. The high swelling capacity of D would be explainable by the possible presence of new bonds between chlorine and wood matrix, but no significant weight gain was

observed which could justify such reasoning. Being an apolar solvent, D has been reported to have less swelling abilities than AC, which at the same time are not negligible (Mantanis et al. 1994b). As much as great those swelling effects could be in our case, considering the small WL caused by D, it is improbable that this solvent has reached the cell wall.

Following the same reasoning, AC and ME, having higher polarities, are generally disruptive agents which remove components from cell wall. This is confirmed by the high WL for these two solvents even when used after other apolar solvents (which are presumed to have removed what was in cell cavities and inter cellular sites). Having said that, the changes in  $\Delta V_0/\Delta S_0$  are not in harmony with those findings, as the least changes occur especially with AC and ME. As much as this might look like a compound removal from cavity, considering these solvents alteration effects on vibrational properties (§6-2-3), they most definitely removed substances from cell wall. At the same time, it is interesting that removing these substances is nearly without effect on the macroscopic dimensions.

In the end, the results of  $\Delta V_0/\Delta S_0$  are not conclusive enough for us to localize the removed compounds undoubtedly.

**6-2-2.d. Effect on moisture content: vibrational specimens**

Secondary compounds in wood matrix modify the equilibrium moisture content at a fixed temperature and relative humidity (EMC) (Wangaard and Granados 1967, Mantanis 1995 and Hernandez 2007). Changes in EMC after extraction are strongly related to nature and place of the removed compounds (Wangaard and Granados 1967). In the simplest view, as EMC is in direct relation with the available absorbing sites in wood structure, any treatment increasing the number of disposable sorption sites, would consequently increase EMC.

Fig.6.12 presents the relative variations in EMC after independent, successive and cumulated-successive extraction in vibrational specimens. The first thing that can be retained from this figure is the small changes in EMC due to most extractive agents. ME is the only polar solvent that decreases EMC in both independent and serial use ( $\approx 5\%$ ).

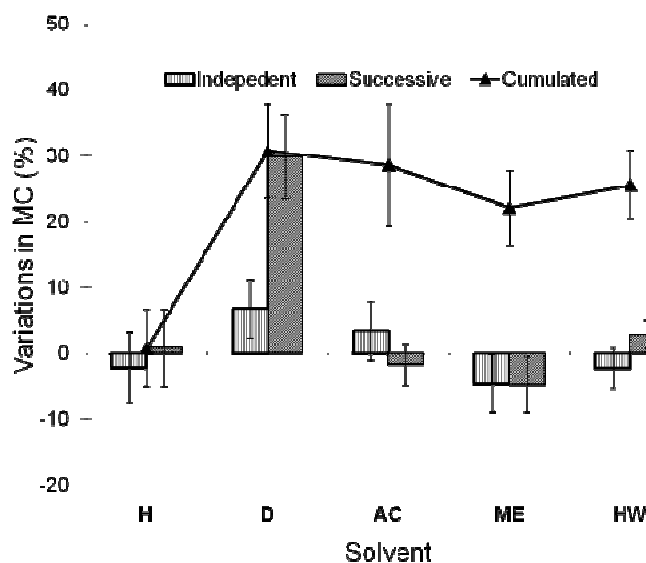



Fig.6.12. EMC relative variations due to extractions. “Successive” variations are relative to the previous step, “independent” and “successive-cumulated” are relative to native oven-dry weight. The values of EMC are corrected for the contributions of extractives (for more details look further to this part).

Other solvents all modify EMC by less than 5%. This is with the exception of D, which increases EMC by  $\approx 8\%$  individually. This raise is much more important in successive extraction, where D increased EMC by  $\approx 30\%$ . A change which not consistent by neither the corresponding WL nor with the solvent’s property.

Fig.6.12, even though giving information on the direction and order of EMC variations due to each solvent cannot really be useful when it comes to the relationship between removed compounds and the consequent EMC variations. For that, Fig.6.13 (a-d) are presenting the WL (%) and  $\Delta\text{EMC}$  (%) for both methods of extractions. The variations of EMC are calculated based on the following formula:

$$\Delta\text{MC}(\%) = \frac{\text{MC}_{\text{extracted}} - \text{MC}_{\text{native}}}{\text{MC}_{\text{extracted}}} \times 100 \quad (6-3)$$

EMC is calculated based on the oven-dry mass, which decreased after the extractions. To take into account the possible contribution of the extractives, both  $\text{EMC}_{\text{native}}$  and  $\text{EMC}_{\text{extracted}}$  have been corrected according to the extraction yield after the most effective extraction (ME in all cases) (§equation 3-27 and 3-28).

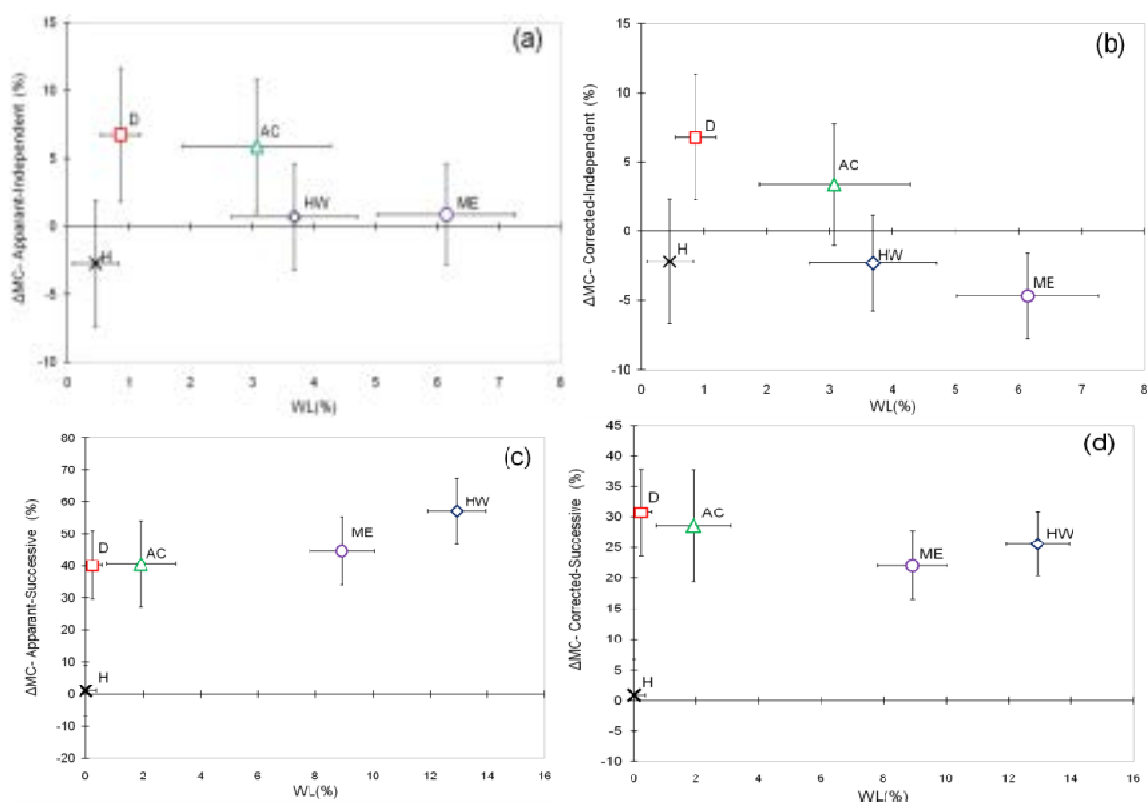

Fig.6.13. EMC Variations (%) in relation with WL (%) for specimens submitted to independent extractions (a, b) and successive extractions (c, d).  $\Delta$ EMC is corrected for the contribution of extractives in the figures on the right. The values in all cases are calculated in relation to native state (independent and cumulated successive).

Once corrected for the contribution of extractives, both groups of specimens (independent and successive) exhibit almost the same trend in EMC modifications. The first apolar agent, H, does not really modify EMC, limited to  $\approx -2\%$  in the independently extracted series and some negligible changes in successive series. D, in both cases, increases EMC, however the amplitude of change is much higher in successive series<sup>17</sup>. (Fig.6.13. b and d).

Being in the midst range of our solvent selection, AC has always been reported to remove compounds from the cell wall but also to be able to slightly touch the lumens (Fengel and Wegner 1989, Brémaud 2006, Hernandez 2007). Having the same extraction yield as HW and half that of ME in independent extraction, AC increases EMC less than D in independent extraction and barely changes it in successive one. A possible explanation for this change can be based on D, penetrating the cell wall. It was mentioned that D is not normally expected to reach the cell wall, and its access should be limited to lumen. However, changes in EMC and  $\Delta S_0$  (§Fig.6.9 and 6.11) indicate that this solvent could get a limited access to cell wall. Not able to remove great amount of extractive, it left the cell wall, disrupting the structure that caused a modified EMC and  $\Delta S_0$ . When used successively, AC coming after D removes comparatively moderate amounts of extracts, but does not change much EMC, as EMC was already greatly modified by D (Fig.6.13.c and d).

Polar solvents, ME and HW, both removing highest amounts of secondary substances, have a decreasing effect on MC, however the changes remain small (Highest  $\Delta$ MC by ME  $\approx -5\%$ ).

Finally, even though modifications of EMC are not conclusive for the apolar solvents, they most definitely point to changes in wood matrix structure by the stronger solvents. The single act of extraction can be disruptive to the cell wall and it was found that rarely the compound removal consist exclusively of extractives (Mantanis 1995). In addition, the act of cyclic drying (in the successive data) can cause a “history” effect that, more than anything, can alter the observed EMC.

### 6-2-3- Effect on vibrational properties

Vibrational specimens have been tested before and after each treatment, as well as between the steps whenever necessary (i.e., successive extractions and their controls). Changes in modulus and specific modulus ( $E'$  and  $E'/\rho$ ) and damping ( $\tan\delta$ ) have been monitored as closely as possible to evaluate how each of them react to removal of extractives. To study the changes in each factor, extraction yields due to each solvent (presented as WL) will be put in relation with changes in moduli and damping. Possible trends based on polarity of the solvents will be discussed. Finally, looking at the changes of both physical and vibrational factors, we will have

---

<sup>1</sup>.Specimens submitted to successive extraction exhibit higher  $\Delta$ EMC amplitudes than independent series (especially in case of D extraction). This could partly be coming from their lower  $EMC_{\text{native}}$  at the starting point (§5-3) which could indicate a higher sensitivity to the modifications.

a conclusive idea on how our specimens reacted – physically as well as mechanically- to the extractions.

### 6-2-3.a. Modification of specific modulus:

Tables 6.2, 6.3, and Fig.6.6 have shown that both mass and specific gravity change due to extractions, so that  $E'/\rho$  must be corrected for the contribution of the extractives, according to equation (3-26). The correction is done based on the most effective extraction (ME in our case).

Fig.6.14 show the relative changes in  $E'/\rho$  after successive extractions expressed as their corresponding WL. Note that, as here we want to show the decreasing trend, the cumulated changes based on the values of native state has been considered. As shown by Table 6.3, the corrected  $E'/\rho$  is 0.01 to 1.2 GPa higher than the apparent one. This is clearer in case of HW in which  $\Delta E'/\rho$  changes from -9% to -14% after the correction (Fig.6.14.a and b). The correction also causes the trend line to decrease with a steep slope and the trend to be more obvious.

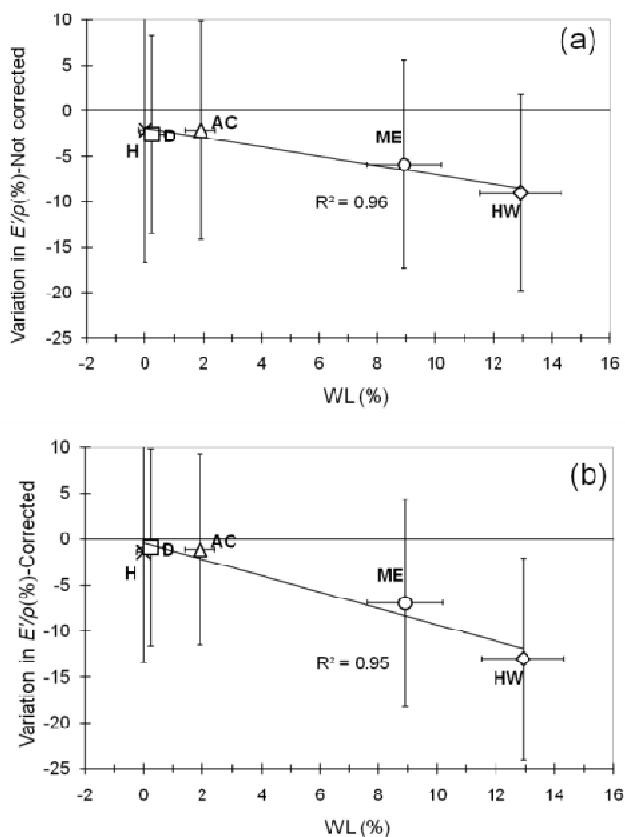

Fig.6.14. Weight loss (WL %) and cumulated change in  $E'/\rho$  (relative to native state) for successively extracted specimens. in (a)  $E'/\rho$  is not corrected for contribution of extractive while in (b) the values are the corrected ones (Nb:12).

Fig.6.15 presents the relations between WL and  $E'$ , and shows clearly that the changes in  $E'/\rho$  are coming from changes in elasticity and not only related to changes in specific gravity due to extractive removals.

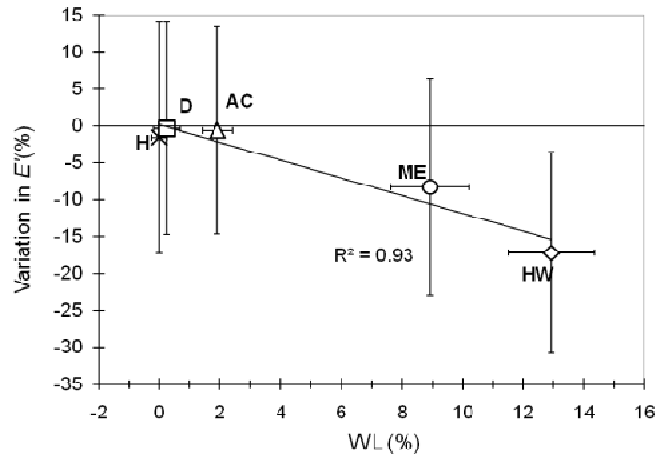

Fig.6.15. Weight loss (WL %) and cumulated change in  $E'$  (relative to native state) for successively extracted specimens (Nb:12).

Successively extracting the specimens gradually decreases  $E'$  and  $E'/\rho$ . When solvents are used independently, nearly the same trend is observed (Fig.6.16).

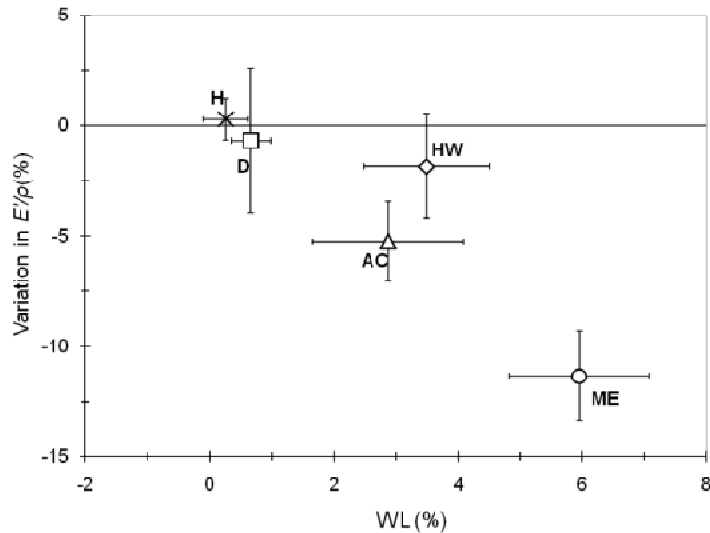

Fig.6.16. Weight loss (WL %) and relative change in  $E'/\rho$  (to native state) for independently extracted specimens (N°:53).

H, D, AC, ME and HW modify  $E'/\rho$  by +0.29%, -68%, -5.24%, -11.35% and -1.38%, respectively, by independent extractions. In these cases, the amplitude always stays lower than that of cumulated change (i.e. relative to native state).

In general, decrease in  $E'/\rho$  appears nearly proportional to WL for different solvents (Fig.6.14), which suggests that extractives removed by AC, ME and HW bulk the cell wall matrix, and affect elasticity independently of compounds removed by these various solvents.

#### 6-2-3.b.Modifications on $\tan\delta$ related to weight loss

Fig.6.17 shows relative changes in  $\tan\delta$  caused by each solvent either used individually or after others (successively). Apolar solvents (H and D) remove small amounts (approx. 1%) of extractives, probably from the lumens, resulting in small changes in  $\tan\delta$ . In successive extraction, however, D increases  $\tan\delta$  by 14%, which probably indicates a “history” effect (previous exposition to H and 3 drying cycles).

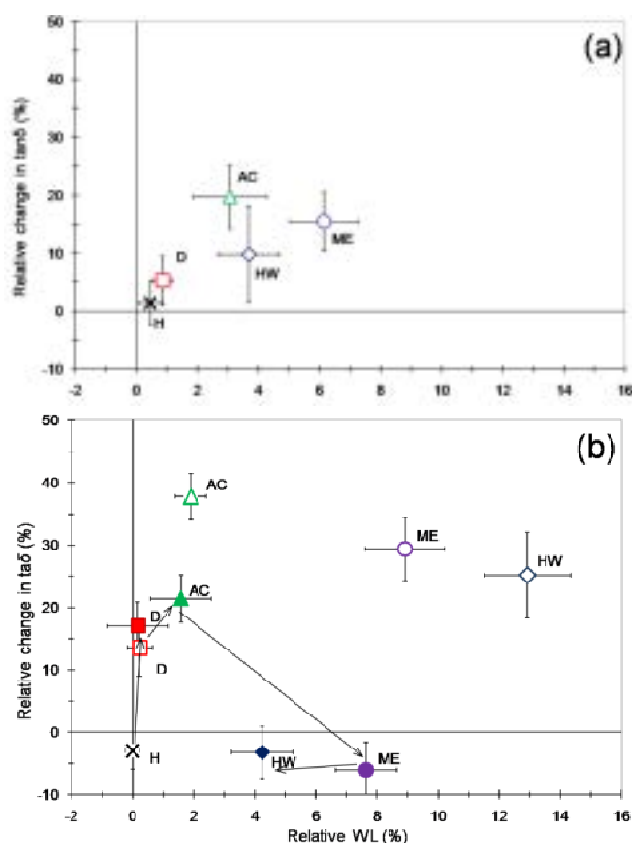

Fig.6.17. Relative changes (%) in  $\tan\delta$  plotted against weight loss (%) for (a) independent and (b) successive extractions. Open marks: changes relative to initial state of native specimens (independent and successive-cumulated), filled marks: changes relative to the previous phase. Arrows: order of successive extractions. Values of  $\tan\delta$  in independent extractions are corrected for controls.

More polar solvents (AC, ME and HW) are expected to remove higher proportions of cell-wall extractives, more susceptible to alter  $\tan\delta$ . However, the highest change in  $\tan\delta$  results from AC extraction ( $\approx +20\%$  independently or used after D,  $\approx +38\%$  for cumulated effect), although its weight loss is moderate ( $WL \approx 2\%$  and  $3\%$  for independent and serial use of AC). ME and HW, despite their higher yields, have smaller effects on  $\tan\delta$  both in independent and in successive-cumulated order. When used after AC, ME even reduces  $\tan\delta$  lower than the value for the previous state (AC-extracted, Fig.6.17.b). On the contrary, in other species, methanol extractives often have a high “anti-damping” effect in wood (Yano 1994, Minato et al. 2010, Brémaud et al. 2010a). These contrasted effects in Mulberry can be explained by different hypotheses: (i) AC reaches all extractives able to alter damping, leaving only “neutral” compounds for subsequent ME or HW extractions. As drying cycles can reduce  $\tan\delta$  by  $\leq 8\%$  (§ 5-3), changes in  $\tan\delta$  after ME and HW in successive order can partly reflect drying history of specimens. Nevertheless, the same trend happens for independent extraction, without cumulated drying cycles. (ii) Two kinds of extractives compounds co-exist in cell walls, some decreasing, and some increasing  $\tan\delta$  in native wood. AC removes the first ones, so that extraction of remaining, “ $\tan\delta$  raising” compounds by ME and HW decreases again the  $\tan\delta$  of solid wood.

In various timbers, methanol is reported to take out non-structural carbohydrates and phenolic compounds (Rowe and Conner 1979). White Mulberry has quite important content of phenolic extractives (De Rosso et al. 2009). In some woods, polyphenols can form part of the fiber cell

wall matrix (Kleist and Bauch 2001), while in some other woods, they may be either preferentially in vessels, parenchyma walls (Dünisch et al. 2010), or too condensed to enter the cell wall substance (Koch and Kleist 2001). In the later hypothesis, ME might remove some lumen deposits, resulting in a lower ratio between changes in  $\tan\delta$  and extraction yield. However, decreases in  $E'/\rho$  after ME or HW suggests cell wall location. Thus, ME could have removed compounds such as sugars or simple phenols, which presence will increase  $\tan\delta$  (Obayata et al. 1999, Sakai et al. 1999). A decrease in  $\tan\delta$  is also observed after ME extraction of *Thuja plicata* sapwood – which should contain non-structural carbohydrates – whereas a completely opposite effect is observed in the heartwood of the same species (Yano 1994). In Mulberry, extraction in HW, following ME, does not bring any additional changes in  $\tan\delta$ , although it further removed  $\approx 4\%$  extractives. In *Caesalpinia echinata*, water soluble extractives decrease  $\tan\delta$  in wood, which was first ascribed to their ability to form hydrogen bonds with cell walls components (Matsunaga et al. 1999). But other extractives, without hydroxyl groups and/or insoluble in water, also reduce  $\tan\delta$  (Minato et al. 2010, Brémaud et al. 2010a). Finally, differences in  $\tan\delta$  might be related to changes in wood moisture content (Dunlop 1978, Obayata et al. 1998, Inokuchi et al. 1999). However, changes in EMC due to independent extractions are small (Table 6.2 and §6-2-2.d). In successive extractions (Table 6.2), with higher cumulated yields, EMC is more significantly increased after ME and HW. This, however, should lead to an increase in  $\tan\delta$ , instead of the observed decrease for successive use of ME and HW.

Therefore, the present results suggest the co-existence of some “ $\tan\delta$  – raising” and of some “ $\tan\delta$  – lowering” compounds in the heartwood of white Mulberry. The methodology using both independent and successive series of extraction might reveal similar trends in other species.

#### **6-2-4- Effect on anisotropy (DMA)**

For acquiring the anisotropic relationship between three axes in white Mulberry wood, shrinkage specimens from the 3<sup>rd</sup> batch have been cut and tested. Only two individual extractions have been done on these specimens using the solvent giving the highest extraction yield

Both native and treated values for measured physical and mechanical factors of DMA specimens are presented in Table 6.3. Correction on EMC and  $E'/\rho$  are done based on the equations (3-27, 3-28) and (3-26), as discussed in §3-2-3. Statistically speaking, significant differences are observed between all factors once the specimens have been treated. Moreover, the dissimilarity in properties between 3 axes results in statistical differences between  $E'$ ,  $E'/\rho$  and  $\tan\delta$  in specimens native state (Table 6.3).

As a consequence of extractions, all specimens loose some weight. Fig.6.18 presents the variation of oven-dried mass in specimens submitted to DMA. Here, the LRT abbreviation in each case indicates the longest dimension (the direction of applied stress) in a sample.

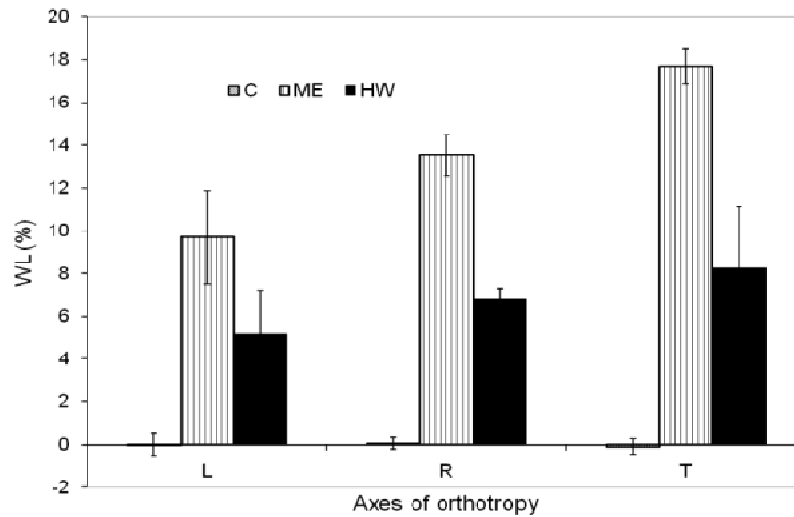

Fig.6.18. Weight loss in 3 axes of orthotropy (L: Longitudinal, R: Radial, T: Tangential) for Controls: C (Nb: 4 in each direction), Methanol extracted ME (Nb: five in each direction) and hot water extracted HW (Nb: five in each direction) specimens.

Like for other treatments/specimens, controls are just gone through physical steps (drying and stabilization according to protocol) and are measured at the same time as the treated ones.

Table 6.3. Variations in properties for DMA specimens submitted to methanol, hot water and two times of drying and stabilizations.

Axes of orthotropy	EMC (%) <sup>g</sup>		Specific gravity ( $\rho$ )		$E'$ (GPa)		$E'/\rho$ (GPa)		$\tan\delta$ ( $10^{-3}$ )	
	Corrected	Apparent	Native	Treated	Native	Treated	Native	Treated	Native	Treated
	Native	Treated								
L (C <sup>h</sup> )	7.09±0.29	7.21±0.52**	0.56±0.03	0.57±0.03**	7.16±0.74**	6.81± 1.19**	13.36± 1.38**	12.68± 2.26**	1.56± 0.23**	1.06± 0.18**
	7.71± 0.32	7.84±0.61 (ab)								
L (ME)	8.28±1.25	7.60±0.33**	0.57±0.05	0.53±0.04	7.36±0.83**	5.32± 0.76**	13.71± 1.51**	9.87± 1.42**	1.50± 0.20**	1.67± 0.05**
	9.03±1.39	9.10±0.32 (c)								
L(HW)	7.60±0.85	7.49±0.39**	0.57±0.05	0.53±0.04	7.04±1.41**	5.74± 0.82**	13.13± 2.64**	10.72± 1.52**	1.15± 0.09**	1.43± 0.06**
	8.27±0.94	8.56±0.31 (a)								
R (C)	7.31±1.03	7.20±0.23**	0.59±0.05	0.58±0.04**	1.7±0.09**	1.63± 0.15**	3.32± 0.19**	3.19± 0.31**	1.51± 0.05**	1.43± 0.05**
	8.23±1.19	8.11±0.25 (bc)								
R (ME)	6.72±0.44	6.68±0.18**	0.56±0.02	0.50±0.01	1.5±0.10**	1.15± 0.09**	3.09± 0.21**	2.22± 0.17**	1.50± 0.09**	2.21± 0.06**
	7.55±0.51	8.65±0.29 (bc)								
R(HW)	7.03±0.31	6.82±0.34	0.58±0.01	0.52±0.01	1.8± 0.05**	1.51± 0.04**	3.60± 0.11**	2.93± 0.09**	1.51±0.07**	1.72± 0.05**
	7.92±0.36	8.14±0.37 (bc)								
T (C)	7.14±0.42	7.06±0.56**	0.53±0.05	0.53±0.04	0.88± 0.06**	0.90± 0.06**	1.90± 0.14**	1.96± 0.13**	1.97± 0.04**	1.71± 0.03**
	8.38±0.51	8.27±0.69 (bc)								
T (ME)	6.86±0.35	5.52±0.33**	0.55±0.04	0.45±0.05**	1.00± 0.25**	0.69± 0.19**	2.17± 0.55**	1.48± 0.42**	1.91± 0.04**	2.35± 0.05**
	8.04±0.43	7.79±0.51 (ab)								
T(HW)	7.06±0.99	5.43±0.45**	0.54±0.04	0.47±0.05**	0.83± 0.25**	0.61± 0.05**	1.80± 0.06**	1.33± 0.12**	2.07± 0.07**	1.96± 0.03**
	8.27±1.21	6.68±0.64 (a)								

(a,b,c,d,e,f):homogenous subset in one-way ANOVA. \*\*: significant at  $\alpha$ : 0.01. g): EMC relative to 103°C oven drying. “Apparent” are measured values; “Corrected” is based on calculated oven-dry mass after the most efficient (ME) removal of extractives (see Hernandez 2007). h) Treated state for controls stands for values measured after one time of drying and stabilization. L: Longitudinal, R: Radial, T: Tangential, C: Control, ME: Methanol and HW: Hot water.





Weight change in controls are small and insignificant; this allow us to confirm that the quasi-anhydrous drying of 60°C has imposed no significant error on the measurements of examined specimens. In all 3 axes, WL for ME is approximately 2 times that of HW. T oriented specimens have the highest WL after both extractions (17.68% and 8.27% for  $WL_{ME}$  and  $WL_{HW}$ , respectively). Between the WL of 3 directions, the following order exist:  $WL_T > WL_R > WL_L$ . This is rather expected as tangential and radial cuts allow more accessibility to the extractives. In R specimens, vessels and rays are more exposed to solvents, the parts that also are susceptible to contain bigger portions of extraneous substances (Hillis 1987, Koch and Kliet 2001). The same applies for T specimens, when the previously unreachable (or at least hardly reachable) lumens of rays, are now perfectly exposed to the treatment. The smaller dimension of the specimens along with the high ratios of height to width, also contribute to remove higher amount of compounds that what was seen in cases of small and vibrational specimens.

Talking about vibrational factors now, both  $E'/\rho$  and  $\tan\delta$  are modified after extractions. These modifications are dependent on the type of utilized solvent as well as direction of orthotropy (Fig.6.19).

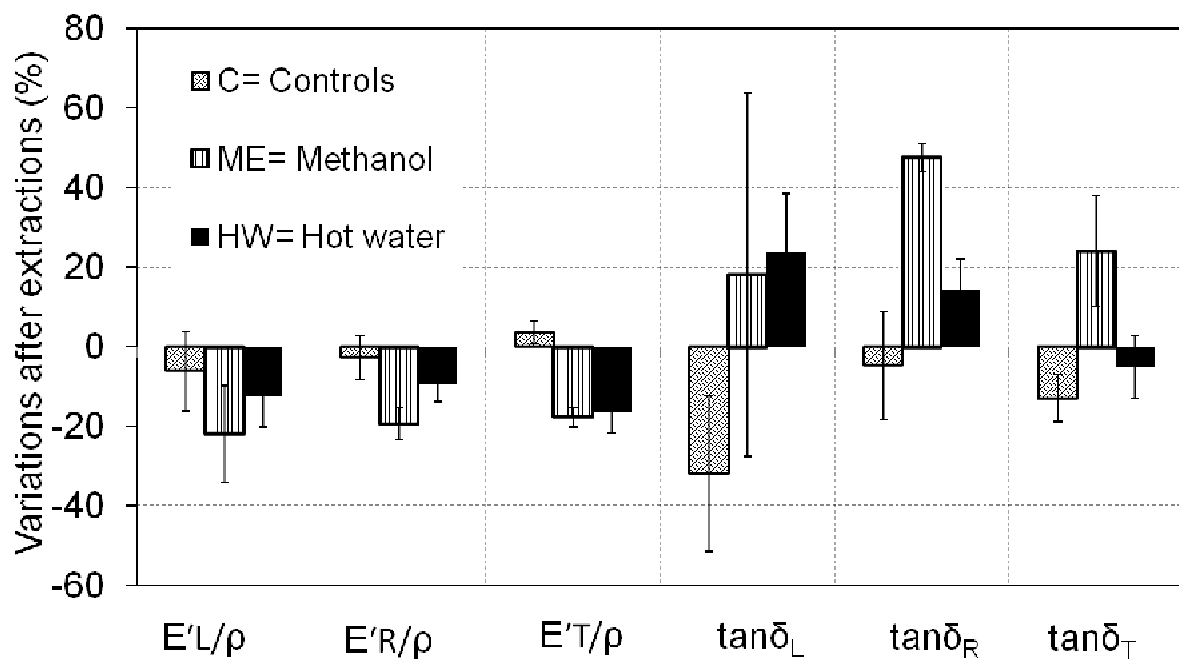

Fig.6.19. Variations in mechanical properties after extractions measured by DMA at 10 Hz. Values for controls were not deduced from treated ones.

Concerning  $\tan\delta$ , uncertainty is high in L direction, as clamping of specimens may crush wood in the softer transverse direction. Even controls show important variations, which cannot be ascribed to physico-chemical changes. However, after ME extraction, change in radial  $\tan\delta$  is at least twice more important than in L (DMA estimations and changes in vibrational tests) and T direction (Fig.6.19).

The quasi-isotropic effect of extractions on  $E'/\rho$  is quite surprising. In previous works, extractives stiffened the transverse moduli (Yano et al. 1995, Minato et al. 2010), but not the axial one, in which the influence of the microfibrillar reinforcement predominates (Ono and Norimoto 1983, 1984, Obataya et al. 2000). However, Mulberry wood has a low axial  $E'/\rho$ , suggesting high microfibril angle, and is characterized by a very low anisotropy in native state. Effects of extractions on  $\tan\delta$  are clearly different in R and T directions. This is interesting, as there are relatively few works on the  $\tan\delta_R/\tan\delta_T$  anisotropy and sources of variations. As Backman and Lindberg (2001) recalled, for a softwood, in tension latewood contributes mostly to the response in T direction while most of the strain occurs in early wood in R direction. In Mulberry, a ring-porous hardwood, radial tension tests would strain more vessels and rays, whose cell walls are thinner, but (as it is seen in Fig.6.18) are also richer in extractives (Kleist and Bauch 2001, Dünisch et al. 2010). Thus, the very high change in  $\tan\delta_R$  after ME extraction (more than 50%) could express a bigger modification of rays and vessels, than of fibers.

### **6-2-5- Effect of extraction on dimensional stability (vibrational and shrinkage specimens)**

In the previous parts, the effect of extractives removal on selected physical and acoustical parameters were presented and discussed. Along with all the mentioned modifications, extraneous substances are reported to greatly affect the dimensional stability of species (Chafe 1987, Hernandez 2007). Dimensional stability is one the most important factors that greatly affects wood end uses. Normally change of dimensions occurs through movement of bonded water molecules through cell structure. Naturally, once the cell-wall-based compounds are removed, the hygroscopicity, and consequently the stability of species would be changed. In addition to that, and in a wider look to the concept, final use of white Mulberry as a musical instrument would call for going through numerous cycles of humidity changes. While the effect of actively performed treatment by artisans on the dimensional stability is discussed in the previous chapter, it is interesting to take a quick look on how chemical modifications of wood can alter dimensional stability.

First, Fig.6.20 shows the variations in oven-dried volume for treated shrinkage specimens as well as their controls.

Here, three conditions are imposed on the treated specimens:

- An additional drying, in the same quasi-anhydrous conditions as the protocol (60°C for 48 hrs) , performed one year after the original treatments were finished, during which time specimens were kept in a climatic chamber ( 20°C±2°C and 65%±5% RH).
- A complete drying (103°C for 48 hrs)
- A mild humidification (27°C and 75% RH)

The details on the last two conditions can be found in §5-2-1.d.

Looking at the Fig.6.20, it can be seen the specimens submitted to successive extraction (CO) show the most instability in two desorption conditions ( $\Delta V \approx 5\%$  and 4.3% after second 60°C and 103°C dryings respectively). They also show a relatively high  $\Delta V$  in adsorption, but the variations between specimens is more significant than the previous

cases ( $5.81\% \pm 7.90$ ). This great variation can be caused by the poor conditions of the specimens as they went through five successive chemical extractions.

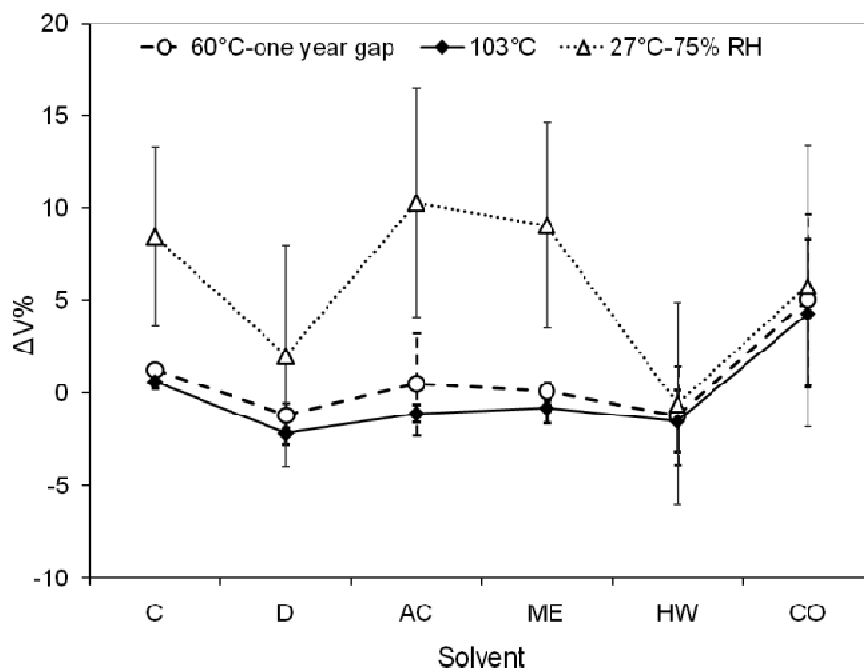

Fig.6.20. Variations in volume ( $\Delta V\%$ ) for shrinkage specimens after second time of quasi anhydrous drying with one year gap, complete drying ( $103^{\circ}\text{C}$ ), and one month in  $27^{\circ}\text{C}$  and 75% RH. C: Controls/no-chemical treatment, D: Dichloromethane, AC: Aceton, ME: Methanol, HW: Hot water, CO: Complete extraction/specimens submitted to successive extraction after last treatment (HW). N° : 18 in each group of treatment.

Other groups of treated specimens, D, AC, ME and HW, act almost the same in desorption. They all exhibit small statically non-significant change in their volumetric dimensions. Nevertheless, variations in C are closer to those of AC and ME, a point at which D and HW are similar.

Volumetric variations are clearer in adsorption. This is expected though, as the imposed desorption conditions are close to what was originally performed according to protocol. In adsorption, most dimensionally unstable specimens are those submitted to AC and ME extractions ( $\Delta V_{AC}$  and  $\Delta V_{ME} \approx 10.31\%$  and  $9.09\%$  respectively). Their  $\Delta V$  are even higher than that of CO ( $5.81\%$ ), which means that the instability in the serially extracted specimens is probably more coming from these two particular solvents than from H, D, or HW.

Until here, the roles of extractives on keeping specimens stability can be confirmed, as the most severe extractive agents (Yield wise/§6-2-2.a) cause the greatest variations in specimens. That being said, the specimens that served as controls might seem bizarre considering their volumetric variations. While they keep all their extraneous compounds, they exhibit a rather high  $\Delta V$ , especially in adsorption ( $8.48\% \pm 4.84$ ). A possible justification for such results is that, even if the control specimens are not chemically treated, they have undergone a series (in case of shrinkage specimens 11 times) of cyclic drying and stabilization according to protocol. These cyclic desorption-adsorptions do not

seem to have an endangering effect when performed in limited times (vibrational specimens below), but apparently would eventually make the wood unstable.

Finally, HW extraction seems to have an improving effect on dimensional stability. In adsorption, the least change in  $V$  occurs after independent submission of specimens to HW ( $-0.55\% \pm 5.43$ ). However, the variations between specimens are rather large. This could be reflecting the fact that being a rather strong treatment (8 hrs in  $70^\circ\text{C}$ ), specimens react differently depending on their specific intrinsic features (which might put up better or worst with the treatment). HW has the half WL of ME (Fig. 6.5) and being the stronger swelling agent, is reported to bring out a combination of tannins, gums, sugars, starches and coloring matters (Row et al. 1979, Mantanis et al. 1994a). Most change during water extraction could happen due to degradation of hemicelluloses, even partially. This however requires a high temperature that is never reached in our study (Matsunaga et al. 1996, Obataya et al. 1999). Finally, Obataya et al (1999) reported that water-soluble sugars in HW could be the cause in a  $\tan\delta$  augmentation after extraction. The latter event happened in our case (Fig. 6.17). To make sure that the same improvement in stability happened in vibrational specimens, changes in their volume in two complementary desorption and adsorption is presented (Fig. 6.21).

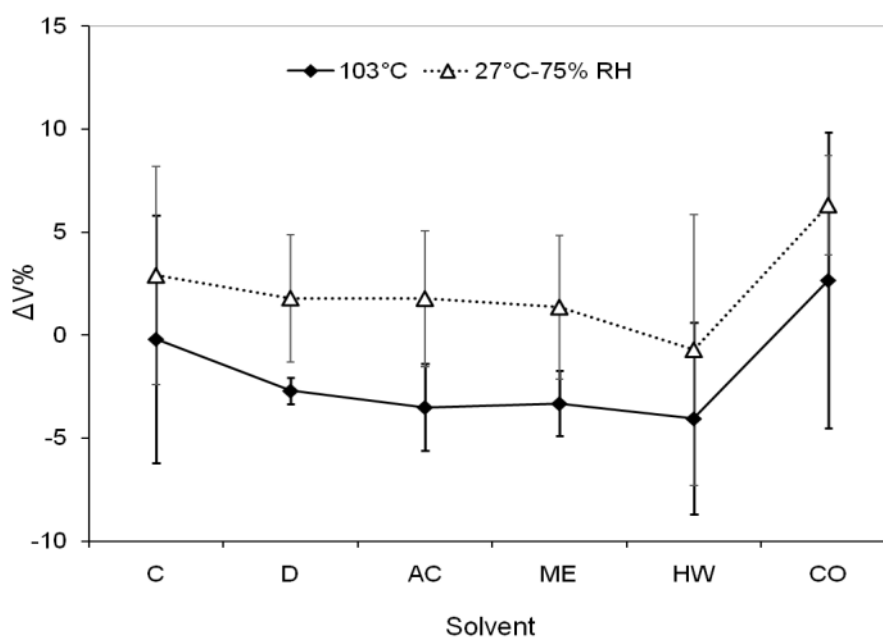

Fig. 6.21. Variations in volume ( $\Delta V\%$ ) for vibrational specimens after  $103^\circ\text{C}$  drying, and one month in  $27^\circ\text{C}$  and 75% RH. N°:12 for each treatment, except for HW : 5specimens for this treatment.

Vibrational specimens are not submitted to second time of  $60^\circ\text{C}$  drying, plus their controls are only exposed to 6 times of cyclic desorption/adsorption. Here again, the most dimensionally unstable specimens are the completely extracted ones ( $6.30\% \pm 2.40$ ). While the same trend as in the shrinkage specimens is observed in vibrational specimens in desorption, in adsorption, D, AC, ME do not seem to affect stability. However as the dimensions are not normalized for such measurement (high L/T ratio) and the variations are important, one could imagine that the same existing extractive effects as in shrinkage specimens is masked by the bigger dimensions. In any case, and even if we do not

consider any masking effect,  $\Delta V$  of specimens of HW and CO change in harmony with what is seen in shrinkage specimens (§Fig.6.20).

Getting back to the reasoning in the previous paragraph, having the same trend in vibrational specimens as in those of shrinkage can be confirmed. Therefore, we can continue with the hypothesis of sugar/hydrophilic compounds removal. That means some substances, possibly sugar type or others, which originally help on trapping the water molecules (increasing hygroscopicity, reducing wood stability) are successfully removed by HW. The removal of these particular substances, even though naturally leaving some spots available for water, is apparently more important considering its effect on dimensional stability. Taking a quick look at Fig.6.13.a and b, we can see that the apparent  $\Delta MC$  (and to some extent corrected  $\Delta MC$  relatively to others) show a small variation which verifies a stability (if not a decrease) in hygroscopicity.

### 6-3- Conclusion

Extractions, using five solvents of different polarities were done on four types of samples (i.e. powder, shrinkage, vibrational and DMA specimens), each of them pointing on clarifying a particular aim.

In the last pages, modifications in various physico-mechanical properties in function of solvents were presented and discussed. Important remarks are summarized as below:

Combining two methods of extractions -using each solvent as an individual agent and using solvents in a successive order on a single sampling- could suggest the importance of extractives nature compared to their amount.

Changes in physical characteristics (e.g. MC and  $\Delta V_0$ ), were not always conclusive. In an overall view, polar solvents (ME and HW) could decrease MC, probably by removing hydrophilic extracts from the cell wall. Their effect on macroscopic dimensions remains small.

The highest changes in  $\tan\delta$  are not due to the most polar solvents, with highest extraction yields, but to AC. Nevertheless, AC does not alter  $E'/\rho$  with the same intensity, suggesting that the extracted amounts or compounds are not essential for wood stiffness.

The different effects of ME extraction on  $\tan\delta$ , between individual extraction and when used successively after AC, suggest the existence of two types of  $\tan\delta$  altering compounds in white Mulberry. Some would be able to increase, some other would be able to reduce the damping, and both types would be accessible by AC and ME independently.

Changes in  $E'/\rho$  are nearly isotropic between the 3 principal axes of orthotropy, may be due to the very low anisotropy of Mulberry in native state. On the contrary,  $\tan\delta$  is much more modified in R than in T direction, suggesting different responses to extractions of rays and vessels walls as compared to fibers ones.

Extractions have no effect on improving stability in desorption. In adsorption however, HW extracted specimens are less affected by the increasing humidity.

As extractives definitely affect vibrational properties of white Mulberry, it would be enlightening to identify the most important compounds present in those extractives and how they cause the observed changes.

## 7. Natural durability of white Mulberry

---

### ➤ Why is it interesting to investigate natural durability of white Mulberry?

Natural durability of white Mulberry was studied for several reasons:

- Existing reports concerning white Mulberry's natural durability are rare as well as inconclusive (§2-6). As the researches were also scarce on Middle-Eastern/Iranian white Mulberry, importance of having a thorough study on the matter was clear.
- One of the hypotheses of this research was based on the probability of extracts' toxicity. A real toxicology was not planned in this study. Nevertheless, we tried to use termites/fungi reactions towards wood in different phases of treatment to get a basic idea of how the extractives are (toxic, repulsive ...).
- A part of pre-treatments before fabrication is to leave wood in ambient water for various amount of time. On the other hand, testing natural durability of leached wood is already established in standards (EN84, 1997). We tried using the second method as a marker of the first (although the test durations were different) in order to investigate how the leached wood would react to risky conditions regarding its durability. It was hoped that by going along with this method, eventually an idea would be established on whether or not this "immersion in water" –beside any possible effect in has on acoustic/ stability features -, is endangering instruments' potentials in long terms keepings.

The European standards helped us continuing on the approach towards these objectives. The tests were performed using the two types of specimens, powder and solid wood, which were then subdivided according to treatments and aggressive biological agents (termites or fungi).

### **7-1- Natural durability of solid wood**

Investigation of natural durability of solid wood is done according to guidelines of XP CEN/TS 15083-1 (2006) for determination of durability against fungi, and according to EN117 (2005) for termites. To understand whether water leaching has any effect on altering specimens' strength against aggressive agents, they are immersed in water according to EN84 (1997). This water leaching could be also considered a semi-perfect way of removing extractives (as water extraction is more effective using high temperatures while in EN 84 water is at ambient temperature) and the results can be somehow enlightening and complementary towards understanding hygro-thermal pre-treatments.

#### **7-1-1- Experimentals**

##### **7-1-1.a. Preparation of the specimens**

The standard cutting plan for solid samples determining natural durability, as well as the following conditioning, were presented in details in chapter3 (§3-1-8).



Scot Pine (*Pinus sylvestris* L.) sapwood and Beech (*Fagus sylvatica* L.) of the same dimensions are also selected as controls according to the criteria described in the XP 15083-1.

All samples (tests specimens and the controls) are conditioned at 20°C and 65% RH. Before the tests, they are all weighed at ±10 mg. To get the initial theoretical MC of the wood, a set of 10 specimens from each batch (Mulberry, Pine, and Beech) were oven-dried at 103°C. The MC is then calculated according to the formula below:

$$MC(\%) = \frac{M_{in} - M_0}{M_0} \times 100 \quad (7-1)$$

where MC (%) is the initial theoretical moisture content,  $M_{in}$  the initial humid mass of the sample before putting in the oven (g) and  $M_0$  the anhydrous mass of the sample after being dried at 103°C.

### **7-1-1.b. Leaching**

Prior to the tests, half of samples are leached according to EN84 (1997). The brief process of leaching can be described as below:

- Specimens are impregnated with distilled water under the vacuum of 4 mbar for 20mins.
- After 2 hours of keeping the specimens immersed in same water at atmospheric pressure, the water is changed with new amount of distilled water (water to wood volume 5 to 1).
- The immersion is continued for 14 days, in which time the water is changed 9 times (water change has to be done between 1 and 3 days)
- At the end of two weeks, the specimens are removed from the water and left to dried at 20°C±2°C and 65%± 5% RH, for at least 2 weeks ( until complete weight stabilization).

### **7-1-1.c. Choice of fungi – Durability Test against Basidiomycetes fungi**

Considering the fact that we are aiming at comparing two kinds of standards regarding natural durability, we are obliged to meet both their requirements.

The obligatory fungi for XP CEN/TS 15083-1 (2006) are *Coniophora puteana* and *Coriolus versicolor* while according to EN350-1, *Coniophora puteana*, *Gloeophyllum trabeum* and *Serpula lacrymans* are the required ones for hardwoods. *Serpula lacrymans* is not considered for the test. The temperate fungal strains used are given in Table 7.1.

In addition to those fungi *Pycnoporus sanguineus* and *Antrodia* sp (both tropical and aggressive fungi) are added first as a discriminator and secondly as a representative of the original region (Table 7.1). Our source of wood was limited and needed to be saved for further acoustical tests, thus, except for the most descriptive fungi (i.e., *Coriolus versicolor* and *Coniophora puteana*, for which 30 specimens were tested), for others only 10 specimens were selected to be exposed to the treatment.

Table 7.1. Fungi descriptions and conditioning situations for tests against Basidiomycetes

Fungi name	Type	Number of specimens	Condition for the test
<i>Coriolus versicolor</i>	Fibrousot/ strain CTB 863-A	30 Leached+ 30 Unleached	22°C, 65% RH
<i>Coniophora puteana</i>	CubicRot/ strain BAM Ebw. 15	30 Leached+ 30 Unleached	
<i>Gloeophyllum trabeum</i>	CubicRot/ strain BAM Ebw. 109	10 Leached+ 10 Unleached	
<i>Poria placenta</i>	CubicRot/ strain FPRL 280	10 Leached+ 10 Unleached	
<i>Pycnoporus sanguineus</i>	FibrousRot/ strain CTFT 270	10 Leached+ 10 Unleached	27°C, 70% RH (Tropical conditions)
<i>Antrodia sp</i>	CubicRot/ strain CTFT 57 A	10 Leached+ 10 Unleached	

#### 7-1-1.d. Practical phases for fungi tests

In the culture flasks, one Mulberry wood specimen is tested along with a control (sapwood Scot pine for cubic rot and beech for fibrous rot). Six virulence control specimens (2 samples per flasks) were also tested in the same conditions.

Following the steps below, resistance of specimens towards fungi was determined:

- Sterilization of unleached and leached samples (including tests specimens and controls) by  $\gamma$ -ray radiations,
- Preparation of cultural media: malt-agar medium (40±0.5 g/L) of malt extract and 20±0.5g/L) of agar-agar in deionizer water,
- Putting the warm cultural media in jars (720 ml), autoclaving them (121°C for 20 min) and then letting the media to solidify,
- Transplanting the concerned fungi (cultured on Petri dishes) to their respective jars,
- Incubation until full coverage of the culture media by fungi,
- Introducing test specimens (white Mulberry) and their concerned controls to each jar
- 16 weeks of exposure,
- End of the test: Delicately cleaning the specimens (agar from cultural media, fungi mycelium...),
- Weighing the specimen just afterward (to determine the humidity of the samples at the end of the test),
- Drying the specimens in 103°C ± 1°C for 24 hrs (until anhydrous weight is reached),
- Measuring the weights of specimens for calculation of moisture content and ML (not corrected and corrected) due to fungi attack (§ next part).

10 specimens of white Mulberry (from both leached and unleached batch), are sterilized and put in malt agar media non-inoculated, for 16 weeks in the same climatic conditions. The remaining steps are the same as before. This helps us on calculating a correction coefficient. Even though correction coefficient is not usually used for natural durability tests (and is more for samples treated with preservatives), but it was interesting to see the behavior of the wood (leached or not in a very humid environment (the flask is roughly

70-80% RH inside). How wood would behave in the conditions mentioned could be related to the behavior of extracts in those situations, that is, if the extractives leach a lot, slightly or not at all, etc.

Humidity of specimens after fungal exposure is calculated as:

$$H_m(\%) = \frac{M_2 - M_3}{M_3} \times 100 \quad (7-2)$$

$H_m$ : moisture content after fungal exposure

$M_2$ : humid mass (mass measured directly at the end of exposure)

$M_3$ : dried mass after the test ( $103^\circ\text{C} \pm 1^\circ\text{C}$ )

The percentage of mass loss is first calculated based on anhydrous mass:

$$ML_{NC}(\%) = \frac{M_0 - M_3}{M_0} \times 100 \quad (7-3)$$

where:

$ML_{NC}$  = Non corrected mass loss percentage after the test

$M_0$  = Theoretical initial anhydrous mass (from formula 7-1) before the test

$M_3$  = Dry mass after the test ( $103 \pm 1^\circ\text{C}$ , 24 hrs).

The correction factors is the average mass loss of the 10 specimens placed on non-inoculated media, the mass loss is calculated according to 7-3.

Then, the corrected mass losses of our test specimens are retained:

$$ML(\%) = \text{Non corrected mass loss}(\%) - C \quad (7-4)$$

The calculations mentioned above, would be used for categorizing the specimens according to XP CEN/TS 15083-1 (2006). Eventually all the results are expressed as mean mass losses as well as median mass losses.

In addition to that, and to calculate the X factor required for categorization according to EN350-1, the formula below is used:

$$X = \frac{ML}{Mr} \quad (7-5)$$

where:

ML is the mass loss of the specimen and Mr is that of the controls.

For the criteria regarding classifications according to both these standards, see annex D.

### **7-1-1.e. Practical phases for testing un-leached and leached wood towards termites**

The durability against termites is evaluated according to the guidelines of EN 117 (2005) for 10 un-leached and 10 leached Mulberry specimens. Virulence controls were also performed using Pine (*Pinus sylvestris*) sapwood. The termites used were *Reticulitermes santonensis*.

Culture flasks are first filled (up to 5cm) with water and Fontainebleau sand (proportion 1 to 4 respectively). A small piece of wood from the original termite culture is placed in the middle of the container and pushed to its bottom. Then, a combination of 250 workers, 3 nymphs and 3 soldiers are added. After the set up of the termite colonies (2 to 3 days), each wood specimen is placed on a glass ring on one side of the flask.

After eight weeks of exposure to termites, visual ratings of the samples (see below) and weight loss (on anhydrous basis, as described for the fungi, except that there is no correction coefficient) are determined.

Visual rating was done according to the following scale:

- 0: No attack
- 1: Attempted attack
- 2: Slight attack
- 3: Moderate attack
- 4: Severe attack

## **7-1-2- Results on the natural durability of leached and un-leached wood**

### **7-1-2.a. Determination of natural durability of white Mulberry towards fungi**

As mentioned in chapter 2, despite some existing reports on the white Mulberry, natural durability of leached specimens has never been investigated before. Furthermore, the standard water leaching, seen as an incomplete prefabrication treatment (see chapter 5), is interesting to be studied for its effects on the wood's resistance towards aggressive agents.

Throughout the test, both leached and un-leached specimens seemed to be resistant towards the fungi attacks. While the exact calculations based on ML are not done but after the ending of test standard duration, the observations involving seemingly untouched white Mulberry beside fungi-covered controls in the same flask, predict a good durability class (Fig.7.1).

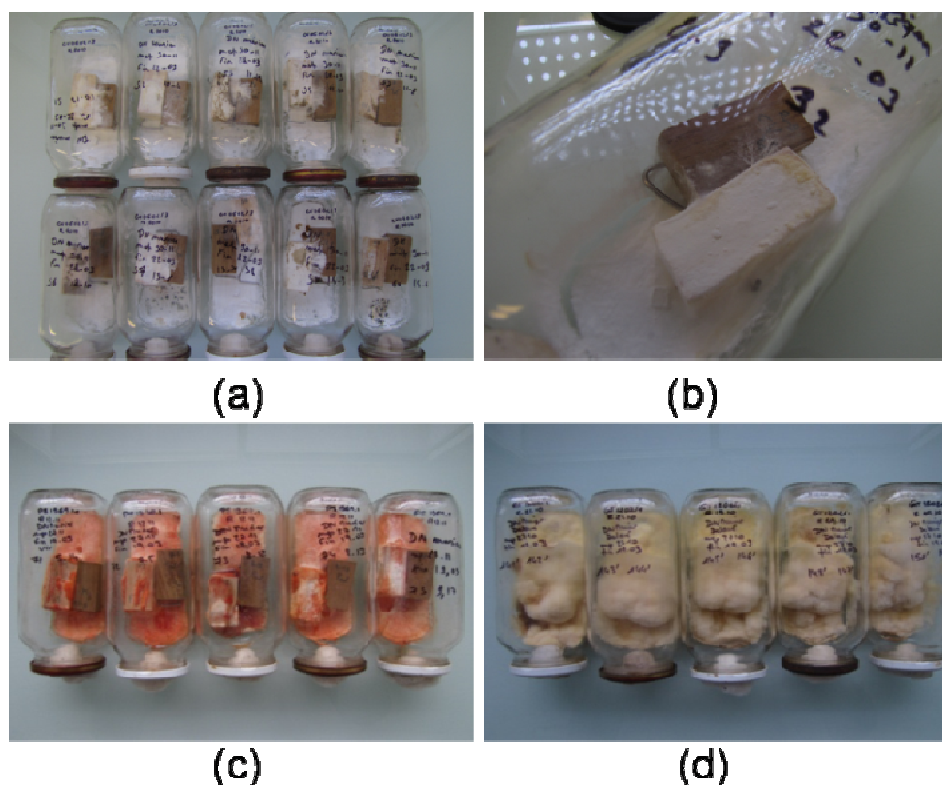

Fig.7.1. Specimens of white Mulberry in their test flasks, (a, b): Leached white Mulberry (left) beside its controls (right) attacked by *Coriolus versicolor*, (c): Un-leached white Mulberry (right) and controls (left) attacked by *Pycnoporus sanguineus* and (d): Controls (Scot pine) completely covered by *Gloeophyllum trabeum*.

To show how the leached and un-leached specimens react towards different fungi, Table 7.2, presents the ML of white Mulberry specimens, controls and those of virulence tests which validate the actual test. Visual view of the categorization based on XP CEN/TS 15083-1, is also illustrated in Fig.7.3.

The fungal test with the un-leached samples can be considered as valid. *Coniophora* virulence controls have an average mass loss below 30%, but one can consider that 29% average mass loss of the controls tested within the same flask as Mulberry specimen allows a test validation. For all the other strains, the ML of the virulence controls validates the tests. According to the requirements of XP CEN/TS 15083-1, the median ML of the tested samples was below 5%, so the white Mulberry can be classified as very durable. The un-leached specimens proved to be very durable, even when tested with very aggressive tropical strains. (Median of the ML  $\approx$  3% against *Antrodia*) (Fig.7.2).

The small mass losses after the attack of *Poria placenta* are reasonable considering the fact that this specific fungus is usually used for softwoods and would hardly make severe effects on hardwoods.

Table 7.2. Resistance of un-leached and leached white Mulberry specimens against Basidiomycete attack

	Fungi type	Mass loss %					
		Test flasks				Virulence control n = 10	
		white Mulberry		Controls			
	Average ± Std dev	Median	Average ± Std dev	Median	Average ± Std dev	Median	
un-leached samples	<i>Coniophora puteana</i>	0.83 ± 0.25	0.80	26.79 ± 7.79	29.01	17.1 ± 10.1	16.9
	<i>Coriolus versicolor</i>	1.39 ± 0.40	1.33	32.47 ± 4.58	33.25	27.2 ± 6.8	26.9
	<i>Gloeophyllum trabeum</i>	0.9 ± 0.3	0.8	40.4 ± 17.7	45.2	46.9 ± 16.5	56.5
	<i>Poria placenta</i>	0.6 ± 0.2	0.6	48.3 ± 3.7	48.0	37.5 ± 3.6	38.7
	<i>Pycnoporus sanguineus</i>	1.0 ± 0.3	1.0	34.3 ± 4.2	33.0	30.6 ± 2.6	30.9
	<i>Antrodia sp</i>	5.2 ± 5.1	3.0	70.0 ± 1.1	69.9	68.6 ± 1.2	69.2
leached samples	<i>Coniophora puteana</i>	0.9 ± 0.5	0.7	33.1 ± 11.6	31.7	26.9 ± 4.2	28.3
	<i>Coriolus versicolor</i>	0.3 ± 0.2	0.3	35.8 ± 7.5	37.0	31.6 ± 4.1	32.7
	<i>Gloeophyllum trabeum</i>	0.3 ± 0.3	0.2	45.5 ± 5.4	47.9	44.3 ± 8.4	44.9
	<i>Poria placenta</i>	0.3 ± 0.4	0.0	38.2 ± 4.6	37.6	29.8 ± 3.9	31.1
	<i>Pycnoporus sanguineus</i>	0.1 ± 0.2	0.1	31.4 ± 3.7	31.1	31.5 ± 9.6	31.7
	<i>Antrodia sp</i>	16.5 ± 7.6	15.9	67.4 ± 2.7	68.8	61.8 ± 3.5	61.8

In case of leached specimens, surprisingly towards majority of standard fungi, the ML of leached specimens is smaller than those of unleached ones (Fig.7.2). This can be indication of the fact that whatever extractives the leaching managed to remove from Mulberry, has absolutely no effect on its resistance towards basidiomycetes. The other hypothesis regarding such results can be based on the duration/ conditions of the water leaching. That is, a fourteen days leaching in water at ambient temperature, has little effects (or probably no effect) on extracting secondary metabolites. Moreover, there is also a possibility that water can extract some compounds but still leave enough amounts in wood to be sufficient to protect it against aggressive agents. Remembering the conclusion in chapter 6 (the probability of co-existing two types of compounds governing vibrational properties), the same hypothesis can also be proposed when natural durability is concerned. Means that, water-extracted compounds (or to that regard what is extracted by water in such conditions) do not play a role in increasing wood's natural durability, nevertheless, the protection is assured by other types of molecules (unextractable by water) which remain un-touched after the leaching.

The statement above is true, with the exception of the case of *Antrodia*. When specimens are tested with this aggressive tropical fungus, the removed compounds seem to play an important role in its resistance, as the durability category changes from durable (even very durable considering the ML being on the limit) to slightly durable (ML ≈ 16%).

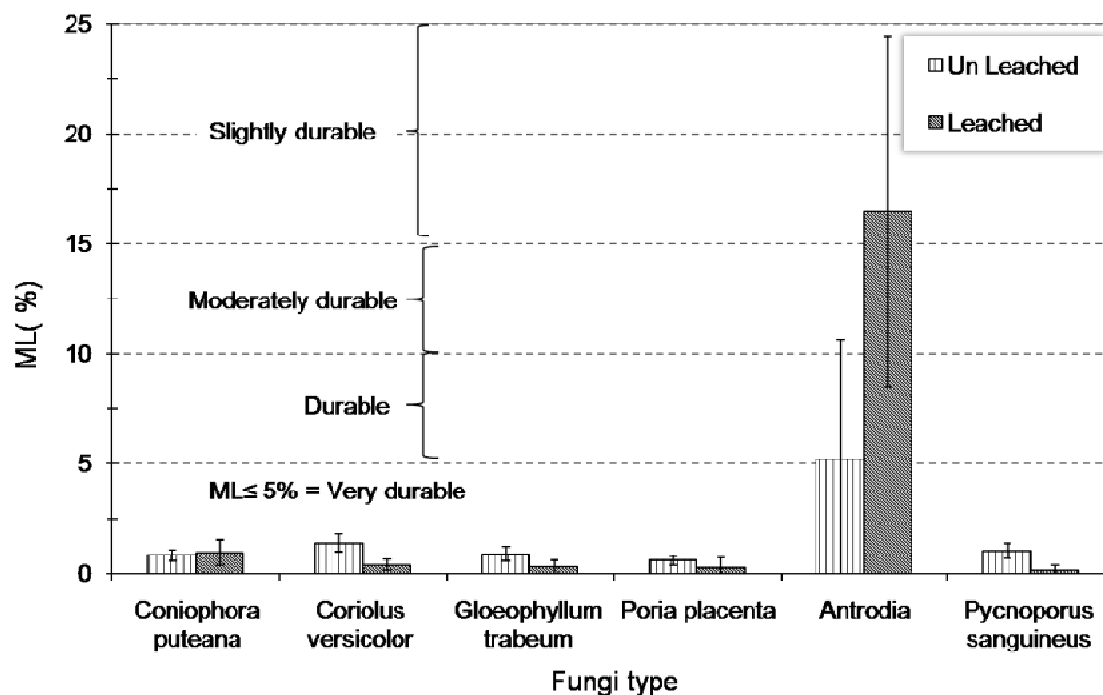

Fig.7.2. Comparison between mass loss of leached and un-leached specimens tested against basidiomycete. The dashed lines show the durability classifications based on XP CEN/TS 15083-1.

Moving to the second standard (EN350-1), the results of X factor, calculated based on the ML of specimens of white Mulberry and controls are shown in Table 7.3.

Table 7.3. Results of X factor for un -leached and leached specimens according to EN 350-1

Fungi type	X results	
	Un-leached	leached
<i>Coniophora puteana</i>	0.03	0.02
<i>Coriolus versicolor</i>	0.04	0.01
<i>Gloeophyllum trabeum</i>	0.02	0.00
<i>Poria placenta</i>	0.01	0.00
<i>Antrodia</i>	0.07	0.24
<i>Pycnoporus sanguineus</i>	0.02	0.00

Getting back to the requirements of EN350-1, all the tests are categorized in “very durable” category ( $X < 0.1$  in all cases) except for the leached specimens tested against *Antrodia*, which are classified under “durable” ( $X \approx 0.24$ ).

Having all the results, and have them classified by both standards, now we can look more profoundly to the results concerning natural durability as well as possible differences between two classifications.

Even though using a variety of fungi with different modes of action (brown or white rot) and dissimilar virulence eventually give an extensive and more applicable classification, according to Van acker et al. (1998), the use of *Coriolus versicolor* and *Coniphora puteana* are more justifiable for categorization. In any case, regarding the classification according to XP CEN/TS 15083-1, the entire un-leached specimens exposed to all six types of fungi are classified as very durable. Water leaching could not negatively affect

on how the specimens reacted towards the majority of fungi, except for *Antrodia*. These results bring us back to the fact that water-removed extractives of the leached wood are probably responsible for its high natural durability when exposed to extreme conditions and that the threshold of the extractives is different for the different fungal strains

We have also tried to compare two kinds of classification: one according to net mass losses of tested specimens (XP CEN/TS 15083-1) and another based on a calculated X values (EN350-1) which in turn are the results of mass losses of both tested specimens and those of their proper references. The two standards result in exactly the same classification towards most fungi. This means that, regardless of the fact that whether we use the net mass loss or the X value, both leached and un-leached specimens end up in the same category (very durable). In this case, too, the specimens exposed to *Antrodia* are classified differently according to each standard. While the leached specimens categorized as “slightly durable” according to XP CEN/TS 15083-1 (ML $\approx$  16%), their average X value of 0.24 place them easily in durable category (EN350-1). These results may seem confusing, especially looking back to the statement above that in extreme conditions the role of extractives are emphasized. That is, according to first standard, water-soluble extractives dramatically change the durability class from “durable” (and even very durable) to “slightly durable”, while in the second one (EN350-1), the class changes from “very durable” to “durable”, which fades out the importance of extractives.

A possible justification for the different results in extreme conditions can come from the way that X-value is calculated. It has been previously stated that the X-value is extremely dependent on the exact mass losses of reference species and therefore it could easily be affected by natural proper differences of each reference test-sample (Van acker et al. 1996, 1998). It was then proposed to use net weight losses as a base of classification along with references as virulence controls (Van acker et al. 1998<sup>18</sup>), which is similar to the way results were expressed in Table 7.3.

The reported results of natural durability of un-leached white Mulberry vary from not-durable (Tewari 1978 cited in Scheffer and Morell 1998), to moderately durable (Sen and Sivrikayan 2009) to very durable (Kazemi et al 2006, Zamir 2008). The inconsistency in those results can be indicator of the differences of the used tests (some were field tests). In any case, the two last references cited, which listed white Mulberry as a very durable species, also studied Asian (Middle-Eastern in one case) ones. The results of our tests, compatible with the last mentioned, marked white Mulberry as a very durable species in both its leached and un-leached conditions.

#### **7-1-2.b. Results on the resistance of un- leached and leached white Mulberry towards termites**

The results of the durability against termites are given in Table 7.4.

The termite tests are valid and the mass loss of virulence controls is homogenous for all the samples. The un-leached Mulberry samples can be classified as moderately durable,

---

<sup>1</sup>In the paper of Van acker et al. (1998), only *Pycnoporus* was used as a tropical strain and *Antrodia* was excluded.



and the leached samples are non-durable. Like the case of basidiomycetes, mass losses of the leached samples are smaller than for the un-leached ones.

Table 7.4. Resistance of white Mulberry specimens towards termites

Samples	Worker survival rate %	Visual rating	Mass loss %	
			Average $\pm$ Std dev	Median
Un-leached N = 2 samples N = 8 samples	0	1 2	2.20 $\pm$ 0.30	2.05
Leached N = 10 samples	0	3	0.91 $\pm$ 0.33	0.83
Virulence controls N=10 samples	>60	4	12.42 $\pm$ 0.97	12.30

The results of visual ratings on the other hand, are contrary of the mass losses. The leached samples rate higher than un-leached ones means that visually the specimens are degraded by the termites in the first case. It must be underline that the observed difference between the lower bound of mass loss in un-leached specimens (1.9 % of dried mass) and the upper bound of leached ones (1.24% of dried mass) is so small that raises real doubts concerning the significance of these variations. The second remark is about the ML calculation being appropriate for such tests. Generally, for termite resistance, ML is not calculated, and visual rating is considered to be sufficient for expressing the results. In our case, both were done; however, the result did not correlate in the end.

To conclude, we can state that white Mulberry is found moderately durable towards termites, and becomes sensible when leached. The extractives are toxic (but not repulsive) as the termites have to eat some of the wood to die. The classification according to visual rating and mass losses are different for leached specimens. Nevertheless, the closeness of the average observed values for leached and un-leached specimens, along with their small ML compared to that of virulence controls (2.20% and 0.91% compared to 12.42% in controls), makes one doubt that mass loss calculation being the appropriate tool for expressing the results in such test.

## 7-2- Investigating extractives toxicity in reaction to the termites

Looking at the results of the fungi and termite resistance in solid wood in the last pages, we can conclude that secondary metabolites of white Mulberry definitely have a role in increasing its natural durability. Furthermore, they seem to be toxic towards termites. Therefore, using the crude extracts themselves in function of the termites, in the following part we will investigate the toxicity of this wood's secondary metabolites more closely.

The material for this part came directly from what was left after powder's independent extraction (see chapter 6). Treated powders and the cumulated extractives are used to be exposed to termites.

## 7-2-1- Experimental details

### 7-2-1.a. Extracted powder

0.2 g ( $0.2 \text{ g} \pm 0.004 \text{ g}$  / N: 24) of each following treated powders is separated:

- Un-extracted powder (which normally has a hold of all its extractives).
- Hexane extracted powder (H)
- Dichloromethane extracted powder (D)
- Acetone extracted powder (AC)
- Methanol extracted powder (ME)
- Hot water extracted powder (HW)

Powder samples are all dried in  $103^{\circ}\text{C} \pm 2^{\circ}\text{C}$  before introducing to Petri dishes. Each Petri dish is filled with 30 g of wet Fontainebleau sand (sand to water proportion 4:1) (Fig.7.3).

Powder is added in the middle of circularly shaped sand. Thirty termites (all workers) are added to each Petri dish. Triplicates are made from each sample. In addition to that, 3 control dishes are prepared using 0.2 g of fine scot pine powder. Three complementary dishes, which contain only sand and 30 termites (so called “diet” controls), are also made.

Termites' type is *Reticulitermes santonensis*.

Samples are kept in a chamber of  $27^{\circ}\text{C} \pm 2^{\circ}\text{C}$  temperature and  $75\% \pm 5\%$  RH for 30 days. The sample/Petri dishes are checked every day for counting the number of dead termites. Number of termites that have not survived are first carefully noted and then they are taken out of the dish. A few drops of distilled water are added every 2-3 days to keep the sand wet enough for the termites' survival.

At the end of 30 days, the results are analyzed and presented in forms of means and standard deviations based on survival rate of termites as well as their activity.

### 7-2-1.b. Extractives

15  $\mu\text{l}$  of each following extract mixed with its respective solvent is separated:

- Removed extractives after H + Hexane
- Removed extractives after D + Dichloromethane
- Removed extractives after AC + Acetone
- Removed extractives after ME + Methanol
- Removed extractives after HW + distilled water

Each solution is added to a cellulosic paper of  $1\text{cm} \times 1\text{cm}$ . In addition to the extract/solvent solutions, 15  $\mu\text{l}$  of each corresponding solvent (H, D, AC, ME and distilled water) is added to a separate cellulosic paper in order to make sure any probable observed effect on termites is coming directly from extractives and not from solvents. The treated cellulosic papers are left to dry at ambient temperature (15 min) before being introduced in the Petri dish. Like in the previous case, diet controls (sand + termites) are prepared. Other conditions are exactly as before (i.e., termites' types, conditions of the conversation, etc).

At the end of 30 days the effect of extractives are compared based on survival rates of termites, termites' activity and surface loss of paper and presented in form of means and standard deviations.

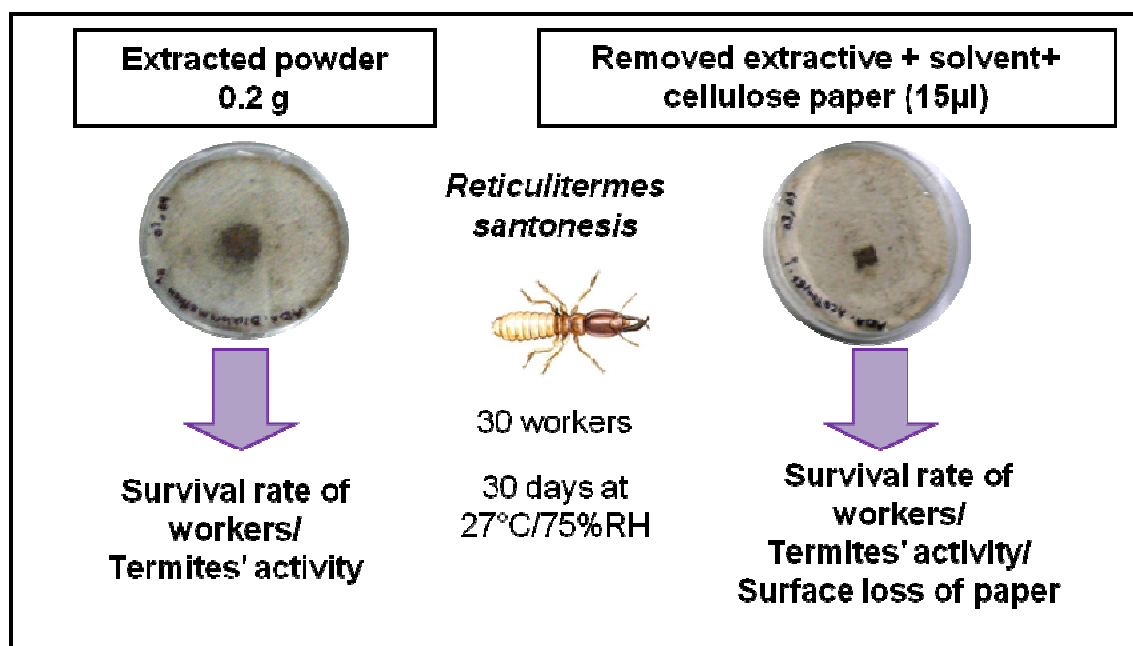

Fig.7.3. brief description of termites' reaction test against extracted powders and their corresponding removed extracts

### 7-2-2- Results on the effect of extractives on termites

#### ➤ Observations on termites activity and survival rate: case of powder and extractives

Fig.7.4 presents the survival rate of the termites in relation with the extracted powders. Looking at the first three samples (un-extracted, H- extracted and D- extracted), the small and similar survival rates, indicate that the secondary compounds important for resistance towards termites are still intact inside the wood. H and D, apparently not removing essential components, leave the wood toxic for the termites.

AC- extracted powder seems to have lost some of its effective extractives (as the survival rate is significantly higher than the previous cases) but still has enough to exhibit only  $\approx$  30% survival rate. ME-extracted powder, on the other hand, having most of its extractives removed, shows the highest proportion of remained termites (Survival rate  $\approx$  70%). In that regard, ME-extracted powder also exceeds that of the controls (containing termite-feeding powder of scot pine). HW-extracted powder turns to have almost the same survival rate as in the sand-control dishes, where the termites are died out of famine.

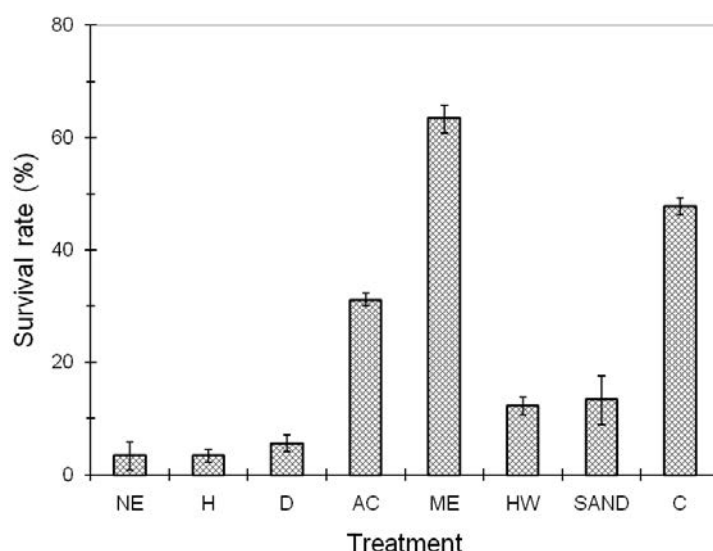

Fig.7.4. The survival rate of the termites in relation with powders extracted with different solvents. NE: Not extracted, H: Hexane, D: Dichloromethane, AC: Acetone, ME: Methanol, HW: Hot water, SAND: diet control, C: control (Scot pine)

Looking at the survival rates in connection with the solvents alone (darker bars on the right) (Fig.7.5), it can be seen that in case of apolar solvents (H and D) the small amounts of removed substances do not play any role in increasing resistance towards termites and the survival rates are approximately the same for extractive solutions and the solvents. In fact, when evaporated, solvents are not really effective on the termites (except maybe for AC). The similar survival rates of the solvents' treated papers (H, D, and ME) with that treated with water (which has no toxicity), is confirming the same fact. Here, the survival rate of the control (termites+ crude cellulosic paper) was  $48\% \pm 2.5$ .

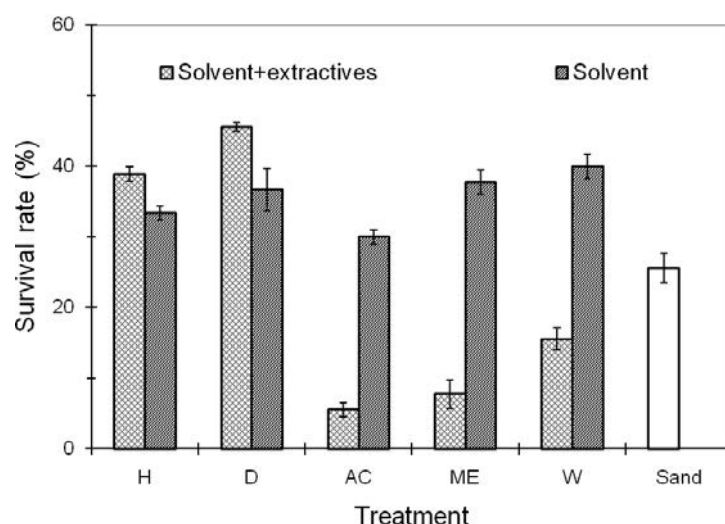

Fig.7.5. The survival rate of the termites in relation with extractives removed by different solvents, Indicators are as in Fig.7.4.

Talking about three solvents with greater polarities, relatively high survival rates are observed after the sole application of ME and W. This can validate the low survival rate coming from the extracts-in-solvent mixture, especially in the case of ME. Looking now at AC, the survival rate caused by the solvent alone, though still high to validate that of

extracts, stays visibly lower than those of ME and W. This means that in fact AC has a toxicity effect stronger than that of others.

To have a more complicated analysis, we can look at the results through another way. The raw material for this phase came from the independently extracted powder thoroughly discussed in chapter 6. Consequently, the WL due to each extraction and extractive contents (EC %) gathered by evaporation of each corresponding solvent are available. However, it should be kept in mind that the WL and EC presented here are relative to extractions done on 3 g of powder, from which only 0.2 g is used in the current test.

Fig.7.6 (a and b) illustrates WL (a) and EC (b) due to five solvents in relation with the survived termites after 30 days of exposure. For a better understanding of this figure, one should consider the Fig.7.4 and Fig.7.5 at the same time.

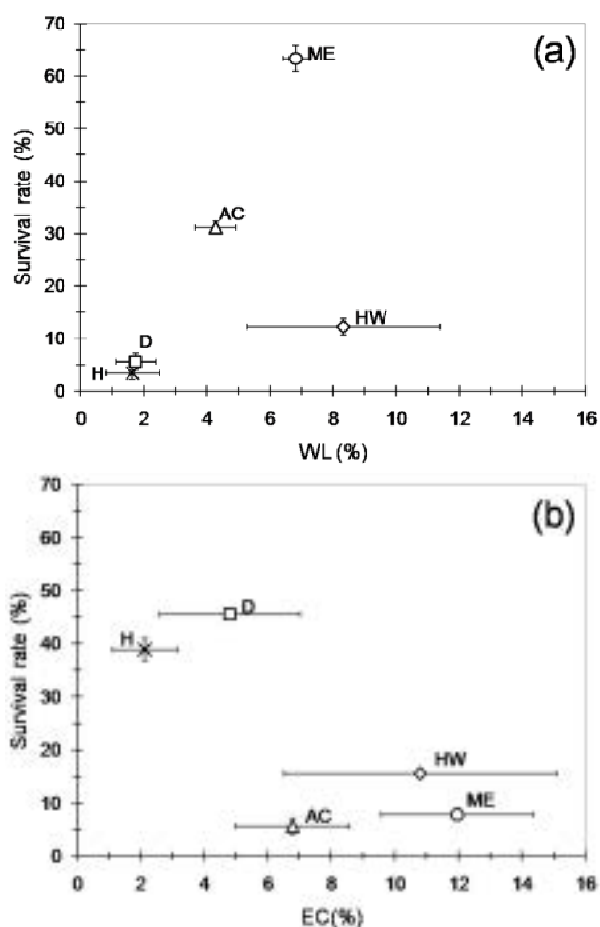

Fig.7.6. Relationship between survival rate of termites (%) and powder weight losses (WL %) (a), and extractive content (EC %) (b). H: Hexane, D: Dichloromethane, AC: Acetone, ME: Methanol and HW: Hot water.

Looking at the Fig.7.6.a, where the survival rate of the termites (when exposed to differently extracted powders by various solvents) is been put beside the average WL observed after each extraction, it can be seen that the termites behave almost accordingly to each solvent's polarity. The H and D-treated samples, having minute yields of extractions, probably have a hold of termite-toxicant extractives and thus the survival rate is low. Indeed that assumption is correct, as the survival rate for H treated powder is the same as for the un-treated one (Fig.7.4).

As the extraction yield is increased, so has the survival rate (AC). Still, the highest survival rate is not of the solvent with the biggest WL (HW), but it was from ME (WL $\approx$  6.82%, survival rate $\approx$  70%).

Ideally Fig.7.6.b should be the mirror of the Fig.7.6.a. That is, the extracted powder with the highest survival rate, loses its effective compounds, which should normally be presented with the least survival rate in Fig.7.6.b. This assumption turns to be correct with the exception for HW in which, the termites survival rates are equal for both extracted powder and its corresponding extractives. Putting HW aside, EC of H, D, AC and ME (with small variations), is acting vice versa of that of powder. Extractives removed by H and D, not including a high percentage of total extract (2-5%) result in highest survival rates amongst all tested samples (This could also be seen in Fig.7.5). Here the least survival rate is caused by the extracts removed by AC, followed closely by that of ME. It seems like here, contrary to what was presented in the case of extracted powder (Fig.7.6.a), the crude extractives of AC and ME, despite their different yields ( $\approx$  6.8% for AC and  $\approx$  12% for ME), acting the same on eradicating the termites. However, the explanation on the Fig.7.5 can enlighten the situation. Previously in the same section, AC was marked toxic and effective on destroying the termites (while ME acted closely as water). Therefore, the survival rates caused by AC-crude extracts, is in fact coming from a combination of solvent/extracts toxicity, and actually, ME-crude extracts (like in its extracted powder in Fig.7.4 and 7.6.a) are the most toxic (regarding both their raw amount and their nature) in effecting the termites

To conclude, we can state that extractive of white Mulberry are observed to have a toxic effect on the termites. This toxicity of course, is highly related to their types as well as their location inside the wood matrix, as the extracts removed by various solvents do not show the same effect on the termites. The survival rate has mostly an inverse relationship with the extraction yield (with the exception of those removed by HW), when ME, being the most exhaustive solvent, brings out the extractives that cause the least survival rate.

### 7-3- Conclusion

Natural durability of white Mulberry (*Morus alba* L.) from Iran, was studied against both termites and basidiomycetes. Following the availability of extracted powder by different solvent, the effect of different degrees of extractives removal, (or in other words various types of secondary metabolites) on termites has been also investigated.

Both un-leached and leach (solid) specimens of white Mulberry are classified as very durable towards five standard fungi. While water leaching is observed to be affectless on how the specimens reacted in temperate conditions (and towards temperate fungal strains), in extreme tropical conditions and with the aggressive *Antrodia* strain, it has definitely essential role on durability.

Un-leached Mulberry is rated as moderately durable towards termites. Water leached specimens, are classified non-durable by visual rating, however their ML results are not compatible.

Regarding the effect of extractives on resistance towards termites, it is revealed that the secondary constituents of wood play significant role as termites' toxicants. ME-extracted compounds are the most affective ones (highest extraction yield), cause the least survival rate in termites.

## 8. Identification of extractive compounds in white Mulberry's wood

---

### ➤ General view

Identification of existent compounds in white Mulberry's wood is done to achieve different objectives, some in relation with the present study, and some as preliminary steps toward possible future research:

- Confirmation of different compound-types removal: looking back to the previous chapters, especially chapter 6, which exclusively talked about the effect of extractives removal on physic-mechanical properties, the modifications due to extractions, was related to the fact that each solvent removed different types of substances based on its polarity. This hypothesis, though completely related to the observed effects and backed up with several references, can still be confirmed with an identification of removed compounds.
- Same-compounds removal by different solvents: this is a complementary objective to the previous one. Using the extractives gathered after serial extractions, one could identify the possible overlapping effect different solvent might have, by comparing the spectra as well as the identified compounds after independent and successive use of the each specific solvent.
- Solvents with close polarities are generally assumed to reach for the same types of compounds. AC is the most efficient solvent, when modifications in vibrational properties are considered, while talking about natural durability, it is ME which has the highest impact. These show that different substances in various depositions sites are responsible for vibrational and natural durability characters of white Mulberry. A further look to the matter will be possible when the removed substances are identified.
- One of the basic hypotheses of this study is the probable toxicity of white Mulberry extractives. This is based on the reports of the professional artisans. Although a complete toxicology test has never been planned in the context of this study, other indirect ways are used to confirm toxicity of the secondary compounds. It is revealed in chapter 7 that the extractive had toxic effects on termites. These results, in addition to those that pointed extractives as the responsible for fungi resistance in extreme conditions, underline the role of secondary metabolites. Identification of the removed compounds, can give the basic ground necessary for further future research.

A complete and precise identification of the compounds can ideally provide us with a path to reach the mentioned objectives. Liquid chromatography (HPLC) (which results are not presented in this study) and two runs of Gas chromatography mass spectrometry (GC-Mass) are done on the samples. While the results of HPLC are put aside for difficulty in interpretation, results of both GC- mass tests are shown and discussed in this chapter.



## **8-1- Reminder of the analyzed material**

The identification tests are done on the cumulated extractives after both independent and successive extractions. The process is fully explained in chapter 6. To put it simply, 3 g of fine powders is extracted by 5 solvents of different polarities, once independently and once successively on the same sample. When the extraction is finished, solvents are evaporated, and the crude extracts are cumulated and kept in sealed vials out of sunlight reach in a refrigerator. Eventually the samples below are the extractives gathered

- after independent extractions: hexane H; dichloromethane: D ; acetone: AC; methanol ME hot water (100°C) HW
- after successive extractions: H+D; H+D+AC; H+D+AC+ME; H+D+AC+ME+ HW

Further details on specific preparation of the material for each test will be found in the following sections.

## **8-2- Methods**

### **8-2-1- High Performance Liquid Chromatography Mass Spectrometry (HPLC-MS) (LMP - Montpellier)**

High Performance Liquid chromatography mass spectrometry (HPLC MS) has been performed in Laboratoire de Mesure physique (LMP) thanks to Mr. Gilles Valette.

HPLC-MS is a method based on analytical and biochemistry, which separates and purifies individual compounds (Lawrence, 1984; Oliver, 1998) and that can be used for the identification of wood secondary metabolites (Gutiérrez et al., 1999; Dorado et al., 2001; Schinor et al. 2006). Conceptually, HPLC uses different stationary phases, a pump that moves the mobile phase and analyzes the extractives through a column, and a detector that recognize the characteristic retention time (§ following). The retention time depends on three factors: 1. strength on interaction between analyte and the stationary phase, 2. the ratio/composition of the solvents used and 3. the flow rate of the mobile phase. HPLC-MS was the first test performed on the extracts. The apparatus setting is as below:

Two carriers (eluent) are used: Carrier A was “water+ trifluoro acetic acid” and carrier B is a combination of “Acetonitrile + 0.1% trifluoro acetic acid”. The column used is a C18 BDS with 3 microns (thickness), Hypersyl, with the dimension of 50mm ×2 mm (Length× diameter). 0.2 ml/min is chosen as the optimum flow rate. The linear gradient of the process is as follow:

- 0 min: 100% carrier A
- 20 min: 20% carrier A and 80% carrier B
- 25 min: 20% carrier A and 80% carrier B
- 26 min: 0% carrier A and 100% carrier B

The most important compounds then appear as distinguished picks in the mass spectra.

HPLC-MS could only deliver the results of the extracts removed by the polar solvents (i.e., AC, ME, and HW). Probably due to the incompatible used solvents or the apparatus

setting (that was not adjusted to work with wood), the picks were complicated to be interpreted. Therefore, we resorted to GC-Mass as a new way for indentifying the white Mulberry's extracts.

### **8-2-2- Gas Chromatography Mass Spectrometry (GC-Mass)**

Gas chromatography (GC) and mass spectrometry (Mass), are two methods combined together to form a strong and trusting tool for chemical analysis. A detailed description of the method is not within the focuses of this study. Nevertheless, we are going to present a small part in form of a “semi-introduction” to the method, hoping that can help to a better understanding on how the results are obtained. Complete details on the matter can be found in chapter 31 of the Handbook of instrumental techniques and analytical chemistry (Settle 1997) and Handbook of GC/ms (Hübschmann 2009) or in “basic of gas chromatography” (McNair and Miller 2009).

#### **8-2-2.a. Principle of GC-Mass**

##### **➤ Definition**

GC analysis depends on different chemical and physical characteristics of compounds present in a particular mixture. In fact, different molecules have dissimilar “travel times” in GC column. The amount of time by which a molecule remains in a column is affected by its mass, its shape, and its active agents.

The equipment used for GC generally consists of an injection port at one end of a metal column packed with substrate material and a detector at the other end of the column. A carrier gas propels the sample down the column. The operator uses flow meters and pressure gauges to maintain a constant gas flow. A gas that does not react with the sample or column is essential for reliable results. For this reason, carrier gases are usually argon, helium, hydrogen, nitrogen, or hydrogen. Many analysts use helium because it does not react. Hydrogen usually is a good carrier gas but it may react and convert the sample into another substance.

##### **➤ Retention time (RT)**

In the results, we will often use retention time (RT) as one of the distinguishing marks for identified compounds. For that, it seems essential to explain briefly the term.

The time length that a compound is retained in the GC column is known as the retention time. The RT can help in differentiating compounds. However, RT is not a reliable factor to determine the identity of a compound. If two samples do not have equal retention times, those samples are not the same substance. However, identical retention times for two samples only indicate a possibility that the samples are the same substance. For that, with separated compounds in hand, a mass detector will be combined with GC to get a trusting compound recognition.

##### **➤ Mass spectrometry (MS)**

MS identifies substances by electrically charging the specimen molecules, accelerating them through a magnetic field, breaking the molecules into charged fragments and detecting the different charges. A spectral plot displays the mass of each fragment. One

can use these fragment masses as pieces of a puzzle together the mass of the original molecule.

The MS instrument produces the output by drawing an array of peaks on a chart, the "mass spectrum." Each peak represents a value for a fragment mass. A peak's height increases with the number of fragments detected with one particular mass.

➤ **GC-Mass application in identification of wood extractives**

Looking back to the brief introduction above, we can see that each method has its particular advantages. GC is particularly reliable on separating the compounds, while MS is giving a remarkably detailed mass spectrum. GC-Mass has been widely used for a rapid and precise identification of wood's extractives. Traditionally the method is applied for isolating and identifying the more volatile terpenoids (Dey et al. 1991). Progressing techniques resulted in using shorter capillary columns (<10m) which allowed an identification of less volatile and/or heavier molecules (Fernandez et al. 2001). From then on, several researchers worked with GC-Mass to get a complete profile of the present compounds in wood extractives (Jüngel and Melcher 2001, Fernandez et al. 2001, Coelho et al. 2007, Zhang et al. 2011). This was specially done in case of raw wood materials for pulp and paper industry, (del Rio et al. 1998, 2000, Gutierrez et al. 1998, Gutierrez and del Rio 2003). Compound identification was also done in order to develop knowledge on distinguishing particular compounds responsible for resistance towards fungal/ corruptive agents (Gutierrez et al. 1999, del Rio et al. 2001).

In the end, considering the context and objectives of this study and keeping in mind the acceptable precision and rapidity of the method, GC-Mass seemed to be the reasonable choice for identifying extractives compounds of white Mulberry.

GC-Mass is performed twice on all the cumulated material mentioned in 8-2. The first GC-Mass could only identify the compounds removed by polar solvents (AC, ME and HW) and not apolar ones (H and D). Eventually a final GC-Mass, using both crude extracts and their sylan derivations (§8-2-2.d), could give us a more profound view of the removed substances.

**8-2-2.b. First GC-Mass test (LMP - Montpellier)**

The analysis is done by Mr. Gilles Valette in Laboratoire de Mesure physique (LMP) using a gas phase chromatography. The particular setting of the apparatus is as below:

- The column used is TG-SQCID 15m/ID = 0.25 mm with a film of 0.25 µm thickness.
- The injection is done under the temperature of 200°C.
- Extractives are injected under the temperature of 90°C, then under a gradual increase (5°C/min), final temperature of 300°C is reached.
- The flow constant is 1.2 ml/min.

This test is only performed on the **crude extracts** and could only identify limited number of compounds removed by polar solvents (AC, ME and HW) and not those of H and D. This can be probably the result of the machine not being set based on wood. In addition, the complexity of the secondary material in wood sometimes makes it difficult to do a

perfectly distinguished analysis based only on the crude extractives. Because of that, it is generally common to introduce additional chemicals to form more-identifiable derivations with substances.

A more complete analysis, based both on raw and derivative compounds is then performed.

#### **8-2-2.c. Second GC-Mass test for crude extracts (Crittbois - Epinal)**

Analyses are done by coupling gas chromatography (Clarus® 500 GC, PerkinElmer Inc., USA) / mass spectrometry (Clarus® 500 MS, PerkinElmer Inc., USA), in laboratory of Crittbois located in Epinal, thanks to Mr. Eric Masson.

##### **➤ Gas chromatography**

The column used is a fused silica capillary (5% diphenyl and 95% dimethyl poly siloxane). The Elite column-5ms, is of 60 m × 0,25 mm dimensions with a film of 0.25 µm thickness of the Mark. PerkinElmer Inc., USA. The carrier gas is helium (Alpha gaz2, Air Liquide, France) and is used at the constant rate of 1ml/min. Injection is done in splitless mode for 0.5 min then at the flow rate of 50ml/min. 0.5µl is injected at 250°C. GC oven is programmed at 35°C for 8 min, then to gradually increase from 35°C to 345°C (5°C/min); just to stay at stable 345°C for 10 min before finishing the procedure.

##### **➤ Mass spectrometry**

Mass spectrometry is carried out by an electronic ionization with the energy of 70 eV.

Temperature of line of transfer is 330°C, while that of source is set at 250°C.

Detection is done in scan mode (ions of 20-500 m/z) and the analysis starts 10 min after the injection

#### **8-2-2.d. Second GC-Mass test for derived extracts (Crittbois - Epinal)**

##### **➤ Preparing the derivation**

The extracted compounds are derived with N, O-bis-(trimethylsilyl) trifluoroacetamide containing 1% trimethylchlorosilane (BSTFA / 1% v/v TMCS) (Acros Organics) and then analyzed by GC / MS coupling:

0.2 ml of BSTFA / 1% TMCS + 0.4 ml of acetonitrile (Fisher Scientific) are added to 5 mg of dry extract and the mixture is stirred before being heated to 70°C for 30 min.

After cooling, the extract is transferred to a secondary injection vial and then analyzed.

##### **➤ Gas chromatography**

The capillary column and the carrier gas details are the same as for un-derived extracts.

GC oven is programmed at 120°C for 6 min, then to gradually increase from 120°C to 345°C (7.5°C/min), just to stay at stable 345°C for 9 min before finishing the procedure.

##### **➤ Mass spectrometry**

Details of the mass spectrometry of the derived extracts are exactly as for the un-derived ones, except for two points:

- Mass to charge ratio of the ions are different (ions of 35-500 m/z)

- The analysis starts 5.5 min after the injection

## 8-3- Results of compounds identification

### 8-3-1- Crude extracts identification

#### 8-3-1.a. Basic categorization based on identified compounds (of crude extracts) removed by each solvent

The first step into an interpretation of the results is to see which compounds are removed by each solvent and then which are the common ones between various solvents.

Table 8.1 contains identified compounds by two GC-Mass tests. As it was already mentioned beforehand, first GC-Mass test could not identify any compound in the extracts of two apolar solvent and thus the results of extracts of H and D are strictly from the second test. There are several compounds identified by both tests (of course with different retention time as the setting of each test is slightly varied from the other). It should be noted that there are several un-identified observed in the spectra of D, AC, ME and HW. Those picks, though un-identified (marked "nd" on the figures), are used to draw conclusions on comparing different solvents reaching various deposition sites in white Mulberry.

An overall look into the compounds identified for an independent use of solvents can give a lot of information about the nature and the origin of chemical compounds present in the crude extracts of white Mulberry (Fig.8.1). There are also common compounds occurring in 3 solvents in a row, then there are also those which are present in both apolar and polar solvents while absent in the intermediary one (AC).

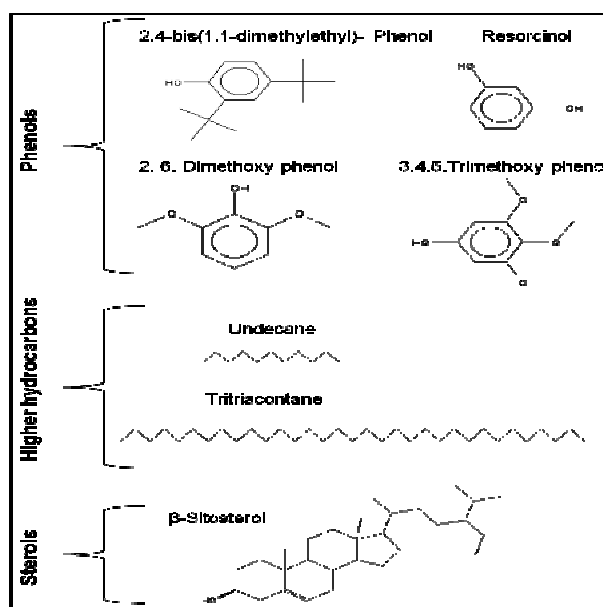

Fig.8.1. Open chemical structure of the most important compounds identified in crude extractives of white Mulberry, several types of higher hydrocarbons are only presented by the lightest ( $C_{11}H_{22}$ /Undecane) and the heaviest ( $C_{33}H_{66}$ /Tritriacontane) ones.

Chapter 8. Identification of extractive compounds in white Mulberry's wood

Table 8.1. List of the compounds found in the **crude extracts** removed by each solvent. Cas N°: Chemical abstract service registry number, MW: molecular weight (g/mol), RT: retention time (min)

Name	Cas n°	Formula	MW	Crude extracts RT (min) in each solvent's spectrum				
				H	D	AC	ME	HW
Undecane <sup>1</sup>	1120-21-4	C <sub>11</sub> H <sub>24</sub>	156.30	-	-	-	(3.70 <sup>1</sup> )	-
Octadecane	593-45-3	C <sub>18</sub> H <sub>38</sub>	254.50	42.247	-	-	-	-
Nonadecane	629-92-5	C <sub>19</sub> H <sub>40</sub>	268.53	44.282	44.263	-	-	-
Heneicosane	629-94-7	C <sub>21</sub> H <sub>44</sub>	296.58	48.059	48.025	-	-	-
Docosane	629-97-0	C <sub>22</sub> H <sub>46</sub>	310.61	49.834	49.797	-	-	-
Tricosan	638-67-5	C <sub>23</sub> H <sub>48</sub>	324.63	51.539	51.478	-	51.408	-
Tetracosane	646-31-1	C <sub>24</sub> H <sub>50</sub>	338.66	53.176	53.094	-	53.019	-
Pentacosane	629-99-2	C <sub>25</sub> H <sub>52</sub>	352.69	54.728	54.641	-	54.570	-
Hexacosane	630-01-3	C <sub>26</sub> H <sub>54</sub>	366.71	56.208	56.129	-	56.058	-
Heptacosane	593-49-7	C <sub>27</sub> H <sub>56</sub>	380.74	57.624	57.553	-	57.489	-
Octacosane	630-02-4	C <sub>28</sub> H <sub>58</sub>	394.77	58.984	58.928	-	58.868	-
Nonacosane	630-03-5	C <sub>29</sub> H <sub>60</sub>	408.79	60.288	60.246	-	-	-
Triacontane	638-68-6	C <sub>30</sub> H <sub>62</sub>	422.82	61.547	61.524	-	-	-
Hentriacontane	630-04-6	C <sub>31</sub> H <sub>64</sub>	436.85	62.775	62.757	-	-	-
Dotriacontane	544-85-4	C <sub>32</sub> H <sub>66</sub>	450.87	63.974	63.963	-	-	-
Tritriacontane	630-05-7	C <sub>33</sub> H <sub>68</sub>	464.90	65.132	-	-	-	-
Sequalene	7683-64-9	C <sub>30</sub> H <sub>50</sub>	410.71	-	-	-	-	59.27
Resorcinol	108-46-3	C <sub>6</sub> H <sub>4</sub> (OH) <sub>2</sub>	110.11	-	30.723	31.749 (5.37 <sup>1</sup> )	31.513 (7.20 <sup>1</sup> )	30.55 (2.88 <sup>1</sup> )
2,4-bis(1,1-dimethylethyl)- Phenol	96-76-4	C <sub>14</sub> H <sub>22</sub> O	206.32	36.080	36.122	-	(10.99 <sup>1</sup> )	(6.16 <sup>1</sup> )
2, 6, Dimethoxy phenol	91-10-1	C <sub>8</sub> H <sub>10</sub> O <sub>3</sub>	154.16	-	32.296	-	-	-
3,4,5,Trimethoxy phenol	642-71-7	C <sub>9</sub> H <sub>12</sub> O <sub>4</sub>	184.18	-	38.673	-	-	-
β-Sitosterol	83-46-5	C <sub>29</sub> H <sub>50</sub> O	414.71	-	66.211	66.219 (39.02 <sup>1</sup> )	66.177 (31.86 <sup>1</sup> )	-

1. Compound identified with first test.

Retention time of the first test is mentioned inside the parentheses. The non- marked RT are all from the second test.



Looking again at Table 8.1, this time with an eye on the common compounds detected in spectra of different solvents, it can be seen that they are mostly organized based on their ability to be brought out by either apolar or polar solvents. Higher alkanes (hydrocarbons) being apolar and hydrophobic, are almost completely extracted by H. One type of phenol is also slightly touched by H ( $C_{14}H_{22}O$ ), but it was D, which could mostly extract it. D, as the second apolar solvent, having more ability to reach different spots and been reported to have somehow the same swelling capacity as AC (Mantanis et al. 1994b) could practically remove parts of all kinds of present compounds (alkanes, phenols and sterols). However, looking at the actual spectrum of D (Fig.8.3), and comparing it to H and AC spectra (Fig.8.2 and 8.4), it is revealed that even though D actually removes all types of present compounds, its ability is limited to small percentages (or maybe it is not able to reach profoundly the deposition spots). The highest amounts of each type are actually removed by H (alkanes) and AC/ME/HW(resorcinol). On the other hand, D-extraction apparently could give availability to some spots that were before hand out of reach. This point will be discussed in the following part when the spectra of successive extractions are going to be presented.

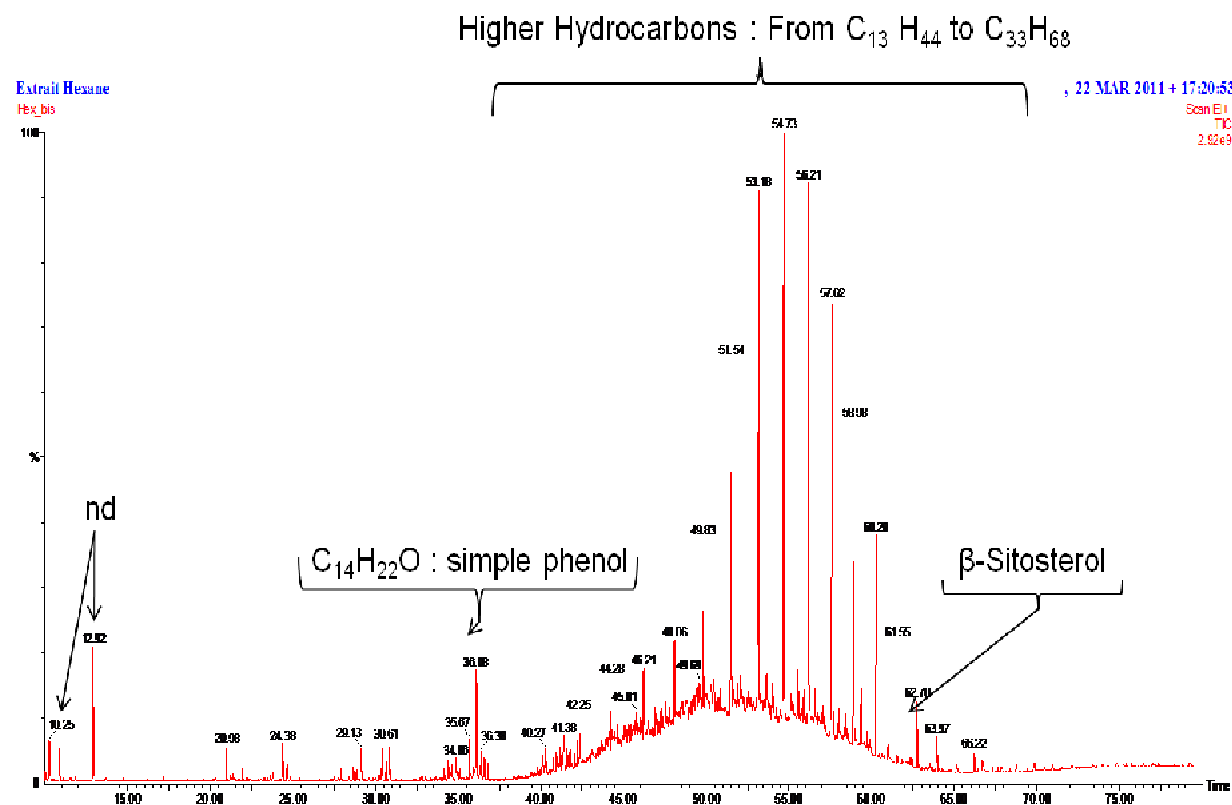

Fig.8.2. Mass spectrum of the Hexane-extracted compounds (Crude extracts). Nd: compound detected but could not be identified with certainty.



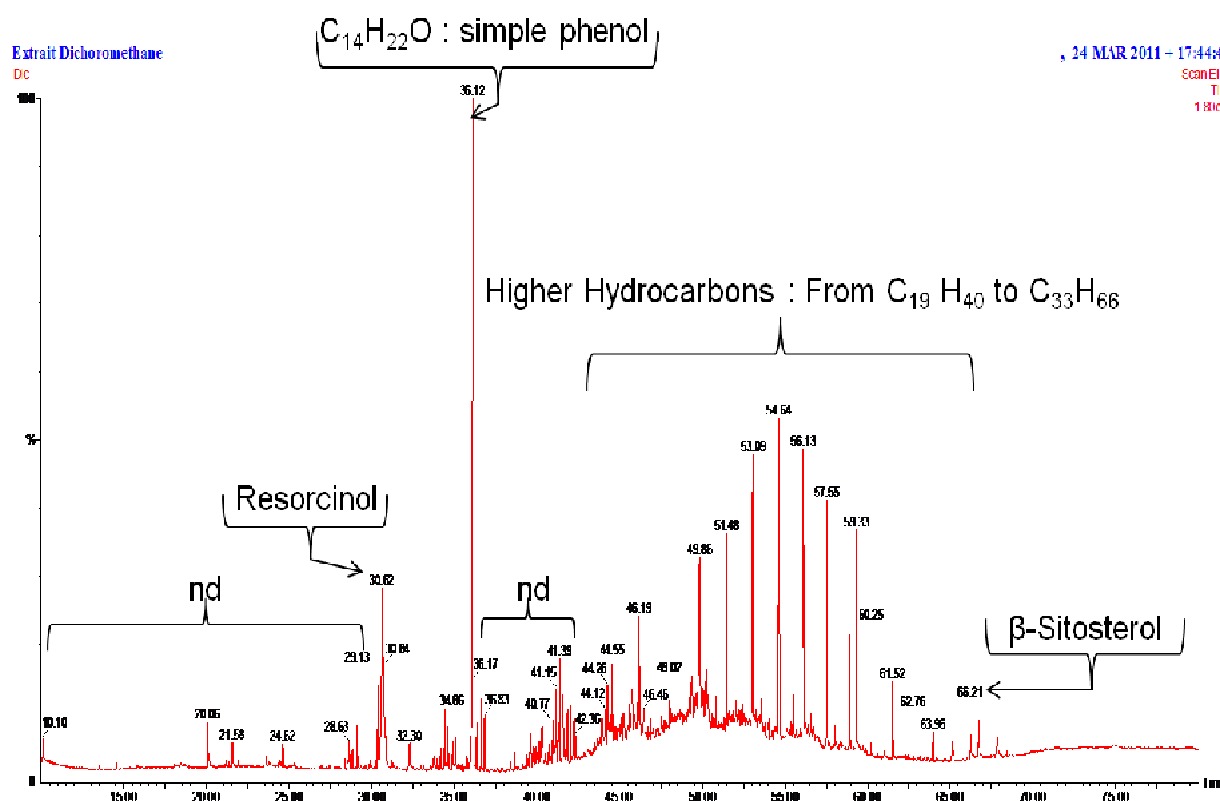

Fig.8.3. Mass spectrum of the Dichloromethane-extracted compounds (Crude extracts).

Moving to three polar solvents (AC, ME and HW), AC as an intermediary one, can not extract the apolar compounds, leaves the higher hydrocarbons untouched, and extracts only resorcinol and  $\beta$ -sitosterol. Interestingly, ME, being the second polar solvent after water, can extract a combination of polar and apolar compounds. It not only removes resorcinol and  $\beta$ -sitosterol, but also brings out a variety of heavy alkanes (mostly those of 23-28 carbon atoms). Expectedly,  $\beta$ -sitosterol, being a hydrophobic compound, is not extracted by water. The same happened for alkanes, as only one hydrocarbon (sequalene:  $C_{30}H_{50}$ ) is extracted by water. Eventually resorcinol remains the major compound removed by hot water.

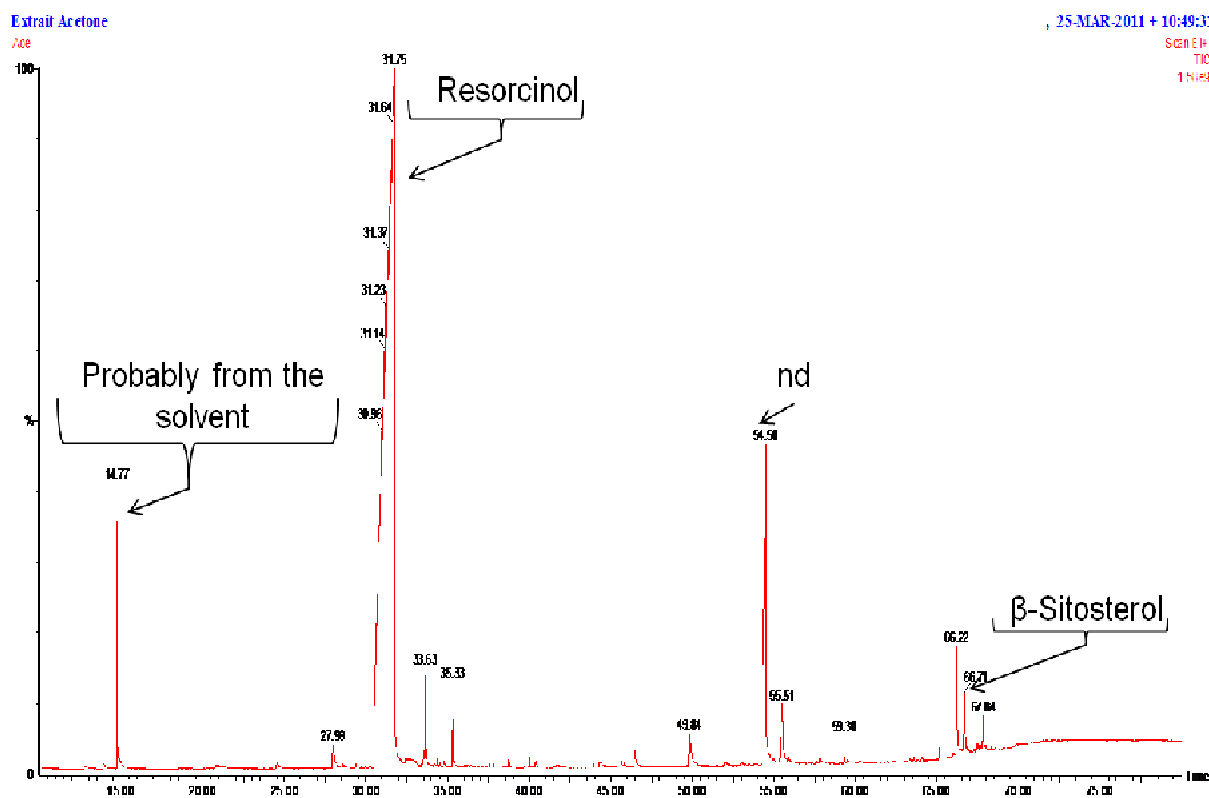

Fig.8.4. Mass spectrum of the **Acetone**-extracted compounds (**Crude extracts**).

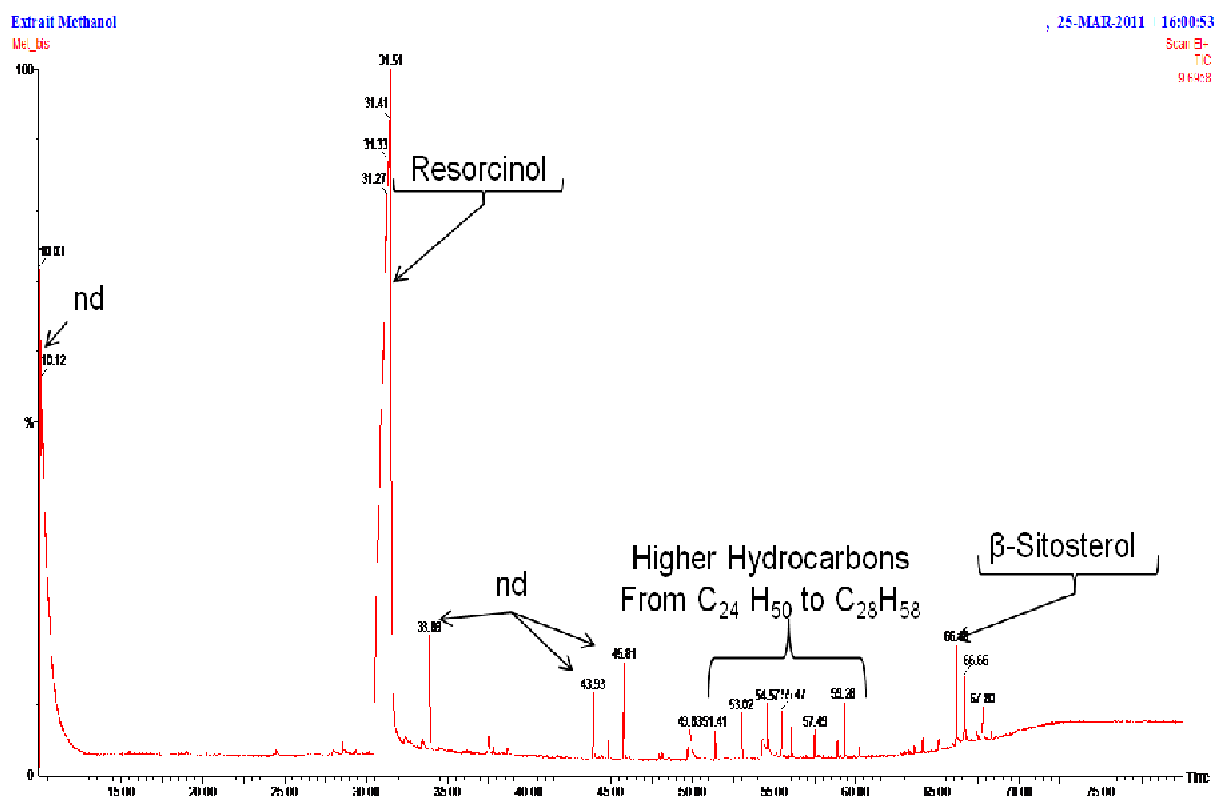

Fig.8.5. Mass spectrum of the **Methanol**-extracted compounds (**Crude extracts**).

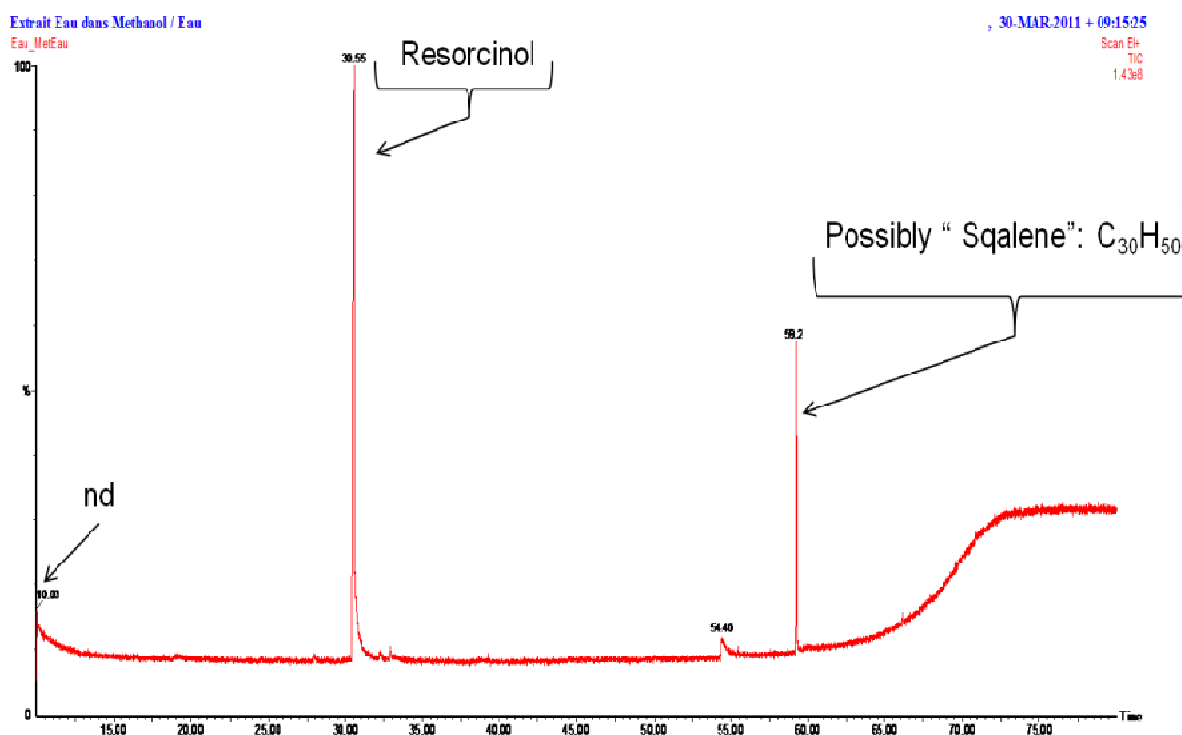

Fig.8.6. Mass spectrum of **Hot Water**-extracted compounds (**Crude extracts**).

Table 8.2 (containing the weight loss (WL) and extractive contents (EC) of independently extracted samples) will help us looking at the data shown in the previous pages through another eye. It should be noted that generally the raw values of WL are more trustworthy than the ones from EC (see chapter 6 for more details).

Table 8.2. The weight loss (WL%) and extractive contents (EC%) after performing independent extractions by different solvents on powder samples.

Solvent	WL (%)	EC (%)
H	1.65± 0.84	2.13± 1.01
D	1.75± 0.62	4.81± 2.21
AC	4.28± 0.63	6.79± 1.80
ME	6.82± 0.43	11.97± 2.39
HW	8.31± 3.06	10.79± 4.28

Comparing Tables 8.1 and 8.2, it is revealed that, different types of heavy hydrocarbons in fact form only a minute percentage of the whole extractives present in the white Mulberry (if we assume that successive extraction of five solvent removed every possible secondary substance)<sup>1</sup>. Considering that D, extracted parts of all types of compounds, its small WL (which is not so different from that of H) tells us that the access of this solvent was limited. Considering the close nature of polarity between H and D, if resorcinol is

<sup>1</sup>Cumulated extractive percentage is in harmony with the results of independent ones (see chapter.6). Moreover, GC-mass results of the serially extracted compounds showed no different substance to the independent ones, therefore, we could assume that the extraction (at least in its successive form) reaches for all the possible compounds.

located in a place available to D, it should also be for H. Nevertheless, H could not extract this phenol. This is bringing us back to the assumptions that, 1) resorcinol is not stored in a place available to apolar solvents and 2) that D has limited access to those spots which are completely available for the more polar ones.

A simple comparison between WL and extracted compounds by AC, ME and HW, can help on determining the leading compounds present in heartwood of white Mulberry. Considering the fact that AC and especially HW extract almost nothing else than this compound, and by looking again to their high yield of extraction ( $\approx 4\%$ ,  $7\%$  and  $8\%$  for AC, ME and HW), we can state resorcinol as the most quantitatively important extracted compound.

### **8-3-1.b. Compounds removal order as it was shown in the spectra of successively removed extractives (crude extracts)**

When discussing the material preparation for GC-Mass in the current chapter, it was said that along with independently cumulated extracts, those after each phase of successive extractions were also restored. This time the interest is not nature and abundance of compounds (as this aim was already reached in the previous part), but rather their reaction to being exposed to a series of solvents. This means that first, the compounds' removal order by different solvents will be revealed, and secondly, the covering action of solvents for each other is going to be un-masked. The second objective is important, as a number of compounds are identified in the spectra of three or four solvents. However, whether or not one particular solvent is able to remove the entire quantity of that specific compound remains unknown. This will also enlighten the question of localization of the extractives, as the partly removal of a specific compound by a weaker solvent (polarity wise) when it is actually highly reached by stronger ones, could mean different storage sites in the wood matrix. Nevertheless, the same event could be indication of limited cell-wall reach (or at least penetration) of a previously lumen-limited solvent. Whichever is the case, comparing the spectra after a known order of solvents would be informative.

In a systematic view, Fig.8.7 to 8.9, illustrate the spectra of the extractives gathered after serial use of each solvent compared to when it was individually applied. Fig.8.7 starts with the spectrum retained from the crude- extracts that are cumulated after successive usage of D (D after H). We can see that all the important picks but one are still present.  $\beta$ -sitosterol, the only identified sterol, is no longer present in the H+D- extracted spectrum. This means the small percentage of this compound, was already been completely removed by H before arriving at the second extraction (D). The picks of two phenols (resorcinol and 2,4-bis(1,1-dimethylethyl)-Phenol) are almost identical between the independent D and D+H spectra. The absence of resorcinol pick in the H spectrum (Fig.8.7) is in harmony with the present results, resorcinol being first touched by D in the category of imposed solvents. Higher hydrocarbons (alkanes) are also still present in the D+H spectrum, but in lower abundances and in limited numbers. While the extracts of individually used H and D, exhibit almost the same types of hydrocarbons (except for the fact that H covers a wider range: Octadecane and Trtriacontane are not present in D); here, D+H spectrum is showing a decrease in both variety and abundance. This means

that most of the hydrocarbons present in white Mulberry extractives are completely removable by H, which leaves only small percentages of selected ones to be removed by D.

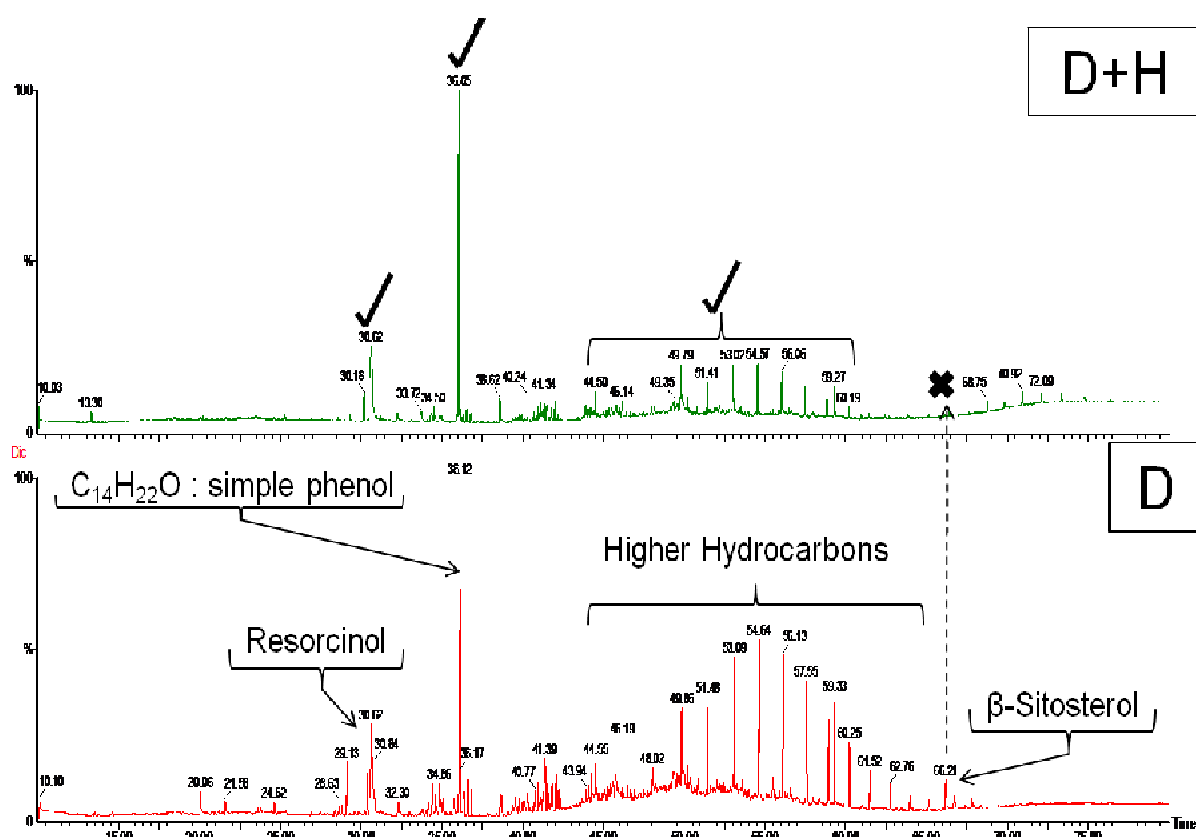

Fig.8.7. Comparison between the mass spectrum of dichloromethane- extracted (D) compounds and those cumulated after hexane/dichloromethane successive extractions (D+H). The crosses indicate the pick disappearance, the ticks are marking the picks that were still present after successive use of two solvents.

Fig.8.8 is illustrating the spectra of the identified extractives after AC independent (AC) and successive (AC+D+H) use. Here again, compatible with the last spectrum (D+H), resorcinol pick is still utterly present. The amount of resorcinol removed by D, must be too small to alter what could be originally removed by individually used AC, thus the resorcinol picks is closely similar in the two spectra (AC and AC+D+H). Nevertheless, this small –almost –negligible removed resorcinol by D, can indicate that D has limited reach to the spots highly reachable by AC. In this hypothesis, D penetrates the cell wall, but unable to bring out higher amounts of substances leaves only with traces of phenols. The other phenol (2,4-bis(1,1-dimethylethyl)-Phenol), apparently is not removable by AC (as its not present in the Fig.8.4). The same phenol is still fully present in D+H spectrum and shows no trace in AC+D+H, indicating that D has the ability to remove phenols. However, this ability remains limited in case of resorcinol. This brings us back to the last hypothesis that, the lack of resorcinol abundance in the D- spectrum (Fig.8.6) is not the due the inability of D for removing the compound but rather is because of incapability in reaching it.

Along with the disappearance of several picks in the AC+D+H spectrum (resulted from them already being removed by the preceding solvents), new picks also appear. These picks (not identified), are not seen in the AC-spectrum. This suggests the possibility of the two previous extractions (D and H) give AC a further access to the sites and/or compounds, which are not originally available to it. However, in the view of the fact that the new compounds could not be identified by certainty from mass spectrum, drawing a net conclusion about the new picks corresponding to chemically important compounds is rather difficult.

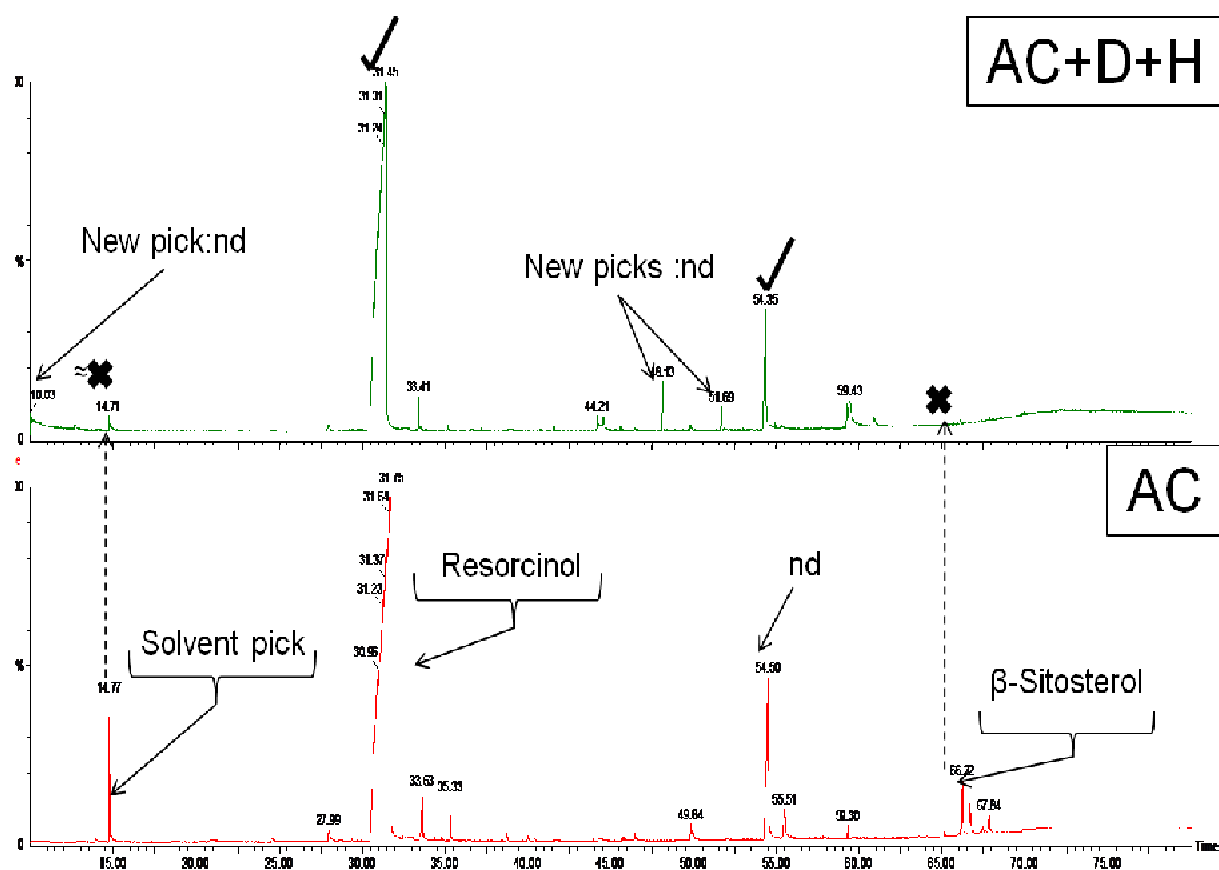

Fig.8.8. Comparison between the mass spectrum of Acetone- extracted (AC) compounds and those cumulated after hexane/dichloromethane/acetone successive extractions (AC+D+H).New picks: are those that did not appear in the spectrum of independently used solvent. nd = non determined

For the last comparison, Fig.8.9, shows the spectra for the identified extractives removed independently (ME) and successively (ME+AC+D+H) by methanol. This time, after the fourth solvent (ME), except for resorcinol, there is nothing left to be removed. There is no trace of  $\beta$ -Sitosterol, several higher hydrocarbons and some other un-identified compounds, (which are present in ME- spectrum) in spectrum of (ME+AC+D+H). Resorcinol still exists even if it is highly removed by AC. Change in the pick's shape from a wide pick to a narrower/sharper one is most probably due to the effect of preceding solvents on this compound. An nd-pick at the RT=10.03, once showing high proportion in the extractives of independent-ME (Fig.8.5), now contributes to a negligible amount in the successive spectrum. Looking back to the other successive spectra (Fig.8.7 and 8.8), the reappearance of the same pick is marking the gradual removal of the

compound that eventually results to an approximate disappearance of the pick in the successive ME spectrum in Fig.8.9.

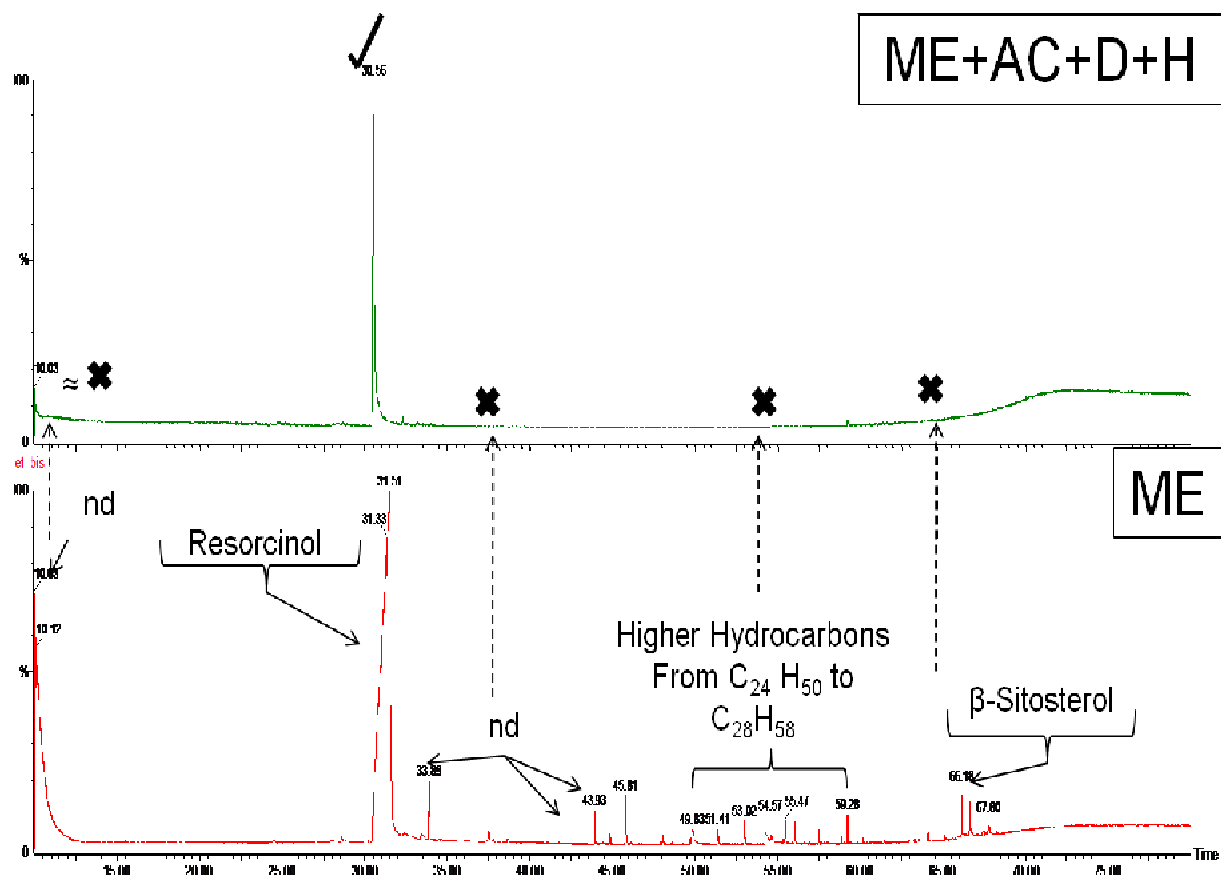

Fig.8.9. Comparison between the mass spectrum of Methanol- extracted (ME) compounds and those cumulated after hexane/dichloromethane/acetone / methanol successive extractions (ME+AC+D+H).

To have an overall look on the removal order of compounds in the case of serial use of solvents, Fig.8.10 is presenting the spectra of 4 first solvent (water was not included), focusing on the overlapping effects that solvents have on each other. β-Sitosterol once present in the spectrum of every solvent's extracts (except for HW), when removed by H, does not reappear in the following ones. Higher hydrocarbons appear outstandingly in H-spectrum, and to lower extent in D, are removed before the third extraction. Resorcinol (as the leading identified compound), has its first appearance in D, and is removed to a large extend by AC and ME.

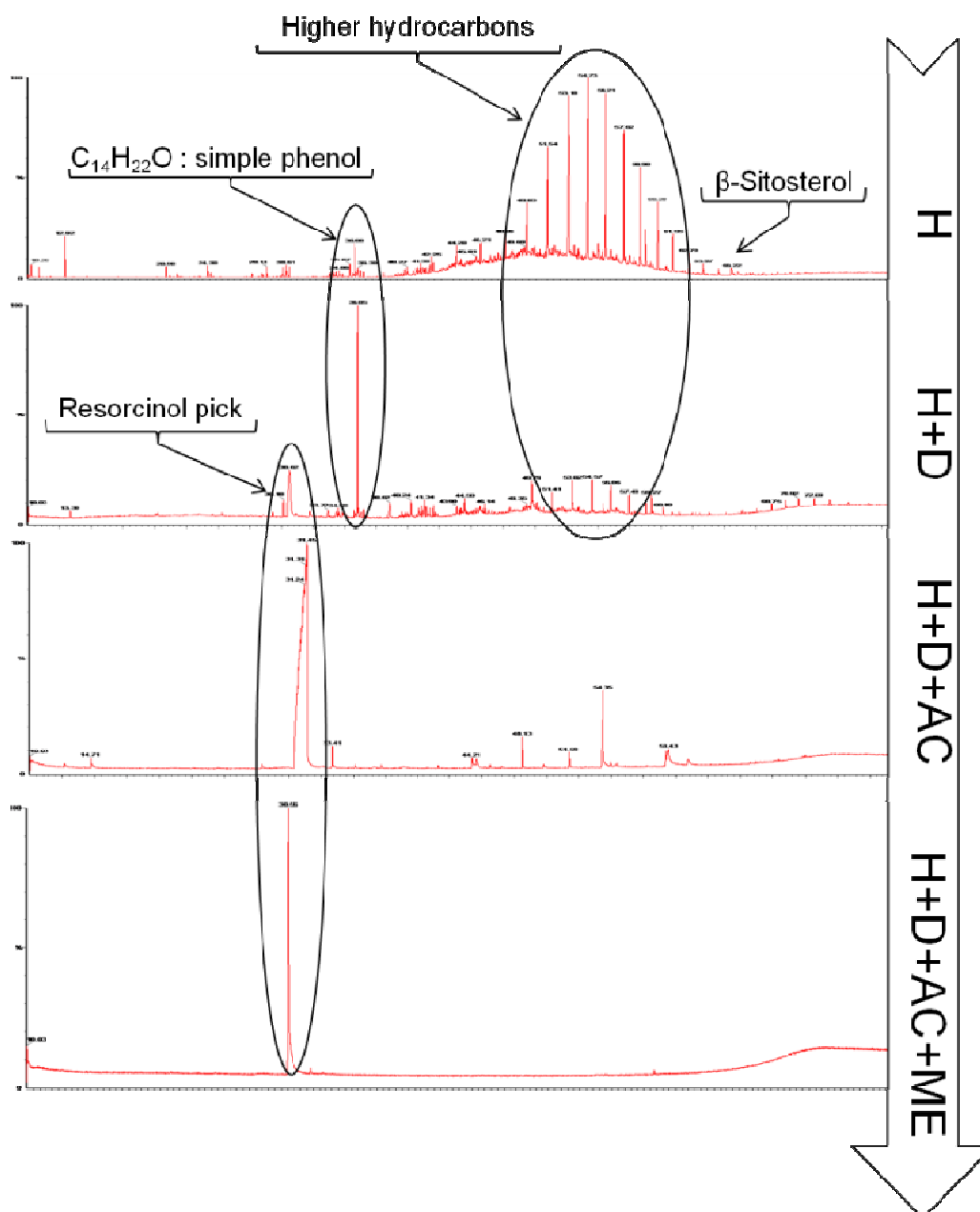

Fig.8.10. Mass spectra of cumulated extracts after four successive extractions, H: Hexane, H+D: successive extraction by dichloromethane, H+D+AC: successive extraction by acetone, H+D+AC+ME: successive extraction by methanol. Mass spectrum of the cumulated extracts after successive hot water extraction was not available<sup>1</sup>.

### 8-3-2- Derived extracts identification

Although it is also possible to do an identification using only the crude extracts, it is a common trend to do a derivation of the extractives, so that the compounds would be easier identified and that the picks become “clearer”. The derivation could be any form of methylation, acetylation or silylation, as in the case of this study.

<sup>1</sup>. It was not possible for us to solubilize the un-derived extracts cumulated after successive use of HW. Those results are therefore limited to what was identified after derived extracts (§8-3-2.b).



Once the GC-Mass results of the derived extracts were in hand, it became clear that there are many un-identified compounds left from each solvent's spectrum. That meant that the information on the compound is not conclusive enough for the detector/operator to make a completely certain decision on the exact type of the detected compound. However, and even with the presence of the "nd" compounds, still some compounds that are apparently missed in the crude extractives identification, become known once the extractives are derived by BSTFA.

**8-3-2.a. Basic categorization based on identified compounds removed by each solvent (derived extracts)**

Table 8.3 and Fig.8.11 to 8.15 illustrate the most important identified compounds from the BSTFA-derived extractives removed by the individual use of solvent (H, D, AC, ME and HW). Compared to the crude extracts, more compounds could not be identified from the mass spectra (nd).

It can be observed in Table 8.3, that although there are several common compounds reoccurring in both crude and derived extracts, there are also those that are strictly identified in the later one. These newly appeared compounds belong (almost totally) to "fatty acids".

Identified compounds in the derived extracts of H assigned the greatest variety to itself. A simple comparison between what was seen in the Table 8.1 /Fig.8.2 and here can bring the differences into the light. While in the crude extracts it is mostly higher hydrocarbons (along with a simple phenol and traces from  $\beta$ -sitosterol) that are identified, in the derived ones, the fatty acids take the lead (Fig.8.11). Even though a few higher hydrocarbons ( $C_{22}$  to  $C_{28}$ ) can still be distinguished from the spectrum, it is a fatty acid (Hexadecanoic acid/ $C_{16}H_{32}O_2$ ) which shows the highest intensity amongst other substances.  $\beta$ -sitosterol is again identified as a silyl derivation.

Chapter 8. Identification of extractive compounds in white Mulberry's wood

Table 8.3. List of the compounds found in the **derived extracts** removed by each solvent. Cas N°: Chemical abstract service registry number, MW: molecular weight (g/mol), RT: retention time (min)

Name	Cas n°	Formula	MW	derived extracts RT (min) in each solvent's spectrum				
				H	D	AC	ME	HW
Tetradecanoic acid	544-63-8	C <sub>14</sub> H <sub>28</sub> O <sub>2</sub>	228.37	19.947	19.940	-	-	-
Pentadecanoic acid, trimethyl silyl ester	74367-22-9	C <sub>18</sub> H <sub>38</sub> O <sub>2</sub> Si	314.57	21.287	-	-	-	-
Hexadecanoic acid	57-10-3	C <sub>16</sub> H <sub>32</sub> O <sub>2</sub>	256.42	22.585	22.60	22.54	22.54	-
Heptadecanoic acid	506-12-7	C <sub>17</sub> H <sub>34</sub> O <sub>2</sub>	270.45	23.746	-	-	-	-
Docosane	629-97-0	C <sub>22</sub> H <sub>46</sub>	310.61	24.406	-	-	-	-
Octadecanoic acid	57-11-4	C <sub>18</sub> H <sub>36</sub> O <sub>2</sub>	284.47	24.914	-	24.58	-	-
Tricosane	638-67-5	C <sub>23</sub> H <sub>48</sub>	324.63	25.539	-	-	-	-
Tetracosane	646-31-1	C <sub>24</sub> H <sub>50</sub>	338.66	26.619	-	-	-	-
Eicosanoic acid, trimethyl silyl ester	55530-70-6	C <sub>23</sub> H <sub>48</sub> O <sub>2</sub> Si	384.71	27.037	27.034	-	-	-
Pentacosane	629-99-2	C <sub>25</sub> H <sub>52</sub>	352.69	27.658	-	-	-	-
Heneicosanoic acid, trimethyl silyl ester	2363-71-5*	C <sub>24</sub> H <sub>50</sub> O <sub>2</sub> Si	398.73	28.045	-	-	-	-
Hexacosane	630-01-3	C <sub>26</sub> H <sub>54</sub>	366.71	28.651	-	-	-	-
Heptacosane	593-49-7	C <sub>27</sub> H <sub>56</sub>	380.74	29.604	-	-	-	-
Octacosane	630-02-4	C <sub>28</sub> H <sub>58</sub>	394.77	30.526	-	-	-	-
Tricosanoic acid, trimethyl silyl ester	2433-96-7*	C <sub>26</sub> H <sub>54</sub> O <sub>2</sub> Si	426.79	29.953	-	-	-	-
Benzoic acid, 2, [(Trimethylsilyl)oxy], trimethyl silyl ester	3789-85-3	C <sub>13</sub> H <sub>22</sub> O <sub>3</sub> Si <sub>2</sub>	282.48	-	17.655	19.47	-	-
Bis(trimethylsilyl)isovanillate	68595-68-6	C <sub>14</sub> H <sub>24</sub> O <sub>4</sub> Si <sub>2</sub>	312.50	-	18.856	-	-	-
β-Sitosterol, trimethyl silyl ester	83-46-5*	C <sub>29</sub> H <sub>50</sub> O	414.71	35.437	35.448	-	-	-
Resorcinol	108-46-3	C <sub>6</sub> H <sub>6</sub> O <sub>2</sub>	110.11	-	11.99	11.95	11.99	11.97

Table8.3. Continued.

Name	Cas n°	Formula	MW	derived extracts RT (min) in each solvent's spectrum				
				H	D	AC	ME	HW
Butanedioic acid	110-15-6	C <sub>4</sub> H <sub>6</sub> O <sub>4</sub>	118.08	-	-	10.47	10.52	10.57
Malic acid (Butanedioic acid, hydroxy-, (s)-)	97-67-6	C <sub>4</sub> H <sub>6</sub> O <sub>5</sub>	134.08	-	-	-	14.02	14.10
D-Mannonic acid, $\gamma$ -lactone	26301-79-1	C <sub>6</sub> H <sub>10</sub> O <sub>6</sub>	178.14	-	-	-	-	20.58
Umbelliferone	93-35-6	C <sub>9</sub> H <sub>6</sub> O <sub>3</sub>	162.14	-	20.309	-	-	-
Campesterol trimethylsilyl ether	55429-62-4	C <sub>31</sub> H <sub>56</sub> OSi	472.86	-	34.760	-	-	-
Benzaldehyde	100-52-7	C <sub>7</sub> H <sub>6</sub> O	106.12	-	-	17.63		
2, 6, Dimethoxy phenol	91-10-1	C <sub>8</sub> H <sub>10</sub> O <sub>3</sub>	154.16	-	-	28.35	28.35	28.35
2,4- dimethoxy- benzoic acid	57-10-3	C <sub>16</sub> H <sub>32</sub> O <sub>2</sub>	256.42	-	-	-	-	19.48

\*. Cas number for the un-derived compound.

The red Cas numbers are marking the compounds that were also identified in the spectra of the crude extracts.

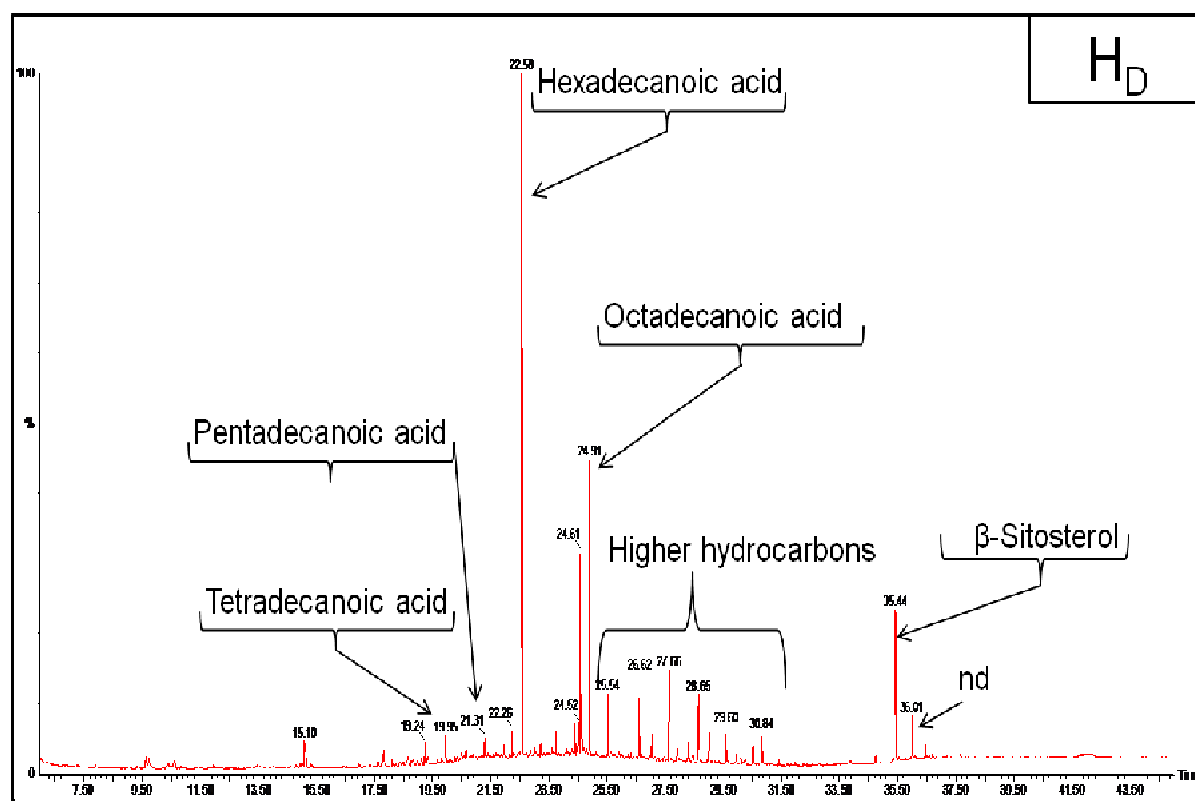

Fig.8.11. Mass spectrum of the Hexane-extracted (BSTFA Derived/H<sub>D</sub>) compounds.

In the identified compounds out of derived extracts of D, there are no more traces of higher hydrocarbons (Table 8.3/ Fig.8.12). This is contrary to the case of its crude extracts where hydrocarbons and traces of sterols and phenols are found in the D-extracted spectrum. However, in the derived extracts, there are fatty acids (previously left un-noticed) which appear more often than any other substances. In addition to that, there are two newly identified compounds: umbelliferone as an aromatic compound, and campesterol as another sterol along with  $\beta$ -Sitosterol. Hexadecanoic acid again assigns the highest proportions between other identified compounds to itself. Resorcinol here shows an intensity half of the leading fatty acid one. In the D-crude extracts, the highest intensity belonged to a simple phenolic compound (2,4-bis(1,1-dimethylethyl)-Phenol) that is absent here (Fig.8.12).

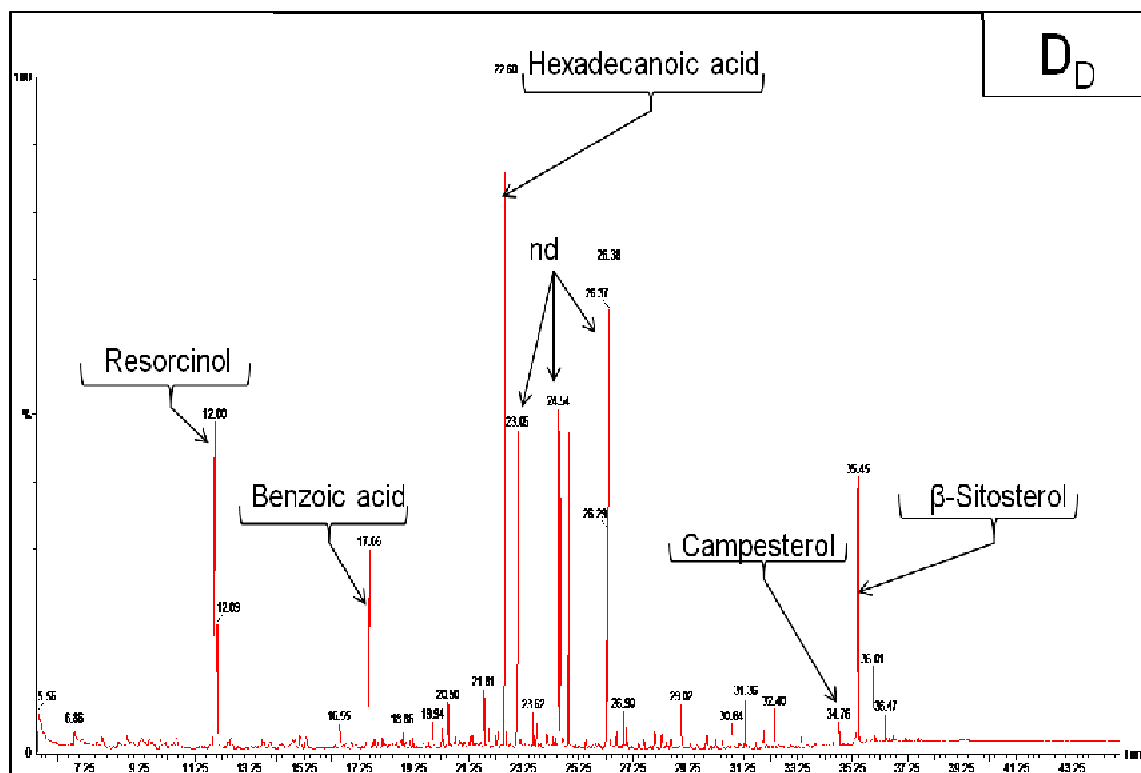

Fig.8.12. Mass spectrum of the **Dichloromethane**-extracted (**BSTFA Derived/D<sub>D</sub>**) compounds.

For the derived extracts of the three polar solvents, identified compounds are closely the same. On the other hand, most of the compounds are turned into derived forms of siloxane which sometimes make them hard to be interpreted. As a result, there are some unidentified compounds left in spectra (e.g. AC<sub>D</sub> spectrum, Fig.8.13). Put that aside, same types of compounds appeared in the spectra of AC<sub>D</sub>, ME<sub>D</sub> and HW<sub>D</sub>: Fatty acids and simple phenols.  $\beta$ -Sitosterol could not be identified in the derived extracts of any of the three polar solvents (reminder : it was appeared in the spectra of the crude extracts of all three). Probably the small proportions of this sterol when derived with BSTFA, become untraceable for the GC-MS apparatus. In the AC<sub>D</sub>, phenols are still the dominant compounds (or molecules), but, when derived, it was 2, 6, dimethoxy phenol that has the most remarkable peak (amongst phenols) and not resorcinol (as it was the case for crude extracts).

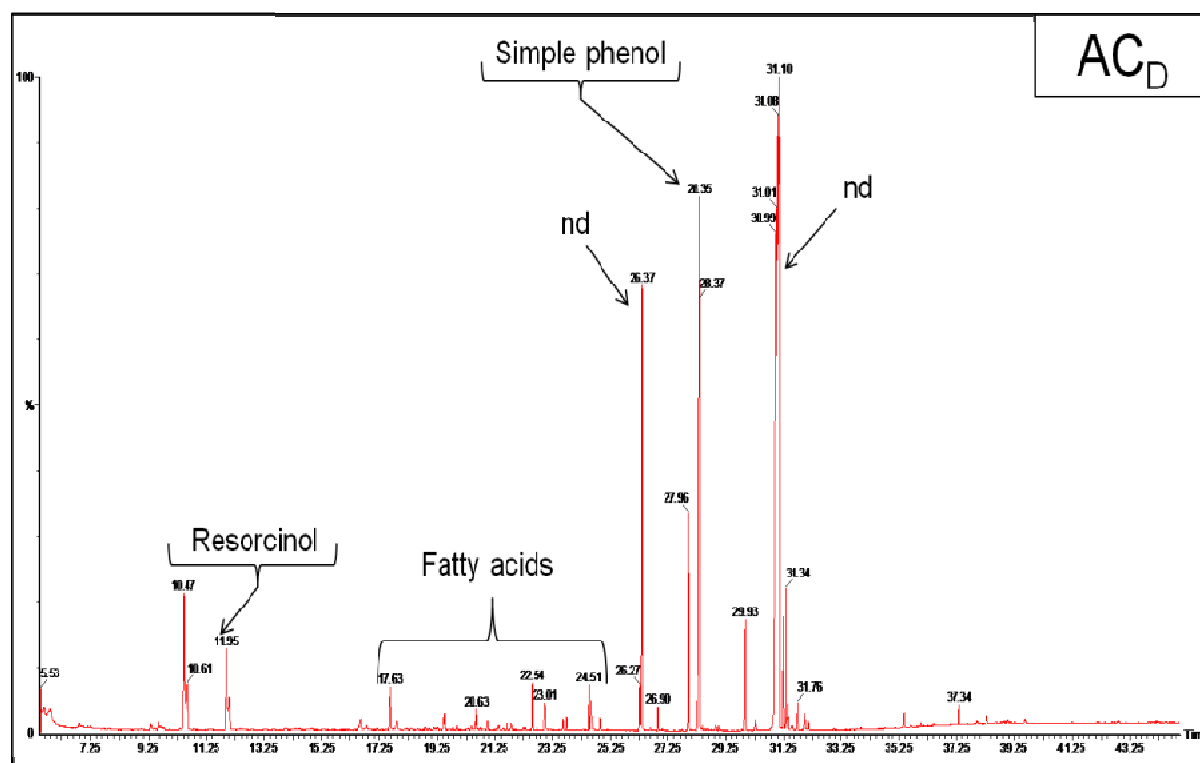

Fig.8.13. Mass spectrum of the **Acetone**-extracted (**BSTFA Derived/AC<sub>D</sub>**) compounds.

As we progress in polarity, the crude extracts compounds that reoccurred in the spectra of the derived ones become scarce. Eventually it is only resorcinol that can be still identified in both crude and derived extracts, while fatty acids appeared as new compounds (Table 8.3).

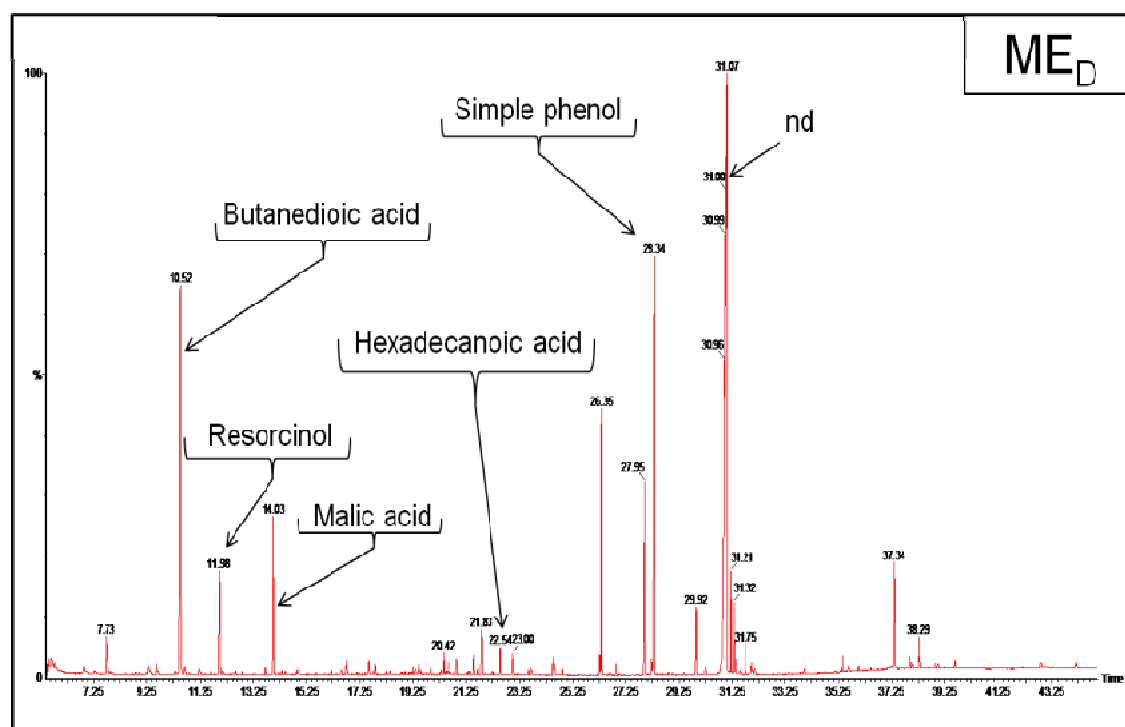

Fig.8.14. Mass spectrum of the **Methanol**-extracted (**BSTFA Derived/ME<sub>D</sub>**) compounds.

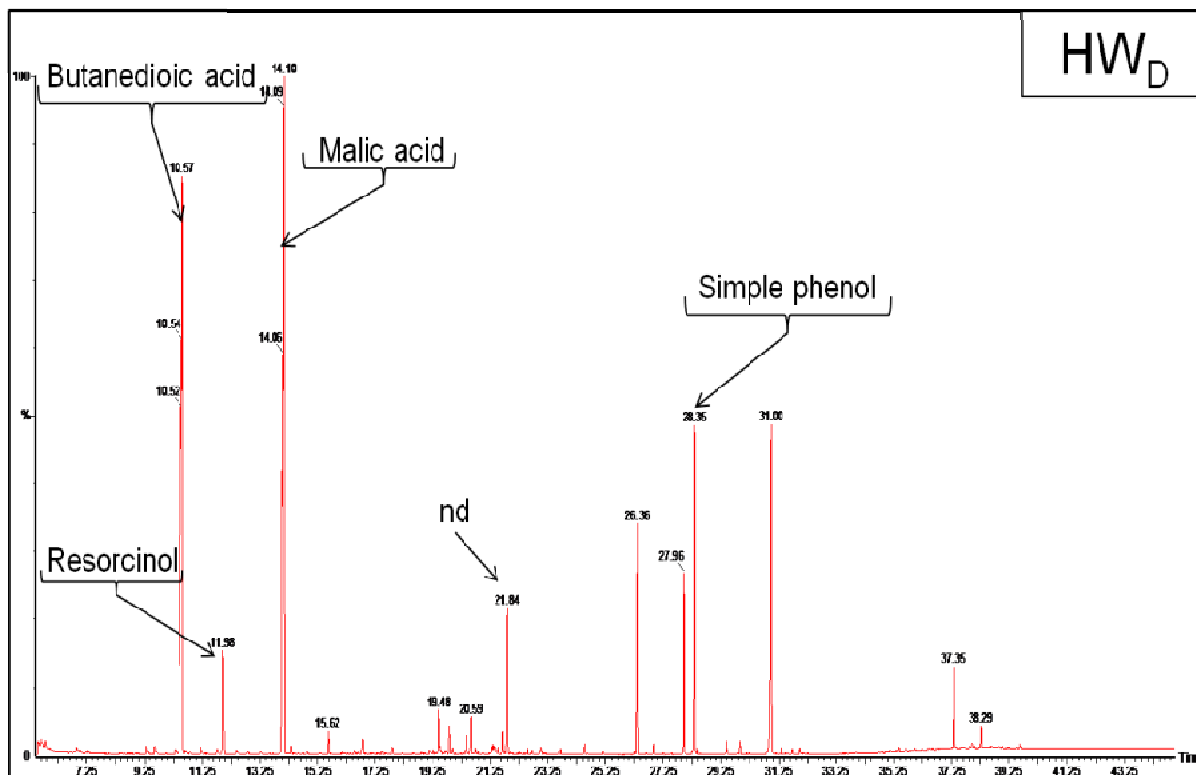

Fig.8.15. Mass spectrum of the **Hot water**-extracted (**BSTFA Derived/HW<sub>D</sub>**) compounds.

In the spectrum of derived HW (HW<sub>D</sub>, Fig.8.15), the most remarkable picks belong to the lighter fatty acid (butanedioic acid, malic acid), while resorcinol and 2, 6, Dimethoxyphenol (previously not identified in the crude extracts), assign the remaining picks to themselves.

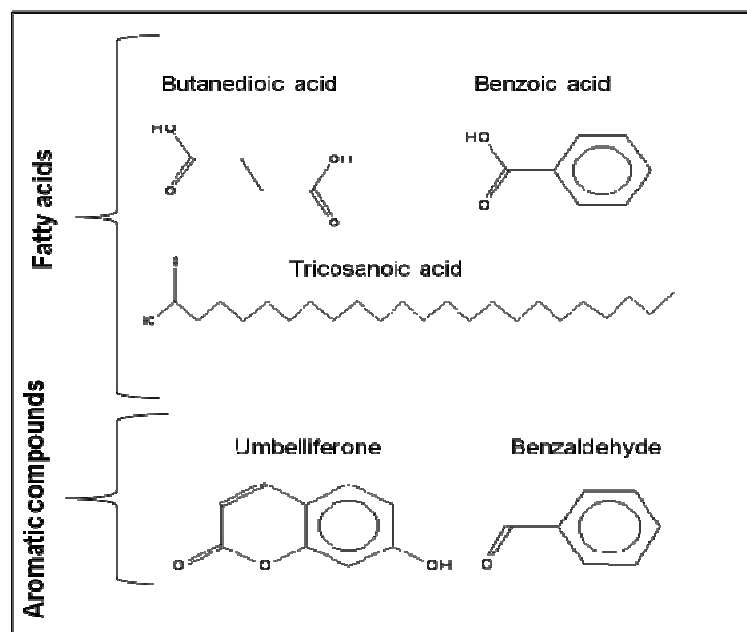

Fig.8.16. Open chemical structure of the most important compounds identified in **derived** extractives of white Mulberry

### **8-3-2.b. Compounds removal order as shown in the spectra of successively removed extractives (derived extracts)**

Similar to what is done for the crude extracts, cumulated extracts after each phase of successive extractions are treated with BSTFA to make easier identification. Fig.8.17 illustrates the five spectra obtained after GC-MS analysis of the derived cumulated extracts.

Considering the fact that derived extracts are mostly different from crude extracts in one type of compound (fatty acids), here we will mainly focus on the removal order of this substance.



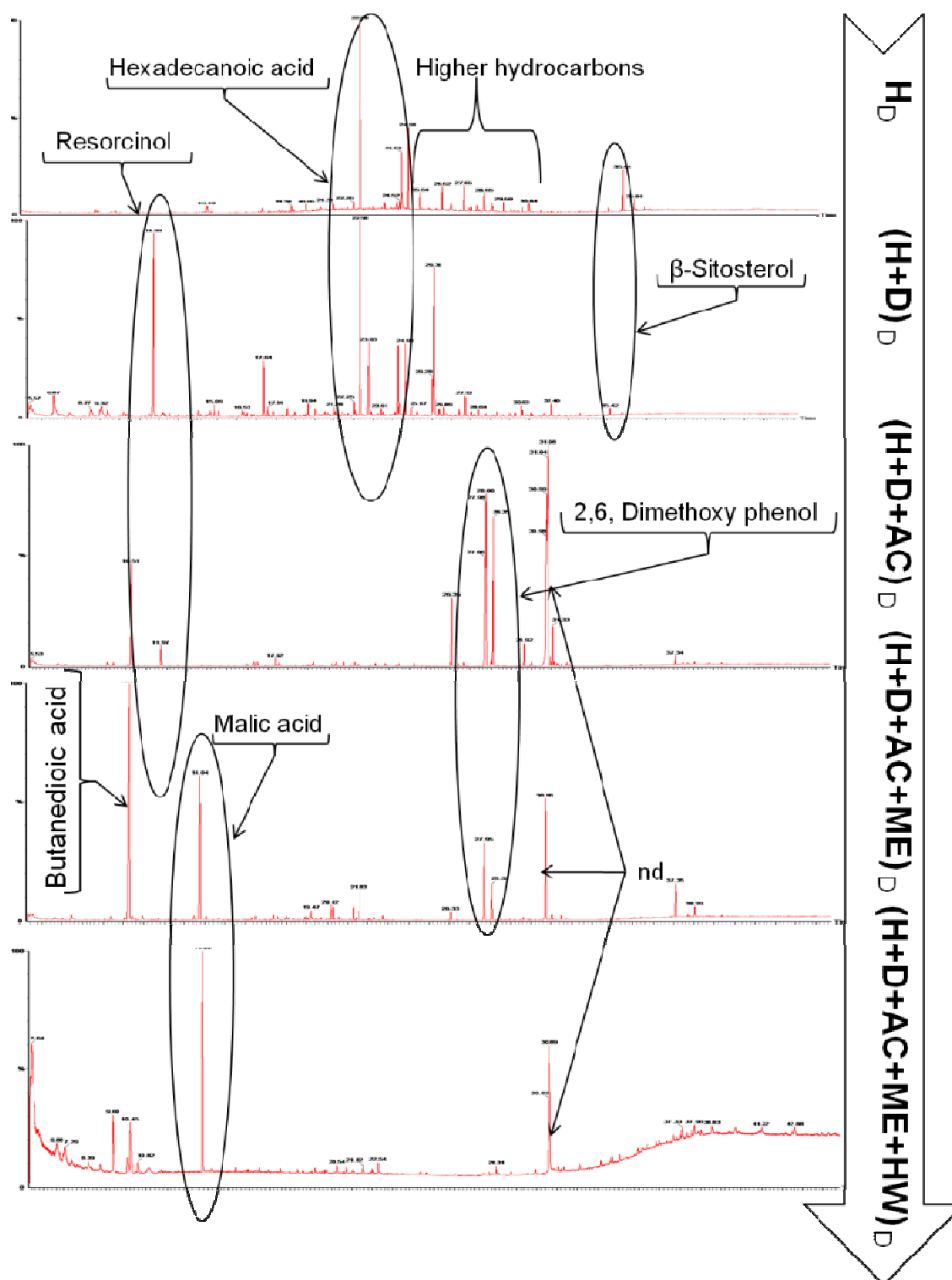

Fig.8.17. Mass spectra of cumulated **derived**-extracts after five successive extractions.  $H_D$ : derived hexane extracts,  $(H+D)_D$ : derived extracts after successive extraction by dichloromethane,  $(H+D+AC)_D$ : derived extracts after successive extraction by acetone,  $(H+D+AC+ME)_D$ : derived extracts after successive extraction by methanol and  $(H+D+AC+ME+HW)_D$ : derived extracts after successive extraction by hot water

The main differences between Fig.8.10 and 8.17 can be resumed in the picks of resorcinol and fatty acids. In the crude extracts spectra, resorcinol was practically the only pick remained strongly untouched between the three polar solvents (not to mention the traces that are picked in the D- spectrum). Here, contrary to the last case, resorcinol makes its biggest appearance in the D<sub>D</sub>, just to turn to small traces in the AC<sub>D</sub> and then becomes undetectable in the last two solvents (ME and HW). However, resorcinol is clearly detected in the cumulated crude extracts (Fig.8.17). Consequently, this surprising absence can be the result of an unknown reaction with the derivative agent that makes the substance un-detectable to machine. Furthermore, looking at the fact that here (for all derived spectra except for AC<sub>D</sub>), it is not resorcinol but a variety of fatty acids which assign relatively high proportions to themselves, the absence of resorcinol pick – compared to fatty acids- can be justifiable.

Fatty acids seem to be removed differently by apolar and polar solvents. Hexadecanoic acid, once identified in the independent extracts of first four solvents, is removed completely by the first two apolar ones and there are no traces of its existence in the AC<sub>D</sub> and ME<sub>D</sub> spectra. This is also the case for β-Sitosterol and higher hydrocarbons, as they are thoroughly removed at the end of (H+D)<sub>D</sub>.

2,6- Dimethoxy phenol, as the other phenol identified along with resorcinol, is removed first by AC and then by ME, leaving nothing to be removed by HW (which independently removed relatively high amounts of the substance § Fig.8.15).

Another fatty acid (malic acid), first detected in the ME spectrum, is removed by ME, but also with HW, marking the fact that probably ME cannot totally remove the substance, leaving still large doses for HW to bring out.

To conclude, analysis of the mass spectra of the cumulated derived extracts showed that:

- A combination of higher hydrocarbons, heavier fatty acids and sterols are removed by two apolar solvents.
- Removal of the phenols definitely starts at D, but continues by AC and ME. The situation however is uncertain about the resorcinol, as the absence of its pick in the last two spectra (ME and HW) cannot be confirmed by the crude extracts – spectra.
- Only two last solvents with higher polarities can remove lighter fatty acids.

## 8-4- Discussion on the compounds present in the extractives of white Mulberry

A general view to the all identified compounds in the wood extractives of white Mulberry (both crude and derived) is given in Table 8.4.

Table 8.4. Complete list of the identified compounds in extractives of white Mulberry.

Category	Compound
Higher hydrocarbons	A variety from Undecan to Squalene (listed completely in Table 8.1)
Phenols	Resorcinol
	2,4-bis(1,1-dimethylethyl)- Phenol
	2, 6, Dimethoxy phenol
	3,4,5,Trimethoxy phenol
	Bis(trimethylsilyl)isovanillate
Fatty acids and their esters	A variety from Butanedioic acid to Tricosanoic acid (listed completely in Table 8.3)
Aromatic compounds	Benzaldehyde
	Umbelliferone
Sterols	$\beta$ -Sitosterol
	Campesterol trimethylsilyl ether

Extractives of white Mulberry from Iran contain compounds of higher hydrocarbons, phenols, fatty acids, aromatic substances and sterols. Higher hydrocarbons and fatty acids have the most diversity of compounds, while the highest proportions assign to phenols. Aromatic compounds and sterols include small proportions of the whole extractives in both variety and quantity.

We have already mentioned that leaves, as well as root bark, of the white Mulberry are extensively used in the traditional and modern medicine. Consequently, there were several researches aiming on identifying the chemical compounds extracted from its root bark (Nomura et al. 1981, 1983, Kapche et al. 2007, Piao et al. 2009, Zheng et al. 2010) or leaves (Matsuyama et al. 1991, Chen and Li 2007, Yatsunami et al. 2008, Nakamura et al. 2009). They all listed flavonoids (e.g. Morin /C<sub>14</sub>H<sub>10</sub>O<sub>4</sub> (Kapche et al. 2007)) and different stilbenes as the leading identified compounds. Those substances were also found to have great antioxidant and anti-cancer activities (Kapche et al. 2009). Osage orange (*Maclura pomifera* from Moraceae), is reported to have high doses of di-hydroxymorin which is the probable reason for its high natural durability (Schultz et al. 1995). This species is also known for being used as the traditional dye material due to its richness in yellow color (Meister 2006). White Mulberry is also exhibiting a less strong yellow color, which could be indicator of the presence of the similar anti-fungal extraneous agents. That being said, the heartwood extractives can be completely different within and between the species as well as between the wood and root-bark/leaves. Therefore, here, we prefer to focus on what was identified strictly from the wood (as much as possible exclusively in white Mulberry). However, we kept a close look on the compounds from other related species to identify any possible similarity.

White Mulberry's extractive compounds, especially phenolics and stilbenes, were reported to be great chemotaxonomy markers (Venkataraman 1972, Rowe and Conner

1979). In their comprehensive report, Rowe and Conner (1979) remarked that the bark of white Mulberry is different in several compounds from its wood. However, several flavonoids were identified in both. Déon and his co-workers (1980) also reported the same flavonoid (Morin) in *Morus mesozygia*. Recently other kinds of flavonoids and stilbenoids were identified in *Bagassa guianensis* Aubl., a species from the moraceae family (Royer et al. 2010). Interestingly, resorcinol and  $\beta$ -sitosterol, which are reported in this study, were also identified in *Bagassa guianensis*. The same two compounds were previously observed by the precedent researchers (Kulkarni et al. 1970, Rowe and Conner 1979), nevertheless neither of them has been the leading identified compound.

Trees from the same species can contain slightly variable compounds and/or in different proportions (Hillis 1987). Benzene–ethanol extractives of white Mulberry from Iran (four different sites) were previously identified with GC-mass (Se Golpayegani 2007). Because of the unselective extraction, the results were too complicated for a thorough analysis. Nevertheless, several heavy hydrocarbons, fatty acids, and phenols, similar to this study were found. On the other hand, the true diversity of the distinguished compounds was left unnoticed. Another recent study on the heartwood extractives of white Mulberry from Iran (Sadeghifar et al. 2011), distinguished resorcinol as the leading compound ( $\approx 90\%$ ). This is compatible with the results of this study, where resorcinol (and in case of derived extracts: resorcinol with other simple phenols) assigned the highest proportions to itself. Having said that, the former study did not take into account the high proportions of fatty acids or the variety of the higher hydrocarbons identified in this study.

Higher hydrocarbons are found to have small roles in protecting plants against fungal attacks (Baker 1982). That is also the case of the resorcinol, as it is used externally in ointments and lotions as an antifungal, and its preservative effects against basidiomycetes were previously established (Adikaram et al. 2010). Furthermore, resorcinol is listed as “harmful if digested”, “irritant to skin and the eyes” and “dangerous to the aquatic organisms” by technical and medical service of INRS (2000). If digested or exposed to skin in great quantities, it can cause many health problems like headache, nausea and vomiting. Respiration difficulties (cough, short breath) were also seen among workers usually exposed to a mixture of resorcinol and 1,3,5-tricyanométhyl hexahydro-s-triazine. However, the most effective component was not identified (Mastromatteo 1965, cited in the report of INRS). In France, 10ppm (or 45 mg/m<sup>3</sup>) is the maximum amount of resorcinol in the air allowed in a working environment. In general, phenols (to which most often found compounds in white Mulberry are belonged), are listed as dangerous in case of inhalation or digestion (INRS report 2011). Phenols are easily absorbed by skin and cause irritations. However, most of the time, signs of the problems will disappear after 24hrs (once the source of irritation is eliminated).

The health problems reviewed above are similar to those reported by Iranian instrument makers. Sometime working up to 16 hrs a day on white Mulberry, artisans complained from headache, coughs and breathlessness. Resorcinol (along with other compounds belong to phenol family) are the most often found extraneous substances in the species and they all causing the same health problems. As they are reported to be absorbed via

skin as well as by inhalation, it is probable that the strong impact of hammer and gauge (the usual working tools of artisans), could free dust containing these harmful and cause those seemingly allergic problems (as they are called by the craftsmen). Moreover, the long hours of exposition is worsening the issue. The recovery normally happens rather quickly (24hrs), if the source is cut off. For an instrument maker, working solely on this species all day long and for several days in a row, the irritation source is always present. This is the reason why, once give up on working on this particular species (as some of instrument makers decide to do), all signs of the problems disappear.

Looking back to chapter 7, the lowest anti-termite activity was observed after AC, ME and HW extractions. By taking a quick look to the spectra of independently extracted substances by ME (Fig.8.5), we can see that ME is the solvent to bring out high proportions of all types of compounds. Even though the decrease in the natural durability of white Mulberry due to extractions is also related to the quantity of the removed secondary substances, but the types of removed compounds are most definitely of great importance. The same irritant effects (§ paragraph above), are reported on lab rats and rabbits when exposed to phenols. Resorcinol, being the primary removed compounds (based on the GC-mass results of the crude extracts), could be the reason why extractions with polar solvents extensively altered the natural durability.

Chapter 6 (effect of the extractions on the physico-mechanical properties) was concluded with the hypothesis that it is the nature and localization of the extractives that is altering the  $\tan\delta$  in white Mulberry. Here, the different deposition sites were confirmed for different solvents. Resorcinol was available to the three polar solvents, and also slightly to the D. The different types of compounds removed by apolar (higher hydrocarbons, heavier fatty acids) and by polar ones (mostly phenols, aromatic compounds and lighter fatty acids), can indicate that those substances are stored in two different sites: lumens (available to apolar ones) and cell wall (available to polar ones). D, is seemingly getting a limited access to cell wall, as it removed small proportions of all types of compounds, but its access didn't resulted in a great extraction yield (§Table 8.2). However, the simple act of D-intrusion, might resulted in some changes in the cell-wall, which exhibited as some unexpected results after D- extraction (e.g. Un-described swelling in dimension...).

## **8-5- Conclusion**

Removed extractives of the white Mulberry from Iran are identified using Gas chromatography mass spectrometry (GC-Mass) method. Both independently removed extracts and those cumulated after serial use of five solvents are analyzed. The identification is done using both crude and derived (by BSTFA) extractives.

Phenols, fatty acids, higher hydrocarbons, sterols, and aromatic compounds are identified as the main categories of the detected compounds. Resorcinol (from phenols) is the leading detected compound followed by a large diversity of fatty acids. Resorcinol is also been indicated as the probable reason for allergic reaction amongst instrument makers due to its toxicity.

Compound removal is done with respect to solvents polarity. Higher hydrocarbons, sterols, and heavier fatty acids are removed first with apolar solvents (Hexane and Dichloromethane). The three polar solvents (Acetone, Methanol and Hot water) then remove phenols, aromatic compounds, and lighter fatty acids. Some types of phenols are also removed in small quantities by second apolar solvent (Dichloromethane).



## 9. Overall conclusion and perspectives

---

### 9-1- Quick return to the study

This study was done in an attempt to clarify several previously un-researched points concerning the wood of white Mulberry (*Morus alba* L.) from Iran. This species was chosen due to its importance in fabricating three traditional lutes in the region.

The objectives of this study included acoustical, biological and chemical aspects:

The first purely acoustical objective was to characterize the vibrational properties of white Mulberry wood as composing the soundboard of a musical instrument. Artisanal traditional pretreatments were reproduced at laboratory scale, and a bridge was drawn between chemical and vibrational properties through the investigation of the relationship between extractives and mechanical features.

Assessing natural durability of white Mulberry wood towards aggressive organisms, either fungi or termites, was the main objective for the biological aspects. Here also a connection was made between chemical and biological characteristics by studying the role of extractives on modifying the natural durability.

Identifying and categorizing the components present in extraneous material and finding their possible toxic effects was fixed as the main objective in the chemical domain.

To reach such objectives, a combination of careful sampling, mechanical tools, and chemical and biological agents were required. Working closely with an instrument maker, the raw material was chosen by him and according to his criteria. Five types of samples, each serving a specific test/treatment were prepared: finely grounded powder along with solid specimens, divided to vibrational, biological, shrinkage and DMA ones.

Three vibrational methods were performed on the specimens: free-free flexural bar vibration, forced vibration of the floating beam (Bing ®) and dynamic mechanical analysis (DMA). The first two tests delivered results of acoustical properties along the grain, while the third one measured the same parameters in three orthotropical directions, giving an idea on the anisotropy of the material. Using a combination of all these three, the first objective, aiming at characterizing this species in vibration, was reached.

Tools for performing tests in the chemical domain consisted of 5 different solvents, 2 kinds of extraction order, and 2 identification methods. Five solvents of different polarities (water included) were used for extracting secondary metabolites once individually (each solvent was used independently on a set of specimens), and once serially (successive order of 5 solvents applied on one set of specimens). Crude extracts were cumulated and stored after each extraction. Both orders were carried out on powder, shrinkage and vibrational specimens; however, for DMA, two selective independent extractions by most effective solvents were chosen. In all cases, vibrational methods were done before and after (as well as in between the steps for successively extracted samples) each treatment.



Vibrational specimens were subjected to 3 laboratory-scaled artisanal pre-treatments, 2 of which included water at different temperatures and for various durations. The 3rd one that only involved oven-drying, consisted of fixed desorption/adsorption cycles. Here again, acoustical properties along the grain were measured by two vibrational methods before and after the treatments.

To determine natural durability of this species, biological samples (Leached and un-leached) were exposed to fungi and termites according to European standards. Two tropical fungi were also added to design an extreme environment. Direct toxic effect of extractives on the termites was investigated using both cumulated extracts and their corresponding extracted powders.

Finally, still in the chemical domain, extracted compounds were submitted to HPLC (High performance liquid chromatography) and GC-Mass (Gas chromatography mass spectrometry). The spectra delivered by the first method could not be interpreted to tangible results, while the second one, using both crude and sylan-derived extracts resulted in identifying several compounds.

Along with all those directly related parameters mentioned above, several complementary ones were either measured or calculated. Factors like oven-dried and stabilized moisture content/weight/dimensions/specific gravity together with partial shrinkage and swelling allowed to analyze each specimen's condition while going through a given test and/or treatment.

## **9-2- Conclusion in relation with the objectives**

Concerning mechanical characteristics, this species has a moderate  $\rho$  ( $\approx 0.55$ ), a low specific modulus ( $E'/\rho \approx 13$  GPa), a lower than expected damping ( $\tan\delta \approx 0.85\%$ ) and small ratios of anisotropy between 3 axes. Regarding specific gravity, white Mulberry can be classified with the species used for soundboards in European instruments, however regarding other vibrational aspects, it is closer to the species used on the back and sides of the musical instruments.

The 2 lab scaled pre-treatments modify vibrational properties differently. Long time water treatment at ambient temperature up to four months could not modify any of the determinant physico-mechanical factors. Irreversible defects, on the other hand, are induced by the treatment. Short time hot water treatment at 70°C, done up to 12 h, causes damping to increase and specific modulus to drop. Cyclic drying and stabilization, up to 5 times, has decreased damping by 8% (from the original value of 0.85%) without significantly modifying the modulus.

Two types of damping-altering extractives have been indentified. Some, extractable by acetone and methanol, lower damping, while others, extractable only by methanol and hot water, increase it. Specific modulus experiences a gradual decrease in face of treatment; however, the highly damping modifier acetone does not change modulus as greatly. Ratios of anisotropy are changed by extractions for damping, but not for specific

modulus. Hot water extracted specimens have an improved stability when exposed to moderate humidity variations.

White Mulberry can be classified as very durable towards both fungi and termites. Water leaching does not change the resistance to fungi, except when the specimens are tested in extreme conditions. Water leached-white Mulberry is moderately durable towards termites. Extractives of this wood are found to be termite-toxicant, as the survival rate of termites is significantly decreased when they are exposed to methanol-extracted compounds.

Concerning chemical aspects, different types of phenols, hydrocarbons, fatty acids and sterol have been identified among extracted components. Resorcinol, the predominant compound found in the species, was previously reported to cause several health problems close to what has been observed with Iranian artisans.

These purely scientific conclusions can be regarded differently from an artisanal/instrumental point of view:

From the reported data in the current and preceding studies, white Mulberry, in its role as a musically important wood, can not be considered with the same “standard” as the classical European species. If we insist on low damping and high modulus as requirements for picking a high quality wood (which are essential for a wood of superior quality in violin fabrication for example), then white Mulberry (like some other hardwoods used in Asian instruments) would be qualified as “*poor*”. This is of course not the case, as instruments are fabricated from it and widely played in the region. The reason for such an incompatibility might be attributed to various tastes in musical sounds. In fact, the type of sound produced by an Asian instrument could be very different and not desirable in a European one (and vice versa).

One should be careful when interpreting the results of reproduction of traditional treatments. For instance, in the atelier, water immersion is done on a halfway-carved wood. The difference in dimension, could actually reduce the possibility of defect appearing due to internal stress, therefore afterwards wood be more “workable” (which might be considered as an improvement in quality). In total, when talking about these pretreatments, the final purpose should be taken into account. A 70°C hot water treatment might result in a more stable wood in a longtime run, while not severely endangering acoustical characteristics.

### **9-3- Perspectives**

At the end of this study, working 3 years exclusively on white Mulberry, we could gather lots of information necessary for fulfilling the objectives fixed in the beginning. Nevertheless, and even if quite few of our questions were answered, new ones came into the sight.

The most basic-still-unresolved matter is the lack of knowledge on the instrument itself. In another words, there is no concrete idea of the desirable music produced by Iranian lutes. “What is the preferable sound yielded from a superior instrument?” or “In what

range of damping this particular sound could be classified?": these questions should be answered by collaborations between artisans, players and researchers. We know that standard criteria for classical European instruments can not be extrapolated to Asian ones. Throughout this study, several treatments were carried out on the samples, each one changing damping in a particular direction. However, the results are not applicable in-situ, unless the real "standard" music of each particular instrument is identified. Afterwards, it would be possible to consider the possibility that a wood artificially made "damper" or "less damped" replaces a normal one, in an attempt to acquire a more desirable sound.

Regarding the instrumental part of *Tar*, the structure of its special double bowls is still un-researched. Music in any instrument results from a combination of structure and material. This study focused only on one material (wood), nevertheless, the lambskin, as another vibratory membrane of *Tar* was not investigated. Furthermore, its long neck fabricated from walnut (*Juglans regia*), was not taken into account. Along with that, effect of different materials' connections (e.g. the glue used between skin and wood) or those of strings/ bridges are yet to be studied.

Overall, even though the results regarding the wood of white Mulberry are at least partly complete, for them to be usable in real situation, other factors should be taken into account.

The results of vibrational tests were interesting and were confirmed by several repetitions. However, they have been all performed on the clearcut laboratory-scaled specimens. The pre-treatments were also applied on the same samples, which make the results valid in laboratory. This is of course not the case in a real atelier, where prefabrication preparations are done on a semi-complete instrument. The next step could be trying to find the methods/tools for performing pretreatments/tests on a sample with dimension much closer to reality. An ultra sound method, adjusted to the special form of the big wooden bowls might be helpful on getting reliable answers.

From a more specifically chemical viewpoint, using two independent and successive extractions have helped us proposing a hypothesis about co-existence of two types of damping-altering compounds. This could be also the case of other woods, but the same method should be applied on different species, for the hypothesis to be generalized among other hardwoods.

Finally it should be noted that this study is one of the first real attempt made on understanding a Middle –Eastern musical instrument. There are also other kinds of instruments, on which the scientific knowledge is practically non-existent. Oud, Ghanoon and Santoor, are all covered with the same myths regarding the process/criteria by which their raw material is chosen and/or fabricated. Creating a database, on the region's musically potential woods (similar to what has been done here in France), would not only help the scientific community to have a clear understanding of the artisanal work, but in a far view, it could be used for comparing, replacing or adding woods of different continents with each other.

## References

- Adikaram, N., Karunanayake, C., Abayasekara, CH. (2010)** *"The Role of Pre-formed Antifungal Substances in the Resistance of Fruits to Postharvest Pathogens Postharvest Pathology"*, D. Prusky and M. L. Gullino, Springer Netherlands. vol.2, p. 1-11.
- Afzal, M. T., Colpits, B., Galik, K. (2003)** *"Dielectric properties of softwood species measured with an open-ended coaxial probe"*, In proceedings 8th International IUFRO Wood Drying Conference, Brasvo, Romania, August 24-29, p.110- 115.
- Akitsu, H., Norimoto, M., Morooka, T., Rowell R.M. (1993)** *"Effect of humidity on vibrational properties of chemically modified wood"*, Wood Fiber Sci, vol. 25, p.250-260.
- Almeida, G., Hernández, R. (2007)** *"Dimensional changes of beech wood resulting from three different re-wetting treatments"*, European Journal of Wood and Wood Products, vol.65(3), p.193-196.
- Amusant, N., Beauchene, J., Fournier, M., Janin, G., Thevenon, MF. (2004)** *"Decay resistance in *Dicorynia guianensis* Amsh.: analysis of inter-tree and intra-tree variability and relations with wood colour"*, Ann For Sci, vol.61, p.373-380.
- Amusant, N., Moretti, C., Richard, B., Prost, E., Nuzillard, J. M., Thévenon, M.F. (2007)** *"Chemical compounds from *Eperua falcata* and *Eperua grandiflora* heartwood and their biological activities against wood destroying fungus (*Coriolus versicolor*)"*, European Journal of Wood and Wood Products, vol. 65(1), p.23-28.
- Aramaki, M., Baillères, H., Brancheriau, L., Kronland-Martinet, R., Ystad, S. (2007)** *"Sound quality assessment of wood for xylophone bars"*, Journal of the Acoustical Society of America, vol.121, p.2407-2421.
- Armstrong, JP., Kyanka, GH., Thorpe, JL. (1977)** *"S<sub>2</sub> fibril angle – elastic modulus relationship of TMP scotch pine fibers"*, Wood Sci, vol. 10, p.72-80.
- Assor, C., Placet, V., Chabbert, B., Habrant, A., Lapierre, C., Pollet, B., Perré, P. (2009)** *"Concomitant Changes in Viscoelastic Properties and Amorphous Polymers during the Hydrothermal Treatment of Hardwood and Softwood"*, J Agric Food Chem, vol. 57, p.6830–6837.
- ASTM standard (2007)** *"D1107- 96, Standard test method for ethanol-toluene solubility of wood"*, ASTM International, West Conshohocken, PA, DOI: 10.1520/D1107-96R07, www.astm.org.
- Backman, AC., Lindberg, KAH. (2001)** *"Differences in wood material responses for radial and tangential direction as measured by dynamic mechanical thermal analysis"*, J Mater Sci, vol.36, p. 3777-3783.
- Baker, E.A. (1982)** *"Chemistry and morphology of plant epicuticular waxes"*, In: The Plant Cuticle, Academic Press, London, p. 139–165.
- Banks, C.H., Schoeman, J.P., Otto, K.P. (1977)** *"The Mechanical Properties of Timbers with particular reference to South Africa"*, South African Forestry Research Institute Bulletin, vol.48.
- Baptista, C., Belgacem, N., Duarte, A.P. (2006)** *"The effect of wood extractives on pulp properties of maritime kraft pulp"*, Appita Journal, vol.59 (4), p.311-316.

- Bardet, S. (2001)**, PhD thesis, "*Comportement thermoviscoélastique transverse du bois humide. Application à une essence tropicale dense : Bocoa prouaencis Aubl.*" Université MontpellierII, Montpellier, France, 226 pp.
- Barnett, J. R., Bonham, V. A. (2004)** "*Cellulose microfibril angle in the cell wall of wood fibres*", *Biological Reviews*, vol.79, p.461–472.
- Bekhta, P., Niemz, P. (2003)** "*Effect of high temperature on the change in color, dimensional stability and mechanical properties of spruce wood*", *Holzforschung*, vol. 57, p. 539-546.
- Bodig, J., Jayne, B.A. (1982)** "*Mechanics of wood and wood composites*", Van Nostrand Reinhold (New York), 712 pp.
- Bordonné, P.A., (1989)**, PhD thesis, "*Module dynamique et frottement intérieur dans le bois. Mesures sur poutres flottantes en vibrations naturelles*". Institut National Polytechnique de Lorraine, Nancy, France, 109 pp.
- Bradley, S. A., Carr, S. H. (1976)** "*Mechanical loss processes in polysaccharides.*" *Journal of Polymer Science, Polymer Physics Edition*, vol.14(1), p.111-124.
- Brancheriau, L. (2002)**, PhD thesis, "*Expertise mécanique des sciages par analyses des vibrations dans le domaine acoustique*". Université de la Méditerranée-Aix-Marseille II. Marseille, France, 267 pp.
- Brancheriau, L., Baillères, H., Détienne, P., Gril, J., Kronland, R. (2006)** "*Key signal and wood anatomy parameters related to the acoustic quality of wood for xylophone-type percussion instruments*", *Journal of Wood Science*, vol. 52(3), p.270-273.
- Brancheriau, L., Baillères, H., Guitard, D. (2002)** "*Comparison between modulus of elasticity values calculated using 3 and 4 point bending tests on wooden samples*". *Wood Sci. Technol*, vol.36, p.367–383.
- Brémaud, I. (2006)**, PhD thesis, "*Diversity of woods used or usable in musical instruments making (In French)*", University of Montpellier II. Montpellier, France, 302 pp.
- Brémaud, I., Amusant, N., Minato, K., Gril, J., Thibaut, B. (2010a)** "*Effect of extractives on vibrational properties of African Padauk (Pterocarpus soyauxii Taub.)*", *Wood Sci Technol*, vol.46, p.461-472.
- Brémaud, I., Cabrolier, P., Gril, J., Clair, B., Gérard, J., Minato, M., Thibaut, B. (2010b)** "*Identification of anisotropic vibrational properties of Padauk wood with interlocked grain*", *Wood Sci Technol*, vol.44 (3), p.355-367.
- Brémaud, I., Gril, J., Thibaut, B. (2010c)** "*Anisotropy of wood vibrational properties: dependence on grain angle and review of literature data*", *Wood Sci Technol*, DOI: 10.1007/s00226-010-0393-8.
- Brémaud, I. (2011)** "*Acoustical properties of wood in string instruments, soundboards and tuned idiophones: biological and cultural diversity*", In press.
- Bremer, B., Bremer, K., Chase, M. (2009)** "*An update of the Angiosperm Phylogeny Group classification for the orders and families of flowering plants: APG III*", *Botanical Journal of the Linnean Society*, vol. 161(2), p. 105-121.
- Bucur, V. (2006)** "*Acoustics of wood*", Springer.
- Butterfield, B. G., Meylan, B. A. (1980)** "*Three-dimensional structure of wood: an ultrastructural approach*", Chapman and Hall.
- Cai, Z., Hunt, M.O., Fridley, K.J., Rosowsky, D. (1997)** "*New technique for evaluating damping of longitudinal free vibration in Wood-based materials*", *Journal of Testing and Evaluation*, vol.25(4), p.456-460.

- Cave, I. D. (1972)** *"A theory of the shrinkage of wood"*, Wood Sci Technol, vol.6(4), p.284-292.
- Cave, I. D., Walker, J. C. F. (1994)** *"Stiffness of wood in fast-grown plantation softwoods: the influence of micro fibril angle"*, Forest products journal, vol.44(5), p.43-48.
- Chafe, C. (1987)** *"Collapse, volumetric shrinkage, specific gravity and extractives in Eucalyptus and others species. Part II: The influence of wood extractives"*, Wood Sci Technol, vol. 21(1), p.27-41.
- Chaffey, N. (2002)**, *"Wood formation in trees: cell and molecular biology techniques"*, Taylor & Francis.
- Chen, JJ., Li, XG. (2007)** *"Hypolipidemic effect of flavonoids from mulberry leaves in triton WR-1339 induced hyperlipidemic mice"*, Asia Pacific J. Clinical. Nutrition, vol. 16, p.290-294.
- Choong, E.T., Achmadi, S.S. (1991)** *"Effect of extractives on moisture sorption and shrinkage in tropical woods"*, Wood and Fiber Science, vol. 23(2), p.185-196.
- Cironei, M., Diaconescu, E., Glovnea, M. (2009)** *"Experimental investigation of wood damping and elastic modulus"*, DOCT-US, vol.1, p. 56-61.
- Coelho, D., Marques, G., Gutiérrez, A., Silvestre, A.R.D., del Río, J.C. (2007)** *"Chemical characterization of the lipophilic fraction of Giant reed (Arundo donax) fibres used for pulp and paper manufacturing"*, Ind. Crops Prod, vol. 26, p.229–236.
- Conard, N. J. (2004)** *"A mammoth ivory flute from the Aurignacian of Geißenklo Sterle (in German, abstract in English)"*, Archaeological Korrespondenzblatt, vol.34, p. 447–462.
- Cooper, G.A. (1974)** *"The effect of Black Walnut extractives on sorption, shrinkage and swelling"*, Wood Science, vol.6 (4), p.380-388.
- Cross, I. (2001)** *"Music cognition, culture and evolution"*, Annals of the New York Academy of Sciences, vol. 930, p.28–42.
- David, B. (1999)**, PhD thesis, *"Caractérisations acoustiques de structures vibrantes par mise en atmosphère raréfiée. Méthodes d'estimation relatives aux fréquences et amortissements des modes propres : Applications en acoustique musicale"*. Université Paris 6. Paris, France, 233 pp.
- De Rosso, M., Cancian, D., Pnighel, A., Dalla Vedova, A., Flamini, R. (2009)** *"Chemical compounds released from five different woods used to make barrels for aging wines and spirits: volatile compounds and polyphenols"*, Wood Sci Technol, vol.43, p. 375-385.
- Déjardin, A., Laurans, F., Arnaud, D., Breton, CH., Pilate, G., Leple, J.CH. (2010)** *"Wood formation in Angiosperms"*, Comptes Rendus Biologies, vol. 333(4), p.325-334.
- del Río J.C., Gutiérrez A., Martínez, M.J., Martínez, A.T. (2001)** *"Py-GC-MS study of Eucalyptus globulus wood treated with different fungi"*, Journal of Analytical and Applied Pyrolysis, vol.58-59, p.441-453.
- del Río, J. C., Romerob, J., Gutiérrez, A. (2000)** *"Analysis of pitch deposits produced in Kraft pulp mills using a totally chlorine free bleaching sequence"*, Journal of Chromatography A., vol.874, p. 235-245.
- del Río, J.C., Gutiérrez, A., Gonzalez-Vila, F.J., Martn, F. (1998)** *"Characterization of organic deposits produced in the Kraft pulping of Eucalyptus globulus wood"*, J. Chromatogr, vol.823, p. 457–465.
- Demaree, L. A., Erickson. R.W. (1976)** *"Temperature-dependent effect of extractive content on redwood shrinkage"*, Wood Science, vol. 8(4), p. 227-233.
- Demirbaş, A. (1991)** *"Analysis of beech wood fatty acids by supercritical acetone extraction"*, Wood Sci Technol, vol. 25(5), p. 365-370.

- Déon, G., Chadenson, M., Hautville, M. (1980)** *"Influence des extraits naturels du bois sur sa résistance a la pourriture"*, Bois et forêt des tropiques, vol.191
- Dey, P., Harborne, J., Banthorpe, D.V. (1991)** *"Terpenoids, Vol.7, Methods in plants biochemistry "*, London, Academic. 580 pp.
- Donaldson, L. (2008)** *"Microfibril angle: measurement, variation and relationships- A review"*, IAWA, vol.29(1-4), p.345-386.
- Dorado, J., van Beek, T. A., Classen, F.W., Sierra- Alvarez, R. (2001)** *"Degradation of lipophilic wood extractive constituents in Pinus sylvestris by the white-rot fungi Bjerkandera sp. and Trametes versicolor"*. Wood Sci Technol, vol. 35(1), p.117-125.
- Duke. J. A. (1983)** *"Handbook of Energy Crops"*, NewCrops website. [http://www.hort.purdue.edu/newcrop/duke\\_energy/dukeindex.html](http://www.hort.purdue.edu/newcrop/duke_energy/dukeindex.html)
- Dünisch, O., Richter, H.G., Koch, G. (2010)** *"Wood properties of juvenile and mature heartwood in Robinia pseudoacacia L"*, Wood Sci Technol, vol.44, p.301-313.
- Dunlop, JI. (1978)** *"Damping loss in wood at mid kilohertz frequencies"*, Wood Sci Technol, vol.12, p.49-63.
- Edvardsen, K., Sandland, K. M. (1999)** *"Increased drying temperature – Its influence on the dimensional stability of wood"*, European Journal of Wood and Wood Products, vol. 57(3), p.207-209.
- El Mouridi, M. E. (2007)**, Master thesis, *"Caractérisation mécanique (module d'élasticité - coefficient d'amortissement) du matériau bois, Cas du pin d'Alep et de chêne vert"*, Université Mohammed V. Maroc, 44 pp.
- EN 117 (2005)** *"Wood preservatives - Determination of toxic values against European Reticulitermes species (Laboratory method)"*
- EN 350-1 (1994)** *"Durability of wood and wood based products – Natural durability of solid wood – Part 1: Guide to the principles of testing and classification of the natural durability of wood"*
- EN 84 (1997)** *"Wood preservatives - Accelerated ageing tests of treated wood prior to biological testing – Leaching procedure"*
- Evans, F., Flæte, P.O., Alfredsen, G. (2008)** *"Natural durability of different wood species in above ground"*, The International Research Group on Wood Protection, IRG/WP 08-10667, 14 pp.
- Faraji, F., Thévenon, M.F., Thibaut, A., Gril, J. (2004)** *"Evaluation de la durabilité naturelle des contreplaqués en mélange d'essences durables et non durables et détection de la dégradation par caractérisation mécanique"*, Colloque Sciences et Industries du Bois, Ecole Nationale Supérieure des Technologies et des Industries du Bois, Epinal, France. 31 pp.
- Fengel, D., Wegener, G. (1989)** *"Wood: chemistry, ultra structure, reactions"*, Walter de Gruyter, Berlin.
- Fernandez, M. P., Watson, P. A., Breuil, C. (2001)** *"Gas chromatography-mass spectrometry method for the simultaneous determination of wood extractive compounds in quaking aspen"*, J Chromatogr A., vol. 922, p.225–233.
- Fletcher, N. H., Rossing, T. D. (1998)** *"The physics of musical instruments"*, Springer.
- Fletcher, N.H. (1999)** *"Materials for musical instruments"*, Acoustics Australia, vol. 27, p.5-9.
- Fortin, Y., Poliquin, J. (1976)** *"Natural durability and preservation of one hundred tropical African woods"*, International Development Centre.

- Gachet, C., Guitard, D. (2006)** "Influence relative de la morphologie cellulaire et de l'angle des microfibrilles sur l'anisotropie élastique tissulaire Longitudinale/Tangentielle du bois sans défaut des résineux", *Annals of Forest Science*, vol.63, p.275-283.
- Gade, S., Herlufsen, H. (1990)**, Technical note, "Digital Filter Techniques vs. FFT Techniques for Damping Measurements", (Part 1+2). Sound and vibration. Brüel & Kjær, Nærum, Denmark.
- Galeotti, F., Barile, E., Curir, P., Dolci, M., Lanzotti, V. (2008)** "Flavonoids from carnation (*Dianthus caryophyllus*) and their antifungal activity", *Phytochemistry Letters*, vol.1 (1), p.44-48.
- Gerhards, C.C. (1982)** "Effect of moisture content and temperature on the mechanical properties of wood: an analysis of immediate effects", *Wood Fiber*, vol.14, p.4-36.
- Grabner, M., Müller, U., Gierlinger N., Wimmer, R. (2005)** "Effects of heartwoods extractives on mechanical properties of Larch", *IAWA Journal*, vol. 26 (2), p.211-220.
- Green, D.W., Winandy, J.E., Kretschmann, D.E. (1999)** "Mechanical properties of wood. In: *Wood Handbook: Wood as an Engineering Material*", General Technical Report FPL-GTR-113. USDA, Forest Products Laboratory, Madison, WI.
- Gril, J. (1987)** PhD thesis, "Une modélisation du comportement hygro-rhéologique du bois à partir de sa microstructure", Université Paris 6. Paris, 268 pp.
- Guitard, D., El Amri, F. (1987)** "Modèles prévisionnels de comportement élastique tridimensionnel pour les bois feuillus et les bois résineux", *Ann Sci For*, vol. 44, p.335-348.
- Gutiérrez, A., del Río, J. C., Gonzáles-Vila, C., Martín, F. J. (1998)** "Analysis of lipophilic extractives from wood and pitch deposits by solid-phase extraction and gas chromatography", *Journal of Chromatography A.*, vol.823, p. 449-455.
- Gutiérrez, A., del Río, J., Gonzáles-Vila, C., Martín, F. J. (1999)** "Chemical composition of lipophilic extractives from *Eucalyptus globulus* Labill. wood". *Holzforschung*, vol. 53, p.481-486.
- Gutiérrez, A., del Río, J.C. (2003)** "Lipids from flax fibers and their fate after alkaline pulping", *Journal of Agriculture and Food Chemistry*, vol. 51, p.4965-4971.
- Haines, D. W., Leban, J. M., Herbé, CH. (1996)** "Determination of Young's modulus for spruce, fir and isotropic materials by the resonance flexure method with comparisons to static flexure and other dynamic methods", *Wood Sci Technol*, vol. 30(4), p.253-263.
- Haines, D.W. (2000)** "The essential mechanical properties of wood prepared for musical instruments", *Catgut Acoustical Society Journal*, vol.4 (two (series II)), p.20-32.
- Haupt, M., Leithoff, H., Meier, D., Puls, J., Richter, H.G., Faix, O. (2003)** "Heartwood extractives and natural durability of plantation-grown teakwood (*Tectona grandis* L.)-a case study", *European Journal of Wood and Wood Products*, vol. 61(6), p.473-474.
- Havimo, M. (2009)** "A literature-based study on the loss tangent of wood in connection with mechanical pulping", *Wood Sci Technol*, vol. 43(7), p.627-642.
- Hernández, R. E. (1989)**, PhD Thesis, "Influence des composantes secondaires et du contrefil sur les propriétés physico-mécaniques de bois tropicaux", Université Laval, Québec.
- Hernández, R.E. (2007)** "Moisture sorption properties of hardwoods as affected by their extraneous substances, wood density, and interlocked grain", *Wood Fiber Sci*, vol. 39, p.132-145.
- Highley, T.L. (1995)** "Comparative durability of untreated wood in use above ground", *International Biodeterioration & Biodegradation*, vol. 35, p. 409-419.



- Hill, C. A. S. (2006)** *"Wood modification: chemical, thermal and other processes"*, John Wiley & Sons.
- Hillis, W. E. (1962)** *"Wood extractives and their significance to the pulp and paper industries"*, Academic Press.
- Hillis, W. E. (1987)** *"Heartwood and tree exudates"*, Springer-Verlag.
- Hillis, W.E., Rozsa, A.N. (1985)** *"High temperature and chemical effects on wood stability"*, Wood Sci Technol, vol.19, p.57-66.
- Hoffman, R., Kearns, K. (1997)** *"Wisconsin manual of control recommendations for ecologically invasive plants"*, Wisconsin Dept. Natural Resources, Bureau of Endangered Resources. Madison, Wisconsin. 102 pp.
- Holz, D. (1996)** *"Acoustically important properties of xylophone-bar materials: can tropical woods be replaced by European species?"*, Acustica/Acta acustica, vol.82, p. 878–884.
- Hu, Y. (2008)** *"Nondestructive Testing of Mechanical Parameters for Wood-based Materials"*, 17th World Conference on Nondestructive Testing, Shanghai, China.
- Hübschmann, H. J. (2009)** *"Handbook of GC/MS: fundamentals and applications"*, Wiley-VCH.
- Huo, Y. (2002)** *"Mulberry Cultivation and Utilization in China"*, In: Sánchez, M. D. (ed.) *Mulberry for Animal Production*, FAO Animal Production, and Health Paper 147. Rome, p. 11-43.
- Ilic, J. (2001)** *"Relationship among the dynamic and static-elastic properties of air-dry Eucalyptus delegatensis"*, Holz Roh Werkst, vol. 59, p.169–175.
- Inokuchi, Y., Fushitani, M., Kubo, T., Sato K (1999)** *"Effects of water extractives on the moisture-content dependence of vibrational properties of Bamboo"*, Mokuzai gakkaiishi, vol.45, p.77-84.
- INRS. (2000)** *"Fiche toxicologique N°78 (Résorcinol)"*, Institut national de recherche et sécurité pour la prévention des accidents au travail et les maladies professionnelles (INRS)
- INRS. (2011)** *"Fiche toxicologique FT15 (Phénol)"*, Institut national de recherche et sécurité pour la prévention des accidents au travail et les maladies professionnelles (INRS)
- Ishimaru, Y., K. Arai., Mizutani, M, Oshima, K., Iida, I. (2001a)** *"Physical and mechanical properties of wood after moisture conditioning"*, Journal of Wood Science, vol. 47(3), p.185-191.
- Ishimaru, Y., K. Oshima, Iida, I. (2001b)** *"Changes in the mechanical properties of wood during a period of moisture conditioning"*, Journal of Wood Science, vol. 47(4), p. 254-261.
- James, W. L. (1961)**, *"Calibration of electric moisture meter for jack and red pine, black spruce, paper birch, black ash, eastern hemlock, and big tooth aspen"*, FPL Rep. 2208. Madison, WI: U.S. Dept. of Agriculture, Forest Service, Forest Products Laboratory.
- James, W. L. (1964)**, *"Calibration of electric moisture meters for some wood species grown in Hawaii"*, Res. Note FPL-061. Madison, WI: U.S. Dept. of Agriculture, Forest Service, Forest Products Laboratory.
- James, W. L. (1975)** *"Dielectric properties of wood and hardboard: variation with temperature, frequency, moisture content, and grain orientation"*, Madison, WI: Dept. of Agriculture, Forest Service, Forest Products Laboratory.
- Jansson, E.V. (2002)** *"Acoustics for Violin and Guitar Makers"*, 4th ed. Royal Institute of Technology, Stockholm.
- Jayne, B.A. (1959)** *"Vibrational properties of wood as indices of quality"*, Forest Products Journal, vol.9 (11), p.413–416.

- Jiang, J., Cai, Z., Lu, J. (2009)** "Effect of Moisture Sorption State on Vibrational Properties of Wood", 16th International symposium on nondestructive testing and evaluation of wood. Beijing, China.
- Jiang, J., Lu, J. (2009)** "Dynamic viscoelastic behavior of wood under drying conditions", *Frontiers of Forestry in China*, vol. 4(3), p.374-379.
- Johansson, C. I., Beatson, R. P., Saddler, J. N. (2000)** "Fate and influence of western red cedar extractives in mechanical pulping", *Wood Sci Technol*, vol. 34, p. 389-401.
- Jüngel, P., Melcher, E. (2001)** "The identification of organic compounds in wood using thermal desorption GC-Mass- Possibilities and limitations", The international research group on wood protection, Doc IRG/WP 01-20224, 7 pp.
- Kadita, S., Yamada, T., Suzuki, M., (1961)** "Studies on rheological properties of wood I. Effect of moisture content on the dynamic Young's modulus of wood" (In Japanese, abstract in English). *Mokuzai Gakkaishi*, vol. 7(1), p.29-33.
- Kapche, G.D., Fozing, W.F., Donfack, J.H., Fotso, G.W., Amadou, D., Tchana, A.N., Bezabih, M., Moundipa, P.F., Ngadjui, B.T., Abegaz, B.M. (2009)** "Prenylated arylbenzofuran derivatives from *Morus mesozygia* with antioxidant activity", *Phytochemistry*, vol.70, p. 216–221.
- Kapche, G.D., Waffo-Tegu, P., Massip, S., Guillon, J., Vitra, C., Krista, S., Ngadjui, B., Merillon, J.M. (2007)** "Crystal Structure of Moracin M.", *Analytical science*, vol.23. p.59-60.
- Karami, E., Pourtahmasi, K., Shahverdi, M. (2010)** "Wood Anatomical Structure of *Morus alba* L. and *Morus nigra* L., Native to Iran", *Notulae Scientia Biologicae*, vol. 2(4), p. 129-132.
- Katz, J. L., Spencer, P., Wang, Y., Misra, A., Marangos, O., Friis, L. (2008)** "On the anisotropic elastic properties of woods", *J Mater Sci*, vol. 43, p. 139-145.
- Kazemi, S., Hosinzadeh, A., Rezaei, M. (2006)** "The effect of woody and non woody plants extractives on microbial resistance of non-durable species", The international research group on wood protection, Doc IRG/WP 06-30392, 11 pp.
- Kilic, A., Niemz, P. (2010)** "Extractives in some tropical woods", *European Journal of Wood and Wood Products*, DOI: 10.1007/s00107-010-0489-8.
- Kleist, G., Bauch, J. (2001)** "Cellular UV Microspectrophotometric Investigation of Sapelli Heartwood (*Entandophragma cylindricum* Sprague) from Natural Provenances in Africa", *Holzforschung*, vol. 55, p.117-122.
- Knowles, R.L., Hansen, L.W., Wendding, A., Downes, G. (2004)** "Evaluation of non-destructive methods for assessing stiffness of douglas fir trees", *New Zealand Journal of Forestry Science*, vol. 34(1), p.87–101.
- Koch, G., Kleist, G. (2001)** "Application of Scanning UV Microspectrophotometry to Localise Lignins and Phenolic Extractives in Plant Cell Walls", *Holzforschung*, vol.55, p.563-567.
- Kojima, Y., Yamamoto, H. (2004)** "Properties of the cell wall constituents in relation to the longitudinal elasticity of wood", *Wood Sci Technol*, vol. 37(5), p. 427-434.
- Kollmann, F.F.P., Krech, M. (1960)** "Dynamic measurement of the elastic properties of wood and the damping" (In German, abstract in English). *Holz Roh Werk*, vol.18(2), p. 41–54.
- Krutul, D. (1983)** "Influence of the isolation of extractives substances and carbohydrates soluble in alkalies on some hygroscopic properties of spruce wood", *DrevarskyVyskum*, vol. 28(2), p.1-12.

## References

---

- Kubojima, Y., Okano, T., Ohata, M. (1998)** *"Vibrational properties of Sitka spruce heat-treated in nitrogen gas"*, Journal of Wood Science, vol. 44(1), p.73-77.
- Kubojima, Y., Okano, T., Ohata, M. (2000)** *"Vibrational properties of heat-treated green wood"*, Journal of Wood Science, vol. 46(1), p. 63-67.
- Kubojima, Y., Wada, M., Suzuki, Y., Tonosaki, M. (2001)** *"Real-time measurement of vibrational properties and fine structural properties of wood at high temperature"*, Wood Sci Technol, vol. 35(6), p. 503-515.
- Kubojima, Y., Suzuki, Y., Tonosaki, M. (2005)** *"Vibrational properties of green wood in high-temperature water vapor"*, Holzforschung, vol. 59(4), p. 446-450.
- Kubojima, Y., Tonosaki, M., Yoshihara, H. (2006)** *"Young's modulus obtained by flexural vibration test of a wooden beam with in homogeneity of density"*, Journal of wood science, vol. 52(1), p. 20-24.
- Kulkarni, D. D., Ghugale, D. D., Narasimhan, R. (1970)** *"Chemical investigations of plant tissues grown in vitro: Isolation of  $\beta$ -sitosterol from Morus alba (mulberry) callus tissue"*, Indian J. Exp. Biol. vol. 8(347).
- Lachenbruch, B., Johnson, G. R., Downes, G., Evans. R. (2010)** *"Relationships of density, microfibril angle, and sound velocity with stiffness and strength in mature wood of Douglas-fir"*, Canadian Journal of Forest Research, vol. 40, p.55-64.
- Lawrence, J. F. (1984)** *"Liquid chromatography in environmental analysis"*, Humana Press.
- Lee, S. S., Lee, H. J., Choi, D.H. (2000)** *"Studies on biological activities of wood extractives (III): On the phenolic compounds isolated from heartwood of M.Bombycis"*, (In Korean, abstract and figures in English). Mokchae konghak, vol. 28(2), 6 pp.
- Li, X. J., Cai, Z. Y., Mou, Q., Wu, Y., Liu, Y. (2011)** *"Effects of Heat Treatment on some Physical Properties of Douglas Fir (Pseudotsuga Menziesii) Wood"*, Advanced Materials Research, vol.197-198, p.90-95.
- Limaye, V.D. (1957)** *"Grouping of Indian Timbers and Their Properties, Uses and Suitability"*, Indian Forest Records (N.S. Timber Mechanics Vol.1 No.2)
- Lines, N. (2002)** *"SP guide to composites"*, University of Bolton, UK. 69 pp.
- Little, E.L. (1980)** *"The Audobon Society Field Guide to North American Trees - Western Region"*, Published by Arthur A. Knopf, New York.640 pp.
- Luxford, R.F. (1931)** *"Effects of extractives on the strength of wood"*, Journal of Agricultural Research, vol.42 (12), p. 801-826.
- Mah, K. (1987)**, Bachelor thesis, *"Toxicological evaluation and methabolic disposition of western red cedar extractives"*. University of British Columbia. 84 pp.
- Mantanis, G.I., Young, R. A., Rowell, R.M. (1994a)** *"Swelling of wood. Part I. Swelling in water"*, Wood Sci Technol, vol. 28(2), p.119-134.
- Mantanis, G.I., Young, R.A., Rowell, R.M. (1994b)** *"Swelling of wood. Part II. Swelling in organic liquid"*, Holzforschung, vol.48(6), p. 480-490.
- Mantanis, G.I., Young, R.A., Rowell, R.M. (1995)** *"Swelling of wood. Part III. Effect of temperature and extractives on rate and maximum swelling"*, Holzforschung, vol. 49(3), p. 239-248.
- Mantanis, G. I., Young, R. A. (1997)** *"Wetting of Wood"*, Wood Sci Technol, vol. 31, p. 339-353.
- Mastromatteo, E. (1965)** *"Recent occupational health experiences in Ontario"*, J Occup Med, vol. 7, p.502-5011.

- Matsunaga, M., Sugiyama, M., Minato, K., Norimoto, M. (1996)** *"Physical and mechanical properties required for violin bow materials"*, *Holzforschung*, vol. 50, p. 511–517.
- Matsunaga, M. Minato, K. (1998)** *"Physical and mechanical properties required for violin bow materials II: Comparison of the processing properties and durability between Pernambuco and substitutable wood species"*, *Journal of Wood Science*, vol. 44, p. 142-146.
- Matsunaga, M., Minato, K., Nakatsubo, F. (1999)** *"Vibrational properties changes of spruce wood by impregnation with water soluble extractives of pernambuco (Guilandina echinata Spreng.)"*, *Journal of Wood Science*, vol.45, p.470-474.
- Matsunaga, M., Obataya, E., Minato, K., Nakatsubo, F. (2000)** *"Working mechanism of adsorbed water on the vibrational properties of wood impregnated with extractives of pernambuco (Guilandina echinata Spreng.)"*, *Journal of Wood Science*, vol. 46, p.122-129.
- Matsuyama, S., Kuwahara, Y., Suzuki, T. (1991)** *"A new 2-arylbenzofuran, xhydroxymoracin N, from mulberry leaves"*. *Agric. Boil. Chem.* vol. 55, p.1409-1410.
- McNair, H. M., Miller, J. M. (2009)** *"Basic gas chromatography"*, John Wiley & Sons. 239 pp.
- Meister, S.A. (2006)** *"Top 10 Fuel Trees for Zone 5 and Above"*, *Permaculture Reflections*, May 17.
- Meyers, M. A. (1994)** *"Dynamic behavior of materials"*, Wiley. 668 pp.
- Michalak, A. (2006)** *"Phenolic compounds and their antioxidant activity in plants growing under heavy metal stress"*, *Pol J Environ Stud*, vol. 15, p.523-530.
- Minato, K., Sakai, K., Matsunaga, M., Nakatsubo, F. (1997)** *"The vibrational properties of wood impregnated with extractives of some species of Leguminosae (Preliminary report)"*, *Mokuzai Gakkaishi*, vol. 43(12), p. 1035-1037.
- Minato, K., Konaka, Y., Brémaud, I., Suzuki, S., Obataya, E. (2010)** *"Extractives of muirapiranga (Brosimum sp.) and its effects on the vibrational properties of wood"*, *Journal of Wood Science*, vol. 56, p.41-46.
- Mitchell, R.L., Seborg, R.M., Millet, M.A. (1953)** *"Effect of heat on the properties and chemical composition of Douglas-fir wood and its major components"*, *Journal of Forest Product Research Society*, vol.3, p.38-42.
- Narin, J.A. (2007)** *"A numerical study of the transverse modulus of wood as a function of grain orientation and properties"*, *Holzforschung*, vol.61, p.406-413.
- Nakamura, M., Nakamura, S., Oku, T. (2009)** *"Suppressive response of confections containing the extractive from leaves of Morus Alba on postprandial blood glucose and insulin in healthy human subjects"*, *Nutrition & Metabolism*, vol. 6(29), 10 pp.
- Nakao, T., Okano, T., Asano, I. (1985)** *"Theoretical and experimental analysis of flexural vibration of the viscoelastic Timoshenko beam"*, *Journal of Applied Mechanics*, vol.52, p. 728-731.
- Nearn, W. T. (1955)** *"Effect of water soluble extractives on the volumetric shrinkage and equilibrium moisture content of eleven tropical and domestic woods"*, Pennsylvania State University, College of Agriculture, Agricultural Experiment Station.
- NF B51-014 (1987)** *"Bois - Dosage des constituants du bois solubles dans le mélange alcool-benzène"*, Norme française.
- Noda, E., Aoki, T., Minato, K. (2002)** *"Physical and chemical characteristics of the blackened portion of Japanese Persimmon (Diospyros kaki)"*, *Journal of Wood Science*, vol.48, p. 245-249.

- Noguchi, T., Obataya, E., Ando, K. (2011)** "*Effects of ageing on the vibrational properties of akamatsu (Pinus densiflora) wood*", Wood Culture and Science, Kyoto, Japan.
- Nomura, T., Fukai, T. (1981)** "*Phenylflavonoids from the root bark of the cultivated mulberry tree*", Heterocycles, vol.15, p.1531-1567.
- Nomura, T., Fukai, T., Hano, Y., Nemoto, K., Terada, S., Kuramochi, T. (1983)** "*Constituents of Cultivated Mulberry Tree*", Planta Med, vol. 47(03), p.151-156.
- Nomura, T., Fukai, T., Yamada, S., Katayanagi, M., (1976)** "*Phenolic constituents of the cultivated mulberry tree (Morus alba L.)* ", Chem. Pharm. Bull, vol.24, p.2898-2900.
- Norimoto, M., Tanaka, F., Ohogama, T., Ikimune, R. (1986)** "*Specific Dynamic Young's Modulus and Internal Friction of Wood in the Longitudinal direction*", (in Japanese, Abstract and figures in English), Wood Research and Technical Notes, vol. 22, p.53-65.
- Nzokou, P., Kamdem, D.P. (2006)** "*The Influence of Wood Extractives on the Photodiscoloration of Wood Surfaces Exposed to Artificial Weathering*", Color Research and Application, vol. 31(4), p. 425-434.
- Obataya, E., Norimoto, M., Gril, J. (1998)** "*The effects of adsorbed water on dynamic mechanical properties of wood*", Polymer, vol. 39, p.3059-3064.
- Obataya, E., Umezawa, T., Nakatsubo, F., Norimoto, M. (1999)** "*The effects of water soluble extractives on the acoustic properties of reed (Arundo donax L.)*", Holzforschung, vol.53(1), p. 63-67.
- Obataya, E., Norimoto, M. (1999)** "*Acoustic properties of a reed (Arundo donax L.) used for the vibrating plate of a clarinet*", J Acoust Soc Am, vol.106, p.1106-1110.
- Obataya, E., Ono, T., Norimoto, M. (2000)** "*Vibrational properties of wood along the grain*", Journal of Materials Science, vol.35, p. 2993-3001.
- Obataya, E., Minato, K., Tomita, B. (2001)** "*Influence of moisture content on the vibrational properties of hematoxylin-impregnated wood*", Journal of Wood Science, vol.47, p.317-321.
- Obataya, E., Higashihara, T., Tomita, B. (2002)** "*Hygroscopicity of heat-treated wood III- Effect of steaming on the hygroscopicity of wood*", Mokuzai Gakkaishi, vol. 48(5), p.348-355.
- Obataya, E., Shibutani, S., Hanata, K., Doi, S. (2006)** "*Effects of high temperature kiln drying on the practical performances of Japanese cedar wood (Cryptomeria japonica) I: changes in hygroscopicity due to heating*", Journal of Wood Science, vol. 52(2), p. 111-114.
- Online website of university of Maine (2011)**  
<http://chemistry.umeche.maine.edu/CHY431/Wood1.html>
- Oliveira, F. G. R., Candian, M., Lucchette, F.F., Salgon, J.L., Sales, A. (2005)** "*Moisture content effect on ultrasonic velocity in Goupia glabra*", Materials Research, vol. 8, p. 11-14.
- Oliver, R. W. A. (1998)** "*HPLC of macromolecules: a practical approach*", IRL Press at Oxford University Press.
- Ono, T., Kataoka, A. (1979)** "*The frequency dependence of the dynamic Young's modulus and internal friction of wood used for the soundboard of musical Instruments II. The dependence of the Young's modulus and internal friction on frequency, and the mechanical frequency dispersion*", (in Japanese, Abstract and figures in English), Mokuzai Gakkaishi, vol. 25(8), p. 535-542.
- Ono, T., Norimoto, M. (1983)** "*Study on Young's modulus and internal friction of wood in relation to the evaluation of wood for musical instruments*", Jpn J Appl Phys, vol. 22, p.611-614.

- Ono, T., Norimoto, M. (1984)** "On physical criteria for the selection of wood for soundboards of musical instruments", *Rheol Acta*, vol. 23, p.652-656.
- Ono, T., Norimoto, M., (1985)** "Anisotropy of dynamic Young's Modulus and internal friction in wood", *Japanese Journal of Applied Physics*, vol. 24(8), p. 960-964.
- Orwa, C., Mutua, A., Kindt, R., Jamnadass, R., Anthony, S., (2009)** "Agro forestry Database: a tree reference and selection guide version 4.0 ", World Agro forestry Centre, Kenya.
- Otto, A., Wilde. V. (2001)** "Sesqui-, di-, and triterpenoids as chemosystematic markers in extant conifers—A review", *The Botanical Review*, vol. 67(2), p. 141-238.
- Petterssen, R.C. (1984)** "Chemical composition of wood", *Chemistry of solid wood*, Ed. R.M. Rowell, Chap. 2, Washington D.C.
- Piao, S. J., Qiu, F., Chen, L.X., Pan, Y., Dou, D. Q. (2009)** "New Stilbene, Benzofuran, and Coumarin Glycosides from *Morus alba*", *Helvetica Chimica Acta*, vol. 92(3), p. 579-587.
- Placet, V., Passard, J., Perré, P. (2007)** "Viscoelastic properties of wood across the grain measured under water-saturated conditions up to 135 °C: evidence of thermal degradation", *J Mater Sci*, vol. 43, p.3210-3217.
- Plomion, C., Leprovost, G., Stokes, A. (2001)** "Wood formation in trees", *Plant physiology*, vol. 127(4)
- Pourtahmasi, K., Se Golpayegani, A. (2008)** "Introducing Mulberry's wood (*Morus alba* L.) used in bowl shaped musical instruments of Iran". *Le bois : instrument du patrimoine musical*. Eds. Leconte S, Vaiedelich S. 29 May 2009 Cité de la Musique, Paris.
- Ross, R. J., Pellerin, R. F. (1994)** "Nondestructive testing for assessing wood members in structures: a review", U.S. Dept. of Agriculture, Forest Service, Forest Products Laboratory. 40 pp.
- Ross, R.J. (2010)** "Wood handbook: wood as an engineering material", Forest Products Laboratory.
- Rossing, T. D., Fletcher, N. H. (2004)** "Principles of vibration and sound", 2nd ed. Springer-Verlag, New York, New York, USA.
- Rowe, J.W., Conner, A. (1979)** "Extractives in Eastern Hardwoods-A Review", Forest Products Laboratory, Forest Service, U.S. Department of Agriculture, Madison, Wisconsin, USA, 72 pp.
- Rowell, R. M. (1984)** "The Chemistry of solid wood", American Chemical Society.
- Rowell, R. M. (2005)** "Handbook of wood chemistry and wood composites", CRC Press.
- Royer, M., Herbertte, G., Eparvier, V., Beauchêne, J., Thibaut, B., Stien, D. (2010)** "Secondary metabolites of *Bagassa guianensis* Aubl. wood: a study of the chemotaxonomy of the *Moraceae* family", *Phytochemistry*, vol. 71(14-15), p. 1708-1713.
- Rudman, P., (1960)** "Anthroquinones of Teak (*Tectona grandis* L.) ", *Chem. and Ind*, vol.44, p. 1356-1357.
- Rujinirun, C., Phinyocheep, W., Prachyabrued, W., Laemsak, N. (2005)** "Chemical treatment of wood for musical instruments. Part I. Acoustically important properties of wood for the ranad (Thai traditional xylophone) ", *Wood Sci and Technol*, vol. 39, p. 77-85.
- Sadeghifar, H., Sheikh, A., Khalilzadeh, M.A., Ebadi, A. Gh. (2011)** "Heartwood Extractives of Iranian *Morus alba* Wood", *J.Chem.Soc.Pak*, vol. 33(1), p.104-106.
- Sakai, K., Matsunaga, M., Minao, K., Nakatsubo, F. (1999)** "Effect of impregnation of simple phenolics and natural polycyclic compounds on physical properties of wood", *J wood Sci*, vol. 45, p. 227-232.

- Salmén, L. (2004)** *"Micromechanical understanding of the cell-wall structure"*, Comptes Rendus Biologies, vol. 327(9-10), p.873-880.
- Sasaki, T., Norimoto, M., Yamada, T., Rowell, R.M. (1988)** *"Effect of moisture content on the acoustical properties of wood"*, Mokuzai Gakkaishi, vol. 34(10), p.794–803.
- Savidge, R. A., Barnett, J. R., Napier, R. (2000)** *"Cell and molecular biology of wood formation"*, BIOS. 530 pp.
- Scheffer, T.C., Cowling, E.B. (1966)** *"Natural resistance of wood to microbial deterioration"*, Annual Review of Phytopathology, vol. 4, p.147–170.
- Scheffer, T.C., Morrell, J.J. (1998)** *"Natural durability of wood: a worldwide checklist of species"*. Forest Research Laboratory, Oregon State University Research Contribution 22, Corvallis, Oregon, 58 pp.
- Schinor, E. C., Salvador, M. J., Tomaz, J.C., Furusho Pral, E.M., Alfieri, S.C., Albuquerque, S., Ito. I.Y., Aparecida Dias, D. (2006)** *"Biological activities and chemical composition of crude extracts from Chresta exsucca"*, Revista Brasileira de Ciências Farmacêuticas, vol. 42, p. 83-90.
- Schultz, T.P., Harms, W.B., Fisher, T.H., McMurtrey, K.D., Minn, J., Nicholas, D.D., (1995)** *"Durability of angiosperm wood: importance of extractives"*, Holzforschung, vol. 49, p. 29-34.
- Se Golpayegani, A. (2007)** Master thesis, *"Evaluation of mulberry's wood (Morus alba L.), considering its use in making Iranian musical instruments"*, (in Farsi). University of Tehran, Iran, 150 pp.
- Sedik, Y., Hamdan, S., Jusoh, I. (2010)** *"Acoustic properties of selected tropical wood species"*, Journal of Non-destructive Evaluation, vol. 29, p.38–42.
- Shelstedt- Persson, M. (2001)** *"Effect of extractive contents on the moisture diffusion properties for Scot Pine and Norway Spruce"*, unpublished. <http://www1.uni-hamburg.de/cost/e15/papers/helsinki/helsinki-paper0403.pdf>
- Sen, S., Sivrikaya , H. (2009)** *"Natural durability of hearth woods from European and tropical Africa trees exposed to marine conditions"*, African Journal of Biotechnology, vol. 8 (18), p. 4425-4432.
- Settle, F. A. (1997)** *"Handbook of instrumental techniques for analytical chemistry"*, Prentice Hall PTR.
- Simpson, W., TenWolde, A. (1999)** *"Physical Properties and Moisture Relations of Wood. In: Forest Products Lab. Wood Handbook- Wood as an engineering material"*, Madison, WI: USDA Forest Service, Forest Products Lab, 463 pp.
- Simpson, W.T. (1993)** *"Specific gravity, moisture content and density relationship for wood"*, Gen. Tech. Rep. FPL-GTR-76. Madison, WI: US Department of Agriculture, Forest Service, Forest Products Laboratory 13.
- Singh, B., Makkar, Harinder P.S. (1976)** *"The potential of mulberry tree foliage as an animal feed supplement in India"*, <http://www.iaea.org/programmes/nafa/d3/public/mulberry-fullpaper.pdf>
- Sjöström, E. (1981)** *"Wood chemistry: fundamentals and applications"*, Academic Press.
- Skaar, C. (1988)** *"Wood-Water Relations"*, Springer Series in Wood Science, Springer-Verlag, 279 pp.
- Smith, D. M. (1955)** *"A comparison of two methods for determining the specific gravity of small samples of second-growth Douglas fir"*, U.S.D.A., Forest Service, Forest Prod. Lab., Report No. 2033.

## References

---

- Smith, J. F., Claydon, N., Love, M. E., Allan, M., Wood, D. A. (1989)** *"Effect of substrate depth on extracellular endocellulase and laccase production of Agaricus bisporus"*, Mycological Research, vol. 93(3), p. 292-296.
- Smith, M. B., March, J. (2007)** *"Advanced Organic Chemistry: Reactions, Mechanisms, and Structure (6th ed.)"*, New York: Wiley-Interscience, ISBN 0-471-72091-7
- Stamm, A. J., Loughborough, W. K. (1942)** *"Variation in shrinkage and swelling of wood"*, Trans. Ame. Soc. Mech. Eng, vol. 64, p. 379-386.
- Stamm, A.J. (1964)** *"Wood and Cellulose Science"*, Ronald Press, New York.
- Suzuki, M. (1980)** *"Relationship between specific gravity and dynamic decrement with water contents"*, Mokuzai Gakkaishi, vol. 26(5), p.299–304.
- Tappi standard (2007)** *"T204cm-07, T.S.m. Solvent extractives of wood and pulp"*, Technical Association of the Pulp and Paper Industry, USA.
- Tappi standard (2008)** *"T207cm-08, T.S.m. Water solubility of wood and pulp"*, Technical Association of the Pulp and Paper Industry, USA.
- Taylor, A. M., Gartner, B. L., Morelle, J.J. (2002)** *"Heartwood formation and natural durability: A review"*, Wood and fiber science, vol. 34(4), 25 pp.
- Tewari, M.C. (1978)** *"Data on Natural Durability of Timber Species (Installed in the Test Yard at New Forest, Dehra Dun) According to 1976 Inspection, Their Treatability and Seasoning Characteristics"*, IRG/WP/3127. International Research Group on Wood Preservation, Stockholm, Sweden.
- Torgovnikov, G. I. (1993)** *"Dielectric properties of wood and wood-based materials"*, Springer-Verlag. NewYork.
- USDA, ARS. (2011)** *"National Genetic Resources Program"*, Germplasm Resources Information Network - (GRIN) [Online Database]. National Germplasm Resources Laboratory, Beltsville, Maryland.URL: <http://www.ars-grin.gov/cgi-bin/npgs/html/taxon.pl?24607>
- Van Acker,J., Stevens, M., Van cauwenberghe, T. (1996)** *"Is laboratory testing of decay resistance questionable as a single criterion for natural durability?"*, The international research group on wood protection, Doc IRG/WP 96-20096.
- Van Acker,J., Stevens, M., Carey, J.(1998)** *"Criteria for basidiomycetes testing and ways of defining natural durability classes"*, The international research group on wood protection, Doc IRG/WP 98-20144, 18 pp.
- Venkataraman, K. (1972)** *"Wood phenolics in the chemotaxonomy of the moraceae"*, Phytochemistry, vol. 11, p.1571-1586.
- Von Hornbostel, E. M., Sachs, C. (1914)** *"Classification of musical instruments: An experiment"*, Zeitschrift fur Ethnologie, vol. 46, p. 553–590.
- Wang, X., Ross, R.J., Mattson, J.A., Erickson, J.R., Forsman, J.W., Geske, E.A., Wehr. M.A., (2001)** *"Several nondestructive evaluation techniques for assessing stiffness and MOE of small-diameter logs"*, Res. Paper FPL-RP-600. USDA Forest Serv., Forest Prod. Lab., Madison, WI. 12 pp.
- Wangaard, F.F. Granados, L.A., (1967)** *"The effect of extractives on water-vapor sorption by wood"*, Wood Sci Technol, vol. 1(3), p. 253-277.
- Wegst, U. G. K. (2006)** *"Wood for sound"*, American Journal of Botany, vol. 93(10), p. 1439-1448.



- Windeisen, E., Wegener, G. Lesnino, G., Schumacher, P. (2002)** "Investigation of the correlation between extractives content and natural durability in 20 cultivated larch trees", *European Journal of Wood and Wood Products*, vol. 60(5), p. 373-374.
- XP CEN/TS 15083-1 (2006)** "Durability of wood and wood based products. Determination of solid wood durability against wood destroying fungi Test methods. Part 1: Basidiomycetes".
- Yamamoto, H., Sassus, F., Ninomiya, M., Gril, J., (2001)** "A model of anisotropic swelling and shrinking process of wood. Part 2: A simulation of shrinking wood", *Wood Sci and Technol*, vol. 35, p. 167-181.
- Yano, H., (1994)** "The changes in the acoustic properties of Western Red Cedar due to methanol extraction", *Holzforschung*, vol. 48(6), p. 491-495.
- Yano, H., Kajita, H., Minato, K. (1994)** "Chemical treatment of wood for musical instruments", *Journal of the Acoustical Society of America*, vol. 96(6), p. 3380-3391.
- Yano, H., Kyou, K., Furuta, Y., Kajita, H. (1995)** "Acoustic properties of Brazilian Rosewood used for guitar back plate" (In Japanese, Abstract and figures in English), *Mokuzai Gakkaishi*, vol. 41(1), p. 17-24.
- Yano, H., Furuta, Y., Nakagawa, H. (1997)** "Materials for guitar back plate made from sustainable forest resources", *Journal of the Acoustical Society of America*, vol. 101(2), p.1112-1119.
- Yatsunami, K., Ichida, M, Onodera, S. (2008)** "The relationship between 1- deoxynojirimycin content and  $\alpha$ -glucosidase inhibitory activity in leaves of 276 mulberry cultivars (*Morus spp.*) in Kyoto. Japan", *J. Nat. Med*, vol. 62, p. 63-66.
- Yoshihara, H. (2011)** "Off-axis Young's modulus and off-axis shear modulus of wood measured by flexural vibration tests", *Holzforschung*, DOI: 10.1515/HF.2011.118.
- Yoshikawa, S. (2007)** "Acoustical classification of woods for string instruments", *The Journal of the Acoustical Society of America*, vol. 122, p. 568-573.
- Zamir, K. (2008)** "Feeding preferences of *Microcerotermes Championi* (Snyder) on different timbers dried at different temperature under choice and no choice trials", *Nature preceding*: hdl:10101/npre.2008-2048.1, 38 pp.
- Zhang, D. Q., Zhang, H. Y., Guo, L.L., Peng, K.(2011)** "Determination of Bioactive Components of Acetone Extractives of *Cinnamomum camphora* Root Wood by Py-GC/MS under 350°C", *Advanced Materials Research*, vol. 230 – 232, p. 837-841.
- Zheng, Z.P., Cheng, K.W., Zhu, Q., Wang, X.C., Lin, Z.X., Wang, M. (2010)** "Tyroinase inhibitory constituents from the roots of *Morus nigra*: Structure-activity relationship study", *J. Agric. Food Chem*, vol. 58, p. 5368-5373.

## Table of figures

Fig.0.1. Densités moyennes des trois lots utilisés dans cette étude, les données d'une étude précédente (Se Golpayegani 2007) sont aussi incluses. (a, b, c) les groupes significativement différentes (ANOVA à un facteur).....	16
Fig. 0.2. La relation entre $\tan\delta$ (le facteur d'amortissement par largeur de bande en demi puissance retirés de la vibration forcées) et $E'/\rho$ pour le bois natif (N°:207). Les données d'une étude précédente (Se Golpayegani 2007) ont également été incluses. La courbe standard a été ajoutée à partir de (Ono et Norimoto, 1983, 1984).....	17
Fig.0.3. les ratios d'anisotropies de $\tan\delta$ entre les trois axes d'orthotropie. N° : 14 pour chaque direction.....	18
Fig.0.4. Pertes de masse moyenne (moyenne de 12 échantillons exposés à chaque solvant), après l'extraction indépendante, successive (relative : par rapport la phase précédant) et cumulée (par rapport à la phase native) dans le bois solide.....	19
Fig.0.5. Changements relatifs (%) de $\tan\delta$ en fonction des pertes de masses (%) (a) indépendante (b) successive. Les symboles vides: les changements relatifs à l'état initial des échantillons natifs (indépendants et successives-cumulés) ; les symboles pleins : des changements relatifs à la phase précédente. Les flèches: l'ordre des extractions successives. Les valeurs de $\tan\delta$ des extractions indépendantes ont été corrigées pour les témoins.....	21
Fig.0.6. Variations des propriétés mécaniques après extractions mesurées par ADM à 10 Hz. Les valeurs pour les témoins n'ont pas été déduites de celles traitées.....	22
Fig.0.7. Variations relatives des pertes de masse (% PM) et $\tan\delta$ (%) pour quatre groupes d'échantillons soumis à différentes durées d'immersion dans l'eau. T (0) : Témoins, 1, 2, 3 et 4 : nombre de mois d'immersion. Les flèches indiquent la continuité dans le temps. ...	23
Fig.0.8. Pertes de masse (PM%) des échantillons soumis à des traitements à l'eau chaude (70 °C). N °: 5 pour chaque intervalle de temps: $5 \times 6 = 30$ au total. ....	24
Fig.0.9. Variation relative des pertes de masse (PM%) et $\tan\delta$ (%) pour six groupes d'échantillons soumis à des durées différentes du traitement dans l'eau (70°C). Les flèches sont indicatives de la continuité dans le temps. ....	24
Fig.0.10. $\tan\delta$ en relation avec $E'/\rho$ après 5 fois de séchage et stabilisation. La courbe de référence a été ajouté à partir de Ono et Norimoto (1983, 1984 ). ....	25
Fig.0.11. Comparaison entre les pertes la perte de masse des échantillons délavés et non délavés testés contre des champignons basidiomycètes. ....	26
Fig.2.1. Basic wood cell structure, showing the layers of the cell wall (Plomion et al. 2001). ....	40
Fig.2.2. Partial structure of cellulose and hemicelluloses (From online website of University of Maine, Orono, USA).....	41
Fig.2.3. Partial structure of lignin (From online website of University of Maine, Orono, USA) .....	42

Fig.2.4. Moisture content–relative humidity relationship for wood under adsorption and various desorption conditions (Wood Handbook 2010). .....	44
Fig.2.5. Three orthotropical directions in a timber (Wood Handbook 2010).....	46
Fig.2.6. Non-damped (up) and damped wave form (down) .....	48
Fig.2.7. Illustration of the loss factor ( $\tan\delta$ ) in the time domain via logarithmic decrement .....	50
Fig.2.8. Illustration of the loss factor ( $\tan\delta$ ) in the frequency domain via bandwidth at the half power (Q or quality factor). .....	51
Fig.2.9. Illustration transition zones for modulus and $\tan\delta$ in a constant moisture content (MC) and temperature conditions. ....	52
Fig.2.10. Changes in $\tan\delta_L$ in Sitka spruce in function of impregnation of simple phenolic. The crosses are indicators of specimens treated with Resorcinol (from Sakai et al. 1999). .....	55
Fig.2.11. White Mulberry’s tree (left), its fruit (right-up) and different shapes of its leaves (right- down). .....	57
Fig.2.12. Plan of white Mulberry’s distribution (natural and cultivated) in Asia, Europe and North America.....	58
Fig.2.13. Microscopic cross-section (left) and a separated vessel along with its paratracheal parenchyma of white Mulberry from Iran. Courtesy of the photos: Dr. Kambiz Pourtahmasi.....	59
Fig.2.14. Open chemical structure of the representative compounds of the main categories found in the wood extractives of <i>Moraceae</i> family. ....	63
Fig.2.15. Material property chart for wood used for different vibratory parts of musical instrument (Wegst 2004 in Wegst 2006). The x-axis is specific gravity ( $\rho$ ), y-axis is $c$ (1000 m/s). Specimens belonging to soundboards are marked in an orange oval. ....	67
Fig.2.16. Iranian lutes <i>Setar</i> (left) and <i>Tar</i> (middle) beside Japanese lute <i>Biwa</i> (right)....	68
Fig.3.1. Schematic of cutting wood bars from original log in Iran.....	73
Fig.3.2. distributions of three dimensions measured in 180 specimens.....	74
Fig.3.3. Detailed cutting plan for vibrational specimens .....	75
Fig.3.4. Cutting plan of specimens for DMA from a perfectly oriented bar .....	75
Fig.3.5. Requirements of standards for specimens cutting and annual ring angle for biological tests. ....	76
Fig.3.6: Residual MC (%) (Between MC after 48 hrs in 60°C and MC obtained after 48hrs in 103°C) against anhydrous specific gravity and stabilized EMC (air dried %). ...	77
Fig.3.7. Relative MC variation during the free-free flexural test in LMGC in relation with the duration of each measurement -3 repetitions for each specimen- (Nb: 180). ....	79
Fig.3.8. Specifying the test specimens coming from each batch. First and second batch are only different by their air drying duration. ....	80
Fig.3.9. Balances used in this study: (a): Mettler balance (CIRAD and LMGC) and (b): Sartorius balance (CIRAD). .....	82
Fig.3.10. Devices for measuring dimensions: (a): Digital comparator stand and (b): Vernier scale. ....	84
Fig.3.11. Schematic plan of the vibration test in LMGC.....	89

Fig.3.12. the visualization of detected resonance frequency which would result in calculating Q-1 based on bandwidth of half power. In second photo the red window shows the place for changing the setting of parameters.....	89
Fig.3.13. Visualization of a regular signal (left) and selection of a major part with a strong $R^2$ (right, down and up respectively) which eventually results in $\tan\delta$ from logarithmic decrement.....	90
Fig.3.14. Distribution of obtained values for $\tan\delta$ of 30 repetitions on one clear specimen using LMGC method .....	91
Fig.3.15. Schematic description of BING® method.....	93
Fig.3.16. Distribution of obtained values for $\tan\delta$ by 30 repetitions on one clear specimen using BING method .....	94
Fig.3.17. Relationship between specific modulus ( $E'/\rho$ ) (a) and $\tan\delta$ (b) obtained by forced and free vibration. The error bars in 1b are calculated based on three repetitions of measurements done on the same specimen. Nb: 80.....	96
Fig.3.18. Relationship between specific modulus ( $E'/\rho$ ) (a) and $\tan\delta$ (b) obtained by forced and free vibration. The error bars in 2b are calculated based on three repetitions of measurements done on the same specimen. Nb: 62. (both values are collected from running the tests in same range of frequency-i.e. 360 Hz in average).....	97
Fig.3.19. DMA machine (A ) and a close look to the fixation of the specimen between the clamps (B).....	100
Fig.3.20. The equipments for rinsing the specimens .....	105
Fig.4.1. Average specific gravity of specimens of the 3 batches used in this study, Data from a previous study (Se Golpayegani 2007) are also included. (a, b, c): significantly different groups based on one-way ANOVA.....	112
Fig.4.2. the relationship between $\tan\delta$ (damping factor by bandwidth from forced vibration/LMGC method) and $E'/\rho$ for native wood (N°:207), data from previous study (Se Golpayegani 2007) is also included. Standard curve is added from (Ono and Norimoto 1983, 1984).....	113
Fig.4.3. relationship between $\tan\delta$ by logarithmic decrement (a) and $\tan\delta$ by BING (b) method and their corresponding $E'/\rho$ , note that BING test was not done for all the specimens and thus, the number of specimens is lower (N°: 143). .....	114
Fig.4.4. Relationship between logarithm of ratio of $\tan\delta/E'/\rho$ and logarithm of $E'/\rho$ for ensemble the specimens (N°= 207). The curve in red is added from Ono and Norimoto (1984).....	114
Fig.4.5. $E''/\rho$ (Specific loss modulus) and $E'/\rho$ (specific modulus) relationship for all the specimens, different batches are separated by colors and shapes.....	115
Fig.4.6. Modulus (E') and stabilized specific gravity ( $\rho$ ) for 3 batches of this study, specimens from previous study are also included.....	116
Fig.4.7. Relationship between specific modulus ( $E'/\rho$ ) and pstab (stabilized specific gravity measured after 3 weeks at $20^\circ\text{C}\pm 2$ and $65\% \text{ HR}\pm 5$ ) for all the specimens (N°: 207). .....	116
Fig.4.8. Stabilized moisture content (MCstab) and specific modulus ( $E'/\rho$ ) relation for all the specimens (N°:207). MC (at $60^\circ\text{C}$ ) is not corrected for the residual MC (at $103^\circ\text{C}$ )	

and (b) MC (at 60°C) is corrected for the residual MC (103°C). The black circle is focusing on abnormal data. .... 118

Fig.4.9. MC<sub>stab</sub> and tanδ relationship for specimens in their native state (batches separated). MC (60°C) is corrected for the residual MC (103°C). .... 119

Fig.4.10. MC<sub>stab</sub> and tanδ relationship; MC<sub>stab</sub> is corrected for the contribution of the extractives. .... 120

Fig.4.11. Volumetric swelling (S<sub>v0l</sub>) and stabilized specific gravity (ρ<sub>stab</sub>) for all the specimens measured in three batches. .... 120

Fig.4.12. Volumetric swelling coefficient ( $\alpha_{v0l} = S_{v0l}/MC \text{ \%}/\%$ ) and ρ<sub>stab</sub> relationship for three batches. .... 121

Fig.4.13. Longitudinal tanδ and specific modulus obtained by LMGC vibration method and DMA. For DMA, each point is the average of 14 longitudinally oriented specimens tested 3 times. For vibration, each point represents the average of 27 specimens tested three times. All specimens came from batch 3. .... 123

Fig.4.14. Changes in tanδ<sub>R</sub> and tanδ<sub>T</sub> in function of the frequency. Results of DMA method for 14 samples. .... 125

Fig.4.15. anisotropic ratios for E' (storage modulus (up)) and tanδ (down) between three axes of orthotropy, N°: 14 L, R and T samples (42 in total). .... 126

Fig.5.1. General protocol for hygro- thermal treatments ..... 131

Fig.5.2. Oven dried weight loss (%) for specimens submitted to different months of water immersion. N°: 12 for each time interval. The values in each case are calculated based on the initial dry weight of each group of specimens submitted to that particular month. .... 134

Fig.5.3. Scheme of water reaching in the cell wall structure. .... 135

Fig.5.4. Variations in corrected moisture content (ΔMC (%)-Corrected for the contribution of extractives) and oven- dry volume change (ΔV<sub>0</sub> -60° (%)) for four groups of specimens submitted to different durations of immersion in water. C (0): controls, 1, 2, 3 and 4: number of immersion months. The arrows are indicative of the time continuity. The values in each case are calculated based on the initial dry weight of each group of specimens submitted to that particular month. Presented values of controls are those of one cycle of drying and stabilization (see the explanation below). .... 135

Fig.5.5. Relative variation in weight losses (WL %) and tanδ (%) for four groups of specimens submitted to different months of immersion in water. C (0): controls, 1, 2, 3 and 4: number of immersion months. The arrows are indicative of the time continuity. The values in each case are calculated based on the initial dry weight of each group of specimens submitted to that particular month. .... 136

Fig.5.6 Specimens submitted to two months water immersion (left) and the magnified view of one specimen with cracks—marked with black ovals- appeared after the treatment (right). Note that the specimens of two months were scanned as an example and same defects were observed in the specimens submitted to all four months. .... 137

Fig.5.7. Variations in tanδ in relation with different time of water immersion where in (a): controls are presented separately and (b): values of controls were subtracted from tanδ of different months. .... 138

Fig.5.8. Variations in ΔE'/ρ and Δρ for four groups of specimens submitted to different months of immersion in water. Indicators are as in before. .... 138

Fig.5.9 Changes in oven- dried volume ( $\Delta V_0$ %) for long- time water treatment specimens, after perfect drying (103°C) and one month in 27°C and 75% RH.N°:12 each×5=60 total.....	140
Fig.5.10. Oven dried weight loss (WL %) for specimens submitted to different hours of 70°C water. N°: 5 for each time gap: 5×6 =30. ....	142
Fig.5.11. Variations in corrected moisture content ( $\Delta MC$ (%)-Corrected for the contribution of extractives) and oven- dry volume change ( $\Delta V_0$ -60° (%)) for six groups of specimens submitted to different hours of 70°C water treatment. 2-12: hours of treatments.....	143
Fig.5.12. Relative variation in weight losses (WL %) and $\tan\delta$ (%) for six groups of specimens submitted to different hours of 70°C water. The arrows are indicative of the time continuity. The other indicators are as in before.....	144
Fig.5.13. variations in $E'/\rho$ after different hours of 70°C water treatment as measured by two acoustical methods. Arrows are indicative of time continuity.....	145
Fig.5.14. Variations in $E'/\rho$ , $\tan\delta$ and MC in relation to different hours of 70°C water treatment, values of $E'/\rho$ are from free vibration (Bing) method.....	146
Fig.5.15. Changes in oven- dried volume ( $\Delta V_0$ %) for short time hot water (70°C) treatment specimens, after complete drying and one month in 27°C and 75% RH. N°:5each×6=30 plus 12 controls.....	147
Fig.5.16. $\tan\delta$ and $E'/\rho$ relationship for specimens submitted to cyclic drying and stabilization. N°:15. Two specimens considered statistically as outliers are excluded. ....	149
Fig.5.17. $\tan\delta$ and $E'/\rho$ relationship after 5 times of drying and stabilization. Reference curve is added from Ono and Norimoto 1983, 1984). ....	150
Fig.6.1. Soxhlet system of powder extraction: The color change by methanol can be seen in the picture on the right. ....	154
Fig.6.2 the assembly of rotavapor for solvent evaporation.....	155
Fig.6.3. General extraction protocols for solid specimens.....	157
Fig.6.4. Comparison of weight loss (WL %) and extractive contents (EC %) of powder specimens using an independent method (a) and successive method of extractions (b), N: 6 each for independent: 6×5: 30 and 6 for successive. ....	164
Fig.6.5.Weight loss (WL %) due to extraction on shrinkage (filled symbols) and vibrational (empty symbols) specimens, as a function of powder WL.....	165
Fig.6.6. Weight loss (WL %) for (a) powder, (b) shrinkage and (c) vibrational specimens. “Successive” weight losses are relative to the previous step, “independent” and “successive-cumulated” are relative to native oven-dry weight. H: Hexane, D: Dichloromethane, AC: Acetone, ME: Methanol and HW: Hot water.....	166
Fig.6.7. Variations in oven dry volume ( $\Delta V_0$ %) and weight loss (WL %) after independent extractions in vibrational specimens. (a) uncorrected, (b) corrected for control. ....	168
Fig.6.8.Variation in ovendry surface ( $\Delta S_0$ %) and weight loss (WL%) after independent extraction in vibrational specimens. Data is corrected for the corresponding controls. ..	168
Fig.6.9. Variations in oven dry volume ( $\Delta V_0$ %) and weight loss (WL %) after independent (a) and successive (b) extractions in shrinkage specimens. Open marks are	

changes relative to native state (Independent and cumulated-successive), filled marks are relative to previous phase (successive).....	169
Fig.6.10. Variation in oven dry surface ( $\Delta S_0\%$ ) and weight loss (WL%) after independent extraction in shrinkage specimens. ....	170
Fig.6.11. Variations in oven dry $\Delta S_0$ (%) – based on 103°C drying- and weight loss (WL%) for shrinkage specimens submitted to independent extractions. value for H is that of 60°C drying.....	170
Fig.6.12. EMC relative variations due to extractions. “Successive” variations are relative to the previous step, “independent” and “successive-cumulated” are relative to native oven-dry weight. The values of EMC are corrected for the contributions of extractives (for more details look further to this part). ....	172
Fig.6.13. EMC Variations (%) in relation with WL (%) for specimens submitted to independent extractions (a, b) and successive extractions(c, d). $\Delta EMC$ is corrected for the contribution of extractives in the figures on the right. The values in all cases are calculated in relation to native state (independent and cumulated successive). ....	173
Fig.6.14. Weight loss (WL %) and cumulated change in $E'/\rho$ (relative to native state) for successively extracted specimens. in (a) $E'/\rho$ is not corrected for contribution of extractive while in (b) the values are the corrected ones (Nb:12). ....	174
Fig.6.15. Weight loss (WL %) and cumulated change in $E'$ (relative to native state) for successively extracted specimens (Nb:12).....	175
Fig.6.16. Weight loss (WL %) and relative change in $E'/\rho$ (to native state) for independently extracted specimens (N°:53). ....	175
Fig.6.17. Relative changes (%) in $\tan\delta$ plotted against weight loss (%) for (a) independent and (b) successive extractions. Open marks: changes relative to initial state of native specimens (independent and successive-cumulated), filled marks: changes relative to the previous phase. Arrows: order of successive extractions. Values of $\tan\delta$ in independent extractions are corrected for controls.....	176
Fig.6.18. Weight loss in 3 axes of orthotropy (L: Longitudinal, R: Radial, T: Tangential) for Controls: C (Nb: 4 in each direction), Methanol extracted ME (Nb: five in each direction) and hot water extracted HW (Nb: five in each direction) specimens.....	178
Fig.6.19. Variations in mechanical properties after extractions measured by DMA at 10 Hz. Values for controls were not deduced from treated ones.....	181
Fig.6.20. Variations in volume ( $\Delta V\%$ ) for shrinkage specimens after second time of quasi anhydrous drying with one year gap, complete drying (103°C), and one month in 27°C and 75% RH. C: Controls/no-chemical treatment, D: Dichloromethane, AC: Aceton, ME: Methanol, HW: Hot water, CO: Complete extraction/specimens submitted to successive extraction after last treatment (HW). N° : 18 in each group of treatment. ....	183
Fig.6.21. Variations in volume ( $\Delta V\%$ ) for vibrational specimens after 103°C drying, and one month in 27°C and 75% RH.N°:12 for each treatment, except for HW : 5specimens for this treatment. ....	184
Fig.7.1. Specimens of white Mulberry in their test flasks, (a, b): Leached white Mulberry (left) beside its controls (right) attacked by <i>Coriohus versicolor</i> , (c):Un-leached white Mulberry (right) and controls (left) attacked by <i>Pycnoporus sanguineus</i> and (d): Controls (Scot pine) completely covered by <i>Gloeophyllum trabeum</i> . ....	192

Fig.7.2. Comparison between mass loss of leached and un-leached specimens tested against basidiomycete. The dashed lines show the durability classifications based on XP CEN/TS 15083-1. .... 194

Fig.7.3. brief description of termites' reaction test against extracted powders and their corresponding removed extracts ..... 198

Fig.7.4. The survival rate of the termites in relation with powders extracted with different solvents. NE: Not extracted, H: Hexane, D: Dichloromethane, AC: Acetone, ME: Methanol, HW: Hot water, SAND: diet control, C: control (Scot pine) ..... 199

Fig.7.5. The survival rate of the termites in relation with extractives removed by different solvents, Indicators are as in Fig.7.4. .... 199

Fig.7.6. Relationship between survival rate of termites (%) and powder weight losses (WL %) (a), and extractive content (EC %) (b). H: Hexane, D: Dichloromethane, AC: Acetone, ME: Methanol and HW: Hot water. .... 200

Fig.8.1. Open chemical structure of the most important compounds identified in crude extractives of white Mulberry, several types of higher hydrocarbons are only presented by the lightest (C<sub>11</sub>H<sub>28</sub>/Undecane) and the heaviest (C<sub>33</sub>H<sub>66</sub>/Tritriacontane) ones. .... 208

Fig.8.2. Mass spectrum of the **Hexane**-extracted compounds (**Crude extracts**). Nd: compound detected but could not be identified with certainty. .... 211

Fig.8.3. Mass spectrum of the **Dichloromethane**-extracted compounds (**Crude extracts**). .... 212

Fig.8.4. Mass spectrum of the **Acetone**-extracted compounds (**Crude extracts**). .... 213

Fig.8.5. Mass spectrum of the **Methanol**-extracted compounds (**Crude extracts**). .... 213

Fig.8.6. Mass spectrum of **Hot Water**-extracted compounds (**Crude extracts**). .... 214

Fig.8.7. Comparison between the mass spectrum of dichloromethane- extracted (D) compounds and those cumulated after hexane/dichloromethane successive extractions (D+H). The crosses indicate the pick disappearance, the ticks are marking the picks that were still present after successive use of two solvents. .... 216

Fig.8.8. Comparison between the mass spectrum of Acetone- extracted (AC) compounds and those cumulated after hexane/dichloromethane/acetone successive extractions (AC+D+H).New picks: are those that did not appear in the spectrum of independently used solvent. nd = non determined ..... 217

Fig.8.9. Comparison between the mass spectrum of Methanol- extracted (ME) compounds and those cumulated after hexane/dichloromethane/acetone / methanol successive extractions (ME+AC+D+H). .... 218

Fig.8.10. Mass spectra of cumulated extracts after four successive extractions, H: Hexane, H+D: successive extraction by dichloromethane, H+D+AC: successive extraction by acetone, H+D+AC+ME: successive extraction by methanol. Mass spectrum of the cumulated extracts after successive hot water extraction was not available. .... 219

Fig.8.11. Mass spectrum of the **Hexane**-extracted (**BSTFA Derived/H<sub>D</sub>**) compounds. . 223

Fig.8.12. Mass spectrum of the **Dichloromethane**-extracted (**BSTFA Derived/D<sub>D</sub>**) compounds. .... 224

Fig.8.13. Mass spectrum of the **Acetone**-extracted (**BSTFA Derived/AC<sub>D</sub>**) compounds. .... 225



Fig.8.14. Mass spectrum of the <b>Methanol</b> -extracted ( <b>BSTFA Derived/ME<sub>D</sub></b> ) compounds. ....	225
Fig.8.15. Mass spectrum of the <b>Hot water</b> -extracted ( <b>BSTFA Derived/HW<sub>D</sub></b> ) compounds. ....	226
Fig.8.16. Open chemical structure of the most important compounds identified in <b>derived</b> extractives of white Mulberry .....	227
Fig.8.17. Mass spectra of cumulated <b>derived</b> -extracts after five successive extractions. H <sub>D</sub> : derived hexane extracts, (H+D) <sub>D</sub> : derived extracts after successive extraction by dichloromethane, (H+D+AC) <sub>D</sub> : derived extracts after successive extraction by acetone, (H+D+AC+ME) <sub>D</sub> : derived extracts after successive extraction by methanol and (H+D+AC+ME+HW) <sub>D</sub> : derived extracts after successive extraction by hot water .....	228
Fig.A.1. Arched harps on Iranian seal impressions from the third millennium B.C.E (From Encyclopedia Iranica). ....	265
Fig.A.2. <i>Barbat</i> , the first form of lute originated in Iran. ....	266
Fig.A.3. Two identical halves of white Mulberry's wood prepared for <i>Târ</i> fabrication (Yousef Pouria's interview. Jadidonline magazine, 16 November 2007). ....	268
Fig.A.4. Fixing the pattern to the wood block (Mr. Pouria's interview. Jadidonline magazine, 16 November 2007). ....	268
Fig.A.5. Outer and inner parts carved into wood block. Photos from Mr.Zareh's atelier. ....	269
Fig.A.6. Attaching two completely carved halves together to form the final shape (Mr. Pouria's interview. Jadidonline magazine, 16 November 2007). ....	270
Fig.A.7. Half of a semi- carved bowl part, neck and pegs. Photo from Mr.Zareh's atelier. ....	270
Fig.A.8. Lambskin unattached (Left- From Mr.Zareh's atelier) and glued on the upper bowl (Right- Mr. Pouria's Interview). ....	271
Fig.A.9. A complete <i>Târ</i> made by Mr. Zareh. Photo from Mr.Zareh's atelier.....	271
Fig.C.1. Comparison of relative oven –dried (60°C) weight losses (WL%) for both series submitted to successive extractions. ....	277
Fig .C.2.Variation in relative MC in two series submitted to successive extractions. Raw values of MC were corrected both for contribution of the extractives and the residual MC for drying at 103°C. ....	278
Fig.C.3. Relative variations in volume ( $\Delta V_0\%$ ) (based on oven dried weight-60°C /48 hrs-before and after each extraction) for two series submitted to successive extractions.....	279
Fig.C.4. Variations in specific modulus $E'/\rho$ (%) for both sets submitted to successive extractions. The values of moduli are corrected for the contribution of extractives. Relative values are calculated based on the previous phase. ....	280
Fig.C.5. relationship between native $\tan\delta$ and $E'/\rho$ (GPa) for both series when mixed (a) and when separated (b). Standard trend (black curve) was added from Ono and Norimoto (1983, 1984). ....	281
Fig.C.6. Relative changes in $\tan\delta$ and weight loss (WL %) in specimens of first series (Batch 1) (a) and second series (Batch 2) (b) submitted to successive extractions. $\tan\delta$ of the first series (a) were not corrected for the controls. ....	282

## *Table of figures*

---

- Fig.C.7. Relative changes in  $\tan\delta$  and weight loss (WL %) for specimens submitted to independent extractions. Values of  $\tan\delta$  were corrected for the corresponding controls. IN suffixes are indicating the independent use of a particular solvent on a specimen. ....283
- Fig.C.8. Cumulated changes in  $\tan\delta$  and weight losses (WL %) based on the first native state of the specimens for specimens of first (a) and second series (b). Each colored curve represents one specimen, each point represents one solvent/extraction. ....284

## Table of tables

Tableau 0.1. Les champignons et les conditions des tests contre les basidiomycètes .....	26
Tableau 0.2. Résistance des échantillons de <i>Morus alba</i> contre les termites.....	27
Tableau 0.3. Classement des composés identifiés dans les extraits du mûrier blanc. ....	28
Table 2.1. basic physical and mechanical properties of some construction materials (From: SP guide to composites, Lines (2002)). .....	38
Table 2.2. Physico- mechanical properties of white Mulberry <sup>a</sup> .....	59
a. (Limaye 1957, Banks et al. 1977, Little 1980) .....	59
Table 2.3. Heartwood extractives of <i>Morus alba</i> and <i>Morus rubra</i> (Row and Conner 1979). .....	60
Table 2.4. Identified compounds in the benzen/ethanol extracts of white Mulberry wood from Iran (Se Golpayegani 2007). .....	61
Table 2.5. Vibrational properties measured for Iranian white Mulberry of two sites (Data from Pourtahmasi and Se Golpayegani 2008) .....	69
Table 3.1. Specifications on the location and conditions of the humidity sensible tests/measurements. ....	78
Table 3.2. Characteristics and specifications of the balances and mass measurements. ....	82
Table 3.3. characteristics and specifications of the devices used for dimensional measurements.....	83
Table 4.1. Raw values for physical and vibrational properties of vibrational specimens. ....	109
Table 4.2. the correlations between the physical and vibrational properties (Native state/all batches), indicators are as in Table 4.1. *: significant at $\alpha$ : 0.05, **: significant at $\alpha$ : 0.01. ....	110
Table 4.3. The correlations between the physical and vibrational properties (Native state/ Batch 1).....	110
Table 4.4. Analysis of variance between the mean values of different physical and vibrational factors obtained from three batches. * significant at $\alpha$ : 0.01.....	111
Table 4.5. Raw values for factors measured by DMA. $E^*$ : complex modulus, $E'$ : Storage modulus, $E''$ : Loss modulus. All values are those of 10 Hz frequency. $N^\circ$ : 14 in each direction of orthotropy. ....	125
Table 5.1. variation in some representative values due to water immersion. ....	133
Table 5.2. Variation of properties due to hot water treatment. ....	141
Table 5.3. Recorded values for EMC (%), specific gravity $\rho$ , specific modulus $E'/\rho$ (GPa) and $\tan\delta$ (%) for specimens submitted to 5 times of drying and stabilization .....	148
Table 6.1. Properties for groups submitted to independent extractions.....	162
Table 6.2. Measured values for the group of specimens submitted to successive extraction. ....	163
Table 7.1. Fungi descriptions and conditioning situations for tests against Basidiomycetes .....	189

## Table of tables

---

Table 7.2. Resistance of un-leached and leached white Mulberry specimens against Basidiomycete attack.....	193
Table 7.3. Results of X factor for un -leached and leached specimens according to EN 350-1 .....	194
Table 7.4. Resistance of white Mulberry specimens towards termites.....	196
Table 8.1. List of the compounds found in the <b>crude extracts</b> removed by each solvent. Cas N°: Chemical abstract service registry number, MW: molecular weight (g/mol), RT: retention time (min) .....	209
Table 8.2. The weight loss (WL%) and extractive contents (EC%) after performing independent extractions by different solvents on powder samples.....	214
Table 8.3. List of the compounds found in the <b>derived extracts</b> removed by each solvent. Cas N°: Chemical abstract service registry number, MW: molecular weight (g/mol), RT: retention time (min) .....	221
Table 8.3. Continued.....	222
Table 8.4. Complete list of the identified compounds in extractives of white Mulberry.....	230
Table B.1: Solvents' characteristics.* .....	274
Table D.1. Classification according to XP CEN/TS 15083-1 M.L: Mass loss (%) of the fungi- attacked specimens.....	286
Table D.2. Classification according to EN350-1. X factor is calculated according to the mass losses of the fungi-attacked specimens and that of the controls (§7-1-1. d).....	286

## Annex A.

### Iranian lutes: an intro to *Târ*

---

#### **A-1- Music history in Iran until the appearance of lutes**

The history of music in Iran (or Persia as it was called between 6<sup>th</sup> century up to 1935) is not very well documented before the time of Sassanid dynasty (224-651). Archeological reports have revealed for instrumental music to be in use around Elamite era (around 800 B.C.E), but the details are unknown. However, in ancient documents, there are references to music being played at special occasions (e.g. during the preparation for war or feasts (Lawergren 2009)). There are also the bas-reliefs, which shows musicians playing harps and tambourine. It is possible that there was not a lot of difference between Babylonian-Assyrian music and Iran at that time<sup>1</sup>.

Music played an important role in the courts of Sassanid kings in the much later Sassanid Empire. Of this period, the names of various court musicians (*Barbad*) and the types of various instruments that were used (harps, lutes, flutes, bagpipes) are known.

Most commonly, the history of Iranian music have been categorized to two basic eras: i. Pre-Islam music and ii. Post-Islam music

The pre Islam music was classified to four main parts, each having their individual instrumental marks:

- Third millennium B.C.E. : from which time archeological evidences from arched harps and bull lyres ( in western Iran) and Oxus trumpets ( in eastern Iran) have been found.
- Second millennium B.C.E. : Early angular harps from that era has been found in archeological sites of Elam. Furthermore, this time is known as the birth of lutes in western Iran (Lawergren 2009).
- First millennium B.C.E.: several harps found in Elam (650 – 224 B.C.E) have marked the musical richness of this era.
- First millennium C.E.: this period is mostly defined by Sassanid music and instruments.

Arched harps in western Iran were the first complex instruments to appear in archeological reports (Fig.A.1). Iran was their apparent birthplace (3300-3100 B.C.E.), although Mesopotamia was not far behind (3000 B.C.E.). Since the dates are close and the representations are few, it is not possible to determine the region of origin.

Lutes rose in the second millennium B.C.E (2300 B.C.E.), a millennium after the first harps. Lutes exploit a different acoustic principal than harps. In the latter, one string gives one pitch so that many strings are required for a range of pitches. However, in a lute,

---

<sup>1</sup>.It is rather difficult to talk about Iran's ancient music exclusively, as the border at the time exceeded to several other (now independent) countries. Nevertheless, Iranian languages and culture spread to the much wider regions, comprising parts of Transcaucasia, Central Asia, northwest India, Mesopotamia, as well as Afghanistan (Lawergren 2009).

many pitches are produced on a single string, and thus fewer strings are needed. The lute offered a more economical tone production, which quickly led to its dominance.

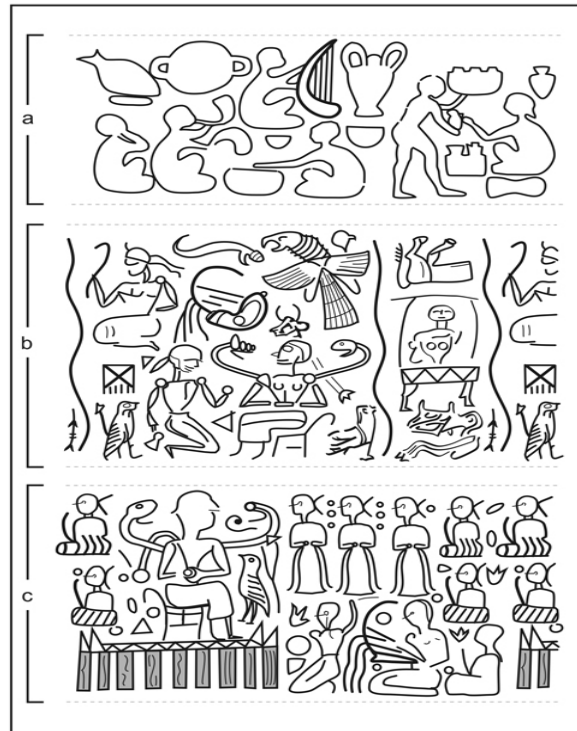

Fig.A.1. Arched harps on Iranian seal impressions from the third millennium B.C.E (From Encyclopedia Iranica).

Another millennium later, lutes had become the dominant string instruments in Iran. Their body was 15 to 25 cm long, while their neck was twice as long as their short body. For the first two millennia, all lutes were long-necked. Lutes grew in size during the second millennium B.C.E., though those from the first half were shorter than those from the second half. On Iranian bronze beakers from the 10th to 9th centuries B.C.E., lutes were approx. 140 cm long. Short-necked lutes emerged between 100 B.C.E. and 100 C.E., and the length of their neck was less than half of that of their bodies.

During the first millennium C.E., the popularity of lutes grew dramatically, and resulted in a large diversity of types. They spread through much the Islamic world, in particular Egypt, Iraq, and Iran.

On Sassanid terracotta, lute players are often nude women and grotesque men. These figurines seem closer to folk art than to the royal art of Assyria and the Hellenistic ivory drinking horn of Parthia, on which very few lutes are depicted. Although lutes are not shown on elite artifacts during the first millennium B.C.E., they likely remained folk instruments, and migrated from Iran into western Central Asia. During the first millennium C.E., lutes probably spread from this vast Central Asian reservoir into eastern and southern Asia (Lawergren 1994, 1997). For more information about both music history and instruments in Iran, see: (Khaleqi 1954, Farhat 1978, 1980, 2004, Caron and Safvat 1966, Zonis 1965, 1973, During et al. 1990, Movahed 1993, Lawergren 2009).

## A-2- Lutes

The term “*lute*” in general refers to any plucked instrument with a neck (either fretted or unfretted) and a deep round back. The European *lute* and the modern Near-Eastern *oud* both descend from a common ancestor via diverging evolutionary paths. The lute is used in a great variety of instrumental music from the Medieval to the late Baroque eras and was probably the most important instrument for secular music in the Renaissance.

The word lute (and *oud*) comes from the Arabic word “*Al’oud*” which literally means wood. However, recent reaches have proposed the possibility for the word “*oud*” to be the arabized version of the Persian word “*rud*” which means string (Neubauer 1993).

The origins of lutes are obscure, and organologists disagree on the very definition of lute. Some agree that both long and short-necked lutes belong to the family of chordophones (Sachs 2006), however, as long-necked lutes existed a millennium before the appearance of short-necked ones, some proposed that the former should not be included in the lutes (Smith 2002). The name “lute” has never been used until the 20<sup>th</sup> century for calling these types of instruments.

In ancient Iran, *Barbat* had the first form of lute (Fig. A.2). Then, during centuries, other kinds of lutes (e.g. *Târ*, *Dotâr*, *Setâr*, and *Kamancheh*) have been developed and became popular in the region. Iranian lutes have also been transported and naturalized to other countries in which the Iranian culture was influential. Examples from those could be found in forms of similar lutes in India, Afghanistan, Armenia, Iraq or Georgia.



Fig.A.2. *Barbat*, the first form of lute originated in Iran.

The two main Iranian instruments are *Setâr* and *Târ*, related to each other in tuning and both used for classical Iranian music. *Barbat* is nowadays hardly played in Iran. Azerbaijan’s *Saz* (also called *Qopuz*, or *Chogur*) and the Azeri *Târ*<sup>1</sup> could be found in the north of Iran. In the southeast (Baluchistan), the *Tanburag* (mostly played in Pakistan) and *Benju* (Popular to India) are played. In several areas, *Dotâr* (in different types) is in use.

### A-2-1- *Târ*

*Târ* (Literally means string in Farsi), a long-necked two-bowled lute, is one of the most widely played instruments in Iran. It was adopted by other cultures and countries like Azerbaijan, Armenia, Georgia and other areas near the Caucasus region. This is partly due to the structure of *Târ* which make it possible for different modes to be played.

---

<sup>1</sup>The "Azeri *Târ*" or "Caucasus *Târ*" or "11 string *Târ*" is slightly different from the Iranian *Târ* in its shape and was developed from the Iranian *Târ* around 1870. The Azeri *Târ* has one extra bass-string on the side, on a raised nut, and usually 2 double resonance strings via small metal nuts halfway the neck.

*Târ* appeared in its present form in the middle of the eighteenth century in Iran. The body is a double-bowled shape carved from Mulberrywood, with a thin membrane of stretched lambskin covering the top.

The fingerboard has twenty-five to twenty-eight adjustable gut frets, and there are three double courses of strings (6 in total). Its range is about two and one-half octaves, and is played with a small brass plectrum (Often held in a box of wax). The long and narrow neck has a flat fingerboard running level to the membrane and ends in an elaborate peg box with six wooden tuning pegs of different dimensions.

➤ ***Yahya's pattern***

Like other traditional musical instruments, *Târ*, was always been fabricated according to each artisans' taste, design and experience. As a result, until 100 years ago there was no unique pattern between *Târs* fabricated by various artisans. Furthermore, instruments fabricated by one artisan were rarely the same. *Hovanes Abkarian* (Known professionally as *Yahya*) (1875-1931), was the first person who intended to form a similar pattern for all his instruments. He developed the design of *Târ* to its modern shape, by making the walls thinner and the bowls to be more angular (Khaleqi 1954). He made *Târs* in three sizes (small, medium and large). Application of these various patterns was dependent on the diameter of the available Mulberry's tree, as well as the demand of the player. Nowadays only 150 instruments fabricated by him have remained and are mostly treated as national treasures. Those instruments (aged over 80 years old) are known to produce superior sounds. Among artisans, it has been said that the high sound quality yielded from his instruments could partly be due to the long careful preparation of the Mulberry's wood (which sometime took more than 4 years). His pattern (that of the large size *Târ*) is the most widely used one within current *Târ* makers.

### **A-2-2- *Târ* fabrication process**

Following, a step-by-step manual<sup>1</sup> for making *Târ* is presented. However, it should be kept in mind that there is no "standardize" fabrication way. Each Instrument maker has his own rituals, pretreatments and tools. Even though recently the majority of *Târ* makers use the same pattern (i.e. *Yahya's* pattern), but in the end, instruments made by different artisans do not sound the same. This is the reason why some specific artisanal instruments are more in demand.

➤ **Picking wood for fabrication**

Wood is being chosen based on its aesthetic feature and its ability for making a sound of best quality. While from artisan's point of view, Mulberry's aesthetic feature is related to the color and homogeneity of the growth rings, a fine sound quality is attributed to a wood with medium density (with not so narrow growth rings).

If a living tree is chosen to be cut later, its circumference should be at least 180cm. For a timber that has already been cut, the minimum diameter allowed is 60cm.

---

<sup>1</sup>The manual presented here is extracted from an interview done by the author with Mr. Zareh (the main professional *Târ* maker consulted for this study) in 2008. Therefore, all the details are from his personal process of fabrication unless stated otherwise.



➤ **First in-situ cutting**

Timber is axially cut to a 50cm piece, and then a second cut into the middle of the piece is performed. Two final pieces should be exactly the same regarding their dimensions and their aesthetic features, as they are going to form two halves of one instrument (the bowl parts) (Fig.A.3).



Fig.A.3. Two identical halves of white Mulberry's wood prepared for *Târ* fabrication (Yousef Pouria's interview. Jadidonline magazine, 16 November 2007).

The core part is carved in ( $\approx 5\text{cm}$ ) as it is known to cause cracks as the fabrication process progresses. Eventually two cubes of following dimensions are prepared:  $50 \times 14 \times 25$  (LRT)<sup>1</sup>



Fig.A.4. Fixing the pattern to the wood block (Mr. Pouria's interview. Jadidonline magazine, 16 November 2007).

➤ **Second cuts**

For the second cuts, two different patterns are used: one wet pattern, which is larger in size and a dry pattern, which is smaller and used later on in the fabrication, once the drying is done.

Using the wet pattern, two halves are trimmed to the approximate outer shape of the instrument (Fig.A.4). Two halves are glued together (a temporary glue), and the outer line is carved to form a semi-complete design. Approximate lines of the inner part is also carved (Fig.A.5).

---

<sup>1</sup>The orthotropical directions are approximate (especially for R and T). An artisanal cut could be in the middle point of each direction.



Fig.A.5. Outer and inner parts carved into wood block. Photos from Mr.Zareh's atelier.

➤ **Pretreatments**

This phase is completely different between artisans. Some examples of the more common pre-fabrication treatments are as below:

Immersing the wood in the water at ambient temperature. Before, as the ateliers were outside the city and close to a river, the wood would be put inside the river for several months. *Yahya* is known to put the wood of his instruments up to one year in a river near his atelier. In the modern time, wood is put inside the containers full of water, up to six months, while the water is changed each week.

Treating the wood in the hot water up to 8 hrs. The temperature is reported to be below boiling, some artisans indicated it to be close to 70°C, but the real temperature has never been measured. Compared to the last one, this pretreatment is less common.

The least common pretreatment is to put the wood in a mixture of water and HNO<sub>3</sub> (2%). No details could be found on this treatments (time/ temperature), probably because recently it has been rarely done.

➤ **Drying**

Depending on the type of pretreatment used in the last phase, drying time could be different. Drying is done gradually, first by keeping the wood in a shade with rather limited airflow. Few months later (at least 6 months), the outer part is covered with wood glue and the inner part is filled with wood's sawdust. Wood is left for 4- 6 months<sup>1</sup> in these conditions, before being ready to be worked into the final instrument.

Drying methods are not the same for different craftsmen. *Yahya's* drying process is reported to last more than three years (Khachatoor 2008). For another artisan<sup>2</sup>, all trimmings, cuttings, or carvings are done after the end of pretreatments and drying.

➤ **Final carving**

The two halves, now dried and ready, are first carved to their final shape in their outer parts, then the inner parts are fabricated. The diameters of the inner parts are not the same

---

<sup>1</sup>.Mr. Zareh 's process of drying.

<sup>2</sup>.In an interview, Mr.Yousef Pouria (professional *Târ* maker) has stated that no carving is done until the end of pretreatments. He also immersed the mulberry's wood in water (ambient temperature) for two years. (Interview with Jadidonline (online magazine) 16 November 2007).

throughout the instrument. At this time, the dry pattern (i.e. the final pattern) is used as the template. Eventually two parts are reattached, using animal glue, to form a final two bowled shape (Fig.A.6). The best dimensions obtained for the two bowls are: depth: 21 cm, diameter of the upper bowl: 24 cm, and diameter of the lower bowl: 20 cm.



Fig.A.6. Attaching two completely carved halves together to form the final shape (Mr. Pouria's interview. Jadidonline magazine, 16 November 2007).

➤ **Neck and bridges**

The neck is made from a radially cut walnut (*Juglans regia*). Surface is covered with a thin layer ( $\approx 5\text{mm}$ ) of Ebony (*Diospyros*), to make the neck visually desirable as well as more stable. Walnut is also used for fabricating pegs (Fig.A.7). Bridges, tailpiece and the pawls are made from ram's horns.



Fig.A.7. Half of a semi- carved bowl part, neck and pegs. Photo from Mr.Zareh's atelier.

➤ **Final attachments**

After attaching the neck to the bowls, the open surface of bowls is covered with a thin layer of lambskin (Fig.A.8).

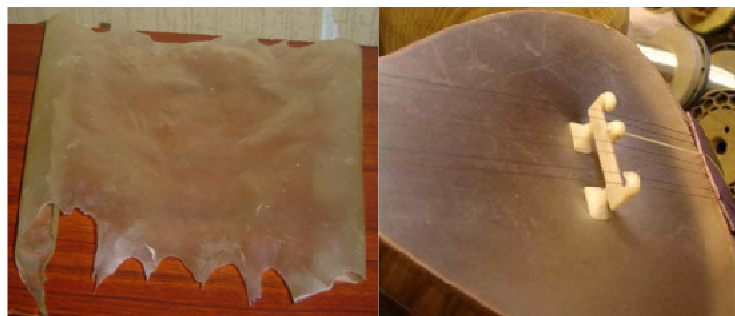

Fig.A.8. Lambskin unattached (Left- From Mr.Zareh's atelier) and glued on the upper bowl (Right- Mr. Pouria's Interview).

With everything in place, strings attached, the instrument is painted and eventually tested (Fig.A.9).



Fig.A.9. A complete *Târ* made by Mr. Zareh. Photo from Mr.Zareh's atelier.

### **A-3- References for Annex A.**

---

- Caron, N., Safvat, D. (1965)**, *"Iran (les Traditions musicales)"*, Buchet- Chastel, Paris.
- During, J., Safvat, D., Mirabdolbaghi, Z. (1990)** *"The Art of Persian Music"*, Washington D.C. Mage Publishers.
- Farhat, H. (1978)** *"Form and Style in Persian Music"*, World of Music, vol.20 (2), p. 109-118.
- Farhat, H. (1980)** *"Iran, I: Art music"*, in Stanley Sadie, ed., *The New Grove Dictionary of Music and Musicians*, vol. 9, p.292- 300.
- Farhat, H. (2004)** *"The Dastgah Concept in Persian Music"*, Cambridge University Press.
- Khachatoor, Z (2008)** *"Yahya Khan, the genius Târ maker from Jolfa region in Isfahan"* (In Farsi), Peyman cultural magazine, vol.45.  
<http://www.paymanonline.com/article.aspx?id=302EA084-4427-4864-B338-1C35DFD463CF>
- Khaleqi, R. (1954)** *"The story of Iranian music"*, (In Farsi), Ferdowsi Press.3 vols, Tehran. Iran.
- Lawergren, B. (1994)** *"Counting Strings on Ancient Egyptian Chordophones"* in *La pluridisciplinarité en archéologie musicale*, ed. C. Homo-Lechner and A. Bélis. Paris: Editions de la Maison des Sciences de l'Homme, p. 519-533.
- Lawergren, B. (1997)** *"To Tune a String: Dichotomies and Diffusions between the Near and Far East"*, in *Ultra Terminum Vagari. Scritti in onore di Carl Nylander*, eds. B. Magnusson, S. Renzetti, P. Vian, and S.J. Voicu. Rome: Edizioni Quasar, p. 175-192.
- Lawergren, B. (2009)** *"Music in Iranian land, history. i. Pre-Islamic Iran"*, Encyclopaedia Iranica.
- Movahed, Azin. (1993)** *"The Persian Nei: A Study of the Instrument and Its Musical Style"*, University of Illinois.
- Neubauer, E. (1993)** *"The construction of the lute and strings to their Arab, Persian and Turkish sources of the 9th to 15 Century"* (In German, abstract in English), *Journal of the History of Arabic-Islamic Science*, vol. 8, p. 279-378.

- Pouria, Y. (2007)** *"Interview with Jadid Online magazine"*, 16 November 2007.  
[http://www.jadidonline.com/story/161107/akmf/tarsazi\\_eng](http://www.jadidonline.com/story/161107/akmf/tarsazi_eng)
- Sachs, C. (2006)** *"The History of Musical Instruments"*, Dover Publications.
- Smith, D.A. (2002)** *"A History of the Lute from Antiquity to the Renaissance"*, Lute Society of America (LSA).
- Yar-Shater, E. (2004)** *"Encyclopaedia Iranica"*, Routledge & Kegan Paul.
- Zonis, E. (1965)** *"Contemporary art music in Persia"*, *Musical Quarterly*, vol. 51(4), p.636-48.
- Zonis, E. (1973)** *"Classical Persian music: An introduction"*, Cambridge, MA: Harvard University Press.



## Annex B.

### Details on the solvents used for extraction

All solvents were from the mark Carlo Erba.

Table B.1: Solvents' characteristics.\*

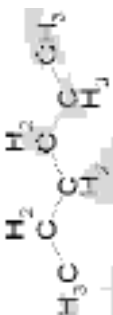
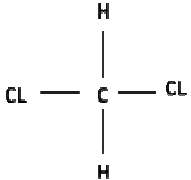
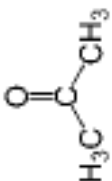
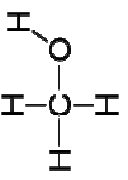
Solvent	Hexane	Dichloromethane	Acetone	Methanol
Category	Alkane	Alkyle Halyde	Ketone	Alcohol
CAS No	110-54-3	75-09-2	67-64-1	67-56-1
Formula	C <sub>6</sub> H <sub>12</sub>	CH <sub>2</sub> CL <sub>2</sub>	(CH <sub>3</sub> ) <sub>2</sub> CO	CH <sub>3</sub> OH
Density (g/cm <sup>3</sup> )	0.65	1.33	0.79	0.79
Dielectric constant	1.9	9.1	20.7	32.6
Molecular weight (g/mole)	86.2	84.9	58.1	32.0
Boiling point (°C)	68	39	56	65
Structure				

\* All solvent were technical grades.





## Annex C.

# Differences in 2 series of specimens submitted to successive extractions

---

### ➤ Process of picking the second series as the representative

#### **C-1- Origin of the problem**

First series of specimens, coming from batch 1, was submitted to hexane-, which results were used as the independent effect of hexane-, and then was subsequently submitted to other solvents in an attempt to find the cumulative effects of serial utilization of chemical agents. According to general protocol, all specimens must be tested with both vibrational methods (Free and forced vibration§ methods) before and after each extraction, as well as in between the steps for those exposed to more than one solvent. However, the Bing test was missed between D and AC. This means that the Bing results were unavailable for the specimens submitted to dichloromethane as the second solvent after hexane. As the discovery of the missing test did not happen until the AC extraction was performed, there was no going back. Although the data for the forced vibration was available, we decided to introduce a second series of specimens to be serially exposed to the solvents. This decision was made despite of the fact that there were no raw material left in batch 1. Thus for the second set, specimens were picked from batch 2 (from the same tree as batch 1). These two batches were supposedly not different but in the duration of rods being air-dried.

Twelve specimens were cut from a rod of batch 2, no controls were predicted for this series. The extractions and conditionings were followed according to the protocol in details. Once the data was out, the raw values were added to the same excel sheet as the first series (24 specimens in total) for further analyses.

A few step into data analysis, it was revealed that two series were showing different trends concerning changes in their damping ( $\tan\delta$ ) which were individually unique for each one of them and could not be integrated with the other one. On the other hand, variations in other measured physico-mechanical properties were the same – or at least in the same direction- for both series. This made it harder to decide whether we should go with an average value of both series, or it would be better to use the results of only one of the sets. As both series exhibited completely different  $\tan\delta$ -variations, the first solution (an overall average) was out. Nevertheless, and even by limiting the options, one important question remained: which series should be chosen, and more importantly why?

Following, we are going to present the variations in some controversial factors in both series. In addition, the visual rating of the specimens of each set, which lead us to identify the series with less problems, put more confidence on the final decision. Finally, the choice of using second series instead of the first – or even the average of both- was made

based on the more reasonable results, less variation in between the specimens belonging to same series and better visual ratings.

Before starting with the results, it should be reminded that each data point is the average of three repetitions on the same specimen. Therefore, the data point representing the whole set is the average of 36 measurements (12 specimens  $\times$  3 repetitions: 36).

## **C-2- Common trends between both series**

### **C-2-1- Weight loss**

Figure C.1 is illustrating the WL of both series. These are the relative values that are calculated based on the previous extracted oven-dried phase (i.e. they are not cumulated). It could be observed that both directions and the amplitudes of changes are following the same trend. The variations between specimens are also almost in the same range.

In both series, the highest extraction yield is that of ME (8.16% and 7.14% for first and second series respectively) followed by HW, AC, D, and H. While the amplitude of WL was slightly lower in second series, (lower amount of substances removed from the cell wall), the difference was later covered by HW, where the amplitude of WL was higher in second series – what was remained was taken out by HW-. Consequently, the accumulative values of WL were approximately the same ( $\approx$  14% and 13.5% for first and second series).

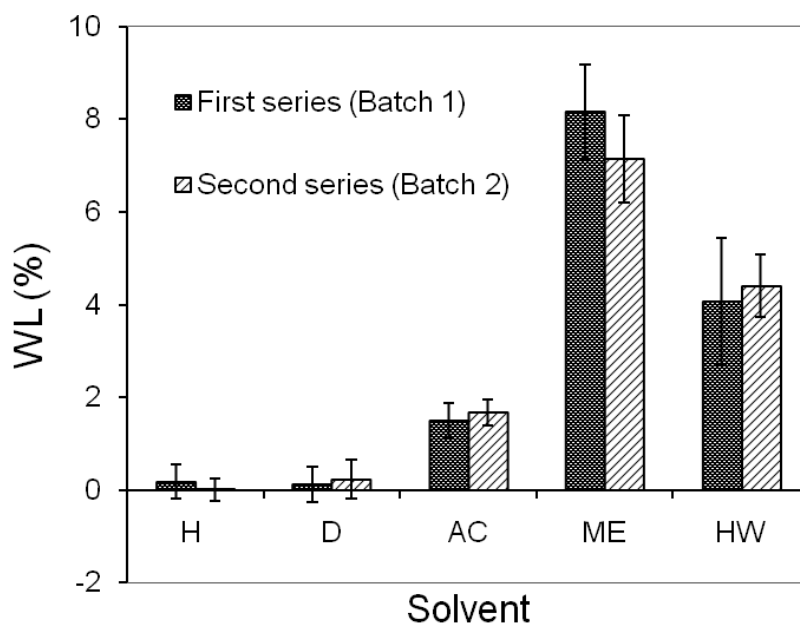

Fig.C.1. Comparison of relative oven –dried (60°C) weight losses (WL%) for both series submitted to successive extractions.

To conclude, the quantity, and probably the location of extractives, could not be the origin of different reactions of two series to same treatments.

### C-2-2- $\Delta MC$ and $\Delta V_0$ due to extractions in both series:

As  $\tan\delta$  was found to be strongly relative to MC, the different variations in MC in two series could explain the situation. The relative variations in  $\Delta MC$  (%) due to each treatment is separately presented for each series in Fig. C.2.

Looking at Fig. C.2, one can confirm that both series are acting the same towards treatments. Having said that, first series seems to be more sensible in its MC variations after polar treatments (AC, ME and HW). But as the WL is approximately the same for both sets (Fig C.1), the difference in MC changes (e.g. 23% decrease in MC after ME for first set, 5% for second set while the WL% were  $\approx 8$  and 7% respectively) could not be coming of the greater amount of extractive removals.

It should be remarked that first series were tested during winter- spring 2009, while the second tests were mostly carried out during late spring- summer 2009. Although close care was taken during drying and stabilization, and as the weights concerning the  $\Delta MC$  were those of controlled conditions, ideally the climate conditions should not severely affected the results.

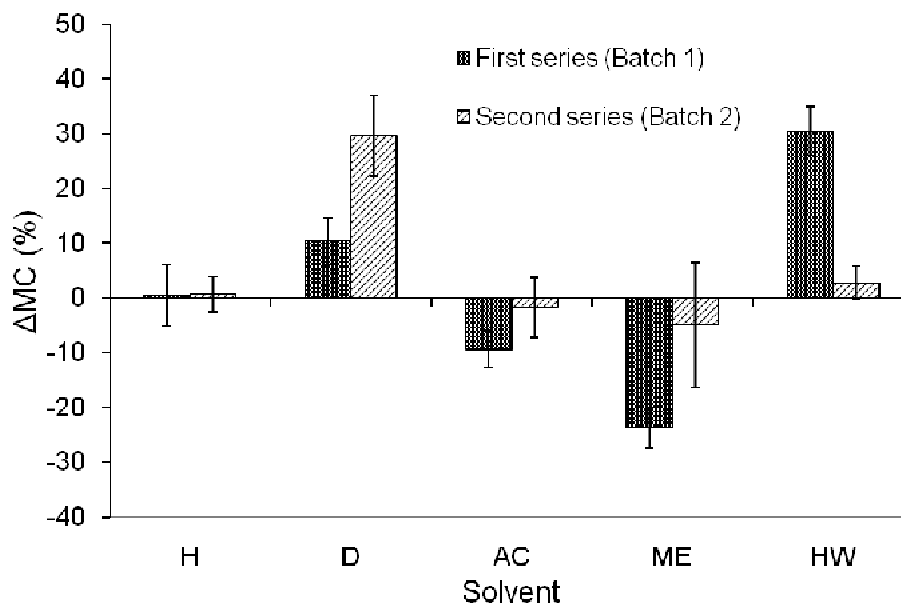

Fig .C.2.Variation in relative MC in two series submitted to successive extractions. Raw values of MC were corrected both for contribution of the extractives and the residual MC for drying at 103°C.

To analysis the behavior of two sets in face of extractions a little bit further, one can also look at the changes in oven dried volumetric dimensions ( $\Delta V_0$  %). Notwithstanding the similar weight yields in the specimens of both sets, the simple WL does not give much information about the location of the removed substances. Whereas, generally the dimension change happens when compounds are removed from cell- wall matrix and not from lumens. The results of  $\Delta MC$  (Fig.C.2), though similar in the final trend, could be better explained if the  $\Delta V_0$  of two series are significantly different. Then, the dissimilar

variations in  $\tan\delta$ , even by having the same WL, could be justified as a result of compound removal from different locations.

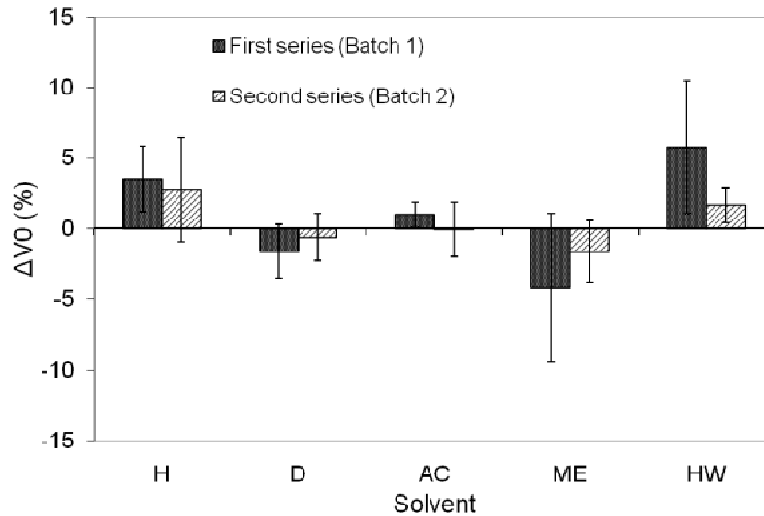

Fig.C.3. Relative variations in volume ( $\Delta V_0\%$ ) (based on oven dried weight-60°C /48 hrs- before and after each extraction) for two series submitted to successive extractions.

Two things could be retained by comparing the variations in  $\Delta V_0$  of two series (Fig.C.3):

- i) Direction of changes is similar in both sets (i.e. specimens of both series acted the same concerning their volumetric shrinkage or swelling) and ii) There are high variations in obtained  $\Delta V_0$  within the specimens of the same series (large error bars).

It was mentioned several times in the main manuscript that vibrational specimens (from which the current results are being presented) were not normalized for dimensions measurements, which ultimately lead to the inconclusive  $\Delta V_0$ . This could explain the high variation between specimens of one group. In any case, and by putting aside the local variations, specimens in each solvent case reacted closely the same regarding their oven-dried volume, although the amplitude of variations remained bigger in case of first set ( Like for  $\Delta MC$ ).

To sum up, variations in none of three presented parameters (WL,  $\Delta MC$  and  $\Delta V_0$ ) were significantly different between the two series of specimens. Wherever specimens of one group seemed to react differently from another, the variations were not extreme enough to be considered a source for further changes in vibrational properties. Overall, never in any case specimens of two sets behaved contradictory regarding their extraction-triggered-variations in physical properties.

### C-2-2- Change in $E'/\rho$ due to successive extractions in two series

Two main vibrationally important factors measured in this study, were damping ( $\tan\delta$ ) and specific modulus. When it was revealed that two groups of specimens reacted differently to extractions concerning their  $\tan\delta$ , the variations in  $E'/\rho$  were focused on to see if the same dissimilarity could be traced. Figure C.4 is illustrating the relative

variation in  $E'/\rho$  of both series. Relative differences were calculated based on the values of the previous phase.

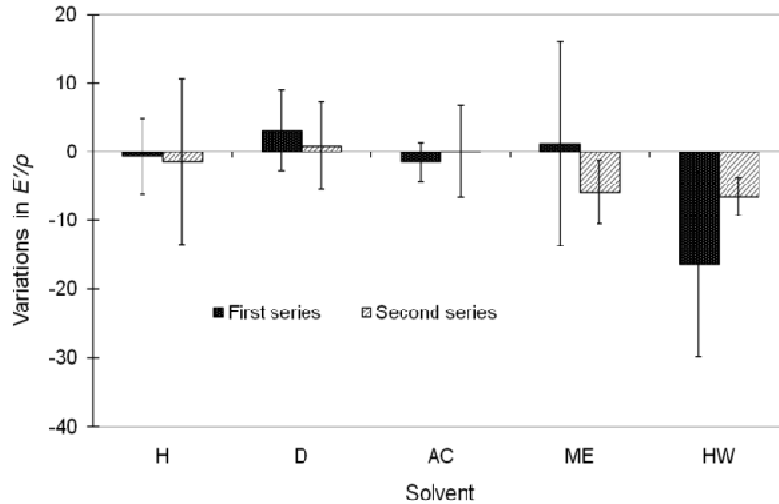

Fig.C.4. Variations in specific modulus  $E'/\rho$  (%) for both sets submitted to successive extractions. The values of moduli are corrected for the contribution of extractives. Relative values are calculated based on the previous phase.

Looking at Fig.C.4, the large error bars could be seen practically for all the measurements of first set – with exception of AC-. This also the case for H- extracted specimens of the second set. On the other hand, turning a blind eye on the large variations, the two sets reacted the same to the treatments, especially to the last three polar solvents.

Overall, tracing the variations, same trends could be found in two sets, which could even allow us to analysis the data based on an average of both. The dissimilar amplitudes could simply come from intrinsic specific properties of the specimens of each series.

### C-3- Differences between two series

#### C-3-1- Dissimilarity from the beginning?

When first analyzing the data, the results of first and second series vibrational tests were combined to compare with the standard trend (Ono and Norimoto 1983, 1984). For that, the data of the first forced vibration test (specimens in their native state before introducing to any treatment). The results are presented in Fig. C.5.a.

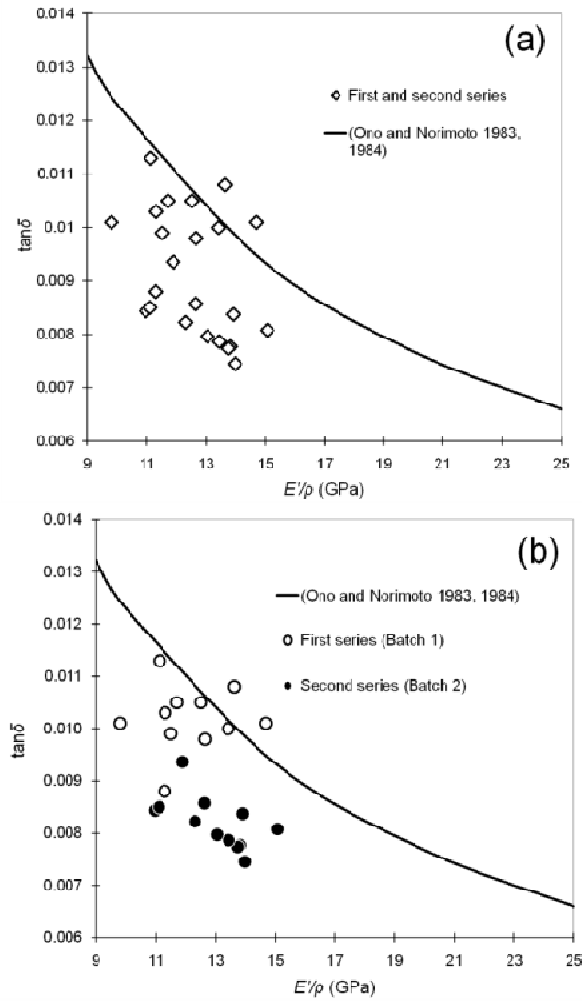

Fig.C.5. relationship between native  $\tan\delta$  and  $E'/\rho$  (GPa) for both series when mixed (a) and when separated (b). Standard trend (black curve) was added from Ono and Norimoto (1983, 1984).

From first graph (Fig.C.5.a), it seems that the standard relation of  $E'/\rho$  and  $\tan\delta$  could be observed. Separating the two series however, it was revealed that the first set is not at all showing the standard relation, on the other hand, second set is more in the range of having ‘‘reasonable’’  $E'/\rho$  and  $\tan\delta$  relation.

The absence of ‘‘normal’’ trend in the first series should not have been really effective on our final results. First because both  $\tan\delta$  and  $E'/\rho$  of the specimens of the first series stay in the same range as other samples (§Fig.4.2 in chapter4) and could not really considered as outliers. Moreover, the aim of this study was to look at the variations due to extractions and not the raw values; thus, the dispersed raw values should not be of great importance.

### C-3-2- Dissimilar variations in $\tan\delta$ due to extractions

Fig. C.6.a and C.6.b illustrate the relative changes of  $\tan\delta$  and WL for both series submitted to successive extractions. It should be recalled to mind that each data point in these figures is calculated based on the previous extracted state of the specimens and not the first native state.

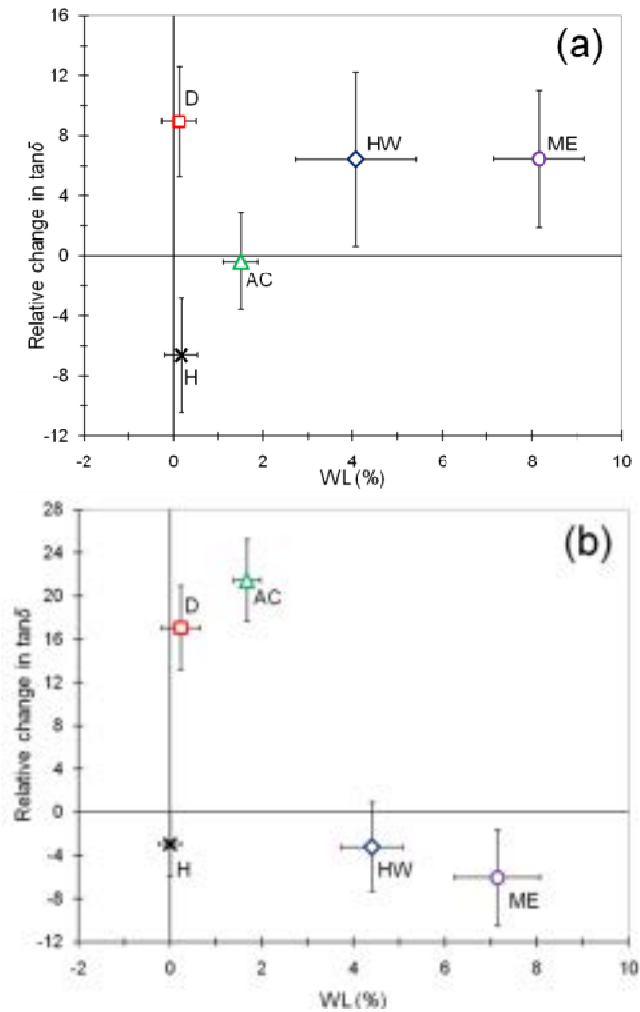

Fig.C.6. Relative changes in  $\tan\delta$  and weight loss (WL %) in specimens of first series (Batch 1) (a) and second series (Batch 2) (b) submitted to successive extractions.  $\tan\delta$  of the first series (a) were not corrected for the controls.

Even in the first look, one can see that specimens of two sets of had not reacted similarly. In fact, when it came to three polar solvents, two sets reacted utterly different. To first talk about similarities,  $\tan\delta$  decreases after H and increased after a successive use of D, in both series, still the amplitude of changes stayed bigger in the second one (Figure C.6.b). Starting from AC, two series behaved contradictory to each other. For the specimens of first series, AC extraction has barely changed  $\tan\delta$ , while ME and HW have increased it by the same value ( $\approx 6.4\%$ ). On the other hand, in specimens of second series, AC has acted as the most efficient solvent, considering its effect on raising  $\tan\delta$  ( $\approx 21.5\%$ ). ME and HW, being used after AC, both reduced damping ( $\approx 6\%$  and  $3\%$  for ME and HW).

After analyzing the raw data, it was clear that two series functioned in two separate ways regarding polar solvents' effects of on  $\tan\delta$  and the results could not be mixed to form an unique group. However, the question remained unanswered on which series is more of a representative of the results.

For choosing one set, we used a combination of reasoning from which one of the important ones was the results of independent extractions (Fig.C.7). One could justify, as

individual and serial extractions were done on the same species –white Mulberry-, regardless of the different batches, there should be some relations on the results of successive extraction and what was observed after using each solvent individually. Focusing on the relative changes in  $\tan\delta$  after independent extractions, AC stands out for being the most efficient treatment. The two following polar solvents (ME and HW), when used independently, have also increased  $\tan\delta$ , but the amplitude has never reached that of AC. These results are more coherent with what is seen in specimens of second series. While the same increasing effect of D could be seen in all three series of specimens (independent, first and second series of successive), it is rather unjustifiable that how could AC be affectless when used after D (as it is the case of first series of successive). This is even more clear in second series, where regardless of the large raise in  $\tan\delta$  after D, AC still holds its efficiency.

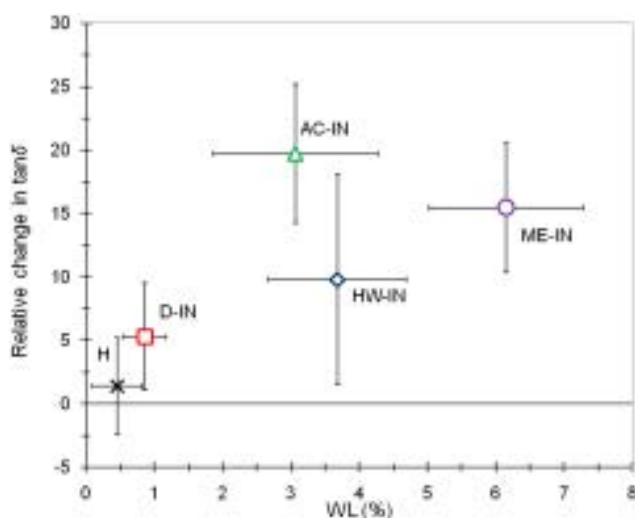

Fig.C.7. Relative changes in  $\tan\delta$  and weight loss (WL %) for specimens submitted to independent extractions. Values of  $\tan\delta$  were corrected for the corresponding controls. IN suffixes are indicating the independent use of a particular solvent on a specimen.

The important error bars in  $\tan\delta$  variations of first series, were also a source of concern on whether or not those results could be trusted in comparison with those of second series. For that, we decided to look at the  $\tan\delta$  and WL variations, specimen by specimen in each series (Fig.C.8.a and C.8.b). Here again, like the error bars have already indicated, the variations within the specimens of first series are clear. While specimens of second series stick together in one unique trend of change (Figure A.8.b), specimens of first series are greatly varying from each other. The greater amplitude of change in second series is clearer in Fig.C.8, the cumulated value of  $\Delta\tan\delta$  reaches  $\approx 45\%$  (case of AC) for the specimens of second series, while the maximum cumulated  $\Delta\tan\delta$  for the first series is  $\approx 30\%$ .



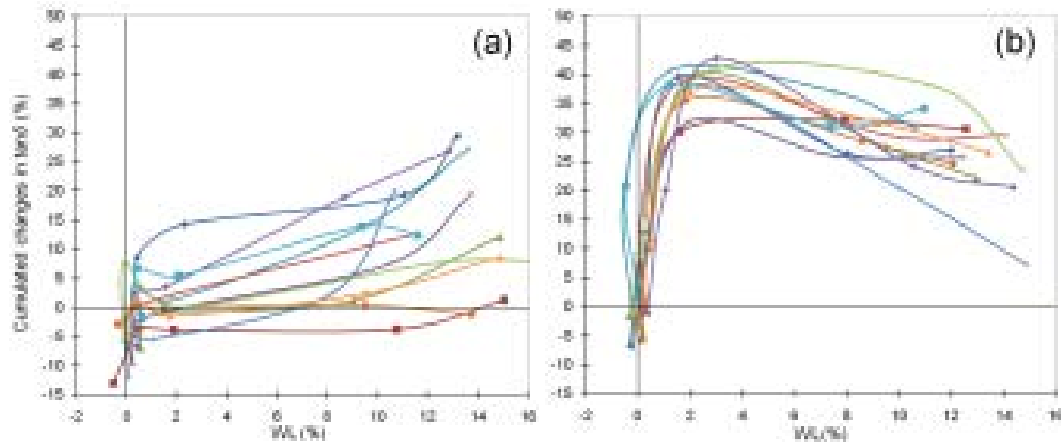

Fig.C.8. Cumulated changes in  $\tan\delta$  and weight losses (WL %) based on the first native state of the specimens for specimens of first (a) and second series (b). Each colored curve represents one specimen, each point represents one solvent/extraction.

Finally, to verify our eventual choice of second series as the representative, the visual rating of the specimens was taken to account. In an overall view of the samples, specimens of second series had no important defects. Ten out of twelve specimens could be rated as having “no visually detectable problems”. We looked for cracks, inhomogeneity of the surface \_ that could be caused by saw or plane \_ spiral growth rings and any other defect that could cause modifications in  $\tan\delta$ . For the same defects, specimens of the first series stood lower than the latter ones. Only five specimens out of all twelve could be rated as having no problems. Four were rated medium (for having variety of problems from spiral growth rings to small micro cracks) while three have completely failed the visual rating.

#### C-4- Summary of arguments

One missing vibrational test has obliged us to introduce a second series of specimens to serial use of solvents. When analyzing the data, it became known that the variations in  $\tan\delta$  were different in specimens of two series. As the contradictory variations were not those of a few outliers, we had to decide which series is showing the most trustworthy changes. The choosing process started by studying the similarities between two series. These common points on how specimens reacted physically, as well as mechanically, to the treatment, have prevented us to invalidate one test/series. Nevertheless, the large variation within the specimens of the same series along with weak relations with the results of independently extracted specimens (not to mention the worse rating when it came to visually detectable defects), have helped on deciding to choose the results of second series to be used as the representative of successive extractions.



## Annex D.

### Criteria of natural durability standards

Requirements of XP CEN/TS 15083-1 and EN350-1, by which white Mulberry has been classified in chapter 7 are given in Tables D.1 and D.2 respectively.

Table D.1. Classification according to XP CEN/TS 15083-1 M.L: Mass loss (%) of the fungi- attacked specimens

<b>Durability class</b>	<b>Description</b>	<b>Mass loss %</b>
<b>1</b>	very durable	$M.L \leq 5$
<b>2</b>	durable	$M.L > 5$ but $\leq 10$
<b>3</b>	moderately durable	$M.L > 10$ but $\leq 15$
<b>4</b>	slightly durable	$M.L > 15$ but $\leq 30$
<b>5</b>	not durable	$M.L > 30$

Table D.2. Classification according to EN350-1. X factor is calculated according to the mass losses of the fungi-attacked specimens and that of the controls (§7-1-1. d)

<b>Durability class</b>	<b>Description</b>	<b>X Results</b>
<b>1</b>	very durable	$X \leq 0.15$
<b>2</b>	durable	$X > 0.15$ to $0.3$
<b>3</b>	moderately durable	$X > 0.3$ to $0.60$
<b>4</b>	slightly durable	$X > 0.60$ to $0.90$
<b>5</b>	not durable	$X > 0.9$

