



**HAL**  
open science

# Equivariance et invariants de type fini en dimension trois

Delphine Moussard

► **To cite this version:**

Delphine Moussard. Equivariance et invariants de type fini en dimension trois. Mathématiques générales [math.GM]. Université de Grenoble, 2012. Français. NNT : 2012GRENM071 . tel-00808274

**HAL Id: tel-00808274**

**<https://theses.hal.science/tel-00808274v1>**

Submitted on 5 Apr 2013

**HAL** is a multi-disciplinary open access archive for the deposit and dissemination of scientific research documents, whether they are published or not. The documents may come from teaching and research institutions in France or abroad, or from public or private research centers.

L'archive ouverte pluridisciplinaire **HAL**, est destinée au dépôt et à la diffusion de documents scientifiques de niveau recherche, publiés ou non, émanant des établissements d'enseignement et de recherche français ou étrangers, des laboratoires publics ou privés.

## THÈSE

Pour obtenir le grade de

### DOCTEUR DE L'UNIVERSITÉ DE GRENOBLE

Spécialité : **Mathématiques**

Arrêté ministériel : 7 août 2006

Présentée par

**Delphine Moussard**

Thèse dirigée par **Christine Lescop**

préparée au sein de l'**Institut Fourier**  
et de l'**école doctorale MSTII**

## Équivariance et invariants de type fini en dimension 3

Thèse soutenue publiquement le **30 novembre 2012**,  
devant le jury composé de :

**Christine Lescop**

Directrice de recherches, Université de Grenoble, Directrice de thèse

**Thang Le**

Professeur, Georgia Institute of Technology, Rapporteur

**Gwénaél Massuyeau**

Chargé de recherches, Université de Strasbourg, Rapporteur

**Christian Blanchet**

Professeur, Université Paris Diderot-Paris 7, Examineur

**Kazuo Habiro**

Professeur, Kyoto University, Examineur

**Julien Marché**

Professeur, Université Pierre et Marie Curie, Examineur

**Jean-Baptiste Meilhan**

Maître de conférences, Université de Grenoble, Examineur







## Remerciements

En premier lieu, je voudrais exprimer ma sincère reconnaissance à Christine Lescop, qui a guidé mes premiers pas dans le monde de la recherche. Ses compétences mathématiques bien sûr, mais aussi son professionnalisme et sa rigueur intellectuelle m'ont été très profitables, et resteront pour moi un exemple. Merci aussi pour ta disponibilité et les relectures nombreuses et détaillées de mes productions.

Je remercie vivement mes rapporteurs, Thang Le et Gwénaél Massuyeau, pour leur relecture attentionnée de mon travail. Merci Gwénaél pour tes commentaires, qui m'ont permis d'améliorer mon manuscrit, et me seront encore utiles par la suite. Je remercie également Christian Blanchet, Kazuo Habiro, Julien Marché, et Jean-Baptiste Meilhan, qui ont accepté de faire parti de mon jury.

Un grand merci au gang des mexicains qui m'a accueillie à mon arrivée au labo. Avec Aline et Jorge, j'ai d'abord partagé un bureau, quand le froid polaire qui y règne l'hiver ne les faisait pas fuir. Hernan n'était jamais très loin, à nous narguer avec son double-vitrage. Mon passage à Grenoble restera étroitement associé aux moments partagés avec vous. Vous voilà tous trois repartis au Mexique, mais je saurai bien vous y retrouver !

Ces années passées à l'intitut auront été le cadre de bien d'autres bonnes rencontres. Merci Izabela, infatigable cuisinière et co-bureau pleine d'enthousiasme. Merci à Fred Mouton, mon tuteur pédagogique, grimpeur invétéré, égal dans la bonne humeur. Merci à Ariadna, notamment pour m'avoir fait découvrir les lacs de Laffrey, c'eût été dommage de passer à côté. Merci à Maxime, je ne t'ai pas beaucoup suivi pour le jogging, mais je me suis rattrapée avec le séminaire compréhensible. Merci aux p'tits jeunes, Kévin et Jean-Mathieu, pas tant pour m'avoir fait prendre conscience de mon grand âge que pour cette bonne semaine passée à la Llagonne, même sans ballon. Merci aussi Jean-Mathieu pour la page web du séminaire ; personnellement, j'aime beaucoup la photo. Merci Julien pour ton éternelle bonne humeur et ton enthousiasme inattaquable. Merci à l'équipe "barbeuc", Max bien sûr, mais aussi Alvaro, Ximena, et Hervé. Merci à Sacha, Helena, Marianne, et tous ceux que j'oublie. Merci aux actifs du séminaire, et désolée pour le harcèlement quand il me manque un orateur.

Les diverses écoles et conférences ont aussi été des occasions de partager de bons moments, mathématiques ou autres, avec des topologues de toutes horizons. Je pense notamment à Matthieu, Bruno, Hoël, LH... Merci aux organisateurs de Winterbraids pour ce rendez-vous incontournable dans les frimas de décembre. Merci à Thomas Fiedler pour ces écoles originales, et non moins incontournables, à la Llagonne. Merci Christian d'avoir pris du temps pour parler de mon travail et me suggérer des pistes intéressantes à explorer.

L'institut Fourier a été pour moi un environnement de travail très appréciable, tant humainement que professionnellement. Merci à l'équipe de topologie, aux membres du groupe de travail "topologie en dimension 3". Merci Roland pour ton aide sur les réseaux

k-voisins. Merci JB de m'avoir introduite parmi les Vaskhimis. Merci à tous les administratifs, sans qui bien des choses seraient beaucoup plus compliquées.

Merci à mes parents, pour plein de choses, et en l'occurrence pour le pot de soutenance.

*Last, but not least*, merci Airelle de n'avoir jamais hésité à soumettre nos choix de vie à mes caprices professionnels, merci d'être là.

# Introduction

Cette thèse a pour objet l'étude des invariants de type fini des sphères d'homologie rationnelle de dimension 3, et des nœuds homologiquement triviaux dans ces sphères. Les principaux résultats sont présentés dans le chapitre 2. Ils sont démontrés dans les chapitres 3 à 6. Le chapitre 3 est un article intitulé "Finite type invariants of rational homology 3-spheres", à paraître dans *Algebraic & Geometric Topology*. Il décrit le gradué associé à la filtration de l'espace vectoriel rationnel engendré par les sphères d'homologie rationnelle, définie par les chirurgies rationnelles préservant le lagrangien. Le chapitre 4 est un article intitulé "On Alexander modules and Blanchfield forms of null-homologous knots in rational homology spheres", publié dans *Journal of Knot Theory and its Ramifications*. Il contient la classification des modules d'Alexander des nœuds homologiquement triviaux dans les sphères d'homologie rationnelle, et une étude des formes de Blanchfield définies sur ces modules. Dans la suite, on considère les paires  $(M, K)$  formées d'une sphère d'homologie rationnelle  $M$  et d'un nœud  $K$  homologiquement trivial dans  $M$ . Dans le chapitre 5, on montre que deux telles paires ont des modules d'Alexander rationnels munis de leurs formes de Blanchfield isomorphes si et seulement si elles s'obtiennent l'une de l'autre par une suite finie de chirurgies rationnelles nulles préservant le lagrangien, c'est-à-dire effectuées sur des corps en anses d'homologie rationnelle homologiquement triviaux dans le complémentaire du nœud. Dans le chapitre 6, on étudie le gradué associé à la filtration de l'espace vectoriel rationnel engendré par les paires  $(M, K)$  définie par les chirurgies rationnelles nulles préservant le lagrangien. Ces deux derniers chapitres comportent des travaux en progrès, qui seront complétés avant d'être soumis à publication. On expose dans le dernier chapitre les questions qu'il reste à étudier pour les compléter.

Le premier chapitre est une introduction aux invariants de type fini. Il présente le contexte de la thèse, et décrit les principaux résultats connus sur les invariants de Vassiliev et la filtration de Goussarov-Habiro. Le deuxième chapitre est une description des objets étudiés et des résultats démontrés dans les chapitres 3 à 6.

## Premières définitions et notations

Dans tout le texte, sauf mention expresse du contraire, le terme variété désignera une variété topologique, compacte, sans bord, connexe, et orientée. Une *sphère d'homologie rationnelle (resp. entière)*, ou  *$\mathbb{Q}$ -sphère (resp.  $\mathbb{Z}$ -sphère)*, ou  *$\mathbb{Q}HS$  (resp.  $\mathbb{Z}HS$ )*, est une variété de dimension 3 qui a la même homologie à coefficients dans  $\mathbb{Q}$  (resp.  $\mathbb{Z}$ ) que la sphère standard  $S^3$ . Notons  $\mathbb{K} = \mathbb{Q}$  ou  $\mathbb{Z}$ . On note  $\mathcal{M}$  l'ensemble des variétés de dimension 3 à homéomorphisme préservant l'orientation près, et  $\mathcal{M}_{\mathbb{K}}$  l'ensemble des  $\mathbb{K}$ -sphères à homéomorphisme préservant l'orientation près.

Un *nœud* dans une variété de dimension 3 est un plongement d'un cercle orienté. On note  $\mathcal{K}$  l'ensemble des nœuds de  $\mathbb{R}^3$  à isotopie ambiante près. Un nœud  $K$  dans une variété  $M$  de dimension 3 est *homologiquement trivial* si la classe de  $K$  dans  $H_1(M; \mathbb{Z})$  est nulle.

Une  $\mathbb{K}SK$ -*paire* est une paire  $(M, K)$  formée d'une  $\mathbb{K}$ -sphère  $M$  et d'un nœud  $K$  homotopiquement trivial dans  $M$ . On note  $\mathcal{K}_{\mathbb{K}}$  l'ensemble des  $\mathbb{K}SK$ -paires à homéomorphisme préservant l'orientation près. Un *entrelacs* dans une variété de dimension 3 est une réunion disjointe de nœuds.

Le bord d'une variété est orienté selon la convention de la normale extérieure en premier. Lorsque cela ne prête pas à confusion, on utilise la même notation pour une courbe et pour sa classe d'homologie.



# Table des matières

<b>Chapitre 1 : Invariants de type fini</b>	<b>12</b>
1 Définition	13
2 Invariants de Vassiliev	14
3 Filtration de Goussarov-Habiro	16
4 Chirurgies préservant le lagrangien	19
<b>Chapitre 2 : Description des principaux résultats de la thèse</b>	<b>22</b>
<b>1 Invariants de type fini des sphères d'homologie rationnelle</b>	<b>23</b>
1.1 Chirurgies LP rationnelles . . . . .	23
1.2 Invariants de degré 1 . . . . .	24
1.3 Invariants de degré 1 des tores d'homologie rationnelle . . . . .	24
1.4 Invariants additifs . . . . .	25
1.5 L'algèbre graduée associée à la filtration . . . . .	26
1.6 Les invariants LMO et KKT . . . . .	27
<b>2 Caractérisation des classes d'isomorphisme de modules d'Alexander munis de leurs formes de Blanchfield</b>	<b>27</b>
2.1 Définitions . . . . .	28
2.2 Classification des modules d'Alexander . . . . .	29
2.3 Caractérisation de la forme de Blanchfield . . . . .	30
2.4 Compléments sur la réalisation des modules d'Alexander . . . . .	31
<b>3 Caractérisation des classes de QSK-paires modulo chirurgies LP nulles</b>	<b>33</b>
3.1 Chirurgies LP nulles . . . . .	33
3.2 Matrices de Seifert . . . . .	34
3.3 S-équivalence rationnelle . . . . .	35
<b>4 Invariants de type fini des QSK-paires</b>	<b>36</b>
4.1 Les quotients $\mathcal{G}_n(\mathcal{K}_{\mathbb{Q}})$ . . . . .	37
4.2 Diagrammes coloriés et entrelacs en Y . . . . .	39
4.3 La filtration de $\mathcal{F}_0(\mathcal{K}_{\mathbb{Z}})$ . . . . .	41

**Chapitre 3 : Invariants de type fini des sphères d'homologie rationnelle** **42**

<b>1 Introduction</b>	<b>43</b>
1.1 Finite type invariants . . . . .	43
1.2 The Goussarov-Habiro filtration . . . . .	44
1.3 Statement of the results . . . . .	46
<b>2 Elementary surgeries</b>	<b>50</b>
2.1 Homological properties of $\mathbb{Q}HH$ 's . . . . .	50
2.2 $d$ -tori . . . . .	51
2.3 Relating $\mathbb{Q}HH$ 's by elementary surgeries . . . . .	52
<b>3 Borromean surgeries and clasper calculus</b>	<b>56</b>
<b>4 Finite type invariants of degree 1</b>	<b>60</b>
4.1 The family $(M_p - S^3)_p$ <i>prime</i> generates $\mathcal{G}_1$ . . . . .	60
4.2 The invariants $\nu_p$ . . . . .	62
<b>5 Additive invariants of degree <math>n &gt; 1</math></b>	<b>64</b>
5.1 Degree 1 invariants of framed rational homology tori . . . . .	64
5.2 The quotients $\frac{\mathcal{I}_n^c}{\mathcal{I}_{n-1}^c}$ . . . . .	68
<b>6 The graded algebras <math>\mathcal{G}</math> and <math>\mathcal{H}</math></b>	<b>70</b>
6.1 The products in $\mathcal{G}$ and $\mathcal{H}$ . . . . .	70
6.2 Dual systems in $\mathcal{G}$ and $\mathcal{H}$ . . . . .	71
6.3 The coproduct on $\mathcal{H}$ . . . . .	74

**Chapitre 4 : Modules d'Alexander et forme de Blanchfield des nœuds homologiquement triviaux dans les sphères d'homologie rationnelle** **78**

<b>1 Introduction</b>	<b>79</b>
1.1 Short introduction . . . . .	79
1.2 Statement of the results . . . . .	79
1.3 Plan of the article . . . . .	81
1.4 Acknowledgements . . . . .	82
<b>2 Classification of Alexander modules</b>	<b>82</b>
2.1 Surgery presentation of a knot . . . . .	82
2.2 Hermitian presentation matrix . . . . .	83

2.3	Properties of the Alexander module . . . . .	85
2.4	Realization of equivariant linking matrices . . . . .	87
2.5	Proof of Theorem 1.5 . . . . .	90
<b>3</b>	<b>Blanchfield forms</b>	<b>91</b>
3.1	An expression of the Blanchfield form . . . . .	91
3.2	Orthogonal decomposition . . . . .	92
3.3	Realization of Blanchfield forms . . . . .	95
3.4	Isomorphism classes of Blanchfield forms . . . . .	96

**Chapitre 5 : Formes de Blanchfield rationnelles, S-équivalence, et chirurgies LP nulles** **100**

<b>1</b>	<b>Introduction</b>	<b>101</b>
1.1	Context . . . . .	101
1.2	Statement of the results . . . . .	102
<b>2</b>	<b>Conservation of the Blanchfield form</b>	<b>106</b>
<b>3</b>	<b>Relating Seifert matrices</b>	<b>108</b>
<b>4</b>	<b>Rational S-equivalence</b>	<b>111</b>
<b>5</b>	<b>Topological realization of matrix relations</b>	<b>113</b>
<b>6</b>	<b>Sequences of LP-surgeries</b>	<b>116</b>

**Chapitre 6 : Invariants de type fini des nœuds homologiquement triviaux dans les sphères d’homologie rationnelle** **118**

<b>1</b>	<b>Introduction</b>	<b>119</b>
1.1	Null LP-surgeries . . . . .	119
1.2	Borromean surgeries . . . . .	121
1.3	Spaces of diagrams . . . . .	123
1.4	Colored diagrams and Y-links . . . . .	125
<b>2</b>	<b>Borromean surgeries and colored diagrams</b>	<b>127</b>
<b>3</b>	<b>The surjective map <math>\varphi_n : \mathcal{A}_n^{aug}(\mathfrak{A}, \mathfrak{b}) \rightarrow \mathcal{G}_n(\mathfrak{A}, \mathfrak{b})</math></b>	<b>134</b>
<b>4</b>	<b>Nullity of <math>\mathcal{G}_{2n+1}^{\mathbb{Z}}(\mathfrak{A}_{\mathbb{Z}}, \mathfrak{b}_{\mathbb{Z}})</math></b>	<b>138</b>

<b>5</b>	<b>Case of a trivial Alexander module</b>	<b>140</b>
5.1	Additive invariants of null-degree $n > 1$ . . . . .	140
5.2	The graded algebra $\mathcal{G}(\mathfrak{A}_0)$ . . . . .	141
 <b>Chapitre 7 : Perspectives</b>		<b>144</b>
<b>1</b>	<b>Détermination du gradué <math>\bigoplus_{n \in \mathbb{N}} \mathcal{G}_n(\mathfrak{A}, \mathfrak{b})</math></b>	<b>145</b>
<b>2</b>	<b>Le gradué <math>\bigoplus_{n \in \mathbb{N}} \mathcal{G}_n^{\mathbb{Z}}(\mathfrak{A}_{\mathbb{Z}}, \mathfrak{b}_{\mathbb{Z}})</math></b>	<b>146</b>

# Chapitre 1 : Invariants de type fini

## 1 Définition

Considérons un ensemble  $X$  (qui sera dans la suite  $\mathbb{Z}^d$ , l'ensemble  $\mathcal{K}$  des nœuds de  $\mathbb{R}^3$ , l'ensemble des variétés de dimension 3, ...). Un *invariant rationnel* des éléments de  $X$  est une fonction de  $X$  dans  $\mathbb{Q}$ . Pour étudier une fonction, il est souvent pratique d'étudier ses dérivées, les dérivées de ses dérivées, et ainsi de suite. Si  $X = \mathbb{Z}^d$ , pour  $f : \mathbb{Z}^d = \bigoplus_{i=1}^d \mathbb{Z}e_i \rightarrow \mathbb{Q}$ , on peut définir des dérivées partielles de  $f$  par :

$$\frac{\partial f}{\partial e_i}(z) = f(z + e_i) - f(z).$$

La fonction  $f$  a toutes ses dérivées nulles si et seulement si elle est constante. Définissons par récurrence les dérivées  $n$ -ièmes de  $f$ . On peut alors vérifier que  $f$  a toutes ses dérivées  $(n+1)$ -ièmes nulles si et seulement si  $f$  est une fonction polynômiale de degré  $n$ .

De la même façon, pour étudier les invariants topologiques, on peut s'intéresser à leurs variations sous l'effet d'opérations élémentaires. Notons  $\Theta(X)$  un ensemble d'opérations élémentaires agissant sur certains éléments de  $X$ . Pour  $X = \mathbb{Z}^d$ ,  $\Theta(\mathbb{Z}^d)$  est l'ensemble des  $(z \mapsto z \pm e_i)$ . Pour  $X = \mathcal{K}$ ,  $\Theta(\mathcal{K})$  est l'ensemble des changements de croisements  $(\nearrow \leftrightarrow \nwarrow) \leftrightarrow (\nwarrow \leftrightarrow \nearrow)$ . Pour  $X = \mathcal{M}_{\mathbb{Z}}$  ou  $\mathcal{M}_{\mathbb{Q}}$ , on définira dans la suite comme opérations élémentaires des chirurgies spécifiques.

Si plusieurs opérations élémentaires commutent, on peut les effectuer de façon simultanée. C'est le cas ci-dessus pour  $X = \mathbb{Z}^d$ , c'est le cas pour des changements de croisements s'ils sont effectués dans des boules disjointes, et ce sera le cas pour des chirurgies à support disjoint. On parle alors d'opérations élémentaires *indépendantes*. Soit  $\mathcal{F}_0(X)$  le  $\mathbb{Q}$ -espace vectoriel engendré par les éléments de  $X$ . Pour  $n \in \mathbb{N}$ , si  $x \in X$  et si  $o_1, o_2, \dots, o_n$  sont des opérations élémentaires deux à deux indépendantes agissant sur  $x$ , on définit :

$$[x; o_1, o_2, \dots, o_n] = \sum_{I \subset \{1, \dots, n\}} (-1)^{|I|} x((o_i)_{i \in I}) \in \mathcal{F}_0(X),$$

où  $x((o_i)_{i \in I}) \in X$  est obtenu en appliquant à  $x$  les opérations  $o_i$  pour  $i \in I$ . Pour  $n \in \mathbb{N}$ , on note  $\mathcal{F}_n(X)$  le sous-espace vectoriel de  $\mathcal{F}_0(X)$  engendré par les  $[x; o_1, o_2, \dots, o_n]$  pour tout  $x \in X$  et tout  $n$ -uplet  $(o_1, o_2, \dots, o_n)$  d'opérations élémentaires deux à deux indépendantes agissant sur  $x$ . L'égalité

$$[x; o_1, o_2, \dots, o_n, o_{n+1}] = [x; o_1, o_2, \dots, o_n] - [x(o_{n+1}); o_1, o_2, \dots, o_n]$$

montre que  $\mathcal{F}_{n+1}(X) \subset \mathcal{F}_n(X)$ , pour tout  $n \in \mathbb{N}$ . On note  $\mathcal{G}_n(X) = \frac{\mathcal{F}_n(X)}{\mathcal{F}_{n+1}(X)}$ .

**Définition 1.1.** Une fonction  $f : X \rightarrow \mathbb{Q}$  s'étend de manière unique en une application  $\mathbb{Q}$ -linéaire  $f : \mathcal{F}_0(X) \rightarrow \mathbb{Q}$ . Pour  $n \in \mathbb{N}$ , l'invariant  $f$  est de *degré au plus  $n$*  si et seulement si  $f(\mathcal{F}_{n+1}(X)) = 0$ . L'invariant  $f$  est de *type fini* s'il est de degré au plus  $n$  pour un certain entier  $n$ . Le *degré* d'un tel invariant  $f$  est le plus petit entier  $n$  tel que  $f$  est de degré au plus  $n$ .

On note  $\mathcal{I}_n(X)$  le  $\mathbb{Q}$ -espace vectoriel des invariants de degré au plus  $n$ . On a  $\mathcal{I}_n(X) \subset \mathcal{I}_{n+1}(X)$  pour tout entier  $n \in \mathbb{N}$ . Pour  $n \in \mathbb{N}$ ,  $\mathcal{I}_n(X)$  est canoniquement isomorphe à  $(\frac{\mathcal{F}_0(X)}{\mathcal{F}_{n+1}(X)})^* = \text{Hom}(\frac{\mathcal{F}_0(X)}{\mathcal{F}_{n+1}(X)}, \mathbb{Q})$ . On a la suite exacte suivante :

$$0 \rightarrow \mathcal{G}_n(X) \rightarrow \frac{\mathcal{F}_0(X)}{\mathcal{F}_{n+1}(X)} \rightarrow \frac{\mathcal{F}_0(X)}{\mathcal{F}_n(X)} \rightarrow 0.$$

Comme le foncteur  $\text{Hom}(\cdot, \mathbb{Q})$  est exact, la suite duale

$$0 \rightarrow \mathcal{I}_{n-1}(X) \rightarrow \mathcal{I}_n(X) \rightarrow (\mathcal{G}_n(X))^* \rightarrow 0$$

est aussi exacte. Donc  $\frac{\mathcal{I}_n(X)}{\mathcal{I}_{n-1}(X)} \cong (\mathcal{G}_n(X))^*$ .

## 2 Invariants de Vassiliev

La première notion d'invariants de type fini a été introduite par Mikhail Goussarov et Victor Anatolievich Vassiliev. Il s'agit des invariants des nœuds de  $\mathbb{R}^3$  définis par les changements de croisements. On parle alors d'*invariants de Vassiliev*.

On peut montrer que tout nœud peut être transformé en un nœud trivial par une suite finie de changements de croisements. Ainsi  $\mathcal{G}_0(\mathcal{K}) \cong \mathbb{Q}$ . Pour étudier les quotients  $\mathcal{G}_n(\mathcal{K})$  d'ordre supérieur, il est pratique d'introduire les nœuds singuliers. Un *nœud singulier* à

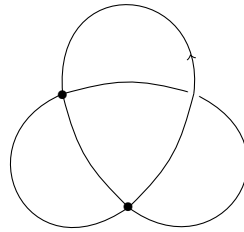

FIGURE 1 – Nœud singulier à 2 points doubles

$n$  *points doubles* est une immersion d'un cercle orienté dans  $\mathbb{R}^3$  avec exactement  $n$  points multiples, qui sont des points doubles transverses. Un point double code le changement de croisement d'un croisement positif vers un croisement négatif (Figure 2). Ainsi, à un nœud singulier  $K_S$  à  $n$  points doubles, on associe le crochet  $[K; (o_i)_{1 \leq i \leq n}]$ , où  $K$  est obtenu à partir de  $K_S$  en remplaçant les  $n$  points doubles par des croisements positifs, et l'opération  $o_i$  change le  $i$ -ème croisement en un croisement négatif. On assimilera un nœud singulier à son crochet associé. On voit facilement que les crochets définis par des nœuds singuliers engendrent  $\mathcal{F}_n(\mathcal{K})$ .

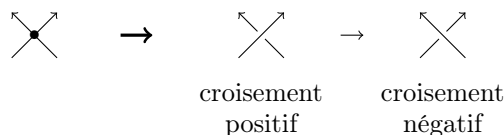

FIGURE 2 – Réalisation d'un point double



FIGURE 3 – Crochet associé à un nœud singulier

Étant donné un nœud singulier  $K_S$  à  $n$  points doubles, on définit le *diagramme de cordes*  $\Gamma(K_S)$  comme suit. On représente la préimage de  $K_S$  par un cercle orienté en pointillés, sur lequel  $2n$  points représentent les préimages des  $n$  points doubles, et on relie par des segments en traits pleins (les *cordes*) les points qui ont la même image. Notons que,

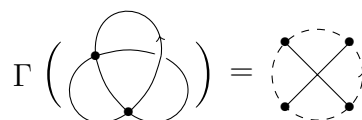

FIGURE 4 – Diagramme de corde associé à un nœud singulier

si  $f$  est un invariant de degré  $n$ , sa valeur sur  $K_S$  ne dépend pas d'éventuels changements de croisements effectués sur  $K_S$  en dehors des  $n$  points doubles, donc  $f(K_S)$  ne dépend que du diagramme de cordes  $\Gamma(K_S)$ . Ainsi les crochets de deux nœuds singuliers auxquels est associé un même diagramme de cordes ne peuvent être différenciés par un invariant de degré  $n$ . Comme  $(\mathcal{G}_n(\mathcal{K}))^* \cong \frac{\mathcal{I}_n(\mathcal{K})}{\mathcal{I}_{n-1}(\mathcal{K})}$ , on en déduit une application  $\mathbb{Q}$ -linéaire bien définie et surjective :

$$\phi_n : \mathcal{D}_n \twoheadrightarrow \mathcal{G}_n(\mathcal{K}),$$

où  $\mathcal{D}_n$  est le  $\mathbb{Q}$ -espace vectoriel engendré par les diagrammes à  $n$  cordes. Notons que, comme  $\mathcal{D}_n$  est de dimension finie,  $\mathcal{G}_n(\mathcal{K})$  et  $\mathcal{I}_n(\mathcal{K})$  sont également de dimension finie.



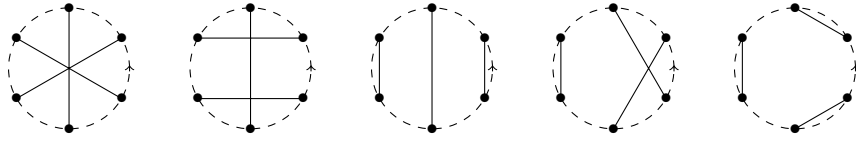

FIGURE 5 – Les diagrammes à trois cordes

On peut vérifier que  $\phi_n$  s'annule sur les relations (1T) et (4T) ci-dessous.

$$(1T) \quad \begin{array}{c} \text{---} \\ | \\ \text{---} \\ | \\ \text{---} \end{array} = 0$$

$$(4T) \quad \begin{array}{c} \nearrow \\ \searrow \\ \nearrow \\ \searrow \end{array} - \begin{array}{c} \searrow \\ \nearrow \\ \searrow \\ \nearrow \end{array} = \begin{array}{c} \nearrow \\ \searrow \\ \nearrow \\ \searrow \end{array} - \begin{array}{c} \searrow \\ \nearrow \\ \searrow \\ \nearrow \end{array}$$

Ainsi  $\phi_n$  passe au quotient pour définir une application :

$$\bar{\phi}_n : \frac{\mathcal{D}_n}{((1T), (4T))} \rightarrow \mathcal{G}_n(\mathcal{K}).$$

Grâce à l'intégrale de Kontsevich  $Z^K = (Z_n^K)_{n \in \mathbb{N}}$ , Maxim Kontsevich et Dror Bar-Natan ont montré que cette application est en fait un isomorphisme.

**Théorème 2.1** (D.Bar-Natan [BN95], M.Kontsevich). *Il existe une famille d'applications linéaires  $(Z_n^K : \mathcal{F}_0(\mathcal{K}) \rightarrow \frac{\mathcal{D}_n}{((1T), (4T))})_{n \in \mathbb{N}}$  telle que  $Z_n^K(\mathcal{F}_{n+1}(\mathcal{K})) = 0$  et  $Z_n^K$  induit l'inverse de  $\bar{\phi}_n$  de  $\mathcal{G}_n(\mathcal{K})$  dans  $\frac{\mathcal{D}_n}{((1T), (4T))}$ . En particulier :*

$$\mathcal{G}_n(\mathcal{K}) \cong \frac{\mathcal{D}_n}{((1T), (4T))},$$

et :

$$\frac{\mathcal{I}_n(\mathcal{K})}{\mathcal{I}_{n-1}(\mathcal{K})} \cong \left( \frac{\mathcal{D}_n}{((1T), (4T))} \right)^*.$$

### 3 Filtration de Goussarov-Habiro

Différentes théories d'invariants de type fini des variétés de dimension 3 ont été construites. La première historiquement, due à Tomotada Ohtsuki, est définie pour les sphères d'homologie entière à partir de chirurgies sur les entrelacs algébriquement scindés. Mikhail Goussarov et Kazuo Habiro ont défini indépendamment une théorie d'invariants de type

fini des variétés de dimension 3 à partir des chirurgies borroméennes définies par Sergei V. Matveev dans [Mat87]. La filtration associée a été plus particulièrement étudiée dans le cas des sphères d'homologie entière.

Soit  $J$  un nœud dans une variété  $M$  de dimension 3. Soit  $T(J)$  un voisinage tubulaire de  $J$ . Soit  $\mu$  une courbe fermée simple non séparante de  $\partial T(J)$ . La variété obtenue à partir de  $M$  par *chirurgie sur  $(J, \mu)$*  est la variété  $\chi(M, (J, \mu)) = X \cup_h T$ , réunion de l'extérieur  $X = M \setminus \text{Int}(T(J))$  de  $J$  et d'un tore plein  $T$  recollés le long de leurs bords à l'aide d'un homéomorphisme  $h : \partial X \xrightarrow{\cong} -\partial T$  tel que  $h(\mu)$  borde un disque dans  $T$ . Un *méridien*  $m(J)$  de  $J$  est une courbe fermée simple de  $\partial J$  qui borde un disque  $D$  dans  $T(J)$ , transverse à  $J$ , tel que  $\langle D, J \rangle = 1$ , où  $\langle \cdot, \cdot \rangle$  désigne le nombre d'intersection algébrique. La courbe  $\mu$  est un *parallèle* de  $J$  si  $\langle m(J), \mu \rangle_{\partial T(J)} = 1$ . Le nœud  $J$  est *parallélisé* s'il est muni d'un parallèle fixé  $\ell(J)$ . La *chirurgie sur le nœud parallélisé  $J$*  est la chirurgie sur  $(J, \ell(J))$ . Un *entrelacs parallélisé*  $L$  dans  $M$  est une réunion disjointe de nœuds parallélisés. La *chirurgie sur l'entrelacs parallélisé  $L$*  est la chirurgie simultanée sur toutes ses composantes.

Le *graphe en  $Y$  standard* est le graphe  $\Gamma_0 \subset \mathbb{R}^2$  représenté Figure 6. Les arêtes dont les extrémités coïncident sont les *feuilles*. Le sommet qui relie trois arêtes distinctes est le *sommet interne*. À  $\Gamma_0$  est associé un voisinage régulier  $\Sigma(\Gamma_0)$  de  $\Gamma_0$  dans le plan. La

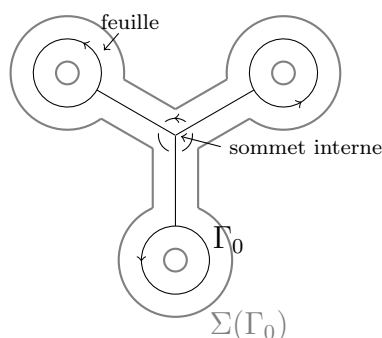

FIGURE 6 – Le graphe en  $Y$  standard

surface  $\Sigma(\Gamma_0)$  est orientée par l'orientation de  $\mathbb{R}^2$ . Cela induit une orientation des feuilles dans le sens trigonométrique, et une *orientation du sommet interne*, c'est-à-dire un ordre cyclique des trois arêtes, également dans le sens trigonométrique. Soit  $M$  une variété de dimension 3 et  $h : \Sigma(\Gamma_0) \hookrightarrow M$  un plongement. L'image  $\Gamma$  de  $\Gamma_0$  est un *graphe en  $Y$* , muni de sa *surface associée*  $\Sigma(\Gamma) = h(\Sigma(\Gamma_0))$ . Le graphe  $\Gamma$  est équipé d'une parallélisation induite par  $\Sigma(\Gamma)$ . Un *entrelacs en  $Y$*  dans une variété de dimension 3 est une collection de graphes en  $Y$  disjoints.

Soit  $\Gamma$  un graphe en  $Y$  dans une variété  $M$  de dimension 3. Soit  $\Sigma(\Gamma)$  sa surface associée. Dans  $\Sigma \times [-1, 1]$ , on associe à  $\Gamma$  l'entrelacs à six composantes  $L$  représenté Figure 7, où chaque composante est munie de son parallèle dans le plan de la figure. La *chirurgie*

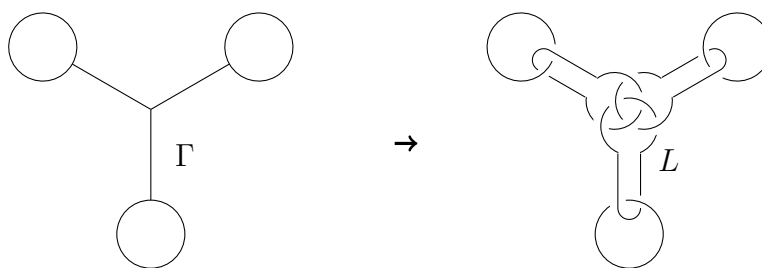

FIGURE 7 – Graphe en Y et entrelacs de chirurgie associé

borroméenne sur  $\Gamma$  est la chirurgie le long de l'entrelacs parallélisé  $L$ . S.V.Matveev a montré dans [Mat87] qu'une chirurgie borroméenne peut être réalisée en coupant un corps en anses de genre 3 (un voisinage régulier du graphe en Y) et en le recollant d'une autre façon.

La *filtration de Goussarov-Habiro* est la filtration définie sur  $\mathcal{F}_0(\mathcal{M}_{\mathbb{Z}})$  par l'ensemble d'opérations  $\Theta(\mathcal{M}_{\mathbb{Z}})$  constitué des chirurgies borroméennes. Si  $\Gamma$  est un entrelacs en Y à  $n$  composantes dans une  $\mathbb{Q}$ -sphère  $M$ , on note  $[M; \Gamma]$  le crochet défini par les  $n$  chirurgies borroméennes associées aux composantes de  $\Gamma$ . Les quotients associés  $\mathcal{G}_n(\mathcal{M}_{\mathbb{Z}})$  peuvent être décrits en termes de diagrammes de Jacobi, d'après un théorème de Thang Le [Le97] montré à l'aide de l'invariant LMO de Thang Le, Jun Murakami, et Tomotada Ohtsuki.

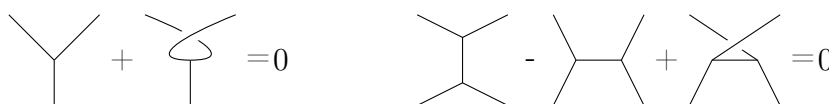



FIGURE 8 – Les relations AS et IHX

Un *diagramme de Jacobi* est un graphe trivalent dont les sommets sont orientés. Une *orientation d'un sommet* d'un tel diagramme est un ordre cyclique des trois demi-arêtes qui se rencontrent à ce sommet. Dans les figures, cette orientation est induite par l'ordre cyclique . Le *degré* d'un diagramme de Jacobi est la moitié de son nombre de sommet. Notons que c'est un entier. Soit  $\mathcal{A}_n$  le  $\mathbb{Q}$ -espace vectoriel engendré par les diagrammes de Jacobi de degré  $n$ , soumis aux relations AS et IHX (Figure 8). L'espace  $\mathcal{A}_0$  est engendré par le diagramme vide. Soit  $\mathcal{A}_n^c$  le sous-espace de  $\mathcal{A}_n$  engendré par les diagrammes connexes.

Soit  $\Gamma$  un diagramme de Jacobi de degré  $n$ . Soit  $\varphi : \Gamma \hookrightarrow \mathbb{R}^3$  un plongement tel que la projection orthogonale sur  $\mathbb{R}^2 \times \{0\}$  de  $\varphi(\Gamma)$  est régulière, et donc induit une parallélisation de  $\varphi(\Gamma)$ . On associe alors à  $\Gamma$  un entrelacs en Y, noté  $\tilde{\Gamma}$ , dans  $S^3$  en remplaçant les arêtes de  $\varphi(\Gamma)$  comme indiqué Figure 9.

**Théorème 3.1** (Stavros Garoufalidis, Mikhail Goussarov, Michael Polyak, [GGP01] §4).



FIGURE 9 – Remplacement d’une arête

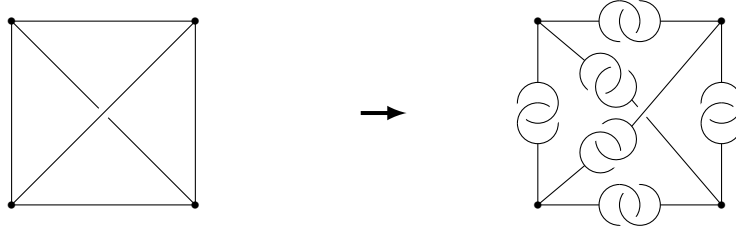

FIGURE 10 – Diagramme de Jacobi et entrelacs en Y associé

Le crochet  $[S^3; \tilde{\Gamma}] \in \mathcal{G}_{2n}(\mathcal{M}_{\mathbb{Z}})$  ne dépend que de la classe de  $\Gamma$  dans  $\mathcal{A}_n$ . D’où :

$$\begin{aligned} \Phi_n : \mathcal{A}_n &\rightarrow \mathcal{G}_{2n}(\mathcal{M}_{\mathbb{Z}}) \\ \Gamma &\mapsto [S^3; \Gamma] := [S^3; \tilde{\Gamma}] \end{aligned}$$

De plus, l’application  $\Phi_n$  est surjective.

T.Le, J.Murakami, et T.Ohtsuki ont défini dans [LMO98] un invariant  $Z^{LMO} = (Z_n^{MLO})_{n \in \mathbb{N}}$  des variétés de dimension 3. Dans [Le97], T.Le a montré que  $Z_n^{LMO}$  induit l’inverse de  $\Phi_n$ . Finalement :

**Théorème 3.2** (S.Garoufalidis, M.Goussarov, M.Polyak [GGP01], K.Habiro [Hab00b], T.Le [Le97]). *Pour  $n$  impair,  $\mathcal{G}_n(\mathcal{M}_{\mathbb{Z}}) = 0$ . Pour  $n$  pair, l’application  $\Phi_n : \mathcal{A}_{\frac{n}{2}} \rightarrow \mathcal{G}_n(\mathcal{M}_{\mathbb{Z}})$  est un isomorphisme.*

## 4 Chirurgies préservant le lagrangien

Les chirurgies préservant le lagrangien forment un autre ensemble d’opérations agissant sur des éléments de  $\mathcal{M}$ . On définit ci-dessous les chirurgies entières préservant le lagrangien et les chirurgies rationnelles préservant le lagrangien.

**Définition 4.1.** Pour  $g \in \mathbb{N}$ , un *corps en anses d’homologie entière (resp. rationnelle) de genre  $g$*  ( $\mathbb{Z}HH$ , resp.  $\mathbb{Q}HH$ ) est une variété de dimension 3, compacte, orientée, à bord, qui a la même homologie à coefficients entiers (resp. rationnels) que le corps en anses standard de genre  $g$ .

Notons qu'un  $\mathbb{Z}$ HH est un QHH. Un QHH est connexe, et son bord est nécessairement homéomorphe à la surface standard de genre  $g$ .

**Définition 4.2.** Le *lagrangien*  $\mathcal{L}_A$  d'un QHH  $A$  est le noyau de l'application

$$i_* : H_1(\partial A; \mathbb{Q}) \rightarrow H_1(A; \mathbb{Q})$$

induite par l'inclusion. Deux QHH  $A$  et  $B$  ont des bords *LP-identifiés* si on s'est donné un homéomorphisme  $h : \partial A \rightarrow \partial B$  tel que  $h_*(\mathcal{L}_A) = \mathcal{L}_B$ .

Le lagrangien d'un QHH  $A$  est un sous-espace lagrangien de  $H_1(\partial A; \mathbb{Q})$  pour la forme d'intersection.

Soient  $M$  une  $\mathbb{Q}$ -sphère,  $A \subset M$  un QHH, et  $B$  un QHH dont le bord est LP-identifié à  $\partial A$ . Soit  $M(\frac{B}{A}) = (M \setminus \text{Int}(A)) \cup_{\partial A =_h \partial B} B$ . On dit que la  $\mathbb{Q}$ -sphère  $M(\frac{B}{A})$  est obtenue à partir de  $M$  par *chirurgie rationnelle préservant le lagrangien*, ou *chirurgie LP rationnelle*. La chirurgie LP est dite *entière* lorsque  $A$  et  $B$  sont des  $\mathbb{Z}$ HH. Notons qu'une chirurgie borroméenne est un cas particulier de chirurgie LP entière. Si  $(A_i)_{1 \leq i \leq n}$  est une famille de QHH disjoints dans  $M$ , et si, pour chaque  $i$ ,  $B_i$  est un QHH dont le bord est LP-identifié à  $\partial A_i$ , on note  $M(\frac{B_i}{A_i})_{1 \leq i \leq n}$  la variété obtenue à partir de  $M$  par les  $n$  chirurgies LP  $(\frac{B_i}{A_i})$ .

Le résultat suivant, prouvé indépendamment par Nathan Habegger et par Emmanuel Auclair et Christine Lescop, montre qu'une chirurgie LP entière peut être réalisée par une suite de chirurgies borroméennes.

**Proposition 4.3** ([AL05] Lemma 4.11, [Hab00a] Theorem 2.5). *Si  $A$  et  $B$  sont deux  $\mathbb{Z}$ HH dont les bords sont LP-identifiés, alors  $A$  et  $B$  s'obtiennent l'un de l'autre par une suite finie de chirurgies borroméennes dans l'intérieur des  $\mathbb{Z}$ HH.*

Ce résultat fournit une définition alternative de la filtration de Goussarov-Habiro de  $\mathcal{F}_0(\mathcal{M}_{\mathbb{Z}})$ . En effet, on obtient la même filtration en prenant comme ensemble d'opérations  $\Theta(\mathcal{M}_{\mathbb{Z}})$  l'ensemble des chirurgies LP entières.

Dans la suite, sauf mention expresse du contraire, les chirurgies LP seront toujours rationnelles.



## Chapitre 2 : Description des principaux résultats de la thèse

# 1 Invariants de type fini des sphères d'homologie rationnelle

Dans cette section, on considère l'ensemble  $\mathcal{M}_{\mathbb{Q}}$  des sphères d'homologie rationnelle à homéomorphisme préservant l'orientation près, et l'ensemble  $\Theta(\mathcal{M}_{\mathbb{Q}})$  des chirurgies LP rationnelles. On expose les résultats du chapitre 3, dont le principal objectif est d'identifier le gradué  $\mathcal{G}(\mathcal{M}_{\mathbb{Q}}) = \bigoplus_{n \in \mathbb{N}} \mathcal{G}_n(\mathcal{M}_{\mathbb{Q}})$  à un espace gradué de diagrammes.

## 1.1 Chirurgies LP rationnelles

De même que les chirurgies LP entières peuvent être réalisées par des chirurgies borroméennes (Proposition 4.3 du chapitre 1), les chirurgies LP rationnelles peuvent être réalisées par des mouvements plus spécifiques.

**Définition 1.1.** Soit  $d$  un entier strictement positif. Un  $d$ -tore est un tore d'homologie rationnelle  $T_d$  tel que :

- $H_1(\partial T_d; \mathbb{Z}) = \mathbb{Z}\alpha \oplus \mathbb{Z}\beta$ , avec  $\langle \alpha, \beta \rangle = 1$ ,
- $d\alpha = 0$  dans  $H_1(T_d; \mathbb{Z})$ ,
- $\beta = d\gamma$  dans  $H_1(T_d; \mathbb{Z})$ , où  $\gamma$  est une courbe dans  $T_d$ ,
- $H_1(T_d; \mathbb{Z}) = \frac{\mathbb{Z}}{d\mathbb{Z}}\alpha \oplus \mathbb{Z}\gamma$ .

**Définition 1.2.** Une *chirurgie élémentaire* est une chirurgie LP parmi les suivantes :

1. somme connexe (genre 0),
2. chirurgie LP remplaçant un tore standard par un  $d$ -tore (genre 1),
3. chirurgie borroméenne (genre 3).

**Théorème 1.3** ([Chap. 3] Theorem 1.15). *Si  $A$  et  $B$  sont des  $\mathbb{Q}HH$  dont les bords sont LP-identifiés, alors  $A$  et  $B$  s'obtiennent l'un de l'autre par une suite finie de chirurgies élémentaires et leurs inverses dans l'intérieur des  $\mathbb{Q}HH$ .*

Une conséquence immédiate de ce théorème est que les sous-espaces  $\mathcal{F}_n(\mathcal{M}_{\mathbb{Q}})$  de la filtration sont engendrés par les crochets définis par des chirurgies élémentaires.



## 1.2 Invariants de degré 1

Toute  $\mathbb{Q}$ -sphère peut être vue comme l'union d'une boule d'homologie rationnelle (un  $\mathbb{Q}$ HH de genre 0) et d'une boule standard  $B^3$ , recollées le long de leurs bords. Ainsi deux  $\mathbb{Q}$ -sphères s'obtiennent l'une de l'autre par une chirurgie LP. On en déduit que  $\mathcal{G}_0(\mathcal{M}_{\mathbb{Q}}) \cong \mathbb{Q}$  et que les invariants de degré 0 sont les applications constantes sur l'ensemble des  $\mathbb{Q}$ -sphères. Dans le chapitre 3, on montre que les invariants de degré 1 des  $\mathbb{Q}$ -sphères sont donnés par les valuations  $p$ -adiques du cardinal du premier groupe d'homologie.

Pour un entier premier  $p$ , on note  $\nu_p$  la valuation  $p$ -adique, définie sur  $\mathbb{N} \setminus \{0\}$  par  $\nu_p(p^k n) = k$  si  $n$  est premier à  $p$ .

**Proposition 1.4** ([Chap. 3] Proposition 1.9). *Pour tout entier premier  $p$ , on définit une application linéaire  $\nu_p$  sur  $\mathcal{F}_0(\mathcal{M}_{\mathbb{Q}})$  en posant  $\nu_p(M) = \nu_p(|H_1(M; \mathbb{Z})|)$  pour toute  $\mathbb{Q}$ -sphère  $M$ . Alors  $\nu_p$  est un invariant de degré 1 des  $\mathbb{Q}$ -sphères.*

Pour tout entier premier  $p$ , soit  $M_p$  une  $\mathbb{Q}$ -sphère telle que  $|H_1(M_p; \mathbb{Z})| = p$ . On a  $\nu_p(M_p) = 1$ ,  $\nu_p(M_q) = 0$  pour tout entier premier  $q \neq p$ , et  $\nu_p(S^3) = 0$  pour tout entier premier  $p$ . En particulier, si  $\overline{M_p - S^3}$  est la classe de  $(M_p - S^3)$  dans  $\mathcal{G}_1(\mathcal{M}_{\mathbb{Q}})$ , la famille  $(\overline{M_p - S^3})_{p \text{ premier}}$  est libre. On a en fait :

**Proposition 1.5** ([Chap. 3] Proposition 1.8). *Pour tout entier premier  $p$ , soit  $M_p$  une  $\mathbb{Q}$ -sphère telle que  $|H_1(M_p; \mathbb{Z})| = p$ . Alors  $(\overline{M_p - S^3})_{p \text{ premier}}$  est une base de  $\mathcal{G}_1(\mathcal{M}_{\mathbb{Q}})$ .*

**Remarque :** Les  $\mathbb{Q}$ -sphères  $M_p$  ne sont pas uniques dans  $\mathcal{F}_0(\mathcal{M}_{\mathbb{Q}})$ , mais elles sont uniques modulo  $\mathcal{F}_2(\mathcal{M}_{\mathbb{Q}})$ .

**Corollaire 1.6** ([Chap. 3] Corollary 1.10). 
$$\frac{\mathcal{I}_1(\mathcal{M}_{\mathbb{Q}})}{\mathcal{I}_0(\mathcal{M}_{\mathbb{Q}})} = \prod_{p \text{ premier}} \mathbb{Q} \nu_p.$$

## 1.3 Invariants de degré 1 des tores d'homologie rationnelle

Pour décrire les quotients  $\mathcal{G}_n(\mathcal{M}_{\mathbb{Q}})$ , on cherche à réduire au maximum l'ensemble de leurs générateurs. On a vu que ces quotients sont engendrés par les crochets définis par des chirurgies élémentaires. On peut en fait se limiter aux chirurgies élémentaires de genre 0 ou 3 grâce à l'étude des invariants de degré 1 des tores d'homologie rationnelle parallélisés.

Soit  $T$  un tore d'homologie rationnelle. Un *méridien* de  $T$  est une courbe fermée simple de  $\partial T$  dont la classe d'homologie engendre  $\mathcal{L}_T$ . Il existe toujours un tel méridien  $m(T)$ , et sa classe d'homologie dans  $H_1(\partial T; \mathbb{Q})$  est bien définie au signe près. Un *parallèle* de  $T$  est une courbe fermée simple  $\ell(T)$  de  $\partial T$  telle que  $\langle m(T), \ell(T) \rangle_{\partial T} = \pm 1$ , où  $\langle \cdot, \cdot \rangle_{\partial T}$  désigne le nombre d'intersection algébrique sur  $\partial T$ . Un tore d'homologie rationnelle est dit *parallélisé* s'il est muni d'un parallèle fixé  $\ell(T)$ . On oriente alors le méridien  $m(T)$  de façon à avoir  $\langle m(T), \ell(T) \rangle_{\partial T} = 1$ . Étant donnés deux tels tores, la donnée des parallèles fixés induit une LP-identification canonique de leurs bords.

Soit  $\mathcal{T}_{\mathbb{Q}}$  l'ensemble des tores d'homologie rationnelle parallélisés. Soit  $\Theta(\mathcal{T}_{\mathbb{Q}})$  l'ensemble des chirurgies LP rationnelles définies dans l'intérieur de ces tores.

Soit  $T_0$  un tore solide standard parallélisé. Pour tout entier premier  $p$ , soit  $M_p$  une  $\mathbb{Q}$ -sphère telle que  $H_1(M_p; \mathbb{Z}) \cong \mathbb{Z}/p\mathbb{Z}$ . Soit  $B_p$  la boule d'homologie rationnelle obtenue à partir de  $M_p$  en retirant l'intérieur d'une boule fermée plongée.

**Proposition 1.7** ([Chap. 3] Proposition 5.1).  $\mathcal{G}_1(\mathcal{T}_{\mathbb{Q}}) = \bigoplus_{p \text{ premier}} \mathbb{Q}[T_0; \frac{B_p}{B^3}]$

La famille d'invariants duale de  $(-[T_0; \frac{B_p}{B^3}])_{p \text{ premier}}$  est donnée par les  $\mu_p$  définis comme suit. À un tore d'homologie rationnelle parallélisé  $T$ , on associe une  $\mathbb{Q}$ -sphère  $M(T) = T \cup T_0$  obtenue en recollant  $T$  et le tore standard  $T_0$  le long de leurs bords de façon à identifier le parallèle préféré de l'un au méridien de l'autre. On pose alors  $\mu_p(T) = \nu_p(M(T))$ .

**Corollaire 1.8** ([Chap. 3] Corollary 5.10). *Si  $\mu$  est un invariant de degré 1 des tores d'homologie rationnelle parallélisés, tel que  $\mu(T_0) = 0$  et  $\mu(T_0 \sharp M_p) = 0$  pour tout  $p$  premier, alors  $\mu = 0$ .*

Ce résultat implique qu'un invariant de degré  $n$  qui s'annule sur les crochets, définis par  $n$  chirurgies, contenant des chirurgies de genre 0 s'annule aussi sur les crochets contenant des chirurgies de genre 1 (voir [Chap. 3, Lemma 5.15]).

## 1.4 Invariants additifs

On a vu la description des quotients  $\mathcal{G}_0(\mathcal{M}_{\mathbb{Q}})$  et  $\mathcal{G}_1(\mathcal{M}_{\mathbb{Q}})$ . Pour les degrés supérieurs, on détermine dans un premier temps les espaces d'invariants additifs.

Soient  $M_1$  et  $M_2$  deux  $\mathbb{Q}$ -sphères. Soit  $B_1$  (resp.  $B_2$ ) la boule d'homologie rationnelle obtenue à partir de  $M_1$  (resp.  $M_2$ ) en retirant l'intérieur d'une boule standard fermée plongée. La *somme connexe* de  $M_1$  et  $M_2$  est la variété  $M_1 \sharp M_2$  obtenue en collant  $B_1$  et  $B_2$  le long de leurs bords.

**Définition 1.9.** Un invariant  $\lambda$  des  $\mathbb{Q}$ -sphères est *additif* si  $\lambda(M_1 \sharp M_2) = \lambda(M_1) + \lambda(M_2)$  pour toutes  $\mathbb{Q}$ -sphères  $M_1$  et  $M_2$ .

On note  $\mathcal{I}_n^c(\mathcal{M}_{\mathbb{Q}})$  l'ensemble des invariants additifs de degré au plus  $n$  des  $\mathbb{Q}$ -sphères. Notons que  $\mathcal{I}_0^c(\mathcal{M}_{\mathbb{Q}}) = 0$  et  $\mathcal{I}_1^c(\mathcal{M}_{\mathbb{Q}}) = \frac{\mathcal{I}_1(\mathcal{M}_{\mathbb{Q}})}{\mathcal{I}_0(\mathcal{M}_{\mathbb{Q}})}$ .

On voit facilement qu'un invariant additif de degré  $n > 1$  s'annule sur les crochets définis par  $n$  chirurgies contenant une chirurgie de genre 0. Les résultats mentionnés ci-dessus montrent alors qu'un tel invariant est déterminé par ses variations sur les chirurgies borroméennes. Dans [Chap. 3, Section 3], on reprend les méthodes de S.Garoufalidis, M.Goussarov et M.Polyak dans [GGP01] pour étudier les crochets définis par  $n$  chirurgies borroméennes, c'est-à-dire par un entrelacs en  $Y$  à  $n$  composantes. On voit que, comme

dans le cas de la filtration de Goussarov-Habiro, on est ramené à des diagrammes de Jacobi.

Soit  $\mathcal{A}_n^c$  le sous-espace de  $\mathcal{A}_n$  engendré par les diagrammes connexes.

**Proposition 1.10** ([Chap. 3] Proposition 1.11). *Pour  $n > 1$ ,  $\frac{\mathcal{I}_n^c(\mathcal{M}_{\mathbb{Q}})}{\mathcal{I}_{n-1}^c(\mathcal{M}_{\mathbb{Q}})} \cong (\mathcal{A}_{\frac{n}{2}}^c)^*$  si  $n$  est pair, et  $\frac{\mathcal{I}_n^c(\mathcal{M}_{\mathbb{Q}})}{\mathcal{I}_{n-1}^c(\mathcal{M}_{\mathbb{Q}})} \cong 0$  si  $n$  est impair.*

Le produit  $\lambda\mu$  de deux invariants  $\lambda$  et  $\mu$  vérifie :

$$\lambda\mu\left(\sum_{i \in I} a_i M_i\right) = \sum_{i \in I} a_i \lambda(M_i)\mu(M_i),$$

pour tout ensemble fini  $I$ , tous nombres rationnels  $a_i$ , et toutes  $\mathbb{Q}$ -sphères  $M_i$ .

**Lemme 1.11** ([Chap. 3] Lemma 6.2). *Si  $\lambda \in \mathcal{I}_k(\mathcal{M}_{\mathbb{Q}})$  et  $\mu \in \mathcal{I}_\ell(\mathcal{M}_{\mathbb{Q}})$ , alors  $\lambda\mu \in \mathcal{I}_{k+\ell}(\mathcal{M}_{\mathbb{Q}})$ .*

Ainsi le produit des invariants de type fini induit une structure d'algèbre graduée sur  $\mathcal{H}(\mathcal{M}_{\mathbb{Q}}) = \bigoplus_{n \in \mathbb{N}} \frac{\mathcal{I}_n(\mathcal{M}_{\mathbb{Q}})}{\mathcal{I}_{n-1}(\mathcal{M}_{\mathbb{Q}})}$ , où  $\mathcal{I}_{-1}(\mathcal{M}_{\mathbb{Q}}) = 0$ .

On définit dans [Chap. 3, Section 6] un coproduit  $\Delta$  sur l'algèbre  $\mathcal{H}(\mathcal{M}_{\mathbb{Q}})$ , qui la munit d'une structure d'algèbre de Hopf. John W. Milnor et John C. Moore [MM65] ont montré que, sous certaines conditions, une algèbre de Hopf est engendrée comme algèbre par ses éléments primitifs. On donne dans le chapitre 3 une preuve explicite et élémentaire de ce fait pour l'algèbre  $\mathcal{H}(\mathcal{M}_{\mathbb{Q}})$ . Les éléments primitifs de  $\mathcal{H}(\mathcal{M}_{\mathbb{Q}})$  (les invariants  $\lambda$  tels que  $\Delta(\lambda) = \lambda \otimes 1 + 1 \otimes \lambda$ ) sont les invariants additifs. On en déduit que tout invariant de type fini des  $\mathbb{Q}$ -sphères, nul sur  $S^3$ , s'écrit comme somme de produits d'invariants additifs.

### 1.5 L'algèbre graduée associée à la filtration

Un *diagramme augmenté de degré  $n$*  est l'union d'un diagramme de Jacobi de degré  $k \leq \frac{n}{2}$  et de  $(n - 2k)$  sommets pondérés par des entiers premiers. Notons que le degré d'un dia-

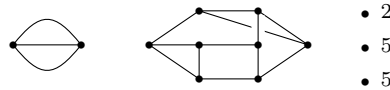

FIGURE 1 – Diagramme augmenté de degré 13

gramme augmenté est égal à son nombre de sommets. On note  $\mathcal{A}_n^{aug}$  le  $\mathbb{Q}$ -espace vectoriel engendré par les diagrammes augmentés de degré  $n$ , quotienté par les relations AS et IHX.

**Théorème 1.12** ([Chap. 3] Theorem 1.7). *Pour  $n \in \mathbb{N}$ ,  $\mathcal{A}_n^{aug} \cong \mathcal{G}_n(\mathcal{M}_{\mathbb{Q}})$ .*

Un isomorphisme peut être décrit de la manière suivante. Soit  $\Gamma_a$  un diagramme augmenté de degré  $n$ , union d'un diagramme de Jacobi  $\Gamma$  de degré  $k$  et de  $(n - 2k)$  sommets isolés pondérés par  $(p_i)_{1 \leq i \leq n-2k}$ . On définit  $\varphi(\Gamma) \subset S^3$  et l'entrelacs en  $Y$  associé  $\tilde{\Gamma}$  comme dans le cas de la filtration de Goussarov-Habiro. Pour tout  $i$ , on note  $B_{p_i}$  une boule d'homologie rationnelle telle que  $H_1(B_{p_i}; \mathbb{Z}) \cong \frac{\mathbb{Z}}{p_i \mathbb{Z}}$ . On définit alors l'image de  $\Gamma_a$  comme  $[S^3; \tilde{\Gamma}, (\frac{B_{p_i}}{B^3})_{1 \leq i \leq n-2k}] \in \mathcal{G}_n(\mathcal{M}_{\mathbb{Q}})$ .

La somme connexe, étendue à  $\mathcal{F}_0(\mathcal{M}_{\mathbb{Q}})$  par bilinéarité, induit un produit sur le gradué  $\mathcal{G}(\mathcal{M}_{\mathbb{Q}})$  qui le munit d'une structure d'algèbre graduée. Le gradué  $\mathcal{A}^{aug} = \bigoplus_{n \in \mathbb{N}} \mathcal{A}_n^{aug}$  est aussi muni d'une structure d'algèbre graduée grâce au produit défini par l'union disjointe des diagrammes. Les isomorphismes décrits ci-dessus induisent un isomorphisme d'algèbres graduées  $\mathcal{A}^{aug} \cong \mathcal{G}(\mathcal{M}_{\mathbb{Q}})$ .

## 1.6 Les invariants LMO et KKT

L'invariant  $Z_{KKT} = (Z_{n,KKT})_{n \in \mathbb{N}}$  est un invariant des  $\mathbb{Q}$ -sphères construit par M.Kontsevich. Dans [KT99], Greg Kuperberg et Dylan Thurston ont montré que c'est un invariant universel pour les invariants de type fini des  $\mathbb{Z}$ -sphères. Dans [Les04], C.Lescop a montré que cet invariant vérifie des formules de scindement par rapport aux chirurgies LP rationnelles. Ces formules nous permettent de d'obtenir la proposition 1.10 en montrant que  $Z_{KKT}$  est un invariant universel pour les invariants de type fini additifs des  $\mathbb{Q}$ -sphères. Le théorème 1.12 découle du fait que les valuations  $p$ -adiques du cardinal du premier groupe d'homologie complètent cet invariant en un invariant universel pour les invariants de type fini des  $\mathbb{Q}$ -sphères.

Dans [Mas12], Gwénaél Massuyeau a montré que l'invariant  $Z_{LMO} = (Z_{n,LMO})_{n \in \mathbb{N}}$  vérifie les mêmes formules de scindement que l'invariant  $Z_{KKT}$ . Il s'ensuit que ces deux invariants sont équivalents au sens suivant :

**Théorème 1.13** ([Chap. 3] Theorem 1.1). *Soient  $M$  et  $N$  des  $\mathbb{Q}$ -sphères qui vérifient  $|H_1(M; \mathbb{Z})| = |H_1(N; \mathbb{Z})|$ . Alors, pour tout  $n \in \mathbb{N}$  :*

$$(Z_{k,LMO}(M) = Z_{k,LMO}(N) \quad \forall k \leq n) \Leftrightarrow (Z_{k,KKT}(M) = Z_{k,KKT}(N) \quad \forall k \leq n).$$

## 2 Caractérisation des classes d'isomorphisme de modules d'Alexander munis de leurs formes de Blanchfield

On décrit dans ce paragraphe les résultats du chapitre 4, dont l'objet est l'étude des modules d'Alexander rationnels, munis de leurs formes de Blanchfield, des QSK-paires.

Ces invariants jouent un rôle important dans l'étude des invariants de type fini des  $\mathbb{Q}SK$ -paires.

## 2.1 Définitions

Soient  $K_1$  et  $K_2$  deux nœuds disjoints dans une  $\mathbb{Q}$ -sphère  $M$ . Le *nombre d'enlacement* de  $K_1$  et  $K_2$  est le nombre rationnel  $lk(K_1, K_2)$  tel que  $K_1 = lk(K_1, K_2)m(K_2)$  dans  $H_1(M \setminus K_2; \mathbb{Q})$ , où  $m(K_2)$  est un méridien de  $K_2$ . Le nombre d'enlacement est symétrique. Si  $K_2$  est le bord d'une surface compacte, connexe et orientée  $\Sigma$ , alors le nombre d'enlacement  $lk(K_1, K_2)$  est égal au nombre d'intersection algébrique  $\langle \Sigma, K_1 \rangle$ .

Soit  $(M, K)$  une  $\mathbb{Q}SK$ -paire. Soit  $T(K)$  un voisinage tubulaire de  $K$ . L'*extérieur* de  $K$  est  $X = M \setminus Int(T(K))$ . Soit  $\pi : \pi_1(X) \rightarrow \frac{H_1(X; \mathbb{Z})}{torsion} \cong \mathbb{Z}$  la projection naturelle, et soit  $p : \tilde{X} \rightarrow X$  l'application de revêtement associée au noyau de  $\pi$ . Le revêtement  $\tilde{X}$  est le *revêtement infini cyclique* de  $X$ . Le groupe d'automorphismes du revêtement,  $Aut(\tilde{X})$ , est isomorphe à  $\mathbb{Z}$ . Il agit sur  $H_1(\tilde{X}; \mathbb{Q})$ . Soit  $\tau$  un générateur de  $Aut(\tilde{X})$ . On définit une structure de  $\mathbb{Q}[t^{\pm 1}]$ -module sur  $\mathfrak{A}(K) = H_1(\tilde{X}; \mathbb{Q})$  en définissant la multiplication par  $t$  comme l'action de  $\tau$ . Le  $\mathbb{Q}[t^{\pm 1}]$ -module  $\mathfrak{A}(K)$  est le *module d'Alexander* de  $K$ . C'est un  $\mathbb{Q}[t^{\pm 1}]$ -module de torsion.

Sur le module d'Alexander  $\mathfrak{A}(K)$ , on définit la *forme de Blanchfield*, ou *forme d'enlacement équivariante*,  $\mathfrak{b}_K : \mathfrak{A}(K) \times \mathfrak{A}(K) \rightarrow \frac{\mathbb{Q}(t)}{\mathbb{Q}[t^{\pm 1}]}$ , comme suit. On commence par définir le nombre d'enlacement équivariant de deux nœuds.

**Définition 2.1.** Soient  $J_1$  et  $J_2$  deux nœuds dans  $\tilde{X}$  tels que  $J_1 \cap \tau^k(J_2) = \emptyset$  pour tout  $k \in \mathbb{Z}$ . Soit  $\delta(t)$  l'annulateur de  $\mathfrak{A}(K)$ . Alors  $\delta(\tau)J_1$  et  $\delta(\tau)J_2$  sont des entrelacs triviaux dans  $\mathfrak{A}(K)$ . Le *nombre d'enlacement équivariant* de  $J_1$  et  $J_2$  est :

$$lk_e(J_1, J_2) = \frac{1}{\delta(t)\delta(t^{-1})} \sum_{k \in \mathbb{Z}} lk(\delta(\tau)J_1, \tau^k(\delta(\tau)J_2))t^k.$$

On montre facilement que  $lk_e(J_1, J_2) \in \frac{1}{\delta(t)}\mathbb{Q}[t^{\pm 1}]$ ,

$$lk_e(J_2, J_1)(t) = lk_e(J_1, J_2)(t^{-1}),$$

et

$$lk_e(P(\tau)J_1, Q(\tau)J_2)(t) = P(t)Q(t^{-1})lk_e(J_1, J_2)(t).$$

Maintenant, si  $\gamma$  (resp.  $\eta$ ) est la classe d'homologie de  $J_1$  (resp.  $J_2$ ) dans  $\mathfrak{A}(K)$ , on définit  $\mathfrak{b}_K(\gamma, \eta)$  par :

$$\mathfrak{b}_K(\gamma, \eta) = lk_e(J_1, J_2) \text{ mod } \mathbb{Q}[t^{\pm 1}].$$

La forme de Blanchfield est *hermitienne* :

$$\mathfrak{b}_K(P(t)\gamma, Q(t)\eta)(t) = P(t)Q(t^{-1})\mathfrak{b}_K(\gamma, \eta)(t)$$

et

$$\mathfrak{b}_K(\gamma, \eta)(t) = \mathfrak{b}_K(\eta, \gamma)(t^{-1})$$

pour tous  $\gamma, \eta \in \mathfrak{A}(K)$  et tous  $P, Q \in \mathbb{Q}[t^{\pm 1}]$ . De plus, Richard C. Blanchfield a montré dans [Bla57] qu'elle est *non dégénérée* :  $\mathfrak{b}_K(\gamma, \eta) = 0$  pour tout  $\eta \in \mathfrak{A}(K)$  implique  $\gamma = 0$ .

On définit de la même façon le module d'Alexander entier  $\mathfrak{A}_{\mathbb{Z}}(K)$  de  $K$  comme le  $\mathbb{Z}[t^{\pm 1}]$ -module  $H_1(\tilde{X}; \mathbb{Z})$ , et la forme de Blanchfield  $\mathfrak{b}_{\mathbb{Z}, K}$  sur ce module.

## 2.2 Classification des modules d'Alexander

Une *présentation de chirurgie admissible* est la donnée d'une QSK-paire  $(M_0, K_0)$  où  $K_0$  est un nœud trivial, et d'un entrelacs parallélisé  $L = \sqcup_{i \in I} J_i \subset (M_0 \setminus K_0)$ , où les  $J_i$  sont des nœuds parallélisés satisfaisant  $lk(J_i, K_0) = 0$  pour tout  $i$  et  $\det((lk(J_i, J_j))_{1 \leq i, j \leq n}) \neq 0$ . Le nombre d'enlacement  $lk(J_i, J_i)$  est défini comme le nombre d'enlacement de  $J_i$  avec son parallèle fixé. On note  $\chi(M_0, L)$  la variété obtenue à partir de  $M_0$  par chirurgie sur  $L$ . On vérifie facilement que  $(M, K) = (\chi(M_0, L), K_0)$  est encore une QSK-paire. Réciproquement :

**Lemme 2.2** ([Chap. 4] Lemmes 2.1 et 2.2). *Pour toute QSK-paire  $(M, K)$ , il existe une présentation de chirurgie admissible  $(S^3, K_0, L)$  telle que  $(M, K) \cong (\chi(S^3, L), K_0)$ .*

Une présentation de chirurgie admissible d'une QSK-paire fournit une méthode de calcul du module d'Alexander et de la forme de Blanchfield associés. C'est cette méthode qu'on utilise dans le chapitre 4 pour étudier le module d'Alexander et la forme de Blanchfield.

Étant donnée une présentation de chirurgie admissible  $(M_0, K_0, L)$ , le revêtement infini cyclique associé à la QSK-paire  $(M, K) = (\chi(M_0, L), K_0)$  s'obtient à partir du revêtement infini cyclique associé à  $(M_0, K_0)$  par chirurgie sur tous les relevés de  $L$ . On en déduit une matrice de présentation du module d'Alexander  $\mathfrak{A}(K)$ .

**Proposition 2.3** ([Chap. 4] Proposition 2.5). *Soit  $(M, K)$  une QSK-paire. Soit  $(M_0, K_0, L = \amalg_{i=1}^n J_i)$  une présentation de chirurgie admissible telle que  $(M, K) = (\chi(M_0, L), K_0)$ . Soit  $\tilde{X}_0$  le revêtement infini cyclique associé à  $(M_0, K_0)$ . Pour  $1 \leq i \leq n$ , soit  $\tilde{J}_i$  un relevé de  $J_i$  dans  $\tilde{X}_0$ . La matrice d'enlacement équivariant  $A(t)$  définie par  $A_{ij}(t) = lk_e(\tilde{J}_j, \tilde{J}_i)$  est une matrice de présentation du module d'Alexander  $\mathfrak{A}(K)$ . Cette matrice est hermitienne, c'est-à-dire que la transposée de  $A(t)$  est  $A(t^{-1})$ , et elle vérifie  $\det(A(1)) \neq 0$ .*

Cette proposition permet d'établir les propriétés du module d'Alexander, à savoir les propriétés mentionnées dans le théorème 2.5 ci-dessous. La proposition qui suit permet de réaliser tout module vérifiant ces propriétés comme module d'Alexander d'une QSK-paire.

**Proposition 2.4** ([Chap. 4] Proposition 2.10). *Soit  $A(t)$  une matrice à coefficients dans  $\mathbb{Q}[t^{\pm 1}]$ , hermitienne, telle que  $\det(A(1)) \neq 0$ . Alors la matrice  $A(t)$  est la matrice d'enlacement équivariant associée à une présentation de chirurgie admissible d'une QSK-paire  $(M, K)$ .*

**Théorème 2.5** ([Chap. 4] Theorem 1.5). *Soit  $(\delta_1, \dots, \delta_p)$  une famille de polynômes de  $\mathbb{Q}[t^{\pm 1}]$  tels que  $\delta_{i+1} | \delta_i$  pour  $1 \leq i < p$ . Alors le module  $\bigoplus_{i=1}^p \frac{\mathbb{Q}[t^{\pm 1}]}{\delta_i(t)}$  est le module d'Alexander d'une  $\mathbb{Q}SK$ -paire  $(M, K)$  si et seulement si les  $\delta_i$  vérifient les conditions suivantes :*

- $\delta_i(1) \neq 0$  pour  $1 \leq i \leq p$ ,
- $\delta_i(t^{-1}) = t^{q_i} \delta_i(t)$ , avec  $q_i \in \mathbb{Z}$ , pour  $1 \leq i \leq p$ ,
- si, pour  $1 \leq i \leq p$ , on note  $m_i$  la multiplicité de  $-1$  comme racine de  $\delta_i$ , alors, pour tout entier impair  $m$ , le nombre d'indices  $i$  tels que  $m_i = m$  est pair.

Les  $\mathbb{Q}[t^{\pm 1}]$ -modules apparaissant comme module d'Alexander d'un nœud dans  $S^3$  (ou dans une sphère d'homologie entière) ont été déterminés par Jerome Levine dans [Lev65]. Ce sont tous ceux pour lesquels les  $\delta_i$  peuvent être choisis à coefficients entiers et vérifiant  $\delta_i(1) = 1$ . En particulier,  $-1$  n'apparaît jamais comme racine de ces  $\delta_i$ .

## 2.3 Caractérisation de la forme de Blanchfield

La proposition qui suit récapitule certaines propriétés du module d'Alexander et de la forme de Blanchfield.

**Proposition 2.6** ([Chap. 4] Proposition 1.2). *Soit  $(\mathfrak{A}(K), \mathfrak{b}_K)$  le module d'Alexander d'une  $\mathbb{Q}SK$ -paire  $(M, K)$  muni de sa forme de Blanchfield.*

1. *Le module  $\mathfrak{A}(K)$  est un  $\mathbb{Q}[t^{\pm 1}]$ -module de type fini de torsion.*
2. *L'application  $x \mapsto (1-t)x$  définit un isomorphisme de  $\mathfrak{A}(K)$ .*
3. *La forme  $\mathfrak{b}_K$  est hermitienne et non dégénérée.*

Par une étude purement algébrique des modules munis de formes hermitiennes vérifiant ces propriétés, on obtient :

**Théorème 2.7** ([Chap. 4] Theorem 1.3). *Si  $(\mathfrak{A}, \mathfrak{b})$  vérifie les conditions (1. 2. 3.), alors  $\mathfrak{A}$  est une somme directe, orthogonale pour  $\mathfrak{b}$ , de sous-modules de ces deux types :*

- $\frac{\mathbb{Q}[t^{\pm 1}]}{(\pi^n)} \gamma$ , avec  $\pi$  irréductible et symétrique, ou  $\pi = t+2+t^{-1}$ ,  $n > 0$ , et  $\mathfrak{b}(\gamma, \gamma) = \frac{P}{\pi^n}$ ,  $P$  symétrique et premier à  $\pi$ .
- $\frac{\mathbb{Q}[t^{\pm 1}]}{(\pi^n)} \gamma_1 \oplus \frac{\mathbb{Q}[t^{\pm 1}]}{(\bar{\pi}^n)} \gamma_2$ , où  $\bar{\pi}(t) = \pi(t^{-1})$ , avec soit  $\pi$  irréductible, non symétrique,  $\pi(-1) \neq 0$ ,  $n > 0$ , soit  $\pi = 1+t$ ,  $n$  impair, et dans les deux cas  $\mathfrak{b}(\gamma_1, \gamma_2) = \frac{1}{\pi^n}$ ,  $\mathfrak{b}(\gamma_i, \gamma_i) = 0$  pour  $i = 1, 2$ .

Cette description permet de montrer la réciproque de la proposition 2.6.

**Théorème 2.8** ([Chap. 4] Theorem 1.4). *Si  $(\mathfrak{A}, \mathfrak{b})$  vérifie les conditions (1. 2. 3.), alors il existe une QSK-paire  $(M, K)$  telle que  $(\mathfrak{A}(K), \mathfrak{b}_K)$  est isomorphe à  $(\mathfrak{A}, \mathfrak{b})$ .*

Si une QSK-paire  $(M, K)$  est définie comme somme connexe de deux QSK-paires  $(M_1, K_1)$  et  $(M_2, K_2)$ , alors  $(\mathfrak{A}(K), \mathfrak{b}_K)$  est la somme directe orthogonale de  $(\mathfrak{A}(K_1), \mathfrak{b}_{K_1})$  et  $(\mathfrak{A}(K_2), \mathfrak{b}_{K_2})$ . Ainsi, pour obtenir le théorème 2.8, il suffit de réaliser les deux types de modules munis de formes hermitiennes décrits dans le théorème 2.7. Dans le second cas, la description donnée montre qu'il existe une unique classe d'isomorphisme de formes de Blanchfield sur un tel module, donc la réalisation est donnée par le théorème 2.5. Dans le premier cas, on utilise une expression de la forme de Blanchfield en fonction d'une matrice d'enlacement équivariant.

Soit  $(M, K) = (\chi(M_0, L), K_0)$ , où  $(M_0, K_0, L)$  est une présentation de chirurgie admissible. La proposition 2.3 dit que la matrice d'enlacement équivariant  $A(t)$  associée à des relevés  $\tilde{J}_i$  des composantes  $J_i$  de  $L$  dans le revêtement infini cyclique est une matrice de présentation de  $\mathfrak{A}(K)$ . Les générateurs de  $\mathfrak{A}(K)$  correspondants sont les méridiens  $m_i$  des  $\tilde{J}_i$ .

**Lemme 2.9** ([Chap. 4] Corollary 3.2). *Pour  $1 \leq i, j \leq n$  :*

$$\mathfrak{b}_K(m_i, m_j) = (-A(t)^{-1})_{ji} \text{ mod } \mathbb{Q}[t^{\pm 1}].$$

Fixons un module d'Alexander  $\mathfrak{A}(K) = \frac{\mathbb{Q}[t^{\pm 1}]}{(\pi^n)}$  avec  $\pi$  irréductible et symétrique, ou  $\pi(t) = t + 2 + t^{-1}$ . La réalisation du module décrite dans [Chap. 4, Subsection 2.5] fournit un générateur  $\gamma$  de  $\mathfrak{A}(K)$  tel que  $\mathfrak{b}_K(\gamma, \gamma) = \frac{-1}{\pi^n}$ . Tout autre générateur  $\eta$  s'écrit  $\eta = R\gamma$ , avec  $R$  premier à  $\pi$ , et on a  $\mathfrak{b}_K(\eta, \eta) = \frac{-R\bar{R}}{\pi^n}$ . Ainsi les classes d'isomorphisme de formes de Blanchfield sont en bijection naturelle avec les classes de polynômes symétriques premiers à  $\pi$  modulo  $\pi^n$  et tous les  $R\bar{R}$ . Grâce à des méthodes de théorie algébrique des nombres, on montre dans [Chap. 4, Subsection 3.4] qu'il existe un nombre infini de telles classes distinctes.

**Proposition 2.10** ([Chap. 4] Proposition 3.8). *Soit  $\mathfrak{A} = \frac{\mathbb{Q}[t^{\pm 1}]}{(\pi^n)}$ , avec  $\pi$  irréductible et symétrique, ou  $\pi(t) = t + 2 + t^{-1}$ , et  $n > 0$ . L'ensemble des classes d'isomorphisme de formes hermitiennes non dégénérées sur  $\mathfrak{A}$  est infini.*

## 2.4 Compléments sur la réalisation des modules d'Alexander

Pour réaliser comme modules d'Alexander les modules vérifiant les conditions du théorème 2.5, on remarque qu'un tel module s'écrit comme somme directe de modules de la forme  $\frac{\mathbb{Q}[t^{\pm 1}]}{(P(t))}$ , avec  $P(t)$  symétrique et  $P(1) \neq 0$ , et de modules  $\frac{\mathbb{Q}[t^{\pm 1}]}{(1+t)^n} \oplus \frac{\mathbb{Q}[t^{\pm 1}]}{(1+t)^n}$ . Comme le



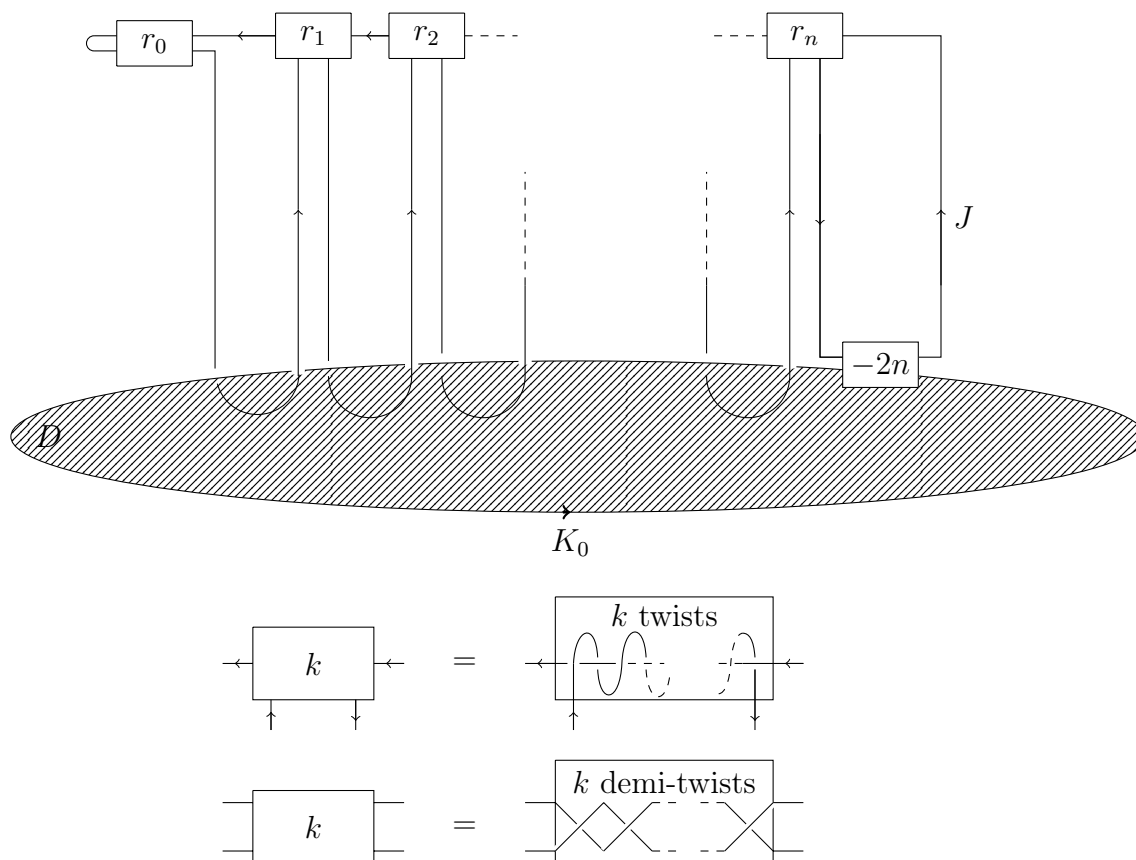

FIGURE 2 – Première présentation de chirurgie

module d'Alexander d'une somme connexe est la somme directe des modules d'Alexander des composantes, il suffit de savoir réaliser ces deux types de modules. On obtient facilement cette réalisation à partir des propositions 2.3 et 2.4. On peut cependant l'obtenir de façon plus élémentaire, en utilisant des présentations de chirurgie définies dans  $S^3$ . Pour  $\mathfrak{A} = \frac{\mathbb{Q}[t^{\pm 1}]}{(P(t))}$  avec  $P(t) = r_0 + \sum_{k=1}^n r_k(t^k + t^{-k})$ ,  $r_k \in \mathbb{Z}$ , la figure 2 donne une présentation de chirurgie  $(S^3, K_0, J)$  qui réalise  $\mathfrak{A}$  comme module d'Alexander associé à la QSK-paire  $(\chi(S^3, J), K_0)$ . De même, pour  $\mathfrak{A} = \frac{\mathbb{Q}[t^{\pm 1}]}{(R(t))} \oplus \frac{\mathbb{Q}[t^{\pm 1}]}{(R(t^{-1}))}$  avec  $R(t) = \sum_{k=0}^n r_k t^k$ ,  $r_k \in \mathbb{Z}$ , la figure 3 donne une présentation de chirurgie  $(S^3, K_0, J_1 \cup J_2)$  qui réalise  $\mathfrak{A}$  comme module d'Alexander associé à la QSK-paire  $(\chi(S^3, J_1 \cup J_2), K_0)$ .

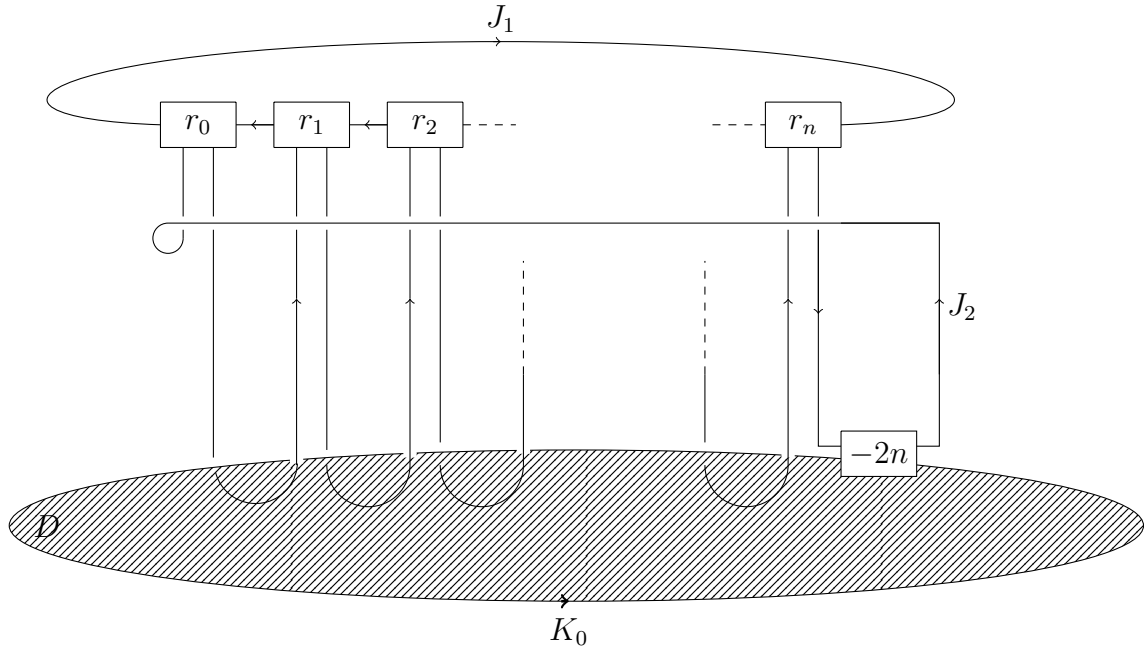

FIGURE 3 – Deuxième présentation de chirurgie

### 3 Caractérisation des classes de QSK-paires modulo chirurgies LP nulles

Soit  $\mathcal{K}_{\mathbb{Q}}$  l'ensemble des QSK-paires à homéomorphisme préservant l'orientation près. On définit ci-dessous les chirurgies LP nulles, qui fournissent un ensemble d'opérations  $\Theta(\mathcal{K}_{\mathbb{Q}})$ . Dans le but d'étudier le gradué associé, on étudie dans le chapitre 5 les classes de QSK-paires modulo chirurgies LP nulles.

#### 3.1 Chirurgies LP nulles

Soit  $(M, K)$  une QSK-paire. Un QHH nul dans  $M \setminus K$  est un QHH  $A \subset M \setminus K$  tel que l'application  $i_* : H_1(A; \mathbb{Q}) \rightarrow H_1(M \setminus K; \mathbb{Q})$  induite par l'inclusion a une image nulle. Une chirurgie LP nulle sur  $(M, K)$  est une chirurgie LP  $(\frac{B}{A})$  telle que  $A$  est nul dans  $M \setminus K$ . On note  $(M, K)(\frac{B}{A})$  la QSK-paire obtenue par chirurgie. Une telle chirurgie préserve le module d'Alexander et la forme de Blanchfield. Plus précisément :

**Lemme 3.1** ([Chap. 5] Lemma 2.1). *Soit  $(M, K)$  une QSK-paire. Soit  $A$  un QHH nul dans  $M \setminus K$ . Soit  $B$  un QHH dont le bord est LP-identifié à  $\partial A$ . Soit  $(M', K') = (M, K)(\frac{B}{A})$ . Alors la chirurgie induit un isomorphisme canonique  $\xi : \mathfrak{A}(K) \rightarrow \mathfrak{A}(K')$  qui préserve la forme de Blanchfield.*

Réciproquement, un tel isomorphisme se réalise par une suite de chirurgies LP nulles, modulo un automorphisme du module d'Alexander induit par un automorphisme du revêtement infini cyclique.

**Définition 3.2.** Soient  $(M, K)$  et  $(M', K')$  des  $\mathbb{Q}SK$ -paires. Soit  $\xi : \mathfrak{A}(K) \rightarrow \mathfrak{A}(K')$  un isomorphisme. La  $\tau$ -classe de  $\xi$  est l'ensemble des isomorphismes  $\xi \circ m_k$  pour  $k \in \mathbb{Z}$ , où  $m_k$  est la multiplication par  $t^k$ .

**Théorème 3.3** ([Chap. 5] Theorem 1.11). Soient  $(M, K)$  et  $(M', K')$  des  $\mathbb{Q}SK$ -paires. Soit  $\xi : \mathfrak{A}(K) \rightarrow \mathfrak{A}(K')$  un isomorphisme qui préserve la forme de Blanchfield. Alors  $(M', K')$  s'obtient à partir de  $(M, K)$  par une suite finie de chirurgies LP nulles qui induit un isomorphisme dans la  $\tau$ -classe de  $\xi$ .

Pour démontrer ce résultat, on utilise l'expression du module d'Alexander et de la forme de Blanchfield donnée par une matrice de Seifert.

### 3.2 Matrices de Seifert

Soit  $(M, K)$  une  $\mathbb{Q}SK$ -paire. Une *surface de Seifert* de  $K$  dans  $M$  est une surface compacte connexe orientée telle que  $\partial\Sigma = K$ . Une telle surface existe toujours car  $K$  est homologiquement trivial. Soit  $g$  le genre de  $\Sigma$ . Une *base symplectique* de  $H_1(\Sigma; \mathbb{Z})$  est une base  $(f_i)_{1 \leq i \leq 2g}$  dans laquelle la matrice de la forme d'intersection est  $-J$ , où  $J$  est une matrice diagonale par blocs, faite de blocs diagonaux  $\begin{pmatrix} 0 & -1 \\ 1 & 0 \end{pmatrix}$ . Étant donnée une telle

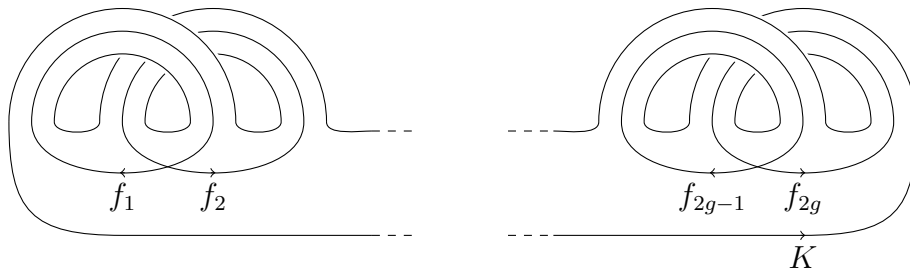

FIGURE 4 – La surface  $\Sigma$  et les courbes  $f_i$

base, la *matrice de Seifert* de  $K$  associée à  $\Sigma$  et  $(f_i)_{1 \leq i \leq 2g}$  est la matrice  $V \in \mathcal{M}_{2g}(\mathbb{Q})$  définie par  $V_{ij} = lk(f_i, f_j^+)$ , où  $f_j^+$  est la courbe  $f_j \times \{1\}$  définie par un épaississement  $\Sigma \times [-1, 1]$  de  $\Sigma$  dans  $M$ . Cette matrice vérifie  $V - V^t = J$ , où  $V^t$  représente la transposée de  $V$ . Réciproquement :

**Lemme 3.4** ([Chap. 5] Lemma 3.5). Pour toute matrice  $V \in \mathcal{M}_{2g}(\mathbb{Q})$ , avec  $g > 0$ , telle que  $V - V^t = J$ , il existe une  $\mathbb{Q}SK$ -paire  $(M, K)$  qui admet  $V$  comme matrice de Seifert.

On appellera *matrice de Seifert* toute matrice  $V \in \mathcal{M}_{2g}(\mathbb{Q})$  telle que  $V - V^t = J$ .

À partir de la matrice de Seifert  $V$  associée à  $\Sigma$  et  $(f_i)_{1 \leq i \leq 2g}$ , on peut calculer le module d'Alexander  $\mathfrak{A}(K)$  et la forme de Blanchfield  $\mathfrak{b}_K$ . Soit  $\hat{\Sigma}$  la surface obtenue à partir de  $\Sigma$  en recollant une bande le long de  $K$ , de telle façon que  $\hat{\Sigma}$  est homéomorphe à  $\Sigma$  et contient  $\Sigma$  et  $K$  dans son intérieur. Soit  $T(\Sigma) = \hat{\Sigma} \times [-1, 1]$  un voisinage tubulaire de  $\Sigma$ . Pour  $1 \leq i \leq 2g$ , soit  $e_i \subset (\text{Int}(T(\Sigma))) \setminus \Sigma$  un méridien de  $f_i$ . Le module  $\mathfrak{A}(K)$  peut être présenté ainsi :

$$\mathfrak{A}(K) = \frac{\bigoplus_{1 \leq i \leq 2g} \mathbb{Q}[t^{\pm 1}]b_i}{\bigoplus_{1 \leq j \leq 2g} \mathbb{Q}[t^{\pm 1}]\partial S_j},$$

où les  $b_i$  sont des relevés des  $e_i$  dans le revêtement infini cyclique  $\tilde{X}$  associé à  $(M, K)$ , et les  $S_j$  sont des relevés des  $f_j \times [-1, 1]$ . Soit  $f_j^+ = f_j \times \{1\}$  et  $f_j^- = f_j \times \{-1\}$ . On choisit tous les  $b_i$  dans la même copie de  $M \setminus \Sigma$ . Pour  $1 \leq j \leq 2g$ , soit  $\tilde{f}_j^+$  et  $\tilde{f}_j^-$  les relevés de  $f_j^+$  et  $f_j^-$  dans la même copie de  $M \setminus \Sigma$  que les  $b_i$ . On choisit les  $S_j$  tels que  $\partial S_j = t\tilde{f}_j^+ - \tilde{f}_j^-$ . Alors  $\partial S_j = \sum_{1 \leq i \leq 2g} (tV - V^t)_{ij} b_i$ , donc  $tV - V^t$  est une matrice de présentation de  $\mathfrak{A}(K)$  (voir [Lic97, Chapter 6]). De plus,  $lk_e(\partial S_j, b_i) = (1 - t)\delta_{ij}$ . En utilisant l'expression de  $\partial S_j$  en fonction des  $b_i$ , on en déduit que la forme  $\mathfrak{b}_K$  est donnée par  $\mathfrak{b}_K(b_i, b_j) = (1 - t)((tV - V^t)^{-1})_{ji} \text{ mod } \mathbb{Q}[t^{\pm 1}]$  (voir C.Kearton dans [Kea75, §8]).

Un  $\mathbb{Q}SK$ -système est un quintuplet  $(M, K, \Sigma, \underline{f}, V)$  où  $(M, K)$  est une  $\mathbb{Q}SK$ -paire,  $\Sigma$  est une surface de Seifert de  $K$  dans  $M$ ,  $\underline{f} = (f_i)_{1 \leq i \leq 2g}$  est une base de  $H_1(\Sigma; \mathbb{Z})$ , et  $V$  est la matrice de Seifert associée. Étant donné un  $\mathbb{Q}SK$ -système, la famille  $(b_i)_{1 \leq i \leq 2g}$  de générateurs de  $\mathfrak{A}(K)$  associée est déterminée à multiplication près de toute la famille par  $t^k$  pour un  $k \in \mathbb{Z}$ .

### 3.3 S-équivalence rationnelle

**Définition 3.5.** Un *agrandissement par ligne* d'une matrice  $V \in \mathcal{M}_{2g}(\mathbb{Q})$  est une matrice

$$W = \begin{pmatrix} 0 & 0 & 0 \\ 1 & x & \rho^t \\ 0 & \rho & V \end{pmatrix}, \text{ où } x \in \mathbb{Q} \text{ et } \rho \in \mathbb{Q}^{2g}. \text{ La matrice } V \text{ est alors une } \textit{réduction par ligne} \text{ de } W.$$

Un *agrandissement par colonne* de  $V$  est une matrice  $W = \begin{pmatrix} 0 & -1 & 0 \\ 0 & x & \rho^t \\ 0 & \rho & V \end{pmatrix}$ , où  $x \in \mathbb{Q}$  et  $\rho \in \mathbb{Q}^{2g}$ . La matrice  $V$  est alors une *réduction par colonne* de  $W$ .

Notons qu'un agrandissement ou une réduction d'une matrice de Seifert est toujours une matrice de Seifert. Un agrandissement d'une matrice de Seifert correspond à l'ajout d'un tube à la surface de Seifert.

**Définition 3.6.** Une matrice  $P \in \mathcal{M}_{2g}(\mathbb{Q})$  est *symplectique* si  $PJP^t = J$ . Une *congruence symplectique rationnelle* (resp. *entière*) d'une matrice  $V$  vers une matrice  $V'$  est une égalité  $V' = PVP^t$ , où  $P$  est une matrice symplectique rationnelle (resp. entière).

Notons que, comme une matrice symplectique a déterminant 1, une matrice symplectique entière est inversible sur  $\mathbb{Z}$ .

**Définition 3.7.** Une *S-équivalence rationnelle élémentaire* est un agrandissement, une réduction, ou une congruence symplectique rationnelle. Deux matrices de Seifert sont *rationnellement S-équivalentes* si elles s'obtiennent l'une de l'autre par une suite finie S-équivalences rationnelles élémentaires.

En particulier, deux matrices de Seifert d'une même QSK-paire  $(M, K)$  sont rationnellement S-équivalentes. On déduit facilement du travail de H.F.Trotter dans [Tro73] que deux QSK-paires ont des matrices de Seifert rationnellement S-équivalentes si et seulement si leurs modules d'Alexander munis de leurs formes de Blanchfield sont isomorphes. Dans le chapitre 5, on précise ce résultat :

**Proposition 3.8** ([Chap. 5] Lemma 2.4, Proposition 1.6). *Soient deux QSK-systèmes  $(M, K, \Sigma, \underline{f}, V)$  et  $(M', K', \Sigma', \underline{f}', V')$ . Si  $V$  et  $V'$  sont rationnellement S-équivalentes, alors toute S-équivalence de  $V$  vers  $V'$  induit une  $\tau$ -classe canonique d'isomorphismes de  $\mathfrak{A}(K)$  dans  $\mathfrak{A}(K')$  qui préservent la forme de Blanchfield. Réciproquement, si un isomorphisme  $\xi : \mathfrak{A}(K) \rightarrow \mathfrak{A}(K')$  qui préserve la forme de Blanchfield est fixé, alors  $V'$  s'obtient de  $V$  par une S-équivalence rationnelle qui induit canoniquement la  $\tau$ -classe de  $\xi$ .*

Une congruence entière symplectique entre deux matrices de Seifert peut s'interpréter comme un changement de base du  $H_1$  de la surface de Seifert. En revanche, il est plus délicat de donner un sens géométrique à une congruence rationnelle. L'idée de la preuve du théorème 3.3 est de considérer une S-équivalence rationnelle qui induit la bonne  $\tau$ -classe d'isomorphismes, et de réaliser chaque étape élémentaire par des chirurgies LP nulles. On obtient effectivement une telle réalisation pour les agrandissements et les congruences entières, et le cas des réductions s'ensuit. Quant aux congruences rationnelles, on montre qu'on peut s'en affranchir.

**Définition 3.9.** Deux matrices de Seifert sont *semi-entièrement S-équivalentes* si elles s'obtiennent l'une de l'autre par une suite finie d'agrandissements, de réductions, et de congruences entières symplectiques.

**Proposition 3.10** ([Chap. 5] Proposition 1.8). *Deux matrices de Seifert sont rationnellement S-équivalentes si et seulement si elles sont semi-entièrement S-équivalentes. De plus, soient  $(M, K, \Sigma, \underline{f}, V)$  et  $(M', K', \Sigma', \underline{f}', V')$  des QSK-systèmes. Soit  $\xi : \mathfrak{A}(K) \rightarrow \mathfrak{A}(K')$  un isomorphisme qui préserve la forme de Blanchfield. Alors  $V'$  s'obtient de  $V$  par une S-équivalence semi-entière qui induit canoniquement la  $\tau$ -classe de  $\xi$ .*

## 4 Invariants de type fini des QSK-paires

Dans cette section, on décrit les résultats du chapitre 6, qui concernent les gradués associés aux filtrations de  $\mathcal{F}_0(\mathcal{K}_{\mathbb{Q}})$  et  $\mathcal{F}_0(\mathcal{K}_{\mathbb{Z}})$  définies par les chirurgies LP nulles, respectivement

rationnelles et entières.

### 4.1 Les quotients $\mathcal{G}_n(\mathcal{K}_{\mathbb{Q}})$

Pour toute classe d'isomorphisme  $(\mathfrak{A}, \mathfrak{b})$  de modules d'Alexander rationnels munis de leurs formes de Blanchfield, on note  $\mathcal{P}(\mathfrak{A}, \mathfrak{b})$  l'ensemble des QSK-paires dont les modules d'Alexander munis de leurs formes de Blanchfield sont isomorphes à  $(\mathfrak{A}, \mathfrak{b})$ . Soit  $\mathcal{F}_0(\mathfrak{A}, \mathfrak{b})$  le sous-espace de  $\mathcal{F}_0(\mathcal{K}_{\mathbb{Q}})$  engendré par les QSK-paires  $(M, K) \in \mathcal{P}(\mathfrak{A}, \mathfrak{b})$ . Soit  $(\mathcal{F}_n(\mathfrak{A}, \mathfrak{b}))_{n \in \mathbb{N}}$  la filtration définie sur  $\mathcal{F}_0(\mathfrak{A}, \mathfrak{b})$  par les chirurgies LP nulles. Alors, pour  $n \in \mathbb{N}$ ,  $\mathcal{F}_n(\mathcal{K}_{\mathbb{Q}})$  est la somme directe sur toutes les classes d'isomorphisme  $(\mathfrak{A}, \mathfrak{b})$  de modules d'Alexander rationnels munis de leurs formes de Blanchfield des  $\mathcal{F}_n(\mathfrak{A}, \mathfrak{b})$ . On pose  $\mathcal{G}_n(\mathfrak{A}, \mathfrak{b}) = \mathcal{F}_n(\mathfrak{A}, \mathfrak{b})/\mathcal{F}_{n+1}(\mathfrak{A}, \mathfrak{b})$ . Le théorème 3.3 implique  $\mathcal{G}_0(\mathfrak{A}, \mathfrak{b}) \cong \mathbb{Q}$ . Le quotient  $\mathcal{G}_1(\mathfrak{A}, \mathfrak{b})$  se décrit comme suit :

**Théorème 4.1** ([Chap. 6] Theorem 1.6). *Soit  $(M_0, K_0) \in \mathcal{P}(\mathfrak{A}, \mathfrak{b})$ . Pour tout  $p$  premier, on note  $B_p$  une boule d'homologie rationnelle telle que  $H_1(B_p; \mathbb{Z}) \cong \mathbb{Z}/p\mathbb{Z}$ . Alors :*

$$\mathcal{G}_1(\mathfrak{A}, \mathfrak{b}) = \bigoplus_{p \text{ premier}} \mathbb{Q}[(M_0, K_0); \frac{B_p}{B^3}].$$

Pour étudier les quotients d'ordre supérieur, on introduit des espaces de diagrammes.

Un *graphe  $\mathfrak{A}$ -colorié* est un graphe uni-trivalent sans bâton  $(\begin{smallmatrix} \bullet \\ | \\ \bullet \end{smallmatrix})$ , dont les arêtes sont orientées et coloriées par  $\mathbb{Q}[t^{\pm 1}]$ , dont les sommets univalents sont coloriés par  $\mathfrak{A}$ , et dont les sommets trivalents sont orientés. Une *orientation d'un sommet trivalent* d'un tel dia-

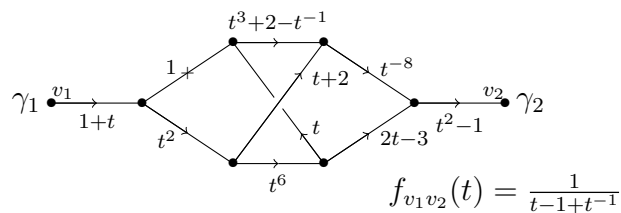

FIGURE 5 – Diagramme colorié de degré 6

gramme est toujours la donnée d'un ordre cyclique des trois demi-arêtes qui se rejoignent à ce sommet, induite dans les figures par l'ordre cyclique  $\begin{smallmatrix} \leftarrow \\ \vee \\ \rightarrow \end{smallmatrix}$ . Soit  $\delta(t)$  l'annulateur de  $\mathfrak{A}$ . Un *diagramme  $(\mathfrak{A}, \mathfrak{b})$ -colorié*  $D$  est un graphe  $\mathfrak{A}$ -colorié, dont les sommets univalents forment un ensemble  $V$ , muni d'une famille  $(f_{vv'}^D(t))_{\{(v,v') \in V^2; v \neq v'\}} \subset \frac{1}{\delta(t)}\mathbb{Q}[t^{\pm 1}]$  telle que  $f_{vv'}^D(t) \bmod \mathbb{Q}[t^{\pm 1}] = \mathfrak{b}(\gamma, \gamma')$  si  $\gamma$  (resp.  $\gamma'$ ) est la couleur de  $v$  (resp.  $v'$ ), et  $f_{v'v}^D(t) = f_{vv'}^D(t^{-1})$ . Lorsque cela ne prête pas à confusion, on note  $f_{vv'}$  pour  $f_{vv'}^D$ . Le *degré*

d'un diagramme colorié est le nombre de sommets trivalents du graphe sous-jacent. Le seul diagramme de degré 0 est le diagramme vide. Pour  $n \geq 0$ , on pose :

$$\tilde{\mathcal{A}}_n(\mathfrak{A}, \mathfrak{b}) = \frac{\mathbb{Q} \langle \text{diagrammes } (\mathfrak{A}, \mathfrak{b})\text{-coloriés de degré } n \rangle}{\mathbb{Q} \langle \text{AS, IHX, LE, OR, Hol, LV, EV, LD} \rangle},$$

où les relations AS (antisymétrie), IHX, LE (linéarité pour les arêtes – edges), OR (changement d'orientation – orientation reversal), Hol (holonomie), LV (linéarité pour les sommets – vertices), EV (edge-vertex), et LD (linking difference) sont décrites Figure 6.

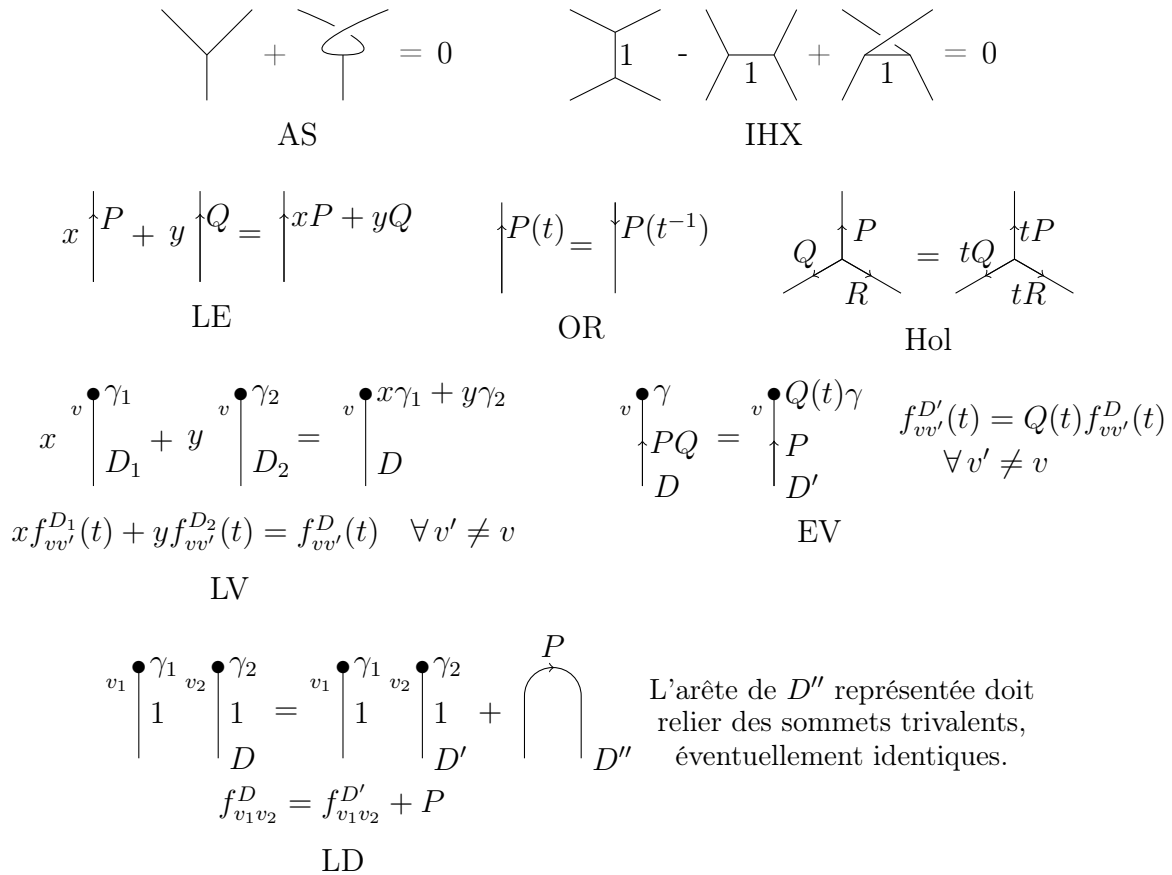

AS

IHX

LE

OR

Hol

LV

EV

LD

L'arête de  $D''$  représentée doit relier des sommets trivalents, éventuellement identiques.

FIGURE 6 – Relations, avec  $x, y \in \mathbb{Q}$ ,  $P, Q, R \in \mathbb{Q}[t^{\pm 1}]$ ,  $\gamma, \gamma_1, \gamma_2 \in \mathfrak{A}$ .

Le groupe d'automorphismes  $Aut(\mathfrak{A}, \mathfrak{b})$  est le groupe des automorphismes de  $\mathbb{Q}[t^{\pm 1}]$ -module de  $\mathfrak{A}$  qui préservent la forme de Blanchfield. Il agit sur  $\tilde{\mathcal{A}}_n(\mathfrak{A}, \mathfrak{b})$  par action simultanée sur tous les sommets univalents d'un diagramme. Soit  $\mathcal{A}_n(\mathfrak{A}, \mathfrak{b})$  le quotient de  $\tilde{\mathcal{A}}_n(\mathfrak{A}, \mathfrak{b})$  par cette action. Comme l'opposé de l'identité est un automorphisme de  $(\mathfrak{A}, \mathfrak{b})$ , on a  $\mathcal{A}_{2n+1}(\mathfrak{A}, \mathfrak{b}) = 0$  pour tout  $n \geq 0$ .

Un *diagramme*  $(\mathfrak{A}, \mathfrak{b})$ -*augmenté* est une union d'un diagramme  $(\mathfrak{A}, \mathfrak{b})$ -colorié (sa *composante de Jacobi*) et d'un nombre fini de sommets isolés pondérés par des entiers premiers. Le *degré* d'un diagramme  $(\mathfrak{A}, \mathfrak{b})$ -augmenté est le nombre de ses sommets de valence 0 ou 3. Pour  $n \geq 0$ , on pose :

$$\mathcal{A}_n^{aug}(\mathfrak{A}, \mathfrak{b}) = \frac{\mathbb{Q} \langle \text{diagrammes } (\mathfrak{A}, \mathfrak{b})\text{-augmentés de degré } n \rangle}{\mathbb{Q} \langle \text{AS, IHX, LE, OR, Hol, LV, EV, LD, Aut} \rangle},$$

où la relation Aut identifie deux diagrammes obtenus l'un de l'autre par l'action d'un élément de  $\text{Aut}(\mathfrak{A}, \mathfrak{b})$ .

**Théorème 4.2** ([Chap. 6] Theorem 1.10). *Pour tout  $n \geq 0$ , il existe une application canonique,  $\mathbb{Q}$ -linéaire et surjective :*

$$\varphi_n : \mathcal{A}_n^{aug}(\mathfrak{A}, \mathfrak{b}) \rightarrow \mathcal{G}_n(\mathfrak{A}, \mathfrak{b}).$$

Pour la classe du module d'Alexander trivial  $\mathfrak{A}_0$ , on montre que ces applications sont en fait des isomorphismes. De plus, la somme connexe des  $\mathbb{Q}$ SK-paires dans  $\mathcal{P}(\mathfrak{A}_0)$  induit une opération sur le gradué  $\mathcal{G}(\mathfrak{A}_0) = \bigoplus_{n \in \mathbb{N}} \mathcal{G}_n(\mathfrak{A}_0)$  qui le munit d'une structure d'algèbre graduée. De même, l'espace gradué  $\mathcal{A}^{aug}(\mathfrak{A}_0) = \bigoplus_{n \in \mathbb{N}} \mathcal{A}_n^{aug}(\mathfrak{A}_0)$  est une algèbre graduée via le produit défini sur les diagrammes par la réunion disjointe. Les isomorphismes  $\mathcal{G}_n(\mathfrak{A}_0) \cong \mathcal{A}_n^{aug}(\mathfrak{A}_0)$  induisent un isomorphisme d'algèbres graduées.

**Théorème 4.3** ([Chap. 6] Theorem 1.11).  $\mathcal{A}^{aug}(\mathfrak{A}_0) \cong \mathcal{G}(\mathfrak{A}_0)$

## 4.2 Diagrammes coloriés et entrelacs en Y

Pour définir l'application  $\varphi_n$  du théorème 4.2, on la définit d'abord sur  $\mathcal{A}_n(\mathfrak{A}, \mathfrak{b})$ . Pour cela, on associe à des diagrammes de  $\tilde{\mathcal{A}}_n(\mathfrak{A}, \mathfrak{b})$ , qui engendrent  $\tilde{\mathcal{A}}_n(\mathfrak{A}, \mathfrak{b})$  sur  $\mathbb{Q}$ , des entrelacs en Y nuls dans les  $\mathbb{Q}$ SK-paires de  $\mathcal{P}(\mathfrak{A}, \mathfrak{b})$ .

Un diagramme  $D \in \tilde{\mathcal{A}}_n(\mathfrak{A}, \mathfrak{b})$  est un *diagramme élémentaire* si ses arêtes qui relient deux sommets trivalents sont coloriées par des puissances de  $t$ , et si ses arêtes adjacentes à un sommet univalent sont coloriées par 1. Fixons  $(M, K) \in \mathcal{P}(\mathfrak{A}, \mathfrak{b})$ . Soit  $\xi : (\mathfrak{A}, \mathfrak{b}) \rightarrow (\mathfrak{A}(K), \mathfrak{b}_K)$  un isomorphisme. Fixons un méridien  $m(K)$  de  $K$ .

**Définition 4.4.** Soit  $D$  un diagramme élémentaire. Un plongement de  $D$  dans  $M \setminus K$  est *admissible* si les conditions suivantes sont vérifiées.

- Les sommets de  $D$  sont plongés dans une boule  $B \subset (M \setminus K)$ .
- Considérons une arête coloriée par  $t^k$ . La classe d'homologie dans  $H_1(M \setminus K; \mathbb{Z})$  de la courbe obtenue en reliant les extrémités de cette arête par un chemin dans  $B$  est  $k m(K)$ .



Il existe toujours un tel plongement. Il suffit de plonger le diagramme dans  $B$ , et de faire tourner chaque arête coloriée par  $t^k$  autour de  $K$ ,  $k$  fois. À un plongement admissible d'un diagramme élémentaire, on veut associer un entrelacs en  $Y$  nul dans  $M \setminus K$ .

Soit  $\Gamma$  un graphe en  $Y$  nul dans  $M \setminus K$ . Soit  $p$  le sommet interne de  $\Gamma$ . Soit  $\ell$  une feuille de  $\Gamma$ , et soit  $e$  l'arête qui connecte  $p$  à  $\ell$ . La courbe  $\hat{\ell}$  dessinée Figure 7 est l'extension de  $\ell$  dans  $\Gamma$ .

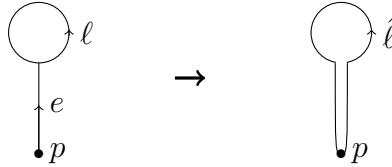

FIGURE 7 – Extension d'une feuille dans un graphe en  $Y$

Soit  $D$  un diagramme élémentaire, muni d'un plongement admissible dans  $M \setminus K$ . On munit  $D$  de la parallélisation induite par une immersion dans le plan qui induit la bonne orientation des sommets trivalents. Si une arête relie deux sommets trivalents, on y insère un petit entrelacs de Hopf, comme le montre la figure 8. À chaque sommet univalent  $v$ ,



FIGURE 8 – Remplacement d'une arête

on colle une feuille  $\ell_v$ , de façon à obtenir un entrelacs en  $Y$  nul dans  $M \setminus K$ , noté  $\Gamma$ . Soit  $V$  l'ensemble des sommets univalents de  $D$ . Pour  $v \in V$ , soit  $\gamma_v$  la couleur de  $v$ , soit  $\hat{\ell}_v$  l'extension de  $\ell_v$  dans  $\Gamma$ , et soit  $\tilde{\ell}_v$  le relevé de  $\hat{\ell}_v$  défini en relevant le point base dans un relevé  $\tilde{B}$  de  $B$  fixé. L'entrelacs en  $Y$  nul  $\Gamma$  est appelé une réalisation de  $D$  dans  $(M, K)$  par rapport à  $\xi$  si les conditions suivantes sont vérifiées :

- pour tout  $v \in V$ ,  $\tilde{\ell}_v$  est homologue à  $\xi(\gamma_v)$ ,
- pour tout  $(v, v') \in V^2$ ,  $lk_e(\tilde{\ell}_v, \tilde{\ell}_{v'}) = f_{vv'}$ .

Si une telle réalisation existe, le diagramme élémentaire  $D$  est dit  $\xi$ -réalisable.

Soit  $D$  un diagramme élémentaire. Soit  $V$  l'ensemble de ses sommets univalents. Soit  $(q_v)_{v \in V}$  une famille de nombres rationnels. On définit un diagramme  $D' = (q_v)_{v \in V} \cdot D$  à partir de  $D$  de la manière suivante. On conserve le graphe sous-jacent et les couleurs des arêtes. Pour  $v \in V$ , on multiplie par  $q_v$  la couleur du sommet  $v$ . Pour  $v \neq v' \in V$ , on pose  $f_{vv'}^{D'} = q_v q_{v'} f_{vv'}^D$ . On montre que pour tout diagramme élémentaire  $D$ , il existe  $(q_v)_{v \in V} \subset \mathbb{Q}$  tel que  $(q_v)_{v \in V} \cdot D$  est  $\xi$ -réalisable.

Dans [Chap. 6, Section 2], on montre que  $[(M, K); \Gamma] \in \mathcal{G}_n(\mathfrak{A}, \mathfrak{b})$  ne dépend pas de  $B$ ,  $\tilde{B}$ ,  $(M, K)$ ,  $\xi$ , et de la réalisation de  $D$ , et on prouve :

**Proposition 4.5** ([Chap. 6] Proposition 1.14). *Soit  $n > 0$ . Il existe une application canonique,  $\mathbb{Q}$ -linéaire et surjective :*

$$\varphi_n : \mathcal{A}_n(\mathfrak{A}, \mathfrak{b}) \rightarrow \mathcal{G}_n^b(\mathfrak{A}, \mathfrak{b}),$$

qui associe à tout diagramme élémentaire  $D$ ,  $\xi$ -réalisable pour une  $\mathbb{Q}SK$ -paire  $(M, K) \in \mathcal{P}(\mathfrak{A}, \mathfrak{b})$  et un isomorphisme  $\xi : (\mathfrak{A}, \mathfrak{b}) \rightarrow (\mathfrak{A}(K), \mathfrak{b}_K)$ , le crochet  $[(M, K); \Gamma_D]$ , où  $\Gamma_D$  est une réalisation de  $D$  dans  $(M, K)$  par rapport à  $\xi$ .

L'application du théorème 4.2 s'obtient en étendant cette application  $\varphi_n$  à  $\mathcal{A}_n^{aug}(\mathfrak{A}, \mathfrak{b})$ .

### 4.3 La filtration de $\mathcal{F}_0(\mathcal{K}_{\mathbb{Z}})$

La filtration  $(\mathcal{F}_n(\mathcal{K}_{\mathbb{Q}}))_{n \in \mathbb{N}}$  généralise la filtration de  $\mathcal{F}_0(\mathcal{K}_{\mathbb{Z}})$  introduite par Stavros Garoufalidis et Lev Rozansky dans [GR04]. L'ensemble d'opérations  $\Theta(\mathcal{K}_{\mathbb{Z}})$  considéré par S.Garoufalidis et L.Rozansky est l'ensemble des chirurgies borroméennes nulles. La proposition 4.3 du chapitre 1 montre qu'on obtient la même filtration en considérant les chirurgies LP entières nulles. À partir de résultats de S.V.Matveev [Mat87], Swatee Naik et Theodore Stanford [NS03], et H.F.Trotter [Tro73], S.Garoufalidis et L.Rozansky ont montré que deux  $\mathbb{Z}SK$ -paires s'obtiennent l'une de l'autre par une suite finie de chirurgies borroméennes nulles si et seulement si leurs modules d'Alexander entiers munis de leurs formes de Blanchfield sont isomorphes [GR04, Lemma 1.3]. On a donc, comme ci-dessus, une décomposition de la filtration  $(\mathcal{F}_n(\mathcal{K}_{\mathbb{Z}}))_{n \in \mathbb{N}}$  comme somme directe de filtrations  $(\mathcal{F}_n^{\mathbb{Z}}(\mathfrak{A}_{\mathbb{Z}}, \mathfrak{b}_{\mathbb{Z}}))_{n \in \mathbb{N}}$  de sous-espaces  $\mathcal{F}_0^{\mathbb{Z}}(\mathfrak{A}_{\mathbb{Z}}, \mathfrak{b}_{\mathbb{Z}})$  de  $\mathcal{F}_0(\mathcal{K}_{\mathbb{Z}})$ , où  $(\mathfrak{A}_{\mathbb{Z}}, \mathfrak{b}_{\mathbb{Z}})$  représente une classe d'isomorphismes de modules d'Alexander entiers munis de leurs formes de Blanchfield. On note  $\mathcal{P}(\mathfrak{A}_{\mathbb{Z}}, \mathfrak{b}_{\mathbb{Z}})$  l'ensemble des  $\mathbb{Z}SK$ -paires dont le module d'Alexander entier muni de sa forme de Blanchfield est isomorphe à  $(\mathfrak{A}_{\mathbb{Z}}, \mathfrak{b}_{\mathbb{Z}})$ .

S.Garoufalidis, A.Kricker et L.Rozansky ([GK04] et [GR04]) ont identifié le gradué  $\bigoplus_{n \in \mathbb{N}} \mathcal{G}_n^{\mathbb{Z}}((\mathfrak{A}_{\mathbb{Z}})_0)$ , pour un module d'Alexander trivial  $(\mathfrak{A}_{\mathbb{Z}})_0$ , à une algèbre de diagrammes. Le théorème 4.3 généralise ce résultat au cas des  $\mathbb{Q}SK$ -paires. Dans le chapitre 6, on établit les deux résultats suivants sur les quotients  $\mathcal{G}_n^{\mathbb{Z}}(\mathfrak{A}_{\mathbb{Z}}, \mathfrak{b}_{\mathbb{Z}})$  pour un  $(\mathfrak{A}_{\mathbb{Z}}, \mathfrak{b}_{\mathbb{Z}})$  quelconque.

**Proposition 4.6** ([Chap. 6] Proposition 1.15). *Soit  $(M_0, K_0) \in \mathcal{P}(\mathfrak{A}_{\mathbb{Z}}, \mathfrak{b}_{\mathbb{Z}})$ . Soit  $(\mathfrak{A}, \mathfrak{b}) = \mathbb{Q} \otimes_{\mathbb{Z}} (\mathfrak{A}_{\mathbb{Z}}, \mathfrak{b}_{\mathbb{Z}})$ . Soit  $\xi : (\mathfrak{A}, \mathfrak{b}) \rightarrow (\mathfrak{A}(K_0), \mathfrak{b}_{K_0})$  un isomorphisme. Soit  $n > 0$ . Il existe une application bien définie,  $\mathbb{Q}$ -linéaire, et surjective  $\varphi_n^{\mathbb{Z}}(\xi) : \tilde{\mathcal{A}}_n(\mathfrak{A}, \mathfrak{b}) \rightarrow \mathcal{G}_n^{\mathbb{Z}}(\mathfrak{A}_{\mathbb{Z}}, \mathfrak{b}_{\mathbb{Z}})$  définie par  $D \mapsto [(M_0, K_0); \Gamma_D]$  pour tout diagramme élémentaire  $D$   $\xi$ -réalisable, où  $\Gamma_D$  est une réalisation de  $D$  dans  $(M_0, K_0)$  par rapport à  $\xi$ .*

**Théorème 4.7** ([Chap. 6] Theorem 1.9). *Pour  $n \geq 0$ ,  $\mathcal{G}_{2n+1}^{\mathbb{Z}}(\mathfrak{A}_{\mathbb{Z}}, \mathfrak{b}_{\mathbb{Z}}) = 0$ .*

# Chapitre 3 : Invariants de type fini des sphères d'homologie rationnelle

## Résumé

Ce chapitre contient la version à paraître dans *Algebraic & Geometric Topology* de l'article "Finite type invariants of rational homology 3-spheres", sans sa bibliographie, avec une pagination différente, mais avec les numérotations originales. Dans cet article, on étudie l'espace vectoriel rationnel engendré par toutes les sphères d'homologie rationnelle à homéomorphisme préservant l'orientation près, et la filtration définie sur cet espace par les chirurgies LP rationnelles. On identifie l'espace gradué associé à cette filtration à un espace gradué de diagrammes de Jacobi augmentés.

# Finite type invariants of rational homology 3-spheres

## Abstract

We consider the rational vector space generated by all rational homology spheres up to orientation-preserving homeomorphism, and the filtration defined on this space by Lagrangian-preserving rational homology handlebody replacements. We identify the graded space associated with this filtration with a graded space of augmented Jacobi diagrams.

## 1 Introduction

### 1.1 Finite type invariants

The greatest achievements in the theories of finite type invariants are theorems that express the graded spaces associated with topological filtrations of vector spaces generated by knots or manifolds as combinatorial vector spaces generated by Feynman diagrams. The two main examples of these theorems, that are useful to classify invariants and to evaluate their power, concern the Vassiliev filtration of the space generated by the knots in  $S^3$ , and the Goussarov-Habiro filtration of the space generated by the integral homology 3-spheres ( $\mathbb{Z}$ HS), that are oriented compact 3-manifolds with the same integral homology as  $S^3$ . The graded space associated with the Vassiliev filtration was identified with a space of Jacobi diagrams by an isomorphism induced by the Kontsevich integral (see [Kon93] and the Bar-Natan article [BN95]). Several filtrations of the space generated by the  $\mathbb{Z}$ HS's were defined. In [GGP01], Garoufalidis, Goussarov and Polyak compared various filtrations, and defined a surjective map from a graded space of Jacobi diagrams to the graded space associated with the Goussarov-Habiro filtration. In [Le97], Le proved that this map is an isomorphism by showing that the LMO invariant that he constructed in [LMO98] with the help of Murakami and Ohtsuki is a universal finite type invariant of  $\mathbb{Z}$ HS's. In [AL05], Auclair and Lescop defined the Goussarov-Habiro filtration and the properties of the graded space, algebraically, using Lagrangian-preserving integral homology handlebody replacements.

In this article, we will consider the rational vector space generated by all the rational homology spheres ( $\mathbb{Q}$ HS), that are the oriented compact 3-manifolds with the same rational homology as  $S^3$ . We will define a filtration on this space by means of LP-surgeries, that are Lagrangian-preserving rational homology handlebody replacements. Our main result (Theorem 1.7) identifies the graded space associated with this filtration with a graded space of diagrams. The role of the LMO invariant in the integral case will be held here by the KKT invariant of rational homology spheres constructed by Kontsevich,

and proved to be a universal finite type invariant of  $\mathbb{Z}$ HS's by Kuperberg and Thurston in [KT99]. Lescop has proved in [Les04] that the KKT invariant  $Z_{KKT} = (Z_{n,KKT})_{n \in \mathbb{N}}$  satisfies a universality property with respect to LP-surgeries. Massuyeau has proved in [Mas12] that the LMO invariant  $Z_{LMO} = (Z_{n,LMO})_{n \in \mathbb{N}}$  satisfies the same property. As we prove at the end of Section 6, these results and our main theorem imply that  $Z_{LMO}$  and  $Z_{KKT}$  are equivalent in the following sense:

**Theorem 1.1.** *Let  $M$  and  $N$  be  $\mathbb{Q}$ HS's such that  $|H_1(M; \mathbb{Z})| = |H_1(N; \mathbb{Z})|$ , where  $|\cdot|$  denotes the cardinality. Then, for any  $n \in \mathbb{N}$ :*

$$\left( Z_{k,LMO}(M) = Z_{k,LMO}(N) \text{ for all } k \leq n \right) \Leftrightarrow \left( Z_{k,KKT}(M) = Z_{k,KKT}(N) \text{ for all } k \leq n \right).$$

## 1.2 The Goussarov-Habiro filtration

Throughout the article, the manifolds will be compact, connected, and oriented. When it does not seem to cause confusion, we will use the same notation for a curve and its homology class.

The *standard Y-graph* is the graph  $\Gamma_0 \subset \mathbb{R}^2$  represented in Figure 1. With  $\Gamma_0$  is associated a regular neighborhood  $\Sigma(\Gamma_0)$  of  $\Gamma_0$  in the plane. Consider a 3-manifold  $M$

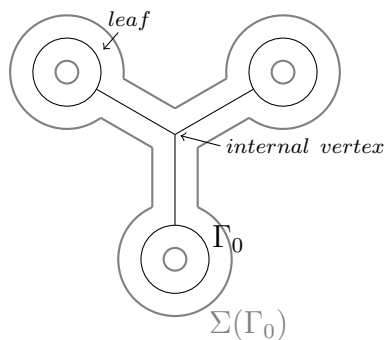

Figure 1: the standard Y-graph

and an embedding  $h : \Sigma(\Gamma_0) \rightarrow M$ . The image  $\Gamma$  of  $\Gamma_0$  is a *Y-graph*, and  $\Sigma(\Gamma) = h(\Sigma(\Gamma_0))$  is the *associated surface* of  $\Gamma$ . The Y-graph  $\Gamma$  is equipped with the framing induced by  $\Sigma(\Gamma)$ . The looped edges of a Y-graph are called *leaves*. The vertex incident to three different edges is the *internal vertex*.

Consider a Y-graph  $\Gamma$  in a 3-manifold  $M$ . Associate with  $\Gamma$  the six-component link  $L$  represented in Figure 2. The *borromean surgery on  $\Gamma$*  is the surgery along the framed link  $L$ . As proved by Matveev in [Mat87], a borromean surgery can be realised by cutting a genus 3 handlebody (a regular neighborhood of the Y-graph) and regluing it another way. A *Y-link* in a 3-manifold is a collection of disjoint Y-graphs.

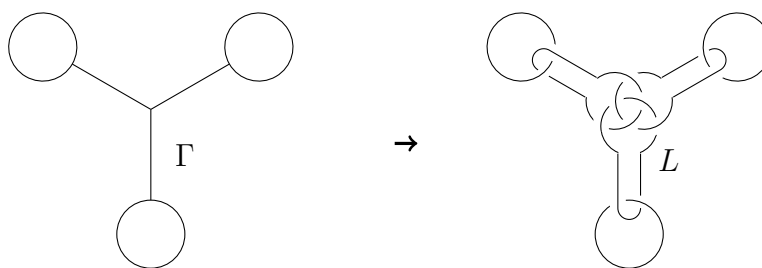

Figure 2: Y-graph and associated surgery link

Consider the rational vector space  $\mathcal{F}_0^{\mathbb{Z}}$  generated by all  $\mathbb{Z}$ HS's up to orientation-preserving homeomorphism. Let  $\mathcal{F}_n^{\mathbb{Z}}$  denote the subspace generated by all the

$$[M; \Gamma] = \sum_{I \subset \{1, \dots, n\}} (-1)^{|I|} M(\cup_{i \in I} \Gamma_i),$$

where  $M$  is a  $\mathbb{Z}$ HS, the  $\Gamma_i$  are disjoint Y-graphs in  $M$ ,  $\Gamma = \cup_{i=1}^n \Gamma_i$ , and  $M(\cup_{i \in I} \Gamma_i)$  is the manifold obtained from  $M$  by surgery on the  $\Gamma_i$  for  $i \in I$ . Here and in all the article,  $|I|$  stands for the cardinality of the set  $I$ . The associated quotients  $\mathcal{G}_n^{\mathbb{Z}} = \frac{\mathcal{F}_n^{\mathbb{Z}}}{\mathcal{F}_{n+1}^{\mathbb{Z}}}$  can be described in terms of Jacobi diagrams.

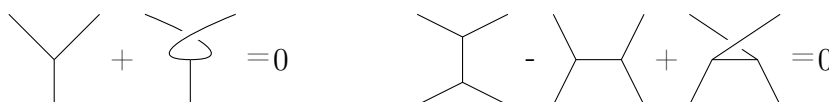

Figure 3: AS and IHX relations

A *Jacobi diagram* is a trivalent graph with oriented vertices. An orientation of a vertex of such a diagram is a cyclic order of the three half-edges that meet at this vertex. In the pictures, this orientation is induced by the cyclic order  $\begin{matrix} \curvearrowright \\ \vee \end{matrix}$ . The *degree* of a Jacobi diagram is half the number of its vertices. Note that it is an integer. Let  $\mathcal{A}_n$  denote the rational vector space generated by all degree  $n$  Jacobi diagrams, quotiented out by the AS and IHX relations (Figure 3). The space  $\mathcal{A}_0$  is generated by the empty diagram. Let  $\mathcal{A}_n^c$  denote the subspace of  $\mathcal{A}_n$  generated by the connected diagrams.

Let  $\Gamma$  be a Jacobi diagram of degree  $n$ . Let  $\varphi : \Gamma \hookrightarrow \mathbb{R}^3$  be an embedding such that the orthogonal projection on  $\mathbb{R}^2 \times \{0\}$  of  $\varphi(\Gamma)$  is regular, and hence induces a framing of  $\varphi(\Gamma)$ . Now associate a Y-link  $\tilde{\Gamma}$  in  $S^3$  with  $\Gamma$  by replacing all edges of  $\varphi(\Gamma)$  as indicated in Figure 4.



Figure 4: Replacement of an edge

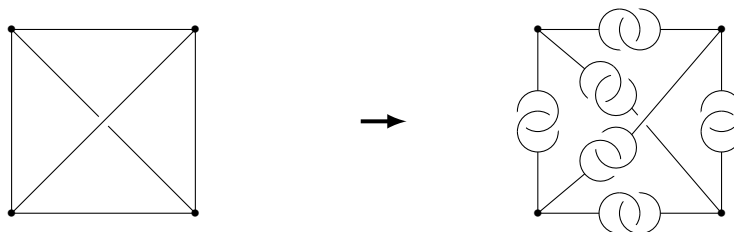

Figure 5: Jacobi diagram and associated Y-link

**Lemma 1.2** (GGP, Corollary 4.2, Corollary 4.6, Theorem 4.11). *The bracket  $[S^3; \tilde{\Gamma}] \in \mathcal{G}_{2n}^{\mathbb{Z}}$  only depends on the class of  $\Gamma$  in  $\mathcal{A}_n$ . Hence it defines:*

$$\begin{aligned} \Phi : \mathcal{A}_n &\rightarrow \mathcal{G}_{2n}^{\mathbb{Z}} \\ \Gamma &\mapsto [S^3; \Gamma] := [S^3; \tilde{\Gamma}] \end{aligned}$$

Moreover:

**Theorem 1.3** (Garoufalidis, Goussarov, Polyak [GGP01], Habiro [Hab00b], Le [Le97]). *For  $n$  odd,  $\mathcal{G}_n^{\mathbb{Z}} = 0$ . For  $n$  even, the map  $\Phi : \mathcal{A}_{\frac{n}{2}} \rightarrow \mathcal{G}_n^{\mathbb{Z}}$  is an isomorphism.*

### 1.3 Statement of the results

We first define the filtration on the rational vector space  $\mathcal{F}_0$  generated by all QHS's up to orientation-preserving homeomorphism.

**Definition 1.4.** For  $g \in \mathbb{N}$ , a *genus  $g$  rational (resp. integral) homology handlebody* (QHH, resp. ZHH) is a 3-manifold which is compact, oriented, and which has the same homology with rational (resp. integral) coefficients as the standard genus  $g$  handlebody.

Such a QHH (resp. ZHH) is connected, and its boundary is necessarily homeomorphic to the standard genus  $g$  surface.

**Definition 1.5.** The *Lagrangian*  $\mathcal{L}_A$  of a QHH  $A$  is the kernel of the map

$$i_* : H_1(\partial A; \mathbb{Q}) \rightarrow H_1(A; \mathbb{Q})$$

induced by the inclusion. Two QHH's  $A$  and  $B$  have *LP-identified* boundaries if we have a homeomorphism  $h : \partial A \rightarrow \partial B$  such that  $h_*(\mathcal{L}_A) = \mathcal{L}_B$ .

The Lagrangian of a QHH  $A$  is indeed a Lagrangian subspace of  $H_1(\partial A; \mathbb{Q})$  with respect to the intersection form.

Consider a QHS  $M$ , a QHH  $A \subset M$ , and a QHH  $B$  whose boundary is LP-identified with  $\partial A$ . Set  $M(\frac{B}{A}) = (M \setminus \text{Int}(A)) \cup_{\partial A = \partial B} B$ . We say that the QHS  $M(\frac{B}{A})$  is obtained from  $M$  by *Lagrangian preserving surgery*, or *LP-surgery*. Note that a borromean surgery is a special type of LP-surgery. If  $(A_i)_{1 \leq i \leq n}$  is a family of disjoint QHH's in  $M$ , and if, for each  $i$ ,  $B_i$  is a QHH whose boundary is LP-identified with  $\partial A_i$ , we denote by  $M((\frac{B_i}{A_i})_{1 \leq i \leq n})$  the manifold obtained from  $M$  by the  $n$  LP-surgeries  $(\frac{B_i}{A_i})$ .

Let  $\mathcal{F}_n$  denote the subspace of  $\mathcal{F}_0$  generated by the

$$[M; (\frac{B_i}{A_i})_{1 \leq i \leq n}] = \sum_{I \subset \{1, \dots, n\}} (-1)^{|I|} M((\frac{B_i}{A_i})_{i \in I})$$

for all QHS's  $M$  and all families of QHH's  $(A_i, B_i)_{1 \leq i \leq n}$ , where the  $A_i$  are embedded in  $M$  and disjoint, and each  $\partial B_i$  is LP-identified with the corresponding  $\partial A_i$ . Since  $\mathcal{F}_{n+1} \subset \mathcal{F}_n$ , this defines a filtration. Set  $\mathcal{G}_n = \mathcal{F}_n / \mathcal{F}_{n+1}$  and  $\mathcal{G} = \bigoplus_{n \in \mathbb{N}} \mathcal{G}_n$ .

**Definition 1.6.** A *finite type invariant of degree at most  $n$*  of rational homology spheres is a linear map  $\lambda : \mathcal{F}_0 \rightarrow \mathbb{Q}$  such that  $\lambda(\mathcal{F}_{n+1}) = 0$ . It is said to be *additive* if  $\lambda(M \sharp N) = \lambda(M) + \lambda(N)$  for all QHS's  $M$  and  $N$ .

Let  $\mathcal{I}_n$  (resp.  $\mathcal{I}_n^c$ ) denote the rational vector space of all invariants (resp. additive invariants) of degree at most  $n$ . Set  $\mathcal{H}_n = \mathcal{I}_n / \mathcal{I}_{n-1}$  and  $\mathcal{H} = \bigoplus_{n \in \mathbb{N}} \mathcal{H}_n$ . Note that  $\mathcal{I}_n$  is canonically isomorphic to  $(\mathcal{F}_0 / \mathcal{F}_{n+1})^* := \text{Hom}(\frac{\mathcal{F}_0}{\mathcal{F}_{n+1}}, \mathbb{Q})$ . We have an exact sequence:

$$0 \rightarrow \mathcal{G}_n \rightarrow \frac{\mathcal{F}_0}{\mathcal{F}_{n+1}} \rightarrow \frac{\mathcal{F}_0}{\mathcal{F}_n} \rightarrow 0.$$

Since the functor  $\text{Hom}(\cdot, \mathbb{Q})$  is exact, the dual sequence

$$0 \rightarrow \mathcal{I}_{n-1} \rightarrow \mathcal{I}_n \rightarrow (\mathcal{G}_n)^* \rightarrow 0$$

is also exact. Thus  $\mathcal{H}_n \cong (\mathcal{G}_n)^*$ .

We will call *augmented diagram of degree  $n$*  the union of a Jacobi diagram of degree  $k \leq \frac{n}{2}$  and of  $(n - 2k)$  weighted vertices, where the weights are prime integers. Note that

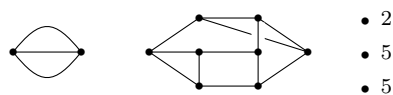

Figure 6: augmented diagram of degree 13



the degree of an augmented diagram is equal to its number of vertices. Let  $\mathcal{A}_n^{aug}$  denote the rational vector space generated by all augmented diagrams of degree  $n$ , quotiented out by the AS and IHX relations. The main goal of this article is to prove the following theorem:

**Theorem 1.7.** *For  $n \in \mathbb{N}$ ,  $\mathcal{A}_n^{aug} \cong \mathcal{G}_n$ .*

This result will follow from Proposition 1.8, Proposition 1.11, and Proposition 6.9. An isomorphism can be described in the following way. Consider an augmented diagram  $\Gamma_a$  of degree  $n$  given by a Jacobi diagram  $\Gamma$  of degree  $k$ , and  $(n - 2k)$  vertices with weights  $(p_i)_{1 \leq i \leq n-2k}$ . Define  $\varphi(\Gamma) \subset S^3$  and the associated Y-link  $\tilde{\Gamma}$  as before. For each  $i$ , consider a rational homology ball  $B_{p_i}$  such that  $H_1(B_{p_i}; \mathbb{Z}) = \frac{\mathbb{Z}}{p_i \mathbb{Z}}$ . Then define the image of  $\Gamma_a$  as  $[S^3; \tilde{\Gamma}, (\frac{B_{p_i}}{B^3})_{1 \leq i \leq n-2k}] \in \mathcal{G}_n$ .

Since connected sums are LP-surgeries of genus 0, one can easily see that  $\mathcal{G}_0 \cong \mathbb{Q}S^3$ . In Section 4, we give a description of  $\mathcal{G}_1$ .

**Proposition 1.8.** *For any prime integer  $p$ , fix a  $\mathbb{Q}$ HS  $M_p$  such that  $|H_1(M_p)| = p$ . Then  $(M_p - S^3)_{p \text{ prime}}$  is a basis for  $\mathcal{G}_1$ .*

**Remark:** The  $\mathbb{Q}$ HS's  $M_p$  are not unique in  $\mathcal{F}_0$ , but we will see in Subsection 4.1 that they are unique modulo  $\mathcal{F}_2$ .

We will show in Subsection 4.1 that the family  $(M_p - S^3)_{p \text{ prime}}$  generates  $\mathcal{G}_1$ . To see that it is a basis, we will prove the following proposition in Subsection 4.2.

For a prime integer  $p$ , let  $\nu_p$  denote the  $p$ -adic valuation, defined on  $\mathbb{N} \setminus \{0\}$  by  $\nu_p(p^k n) = k$  if  $n$  is prime to  $p$ .

**Proposition 1.9.** *For any prime  $p$ , define a linear map  $\nu_p$  on  $\mathcal{F}_0$  by setting  $\nu_p(M) = \nu_p(|H_1(M)|)$  when  $M$  is a  $\mathbb{Q}$ HS. Then  $\nu_p$  is a degree 1 invariant of  $\mathbb{Q}$ HS's.*

Since  $\nu_p(M_p) = 1$ ,  $\nu_p(M_q) = 0$  for any prime  $q \neq p$ , and  $\nu_p(S^3) = 0$  for any prime  $p$ , this result shows that the family  $(M_p - S^3)_{p \text{ prime}}$  is free.

**Corollary 1.10.**  $\frac{\mathcal{I}_1}{\mathcal{I}_0} = \mathcal{I}_1^c = \prod_{p \text{ prime}} \mathbb{Q} \nu_p$ .

In Section 5, we prove:

**Proposition 1.11.** *For  $n > 1$ ,  $\frac{\mathcal{I}_n^c}{\mathcal{I}_{n-1}^c} \cong (\mathcal{A}_{\frac{n}{2}}^c)^*$  if  $n$  is even, and  $\frac{\mathcal{I}_n^c}{\mathcal{I}_{n-1}^c} \cong 0$  if  $n$  is odd.*

In this proof, we will use the description of finite type invariants of degree 1 of framed rational homology tori given in Subsection 5.1.

In Section 6, we use the structures of graded algebras on  $\mathcal{G}$  and  $\mathcal{H}$  in order to show that any finite type invariant  $\lambda$  such that  $\lambda(S^3) = 0$  can be written as a sum of products

of additive invariants. More precisely, let  $\mathcal{I}_n^\pi$  denote the subspace of  $\mathcal{I}_n$  generated by all the products  $\prod_{1 \leq i \leq k} \lambda_i$ , where  $k > 1$ , the  $\lambda_i$  are additive invariants of degree  $k_i < n$ , and  $\sum_{1 \leq i \leq k} k_i \leq n$ . Our version of the Milnor-Moore theorem about the structure of Hopf algebras implies that:

**Proposition 1.12.** *For all  $n > 0$ ,  $\mathcal{I}_n = \mathcal{I}_0 \oplus \mathcal{I}_n^c \oplus \mathcal{I}_n^\pi$ .*

We will obtain this result as a consequence of Proposition 6.9.

In order to describe the spaces of additive invariants, we shall prove that LP-surgeries can be reduced to more specific moves.

**Definition 1.13.** Consider a positive integer  $d$ . We call  $d$ -torus a rational homology torus such that:

- $H_1(\partial T_d; \mathbb{Z}) = \mathbb{Z}\alpha \oplus \mathbb{Z}\beta$ , with  $\langle \alpha, \beta \rangle = 1$ ,
- $d\alpha = 0$  in  $H_1(T_d; \mathbb{Z})$ ,
- $\beta = d\gamma$  in  $H_1(T_d; \mathbb{Z})$ , where  $\gamma$  is a curve in  $T_d$ ,
- $H_1(T_d; \mathbb{Z}) = \mathbb{Z}_d\alpha \oplus \mathbb{Z}\gamma$ .

**Definition 1.14.** An *elementary surgery* is an LP-surgery among the following ones:

1. connected sum (genus 0),
2. LP-replacement of a standard torus by a  $d$ -torus (genus 1),
3. borromean surgery (genus 3).

In Section 2, we prove:

**Theorem 1.15.** *If  $A$  and  $B$  are two  $\mathbb{Q}$ HH's with LP-identified boundaries, then  $B$  can be obtained from  $A$  by a finite sequence of elementary surgeries and their inverses in the interior of the  $\mathbb{Q}$ HH's.*

This proposition generalises a result of Auclair and Lescop which says that any two  $\mathbb{Z}$ HH's with LP-identified boundaries can be obtained from one another by a finite sequence of borromean surgeries in the interior of the  $\mathbb{Z}$ HH's ([AL05, Lemma 4.11]).

In Section 3, we recall some facts about borromean surgeries proved in [GGP01], and we give consequences of these facts that are useful in the sequel.

**Acknowledgements** I wish to thank the referee for his careful reading. My thanks also go to my advisor, Christine Lescop, for her helpful advice and rigorous supervision.

## 2 Elementary surgeries

### 2.1 Homological properties of $\mathbb{Q}HH$ 's

**Definition 2.1.** Consider the genus  $g$  compact surface  $\Sigma_g$ . A basis  $(\alpha_i, \beta_i)_{1 \leq i \leq g}$  of  $H_1(\Sigma_g; \mathbb{Z})$  is called *symplectic* if the matrix of the intersection form in  $(\alpha_1, \dots, \alpha_g, \beta_1, \dots, \beta_g)$  is  $\begin{pmatrix} 0 & I_g \\ -I_g & 0 \end{pmatrix}$ .

**Notation** We denote by  $Tors(H)$  the torsion submodule of a module  $H$ .

**Lemma 2.2.** *If  $A$  is a genus  $g$   $\mathbb{Q}HH$ , then:*

- $H_1(A; \mathbb{Z}) \cong \mathbb{Z}^g \oplus Tors(H_1(A; \mathbb{Z}))$ ,
- $H_2(A; \mathbb{Z}) = 0$ ,
- $H_2(A, \partial A; \mathbb{Z}) \cong \left( \frac{H_1(A; \mathbb{Z})}{Tors(H_1(A; \mathbb{Z}))} \right)^* \cong \mathbb{Z}^g$ .

*Proof.* The first point is given by  $H_1(A; \mathbb{Z}) \otimes \mathbb{Q} \cong H_1(A; \mathbb{Q}) \cong \mathbb{Q}^g$ .

By the Poincaré duality, we have  $H_2(A; \mathbb{Z}) \cong H^1(A, \partial A; \mathbb{Z})$ . The universal coefficient theorem gives  $H^1(A, \partial A; \mathbb{Z}) \cong Hom(H_1(A, \partial A; \mathbb{Z}), \mathbb{Z})$ . Hence  $H_2(A; \mathbb{Z})$  is torsion free. Since  $H_2(A; \mathbb{Q}) = 0$ , we get the second point.

The last point also follows from the Poincaré duality and the universal coefficient theorem:

$$H_2(A, \partial A; \mathbb{Z}) \cong H^1(A; \mathbb{Z}) \cong Hom(H_1(A; \mathbb{Z}), \mathbb{Z}) \cong \mathbb{Z}^g.$$

□

**Lemma 2.3.** *Consider a genus  $g$   $\mathbb{Q}HH$   $A$ . Consider the map  $i_* : H_1(\partial A; \mathbb{Z}) \rightarrow H_1(A; \mathbb{Z})$  induced by the inclusion. Set:*

$$\mathcal{L}_A^{\mathbb{Z}} = Ker(i_*), \quad \mathcal{L}_A^T = (i_*)^{-1}(Tors(H_1(A; \mathbb{Z}))).$$

*Then there is a symplectic basis  $(\alpha_i, \beta_i)_{1 \leq i \leq g}$  of  $H_1(\partial A; \mathbb{Z})$ , a family  $(\gamma_i)_{1 \leq i \leq g}$  of curves in  $A$ , and positive integers  $d_i$ ,  $1 \leq i \leq g$ , such that:*

$$\mathcal{L}_A^{\mathbb{Z}} = \bigoplus_{1 \leq i \leq g} \mathbb{Z}(d_i \alpha_i), \quad \mathcal{L}_A^T = \bigoplus_{1 \leq i \leq g} \mathbb{Z} \alpha_i, \quad \frac{H_1(A; \mathbb{Z})}{Tors(H_1(A; \mathbb{Z}))} = \bigoplus_{1 \leq i \leq g} \mathbb{Z} \gamma_i,$$

and  $\beta_i = d_i \gamma_i$  in  $\frac{H_1(A; \mathbb{Z})}{Tors(H_1(A; \mathbb{Z}))}$  for  $1 \leq i \leq g$ .

In particular,  $\frac{\mathcal{L}_A^T}{\mathcal{L}_A^{\mathbb{Z}}}$  and  $\frac{H_1(A; \mathbb{Z})}{Tors(H_1(A; \mathbb{Z})) \oplus (\bigoplus_{1 \leq i \leq g} \mathbb{Z} \beta_i)}$  are isomorphic to  $\prod_{1 \leq i \leq g} \frac{\mathbb{Z}}{d_i \mathbb{Z}}$ .

*Proof.* The exact sequence over  $\mathbb{Z}$  associated with  $(A, \partial A)$  yields the following exact sequence:

$$0 \rightarrow H_2(A, \partial A) \rightarrow H_1(\partial A) \xrightarrow{i_*} H_1(A),$$

thus  $\mathcal{L}_A^{\mathbb{Z}}$  is a free submodule of rank  $g$  of  $H_1(\partial A; \mathbb{Z})$ . Hence there is a basis  $(\alpha_i, \beta_i)_{1 \leq i \leq g}$  of  $H_1(\partial A; \mathbb{Z})$ , and positive integers  $d_i$ ,  $1 \leq i \leq g$ , such that  $(d_i \alpha_i)_{1 \leq i \leq g}$  is a basis of  $\mathcal{L}_A^{\mathbb{Z}}$ . It follows that  $\mathcal{L}_A^T = \bigoplus_{1 \leq i \leq g} \mathbb{Z} \alpha_i$ . Since the intersection form is trivial on  $\mathcal{L}_A^T$ , we can choose the  $\beta_i$  in such a way that the basis  $(\alpha_i, \beta_i)_{1 \leq i \leq g}$  is symplectic.

The boundary map  $H_2(A, \partial A) \rightarrow H_1(\partial A)$  in the above exact sequence induces an isomorphism  $H_2(A, \partial A; \mathbb{Z}) \cong \mathcal{L}_A^{\mathbb{Z}}$ . Thus we can choose a basis  $(S_i)_{1 \leq i \leq g}$  of  $H_2(A, \partial A; \mathbb{Z})$  such that  $\partial S_i = d_i \alpha_i$  for  $1 \leq i \leq g$ . Let  $(\gamma_i)_{1 \leq i \leq g}$  denote the basis of  $\frac{H_1(A; \mathbb{Z})}{\text{Tors}(H_1(A; \mathbb{Z}))}$  Poincaré dual to  $(S_i)_{1 \leq i \leq g}$ .

For  $1 \leq i, j \leq g$ ,  $\langle S_j, \beta_i \rangle_A = \langle d_j \alpha_j, \beta_i \rangle_{\partial A} = \delta_{ij} d_i$ , where  $\delta_{ij}$  is the Kronecker delta, equal to 1 if  $i = j$ , and 0 otherwise. Thus  $\beta_i = d_i \gamma_i$  in  $\frac{H_1(A; \mathbb{Z})}{\text{Tors}(H_1(A; \mathbb{Z}))}$ .  $\square$

**Corollary 2.4.** *Let  $A$  be a  $\mathbb{Q}$ HH. If the map  $H_1(\partial A; \mathbb{Z}) \rightarrow H_1(A; \mathbb{Z})$ , induced by the inclusion  $\partial A \hookrightarrow A$ , is surjective, then  $A$  is a  $\mathbb{Z}$ HH.*

## 2.2 $d$ -tori

**Lemma 2.5.** *For any positive integer  $d$ , there exists a  $d$ -torus  $T_d$ .*

*Proof.* Consider the standard genus 2 handlebody  $A$  represented in Figure 7. Consider a

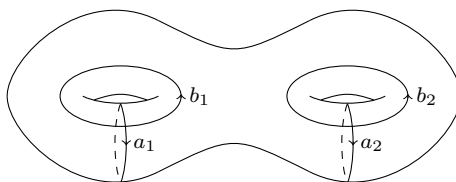
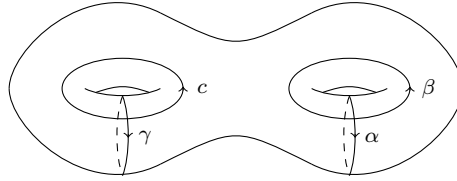

Figure 7: The handlebody  $A$

curve  $c$  on  $\partial A$  such that  $c = a_1 + db_2$  in  $H_1(\partial A; \mathbb{Z})$ . According to Meyerson in [Mey76], since  $c$  is primitive, it can be chosen simple and closed. The torus  $T_d$  will be obtained from  $A$  by adding a 2-handle to  $A$  along  $c$  as follows. Define  $T_d = A \cup_h (D^2 \times [-1, 1])$ , where  $h : \partial D^2 \times [-1, 1] \rightarrow \partial A$  is an embedding such that  $h(\partial D^2 \times \{0\}) = c$ . We have  $H_1(T_d; \mathbb{Z}) = \langle b_1, b_2 \mid db_2 = 0 \rangle$ .

Moreover, we can define curves  $\alpha, \beta, \gamma$ , on  $\partial A$ , with  $\alpha = b_2$ ,  $\beta = -a_2 - db_1$  and  $\gamma = -b_1$  in  $H_1(\partial A; \mathbb{Z})$  such that the boundary of  $A$  is homeomorphic to the surface represented in Figure 8. We get  $H_1(T_d; \mathbb{Z}) = \langle \gamma, \alpha \mid d\alpha = 0 \rangle$ , and  $H_1(\partial T_d; \mathbb{Z}) = \mathbb{Z}\alpha \oplus \mathbb{Z}\beta$ .  $\square$

 Figure 8: The surface  $\partial A$ 

Given a curve  $\gamma$  in a 3-manifold  $M$ , we will call *exterior of  $\gamma$  in  $M$*  the complement of the open tubular neighborhood of  $\gamma$  in  $M$ .

**Lemma 2.6.** *Let  $d$  be a positive integer. Let  $T_d$  be a  $d$ -torus. Let  $\gamma$  be a curve in  $T_d$  whose homology class generates  $\frac{H_1(T_d; \mathbb{Z})}{\text{Tors}(H_1(T_d; \mathbb{Z}))}$ . Let  $m(\gamma)$  and  $\ell(\gamma)$  be respectively a meridian and a parallel of  $\gamma$ . For any integer  $k$ , there is a symplectic basis  $(\alpha, \beta)$  of  $H_1(\partial T_d; \mathbb{Z})$  such that  $d\alpha = 0$  in  $H_1(T_d; \mathbb{Z})$ , and such that the curve  $\beta - d\ell(\gamma) + km(\gamma)$  bounds a surface in the exterior of  $\gamma$  in  $T_d$ .*

*Proof.* Let  $X$  be the exterior of  $\gamma$  in  $T_d$ . Consider a symplectic basis  $(\alpha, \beta_0)$  of  $H_1(\partial T_d; \mathbb{Z})$  such that  $d\alpha = 0$  and  $\beta_0 = d\gamma$  in  $H_1(T_d; \mathbb{Z})$ . There is an integer  $k_0$  such that  $\beta_0 - d\ell(\gamma) + k_0 m(\gamma)$  bounds a surface in  $X$ , i.e. is trivial in  $H_1(X; \mathbb{Z})$ . Since  $d\alpha$  bounds a surface in  $T_d$  that  $\gamma$  meets once,  $d\alpha - m(\gamma)$  is trivial in  $H_1(X; \mathbb{Z})$ . Let  $k$  be any integer, and set  $\beta = \beta_0 + (k_0 - k)d\alpha$ . The curve  $\beta - d\ell(\gamma) + km(\gamma) = (\beta_0 - d\ell(\gamma) + k_0 m(\gamma)) + (k_0 - k)(d\alpha - m(\gamma))$  is trivial in  $H_1(X; \mathbb{Z})$ .  $\square$

### 2.3 Relating $\mathbb{Q}HH$ 's by elementary surgeries

In this subsection, we prove Theorem 1.15.

**Definition 2.7.** Consider a  $\mathbb{Q}HH$   $A$ . Consider a simple closed curve  $\gamma \subset A$ . Consider a disk  $D \subset \partial A$ . Consider two distinct points  $y$  and  $z$  in  $\text{Int}(D)$ , and a path  $s$  from  $z$  to  $y$  in  $\text{Int}(D)$ . Consider a cylinder  $C = h(D^2 \times [0, 1]) \subset A$ , where  $h$  is an embedding such that:

- $h(D^2 \times \{0\})$  (resp.  $h(D^2 \times \{1\})$ ) is a disk  $D_y$  (resp.  $D_z$ ) in  $\text{Int}(D)$ ,
- $h(0, 0) = y$  and  $h(0, 1) = z$ ,
- $C \cap \partial A = D_y \cup D_z$ ,
- $h(\{0\} \times [0, 1]) \cup s$  is homologous to  $\gamma$  in  $A$ .

We will call *tunnel around  $\gamma$*  such a cylinder  $C$ .

**Lemma 2.8.** *Let  $A$  be a  $\mathbb{Q}$ HH of genus  $g$ . Let  $\gamma$  be a simple closed curve in  $A$ . Let  $C$  be a tunnel around  $\gamma$ . Set  $B = A \setminus \overline{C}$ . Then  $B$  is a  $\mathbb{Q}$ HH of genus  $g + 1$ .*

*Proof.* Consider the pair  $(A, B)$ . By excision, for  $i \in \mathbb{N}$ ,  $H_i(A, B; \mathbb{Q}) \cong H_i(C, C \cap B; \mathbb{Q})$ . Since  $(C, C \cap B) \cong (D^2 \times [0, 1], (\partial D^2) \times [0, 1])$ , it follows that  $H_i(A, B; \mathbb{Q}) = 0$  if  $i \neq 2$ , and  $H_2(A, B; \mathbb{Q}) \cong \mathbb{Q}$ . The exact sequence over  $\mathbb{Q}$  associated with the pair  $(A, B)$  yields the following exact sequence:

$$0 \rightarrow H_2(B) \rightarrow 0 \rightarrow H_2(A, B) \cong \mathbb{Q} \rightarrow H_1(B) \rightarrow H_1(A) \cong \mathbb{Q}^g \rightarrow 0.$$

Hence  $H_2(B; \mathbb{Q}) = 0$  and  $H_1(B; \mathbb{Q}) \cong \mathbb{Q}^{g+1}$ .  $\square$

**Lemma 2.9.** *Let  $A$  be a  $\mathbb{Q}$ HH of genus  $g$ . The quotient  $\frac{H_1(A; \mathbb{Z})}{H_1(\partial A; \mathbb{Z})}$  is a torsion module.*

*Set  $\frac{H_1(A; \mathbb{Z})}{H_1(\partial A; \mathbb{Z})} = \bigoplus_{i=1}^n \frac{\mathbb{Z}}{d_i \mathbb{Z}} \mu_i$ . Let  $C_i$ ,  $1 \leq i \leq n$ , be pairwise disjoint tunnels around the  $\mu_i$ . Then  $B = A \setminus \overline{(\cup_{1 \leq i \leq n} C_i)}$  is a  $\mathbb{Z}$ HH of genus  $g + n$ .*

*Proof.* The fact that  $\frac{H_1(A; \mathbb{Z})}{H_1(\partial A; \mathbb{Z})}$  is a torsion module follows from Lemma 2.3.

By Lemma 2.8,  $B$  is a  $\mathbb{Q}$ HH of genus  $g + n$ . Hence, by Corollary 2.4, it suffices to show that the map  $H_1(\partial B; \mathbb{Z}) \rightarrow H_1(B; \mathbb{Z})$  induced by the inclusion is surjective, or, equivalently, that  $H_1(B, \partial B; \mathbb{Z})$  is trivial. By excision,  $H_1(B, \partial B; \mathbb{Z})$  is isomorphic to  $H_1(A, \partial A \cup (\cup_{1 \leq i \leq n} C_i); \mathbb{Z})$ , which is trivial by definition of the  $C_i$ 's.  $\square$

For a 3-manifold  $A$ , let  $lk_A : Tors(H_1(A; \mathbb{Z})) \times Tors(H_1(A; \mathbb{Z})) \rightarrow \mathbb{Q}/\mathbb{Z}$  denote the *linking form* on  $A$ , defined in the following way. Consider disjoint representatives  $\alpha, \beta$  of two homology classes in  $Tors(H_1(A; \mathbb{Z}))$ . Consider a surface  $S \subset A$ , transverse to  $\beta$ , such that  $\partial S = k\alpha$  for some positive integer  $k$ . Then  $lk_A(\alpha, \beta) = \frac{1}{k} \langle S, \beta \rangle$ , where  $\langle \cdot, \cdot \rangle$  is the algebraic intersection number in  $A$ . For a  $\mathbb{Q}$ HS  $M$ , the linking form  $lk_M$  is defined on  $H_1(M; \mathbb{Z}) \times H_1(M; \mathbb{Z})$ , and it is known to be bilinear, symmetric, and non degenerate.

**Lemma 2.10.** *Let  $A$  be a  $\mathbb{Q}$ HH of genus  $g$ . Assume  $\frac{\mathcal{L}_A^T}{\mathcal{L}_A^Z} = 0$ . Then there exists a  $\mathbb{Q}$ HS  $M$  such that  $(H_1(M; \mathbb{Z}), lk_M)$  is isomorphic to  $(Tors(H_1(A; \mathbb{Z})), lk_A)$ .*

*Proof.* By Lemma 2.3, there is a symplectic basis  $(\alpha_i, \beta_i)_{1 \leq i \leq g}$  of  $H_1(\partial A; \mathbb{Z})$  such that the  $\alpha_i$  are null-homologous in  $A$ , and  $H_1(A; \mathbb{Z}) = Tors(H_1(A)) \oplus (\bigoplus_{1 \leq i \leq g} \mathbb{Z} \beta_i)$ . Consider a standard handlebody  $H_g$ , and a symplectic basis  $(a_i, b_i)_{1 \leq i \leq g}$  of  $H_1(\partial H_g; \mathbb{Z})$ , where each  $a_i$  bounds a disk in  $H_g$ . Construct a  $\mathbb{Q}$ HS  $M$  by gluing  $A$  and  $H_g$  along their boundaries, in such a way that, for  $1 \leq i \leq g$ ,  $\alpha_i$  is identified with  $b_i$ , and  $\beta_i$  is identified with  $a_i$ . We have  $H_1(M; \mathbb{Z}) \cong Tors(H_1(A; \mathbb{Z}))$ . Moreover, the linkings of the curves in  $A$  are preserved, thus the linking forms on  $H_1(M)$  and  $Tors(H_1(A))$  are isomorphic.  $\square$

**Lemma 2.11.** *Let  $A$  and  $A'$  be  $\mathbb{Q}$ HH's of genus  $g$  with LP-identified boundaries. Assume  $\frac{\mathcal{L}_A^T}{\mathcal{L}_A^Z} = 0$  and  $\frac{\mathcal{L}_{A'}^T}{\mathcal{L}_{A'}^Z} = 0$ . If  $(Tors(H_1(A)), lk_A)$  is isomorphic to  $(Tors(H_1(A')), lk_{A'})$ , then  $A$  and  $A'$  can be obtained from one another by a finite sequence of borromean surgeries.*

*Proof.* Consider a basis  $(\mu_i)_{1 \leq i \leq n}$  of  $Tors(H_1(A))$ , and its image  $(\mu'_i)_{1 \leq i \leq n}$  under an isomorphism  $(Tors(H_1(A)), lk_A) \cong (Tors(H_1(A')), lk_{A'})$ . Fix framed representatives of the  $\mu_i$  and  $\mu'_i$  such that  $lk(\mu_i, \mu_j) = lk(\mu'_i, \mu'_j) \in \mathbb{Q}$  for  $1 \leq i, j \leq n$ . Consider pairwise disjoint tunnels  $C_i$  (resp.  $C'_i$ ) around the  $\mu_i$  (resp.  $\mu'_i$ ). Set  $B = \overline{A \setminus (\cup_{1 \leq i \leq n} C_i)}$  and  $B' = \overline{A' \setminus (\cup_{1 \leq i \leq n} C'_i)}$ . Extend the identification  $\partial A \cong \partial A'$  to an identification  $\partial B \cong \partial B'$  so that the longitude of each  $\mu_i$  is identified with the longitude of the corresponding  $\mu'_i$ . By Lemma 2.9,  $B$  and  $B'$  are  $\mathbb{Z}$ HH's of genus  $g+n$ . The equality between the linking numbers ensures that the identification of their boundaries preserves the Lagrangian. Thus, by [AL05, Lemma 4.11],  $B$  can be obtained from  $B'$  by a finite sequence of borromean surgeries. Gluing back the cylinders, we get that  $A$  can be obtained from  $A'$  by a finite sequence of borromean surgeries.  $\square$

**Corollary 2.12.** *Consider a  $\mathbb{Q}$ HH  $A$  such that  $\mathcal{L}_A^T/\mathcal{L}_A^Z = 0$ . Let  $H_g$  be a standard handlebody such that  $\partial H_g$  and  $\partial A$  are LP-identified. Then there exists a  $\mathbb{Q}$ HS  $M$  such that  $A$  is obtained from  $H_g \sharp M$  by a finite sequence of borromean surgeries.*

**Lemma 2.13.** *Let  $A$  be a genus  $g$   $\mathbb{Q}$ HH. Let  $H_g$  be a standard handlebody such that  $\partial H_g$  and  $\partial A$  are LP-identified. Assume there are a symplectic basis  $(\alpha_i, \beta_i)_{1 \leq i \leq g}$  of  $H_1(\partial A; \mathbb{Z})$ , a curve  $\gamma$  in  $A$ , and a positive integer  $d$  such that  $H_1(A; \mathbb{Z}) = \frac{\mathbb{Z}}{d\mathbb{Z}}\alpha_1 \oplus \mathbb{Z}\gamma \oplus (\bigoplus_{2 \leq i \leq g} \mathbb{Z}\beta_i)$  and  $\beta_1 = d\gamma$ . Then there are a solid torus  $T_0$  embedded in  $H_g$ , a  $d$ -torus  $T_d$ , and an LP-identification  $\partial T_d \cong \partial T_0$ , such that  $A$  is obtained from  $H_g(\frac{T_d}{T_0})$  by a finite sequence of borromean surgeries.*

*Proof.* Consider a tunnel  $C$  around  $\gamma$  in  $A$ . Set  $B = \overline{A \setminus C}$ . By Lemma 2.9,  $B$  is a  $\mathbb{Z}$ HH of genus  $g+1$ . There is a surface  $S \subset B$  such that  $\partial S \subset \partial B$  is homologous to  $\beta_1 - d\ell + km$  in  $\partial B$ , where  $m$  is a meridian of  $\gamma$ ,  $\ell$  is a longitude of  $\gamma$ , and  $k$  is an integer. Consider simple closed curves  $\sigma_1$  and  $\sigma_2$  in  $\partial B$  such that  $\sigma_1 = m - d\alpha_1$  and  $\sigma_2 = \beta_1 - d\ell + km$  in  $H_1(\partial B)$ . Then  $(\sigma_1, \sigma_2, \alpha_2, \dots, \alpha_g)$  is a basis of  $\mathcal{L}_B^Z$ .

Consider the symplectic basis  $(a_i, b_i)_{1 \leq i \leq g}$  of  $H_1(\partial H_g; \mathbb{Z})$  image of  $(\alpha_i, \beta_i)_{1 \leq i \leq g}$  by the LP-identification  $\partial A \cong \partial H_g$ . Consider a simple closed curve representing  $b_1$  in  $Int(H_g)$ , and a tubular neighborhood  $T_0$  of this curve. Consider a  $d$ -torus  $T_d$ , a symplectic basis  $(\alpha', \beta')$  of  $H_1(\partial T_d; \mathbb{Z})$ , and a curve  $\gamma'$  in  $T_d$ , such that  $H_1(T_d; \mathbb{Z}) = \frac{\mathbb{Z}}{d\mathbb{Z}}\alpha' \oplus \mathbb{Z}\gamma'$  and  $\beta' = d\gamma'$ . By Lemma 2.6,  $\beta'$  can be chosen so that  $\beta' - d\ell(\gamma') + km(\gamma')$  bounds a surface in the exterior of  $\gamma'$  in  $T_d$  (where  $k$  is the integer that appears when tunneling  $A$ ). Choose an LP-identification  $\partial T_d \cong \partial T_0$  that identifies  $\beta'$  with a curve on  $\partial T_0$  homologous to  $b_1$  in  $H_g \setminus Int(T_0)$ . Set  $A' = H_g(\frac{T_d}{T_0})$ .

Consider a tunnel  $C'$  around  $\gamma'$  in  $A'$ . Set  $B' = \overline{A' \setminus C'}$ . By Lemma 2.9,  $B'$  is a  $\mathbb{Z}$ HH of genus  $g+1$ . Like in  $B$ , there is a surface  $S'$  in  $B'$  bounded by  $b_1 - d\ell(\gamma') + km(\gamma')$ ,

and we can define a basis of  $\mathcal{L}_{B'}^{\mathbb{Z}}$ , similarly. Hence the LP-identification  $\partial A \cong \partial H_g \cong \partial A'$  extends to an LP-identification  $\partial B \cong \partial B'$ . By [AL05, Lemma 4.11],  $B$  can be obtained from  $B'$  by a finite sequence of borromean surgeries. Gluing back the cylinders, we get that  $A$  can be obtained from  $A' = H_g(\frac{T_d}{T_0})$  by a finite sequence of borromean surgeries.  $\square$

*Proof of Theorem 1.15.* It suffices to prove the result when  $B$  is a standard handlebody. We will proceed by induction on  $|\mathcal{L}_A^T/\mathcal{L}_A^{\mathbb{Z}}|$ . The case  $|\mathcal{L}_A^T/\mathcal{L}_A^{\mathbb{Z}}| = 1$  is given by Corollary 2.12.

Consider a QHH  $A$  of genus  $g$  with  $|\mathcal{L}_A^T/\mathcal{L}_A^{\mathbb{Z}}| > 1$ , and a standard genus  $g$  handlebody  $H_g$  whose boundary is LP-identified with  $\partial A$ . By Lemma 2.3, there is a symplectic basis  $(\alpha_i, \beta_i)_{1 \leq i \leq g}$  of  $H_1(\partial A; \mathbb{Z})$ , positive integers  $d_i$ , and a basis  $(\gamma_i)_{1 \leq i \leq g}$  of  $H_1(A; \mathbb{Z})/Tors(H_1(A; \mathbb{Z}))$ , such that, in  $H_1(A; \mathbb{Z})$ ,  $d_i \alpha_i = 0$  and  $\beta_i = d_i \gamma_i + t_i$ , with  $t_i \in Tors(H_1(A; \mathbb{Z}))$ . Note that  $|\mathcal{L}_A^T/\mathcal{L}_A^{\mathbb{Z}}| = \prod_{1 \leq i \leq g} d_i$ . Assume  $d_1 > 1$ .

Consider a tubular neighborhood  $T$  of  $t_1$ , with a meridian  $m(t_1)$ . Consider a  $d_1$ -torus  $T_{d_1}$ , a basis  $(\alpha, \beta)$  of  $H_1(\partial T_{d_1}; \mathbb{Z})$ , and a curve  $t$  in  $T_{d_1}$ , such that  $d_1 \alpha = 0$  and  $\beta = d_1 t$  in  $H_1(T_{d_1}; \mathbb{Z})$ . Define an LP-surgery  $(\frac{T_{d_1}}{T})$  by identifying  $\alpha$  with  $m(t_1)$  and  $\beta$  with  $t_1$ . Set  $A' = A(\frac{T_{d_1}}{T})$ . In  $A'$ ,  $t_1 = d_1 t$ , thus we have  $\beta_1 = d_1 \gamma$  with  $\gamma = \gamma_1 + t$ .

Consider a tunnel  $C$  around  $\gamma$ . Set  $B = \overline{A' \setminus C}$ . By Lemma 2.8,  $B$  is a QHH of genus  $(g + 1)$ . There is a surface  $S \subset B$  such that  $\partial S \subset \partial B$  is homologous to  $\beta_1 - d_1 \ell + km$  in  $\partial B$ , where  $m$  is a meridian of  $\gamma$ ,  $\ell$  is a longitude of  $\gamma$ , and  $k$  is an integer. Consider simple closed curves  $\sigma_1$  and  $\sigma_2$  in  $\partial B$  such that  $\sigma_1 = m - d_1 \alpha_1$  and  $\sigma_2 = \beta_1 - d_1 \ell + km$  in  $H_1(\partial B)$ . The curves  $\sigma_1$  and  $\sigma_2$  are null-homologous in  $B$ , and  $(\sigma_1, \sigma_2, \alpha_2, \dots, \alpha_g)$  is a basis of  $\mathcal{L}_B^{\mathbb{Z}}$ . Hence  $|\mathcal{L}_B^T/\mathcal{L}_B^{\mathbb{Z}}| < |\mathcal{L}_A^T/\mathcal{L}_A^{\mathbb{Z}}|$ .

Consider a genus  $(g + 1)$  standard handlebody  $H_{g+1}$  of boundary  $\partial B$ , where the  $\sigma_i$  and the  $\alpha_i$  bound disks in  $H_{g+1}$ . By induction,  $B$  can be obtained from  $H_{g+1}$  by a finite sequence of elementary surgeries or their inverses. Gluing back the cylinder  $C$  to  $H_{g+1}$ , we get a genus  $g$  QHH  $\tilde{A}$  satisfying  $H_1(\tilde{A}) = \frac{\mathbb{Z}}{d_1 \mathbb{Z}} \alpha_1 \oplus \mathbb{Z} \gamma \oplus (\oplus_{2 \leq i \leq g} \mathbb{Z} \beta_i)$ , such that  $A'$  can be obtained from  $\tilde{A}$  by a finite sequence of elementary surgeries or their inverses. Hence  $A$  can be obtained from  $\tilde{A}$  by a finite sequence of elementary surgeries or their inverses. Since  $\partial \tilde{A}$  and  $\partial H_g$  are both LP-identified with  $\partial A$ , they are LP-identified with each other. By Lemma 2.13,  $\tilde{A}$  can be obtained from  $H_g$  by a finite sequence of elementary surgeries or their inverses.  $\square$

**Remark** We could have defined elementary surgeries by restricting the genus 1 case to LP-replacements of standard tori by  $p$ -tori, for  $p$  prime, and keep Theorem 1.15 true. Indeed, consider a  $d$ -torus  $T_d$  and the usual curve  $\gamma$  in  $T_d$  that generates  $\frac{H_1(T_d; \mathbb{Z})}{Torsion}$ . One can check that an LP-replacement of a tubular neighborhood of  $\gamma$  by a  $d'$ -torus produces a  $dd'$ -torus. Hence, for any positive integer  $d$ , a  $d$ -torus  $T_d$  can be obtained from a standard torus by a finite sequence of “prime” elementary surgeries of genus 1. Use then



the “tunneling method” to see that any  $d$ -torus can be obtained from this  $T_d$ , with the right choice of longitude, by a finite sequence of borromean surgeries.

### 3 Borromean surgeries and clasper calculus

Fix a 3-manifold  $M$ , possibly with boundary. Let  $\mathcal{F}_0^{\mathbb{Z}}(M)$  denote the rational vector space generated by all the 3-manifolds that can be obtained from  $M$  by a finite sequence of borromean surgeries, up to orientation-preserving homeomorphism. Let  $\mathcal{F}_n^{\mathbb{Z}}(M)$  denote the subspace generated by the  $[M; \Gamma]$  for all  $m$ -component Y-link  $\Gamma$  in  $M$ , with  $m \geq n$ . Let “ $=_n$ ” denote the equality modulo  $\mathcal{F}_{n+1}^{\mathbb{Z}}(M)$ .

**Lemma 3.1** (GGP, Corollary 4.3). *Let  $\Gamma$  be an  $n$ -component Y-link in a 3-manifold  $M$ . Let  $\ell$  be a leaf of  $\Gamma$ . Let  $\gamma$  be a framed arc starting at the vertex incident to  $\ell$  and ending in another point of  $\ell$ , embedded in  $M$  as the core of a band glued to the associated surface of  $\Gamma$  as shown in Figure 9. The arc  $\gamma$  splits the leaf  $\ell$  into two leaves  $\ell'$  and  $\ell''$ . Denote by  $\Gamma'$  and  $\Gamma''$  the Y-links obtained from  $\Gamma$  by replacing the leaf  $\ell$  by  $\ell'$  and  $\ell''$  respectively. Then  $[M; \Gamma] =_n [M; \Gamma'] + [M; \Gamma'']$ .*

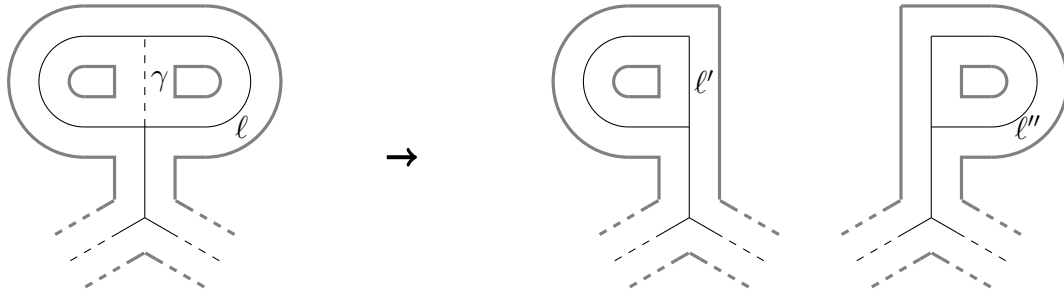

Figure 9: cutting a leaf

**Lemma 3.2** (GGP, Lemma 4.8). *Let  $\Gamma$  be an  $n$ -component Y-link in a 3-manifold  $M$ . If  $\Gamma$  has a leaf  $\ell$  that bounds a disk in  $M \setminus (\Gamma \setminus \ell)$  and has framing 1, then  $[M; \Gamma] = 0$ .*

These two lemmas imply that the class of  $[M; \Gamma]$  modulo  $\mathcal{F}_{n+1}^{\mathbb{Z}}(M)$  does not depend on the framing of the leaves.

**Lemma 3.3** (GGP, Corollary 4.2). *Let  $\Gamma$  be an  $n$ -component Y-link in a 3-manifold  $M$ . Let  $K$  be a framed knot in  $M \setminus \Gamma$ . Let  $\Gamma'$  be obtained from  $\Gamma$  by sliding an edge of  $\Gamma$  along  $K$  (see Figure 10). Then  $[M; \Gamma] =_n [M; \Gamma']$ .*

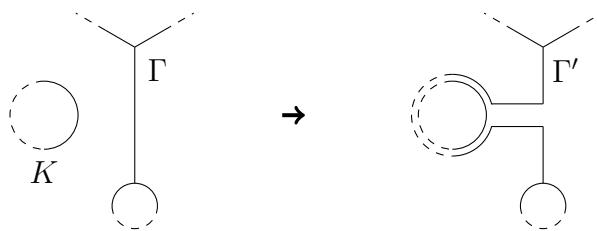

Figure 10: sliding an edge

**Lemma 3.4** (GGP, Lemma 4.4). *Let  $\Gamma$  be an  $n$ -component Y-link in a 3-manifold  $M$ . Let  $\Gamma'$  be obtained from  $\Gamma$  by twisting the framing of an edge by a half twist. Then  $[M; \Gamma'] =_n -[M; \Gamma]$ .*

In the following, we will consider *oriented Y-links*, defined as follows. A Y-graph is *oriented* if its associated surface is oriented. An orientation of a Y-graph induces an orientation of its leaves and of its internal vertex, as shown in Figure 11, where the surface drawn is given the standard orientation of the plane. A Y-link is oriented if its components

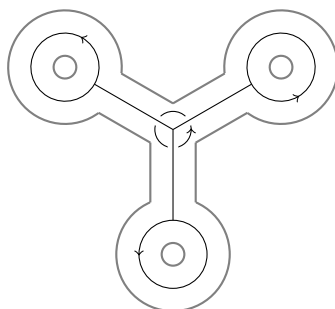

Figure 11: oriented Y-graph

are oriented. In this setting, one can twist the framing of an edge only by an integral number of twists. A half twist corresponds to a change of orientation of the adjacent leaf.

Let  $\Gamma$  be an oriented Y-link in a 3-manifold  $M$ . The above results imply that the class of  $[M; \Gamma]$  modulo  $\mathcal{F}_{n+1}^{\mathbb{Z}}(M)$  does not depend on the edges of  $\Gamma$  and on the incident vertices of the leaves of  $\Gamma$ . We shall see that, in some sense, it only depends on the homology classes of the leaves.

**Lemma 3.5** (GGP, Lemma 2.2). *Let  $\Gamma$  be a Y-graph in a 3-manifold  $M$ , which has a 0-framed leaf  $\ell$  that bounds a disk in  $M \setminus (\Gamma \setminus \ell)$ . Then  $M(\Gamma) \cong M$ .*

**Lemma 3.6.** *Let  $\Gamma$  be an oriented  $n$ -component Y-link in a 3-manifold  $M$ . Assume  $\Gamma$  has a leaf  $\ell$  which is trivial in  $H_1(M \setminus (\Gamma \setminus \ell); \mathbb{Z})$ . Then  $[M; \Gamma] =_n 0$ .*

*Proof.* We can assume that  $\ell$  is 0-framed. The leaf  $\ell$  bounds a surface  $\Sigma$  whose interior does not meet  $\Gamma$ . First assume  $\Sigma$  has a positive genus. Thanks to Lemma 3.1, we can assume  $\Sigma$  has genus 1. Apply Lemma 3.1 to decompose  $\ell$  into four leaves, and apply it again to re-glue them by pairs, as shown in Figure 12. This leads us to the case of a leaf

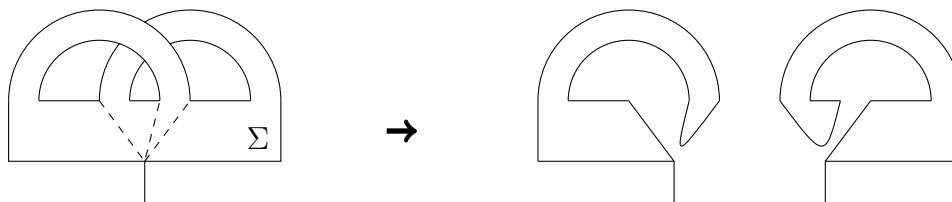

Figure 12: decomposing a leaf

which bounds a disk. The result follows then from Lemma 3.5.  $\square$

**Lemma 3.7.** *Let  $\Gamma$  be an  $n$ -component Y-link in a 3-manifold  $M$ . Let  $\ell$  be a leaf of  $\Gamma$ . Fix  $\Gamma \setminus \ell$ . Then the class of  $[M; \Gamma] \bmod \mathcal{F}_{n+1}^{\mathbb{Z}}(M)$  is a linear function of  $\ell \in H_1(M \setminus (\Gamma \setminus \ell); \mathbb{Q})$ .*

*Proof.* Consider an  $n$ -component Y-link  $\Gamma'$  that has a leaf  $\ell'$  such that  $\Gamma' \setminus \ell'$  coincides with  $\Gamma \setminus \ell$  and  $\ell'$  is homologous to  $\ell$  in  $M \setminus (\Gamma \setminus \ell)$ . Construct another  $n$ -component Y-link  $\Gamma^\delta$  by replacing the leaf  $\ell$  by  $\ell - \ell'$  in  $\Gamma$  (see Figure 13). By Lemma 3.6,  $[M; \Gamma^\delta] = 0$ .

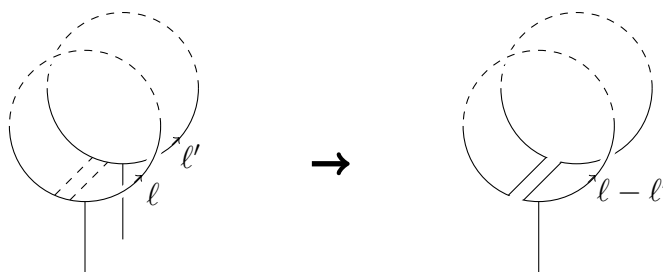

Figure 13: the leaf  $\ell - \ell'$

Thus Lemma 3.1 implies  $[M; \Gamma] =_n [M; \Gamma']$ . Hence, for  $\Gamma \setminus \ell$  fixed,  $[M; \Gamma] \bmod \mathcal{F}_{n+1}^{\mathbb{Z}}(M)$  only depends on the class of  $\ell$  in  $H_1(M \setminus (\Gamma \setminus \ell); \mathbb{Z})$ . The linearity follows from Lemma 3.1. Since the  $\mathcal{F}_n^{\mathbb{Z}}(M)$  are rational vector spaces,  $[M; \Gamma] \bmod \mathcal{F}_{n+1}^{\mathbb{Z}}(M)$  only depends on the rational homology class of  $\ell$ .  $\square$

Now, in the case of QHS's, we want to restrict the set of generators of  $\mathcal{F}_n^{\mathbb{Z}}(M)/\mathcal{F}_{n+1}^{\mathbb{Z}}(M)$  to brackets defined by Jacobi diagrams.

Lemma 3.3 implies:

**Lemma 3.8.** *Let  $J$  be a Jacobi diagram of degree  $\frac{n}{2}$ . Equip  $J$  with a framing induced by an immersion of  $J$  in the plane. Embed the framed diagram  $J$  in a 3-manifold  $M$ . Let  $\Gamma$  be the oriented  $n$ -component  $Y$ -link obtained from  $J$  by replacing its edges as shown in Figure 14. Then the class of  $[M; \Gamma]$  modulo  $\mathcal{F}_{n+1}^{\mathbb{Z}}(M)$  does not depend on the embedding and framing of  $J$ .*

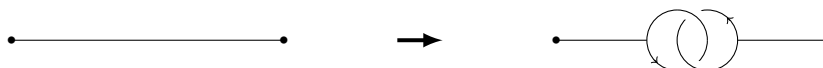

Figure 14: Replacement of an edge

In the sequel, we will denote by  $[M; J]$  the class of  $[M; \Gamma]$  modulo  $\mathcal{F}_{n+1}^{\mathbb{Z}}(M)$ .

**Lemma 3.9.** *Let  $\Gamma$  be an oriented  $n$ -component  $Y$ -link in a 3-manifold  $M$ . Assume that all the leaves of  $\Gamma$  are trivial in  $H_1(M; \mathbb{Q})$ . Then  $[M; \Gamma]$  is equal to a  $\mathbb{Q}$ -linear combination of terms  $[M; J]$  for some Jacobi diagrams  $J$ , modulo  $\mathcal{F}_{n+1}^{\mathbb{Z}}(M)$ .*

*Proof.* Suppose  $\Gamma$  has a leaf  $\ell$  which is non trivial in  $H_1(M; \mathbb{Z})$ . Then there is a positive integer  $k$  such that  $k\ell = 0$  in  $H_1(M; \mathbb{Z})$ . Denote by  $\Gamma'$  the  $Y$ -link obtained from  $\Gamma$  by replacing the leaf  $\ell$  by a leaf homologous to  $k\ell$  in  $H_1(M \setminus (\Gamma \setminus \ell); \mathbb{Z})$ . By Lemma 3.7, we have  $[M; \Gamma] =_n \frac{1}{k} [M; \Gamma']$ . Thus we can assume that all the leaves of  $\Gamma$  are null-homologous in  $M$ . As we have seen above, we also can assume that they are 0-framed.

Such leaves bound embedded surfaces in  $M$ . Thanks to Lemma 3.3, we can assume that the interior of these surfaces do not meet the edges of  $\Gamma$ . Consider a leaf  $\ell$  of  $\Gamma$ . Apply Lemma 3.1 to cut  $\ell$  into some leaves which are meridians of other leaves, and one leaf which bounds a surface in  $M \setminus (\Gamma \setminus \ell)$ . The last one can be excluded by applying Lemma 3.6. Cutting similarly each leaf of  $\Gamma$ , we obtain  $Y$ -links whose leaves are linked by pairs, in the pattern of Hopf links. Since Lemma 3.7 allows us to change the orientation of a leaf, modulo a sign, we get  $Y$ -links obtained from Jacobi diagrams.  $\square$

**Corollary 3.10.** *Let  $M$  be a  $\mathbb{Q}HS$ . Then  $\frac{\mathcal{F}_n^{\mathbb{Z}}(M)}{\mathcal{F}_{n+1}^{\mathbb{Z}}(M)}$  is generated by the  $[M; J]$  for all Jacobi diagrams  $J$  of degree  $\frac{n}{2}$ . In particular, if  $n$  is odd,  $\mathcal{F}_n^{\mathbb{Z}}(M) = \mathcal{F}_{n+1}^{\mathbb{Z}}(M)$ .*

We end the section by focusing the case of  $Y$ -graphs.

**Lemma 3.11.** *Let  $\Gamma$  be an oriented  $Y$ -graph in a 3-manifold  $M$ . Suppose that  $\Gamma$  has two leaves  $\ell$  and  $\ell'$  that bound disks in  $M \setminus (\Gamma \setminus (\ell \cup \ell'))$  and that form a positive Hopf link. Then  $[M; \Gamma] =_2 0$ .*

*Proof.* If the curve  $\alpha$  obtained from the leaves  $\ell$  and  $\ell'$  and their adjacent edges, as shown in Figure 15, is 0-framed and bounds a disk whose interior does not meet  $\Gamma$ , then, according to [GGP01, Lemma 2.3], the surgery on  $\Gamma$  preserves the homeomorphism class of  $M$ . Lemma 3.3 allows us to reduce the proof to this case.  $\square$

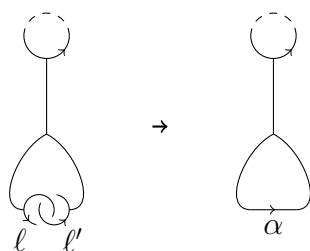
 Figure 15: The Y-graph  $\Gamma$  and the associated curve  $\alpha$ 

**Lemma 3.12.** *Let  $\Gamma$  be an oriented Y-graph in a 3-manifold  $M$ . If  $\Gamma$  has a leaf  $\ell$  which is trivial in  $H_1(M; \mathbb{Q})$ , then  $[M; \Gamma] =_2 0$ .*

*Proof.* As in the proof of Lemma 3.9, we can assume that  $\ell$  is null-homologous in  $M$  and 0-framed. Then  $\ell$  bounds a surface  $\Sigma$ . Using Lemma 3.3, we can assume that its interior  $\mathring{\Sigma}$  does not meet the edges of  $\Gamma$ . However, it can meet the other leaves. Using Lemma 3.1 to decompose the different leaves of  $\Gamma$ , we can restrict to two cases. Either  $\mathring{\Sigma}$  does not meet  $\Gamma$ , or  $\ell$  is linked with another leaf in the pattern of a Hopf link. Conclude with Lemma 3.6 in the first case. In the second case, since Lemma 3.7 allows us to change the orientation of a leaf, modulo a sign, conclude with Lemma 3.11.  $\square$

**Lemma 3.13.** *Let  $\Gamma$  be an oriented Y-graph in a 3-manifold  $M$ . The class of  $[M; \Gamma]$  modulo  $\mathcal{F}_2^{\mathbb{Z}}(M)$  only depends on the classes of the leaves of  $\Gamma$  in  $H_1(M; \mathbb{Q})$ . Moreover, the dependance is trilinear and alternating.*

*Proof.* Consider a leaf  $\ell$  of  $\Gamma$ . Consider an oriented Y-graph  $\Gamma'$  and a leaf  $\ell'$  of  $\Gamma'$  such that  $\Gamma' \setminus \ell'$  coincides with  $\Gamma \setminus \ell$  and  $\ell' = \ell$  in  $H_1(M; \mathbb{Q})$ . Construct another Y-graph  $\Gamma^\delta$  by replacing the leaf  $\ell$  by  $\ell - \ell'$  in  $\Gamma$  (see Figure 13). By Lemma 3.12,  $[M; \Gamma^\delta] = 0$ . Thus Lemma 3.1 implies  $[M; \Gamma] =_n [M; \Gamma']$ . Hence, for  $\Gamma \setminus \ell$  fixed,  $[M; \Gamma] \bmod \mathcal{F}_2^{\mathbb{Z}}(M)$  only depends on the class of  $\ell$  in  $H_1(M; \mathbb{Q})$ . The linearity follows from Lemma 3.1. To get the alternating property, note that exchanging two leaves is equivalent to changing the orientation of the three leaves.  $\square$

## 4 Finite type invariants of degree 1

### 4.1 The family $(M_p - S^3)_{p \text{ prime}}$ generates $\mathcal{G}_1$

We denote by “ $=_2$ ” the equality modulo  $\mathcal{F}_2$ . Note that  $\mathcal{F}_1$  is generated by the  $(M - S^3)$ . For any  $\mathbb{Q}$ HS  $M$ , let  $lk_M : H_1(M; \mathbb{Z}) \times H_1(M; \mathbb{Z}) \rightarrow \frac{\mathbb{Q}}{\mathbb{Z}}$  be the linking form on  $H_1(M; \mathbb{Z})$ .

**Lemma 4.1.** *Let  $M$  and  $N$  be  $\mathbb{Q}$ HS's such that  $(H_1(M; \mathbb{Z}), lk_M) \cong (H_1(N; \mathbb{Z}), lk_N)$ . Then  $M =_2 N$ .*

*Proof.* By [Mat87, Theorem 2],  $N$  can be obtained from  $M$  by a finite sequence of borromean surgeries. It suffices to show that  $M(\frac{B'}{B}) =_2 M$  for one borromean surgery  $(\frac{B'}{B})$ . This follows from Corollary 3.10.  $\square$

Like in [KK80], we call *linking* a pair  $(H, \phi)$ , where  $H$  is a finite abelian group, and  $\phi$  is a non degenerate symmetric bilinear form on  $H$ , with values in  $\mathbb{Q}/\mathbb{Z}$ . Consider the abelian semigroup  $\mathfrak{N}$  of all linkings under orthogonal sum. We have a homomorphism  $\mathcal{H}$  from the semigroup of all  $\mathbb{Q}$ HS's under connected sum to  $\mathfrak{N}$ , given by  $\mathcal{H}(M) = (H_1(M; \mathbb{Z}), lk_M)$ . By [KK80, Theorem 6.1], this homomorphism is onto. So we can define an equivalence relation on  $\mathfrak{N}$  by  $H_1 \sim_2 H_2$  if  $H_1 = \mathcal{H}(M_1)$ ,  $H_2 = \mathcal{H}(M_2)$ , and  $M_1 - S^3 =_2 M_2 - S^3$ .

Note that:

$$M \sharp N - S^3 =_2 (M - S^3) + (N - S^3). \quad (\star)$$

Thus, by Lemma 4.1, in order to prove that  $(M_p - S^3)_{p \text{ prime}}$  generates  $\mathcal{G}_1$ , it suffices to show that any  $H \in \mathfrak{N}$  is 2-equivalent to a direct sum of groups  $\mathbb{Z}_p := \mathbb{Z}/p\mathbb{Z}$ , with  $p$  prime, independently of the associated bilinear form. Since  $\mathfrak{N}$  is the direct sum of the abelian semigroups  $\mathfrak{N}_p$  of linkings on  $p$ -groups, we restrict ourselves to the study of  $p$ -groups.

**Lemma 4.2.** *Any linking in  $\mathfrak{N}_p$  is 2-equivalent to an orthogonal sum of linkings on cyclic  $p$ -groups. Two linkings defined on the same cyclic group are 2-equivalent.*

*Proof.* In the case of odd primes  $p$ , by [Wal63, Theorem 4],  $\mathfrak{N}_p$  has generators  $A_{p^k}, B_{p^k}$ ,  $k \geq 1$ , and sole relation  $2A_{p^k} = 2B_{p^k} (\mathcal{R}_{p^k})$ , where:

- $A_{p^k} = (\mathbb{Z}_{p^k}, \phi_A)$ ,  $\phi_A(1, 1) = \frac{1}{p^k}$ ,
- $B_{p^k} = (\mathbb{Z}_{p^k}, \phi_B)$ ,  $\phi_B(1, 1) = \frac{x}{p^k}$ , with  $x$  non square modulo  $p^k$ .

The relations  $(\star)$  and  $(\mathcal{R}_{p^k})$  show that  $A_{p^k} \sim_2 B_{p^k}$ .

In the case of 2-groups, we will use the presentation of  $\mathfrak{N}_2$  given in the introduction of [Mir84] by Miranda, who gives an alternative version of the description of  $\mathfrak{N}_2$  obtained by Kawauchi and Kojima in [KK80]. The generators are 4 linkings  $A_k, B_k, C_k, D_k$ , defined on  $\mathbb{Z}_{2^k}$ , and 2 linkings  $E_k, F_k$ , defined on  $\mathbb{Z}_{2^k} \times \mathbb{Z}_{2^k}$ . The relation  $A_k + E_k = 2A_k + B_k$  implies  $E_k \sim_2 A_k + B_k$ , and the relation  $2E_k = 2F_k$  implies  $E_k \sim_2 F_k$ . So we're lead to the cyclic case. The relations  $2A_k = 2C_k, 2B_k = 2D_k, 4A_k = 4B_k$ , give  $A_k \sim_2 B_k \sim_2 C_k \sim_2 D_k$ .  $\square$

Lemma 4.2 reduces our study to the case of cyclic groups with arbitrary linkings.

**Lemma 4.3.** *Denote by  $G_{p^k}$  any linking on  $\mathbb{Z}_{p^k}$ . We have  $G_{p^{k+k'}} \sim_2 G_{p^k} + G_{p^{k'}}$  for any prime  $p$  and any positive integers  $k$  and  $k'$ . It follows that  $G_{p^k} \sim_2 k G_p$ .*

*Proof.* We will use the following easy result.

**Sublemma 4.4.** *Let  $d$  be a positive integer. Let  $T_d$  be a  $d$ -torus. Let  $(\alpha, \beta)$  be a symplectic basis of  $H_1(\partial T_d; \mathbb{Z})$  such that  $\alpha$  generates  $\mathcal{L}_{T_d}$  and  $\beta = d\gamma$  in  $H_1(T_d; \mathbb{Z})$ . Let  $T$  be a standard solid torus trivially embedded in  $S^3$ . Define an LP-identification  $\partial T_d \cong \partial T$  that identifies  $\beta$  with the preferred longitude of  $T$ . Then  $H_1(S^3(\frac{T_d}{T})) = \mathbb{Z}_d\alpha \oplus \mathbb{Z}_d\gamma$ .*

In  $S^3$ , consider two disjoint, trivially embedded, tori  $T$  and  $T'$ , linked in the pattern of a Hopf link. Consider the LP-surgeries given by Sublemma 4.4 for  $d = p^k$  and for  $d = p^{k'}$ . We still denote by  $\alpha, \beta, \gamma$  (resp.  $\alpha', \beta', \gamma'$ ) the curves defined in the lemma. We have  $H_1(S^3(\frac{T_{p^k}}{T})) = \mathbb{Z}_{p^k}\alpha \times \mathbb{Z}_{p^k}\gamma$  and  $H_1(S^3(\frac{T_{p^{k'}}}{T'})) = \mathbb{Z}_{p^{k'}}\alpha' \times \mathbb{Z}_{p^{k'}}\gamma'$ . Now, in  $S^3(\frac{T_{p^k}}{T}, \frac{T_{p^{k'}}}{T'})$ , we have  $\alpha' = \beta = p^k\gamma$  and  $\alpha = \beta' = p^{k'}\gamma'$ . Thus  $H_1(S^3(\frac{T_{p^k}}{T}, \frac{T_{p^{k'}}}{T'})) = \mathbb{Z}_{p^{k+k'}}\gamma \times \mathbb{Z}_{p^{k+k'}}\gamma'$ . Conclude with the following equality:  $S^3(\frac{T_{p^k}}{T}, \frac{T_{p^{k'}}}{T'}) - S^3 =_2 (S^3(\frac{T_{p^k}}{T}) - S^3) + (S^3(\frac{T_{p^{k'}}}{T'}) - S^3)$ .  $\square$

This achieves the proof of the first part of Proposition 1.8, namely the fact that the family  $(M_p - S^3)_{p \text{ prime}}$  generates  $\mathcal{G}_1$ .

## 4.2 The invariants $\nu_p$

In this subsection, unless otherwise mentioned, all the homology modules are considered with integral coefficients. We prove the following proposition that implies Proposition 1.9.

**Proposition 4.5.** *Consider a  $\mathbb{Q}$ HS  $M$ , two disjoint genus  $g$   $\mathbb{Q}$ HH's  $A$  and  $B$  in  $M$ , and two  $\mathbb{Q}$ HH's  $A'$  and  $B'$  whose boundaries are LP-identified with  $\partial A$  and  $\partial B$  respectively. Then:*

$$\frac{|H_1(M)|}{|H_1(M(\frac{A'}{A}))|} = \frac{|H_1(M(\frac{B'}{B}))|}{|H_1(M(\frac{A'}{A}, \frac{B'}{B}))|}.$$

*Proof.* The exact sequence associated with  $(M, A)$  gives:

$$0 \rightarrow H_2(M, A) \rightarrow H_1(A) \rightarrow H_1(M) \rightarrow H_1(M, A) \rightarrow 0.$$

Set  $X = M \setminus \text{Int}(A)$ . By excision, we have  $H_i(M, A) = H_i(X, \partial X)$  for any integer  $i$ . So the above exact sequence can be rewritten as follows.

$$0 \rightarrow H_2(X, \partial X) \xrightarrow{\varphi_1} H_1(A) \xrightarrow{\varphi_2} H_1(M) \xrightarrow{\varphi_3} H_1(X, \partial X) \rightarrow 0$$

Since  $H_1(M)$  is finite,  $H_1(X, \partial X)$  also is, and we have  $|H_1(M)| = |H_1(X, \partial X)| \cdot |\text{Im}(\varphi_2)|$ .

Similarly, we have an exact sequence:

$$0 \rightarrow H_2(X, \partial X) \xrightarrow{\varphi'_1} H_1(A') \xrightarrow{\varphi'_2} H_1(M(\frac{A'}{A})) \xrightarrow{\varphi'_3} H_1(X, \partial X) \rightarrow 0.$$

We get:

$$\frac{|H_1(M)|}{|H_1(M(\frac{A'}{A}))|} = \frac{|Im(\varphi_2)|}{|Im(\varphi'_2)|}.$$

Similarly arguing with  $M(\frac{B'}{B})$  instead of  $M$ , and setting  $X' = X(\frac{B'}{B})$ , we have the exact sequences:

$$0 \rightarrow H_2(X', \partial X') \xrightarrow{\psi_1} H_1(A) \xrightarrow{\psi_2} H_1(M(\frac{B'}{B})) \xrightarrow{\psi_3} H_1(X', \partial X') \rightarrow 0,$$

$$0 \rightarrow H_2(X', \partial X') \xrightarrow{\psi'_1} H_1(A') \xrightarrow{\psi'_2} H_1(M(\frac{A'}{A}, \frac{B'}{B})) \xrightarrow{\psi'_3} H_1(X', \partial X') \rightarrow 0,$$

and we get:

$$\frac{|H_1(M(\frac{B'}{B}))|}{|H_1(M(\frac{A'}{A}, \frac{B'}{B}))|} = \frac{|Im(\psi_2)|}{|Im(\psi'_2)|}.$$

We now relate  $|Im(\varphi_2)|$  and  $|Im(\psi_2)|$ . Since  $Im(\varphi_2) \cong \frac{H_1(A)}{Im(\varphi_1)}$  and  $Im(\psi_2) \cong \frac{H_1(A)}{Im(\psi_1)}$ , we shall study  $Im(\varphi_1)$  and  $Im(\psi_1)$ .

The following sublemma gives us additional information about  $X$ .

**Sublemma 4.6.** *If  $M$  is a  $\mathbb{Q}HS$  and if  $A$  is a genus  $g$   $\mathbb{Q}HH$  in  $M$ , then  $X = M \setminus Int(A)$  also is a genus  $g$   $\mathbb{Q}HH$ .*

*Proof.* It is clear that  $H_3(X; \mathbb{Q}) = 0$  and  $H_0(X; \mathbb{Q}) = \mathbb{Q}$ .

The Mayer-Vietoris sequence associated with  $M = A \cup X$  gives:

$$0 \rightarrow H_3(M; \mathbb{Q}) \rightarrow H_2(\partial A; \mathbb{Q}) \rightarrow H_2(A; \mathbb{Q}) \oplus H_2(X; \mathbb{Q}) \rightarrow 0.$$

Since  $H_3(M; \mathbb{Q}) \rightarrow H_2(\partial A; \mathbb{Q})$  is an isomorphism that identifies the fundamental classes, we have  $H_2(X; \mathbb{Q}) = 0$ .

The Mayer-Vietoris sequence also gives an isomorphism  $H_1(\partial A; \mathbb{Q}) \cong H_1(A; \mathbb{Q}) \oplus H_1(X; \mathbb{Q})$ , thus  $H_1(X; \mathbb{Q}) = \mathbb{Q}^g$ .  $\square$

We have the following commutative diagram, where  $i_*$  is the map induced by the inclusion  $i : \partial A \hookrightarrow A$ .

$$\begin{array}{ccccc} H_2(X, \partial X) & \xrightarrow{\partial} & H_1(\partial A) & \xleftarrow{\partial} & H_2(X', \partial X') \\ & \searrow \varphi_1 & \downarrow i_* & \swarrow \psi_1 & \\ & & H_1(A) & & \end{array}$$



Denote the images of  $H_2(X, \partial X)$  and  $H_2(X', \partial X')$  in  $H_1(\partial A)$  by  $F$  and  $F'$  respectively. Since  $\varphi_1$  and  $\psi_1$  are injective, the two boundary operators also are. Thus, by Sublemma 4.6 and Lemma 2.2,  $F$  and  $F'$  are free submodules of  $H_1(\partial A)$ , of rank  $g$ . Consider bases  $\gamma$  of  $F$  and  $\gamma'$  of  $F'$ . Over  $\mathbb{Q}$ ,  $F$  generates the Lagrangian  $\mathcal{L}_X$ , and  $F'$  generates  $\mathcal{L}_{X'}$ . Since  $X'$  is obtained from  $X$  by an LP-surgery, we have  $\mathcal{L}_X = \mathcal{L}_{X'}$ . Hence we have a matrix  $R \in GL_g(\mathbb{Q})$  of change of basis from  $\gamma$  to  $\gamma'$ . Thus:

$$|Im(\psi_2)| = \left| \frac{H_1(A)}{Im(\psi_1)} \right| = \left| \frac{H_1(A)}{i_*(F')} \right| = |\det(R)| \cdot \left| \frac{H_1(A)}{i_*(F)} \right| = |\det(R)| \cdot |Im(\varphi_2)|.$$

Since the same submodules  $F$  and  $F'$  occur in the decomposition of  $\varphi'_1$  and  $\psi'_1$ , we also have:

$$|Im(\psi'_2)| = |\det(R)| \cdot |Im(\varphi'_2)|.$$

Finally,

$$\frac{|H_1(M(\frac{B'}{B}))|}{|H_1(M(\frac{A'}{A}, \frac{B'}{B}))|} = \frac{|Im(\psi_2)|}{|Im(\psi'_2)|} = \frac{|\det(R)| \cdot |Im(\varphi_2)|}{|\det(R)| \cdot |Im(\varphi'_2)|} = \frac{|H_1(M)|}{|H_1(M(\frac{A'}{A}))|}.$$

□

## 5 Additive invariants of degree $n > 1$

### 5.1 Degree 1 invariants of framed rational homology tori

Fix a genus 1 surface  $\Sigma_1$  and a symplectic basis  $(\alpha_0, \beta_0)$  of  $H_1(\Sigma_1; \mathbb{Z})$ . Define  $\mathcal{F}_0(\Sigma_1)$  as the rational vector space generated by all the rational homology tori  $T$ , equipped with an oriented longitude  $\ell(T)$ . Denote by  $m(T)$  the meridian of  $T$  that satisfies  $\langle m(T), \ell(T) \rangle_{\partial T} = 1$ . The data of the framing is equivalent to the data of an orientation-preserving homeomorphism  $h : \Sigma_1 \rightarrow \partial T$  such that  $h_*(\mathbb{Q}\alpha_0) = \mathcal{L}_T$ , the equivalence being given by  $m(T) = h(\alpha_0)$  and  $\ell(T) = h(\beta_0)$ . In particular, given two framed rational homology tori, we have a canonical LP-identification of their boundaries, which identifies the fixed longitudes. Define a filtration  $(\mathcal{F}_n(\Sigma_1))_{n \in \mathbb{N}}$ , and quotients  $(\mathcal{G}_n(\Sigma_1))_{n \in \mathbb{N}}$ , as in the case of QHS's. Note that  $\mathcal{G}_0(\Sigma_1) \cong \mathbb{Q}$ .

Denote by  $T_0$  the standard solid torus with a fixed longitude  $\ell(T_0)$ . For any prime  $p$ , fix a QHS  $M_p$  such that  $H_1(M_p; \mathbb{Z}) \cong \mathbb{Z}/p\mathbb{Z}$ . Define a rational homology ball  $B_p$  by removing an open ball from  $M_p$ . In this subsection, we prove:

**Proposition 5.1.**  $\mathcal{G}_1(\Sigma_1) = \bigoplus_{p \text{ prime}} \mathbb{Q}[T_0; \frac{B_p}{B^3}]$

Consider a framed rational homology torus  $T$ . Set  $d(T) = |\mathcal{L}_T^T / \mathcal{L}_T^Z|$  (see Lemma 2.3 for the definition of  $\mathcal{L}_T^T$  and  $\mathcal{L}_T^Z$ ). For  $p$  prime, define  $\mu_p(T) = v_p(d(T) |Tors(H_1(T; \mathbb{Z}))|)$ , where  $v_p$  denotes the  $p$ -adic valuation.

**Lemma 5.2.** *For any prime  $p$ ,  $\mu_p$  is a degree 1 invariant of the framed rational homology tori.*

*Proof.* Consider a framed rational homology torus  $T$ . Define a QHS  $M(T)$  by gluing  $T$  and the standard torus  $T_0$  along their boundaries, in such a way that  $\ell(T)$  is identified with  $m(T_0)$ . We have  $H_1(M(T)) = \frac{H_1(T)}{\mathbb{Z}\ell(T)}$ . By Lemma 2.3,  $|H_1(M(T))| = d(T) |Tors(H_1(T))|$ . Thus  $\mu_p(T) = v_p(|H_1(M(T))|) = \nu_p(M(T))$ . The result follows from the fact that  $\nu_p$  is a degree 1 invariant of QHS's.  $\square$

**Corollary 5.3.** *The sum  $\bigoplus_{p \text{ prime}} \mathbb{Q}[T_0; \frac{B_p}{B^3}]$  is direct.*

**Lemma 5.4.** *The space  $\mathcal{G}_1(\Sigma_1)$  is generated by the  $[T; \frac{E'}{E}]$ , where  $(\frac{E'}{E})$  is an elementary surgery.*

*Proof.* Consider  $[T; \frac{A'}{A}] \in \mathcal{F}_1(\Sigma_1)$ . By Theorem 1.15,  $A'$  is obtained from  $A$  by a sequence of elementary surgeries, or their inverses,  $(\frac{E'_i}{E_i})_{1 \leq i \leq k}$ . Set  $A_i = A(\frac{E'_1}{E_1})(\frac{E'_2}{E_2}) \dots (\frac{E'_i}{E_i})$ . Then:

$$[T; \frac{A'}{A}] = \sum_{i=0}^{k-1} [T(\frac{A_i}{A}); \frac{A_{i+1}}{A_i}] = \sum_{i=0}^{k-1} [T(\frac{A_i}{A}); \frac{E'_{i+1}}{E_{i+1}}].$$

Now, for any  $[T; \frac{E'}{E}] \in \mathcal{F}_1(\Sigma_1)$ , we have  $[T; \frac{E'}{E}] = -[T(\frac{E'}{E}); \frac{E}{E'}]$ .  $\square$

We shall get rid of the elementary surgeries of genus 1 with the help of the following two lemmas.

**Lemma 5.5.** *Let  $E$  be a framed standard torus. Let  $E'$  be a framed  $d$ -torus. Assume  $\ell(E') = d\gamma$  in  $H_1(E'; \mathbb{Z})$  for a curve  $\gamma$  in  $E'$ . Embed two disjoint copies  $E_1$  and  $E_2$  of  $E$  in  $\text{Int}(E)$  so that  $\ell(E_1) = \ell(E_2) = \ell(E)$  in  $H_1(E \setminus \text{Int}(E_1 \cup E_2); \mathbb{Z})$ . Let  $E'_1$  and  $E'_2$  be two copies of  $E'$ . Set  $A = E(\frac{E'_1}{E_1}, \frac{E'_2}{E_2})$ . Then there is a QHS  $M$  such that  $A$  can be obtained from  $E' \sharp M$  by a finite sequence of borromean surgeries.*

*Proof.* For  $i = 1, 2$ , denote by  $\gamma_i$  the copy of  $\gamma$  in  $E'_i$ , so that  $\ell(E'_i) = d\gamma_i$  in  $H_1(E'_i; \mathbb{Z})$ . Note that, in  $H_1(A)$ ,  $\ell(A) = \ell(E'_1) = \ell(E'_2)$ , and  $m(A) = m(E'_1) + m(E'_2)$ . We have :

$$\begin{aligned} H_1(A; \mathbb{Z}) &= \langle m(E'_1), m(E'_2), \gamma_1, \gamma_2 | d m(E'_1) = 0, d m(E'_2) = 0, d\gamma_1 = d\gamma_2 \rangle \\ &= \langle m(E'_1), m(A), \gamma_1, \gamma_2 - \gamma_1 | d m(E'_1) = 0, d m(A) = 0, d(\gamma_2 - \gamma_1) = 0 \rangle \\ &= \mathbb{Z}_d m(A) \oplus \mathbb{Z} \gamma_1 \oplus \mathbb{Z}_d m(E'_1) \oplus \mathbb{Z}_d (\gamma_2 - \gamma_1) \end{aligned}$$

Note that  $\ell(A) = d\gamma_1$ . Consider a tunnel  $C$  around  $\gamma_1$ . Set  $B = \overline{A \setminus C}$ . There is a surface  $S \subset B$  such that  $\partial S \subset \partial B$  is homologous to  $\ell(A) - d\ell + km$  in  $\partial B$ , where  $m$  is a meridian of  $\gamma_1$ ,  $\ell$  is a longitude of  $\gamma_1$ , and  $k$  is an integer. Consider simple closed curves  $\sigma_1, \sigma_2, \mu_1$  and  $\mu_2$  in  $\partial B$  such that  $\sigma_1 = m - dm(A)$ ,  $\sigma_2 = \ell(A) - d\ell + km$ ,  $\mu_1 = -\ell + km(A)$

and  $\mu_2 = -m(A)$  in  $H_1(\partial B)$ . The curves  $\sigma_1$  and  $\sigma_2$  bound embedded surfaces in  $B$ , and  $(\sigma_1, \mu_1, \sigma_2, \mu_2)$  is a symplectic basis of  $H_1(\partial B; \mathbb{Z})$ . Thus  $B$  is a genus 2  $\mathbb{Q}$ HH with  $|\mathcal{L}_B^T/\mathcal{L}_B^Z| = 0$ . By Lemma 2.12, there are a standard genus 2 handlebody  $H_2$  and a  $\mathbb{Q}$ HS  $M$  such that  $B$  is obtained from  $H_2\sharp M$  by a finite sequence of borromean surgeries.

Now consider the  $d$ -torus  $E'$ . It is homeomorphic to  $E(\frac{E'_1}{E_1})$ . Consider a tunnel  $C'$  around  $\gamma$  in  $E'$ . We can choose a meridian  $m'$  and a longitude  $\ell'$  of  $\gamma$  in such a way that there are curves  $\sigma'_1$  and  $\sigma'_2$  on the boundary of  $B' = \overline{E' \setminus C'}$  which bound surfaces in  $B'$  and which are respectively homologous to  $m' - d\alpha$  and  $\beta - d\ell' + km'$  in  $H_1(\partial B'; \mathbb{Z})$ . Thus the LP-identification  $\partial E' \cong \partial A$  extends to an LP-identification  $\partial B' \cong \partial B \cong \partial H_2$ . Since  $H_1(B'; \mathbb{Z}) = \mathbb{Z}(\ell' - k\alpha) \oplus \mathbb{Z}m'$ ,  $B'$  and  $H_2$  are two  $\mathbb{Z}$ HH whose boundaries are LP-identified. By [AL05, Lemma 4.11],  $H_2$  can be obtained from  $B'$  by a finite sequence of borromean surgeries. Thus  $H_2\sharp M$ , and  $B$ , can be obtained from  $B'\sharp M$  by a finite sequence of borromean surgeries. Gluing back the cylinders, we see that  $A$  can be obtained from  $E'\sharp M$  by a finite sequence of borromean surgeries.  $\square$

**Lemma 5.6.** *The quotient  $\mathcal{G}_1(\Sigma_1)$  is generated by the  $[T; \frac{E'}{E}]$ , where  $(\frac{E'}{E})$  is an elementary surgery of genus 0 (connected sum) or 3 (borromean surgery).*

*Proof.* Consider a framed rational homology torus  $T$  and an elementary surgery  $\frac{E'}{E}$  of genus 1 in  $T$ , i.e.  $E$  is an embedded standard torus, and  $E'$  is a  $d$ -torus. Fix a longitude  $\ell(E')$  such that  $\ell(E') = d\gamma$  in  $H_1(E'; \mathbb{Z})$  for a curve  $\gamma$  in  $E'$ . Choose the longitude  $\ell(E)$  which is identified with  $\ell(E')$  by the LP-identification  $\partial E \cong \partial E'$ .

Consider the copies  $E_1$  and  $E_2$  of  $E$  in  $\text{Int}(E)$ , the copies  $E'_1$  and  $E'_2$  of  $E'$ , the rational homology torus  $A$ , and the  $\mathbb{Q}$ HS  $M$ , defined in Lemma 5.5. Set  $T' = T(\frac{E'_1}{E_1}, \frac{E'_2}{E_2}) \cong T(\frac{A}{E})$ . Write  $A = E'(\frac{B(M)}{B^3})(\frac{B'_1}{B_1})(\frac{B'_2}{B_2}) \dots (\frac{B'_k}{B_k})$ , where  $B(M)$  is the rational homology ball obtained by removing a ball  $B^3$  from  $M$ , and the  $(\frac{B'_i}{B_i})$  are borromean surgeries. On the one hand, we have  $[T; \frac{E'_1}{E_1}, \frac{E'_2}{E_2}] = 2[T; \frac{E'}{E}] - T + T'$ , thus:

$$T - T' = 2[T; \frac{E'}{E}] \quad \text{mod } \mathcal{F}_2(\Sigma_1),$$

and, on the other hand:

$$T - T' = [T; \frac{A}{E}] = [T; \frac{E'}{E}] + [T(\frac{E'}{E}); \frac{B(M)}{B^3}] + \sum_{i=1}^k [T(\frac{E'}{E})(\frac{B(M)}{B^3})(\frac{B'_1}{B_1}) \dots (\frac{B'_{i-1}}{B_{i-1}}); \frac{B'_i}{B_i}]$$

Thus:

$$[T; \frac{E'}{E}] = [T(\frac{E'}{E}); \frac{B(M)}{B^3}] + \sum_{i=1}^k [T(\frac{E'}{E})(\frac{B(M)}{B^3})(\frac{B'_1}{B_1}) \dots (\frac{B'_{i-1}}{B_{i-1}}); \frac{B'_i}{B_i}] \quad \text{mod } \mathcal{F}_2(\Sigma_1).$$

$\square$

We shall now restrict the set of generators  $[T; \frac{E'}{E}]$  where  $(\frac{E'}{E})$  is an elementary surgery of genus 0.

**Lemma 5.7.** *Let  $T$  be a framed rational homology torus and let  $B$  be a rational homology ball. Then  $[T; \frac{B}{B^3}] \in \bigoplus_p \text{prime } \mathbb{Q}[T_0; \frac{B_p}{B^3}] \subset \mathcal{G}_1(\Sigma_1)$ .*

This result follows from the next two sublemmas.

**Sublemma 5.8.** *Let  $T$  be a framed rational homology torus and let  $B$  be a rational homology ball. Then, in  $\mathcal{G}_1(\Sigma_1)$ ,  $[T; \frac{B}{B^3}]$  is a linear combination of the  $[T; \frac{B_p}{B^3}]$ .*

*Proof.* Set  $M = B \cup_{\partial B = -\partial B^3} B^3$ . We have  $T(\frac{B}{B^3}) = T\sharp M$  and  $T(\frac{B_p}{B^3}) = T\sharp M_p$ . Now use that  $(M_p - S^3)_p \text{ prime}$  generates  $\mathcal{G}_1$  (see Subsection 4.1).  $\square$

**Sublemma 5.9.** *For any framed rational homology torus  $T$ , and any rational homology ball  $B$ ,*

$$[T; \frac{B}{B^3}] = [T_0; \frac{B}{B^3}] \quad \text{mod } \mathcal{F}_2(\Sigma_1).$$

*Proof.* Define  $T'_0$  as  $T_0$  minus a regular open neighborhood of its boundary. We can suppose that  $T'_0$  and  $B^3$  are disjoint in  $T_0$ . We have  $T \cong T_0(\frac{T}{T'_0})$ , and:

$$[T_0; \frac{T}{T'_0}, \frac{B}{B^3}] = [T_0; \frac{B}{B^3}] - [T; \frac{B}{B^3}].$$

$\square$

*Proof of Proposition 5.1.* By Lemmas 5.6 and 5.7,  $\mathcal{G}_1(\Sigma_1)$  is generated by the  $[T_0; \frac{B_p}{B^3}]$  and the  $[T; \frac{A'}{A}]$  where  $(\frac{A'}{A})$  is a borromean surgery. Consider  $\mu \in (\mathcal{G}_1(\Sigma_1))^*$ . For all prime integer  $p$ , set  $c_p = \mu([T_0; \frac{B_p}{B^3}])$ . Set  $\tilde{\mu} = \mu - \sum_p \text{prime } c_p \mu_p$ . The invariant  $\tilde{\mu}$  is determined by its values on the terms  $[T; \frac{A'}{A}]$ , where  $(\frac{A'}{A})$  is a borromean surgery. Let  $\Gamma$  denote the Y-graph associated with the borromean surgery  $(\frac{A'}{A})$ . By Lemma 3.13, if  $T$  is fixed,  $\tilde{\mu}([T; \frac{A'}{A}])$  only depends on the rational homology classes of the three leaves of  $\Gamma$ , and this dependence is trilinear and alternating. Since  $H_1(T; \mathbb{Q}) \cong \mathbb{Q}$ , we have  $\tilde{\mu} = 0$ . Hence  $\mu = \sum_p \text{prime } c_p \mu_p$ . This implies that  $\mathcal{G}_1(\Sigma_1)$  is generated by the  $[T_0; \frac{B_p}{B^3}]$ . Conclude with Corollary 5.3.  $\square$

**Corollary 5.10.** *If  $\mu$  is a degree 1 invariant of framed rational homology tori, such that  $\mu(T_0) = 0$  and  $\mu(T_0\sharp M_p) = 0$  for any prime  $p$ , then  $\mu = 0$ .*

## 5.2 The quotients $\frac{\mathcal{I}_n^c}{\mathcal{I}_{n-1}^c}$

The main point of this subsection will be the proof of the next proposition. We will end the subsection by showing that this result implies Proposition 1.11.

**Proposition 5.11.** *If  $\lambda$  is an additive invariant of degree  $n > 1$ , then  $\lambda|_{\mathcal{F}_n}$  is determined by  $\lambda(\Phi(\mathcal{A}_{\frac{n}{2}}^c))$ . In particular, if  $n$  is odd,  $\lambda|_{\mathcal{F}_n} = 0$ .*

Recall the map  $\Phi : \mathcal{A}_n \rightarrow \mathcal{G}_{2n}^{\mathbb{Z}}$  has been defined in Lemma 1.2. Since we have a canonical map  $\mathcal{G}_{2n}^{\mathbb{Z}} \rightarrow \mathcal{G}_{2n}$  (we will see later that it is an embedding),  $\lambda(\Phi(\mathcal{A}_n^c))$  is well defined.

We will often use the following easy formula.

**Lemma 5.12.** *For any  $[M; (\frac{A'_i}{A_i})_{1 \leq i \leq n}] \in \mathcal{F}_n$ ,*

$$[M; (\frac{A'_i}{A_i})_{1 \leq i \leq n}] = [M; (\frac{A'_i}{A_i})_{2 \leq i \leq n}] - [M(\frac{A'_1}{A_1}); (\frac{A'_i}{A_i})_{2 \leq i \leq n}].$$

**Lemma 5.13.** *The space  $\mathcal{G}_n$  is generated by the  $[M; (\frac{E'_i}{E_i})_{1 \leq i \leq n}]$ , where the  $(\frac{E'_i}{E_i})$  are elementary surgeries.*

To see this, just adapt the proof of Lemma 5.4.

**Lemma 5.14.** *Let  $\lambda$  be an additive invariant of degree  $n > 1$ . Consider  $[M; (\frac{E'_i}{E_i})_{1 \leq i \leq n}] \in \mathcal{F}_n$ . If at least one of the surgeries  $(\frac{E'_i}{E_i})$  is an elementary surgery of genus 0 (connected sum), then  $\lambda([M; (\frac{E'_i}{E_i})_{1 \leq i \leq n}]) = 0$ .*

*Proof.* Assume  $\frac{E'_1}{E_1}$  is a connected sum, i.e.  $E_1$  is a ball  $B^3$ , and  $E'_1$  is a rational homology ball. Define a  $\mathbb{Q}$ HS  $M_1$  by gluing  $E'_1$  and a ball  $B^3$  along their boundaries.

$$\begin{aligned} \lambda([M; (\frac{E'_i}{E_i})_{1 \leq i \leq n}]) &= \lambda([M; (\frac{E'_i}{E_i})_{2 \leq i \leq n}]) - \lambda([M \sharp M_1; (\frac{E'_i}{E_i})_{2 \leq i \leq n}]) \\ &= - \sum_{I \subset \{2, \dots, n\}} (-1)^{|I|} \lambda(M_1) \\ &= 0 \end{aligned}$$

□

**Lemma 5.15.** *Consider a  $\mathbb{Q}$ HS  $M$ , and disjoint LP-surgeries  $(\frac{T_d}{T_0}, (\frac{A'_i}{A_i})_{1 \leq i \leq n-1})$  in  $M$ , where  $T_0$  is a standard torus, and  $T_d$  is a  $d$ -torus. If  $\lambda$  is an additive invariant of degree  $n > 1$ , then  $\lambda([M; \frac{T_d}{T_0}, (\frac{A'_i}{A_i})_{1 \leq i \leq n-1}]) = 0$ .*

*Proof.* Fix  $M$ , the embedding of  $T_0$ , and the surgeries  $(\frac{A'_i}{A_i})_{1 \leq i \leq n-1}$ . Fix a longitude  $\ell(T_0)$  of  $T_0$ . For any framed rational homology torus  $T$ , set  $\bar{\lambda}(T) = \lambda([M; \frac{T}{T_0}, (\frac{A'_i}{A_i})_{1 \leq i \leq n-1}])$ . Then  $\bar{\lambda}$  is a degree 1 invariant of framed rational homology tori:

$$\bar{\lambda}([T; \frac{B'_1}{B_1}, \frac{B'_2}{B_2}]) = \lambda(-[M(\frac{T}{T_0}); \frac{B'_1}{B_1}, \frac{B'_2}{B_2}, (\frac{A'_i}{A_i})_{1 \leq i \leq n-1}]) = 0.$$

We have  $\bar{\lambda}(T_0) = \lambda(0) = 0$ , and:

$$\bar{\lambda}(T_0 \# M_p) = \lambda([M; \frac{B_p}{B^3}, (\frac{A'_i}{A_i})_{1 \leq i \leq n-1}]) = 0,$$

since  $\lambda$  is additive, and  $n - 1 > 0$ . By Corollary 5.10,  $\bar{\lambda} = 0$ .  $\square$

*Proof of Proposition 5.11.* By Lemmas 5.14 and 5.15, an additive invariant  $\lambda$  of degree  $n > 1$  is determined on  $\mathcal{F}_n$  by its values on the  $[M; (\frac{B'_i}{B_i})_{1 \leq i \leq n}]$ , for all QHS's  $M$  and all sets of  $n$  disjoint borromean surgeries  $(\frac{B'_i}{B_i})_{1 \leq i \leq n}$  in  $M$ . Hence, by Corollary 3.10,  $\lambda$  is determined on  $\mathcal{F}_n$  by the  $\lambda([M; \Gamma])$  for all QHS  $M$  and all Jacobi diagram  $\Gamma$  of degree  $\frac{n}{2}$ .

We can write  $M = M \# S^3$  and suppose  $\Gamma$  is embedded in  $S^3$ . Hence for an additive invariant  $\lambda$  of degree  $n$ , we have  $\lambda([M; \Gamma]) = \lambda([S^3; \Gamma])$ .

If the Jacobi diagram  $\Gamma$  is not connected, we can assume that  $\Gamma$  is made of two components  $\Gamma_1$  and  $\Gamma_2$  that are embedded in disjoint balls in  $S^3$ . Noting that  $(S^3, \Gamma) = (S^3, \Gamma_1) \# (S^3, \Gamma_2)$ , it is easy to see that any additive invariant vanishes on  $[S^3; \Gamma]$  in this case.  $\square$

Proposition 1.11 follows from Proposition 5.11 in the case of odd degrees. For even degrees, it is a consequence of the following lemma.

**Lemma 5.16.** *Let  $n > 1$  be an even integer. Let  $(\Gamma_{n,i})_{i \in C_n}$  be a basis of diagrams of the finite dimensional vector space  $\mathcal{A}_{\frac{n}{2}}^c$ . Let  $(\Gamma_{n,i}^*)_{i \in C_n}$  be the dual basis of  $(\mathcal{A}_{\frac{n}{2}}^c)^*$ . Let  $Z_{\frac{n}{2}}$  denote the degree  $\frac{n}{2}$  part of the KKT invariant. Let  $p^c : \mathcal{A}_{\frac{n}{2}} \rightarrow \mathcal{A}_{\frac{n}{2}}^c$  be the projection that maps any non connected diagram to 0 and which restricts to the identity on  $\mathcal{A}_{\frac{n}{2}}^c$ . For  $i \in C_n$ , set  $\lambda_{n,i} = \Gamma_{n,i}^* \circ p^c \circ Z_{\frac{n}{2}}$ . Then  $(\lambda_{n,i})_{i \in C_n}$  is a basis of  $\frac{\mathcal{I}_n^c}{\mathcal{I}_{n-1}^c}$ .*

*Proof.* By [KT99, Theorem 1],  $p^c \circ Z_{\frac{n}{2}}$  is an additive invariant of QHS's, thus the  $\lambda_{n,i}$  are additive. By [Les04, Theorem 2.4] and [AL05, Proposition 4.1],  $Z_{\frac{n}{2}}$  is a finite type invariant of degree  $n$  and satisfies  $Z_{\frac{n}{2}}([S^3; \Gamma_{n,i}]) = \Gamma_{n,i} \in \mathcal{A}_{\frac{n}{2}}^c$ . Hence  $\lambda_{n,i} \in \mathcal{I}_n^c$ , and  $\lambda_{n,i}([S^3; \Gamma_{n,j}]) = \delta_{i,j}$ . Consider  $\lambda \in \frac{\mathcal{I}_n^c}{\mathcal{I}_{n-1}^c}$ . By Proposition 5.11,  $\lambda = \sum_{i \in C_n} \lambda([S^3; \Gamma_{n,i}]) \lambda_{n,i}$  in  $\frac{\mathcal{I}_n^c}{\mathcal{I}_{n-1}^c}$ . Hence  $(\lambda_{n,i})_{i \in C_n}$  is a basis of  $\frac{\mathcal{I}_n^c}{\mathcal{I}_{n-1}^c}$ .  $\square$

## 6 The graded algebras $\mathcal{G}$ and $\mathcal{H}$

### 6.1 The products in $\mathcal{G}$ and $\mathcal{H}$

Extend the connected sum to  $\mathcal{F}_0$  by bilinearity:

$$\left(\sum_{i \in I} a_i M_i\right) \sharp \left(\sum_{j \in J} b_j N_j\right) = \sum_{i \in I} \sum_{j \in J} a_i b_j (M_i \sharp N_j),$$

for any finite sets  $I$  and  $J$ , any rational numbers  $a_i, b_j$ , and any QHS's  $M_i, N_j$ .

**Lemma 6.1.**  $\mathcal{F}_n \sharp \mathcal{F}_m \subset \mathcal{F}_{n+m}$

*Proof.* Just check that  $[M; (\frac{B_i}{A_i})_{1 \leq i \leq n}] \sharp [M'; (\frac{B'_i}{A'_i})_{1 \leq i \leq m}] = [M \sharp M'; (\frac{B_i}{A_i})_{1 \leq i \leq n}, (\frac{B'_i}{A'_i})_{1 \leq i \leq m}]$ .  $\square$

Thus the connected sum defines a product  $\sharp : \mathcal{G}_n \times \mathcal{G}_m \rightarrow \mathcal{G}_{n+m}$  which induces a graded algebra structure on  $\mathcal{G}$ .

Given two finite type invariants  $\lambda$  and  $\mu$ , note that the product  $\lambda\mu$  satisfies:

$$\lambda\mu\left(\sum_{i \in I} a_i M_i\right) = \sum_{i \in I} a_i \lambda(M_i) \mu(M_i),$$

for any finite set  $I$ , rational numbers  $a_i$ , and QHS's  $M_i$ .

**Lemma 6.2.** *If  $\lambda \in \mathcal{I}_k$  and  $\mu \in \mathcal{I}_\ell$ , then  $\lambda\mu \in \mathcal{I}_{k+\ell}$ .*

*Proof.* Consider  $[M; (\frac{B_i}{A_i})_{i \in I}]$  with  $|I| = k + \ell + 1$ . We have the following equality.

$$\lambda\mu\left([M; (\frac{B_i}{A_i})_{i \in I}]\right) = \sum_{J \subset I} \lambda\left([M; (\frac{B_i}{A_i})_{i \in J}]\right) \mu\left([M; (\frac{B_i}{A_i})_{i \in I \setminus J}]\right) \quad (1)$$

Indeed, the right hand side is equal to:

$$\begin{aligned} & \sum_{J \subset I} (-1)^{|J|} \left( \sum_{K \subset J} (-1)^{|K|} \lambda\left(M\left(\left(\frac{B_i}{A_i}\right)_{i \in K}\right)\right) \right) \left( \sum_{L \supset J} (-1)^{|L|} \mu\left(M\left(\left(\frac{B_i}{A_i}\right)_{i \in L}\right)\right) \right) \\ &= \sum_{L \subset I} \sum_{K \subset L} (-1)^{|K|+|L|} \lambda\left(M\left(\left(\frac{B_i}{A_i}\right)_{i \in K}\right)\right) \mu\left(M\left(\left(\frac{B_i}{A_i}\right)_{i \in L}\right)\right) \left( \sum_{K \subset J \subset L} (-1)^{|J|} \right). \end{aligned}$$

Since  $\sum_{K \subset J \subset L} (-1)^{|J|} = \begin{cases} 0 & \text{if } K \subsetneq L \\ (-1)^{|K|} & \text{if } K = L \end{cases}$ , we get (1).

In (1), we have, if  $|J| > k$ ,

$$\lambda\left([M; (\frac{B_i}{A_i})_{i \in J}]\right) = 0,$$

and, if  $|J| \leq k$ , then  $|I \setminus J| > \ell$  and

$$\mu([M((\frac{B_i}{A_i})_{i \in J}); (\frac{B_i}{A_i})_{i \in I \setminus J}]) = 0.$$

Thus

$$\lambda\mu([M; (\frac{B_i}{A_i})_{i \in I}]) = 0.$$

□

Thus the product of finite type invariants induces a graded algebra structure on  $\mathcal{H}$ .

## 6.2 Dual systems in $\mathcal{G}$ and $\mathcal{H}$

For an even integer  $n > 1$ , consider the basis  $(\Gamma_{n,i})_{i \in C_n}$  of  $\mathcal{A}_{\frac{n}{2}}^c$  and the associated invariants  $\lambda_{n,i}$  defined in Lemma 5.16. For  $n > 1$  odd, set  $C_n = \emptyset$ . For  $n = 1$ , let  $C_1$  denote the set of all prime integers, and for any  $p$  prime, set  $\lambda_{1,p} = \nu_p$  and  $\Gamma_{1,p} = \bullet_p \in \mathcal{A}_1^{aug}$ . Note that adding to  $\lambda_{n,i}$  a weighted sum of the  $\lambda_{k,i}$ ,  $0 < k < n$ ,  $i \in C_k$ , does not change the values of  $\lambda_{n,i}$  on  $\mathcal{F}_n$ . Thus we can (and we do) choose the basis  $(\lambda_{n,i})_{i \in C_n}$  so that  $\lambda_{n,i}([S^3; \Gamma_{k,j}]) = \delta_{nk}\delta_{ij}$  for all positive integers  $n$  and  $k$ , all  $i \in C_n$ , all  $j \in C_k$ .

For a multi-index  $\underline{\varepsilon} = (\varepsilon_t)_{1 \leq t \leq \ell}$ , set  $\ell(\underline{\varepsilon}) = \ell$ . For  $n > 0$ , fix a total order on  $C_n$ . Let  $\preccurlyeq$  denote the lexicographic order induced on  $\bigcup_{n \in \mathbb{N} \setminus \{0\}} (\{n\} \times C_n)$ . For  $n > 0$ , let  $\mathcal{T}_n^\pi$  denote the set of all triples  $(\underline{k}, \underline{i}, \underline{\varepsilon})$  such that  $\ell(\underline{k}) = \ell(\underline{i}) = \ell(\underline{\varepsilon})$ ,  $\underline{k} = (k_t)_{1 \leq t \leq \ell(\underline{k})}$ ,  $k_t \in \mathbb{N}$  and  $0 < k_t < n$  for all  $t$ ,  $\underline{i} = (i_t)_{1 \leq t \leq \ell(\underline{k})}$  with  $i_t \in C_{k_t}$  for all  $t$ ,  $(k_1, i_1) \prec (k_2, i_2) \prec \dots \prec (k_{\ell(\underline{k})}, i_{\ell(\underline{k})})$ ,  $\underline{\varepsilon} = (\varepsilon_t)_{1 \leq t \leq \ell(\underline{\varepsilon})}$  with  $\varepsilon_t \in \mathbb{N} \setminus \{0\}$  for all  $t$ , and  $\sum_{1 \leq t \leq \ell(\underline{k})} \varepsilon_t k_t = n$ . Define a family  $(\lambda_{n,\iota})_{\iota \in \mathcal{T}_n^\pi}$  of invariants of degree  $n$  by  $\lambda_{n,\iota} = \prod_{1 \leq t \leq \ell(\underline{k})} \lambda_{k_t, i_t}^{\varepsilon_t}$  if  $\iota = (\underline{k}, \underline{i}, \underline{\varepsilon})$ . Set  $\mathcal{T}_n = C_n \sqcup \mathcal{T}_n^\pi$ . We will see in Subsection 6.3 that the family  $(\lambda_{k,i})_{\substack{0 < k \leq n \\ i \in \mathcal{T}_k}}$  is a basis of  $\frac{\mathcal{I}_n}{\mathcal{I}_0}$ . The main goal of this subsection is to construct a family  $(G_{k,i}^{(n)})_{\substack{0 < k \leq n \\ i \in \mathcal{T}_k}}$  of  $\frac{\mathcal{F}_1}{\mathcal{F}_{n+1}}$ , dual to  $(\lambda_{k,i})_{\substack{0 < k \leq n \\ i \in \mathcal{T}_k}}$ .

**Definition 6.3.**  $G \in \mathcal{F}_0$  is said to be *multiplicative* if  $\lambda\mu(G) = \lambda(G)\mu(G)$  for all finite type invariants  $\lambda$  and  $\mu$  such that  $\lambda(S^3) = 0$  and  $\mu(S^3) = 0$ .

For any  $p$  prime, set  $G_{1,p}^{(1)} = M_p - S^3$ . Note that the  $G_{1,p}^{(1)}$  are multiplicative. Fix  $n > 1$ . If  $n$  is even, set  $G_{n,i}^{(n)} = [S^3; \Gamma_{n,i}]$  for  $i \in C_n$ . Since  $[S^3; \Gamma_{n,i}] = S^3(\Gamma_{n,i}) - S^3$ ,  $G_{n,i}^{(n)}$  is multiplicative for all  $i \in C_n$ . For  $\iota = (\underline{k}, \underline{i}, \underline{\varepsilon}) \in \mathcal{T}_n^\pi$ , set  $\tilde{G}_{n,\iota}^{(n)} = \prod_{1 \leq t \leq \ell(\underline{k})} (G_{k_t, i_t}^{(k_t)})^{\varepsilon_t}$ .

**Lemma 6.4.** Consider positive integers  $p$  and  $q$ , additive invariants  $\lambda_1, \dots, \lambda_p$ , and elements  $[M_1; (\frac{B_u}{A_u})_{u \in U_1}], \dots, [M_q; (\frac{B_u}{A_u})_{u \in U_q}]$  of  $\mathcal{F}_0$ , for non empty sets  $U_j$ . Then:

$$\left( \prod_{i=1}^p \lambda_i \right) \left( \prod_{j=1}^q [M_j; (\frac{B_u}{A_u})_{u \in U_j}] \right) = \sum_{j \in E_{pq}} \prod_{\ell=1}^q \left( \prod_{i \in j^{-1}(\{\ell\})} \lambda_i \right) \left( [M_\ell; (\frac{B_u}{A_u})_{u \in U_\ell}] \right),$$



where  $E_{pq}$  is the set of all surjective maps  $j : \{1, \dots, p\} \rightarrow \{1, \dots, q\}$ .

In particular, if  $p < q$ ,

$$\left( \prod_{i=1}^p \lambda_i \right) \left( \#_{j=1}^q [M_j; \left( \frac{B_u}{A_u} \right)_{u \in U_j}] \right) = 0,$$

and, if  $p = q$ ,

$$\left( \prod_{i=1}^p \lambda_i \right) \left( \#_{j=1}^p [M_j; \left( \frac{B_u}{A_u} \right)_{u \in U_j}] \right) = \sum_{\sigma \in \mathcal{S}_p} \prod_{\ell=1}^p \lambda_{\sigma(\ell)} \left( [M_\ell; \left( \frac{B_u}{A_u} \right)_{u \in U_\ell}] \right),$$

where  $\mathcal{S}_p$  is the set of permutations of  $\{1, \dots, p\}$ .

*Proof.*

$$\begin{aligned} & \left( \prod_{i=1}^p \lambda_i \right) \left( \#_{j=1}^q [M_j; \left( \frac{B_u}{A_u} \right)_{u \in U_j}] \right) \\ &= \sum_{V_1 \subset U_1} \dots \sum_{V_q \subset U_q} (-1)^{\sum_{\ell=1}^q |V_\ell|} \prod_{i=1}^p \lambda_i \left( \#_{j=1}^q M_j \left( \left( \frac{B_u}{A_u} \right)_{u \in V_j} \right) \right) \\ &= \sum_{V_1 \subset U_1} \dots \sum_{V_q \subset U_q} (-1)^{\sum_{\ell=1}^q |V_\ell|} \prod_{i=1}^p \sum_{j=1}^q \lambda_i \left( M_j \left( \left( \frac{B_u}{A_u} \right)_{u \in V_j} \right) \right) \\ &= \sum_{j: \{1, \dots, p\} \rightarrow \{1, \dots, q\}} \sum_{V_1 \subset U_1} \dots \sum_{V_q \subset U_q} (-1)^{\sum_{\ell=1}^q |V_\ell|} \prod_{i=1}^p \lambda_i \left( M_{j(i)} \left( \left( \frac{B_u}{A_u} \right)_{u \in V_{j(i)}} \right) \right) \\ &= \sum_{j: \{1, \dots, p\} \rightarrow \{1, \dots, q\}} \prod_{\ell=1}^q \left( \sum_{V_\ell \subset U_\ell} (-1)^{|V_\ell|} \prod_{i \in j^{-1}(\{\ell\})} \lambda_i \left( M_\ell \left( \left( \frac{B_u}{A_u} \right)_{u \in V_\ell} \right) \right) \right) \\ &= \sum_{j \in E_{pq}} \prod_{\ell=1}^q \left( \prod_{i \in j^{-1}(\{\ell\})} \lambda_i \right) \left( [M_\ell; \left( \frac{B_u}{A_u} \right)_{u \in U_\ell}] \right) \end{aligned}$$

□

**Lemma 6.5.** *Let  $n$  and  $k$  be positive integers. For  $\iota = (\underline{k}, \underline{i}, \underline{\varepsilon}) \in \mathcal{T}_k^\pi$ , set  $\mathcal{T}_n(\iota) = \{(\underline{k}, \underline{i}, \underline{\eta}) \in \mathcal{T}_n^\pi \mid \forall t, \eta_t \geq \varepsilon_t\}$ . For  $\kappa \in \mathcal{T}_n^\pi$ , we have  $\lambda_{n, \kappa}(\tilde{G}_{k, \iota}^{(k)}) \neq 0$  if and only if  $\kappa \in \mathcal{T}_n(\iota)$ .*

Note that the set  $\mathcal{T}_n(\iota)$  is finite.

*Proof.* Set  $\kappa = (\underline{\ell}, \underline{j}, \underline{\eta})$ . We have  $\lambda_{n, \kappa} = \prod_{1 \leq s \leq \ell(\underline{\ell})} \lambda_{\ell_s, j_s}^{\eta_s}$  and  $\tilde{G}_{k, \iota}^{(k)} = \#_{1 \leq t \leq \ell(\underline{k})} (G_{k_t, i_t}^{(k_t)})^{\# \varepsilon_t}$ . By Lemma 6.4:

$$\lambda_{n, \kappa}(\tilde{G}_{k, \iota}^{(k)}) = \sum_{\xi \in E_{\underline{\eta}, \underline{\varepsilon}}(t, u) \in \Theta(\underline{\varepsilon})} \prod_{(s, v) \in \xi^{-1}(\{(t, u)\})} \lambda_{\ell_s, j_s} \left( G_{k_t, i_t}^{(k_t)} \right),$$

where  $\Theta(\underline{\varepsilon}) = \{(t, u) \mid 1 \leq t \leq \ell(\underline{\varepsilon}); \forall t, 1 \leq u \leq \varepsilon_t\}$  and  $E_{\eta\underline{\varepsilon}}$  is the set of all surjective maps  $\xi : \Theta(\eta) \rightarrow \Theta(\underline{\varepsilon})$ . Since the  $G_{k_t, i_t}^{(k_t)}$  are multiplicative, we get:

$$\lambda_{n, \kappa}(\tilde{G}_{k, \iota}^{(k)}) = \sum_{\xi \in E_{\eta\underline{\varepsilon}}} \prod_{(t, u) \in \Theta(\underline{\varepsilon})} \prod_{(s, v) \in \xi^{-1}(\{(t, u)\})} (\lambda_{\ell_s, j_s}(G_{k_t, i_t}^{(k_t)})).$$

Recall  $\lambda_{\ell_s, j_s}(G_{k_t, i_t}^{(k_t)}) = \delta_{\ell_s k_t} \delta_{j_s i_t}$ . Hence  $\lambda_{n, \kappa}(\tilde{G}_{k, \iota}^{(k)}) \neq 0$  if and only if  $\underline{\ell} = \underline{k}$ ,  $\underline{j} = \underline{i}$  and  $\eta_t \geq \varepsilon_t$  for all  $t$ .  $\square$

For  $n > 1$  and  $\iota \in \mathcal{T}_n^\pi$ , set  $G_{n, \iota}^{(n)} = \frac{1}{\lambda_{n, \iota}(\tilde{G}_{n, \iota}^{(n)})} \tilde{G}_{n, \iota}^{(n)}$ , so that  $\lambda_{n, \iota}(G_{n, \iota}^{(n)}) = 1$ . Note that,

for all  $n$  and all  $i \in \mathcal{T}_n$ ,  $G_{n, i}^{(n)} \in \mathcal{F}_n$ .

Let  $n$  and  $k$  be positive integers. For  $\iota \in C_k$ , set  $\mathcal{T}_n(\iota) = \{(\underline{k}, \underline{i}, \eta) \in \mathcal{T}_n^\pi \mid \underline{k} = (k), \underline{i} = (\iota)\}$ . The following result is an easy generalisation of Lemma 6.5.

**Lemma 6.6.** *Let  $n$  and  $k$  be positive integers. For  $\kappa \in \mathcal{T}_n$  and  $\iota \in \mathcal{T}_k$ , we have  $\lambda_{n, \kappa}(G_{k, \iota}^{(k)}) \neq 0$  if and only if  $\kappa \in \mathcal{T}_n(\iota)$ .*

**Corollary 6.7.** *For  $n > 0$ ,  $i \in \mathcal{T}_n$ ,  $j \in \mathcal{T}_n$ , we have  $\lambda_{n, i}(G_{n, j}^{(n)}) = \delta_{ij}$ .*

For  $n > 1$ , define  $G_{k, i}^{(n)} \in \mathcal{F}_k$  for  $0 < k < n$  and  $i \in \mathcal{T}_k$ , by induction on  $n$ , by:

$$G_{k, i}^{(n)} = G_{k, i}^{(n-1)} - \sum_{\iota \in \mathcal{T}_n(i)} \lambda_{n, \iota}(G_{k, i}^{(n-1)}) G_{n, \iota}^{(n)}.$$

Note that  $G_{k, i}^{(n)} = G_{k, i}^{(m)}$  in  $\mathcal{G}_m$  if  $m \leq n$ .

**Lemma 6.8.** *Let  $n$  be a positive integer. The family  $(G_{k, i}^{(n)})_{\substack{0 < k \leq n \\ i \in \mathcal{T}_k}}$  of  $\frac{\mathcal{F}_1}{\mathcal{F}_{n+1}}$  is dual to the family  $(\lambda_{k, i})_{\substack{0 < k \leq n \\ i \in \mathcal{T}_k}}$  of  $\frac{\mathcal{T}_n}{\mathcal{T}_0}$ .*

*Proof.* We proceed by induction on  $n$ . The result is clear for  $n = 1$ . Fix  $n > 1$ . We shall prove that  $\lambda_{\ell, j}(G_{k, i}^{(n)}) = \delta_{\ell k} \delta_{ji}$  for all  $0 < \ell \leq n$ ,  $j \in \mathcal{T}_\ell$ ,  $0 < k \leq n$ ,  $i \in \mathcal{T}_k$ . If  $\ell = n$  and  $k = n$ , it is given by Corollary 6.7. If  $\ell < n$  and  $k = n$ , it is clear since  $G_{n, i}^{(n)} \in \mathcal{F}_n$ . If  $\ell < n$  and  $k < n$ , it follows from the induction hypothesis. It remains to show that  $\lambda_{n, j}(G_{k, i}^{(n)}) = 0$  if  $k < n$ . It is immediate if  $j \in \mathcal{T}_n(i)$ . Consider  $j \in \mathcal{T}_n \setminus \mathcal{T}_n(i)$ . We have:

$$G_{k, i}^{(n)} = G_{k, i}^{(k)} - \sum_{k < m \leq n} \sum_{\iota \in \mathcal{T}_m(i)} \lambda_{m, \iota}(G_{k, i}^{(m-1)}) G_{m, \iota}^{(m)}.$$

By Lemma 6.6, for  $k \leq m \leq n$  and  $\iota \in \mathcal{T}_m(i)$ ,  $\lambda_{n, j}(G_{m, \iota}^{(m)}) \neq 0$  if and only if  $j \in \mathcal{T}_n(\iota)$ , and this implies  $j \in \mathcal{T}_n(i)$ . Hence, for  $j \notin \mathcal{T}_n(i)$ ,  $\lambda_{n, j}(G_{k, i}^{(n)}) = 0$ .  $\square$

### 6.3 The coproduct on $\mathcal{H}$

In the previous subsection, we have constructed dual systems  $(G_{k,i}^{(n)})_{\substack{0 < k \leq n \\ i \in \mathcal{T}_k}} \subset \frac{\mathcal{F}_1}{\mathcal{F}_{n+1}}$  and  $(\lambda_{k,i})_{\substack{0 < k \leq n \\ i \in \mathcal{T}_k}} \subset \frac{\mathcal{I}_n}{\mathcal{I}_0}$  that satisfy the following properties :

- $\lambda_{n,i}$  is a finite type invariant of degree  $n$ ,
- $\mathcal{T}_n = C_n \sqcup \mathcal{T}_n^\pi$ ,  $\lambda_{n,i}$  is additive if  $i \in C_n$ ,  $\lambda_{n,i}$  is a product of some  $\lambda_{k,i}$ ,  $k < n$ ,  $i \in C_k$ , if  $i \in \mathcal{T}_n^\pi$ ,
- $\frac{\mathcal{I}_n^c}{\mathcal{I}_{n-1}^c} = \prod_{i \in C_n} \mathbb{Q} \lambda_{n,i}$ ,
- if  $i \in C_n$ ,  $G_{n,i}^{(n)}$  is multiplicative,
- $G_{k,i}^{(n)} \in \mathcal{F}_k$ , and, if  $m \leq n$ ,  $G_{k,i}^{(n)} = G_{k,i}^{(m)}$  in  $\mathcal{G}_m$ .

**Proposition 6.9.** *The family  $(G_{k,i}^{(n)})_{\substack{0 < k \leq n \\ i \in \mathcal{T}_k}}$  is a basis of  $\frac{\mathcal{F}_1}{\mathcal{F}_{n+1}}$ . The family  $(\lambda_{k,i})_{\substack{0 < k \leq n \\ i \in \mathcal{T}_k}}$  is the dual basis of  $\frac{\mathcal{I}_n}{\mathcal{I}_0}$ . Moreover:*

$$\frac{\mathcal{I}_n}{\mathcal{I}_{n-1}} = \prod_{i \in \mathcal{T}_n} \mathbb{Q} \lambda_{n,i}, \quad \frac{\mathcal{I}_n^\pi}{\mathcal{I}_{n-1}^\pi} = \prod_{i \in \mathcal{T}_n^\pi} \mathbb{Q} \lambda_{n,i}, \quad \mathcal{G}_n = \bigoplus_{i \in \mathcal{T}_n} \mathbb{Q} G_{n,i}^{(n)}.$$

This result implies Proposition 1.12.

*Proof.* We will proceed by induction. For  $n = 1$ , the result follows from Proposition 1.8 and Corollary 1.10. Fix  $n > 1$ . We will write  $\underline{\eta} \leq \underline{\varepsilon}$  if  $\eta_t \leq \varepsilon_t$  for all  $t$ ,  $\underline{\eta} < \underline{\varepsilon}$  if  $\underline{\eta} \leq \underline{\varepsilon}$  and  $\eta \neq \varepsilon$ , and  $\underline{0} < \underline{\eta}$  if  $\eta_t > 0$  for at least one  $t$ .

**Lemma 6.10.** *Consider  $\lambda \in \mathcal{I}_n$  such that  $\lambda(S^3) = 0$ . There are constants  $\alpha_{m,\iota}$ , for  $1 \leq m \leq n$  and  $\iota \in \mathcal{T}_m^\pi$ , such that:*

$$\lambda(M_1 \sharp M_2) = \lambda(M_1) + \lambda(M_2) + \sum_{m=1}^n \sum_{\iota=(k,i,\varepsilon) \in \mathcal{T}_m^\pi} \alpha_{m,\iota} \sum_{\underline{0} < \underline{\eta} < \underline{\varepsilon}} \prod_{1 \leq t \leq \ell(k)} \binom{\varepsilon_t}{\eta_t} \lambda_{k_t, i_t}^{\eta_t}(M_1) \lambda_{k_t, i_t}^{\varepsilon_t - \eta_t}(M_2),$$

for all  $\mathbb{Q}$ HS's  $M_1$  and  $M_2$ .

**Remark** The above expression of  $\lambda(M_1 \sharp M_2)$  defines a coproduct  $\Delta$  on the algebra  $\mathcal{H}$ :

$$\Delta(\lambda) = \lambda \otimes 1 + 1 \otimes \lambda + \sum_{m=1}^n \sum_{\iota=(\underline{k}, i, \underline{\varepsilon}) \in \mathcal{T}_m^\pi} \alpha_{m, \iota} \sum_{0 < \eta < \varepsilon} \prod_{1 \leq t \leq \ell(\underline{k})} \binom{\varepsilon_t}{\eta_t} \lambda_{k_t, i_t}^{\eta_t} \otimes \lambda_{k_t, i_t}^{\varepsilon_t - \eta_t}.$$

Thus  $\mathcal{H}$  has a Hopf algebra structure. The primitive elements associated with this coproduct (the invariants  $\lambda$  satisfying  $\Delta(\lambda) = \lambda \otimes 1 + 1 \otimes \lambda$ ) are the additive invariants. Milnor and Moore ([MM65]) proved that, under conditions, a Hopf algebra is generated as an algebra by its primitive elements. Here, we give an explicit and elementary proof of this result in our setting.

*Proof.* Define a bilinear map  $\mu$  on  $\mathcal{F}_0$  by

$$\mu(M_1, M_2) = \lambda(M_1 \sharp M_2) - \lambda(M_1) - \lambda(M_2)$$

for all QHS's  $M_1$  and  $M_2$ . Fix  $M_2$ , and consider  $[M; (\frac{A'_i}{A_i})_{1 \leq i \leq n}] \in \mathcal{F}_n$ . We have:

$$\begin{aligned} \mu([M; (\frac{A'_i}{A_i})_{1 \leq i \leq n}], M_2) &= \sum_{I \subset \{1, \dots, n\}} (-1)^{|I|} \mu(M((\frac{A'_i}{A_i})_{i \in I}), M_2) \\ &= \sum_{I \subset \{1, \dots, n\}} (-1)^{|I|} (\lambda(M((\frac{A'_i}{A_i})_{i \in I}) \sharp M_2) - \lambda(M((\frac{A'_i}{A_i})_{i \in I}))) \\ &= -\lambda([M; (\frac{A'_i}{A_i})_{1 \leq i \leq n}, \frac{B_2}{B^3}]) \\ &= 0, \end{aligned}$$

where  $B_2$  is a rational homology ball obtained from  $M_2$  by removing an open ball. Thus  $\mu(\cdot, M_2)$  is an invariant of degree at most  $n - 1$ . Note that  $\mu(S^3, M_2) = 0$ . By induction,  $\mathcal{I}_{n-1}/\mathcal{I}_0$  is freely generated by the  $\lambda_{k,i}$  for  $0 < k < n$  and  $i \in \mathcal{T}_k$ . Hence we can write:

$$\mu(M_1, M_2) = \sum_{0 < k < n} \sum_{i \in \mathcal{T}_k} \beta_{k,i}(M_2) \lambda_{k,i}(M_1).$$

Note that the sum may be infinite. We have  $\beta_{k,i}(M_2) = \mu(G_{k,i}^{(n)}, M_2)$  and  $\beta_{k,i}(S^3) = 0$ . Extend  $\beta_{k,i}$  to  $\mathcal{F}_0$  by linearity. Consider  $[M; (\frac{A'_i}{A_i})_{i \in I}] \in \mathcal{F}_{n-k+1}$ ,  $|I| = n - k + 1$ , and set  $G_{k,i}^{(n)} = \sum_{u \in U} c_u [N_u; (\frac{B'_j}{B_j})_{j \in J_u}]$ , where the  $c_u$  are rational numbers and  $|J_u| = k$  for all  $u$ .

$$\begin{aligned} \beta_{k,i}([M; (\frac{A'_i}{A_i})_{i \in I}]) &= \sum_{u \in U} c_u \sum_{I' \subset I} \sum_{K_u \subset J_u} (-1)^{|I'| + |K_u|} \mu(N_u((\frac{B'_j}{B_j})_{j \in K_u}), M((\frac{A'_i}{A_i})_{i \in I'})) \\ &= \sum_{u \in U} c_u \lambda([M \sharp N_u; (\frac{A'_i}{A_i})_{i \in I}, (\frac{B'_j}{B_j})_{j \in J_u}]) \\ &= 0 \end{aligned}$$

Thus  $\beta_{k,i}$  is an invariant of degree at most  $n - k$ . Using the induction hypothesis, we can decompose the invariants  $\beta_{k,i}$  and get:

$$\mu(M_1, M_2) = \sum_{m=1}^n \sum_{\iota=(\underline{k}, \underline{i}, \underline{\varepsilon}) \in \mathcal{T}_m^\pi} \sum_{\underline{0} < \underline{\eta} < \underline{\varepsilon}} \alpha_{m,\iota}^{(\underline{\eta})} \prod_{1 \leq t \leq \ell(\underline{k})} \binom{\varepsilon_t}{\eta_t} \lambda_{k_t, i_t}^{\eta_t}(M_1) \lambda_{k_t, i_t}^{\varepsilon_t - \eta_t}(M_2),$$

where the  $\alpha_{m,\iota}^{(\underline{\eta})}$  are rational constants. It gives:

$$\lambda(M_1 \# M_2) = \lambda(M_1) + \lambda(M_2) + \sum_{m=1}^n \sum_{\iota=(\underline{k}, \underline{i}, \underline{\varepsilon}) \in \mathcal{T}_m^\pi} \sum_{\underline{0} < \underline{\eta} < \underline{\varepsilon}} \alpha_{m,\iota}^{(\underline{\eta})} \prod_{1 \leq t \leq \ell(\underline{k})} \binom{\varepsilon_t}{\eta_t} \lambda_{k_t, i_t}^{\eta_t}(M_1) \lambda_{k_t, i_t}^{\varepsilon_t - \eta_t}(M_2).$$

Now, we use the commutativity and associativity of the connected sum to show that the well-determined constants  $\alpha_{m,\iota}^{(\underline{\eta})}$  do not depend on  $\underline{\eta}$ . The commutativity gives  $\alpha_{m,\iota}^{(\underline{\varepsilon} - \underline{\eta})} = \alpha_{m,\iota}^{(\underline{\eta})}$ . Consider  $M_1 = N_1 \# N_2$ .

$$\begin{aligned} \lambda(N_1 \# N_2 \# M_2) &= \\ &= \lambda(N_1) + \lambda(N_2) + \lambda(M_2) + \sum_{m=1}^n \sum_{\iota=(\underline{k}, \underline{i}, \underline{\varepsilon}) \in \mathcal{T}_m^\pi} \sum_{\underline{0} < \underline{\eta} < \underline{\varepsilon}} \alpha_{m,\iota}^{(\underline{\eta})} \prod_{1 \leq t \leq \ell(\underline{k})} \binom{\varepsilon_t}{\eta_t} \lambda_{k_t, i_t}^{\eta_t}(N_1) \lambda_{k_t, i_t}^{\varepsilon_t - \eta_t}(N_2) \\ &+ \sum_{m=1}^n \sum_{\iota=(\underline{k}, \underline{i}, \underline{\varepsilon}) \in \mathcal{T}_m^\pi} \sum_{\underline{0} < \underline{\eta} < \underline{\varepsilon}} \alpha_{m,\iota}^{(\underline{\eta})} \sum_{\underline{0} \leq \underline{\nu} \leq \underline{\eta}} \prod_{1 \leq t \leq \ell(\underline{k})} \binom{\varepsilon_t}{\eta_t} \binom{\eta_t}{\nu_t} \lambda_{k_t, i_t}^{\nu_t}(N_1) \lambda_{k_t, i_t}^{\eta_t - \nu_t}(N_2) \lambda_{k_t, i_t}^{\varepsilon_t - \eta_t}(M_2) \end{aligned}$$

Consider  $\underline{\nu}$  such that  $\underline{0} < \underline{\nu} \leq \underline{\eta}$ . The terms

$$\prod_{1 \leq t \leq \ell(\underline{k})} \lambda_{k_t, i_t}^{\nu_t}(N_1) \lambda_{k_t, i_t}^{\eta_t - \nu_t}(N_2) \lambda_{k_t, i_t}^{\varepsilon_t - \eta_t}(M_2)$$

and

$$\prod_{1 \leq t \leq \ell(\underline{k})} \lambda_{k_t, i_t}^{\varepsilon_t - \eta_t}(N_1) \lambda_{k_t, i_t}^{\eta_t - \nu_t}(N_2) \lambda_{k_t, i_t}^{\nu_t}(M_2)$$

must have the same coefficient. Since  $\binom{\varepsilon_t}{\eta_t} \binom{\eta_t}{\nu_t} = \binom{\varepsilon_t}{\varepsilon_t - \nu_t} \binom{\varepsilon_t - \nu_t}{\varepsilon_t - \eta_t}$ , we have  $\alpha_{m,\iota}^{\underline{\eta}} = \alpha_{m,\iota}^{\underline{\varepsilon} - \underline{\nu}} = \alpha_{m,\iota}^{\underline{\nu}}$ . Now, consider any  $\underline{\eta}$  and  $\underline{\nu}$  with  $\underline{0} < \underline{\eta}, \underline{\nu} < \underline{\varepsilon}$ . Either there is  $\underline{\tau} > \underline{0}$  with  $\underline{\tau} \leq \underline{\eta}$  and  $\underline{\tau} \leq \underline{\nu}$ , or we have  $\underline{\eta} \leq \underline{\varepsilon} - \underline{\nu}$ . In both cases, we get  $\alpha_{m,\iota}^{\underline{\eta}} = \alpha_{m,\iota}^{\underline{\nu}}$ . Finally:

$$\lambda(M_1 \# M_2) = \lambda(M_1) + \lambda(M_2) + \sum_{m=1}^n \sum_{\iota=(\underline{k}, \underline{i}, \underline{\varepsilon}) \in \mathcal{T}_m^\pi} \alpha_{m,\iota} \sum_{\underline{0} < \underline{\eta} < \underline{\varepsilon}} \prod_{1 \leq t \leq \ell(\underline{k})} \binom{\varepsilon_t}{\eta_t} \lambda_{k_t, i_t}^{\eta_t}(M_1) \lambda_{k_t, i_t}^{\varepsilon_t - \eta_t}(M_2),$$

where  $\alpha_{m,\iota}$  is the common value of the  $\alpha_{m,\iota}^{(\underline{\eta})}$ .  $\square$

Back to the proof of Proposition 6.9, use the constants  $\alpha_{m,\ell}$  given by the lemma to define an invariant  $\tilde{\lambda}$ :

$$\tilde{\lambda} = \lambda - \sum_{m=1}^n \sum_{\iota=(\underline{k}, \underline{i}, \underline{\varepsilon}) \in \mathcal{T}_m^\pi} \alpha_{m,\iota} \prod_{1 \leq t \leq \ell(\underline{k})} \lambda_{k_t, i_t}^{\varepsilon_t}.$$

It is easy to see that  $\tilde{\lambda}$  is additive. Thus  $\lambda \in \mathcal{I}_n^c \oplus \mathcal{I}_n^\pi$ , and  $(\lambda_{k,i})_{\substack{0 < k \leq n \\ i \in \mathcal{T}_k^\pi}}$  is a basis of  $\mathcal{I}_n^\pi$ .

It remains to show that  $(G_{k,i}^{(n)})_{\substack{0 < k \leq n \\ i \in \mathcal{T}_k}}$  is a basis of  $\frac{\mathcal{F}_1}{\mathcal{F}_{n+1}}$ . It suffices to show that  $(G_{n,i}^{(n)})_{i \in \mathcal{T}_n}$  is a basis of  $\mathcal{G}_n$ . Consider  $G \in \mathcal{G}_n$ . We shall prove that the sum  $\sum_{i \in \mathcal{T}_n} \lambda_{n,i}(G) G_{n,i}^{(n)}$  is finite and equal to  $G$  in  $\mathcal{G}_n$ . The term  $G$  is a finite linear combination of QHS's. Let  $C_1(G) \subset C_1$  denote the set of all prime integers  $p$  such that  $\nu_p(M) \neq 0$  for a QHS  $M$  in this combination. The set  $C_1(G)$  is finite. If an invariant  $\lambda_{n,i}$  is a multiple of an invariant  $\nu_p$  for some  $p \notin C_1(G)$ , then  $\lambda_{n,i}(G) = 0$ . Thus if  $\lambda_{n,i}(G) \neq 0$ , then  $\lambda_{n,i}$  is a product of invariants  $\nu_p$  for  $p \in C_1(G)$  and  $\lambda_{k,j}$  for  $1 < k \leq n$  and  $j \in C_k$ . Recall the set  $C_k$  is finite for all  $k > 1$ . Hence the sum  $\sum_{i \in \mathcal{T}_n} \lambda_{n,i}(G) G_{n,i}^{(n)}$  is well defined in  $\mathcal{G}_n$ , and is equal to  $G$  since the  $\lambda_{n,i}$  generate  $\frac{\mathcal{I}_n}{\mathcal{I}_{n-1}}$ .  $\square$

**Lemma 6.11.** *Let  $M$  and  $N$  be QHS's. For  $n > 0$ :*

$$\left( (M-N) \in \mathcal{F}_{n+1} \right) \Leftrightarrow \left( Z_{k,KKT}(M-N) = 0 \text{ for all } k \leq \frac{n}{2} \text{ and } |H_1(M; \mathbb{Z})| = |H_1(N; \mathbb{Z})| \right).$$

*Proof.* The direct implication is clear since the  $Z_{k,KKT}$ ,  $k \leq \frac{n}{2}$ , and the  $\nu_p$ ,  $p$  prime, are finite type invariants of degree at most  $n$ . To see that Proposition 6.9 implies the converse implication, recall that the invariants  $\lambda_{k,i}$ , for  $0 < k \leq n$  and  $i \in \mathcal{T}_k$ , were defined in Subsection 6.2 as products of linear combinations of the  $\nu_p$ ,  $p$  prime, and the  $\lambda_{k,i}$ ,  $0 < k \leq n$ ,  $i \in C_k$ , that were defined from the  $Z_{k,KKT}$ ,  $k \leq \frac{n}{2}$  in Lemma 5.16.  $\square$

*Proof of Theorem 1.1.* According to [LMO98],  $p^c \circ Z_{LMO}$  is additive under connected sum, where  $p^c$  is the projection defined in Lemma 5.16. In [Mas12], Massuyeau proved that  $Z_{LMO}$  satisfies the same splitting formulae as  $Z_{KKT}$ . Hence, the invariants  $(\lambda_{n,i})_{i \in C_n}$  of Lemma 5.16 could have been defined with  $Z_{LMO}$  instead of  $Z_{KKT}$ . Therefore, Lemma 6.11 holds for  $Z_{LMO}$  instead of  $Z_{KKT}$  as well.  $\square$

# Chapitre 4 : Modules d'Alexander et formes de Blanchfield des nœuds homologiquement triviaux dans les sphères d'homologie rationnelle

## Résumé

Ce chapitre contient la version publiée dans *Journal of Knot Theory and its Ramifications* de l'article "On Alexander modules and Blanchfield forms of null-homologous knots in rational homology spheres", sans sa bibliographie, avec une pagination différente, mais avec les numérotations originales. Dans cet article, on donne une classification des modules d'Alexander des nœuds homologiquement triviaux dans les sphères d'homologie rationnelle. On caractérise ces modules  $\mathfrak{A}$  munis de leurs formes de Blanchfield  $\mathfrak{b}$ , et les modules  $\mathfrak{A}$  tels qu'il existe une unique classe d'isomorphisme de  $(\mathfrak{A}, \mathfrak{b})$ , et on démontre que pour les autres modules  $\mathfrak{A}$ , il y a une infinité de telles classes. On réalise tous ces  $(\mathfrak{A}, \mathfrak{b})$  par des nœuds explicites dans des  $\mathbb{Q}$ -sphères.

# On Alexander modules and Blanchfield forms of null-homologous knots in rational homology spheres

## Abstract

In this article, we give a classification of Alexander modules of null-homologous knots in rational homology spheres. We characterize these modules  $\mathfrak{A}$  equipped with their Blanchfield forms  $\mathfrak{b}$ , and the modules  $\mathfrak{A}$  such that there is a unique isomorphism class of  $(\mathfrak{A}, \mathfrak{b})$ , and we prove that for the other modules  $\mathfrak{A}$ , there are infinitely many such classes. We realise all these  $(\mathfrak{A}, \mathfrak{b})$  by explicit knots in  $\mathbb{Q}$ -spheres.

## 1 Introduction

### 1.1 Short introduction

The  $\mathbb{Q}[t, t^{-1}]$ -modules appearing as Alexander modules of knots in  $S^3$  were determined by Levine [Lev65]. They are all the  $\bigoplus_{i=1}^k \mathbb{Q}[t, t^{-1}]/(P_i)$ , where the  $P_i$  are symmetric polynomials ( $P_i(t) = P_i(t^{-1})$ ) in  $\mathbb{Z}[t, t^{-1}]$  such that  $P_i(1) = 1$ . We will generalize this classification to null-homologous knots in rational homology spheres. The Alexander modules of these knots are finitely generated  $\mathbb{Q}[t, t^{-1}]$ -torsion-modules on which  $x \mapsto (1 - t)x$  defines an isomorphism. The equivariant linking number defined in the infinite cyclic covering induces a hermitian form on these Alexander modules, called the Blanchfield form since Blanchfield showed that it is non degenerate [Bla57]. We will show that these properties characterize the Alexander modules  $\mathfrak{A}$  equipped with their Blanchfield forms  $\mathfrak{b}$ . We characterize these modules  $\mathfrak{A}$  equipped with their Blanchfield forms  $\mathfrak{b}$ , and the modules  $\mathfrak{A}$  such that there is a unique isomorphism class of  $(\mathfrak{A}, \mathfrak{b})$ , and we prove that for the other modules  $\mathfrak{A}$ , there are infinitely many such classes.

In [Kri00], Kriker defined a rational lift of the Kontsevich integral for null-homologous knots in  $\mathbb{Q}$ -spheres. Garoufalidis and Rozansky [GR04] introduced a filtration of the space of these knots by null moves. Null moves preserve the isomorphism classes of  $(\mathfrak{A}, \mathfrak{b})$ . Garoufalidis and Rozansky computed the graded space of the filtration for the isomorphism class of the unknot. This computation allowed Lescop to prove that the invariant she constructed in [Les10] is equivalent to the 2-loop part of the Kriker lift for knots with trivial Alexander modules. The work contained here should be useful to generalize this result.

### 1.2 Statement of the results

Except otherwise mentioned, all manifolds will be compact and oriented, and all manifolds of dimension 2 or 3 will be connected. We set  $\Lambda = \mathbb{Q}[t, t^{-1}]$ .



A *rational homology 3-sphere*, or  $\mathbb{Q}$ -*sphere*, is a 3-manifold, without boundary, which has the same rational homology as the standard sphere  $S^3$ . In such a  $\mathbb{Q}$ -sphere  $M$ , a *null-homologous knot*  $K$  is a knot whose homology class in  $H_1(M; \mathbb{Z})$  is zero. Let  $T(K)$  be a tubular neighborhood of  $K$ . The *exterior* of  $K$  is  $X = M \setminus \text{Int}(T(K))$ . Consider the projection  $\pi : \pi_1(X) \rightarrow \frac{H_1(X; \mathbb{Z})}{\text{torsion}} \cong \mathbb{Z}$ , and the covering map  $p : \tilde{X} \rightarrow X$  associated with its kernel. The covering  $\tilde{X}$  is the *infinite cyclic covering* of  $X$ . The automorphism group of the covering,  $\text{Aut}(\tilde{X})$ , is isomorphic to  $\mathbb{Z}$ . It acts on  $H_1(\tilde{X}; \mathbb{Q})$ . Denoting the action of a generator  $\tau$  of  $\text{Aut}(\tilde{X})$  as the multiplication by  $t$ , we get a structure of  $\Lambda$ -module on  $H_1(\tilde{X}; \mathbb{Q})$ . This  $\Lambda$ -module is called the *Alexander module* of  $K$ , and we will denote it by  $\mathfrak{A}(K)$ .

On the Alexander module  $\mathfrak{A}(K)$ , one can define the *Blanchfield form*, or *equivariant linking pairing*,  $\mathfrak{b}_K : \mathfrak{A}(K) \times \mathfrak{A}(K) \rightarrow \frac{\mathbb{Q}(t)}{\Lambda}$ , as follows. First define the equivariant linking number of two knots.

**Definition 1.1.** Let  $J_1$  and  $J_2$  be two links in  $\tilde{X}$  such that  $J_1 \cap \tau^k(J_2) = \emptyset$  for all  $k \in \mathbb{Z}$ . Let  $\delta(t)$  be the annihilator of  $\mathfrak{A}(K)$ . Then  $\delta(\tau)J_1$  and  $\delta(\tau)J_2$  are rationally null-homologous knots. The *equivariant linking number* of  $J_1$  and  $J_2$  is

$$lk_e(J_1, J_2) = \frac{1}{\delta(t)\delta(t^{-1})} \sum_{k \in \mathbb{Z}} lk(\delta(\tau)J_1, \tau^k(\delta(\tau)J_2))t^k.$$

One can easily see that  $lk_e(J_1, J_2) \in \frac{1}{\delta(t)}\Lambda$ , and  $lk_e(J_2, J_1)(t) = lk_e(J_1, J_2)(t^{-1})$ . Now, if  $\gamma$  (resp.  $\eta$ ) is the homology class of  $J_1$  (resp.  $J_2$ ) in  $\mathfrak{A}(K)$ , define  $\mathfrak{b}_K(\gamma, \eta)$  by:

$$\mathfrak{b}_K(\gamma, \eta) = lk_e(J_1, J_2) \text{ mod } \Lambda$$

The Blanchfield form is hermitian ( $\mathfrak{b}_K(\gamma, \eta)(t) = \mathfrak{b}_K(\eta, \gamma)(t^{-1})$  for all  $\gamma, \eta \in \mathfrak{A}(K)$ ), and non degenerate:  $\mathfrak{b}_K(\gamma, \eta) = 0$  for all  $\eta \in \mathfrak{A}(K)$  implies  $\gamma = 0$ .

**Proposition 1.2.** Let  $(\mathfrak{A}(K), \mathfrak{b}_K)$  be the Alexander module and the Blanchfield form of a null-homologous knot  $K$  in a  $\mathbb{Q}$ -sphere  $M$ .

1. The module  $\mathfrak{A}(K)$  is a finitely generated  $\Lambda$ -torsion-module.
2. The map  $x \mapsto (1-t)x$  defines an isomorphism of  $\mathfrak{A}(K)$ .
3. The form  $\mathfrak{b}_K$  is hermitian and non degenerate.

Blanchfield showed (3.), we will show (1. 2.) in Section 2.2. We will also show the following description of  $(\mathfrak{A}(K), \mathfrak{b}_K)$ .

**Theorem 1.3.** If  $(\mathfrak{A}, \mathfrak{b})$  satisfy Conditions (1. 2. 3.), then  $\mathfrak{A}$  is a direct sum, orthogonal with respect to  $\mathfrak{b}$ , of submodules of these two kinds:

- $\frac{\Lambda}{(\pi^n)}\gamma$ , with  $\pi$  prime and symmetric, or  $\pi = t + 2 + t^{-1}$ ,  $n > 0$ , and  $\mathfrak{b}(\gamma, \gamma) = \frac{P}{\pi^n}$ ,  $P$  symmetric and prime to  $\pi$ .
- $\frac{\Lambda}{(\pi^n)}\gamma_1 \oplus \frac{\Lambda}{(\pi^n)}\gamma_2$ , with either  $\pi$  prime, non symmetric,  $\pi(-1) \neq 0$ ,  $n > 0$ , or  $\pi = 1 + t$ ,  $n$  odd, and in both cases  $\mathfrak{b}(\gamma_1, \gamma_2) = \frac{1}{\pi^n}$ ,  $\mathfrak{b}(\gamma_i, \gamma_i) = 0$  for  $i = 1, 2$ .

This description will allow us to show the reciprocal result of Proposition 1.2.

**Theorem 1.4.** *If  $(\mathfrak{A}, \mathfrak{b})$  satisfy Conditions (1. 2. 3.), then there is a null-homologous knot  $K$  in a  $\mathbb{Q}$ -sphere  $M$  such that  $(\mathfrak{A}(K), \mathfrak{b}_K)$  is isomorphic to  $(\mathfrak{A}, \mathfrak{b})$ .*

We will give an explicit construction of a knot for the two kinds of modules of Theorem 1.3, and we will get the general case by using connected sums.

Considering only the Alexander modules, we have the following classification.

**Theorem 1.5.** *Given a family  $(\delta_1, \dots, \delta_p)$  of polynomials in  $\Lambda$  such that  $\delta_{i+1} | \delta_i$  for  $1 \leq i < p$ , the module  $\bigoplus_{i=1}^p \frac{\Lambda}{\delta_i(t)}$  is the Alexander module of a null-homologous knot in a  $\mathbb{Q}$ -sphere if and only if the  $\delta_i$  satisfy the following conditions:*

- $\delta_i(1) \neq 0$  for  $1 \leq i \leq p$ ,
- $\delta_i(t^{-1}) = t^{q_i} \delta_i(t)$ , with  $q_i \in \mathbb{Z}$ , for  $1 \leq i \leq p$ ,
- if, for  $1 \leq i \leq p$ ,  $m_i$  denotes the multiplicity of  $-1$  as a root of  $\delta_i$ , then, for any odd integer  $m$ , the number of indices  $i$  such that  $m_i = m$  is even.

Then the Alexander polynomial of  $K$  is the order of  $\mathfrak{A}(K)$ ,  $\Delta = \prod_{i=1}^p \delta_i$ . The annihilator of  $\mathfrak{A}(K)$  is  $\delta = \delta_1$ . This result can be viewed as a corollary of the previous ones, but we will show it first, independently of the existence of the Blanchfield form.

Moreover, using algebraic number theory, we will show:

**Theorem 1.6.** *Let  $\mathfrak{A} = \bigoplus_{i=1}^p \frac{\Lambda}{\delta_i(t)}$ , with  $\delta_{i+1} | \delta_i$  for  $1 \leq i < p$ . Let  $\Delta = \prod_{i=1}^p \delta_i$  be the order of  $\mathfrak{A}$ . For  $1 \leq i \leq p$ , let  $m_i$  denote the multiplicity of  $-1$  as a root of  $\delta_i$ . If  $\Delta$  has no prime and symmetric divisor, and if all  $m_i$  are odd, then there is a unique isomorphism class of non degenerate hermitian forms  $\mathfrak{b} : \mathfrak{A} \times \mathfrak{A} \rightarrow \mathbb{Q}(t)/\Lambda$ . Otherwise, there are infinitely many isomorphism classes of such forms.*

### 1.3 Plan of the article

The first section is devoted to the proof of Theorem 1.5. We introduce surgery presentations of knots in Section 2.1, and show in Section 2.2 that the associated equivariant linking matrices are presentation matrices of the Alexander module. We deduce the properties of the Alexander modules in Section 2.3. In Section 2.4, we realize any hermitian

matrix with coefficients in  $\Lambda$  whose determinant does not vanish at  $t = 1$  as an equivariant linking matrix. We conclude the proof of Theorem 1.5 in Section 2.5.

Section 3.1 gives an expression of the Blanchfield form in terms of an equivariant linking matrix associated with a surgery presentation of the knot. Then, we prove Theorem 1.3 in Section 3.2, Theorem 1.4 in Section 3.3, and Theorem 1.6 in Section 3.4.

## 1.4 Acknowledgements

I wish to thank Greg Kuperberg and Gaël Rémond for their help and ideas concerning the use of algebraic number theory in the last section. I am very thankful to my advisor, Christine Lescop, for her precious guidance and advice.

# 2 Classification of Alexander modules

## 2.1 Surgery presentation of a knot

Let  $M_0$  be a 3-manifold such that  $H_1(M_0; \mathbb{Q}) = 0$ . Consider a link  $L = \amalg_{i \in I} J_i$  in  $M_0$ , with knot components  $J_i$ . For each  $i \in I$ , let  $T(J_i)$  be a tubular neighborhood of  $J_i$ , let  $m(J_i)$  be a meridian of  $J_i$  in  $\partial T(J_i)$ , and let  $l(J_i)$  be a parallel of  $J_i$  in  $\partial T(J_i)$ . Define the manifold  $M = \chi(M_0, L)$  obtained from  $M_0$  by surgery along the framed link  $L$  by  $M = X_L \amalg_h (\amalg_{i \in I} T_i)$ , where  $X_L = M_0 \setminus \amalg_{i \in I} T(J_i)$  is the exterior of  $L$ , the  $T_i$  are solid tori, and  $h : \partial X_L = \amalg_{i \in I} \partial T(J_i) \rightarrow \amalg_{i \in I} \partial T_i$  is a homeomorphism sending  $\partial T(J_i)$  onto  $\partial T_i$  and the parallel  $l(J_i)$  onto a meridian  $m_i$  of  $T_i$ , for each  $i \in I$ . We have:

$$H_1(\chi(M_0, L), \mathbb{Q}) = \frac{\bigoplus_{i \in I} \mathbb{Q} m(J_i)}{\bigoplus_{i \in I} \mathbb{Q} l(J_i)}$$

**Remark** If  $H_1(M_0, \mathbb{Z}) = 0$ ,  $\mathbb{Q}$  can be replaced by  $\mathbb{Z}$ .

In the manifold  $M$ , one can consider the link  $\hat{L}$ , whose components are the cores of the tori  $T_i$ , parallelised by the meridians  $m(J_i)$ . The surgery along  $\hat{L}$  in  $M$  is the *inverse surgery* of the surgery along  $L$  in  $M_0$ . We have  $\chi(\chi(M_0, L), \hat{L}) = M_0$ .

A *surgery presentation* is a triple  $(M_0, L, K_0)$ , where  $M_0$  is a  $\mathbb{Q}$ -sphere,  $K_0$  is a trivial knot in  $M_0$ , and  $L = \amalg_{i=1}^n J_i$  is a framed link in  $M_0$ , such that  $lk(K_0, J_i) = 0$  for  $1 \leq i \leq n$ . It is called *admissible* if  $\det((lk(J_i, J_j))_{1 \leq i, j \leq n}) \neq 0$ .

**Lemma 2.1.** *Set  $(M, K) = (\chi(M_0, L), K_0)$ .*

1. *The knot  $K$  is null-homologous.*
2. *The manifold  $M$  is a  $\mathbb{Q}$ -sphere if and only if the surgery presentation is admissible.*

*Proof.* Consider a disk  $D$  bounded by  $K_0$ , and tranverse to all the  $J_i$ . For all  $i$ ,  $\langle J_i, D \rangle = 0$ . So  $K$  bounds a surface obtained from  $D$  by tubing, that is by adding tubes around the  $J_i$  connecting pairs of points of  $J_i \cap D$  with opposite signs.

We have:

$$H_1(M; \mathbb{Q}) = \frac{\bigoplus_{i=1}^n \mathbb{Q} m(J_i)}{\bigoplus_{i=1}^n \mathbb{Q} l(J_i)}.$$

Now  $l(J_i) = \sum_{j=1}^n lk(J_i, J_j) m(J_j)$ , so  $(lk(J_j, J_i))_{1 \leq i, j \leq n}$  is a presentation matrix for the  $\mathbb{Q}$ -module  $H_1(M; \mathbb{Q})$ . Thus  $\det((lk(J_j, J_i))_{1 \leq i, j \leq n}) \neq 0$  if and only if  $H_1(M; \mathbb{Q}) = 0$ .  $\square$

Such a presentation always exists:

**Lemma 2.2.** *If  $K$  is a null-homologous knot in a  $\mathbb{Q}$ -sphere  $M$ , then  $K$  admits a surgery presentation  $(S^3, L, K_0)$ .*

See Garoufalidis and Kriker [GK04, p.117, Fact 1] for the case  $M = S^3$ . The generalization to any  $\mathbb{Q}$ -sphere  $M$  easily follows from:

**Theorem 2.3** (Lickorish-Wallace, 1960). *Any 3-manifold without boundary can be obtained from  $S^3$  by surgery along a framed link.*

## 2.2 Hermitian presentation matrix

**Definition 2.4.** A matrix  $A \in \mathcal{M}(\Lambda)$  is called *hermitian* if  $\bar{A}^t = A$ , where  $\bar{A}$  is defined by  $\bar{A}(t) = A(t^{-1})$ .

Given a null-homologous knot  $K$  in a rational homology sphere  $M$ , we aim to determine a hermitian presentation matrix of the Alexander module  $\mathfrak{A}(K)$ .

**Proposition 2.5.** *Let  $K$  be a null-homologous knot in a rational homology sphere  $M$ . Consider a surgery presentation  $(M_0, L = \amalg_{i=1}^n J_i, K_0)$  such that  $(M, K) = (\chi(M_0, L), K_0)$ . Let  $\tilde{X}_0$  be the infinite cyclic covering of the exterior  $X_0$  of  $K_0$ , and, for  $1 \leq i \leq n$ , let  $\tilde{J}_i$  be a lift of  $J_i$  in  $\tilde{X}_0$ . The equivariant linking matrix  $A(t)$  defined by  $A_{ij}(t) = lk_e(\tilde{J}_j, \tilde{J}_i)$  is a presentation matrix of the Alexander module  $\mathfrak{A}(K)$ . This matrix is hermitian and satisfies  $\det(A(1)) \neq 0$ .*

*Proof.* We will need the following lemma:

**Lemma 2.6.** *Let  $U$  be a trivial knot in a  $\mathbb{Q}$ -sphere  $M$ , let  $X$  be the exterior of  $U$ , and let  $\tilde{X}$  be the infinite cyclic covering associated. We have  $H_1(\tilde{X}, \mathbb{Q}) = 0$  and  $H_2(\tilde{X}, \mathbb{Q}) = 0$ .*

*Proof.* Let  $D$  be a disk bounded by  $U$ , and set  $Y = M \setminus D$ . Denote by  $\tau$  the automorphism of  $\tilde{X}$  corresponding to the action of  $t$ . Let  $\tilde{Y}$  be (resp.  $\tilde{D}$ ) a copy of  $Y$  (resp.  $D$ ) in  $\tilde{X}$ . Set  $Y_p = \amalg_{k \in \mathbb{Z}} \tau^{2k}(Y)$ , and  $Y_i = \amalg_{k \in \mathbb{Z}} \tau^{2k+1}(Y)$ .

We first show that  $H_2(\tilde{X}, \mathbb{Q}) = 0$ . Use the Mayer-Vietoris sequence associated with  $\tilde{X} = Y_p \cup Y_i$ :

$$H_2(\coprod_{k \in \mathbb{Z}} \tau^k(\tilde{D})) \longrightarrow H_2(Y_p) \oplus H_2(Y_i) \longrightarrow H_2(\tilde{X}) \longrightarrow H_1(\coprod_{k \in \mathbb{Z}} \tau^k(\tilde{D}))$$

For  $i > 0$ ,  $H_i(\coprod_{k \in \mathbb{Z}} \tau^k(\tilde{D})) = \Lambda \otimes_{\mathbb{Q}} H_i(D) = 0$ . Thus  $H_2(\tilde{X}) \simeq H_2(Y_p) \oplus H_2(Y_i) \simeq \Lambda \otimes_{\mathbb{Q}} H_2(Y)$ . It remains to show that  $H_2(Y) = 0$ .

Let  $V$  be a regular neighborhood of  $D$ . Since  $Y$  deformation retracts to  $Z = M \setminus V$ , we have  $H_2(Y) = H_2(Z)$ . Then use the exact sequence associated with  $(M, Z)$ .

$$H_3(M) = \mathbb{Q}[M] \longrightarrow H_3(M, Z) \longrightarrow H_2(Z) \longrightarrow H_2(M) = 0$$

By excision,  $H_3(M, Z) = H_3(V, \partial V) = \mathbb{Q}[V]$ . Since  $[V]$  is the image of  $[M]$  by the first morphism, the second morphism is trivial and  $H_2(Z) = 0$ .

We now show, with the same method, that  $H_1(\tilde{X}, \mathbb{Q}) = 0$ . Use the Mayer-Vietoris sequence associated with  $\tilde{X} = Y_p \cup Y_i$ :

$$0 \longrightarrow H_1(Y_p) \oplus H_1(Y_i) \longrightarrow H_1(\tilde{X}) \longrightarrow H_0(\coprod_{k \in \mathbb{Z}} \tau^k(\tilde{D})) \longrightarrow H_0(Y_p) \oplus H_0(Y_i)$$

The last morphism is injective, so  $H_1(\tilde{X}) \simeq H_1(Y_p) \oplus H_1(Y_i) \simeq \Lambda \otimes_{\mathbb{Q}} H_1(Y)$ . It remains to show that  $H_1(Y) = 0$ . We have  $H_1(Y) = H_1(Z)$ . Then use the exact sequence associated with the pair  $(M, Z)$ .

$$H_2(M) = 0 \longrightarrow H_2(M, Z) \longrightarrow H_1(Z) \longrightarrow H_1(M) = 0$$

Thus  $H_1(Z) \simeq H_2(M, Z) \simeq H_2(V, \partial V)$ . Since  $V$  is a ball, we have  $H_2(V, \partial V) = 0$ .  $\square$

We now prove the proposition. First note that the  $J_i$  lift in  $\tilde{X}_0$  into homeomorphic copies, because  $lk(J_i, K_0) = 0$ . The infinite cyclic covering  $\tilde{X}$  associated with  $K \subset M$  is obtained from  $\tilde{X}_0$  by surgery along all the  $\tilde{J}_{i,k} = \tau_0^k(\tilde{J}_i)$ , where  $\tau_0$  is the generator of  $Aut(\tilde{X}_0)$  which induces the action of  $t$ .

We calculate  $H_1(\tilde{X}; \mathbb{Q})$ , using the exact sequence associated with the pair  $(\tilde{X}, \tilde{Z})$ , where  $\tilde{Z}$  is the preimage of  $Z = M_0 \setminus \coprod_{i=1}^n Int(T(J_i))$  by the covering map.

$$H_2(\tilde{X}, \tilde{Z}) \xrightarrow{\partial} H_1(\tilde{Z}) \longrightarrow H_1(\tilde{X}) \longrightarrow H_1(\tilde{X}, \tilde{Z})$$

By excision, we have  $H_j(\tilde{X}, \tilde{Z}) = H_j(\coprod_{1 \leq i \leq n, k \in \mathbb{Z}} \tilde{T}_{i,k}, \coprod_{1 \leq i \leq n, k \in \mathbb{Z}} \partial \tilde{T}_{i,k})$  for all  $j$ , where the  $\tilde{T}_{i,k}$  are the lifts of the solid tori  $T_i$  glued during the surgery. Thus  $H_j(\tilde{X}, \tilde{Z}) = \bigoplus_{1 \leq i \leq n, k \in \mathbb{Z}} H_j(\tilde{T}_{i,k}, \partial \tilde{T}_{i,k})$ , and we have  $H_1(\tilde{X}, \tilde{Z}) = 0$ . For  $j = 2$ , we get  $H_2(\tilde{X}, \tilde{Z}) = \bigoplus_{1 \leq i \leq n, k \in \mathbb{Z}} \mathbb{Q} D_{i,k} = \bigoplus_{1 \leq i \leq n} \Lambda D_{i,0}$ , where  $D_{i,k}$  is a meridian disk for  $\tilde{T}_{i,k}$  bounded by  $l(\tilde{J}_{i,k})$ .

We now calculate  $H_1(\tilde{Z}; \mathbb{Q})$  using the exact sequence associated with the pair  $(\tilde{X}_0, \tilde{Z})$ .

$$H_2(\tilde{X}_0) \longrightarrow H_2(\tilde{X}_0, \tilde{Z}) \longrightarrow H_1(\tilde{Z}) \longrightarrow H_1(\tilde{X}_0)$$

By Lemma 2.6,  $H_2(\tilde{X}_0, \tilde{Z}) \rightarrow H_1(\tilde{Z})$  is an isomorphism. Moreover,

$$H_2(\tilde{X}_0, \tilde{Z}) = \bigoplus_{1 \leq i \leq n, k \in \mathbb{Z}} \mathbb{Q} \Sigma_{i,k},$$

where  $\Sigma_{i,k}$  is a meridian disk for  $T(\tilde{J}_{i,k})$  bounded by  $m(\tilde{J}_{i,k})$ . So:

$$H_1(\tilde{Z}) = \bigoplus_{1 \leq i \leq n, k \in \mathbb{Z}} \mathbb{Q} m(\tilde{J}_{i,k}) = \bigoplus_{1 \leq i \leq n} \mathbb{Q}[t, t^{-1}] m(\tilde{J}_i).$$

We can then rewrite the first sequence:

$$\bigoplus_{1 \leq i \leq n} \Lambda D_{i,0} \xrightarrow{\partial} \bigoplus_{1 \leq i \leq n} \mathbb{Q}[t, t^{-1}] m(\tilde{J}_i) \longrightarrow H_1(\tilde{X}; \mathbb{Q}) \longrightarrow 0$$

We get a presentation of  $H_1(\tilde{X}; \mathbb{Q})$  with  $n$  generators  $m(\tilde{J}_i)$  and  $n$  relations given by the images of  $D_{i,0}$ , that are the parallels  $l(\tilde{J}_i)$ .

We now write  $l(\tilde{J}_i)$  in function of the  $m(\tilde{J}_i)$ .

$$\begin{aligned} l(\tilde{J}_i) &= \sum_{j=1}^n \sum_{k \in \mathbb{Z}} lk(\tilde{J}_i, \tilde{J}_{j,k}) m(\tilde{J}_{j,k}) \\ &= \sum_{j=1}^n \sum_{k \in \mathbb{Z}} lk(\tilde{J}_i, \tilde{J}_{j,k}) t^k m(\tilde{J}_j) \\ &= \sum_{j=1}^n lk_e(\tilde{J}_i, \tilde{J}_j) m(\tilde{J}_j) \end{aligned}$$

Therefore  $A(t)$  is a presentation matrix for  $\mathfrak{A}(K)$ .

It follows from the properties of the equivariant linking number that  $A(t)$  is hermitian. Since  $M$  is a  $\mathbb{Q}$ -sphere, we have  $\det(A(1)) = \det((lk(J_j, J_i))_{1 \leq i, j \leq n}) \neq 0$ .  $\square$

### 2.3 Properties of the Alexander module

Consider a null-homologous knot  $K$  in a  $\mathbb{Q}$ -sphere  $M$ , and write its Alexander module  $\mathfrak{A}(K) = \bigoplus_{i=1}^p \frac{\Lambda}{\delta_i(t)}$ , with  $\delta_{i+1} | \delta_i$  for  $1 \leq i < p$ . Denote by  $\doteq$  the equality modulo a unit of  $\Lambda$ .

**Lemma 2.7.** *For  $1 \leq i \leq p$ ,  $\delta_i(t) \doteq \delta_i(t^{-1})$  and  $\delta_i(1) \neq 0$ .*

*Proof.* Consider an equivariant linking matrix  $A(t)$  associated with  $K$ . By Proposition 2.5,  $A(t)$  is a presentation matrix of  $\mathfrak{A}(K)$ . The matrix  $A$  is equivalent to a diagonal matrix  $D$  with diagonal  $(1, \dots, 1, \delta_p, \dots, \delta_1)$ : there are two matrices  $P$  and  $Q$  in  $GL_n(\Lambda)$

such that  $A = PDQ$ . So  $A = \bar{A}^t = \bar{Q}^t \bar{D} \bar{P}^t$ , and  $A$  is also equivalent to  $\bar{D}$ . By unicity of the  $\delta_i$  modulo a unit of  $\Lambda$ , we have  $\delta_i(t) \doteq \delta_i(t^{-1})$ .

Moreover,  $\det(A(t)) = \prod_{i=1}^p \delta_i(t)$ , and this determinant does not vanish for  $t = 1$ .  $\square$

We call *degree* of a polynomial  $\sum_{i=q}^r \alpha_i t^i \in \mathbb{Q}[t, t^{-1}]$  with  $\alpha_q \neq 0$  and  $\alpha_r \neq 0$  the integer  $r - q$ . The  $\delta_i$  with even degree can be normalised as symmetric polynomials.

**Lemma 2.8.** *For  $1 \leq i \leq p$ , if  $\delta_i$  has even degree  $2m$ , then there are  $r_j \in \mathbb{Q}$  for  $0 \leq j \leq m$  such that:*

$$\delta_i(t) \doteq r_0 + \sum_{j=1}^m r_j (t^j + t^{-j})$$

*Proof.* Multiplying by a suitable power of  $t$ , we get  $\delta_i(t) \doteq \sum_{j=-m}^m r_j t^j$ , with  $r_m r_{-m} \neq 0$ . Since  $\delta_i(t) \doteq \delta_i(t^{-1})$ , there is  $\lambda \in \mathbb{Q}$  and  $k \in \mathbb{Z}$  such that  $\sum_{j=-m}^m r_j t^j = \lambda t^k \sum_{j=-m}^m r_j t^{-j}$ . Necessarily  $k = 0$ , and  $r_j = \lambda r_{-j}$  for  $-m \leq j \leq m$ . Thus  $r_m = \lambda r_{-m} = \lambda^2 r_m$ , and  $\lambda^2 = 1$ . If  $\lambda = -1$ , then  $\delta_i(1) = \sum_{j=-m}^m r_j = r_0 = 0$ . But  $\delta_i(1) \neq 0$ , so  $\lambda = 1$ .  $\square$

The degree parity of  $\delta_i$  is related to the multiplicity of the root  $-1$ . Indeed, since  $\delta_i(t) \doteq \delta_i(t^{-1})$ , if  $\alpha$  is a root for  $\delta_i$ , then  $\alpha^{-1}$  is a root for  $\delta_i$  with the same multiplicity. So the roots of  $\delta_i$  come by pairs  $(\alpha, \alpha^{-1})$ , except for  $\alpha = \pm 1$ . The case  $\alpha = 1$  does not occur, so  $\delta_i$  has odd degree if and only if it admits  $-1$  as a root with odd multiplicity.

**Proposition 2.9.** *Consider a null-homologous knot  $K$  in a  $\mathbb{Q}$ -sphere  $M$ , and its Alexander module  $\mathfrak{A}(K) = \bigoplus_{i=1}^p \frac{\Lambda}{\delta_i(t)}$ , with  $\delta_{i+1} | \delta_i$  for  $1 \leq i < p$ . The  $\delta_i$  satisfy the following conditions:*

- $\delta_i(t^{-1}) \doteq \delta_i(t)$  and  $\delta_i(1) \neq 0$  for  $1 \leq i \leq p$ ,
- if, for  $1 \leq i \leq p$ ,  $m_i$  denotes the multiplicity of  $-1$  as a root of  $\delta_i$ , then for any odd integer  $m$ , the number of indices  $i$  such that  $m_i = m$  is even.

**Remark** These conditions imply that the Alexander polynomial  $\prod_{i=1}^p \delta_i$  has even degree.

*Proof.* Proposition 2.5 gives a hermitian presentation matrix  $A \in \mathcal{M}_n(\Lambda)$  for  $\mathfrak{A}(K)$ . There are matrices  $P, Q \in GL_n(\Lambda)$  such that  $D = PAQ$  is a diagonal matrix with diagonal  $(1, \dots, 1, \delta_p, \dots, \delta_1)$ . The matrix  $B = \bar{Q}^t A Q = \bar{Q}^t P^{-1} D$  is a hermitian matrix which has its  $i^{\text{th}}$  column (and thus its  $i^{\text{th}}$  row) divisible by  $\delta_i$ . Moreover,  $\det(B) \doteq \det(A) \doteq \prod_{i=1}^p \delta_i$ . The multiplicity of  $-1$  as a root for  $\det(B)$  is  $m_0 = \sum_{i=1}^p m_i$ . Denote by  $\beta_{ij}$  the coefficients of  $B$ . Note that  $(t+1)^{\max(m_i, m_j)}$  divides  $\beta_{ij}$ .

$$\begin{aligned} \det(B) &= \sum_{\sigma} \text{sign}(\sigma) \prod_{i=1}^n \beta_{i\sigma(i)} \\ &= \sum_{\sigma; m_i = m_{\sigma(i)} \forall i} \text{sign}(\sigma) \prod_{i=1}^n \beta_{i\sigma(i)} \quad \text{mod } (t+1)^{m_0+1} \end{aligned}$$

Set  $I_m = \{i \in \{1 \dots n\} | m_i = m\}$ ,  $J = \{m \in \mathbb{N} | I_m \neq \emptyset\}$ , and  $B_m = (\beta_{ij})_{(i,j) \in I_m \times I_m}$ .

$$\det(B) = \prod_{m \in J} \det(B_m) \quad \text{mod } (t+1)^{m_0+1}$$

For  $m \in J$ , the matrix  $B_m$  is hermitian, and has all coefficients divisible by  $(t+1)^m$ . So  $\det(B_m)$  is symmetric and divisible by  $(t+1)^{mk(m)}$ , where  $k(m) = |I_m|$ . As  $\det(B_m)$  is symmetric, it is divisible by an even power of  $(t+1)$ , so if  $mk(m)$  is odd,  $\det(B_m)$  is divisible by  $(t+1)^{mk(m)+1}$ . But  $\sum_{m \in J} mk(m) = m_0$ , and  $\det(B) \neq 0 \text{ mod } (t+1)^{m_0+1}$ , so for  $m \in J$ , the multiplicity of  $-1$  as a root of  $\det(B_m)$  is  $mk(m)$ , and  $mk(m)$  is even. Thus, if  $m$  is odd,  $k(m)$  is even.  $\square$

**Remark** This proposition is a consequence of the existence of the Blanchfield form (see Theorem 1.3). It shows one implication of Theorem 1.5.

## 2.4 Realization of equivariant linking matrices

In this subsection, we prove:

**Proposition 2.10.** *Consider a matrix  $A(t)$  with coefficients in  $\Lambda$ , hermitian, and satisfying  $\det(A(1)) \neq 0$ . The matrix  $A(t)$  is the equivariant linking matrix associated with a surgery presentation of a null-homologous knot  $K$  in a  $\mathbb{Q}$ -sphere  $M$ .*

*Proof.* We first need to realize arbitrary linking numbers in  $\mathbb{Q}$ -spheres.

**Lemma 2.11.** *Consider coprime integers  $n$  and  $k$ , with  $n > 0$ . In the lens space  $L(n, k)$  obtained by  $(-\frac{n}{k})$ -surgery on the trivial knot  $U$ , we have  $H_1(L(n, k); \mathbb{Z}) = \frac{\mathbb{Z}}{n\mathbb{Z}}m(U)$  and  $lk(m(U), m(U)) = \frac{k}{n}$ .*

*Proof.* Consider a tubular neighborhood  $T(U)$  of  $U$ , and the exterior  $X$  of  $U$ . Define the preferred parallel  $l_0(U)$  of  $U$  as the intersection of  $T(U)$  with a disk bounded by  $U$ , and define the surgery curve of  $U$  by  $l(U) = nm(U) - kl_0(U)$  in  $H_1(\partial T(U))$ . Now consider the manifold  $L(n, k) = \chi(S^3, U)$ . We have  $H_1(L(n, k); \mathbb{Z}) = \frac{\mathbb{Z}m(U)}{\mathbb{Z}l(U)}$ . In  $H_1(X)$ ,  $l(U) = nm(U)$ . Thus  $H_1(L(n, k); \mathbb{Z}) = \frac{\mathbb{Z}}{n\mathbb{Z}}m(U)$ .

We now compute  $lk(m(U), m(U))$ . Let  $T = S^1 \times D^2$  be the solid torus glued during the surgery. Set  $S_t = \{x \in D^2 | \|x\| = t\}$ . Define a homeomorphism  $h : \partial T = S^1 \times S_1 \rightarrow S^1 \times S_{\frac{1}{2}}$  by  $(s, x) \mapsto (s, \frac{1}{2}x)$ , and set  $m_{int}(U) = h(m(U))$ . Then  $lk(m(U), m(U)) = lk(m_{int}(U), m(U))$ . Consider a meridian disk  $D$  of  $T$  bounded by  $l(U)$ . Then

$$lk(m_{int}(U), l(U)) = \langle m_{int}(U), D \rangle = \langle l(U), m(U) \rangle_{\partial T(U)} = k,$$



and

$$\begin{aligned} lk(m_{int}(U), l(U)) &= lk(m_{int}(U), nm(U) - kl_0(U)) \\ &= n lk(m_{int}(U), m(U)) - k lk(m_{int}(U), l_0(U)). \end{aligned}$$

Since  $lk(m_{int}(U), l_0(U)) = 0$ , we have  $lk(m(U), m(U)) = \frac{k}{n}$ .  $\square$

**Corollary 2.12.** *Take  $m > 0$ , and for all  $1 \leq i \leq m$ , consider coprime integers  $k_i \in \mathbb{Z}$  and  $n_i \in \mathbb{N}^*$ . There exist a  $\mathbb{Q}$ -sphere  $M$  and curves  $c_i$  such that  $H_1(M; \mathbb{Z}) = \bigoplus_{i=1}^m \mathbb{Z}/n_i \mathbb{Z} c_i$ , with  $lk(c_i, c_i) = \frac{k_i}{n_i} \bmod \mathbb{Z}$  et  $lk(c_i, c_j) = 0$  pour  $i \neq j$ .*

*Proof.* By Lemma 2.11, there are  $m$   $\mathbb{Q}$ -spheres  $M_i$  such that  $H_1(M_i; \mathbb{Z}) = \mathbb{Z}/n_i \mathbb{Z} c_i$ , with  $lk(c_i, c_i) = \frac{k_i}{n_i}$ . Define  $M$  as the connected sum of the  $M_i$ .  $\square$

**Corollary 2.13.** *For any family of rational numbers  $(a_{ij})_{1 \leq j \leq i \leq r}$ , there are a  $\mathbb{Q}$ -sphere  $M$  and simple, closed, pairwise disjoint, framed curves  $f_i$ ,  $1 \leq i \leq r$ , in  $M$  such that  $lk(f_i, f_j) = a_{ij}$  for  $j \leq i$ .*

*Proof.* Given integers  $(n_{ij})_{1 \leq j \leq i \leq r}$  and  $(k_{ij})_{1 \leq j \leq i \leq r}$ , with  $n_{ij} > 0$  et  $k_{ij}$  prime to  $n_{ij}$  for all  $1 \leq j \leq i \leq r$ , Corollary 2.12 gives a  $\mathbb{Q}$ -sphere  $M$  such that  $H_1(M; \mathbb{Z}) = \bigoplus_{1 \leq j \leq i \leq r} \mathbb{Z}/n_{ij} \mathbb{Z} c_{ij}$ , with  $lk(c_{ij}, c_{ij}) = \frac{k_{ij}}{n_{ij}} \bmod \mathbb{Z}$  and  $lk(c_{ij}, c_{st}) = 0$  if  $(i, j) \neq (s, t)$ . For  $j < i$ , take  $n_{ij}$  and  $k_{ij}$  such that  $a_{ij} = \frac{k_{ij}}{n_{ij}} \bmod \mathbb{Z}$ . For  $i < j$ , set  $c_{ij} = c_{ji}$ ,  $n_{ij} = n_{ji}$ , and  $k_{ij} = k_{ji}$ . Then, for  $1 \leq i \leq r$ , choose curves  $\gamma_i$  such that  $\gamma_i = \sum_{l \neq i} c_{il}$  in  $H_1(M; \mathbb{Z})$ . For  $i \neq j$ , we get:

$$\begin{aligned} lk(\gamma_i, \gamma_j) &= lk(c_{ij}, c_{ij}) \bmod \mathbb{Z} \\ &= \frac{k_{ij}}{n_{ij}} \bmod \mathbb{Z} \end{aligned}$$

For  $1 \leq i \leq r$ , choose  $n_{ii}$  and  $k_{ii}$  such that  $lk(\gamma_i, \gamma_i) + \frac{k_{ii}}{n_{ii}} = a_{ii} \bmod \mathbb{Z}$ , then consider  $f'_i$  such that  $f'_i = \gamma_i + c_{ii}$  in  $H_1(M; \mathbb{Z})$ . Then:

$$\begin{aligned} lk(f'_i, f'_i) &= lk(\gamma_i, \gamma_i) + lk(c_{ii}, c_{ii}) \bmod \mathbb{Z} \\ &= a_{ii} \bmod \mathbb{Z}, \end{aligned}$$

and, if  $j < i$ ,

$$lk(f'_i, f'_j) = lk(\gamma_i, \gamma_j) = a_{ij} \bmod \mathbb{Z}.$$

Now, we can choose the curves  $f_i$  in the homology classes of the  $f'_i$ , and their preferred parallels  $l(f_i)$ , such that  $lk(f_i, f_j) = a_{ij}$  in  $\mathbb{Q}$  for all  $1 \leq j \leq i \leq r$ .  $\square$

We now prove the proposition, generalizing the method of Levine [Lev65] for knots in  $S^3$ .

Write  $A(t) = (P_{ji}(t))_{1 \leq i, j \leq n}$ , and  $P_{ij}(t) = \sum_{k=-d}^d r_{ij}^{(k)} t^k$ , with  $r_{ij}^{(k)} = r_{ji}^{(-k)}$  for all  $i, j, k$ . By Corollary 2.13, there are a  $\mathbb{Q}$ -sphere  $M_0$  and pairwise disjoint simple closed framed curves  $\gamma_{ik}$ ,  $1 \leq i \leq n$ ,  $0 \leq k \leq d$ , such that, for  $1 \leq i, j \leq n$  and  $0 \leq k, l \leq d$ :

$$lk(\gamma_{ik}, \gamma_{jl}) = \begin{cases} r_{ij}^{(k)} & \text{if } l = 0 \\ r_{ji}^{(l)} & \text{if } k = 0 \\ 0 & \text{otherwise} \end{cases}$$

Consider a disk  $D$  in  $M_0$ , disjoint from all  $\gamma_{ik}$ . Set  $K_0 = \partial D$ . For  $1 \leq i \leq n$  and  $1 \leq k \leq d$ , connect  $\gamma_{i,k-1}$  to  $\gamma_{ik}$  with an arc  $\alpha_{ik}$  such that  $\langle \alpha_{ik}, D \rangle = 1$ , where  $\langle \cdot, \cdot \rangle$  denotes the algebraic intersection number. Choose the  $\alpha_{ik}$  pairwise disjoint, and disjoint from all the  $\gamma_{ik}$ . Now consider a band  $B_{ik} = h_{ik}([-1, 1] \times [0, 1])$  such that:

- $h_{ik}(\{0\} \times [0, 1]) = \alpha_{ik}$ ,
- $h_{ik}([-1, 1] \times \{0\}) = B_{ik} \cap (-\gamma_{i,k-1}) \subset \partial B_{ik}$ ,
- $h_{ik}([-1, 1] \times \{1\}) = B_{ik} \cap \gamma_{ik} \subset -\partial B_{ik}$ .

We also suppose that  $B_{ik}$  meets the tubular neighborhoods  $T(\gamma_{i,k-1})$  and  $T(\gamma_{ik})$  along the preferred parallels  $l(\gamma_{i,k-1})$  and  $l(\gamma_{ik})$ .

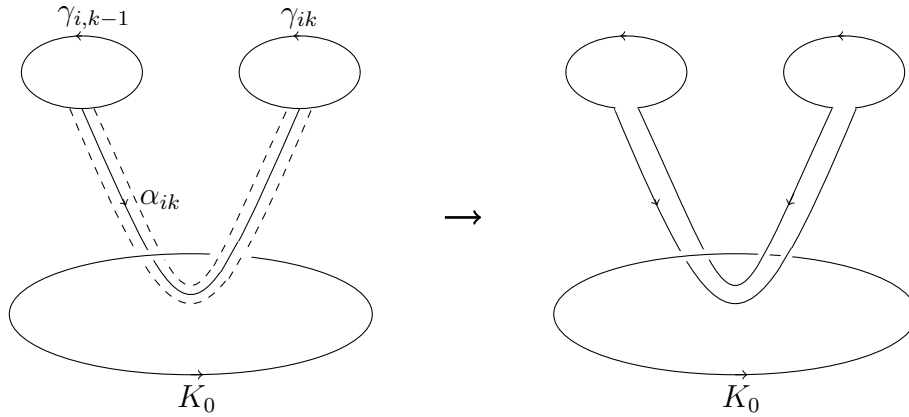

For all  $i$ , define a knot  $J_i$  by:

$$J_i = \left( \left( \prod_{k=0}^d \gamma_{ik} \right) \setminus \left( \prod_{k=0}^d h_{ik}([-1, 1] \times \partial[0, 1]) \right) \right) \cup \left( \prod_{k=0}^d h_{ik}(\partial[-1, 1] \times [0, 1]) \right).$$

Define the preferred parallels  $l(J_i)$  similarly from the  $l(\gamma_{ik})$ . Note that  $J_i$  is homologous to  $\sum_{k=0}^d \gamma_{ik}$ .

Set  $L = \amalg_{i=1}^n J_i$ . For all  $i$ , we have  $lk(J_i, K_0) = 0$ . Since  $\det(A(1)) \neq 0$ ,  $(M_0, L, K_0)$  is an admissible surgery presentation. Set  $(M, K) = (\chi(M_0, L), K_0)$ .

The  $J_i$  lift in the infinite cyclic covering  $\tilde{X}_0$  associated with  $K_0$ . Since  $\langle J_i, D \rangle = 0$ , the lifts are homeomorphic to the  $J_i$ . Choose lifts  $\tilde{J}_i$  such that the corresponding lifts of the  $\gamma_{i0}$  all lie in the same copy of  $M \setminus D$  in  $\tilde{X}_0$ . By Proposition 2.5, the equivariant linking matrix associated with the surgery presentation  $(M_0, L, K_0)$  is a square matrix of order  $n$ , whose coefficients are  $lk_e(\tilde{J}_i, \tilde{J}_j) = \sum_{k \in \mathbb{Z}} lk(\tilde{J}_i, \tilde{J}_{j,k}) t^k$ , with  $\tilde{J}_{j,k} = \tau_0^k(\tilde{J}_j)$ . We have

$$lk(\tilde{J}_i, \tilde{J}_{j,k}) = \begin{cases} \sum_{l=\max(0,k)}^{\min(d,d+k)} lk(\gamma_{il}, \gamma_{j,l-k}) & \text{if } -d \leq k \leq d \\ 0 & \text{otherwise} \end{cases}$$

Fix  $k$  such that  $-d \leq k \leq d$ .

$$lk(\tilde{J}_i, \tilde{J}_{j,k}) = \begin{cases} r_{ij}^{(k)} & \text{if } k \geq 0 \\ r_{ji}^{(-k)} & \text{if } k \leq 0 \end{cases}$$

Since  $r_{ji}^{(-k)} = r_{ij}^{(k)}$ , we get  $lk_e(\tilde{J}_i, \tilde{J}_j) = P_{ij}(t)$ .  $\square$

## 2.5 Proof of Theorem 1.5

The modules satisfying the conditions of Theorem 1.5 can be written as a direct sum of terms  $\frac{\Lambda}{(P)}$ , with  $P$  symmetric,  $P(1) \neq 0$ , and terms  $\frac{\Lambda}{((1+t)^n)} \oplus \frac{\Lambda}{((1+t)^n)}$ , with  $n$  odd. Hence we have to realize these two kinds of modules, and the direct sums of Alexander modules.

**Lemma 2.14.** *If  $P \in \Lambda$  satisfies  $P(t^{-1}) = P(t)$  et  $P(1) \neq 0$ , then there exist a  $\mathbb{Q}$ -sphere  $M$  and a null-homologous knot  $K$  in  $M$  such that the Alexander module of  $K$  is  $\mathfrak{A}(K) = \Lambda/(P)$ .*

*Proof.* Apply Proposition 2.10 and Proposition 2.5 to the  $1 \times 1$  matrix  $A(t) = (P(t))$ .  $\square$

**Lemma 2.15.** *For all integer  $n > 0$ , there exist a  $\mathbb{Q}$ -sphere  $M$  and a null-homologous knot  $K$  in  $M$  such that the Alexander module of  $K$  is:*

$$\mathfrak{A}(K) = \frac{\Lambda}{(1+t)^n} \oplus \frac{\Lambda}{(1+t)^n}$$

*Proof.* Apply Proposition 2.10 and Proposition 2.5 to the matrix:

$$A(t) = \begin{pmatrix} 0 & (1+t)^n \\ (1+t^{-1})^n & 0 \end{pmatrix}.$$

□

Given two null-homologous knots  $K_1$  and  $K_2$  in  $\mathbb{Q}$ -spheres  $M_1$  and  $M_2$ , we define the connected sum  $K_1 \sharp K_2$  of  $K_1$  and  $K_2$  in the connected sum  $M_1 \sharp M_2$  of  $M_1$  and  $M_2$  in the following way. For  $i = 1, 2$ , remove from  $M_i$  a ball  $B_i$  which intersects  $K_i$  along an arc  $\alpha_i([0, 1])$ , trivial in the sense that the complement of a regular neighborhood of  $\alpha_i([0, 1])$  in  $B_i$  is a solid torus. Orient these arcs from  $\alpha_i(0)$  to  $\alpha_i(1)$ . Then glue  $M_1 \setminus \text{Int}(B_1)$  to  $M_2 \setminus \text{Int}(B_2)$  along a homeomorphism  $h : \partial B_1 \rightarrow -\partial B_2$  such that  $h(\alpha_1(0)) = \alpha_2(1)$  and  $h(\alpha_1(1)) = \alpha_2(0)$ .

**Lemma 2.16.** *If  $K_1$  and  $K_2$  are null-homologous knots in  $\mathbb{Q}$ -spheres  $M_1$  and  $M_2$  respectively, then their connected sum  $K = K_1 \sharp K_2$  is a null-homologous knot in the  $\mathbb{Q}$ -sphere  $M = M_1 \sharp M_2$ , and  $\mathfrak{A}(K) = \mathfrak{A}(K_1) \oplus \mathfrak{A}(K_2)$ .*

*Proof.* For  $i = 1, 2$ , consider a surgery presentation  $(S_i^3, L_i, J_i)$  of  $K_i$ . Setting  $S_0^3 = S_1^3 \sharp S_2^3$ ,  $J = J_1 \sharp J_2$  and  $L = L_1 \amalg L_2$ , we get a surgery presentation  $(S_0^3, L, J)$  of  $K$ . Proposition 2.5 gives the presentation matrix  $\begin{pmatrix} A_1(t) & 0 \\ 0 & A_2(t) \end{pmatrix}$  for  $\mathfrak{A}(K)$ , where, for  $i = 1, 2$ ,  $A_i(t)$  is a presentation matrix for  $\mathfrak{A}(K_i)$ . □

## 3 Blanchfield forms

### 3.1 An expression of the Blanchfield form

Consider a null-homologous knot  $K$  in a  $\mathbb{Q}$ -sphere  $M$ , with a surgery presentation  $(M_0, L = \amalg_{i=1}^n J_i, K_0)$ . By Proposition 2.5, the associated equivariant linking matrix  $A(t)$  is a presentation matrix of  $\mathfrak{A}(K)$ . The generators of  $\mathfrak{A}(K)$  associated with this presentation are the meridians  $m_i$  of the  $\tilde{J}_i$  (fixed lifts of the  $J_i$  in the infinite cyclic covering  $\tilde{X}_0$  associated with  $K_0$ ).

**Lemma 3.1.** *Set  $L = -A(t)^{-1}$ . Then  $lk_e(m_i, m_j) = L_{ji}$ .*

Note that  $lk_e(m_i, m_i)$  is well defined, because the  $m_i$  are framed by the  $\partial T(\tilde{J}_i)$ .

*Proof.* The parallel  $l(\tilde{J}_i)$  is rationally null-homologous, so it bounds a rational chain  $\Sigma_i^{(1)}$  in  $\tilde{X}_0$ , which can be chosen to intersect the  $T(\tilde{J}_{j,k})$  along meridian disks. Removing from  $\Sigma_i^{(1)}$  its intersections with the interiors of the  $T(\tilde{J}_{j,k})$  for all  $j \in \{1 \dots n\}$ ,  $k \in \mathbb{Z}$ , we get a new rational chain  $\Sigma_i^{(2)}$  such that:

$$\partial \Sigma_i^{(2)} = l(\tilde{J}_i) - \sum_{j=1}^n lk_e(\tilde{J}_i, \tilde{J}_j) m_j.$$

The chain  $\Sigma_i^{(2)}$  can be viewed in the infinite cyclic covering  $\tilde{X}$  associated with  $K$ . Now, in  $\tilde{X}$ ,  $l(\tilde{J}_i)$  bounds a disk  $D_{i,0}$  contained in the solid torus  $\tilde{T}_{i,0}$  glued during the surgery. Gluing  $D_{i,0}$  and  $-\Sigma_i^{(2)}$  along  $l(\tilde{J}_i)$ , we get a rational chain  $\Sigma_i$  in  $\tilde{X}$  such that:

$$\partial\Sigma_i = \sum_{j=1}^n lk_e(\tilde{J}_i, \tilde{J}_j)m_j = \sum_{j=1}^n A_{ji}(t)m_j.$$

This gives:

$$lk_e(\partial\Sigma_i, m_j) = \sum_{k=1}^n A_{ki}(t)lk_e(m_k, m_j).$$

Now, defining the  $(m_j)_{int}$  as in the proof of Lemma 2.11, we have:

$$\begin{aligned} \langle (m_j)_{int}, \Sigma_i \rangle_e &= \sum_{k \in \mathbb{Z}} \langle (m_j)_{int}, \tau^k(\Sigma_i) \rangle t^k \\ &= -\delta_{ij}, \end{aligned}$$

where  $\langle \cdot, \cdot \rangle_e$  denotes the *equivariant algebraic intersection number*, given by definition by the first equality. So  $lk_e(m_j, \partial\Sigma_i) = -\delta_{ij}$ . Thus  $\sum_{k=1}^n A_{ki}(t)lk_e(m_k, m_j) = -\delta_{ij}$ .  $\square$

**Corollary 3.2.** For  $1 \leq i, j \leq n$ ,  $\mathfrak{b}_K(m_i, m_j) = (-A(t)^{-1})_{ji} \text{ mod } \Lambda$ .

## 3.2 Orthogonal decomposition

In this section, we prove Theorem 1.3. We begin with three useful lemmas.

**Lemma 3.3.** If  $\gamma \in \mathfrak{A}$  has order  $P$ , then there exists  $\eta \in \mathfrak{A}$  such that  $\mathfrak{b}(\gamma, \eta) = \frac{1}{P}$ .

*Proof.* If there exists a strict divisor  $Q$  of  $P$  such that  $Im(\mathfrak{b}(\gamma, \cdot)) \in \frac{1}{Q}\Lambda$ , then  $Q\gamma \in ker(\mathfrak{b})$ , and so  $Q\gamma = 0$ , which is a contradiction. Thus  $PIm(\mathfrak{b}(\gamma, \cdot))$  is an ideal of  $\Lambda/(P)$  which contains a unit. So  $PIm(\mathfrak{b}(\gamma, \cdot)) = \Lambda/(P)$ .  $\square$

**Lemma 3.4.** Let  $\gamma_1, \gamma_2 \in \mathfrak{A}$  have respective orders  $\pi_1$  and  $\pi_2$ . If  $\pi_1$  is prime to  $\bar{\pi}_2$ , then  $\mathfrak{b}(\gamma_1, \gamma_2) = 0$ .

*Proof.* We have  $\pi_1\mathfrak{b}(\gamma_1, \gamma_2) \in \Lambda$  and  $\bar{\pi}_2\mathfrak{b}(\gamma_1, \gamma_2) \in \Lambda$ . As  $\Lambda$  is a principal ideal domain, there are  $A$  and  $B$  in  $\Lambda$  such that  $A\pi_1 + B\bar{\pi}_2 = 1$ , thus  $\mathfrak{b}(\gamma_1, \gamma_2) = A\pi_1\mathfrak{b}(\gamma_1, \gamma_2) + B\bar{\pi}_2\mathfrak{b}(\gamma_1, \gamma_2) \in \Lambda$ .  $\square$

**Lemma 3.5.** Let  $F$  be a  $\Lambda$ -submodule of  $\mathfrak{A}$ , and denote by  $F^\perp$  its orthogonal with respect to  $\mathfrak{b}$ . We have  $\mathfrak{A} = F \oplus F^\perp$  if and only if  $F \cap F^\perp = 0$ .

*Proof.* Write  $F = \bigoplus_{i=1}^p \frac{\Lambda}{(P_i)} x_i$ . For  $y \in \mathfrak{A}$ ,  $\mathfrak{b}(x_i, y) = \frac{P}{P_i}$ , with  $P$  defined modulo  $P_i$ . So  $\text{codim}_{\mathbb{Q}} x_i^\perp \leq \deg(P_i)$  for  $1 \leq i \leq p$ . Now  $F^\perp = \bigcap_{i=1}^p x_i^\perp$ , so  $\text{codim}_{\mathbb{Q}} F^\perp \leq \sum_{i=1}^p \deg(P_i) = \dim_{\mathbb{Q}} F$ . Thus  $\dim_{\mathbb{Q}} F + \dim_{\mathbb{Q}} F^\perp \geq \dim_{\mathbb{Q}} \mathfrak{A}$ .  $\square$

We now prove Theorem 1.3. We can write  $\mathfrak{A} = \bigoplus_{i \in I} \frac{\Lambda}{(\pi_i^{n_i})}$  with  $I$  finite and each  $\pi_i$  prime. Lemma 3.4 gives an orthogonal decomposition into terms  $\bigoplus_{i \in I} \frac{\Lambda}{\pi^{n_i}}$  with  $\pi$  prime and symmetric, and terms  $(\bigoplus_{i \in I} \frac{\Lambda}{(\pi^{n_i})}) \oplus (\bigoplus_{i \in J} \frac{\Lambda}{(\bar{\pi}^{n_i})})$ , with  $\pi$  prime and non symmetric. We have three cases to treat (the case  $\pi = 1 + t$  being particular).

**First case** :  $\mathfrak{A} = \bigoplus_{i \in I} \frac{\Lambda}{\pi^{n_i}}$ ,  $\pi$  prime and symmetric, and  $I$  finite. Denote  $n = \max\{n_i; i \in I\}$ .

First note that there exists  $\gamma \in \mathfrak{A}$  such that  $\mathfrak{b}(\gamma, \gamma) = \frac{P}{\pi^n}$ ,  $P$  prime to  $\pi$ . Indeed, if such a  $\gamma$  does not exist, then, for  $\eta_1$  of order  $\pi^n$  and  $\eta_2$  such that  $\mathfrak{b}(\eta_1, \eta_2) = \frac{1}{\pi^n}$ , we have  $\mathfrak{b}(\eta_1 + \eta_2, \eta_1 + \eta_2) = \frac{Q}{\pi^n}$  with  $Q = 2 \pmod{\pi}$ , which gives a contradiction.

Consider such a  $\gamma$ , and denote by  $F$  the  $\Lambda$ -submodule of  $\mathfrak{A}$  generated by  $\gamma$ . If  $x \in F \cap F^\perp$ , then  $x = \lambda\gamma$  for a  $\lambda \in \Lambda$ , and  $\mathfrak{b}(x, \gamma) = 0$  implies  $\lambda \in \pi^n \Lambda$ . Hence  $\mathfrak{A} = F \oplus F^\perp$ .

As  $\dim_{\mathbb{Q}}(F^\perp) < \dim_{\mathbb{Q}}(\mathfrak{A})$ , we can conclude by induction.

**Second case** :  $\mathfrak{A} = (\bigoplus_{i \in I} \frac{\Lambda}{(\pi^{n_i})}) \oplus (\bigoplus_{i \in J} \frac{\Lambda}{(\bar{\pi}^{n_i})})$ , with  $\pi$  prime, non symmetric,  $\pi(-1) \neq 0$ , and  $I$  and  $J$  finite. The conditions on  $\pi$  imply that  $\pi$  is prime to  $\bar{\pi}$ . In particular, in the direct sum above, the two main terms are submodules isotropic for  $\mathfrak{b}$ .

Denote  $n = \max\{n_i; i \in I \cup J\}$ . Without loss of generality, we suppose that  $n$  appears as a power of  $\pi$ . Consider  $\gamma_1$  of order  $\pi^n$ , and  $\gamma_2$  such that  $\mathfrak{b}(\gamma_1, \gamma_2) = \frac{1}{\pi^n}$ . Since projecting  $\gamma_2$  on  $\bigoplus_{i \in J} \frac{\Lambda}{(\bar{\pi}^{n_i})}$  does not change  $\mathfrak{b}(\gamma_1, \gamma_2)$ , we can suppose  $\gamma_2$  has order  $\bar{\pi}^k$ , and  $\mathfrak{b}(\gamma_1, \gamma_2) = \frac{1}{\pi^n}$  implies  $k = n$ .

Now denote by  $G$  the  $\Lambda$ -submodule of  $\mathfrak{A}$  generated by  $\gamma_1$  and  $\gamma_2$ . If  $x \in G \cap G^\perp$ , write  $x = \lambda\gamma_1 + \mu\gamma_2$  with  $\lambda, \mu \in \Lambda$ . Then  $\mathfrak{b}(x, \gamma_1) = 0$  implies  $\mu \in \bar{\pi}^n \Lambda$ , and  $\mathfrak{b}(x, \gamma_2) = 0$  implies  $\lambda \in \pi^n \Lambda$ . So  $x = 0$ . Hence  $\mathfrak{A} = G \oplus G^\perp$ . Again  $\dim_{\mathbb{Q}}(G^\perp) < \dim_{\mathbb{Q}}(\mathfrak{A})$ , and we conclude by induction.

**Third case** :  $\mathfrak{A} = \bigoplus_{i \in I} \frac{\Lambda}{((1+t)^{n_i})}$ , with  $I$  finite. Denote  $n = \max\{n_i; i \in I\}$ .

If  $n$  is even, we can replace  $(1+t)^n$  by  $(t+2+t^{-1})^{n/2}$ , and proceed exactly like in the first case. Now suppose  $n$  is odd.

First note that, for all  $\gamma \in \mathfrak{A}$ ,  $\mathfrak{b}(\gamma, \gamma) = \frac{P}{(1+t)^k}$ , with  $k$  even,  $P(-1) \neq 0$  or  $P = 0$ . Indeed, if  $\mathfrak{b}(\gamma, \gamma) = \frac{P}{(1+t)^k}$ , we have  $\frac{P}{(1+t)^k} = \frac{\bar{P}}{(1+t^{-1})^k}$ , so  $P = t^k \bar{P}$ , and  $k$  odd implies  $P(-1) = 0$ .

Consider  $\gamma_1$  of order  $(1+t)^n$  and  $\gamma_2$  such that  $\mathfrak{b}(\gamma_1, \gamma_2) = \frac{1}{(1+t)^n}$ . Note that  $\gamma_2$  also has order  $(1+t)^n$ . Denote by  $H$  the  $\Lambda$ -submodule of  $\mathfrak{A}$  generated by  $\gamma_1$  and  $\gamma_2$ . For

$x \in H \cap H^\perp$ , write  $x = \lambda\gamma_1 + \mu\gamma_2$ , with  $\lambda, \mu \in \Lambda$ . If  $\lambda$  or  $\mu$  is in  $(1+t)^n\Lambda$ , then  $x = 0$ . Suppose  $\lambda$  and  $\mu$  are not in  $(1+t)^n\Lambda$ . We have:

$$\begin{cases} \lambda \mathfrak{b}(\gamma_1, \gamma_1) + \frac{\mu}{(1+t^{-1})^n} = 0 \\ \frac{\lambda}{(1+t)^n} + \mu \mathfrak{b}(\gamma_2, \gamma_2) = 0 \end{cases}.$$

Define minimal integers  $j$  and  $k$  such that  $(1+t)^j \mathfrak{b}(\gamma_1, \gamma_1)$  and  $(1+t)^k \mathfrak{b}(\gamma_2, \gamma_2)$  are in  $\Lambda$ , and denote by  $m_\lambda$  (resp.  $m_\mu$ ) the multiplicity of the root  $-1$  in  $\lambda$  (resp.  $\mu$ ). We get:

$$\begin{cases} m_\lambda - j = m_\mu - n \\ m_\lambda - n = m_\mu - k \end{cases}.$$

This implies  $n - j = k - n$ . But  $n - j \geq 0$  and  $k - n \leq 0$ , so  $j = k = n$ , which is a contradiction, because  $n$  is odd, whereas  $j$  and  $k$  are even. Hence  $\mathfrak{A} = H \oplus H^\perp$ .

We have showed in particular that  $\lambda\gamma_1 + \mu\gamma_2 = 0$  implies  $(1+t)^n$  divides  $\lambda$  and  $\mu$ . So  $H = \frac{\Lambda}{((1+t)^n)}\gamma_1 \oplus \frac{\Lambda}{((1+t)^n)}\gamma_2$ . The last point is to describe the form  $\mathfrak{b}$  over this submodule.

The matrix of the form  $\mathfrak{b}$  on  $H$ , with respect to the basis  $(\gamma_1, \gamma_2)$ , is

$$\begin{pmatrix} \frac{\alpha(t)}{(t+2+t^{-1})^k} & \frac{1}{(1+t)^n} \\ \frac{1}{(1+t^{-1})^n} & \frac{\beta(t)}{(t+2+t^{-1})^l} \end{pmatrix},$$

with  $k, l < \frac{n}{2}$ ,  $\alpha$  and  $\beta$  symmetric. We want to show that there is a basis such that  $\alpha$  and  $\beta$  vanish. We shall first get  $\alpha = 0$ . Define  $\eta_1 = \gamma_1 + \frac{(-1)^k \alpha(-1)}{2} (1+t)^{n-2k} \gamma_2$ . We get:

$$\mathfrak{b}(\eta_1, \eta_1) = \frac{\alpha(t) + \frac{(-1)^k \alpha(-1)}{2} (t^{k-n} + t^{n-k}) + \frac{\alpha(-1)^2}{4} (t+2+t^{-1})^{(n-k-l)} \beta(t)}{(t+2+t^{-1})^k}$$

Since  $n - k - l > 0$ , the numerator vanishes for  $t = -1$ . So  $\mathfrak{b}(\eta_1, \eta_1)$  can be written  $\mathfrak{b}(\eta_1, \eta_1) = \frac{\nu(t)}{(t+2+t^{-1})^{k'}}$ , where  $k' < k$ . Now choose  $\eta_2 \in H$  such that  $\mathfrak{b}(\eta_1, \eta_2) = \frac{1}{(1+t)^n}$ . Replacing the basis  $(\gamma_1, \gamma_2)$  by the basis  $(\eta_1, \eta_2)$  makes the integer  $k$  decrease. Iterating this process, we get a basis, again denoted  $(\gamma_1, \gamma_2)$ , such that  $\alpha = 0$ .

Now consider  $\gamma = \gamma_2 + a(t)\gamma_1$ . We have:

$$\mathfrak{b}(\gamma, \gamma) = \frac{a(t) + \bar{a}(t)t^n + \beta(t)t^l(1+t)^{n-2l}}{(1+t)^n}.$$

Set  $a(t) = -\frac{1}{2}\beta(t)t^l(1+t)^{n-2l}$ . Then  $\bar{a}(t)t^n = a(t)$ , so  $\mathfrak{b}(\gamma, \gamma) = 0$ . Hence in the basis  $(\gamma_1, \gamma)$ , we get  $\alpha = 0$  and  $\beta = 0$ . This concludes the proof of Theorem 1.3.

As a direct consequence of Theorem 1.3, we get the following lemma.







*Proof.* Consider the following commutative diagram of groups, where the morphisms  $\pi_n$ ,  $\pi_1$ ,  $p_E$ ,  $p_D$  are the natural projections:

$$\begin{array}{ccccccc} E_n^* & \xrightarrow{\varphi_n} & D_n^* & \xrightarrow{\pi_n} & \text{coker}(\varphi_n) & & \\ \downarrow p_E & & \downarrow p_D & & & & \\ E_1^* & \xrightarrow{\varphi_1} & D_1^* & \xrightarrow{\pi_1} & \text{coker}(\varphi_1) & & \end{array}$$

Let us show the existence of a morphism  $p_c : \text{coker}(\varphi_n) \rightarrow \text{coker}(\varphi_1)$  such that the diagram still commutes. We have to show that  $\pi_n(P) = \pi_n(Q)$  implies  $\pi_1 \circ p_D(P) = \pi_1 \circ p_D(Q)$ , i.e.  $\ker(\pi_n) \subset \ker(\pi_1 \circ p_D)$ .

$$\pi_1 \circ p_D(\ker(\pi_n)) = \pi_1 \circ p_D(\varphi_n(E_n^*)) = \pi_1 \circ \varphi_1 \circ p_E(E_n^*) = 0$$

So  $p_c$  is well defined, and it is obviously surjective. It remains to show that it is injective.

Consider  $x \in \ker(p_c)$ . There is  $y$  in  $D_n^*$  such that  $x = \pi_n(y)$ . Then  $\pi_1 \circ p_D(y) = 1$ , so  $p_D(y) = \varphi_1 \circ p_E(z) = p_D \circ \varphi_n(z)$ . Thus  $p_D(y\varphi_n(z^{-1})) = 1$ . It remains to show that  $P = y\varphi_n(z^{-1}) \in \text{Im}(\varphi_n)$ .

We can write  $P = 1 + \sum_{i=1}^{n-1} P_i \Delta_s^i$  with  $d^\circ P_i < d^\circ \Delta_s$  for  $1 \leq i \leq n-1$ . We shall search  $R \in E_n^*$  such that  $R\bar{R}(t) = P(t+t^{-1})$  of the form  $R = 1 + \sum_{i=1}^{n-1} R_i \Delta^i$ , with  $R_i$  symmetric and  $d^\circ R_i < d^\circ \Delta$  for  $1 \leq i \leq n-1$ . We have  $R\bar{R} = 1 + \sum_{i=1}^{n-1} Q_i \Delta^i$ , where  $Q_i$  is the sum of  $2R_i$  and a term depending on the  $R_j$  for  $j < i$ . So we can define the  $R_i$  by induction in order to get  $Q_i(t) = P_i(t+t^{-1})$ . Hence  $P \in \varphi_n(E_n^*)$ .  $\square$

We now suppose  $n = 1$ , and denote  $D_1$ ,  $E_1$ ,  $\varphi_1$ , by  $D$ ,  $E$ ,  $\varphi$ . We first treat the case  $\Delta(t) = t + 2 + t^{-1}$ .

**Lemma 3.10.** *If  $\Delta(t) = t + 2 + t^{-1}$ , then*

$$\text{coker}(\varphi) \cong \mathbb{Q}^*/(\mathbb{Q}^*)^2 \cong \mathbb{Z}/2\mathbb{Z} \times \bigoplus_{\text{prime integers}} \mathbb{Z}/2\mathbb{Z}.$$

*Proof.* We have  $D = \frac{\mathbb{Q}[s]}{(s+2)} \simeq \mathbb{Q}$  and  $E = \frac{\Lambda}{(t+2+t^{-1})}$ . The elements of  $E^*$  can be written  $at + b$ , with  $a \neq b$  in  $\mathbb{Q}$ . Now  $\varphi(at + b) = a^2 + b^2 + abs = (a - b)^2 \pmod{(s+2)}$ . So  $\text{Im}(\varphi) = (\mathbb{Q}^*)^2$ .

Each element of  $\mathbb{Q}^*$  can be written uniquely  $\varepsilon \prod_p \text{prime} p^{n(p)}$  with only a finite number of non-zero  $n(p)$ , and  $\varepsilon = \pm 1$ . Thus each element in the quotient  $\mathbb{Q}^*/(\mathbb{Q}^*)^2$  can be written uniquely  $\varepsilon \prod_p \text{prime} p^{n(p)}$  with  $n(p) = 1$  for a finite number of primes  $p$ , and  $n(p) = 0$  for the others.  $\square$

We now suppose  $\Delta$  prime. In the general case, we will use some material of algebraic number theory. We will not detail these notions, and we refer the reader to [Sam67].

Since  $\Delta$  is prime,  $\Delta_s$  is prime too, so  $D$  is a number field, that is a finite extension of  $\mathbb{Q}$ . We can write  $E = \frac{D[t]}{(t^2-st+1)}$ , so  $E$  is a Galois extension of  $D$  of degree 2. We denote by  $\sigma$  the only non trivial element of its Galois group. Denote by  $\alpha$  the image of  $t$  in  $\frac{D[t]}{(t^2-st+1)}$ . It is a primitive element in  $E$ , *i.e.*  $E = D[\alpha]$ , and the morphism  $\sigma$  is given by  $\sigma|_D = id_D$  and  $\sigma(\alpha) = \alpha^{-1}$ . Note that  $\sigma$  is induced by the conjugation  $t \mapsto t^{-1}$  in  $\Lambda$ . Define the norm  $N_{E/D} : E \rightarrow D$  by  $N_{E/D}(x) = x\sigma(x)$ . On  $E^*$ , the norm  $N_{E/D}$  coincides with the morphism  $\varphi$ .

Denote by  $A_D$  the ring of integers of  $D$ . A *fractional ideal* of  $D$  is a  $A_D$ -module  $I$  such that  $I \subset D$  and  $kI \subset A_D$  for a  $k \in D^*$ . The *product* of two fractional ideals  $I$  and  $J$  is made of all finite sums of products  $ij$  with  $i \in I$  and  $j \in J$ . It is again a fractional ideal. With this multiplication, the non trivial fractional ideals of  $D$  form a group denoted by  $\mathcal{F}_D$ . The principal fractional ideals of  $D$  are the fractional ideals of type  $kA_D$  for  $k \in D^*$ . They form a sub-group  $\mathcal{P}_D$  of  $\mathcal{F}_D$ . The quotient group  $\mathcal{C}_D = \mathcal{F}_D/\mathcal{P}_D$  is called the *ideal class group* of  $D$ .

**Theorem 3.11** (Dirichlet). (*[Sam67, p.71, Theorem 2]*)  
*The ideal class group of a number field is finite.*

We have a short exact sequence:

$$0 \rightarrow \mathcal{P}_D \rightarrow \mathcal{F}_D \rightarrow \mathcal{C}_D \rightarrow 0.$$

This can be related to  $D^*$  by the surjective map  $D^* \twoheadrightarrow \mathcal{P}_D$  given by  $k \mapsto kA_D$ .

The field  $E$  also is a number field, so all the previous definitions and results apply to  $E$ . We shall define commutative diagrams based on the above exact sequence and surjective map, and the norm morphism. For an ideal  $xA_E$ , define  $N_{E/D}(xA_E) = N_{E/D}(x)A_D$ . Now we have the following commutative diagram, where the vertical arrows are given by the norm  $N_{E/D}$ .

$$\begin{array}{ccc} E^* & \twoheadrightarrow & \mathcal{P}_E \\ \downarrow & & \downarrow \\ D^* & \twoheadrightarrow & \mathcal{P}_D \end{array}$$

This induces a surjective map  $\text{coker}(N_{E/D} : E^* \rightarrow D^*) \twoheadrightarrow \text{coker}(N_{E/D} : \mathcal{P}_E \rightarrow \mathcal{P}_D)$ . Recall our aim is to show that  $\text{coker}(N_{E/D} : E^* \rightarrow D^*)$  is infinite. It suffices to show that  $\text{coker}(N_{E/D} : \mathcal{P}_E \rightarrow \mathcal{P}_D)$  is infinite. To see this, we will use the above exact sequence.

For a fractional ideal  $J$  of  $E$ , define  $N_{E/D}(J)$  as the ideal of  $D$  generated over  $A_D$  by all the  $N_{E/D}(x)$  for  $x \in J$ . For a principal ideal, we recover the previous definition. We get the following commutative diagram, where the vertical arrows are again given by the norm  $N_{E/D}$ .

$$\begin{array}{ccccccccc} 0 & \longrightarrow & \mathcal{P}_E & \longrightarrow & \mathcal{F}_E & \longrightarrow & \mathcal{C}_E & \longrightarrow & 0 \\ & & \downarrow & & \downarrow & & \downarrow & & \\ 0 & \longrightarrow & \mathcal{P}_D & \longrightarrow & \mathcal{F}_D & \longrightarrow & \mathcal{C}_D & \longrightarrow & 0 \end{array}$$

Since  $\mathcal{C}_E$  and  $\mathcal{C}_D$  are finite, it remains to show that  $\text{coker}(N_{E/D} : \mathcal{F}_E \rightarrow \mathcal{F}_D)$  is infinite.

Any fractional ideal  $I$  of  $D$  has a unique factorisation  $I = \prod_{i=1}^q \mathfrak{p}_i^{e_i}$  where  $q \in \mathbb{N}^*$  and for each  $i$ ,  $\mathfrak{p}_i$  is a prime ideal of  $A_D$  and  $e_i \in \mathbb{Z}$  ([Sam67, p.60, Theorem 3]). Now, for any  $J \in \mathcal{F}_D$ , we have  $N_{E/D}(JA_E) = J^2$  ([Lan94, p.25, Corollary 1]). So  $I$  is in the image of  $N_{E/D}$  if and only if, for each  $i$  such that  $e_i$  is odd,  $\mathfrak{p}_i$  is in the image of  $N_{E/D}$ .

Note that there are infinitely many prime ideals in  $A_D$ . Indeed, if  $p$  is a prime integer, there is a prime ideal  $I_p$  of  $A_D$  such that  $I_p \cap \mathbb{Z} = p\mathbb{Z}$  ([Lan94, p.9, Proposition 9]).

Now consider a prime ideal  $\mathfrak{p}$  of  $A_D$  and set  $J = \mathfrak{p}A_E$ . The primes that appear in the decomposition of  $J$  are exactly those whose intersection with  $A_D$  is  $\mathfrak{p}$ . We have three cases ([Sam67, §5.2]):

- $J = \mathfrak{P}^2$ , with  $\mathfrak{P}$  prime in  $A_E$ , and  $N_{E/D}(\mathfrak{P}) = \mathfrak{p}$ ,
- $J$  itself is prime, and  $N_{E/D}(J) = \mathfrak{p}^2$ ,
- $J = \mathfrak{P}_1\mathfrak{P}_2$ , with  $\mathfrak{P}_1$  and  $\mathfrak{P}_2$  primes,  $\mathfrak{P}_2 = \sigma(\mathfrak{P}_1)$ , and  $N_{E/D}(\mathfrak{P}_i) = \mathfrak{p}$  for  $i = 1, 2$ .

In the second case, the ideal  $\mathfrak{p}$  is not in the image of  $N_{E/D}$ . It follows from the Tchebotarev density theorem ([Lan94, p.169, Theorem 10]) that the density of the subset of prime ideals  $\mathfrak{p}$  of  $A_D$  for which  $J$  is prime is equal to  $\frac{1}{2}$  in the set of all prime ideals. This concludes the proof.  $\square$

# Chapitre 5 : Formes de Blanchfield rationnelles, S-équivalence, et chirurgies LP nulles

## Résumé

Dans ce chapitre, on montre qu'une chirurgie LP nulle induit un isomorphisme canonique entre les  $\mathbb{Q}[t^{\pm 1}]$ -modules d'Alexander des paires concernées, qui préserve la forme de Blanchfield. Réciproquement, on montre qu'un isomorphisme fixé entre des modules d'Alexander munis de leurs formes de Blanchfield peut être réalisé, à multiplication près par une puissance de  $t$ , par une suite finie de chirurgies LP nulles. On montre aussi que ces classes d'isomorphismes peuvent être réalisées par des S-équivalences rationnelles. Une version antérieure de ce texte a été publiée sur *ArXiv*. On y montre que deux QSK-paires ont des modules d'Alexander rationnels munis de leurs formes de Blanchfield isomorphes si et seulement si elles admettent des matrices de Seifert S-équivalentes, et si et seulement si elles s'obtiennent l'une de l'autre par une suite finie de chirurgies LP rationnelles nulles, mais on n'y traite pas la question de la réalisabilité d'un isomorphisme fixé.

# Rational Blanchfield forms, S-equivalence, and null LP-surgeries

## Abstract

Garoufalidis and Rozansky introduced null-moves on the set of pairs  $(M, K)$ , where  $M$  is an integral homology sphere and  $K$  is a knot in  $M$ . These null-moves are suitable to study the Kriker lift of the Kontsevich integral. They induce a filtration on the space generated by pairs  $(M, K)$  up to orientation-preserving homeomorphism. This filtration splits with respect to the isomorphism classes of integral Alexander modules equipped with their Blanchfield forms. Null Lagrangian-preserving surgeries are a generalization of the Garoufalidis and Rozansky null-moves in the setting of pairs  $(M, K)$  composed of a rational homology sphere  $M$  and a null-homologous knot  $K$  in  $M$ . They are defined as replacements of null-homologous rational homology handlebodies of  $M \setminus K$  by other such handlebodies with identical Lagrangian. A null Lagrangian-preserving surgery induces a canonical isomorphism between the Alexander  $\mathbb{Q}[t^{\pm 1}]$ -modules of the involved pairs, which preserves the Blanchfield form. Conversely, we prove that a fixed isomorphism between Alexander  $\mathbb{Q}[t^{\pm 1}]$ -modules which preserves the Blanchfield form can be realized, up to multiplication by a power of  $t$ , by a finite sequence of null Lagrangian-preserving surgeries. We also prove that such classes of isomorphisms can be realized by rational S-equivalence.

## 1 Introduction

### 1.1 Context

In [GR04], Garoufalidis and Rozansky studied the rational vector space generated by the pairs  $(M, K)$  modulo orientation-preserving homeomorphism, where  $M$  is an *integral homology 3-sphere* (ZHS), that is an oriented compact 3-manifold which has the same homology with integral coefficients as  $S^3$ , and  $K$  is a knot in  $M$ . They defined a filtration on this space by means of null-moves, that are surgeries on claspers (see Garoufalidis, Goussarov and Polyak in [GGP01] and Habiro in [Hab00b]) whose leaves are trivial in  $H_1(M \setminus K; \mathbb{Z})$ . They studied this filtration with the Kriker lift of the Kontsevich integral defined in [GK04]. The first step in the study of this filtration is the determination of the classes of pairs  $(M, K)$  up to null-moves. As a corollary of results of Matveev in [Mat87], Naik and Stanford in [NS03], and Trotter in [Tro73], Garoufalidis and Rozansky established that two pairs can be obtained from one another by a finite sequence of null-moves if and only if they admit S-equivalent Seifert matrices, and if and only if they have isomorphic integral Alexander modules and Blanchfield forms.

In this article, we consider pairs  $(M, K)$ , where  $M$  is a *rational homology 3-sphere* (QHS), *i.e.* an oriented compact 3-manifold which has the same homology with rational coefficients as  $S^3$ , and  $K$  is a *null-homologous knot* in  $M$ , *i.e.* a knot whose class in  $H_1(M; \mathbb{Z})$  is trivial. We define the null Lagrangian-preserving surgeries, which play the role played by the null-moves in the integral case. We prove that the classes of pairs  $(M, K)$  modulo null Lagrangian-preserving surgeries are characterized by the classes of rational S-equivalence of their Seifert matrices, and by the isomorphism classes of their rational Alexander modules equipped with their Blanchfield forms. Furthermore, we prove that a fixed isomorphism between rational Alexander modules which preserves the Blanchfield form can be realized, up to multiplication by a power of  $t$ , by a finite sequence of null Lagrangian-preserving surgeries. Null Lagrangian-preserving surgeries define a filtration of the rational vector space generated by pairs  $(M, K)$  modulo orientation-preserving homeomorphism. This article is a first step in the study of this filtration, that is useful in the study of equivariant finite type knot invariants.

## 1.2 Statement of the results

When it does not seem to cause confusion, we use the same notation for a curve and its homology class.

We first recall the definition of the Alexander module and of the Blanchfield form. Let  $(M, K)$  be a  $\mathbb{Q}SK$ -pair, that is a pair made of a rational homology sphere  $M$  and a null-homologous knot  $K$  in  $M$ . Let  $T(K)$  be a tubular neighborhood of  $K$ . The *exterior* of  $K$  is  $X = M \setminus \text{Int}(T(K))$ . Consider the projection  $\pi : \pi_1(X) \rightarrow \frac{H_1(X; \mathbb{Z})}{\text{torsion}} \cong \mathbb{Z}$ , and the covering map  $p : \tilde{X} \rightarrow X$  associated with its kernel. The covering  $\tilde{X}$  is the *infinite cyclic covering* of  $X$ . The automorphism group of the covering,  $\text{Aut}(\tilde{X})$ , is isomorphic to  $\mathbb{Z}$ . It acts on  $H_1(\tilde{X}; \mathbb{Q})$ . Denoting the action of a generator  $\tau$  of  $\text{Aut}(\tilde{X})$  as the multiplication by  $t$ , we get a structure of  $\mathbb{Q}[t^{\pm 1}]$ -module on  $\mathfrak{A}(K) = H_1(\tilde{X}; \mathbb{Q})$ . This  $\mathbb{Q}[t^{\pm 1}]$ -module is the *Alexander module* of  $K$ . It is a torsion  $\mathbb{Q}[t^{\pm 1}]$ -module.

**Definition 1.1.** Let  $(M, K)$  and  $(M', K')$  be  $\mathbb{Q}SK$ -pairs. Let  $\xi : \mathfrak{A}(K) \rightarrow \mathfrak{A}(K')$  be an isomorphism. The  $\tau$ -class of  $\xi$  is the set of the isomorphisms  $\xi \circ m_k$  for  $k \in \mathbb{Z}$ , where  $m_k$  is the multiplication by  $t^k$ .

Note that the  $\tau$ -class of  $\xi$  is composed of all the isomorphisms that can be obtained from  $\xi$  by composition by isomorphisms of  $\mathfrak{A}(K)$  or  $\mathfrak{A}(K')$  induced by automorphisms of the underlying coverings.

On the Alexander module  $\mathfrak{A}(K)$ , one can define the *Blanchfield form*, or *equivariant linking pairing*,  $\mathfrak{b}_K : \mathfrak{A}(K) \times \mathfrak{A}(K) \rightarrow \frac{\mathbb{Q}(t)}{\mathbb{Q}[t^{\pm 1}]}$ , as follows. First define the equivariant linking number of two knots.

**Definition 1.2.** Let  $J_1$  and  $J_2$  be two knots in  $\tilde{X}$  such that  $J_1 \cap \tau^k(J_2) = \emptyset$  for all  $k \in \mathbb{Z}$ . Let  $\delta(t)$  be the annihilator of  $\mathfrak{A}(K)$ . Then  $\delta(\tau)J_1$  and  $\delta(\tau)J_2$  are rationally

null-homologous links. The *equivariant linking number* of  $J_1$  and  $J_2$  is

$$lk_e(J_1, J_2) = \frac{1}{\delta(t)\delta(t^{-1})} \sum_{k \in \mathbb{Z}} lk(\delta(\tau)J_1, \tau^k(\delta(\tau)J_2))t^k.$$

One can easily see that  $lk_e(J_1, J_2) \in \frac{1}{\delta(t)}\mathbb{Q}[t^{\pm 1}]$ ,  $lk_e(J_2, J_1)(t) = lk_e(J_1, J_2)(t^{-1})$ , and  $lk_e(P(\tau)J_1, Q(\tau)J_2)(t) = P(t)Q(t^{-1})lk_e(J_1, J_2)(t)$ . Now, if  $\gamma$  (resp.  $\eta$ ) is the homology class of  $J_1$  (resp.  $J_2$ ) in  $\mathfrak{A}(K)$ , define  $\mathfrak{b}_K(\gamma, \eta)$  by:

$$\mathfrak{b}_K(\gamma, \eta) = lk_e(J_1, J_2) \text{ mod } \mathbb{Q}[t^{\pm 1}].$$

The Blanchfield form is hermitian:  $\mathfrak{b}_K(\gamma, \eta)(t) = \mathfrak{b}_K(\eta, \gamma)(t^{-1})$  and  $\mathfrak{b}_K(P(t)\gamma, Q(t)\eta)(t) = P(t)Q(t^{-1})\mathfrak{b}_K(\gamma, \eta)(t)$  for all  $\gamma, \eta \in \mathfrak{A}(K)$  and all  $P, Q \in \mathbb{Q}[t^{\pm 1}]$ . Moreover, it is non degenerate (see Blanchfield in [Bla57]) :  $\mathfrak{b}_K(\gamma, \eta) = 0$  for all  $\eta \in \mathfrak{A}(K)$  implies  $\gamma = 0$ .

We turn to the notion of Seifert matrices. Let  $\Sigma$  be a *Seifert surface* of  $K$ , *i.e.* a compact connected oriented surface in  $M$  such that  $\partial\Sigma = K$ . Such a surface exists since  $K$  is null-homologous. Let  $g$  be the genus of  $\Sigma$ . Let  $(f_i)_{1 \leq i \leq 2g}$  be a symplectic basis of  $H_1(\Sigma; \mathbb{Z})$ , *i.e.* a basis such that the matrix of the intersection form in  $(f_i)_{1 \leq i \leq 2g}$  is  $-J$ , where  $J$  is made of blocks  $\begin{pmatrix} 0 & -1 \\ 1 & 0 \end{pmatrix}$  on the diagonal, and zeros elsewhere. The *Seifert matrix* of  $K$  associated with  $\Sigma$  and  $(f_i)_{1 \leq i \leq 2g}$  is the matrix  $V \in \mathcal{M}_{2g}(\mathbb{Q})$  defined by  $V_{ij} = lk(f_i, f_j^+)$ , where  $f_j^+$  is a push-off of  $f_j$  in the direction of the positive normal of  $\Sigma$ . This matrix satisfies  $V - V^t = J$ , where  $V^t$  denotes the transpose of  $V$ . Any rational matrix with this property will be called a *Seifert matrix*. In Section 5, we prove that any such matrix is indeed the Seifert matrix of a QSK-pair  $(M, K)$ .

Given the Seifert matrix  $V$ , one can compute the Alexander module  $\mathfrak{A}(K)$  and the Blanchfield form  $\mathfrak{b}_K$ . Construct a surface  $\hat{\Sigma}$  by adding a band to  $\Sigma$  along  $K$ , so that  $\hat{\Sigma}$  is homeomorphic to  $\Sigma$  and contains  $\Sigma$  and  $K$  in its interior. Let  $T(\Sigma) = \hat{\Sigma} \times [-1, 1]$  be a tubular neighborhood of  $\Sigma$ . For  $1 \leq i \leq 2g$ , let  $e_i \subset (Int(T(\Sigma))) \setminus \Sigma$  be a meridian of  $f_i$ . The module  $\mathfrak{A}(K)$  can be presented as:

$$\mathfrak{A}(K) = \frac{\bigoplus_{1 \leq i \leq 2g} \mathbb{Q}[t^{\pm 1}]b_i}{\bigoplus_{1 \leq j \leq 2g} \mathbb{Q}[t^{\pm 1}]\partial S_j},$$

where the  $b_i$  are lifts of the  $e_i$  in  $\tilde{X}$ , and the  $S_j$  are lifts of the  $f_j \times [-1, 1]$ . Set  $f_i^+ = f_i \times \{1\}$  and  $f_i^- = f_i \times \{-1\}$ . Assume the  $b_i$  are all chosen in the same copy of  $M \setminus \Sigma$ . For  $1 \leq i \leq 2g$ , let  $\tilde{f}_i^+$  and  $\tilde{f}_i^-$  be lifts of  $f_i^+$  and  $f_i^-$  in the same copy of  $M \setminus \Sigma$  as the  $b_j$ . Assume the  $S_j$  are chosen so that  $\partial S_j = t\tilde{f}_j^+ - \tilde{f}_j^-$ . Then  $\partial S_j = \sum_{1 \leq i \leq 2g} (tV - V^t)_{ij}b_i$ , hence  $tV - V^t$  is a presentation matrix of  $\mathfrak{A}(K)$  (see [Lic97, Chapter 6]). Moreover, we have  $lk_e(\partial S_j, b_i) = (1-t)\delta_{ij}$ . Using the expression of  $\partial S_j$  in terms of the  $b_i$ , it follows that the form  $\mathfrak{b}_K$  is given by  $\mathfrak{b}_K(b_i, b_j) = (1-t)((tV - V^t)^{-1})_{ji} \text{ mod } \mathbb{Q}[t^{\pm 1}]$  (see Kearton in [Kea75, §8]).



A  $\mathbb{Q}SK$ -system is a quintuple  $(M, K, \Sigma, \underline{f}, V)$  where  $(M, K)$  is a  $\mathbb{Q}SK$ -pair,  $\Sigma$  is a Seifert surface of  $K$  in  $M$ ,  $\underline{f} = (f_i)_{1 \leq i \leq 2g}$  is a symplectic basis of  $H_1(\Sigma; \mathbb{Z})$ , and  $V$  is the associated Seifert matrix. Given a  $\mathbb{Q}SK$ -system, the associated family  $(b_i)_{1 \leq i \leq 2g}$  of generators of  $\mathfrak{A}(K)$  is determined up to multiplication of the whole family by  $t^k$  for some integer  $k$ .

**Definition 1.3.** A *row enlargement* of a matrix  $V \in \mathcal{M}_{2g}(\mathbb{Q})$  is a matrix  $W = \begin{pmatrix} 0 & 0 & 0 \\ 1 & x & \rho^t \\ 0 & \rho & V \end{pmatrix}$ , where  $x \in \mathbb{Q}$  and  $\rho \in \mathbb{Q}^{2g}$ . Then the matrix  $V$  is a *row reduction* of  $W$ . A *column enlargement* of  $V$  is a matrix  $W = \begin{pmatrix} 0 & -1 & 0 \\ 0 & x & \rho^t \\ 0 & \rho & V \end{pmatrix}$ , where  $x \in \mathbb{Q}$  and  $\rho \in \mathbb{Q}^{2g}$ . Then the matrix  $V$  is a *column reduction* of  $W$ .

Note that an enlargement or a reduction of a Seifert matrix still is a Seifert matrix. An enlargement of a Seifert matrix corresponds to the addition of a tube to the Seifert surface.

**Definition 1.4.** A matrix  $P \in \mathcal{M}_{2g}(\mathbb{Q})$  is *symplectic* if  $PJP^t = J$ .

A *rational (resp. integral) symplectic congruence* from a matrix  $V$  to a matrix  $V'$  is an equality  $V' = PVP^t$  for some rational (resp. integral) symplectic matrix  $P$ .

Note that, since a symplectic matrix has determinant 1, a symplectic integral matrix is invertible over the integers.

**Definition 1.5.** An *elementary rational S-equivalence* is an enlargement, a reduction, or a rational symplectic congruence.

Two Seifert matrices are *rationally S-equivalent* if they can be obtained from one another by a finite sequence of elementary rational S-equivalences.

In particular, two Seifert matrices of a  $\mathbb{Q}SK$ -pair  $(M, K)$  are rationally S-equivalent (see [Lic97, Theorem 8.4] for the integral case, which easily generalizes). In Section 2, we prove that, given two  $\mathbb{Q}SK$ -systems, a rational S-equivalence between their Seifert matrices induces a canonical  $\tau$ -class of isomorphisms between their Alexander modules preserving the Blanchfield form. In Section 3, we prove the converse:

**Proposition 1.6.** *Let  $(M, K, \Sigma, \underline{f}, V)$  and  $(M', K', \Sigma', \underline{f}', V')$  be two  $\mathbb{Q}SK$ -systems. Let  $\xi : \mathfrak{A}(K) \rightarrow \mathfrak{A}(K')$  be an isomorphism which preserves the Blanchfield form. Then  $V$  and  $V'$  are related by a rational S-equivalence which canonically induces the  $\tau$ -class of  $\xi$ .*

**Definition 1.7.** Two Seifert matrices are *semi-integrally S-equivalent* if they can be obtained from one another by a finite sequence of enlargements, reductions, and integral symplectic congruences.

In Section 4, as a consequence of Lemmas 4.1 and 4.2, we obtain:

**Theorem 1.8.** *Two Seifert matrices are rationally  $S$ -equivalent if and only if they are semi-integrally  $S$ -equivalent. Furthermore, let  $(M, K, \Sigma, \underline{f}, V)$  and  $(M', K', \Sigma', \underline{f}', V')$  be two  $\mathbb{Q}SK$ -systems. Let  $\xi : \mathfrak{A}(K) \rightarrow \mathfrak{A}(K')$  be an isomorphism which preserves the Blanchfield form. Then  $V$  and  $V'$  are related by a semi-integral  $S$ -equivalence which canonically induces the  $\tau$ -class of  $\xi$ .*

We now define homology handlebodies and Lagrangian-preserving surgeries.

**Definition 1.9.** For  $g \in \mathbb{N}$ , a *genus  $g$  rational (resp. integral) homology handlebody* ( $\mathbb{Q}HH$ , resp.  $\mathbb{Z}HH$ ) is a 3-manifold which is compact, oriented, and which has the same homology with rational (resp. integral) coefficients as the standard genus  $g$  handlebody.

Such a  $\mathbb{Q}HH$  is connected, and its boundary is necessarily homeomorphic to the standard genus  $g$  surface. Note that a  $\mathbb{Z}HH$  is a  $\mathbb{Q}HH$ .

**Definition 1.10.** The *Lagrangian*  $\mathcal{L}_A$  of a  $\mathbb{Q}HH$   $A$  is the kernel of the map

$$i_* : H_1(\partial A; \mathbb{Q}) \rightarrow H_1(A; \mathbb{Q})$$

induced by the inclusion. Two  $\mathbb{Q}HH$ 's  $A$  and  $B$  have *LP-identified* boundaries if  $(A, B)$  is equipped with a homeomorphism  $h : \partial A \rightarrow \partial B$  such that  $h_*(\mathcal{L}_A) = \mathcal{L}_B$ .

The Lagrangian of a  $\mathbb{Q}HH$   $A$  is indeed a Lagrangian subspace of  $H_1(\partial A; \mathbb{Q})$  with respect to the intersection form.

Let  $M$  be a  $\mathbb{Q}HS$ , let  $A \subset M$  be a  $\mathbb{Q}HH$ , and let  $B$  be a  $\mathbb{Q}HH$  whose boundary is LP-identified with  $\partial A$ . Set  $M(\frac{B}{A}) = (M \setminus \text{Int}(A)) \cup_{\partial A = \partial B} B$ . We say that the  $\mathbb{Q}HS$   $M(\frac{B}{A})$  is obtained from  $M$  by *Lagrangian-preserving surgery*, or *LP-surgery*.

Given a  $\mathbb{Q}SK$ -pair  $(M, K)$ , a *null- $\mathbb{Q}HH$*  in  $M \setminus K$  is a  $\mathbb{Q}HH$   $A \subset M \setminus K$  such that the map  $i_* : H_1(A; \mathbb{Q}) \rightarrow H_1(M \setminus K; \mathbb{Q})$  induced by the inclusion has a trivial image. A *null LP-surgery* on  $(M, K)$  is an LP-surgery  $(\frac{B}{A})$  such that  $A$  is null in  $M \setminus K$ . The  $\mathbb{Q}SK$ -pair obtained by surgery is denoted by  $(M, K)(\frac{B}{A})$ .

In Section 2, we prove that a null LP-surgery induces a canonical isomorphism from the Alexander module of the initial  $\mathbb{Q}SK$ -pair to the Alexander module of the surgered  $\mathbb{Q}SK$ -pair, which preserves the Blanchfield form. Conversely, in Section 5, we prove:

**Theorem 1.11.** *Let  $(M, K)$  and  $(M', K')$  be  $\mathbb{Q}SK$ -pairs. Assume there is an isomorphism  $\xi : \mathfrak{A}(K) \rightarrow \mathfrak{A}(K')$  which preserves the Blanchfield form. Then  $(M', K')$  can be obtained from  $(M, K)$  by a finite sequence of null LP-surgeries which induces an isomorphism in the  $\tau$ -class of  $\xi$ .*

We end the article by proving the following proposition in Section 6.

**Proposition 1.12.** *There are  $\mathbb{Q}SK$ -pairs  $(M, K)$  and  $(M', K')$  that can be obtained from one another by a finite sequence of null LP-surgeries, but not by a single null LP-surgery.*

## 2 Conservation of the Blanchfield form

In this section, we prove that null LP-surgeries (Lemma 2.1) and relations of rational S-equivalence (Lemma 2.4) induce  $\tau$ -classes of isomorphisms between the Alexander modules which preserve the Blanchfield form.

**Lemma 2.1.** *Let  $(M, K)$  be a  $\mathbb{Q}SK$ -pair. Let  $A$  be a null- $\mathbb{Q}HH$  in  $M \setminus K$ . Let  $B$  be a  $\mathbb{Q}HH$  whose boundary is LP-identified with  $\partial A$ . Set  $(M', K') = (M, K) \left( \frac{B}{A} \right)$ . Then the surgery induces a canonical isomorphism  $\xi : \mathfrak{A}(K) \rightarrow \mathfrak{A}(K')$  which preserves the Blanchfield form.*

*Proof.* Throughout this proof, the homology modules are considered with rational coefficients. Let  $\tilde{X}$  (resp.  $\tilde{X}'$ ) be the infinite cyclic covering associated with  $(M, K)$  (resp.  $(M', K')$ ). The preimage  $\tilde{A}$  of  $A$  in  $\tilde{X}$  (resp.  $\tilde{B}$  of  $B$  in  $\tilde{X}'$ ) is the disjoint union of  $\mathbb{Z}$  copies  $A_i$  of  $A$  (resp.  $B_i$  of  $B$ ).

Set  $Y = \tilde{X} \setminus \text{Int}(\tilde{A})$ . The Mayer-Vietoris sequence associated with  $\tilde{X} = \tilde{A} \cup Y$  yields the exact sequence:

$$H_1(\partial\tilde{A}) \rightarrow H_1(\tilde{A}) \oplus H_1(Y) \rightarrow H_1(\tilde{X}) \rightarrow 0.$$

Since  $H_1(\partial\tilde{A}) \cong H_1(\tilde{A}) \oplus (\mathbb{Q}[t^{\pm 1}] \otimes \mathcal{L}_A)$ , we get  $H_1(\tilde{X}) \cong \frac{H_1(Y)}{\mathbb{Q}[t^{\pm 1}] \otimes \mathcal{L}_A}$ . Similarly,  $H_1(\tilde{X}') \cong \frac{H_1(Y)}{\mathbb{Q}[t^{\pm 1}] \otimes \mathcal{L}_B}$ . Since  $\mathcal{L}_A = \mathcal{L}_B$ , the Alexander modules  $H_1(\tilde{X})$  and  $H_1(\tilde{X}')$  are canonically identified.

Now consider two null-homologous knots  $J$  and  $J'$  in  $\tilde{X}$  that do not meet  $\tilde{A}$ , and such that  $J \cap \tau^k(J') = \emptyset$  for all  $k \in \mathbb{Z}$ . Consider a Seifert surface  $\Sigma$  of  $J$ . Assume that  $\Sigma$  is transverse to  $\partial\tilde{A}$  and  $J'$ . Write  $\Sigma = \Sigma_1 \cup \Sigma_2$ , where  $\Sigma_1 = \Sigma \cap Y$  and  $\Sigma_2 = \Sigma \cap \tilde{A}$ . Since  $J'$  does not meet  $\Sigma_2$ , the linking number  $lk_{\tilde{X}}(J, J')$  is equal to the algebraic intersection number  $\langle J', \Sigma_1 \rangle$ . Now  $\partial\Sigma_2$  is an integral linear combination of curves  $\alpha_i \in \mathcal{L}_{A_i}$ . In  $\tilde{X}'$ , each  $\alpha_i$  lies in  $\mathcal{L}_{B_i}$ , so each  $\alpha_i$  has a multiple that bounds a surface in  $B_i$ . Thus, there is a surface  $\Sigma_3 \subset \tilde{B}$  such that  $\partial\Sigma_3 = n\partial\Sigma_2$  for some integer  $n$ . We have  $nJ = \partial(n\Sigma_1 \cup \Sigma_3)$ , thus:

$$lk_{\tilde{X}'}(J, J') = \frac{1}{n} \langle J', n\Sigma_1 \cup \Sigma_3 \rangle = \langle J', \Sigma_1 \rangle = lk_{\tilde{X}}(J, J').$$

Since any class  $\gamma$  in  $H_1(\tilde{X})$  has a multiple that can be represented by a knot  $J$  in  $Y$  such that  $P(t).J$  is null-homologous for some  $P \in \mathbb{Q}[t^{\pm 1}]$ , the Blanchfield form is preserved.  $\square$

**Definition 2.2.** An *integral null LP-surgery* is a null LP-surgery  $\frac{B}{A}$  such that  $A$  and  $B$  are  $\mathbb{Z}HH$ 's.

The previous proof still works, with  $\mathbb{Q}$  replaced by  $\mathbb{Z}$ . Therefore:

**Lemma 2.3.** *Let  $(M, K)$  and  $(M', K')$  be  $\mathbb{Q}SK$ -pairs. Assume  $(M', K')$  can be obtained from  $(M, K)$  by an integral null LP-surgery. Then this surgery induces a canonical isomorphism between their integral Alexander modules which preserves the integral Blanchfield form.*

**Lemma 2.4.** *Let  $(M, K, \Sigma, \underline{f}, V)$  and  $(M', K', \Sigma', \underline{f}', V')$  be  $\mathbb{Q}SK$ -systems. If  $V$  and  $V'$  are rationally  $S$ -equivalent, then any  $S$ -equivalence from  $V$  to  $V'$  induces a canonical  $\tau$ -class of isomorphisms from  $\mathfrak{A}(K)$  to  $\mathfrak{A}(K')$  which preserve the Blanchfield form.*

*Proof.* Let  $(b_i)_{1 \leq i \leq 2g}$  be a family of generators of  $\mathfrak{A}(K)$  associated with  $V$ . Set  $W = tV - V^t$ . Recall the Blanchfield form  $\mathfrak{b}_K$  is given by  $\mathfrak{b}_K(b_i, b_j) = (1 - t)(W^{-1})_{ji}$ . Set  $b = (b_1 \ b_2 \ \dots \ b_{2g})$ , and  $r = (r_1 \ r_2 \ \dots \ r_{2g}) = bW$ . We have:

$$\mathfrak{A}(K) = \frac{\bigoplus_{1 \leq i \leq 2g} \mathbb{Q}[t^{\pm 1}]b_i}{\bigoplus_{1 \leq j \leq 2g} \mathbb{Q}[t^{\pm 1}]r_j}.$$

Define the same notation with primes for the  $\mathbb{Q}SK$ -pair  $(M', K')$ .

First assume that  $V' = PV P^t$  for a rational symplectic matrix  $P$ . Note that  $W' = P W P^t$ . Define a  $\mathbb{Q}[t^{\pm 1}]$ -isomorphism:

$$\tilde{\xi} : \begin{array}{ccc} \bigoplus_{1 \leq i \leq 2g} \mathbb{Q}[t^{\pm 1}]b_i & \rightarrow & \bigoplus_{1 \leq i \leq 2g} \mathbb{Q}[t^{\pm 1}]b'_i \\ b_i & \mapsto & (b'P)_i \end{array}.$$

We have  $\tilde{\xi}(r_j) = (b'PW)_j = (r'(P^t)^{-1})_j$ , thus  $\tilde{\xi}(\bigoplus_{1 \leq j \leq 2g} \mathbb{Q}[t^{\pm 1}]r_j) = \bigoplus_{1 \leq j \leq 2g} \mathbb{Q}[t^{\pm 1}]r'_j$ . Hence  $\tilde{\xi}$  induces an isomorphism  $\xi : \mathfrak{A}(K) \rightarrow \mathfrak{A}(K')$ . Now, we have:

$$\begin{aligned} \mathfrak{b}_{K'}(\xi(b_i), \xi(b_j)) &= \mathfrak{b}_{K'}((b'P)_i, (b'P)_j) \\ &= \sum_{k,l} p_{ki} p_{lj} (1 - t) ((W')^{-1})_{lk} \\ &= (1 - t) (P^t ((P^t)^{-1} W^{-1} P^{-1}) P)_{ji} \\ &= \mathfrak{b}_K(b_i, b_j). \end{aligned}$$

It remains to treat the case of an enlargement. Assume  $V = \begin{pmatrix} 0 & 0 & 0 \\ 1 & x & \rho^t \\ 0 & \rho & V' \end{pmatrix}$ . Then:

$$W = \begin{pmatrix} 0 & -1 & 0 \\ t & x(t-1) & (t-1)\rho^t \\ 0 & (t-1)\rho & W' \end{pmatrix}.$$

Thus  $b_2$  is trivial, and  $b_1$  is a linear combination over  $\mathbb{Q}[t^{\pm 1}]$  of the  $b_i$  for  $3 \leq i \leq 2g$ . Hence there is an isomorphism  $(\mathfrak{A}(K), \mathfrak{b}_K) \cong (\mathfrak{A}(K'), \mathfrak{b}_{K'})$  which identifies  $b_i$  with  $b'_{i-2}$  for  $3 \leq i \leq 2g$ . Proceed similarly for a column enlargement.

Since the families  $(b_i)_{1 \leq i \leq 2g}$  and  $(b'_i)_{1 \leq i \leq 2g}$  are determined up to multiplication by a power of  $t$ , we have associated a  $\tau$ -class of isomorphisms to each elementary S-equivalence. For a general rational S-equivalence, just compose the  $\tau$ -classes associated with the elementary S-equivalences.  $\square$

### 3 Relating Seifert matrices

In this section, we prove the next proposition, which implies Proposition 1.6 for invertible Seifert matrices  $V$  and  $V'$ . We end the section by deducing the general case.

**Proposition 3.1.** *Let  $(M, K, \Sigma, \underline{f}, V)$  and  $(M', K', \Sigma', \underline{f}', V')$  be two QSK-systems. Let  $\xi : \mathfrak{A}(K) \rightarrow \mathfrak{A}(K')$  be an isomorphism which preserves the Blanchfield form. Let  $\underline{b} = (b_i)_{1 \leq i \leq 2g}$  (resp.  $\underline{b}' = (b'_i)_{1 \leq i \leq 2g}$ ) be a family of generators of  $\mathfrak{A}(K)$  (resp.  $\mathfrak{A}(K')$ ) associated with  $V$  (resp.  $V'$ ). If  $V$  and  $V'$  are invertible, then  $\underline{b}$  and  $\underline{b}'$  are  $\mathbb{Q}$ -bases of  $\mathfrak{A}(K)$  and  $\mathfrak{A}(K')$  respectively, and  $V' = PVP^t$ , where  $P$  is the matrix of  $\xi$  with respect to the bases  $\underline{b}$  and  $\underline{b}'$ .*

This proposition specifies a result of Trotter [Tro73, Proposition 2.12].

**Lemma 3.2.** *Let  $(M, K, \Sigma, \underline{f}, V)$  be a QSK-system. Let  $\underline{b} = (b_i)_{1 \leq i \leq 2g}$  be a family of generators of  $\mathfrak{A}(K)$  associated with  $V$ . If  $V$  is invertible, then  $\underline{b}$  is a  $\mathbb{Q}$ -basis of  $\mathfrak{A}(K)$ , and the action of  $t$  is given by the matrix  $V^t V^{-1}$  with respect to the basis  $\underline{b}$ .*

*Proof.* We have:

$$\mathfrak{A}(K) = \frac{\bigoplus_{1 \leq i \leq 2g} \mathbb{Q}[t^{\pm 1}]b_i}{\bigoplus_{1 \leq j \leq 2g} \mathbb{Q}[t^{\pm 1}]r_j},$$

where  $r_j = \sum_{1 \leq i \leq 2g} (tV - V^t)_{ij} b_i$ . Represent the elements of  $(\mathbb{Q}[t^{\pm 1}])^{2g} = \bigoplus_{1 \leq i \leq 2g} \mathbb{Q}[t^{\pm 1}]b_i$  (resp.  $\mathbb{Q}^{2g}$ ) by column vectors giving their coordinates in the basis  $\underline{b}$  (resp. in the canonical basis). Define a  $\mathbb{Q}$ -linear map  $\varphi : (\mathbb{Q}[t^{\pm 1}])^{2g} \rightarrow \mathbb{Q}^{2g}$  by  $t^k X \mapsto (V^t V^{-1})^k X$  for all vector  $X$  with rational coefficients. Let us prove that  $\varphi$  induces a  $\mathbb{Q}$ -isomorphism from  $\mathfrak{A}(K)$  to  $\mathbb{Q}^{2g}$ .

It is easy to see that  $r_j \in \ker(\varphi)$  for all  $j$ . Let  $u \in \ker(\varphi)$ . Write  $u = \sum_{p \leq k \leq q} t^k X_k$ , where the  $X_k$  are column vectors with rational coefficients. Since  $\sum_{p \leq k \leq q} (V^t V^{-1})^k X_k = 0$ , we have  $X_p = -\sum_{p < k \leq q} (V^t V^{-1})^{k-p} X_k$ . Thus:

$$\begin{aligned} u &= \sum_{p < k \leq q} (t^k X_k - t^p (V^t V^{-1})^{k-p} X_k) \\ &= (tV - V^t) \cdot \sum_{p < k \leq q} \sum_{p < i \leq k} t^{i-1} (V^{-1} V^t)^{k-i} V^{-1} X_k \end{aligned}$$

Hence  $u \in \bigoplus_{1 \leq j \leq 2g} \mathbb{Q}[t^{\pm 1}]r_j$ , and it follows that  $\ker(\varphi) = \bigoplus_{1 \leq j \leq 2g} \mathbb{Q}[t^{\pm 1}]r_j$ .  $\square$

Consider  $\mathbb{Q}(t)$  as the direct sum over  $\mathbb{Q}$  of  $\Lambda = \mathbb{Q}[t, t^{-1}, (1-t)^{-1}]$  and the subspace  $\mathcal{E}$  consisting of 0 and all proper fractions with denominator prime to  $t$  and  $(1-t)$ , where proper means that the numerator of the fraction has strictly lower degree than the denominator. Define a  $\mathbb{Q}$ -linear function  $\chi$  on  $\mathbb{Q}(t)$  by  $\chi(E) = E'(1)$  if  $E \in \mathcal{E}$  and  $\chi(E) = 0$  if  $E \in \Lambda$ . As  $\chi$  vanishes on  $\mathbb{Q}[t^{\pm 1}]$ , we may also consider it as a function on  $\frac{\mathbb{Q}(t)}{\mathbb{Q}[t^{\pm 1}]}$ .

**Lemma 3.3.** *For  $E \in \mathcal{E}$ ,  $\chi((t-1)E) = E(1)$ .*

*Proof.* If  $F \in \mathbb{Q}(t)$  has denominator prime to  $t$  and  $1-t$  and numerator of degree less than or equal to the degree of its denominator, then  $F$  can be written as the sum of a rational constant and of an element of  $\mathcal{E}$ . Hence  $\chi(F) = F'(1)$ . Apply this to  $F = (t-1)E$ .  $\square$

**Lemma 3.4.** *Let  $(M, K, \Sigma, \underline{f}, V)$  be a QSK-system. Let  $(b_i)_{1 \leq i \leq 2g}$  be a family of generators of  $\mathfrak{A}(K)$  associated with  $V$ . Define a matrix  $S$  by  $S_{ij} = -\chi(\mathbf{b}_K(b_j, b_i))$ . Then  $S = (V - V^t)^{-1} = -J$ .*

*Proof.* We have  $S_{ij} = \chi((t-1)((tV - V^t)^{-1})_{ij})$ . Let  $\Delta(t) = \det(tV - V^t)$  be the Alexander polynomial of  $(M, K)$ . Then  $\Delta(1) \neq 0$ , and since  $V$  is invertible,  $\Delta(0) \neq 0$  and the degree of  $\Delta$  is equal to the size of the matrix  $V$ . Hence, by Lemma 3.3,  $S_{ij} = ((tV - V^t)^{-1})_{ij}(1)$ . Conclude with  $V - V^t = J$  and  $J^{-1} = -J$ .  $\square$

*Proof of Proposition 3.1.* Let  $T$  (resp.  $T'$ ) be the matrix of the action of  $t$  in the basis  $\underline{b}$  (resp.  $\underline{b}'$ ). By Lemma 3.2,  $T = V^t V^{-1}$  and  $T' = (V')^t (V')^{-1}$ . Since  $\xi$  preserves the action of  $t$ , we have  $PT = T'P$ . Since  $\xi$  preserves the Blanchfield form, Lemma 3.4 implies  $J = P^t J P$ . An easy computation gives  $V = (I_{2g} - T)^{-1} J$  and  $V' = (I_{2g} - T')^{-1} J$ . It follows that  $V' = P V P^t$ .  $\square$

**Lemma 3.5.** *For any matrix  $V \in \mathcal{M}_{2g}(\mathbb{Q})$ , with  $g > 0$ , satisfying  $V - V^t = J$ , there exists a QSK-pair  $(M, K)$  that admits  $V$  as a Seifert matrix.*

*Proof.* Set  $V = (v_{ij})_{1 \leq i, j \leq 2g}$ . By [Chap. 4, Corollary 2.13], there is a QHS  $M$  and pairwise disjoint simple closed framed curves  $f_i$ ,  $1 \leq i \leq 2g$ , in  $M$ , such that  $lk(f_i, f_j) = v_{ij}$  for  $j \leq i$ . Consider bands around the  $f_i$ , that are images of embeddings  $h_i : [-1, 1] \times S^1 \hookrightarrow M$  such that  $h_i(\{0\} \times S^1) = f_i$ , and  $\ell(f_i) = h_i(\{1\} \times S^1)$  is the parallel of  $f_i$  such that  $lk(f_i, \ell(f_i)) = v_{ii}$ . Connecting these bands as indicated in Figure 1, we get a surface bounded by a knot  $K$  which satisfies the required conditions.  $\square$

*Proof of Proposition 1.6.* If  $V$  is non invertible, there exists  $g_1 \in H_1(\Sigma; \mathbb{Z})$  such that  $lk(g_1, \gamma^+) = 0$  for all  $\gamma \in H_1(\Sigma; \mathbb{Z})$ . Choose for  $g_1$  a primitive element of  $H_1(\Sigma; \mathbb{Z})$ , i.e. an element whose only submultiples are itself and its opposite. In any symplectic basis of  $H_1(\Sigma; \mathbb{Z})$ ,  $g_1$  has coprime coefficients, hence there is  $g_2 \in H_1(\Sigma; \mathbb{Z})$  such that  $\langle g_1, g_2 \rangle_\Sigma = 1$ ,

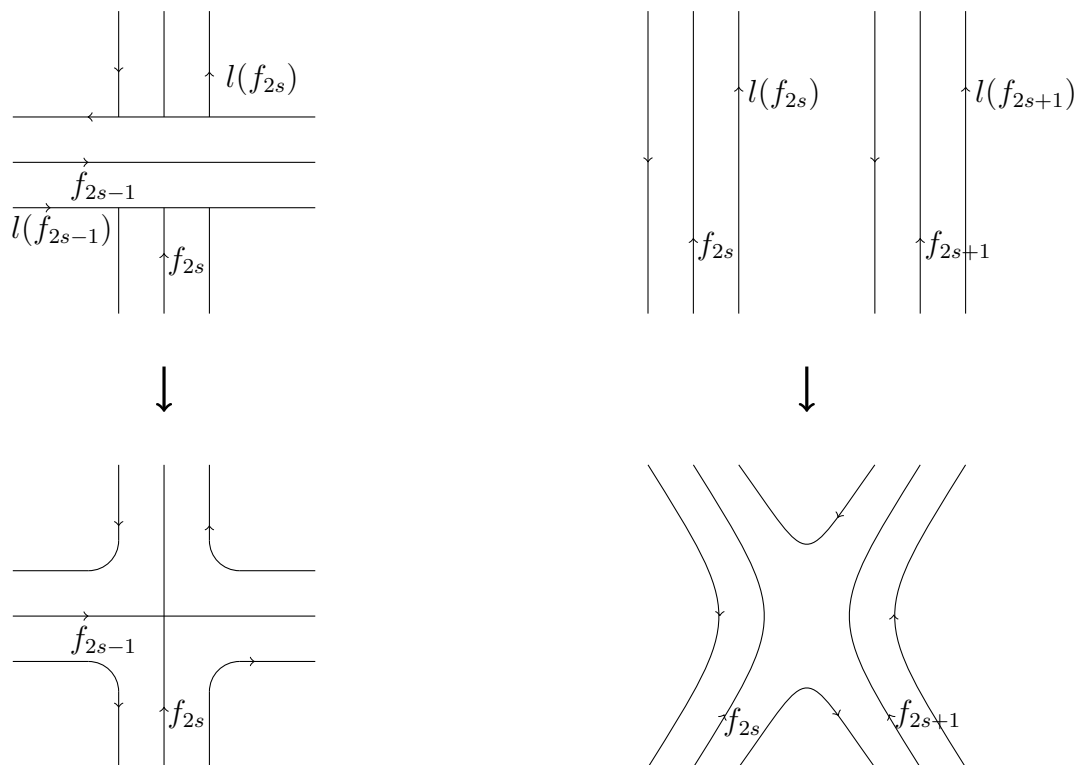

Figure 1: Gluing bands

where  $\langle \cdot, \cdot \rangle_\Sigma$  denotes the intersection form on  $\Sigma$ . Consider a symplectic basis  $(g_i)_{3 \leq i \leq 2g}$  of the orthogonal of  $\mathbb{Z}g_1 \oplus \mathbb{Z}g_2$  in  $H_1(\Sigma; \mathbb{Z})$  with respect to the intersection form. Then  $(g_i)_{1 \leq i \leq 2g}$  is a symplectic basis of  $H_1(\Sigma; \mathbb{Z})$ , and the associated Seifert matrix  $V_1$  is a row enlargement of a Seifert matrix  $V_2$ . Since  $V$  and  $V_1$  are associated with the same Seifert surface, they are related by a change of basis of  $H_1(\Sigma; \mathbb{Z})$ , *i.e.* they are congruent. Hence  $V$  is rationally S-equivalent to the smaller matrix  $V_2$ . Iterating this process, we see that  $V$  is rationally S-equivalent to an invertible Seifert matrix  $W$ , where we consider that there exists an empty matrix, which is invertible. Similarly,  $V'$  is rationally S-equivalent to an invertible Seifert matrix  $W'$ . The matrices  $W$  and  $W'$  are invertible Seifert matrices that define isomorphic Blanchfield forms.

By Lemma 3.5, there are QSK-systems  $(N, J, S, \underline{\eta}, W)$  and  $(N', J', S', \underline{\eta}', W')$ . The rational S-equivalence relation between  $V$  and  $W$  (resp.  $V'$  and  $W'$ ) induces the  $\tau$ -class of an isomorphism  $\zeta : \mathfrak{A}(J) \rightarrow \mathfrak{A}(K)$  (resp.  $\zeta' : \mathfrak{A}(J') \rightarrow \mathfrak{A}(K')$ ). By Proposition 3.1, there is an invertible rational matrix  $P$  such that  $W' = PWP^t$  and  $P$  induces the  $\tau$ -class of the isomorphism  $(\zeta')^{-1} \circ \xi \circ \zeta : \mathfrak{A}(J) \rightarrow \mathfrak{A}(J')$ .  $\square$

## 4 Rational S-equivalence

In this section, we prove Theorem 1.8 by proving that we can realize a symplectic rational congruence by a finite sequence of enlargements, reductions, and integral symplectic congruences which, for given  $\mathbb{Q}SK$ -systems, induces the same  $\tau$ -class of isomorphisms between the Alexander modules as the initial congruence. We first treat a particular type of congruence matrices.

**Lemma 4.1.** *Let  $V$  and  $W$  be two Seifert matrices such that  $\Delta_n V \Delta_n = W$ , where  $n$  or  $\frac{1}{n}$  is a positive integer, and*

$$\Delta_n = \begin{pmatrix} n & & & \\ & \frac{1}{n} & & \\ & & 1 & \\ & & & \ddots \\ & 0 & & & 1 \end{pmatrix}.$$

*Then there are enlargements  $\tilde{V}$  of  $V$  and  $\tilde{W}$  of  $W$  that are related by an integral symplectic congruence. Furthermore, if  $(M, K, \Sigma, \underline{f}, V)$  and  $(M', K', \Sigma', \underline{f}', W)$  are two  $\mathbb{Q}SK$ -systems,  $W$  can be obtained from  $V$  by a sequence of an enlargement, an integral symplectic congruence, and a reduction, which induces the same  $\tau$ -class of isomorphisms from  $\mathfrak{A}(K)$  to  $\mathfrak{A}(K')$  as the congruence matrix  $\Delta_n$ .*

*Proof.* Assume  $n$  is a positive integer.

Set  $V = \begin{pmatrix} p & q & \omega^t \\ r & s & \rho^t \\ \omega & \rho & U \end{pmatrix}$ . Then  $W = \begin{pmatrix} n^2 p & q & n\omega^t \\ r & \frac{s}{n^2} & \frac{1}{n}\rho^t \\ n\omega & \frac{1}{n}\rho & U \end{pmatrix}$ . Note that  $r = q + 1$ . Set:

$$P = \left( \begin{array}{cccc|c} 0 & n & 0 & -1 & \\ 0 & 0 & 1 & 0 & 0 \\ 1 & 0 & n & 0 & \\ 0 & 1 & 0 & 0 & \\ \hline & & & & I \end{array} \right), \quad \tilde{V} = \left( \begin{array}{cccc|c} 0 & -1 & 0 & 0 & 0 \\ 0 & \frac{s}{n^2} & \frac{r}{n} & \frac{s}{n} & \frac{1}{n}\rho^t \\ 0 & \frac{r}{n} & p & q & \omega^t \\ 0 & \frac{s}{n} & r & s & \rho^t \\ \hline 0 & \frac{1}{n}\rho & \omega & \rho & U \end{array} \right),$$

$$\text{and } \tilde{W} = \left( \begin{array}{cccc|c} 0 & 0 & 0 & 0 & 0 \\ 1 & p & np & \frac{r}{n} & \omega^t \\ 0 & np & n^2 p & q & n\omega^t \\ 0 & \frac{r}{n} & r & \frac{s}{n^2} & \frac{1}{n}\rho^t \\ \hline 0 & \omega & n\omega & \frac{1}{n}\rho & U \end{array} \right).$$



The matrix  $P$  is integral and symplectic, and we have  $\tilde{W} = P\tilde{V}P^t$ .

Let  $(b_i)_{1 \leq i \leq 2g}$  (resp.  $(b'_i)_{1 \leq i \leq 2g}$ ) be a family of generators of  $\mathfrak{A}(K)$  (resp.  $\mathfrak{A}(K')$ ) associated with  $V$  (resp.  $W$ ). The congruence matrix  $\Delta_n$  induces the  $\tau$ -class of the isomorphism  $\xi : \mathfrak{A}(K) \rightarrow \mathfrak{A}(K')$  such that  $\xi(b_i) = ((b'_1 \ \dots \ b'_{2g}) \Delta_n)_i$ . Let us check that the obtained sequence of an enlargement, an integral symplectic congruence, and a reduction, also induces  $\xi$ . The matrix  $\tilde{V}$  defines a  $\mathbb{Q}[t^{\pm 1}]$ -module  $\mathfrak{A} \cong \mathfrak{A}(K)$  with a generating family  $(\tilde{b}_i)_{1 \leq i \leq 2g+2}$  subject to the relations  $((\tilde{b}_1 \ \dots \ \tilde{b}_{2g+2}) (t\tilde{V} - \tilde{V}^t))_j$ . The enlargement of  $V$  into  $\tilde{V}$  induces the  $\tau$ -class of the isomorphism  $\zeta : \mathfrak{A}(K) \rightarrow \mathfrak{A}$  such that  $\zeta(b_i) = \tilde{b}_{i+2}$ . Similarly, define  $\mathfrak{A}'$ ,  $(\tilde{b}'_i)_{1 \leq i \leq 2g+2}$  and  $\zeta'$ . The congruence matrix  $P$  induces the  $\tau$ -class of the isomorphism  $\vartheta : \mathfrak{A} \rightarrow \mathfrak{A}'$  such that  $\vartheta(\tilde{b}_i) = ((\tilde{b}'_1 \ \dots \ \tilde{b}'_{2g+2}) P)_i$ . Set  $\xi' = (\zeta')^{-1} \circ \vartheta \circ \zeta$ . Let us check that  $\xi'(b_i) = \xi(b_i)$  for all  $i \in \{1, \dots, 2g\}$ . For  $i \geq 3$ , it is obvious. For  $i = 1$ , it follows from the relation  $\tilde{b}'_2 = 0$  given by the first column of the matrix  $t\tilde{W} - \tilde{W}^t$ . For  $i = 2$ , we have  $\xi'(b_2) = (\zeta')^{-1}(-\tilde{b}'_1)$ . Since the second column of  $t\tilde{W} - \tilde{W}^t$  gives:

$$\tilde{b}'_1 = (t-1) \left( np\tilde{b}'_3 + \frac{r}{n}\tilde{b}'_4 + (\tilde{b}'_5 \ \dots \ \tilde{b}'_{2g+2}) \omega \right),$$

and since the first column of  $tW - W^t$  gives:

$$b'_2 = -(t-1) \left( n^2pb'_1 + rb'_2 + n(b'_3 \ \dots \ b'_{2g}) \omega \right),$$

we have  $\xi'(b_2) = \frac{1}{n}b'_2$ .

Since  $\Delta_{\frac{1}{n}} = \Delta_n^{-1}$ , the case  $\frac{1}{n} \in \mathbb{N} \setminus \{0\}$  follows.  $\square$

**Lemma 4.2.** *Any symplectic rational matrix  $P$  can be written as a product of integral symplectic matrices and matrices  $\Delta_n$  or  $\Delta_{\frac{1}{n}}$  for positive integers  $n$ .*

*Proof.*

**Step 1:** There is no loss in assuming that the first column of  $P$  is  $\begin{pmatrix} 1 \\ 0 \\ \vdots \\ 0 \end{pmatrix}$ .

Denote by  $d$  a common denominator for the terms of the first column of  $P$ . The matrix  $P\Delta_d$  has integral coefficients in its first column. Denote by  $\delta$  their gcd. The terms of the first column of  $P\Delta_d\Delta_{\frac{1}{\delta}}$  are coprime integers. There is an integral symplectic matrix  $Q$  with the same first column. The matrix  $Q^{-1}P\Delta_d\Delta_{\frac{1}{\delta}}$  has the required first column.

**Step 2:** We can assume that the first two columns of  $P$  are  $\begin{pmatrix} 1 & 0 \\ 0 & 1 \\ \vdots & 0 \\ \vdots & \vdots \\ 0 & 0 \end{pmatrix}$ .

The matrix  $P^{-1}$  has the same first column as  $P$ . Since it is symplectic, its second column is  $\begin{pmatrix} x_1 \\ \vdots \\ x_{2g} \end{pmatrix}$ , with  $x_2 = 1$ . Set:

$$Q = \begin{pmatrix} 1 & x_1 & -x_4 & x_3 & \dots & -x_{2g} & x_{2g-1} \\ 0 & 1 & 0 & \dots & \dots & \dots & 0 \\ 0 & x_3 & 1 & & & & \\ \vdots & \vdots & & \ddots & & 0 & \\ \vdots & \vdots & & & \ddots & & \\ \vdots & \vdots & & 0 & & \ddots & \\ 0 & x_{2g} & & & & & 1 \end{pmatrix}.$$

Since  $Q$  has the same first two columns as  $P^{-1}$ , the matrix  $PQ$  has the required first two columns. Now, if  $n$  is a common denominator for all the  $x_i$ , the matrix  $\Delta_n Q \Delta_{\frac{1}{n}}$  has integral coefficients, and is symplectic.

**Step 3:** Induction.

We have  $P = \begin{pmatrix} I_2 & R \\ 0 & Q \end{pmatrix}$ . Since  $P$  is symplectic,  $R = 0$  and  $Q$  is symplectic. Thus we can conclude by induction on  $g$ . □

## 5 Topological realization of matrix relations

In this section, we prove Theorem 1.11.

**Lemma 5.1.** *Let  $M$  be a  $\mathbb{Q}HS$  (resp.  $\mathbb{Z}HS$ ). Let  $\Sigma$  be a genus  $g$  closed connected surface embedded in  $M$ . Then  $M \setminus \Sigma$  has exactly two connected components, whose closures are  $\mathbb{Q}HH$ 's (resp.  $\mathbb{Z}HH$ 's) of genus  $g$ .*

*Proof.* Any point of  $M \setminus \Sigma$  can be connected to a point of  $\Sigma \times [-1, 1]$  in  $M \setminus \Sigma$ . Since  $(\Sigma \times [-1, 1]) \setminus \Sigma$  has two connected components,  $M \setminus \Sigma$  has at most two connected components. Let  $x_1$  and  $x_2$  be points of  $(\Sigma \times [-1, 1]) \setminus \Sigma$ , one in each connected component. If there were a path from  $x_1$  to  $x_2$  in  $M \setminus \Sigma$ , we could construct a closed curve in  $M$  which

would meet  $\Sigma$  exactly once. Since  $M$  is a  $\mathbb{Q}$ HS, this is not possible. Hence  $M \setminus \Sigma$  has exactly two connected components. Let  $A_1$  and  $A_2$  be their closures. Note that  $\partial A_1 = \partial A_2 = \Sigma$  (up to orientation).

For  $i = 1, 2$ , we have  $H_3(A_i; \mathbb{Z}) = 0$  and  $H_0(A_i; \mathbb{Z}) = \mathbb{Z}$ . The Mayer-Vietoris sequence associated with  $M = A_1 \cup A_2$  yields the exact sequence:

$$H_3(M; \mathbb{Z}) \xrightarrow{\partial} H_2(\Sigma; \mathbb{Z}) \longrightarrow H_2(A_1; \mathbb{Z}) \oplus H_2(A_2; \mathbb{Z}) \longrightarrow 0.$$

The map  $\partial$  is an isomorphism that identifies the fundamental classes. Thus  $H_2(A_1; \mathbb{Z}) = H_2(A_2; \mathbb{Z}) = 0$ . It follows that  $A_1$  and  $A_2$  are  $\mathbb{Q}$ HH's. Their genus is given by their boundary.

Assume  $M$  is a  $\mathbb{Z}$ HS. The Mayer-Vietoris sequence associated with  $M = A_1 \cup A_2$  yields an isomorphism  $H_1(\Sigma; \mathbb{Z}) \cong H_1(A_1; \mathbb{Z}) \oplus H_1(A_2; \mathbb{Z})$ . Hence, for  $i = 1, 2$ ,  $H_1(A_i; \mathbb{Z})$  is torsion-free, thus  $A_i$  is a  $\mathbb{Z}$ HH.  $\square$

**Lemma 5.2.** *Let  $(M, K, \Sigma, \underline{f}, V)$  and  $(M', K', \Sigma', \underline{f}', V')$  be  $\mathbb{Q}$ SK-systems. Let  $P$  be an integral symplectic matrix. Assume  $V' = PV P^t$ . Then there is a null LP-surgery  $(\frac{B}{A})$  in  $M \setminus K$  such that  $(M', K') \cong (M, K)(\frac{B}{A})$  and the  $\tau$ -class of the isomorphism  $\xi : \mathfrak{A}(K) \rightarrow \mathfrak{A}(K')$  induced by this surgery is the  $\tau$ -class induced by  $P$ .*

*Proof.* There is a homeomorphism  $h : \Sigma \rightarrow \Sigma'$ , such that the matrix of the induced isomorphism  $h_* : H_1(\Sigma; \mathbb{Z}) \rightarrow H_1(\Sigma'; \mathbb{Z})$  with respect to the bases  $(f_i)_{1 \leq i \leq 2g}$  and  $(f'_i)_{1 \leq i \leq 2g}$  is  $(P^t)^{-1}$  (see [FM12, theorem 6.4]). Let  $\hat{\Sigma}$  be obtained from  $\Sigma$  by adding a band glued along  $\partial \Sigma$ , so that  $\hat{\Sigma}$  is homeomorphic to  $\Sigma$ , and contains  $\Sigma$  and  $K$  in its interior. Let  $H = \hat{\Sigma} \times [-1, 1]$  be a regular neighborhood of  $\Sigma$ . Similarly, define  $\hat{\Sigma}'$  and  $H'$ . Extend  $h$  to a homeomorphism  $h : \hat{\Sigma} \rightarrow \hat{\Sigma}'$ , and then extend it by product with the identity to a homeomorphism  $h : H \rightarrow H'$ .

Let  $A = M \setminus \text{Int}(H)$  and let  $B = M' \setminus \text{Int}(H')$ . By Lemma 5.1,  $A$  (resp.  $B$ ) is a  $\mathbb{Q}$ HH, and it is clearly null in  $M \setminus K$  (resp.  $M' \setminus K'$ ). The  $\mathbb{Q}$ SK-pair  $(M', K')$  is obtained from  $(M, K)$  by the surgery  $(\frac{B}{A})$ . Let us prove that the homeomorphism  $h|_{\partial A} : \partial A \rightarrow \partial B$  preserves the Lagrangian.

For  $1 \leq i \leq 2g$ , let  $e_i \subset \partial H$  be a meridian of  $f_i$ . The Lagrangian  $\mathcal{L}_A$  is generated by the  $\alpha_i = f_i^+ - \sum_{1 \leq j \leq 2g} V_{ji} e_j$ , where  $f_i^+$  is the copy of  $f_i$  in  $(\Sigma \times \{1\}) \subset H$ . Similarly, define the  $e'_i, (f'_i)^+$  and  $\alpha'_i$ . Since  $h : H \rightarrow H'$  is a homeomorphism,  $(h|_{\partial H})_*(\mathcal{L}_H) = \mathcal{L}_{H'}$ . Hence  $(h|_{\partial H})_*(e_i)$  is a linear combination of the  $e'_j$ . Since  $\langle h(e_i), h(f_j^+) \rangle_{\partial H'} = \langle e'_i, (f'_j)^+ \rangle_{\partial H'} = \delta_{ij}$ , an easy computation gives  $(h|_{\partial H})_*(e_i) = \left( \begin{pmatrix} e'_1 & \dots & e'_{2g} \end{pmatrix} P \right)_i$ . It follows that  $(h|_{\partial H})_*(\alpha_i) = \left( \begin{pmatrix} \alpha'_1 & \dots & \alpha'_{2g} \end{pmatrix} (P^t)^{-1} \right)_i$ . Hence  $(h|_{\partial A})_*(\mathcal{L}_A) = \mathcal{L}_B$ .

The relation between the  $h(e_i)$  and the  $e'_i$  shows that the isomorphism  $\xi$  induced by the surgery is in the  $\tau$ -class of isomorphisms induced by the congruence matrix  $P$ .  $\square$

**Lemma 5.3.** *Let  $(M, K, \Sigma, f, V)$  be a QSK-system. Let  $W$  be an enlargement of  $V$ . Then there is a QSK-system  $(M', \bar{K}', \Sigma', \underline{f}', W)$  such that  $(M', K')$  can be obtained from  $(M, K)$  by a single null LP-surgery, and the surgery and the enlargement induce the same  $\tau$ -class of isomorphisms from  $\mathfrak{A}(K)$  to  $\mathfrak{A}(K')$ .*

*Proof.* We have

$$W = \begin{pmatrix} 0 & 0 & 0 \\ 1 & x & \rho^t \\ 0 & \rho & V \end{pmatrix} \text{ or } \begin{pmatrix} 0 & -1 & 0 \\ 0 & x & \rho^t \\ 0 & \rho & V \end{pmatrix}.$$

We want to add a tube to  $\Sigma$ , whose linking numbers with the  $f_i$  are given by  $\rho$ . This may not be possible in  $M$ , so we first modify  $M$  by null LP-surgeries.

Set  $\rho = \begin{pmatrix} \frac{c_1}{d_1} \\ \vdots \\ \frac{c_{2g}}{d_{2g}} \end{pmatrix}$ , where the  $c_i$  and  $d_i$  are integers, and  $d_i > 0$ . Consider trivial knots  $J_i$ , disjoint from  $\Sigma$ , such that  $lk(J_i, f_j) = \delta_{ij}c_i$ . For each  $i$ , consider a tubular neighborhood  $T(J_i)$  of  $J_i$ . By [Chap. 3, Lemma 1.5], there are rational homology tori  $A_i$  that satisfy:

- $H_1(\partial A_i; \mathbb{Z}) = \mathbb{Z}\alpha_i \oplus \mathbb{Z}\beta_i$ , with  $\langle \alpha_i, \beta_i \rangle = 1$ ,
- $\beta_i = d_i\gamma_i$  in  $H_1(A_i; \mathbb{Z})$ , where  $\gamma_i$  is a curve in  $A_i$ ,
- $H_1(A_i; \mathbb{Z}) = \mathbb{Z}\gamma_i \oplus \frac{\mathbb{Z}}{d_i\mathbb{Z}}\alpha_i$ .

Let  $N$  be the manifold obtained from  $M$  by the null LP-surgeries  $(\frac{A_i}{T(J_i)})$ , where the identifications  $\partial T(J_i) = \partial A_i$  identify  $\alpha_i$  with a meridian of  $J_i$ , and  $\beta_i$  with a parallel of  $J_i$  that does not link  $J_i$ . We get  $lk(\gamma_i, f_j) = \delta_{ij} \frac{c_i}{d_i}$ .

In  $N$ , consider a ball  $B$  disjoint from  $\Sigma$  and all the  $A_i$ . Consider a rational homology ball  $B'$  that contains a curve  $\gamma_0$  with self-linking  $(x - \sum_{1 \leq i, j \leq 2g} lk(\gamma_i, \gamma_j)) \bmod \mathbb{Z}$ . Note that  $lk(\gamma_0, \gamma_i) = 0$  for  $1 \leq i \leq 2g$ . Set  $M' = N(\frac{B'}{B})$ , and  $K' = K$ .

Define a curve  $\gamma'$  in  $M'$  as a band sum of the  $\gamma_i$  for  $0 \leq i \leq 2g$ , with bands outside  $\Sigma$ . Consider a disk  $D$  in  $\Sigma$ , and two distinct points  $p$  and  $q$  in  $D$ . Consider an embedded band  $[0, 1] \times [0, 1]$  in  $M'$  such that  $[0, 1] \times \{0\} = ([0, 1] \times [0, 1]) \cap \Sigma$  is a curve from  $p$  to  $q$  in  $D$ ,  $[0, 1] \times \{1\} = ([0, 1] \times [0, 1]) \cap \gamma'$ , and the tangent vector to  $\{0\} \times [0, 1]$  at  $\{0\} \times \{0\}$  is the positive normal vector of  $\Sigma$  if  $W$  is a row enlargement of  $V$ , and the negative one if it is a column enlargement. Figure 2 represents the first case. Now set  $\gamma = (\gamma' \cup \partial([0, 1] \times [0, 1])) \setminus ([0, 1] \times \{1\})$ , and construct a surface  $\Sigma'$  by adding a tube around  $\gamma \setminus ([0, 1] \times \{0\})$  to  $\Sigma$ . The surface  $\Sigma'$  is a Seifert surface for  $K'$ . On  $\Sigma'$ , consider a meridian  $f_{2g+1}$  of the tube and a parallel  $f_{2g+2}$  of  $\gamma$  such that  $\langle f_{2g+1}, f_{2g+2} \rangle_{\Sigma'} = 1$  and  $lk(f_{2g+2}, \gamma) = x$ . Note that the orientation of the meridian depends on the type of enlargement. The Seifert matrix associated with  $\Sigma'$  with respect to the basis  $(f_{2g+1}, f_{2g+2}, f_1, \dots, f_{2g})$  is  $W$ .

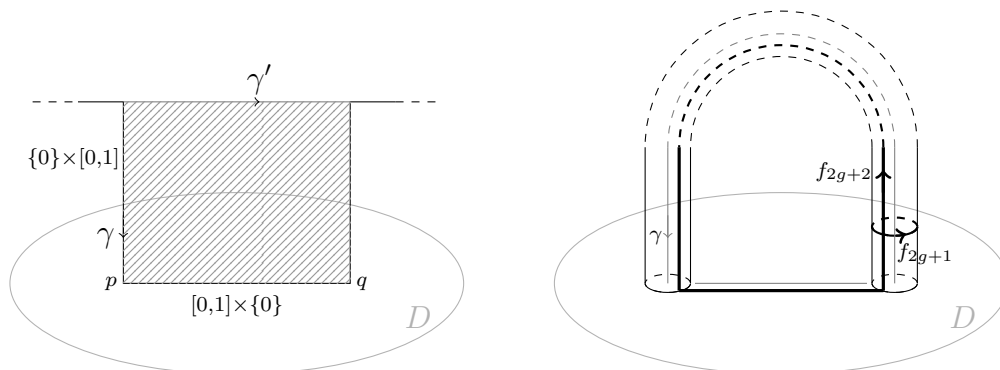
 Figure 2: Adding a tube to  $\Sigma$ 

Since the different QHH's replaced by surgery are disjoint, they can be connected by tubes. Thus  $(M', K')$  can be obtained from  $(M, K)$  by one surgery on a genus  $2g$  QHH. Let  $(b_i)_{1 \leq i \leq 2g}$  (resp.  $(b'_i)_{1 \leq i \leq 2g+2}$ ) be a family of generators of  $\mathfrak{A}(K)$  (resp.  $\mathfrak{A}(K')$ ) associated with  $V$  (resp.  $W$ ). The  $b'_i$  can be chosen so that the isomorphism  $\xi : \mathfrak{A}(K) \rightarrow \mathfrak{A}(K')$  induced by the surgery satisfies  $\xi(b_i) = b'_{i+2}$ .  $\square$

*Proof of Theorem 1.11.* Let  $V$  and  $V'$  be Seifert matrices associated with  $(M, K)$  and  $(M', K')$  respectively. By Theorem 1.8,  $V'$  can be obtained from  $V$  by a sequence of enlargements, reductions, and integral symplectic congruences which induces the  $\tau$ -class of the isomorphism  $\xi$ . This provides a finite sequence  $V_1, V_2, \dots, V_n$  of Seifert matrices such that  $V_1 = V$ ,  $V_n = V'$ , and  $V_{i+1}$  is obtained from  $V_i$  by one of these equivalences. By Lemma 3.5, for each  $i$ , we can fix a QSK-system  $\mathcal{S}_i$  with Seifert matrix  $V_i$ . To see that  $\mathcal{S}_{i+1}$  can be obtained from  $\mathcal{S}_i$  by one, or two successive, null LP-surgeries, which induce the required  $\tau$ -class of isomorphisms, apply Lemma 5.2 in the case of a (possibly trivial) congruence, and apply Lemma 5.3 in the case of an enlargement or a reduction.  $\square$

## 6 Sequences of LP-surgeries

In this section, we prove Proposition 1.12.

**Lemma 6.1.** *There exist two knots in  $S^3$  which have isomorphic rational Blanchfield forms, and different integral Alexander modules.*

*Proof.* In  $S^3$ , consider a knot  $K$  with Seifert matrix  $\begin{pmatrix} -1 & 0 \\ 1 & 2 \end{pmatrix}$ , and a knot  $K'$  with Seifert matrix  $\begin{pmatrix} 3 & 1 \\ 2 & 0 \end{pmatrix}$ . Their Alexander modules have presentation matrices  $\begin{pmatrix} 1-t & -1 \\ t & 2t-2 \end{pmatrix}$

and  $\begin{pmatrix} 3t - 3 & t - 2 \\ 2t - 1 & 0 \end{pmatrix}$ . Both have Alexander polynomial  $\Delta(t) = (2t - 1)(2 - t)$ . Since it is the product of two dual non symmetric prime polynomials, their rational Blanchfield forms are isomorphic (see [Chap. 4, Lemma 3.6]). But  $K$  has integral Alexander module  $\frac{\mathbb{Z}[t^{\pm 1}]}{(\Delta(t))}$ , whereas the integral Alexander module of  $K'$  has a non trivial second elementary ideal (the  $k$ -th elementary ideal associated with a  $\mathbb{Z}[t^{\pm 1}]$ -module is the ideal of  $\mathbb{Z}[t^{\pm 1}]$  generated by the minors of size  $n - k + 1$  of a presentation matrix with  $n$  generators of the module, see [Lic97, Chapter 6]). Indeed, this ideal is generated by  $(t - 2)$  and  $(2t - 1)$  in  $\mathbb{Z}[t^{\pm 1}]$ , so the evaluation at  $t = -1$  maps it onto  $3\mathbb{Z}$ .  $\square$

*Proof of Proposition 1.12.* Consider the QSK-pairs  $(S^3, K)$  and  $(S^3, K')$  of Lemma 6.1. By Theorem 1.11,  $(S^3, K')$  can be obtained from  $(S^3, K)$  by a finite sequence of null LP-surgeries. Suppose we can restrict to a single surgery  $(\frac{B}{A})$ . Then  $A$  and  $B$  would be QHH's embedded in a ZHS. It follows from Lemma 5.1 that  $A$  and  $B$  would be ZHH's. Thus, by Lemma 2.3, the surgery would preserve the integral Alexander module.  $\square$

# Chapitre 6 : Invariants de type fini des nœuds homologiquement triviaux dans les sphères d'homologie rationnelle

## Résumé

Dans ce chapitre, on étudie l'espace vectoriel rationnel  $\mathcal{F}_0$  engendré par les QSK-paires, et la filtration définie sur cet espace par les chirurgies LP rationnelles nulles. On étudie aussi l'espace vectoriel rationnel  $\mathcal{F}_0^{\mathbb{Z}}$  engendré par les ZSK-paires, et la filtration définie sur cet espace par les chirurgies LP entières nulles. On étudie les quotients gradués associés à ces filtrations. On détermine le premier quotient dans le cas général, et on montre que les quotients impairs associés à la filtration de  $\mathcal{F}_0^{\mathbb{Z}}$  sont triviaux.

# Invariants of finite null-degree of null-homologous knots in rational homology 3-spheres

## Abstract

We study the rational vector space  $\mathcal{F}_0$  generated by pairs  $(M, K)$ , where  $M$  is a rational homology sphere and  $K$  is a null-homologous knot in  $M$ , and the filtration defined on this space by Lagrangian-preserving replacements of rational homology handlebodies whose homology vanishes in  $M \setminus K$ . We also study the rational vector space  $\mathcal{F}_0^{\mathbb{Z}}$  generated by pairs  $(M, K)$ , where  $M$  is an integral homology sphere and  $K$  is a knot in  $M$ , and the filtration defined on this space by the Garoufalidis and Rozansky null-moves. We study the graded quotients associated with these filtrations. We determine the first quotient in the general case, and we prove that the odd quotients associated with the filtration on  $\mathcal{F}_0^{\mathbb{Z}}$  are trivial. Our determination of the first quotient can be used to compare the two-loop part of the Kricker rational lift of the Kontsevich integral defined in [GK04] and the configuration space invariant of Lescop defined in [Les10].

## 1 Introduction

### 1.1 Null LP-surgeries

We first recall the definition of the Alexander module and of the Blanchfield form. Let  $(M, K)$  be a  $\mathbb{Q}SK$ -pair, that is a pair made of a rational homology 3-sphere  $M$  and a null-homologous knot  $K$  in  $M$ . Let  $T(K)$  be a tubular neighborhood of  $K$ . The *exterior* of  $K$  is  $X = M \setminus \text{Int}(T(K))$ . Consider the projection  $\pi : \pi_1(X) \rightarrow \frac{H_1(X; \mathbb{Z})}{\text{torsion}} \cong \mathbb{Z}$ , and the covering map  $p : \tilde{X} \rightarrow X$  associated with its kernel. The covering  $\tilde{X}$  is the *infinite cyclic covering* of  $X$ . The automorphism group of the covering,  $\text{Aut}(\tilde{X})$ , is isomorphic to  $\mathbb{Z}$ . It acts on  $H_1(\tilde{X}; \mathbb{Q})$ . Denoting the action of a generator  $\tau$  of  $\text{Aut}(\tilde{X})$  as the multiplication by  $t$ , we get a structure of  $\mathbb{Q}[t^{\pm 1}]$ -module on  $\mathfrak{A} = H_1(\tilde{X}; \mathbb{Q})$ . This  $\mathbb{Q}[t^{\pm 1}]$ -module is called the *Alexander module* of  $K$ . It is a torsion  $\mathbb{Q}[t^{\pm 1}]$ -module.

On the Alexander module, the *Blanchfield form*, or *equivariant linking pairing*,  $\mathfrak{b} : \mathfrak{A} \times \mathfrak{A} \rightarrow \frac{\mathbb{Q}(t)}{\mathbb{Q}[t^{\pm 1}]}$ , is defined as follows. First define the equivariant linking number of two knots.

**Definition 1.1.** Let  $J_1$  and  $J_2$  be two knots in  $\tilde{X}$  such that  $J_1 \cap \tau^k(J_2) = \emptyset$  for all  $k \in \mathbb{Z}$ . Let  $\delta(t)$  be the annihilator of  $\mathfrak{A}$ . Then  $\delta(\tau)J_1$  and  $\delta(\tau)J_2$  are rationally null-homologous links. The *equivariant linking number* of  $J_1$  and  $J_2$  is

$$lk_e(J_1, J_2) = \frac{1}{\delta(t)\delta(t^{-1})} \sum_{k \in \mathbb{Z}} lk(\delta(\tau)J_1, \tau^k(\delta(\tau)J_2))t^k.$$



One can easily see that  $lk_e(J_1, J_2) \in \frac{1}{\delta(t)}\mathbb{Q}[t^{\pm 1}]$ ,  $lk_e(J_2, J_1)(t) = lk_e(J_1, J_2)(t^{-1})$ , and  $lk_e(P(\tau)J_1, Q(\tau)J_2)(t) = P(t)Q(t^{-1})lk_e(J_1, J_2)(t)$ . Now, if  $\gamma$  (resp.  $\eta$ ) is the homology class of  $J_1$  (resp.  $J_2$ ) in  $\mathfrak{A}$ , define  $\mathfrak{b}(\gamma, \eta)$  by:

$$\mathfrak{b}(\gamma, \eta) = lk_e(J_1, J_2) \text{ mod } \mathbb{Q}[t^{\pm 1}].$$

The Blanchfield form is *hermitian*:  $\mathfrak{b}(\gamma, \eta)(t) = \mathfrak{b}(\eta, \gamma)(t^{-1})$  and  $\mathfrak{b}(P(t)\gamma, Q(t)\eta)(t) = P(t)Q(t^{-1})\mathfrak{b}(\gamma, \eta)(t)$  for all  $\gamma, \eta \in \mathfrak{A}$  and all  $P, Q \in \mathbb{Q}[t^{\pm 1}]$ . Moreover, it is *non degenerate* (see Blanchfield in [Bla57]) :  $\mathfrak{b}(\gamma, \eta) = 0$  for all  $\eta \in \mathfrak{A}$  implies  $\gamma = 0$ .

Similarly, define the *integral Alexander module* of  $K$  as the  $\mathbb{Z}[t^{\pm 1}]$ -module  $\mathfrak{A}_{\mathbb{Z}} = H_1(\tilde{X}; \mathbb{Z})$ , and the *Blanchfield form*  $\mathfrak{b}_{\mathbb{Z}}$  on this module.

The Alexander module (resp. integral Alexander module) of a QSK-pair  $(M, K)$  endowed with its Blanchfield form is denoted by  $(\mathfrak{A}, \mathfrak{b})(M, K)$  (resp.  $(\mathfrak{A}_{\mathbb{Z}}, \mathfrak{b}_{\mathbb{Z}})(M, K)$ ).

We now define LP-surgeries.

**Definition 1.2.** For  $g \in \mathbb{N}$ , a *genus  $g$  rational homology handlebody* ( $\mathbb{Q}$ HH) is a 3-manifold which is compact, oriented, and which has the same homology with rational coefficients as the standard genus  $g$  handlebody.

Such a  $\mathbb{Q}$ HH is connected, and its boundary is necessarily homeomorphic to the standard genus  $g$  surface.

**Definition 1.3.** The *Lagrangian*  $\mathcal{L}_A$  of a  $\mathbb{Q}$ HH  $A$  is the kernel of the map

$$i_* : H_1(\partial A; \mathbb{Q}) \rightarrow H_1(A; \mathbb{Q})$$

induced by the inclusion. Two  $\mathbb{Q}$ HH's  $A$  and  $B$  have *LP-identified* boundaries if  $(A, B)$  is equipped with a homeomorphism  $h : \partial A \rightarrow \partial B$  such that  $h_*(\mathcal{L}_A) = \mathcal{L}_B$ .

The Lagrangian of a  $\mathbb{Q}$ HH  $A$  is indeed a Lagrangian subspace of  $H_1(\partial A; \mathbb{Q})$  with respect to the intersection form.

Let  $M$  be a  $\mathbb{Q}$ HS, let  $A \subset M$  be a  $\mathbb{Q}$ HH, and let  $B$  be a  $\mathbb{Q}$ HH whose boundary is LP-identified with  $\partial A$ . Set  $M(\frac{B}{A}) = (M \setminus \text{Int}(A)) \cup_{\partial A = h \partial B} B$ . We say that the  $\mathbb{Q}$ HS  $M(\frac{B}{A})$  is obtained from  $M$  by *Lagrangian-preserving surgery*, or *LP-surgery*.

Given a QSK-pair  $(M, K)$ , a  $\mathbb{Q}$ HH *null in  $M \setminus K$*  is a  $\mathbb{Q}$ HH  $A \subset M \setminus K$  such that the map  $i_* : H_1(A; \mathbb{Q}) \rightarrow H_1(M \setminus K; \mathbb{Q})$  induced by the inclusion has a trivial image. A *null LP-surgery* on  $(M, K)$  is an LP-surgery  $(\frac{B}{A})$  such that  $A$  is null in  $M \setminus K$ . The QSK-pair obtained by surgery is denoted by  $(M, K)(\frac{B}{A})$ .

Replacing  $\mathbb{Q}$  by  $\mathbb{Z}$  above, define *integral homology handlebodies* ( $\mathbb{Z}$ HH), *integral Lagrangians*, *integral LP-surgeries*, and *integral null LP-surgeries*, similarly.

Let  $\mathcal{F}_0$  be the rational vector space generated by all QSK-pairs up to orientation-preserving homeomorphism. Let  $\mathcal{F}_n$  be the subspace of  $\mathcal{F}_0$  generated by the

$$[(M, K); (\frac{B_i}{A_i})_{1 \leq i \leq n}] = \sum_{I \subset \{1, \dots, n\}} (-1)^{|I|} (M, K)((\frac{B_i}{A_i})_{i \in I})$$

for all QSK-pairs  $(M, K)$  and all families of QHH's  $(A_i, B_i)_{1 \leq i \leq n}$ , where the  $A_i$  are null in  $M \setminus K$  and disjoint, and each  $\partial B_i$  is LP-identified with the corresponding  $\partial A_i$ . Here and in all the article,  $|\cdot|$  stands for the cardinality. Since  $\mathcal{F}_{n+1} \subset \mathcal{F}_n$ , this defines a filtration.

**Definition 1.4.** An *invariant of null-degree at most  $n$*  of QSK-pairs  $(M, K)$  is a linear map  $\lambda : \mathcal{F}_0 \rightarrow \mathbb{Q}$  such that  $\lambda(\mathcal{F}_{n+1}) = 0$ .

The following result provides a splitting of the filtration  $(\mathcal{F}_n)_{n \in \mathbb{N}}$ :

**Theorem 1.5** ([Chap. 5] Theorem 1.11). *A null LP-surgery induces a canonical isomorphism between the Alexander modules of the involved QSK-pairs, which preserves the Blanchfield form. Conversely, any isomorphism between the Alexander modules of two QSK-pairs which preserves the Blanchfield form can be realized by a finite sequence of null LP-surgeries, up to multiplication by a power of  $t$ .*

For an isomorphism class  $(\mathfrak{A}, \mathfrak{b})$  of rational Alexander modules endowed with their Blanchfield forms, let  $\mathcal{P}(\mathfrak{A}, \mathfrak{b})$  be the set of all QSK-pairs, up to orientation-preserving homeomorphism, whose Alexander modules endowed with their Blanchfield forms are isomorphic to  $(\mathfrak{A}, \mathfrak{b})$ . Let  $\mathcal{F}_0(\mathfrak{A}, \mathfrak{b})$  be the subspace of  $\mathcal{F}_0$  generated by the QSK-pairs  $(M, K) \in \mathcal{P}(\mathfrak{A}, \mathfrak{b})$ . Let  $(\mathcal{F}_n(\mathfrak{A}, \mathfrak{b}))_{n \in \mathbb{N}}$  be the filtration defined on  $\mathcal{F}_0(\mathfrak{A}, \mathfrak{b})$  by null LP-surgeries. Then, for  $n \in \mathbb{N}$ ,  $\mathcal{F}_n$  is the direct sum over all isomorphism classes  $(\mathfrak{A}, \mathfrak{b})$  of rational Alexander modules endowed with their Blanchfield forms of the  $\mathcal{F}_n(\mathfrak{A}, \mathfrak{b})$ . Set  $\mathcal{G}_n(\mathfrak{A}, \mathfrak{b}) = \mathcal{F}_n(\mathfrak{A}, \mathfrak{b}) / \mathcal{F}_{n+1}(\mathfrak{A}, \mathfrak{b})$ . The main goal of the article is to study the graded quotients  $\mathcal{G}_n(\mathfrak{A}, \mathfrak{b})$ . By Theorem 1.5,  $\mathcal{G}_0(\mathfrak{A}, \mathfrak{b}) \cong \mathbb{Q}$ . In Section 3, as a consequence of Theorem 1.10, we prove:

**Theorem 1.6.** *Let  $(M_0, K_0) \in \mathcal{P}(\mathfrak{A}, \mathfrak{b})$ . For any prime integer  $p$ , let  $B_p$  be a rational homology ball such that  $H_1(B_p; \mathbb{Z}) \cong \mathbb{Z}/p\mathbb{Z}$ . Then:*

$$\mathcal{G}_1(\mathfrak{A}, \mathfrak{b}) = \bigoplus_{p \text{ prime}} \mathbb{Q}[(M_0, K_0); \frac{B_p}{B^3}].$$

## 1.2 Borromean surgeries

Let us define a specific type of LP-surgeries.

The *standard Y-graph* is the graph  $\Gamma_0 \subset \mathbb{R}^2$  represented in Figure 1. The looped edges of  $\Gamma_0$  are the *leaves*. The vertex incident to three different edges is the *internal vertex*. With  $\Gamma_0$  is associated a regular neighborhood  $\Sigma(\Gamma_0)$  of  $\Gamma_0$  in the plane. The surface  $\Sigma(\Gamma_0)$  is oriented with the usual convention. This induces an orientation of the leaves, and an orientation of the internal vertex, *i.e.* a cyclic order of the three edges. Consider a 3-manifold  $M$  and an embedding  $h : \Sigma(\Gamma_0) \rightarrow M$ . The image  $\Gamma$  of  $\Gamma_0$  is a *Y-graph*, endowed with its *associated surface*  $\Sigma(\Gamma) = h(\Sigma(\Gamma_0))$ . The Y-graph  $\Gamma$  is equipped with the framing induced by  $\Sigma(\Gamma)$ . A *Y-link* in a 3-manifold is a collection of disjoint Y-graphs.

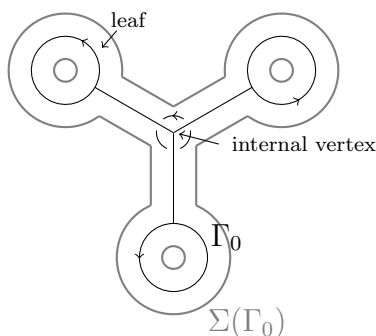

Figure 1: The standard Y-graph

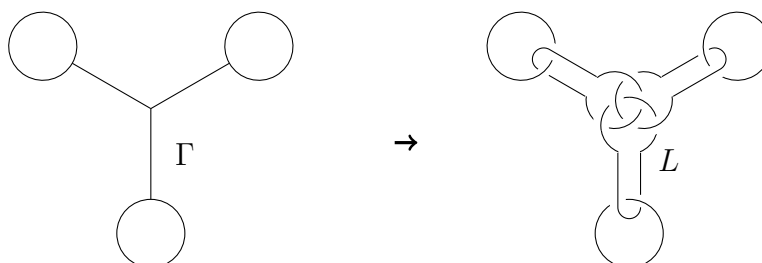

Figure 2: Y-graph and associated surgery link

Let  $\Gamma$  be a Y-graph in a 3-manifold  $M$ . Let  $\Sigma(\Gamma)$  be its associated surface. In  $\Sigma \times [-1, 1]$ , associate with  $\Gamma$  the six-component link  $L$  represented in Figure 2. The *Borromean surgery on  $\Gamma$*  is the surgery along the framed link  $L$ . As proved by Matveev in [Mat87], a Borromean surgery can be realised by cutting a genus 3 handlebody (a regular neighborhood of the Y-graph) and regluing it another way. Moreover, this surgery is an integral LP-surgery. If  $(M, K)$  is a  $\mathbb{Q}SK$ -pair and if  $\Gamma$  is an  $n$ -component Y-link, null in  $M \setminus K$ , then  $[(M, K); \Gamma] \in \mathcal{F}_0$  denotes the bracket defined by the  $n$  disjoint null LP-surgeries on the components of  $\Gamma$ .

For  $n \geq 0$ , let  $\mathcal{G}_n^b(\mathfrak{A}, \mathfrak{b})$  be the subspace of  $\mathcal{G}_n(\mathfrak{A}, \mathfrak{b})$  generated by the brackets defined by null Borromean surgeries. The following result is a consequence of Proposition 1.14.

**Proposition 1.7.** *For  $n \geq 0$ ,  $\mathcal{G}_{2n+1}^b(\mathfrak{A}, \mathfrak{b}) = 0$ .*

The filtration  $(\mathcal{F}_n)_{n \in \mathbb{N}}$  generalizes the following filtration introduced by Garoufalidis and Rozansky in [GR04]. Let  $\mathcal{F}_0^{\mathbb{Z}}$  be the rational vector space generated by all  $\mathbb{Z}SK$ -pairs, that are pairs  $(M, K)$  made of an integral homology sphere  $M$  and a knot  $K$  in  $M$ , up to orientation-preserving homeomorphism. Define a filtration  $(\mathcal{F}_n^{\mathbb{Z}})_{n \in \mathbb{N}}$  of  $\mathcal{F}_0^{\mathbb{Z}}$  by means of null Borromean surgeries.

**Lemma 1.8** ([GR04] Lemma 1.3). *Two  $\mathbb{Z}SK$ -pairs can be obtained from one another by a finite sequence of null Borromean surgeries if and only if their integral Alexander modules endowed with their Blanchfield forms are isomorphic.*

As above, this result provides a splitting of the filtration  $(\mathcal{F}_n^{\mathbb{Z}})_{n \in \mathbb{N}}$  as the direct sum of filtrations  $(\mathcal{F}_n^{\mathbb{Z}}(\mathfrak{A}_{\mathbb{Z}}, \mathfrak{b}_{\mathbb{Z}}))_{n \in \mathbb{N}}$  of subspaces  $\mathcal{F}_0^{\mathbb{Z}}(\mathfrak{A}_{\mathbb{Z}}, \mathfrak{b}_{\mathbb{Z}})$  of  $\mathcal{F}_0^{\mathbb{Z}}$ , where  $(\mathfrak{A}_{\mathbb{Z}}, \mathfrak{b}_{\mathbb{Z}})$  represents an isomorphism class of integral Alexander modules endowed with their Blanchfield forms. Let  $\mathcal{P}(\mathfrak{A}_{\mathbb{Z}}, \mathfrak{b}_{\mathbb{Z}})$  be the set of all  $\mathbb{Z}SK$ -pairs whose integral Alexander modules endowed with their Blanchfield forms are isomorphic to  $(\mathfrak{A}_{\mathbb{Z}}, \mathfrak{b}_{\mathbb{Z}})$ .

In Section 4, we prove:

**Theorem 1.9.** *For  $n \geq 0$ ,  $\mathcal{G}_{2n+1}^{\mathbb{Z}}(\mathfrak{A}_{\mathbb{Z}}, \mathfrak{b}_{\mathbb{Z}}) = 0$ .*

**Remark:** Auclair and Lescop proved in [AL05] that two  $\mathbb{Z}HH$ 's whose boundaries are LP-identified can be obtained from one another by a finite sequence of Borromean surgeries. Therefore, the filtration defined on  $\mathcal{F}_0^{\mathbb{Z}}$  by integral null LP-surgeries is equal to the filtration  $(\mathcal{F}_n^{\mathbb{Z}})_{n \in \mathbb{N}}$  defined above.

### 1.3 Spaces of diagrams

An  $\mathfrak{A}$ -colored graph is a uni-trivalent graph without strut  $(\begin{smallmatrix} \bullet \\ | \\ \bullet \end{smallmatrix})$ , whose edges are oriented and colored by  $\mathbb{Q}[t^{\pm 1}]$ , whose univalent vertices are colored by  $\mathfrak{A}$ , and whose trivalent vertices are oriented. An *orientation of a trivalent vertex* of such a diagram is a cyclic order of the three half-edges that meet at this vertex. In the pictures, this orientation is induced by the cyclic order  $\curvearrowright$ . Let  $\delta(t)$  be the annihilator of  $\mathfrak{A}$ . An  $(\mathfrak{A}, \mathfrak{b})$ -colored diagram  $D$  is an  $\mathfrak{A}$ -colored graph whose univalent vertices form a set  $V$ , equipped with a family  $(f_{vv'}^D(t))_{\{(v,v') \in V^2; v \neq v'\}} \subset \frac{1}{\delta(t)}\mathbb{Q}[t^{\pm 1}]$  such that  $f_{vv'}^D(t) \bmod \mathbb{Q}[t^{\pm 1}] = \mathfrak{b}(\gamma, \gamma')$  if  $\gamma$  (resp.  $\gamma'$ ) is the coloring of  $v$  (resp.  $v'$ ), and  $f_{vv'}^D(t) = f_{vv'}^D(t^{-1})$ . When it does not seem to cause confusion, we write  $f_{vv'}$  for  $f_{vv'}^D$ . The *degree* of a colored diagram is the number of trivalent vertices of its underlying graph. The unique degree 0 diagram is the empty diagram. For  $n \geq 0$ , set:

$$\tilde{\mathcal{A}}_n(\mathfrak{A}, \mathfrak{b}) = \frac{\mathbb{Q} \langle (\mathfrak{A}, \mathfrak{b})\text{-colored diagrams of degree } n \rangle}{\mathbb{Q} \langle \text{AS, IHX, LE, OR, Hol, LV, EV, LD} \rangle},$$

where the relations AS (anti-symmetry), IHX, LE (linearity for edges), OR (orientation reversal), Hol (holonomy), LV (linearity for vertices), EV (edge-vertex), and LD (linking difference) are described in Figure 3.

The automorphism group  $Aut(\mathfrak{A}, \mathfrak{b})$  is the group of the automorphisms of  $\mathbb{Q}[t^{\pm 1}]$ -module of  $\mathfrak{A}$  which preserve the Blanchfield form. It acts on  $\tilde{\mathcal{A}}_n(\mathfrak{A}, \mathfrak{b})$  by acting on the colorings of all the univalent vertices of a diagram simultaneously. Let  $\mathcal{A}_n(\mathfrak{A}, \mathfrak{b})$  be the

$$\begin{array}{c}
 \begin{array}{ccc}
 \begin{array}{c} \diagup \\ | \\ \diagdown \end{array} + \begin{array}{c} \diagup \\ | \\ \diagdown \\ | \\ \diagup \end{array} = 0 \\
 \text{AS}
 \end{array} &
 \begin{array}{ccc}
 \begin{array}{c} \diagup \\ | \\ \diagdown \\ | \\ \diagup \end{array} - \begin{array}{c} \diagup \\ | \\ \diagdown \\ | \\ \diagup \\ | \\ \diagdown \end{array} + \begin{array}{c} \diagup \\ | \\ \diagdown \\ | \\ \diagup \\ | \\ \diagdown \end{array} = 0 \\
 \text{IHX}
 \end{array} \\
 \\
 \begin{array}{ccc}
 x \begin{array}{c} | \\ \uparrow P \end{array} + y \begin{array}{c} | \\ \uparrow Q \end{array} = \begin{array}{c} | \\ \uparrow xP + yQ \end{array} &
 \begin{array}{c} | \\ \uparrow P(t) \end{array} = \begin{array}{c} | \\ \uparrow P(t^{-1}) \end{array} &
 \begin{array}{c} \diagup \\ | \\ \diagdown \\ | \\ \diagup \end{array} \begin{array}{c} | \\ \uparrow P \end{array} = \begin{array}{c} \diagup \\ | \\ \diagdown \\ | \\ \diagup \end{array} \begin{array}{c} | \\ \uparrow tP \end{array} \\
 \text{LE} & \text{OR} & \text{Hol}
 \end{array} \\
 \\
 \begin{array}{ccc}
 x \begin{array}{c} \bullet \gamma_1 \\ | \\ D_1 \end{array} + y \begin{array}{c} \bullet \gamma_2 \\ | \\ D_2 \end{array} = \begin{array}{c} \bullet x\gamma_1 + y\gamma_2 \\ | \\ D \end{array} &
 \begin{array}{c} \bullet \gamma \\ | \\ P \\ | \\ D \end{array} = \begin{array}{c} \bullet Q(t)\gamma \\ | \\ P \\ | \\ D' \end{array} &
 f_{vv'}^{D'}(t) = Q(t)f_{vv'}^D(t) \\
 & & \forall v' \neq v \\
 x f_{vv'}^{D_1}(t) + y f_{vv'}^{D_2}(t) = f_{vv'}^D(t) \quad \forall v' \neq v & & \text{EV} \\
 \text{LV} & & \\
 \\
 \begin{array}{ccc}
 \begin{array}{c} \bullet \gamma_1 \\ | \\ 1 \end{array} \begin{array}{c} \bullet \gamma_2 \\ | \\ 1 \end{array} = \begin{array}{c} \bullet \gamma_1 \\ | \\ 1 \end{array} \begin{array}{c} \bullet \gamma_2 \\ | \\ 1 \end{array} + \begin{array}{c} \diagup \\ | \\ \diagdown \\ | \\ \diagup \end{array} \begin{array}{c} P \end{array} \\
 \begin{array}{c} \bullet \gamma_1 \\ | \\ 1 \end{array} \begin{array}{c} \bullet \gamma_2 \\ | \\ 1 \end{array} \begin{array}{c} D \end{array} = \begin{array}{c} \bullet \gamma_1 \\ | \\ 1 \end{array} \begin{array}{c} \bullet \gamma_2 \\ | \\ 1 \end{array} \begin{array}{c} D' \end{array} + \begin{array}{c} \diagup \\ | \\ \diagdown \\ | \\ \diagup \end{array} \begin{array}{c} D'' \end{array} \\
 f_{v_1 v_2}^D = f_{v_1 v_2}^{D'} + P & & \text{The drawn edge of } D'' \text{ must} \\
 & & \text{connect trivalent vertices,} \\
 & & \text{maybe identical.} \\
 \text{LD} & &
 \end{array}
 \end{array}$$

 Figure 3: Relations, where  $x, y \in \mathbb{Q}$ ,  $P, Q, R \in \mathbb{Q}[t^{\pm 1}]$ ,  $\gamma, \gamma_1, \gamma_2 \in \mathfrak{A}$ .

quotient of  $\tilde{\mathcal{A}}_n(\mathfrak{A}, \mathfrak{b})$  by this action. Since the opposite of the identity is an automorphism of  $(\mathfrak{A}, \mathfrak{b})$ , we have  $\mathcal{A}_{2n+1}(\mathfrak{A}, \mathfrak{b}) = 0$  for all  $n \geq 0$ .

An  $(\mathfrak{A}, \mathfrak{b})$ -augmented diagram is the union of an  $(\mathfrak{A}, \mathfrak{b})$ -colored diagram (its *Jacobi part*) and of finitely many isolated vertices colored by prime integers. The *degree* of an  $(\mathfrak{A}, \mathfrak{b})$ -augmented diagram is the number of its vertices of valence 0 or 3. For  $n \geq 0$ , set:

$$\mathcal{A}_n^{aug}(\mathfrak{A}, \mathfrak{b}) = \frac{\mathbb{Q} \langle (\mathfrak{A}, \mathfrak{b})\text{-augmented diagrams of degree } n \rangle}{\mathbb{Q} \langle \text{AS, IHX, LE, OR, Hol, LV, EV, LD, Aut} \rangle},$$

where the relation *Aut* identifies two diagrams obtained from one another by the action of an element of  $\text{Aut}(\mathfrak{A}, \mathfrak{b})$ .

In Section 3, we prove:

**Theorem 1.10.** *For all  $n \geq 0$ , there is a canonical surjective  $\mathbb{Q}$ -linear map:*

$$\varphi_n : \mathcal{A}_n^{aug}(\mathfrak{A}, \mathfrak{b}) \twoheadrightarrow \mathcal{G}_n(\mathfrak{A}, \mathfrak{b}).$$

In [GR04], Garoufalidis and Rozansky identified the graded quotients  $\mathcal{G}_n^{\mathbb{Z}}(\mathfrak{A}_0)$ , where  $\mathfrak{A}_0$  is the trivial Alexander module, with graded spaces of diagrams. We generalize this result with the following theorem, obtained as a consequence of Theorem 1.6 and Proposition 5.5.

**Theorem 1.11.** *For  $n \geq 0$ ,  $\mathcal{G}_n(\mathfrak{A}_0) \cong \mathcal{A}_n^{aug}(\mathfrak{A}_0)$ .*

### 1.4 Colored diagrams and Y-links

A diagram  $D \in \tilde{\mathcal{A}}_n(\mathfrak{A}, \mathfrak{b})$  is an *elementary diagram* if its edges which connect two trivalent vertices are colored by powers of  $t$ , and if its edges adjacent to univalent vertices are colored by 1. Below, we associate a null Y-link with some elementary diagrams which generate  $\tilde{\mathcal{A}}_n(\mathfrak{A}, \mathfrak{b})$ . Let  $(M, K) \in \mathcal{P}(\mathfrak{A}, \mathfrak{b})$ . Let  $\xi : (\mathfrak{A}, \mathfrak{b}) \rightarrow (\mathfrak{A}, \mathfrak{b})(M, K)$  be an isomorphism. Let  $m(K)$  be a meridian of  $K$ .

**Definition 1.12.** Let  $D$  be an elementary diagram. An embedding of  $D$  in  $M \setminus K$  is *admissible* if the following conditions are satisfied.

- The vertices of  $D$  are embedded in some ball  $B \subset M \setminus K$ .
- Consider an edge colored by  $t^k$ . The homology class in  $H_1(M \setminus K; \mathbb{Z})$  of the closed curve obtained by connecting the extremities of this edge by a path in  $B$  is  $k m(K)$ .

Such an embedding always exists. It suffices to embed the diagram in  $B$ , and to let each edge colored by  $t^k$  turn around  $K$ ,  $k$  times. With an admissible embedding of an elementary diagram, we wish to associate a null Y-link.

Let  $\Gamma$  be a Y-graph null in  $M \setminus K$ . Let  $p$  be the internal vertex of  $\Gamma$ . Let  $\ell$  be a leaf of  $\Gamma$ , and let  $e$  be the edge which connects  $p$  to  $\ell$ . The curve  $\hat{\ell}$  drawn in Figure 4 is the *extension of  $\ell$  in  $\Gamma$* .

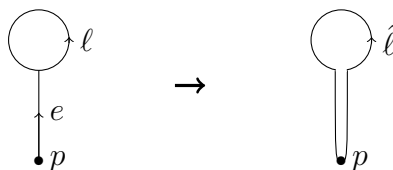

Figure 4: Extension of a leaf in a Y-graph

Let  $D$  be an elementary diagram, equipped with an admissible embedding in  $M \setminus K$ . Equip  $D$  with the framing induced by an immersion in the plane which induces the fixed orientation of the trivalent vertices. If an edge connects two trivalent vertices, then insert a little Hopf link in this edge, as shown in Figure 5. At each univalent vertex  $v$ , glue a leaf  $\ell_v$ , trivial in  $H_1(M \setminus K; \mathbb{Q})$ , in order to obtain a null Y-link  $\Gamma$ . Let  $V$  be the set of all

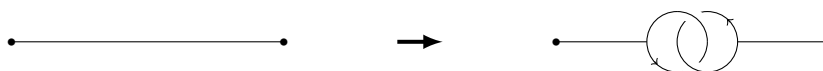

Figure 5: Replacement of an edge

univalent vertices of  $D$ . For  $v \in V$ , let  $\gamma_v$  be the coloring of  $v$ , let  $\hat{\ell}_v$  be the extension of  $\ell_v$  in  $\Gamma$ , and let  $\tilde{\ell}_v$  be the lift of  $\hat{\ell}_v$  defined by lifting the basepoint in some chosen lift  $\tilde{B}$  of  $B$ . The null Y-link  $\Gamma$  is a *realization of  $D$  in  $(M, K)$  with respect to  $\xi$*  if the following conditions are satisfied:

- for all  $v \in V$ ,  $\tilde{\ell}_v$  is homologous to  $\xi(\gamma_v)$ ,
- for all  $(v, v') \in V^2$ ,  $lk_e(\tilde{\ell}_v, \tilde{\ell}_{v'}) = f_{vv'}$ .

If such a realization exists, the elementary diagram  $D$  is  $\xi$ -realizable.

Let  $D$  be any elementary diagram. Let  $V$  be the set of all univalent vertices of  $D$ . For any family of rational numbers  $(q_v)_{v \in V}$ , define an elementary diagram  $D' = (q_v)_{v \in V} \cdot D$  from  $D$  in the following way. Keep the same graph and the same colorings of the edges. For  $v \in V$ , multiply the coloring of  $v$  by  $q_v$ . For  $v \neq v' \in V$ , set  $f_{vv'}^{D'} = q_v q_{v'} f_{vv'}^D$ .

**Lemma 1.13.** *Let  $(M, K) \in \mathcal{P}(\mathfrak{A}, \mathfrak{b})$ . Let  $\xi : (\mathfrak{A}, \mathfrak{b}) \rightarrow (\mathfrak{A}, \mathfrak{b})(M, K)$  be an isomorphism. Let  $D$  be any elementary diagram. Let  $V$  be the set of all univalent vertices of  $D$ . Then there exists a family of positive integers  $(s_v)_{v \in V}$  such that  $(s_v)_{v \in V} \cdot D$  is  $\xi$ -realizable.*

*Proof.* Let  $\tilde{X}$  be the infinite cyclic covering associated with  $(M, K)$ . Since any homology class in  $\mathfrak{A}$  has a multiple which can be represented by a knot in  $\tilde{X}$ , we can assume that the color  $\gamma_v$  of each vertex  $v$  in  $V$  can be represented by a knot in  $\tilde{X}$ . From  $D$ , define as above a Y-link  $\Gamma$ , null in  $M \setminus K$ , with leaves  $\ell_v$  which satisfy the condition that  $\tilde{\ell}_v$  is homologous to  $\xi(\gamma_v)$  for all  $v \in V$ . For  $v \neq v' \in V$ , set  $P_{vv'} = lk_e(\tilde{\ell}_v, \tilde{\ell}_{v'}) - f_{vv'}$ . Multiplying if necessary the diagram  $D$  by some  $(s_v)_{v \in V} \subset (\mathbb{N} \setminus \{0\})$ , we can assume that  $P_{vv'} \in \mathbb{Z}[t^{\pm 1}]$  for all  $v \neq v' \in V$ . Now, the equivariant linking number  $lk_e(\tilde{\ell}_v, \tilde{\ell}_{v'})$  can be added any polynomial in  $\mathbb{Z}[t^{\pm 1}]$  by adding well chosen meridians of  $\ell_v$  to  $\ell_{v'}$ .  $\square$

In Section 2, we show that  $[(M, K); \Gamma] \in \mathcal{G}_n(\mathfrak{A}, \mathfrak{b})$  does not depend on  $B, \tilde{B}, (M, K), \xi$ , and the realization of  $D$ , and we prove:

**Proposition 1.14.** *Let  $n > 0$ . There is a canonical,  $\mathbb{Q}$ -linear, and surjective map  $\varphi_n : \mathcal{A}_n(\mathfrak{A}, \mathfrak{b}) \rightarrow \mathcal{G}_n^b(\mathfrak{A}, \mathfrak{b})$  given by  $D \mapsto [(M, K); \Gamma_D]$  for any elementary diagram  $D$   $\xi$ -realizable, where  $(M, K) \in \mathcal{P}(\mathfrak{A}, \mathfrak{b})$ ,  $\xi : (\mathfrak{A}, \mathfrak{b}) \rightarrow (\mathfrak{A}, \mathfrak{b})(M, K)$  is an isomorphism, and  $\Gamma_D$  is a realization of  $D$  in  $(M, K)$  with respect to  $\xi$ .*

The map of Theorem 1.10 will be obtained by extending this map  $\varphi_n$  to  $\mathcal{A}_n^{aug}(\mathfrak{A}, \mathfrak{b})$ . In Section 2, we also prove:

**Proposition 1.15.** *Let  $(M_0, K_0) \in \mathcal{P}(\mathfrak{A}_{\mathbb{Z}}, \mathfrak{b}_{\mathbb{Z}})$ . Let  $(\mathfrak{A}, \mathfrak{b}) = \mathbb{Q} \otimes_{\mathbb{Z}} (\mathfrak{A}_{\mathbb{Z}}, \mathfrak{b}_{\mathbb{Z}})$ . Let  $\xi : (\mathfrak{A}, \mathfrak{b}) \rightarrow (\mathfrak{A}, \mathfrak{b})(M_0, K_0)$  be an isomorphism. Let  $n > 0$ . There is a well-defined,  $\mathbb{Q}$ -linear, and surjective map  $\varphi_n^{\mathbb{Z}}(\xi) : \tilde{\mathcal{A}}_n(\mathfrak{A}, \mathfrak{b}) \twoheadrightarrow \mathcal{G}_n^{\mathbb{Z}}(\mathfrak{A}_{\mathbb{Z}}, \mathfrak{b}_{\mathbb{Z}})$  given by  $D \mapsto [(M_0, K_0); \Gamma_D]$  for any elementary diagram  $D$   $\xi$ -realizable, where  $\Gamma_D$  is a realization of  $D$  in  $(M_0, K_0)$  with respect to  $\xi$ .*

Fix  $(\mathfrak{A}_{\mathbb{Z}}, \mathfrak{b}_{\mathbb{Z}})$  and set  $(\mathfrak{A}, \mathfrak{b}) = (\mathbb{Q} \otimes_{\mathbb{Z}} \mathfrak{A}_{\mathbb{Z}}, Id_{\mathbb{Q}} \otimes \mathfrak{b}_{\mathbb{Z}})$ . The corresponding map  $\varphi_n$  satisfies  $\varphi_n \circ p = \psi_n \circ \varphi_n^{\mathbb{Z}}(\xi)$ , where  $\psi_n : \mathcal{G}_n^{\mathbb{Z}}(\mathfrak{A}_{\mathbb{Z}}, \mathfrak{b}_{\mathbb{Z}}) \rightarrow \mathcal{G}_n^b(\mathfrak{A}, \mathfrak{b})$  is the map induced by the inclusion  $\mathcal{F}_n^{\mathbb{Z}}(\mathfrak{A}_{\mathbb{Z}}, \mathfrak{b}_{\mathbb{Z}}) \hookrightarrow \mathcal{F}_n(\mathfrak{A}, \mathfrak{b})$ , and  $p$  is the projection  $p : \tilde{\mathcal{A}}_n(\mathfrak{A}, \mathfrak{b}) \twoheadrightarrow \mathcal{A}_n(\mathfrak{A}, \mathfrak{b})$ .

## 2 Borromean surgeries and colored diagrams

In this section, we prove Proposition 1.14 and Proposition 1.15.

For a  $\mathbb{Q}$ SK-pair  $(M, K)$ , let  $\mathcal{F}_0^b(M, K)$  be the rational vector space generated by all the  $\mathbb{Q}$ SK-pairs that can be obtained from  $(M, K)$  by a finite sequence of null Borromean surgeries, up to orientation-preserving homeomorphism. For  $n > 0$ , let  $\mathcal{F}_n^b(M, K)$  be the subspace of  $\mathcal{F}_0^b(M, K)$  generated by the  $[(M, K); \Gamma]$  for all  $m$ -component null Y-links with  $m \geq n$ .

**Lemma 2.1** ([GGP01] Lemma 2.2). *Let  $\Gamma$  be a Y-graph in a 3-manifold  $V$ , which has a 0-framed leaf that bounds a disk in  $V$  whose interior does not meet  $\Gamma$ . Then  $V(\Gamma) \cong V$ .*

**Lemma 2.2** ([GGP01] Theorem 3.1, [Auc] Lemma 5.1.1). *Let  $\Gamma_0, \Gamma_1, \Gamma_2$  be the Y-graphs drawn in a genus 4 handlebody in Figure 6. Assume this handlebody is embedded in a 3-manifold  $V$ . Then  $V(\Gamma_0) \cong V(\Gamma_1 \cup \Gamma_2)$ .*

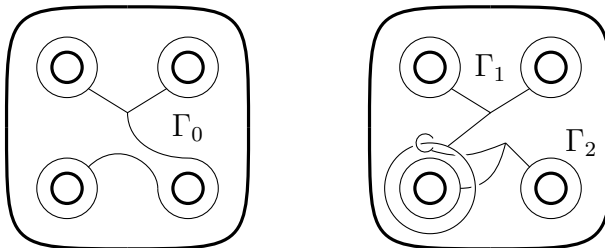

Figure 6: Topological equivalence for edge sliding

**Lemma 2.3.** *Let  $\Gamma$  be an  $n$ -component Y-link null in  $M \setminus K$ . Let  $J$  be a framed knot, null-homologous in  $M \setminus K$ , and disjoint from  $\Gamma$ . Let  $\Gamma'$  be obtained from  $\Gamma$  by sliding an edge of  $\Gamma$  along  $J$  (see Figure 7). Then  $[(M, K); \Gamma] = [(M, K); \Gamma'] \text{ mod } \mathcal{F}_{n+1}^b(M, K)$ .*



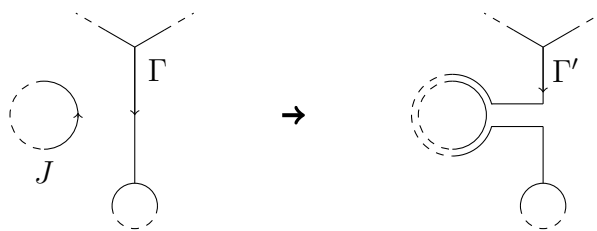

Figure 7: Sliding an edge

*Proof.* Let  $\Gamma'_0$  be the component of  $\Gamma'$  that contains the slid edge, and let  $\Gamma_0$  be the corresponding component of  $\Gamma$ . By Lemma 2.2, the surgery on  $\Gamma'_0$  is equivalent to the simultaneous surgeries on  $\Gamma_0$  and on a null Y-graph  $\hat{\Gamma}_0$  which has a leaf which is a meridian of a leaf of  $\Gamma_0$ . It follows that  $[(M, K); \Gamma] - [(M, K); \Gamma'] = [(M, K); \Gamma \cup \hat{\Gamma}_0] \in \mathcal{F}_{n+1}^b(M, K)$ .  $\square$

In particular, the above lemma shows that the class of  $[(M, K); \Gamma] \bmod \mathcal{F}_{n+1}^b(M, K)$  is invariant under an integral number of twists of the edges.

**Lemma 2.4** ([GGP01] Theorem 3.1). *Let  $\Gamma_0, \Gamma_1, \Gamma_2$  be the Y-graphs drawn in a genus 4 handlebody in Figure 8. Assume this handlebody is embedded in a 3-manifold  $V$ . Then  $V(\Gamma_0) \cong V(\Gamma_1 \cup \Gamma_2)$ .*

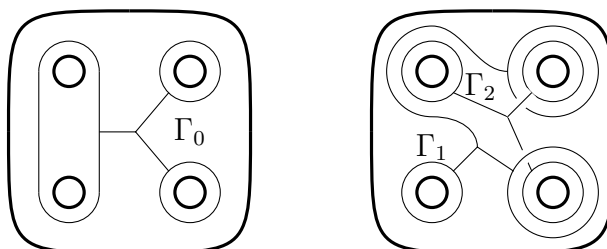

Figure 8: Topological equivalence for leaf cutting

**Lemma 2.5.** *Let  $\Gamma$  be an  $n$ -component Y-link null in  $M \setminus K$ . Let  $\ell$  be a leaf of  $\Gamma$ . Let  $\gamma$  be a framed arc starting at the vertex incident to  $\ell$  and ending in another point of  $\ell$ , embedded in  $M \setminus K$  as the core of a band glued to the associated surface of  $\Gamma$  as shown in Figure 9. The arc  $\gamma$  splits the leaf  $\ell$  into two leaves  $\ell'$  and  $\ell''$ . Denote the Y-links obtained from  $\Gamma$  by replacing the leaf  $\ell$  by  $\ell'$  and  $\ell''$  by  $\Gamma'$  and  $\Gamma''$ , respectively. If  $\ell'$  and  $\ell''$  are null-homologous in  $M \setminus K$ , then  $\Gamma'$  and  $\Gamma''$  are null Y-links, and  $[(M, K); \Gamma] = [(M, K); \Gamma'] + [(M, K); \Gamma''] \bmod \mathcal{F}_{n+1}^b(M, K)$ .*

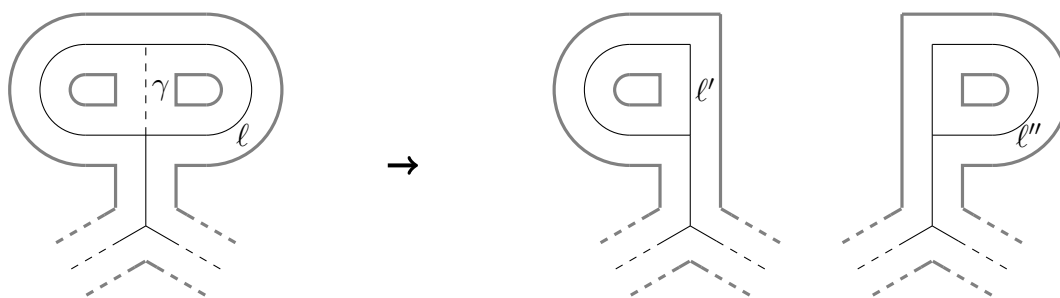

Figure 9: Cutting a leaf

*Proof.* Let  $\Gamma_0$  (resp.  $\Gamma'_0, \Gamma''_0$ ) be the component of  $\Gamma$  (resp.  $\Gamma', \Gamma''$ ) that contains the leaf  $\ell$  (resp.  $\ell', \ell''$ ). By Lemma 2.4, the surgery on  $\Gamma_0$  is equivalent to simultaneous surgeries on  $\Gamma''_0$  and on a null Y-graph  $\hat{\Gamma}'_0$  obtained from  $\Gamma'_0$  by sliding an edge along  $\ell''$ . Set  $\hat{\Gamma}' = (\Gamma \setminus \Gamma_0) \cup \hat{\Gamma}'_0$ . We have  $[(M, K); \hat{\Gamma}'] + [(M, K); \Gamma''] - [(M, K); \Gamma] = [(M, K); (\Gamma \setminus \Gamma_0) \cup \hat{\Gamma}'_0 \cup \Gamma''_0] \in \mathcal{F}_{n+1}^b(M, K)$ . Conclude with Lemma 2.3.  $\square$

The next lemma is a consequence of [GGP01, Lemma 4.8].

**Lemma 2.6.** *Let  $\Gamma$  be an  $n$ -component Y-link null in  $M \setminus K$ . If a leaf  $\ell$  of  $\Gamma$  bounds a disk in  $M \setminus (\Gamma \setminus \ell)$  and has framing 1, i.e. the linking number of  $\ell$  with its parallel induced by the framing of  $\Gamma$  is 1, then  $[(M, K); \Gamma] = 0 \text{ mod } \mathcal{F}_{n+1}^b(M, K)$ .*

The above two lemmas imply that the class of  $[(M, K); \Gamma] \text{ mod } \mathcal{F}_{n+1}^b(M, K)$  does not depend on the framing of the leaves of  $\Gamma$ .

**Lemma 2.7.** *Let  $\Gamma$  be an  $n$ -component Y-link null in  $M \setminus K$ . Let  $\ell$  be a leaf of  $\Gamma$ . Assume  $\Gamma \setminus \ell$  is fixed. Then  $[(M, K); \Gamma] \text{ mod } \mathcal{F}_{n+1}^b(M, K)$  only depends on the homotopy class of  $\ell$  in  $(M \setminus K) \setminus (\Gamma \setminus \ell)$ .*

*Proof.* If the leaf  $\ell$  is modified by an isotopy in  $(M \setminus K) \setminus (\Gamma \setminus \ell)$ , then the homeomorphism class of  $(M, K)(\Gamma)$  is preserved. If the leaf  $\ell$  crosses itself during a homotopy, apply Lemma 2.5, as shown in Figure 10, and conclude that  $[(M, K); \Gamma] \text{ mod } \mathcal{F}_{n+1}^b(M, K)$  is unchanged by applying Lemma 2.1.  $\square$

**Lemma 2.8.** *Let  $\Gamma$  be an  $n$ -component Y-link null in  $M \setminus K$ . Let  $\ell$  be a leaf of  $\Gamma$ . Let  $\Gamma'$  be an  $n$ -component null Y-link such that  $\Gamma' \setminus \ell'$  coincides with  $\Gamma \setminus \ell$ , where  $\ell'$  is a leaf of  $\Gamma'$ . Let  $\widetilde{\Gamma \setminus \ell}$  be the preimage of  $\Gamma \setminus \ell$  in the infinite cyclic covering  $\tilde{X}$  associated with  $(M, K)$ . Let  $\tilde{\ell}$  and  $\tilde{\ell}'$  be lifts of  $\ell$  and  $\ell'$  respectively, with the same basepoint. If  $\ell$  and  $\ell'$  are homotopic in  $M \setminus K$  and if  $\tilde{\ell}$  and  $\tilde{\ell}'$  are rationally homologous in  $\tilde{X} \setminus (\Gamma \setminus \ell)$ , then  $[(M, K); \Gamma] = [(M, K); \Gamma'] \text{ mod } \mathcal{F}_{n+1}^b(M, K)$ .*

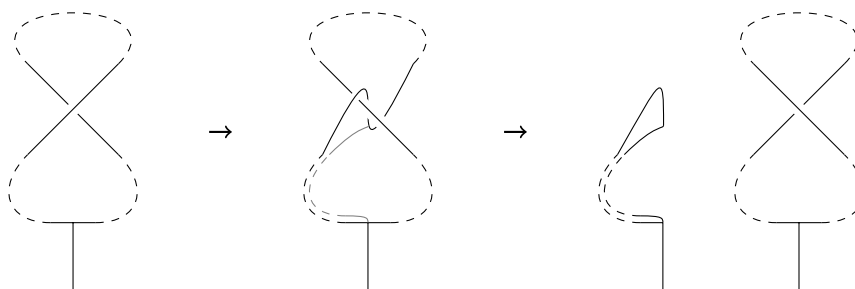

Figure 10: Self-crossing of a leaf

*Proof.* Consider a homotopy from  $\ell$  to  $\ell'$  in  $M \setminus K$ . Thanks to Lemma 2.7, it suffices to treat the case when the leaf crosses an edge or a leaf of  $\Gamma \setminus \ell$  during the homotopy. As shown in Figure 11, Lemma 2.5 implies that the bracket  $[(M, K); \Gamma]$  is then added a

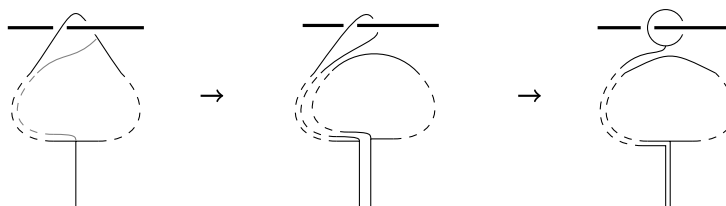

Figure 11: Crossing of an edge or a leaf

bracket  $[(M, K); \hat{\Gamma}]$ , where  $\hat{\Gamma}$  is the null Y-link obtained from  $\Gamma$  by adding the cutting arc to the edge adjacent to  $\ell$ , and by replacing  $\ell$  by a meridian of the crossed edge or leaf. In the case of a meridian of an edge, Lemmas 2.1 and 2.3 show that the added bracket vanishes.

Fix a leaf  $\ell_0$  of  $\Gamma \setminus \ell$ . Let the  $[(M, K); \hat{\Gamma}_i]$ , for  $i \in I$ , be the brackets added during the homotopy when the leaf  $\ell$  crosses the leaf  $\ell_0$ . In each  $\hat{\Gamma}_i$ , pull the basepoint of the leaf replacing the leaf  $\ell$  onto the initial basepoint of  $\ell$ . Let  $\ell_i$  be the obtained leaf. Let  $\tilde{\ell}_i$  be the lift of  $\ell_i$  which has the same basepoint as  $\tilde{\ell}$ . Let  $Y$  be the complement in  $\tilde{X}$  of the preimage of  $\ell_0$ . In  $\pi_1(Y)$ , and hence in  $H_1(Y; \mathbb{Q})$ , we have  $\tilde{\ell} = \sum_{i \in I} \tilde{\ell}_i + \tilde{\ell}'$ . Since  $\tilde{\ell}$  and  $\tilde{\ell}'$  are homologous in  $\tilde{X} \setminus (\Gamma \setminus \ell)$ , it implies that  $\sum_{i \in I} lk_e(\tilde{\ell}_i, \tilde{\ell}_0) = 0$ , where  $\tilde{\ell}_0$  is a lift of  $\ell_0$ . By construction of the  $\tilde{\ell}_i$ , each  $lk_e(\tilde{\ell}_i, \tilde{\ell}_0)$  is equal to  $\pm t^k$  for some  $k \in \mathbb{Z}$ . Thanks to Lemmas 2.1, 2.3, and 2.5, it follows that the  $\hat{\Gamma}_i$  can be grouped by pairs with opposite corresponding brackets. Hence  $[(M, K); \Gamma] = [(M, K); \Gamma'] \text{ mod } \mathcal{F}_{n+1}^b(M, K)$ .  $\square$

**Lemma 2.9.** *Let  $\Gamma$  be an  $n$ -component Y-link null in  $M \setminus K$ . Let  $\ell$  be a leaf of  $\Gamma$ . Let  $\widetilde{\Gamma \setminus \ell}$  be the preimage of  $\Gamma \setminus \ell$  in the infinite cyclic covering  $\tilde{X}$  associated with  $(M, K)$ . Let*

$\tilde{\ell}$  be a lift of  $\ell$ . If  $\tilde{\ell}$  is trivial in  $H_1(\tilde{X} \setminus (\Gamma \setminus \ell); \mathbb{Q})$ , then  $[(M, K); \Gamma] = 0 \bmod \mathcal{F}_{n+1}^b(M, K)$ .

*Proof.* Since  $\tilde{\ell}$  has a multiple which is trivial in  $H_1(\tilde{X}; \mathbb{Z})$ , Lemma 2.5 allows us to assume  $\tilde{\ell}$  itself is trivial in  $H_1(\tilde{X}; \mathbb{Z})$ . Hence  $\tilde{\ell}$  is a product of commutators of loops in  $\tilde{X}$ . It follows that  $\ell$  is homotopic to  $\prod_{i \in I} [\alpha_i, \beta_i]$  in  $M \setminus K$ , where  $I$  is a finite set, and the  $\alpha_i$  and  $\beta_i$  satisfy  $lk(\alpha_i, K) = 0$ ,  $lk(\beta_i, K) = 0$ . Construct a surface  $\Sigma$  in  $(M \setminus K) \setminus \Gamma$  whose handles are bands around the  $\alpha_i$  and  $\beta_i$ , so that  $\partial\Sigma$  is homotopic to  $\ell$  in  $M \setminus K$ . Let  $\Gamma'$  be the Y-link obtained from  $\Gamma$  by replacing  $\ell$  by  $\partial\Sigma$ . Note that the lifts of  $\partial\Sigma$  are null-homologous in  $\tilde{X} \setminus (\Gamma \setminus \ell)$ . Hence, by Lemma 2.8,  $[(M, K); \Gamma] = [(M, K); \Gamma'] \bmod \mathcal{F}_{n+1}^b(M, K)$ .

Let us prove that  $[(M, K); \Gamma'] = 0 \bmod \mathcal{F}_{n+1}^b(M, K)$ . Apply Lemma 2.5 to cut the leaf  $\partial\Sigma$  into leaves  $\alpha_i$ ,  $\beta_i$ ,  $\alpha_i^{-1}$ ,  $\beta_i^{-1}$ . Apply it again to reglue each leaf  $\alpha_i$  with the corresponding leaf  $\alpha_i^{-1}$ , and each leaf  $\beta_i$  with the corresponding leaf  $\beta_i^{-1}$ . The obtained Y-links all have a leaf which is homotopically trivial in the complement of  $K$  and of the complement of the leaf in the Y-link. Then the result follows from Lemma 2.7.  $\square$

**Lemma 2.10.** *Let  $\Gamma$  be an  $n$ -component Y-link null in  $M \setminus K$ . Let  $\ell$  be a leaf of  $\Gamma$ . Let  $\tilde{\Gamma} \setminus \tilde{\ell}$  be the preimage of  $\Gamma \setminus \ell$  in the infinite cyclic covering  $\tilde{X}$  associated with  $(M, K)$ . Let  $\tilde{\ell}$  be a lift of  $\ell$ . Fix  $\tilde{\Gamma} \setminus \tilde{\ell}$ . Then the class of  $[(M, K); \Gamma] \bmod \mathcal{F}_{n+1}^b(M, K)$  only depends on the class of  $\tilde{\ell}$  in  $H_1(\tilde{X} \setminus (\tilde{\Gamma} \setminus \tilde{\ell}); \mathbb{Q})$ , and this dependence is  $\mathbb{Q}$ -linear.*

*Proof.* Let  $\Gamma'$  be a null Y-link which has a leaf  $\ell'$  such that  $\Gamma' \setminus \ell'$  coincides with  $\Gamma \setminus \ell$ , and  $\tilde{\ell}'$  is homologous to  $\tilde{\ell}$  in  $\tilde{X} \setminus (\tilde{\Gamma} \setminus \tilde{\ell})$ , where  $\tilde{\ell}'$  is the lift of  $\ell'$  which has the same basepoint as  $\tilde{\ell}$ . Construct another null Y-link  $\Gamma^\delta$  by replacing the leaf  $\ell$  by  $\ell - \ell'$  in  $\Gamma$  (see Figure 12). By Lemma 2.9,  $[(M, K); \Gamma^\delta] = 0 \bmod \mathcal{F}_{n+1}^b(M, K)$ . Thus Lemma 2.5 implies

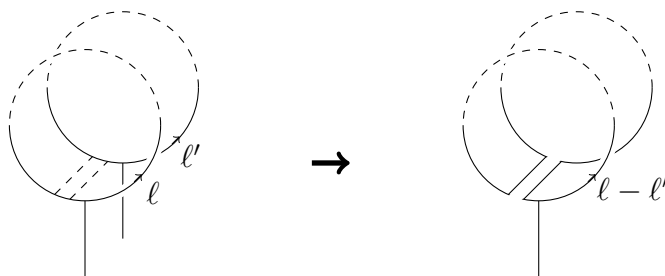

Figure 12: The leaf  $\ell - \ell'$

$[(M, K); \Gamma] = [(M, K); \Gamma'] \bmod \mathcal{F}_{n+1}^b(M, K)$ . Linearity follows from Lemma 2.5.  $\square$

**Lemma 2.11.** *Let  $(M, K) \in \mathcal{P}(\mathfrak{A}, \mathfrak{b})$ . Let  $\xi : (\mathfrak{A}, \mathfrak{b}) \rightarrow (\mathfrak{A}, \mathfrak{b})(M, K)$  be an isomorphism. Let  $D \in \tilde{\mathcal{A}}_n(\mathfrak{A}, \mathfrak{b})$  be an elementary diagram of degree  $n > 0$ . Let  $\Gamma$  be a realization of  $D$  in  $(M, K)$  with respect to  $\xi$ . Then the class of  $[(M, K); \Gamma] \bmod \mathcal{F}_{n+1}^b(M, K)$  does not depend on the realization of  $D$ .*

*Proof.* If the ball  $B$  of Definition 1.12 and its lift  $\tilde{B}$ , used to define  $\Gamma$ , are fixed, then the result follows from Lemmas 2.3 and 2.10. Fix the ball  $B$ , and consider another lift  $\tilde{B}' = \tau^k(\tilde{B})$  of  $B$ , where  $\tau$  is the automorphism of  $\tilde{X}$  which induces the action of  $t$ , and  $k \in \mathbb{Z}$ . A realization of  $D$  with respect to  $\tilde{B}'$  can be obtained from  $\Gamma$  by letting the internal vertex of each  $Y$ -graph in  $\Gamma$  turn around  $K$ ,  $k$  times, and come back into  $B$ , by an isotopy of  $(M, K, \Gamma)$ . This does not change the result of the surgeries on these  $Y$ -graphs, hence this does not modify the bracket  $[(M, K); \Gamma]$ . Now consider two balls  $B_1$  and  $B_2$  in  $M \setminus K$ . If  $B_1 \subset B_2$ , a realization of  $D$  with respect to  $B_1$  is a realization of  $D$  with respect to  $B_2$ . If  $B_1 \cap B_2 \neq \emptyset$ , there is a ball  $B_3 \subset B_1 \cap B_2$ , and if  $B_1 \cap B_2 = \emptyset$ , there is a ball  $B_3 \supset B_1 \cup B_2$ . Hence the class of the bracket  $[(M, K); \Gamma]$  does not depend on the chosen ball  $B$ .  $\square$

In the sequel, if  $D$  is a  $\xi$ -realizable elementary diagram,  $[(M, K); D]_\xi$  denotes the class of  $[(M, K); \Gamma]$  modulo  $\mathcal{F}_{n+1}^b(M, K)$ .

**Lemma 2.12.** *Let  $(M, K) \in \mathcal{P}(\mathfrak{A}, \mathfrak{b})$ . Let  $\xi : (\mathfrak{A}, \mathfrak{b}) \rightarrow (\mathfrak{A}, \mathfrak{b})(M, K)$  be an isomorphism. Let  $D$  be an elementary  $(\mathfrak{A}, \mathfrak{b})$ -colored diagram. Let  $V$  be the set of all univalent vertices of  $D$ . Let  $(s_v)_{v \in V}$  and  $(s'_v)_{v \in V}$  be families of integers such that  $(s_v)_{v \in V} \cdot D$  and  $(s'_v)_{v \in V} \cdot D$  are  $\xi$ -realizable. Then:*

$$\prod_{v \in V} s'_v [(M, K); (s_v)_{v \in V} \cdot D]_\xi = \prod_{v \in V} s_v [(M, K); (s'_v)_{v \in V} \cdot D]_\xi.$$

*Proof.* Let  $\Gamma$  be a realization of  $(s_v)_{v \in V} \cdot (s'_v)_{v \in V} \cdot D$  in  $(M, K)$  with respect to  $\xi$ . By Lemma 2.10,  $[(M, K); \Gamma]$  is equal to  $\prod_{v \in V} s_v [(M, K); (s'_v)_{v \in V} \cdot D]_\xi$  and to  $\prod_{v \in V} s'_v [(M, K); (s_v)_{v \in V} \cdot D]_\xi$ .  $\square$

Let  $D$  be an elementary  $(\mathfrak{A}, \mathfrak{b})$ -colored diagram. Let  $V$  be the set of all univalent vertices of  $D$ . The above result allows us to define:

$$[(M, K); D]_\xi = \prod_{v \in V} \frac{1}{s_v} [(M, K); (s_v)_{v \in V} \cdot D]_\xi,$$

where  $(s_v)_{v \in V}$  is any family of integers such that  $(s_v)_{v \in V} \cdot D$  is  $\xi$ -realizable.

**Lemma 2.13.** *Let  $D$  be an elementary  $(\mathfrak{A}, \mathfrak{b})$ -colored diagram. Let  $(M, K)$  and  $(M', K')$  be  $\mathbb{Q}SK$ -pairs in  $\mathcal{P}(\mathfrak{A}, \mathfrak{b})$ . Let  $\xi : (\mathfrak{A}, \mathfrak{b}) \rightarrow (\mathfrak{A}, \mathfrak{b})(M, K)$  and  $\xi' : (\mathfrak{A}, \mathfrak{b}) \rightarrow (\mathfrak{A}, \mathfrak{b})(M', K')$  be isomorphisms. Then  $[(M', K'); D]_{\xi'} = [(M, K); D]_\xi \text{ mod } \mathcal{F}_{n+1}(\mathfrak{A}, \mathfrak{b})$ .*

*Proof.* Set  $\zeta = \xi' \circ \xi^{-1}$ . By Theorem 1.5,  $(M', K')$  can be obtained from  $(M, K)$  by a finite sequence of null LP-surgeries which induces  $\zeta \circ m_k$ , for  $k \in \mathbb{Z}$ , where  $m_k$  is the multiplication by  $t^k$ . Assume the sequence contains a single surgery  $(\frac{A'}{A})$ . Let  $V$  be the

set of all univalent vertices of  $D$ . Let  $(s_v)_{v \in V}$  be a family of integers such that  $(s_v)_{v \in V} \cdot D$  is  $\xi$ -realizable by a null Y-link  $\Gamma$  in  $(M \setminus K) \setminus A$ . Then:

$$[(M, K); \Gamma, \frac{A'}{A}] = [(M, K); \Gamma] - [(M', K'); \Gamma].$$

In  $(M', K')$ ,  $\Gamma$  is a realization of  $D$  with respect to  $\xi' \circ m_k$ . Hence it is also a realization of  $D$  with respect to  $\xi'$  (it suffices to change the lift  $\tilde{B}$  of the ball  $B$ , see Lemma 2.11).

The case of several surgeries easily follows.  $\square$

In the sequel, the class of  $[(M, K); D]_\xi$  modulo  $\mathcal{F}_{n+1}(\mathfrak{A}, \mathfrak{b})$  is denoted by  $[(M, K); D]$ .

*Proof of Proposition 1.14.* Let  $\mathcal{D}_n$  be the rational vector space freely generated by the  $(\mathfrak{A}, \mathfrak{b})$ -colored diagrams of degree  $n$ . If  $D$  is an elementary  $(\mathfrak{A}, \mathfrak{b})$ -colored diagram, set  $\tilde{\varphi}_n(D) = [(M, K); D]$  for  $(M, K) \in \mathcal{P}(\mathfrak{A}, \mathfrak{b})$ . Define  $\tilde{\varphi}_n(D)$  for any  $(\mathfrak{A}, \mathfrak{b})$ -colored diagram  $D$  so that the obtained  $\mathbb{Q}$ -linear map  $\tilde{\varphi}_n : \mathcal{D}_n \rightarrow \mathcal{G}_n^b(\mathfrak{A}, \mathfrak{b})$  satisfies the relation LE and EV. Let us check that  $\tilde{\varphi}_n$  satisfies the relations AS, IHX, OR, Hol, LV, LD, and Aut. OR is trivial. LV follows from Lemma 2.10. Hol is obtained by letting the corresponding vertex turn around the knot  $K$ . AS and IHX respectively follow from [GGP01, Corollary 4.6] and [GGP01, Lemma 4.10]. Aut follows from Lemma 2.13. For the relation LD, it suffices to prove that  $\tilde{\varphi}_n(D) = \tilde{\varphi}_n(D') + \tilde{\varphi}_n(D_0)$ , where  $D$ ,  $D'$ , and  $D_0$  are elementary diagrams identical, except for the part drawn in Figure 13. Note that the edges adjacent to  $v_1$  and  $v_2$  are colored by 1. Since the diagram  $D_0$  and the diagram  $D'_0$  drawn in Figure 14 can be realized by the same null Y-link, we have  $\tilde{\varphi}_n(D_0) = \tilde{\varphi}_n(D'_0)$ . To see that  $\tilde{\varphi}_n(D'_0) = \tilde{\varphi}_n(D''_0)$ , apply the relation LV at the vertex  $v_2$  to obtain a similar diagram in which the vertex  $v_1$  is colored by 0 and  $f_{v_1 v} = 0$  for all  $v \neq v_1$ , and apply then the relation LV at the vertex  $v_1$ . Use again the relation LV to see that  $\tilde{\varphi}_n(D') + \tilde{\varphi}_n(D''_0) = \tilde{\varphi}_n(D)$ .

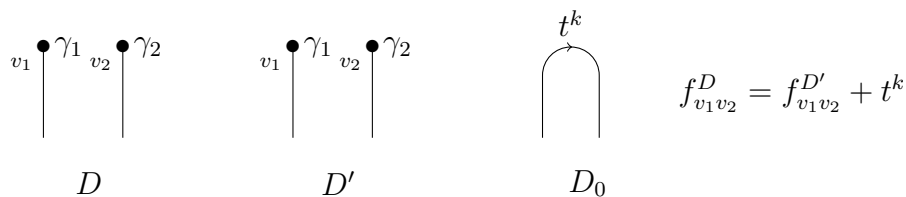
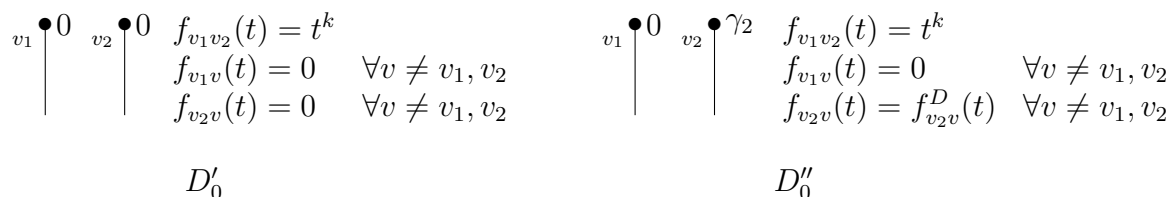

Figure 13: The diagrams  $D$ ,  $D'$ , and  $D_0$ , where  $\gamma_1, \gamma_2 \in \mathfrak{A}$  and  $k \in \mathbb{Z}$ .

Finally, the map  $\tilde{\varphi}_n$  induces a canonical  $\mathbb{Q}$ -linear map  $\varphi_n : \mathcal{A}_n(\mathfrak{A}, \mathfrak{b}) \rightarrow \mathcal{G}_n^b(\mathfrak{A}, \mathfrak{b})$ . The surjectivity follows from the fact that, for  $(M, K) \in \mathcal{P}(\mathfrak{A}, \mathfrak{b})$ , any  $n$ -component Y-link null in  $M \setminus K$  is a realization of an elementary  $(\mathfrak{A}, \mathfrak{b})$ -colored diagram, which is the disjoint union of  $n$  diagrams of degree 1.  $\square$

*Proof of Proposition 1.15.* Check as in the above proof that  $D \mapsto [(M_0, K_0); D]_\xi$  defines a  $\mathbb{Q}$ -linear map  $\varphi_n^{\mathbb{Z}}(\xi) : \tilde{\mathcal{A}}_n(\mathfrak{A}, \mathfrak{b}) \rightarrow \mathcal{G}_n^{\mathbb{Z}}(\mathfrak{A}, \mathfrak{b})$ , and that  $[(M_0, K_0); \Gamma] \in \text{Im}(\varphi_n^{\mathbb{Z}}(\xi))$  for all

 Figure 14: The diagrams  $D'_0$  and  $D''_0$ 

$n$ -component Y-link  $\Gamma$  null in  $M_0 \setminus K_0$ . To conclude that  $\varphi_n^{\mathbb{Z}}(\xi)$  is surjective, it suffices to prove that for any  $(M, K) \in \mathcal{P}(\mathfrak{A}_{\mathbb{Z}}, \mathfrak{b}_{\mathbb{Z}})$ , there is an isomorphism  $\xi_{(M, K)} : (\mathfrak{A}, \mathfrak{b}) \rightarrow (\mathfrak{A}, \mathfrak{b})(M, K)$  such that  $[(M, K); D]_{\xi_{(M, K)}} = [(M_0, K_0); D]_{\xi}$  for any elementary diagram  $D$ . According to Lemma 1.8, it suffices to prove this for  $(M, K) = (M_0, K_0)(\frac{A'}{A})$ , where  $(\frac{A'}{A})$  is a null Borromean surgery. Let  $V$  be the set of all univalent vertices of  $D$ . Let  $(s_v)_{v \in V}$  be a family of integers such that  $(s_v)_{v \in V} \cdot D$  is  $\xi$ -realizable by a null Y-link  $\Gamma$  in  $(M_0 \setminus K_0) \setminus A$ . Then:

$$[(M_0, K_0); (s_v)_{v \in V} \cdot D]_{\xi} - [(M, K); (s_v)_{v \in V} \cdot D]_{\zeta \circ \xi} = [(M_0, K_0); \Gamma, \frac{A'}{A}] \in \mathcal{F}_{n+1}^{\mathbb{Z}}(\mathfrak{A}_{\mathbb{Z}}, \mathfrak{b}_{\mathbb{Z}}),$$

where  $\zeta : (\mathfrak{A}, \mathfrak{b})(M_0, K_0) \rightarrow (\mathfrak{A}, \mathfrak{b})(M, K)$  is the isomorphism induced by the surgery  $(\frac{A'}{A})$ .  $\square$

### 3 The surjective map $\varphi_n : \mathcal{A}_n^{aug}(\mathfrak{A}, \mathfrak{b}) \rightarrow \mathcal{G}_n(\mathfrak{A}, \mathfrak{b})$

In this section, we prove Theorem 1.10, and Theorem 1.6.

Let  $(M, K)$  be a pair in  $\mathcal{P}(\mathfrak{A}, \mathfrak{b})$ . Let  $\xi : (\mathfrak{A}, \mathfrak{b}) \rightarrow (\mathfrak{A}, \mathfrak{b})(M, K)$  be an isomorphism. Let  $n > 0$ . Let  $D$  be an  $(\mathfrak{A}, \mathfrak{b})$ -augmented diagram of degree  $n$  whose Jacobi part  $D_J$  is elementary. With an isolated vertex colored by a prime integer  $p$ , we associate a surgery  $\frac{B_p}{B^3}$ , where  $B_p$  is a fixed rational homology ball such that  $|H_1(B_p; \mathbb{Z})| = p$ . Hence, if  $D_J$  is  $\xi$ -realizable, with a realization of  $D_J$ , we associate a family of  $n$  disjoint null LP-surgeries.

**Lemma 3.1.** *Let  $(M, K) \in \mathcal{P}(\mathfrak{A}, \mathfrak{b})$ . Let  $\xi : (\mathfrak{A}, \mathfrak{b}) \rightarrow (\mathfrak{A}, \mathfrak{b})(M, K)$  be an isomorphism. Let  $n > 0$ . Let  $D$  be an  $(\mathfrak{A}, \mathfrak{b})$ -augmented diagram whose Jacobi part  $D_J$  is elementary. Let  $(\frac{C_i}{B^3})_{1 \leq i \leq n-k}$  be the genus 0 surgeries associated with the 0-valent part of  $D$ . If  $D_J$  is  $\xi$ -realizable, let  $\Gamma$  be a realization of  $D_J$  in  $(M, K)$  with respect to  $\xi$ . Then:*

- $[(M, K); D]_{\xi} := [(M, K); (\frac{C_i}{B^3})_{1 \leq i \leq n-k}, \Gamma] \in \mathcal{G}_n(\mathfrak{A}, \mathfrak{b})$  does not depend on the realization of  $D_J$ .

If  $D_J$  is any elementary diagram, set  $[(M, K); D] = \prod_{v \in V} \frac{1}{s_v} [(M, K); (s_v)_{v \in V} \cdot D]_{\xi}$ , where  $(s_v)_{v \in V}$  is a family of integers such that  $(s_v)_{v \in V} \cdot D_J$  is  $\xi$ -realizable. Then:

- $[(M, K); D] \in \mathcal{G}_n(\mathfrak{A}, \mathfrak{b})$  does not depend on  $(s_v)_{v \in V}$ ,  $(M, K)$ , and  $\xi$ .

*Proof.* By Proposition 1.14, we have  $[(M, K); \Gamma] = \sum_{i \in I} a_i [(M, K); D_i]$  in  $\mathcal{G}_k(\mathfrak{A}, \mathfrak{b})$  for a finite set  $I$ , rational numbers  $a_i$ , and elementary  $\xi$ -realizable diagrams  $D_i \in \mathcal{A}_k(\mathfrak{A}, \mathfrak{b})$ . For  $i \in I$ , let  $\Gamma_i$  be a realization of  $D_i$  in  $(M, K)$  with respect to  $\xi$ . We have:

$$[(M, K); \Gamma] = \sum_{i \in I} a_i [(M, K); \Gamma_i] \text{ mod } \mathcal{F}_{k+1}(\mathfrak{A}, \mathfrak{b}).$$

Let  $p$  be a prime integer. Let  $M_p = B^3 \cup_{\partial B^3} B_p$ . In the equality in  $\mathcal{F}_0(\mathfrak{A}, \mathfrak{b})$  corresponding to the above relation, make a connected sum of each QSK-pair with  $M_p$ . Then subtract the new equality from the original one, to obtain:

$$[(M, K); \frac{B_p}{B^3}, \Gamma] = \sum_{i \in I} a_i [(M, K); \frac{B_p}{B^3}, \Gamma_i] \text{ mod } \mathcal{F}_{k+2}(\mathfrak{A}, \mathfrak{b}).$$

Applying this process  $n - k$  times, we get:

$$[(M, K); (\frac{C_i}{B^3})_{1 \leq i \leq n-k}, \Gamma] = \sum_{i \in I} a_i [(M, K); (\frac{C_i}{B^3})_{1 \leq i \leq n-k}, \Gamma_i] \text{ mod } \mathcal{F}_{n+1}(\mathfrak{A}, \mathfrak{b}).$$

Since we can change the realization of  $D_J$  while keeping fixed the right side of the equality, this proves the first point.

If  $D_J$  is any elementary diagram, use Lemma 2.10, as in Lemma 2.13, to prove that  $[(M, K); D]_\xi = \prod_{v \in V} \frac{1}{s_v} [(M, K); (s_v)_{v \in V} \cdot D]_\xi$  does not depend on the family of integers  $(s_v)_{v \in V}$  such that  $(s_v)_{v \in V} \cdot D_J$  is  $\xi$ -realizable. Conclude by noting that, in the above computation, the  $[(M, K); \Gamma_i]$  do not depend on  $(M, K)$  and  $\xi$ .  $\square$

The above result implies that the map  $\varphi_n : \mathcal{A}_n(\mathfrak{A}, \mathfrak{b}) \rightarrow \mathcal{G}_n^b(\mathfrak{A}, \mathfrak{b})$  extends to a canonical  $\mathbb{Q}$ -linear map  $\varphi_n : \mathcal{A}_n^{aug}(\mathfrak{A}, \mathfrak{b}) \rightarrow \mathcal{G}_n(\mathfrak{A}, \mathfrak{b})$ , defined by  $\varphi_n(D) = [(M, K); D]$  for any diagram  $D \in \mathcal{A}_n^{aug}(\mathfrak{A}, \mathfrak{b})$  whose Jacobi part is elementary, where  $(M, K)$  is any QSK-pair in  $\mathcal{P}(\mathfrak{A}, \mathfrak{b})$ . To prove Theorem 1.10, it remains to show that the map  $\varphi_n : \mathcal{A}_n^{aug}(\mathfrak{A}, \mathfrak{b}) \rightarrow \mathcal{G}_n(\mathfrak{A}, \mathfrak{b})$  is surjective. We first recall a result from [Chap. 3], and give a consequence of this result.

**Definition 3.2.** Let  $d$  be a positive integer. A  $d$ -torus is a rational homology torus  $T_d$  such that:

- $H_1(\partial T_d; \mathbb{Z}) = \mathbb{Z}\alpha \oplus \mathbb{Z}\beta$ , with  $\langle \alpha, \beta \rangle = 1$ ,
- $d\alpha = 0$  in  $H_1(T_d; \mathbb{Z})$ ,
- $\beta = d\gamma$  in  $H_1(T_d; \mathbb{Z})$ , where  $\gamma$  is a curve in  $T_d$ ,
- $H_1(T_d; \mathbb{Z}) = \mathbb{Z}_d\alpha \oplus \mathbb{Z}\gamma$ .



**Definition 3.3.** An *elementary surgery* is an LP-surgery among the following ones:

1. connected sum (genus 0),
2. LP-replacement of a standard torus by a  $d$ -torus (genus 1),
3. Borromean surgery (genus 3).

**Theorem 3.4** ([Chap. 3] Theorem 1.15). *If  $A$  and  $B$  are two  $\mathbb{Q}HH$ 's with LP-identified boundaries, then  $B$  can be obtained from  $A$  by a finite sequence of elementary surgeries and their inverses in the interior of the  $\mathbb{Q}HH$ 's.*

**Corollary 3.5.** *The space  $\mathcal{F}_n(\mathfrak{A}, \mathfrak{b})$  is generated by the  $[(M, K); (\frac{E'_i}{E_i})_{1 \leq i \leq n}]$  where  $(M, K) \in \mathcal{P}(\mathfrak{A}, \mathfrak{b})$  and the  $(\frac{E'_i}{E_i})$  are elementary null LP-surgeries.*

*Proof.* Consider  $[(M, K); (\frac{A'_i}{A_i})_{1 \leq i \leq n}] \in \mathcal{F}_n(\mathfrak{A}, \mathfrak{b})$ . By Theorem 3.4, for each  $i$ ,  $A_i$  and  $A'_i$  can be obtained from one another by a finite sequence of elementary surgeries or their inverses. Write  $A'_1 = A_1(\frac{E'_1}{E_1}) \dots (\frac{E'_k}{E_k})$ . For  $0 \leq j \leq k$ , set  $B_j = A_1(\frac{E'_1}{E_1}) \dots (\frac{E'_j}{E_j})$ . Then:

$$[(M, K); (\frac{A'_i}{A_i})_{1 \leq i \leq n}] = \sum_{j=1}^k [(M, K)(\frac{B_{j-1}}{B_0}); \frac{E'_j}{E_j}, (\frac{A'_i}{A_i})_{2 \leq i \leq n}].$$

Decompose each surgery  $(\frac{A'_i}{A_i})$  in this way, and conclude with:

$$[(M, K); \frac{E'}{E}, (\frac{A'_i}{A_i})_{2 \leq i \leq n}] = -[(M, K)(\frac{E'}{E}); \frac{E}{E'}, (\frac{A'_i}{A_i})_{2 \leq i \leq n}].$$

□

Let  $\mathcal{F}_0^{\mathbb{Q}HS}$  be the rational vector space generated by all  $\mathbb{Q}HS$ 's up to orientation-preserving homeomorphism. Let  $(\mathcal{F}_n^{\mathbb{Q}HS})_{n \in \mathbb{N}}$  be the filtration of  $\mathcal{F}_0^{\mathbb{Q}HS}$  defined by LP-surgeries, as before Definition 1.4. Let  $\mathcal{G}_n^{\mathbb{Q}HS} = \frac{\mathcal{F}_n^{\mathbb{Q}HS}}{\mathcal{F}_{n+1}^{\mathbb{Q}HS}}$  be the associated quotients.

**Lemma 3.6** ([Chap. 3] Proposition 1.8). *For each prime integer  $p$ , let  $B_p$  be a rational homology ball such that  $H_1(B_p; \mathbb{Z}) \cong \frac{\mathbb{Z}}{p\mathbb{Z}}$ . Then  $\mathcal{G}_1^{\mathbb{Q}HS} = \bigoplus_{p \text{ prime}} \mathbb{Q}[S^3; \frac{B_p}{B^3}]$ .*

**Lemma 3.7.** *For each prime integer  $p$ , let  $B_p$  be a rational homology ball such that  $H_1(B_p; \mathbb{Z}) \cong \frac{\mathbb{Z}}{p\mathbb{Z}}$ . Let  $(M, K) \in \mathcal{P}(\mathfrak{A}, \mathfrak{b})$ . Let  $B$  be a rational homology ball. Let  $(\frac{A'_i}{A_i})_{1 \leq i < n}$  be disjoint null LP-surgeries in  $(M, K)$ . Then  $[(M, K); \frac{B}{B^3}, (\frac{A'_i}{A_i})_{1 \leq i < n}]$  is a rational linear combination of the  $[(M, K); \frac{B_p}{B^3}, (\frac{A'_i}{A_i})_{1 \leq i < n}]$  and elements of  $\mathcal{F}_{n+1}(\mathfrak{A}, \mathfrak{b})$ .*

*Proof.* By Lemma 3.6, there is a relation:

$$[S^3; \frac{B}{B^3}] = \sum_{p \text{ prime}} a_p [S^3; \frac{B_p}{B^3}] + \sum_{j \in J} b_j [N_j; \frac{C'_j}{C_j}, \frac{D'_j}{D_j}],$$

where  $J$  is a finite set, the  $a_p$  and  $b_j$  are rational numbers, the  $a_p$  are all trivial except a finite number, and for  $j \in J$ ,  $[N_j; \frac{C'_j}{C_j}, \frac{D'_j}{D_j}] \in \mathcal{F}_2^{\text{QHS}}$ . Make the connected sum of each QHS in the relation with  $M$ . Since the  $C_j$  and  $D_j$  are contained in the complement of the punctured  $M$  in these connected sums, for any  $I \subset \{1, \dots, n-1\}$ , we obtain:

$$[(M, K) (\frac{A'_i}{A_i})_{i \in I}; \frac{B}{B^3}] = \sum_{p \text{ prime}} a_p [(M, K) (\frac{A'_i}{A_i})_{i \in I}; \frac{B_p}{B^3}] + \sum_{j \in J} b_j [(M \# N_j, K) (\frac{A'_i}{A_i})_{i \in I}; \frac{C'_j}{C_j}, \frac{D'_j}{D_j}].$$

Summing these equalities for all  $I \subset \{1, \dots, n-1\}$ , we get:

$$\begin{aligned} [(M, K); \frac{B}{B^3}, (\frac{A'_i}{A_i})_{1 \leq i < n}] = \\ \sum_{p \text{ prime}} a_p [(M, K); \frac{B_p}{B^3}, (\frac{A'_i}{A_i})_{1 \leq i < n}] + \sum_{j \in J} b_j [(M \# N_j, K); \frac{C'_j}{C_j}, \frac{D'_j}{D_j}, (\frac{A'_i}{A_i})_{1 \leq i < n}]. \end{aligned}$$

□

**Corollary 3.8.** *Let  $(M, K) \in \mathcal{P}(\mathfrak{A}, \mathfrak{b})$ . Let  $(\frac{E'_i}{E_i})_{1 \leq i \leq n}$  be null elementary surgeries of genus 0 or 3. Then  $[(M, K); (\frac{E'_i}{E_i})_{1 \leq i \leq n}] \in \varphi_n(\mathcal{A}_n^{\text{aug}}(\mathfrak{A}, \mathfrak{b}))$ .*

*Proof.* Thanks to Lemma 3.7, it suffices to treat the case when the genus 0 surgeries are surgeries of type  $(\frac{B}{B^3})$  for a rational homology ball  $B$  such that  $|H_1(B; \mathbb{Z})|$  is a prime integer. In this case, the considered bracket is the image of a diagram given as the disjoint union of 0-valent vertices and of  $(\mathfrak{A}, \mathfrak{b})$ -colored diagrams of degree 1. □

To conclude the proof of Theorem 1.10, we need the following result about degree 1 invariants of framed rational homology tori (see [Chap. 3, §5.1] for a definition):

**Lemma 3.9** ([Chap. 3] Corollary 5.10). *For all prime integer  $p$ , let  $M_p$  be a QHS such that  $H_1(M_p; \mathbb{Z}) \cong \mathbb{Z}/p\mathbb{Z}$ . Let  $T_0$  be a framed standard torus. If  $\mu$  is a degree 1 invariant of framed rational homology tori, such that  $\mu(T_0) = 0$  and  $\mu(T_0 \# M_p) = 0$  for any prime integer  $p$ , then  $\mu = 0$ .*

*Proof of Theorem 1.10.* Let  $\lambda \in (\mathcal{F}_n(\mathfrak{A}, \mathfrak{b}))^*$  such that  $\lambda(\mathcal{F}_{n+1}(\mathfrak{A}, \mathfrak{b})) = 0$ . Assume  $\lambda(\varphi_n(\mathcal{A}_n^{\text{aug}}(\mathfrak{A}, \mathfrak{b}))) = 0$ . In order to prove that  $\varphi_n$  is onto, it is enough to prove that  $\lambda = 0$ . Let us do it. Thanks to Corollary 3.5, it suffices to prove that  $\lambda$  vanishes on the

brackets defined by elementary surgeries. For elementary surgeries of genus 0 and 3, it follows from Corollary 3.8.

Consider a bracket  $[(M, K); (\frac{T_{d_i}}{T_i})_{1 \leq i \leq k}, (\frac{E'_i}{E_i})_{1 \leq i \leq n-k}]$ , where  $(M, K) \in \mathcal{P}(\mathfrak{A}, \mathfrak{b})$ , the  $T_i$  are standard tori null in  $M \setminus K$ , the  $T_{d_i}$  are  $d_i$ -tori for some positive integers  $d_i$ , and the  $(\frac{E'_i}{E_i})$  are null elementary surgeries of genus 0 or 3. By induction on  $k$ , we will prove that  $\lambda$  vanishes on this bracket. We have treated the case  $k = 0$ . Assume  $k > 0$ . Fix a parallel of  $T_1$ . If  $T$  is a framed rational homology torus, set:

$$\bar{\lambda}(T) = \lambda([(M, K); \frac{T}{T_1}, (\frac{T_{d_i}}{T_i})_{2 \leq i \leq k}, (\frac{E'_i}{E_i})_{1 \leq i \leq n-k}]),$$

where the LP-identification  $\partial T \cong \partial T_1$  identifies the preferred parallels. Then  $\bar{\lambda}$  is a degree 1 invariant of framed homology tori:

$$\bar{\lambda}([T; \frac{B_1}{A_1}, \frac{B_2}{A_2}]) = -\lambda([(M, K)(\frac{T}{T_1}); \frac{B_1}{A_1}, \frac{B_2}{A_2}, (\frac{T_{d_i}}{T_i})_{2 \leq i \leq k}, (\frac{E'_i}{E_i})_{1 \leq i \leq n-k}]) = 0.$$

Moreover, we have  $\bar{\lambda}(T_1) = 0$ , and  $\bar{\lambda}(T_1(\frac{B_p}{B^3})) = 0$  by induction. Thus, by Lemma 3.9,  $\bar{\lambda} = 0$ .  $\square$

*Proof of Theorem 1.6.* Theorem 1.10 provides a surjective map  $\varphi_1 : \mathcal{A}_1^{aug}(\mathfrak{A}, \mathfrak{b}) \rightarrow \mathcal{G}_1(\mathfrak{A}, \mathfrak{b})$ . According to Subsection 1.3, we have  $\mathcal{A}_1^{aug}(\mathfrak{A}, \mathfrak{b}) = \bigoplus_{p \text{ prime}} \mathbb{Q} \bullet_p$ . Hence  $\mathcal{G}_1(\mathfrak{A}, \mathfrak{b})$  is generated by the images of the diagrams  $\bullet_p$ , that are the brackets  $[(M_0, K_0); \frac{B_p}{B_3}]$ , for all prime integer  $p$ .

For any prime integer  $p$ , define a  $\mathbb{Q}$ -linear map  $\nu_p : \mathcal{F}_0 \rightarrow \mathbb{Q}$  by setting  $\nu_p(M, K) = v_p(|H_1(M; \mathbb{Z})|)$  for all QSK-pair  $(M, K)$ , where  $v_p$  denotes the  $p$ -adic valuation. By [Chap. 3, Proposition 1.9], the  $\nu_p$  are degree 1 invariants of QHS's, hence they are also invariants of null-degree 1 of QSK-pairs. This implies that the family  $([(M_0, K_0); \frac{B_p}{B_3}])_{p \text{ prime}}$  is free in  $\mathcal{G}_1(\mathfrak{A}, \mathfrak{b})$ .  $\square$

## 4 Nullity of $\mathcal{G}_{2n+1}^{\mathbb{Z}}(\mathfrak{A}_{\mathbb{Z}}, \mathfrak{b}_{\mathbb{Z}})$

In this section, we prove the following proposition, which, together with Proposition 1.15, implies Theorem 1.9.

**Proposition 4.1.** *Let  $(M, K) \in \mathcal{P}(\mathfrak{A}_{\mathbb{Z}}, \mathfrak{b}_{\mathbb{Z}})$ . Let  $(\mathfrak{A}, \mathfrak{b}) = \mathbb{Q} \otimes_{\mathbb{Z}} (\mathfrak{A}_{\mathbb{Z}}, \mathfrak{b}_{\mathbb{Z}})$ . Let  $\xi : (\mathfrak{A}, \mathfrak{b}) \rightarrow (\mathfrak{A}, \mathfrak{b})(M, K)$  be an isomorphism. Let  $n$  be an odd positive integer. Let  $D \in \tilde{\mathcal{A}}_n(\mathfrak{A}, \mathfrak{b})$  be an  $(\mathfrak{A}, \mathfrak{b})$ -elementary diagram. Then  $[(M, K); D]_{\xi} = 0$  in  $\mathcal{G}_n^{\mathbb{Z}}(\mathfrak{A}_{\mathbb{Z}}, \mathfrak{b}_{\mathbb{Z}})$ .*

*Proof.* Let  $\Sigma$  be a Seifert surface of  $K$  in  $M$ . Let  $\hat{\Sigma}$  be obtained from  $\Sigma$  by adding a band glued along  $\partial\Sigma$ , so that  $\hat{\Sigma}$  is homeomorphic to  $\Sigma$ , and contains  $\Sigma$  and  $K$  in its interior. Let  $H = \hat{\Sigma} \times [-1, 1]$  be a regular neighborhood of  $\Sigma$ .

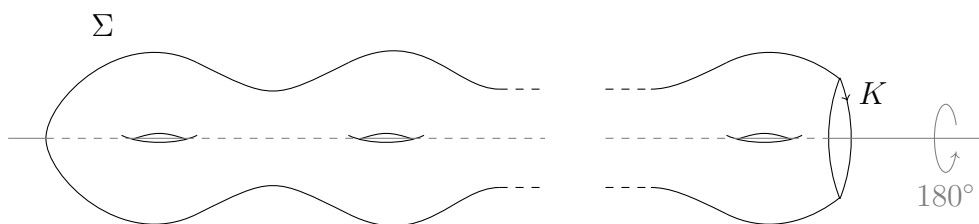

Figure 15: Hyperelliptic involution

The surface  $\Sigma$  is homeomorphic to the surface drawn in Figure 15. Rotation of  $180^\circ$  around the drawn axis defines a hyperelliptic involution of  $\Sigma$ . Let  $h$  be a homeomorphism of  $\Sigma$ , which is isotopic to this involution, and which fixes  $K$  pointwise. Extend  $h$  to  $\hat{\Sigma}$  by the identity on the added band, and then extend  $h$  to  $H$  by product with the identity. Note that the isomorphism induced by  $h$  on  $H_1(H; \mathbb{Z})$  is the opposite of the identity.

Let  $T(K)$  be a tubular neighborhood of  $K$ , included in  $H$ . Let  $X = M \setminus \text{Int}(T(K))$  be the exterior of  $K$  in  $M$ . Set  $Y = H \setminus \text{Int}(T(K))$ . Let  $B \subset (\Sigma \times [-1, 1]) \setminus \text{Int}(T(K))$  be a standard ball. Consider an admissible embedding of  $D$  in  $B$ . Let  $\Gamma \subset Y$  be an associated null Y-link which realizes  $D$  with respect to  $\xi$ . We first prove that  $[(M, K); h(\Gamma)] = [(M, K); \Gamma]$  in  $\mathcal{G}_n^{\mathbb{Z}}(\mathfrak{A}_{\mathbb{Z}}, \mathfrak{b}_{\mathbb{Z}})$ , and we next prove that  $[(M, K); h(\Gamma)] = -[(M, K); \Gamma]$  in  $\mathcal{G}_n^{\mathbb{Z}}(\mathfrak{A}_{\mathbb{Z}}, \mathfrak{b}_{\mathbb{Z}})$ .

Let  $A = M \setminus \text{Int}(H)$ . Then  $M = H \cup_{\beta} A$ , where  $\beta$  is an orientation-preserving homeomorphism from  $\partial H$  to  $(-\partial A)$ . Define  $N = H \cup_{\beta \circ h^{-1}} A$ . There is a homeomorphism from  $M$  to  $N$  given by  $h$  on  $H$  and by the identity on  $A$ . Hence  $(M, K, \Gamma) \cong (N, K, h(\Gamma))$ , and  $[(M, K); \Gamma] = [(N, K); h(\Gamma)]$ .

By [Chap. 5, Lemma 5.1],  $A$  is a  $\mathbb{Z}$ HH, and it is clearly null in  $M \setminus K$ . Since the homeomorphism  $h|_{\partial A}$  preserves the Lagrangian  $\mathcal{L}_A$ , the  $\mathbb{Z}$ SK-pair  $(N, K)$  is obtained from  $(M, K)$  by the integral null LP-surgery  $(\frac{A_N}{A_M})$ , where  $A_M$  (resp.  $A_N$ ) is the  $\mathbb{Z}$ HH  $A$  equipped with the identification  $\beta : \partial H \cong -\partial A$  (resp.  $\beta \circ h^{-1} : \partial H \cong -\partial A$ ). Hence:

$$[(M, K); \frac{A_N}{A_M}, h(\Gamma)] = [(M, K); h(\Gamma)] - [(N, K); h(\Gamma)].$$

It follows that  $[(M, K); h(\Gamma)] = [(M, K); \Gamma] \bmod \mathcal{F}_{n+1}^{\mathbb{Z}}(\mathfrak{A}_{\mathbb{Z}}, \mathfrak{b}_{\mathbb{Z}})$ .

Let  $p : \tilde{X} \rightarrow X$  be the infinite cyclic covering map. Set  $\tilde{Y} = p^{-1}(Y)$ . The homeomorphism  $h$  induces a homeomorphism  $\tilde{h}$  of  $\tilde{Y}$ . The isomorphism of  $H_1(\tilde{Y}; \mathbb{Q})$  induced by  $\tilde{h}$  is the opposite of the identity. Hence, if  $\tilde{\Gamma}$  is a lift of  $\Gamma$  in  $\tilde{X}$ , the homology classes of the leaves of  $\tilde{h}(\tilde{\Gamma})$  in  $\mathfrak{A}$  are the opposites of the homology classes of the leaves of  $\tilde{\Gamma}$ . Now, since the homeomorphism  $h$  fixes the added band of  $\hat{\Sigma}$ , the edges of  $h(\Gamma)$  respect the colorings of the edges of  $D$ . Hence  $h(\Gamma)$  realizes the elementary diagram obtained from  $D$  by changing the colorings of the leaves into their opposites. Thus Proposition

1.15 implies  $[(M, K); h(\Gamma)] = -[(M, K); \Gamma]$  in  $\mathcal{G}_n^{\mathbb{Z}}(\mathfrak{A}_{\mathbb{Z}}, \mathfrak{b}_{\mathbb{Z}})$ , since there is an odd number of leaves.  $\square$

## 5 Case of a trivial Alexander module

### 5.1 Additive invariants of null-degree $n > 1$

Let  $\mathfrak{A}_0$  be the trivial Alexander module. If  $(M_1, K_1)$  and  $(M_2, K_2)$  are QSK-pairs in  $\mathcal{P}(\mathfrak{A}_0)$ , then define their connected sum  $(M_1, K_1)\sharp(M_2, K_2) = (M_1\sharp M_2, K_1\sharp K_2)$  in the following way. For  $i = 1, 2$ , remove from  $M_i$  a ball  $B_i$  which intersects  $K_i$  along an arc  $\alpha_i([0, 1])$ , trivial in the sense that the complement of a regular neighborhood of  $\alpha_i([0, 1])$  in  $B_i$  is a solid torus. Orient these arcs from  $\alpha_i(0)$  to  $\alpha_i(1)$ . Then glue  $M_1 \setminus \text{Int}(B_1)$  to  $M_2 \setminus \text{Int}(B_2)$  along a homeomorphism  $h : \partial B_1 \rightarrow -\partial B_2$  such that  $h(\alpha_1(0)) = \alpha_2(1)$  and  $h(\alpha_1(1)) = \alpha_2(0)$ . We have  $(M_1, K_1)\sharp(M_2, K_2) \in \mathcal{P}(\mathfrak{A}_0)$ . Extending this operation to  $\mathcal{F}_0(\mathfrak{A}_0)$  by bilinearity defines a graded algebra structure on  $\mathcal{G}(\mathfrak{A}_0) = \bigoplus_{n \geq 0} \mathcal{G}_n(\mathfrak{A}_0)$ . Set  $\mathcal{I}_n(\mathfrak{A}_0) = \text{Hom}(\frac{\mathcal{F}_0(\mathfrak{A}_0)}{\mathcal{F}_{n+1}(\mathfrak{A}_0)}, \mathbb{Q})$ . Set  $\mathcal{I}(\mathfrak{A}_0) = \bigcup_{n \in \mathbb{N}} \mathcal{I}_n(\mathfrak{A}_0)$ . An invariant in  $\mathcal{I}(\mathfrak{A}_0)$  is an *additive invariant* if it is additive with respect to the connected sum. Let  $\mathcal{I}_n^c(\mathfrak{A}_0)$  be the subspace of additive invariants of  $\mathcal{I}_n(\mathfrak{A}_0)$ . Let  $\mathcal{A}_n^c(\mathfrak{A}_0)$  be the subspace of  $\mathcal{A}_n(\mathfrak{A}_0)$  generated by connected diagrams. Note that  $\mathcal{A}_n(\mathfrak{A}_0)$  is generated by diagrams without univalent vertices.

**Proposition 5.1.** For  $n > 1$ ,  $\frac{\mathcal{I}_n^c(\mathfrak{A}_0)}{\mathcal{I}_{n-1}^c(\mathfrak{A}_0)} \cong (\mathcal{A}_n^c(\mathfrak{A}_0))^*$ . In particular, if  $n$  is odd,

$$\frac{\mathcal{I}_n^c(\mathfrak{A}_0)}{\mathcal{I}_{n-1}^c(\mathfrak{A}_0)} = 0.$$

This result is a consequence of Lemmas 5.2 and 5.3 below.

**Lemma 5.2.** Let  $n > 1$ . Let  $\lambda \in \mathcal{I}_n^c(\mathfrak{A}_0)$ . Then the image of  $\lambda$  in  $\frac{\mathcal{I}_n^c(\mathfrak{A}_0)}{\mathcal{I}_{n-1}^c(\mathfrak{A}_0)}$  is determined by  $\lambda(\varphi_n(\mathcal{A}_n^c(\mathfrak{A}_0)))$ .

*Proof.* By Theorem 1.10,  $\lambda$  is determined by  $\lambda(\varphi_n(\mathcal{A}_n^{\text{aug}}(\mathfrak{A}_0)))$ . Let  $D$  be a non connected elementary augmented diagram of degree  $n$ . Write  $D = D_1 \sqcup D_2$ , where  $D_1$  and  $D_2$  are non empty augmented diagrams. Let  $\mathcal{O} \subset S^3$  denote the trivial knot. Realize  $D$  in  $(S^3, \mathcal{O})$  so that  $D_1$  and  $D_2$  are realized in two summands of  $(S^3, \mathcal{O}) \cong (S^3, \mathcal{O})\sharp(S^3, \mathcal{O})$ . From such a realization, it is easy to see that  $\lambda([(S^3, \mathcal{O}); D]) = 0$ . This concludes since the connected diagrams in  $\mathcal{A}_n^{\text{aug}}(\mathfrak{A}_0)$  and in  $\mathcal{A}_n(\mathfrak{A}_0)$  are the same.  $\square$

**Lemma 5.3.** Let  $n > 1$  be an even integer. Let  $(D_{n,i})_{i \in C_n}$  be a basis of diagrams of the rational vector space  $\mathcal{A}_n^c(\mathfrak{A}_0)$ . Let  $(D_{n,i}^*)_{i \in C_n}$  be the dual basis of  $(\mathcal{A}_n^c(\mathfrak{A}_0))^*$ . Let  $p^c : \mathcal{A}_n(\mathfrak{A}_0) \rightarrow \mathcal{A}_n^c(\mathfrak{A}_0)$  be the projection that maps any non connected diagram to 0 and which restricts to the identity on  $\mathcal{A}_n^c(\mathfrak{A}_0)$ . For  $i \in C_n$ , set  $\lambda_{n,i} = D_{n,i}^* \circ p^c \circ Z_n$ , where  $Z_n$

is the degree  $n$  part of the Lescop invariant  $Z_e = (Z_n)_{n \geq 0} : \mathcal{F}_0(\mathfrak{A}_0) \rightarrow \bigoplus_{n \geq 0} \mathcal{A}_n(\mathfrak{A}_0)$  (see [Les11]). Then  $(\lambda_{n,i})_{i \in C_n}$  is a basis of  $\frac{\mathcal{I}_n^c(\mathfrak{A}_0)}{\mathcal{I}_{n-1}^c(\mathfrak{A}_0)}$ .

*Proof.* According to [Les12],  $p^c \circ Z_n$  is an additive invariant of QSK-pairs and  $Z_n$  is an invariant of null-degree  $n$  that satisfies  $Z_n([(S^3, \mathcal{O}); D_{n,i}]) = D_{n,i} \in \mathcal{A}_n(\mathfrak{A}_0)$ . Hence  $\lambda_{n,i} \in \mathcal{I}_n^c(\mathfrak{A}_0)$ , and  $\lambda_{n,i}([(S^3, \mathcal{O}); D_{n,j}]) = \delta_{i,j}$ . Consider  $\lambda \in \mathcal{I}_n^c(\mathfrak{A}_0)$ . By Lemma 5.2:

$$\lambda = \sum_{i \in C_n} \lambda([(S^3, \mathcal{O}); D_{n,i}]) \lambda_{n,i} \text{ mod } \mathcal{I}_{n-1}^c(\mathfrak{A}_0).$$

Hence  $(\lambda_{n,i})_{i \in C_n}$  is a basis of  $\frac{\mathcal{I}_n^c(\mathfrak{A}_0)}{\mathcal{I}_{n-1}^c(\mathfrak{A}_0)}$ . □

## 5.2 The graded algebra $\mathcal{G}(\mathfrak{A}_0)$

The method for determining  $\mathcal{G}(\mathfrak{A}_0)$  is the same as the method used in [Chap. 3] to determine the graded algebra  $\mathcal{G}^{\text{QHS}} = \bigoplus_{n \geq 0} \mathcal{G}_n^{\text{QHS}}$ . Hence we only give the definitions and the results. For proofs and details, see [Chap. 3, Section 6].

For  $n > 0$ , let  $\mathcal{H}_n(\mathfrak{A}_0) = \frac{\mathcal{I}_n(\mathfrak{A}_0)}{\mathcal{I}_{n-1}(\mathfrak{A}_0)}$ . Set  $\mathcal{H}_0(\mathfrak{A}_0) = \mathcal{I}_0(\mathfrak{A}_0)$  and  $\mathcal{H}(\mathfrak{A}_0) = \bigoplus_{n \geq 0} \mathcal{H}_n(\mathfrak{A}_0)$ .

**Lemma 5.4.** *If  $\lambda \in \mathcal{I}_k(\mathfrak{A}_0)$  and  $\mu \in \mathcal{I}_\ell(\mathfrak{A}_0)$ , then  $\lambda\mu \in \mathcal{I}_{k+\ell}(\mathfrak{A}_0)$ .*

Thus the product of invariants induces a graded algebra structure on  $\mathcal{H}(\mathfrak{A}_0)$ . The main idea in the following is that additive invariants generate  $\mathcal{H}(\mathfrak{A}_0)$  as an algebra. We construct dual bases of  $\mathcal{G}_n(\mathfrak{A}_0)$  and  $\mathcal{H}_n(\mathfrak{A}_0)$  for  $n \geq 0$ .

For an even integer  $n > 1$ , consider the basis  $(D_{n,i})_{i \in C_n}$  of  $\mathcal{A}_n^c(\mathfrak{A}_0)$  and the associated invariants  $\lambda_{n,i}$  defined in Lemma 5.3. For  $n > 1$  odd, set  $C_n = \emptyset$ . For  $n = 1$ , let  $C_1$  denote the set of all prime integers, and for any  $p$  prime, set  $\lambda_{1,p} = \nu_p$  and  $D_{1,p} = \bullet_p \in \mathcal{A}_1^{\text{aug}}(\mathfrak{A}_0)$ . Note that adding to  $\lambda_{n,i}$  a weighted sum of the  $\lambda_{k,i}$ ,  $0 < k < n$ ,  $i \in C_k$ , does not change the values of  $\lambda_{n,i}$  on  $\mathcal{F}_n$ . Thus we can (and we do) choose the basis  $(\lambda_{n,i})_{i \in C_n}$  so that  $\lambda_{n,i}([(S^3, \mathcal{O}); D_{k,j}]) = \delta_{nk} \delta_{ij}$  for all positive integers  $n$  and  $k$ , all  $i \in C_n$ , all  $j \in C_k$ .

For a multi-index  $\underline{\varepsilon} = (\varepsilon_t)_{1 \leq t \leq \ell}$ , set  $\ell(\underline{\varepsilon}) = \ell$ . For  $n > 0$ , fix a total order on  $C_n$ . Let  $\prec$  denote the lexicographic order induced on  $\bigcup_{n \in \mathbb{N} \setminus \{0\}} (\{n\} \times C_n)$ . For  $n > 0$ , let  $\mathcal{T}_n^\pi$  denote the set of all triples  $(\underline{k}, \underline{i}, \underline{\varepsilon})$  such that  $\ell(\underline{k}) = \ell(\underline{i}) = \ell(\underline{\varepsilon})$ ,  $\underline{k} = (k_t)_{1 \leq t \leq \ell(\underline{k})}$ ,  $k_t \in \mathbb{N}$  and  $0 < k_t < n$  for all  $t$ ,  $\underline{i} = (i_t)_{1 \leq t \leq \ell(\underline{k})}$  with  $i_t \in C_{k_t}$  for all  $t$ ,  $(k_1, i_1) \prec (k_2, i_2) \prec \dots \prec (k_{\ell(\underline{k})}, i_{\ell(\underline{k})})$ ,  $\underline{\varepsilon} = (\varepsilon_t)_{1 \leq t \leq \ell(\underline{\varepsilon})}$  with  $\varepsilon_t \in \mathbb{N} \setminus \{0\}$  for all  $t$ , and  $\sum_{1 \leq t \leq \ell(\underline{k})} \varepsilon_t k_t = n$ . Define a family  $(\lambda_{n,\iota})_{\iota \in \mathcal{T}_n^\pi}$  of invariants of null-degree  $n$  by  $\lambda_{n,\iota} = \prod_{1 \leq t \leq \ell(\underline{k})} \lambda_{k_t, i_t}^{\varepsilon_t}$  if  $\iota = (\underline{k}, \underline{i}, \underline{\varepsilon})$ . Set  $\mathcal{T}_n = C_n \sqcup \mathcal{T}_n^\pi$ .

Construct by induction a family  $(G_{k,i}^{(n)})_{\substack{0 < k \leq n \\ i \in \mathcal{T}_k}} of  $\frac{\mathcal{F}_1(\mathfrak{A}_0)}{\mathcal{F}_{n+1}(\mathfrak{A}_0)}$ , dual to  $(\lambda_{k,i})_{\substack{0 < k \leq n \\ i \in \mathcal{T}_k}}$ , as follows.$

For any  $p$  prime, set  $G_{1,p}^{(1)} = (M_p, \mathcal{O}) - (S^3, \mathcal{O})$ . For  $n > 1$  even, set  $G_{n,i}^{(n)} = [(S^3, \mathcal{O}); D_{n,i}]$  for  $i \in C_n$ . For  $n > 1$  and  $\iota = (\underline{k}, \underline{i}, \underline{\varepsilon}) \in \mathcal{T}_n^\pi$ , set  $\tilde{G}_{n,\iota}^{(n)} = \prod_{1 \leq t \leq \ell(\underline{k})} (G_{k_t, i_t}^{(k_t)})^{\varepsilon_t}$ , and  $G_{n,\iota}^{(n)} = \frac{1}{\lambda_{n,\iota}(\tilde{G}_{n,\iota}^{(n)})} \tilde{G}_{n,\iota}^{(n)}$ . Note that, for all  $n$  and all  $i \in \mathcal{T}_n$ ,  $G_{n,i}^{(n)} \in \mathcal{F}_n(\mathfrak{A}_0)$ .

Let  $n$  and  $k$  be positive integers. For  $\iota \in C_k$ , set  $\mathcal{T}_n(\iota) = \{(\underline{k}, \underline{i}, \eta) \in \mathcal{T}_n^\pi \mid \underline{k} = (k), \underline{i} = (i)\}$ . For  $\iota = (\underline{k}, \underline{i}, \varepsilon) \in \mathcal{T}_k^\pi$ , set  $\mathcal{T}_n(\iota) = \{(\underline{k}, \underline{i}, \eta) \in \mathcal{T}_n^\pi \mid \eta_t \geq \varepsilon_t \forall t\}$ . For  $n > 1$ , define  $G_{k,i}^{(n)} \in \mathcal{F}_k(\mathfrak{A}_0)$  for  $0 < k < n$  and  $i \in \mathcal{T}_k$ , by induction on  $n$ , by:

$$G_{k,i}^{(n)} = G_{k,i}^{(n-1)} - \sum_{\iota \in \mathcal{T}_n(i)} \lambda_{n,\iota} (G_{k,i}^{(n-1)}) G_{n,\iota}^{(n)}.$$

Note that  $G_{k,i}^{(n)} = G_{k,i}^{(m)}$  in  $\mathcal{G}_m(\mathfrak{A}_0)$  if  $m \leq n$ .

**Proposition 5.5.** *The family  $(G_{k,i}^{(n)})_{\substack{0 < k < n \\ i \in \mathcal{T}_k}}$  is a basis of  $\frac{\mathcal{F}_1(\mathfrak{A}_0)}{\mathcal{F}_{n+1}(\mathfrak{A}_0)}$ . The family  $(\lambda_{k,i})_{\substack{0 < k \leq n \\ i \in \mathcal{T}_k}}$  is the dual basis of  $\frac{\mathcal{I}_n(\mathfrak{A}_0)}{\mathcal{I}_0(\mathfrak{A}_0)}$ . Moreover:*

$$\frac{\mathcal{I}_n(\mathfrak{A}_0)}{\mathcal{I}_{n-1}(\mathfrak{A}_0)} = \prod_{i \in \mathcal{T}_n} \mathbb{Q} \lambda_{n,i}, \quad \mathcal{G}_n(\mathfrak{A}_0) = \bigoplus_{i \in \mathcal{T}_n} \mathbb{Q} G_{n,i}^{(n)}.$$

This proposition is mostly based on the following lemma:

**Lemma 5.6.** *Consider  $\lambda \in \mathcal{I}_n(\mathfrak{A}_0)$  such that  $\lambda(S^3, \mathcal{O}) = 0$ . There are constants  $\alpha_{m,\iota}$ , for  $1 \leq m \leq n$  and  $\iota \in \mathcal{T}_m^\pi$ , such that:*

$$\begin{aligned} \lambda((M_1, K_1) \sharp (M_2, K_2)) &= \lambda(M_1, K_1) + \lambda(M_2, K_2) \\ &+ \sum_{m=1}^n \sum_{\iota=(\underline{k}, \underline{i}, \varepsilon) \in \mathcal{T}_m^\pi} \alpha_{m,\iota} \sum_{\substack{0 < \eta < \varepsilon \\ 1 \leq t \leq \ell(\underline{k})}} \prod_{\eta_t} \binom{\varepsilon_t}{\eta_t} \lambda_{k_t, i_t}^{\eta_t} (M_1, K_1) \lambda_{k_t, i_t}^{\varepsilon_t - \eta_t} (M_2, K_2), \end{aligned}$$

for all  $\mathbb{Q}SK$ -pairs  $(M_1, K_1)$  and  $(M_2, K_2)$ .

Note that the invariant  $\lambda - \sum_{m=1}^n \sum_{\iota=(\underline{k}, \underline{i}, \varepsilon) \in \mathcal{T}_m^\pi} \alpha_{m,\iota} \prod_{1 \leq t \leq \ell(\underline{k})} \lambda_{k_t, i_t}^{\varepsilon_t}$  is additive.

The above expression of  $\lambda((M_1, K_1) \sharp (M_2, K_2))$  defines a coproduct  $\Delta$  on the algebra  $\mathcal{H}(\mathfrak{A}_0)$ :

$$\Delta(\lambda) = \lambda \otimes 1 + 1 \otimes \lambda + \sum_{m=1}^n \sum_{\iota=(\underline{k}, \underline{i}, \varepsilon) \in \mathcal{T}_m^\pi} \alpha_{m,\iota} \sum_{\substack{0 < \eta < \varepsilon \\ 1 \leq t \leq \ell(\underline{k})}} \prod_{\eta_t} \binom{\varepsilon_t}{\eta_t} \lambda_{k_t, i_t}^{\eta_t} \otimes \lambda_{k_t, i_t}^{\varepsilon_t - \eta_t}.$$

Thus  $\mathcal{H}(\mathfrak{A}_0)$  has a Hopf algebra structure. The primitive elements associated with this coproduct (the invariants  $\lambda$  satisfying  $\Delta(\lambda) = \lambda \otimes 1 + 1 \otimes \lambda$ ) are the additive invariants.

**Remark:** The graded space  $\mathcal{A}^{aug}(\mathfrak{A}_0) = \bigoplus_{n \in \mathbb{N}} \mathcal{A}_n^{aug}(\mathfrak{A}_0)$  is a graded algebra with the product defined on diagrams by the disjoint union. It is easy to see that the isomorphisms of Theorem 1.11 provide an isomorphism  $\mathcal{G}(\mathfrak{A}_0) \cong \mathcal{A}^{aug}(\mathfrak{A}_0)$  of graded algebras.





## Chapitre 7 : Perspectives

# 1 Détermination du gradué $\bigoplus_{n \in \mathbb{N}} \mathcal{G}_n(\mathfrak{A}, \mathfrak{b})$

On reprend dans ce chapitre les notations du chapitre 6.

Soit  $\delta \in \mathbb{Q}[t^{\pm 1}]$ . Un *diagramme  $\delta$ -colorié* est un graphe trivalent dont les sommets sont orientés et dont les arêtes sont orientées et coloriées par  $\frac{1}{\delta(t)}\mathbb{Q}[t^{\pm 1}]$ . Le degré d'un diagramme  $\delta$ -colorié est son nombre de sommets. On pose :

$$\mathcal{A}_n(\delta) = \frac{\mathbb{Q} \langle \text{diagrammes } \delta\text{-coloriés de degré } n \rangle}{\mathbb{Q} \langle \text{AS, IHX, LE, OR, Hol, Hol}' \rangle},$$

où la relation Hol' est représentée Figure 1. Notons que, dans le cas de  $\mathcal{A}_n(\mathfrak{A}, \mathfrak{b})$ , cette relation se déduit des relations Hol et LD.

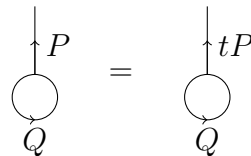

FIGURE 1 – La relation Hol', avec  $P, Q \in \mathbb{Q}[t^{\pm 1}]$ .

À un diagramme  $(\mathfrak{A}, \mathfrak{b})$ -colorié  $D$ , on veut associer un diagramme  $\delta$ -colorié  $\psi_n(D)$ . Soit  $V_D$  l'ensemble des sommets univalents de  $D$ . Un *groupement par paires de  $V_D$*  est une involution de  $V_D$  sans point fixe. On note  $\mathfrak{p}_D$  l'ensemble des groupements par paires de  $V_D$ . Fixons  $p \in \mathfrak{p}_D$ . On définit un diagramme  $\delta$ -colorié  $p(D)$  de la manière suivante. Si  $v \in V$  et  $v' = p(v)$ , on remplace dans  $D$  les sommets  $v$  et  $v'$ , et leurs arêtes adjacentes, par une arête coloriée, comme indiqué Figure 2. On pose alors :

$$\psi_n(D) = \sum_{p \in \mathfrak{p}_D} p(D).$$

Notons que, si le nombre de sommets univalents est impair, on a  $\psi_n(D) = 0$ . On obtient

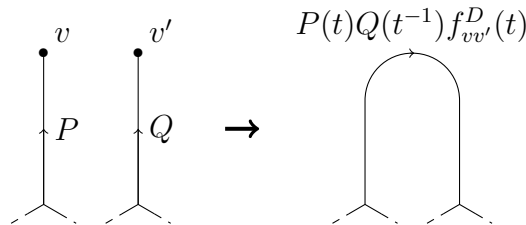

FIGURE 2 – Groupement des sommets

ainsi une application  $\mathbb{Q}$ -linéaire  $\psi_n$  de l'espace vectoriel rationnel librement engendré par les diagrammes  $(\mathfrak{A}, \mathfrak{b})$ -coloriés de degré  $n$  dans  $\mathcal{A}_n(\delta)$ . On vérifie facilement que  $\psi_n$  passe au quotient en une application :

$$\tilde{\psi}_n : \mathcal{A}_n(\mathfrak{A}, \mathfrak{b}) \rightarrow \mathcal{A}_n(\delta).$$

Il sera intéressant d'étudier le noyau de cette application pour déterminer si  $\tilde{\psi}_n$  est un isomorphisme sur son image, ou, dans le cas contraire, pour déterminer ce noyau et vérifier que l'application  $\varphi_n$  se factorise bien par  $\tilde{\psi}_n$ .

C.Lescop a décrit dans [Les11] un invariant  $Z_e = ((Z_e)_n)_{n \in \mathbb{N}}$  des QSK-paires tel que  $Z_n$  s'annule sur  $\mathcal{F}_{n+1}(\mathcal{K}_{\mathbb{Q}})$ , et la restriction de  $Z_n$  à  $\mathcal{F}_0(\mathfrak{A}, \mathfrak{b})$  est à valeurs dans  $\mathcal{A}_n(\delta)$ . La propriété d'universalité de cet invariant démontrée dans [Les12] implique  $Z_n \circ \varphi_n = \tilde{\psi}_n$ . Ainsi, si on montre que l'application  $\tilde{\psi}_n$  est un isomorphisme sur son image, on pourra en déduire que l'application  $\varphi_n : \mathcal{A}_n(\mathfrak{A}, \mathfrak{b}) \rightarrow \mathcal{G}_n^b(\mathfrak{A}, \mathfrak{b})$  est aussi un isomorphisme.

Obtenir ces isomorphismes nous permettrait d'aborder l'étude de la structure du quotient  $\mathcal{G}_n(\mathfrak{A}, \mathfrak{b})$ .

## 2 Le gradué $\bigoplus_{n \in \mathbb{N}} \mathcal{G}_n^{\mathbb{Z}}(\mathfrak{A}_{\mathbb{Z}}, \mathfrak{b}_{\mathbb{Z}})$

L'application  $\varphi_n^{\mathbb{Z}}(\xi) : \tilde{\mathcal{A}}_n(\mathfrak{A}, \mathfrak{b}) \rightarrow \mathcal{G}_n^{\mathbb{Z}}(\mathfrak{A}_{\mathbb{Z}}, \mathfrak{b}_{\mathbb{Z}})$  de la proposition 4.6, contrairement à l'application  $\varphi_n : \mathcal{A}_n(\mathfrak{A}, \mathfrak{b}) \rightarrow \mathcal{G}_n^b(\mathfrak{A}, \mathfrak{b})$ , n'est pas a priori canonique. Pour obtenir une application canonique, il faudrait montrer que  $\varphi_n^{\mathbb{Z}}(\xi)$  vérifie une relation analogue à la relation Aut, définie à partir des automorphismes de  $(\mathfrak{A}, \mathfrak{b}) = \mathbb{Q} \otimes_{\mathbb{Z}} (\mathfrak{A}_{\mathbb{Z}}, \mathfrak{b}_{\mathbb{Z}})$  induits par les automorphismes de  $(\mathfrak{A}_{\mathbb{Z}}, \mathfrak{b}_{\mathbb{Z}})$  (il se pose ici une question intermédiaire : obtient-on tous les automorphismes de  $(\mathfrak{A}, \mathfrak{b})$  de cette façon?). Pour cela, il faut revenir au chapitre 5. D'après [GR04, Lemma 1.3] et [AL05, Lemma 4.11], deux ZSK-paires ont des modules d'Alexander entiers munis de leurs formes de Blanchfield isomorphes si et seulement si on peut passer de l'une à l'autre par chirurgies LP entières nulles. Dans le chapitre 5, on montre le résultat analogue pour les QSK-paires et les chirurgies rationnelles, et, plus précisément, on montre que toute chirurgie LP rationnelle nulle induit un isomorphisme canonique entre les modules d'Alexander, qui préserve la forme de Blanchfield, et que tout isomorphisme entre des modules d'Alexander rationnels munis de leurs formes de Blanchfield peut être réalisé, modulo multiplication par une puissance de  $t$ , par une suite finie de chirurgies LP rationnelles nulles. C'est ce résultat plus précis qui permet d'obtenir une application  $\varphi_n$  canonique qui satisfait la relation Aut. Il serait donc intéressant de reprendre le chapitre 5 dans le cas des ZSK-paires et des chirurgies LP entières. La plupart des résultats se transposent facilement. La principale difficulté est de réaliser la  $\tau$ -classe d'un isomorphisme entre deux modules d'Alexander entiers munis de leurs formes de Blanchfield par une S-équivalence entière, c'est-à-dire une succession de congruences entières et d'agrandissements et de réductions dont tous les coefficients sont entiers. Dans

le cas rationnel, cela se déduit facilement de la proposition ci-dessous du fait que toute classe de S-équivalence rationnelle contient une matrice de Seifert inversible sur  $\mathbb{Q}$ .

**Proposition 2.1** ([Chap. 5] Proposition 3.1). *Soient  $(M, K, \Sigma, \underline{f}, V)$  et  $(M', K', \Sigma', \underline{f}', V')$  des  $\mathbb{Q}SK$ -systèmes. Soit  $\xi : \mathfrak{A}(K) \rightarrow \mathfrak{A}(K')$  un isomorphisme qui préserve la forme de Blanchfield. Soit  $\underline{b} = (b_i)_{1 \leq i \leq 2g}$  (resp.  $\underline{b}' = (b'_i)_{1 \leq i \leq 2g}$ ) une famille de générateurs de  $\mathfrak{A}(K)$  (resp.  $\mathfrak{A}(K')$ ) associée à  $V$  (resp.  $V'$ ). Si  $V$  et  $V'$  sont inversibles, alors  $(\underline{b})$  et  $(\underline{b}')$  sont des  $\mathbb{Q}$ -bases de  $\mathfrak{A}(K)$  et  $\mathfrak{A}(K')$  respectivement, et  $V' = PVP^t$ , où  $P$  est la matrice de  $\xi$  par rapport aux bases  $(\underline{b})$  et  $(\underline{b}')$ .*

De même, toute classe de S-équivalence entière contient une matrice de Seifert entière inversible sur  $\mathbb{Q}$ , mais pas nécessairement une matrice de Seifert inversible sur  $\mathbb{Z}$ .

Si ces problèmes sont résolus, on peut alors étudier le gradué associé à la filtration de  $\mathcal{F}_0(\mathcal{M}_{\mathbb{Q}})$  définie par les chirurgies LP entières nulles en suivant le schéma du premier paragraphe de ce chapitre.

## Références

- [AL05] E. AUCLAIR & C. LESCOP – « Clover calculus for homology 3-spheres via basic algebraic topology », *Algebr. Geom. Topol.* **5** (2005), p. 71–106 (electronic).
- [Auc] E. AUCLAIR – « Surfaces et invariants de type fini en dimension 3 », Thèse, Université Joseph Fourier, Grenoble.
- [Bla57] R. C. BLANCHFIELD – « Intersection theory of manifolds with operators with applications to knot theory », *Ann. of Math. (2)* **65** (1957), p. 340–356.
- [BN95] D. BAR-NATAN – « On the Vassiliev knot invariants », *Topology* **34** (1995), no. 2, p. 423–472.
- [FM12] B. FARB & D. MARGALIT – *A primer on mapping class groups*, Princeton Mathematical Series, vol. 49, Princeton University Press, Princeton, NJ, 2012.
- [GGP01] S. GAROUFALIDIS, M. GOUSSAROV & M. POLYAK – « Calculus of clovers and finite type invariants of 3-manifolds », *Geom. Topol.* **5** (2001), p. 75–108 (electronic).
- [GK04] S. GAROUFALIDIS & A. KRICKER – « A rational noncommutative invariant of boundary links », *Geom. Topol.* **8** (2004), p. 115–204 (electronic).
- [GR04] S. GAROUFALIDIS & L. ROZANSKY – « The loop expansion of the Kontsevich integral, the null-move and  $S$ -equivalence », *Topology* **43** (2004), no. 5, p. 1183–1210.
- [Hab00a] N. HABEGGER – « Milnor, Johnson, and tree level perturbative invariants », *Preprint* (2000).
- [Hab00b] K. HABIRO – « Claspers and finite type invariants of links », *Geom. Topol.* **4** (2000), p. 1–83 (electronic).
- [Kea75] C. KEARTON – « Blanchfield duality and simple knots », *Trans. Amer. Math. Soc.* **202** (1975), p. 141–160.
- [KK80] A. KAWAUCHI & S. KOJIMA – « Algebraic classification of linking pairings on 3-manifolds », *Math. Ann.* **253** (1980), no. 1, p. 29–42.
- [Kon93] M. KONTSEVICH – « Vassiliev’s knot invariants », in *I. M. Gelfand Seminar*, Adv. Soviet Math., vol. 16, Amer. Math. Soc., Providence, RI, 1993, p. 137–150.
- [Kri00] A. KRICKER – « The lines of the Kontsevich integral and Rozansky’s rationality conjecture », arXiv :math/0005284, 2000.

- [KT99] G. KUPERBERG & D. THURSTON – « Perturbative 3-manifold invariants by cut-and-paste topology », math.GT/9912167, 1999.
- [Lan94] S. LANG – *Algebraic number theory*, second éd., Graduate Texts in Mathematics, vol. 110, Springer-Verlag, New York, 1994.
- [Le97] T. T. Q. LE – « An invariant of integral homology 3-spheres which is universal for all finite type invariants », in *Solitons, geometry, and topology : on the cross-road*, Amer. Math. Soc. Transl. Ser. 2, vol. 179, Amer. Math. Soc., Providence, RI, 1997, p. 75–100.
- [Les04] C. LESCOP – « Splitting formulae for the Kontsevich-Kuperberg-Thurston invariant of rational homology 3-spheres », math.GT/0411431, 2004.
- [Les10] C. LESCOP – « On the cube of the equivariant linking pairing for knots and 3-manifolds of rank one », *Arxiv preprint arXiv :1008.5026* (2010).
- [Les11] C. LESCOP – « Invariants of knots and 3-manifolds derived from the equivariant linking pairing », in *Chern-Simons gauge theory : 20 years after*, AMS/IP Stud. Adv. Math., vol. 50, Amer. Math. Soc., Providence, RI, 2011, p. 217–242.
- [Les12] — , « A universal equivariant finite type knot invariant defined from configuration space integrals », in preparation, 2012.
- [Lev65] J. LEVINE – « A characterization of knot polynomials », *Topology* **4** (1965), p. 135–141.
- [Lic97] W. B. R. LICKORISH – *An introduction to knot theory*, Graduate Texts in Mathematics, vol. 175, Springer-Verlag, New York, 1997.
- [LMO98] T. T. Q. LE, J. MURAKAMI & T. OHTSUKI – « On a universal perturbative invariant of 3-manifolds », *Topology* **37** (1998), no. 3, p. 539–574.
- [Mas12] G. MASSUYEAU – « Splitting formulas for the lmo invariant of rational homology three-spheres », in preparation, 2012.
- [Mat87] S. V. MATVEEV – « Generalized surgeries of three-dimensional manifolds and representations of homology spheres », *Mat. Zametki* **42** (1987), no. 2, p. 268–278, 345.
- [Mey76] M. D. MEYERSON – « Representing homology classes of closed orientable surfaces », *Proc. Amer. Math. Soc.* **61** (1976), no. 1, p. 181–182 (1977).
- [Mir84] R. MIRANDA – « Nondegenerate symmetric bilinear forms on finite abelian 2-groups », *Trans. Amer. Math. Soc.* **284** (1984), no. 2, p. 535–542.

- [MM65] J. W. MILNOR & J. C. MOORE – « On the structure of Hopf algebras », *Ann. of Math. (2)* **81** (1965), p. 211–264.
- [Chap. 3] D. MOUSSARD – « Finite type invariants of rational homology 3-spheres », arXiv :1203.1603v1, to appear in *Algebraic & Geometric Topology*, (2012).
- [Chap. 4] D. MOUSSARD – « On Alexander modules and Blanchfield forms of null-homologous knots in rational homology spheres », *J. Knot Theory Ramifications* **21** (2012), no. 5, p. 1250042, 21.
- [Chap. 5] — , « Rational blanchfield forms, S-equivalence, and null LP-surgeries », version révisée de *ArXiv e-prints* ArXiv : 1207.1954 (2012).
- [Chap. 6] — , « Invariants of finite null-degree of null-homologous knots in rational homology 3-spheres », version préliminaire, 2012.
- [NS03] S. NAIK & T. STANFORD – « A move on diagrams that generates  $S$ -equivalence of knots », *J. Knot Theory Ramifications* **12** (2003), no. 5, p. 717–724.
- [Sam67] P. SAMUEL – *Théorie algébrique des nombres*, Hermann, Paris, 1967.
- [Tro73] H. F. TROTTER – « On  $S$ -equivalence of Seifert matrices », *Invent. Math.* **20** (1973), p. 173–207.
- [Wal63] C. T. C. WALL – « Quadratic forms on finite groups, and related topics », *Topology* **2** (1963), p. 281–298.





## Résumé

Cette thèse a pour objet l'étude des invariants de type fini des sphères d'homologie rationnelle de dimension 3, et des nœuds homologiquement triviaux dans ces sphères. Les principaux résultats sont présentés dans le chapitre 2. Ils sont démontrés dans les chapitres 3 à 6. Le chapitre 3 est un article intitulé "Finite type invariants of rational homology 3-spheres", à paraître dans *Algebraic & Geometric Topology*. Il décrit le gradué associé à la filtration de l'espace vectoriel rationnel engendré par les sphères d'homologie rationnelle, définie par les chirurgies rationnelles préservant le lagrangien. Le chapitre 4 est un article intitulé "On Alexander modules and Blanchfield forms of null-homologous knots in rational homology spheres", publié dans *Journal of Knot Theory and its Ramifications*. Il contient la classification des modules d'Alexander des nœuds homologiquement triviaux dans les sphères d'homologie rationnelle, et une étude des formes de Blanchfield définies sur ces modules. Dans la suite, on considère les paires  $(M, K)$  formées d'une sphère d'homologie rationnelle  $M$  et d'un nœud  $K$  homologiquement trivial dans  $M$ . Dans le chapitre 5, on montre que deux telles paires ont des modules d'Alexander rationnels munis de leurs formes de Blanchfield isomorphes si et seulement si elles s'obtiennent l'une de l'autre par une suite finie de chirurgies rationnelles nulles préservant le lagrangien, c'est-à-dire effectuées sur des corps en anses d'homologie rationnelle homologiquement triviaux dans le complémentaire du nœud. Dans le chapitre 6, on étudie le gradué associé à la filtration de l'espace vectoriel rationnel engendré par les paires  $(M, K)$  définie par les chirurgies rationnelles nulles préservant le lagrangien. Ces deux derniers chapitres comportent des travaux en progrès.

## Abstract

This thesis contains a study of finite type invariants of rational homology 3-spheres, and of null-homologous knots in these spheres. The main results are described in Chapter 2, and proved in Chapters 3 to 6. Chapter 3 is an article entitled "Finite type invariants of rational homology 3-spheres", to appear in *Algebraic & Geometric Topology*. In this article, we describe the graded space associated with the filtration of the rational vector space generated by rational homology spheres, defined by rational Lagrangian-preserving surgeries. Chapter 4 is an article entitled "On Alexander modules and Blanchfield forms of null-homologous knots in rational homology spheres", published in *Journal of Knot Theory and its Ramifications*. It contains the classification of the Alexander modules of null-homologous knots in rational homology spheres, and a study of the Blanchfield forms defined on these modules. In the sequel, we consider pairs  $(M, K)$  made of a rational homology sphere  $M$  and a null-homologous knot  $K$  in  $M$ . In Chapter 5, we prove that two such pairs have isomorphic rational Alexander modules endowed with their Blanchfield forms if and only if they can be obtained from one another by a finite sequence of null rational Lagrangian-preserving surgeries, *i.e.* Lagrangian-preserving surgeries performed on rational homology handlebodies homologically trivial in the complement of the knot. In Chapter 6, we study the graded space associated with the filtration of the rational vector space generated by pairs  $(M, K)$  defined by null rational Lagrangian-preserving surgeries. These last two chapters contain work in progress.