



HAL
open science

Impact of SR-BI and CD81 on Hepatitis C virus entry and evasion

Muhammad Nauman Zahid

► **To cite this version:**

Muhammad Nauman Zahid. Impact of SR-BI and CD81 on Hepatitis C virus entry and evasion. Biochemistry, Molecular Biology. Université de Strasbourg, 2012. English. NNT : 2012STRAJ014 . tel-00818590

HAL Id: tel-00818590

<https://theses.hal.science/tel-00818590v1>

Submitted on 28 Apr 2013

HAL is a multi-disciplinary open access archive for the deposit and dissemination of scientific research documents, whether they are published or not. The documents may come from teaching and research institutions in France or abroad, or from public or private research centers.

L'archive ouverte pluridisciplinaire **HAL**, est destinée au dépôt et à la diffusion de documents scientifiques de niveau recherche, publiés ou non, émanant des établissements d'enseignement et de recherche français ou étrangers, des laboratoires publics ou privés.

ÉCOLE DOCTORALE _Sciences de la vie (ED414)_____

[Institute de virologie, Inserm U748]

THÈSE présentée par :

[**MUHAMMAD NAUMAN ZAHID**]

soutenue le : 27 Avril 2012

pour obtenir le grade de : **Docteur de l'université de Strasbourg**

Discipline/ Spécialité : **Aspects Moléculaire et Cellulaire de la Biologie**

**Impact of SR-BI and CD81 on Hepatitis C virus
entry and evasion**

THÈSE dirigée par :
[Baumert Thomas]

Directeur de Recherche, Inserm U748, Université de Strasbourg

RAPPORTEURS :
[Boulangier Nathalie]

MC, MD, PHD, Université de Strasbourg

AUTRES MEMBRES DU JURY :
[Hirsch Ivan]
[Durantel David]

Directeur de Recherche, Inserm U1068, Marseille
Chargé de Recherche, Inserm U1052, Lyon

Résumé

Le virus de l'hépatite C (VHC) est l'une des causes majeures de cirrhose du foie et de carcinome hépatocellulaire. Il n'existe à ce jour pas de vaccin et les options thérapeutiques actuelles sont limitées par la résistance, la toxicité et le coût élevé du traitement. L'entrée du VHC dans les hépatocytes est un processus complexe impliquant les glycoprotéines de l'enveloppe virale E1 et E2, de même que de nombreux autres facteurs de l'hôte comme le récepteur scavenger de type BI (SR-BI), le CD81, la claudine 1, l'occludine et les récepteurs à activité tyrosine kinase tels que le récepteur du facteur de croissance épidermique (EGFR) et l'ephrine A2 (EphA2). Au courant de la première partie de ma thèse, nous nous sommes intéressés à caractériser plus en détail le rôle de SR-BI dans l'infection par le VHC. Le SR-BI humain est impliqué dans la capture sélective des esters de cholestérol HDL et le transport bidirectionnel du cholestérol libre à la membrane. Il a été démontré que SR-BI joue un rôle dans l'infection par le VHC lors de la liaison du virus à la cellule hôte et lors d'étapes suivant la liaison. Bien que les mécanismes impliquant SR-BI dans la liaison du virus à l'hépatocyte aient été partiellement caractérisés, le rôle de SR-BI dans les étapes suivant la liaison du VHC reste encore largement méconnu. Afin de mieux caractériser le rôle de l'interaction VHC/SR-BI dans l'infection par le VHC, notre laboratoire a généré une nouvelle classe d'anticorps monoclonaux anti-SR-BI inhibant l'infection virale. Nous avons pu démontrer que SR-BI humain jouait un rôle dans le processus d'entrée du virus à la fois lors de l'étape de liaison du virus à la cellule hôte mais aussi au cours d'étapes suivant cette liaison. Nos données indiquent que la fonction de SR-BI impliquée dans les processus suivant l'attachement du virus aux hépatocytes peut être dissociée de sa fonction de liaison du virus aux hépatocytes. Par ailleurs, nous avons démontré que cette fonction de SR-BI est également importante pour l'initiation et la dissémination du VHC. Ainsi il serait intéressant de cibler cette fonction de SR-BI dans le cadre d'une stratégie antivirale pour lutter contre l'infection par le VHC. Dans la seconde partie de ma thèse, nous avons pour but de caractériser les mécanismes moléculaires intervenant dans la réinfection du greffon lors de la transplantation hépatique (TH). En effet, la réinfection systématique du greffon hépatique est la limitation majeure de la TH. Il a été montré précédemment au sein de notre laboratoire que l'entrée virale et l'échappement aux anticorps neutralisants jouent un rôle déterminant dans la sélection des variants du VHC lors des phases précoces de TH. Cependant, les mécanismes moléculaires par lesquels le virus échappe à la réponse immunitaire de l'hôte ne sont toujours pas élucidés. Nous avons ainsi identifiés 3 mutations adaptatives dans la glycoprotéine d'enveloppe E2 responsables de l'entrée virale augmentée du variant hautement infectieux. Ces mutations influent sur la dépendance au récepteur CD81 du VHC résultant en une entrée virale accrue. Cette étude nous a permis d'identifier un nouveau mécanisme moléculaire de l'échappement viral dans lequel on observe une association entre l'utilisation des facteurs d'entrée par le VHC et l'échappement viral. L'identification de ces mécanismes va nous permettre une meilleure compréhension de la pathogénèse de l'infection par le VHC, et est un premier pas pour le développement d'une stratégie préventive antivirale ou vaccinale. De plus les anticorps anti-SR-BI développés au sein de notre laboratoire, compte tenu des mécanismes d'action novateur et du profil de toxicité potentiellement différent, représentent une nouvelle classe d'anticorps anti-SR-BI qui pourrait être utilisée comme antiviraux dans la prévention de l'infection par le VHC lors de la transplantation hépatique et / ou dans le traitement de l'infection chronique par le VHC.

Abstract

Hepatitis C virus (HCV) is a major cause of liver cirrhosis and hepatocellular carcinoma. Preventive modalities are absent and the current antiviral treatment is limited by resistance, toxicity and high costs. HCV entry into hepatocytes is a complex and multistep process involving the viral envelope glycoproteins E1 and E2, as well as several host factors such as SR-BI, CD81, CLDN1, OCLN, RTKs and NPC1L1. In the first part of my PhD, we aimed to further characterize the role of scavenger receptor class B type I (SR-BI) in HCV infection. Human SR-BI is a glycoprotein involved in the selective uptake of HDL cholesterol ester as well as the bidirectional free cholesterol transport at the cell membrane. SR-BI has been demonstrated to act during binding and post-binding steps of HCV entry. While the SR-BI determinants involved in HCV binding have been partially characterized, the post-binding function of SR-BI remains largely unknown. To further explore the role of HCV-SR-BI interaction during HCV infection, we generated a novel class of anti-SR-BI monoclonal antibodies inhibiting HCV infection. We demonstrated that human SR-BI plays a dual role in the HCV entry process during both binding and post-binding steps. Our data indicate that the HCV post-binding function of human SR-BI can be dissociated from its binding function. Moreover, we demonstrated that the post-binding function of SR-BI is most relevant for initiation of HCV infection and viral dissemination. Targeting the post-binding function of SR-BI thus represents an interesting antiviral strategy against HCV infection. In the second part of my PhD, we aimed to characterize the molecular mechanisms underlying HCV re-infection of the graft after liver transplantation (LT). A major limitation of LT is the universal re-infection of the liver graft with accelerated recurrence of liver disease. It had been previously shown in our laboratory that viral entry and escape from host neutralizing responses are important determinants allowing the virus to rapidly infect the liver during the early phase of transplantation. However, the molecular mechanisms by which the virus evades host immunity to persistently re-infect the liver graft are unknown. We identified three adaptive mutations in envelope glycoprotein E2 mediating enhanced entry and evasion of a highly infectious escape variant. These mutations markedly modulated CD81 receptor dependency resulting in enhanced viral entry. We identified a novel and clinically important mechanism of viral evasion, where co-evolution simultaneously occurs between cellular entry factor usage and escape from neutralization. The identification of these mechanisms advances our understanding of the pathogenesis of HCV infection and paves the way for the development of novel antiviral strategies and vaccines. Moreover, given the novel mechanism of action and the potential differential toxicity profile, our anti-SR-BI antibodies represent a novel class of antibodies that may be used as antivirals for prevention of HCV infection, such as during liver transplantation, and/or treatment of HCV infection.

Acknowledgements

These three and half years in Strasbourg have been extremely rich for me. Now that this thesis arrives at its end, I have many people to thank for having made my stay and my work here so lively. It is a pleasure to convey my indebtedness to them in my humble acknowledgment. First and foremost I would like to thank God the most beneficent and merciful. I could never have done this without the faith I have in you, the Almighty.

I would like to express my deep and sincere gratitude to my supervisor, Professor Dr. Thomas Baumert, for making it possible for me to work in such a prestigious scientific environment. Thomas has been very supportive, encouraging and kind. I owe a great deal of appreciation for his valuable advice, constructive criticism and extensive discussions around my work which will not only nourish my intellectual maturity but also be helpful in my future perspectives.

I feel immense pleasure to gratefully acknowledge and to express deep sense of gratitude to my supervising guide and mentor, Dr. Mirjam Zeisel, for her enthusiasm, creative suggestions, motivation and exemplary guidance throughout the course of my doctoral research and also during thesis writing. I am also truly indebted to Mirjam for her understanding, patience and personal attention which have provided good and smooth basis for my PhD tenure. Apart from her scientific knowledge and devotion to research, I found her an adorable, upright, pure and kind-hearted human being. I solemnly submit my honest and humble thanks to her for bringing my dreams into reality.

I wish to express my cordial appreciation to my examiners, Dr. Ivan Hirsch, Dr. David Durantel and Dr. Nathalie Boulanger, for the acceptance to be my referees.

My heartiest thanks go in particular to Dr. Isabel Fofana. I learnt first experiment of my PhD from her and she has been very kind to me during all these years. Her charming and delightful personality has always pleasant affect on environment of the lab.

It is a pleasure to pay attribute to Marine Turek, my sweet office fellow, for her support during my projects and for all scientific as well as social discussions.

I offer my profound gratitude to Dr. Joachim Lupberger for his scientific and moral support. It has always been a pleasure talking to him.

I sincerely acknowledge my colleagues especially Laetitia, Fei, Daniel, Patric, Catherine, Roxane, Sarah and Laura for the time we spent together in the lab and also at “beer time” where I found my favorite “orangina”. I will always feel the warmth and geniality of those moments.

I also benefited by outstanding support of Christine, Samira, Jochen and offer them my zealous thanks.

I would like to express my gratitude to Dan and Rajeev. It has always been nice to discuss with Rajeev on scientific issues as well as on cricket.

I would like to extend my thanks to Sigis, Dominique and Patricia for their assistance and humor during my stay and also to Catherine C and Anne Z for facilitating all administrative issues.

Words are lacking to express my gratitude for Higher Education Commission of Pakistan, for providing me with scholarship during my study in France. The opportunity of studying in France has really broadened my horizon and widened my perspectives in life.

I cherish the friendship I have and would like to thank each one of them. I would like to thank Sultan Ali, Azeem Sultan, Sarfraz Shafiq, Rizwan Aslam, Asghar Shabbir and Ghulam Hussain for their support, guidance and affection. I have spent some most beautiful moments of my life with them. I would also like to extend huge, warm thanks to my friends in Pakistan, Zulfiqar, Zubair, Abbas, Ahsan and Imran, for their love and sincerity.

I am eternally grateful to my beloved parents, Ch. M. Riaz and Naseem Akhtar, for their unconditional love, fidelity, endurance and encouragement. They have been selfless in giving me the best of everything. I would also like to express my gratitude and deep love for my brother, M.Imran, who has always been a source of inspiration for me. Behind my every success, my brother is always there. I wish to thank my sister-in-law, Saima, for her affection and prayers. My heartfelt thanks to my better half, Ayesha, for her support, understanding and love and last but not least my mother, though no longer with us, remains the compass of my life.

There are so many others whom I may have inadvertently left out and I sincerely thank all of them for their help.

TABLE OF CONTENT

Index of figures and tables	5
Abbreviations	6
1. Introduction	8
1.1. Epidemiology, mode of transmission and clinical signs	8
1.2. Molecular biology of hepatitis C virus	11
1.3. Model systems to study HCV-host cell interactions	20
1.3.1. <i>In vitro</i> model systems	21
1.3.2. <i>In vivo</i> model systems	25
1.4. HCV host factors required for viral attachment and entry	26
1.5. HCV life cycle	35
1.6. Adaptive immune response to HCV and escape from antibody mediated neutralization	39
1.7. Treatment of chronic HCV infection	44
1.8. HCV infection after liver transplantation	46
2. Aims of the study	48
3. Results	49
3.1. The post-binding activity of SR-BI mediates initiation of hepatitis C virus infection and viral dissemination	49
Publication n°1 (Zahid et al; Hepatology, in revision)	
3.2. Mutations that alter hepatitis C virus cell entry factor usage mediate escape from neutralizing antibodies	51
Publication n°2 (Fofana, Fafi-Kremer, Carolla et al; Gastroenterology, accepted with minor revision)	
4. Discussion	54
5. Conclusions and perspectives	60
6. References	61
Annex	
Publication n°3 (Lupberger, Zeisel et al; 2011, Nature Medicine)	
Publication n°4 (Dhillon et al; 2010, Journal of Virology)	

INDEX OF FIGURES AND TABLES

Figure index:

Figure no.	Title	Page
1	Geographical distribution of HCV infection	9
2	Natural history of HCV infection	10
3	Schematic representation of HCV	11
4	Genomic organization of HCV	13
5	Production of HCV pseudoparticles	23
6	Production of HCVcc	25
7	Structure of CD81	29
8	Structure of SR-BI	31
9	Model of HCV entry	39
10	Evolution of HCV variants before and 7 d after LT	52

Table index:

Table no.	Title	Page
1	HCV proteins and their functions in the viral life cycle	19
2	Genetic variability of HCV	20

ABBREVIATIONS

ALT	Alanine aminotransferase
ApoE	Apolipoprotein E
ARFP	Alternate reading frame protein
AST	Aspartate aminotransferase
BOC	Boceprevir
C	Core
CARs	Coxsackie virus B adenovirus receptors
CE	Cholesteryl ester
CETP	Cholesterol ester transfer protein
CHO	Chinese hamster ovary cells
CLDN1	Claudin-1
CRE	<i>cis</i> -acting replication element
DAA	Direct-acting antiviral agents
ECL1	Extracellular loop 1
EGF	Epidermal growth factor
EGFR	Epidermal growth factor receptor
EHM	Extra-hepatic manifestations
eIF 3	Eukaryotic translation initiation factor 3
EMCV	Encephalomyocarditis virus
EphA2	Ephrin A2
ER	Endoplasmic reticulum
EVR	Early virological response
F	Frameshift
FDA	Food and Drug Administration
GAGs	Glycosaminoglycans
GFP	Green fluorescent protein
HCC	Hepatocellular carcinoma
HCV	Hepatitis C virus
HCV _{cc}	Cell culture-derived HCV
HCV-LPs	HCV-like particles
HCVpp	HCV pseudoparticles
HDL	High density lipoproteins
His	Histidine
HIV	Human immunodeficiency virus
HS	Heparan sulfate
HVR	Hypervariable region
IDU	Injecting drug use
IFN	Interferon
IRES	Internal ribosome entry site
JFH1	Japanese fulminant hepatitis
LDL	Low-density-lipoproteins
LEL	Large extracellular loop
LT	Liver transplantation
mAb	Monoclonal antibody
MHC	Major histocompatibility complex
MHC	Major histocompatibility complex
miRNA	microRNA
MLV	Murine leukemia virus
nAb	Neutralizing antibody

NPC1L1	Niemann-Pick C1-Like 1
NS	Non-structural
OCLN	Occludin
ORF	Open reading frame
PHH	Primary human hepatocytes
PIs	Protease inhibitors
PKIs	Protein kinase inhibitors
RBV	Ribavirin
RC	Replication complex
RdRP	RNA-dependent RNA polymerase
RFP	Red fluorescent protein
RTKs	Receptor tyrosine kinases
RVR	Rapid virological response
SAA	Serum amyloid A
SCID	Severe combined immunodeficiency disorder
SEL	Small extracellular loop
SL	Stem-loop
SR-BI	Scavenger receptor class B type I
SVR	Sustained virological response
TEM	Tetraspanin-enriched microdomains
TJ	Tight junctions
TMD	Transmembrane domain
TPV	Telaprevir
uPA	Urokinase plasminogen activator
UTR	Untranslated regions
VLDL	Very-low-density lipoprotein
VSV	Vesicular stomatitis virus

1. Introduction

Hepatitis C is an infectious disease caused by the hepatitis C virus (HCV). HCV has a major impact on public health with over 170 million infected individuals. HCV infects only humans and chimpanzees. HCV mainly affects injecting drug users. Early diagnosis is difficult because acute infection is usually asymptomatic and in 70% of cases, it leads to chronic infection. Development of liver cirrhosis is about 20-30% in chronically infected patients and up to 2.5% of chronic cases will develop hepatocellular carcinoma. The rate of progression of liver disease varies in different individuals, but usually takes 15-20 years with a risk of 5% liver cancer per year. HCV is a leading indication for liver transplantation in Europe and the United States. Re-infection of the graft occurs in all patients. A vaccine protecting against HCV infection is not available. Although novel direct acting antivirals were recently approved for HCV therapy in Europe and the United States, the current antiviral therapies and treatment options, e.g. pegylated interferon-alpha and ribavirin in association or not with protease inhibitors, are still characterized by limited efficiency, high costs and substantial side effects. Thus, the development of new antiviral strategies remains an important issue. The lack of data on mechanisms involved in HCV infection has long been a hurdle to develop effective strategies to treat this disease. A better understanding of the molecular mechanisms involved in HCV entry into cells and re-infection of graft after liver transplantation will help to combat HCV infection.

1.1. Epidemiology, mode of transmission and clinical signs

HCV infection is responsible for major global health hazard. There are around 170 million people worldwide who are chronically infected by HCV (George et al. 2001). HCV has been considered to cause 25% of hepatocellular carcinoma (HCC) and 27% of cirrhosis all over the world (Alter, 2007). Death rate due to HCV infection is very high and approximately 350 000 people die every year after being infected with HCV. It is thought that HCV is 10 times more infectious than human immunodeficiency virus (HIV) (Hatzakis et al., 2011). HCV has a heterogenous geographical distribution (Figure 1). The lowest prevalence has been recorded in United Kingdom and Scandinavia (0.01%-0.1%) and Egypt is the country showing the highest prevalence (15%-20%) (Alter, 2007). In Europe, chronically infected patients are around 9 million in comparison with 1.5 million infected by HIV (Hatzakis et al., 2011). Prevalence of HCV in Pakistan is 4.7% whereas in India, Nepal, Myanmar, Iran, China, Taiwan and Afghanistan is 0.66%, 1%, 2.5%, 0.87%, 1%, 4.4% and 1.1% respectively (Attaullah et al., 2011; Sievert et al., 2011). In France, it is considered that 550,000 to 600,000 people are carriers of this virus, representing 1 to 1.2% of the population. HCC induced by

HCV is 60%- 70% in Europe, 50%-60% in North America and 20 % in Asia and Africa (Hatzakis et al., 2011).

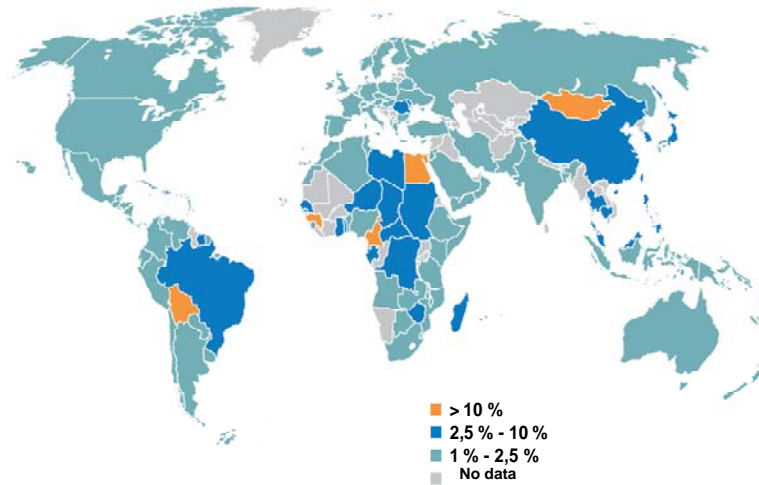

Figure 1: Geographical distribution of HCV infection (WHO 2007)

HCV is transmitted mainly through parenteral route. Blood transfusion was one of the major threats for HCV infection before the launching of improved blood screening measures in 1990 and 1992 (Lauer and Walker, 2001). Injecting drug use (IDU) is the most significant HCV transmission risk in most developed countries like United Kingdom where 90% of infectious cases are due to injecting drug abuse (Martin et al., 2012). The rate of occurrence of HCV infection among at-risk IDUs is quite high; normally it is 25-40 per 100 individual years (Grebely et al., 2011). Iatrogenic exposures are also major causes of HCV transmission. It involves unsafe therapeutic injections and usage of poorly sterilized surgical and dental equipments. Hemodialysis and organ transplants are also important factors for HCV transmission (Qureshi, 2007). The other modes of transmission include intranasal drug use, body-piercing, tattooing, circumcision and acupuncture (Alter, 2007). Vertical transmission occurs but not frequently and it is mostly associated with coinfection with HIV in the mother (Lauer and Walker, 2001). Sexual transmission is very rare as compared to HIV but certain sexual activities may involve exposure to blood and may enhance the risk of transmission (O'Reilly et al., 2011).

HCV infection exists in two forms i.e. acute hepatitis and chronic hepatitis (Figure 2). **Acute phase** of HCV infection is not diagnosed frequently. Only 15% to 30% of infected patients show clinical signs which usually appear 2 to 26 weeks after the infection (Lauer and Walker, 2001). In acute hepatitis, majority of individuals are able to clear the infection without showing any symptoms. Symptomatic acute infection involves nonspecific symptoms like malaise, lethargy, jaundice and

nausea. There is also an increase in the level of liver-associated serum enzymes like alanine aminotransferase (ALT) and aspartate aminotransferase (AST) after initial HCV infection (Grebely et al., 2011). Fulminant hepatitis is rare as it is observed within less than 1% patients. Viral clearance after acute HCV infection is evident in around 25% of patients. After the initial infection, HCV persists in approximately 70% of individuals despite the presence of cellular and humoral immunity. **Chronic HCV infection** is defined as the presence of HCV RNA 6 months after the estimated time of infection. Hepatitis will be developed in majority of chronic infections and to some extent of fibrosis which may be linked to some nonspecific signs as fatigue. It has been observed that spontaneous elimination of chronic HCV infection appears in 0.5%-0.74% per person-year annually (Craxi et al., 2008). The chronic infection will gradually show severe complications and almost 15 to 20 percent individuals develop liver cirrhosis which may lead to HCC, hepatic decompensation or ultimately death. The frequency of HCC is 1-4% per year after the development of liver cirrhosis. HCC can appear without cirrhosis but not often (Lauer and Walker, 2001) (Figure 2). It has become one of the major indications for liver transplantation.

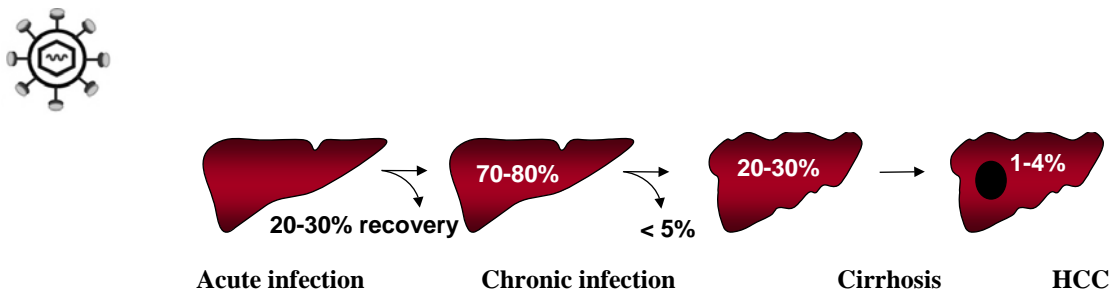

Figure 2: Natural history of HCV infection. Approximately 25% of infected individuals recover spontaneously after acute infection but around 75% become chronically infected and it can be complicated by cirrhosis and hepatocellular carcinoma (HCC) in 20-30 years after infection.

Along with acute and chronic infections, HCV is also responsible for extra-hepatic manifestations (EHMs). It has been reported that at least one EHM is found in approximately 60% of patients infected with HCV like autoimmune disorders and lymphoma (Bockle et al., 2012). Among EHMs, mixed cryoglobulinemia, a prototype of B-cell lymphoproliferative disorders, has been mostly scrutinized in HCV patients (Craxi et al., 2008). Some other extra-hepatic manifestations include malignant lymphoproliferative disorders, cutaneous diseases like porphyria cutanea tarda and oral lichen planus (Zignego et al., 2007). Neurological disorders (Lidove et al., 2001) and diabetes mellitus type 2 is also found in chronically infected HCV individuals (Antonelli et al., 2005).

1.2. Molecular biology of hepatitis C virus

HCV is an enveloped positive-strand RNA virus which belongs to the genus *hepacivirus* of the Flaviviridae family. The Flaviviridae includes two other genera: *flavivirus* (dengue fever virus, yellow fever virus, tick-borne encephalitis virus and Japanese encephalitis virus) and *pestivirus* (bovine viral diarrhea, swine fever virus and Border disease virus) (Lindenbach et al., 2007). HCV was identified through expression cloning of immunoreactive cDNA derived from the infectious non-A, non-B hepatitis agent (Choo et al., 1989). The size of HCV particle is about 55-65 nm in diameter (Kaito et al., 1994; Shimizu et al., 1996) (Figure 3). HCV can be found in different forms in patient's serum e.g. (i) virion associated with very-low-density lipoprotein (VLDL) and low-density-lipoproteins (LDL), (ii) virion associated with immunoglobulins and (iii) free virion (Penin et al., 2004). The HCV genome of about 9600 nucleotides carries a single open reading frame (ORF) encoding a polyprotein of about 3010 amino acids which is flanked at the 5'- and 3'- ends by small highly structured untranslated regions (UTR). The cleavage of this polyprotein precursor occurs co-translationally and post-translationally by viral and cellular proteases at the endoplasmic reticulum (ER) and results in 10 mature structural and nonstructural proteins. The structural proteins consist of core (C) and envelope glycoproteins E1 and E2. A small hydrophobic peptide p7 separates the structural proteins from nonstructural proteins (NS). The nonstructural proteins include NS2, NS3, NS4A, NS4B, NS5A, and NS5B (Moradpour et al., 2007) (Figure 4).

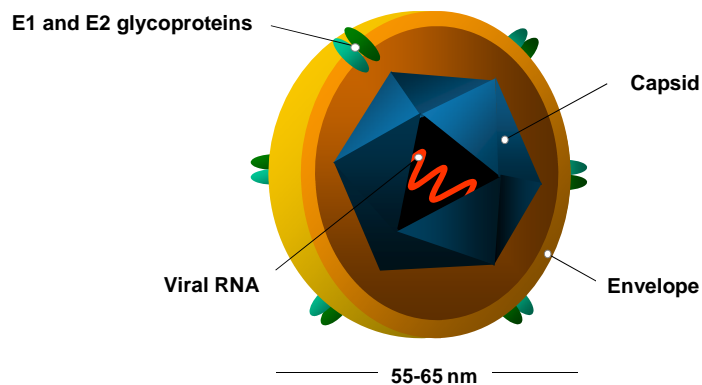

Figure 3: Schematic representation of HCV. HCV is a small enveloped virus of 55-65 nm in diameter. Its genome is a single-stranded RNA of positive polarity of about 9600 nucleotides. It is contained in an icosahedral protein capsid, located within a lipid envelope in which envelope glycoproteins E1 and E2 are inserted.

➤ **Untranslated regions 5' and 3'**

The **5' UTR** is a highly conserved, 341 nucleotides long element. It contains four well structured domains containing numerous stem-loops and a pseudoknot (Lindenbach and Rice, 2001). The pseudoknot is present in domain III and the domain IV contains the ORF translation initiation codon. The 5' UTR carries an internal ribosome entry site (IRES) which is crucial for cap-independent translation of the viral RNA (Bartenschlager et al., 2004a). Domain I has no role in IRES activity but domain II, III and IV along with first 24 to 40 nucleotides of core-encoding region constitute the IRES. Electron microscopy revealed that domain II, III and IV constitute distinct regions within the molecules and a flexible hinge exists between domain II and III (Beales et al., 2001). The 5'UTR region contains both the determinants for translation and the elements for RNA replication (Astier-Gin et al., 2005). The upstream sequence of the IRES is essential for viral RNA replication (Friebe et al., 2001) and the stem-loop of domain II of the IRES is essential for replication (Appel and Bartenschlager, 2006). The formation of a binary complex between the IRES and the 40S ribosomal subunit is required for initiation of HCV translation. The IRES-40S complex then binds to eukaryotic translation initiation factor 3 (eIF 3) and ternary complex i.e. eIF2.GTP.Met-tRNA_i to constitute a 48S intermediate complex at the AUG initiation codon. Finally, after GTP hydrolysis and recruitment of the 60S ribosomal subunit, the 48S intermediate complex is converted into translationally active 80S complex.

It has been shown that an abundant liver-specific microRNA (miRNA), miR-122, is able to increase HCV RNA replication after binding to the 5' UTR (Jopling et al., 2005). *In vivo* experiments in chimpanzees showed that the suppression of miR-122 by an antagomir results in a decrease in viral load (Lanford et al., 2010).

The **3' UTR** contains around 225 nucleotides and is essential for viral replication (Friebe and Bartenschlager, 2002; Kolykhalov et al., 2000). It is composed of a short (about 40 nucleotides) variable region, a polyuridine/polypyrimidine (poly U/UC) tract of an average length of 80 nucleotides and a highly conserved 98 nucleotides long sequence which is designated as X-tail and contains three stable stem-loop structures SL1, SL2 and SL3 (Appel et al., 2006; Kolykhalov et al., 1996; Tanaka et al., 1996). It has been suggested that the complete X-tail as well as at least 25 nucleotides of poly U/UC are compulsory for RNA replication in cell culture and for the infectivity of the viral genome *in vivo* (Yi and Lemon, 2003; You et al., 2004). An essential *cis*-acting replication element (CRE) was identified in the 3'-terminal coding region of NS5B. This CRE (designated 5BSL3.2) was found to interact with a stem-loop (SL2) in the X-tail, suggesting that a pseudoknot is formed at the 3'-end of the HCV genome which is indispensable for RNA replication (Friebe et al., 2005; You et al., 2004).

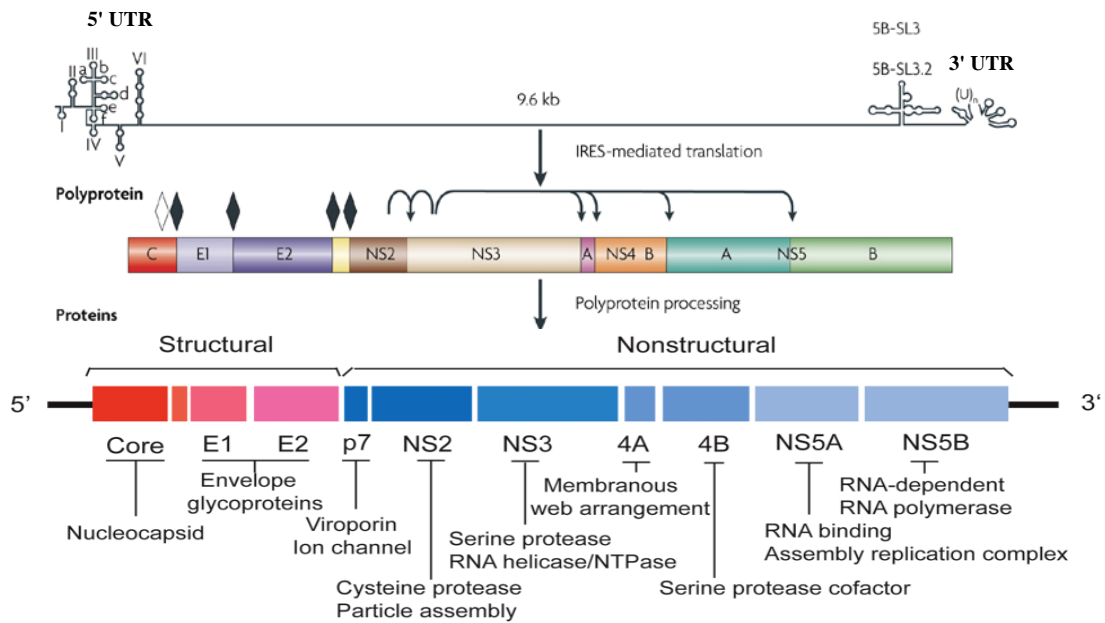

Figure 4: Genomic organization of HCV. The HCV genome contains a positive RNA of 9.6 kb. The 5'UTR region containing the IRES, is followed by an open reading frame encoding the structural proteins and nonstructural proteins (NS), and the 3'UTR region required for replication. The polyprotein of about 3011 amino acids is cleaved co- and post-translationally by cellular and viral proteases to yield the structural proteins and NS proteins. Solid diamonds denote cleavage sites of HCV polyprotein precursor by the endoplasmic reticulum signal peptidase and open diamond shows further C-terminal processing of the core protein by signal peptide peptidase (Moradpour et al., 2007).

➤ Structural proteins

Core protein

The first structural protein encoded by HCV is called core, C or capsid protein, which constitutes the viral nucleocapsid. The nascent polypeptide is targeted by an internal signal sequence located between the core and E1 sequence, to the host ER membrane for translocation of the E1 ectodomain into the ER lumen. The signal peptidase cuts the signal sequence and yields an immature form of core protein (191 amino acids), further C-terminal processing by signal peptide peptidase results in mature 21-kDa core protein (173-179 amino acids) (McLauchlan et al., 2002).

The core protein is composed of three distinct domains. Domain D1 is an N-terminal hydrophilic domain which contains 120 amino acids. It contains high portion of basic amino acids and mainly participates in RNA binding and nuclear localization (Suzuki et al., 2005). Domain D2 is a C-terminal hydrophobic domain of about 50 amino acids. This domain is involved in binding of core protein with ER membranes, outer mitochondrial membranes and lipid droplets (Schwer et al., 2004; Suzuki et al., 2005). The last domain is of about 20 amino acids that work as a signal peptide for the

downstream envelope protein E1 (Grakoui et al., 1993). The association of core protein with lipid droplets may affect lipid metabolism and may play a role in sterosis (Asselah et al., 2006). In addition to nucleocapsid formation, the core protein has been involved in many cellular pathways including gene transcription, apoptosis, cell signaling and cellular transformation (Kato, 2001; Lai and Ware, 2000).

ARFP/F protein

The ARFP (alternate reading frame protein) or F (frameshift) protein is produced as a result of -2/+1 ribosomal frameshift in the N-terminal core-coding region of the HCV polyprotein (Branch et al., 2005; Varaklioti et al., 2002; Wolf et al., 2008). This frameshift may occur at or near to codon 11 of the core protein sequence as revealed by amino acid sequencing. The ARFP/F protein is a small protein of 17 kDa which is localized in the ER after translation. The lifespan of this protein is about 10 minutes due to its degradation by proteasome (Xu et al., 2003). Antibodies and T cells, specific against ARFP/F protein, were detected in chronically infected patients. This suggests that the protein is expressed during HCV infection (Walewski et al., 2001; Wolf et al., 2008). ARFP/F protein is not required for HCV replication both *in vivo* and *in vitro* (McMullan et al., 2007). The function of this protein in the HCV lifecycle is unknown but it was considered to be involved in viral persistence (Baril and Brakier-Gingras, 2005).

Envelope glycoproteins E1 and E2

The two envelope glycoproteins E1 and E2 are essential components of the HCV virion (Figure 3) and play a vital role in HCV entry and fusion (Bartosch et al., 2003b; Nielsen et al., 2004) (Figure 9). E1 and E2 are type I transmembrane glycoproteins, with N-terminal ectodomains of 160 and 334 amino acids, respectively, and a 30 amino acids C-terminal transmembrane domain (TMD). Two short stretches of hydrophobic amino acids, separated by a small polar segment comprising of fully conserved charged residues, are involved in the composition of E1 and E2 TMDs. (Penin et al., 2004). They are responsible for many functions e.g. membrane anchoring, ER localization and heterodimer assembly (Cocquerel et al., 1998; Cocquerel et al., 2000). The molecular weights of E1 and E2 are approximately 31 kDa and 70 kDa, respectively. E1 and E2 ectodomains carry several proline and cystein residues (Matsuura et al., 1994). The ectodomains of E1 and E2 are heavily N-glycosylated, containing up to 5 and 11 glycosylation sites respectively and also multiple disulfide-linked cysteines. Maturation and folding of HCV envelope protein occur through a very complex process involving the ER chaperone machinery and relying on glycosylation and on core protein co-expression (Merola et al., 2001).

Several hypervariable regions in envelope glycoprotein E2 have been identified where amino acid sequences differ about 80%, not only among HCV genotypes but even among subtypes of a same genotype (Kato, 2001; Weiner et al., 1991). This variability may result in viral escape from the host immune system and persistence of the virus (von Hahn et al., 2007) (see HCV heterogeneity on page 19). Hypervariable region 1 (HVR1) is composed of 27 amino acids and serves as HCV neutralizing epitope (Farci et al., 1996; Zibert et al., 1997). *In vivo* studies in chimpanzees have demonstrated that after the deletion of HVR1, HCV was still infectious but highly attenuated suggesting a role of this region in host cell entry (Bankwitz et al., 2010; Callens et al., 2005; Forns et al., 2000). The physicochemical properties of HVR1 residues at each position and its conformation are highly conserved among the various genotypes (Penin et al., 2001). The positively charged residues of HVR1 can interact with negatively charged molecules at the cell surface. This association can take part in host cell recognition and attachment as well as in cell or tissue compartmentalization (Barth et al., 2003; Bartosch et al., 2003c). HVR2 is another hypervariable region consisting of 7 amino acids (Kato, 2001). The functional role of HVR2 is not well defined. This region seems to be involved in E2 binding to cellular factors such as CD81 (Roccasecca et al., 2003). A third region called HVR3 has been identified between HVR1 and HVR2 (Troesch et al., 2006), which also appears to be involved in binding to host factors (Callens et al., 2005).

E1 and E2 have a crucial role in the early steps of viral infection. Interaction of E2 with one or several components of the receptor complex results in viral attachment (Barth et al., 2003; Barth, 2006; Flint and McKeating, 2000; Scarselli et al., 2002). It has been shown that both E1 and E2 interact with heparan sulfate (HS) (Barth et al., 2006; Barth et al., 2003), while only E2 interacts CD81 (Pileri et al., 1998), scavenger receptor class B type I (SR-BI) (Scarselli et al., 2002) and probably occludin (OCLN) (Liu et al., 2009). The two glycoproteins E1 and E2 have one for the other chaperone activity (Lavillette et al., 2007) and both appear to be involved in the process of membrane fusion required for internalization of the virus into the host cell (Flint and McKeating, 2000; Lavillette et al., 2007). The precise role of envelope glycoproteins E1 and E2 in the fusion step is not yet well defined. Given their importance in virus-host interactions, the envelope glycoproteins are major targets of neutralizing antibodies (El Abd et al., 2011; Kachko et al., 2011; Owsianka et al., 2005) (see chapter 1.6 adaptive immune response to HCV and escape from antibody mediated neutralization on page 39).

p7 protein

Partial cleavage of E2 results in a small polypeptide, p7, which contains 63 amino acids and has been described to be an integral membrane protein (Carrere-Kremer et al., 2002; Steinmann et al., 2007). It comprises two transmembrane domains organized in α -helices, linked together by a cytoplasmic loop.

The orientation of its both N-terminus and C-terminus is towards the ER lumen. p7 is not needed for RNA replication *in vitro* but data have shown that it is essential for *in vivo* HCV infection in chimpanzees (Sakai et al., 2003). It has been suggested that p7 forms oligomers and could act as a calcium ion channel which indicate its belonging to the viroporin family of proteins (Gonzalez and Carrasco, 2003; Luik et al., 2009). p7 plays a critical role in assembly and release of HCV particles (Bankwitz et al., 2010; Brohm et al., 2009; Jones et al., 2007; Steinmann et al., 2007). Using a trans-complementation system, Brohm and colleagues described that p7-defective full length genomes are rescued by HCV replicons expressing p7 in *trans* (Brohm et al., 2009). They also showed that p7 function cannot be replaced by viroporins from other viruses (Brohm et al., 2009). The importance of p7 for virus production has made it another target for antiviral strategy. Several p7 inhibitors e.g. amantadine (Bankwitz et al., 2010; Cook and Opella, 2010; Griffin et al., 2008) and amilorides (Griffin et al., 2008; Steinmann and Pietschmann, 2010) have shown antiviral activity in cell culture.

➤ **Non-structural proteins**

Non-structural (NS) proteins play a crucial role in replication, translation and assembly of HCV.

NS2 protein

NS2, a non-glycosylated transmembrane protein of 21-23 kDa, is not crucial for the replication complex but takes part in production of infectious particles (Jirasko et al., 2008; Jones et al., 2007). It has been described that NS2 is composed of three transmembrane segments (TMS) (Yamaga and Ou, 2002). The C-terminal half of NS2 and the N-terminal one-third of NS3 participate in the catalytic activity of the NS2-3 protease (Grakoui et al., 1993). It has been demonstrated by site directed mutagenesis that amino acid His 143, Glu 143 and Cys 184 are crucial for NS2 catalytic activity (Moradpour et al., 2007). It has been suggested that the protease domain of NS2, but not its enzymatic activity, is required for infectious virus production (Jirasko et al., 2008; Jones et al., 2007). Full length NS2 protein has been shown to be essential for HCV assembly (Jirasko et al., 2008). Mutations in NS2 that hinder HCV assembly can be rescued by *trans*-complementation (Jirasko et al., 2008). It has been reported that NS2 interacts with envelope glycoproteins, p7 and NS3 and seems to recruit viral proteins to lipid droplets, so NS2 acts as a key organizer of the assembly of infectious HCV particles (Jirasko et al., 2010). Moreover, genetic data suggested that functional interactions exist among NS2, E1-E2 and NS3-NS4A during virus assembly (Phan et al., 2009; Stapleford and Lindenbach, 2011). Recently, it has been reported that interaction of p7 and NS2 induces core-ER colocalization which is required for initiation of viral assembly (Boson et al., 2011). The life span of NS2 is short and its protease activity is lost after self-cleavage from NS3 (Franck et al., 2005).

NS3-NS4A proteins

HCV NS3 is a multifunctional protein which contains an N-terminal serine protease domain and a C-terminal RNA helicase/NTPase domain. Enzyme activity of both is essential for viral replication (Bartenschlager et al., 2004b; Lindenbach and Rice, 2001). NS4A polypeptide serves as a cofactor for the NS3 serine protease. NS3-NS4A protease plays a critical role in HCV life cycle and catalyzes the cleavage of HCV polyprotein at NS3/NS4A, NS4A/NS4B, NS4B/NS5A and NS5A/NS5B junctions (Kim et al., 1996; Penin et al., 2004). The NS3 helicase-NTPase domain performs several functions such as RNA-stimulated NTPase activity, RNA binding and unwinding of RNA regions with secondary structures. Recently, it has been suggested that NS3 protein takes part in the early steps of morphogenesis of viral particles i.e. it is involved in the recruitment of NS5A to lipid droplets and in the assembly of viral particles (Ma et al., 2008). NS3-NS4A protease is considered to be an important target of antiviral therapy and indeed in 2011, two protease inhibitors (telaprevir and boceprevir) have obtained approval from U.S. Food and Drug Administration (FDA) for treatment of HCV infection (genotype 1).

NS4B protein

NS4B is an integral membrane protein with a molecular weight of 27 kDa. It is associated with ER or ER-derived membranes (Hugle et al., 2001; Lundin et al., 2003). NS4B contains 4 TMDs which separate cytoplasmic N- and C-terminals (Elazar et al., 2004). It also plays a crucial role in membrane-bound replication complex. (Gosert et al., 2003; Gretton et al., 2005). The induction of membranous web, the specific membrane alteration that serves as a scaffold for HCV replication, is an important function of NS4B (Egger et al., 2002). However, the detailed characteristics of this protein have still to be elucidated.

NS5A protein

NS5A is a 56-58 kDa phosphoprotein which plays a key role in RNA replication. The N-terminal of NS5A carries an amphipathic α -helix which is involved in protein-protein interaction essential for the formation of a functional HCV replication complex (Brass et al., 2002; Penin et al., 2004). NS5A contains 3 domains (I, II and III). Domain I is an N-terminal Zn^{2+} binding domain, domain II is central and may be helix-rich and domain III is an unfolded C-terminal domain (Tellinghuisen et al., 2004; Tellinghuisen et al., 2005). Domain III has been recently described as a key factor in the assembly of viral particles and the phosphorylation of this domain may regulate assembly (Appel et al., 2008; Hughes et al., 2009; Tellinghuisen et al., 2008). The amino acid sequence of domain III is

poorly conserved among different HCV genotypes (Hanouille et al., 2009). Noteworthy, it has been reported that NS5A of genotype 1a (H77S) shares only 58% amino acid identity with genotype 2a protein overall and only 46% identity within domain III (Kim et al., 2011). Furthermore, it has been suggested that existence of major differences in the sequences and/or structures of the genotypes 1a and 2a NS5A proteins hinders them from functioning interchangeably in support of viral RNA replication (Kim et al., 2011). Cyclophilin A has been shown to bind with domain II of NS5A protein (Foster et al., 2011). It has been reported that the isomerase activity of Cyclophilin A plays a vital role in HCV replication (Chatterji et al., 2009; Foster et al., 2011) and importantly, specific residues within NS5A are the target for this isomerase activity (Hanouille et al., 2009). The interaction of NS5A and apolipoprotein (ApoE) is required for the assembly and export of infectious virions (Benga et al., 2010). NS5A takes part in different functions depending on its interaction with cellular proteins (Tellinghuisen and Rice, 2002). It can play a role in interferon resistance by binding to and inhibiting PKR, an antiviral effector of interferon- α (Gale et al., 1998). NS5A is also involved in regulation of cell growth and cellular signaling pathways (Tan and Katze, 2001). NS5A is also a target for direct acting antivirals such as the BMS-790052 compound (Bourliere et al., 2011). Cyclosporin, a cyclophilin inhibitor, has been reported to inhibit HCV replication *in vitro* and in patients as well. Alisporivir (Debio 025) is a synthetic form of cyclosporine is in a phase-I study (Flisiak et al., 2008).

NS5B protein

NS5B, a RNA-dependent RNA polymerase (RdRP), is the key enzyme of HCV RNA replication. NS5B belongs to a class of membrane proteins termed tail-anchored proteins (Ivashkina et al., 2002; Schmidt-Mende et al., 2001). Its C-terminal post-translationally inserts into the ER membrane (Moradpour and Blum, 2004). Like other polymerases, NS5B has a classical right hand structure with distinct finger, palm and thumb domains (Bressanelli et al., 1999; Lesburg et al., 1999). The catalytic domain of NS5B is membrane-associated via a C-terminal transmembrane domain that is critical for HCV RNA replication (Appel et al., 2006). The interaction of viral proteins NS3 and NS5A modulate the activity of NS5B (Bartenschlager et al., 2004a). Recently, it has been suggested that NS5B may also be involved in virus assembly (Gouklani et al., 2012). The RdRP is an important target for the development of anti-HCV drugs, polymerase inhibitors (Di Marco et al., 2005; Pawlotsky, 2006; Qureshi, 2007).

Table1. HCV proteins and their functions in the viral life cycle.

HCV protein	Function	Molecular weight (kDa)
core	Nucleocapsid	23 (immature) 21 (mature)
ARFP/F	Unknown	16-17
E1	Envelope, attachment, entry, fusion	33-35
E2	Envelope, attachment, receptor binding/entry, fusion	70-72
p7	Calcium ion channel (viroporin), assembly	7
NS2	NS2-3 autoprotease, assembly	21-23
NS3	Component of NS2-3 and NS3-4A proteinases NTPase/helicase	69
NS4A	NS3-4A proteinase cofactor	6
NS4B	Membranous web induction	27
NS5A	RNA replication by formation of replication complexes, assembly	56-58
NS5B	RNA-dependent RNA polymerase, replication	68

➤ **HCV heterogeneity**

HCV has been classified into six major genotypes (1-6) and into multiple subtypes (1a, 1b, 2a, 2b....) (Bukh et al., 1995b; Simmonds et al., 2005). HCV has a high genetic variability. The absence of proof-reading function of the RNA-dependent RNA polymerase and the rapid viral replication (10^{10} - 10^{12} per day in human) are the main reasons of this variability (Neumann et al., 1998). The average frequency of mutation per nucleotide site varies from 1.4×10^3 to 1.9×10^3 per year. One of the most conserved parts of the genome is 5' UTR which contains more than 90% homology between the sequences of different strains (Bukh et al., 1992). Another highly conserved region containing around 80% homology between different isolates is the capsid encoding region (Simmonds et al., 1994). The region encoding HCV envelope glycoproteins E1 and E2 is the most variable region of the HCV genome. In fact, sequence encoding HVR 1, 2 and 3 of envelope glycoprotein E2 may display genetic variability of approximately 50% from one strain to another (Troesch et al., 2006). Nucleotide sequence variability of 30% to 50% exists among different genotypes while subtypes have 20%-25% variability throughout the genome. As a consequence of high genetic variability and pressure exerted by host immune responses, HCV circulates in the patients in the form of genetically distinct but

closely related viral variants termed quasispecies. Viral variants within a quasispecies differ by 1%-5% in their nucleotide sequences. The presence of distinct viral variants results in rapid and continuous selection of variants best suited to the environment. These selected variants play a key role in viral pathogenesis, persistence and resistance to antiviral therapy.

Genotype 1a is common in North Europe and the United States, 1b is the most frequent genotype and has a worldwide distribution. Genotypes 2a and 2b, representing 10% to 30% of HCV types, are mainly common in north Italy and Japan but are also worldwide distributed. Genotype 3 is most common in the Indian subcontinent whereas genotype 4 is most common in the Middle East and Africa. Genotypes 5 and 6 are relatively rare and can be found in South Africa and Southeast Asia, respectively. Interestingly, the genotypes have little impact on clinical expression and are not evidently related to a different clinical outcome (Hoofnagle, 2002). However, response to pegylated interferon-alfa/ribavirin therapy differs between HCV genotypes. Response rates of patients infected with genotypes 2 and 3 range from 76% - 80% in contrast to genotype 1 and 4 with rates from 42% - 46% (Feld and Hoofnagle, 2005).

Table 2: Genetic variability of HCV

Term	Nomenclature	Degree of nucleotide sequence variation
Genoytpe	1 to 6	30% to 50%
Subtype	a, b, c, ...	15% to 30%
Isolate		5% to 15%
Quasispecies		1% to 5%

1.3. Model systems to study HCV-host cell interactions

HCV life cycle and its interaction with host cells have long been difficult to study due to the lack of appropriate HCV cell culture infection systems and suitable small animal models. Consequently, it has been an obstacle to develop preventive vaccines and anti-HCV therapeutics. However, the development of different *in vitro* and *in vivo* systems has significantly advanced our understandings of the HCV life cycle.

1.3.1. In vitro systems

The *in vitro* model systems include plasma derived HCV, recombinant HCV envelope glycoproteins, HCV-like particles (HCV-LPs), HCV pseudoparticles (HCVpp), HCV replicons and cell culture-derived HCV (HCVcc).

➤ **Plasma-derived HCV**

Inoculation of primary hepatocytes with serum-derived HCV was one of the first approaches to study HCV infection *in vitro* (Rumin et al., 1999; Shimizu et al., 1992). Primary hepatocytes of humans, chimpanzees, or tree shrews can be successfully infected with serum-derived HCV (Barth et al., 2005a; Castet et al., 2002). Serum-derived HCV has been used to identify the role of LDL-receptor (LDL-R) in HCV infection (Agnello et al., 1999). The drawback of this system was the low level of replication of HCV which required RT-PCR for the detection of viral RNA in infected cells. Secondly, there was absence or very low production of infectious virus particles (von Hahn and Rice, 2008). Moreover, due to heterogeneity of the virus in the serum and its association with lipoproteins, it was difficult to obtain a homogenous and well-characterized inoculum.

➤ **Recombinant E1 and E2 glycoproteins**

A truncated, soluble form of recombinant E2 glycoprotein was used to study virus-host cell interaction leading to the identification of putative HCV receptor candidates involved in HCV entry. These include tetraspanin CD81 (Pileri et al., 1998) and SR-BI (Scarselli et al., 2002). It also helped to study the interaction of E1 and E2 with heparan sulfate (HS) proteoglycan (Barth et al., 2003; Barth, 2006; Haberstroh et al., 2008). Recombinant E1 and E2 glycoproteins have been used to detect virus neutralizing antibodies (Rosa et al., 1996). Recently, it has been demonstrated that the immunization of mice and chimpanzees with recombinant E1E2 proteins induces neutralizing antibodies (Kachko et al., 2011). As in this system E1 and E2 form a heterodimer on the viral envelope and the isolated recombinant E2 may act differently (Burlone and Budkowska, 2009), it cannot be used to study the entire attachment and entry process.

➤ **HCV-like particles (HCV-LPs)**

Virus-like particles are defined as particles generated by self-assembly of the HCV structural proteins core, E1, E2 and p7 in a baculovirus-insect cell expression system (Baumert et al., 1998). They do not replicate because of the lack of the viral genome. HCV-LPs are characterized by morphological, biophysical and antigenic properties similar to those of putative virions isolated from HCV-infected patients. The E1 and E2 heterodimeric complex similar to native virions and the ability of HCV-LPs to attach and enter hepatic cell lines, primary human hepatocytes (PHH) and dendritic cells, make this

an attractive model to study virus-host interactions (Barth et al., 2005b; Triyatni et al., 2002; Wellnitz et al., 2002). In addition, HCV-LP have been shown also to have antigenic properties similar to those of virions isolated from HCV infected patients (Baumert et al., 1998), so it has been proposed as potential vaccine (Baumert et al., 1999; Steinmann et al., 2004). Interestingly, HCV-LP induced HCV-specific cellular immune responses protected chimpanzees from persistent HCV infection following HCV challenge (Elmowalid et al., 2007). A limitation of this model is the fact that these particles do not contain a reporter gene, therefore the mechanism of attachment and cell entry require the use of microscopy techniques or flow cytometry.

➤ **HCV pseudoparticles (HCVpp)**

HCV pseudotyped particles (HCVpp) were the first robust *in vitro* model to study the early steps of virus binding and cell entry that can be used in high-throughput assays. Infectious HCVpp consist of unmodified HCV envelope glycoproteins E1 and E2 assembled onto retroviral or lentiviral core particles (Bartosch et al., 2003b; Hsu et al., 2003). HCVpp are produced by transfecting human embryonic kidney cells (HEK 293T) with three expression vectors. The first vector encodes the capsid protein of retrovirus i.e. murine leukemia virus (MLV) or lentivirus (HIV), the second vector expresses the unmodified E1 and E2 envelope glycoproteins and the third one carries a retrovirus genome containing only the long terminal repeats and packaging signal and encoding a reporter gene such as green fluorescent protein (GFP) or luciferase (Bartosch et al., 2003b; Hsu et al., 2003) (Figure 5). The presence of marker gene encoding for GFP or luciferase reporter gene allows reliable and fast determination of infectivity mediated through the envelope glycoproteins (Bartosch et al., 2003b). HCVpp are considered as reference tools to study the properties of HCV envelope glycoproteins. HCVpp are infectious for hepatoma cells lines, like Huh-7 cells, as well as for primary human hepatocytes (Bartosch et al., 2003b; Hsu et al., 2003) showing HCV tropism. This model has been used to identify two co-receptors of HCV: claudin 1 (CLDN1) (Evans et al., 2007) and occludin (OCLN) (Ploss et al., 2009). HCVpp infectivity has been demonstrated to be neutralized by anti-E1 and anti-E2 antibodies as well as by sera from human and chimpanzees infected with HCV, but not sera from healthy controls (Bartosch et al., 2003b; Hsu et al., 2003; Lavillette et al., 2005; Law et al., 2008; Meunier et al., 2005; Pestka et al., 2007; Vanwolleghem et al., 2008; von Hahn et al., 2007). HCVpp indeed mimic the entry of HCV into cell and have antigenic properties similar to those of native HCV but unlike the natural virus, HCVpp are not associated with lipoproteins, as they are produced in 293T kidney cells that do not synthesize lipoproteins.

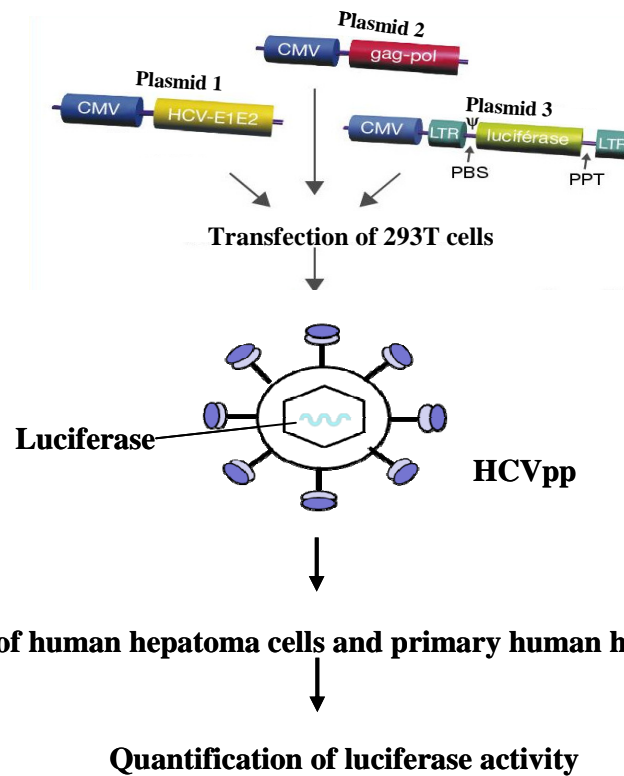

Figure 5: Production of HCV pseudoparticles (HCVpp). The HCVpp are infectious chimeric viruses obtained by incorporation of the E1 and E2 glycoproteins, in their native form on the surface of retroviral particles. HCVpp are generated by transfecting human embryonic kidney cells with expression vectors encoding the entire E1E2 polyprotein, capsid protein of a retrovirus/lentivirus and a defective retroviral genome carrying a marker gene that will allow to assess the infectivity of the HCVpp. HCVpp infect hepatoma cells, especially Huh7 and PHH. (LTR- long terminal repeat, PBS- primer binding site, PPT- polyurine tract, Ψ - packaging sequence).

➤ HCV replicons

The subgenomic HCV replicons have made it possible to study viral replication (Lohmann et al., 1999). These bicistronic RNAs replicate autonomously and contain (i) 5' IRES of HCV, which provides the translation of an antibiotic gene (neomycin), (ii) IRES of encephalomyocarditis virus (EMCV) ensuring translation of non-structural proteins and (iii) all framed by 5' and 3' UTR of HCV. Only neomycin-resistant clones replicate HCV RNA (Lohmann et al., 1999). It has been demonstrated that the cell culture replicons contain adaptive mutations in the virus, mainly in NS3, NS4B and NS5A (Bartenschlager et al., 2004a), which markedly increase the rate of replication of transfected cells (Lohmann et al., 2001). Many of these mutations alter the phosphorylation of NS5A, and the hyperphosphorylated form is deleterious for efficient replication of HCV (Evans et al., 2004). Noteworthy, genomic replicons replicate efficiently under antibiotic pressure but do not allow the production of virus particles (Pietschmann et al., 2002).

➤ **Cell culture-derived HCV (HCVcc)**

The ability to recapitulate the entire viral life cycle *in vitro* was achieved in 2005. The transfection of RNA of a viral isolate of a Japanese patient with fulminant hepatitis C (JFH-1) into highly permissive Huh-7-derived cell clones led to efficient HCVcc production *in vitro* (Lindenbach et al., 2005; Wakita et al., 2005; Zhong et al., 2005). The cell culture supernatant containing the virions successfully infects naïve Huh-7 and Huh-7-derived hepatoma cells (Lindenbach et al., 2005; Wakita et al., 2005) (Figure 6). HCVcc infection and replication can be easily monitored using different assays. These include assays to determine focus forming units (FFU), 50% tissue culture infectivity dose (TCID₅₀) (Lindenbach et al., 2005), immunostaining of viral proteins and highly reproducible time-dependent increase of viral RNA in infected cells (Lindenbach et al., 2005; Wakita et al., 2005) or alternatively by the expression of a firefly luciferase reporter gene (Koutsoudakis et al., 2006), or green fluorescent protein (GFP) (Suratanee et al., 2010) or red fluorescent protein (RFP) (Jones et al., 2010) as reporter genes. Recently, a new construction strategy was developed to produce a dual reporter HCV virus containing a humanized Renilla luciferase gene and an enhanced GFP gene (Wu et al., 2010). HCVcc are able to infect chimpanzees and uPA-SCID mice transplanted with human hepatocytes (Lindenbach et al., 2006; Wakita et al., 2005; Zhong et al., 2005). HCVcc production of different genotypes is also possible through the use of intra-genotypic (Lindenbach et al., 2005; Pietschmann et al., 2006) or inter-genotypic (Pietschmann et al., 2006) chimeric viruses. Recombinant HCVcc with core-NS2 (Scheel et al., 2011a), NS3/4A (Gottwein et al., 2011) and NS5A (Scheel et al., 2011b) for all major genotypes have been developed to study resistance to antiviral therapy. The HCVcc system allows major advances in HCV research as it helps to study the complete life cycle of HCV. Moreover, this model has confirmed the results obtained with previous model systems such as the role of envelope glycoproteins in virus entry (Wakita et al., 2005), the role of host cell factors involved in attachment and entry of the virus (Koutsoudakis et al., 2006; Lindenbach et al., 2005; Wakita et al., 2005; Zeisel et al., 2007a; Zhong et al., 2005) and activity of neutralizing antibodies (Haberstroh et al., 2008; Law et al., 2008). However, the handling of HCVcc requires a BSL3 laboratory which is less user friendly.

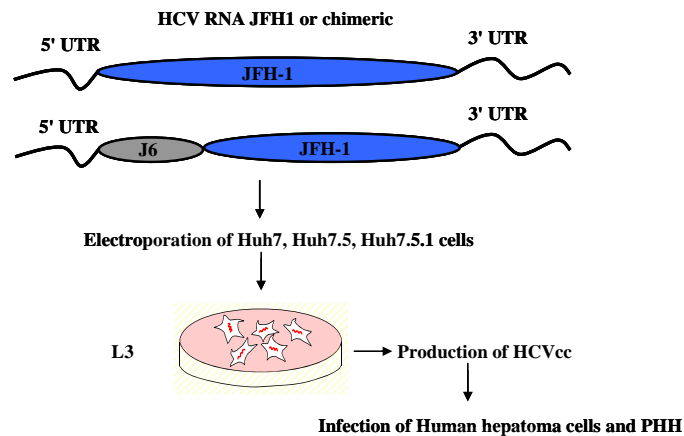

Figure 6: Production of HCVcc. Cell culture-derived HCV (HCVcc) are produced by electroporation of Huh7-derived cells with JFH1 RNA or a chimeric RNA. Viruses are secreted in the supernatants few days after the transfection. The infectivity and replication potential of HCVcc can be assessed on Huh7-derived cell lines and analysing by expression of viral or reporter proteins or by quantification of intracellular viral RNA.

1.3.2. *In vivo systems*

The study of HCV infection and pathogenesis was long performed in chimpanzees (*Pan troglodytes*). The infection follows a progression similar to that observed in humans. HCV RNA can be detected in the blood several days after infection, followed by an acute hepatitis which is characterized by increase of ALT. Liver cirrhosis or fibrosis in chimpanzees is rare. There are several drawbacks of this model: the chronic infection is less severe as compared to human, chimpanzees are expensive and difficult to handle as they require special housing (Barth et al., 2008a); moreover, since 1988 the chimpanzee has been listed as an endangered species. These limitations of the chimpanzee model have stimulated progress toward developing alternative animal models for HCV research.

Mice or rats are the key candidates to generate such a model but the strict tropism of HCV requires the hepatocytes of man or chimpanzee to be transplanted in these rodents. The survival and expansion of xenogenic donor hepatocytes in the recipient animal need an environment that is permissive for the engraftment and the expansion of liver cells. An immune deficient animal suffering from a severe liver disease can provide the desired environment. Therefore, the current state-of-the-art small animal model was developed by using transgenic mice carrying the transgene "urokinase plasminogen activator" (alb-uPA) and crossing of these mice with SCID (severe combined immunodeficiency disorder) mice for the complete reconstruction of the liver of mice with xenograft of human hepatocytes (Mercer et al., 2001). This model has allowed the study of hepatitis B and C virus infection. In 2001, Mercer and collaborators have shown for the first time that uPA-SCID mice transplanted with human hepatocytes could be infected with HCV *in vivo* (Mercer et al., 2001). The

measurement of albumin is used to evaluate the integrity and functionality of transplanted human hepatocytes. Once stabilized, the uPA-SCID mice can be infected either by the serum of patients or chimpanzees infected with HCV, or by HCVcc (Law et al., 2008; Lindenbach et al., 2006; Mercer et al., 2001; Meuleman et al., 2005; Vanwolleghem et al., 2008). HCV loads measured in the serum of these mice are comparable to those observed in humans. In addition, plasma derived from these mice is able to infect other mice allowing massed infection. The HCV infection in this model can be maintained for at least 4 months. During this period, the function and architecture of the liver are not altered (Barth et al., 2008a). This mouse model allowed to confirm the role of anti-receptor antibodies and neutralizing antibodies in controlling viral infection (Law et al., 2008; Meuleman et al., 2008; Meuleman et al., 2012; Vanwolleghem et al., 2008). This mouse model has the advantage of being cheaper than chimpanzees, more easily maintainable and breeding faster than the chimpanzee. However, this animal model is very difficult to implement. It requires considerable expertise to isolate and transplant human hepatocytes and maintain colonies of mice because of their immunosuppression. The mortality rate of infants is estimated at about 35% (Mercer et al., 2001). In addition, the study of virus-host interactions is limited by the mouse genetic background, as the absence of functional immune system precludes the study of HCV interaction with the host immune system. To further improve the *in vivo* study of HCV, Bissig and colleagues have developed a new mouse model. They described a regulatable system for repopulating the liver of immunodeficient mice [specifically mice lacking fumaryl acetoacetate hydrolase (Fah), recombination activating gene 2 (Rag2) and the γ -chain of the receptor for IL-2 (Il-2r γ)] with human hepatocytes (Bissig et al., 2010). Selection pressure for transplanted human hepatocytes in these animals can be regulated by oral administration of 2-(2-nitro-4-trifluoro-methylbenzoyl)-1.3-cyclohexanedione (NTBC), absence of which results in the death of mouse hepatocytes due to accumulation of toxic tyrosine catabolites caused by the lack of Fah, whereas presence of human homolog keeps human hepatocytes healthy (Bissig et al., 2010). The advantage of this Fah⁻Rag⁻Il2rg⁻ mouse is that animals with low human chimerism can be put back on the drug NTBC and therefore do not result in liver failure and eventually death (Bissig et al., 2010).

1.4. HCV host factors required for viral attachment and entry

HCV entry into host cells is a complex and multistep process. Many efforts have been made to develop different model systems to study HCV-host interactions in order to identify several host cell surface molecules such as the tetraspanin CD81 (Pileri et al., 1998), the low-density lipoprotein (LDL) receptor (Agnello et al., 1999), highly sulfated heparan sulfate (HS) (Barth et al., 2003; Koutsoudakis et al., 2006), the scavenger receptor class B type I (SR-BI) (Bartosch et al., 2005; Scarselli et al., 2002; Zeisel et al., 2007b), the C-type lectins (DC-SIGN/L-SIGN) (Lozach et al.,

2004; Pohlmann et al., 2003), the tight junction proteins claudin-1 (CLDN-1) (Evans et al., 2007) and occludin (OCLN) (Ploss et al., 2009) receptor tyrosine kinases (RTKs) such as epidermal growth factor receptor (EGFR) and ephrin A2 (EphA2) (Lupberger et al., 2011) as well as the recently described Niemann-Pick C1-Like 1 receptor (NPC1L1) (Sainz et al., 2012).

➤ **Glycosaminoglycans**

Glycosaminoglycans (GAGs) are thought to be the first attachment sites of HCV (Barth et al., 2003; Germe et al., 2002). There are several different types of glycosaminoglycans e.g. chondroitin sulfate, dermatan sulfate, keratan sulfate, heparan sulfate, heparin and hyaluronan (Helle and Dubuisson, 2008). Among them, heparan sulfate (HS) is involved in attachment of many viruses like human herpes virus 8 or dengue virus. The glycosaminoglycan HS is composed of a family of linear polysaccharides located at the surface of mammalian cells and in the extracellular matrix. The repeating disaccharide units [GLcA-GlcNAc]_n define the structure of HS. GlcA is the glucuronic acid and GlcNAc is N-acetylglucosamine (Esko and Lindahl, 2001). It has been shown that HCV envelope glycoproteins E1 and E2 interact with HS (Barth et al., 2006). Moreover, the use of heparin, which is an analogue of HS, and heparinase, an enzyme which degrades HS, hamper the attachment of HCV to cells (Haberstroh et al., 2008; Koutsoudakis et al., 2006). Similarly, glycosidase treatment of the cells decreases the infectivity of HCV (Barth et al., 2006; Basu et al., 2007; Morikawa et al., 2007). These findings demonstrate the important role of HS in HCV binding to cells. HS may play a role in HCV infection by concentrating the virus on the surface of target cells and allow subsequent interaction with other host factors responsible for viral entry (Morikawa et al., 2007).

➤ **The low-density lipoprotein receptor (LDL-R)**

HCV is able to associate with high-density lipoproteins (HDL), low-density lipoproteins (LDL) and very low-density lipoproteins (VLDL). The low-density lipoprotein receptor (LDL-R) has been suggested for HCV entry (Agnello et al., 1999; Burlone and Budkowska, 2009; Wunschmann et al., 2000). LDL-R is an endocytotic receptor with a molecular weight of 160 kDa. LDL-R plays an important role in cholesterol homeostasis. The apolipoprotein B (apoB)-containing LDL and apolipoprotein E (apoE)-containing VLDL are the major ligands of LDL-R (Hishiki et al., 2010; Owen et al., 2009). Serum-derived HCV has been suggested to be internalized by binding of virus-LDL particles to LDL-R (Agnello et al., 1999). Moreover, antibodies directed against LDL-R as well as anti-apoB and anti-apoE antibodies inhibited HCV endocytosis (Agnello et al., 1999; Chang et al., 2007; Jiang and Luo, 2009; Long et al., 2011; Wunschmann et al., 2000). It was also observed that LDL-R plays a role in an early step of serum-derived HCV infection of primary human hepatocytes (Molina et al., 2007). HCVpp are not associated with lipoproteins, so the interaction of LDL-R and

HCVpp could not be studied to understand the role of LDL-R in viral entry (Bartosch et al., 2003c). Most recently, using HCVcc, it has been shown that LDL-R could participate in non-productive entry of HCV particles and the physiological function of LDL-R plays a critical role in optimal replication of HCV genome (Albecka et al., 2011). In conclusion, similar to SR-BI, LDL-R may be involved in viral cell entry through interaction with lipoproteins that are associated with HCV at an early stage of infection.

➤ **Lectins: DC-SIGN and L-SIGN**

HCV enters the liver through blood. Liver macrophages (Kupffer cells) and endothelial cells may capture the infectious virus particles and transfer them to adjacent hepatocytes which are not directly in contact with circulating blood. This process could be mediated by C-type lectins such as dendritic cell-specific intercellular adhesion molecule-3-grabbing non-integrin (DC-SIGN) and lymph node-specific intercellular adhesion molecule-3 (ICAM-3)-grabbing integrin (L-SIGN or CD209L). DC-SIGN and L-SIGN could be involved in viral pathogenesis and tissue tropism (Gardner et al., 2003; Lozach et al., 2004; Lozach et al., 2003; Pohlmann et al., 2003). DC-SIGN is expressed in Kupffer cells, dendritic cells and lymphocytes while L-SIGN is expressed in liver sinusoidal endothelial cells (van Kooyk and Geijtenbeek, 2003). Both lectins participate in binding, internalization and elimination of many pathogens (Cambi et al., 2005). Studies have shown that binding of E2 to L-SIGN could induce transmission of HCVpp to adjacent hepatocytes (Cormier et al., 2004a). However, these molecules do not facilitate entry of HCVpp and HCVcc on their own behalf (Lai et al., 2006). Because neither molecule is expressed on hepatocytes, they are unlikely to function as direct entry receptors (von Hahn and Rice, 2008) but DC-SIGN and L-SIGN may function as capture receptors which have the ability to transmit the virus to permissive cells and may be involved in the initiation of HCV infection and tissue tropism (Cormier et al., 2004a; Lozach et al., 2004).

➤ **The tetraspanin CD81**

The first host factor revealed to be required for HCV entry was the tetraspanin CD81 which interacts with soluble E2 (sE2) (Pileri et al., 1998). CD81 is 25 kDa tetraspanin which is ubiquitously expressed. It comprises four transmembrane domains, one small extracellular loop (SEL), one large extracellular loop (LEL) and N- and C-terminal intracellular domains (Figure 7). It is involved in pleiotropic activities such as cell adhesion, motility, metastasis, cell activation, and signal transduction (Levy et al., 1998). The CD81-LEL has been demonstrated to play its role in HCV binding through interaction with sE2 (Pileri et al., 1998). Several amino acids were considered to be crucial for the interaction between E2 and CD81-LEL (Bertaux and Dragic, 2006; Boo et al., 2012; Drummer et al., 2002; Higginbottom et al., 2000; Pileri et al., 1998). Recently, it has been suggested

that deletion of HVR2 of E2 results in decrease of 50% in the CD81-binding ability of HCVpp (McCaffrey et al., 2011). The binding of sE2 is species-specific as it does not bind to mouse or rat CD81 (Flint et al., 2006). Furthermore, using HCVpp and HCVcc infection, it has been reported that the glycoprotein E2 residues at position 415, 420, 527, 529, 530 and 535 play a critical role in HCV E2-CD81 interaction (Dhillon et al., 2010; Owsianka et al., 2006). The role of CD81 in HCV infection was elucidated by using different human hepatoma cell lines which do not express CD81 and are non-permissive for HCV such as HepG2 and HH29. These cell lines became susceptible to both HCVcc and HCVpp infection upon ectopic expression of CD81 after transduction (Bartosch et al., 2003b; Cormier et al., 2004b; Lavillette et al., 2005; Zhang et al., 2004a). Anti-CD81 antibodies as well as a soluble form of the CD81 extracellular loop have been shown to inhibit HCVpp and HCVcc entry into Huh-7 hepatoma cells and human hepatocytes (Bartosch et al., 2003b; Wakita, 2005 #1791; Lindenbach et al., 2005; McKeating et al., 2004; Zhang et al., 2004a). Moreover, using uPA-SCID mouse model, it has been shown that CD81 is an essential factor for HCV infection *in vivo* (Meuleman et al., 2008). The down regulation of CD81 expression by siRNA also resulted in the inhibition of serum-derived HCV (sHCV) (Molina et al., 2008; Zhang et al., 2004a). It is worth mentioning that CD81 is one of the two HCV entry factors responsible for the species-specificity of HCV as expression of human CD81 and human OCLN may confer HCV permissivity to mouse cell lines (Ploss et al., 2009).

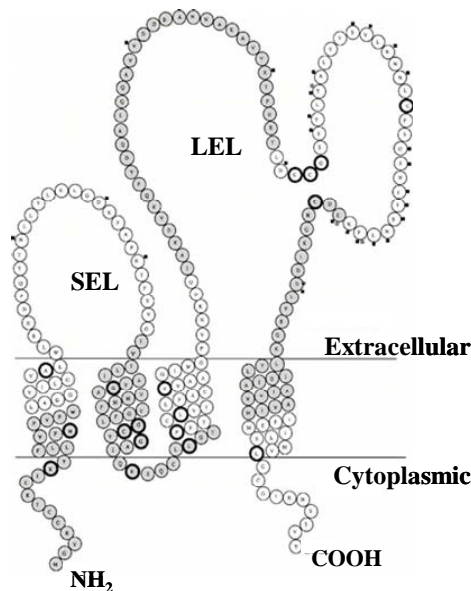

Figure 7: Structure of CD81. Amino acids are shown as circles; specific residues of human CD81 are indicated by single letter designation, bolded circles mark the position of residues that are conserved in the core (CD9, CD37, CD53, CD63, CD81, CD82, CO-029, CD151, A15, SAS, sm23 and late bloomer) tetraspanins (Levy et al., 1998).

Antibodies directed against CD81 and human recombinant CD81-LEL inhibit HCV infection after virus attachment suggesting that CD81 serves as a postbinding entry factor (Cormier et al., 2004b; Flint et al., 2006; Koutsoudakis et al., 2006). A correlation exists between the level of CD81

expression and HCV infectivity (Akazawa et al., 2007; Koutsoudakis et al., 2007) as well as the density of expression of CD81 at the cell surface and the level of infection (Kapadia et al., 2007). It has been determined that higher level of CD81 is required for efficient HCV RNA replication (Zhang et al., 2010). Recently, it has been shown that EWI-2 is a cellular partner of CD81. EWI-2 is expressed in most cells but not in hepatocytes. EWI-2 is proteolytically cleaved into EWI-2wint, which has been found to hinder HCV cell entry by inhibiting viral glycoproteins interaction with CD81 (Rocha-Perugini et al., 2008). The mechanism of inhibition of HCV glycoprotein-CD81 interaction by EWI-2wint is still unclear. EWI-2 is not directly involved in the life cycle of HCV as its silencing does not effect HCV infection (Montpellier et al., 2011). The lack of this natural inhibitor of CD81 in hepatic cells may help viral entry and contribute to the hepatotropism of HCV. EWI-2wint may thus be used to develop a new antiviral strategy.

HCV interaction with host entry factors provides multiple targets for the development of antiviral therapy. CD81 is one of these potential targets. Noteworthy, Anti-CD81 antibodies have been reported to inhibit HCV infection *in vitro* (Bartosch et al., 2003c; Lindenbach et al., 2005; Molina et al., 2008; Wakita et al., 2005; Zhang et al., 2004a), as well as *in vivo* (Dorner et al., 2011; Meuleman et al., 2008) but the ubiquitous expression of CD81 may represent a risk of toxicity. These results demonstrated for the first time the proof-of-concept that HCV infection can be inhibited by anti-receptor antibodies.

➤ **Scavenger receptor BI (SR-BI)**

The human scavenger receptor class B type I (SR-BI), also called CLA-1 (CD36 and LIMPII Analogous-1), has been identified as another putative receptor for HCV on the basis of its reactivity with sE2 (Scarselli et al., 2002). SR-BI is a 509 amino acid glycoprotein which is highly expressed in the liver and steroidogenic tissues (ovaries and adrenal glands) (Krieger, 2001) as well as on human monocyte-derived dendritic cells but not on any other peripheral blood mononuclear cell (Yamada et al., 2005). SR-BI contains two C- and N-terminal cytoplasmic domains, two transmembrane domains and a large extracellular loop with nine potential N-glycosylation sites (Acton et al., 1996; Krieger, 2001; Rhainds and Brissette, 2004) (Figure 8). SR-BI binds to various classes of lipoproteins including HDL, LDL and VLDL as well as oxLDL (oxidized low density lipoproteins) and is involved in bidirectional cholesterol transport at the cell membrane (Dao Thi et al., 2011). The critical physiological function of SR-BI is the selective cholesteryl ester (CE) uptake from HDL. SR-BI is also involved in the catabolism of VLDL and in the selective uptake of CE from VLDL (Van Eck et al., 2008). Recently, it has been demonstrated that the highly conserved C323 is critical for SR-BI-mediated HDL binding and cholesteryl ester uptake (Guo et al., 2011). A study using SR-BI knockout mice suggested that SR-BI is a multi-purpose player in cholesterol and steroid metabolism and is

involved in reverse cholesterol transport, adrenal steroidogenesis and platelet function (Hoekstra et al., 2010). Recently, Yu et al, have described that out of six exoplasmic cysteines of SR-BI, Cys384 is crucial for its interaction with blocker of lipid transport1 (BLT-1) and normal lipid transport activity of SR-BI (Yu et al., 2011). It has been shown that SR-BI is also essential for the binding, uptake and cross-presentation of HCV by human dendritic cells (Barth et al., 2008b).

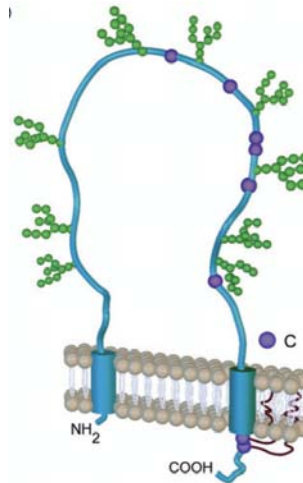

Figure 8: Structure of SR-BI. The extracellular loop of SR-BI contains nine potential glycosylation sites (green) and six cysteine (purple) (Hoekstra et al., 2010).

The extracellular loop of SR-BI has been demonstrated to interact with HVR1 region of E2 because deletion of HVR1 has been shown to impair the interaction of SR-BI with sE2 as well as it also results in the reduction of HCVpp entry (Bartosch et al., 2003b; Scarselli et al., 2002). The binding of SR-BI to sE2 is species-specific as mouse SR-BI does not bind sE2. It has been reported that amino acids 70-87 and E210 of SR-BI are important for E2 recognition (Catanese et al., 2010).

SR-BI is involved in viral binding as well as in post-binding steps of HCV infection (Catanese et al., 2010; Zeisel et al., 2007b). It has been reported that the silencing of SR-BI expression by small interfering RNAs and the use of anti-SR-BI antibodies block the infection of both HCVpp and HCVcc which shows the importance of SR-BI in viral entry (Bartosch et al., 2003c; Lavillette et al., 2005; Voisset et al., 2005; Zeisel et al., 2007a). Moreover, SR-BI overexpression increases the infection of HCVpp and HCVcc (Grove et al., 2008; Schwarz et al., 2009). The main SR-BI ligand, HDL, facilitates HCVpp and HCVcc cell entry but there is no proof that HDL directly interacts with HCV particles (Bartosch et al., 2005; Dreux et al., 2006; Voisset et al., 2005). In contrast, oxidized LDL hampers HCVpp and HCVcc infection (von Hahn et al., 2006). Interestingly, the use of serum-derived HCV has suggested that instead of E2 protein, these are virus associated lipoproteins which interact with SR-BI in SR-BI-transfected Chinese hamster ovary cells (CHO) (Maillard et al., 2006). SR-BI co-operatively interacts with CD81 and the HDL mediated enhancement of HCVcc infection was possible only when CD81 was expressed (Dreux et al., 2006; Zeisel et al., 2007b). It has been shown

in a mapping study that HCV and HDL binding to SR-BI and lipid transfer function of SR-BI are required for SR-BI to behave as HCV entry factor (Dreux et al., 2009). Anti-SR-BI antibodies and genetically humanized mouse have been used to describe the critical role of SR-BI in HCV infection *in vivo* (Dorner et al., 2011; Meuleman et al., 2012). PDZK1, a four PDZ domain-containing adaptor protein that is predominantly expressed in liver, kidney and small intestines, interacts with SR-BI and indirectly enhances HCV entry (Eyre et al., 2010).

SR-BI represents another interesting target for anti-HCV therapy. SR-BI binds and internalizes serum amyloid A (SAA), which inhibits HCV entry by interacting with the virus (Lavie et al., 2006). Anti-SR-BI antibodies have been demonstrated to inhibit HCV infection *in vitro* (Bartosch et al., 2003c; Catanese et al., 2010; Catanese et al., 2007; Zeisel et al., 2007b), as well as *in vivo* (Dorner et al., 2011; Meuleman et al., 2012). ITX 5061, a small molecule SR-BI antagonist that inhibits HCV infection, has entered phase I clinical trials in HCV-infected patients (Syder et al., 2011).

➤ **Claudin-1 (CLDN1)**

The tight junction protein claudin-1 (CLDN1) has been identified as another entry factor for HCV by expression cloning (Evans et al., 2007). CLDN1, a 24 kDa protein, is expressed in all epithelial tissues but predominantly in the liver, forming networks at tight junctions (TJ) (Furuse et al., 1998). TJs are multiprotein complexes that contain four kinds of transmembrane proteins including claudins, occludin, junction-associated molecules and the coxsackie virus B adenovirus receptors (CARs) (Burlone and Budkowska, 2009). TJs are responsible for the control of paracellular transport and maintenance of cell polarity. CLDN1 is comprised of two extracellular loops, three intra cellular domains and four transmembrane segments (Furuse and Tsukita, 2006). It has been shown that CLDN1 is localized at TJ of hepatocytes but also on the sinusoidal basolateral surfaces of these cells (Reynolds et al., 2008). Noteworthy, non-junctional CLDN1 has been suggested to be involved in HCV entry (Cukierman et al., 2009; Evans et al., 2007; Harris et al., 2010; Krieger et al., 2010) while other studies demonstrated that the distribution of CLDN1 in tight junctions is affiliated with permissiveness to HCV infection (Liu et al., 2009; Yang et al., 2008), so subcellular localization of CLDN1 appears to be critical for viral entry and cellular tropism of HCV (Burlone and Budkowska, 2009).

Studies suggest that the first extracellular loop (ECL1) and residues in the highly conserved claudin motif W(30)-GLW(51)-C(54)-C(64) are crucial for HCV entry (Cukierman et al., 2009; Evans et al., 2007; Zhang et al., 2007). Expression of CLDN1 in non-permissive cell lines such as 293T and SW13, make them permissive for HCV infection while the silencing of CLDN1 hinders infection of HCV in susceptible cells like Huh7.5 (Evans et al., 2007). However, there is no evidence of direct interaction between CLDN1 and HCV (Krieger et al., 2010). In contrast to SR-BI,

overexpression of CLDN1 does not increase the infectivity of HCV (Schwarz et al., 2009). The study of HCV entry kinetics using anti-Flag and anti-CLDN1 antibodies demonstrated that CLDN1 is involved in post-binding stages of HCV infection (Evans et al., 2007; Krieger et al., 2010). CLDN1-HCV interaction had initially been considered to take place after the virus-SR-BI/CD81 complex is laterally migrated to the tight junctions (Coyne et al., 2007), while more recent data have shown that SR-BI, CD81 and CLDN1 act at closely related time points in the viral entry process (Krieger et al., 2010). Moreover, it has been demonstrated that CD81 and CLDN1 co-localize at the apical and basolateral regions of hepatocytes (Mee et al., 2009; Reynolds et al., 2008). The formation of CLDN1-CD81 complexes is critical for HCV infection (Harris et al., 2010; Harris et al., 2008; Krieger et al., 2010). Indeed, mutations at residues 32 and 48 in ECL1 of CLDN1 disrupt the association with CD81 which results in obstruction of the viral receptor activity (Harris et al., 2010). Some other members of the claudin family i.e. CLDN6 and CLDN9 are also able to mediate HCV entry (Meertens et al., 2008; Zhang et al., 2007). Both CLDN6 and CLDN9 contain a highly conserved ECL1 (Zhang et al., 2007).

CLDN1 is a promising antiviral target as it is critical for HCV entry. Recently, anti-CLDN1 antibodies have been shown to inhibit HCV infection *in vitro* (Fofana et al., 2010; Krieger et al., 2010). Polyclonal anti-CLDN1 antibodies reduce HCV E2 interaction with cell surface and disrupt CLDN1-CD81 interaction (Krieger et al., 2010). Noteworthy, monoclonal anti-CLDN1 antibodies markedly block entry of highly infectious escape variants of HCV that are resistant to host neutralizing antibodies (Fofana et al., 2010). These data indicate that antibodies against CLDN1 represent interesting new antivirals to inhibit HCV infection.

➤ **Occludin (OCLN)**

Occludin (OCLN) has been identified as another host cell factor essential for HCV entry which plays its role probably at a late post-binding stage (Benedicto et al., 2009; Liu et al., 2009; Ploss et al., 2009). OCLN is a 65 kDa protein expressed in TJ. OCLN is comprised of four transmembrane regions, two extracellular loops and N- and C- terminal cytoplasmic regions. It is important to note that OCLN is one of the two HCV entry factors responsible for the species-specificity of HCV as expression of human OCLN and human CD81 may confer HCV permissivity *in vitro* and *in vivo* (Dorner et al., 2011; Ploss et al., 2009). Amino acids responsible for the species-specificity are found in the second extracellular loop of OCLN (Ploss et al., 2009). Glucocorticoid treatment results in enhancement of expression of OCLN as well as HCV entry in Huh7.5 cells and PHH (Ciesek et al., 2010).

In contrast, the silencing of OCLN by siRNA suggested that reduction of OCLN expression inhibits HCVpp and HCVcc cell entry (Liu et al., 2009). Confocal microscopy studies demonstrated

that in HCV infected cells OCLN accumulates in the endoplasmic reticulum and co-localizes with HCV glycoprotein E2 (Benedicto et al., 2008; Liu et al., 2009). Interestingly, HCV infection may result in the reduction of TJ proteins as it has been shown that following HCV infection, the expressions of OCLN and CLDN were downregulated to prevent superinfection (Liu et al., 2009).

OCLN may also be targeted to prevent HCV infection. To date, there is unavailability of any anti-OCLN antibody inhibiting HCV infection. Further characterization of the role of OCLN in HCV entry may lead to the development of novel compounds interfering with HCV infection.

➤ **Receptor tyrosine kinases (RTKs)**

Recently, using a functional siRNA screen, our laboratory identified receptor tyrosine kinases (RTKs) such as epidermal growth factor receptor (EGFR) and ephrin A2 (EphA2) as novel HCV entry factor (Lupberger et al., 2011). EGFR exists on the cell surface and is activated by binding of its endogenous ligands including epidermal growth factor (EGF) and transforming growth factor α (TGF- α). EGFR is involved in cell proliferation, survival, differentiation during development, tissue homeostasis and tumorigenesis (Schneider and Wolf, 2009). EphA2 is a member of the largest class of RTKs and mediates cell positioning, cell morphology and motility (Lackmann and Boyd, 2008). The functional significance of the RTKs for HCV entry was studied using protein kinase inhibitors (PKIs) such as Erlotinib (EGFR inhibitor) and Dasatinib (EphA2 inhibitor). Inhibition of RTKs by Erlotinib and Dasatinib suggests their role in HCV entry process. Usage of PKIs and silencing of RTK expression by siRNA did not effect E2 binding to target cells, which shows that RTKs are not involved in HCV binding and RTK-mediated HCV entry does not require direct E2-RTK binding. Moreover, it has been suggested that RTKs act at post-binding steps of viral entry (Lupberger et al., 2011). Interestingly, it has been demonstrated that EGFR and EphA2 take part in regulating the formation of CD81-CLDN1 complexes that are crucial for HCV entry and both Erlotinib and Dasatinib hinder HCV entry by interfering with the CD81-CLDN1 co-receptor association (Lupberger et al., 2011). Inhibition of HCV entry at late steps in the kinetic infection assay and HCV cell fusion assay demonstrated a functional role for EGFR in pH-dependent fusion of viral and host cell membranes (Lupberger et al., 2011). Furthermore, EGF significantly accelerates the rate of HCV entry (Lupberger et al., 2011). Moreover, using uPA-SCID mouse model, functional role of EGFR as a co-factor for HCV entry and dissemination has been demonstrated *in vivo* (Lupberger et al., 2011).

Thus, EGFR may be another promising target to control HCV infection. Importantly, clinically licensed PKIs have shown marked antiviral activity *in vitro* and *in vivo* (Lupberger et al., 2011). Furthermore, EGFR-specific antibody has been identified to inhibit HCV infection (Lupberger et al., 2011) which shows that RTKs may offer a perspective for novel antiviral strategies against HCV infection.

➤ **Niemann-Pick C1-Like 1 (NPC1L1)**

HCV is associated with cellular lipoproteins (LDL and VLDL) and dependence of HCV infectivity on cholesterol (Gastaminza et al., 2007) suggests the involvement of cholesterol-uptake receptors in HCV cell entry. As NPC1L1 receptor is involved in cellular cholesterol absorption and whole-body cholesterol homeostasis (Altmann et al., 2004), NPC1L1 has recently been identified as a putative HCV host factor. NPC1L1, a 1332 amino acid protein, is a cell surface cholesterol sensing receptor (Yu, 2008). NPC1L1 contains 13 transmembrane domains, a conserved amino-terminal 'NPC' domain and extensive N-linked glycosylation sites (Yu, 2008). NPC1L1 is expressed on the apical surface of enterocytes and on the canalicular membrane of hepatocytes (Jia et al., 2011; Sainz et al., 2012; Temel et al., 2007; Yu, 2008). It has been demonstrated that NPC1L1 takes part in cholesterol absorption into enterocytes from the apical surface and on the other side; it recovers cholesterol from canalicular bile and transfers it back into hepatocytes (Temel et al., 2007; Yamanashi et al., 2007; Yu et al., 2006). It has been demonstrated that silencing and antibody mediated blocking of NPC1L1 decreased HCV infection (Sainz et al., 2012). NPC1L1 has three large extracellular loops (LEL) but only first large extracellular loop (LEL1) mediates HCV infection (Sainz et al., 2012). Furthermore, pharmacological inhibition of NPC1L1 by ezetimibe has been shown to reduce HCV infection by direct inhibition of HCV entry at or before virus-host fusion which also suggests that NPC1L1 acts at post-binding steps of viral entry (Sainz et al., 2012). It has also been shown that a correlation exists between amount of virion-linked cholesterol and NPC1L1 reliance for entry of HCV (Sainz et al., 2012). The presence of NPC1L1 in only human and primate hepatocytes makes this receptor a potential HCV tropism determinant (Davis et al., 2004). Moreover, blocking of NPC1L1 by ezetimibe can delay HCV infection in uPA-SCID mice suggesting a role of NPC1L1 for HCV infection *in vivo*. Thus, this new receptor may represent another therapeutic target for controlling HCV infection.

1.5. HCV life cycle

HCV seems to interact initially with the basolateral surface of hepatocytes *in vivo*. HS glycosaminoglycans may serve as the first attachment site for HCV (Barth et al., 2003), (Barth, 2006; Koutsoudakis et al., 2006) and then the virus requires several entry factors to gain access into its host cell: SR-BI (Barth et al., 2008b; Bartosch et al., 2003b; Scarselli et al., 2002; Voisset et al., 2005; Zeisel et al., 2007b), CD81 (Koutsoudakis et al., 2006; Pileri et al., 1998), CDLN1 (Evans et al., 2007; Krieger et al., 2010), OCLN (Liu et al., 2009; Ploss et al., 2009; Yang et al., 2008) and NPC1L1 (Sainz et al., 2012). This suggests that HCV entry may be mediated through well organized HCV-entry factor complexes at the plasma membrane (Krieger et al., 2010; Zeisel et al., 2007b). The

formation of such complexes between entry factors was demonstrated by FRET (fluorescence resonance energy transfer). Indeed, CLDN1-CD81 complexes have been shown to participate in HCV infection (Harris et al., 2010; Harris et al., 2008). Interestingly, only the members of CLDN family involved in HCV entry i.e. CLDN1, CLDN6 and CLDN9, are able to form complexes with CD81 (Harris et al., 2010). To date, the formation of other potential complexes is poorly understood. Early studies have shown that the majority of CLDN1 proteins at the plasma membrane interact with OCLN but there is no evidence of any relationship between the formation of CLDN1-OCLN association and HCV infection (Harris et al., 2010).

Following the interaction of HCV with different host factors, it was shown that HCV entry into hepatoma cells and into primary human hepatocytes occurs through clathrin-mediated endocytosis (Blanchard et al., 2006; Codran et al., 2006). The sequence of events leading to virus internalization, fusion and replication are still not well known. It was shown that contact between cells modulates the expression levels of SR-BI and CLDN1 and promotes internalization of the virus (Schwarz et al., 2009). Recently, it has been shown that during internalization, HCV is associated with CD81 and CLDN1 (Coller et al., 2009). It has also been suggested that OCLN may interact with E2 to promote HCV entry (Liu et al., 2009). In addition, it has been suggested that PKA also takes part in this process as inhibition of PKA results in reorganization of CLDN1 from plasma membrane to intracellular vesicular location and disrupts CLDN1-CD81 complexes (Farquhar et al., 2008). Recently, EGFR has been reported to play a role in HCV entry by promoting particle internalization (Lupberger et al., 2011). Moreover, it has been reported that RTks such as EGFR and EphA2 play a role in regulating the formation of CD81-CLDN complex that is crucial for HCV entry (Lupberger et al., 2011). Furthermore, it has been demonstrated that HCV promotes CD81 and CLDN1 endocytosis suggesting a direct role of these receptors in virus internalization (Farquhar et al., 2012).

After clathrin-mediated endocytosis, viruses along with their receptors are directed towards early and late endosomes (Marsh and Helenius, 2006). HCVpp has been described to be transported to early endosomes (Meertens et al., 2006). It is still unknown whether either all or part of the membrane expressing host factors is internalized along with HCV. As a result of acidification of pH in early endosomes, membranes of HCV fuse with membranes of endosomes to release the genomic viral RNA into the cytosol. This is shown by a recent study, demonstrating co-localization between HCV and Rab5a, a marker of early endosomes (Coller et al., 2009), also by the fact that the entry of HCVpp (Bartosch et al., 2003b; Lavillette et al., 2006), and the infection of HCVcc is pH-dependent (Blanchard et al., 2006; Tscherne et al., 2006). Furthermore, it has been shown that EGFR may be involved in pH-dependent fusion of virus and host membranes (Lupberger et al., 2011). Recently, using anti-CD81 mAbs that inhibit HCV infection after virus internalization, it has been suggested

that CD81 plays a role in trafficking the virus to the endosomes for subsequent fusion events (Farquhar et al., 2012).

There are two broad classes of fusion proteins: (i) fusion proteins of class I (such as the hemagglutinin of influenza virus or HIV gp41) and (ii) fusion proteins of class II (as in *Flaviridae*) which have some internal fusion peptide that is synthesized in the form of a complex, which acts as chaperone on the other (Sollner, 2004). In case of HCV, it is thought that the envelope glycoproteins have a way of folding similar to that of fusion proteins of class II, since it belongs to the family of *Flaviridae*. The precise role of envelope glycoproteins E1 and E2 in the fusion step is not yet well defined. The two glycoproteins E1 and E2 have one for the other chaperone activity (Lavillette et al., 2007) and appear to be involved both in the fusion process (Lavillette et al., 2007). These fusion assays are pH-dependent and interestingly, these assays described the role of CD81 and CLDN1 in the fusion process (Evans et al., 2007; Kobayashi et al., 2006). The role of both viral and host factors in HCV fusion has been demonstrated through cell-to-cell fusion assay where HCV envelope glycoproteins are expressed on one cell type whereas the host entry factors on other cell type (Kobayashi et al., 2006). Yet, it is not clear whether host factors are directly involved in the fusion process of HCV or if they only play a role in early steps required for this process.

Following the release of the genomic RNA in the cytoplasm, replication of RNA strands of positive polarity can be started with the synthesis of a complementary RNA strand of negative polarity, which serves as a template for the production of RNA strands of positive polarity. The non-structural proteins of HCV i.e. NS3, NS4A, NS4B, NS5A and NS5B, form the replication machinery. NS4B induces the formation of a specific membranous web that serves as a scaffold for the HCV replication complex (RC) (Egger et al., 2002). NS3 is the only soluble protein among all the non-structural proteins, and its serine protease and RNA helicase activities play a crucial role in HCV RNA replication. NS4A serves as a cofactor for the NS3 serine protease and its N-terminal assists in the anchoring of NS3-4A complex to the membrane (Wolk et al., 2000). Several host cell proteins are involved in HCV replication. Interestingly, using siRNA screen of the human kinome, 13 different kinases, including phosphatidylinositol-4 kinase III alpha (PI4KIIIa), have been identified to be required for HCV replication (Reiss et al., 2010). Recently, a host cell protein, annexin A2 has been reported to be involved in the formation of HCV RC (Saxena et al., 2012). Noteworthy, it has been demonstrated that miR-122 also plays important role in HCV replication and infectious virus production (Jopling et al., 2005).

HCVcc were used to investigate the late stages of the replicative cycle, such as particle assembly and release of virions. The assembly of viral particles at the interface of endoplasmic reticulum (ER) and storage organelles of fat called "lipid droplets" is triggered by the association of protein C to lipids (Miyanari et al., 2007). Co-localization of RC with HCV envelope proteins E1 and

E2 facilitates the production of infectious virus. It is in the ER that the envelope proteins E1 and E2 will undergo various post-translational modifications including N-glycosylation (Goffard et al., 2005). Associated glycans play a major role in the folding, but also in the entry functions of the virus and in modulating the immune response (Lavie et al., 2006). Indeed, glycosylation plays a key role in HCV life cycle, since deletion or mutation of some glycosylation sites induces a reduction of HCVpp and HCVcc entry (Falkowska et al., 2007; Helle et al., 2007). In addition, glycans associated with E2 mask functional domains important for the accessibility of neutralizing antibodies (Falkowska et al., 2007; Helle et al., 2007). The newly synthesized virions are then released into the ER lumen and may leach out of the cell through the secretion of VLDL (Gastaminza et al., 2007; Huang et al., 2007). Notably, apolipoprotein E (apoE) is required for HCV assembly (Benga et al., 2010; Chang et al., 2007) and is also part of infectious HCV particles (Chang et al., 2007). It has been shown that antibodies against apoE can inhibit HCV entry (Agnello et al., 1999; Chang et al., 2007). The viral particles produced from the infectious cells at this time can infect naive cells through a receptor-dependent pathway.

There are two mechanisms for viral dissemination within a host: release of cell-free virions and direct cell-to-cell transfer between infected and uninfected cells. Direct cell-to-cell transmission seems to be more efficient and quick as it precludes early steps of the virus life cycle (Johnson and Huber, 2002). Moreover, this route of transmission may allow viruses to escape from immune responses such as neutralizing antibodies. It has recently been shown *in vitro* that HCV can be transmitted directly from cell to cell (Timpe et al., 2008) and thus escapes the action of neutralizing antibodies present in the extracellular medium. SR-BI, CLDN1, OCLN and CD81 appear to be involved in this mode of transmission (Brimacombe et al., 2011; Russell et al., 2008; Schwarz et al., 2009; Timpe et al., 2008). In addition, CD81-independent routes of cell-to-cell transmission have also been demonstrated (Timpe et al., 2008; Witteveldt et al., 2009). Recently, it has been described that SR-BI plays a critical role in cell-to-cell transmission and SR-BI antagonists markedly reduced HCV cell-to-cell transmission (Brimacombe et al., 2011). It has also been shown that viral envelope glycoproteins are crucial for HCV cell-to-cell transmission (Witteveldt et al., 2009). Interestingly, although cell-to-cell transmission has been reported to be resistant to neutralizing antibodies, some monoclonal antibodies directed against the HCV glycoproteins, particularly, monoclonal anti-HVR antibodies reduced HCV cell-to-cell transmission (Brimacombe et al., 2011). This mode of transmission has a direct impact on the development of antiviral drugs, as this transmission process allows viral spread by escaping most of the neutralizing antibodies present in the extracellular medium.

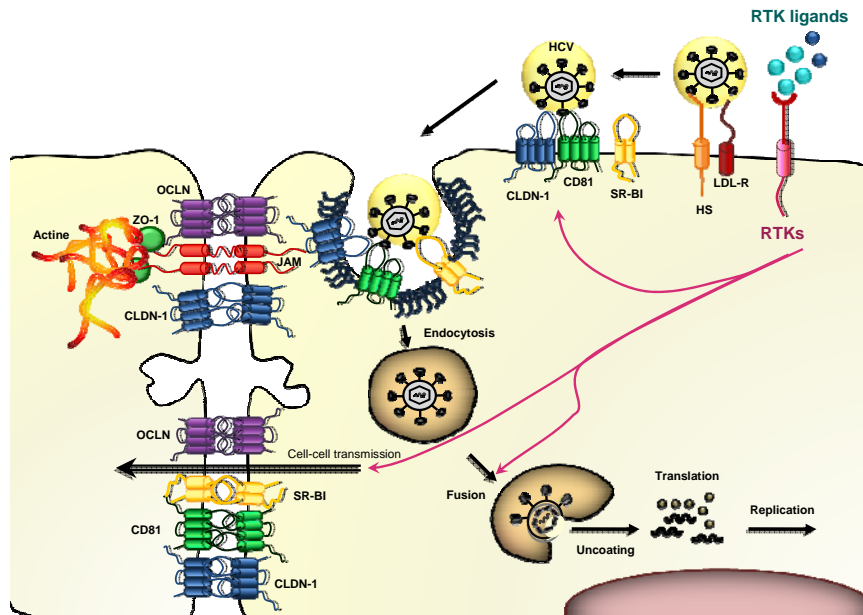

Figure 9: Model of HCV entry. Virus binding to the cell surface may involve heparan sulfate (HS) and LDL receptor (LDL-R) and viral entry may be mediated by scavenger receptor class B type I (SR-BI), the tetraspanin CD81 (CD81), claudin-1 (CLDN1) and occludin (OCLN). Recently discovered host factors like receptor tyrosine kinases (TRKs) and NPC1L1 also contribute in the entry process. Internalization depends on clathrin-mediated endocytosis. The fusion between membranes of the virus and endosomes results in release of genomic RNA into the cytoplasm where translation and replication occur. HCV particles are then assembled and secreted outside the cell. Cell-to-cell transmission is an alternative route of HCV infection. (adapted from Zeisel et al. *J Hepatol* 2011 and Turek et al. *Med./Sci.* 2011)

1.6. Adaptive immune response to HCV and escape from antibody mediated neutralization

The immune system protects organisms from infection with layered defenses of increasing specificity. The immune system is divided into two parts: the innate immune system and the adaptive immune system. The innate immune system provides an immediate, but non-specific response (Litman et al., 2005). The major functions of the innate immune system include acting as physical and chemical barrier to pathogens, recruiting immune cells to the site of infection through specialized chemical mediators called cytokines, activation of complement cascade and activation of adaptive immune system through a process called antigen presentation. The adaptive immune system is composed of highly specialized cells and processes to eliminate or prevent pathogens to infect human body. The adaptive immune response is antigen-specific. The adaptive immune system is composed of T lymphocytes and B lymphocytes. T cells are involved in cell-mediated immune response and B cells are involved in humoral immune response. T cells recognize an antigen when it is processed and presented with major histocompatibility complex (MHC) molecules. There are two major types of T cells: the CD8⁺ killer T cells and the CD4⁺ helper T cells. The killer T cells recognize an antigen which is coupled with class I MHC molecules while the helper T cells recognize an antigen which is

coupled with class II MHC molecules (Holtmeier and Kabelitz, 2005). B cells are involved in the production of antibodies. B cells recognize pathogens without any need for antigen processing. In addition, B cells differentiate into plasma cells after encountering with their specific antigen. Plasma cells are short lived cells which secrete antibodies. About 10% of plasma cells will survive to become long-lived antigen specific memory B cells.

Cellular and humoral immune responses are generated by the body during HCV infection. However, in the majority of individuals, they are insufficient to achieve viral clearance. It has been indicated that after 5 to 9 weeks of HCV infection, HCV-specific T lymphocytes emerge and play their part to control the virus and liver injury (Zeisel et al., 2008). Regulatory function of CD4⁺ T cells supports CD8⁺ T cells to eliminate infected cells and help B cells for the production of antibodies. It has been shown that dynamic multi-epitope-specific CD4⁺ and CD8⁺ T cell responses are required for spontaneous clearance of HCV infection (Diepolder et al., 1995; Missale et al., 1996; Rehmann, 2009; Thimme et al., 2001). Proliferative HCV-specific CD4⁺ T Cell responses are usually undetectable in acute persisting and chronic HCV infection (Chang et al., 2001; Schulze zur Wiesch et al., 2005; Shoukry et al., 2004). It has been demonstrated that HCV-specific CD4⁺ T cell response is directly dependent on HCV viremia and early initiation of antiviral treatment may protect HCV-specific CD4⁺ T cells from complete deletion. In addition, failure to build up a broad CD4⁺ T cell response is not the cause of progression of acute HCV infection into chronic infection because the breadth of CD4⁺ T cell response during early acute infection is similar in patients who spontaneously clear viral infection and also who develop chronic infection (Schulze Zur Wiesch et al., 2012). The emergence of viral variants containing escape mutations in CD8⁺ T cell epitopes is related to the development of chronic infection (Cox et al., 2005; Erickson et al., 2001; Timm et al., 2004). Von Hahn and colleagues screened PBMCs from patient H for reactivity to a series of overlapping peptides representing the H77 E1E2 sequence and recognized three peptides located at residues E1 226-240, E1 296-310 and E2 436-450, representing new T cell epitopes. Both E1 peptides were recognized by CD4⁺ T cell while E2 peptide was recognized by both CD4⁺ T and CD8⁺ T cells (von Hahn et al., 2007). Interestingly, the mutations in the sequences of these peptides abrogated CD4⁺ T cell recognition of one of the E1 peptide and CD4⁺ T and CD8⁺ T cells recognition of E2 peptide suggesting that HCV sequence change mediates viral escape from T cell responses (von Hahn et al., 2007). In another study, Osburn and colleagues investigated whether re-infection altered cellular immune response to HCV. They have demonstrated that exposure to a genetically distinct virus following a period of aviremia resulted in acquisition of a significant greater number of new T cell responses than in persistent viremia, however one of the re-infected subject with new T cell responses developed a persistent infection suggesting that the development of new T cell responses does not provide absolute protection against persistence (Osburn et al., 2010). Studies in chimpanzees have

demonstrated that animals re-challenged with homologous or heterologous strains of HCV are not consistently protected against re-infection following acute resolving infection (Bukh et al., 2008). Barth and colleagues have demonstrated the importance of T cells in viral clearance and protection following HCV re-exposure of two chimpanzees that has previously recovered from HCV-JFH1 infection (Barth et al., 2011). They reported that one of the chimpanzees became infected with heterologous re-challenge with HCV H77 virus while the other chimpanzee was protected from a similar challenge. Interestingly, peripheral HCV-specific T cell responses were present in both chimpanzees but uninfected chimpanzee exhibited a more robust CD8⁺ T cell response. In addition, the protective immunity in uninfected chimpanzee was associated with a rapid and durable increase of specific T, natural killer (NK) and natural killer T (NKT) cell markers and increased level of IFN- γ mRNA in the liver. In contrast, chimpanzee that became re-infected showed a weak increase of T, NK and NKT cell marker with marginally induced IFN- γ mRNA in the liver (Barth et al., 2011). After the clearance of virus from infected individual, cellular immune responses stay for a long period as compare to neutralizing antibody responses which appear to be feeble or vanish after viral clearance (Pestka et al., 2007; Takaki et al., 2000).

Detection of antibodies against HCV is possible after 4 to 14 weeks of infection (Farci et al., 1991; Netski et al., 2005). There may be a delayed appearance of antibodies in persistent infection (Rahman et al., 2004). Moreover, it has been demonstrated that HCV-specific antibodies appear after cellular immune response and aminotransferase elevation (Heller and Rehermann, 2005). High-titer neutralizing antibody (nAbs) levels were detected in plasma from chronically infected chimpanzees and humans (Bartosch et al., 2003a; Bartosch et al., 2003b; Hsu et al., 2003; Lavillette et al., 2006). A large range of epitopes of both structural and nonstructural proteins are targeted by these antibodies. A hypervariable region in the E2 envelope glycoprotein has been proposed to be a target for nAbs (Bartosch et al., 2003a; Farci et al., 1996). Antibodies mediated neutralization may occur through many different mechanisms (Hangartner et al., 2006; Parren and Burton, 2001; Reading and Dimmock, 2007). nAbs can block viral spread by directly inhibiting attachment of the virus to the host cell or interfere with entry of virus into cells or they may target post-binding steps of viral infection. Neutralizing antibodies can be divided into two classes: isolate-specific antibodies which neutralize only autologous virus (a well defined strain that exists in patient of interest) or cross-neutralizing antibodies which neutralize heterologous viral strain (these strains are taken from individuals different from the patient of interest) (Zeisel et al., 2008).

The prognosis of infection depends upon the strength of the immune system of patient during the acute phase of HCV infection. A study conducted by Lavillette and colleagues demonstrated that a correlation may exist between the viral load and the presence of nAbs during the early phase of infection. Appearance of strong neutralizing responses resulted in low viremia and control of HCV

replication while high viremia and inability to control HCV infection was a consequence of absence of neutralizing antibodies (Lavillette et al., 2005). In another study from our laboratory, it has been suggested that a rapid induction of high titer and cross-neutralizing antibodies in the acute phase of HCV infection may contribute to clear the virus. Contrarily, in majority of patients, absence or decreased ability to neutralize the virus resulted in chronic HCV infection (Pestka et al., 2007). Von Hahn and colleagues have shown that nAbs against HCVpp-bearing glycoproteins representing the infecting strain are detected at seroconversion and these nAbs target HVR (von Hahn et al., 2007). They further demonstrated that cross-reactive nAb responses were first detected at 111 weeks after infection and their titer and breadth increased to recognize distant HCV genotypes but yet the nAb response was less able to neutralize the viruses that were dominating in the serum at the time of sampling which suggests that nAb response lags behind the rapidly evolving glycoprotein sequences present within the quasispecies (von Hahn et al., 2007). In another study, Osburn and colleagues showed that nAbs with high titers against heterologous virus were detected in re-infected individuals independent of the sequence of the stimulating virus during initial infection and re-infection, indicating that the presence of cross-reactive nAbs is able to neutralize heterologous HCVpp. Moreover, detection of cross-reactive nAbs during re-infection of short duration suggests that clearance of an initial infection alters the subsequent humoral response to repeated HCV infection, therefore resulting in rapid generation of broadly nAbs (Osburn et al., 2010). It has been demonstrated that viral clearance in acute HCV infection does not correlate with the development of nAbs in chimpanzees (Bukh et al., 2008). Recently, it has been reported that nAbs were not able to prevent re-infection with H77 strain in chimpanzees (Barth et al., 2011). Taken together these studies suggest that induction of neutralizing antibodies in initial phase of infection contributes to clear or control the viral infection.

The immune system of most of the patients is unable to clear the virus during the first 6 months which results in persistence of HCV infection. Both kind of nAbs i.e. isolate-specific and cross-neutralizing antibodies, produced during chronic infection fail to eliminate the virus. It has been suggested that viral escape from antibody-mediated neutralization involves different mechanisms. The existence of quasispecies has been shown to contribute in viral evasion from neutralizing antibodies (Farci, 2011; Forns et al., 1999). HCV circulates in an infected individual as a quasispecies, which is a dynamic population of closely related but divergent genomes subjected to a continuous process of genetic variation, competition, and selection (Bukh et al., 1995a; Farci, 2011; Martell et al., 1992). It has been demonstrated that the humoral immune response may mediate quasispecies selection by exerting selection pressure against the predominant strain which results in the production of new variants (Forns et al., 1999). It has been suggested that the acute phase of infection is characterized by a high level of viral mutations due to a high level of immune pressure during this stage, whereas

during chronic phase, less immune pressure is exerted which results in decreased level of viral mutations (Fernandez et al., 2004; Ray et al., 2000). Moreover, mutations in HVR also result in escape from neutralization suggesting its role in maintenance of persistent HCV infection (Farci et al., 2000; Kato et al., 1993). It has been reported that HVR1 mutates more quickly *in vivo* than the rest of viral genome (Kurosaki et al., 1993). Interestingly, HVR1 has been suggested to function as an immunological decoy during infection as it masks highly conserved structure within the viral envelope (Bankwitz et al., 2010; Mondelli et al., 2001; Ray et al., 1999). In addition to HVR1, escape from nAbs has been shown in other regions of the HCV E2 envelope glycoprotein (Dhillon et al., 2010; Gal-Tanamy et al., 2008; Keck et al., 2011).

Induction of interfering antibodies has been shown to be a novel escape mechanism (Zhang et al., 2007; Zhang et al., 2009). Zhang and colleagues reported that the existence of non-neutralizing antibodies in HCV-specific immunoglobulins impedes the function of neutralizing antibodies. They mapped two epitopes within HCV envelope glycoprotein E2 and showed that epitope I (amino acids 412-419) took part in the viral neutralization process while epitope II (amino acids 434-446) did not participate in this process. The binding of epitope II by an antibody results in the shielding of epitope I, so epitope I is not recognized by specific nAbs. These findings demonstrated that the existence of such an interfering antibody can disrupt the function of an nAb produced against epitope I and it will lead to the chronic infection even in the presence of high titer of neutralizing antibodies (Zhang et al., 2007; Zhang et al., 2009).

Furthermore, it has been demonstrated that glycans associated with viral envelope proteins protect HCV from nAbs by shielding important epitopes (Balzarini, 2005; Goffard et al., 2005; Goffard and Dubuisson, 2003; Zhang et al., 2004b). HCV envelope glycoproteins E1 and E2 have been demonstrated to contain 5 and 11 N-linked glycans respectively. These glycans take part in the folding of glycoproteins, viral entry or in evasion of neutralizing responses. Helle and colleagues indicated that N-linked glycans of E1 do not help in shielding of neutralizing epitopes but three glycans on E2 (E2N1, E2N6 and E2N11) enhance the ability of HCVpp to evade neutralization (Helle et al., 2007). Interestingly, mutation of different glycosylation sites can contribute to boost the immunogenicity of viral proteins (Fournillier et al., 2001; Liu et al., 2007).

The association of lipoproteins with HCV has been considered to be another mechanism that could help in viral evasion (Andre et al., 2002; Bartosch et al., 2005; Dreux and Cosset, 2007; Molina et al., 2007). HCV associated with LDL and VLDL and has been shown to be internalized through LDL-R (Agnello et al., 1999; Monazahian et al., 1999). Moreover, only low-density fractions of infectious serum have been demonstrated to transmit infection to chimpanzees (Bradley et al., 1991) and to cultured cells *in vitro* (Agnello et al., 1999; Andre et al., 2002). It has been reported that immature intracellular HCVcc virions which contain less lipoprotein content than released virions, are

better neutralized by anti-E2 antibodies and show less sensitivity to anti apo-E antibodies than released virions (Di Lorenzo et al., 2011; Merz et al., 2011). In line with this, a cell culture-adaptive mutation in E2 (I414T) that decreased the lipoprotein content of HCVcc virions also enhanced the sensitivity to neutralization (Tao et al., 2009). Furthermore, HDL has also been shown to attenuate antibody-mediated neutralization of HCV (Bartosch et al., 2005; Lavillette et al., 2005; Voisset et al., 2006). It has been reported that HDL facilitates HCV entry which limits the virus exposure to nAbs (Dreux et al., 2006). The interaction between SR-BI and HVR1 region of E2 seems to be involved in this process (Dreux et al., 2006). Moreover, apoC-I, an essential component of HDL appears to be involved in infection enhancement (Dreux et al., 2007). Antibodies against apoC-I have been shown to neutralize HCVcc and virus derived from infected chimpanzees suggesting that apoC-I is a component of HCV (Dreux et al., 2007; Merz et al., 2011; Meunier et al., 2008).

Cell-to-cell transmission also allows HCV to escape from nAbs (see chapter 1.5 HCV life cycle). It has been shown that HCV is efficiently transmitted in the presence of anti-HCV glycoprotein antibodies suggesting a direct cell-to-cell transfer (Timpe et al., 2008; Witteveldt et al., 2009). These data suggest a role of cell-to-cell transmission in evasion from neutralizing antibodies and viral persistence.

All above studies describe the different mechanisms executed by HCV to evade the immune response of host. These findings suggest a need for the development of a prophylactic vaccine competent enough to stimulate robust and long-lasting humoral and cellular immune response against different HCV genotypes.

1.7. Treatment of chronic HCV infection

To date, there is unavailability of preventive or therapeutic vaccine against HCV. Current standard of care is based on combination of pegylated (PEG) interferon (IFN) alfa-2a or -2b with ribavirin. IFN α is a key component of host innate response to viral infection while ribavirin (RBV) is a guanosine analog with broad antiviral activity. A weekly injection of IFN is administered and ribavirin is given twice a day through oral route. The combination of PEG-IFN with ribavirin yields sustained virological response (SVR) which is defined as the absence of detectable HCV RNA in the serum 6 months after the end of treatment, of about 54-56% of treated patients (Fried et al., 2002; Manns et al., 2001). The duration of treatment is variable from 24 weeks for patients infected with HCV genotype 2/3 to 48 weeks for the patients infected with genotype 1/4. Measurement of virological response at 4 and 12 weeks of combination therapy is a simple and reliable tool that allows a treatment regimen to be administered to the patient. The treatment is discontinued for patients for whom a decrease of $\geq 2\log_{10}$ in HCV RNA after 12 weeks is not achieved because the probability of cure is very low. Contrarily, the patients showing rapid decrease in viral load means undetectable HCV RNA by 4

weeks, termed as rapid virological response (RVR), have significantly high chances of cure. Patients with a $>2\log_{10}$ decrease in HCV RNA at week 12 are said to have an early virological response (EVR). For better clinical utility, EVR can be further divided into two sub-classes, (i) patients who have complete EVR (cEVR) i.e. no RVR and HCV RNA negative after 12 weeks and (ii) patients who have partial EVR i.e. no RVR and HCV RNA positive but have a $>2\log_{10}$ decrease in HCV RNA at week 12 (Ferenci, 2012). Patients infected with HCV genotype 1 who obtain RVR are potential candidates for 24-week treatment regimens, while those having cEVR are recommended for 48-week regimens. Conversely, the patients who have pEVR are slow responders and they are potential candidates for intense treatment of 72-week regimens (Ferenci, 2012). Current HCV therapy is expensive and is constrained by resistance and adverse effects (Qureshi, 2007; Zeisel et al., 2011). The side effects of HCV therapy include influenza like symptoms (rigors, pyrexia, fatigue, and myalgia), depression, neutropenia, anemia, thrombocytopenia and neuropsychiatric symptoms (Russo and Fried, 2003).

Several new strategies have recently obtained FDA approval or are under development for the treatment of HCV. Direct-acting antiviral agents (DAAs) and host cofactor inhibitors show promising results against HCV. DAAs inhibit many HCV proteins, including NS3/4A serine protease, NS5B RNA polymerase, NS5A and NS4B. Since 2011 two NS3/4A protease inhibitors (telaprevir and boceprevir) have obtained FDA approval in Europe and the United States in combination with IFN- α and ribavirin for the treatment of chronic hepatitis C related to HCV genotype 1, in both treatment-naïve and treatment-experienced patients. These two patient populations have obtained SVR rates in the range of 66-75% and 59-66%, respectively, with treatment duration of 24 to 48 weeks (Sarrazin et al., 2012). The peptidomimetic NS3/4A protease inhibitors (PIs) hinder enzymatic activity by mimicking the cleavage end product of the proteolytic reaction. Protease inhibitors are of two type: linear (covalent) ketoamide derivatives and macrocyclic (non-covalent) PIs (Fusco and Chung, 2011). FDA approved Telaprevir, boceprevir and BI201335, linear PIs which are in clinical development. Macrocyclic PIs comprise TMC435350, danoprevir, MK7009, GS-9256 and many others are at initial phases of development. In a phase III trial that included treatment-naïve patients infected with HCV genotype 1, telaprevir (750mg tid) was administered for 12 or 8 weeks in combination with PEG IFN- α (180 μ g/week) and ribavirin (1000 or 1200 mg/day). PEG IFN- α and ribavirin were administered until week 24 in patients who achieved an extended RVR (eRVR), defined as an undetectable HCV RNA (< 10 IU/ml) at week 4 of therapy that was still undetectable at week 12. Patients without eRVR received PEG IFN- α and ribavirin until week 48 (Jacobson et al., 2011). SVR rates were 75% and 69% in 12-week and 8-week of telaprevir treatment, respectively. Another study has revealed that telaprevir in combination with IFN and ribavirin markedly improved

rates of SVR in patients with genotype 1 but has limitation of high rates of discontinuation due to adverse effects like (Jacobson et al., 2011; McHutchison et al., 2009).

Triple regimens i.e. PIs in association with PEG IFN and ribavirin, are now the new standard of care in genotype 1 patients. However, due to increased rate of side effects, there are more treatment withdrawals. In addition, they have been restricted to only genotype 1 patients. The other major problem associated with first-generation PIs is their low genetic barrier to resistance. Therefore, second-wave PIs seem to have many advantages over first-generation. They have higher genetic barrier to resistance, improved activity against multiple genotypes and better tolerability (Bourliere et al., 2011). Among the second-generation PIs, MK-5172 and ACH-264 have shown promising activity against broad range of HCV genotypes (Bourliere et al., 2011).

Other drugs under study include NS5B RNA-dependent RNA polymerase (RdRp) inhibitors which are competing with nucleotide triphosphate at the polymerase active site for incorporation into nascent HCV RNA termed as nucleoside inhibitors (NIs) or stimulate conformational changes in RdRp by inhibiting chain elongation known as non-nucleoside inhibitors (NNIs). Recently, BMS-790052 has been reported to be the first documented inhibitor of NS5A (Bourliere et al., 2011). Cyclosporin, a cyclophilin inhibitor was found to inhibit HCV replication *in vitro* and in patients as well. Alisporivir (Debio 025), a synthetic form of cyclosporine, has shown potent antiviral activity against a broad range of HCV genotypes is in a phase-I study (Flisiak et al., 2008).

1.8. HCV infection after liver transplantation

In the majority of patients, HCV infection leads to chronic liver disease, cirrhosis and hepatocellular carcinoma which are major indications for liver transplantation. However, universal re-infection of the graft leads to critical complications and threats to both allograft and survival of patient. HCV re-infects the graft in the reperfusion phase during liver transplantation (LT) and after one to three months of transplantation, acute hepatitis can be observed (Roche and Samuel, 2008). It has been observed that 8% to 30% of the recipients will develop cirrhosis within 5 years after transplantation (Garcia-Retortillo et al., 2002; Sugawara et al., 2010). After the development of cirrhosis, around 40% of patients are in danger of decompensation within one year and more than 50% have risk of death after initiation of decompensation. It has been illustrated that 10% of patients who receive a new graft after transplantation due to HCV cirrhosis will be in need for re-transplantation because of loss of first graft (Roche and Samuel, 2008). To date, no therapy is available to prevent the re-infection of the transplanted graft. After LT, combined treatment of PEG-IFN and ribavirin is used which allows to achieved 30% SVR with histological improvements. To date, PIs are contraindicated in liver transplant patients due to severe drug toxicity (Mukherjee, 2012).

The factors reported for severe recurrent HCV include donor age, treatment of acute rejection, high viral titer in the pre-operative or early post-operative phases and long gap between the antiviral therapy and transplantation (Sugawara et al., 2010). It has been reported that the titer of virus starts to increase after 15 hours of anhepatic phase, around 19% of hepatocytes are infected after one month and the virus titer reaches its peak at fourth post-operative month (Charlton, 2005; Powers et al., 2006). The level of HCV RNA after one year of transplantation is 10-20 folds higher than its pre-transplant level. More than 70% of the patients develop acute lobular hepatitis after 6 months of liver transplantation (Charlton, 2005). Garcia-Retrotillo and colleagues studied the kinetics of HCV during and after transplantation of liver. Their study was based on 20 consecutive patients undergoing liver transplantation. They showed that during the anhepatic phase which ranges from 45 to 207 minutes, HCV-RNA level decreased in 18 patients. The mean half-life of HCV was 2.2 hours. After 8 to 24 hours of reperfusion, the HCV viral load was at its lower level and the elimination half life of HCV virions was 3.44 hours. After this decline phase of viral load, HCV-RNA level increased quickly in 10 patients and the average HCV doubling time was 13.8 hours. There was a progressive increase in the concentration of HCV-RNA after first week and it attained the plateau in a month after transplantation (Garcia-Retortillo et al., 2002). In the same way, Powers and colleagues also studied kinetics of HCV re-infection after LT in a cohort of 6 patients. They found the half life of HCV virion around 40 minutes during the anhepatic period which is much quicker than the estimation of Garcia- Retrotillo et al. i.e. 2.2 hours. The HCV-RNA load in the serum continued to reduced up to 23 hours after reperfusion and the elimination half life was similar as revealed by Garcia-Retrotillo et al (Powers et al., 2006).

Noteworthy, it has been reported that the population of HCV quasispecies is more homogenous among patients after LT (Garcia et al., 2003; Schvoerer et al., 2007). Hughes et al. conducted a study of 8 patients where biopsies of graft were taken 1.5 to 2.5 hours after reperfusion. They described that HCV quasispecies genetic complexity and diversity were decreased (Hughes et al., 2004). HCV quasispecies displayed a marked decrease in HCV amino acid diversity when estimated after one week and one month of LT as compare to its level before transplantation (Feliu et al., 2004). It has been shown that after LT, the diversity of HVR1 region of E2 glycoprotein declined in 70% patients while its genetic complexity has decreased in 61% patients. It has recently been demonstrated by our laboratory that the selection of HCV population during liver transplantation is characterized by efficient entry and poor neutralization by the pre-transplant serum circulating antibodies as compared to HCV population which is undetectable after transplantation (Fafi-Kremer et al., 2010). Recently, it has been suggested that HCV recurrence after LT is associated with increased levels of CLDN1 and OCLN in hepatocytes membranes without altering their localization or expression pattern within the tight junctions (Mensa et al., 2011).

2. Aims of the study

HCV infection is a major health problem of the world affecting approximately 200 million people worldwide. After the initial infection, HCV persists in approximately 70% of individuals despite the presence of cellular and humoral immunity. Chronic hepatitis leads to liver cirrhosis and HCC which is a major indication for liver transplantation. The current antiviral treatment is based on combination of PEG-IFN and ribavirin and is still limited by resistance, toxicity and high costs. Thus, novel antiviral treatment and a vaccine are urgently needed. HCV entry is needed for initiation, spread and persistence of infection and hence represents an interesting target for novel antiviral strategy.

Several host entry factors have been described during the past years including SR-BI, CD81, CLDN, OCLN, RTKs and NPC1L1. Yet detailed mechanism of entry is not completely understood. Human SR-BI is a glycoprotein highly expressed in tissues with a high cholesterol need for steroidogenesis and the liver. The physiological role of SR-BI is to mediate the selective uptake of HDL cholesterol ester as well as the bidirectional free cholesterol transport at the cell membrane. SR-BI has been demonstrated to act during binding and post-binding steps of HCV entry suggesting that this receptor can play a dual role in HCV infection (Zeisel et al., 2007b). While the SR-BI determinants involved in HCV binding had been partially characterized, the post-binding function of SR-BI remained largely unknown. In the first part of my PhD, we aimed to further characterize the role of SR-BI in HCV infection by using a novel class of anti-SR-BI mAbs specifically targeting the post-binding function of SR-BI.

HCV-related cirrhosis and hepatocellular carcinoma are leading indications for liver transplantation (LT). A major limitation is the universal HCV re-infection of the graft followed by an accelerated course of virus-induced liver disease. Re-infection occurs within few hours of graft reperfusion despite the presence of anti-HCV antibodies. Currently, there is no strategy to prevent re-infection of liver grafts. Only a small portion of viral variants present before transplantation is selected following LT. Our laboratory has previously shown that viral entry and escape from host neutralizing antibodies are important factors which permit the virus to quickly infect the liver during the early phase of LT (Fafi-Kremer et al., 2010). However, the molecular mechanisms involved in the virus evasion from the immunity of host to re-infect the graft are unknown. In the second part of my PhD, we aimed to characterize the molecular mechanisms underlying HCV re-infection of the graft after liver transplantation. Using HCVpp and HCVcc expressing patient-derived viral envelopes, we uncovered viral and host factors mediating evasion from immune responses.

3. Results

3.1. The post-binding activity of SR-BI mediates initiation of hepatitis C virus infection and viral dissemination

A manuscript presenting the results from this study is currently in revision in Hepatology.

Publication n°1:

M. N. Zahid, M. Turek, F. Xiao, V. L. D. Thi, M. Guérin, M. Dreux, F-L. Cosset, I. Fofana, P. Bachellier, J. Thompson, F. Grunert, T. F. Baumert*, M. B. Zeisel*

* TFB and MBZ equally contributed to this work

The post-binding activity of scavenger receptor BI mediates initiation of hepatitis C virus infection and viral dissemination.

Hepatology, in revision

In the first part of my PhD, we aimed to further explore the role of HCV-SR-BI interaction during HCV infection. SR-BI has been identified as a putative host cell factor for HCV on the basis of its reactivity with sE2 (Scarselli et al., 2002). SR-BI is a 509 amino acid glycoprotein which is highly expressed in the liver and steroidogenic tissues. Earlier, it was identified as the major physiological receptor for HDL (Krieger, 2001) (Rigotti et al., 2003). It has been demonstrated that SR-BI is involved in viral binding as well as in post-binding steps of HCV infection (Catanese et al., 2010; Zeisel et al., 2007b). The SR-BI determinants involved in HCV binding have been partially characterized but the post-binding function of SR-BI is still not well known.

To find out the mechanistic role SR-BI in viral initiation and dissemination, we generated a novel class of anti-SR-BI monoclonal antibodies (mAbs) inhibiting HCV infection. To characterize the steps of the viral entry process targeted by these anti-SR-BI antibodies, I first assessed the ability of these antibodies to interfere with HCV E2 binding to human SR-BI. None of the anti-SR-BI mAbs inhibited binding of recombinant soluble E2 (sE2) to Huh7.5.1 cells (Figure 2A of the manuscript) suggesting that these antibodies do not directly interfere with E2-SR-BI but most probably inhibit a post-binding step during HCV entry. I next investigated the HCVcc entry kinetics into Huh7.5.1 cells in the presence of anti-SR-BI mAbs which demonstrated that the anti-SR-BI mAbs target HCV infection during post-binding steps of viral entry. These data indicate that a post-binding function of SR-BI is essential for initiation of HCV infection (Figure 2C of the manuscript). These antibodies are the first molecules exclusively targeting the post-binding function of SR-BI and thus enabled us to more thoroughly assess the relevance of this function for HCV infection. Additional experiments performed in our laboratory demonstrated that these anti-SR-BI mAbs also interfered with HCV cell-

cell transmission which plays a major role in viral dissemination. Taken together, these data suggest that SR-BI-E2 binding is not required for cell-free infection and cell-cell transmission but a postbinding function of SR-BI is essential for these processes.

SR-BI has been demonstrated to be important for both HDL binding and cholesteryl-ester uptake but the SR-BI determinants involved in these processes are largely unknown. I demonstrated that these antibodies do not block HDL binding to SR-BI but partially inhibit lipid transfer function of SR-BI (Figure 5B, C of the manuscript). These data suggest that SR-BI determinants involved in HCV post-binding events do not mediate HDL binding but may play a role in lipid transfer, in line with the reported link between the lipid transfer function of SR-BI and HCV infection (Bartosch et al., 2005; Dreux et al., 2009).

Taken together, in this study we confirmed the hypothesis that human SR-BI plays a multifunctional role in the HCV entry process during both binding and postbinding steps. Our data indicate that the HCV post-binding function of human SR-BI can be dissociated from its binding function. Moreover, we demonstrated that the post-binding function of SR-BI is most relevant for initiation of HCV infection and viral dissemination. Targeting the post-binding function of SR-BI thus represents an interesting antiviral strategy against HCV infection.

**The post-binding activity of scavenger receptor BI mediates initiation
of hepatitis C virus infection and viral dissemination**

Muhammad N. Zahid^{1,2}, Marine Turek^{1,2}, Fei Xiao^{1,2}, Viet Loan Dao Thi³, Maryse Guérin⁴, Isabel Fofana^{1,2}, Philippe Bachellier⁵, John Thompson⁶, Marlène Dreux³, François-Loïc Cosset³, Fritz Grunert⁶, Thomas F. Baumert^{1,2,7*}, Mirjam B. Zeisel^{1,2*}

* these authors contributed equally

¹Inserm, U748, Université de Strasbourg, Strasbourg, France ; ²Université de Strasbourg, Strasbourg, France; ³Inserm, U758, Ecole Normale Supérieure de Lyon, IFR128 BioSciences Lyon-Gerland, Lyon, France ; ⁴Inserm, U939, Hôpital de la Pitié, Paris, France; ⁵Pôle des Pathologies Digestives Hépatiques et Transplantation, Hôpitaux Universitaires de Strasbourg, France ; ⁶Aldevron GmbH, Freiburg, Germany, ⁷Pôle Hépatodigestif, Nouvel Hôpital Civil, Strasbourg, France

Word count

Abstract: 255 words; main manuscript: 4950 words; figures: 6; tables: 2

Corresponding authors

Mirjam B. Zeisel, PhD, PharmD, Inserm U748, Université de Strasbourg, 3 Rue Koeberlé, F-67000 Strasbourg, France; Phone: (++33) 3 68 85 37 03, Fax: (++33) 3 68 85 37 24, e-mail: Mirjam.Zeisel@unistra.fr and Thomas F. Baumert, M. D., Inserm U748, Université de Strasbourg, 3 Rue Koeberlé and Pôle Hépatodigestif, Nouvel Hôpital Civil, F-67000 Strasbourg, France; Phone: (++33) 3 68 85 37 03, Fax: (++33) 3 68 85 37 24, e-mail: Thomas.Baumert@unistra.fr

Keywords

Hepatitis C virus, scavenger receptor BI, virus entry, viral dissemination, antiviral

Abbreviations

CE: cholesteryl ester; CLDN1: claudin-1; HCV: hepatitis C virus; HCVcc: cell culture-derived HCV; HCVpp: HCV pseudotype particles; HDL: high-density lipoprotein; SR-BI: scavenger receptor class B type I

Financial support

This work was supported by the European Union (ERC-2008-AdG-233130-HEPCENT, INTERREG-IV-Rhin Supérieur-FEDER-Hepato-Regio-Net 2009), ANR-05-CEXC-008, ANRS (2008/354, 2009/183, 2011/132), Région Alsace, Inserm, University of Strasbourg, and Aldevron Freiburg. M. N. Z. was supported by HEC fellowship.

Author contribution

M. B. Z. and T. F. B. designed and supervised research. M. N. Z., M. T., F. X., V. L. D. T., M. G., I. F., P. B., J. T., F.-L. C, F. G. and M. B. Z. performed experiments. M. N. Z., M. T., F. X., V. L. D. T., M. G., I. F., J. T., F.-L. C., F. G., T. F. B. and M. B. Z. analyzed data. M.B.Z. and T. F. B. wrote the paper. The authors declare no conflict of interest. * these authors contributed equally

Abstract

Scavenger receptor class B type I (SR-BI) is a high-density lipoprotein (HDL) receptor highly expressed in the liver and modulating HDL metabolism. Hepatitis C virus (HCV) is able to directly interact with SR-BI and requires this receptor to efficiently enter into hepatocytes to establish productive infection. A complex interplay between lipoproteins, SR-BI and HCV envelope glycoproteins has been reported to take place during this process. SR-BI has been demonstrated to act during binding and post-binding steps of HCV entry. While the SR-BI determinants involved in HCV binding have been partially characterized, the post-binding function of SR-BI remains largely unknown. To uncover the mechanistic role of SR-BI in viral initiation and dissemination we generated a novel class of anti-SR-BI monoclonal antibodies that interfere with post-binding steps during the HCV entry process without interfering with envelope glycoprotein E2 binding to the target cell surface. Using the novel class of antibodies and cell lines expressing murine and human SR-BI we demonstrate that the post-binding function of SR-BI is of key impact for both initiation of HCV infection and viral dissemination. Interestingly, this post-binding function of SR-BI seems not to be related to HDL interaction but appears to be directly linked to its lipid transfer function. Conclusion: Taken together, our results uncover a crucial role of the SR-BI post-binding function for initiation and maintenance of viral HCV infection which does not require receptor-E2/HDL interactions. The dissection of the molecular mechanisms of SR-BI-mediated HCV entry opens a novel perspective for entry inhibitors interfering specifically with the proviral function of SR-BI.

Hepatitis C virus (HCV) is a major cause of liver cirrhosis and hepatocellular carcinoma. Preventive modalities are absent and the current antiviral treatment is limited by resistance, toxicity and high costs.¹ Viral entry is required for initiation, spread, and maintenance of infection, and thus is a promising target for antiviral therapy. HCV binding and entry into hepatocytes is a complex process involving the viral envelope glycoproteins E1 and E2, as well as several host factors, among which highly sulfated heparan sulfate glycosaminoglycans, CD81, the low-density lipoprotein (LDL) receptor, scavenger receptor class B type I (SR-BI), claudin-1 (CLDN1), occludin (OCLN), as well as receptor tyrosine kinases² (reviewed in³).

Human SR-BI is a glycoprotein highly expressed in tissues with a high cholesterol need for steroidogenesis and the liver.⁴ SR-BI is a multifunctional molecule well known to modulate high-density lipoprotein (HDL) metabolism. Indeed, SR-BI binds a variety of lipoproteins and mediates the selective uptake of HDL cholesterol ester (CE) as well as the bidirectional free cholesterol transport at the cell membrane. Genetic SR-BI variants have been associated with HDL levels in humans and a recent study uncovered a functional mutation in SR-BI impairing SR-BI function and affecting cholesterol homeostasis.⁵ SR-BI also interacts with different pathogens, including HCV⁶⁻⁸, plasmodium sporozoites⁹ and various bacteria¹⁰, and mediates their entry/uptake into host cells. Noteworthy, the importance of SR-BI for HCV infection *in vivo* and its potential as an antiviral target has recently been reported.¹¹

SR-BI directly binds HCV E2^{6, 8} but virus-associated lipoproteins also contribute to host cell binding and uptake.¹² Moreover, physiological SR-BI ligands modulate HCV infection.¹³⁻¹⁶ This suggests the existence of a complex interplay between lipoproteins, SR-BI and HCV envelope glycoproteins for HCV entry. Furthermore, SR-BI has also been demonstrated to mediate post-binding events during HCV entry.¹⁷⁻¹⁹ The HCV-SR-BI interaction during post-binding steps occurs at similar time-points to HCV interaction with CD81 and CLDN1, suggesting that HCV entry may be mediated through the formation of co-receptor complex(es).^{17, 20, 21} These data suggest that SR-BI plays a multifunctional role during HCV entry at both binding and post-binding steps.^{17, 22} This is corroborated by the fact that murine SR-BI does not bind HCV E2^{22, 23} although promoting HCV entry.^{22, 24}

To elucidate the mechanistic function of SR-BI in the HCV entry process and to explore its impact as an antiviral target, we generated a novel class of monoclonal antibodies (mAbs) directed against human SR-BI that inhibit HCV entry during post-binding steps without preventing HCV E2 binding to target cells.

Material and Methods

Cells. HEK293T, Chinese hamster ovary (CHO), Buffalo Rat Liver (BRL3A), Huh7 and Huh7.5.1 cells were cultured as described.²⁵⁻²⁷ Primary human hepatocytes (PHH) were isolated as described.²⁰ CHO and BRL3A cells expressing human, mouse or human/mouse chimeric SR-BI (CLA-1, BD Bioscience) were produced as described.^{17, 27} Briefly, cDNAs encoding three human/murine SR-BI chimeras were generated through PCR by swapping three SR-BI domains between amino acid positions 38-215, 216-398 and 399-432, respectively (primer sequences are available upon request). While the HHH and MMM SR-BI constructs refer to the wild-type human (H) and murine (M) SR-BI molecules, respectively, the human/mouse SR-BI chimeras were denominated according to the origin of either SR-BI domain, *e.g.*, HMM bears the domain 1 from human SR-BI and the domains 2 and 3 from murine SR-BI. All mutants were sequenced to ensure that the clones possessed the expected sequences (Dao Thi et al. submitted manuscript).

Antibodies. Polyclonal and monoclonal antibodies directed against the extracellular loop of SR-BI (QQ-4A3-A1, QQ-2A10-A5, QQ-4G9-A6, PS-6A7-C4, PS-7B11-E3, NK-8H5-E3, NK-6B10-E6, NK-6G8-B5) were raised by genetic immunization of Wistar rats and Balb/c mice as previously described¹⁷ according to proprietary technology (Aldevron Freiburg GmbH, Freiburg, Germany). Antibodies were selected by flow cytometry for their ability to bind to human SR-BI expressed on CHO cells as described.¹⁷ Anti-CD81 (JS-81), anti-SR-BI (CLA-1) and phycoerythrin (PE)-conjugated anti-mouse antibodies were from Beckman Coulter. Anti-His and FITC-conjugated anti-His antibodies were from Qiagen and rabbit anti-actin (AA20-30) antibodies from Sigma-Aldrich. Anti-E1 mAb (IGH526; Innogenetics), anti-E2 mAb (IGH461; Innogenetics) and patient-derived heterologous anti-HCV IgG have been described.^{18, 28}

Cell culture-derived HCV (HCVcc) and HCV pseudoparticle (HCVpp) production and infection.

Production of HCVcc, HCVpp, MLVpp and VSVpp, infection and kinetic experiments have been described.^{17, 20, 26, 28-30} For combination experiments, each antibody was tested individually or in combination with the second antibody. Huh7.5.1 cells were pre-incubated with anti-SR-BI or control

antibody for 1 h and then incubated for 4 h at 37°C with HCVcc or HCVpp (pre-incubated for 1 h with or without anti-envelope antibodies). The Combination Index (CI) was calculated as described.³¹ A CI less than, equal to, and more than 1 indicates synergy, additivity, and antagonism, respectively³¹. Cell viability was assessed using a MTT test as described.²

Cellular binding of envelope glycoprotein E2. Recombinant His-tagged soluble E2 (sE2) was produced as described.²⁷ Huh7.5.1 cells were preincubated with control or polyclonal anti-SR-BI serum (1:50), monoclonal anti-SR-BI or control antibodies (20 µg/mL) for 1 h at room temperature (RT) and then incubated with sE2 for 1 h at RT. Binding of sE2 was revealed using flow cytometry as described.^{20, 27}

Epitope mapping. BRL3A or CHO cells were transduced with retroviral vectors expressing human, mouse or human-mouse chimeric SR-BI (Dao Thi et al. submitted manuscript). Transduced cells were selected using antibiotics and proper SR-BI expression was studied using flow cytometry and commercial anti-SR-BI antibodies. Anti-SR-BI mAb binding was assessed using flow cytometry.²⁷

HCV cell-to-cell transmission. Cell-to-cell transmission of HCV was assessed as described.^{2, 32} Briefly, producer Huh7.5.1 cells were electroporated with HCV Jc1 RNA and cultured with naive target Huh7.5-GFP cells in the presence or absence of anti-SR-BI or control monoclonal antibodies. An HCV E2-neutralizing antibody (AP33, 25 µg/mL) was added to block cell-free transmission.³² After 24 h of co-culture, cells were fixed with paraformaldehyde, stained with an NS5A-specific antibody (0.1 µg/mL) (Virostat) and analyzed by flow cytometry.^{2, 32}

Immunoblotting. Huh7.5.1 cells were lysed with Glo lysis buffer (Promega) and 50 µg of protein of each sample were separated by 12% SDS-PAGE, transferred to HyBond-P nitrocellulose membranes (GE Healthcare) and then incubated with monoclonal anti-SR-BI (5 µg/mL) and AP-labelled secondary antibodies.¹⁷

HDL binding. HDL was labeled using Amersham Cy5 Mono-Reactive Dye Pack (GE Healthcare). Unbound Cy5 was removed by applying labeled HDL on illustra MicroSpin G-25 Columns (GE Healthcare). Blocking of Cy5-HDL binding with indicated reagents was performed for 1 h at RT prior to Cy5-HDL binding for 1 h at 4°C on 10^6 target cells.

Lipid transfer assays. Selective HDL-CE uptake and lipid efflux assays were performed as previously described.^{27, 33} Briefly, HDL-CE uptake was assessed in the presence or absence of monoclonal anti-SR-BI antibodies (20 µg/mL) and ³H-CE-labelled HDL (60 µg protein) for 5 h at 37° C. Selective uptake was calculated from the known specific radioactivity of radiolabelled HDL-CE and is denoted in µg HDL-CE/ µg cell protein. For lipid efflux assay, Huh7 cells were labeled with ³H-cholesterol (1 µCi/mL) and incubated at 37° C for 48 h as previously described.^{27, 34} Cells were incubated with monoclonal anti-SR-BI (20 µg/mL) for 1 h prior to incubation with unlabeled HDL at different concentrations for 4 h. Fractional cholesterol efflux was calculated as the amount of label obtained in the medium divided by the total in each well (radioactivity in the medium + radioactivity in the cells) regained after lipid extraction from cells.

Results

Production of SR-BI-specific monoclonal antibodies interfering with the post-binding steps of viral entry. To further explore the role of HCV-SR-BI interaction during HCV infection, we generated five rat and three mouse monoclonal antibodies (mAbs) directed against the human SR-BI ectodomain (Table 1). These antibodies bound to endogenous SR-BI on human hepatoma Huh7.5.1 cells and primary human hepatocytes (PHH) but did not bind to mouse SR-BI expressed on rat BRL cells (Figure 1A, B, Table 1). Among these antibodies, three rat (QQ-4A3-A1, QQ-2A10-A5 and QQ-4G9-A6) and one mouse mAb (NK-8H5-E3) markedly inhibited HCVcc infection in a dose-dependent manner with 50% inhibitory concentrations (IC_{50}) between 0.2 to 8 μ g/mL (Figure 1C, D, Table 1). The apparent K_d (K_{dapp}) corresponding to the half-saturating concentrations for binding to Huh7.5.1 cells ranged from 0.5 to 7.4 nM demonstrating that these antibodies recognize SR-BI with high affinity (Table 1). To characterize the steps of the viral entry process targeted by these anti-SR-BI mAbs, we first assessed their ability to interfere with HCV E2 binding to human SR-BI. In contrast to a polyclonal anti-SR-BI rat serum and an anti-CD81 mAb, none of the anti-SR-BI mAbs inhibited binding of recombinant soluble E2 (sE2) to SR-BI on the cell surface of Huh7.5.1 cells (Figure 2A). Moreover, while rat anti-SR-BI mAbs increased sE2 binding to human SR-BI expressed on BRL cells, mouse anti-SR-BI mAbs did not modulate sE2 binding in this assay (Figure 2B). These data suggest that interference with HCV E2 binding to target cells does not account for the antiviral action of anti-SR-BI mAbs. Next, to characterize potential post-binding steps targeted by these anti-SR-BI mAbs, we assessed HCVcc entry kinetics into Huh7.5.1 cells in the presence of anti-SR-BI mAbs inhibiting HCV infection (QQ-4A3-A1, QQ-2A10-A5 and QQ-4G9-A6 and NK-8H5-E3). These anti-SR-BI mAbs inhibited HCVcc infection when added immediately after viral binding as well as 20 to 30 min after initiation of viral entry (Figure 2C) demonstrating that QQ-4A3-A1, QQ-2A10-A5 and QQ-4G9-A6 and NK-8H5-E3 indeed target post-binding steps of the HCV entry process. Taken together, these data indicate that a post-binding function of SR-BI is essential for initiation of HCV infection. In contrast to previous anti-SR-BI mAbs inhibiting HCV binding²² and small molecules interfering with both viral binding and post-binding^{19, 27}, these antibodies are the first molecules exclusively targeting

the post-binding function of SR-BI and thus represent a unique tool to more thoroughly assess the relevance of this function for HCV infection.

A post-binding function of SR-BI is essential for cell-to-cell transmission and viral spread.

HCV disseminates via direct cell-to-cell transmission.^{32, 35} To assess the role of SR-BI post-binding function in viral dissemination, we first investigated the ability of the anti-SR-BI mAbs to interfere with neutralizing antibody-resistant viral spread by studying direct HCV cell-to-cell transmission in the presence of anti-SR-BI mAbs QQ-2A10-A5 and QQ-4G9-A6. Both anti-SR-BI mAbs efficiently blocked HCV cell-to-cell transmission (Figure 3A-C) indicating that these antibodies may prevent viral spread *in vitro*. As these anti-SR-BI mAbs do not block sE2-SR-BI binding (Figure 2A, B) but inhibit HCV entry during post-binding steps (Figure 2C), these data suggest that a post-binding function of SR-BI plays an important role during HCV cell-to-cell transmission. To ascertain the importance of the SR-BI post-binding function in this process, we performed additional HCV cell-to-cell transmission assays using Huh7.5 cells or Huh7.5 cells overexpressing either mouse SR-BI, unable to bind HCV E2, or human SR-BI, able to bind HCV E2, as target cells. Cell-to-cell transmission was enhanced in Huh7.5 cells overexpressing either human or mouse SR-BI as compared to parental cells (Figure 3D). These data indicate that HCV E2-SR-BI binding is not mandatory for viral dissemination and confirm the crucial role of SR-BI post-binding function in this process. Finally, to assess whether anti-SR-BI mAbs may prevent viral dissemination when added post-infection, we performed a long-term analysis of HCVcc infection in the presence or absence of control or anti-SR-BI mAbs QQ-4G9-A6 and NK-8H5-E3. When added 48 h after infection, these anti-SR-BI mAbs efficiently inhibited HCV spread over 2 weeks in a dose-dependent manner without affecting cell viability (Figure 3E, F and data not shown). Taken together, these data indicate that a post-binding function of SR-BI is required for HCV cell-to-cell transmission and spread.

Protein determinants relevant for HCV post-binding steps lie within the N-terminal ectodomain of human SR-BI.

To map the protein determinants important for SR-BI post-binding function during HCV entry, we first performed cross-competition studies in order to determine whether these antibodies recognize overlapping or distinct epitopes. Labeled anti-SR-BI mAb NK-

8H5-E3 was incubated with Huh7.5.1 cells in the presence of increasing concentrations of unlabeled anti-SR-BI mAbs. In contrast to unlabeled mouse NK-8H5-E3, none of the three unlabeled rat mAbs (QQ-4A3-A1, QQ-2A10-A5 and QQ-4G9-A6) reduced binding of NK-8H5-E3 to Huh7.5.1 cells, comparable to control isotype mAb (Figure 4A). In contrast, cross-competition experiments with labeled versions of QQ-4A3-A1, QQ-2A10-A5 and QQ-4G9-A6 demonstrated that each of these mAbs reduced binding of unlabeled rat mAbs but not mouse mAb (Figure 4B and data not shown). The mutual cross competition between the three rat mAbs suggests that they recognize overlapping or closely related epitopes on SR-BI while the mouse mAb recognizes a distinct epitope. To further define the epitopes targeted by these antibodies, we investigated their ability to bind to human-mouse SR-BI chimeras, where part of the mouse SR-BI ectodomain was replaced by the corresponding human sequence (Table 2). Side-by-side flow cytometry binding studies using anti-SR-BI mAbs inhibiting HCV infection (QQ-4A3-A1, QQ-2A10-A5, QQ-4G9-A6 and NK-8H5-E3) and anti-SR-BI mAbs that have no effect on HCV infection (NK-6B10-E6, NK-6G8-B5) suggest that the epitopes responsible for inhibition of HCV infection lie within the N-terminal ectodomain of human SR-BI (Table 2). Finally, to determine whether these epitopes are linear or conformationally dependent we assessed the ability of the anti-SR-BI mAbs to bind to human SR-BI using SDS-PAGE and Western blot. Staining of SR-BI by anti-SR-BI mAb PS-6A7-C4, NK-6B10-E6 and NK-6G8-B5 suggest that these antibodies may recognize linear epitopes (data not shown). In contrast, none of the antibodies inhibiting HCV infection interacted with linear SR-BI (data not shown). Taken together, these data indicate that anti-SR-BI mAbs inhibiting HCVcc infection recognize conformational epitopes within the N-terminal ectodomain of SR-BI. Moreover, these data suggest that the N-terminal ectodomain of SR-BI contains protein determinants relevant for the SR-BI post-binding function in HCV entry.

SR-BI determinants relevant for HCV post-binding steps may be linked to the lipid transfer function of the entry factor. The SR-BI ectodomain has been demonstrated to be important for both HDL binding and CE uptake but the determinants involved in these processes have not been precisely defined yet. To assess whether anti-SR-BI mAbs inhibiting HCV post-binding steps affect HDL binding to SR-BI, we studied Cy5-labeled HDL binding to human SR-BI in the presence or

absence of anti-SR-BI mAbs. In contrast to polyclonal anti-SR-BI serum which inhibited Cy5-labeled HDL binding, none of the anti-SR-BI mAbs markedly interfered with HDL-SR-BI binding at concentrations inhibiting HCV infection by up to 90% (Figure 5A). Furthermore, we investigated the effect of these mAbs on CE uptake and cholesterol efflux. While PS-6A7-C4, PS-7B11-E3, NK-6B10-E6 and NK-6G8-B5 had no effect on lipid transfer, QQ-4A3-A1, QQ-2A10-A5, QQ-4G9-A6 and NK-8H5-E3 partially reduced both CE uptake and cholesterol efflux at concentrations inhibiting HCV infection by up to 90% (Figure 5B, C). These data indicate that the anti-SR-BI mAbs inhibiting HCVcc infection also partially inhibit SR-BI mediated lipid transfer (Table 1). Taken together, these data suggest that SR-BI determinants involved in HCV post-binding events do not mediate HDL binding but may contribute to lipid transfer, in line with the reported link between the SR-BI lipid transfer function and HCV infection.^{13, 27}

Synergy between antibodies targeting SR-BI post-binding function and neutralizing antibodies on inhibition of HCV infection. Finally, to assess the clinical relevance of blocking SR-BI post-binding function to inhibit HCV infection, we determined the effect of anti-SR-BI mAbs on entry into Huh7.5.1 cells of HCVpp bearing the envelope glycoproteins of genotypes 1 to 6 and of highly infectious HCV strains selected during liver transplantation and re-infecting the liver graft (P02VJ).³⁰ All anti-SR-BI mAbs inhibiting HCVcc genotype 2a infection (QQ-4A3-A1, QQ-2A10-A5, QQ-4G9-A6 and NK-8H5-E3) also inhibited entry of HCVpp of all major genotypes into Huh7.5.1 cells (data not shown). Moreover, entry of patient-derived HCVpp P02VJ into both Huh7.5.1 cells and PHH was also efficiently inhibited by these anti-SR-BI mAbs while VSVpp entry was not affected (Figure 6 and data not shown). Given that combining compounds targeting both viral and host cell factors represents a promising future approach to prevent and treat HCV infection, we next determined whether the combination of anti-SR-BI mAb NK-8H5-E3 and anti-HCV envelope glycoprotein antibodies results in an additive or synergistic effect on inhibiting HCV infection. Combination of anti-SR-BI and anti-HCV envelope antibodies resulted in a synergistic effect on inhibition of HCVpp P02VJ entry and HCVcc infection as assessed by calculation of the combination index.³¹ It is noteworthy, that these combinations reduced the IC₅₀ of anti-SR-BI mAb by up to 100-fold (Figure 6A-D). The marked synergy may be explained by the fact the E2- and SR-BI-specific

antibodies target highly complementary steps during HCV entry. Taken together, these data indicate that interfering with SR-BI post-binding function may hold promise for the design of novel antiviral strategies targeting HCV entry factors.

Discussion

In this study, we generated novel anti-SR-BI mAbs specifically inhibiting HCV entry during post-binding steps that enabled us for the first time, using endogenous SR-BI, to explore and validate the hypothesis that SR-BI has a multifunctional role during HCV entry and to elucidate the functional role of SR-BI post-binding activity for HCV infection. Our data demonstrate that the HCV post-binding function of human SR-BI can indeed be dissociated from its E2-binding function. Moreover, we demonstrate that the post-binding activity of SR-BI is of key relevance for cell-free HCV infection as well as cell-to-cell transmission.

SR-BI mediates uptake of HDL-CE in a two-step process including HDL binding and subsequent transfer of CE into the cell without internalization of the HDL molecule. At the same time, SR-BI also participates in HCV binding and entry into target cells. SR-BI is able to directly bind HCV E2 and virus-associated lipoproteins but additional function(s) of SR-BI have been reported to be at play during HCV infection.^{13, 17, 27} The results from this study highlight the importance of a SR-BI post-binding function for HCV entry and further extend the relevance of this function for HCV cell-to-cell transmission.

The molecular mechanisms underlying HCV cell-to-cell transmission are only partially understood. A recent study showed that SR-BI contributes to this process³⁵ and that HCV E2-SR-BI interaction and/or SR-BI-mediated lipid transfer likely takes place during HCV dissemination as antibodies and small molecule inhibitors targeting both SR-BI binding and lipid transfer reduce HCV cell-to-cell transmission.^{11, 19} However, which SR-BI functions are relevant for this process remained to be determined. Taking advantage of our novel mAbs uniquely inhibiting SR-BI post-binding activity required for HCV entry, we demonstrated that an E2 binding-independent post-binding function is involved in neutralizing antibody-resistant cell-to-cell transmission. E2-independent SR-BI function in HCV dissemination is in line with the observation that cell-to-cell transmission is insensitive to E2-specific antiviral mAbs.³⁵ Given that mouse SR-BI does not bind sE2 but mediates HCV entry and promotes HCV cell-to-cell transmission, the post-binding function of SR-BI seems to be essential for HCV infection and dissemination while the binding function may be dispensable.

Previous studies using small molecule inhibitors indicated a role for SR-BI lipid transfer function in HCV infection and HDL-mediated HCV entry enhancement.^{13, 14, 27} As inhibition of cell-free HCV entry and cell-to-cell transmission by our novel anti-SR-BI mAbs was associated with interference with lipid transfer, our data suggest that the SR-BI lipid transfer function may be relevant for both initiation of HCV infection and viral dissemination. It is noteworthy that our anti-SR-BI mAbs are the first anti-SR-BI mAbs that do not inhibit HDL binding to SR-BI. These data suggest that HCV entry and dissemination can be inhibited without blocking HDL-SR-BI binding. The further characterization of the SR-BI post-binding function will allow to determine whether the SR-BI-mediated post-binding steps of HCV entry and dissemination are directly linked to its lipid transfer function.

Using SR-BI chimeras, we demonstrate that the determinants relevant for HCV post-binding steps lie within the human SR-BI N-terminal ectodomain. Amino acids 70 to 87 and residue E210 of SR-BI are required for HCV E2 binding while distinct protein regions are involved in HDL binding.^{22, 36} Although the SR-BI determinants involved in HDL binding and CE uptake have not been precisely defined yet, a recent study reported that amino acid C323 is critical for these processes³⁶. Given that our anti-SR-BI mAbs do not interfere with E2 and HDL binding, amino acids 70-87 and residues E210 and C323 are most likely not part of the targeted epitope(s). Interestingly, the amino acid associated with cholesterol homeostasis⁵ probably also lies outside these epitope(s). The further characterization of the(se) epitope(s) may allow to more thoroughly determine the regions of SR-BI relevant for its post-binding function during initiation of HCV infection and spread.

Finally, our data suggest that the SR-BI post-binding function is a highly relevant target for antivirals. Therapeutic options for a large proportion of HCV-infected patients are still limited by drug resistance and adverse effects.¹ Furthermore, a strategy for prevention of HCV liver graft infection is absent. Antivirals targeting essential host factors required for the HCV life cycle are attractive since they may increase the genetic barrier for antiviral resistance.^{2, 3} Indeed, our data demonstrate a marked synergistic effect on the inhibition of HCV entry when combining antibodies directed against the viral envelope and SR-BI. These results suggest that combination of molecules directed against the virus and host entry factors are a promising strategy for prevention of HCV infection such as liver

graft infection. The potent effect on cell-to-cell transmission and viral spread also opens a perspective of SR-BI-based entry inhibitors for treatment of chronic infection.

Small molecules and mAbs targeting SR-BI and interfering with HCV infection have previously been described.^{13, 19, 37} A human anti-SR-BI mAb has been reported to inhibit HDL binding, to interfere with cholesterol efflux and to decrease HCVcc entry during attachment steps without having a relevant impact on SR-BI mediated post-binding steps.^{22, 37} Indeed, a codon-optimized version of this mAb has been demonstrated to prevent HCV spread *in vivo*¹¹ underscoring the potential of SR-BI as an antiviral target. The mAbs generated in our study are highly novel in their function as they do not interfere with sE2-SR-BI binding but inhibit HCV entry during post-binding steps of cell-free infection and cell-to-cell transmission. Furthermore, in contrast to previously described anti-SR-BI mAbs³⁷, these mAbs do not hinder HDL binding to SR-BI and only partially inhibit lipid transfer at concentrations significantly inhibiting HCV infection. Given their novel mechanism of action and their potential differential toxicity profile, QQ-4A3-A1, QQ-2A10-A5, QQ-4G9-A6 and NK-8H5-E3 define a novel class of anti-SR-BI mAbs for prevention and treatment of HCV infection.

Acknowledgements

We thank R. Bartenschlager (University of Heidelberg) for providing Luc-Jc1 expression vectors, T. Wakita (National Institute of Infectious Diseases, Japan) for the JFH1 construct, C. M. Rice (The Rockefeller University) and F. V. Chisari (The Scripps Research Institute) for Huh7.5 and Huh7.5.1 cells, respectively. Moreover, we would like to thank A. H. Patel (MRC University of Glasgow Centre for Virus Research) for the Huh7.5-GFP cells and the AP33 antibody. We also acknowledge Eva Schnober (University of Freiburg) for contributing to sE2 binding assays and excellent technical assistance of Sarah Durand (Inserm U748) and Sandra Glauben (Aldevron Freiburg).

References

1. Pawlotsky JM. Treatment failure and resistance with direct-acting antiviral drugs against hepatitis C virus. *Hepatology* 2011;53:1742-1751.
2. Lupberger J, Zeisel MB, Xiao F, Thumann C, Fofana I, Zona L, Davis C, et al. EGFR and EphA2 are host factors for hepatitis C virus entry and possible targets for antiviral therapy. *Nature Medicine* 2011;17:589-595.
3. Zeisel MB, Fofana I, Fafi-Kremer S, Baumert TF. Hepatitis C virus entry into hepatocytes: Molecular mechanisms and targets for antiviral therapies. *J Hepatol* 2011;54:566-576.
4. Krieger M. Scavenger receptor class B type I is a multiligand HDL receptor that influences diverse physiologic systems. *J Clin Invest* 2001;108:793-797.
5. Vergeer M, Korporaal SJ, Franssen R, Meurs I, Out R, Hovingh GK, Hoekstra M, et al. Genetic variant of the scavenger receptor BI in humans. *N Engl J Med* 2011;364:136-145.
6. Scarselli E, Ansuini H, Cerino R, Roccasecca RM, Acali S, Filocamo G, Traboni C, et al. The human scavenger receptor class B type I is a novel candidate receptor for the hepatitis C virus. *EMBO J* 2002;21:5017-5025.
7. Bartosch B, Vitelli A, Granier C, Goujon C, Dubuisson J, Pascale S, Scarselli E, et al. Cell entry of hepatitis C virus requires a set of co-receptors that include the CD81 tetraspanin and the SR-B1 scavenger receptor. *J Biol Chem* 2003;278:41624-41630.
8. Evans MJ, von Hahn T, Tscherne DM, Syder AJ, Panis M, Wolk B, Hatzioannou T, et al. Claudin-1 is a hepatitis C virus co-receptor required for a late step in entry. *Nature* 2007;446:801-805.
9. Rodrigues CD, Hannus M, Prudencio M, Martin C, Goncalves LA, Portugal S, Epiphany S, et al. Host scavenger receptor SR-BI plays a dual role in the establishment of malaria parasite liver infection. *Cell Host Microbe* 2008;4:271-282.
10. Vishnyakova TG, Kurlander R, Bocharov AV, Baranova IN, Chen Z, Abu-Asab MS, Tsokos M, et al. CLA-1 and its splicing variant CLA-2 mediate bacterial adhesion and cytosolic bacterial invasion in mammalian cells. *Proc Natl Acad Sci U S A* 2006;103:16888-16893.

11. Meuleman P, Catanese M, Verhoye L, Desombere I, Farhoudi A, Jones C, Sheahan T, et al. A human monoclonal antibody targeting SR-BI precludes hepatitis C virus infection and viral spread in vitro and in vivo. *Hepatology* 2011;Sep 27 [Epub ahead of print].
12. Maillard P, Huby T, Andreo U, Moreau M, Chapman J, Budkowska A. The interaction of natural hepatitis C virus with human scavenger receptor SR-BI/Cla1 is mediated by ApoB-containing lipoproteins. *Faseb J* 2006;20:735-737.
13. Bartosch B, Verney G, Dreux M, Donot P, Morice Y, Penin F, Pawlotsky JM, et al. An interplay between hypervariable region 1 of the hepatitis C virus E2 glycoprotein, the scavenger receptor BI, and high-density lipoprotein promotes both enhancement of infection and protection against neutralizing antibodies. *J Virol* 2005;79:8217-8229.
14. Voisset C, Callens N, Blanchard E, Op De Beeck A, Dubuisson J, Vu-Dac N. High density lipoproteins facilitate hepatitis C virus entry through the scavenger receptor class B type I. *J Biol Chem* 2005;280:7793-7799.
15. von Hahn T, Lindenbach BD, Boullier A, Quehenberger O, Paulson M, Rice CM, McKeating JA. Oxidized low-density lipoprotein inhibits hepatitis C virus cell entry in human hepatoma cells. *Hepatology* 2006;43:932-942.
16. Molina S, Castet V, Fournier-Wirth C, Pichard-Garcia L, Avner R, Harats D, Roitelman J, et al. The low-density lipoprotein receptor plays a role in the infection of primary human hepatocytes by hepatitis C virus. *J Hepatol* 2007;46:411-419.
17. Zeisel MB, Koutsoudakis G, Schnober EK, Haberstroh A, Blum HE, Cosset F-L, Wakita T, et al. Scavenger receptor BI is a key host factor for Hepatitis C virus infection required for an entry step closely linked to CD81. *Hepatology* 2007; 46:1722-1731.
18. Haberstroh A, Schnober EK, Zeisel MB, Carolla P, Barth H, Blum HE, Cosset FL, et al. Neutralizing host responses in hepatitis C virus infection target viral entry at postbinding steps and membrane fusion. *Gastroenterology* 2008;135:1719-1728 e1711.
19. Syder AJ, Lee H, Zeisel MB, Grove J, Soulier E, Macdonald J, Chow S, et al. Small molecule scavenger receptor BI antagonists are potent HCV entry inhibitors. *J Hepatol* 2011;54:48-55.

20. Krieger SE, Zeisel MB, Davis C, Thumann C, Harris HJ, Schnober EK, Mee C, et al. Inhibition of hepatitis C virus infection by anti-claudin-1 antibodies is mediated by neutralization of E2-CD81-claudin-1 associations. *Hepatology* 2010;51:1144-1157.
21. Harris HJ, Farquhar MJ, Mee CJ, Davis C, Reynolds GM, Jennings A, Hu K, et al. CD81 and claudin 1 coreceptor association: role in hepatitis C virus entry. *J Virol* 2008;82:5007-5020.
22. Catanese MT, Ansuini H, Graziani R, Huby T, Moreau M, Ball JK, Paonessa G, et al. Role of scavenger receptor class B type I in hepatitis C virus entry: kinetics and molecular determinants. *J Virol* 2010;84:34-43.
23. Barth H, Cerino R, Arcuri M, Hoffmann M, Schurmann P, Adah MI, Gissler B, et al. Scavenger receptor class B type I and hepatitis C virus infection of primary tupaia hepatocytes. *J Virol* 2005;79:5774-5785.
24. Ploss A, Evans MJ, Gaysinskaya VA, Panis M, You H, de Jong YP, Rice CM. Human occludin is a hepatitis C virus entry factor required for infection of mouse cells. *Nature* 2009;457:882-886.
25. Zhong J, Gastaminza P, Cheng G, Kapadia S, Kato T, Burton DR, Wieland SF, et al. Robust hepatitis C virus infection in vitro. *Proc Natl Acad Sci U S A* 2005;102:9294-9299.
26. Pestka JM, Zeisel MB, Blaser E, Schurmann P, Bartosch B, Cosset FL, Patel AH, et al. Rapid induction of virus-neutralizing antibodies and viral clearance in a single-source outbreak of hepatitis C. *Proc Natl Acad Sci U S A* 2007;104:6025-6030.
27. Dreux M, Dao Thi VL, Fresquet J, Guerin M, Julia Z, Verney G, Durantel D, et al. Receptor complementation and mutagenesis reveal SR-BI as an essential HCV entry factor and functionally imply its intra- and extra-cellular domains. *PLoS Pathog* 2009;5:e1000310.
28. Fofana I, Krieger SE, Grunert F, Glaubens S, Xiao F, Fafi-Kremer S, Soulier E, et al. Monoclonal anti-claudin 1 antibodies prevent hepatitis C virus infection of primary human hepatocytes. *Gastroenterology* 2010;39:953-964.
29. Bartosch B, Dubuisson J, Cosset FL. Infectious hepatitis C virus pseudo-particles containing functional E1-E2 envelope protein complexes. *J Exp Med* 2003;197:633-642.

30. Fafi-Kremer S, Fofana I, Soulier E, Carolla P, Meuleman P, Leroux-Roels G, Patel AH, et al. Viral entry and escape from antibody-mediated neutralization influence hepatitis C virus reinfection in liver transplantation. *J Exp Med* 2010;207:2019-2031.
31. Zhao L, Wientjes MG, Au JL. Evaluation of combination chemotherapy: integration of nonlinear regression, curve shift, isobologram, and combination index analyses. *Clin Cancer Res* 2004;10:7994-8004.
32. Witteveldt J, Evans MJ, Bitzegeio J, Koutsoudakis G, Owsianka AM, Angus AG, Keck ZY, et al. CD81 is dispensable for hepatitis C virus cell-to-cell transmission in hepatoma cells. *J Gen Virol* 2009;90:48-58.
33. Le Goff W, Settle M, Greene DJ, Morton RE, Smith JD. Reevaluation of the role of the multidrug-resistant P-glycoprotein in cellular cholesterol homeostasis. *J Lipid Res* 2006;47:51-58.
34. de la Llera Moya M, Atger V, Paul JL, Fournier N, Moatti N, Giral P, Friday KE, et al. A cell culture system for screening human serum for ability to promote cellular cholesterol efflux. Relations between serum components and efflux, esterification, and transfer. *Arterioscler Thromb* 1994;14:1056-1065.
35. Brimacombe CL, Grove J, Meredith LW, Hu K, Syder AJ, Flores MV, Timpe JM, et al. Neutralizing antibody-resistant hepatitis C virus cell-to-cell transmission. *J Virol* 2011;85:596-605.
36. Guo L, Chen M, Song Z, Daugherty A, Li XA. C323 of SR-BI is required for SR-BI-mediated HDL binding and cholesteryl ester uptake. *J Lipid Res* 2011;52:2272-2278.
37. Catanese MT, Graziani R, von Hahn T, Moreau M, Huby T, Paonessa G, Santini C, et al. High-avidity monoclonal antibodies against the human scavenger class B type I receptor efficiently block hepatitis C virus infection in the presence of high-density lipoprotein. *J Virol* 2007;81:8063-8071.

Figure legends

Figure 1. Binding of monoclonal anti-SR-BI antibodies to human hepatocytes and inhibition of HCV infection. (A) Huh7.5.1 cells and (B) primary human hepatocytes (PHH) were incubated with anti-SR-BI mAbs and antibody binding was assessed using flow cytometry. (C) Inhibition of HCVcc infection by monoclonal anti-SR-BI antibodies. Huh7.5.1 cells were preincubated for 1 h at 37°C with anti-SR-BI or control monoclonal antibodies (100 µg/mL) before infection with HCVcc (Luc-Jc1) for 4 h at 37°C. HCV infection was assessed by luciferase activity in lysates of infected Huh7.5.1 cells 72 h post-infection. Results are expressed as means \pm SD % HCVcc infectivity in the absence of antibody of three independent experiments. (D) Dose-dependent inhibition of HCVcc infection by monoclonal anti-SR-BI antibodies. Huh7.5.1 cells were preincubated for 1 h at 37°C with anti-SR-BI or control monoclonal antibodies at the indicated concentrations before infection with HCVcc (Luc-Jc1) for 4 h at 37°C. HCV infection was assessed by luciferase activity in lysates of infected Huh7.5.1 cells 72 h post-infection. Results are expressed as mean \pm SD % HCVcc infectivity in the absence of antibody of three independent experiments performed in duplicate.

Figure 2. Monoclonal anti-SR-BI antibodies do not interfere with sE2 binding to SR-BI but inhibit HCV entry at post-binding steps. Huh7.5.1 cells (A) or BRL cells engineered to express human SR-BI (B) were preincubated with anti-CD81 (5 µg/mL), anti-SR-BI (20 µg/mL) or control antibodies for 1 h at room temperature before incubation with sE2 for 1 h at room temperature. sE2 binding was detected using FITC-labelled mouse anti-His antibody or mouse anti-His antibody followed by PE-labelled anti-mouse antibody and flow cytometry. Results are expressed as mean \pm SD % sE2 binding in the absence of antibody of two independent experiments performed in duplicate. (C) HCV entry kinetics. To discriminate between virus binding and post-binding events, HCVcc binding to Huh7.5.1 cells was performed in the presence or absence of anti-CD81 (5 µg/mL), anti-SR-BI (20 µg/mL) or control monoclonal antibodies (20 µg/mL) at 4 °C, before cells were washed and incubated at 37 °C with antibodies added at different time-points during infection. Time-course of HCVcc infection of Huh7.5.1 cells following addition of the indicated antibodies at different time-points during infection is shown. HCV infection was assessed by luciferase activity in lysates of

infected Huh7.5.1 cells 48 h post-infection. Results are expressed as mean % HCVcc infectivity in the absence of antibody of three independent experiments performed in triplicate.

Figure 3. The SR-BI post-binding function is relevant for HCV cell-to-cell transmission and viral spread.

(A-B) Quantification of HCV-infected target cells (Ti) after co-cultivation with HCV producer cells (Pi) during incubation with control (A) or anti-SR-BI (B) monoclonal antibodies in the presence of anti-HCV E2 antibody by flow cytometry. (C) HCV cell-to-cell transmission in the presence of anti-SR-BI or control monoclonal antibodies is shown. Data are expressed as % infected target cells in the presence of anti-HCV E2 antibody and represent means \pm SD of three independent experiments. (D) Quantification of HCV cell-to-cell transmission in parental target cells compared to target cells overexpressing mouse (m) or human (h) SR-BI. Data are expressed as means \pm SD from three different experiments. (E) Long-term analysis of HCVcc infection in the presence or absence of control (10 μ g/mL) or anti-SR-BI mAb (QQ-4G9-A6) at the indicated concentrations. Antibodies were added 48 h after HCVcc infection and control medium or medium containing antibodies were replenished every 4 days. Luciferase activity was determined in cell lysates every 2 days. Data are expressed as Log₁₀ RLU and represent means \pm SD of three different experiments performed in duplicate. (F) Cell viability after long-term exposure to anti-SR-BI mAbs. Cell viability was assessed using MTT assay after incubation of Huh7.5.1 cells for 14 days in the presence or absence of control or anti-SR-BI (QQ-4G9-A6) mAbs at 1 μ g/mL, 10 μ g/mL or 100 μ g/mL. Control medium and medium containing antibodies were replenished every 4 days. Data are expressed as % cell viability relative to cells incubated in the absence of mAb and represent means \pm SD from one experiment.

Figure 4. Competition of monoclonal anti-SR-BI antibodies for cellular binding. Huh7.5.1 cells were incubated with 0.1 μ g/mL of biotinylated anti-SR-BI mAb (A) NK-8H5-E3 or (B) QQ-4A3-A1 together with increasing concentrations of unlabeled anti-SR-BI mAb (QQ-4A3-A1, QQ-2A10-A5, QQ-4G9-A6, NK-8H5-E3) as competitors. Following washing of cells with PBS, binding of labelled mAbs was determined by flow cytometry and is shown as relative fluorescence.

Figure 5. Anti-SR-BI mAbs do not interfere with HDL binding but partially inhibit lipid transfer.

(A) HDL binding to BRL3-hSR-BI cells. BRL3-hSR-BI cells were incubated in the presence or

absence of anti-SR-BI mAbs (20 $\mu\text{g}/\text{mL}$) or polyclonal serum (1:50) or respective controls, prior to Cy5-HDL binding for 1 h at 4°C. Bound Cy5-HDL was quantified using flow cytometry. Results represent mean \pm SD of two different experiments performed in duplicate. (B) Lipid uptake by Huh7 cells. Huh7 cells were incubated with a mixture of anti-SR-BI mAbs (20 $\mu\text{g}/\text{mL}$) and ^3H -CE-labeled HDL for 5 h before incubation with unlabelled HDL for 30 min. Selective uptake was calculated from the known specific radioactivity of radiolabelled HDL-CE and is denoted in μg HDL-CE/ μg cell protein. Results represent mean \pm SD of two different experiments performed in duplicate. (C) Cholesterol efflux from Huh7 cells. Huh7 cells were first incubated with ^3H -cholesterol for 48 h and then with BSA (0.5%) for 24 h. Subsequently, cells were first incubated with anti-SR-BI mAbs (20 $\mu\text{g}/\text{mL}$) for 1 h and then with unlabeled HDL for 4 h. Fractional cholesterol efflux was calculated as the amount of the label obtained in the medium divided by the total label in each well regained after lipid extraction from cells. Results represent mean \pm SD of two different experiments performed in duplicate.

Figure 6. Synergy between anti-SR-BI and neutralizing antibodies in inhibiting HCV infection.

Patient derived HCVpp P02VJ (A-C) or HCVcc (D) were pre-incubated with (A) anti-E1 or (B) anti-E2 mAbs or (C-D) purified heterologous anti-HCV IgG (1 or 10 $\mu\text{g}/\text{mL}$) obtained from an unrelated chronically infected subject or isotype control IgGs for 1 h at 37°C and added to Huh7.5.1 cells pre-incubated with increasing concentrations of control or anti-SR-BI mAbs (NK-8H5-E3). HCVpp and HCVcc infection was analyzed by luciferase reporter gene expression. Results are expressed as mean % HCVpp entry or HCVcc infection from a representative experiment.

Table 1. Monoclonal antibodies directed against human SR-BI. Isotype, binding affinity to Huh7.5.1 cells ($K_{d_{app}}$) as well as inhibition of HCVcc infection (IC_{50}) and lipid transfer of anti-SR-BI mAbs are shown. IC_{50} was determined after incubation of Huh7.5.1 cells with serial dilutions of anti-SR-BI mAbs for 1 h at room temperature before infection with HCVcc. The results represent means of three independent experiments. Lipid uptake and efflux was assessed in Huh7 cells as described in Material and Methods in the presence of anti-SR-BI mAbs (20 μ g/mL). The results are representative of two independent experiments.

mAb	Isotype	$K_{d_{app}}$ Huh7.5.1 (nM)	IC_{50} HCVcc (μ g/mL)	Inhibition of lipid transfer
QQ-4A3-A1	rat IgG2b	1.0	0.7	yes
QQ-2A10-A5	rat IgG2b	0.5	0.2	yes
QQ-4G9-A6	rat IgG2b	0.5	1.0	yes
PS-6A7-C4	rat IgG2b	low	no inhibition	no
PS-7B11-E3	rat IgG2b	low	no inhibition	no
NK-8H5-E3	mouse IgG2b	7.4	8.0	yes
NK-6B10-E6	mouse IgG1	low	no inhibition	no
NK-6G8-B5	mouse IgG1	low	no inhibition	no

Table 2. Binding of monoclonal anti-SR-BI antibodies to human, mouse or chimeric mouse and human SR-BI. Three human/murine SR-BI chimeras were generated through PCR by swapping three SR-BI domains between amino-acid positions 38-215, 216-398 and 399-432, respectively. While the HHH and MMM SR-BI constructs refer to the wild-type human (H) and murine (M) SR-BI molecules, respectively, the human/mouse SR-BI chimeras were denominated according to the origin of either SR-BI domain, e.g., HMM bears the domain 1 from human SR-BI and the domains 2 and 3 from murine SR-BI (Dao Thi et al. submitted manuscript). BRL3A cells engineered to express human (HHH), mouse (MMM) or chimeric mouse and human (HMM, MHM, MMH) SR-BI were first incubated with monoclonal anti-SR-BI antibodies (20 µg/mL) for 1 h at room temperature before bound antibodies were detected using PE-labelled secondary antibodies. (+++) shift of mean fluorescent intensity (MFI) > 200, (++) shift of MFI > 100, (+) shift of MFI > 15 and (-) shift of MFI < 10. These results are representative of two independent experiments.

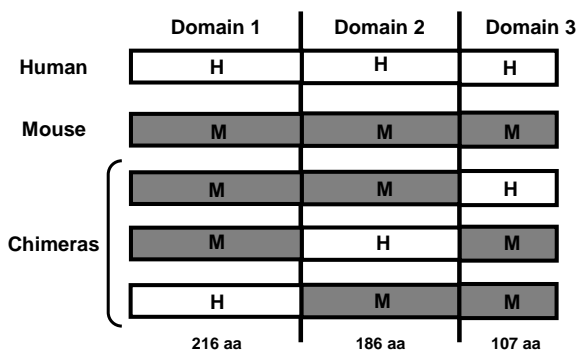

	QQ-4A3-A1	QQ-2A10-A5	QQ-4G9-A6	NK-5H8-E3	NK-6B10-E6	NK-6G8-B5
HHH	+++	+++	+++	+++	+	+
MMM	+	+	+	-	-	+
HMM	+++	+++	+++	+++	-	+
MHM	++	++	++	-	+	+
MMH	-	-	-	+	-	+

Figure 1

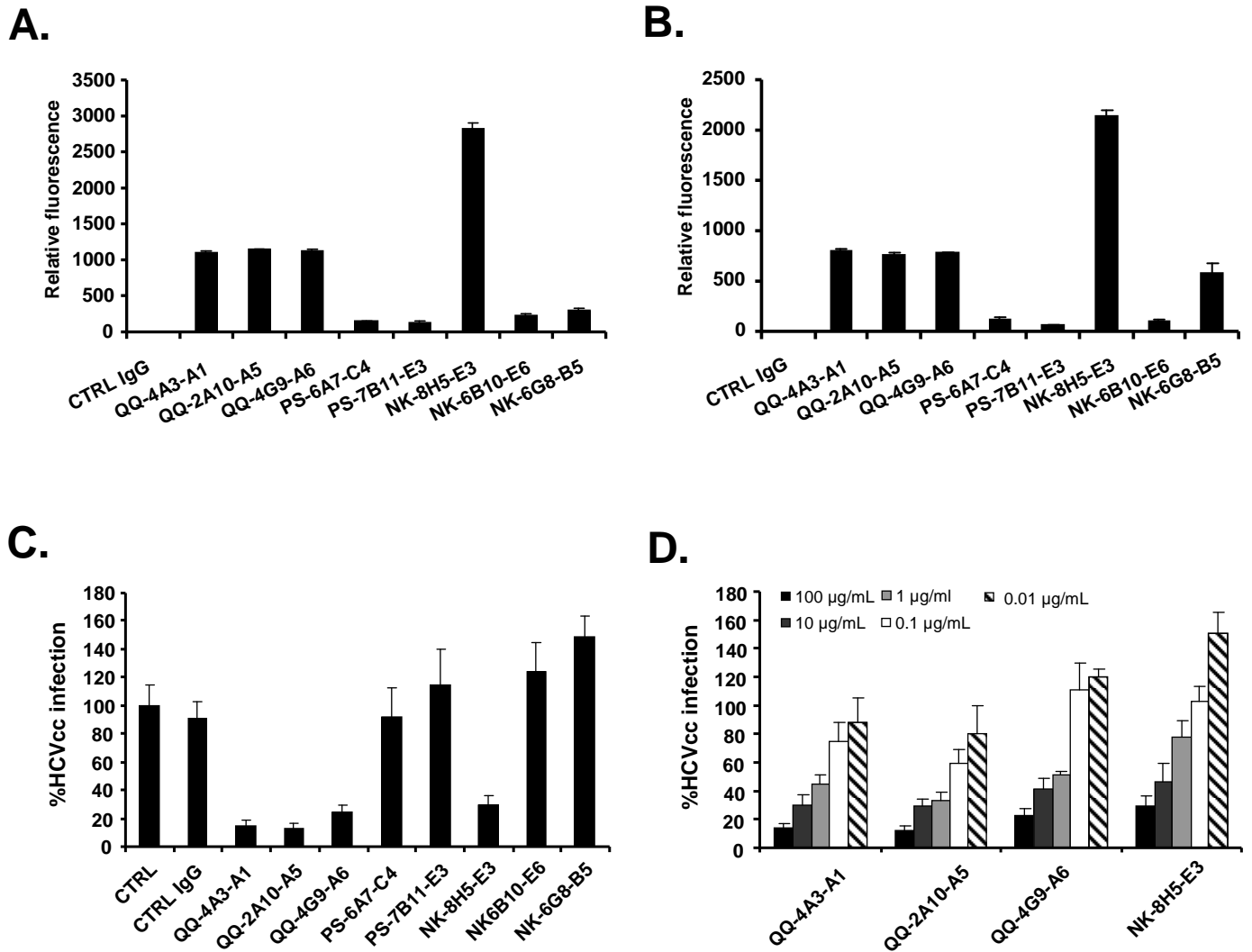
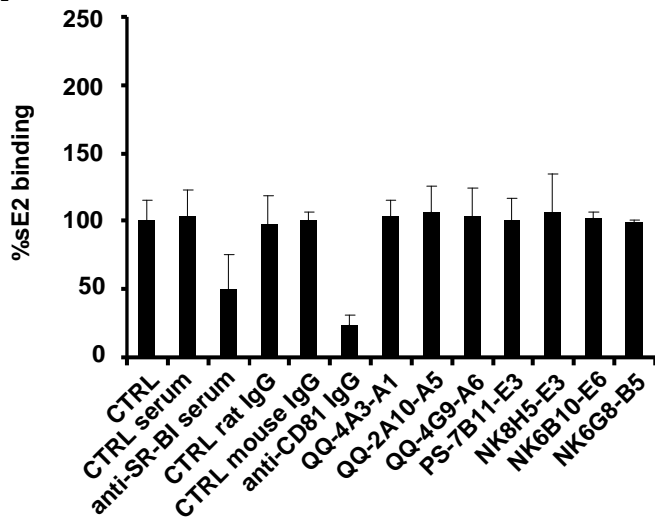
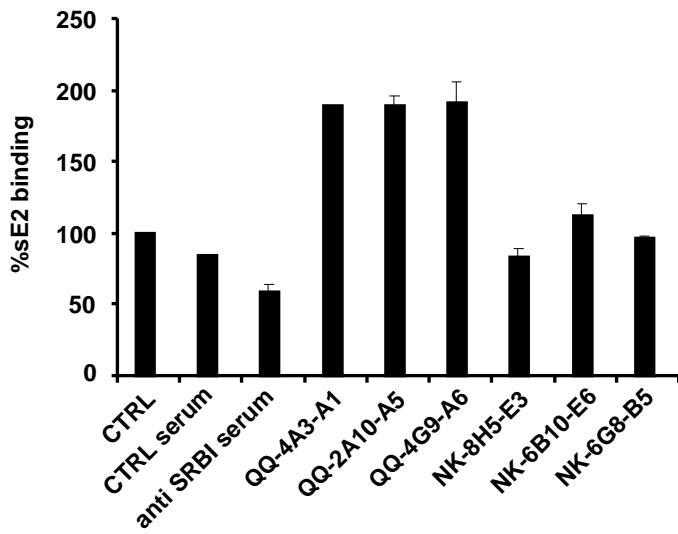

Figure 2

A.



B.



C.

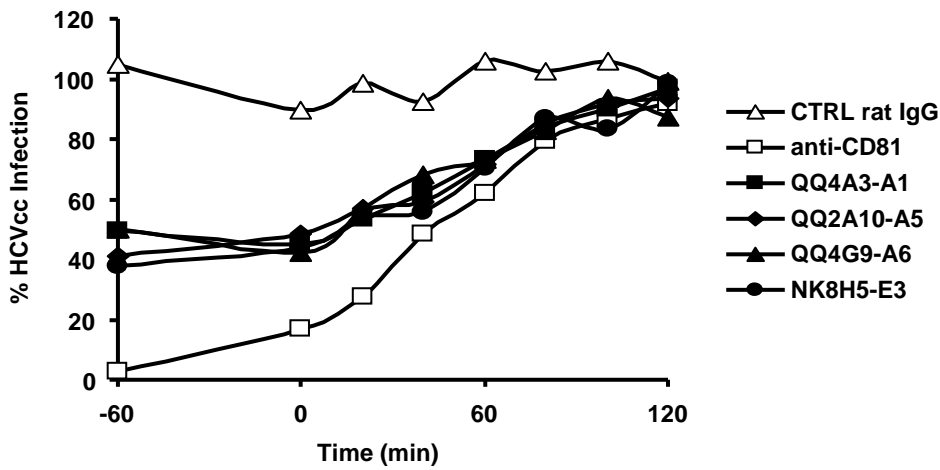
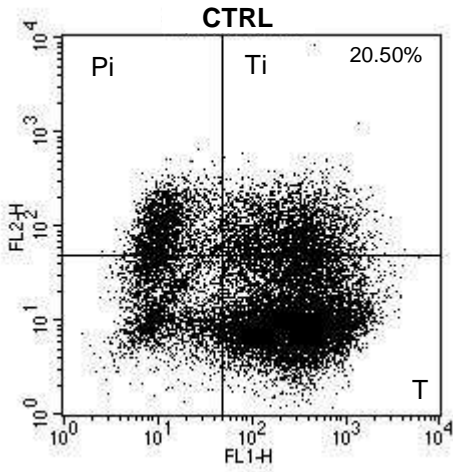
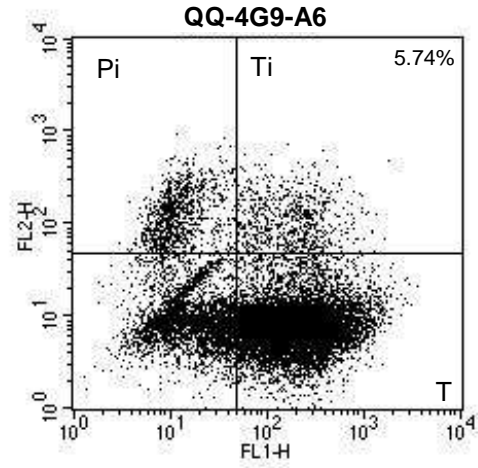

Figure 3

A.



B.



C.

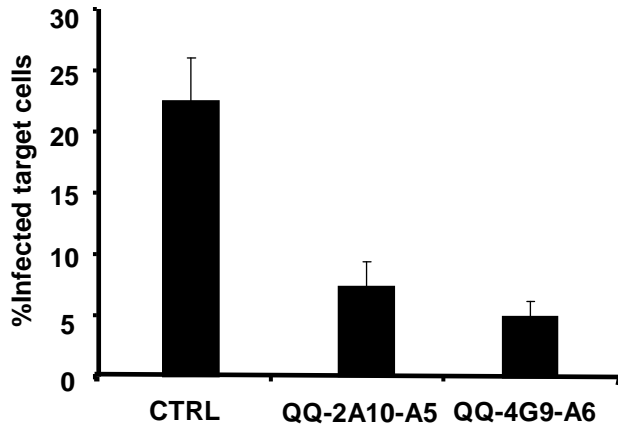

D.

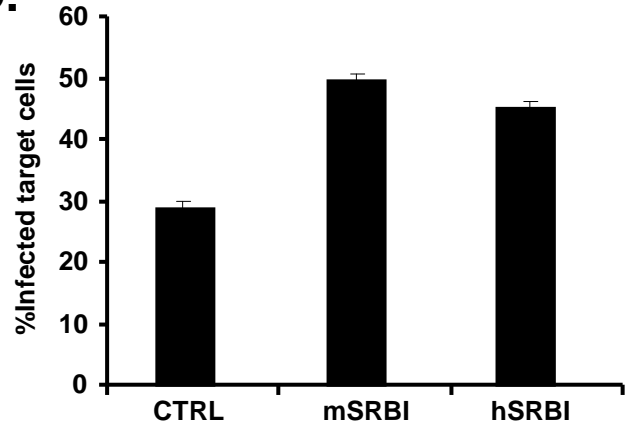

E.

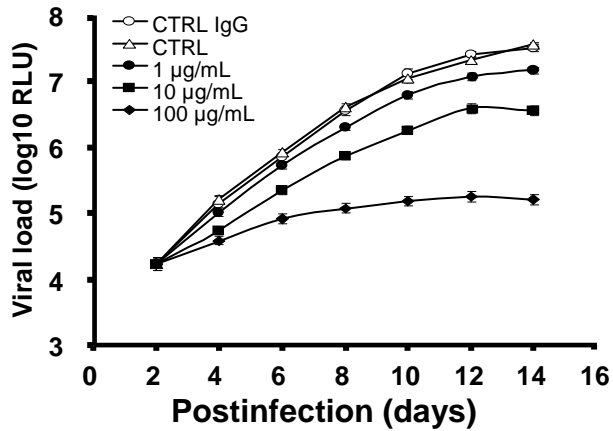

F.

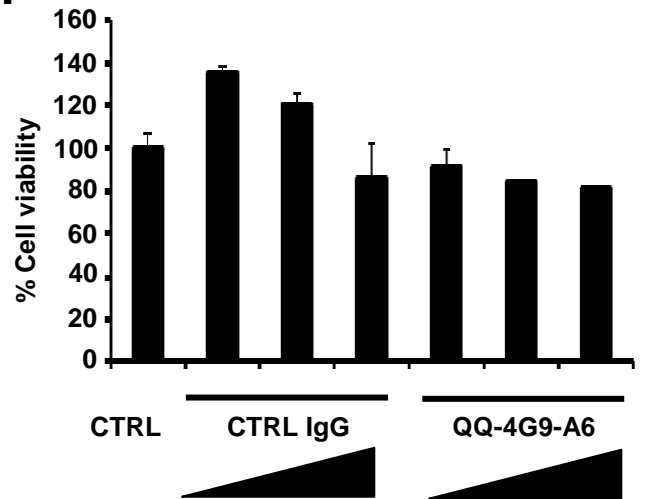
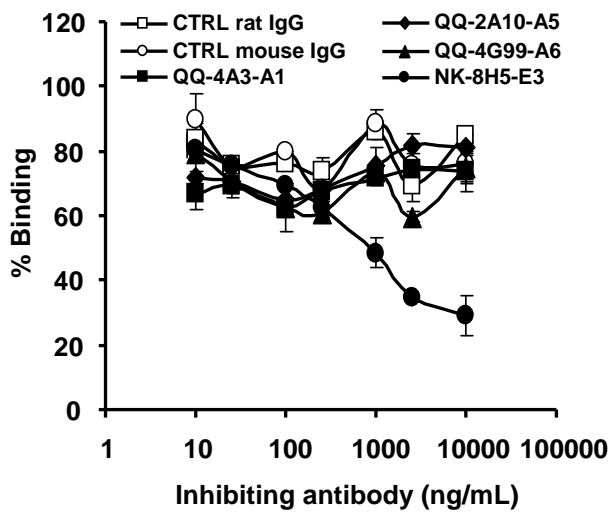

Figure 4

A.



B.

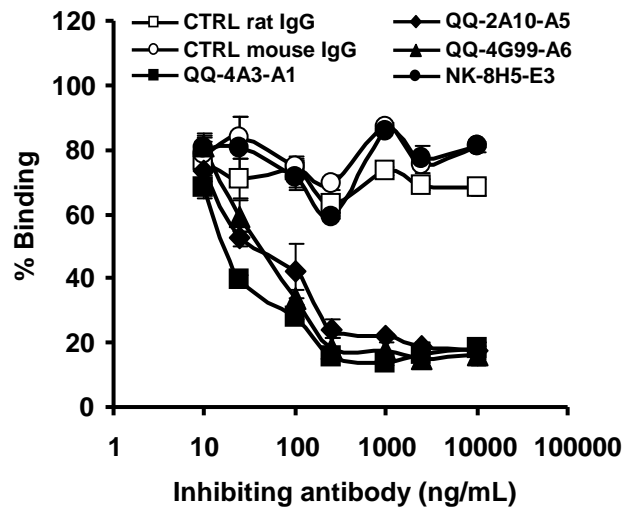
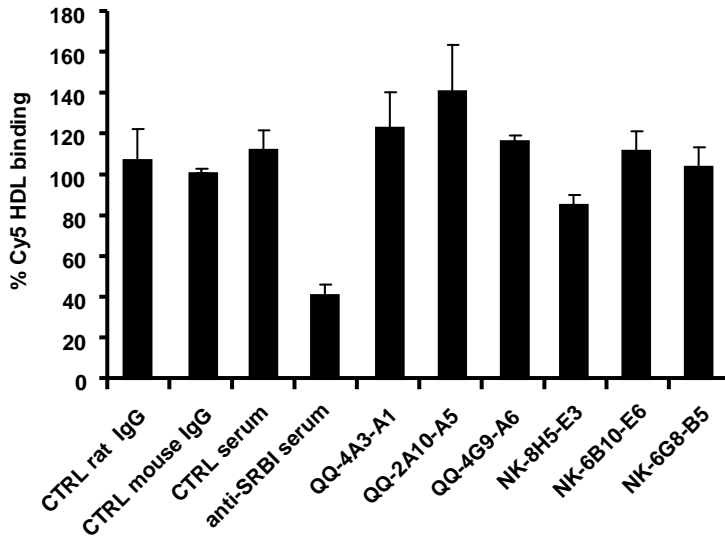
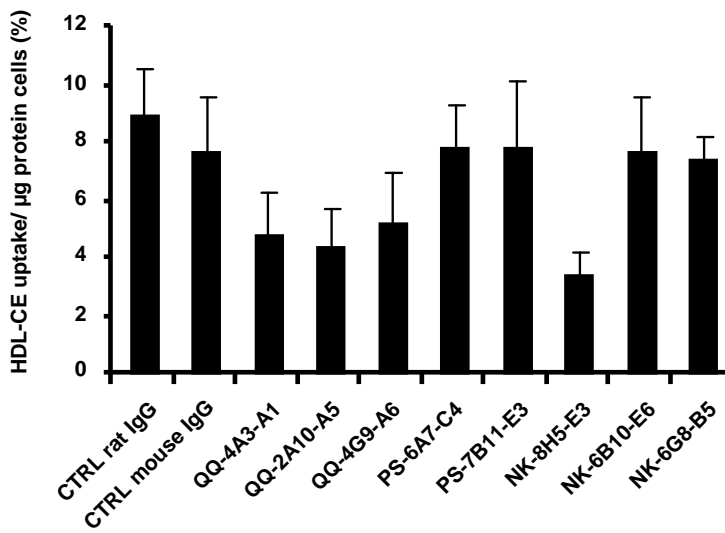

Figure 5

A.



B.



C.

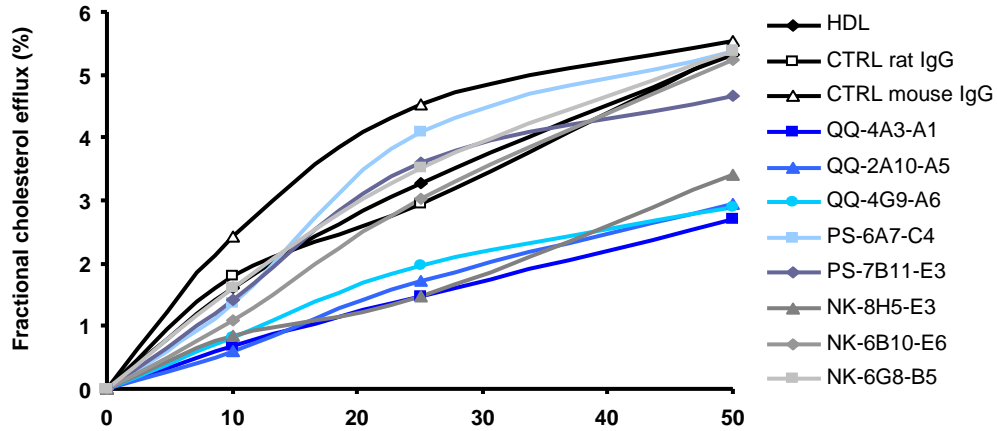
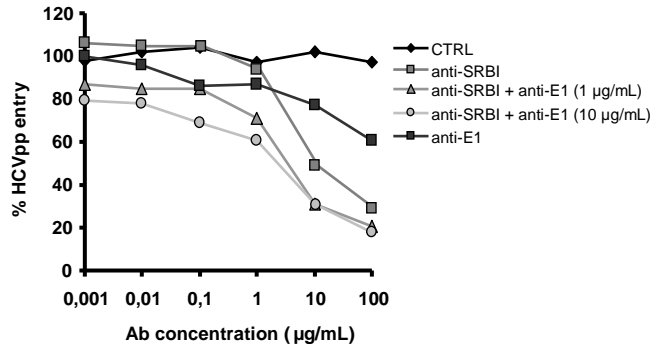
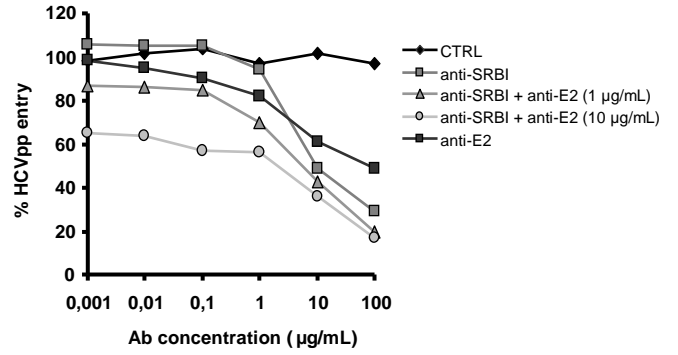

Figure 6

A.



B.



C.

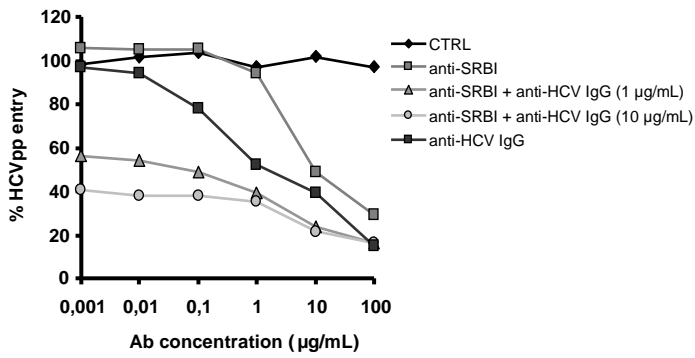

D.

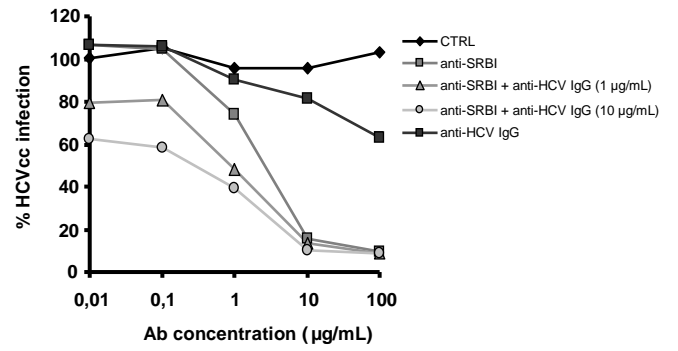

3.2. Mutations that alter hepatitis C virus cell entry factor usage mediate escape from neutralizing antibodies

A manuscript presenting the results from this study is accepted with minor revision in Gastroenterology.

Publication n°2:

Isabel Fofana*, Samira Fafi-Kremer*, Patric Carolla*, Catherine Fauvelle, **Muhammad Nauman Zahid**, Marine Turek, Laura Heydmann, Karine Cury, Juliette Hayer, Christophe Combet, François-Loïc Cosset, Thomas Pietschmann, Marie-Sophie Hiet, Ralf Bartenschlager, François Habersetzer, Michel Doffoël, Zhen-Yong Keck, Steven K.H. Fong, Mirjam B. Zeisel, Françoise Stoll-Keller, Thomas F. Baumert

* IF, SF-K and PC equally contributed to this work

Mutations that alter hepatitis C virus cell entry factor usage mediate escape from neutralizing antibodies

Gastroenterology, accepted with minor revision

In the second part of my PhD, we aimed to characterize the molecular mechanisms underlying HCV re-infection of the graft after liver transplantation (LT). A major limitation of LT is the universal re-infection of the liver graft with accelerated recurrence of liver disease. It had been previously shown in the lab that viral entry and escape from host neutralizing responses are important determinants allowing the virus to rapidly infect the liver during the early phase of transplantation. However, the molecular mechanisms by which the virus evades host immunity to persistently re-infect the liver graft are unknown.

To uncover enhanced viral entry and evasion mechanisms, we analyzed genetically closely related prototype variants derived from a well-characterized patient undergoing LT (Fafi-Kremer et al., 2010) (Figure 10). One variant, termed P01 VL, had re-infected the liver graft and was characterized by high-infectivity and escape from neutralizing antibodies present in autologous pre-transplant serum. The other variants, termed P01 VA and VC, were not selected during graft infection and were characterized by lower infectivity and high-sensitivity to neutralization by autologous pre-transplant serum (Fafi-Kremer et al., 2010).

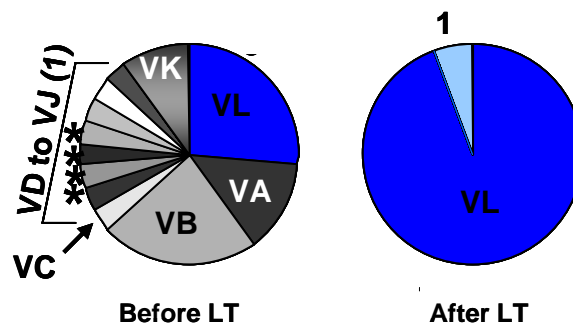

Figure 10: Evolution of HCV variants before and 7 d after LT. Distribution of full-length E1E2 variants is shown in the figure. Circle graphs represent the percentage of each clone detected. Viral isolates are indicated by an individual color and capital letters. Variants re-infecting the liver graft are depicted in blue, and non-selected variants not detected after transplantation are depicted in white, grey or black (Fafi-Kremer et al., 2010).

To investigate the molecular mechanism of enhanced entry of the selected variant VL, individual mutations of envelope glycoprotein region F447, S458G and R478C of non selected mutant VA and VC were introduced into infectious HCV pseudoparticles (HCVpp) expressing envelope glycoproteins of escape variant VL. The results obtained from these mutations demonstrate that residues F447L, S458G and R478C are largely responsible for the high infectivity of the escape variant VL.

In the framework of this project, I assessed that the envelope glycoprotein expression was similar for parental and chimeric strains which indicates that the differences in viral entry are not due to impaired production in HCVpp 293T producer cells or impaired assembly (Figure S3A, C of the manuscript). Then I investigated internalization kinetics of the parental and chimeric variants in the presence of anti-CD81 antibody. Since entry kinetics of parental and chimeric variants were similar, it is unlikely that the mutant induced modulation of CD81-dependency alters the velocity of viral entry (Figure 3D of the manuscript). In another experiment, we showed that overexpression of SR-BI and CD81 enhanced viral entry of the VL and the VC variants, but in contrast to CD81 overexpression, no specific increase was observed for the chimeric strains containing substitutions at positions 458 and 478 in SR-BI overexpression. I further investigated whether the mutations affect HCV-CD81 binding. We showed that E1E2 complexes of the escape variant VL bound less efficiently to shCD81-Huh7.5 cells than glycoproteins of the variants VC and VA. Exchange of the mapped residues conferred similar phenotypes suggesting that the residues at positions 447, 458 and 478 alter E1E2 interactions with cell surface CD81 (Figure 3B of the manuscript).

Next, I investigated the neutralization kinetics of parental and chimeric variants using a well-defined human antibody directed against HCV envelope glycoprotein E2 (HMAb CBH-23). The HMAb CBH-23 inhibited viral entry of VC and VLVC₄₅₈₊₄₇₈ at post-binding steps during time points

closely related to HCV-CD81 interaction (Figure 5C of the manuscript) and partially inhibited VA and VLVA₄₄₇ (Figure 5D of the manuscript). The VL variant escaped antibody mediated neutralization at the same steps. These data indicate that the positions 447, 458 and 478 mediate viral evasion from neutralizing antibodies at post-binding steps and time points closely related to HCV-CD81 interaction.

Taken together, in this study we identified a novel and clinically important mechanism of viral evasion, where co-evolution simultaneously occurs between cellular entry factor usage and escape from neutralization. The identification of these mechanisms advances our understanding of the pathogenesis of HCV infection and paves the way for the development of novel antiviral strategies and vaccines.

Mutations that Alter Use of Hepatitis C Virus Cell Entry Factors Mediate Escape from Neutralizing Antibodies

Molecular mechanisms of viral evasion in HCV infection

Isabel Fofana^{1,2,*}, Samira Fafi-Kremer^{1,2,3,*}, Patric Carolla^{1,2,*}, Catherine Fauvelle^{1,2}, Muhammad Nauman Zahid^{1,2}, Marine Turek^{1,2}, Laura Heydmann^{1,2}, Karine Cury^{1,2}, Juliette Hayer⁴, Christophe Combet⁴, François-Loïc Cosset⁵, Thomas Pietschmann⁶, Marie-Sophie Hiet⁷, Ralf Bartenschlager⁷, François Habersetzer^{1,2,8}, Michel Doffoël^{1,2,8}, Zhen-Yong Keck⁹, Steven K.H. Fong⁹, Mirjam B. Zeisel^{1,2}, Françoise Stoll-Keller^{1,2,3}, Thomas F. Baumert^{1,2,8,§}

¹Inserm, U748, 67000 Strasbourg, France, ²Université de Strasbourg, 67000 Strasbourg, France, ³Laboratoire de Virologie, Hôpitaux Universitaires de Strasbourg, 67000 Strasbourg, France, ⁴Bases Moléculaires et Structurales des Systèmes Infectieux, UMR 5086, CNRS, Université de Lyon, Institut de Biologie et Chimie des Proteines, 69367 Lyon, France, ⁵Université de Lyon, Université Claude Bernard Lyon1; IFR 128 ; Inserm, U758; Ecole Normale Supérieure de Lyon, 69364 Lyon, France, ⁶Division of Experimental Virology, TWINCORE, Centre for Experimental and Clinical Infection Research, a joint venture between the Medical School Hannover and the Helmholtz Centre for Infection Research, 30625 Hannover, Germany, ⁷The Department of Infectious Diseases, Molecular Virology, Heidelberg University, 69120 Heidelberg, Germany, ⁸Pôle Hepato-digestif, Hôpitaux Universitaires de Strasbourg, 67000 Strasbourg, France, ⁹Department of Pathology, Stanford University School of Medicine, Stanford, 94304 California, USA

Grant support: This work was supported by Inserm, the European Union (ERC-2008-AdG-233130-HEPCENT and Interreg IV FEDER-Hepato-Regio-Net 2009), the ANR chair of excellence program (ANR-05-CEXC-008), ANRS (2007/306, 2008/354, 2009/183, 2011/132), the Région d'Alsace (2007/09), the Else Kröner-Fresenius Stiftung (EKFS P17//07//A83/06), the Ligue Contre le Cancer (CA 06/12/08), INCA (2009-143) and Canceropôle du Grand-Est (30/03/09), the Finovi Foundation, the IBiSA GIS, the SFERE program and PHS grants HL079381 and AI081903.

Acknowledgements: The authors thank F. Chisari (The Scripps Research Institute, La Jolla) for the gift of Huh7.5.1 cells, J. A. McKeating (University of Birmingham, Birmingham, UK), C. Rice (Rockefeller University, New York City), C. Schuster (Inserm U748, Strasbourg, France), M. Heim (University of Basel, Basel Switzerland), F. Wong-Staal (Itherx, San Diego), J. Dubuisson (Inserm U1019, Lille, France) and F. Rey (Institut Pasteur, Paris) for helpful discussions. We acknowledge excellent technical assistance of Michèle Bastien-Valle (Inserm U748, Strasbourg, France).

Abbreviations: CLDN - claudin; CTRL - control; HCV - hepatitis C virus; HCVpp - HCV pseudoparticles; HMAb - human monoclonal antibody; HVR - hypervariable region; IgG - immune globulin G; mAb - monoclonal antibody; RLU - relative light units; SR-BI - scavenger receptor class B type I; LT - liver transplantation; OCLN – occludin ; V- viral variant.

§**Correspondence:** Thomas F. Baumert, M. D., Inserm Unit 748, Hôpitaux Universitaires de Strasbourg, 3 rue Koeberlé, F-67000 Strasbourg, France; phone: (33) 3 68 85 37 02; fax: (33) 3 68 85 37 50, e-mail: Thomas.Baumert@unistra.fr

Disclosures: This author discloses the following: T.P. is member of the advisory board of Biotest AG and reports receiving consultancies. The remaining authors disclose no conflicts.

Author contribution: I.F., S. F.-K and P.C. contributed equally to this work. S. F.-K, M. B. Z., F. S.-K and T. F. B. designed and supervised research. I. F., S. F.-K, P. C, C. F., M. N. Z., M. T., L. H., K. C., J. H., C. C., M.-S. H., F.-L. C, F. H., Z.-Y. K., S. K. H. F, M. B. Z., F. S.-K and T. F. B. performed research. I. F., S. F.-K, P. C, C. F., M. N. Z., M. T., M. B. Z., F. S.-K and T. F. B analyzed data. F.-L. C, T. P., R. B., F. H., M. D. F. S.-K provided reagents. I. F., S. F.-K, P. C, M. B. Z. and T. F. B. wrote the paper.

Word count: title – 93 characters, abstract – 261 words, text – 5,993 words

ABSTRACT

Background & Aims: The development of vaccines and other strategies to prevent hepatitis C virus (HCV) infection is limited by rapid viral evasion. HCV entry is the first step of infection; this process involves several viral and host factors and is targeted by host neutralizing responses. Although the roles of host factors in HCV entry have been well characterized, their involvement in evasion of immune responses is poorly understood. We used acute infection of liver graft as a model to investigate the molecular mechanisms of viral evasion.

Methods: We studied factors that contribute to evasion of host immune responses using patient-derived antibodies, HCV pseudoparticles, and cell culture-derived HCV that express viral envelopes from patients who have undergone liver transplantation. These viruses were used to infect hepatoma cell lines that express different levels of HCV entry factors.

Results: Using reverse genetic analyses, we identified altered use of host-cell entry factors as a mechanism by which HCV evades host immune responses. Mutations that alter use of the CD81 receptor also allowed the virus to escape neutralizing antibodies. Kinetic studies demonstrated that these mutations affect virus–antibody interactions during post-binding steps of the HCV entry process. Functional studies with a large panel of patient-derived antibodies showed that this mechanism mediates viral escape, leading to persistent infection in general.

Conclusion: We identified a mechanism by which HCV evades host immune responses, in which use of cell entry factors evolves with escape from neutralizing antibodies. These findings advance our understanding of the pathogenesis of HCV infection and might be used to develop antiviral strategies and vaccines.

Keywords: virology; liver disease; tissue culture model; immunity

INTRODUCTION

Hepatitis C virus (HCV) infection is a major cause of liver disease.¹ A vaccine is not available and antiviral treatment is limited by resistance and adverse effects.² HCV-induced liver disease is a leading indication for liver transplantation (LT).³ A major limitation of LT is the universal re-infection of the liver graft with accelerated recurrence of liver disease. A strategy to prevent re-infection is lacking.³ Thus, there is an urgent unmet medical need for the development of efficient and safe antivirals and vaccines.

HCV entry is required for initiation, maintenance and dissemination of infection. Viral entry is a key target for adaptive host responses and antiviral strategies.^{4, 5} Functional studies in clinical cohorts highlight that viral entry and escape from antibody-mediated neutralization play an important role in viral persistence and liver disease.⁶⁻¹² HCV entry is a highly orchestrated process mediated by viral envelope glycoproteins E1 and E2 and several host factors including heparan sulfate, CD81, scavenger receptor BI (SR-BI), claudin-1 (CLDN1), occludin (OCLN) (reviewed in ⁵) and kinases.¹³ While the role of E1E2 in antibody-mediated neutralization has intensively been studied,^{4, 5, 14} the role of host factors for viral evasion *in vivo* is only poorly understood.

Acute graft infection is an established *in vivo* model to study viral evasion since viral infection and host neutralizing responses can be precisely monitored.⁸ Viral entry and escape from host neutralizing responses are important determinants allowing the virus to rapidly infect the liver during transplantation.⁸ However, the molecular mechanisms by which the virus evades host immunity to persistently re-infect the liver graft are unknown.

To uncover viral and host factors mediating enhanced viral entry and escape, we functionally analyzed genetically closely related prototype variants derived from a well-characterized patient undergoing LT.⁸ One variant P01VL re-infecting the liver graft was characterized by high infectivity and escape from neutralizing antibodies present in autologous pre-transplant serum.⁸ The other closely related variants, P01VA and VC, were not selected during LT and characterized by lower infectivity and high sensitivity to neutralization by autologous pre-transplant serum.⁸ Previous studies had indicated that an E2 region comprising amino acids 425-483 most likely contained mutations responsible for the phenotype of enhanced entry and viral evasion of variants re-infecting the liver graft.⁸

MATERIALS AND METHODS

Patients. Evolution and functional analysis of viral variants of patient P01 have been described.⁸ Anti-HCV-positive serum samples from patients undergoing transplantation and chronic HCV infection were obtained with approval from the Strasbourg University Hospital IRB (ClinicalTrial.gov Identifiers NCT00638144 and NCT00213707).

Plasmids. Plasmids for HCVpp production of variants VL, VA and VC have been described.⁸ E1E2-encoding sequences were used as templates for individual and combinations of mutations using the QuikChange II XL site-directed mutagenesis kit (Stratagene). Mutations were confirmed by DNA sequence analysis (GATC Biotech) for the desired mutation and for exclusion of unexpected residue changes in the full-length E1E2 encoding sequences. Mutated constructs were designated X#Y, where # is the residue location in H77c,¹⁵ X is the mutated and Y the original amino acid.

Antibodies. Monoclonal anti-E1 (11B7) and anti-E2 (AP33, IGH461, 16A6), human anti-HCV IgG,^{10, 16} HMAbs CBH-2, CBH-5, CBH-23 and HC-1 have been described.^{9, 17} Anti-CD81 (JS-81) was from BD Biosciences, AP33 from Genentech, 11B7, IGH461 and 16A6 from Innogenetics.

Cell lines. HEK 293T and Huh7.5.1 cells were cultured as described.^{10, 13, 16} Huh7.5.1 cells overexpressing HCV entry factors were created by stable lentiviral gene transfer of CLDN1, OCLN, SR-BI or CD81.¹⁸ Huh7.5 stably transduced with retroviral vectors encoding for CD81 and CD13-specific shRNAs have been described.¹⁹ Receptor expression was assessed by flow cytometry.¹³

HCVpp and HCVcc production, infection and neutralization. Lentiviral HCVpp bearing patient-derived envelope glycoproteins were produced as described.^{8, 10, 20} The amount of HCVpp was normalized following quantification of HIV p24 antigen expression (Innotest HIV Antigen mAb Kit, Innogenetics) and HCVpp entry was performed as described.^{8, 10, 11, 16} Chimeric HCVcc expressing patient-derived structural proteins were constructed and produced as described in Supplementary Materials and Methods. HCVcc infectivity was determined by determining the TCID₅₀²¹ or intracellular HCV RNA levels as described.^{13, 21, 22} HCVpp and HCVcc neutralization were performed as described.^{8, 10, 11, 16}

Kinetic assays. HCVpp kinetic assays were performed in Huh7.5.1 cells using anti-CD81 (JS-81) and anti-E2 (CBH-23) mAbs as described.^{16, 23}

Statistical analysis. Statistical analysis (Repeated Measures ANOVA) was performed using the SPSS 16.0 software for Windows (SPSS Inc., Chicago, IL).

RESULTS

HCV E2 residues at positions 447, 458 and 478 confer enhanced viral entry of a high-infectivity variant re-infecting the liver graft. To investigate the molecular mechanism of enhanced entry of the variant VL re-infecting the liver graft, we first introduced individual mutations of region E₄₂₅₋₄₈₃⁸ of the low-entry and neutralization-sensitive mutant VC into HCV pseudoparticles (HCVpp) expressing envelope glycoproteins of the highly infectious escape variant VL (Fig. 1A). Previous studies had indicated that this region most likely contains the mutations responsible for the high-infectivity phenotype of VL.⁸ Following normalization of HCVpp levels by p24 antigen expression, viral entry was quantified relative to the escape variant VL. The entry level of the nonselected variant VC was 5% compared to the escape variant VL (Fig. 1B). By introducing the mutations S458G and R478C into VC, chimeric HCVpp showed similar viral entry level as the paternal variant VL whereas introduction of individual or combination of other mutations only had a partial effect (Fig. 1B, Fig. S1). To explore the impact of other positions on viral entry we introduced mutations from another nonselected variant termed VA into VL (Fig. 1A) and identified position F447 as an additional residue relevant for enhanced entry of the escape variant VL (Fig. 1C). These results demonstrate that residues F447L, S458G and R478C are largely responsible for the high-infectivity of the escape variant VL.

Enhanced viral entry by mutations F447L, S458G and R478C of the escape variant is the result of altered use of CD81. To address whether the mutations affect viral entry by different usage of cell entry factors SR-BI, CD81, CLDN1 and OCLN, we studied viral entry of HCVpp derived from parental and chimeric variants in Huh7.5.1 cells stably overexpressing individually the four main entry factors (Fig. 2A). Overexpression of either SR-BI, CD81, CLDN1 or OCLN, did not affect the stability or proportion of other cell surface HCV receptors (Fig. 2B and data not shown).

Overexpression of CD81 significantly enhanced viral entry of VL (3.2fold) and VC (2fold) compared to parental cells ($P < .001$) (Fig. 2C). The fold change in HCVpp entry was significantly higher for VL than for VC ($P < .001$). Exchanging the two residues at position 458 and 478 similarly increased viral entry. This suggests that combination of the two individual mutations modulates viral entry by altering CD81-dependency. Overexpression of SR-BI also increased viral entry of VL and VC, but no specific increase was observed for the chimeric strains containing substitutions at positions 458 and 478 (Fig. 2C). These data confirm an important role for SR-BI as an entry factor for patient-derived variants, but also demonstrate that positions 458 and 478 do not significantly alter SR-BI-dependency. Thus,

increased entry efficiency of VL in SR-BI-overexpressing cells is most likely due to other mutations, e. g. in HVR1. Viral entry enhancement was less pronounced in cells overexpressing CLDN1 or OCLN than CD81 and SR-BI (Fig. 2C) and no specific modulation of viral entry was associated with the two variants or chimeric strains.

The CD81 usage of viral variants VL, VC and VA was further investigated using Huh7.5 cells with silenced CD81 expression (Fig. 3A).¹⁹ The escape variant VL showed the highest decrease (5.4fold) of viral entry in shCD81-Huh7.5 cells compared to the decrease of variants VC (4.3fold, $P < .001$) and VA (2.9fold, $P < .001$) (Fig. 3B-C). Exchange of the mapped residues into chimeric expression plasmids conferred the phenotype of decreased entry of VL (Fig. 3B-C) confirming that identified residues modulate viral entry by different CD81 usage. Moreover, using a relevant model system for HCV-CD81 interactions occurring *in vivo* consisting of cell surface-expressed CD81, we demonstrate that E1E2 complexes of the escape variant VL bound less efficiently to shCD81-Huh7.5 cells than glycoproteins of variants VC and VA (Fig. S2A). Exchange of the mapped residues conferred similar phenotypes as the parental glycoproteins (Fig. S2B) suggesting that the residues at positions 447, 458 and 478 alter E1E2 interactions with cell surface CD81.

Taken together, these data demonstrate that (i) the escape variant is characterized by markedly altered CD81 usage and (ii) altered CD81 usage of the variant is mediated by residues at positions 447, 458 and 478.

Since the levels of E1E2 incorporation into HCVpp and lentiviral p24 antigen expression were similar for all strains (Fig. S3A-D), it is unlikely that the differences in viral entry are the result of impaired HCVpp assembly or release.

Next, to assess whether enhanced entry is due to more rapid internalization of viral particles we investigated internalization kinetics of the parental and chimeric variants in the presence of anti-CD81 antibody.^{16, 21, 23, 24} Since entry kinetics of parental and chimeric variants were similar (Fig. 3D), it is unlikely that the mutant-induced modulation of CD81-dependency alters the velocity of viral entry.

Positions 447, 458 and 478 mediate escape from autologous transplant serum during graft re-infection. To assess whether the residues in region E2₄₂₅₋₄₈₃ influencing viral entry (Fig. 1) were also responsible for escape from antibody-mediated neutralization, we studied the impact of each single and combined substitutions of the nonselected variant VC on neutralization by autologous pre-transplant serum. Autologous pre-transplant serum only poorly neutralized the selected variant VL as well as the variants substituted at position 434, 444, and 445 while individual substitution at positions 458 and 478 significantly ($P < .001$, P

$\leq .05$) increased the sensitivity of VLVC₄₅₈ and VLVC₄₇₈ to autologous neutralizing antibodies (1:400 and 1:200) (Fig. 4A). Noteworthy, only the variant VLVC₄₅₈₊₄₇₈ showed a similar neutralization titer as the nonselected variant VC (1:6,400, $P < .001$). To confirm that these mutations were indeed responsible for the phenotype of the parental variant VL, we investigated neutralization of VCVL₄₅₈₊₄₇₈ by autologous serum. The variant VCVL₄₅₈₊₄₇₈ escaped autologous neutralization similarly to the escape variant VL (Fig. 4A). A similar phenotype was observed when mutation 447 of VA was introduced into the VL cDNA (Fig. 4B). In contrast, the introduction of other residues into VL only had a minor effect on neutralization (Fig. 4B). Taken together, these findings suggest that the residues at positions 447, 458 and 478 are simultaneously responsible for both enhanced viral entry and evasion from antibody-mediated neutralization.

Positions 447, 458 and 478 define a conformational epitope involved in evasion from host neutralizing responses. To further elucidate the mechanism of viral evasion of the escape variant VL from patient-derived neutralizing antibodies, we investigated whether the identified mutations F447L, S458G and R478C confer resistance or sensitivity to a panel of mAbs directed against conformational^{9, 17} and linear E2 epitopes.¹⁶ The conformational HMAs (CBH-2, CBH-5, CBH-23, HC-1) have been shown to exhibit a broad cross-neutralizing activity by interfering with E2-CD81 interaction^{9, 17} and their epitopes are only partially defined (Table S1). AP33 is directed against a conserved epitope comprising aa 412-423.²⁵ While the escape variant VL was poorly neutralized by several HMAs directed against conformational epitopes, VC and VA were efficiently neutralized by all HMAs (Fig. 5A-B). Moreover, by substituting the residues at positions 458 and 478 or 447, the well neutralized nonselected variants VC (VCVL₄₅₈₊₄₇₈) and VA (VAVL₄₄₇) became neutralization-resistant as the escape variant VL. Introducing the residues of VC or VA into VL (VLVC₄₅₈₊₄₇₈ and VLVA₄₄₇) restored neutralization by HMAs, suggesting that these residues are part of the HMAs epitopes. In contrast, anti-E2 antibodies (AP33, 16A6, IGH461) targeting linear epitopes similarly neutralized parental and chimeric variants (Fig. 5A-B and Table S1).

Antibody-mediated neutralization occurs at binding and post-binding steps during viral entry.¹⁶ To map the entry step involved in viral evasion from neutralizing antibodies by VL, we investigated the neutralization kinetics of parental and chimeric variants.^{16, 21, 23} The anti-E2 HMA CBH-23 inhibited viral entry of VC and VLVC₄₅₈₊₄₇₈ at post-binding steps during time points closely related to HCV-CD81 interaction (Fig. 5C). Partial inhibition at post-

binding steps by CBH-23 was also observed for VA and VLVA₄₄₇ (Fig. 5D). The VL variant escaped antibody-mediated neutralization at the same steps.

Interestingly, purified HCVpp expressing envelope glycoproteins of the escape variant bound similarly to neutralizing anti-E2 antibody CBH-23 as the envelope glycoproteins of non selected variants or variants containing mutations of the identified escape residue (Fig. S4). Thus, it is likely that viral evasion is not due to decreased antibody-binding to circulating virions but rather occurs during post-binding steps of viral entry where E2-host entry factor interactions result in conformational changes of the envelope and failure of antibodies to inhibit entry. Taken together, these data indicate that positions 447, 458 and 478 mediate viral evasion from neutralizing antibodies at post-binding steps and time points closely related to HCV-CD81 interaction.

Positions 447, 458 and 478 mediate escape from antiviral antibodies in non-related patients with chronic HCV infection. To investigate whether these mutations not only result in escape from antibodies from the same patient but also confer resistance to antiviral antibodies of non-related HCV infected patients, we studied the neutralization of the parental variants by a large panel of sera randomly selected from chronically infected patients (n = 102). While VL was not neutralized by 53 out of 102 patient sera (mean neutralizing titer, 1:144) VC was significantly neutralized by 90 out of 102 patient sera (mean neutralizing titer, 1:1,088, $P < .001$) (Fig. 6 and Table S2). Similar results were obtained for VA (neutralization by 80 out of 102 patient sera, mean neutralizing titer of 1:322, $P = .01$). Functional analysis of HCVpp expressing chimeric envelope glycoproteins demonstrated that neutralization of VC and VA was predominantly mediated by the identified mutations in residues 447, 458 and 478 (Fig. 6).

Confirmation of differential cell entry factor usage and viral evasion using chimeric HCVcc. Finally, we confirmed the functional impact of the three residues on virus-host interactions using the HCVcc system. To address this issue we constructed chimeric JFH-1 based HCVcc expressing the VL wild-type envelope or VL containing VC and VA-specific functional residues. Viruses containing patient-derived envelopes showed similar levels of replication and envelope production (data not shown). Phenotypic analyses of infection and neutralization of chimeric HCVcc confirmed the relevance of the identified residues for enhanced entry, differential CD81 usage and viral evasion (Fig. 7A-D). While the escape variant VL was poorly neutralized, the identified mutations at positions 447, 458 and 478 restored its sensitivity to conformational HMAb CBH-23 (Fig. 7C) as well as to heterologous

sera from chronically infected patients (Fig. 7D). These data confirm the functional relevance of the obtained results in the HCVcc system expressing authentic patient-derived envelopes.

DISCUSSION

Using acute infection of the liver graft as an *in vivo* model, we identified a novel, clinically and therapeutically important mechanism of viral evasion, where co-evolution simultaneously occurs between cellular entry factor usage and escape from neutralization.

Several host selection forces operate concomitantly during HCV infection. These include pro-viral host factors resulting in selection of most infectious viruses best adapted to host factors and anti-viral host immune responses leading to escape from immune responses. Antibody-mediated selective pressure is thought to be an important driver of viral evolution.^{8, 11} The immune response may fail to resolve HCV infection because neutralizing antibody-mediated response lags behind the rapidly and continuously evolving HCV glycoprotein sequences.¹¹ However, continuous generation of escape mutations during chronic HCV infection may also compromise virus infectivity: indeed, it has been reported that structural changes in E2 leading to complete escape from neutralizing antibodies simultaneously compromised viral fitness by reducing CD81-binding.⁹ Moreover, escape from T cell responses has been associated with impaired viral replication.^{26, 27} We show for the first time that clinically occurring mutations simultaneously lead to enhanced viral infectivity by optimizing host factor usage and escape from host immune responses. Since this mechanism was uncovered in patient strains isolated during acute liver graft infection it is likely that the novel and unique mechanism of co-evolution between host factor usage and viral evasion ensures optimal initiation, dissemination and maintenance of viral infection in the early phase of liver graft infection. In addition, since the VL strain escapes autologous antibodies from the transplant patient (Fig. 4) and resists to monoclonal and polyclonal antibodies of heterologous patients (Figs. 5, 6, 7 and Tables S1, S2), and given the high prevalence of the identified mutations in a large genomic database of viral isolates (Fig. S5 and Supplementary Results), the co-evolution of receptor usage and escape from neutralizing antibodies may also play an important role for viral evasion in chronic HCV infection in general.

Our mechanistic studies demonstrate that the identified viral evasion factors are part of a conformational neutralizing epitope modulating E2-CD81 interactions at post-binding entry steps.^{28, 29} Noteworthy, the same mutations were also responsible for immune escape of VL. Neutralization studies using HMAbs directed against discontinuous envelope glycoprotein regions termed domain B and C^{30, 31} demonstrate that the three positions are part of an epitope which plays a key role for neutralization and viral evasion. Since the mutations are outside the known contact residues within the epitopes of the HMAbs CBH-2, CBH-5, CBH-23 and HC-1^{9, 17} (Table S1) and complementary to previously identified regions

associated with escape from neutralizing monoclonal antibodies,²⁵ positions 447, 458 and 478 either modulate the interaction of the majority of antibodies directed against domain B and C epitopes or are part of a novel E2 epitope mediating evasion from host neutralizing antibodies.

Based on previous functional observations and structural predictions, Krey and colleagues proposed a model for a potential tertiary organisation of E2. In this model, E2 comprises three subdomains with the CD81 binding regions located within domain I (W420, A440LFY, Y527, W529, G530 and D535) and potential CD81 binding sites overlapping with domain III (Y613RLWHY).^{28, 29, 32, 33} In this model, positions 447, 458 and 478 are located outside but in close proximity of the previously suggested CD81 binding domains. Moreover, position 447 is located immediately downstream a conserved motif between HVR1 and HVR2 which has been shown to play an important role in CD81 recognition as well as pre- or post-CD81 dependent stages of viral entry.³² Position 478 is located within HVR2 which modulates, by a complex interplay with HVR1, binding of E2 glycoprotein to CD81.³⁴

Since mutations F447L, S458G and R478C (i) modulate CD81-dependency of HCV entry (Fig. 2 and 3), (ii) alter the interaction with cell surface CD81 (Fig. S2), (iii) mediate viral evasion from antibodies at post-binding steps closely related to HCV-CD81 interactions (Fig. 5) and (iv) are located within E2 loops of the predicted E2 secondary structure and tertiary organization²⁹ positions 447, 458 and 478 may be part of two loops belonging to a larger cluster of closely related surface-exposed E2 loops. These loops are most likely involved in E2-CD81 binding either directly or indirectly as a key point for structural rearrangement during viral entry.^{34, 35}

The polar S and R residues present in the escape variant can form non-bonded interactions with other residues by hydrogen bonds and salt bridge, respectively. These interactions could increase the stability of the interacting E2-CD81 interface allowing efficient entry of the VL escape variant through E2-CD81-CLDN1 co-receptor complexes which are key determinants for viral entry.^{13, 23, 36} Furthermore, the E2 cluster of loops containing the mutations bears linear epitopes but also defines at least one conformational epitope that is a target of neutralizing antibodies. According to residue physical-chemical properties, the VL variant S458 and R478 residues enhance the hydrophilicity of the loops they belong to and may promote the surface exposure of the loops. This change could further modulate E2-CD81 interactions and impair the binding of neutralizing antibodies by blocking access to their target epitopes. The F to L substitution present in the VA strain most likely does not profoundly alter the tertiary or quaternary structure of E2. This is suggested by the fact that this position is located in a loop as predicted by the proposed E2 model.²⁹ Thus, it is

conceivable that this mutation which increases E2 hydrophobicity may reduce accessibility of the loop and its interactions with CD81 or CD81-CLDN1 co-receptor complexes. Alternatively, allosteric mechanisms may play a role in the observed virus-antibody-host interactions.

Taken together, our data identified key determinants of immune evasion *in vivo*. Mutations conferring neutralization escape altered CD81 receptor usage and enhanced cell entry. Moreover, our data suggest that mutations in HVR1 which may modulate entry and neutralization by altering SR-BI-dependency (Fig. 1, 2, 4 and data not shown) may contribute to the high-entry and escape phenotype of the escape variant. Furthermore, interfering non-neutralizing antibodies may constitute another mechanism of escape (data not shown).

Although proof-of-concept studies in animal models have demonstrated a potential role for HMAs in prevention of HCV infection,^{37, 38} the partial or complete escape of the VL variant from autologous and heterologous serum-derived antibodies as well as many broadly cross-neutralizing HMAs (Fig. 5; Table S1) demonstrates the ability of the virus to evade cross-neutralizing anti-envelope mAbs. By identifying viral and host factors mediating immune evasion in the HCV-infected patient, our results may open new perspectives for the development of broadly cross-neutralizing anti-envelope or anti-receptor antibodies overcoming viral escape.

REFERENCES

1. Alter H. Viral hepatitis. *Hepatology* 2006;43:S230-4.
2. Hofmann WP, Zeuzem S. A new standard of care for the treatment of chronic HCV infection. *Nat Rev Gastroenterol Hepatol* 2011;8:257-64.
3. Watt K, Veldt B, Charlton M. A practical guide to the management of HCV infection following liver transplantation. *Am J Transplant* 2009;9:1707-13.
4. Zeisel MB, Cosset FL, Baumert TF. Host neutralizing responses and pathogenesis of hepatitis C virus infection. *Hepatology* 2008;48:299-307.
5. Zeisel MB, Fofana I, Fafi-Kremer S, Baumert TF. HCV entry into hepatocytes: mechanism and potential therapeutic implications. *J Hepatol* 2011;54:566-576.
6. Lavillette D, Morice Y, Germanidis G, Donot P, Soulier A, Pagkalos E, Sakellariou G, Intrator L, Bartosch B, Pawlotsky JM, Cosset FL. Human serum facilitates hepatitis C virus infection, and neutralizing responses inversely correlate with viral replication kinetics at the acute phase of hepatitis C virus infection. *J Virol* 2005;79:6023-34.
7. Dowd KA, Netski DM, Wang XH, Cox AL, Ray SC. Selection Pressure From Neutralizing Antibodies Drives Sequence Evolution During Acute Infection With Hepatitis C Virus. *Gastroenterology* 2009;136:2377-86.
8. Fafi-Kremer S, Fofana I, Soulier E, Carolla P, Meuleman P, Leroux-Roels G, Patel AH, Cosset F-L, Pessaux P, Doffoël M, Wolf P, Stoll-Keller F, Baumert TF. Enhanced viral entry and escape from antibody-mediated neutralization are key determinants for hepatitis C virus re-infection in liver transplantation. *J Exp Med* 2010;207:2019-2031.
9. Keck ZY, Li SH, Xia J, von Hahn T, Balfe P, McKeating JA, Witteveldt J, Patel AH, Alter H, Rice CM, Fong SK. Mutations in hepatitis C virus E2 located outside the CD81 binding sites lead to escape from broadly neutralizing antibodies but compromise virus infectivity. *J Virol* 2009;83:6149-60.
10. Pestka JM, Zeisel MB, Blaser E, Schurmann P, Bartosch B, Cosset FL, Patel AH, Meisel H, Baumert J, Viazov S, Rispeter K, Blum HE, Roggendorf M, Baumert TF. Rapid induction of virus-neutralizing antibodies and viral clearance in a single-source outbreak of hepatitis C. *Proc Natl Acad Sci U S A* 2007;104:6025-30.
11. von Hahn T, Yoon JC, Alter H, Rice CM, Rehmann B, Balfe P, McKeating JA. Hepatitis C virus continuously escapes from neutralizing antibody and T-cell responses during chronic infection in vivo. *Gastroenterology* 2007;132:667-78.
12. Osburn WO, Fisher BE, Dowd KA, Urban G, Liu L, Ray SC, Thomas DL, Cox AL. Spontaneous control of primary hepatitis C virus infection and immunity against persistent reinfection. *Gastroenterology* 2010;138:315-24.

13. Lupberger J, Zeisel MB, Xiao F, Thumann C, Fofana I, Zona L, Davis C, Mee CJ, Turek M, Gorke S, Royer C, B. F, Zahid MN, Lavillette D, J. F, Cosset F-L, Rothenberg SM, Pietschmann T, Patel AH, Pessaux P, Doffoël M, Raffelsberger W, Poch O, McKeating JA, Brino L, Baumert TF. EGFR and EphA2 are hepatitis C virus host entry factors and targets for antiviral therapy. *Nat Med* 2011;17:589-95.
14. Stamatakis Z, Grove J, Balfe P, McKeating JA. Hepatitis C virus entry and neutralization. *Clin Liver Dis* 2008;12:693-712.
15. Kuiken C, Combet C, Bukh J, Shin IT, Deleage G, Mizokami M, Richardson R, Sablon E, Yusim K, Pawlotsky JM, Simmonds P. A comprehensive system for consistent numbering of HCV sequences, proteins and epitopes. *Hepatology* 2006;44:1355-61.
16. Haberstroh A, Schnober EK, Zeisel MB, Carolla P, Barth H, Blum HE, Cosset FL, Koutsoudakis G, Bartenschlager R, Union A, Depla E, Owsianka A, Patel AH, Schuster C, Stoll-Keller F, Doffoel M, Dreux M, Baumert TF. Neutralizing host responses in hepatitis C virus infection target viral entry at postbinding steps and membrane fusion. *Gastroenterology* 2008;135:1719-1728.
17. Hadlock KG, Lanford RE, Perkins S, Rowe J, Yang Q, Levy S, Pileri P, Abrignani S, Fong SK. Human monoclonal antibodies that inhibit binding of hepatitis C virus E2 protein to CD81 and recognize conserved conformational epitopes. *J Virol* 2000;74:10407-16.
18. Haid S, Windisch MP, Bartenschlager R, Pietschmann T. Mouse-specific residues of claudin-1 limit hepatitis C virus genotype 2a infection in a human hepatocyte cell line. *J Virol* 2009;84:964-75.
19. Koutsoudakis G, Herrmann E, Kallis S, Bartenschlager R, Pietschmann T. The level of CD81 cell surface expression is a key determinant for productive entry of Hepatitis C Virus into host cells. *J Virol* 2007;81:588-598.
20. Bartosch B, Dubuisson J, Cosset FL. Infectious hepatitis C virus pseudo-particles containing functional E1-E2 envelope protein complexes. *J. Exp. Med.* 2003;197:633-42.
21. Zeisel MB, Koutsoudakis G, Schnober EK, Haberstroh A, Blum HE, Cosset F-L, Wakita T, Jaeck D, Doffoel M, Royer C, Soulier E, Schvoerer E, Schuster C, Stoll-Keller F, Bartenschlager R, Pietschmann T, Barth H, Baumert TF. Scavenger receptor BI is a key host factor for Hepatitis C virus infection required for an entry step closely linked to CD81. *Hepatology* 2007; 46:1722-1731.
22. Fofana I, Krieger SE, Grunert F, Glauben S, Xiao F, Fafi-Kremer S, Soulier E, Mee CJ, McKeating JA, Dragic T, Schuster C, Thompson J, Baumert TF. Monoclonal anti-

- claudin 1 antibodies for prevention of hepatitis C virus infection. *Gastroenterology* 2010;139:953-964, 964.e1-4.
23. Krieger SE, Zeisel MB, Davis C, Thumann C, Harris HJ, Schnober EK, Mee C, Soulier E, Royer C, Lambotin M, Grunert F, Dao Thi VL, Dreux M, Cosset FL, McKeating JA, Schuster C, Baumert TF. Inhibition of hepatitis C virus infection by anti-claudin-1 antibodies is mediated by neutralization of E2-CD81-claudin-1 associations. *Hepatology* 2010;51:1144-57.
 24. Koutsoudakis G, Kaul A, Steinmann E, Kallis S, Lohmann V, Pietschmann T, Bartenschlager R. Characterization of the early steps of hepatitis C virus infection by using luciferase reporter viruses. *J Virol* 2006;80:5308-20.
 25. Owsianka A, Tarr AW, Juttla VS, Lavillette D, Bartosch B, Cosset FL, Ball JK, Patel AH. Monoclonal antibody AP33 defines a broadly neutralizing epitope on the hepatitis C virus E2 envelope glycoprotein. *J Virol* 2005;79:11095-104.
 26. Dazert E, Neumann-Haefelin C, Bressanelli S, Fitzmaurice K, Kort J, Timm J, McKiernan S, Kelleher D, Gruener N, Tavis JE, Rosen HR, Shaw J, Bowness P, Blum HE, Klenerman P, Bartenschlager R, Thimme R. Loss of viral fitness and cross-recognition by CD8+ T cells limit HCV escape from a protective HLA-B27-restricted human immune response. *J Clin Invest* 2009;119:376-86.
 27. Uebelhoer L, Han JH, Callendret B, Mateu G, Shoukry NH, Hanson HL, Rice CM, Walker CM, Grakoui A. Stable cytotoxic T cell escape mutation in hepatitis C virus is linked to maintenance of viral fitness. *PLoS Pathog* 2008;4:e1000143.
 28. Owsianka AM, Timms JM, Tarr AW, Brown RJ, Hickling TP, Szwejk A, Bienkowska-Szewczyk K, Thomson BJ, Patel AH, Ball JK. Identification of conserved residues in the E2 envelope glycoprotein of the hepatitis C virus that are critical for CD81 binding. *J Virol* 2006;80:8695-704.
 29. Krey T, d'Alayer J, Kikuti CM, Saulnier A, Damier-Piolle L, Petitpas I, Johansson DX, Tawar RG, Baron B, Robert B, England P, Persson MA, Martin A, Rey FA. The disulfide bonds in glycoprotein E2 of hepatitis C virus reveal the tertiary organization of the molecule. *PLoS Pathog* 2010;6:e1000762.
 30. Keck ZY, Op De Beeck A, Hadlock KG, Xia J, Li TK, Dubuisson J, Fong SK. Hepatitis C virus E2 has three immunogenic domains containing conformational epitopes with distinct properties and biological functions. *J Virol* 2004;78:9224-32.
 31. Helle F, Goffard A, Morel V, Duverlie G, McKeating J, Keck ZY, Fong S, Penin F, Dubuisson J, Voisset C. The neutralizing activity of anti-hepatitis C virus antibodies is modulated by specific glycans on the E2 envelope protein. *J Virol* 2007;81:8101-11.

32. Drummer HE, Boo I, Maerz AL, Pountourios P. A Conserved Gly436-Trp-Leu-Ala-Gly-Leu-Phe-Tyr Motif in Hepatitis C Virus Glycoprotein E2 Is a Determinant of CD81 Binding and Viral Entry. *J Virol* 2006;80:7844-7853.
33. Boo I, Tewierek K, Douam F, Lavillette D, Pountourios P, Drummer HE. Distinct roles in folding, CD81 receptor binding and viral entry for conserved histidines of HCV glycoprotein E1 and E2. *Biochem J* 2012.
34. Roccasecca R, Ansuini H, Vitelli A, Meola A, Scarselli E, Acali S, Pezzanera M, Ercole BB, McKeating J, Yagnik A, Lahm A, Tramontano A, Cortese R, Nicosia A. Binding of the hepatitis C virus E2 glycoprotein to CD81 is strain specific and is modulated by a complex interplay between hypervariable regions 1 and 2. *J Virol* 2003;77:1856-67.
35. McCaffrey K, Boo I, Pountourios P, Drummer HE. Expression and characterization of a minimal hepatitis C virus glycoprotein E2 core domain that retains CD81 binding. *J Virol* 2007;81:9584-90.
36. Harris HJ, Davis C, Mullins JG, Hu K, Goodall M, Farquhar MJ, Mee CJ, McCaffrey K, Young S, Drummer H, Balfe P, McKeating JA. Claudin association with CD81 defines hepatitis C virus entry. *J Biol Chem* 2010;285:21092-102.
37. Law M, Maruyama T, Lewis J, Giang E, Tarr AW, Stamatakis Z, Gastaminza P, Chisari FV, Jones IM, Fox RI, Ball JK, McKeating JA, Kneteman NM, Burton DR. Broadly neutralizing antibodies protect against hepatitis C virus quasispecies challenge. *Nat Med* 2008;14:25-7.
38. Vanwolleghem T, Bukh J, Meuleman P, Desombere I, Meunier JC, Alter H, Purcell RH, Leroux-Roels G. Polyclonal immunoglobulins from a chronic hepatitis C virus patient protect human liver-chimeric mice from infection with a homologous hepatitis C virus strain. *Hepatology* 2008;47:1846-55.
39. Rychlowska M, Owsianka AM, Fong SK, Dubuisson J, Bienkowska-Szewczyk K, Patel AH. Comprehensive linker-scanning mutagenesis of the hepatitis C virus E1 and E2 envelope glycoproteins reveals new structure-function relationships. *J Gen Virol* 2011;92:2249-61.

FIGURE LEGENDS

Figure 1. Positions 447, 458 and 478 confer enhanced viral entry of a high-infectivity variant re-infecting the liver graft. (A) Genomic organisation and mutations of envelope glycoproteins of escape variant VL and nonselected variants VC and VA. HVR1 and HVR2 are depicted in green; E2 domains in red (DI), yellow (DII) and blue (DIII); and CD81 binding domains in dark blue.^{29, 33, 39} Positions 447, 458 and 478 are highlighted in black vertical lines. Differences between VL, VC and VA in region E1E2₃₈₄₋₄₈₃ are displayed. (B-C) Viral entry in Huh7.5.1 cells of the escape variant VL, the nonselected variants VC and VA as well as chimeric variants containing defined mutations of VC and VA in VL or vice-versa (see Fig. S1). HCVpp infection was analyzed by luciferase reporter gene expression. Results are expressed as percentage of viral entry compared to VL. Means±SD from at least four independent experiments performed in triplicate are shown. Significant differences in HCVpp entry between variants are indicated (*, $P \leq .05$; **, $P < .001$). Abbreviations: aa - amino acid; BD - binding domain; n.s. - not significant

Figure 2. Altered usage of CD81 is responsible for enhanced viral entry of the escape variant. (A) Entry factor expression in clones of SR-BI-, CD81-, CLDN1- or OCLN-transduced Huh7.5.1 cells. The relative overexpression of each entry factors was determined by flow cytometry and is indicated as fold expression compared to parental Huh7.5.1 cells. (B) Entry factor expression in pools of CD81-overexpressing Huh7.5.1 cells (grey bars). The relative entry factor expression was determined as described in (A). (C) Receptor-dependency of patient-derived HCVpp entry. Parental and transduced Huh7.5.1 cells were incubated with parental or chimeric HCVpp and viral entry was determined as described in Fig. 1. Viral entry is expressed as fold change of viral entry compared to parental cells. Means±SD from three independent experiments performed in triplicate are shown. Significant differences in HCVpp entry between variants are indicated (**, $P < .001$).

Figure 3. Different CD81 usage of viral variants in Huh7.5 cells with silenced CD81 expression. (A) Entry factor expression in Huh7.5 cells with silenced CD81 (grey bars) or CD13 (black bars) expression. CD81 expression was determined by flow cytometry and is indicated as fold expression compared to control shCD13-Huh7.5 cells. (B-C) Entry of patient-derived HCVpp VL, VC (B) and VA (C). Huh7.5 cells with silenced CD81 or CD13 expression were incubated with parental or chimeric HCVpp and viral entry was determined as described in Fig. 1. Viral entry is expressed as fold change of viral entry compared to shCD13-Huh7.5 control cells. Means±SD from three independent experiments performed in

triplicate are shown. Significant differences in HCVpp entry between wildtype and chimeric variants are indicated (**, $P < .001$). (D) Entry kinetics of patient-derived variants. Kinetics of HCVpp entry was performed using anti-CD81 or isotype control antibody (5 $\mu\text{g/ml}$). HCV entry was determined as described in Fig.1. A representative experiment out of four is shown.

Figure 4. Positions 447, 458 and 478 mediate viral escape from neutralization by autologous transplant serum. Neutralization of the escape variant VL, variants VC and VA and the chimeric strains. HCVpp were incubated with autologous anti-HCV positive or control serum in serial dilutions for 1 h at 37°C before incubation with Huh7.5.1 cells. Neutralization titers obtained by endpoint dilution are indicated. Dotted line indicates the threshold for a positive neutralization titer (1/40). Means \pm SD from at least four experiments performed in triplicate are shown. (A) Neutralization of variants VL, VL containing individual or combined mutations of VC and VC with double substitutions of VL by autologous anti-HCV positive pre-transplant serum. (B) Neutralization of variants VL, VL containing individual mutations of VA and VA with single substitution of VL by autologous anti-HCV positive pre-transplant serum. Significant differences in neutralization between variants are indicated (*, $P \leq .05$; **, $P < .001$).

Figure 5. Mechanisms of viral evasion from neutralizing antibodies. (A-B) Escape from neutralization by HMAbs directed against conformational and linear epitopes. HCVpp produced from isolates shown in Fig. 1 were incubated with HMAbs (Table S1) or control Ab (10 $\mu\text{g/ml}$) for 1 h at 37°C prior to incubation with Huh7.5.1 cells. Results are expressed as percentage of viral entry relative to HCVpp incubated with control mAb. Means \pm SD from at least four experiments performed in triplicate are shown. Significant differences in HCVpp entry between variants are indicated (**, $P < .001$). (C-D) Escape from neutralization of anti-E2 antibody CBH-23 in kinetic assays. Kinetics were performed as described in Fig. 3 (HMAb 10 $\mu\text{g/ml}$; JS-81: 5 $\mu\text{g/ml}$). A representative experiment out of four is shown.

Figure 6. HCV VL strain is poorly neutralized by antibodies present in sera from a large panel of non-related patients with chronic HCV infection. Parental HCVpp (VL, VC and VA) and chimeric HCVpp (VLVC₄₅₈₊₄₇₈ and VLVA₄₄₇) strains, adjusted for p24 antigen expression, were preincubated for 1 h with serial dilutions of anti-HCV positive sera from randomly selected patients with chronic hepatitis C prior to incubation with Huh7.5.1 target cells. Patient number, gender, HCV genotype and viral load are indicated in Table S2.

Neutralization was determined as in Fig. 4. Mean neutralization titers are marked by lines. Means from at least three independent experiments performed in triplicate are shown. Significant differences in neutralization are indicated.

Figure 7. Entry viral and escape from neutralization of chimeric HCVcc expressing patient-derived viral envelopes. (A) Infectivity of HCVcc expressing envelopes of variant VL and functional residues of VA and VC is indicated by TCID₅₀. Means±SD from one representative experiment are shown. (B) Relative infectivity of chimeric HCVcc expressing patient-derived viral envelopes in Huh7.5 cells with silenced CD81 or CD13 expression. Means±SD from three independent experiments performed in triplicate are shown. (C) Escape from neutralization by HMAb CBH-23. Neutralization was performed as described in Fig. 5. Results are expressed as percentage of viral infectivity relative to HCVcc incubated with control mAb. Means±SD from at least three experiments performed in triplicate are shown. (D) Inhibition of HCVcc infection by anti-HCV positive sera described in Table S2B. Neutralization was performed as described in Fig. 6. Means from one representative experiment performed in triplicate are shown. Significant differences in HCVcc infection between wildtype and chimeric variants are indicated (*, $P \leq .05$; **, $P < .001$)

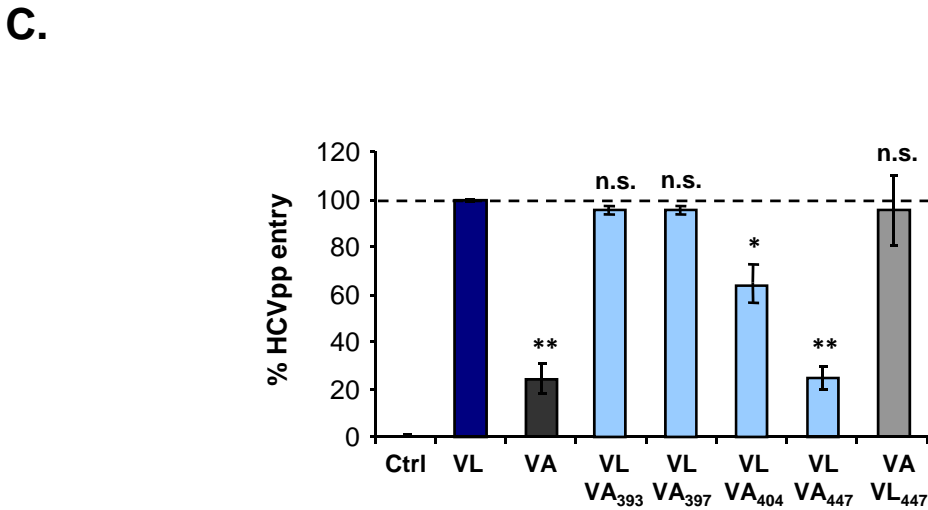
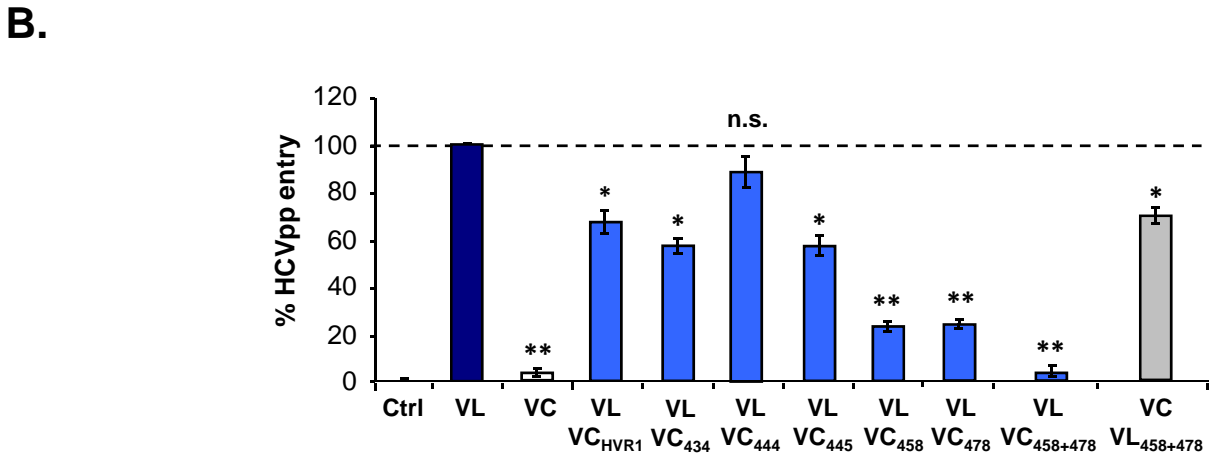
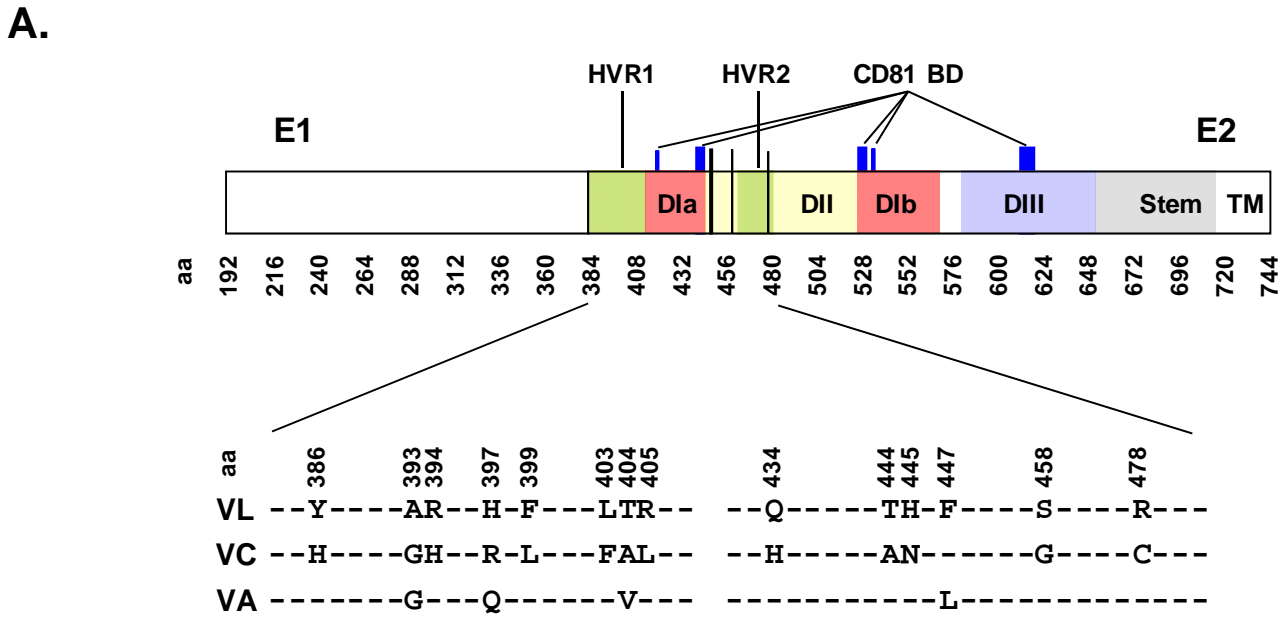

Figure 1

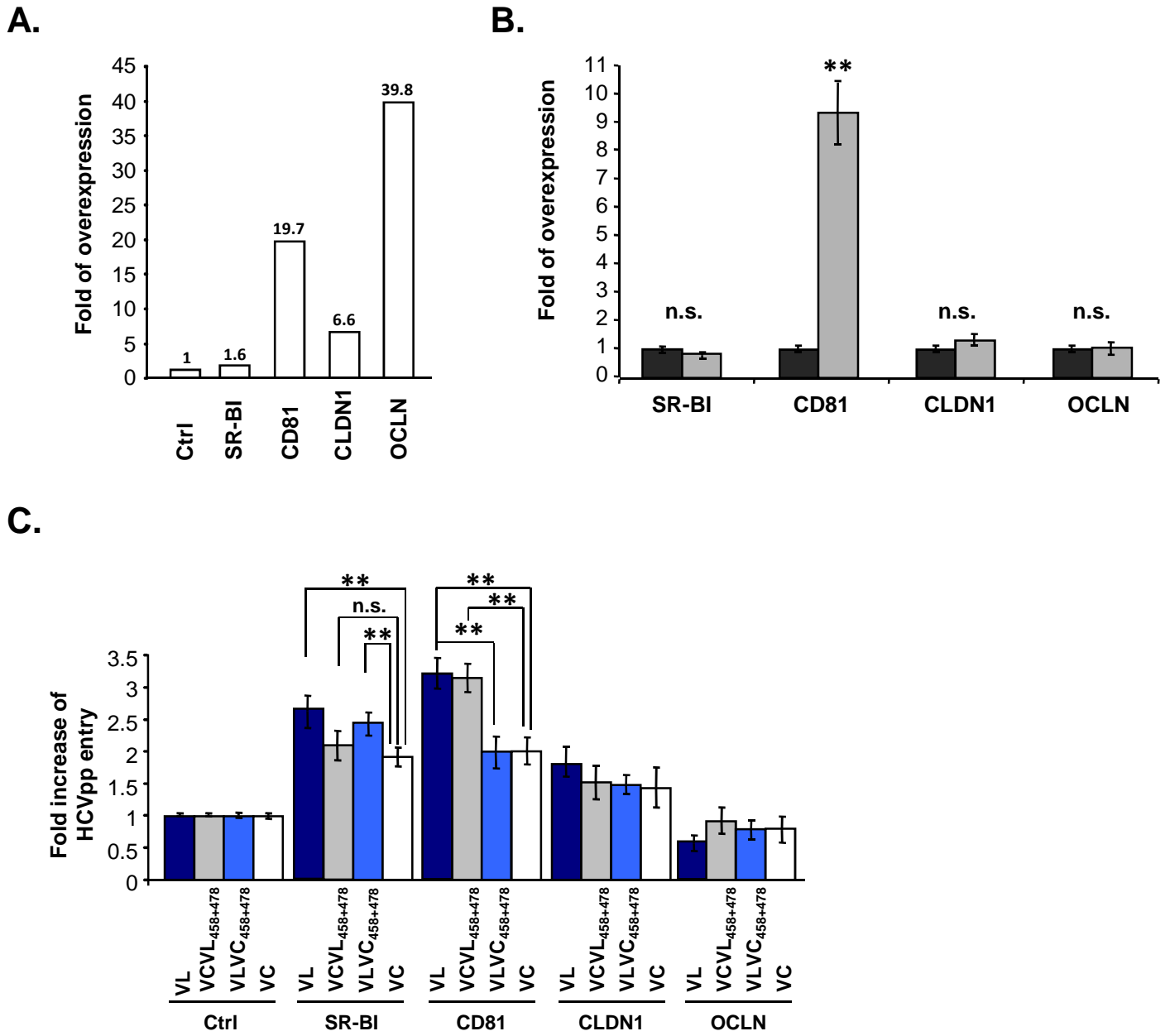
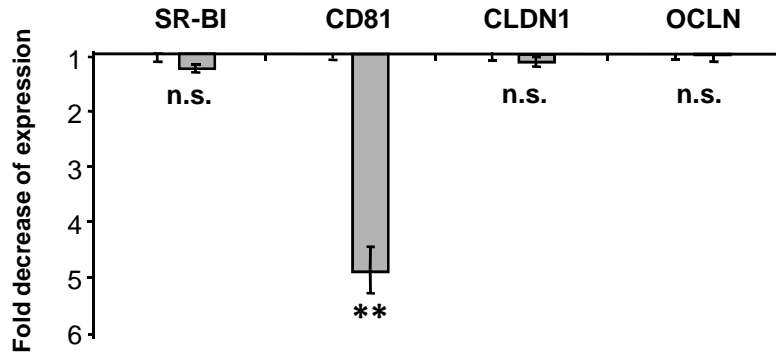
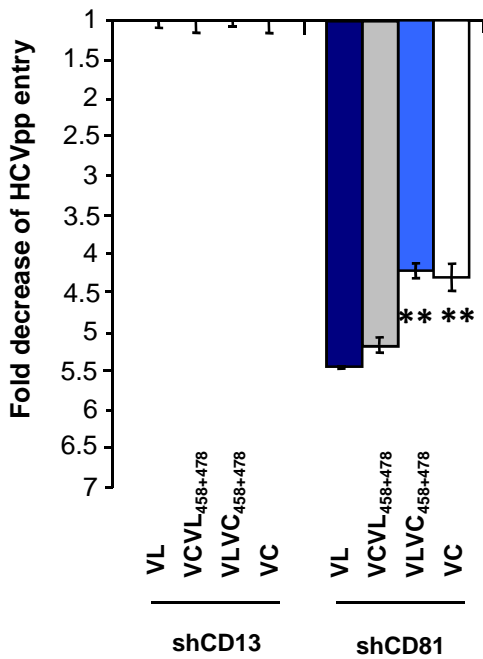

Figure 2

A.



B.



C.

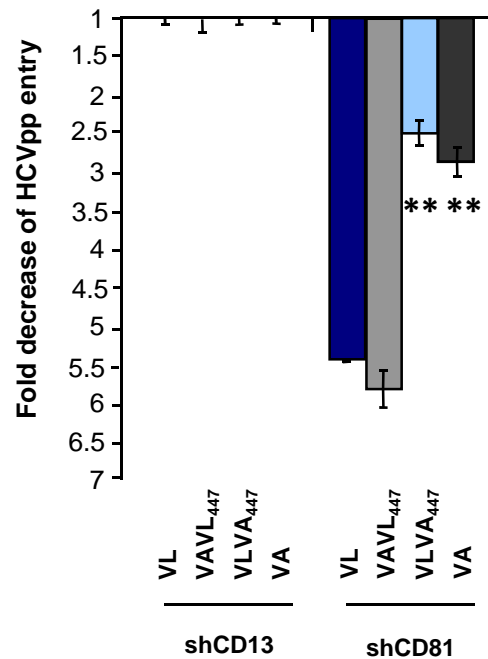

D.

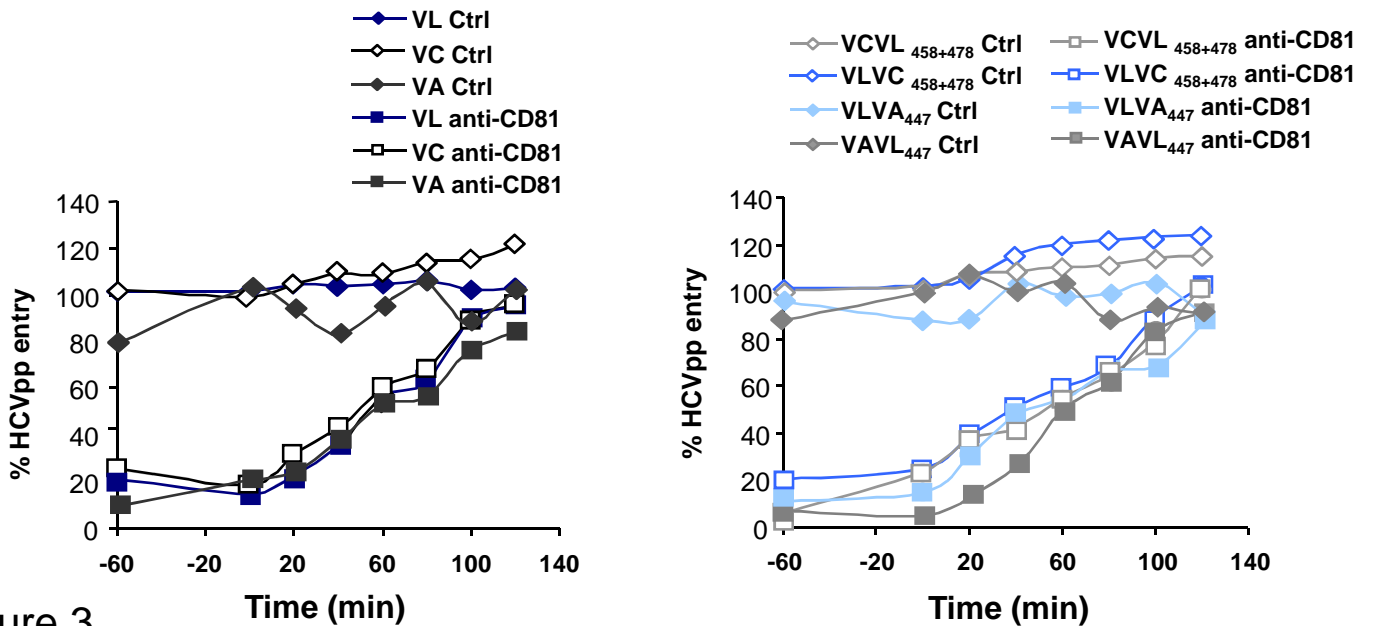
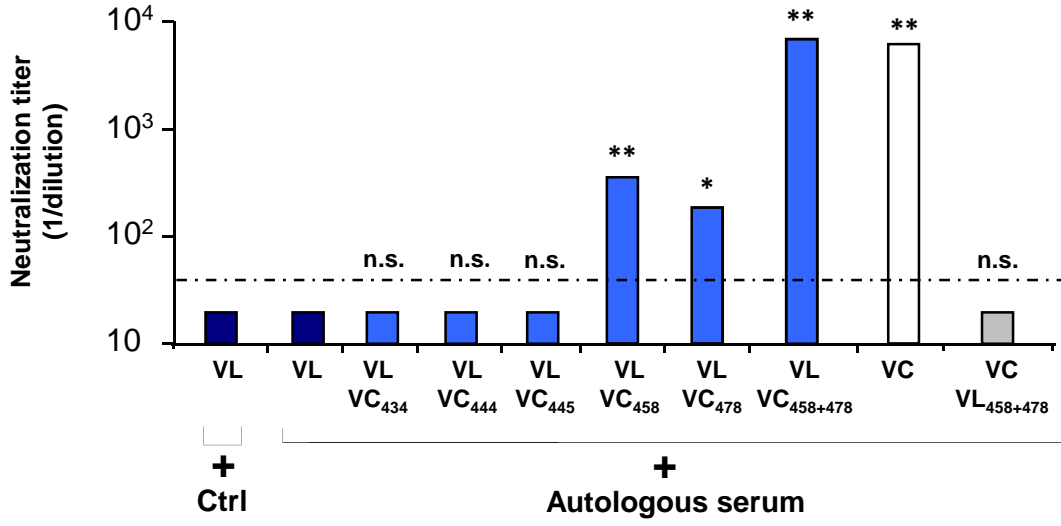

Figure 3

A.



B.

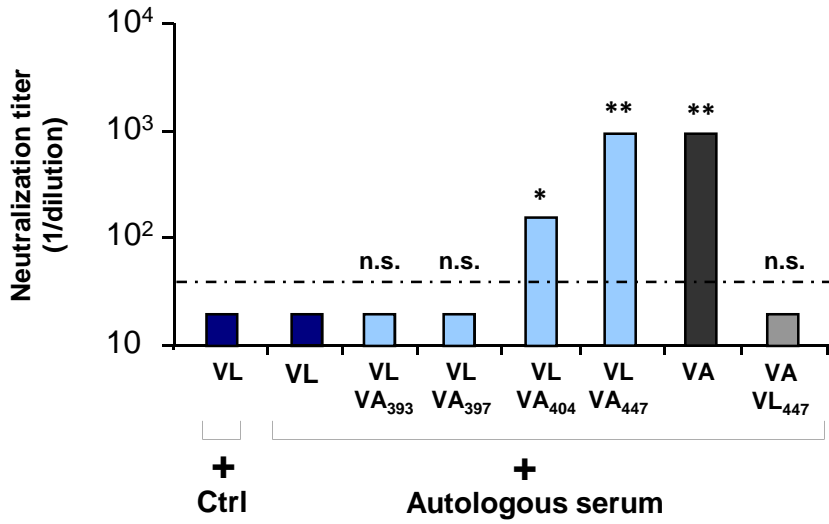
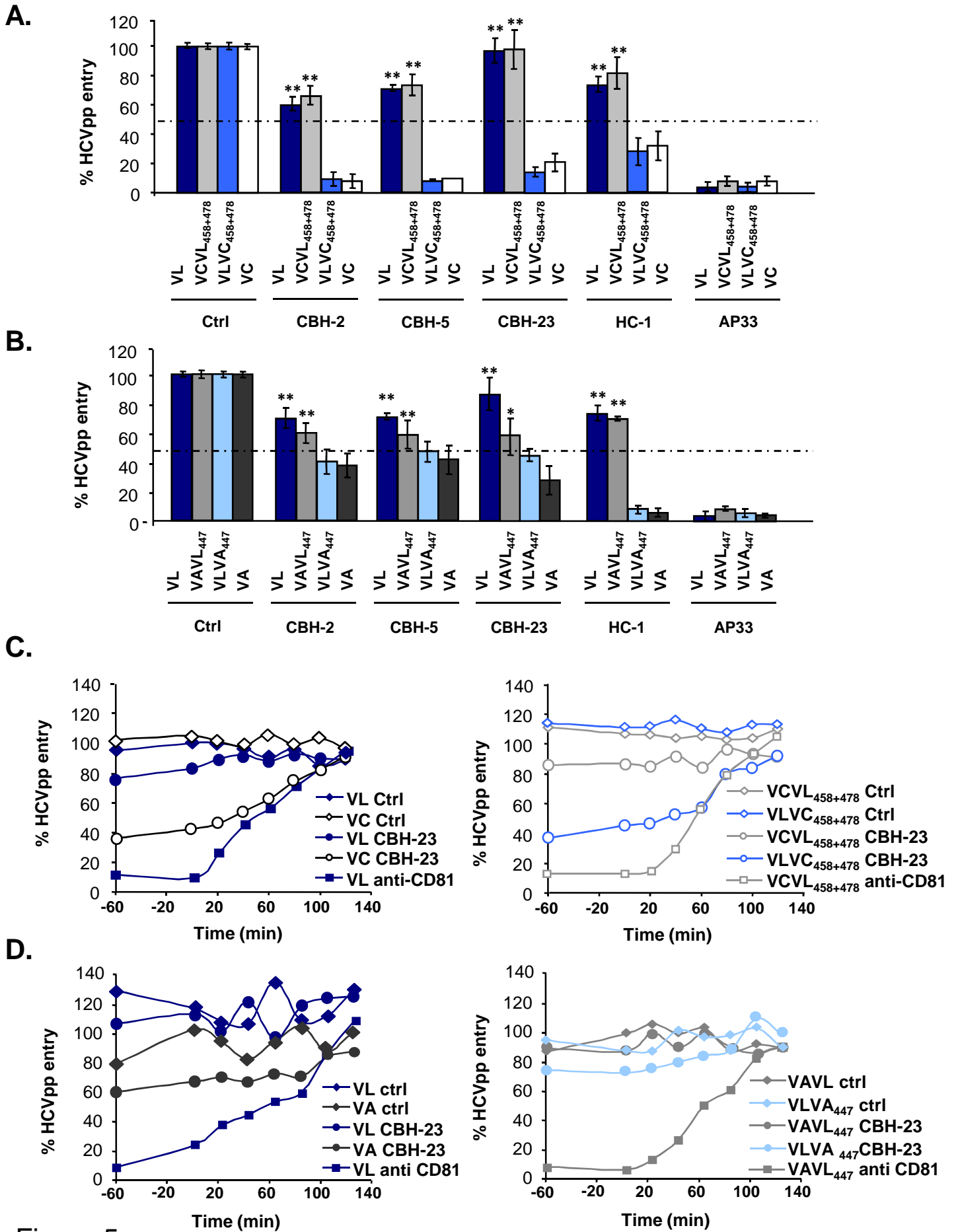

Figure 4



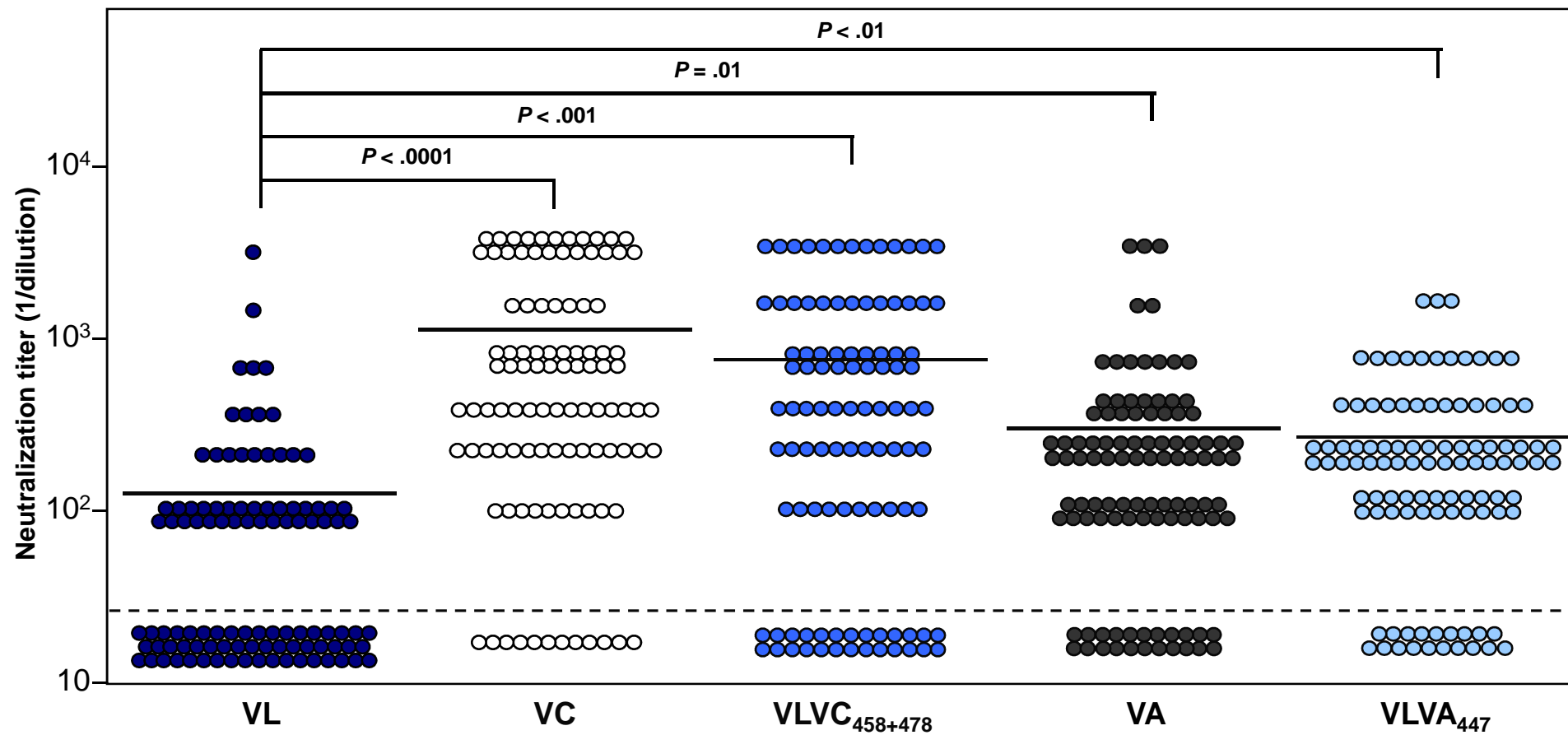

Figure 6

SUPPLEMENTARY DATA

SUPPLEMENTARY MATERIALS AND METHODS

Analysis of HCVpp envelope glycoprotein expression. Expression of HCV glycoproteins was characterized in HEK 293T producer cells and HCVpp purified through a 20% sucrose cushion ultracentrifugation as described.¹ Immunoblots of HCV glycoproteins were performed using anti-E1 11B7 and anti-E2 AP33 mAbs as described.²

Cellular binding of envelope glycoproteins. Envelope glycoprotein-expressing HEK 293T cells were lysed in PBS by four freezing and thawing cycles. Cell debris and nuclei were removed by low-speed centrifugation and supernatants containing native intracellular E1E2 complexes were used for binding studies. shCD81- or shCD13-Huh7.5 cells (2×10^5 cells per well) were seeded in 96 well plates. Following incubation with lysates containing patient-derived E1E2 proteins, Huh7.5.1 target cells were first incubated with mAb AP33 (10 $\mu\text{g/ml}$) and then with phycoerythrin-conjugated anti-mouse Ab (5 $\mu\text{g/ml}$, BD). Bound E2 was analyzed by flow cytometry as described.³

Construction of plasmids for production of chimeric HCVcc expressing patient-derived envelopes. Genotype 1 JFH-based HCVcc chimeras expressing the structural proteins of patient-derived viruses were produced as previously described for Con1/C3-JFH1-V2440L.^{4, 5} Briefly, the cDNA region encoding for the HCV core to first transmembrane domain of NS2 (C3 junction site) from variant VL was inserted into pFK-Con1/C3-JFH1-V2440L using fusion polymerase chain reaction (PCR) with Pfu DNA polymerase (Stratagene) and standard cloning procedures using appropriate restriction sites including BsmI and AvrII. The obtained construct was designated VL/JFH1. VL/JFH1 encoding sequence was used as template to insert individual and combined mutations using the QuikChange II XL site-directed as described previously.¹

GNA Capture ELISA. Binding of HMAb CBH-23 to viral envelopes was analyzed using an ELISA with HCVpp as a capture antigen as described.⁶ HCVpp expressing the E1E2 glycoproteins of HCV variants or control (Ctrl) pseudoparticles with absent HCV envelope glycoprotein expression were partially purified and enriched through ultracentrifugation as described.¹ Purified particles were quantified as described before.¹ Partially purified HCVpp or control pseudoparticles were captured onto GNA-coated microtiter plates as described.⁶ Soluble E2 (sE2, derived from strain HCV-H77 and expressed in 293T cells as described

previously³) was used as a positive control for antibody binding. Neutralizing human anti-E2 antibody CBH-23 (25 µg/ml diluted in PBS) was then added to captured HCVpp or sE2 (1 h at RT). Following washing and removal of nonbound antibody, mAb binding to HCV envelopes was detected using horseradish peroxidase anti-human IgG (GEhealthcare) at a concentration of 1/3000 for 1 h at RT, followed by incubation with 1-step™ Turbo TMB-ELISA (Thermo Scientific) for color development. Absorbance was measured at 450 nm using a microplate reader (Molecular Devices) and the Softmax program.

Bioinformatics. Multiple sequence alignment of complete E2 proteins was performed using the European HCV databases (<http://euhcvdb.ibcp.fr>).⁷ Two amino-acid repertoires were computed with all E2 sequences of provisional/confirmed genotype 1b using the *ComputeRepertoire* tool as part of the euHCVdb *Extract* tool.

SUPPLEMENTARY RESULTS

Prevalence of the identified mutations in a large genomic database of viral isolates.

Bioinformatic sequence analysis of a large panel of 2,074 HCV strains within the European HCV database further supports the potential relevance of the identified positions for pathogenesis of HCV infection in general.⁷ Residues F, S and R are much more frequently observed at positions 447, 458 and 478 than L, G and C. F and S are the most predominant residues at positions 447 and 458 in the large majority of 1b strains, respectively (F447 all: 98.4%, 1b: 96.2%; S458 all: 94% for 1b: 90.3%; Fig. S5). The position 478 is variable but R (all: 2.4% for 1b: 10.8%) is more frequent than C (all: 0.2%, 1b: 0.9%) (Fig. S5). The high prevalence of identified residues supports their functional relevance for virus survival and selection as more structurally and functionally relevant residues will be more frequently observed. These data suggest that the epitope containing the identified residues at positions 447, 458 and 478 is not only responsible for viral evasion from autologous antiviral antibodies during LT but may also contribute to viral evasion in chronic HCV infection in general.

SUPPLEMENTARY TABLE LEGENDS AND TABLES

Table S1. Neutralization of patient-derived and chimeric HCVpp by monoclonal anti-envelope antibodies. HCVpp produced from isolates shown in Figure 1 were incubated with mAbs (10 µg/ml) for 1 h at 37°C. HCVpp-antibody complexes were then added to Huh7.5.1 cells. Viral epitopes targeted by the respective antibody, percentage of HCV entry in the presence of antibody (strains VL, VC, VCVL₄₅₈₊₄₇₈, VLVC₄₅₈₊₄₇₈, VA, VAVL₄₄₇ and VLVA₄₄₇) and source or reference of antibody are shown. Means±SD from at least three experiments each performed in triplicate are shown. Abbreviations: V - viral variant; aa - amino acid.

Antibody	Source or reference	Epitope (aa)	HCVpp entry (%)						
			VL	VC	VCVL ₄₅₈₊₄₇₈	VLVC ₄₅₈₊₄₇₈	VA	VAVL ₄₄₇	VLVA ₄₄₇
AP33	8	412-423	6 ± 3	12 ± 1	3 ± 1	11 ± 5	2 ± 1	5 ± 1	3 ± 1
IGH461	9	436-448	58 ± 4	56 ± 8	51 ± 7	53 ± 3	55 ± 2	56 ± 6	52 ± 7
16A6	9	523-530	76 ± 10	74 ± 8	83 ± 9	82 ± 2	73 ± 9	74 ± 4	81 ± 9
CBH-2	10	Domain B, conformational 431, 523-540	60 ± 5	8 ± 5	65 ± 6	9 ± 5	39 ± 8	61 ± 4	39 ± 10
CBH-5	10	Domain B, conformational 523-540	71 ± 2	10 ± 4	73 ± 7	8 ± 1	36 ± 5	59 ± 7	47 ± 8
CBH-23	Keck and Fong, unpublished	Domain C, conformational	97 ± 9	21 ± 6	98 ± 13	14 ± 3	32 ± 7	53 ± 12	44 ± 3
HC-1	11	Domain B, conformational 523-540	73 ± 5	31 ± 9	81 ± 10	27 ± 9	2 ± 1	2 ± 1	77 ± 1

Table S2. Characteristics of patients and viruses used for neutralization studies. (A) HCVpp were incubated with anti-HCV positive sera from 102 patients with chronic HCV infection (ClinicalTrial.gov Identifier NCT00638144). Patient number, age, gender, viral genotype and load in serum are indicated. HCVpp- antibody complexes were added to Huh7.5.1 cells and infection was analyzed as described in Fig. 4. Calculation of neutralization and determination of background and thresholds for neutralization were performed as described in Fig. 6. Neutralization titers obtained by endpoint dilution are indicated for each variant. (B) Results were confirmed using chimeric HCVcc expressing the HCV envelope glycoproteins depicted in Fig. 7 and using 12 representative sera from patients. Neutralization assays were performed using a similar protocol as described in (A). Means from at least three independent experiments each performed in triplicate are shown. Abbreviations: V - viral variant ; M - male ; F - female.

A.

Patient number	Age	Gender	Genotype	Viral Load (IU/mL)	HCVpp neutralization titer (1/dilution)		
					VL	VC	VA
1	65	M	1b	2.29 x 10 ⁵	100	100	100
2	27	F	1b	9.7 x 10 ⁴	100	3200	200
3	31	F	1b	1.53 x 10 ⁵	400	3200	400
4	47	M	3a	1.02 x 10 ⁶	20	20	100
5	58	M	1b	1.15 x 10 ⁶	100	3200	200
6	72	M	1b	1.50 x 10 ⁶	20	200	100
7	51	M	4	4.38 x 10 ⁶	20	20	20
8	69	F	1b	9.7 x 10 ⁵	20	400	100
9	36	F	1	1.29 x 10 ⁵	800	1600	100
10	46	M	1a	1.05 x 10 ⁶	100	800	100
11	55	M	1a	1.54 x 10 ⁶	400	3200	200
12	56	M	4c/4d	2.41 x 10 ⁴	20	800	200
13	56	F	4a	1.09 x 10 ⁶	100	400	400
14	59	F	1b	3.54 x 10 ⁵	200	800	200
15	62	M	1a	3.37 x 10 ⁶	20	20	20
16	50	M	4a	1.48 x 10 ⁶	20	200	20
17	46	M	4a	4 x 10 ⁵	20	200	100
18	70	F	1b	1.3 x 10 ⁶	100	800	20
19	77	F	1b	6.2 x 10 ⁴	20	100	100
20	61	F	1b	2.58 x 10 ⁴	200	800	200
21	46	F	1b	2.11 x 10 ⁵	100	400	800
22	36	M	1a	2.04 x 10 ⁶	20	200	400
23	52	F	4a	9.12 x 10 ⁵	20	3200	400

24	54	M	1a	9.77×10^5	100	800	200
25	54	M	1b	1.12×10^6	20	100	200
26	54	F	1a	3.38×10^6	20	400	20
27	47	M	3a	6.16×10^5	100	3200	3200
28	43	M	1a	5.75×10^6	20	800	200
29	51	M	4a	1.44×10^6	100	400	400
30	54	M	2c	4.67×10^5	100	100	3200
31	51	M	1a	6.16×10^6	100	400	100
32	39	M	4a	1.12×10^6	20	200	800
33	62	F	4f	2.88×10^6	20	800	20
34	46	M	4k	3.54×10^5	20	20	100
35	42	M	1a	9.54×10^5	400	800	400
36	54	M	2c	4.67×10^5	200	3200	100
37	34	M	3a	3.23×10^6	20	20	100
38	47	M	3a	7.94×10^4	20	400	20
39	30	F	1b	1.00×10^6	20	200	400
40	47	F	1b	2.29×10^6	100	400	200
41	52	M	1a	1.73×10^6	200	3200	400
42	34	M	1b	1.45×10^6	3200	3200	200
43	46	M	1a	4.34×10^6	200	800	400
44	66	F	1b	3.89×10^5	200	1600	200
45	29	F	1a	1.08×10^5	400	400	200
46	45	M	3a	2.78×10^5	20	200	200
47	65	F	4f	1.46×10^6	20	3200	20
48	55	M	1a	8.81×10^6	20	800	100
49	53	M	1a	1.15×10^6	100	100	100
50	40	M	3a	2.46×10^6	100	3200	200
51	48	F	1a	1.00×10^5	20	800	20
52	37	M	1a	5.08×10^6	20	400	200
53	47	M	3a	6.8×10^6	100	1600	400
54	37	M	1a	1.84×10^6	800	800	200
55	65	F	1b	2.18×10^5	100	100	800
56	45	F	1a	3.93×10^6	1600	1600	400
57	49	M	4a	2.06×10^6	800	3200	200
58	30	M	1b	7.21×10^5	100	800	200
59	31	M	3a	6.66×10^6	100	200	200
60	37	M	1a	6.70×10^6	20	100	100
61	49	M	1a	3.16×10^5	20	800	20
62	43	M	1	6.83×10^5	20	20	20
63	69	M	1b	4.7×10^5	20	20	200
64	48	M	1a	3.28×10^6	20	3200	100
65	46	M	3a	8.55×10^5	20	800	100

66	51	M	1b	1.07×10^6	20	200	1600
67	43	M	1b	4.27×10^5	20	100	800
68	36	M	3a	1.14×10^6	20	800	20
69	53	F	1b	3.06×10^5	20	400	20
70	24	F	3a	1.29×10^6	20	20	20
71	63	M	1b	3.01×10^6	100	200	100
72	44	M	1	1.10×10^5	20	3200	200
73	28	M	3a	1.85×10^6	20	3200	20
74	54	M	1b	1.29×10^5	20	3200	20
75	17	F	1b	2.41×10^5	20	20	200
76	40	M	3a	1.26×10^6	20	20	100
77	35	M	1b	8.89×10^5	20	20	800
78	36	F	6a	1.4×10^7	20	100	400
79	70	F	1b	1.13×10^5	100	100	400
80	62	M	1a	2.68×10^6	100	200	20
81	70	M	1b	2.85×10^5	20	200	3200
82	63	M	1b	1.95×10^5	200	400	400
83	33	M	1a	1.76×10^6	100	200	800
84	35	M	1a	2.78×10^6	20	20	200
85	60	F	1	6.39×10^5	20	200	100
86	57	M	3a	1.22×10^6	200	3200	400
87	60	M	1	3.6×10^6	100	3200	20
88	49	M	4	2.24×10^6	20	1600	20
89	37	M	4	9.35×10^5	100	800	100
90	55	M	1a	3.77×10^6	20	3200	100
91	47	M	1a	2.36×10^6	20	1600	20
92	72	M	3a	3.83×10^5	20	400	20
93	79	M	1b	2.81×10^5	100	1600	100
94	58	F	1b	6.58×10^5	100	3200	200
95	50	M	3a	6.07×10^5	20	3200	100
96	67	F	1b	4.13×10^5	100	800	20
97	49	M	3a	5.22×10^5	200	400	200
98	53	F	1b	2.31×10^6	20	400	1600
99	37	M	1a	1.87×10^5	100	3200	200
100	54	F	4a	9.23×10^5	20	200	100
101	39	M	1a	1.76×10^5	100	800	200
102	51	F	2b	1.10×10^6	100	3200	800

B.

Patient number	HCVcc neutralization titer (1/dilution)		
	VL	VLVC ₄₅₈₊₄₇₈	VLVA ₄₄₇
11	400	1600	800
28	20	1600	800
33	20	400	400
35	400	1600	1600
36	200	1600	3200
45	800	1600	800
65	20	1600	1600
66	20	3200	800
68	20	1600	1600
94	100	3200	800
98	100	800	3200
99	100	3200	1600

REFERENCES

1. Fafi-Kremer S, Fofana I, Soulier E, Carolla P, Meuleman P, Leroux-Roels G, Patel AH, Cosset F-L, Pessaux P, Doffoël M, Wolf P, Stoll-Keller F, Baumert TF. Enhanced viral entry and escape from antibody-mediated neutralization are key determinants for hepatitis C virus re-infection in liver transplantation. *J Exp Med* 2010;207:2019-2031.
2. Pestka JM, Zeisel MB, Blaser E, Schurmann P, Bartosch B, Cosset FL, Patel AH, Meisel H, Baumert J, Viazov S, Rispeter K, Blum HE, Roggendorf M, Baumert TF. Rapid induction of virus-neutralizing antibodies and viral clearance in a single-source outbreak of hepatitis C. *Proc Natl Acad Sci U S A* 2007;104:6025-30.
3. Krieger SE, Zeisel MB, Davis C, Thumann C, Harris HJ, Schnober EK, Mee C, Soulier E, Royer C, Lambotin M, Grunert F, Dao Thi VL, Dreux M, Cosset FL, McKeating JA, Schuster C, Baumert TF. Inhibition of hepatitis C virus infection by anti-claudin-1 antibodies is mediated by neutralization of E2-CD81-claudin-1 associations. *Hepatology* 2010;51:1144-57.
4. Pietschmann T, Kaul A, Koutsoudakis G, Shavinskaya A, Kallis S, Steinmann E, Abid K, Negro F, Dreux M, Cosset FL, Bartenschlager R. Construction and characterization of infectious intragenotypic and intergenotypic hepatitis C virus chimeras. *Proc Natl Acad Sci U S A* 2006;103:7408-13.
5. Kaul A, Woerz I, Meuleman P, Leroux-Roels G, Bartenschlager R. Cell culture adaptation of hepatitis C virus and in vivo viability of an adapted variant. *J Virol* 2007;81:13168-79.
6. Wang Y, Keck ZY, Saha A, Xia J, Conrad F, Lou J, Eckart M, Marks JD, Fong SK. Affinity maturation to improve human monoclonal antibody neutralization potency and breadth against hepatitis C virus. *J Biol Chem* 2011;286:44218-33.
7. Combet C, Garnier N, Charavay C, Grando D, Crisan D, Lopez J, Dehne-Garcia A, Geourjon C, Bettler E, Hulo C, Le Mercier P, Bartenschlager R, Diepolder H, Moradpour D, Pawlotsky JM, Rice CM, Trepo C, Penin F, Deleage G. euHCVdb: the European hepatitis C virus database. *Nucleic Acids Res* 2007;35:D363-6.
8. Owsianka A, Tarr AW, Juttla VS, Lavillette D, Bartosch B, Cosset FL, Ball JK, Patel AH. Monoclonal antibody AP33 defines a broadly neutralizing epitope on the hepatitis C virus E2 envelope glycoprotein. *J Virol* 2005;79:11095-104.
9. Haberstroh A, Schnober EK, Zeisel MB, Carolla P, Barth H, Blum HE, Cosset FL, Koutsoudakis G, Bartenschlager R, Union A, Depla E, Owsianka A, Patel AH, Schuster C, Stoll-Keller F, Doffoel M, Dreux M, Baumert TF. Neutralizing host

- responses in hepatitis C virus infection target viral entry at postbinding steps and membrane fusion. *Gastroenterology* 2008;135:1719-1728.
10. Hadlock KG, Lanford RE, Perkins S, Rowe J, Yang Q, Levy S, Pileri P, Abrignani S, Fong SK. Human monoclonal antibodies that inhibit binding of hepatitis C virus E2 protein to CD81 and recognize conserved conformational epitopes. *J Virol* 2000;74:10407-16.
 11. Keck ZY, Li SH, Xia J, von Hahn T, Balfe P, McKeating JA, Witteveldt J, Patel AH, Alter H, Rice CM, Fong SK. Mutations in hepatitis C virus E2 located outside the CD81 binding sites lead to escape from broadly neutralizing antibodies but compromise virus infectivity. *J Virol* 2009;83:6149-60.
 12. Dimitrova M, Affolter C, Meyer F, Nguyen I, Richard DG, Schuster C, Bartenschlager R, Voegel JC, Ogier J, Baumert TF. Sustained delivery of siRNAs targeting viral infection by cell-degradable multilayered polyelectrolyte films. *Proc Natl Acad Sci U S A* 2008;105:16320-5.
 13. Lupberger J, Zeisel MB, Xiao F, Thumann C, Fofana I, Zona L, Davis C, Mee CJ, Turek M, Gorke S, Royer C, B. F, Zahid MN, Lavillette D, J. F, Cosset F-L, Rothenberg SM, Pietschmann T, Patel AH, Pessaux P, Dozzoël M, Raffelsberger W, Poch O, McKeating JA, Brino L, Baumert TF. EGFR and EphA2 are hepatitis C virus host entry factors and targets for antiviral therapy. *Nat Med* 2011;17:589-95.
 14. Bartosch B, Vitelli A, Granier C, Goujon C, Dubuisson J, Pascale S, Scarselli E, Cortese R, Nicosia A, Cosset FL. Cell entry of hepatitis C virus requires a set of co-receptors that include the CD81 tetraspanin and the SR-B1 scavenger receptor. *J Biol Chem* 2003;278:41624-41630.

SUPPLEMENTARY FIGURE LEGENDS

Figure S1. Actual viral infectivity of HCVpp derived from variants VL, VC and VA shown as relative light units of luciferase reporter gene expression. (A-B) Comparative analysis of viral entry of HCVpp shown in Fig. 1. Results are expressed in relative light units (RLU) plotted in a logarithmic scale. The threshold for a detectable infection in this system is indicated by dashed lines. The detection limit for positive luciferase reporter protein expression was 3×10^3 RLU/assay, corresponding to the mean \pm 3 SD of background levels, i.e., luciferase activity of naive noninfected cells or cells infected with pseudotypes without HCV envelopes.^{1, 12, 13} Background levels of the assay were determined in each experiment. Means \pm SD from at least four independent experiments performed in triplicate are shown. Significant differences in HCVpp entry VC, VA and VL wildtype and mutant variants are indicated by stars (*, $P \leq .05$; **, $P < .001$). Abbreviations: Ctrl - control; HVR - hypervariable region; n.s. - not significant; V - viral variant.

Figure S2. Positions 447, 458 and 478 modulate binding of envelope glycoproteins to CD81 expressed at the cell surface. Binding of native E1E2 complexes expressed from patient-derived cDNAs to Huh7.5 cells with silenced CD81 expression (described in Fig. 3) was detected by flow cytometry. Results are expressed as percentage of E1E2 binding compared to shCD13-Huh7.5 control cells. Means \pm SD from three independent experiments performed in triplicate are shown. Significant differences in binding between variants are indicated by stars (**, $P < .001$).

Figure S3. Differences in viral entry are not due to impaired HCVpp production. (A) Analysis of envelope glycoprotein expression. Protein expression was analyzed by immunoblotting as described in Materials and Methods. Molecular markers (kDa) are indicated on the right. (B) Transfection efficiency during HCVpp production. Transfection efficiency was analyzed for each variant and quantified by determining luciferase expression in HEK 293T producer cells expressed as normalized percentage compared to control transfected cells. (C) Envelope glycoprotein expression in HCVpp. HCVpp were purified as described previously^{1, 2} and subjected to immunoblot as described in panel (A). (D) Lentiviral p24 antigen expression was analyzed by ELISA and is indicated as optical density (O.D.) values at 450 nm. Abbreviations: Da - Dalton; MW - molecular weight; n.s. - not significant.

Figure S4. Binding of neutralizing anti-E2 HMAb CBH-23 to patient derived-envelope glycoproteins expressed on HCVpp as capture antigens in an ELISA. HCVpp expressing envelope glycoproteins of variants VL, VA, VC, VLVA₄₄₇ and VLVC₄₅₈₊₄₇₈ were used as capture antigens on GNA-coated ELISA plates. Control (Ctrl) pseudoparticles with absent HCV envelope glycoprotein expression and recombinant soluble E2 (sE2 derived from strain H77)¹⁴ served as negative and positive controls, respectively. Anti-E2 CBH-23 reactivity was detected as described in supplementary Materials and Methods and is indicated as optical density (O.D.) values at 450 nm. Means±SD from one representative experiment are shown.

Figure S5. Distribution of residues at positions 447, 458 and 478 of HCV E2 sequences in the European HCV databases. Distribution of residues at positions 447, 458 and 478 for HCV complete E2 sequences from all subtypes (black) and from subtype 1b only (white) within the European Hepatitis C Virus databases ⁷, (<http://euhcvdb.ibcp.fr>). F and S are the predominant residue at positions 447 and 458 (F447: 98.4%, 1b: 96.2%; S458 all: 94%, 1b: 90.3%). The position 478 is variable (it belongs to HVR2) but R (all: 2.4% for, 1b: 10.8%) is more frequent than C (all: 0.2%, 1b: 0.9%).

A.

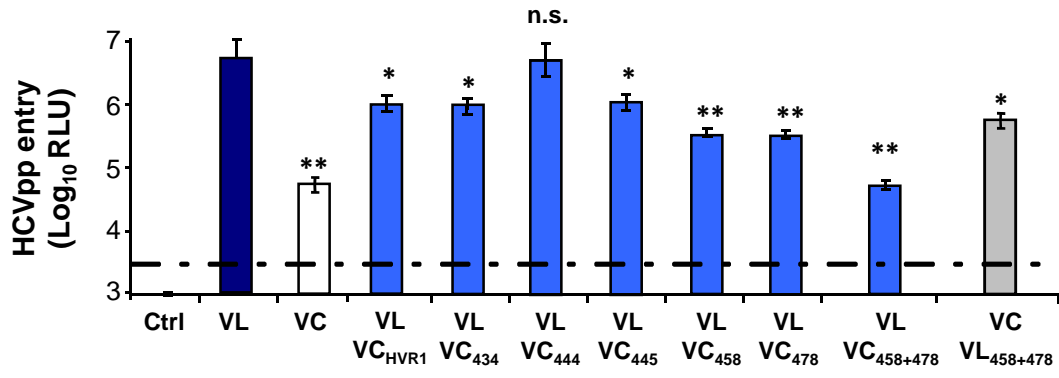

B.

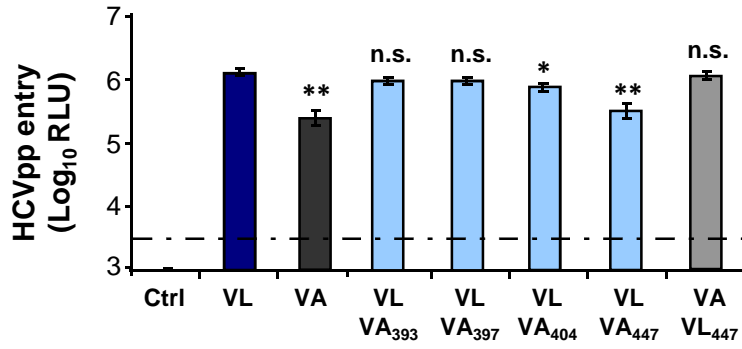

Figure S1

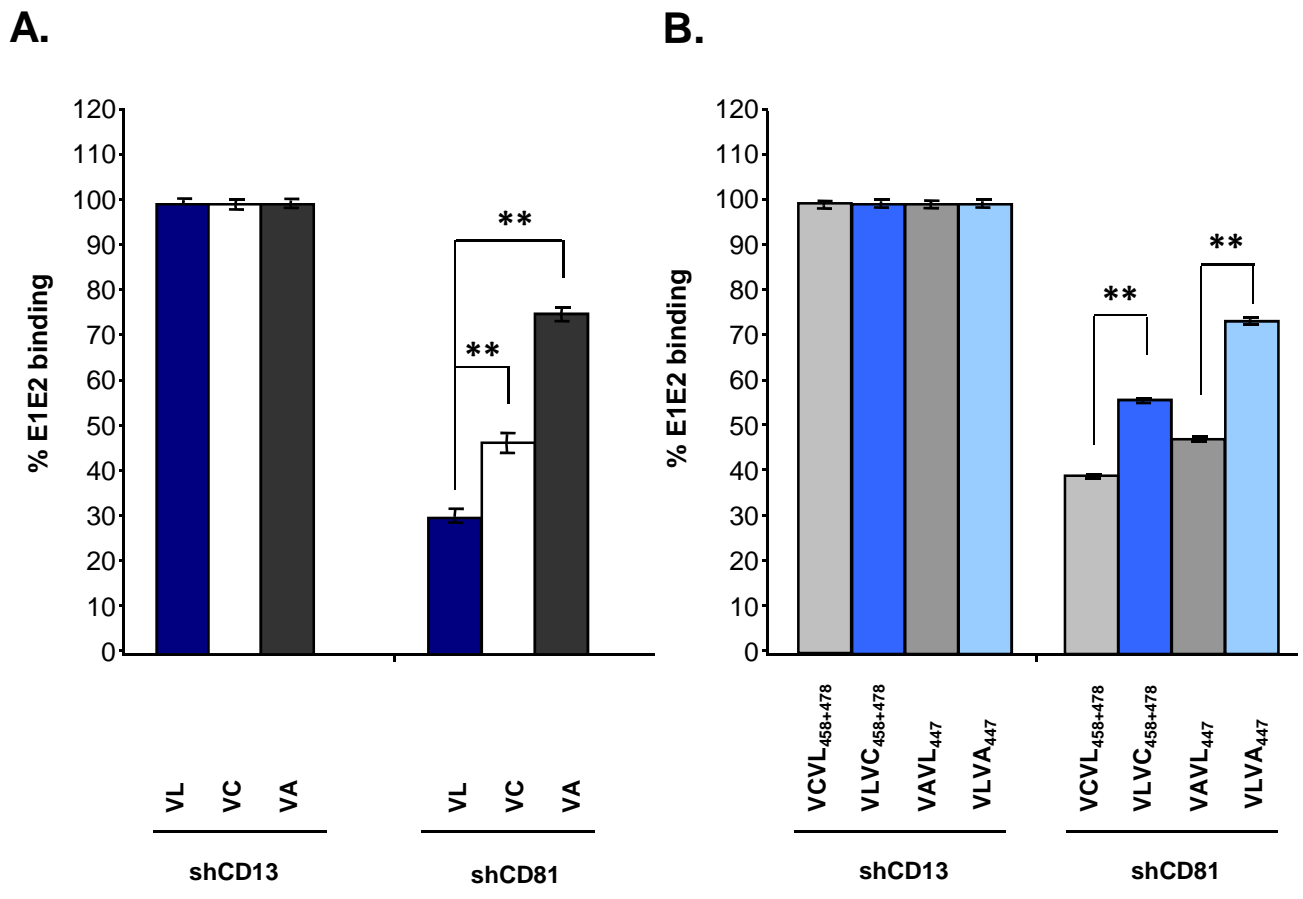

Figure S2

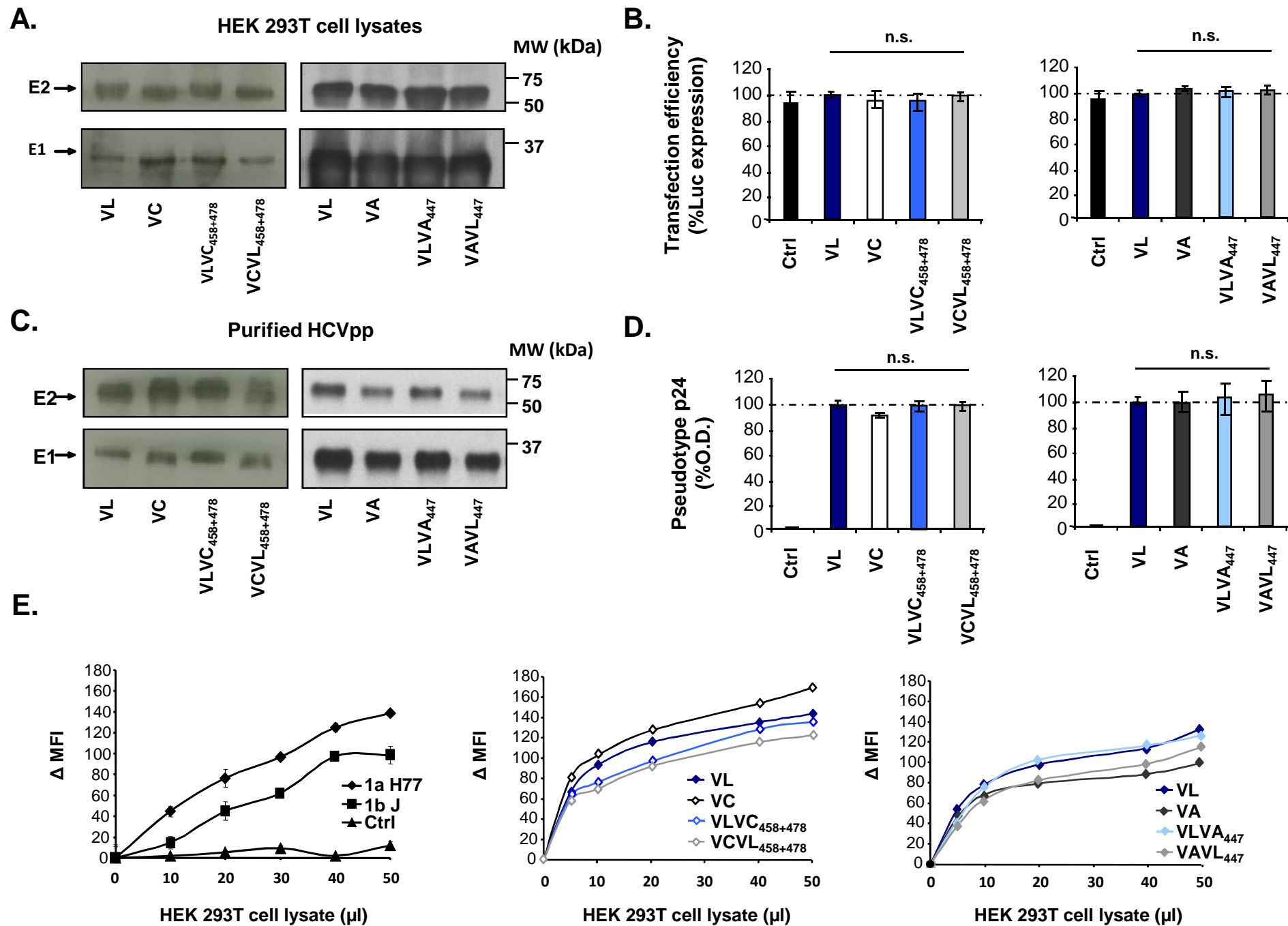

Figure S3

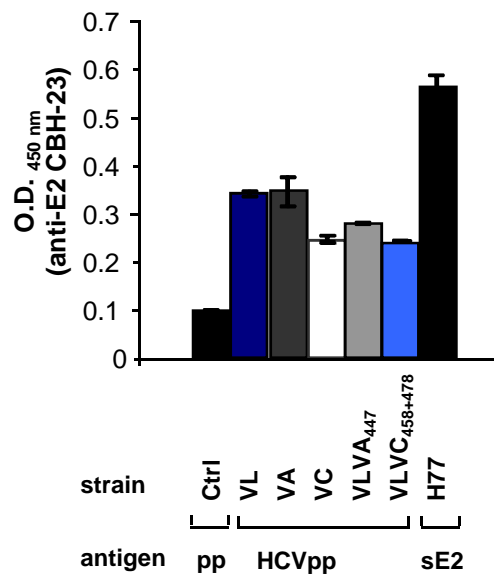

Figure S4

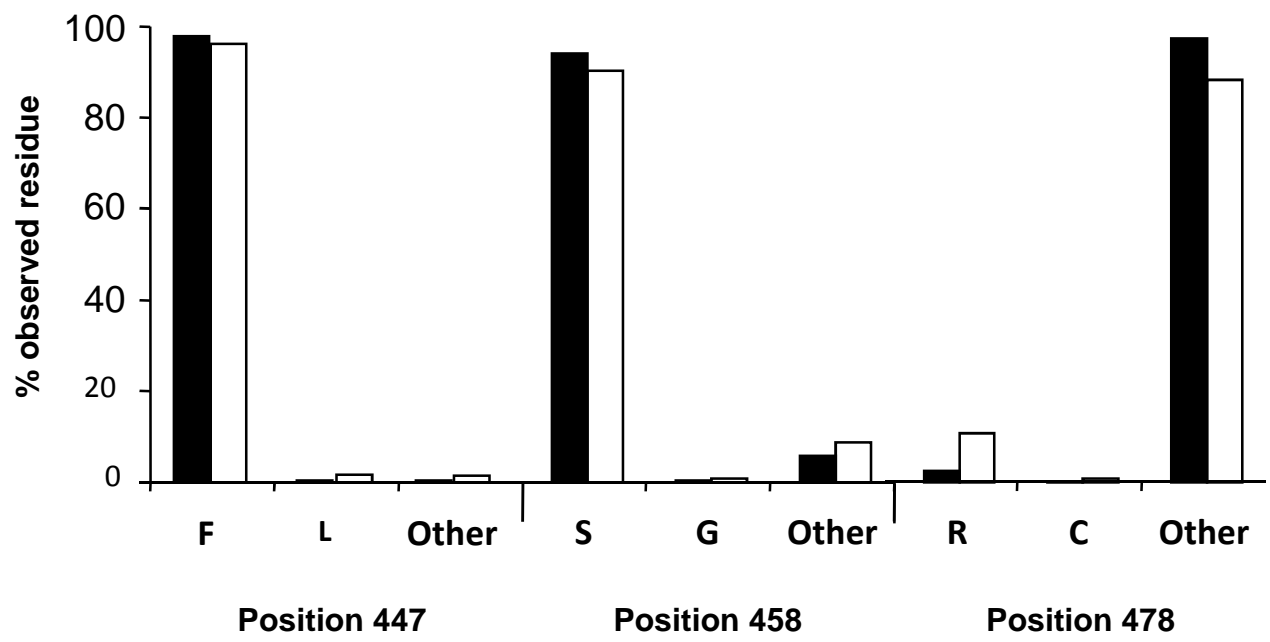

Figure S5

4. Discussion

HCV entry into hepatocytes is a multistep process involving a variety of receptors such as HS proteoglycans, LDL-R, CD81, SR-BI, CLDN1, OCLN and recently described RTKs and NPC1L1 (Albecka et al., 2011; Evans et al., 2007; Lupberger et al., 2011; Pileri et al., 1998; Ploss et al., 2009; Sainz et al., 2012; Scarselli et al., 2002). However, the role of these receptors in virus binding, entry into target cells and release of viral particles, is not yet completely understood. Moreover, little is known about the sequence of events leading to virus internalization.

Different tools including truncated forms of receptors (CD81 large extracellular loop), molecular mimics (heparin) and neutralizing antibodies have been used to describe the kinetics of HCV entry. It has been reported that heparin, a homolog of HS, inhibits HCV infection only when present before or during virus binding suggesting that HS proteoglycans are involved in the initial attachment of HCV (Barth et al., 2003; Koutsoudakis et al., 2006). Studies have shown that anti-CD81 antibodies can inhibit HCV infection at postbinding steps which suggest that CD81 acts as HCV entry coreceptor after the docking of the virus to attachment factors (Cormier et al., 2004b; Koutsoudakis et al., 2007). The tight junction molecules CLDN1 and OCLN have been described to be involved in HCV infection (Evans et al., 2007; Ploss et al., 2009) but for the moment, there is no evidence for their direct binding to the virus (Evans et al., 2007; Krieger et al., 2010). Initial kinetic studies using anti-Flag antibody and Flag-tagged CLDN1 have suggested that CLDN1 acts late in the HCV entry process (Evans et al., 2007). Subsequently, studies from our laboratory have shown that CLDN1, SR-BI and CD81 act at closely related time points in the viral entry process (Krieger et al., 2010; Zeisel et al., 2007b). Downregulation of both CLDN1 and OCLN resulted in a decrease in HCV glycoprotein dependent fusion which suggests their possible role in the fusion process (Benedicto et al., 2009; Evans et al., 2007). Recently, it has been demonstrated that LDL-R may be involved in non-productive entry of HCV particles and as a lipid providing receptor; it can modulate HCV RNA replication (Albecka et al., 2011).

SR-BI is a multifunctional molecule that modulate high-density lipoprotein (HDL) metabolism. SR-BI was initially identified as host factor for HCV binding step (Scarselli et al., 2002). Later, it has been described that SR-BI also mediates post-binding events during HCV entry (Haberstroh et al., 2008; Syder et al., 2011; Zeisel et al., 2007b). Interestingly, it has been reported that HDL which is a physiological ligand of SR-BI, enhances HCVpp entry and HCVcc infection (Bartosch et al., 2005; Dreux et al., 2006; Voisset et al., 2005). These findings indicate that SR-BI may play a multifunctional role in HCV infection. Therefore, in the first part of my work, we aimed to further characterize the role of SR-BI in the HCV entry process.

SR-BI binds a wide variety of lipoproteins and plays an important role in cholesterol homeostasis. One of its physiological functions is the bilateral cholesterol transfer at the cell membrane. For cholesteryl ester (CE) uptake, HDL first binds to SR-BI and then CE is transferred into the cell without internalization of HDL molecule. It has been proposed that the extracellular domain of SR-BI is crucial for these steps. Recently, it has been reported that amino acid C323 is highly conserved site in SR-BI and it takes part in HDL binding and SR-BI mediated CE uptake (Guo et al., 2011). During my PhD, we have characterized novel anti-SR-BI mAbs that do not interfere with HDL binding which is an indication that our mAbs do not target C323 amino acid and also that these antibodies do not modulate this physiological function of SR-BI. In addition to SR-BI, there are some other molecules in human hepatocytes that participate in cholesterol transport. These include LDL-R, NPC1L1 and CETP (cholesterol ester transfer protein) (Agnello et al., 1999; Barter et al., 2003; Sainz et al., 2012). CETP mediates the exchange of cholesterol and triglycerides between HDL and LDL and it is present in human but absent in mice (Barter et al., 2003). Moreover, in contrast to humans, it has been demonstrated that in mice, SR-BI is the only molecule in hepatic cells which takes part in selective uptake of CE from HDL (Hoekstra et al., 2010). Noteworthy, SR-BI-knockout mice faces severe complications like atherosclerosis, adrenal corticoid insufficiency under stress and altered cholesterol distribution in platelets whereas there is no evidence that impaired SR-BI function affects human physiology. This may be due to the presence of alternative routes for cholesterol metabolism in human.

SR-BI is expressed at the sinusoidal surface of hepatocytes (Reynolds et al., 2008), which appears as physiological route of viral access. The interaction between SR-BI and sE2 was found to be specific as closely related human scavenger receptor CD36 and mouse SR-BI were not able to bind to sE2 (Bartosch et al., 2003c; Scarselli et al., 2002). Further, it has been demonstrated that HVR1 of E2 envelope glycoprotein plays a crucial role in the functional interaction between SR-BI and E2 (Bartosch et al., 2005). The deletion of this region results in reduction of E2 binding to SR-BI and SR-BI mediated cell entry (Bartosch et al., 2003c; Scarselli et al., 2002). Moreover, HDL enhances HCV infectivity and there exists a complex interplay between SR-BI, HDL and HVR1 of HCV envelope glycoprotein E2 (Bartosch et al., 2005; Dreux and Cosset, 2007; Voisset et al., 2005). SR-BI binding to sE2 has been described to be hampered by polyclonal sera, monoclonal antibodies and small molecules targeting SR-BI which resulted in decrease in HCV infection (Barth et al., 2005a; Catanese et al., 2007; Syder et al., 2011). Catanese and colleagues described a panel of monoclonal antibodies directed against human SR-BI. Among these monoclonal antibodies, C167 inhibited the interaction of sE2 with SR-BI and HCVcc infection during attachment steps but did not affect the post-binding function of SR-BI during HCV entry (Catanese et al., 2010; Catanese et al., 2007). This antibody also blocked HDL binding to SR-BI and hampered the SR-BI mediated cholesterol efflux. A codon-

optimized version of this monoclonal antibody (mAb 16-71) has been reported to inhibit HCV infection *in vitro* and *in vivo* by interfering with direct cell-to-cell transmission (Meuleman et al., 2012). Noteworthy, our anti-SR-BI mAbs are novel in their functions as these antibodies unlike previously described antibodies do not block binding of sE2 to SR-BI. In fact, they inhibit entry of HCV only during post-binding steps of cell-free infection and cell-to-cell transmission. This indicates that E2 and SR-BI binding is not the sole function of SR-BI during HCV entry and that the post-binding function of SR-BI may play a crucial role for HCV infection.

Recently, it has been demonstrated that SR-BI is involved in HCV cell-to-cell transmission which plays a major role in viral dissemination (Brimacombe et al., 2011; Meuleman et al., 2012; Syder et al., 2011). Our novel mAbs specifically inhibiting post-binding function of SR-BI enabled us to understand the importance of the SR-BI post-binding function in cell-free HCV entry and in neutralizing antibody-resistant cell-to-cell transmission. Taking into consideration the findings that our mAbs do not hamper sE2 and HDL binding to SR-BI and inhibit HCV entry only during post-binding steps, it comes into view that our mAbs target different epitope(s) than those targeted by other anti-SR-BI mAbs. Thus, our novel mAbs will open the way to further characterize the post-binding function of SR-BI in HCV entry. Moreover, these mAbs also inhibit entry of patient-derived HCVpp of escape variants selected during liver transplantation. It is worth mentioning that the combination of anti-SR-BI and anti-HCV envelope antibodies resulted in a synergistic effect on inhibition of escape variants entry and HCVcc infection. Importantly, these combinations allow to reduce the IC₅₀ of anti-SR-BI mAb by up to 100-fold. These data suggest an attractive antiviral approach against HCV infection by targeting the post-binding function of SR-BI.

Two previous studies using HCVcc, demonstrated a cooperation of CD81 and SR-BI in HCV infection (Kapadia et al., 2007; Zeisel et al., 2007b). It has been reported that all cells showing permissivity to HCVpp co-express CD81 and SR-BI (Heo et al., 2006). HCV envelope glycoproteins play a critical role in virus attachment and entry into host cells and it was reported that soluble forms of CD81 and SR-BI could have indirect link with each other by direct association with HCV envelope glycoprotein E2 (Heo et al., 2006). CD81 belongs to the tetraspanin family consisting of four transmembrane domains, short intracellular N and C terminals, a small extracellular loop (SEL) and a large extracellular loop (LEL) (Levy et al., 1998). It has been shown that the LEL plays a critical role in CD81-sE2 binding (Flint et al., 1999; Flint et al., 2006; Pileri et al., 1998). Molina and colleague showed that CD81 is compulsory for HCV infection of cultured primary human hepatocytes (Molina et al., 2008). Moreover, CD81 is also considered to be indispensable HCV receptor for *in vivo* HCV infection (Meuleman et al., 2008). CD81 may not only contribute to initial virus binding to cellular surface but also regulates the endogenous cellular responses that assist the virus at different stages of its life cycle e.g. CD81-mediated signals result in Rho GTPase-dependent actin rearrangement may

help the lateral movement of the CD81-E2 complex (Brazzoli et al., 2008; Farquhar et al., 2012). Further, it was demonstrated that the Raf/MEK/ERK signalling pathway is also activated by CD81 engagement (Brazzoli et al., 2008). Tetraspanin family members have the ability to interact with each other and with other transmembrane proteins to form tetraspanin-enriched microdomains (TEM). While association of CD81 with TEM is important for *Plasmodium* infection, it has been suggested that CD81 linked with TEM is not essential for early events of HCV infection (Rocha-Perugini et al., 2009). Recently, another function of CD81 in the HCV life cycle has been demonstrated; it also plays a critical role in HCV replication (Zhang et al., 2010). The sequence in which cell receptors interact with HCV and the mechanism by which HCV glycoproteins are activated to mediate membrane fusion are still unknown. It has been described that CD81 primes HCV for low pH-dependent fusion during early steps of HCV entry (Sharma et al., 2011). However, CD81 is not the sole determinant of HCV infection as transgenic mice expressing human CD81 failed to support HCV infection (Dorner et al., 2011; Flint et al., 1999; Higginbottom et al., 2000; Ploss et al., 2009). Furthermore, many cell lines expressing both SR-BI and CD81 remained unable to support HCV infection which suggests that additional host factors such as OCLN, CLDN1, RTKs and NPC1L1 are required for HCV entry.

HCV, after using host factors for entry and fusion, replicates and infects neighbouring cells. The persistence of infection causes chronic hepatitis which leads to cirrhosis and HCC. Due to absence of potent therapy, LT is the only remedy for the patients affected by cirrhosis and HCC related to HCV. Re-infection of the liver graft with HCV is a major problem in patients infected with HCV. Our lab has previously demonstrated that HCV variants re-infecting the liver graft were characterized by efficient entry and poor neutralization by antibodies present in pre-transplant serum compared to variants not detected after transplantation (Fafi-Kremer et al., 2010). However, the molecular mechanisms by which the virus evades host immunity to persistently re-infect the liver graft are unknown. As described above, HCV uses different host factors for entry into host cells, so in second part of my PhD, we aimed to assess the role of host factors in efficient HCV entry and evasion from neutralizing antibodies.

During LT, the new liver is re-infected by HCV in the early hours of reperfusion and only a fraction of HCV variants circulating prior to transplant is selected and persists after transplantation. In chronic infection, the composition of quasispecies is gradually changing and it has been observed that highly neutralized variants and variants resistant to humoral immune response co-exist. Our lab has previously demonstrated that the change of the host environment during LT results in an abrupt change in the composition of HCV quasispecies (Fafi-Kremer et al., 2010). Phylogenetic analysis revealed a reduction in genetic diversity after LT with the selection of a relatively homogeneous fraction of variants. It appears that the implantation of a new liver and the start of immunosuppressive therapy results in a bottleneck effect by selecting the variants which are able to efficiently penetrate

the new liver cells. Viral entry is a key aspect of rapid initiation of HCV infection and neutralizing antibodies are the first line host defense in transplanted liver. Study of patient-derived viral particles has revealed that viral variants selected during LT were characterized by enhanced viral entry and escape from neutralizing antibodies as compared to those variants which were undetectable after transplantation (Fafi-Kremer et al., 2010). This shows that entry and escape from antibody-mediated neutralization are key determinants for the selection of viral variants in the early steps of LT. HCV infection in chimeric uPA-SCID mouse model has demonstrated that the variants which were selected after LT were the most prevalent variant in both plasma and liver of infected uPA-SCID mouse (Fafi-Kremer et al., 2010).

To elucidate the mechanism of enhanced viral entry and escape from neutralizing antibodies, we studied genetically close variants derived from a well characterized patient undergoing LT. The selected variant VL showed high-infectivity and escape from neutralizing antibodies while non-selected variants (VA and VC) had lower infectivity and they were highly sensitive to neutralization by autologous serum. To investigate the molecular mechanisms of enhanced entry of VL, mutations of the envelope glycoprotein region F447, S458G and R478C of the non-selected variants VA and VC were introduced into infectious HCV pseudoparticles (HCVpp) expressing envelope glycoproteins of the escape variant VL. The results show that these mutations play a critical role for high infectivity and escape from neutralizing antibodies of the selected variant VL.

We further studied whether the mutations F447, S458G and R478C have an effect on viral entry due to different usage of host cell factors including CD81, SR-BI, CLDN1 and OCLN. Using HCVpp derived from parental and chimeric strains, we showed that overexpression of CD81 on Huh7.5.1 cells markedly increased viral entry of VL as compared to VC. The pattern of enhancement of viral entry was similar when residues at position 458 and 478 were exchanged between VL and VC. These results indicate that the double mutation in the viral strain modifies the ability of the virus to enter into target cells by changing the CD81-usage. Moreover, SR-BI overexpression also showed a tendency to enhance the viral entry of parental strains but there was no effect of altered expression of SR-BI on chimeric strains. These data suggest the importance of SR-BI as an entry factor for patient-derived variants, but also demonstrate that positions 458 and 478 do not significantly alter SR-BI-dependency. Therefore, other mutations might be involved in the increased entry efficiency of the VL variant in SR-BI-overexpressing cells e. g. in HVR1. In addition, cells overexpressing CLDN1 and OCLN illustrated a mild increase in viral entry and modulations of chimeric strains were non-specific suggesting a significant role of CD81 in enhancement of viral entry. These data are in line with another study demonstrating absence of increase of HCV entry after CLDN1 overexpression (Schwarz et al., 2009).

The silencing of CD81 expression further uncovered the importance of CD81 usage. The entry of the selected variant and related chimeric strains was highly affected in CD81 silenced cells as compared to non-selected variants and chimeric strains. It has been demonstrated that there are three subdomains of envelope glycoprotein E2, domain I contains CD81 binding regions while potential CD81 binding sites overlaps with domain III (Boo et al., 2012; Drummer et al., 2006; Krey et al., 2010; Owsianka et al., 2006). The residues 447, 458 and 478 are located close to previously described CD81 binding domains. These findings suggest that acquired mutations at position 447, 458 and 478 play a critical role in E2-CD81 interaction and the interaction between the virus and CD81 is an important factor in the selection and escape from neutralizing antibodies of viral variants during liver transplantation. Taken together, our data indicate that mutations F447, S458G and R478C modulate CD81 dependency; they increase affinity to cell surface CD81 and result in viral escape at post-binding steps closely related to HCV-CD81 interaction. We can assume the possibility of some other mechanisms that may contribute to the high entry of HCV particles and their escape from neutralizing antibodies. These may include some uncovered entry factors or physico-chemical properties of HCV like association of HCV with lipoproteins. Further understanding of HCV life cycle will help to develop a better antiviral strategy.

Viral attachment and entry are important targets of host cellular defenses and neutralizing antibodies against HCV (Haberstroh et al., 2008). Our work highlights that virus-host factor interactions play a key role in evasion from neutralizing antibodies. This suggests that targeting the virus and/or host factors represents a promising approach to develop novel antiviral strategies against HCV infection. Targeting the virus to control HCV infection would be advantageous because there will be less side effects. However, it will be a challenge to develop neutralizing antibodies capable of targeting epitopes conserved across genotypes as the virus rapidly adapts to its environment and constantly escapes the host's immune responses. Some nAbs have been shown to inhibit HCV cell-to-cell transmission (Brimacombe et al., 2011) and cross-neutralizing ability of these antibodies would make them an interesting antiviral strategy. Indeed, the rapid emergence of mutants resistant to autologous neutralizing antibodies has been reported (Gal-Tanamy et al., 2008; von Hahn et al., 2007). Thus targeting host entry factors which are essential for viral spread and are less subject to mutation will represent another exciting way in the development of novel antiviral strategies against HCV infection. Finally, the synergistic effect between antivirals targeting host factors and nAbs represents another interesting combination to prevent HCV re-infection and/or chronic HCV infection.

5. Conclusions and perspectives

In this study, we have described the impact of host cell receptors, particularly SR-BI and CD81 on initiation of HCV infection, viral dissemination as well as on the mechanisms involved in the re-infection of liver graft. In the first part of my work, we characterized the role of SR-BI during HCV infection. Our new anti-SR-BI monoclonal antibodies allowed us to distinguish between the binding and post-binding function of SR-BI. In addition, we demonstrated that the SR-BI post-binding function plays a critical role in both cell-free infection of HCV and cell-to-cell transmission of HCV. In contrast to previously described anti-SR-BI monoclonal antibodies, our data showed that these novel antibodies have less effects on physiological functions of SR-BI i.e. (i) HDL binding and (ii) bidirectional cholesterol transfer and no effect on E2 binding which suggest that these antibodies target distinct epitopes and represent a novel class of anti-SR-BI antibodies.

In the second part of my thesis, we characterized the molecular mechanisms involved in the selection of variants after liver transplantation. We have identified three residues in the region 425-483 of E2 glycoprotein responsible for the selection of the escape variant re-infecting the liver graft. These three residues i.e. F447, S458G and R478C play a crucial role in the interaction of HCV and host cell factor CD81. These results provide a deeper understanding of the molecular mechanisms of viral escape during acute infection of the liver transplant and highlight the importance of the interaction between virus and host factors for this process.

The dependence of viral variants on host entry factors during liver transplantation opens new therapeutic prospects for the large number of individuals infected with HCV. Therapeutic options for HCV-infected individuals are still limited by drug resistance and adverse effects. Furthermore, to date there is no therapy available to prevent re-infection of HCV liver graft. Host entry factors are interesting targets for antiviral therapy against HCV infection as they may enhance the genetic barrier for antiviral resistance. In the near future, the optimal treatment for HCV is likely to be based on combination of several molecules targeting the virus and host cell factors and interfering with different stages of the viral cycle. We have shown the potential of combination of antiviral targeting the viral envelope and a host factor as we observed synergistic inhibition in HCV infection when a combination of anti-E2 and SR-BI antibodies were used. Taken together, our data suggest that targeting the virus and host entry factors represents a promising strategy to prevent re-infection of the graft during liver transplantation as well as viral dissemination during chronic HCV infection.

6. References

A

- Acton, S., Rigotti, A., Landschulz, K.T., Xu, S., Hobbs, H.H., and Krieger, M. (1996). Identification of scavenger receptor SR-BI as a high density lipoprotein receptor. *Science* 271, 518-520.
- Agnello, V., Abel, G., Elfahal, M., Knight, G.B., and Zhang, Q.X. (1999). Hepatitis C virus and other flaviviridae viruses enter cells via low density lipoprotein receptor. *Proc Natl Acad Sci U S A* 96, 12766-12771.
- Akazawa, D., Date, T., Morikawa, K., Murayama, A., Miyamoto, M., Kaga, M., Barth, H., Baumert, T.F., Dubuisson, J., and Wakita, T. (2007). Cd81 Expression Is Important For Heterogeneous Hcv Permissiveness Of Huh7 Cell Clones. *Journal of Virology* 81, 5036-5045.
- Albecka, A., Belouzard, S., de Beeck, A.O., Descamps, V., Goueslain, L., Bertrand-Michel, J., Terce, F., Duverlie, G., Rouille, Y., and Dubuisson, J. (2011). Role of LDL receptor in the hepatitis c virus life cycle. *Hepatology* .
- Alter, M.J. (2007). Epidemiology of hepatitis C virus infection. *World J Gastroenterol* 13, 2436-2441.
- Altmann, S.W., Davis, H.R., Jr., Zhu, L.J., Yao, X., Hoos, L.M., Tetzloff, G., Iyer, S.P., Maguire, M., Golovko, A., Zeng, M., *et al.* (2004). Niemann-Pick C1 Like 1 protein is critical for intestinal cholesterol absorption. *Science* 303, 1201-1204.
- Andre, P., Komurian-Pradel, F., Deforges, S., Perret, M., Berland, J.L., Sodoyer, M., Pol, S., Brechot, C., Paranhos-Baccala, G., and Lotteau, V. (2002). Characterization of low- and very-low-density hepatitis C virus RNA-containing particles. *Journal of Virology* 76, 6919-6928.
- Antonelli, A., Ferri, C., Fallahi, P., Pampana, A., Ferrari, S.M., Goglia, F., and Ferrannini, E. (2005). Hepatitis C virus infection: evidence for an association with type 2 diabetes. *Diabetes Care* 28, 2548-2550.
- Appel, N., and Bartenschlager, R. (2006). A novel function for a micro RNA: negative regulators can do positive for the hepatitis C virus. *Hepatology* 43, 612-615.
- Appel, N., Schaller, T., Penin, F., and Bartenschlager, R. (2006). From structure to function: new insights into hepatitis C virus RNA replication. *The Journal of Biological Chemistry* 281, 9833-9836.
- Appel, N., Zayas, M., Miller, S., Krijnse-Locker, J., Schaller, T., Friebe, P., Kallis, S., Engel, U., and Bartenschlager, R. (2008). Essential role of domain III of nonstructural protein 5A for hepatitis C virus infectious particle assembly. *PLoS Pathogens* 4, e1000035.
- Asselah, T., Rubbia-Brandt, L., Marcellin, P., and Negro, F. (2006). Steatosis in chronic hepatitis C: why does it really matter? *Gut* 55, 123-130.
- Astier-Gin, T., Bellecave, P., Litvak, S., and Ventura, M. (2005). Template requirements and binding of hepatitis C virus NS5B polymerase during in vitro RNA synthesis from the 3'-end of virus minus-strand RNA. *Febs J* 272, 3872-3886.
- Attaullah, S., Khan, S., and Ali, I. (2011). Hepatitis C virus genotypes in Pakistan: a systemic review. *Virol J* 8, 433.

B

- Balzarini, J. (2005). Targeting the glycans of gp120: a novel approach aimed at the Achilles heel of HIV. *The Lancet Infectious Diseases* 5, 726-731.
- Bankwitz, D., Steinmann, E., Bitzegeio, J., Ciesek, S., Friesland, M., Herrmann, E., Zeisel, M.B., Baumert, T.F., Keck, Z.Y., Fong, S.K., *et al.* (2010). Hepatitis C virus hypervariable region 1

modulates receptor interactions, conceals the CD81 binding site, and protects conserved neutralizing epitopes. *Journal of Virology* 84, 5751-5763.

Baril, M., and Brakier-Gingras, L. (2005). Translation of the F protein of hepatitis C virus is initiated at a non-AUG codon in a +1 reading frame relative to the polyprotein. *Nucleic Acids Res* 33, 1474-1486.

Bartenschlager, R., Frese, M., and Pietschmann, T. (2004a). Novel insights into hepatitis C virus replication and persistence. *Adv Virus Res* 63, 71-180.

Bartenschlager, R., Frese, M., and Pietschmann, T. (2004b). Novel insights into hepatitis C virus replication and persistence. *Adv Virus Res* 63, 71-180.

Barter, P.J., Brewer, H.B., Jr., Chapman, M.J., Hennekens, C.H., Rader, D.J., and Tall, A.R. (2003). Cholesteryl ester transfer protein: a novel target for raising HDL and inhibiting atherosclerosis. *Arteriosclerosis, thrombosis, and vascular biology* 23, 160-167.

Barth, H., Cerino, R., Arcuri, M., Hoffmann, M., Schurmann, P., Adah, M.I., Gissler, B., Zhao, X., Ghisetti, V., Lavezzo, B., *et al.* (2005a). Scavenger receptor class B type I and hepatitis C virus infection of primary tupaia hepatocytes. *Journal of Virology* 79, 5774-5785.

Barth, H., Liang, T.J., and Baumert, T.F. (2006). Hepatitis C virus entry: molecular biology and clinical implications. *Hepatology* 44, 527-535.

Barth, H., Robinet, E., Liang, T.J., and Baumert, T.F. (2008a). Mouse models for the study of HCV infection and virus-host interactions. *Journal of Hepatology* 49, 134-142.

Barth, H., Rybczynska, J., Patient, R., Choi, Y., Sapp, R.K., Baumert, T.F., Krawczynski, K., and Liang, T.J. (2011). Both innate and adaptive immunity mediate protective immunity against hepatitis C virus infection in chimpanzees. *Hepatology* 54, 1135-1148.

Barth, H., Schäfer, C., Adah, M.I., Zhang, F., Linhardt, R.J., Toyoda, H., Kinoshita-Toyoda, A., Toida, T., Van Kuppevelt, T.H., Depla, E., *et al.* (2003). Cellular binding of hepatitis C virus envelope glycoprotein E2 requires cell surface heparan sulfate. *J Biol Chem* 278, 41003-41012.

Barth, H., Schnober E.K., Zhang F., Linhardt R.J., Depla E., Boson B., Cosset F.-L., Patel A.H., Blum H.E., Baumert T.F. (2006). Viral and cellular determinants of hepatitis C virus envelope-heparan sulfate interaction. *Journal of Virology* 80, 10579-10590.

Barth, H., Schnober, E.K., Neumann-Haefelin, C., Thumann, C., Zeisel, M.B., Diepolder, H.M., Hu, Z., Liang, T.J., Blum, H.E., Thimme, R., *et al.* (2008b). Scavenger Receptor Class B is Required for Hepatitis C Virus Uptake and Cross-presentation by Human Dendritic Cells. *Journal of virology* 82, 3466-3479.

Barth, H., Ulsenheimer, A., Pape, G.R., Diepolder, H.M., Hoffmann, M., Neumann-Haefelin, C., Thimme, R., Henneke, P., Klein, R., Paranhos-Baccala, G., *et al.* (2005b). Uptake and presentation of hepatitis C virus-like particles by human dendritic cells. *Blood* 105, 3605-3614. Epub 2005 Jan 3618.

Bartosch, B., Bukh, J., Meunier, J.C., Granier, C., Engle, R.E., Blackwelder, W.C., Emerson, S.U., Cosset, F.L., and Purcell, R.H. (2003a). In vitro assay for neutralizing antibody to hepatitis C virus: evidence for broadly conserved neutralization epitopes. *Proceedings of the National Academy of Sciences of the United States of America* 100, 14199-14204. .

Bartosch, B., Dubuisson, J., and Cosset, F.L. (2003b). Infectious hepatitis C virus pseudo-particles containing functional E1-E2 envelope protein complexes. *J Exp Med* 197, 633-642.

Bartosch, B., Verney, G., Dreux, M., Donot, P., Morice, Y., Penin, F., Pawlotsky, J.M., Lavillette, D., and Cosset, F.L. (2005). An interplay between hypervariable region 1 of the hepatitis C virus E2 glycoprotein, the scavenger receptor BI, and high-density lipoprotein promotes both enhancement of infection and protection against neutralizing antibodies. *Journal of Virology* 79, 8217-8229.

Bartosch, B., Vitelli, A., Granier, C., Goujon, C., Dubuisson, J., Pascale, S., Scarselli, E., Cortese, R., Nicosia, A., and Cosset, F.L. (2003c). Cell entry of hepatitis C virus requires a set of co-receptors that

include the CD81 tetraspanin and the SR-B1 scavenger receptor. *The Journal of Biological Chemistry* 278, 41624-41630.

Basu, A., Kanda, T., Beyene, A., Saito, K., Meyer, K., and Ray, R. (2007). Sulfated homologues of heparin inhibit hepatitis C virus entry into mammalian cells. *Journal of Virology* 81, 3933-3941.

Baumert, T.F., Ito, S., Wong, D.T., and Liang, T.J. (1998). Hepatitis C virus structural proteins assemble into viruslike particles in insect cells. *Journal of Virology* 72, 3827-3836.

Baumert, T.F., Vergalla, J., Satoi, J., Thomson, M., Lechmann, M., Herion, D., Greenberg, H.B., Ito, S., and Liang, T.J. (1999). Hepatitis C virus-like particles synthesized in insect cells as a potential vaccine candidate. *Gastroenterology* 117, 1397-1407.

Beales, L.P., Rowlands, D.J., and Holzenburg, A. (2001). The internal ribosome entry site (IRES) of hepatitis C virus visualized by electron microscopy. *RNA* 7, 661-670.

Benedicto, I., Molina-Jimenez, F., Barreiro, O., Maldonado-Rodriguez, A., Prieto, J., Moreno-Otero, R., Aldabe, R., Lopez-Cabrera, M., and Majano, P.L. (2008). Hepatitis C virus envelope components alter localization of hepatocyte tight junction-associated proteins and promote occludin retention in the endoplasmic reticulum. *Hepatology* 48, 1044-1053.

Benedicto, I., Molina-Jimenez, F., Bartosch, B., Cosset, F.L., Lavillette, D., Prieto, J., Moreno-Otero, R., Valenzuela-Fernandez, A., Aldabe, R., Lopez-Cabrera, M., *et al.* (2009). The tight junction-associated protein occludin is required for a postbinding step in hepatitis C virus entry and infection. *Journal of Virology* 83, 8012-8020.

Benga, W.J., Krieger, S.E., Dimitrova, M., Zeisel, M.B., Parnot, M., Lupberger, J., Hildt, E., Luo, G., McLauchlan, J., Baumert, T.F., *et al.* (2010). Apolipoprotein E interacts with hepatitis C virus nonstructural protein 5A and determines assembly of infectious particles. *Hepatology* 51, 43-53.

Bertaux, C., and Dragic, T. (2006). Different domains of CD81 mediate distinct stages of hepatitis C virus pseudoparticle entry. *Journal of Virology* 80, 4940-4948.

Bissig, K.D., Wieland, S.F., Tran, P., Isogawa, M., Le, T.T., Chisari, F.V., and Verma, I.M. (2010). Human liver chimeric mice provide a model for hepatitis B and C virus infection and treatment. *The Journal of Clinical Investigation* 120, 924-930.

Blanchard, E., Belouzard, S., Goueslain, L., Wakita, T., Dubuisson, J., Wychowski, C., and Rouille, Y. (2006). Hepatitis C virus entry depends on clathrin-mediated endocytosis. *Journal of Virology* 80, 6964-6972.

Bockle, B.C., Baltaci, M., Ratzinger, G., Graziadei, I., Vogel, W., and Sepp, N.T. (2012). Hepatitis C and autoimmunity: a therapeutic challenge. *J Intern Med* 271, 104-106.

Boo, I., Tewierek, K., Douam, F., Lavillette, D., Pountourios, P., and Drummer, H.E. (2012). Distinct roles in folding, CD81 receptor binding and viral entry for conserved histidines of HCV glycoprotein E1 and E2. *The Biochemical Journal* 443, 85-94.

Boson, B., Granio, O., Bartenschlager, R., and Cosset, F.L. (2011). A concerted action of hepatitis C virus p7 and nonstructural protein 2 regulates core localization at the endoplasmic reticulum and virus assembly. *PLoS Pathogens* 7, e1002144.

Bourliere, M., Khaloun, A., Wartelle-Bladou, C., Oules, V., Portal, I., Benali, S., Adhoute, X., and Castellani, P. (2011). Chronic hepatitis C: Treatments of the future. *Clinics and research in hepatology and gastroenterology* 35 Suppl 2, S84-95.

Bradley, D., McCaustland, K., Krawczynski, K., Spelbring, J., Humphrey, C., and Cook, E.H. (1991). Hepatitis C virus: buoyant density of the factor VIII-derived isolate in sucrose. *J Med Virol* 34, 206-208.

Branch, A.D., Stump, D.D., Gutierrez, J.A., Eng, F., and Walewski, J.L. (2005). The hepatitis C virus alternate reading frame (ARF) and its family of novel products: the alternate reading frame protein/F-protein, the double-frameshift protein, and others. *Seminars in liver disease* 25, 105-117.

- Brass, V., Bieck, E., Montserret, R., Wolk, B., Hellings, J.A., Blum, H.E., Penin, F., and Moradpour, D. (2002). An amino-terminal amphipathic alpha-helix mediates membrane association of the hepatitis C virus nonstructural protein 5A. *The Journal of Biological Chemistry* 277, 8130-8139.
- Brazzoli, M., Bianchi, A., Filippini, S., Weiner, A., Zhu, Q., Pizza, M., and Crotta, S. (2008). CD81 is a central regulator of cellular events required for hepatitis C virus infection of human hepatocytes. *Journal of Virology* 82, 8316-8329.
- Bressanelli, S., Tomei, L., Roussel, A., Incitti, I., Vitale, R.L., Mathieu, M., De Francesco, R., and Rey, F.A. (1999). Crystal structure of the RNA-dependent RNA polymerase of hepatitis C virus. *Proceedings of the National Academy of Sciences of the United States of America* 96, 13034-13039.
- Brimacombe, C.L., Grove, J., Meredith, L.W., Hu, K., Syder, A.J., Flores, M.V., Timpe, J.M., Krieger, S.E., Baumert, T.F., Tellinghuisen, T.L., *et al.* (2011). Neutralizing antibody-resistant hepatitis C virus cell-to-cell transmission. *Journal of Virology* 85, 596-605.
- Brohm, C., Steinmann, E., Friesland, M., Lorenz, I.C., Patel, A., Penin, F., Bartenschlager, R., and Pietschmann, T. (2009). Characterization of determinants important for hepatitis C virus p7 function in morphogenesis by using trans-complementation. *Journal of Virology* 83, 11682-11693.
- Bukh, J., Miller, R.H., and Purcell, R.H. (1995a). Genetic heterogeneity of hepatitis C virus: quasispecies and genotypes. *Semin Liver Dis* 15, 41-63.
- Bukh, J., Miller, R.H., and Purcell, R.H. (1995b). Genetic heterogeneity of the hepatitis C virus. *Princess Takamatsu Symp* 25, 75-91.
- Bukh, J., Purcell, R.H., and Miller, R.H. (1992). Sequence analysis of the 5' noncoding region of hepatitis C virus. *Proceedings of the National Academy of Sciences of the United States of America* 89, 4942-4946.
- Bukh, J., Thimme, R., Meunier, J.C., Faulk, K., Spangenberg, H.C., Chang, K.M., Satterfield, W., Chisari, F.V., and Purcell, R.H. (2008). Previously infected chimpanzees are not consistently protected against reinfection or persistent infection after reexposure to the identical hepatitis C virus strain. *Journal of Virology* 82, 8183-8195.
- Burlone, M.E., and Budkowska, A. (2009). Hepatitis C virus cell entry: role of lipoproteins and cellular receptors. *The Journal of General Virology* 90, 1055-1070.

C

- Callens, N., Ciczora, Y., Bartosch, B., Vu-Dac, N., Cosset, F.L., Pawlotsky, J.M., Penin, F., and Dubuisson, J. (2005). Basic residues in hypervariable region 1 of hepatitis C virus envelope glycoprotein e2 contribute to virus entry. *Journal of Virology* 79, 15331-15341.
- Cambi, A., Koopman, M., and Figdor, C.G. (2005). How C-type lectins detect pathogens. *Cell Microbiol* 7, 481-488.
- Carrere-Kremer, S., Montpellier-Pala, C., Cocquerel, L., Wychowski, C., Penin, F., and Dubuisson, J. (2002). Subcellular localization and topology of the p7 polypeptide of hepatitis C virus. *Journal of Virology* 76, 3720-3730.
- Castet, V., Fournier, C., Soulier, A., Brillet, R., Coste, J., Larrey, D., Dhumeaux, D., Maurel, P., and Pawlotsky, J.M. (2002). Alpha interferon inhibits hepatitis C virus replication in primary human hepatocytes infected in vitro. *Journal of Virology* 76, 8189-8199.
- Catanese, M.T., Ansuini, H., Graziani, R., Huby, T., Moreau, M., Ball, J.K., Paonessa, G., Rice, C.M., Cortese, R., Vitelli, A., *et al.* (2010). Role of scavenger receptor class B type I in hepatitis C virus entry: kinetics and molecular determinants. *Journal of Virology* 84, 34-43.

- Catanese, M.T., Graziani, R., von Hahn, T., Moreau, M., Huby, T., Paonessa, G., Santini, C., Luzzago, A., Rice, C.M., Cortese, R., *et al.* (2007). High-avidity monoclonal antibodies against the human scavenger class B type I receptor efficiently block hepatitis C virus infection in the presence of high-density lipoprotein. *Journal of Virology* 81, 8063-8071.
- Chang, K.M., Thimme, R., Melpolder, J.J., Oldach, D., Pemberton, J., Moorhead-Loudis, J., McHutchison, J.G., Alter, H.J., and Chisari, F.V. (2001). Differential CD4(+) and CD8(+) T-cell responsiveness in hepatitis C virus infection. *Hepatology* 33, 267-276.
- Chang, K.S., Jiang, J., Cai, Z., and Luo, G. (2007). Human apolipoprotein e is required for infectivity and production of hepatitis C virus in cell culture. *Journal of Virology* 81, 13783-13793.
- Charlton, M. (2005). Recurrence of hepatitis C infection: Where are we now? *Liver Transpl*, S57-62.
- Chatterji, U., Bobardt, M., Selvarajah, S., Yang, F., Tang, H., Sakamoto, N., Vuagniaux, G., Parkinson, T., and Gallay, P. (2009). The isomerase active site of cyclophilin A is critical for hepatitis C virus replication. *The Journal of Biological Chemistry* 284, 16998-17005.
- Choo, Q.-L., Kuo, A., Weiner, A.J., Overby, L.R., Bradley, D.W., and Houghton, M. (1989). Isolation of a cDNA clone derived from a blood-borne non-A, non-B viral hepatitis genome. *Science* 244, 359-362.
- Ciesek, S., Steinmann, E., Iken, M., Ott, M., Helfritz, F.A., Wappler, I., Manns, M.P., Wedemeyer, H., and Pietschmann, T. (2010). Glucocorticosteroids increase cell entry by hepatitis C virus. *Gastroenterology* 138, 1875-1884.
- Cocquerel, L., Meunier, J.-C., Pillez, A., Wychowski, C., and Dubuisson, J. (1998). A retention signal necessary and sufficient for endoplasmic reticulum localization maps to the transmembrane domain of hepatitis C virus glycoprotein E2. *Journal of Virology* 72, 2183-2191.
- Cocquerel, L., Wychowski, C., Minner, F., Penin, F., and Dubuisson, J. (2000). Charged residues in the transmembrane domains of hepatitis C virus glycoproteins play a major role in the processing, subcellular localization, and assembly of these envelope proteins. *Journal of Virology* 74, 3623-3633.
- Codran, A., Royer, C., Jaeck, D., Bastien-Valle, M., Baumert, T.F., Kieny, M.P., Pereira, C.A., and Martin, J.P. (2006). Entry of hepatitis C virus pseudotypes into primary human hepatocytes by clathrin-dependent endocytosis. *The Journal of General Virology* 87, 2583-2593.
- Coller, K.E., Berger, K.L., Heaton, N.S., Cooper, J.D., Yoon, R., and Randall, G. (2009). RNA interference and single particle tracking analysis of hepatitis C virus endocytosis. *PLoS Pathogens* 5, e1000702.
- Cook, G.A., and Opella, S.J. (2010). NMR studies of p7 protein from hepatitis C virus. *Eur Biophys J* 39, 1097-1104.
- Cormier, E.G., Durso, R.J., Tsamis, F., Boussebart, L., Manix, C., Olson, W.C., Gardner, J.P., and Dragic, T. (2004a). L-SIGN (CD209L) and DC-SIGN (CD209) mediate transinfection of liver cells by hepatitis C virus. *Proceedings of the National Academy of Sciences of the United States of America* 101, 14067-14072.
- Cormier, E.G., Tsamis, F., Kajumo, F., Durso, R.J., Gardner, J.P., and Dragic, T. (2004b). CD81 is an entry coreceptor for hepatitis C virus. *Proceedings of the National Academy of Sciences of the United States of America* 101, 7270-7274.
- Cox, A.L., Mosbrugger, T., Mao, Q., Liu, Z., Wang, X.H., Yang, H.C., Sidney, J., Sette, A., Pardoll, D., Thomas, D.L., *et al.* (2005). Cellular immune selection with hepatitis C virus persistence in humans. *The Journal of Experimental Medicine* 201, 1741-1752.
- Coyne, C.B., Shen, L., Turner, J.R., and Bergelson, J.M. (2007). Coxsackievirus entry across epithelial tight junctions requires occludin and the small GTPases Rab34 and Rab5. *Cell host & Microbe* 2, 181-192.

Craxi, A., Laffi, G., and Zignego, A.L. (2008). Hepatitis C virus (HCV) infection: a systemic disease. *Molecular Aspects of Medicine* 29, 85-95.

Cukierman, L., Meertens, L., Bertaux, C., Kajumo, F., and Dragic, T. (2009). Residues in a highly conserved claudin-1 motif are required for hepatitis C virus entry and mediate the formation of cell-cell contacts. *Journal of Virology* 83, 5477-5484.

D

Dao Thi, V.L., Dreux, M., and Cosset, F.L. (2011). Scavenger receptor class B type I and the hypervariable region-1 of hepatitis C virus in cell entry and neutralisation. *Expert Reviews in Molecular Medicine* 13, e13.

Davis, H.R., Jr., Zhu, L.J., Hoos, L.M., Tetzloff, G., Maguire, M., Liu, J., Yao, X., Iyer, S.P., Lam, M.H., Lund, E.G., *et al.* (2004). Niemann-Pick C1 Like 1 (NPC1L1) is the intestinal phytosterol and cholesterol transporter and a key modulator of whole-body cholesterol homeostasis. *The Journal of Biological Chemistry* 279, 33586-33592.

Dhillon, S., Witteveldt, J., Gatherer, D., Owsianka, A.M., Zeisel, M.B., Zahid, M.N., Rychlowska, M., Fong, S.K., Baumert, T.F., Angus, A.G., *et al.* (2010). Mutations within a conserved region of the hepatitis C virus E2 glycoprotein that influence virus-receptor interactions and sensitivity to neutralizing antibodies. *Journal of Virology* 84, 5494-5507.

Di Lorenzo, C., Angus, A.G., and Patel, A.H. (2011). Hepatitis C virus evasion mechanisms from neutralizing antibodies. *Viruses* 3, 2280-2300.

Di Marco, S., Volpari, C., Tomei, L., Altamura, S., Harper, S., Narjes, F., Koch, U., Rowley, M., De Francesco, R., Migliaccio, G., *et al.* (2005). Interdomain communication in hepatitis C virus polymerase abolished by small molecule inhibitors bound to a novel allosteric site. *The Journal of Biological Chemistry* 280, 29765-29770.

Diepolder, H.M., Zachoval, R., Hoffmann, R.M., Wierenga, E.A., Santantonio, T., Jung, M.C., Eichenlaub, D., and Pape, G.R. (1995). Possible mechanism involving T-lymphocyte response to non-structural protein 3 in viral clearance in acute hepatitis C virus infection. *Lancet* 346, 1006-1007.

Dorner, M., Horwitz, J.A., Robbins, J.B., Barry, W.T., Feng, Q., Mu, K., Jones, C.T., Schoggins, J.W., Catanese, M.T., Burton, D.R., *et al.* (2011). A genetically humanized mouse model for hepatitis C virus infection. *Nature* 474, 208-211.

Dreux, M., Boson, B., Ricard-Blum, S., Molle, J., Lavillette, D., Bartosch, B., Pecheur, E.I., and Cosset, F.L. (2007). The Exchangeable Apolipoprotein ApoC-I Promotes Membrane Fusion of Hepatitis C Virus. *The Journal of Biological Chemistry* 282, 32357-32369.

Dreux, M., and Cosset, F.L. (2007). The scavenger receptor BI and its ligand, HDL: Partners in Crime with HVR1 against HCV neutralising antibodies. *Journal of Viral Hepatitis* 14 Suppl 1, 68-76.

Dreux, M., Dao Thi, V.L., Fresquet, J., Guerin, M., Julia, Z., Verney, G., Durantel, D., Zoulim, F., Lavillette, D., Cosset, F.L., *et al.* (2009). Receptor complementation and mutagenesis reveal SR-BI as an essential HCV entry factor and functionally imply its intra- and extra-cellular domains. *PLoS Pathogens* 5, e1000310.

Dreux, M., Pietschmann, T., Granier, C., Voisset, C., Ricard-Blum, S., Mangeot, P.E., Keck, Z., Fong, S., Vu-Dac, N., Dubuisson, J., *et al.* (2006). High density lipoprotein inhibits hepatitis C virus-neutralizing antibodies by stimulating cell entry via activation of the scavenger receptor BI. *The Journal of Biological Chemistry* 281, 18285-18295.

Drummer, H.E., Boo, I., Maerz, A.L., and Pountourios, P. (2006). A Conserved Gly436-Trp-Leu-Ala-Gly-Leu-Phe-Tyr Motif in Hepatitis C Virus Glycoprotein E2 Is a Determinant of CD81 Binding and Viral Entry. *Journal of Virology* 80, 7844-7853.

Drummer, H.E., Wilson, K.A., and Pountourios, P. (2002). Identification of the hepatitis C virus E2 glycoprotein binding site on the large extracellular loop of CD81. *Journal of Virology* 76, 11143-11147.

E

Egger, D., Wolk, B., Gosert, R., Bianchi, L., Blum, H.E., Moradpour, D., and Bienz, K. (2002). Expression of hepatitis C virus proteins induces distinct membrane alterations including a candidate viral replication complex. *Journal of Virology* 76, 5974-5984.

El Abd, Y.S., Tabll, A.A., El Din, N.G., Hosny Ael, D., Moustafa, R.I., El-Shenawy, R., Atef, K., and El-Awady, M.K. (2011). Neutralizing activities of caprine antibodies towards conserved regions of the HCV envelope glycoprotein E2. *Virology* 8, 391.

Elazar, M., Liu, P., Rice, C.M., and Glenn, J.S. (2004). An N-terminal amphipathic helix in hepatitis C virus (HCV) NS4B mediates membrane association, correct localization of replication complex proteins, and HCV RNA replication. *Journal of Virology* 78, 11393-11400.

Elmowalid, G.A., Qiao, M., Jeong, S.H., Borg, B.B., Baumert, T.F., Sapp, R.K., Hu, Z., Murthy, K., and Liang, T.J. (2007). Immunization with hepatitis C virus-like particles results in control of hepatitis C virus infection in chimpanzees. *Proceedings of the National Academy of Sciences of the United States of America* 104, 8427-8432.

Erickson, A.L., Kimura, Y., Igarashi, S., Eichelberger, J., Houghton, M., Sidney, J., McKinney, D., Sette, A., Hughes, A.L., and Walker, C.M. (2001). The outcome of hepatitis C virus infection is predicted by escape mutations in epitopes targeted by cytotoxic T lymphocytes. *Immunity* 15, 883-895.

Esko, J.D., and Lindahl, U. (2001). Molecular diversity of heparan sulfate. *The Journal of Clinical Investigation* 108, 169-173.

Evans, M.J., Rice, C.M., and Goff, S.P. (2004). Phosphorylation of hepatitis C virus nonstructural protein 5A modulates its protein interactions and viral RNA replication. *Proceedings of the National Academy of Sciences of the United States of America* 101, 13038-13043.

Evans, M.J., von Hahn, T., Tschernie, D.M., Syder, A.J., Panis, M., Wolk, B., Hatzioannou, T., McKeating, J.A., Bieniasz, P.D., and Rice, C.M. (2007). Claudin-1 is a hepatitis C virus co-receptor required for a late step in entry. *Nature* 446, 801-805.

Eyre, N.S., Drummer, H.E., and Beard, M.R. (2010). The SR-BI partner PDZK1 facilitates hepatitis C virus entry. *PLoS Pathogens* 6, e1001130.

F

Fafi-Kremer, S., Fofana, I., Soulier, E., Carolla, P., Meuleman, P., Leroux-Roels, G., Patel, A.H., Cosset, F.L., Pessaux, P., Doffoel, M., *et al.* (2010). Viral entry and escape from antibody-mediated neutralization influence hepatitis C virus reinfection in liver transplantation. *The Journal of Experimental Medicine* 207, 2019-2031.

Falkowska, E., Kajumo, F., Garcia, E., Reinus, J., and Dragic, T. (2007). Hepatitis C virus envelope glycoprotein E2 glycans modulate entry, CD81 binding, and neutralization. *Journal of Virology* 81, 8072-8079.

Farci, P. (2011). New insights into the HCV quasispecies and compartmentalization. *Seminars in Liver Disease* 31, 356-374.

- Farci, P., Alter, H.J., Wong, D., Miller, R.H., Shih, J.W., Jett, B., and Purcell, R.H. (1991). A long-term study of hepatitis C virus replication in non-A, non-B hepatitis. *The New England Journal of Medicine* 325, 98-104.
- Farci, P., Shimoda, A., Coiana, A., Diaz, G., Peddis, G., Melpolder, J.C., Strazzera, A., Chien, D.Y., Munoz, S.J., Balestrieri, A., *et al.* (2000). The outcome of acute hepatitis C predicted by the evolution of the viral quasispecies. *Science* 288, 339-344.
- Farci, P., Shimoda, A., Wong, D., Cabezon, T., De Gioannis, D., Strazzera, A., Shimizu, Y., Shapiro, M., Alter, H.J., and Purcell, R.H. (1996). Prevention of hepatitis C virus infection in chimpanzees by hyperimmune serum against the hypervariable region 1 of the envelope 2 protein. *Proc Natl Acad Sci U S A* 93, 15394-15399.
- Farquhar, M.J., Harris, H.J., Diskar, M., Jones, S., Mee, C.J., Nielsen, S.U., Brimacombe, C.L., Molina, S., Toms, G.L., Maurel, P., *et al.* (2008). Protein kinase A-dependent step(s) in hepatitis C virus entry and infectivity. *Journal of Virology* 82, 8797-8811.
- Farquhar, M.J., Hu, K., Harris, H.J., Davis, C., Brimacombe, C.L., Fletcher, S.J., Baumert, T.F., Rappoport, J.Z., Balfe, P., and McKeating, J.A. (2012). Hepatitis C virus induces CD81 and claudin-1 endocytosis. *Journal of Virology* 06996-11.
- Feld, J.J., and Hoofnagle, J.H. (2005). Mechanism of action of interferon and ribavirin in treatment of hepatitis C. *Nature* 436, 967-972.
- Feliu, A., Gay, E., Garcia-Retortillo, M., Saiz, J.C., and Forns, X. (2004). Evolution of hepatitis C virus quasispecies immediately following liver transplantation. *Liver Transpl* 10, 1131-1139.
- Ferenci, P. (2012). Optimal treatment duration for patients with HCV genotype 1 infection. *Journal of Viral Hepatitis* 19 Suppl 1, 7-13.
- Fernandez, J., Taylor, D., Morhardt, D.R., Mihalik, K., Puig, M., Rice, C.M., Feinstone, S.M., and Major, M.E. (2004). Long-term persistence of infection in chimpanzees inoculated with an infectious hepatitis C virus clone is associated with a decrease in the viral amino acid substitution rate and low levels of heterogeneity. *Journal of Virology* 78, 9782-9789.
- Flint, M., Maidens, C.M., Loomis-Price, L.D., Shotton, C., Dubuisson, J., Monk, P., Hittingbottom, A., Levy, S., and McKeating, J. (1999). Characterization of hepatitis C virus E2 glycoprotein interaction with a putative cellular receptor CD81. *Journal of Virology* 73, 6235-6244.
- Flint, M., and McKeating, J.A. (2000). The role of the hepatitis C virus glycoproteins in infection. *Rev Med Virol* 10, 101-117.
- Flint, M., von Hahn, T., Zhang, J., Farquhar, M., Jones, C.T., Balfe, P., Rice, C.M., and McKeating, J.A. (2006). Diverse CD81 proteins support hepatitis C virus infection. *Journal of Virology* 80, 11331-11342.
- Flisiak, R., Horban, A., Gallay, P., Bobardt, M., Selvarajah, S., Wiercinska-Drapalo, A., Siwak, E., Cielniak, I., Higersberger, J., Kierkus, J., *et al.* (2008). The cyclophilin inhibitor Debio-025 shows potent anti-hepatitis C effect in patients coinfecting with hepatitis C and human immunodeficiency virus. *Hepatology* 47, 817-826.
- Fofana, I., Krieger, S.E., Grunert, F., Glauben, S., Xiao, F., Fafi-Kremer, S., Soulier, E., Mee, C.J., McKeating, J.A., Dragic, T., *et al.* (2010). Monoclonal anti-claudin 1 antibodies for prevention of hepatitis C virus infection. *Gastroenterology* 139, 953-964, 964.e951-954.
- Forns, X., Purcell, R.H., and Bukh, J. (1999). Quasispecies in viral persistence and pathogenesis of hepatitis C virus. *Trends in Microbiology* 7, 402-410.
- Forns, X., Thimme, R., Govindarajan, S., Emerson, S.U., Purcell, R.H., Chisari, F.V., and Bukh, J. (2000). Hepatitis C virus lacking the hypervariable region 1 of the second envelope protein is infectious and causes acute resolving or persistent infection in chimpanzees. *Proceedings of the National Academy of Sciences of the United States of America* 97, 13318-13323.

- Foster, T.L., Gallay, P., Stonehouse, N.J., and Harris, M. (2011). Cyclophilin A interacts with domain II of hepatitis C virus NS5A and stimulates RNA binding in an isomerase-dependent manner. *Journal of Virology* 85, 7460-7464.
- Fournillier, A., Wychowski, C., Boucreux, D., Baumert, T.F., Meunier, J.C., Jacobs, D., Muguet, S., Depla, E., and Inchauspe, G. (2001). Induction of hepatitis C virus E1 envelope protein-specific immune response can be enhanced by mutation of N-glycosylation sites. *Journal of Virology* 75, 12088-12097.
- Franck, N., Le Seyec, J., Guguen-Guillouzo, C., and Erdtmann, L. (2005). Hepatitis C virus NS2 protein is phosphorylated by the protein kinase CK2 and targeted for degradation to the proteasome. *Journal of Virology* 79, 2700-2708.
- Friebe, P., and Bartenschlager, R. (2002). Genetic analysis of sequences in the 3' nontranslated region of hepatitis C virus that are important for RNA replication. *Journal of Virology* 76, 5326-5338.
- Friebe, P., Boudet, J., Simorre, J.P., and Bartenschlager, R. (2005). Kissing-loop interaction in the 3' end of the hepatitis C virus genome essential for RNA replication. *Journal of Virology* 79, 380-392.
- Friebe, P., Lohmann, V., Krieger, N., and Bartenschlager, R. (2001). Sequences in the 5' nontranslated region of hepatitis C virus required for RNA replication. *Journal of Virology* 75, 12047-12057.
- Fried, M.W., Shiffman, M.L., Reddy, K.R., Smith, C., Marinos, G., Goncales, F.L., Jr., Haussinger, D., Diago, M., Carosi, G., Dhumeaux, D., *et al.* (2002). Peginterferon alfa-2a plus ribavirin for chronic hepatitis C virus infection. *N Engl J Med* 347, 975-982.
- Furuse, M., Fujita, K., Hiiragi, T., Fujimoto, K., and Tsukita, S. (1998). Claudin-1 and -2: novel integral membrane proteins localizing at tight junctions with no sequence similarity to occludin. *J Cell Biol* 141, 1539-1550.
- Furuse, M., and Tsukita, S. (2006). Claudins in occluding junctions of humans and flies. *Trends in Cell Biology* 16, 181-188.
- Fusco, D.N., and Chung, R.T. (2011). Novel Therapies for Hepatitis C: Insights from the Structure of the Virus. *Annu Rev Med* 63, 373-87.

G

- Gal-Tanamy, M., Keck, Z.Y., Yi, M., McKeating, J.A., Patel, A.H., Fong, S.K., and Lemon, S.M. (2008). In vitro selection of a neutralization-resistant hepatitis C virus escape mutant. *Proceedings of the National Academy of Sciences of the United States of America* 105, 19450-19455.
- Gale, M., Jr., Blakely, C.M., Kwieciszewski, B., Tan, S.L., Dossett, M., Tang, N.M., Korth, M.J., Polyak, S.J., Gretch, D.R., and Katze, M.G. (1998). Control of PKR protein kinase by hepatitis C virus nonstructural 5A protein: molecular mechanisms of kinase regulation. *Mol Cell Biol* 18, 5208-5218.
- Garcia-Retortillo, M., Forns, X., Feliu, A., Moitinho, E., Costa, J., Navasa, M., Rimola, A., and Rodes, J. (2002). Hepatitis C virus kinetics during and immediately after liver transplantation. *Hepatology* 35, 680-687.
- Garcia, J.M., Serrano, P.L., Terron Sdel, C., Marugan, R.B., Garcia, G.M., Grande, L.G., Miquel, J., and Plaza, A.G. (2003). Very rapid evolution of infection with hepatitis C virus transmitted by an accidental needlestick. *Clin Infect Dis* 36, 1632-1634.
- Gardner, J.P., Durso, R.J., Arrigale, R.R., Donovan, G.P., Maddon, P.J., Dragic, T., and Olson, W.C. (2003). L-SIGN (CD 209L) is a liver-specific capture receptor for hepatitis C virus. *Proc Natl Acad Sci U S A* 100, 4498-4503.
- Gastaminza, P., Cheng, G., Wieland, S., Zhong, J., Liao, W., and Chisari, F.V. (2007). Cellular determinants of hepatitis C virus assembly, maturation, degradation and secretion. *Journal of Virology* 82, 2120-9.

- Germi, R., Crance, J.M., Garin, D., Guimet, J., Lortat-Jacob, H., Ruigrok, R.W., Zarski, J.P., and Drouet, E. (2002). Heparan sulfate-mediated binding of infectious dengue virus type 2 and yellow fever virus. *Virology* 292, 162-168.
- Goffard, A., Callens, N., Bartosch, B., Wychowski, C., Cosset, F.L., Montpellier, C., and Dubuisson, J. (2005). Role of N-linked glycans in the functions of hepatitis C virus envelope glycoproteins. *Journal of Virology* 79, 8400-8409.
- Goffard, A., and Dubuisson, J. (2003). Glycosylation of hepatitis C virus envelope proteins. *Biochimie* 85, 295-301.
- Gonzalez, M.E., and Carrasco, L. (2003). Viroporins. *FEBS Lett* 552, 28-34.
- Gosert, R., Egger, D., Lohmann, V., Bartenschlager, R., Blum, H.E., Bienz, K., and Moradpour, D. (2003). Identification of the hepatitis C virus RNA replication complex in Huh-7 cells harboring subgenomic replicons. *Journal of Virology* 77, 5487-5492.
- Gottwein, J.M., Scheel, T.K., Jensen, T.B., Ghanem, L., and Bukh, J. (2011). Differential efficacy of protease inhibitors against HCV genotypes 2a, 3a, 5a, and 6a NS3/4A protease recombinant viruses. *Gastroenterology* 141, 1067-1079.
- Gouklani, H., Bull, R.A., Beyer, C., Coulibaly, F., Gowans, E.J., Drummer, H.E., Netter, H.J., White, P.A., and Haqshenas, G. (2012). Hepatitis C virus NS5B is involved in virus morphogenesis. *Journal of Virology* 07089-11.
- Grakoui, A., Wychowski, C., Lin, C., Feinstone, S.M., and Rice, C.M. (1993). Expression and identification of hepatitis C virus polyprotein cleavage products. *Journal of Virology* 67, 1385-1395.
- Grebely, J., Matthews, G.V., and Dore, G.J. (2011). Treatment of acute HCV infection. *Nat Rev Gastroenterol Hepatol* 8, 265-274.
- Gretton, S.N., Taylor, A.I., and McLauchlan, J. (2005). Mobility of the hepatitis C virus NS4B protein on the endoplasmic reticulum membrane and membrane-associated foci. *The Journal of General Virology* 86, 1415-1421.
- Griffin, S., Stgelais, C., Owsianka, A.M., Patel, A.H., Rowlands, D., and Harris, M. (2008). Genotype-dependent sensitivity of hepatitis C virus to inhibitors of the p7 ion channel. *Hepatology* 48, 1779-1790.
- Grove, J., Nielsen, S., Zhong, J., Bassendine, M.F., Drummer, H.E., Balfe, P., and McKeating, J.A. (2008). Identification of a residue in hepatitis C virus E2 glycoprotein that determines scavenger receptor BI and CD81 receptor dependency and sensitivity to neutralizing antibodies. *Journal of Virology* 82, 12020-12029.
- Guo, L., Chen, M., Song, Z., Daugherty, A., and Li, X.A. (2011). C323 of SR-BI is required for SR-BI-mediated HDL binding and cholesteryl ester uptake. *J Lipid Res* 52, 2272-2278.

H

- Haberstroh, A., Schnober, E.K., Zeisel, M.B., Carolla, P., Barth, H., Blum, H.E., Cosset, F.L., Koutsoudakis, G., Bartenschlager, R., Union, A., *et al.* (2008). Neutralizing host responses in hepatitis C virus infection target viral entry at postbinding steps and membrane fusion. *Gastroenterology* 135, 1719-1728.
- Hangartner, L., Zinkernagel, R.M., and Hangartner, H. (2006). Antiviral antibody responses: the two extremes of a wide spectrum. *Nature Reviews* 6, 231-243.
- Hanoulle, X., Verdegem, D., Badillo, A., Wieruszkeski, J.M., Penin, F., and Lippens, G. (2009). Domain 3 of non-structural protein 5A from hepatitis C virus is natively unfolded. *Biochemical and Biophysical Research Communications* 381, 634-638.

- Harris, H.J., Davis, C., Mullins, J.G., Hu, K., Goodall, M., Farquhar, M.J., Mee, C.J., McCaffrey, K., Young, S., Drummer, H., *et al.* (2010). Claudin association with CD81 defines hepatitis C virus entry. *The Journal of Biological Chemistry* 285, 21092-21102.
- Harris, H.J., Farquhar, M.J., Mee, C.J., Davis, C., Reynolds, G.M., Jennings, A., Hu, K., Yuan, F., Deng, H., Hubscher, S.G., *et al.* (2008). CD81 and claudin 1 coreceptor association: role in hepatitis C virus entry. *Journal of Virology* 82, 5007-5020.
- Hatzakis, A., Wait, S., Bruix, J., Buti, M., Carballo, M., Cavaleri, M., Colombo, M., Delarocque-Astagneau, E., Dusheiko, G., Esmat, G., *et al.* (2011). The state of hepatitis B and C in Europe: report from the hepatitis B and C summit conference. *Journal of Viral Hepatitis* 18 Suppl 1, 1-16.
- Helle, F., and Dubuisson, J. (2008). Hepatitis C virus entry into host cells. *Cell Mol Life Sci* 65, 100-112.
- Helle, F., Goffard, A., Morel, V., Duverlie, G., McKeating, J., Keck, Z.Y., Fong, S., Penin, F., Dubuisson, J., and Voisset, C. (2007). The neutralizing activity of anti-hepatitis C virus antibodies is modulated by specific glycans on the E2 envelope protein. *Journal of Virology* 81, 8101-8111.
- Heller, T., and Rehermann, B. (2005). Acute hepatitis C: a multifaceted disease. *Seminars in liver Disease* 25, 7-17.
- Heo, T.H., Lee, S.M., Bartosch, B., Cosset, F.L., and Kang, C.Y. (2006). Hepatitis C virus E2 links soluble human CD81 and SR-B1 protein. *Virus Research* 121, 58-64.
- Higginbottom, A., Quinn, E.R., Kuo, C.C., Flint, M., Wilson, L.H., Bianchi, E., Nicosia, A., Monk, P.N., McKeating, J.A., and Levy, S. (2000). Identification of amino acid residues in CD81 critical for interaction with hepatitis C virus envelope glycoprotein E2. *Journal of Virology* 74, 3642-3649.
- Hishiki, T., Shimizu, Y., Tobita, R., Sugiyama, K., Ogawa, K., Funami, K., Ohsaki, Y., Fujimoto, T., Takaku, H., Wakita, T., *et al.* (2010). Infectivity of hepatitis C virus is influenced by association with apolipoprotein E isoforms. *Journal of Virology* 84, 12048-12057.
- Hoekstra, M., Van Berkel, T.J., and Van Eck, M. (2010). Scavenger receptor BI: a multi-purpose player in cholesterol and steroid metabolism. *World J Gastroenterol* 16, 5916-5924.
- Holtmeier, W., and Kabelitz, D. (2005). gammadelta T cells link innate and adaptive immune responses. *Chemical Immunology and Allergy* 86, 151-183.
- Hoofnagle, J.H. (2002). Course and outcome of hepatitis C. *Hepatology* (Baltimore, Md) 36, S21-29.
- Hsu, M., Zhang, J., Flint, M., Logvinoff, C., Cheng-Mayer, C., Rice, C.M., and McKeating, J.A. (2003). Hepatitis C virus glycoproteins mediate pH-dependent cell entry of pseudotyped retroviral particles. *Proc Natl Acad Sci U S A* 100, 7271-7276.
- Huang, H., Sun, F., Owen, D.M., Li, W., Chen, Y., Gale, M., Jr., and Ye, J. (2007). Hepatitis C virus production by human hepatocytes dependent on assembly and secretion of very low-density lipoproteins. *Proceedings of the National Academy of Sciences of the United States of America* 104, 5848-5853.
- Hughes, M., Griffin, S., and Harris, M. (2009). Domain III of NS5A contributes to both RNA replication and assembly of hepatitis C virus particles. *The Journal of General Virology* 90, 1329-1334.
- Hughes, M.G., Jr., Rudy, C.K., Chong, T.W., Smith, R.L., Evans, H.L., Iezzoni, J.C., Sawyer, R.G., and Pruett, T.L. (2004). E2 quasispecies specificity of hepatitis C virus association with allografts immediately after liver transplantation. *Liver Transpl* 10, 208-216.
- Hugle, T., Fehrmann, F., Bieck, E., Kohara, M., Krausslich, H.G., Rice, C.M., Blum, H.E., and Moradpour, D. (2001). The hepatitis C virus nonstructural protein 4B is an integral endoplasmic reticulum membrane protein. *Virology* 284, 70-81.

I

Ivashkina, N., Wolk, B., Lohmann, V., Bartenschlager, R., Blum, H.E., Penin, F., and Moradpour, D. (2002). The hepatitis C virus RNA-dependent RNA polymerase membrane insertion sequence is a transmembrane segment. *Journal of Virology* 76, 13088-13093.

J

Jacobson, I.M., McHutchison, J.G., Dusheiko, G., Di Bisceglie, A.M., Reddy, K.R., Bzowej, N.H., Marcellin, P., Muir, A.J., Ferenci, P., Flisiak, R., *et al.* (2011). Telaprevir for previously untreated chronic hepatitis C virus infection. *The New England Journal of Medicine* 364, 2405-2416.

Jia, L., Betters, J.L., and Yu, L. (2011). Niemann-pick C1-like 1 (NPC1L1) protein in intestinal and hepatic cholesterol transport. *Annu Rev Physiol* 73, 239-259.

Jiang, J., and Luo, G. (2009). Apolipoprotein E but not B is required for the formation of infectious hepatitis C virus particles. *Journal of Virology* 83, 12680-12691.

Jirasko, V., Montserret, R., Appel, N., Janvier, A., Eustachi, L., Brohm, C., Steinmann, E., Pietschmann, T., Penin, F., and Bartenschlager, R. (2008). Structural and functional characterization of nonstructural protein 2 for its role in hepatitis C virus assembly. *The Journal of Biological Chemistry* 283, 28546-28562.

Jirasko, V., Montserret, R., Lee, J.Y., Gouttenoire, J., Moradpour, D., Penin, F., and Bartenschlager, R. (2010). Structural and functional studies of nonstructural protein 2 of the hepatitis C virus reveal its key role as organizer of virion assembly. *PLoS Pathogens* 6, e1001233.

Johnson, D.C., and Huber, M.T. (2002). Directed egress of animal viruses promotes cell-to-cell spread. *Journal of Virology* 76, 1-8.

Jones, C.T., Catanese, M.T., Law, L.M., Khetani, S.R., Syder, A.J., Ploss, A., Oh, T.S., Schoggins, J.W., MacDonald, M.R., Bhatia, S.N., *et al.* (2010). Real-time imaging of hepatitis C virus infection using a fluorescent cell-based reporter system. *Nat Biotechnol* 28, 167-171.

Jones, C.T., Murray, C.L., Eastman, D.K., Tassello, J., and Rice, C.M. (2007). Hepatitis C virus p7 and NS2 proteins are essential for production of infectious virus. *Journal of Virology* 81, 8374-8383.

Jopling, C.L., Yi, M., Lancaster, A.M., Lemon, S.M., and Sarnow, P. (2005). Modulation of hepatitis C virus RNA abundance by a liver-specific MicroRNA. *Science* 309, 1577-1581.

K

Kachko, A., Kochneva, G., Sivolobova, G., Grazhdantseva, A., Lupan, T., Zubkova, I., Wells, F., Merchlinsky, M., Williams, O., Watanabe, H., *et al.* (2011). New neutralizing antibody epitopes in hepatitis C virus envelope glycoproteins are revealed by dissecting peptide recognition profiles. *Vaccine* 30, 69-77.

Kaito, M., Watanabe, S., Tsukiyama-Kohara, K., Yamaguchi, K., Kobayashi, Y., Konishi, M., Yokoi, M., Ishida, S., Suzuki, S., and Kohara, M. (1994). Hepatitis C virus particle detected by immunoelectron microscopic study. *J Gen Virol* 75, 1755-1760.

Kapadia, S.B., Barth, H., Baumert, T., McKeating, J.A., and Chisari, F.V. (2007). Initiation of Hepatitis C Virus Infection Is Dependent on Cholesterol and Cooperativity between CD81 and Scavenger Receptor B Type I. *Journal of Virology* 81, 374-383.

Kato, N. (2001). Molecular virology of hepatitis C virus. *Acta Med Okayama* 55, 133-159.

Kato, N., Sekiya, H., Ootsuyama, Y., Nakazawa, T., Hijikata, M., Ohkoshi, S., and Shimotohno, K. (1993). Humoral immune response to hypervariable region 1 of the putative envelope glycoprotein (gp70) of hepatitis C virus. *Journal of Virology* 67, 3923-3930.

Keck, Z.Y., Saha, A., Xia, J., Wang, Y., Lau, P., Krey, T., Rey, F.A., and Fong, S.K. (2011). Mapping a region of hepatitis C virus E2 that is responsible for escape from neutralizing antibodies and a core CD81-binding region that does not tolerate neutralization escape mutations. *Journal of Virology* 85, 10451-10463.

Kim, J.L., Morgenstern, K.A., Lin, C., Fox, T., Dwyer, M.D., Landro, J.A., Chambers, S.P., Markland, W., Lepre, C.A., O'Malley, E.T., *et al.* (1996). Crystal structure of the hepatitis C virus NS3 protease domain complexed with a synthetic NS4A cofactor peptide. *Cell* 87, 343-355.

Kim, S., Welsch, C., Yi, M., and Lemon, S.M. (2011). Regulation of the production of infectious genotype 1a hepatitis C virus by NS5A domain III. *Journal of Virology* 85, 6645-6656.

Kobayashi, M., Bennett, M.C., Bercot, T., and Singh, I.R. (2006). Functional analysis of hepatitis C virus envelope proteins, using a cell-cell fusion assay. *Journal of Virology* 80, 1817-1825.

Kolykhalov, A.A., Feinstone, S.M., and Rice, C.M. (1996). Identification of a highly conserved sequence element at the 3' terminus of hepatitis C virus genome RNA. *Journal of Virology* 70, 3363-3371.

Kolykhalov, A.A., Mihalik, K., Feinstone, S.M., and Rice, C.M. (2000). Hepatitis C virus-encoded enzymatic activities and conserved RNA elements in the 3' nontranslated region are essential for virus replication *In vivo*. *Journal of Virology* 74, 2046-2051.

Koutsoudakis, G., Herrmann, E., Kallis, S., Bartenschlager, R., and Pietschmann, T. (2007). The level of CD81 cell surface expression is a key determinant for productive entry of Hepatitis C Virus into host cells. *Journal of Virology* 81, 588-598.

Koutsoudakis, G., Kaul, A., Steinmann, E., Kallis, S., Lohmann, V., Pietschmann, T., and Bartenschlager, R. (2006). Characterization of the early steps of hepatitis C virus infection by using luciferase reporter viruses. *Journal of Virology* 80, 5308-5320.

Krey, T., d'Alayer, J., Kikuti, C.M., Saulnier, A., Damier-Piolle, L., Petitpas, I., Johansson, D.X., Tawar, R.G., Baron, B., Robert, B., *et al.* (2010). The disulfide bonds in glycoprotein E2 of hepatitis C virus reveal the tertiary organization of the molecule. *PLoS Pathogens* 6, e1000762.

Krieger, M. (2001). Scavenger receptor class B type I is a multiligand HDL receptor that influences diverse physiological systems. *J Clin Invest* 108, 793-797.

Krieger, S.E., Zeisel, M.B., Davis, C., Thumann, C., Harris, H.J., Schnober, E.K., Mee, C., Soulier, E., Royer, C., Lambotin, M., *et al.* (2010). Inhibition of hepatitis C virus infection by anti-claudin-1 antibodies is mediated by neutralization of E2-CD81-claudin-1 associations. *Hepatology* 51, 1144-1157.

Kurosaki, M., Enomoto, N., Marumo, F., and Sato, C. (1993). Rapid sequence variation of the hypervariable region of hepatitis C virus during the course of chronic infection. *Hepatology* 18, 1293-1299.

L

Lackmann, M., and Boyd, A.W. (2008). Eph, a protein family coming of age: more confusion, insight, or complexity? *Sci Signal* 1, re2.

Lai, M.M., and Ware, C.F. (2000). Hepatitis C virus core protein: possible roles in viral pathogenesis. *Curr Top Microbiol Immunol* 242, 117-134.

- Lai, W.K., Sun, P.J., Zhang, J., Jennings, A., Lalor, P.F., Hubscher, S., McKeating, J.A., and Adams, D.H. (2006). Expression of DC-SIGN and DC-SIGNR on human sinusoidal endothelium: a role for capturing hepatitis C virus particles. *Am J Pathol* 169, 200-208.
- Lanford, R.E., Hildebrandt-Eriksen, E.S., Petri, A., Persson, R., Lindow, M., Munk, M.E., Kauppinen, S., and Orum, H. (2010). Therapeutic silencing of microRNA-122 in primates with chronic hepatitis C virus infection. *Science* 327, 198-201.
- Lauer, G.M., and Walker, B.D. (2001). Hepatitis C virus infection. *N Engl J Med* 345, 41-52.
- Lavie, M., Voisset, C., Vu-Dac, N., Zurawski, V., Duverlie, G., Wychowski, C., and Dubuisson, J. (2006). Serum amyloid A has antiviral activity against hepatitis C virus by inhibiting virus entry in a cell culture system. *Hepatology*, 1626-1634.
- Lavillette, D., Bartosch, B., Nourrisson, D., Verney, G., Cosset, F.L., Penin, F., and Pecheur, E.I. (2006). Hepatitis C virus glycoproteins mediate low pH-dependent membrane fusion with liposomes. *The Journal of Biological Chemistry* 281, 3909-3917.
- Lavillette, D., Morice, Y., Germanidis, G., Donot, P., Soulier, A., Pagkalos, E., Sakellariou, G., Intrator, L., Bartosch, B., Pawlotsky, J.M., *et al.* (2005). Human serum facilitates hepatitis C virus infection, and neutralizing responses inversely correlate with viral replication kinetics at the acute phase of hepatitis C virus infection. *Journal of Virology* 79, 6023-6034.
- Lavillette, D., Pecheur, E.I., Donot, P., Fresquet, J., Molle, J., Corbau, R., Dreux, M., Penin, F., and Cosset, F.L. (2007). Characterization of fusion determinants points to the involvement of three discrete regions of both E1 and E2 glycoproteins in the membrane fusion process of hepatitis C virus. *Journal of Virology* 81, 8752-8765.
- Law, M., Maruyama, T., Lewis, J., Giang, E., Tarr, A.W., Stamataki, Z., Gastaminza, P., Chisari, F.V., Jones, I.M., Fox, R.I., *et al.* (2008). Broadly neutralizing antibodies protect against hepatitis C virus quasispecies challenge. *Nat Med* 14, 25-27.
- Lesburg, C.A., Cable, M.B., Ferrari, E., Hong, Z., Mannarino, A.F., and Weber, P.C. (1999). Crystal structure of the RNA-dependent RNA polymerase from hepatitis C virus reveals a fully encircled active site. *Nat Struct Biol* 6, 937-943.
- Levy, S., Todd, S.C., and Maecker, H.T. (1998). CD81 (TAPA-1): a molecule involved in signal transduction and cell adhesion in the immune system. *Annu Rev Immunol* 16, 89-109.
- Lidove, O., Cacoub, P., Maisonobe, T., Servan, J., Thibault, V., Piette, J.C., and Leger, J.M. (2001). Hepatitis C virus infection with peripheral neuropathy is not always associated with cryoglobulinaemia. *Ann Rheum Dis* 60, 290-292.
- Lindenbach, B.D., Evans, M.J., Syder, A.J., Wolk, B., Tellinghuisen, T.L., Liu, C.C., Maruyama, T., Hynes, R.O., Burton, D.R., McKeating, J.A., *et al.* (2005). Complete replication of hepatitis C virus in cell culture. *Science* 309, 623-626.
- Lindenbach, B.D., Meuleman, P., Ploss, A., Vanwolleghem, T., Syder, A.J., McKeating, J.A., Lanford, R.E., Feinstone, S.M., Major, M.E., Leroux-Roels, G., *et al.* (2006). Cell culture-grown hepatitis C virus is infectious in vivo and can be recultured in vitro. *Proceedings of the National Academy of Sciences of the United States of America* 103, 3805-3809.
- Lindenbach, B.D., and Rice, C.M. (2001). Flaviviridae: the viruses and their replication. In *Fields Virology*, D.M. Knipe, P.M. Howley, D.E. Griffin, R.A. Lamb, M.A. Martin, B. Roizman, and S.E. Straus, 991-1041.
- Lindenbach, B.D., Thiel, H.J., and Rice, C.M. (2007). Flaviviridae: the viruses and their replication. In *Fields Virology*, D.M. Knipe, and P.M. Howley, 1101-1152.
- Litman, G.W., Cannon, J.P., and Dishaw, L.J. (2005). Reconstructing immune phylogeny: new perspectives. *Nature Reviews* 5, 866-879.

- Liu, M., Chen, H., Luo, F., Li, P., Pan, Q., Xia, B., Qi, Z., Ho, W.Z., and Zhang, X.L. (2007). Deletion of N-glycosylation sites of hepatitis C virus envelope protein E1 enhances specific cellular and humoral immune responses. *Vaccine* 25, 6572-6580.
- Liu, S., Yang, W., Shen, L., Turner, J.R., Coyne, C.B., and Wang, T. (2009). Tight junction proteins claudin-1 and occludin control hepatitis C virus entry and are downregulated during infection to prevent superinfection. *Journal of Virology* 83, 2011-2014.
- Lohmann, V., Korner, F., Dobierzewska, A., and Bartenschlager, R. (2001). Mutations in Hepatitis C Virus RNAs Conferring Cell Culture Adaptation. *Journal of Virology* 75, 1437-1449.
- Lohmann, V., Körner, F., Koch, J.O., Herian, U., Theilmann, L., and Bartenschlager, R. (1999). Replication of subgenomic hepatitis C virus RNAs in a hepatoma cell line. *Science* 285, 110-113.
- Long, G., Hiet, M.S., Windisch, M.P., Lee, J.Y., Lohmann, V., and Bartenschlager, R. (2011). Mouse hepatic cells support assembly of infectious hepatitis C virus particles. *Gastroenterology* 141, 1057-1066.
- Lozach, P.Y., Amara, A., Bartosch, B., Virelizier, J.L., Arenzana-Seisdedos, F., Cosset, F.L., and Altmeyer, R. (2004). C-type lectins L-SIGN and DC-SIGN capture and transmit infectious hepatitis C virus pseudotype particles. *The Journal of Biological Chemistry* 279, 32035-32045.
- Lozach, P.Y., Lortat-Jacob, H., de Lacroix de Lavalette, A., Staropoli, I., Foug, S., Amara, A., Houles, C., Fieschi, F., Schwartz, O., Virelizier, J.L., *et al.* (2003). DC-SIGN and L-SIGN are high affinity binding receptors for hepatitis C virus glycoprotein E2. *J Biol Chem* 278, 20358-20366.
- Luik, P., Chew, C., Aittoniemi, J., Chang, J., Wentworth, P., Jr., Dwek, R.A., Biggin, P.C., Venien-Bryan, C., and Zitzmann, N. (2009). The 3-dimensional structure of a hepatitis C virus p7 ion channel by electron microscopy. *Proceedings of the National Academy of Sciences of the United States of America* 106, 12712-12716.
- Lundin, M., Monne, M., Widell, A., Von Heijne, G., and Persson, M.A. (2003). Topology of the membrane-associated hepatitis C virus protein NS4B. *Journal of Virology* 77, 5428-5438.
- Lupberger, J., Zeisel, M.B., Xiao, F., Thumann, C., Fofana, I., Zona, L., Davis, C., Mee, C.J., Turek, M., Gorke, S., *et al.* (2011). EGFR and EphA2 are hepatitis C virus host entry factors and targets for antiviral therapy. *Nature Medicine* 17, 589-595.

M

- Ma, Y., Yates, J., Liang, Y., Lemon, S.M., and Yi, M. (2008). NS3 helicase domains involved in infectious intracellular hepatitis C virus particle assembly. *Journal of Virology* 82, 7624-7639.
- Maillard, P., Huby, T., Andreo, U., Moreau, M., Chapman, J., and Budkowska, A. (2006). The interaction of natural hepatitis C virus with human scavenger receptor SR-BI/Cla1 is mediated by ApoB-containing lipoproteins. *Faseb J* 20, 735-737.
- Manns, M.P., McHutchison, J.G., Gordon, S.C., Rustgi, V.K., Shiffman, M., Reindollar, R., Goodman, Z.D., Koury, K., Ling, M., and Albrecht, J.K. (2001). Peginterferon alfa-2b plus ribavirin compared with interferon alfa-2b plus ribavirin for initial treatment of chronic hepatitis C: a randomised trial. *Lancet* 358, 958-965.
- Marsh, M., and Helenius, A. (2006). Virus entry: open sesame. *Cell* 124, 729-740.
- Martell, M., Esteban, J.I., Quer, J., Genesca, J., Weiner, A., Esteban, R., Guardia, J., and Gomez, J. (1992). Hepatitis C virus (HCV) circulates as a population of different but closely related genomes: quasispecies nature of HCV genome distribution. *Journal of Virology* 66, 3225-3229.

- Martin, N.K., Vickerman, P., Miners, A., Foster, G.R., Hutchinson, S.J., Goldberg, D.J., and Hickman, M. (2012). The cost-effectiveness of HCV antiviral treatment for injecting drug user populations. *Hepatology* 55, 49-57.
- Matsuura, Y., Suzuki, T., Suzuki, R., Sato, M., Aizaki, H., Saito, I., and Miyamura, T. (1994). Processing of E1 and E2 glycoproteins of hepatitis C virus expressed in mammalian and insect cells. *Virology* 205, 141-150.
- McCaffrey, K., Gouklani, H., Boo, I., Pountourios, P., and Drummer, H.E. (2011). The variable regions of hepatitis C virus glycoprotein E2 have an essential structural role in glycoprotein assembly and virion infectivity. *The Journal of General Virology* 92, 112-121.
- McHutchison, J.G., Everson, G.T., Gordon, S.C., Jacobson, I.M., Sulkowski, M., Kauffman, R., McNair, L., Alam, J., and Muir, A.J. (2009). Telaprevir with peginterferon and ribavirin for chronic HCV genotype 1 infection. *The New England Journal of Medicine* 360, 1827-1838.
- McKeating, J.A., Zhang, L.Q., Logvinoff, C., Flint, M., Zhang, J., Yu, J., Butera, D., Ho, D.D., Dustin, L.B., Rice, C.M., *et al.* (2004). Diverse hepatitis C virus glycoproteins mediate viral infection in a CD81-dependent manner. *Journal of Virology* 78, 8496-8505.
- McLauchlan, J., Lemberg, M.K., Hope, G., Martoglio, B., Barba, G., and Harper, F. (2002). Intramembrane proteolysis promotes trafficking of hepatitis C virus core protein to lipid droplets. *EMBO J* 21, 3980-3988.
- McMullan, L.K., Grakoui, A., Evans, M.J., Mihalik, K., Puig, M., Branch, A.D., Feinstone, S.M., and Rice, C.M. (2007). Evidence for a functional RNA element in the hepatitis C virus core gene. *Proceedings of the National Academy of Sciences of the United States of America* 104, 2879-2884.
- Mee, C.J., Harris, H.J., Farquhar, M.J., Wilson, G., Reynolds, G., Davis, C., van, I.S.C., Balfe, P., and McKeating, J.A. (2009). Polarization restricts hepatitis C virus entry into HepG2 hepatoma cells. *Journal of Virology* 83, 6211-6221.
- Meertens, L., Bertaux, C., Cukierman, L., Cormier, E., Lavillette, D., Cosset, F.L., and Dragic, T. (2008). The tight junction proteins claudin-1, -6, and -9 are entry cofactors for hepatitis C virus. *Journal of Virology* 82, 3555-3560.
- Meertens, L., Bertaux, C., and Dragic, T. (2006). Hepatitis C virus entry requires a critical postinternalization step and delivery to early endosomes via clathrin-coated vesicles. *Journal of Virology* 80, 11571-11578.
- Mensa, L., Crespo, G., Gastinger, M.J., Kabat, J., Perez-del-Pulgar, S., Miquel, R., Emerson, S.U., Purcell, R.H., and Forns, X. (2011). Hepatitis C virus receptors claudin-1 and occludin after liver transplantation and influence on early viral kinetics. *Hepatology* 53, 1436-1445.
- Mercer, D.F., Schiller, D.E., Elliott, J.F., Douglas, D.N., Hao, C., Rinfret, A., Addison, W.R., Fischer, K.P., Churchill, T.A., Lakey, J.R., *et al.* (2001). Hepatitis C virus replication in mice with chimeric human livers. *Nat Med* 7, 927-933.
- Merola, M., Brazzoli, M., Cocchiarella, F., Heile, J.M., Helenius, A., Weiner, A.J., Houghton, M., and Abrignani, S. (2001). Folding of hepatitis C virus E1 glycoprotein in a cell-free system. *Journal of Virology* 75, 11205-11217.
- Merz, A., Long, G., Hiet, M.S., Brugger, B., Chlanda, P., Andre, P., Wieland, F., Krijnse-Locker, J., and Bartenschlager, R. (2011). Biochemical and morphological properties of hepatitis C virus particles and determination of their lipidome. *The Journal of Biological Chemistry* 286, 3018-3032.
- Meuleman, P., Hesselgesser, J., Paulson, M., Vanwolleghem, T., Desombere, I., Reiser, H., and Leroux-Roels, G. (2008). Anti-CD81 antibodies can prevent a hepatitis C virus infection in vivo. *Hepatology* 48, 1761-1768.

- Meuleman, P., Libbrecht, L., De Vos, R., de Hemptinne, B., Gevaert, K., Vandekerckhove, J., Roskams, T., and Leroux-Roels, G. (2005). Morphological and biochemical characterization of a human liver in a uPA-SCID mouse chimera. *Hepatology* 41, 847-856.
- Meuleman, P., Teresa Catanese, M., Verhoye, L., Desombere, I., Farhoudi, A., Jones, C.T., Sheahan, T., Grzyb, K., Cortese, R., Rice, C.M., *et al.* (2012). A Human monoclonal antibody targeting scavenger receptor class B type I precludes hepatitis C virus infection and viral spread in vitro and in vivo. *Hepatology* 55, 364-72.
- Meunier, J.C., Engle, R.E., Faulk, K., Zhao, M., Bartosch, B., Alter, H., Emerson, S.U., Cosset, F.L., Purcell, R.H., and Bukh, J. (2005). Evidence for cross-genotype neutralization of hepatitis C virus pseudo-particles and enhancement of infectivity by apolipoprotein C1. *Proceedings of the National Academy of Sciences of the United States of America* 102, 4560-4565. .
- Meunier, J.C., Russell, R.S., Engle, R.E., Faulk, K.N., Purcell, R.H., and Emerson, S.U. (2008). Apolipoprotein c1 association with hepatitis C virus. *Journal of Virology* 82, 9647-9656.
- Missale, G., Bertoni, R., Lamonaca, V., Valli, A., Massari, M., Mori, C., Rumi, M.G., Houghton, M., Fiaccadori, F., and Ferrari, C. (1996). Different clinical behaviors of acute hepatitis C virus infection are associated with different vigor of the anti-viral cell-mediated immune response. *The Journal of Clinical Investigation* 98, 706-714.
- Miyazari, Y., Atsuzawa, K., Usuda, N., Watashi, K., Hishiki, T., Zayas, M., Bartenschlager, R., Wakita, T., Hijikata, M., and Shimotohno, K. (2007). The lipid droplet is an important organelle for hepatitis C virus production. *Nat Cell Biol* 9, 1089-1097.
- Molina, S., Castet, V., Fournier-Wirth, C., Pichard-Garcia, L., Avner, R., Harats, D., Roitelman, J., Barbaras, R., Graber, P., Ghersa, P., *et al.* (2007). The low-density lipoprotein receptor plays a role in the infection of primary human hepatocytes by hepatitis C virus. *Journal of Hepatology* 46, 411-419.
- Molina, S., Castet, V., Pichard-Garcia, L., Wychowski, C., Meurs, E., Pascussi, J.M., Sureau, C., Fabre, J.M., Sacunha, A., Larrey, D., *et al.* (2008). Serum-derived hepatitis C virus infection of primary human hepatocytes is tetraspanin CD81 dependent. *Journal of Virology* 82, 569-574.
- Monazahian, M., Bohme, I., Bonk, S., Koch, A., Scholz, C., Grethe, S., and Thomssen, R. (1999). Low density lipoprotein receptor as a candidate receptor for hepatitis C virus. *J Med Virol* 57, 223-229.
- Mondelli, M.U., Cerino, A., Segagni, L., Meola, A., Cividini, A., Silini, E., and Nicosia, A. (2001). Hypervariable region 1 of hepatitis C virus: immunological decoy or biologically relevant domain? *Antiviral Research* 52, 153-159.
- Montpellier, C., Tews, B.A., Poitrimole, J., Rocha-Perugini, V., D'Arienzo, V., Potel, J., Zhang, X.A., Rubinstein, E., Dubuisson, J., and Cocquerel, L. (2011). Interacting regions of CD81 and two of its partners, EWI-2 and EWI-2wint, and their effect on hepatitis C virus infection. *The Journal of Biological Chemistry* 286, 13954-13965.
- Moradpour, D., and Blum, H.E. (2004). A primer on the molecular virology of hepatitis C. *Liver Int* 24, 519-525.
- Moradpour, D., Penin, F., and Rice, C.M. (2007). Replication of hepatitis C virus. *Nat Rev Microbiol* 5, 453-463.
- Morikawa, K., Zhao, Z., Date, T., Miyamoto, M., Murayama, A., Akazawa, D., Tanabe, J., Sone, S., and Wakita, T. (2007). The roles of CD81 and glycosaminoglycans in the adsorption and uptake of infectious HCV particles. *J Med Virol* 79, 714-723.
- Mukherjee, S. (2012). Natural History, Risk Factors And Management Of Hepatitis C After Liver Transplantation. *Inflammation & Allergy drug targets*.

N

- Netski, D.M., Mosbrugger, T., Depla, E., Maertens, G., Ray, S.C., Hamilton, R.G., Roundtree, S., Thomas, D.L., McKeating, J., and Cox, A. (2005). Humoral immune response in acute hepatitis C virus infection. *Clin Infect Dis* 41, 667-675.
- Neumann, A.U., Lam, N.P., Dahari, H., Gretch, D.R., Wiley, T.E., Layden, T.J., and Perelson, A.S. (1998). Hepatitis C viral dynamics in vivo and the antiviral efficacy of interferon-alpha therapy. *Science* 282, 103-107.
- Nielsen, S.U., Bassendine, M.F., Burt, A.D., Bevitt, D.J., and Toms, G.L. (2004). Characterization of the genome and structural proteins of hepatitis C virus resolved from infected human liver. *The Journal of General Virology* 85, 1497-1507.

O

- O'Reilly, J.I., Ocama, P., Opio, C.K., Alfred, A., Paintsil, E., Seremba, E., and Sofair, A.N. (2011). Risk Factors and Seroprevalence of Hepatitis C among Patients Hospitalized at Mulago Hospital, Uganda. *J Trop Med* 2011, 598341.
- Osburn, W.O., Fisher, B.E., Dowd, K.A., Urban, G., Liu, L., Ray, S.C., Thomas, D.L., and Cox, A.L. (2010). Spontaneous control of primary hepatitis C virus infection and immunity against persistent reinfection. *Gastroenterology* 138, 315-324.
- Owen, D.M., Huang, H., Ye, J., and Gale, M., Jr. (2009). Apolipoprotein E on hepatitis C virion facilitates infection through interaction with low-density lipoprotein receptor. *Virology* 394, 99-108.
- Owsianka, A., Tarr, A.W., Juttla, V.S., Lavillette, D., Bartosch, B., Cosset, F.L., Ball, J.K., and Patel, A.H. (2005). Monoclonal antibody AP33 defines a broadly neutralizing epitope on the hepatitis C virus E2 envelope glycoprotein. *Journal of Virology* 79, 11095-11104.
- Owsianka, A.M., Timms, J.M., Tarr, A.W., Brown, R.J., Hickling, T.P., Szwejk, A., Bienkowska-Szewczyk, K., Thomson, B.J., Patel, A.H., and Ball, J.K. (2006). Identification of conserved residues in the E2 envelope glycoprotein of the hepatitis C virus that are critical for CD81 binding. *Journal of Virology* 80, 8695-8704.

P

- Parren, P.W., and Burton, D.R. (2001). The antiviral activity of antibodies in vitro and in vivo. *Adv Immunol* 77, 195-262.
- Pawlotsky, J.M. (2006). Therapy of hepatitis C: from empiricism to eradication. *Hepatology* 43, S207-220.
- Penin, F., Combet, C., Germanidis, G., Frainais, P.O., Deleage, G., and Pawlotsky, J.M. (2001). Conservation of the conformation and positive charges of hepatitis C virus E2 envelope glycoprotein hypervariable region 1 points to a role in cell attachment. *Journal of Virology* 75, 5703-5710.
- Penin, F., Dubuisson, J., Rey, F.A., Moradpour, D., and Pawlotsky, J.M. (2004). Structural biology of hepatitis C virus. *Hepatology* 39, 5-19.
- Pestka, J.M., Zeisel, M.B., Blaser, E., Schurmann, P., Bartosch, B., Cosset, F.L., Patel, A.H., Meisel, H., Baumert, J., Viazov, S., *et al.* (2007). Rapid induction of virus-neutralizing antibodies and viral clearance in a single-source outbreak of hepatitis C. *Proceedings of the National Academy of Sciences of the United States of America* 104, 6025-6030.

Phan, T., Beran, R.K., Peters, C., Lorenz, I.C., and Lindenbach, B.D. (2009). Hepatitis C virus NS2 protein contributes to virus particle assembly via opposing epistatic interactions with the E1-E2 glycoprotein and NS3-NS4A enzyme complexes. *Journal of Virology* 83, 8379-8395.

Pietschmann, T., Kaul, A., Koutsoudakis, G., Shavinskaya, A., Kallis, S., Steinmann, E., Abid, K., Negro, F., Dreux, M., Cosset, F.L., *et al.* (2006). Construction and characterization of infectious intragenotypic and intergenotypic hepatitis C virus chimeras. *Proceedings of the National Academy of Sciences of the United States of America* 103, 7408-7413.

Pietschmann, T., Lohmann, V., Kaul, A., Krieger, N., Rinck, G., Rutter, G., Strand, D., and Bartenschlager, R. (2002). Persistent and transient replication of full-length hepatitis C virus genomes in cell culture. *Journal of Virology* 76, 4008-4021.

Pileri, P., Uematsu, Y., Campagnoli, S., Galli, G., Falugi, F., Petracca, R., Weiner, A.J., Houghton, M., Rosa, D., Grandi, G., *et al.* (1998). Binding of hepatitis C virus to CD81. *Science* 282, 938-941.

Ploss, A., Evans, M.J., Gaysinskaya, V.A., Panis, M., You, H., de Jong, Y.P., and Rice, C.M. (2009). Human occludin is a hepatitis C virus entry factor required for infection of mouse cells. *Nature* 457, 882-886.

Pohlmann, S., Zhang, J., Baribaud, F., Chen, Z., Leslie, G.J., Lin, G., Granelli-Piperno, A., Doms, R.W., Rice, C.M., and McKeating, J.A. (2003). Hepatitis C Virus Glycoproteins Interact with DC-SIGN and DC-SIGNR. *Journal of Virology* 77, 4070-4080.

Powers, K.A., Ribeiro, R.M., Patel, K., Pianko, S., Nyberg, L., Pockros, P., Conrad, A.J., McHutchison, J., and Perelson, A.S. (2006). Kinetics of hepatitis C virus reinfection after liver transplantation. *Liver Transpl* 12, 207-216.

Q

Qureshi, S.A. (2007). Hepatitis C virus--biology, host evasion strategies, and promising new therapies on the horizon. *Med Res Rev* 27, 353-373.

R

Rahman, F., Heller, T., Sobao, Y., Mizukoshi, E., Nascimbeni, M., Alter, H., Herrine, S., Hoofnagle, J., Liang, T.J., and Rehermann, B. (2004). Effects of antiviral therapy on the cellular immune response in acute hepatitis C. *Hepatology* 40, 87-97.

Ray, S.C., Mao, Q., Lanford, R.E., Bassett, S., Laeyendecker, O., Wang, Y.M., and Thomas, D.L. (2000). Hypervariable region 1 sequence stability during hepatitis C virus replication in chimpanzees. *Journal of Virology* 74, 3058-3066.

Ray, S.C., Wang, Y.M., Laeyendecker, O., Ticehurst, J.R., Villano, S.A., and Thomas, D.L. (1999). Acute hepatitis C virus structural gene sequences as predictors of persistent viremia: hypervariable region 1 as a decoy. *Journal of Virology* 73, 2938-2946.

Reading, S.A., and Dimmock, N.J. (2007). Neutralization of animal virus infectivity by antibody. *Arch Virol* 152, 1047-1059.

Rehermann, B. (2009). Hepatitis C virus versus innate and adaptive immune responses: a tale of coevolution and coexistence. *The Journal of Clinical Investigation* 119, 1745-1754.

Reiss, S., Rebhan, I., Backes, P., Romero-Brey, I., Erfle, H., Matula, P., Kaderali, L., Poenisch, M., Blankenburg, H., Hiet, M.S., *et al.* (2010). Recruitment and activation of a lipid kinase by hepatitis C virus NS5A is essential for integrity of the membranous replication compartment. *Cell Host & Microbe* 9, 32-45.

- Reynolds, G.M., Harris, H.J., Jennings, A., Hu, K., Grove, J., Lalor, P.F., Adams, D.H., Balfe, P., Hubscher, S.G., and McKeating, J.A. (2008). Hepatitis C virus receptor expression in normal and diseased liver tissue. *Hepatology* 47, 418-427.
- Rhainds, D., and Brissette, L. (2004). The role of scavenger receptor class B type I (SR-BI) in lipid trafficking. defining the rules for lipid traders. *Int J Biochem Cell Biol* 36, 39-77.
- Rigotti, A., Miettinen, H.E., and Krieger, M. (2003). The role of the high-density lipoprotein receptor SR-BI in the lipid metabolism of endocrine and other tissues. *Endocrine Reviews* 24, 357-387.
- Roccasecca, R., Ansuini, H., Vitelli, A., Meola, A., Scarselli, E., Acali, S., Pezzanera, M., Ercole, B.B., McKeating, J., Yagnik, A., *et al.* (2003). Binding of the hepatitis C virus E2 glycoprotein to CD81 is strain specific and is modulated by a complex interplay between hypervariable regions 1 and 2. *Journal of Virology* 77, 1856-1867.
- Rocha-Perugini, V., Lavie, M., Delgrange, D., Canton, J., Pillez, A., Potel, J., Lecoœur, C., Rubinstein, E., Dubuisson, J., Wychowski, C., *et al.* (2009). The association of CD81 with tetraspanin-enriched microdomains is not essential for Hepatitis C virus entry. *BMC Microbiol* 9, 111.
- Rocha-Perugini, V., Montpellier, C., Delgrange, D., Wychowski, C., Helle, F., Pillez, A., Drobecq, H., Le Naour, F., Charrin, S., Levy, S., *et al.* (2008). The CD81 partner EWI-2wint inhibits hepatitis C virus entry. *PLoS One* 3, e1866.
- Roche, B., and Samuel, D. (2008). Liver transplantation in viral hepatitis: prevention of recurrence. *Best Pract Res Clin Gastroenterol* 22, 1153-1169.
- Rosa, D., Campagnoli, S., Moretto, C., Guenzi, E., Cousens, L., Chin, M., Dong, C., Weiner, A., Lau, J.Y.N., Choo, Q.-L., *et al.* (1996). A quantitative test to estimate neutralizing antibodies to the hepatitis C virus: cytofluorimetric assessment of envelope glycoprotein 2 binding to target cells. *Proc Natl Acad Sci USA* 93, 1759-1763.
- Rumin, S., Berthillon, P., Tanaka, E., Kiyosawa, K., Trabaud, M.A., Bizollon, T., Guillaat, C., Gripon, P., Guguen-Guillouzo, C., Inchauspe, G., *et al.* (1999). Dynamic analysis of hepatitis C virus replication and quasispecies selection in long-term cultures of adult human hepatocytes infected in vitro. *The Journal of General Virology* 80, 3007-3018.
- Russell, R.S., Meunier, J.C., Takikawa, S., Faulk, K., Engle, R.E., Bukh, J., Purcell, R.H., and Emerson, S.U. (2008). Advantages of a single-cycle production assay to study cell culture-adaptive mutations of hepatitis C virus. *Proceedings of the National Academy of Sciences of the United States of America* 105, 4370-4375.
- Russo, M.W., and Fried, M.W. (2003). Side effects of therapy for chronic hepatitis C. *Gastroenterology* 124, 1711-1719.

S

- Sainz, B., Jr., Barretto, N., Martin, D.N., Hiraga, N., Imamura, M., Hussain, S., Marsh, K.A., Yu, X., Chayama, K., Alrefai, W.A., *et al.* (2012). Identification of the Niemann-Pick C1-like 1 cholesterol absorption receptor as a new hepatitis C virus entry factor. *Nat Med* 81, 281-5.
- Sakai, A., Claire, M.S., Faulk, K., Govindarajan, S., Emerson, S.U., Purcell, R.H., and Bukh, J. (2003). The p7 polypeptide of hepatitis C virus is critical for infectivity and contains functionally important genotype-specific sequences. *Proc Natl Acad Sci U S A* 100, 11646-11651.
- Sarrazin, C., Hezode, C., Zeuzem, S., and Pawlotsky, J.M. (2012). Antiviral strategies in hepatitis C virus infection. *Journal of Hepatology* 56 *Suppl*, S88-S100.
- Saxena, V., Lai, C.K., Chao, T.C., Jeng, K.S., and Lai, M.M. (2012). Annexin A2 is involved in the formation of hepatitis C virus replication complex on the lipid raft. *Journal of Virology* 06327-11.

- Scarselli, E., Ansuini, H., Cerino, R., Roccasecca, R.M., Acali, S., Filocamo, G., Traboni, C., Nicosia, A., Cortese, R., and Vitelli, A. (2002). The human scavenger receptor class B type I is a novel candidate receptor for the hepatitis C virus. *EMBO J* 21, 5017-5025.
- Scheel, T.K., Gottwein, J.M., Carlsen, T.H., Li, Y.P., Jensen, T.B., Spengler, U., Weis, N., and Bukh, J. (2011a). Efficient culture adaptation of hepatitis C virus recombinants with genotype-specific core-NS2 by using previously identified mutations. *Journal of Virology* 85, 2891-2906.
- Scheel, T.K., Gottwein, J.M., Mikkelsen, L.S., Jensen, T.B., and Bukh, J. (2011b). Recombinant HCV variants with NS5A from genotypes 1-7 have different sensitivities to an NS5A inhibitor but not interferon-alpha. *Gastroenterology* 140, 1032-1042.
- Schmidt-Mende, J., Bieck, E., Hugle, T., Penin, F., Rice, C.M., Blum, H.E., and Moradpour, D. (2001). Determinants for membrane association of the hepatitis C virus RNA-dependent RNA polymerase. *The Journal of Biological Chemistry* 276, 44052-44063.
- Schneider, M.R., and Wolf, E. (2009). The epidermal growth factor receptor ligands at a glance. *J Cell Physiol* 218, 460-466.
- Schulze Zur Wiesch, J., Ciuffreda, D., Lewis-Ximenez, L., Kasprovicz, V., Nolan, B.E., Streeck, H., Aneja, J., Reyor, L.L., Allen, T.M., Lohse, A.W., *et al.* (2012). Broadly directed virus-specific CD4+ T cell responses are primed during acute hepatitis C infection, but rapidly disappear from human blood with viral persistence. *The Journal of Experimental Medicine* 209, 61-75.
- Schulze zur Wiesch, J., Lauer, G.M., Day, C.L., Kim, A.Y., Ouchi, K., Duncan, J.E., Wurcel, A.G., Timm, J., Jones, A.M., Mothe, B., *et al.* (2005). Broad repertoire of the CD4+ Th cell response in spontaneously controlled hepatitis C virus infection includes dominant and highly promiscuous epitopes. *J Immunol* 175, 3603-3613.
- Schvoerer, E., Soulier, E., Royer, C., Renaudin, A.C., Thumann, C., Fafi-Kremer, S., Brignon, N., Doridot, S., Meyer, N., Pinson, P., *et al.* (2007). Early evolution of hepatitis C virus (HCV) quasispecies after liver transplant for HCV-related disease. *J Infect Dis* 196, 528-536.
- Schwarz, A.K., Grove, J., Hu, K., Mee, C.J., Balfe, P., and McKeating, J.A. (2009). Hepatoma cell density promotes claudin-1 and scavenger receptor BI expression and hepatitis C virus internalization. *Journal of Virology* 83, 12407-12414.
- Schwer, B., Ren, S., Pietschmann, T., Kartenbeck, J., Kaehlcke, K., Bartenschlager, R., Yen, T.S., and Ott, M. (2004). Targeting of hepatitis C virus core protein to mitochondria through a novel C-terminal localization motif. *Journal of Virology* 78, 7958-7968.
- Sharma, N.R., Mateu, G., Dreux, M., Grakoui, A., Cosset, F.L., and Melikyan, G.B. (2011). Hepatitis C virus is primed by CD81 protein for low pH-dependent fusion. *The Journal of Biological Chemistry* 286, 30361-30376.
- Shimizu, Y., Iwamoto, A., Hijikata, M., Purcell, R.H., and Yoshikura, H. (1992). Evidence for in vitro replication of hepatitis C virus genome in a human T-cell line. *Proc Natl Acad Sci USA* 89, 5477-5481.
- Shimizu, Y.K., Igarashi, H., Kiyohara, T., Cabezon, T., Farci, P., Purcell, R.H., and Yoshikura, H. (1996). A hyperimmune serum against a synthetic peptide corresponding to the hypervariable region 1 of hepatitis C virus can prevent viral infection in cell cultures. *Virology* 223, 409-412.
- Shoukry, N.H., Cawthon, A.G., and Walker, C.M. (2004). Cell-mediated immunity and the outcome of hepatitis C virus infection. *Annu Rev Microbiol* 58, 391-424.
- Sievert, W., Altraif, I., Razavi, H.A., Abdo, A., Ahmed, E.A., Alomair, A., Amarapurkar, D., Chen, C.H., Dou, X., El Khayat, H., *et al.* (2011). A systematic review of hepatitis C virus epidemiology in Asia, Australia and Egypt. *Liver Int* 31 Suppl 2, 61-80.

Simmonds, P., Alberti, A., Alter, H.J., Bonino, F., Bradley, D.W., Brechot, C., Brouwer, J.T., Chan, S.W., Chayama, K., Chen, D.S., *et al.* (1994). A proposed system for the nomenclature of hepatitis C viral genotypes [letter]. *Hepatology* 19, 1321-1324.

Simmonds, P., Bukh, J., Combet, C., Deleage, G., Enomoto, N., Feinstone, S., Halfon, P., Inchauspe, G., Kuiken, C., Maertens, G., *et al.* (2005). Consensus proposals for a unified system of nomenclature of hepatitis C virus genotypes. *Hepatology* 42, 962-973.

Sollner, T.H. (2004). Intracellular and viral membrane fusion: a uniting mechanism. *Curr Opin Cell Biol* 16, 429-435.

Stapleford, K.A., and Lindenbach, B.D. (2011). Hepatitis C virus NS2 coordinates virus particle assembly through physical interactions with the E1-E2 glycoprotein and NS3-NS4A enzyme complexes. *Journal of Virology* 85, 1706-1717.

Steinmann, D., Barth, H., Gissler, B., Schürmann, P., Adah, M.I., Gerlach, J.T., Pape, G.R., Depla, E., Jacobs, D., Maertens, G., *et al.* (2004). Inhibition of hepatitis C virus-like particle binding to target cells by antiviral antibodies in acute and chronic hepatitis C. *Journal of Virology* 78, 9030-9040.

Steinmann, E., Penin, F., Kallis, S., Patel, A.H., Bartenschlager, R., and Pietschmann, T. (2007). Hepatitis C Virus p7 Protein Is Crucial for Assembly and Release of Infectious Virions. *PLoS pathogens* 3, e103.

Steinmann, E., and Pietschmann, T. (2010). Hepatitis C virus p7-a viroporin crucial for virus assembly and an emerging target for antiviral therapy. *Viruses* 2, 2078-2095.

Sugawara, Y., Tamura, S., and Kokudo, N. (2010). Antiviral treatment for hepatitis C virus infection after liver transplantation. *Hepat Res Treat* 2010, 475746.

Suratane, A., Rebhan, I., Matula, P., Kumar, A., Kaderali, L., Rohr, K., Bartenschlager, R., Eils, R., and König, R. (2010). Detecting host factors involved in virus infection by observing the clustering of infected cells in siRNA screening images. *Bioinformatics* 26, i653-658.

Suzuki, R., Sakamoto, S., Tsutsumi, T., Rikimaru, A., Tanaka, K., Shimoike, T., Moriishi, K., Iwasaki, T., Mizumoto, K., Matsuura, Y., *et al.* (2005). Molecular determinants for subcellular localization of hepatitis C virus core protein. *Journal of Virology* 79, 1271-1281.

Syder, A.J., Lee, H., Zeisel, M.B., Grove, J., Soulier, E., Macdonald, J., Chow, S., Chang, J., Baumert, T.F., McKeating, J.A., *et al.* (2011). Small molecule scavenger receptor BI antagonists are potent HCV entry inhibitors. *Journal of Hepatology* 54, 48-55.

T

Takaki, A., Wiese, M., Maertens, G., Depla, E., Seifert, U., Liebetrau, A., Miller, J.L., Manns, M.P., and Rehermann, B. (2000). Cellular immune responses persist and humoral responses decrease two decades after recovery from a single-source outbreak of hepatitis C. *Nat Med* 6, 578-582.

Tan, S.L., and Katze, M.G. (2001). How hepatitis C virus counteracts the interferon response: the jury is still out on NS5A. *Virology* 284, 1-12.

Tanaka, T., Kato, N., Cho, M.J., Sugiyama, K., and Shimotohno, K. (1996). Structure of the 3' terminus of the hepatitis C virus genome. *Journal of Virology* 70, 3307-3312.

Tao, W., Xu, C., Ding, Q., Li, R., Xiang, Y., Chung, J., and Zhong, J. (2009). A single point mutation in E2 enhances hepatitis C virus infectivity and alters lipoprotein association of viral particles. *Virology* 395, 67-76.

Tellinghuisen, T.L., Foss, K.L., and Treadaway, J. (2008). Regulation of hepatitis C virion production via phosphorylation of the NS5A protein. *PLoS Pathogens* 4, e1000032.

- Tellinghuisen, T.L., Marcotrigiano, J., Gorbalenya, A.E., and Rice, C.M. (2004). The NS5A protein of hepatitis C virus is a zinc metalloprotein. *The Journal of Biological Chemistry* 279, 48576-48587.
- Tellinghuisen, T.L., Marcotrigiano, J., and Rice, C.M. (2005). Structure of the zinc-binding domain of an essential component of the hepatitis C virus replicase. *Nature* 435, 374-379.
- Tellinghuisen, T.L., and Rice, C.M. (2002). Interaction between hepatitis C virus proteins and host cell factors. *Curr Opin Microbiol* 5, 419-427.
- Temel, R.E., Tang, W., Ma, Y., Rudel, L.L., Willingham, M.C., Ioannou, Y.A., Davies, J.P., Nilsson, L.M., and Yu, L. (2007). Hepatic Niemann-Pick C1-like 1 regulates biliary cholesterol concentration and is a target of ezetimibe. *The Journal of Clinical Investigation* 117, 1968-1978.
- Thimme, R., Oldach, D., Chang, K.M., Steiger, C., Ray, S.C., and Chisari, F.V. (2001). Determinants of viral clearance and persistence during acute hepatitis C virus infection. *J Exp Med* 194, 1395-1406.
- Timm, J., Lauer, G.M., Kavanagh, D.G., Sheridan, I., Kim, A.Y., Lucas, M., Pillay, T., Ouchi, K., Reyor, L.L., Schulze zur Wiesch, J., *et al.* (2004). CD8 epitope escape and reversion in acute HCV infection. *The Journal of Experimental Medicine* 200, 1593-1604.
- Timpe, J.M., Stamataki, Z., Jennings, A., Hu, K., Farquhar, M.J., Harris, H.J., Schwarz, A., Desombere, I., Roels, G.L., Balfe, P., *et al.* (2008). Hepatitis C virus cell-cell transmission in hepatoma cells in the presence of neutralizing antibodies. *Hepatology* 47, 17-24.
- Triyatni, M., Saunier, B., Maruvada, P., Davis, A.R., Ulianich, L., Heller, T., Patel, A., Kohn, L.D., and Liang, T.J. (2002). Interaction of hepatitis C virus-like particles and cells: a model system for studying viral binding and entry. *Journal of Virology* 76, 9335-9344.
- Troesch, M., Meunier, I., Lapierre, P., Lapointe, N., Alvarez, F., Boucher, M., and Soudeyins, H. (2006). Study of a novel hypervariable region in hepatitis C virus (HCV) E2 envelope glycoprotein. *Virology* 352, 357-367.
- Tscherne, D.M., Jones, C.T., Evans, M.J., Lindenbach, B.D., McKeating, J.A., and Rice, C.M. (2006). Time- and temperature-dependent activation of hepatitis C virus for low-pH-triggered entry. *Journal of Virology* 80, 1734-1741.

UV

- Van Eck, M., Hoekstra, M., Out, R., Bos, I.S., Kruijt, J.K., Hildebrand, R.B., and Van Berkel, T.J. (2008). Scavenger receptor BI facilitates the metabolism of VLDL lipoproteins in vivo. *J Lipid Res* 49, 136-146.
- Van Kooyk, Y., and Geijtenbeek, T.B. (2003). DC-SIGN: escape mechanism for pathogens. *Nature reviews* 3, 697-709.
- Vanwolleghem, T., Bukh, J., Meuleman, P., Desombere, I., Meunier, J.C., Alter, H., Purcell, R.H., and Leroux-Roels, G. (2008). Polyclonal immunoglobulins from a chronic hepatitis C virus patient protect human liver-chimeric mice from infection with a homologous hepatitis C virus strain. *Hepatology* 47, 1846-1855.
- Varaklioti, A., Vassilaki, N., Georgopoulou, U., and Mavromara, P. (2002). Alternate translation occurs within the core coding region of the hepatitis C viral genome. *The Journal of Biological Chemistry* 277, 17713-17721.
- Voisset, C., Callens, N., Blanchard, E., Op De Beeck, A., Dubuisson, J., and Vu-Dac, N. (2005). High density lipoproteins facilitate hepatitis C virus entry through the scavenger receptor class B type I. *The Journal of Biological Chemistry* 280, 7793-7799.
- Voisset, C., Op de Beeck, A., Horellou, P., Dreux, M., Gustot, T., Duverlie, G., Cosset, F.L., Vu-Dac, N., and Dubuisson, J. (2006). High-density lipoproteins reduce the neutralizing effect of hepatitis C

virus (HCV)-infected patient antibodies by promoting HCV entry. *The Journal of General Virology* 87, 2577-2581.

Von Hahn, T., Lindenbach, B.D., Boullier, A., Quehenberger, O., Paulson, M., Rice, C.M., and McKeating, J.A. (2006). Oxidized low-density lipoprotein inhibits hepatitis C virus cell entry in human hepatoma cells. *Hepatology* 43, 932-942.

Von Hahn, T., and Rice, C.M. (2008). Hepatitis C virus entry. *The Journal of Biological Chemistry* 283, 3689-3693.

von Hahn, T., Yoon, J.C., Alter, H., Rice, C.M., Rehermann, B., Balfe, P., and McKeating, J.A. (2007). Hepatitis C virus continuously escapes from neutralizing antibody and T-cell responses during chronic infection in vivo. *Gastroenterology* 132, 667-678.

W

Wakita, T., Pietschmann, T., Kato, T., Date, T., Miyamoto, M., Zhao, Z., Murthy, K., Habermann, A., Krausslich, H.G., Mizokami, M., *et al.* (2005). Production of infectious hepatitis C virus in tissue culture from a cloned viral genome. *Nat Med* 11, 791-796.

Walewski, J.L., Keller, T.R., Stump, D.D., and Branch, A.D. (2001). Evidence for a new hepatitis C virus antigen encoded in an overlapping reading frame. *RNA* 7, 710-721.

Weiner, A.J., Brauer, M.J., Rosenblatt, J., Richman, K.H., Tung, J., Crawford, K., Bonino, F., Saracco, G., Choo, Q.L., Houghton, M., *et al.* (1991). Variable and hypervariable domains are found in the regions of HCV corresponding to the flavivirus envelope and NS1 proteins and the pestivirus envelope glycoproteins. *Virology* 180, 842-848.

Wellnitz, S., Klumpp, B., Barth, H., Ito, S., Depla, E., Dubuisson, J., Blum, H.E., and Baumert, T.F. (2002). Binding of hepatitis C virus-like particles derived from infectious clone H77C to defined human cell lines. *Journal of Virology* 76, 1181-1193.

Witteveldt, J., Evans, M.J., Bitzegeio, J., Koutsoudakis, G., Owsianka, A.M., Angus, A.G., Keck, Z.Y., Fong, S.K., Pietschmann, T., Rice, C.M., *et al.* (2009). CD81 is dispensable for hepatitis C virus cell-to-cell transmission in hepatoma cells. *The Journal of General Virology* 90, 48-58.

Wolf, M., Dimitrova, M., Baumert, T.F., and Schuster, C. (2008). The major form of hepatitis C virus alternate reading frame protein is suppressed by core protein expression. *Nucleic Acids Res* 36, 3054-3064.

Wolk, B., Sansonno, D., Krausslich, H.G., Dammacco, F., Rice, C.M., Blum, H.E., and Moradpour, D. (2000). Subcellular localization, stability, and trans-cleavage competence of the hepatitis C virus NS3-NS4A complex expressed in tetracycline-regulated cell lines. *Journal of Virology* 74, 2293-2304.

Wu, Y., Liao, Q., Yang, R., Chen, X., and Chen, X. (2010). A novel luciferase and GFP dual reporter virus for rapid and convenient evaluation of hepatitis C virus replication. *Virus research* 155, 406-414.

Wunschmann, S., Medh, J.D., Klinzmann, D., Schmidt, W.N., and Stapleton, J.T. (2000). Characterization of hepatitis C virus (HCV) and HCV E2 interactions with CD81 and the low-density lipoprotein receptor. *Journal of Virology* 74, 10055-10062.

XYZ

Xu, Z., Choi, J., Lu, W., and Ou, J.H. (2003). Hepatitis C virus f protein is a short-lived protein associated with the endoplasmic reticulum. *Journal of Virology* 77, 1578-1583.

- Yamada, E., Montoya, M., Schuettler, C.G., Hickling, T.P., Tarr, A.W., Vitelli, A., Dubuisson, J., Patel, A.H., Ball, J.K., and Borrow, P. (2005). Analysis of the binding of hepatitis C virus genotype 1a and 1b E2 glycoproteins to peripheral blood mononuclear cell subsets. *The Journal of General Virology* *86*, 2507-2512.
- Yamaga, A.K., and Ou, J.H. (2002). Membrane topology of the hepatitis C virus NS2 protein. *The Journal of Biological Chemistry* *277*, 33228-33234.
- Yamanashi, Y., Takada, T., and Suzuki, H. (2007). Niemann-Pick C1-like 1 overexpression facilitates ezetimibe-sensitive cholesterol and beta-sitosterol uptake in CaCo-2 cells. *J Pharmacol Exp Ther* *320*, 559-564.
- Yang, W., Qiu, C., Biswas, N., Jin, J., Watkins, S.C., Montelaro, R.C., Coyne, C.B., and Wang, T. (2008). Correlation of the tight junction-like distribution of Claudin-1 to the cellular tropism of hepatitis C virus. *The Journal of Biological Chemistry* *283*, 8643-8653.
- Yi, M., and Lemon, S.M. (2003). 3' nontranslated RNA signals required for replication of hepatitis C virus RNA. *Journal of Virology* *77*, 3557-3568.
- You, S., Stump, D.D., Branch, A.D., and Rice, C.M. (2004). A cis-acting replication element in the sequence encoding the NS5B RNA-dependent RNA polymerase is required for hepatitis C virus RNA replication. *Journal of Virology* *78*, 1352-1366.
- Yu, L. (2008). The structure and function of Niemann-Pick C1-like 1 protein. *Curr Opin Lipidol* *19*, 263-269.
- Yu, L., Bharadwaj, S., Brown, J.M., Ma, Y., Du, W., Davis, M.A., Michaely, P., Liu, P., Willingham, M.C., and Rudel, L.L. (2006). Cholesterol-regulated translocation of NPC1L1 to the cell surface facilitates free cholesterol uptake. *The Journal of Biological Chemistry* *281*, 6616-6624.
- Yu, M., Romer, K.A., Nieland, T.J., Xu, S., Saenz-Vash, V., Penman, M., Yesilaltay, A., Carr, S.A., and Krieger, M. (2011). Exoplasmic cysteine Cys384 of the HDL receptor SR-BI is critical for its sensitivity to a small-molecule inhibitor and normal lipid transport activity. *Proceedings of the National Academy of Sciences of the United States of America* *108*, 12243-12248.
- Zeisel, M.B., Cosset, F.L., and Baumert, T.F. (2008). Host neutralizing responses and pathogenesis of hepatitis C virus infection. *Hepatology* *48*, 299-307.
- Zeisel, M.B., Fafi-Kremer, S., Fofana, I., Barth, H., Stoll-Keller, F., Doffoel, M., and Baumert, T.F. (2007a). Neutralizing antibodies in hepatitis C virus infection. *World J Gastroenterol* *13*, 4824-4830.
- Zeisel, M.B., Fofana, I., Fafi-Kremer, S., and Baumert, T.F. (2011). HCV entry into hepatocytes: mechanism and potential therapeutic implications. *Journal of Hepatology* *54*, 566-576.
- Zeisel, M.B., Koutsoudakis, G., Schnober, E.K., Haberstroh, A., Blum, H.E., Cosset, F.-L., Wakita, T., Jaeck, D., Doffoel, M., Royer, C., *et al.* (2007b). Scavenger receptor BI is a key host factor for Hepatitis C virus infection required for an entry step closely linked to CD81. *Hepatology* *46*, 1722-1731.
- Zhang, J., Randall, G., Higginbottom, A., Monk, P., Rice, C.M., and McKeating, J.A. (2004a). CD81 is required for hepatitis C virus glycoprotein-mediated viral infection. *Journal of Virology* *78*, 1448-1455.
- Zhang, M., Gaschen, B., Blay, W., Foley, B., Haigwood, N., Kuiken, C., and Korber, B. (2004b). Tracking global patterns of N-linked glycosylation site variation in highly variable viral glycoproteins: HIV, SIV, and HCV envelopes and influenza hemagglutinin. *Glycobiology* *14*, 1229-1246.
- Zhang, P., Wu, C.G., Mihalik, K., Virata-Theimer, M.L., Yu, M.Y., Alter, H.J., and Feinstone, S.M. (2007). Hepatitis C virus epitope-specific neutralizing antibodies in Igs prepared from human plasma. *Proceedings of the National Academy of Sciences of the United States of America* *104*, 8449-8454.

- Zhang, P., Zhong, L., Struble, E.B., Watanabe, H., Kachko, A., Mihalik, K., Virata-Theimer, M.L., Alter, H.J., Feinstone, S., and Major, M. (2009). Depletion of interfering antibodies in chronic hepatitis C patients and vaccinated chimpanzees reveals broad cross-genotype neutralizing activity. *Proceedings of the National Academy of Sciences of the United States of America* *106*, 7537-7541.
- Zhang, Y.Y., Zhang, B.H., Ishii, K., and Liang, T.J. (2010). Novel function of CD81 in controlling hepatitis C virus replication. *Journal of Virology* *84*, 3396-3407.
- Zhong, J., Gastaminza, P., Cheng, G., Kapadia, S., Kato, T., Burton, D.R., Wieland, S.F., Uprichard, S.L., Wakita, T., and Chisari, F.V. (2005). Robust hepatitis C virus infection in vitro. *Proceedings of the National Academy of Sciences of the United States of America* *102*, 9294-9299.
- Zibert, A., Dudziak, P., Schreier, E., and Roggendorf, M. (1997). Characterization of antibody response to hepatitis C virus protein E2 and significance of hypervariable region 1-specific antibodies in viral neutralization. *Arch Virol* *142*, 523-534.
- Zignego, A.L., Ferri, C., Pileri, S.A., Caini, P., and Bianchi, F.B. (2007). Extrahepatic manifestations of Hepatitis C Virus infection: a general overview and guidelines for a clinical approach. *Dig Liver Dis* *39*, 2-17.

Annex

During the tenure of my PhD, I also participated in two additional projects, one conducted by our lab while the second one was a collaboration with the group of A. H. Patel, MRC, University of Glasgow Centre for Virus Research, Glasgow, UK.

In the framework of the characterization of the role of EGFR and EphA2 in HCV entry by our team, I demonstrated that RTK-specific antibodies or silencing of RTK expression by siRNAs did not affect E2 binding to target cells, while preincubation with anti-SR-BI antibodies or silencing SR-BI expression significantly reduced E2 binding. These data indicate that EGFR and EphA2 are not involved in HCV binding. Moreover, using a well-characterized binding and postbinding assay I demonstrated that both RTKs act at post-binding steps of viral entry (Publication n°3: Lupberger et al., 2011).

In collaboration with the group of A. H. Patel, we showed that several mutations located within a conserved HCV envelope glycoprotein E2 region influence the interaction(s) of viral glycoprotein with host cell receptors and neutralizing antibodies. In the framework of this study, I analysed the binding of E1E2 of different mutants to Huh7.5.1 cells and their neutralization by anti-E2 antibodies (Publication n°4: Dhillon et al., 2010).

EGFR and EphA2 are host factors for hepatitis C virus entry and possible targets for antiviral therapy

Joachim Lupberger^{1,2,13}, Mirjam B Zeisel^{1,2,13}, Fei Xiao^{1,2}, Christine Thumann^{1,2}, Isabel Fofana^{1,2}, Laetitia Zona^{1,2}, Christopher Davis³, Christopher J Mee³, Marine Turek^{1,2}, Sebastian Gorke⁴, Cathy Royer^{1,2}, Benoit Fischer⁵, Muhammad N Zahid^{1,2}, Dimitri Lavillette⁶, Judith Fresquet⁶, François-Loïc Cosset⁶, S Michael Rothenberg⁷, Thomas Pietschmann⁸, Arvind H Patel⁹, Patrick Pessaux¹⁰, Michel Doffoël¹¹, Wolfgang Raffelsberger¹², Olivier Poch¹², Jane A McKeating³, Laurent Brino⁵ & Thomas F Baumert^{1,2,11}

Hepatitis C virus (HCV) is a major cause of liver disease, but therapeutic options are limited and there are no prevention strategies. Viral entry is the first step of infection and requires the cooperative interaction of several host cell factors. Using a functional RNAi kinase screen, we identified epidermal growth factor receptor and ephrin receptor A2 as host cofactors for HCV entry. Blocking receptor kinase activity by approved inhibitors broadly impaired infection by all major HCV genotypes and viral escape variants in cell culture and in a human liver chimeric mouse model *in vivo*. The identified receptor tyrosine kinases (RTKs) mediate HCV entry by regulating CD81–claudin-1 co-receptor associations and viral glycoprotein–dependent membrane fusion. These results identify RTKs as previously unknown HCV entry cofactors and show that tyrosine kinase inhibitors have substantial antiviral activity. Inhibition of RTK function may constitute a new approach for prevention and treatment of HCV infection.

HCV is a major cause of liver cirrhosis and hepatocellular carcinoma. Current antiviral treatment is limited by drug resistance, toxicity and high costs¹. Although newly developed antiviral substances targeting HCV protein processing have been shown to improve virological response, toxicity and resistance remain major challenges². Thus, new antiviral preventive and therapeutic strategies are urgently needed. Because HCV entry is required for initiation, dissemination and maintenance of viral infection, it is a promising target for antiviral therapy^{3,4}.

HCV entry is a multistep process involving viral envelope glycoproteins as well as several cellular attachment and entry factors⁵. Attachment of the virus to the target cell is mediated through binding of HCV envelope glycoproteins to glycosaminoglycans⁶. HCV is internalized in a clathrin-dependent endocytic process requiring CD81 (ref. 7), scavenger receptor type B class I (SR-BI)⁸, claudin-1 (CLDN1)⁹ and occludin (OCLN)¹⁰. To elucidate the functional role of host cell kinases within the HCV entry process, we performed a functional RNAi screen.

RESULTS

Host cell kinases are host cofactors for HCV entry

Using a siRNA screen, we identified a network of kinases with functional impact on HCV entry (Supplementary Results, Supplementary Tables 1 and 2 and Supplementary Figs. 1 and 2). To study the relevance of the identified kinases on the HCV life cycle, we further validated and characterized the functional impact of epidermal growth factor receptor (EGFR), ephrin receptor A2 (EphA2) and cell division cycle 2 kinase (CDC2) (Supplementary Results and Supplementary Fig. 3) on HCV entry. We focused on EGFR and EphA2 because they are key components in the identified networks (Supplementary Fig. 2c), they are highly expressed in human liver (Supplementary Table 2) and their kinase function is inhibited by clinically approved protein kinase inhibitors (PKIs)^{11–13}, allowing us to explore the potential of these molecules as therapeutic targets.

Using individual siRNAs, we first confirmed that silencing of mRNAs reduced EGFR and EphA2 mRNA and protein expression (Fig. 1a,b and Supplementary Fig. 4a,b). Infection of siEGFR or

¹Institut National de la Santé et de la Recherche Médicale, U748, Strasbourg, France. ²Université de Strasbourg, Strasbourg, France. ³Hepatitis C Research Group, Division of Immunity and Infection, University of Birmingham, Birmingham, UK. ⁴Department of Medicine II, University of Freiburg, Freiburg, Germany.

⁵High-Throughput Screening Platform, Institut de Génétique et de Biologie Moléculaire et Cellulaire, Institut National de la Santé et de la Recherche Médicale U964/Centre National de la Recherche Scientifique UMR1704/Université de Strasbourg, Illkirch, France. ⁶Université de Lyon, Université Claude Bernard-Lyon 1, Institut Fédératif de Recherche 128, Institut National de la Santé et de la Recherche Médicale, U758, Ecole Normale Supérieure de Lyon, Lyon, France.

⁷Massachusetts General Hospital Cancer Center, Howard Hughes Medical Institute and Harvard Medical School, Charlestown, Massachusetts, USA. ⁸Division of Experimental Virology, TWINCORE, Centre for Experimental and Clinical Infection Research, Hanover, Germany. ⁹Medical Research Council–University of Glasgow Centre for Virus Research, Glasgow, UK. ¹⁰Pôle des Pathologies Digestives, Hépatiques et Transplantation, Hôpitaux Universitaires de Strasbourg, Strasbourg, France.

¹¹Pôle Hépatodigestif, Hôpitaux Universitaires de Strasbourg, Strasbourg, France. ¹²Institut de Génétique et de Biologie Moléculaire et Cellulaire, Institut National de la Santé et de la Recherche Médicale U964/Centre National de la Recherche Scientifique UMR7104 /Université de Strasbourg, Illkirch, France. ¹³These authors contributed equally to this work. Correspondence should be addressed to T.F.B. (thomas.baumert@unistra.fr).

Received 7 December 2010; accepted 3 March 2011; published online 24 April 2011; doi:10.1038/nm.2341

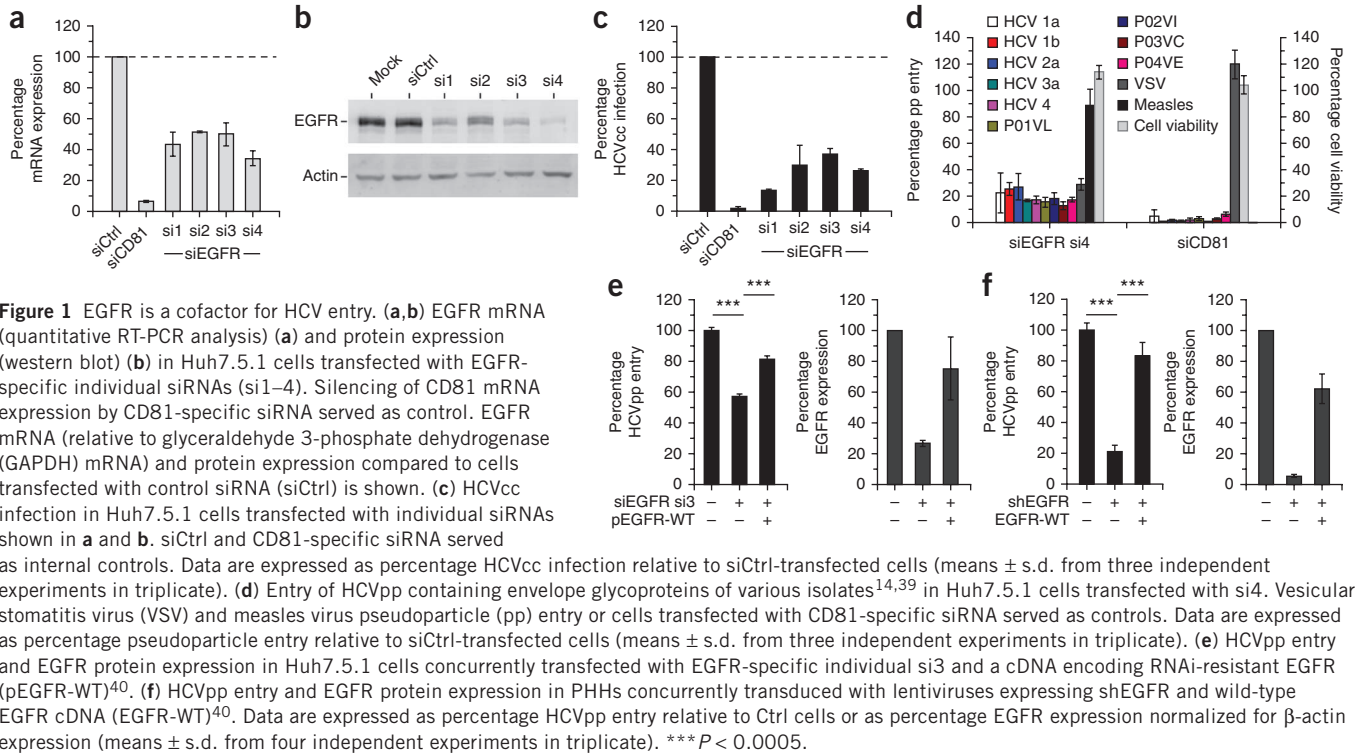

Figure 1 EGFR is a cofactor for HCV entry. **(a,b)** EGFR mRNA (quantitative RT-PCR analysis) **(a)** and protein expression (western blot) **(b)** in Huh7.5.1 cells transfected with EGFR-specific individual siRNAs (si1–4). Silencing of CD81 mRNA expression by CD81-specific siRNA served as control. EGFR mRNA (relative to glyceraldehyde 3-phosphate dehydrogenase (GAPDH) mRNA) and protein expression compared to cells transfected with control siRNA (siCtrl) is shown. **(c)** HCVcc infection in Huh7.5.1 cells transfected with individual siRNAs shown in **a** and **b**. siCtrl and CD81-specific siRNA served as internal controls. Data are expressed as percentage HCVcc infection relative to siCtrl-transfected cells (means \pm s.d. from three independent experiments in triplicate). **(d)** Entry of HCVpp containing envelope glycoproteins of various isolates^{14,39} in Huh7.5.1 cells transfected with si4. Vesicular stomatitis virus (VSV) and measles virus pseudoparticle (pp) entry or cells transfected with CD81-specific siRNA served as controls. Data are expressed as percentage pseudoparticle entry relative to siCtrl-transfected cells (means \pm s.d. from three independent experiments in triplicate). **(e)** HCVpp entry and EGFR protein expression in Huh7.5.1 cells concurrently transfected with EGFR-specific individual si3 and a cDNA encoding RNAi-resistant EGFR (pEGFR-WT)⁴⁰. **(f)** HCVpp entry and EGFR protein expression in PHHs concurrently transduced with lentiviruses expressing shEGFR and wild-type EGFR cDNA (EGFR-WT)⁴⁰. Data are expressed as percentage HCVpp entry relative to Ctrl cells or as percentage EGFR expression normalized for β -actin expression (means \pm s.d. from four independent experiments in triplicate). *** $P < 0.0005$.

siEphA2-treated cells by cell culture–derived HCV (HCVcc) was markedly reduced, as compared to control siRNA-treated cells indicating that both EGFR and EphA2 are involved in the initiation of a productive infection (**Fig. 1c** and **Supplementary Fig. 4c**). Silencing of kinase expression inhibited the entry of HCV pseudoparticles (HCVpp) derived from major genotypes, including highly diverse HCV strains¹⁴ (**Fig. 1d** and **Supplementary Fig. 4d**). The effects of silencing of endogenous EGFR or EphA2 on HCV infection were rescued by RNAi-resistant ectopic expression of wild-type EGFR or EphA2 (**Fig. 1e,f** and **Supplementary Fig. 4e,f**), largely excluding the possibility of off-target effects causing the observed phenotype. Furthermore, silencing and rescue experiments using well-characterized lentiviral vectors expressing EGFR-specific shRNA showed a key role for EGFR in HCV entry into primary human hepatocytes (PHHs) (**Fig. 1f**). We then assessed the functional impact of EGFR as a cofactor for HCV entry by expressing human EGFR in mouse hepatoma cell lines engineered to express the four human entry factors CD81, SR-BI, CLDN1 and OCLN (AML12 4R; **Supplementary Fig. 5**). Cell surface expression of human EGFR in AML12 4R cells markedly enhanced the susceptibility of mouse cells to HCVpp entry (**Supplementary Fig. 5**).

RTK kinase function is relevant for HCV entry

We used PKIs to further study the functional relevance of the identified kinases for HCV entry and infection. Erlotinib (an EGFR inhibitor) and dasatinib (an EphA2 inhibitor) impaired HCV entry and infection in a dose-dependent manner without a detectable effect on replication of the corresponding subgenomic replicon (**Fig. 2, Supplementary Fig. 6** and **Supplementary Fig. 7**). The half-maximal inhibitory concentration (IC_{50}) values for erlotinib and dasatinib to block HCVpp entry (erlotinib, $0.45 \pm 0.09 \mu\text{M}$; dasatinib, $0.53 \pm 0.02 \mu\text{M}$) and HCVcc infection (erlotinib, $0.53 \pm 0.08 \mu\text{M}$; dasatinib, $0.50 \pm 0.30 \mu\text{M}$) of human hepatoma Huh7.5.1 cells were comparable (**Fig. 2a** and

Supplementary Fig. 7a,b). These data indicate that inhibiting RTKs by erlotinib and dasatinib has a marked effect on HCV entry.

To evaluate the effects of the inhibitors on HCV entry into cells more closely resembling the HCV target cells *in vivo*, we investigated HCVpp entry into polarized HepG2-CD81 hepatoma cells¹⁵ and PHHs. PKIs markedly and significantly ($P < 0.005$) inhibited HCVpp entry into polarized HepG2-CD81 cells (**Fig. 2c** and **Supplementary Fig. 7d**) and PHHs (**Fig. 2d** and **Supplementary Fig. 7e**). We obtained similar results for infection of PHHs with HCVcc and serum-derived HCV (**Fig. 3** and **Supplementary Fig. 7**), confirming the role of the kinases as auxiliary host cell cofactors in models that more closely mimic *in vivo* infection.

A specific effect of erlotinib on EGFR-mediated HCV entry was further confirmed by the inhibition of HCV entry and infection by other EGFR inhibitors. The EGFR inhibitors gefitinib and lapatinib markedly inhibited HCVpp entry and HCVcc infection in PHHs and Huh7.5.1 cells similarly to erlotinib (**Fig. 2e,f**). The specificity of the PKIs in preventing HCV entry was further corroborated by their lack of an effect on murine leukemia virus and measles virus entry (**Fig. 2c** and **Supplementary Fig. 8**). Moreover, PKI treatment of RTK-silenced Huh7.5.1 cells reversed the rescue of HCV entry conferred by expressing EGFR and EphA2 *in trans* (data not shown). Taken together, these results suggest that the RTK kinase function is necessary for efficient HCV entry.

RTK-specific ligands and antibodies modulate HCV entry

We assessed virus entry in the presence of RTK-specific ligands and antibodies. Epidermal growth factor (EGF) and transforming growth factor- α (TGF- α) are well-characterized EGFR ligands whose binding promotes receptor dimerization and subsequent phosphorylation of the intracytoplasmic kinase domain¹⁶. To confirm the biological activity of EGFR-specific reagents in the target cells of our HCV model systems, we first studied their effect on EGFR phosphorylation. Preincubation of PHHs with EGF markedly increased basal

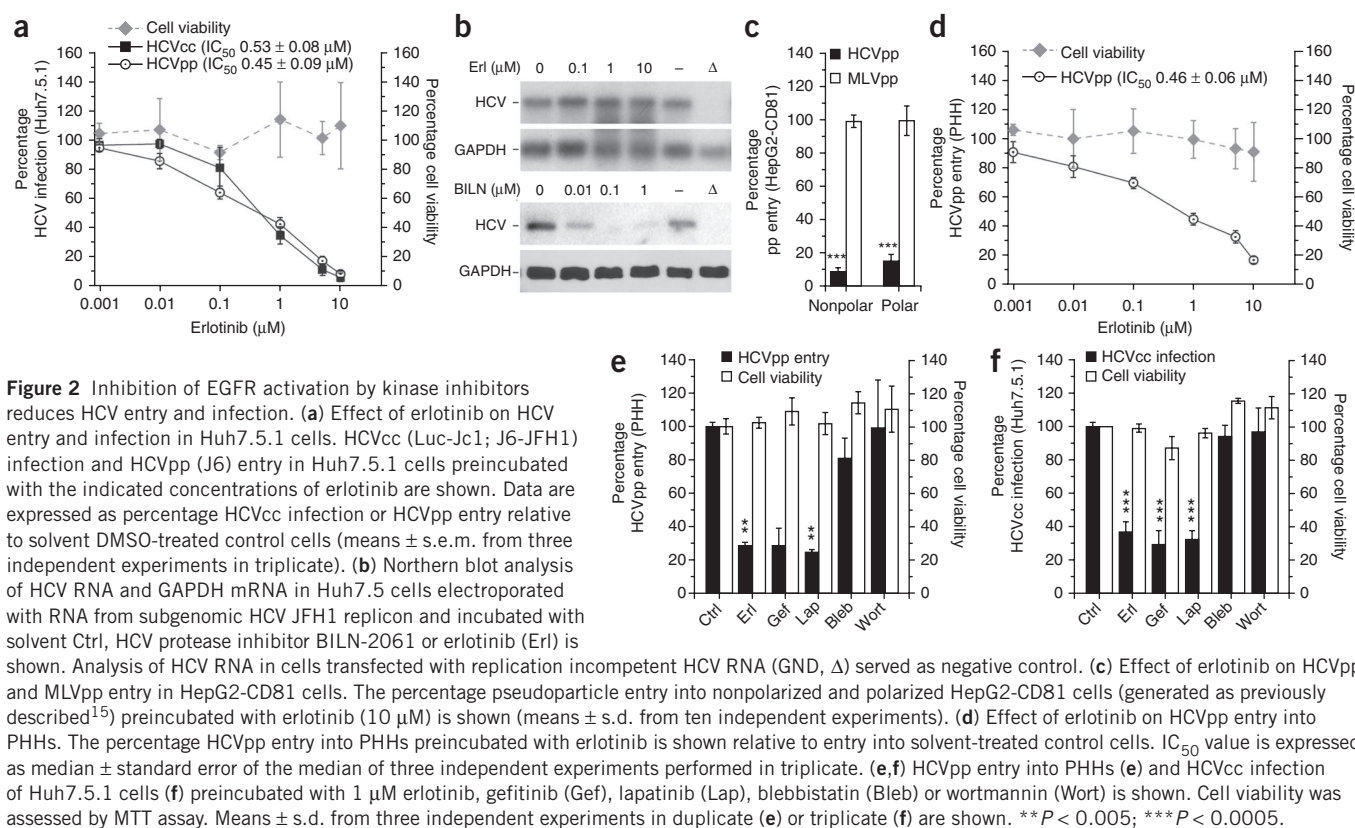

levels of EGFR phosphorylation (**Fig. 3a**). In contrast, EGF had no effect on the phosphorylation of c-met protooncogene tyrosine kinase (MERTK), an unrelated kinase (**Fig. 3a**). EGF-induced enhancement of basal EGFR phosphorylation was markedly inhibited by erlotinib

and an EGFR-specific antibody (**Fig. 3a**), indicating their specific effect on EGFR phosphorylation and activation.

We next examined the role of EGFR ligands on HCV entry. Binding of EGF and TGF- α markedly enhanced entry of HCVpp into

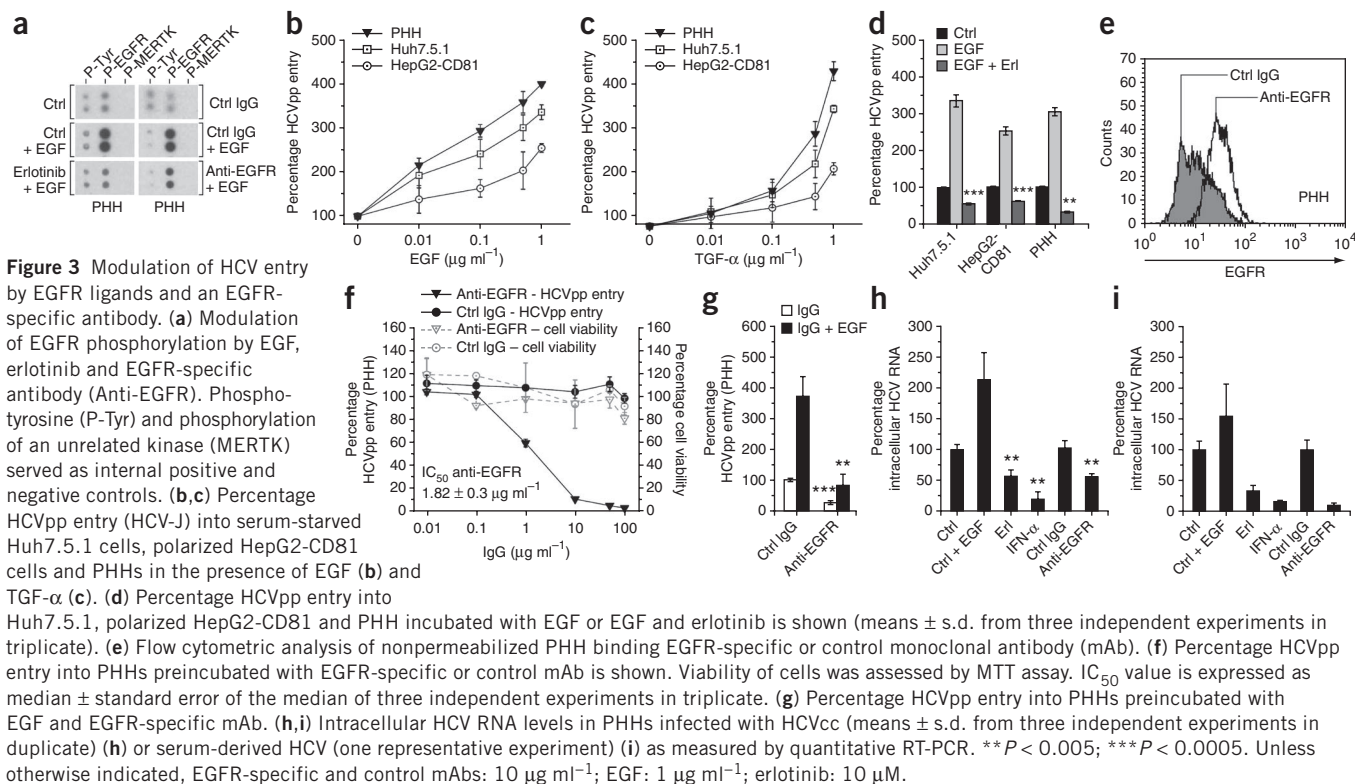

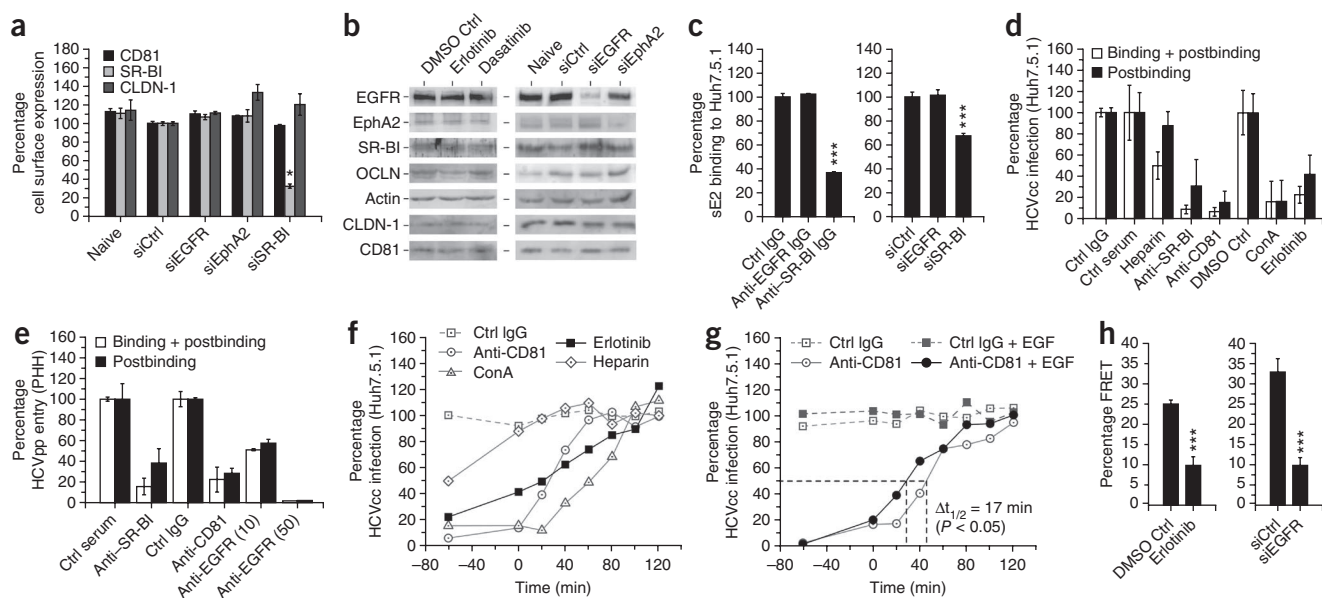

Figure 4 EGFR mediates HCV entry at postbinding steps by promoting CD81-CLDN1 co-receptor interactions and membrane fusion. (a) Cell surface expression of entry factors in EGFR- or EphA2-silenced Huh7.5.1 cells, as assessed by flow cytometry. SR-BI silencing served as positive control (means \pm s.d. from three independent experiments in duplicate). (b) Western blot analysis of HCV entry factor expression in PKI- or siRNA-treated Huh7.5.1 cells. (c) Flow cytometric analysis of HCV glycoprotein sE2 binding to Huh7.5.1 cells incubated with EGFR-specific mAb or transfected with siEGFR. SR-BI-specific antibody (Anti-SR-BI) or siSR-BI served as positive controls (means \pm s.d. from three independent experiments in duplicate). EGFR-specific and control mAbs: 100 μ g ml⁻¹. (d,e) Percentage HCVcc infection of Huh7.5.1 cells (means \pm s.d. from five independent experiments in triplicate) (d) and percentage HCVpp entry into PHHs (means \pm s.d. from three independent experiments in duplicate) (e) after inhibition of binding and postbinding steps by the indicated compounds (EGFR-specific mAb: 10 and 50 μ g ml⁻¹). (f) Time course of HCVcc infection of Huh7.5.1 cells after incubation with erlotinib or the indicated compounds (means \pm s.d. from five independent experiments in triplicate) (f) or EGF at various timepoints during infection (means \pm s.d. from three independent experiments in triplicate) (g) (Supplementary Methods). (h) FRET of CD81-CLDN1 co-receptor associations in HepG2-CD81 cells incubated with erlotinib or EGFR-specific siRNA (means \pm s.e.m. from ten independent experiments). (i) Percentage viral glycoprotein-dependent fusion of 293T with Huh7 cells incubated with EGF, erlotinib or EGFR-specific siRNA, assessed as previously described²⁵. Means \pm s.d. from three independent experiments in triplicate are shown. * P < 0.05; *** P < 0.0005. Unless otherwise indicated, EGFR-specific and control mAbs: 10 μ g ml⁻¹; EGF: 1 μ g ml⁻¹; erlotinib: 10 μ M.

serum-starved Huh7.5.1 cells, polarized HepG2-CD81 cells and PHHs (Fig. 3b,c), whereas TGF- β had no effect (data not shown). These data suggest that direct interaction of EGF or TGF- α with the EGFR ligand-binding domain modulates HCV entry. The higher affinity of EGF for EGFR on hepatocytes¹⁷ may explain the differences between EGF and TGF- α in enhancing HCVpp entry. Erlotinib, at doses used in HCV entry inhibition experiments, reversed the enhancing effects of EGF (Fig. 3d) and TGF- α (data not shown) on HCV entry. These data confirm that erlotinib inhibits HCV entry by modulating EGFR activity.

We screened a large panel of EGFR-specific antibodies and identified a monoclonal human EGFR-specific antibody that bound PHHs (Fig. 3e) and inhibited HCV entry into PHH in a dose-dependent manner (Fig. 3f), with an IC₅₀ value of 1.82 \pm 0.3 μ g ml⁻¹. The antibody inhibited EGFR phosphorylation (Fig. 3a) and reversed the EGF-induced enhancement of HCV entry (Fig. 3g). Ligand-induced enhancement and EGFR-specific antibody-mediated inhibition of HCV entry were also observed for infection of PHHs with HCVcc (Fig. 3h) and with serum-derived HCV (Fig. 3i). Taken together, these results suggest that the EGFR ligand-binding domain is relevant for HCV entry. Similarly, EphA2 ligands and EphA2-specific antibodies modulated HCV entry, suggesting a functional relevance of the EphA2 ligand-binding domain for HCV entry (Supplementary Results and Supplementary Fig. 9).

RTKs promote CD81-CLDN1 associations and membrane fusion

To understand the mechanistic role of EGFR and EphA2 in HCV entry, we first investigated whether the RTKs regulate SR-BI, CD81, CLDN1 and OCLN expression. However, silencing RTK expression with specific siRNAs or inhibiting RTK function with PKIs had no significant effect on HCV entry factor expression (Fig. 4a,b).

Next, we aimed to fine-map the entry steps affected by the RTKs. Viral attachment is the first step of viral entry. To ascertain whether PKI-mediated inhibition of RTK function modulates HCV binding, we used a surrogate model that measures binding of the recombinant soluble form of HCV envelope glycoprotein E2 to Huh7.5.1 cells¹⁸. RTK-specific antibodies or silencing RTK expression by siRNAs had no significant effect on E2 binding of target cells, whereas preincubation with SR-BI-specific antibodies or silencing SR-BI expression markedly reduced E2 binding (Fig. 4c and Supplementary Fig. 10a). Furthermore, in contrast to the case with CD81 and SR-BI¹⁹, RTKs did not increase cellular E2 binding when expressed on the cell surface of Chinese hamster ovary cells (data not shown). These data suggest that RTKs do not modulate HCV binding to target cells.

After viral envelope binding, HCV enters its target cell in a multistep temporal process. To identify the time at which the PKIs exert their effects, we used a well-characterized assay allowing us to investigate

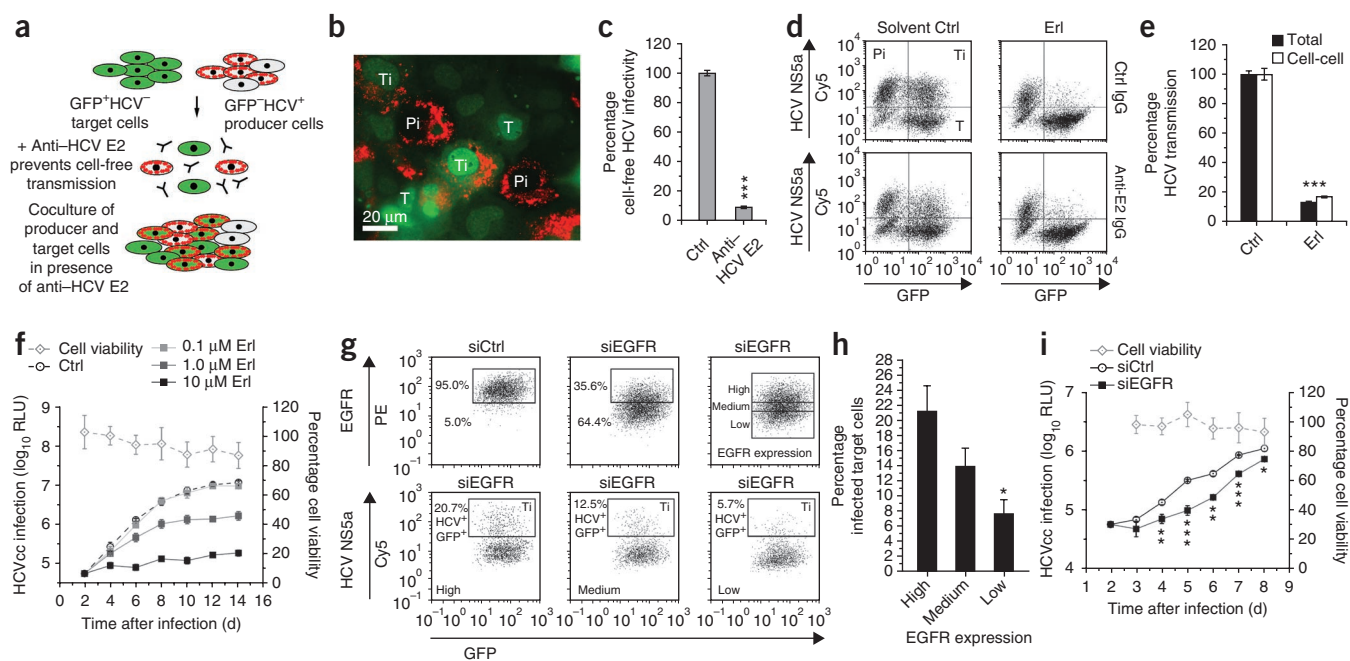

Figure 5 Functional role of EGFR in viral cell-to-cell transmission and spread. **(a)** Experimental setup. HCV producer cells cultured with uninfected target cells²⁶ were incubated with siEGFR or PKIs. Cell-free HCV transmission was blocked by an E2-neutralizing antibody (Anti-HCV E2, 25 $\mu\text{g ml}^{-1}$)²⁶. HCV-infected target cells were quantified by flow cytometry²⁶. **(b)** Immunofluorescence analysis of Pi (HCV RNA-electroporated Huh7.5.1 producer cells), T (GFP-expressing Huh7.5 target cells) and Ti (GFP+HCV NS5A⁺ HCV-infected target cells) cells stained with an HCV non structural protein 5A (NS5A)-specific antibody (red). **(c)** Infectivity of Pi-T cell co-cultivation supernatants (cell-free HCV transmission). **(d, e)** Quantification of infected Ti cells during erlotinib (10 μM) treatment in the absence (total transmission) and presence (cell-to-cell transmission) of E2-specific antibody by flow cytometry (means \pm s.d. from three independent experiments in duplicate). **(f)** Effect of PKIs on viral spread. Long-term HCVcc infection of Huh7.5.1 cells incubated with erlotinib 48 h after infection at the indicated concentrations. Medium with solvent (Ctrl) or PKI was replenished every second day. Cell viability was assessed by MTT test. Means \pm s.d. from three independent experiments in triplicate are shown. RLU, relative light units. **(g)** EGFR expression in target cells with silenced EGFR expression. Cell surface EGFR expression was analyzed by flow cytometry and target cells were divided in three groups displaying high, medium and low EGFR expression. **(h)** HCV infection in GFP-positive target cells expressing EGFR at high, medium and low levels (see **g**) assessed as described above (means \pm s.d. from three independent experiments in triplicate). **(i)** Effect of EGFR silencing on viral spread. Long-term analysis of HCVcc infection in Huh7.5.1 cells transfected with EGFR-specific or control siRNA 24 h after infection. Cell viability was assessed by MTT test. Means \pm s.d. from three independent experiments in triplicate are shown. * $P < 0.05$; ** $P < 0.005$; *** $P < 0.0005$.

whether an inhibitory molecule interferes with viral envelope binding or affects entry steps after binding of the virus to the target cell^{19–21}. In contrast to heparin (an inhibitor of HCV binding) but similarly to CD81- and SR-BI-specific antibodies and concanamycin A (an inhibitor of endosomal acidification), PKIs inhibited HCVcc infection when added after virus binding to target cells (**Fig. 4d**). We obtained similar results for HCVpp entry into PHHs after treatment with an EGFR-specific antibody (**Fig. 4e**). These data suggest that the RTKs act at postbinding steps of viral entry.

To further elucidate the entry steps targeted by the RTKs, we performed a kinetic entry assay^{19,21} (**Supplementary Fig. 10b**). Notably, the half-maximal times ($t_{1/2}$) for erlotinib ($t_{1/2} = 20$ min) and dasatinib ($t_{1/2} = 26$ min) to inhibit HCV entry were similar to the half-maximal time of a CD81-specific antibody ($t_{1/2} = 26$ min) (**Fig. 4f** and **Supplementary Fig. 10d**). Moreover, similar to concanamycin A, PKIs also had an inhibitory effect when added at late times (60–80 min) after infection (**Fig. 4** and **Supplementary Fig. 10**). We further confirmed the role of EGFR as a postbinding factor by kinetic assays under serum-free conditions. In line with previous reports²², HCV entry kinetics were delayed under serum-free conditions (**Fig. 4g**). EGF significantly ($P < 0.05$) reduced the time needed for HCVcc to escape the inhibiting effects of a CD81-specific antibody in serum-starved cells from 44 ± 8 min to 27 ± 6 min (mean \pm s.d. of three independent experiments), suggesting that EGF markedly and

significantly ($P < 0.05$) accelerates the rate of HCV entry (**Fig. 4g**). In summary, these data suggest that EGFR is required for efficient viral entry by modulating early and late steps of postbinding events.

Postbinding steps of HCV entry are mediated by the HCV entry factors SR-BI, CD81, CLDN1 and OCLN. As PKIs inhibited HCV entry at similar timepoints as a CD81-specific antibody, we investigated whether PKIs interfere with CD81-CLDN1 co-receptor interactions using a fluorescence resonance energy transfer (FRET)-based assay^{15,23,24}. PKIs significantly ($P < 0.0005$) reduced CD81-CLDN1 FRET in polarized HepG2 cells (**Fig. 4h** and **Supplementary Fig. 10e**). We obtained similar results with RTK-specific siRNAs (**Fig. 4h** and **Supplementary Fig. 10e**), confirming that the observed inhibition is RTK specific and not mediated by off-target effects of the PKIs. These results suggest that EGFR and EphA2 regulate the formation of the CD81-CLDN1 co-receptor complexes that are essential for HCV entry²³ and that erlotinib and dasatinib inhibit HCV entry by interfering with the CD81-CLDN1 co-receptor association.

As kinetic assays showed that PKIs inhibited late steps of viral entry (**Fig. 4f** and **Supplementary Fig. 10d**), we investigated the impact of these kinases in a viral glycoprotein-dependent cell-cell fusion assay²⁵. Both PKIs significantly ($P < 0.05$) inhibited membrane fusion of cells expressing glycoproteins derived from genotypes 1a (H77), 1b (Con1) and 2a (J6) (**Fig. 4i** and **Supplementary Fig. 10f**), whereas the EGFR ligand EGF enhanced membrane fusion of cells expressing

Figure 6 Erlotinib modulates HCV kinetics and inhibits infection *in vivo*. Chimeric uPA-SCID mice repopulated with PHHs^{27,28} were treated with erlotinib or placebo during infection with human-derived HCV as indicated by the bar and dashed lines. Serum HCV load was analyzed at the timepoints indicated. Results are shown as median viral load of erlotinib-treated ($n = 4$) or placebo-treated control ($n = 3$) mice, medians \pm standard error of the median. (a,b) Two independent studies (seven mice each) are shown. (c) Pooled data of the results shown in a and b ($n = 14$), medians \pm standard error of the median; $*P < 0.05$.

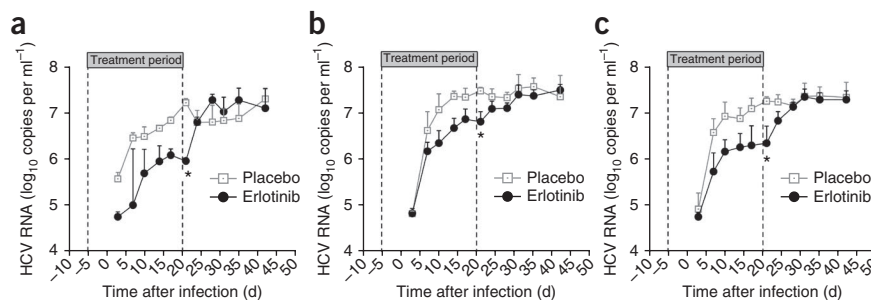

these HCV envelope glycoproteins (Fig. 4i). In contrast, neither erlotinib nor EGF had a marked effect on the membrane fusion of cells expressing measles virus envelope glycoproteins (Fig. 4i). We obtained comparable results in EGFR- and EphA2-silenced cells (Fig. 4i, data not shown) confirming that the RTKs are involved in viral glycoprotein-dependent membrane fusion.

Impact of RTKs in cell-to-cell transmission and viral spread

To investigate the relevance of RTK-mediated virus-host interactions for cell-to-cell transmission and viral spread, we used a cell-to-cell transmission assay²⁶ (Fig. 5a–c). Erlotinib and dasatinib significantly ($P < 0.0005$) blocked HCV cell-to-cell transmission during short-term coculture experiments (24 h) (Fig. 5d–f and Supplementary Fig. 11a–c). We also observed a marked inhibition of cell-to-cell transmission when we silenced EGFR and EphA2 with specific siRNAs: infection of GFP-positive target cells directly correlated with RTK cell surface expression (Fig. 5g,h and Supplementary Fig. 11d,e). Because PKIs inhibited cell-to-cell transmission, we investigated whether erlotinib and dasatinib also impede viral spread in the HCVcc system when added after infection during long-term experiments. Both PKIs inhibited viral spread in a dose-dependent manner for up to 14 d when added 48 h after infection to HCV-infected cells (Fig. 5f and Supplementary Fig. 11c). Cell viability was not affected by long-term PKI treatment. We also observed a specific decrease in viral spread in cells with silenced RTK expression (Fig. 5i and Supplementary Fig. 11f). Taken together, these data indicate that PKIs reduce viral spread and suggest a key function of these RTKs in cell-to-cell transmission and dissemination.

Erlotinib inhibits HCV infection *in vivo*

To address the *in vivo* relevance of the identified virus-host interactions, we assessed the effect of erlotinib on HCV infection in the chimeric urokinase plasminogen activator-severe combined immunodeficiency (uPA-SCID) mouse model^{27–29}. Erlotinib dosing and administration was performed as described previously for cancer xenograft models³⁰ and is indicated in Figure 6. Erlotinib treatment significantly ($P < 0.05$) delayed the kinetics of HCV infection (Fig. 6). The median time to reach steady-state levels of infection increased from 15 d (placebo group) to 30 d (erlotinib group) (median of pooled data from six placebo-treated and eight erlotinib-treated mice). Furthermore, erlotinib treatment decreased steady-state HCV RNA levels by more than 90% (mean of pooled data from six placebo-treated and eight erlotinib-treated mice; $P < 0.05$). After discontinuation of treatment, viral load reached similar levels as in placebo-treated mice (Fig. 6). The treatment was well tolerated and did not induce any marked changes in safety parameters such as serum concentrations of alanine transaminase, albumin or body weight (data not shown). Erlotinib plasma concentrations were similar to those described previously in preclinical studies of cancer

mouse models³⁰ (data not shown). Taken together, these data suggest that EGFR acts as a cofactor for HCV entry and dissemination *in vivo* and show that erlotinib has antiviral activity *in vivo*.

DISCUSSION

Using RNAi screening, we uncovered a network of kinases that have a functional impact on HCV entry and identified EGFR and EphA2 as previously unrecognized cofactors for HCV entry. This identification of kinases as HCV entry factors advances knowledge on the molecular mechanisms and cellular requirements of HCV entry, and the discovery of PKIs as candidate antivirals defines a potential new strategy for preventing and treating HCV infection.

EGFR is a RTK that regulates a number of key processes, including cell proliferation, survival, differentiation during development, tissue homeostasis and tumorigenesis³¹. EphA2 mediates cell positioning, cell morphology, polarity and motility³². As PKIs had no effect on HepG2 polarization (Supplementary Fig. 12), it is unlikely that changes in polarity explain their mode of action. Our results rather highlight a role of these RTKs in the formation of HCV entry factor complexes and membrane fusion. EGF accelerated HCV entry, suggesting that EGFR plays a key part in the HCV entry process, allowing HCV to efficiently enter its target cell. Applying FRET proximity analysis, we found that inhibition of EGFR or EphA2 activity reduced CD81-CLDN1 association. As EGFR activation has been reported to promote CLDN1 redistribution^{33,34}, and we found that the level of CD81 or CLDN1 cell surface expression was not altered by EGFR silencing (Fig. 4a), we hypothesize that EGFR activation modulates intracellular or cell surface trafficking of CLDN1, CD81 or both, which is necessary to form viral envelope-CD81-CLDN1 co-receptor complexes^{19,23,24}. The observations that erlotinib inhibits late steps in the kinetic infection assay and in the HCV cell fusion assay suggest a functional role for EGFR in pH-dependent fusion of viral and host cell membranes^{25,35}.

Our functional experiments with specific ligands, antibodies and kinase inhibitors implicated both ligand-binding and kinase domains of EGFR in promoting HCV entry. EGFR ligands enhanced HCV infection, and an EGFR-specific antibody inhibited HCV infection. This antibody binds between ligand-binding domain III and the autoinhibition (tether) domain IV of the extracellular part of EGFR³⁶ and prevents EGF- and TGF- α -induced receptor dimerization³⁷. Thus, it is likely that receptor dimerization and/or the domain targeted by the antibody are required for HCV entry. Taken together, these findings support a model in which EGFR-ligand binding activates the EGFR kinase function that is required for HCV entry.

We obtained similar results for EphA2, where antibodies specific for the extracellular domain of EphA2 inhibited HCV entry into PHHs and EphA2 surrogate ligands decreased viral entry. Because addition of surrogate ligands only reduced HCV entry to a small extent, it is

conceivable that the effect of EphA2 on HCV entry could be both ligand independent and ligand dependent. This is consistent with other well-characterized EphA2 functions such as cell invasion and migration³⁸.

Given that our functional and mechanistic studies indicate that the expression and activity of EGFR and EphA2 seem to be involved in similar entry steps, it is likely that both RTKs are part of the same entry regulatory pathway. Because erlotinib and EGF modulated entry of HCVpp but showed minimal effects on the unrelated viruses studied (Supplementary Fig. 8), it is likely that the molecular mechanisms that we uncovered are most relevant for HCV entry.

Finally, our results have clinical implications for the prevention and treatment of HCV infection, as they show that licensed PKIs have antiviral activity *in vitro* and *in vivo* and identified a monoclonal RTK-specific antibody that inhibits viral entry. Thus, targeting RTKs as HCV entry factors using small molecules or antibodies may constitute a new approach to prevent and treat HCV infection and address antiviral resistance.

METHODS

Methods and any associated references are available in the online version of the paper at <http://www.nature.com/naturemedicine/>.

Note: Supplementary information is available on the Nature Medicine website.

ACKNOWLEDGMENTS

This work was supported by the European Research Council (ERC-2008-AdG-233130-HEPCENT), INTERREG-IV-Rhin Supérieur-FEDER-Hepato-Regio-Net 2009, Agence Nationale de la Recherche (ANR-05-CEXC-008), Agence Nationale de Recherche sur le Sida 2008/354, Région Alsace, Institut National du Cancer, the Institut de Génétique et de Biologie Moléculaire et Cellulaire, Institut National de la Santé et de la Recherche Médicale, Centre National de la Recherche Scientifique, Université de Strasbourg, the US National Institutes of Health (1K08DE020139-01A1), the UK Medical Research Council and the Wellcome Trust. We acknowledge A.-L. Morand, L. Froidevaux, A. Weiss, L. Poidevin, S. Durand and E. Soulier for excellent technical work. We thank R. Bartschlagler (University of Heidelberg) for providing Jc1 and Luc-Jc1 expression vectors, J. Ball (University of Nottingham) for UKN2A.2.4, UKN3A1.28 and UKN4.21.16 expression vectors, T. Wakita (National Institute of Infectious Diseases, Japan) for JFH1 constructs, C.M. Rice (The Rockefeller University) for Huh7.5 cells, F.V. Chisari (The Scripps Research Institute) for Huh7.5.1 cells, E. Harlow (Harvard University) for CDC2 expression plasmids and M. Tanaka (Hamamatsu University) for EphA2 expression plasmids.

AUTHOR CONTRIBUTIONS

J.L., M.B.Z. and T.F.B. wrote the manuscript. J.L., M.B.Z., F.X., D.L., F.-L.C., J.A.M., and T.F.B. designed experiments and analyzed data. J.L., M.B.Z., F.X., C.T., I.F., L.Z., C.D., C.J.M., M.T., S.G., C.R., M.N.Z., D.L. and J.F. performed experiments. S.M.R., T.P., A.H.P., P.P. and M.D. contributed essential reagents. W.R. and O.P. performed bioinformatic analyses. J.L., B.F. and L.B. implemented and coordinated the siRNA screen. T.F.B. designed and supervised the project.

COMPETING FINANCIAL INTERESTS

The authors declare no competing financial interests.

Published online at <http://www.nature.com/naturemedicine/>.

Reprints and permissions information is available online at <http://www.nature.com/reprints/index.html>.

- Tai, A.W. & Chung, R.T. Treatment failure in hepatitis C: mechanisms of non-response. *J. Hepatol.* **50**, 412–420 (2009).
- Hézode, C. *et al.* Telaprevir and peginterferon with or without ribavirin for chronic HCV infection. *N. Engl. J. Med.* **360**, 1839–1850 (2009).
- Timpe, J.M. *et al.* Hepatitis C virus cell-cell transmission in hepatoma cells in the presence of neutralizing antibodies. *Hepatology* **47**, 17–24 (2008).
- Zeisel, M.B., Cosset, F.L. & Baumert, T.F. Host neutralizing responses and pathogenesis of hepatitis C virus infection. *Hepatology* **48**, 299–307 (2008).
- von Hahn, T. & Rice, C.M. Hepatitis C virus entry. *J. Biol. Chem.* **283**, 3689–3693 (2008).
- Barth, H. *et al.* Viral and cellular determinants of the hepatitis C virus envelope-heparan sulfate interaction. *J. Virol.* **80**, 10579–10590 (2006).
- Pileri, P. *et al.* Binding of hepatitis C virus to CD81. *Science* **282**, 938–941 (1998).

- Scarselli, E. *et al.* The human scavenger receptor class B type I is a novel candidate receptor for the hepatitis C virus. *EMBO J.* **21**, 5017–5025 (2002).
- Evans, M.J. *et al.* Claudin-1 is a hepatitis C virus co-receptor required for a late step in entry. *Nature* **446**, 801–805 (2007).
- Ploss, A. *et al.* Human occludin is a hepatitis C virus entry factor required for infection of mouse cells. *Nature* **457**, 882–886 (2009).
- Hidalgo, M. & Bloedow, D. Pharmacokinetics and pharmacodynamics: maximizing the clinical potential of erlotinib (Tarceva). *Semin. Oncol.* **30**, 25–33 (2003).
- Shepherd, F.A. *et al.* Erlotinib in previously treated non-small-cell lung cancer. *N. Engl. J. Med.* **353**, 123–132 (2005).
- Li, J. *et al.* A chemical and phosphoproteomic characterization of dasatinib action in lung cancer. *Nat. Chem. Biol.* **6**, 291–299 (2010).
- Fafi-Kremer, S. *et al.* Viral entry and escape from antibody-mediated neutralization influence hepatitis C virus reinfection in liver transplantation. *J. Exp. Med.* **207**, 2019–2031 (2010).
- Mee, C.J. *et al.* Polarization restricts hepatitis C virus entry into HepG2 hepatoma cells. *J. Virol.* **83**, 6211–6221 (2009).
- Schlessinger, J. Ligand-induced, receptor-mediated dimerization and activation of EGF receptor. *Cell* **110**, 669–672 (2002).
- Thoresen, G.H. *et al.* Response to transforming growth factor α (TGF α) and epidermal growth factor (EGF) in hepatocytes: lower EGF receptor affinity of TGF α is associated with more sustained activation of p42/p44 mitogen-activated protein kinase and greater efficacy in stimulation of DNA synthesis. *J. Cell. Physiol.* **175**, 10–18 (1998).
- Dreux, M. *et al.* Receptor complementation and mutagenesis reveal SR-BI as an essential HCV entry factor and functionally imply its intra- and extra-cellular domains. *PLoS Pathog.* **5**, e1000310 (2009).
- Krieger, S.E. *et al.* Inhibition of hepatitis C virus infection by anti-claudin-1 antibodies is mediated by neutralization of E2-CD81-claudin-1 associations. *Hepatology* **51**, 1144–1157 (2010).
- Koutsoudakis, G. *et al.* Characterization of the early steps of hepatitis C virus infection by using luciferase reporter viruses. *J. Virol.* **80**, 5308–5320 (2006).
- Zeisel, M.B. *et al.* Scavenger receptor class B type I is a key host factor for hepatitis C virus infection required for an entry step closely linked to CD81. *Hepatology* **46**, 1722–1731 (2007).
- Dreux, M. *et al.* High density lipoprotein inhibits hepatitis C virus-neutralizing antibodies by stimulating cell entry via activation of the scavenger receptor BI. *J. Biol. Chem.* **281**, 18285–18295 (2006).
- Harris, H.J. *et al.* Claudin association with CD81 defines hepatitis C virus entry. *J. Biol. Chem.* **285**, 21092–21102 (2010).
- Harris, H.J. *et al.* CD81 and claudin 1 coreceptor association: role in hepatitis C virus entry. *J. Virol.* **82**, 5007–5020 (2008).
- Lavillette, D. *et al.* Characterization of fusion determinants points to the involvement of three discrete regions of both E1 and E2 glycoproteins in the membrane fusion process of hepatitis C virus. *J. Virol.* **81**, 8752–8765 (2007).
- Witteveldt, J. *et al.* CD81 is dispensable for hepatitis C virus cell-to-cell transmission in hepatoma cells. *J. Gen. Virol.* **90**, 48–58 (2009).
- Hiraga, N. *et al.* Absence of viral interference and different susceptibility to interferon between hepatitis B virus and hepatitis C virus in human hepatocyte chimeric mice. *J. Hepatol.* **51**, 1046–1054 (2009).
- Kamiya, N. *et al.* Practical evaluation of a mouse with chimeric human liver model for hepatitis C virus infection using an NS3-4A protease inhibitor. *J. Gen. Virol.* **91**, 1668–1677 (2010).
- Meuleman, P. *et al.* Morphological and biochemical characterization of a human liver in a uPA-SCID mouse chimera. *Hepatology* **41**, 847–856 (2005).
- Higgins, B. *et al.* Antitumor activity of erlotinib (OSI-774, Tarceva) alone or in combination in human non-small cell lung cancer tumor xenograft models. *Anticancer Drugs* **15**, 503–512 (2004).
- Schneider, M.R. & Wolf, E. The epidermal growth factor receptor ligands at a glance. *J. Cell. Physiol.* **218**, 460–466 (2009).
- Lackmann, M. & Boyd, A.W. Eph, a protein family coming of age: more confusion, insight, or complexity? *Sci. Signal.* **1**, re2 (2008).
- Singh, A.B. & Harris, R.C. Epidermal growth factor receptor activation differentially regulates claudin expression and enhances transepithelial resistance in Madin-Darby canine kidney cells. *J. Biol. Chem.* **279**, 3543–3552 (2004).
- Flores-Benitez, D. *et al.* Control of tight junctional sealing: roles of epidermal growth factor and prostaglandin E2. *Am. J. Physiol. Cell Physiol.* **297**, C611–C620 (2009).
- Blanchard, E. *et al.* Hepatitis C virus entry depends on clathrin-mediated endocytosis. *J. Virol.* **80**, 6964–6972 (2006).
- Reiter, J.L. & Mailhe, N.J. A 1.8 kb alternative transcript from the human epidermal growth factor receptor gene encodes a truncated form of the receptor. *Nucleic Acids Res.* **24**, 4050–4056 (1996).
- McCole, D.F., Keely, S.J., Coffey, R.J. & Barrett, K.E. Transactivation of the epidermal growth factor receptor in colonic epithelial cells by carbachol requires extracellular release of transforming growth factor- α . *J. Biol. Chem.* **277**, 42603–42612 (2002).
- Miao, H. *et al.* EphA2 mediates ligand-dependent inhibition and ligand-independent promotion of cell migration and invasion via a reciprocal regulatory loop with Akt. *Cancer Cell* **16**, 9–20 (2009).
- Pestka, J.M. *et al.* Rapid induction of virus-neutralizing antibodies and viral clearance in a single-source outbreak of hepatitis C. *Proc. Natl. Acad. Sci. USA* **104**, 6025–6030 (2007).
- Rothenberg, S.M. *et al.* Modeling oncogene addiction using RNA interference. *Proc. Natl. Acad. Sci. USA* **105**, 12480–12484 (2008).

ONLINE METHODS

Infection of cell lines and primary human hepatocytes with HCVpp, HCVcc and serum-derived HCV. Pseudotyped particles expressing envelope glycoproteins from various HCV strains (**Supplementary Methods**), vesicular stomatitis virus, murine leukemia virus, influenza, measles and endogenous feline leukemia virus (RD114) and HCVcc were generated as previously described^{14,41,42,44–46}. Infection of Huh7, Huh7.5.1 cells and PHHs with HCVpp, HCVcc (half-maximal tissue culture infectious dose (TCID₅₀) 1×10^3 – 1×10^4 ml⁻¹ for Huh7.5.1 experiments, TCID₅₀ 1×10^5 – 1×10^6 ml⁻¹ for PHH experiments) and serum-derived HCV (genotype 1b)⁴⁷ was performed as previously described^{14,19,21,48}. Polarization of HepG2-CD81, determination of tight junction integrity and cell polarity index were performed, measured and calculated as previously described¹⁵. Gene silencing was performed 3 d before infection as described for the RNAi screen in the **Supplementary Methods**. Inhibitors, antibodies or ligands were added 1 h before HCVpp or HCVcc infection and during infection unless otherwise stated. Experiments with RTK ligands were conducted with serum-starved cells. Unless otherwise stated, HCV entry and infection was assessed by luciferase reporter gene expression.

Analysis of HCV replication. Electroporation of RNA derived from plasmid pSGR-JFH1 or replication-deficient mutant pSGR-JFH1/GND (Δ)⁴³ was performed as previously described⁴². Twenty-four hours after electroporation, cells were incubated with inhibitors. Total RNA was isolated and HCV RNA was analyzed by northern blotting as previously described⁴⁹.

Rescue of gene silencing. To assess whether silencing of endogenous RTKs could be rescued by expression of RNAi-resistant RTK expression, 4×10^6 Huh7.5.1 cells were co-electroporated with 10 μ g siRNA targeting the 3' untranslated region of the endogenous cellular mRNA (siEGFR si3, siEphA2 si4, HS-CDC2_14) and an RTK-encoding plasmid expressing siRNA-resistant mRNA containing a deletion of the 3' untranslated region (pEGFR, pEphA2, pCDC2)^{40,50,51}. We seeded 2.5×10^4 cells per cm² 72 h before infection with HCVcc (Luc-Jc1; genotype 2a/2a) or HCVpp (H77; genotype 1a). EGFR rescue in PHHs was performed by co-transduction with lentiviruses expressing shEGFR and/or EGFR⁴⁰ 72 h before infection with HCVpp (HCV-J; genotype 1b).

Analysis of EGFR phosphorylation in PHHs and Huh7.5.1 cells. EGFR phosphorylation was assessed in cell lysates with the Human Phospho-RTK Array Kit (R&D Systems), where RTKs are captured by antibodies spotted on a nitrocellulose membrane. Amounts of phospho-RTK were assessed with a horseradish peroxidase-conjugated pan-phospho-tyrosine-specific antibody followed by chemiluminescence detection as described by the manufacturer. Phosphotyrosine (P-Tyr) and phosphorylation of the unrelated c-mer proto-oncogene tyrosine kinase (MERTK) served as internal positive and negative controls. PHHs were incubated in EGF-free William's E medium (Sigma). Huh7.5.1 cells were serum-starved overnight before addition of ligands, inhibitors and antibodies.

Analysis of HCV binding, postbinding and entry kinetics. Analysis of HCV glycoprotein E2 binding to cells and HCV postbinding and entry kinetic assays were performed as previously described^{18,19,21} with polyclonal SR-BI-specific²¹ or monoclonal EGFR-specific antibodies (10–100 μ g ml⁻¹) (Millipore, Roche) or SR-BI²¹– or EphA2-specific serum (produced as described in the **Supplementary Methods** and diluted 1 in 100) and corresponding controls²¹ (R&D) (**Supplementary Methods** and **Supplementary Fig. 10**).

Receptor association using fluorescence resonance energy transfer. Homotypic and heterotypic interactions of CD81 and CLDN1 were analyzed as previously described^{15,23,24}. The data from ten cells were normalized, and the localized expression was calculated.

Membrane fusion. HCV membrane fusion during viral entry was investigated with a cell-to-cell fusion assay as previously described²⁵.

Cell-to-cell transmission of HCV. Cell-to-cell transmission of HCV was assessed as previously described²⁶. Briefly, producer Huh7.5.1 cells were electroporated with HCV Jc1 RNA and cultured with gene-silenced or naive target Huh7.5-GFP cells in the presence or absence of PKIs (10 μ M) (IC Laboratories). An HCV E2-neutralizing antibody²⁶ (25 μ g ml⁻¹) was added to block cell-free transmission²⁶. After 24 h of coculture, cells were fixed with paraformaldehyde, stained with an NS5A-specific antibody (0.1 μ g ml⁻¹) (Virostat) and analyzed by flow cytometry²⁶. Total and cell-to-cell transmission were defined as percentage HCV infection of Huh7.5-GFP⁺ target cells (Ti) in the absence (total transmission) or presence (cell-to-cell transmission) of an HCV E2-specific antibody.

HCV infection and treatment of chimeric uPA-SCID mice. Chimeric mice repopulated with PHHs^{27,28} were infected with serum-derived HCV (genotype 2a, 1×10^4 HCV international units per mouse) via the orbital vein during isoflurane anesthetization (PhoenixBio, Japan). Erlotinib (Roche) administration and dosage (50 mg per kg body weight per day) were performed as previously described in xenograft tumor mouse models³⁰. Four mice received 50 mg per kg body weight per day erlotinib and three mice received placebo from day –10 until day 20 of infection in two independent experiments (total 14 mice, two experiments of seven mice each). Serum HCV RNA, alanine transaminase, albumin and erlotinib were monitored as previously described^{28,52}. All experimental procedures used to treat live mice in this study had been approved by the Animal Ethics Committee of PhoenixBio in accordance with Japanese legislation.

Toxicity assays. Cytotoxic effects on cells were assessed in triplicate by analyzing the ability to metabolize 3-(4,5-dimethylthiazol-2-yl)-2,5-diphenyltetrazolium bromide (MTT)⁵³. Formazan crystals were solubilized 5 h after adding MTT (0.6 mg ml⁻¹) (Sigma) as previously described⁵³.

Additional methods. Detailed methodology is described in the **Supplementary Methods**.

- Bartosch, B., Dubuisson, J. & Cosset, F.L. Infectious hepatitis C virus pseudo-particles containing functional E1–E2 envelope protein complexes. *J. Exp. Med.* **197**, 633–642 (2003).
- Pietschmann, T. *et al.* Construction and characterization of infectious intragenotypic and intergenotypic hepatitis C virus chimeras. *Proc. Natl. Acad. Sci. USA* **103**, 7408–7413 (2006).
- Kato, T. *et al.* Efficient replication of the genotype 2a hepatitis C virus subgenomic replicon. *Gastroenterology* **125**, 1808–1817 (2003).
- Lavillette, D. *et al.* Characterization of host-range and cell entry properties of the major genotypes and subtypes of hepatitis C virus. *Hepatology* **41**, 265–274 (2005).
- Frecha, C. *et al.* Efficient and stable transduction of resting B lymphocytes and primary chronic lymphocyte leukemia cells using measles virus GP displaying lentiviral vectors. *Blood* **114**, 3173–3180 (2009).
- Sandrin, V. *et al.* Lentiviral vectors pseudotyped with a modified RD114 envelope glycoprotein show increased stability in sera and augmented transduction of primary lymphocytes and CD34⁺ cells derived from human and nonhuman primates. *Blood* **100**, 823–832 (2002).
- Fofana, I. *et al.* Monoclonal anti-claudin 1 antibodies prevent hepatitis C virus infection of primary human hepatocytes. *Gastroenterology* **139**, 953–964, 964.e1–e4 (2010).
- Meunier, J.C. *et al.* Isolation and characterization of broadly neutralizing human monoclonal antibodies to the e1 glycoprotein of hepatitis C virus. *J. Virol.* **82**, 966–973 (2008).
- Lohmann, V. *et al.* Replication of subgenomic hepatitis C virus RNAs in a hepatoma cell line. *Science* **285**, 110–113 (1999).
- van den Heuvel, S. & Harlow, E. Distinct roles for cyclin-dependent kinases in cell cycle control. *Science* **262**, 2050–2054 (1993).
- Wang, Y. *et al.* Negative regulation of EphA2 receptor by Cbl. *Biochem. Biophys. Res. Commun.* **296**, 214–220 (2002).
- Chahbouni, A., den Burger, J.C., Vos, R.M., Sinjewel, A. & Wilhelm, A.J. Simultaneous quantification of erlotinib, gefitinib and imatinib in human plasma by liquid chromatography tandem mass spectrometry. *Ther. Drug Monit.* **31**, 683–687 (2009).
- Mosmann, T. Rapid colorimetric assay for cellular growth and survival: application to proliferation and cytotoxicity assays. *J. Immunol. Methods* **65**, 55–63 (1983).

Mutations within a Conserved Region of the Hepatitis C Virus E2 Glycoprotein That Influence Virus-Receptor Interactions and Sensitivity to Neutralizing Antibodies^{∇†}

Simrat Dhillon,¹ Jeroen Witteveldt,¹ Derek Gatherer,¹ Ania M. Owsianka,¹ Mirjam B. Zeisel,² Muhammad N. Zahid,² Małgorzata Rychłowska,^{1,3} Steven K. H. Fong,⁴ Thomas F. Baumert,² Allan G. N. Angus,¹ and Arvind H. Patel^{1*}

MRC Virology Unit, Institute of Virology, University of Glasgow, Glasgow, United Kingdom¹; INSERM U748, Université de Strasbourg, Strasbourg, France²; Department of Molecular Virology, University of Gdansk, Kladki 24, 80-822 Gdansk, Poland³; and Department of Pathology, Stanford University School of Medicine, Stanford, California 94305⁴

Received 11 October 2009/Accepted 8 March 2010

Cell culture-adaptive mutations within the hepatitis C virus (HCV) E2 glycoprotein have been widely reported. We identify here a single mutation (N415D) in E2 that arose during long-term passaging of HCV strain JFH1-infected cells. This mutation was located within E2 residues 412 to 423, a highly conserved region that is recognized by several broadly neutralizing antibodies, including the mouse monoclonal antibody (Mab) AP33. Introduction of N415D into the wild-type (WT) JFH1 genome increased the affinity of E2 to the CD81 receptor and made the virus less sensitive to neutralization by an antiserum to another essential entry factor, SR-BI. Unlike JFH1_{WT}, the JFH1_{N415D} was not neutralized by AP33. In contrast, it was highly sensitive to neutralization by patient-derived antibodies, suggesting an increased availability of other neutralizing epitopes on the virus particle. We included in this analysis viruses carrying four other single mutations located within this conserved E2 region: T416A, N417S, and I422L were cell culture-adaptive mutations reported previously, while G418D was generated here by growing JFH1_{WT} under Mab AP33 selective pressure. Mab AP33 neutralized JFH1_{T416A} and JFH1_{I422L} more efficiently than the WT virus, while neutralization of JFH1_{N417S} and JFH1_{G418D} was abrogated. The properties of all of these viruses in terms of receptor reactivity and neutralization by human antibodies were similar to JFH1_{N415D}, highlighting the importance of the E2 412-423 region in virus entry.

Hepatitis C virus (HCV), which belongs to the *Flaviviridae* family, has a positive-sense single-stranded RNA genome encoding a polyprotein that is cleaved by cellular and viral proteases to yield mature structural and nonstructural proteins. The structural proteins consist of core, E1 and E2, while the nonstructural proteins are p7, NS2, NS3, NS4A, NS4B, NS5A, and NS5B (42). The hepatitis C virion comprises the RNA genome surrounded by the structural proteins core (nucleocapsid) and E1 and E2 (envelope glycoproteins). The HCV glycoproteins lie within a lipid envelope surrounding the nucleocapsid and play a major role in HCV entry into host cells (21). The development of retrovirus-based HCV pseudoparticles (HCVpp) (3) and the cell culture infectious clone JFH1 (HCVcc) (61) has provided powerful tools to study HCV entry.

HCV entry is initiated by the binding of virus particles to attachment factors which are believed to be glycosaminoglycans (2), low-density lipoprotein receptor (41), and C-type lectins such as DC-SIGN and L-SIGN (12, 37, 38). Upon attachment at least four entry factors are important for particle

internalization. These include CD81 (50), SR-BI (53) and the tight junction proteins claudin-1 (15) and occludin (6, 36, 51).

CD81, a member of the tetraspanin family, is a cell surface protein with various functions including tissue differentiation, cell-cell adhesion and immune cell maturation (34). It consists of a small and a large extracellular loop (LEL) with four transmembrane domains. Viral entry is dependent on HCV E2 binding to the LEL of CD81 (3, 50). The importance of HCV glycoprotein interaction with CD81 is underlined by the fact that many neutralizing antibodies compete with CD81 and act in a CD81-blocking manner (1, 5, 20, 45).

SR-BI is a multiligand receptor expressed on liver cells and on steroidogenic tissue. It binds to high-density lipoproteins (HDL), low-density lipoproteins (LDL), and very low-density lipoproteins (VLDL) (31). The SR-BI binding site is mapped to the hypervariable region 1 (HVR-1) of HCV E2 (53). SR-BI ligands, such as HDL and oxidized LDL have been found to affect HCV infectivity (4, 14, 58–60). Indeed, HDL has been shown to enhance HCV infection in an SR-BI-dependent manner (4, 14, 58, 59). Antibodies against SR-BI and knockdown of SR-BI in cells result in a significant inhibition of viral infection in both the HCVpp and the HCVcc systems (5, 25, 32).

Although clearly involved in entry and immune recognition, the more downstream function(s) of HCV glycoproteins are poorly understood, as their structure has not yet been solved. Nonetheless, mutational analysis and mapping of neutralizing antibody epitopes have delineated several discontinuous re-

* Corresponding author. Mailing address: MRC Virology Unit, Institute of Virology, University of Glasgow, Glasgow, United Kingdom. Phone: 44 141 330 4026. Fax: 44 141 330 3520. E-mail: a.patel@mrcvugla.ac.uk.

† Supplemental material for this article may be found at <http://jvi.asm.org/>.

[∇] Published ahead of print on 17 March 2010.

gions of E2 that are essential for HCV particle binding and entry (24, 33, 45, 47). One of these is a highly conserved sequence spanning E2 residues 412 to 423 (QLINTNGSWHIN). Several broadly neutralizing monoclonal antibodies (MAbs) bind to this epitope. These include mouse monoclonal antibody (MAB) AP33, rat MAB 3/11, and the human MAbs e137, HCV1, and 95-2 (8, 16, 44, 45, 49). Of these, MAbs AP33, 3/11, and e137 are known to block the binding of E2 to CD81.

Cell culture-adaptive mutations within the HCV glycoproteins are valuable for investigating the virus interaction(s) with cellular receptors (18). In the present study, we characterize an asparagine-to-aspartic acid mutation at residue 415 (N415D) in HCV strain JFH1 E2 that arose during the long-term passaging of infected human hepatoma Huh-7 cells. Alongside N415D, we also characterize three adjacent cell culture adaptive mutations reported previously and a novel substitution generated in the present study by propagating virus under MAB AP33 selective pressure to gain further insight into the function of this region of E2 in viral infection.

MATERIALS AND METHODS

Cell culture and antibodies. Human embryo kidney (HEK)-293T cells (ATCC CRL-1573) and the human hepatoma Huh-7 cells (43) were grown in Dulbecco modified Eagle medium (Invitrogen, United Kingdom) supplemented with 10% fetal calf serum, 100 U of penicillin/ml, 100 μ g of streptomycin/ml, 10 mM HEPES, 0.1 mM nonessential amino acids, and 2 mM glutamine. The secreted alkaline phosphatase (SEAP) reporter cell line Huh7J-20 was described previously (23).

The anti-E2 MAbs AP33, CBH-4B, CBH-5, and HC-11 and the purified polyclonal immunoglobulins (IgGs) from an uninfected individual (IgG20) and HCV-infected patients (IgG2, IgG4, IgG17, and IgG19) have been described previously (11, 19, 20, 45). The anti-E2 MAB 3/11 (16), the anti-NS5A MAB 9E10 (35), and the sheep anti-NS5A antiserum (39) were kindly provided by J. McKeating, C. M. Rice, and M. Harris, respectively. The anti-CD81 MAB (clone JS-81) and the anti-SR-BI MAB CLA-1 were purchased from BD Biosciences. The anti-SR-BI rat serum was generated as described previously (63). The murine leukemia virus (MLV) gag-specific MAB was obtained from rat hybridoma cells (CRL-1912; American Type Culture Collection).

Plasmid constructs and mutagenesis. The plasmid pUC-JFH1 carries the full-length cDNA of HCV genotype 2a strain JFH1. The plasmid pUC-GND JFH1 is identical except for the GND mutation in the NS5B-encoding sequence (61). The plasmids used to generate HCV pseudoparticles (HCVpp) containing the strain JFH1 envelope glycoproteins have been described previously (62). Site-directed mutagenesis was carried out by using a QuikChange-II kit (Stratagene) according to the manufacturer's instructions to introduce amino acid substitutions at the target sites in E2. Briefly, the amino acid substitutions N415D, T416A, N417S, G418D, and I422L in the E2-coding region were individually introduced into the plasmid pUC-JFH1 using appropriate primers (the sequences of which are available upon request). The presence of the desired mutation in the resulting clones was confirmed by nucleotide sequencing the DNA fragment between the BsiWI restriction site (nucleotides 1380 to 1386) and the BsaBI restriction site (nucleotides 2597 to 2606). Sequences carrying the appropriate mutation were subcloned back into pUC-JFH1 and the HCVpp E1E2 expression vector using the restriction enzymes described above.

Generation of HCVcc virus. The JFH1 HCVcc was generated essentially as described previously (61). Briefly, linearized plasmids carrying HCVcc genomic cDNA were used as a template to generate viral genomic RNA by *in vitro* transcription. Approximately 4×10^6 Huh-7 cells were added to a 0.4-cm Gene Pulser cuvette (VWR) suspended in 400 μ l of phosphate-buffered saline (PBS). Ten μ g of *in vitro*-synthesized RNA was then added and pulsed once at 960 μ F and 270 V by using a GenePulser Xcell (Bio-Rad) electroporator. The transfected cells were allowed to rest for 10 min before mixing them with fresh medium and seeding them into tissue culture dishes. After incubation at 37°C for the indicated time period, the medium containing the infectious virus progeny was filtered through a 0.45- μ m-pore-size membrane before the infectivity was determined as described below.

Determination of virus infectivity and RNA replication. To monitor wild-type (WT) JFH1 replication during serial passaging, 5×10^6 naive Huh-7 cells were

infected in a T80 flask at a multiplicity of infection (MOI) of 0.005 in a total volume of 10 ml. Subconfluent cells were split 1:10 into a new flask containing 24 ml of fresh medium. At each passage the cell culture supernatants were harvested, and their tissue culture 50% infective dose(s) (TCID₅₀) were determined by infection of naive cells, followed by immunostaining for NS5A as described previously (35). To measure virus replication after electroporation, the cells were transfected with viral transcript and seeded into 10-cm culture dishes. Four hours later, cells were treated with trypsin and split 1:3 into T25 flasks. After incubation at 37°C for 72 h, culture supernatants were harvested, and the virus titers were determined as described above. Total RNA was prepared from cells by using an RNeasy kit (Qiagen), and the HCV RNA content was measured by quantitative reverse transcription real-time PCR (qRT-PCR) as described previously (62). To measure virus replication postinfection, cells in six-well culture dishes were infected at the indicated MOIs. After incubation at 37°C for 24, 48, and 72 h, infectious virus yields in the medium and the intracellular viral RNA levels were determined as described above.

Virus infectivity and replication were determined by using the focus-forming assay (64) or the recently described reporter cell line, Huh7-J20 (23). For the focus-forming assay, Huh-7 cells were fixed in methanol at 2 days postinfection and immunostained for NS5A using MAB 9E10, and the HCV-positive foci were counted by fluorescence microscopy to calculate focus-forming units (FFU) as described previously (64). The Huh7-J20 cell line is engineered to release SEAP reporter into the medium following HCV infection, thus enabling a rapid and sensitive quantification of virus infectivity and replication (23). The SEAP activity in the medium was measured 72 h postinfection as described previously (23).

The effect of HDL on HCVcc infectivity was tested essentially as described previously (59). Briefly, Huh7-J20 cells were preincubated for 2 h at 37°C in medium supplemented with 3% lipoprotein-deficient fetal calf serum (LPDS). The cells were then infected with WT or mutant HCVcc (generated in medium containing 3% LPDS) in the presence or absence of 20 μ g of human HDL (Athens Research Technology)/ml for 3 h at 37°C. Three hours later, the inoculum was replaced with normal medium, and the SEAP activity in the medium was measured at 72 h postinfection.

Identification of cell culture adaptive mutations. Total RNA was prepared from cells infected with virus collected from passage 9 cells (see Results) as described above. RNA was converted to first-strand DNA by using a Superscript III first-strand synthesis kit (Invitrogen) with the primer 5'-TTGCGAGTGCC CCGGGA-3'. After digestion with 1 U of RNase H (Invitrogen) for 20 min at 37°C, one-quarter of the RT reaction was amplified with appropriate primers that are available on request. The PCR products were gel purified by gel extraction (Qiagen) and used directly for sequencing.

HCVcc neutralization assays. Antibody inhibition assays were performed using either Huh-7 or Huh7-J20 cells, and virus infectivity levels were determined by FFU or SEAP reporter assay, respectively, as described previously (23, 57). Briefly, Huh-7 cells were plated out at a density of 3×10^3 per well in a 96-well plate. For anti-E2 antibody neutralization assays, ~50 FFU of virus was preincubated at 37°C for 1 h with the appropriate inhibitory or control antibody prior to infecting cells. To test neutralization by anti-receptor antibodies, cells were preincubated with appropriate antibodies for 1 h at 37°C prior to infection with 50 FFU of the virus. At 3 h postinfection, the inoculum was replaced with fresh medium and incubated for 48 h. The infectivity was determined as FFU following immunostaining of the cells for NS5A as described above. The Huh7-J20 reporter cells were infected in the presence or absence of appropriate antibody essentially as described above, and the virus infectivity levels were determined by measurement of the SEAP activity released into the medium.

RNA interference. Two prevalidated small interfering RNA (siRNA) duplexes (Applied Biosystems) targeting different regions of human CD81 (14501 and 146379) and SR-BI (s2650 and s2649) were used. The negative control siRNA was composed of a scrambled sequence. Naive Huh-7 cells were transfected with Lipofectamine RNAiMax (Invitrogen) and 50 nM siRNAs according to the manufacturer's protocol and incubated for 2 days prior to virus infection. The efficiency of each gene knockdown at the time of infection was determined by measuring the mRNA transcripts by qRT-PCR using TaqMan probes (ABI) specific for SR-BI (Hs00969819) and CD81 (Hs00174717). In parallel, the cell surface expression of each receptor was measured by incubating cells with the anti-CD81 MAB (JS-81) or the anti-SR-BI MAB CLA-1, followed by an anti-mouse IgG-fluorescein isothiocyanate (FITC) conjugated secondary antibody. A subtype IgG1 was used as control. The cells were then analyzed by flow cytometry in a FACScalibur using CellQuest software (BD Biosciences). The cell viability of siRNA-treated cells was measured by using the colorimetric WST-1 assay (Roche), according to the manufacturer's instructions.

HCVpp genesis, infection, and neutralization assays. HCVpp were generated in HEK-293T cells, following cotransfection with plasmids expressing the MLV

Gag-Pol and the MLV transfer vector carrying the firefly luciferase reporter (kindly provided by F.-L. Cosset and J. Dubuisson, respectively), and HCV E1 and E2 as described previously (3, 57, 62). The medium containing HCVpp was collected, clarified, filtered through a 0.45- μ m-pore-size membrane, and used to infect the Huh-7 target cells. At 3 days postinfection, the luciferase activity in the cell lysates was measured by using a Bright-Glo luciferase assay system (Promega). The levels of particle secretion were tested by immunoblotting for MLV gag protein and E2 in the cell supernatants. For this, 10 ml of medium was pelleted through a 20% sucrose cushion (wt/vol) in PBS at $116,000 \times g$ for 4 h. Virus pellets were analyzed for HCV E2 and MLV gag by Western immunoblotting. For neutralization assays, HCVpp preparations were mixed with appropriate amounts of inhibitory or control antibody and incubated for 1 h at 37°C prior to infection. To control the particle to antibody ratio, each pseudoparticle inoculum was adjusted to the same level of infectivity. The percentage neutralization was expressed relative to infection in the absence of antibody.

For immunoprecipitation of E1 and E2 glycoproteins, HEK-293T cells transfected with the HCV glycoprotein-expressing plasmids were radiolabeled with [³⁵S]methionine and cysteine as described previously (47), and the labeled proteins were immunoprecipitated using the anti-E2 human MAb CBH-5. The immune complexes were subjected to SDS-PAGE, and the proteins were visualized with a Bio-Rad Personal FX phosphorimager.

GNA and CD81 capture assay for E2 analysis. *Galanthus nivalis* agglutinin (GNA)-capture enzyme-linked immunosorbent assays (ELISAs) to detect MAb binding to E2 glycoprotein in lysates from electroporated Huh-7 cells were performed essentially as described previously (48). Bound glycoproteins were detected using the anti-E2 MAbs AP33, CBH-4B, and 3/11, followed by an anti-species IgG-horse radish peroxidase-conjugated antibody and 3,3',5,5'-tetramethylbenzidine (TMB) substrate. Absorbance values were determined at 450 nm after stopping the reaction with 0.5 M sulfuric acid. To assay E2-CD81 binding, E2 from cell lysates was captured onto an ELISA plate coated with human CD81-LEL fused to glutathione *S*-transferase (hCD81-LEL), and the bound E2 was detected using the anti-E2 human MAb CBH-4B as described previously (11).

Isolation of MAb AP33 escape mutants. To isolate MAb AP33 neutralization escape mutants, a selection protocol using a two-chamber cell culture system was developed. JFH1_{WT} RNA-electroporated Huh-7 cells were seeded into 1- μ m-pore-size membrane of Thincert tissue culture inserts (Greiner), while naive Huh-7 cells were grown into the lower compartment underside of the membrane. To select for antibody neutralization escape mutants, MAb AP33 was added to the medium at 100% neutralizing concentration. This system ensures that the naive recipient cells are only infected via cell-free HCVcc that has escaped the neutralizing concentration of AP33 and avoids infection with JFH1_{WT}, thus allowing rapid enrichment and propagation of antibody escape mutants. After approximately 3 days, the infected recipient cells were treated with trypsin and seeded in a fresh insert and placed in a well seeded with naive Huh-7 cells in the medium containing the same neutralizing concentration of MAb AP33. This process was repeated eight times. At each passage, the cells were collected for analysis by immunofluorescence using MAb AP33 and the anti-N5SA antiserum and to prepare total RNA from which the viral RNA was reverse transcribed, and the resulting cDNA was PCR amplified and sequenced as described above.

Amino acid sequence analysis. A total of 1,311 full-length E2 protein sequences were downloaded from the HCV Sequence Database at Los Alamos National Laboratory (<http://hcv.lanl.gov>). Sequences annotated as "bad" and sequences containing obvious long frameshifts were excluded. Alignments were performed by using MAFFT (26) and analyzed in MEGA (54).

RESULTS

Identification of a cell culture-adaptive mutation in E2. Naive Huh-7 cells were infected at a low MOI with the HCV JFH1_{WT} virus generated from cells electroporated with viral RNA and serially passaged over a period of 6 weeks (nine passages). As shown in Fig. 1A, the infectious virus yields in the culture supernatants increased up to cell passage 6 (cp6), at which time the titers peaked at 10^5 . Interestingly, ~100-fold-higher virus yields were obtained after infection of naive Huh-7 cells with the virus collected from cp9 (sp1). Sequence analysis of the structural genes of the JFH1_{sp1} virus revealed a single mutation in E2 (N415D) located within the highly conserved region that represents an epitope for the broadly neutralizing

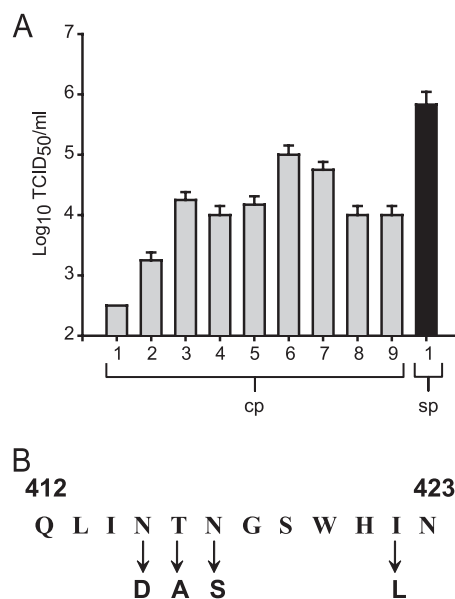

FIG. 1. Determination of infectious virus yield during serial passage of infected cells. (A) Huh-7 cells were infected with the JFH1_{WT} at an MOI of 0.005 and serially passaged (cp) nine times. At each passage, virus released into the medium was titrated by TCID₅₀ assay. Similarly, virus generated at passage 9 (sp1) was used to infect naive Huh-7 cells, and the resultant infectious yield in the medium was measured as described above. (B) The location of adaptive mutations within the E2 residues 412 to 423 characterized in the present study. The arrows denote amino acid substitution.

antibodies, MAb AP33, 3/11, e137, HCV1, and 95-2 (8, 45, 49, 56). Three recent studies have also reported adaptive E2 mutations within this epitope, at positions T416 (10), N417 (52), and I422 (27) (Fig. 1B). These were generated in Huh-7.5 cells using the chimeric J6/JFH1 (T416A) or the WT JFH1 (N417S and I422L) HCVcc. We examined the effect of these four closely positioned mutations on JFH1 infectivity and antibody-mediated neutralization.

Effects of E2 mutations on virus infection. The four E2 mutations were introduced individually into the JFH1 genome by site-directed mutagenesis, and their effect on RNA replication and virus release after transfection in Huh-7 cells was determined. In contrast to JFH1_{GND} (which served as a negative control), both the WT and all E2 mutant virus RNAs were replication competent (Fig. 2A). The released infectious virus yield and intracellular RNA levels of all four mutants were only slightly higher than WT, showing no significant difference at 72 h posttransfection.

We next determined the ability of mutant viruses to expand in naive cells following infection. Extracellular virus collected at 72 h posttransfection was used to inoculate naive Huh-7 cells at an MOI of 0.1. At 24, 48, and 72 h postinfection, the infectious virus released into the medium and the intracellular viral RNA levels were determined. The infectious yield of each mutant was found to be increased compared to the WT (Fig. 2B). Although the average values of each mutant were higher than WT at 48 and 72 h, our statistical analysis found this not to be significant ($n = 3$; $P = <0.054$, <0.171 , <0.063 , and <0.139 , respectively, for mutants N415D, T416A, N417S, and I422L; unpaired Student *t* test). The intracellular HCV RNA

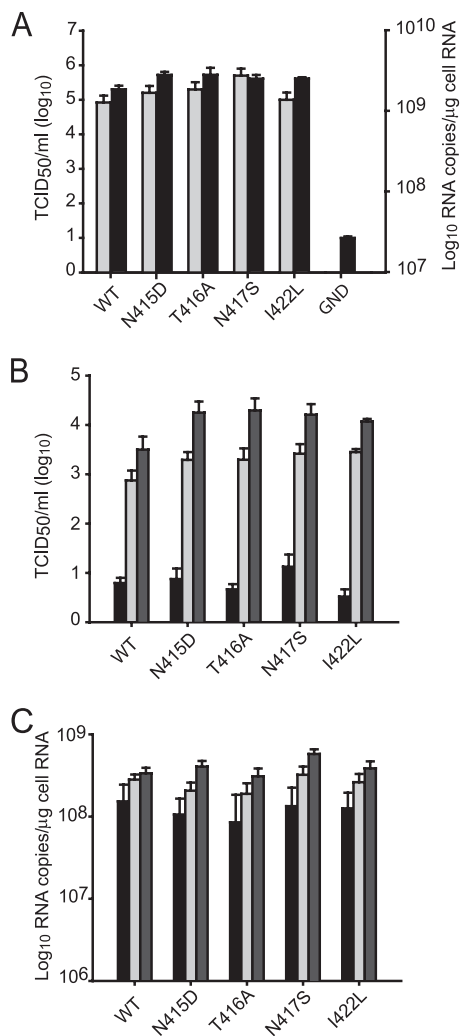

FIG. 2. Determination of infectious virus yield and replication. (A) Huh-7 cells were electroporated with *in vitro*-transcribed viral RNA. At 72 h posttransfection, virus released in the medium was titrated by TCID₅₀ (light gray bar) and intracellular RNA (black bar) was quantified by qRT-PCR. Means and error ranges from duplicate assays are shown. (B and C) Naive Huh-7 cells were infected at an MOI of 0.1 with virus collected from the electroporated cells above. At 24 h (black bars), 48 h (light gray bars), and 72 h (dark gray bars) postinfection, (B) the virus yield in the culture medium of infected cells and (C) the intracellular viral RNA levels were determined by TCID₅₀ and qRT-PCR, respectively. Means and error ranges from triplicate assays are shown.

levels in cells infected with the E2 mutants were unaltered compared to the WT virus (Fig. 2C). Interestingly, the JFH1_{sp1} virus, which was included for comparison, produced infectious titers 100-fold greater than WT at 72 h postinfection (data not shown), indicating that this virus is better adapted likely due to the presence of additional mutation(s) in the nonstructural regions of the genome.

E2 mutations alter virus-receptor interactions. To establish whether the mutations have altered the affinity of E2 for the virus receptor CD81, a competition assay using the soluble form of CD81 (hCD81-LEL) was performed. This protein has been shown to interact with the E2 glycoprotein and inhibit

HCV infection (5). All four mutant viruses showed increased sensitivity to neutralization by hCD81-LEL (Fig. 3A). To investigate whether this was due to a change in their affinity to CD81, we tested the reactivity of the intracellular viral glycoproteins to hCD81-LEL. The levels of WT or mutant E2 in Huh-7 cells transfected with appropriate viral RNAs was first normalized by measuring their binding to the conformation-sensitive anti-E2 human MAb CBH-4B (see Fig. S1a in the supplemental material). Notably, the various E2s also bound an anti-E2 MAb that recognizes a linear epitope with comparable efficiency (see Fig. S1b in the supplemental material). Consistent with the increased sensitivity of the viruses to hCD81-LEL neutralization, the affinity of E2 mutants N415D, T416A, and N417S to hCD81-LEL was enhanced in a dose-dependent fashion (see Fig. S1c and S1d in the supplemental material), by up to 38, 106, and 64%, respectively (Fig. 3b), indicating an increased exposure of CD81 binding residues on these mutant glycoproteins. However, for reasons that are unclear, the property of the E2 I422L mutant is at odds with this hypothesis as it bound hCD81-LEL with comparable affinity to WT E2 (Fig. 3B and see Fig. S1c and S1d in the supplemental material). A potential explanation for the phenotype of E2 I422L is that some local change may occur during the virion assembly process leading to a better exposure of the CD81-binding region and therefore enhanced neutralization. Incubation of naive cells with anti-CD81 MAb prior to infection showed no difference in inhibition of WT and mutant viruses (Fig. 3C). This may be explained by the higher affinity of the MAb outcompeting the binding of both WT and mutant virus glycoproteins to cellular CD81.

Having established that these mutations influence the HCV-CD81 interaction, we next investigated their effects on SR-BI-dependent entry. Naive cells were preincubated with different concentrations of a neutralizing anti-SRBI rat serum (63) prior to infection with each virus. Interestingly, all mutants were less sensitive than WT to neutralization by this antiserum (Fig. 3D and Table 1). As expected, a control serum had no effect on virus infectivity (data not shown). We next tested the effect of HDL, an SR-BI ligand known to enhance HCV entry through a process that requires the lipid transfer function of SR-BI (see the introduction), on mutant virus infection. As shown in Fig. 3E, while the infectivity of WT was significantly enhanced, the E2 mutants appeared insensitive to HDL treatment. Together, these data suggest that each adaptive mutation alters HDL/SR-BI-mediated uptake of the virus during entry.

To investigate the possibility of these mutants having reduced SR-BI dependency, two siRNAs targeting different regions of SR-BI mRNA were transfected into Huh-7 cells to silence its expression. At the time of infection, these cells expressed 99% less SR-BI mRNA while maintaining 80% of the control cell viability (Fig. 4A). The knockdown of cell surface-expressed SR-BI was also confirmed by FACS analysis (Fig. 4C). Under these conditions, the infectivity of all viruses was inhibited by 94 to 98%, showing the E2 mutant viruses still require sufficient expression of SR-BI for infection (Fig. 4B). Similarly, efficient knockdown of CD81 reduced the infectivity of all viruses (Fig. 4D to F).

E2 mutations alter sensitivity to neutralizing antibodies. Previously, we reported a range of polyclonal anti-HCV IgGs purified from HCV-infected patients that inhibited infection after

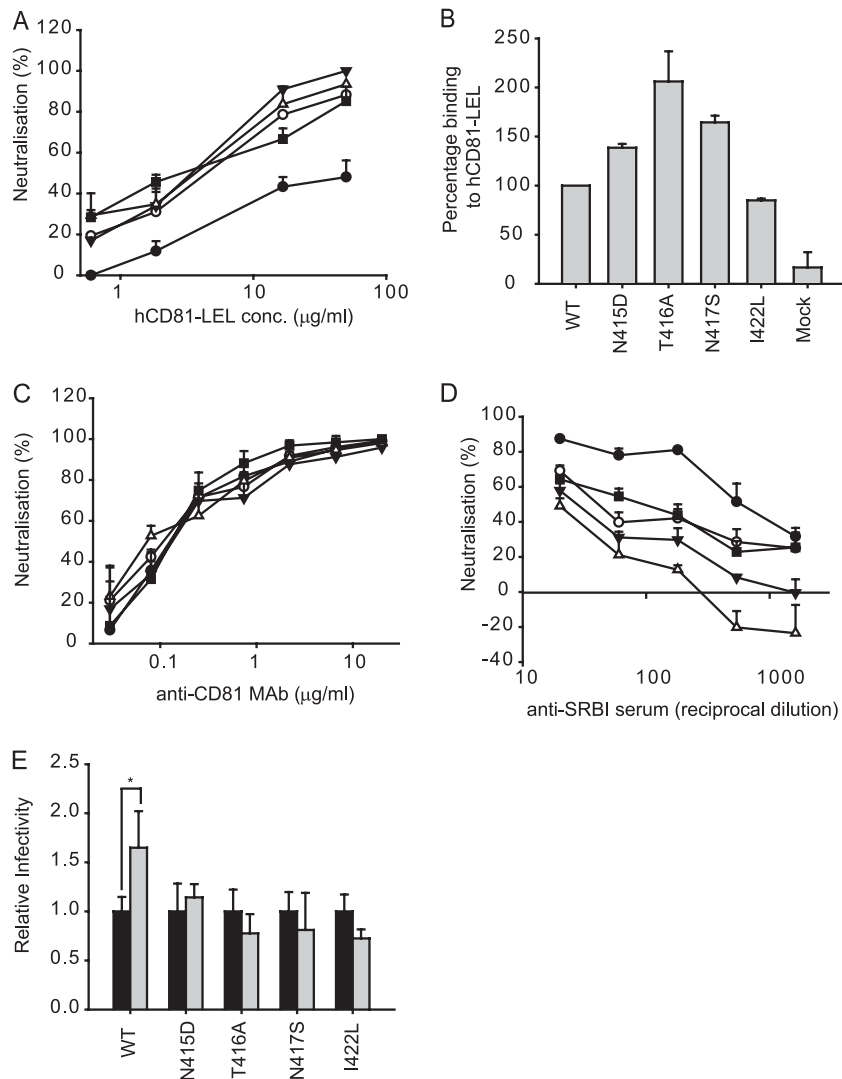

FIG. 3. E2 mutants have altered affinity for CD81 and SR-BI. (A) JFH1_{WT} (●), JFH1_{N415D} (○), JFH1_{T416A} (▼), JFH1_{N417S} (△), or JFH1_{I422L} (■) HCVcc was incubated with different concentrations of hCD81-LEL for 1 h prior to infecting target cells. At 2 days postinfection, virus infectivity was determined by FFU assay. Percent neutralization was calculated by quantifying viral infectivity in the presence of hCD81-LEL relative to standard infection. (B) The levels of WT or mutant E2 in Huh-7 cells transfected with appropriate viral RNAs was first normalized by measuring their binding to the conformation-sensitive anti-E2 human MAb CBH-4B (see Fig. S1 in the supplemental material). Lysates containing equivalent E2 were assessed for binding to hCD81-LEL by ELISA, and the data are presented as the averages of two independent experiments, each performed in triplicate. (C and D) Naive Huh-7 cells were preincubated for 1 h with different amounts of antibodies against (C) CD81 or (D) SR-BI before infection. Cells were then infected with 50 FFU of WT or mutant viruses (key to symbols as in panel A above) for 2 days, and the infectivity levels were determined by FFU assay. The percent neutralization was calculated by quantifying viral infectivity in the presence of inhibitory antibodies relative to a standard “no antibody” infection. (E) Huh7-J20 cells were infected with WT or mutant viruses in the presence or absence of HDL and virus infectivity determined by SEAP assay as described in Materials and Methods. Error bars indicate standard deviation from the mean ($n = 3$; $P = <0.05$, unpaired Student t test).

virus attachment to the cell (19). Here, the sensitivity of the WT and the E2 mutant viruses to neutralization by two of these IgG preparations (IgG17 and IgG19) was tested. The degree of inhibition of the WT virus afforded by both of these IgGs was in accordance with our previous findings (19). However, the mutant viruses were more sensitive to neutralization, with IC_{50} s 18- to 60-fold lower for IgG17 and 9- to 20-fold lower for IgG19 (Fig. 5A and B; Table 1). It is noteworthy that these IgGs did not block E2-CD81 interaction (data not shown). As expected, antibodies purified from an uninfected individual (IgG20) had no effect on virus infectivity (data not shown). We next tested the efficiency of

neutralization of all viruses by the conformation-sensitive anti-E2 human MAbs (HMABs), CBH-5 and HC-11. Both of these HMABs recognize discontinuous overlapping epitopes within the domain B of E2 and inhibit viral entry into cells by blocking the E2-CD81 interaction (28–30, 46). We found that each mutant virus was more sensitive to neutralization by these HMABs compared to JFH1_{WT}, with the IC_{50} s reducing by 12- to 30-fold for CBH-5 and strikingly, by 3 to 4 log for HC-11 (Fig. 5C and D and Table 1). Together, these results suggest that all four mutations enhance the exposure of antibody neutralizing epitopes on the virus particle.

TABLE 1. IC₅₀s of CD81-LEL and inhibitory antibodies for each virus

Inhibitor	IC ₅₀ (μg/ml) ^a					
	WT	N415D	T416A	N417S	G418D	I422L
hCD81-LEL	>50	4.4	3.4	3.7	2.0	3
Anti-CD81	0.12	0.1	0.13	0.07	0.12	0.13
Anti-SR-BI	1:560	1:40	1:25	<1:20	1:170	1:100
IgG17	12.11	0.2	0.3	0.66	ND	0.3
IgG19	22	1.1	1.3	1.4	ND	2.5
IgG2	>50	ND	ND	ND	1.2	ND
IgG4	>50	ND	ND	ND	1.8	ND
CBH-5	0.6	0.02	0.02	0.05	0.12	0.035
AP33	1.5	NN	0.06	NN	NN	0.12
HC11	7.0	0.001	0.0003	0.004	ND	0.002
3/11	44.9	NN	4.1	NN	NN	7.12
AP33 (HCVpp)	1.0	NN	0.01	NN	ND	0.02
CBH-5 (HCVpp)	2.3	0.01	0.016	0.03	ND	0.036

^a NN, non-neutralizable; ND, not done. The anti-SR-BI IC₅₀s are represented as serum dilutions.

We next measured the neutralization of these viruses using the broadly neutralizing MAbs AP33 and 3/11, which recognize distinct but overlapping epitopes within the highly conserved region of E2 spanning residues 412 to 423 (QLINTNGSW HIN) (56), where our four mutations are located. We found that JFH1_{T416A} and JFH1_{I422L} were highly sensitive to neutralization by both AP33 and 3/11, whereas JFH1_{N415D} and JFH1_{N417S} were completely resistant (Fig. 6A and B, respectively; Table 1). We next tested the reactivity of MAbs AP33 and 3/11 to each mutant E2 by ELISA. Normalized E2 from transfected cell lysates was captured onto GNA coated plates and probed with either AP33 or 3/11. Consistent with the neutralization data, both AP33 and 3/11 showed very weak binding to the E2 from JFH1_{N415D} and JFH1_{N417S} (Fig. 6C and D). Together, the neutralization and ELISA data show that the N415D and N417S mutations disrupt the binding of MAbs AP33 and 3/11 to E2. However, while the reactivity of mutants T416A and I422L to both MAbs was unaltered, they were more sensitive to neutralization by these antibodies. The latter phenotype is similar to what we observed in the hCD81-LEL inhibition and binding assays (Fig. 3A and B), again supporting the notion that local changes may occur to E2 during virion assembly affecting neutralization. The increased sensitivity to neutralization by the rodent MAbs (i.e., where the antibody reactivity is not compromised) together with the heightened inhibition of the mutant viruses to human antibodies described above (Fig. 5) indicates that the mutations may induce global conformational alterations in virion E2 allowing enhanced epitope exposure.

Infectivity and neutralization profiling in HCVpp system.

We previously showed that T416A mutation in the HCV genotype 1a strain H77 E2 abolished HCVpp infection (47). However, the results presented here show that the same mutation in the strain JFH1 HCVcc system does not affect infectivity. To resolve this discrepancy, we assessed the infectivity of the JFH1 E2 mutants in the HCVpp system. Although no differences in infectivity was observed for WT and T416A in HCVcc, we found a notable reduction in the infectivity of HCVpp carrying the same mutations (Fig. 7A). Nevertheless, neutralization assays using MAbs AP33 (Fig. 7C) and CBH-5

(Fig. 7D) showed that the effects of the mutations on antibody reactivity were very similar in HCVcc and HCVpp (Table 1). These data further support our notion that the mutations within the amino acids 412 to 423 alter the conformation of E2 on the virus particle.

Using E2 GNA-capture ELISA, we confirmed that the WT and the mutant E2 were expressed in comparable quantities (not shown), and that the mutations affected neither the E2 incorporation into HCVpps nor the E1E2 heterodimer formation (Fig. 7A and B). Thus, the reasons for the lower infectivity of mutant HCVpps are not clear. Several studies have demonstrated functional differences between HCVpp and HCVcc. It is conceivable that the former being a surrogate system may not always mimic the authentic virus in terms of glycoprotein presentation and function. Furthermore, HCVpp purely measure virus entry, excluding complications such as virus spread and RNA replication that exist within the HCVcc system when measuring virus infectivity. Therefore, direct comparisons in infectivity between these two systems are not always appropriate. This point is further strengthened by the observation that the G451R adaptive mutation, which enhances HCVcc infection, renders HCVpps noninfectious (18).

Induced selection of a MAb AP33 escape mutant virus. The cell culture adaptive E2 mutations characterized above occurred in viral variants that emerged after prolonged passaging of infected cells under standard tissue culture conditions. It is intriguing that they each carry an amino acid substitution within a highly conserved E2 region conferring significant phenotypic changes in relation to antibody neutralization and virus entry. We sought to determine whether neutralization escape mutants within the MAb AP33 epitope could be generated under constant antibody selective pressure, and if so, whether such mutants would be phenotypically similar to those arising by spontaneous selection. JFH1_{WT} virus was subjected to several rounds of growth in the continuous presence of a neutralizing concentration of AP33 in the two-chamber Thincert tissue culture system as described in Materials and Methods. The antibody was excluded in a parallel control experiment. The emergence of AP33 escape mutants was examined by dual immunostaining, using MAb AP33 and the sheep anti-NS5A antiserum, of naive cells infected with virus collected at each round of selection. The infectious virus yield arising from cells under antibody selective pressure was considerably lower during the early passages compared to the control cultures. A majority (>90%) of the virus in these early round preparations produced infectious foci in naive cells that were MAb AP33-negative but anti-NS5A-positive in immunofluorescence assay (data not shown). The proportion of the variant virus relative to the WT virus increased at each round of selection, and reached 100% by the eighth passage. Nucleotide sequence analysis of the E1 and E2 coding region of the RT-PCR product of early passage infected cell RNA revealed a single mutation (G to D) in E2 at residue 418 (G418D), which remained fixed throughout the passaging period. In contrast, no mutations were found in the E1 and E2 coding regions of virus passaged in parallel in the absence of MAb AP33.

The glycine at position 418 is one of the residues critical for AP33 recognition (56). To verify that the G418D substitution was responsible for the escape of AP33 neutralization, it was introduced into the JFH1_{WT} genome. We then characterized

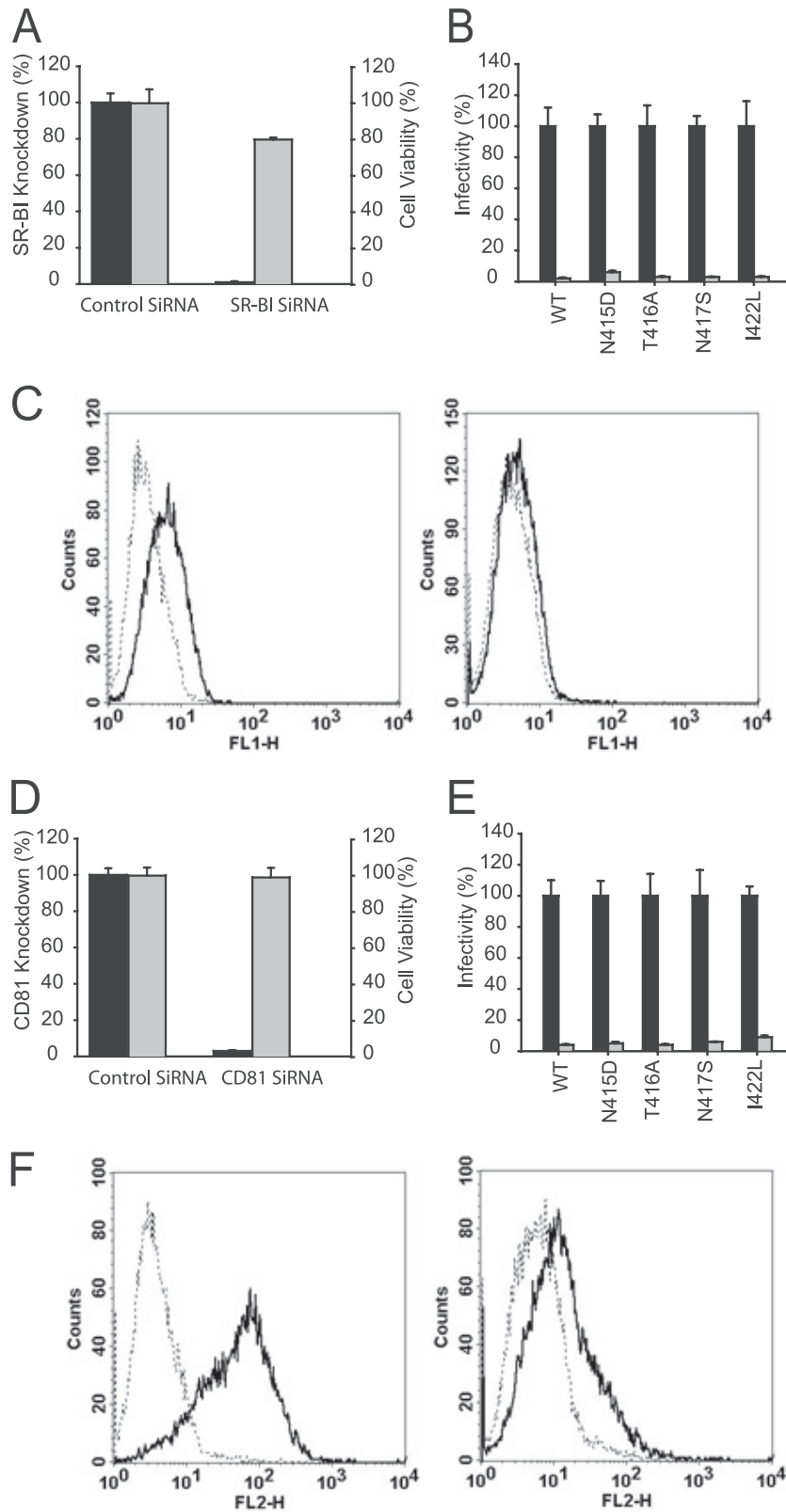

FIG. 4. Silencing CD81 and SR-BI gene expression inhibits E2 mutant virus infection. Huh-7 cells were transfected with control siRNAs or siRNAs targeting SR-BI (A to C) or CD81 (D to F). At 2 days posttransfection, the cell viability (gray bar) and mRNA expression levels (black bar) of SR-BI (A) and CD81 (D) were measured by ELISA and qRT-PCR, respectively. The expression of SR-BI (C) and CD81 (F) on the surface of Huh-7 cells transfected with control siRNAs (left panel) or receptor-specific siRNAs (right panel) was determined by FACS analysis as described in Materials and Methods. Solid and broken lines represent cells stained with an anti-CD81 or anti-SR-BI antibody and IgG subtype control, respectively. In parallel, the control siRNA-transfected Huh-7 cells (black bars) or the SR-BI (B) or CD81 (E) knockout cells (gray bars) were infected with WT or mutant viruses and the intracellular HCV RNA levels measured by qRT-PCR to quantitate infectivity.

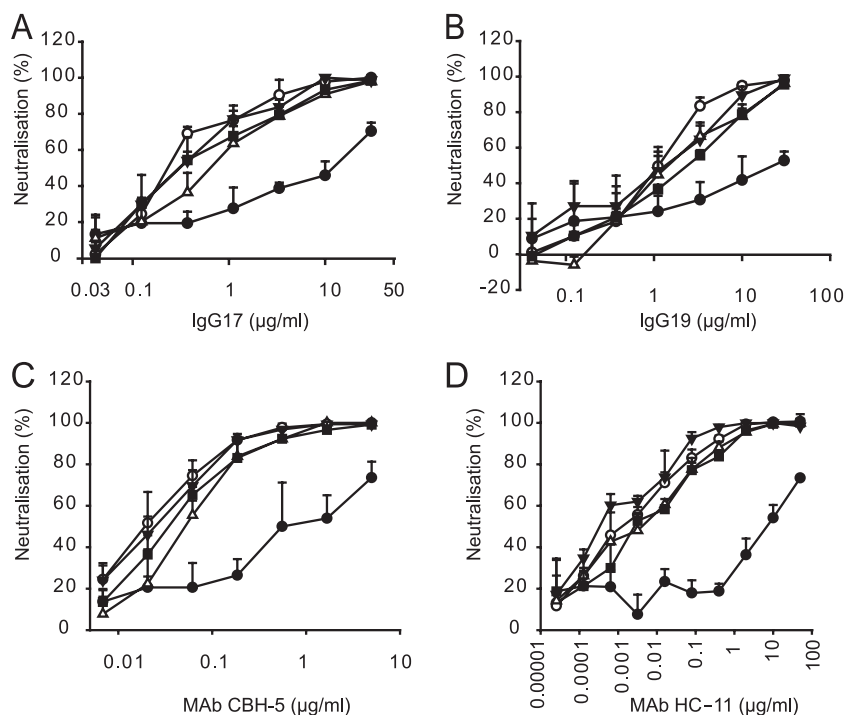

FIG. 5. E2 mutant viruses have increased sensitivity to neutralization by human anti-envelope antibodies. JFH1_{WT} (●), JFH1_{N415D} (○), JFH1_{T416A} (▼), JFH1_{N417S} (△), or JFH1_{I422L} (■) HCVcc was incubated for 1 h with different amounts of HCV-infected patient IgGs IgG17 (A) or IgG19 (B), or the human MAbs CBH-5 (C) and HC-11 (D) prior to infection of target cells. The level of virus inhibition was assayed as described in Materials and Methods. The percent neutralization was calculated by quantifying viral infectivity in the presence of anti-HCV glycoprotein specific antibodies relative to infection in the absence of antibodies.

the phenotype of the JFH1_{G418D} virus in terms of virus infectivity, receptor affinity, and antibody neutralization. Similar to all of the adaptive mutants described above, the JFH1_{G418D} virus was more sensitive to neutralization by the patient IgGs, the human anti-E2 MAb CBH-5 and soluble hCD81-LEL, and less sensitive to inhibition by the anti-SR-BI antiserum (Fig. 8A and Table 1). Furthermore, like JFH1_{N415D} and JFH1_{N417S}, this mutant was resistant to neutralization by both MAbs AP33 and 3/11. As with the adaptive mutants, the infectivity of JFH1_{G418D} was not drastically altered (data not shown).

Amino acid sequence analysis. We next investigated the frequency of changes, if any, of the relevant E2 residues in naturally occurring HCV isolates by sequence alignment. This analysis showed that substitution from N to D at position 415 was very rare in naturally occurring sequences, being found in only a single sequence among a sample of 1,311 full-length E2 protein sequences (Table 2). The substitutions from T to A at position 416 and from N to S at position 417 were more common, being found 13 and 17 times, respectively, within the same sample. Position 416 was more generally variable, with 182 of the 1,311 sequences differing from this residue in the JFH1 sequence. Position 418, in contrast, was extremely conserved. Only 2 of 1,311 sequences varied from the G found in JFH1, and neither of these has the G-to-D substitution produced here. The substitution from I to L at position 422 was also rare, being found only five times.

Analysis of the total number of naturally occurring substitutions at the relevant E2 positions identified the residue at position 415 as the most variable in terms of number of resi-

dues used (eight in total), contrasting with the use of only G and very rarely S at position 418 (Table 3). Although position 416 was the most likely to be substituted in naturally occurring sequences with 182 substitutions found, it used fewer residues than position 415. Position 422 had almost the same overall number of substituted sequences as position 415 (38 versus 37) but used a far lower number of residues (4 compared to 8).

DISCUSSION

In this study, we demonstrate that several mutations located within a conserved E2 region encompassing residues 412 to 423 influence the viral glycoprotein interaction(s) with cell receptors and neutralizing antibodies. This region carries residues that are critical for recognition of two broadly neutralizing antibodies used here, MAbs AP33 and 3/11 (45, 56). These residues—L413, N415, G418, and W420 (AP33) and N415, W420, and H421 (3/11)—are well conserved, which is relevant for future vaccine design. However, this requires a better understanding of the epitope-antibody interaction at the structural level. In this respect, studies of viral variants that escape antibody-mediated neutralization should provide useful information and help identify the role of other residues in antigen-antibody interaction.

Three of the five HCV JFH1 E2 mutations (N415D, N417S, and G418D) described in the present study abrogated E2 reactivity to, and virus neutralization by, MAbs AP33 and 3/11. The N415D and N417S mutations arose spontaneously during cell passaging, while the G418D was generated under AP33

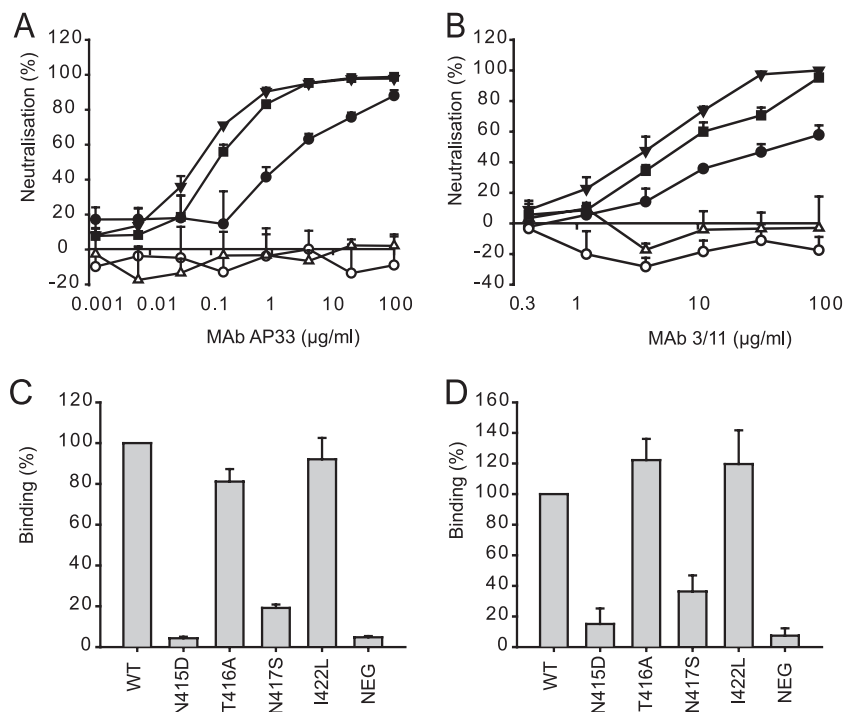

FIG. 6. E2 mutations alter virus neutralization by MAb AP33 and 3/11. JFH1_{WT} (●), JFH1_{N415D} (○), JFH1_{T416A} (▼), JFH1_{N417S} (△), or JFH1_{I422L} (■) HCVcc was preincubated for 1 h with different concentrations of MAb AP33 (A) and 3/11 (B) before infecting target cells. The level of virus inhibition was assayed as described in Materials and Methods. The percent neutralization was calculated by quantifying viral infectivity in the presence of anti-E2 specific MAb relative to infection in the absence of antibodies. (C and D) Reactivity of MAb AP33 or 3/11 to HCV E2. WT or mutant E2 from electroporated Huh-7 cells was normalized as described in the legend to Fig. 3 and tested for reactivity to MAb (C) AP33 or (D) 3/11 by GNA-capture ELISA, and the data are presented as the averages of two independent experiments, each performed in triplicate. Reactivity is expressed as the percentage of binding relative to the WT E2.

selective pressure. Our amino acid sequence alignment shows that N415D and G418D are extremely rare (1 and 0 occurrences, respectively, out of a sample of 1,311 sequences) in natural sequences, whereas N417S, although by no means common, is the major naturally occurring variant (17 occurrences of 27) (Table 2). Recently, we described a MAb AP33 neutralization escape variant of a genotype 1a/2a chimeric HCVcc following repetitive rounds of antibody neutralization and amplification in cell culture (17). This virus contained N415Y and E655G mutations in the E2 glycoprotein. The N415Y mutation alone severely attenuated MAb AP33 (and 3/11) recognition and neutralization, but it did not enhance sensitivity to neutralization by other human anti-E2 MAb and, interestingly, it substantially reduced viral fitness. Y at position 415 occurs 9 times in natural HCV sequences. Of the 37 variant residues at this position (Table 3) it is the third most common, found in genotypes 1a, 1b, 4b, and 6. In contrast, the N415D mutation, although found much rarely in patient isolates, maintained HCVcc fitness, as was the case for the other E2 cell culture-adaptive mutations characterized in the present study. This is likely due to the nature of the substituted amino acid and/or genotypic differences in the E2 glycoprotein. The difference in the E2 sequence could also account for the fact that the repetitive passaging of the genotype 2a JFH1 HCVcc in the presence of a neutralizing concentration of MAb AP33 allowed selection of a virus carrying the E2 G418D substitution. However, the different selection protocols used between the

previous (17) and the present study may, at least in part, be responsible.

We previously showed that alanine replacement of the residue N417 in the HCV genotype 1a H77 E2 moderately reduced MAb AP33 and 3/11 binding (56). In the present study, a change to serine at this position in the genotype 2a JFH1 strain drastically reduced AP33 and 3/11 binding, rendering JFH1_{N417S} HCVcc resistant to neutralization by either antibody and highlighting the contribution of N417 to their binding sites on E2. Furthermore, the residue N417 is part of an N-linked glycosylation site (22, 47), the removal of which from genotype 1a E2 (N417Q) has been shown to increase the sensitivity of HCVpp to antibody neutralization and to increase CD81 binding (22). The latter observations are also in keeping with our findings. Our data show that the molecular weight of the genotype 2a E2 N417S mutant is identical to the WT glycoprotein (Fig. 7b); however, it would be inappropriate to conclude on this basis that this site is not used for glycosylation. This is because the N417S change potentially creates a new N glycosylation site over positions 415 to 417 (i.e., a change from NTN to NTS, see Fig. 1b), which, if utilized, will not alter the migration of the mutant E2 in SDS-PAGE. Clearly, further studies are required to clarify this issue. The N417S change occurs in 17 of the 27 variants at this position (Table 2), suggesting that it may be naturally selected.

Bungyoku et al. (10) previously showed that the E2 T416A mutation in a chimeric J6/JFH1 HCVcc background does not

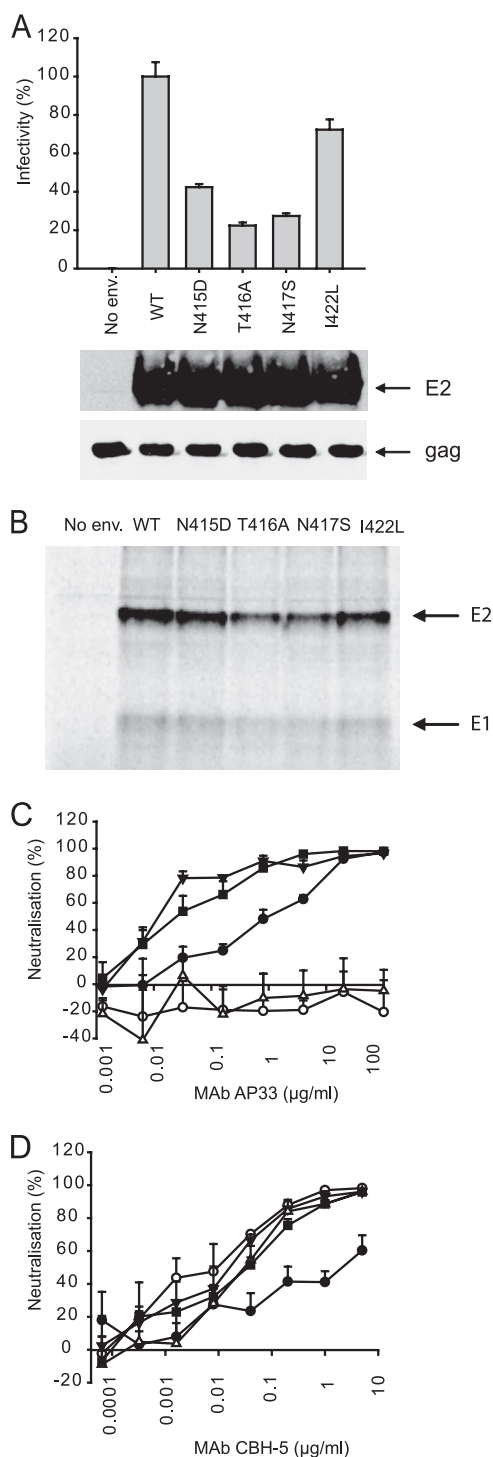

FIG. 7. E2 mutations affect the infectivity conferred by E1E2 in the HCVpp assay. (A) HCVpp bearing WT JFH1 E2 or mutant JFH1 E2 were generated in HEK-293T cells cotransfected with appropriate constructs as described in Materials and Methods. Naive Huh-7 cells were infected with HCVpp and infectivity was determined by measuring luciferase levels (top panel). Sucrose cushion enriched HCVpp preparations were Western blotted to detect virion incorporation of E2 using an anti-E2 MAb (middle panel) and MLV gag proteins using a gag-specific MAb (bottom panel). (B) Immunoprecipitation of radio-labeled E1 and E2 proteins expressed in HEK-293T cells was performed using the anti-E2 HMAb CBH-5 as described in Materials and Methods. (C and D) HCVpp bearing WT JFH1 E2 (●), JFH1 E2

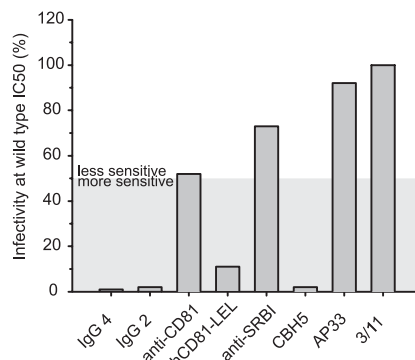

FIG. 8. Characterization of JFH1_{G418D} virus. Huh7-J20 cells were infected with the JFH1_{WT} or JFH1_{G418D} virus that had been preincubated with different concentrations of IgG2 or IgG4, hCD81-LEL, or the anti-E2 MAb AP33, 3/11, or CBH-5. Alternatively, Huh7-J20 cells preincubated with different concentrations of the anti-CD81 MAb or an anti-SR-BI antiserum were infected with JFH1_{WT} or JFH1_{G418D} virus. At 3 days postinfection the virus infectivity levels were determined by measuring SEAP activity in the culture medium. The results are presented as the percent inhibition of JFH1_{G418D} infection by the indicated molecules at 50% inhibitory (IC₅₀) concentrations for the WT virus.

alter virus infectivity in the Huh-7-derived sub line Huh7.5 (7). In accordance with these data, we find here that the same mutation has no significant affect on HCVcc spread in Huh-7 cells. Furthermore, we previously showed that the T416A mutation in the genotype 1a HCVpp system moderately reduced MAb AP33 and 3/11 recognition (56), enhanced CD81 binding, and abrogated pseudoparticle infectivity (47). In contrast, we show here that this mutation in the genotype 2a JFH1 HCVcc enhances E2 reactivity to MAbs AP33 and 3/11 and maintains WT virus infectivity. Together, the different infection systems, viral isolates and/or cell lines used in each study likely account for these inconsistencies. T416A is one of seven variants at a locus subject to positive selection (9), and although occurring 13 times in our sample, is only a minor component (7% of substitutions) of the extensive variability in this position.

The I422L mutation was first isolated alongside other structural and nonstructural mutations after several rounds of JFH1 HCVcc passaging in Huh-7.5 cells and was shown not to alter virus infectivity, which is in agreement with our findings in Huh-7 cells (27). Consistent with our previous findings for I422A (56), the I422L mutation did not affect E2 recognition by MAbs AP33 and 3/11, confirming that this residue is not critical for E2 recognition by either MAb. I422L occurs five times in our sample of 1311 E2 sequences, constituting 13% of the substitutions at this position (Table 2).

The reduced sensitivity of these mutants to inhibition by the

carrying N415D (○), T416A (▼), N417S (△), or I422L (■) mutation were first normalized with respect to their infectivity (luciferase) values and then mixed with MAbs AP33 (B) or CBH-5 (C) 1 h prior to infecting Huh-7 cells. Virus infectivity was measured 3 days postinfection by quantifying luciferase activity. The percent neutralization was calculated by quantifying viral infectivity in the presence of anti-E2 specific MAbs relative to infection in the absence of MAbs.

TABLE 2. Naturally occurring substitutions in 1311 HCV E2 protein sequences

Position	JFH1 residue	Variant ^a	No. ^b	Total ^c	Prop. ^d	Accession no. (genotype) ^e
415	N	D	1	37	0.03	EU482838 (1a)
416	T	A	13	182	0.07	AY956468 (1a), AY958005 (3a), EU155215 (1a), EU155249 (1a), EU155282 (1a), EU155285 (1a), EU155288 (1a), EU155379 (1a), EU255930 (1a), EU255980 (1a), EU482845 (1a), EU482836 (1a), EU643835 (6)
417	N	S	17	27	0.63	EU256046 (1a), EU256031 (1a), EU255964 (1a), EU255952 (1a), EU255943 (1a), EU155354 (1a), EU155347 (1a), EU155297 (1a), EU155274 (1a), EU155215 (1a), EF407468 (1b), EF407466 (1a), EF407477 (1a), EU407415 (1a), EF026073 (2/5 natural recombinant), AY957988 (3a), AM408911 (2/5)
418	G	D	0	2	0.00	
422	I	L	5	38	0.13	AB047643 (2a), AF271632 (1a), FJ828970 (1a), FJ828971 (1a), M62321 (1a)

^a That is, substitutions as described in the text.

^b That is, the total number of sequences in a sample of 1,311 HCV E2 proteins with the same substitution.

^c That is, the total number of substituted residues in the sample of 1,311 (see Table 3).

^d Prop., the proportion of naturally occurring substitutions that are identical to the substitutions produced in the present study.

^e The accession number(s) of HCV sequences (genotypes are shown in parentheses) carrying the relevant variant is listed.

anti-SR-BI antibody was an unexpected result. In keeping with these observations, we found that all of the mutants studied here were insensitive to HDL-mediated enhancement of virus infection. The exact mechanism by which the HDL-SR-BI association facilitates HCV entry is currently unknown. Although no interaction between HDL and HCVpp particles has been demonstrated in culture medium, the possibility of an association occurring at a postbinding stage cannot be discounted (58). More importantly, the binding of HDL to HCVcc virions has yet to be investigated. Also, it has been postulated that the lipid transfer events resulting from HDL-SR-BI binding, known to be essential for regulating the properties of cells membranes, may affect the fusion efficiency of the HCV envelope with cell membranes (58). SR-BI was first identified as a putative HCV receptor based on its ability to bind soluble, truncated E2 (sE2) via HVR1 (53). However, sE2 may not fully mimic E2 structures on the HCV virion (11, 28) and an interaction between SR-BI and the E1E2 heterodimers has yet to be confirmed. In addition, the initial binding of serum HCV to SR-BI was found not to be mediated by HVR-1 or indeed other regions of the E2 glycoprotein. Instead, the

association of VLDL with virus particles appeared to play a critical role in the primary interaction with SR-BI (40). Thus, there is much uncertainty as to how HCV utilizes this receptor during virus entry. In the absence of definitive assays that can measure an interaction between SR-BI with full-length E1E2 or indeed HCVcc virions, it is difficult to decipher the effects caused by our E2 mutations to the entry process via this receptor. However, the siRNA knockdown experiment shows that SR-BI is not dispensable for the mutant virus entry.

Substitution of N415, T416, and N417 resulted in increased E2-CD81 binding, whereas the binding of E2 I422L mutant to CD81 was unaltered. Moreover, each mutant virus, including JFH1_{G418D}, exhibited a significantly greater sensitivity to neutralization by hCD81-LEL, suggesting an increased affinity of the mutated glycoproteins for CD81. This suggests that the adaptive mutations improve the accessibility of CD81 binding residues of the E2 present on mature virions. The heightened inhibition of these mutants by a range of human anti-HCV glycoprotein antibodies (and by the anti-E2 rodent MAbs AP33 and 3/11 in the case of mutants T416A and I422L) supports this theory.

Other studies have identified cell culture-adaptive mutations within the E2 glycoprotein (13, 18, 65). In particular, the mutation G451R has been extensively characterized (18, 65). This single mutation increases the buoyant density of the virus, as well as its ability to bind CD81. G451R also reduces SR-BI dependency and increases virus sensitivity to neutralization by E2 specific antibodies, indicating the greater availability of epitopes on the mutant particle. The mutations characterized in the present study have very similar phenotypes to G451R, suggesting that the E2 mutations selected in HCVcc may have arisen in response to similar selective pressures. For example, to persist during long-term culture subtle alterations to E2 conformation may enhance virus-receptor interactions and maintain spread. In line with this, it has been shown that during persistent infection of JFH1 in cell culture certain cell populations emerge that are less permissive to HCV infection due to a decrease in the cell surface expression of CD81 (65). Although this possibility was not investigated in our study or the others (10, 27, 52), the increased affinity of each mutant to

TABLE 3. Total number of naturally occurring substitutions in 1,311 HCV E2 protein sequences

Protein sequence	Residue at position:				
	415	416	417	418	422
JFH1	N	T	N	G	I
Variants ^a	K	N	S	S	L
1	Y	S	D		V
2	H	A	H		T
3	S	I	G		
4	T	K	T		
5	R	R			
6	D				
Total no. ^b	37	182	27	2	38

^a Substitutions occurring in the sample of 1,311 E2 protein sequences.

^b Total number of sequences with a substitution. Position 416 is the most polymorphic in terms of total number of substitutions at 14% (182 in 1,311 sequences). However, position 415 has a greater diversity of variants (8 amino acids used at least once, despite only 37 substitutions).

CD81 (Fig. 3) may assist viral spread in cells presenting less CD81.

The E2 region studied here lies immediately C-terminal to the HVR-1, in which positive selection is active. In contrast, the region of interest has only a single site detected as positively selected—that at position 416 (9). Consistent with this, the survey of 1311 E2 sequences reported here shows that 182 of them are variants (ca. 14%) at position 416. At the remaining sites of interest, substitution is much rarer, never higher than 4% of the total sample (Table 3). In addition, the specific mutations described here occur relatively rarely in natural HCV sequences (Table 2). For instance, the G-to-D change at position 418 is not found at all in our sample of 1,311 sequences. Indeed, this position is extremely conserved, with only two substitutions found in the full-length E2 sequences sampled (Tables 2 and 3). Both of those substitutions are G to S and occur in closely related sequences (not shown). The N415D change is similarly very rare in our sample, occurring only once.

The I-to-L substitution at position 422 is also rare (Table 2). Where substitution does occur naturally at position 422, it is confined to relatively hydrophobic residues (Table 3), suggesting that a selective constraint for hydrophobicity applies at this position. In contrast, the N417S change constitutes 63% of all variants found at that position, occurring 17 times (Table 2). The T416A change is intermediate in frequency, constituting 7% of all naturally occurring substitutions at that position. The naturally occurring variants at all positions are found in a wide range of genotypes (Table 2). For instance, position 416 has T to A substitution in genotypes 1a, 3a, and 6 and position 417 has N-to-S substitutions in 1a, 1b, 3a, and 2/5 recombinants. The substitutions produced in the present study at positions 415 to 417 and 422 are spontaneous occurrences in long-term cell passage, where selective conditions may be very different to those found in the natural host. This is a plausible explanation for the relative rarity of these substitutions in naturally occurring sequences.

Broadly neutralizing MAbs to this conserved region hold great promise as therapeutics. Moreover, the epitope recognized by these MAbs can be considered a valid lead for future vaccine design. However, an in-depth understanding of how the neutralizing antibodies interact with E2 is necessary, for both effective vaccine design and understanding the role of the epitope in receptor interaction and virus entry. An additional challenge for vaccine design is the emergence of viral variants during the course of infection that escape antibody neutralization. *In vivo*, the prevalence of antibodies reactive to the E2 region 412-423 (QLINTNGSWHIN) is <2.5% (55). Therefore, there is no great selective pressure acting on this region driving the emergence of neutralization escape mutations. If such mutants do arise spontaneously, they are likely to confer either reduced virus fitness (17) or an increased vulnerability to neutralization by circulating antibodies targeting various glycoprotein regions, thereby eliminating these variants from the virus pool. In summary, our data contribute to further defining the role of key residues within the HCV E2 412-423 region that influence virus-receptor interactions and antibody-mediated neutralization.

ACKNOWLEDGMENTS

We are grateful to F.-L. Cosset, J. Dubuisson, M. Harris, J. A. McKeating, C. M. Rice, and T. Wakita for provision of reagents. We thank Gabrielle Vieyres for expert technical assistance.

This study was funded by the Medical Research Council, United Kingdom, and European Union FP6 contract MRTN-CT-2006-035599 and supported in part by PHS grants HL079381 and AI081903 to S.K.H.F.

REFERENCES

- Allander, T., K. Drakenberg, A. Beyene, D. Rosa, S. Abrignani, M. Houghton, A. Widell, L. Grillner, and M. A. Persson. 2000. Recombinant human monoclonal antibodies against different conformational epitopes of the E2 envelope glycoprotein of hepatitis C virus that inhibit its interaction with CD81. *J. Gen. Virol.* **81**:2451–2459.
- Barth, H., C. Schafer, M. I. Adah, F. Zhang, R. J. Linhardt, H. Toyoda, A. Kinoshita-Toyoda, T. Toida, T. H. Van Kuppevelt, E. Depla, F. Von Weizsacker, H. E. Blum, and T. F. Baumert. 2003. Cellular binding of hepatitis C virus envelope glycoprotein E2 requires cell surface heparan sulfate. *J. Biol. Chem.* **278**:41003–41012.
- Bartosch, B., J. Dubuisson, and F. L. Cosset. 2003. Infectious hepatitis C virus pseudo-particles containing functional E1–E2 envelope protein complexes. *J. Exp. Med.* **197**:633–642.
- Bartosch, B., G. Verney, M. Dreux, P. Donot, Y. Morice, F. Penin, J. M. Pawlowsky, D. Lavillette, and F. L. Cosset. 2005. An interplay between hypervariable region 1 of the hepatitis C virus E2 glycoprotein, the scavenger receptor BI, and high-density lipoprotein promotes both enhancement of infection and protection against neutralizing antibodies. *J. Virol.* **79**:8217–8229.
- Bartosch, B., A. Vitelli, C. Granier, C. Goujon, J. Dubuisson, S. Pascale, E. Scarselli, R. Cortese, A. Nicosia, and F. L. Cosset. 2003. Cell entry of hepatitis C virus requires a set of coreceptors that include the CD81 tetraspanin and the SR-BI scavenger receptor. *J. Biol. Chem.* **278**:41624–41630.
- Benedicto, I., F. Molina-Jimenez, B. Bartosch, F. L. Cosset, D. Lavillette, J. Prieto, R. Moreno-Otero, A. Valenzuela-Fernandez, R. Aldabe, M. Lopez-Cabrera, and P. L. Majano. 2009. The tight junction-associated protein occludin is required for a postbinding step in hepatitis C virus entry and infection. *J. Virol.* **83**:8012–8020.
- Blight, K. J., J. A. McKeating, and C. M. Rice. 2002. Highly permissive cell lines for subgenomic and genomic hepatitis C virus RNA replication. *J. Virol.* **76**:13001–13014.
- Broering, T. J., K. A. Garrity, N. K. Boatright, S. E. Sloan, F. Sandor, W. D. Thomas, Jr., G. Szabo, R. W. Finberg, D. M. Ambrosino, and G. J. Babcock. 16 September 2009, posting date. Identification and characterization of broadly neutralizing human monoclonal antibodies directed against the E2 envelope glycoprotein of hepatitis C virus. *J. Virol.* doi: 10.1128/JVI.01138–09.
- Brown, R. J., V. S. Juttla, A. W. Tarr, R. Finnis, W. L. Irving, S. Hemsley, D. R. Flower, P. Borrow, and J. K. Ball. 2005. Evolutionary dynamics of hepatitis C virus envelope genes during chronic infection. *J. Gen. Virol.* **86**:1931–1942.
- Bungyoku, Y., I. Shoji, T. Makine, T. Adachi, K. Hayashida, M. Nagano-Fujii, Y. H. Ide, L. Deng, and H. Hotta. 2009. Efficient production of infectious hepatitis C virus with adaptive mutations in cultured hepatoma cells. *J. Gen. Virol.* **90**:1681–1691.
- Clayton, R. F., A. Owsianka, J. Aitken, S. Graham, D. Bhella, and A. H. Patel. 2002. Analysis of antigenicity and topology of E2 glycoprotein present on recombinant hepatitis C virus-like particles. *J. Virol.* **76**:7672–7682.
- Cormier, E. G., R. J. Durso, F. Tsamis, L. Boussemart, C. Manix, W. C. Olson, J. P. Gardner, and T. Dragic. 2004. L-SIGN (CD209L) and DC-SIGN (CD209) mediate transinfection of liver cells by hepatitis C virus. *Proc. Natl. Acad. Sci. U. S. A.* **101**:14067–14072.
- Delgrange, D., A. Pillez, S. Castelain, L. Cocquerel, Y. Rouille, J. Dubuisson, T. Wakita, G. Duverlie, and C. Wychowski. 2007. Robust production of infectious viral particles in Huh-7 cells by introducing mutations in hepatitis C virus structural proteins. *J. Gen. Virol.* **88**:2495–2503.
- Dreux, M., T. Pietschmann, C. Granier, C. Voisset, S. Ricard-Blum, P. E. Mangeot, Z. Keck, S. Foug, N. Vu-Dac, J. Dubuisson, R. Bartenschlager, D. Lavillette, and F. L. Cosset. 2006. High-density lipoprotein inhibits hepatitis C virus-neutralizing antibodies by stimulating cell entry via activation of the scavenger receptor BI. *J. Biol. Chem.* **281**:18285–18295.
- Evans, M. J., T. von Hahn, D. M. Tscherner, A. J. Syder, M. Panis, B. Wolk, T. Hatziioannou, J. A. McKeating, P. D. Bieniasz, and C. M. Rice. 2007. Claudin-1 is a hepatitis C virus coreceptor required for a late step in entry. *Nature* **446**:801–805.
- Flint, M., C. Maidens, L. D. Loomis-Price, C. Shotton, J. Dubuisson, P. Monk, A. Higginbottom, S. Levy, and J. A. McKeating. 1999. Characterization of hepatitis C virus E2 glycoprotein interaction with a putative cellular receptor, CD81. *J. Virol.* **73**:6235–6244.
- Gal-Tanamy, M., Z. Y. Keck, M. Yi, J. A. McKeating, A. H. Patel, S. K.

- Foung, and S. M. Lemon.** 2008. In vitro selection of a neutralization-resistant hepatitis C virus escape mutant. *Proc. Natl. Acad. Sci. U. S. A.* **105**:19450–19455.
18. **Grove, J., S. Nielsen, J. Zhong, M. F. Bassendine, H. E. Drummer, P. Balfe, and J. A. McKeating.** 2008. Identification of a residue in hepatitis C virus E2 glycoprotein that determines scavenger receptor BI and CD81 receptor dependency and sensitivity to neutralizing antibodies. *J. Virol.* **82**:12020–12029.
 19. **Haberstroh, A., E. K. Schnober, M. B. Zeisel, P. Carolla, H. Barth, H. E. Blum, F.-L. Cosset, G. Koutsoudakis, R. Bartenschlager, A. Union, E. Depla, A. Owsianka, A. H. Patel, C. Schuster, F. Stoll-Keller, M. Doffoël, M. Dreux, and T. F. Baumert.** 2008. Neutralizing host responses in hepatitis C virus infection target viral entry at post-binding steps and membrane fusion. *Gastroenterology* **135**:1719–1728.
 20. **Hadlock, K. G., R. E. Lanford, S. Perkins, J. Rowe, Q. Yang, S. Levy, P. Pileri, S. Abrignani, and S. K. Foung.** 2000. Human monoclonal antibodies that inhibit binding of hepatitis C virus E2 protein to CD81 and recognize conserved conformational epitopes. *J. Virol.* **74**:10407–10416.
 21. **Helle, F., and J. Dubuisson.** 2008. Hepatitis C virus entry into host cells. *Cell Mol. Life Sci.* **65**:100–112.
 22. **Helle, F., A. Goffard, V. Morel, G. Duverlie, J. McKeating, Z. Y. Keck, S. Foung, F. Penin, J. Dubuisson, and C. Voisset.** 2007. The neutralizing activity of anti-HCV antibodies is modulated by specific glycans on the E2 envelope protein. *J. Virol.* **81**:8101–8111.
 23. **Iro, M., J. Witteveldt, A. G. Angus, I. Woerz, A. Kaul, R. Bartenschlager, and A. H. Patel.** 2009. A reporter cell line for rapid and sensitive evaluation of hepatitis C virus infectivity and replication. *Antivir. Res.* **83**:148–155.
 24. **Johansson, D. X., C. Voisset, A. W. Tarr, M. Aung, J. K. Ball, J. Dubuisson, and M. A. Persson.** 2007. Human combinatorial libraries yield rare antibodies that broadly neutralize hepatitis C virus. *Proc. Natl. Acad. Sci. U. S. A.* **104**:16269–16274.
 25. **Kapadia, S. B., H. Barth, T. Baumert, J. A. McKeating, and F. V. Chisari.** 2007. Initiation of hepatitis C virus infection is dependent on cholesterol and cooperativity between CD81 and scavenger receptor B type I. *J. Virol.* **81**:374–383.
 26. **Katoh, K., K. Kuma, H. Toh, and T. Miyata.** 2005. MAFFT version 5: improvement in accuracy of multiple sequence alignment. *Nucleic Acids Res.* **33**:511–518.
 27. **Kaul, A., I. Woerz, P. Meuleman, G. Leroux-Roels, and R. Bartenschlager.** 2007. Cell culture adaptation of hepatitis C virus and in vivo viability of an adapted variant. *J. Virol.* **81**:13168–131679.
 28. **Keck, Z. Y., T. K. Li, J. Xia, B. Bartosch, F. L. Cosset, J. Dubuisson, and S. K. Foung.** 2005. Analysis of a highly flexible conformational immunogenic domain a in hepatitis C virus E2. *J. Virol.* **79**:13199–13208.
 29. **Keck, Z. Y., T. K. Li, J. Xia, M. Gal-Tanamy, O. Olson, S. H. Li, A. H. Patel, J. K. Ball, S. M. Lemon, and S. K. Foung.** 2008. Definition of a conserved immunodominant domain on hepatitis C virus E2 glycoprotein by neutralizing human monoclonal antibodies. *J. Virol.* **82**:6061–6066.
 30. **Keck, Z. Y., A. Op De Beeck, K. G. Hadlock, J. Xia, T. K. Li, J. Dubuisson, and S. K. Foung.** 2004. Hepatitis C virus E2 has three immunogenic domains containing conformational epitopes with distinct properties and biological functions. *J. Virol.* **78**:9224–9232.
 31. **Krieger, M.** 2001. Scavenger receptor class B type I is a multiligand HDL receptor that influences diverse physiologic systems. *J. Clin. Invest.* **108**:793–797.
 32. **Lavillette, D., A. W. Tarr, C. Voisset, P. Donot, B. Bartosch, C. Bain, A. H. Patel, J. Dubuisson, J. K. Ball, and F. L. Cosset.** 2005. Characterization of host-range and cell entry properties of the major genotypes and subtypes of hepatitis C virus. *Hepatology* **41**:265–274.
 33. **Law, M., T. Maruyama, J. Lewis, E. Giang, A. W. Tarr, Z. Stamataki, P. Gastaminza, F. V. Chisari, I. M. Jones, R. I. Fox, J. K. Ball, J. A. McKeating, N. M. Kneteman, and D. R. Burton.** 2008. Broadly neutralizing antibodies protect against hepatitis C virus quasispecies challenge. *Nat. Med.* **14**:25–27.
 34. **Levy, S., S. C. Todd, and H. T. Maecker.** 1998. CD81 (TAPA-1): a molecule involved in signal transduction and cell adhesion in the immune system. *Annu. Rev. Immunol.* **16**:89–109.
 35. **Lindenbach, B. D., M. J. Evans, A. J. Syder, B. Wolk, T. L. Tellinghuisen, C. C. Liu, T. Maruyama, R. O. Hynes, D. R. Burton, J. A. McKeating, and C. M. Rice.** 2005. Complete replication of hepatitis C virus in cell culture. *Science* **309**:623–626.
 36. **Liu, S., W. Yang, L. Shen, J.-R. Turner, C. B. Coyne, and T. Wang.** 2009. Tight junction proteins claudin-1 and occludin control hepatitis C virus entry and are downregulated during infection to prevent superinfection. *J. Virol.* **83**:2011–2014.
 37. **Lozach, P. Y., A. Amara, B. Bartosch, J. L. Virelizier, F. Arenzana-Seisdedos, F. L. Cosset, and R. Altmeyer.** 2004. C-type lectins L-SIGN and DC-SIGN capture and transmit infectious hepatitis C virus pseudotype particles. *J. Biol. Chem.* **279**:32035–32045.
 38. **Lozach, P. Y., H. Lortat-Jacob, A. de Lacroix de Lavalette, I. Staropoli, S. Foung, A. Amara, C. Houles, F. Fieschi, O. Schwartz, J. L. Virelizier, F. Arenzana-Seisdedos, and R. Altmeyer.** 2003. DC-SIGN and L-SIGN are high-affinity binding receptors for hepatitis C virus glycoprotein E2. *J. Biol. Chem.* **278**:20358–20366.
 39. **Macdonald, A., K. Crowder, A. Street, C. McCormick, K. Saksela, and M. Harris.** 2003. The hepatitis C virus nonstructural NSSA protein inhibits activating protein-1 function by perturbing ras-ERK pathway signaling. *J. Biol. Chem.* **278**:17775–17784.
 40. **Maillard, P., T. Huby, U. Andreo, M. Moreau, J. Chapman, and A. Budkowska.** 2006. The interaction of natural hepatitis C virus with human scavenger receptor SR-BI/ClA1 is mediated by ApoB-containing lipoproteins. *FASEB J.* **20**:735–737.
 41. **Molina, S., V. Castet, C. Fournier-Wirth, L. Pichard-Garcia, R. Avner, D. Harats, J. Roitelman, R. Barbaras, P. Graber, P. Ghersa, M. Smolarsky, A. Funaro, F. Malavasi, D. Larrey, J. Coste, J. M. Fabre, A. Sa-Cunha, and P. Maurel.** 2007. The low-density lipoprotein receptor plays a role in the infection of primary human hepatocytes by hepatitis C virus. *J. Hepatol.* **46**:411–419.
 42. **Moradpour, D., F. Penin, and C. M. Rice.** 2007. Replication of hepatitis C virus. *Nat. Rev. Microbiol.* **5**:453–463.
 43. **Nakabayashi, H., K. Taketa, K. Miyano, T. Yamane, and J. Sato.** 1982. Growth of human hepatoma cell lines with differentiated functions in chemically defined medium. *Cancer Res.* **42**:3858–3863.
 44. **Owsianka, A., R. F. Clayton, L. D. Loomis-Price, J. A. McKeating, and A. H. Patel.** 2001. Functional analysis of hepatitis C virus E2 glycoproteins and virus-like particles reveals structural dissimilarities between different forms of E2. *J. Gen. Virol.* **82**:1877–1883.
 45. **Owsianka, A., A. W. Tarr, V. S. Juttla, D. Lavillette, B. Bartosch, F. L. Cosset, J. K. Ball, and A. H. Patel.** 2005. Monoclonal antibody AP33 defines a broadly neutralizing epitope on the hepatitis C virus E2 envelope glycoprotein. *J. Virol.* **79**:11095–11104.
 46. **Owsianka, A. M., A. W. Tarr, Z. Y. Keck, T. K. Li, J. Witteveldt, R. Adair, S. K. Foung, J. K. Ball, and A. H. Patel.** 2008. Broadly neutralizing human monoclonal antibodies to the hepatitis C virus E2 glycoprotein. *J. Gen. Virol.* **89**:653–659.
 47. **Owsianka, A. M., J. M. Timms, A. W. Tarr, R. J. Brown, T. P. Hickling, A. Szejnk, K. Bienkowska-Szewczyk, B. J. Thomson, A. H. Patel, and J. K. Ball.** 2006. Identification of conserved residues in the E2 envelope glycoprotein of the hepatitis C virus that are critical for CD81 binding. *J. Virol.* **80**:8695–8704.
 48. **Patel, A. H., J. Wood, F. Penin, J. Dubuisson, and J. A. McKeating.** 2000. Construction and characterization of chimeric hepatitis C virus E2 glycoproteins: analysis of regions critical for glycoprotein aggregation and CD81 binding. *J. Gen. Virol.* **81**:2873–2883.
 49. **Perotti, M., N. Mancini, R. A. Diotti, A. W. Tarr, J. K. Ball, A. Owsianka, R. Adair, A. H. Patel, M. Clementi, and R. Burioni.** 2008. Identification of a broadly cross-reacting and neutralizing human monoclonal antibody directed against the hepatitis C virus E2 protein. *J. Virol.* **82**:1047–1052.
 50. **Pileri, P., Y. Uematsu, S. Campagnoli, G. Galli, F. Falugi, R. Petracca, A. J. Weiner, M. Houghton, D. Rosa, G. Grandi, and S. Abrignani.** 1998. Binding of hepatitis C virus to CD81. *Science* **282**:938–941.
 51. **Ploss, A., M. J. Evans, V. A. Gaysinskaya, M. Panis, H. You, Y. P. de Jong, and C. M. Rice.** 2009. Human occludin is a hepatitis C virus entry factor required for infection of mouse cells. *Nature* **457**:882–886.
 52. **Russell, R. S., J. C. Meunier, S. Takikawa, K. Faulk, R. E. Engle, J. Bukh, R. H. Purcell, and S. U. Emerson.** 2008. Advantages of a single-cycle production assay to study cell culture-adaptive mutations of hepatitis C virus. *Proc. Natl. Acad. Sci. U. S. A.* **105**:4370–4375.
 53. **Scarselli, E., H. Ansuini, R. Cerino, R. M. Roccasecca, S. Acali, G. Filocamo, C. Traboni, A. Nicosia, R. Cortese, and A. Vitelli.** 2002. The human scavenger receptor class B type I is a novel candidate receptor for the hepatitis C virus. *EMBO J.* **21**:5017–5025.
 54. **Tamura, K., J. Dudley, M. Nei, and S. Kumar.** 2007. MEGA4: Molecular Evolutionary Genetics Analysis (MEGA) software version 4.0. *Mol. Biol. Evol.* **24**:1596–1599.
 55. **Tarr, A. W., A. M. Owsianka, D. Jayaraj, R. J. Brown, T. P. Hickling, W. L. Irving, A. H. Patel, and J. K. Ball.** 2007. Determination of the human antibody response to the epitope defined by the hepatitis C virus-neutralizing monoclonal antibody AP33. *J. Gen. Virol.* **88**:2991–3001.
 56. **Tarr, A. W., A. M. Owsianka, J. M. Timms, C. P. McClure, R. J. Brown, T. P. Hickling, T. Pietschmann, R. Bartenschlager, A. H. Patel, and J. K. Ball.** 2006. Characterization of the hepatitis C virus E2 epitope defined by the broadly neutralizing monoclonal antibody AP33. *Hepatology* **43**:592–601.
 57. **Vieyres, G., A. G. Angus, A. Haberstroh, T. F. Baumert, J. Dubuisson, and A. H. Patel.** 2009. Rapid synchronization of hepatitis C virus infection by magnetic adsorption. *J. Virol. Methods* **157**:69–79.
 58. **Voisset, C., N. Callens, E. Blanchard, A. Op De Beeck, J. Dubuisson, and N. Vu-Dac.** 2005. High density lipoproteins facilitate hepatitis C virus entry through the scavenger receptor class B type I. *J. Biol. Chem.* **280**:7793–7799.
 59. **Voisset, C., A. Op de Beeck, P. Horellou, M. Dreux, T. Gustot, G. Duverlie, F. L. Cosset, N. Vu-Dac, and J. Dubuisson.** 2006. High-density lipoproteins reduce the neutralizing effect of hepatitis C virus (HCV)-infected patient antibodies by promoting HCV entry. *J. Gen. Virol.* **87**:2577–2581.
 60. **von Hahn, T., B. D. Lindenbach, A. Boullier, O. Quehenberger, M. Paulson,**

- C. M. Rice, and J. A. McKeating. 2006. Oxidized low-density lipoprotein inhibits hepatitis C virus cell entry in human hepatoma cells. *Hepatology* **43**:932–942.
61. Wakita, T., T. Pietschmann, T. Kato, T. Date, M. Miyamoto, Z. Zhao, K. Murthy, A. Habermann, H. G. Krausslich, M. Mizokami, R. Bartenschlager, and T. J. Liang. 2005. Production of infectious hepatitis C virus in tissue culture from a cloned viral genome. *Nat. Med.* **11**:791–796.
62. Witteveldt, J., M. J. Evans, J. Bitzegeio, G. Koutsoudakis, A. M. Owsianka, A. G. Angus, Z. Y. Keck, S. K. Fount, T. Pietschmann, C. M. Rice, and A. H. Patel. 2009. CD81 is dispensable for hepatitis C virus cell-to-cell transmission in hepatoma cells. *J. Gen. Virol.* **90**:48–58.
63. Zeisel, M. B., G. Koutsoudakis, E. K. Schnober, A. Haberstroh, H. E. Blum, F. L. Cosset, T. Wakita, D. Jaeck, M. Doffoel, C. Royer, E. Soulier, E. Schvoerer, C. Schuster, F. Stoll-Keller, R. Bartenschlager, T. Pietschmann, H. Barth, and T. F. Baumert. 2007. Scavenger receptor class B type I is a key host factor for hepatitis C virus infection required for an entry step closely linked to CD81. *Hepatology* **46**:1722–1731.
64. Zhong, J., P. Gastaminza, G. Cheng, S. Kapadia, T. Kato, D. R. Burton, S. F. Wieland, S. L. Uprichard, T. Wakita, and F. V. Chisari. 2005. Robust hepatitis C virus infection in vitro. *Proc. Natl. Acad. Sci. U. S. A.* **102**:9294–9299.
65. Zhong, J., P. Gastaminza, J. Chung, Z. Stamataki, M. Isogawa, G. Cheng, J. A. McKeating, and F. V. Chisari. 2006. Persistent hepatitis C virus infection in vitro: coevolution of virus and host. *J. Virol.* **80**:11082–11093.

MUHAMMAD NUAMAN ZAHID

Impact of SR-BI and CD81 on Hepatitis C virus entry and evasion

Résumé

Le virus de l'hépatite C (VHC) est l'une des causes majeures de cirrhose du foie et de carcinome hépatocellulaire. Au cours de la première partie de ma thèse, nous nous sommes intéressés à caractériser plus en détail le rôle de SR-BI dans l'infection par le VHC. Bien que les mécanismes impliquant SR-BI dans la liaison du virus à l'hépatocyte aient été partiellement caractérisés, le rôle de SR-BI dans les étapes suivant la liaison du VHC reste encore largement méconnu. Afin de mieux caractériser le rôle de l'interaction VHC/SR-BI dans l'infection par le VHC, notre laboratoire a généré une nouvelle classe d'anticorps monoclonaux anti-SR-BI inhibant l'infection virale. Nous avons pu démontrer que SR-BI humain jouait un rôle dans le processus d'entrée du virus à la fois lors de l'étape de liaison du virus à la cellule hôte mais aussi au cours d'étapes suivant cette liaison. Ainsi il serait intéressant de cibler cette fonction de SR-BI dans le cadre d'une stratégie antivirale pour lutter contre l'infection par le VHC. Dans la seconde partie de ma thèse, nous avons pour but de caractériser les mécanismes moléculaires intervenant dans la réinfection du greffon lors de la transplantation hépatique (TH). Nous avons ainsi identifiés 3 mutations adaptatives dans la glycoprotéine d'enveloppe E2 responsables de l'entrée virale augmentée du variant hautement infectieux. Ces mutations influent sur la dépendance au récepteur CD81 du VHC résultant en une entrée virale accrue. L'identification de ces mécanismes va nous permettre une meilleure compréhension de la pathogénèse de l'infection par le VHC, et est un premier pas pour le développement d'une stratégie préventive antivirale ou vaccinale.

Mot clés: virus de l'hépatite C, SR-BI, anticorps monoclonaux, CD81, transplantation hépatique, glycoprotéine d'enveloppe E2

Résumé en anglais

Hepatitis C virus (HCV) is a major cause of liver cirrhosis and hepatocellular carcinoma. In the first part of my PhD, we aimed to further characterize the role of scavenger receptor class B type I (SR-BI) in HCV infection. While the SR-BI determinants involved in HCV binding have been partially characterized, the post-binding function of SR-BI remains largely unknown. To further explore the role of HCV-SR-BI interaction during HCV infection, we generated a novel class of anti-SR-BI monoclonal antibodies inhibiting HCV infection. We demonstrated that human SR-BI plays a dual role in the HCV entry process during both binding and post-binding steps. Targeting the post-binding function of SR-BI thus represents an interesting antiviral strategy against HCV infection. In the second part of my PhD, we aimed to characterize the molecular mechanisms underlying HCV re-infection of the graft after liver transplantation (LT). We identified three adaptive mutations in envelope glycoprotein E2 mediating enhanced entry and evasion of a highly infectious escape variant. These mutations markedly modulated CD81 receptor dependency resulting in enhanced viral entry. The identification of these mechanisms advances our understanding of the pathogenesis of HCV infection and paves the way for the development of novel antiviral strategies and vaccines.

Keywords: hepatitis c virus, SR-BI, monoclonal antibodies, CD81, Liver transplantation, envelope glycoprotein E2