



HAL
open science

Oncolytic H-1 parvovirus NS1 protein : identifying and characterizing new transcriptional and posttranslational regulatory elements

Audrey Richard

► **To cite this version:**

Audrey Richard. Oncolytic H-1 parvovirus NS1 protein : identifying and characterizing new transcriptional and posttranslational regulatory elements. Human health and pathology. Université du Droit et de la Santé - Lille II, 2011. English. NNT : 2011LIL2S045 . tel-00826936

HAL Id: tel-00826936

<https://theses.hal.science/tel-00826936>

Submitted on 28 May 2013

HAL is a multi-disciplinary open access archive for the deposit and dissemination of scientific research documents, whether they are published or not. The documents may come from teaching and research institutions in France or abroad, or from public or private research centers.

L'archive ouverte pluridisciplinaire **HAL**, est destinée au dépôt et à la diffusion de documents scientifiques de niveau recherche, publiés ou non, émanant des établissements d'enseignement et de recherche français ou étrangers, des laboratoires publics ou privés.

Oncolytic H-1 parvovirus NS1 protein

**Identifying and characterizing new
transcriptional and post-translational
regulatory elements**

**Public defence Friday, December 9th 2011 in the
presence of :**

Pr. Bruno Quesnel, President

Dr. Anne Op de beeck, Reviewer

Dr. Jürg Nüesch, Reviewer

Dr. Anna Salvetti, Examiner

Pr. Jean Rommelaere, Examiner

Dr. David Tulasne, Examiner

Pr. Yvan de Launoit, Examiner

By Audrey RICHARD

The most exciting phrase to hear in science, the one that heralds the most discoveries, is not 'Eureka!', but 'Mmmmh... That's funny...'"

Isaac Asimov, American writer

"Contrary to what Asimov says, the most exciting phrase in science, the one that heralds new discoveries, is not 'Eureka!' or 'That's funny...,' it's 'Your research grant has been approved.'"

John Alejandro King, aka The Covert Comic

"A theory is something nobody believes, except the person who made it.
An experiment is something everybody believes, except the person who made it."

Albert Einstein

"Je finirai par répondre à Blaise Pascal, qui disait que le silence éternel des espaces infinis l'effrayait, en lui répondant que c'est exactement l'éternité de l'espace qui a permis la complexité moléculaire dont nous sommes faits. Nous sommes les enfants des silences éternels et des espaces infinis.

Voilà Blaise Pascal, ça, c'est pour ton p'tit cul !"

Alexandre Astier (Extrait de « La physique quantique »)

TABLE OF CONTENTS

TABLE OF CONTENTS	
ACKNOWLEDGMENTS	1
ABSTRACT	7
PROLOGUE ONCE UPON A TIME (IMMEMORIAL)	
ONCE UPON A TIME (IMMEMORIAL)	8
INTRODUCTION BOOK I. THE <i>PARVOVIRIDAE</i> STORY	
BOOK I. THE <i>PARVOVIRIDAE</i> STORY	9
<i>Part 1. Family portrait of a killer</i>	9
Chapter 1. The family.....	10
Chapter 2. The subfamilies	11
Chapter 3. The genera	12
Chapter 4. The species	13
<i>Part 2. Anatomy of the killer</i>	14
Chapter 1. Organization and structure of H-1PV genome	15
Paragraph 1. General features	15
Paragraph 2. The right-hand end hairpin	16
Paragraph 3. The left-hand end hairpin	16
Description of the hairpin	16
Importance of the left-end hairpin's asymmetry	17
Additional functions of the left-end hairpin.....	18
Chapter 2. The viral particle.....	18
Chapter 3. Associated diseases.....	19
BOOK II. THE H-1 PARVOVIRUS STORY	20
<i>Part 1. Typical day of the killer</i>	20
Chapter 1. The virus enters the cell... ..	20
Chapter 2. ...then heads the nucleus through the endosomal pathway... ..	21
Chapter 3. ...before uncoating, which makes the viral DNA available for... ..	23
Chapter 4. ...rolling-hairpin replication... ..	24

Chapter 5. ... as well as transcription...	25
Chapter 6. ...in order to create new virions	26
Chapter 7. ...that are transported and release back to the extracellular matrix.....	27
<i>Part 2. Modus operandi of the killer.....</i>	28
Chapter 1. Oncosuppression.....	29
Chapter 2. Oncotropism	31
Paragraph 1. The P4 connection	31
Paragraph 2. Beyond transcription	33
Paragraph 3. New findings	33
Paragraph 4. The unreachable definition of oncotropism	35
Chapter 3. Oncolysis	36
<i>Part 3. Redemption of the killer.....</i>	37
Chapter 1. Oncolytic viruses as clinical anticancer agents.....	37
Chapter 2. H-1PV as an anticancer therapy: interactions with the immune system and clinical developments.....	39
Paragraph 1. Antiviral immune responses	40
Paragraph 2. Antitumor vaccination and H-1PV adjuvant effect	40
Paragraph 3. Direct and indirect interactions with the immune system	41
Paragraph 4. Immunomodulation by engineered infectious H-1PV.	42
Paragraph 5. Clinical developments.....	42
BOOK III. THE NS PROTEIN STORY.....	45
<i>Part 1. NS2, the shy arm of the killer.....</i>	45
<i>Part 2. NS1, the versatile arm of the killer.....</i>	46
Chapter 1. NS1 involvement throughout H-1PV life cycle.	47
Paragraph 1. Involvement in viral DNA amplification	47
Paragraph 2. Involvement in viral and cellular transcription	48
Paragraph 3. Involvement in viral cytotoxicity.....	49
Necrosis.....	49
Cytoskeleton-related cell death	50
Apoptosis	51
Cell cycle arrest	52
Chapter 2. Different levels of NS1 regulation.	52
Paragraph 1. Posttranslational level of NS1 regulation.....	53
Paragraph 2. Spatial level of NS1 regulation.....	54
Paragraph 3. Temporal level of NS1 regulation	54
BOOK IV. THE NARROW ESCAPE STORY	55
<i>Part 1. Apoptosis, the first molecular barrier raised to eradicate viruses.</i>	55
<i>Part 2. Apoptosis, the first molecular barrier viruses have learnt to handle.....</i>	56
<i>Review. Caspase cleavage of viral proteins, another way for viruses to make the best of apoptosis.....</i>	57
AIMS OF THE WORK	
SHOOTING AN ARROW INTO THE AIR AND, WHERE IT LANDS, PAINTING A TARGET	58

RESULTS & DISCUSSION.....	
<i>Article I. Different involvement in the viral life cycle of the Y-boxes within H-1 parvovirus P4 promoter. ...</i>	59
<i>Discussion about Article I.</i>	68
About results related to standard P4 promoter analysis by transactivation assays	68
About results related to the study of H-1PV molecular clones carrying modified Y-boxes.	69
<i>Article II. Caspase cleavage of H-1 parvovirus NS1 protein in non transformed cells generates fragments with dominant negative functions.....</i>	71
<i>Discussion about Article II.</i>	92
Induction of apoptosis in H-1PV-infected non transformed cells: the result of an immune antiviral response ?	92
EPILOGUE.....	
AND THEY KILLED HAPPILY EVER AFTER	95
REFERENCES	97
ANNEXES.....	111

ACKNOWLEDGMENTS

I am deeply indebted to:

Pr. **Yvan de Launoit**. Things have not always been easy for me for the five last years. I am deeply grateful that you have always tried to do everything you could to make things better for me and convince me that it was worth it. I hope that both my manuscript and defense will reinforce your opinion about me being worthy of your trust.

Dr. **David Tulasne**. I know that you will not really admit that you greatly contributed to the writing of this manuscript. But you did. Besides many other things. I really want to thank you for all your support, optimism, understanding and more than anything for never letting me down. I know I owe you much.

Pr. **Jean Rommelaere**. You were supposed to be officially my co-supervisor but unfortunately, administrative issues would not let that happen. I am not sure that I told you often enough how grateful I am for all your support and help throughout these years.

Dr. **Perrine Caillet-Fauquet**. I hope that you know that I am really grateful for everything you did for me, from professional help to more personal support when things were going bad. Knowing that I could always turn to you was a relief.

Dr. **Anne Op de beeck** and Dr. **Jürg Nüesch**. I am sincerely honored that both of you agreed to review my work. I am (*almost*) sure that you will not blame me (*too much*) for not making your own work easier by being so lame with deadlines. I hope I managed to pay tribute to all the scientists whose work improved our knowledge about parvoviruses, including yours of course. I am really eager for you to comment and criticize my manuscript and will try to answer any of your questions the best I can.

Dr. **Anna Salvetti** and Pr. **Bruno Quesnel**. I am really proud that you agreed to be part of the jury in charge of judging my work and hope you will find it worthy enough to make people call me Doctor at the end of the day.

Pr **Dominique Stéhelin**. Even though I chose to stay when you left, I am grateful for what you did for me during my first years in Lille and appreciate you still being so friendly with me.

My friends and family. A quick word for you here: thank you for everything you did, do and will. But rest assured that I will be more specific as soon as I can.

Ceux qui me connaissent bien savent que j'ai ce qu'on pourrait appeler un léger problème de procrastination. Je serais bien malhonnête de le nier puisque, dans l'urgence de la rédaction du présent manuscrit, il ne m'a pas été possible de rendre hommage comme il se devait à tous ceux que je souhaitais évoquer dans la sacro-sainte partie "Remerciements", celle que je rêvais pourtant d'écrire depuis quatre ans. J'ai soutenu le vendredi 9 décembre 2011 et aujourd'hui, lundi 5 mars 2012, je m'y attèle enfin car le délai qui m'est imparti pour fournir une version finale s'achève. Il y a définitivement des choses qui ne changent pas. MAIS je suis intimement convaincue que le temps que je me suis accordé avant de m'atteler à cette tâche est un bienfait. Parce qu'il m'a permis de me libérer de certains principes que je pensais immuables pour l'exécution de cet exercice. Et même si cela peut paraître stupide, il faut simplement y voir le profond attachement que je ressens pour le travail que j'ai réalisé et le souhait qu'on perçoive ici aussi la part de moi que j'y ai investi pendant quatre ans.

Ceux qui me connaissent vraiment bien s'étonneront probablement du ton que je vais employer pour ce que je considère être une déclaration. D'amour, d'amitié, de respect et/ou de reconnaissance selon celles et ceux que je m'apprête à citer. Certains sont concernés par tout ça en même temps car certains sont, disons-le, vraiment supers.

Beaucoup d'emphase pour finalement une prise de position d'une simplicité effarante : mes remerciements commenceront, comme il se doit et non comme il se fait habituellement, par un hommage à mes parents et mon frère. J'aurais trouvé absolument désolant de répondre au schéma classique qui consiste à reléguer la famille en queue de peloton. Je souhaite donc dire à **mes parents (aka Papa & Maman)** que j'ai conscience, en plus de tous les défauts et faiblesses qu'ils me connaissent, que j'ai changé depuis mon départ en juillet 2006 du cocon familial si confortable dans lequel ils m'ont éduquée. Je ne sais pas leur dire mon amour, j'ose à peine leur exprimer toute ma reconnaissance et coucher ses mots sur le papier ne remplace malheureusement pas les démonstrations manquées. Malgré cela, je souhaiterais qu'ils comprennent que ma pudeur, ma distance même parfois, ne sont que le résultat des expériences vécues ici qui m'ont forgée un peu plus dure que je ne le voudrais. Je tiens également à exprimer tout mon amour à **mon frère Franck** qui doit parfois également ne pas forcément reconnaître sa petite sœur. Il ne s'est pourtant pas passé (et ne se passe d'ailleurs toujours pas) un jour sans que je ne

pense à lui et me dise à quel point son existence m'est indispensable. Je veux qu'il sache également combien j'admire la personne qu'il est, au-delà du lien du sang qui m'unit à lui. J'espère qu'il est lui aussi fier de sa petite sœur. Je terminerai en embrassant tous les membres de ma nombreuse famille, multiples tantes et oncles, innombrables cousins et cousines, et en adressant une pensée toute particulière à **ma grand-mère maternelle**. Je lui demande de me pardonner de n'avoir pas été suffisamment présente pour que mon souvenir résiste aux faiblesses de sa mémoire déclinante.

Mes pensées se tournent maintenant naturellement vers ceux que j'ai la chance de compter parmi mes amis. **Séverine, Céline, Lydie**, les souvenirs qui m'unissent à vous s'étalent sur un nombre d'années qui a maintenant atteint deux chiffres. Je sais pas vous, mais moi, limite, ça m'fait un peu mal. Mais certainement parce que je serais la première à me prendre 30 ans dans les dents. **Séverine**, j'espère que tu sais à quel point ta présence ici a été salvatrice et combien je suis heureuse de t'avoir retrouvée. Notre relation n'étant pas basée sur une orgie de démonstrations, j'en respecterai ici la dynamique en te disant simplement que ton amitié et ton soutien ne sont rien de moins qu'indispensables pour moi. Souvent d'ailleurs, j'ai peur de ne pas être à la hauteur. **Céline**, en écrivant à l'instant même ton prénom, tu n'imagines pas comme je m'en veux de ne pas avoir entendu le son de ta voix depuis si longtemps. Mon laxisme vis-à-vis des gens qui comptent pourtant le plus pour moi me laisse perplexe et je me demande si parfois, je ne me repose pas trop sur l'indulgence de gens tels que toi. Si on m'avait soutenu qu'au cours de ma thèse, tu me ferais l'honneur de me demander d'être témoin de ton mariage, ne m'en veux pas si je réponds que je n'y aurais jamais cru. Pourtant le 16 juillet 2011, c'est bien pour sceller ton union avec Florent que j'ai apposé ma signature au bas d'un document. Je me permets de te confier ici que je suis heureuse que ton sentiment ait changé quant à ce genre d'engagement, et je le suis plus encore que tu m'aies témoigné suffisamment d'amour et de confiance pour me donner un rôle dans ce qui est l'un des jours les plus importants de ta vie. **Lydie**, ta "troisième position" ici n'est en rien le reflet d'une quelconque vérité sur la place que ton amitié occupe dans ma vie car elle est, si tu ne le sais déjà, inclassable, indescriptible et irremplaçable. Pour les raisons que nous connaissons, je suis particulièrement heureuse que tu aies eu la joie de m'annoncer au cours de ma thèse que tu attendais l'enfant qui fait désormais de toi la mère que tu t'es toujours sentie être.

Comme avec Céline, mes efforts ont souvent été insuffisants pour être dignes de toi. Pourtant, notre relation n'a en rien été entachée, ce qui prouve, à mon sens, sa force et sa qualité. **Séverine, Céline, Lydie**, vous m'êtes précieuses. Toutes les trois à votre façon, chacune unique et extraordinaire. A vous trois, merci.

Il est temps maintenant de rendre hommage à un autre trio magique que j'ai le bonheur de compter parmi mes amis depuis un peu moins longtemps que le précédent, mais la valeur, dit-on, n'attendrait pas le nombre des années. C'est parfaitement vrai en ce qui concerne leur importance à mes yeux. **Ghaffar, Majid, Alexandra**, vous l'avez bien compris, c'est bien de vous dont il s'agit là. **Ghaffar**, collègue devenu rapidement ami, tu es probablement tout ce que je ne suis pas et franchement, je pense qu'il vaut mieux pour toi ! Quand tu es parti il y a maintenant presque deux ans, tu n'as pas idée du vide que tu as laissé. Il a fallu se faire à un quotidien dépourvu de ta bonne humeur, ton optimisme, ta légèreté et plus généralement de ta lumière. Tout ce que je suis, pour ainsi dire, incapable d'incarner sans quelqu'un comme toi pour m'y encourager. Malgré tout, aujourd'hui encore, tu luttas à distance pour me convaincre d'entrevoir en moi ce que toi, envers et contre tout, tu perçois. J'espère que les choix que je ferai, le chemin que j'emprunterai, seront à la hauteur de ce que ton amitié et ta confiance inébranlables ambitionnent pour moi, et j'attends vraiment impatiemment le jour où tu pourras me dire, avec la bienveillance qui te caractérise, "Tu vois que j'avais raison". **Majid**, lumineux toi aussi et aussi rare que le soleil ici... Tu es le premier d'entre nous que les choix de vie ont conduit à quitter Lille. Heureusement, tes succès me rappellent combien tu as bien fait et parviennent la plupart du temps à étouffer la voix de mon égoïsme qui, s'il avait pu, t'aurait injustement demandé de rester. Même si aujourd'hui tes responsabilités te retiennent loin de nous probablement plus que tu ne le voudrais toi-même, tu existes en moi et tu ris aux éclats, solaire. **Alexandra**... J'écris simplement ton nom et déjà je souris. Et si tu me lis, probablement que toi aussi, si te viennent à l'esprit, comme moi, les morceaux choisis (also known as "The best of") de nos nuits d'élucubrations. Parfois, je pense à la genèse de notre amitié et la plupart du temps je regrette qu'elle ait tardé. J'ai presque l'impression de ne pas avoir assez profité. Pourtant, je suis vraiment reconnaissante de l'opportunité qui m'a été donnée de ne malgré tout pas te rater. Car aujourd'hui, de façon complètement naturelle et instinctive, notre amitié a suffisamment grandi pour rendre quasi anodine la distance Lille-Boston. Sachant que ma propre sensibilité n'a d'égale que la tienne,

je vais, comme avec Séverine, respecter la pudeur naturelle qui caractérise notre amitié et te dire simplement merci de tout ce que tu fais et surtout es. **Ghaffar, Majid, Alexandra**, un profond merci à vous trois, et rendez-vous je l'espère bientôt pour le week-end au sommet dont nous osons parfois rêver pour créer de nouveaux moments d'anthologie dont nous seuls avons le secret.

Cédric, Laetitia, Jean-Benoît, François, Anne-Lise, Christophe, Cécile, Nico, Alex, Arnaud, Marie, Manuelle, Marie, Julien, Florence, Jérémy, mes lorrains préférés... Même s'il est vrai que nous ne nous connaissons actuellement peut-être plus aussi bien, je pense à vous souvent, vraiment. Je regrette d'être devenue cette personne qui peine à venir vers vous et qui a pour ainsi dire jeté l'éponge devant le challenge que représentaient les efforts nécessaires pour continuer de vous suivre dans votre quotidien. Je sais pourtant que mon plaisir restera toujours le même quand se présenteront les occasions de vous retrouver. J'espère sincèrement que vous me reconnaîtrez et que le chemin que j'ai pris et m'a éloignée sera aisément rebroussé. J'ai honte par exemple de ne pas mieux connaître vos enfants. **Cédric et Laetitia**, je ne peux m'empêcher de vous adresser une pensée particulière car cette année 2012 marquera en juillet nos quinze ans d'amitié. J'en suis à la fois émue et impressionnée, et croise les doigts pour en fêter quinze de plus avec vous en 2027.

Alioune, Franck et Guillaume, même si le temps où nous fréquentions tous les quatre le laboratoire paraît loin, vous restez bien sûr ceux grâce à qui certaines journées pas faciles-faciles parurent plus douces. Je sais que je parlais beaucoup, râlais beaucoup, me plaignais beaucoup, bref que j'ai vraiment été une meuf au milieu de trois grands taciturnes que je félicite pour leur patience et remercie pour leur amitié. Merci aussi bien sûr pour tous les moments, si agréables et salvateurs, passés ensemble en dehors des trop nombreuses heures de travail. Et bien évidemment je vous souhaite à chacun tout le meilleur pour la suite. **Franck, Alioune**, j'ai très souvent une pensée pour vous, me demandant si tout se passe comme vous le méritez dans votre nouvelle vie. **Guillaume**, même si le contexte semble être identique puisque tu es resté, les choses ne sont pourtant plus tout à fait les mêmes pour toi non plus et j'espère bien sûr que ta vie t'offre tout ce que tu en attends.

De même, mes années "Parvo" remontent maintenant à quelques temps mais ne comptent pas moins pour autant. Je me souviens distinctement du plaisir de travailler avec vous **Annie, Nathalie, Agnès et Pierre**. Merci à vous quatre pour votre soutien et votre gentillesse. **Pierre**, merci à toi particulièrement, toujours là, calme,

disponible, attentif. Autant de qualités indispensables pour pouvoir supporter en toute sérénité d'être mon ami.

Je suis également extrêmement reconnaissante à la dernière équipe à laquelle j'ai eu la chance d'appartenir. Je remercie vraiment sincèrement **David** (à titre plus personnel qu'officiel, les remerciements officiels se trouvant juste avant, merci d'avance de vous y référer), **Jonathan, Catherine, Zoulika, Rémi, Isabelle et Anne** qui, grâce à leur accueil – je n'aurais pu en recevoir de meilleur – ont permis que je termine ma thèse dans un environnement ENFIN sain et serein. Ils ont même réussi à me rappeler qu'il était possible de trouver une ambiance de travail agréable, voire chaleureuse. Plus particulièrement, merci à **Jonathan** pour ton infini sens de la dérision. J'ai pu te trouver de vrais défauts pour souvent les caricaturer mais il m'est impossible de ne pas reconnaître tes bien plus nombreuses qualités et j'espère que tu te construis à Nice une existence faite de satisfaction et d'épanouissement. **Catherine**, de façon, avouons-le, parfaitement improbable, j'ai pu découvrir en rejoignant l'équipe que nous partageons bien plus de valeurs que je ne pouvais l'imaginer. Au-delà de l'admiration que m'inspire sincèrement ta dévotion professionnelle, tu constitues surtout une très belle rencontre humaine et je te suis reconnaissante de tout ce que tu as fait. **Zoulika**, même si je sais que les choses ne sont pas toujours faciles au laboratoire pour toi, je te remercie d'avoir gardé les yeux ouverts. Je considère que tu as en quelque sorte veillé sur moi lorsque, sur la fin, j'étais désœuvrée. Merci pour le temps que tu as pris afin de m'écouter. Ta compréhension m'a permis, vraiment, de me sentir moins seule.

Je terminerai en disant que j'exprime toute ma gratitude à tous ceux que j'ai pu croiser au laboratoire au quotidien et qui m'ont, selon les cas, apporté leur aide, donné un sourire, adressé un regard. Si "vous", que j'englobe paresseusement mais volontairement dans un ensemble humain indéfini, si vous, donc, avez besoin de réfléchir et vous demander si vous êtes concernés, ne vous fatiguez pas : ce petit temps qu'il vous a été nécessaire de prendre est probablement signe que ce n'est pas le cas.

ABSTRACT

H-1 parvovirus (H-1PV) is a little single stranded DNA virus that preferentially replicates in a lytic manner in transformed cells due to their expression profile that meets the requirements for the activation of H-1 PV life cycle unlike normal cells. This feature is known as oncotropism. H-1PV genome is constituted by two transcriptional units. The first one is driven by the proliferation and transformation dependent P4 promoter and allows the expression of both non structural proteins NS1 and NS2, and the second one controls the expression of both capsid proteins VP1 and VP2 through the activation of P38 promoter. H-1PV life cycle tightly depends on NS1 protein that is involved in crucial events, including viral DNA replication, P38 promoter activation as well as cytotoxicity. NS1 protein is regulated at both transcriptional and post translational levels. My thesis aimed at identifying new determining elements for both of these regulations and characterizing their involvement in both H-1PV life cycle and oncotropism.

On one hand, we determined that two symmetrical Y-boxes resulting from the extension of the palindromic hairpin of the viral genome. Here we show that these identical, but inverted, binding elements for NF-Y transcription factor are not functionally equivalent, the P4 promoter-activating capacity of proximal Y2-box being greater. However, H-1 PV gene expression and infectivity require at least one of them since their simultaneous disruption leads to a complete abortion of NS1 synthesis and viral production.

On the other hand, we identified non transformed cell lines where H-1PV infection leads to apoptosis induction with caspase activation, including caspase 3. In such cells, NS1 protein is a caspase substrate and generates a 65-kDa product (NS1-Nterm). NS1 protein cleavage is suppressed by either the substitution of Aspartate residue at position 606 with an Asparagyl or caspase 3 inhibition. Ectopic expression of NS1-Nterm, which lacks NS1 transactivation domain, was shown to inhibit NS1-driven gene expression, thereby impairing the production of progeny virions. Inhibiting NS1 caspase cleavage in infected non transformed cells, by either mutating the caspase site or suppressing caspase activation, results in increased viral productivity. Collectively, our data provide molecular evidence that could explain, at least in part, why non transformed cells are less efficient than transformed cells to complete the viral life cycle.

PROLOGUE

ONCE UPON A TIME (IMMEMORIAL)

ONCE UPON A TIME (IMMEMORIAL)

Because they were long considered as inert entities, viruses were also thought to be irrelevant as far as evolution is concerned. But we do know now that viruses not only have their own evolution history – actually at least as old as the very origin of life – but might also be the ancestors of DNA molecule (92, 252) and even cell nucleus (195).

There are close to 10^{31} viral particles supposed to exist on Earth, meaning that viruses clearly overwhelm the diversity encompassed by the whole living taken together. They have been discovered everywhere we have for looked them, from abysses to deserts, from acidic hot springs to polar lakes (110), with obviously a lot to teach us about how they manage to adapt and survive the most extreme conditions. But only 10 000 viruses have been identified so far, leaving us almost blind regarding our knowledge of virosphere.

I will not pretend that my modest contribution to the field of parvovirology is breathtaking in the light of the outstanding things we already know about viruses in general and parvoviruses in particular. But I do think it feels good to remember that virologists are working on somehow creative entities that are as interesting as they are small.

I hope you will enjoy my attempt to pay tribute to these entities I learnt to become fascinated by.

INTRODUCTION

BOOK I. The *Parvoviridae* story

BOOK II. The H-1 parvovirus story

BOOK III. The NS protein story

BOOK IV. The narrow escape story

REVIEW

BOOK I.

THE *PARVOVIRIDAE* STORY

Part 1. Family portrait of a killer

This Part is not supposed to appear as an easy, conventional way to start my speech even though taxonomy is somehow inevitable to begin with parvoviruses. I hope it will be considered as a modest attempt to replace the “nanoentity” I was working on for four years in the field of Parvovirology while providing the elements required to eventually build a correct picture of H-1 parvovirus.

Virus taxonomy is such a complex, constantly evolving science that it is not always understood or even admitted by virologists themselves. The International Committee on Taxonomy of Viruses (ICTV) is in charge of the difficult task of developing, refining and maintaining universal virus taxonomy. Moreover, even harder is to make people notice and use ICTV recommendations. However, in this Part in particular and my whole manuscript in general, I will do my best to use proper terminology, at least as much as my own understanding of taxonomy allows me.

The system adopted by ICTV shares similarities with the classification system of cellular organisms with hierarchical taxa structuring as follows:

Order (-virales)

Family (-viridae)

Subfamily (-virinae)

Genus (-virus)

Species

[Serotypes, genotypes, strains, variants, isolates]
whose naming ICTV is not responsible for.

Only strains (or viral isolates, genotypes, serotypes, variants) are physical entities and can therefore be isolated, described and characterized. In contrast, the higher levels of the classification, from species to order, are taxa, meaning they are concepts created by the committee to build a universal classification that can consequently undergo major restructuring.

Chapter 1. The family

According to ICTV, the family **Parvoviridae** is not, like the overwhelming majority of virus families, assigned to any of the six orders of viruses currently admitted. However, creating an order is not an easy decision to make. For example, the first order that was approved by ICTV, *Mononegavirales* (202), remained also the only one for a long time before being joined, very recently for most of them, by *Caudovirales*, *Herpesvirales*, *Nidovirales*, *Picornavirales* and *Tymovirales*. New orders will undoubtedly be proposed for ratification by ICTV in the next years and *Parvoviridae* might join one of them.

The family *Parvoviridae* encompasses all small, isometric, non-enveloped DNA viruses containing linear, single-stranded genomes. The nature of the latter is particularly striking since no other entity in the biosphere has such a DNA genome, namely both linear and single-stranded. Each virus belonging to this family contains a 4- to 6-kilobase (kb) single genomic molecule which ends with short palindromic sequences folding back on themselves to create duplex hairpin telomeres. These hairpins are either different – in sequence and predicted structure – or part of an inverted terminal repeat (ITR), and allow self-priming for the synthesis of complementary strands. They are thus essential and serve as an invariant hallmark of the family.

The members of *Parvoviridae* are exceptionally stable and their resistance to inactivation by organic solvents indicates the absence of lipids in the virions. To our current knowledge, structural proteins are not glycosylated but they undergo major phosphorylation events. These viruses are also quite simple at both antigenic and structural levels. Using protein analysis, electron microscopy as well as X-ray crystallography, it was established that members of *Parvoviridae* are icosahedral structures just like all viruses are (with few exceptions), with more particularly a T=1

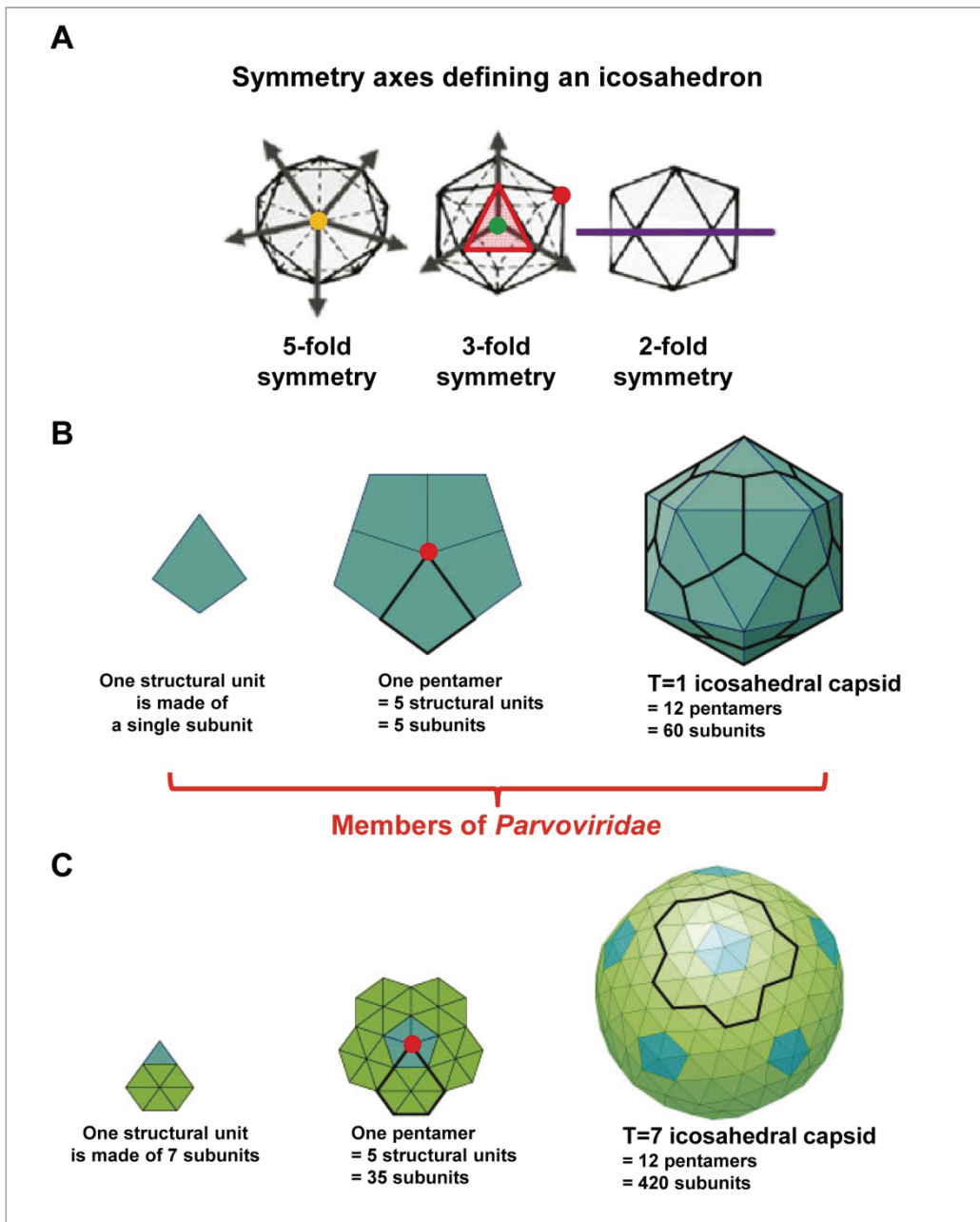

Figure 1.
Dissecting an icosahedron.

- A. A genuine icosahedron is represented. One of its 20 facets and one of its 12 vertices are highlighted in red. The yellow dot indicates a 5-fold axis, defined by the 5 vectors depicted. Likewise, the green dot represents a 3-fold axis at the intersection of the 3 vectors. A 2-fold axis is highlighted in purple.
- B. A T=1 icosahedral capsid is represented as well as one of its minimal structural units and one of its pentamers. Members of *Parvoviridae* family were described to possess such structure.
- C. A T=7 icosahedral capsid is represented for general information purposes, as well as one of its minimal structural units and one of its pentamers.

Source : viralzone.expasy.org

symmetry. A genuine icosahedron is composed of 20 facets, each being an equilateral triangle, and 12 vertices (i.e. points where the facets meet ; plural of vertex) (**Figure 1A**). Because the symmetry of such solids is defined by three types of axes named 2-, 3- and 5-fold axes, they are said to have 5:3:2 symmetry. Rotational symmetry of order n (n -fold symmetry) with respect to a particular point (in 2D) or axis (in 3D) means that rotation by an angle of $360^\circ/n$ does not change the object (**Figure 1A**). Watson and Crick pointed out that a virus with 5:3:2 symmetry requires a multiple of 60 subunits to cover the surface completely (66). Icosahedral structure is also characterized by a T (triangulation) number calculated according to Caspar and Klug system (33). They defined all possible polyhedra in terms of structure units made of one or several subunits. An icosahedron can also be considered as made of 12 identical pentamers made of five of these structure units (**Figure 1**). In the cases of viruses, a subunit is a capsid protein and T corresponds to the number of subunits composing a structure unit. Multiplying the T number by 60 gives the total number of proteins constituting the capsid. For example, in a T=1 icosahedron, the minimal structural unit is made of a single subunit (i.e. capsid protein) and so, such a solid contains 60 copies of the same protein (**Figure 1B**). The example of a T=7 icosahedron, like simian virus 40 (SV40), with a structure unit made of seven capsid proteins, is also given in **Figure 1C** for general information purposes.

Chapter 2. The subfamilies

The division of *Parvoviridae* into two subfamilies was based on the host range, with **Parvovirinae** having vertebrate hosts and **Densovirinae** infecting insects and arthropods. When this distinction was made, genome sequences were not available but as soon as they were, it appeared that all viruses share a common evolutionary history and cluster together into two distant groups, confirming the validity of the initial classification.

From now on, only *Parvovirinae* will be discussed.

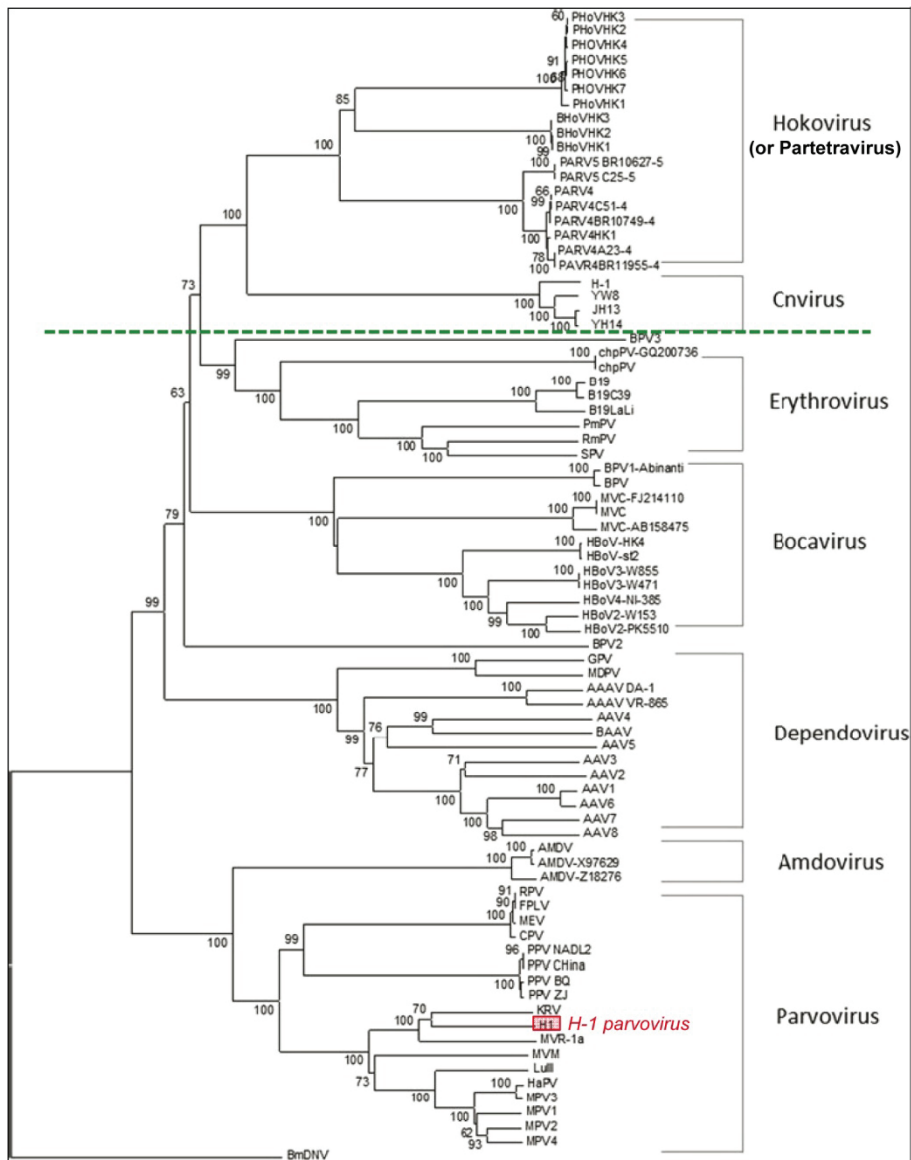

Figure 2. Phylogenetic tree depicting evolutionary relationship between the members of *Parvovirinae* subfamily based on recent studies.

Bootstrap values are plotted at the main internal branches. BmDnV was used as outgroup. When the bootstrap value is 100%, it means that it is almost certain that the clustered species are phylogenetically related one to each other. Sequences were either determined by the authors or obtained from GenBank.

Note that the species *H-1 parvovirus* is referred to as H1 in *Parvovirus* genus (different from H-1 in *Cnivirus* genus) and is highlighted in red to avoid confusion.

The inclusion of genera *CnVirus* and *Hokovirus* (or *Partetravirus*) have not been ratified by ICTV yet, hence the dividing dotted green line leaving them apart from the rest of the classification.

Sources :

- Wang F, Wei Y, Zhu C, Huang X, Xu Y, Yu L, Yu X. *Virus Genes*. 2010 Oct; 41(2):305-8.
- Tse H, Tsoi HW, Teng JL, Chen XC, Liu H, Zhou B, Zheng BJ, Woo PC, Lau SK, Yuen KY. *PLoS One*. 2011;6(9):e25619. Epub 2011 Sep 27.

Chapter 3. The genera

Initially, defining genera was based on grouping together members with similar biological or structural characteristics. Doing this way, one genus might as well contain viruses capable of autonomous replication as well as those dependent on a helper virus, or viruses with a different number of transcriptional units. However, with the increasing availability of DNA sequences and bioinformatics tools, the old criteria appeared to not strictly reflect divergent evolution from common ancestors. Thus, a genus is now identified as a monophyletic group of species representing a single branch of a phylogenetic tree (**Figure 2**). Within each genus, a species is designed as the type one.

Based on these considerations, *Parvoviridae* family was deeply rearranged in 2004, particularly regarding *Parvovirinae* subfamily with two new genera being created and several species being removed from one genus to another (156).

Five genera are currently part of *Parvovirinae*:

❶ **Amdovirus**

with 1 species assigned, *Aleutian mink disease virus* (AMDV) which is inevitably the type species

❷ **Bocavirus**

with 2 species assigned, *Bovine parvovirus* being the type species

❸ **Dependovirus**

with 12 species assigned, *Adeno-associated virus 2* (AAV-2) being the type species

❹ **Erythrovirus**

with 4 species assigned, *Human parvovirus B19* being the type species

❺ **Parvovirus**

with 12 species assigned, *Minute virus of mice* (MVM) being the type species

It should be stated that the subfamily *Parvovirinae* might undergo major changes in the next years. In 2005 was discovered a new strain referred to as human parvovirus 4 (PARV4), followed in 2008 by the isolation of several PARV4-like viruses, with 7 strains of Porcine hokovirus (PHoV) and 3 of Bovine hokovirus (BHoV). Based on their sequence homologies together with predicted major differences with the other

members of the subfamily *Parvovirinae*, the creation of a new genus called *Hokovirus* is proposed to cluster these viruses, with PARV4 being renamed Human hokovirus (HHoV) to fit it (133). Whether Human, Bovine and Porcine hokoviruses are suggested to become 3 distinct species or belong to the same is unclear. While this has not been considered by ICTV yet, a very recent study reported the existence of hokovirus-like viruses in ovines as well, and also recommends the creation of a new genus which would be called *Partetravirus* instead of *Hokovirus* (240). Meanwhile, swine sera analysis revealed new strains belonging to subfamily *Parvovirinae* and suggesting to cluster into a new genus called *Cnvirus* (250) (**Figure 2**).

From now on, only *Parvovirus* genus will be discussed.

Chapter 4. The species

The ICTV defines species as “a polythetic class of viruses that constitutes a replicating lineage and occupies a particular ecologic niche”. This implies that all individuals do not have to share a single characteristic for them to belong to the same species and that inherent variability may exist. Phylogenetic analysis is thus not as useful at the species level as it is for establishing the classification in higher taxa.

Taxa such as order, family, subfamily and genus, are concepts and are thereby created, neither discovered nor characterized. Species is a taxon as well but virologists often amalgamate the species with the isolates and strains belonging to it. This confusion is more likely to occur in virology since many species are represented by only one strain that shares the same name as the species it is assigned to. As pointed by Jens Kuhn and Peter Jahrling in a recent review emphasizing the increasing discrepancy virological terminology suffers, we intuitively understand that a standard poodle and a German shepherd are very different although both being “domestic dogs”, meaning they belong to the species *Canis lupus familiaris*. In other words, a standard poodle and a German shepherd are closely related enough on genomic and other levels to be grouped in a taxonomic class as low as species. But it is although way obvious that both of them can still be easily discriminated based on countless factors, including genomic (127). Virus and virus species should be considered that way.

The genus *Parvovirus* currently gathers 12 species according to the latest ICTV release (2009). The removal from the genus *Parvovirus* of feline parvovirus, canine parvovirus, raccoon parvovirus and mink enteritis virus was ratified by the 2004 ICTV report and corresponds to their assignment as strains in the species *Feline panleukopenia virus*.

The genome of the members belonging to these species harbors different terminal palindromic hairpins regarding their structure and sequence, and two promoters at map units ~4 and ~40 (starting from the left-hand end). The virions display cytopathic effects in cell culture and host range can be dramatically extended under experimental conditions.

From now on, unless otherwise specified, I will only be referring to the species **H-1 parvovirus** and its single sequenced homonym strain (abbreviation H-1PV) and when needed, **Minute virus of mice** represented by the strain minute virus of mice prototype (MVMp) because they share 86 % of their sequence based on *Basic Local Alignment Search Tool* (BLAST) (GenBank #X01457.1 for H-1PV vs. NCBI #NC_001510 for MVMp). Given this high identity rate as well as similar functional patterns, the observations made with one are often considered to be also true for the other. In our case, since the most recent data collected concern MVMp, some of my writing will be based on this literature and the virus will be referred simply to as MVM. The terms “parvovirus”, “virus” and “virion” will be used as well to refer to both H-1PV and MVM physical viral entities.

Part 2. Anatomy of the killer

This Part is meant to take some distance with the big-picture view adopted so far and zoom in to provide detailed, specific information regarding H-1PV genome and capsid (or MVM as mentioned right above). The specific aspects required to address my own work will be more especially discussed.

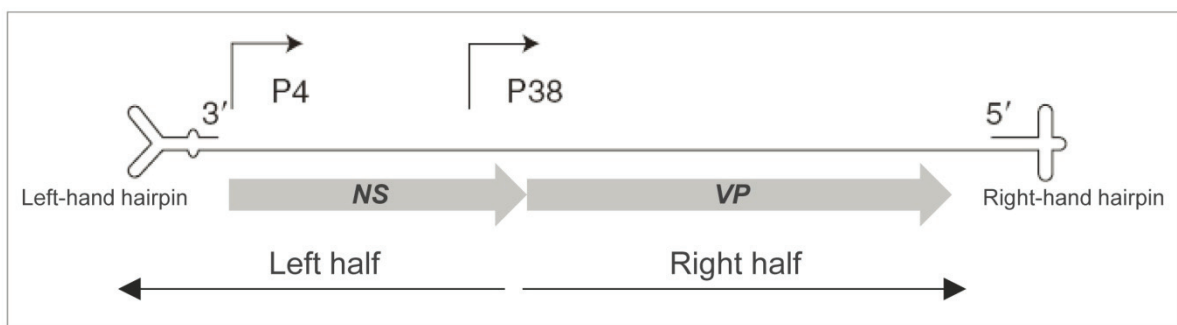

Figure 3.
Structure and major characteristics of H-1 parvovirus genome.

Negative sense, single-stranded genome is represented with its terminal palindromic sequences folded into the left- and right-end hand hairpins that are here approximately 10-fold magnified. The positions of both promoters are indicated (P4 and P38) and their major gene blocks are represented by grey arrows showing the N- to C-terminal direction.

Source: *Parvoviruses*, C.S.F. Kerr J. R., Bloom M. E., Linden R. M., Parrish C. R., Editor. 2006, Hodder Arnold: London.

Chapter 1. Organization and structure of H-1PV genome

Paragraph 1. General features

As already mentioned, H-1PV genome is a **linear, single-stranded DNA** molecule bracketed by short, imperfect terminal palindromes structured into the **left-hand and right-hand hairpins** that play a crucial role in the “rolling-hairpin replication” (RHR) strategy employed by parvoviruses. Indeed, they create proper origins for DNA replication (i.e double-stranded structure with a floating 3'-OH) and allow the direction of DNA synthesis to reverse by repeatedly folding and unfolding.

H-1PV encodes two major genes:

- a non structural gene or *NS* controlled by the early P4 promoter and generating non structural proteins 1 and 2 (NS1 and NS2)
- a structural gene or *VP* driven by the late P38 promoter and encoding viral proteins 1 and 2 (VP1 and VP2).

NS proteins are involved in the achievement of the viral life cycle, particularly NS1 which plays roles in viral DNA replication and gene expression among others. As for VP proteins, they are required to build new capsids.

When compared with cellular DNA, parvoviral genomes have a high content of G+C nucleotides (~50%), probably because of the many transcriptional elements they harbor. Regarding H-1PV and MVMP notably, these elements often overlap other regulatory elements involved in crucial events, including DNA replication or RNA splicing. Therefore, the DNA sequence can be considered as a primary level of parvovirus regulation since mutations are not just likely to affect gene products but many other processes as well.

The major characteristics of H-1PV genome, as well as the usual conventions, are summarized in **Figure 3**.

Parvoviral right-end in stem extended form

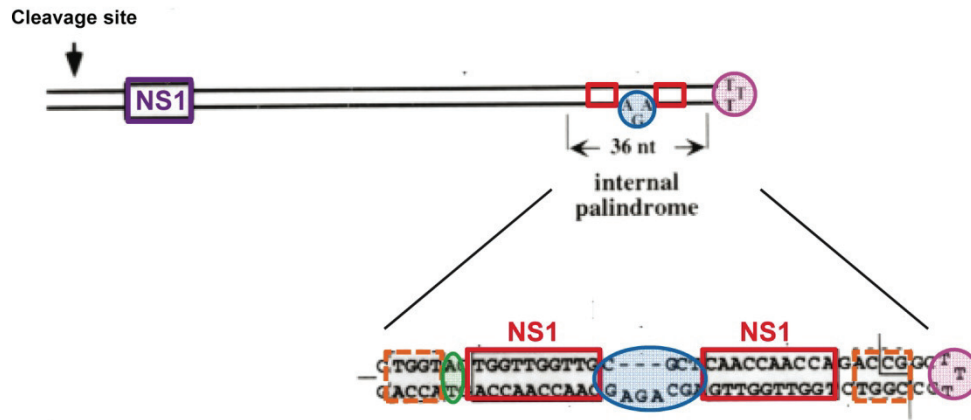

Parvoviral right-end in cruciform shape

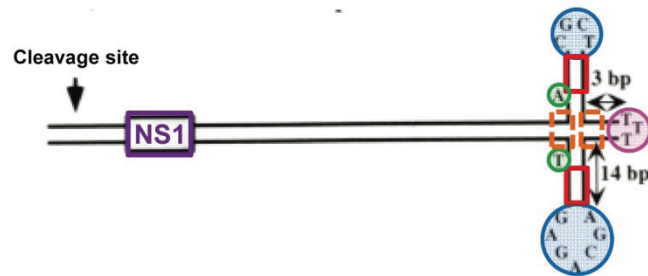

Figure 4.
MVM right-hand end.

The right-hand end (5') hairpin of MVM is represented in both extended form and predicted cruciform shape.

The small internal palindrome potentially allows the cruciform folding and contains sequences for NS1 binding (boxed with solid red lines) in opposite orientations. Additional motifs which likely contribute to NS1 binding are boxed with orange dashed lines. The different ellipses help understanding the way the sequence is supposed to fold into a cross. The cleavage site targeted by NS1 endonuclease activity is indicated by the vertical black arrow. The NS1 recognition element proximal to this cleavage site and positioning the protein over the latter is highlighted in purple boxes.

Source: *Parvoviruses*, C.S.F. Kerr J. R., Bloom M. E., Linden R. M., Parrish C. R., Editor. 2006, Hodder Arnold: London.

Paragraph 2. The right-hand end hairpin

The right-end hairpin is made of about 250 nucleotides which fold into an almost perfect duplex with very few mismatches (**Figure 4**). A cruciform shape may also be adopted through an internal palindromic sequence although this structure has not been proved to be required for viability yet. *In vitro*, both the hairpin and extended forms are NS1-dependent origins of replication (62), with at least 3 elements found to be essential to be so:

- a cleavage site consensus (5'-CTWWTCA-3') targeted by NS1 protein and located right upstream from
- a duplex NS1 recognition sequence in the stem meant to orient an NS1 complex over the adjacent nick site
- a second NS1-binding site located within the palindromic sequence, more than 100 bp distant from the nick site but required for NS1-mediated cleavage.

Paragraph 3. The left-hand end hairpin

I will more extensively describe this hairpin since a part of my work was more particularly related to this region of H-1PV genome.

○ Description of the hairpin

The left-end hairpin comprises about 120 nucleotides folding into a Y-shaped structure made of a duplex stem and two "ears" resulting from the basepairing of small internal palindromic sequences (**Figure 5**). The duplex stem is interrupted by a "bubble" where a GA dinucleotide in the outboard strand of the stem faces a GAA triplet located in the inboard strand (30).

The left-end hairpin is endowed with multiples sequences involved in both replication and transcription processes, each type of elements being supposed to segregate in either the outboard or inboard arms respectively when the genome harbors its extended double-stranded configuration (**Figure 5**).

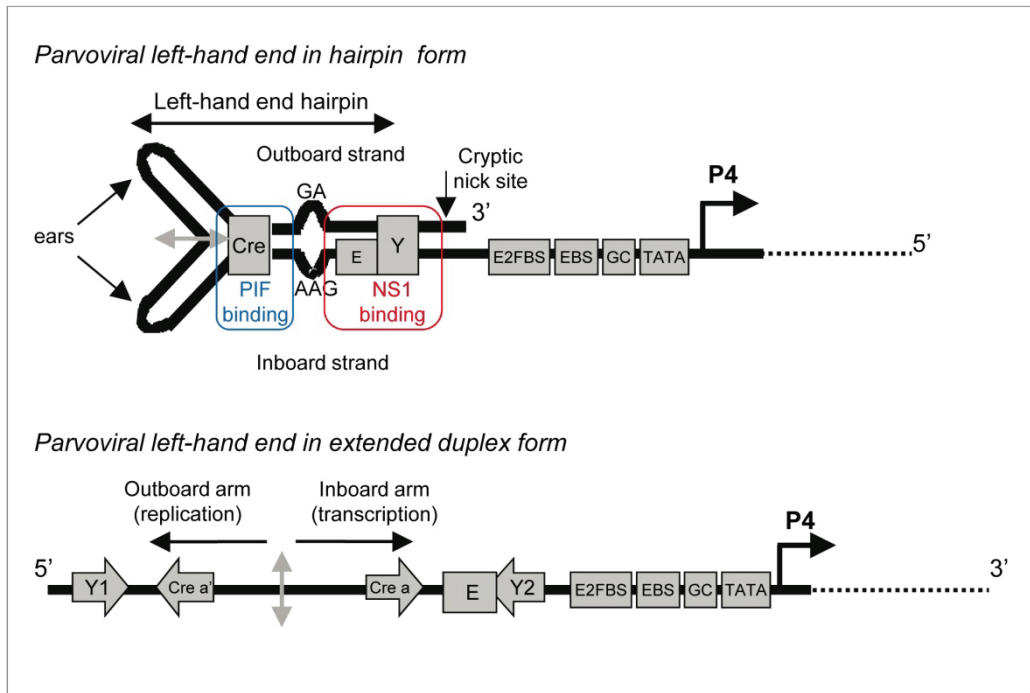

Figure 5.
MVM left-hand end.

Terminal palindromic sequence organizes into a double-stranded stem ended with two hairpins also known as the ears, and lies right upstream from the proximal elements of P4 promoter. The arrows are oriented according to the admitted consensus binding sites known for both Cre- and Y-boxes. PIF and NS1 binding regions are indicated in blue and red respectively, as well as the cryptic nick site in the hairpin configuration. The asymmetric bubble with GA facing GAA is shown. Inboard and outboard strands are indicated in the left-hand end hairpin, as well as their corresponding arms and suggested functions in the extended form. The grey double arrow shows the junction between inboard and outboard arms.

Sources:

- Paglino J, Burnett E, Tattersall P. *Virology*. 2007 Apr 25;361(1):174-84.
- Burnett E, Cotmore SF, Tattersall P. *J Virol*. 2006 Nov;80(21):10879-83.

○ Importance of the left-end hairpin's asymmetry

The minimal origin of replication in the duplex derived from this hairpin is made of about 50 bp that extend from the two 5'-ACGT-3' motifs near the ears to a downstream region near the nick site, and therefore include the GA dinucleotide (59) (**Figure 5**). Adding a third nucleotide (i.e making the bubble symmetrical) purely inactivates the origin, highlighting that the bubble acts as a critical spacer (30). Because of this element, the outboard and inboard arms are prevented from exhibiting strictly similar sequences when the genome extends. The asymmetry of the bubble is thus suggested to account for the functional asymmetry between both arms, with the outboard one being endowed with replicative functions while the inboard one more particularly drives transcription.

Three recognition motifs are also found in the left-end hand hairpin:

- a consensus nick site (5'-CTWWTCA-3')
- an NS1 binding site that orients the NS1 complex over the nick site
- two 5'-ACGT-3' motifs.

Each 5'-ACGT-3' quadruplet actually represents a half-site for the binding of a cellular heterodimer called Parvoviral Initiation Factor (PIF) (41-43) which interacts with and stabilizes NS1 in the active form of the origin of replication. Through this interaction NS1 is able to unwind the DNA at the nick site, then to cleave (**Figure 5**). PIF does not bind to NS1 over the GAA triplet present in the inboard arm and resulting from the above-mentioned "bubble". The GA dinucleotide found in the outboard arm is suggested to properly space PIF and NS1 binding sites while inboard GAA does not. DNA cleavage by NS1 is thus impossible in the inboard arm (39), confirming the idea that the asymmetry of the bubble allows the outboard and inboard arms to specialize. However, the clear segregation between sequences dedicated to either replication or transcription may not be necessarily that strict and may be moderated depending on the context as you will see further in this manuscript. The transcriptional elements embedded in this region are more particularly discussed in the Chapter devoted to Oncotropism and in the paper resulting from the work on NF-Y-mediated regulation of P4-driven transcription.

○ Additional functions of the left-end hairpin

Willwand and Hirt reported that the region located to the branch point between the stem and the “ears” is able to bind to empty capsids and suggested that this interaction might be involved in the oriented 3' to 5' DNA packaging process (253). Interestingly, a similar, remarkably strong interaction was also observed in *in vitro* assays where cellular factors were used to induce MVM uncoating, although the data remained unpublished by Cotmore and Tattersall due to the assay lacking some robustness and being reported to hardly apply to other parvoviral systems (124). Alternatively, such interaction was hypothesized to keep the genome associated with the capsid after viral entry into the host cytoplasm where the viral DNA ends up exposed (55, 249).

Chapter 2. The viral particle

The protein capsid provides a protective coat to the genome, preventing it from encountering environmental constraints. A capsid may have several other functions, including host cell recognition, entry, intracellular transport, DNA release at the appropriate time and place and assembly of progeny virions. The capsid is made of 60 equivalent units which therefore form an icosadeltahedron. However two types of proteins are used to build MVMp capsid, VP1 and VP2, with a ratio of 1 to 5. In addition, a maturation step consisting of the proteolytic cleavage of VP2 into VP3 was reported and MVMp capsid eventually contains three different components. But their common C-terminus sequence only is used to build the particle, as though it was constituted by 60 copies of a single protein. VP1, the minor parvovirus capsid component possesses a unique part at its N-terminus (VP1up) that was shown to be refractory to structural elucidation. Nonetheless, VP1up is functional and displays a phospholipase A2 (PLA2) activity required for escape from late endosomes during viral trafficking to the nucleus after entry (259).

Such a 60-unit made solid has the same point group rotational symmetry elements as a 20-sided genuine icosahedron, leading to the common terminology of “icosahedral viruses”. This icosahedral nature of parvoviruses was unequivocally established from symmetry detected in the preliminary characterization of canine

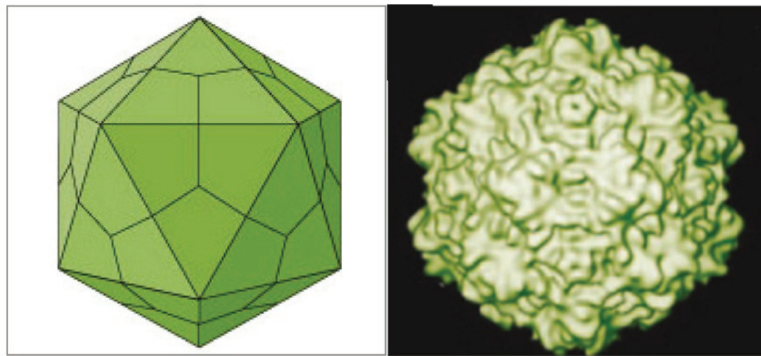

Figure 6.
Modelisation of MVM capsid.

Illustration based on *viralzone.expasy.org* and [227].

A genuine icosahedron is shown on the left and the modelisation of MVMp surface topology is represented based on the atomic and pseudo-atomic coordinates obtained at a 13 Å resolution.

Sources:

- *viralzone.expasy.org*

- Padron E, Bowman V, Kaludov N, Govindasamy L, Levy H, Nick P, McKenna R, Muzyczka N, Chiorini JA, Baker TS, Agbandje-McKenna M. *J Virol.* 2005 Apr;79(8):5047-58.

parvovirus crystals (151). Within *Parvoviridae* family, members of *Parvovirus* genus are the best characterized regarding capsid structure and MVM's one was obtained in 1998 (2) (**Figure 6**).

Although H-1PV is expected to have a structure very similar to MVM, the major coat protein VP2 (and VP3) was reported to play a major role in tissue tropism and pathogenicity (8, 9, 27). Thus, very slight differences in H-1PV capsid topology might be responsible for the differences in tropism observed between H-1PV and MVM. However, various steps of the life cycle other than cell receptor recognition and attachment are likely to influence tropism. So what distinguishes H-1PV and MVMp might as well result from little variations in several aspects of the viral life cycle.

Chapter 3. Associated diseases

H-1 parvovirus natural hosts are rats. Few studies have been performed to decipher its pathogenesis but H-1PV's discoverer Helen Toolan reported that the inoculation of pregnant hamsters with the virus results in fetal mortality at mid-gestation (237). In addition, when Li and Rhode were investigating the role of NS2 protein in H-1PV life cycle, they used wild type H-1PV and an NS2null mutant to infect newborn hamsters and rats. Both viruses lead to lethal infection of the former while wild type H-1PV is fatal to the latter only. In addition, high titers of viruses were found in rat tissues only following their inoculation with wild type H-1PV, highlighting that NS2 is required for the productive infection of newborn rats (142). A few years later, H-1PV infection of newborn rats was associated with signs of emaciation, jaundice and ataxia. *In situ* hybridization revealed viral DNA in tissue brain while TUNEL assays showed higher frequency of apoptosis-related signals in infected tissues, which correlated with the observation of apoptosis induction in H-1PV-infected rat glioblastoma cells (187). However, no direct link was genuinely established between *in vivo* apoptosis induction and physiopathological manifestations in newborn rats. H-1PV is currently considered apathogenic for humans.

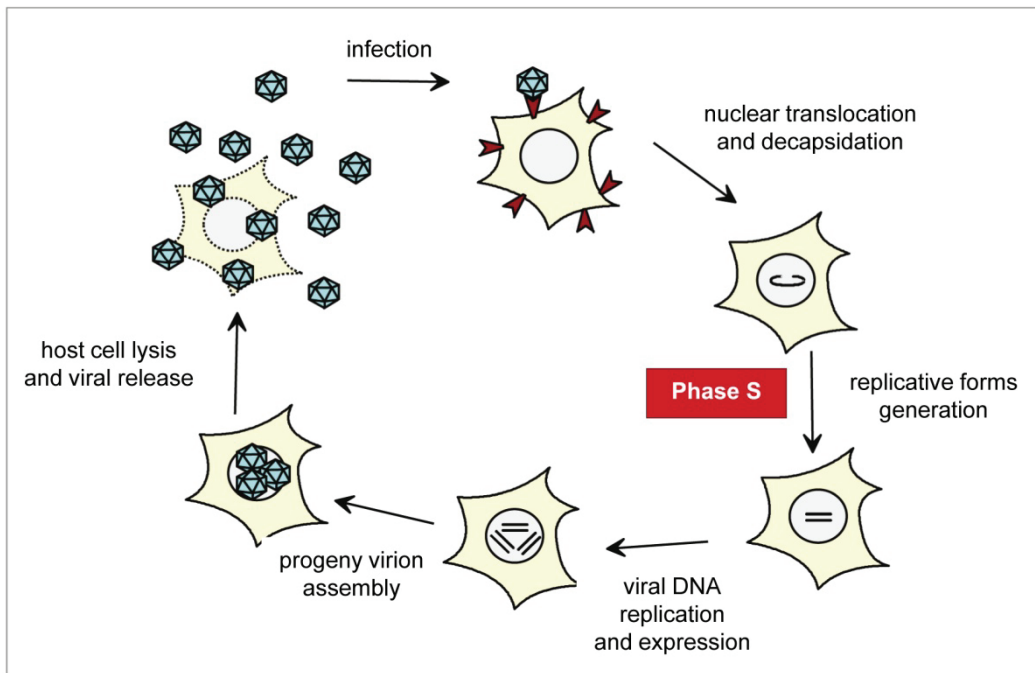

Figure 7.
Main steps of autonomous parvovirus life cycle.

After its entry, virion is transported to the nucleus where genome is released. When the cell enters S phase, viral replication occurs. Viral genome expression results in the production of capsid components. Newly synthesized genomes are packaged and progeny virions are transported back to the cell surface and released while the cell undergoes lysis.

Illustration kindly provided by Dr Perrine Caillet-Fauquet.

BOOK II.

THE H-1 PARVOVIRUS STORY

Part 1. Typical day of the killer

*This Part is meant to give some details about the parvoviral life cycle, from the early steps including binding to and entry into the cell to the latter ones which eventually lead to the release of new infectious viral particles. **Figure 7** shows an overview of the different steps to complete to achieve a whole, productive cycle.*

It should be stated that the term “infection” normally encompasses the steps from the cell attachment to the release of the viral genome into the nucleus (Chapters 1 to 3). Thus I will try to use this term in this Part only when referring to the early steps of the viral life cycle. However, “infection” and “viral life cycle” may be used equally elsewhere in this manuscript.

Chapter 1. The virus enters the cell...

Viruses that infect animals have evolved multiple strategies to infect their host cells but they almost all include the same steps: adsorption to the cell surface through receptors, entry into the cell, as well as trafficking and release of the virion and its genome to the nucleus.

Enveloped viruses can often get into the cell through the fusion of the viral envelope with the cell membrane, which is not possible for naked viruses such as parvoviruses.

Little is known about how MVM, and all the more H-1PV, enters host cells. Pretreating cells with trypsin and/or neuraminidase were shown to prevent the virus to adsorb to the cell surface, highlighting that this step requires a glycosylated protein with sialic acid (60, 61), which however tells not much about the nature of what allows viral attachment since such description applies to many cell receptors.

The ability of the virus to infect a lot of cell types implies that its receptor must be ubiquitous.

The characterization of the osidic structures of the receptor was made possible only because of the advent of microarray technology. Regarding MVM and using glycan array it was eventually established that its binding to the cell membrane involves a motif with at least five osidic residues ending with the motif Neu5Aca2-3Gal β 1-4GlcNac (175). However, even though advances have been made in the process of identifying MVM and/or H-1PV receptor, its identity remains unknown so far. It should be stated that none of the receptors known to bind other viruses of *Parvovirinae* subfamily is able to attach MVM and/or H-1PV (Transferrin Receptor TfR for members of the *Feline panleukopenia virus* species and the P antigen globoside for B19 parvovirus) (26, 114, 194).

On the viral side, VP2 protein is thought to encompass some of the determinants of the viral tropism. MVMp is known to infect fibroblasts while the strain MVMi is lymphotropic. Mutating both residues 317 and 321 in VP2 protein allows MVMi to infect fibroblasts with a 100 times higher efficiency than its usual (8, 9). Although the capsid is necessarily a crucial actor in the viral binding to the cell and the structures of many parvoviral capsids have been obtained, the role of the different structural elements identified remains elusive.

Chapter 2. ...then heads the nucleus through the endosomal pathway...

Viral trafficking is summarized and illustrated in **Figure 8**.

Electron microscopy early showed that parvoviral infection was accompanied with membrane invaginations reminding of the formation of clathrin-coated structures and followed by the clustering of virions into vesicles in the cytoplasm (60). More recently, the vesicles resulting from endocytosis were proved to merge with endosomes. Indeed, either bafilomycin A1 or chloroquin treatments were able to inhibit parvoviral infection, proving that the virions take the endosomal pathway (218). Because of the low pH characteristic of endosomes, viral capsids are likely to undergo structural transitions. And indeed, during endosomal trafficking, i) VP1 N-terminus gets externalized, ii) already exposed VP2 N-terminus is cleaved and iii)

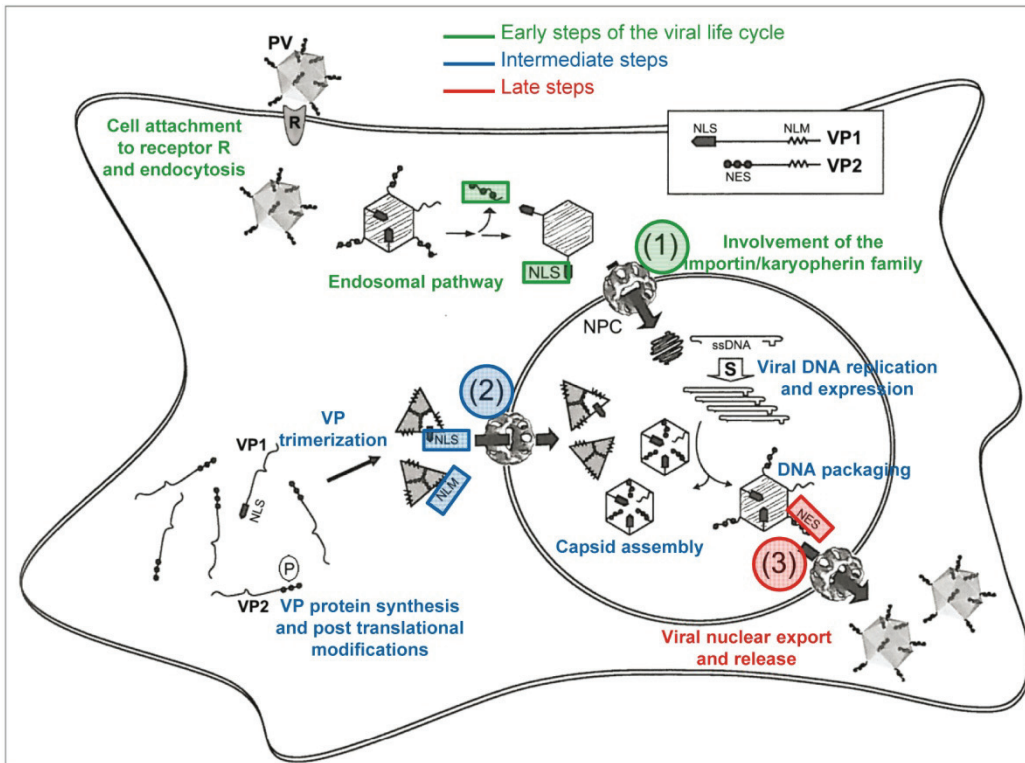

Figure 8.
Parvoviral trafficking throughout viral life cycle.

- (1) The virus (PV) enters the cell using a receptor (R) and follow the endosomal pathway. VP nuclear localization signals (NLS) target the virus to the nucleus where it passes through nuclear pore complexes (NPC) using probably proteins from the importin/karyopherin family.
- (2) Single-stranded genome (ssDNA) undergoes replication and transcription. VP1 and VP2 are produced in the cytoplasm and appropriately phosphorylated before getting back to the nucleus as trimers using VP1 NLS and nuclear localization motifs (NLM) found in both VP proteins. In the nucleus, the trimers assemble into capsids and genomes are encapsidated.
- (3) Progeny virions leave the nucleus through NPC using VP2 nuclear export signals (NES).

The different transport signals found in VP1 and VP2 proteins are shown in the box and highlighted in the three main steps requiring trafficking.

Source: *Parvoviruses*, C.S.F. Kerr J. R., Bloom M. E., Linden R. M., Parrish C. R., Editor. 2006, Hodder Arnold: London.

genome is uncoated. All of these changes can be blocked by raising endosomal pH (153). Regarding MVM, VP2 N-terminus being proteolytically cleaved into what is referred to as VP3 is a maturation step occurring in the extracellular environment or right after the virus enters the host cell (60, 212). Likewise, H-1PV VP2 was also shown to be converted into a shorter form although this was not correlated with any involvement in H-1PV infectivity (125, 193). In several families of nonenveloped viruses, a viral protein involved in membrane penetration is known to undergo proteolytic cleavage suggested to allow the virus to exist in a metastable state. When the virus encounters some catalysts, including low pH or an interaction with a specific receptor, this metastable configuration is thought to be released leading to the exposure of sequences required for trafficking and membrane crossing.

The release of the capsids from late endosomes is supposed to occur at a perinuclear location. The above-mentioned exposure of VP1 N-terminus (or VP1_{up} for VP1 unique part) is crucial since it is endowed with phospholipase A2-like (PLA2) activity (243) which is thought to alter the phospholipidic membranes of the vesicles and allow the viral release near the nucleus. However, it appears that additional events might occur between the release of the virions and the entry into the nucleus. Indeed, the use of reversible proteasome inhibitors was associated with perinuclear accumulation of full capsids whereas the removal of these inhibitors restored nuclear translocation of the virions. But given that neither ubiquitination nor direct proteolysis of capsids has been observed, the involvement of the proteasome pathway remains elusive (219).

The host cell machinery being absolutely required for both viral replication and gene expression, the virus has to enter the nucleus and pass the nuclear envelope (**Figure 8**). When ectopically expressed, VP1 and VP2 are able to target this compartment, indicating that both of them possess signals for nuclear transport (146, 241). On one hand, VP2 lacks any consensus Nuclear Localization Sequence (NLS) at a primary structure level but some of its secondary structures display nuclear targeting capacity through what was called a Nuclear Localization Motif (NLM) also found in VP1. Interestingly, the aminoacyl residues conferring its biochemical characteristics to the NLM (145) are strictly conserved in most of the members of *Parvovirus* genus, suggesting that NLM is a key factor for nuclear transport of these viruses as well. Nonetheless, the NLM is more likely to be involved in newly generated VP proteins reaching the nucleus to assemble progeny particles. On the other hand,

VP1 contains four basic clusters of amino acids with both of them fitting conventional NLS sequence known to be recognized by the receptors of the importin/karyopherin family that promotes transport in the import direction. These NLS are near the N-terminus of the protein and apparently exposed upon the conformational changes the capsid undergoes in the endosomes. It is currently admitted that the virions go through the Nuclear Pore Complex (NPC) through an active mechanism involving ATP in addition to the NLS and importins mentioned above (**Figure 8**).

However, recent studies suggest that MVM would rather (or in addition) provoke the nuclear envelope to disintegrate. Fluorescence microscopy and electron microscopy showed that MVM infection is associated with dramatic changes in nuclear shape, alterations of nuclear lamin and breaks in the nuclear envelope (47, 49). Very recently, the same authors suggested that this phenomenon works in a VP1 PLA2-independent manner but depends on caspase 3 activity which would facilitate nuclear membrane disruptions. In support of this hypothesis is the fact that the pharmacological inhibition of caspase 3 reduced nuclear entry of the capsids as well as viral gene expression. Under these conditions MVM did not trigger caspase 3 activation and nuclear disruption would result from the basal protease activity relocating to the nuclei of cells upon infection (48). Nonetheless, the hypothesis of an active transport of the virions through NPC remains preferred so far, perhaps because the MVM-mediated nuclear disruption theory completely keeps aside the localization signals and motifs mapped in VP proteins and proved to be functional. The actual nuclear transport of parvoviral particles into the nucleus perhaps lies somewhere in-between.

Chapter 3. ...before uncoating, which makes the viral DNA available for...

Mechanisms leading to the genome release from the capsid in order to undergo replication are not yet fully understood. Twenty to thirty nucleotides belonging to the 5' end of MVM genome are exposed outside of the virion and covalently bound to NS1 when new particles are assembled (63). The 3' end of the viral DNA is also likely to be exposed *in vitro* after treatments causing the structure of the capsid to change without disassembling (55, 249). Thus the extracapsid DNA is

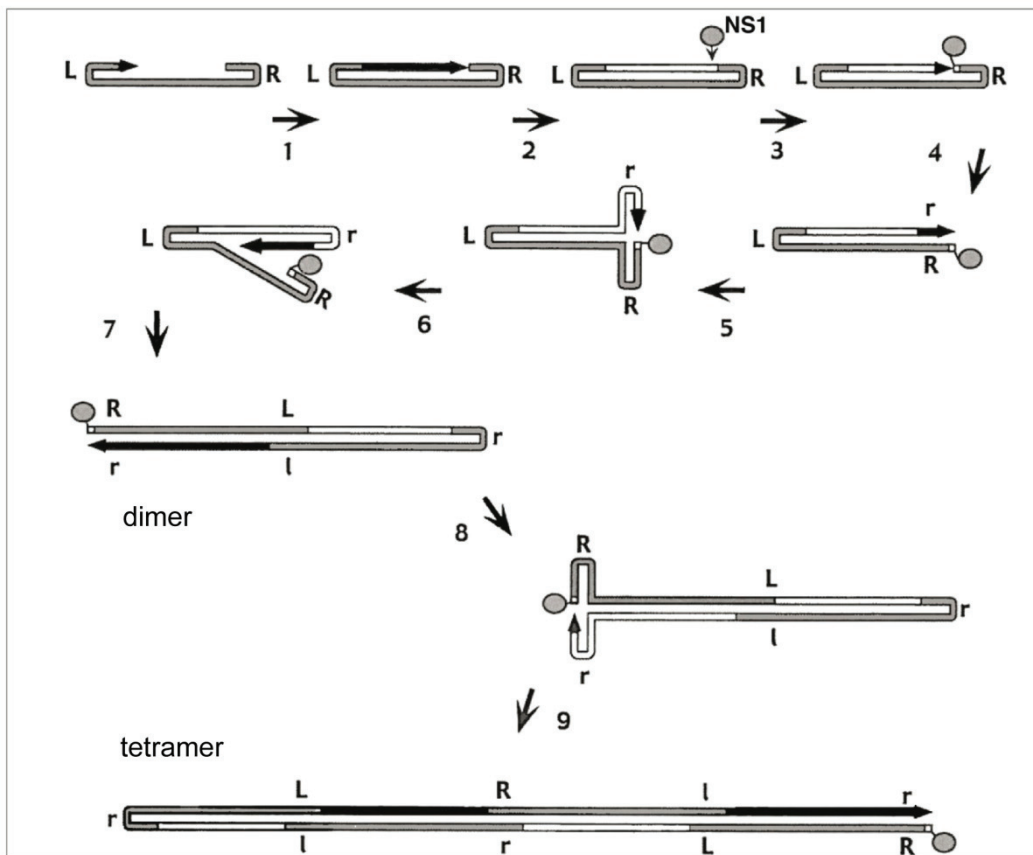

Figure 9.
Rolling-hairpin replication model.

Viral genome is depicted as: i) a grey line when representing the initial genome, ii) a white line when corresponding to replicated genomes and iii) a black line when showing new DNA being synthesized, with the arrow pointing to the 3' extremity. Grey spheres are for NS1 proteins.

L = Left-hand end ; R = Right-hand end
 l = Left-hand end copy ; r = Right-hand end copy

Source: *Parvoviruses*, C.S.F. Kerr J. R., Bloom M. E., Linden R. M., Parrish C. R., Editor. 2006, Hodder Arnold: London.

suggested to be used in the nucleus as a template for initiating replication. The viral DNA would be thereby removed from the capsid without its complete disassembly while replication progresses. During infection, the exposure of the 3' end of viral DNA could occur following the low pH-mediated capsid conformational changes that also externalize VP1 N-terminus. However experimental evidence lacks to support this theory and other mechanisms controlling viral DNA release from the capsid have to be considered, including capsid disassembly. Incidentally this latter idea would be consistent with the above-mentioned observation of genome uncoating in late endosomes, although it remains unknown whether such uncoated DNA is then routed to a degradation pathway or to the nucleus to go on with the viral life cycle (153).

Chapter 4. ...rolling-hairpin replication...

Among H-1PV proteins none of them is neither able to act on nor modulate the cell cycle unlike some other DNA viruses. Thus viral replication does not start until the cell goes through S phase. The synthesis of complementary DNA is performed by DNA polymerase δ . Indeed replication can be abolished by trapping PCNA (Proliferating Cell Nuclear Antigen which is a cofactor of this DNA polymerase) by incubating infected cells with p21^{WAF/CIP1}, and restored by adding PCNA. Viral DNA synthesis is also dependent on cyclin A and its related kinase activity (13).

Being the only known entities with a linear, single-stranded DNA, parvoviruses also use a unique replication system called "Rolling Hairpin Replication" (RHR). Tattersall and Ward were the first able to decipher this process which tightly relies on the terminal palindromes (233). RHR resembles the "rolling-circle replication" system used to multiply circular nucleic acids although with slight differences to fit the linearity of parvoviral DNA. The different steps of the mechanism are depicted in **Figure 9** but basically, the terminal palindromes are used as origins of replication, the very first initiation taking place at the left-hand hairpin since it ends with a floating 3'-OH. This step converts viral DNA into the first duplex intermediate, with the two strands covalently cross-linked (ligation between 3'-OH and 5'P). Beyond this point, NS1 is required to perform nicking as indicated in Step 3, with the help of a cellular DNA-bending protein from the high mobility group 1/2 (HMG1/2) (62). The progress of the replication process then relies on repeated unfolding and refolding of the

terminal sequences. They first create duplex hairpin telomeres in which the 3' nucleotide of the strand is paired to an internal base to generate a DNA primer and then unfold to allow the copy of the hairpin. These palindromes serve actually as "toggle-switches" that reverse the direction of DNA synthesis at each end of the genome, which constitutes the main difference with rolling-circle strategy and adapts RHR to linear DNA replication. Parvoviral DNA amplification requires NS1 to function as the 3'-to-5' replicative helicase (44) in addition to its nickase activity and to recruit Replication Protein A (RPA) which is needed for the processivity of the mechanism (41, 42, 44).

Parvoviral replication occurs in particular nuclear structures called Autonomous Parvovirus-Associated Replication bodies or APAR that incidentally were described for both H-1PV and MVMp (14, 68) and do not resemble any other known nuclear structures. They bring together the different molecular factors needed for the achievement of parvoviral DNA replication, including DNA polymerase δ , cyclin A, PCNA and RPA. DNA polymerase α is also found in APAR although its exact involvement remains unknown so far.

Chapter 5. ... as well as transcription...

As mentioned earlier, H-1PV genome contains two transcriptional units. The first one is controlled by P4 promoter and encodes NS1 and NS2. P38 promoter drives the second one to generate VP1 and VP2. As soon as the first duplex replicative intermediate has been synthesized, both P4 and P38 promoters are supposed to be able to drive transcription. Since NS1 is required quite early during the replication process, it is very likely that P4 promoter gets activated early as well.

Besides specific regulatory elements that will be more extensively described further in this manuscript as determinants of parvoviral oncotropism (see Part 2, Chapter 2 of this Book), P4 promoter is endowed with the typical motifs required to initiate eukaryotic transcription, including an unusual GC-box, which recognizes Sp1 transcription factor with high affinity, and a TATA-box known to recruit the basal transcriptional machinery, including TATA-binding protein (TBP), RNA polymerase II and general transcription factors (3, 199).

P38-driven gene expression occurs later during the infection since it depends on NS1 to get fully activated. In addition to specific NS1 recognition motifs, NS1

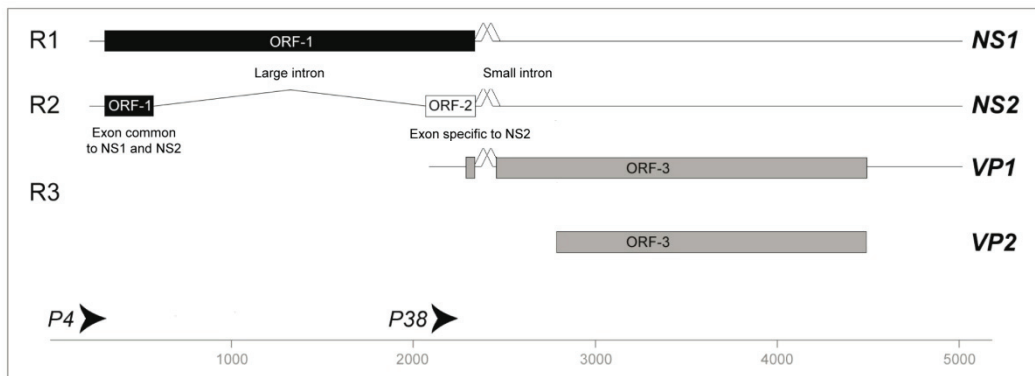

Figure 10.
MVM transcription map.

R1, R2 and R3 are the main transcripts resulting from P4- or P38-driven transcription and alternative splicing. They are translated into the proteins indicated on the right.
 ORF = Open Reading Frame.

Map positions of P4 and P38 promoters are indicated at the bottom of figure, on a graduated line representing the viral genome, with one unit corresponding to 1000 nucleotides.

Source: *Parvoviruses*, C.S.F. Kerr J. R., Bloom M. E., Linden R. M., Parrish C. R., Editor. 2006, Hodder Arnold: London.

requires a GC-box and a TATA-box to transactivate P38 in an ATP-dependent manner (4, 40, 104, 148, 149, 209). A cellular factor is supposed to be able to inhibit P38 although remaining unidentified yet. This repression is suggested to play an important role to tightly regulate the time-course of viral gene expression upon infection.

Parvoviruses have evolved complex patterns of alternative splicing in order to maximize the information encompassed in their size-restricted genomes. All MVM pre-mRNAs contain the same small intron located in the center of the genome which is alternatively spliced using two donor (D1 and D2) and two acceptor (A1 and A2) sites that are perfectly conserved between MVM and H-1PV sequences (58). P4-generated pre-mRNAs undergo a first splicing that leads to R1 mRNAs. Some of R1 mRNAs are further spliced and the elimination of a large intron located upstream of the small one generates R2 mRNAs (116). R1 and R2 are translated into NS1 and NS2 proteins respectively. P38-generated pre-mRNAs are also submitted to the splicing of the central intron (R3). As VP proteins are not equally found in the viral capsid, the alternative splicing of R3 transcripts controls the ratio between VP1 and VP2. R3 is mostly spliced using D1 and A1 resulting in a predominant mRNA that is translated into VP2 (46, 225) while VP1 is translated from mRNAs spliced using D2 and A2 (130). Since VP1 and VP2 do not share their N-terminus, translation of initiation occurs at different initiation codons unlike NS1 and NS2. It should be stated that little is known about how parvoviral mRNAs are transported to the cytoplasm to get translated.

The different transcripts, the location of the alternative splicing sites and the corresponding proteins are depicted in **Figure 10**.

Chapter 6. ...in order to create new virions

When viral genome has been amplified and VP proteins have been produced, new capsids need to be assembled to package the DNA. Regarding H-1PV and MVMp each capsid is made of 60 proteins with a ratio of 1 VP1 for 5 VP2. As already mentioned, VP1 contains two NLS near its N-terminus and an NLM allowing its nuclear transport while VP2 is endowed with NLM only. It appears that newly generated VP proteins are transported to the nucleus as trimeric assembly intermediates of two types, one being made of VP2 only and the other being constituted of two VP2 and one VP1 (**see Figure 8**). These intermediates have to

reach the nucleus at a 1:1 ratio so that proper capsids are assembled (213). However, the nuclear trafficking signals are not sufficient to trigger the trimers to go to the nucleus. Indeed it was reported that Raf-1-mediated phosphorylation of the assembly intermediates is required for their nuclear targeting (214). Consistently, VP trimers from insect cells, which lack Raf-1 signaling, are neither phosphorylated nor imported into the nucleus of mammalian cells while active Raf-1 coexpression restores both. Likewise, inhibition of this pathway in MVM-infected cells correlates with cytoplasmic retention of the unphosphorylated trimers.

Packaging of the viral DNA into newly assembled capsids is the final step to generate progeny viral particles. NS1 protein is found to be associated with the 5' end of the packaged genome while remaining accessible to antibody recognition, indicating that the bound NS1 is located outside of the capsid (61). Thus NS1 could promote DNA packaging by establishing interactions with empty capsids although this has not been directly proven yet.

Chapter 7. ...that are transported and release back to the extracellular matrix.

For an infection to be truly successful, progeny virions need to be released from the host cell to be able to replicate as well. This implies that nuclear envelope and then plasma membrane have to be crossed again.

In mature virions, VP2 protein exhibits an N-terminal Nuclear Export Signal (NES) which allows to go through the nuclear envelope using nuclear pore complexes (**see Figure 8**). Serine phosphorylation of this NES is supposed to be implicated in functional nuclear export. Besides, when grown in cells from its natural host (i.e mouse), MVM also needs NS2 to leave the nucleus. Indeed, NS2 is able to interact through NES sequences with the cellular Crm1 protein also known as Exportin 1. Disruption of one of these NES in particular is related to a strong sequestration of both NS2 and progeny virions, which delays their release and host cell death. Interestingly, this NES was reported to be supraphysiological meaning it binds to Crm1 without the requirement of RanGTP because of its higher affinity for the cellular protein. Most importantly, when NS2 harbors a regular NES sequence MVM is compromised in both nuclear egress and productivity (21, 81, 84).

The achievement of the viral life cycle correlates with the viral particles being eventually freed from host cells. This event was long thought to passively result from the cells dying from the viral toxicity. But this paradigm has been recently questioned with the publication of very interesting studies highlighting that the virions are more likely to use an active way to exit the cells, which is consistent with a quite old observation that viral release and cell death are not inevitably correlated (222).

This active trafficking of progeny virions would start in the perinuclear region, and go on with vesicles thought to be lysosomes or endosomes which would use the cellular microtubule network to reach the cell surface. The involvement of cellular gelsolin, a protein known to facilitate exocytosis by remodeling actin filaments, is suggested to play a major role in active parvoviral release. Gelsolin was indeed reported to accumulate upon parvoviral infection and undergo posttranslational modifications that are likely to influence its subcellular localization, binding to membranes and functions. When gelsolin was impaired in infected cells, progeny virions were no longer taken as vesicle passengers, suggesting that gelsolin helps with assembling, filling and/or mobilizing the vesicles to ensure viral trafficking back to the cell surface (222).

Besides, when infected cells lack functional radixin, a protein from the Ezrin Radixin Moesin family involved in the organization of the cytoskeleton, MVM is no longer able to induce cell lysis. Radixin was actually demonstrated to interact with protein kinase C η , which phosphorylates capsid proteins (176). This is consistent with VP2 N-terminus phosphorylation being required for progeny virions to leave host cells (155). ERM proteins might play a role in this late step of the viral cycle leading to virion release.

Part 2. *Modus operandi* of the killer

Even though fundamental aspects are still the object of many research studies, H-1 parvovirus is also extensively investigated with a view to use it as an alternative anticancer agent due to its specific cytotoxic effect towards cancer cells. This Part will discuss the properties H-1PV is endowed with, with a special interest for the molecular determinants that altogether confer to H-1PV its antitumor ability.

Virus	Route	Tumor	Animals	Effect(s)
Animals infected before tumor graft				
MPV1	ip	Myeloma	Mice	Reject
MPV1	ip +on	Allogenic sarcoma	Balb/c mice	Accelerated reject
RPV1	on	Leukemia	Rats	Decrease in tumor growth Attenuation of the disease
Animals injected with ex vivo infected tumor cells				
H-1PV	-	Cervix carcinoma (HeLa cells)	Nude Swiss CD1 mice	Decrease in tumor incidence
MVMp	-	Syngenic melanoma (B78 cells)	C57B1/6 mice	Detection of tumor delayed
MVMp	-	Syngenic endothelioma (HSV cells)	C57B1/6 mice	Tumor growth slown down, Decrease in metastasis incidence
Animals infected after tumor establishment				
H-1PV	it	Cervix carcinoma (HeLa cells)	SCID balb/c mice	Viral dose-dependent tumor regression
MVMp	it	Syngenic melanoma (B78 cells)	C57B1/6 mice	Tumor growth delayed
MVMp	it	Syngenic mastocytoma (P815 cells)	DBA/2 mice	Tumor growth delayed
H-1PV	iv	Pulmonary metastases following syngenic hepatoma (MH cells)	Immunocompetent ACI rats	Decrease in tumor incidence
H-1PV	it	Syngenic pancreatic adenocarcinoma (HA-RPC cells)	Immunocompetent Lewis rats	Tumor growth delayed, complete regression observed in some cases and decrease in metastasis incidence
H-1PV	ic	Syngenic glioma (RG2 cells)	Immunocompetent Wistar Kyoto rats	Tumor regression
H-1PV	sc	Burkitt's lymphoma (Namalwa cells)	SCID mice	Tumor regression with significant prolongation of survival
H-1PV	on	Syngenic glioma (RG2 cells) or allogenic glioma (U87 cells)	Wistar or RNU rats	Tumor regression with significant prolongation of survival

Table 1.

Parvovirus-induced oncosuppression in animals (data from 1990 to current days).

ip : intraperitoneal ; *on* : oronasal ; - : virus is not injected into animals ; *it* : intratumoral ; *iv* : intravenous ; *ic* : intracranial ; *sc* : subcutaneous.

MPV1 : Mouse parvovirus 1 ; *RPV1* : Rat parvovirus 1 ; *MVMp* : minute virus of mice prototype strain ; *H-1PV* : H-1 parvovirus.

It is quite impossible to refer to H-1 parvovirus (H-1PV) without mentioning cancer, or at least transformed cells, simply because every striking property of the virus is related to them, especially its ability to destroy them both *in vitro* and *in vivo*.

In the 1960's, Helene Toolan isolated the virus from the human HEp-1 tumors which eventually gave it their name (238) but back then, the relation between H-1PV and cancer was more likely thought to be causal, based on multiple observations that could have been – and were in fact – misunderstood. Indeed, besides being found not only in human but also in animal tumors, the virus was, in sharp contrast, never isolated from normal human tissues (60). Moreover, it was contaminating the purification of oncogenic viruses and its reduced size led people to relate it to the *Papovavirus* family that includes the well-known transforming SV40 virus (228).

But the assumption of H-1PV being oncogenic was questioned when a study reported that among 2000 hamsters monitored for three years, the tumor incidence was 20 times lower in animals that were inoculated at birth with the virus compared with non infected ones (236). Since, H-1PV has been clearly admitted as not inducing tumor and even credited with three major anticancer properties:

- ❶ Oncosuppression
- ❷ Oncotropism
- ❸ Oncolysis.

Chapter 1. Oncosuppression

The attribution of *in vivo* oncosuppressive properties to H-1PV directly results from what was first observed by Helen Toolan in her large-scale study, namely that lab animals were protected from cancer development by a preventive inoculation of the virus. Thereafter, many additional reports have corroborated this primary result and described several ways of H-1PV being oncosuppressive as well as other members of the Parvovirus genus like Mouse parvovirus (MPV1), rat parvovirus (RPV1) or minute virus of mice (MVM) (**Table 1**). As previously mentioned, when infected at birth, lab animals are dramatically less likely to develop tumors, either spontaneous or induced (216). Moreover, syngenic or heterologous tumor grafts do not or hardly take when performed in animals carrying the virus (157, 158). Interestingly, allogenic sarcoma cells, which are fully resistant to MPV1 infection *in vitro*, are rejected more

efficiently *in vivo* in preinfected immunocompetent Balb/c mice. This important observation strongly suggests that the selective killing of malignant cells *in vitro* (oncolysis – discussed below) might not be the only reason for oncosuppression and that other mechanisms, probably linked to immunity, are involved. And indeed, the enhanced rejection of tumors by MPV1-infected mice was described later to depend on T cells (158, 172). Likewise, infected neoplastic cells develop less tumors (80, 97)– or later (97) – when injected into lab animals. The interference of parvovirus with oncogenesis establishes a correlation between viral cytotoxicity and anticancer effects, along with the involvement of immunomodulation as well. Concretely, tumor remnants from H-1PV-infected HeLa cells injected into nude mice were found to express markers that are linked to the recruitment of natural killer cells (NK) (109). The idea is that parvoviruses would promote the release of tumor-associated antigens through the killing of cancer cells, thereby triggering bystander immune responses. Interestingly, besides preventing the development of cancer in animals, parvoviruses are also able to slow down tumor growth or even shrink established tumors to spectacular extent depending on the model (132, 172) and in a dose-dependent manner (86). Altogether these many reports have inevitably led researchers in the field to consider parvoviruses as serious candidates for cancer treatment. However, the size of the tumor seems to be a crucial factor regarding parvovirotherapy efficiency. Indeed, the rate of cure of human mammary carcinoma xenografts in nude mice treated with H-1PV was found to drop when the treatment was delayed until tumors reached a large size (80). Besides, in some systems, particularly immunocompetent ones, the protective or curative effects of parvoviruses are sometimes more limited, suggesting that the triggering of antitumor immunity might be counterbalanced by antiviral responses, thereby leading to less pronounced oncosuppressive effects (97, 123, 172).

H-1PV *in vivo* oncosuppressive properties were long thought to exclusively result from parvoviral-mediated oncolysis. Nevertheless, this widely admitted view was eventually challenged in the mid 1990's with the hypothesis that in an immunocompetent context, the immune system would greatly participate to H-1PV-mediated oncosuppression (158), although with the risk of also triggering an antiviral response. In the Chapter dedicated to the clinical prospects of oncolytic viruses, I will further discuss the alternative parvovirus oncosuppressive mechanisms that are proposed to occur in the light of what was recently reported.

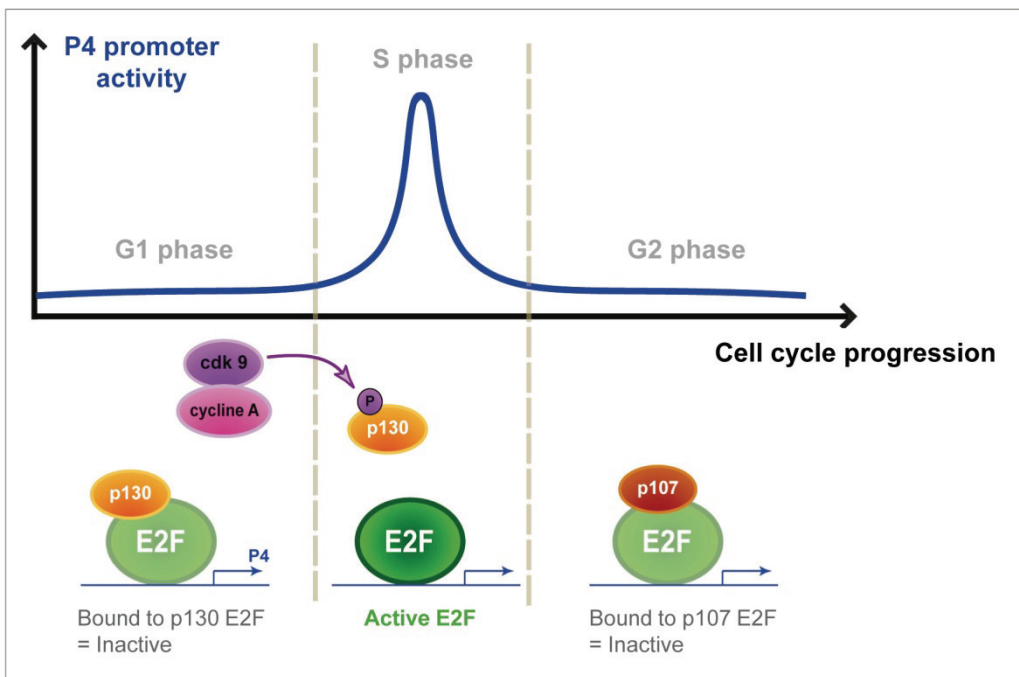

Figure 11.
Variation of E2F activity upon cell cycle progression.

p130 and p107 are members of the pocket protein family. During G1 and G2 phases, they bind E2F factors and inhibit their activity. When the cell enters S phase, pocket proteins gets phosphorylated, mostly by kinases dependent on the cell cycle progression (or cdk for cyclin-dependent kinases). This results in pocket proteins losing their E2F binding capacity. E2F factors are then active and available for transcription.

Illustration created by Dr. Pierre Wizla on the basis of Laurent Deleu's work.

Source: Deleu L, Pujol A, Faisst S, Rommelaere J. J Virol. 1999 May;73(5):3877-85.

Chapter 2. Oncotropism

The comparison of normal cells with their transformed counterparts when infected by H-1PV shows that malignant transformation dramatically influences the viral life cycle. In other words, unlike normal cells, transformed ones are able to perform viral DNA amplification and gene expression, which ultimately leads to their killing (53). This is this very stimulation of H-1PV amplification by cell transformation that is referred to as oncotropism (216).

Paragraph 1. The P4 connection

Viruses like H-1PV that strongly depend on S-phase might take advantage of the characteristic cell-cycle deregulations of cancer cells. Thus, parvoviral oncotropism could be explained by the fact that viral replication and gene expression are controlled, at least in part, by cellular factors activated upon cell transformation.

This is particularly illustrated by what is known about the regulation of early P4 promoter activity (87). Initiation of P4-driven transcription was shown to be limited by the activation of E2F transcription factors which is linked to the G1/S transition (72). Indeed, disrupting E2F binding site (E2FBS) in P4 promoter leads to an 80% decrease in its activity. Besides, E2FBS is differentially bound to the viral DNA upon cell cycle progression in accordance with P4 modulation, which exerts a basal activity in G1 and G2 phases but is hyperactivated when S phase occurs (**Figure 11**). However, even though they are probably available more often and in greater amounts in transformed cells, activated E2F transcription factors are not exclusive to them and their contribution to P4-driven transcription highlights why H-1 PV amplification depends so strongly on cell proliferation more than it explains the importance of transformation. And indeed, lots of investigations pointed to the involvement of other factors that are expressed especially in response to oncogene activation. More particularly, Ras-induced transformation leads to the mobilization of MAPK signaling pathways, resulting in the activation of Ets and ATF/CREB transcription factor families, both of them being able to bind to and modulate P4 promoter (93, 196). Interestingly, Ras ectopic expression in normal cells correlates with the activation of

P4 promoter in an Ets binding site (EBS)-dependent manner (93). In addition, although ATF/CREB factors participate to P4-driven transcription in both normal and transformed cells, the mutation of their binding sites (Cre) in P4 impairs the promoter activity more severely in the latter than in the former (196). Consistent with these observations, viral gene expression is significantly higher in Ras-transformed cells. Likewise, both c-Myc and SV40 large T oncogenes are able to trigger pathways that ultimately activate P4-driven transcription. Some of their targets, including USF and NF-Y transcription factors respectively, are indeed able to bind to the promoter through specific elements (E- and Y-boxes) (105, 106, 200). The most recent add to the understanding of P4 regulation is consistent with P4 being highly dependent on transformation-related factors since it indicates that the proximal region of the promoter comprises binding sites for SMAD4 and c-Jun, which is a proto-oncogene (23, 74).

While the expression profile of transformed cells greatly accounts for parvoviral oncotropism, it should be stated that it would be pointless if P4 promoter was not built to respond to the above-mentioned factors. However, some of the binding elements mapped in P4 sequence deviate from the consensus sequences known to be recognized by the transcription factors we are interested in. Surprisingly, improving the fit of Cre site to the palindromic consensus does not enhance the oncoselectivity but is instead somehow impairing, which shows that parvoviruses benefit from containing an unusual Cre motif (192). PIF factor, which is required for viral DNA replication, binds to the viral DNA through two half-sites within the left-hand end hairpin of the genome, with one of them overlapping Cre (**see Figure 5**). Very interestingly, reducing the spacing between these two half-sites by one base pair enhances oncoselectivity. In such context, the binding of PIF is likely to be impaired, which would disturb viral replication, whereas Cre would be more available for the binding of cellular factors, leading to an improved activity of P4 (192). The oncoselectivity of P4 promoter is very hard to decipher but this suggests that wild-type P4 sequence was not selected to be as oncotropic as it can, but is tightly organized through restricted genetic information to reach a balance between replication-related functions of the left-hand end hairpin and the oncotropic transcriptional elements.

Paragraph 2. Beyond transcription

Comparable to gene expression, viral DNA replication is more likely to occur in a cell that has undergone malignant transformation. In SV40-transformed cells, it has been emphasized that the processing of multimeric DNA replicative intermediates is an oncogene-responsive step of parvoviral DNA amplification, although the molecular components involved have not been identified yet (128). However, the conversion of single-stranded genome to double-stranded replicative form is known to require cyclin A, which is associated with the S-phase of the cell cycle (13). Thus, as discussed above about E2F transcription factors and P4-driven transcription, cyclin A is probably more available in cells suffering from cell cycle deregulations, namely in cells with a high proliferative potential such as transformed cells.

As already mentioned, cell transformation is a crucial factor for parvoviruses to replicate and spread. Nonetheless, sensitization to parvoviruses is restricted to particular oncogenes. Indeed, while Ha-Ras, v-src, v-myc or SV40 large T antigen are efficient in making rat fibroblasts able to complete MVM life cycle, the transformation of the same cells by a bovine papillomavirus (BPV-1) has no such effect, implying that these various oncogenes activate different mechanisms and signaling pathways that are not all able to trigger parvoviral amplification (221). However, the oncotropism issue becomes even more complicated knowing that the same malignant transformation through EJ-ras in different rat fibroblast cell lines does not inevitably result in sensitization to parvovirus infection (244), showing that oncotropism arises from the integration of multiple molecular parameters related to cell transformation as well as the context where it occurs (232, 256).

Paragraph 3. New findings

By defining parvoviral oncotropism as the ability to stimulate and perform the viral life cycle, researches have focused for a long time almost exclusively on what transformed cells feature that normal cells do not. But recent reports highlighted that the favorable context provided to parvoviruses by cancer cells might as well rely on what they do not that normal cells do, giving a new dimension to the notion of oncotropism.

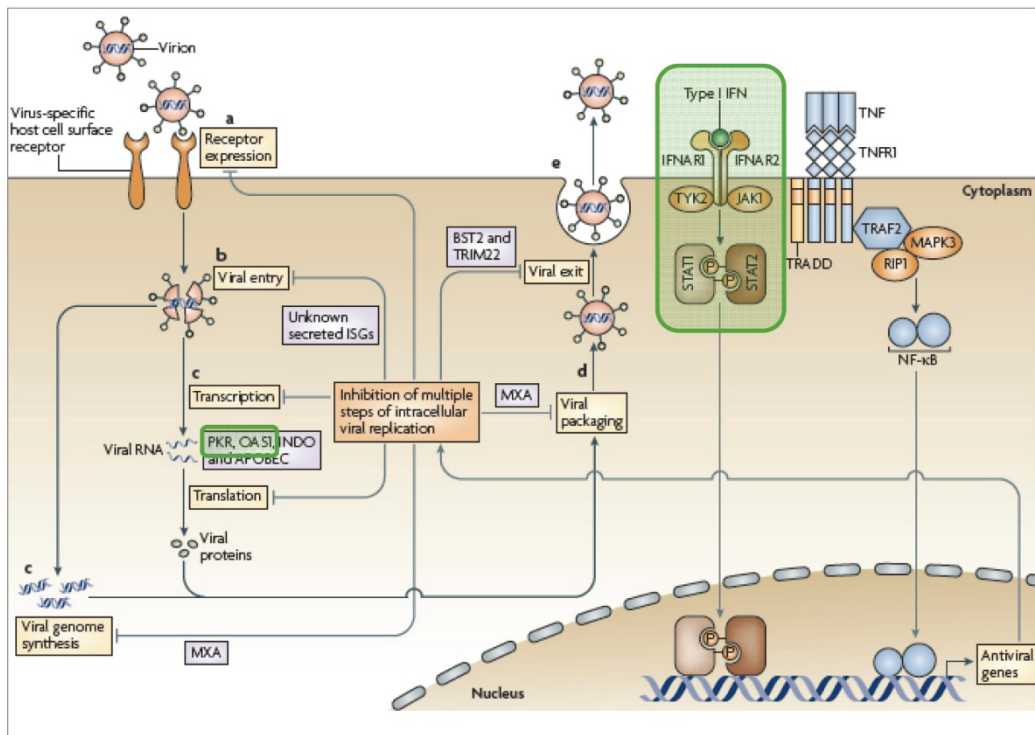

Figure 12. General representation of cell-mediated antiviral responses.

The main steps of a RNA virus life cycle (light yellow boxes) and the cellular molecular effectors meant to inhibit viral replication (light blue boxes) are depicted.

Green boxes highlight pathways and effectors with experimental evidence of their involvement in antiviral response against MVMP.

Source: McFadden G, Mohamed MR, Rahman MM, Barteo E. *Nat Rev Immunol.* 2009 Sep;9(9):645-55.

When exposed to viruses, cells activate an innate antiviral immune response mediated by type I interferons (IFN α and β) that are produced when pathogen-associated molecular patterns (PAMPs) consisting of viral nucleic acids are detected by membrane or intracellular pathogen recognition receptor (PRRs), including Toll-like receptors or protein kinase R (PKR). The integration of such signals results in the activation of the JAK/STAT pathway leading to the expression of IFN-stimulated genes (ISGs), like PKR and 2'-5'-oligoadenylate synthetase (2'-5'-OAS) or STAT to further enhance the antiviral response and achieve pathogen eradication (**Figure 12**). Mouse embryonic fibroblasts (MEFs), which are not able to complete the viral life cycle, were shown to produce and release type I IFNs, leading to the phosphorylation of STAT1 and STAT2, as well as expression of 2'-5'-OAS in response to parvoviral infection (102). Accordingly, viral replication as well as gene expression is dramatically low in these cells. Most interesting is that mouse transformed fibroblasts A9, which are permissive to parvoviral infection, do not exert any strong antiviral response against the virus due to the lack of type I IFNs production and release. However, A9 cells are able to express ISGs in response to non viral stimuli or when exogenous IFN β is administered concomitantly to parvoviral infection. This implies that A9 cells failing to fight back the infection probably relies on the disruption of an event upstream from IFN expression. Knowing that many tumor cells are impaired regarding interferon signaling (67, 231), this all the more argues for an involvement of antiviral immune defect in parvoviral oncotropism. Consistently, Ventoso and coworkers reported that untransformed mouse 3T3 fibroblasts, which do not complete parvoviral infection, become highly permissive to the virus when devoid of PKR, whereas this sensitization is reverted upon PKR rescue (248). This kinase plays a major role in the antiviral response network by sensing PRRs and leading consequently to the phosphorylation of the α -subunit of the initiation factor 2 (eIF2 α), which ultimately aborts translation in infected cells (**Figure 12**). Consistently, parvoviral protein synthesis negatively correlates with PKR activity, thereby implying, like Grekova and coworkers suggested, that the ability of a cell to trigger or not an efficient antiviral response is crucial in the achievement of parvoviral life cycle (102, 248).

Paragraph 4. The unreachable definition of oncotropism

To date, oncotropism has been described in a very broad sense as the stimulation of parvoviral amplification by cell transformation without being related to any precise pattern of molecular determinants. One of the only consensual primary requirements for parvoviral amplification is the ability of the host cell to enter S phase although it cannot be accounted on its own for autonomous parvovirus strong preference for transformed cells since normal ones also express S phase-related factors. Many evidences have been collected and pointed to the fact that many transformation-responsive elements are likely to favor parvoviral life cycle without one or several of them being proved unconditional so far. Indeed, different oncogenes are able to trigger sensitization to parvoviruses without inevitably leading to the expression or activation of the same factors. Thus, transcription factors like Ets, ATF/CREB, NF-Y or c-Jun, that can be upregulated upon transformation, are able to control P4-driven transcription without all of them being required at the same time to allow the achievement of the life cycle. Together with the recent idea that autonomous parvoviruses benefit from transformed cells failing to mount an efficient antiviral response, this highlights that these viruses probably neither control oncotropism themselves through their restricted genetic information nor trigger any particular mechanism but more likely take advantage of any cellular context where many regulatory barriers have fallen. This would be consistent with parvoviral genome being endowed with multiple elements that respond to factors whose regulation is especially lost upon transformation, as well as the spectacularly wide range of host cells able to complete parvoviral life cycle.

I will further discuss this intriguing notion in this manuscript since part of my work might integrate with the most recent findings related to oncotropism, namely the involvement of antiviral responses.

Cells		Immortalized	Transformed	p53 status	Effects	References
Rat Embryo fibroblasts	1	No	No	Wild type	No lysis	(234)
	2	No	Yes	Wild type	No lysis	
	3	No	Yes	Inactive (dominant negative)	Lysis	
Human keratinocytes	4	Yes	No	Mutated	Lysis	(37)
	5	Yes	Yes	Mutated	Lysis	
Human hepatocytes	6	Yes	Yes	Wild type	Lysis	(163)
	7	Yes	Yes	Mutated	Lysis	
Human lymphoblasts	8	Yes	Yes	Wild type	No lysis	(234)
	9	Yes	Yes	Mutated	Lysis	

Table 2.
Impact of different host cell parameters on parvovirus-induced lysis.

Phenotypes expected to be observed in normal cells are in green boxes while cancer-associated phenotypes are in orange ones.

Thus, normal cells (i.e non immortalized, non transformed cells ; line 1) are expected to express a wild type p53 protein and not undergo parvoviral lysis. On the contrary, cancer cells (i.e immortalized, transformed cells, lines 5, 7 and 9) are sensitive to parvoviral oncolysis and show mutated and/or inactive p53 protein.

However in most cases, those parameters are not infallible markers to predict cell sensitivity to parvoviral oncolysis (lines 2, 3, 4, 6 and 8).

Chapter 3. Oncolysis

Malignant transformation affects not only replication and gene expression of parvoviruses but also their cytotoxic ability. The selective killing of transformed cells upon parvoviral infection is referred to as oncolysis.

Like oncotropism, deciphering what exactly in transformed cells allows their killing by parvoviruses is hard to comprehend and most likely results from multiple parameters. Immortalized rat fibroblasts undergoing oncogene activation can be sensitized to the cytotoxicity of parvoviruses (136, 221). However, the impact of oncogenes on non immortalized cells undergoing parvoviral infection is more elusive. Indeed, rat embryonic fibroblasts (REFs) submitted to the combined action of both c-Myc and Ha-Ras oncogenes undergo transformation but are not sensitized to H-1PV oncolysis. Making REFs die upon infection requires the expression of p53 dominant negative in addition to c-Myc and Ha-Ras (234). More than 80% of human tumors harbor p53 mutations. Interestingly, progressive sensitization of human fibroblasts to H-1PV oncolysis correlates with such mutations (52). Inversely, resistances to H-1PV appear in human leukemia cell lines upon wild type p53 rescue (234, 242) (**Table 2**). However, p53 status is certainly not the only clue to parvoviral oncolysis. Thus, immortalized human keratinocytes and their ras-transformed counterparts, carrying mutations in both p53 alleles, are similarly sensitive to H-1PV cytotoxicity, though to a significantly lesser extent than squamous carcinoma cells (37).

Unknown factors, probably associated with oncogenesis, are likely to cooperate with p53 to sensitize cells to parvoviral infection. Some of these factors might be more particularly linked to hormone-dependent pathways. Hormones play a major role in the outcome of different cancers and interestingly, MVM-induced cell death of Ha-Ras-transformed fibroblasts was found to be connected to the thyroid hormone signaling pathway (247). In addition, the expression of estrogen receptors has been reported in 1997 to correlate with the sensitivity of human mammary carcinoma cells to H-1PV toxic effects (245). However a work recently performed in our laboratory on a larger number of mammary tumors did not emphasize any such correlation (169). Because the cytotoxic effects of parvoviruses have been mostly attributed to NS1 protein, the different pathways which were described as mediating

NS1-induced toxicity will be further discussed in the Chapter especially devoted to the protein.

Part 3. Redemption of the killer

Oncolytic virotherapy is a strategy that is more and more considered for the design of new anticancer treatments. Since this particular aspect gets increasing interest in the field of Virology, I thought it might be important to first give a big-picture view about it. Then, what is currently known about the possibility of using H-1PV will be more particularly discussed. Because parvovirus-induced oncosuppression has already been mentioned, this Part will especially address the immunological aspects that are thought to be greatly involved in parvoviral antitumor effects and cannot anyway be ignored during the development of new clinical protocols.

Chapter 1. Oncolytic viruses as clinical anticancer agents.

Using viruses as anticancer agents is a 50-year old idea with notably the assessment of the potential of several viruses during the 1950's and 1960's, including in humans. Back in this time, a vaccine strain of rabies virus proved efficient for tumor regression in eight human patients out of thirty with melanomatosis (191). This study was followed by many others in humans as well as animals which reported lukewarm results with debatable efficiency of virus-induced oncosuppression. Moreover side effects were significant enough to discontinue trials, leading to a major drop in the interest oncolytic viruses initially raised.

Virotherapy had to wait until the early 1990's, which correlates with the burst of biotechnology and the emergence of gene therapy concept, to give rise to scientific enthusiasm again. Besides the intrinsic oncosuppressive properties described for many viruses, other virus-based clinical strategies have been considered. Evoking antitumor immunity through tumor-associated antigens is one of them. Production of such antigens can be stimulated by opsonization of tumor cells with antibodies produced by viral vectors. Viruses can also be used to specifically

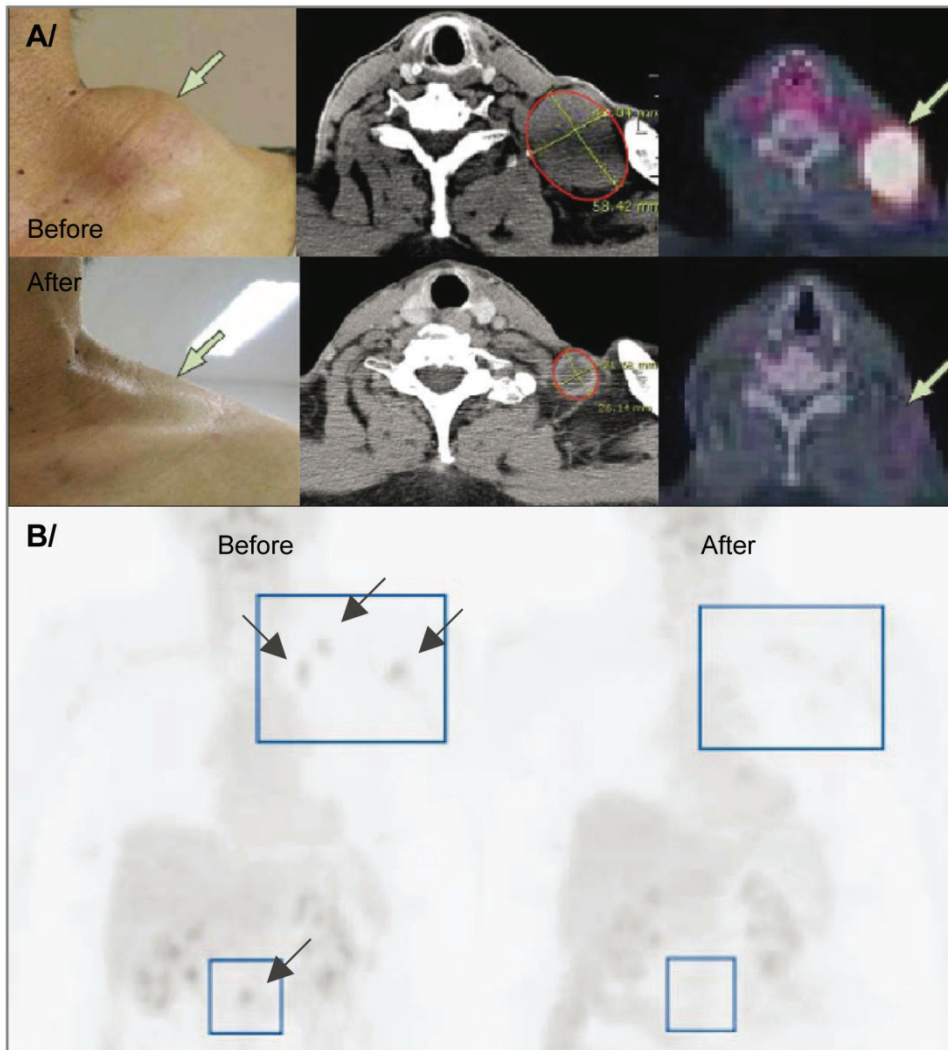

Figure 13.
Effects of oncolytic virotherapy observed in patients bearing metastases in clinical trials.

A/ shows the physical, computerized-tomography (CT) and positron emission tomography (PET)-CT scans of metastatic hepatocellular carcinoma tumor in neck before (top panel) and after (bottom panel) treatment with 4 cycles of a targeted oncolytic poxvirus at $3 \cdot 10^8$ pfu.

B/ shows the PET scans at baseline (left) and 8 months (right) after GM-CSF-armed oncolytic herpes simplex virus in a patient with metastatic melanoma. The grey arrows point metastases that have regressed upon treatment.

Sources:

- Park BH, Hwang T, Liu TC, Sze DY, Kim JS, Kwon HC, Oh SY, Han SY, Yoon JH, Hong SH, Moon A, Speth K, Park C, Ahn YJ, Daneshmand M, Rhee BG, Pinedo HM, Bell JC, Kim D.

Lancet Oncol. 2008 Jun;9(6):533-42.

- Senzer NN, Kaufman HL, Amatruda T, Nemunaitis M, Reid T, Daniels G, Gonzalez R, Glaspy J, Whitman E, Harrington K, Goldsweig H, Marshall T, Love C, Coffin R, Nemunaitis JJ.

J Clin Oncol. 2009 Dec 1;27(34):5763-71.

carry immunostimulatory cytokine genes into tumor cells to improve their recognition by T cells or dendritic cells. Because of their intrinsic nature, viruses are in addition very likely to induce strong immune responses and therefore might function as adjuvants in the context of a virus-based clinical protocol. Oncolytic virotherapy efficiency might actually result from viruses directly destroying cancer cells but also from the immune responses triggered by oncolysate-related antigens that are released during the process. Incidentally, approaches based on this notion were assessed back in the 1970's with *ex vivo* oncolysates used to vaccinate patients against cancer and showed significant successes (34, 171).

But the excitement for the field started to fade again with the beginning of the 21st century before eventually gaining the respect and credibility it deserves in 2011 the day Amgen, the world's biggest independent biotechnology company acquired BioVex Inc and its oncolytic, phase III-material virus (OncoVEX) with it. As stressed by David H. Kirn, a member of *Molecular Therapy* editorial board, this particular field was as promising the day Amgen made the choice to invest millions in it as it was the day before, but such a huge step made by an international well-known industry inevitably changed the perception of people on the subject. The years to come will tell whether oncolytic viruses' story will evolve the way it did for the previously greatly criticized monoclonal antibody and anti-angiogenesis approaches, that is to say with countless improved and even saved lives (122). To make a long fascinating story a little bit shorter, you will find in **Figure 13** examples of what oncolytic viruses are expected to do routinely in the years to come.

Candidates for oncolytic virotherapy come from many viral families, including members of two genera within *Parvovirinae* (including MVMp and H-1PV from *Parvovirus* genus and several serotypes of adeno-associated virus species from *Dependovirus* genus). Moreover, different types of viral constructs are under investigation and can be divided into two main groups, one gathering viruses competent for replication and the other constituted by replication-defective vectors. The latter are devoid of either replication- or structure-related viral genes (or both) and are expected to target and kill tumor cells without spreading, through the delivering of anticancer or immunomodulatory genes into tumor cells in several cases. Nonetheless, replication-competent viruses prove more efficient oncosuppressive ability than their replication-deficient counterparts (197).

Although oncolytic viruses clearly show great potential for the alternative treatment of many types of cancers, using them in an actual organism bearing actual tumors is not without a hitch. In the genuine context of disease, viruses are very likely to encounter many constraints researchers have to focus on to design oncolytic viruses able to efficiently target and kill tumors in patients. The major issue of dealing with the immune system of a patient is discussed right below with a particular interest in what is more especially known about H-1PV-related immune responses.

Chapter 2. H-1PV as an anticancer therapy: interactions with the immune system and clinical developments.

As already mentioned, H-1PV is endowed with oncolytic properties that are likely to account, at least in part, for the strong oncosuppressive effects the virus exerts *in vivo* by curing many cancer types (**see Table 1**). In addition, H-1PV is also able to destroy *ex vivo* breast tumor cells derived from patients while sparing normal cells collected from the same patients, suggesting few aspecific virus-related side-effects (169). Moreover no disease has been associated to H-1PV to date. Altogether these observations meet the requirements for considering H-1PV as a promising candidate for oncolytic virotherapy. Nonetheless, using a virus as a treatment requires the assessment of its interactions with the immune components of the organism supposed to receive the therapy. As expected, H-1PV is likely to trigger an antiviral immune response. But besides its direct oncosuppressive action, indirect virus-related antitumor immune responses were also described. Stress is put on these immune aspects of H-1PV infection right below. A comprehensive review about using oncolytic parvoviruses, particularly H-1PV, as anticancer therapeutics was recently published by Pr. Jean Rommelaere and coworkers (217).

Paragraph 1. Antiviral immune responses

When injected with parvoviruses, animals, as well as humans, exhibit transient viremia quickly followed by the detection of antibodies directed against the viruses (235). Since these specific antibodies are able to neutralize the virus, their production might reduce the amounts of particles available for tumor targeting, thereby making virus-mediated oncosuppression less effective. In accordance with this hypothesis, it has been reported that H-1PV ability to suppress hepatoma metastases in adult rats is impaired in animals inoculated with the virus several weeks prior to the anticancer treatment (206). However, antibodies raised against MVMP in infected B6 mice are mostly IFN γ -dependent with IgG2a and IgG3 isotypes being predominant when compared with the less represented Th2-dependent IgG1, suggesting that MVMP infection rather induces a Th1 immune response (132). Given that Th1 cytokine expression stimulates T cell-mediated mechanisms, eliciting such antiviral responses might not be as deleterious as it seems and even indirectly favor the suppression of tumors. Regardless, H-1PV still proves to act as an efficient anticancer treatment in animals, even in immunocompetent models, indicating that antiviral immunity is not an insurmountable issue for the development of anticancer treatments based on the virus.

Paragraph 2. Antitumor vaccination and H-1PV adjuvant effect

Lab animals bearing tumors treated and cured with H-1PV were reported to be protected against attempts to subsequently induce new tumors with the same cells, suggesting that H-1PV is likely to evoke an antitumor vaccination effect (107). This is consistent with H-1PV-related oncolysis being expected to lead to the release of tumor-associated antigens, as well as pathogen- and damage-associated molecular patterns likely to result in their presentation by specific cells and ultimately trigger an antitumor response. This confirms that the evaluation of H-1PV oncosuppressive effects in immunodeficient animals only provide a limited perspective of H-1PV antitumor potential *in vivo*. Indeed, tumor cells that are very sensitive to H-1PV *in vitro* are likely to give excellent tumor regression in

immunodeficient models due to direct oncolysis as it was observed with HeLa cells injected in SCID mice (80). On the other hand, tumor cells undergoing moderate virus-mediated lysis in cell culture such as pancreatic ductal adenocarcinoma (PDAC) cells might nonetheless be efficiently cured in immunocompetent animals probably as a result of antitumor immune responses raised against the immunogenic oncolysates (101). Incidentally, application of recombinant IFN γ , one of the main mediators of antiviral immune response suggested to mediate H-1PV-related regression of PDAC, was reported very recently to be able to improve the treatment of late incurable stages of PDAC like peritoneal metastases. This co-treatment enhances H-1PV-induced peritoneal macrophage and splenocyte immune responses against tumor while the levels of H-1PV-specific neutralizing antibodies are reduced, resulting in higher survival rates (103).

Paragraph 3. Direct and indirect interactions with the immune system

H-1PV-mediated oncosuppression clearly results from both direct intrinsic oncolysis and indirect ability of the virus to trigger and stimulate antitumor immune responses. Several studies have focused on deciphering the interactions of the virus with immune cells. Cell lysates resulting from H-1PV infection of tumor cells more efficiently activate *in vitro*-matured dendritic cells than non virus-related cell lysates. This results in phagocytosis and cross-presentation of tumor antigens as well as the generation of tumor specific cytotoxic T cells (164). H-1PV-related oncosuppression relying at least in part on adaptative immune responses is supported by the fact that infecting a tumor in immunocompetent rats with H-1PV is sufficient to induce the regression of another distant mass left untreated in the same animal and without viral transmission. Detection of increased expression of markers such as CD8, IFN γ , granzyme B or perforin in uninfected tumors are suggested to result from cytotoxic T cell infiltration and likely to account for tumor regression (101). Since activated and EBV-transformed immune cells undergo abortive infection, H-1PV is suggested to influence them (164). For example, IFN γ release resulting from H-1PV infection of either PDAC-bearing rats or human peripheral blood mononuclear cells (PBMCs) *in vitro* is associated with increased CD3⁺CD4⁺ cell populations, suggesting the possible

induction of downstream cellular immune responses involving antigen presenting cells (101). In addition, H-1PV was reported to directly or indirectly enhance IL2-activated NK cell-mediated PDAC suppression along with the release of IFN γ and TNF α among others, arguing for the development of protocols combining IL2 and H-1PV aiming at enhancing antitumor immune responses able to target and kill PDAC.

Paragraph 4. Immunomodulation by engineered infectious H-1PV.

Unmethylated CpG motifs in microorganism DNA are known to be sensed as potent danger signals leading to the stimulation of antigen-presenting cells. Based on this fact it was hypothesized that inserting CpG patterns into H-1PV genome might lead to the stimulation of dendritic cells cross-presenting viral and tumor antigens as a result of virus-mediated tumor cell lysis. If true, this would ultimately trigger tumor-infiltrating lymphocytes to kill infected cancer cells but also non infected ones. Rats bearing hepatoma lung metastases injected with irradiated autologous tumor cells infected with CpG-armed H-1PV show a significantly greater suppression of their metastases compared with animals receiving control treatments based on wild type or GpC-armed H-1PV. The antitumor effect of such treatment does not rely on the virus being able to reach target metastases. Under these conditions, the virus acts as an adjuvant of the vaccine effect exerted by irradiated infected tumor cells. The therapeutic vaccination effect with either CpG or control H-1PV correlates with IFN γ production and dendritic cell activation, eliciting altogether the induction of a cell-mediated immune response capable of antitumor activity. But interestingly both events are enhanced when CpG-armed H-1PV is used, which is consistent with the stronger oncosuppressive effect of the treatment based on this variant (207).

Paragraph 5. Clinical developments.

The above-mentioned elements together with the observations of effective cure of laboratory animals treated with H-1PV make the virus a promising candidate for the development of a novel anticancer virotherapy. In this regard, Pr. Jean

Rommelaere's laboratory is currently preparing a phase I/IIa trial for the treatment of patients with recurrent glioblastoma multiforme using a GMP-grade (Good Manufacturing Practice) wild type H-1 virus.

Given the sensitivity of many pancreatic ductal adenocarcinoma (PDAC) cells to H-1PV and great immune antitumor responses elicited in this context (7) whereas treatment of this cancer is currently unsatisfactory with unfortunately poor diagnosis, performing a clinical trial including patients bearing this type of tumors would also be greatly relevant.

It should also be mentioned that H-1PV-induced antitumor immune responses do not relate to any strong inflammatory reaction as suggested by its little-to-absent pathogenicity. H-1PV infection of humans was evaluated back in 1965 by Helen Toolan (239) who observed viremia in two young patients injected with 10^9 plaque-forming units (pfu). No significant side effects were reported apart from a moderate elevation of body temperature for one of the patients. Regression of their advanced osteosarcomas was not achieved but abnormal elevated alkaline phosphatase serum level was transiently reduced in one patient. In the early 1990's, purified pyrogen-free H-1PV was injected in patient with cutaneous metastases emerged from different types of tumors. No significant side effects were observed apart from transient fever in some patients shortly after the injection while H-1PV presence was proved by transient viremia, seroconversion and *in situ* viral replication in the lesions. Increasing amounts of virus were tested but interestingly the highest (10^{10} pfu) were still lower than the maximal dose tolerated which remained unreached (1).

Parvoviral infection is likely to trigger different types of immune responses (antiviral directly and antitumoral indirectly) with one being apparently able to overwhelm the other depending on the context. Considering viruses as therapeutic agents not only implies to deal with the complexity of organism responses but also to assess the involvement of other variable parameters such as tumor type and location or route and timing of virus application. These issues are actually very comparable to those encountered with current anticancer treatments which do not work on every type of cancer at every stage of the disease. Interestingly, it appears that H-1PV efficiency might get improved in all likelihood for instance by using immunomodulating co-treatment like IFN γ or IL2, or engineering the virus to induce

stronger antitumor immune responses through the insertion of immunostimulating CpG motifs within the genome. Together with the observation that the virus is also able to improve the efficiency of either standard (chemotherapy, ionizing radiation (7, 96, 227)) or unconventional anticancer treatments (antibiotics (205)), all the evidence is strong enough to support the idea of H-1PV being more than just a candidate for joining the therapeutic arsenal of clinicians.

BOOK III.

THE NS PROTEIN STORY

Part 1. NS2, the shy arm of the killer.

P4 promoter drives the expression of both non structural proteins NS1 and NS2. I will first give a short description of NS2 before more extensively talking about NS1 protein which has been the “leading character” of my work.

Surprisingly, NS2 protein (25 kDa) appears to be required only for the virus to complete its life cycle in cells coming from its host (i.e mouse for MVMp and rat for H-1PV).

Indeed, when MVM NS2 sequence is mutated within the viral genome (without affecting NS1 sequence), replication and infectious virus production are severely impaired in murine cells while being unaffected or even enhanced in human cells, suggesting that NS2 protein is involved in MVM DNA replication and efficient growth in a host cell specific manner (35, 173). Further investigation revealed that NS2 protein might also play a role in the translation of MVM transcripts in murine cells only (174). Altogether these findings emphasize a major involvement of NS2 in MVM life cycle in murine cells specifically while it seems dispensable in non murine models. It was nonetheless established that when NS gene is ectopically expressed in human cells and mutated so that NS2 only is impaired, NS-induced cytotoxicity is slightly less important than when NS1 and NS2 proteins are produced. So even though NS1 is the major effector of viral cytopathic effects, NS2 is likely to act in synergy with the former to reveal parvoviral full cytotoxic potential (24, 137).

Although NS2 is devoid of any specific domains or known enzymatic activities, its role in the achievement of MVM infection in murine cells might be explained by its ability to interact with cellular factors. In particular, NS2 was simultaneously reported by two research teams to bind to the nuclear export factor CRM1, thereby

controlling the egress of progeny virions from the nucleus (21, 81, 161). Very recently, using MVM NS2^{null} mutants, NS2 was shown to have a great impact on the development of autonomous parvovirus-associated replication (APAR) bodies where viral DNA amplification occurs. However, the recruitment of replication-related cellular factors does not depend on NS2, which currently leaves NS2 involvement in MVM replication elusive (220). Besides, NS2 protein also interacts with 14-3-3 family members which are known to influence the regulation of cellular protein involved in signaling (25). Thus, NS2 protein might interconnect with cellular pathways, likely to interfere with them or acquire proper posttranslational modification pattern.

In spite of the fact that H-1PV NS2 functions were less extensively investigated, some of the observations made with MVM also apply to H-1 virus. Indeed, when the generation of R2 transcripts is made impossible by defective splicing, H-1PV NS2 protein is no longer produced, which leads to non productive infection of rat cells while human, hamster and dog cells still undergo lytic growth although to a slightly lesser extent than wild type virus. This host-range phenotype of viral mutants defective for NS2 protein was observed in newborn rats as well and correlated with a dramatic decrease of viral protein synthesis (142). The levels of viral mRNAs remaining quite unchanged, the protein therefore appears to be, like MVM, involved in translation during H-1PV infection in a way that was suggested to depend on 3'-untranslated regions of viral transcripts (143).

Part 2. NS1, the versatile arm of the killer.

Every component of a living entity has its role to play to ensure its survival but this assertion is particularly true regarding the NS1 protein of autonomous parvoviruses given the multiple functions it exerts during the infection. NS1 protein was the central issue of my research work. This Part is meant to provide a detailed picture (although not as comprehensive as it could be) of NS1 activities, involvement in the viral life cycle and regulation.

NS1 protein (76 kDa), which results from the translation of P4-generated R1 transcript, is more stable than its little sister NS2 with a half-life estimated to more than six hours (versus about 90 min for NS2 protein) that are devoted to the achievement of multiple functions relying on several domains. These functions are themselves tightly related to NS1 ability to assemble in an ATP-dependent manner into oligomers

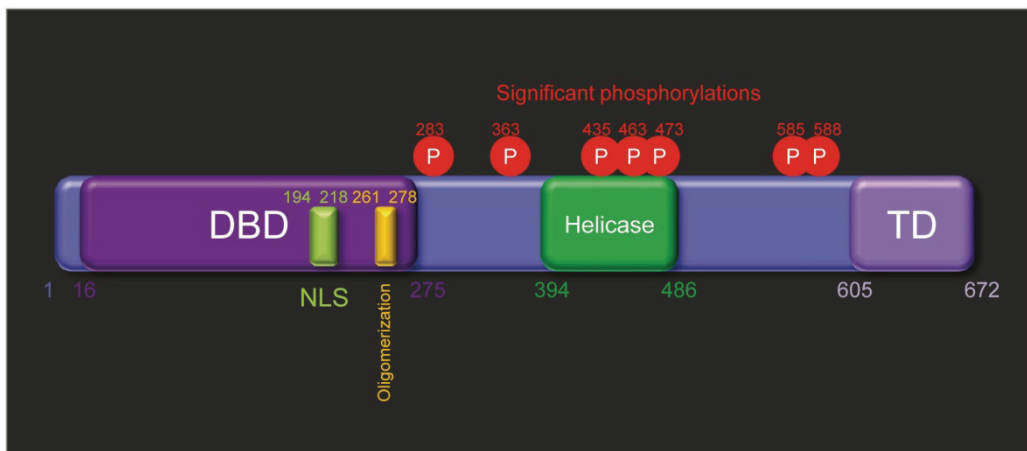

Figure 14.
Map of the functional domains and regions of MVM NS1 protein.

NS1 sequence is represented by a blue rectangle from amino acid 1 to 672.

The location of NS1 functional domains are also depicted with :

- the DNA-binding domain in dark purple (DBD)
- the helicase domain in green
- the transactivation domain in light purple (TD)

The nuclear localization signal (NLS ; in light green) as well as the oligomerization sequence (in yellow) are also indicated.

Amino acids known to be phosphorylated and involved in parvovirus-induced cytotoxicity (as well as other steps of the viral life cycle for some of them) are shown in red.

Source: *Parvoviruses*, C.S.F. Kerr J. R., Bloom M. E., Linden R. M., Parrish C. R., Editor. 2006, Hodder Arnold: London.

through the peptidic sequence ²⁶¹VETTVT(X₉)IQT²⁷⁸ located between the DNA-binding and helicase domains (115, 184, 254) (**Figure 14**). The functional domains include a DNA-binding domain, a helicase activity and a transactivation domain, as well as a NLS motif. The phosphorylation pattern also greatly accounts for NS1 functionality.

Chapter 1. NS1 involvement throughout H-1PV life cycle.

Paragraph 1. Involvement in viral DNA amplification

Because of its endonuclease (or nickase) and helicase activities, NS1 plays a crucial role in H-1PV DNA amplification. NS1 is required as soon as the first replication fork reaches the right-hand end of the genome where both DNA extremities are ligated and no 3'-OH extremity is available anymore to initiate another round of DNA duplication. At this point, NS1 needs to introduce a nick at the right-end of the genome so that replication goes on (62), with the protein remaining covalently attached to the 5' end of the DNA while the 3'-OH recruits a novel fork (54, 179). Bound this way to the DNA, NS1 is thought to help with the progression of the fork by unwinding the helix through its helicase activity and in an ATP-dependent manner (41, 42, 44). Helicase activity was also found to depend on NS1 assembling into oligomers (254), more particularly hexamers as suggested by the analogy with other viral helicases (56).

The left-hand end of the genome also contains sequences constituting a replication origin. NS1 was found to interact through (ACCA)₂₋₃ motifs with the cellular Parvoviral Initiation Factor (PIF) heterodimer which is required for parvoviral replication as indicated by its name (41, 42). There, NS1 is activated to nick one strand while DNA unwinding is facilitated by the distortion created by the NS1-PIF complex. Cellular Replication Protein A (RPA), which is able to bind to single-stranded DNA, was reported to interact with NS1 and catalyze extensive unwinding (44).

Regarding replication, NS1 protein is endowed with multiple roles that implicate a coordinated action of several of its functional domains (i.e DNA binding,

nickase and helicase) and also acts as a platform for the recruitment of cellular factors required for the achievement of viral DNA amplification.

Paragraph 2. Involvement in viral and cellular transcription

NS1 protein preferentially binds to consensus motifs (ACCA)₂₋₃ at both ends of the genome (**see Figures 4 and 5**) to mediate viral replication but these sequences are also highly repeated along the whole viral genome, with the nucleotides 5'-AACCAACCA-3' representing 10% of MVM DNA (22). By also taking into account the highly conserved sequences, with 7 or 8 nucleotides in common with the consensus, it appears that such motifs are reiterated every 75 nucleotides or so (56). NS1 is actually able to recognize these internal elements (56) suggesting that the protein is likely to mediate events other than replication but also requiring NS1 binding to viral DNA.

This is greatly consistent with NS1 being the major transactivator of P38 promoter which drives VP gene expression (40, 95, 135, 147). One of NS1 recognition motifs referred to as *transactivation responsive element* or tar. This element mediates the formation of a transcriptional complex constituted by both viral (DNA and NS1) and cellular components including Sp1 transcription factor (126) as well as TBP and TFIIA. By investigating the effects of different deletions in both MVM and H-1PV NS1 sequences, it was clearly demonstrated that the acidic C-terminus of the protein is responsible for NS1 ability to activate P38 (73, 211) in a manner that requires NS1 self-association (73). Interestingly, an NS1-mediated feedback loop of P4 promoter activity has been observed and leads to opposite effects depending on the constructions used to assess it. On one hand using plasmids containing viral sequences unable to replicate, NS1 expression results in a decrease of P4 promoter activity. On the other hand, with replication-proficient sequences (i.e integrity of the left-hand end), P4 activity is three- to five fold higher, in an NS1-dependent manner (111). Given that NS1 is supposed to be expressed in the presence of replicative viral DNA only, this implies that NS1 protein acts as a transcription activator for both H-1PV promoters.

NS1 protein also modulates viral and cellular promoters, acting as an inhibitor most of the time. The long terminal repeats (LTR) of both Rous sarcoma and human

immunodeficiency viruses (RSV and HIV) are indeed inhibited by NS1 protein (73, 135, 211) as well as Harvey-*ras* oncogene promoter (211). The only cellular promoter that has been reported so far to be transactivated by NS1 drives the expression of the gene encoding the thyroid hormone (T3) receptor α (*c-erbA1*) (247) through DNA elements that do not match the consensus admitted for NS1 binding (246).

Besides the obvious relevance of NS1 transcriptional abilities regarding parvoviral promoters, the exact consequences of NS1-mediated modulation of cellular gene expression upon infection remain unknown yet. It can be assumed that such regulation might be integrated with the chain of events that altogether lead to the achievement of the viral life cycle. However, off-target effects of NS1 protein due to the presence of (ACCA)₂₋₃ repeats along cellular DNA cannot be excluded.

Paragraph 3. Involvement in viral cytotoxicity

The replicative and transcriptional functions of NS1 observed quite early during the viral life cycle shift to cytotoxicity in later steps. In the early 1990's emerged the idea that parvoviral-induced cytotoxicity results from the products of NS gene (24, 31), and more particularly NS1. A cell type-dependent NS1 threshold apparently needs to be reached for the protein to reveal its lethal effect. In addition, like almost every parvoviral property, NS1-induced toxicity widely relies on cell transformation, which is consistent with NS1 being in all likelihood the effector of oncolysis. Thus, a certain NS1 threshold can be toxic for transformed cells while remaining of no particular effect in their immortalized, normal counterparts (168). Similarly to what was said about oncolysis, NS1 is likely to become a cytotoxic product only in response to oncogene-responsive cellular pathways. NS1 protein does not induce a unique type of cell death and has been associated with several mechanisms, suggesting that its cytotoxicity benefits from factors that are made available upon transformation depending on the cell type.

○ Necrosis

During H-1PV infection, transformed cell lines of rat fibroblasts or human keratinocytes show markers of both necrotic and apoptotic cell death, with

membrane disruption for the former, and cleavage of caspase 3 and PolyADP Ribose Polymerase (PARP) for the latter. Knowing that apoptosis requires high levels of intracellular energy (138), the decrease of NAD that reflects an important consumption of ATP in infected cells tends to suggest that H-1PV more likely target necrotic than apoptotic cell death in these cells (138, 204). This is all the more consistent given the fact that PARP was thereafter reported as functioning as a molecular switch between apoptosis and necrosis (150). Thus, PARP activation (i.e cleavage) can as well be considered as a marker of necrosis. Nonetheless it has not been clearly determined whether cell switch from apoptosis to necrosis during parvovirus-induced cell death.

It should be stated that parvovirus-induced cell death is often reported

○ Cytoskeleton-related cell death

Parvovirus-induced cell death has soon been associated with major alterations of cell morphology in fibroblasts, leading particularly to some sort of collapse of their cytoplasm and cell detachment from their support. These phenotypic manifestations result from the specific damaging of some cytoskeleton components, including actin, vimentin and tropomyosin filaments whereas microtubules are preserved (181, 182).

Actin filaments degradation and polymerization are among others controlled respectively by gelsolin and WASP (Wiscott-Aldrich Syndrome Protein). Upon parvoviral infection, WASP expression diminishes while gelsolin expression tends to increase, which creates an imbalance favoring actin filament degradation (181). In this case, cytoskeleton alterations have been related to parvoviral infection in general but NS1 role has been more particularly highlighted regarding the fate of tropomyosin filaments. A9 murine cells express two types of tropomyosins, tropomyosins 2 and 5 (TM2 and TM5), the former being usually phosphorylated by casein kinase II a (CKIIa). But in MVM-infected A9 cells, NS1 Ser473 and Thr363 get phosphorylated by PKC λ , which enables the protein to recruit both CKIIa and TM5. Being brought closer to CKIIa than it usually does, TM5 gets phosphorylated by the kinase while it is not supposed to. This abnormal targeting of TM5 to CKIIa with NS1 as an interaction partner impairs tropomyosin filament organization, which ultimately leads to their degradation and trigger cell death (183).

○ Apoptosis

For a long time investigations about MVM-induced cell death did not provide any evidence of the virus being able to trigger apoptosis. However, MVM infection as well as ectopic NS1 expression has been very recently associated in transformed fibroblasts with mitochondrial membrane permeabilization and activation of caspases 3 and 9, which are basic markers of apoptotic cell death (162).

By contrast, apoptosis induction was reported in 1998 already in H-1PV-infected cells, with the observation of apoptotic markers like apoptotic bodies and DNA fragmentation in rat glioblastoma cells, both events being attenuated by a caspase 3 inhibitor (187). Likewise, U937 cells (human lymphoma) also exhibit signs of apoptosis when they undergo parvoviral infection with the development of apoptotic bodies and the caspase cleavage of PARP (PolyADP Ribose Polymerase). Since the wild type virus and a recombinant variant devoid of capsid proteins are both able to trigger these events, it has been concluded that apoptosis induction resulted from NS expression in these cells. Human hepatoma cells also show apoptotic markers upon H-1PV infection, with apoptotic bodies as well and phosphatidylserine externalization in a manner that apparently depends on promyelocytic leukemia protein (PML) (163, 227). More recently, studies performed on human transformed epithelial cells (293 cells) confirmed that H-1PV infection as well as NS1 ectopic expression causes them to accumulate in G2 phase before triggering caspase-dependent apoptosis with the activation of caspases 3 and 9. This was associated with increased levels of reactive oxygen species (ROS) and DNA double-strand breaks. ROS were suggested as major mediators of H-1PV-induced cell death since antioxidant treatments reduce DNA damages, cell cycle arrest and apoptosis induction (113). Nonetheless the suppression of caspase activity by a pharmacological pan caspase inhibitor does not completely abrogate H-1PV- or NS1-induced cell death and apoptotic cells represent less than 50% of the dying cells, the other being characterized by membrane disruption, suggesting necrosis. Likewise, the study of Moehler and coworkers on human hepatoma cells reported a significant proportion of necrotic cells along with those undergoing apoptosis upon parvoviral infection (163).

○ Cell cycle arrest

Besides genuine cytotoxicity, NS1 protein has been also associated with cytostatic effects. Indeed, parvoviral infection of transformed fibroblasts, either human or murine, was shown to interfere with cell cycle progression, with an accumulation of cells freezing in S and G2 phases (188, 189). Ectopic expression of NS1 leads to the same observations although the mechanisms appear to be slightly different. In infected cells, cell cycle arrest in S phase is associated with active p53 accumulating in the nucleus while cell cycle arrest in G2 phase correlates with p53-dependent expression of p21^{cip1} which inhibits cyclin A/cdk1 and cyclin E/cdk2 complexes. When NS1 is ectopically expressed, the latter event only was observed (190). Accumulation of p53 is known to induce cell cycle arrest in response to DNA damage (159). In addition to introducing nicking in viral replication duplexes, NS1 was also shown to exert its endonuclease activity in cellular chromatin. Thus, in the context of infected cells a lot of DNA lesions would be sensed, leading to p53 activation and ultimately cell cycle arrest (190). Like NS1 cytotoxicity, the cytostatic effects of the protein are enhanced upon cell transformation. Besides, cells resistant to NS1 toxicity do not show any alteration of their cell cycle progression, suggesting that cytostatic effects could be the early manifestation of NS1-mediated full cell killing (188).

Chapter 2. Different levels of NS1 regulation.

NS1 protein encompasses multiple functions exerted at different steps of the viral life cycle and in different cell compartments, meaning that NS1 requires tight regulation to achieve the appropriate chain of events. Regulating NS1 includes several strategies such as interacting with ions (Ca²⁺, Mg²⁺) (143, 151), ATP or cellular partners (40, 89, 115, 203), self-assembling as discussed above (Chapter 1, Paragraph 2 of this part) as well as posttranslational modifications (185).

Residue	S283	T363	T394	T403	K405	T435	T463	S473	T585	S588	
Function	[4]	[4, 6]	[4]	[4]	[1, 2]	[4]	[4]	[3, 4]	[5]	[5]	
Nuclear transloc.					K405 H-1						
DNA binding											
ATP											
Endonuclease					K405 H-1						
Helicase								S473			
Replication		T363	T394	T403	K405 H-1	MVM	T435	S473			
P38 transac.	S283(Δ)	T363	T394(Δ)	T403	K405 H-1	MVM					
Cytotoxicity	S283(-)	T363			K405 H-1		T435	T463	S473	T585(+)	S588(-)
<i>In vivo</i> phospho.		T363		T403			T435		S473	T585	S588

Table 3.
Functional involvement of some NS1 amino acid residues in the functions of the protein.

The residues are identified using the monoletter code and location in MVM NS1 sequence, followed by the references given as numbers in square brackets. NS1 main activities or steps of the viral life cycle concerned are indicated on the left row and associated with colours.

Reading the table horizontally gives all the residues proved to be linked to a single activity of NS1.

Reading the table vertically using the colours gives all the activities or functions a single residue is involved in.

K405 involvement in the viral life cycle and/or NS1 activities can be different depending on the virus. For the other residues, literature refers to MVM NS1 protein and H-1PV NS1 is suggested to display the same characteristics.

(-) : the residue is involved in a negative regulation

(+) : the residue is involved in a positive regulation

(Δ) : the residue is involved in the function but to a moderate extent

Nuclear transloc.: nuclear translocation ; P38 transac: P38 transactivation ; *In vivo* phospho.: *in vivo* phosphorylation.

Sources:

1. Li, X. and S.L. Rhode, 3rd. Mutation of lysine 405 to serine abolishes its functions for viral DNA replication, late trans activation, and cytotoxicity. *J Virol*, 1990. 64(10): 4654-60.
2. Nüesch, J. P., Cotmore, S. F., and P. Tattersall. Expression of functional parvoviral NS1 from recombinant vaccinia virus: effects of mutations in the nucleotide-binding motif. *Virology*, 1992. 191(1): 406-16.
3. Dettwiller, S., J. Rommelaere, and J.P. Nüesch. DNA unwinding functions of minute virus of mice NS1 protein are modulated specifically by the lambda isoform of protein kinase C. *J Virol*, 1999. 73(9): 7410-20.
4. Corbau, R., V. Duverger, J. Rommelaere, and J.P. Nüesch. Regulation of MVM NS1 by protein kinase C : impact of mutagenesis at consensus phosphorylation sites on replicative functions and cytopathic effects. *Virology*, 2000. 278(1): 151-167.
5. Daeffler, L., R. Horlein, J. Rommelaere, and J. P. Nüesch. Modulation of minute virus of mice cytotoxic activities through site-directed mutagenesis within the NS coding region. *J Virol*, 2003. 77(23): 12466-78.
6. Nüesch, J. P., and J. Rommelaere. A viral adaptor protein modulating casein kinase II activity induces cytopathic effects in permissive cells. *PNAS*, 2007. 104(30): 12484-7.

Paragraph 1. Posttranslational level of NS1 regulation

Posttranslational modifications constitute an extensive way to modulate protein activities. Because there is a relation between the structure and function of a protein, the local conformational changes induced by such modifications are associated with the gain or loss of one or several functions. Phosphorylation “runs” the world of posttranslational modifications being probably the most investigated among them. In 1986, Susan Cotmore and Peter Tattersall provide evidences that NS1 is part of the countless proteins known to undergo phosphorylation, showing that at least two forms of NS1 protein are found in the cell, one of them being phosphorylated while the other is not or few (64).

Ever since then, NS1 phosphorylation has been extensively investigated, mostly by Jürg Nüesch whose work has provided a major contribution in the understanding of NS1 regulation. The involvement of phosphorylation in NS1 functions was first demonstrated *in vitro* by the loss of the helicase activity along with a decrease of ATPase and nickase activities when NS1 undergoes dephosphorylation. In addition, incubating dephosphorylated NS1 with kinases from cell extracts makes the protein functional for viral replication again. More particularly, the helicase activity is restored in presence of protein kinase C (PKC) together with cofactors required for the activity of cellular kinases such as calcium or phosphatidylserine (178, 180). These data clearly pointed to the fact that NS1 is a kinase substrate and likely to regulate its multiple functions this way, at least in part. Comprehensive analyses of NS1 sequence by directed mutagenesis enabled the identification of seven amino acids located in regions matching the consensus for PKC-mediated phosphorylation and involved in NS1 activities, with three of these residues being actually targeted by PKC *in vitro* (50). Helicase and nickase activities were thereafter more particularly associated with PKC λ -mediated phosphorylation of NS1 (50, 76, 177, 186) while PKC η is responsible for the protein getting fully functional for viral DNA amplification (131). Just as the early functions of the protein, NS1 late functions, namely cytotoxicity, are controlled by PKC-mediated phosphorylation of mostly Ser and Thr residues (50, 69, 183).

Table 3 shows NS1 amino acid residues proved to be tightly related to one or several functions of the protein. Most of them require phosphorylation to do so.

Paragraph 2. Spatial level of NS1 regulation

NS1 protein participates in events needing nuclear localization (i.e replication and transcription) while cytotoxicity is more likely associated with NS1 interacting with cytoplasmic partners. After its synthesis in the cytosol, NS1 is extensively translocated to the nucleus (64). Amino acid substitution in a triple lysine motif around residue 200 was reported to abrogate NS1 nuclear transport while substitution of a double lysine right upstream severely impairs it as well, suggesting that NS1 NLS is bipartite. In addition, wild type and a C-terminally-deleted NS1 (i.e devoid of transactivation domain) are able to carry to the nucleus an NS1 protein with impaired NLS in an ATP-dependent manner, indicating that NS1 is likely to self-associate prior to nuclear translocation (184).

Paragraph 3. Temporal level of NS1 regulation

NS1 phosphorylation pattern evolves throughout parvoviral infection of synchronized murine cells (51). The variations correlate with the fact that NS1 residues are differentially phosphorylated so that the protein exerts precise functions at precise steps (i.e precise moments) of the viral life cycle (**see Table 3**). For example, viral DNA amplification and P38 transactivation require the phosphorylation of Thr363, 394 and 403, implying that the modification has to occur early. By contrast, Thr463, which is related to NS1 cytotoxicity, is phosphorylated later during the infection (50). Altogether these observations pointed to the elegant hypothesis that the differential phosphorylation of NS1 would allow the protein to switch from its early to its late functions when required during the viral life cycle, meanwhile implying that NS1 is probably a substrate of kinases and phosphatases whose availability also fluctuates, perhaps in response to the progression of the cell cycle.

BOOK IV.

THE NARROW ESCAPE STORY

This Book does not intend to exhaustively discuss every single strategy viruses evolved to escape the mechanisms mobilized by host cells to eradicate them. During my thesis, I demonstrated that H-1PV induces apoptosis in non transformed cells and that NS1 protein is cleaved by caspases in such cells. I will more particularly focus on apoptosis as a primary host cell defense and obstacle to the achievement of viral life cycles and also put the stress on viral strategies to evade such threat.

This also gives me the opportunity to present the review written to highlight the increasing number of viral proteins described as caspase substrates and also discuss the relevance of such cleavages.

Part I. Apoptosis, the first molecular barrier raised to eradicate viruses.

Although it is counterintuitive to relate death at a cellular level to preservation at the scale of organism, the elimination of infected cells through cell death is supposed to also correlate with the elimination of the intruder. By destroying infected tissues, cell death is likely to compromise the replication niche of the infectious agent, thereby hampering further spread (129). The sacrifice of infected cells by Programmed Cell Death (PCD) is actually known as one of the most ancestral defense mechanisms exerted by multicellular organisms against infection and also to trigger both innate and adaptative immune responses (100).

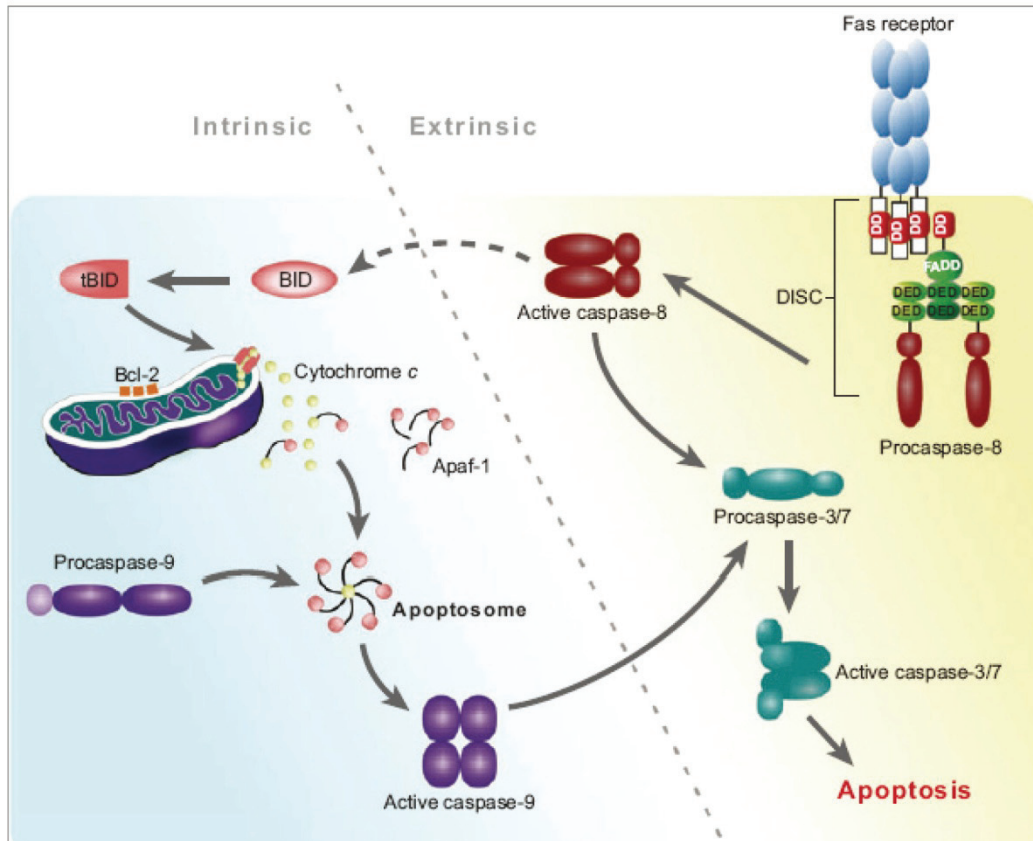

Figure 15. Caspase activation through the extrinsic and intrinsic pathways.

The extrinsic pathway of apoptosis induction is initiated with ligand binding to death receptors such as Fas, resulting in the recruitment of the adaptor protein FADD and procaspase 8 to a complex referred to as DISC (Death-induced signaling complex). Following its activation, initiator caspase 8 activates effector caspases 3 and 7.

Initiation of apoptosis through the intrinsic pathway depends on cleavage and translocation to the mitochondria of proapoptotic proteins of Bcl2 family such as Bid. This results in the release of cytochrome c which bind to Apaf1 to form the apoptosome which is responsible for caspase 9 and subsequent caspases 3 and 7 activation.

Apaf1 : apoptosis protease-activating 1 ; DD : death domain ; DED : death effector domain ; FADD : Fas-associated death domain ; tBid : truncated BID protein.

Source: Best SM. *Annu Rev Microbiol.* 2008;62:171-92. Review.

Apoptosis is probably the most famous mode of PCD and is characterized by a set of morphological and biochemical changes in dying cells, including rounding-up, retraction of pseudopods, reduction of cellular volume, chromatin condensation, nuclear fragmentation and little-to-absent ultrastructural modifications of organelles. Unlike necrotic cell death, cell integrity is usually maintained until the final stages of the process. Although this is not a strict requirement, apoptosis induction is usually associated with the activation of cysteine-dependent aspartate-specific proteases or caspases which are therefore considered as key effectors of apoptotic pathway. Caspases are synthesized as inactive zymogens and require the proteolytic cleavage of their prodomain to become fully functional. Caspases known as initiator ones are activated first and subsequently cleave the prodomain of caspases referred to as effector ones and endowed with the ability to target many cellular proteins, ultimately leading to cell death. Apoptosis can be triggered by either the extrinsic or intrinsic pathways which involves death receptor and mitochondria respectively and are both likely to result in caspase activation (**Figure 15**).

Part 2. Apoptosis, the first molecular barrier viruses have learnt to handle.

Viruses are likely to hijack every single component of the host cell machinery as long as it facilitates viral amplification and spread. They are also known to have developed countless strategies to overcome cellular mechanisms induced during infection and meant to eradicate them. Given the central role of apoptosis in the fighting between host cells and viruses, this process is one they have particularly learnt to deal with. Intuitively, viruses are expected to fight and inhibit apoptosis. Incidentally, most of them do although some viruses are surprisingly able to enhance apoptotic cell death (119). In both cases, viruses prove able to manipulate the apoptotic pathways. Considering the major role played by caspases for the achievement of apoptotic cell death, they are privileged viral targets for inhibition and each level of their regulation is likely to be modulated by viruses. Thus, virus-induced downregulation of death receptor expression has been reported as well as secretion of viral TNF receptor homologs, both of them preventing the

initiation of apoptosis by the extrinsic pathway. But virus-induced caspase inhibition usually occurs way downstream and affects caspases more directly by antagonizing their function (17).

Nonetheless interactions of viruses with caspases are actually not reduced to different ways of inhibiting them. By demonstrating that H-1PV protein is a caspase substrate in non transformed cells, we realized that many viral proteins were also reported as such, quite recently for most of them and without inevitably leading to caspase activity suppression. Such proteolytic processing of viral proteins appears to us as another strategy to adapt to apoptosis induction. Our review aims at updating these cleavages and discussing their biological relevance.

Review. Caspase cleavage of viral proteins, another way for viruses to make the best of apoptosis.

Manuscript in production (accepted in *Cell Death and Disease*)

AIMS OF THE WORK

SHOOTING AN ARROW INTO THE AIR AND, WHERE IT LANDS, PAINTING A TARGET

That is how Homer Adkins, an American organic chemist, colorfully gave its definition of basic research. As pejorative as it can seem *a priori*, it is actually an excellent way to go back to basics, precisely. You do not choose to cure a disease and then search ways to do so. People – researchers to be more specific – do their work: they dig, deeper and deeper, and eventually they find. And based on their discoveries can medical applications or commercial benefits begin to develop, not the other way around.

The possibility of using H-1PV as an anticancer is currently extensively investigated, with Phase I/IIa clinical trials soon to come. Nonetheless, a lot of H-1PV fundamental aspects remain to be deciphered.

Focusing on H-1PV key protein, my whole work was meant to better understand some of the mechanisms underlying NS1 regulation, with specific interest in transcriptional and posttranslational levels. Although several transcriptional analyses have already been performed on P4 promoter, little is known about the actual involvement of some P4 transcriptional elements in the context of the whole viral genome. Moreover, some of these transcriptional motifs overlap binding sites that recognize proteins involved in viral replication, including Y-box which is part of an NS1 binding site. In a first study presented as a short-form article, we will expose our conclusions regarding the involvement of Y1 and Y2 copies of Y-box in P4 promoter activity and in the achievement of the viral life cycle. On the other hand, H-1PV has been reported to induce apoptosis in some cell lines. Given that this mechanism is associated with the activation of caspases which are likely to target viral proteins, we focused on apoptosis induction during H-1PV infection and the biochemical and functional consequences of caspase activity on NS1 protein.

RESULTS & DISCUSSION

ARTICLE I. Different involvement of in the viral life cycle of the Y-boxes within H-1 parvovirus P4 promoter, *and related Discussion.*

ARTICLE II. Caspase cleavage of H-1 parvovirus NS1 protein generates fragments with dominant negative functions in non transformed cells, *and related Discussion.*

Article I. Different involvement in the viral life cycle of the Y-boxes within H-1 parvovirus P4 promoter.

The achievement of H-1PV life cycle is tightly related to the early activation of P4 promoter which drives the expression of the key NS1 protein. P4 sequence partly overlaps cognate motifs binding factors involved in viral replication such as PIF or NS1 itself. These motifs, a cAMP-responsive element (Cre) and a Y-box (or CCAAT-box) to be specific, are located in the terminal palindromic sequence of the left-hand hairpin. The hairpin unfolds during replication and creates an extended duplex form where the Cre and Y-box are duplicated, each copy being segregated in the outboard (with Crea' and Y1) and inboard arms (with Crea and Y2). These outboard and inboard arms are functionally associated with replication and transcription respectively.

PIF binding element is made of two half sites separated one from each other by five nucleotides. Cre in P4 promoter is made of one of PIF half site and three of the five spacing nucleotides, resulting in a sequence diverting from the consensus. Burnett and coworkers demonstrated that efficient viral replication and transcription relies on the tight organization of the overlapping between PIF site and Cre. Modifying PIF site, which is implicated in viral replication, is likely to also influence Cre-driven transcription and vice versa.

On the other hand, Y-box sequence is included in an NS1 binding element. P4 Y-box was shown to be recognized in vitro by the main CCAAT-binding factor NF-Y and involved in P4-driven gene expression. However, Y-box, and particularly respective roles of Y1 and Y2 copies, was never investigated in the viral context to our knowledge.

The aim of this work was then to focus on P4 Y-box and determine the relevance of each copy created when the left hairpin extends. To answer this question, we chose to perform standard transactivation assays together with an approach based on the study of H-1PV molecular clones modified to exhibit a single mutated Y-box or both in their extended forms.

Different involvement in the viral life cycle of the Y-boxes within H-1 parvovirus P4 promoter

Audrey Richard⁺¹, Agnès Bègue¹, Ingrid Loison¹, Pierre Wizla², Perrine Caillet-Fauquet¹, Jean Rommelaere³, David Tulasne¹, Dominique Stéhelin².

⁺Corresponding author audrey.richard@ibl.fr

¹Institut de Biologie de Lille ; UMR 8161, CNRS, Institut Pasteur de Lille, Université Lille-Nord de France ; 1, rue du Professeur Calmette ; 59021 Lille Cedex ; France

²Institut de Biologie de Lille ; UMR 8199, CNRS, Institut Pasteur de Lille, Université Lille 2 ; 1, rue du Professeur Calmette ; 59021 Lille Cedex ; FRANCE

³Deutsches Krebsforschungszentrum ; Research Program Infection and Cancer ; Tumor Virology ; Im Neuenheimer Feld 242, D-69120 Heidelberg, GERMANY.

ABSTRACT

NS1 protein is a crucial H-1 parvovirus (H-1 PV) protein involved in several steps of the viral cycle. Its expression is controlled by the early activated promoter P4 that contains two symmetrical Y-boxes resulting from the extension of the palindromic hairpin of the viral genome. Here we show that these identical, but inverted, binding elements for NF-Y transcription factor are not functionally equivalent, the P4 promoter-activating capacity of proximal Y2-box being greater. However, H-1 PV gene expression and infectivity require at least one of them since their simultaneous disruption leads to a complete abortion of NS1 synthesis and viral production.

H-1 parvovirus (H-1 PV) is a small rodent virus whose genome is a 5 kb single-stranded DNA organized in two overlapping transcriptional units controlled by early P4 and late P38 promoters (57, 65, 134, 210). The first one depends on cellular factors for its activation and drives the expression of both non structural proteins, NS1 and NS2 (3, 87, 199, 230), while the second one, mainly activated by NS1 itself, allows capsid proteins VP1 and VP2 to be generated (209). Apart from P38 transactivation, NS1 protein is known to be involved in viral DNA replication (41, 54, 141, 179, 208), P4 promoter upregulation (111) and H-1 PV cytotoxicity (24, 31). H-1 PV was extensively shown to preferentially replicate in proliferating transformed cells in a lytic way, while sparing normal cells (36, 53, 88, 167, 221), implying that P4 promoter is rather activated in transformed cells (192, 216). Minute Virus of Mice (MVM) parvovirus (LOCUS NC_001510), which is very closely related to H-1 PV (LOCUS NC_001358) since they share almost 90% sequence homology, has already been more extensively investigated in this regard. Besides the classical binding elements required for the achievement of eukaryotic transcription (i.e GC- and TATA-boxes) (3), a proximal E2F binding site was proven to greatly participate in MVM P4 activation (72). Moreover, members of both Ets and ATF/CREB transcription factor families, as well as *Nuclear Factor Y* (NF-Y) also contribute to MVM P4 promoter activity, presumably in a transformation-dependent manner and through EBS, Cre and Y-box elements respectively (71, 93, 106, 196). Although H-1 PV P4-controlled NS1 expression represents a crucial step for the viral life cycle to occur, little is known about the involvement of each putative transcription factor binding site. Being single-stranded, H-1 PV DNA ends with palindromic sequences that allow the formation of a hairpin that is required for the initiation of replication. When H-1 PV DNA is extended, namely during the rolling-hairpin replication process, the putative binding elements within this structure are duplicated (i.e Cre site and Y-box) and

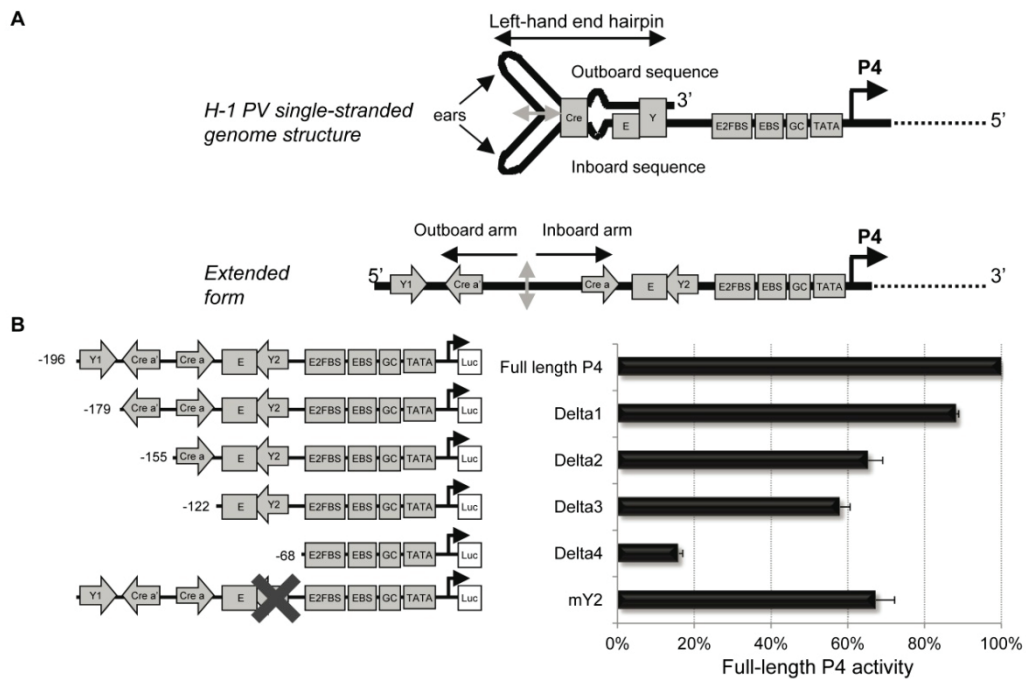

Figure 1: Involvement of Y2-box in H-1 parvovirus P4 promoter activity

(A) Representation of the terminal palindromic sequence of H-1 PV (adapted from (7)). It organizes into a double-stranded stem DNA ended with two hairpins, also known as the "ears", and lies right upstream from the proximal elements of P4 promoter, namely the E2F binding site (E2FBS), the Ets binding site (EBS), the GC and TATA boxes mapped within P4 promoter. It contains a Cre (cAMP responsive element) site as well as a Y-box that are both duplicated in the extended form, and an E-box within the inboard strand only. The arrows are oriented according to the admitted consensus binding sites known for both Cre- and Y-boxes. Inboard and outboard strands are indicated in the left-hand end hairpin, as well as their corresponding arms in the extended form. The grey double arrow shows the junction between inboard and outboard arms. (B) NB324K cells were transfected with plasmids encoding the *Firefly Luciferase* reporter gene whose expression is controlled by wild-type P4 promoter or some deleted versions depicted on the left. 48h after transfection, cells were lysed and luciferase activities were measured. Results from 3 independent experiments performed in triplicates are shown. Normalized luciferase activities are given as percentages of the expression driven by full-length P4 promoter and standard deviations are shown.

found inverted one relative to the other within the inboard and the outboard arms that are asymmetric and suggested to display distinct functions (**Fig. 1A**) (adapted from (30)).

To investigate H-1 PV early gene expression, full-length P4 promoter sequence was amplified by PCR using the molecular reference clone (pSR19) (85) and cloned into the pGL3 Basic plasmid, upstream from the *Firefly luciferase* gene (P4 plasmid). Deletions corresponding to the different putative transcription factor binding elements within P4, according to the homology with MVM, were also performed (Delta1 to Delta4 plasmids). Human SV40-transformed fibroblasts (NB324K) were cotransfected using the ExGen500 reagent according to the manufacturer's instructions with each of these vectors (1000 ng) as well as a *Renilla luciferase*-encoding plasmid (pRL null ; 100 ng) to normalize the measures. After 48 hours, cells were lysed and both luciferase activities were revealed in three experiments performed in triplicate using the Dual-Luciferase Reporter Assay System (Promega). Whereas Y1-box (Delta1), Cre a'(Delta2) and Cre a (Delta3) deletion each leads to a 10 to 20% decrease in P4 activity, the suppression of the overlapping E and Y2-boxes is responsible for a 40% drop in *luciferase* expression. Using the QuickChange® Site-directed Mutagenesis Kit (Stratagene), we mutated Y2-box (mY2) with a point mutation known to prevent the binding of transcription factors (106), and observed that this site is indeed responsible for the third of P4-driven gene expression (**Fig. 1B**). This global approach emphasized the importance of Y-boxes in P4 full capacity in NB324K cells, with a particular highlight on Y2-box that exhibits a greater P4-promoter activating capacity than the Y1 copy.

CCAAT- or Y-boxes are transcriptional regulatory elements that are widely represented within eukaryotic promoters (25 % of them) and mainly recognized by the ubiquitous, cell cycle-related, NF-Y transcription factor that is constituted by three subunits (A, B and C), all required for DNA binding (28, 32, 79, 229). To test NF-Y role in P4-controlled

A**B**

Figure 2: Modulation of H-1 parvovirus P4 promoter activity by a dominant negative analog of NF-YA in NB324K cells

(A) NB324K cells were cotransfected with a plasmid expressing P4-driven *Firefly Luciferase* (Luc) reporter gene and increasing amounts of a plasmid expressing a dominant negative analog of NF-YA (NF-YA DN). 48h after transfection, cells were lysed and luciferase activities were measured. Results from 3 independent experiments performed in triplicates are shown. Normalized luciferase activities are given as percentages of the expression driven by full-length P4 promoter alone and standard deviations are shown. (B) NBK cells were cotransfected with a plasmid encoding the *Firefly Luciferase* reporter gene whose expression is controlled by wild-type P4 promoter or some deleted versions depicted on the left, and a plasmid expressing a dominant negative analog of NF-YA (NF-YA DN) (36) or the empty vector. 48h after transfection, cells were lysed and luciferase activities were measured. Results from 3 independent experiments performed in triplicates are shown. Normalized luciferase activities are given as percentages of the expression driven by full-length P4 promoter alone and standard deviations are shown.

gene expression, we performed transactivation assays using NB324K cells that were cotransfected with the P4 plasmid (1000 ng), increasing amounts of a vector expressing a dominant negative analog of NF-YA (NF-YA DN ; 0-5-10-20-40-100 ng ; kindly provided by R. Mantovani) (154), the pRL null plasmid (100 ng) and empty vector when needed. NF-YA DN still binds to B and C subunits but no longer to DNA. The experiments were performed 3 times in triplicate. As shown in **Fig. 2A**, NF-YA DN expression reduces P4 activity up to 65% in a dose-dependent manner, strongly arguing for a major involvement of NF-Y in P4 regulation. Using the deleted versions of P4 promoter, we confirmed NF-YA-mediated inhibition of *luciferase* expression when compared to control conditions (empty vector), as long as E and Y2 were preserved. However, the effect of the dominant negative was lost when used with the Delta4 vector (**Fig. 2B**), suggesting that P4 activation is triggered by NF-Y-mediated gene regulation through the Y2-box. Our results are consistent with a previous work showing NF-Y ability to directly bind to MVM Y-box in spite of its unconventional sequence, the T nucleotide in the consensus sequence being substituted with a C (106), as it is within H-1 PV DNA. H-1 PV being known to depend on S-phase factors such as E2F and cyclin A (13, 14, 72), the selection of elements which bind a cell cycle-, and more particularly a S-phase-related factor such as NF-Y (15), could be a viral adaptation to meet this primary requirement.

The respective involvement of Y-boxes in the viral life cycle was further investigated with H-1 PV molecular clones carrying mutated Y-boxes that we generated using the reference wild-type (WT) molecular clone pSR19 as a template. Y1- or Y2-box was impaired by a mutation known to abolish NF-Y binding (CCAAC substituted with CACAC in mY1 mutant and GTTGG with GTGTG in mY2 respectively) (106) and a variant carrying both mutations was also created (mY1Y2). The single-stranded genomes of newly generated virions are depicted in **Fig. 3A**. These clones were transfected in NB324K cells and infectious

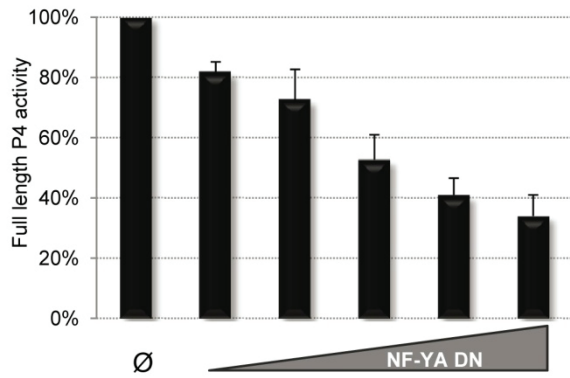
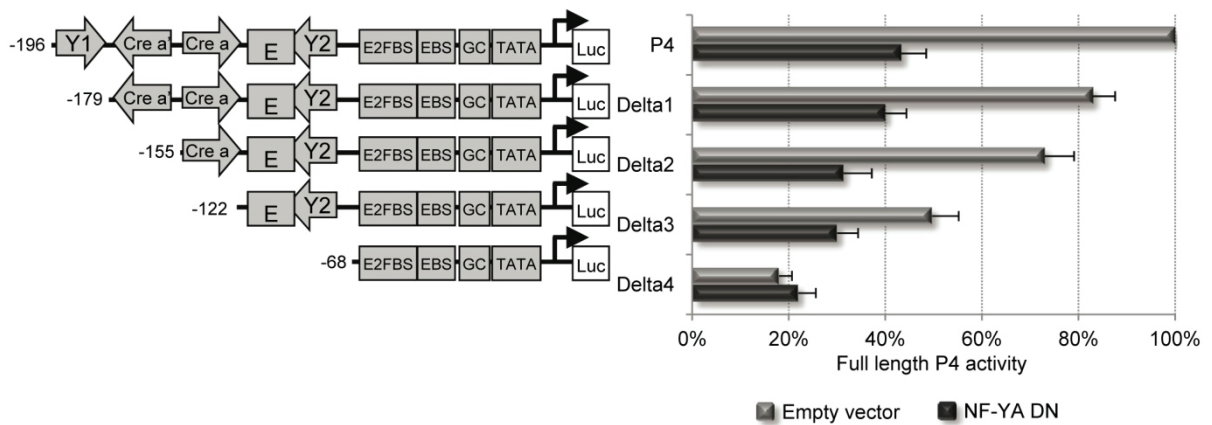
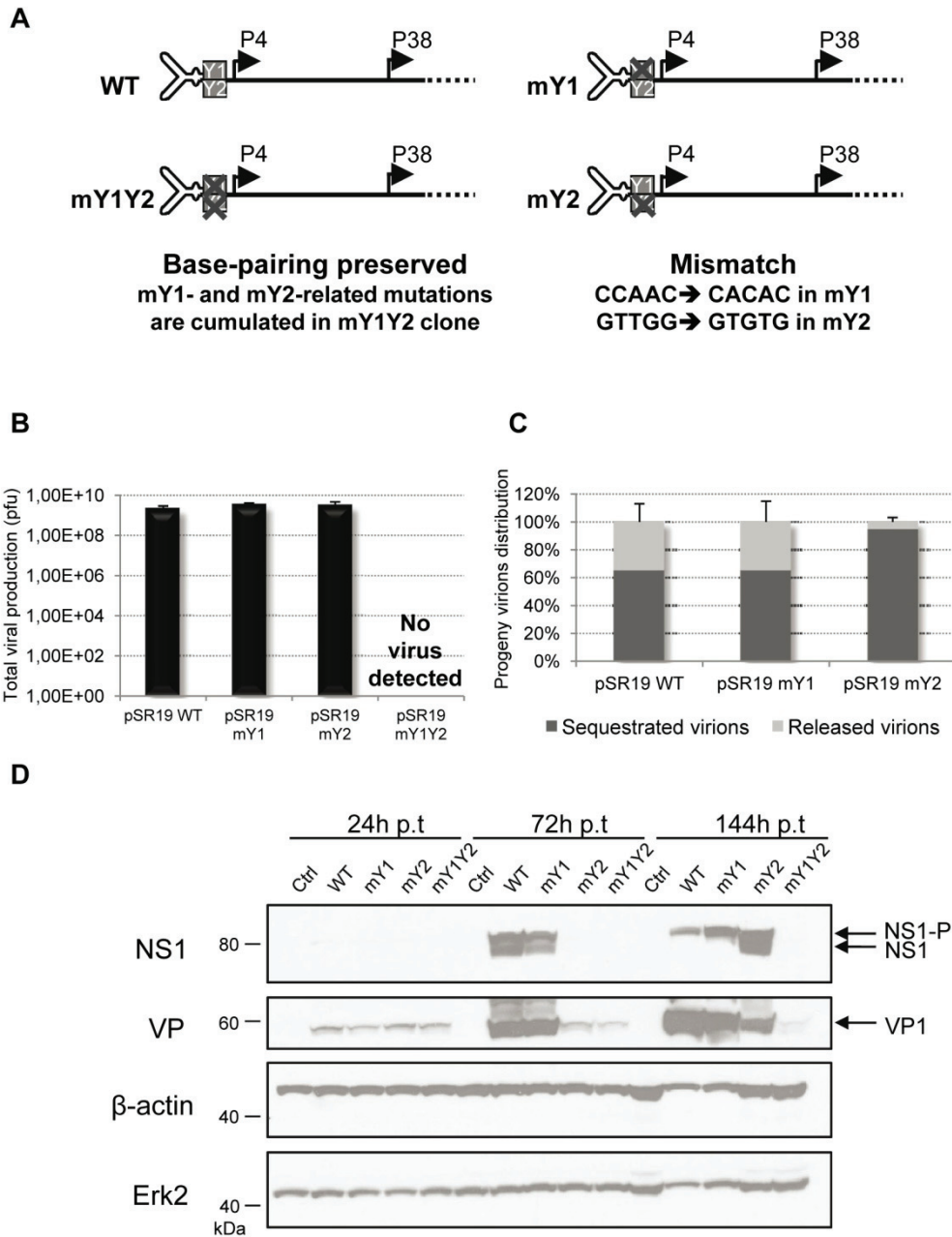

Figure 3: Effect of Y1- and/or Y2-box mutation on H-1 PV life cycle and NS1 protein expression.

(A) Description of the molecular clones. Molecular clones exhibiting a mutation in Y1-box (mY1) or Y2-box (mY2) or both (mY1Y2) were generated from the wild-type reference molecular clone pSR19 (WT). The expected genomes of the variants after progeny virions production are depicted, and the nature and structural effects of the mutations are precised as well. (B), (C) and (D) NB324K cells were transfected with wild-type or mutated H-1 PV molecular clone. (B) and (C) Six days after transfection, viral production was harvested, both in cells and supernatants. (B) The total number of infectious particles was assessed using TCID50 method and (C) its distribution between sequestered and released virions was calculated. Results from 3 independent experiments performed with two different clones for each variant are shown, as well as standard deviations. (D) NS1 and VP1 protein expression was evaluated in a time-course manner by Western blot. β-actin and Erk2 were also probed as a loading control. *p.t post transfection*

viral production (both intracellular and released into the culture supernatant) was harvested from three different experiments performed with two distinct clones for each construction, and evaluated using the TCID₅₀ method according to the Reed-Muench calculation. After six days, WT, mY1 and mY2 clones exhibited comparable total amounts of viral particles (**Fig. 3B**). Previous work performed on P4 promoter distal region indicate that Y-boxes overlap NS1 binding sites that are involved in the replicative functions of the protein (54, 56). In this regard, Y-boxes impairment might alter NS1 binding but, as WT, mY1 and mY2 clones are all able to generate virions, it suggests that H-1 PV replication, including NS1 binding to viral DNA, are not affected. Unexpectedly considering mY1-associated phenotype, we were not able to detect any significant viral production using the mY1Y2 vector. This indicates that Y1-box should not be considered as being intrinsically ineffective since the simultaneous impairment of both Y-boxes completely aborts the viral production. Therefore, at least one intact Y-box is required for H-1 PV infectivity. Besides, mY1Y2 variant failing to perform the viral cycle is clearly due to a DNA sequence alteration since the structure of its left-hand hairpin is comparable to that of the WT virus, unlike the single-mutated variants which harbor a mismatch in their hairpin (see **Fig. 3A**). However, in spite of equal total production, WT and mY1 vectors generated virions that are similarly released into the culture medium (about 40% of the total), while mY2 variants were dramatically retained into the cells (more than 90% of the total) (**Fig. 3C**). Then, even though it does not prevent the variant from producing progeny virions, Y2-box mutation within the viral genome greatly delays their release.

To decipher the actual effect of Y-box disruption in the context of the whole genome, we evaluated NS1 protein status over time by Western blot as previously described (169, 255). As shown in Fig. 3D, the WT and mY1 molecular clones exhibited a similar ability to produce NS1 at all time points tested. On the other hand, mY2 and mY1Y2 clones failed to sustain detectable NS1 expression up to 72h post-transfection. This defect persisted at later

time points after mY1Y2 clone transfection (144h), correlating with its inability to generate virions. In contrast, NS1 protein started to accumulate at late times in cells transfected with the mY2 molecular clone. As expected, VP1 protein, whose expression is controlled by the NS1-driven promoter P38, exhibited the same pattern as NS1. The time lag of NS1 production observed with this variant, but not the mY1 mutant, is likely to account for the delayed release of progeny virions. The biological relevance of Y2-box in P4-driven gene expression is consistent with its location within the inboard arm that is thought to be more particularly involved in early transcription. But Y1-box contribution to P4 promoter activity suggests that the outboard arm is not exclusively dedicated to replication (see Fig 1A). Even though its total viral production is unaffected, mY2 clone dramatically delays progeny virions release and NS1 expression. P4-driven gene expression is not strictly speaking weakened by Y2-box disruption but rather postponed. Interestingly, using inducible cellular clones expressing NS proteins, Caillet-Fauquet et al. demonstrated that non structural proteins are responsible for the viral cytotoxicity but also strongly suggested that a threshold needs to be reached to induce cell death, which is associated with viral release (31). Therefore, the impairment of Y2-box, by altering NS1 expression pattern, would delay cell death and then the achievement of the viral cycle's final step. P4 promoter would be activated by several transcriptional regulatory elements, including NF-Y-binding elements, allowing NS1 to progressively reach the appropriate levels, with the cytotoxic threshold achieved late for sparing cells from premature NS1-induced cell death.

In conclusion, H-1 PV P4 promoter-activating capacity of Y2-box appears to be greater than that of its symmetrical Y1 copy, whose contribution in P4-driven gene expression stays hidden unless it is mutated in a Y2-defective molecular clone which then completely aborts NS1 expression. This highlights that NF-Y-mediated regulation of H-1 PV gene expression depends on the existence of a functional dialog between these Y-boxes.

This work was supported by the French institutions CNRS, Institut Pasteur de Lille and INSERM, and by grants from “Conseil Régional Nord-Pas de Calais” and “Ligue contre le Cancer, comité Nord”.

AR was supported by a fellowship from “Association pour la Recherche sur le Cancer”.

We are very grateful to Pr. Peter Tattersall for the helpful comments he shared with us about this work.

Discussion about Article I.

This manuscript was already submitted to The Journal of Virology as a short-form article and unfortunately recently rejected. As the reviewer comments highlight several common issues, I am gonna discuss them in this part and try to suggest solutions to improve the significance of this work.

About results related to standard P4 promoter analysis by transactivation assays

This part of the work was considered logical and well executed, resulting in a convincing demonstration that at least one copy of the Y-box within the extended form of P4 promoter is required for P4-driven gene expression and that the inboard copy (i.e Y2-box) plays a more determinant role.

However, the effects of Y2-box disruption compared with those mediated by P4 Delta4 mutant in transactivation assays were questioned by one of the three reviewers who considers Y2-box contribution modest (see **Fig.1**). Although Delta4-driven gene expression represents only 20% of full-length P4 transcriptional capacity under our conditions and mY2 P4 mutant retains 60% of it, I would like to stress the fact that both results are consistent one with each other. Indeed, the Delta mutants result from the deletion of entire cognate motifs within P4 promoter. Thus, Delta4 mutant not only lacks Y2-box but also Y1-box and both Cre sites. Delta3 mutant, which is devoid of Y1-box, Crea' and Crea but contains Y2-box, retains 60% of full-length P4 activity, implying that the deleted sequences account for 40% of P4 activity. Delta4 mutant leads to an additional loss of 40%, meaning that the single further deletion of Y2-box is responsible for an additional 40%-loss. On the other hand, the disruption of Y2-box by a point mutation in P4 promoter results in a decrease of 40% of P4 full activity. Both approaches thus point to the same conclusion, namely that Y2-box participates to P4-driven gene expression up to 40% in our system. Given that P4 promoter is endowed with multiple transcription factor binding sites (E2FBS, EBS, both Cre sites, both Y-boxes in addition to TATA- and GC-boxes), we considered that a 40%-contribution of a single one of them could be referred as significant and not modest. Moreover, Delta1 mutant indicates that Y1-box is responsible for about

10% of P4 activity. We also reported that only half of P4 promoter activity could be restored when NF-Y-mediated gene expression was inhibited using an NF-YA dominant negative analog, which corresponds to the addition of Y1-box and Y2-box contributions (see **Fig.2**). These elements are then very likely to be regulated by NF-Y transcription factor. Altogether, our data argue for what we consider a strong contribution of Y-box in P4-driven gene expression, particularly the Y2 copy, with direct or indirect involvement of NF-Y transcription factor.

About results related to the study of H-1PV molecular clones carrying modified Y-boxes.

Our investigation on the relevance of Y-box in H-1PV genome was continued by studying H-1PV molecular clones carrying a mutation in one Y-box copy or both. Basically the conclusions we made based on these experiments were considered too speculative and additional experimental confirmations would have been expected.

Molecular clones were transfected into NBK cells and experiments were performed up to six days after transfection, meaning that our data reflect multiple rounds of replication. The reviewers were concerned by the fact that the mutations we were interested in might have been either suppressed or repaired during the experiments. According to them, the dramatic reversal of NS1 expression profile with mY2 molecular clone particularly suggests that viruses carrying a reversion or a second site mutation had taken over the culture (see **Fig.3**). Such events would incidentally be consistent with parvoviruses having high substitution rates *in vivo*. Our data were greatly reproducible since we obtained similar results several times with several clones of each mutant, but yet we admit that we cannot be a hundred percent positive about progeny virions carrying the expected mutations at day 6. We clearly should have been more careful regarding this kind of issues and will be in near future to guarantee the validity of our assertions. Thus, viral DNA will be extracted from the different viral stocks we produced, and sequenced. Also, we intend to perform single round-replication experiments to assess the impact of Y-box mutations after a single viral life cycle. For this purpose, cells transfected with the molecular clones will be cultured in medium containing neuraminidase which was shown to prevent viral entry into cells. Then, after the first round of replication,

progeny virions will be released but unable to further spread. Reversion and/or point mutation events are also unlikely to occur under such conditions.

Y-box is included into a cognate NS1 binding site. After NS1 is expressed, NF-Y and NS1 must compete for DNA recognition. The mutations of Y1- and Y2-boxes are then suggested by the reviewers to impair NF-Y binding but NS1 binding as well. The outboard arm contains Y1-box but also the active origin of replication meaning that NS1 binds to this region. And yet, even when Y1 is mutated, NS1 expression profile and viral productivity stay unchanged. So we concluded that NS1 binding was not affected, explaining why mY1 mutant was comparable to the wild type molecular clone. We then focused on transcriptional aspects and deduced that the disruption of NF-Y-mediated gene expression accounted for the lethality of the double mutant mY1Y2. But the link we made between unchanged overall viral production and molecular NS1 binding was indirect. We should not have left aside experimental check on NS1 binding and replication events. Our conclusion about replication status was more of a hypothesis and deserved further investigation. As a first approach to address this specific issue we intend to perform kinetic quantitative PCR analysis on NBK cells transfected with the different molecular clones to quantify the amounts of viral DNA actually generated in each case. This way, we will be able to affirm whether or not our single-mutated clones are endowed with similar replicative capacities. In the case they are not, NS1 ability to bind to viral DNA carrying modified Y-boxes will be assessed.

It appears that it was a little premature to submit this work as is. But the results obtained with both approaches are solid enough to consider they are worth trying to improve them and validate the relevance of the whole study. Based on the lacks highlighted by the reviewers, we will perform the additional experiments required to make our speculations more definitive conclusions. Hopefully we will be able to strengthen our work enough to submit it this time as a full-length article.

Article II. Caspase cleavage of H-1 parvovirus NS1 protein in non transformed cells generates fragments with dominant negative functions.

In the light of our review about the relevance of caspase cleavages of viral proteins and the fact that H-1PV infection is associated with apoptosis induction in some cell lines, an important part of my work has been devoted to the investigation of NS1 caspase cleavage.

The data we collected are presented in the following article which should be considered a temporary version we are willing to further improve. Nonetheless the results stated herein are all strongly reproducible. It should be added that a set of experiments is still in progress and aims at strengthening what we already reported about the relevance of NS1 caspase cleavage in H-1PV life cycle. For example, the results related to Figure 7B are currently still being confirmed, notably in other cell lines than MCF10A. Ultimately we will hopefully be able to establish a model giving an insight into the molecular determinants of H-1PV oncotropism.

Caspase cleavage of H-1 parvovirus NS1 protein in non transformed cells generates fragments with dominant negative functions.

Audrey Richard⁺¹, Ghaffar Muharram¹, Catherine Leroy¹, Yvan de Launoit¹, Dominique Stéhelin², David Tulasne¹.

⁺Corresponding author audrey.richard@ibl.fr

¹Institut de Biologie de Lille ; UMR 8161, CNRS, Institut Pasteur de Lille, Université Lille-Nord de France ; 1, rue du Professeur Calmette ; 59021 Lille Cedex ; France

²Institut de Biologie de Lille ; UMR 8199, CNRS, Institut Pasteur de Lille, Université Lille 2 ; 1, rue du Professeur Calmette ; 59021 Lille Cedex ; FRANCE

ABSTRACT

H-1 parvovirus (H-1PV) is an oncolytic virus known to preferentially replicate in and kill transformed cells through an elusive property called oncotropism. Viral NS1 protein is endowed with several functional domains and plays a key role in H-1PV multiplication. We identified non transformed cell lines where H-1PV infection leads to apoptosis induction with caspase activation, including caspase 3. In such cells, NS1 protein is a caspase substrate and generates a 65-kDa product (NS1-Nterm). Further characterization of NS1 caspase cleavage revealed that NS1 protein cleavage is suppressed by either the substitution of Aspartate residue at position 606 with an Asparagyl or caspase 3 inhibition by DEVD-FMK, a caspase 3/7 inhibitor. Ectopic expression of NS1-Nterm, which lacks NS1 transactivation domain, was shown to inhibit NS1-driven gene expression, thereby impairing the production of progeny virions. Inhibiting NS1 caspase cleavage in infected cells, by either mutating the caspase site or suppressing caspase activation, results in increased viral productivity. Collectively, our data provide molecular evidence that could explain, at least in part, why non transformed cells are less efficient than transformed cells to complete the viral life cycle.

INTRODUCTION

Members of the genus *Parvovirus* are small, icosahedral, nonenveloped viruses which infect vertebrates. Their single-stranded DNA genome is approximately 5-kb long and contains two promoters, P4 and P38, which regulate the expression of nonstructural (NS1 and NS2) and capsid (VP1 and VP2) protein-encoding genes, respectively. Several species within the *Parvovirus* genus, in particular rat H-1 parvovirus (H-1PV), are extensively investigated for their potential as anticancer agents. Indeed, these viruses are not pathogenic for humans and possess intrinsic oncolytic and oncosuppressive properties demonstrated by their ability to replicate in and kill various human tumor cell lines of different origins as well as primary cancer cells derived from patients bearing tumors. H-1PV also proves able to inhibit tumorigenesis in both immunodeficient and immunocompetent animal models.

Due to its preferential replication in malignantly transformed cells, H-1PV is defined as oncotropic. Oncotropism is considered to rely, at least in part, on the dependence of H-1PV on host cell ability to proliferate, with viral replication being performed by S phase-related cellular factors. While most normal cells are quite resistant to parvovirus cytotoxicity, they become sensitive as a result of their transformation with various oncogenes. Nonetheless, oncotropism molecular determinants remain mostly elusive.

H-1PV-induced cytotoxicity is mediated by several death pathways. In particular, depending on cell type and growth conditions, H-1PV infection was associated with caspase-dependent apoptosis, necrosis or cathepsin B-dependent cell death. The molecular effectors accounting for the different ways H-1PV-infected host cells are killed are unclear.

Apoptotic cell death is accompanied by characteristic morphological changes (cellular rounding-up and volume reduction, plasma membrane blebbing...) and at a molecular level by the sequential activation of cysteinyl aspartate proteinases or caspases. First, initiator caspases are activated and responsible for secondary activation of effector caspases. Active

caspases act through a catalytic Cys that hydrolyzes peptide bonds within the substrate, with a stringent specificity for Asp residue at P1 position. Caspase substrates include a large number and variety of cellular proteins that participate through their cleavage to the strong apoptosis-related morphological changes, as well as other physiological processes.

Apoptosis is also known to play a key role in host cell and virus interactions. Indeed, this mechanism can be induced in infected cells to make them die before the virus replicates and spread, thereby protecting the other cells from viral invasion. But viruses have evolved many different strategies to hijack deleterious effects of apoptosis. Interestingly, several viral proteins were shown to be targeted by caspases, which ultimately leads to different consequences depending on the virus. Caspase cleavage is suggested to separate functional domains from viral proteins in order to cause either gain or loss of function meant to help the virus deal with apoptosis.

Since H-1PV is associated with apoptosis induction in some cells, this study aimed at investigating whether NS1 protein is a caspase target in such contexts and whether such posttranslational modification is related to either any functional shift of the protein or variation in parvoviral life cycle achievement. To address this issue, we identified cell lines where H-1PV infection induces apoptosis. In these cells, surprisingly non transformed, NS1 is cleaved by caspases and generates a shorter product that we named NS1-Nterm. Further investigation demonstrated that NS1-Nterm lacks NS1 transactivation domain and acts as a dominant negative on NS1-driven gene expression. Caspase activation and NS1 cleavage were reported to decrease viral productivity in infected non transformed cells, suggesting that apoptosis induction is responsible, at least in part, for H-1PV life cycle being less efficiently completed in non transformed cells, which might contribute to oncotropism definition.

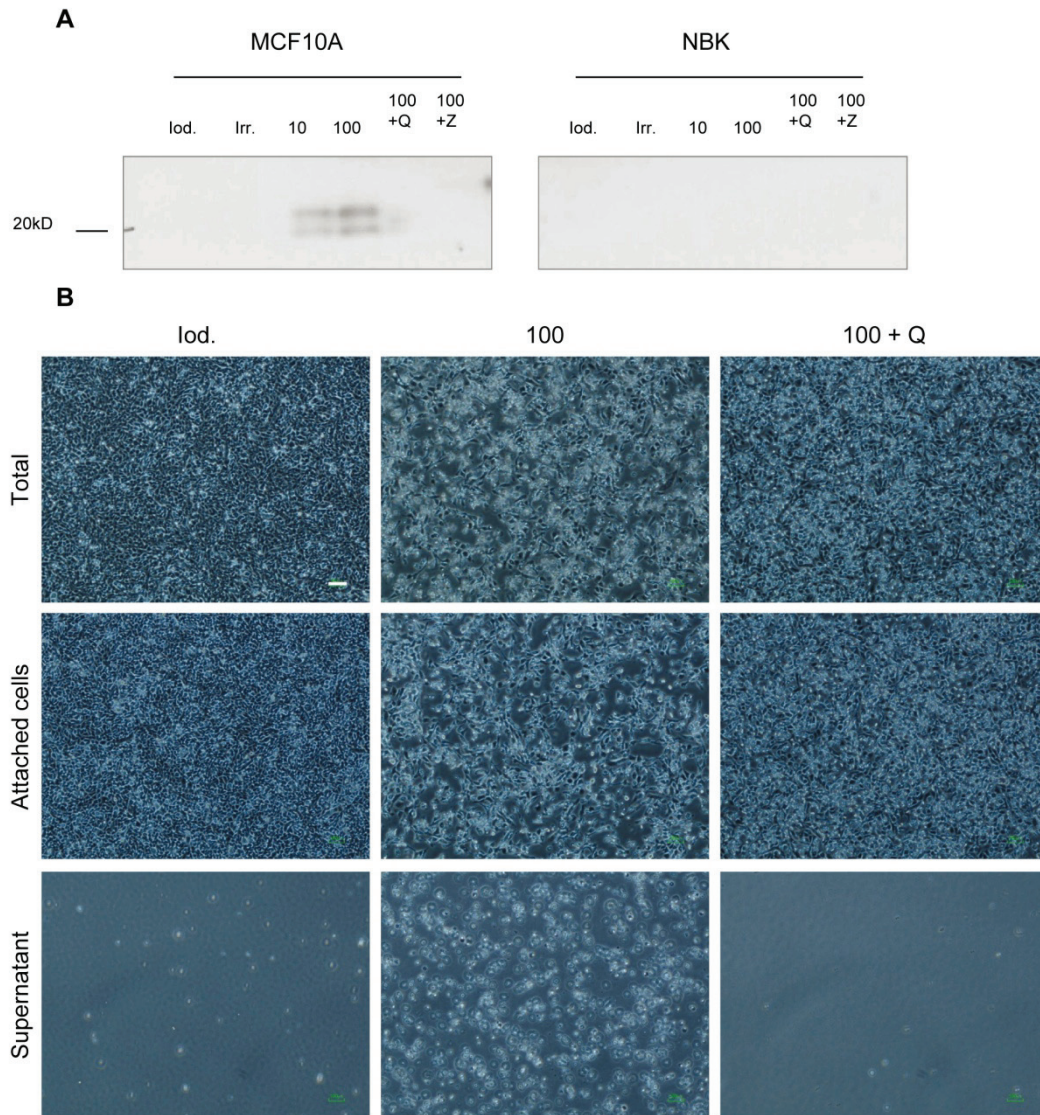

Figure 1. Induction of apoptosis in H-1 parvovirus-infected non transformed cells.

MCF10A and NBK cells were infected with iodixanol-purified H-1PV at MOI 10 (10) or 100 (100). Cells treated with iodixanol (lod.) or irradiated (Irr.) virus were used as controls. The inoculum was removed and cells were treated with either QVD-Oph (Q) (10 μ M) or ZVAD-FMK (Z) (10 μ M) or DMSO as a control.

A. 24 hours post-infection cells were lysed and analyzed by Western blot using an antibody directed against cleaved caspase 3.

B. 24 hours post-infection pictures of MCF10A cells (Total) were taken. The culture medium and detached cells (supernatant) were separated from cells attached to the plate (attached cells) and pictures of each fraction were also taken. Scale bar = 100 μ m.

RESULTS

H-1 parvovirus induces apoptosis in non transformed cells in a replication-dependent manner.

Apoptosis is known to play a major role in the interactions between host cell and virus, each one being likely to influence the other through this process. It has also been described as one of the mechanisms mediating by H-1PV cytotoxicity. Investigating the interplay of H-1PV and apoptosis required to identify cell models where we were able to observe some characteristic apoptotic markers, including cell rounding and detachment along with caspase activation. Many of the standard models used for studying H-1PV were not accompanied with such events, like NBK cells (**Fig. 1A**). Cell lines where H-1PV is supposed to induce apoptosis did not show satisfactory apoptotic markers under our conditions (data not shown). But several cell lines, namely canine MDCK, murine NIH3T3 or human MCF10A cells, which are not routinely considered standard models for H-1PV study, exhibited caspase activation as well as cell rounding and detachment. **Figure 1** presents the specific example of MCF10A cells. After 24 hours of infection, caspase 3 appears activated, with the generation of the 19-kDa and 17-kDa products of the protease. The activation appears to depend on the viral dose since we detected more active caspase in MOI 100- than in MOI 10-infected cells while infection at MOI 1 did not lead to detectable amounts of the protein. Moreover, irradiated virus treatment (with as many capsids as MOI 100) did not result in caspase 3 activation, indicating that capsids alone do not trigger apoptosis. Microscopic observation showed that MCF10A cells were clearly rounding during the infection (**Fig. 1B**). In addition, separating the culture medium from the monolayer revealed a dramatically increased number of detached cells. However, treatment with a pan caspase inhibitor completely reversed cell detachment. Thus, H-1PV induces caspase-dependent apoptosis in MCF10A cells in a manner that requires the virus to be able to replicate.

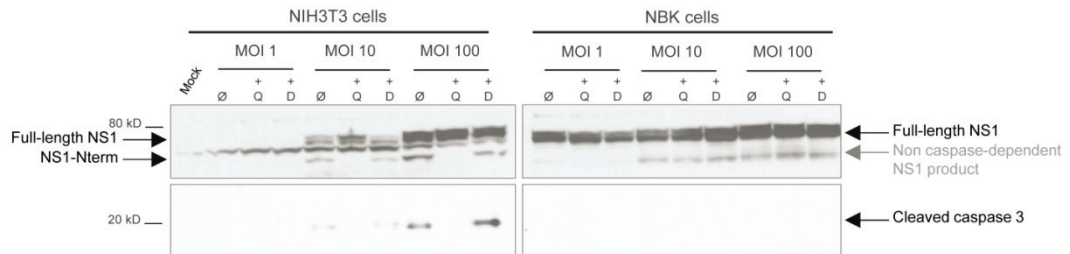

Figure 2. Generation of an NS1 product dependent on caspase activation in non transformed cells.

NIH3T3 and NBK cells were infected with iodixanol-purified H-1PV at MOI 10 (10) or 100 (100). Cells treated with iodixanol (Iod.) were used as controls. The inoculum was removed and cells were treated with either QVD-Oph (Q) (10 μ M) or DEVD-FMK (D) (10 μ M) or DMSO (\emptyset) as a control. 24 hours post-infection cells were lysed and analyzed by Western blot using antibodies directed against NS1 N-terminus extremity and cleaved caspase 3.

A caspase-dependent truncated form of NS1 protein is generated in H-1 PV-infected non transformed NIH3T3 cells.

Although H-1PV is usually not extensively associated with apoptosis induction, we were able to identify several cells lines undergoing clear caspase activation and massive cell rounding and detachment when infected with the virus, including human MCF10A and murine NIH3T3 cells. Knowing that viral proteins are increasingly shown to be targeted by caspases in infected host cells, this raises the question of NS1 fate under such conditions. Different cell lines were infected at MOI 1, 10 or 100 with iodixanol-purified H-1PV and either treated or not with a pan caspase inhibitor, QVD-Oph or a caspase 3/7 inhibitor, DEVD-FMK. Results are shown for NIH3T3 and NBK cells, the former inducing apoptosis in response to H-1PV infection while the latter do not. Western blot analysis revealed caspase 3 activation in NIH3T3 cells infected at moderate to high MOI unlike NBK cells (**Fig. 2**). The generation of cleaved (i.e active) caspase 3 was abolished by QVD-Oph treatment as expected. However, DEVD-FMK failed to suppress caspase 3 activation in this experiment. Using an antibody directed against NS1 C-terminus extremity, we did not observe any additional NS1 caspase-related products in NIH3T3 undergoing apoptosis (data not shown). However, an additional product of about 65 kDa corresponding to a shorter form of NS1 protein was identified with an antibody specific for NS1 N-term extremity. Interestingly, the detection of this 65-kDa product was prevented by a pan caspase inhibitor treatment. Similar observations were made by analyzing MCF10A extracts. In NBK cells, the antibody directed against NS1 N-term also revealed an additional band of comparable molecular weight but its detection remained possible in QVD-treated cells. So NS1 protein is a caspase target in cells able to trigger apoptosis in response to H-1PV, which generates a stable C-terminally truncated NS1 product we named NS1-Nterm.

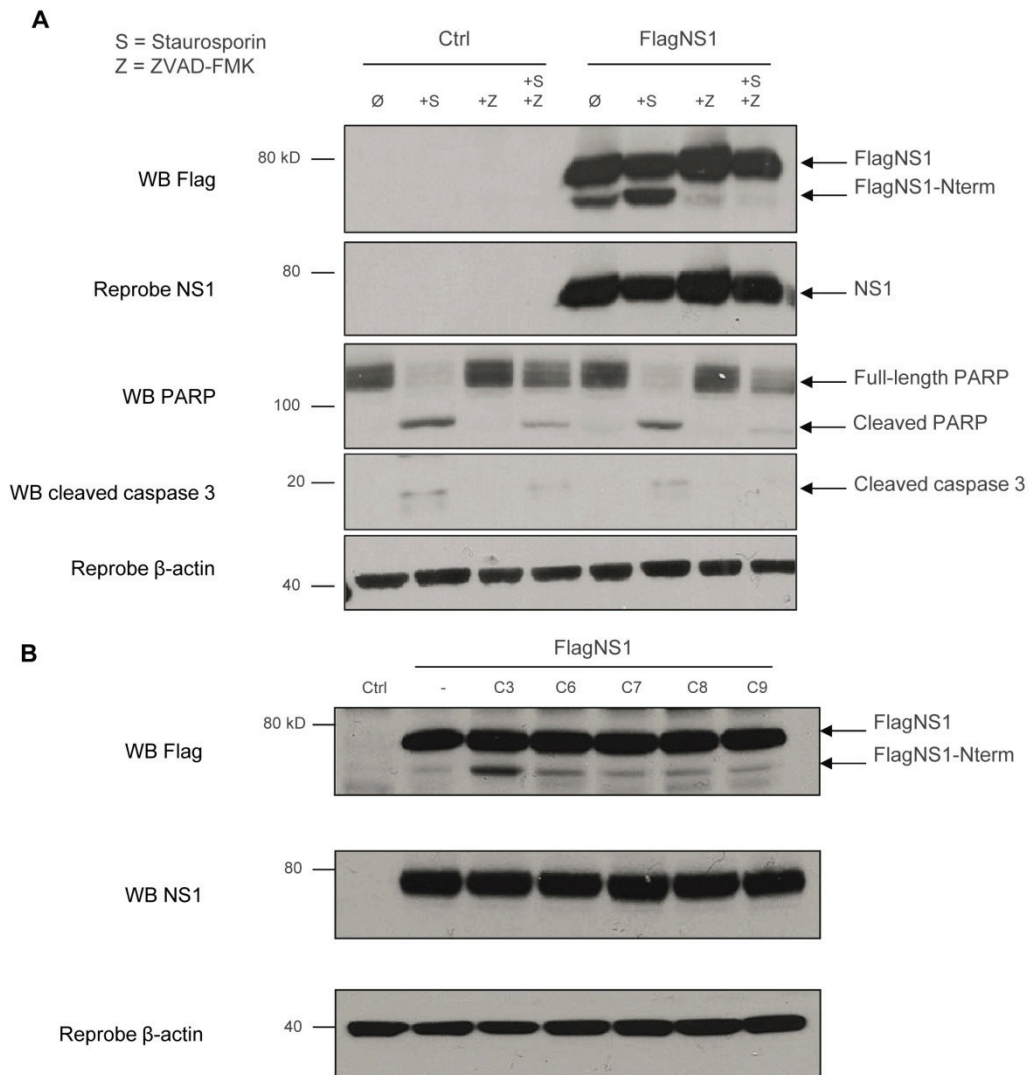

Figure 3. Cleavage of NS1 protein by caspases.

MDCK cells were transfected with a plasmid expressing a Flagged version of NS1 full-length protein (FlagNS1) or the empty vector. (Ctrl)

A. Cells were treated with staurosporin (1 μ M) for 7h and/or ZVAD-FMK (20 μ M) for 7h30 or DMSO as a control. Cells extracts were analyzed by Western blot using an anti-Flag antibody. The membrane was reprobbed with an antibody directed against NS1 C-term extremity. Similar extracts were analyzed for apoptosis status using anti-PARP and anti-cleaved caspase 3 antibodies. β -actin probing serves as a loading control.

B. Cells were lysed and incubated with purified caspases 3, 6, 7, 8 and 9 (C3, C6, C7, C8 and C9) before Western blot analysis using an anti-Flag antibody. Similar extracts were analyzed using antibody directed against NS1 C-term extremity. β -actin probing serves as loading control.

Ectopically expressed H-1PV NS1 protein is a caspase target in non transformed MDCK cells undergoing apoptosis.

To confirm and further investigate NS1 ability to be cleaved in a caspase-dependent manner, non transformed MDCK cells were transiently transfected with a Flagged version of NS1 protein and treated with staurosporin, an antibiotic known to induce caspase-dependent apoptosis and/or ZVAD-FMK, a pan-caspase inhibitor. Total cell extracts were then prepared and analyzed by Western blot. The ability of the drugs to control apoptosis was validated (in this experiment and all through the others) by probing the membranes with antibodies directed against active caspase 3 (i.e its cleaved form) and one of its substrate, Poly-ADP Ribose Polymerase, further referred as PARP (full length and cleaved forms). An antibody which specifically recognizes NS1 carboxy-terminal extremity confirmed proper expression of the plasmid and revealed one single 76 kDa-band corresponding to NS1 expected molecular mass (**Fig. 3A**, reprobe NS1). However using an anti-Flag antibody, we detected an extra 65 kDa-band very similar to NS1-Nterm. This shorter form of NS1 protein was already present under basal conditions but its amount was greatly increased upon staurosporin-induced apoptosis (**Fig 3A**. WB Flag). Its generation was almost suppressed when caspase activity was inhibited by ZVAD-FMK treatment, confirming that H-1 PV NS1 protein is indeed targeted by these proteases upon apoptosis induction. It should be added that we did not detect NS1-Nterm by performing the same type of experiments using different transformed cell lines (data not shown). Caspase cleavage assays performed by incubating FlagNS1-expressing MDCK cell extracts with purified active caspases 3, 6, 7, 8 and 9 showed that FlagNS1-Nterm generation is increased with caspase 3. Thus, NS1 protein is more likely a substrate of caspase 3, at least under these conditions (**Fig. 3B**). Taken together, these data demonstrate that H-1 PV NS1 protein is submitted to a proteolytic processing carried out by caspase 3 upon apoptosis in non transformed cells.

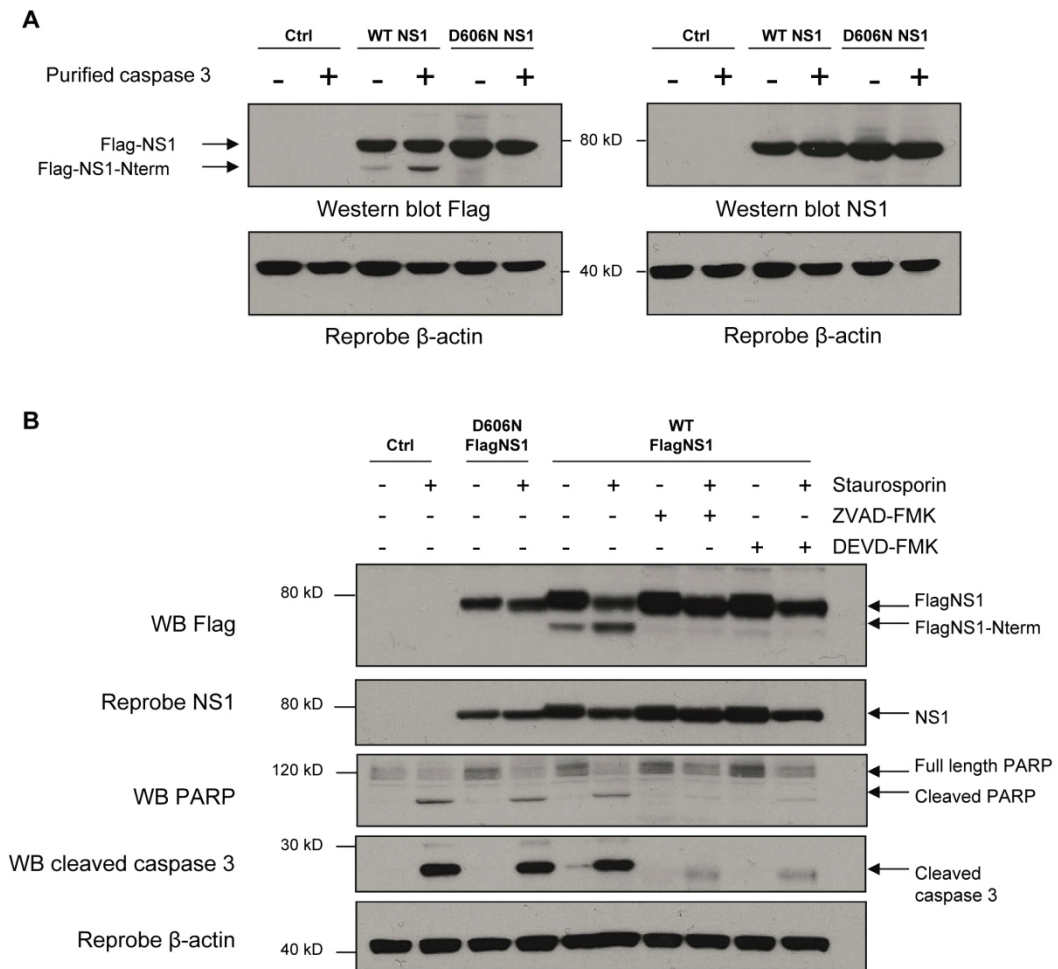

Figure 4. NS1 protein is cleaved by caspases at residue D606.

MDCK cells were transfected with a plasmid expressing either a flagged version of wild type NS1 (WT FlagNS1) or a flagged variant of NS1 in which D₆₀₆ residue was substituted with an Asparagyl residue (D606N FlagNS1).

- A. Cells were lysed and proteins were incubated with purified caspase 3 before Western blot analysis using an anti-Flag antibody. Similar extracts were assessed with an antibody directed against either NS1 C-term extremity or the Flag tag. Actin reprobing serves as loading control in both cases.
- B. The following day, cells were treated, or not, with staurosporin (1 μ M) for 7h, ZVAD-FMK (1 μ M) for 7h30, DEVD-FMK (1 μ M) for 7h30 or DMSO as a control. Proteins were then extracted and analyzed by Western blot using an anti-Flag antibody. The membrane was reprobbed with an antibody directed against NS1 C-term extremity. Similar extracts were also analyzed by Western blot for PARP and cleaved caspase 3 expression to verify apoptosis status. As previously described, the membrane was reprobbed with an anti- β -actin antibody to assess comparable loading.

Aspartyl residue 606 is necessary for H-1 PV NS1 protein to be cleaved by caspases.

NS1 protein ability to be cleaved by caspases being confirmed, we then focused on the specific site targeted upon apoptosis induction. Caspase 3 (as well as caspase 7) preferentially catalyzes the cleavage of the peptide bond after the second Aspartyl residue of a DXXD consensus site, X being any aminoacyl residue. Observation of NS1 primary structure indicated the existence of such a site between residues 603 and 606 (DLAD⁶⁰⁶) whose location within NS1 would be consistent with the generation of an about 65 kDa form of the protein. MDCK cells were transfected with a plasmid expressing either a Flagged version of wild type NS1 protein or a Flagged variant of NS1 in which D₆₀₆ residue was substituted with an Asparagyl residue (NS1 D606N). Incubation with caspase 3 of wild type NS1 expressing-MDCK extracts resulted in the generation of NS1-Nterm (**Fig. 4A**, WB Flag). The single substitution of Aspartyl residue at position 606 with an Asparagyl residue was sufficient to prevent NS1-Nterm detection, proving that NS1 caspase cleavage occurs at the predicted site. We confirmed this result in MDCK cells transfected with a vector encoding either wild type NS1 protein or its D606N version and undergoing staurosporin-induced apoptosis (**Fig. 4B**). Under these conditions, caspase activation led to NS1 N-term generation (WB Flag) in MDCK cells expressing wild type NS1. The inhibition of this event by the caspase 3/7 inhibitor DEVD-FMK confirmed NS1 as a caspase 3 target. In contrast with these observations, caspase activation was not associated with the detection of any additional forms of NS1 protein in MDCK cells ectopically expressing NS1 D606N. Altogether these data show that NS1 is targeted at D606 by caspases, likely caspase 3, in non transformed cells undergoing apoptosis.

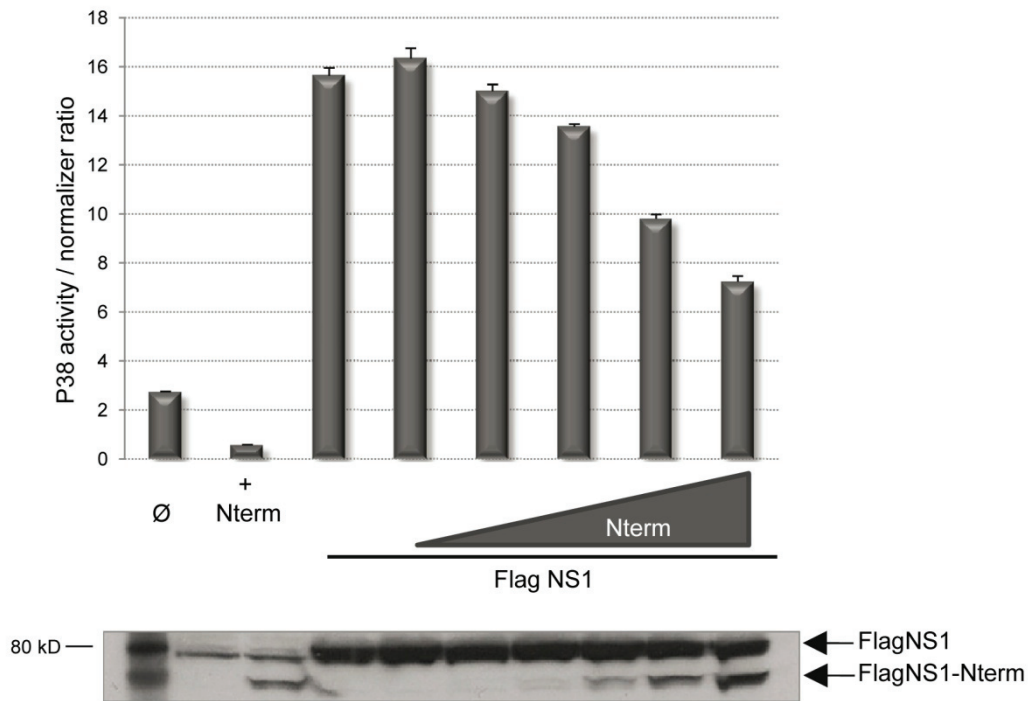

Figure 5. Inhibition of NS1-driven P38 promoter activation by NS1-Nterm.

NBK were cotransfected with a plasmid expressing *Firefly luciferase* gene under the control of P38 promoter, a plasmid expressing FlagNS1 and increasing amounts of a vector expressing a flagged version of NS1-Nterm. Cells were lysed 24 hours after transfection and luciferase activities were measured. Normalized luciferase activities are given as percentages of the expression driven by P38 promoter in the presence of NS1 protein. Results of three independent experiments performed in triplicates are shown with standard deviation. The same cell extracts were also analyzed by Western blot using an anti-Flag antibody to verify proper expression of both full-length and truncated NS1, and representative results are shown.

NS1-Nterm is able to inhibit NS1-driven P38 promoter activation.

Full length NS1 is known to be the major activator of late P38 promoter which drives H-1 PV capsid protein expression. The protein also controls its own promoter (P4) through a positive feedback loop when replication occurs. The carboxy-terminal extremity has been shown to be responsible for NS1 protein ability to upregulate viral transcription. Since the newly described caspase cleavage occurs at this particular region and separates most of the transactivation domain from the rest of NS1 protein, we further characterized NS1-Nterm by assessing its transactivation ability. NBK cells were cotransfected with a plasmid allowing P38-driven expression of *Firefly luciferase* gene, a plasmid expressing full-length wild type NS1 and increasing amounts of a vector expressing a Flagged version of NS1-Nterm (i.e NS1 caspase cleavage product). As expected, when full-length wild type NS1 was coexpressed with *Firefly luciferase* gene, P38 became fully activated with an 8-fold increase compared with P38 basal activity in control cells (**Fig. 5**). In contrast NS1-Nterm does not transactivate P38 promoter and is rather associated with a decrease in P38 basal activation. In addition NS1-Nterm expression resulted in a dose-dependent inhibition of NS1-driven activation of P38 promoter with a ultimate 50% reduction of P38 activity. This suggests that NS1 caspase cleavage generates a dominant negative characterized by the loss of the usual transactivation function of the full-length protein.

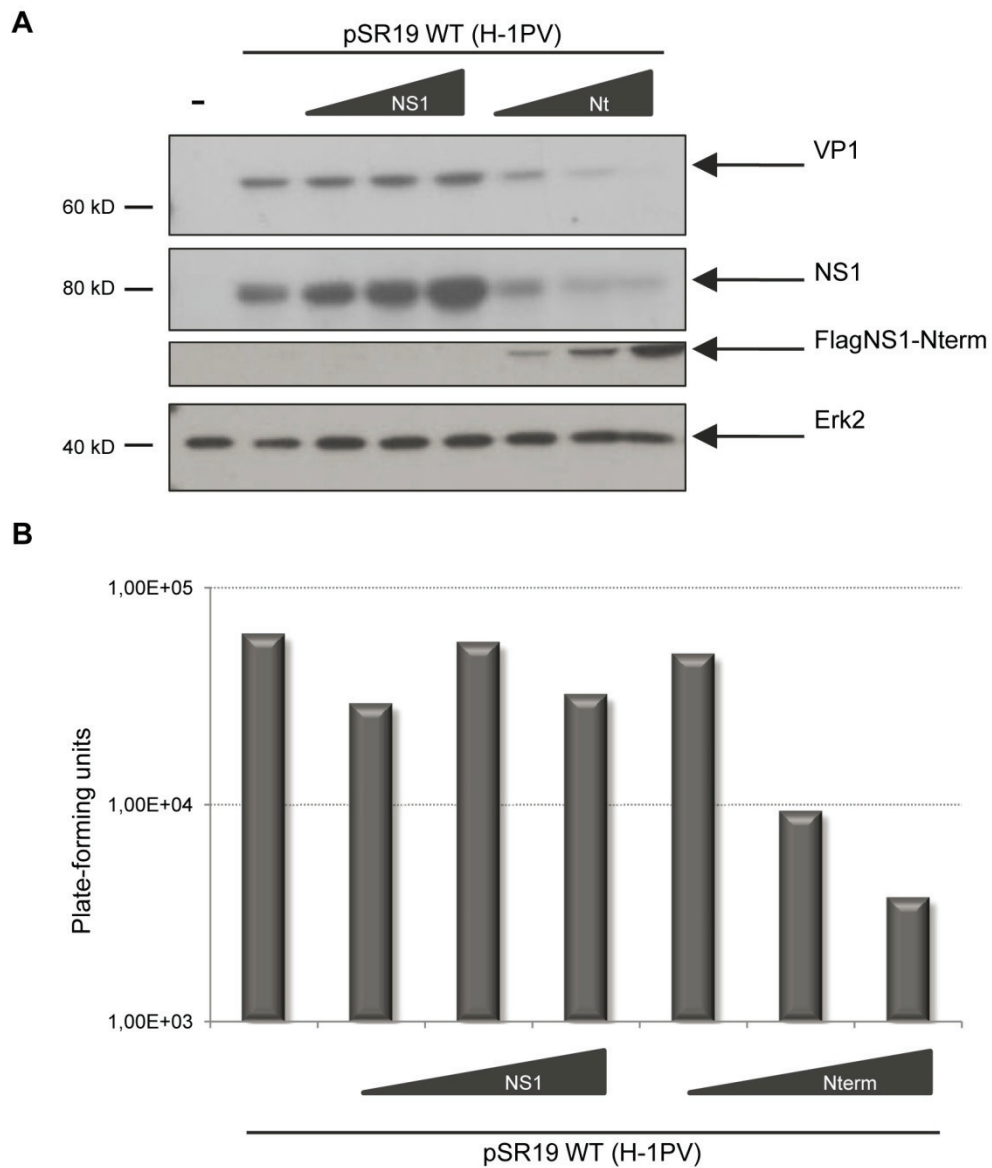

Figure 6. Inhibition of NS1-driven P38 promoter activation by NS1-Nterm.

NBK were cotransfected with a molecular clone of H-1PV (pSR19 WT) and increasing amounts of a vector expressing either wild type NS1 (NS1) or a flagged version of NS1-Nterm (Nterm).

A. Cells were lysed and analyzed by Western blot using antibodies directed against VP1, NS1 C-term extremity and Flag. Erk2 probing serves as loading control. Representative results are shown.

B. Cells were lysed 24 hours after transfection and both intracellular and released viral amounts were evaluated using TCID50 method. Representative results of at least three independent experiments are shown.

NS1-Nterm impairs H-1 PV genome expression and viral production.

Under the conditions of transactivation assays, NS1-Nterm exerts a strong ability to inhibit P38-driven gene expression. To validate the relevance of this dominant negative action, NS1-Nterm was coexpressed in NBK cells with a molecular clone of H-1PV (pSR19) which generates infectious viral particles after transfection in cells where the viral life cycle properly occurs like NBK cells. Cotransfection of increasing amounts of non tagged full-length NS1 protein was also performed as a control. Western blot analysis using appropriate antibodies confirmed proper NS1-Nterm dose-related expression and revealed a strong decrease in VP1 detection dependent on NS1-Nterm dose (**Fig. 6A**). The positive feedback loop exerted by NS1 on its own P4 promoter is observed when viral replication occurs only, so NS1-Nterm effects could not be assessed with standard transactivation assays. Interestingly, in accordance with this feedback loop, NS1 expression was also downregulated in an NS1-Nterm-dependent manner. NS1-term maximal dose resulted in an almost complete abortion of both VP1 and NS1 while ectopic expression of full-length NS1 had no such effect. To the contrary, we detected higher amounts of full-length NS1 due to its accumulated expression by both plasmids. The same type of coexpression experiments were performed and followed by the assessment of viral particle generation using the TCID50 method. While ectopic NS1 did not have any significant impact on the amount of infectious viral particles generated compared with control cells, NS1-Nterm expression led to a dose-dependent reduction of viral production by NBK cells (**Fig. 6B**). This is consistent with NS1-Nterm being associated with much lower amounts of NS1 and VP proteins. NS1-Nterm had such dramatic effect that it could result in an up to 80% loss of progeny virions generated. Together with the results of transactivation assays, these data indicate that NS1 caspase cleavage product shows dominant negative effects and exerts transcriptional downregulation of H-1PV gene expression which ultimately leads to a dramatic impairment of viral progeny production.

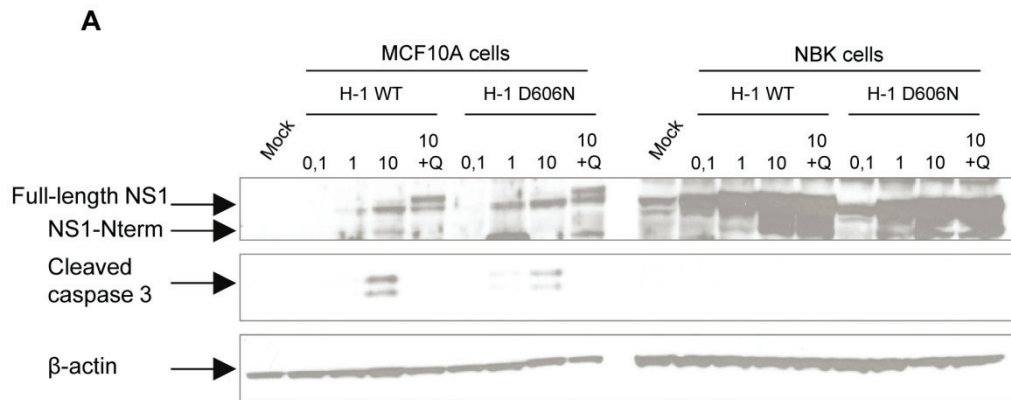

B

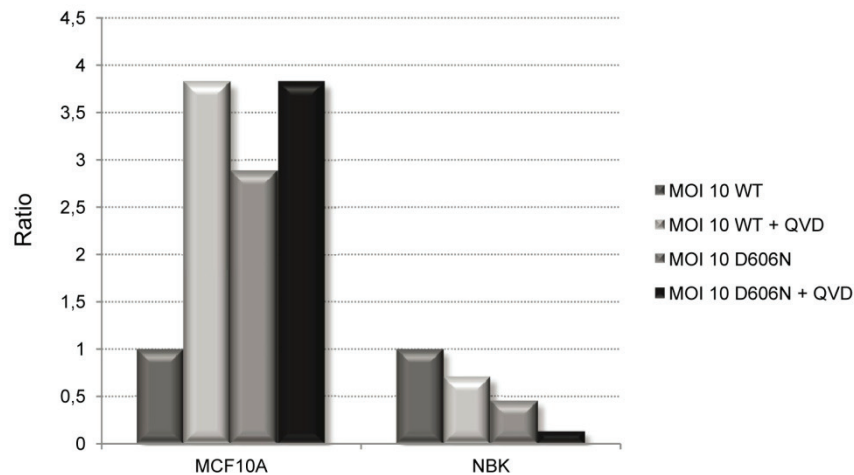

Figure 7. Enhancement of viral production in MCF10A cells upon caspase inhibition or infected with an H-1PV variant expressing an uncleavable NS1 protein.

MCF10A and NBK cells were mock-treated infected with either wild type H-1PV (WT) or a variant encoding NS1 D606N (D606N) at different MOI. After the removal of the inoculum, cells were treated with QVD-Oph (Q or QVD) (10 μ M) or DMSO as a control.

A. 24 hours post-infection cells were lysed and analyzed by Western blot using antibodies directed against NS1 N-term extremity and cleaved caspase 3. Erk2 probing serves as loading control. Representative results are shown.

B. 24 hours post-infection released and intracellular progeny virions were collected and TCID50 experiments were performed to determine the amounts of infectious viral particles. The results are represented as ratios of total viral production to total production yielded by cells infected with WT H-1PV at MOI 10.

Disruption of NS1 caspase cleavage site within H-1 PV genome relates to a caspase-dependent increase in viral production in non transformed MCF10A cells.

We showed that H-1 PV infection of non transformed cells induces apoptosis, resulting in caspase cleavage of NS1 protein. Further investigation revealed that NS1 is targeted at a single Aspartyl residue at position 606 which leads to the generation of NS1-Nterm. To reveal the relevance of NS1 caspase cleavage in the viral life cycle, we generated a molecular clone of H-1PV expressing NS1 D606N (H-1 D606N) instead of the cleavable wild type protein and produced viral stocks of H-1 WT and H-1 D606N. Infection of MCF10A cells with each virus indicated that NS1 mutation did not alter the viral ability to induce caspase activation (**Fig. 7A**). The antibody directed against NS1 N-term extremity revealed the presence of both full-length NS1 and NS1-Nterm in MCF10A cells infected with H-1 WT. Although the background was heavy in this set of experiment, QVD-Oph treatment clearly suppresses a 65-kDa band, allowing the identification of NS1-Nterm. In contrast, cells infected with H-1 D606N only contained full-length NS1. In NBK cells, full-length NS1 was also detected as well as at least one NS1-related product resembling NS1-Nterm and that we had already observed in other experiments. But its generation was confirmed to not depend on caspase activity since QVD-Oph was not able to suppress it. Viral production was assessed using TCID50 method in cells infected at MOI 10 with either H-1 WT or H-1 D606N and either treated or not with QVD-Oph. The amount of progeny virions yielded by untreated cells infected with the wild type virus was considered standard production. In H-1PV WT-infected MCF10A cells, inhibition of caspase activity led to an almost 4-fold increase in viral production, showing that apoptosis induction alters the cell ability to generate progeny virions. Likewise, when NS1 is made uncleavable we reported a 3-fold increase in untreated MCF10A cells infected with H-1 D606N. Additional QVD-Oph treatment on these cells did not significantly alter H-1 PV D606N productivity. NBK cells showed inverse tendencies

with either inhibition of caspase activity or mutation in NS1 caspase cleavage site leading to decreased amounts of infectious viral particles. Altogether these data demonstrate that induction of caspase activation in non transformed MCF10A cells results in decreased viral production. The disruption of NS1 caspase cleavage site leads to comparable effects and caspase inhibition has no significant impact on MCF10A cells infected with H-1PV D606N, meaning that caspase-dependent decrease in the amounts of progeny virions produced likely relies on the generation of NS1-Nterm.

DISCUSSION

Caspase cleavage of NS1 protein

The most described posttranslational modification of NS1 protein is phosphorylation that was extensively shown to regulate the different functions NS1 is expected to exert throughout the viral life cycle. Here we report for the first time another way of modifying NS1 protein through its proteolytic processing. Upon caspase activation NS1 is cleaved at its Aspartate 606 residue, with caspase 3 being most likely responsible for targeting the protein. A single cleavage is supposed to generate two fragments. In the case of NS1 protein we were able to identify a stable 65-kDa product, NS1 N-term, corresponding to residues 1 to 606, with antibodies directed against either NS1 N-term extremity or Flag in experiments performed with ectopically expressed N-terminally Flag-tagged NS1 protein. Using an antibody specific for NS1 C-term extremity, the only NS1-related product we were able to visualize was the full-length 76-kDa protein. A C-terminally tagged NS1 protein expressed in MDCK cells undergoing apoptosis did not lead to the detection of the second NS1 caspase cleavage product and neither did the treatment of such cells with pharmacological inhibitors of known degradation pathways (*i.e* proteasome and lysosomes) (data not shown). Since we did not find a way to stabilize it, the labile NS1 fragment corresponding to residues 607 to 672 (NS1-Cterm) has actually remained undetectable so far. This suggests that NS1-Cterm is devoid of any significant roles and rapidly eliminated. By contrast, NS1-Nterm stability implies that this fragment might be a functional product of NS1 protein.

Generation of a dominant negative form of NS1 protein

NS1 protein is known to be the major transactivator of P38 promoter which controls the expression of VP proteins. For NS1 to exert this function, NS1 transactivation domain, NS1 DNA binding domain and NS1 oligomerization are required. NS1 transactivation domain

is constituted by about the last 70 residues of the protein. Thus, by occurring at Aspartate 606 and eliminating the 66 last residues, NS1 caspase cleavage separates the whole transactivation domain from the rest of the protein. Consistently, our data revealed that NS1-Nterm is able to inhibit P38-driven gene expression activated by full-length NS1 protein, whether P38 controls *Firefly luciferase* gene in a reporter plasmid or VP gene in H-1PV genome. Since NS1-term is likely to still bind to DNA and oligomerize, we suggest that inhibition of P38-driven gene expression is mediated by full-length NS1/NS1-Nterm heterooligomers which compete with full-length NS1 homooligomers for DNA binding. Heterooligomers would contain less transactivation domains than homooligomers which would result in the decrease or even the suppression of transactivation potential. The requirement of oligomerization for NS1-driven gene expression to occur was demonstrated using designed dominant negative forms of NS1 protein. Here we report that NS1 caspase cleavage, which physiologically occurs in H-1PV-infected non transformed cells, generates a natural dominant negative of NS1 protein.

Attenuation of viral amplification in H-1PV-infected non transformed cells

We demonstrated that several non transformed cell lines undergo apoptosis with caspase activation when infected with H-1 parvovirus. To address the relevance of NS1 caspase cleavage in H-1PV life cycle, we assessed the effects of either caspase inhibition or expression by the virus of an “uncleavable” version of NS1 (H-1 D606N) in infected MCF10A cells. The suppression of caspase activity by a pan caspase inhibitor in MCF10A cells infected with wild type H-1PV leads to a 4-fold increase in the amounts of infectious viral particles we measured using TCID50 method. H-1PV infection induces caspase-dependent apoptosis in MCF10A cells, meaning that caspase activation is a sign of cell death. Since the apoptotic mechanism consumes a lot of energy, we could assume that infected MCF10A dying cells are less likely to complete progeny virion production. Inhibiting

caspses in infected cells is expected to improve cell viability, which could result in cells being more able to yield new virions. However, infection of MCF10A cells with H-1 D606N still induces apoptosis but also leads to an increase in viral production. Thus, cell viability improvement does not account for the increased amounts of virions we measured. Also, caspase suppression in H-1 D606N-infected cells does not significantly alter the number of viral particles detected compared with the same infected cells undergoing apoptosis. The single disruption of NS1 caspase site is sufficient to enhance viral production and inhibition of caspase activity displays very similar effects on the amounts of virions detected. This strongly argues for NS1 caspase-dependent cleavage being associated with the attenuation of viral amplification in MCF10A cells. This is greatly consistent with the fact that NS1-Nterm is endowed with dominant negative properties. We suggest that, when infected with H-1PV, MCF10A cells induce caspase-dependent apoptosis which leads to NS1 cleavage into NS1-Nterm. Consequently, NS1 and VP protein production would be altered because of NS1-Nterm dominant negative effect on NS1-driven gene expression, thereby impairing the number of progeny virions MCF10A cells can produce. This mechanism of attenuation is particularly interesting because it occurs in non transformed cells. It is important to point out that while most normal cells are quite resistant to H-1PV infection, they become sensitive as a result of their transformation with various oncogenes. Moreover, transformed cells are often more refractory to proper apoptosis induction than non transformed cells. Thus, we suggest that our model highlights molecular determinants that could, at least in part, account for H-1PV oncotropism.

MATERIALS AND METHODS

Cell culture and treatments

Madin-Darby canine kidney epithelial normal cells (MDCK) and NIH3T3 murine fibroblasts were cultured in DMEM-GlutaMax (Life Technologies) supplemented with 10% fetal bovine serum (Life Technologies) (for MDCK) or fetal calf serum (Hyclone) (for NIH373) and antibiotics. Human SV40-transformed new born kidney fibroblasts (NBK) were cultured in MEM α (Invitrogen) supplemented with 10% fetal bovine serum, L-glutamine and antibiotics. Human MCF10A were cultured in DMEM-GlutaMax and HAM's F12 (Life Technologies; vol/vol) supplemented with 5% horse serum (Life Technologies), 500 ng/ml hydrocortisone (Calbiochem), 20 ng/ml epidermal growth factor (Peprotech), 10 μ g/ml insulin (Sigma), and 100 ng/ml cholera toxin (Calbiochem). When appropriate, cells were cultured in serum-starved medium (0,5% serum) and treated with apoptosis inducer staurosporin (1 μ M) (Calbiochem) for 7h and/or pan-caspase inhibitor Z-VAD-FMK or Q-VD-Oph (20 μ M) (Calbiochem) for 7h30 or overnight respectively, or mock-treated (DMSO).

Plasmid constructions

The reference wild type H-1 PV molecular clone (Faisst et al., 1995), pSR19 WT, was kindly provided by Pr. J. Rommelaere (DKFZ, Heidelberg). pcDNA3-NS1 WT and pcDNA3-FlagNS1 WT plasmids, expressing respectively full length, wild type NS1 protein and an N-terminal Flagged version of full length, wild-type NS1 protein, were kindly created and provided by A. Bègue.

The putative NS1 caspase cleavage site was invalidated within pcDNA3-NS1 WT and pCDNA3-FlagNS1 WT plasmid sequences by substituting the Aspartyl residue at position 606 with an Asparagyl residue using QuickChange site-directed mutagenesis kit (Stratagene) according to the manufacturer's instructions (pcDNA3-NS1 D606N and

pcDNA3-FlagNS1 D606N). A molecular clone of H-1 PV expressing a variant form of NS1 in which Aspartyl residue at position 606 was substituted by an Asparagyl residue was also generated with pSR19 as a template, using the same kit (pSR19 D606N).

A plasmid expressing the truncated NS1 protein (further mentioned as NS1-Nterm) was also created. The sequence encoding residues 1 to 606 was amplified by PCR using pcDNA3-FlagNS1 as a template and appropriate primers carrying BamHI and XhoI restriction sequences. The PCR product was then properly digested and ligated into dephosphorylated linearized pcDNA3-Flag vector.

Every newly generated plasmid was sequenced for final validation.

Transfections

MDCK cells were transiently transfected as follows. Cells were seeded in 6-well plates (300 000 cells per well). The following day, appropriate DNA (2,5 µg per well) was mixed to Lipofectamine Reagent (Life Technologies) (10 µl per well). Culture medium was replaced by serum free OptiMEM (Life Technologies) and incubated for 5h with the tranfection mix at 37°C (95% humidity, 5% CO₂). Transfected cells were cultured in fresh complete medium until further experiments.

NBK cells were transiently transfected as follows. Cells were seeded in 6-well plates (300 000 cells per well). The following day, appropriate DNA (1 µg per well) was mixed to ExGen 500 Reagent (Euromedex) (4 µl per well). Culture medium was replaced by serum free OptiMEM (Life Technologies) and incubated for 6h with the transfection mix at 37°C (95% humidity, 5% CO₂). Transfected cells were cultured in fresh complete medium until further experiments.

Western blot analysis

Cells were scraped directly into culture medium, harvested by centrifugation and washed with cold PBS 1X. Cell pellets were then lysed (10 minutes on ice) in PY buffer consisting of 20 mM Tris-HCl, 50 mM NaCl, 5 mM EDTA, 1% Triton X-100, 0,02% sodium azide and a cocktail of proteases inhibitors (Roche). Cell debris were removed (20000 g, 15 minutes, 4°C) and supernatants were collected. Equal amounts of total cell extracts were then analyzed by Western blotting. First, proteins were separated by SDS-PAGE electrophoresis using gradient pre-cast gels (4-12% gradient, Bis-Tris) (Life Technologies) and then transferred onto PVDF membrane (Millipore). The latter was blocked for 1 hour at room temperature in blocking buffer containing 0,2% casein, 0,1% Tween20 (Sigma) and PBS 1X, and incubated overnight at 4°C with primary antibodies directed against : C-terminal extremity of NS1 protein (SP8 rabbit serum, 1:5000) (Faisst et al., 1995), N-terminal extremity of NS1 protein (1:1000) (kindly provided by Dr J. Nüesch, Heidelberg), cleaved caspase 3 (1:1000) (D175, 5AE1, Cell Signaling, Danvers, MA, USA), Poly-ADP Ribose Polymerase (PARP) (1:1000) (H-250, Santa Cruz Biotechnology, Santa Cruz, CA, USA), β -actin (1:5000) (sc-47778, Santa Cruz Biotechnology) and Erk2 (1:1000) (sc-154, Santa Cruz Biotechnology). Membrane was extensively washed with blocking buffer, incubated for 1 hour at room temperature with peroxydase-conjugated secondary antibodies (anti-mouse and anti-rabbit, 1:10000) (GE Healthcare) and washed again with blocking buffer. Specific protein signals were visualized using Western Lightning® Plus-ECL, Enhanced Chemiluminescence Substrate kit (PerkinElmer, Boston, MA, USA).

Caspase cleavage assay

MDCK cells were transfected using Lipofectamine reagent as described above with a plasmid expressing a Flagged version of full length NS1 protein. The following day, cells

were lysed in caspase buffer (20 mM PIPES pH 7,2 ; 100 mM NaCl ; 1% CHAPS, 10% sucrose ; 5 mM DTT and 0,05 mM EDTA). Cell extracts were incubated for 4h at 37°C with various purified active caspases (3, 6, 7, 8 and 9) and then analyzed by Western blotting.

Transactivation assays

NBK cells were cotransfected using ExGen500 transfection reagent as described above with a plasmid carrying the *Firefly luciferase* gene controlled by parvoviral P38 promoter (kindly provided by A. Bègue), pcDNA3-FlagNS1 WT, increasing amounts of pcDNA3-FlagNS1-Nterm and a plasmid expressing the *Renilla luciferase* gene to normalize reporter data. Total amounts of transfected DNA were adjusted to 1 µg with empty vector when necessary. The day after transfection, cells were washed with cold PBS 1X, lysed with Passive Lysis Buffer (Promega), clarified by centrifugation and analyzed using Dual-Luciferase Reporter Assay (Promega) and a Centro LB 960 microplate luminometer (Berthold Technologies) powered by MikroWin 2000 Software. Normalized luciferase activities are given as percentages of the expression driven by P38 promoter when activated by full length NS1 protein. The experiments were performed three times in triplicate.

Virus production and quantification, and cell infections

NBK cells were transfected using ExGen 500 transfection reagent (Euromedex) with either pSR19 WT or pSR19 D606N as described above. Cells were harvested 6 days after transfection by scraping, pelleted and lysed in 50 mM Tris-HCl / 0,5 mM EDTA (pH 8,7) by two “freezing and thawing” cycles. Cell debris were removed by centrifugation and supernatant was collected for virus quantification using Tissue Culture Infectious Dose 50 (TCID50) method. Briefly, NBK cells were seeded in 96-well plates and infected with serial dilutions of virus at the rate of 10 wells per dilution. Cells were incubated at 37°C (95%

humidity, 5% CO₂) for 4 days and then stained with Giemsa solution (Sigma-Aldrich, St Louis, MO, USA). Virus titers were then calculated according to Reed and Muench method (1938). Stocks used in experiments with iodixanol-purified virus and irradiated virus were prepared and kindly provided by Dr. Nathalie Martin and quantified the same way. Iodixanol- and irradiated H-1 PV-treated cells were used as controls. For infection experiments (with non purified and purified virus), cells were infected at various multiplicities of infection (MOI 0, 1 to MOI 100) by adding the virus at the rate of 10% of culture medium volume to allow proper spread of the virions, and incubated for 1h at 37°C (95% humidity, 5% CO₂). After inoculum removal, cells were washed twice with PBS 1X and cultured in fresh complete medium. Treatments with caspase inhibitors or DMSO were applied at this moment when appropriate.

Discussion about Article II.

Since an important part of the results requiring discussion have already been mentioned in the appropriate section of the article, here will be only addressed issues for which we do not have enough data to mention them for publication and that we intend to experimentally assess in near future.

Induction of apoptosis in H-1PV-infected non transformed cells: the result of an immune antiviral response ?

Our investigation of the consequences of caspase activation on NS1 protein inevitably required to identify one or several cell models where H-1PV infection is associated with apoptosis induction. A recent review focused on parvoviral-induced cell death and cell cycle arrest eventually concluded that cytotoxic effects induced by members of the genus *Parvovirus* could be mediated by either necrosis or apoptosis, depending on the virus and cell type, with NS1 protein playing a key role in inducing cell death and the cell cycle arrest of infected cells via multiple strategies (232). This above all means that we actually do not know much about the exact mechanisms underlying parvovirus-induced cell death.

Apoptosis has been described as mediating H-1PV cytotoxicity in a few studies involving rat glioblastoma cells (187), human promonocytic cells U937 (188) or human hepatocellular carcinoma cells (227). But for instance, the work performed on the latter cells assessed cell death with a cytotoxicity assay based on cell membrane permeabilization, which is inconsistent with what characterizes apoptosis. In another study also involving hepatoma cell lines, the authors asserted that H-1PV induces caspase-dependent cell death while viral toxic effects was only partly inhibited upon caspase inhibition (187). Also, the very same study defines H-1PV-induced cell death using a method based on the release of lactate dehydrogenase into the culture medium, which reflects membrane permeabilization. Moreover, a recent study reported that H-1PV NS1 protein induces apoptosis in 293 and HeLa cells in a manner that depends on the generation of reactive oxygen species and caspase activation (113). However we were not able to detect any caspase activation in 293 and HeLa

cells available at the laboratory. In fact, there is few clear evidence of apoptosis induction in cells sensitive to H-1PV-induced killing.

In contrast, resistance to apoptosis induction observed in many tumor cell lines was reported to not prevent these cells from H-1PV killing effect. Indeed, the virus efficiently kills glioma cells resistant to cisplatin and TNF-related apoptosis-inducing ligand (TRAIL) treatments, both known to trigger apoptosis (77). In addition, non-Hodgkin B cell lymphomas, even those resistant to rituximab-induced apoptosis, have recently been proposed as great targets for oncolytic parvovirotherapy (6). Such results suggest that apoptosis is certainly not H-1PV preferred pathway to induce cell death. And indeed, when we were looking for an appropriate cell model to investigate the effects of caspase activation on NS1 protein, none of the cell lines showing high sensitivity to the virus, with major cytotoxic effects, were satisfactory. Since the standard cell models were not the ones to use, we eventually turned to more unconventional cell lines, expected to display low to moderate sensitivity to H-1PV, namely non transformed cell lines. This way we more easily identified several cell lines where we detected caspase 3 activation upon H-1PV infection. Since some of them were not proficient enough in producing NS1 protein, we selected human MCF10A epithelial cells and murine NIH3T3 fibroblasts for further investigation.

Recent data have highlighted that the induction of an antiviral immune response might account for non transformed cells being refractory to MVMP infection. Indeed, mouse embryonic fibroblasts (MEFs), which are not able to complete the viral life cycle, were shown to produce and release type I IFNs, leading to the phosphorylation of STAT1 and STAT2, as well as expression of 2'-5'-OAS in response to parvoviral infection (102). Inversely, murine transformed fibroblasts A9, which are permissive to parvoviral infection, do not exert any strong antiviral response against the virus due to the lack of type I IFNs production and release. Consistently, Ventoso and coworkers reported that non transformed NIH3T3 fibroblasts, which do not complete parvoviral infection, become highly permissive to the virus when devoid of PKR, whereas this sensitization is reverted upon PKR rescue. This kinase plays a major role in the antiviral response network by sensing PRRs and leading consequently to the phosphorylation of the α -subunit of the initiation factor 2 (eIF2 α), which ultimately aborts translation in infected cells. Thereby the ability of a cell to trigger or not an efficient antiviral response seems crucial in the achievement of parvoviral life cycle. Considering what is known about the molecular pathways

underlying type I interferon response, namely that PKR is the product of an interferon-stimulated gene (ISG), we suggest that what was reported in both studies actually reflects the same response. According to us, parvoviral infection would indeed trigger Type I interferon production and release in non transformed cells, thereby leading to increased expression of PKR.

Moreover, upon sustained activation, PKR is able to promote apoptosis (75, 198). Thus, our own results would also fit into the scheme of the induction of an antiviral response by infected non transformed cells, with caspase activation downstream of type I interferons and PKR. We think that NS1 caspase cleavage and ensuing attenuation of viral amplification would be a strategy evolved by H-1PV to protect and hide itself from this antiviral immune response. In other words, NS1 would act as a sensor of deleterious conditions for viral replication since caspase activation is likely to reflect the occurrence of an antiviral response. To avoid further amplification of this response, the virus would rather exert negative regulation on itself through the generation of dominant negative NS1-Nterm. The point would probably be to replicate less intensively but being able to replicate continuously without stimulating immune responses so intense that they could overwhelm it.

Obviously, all these hypotheses will need to be assessed experimentally. We are willing to determine whether or not type I interferons and/or PKR are stimulated in our own models, particularly in NIH3T3 cells since they were used to demonstrate PKR role in their resistance to parvoviral infection. Knowing that many tumor cells are impaired regarding interferon signaling (67, 231), this all the more argues for an involvement of antiviral immune defect in parvoviral oncotropism. However, it would be important to also prove whether or not transformation-related sensitization to parvoviral infection is associated with a loss of type I interferon response using non transformed cells and their transformed counterparts.

If we eventually confirm it, the integrated model we propose would highlight potential universal molecular determinants accounting for non transformed cells being much less sensitive to parvoviral infection, thereby negatively defining oncotropism.

EPILOGUE

AND THEY KILLED HAPPILY EVER AFTER

AND THEY KILLED HAPPILY EVER AFTER

Although both projects I have been working on all along my thesis might somehow appear very different one from each other, they share the common aim of trying to better understand the mechanisms underlying the regulation of NS1 protein.

While P4 promoter sequence contains many transcriptional regulatory elements, we reported in a first part of the work that NS1 expression particularly depends, at least in our model, on NF-Y-mediated gene expression through P4 Y-boxes. The Y2 copy, which is located in the inboard, transcriptional arm, plays a more dominant role in P4 activation as could have been expected. Nonetheless, the disruption of both Y-boxes in an H-1PV molecular clone results in the complete abortion of NS1 production and progeny virion generation: then, Y1 copy located in the outboard replicative arm of the viral genome would not yet be transcriptionally inactive. If true, this would suggest that the functional discrimination between the inboard and outboard arms of the left-hand of the genome is not absolute. There could be some sort of compensation when viral survival is jeopardized. But as discussed above in this manuscript, the conclusions we made about Y-box relevance in the context of the whole viral genome actually deserve further investigation.

The second project led to the characterization of a new posttranslational modification of NS1 protein consisting of its processing by proteases mostly known to be the main effectors of apoptotic cell death, namely caspases. Surprisingly, we were able to observe caspase activation and then NS1 cleavage in non transformed cells only whereas H-1PV is known to preferentially replicate in transformed cells. Moreover, a stable caspase cleavage product, NS1-Nterm, show dominant negative properties and is able to mediate the attenuation of viral amplification. In the light of recent studies reporting the induction of an antiviral response in MVM-infected non transformed cells, we believe that the model of viral attenuation we reported occurs downstream of an antiviral response. Many viral proteins have been demonstrated

to be caspase targets. The cleavage of viral proteins leads to different functional consequences for the viral life cycle, but it seems reasonable to believe that the selection throughout evolution of viral proteins exhibiting caspase cleavage sites is not neutral. Since viruses have evolved many strategies to counteract cellular antiviral responses we suggest that caspase cleavages represent another way for them to deal with cells trying to resist viral invasion. H-1PV NS1 caspase cleavage and ensuing viral attenuation reflects perhaps a viral attempt to hide from antiviral immunity.

Even though we should not let ourselves become too speculative, we believe that our results, as many others actually, prove that the size-restricted genome of H-1PV is organized with high sophistication. The information rate embedded in no more basepairs than a standard plasmid is actually breathtaking. It seems that everything is done so that the virus can fully benefit from everything its host cell has to offer as proved for instance by the high amounts of transcriptional regulatory elements found in P4 promoter. Meanwhile it remains able to adapt to hostile contexts as suggested by NS1 caspase cleavage.

As far as H-1 parvovirus is concerned, simplicity leads to good design and less is genuinely more.

REFERENCES

1. **A. Le Cesne, T. D., N. Jamin, M. Spielmann, T. Le Chevalier, H. Sancho-Garnier, et al.** 1993. Intra-lesional administration of a live virus, parvovirus H-1, in cancer patients: a feasibility study. *Proc Am Soc Clin Oncol* **12**:297.
2. **Agbandje-McKenna, M., A. L. Llamas-Saiz, F. Wang, P. Tattersall, and M. G. Rossmann.** 1998. Functional implications of the structure of the murine parvovirus, minute virus of mice. *Structure* **6**:1369-81.
3. **Ahn, J. K., B. J. Gavin, G. Kumar, and D. C. Ward.** 1989. Transcriptional analysis of minute virus of mice P4 promoter mutants. *J Virol* **63**:5425-39.
4. **Ahn, J. K., Z. W. Piňluk, and D. C. Ward.** 1992. The GC box and TATA transcription control elements in the P38 promoter of the minute virus of mice are necessary and sufficient for transactivation by the nonstructural protein NS1. *J Virol* **66**:3776-83.
5. **Al-Molawi, N., V. A. Beardmore, M. J. Carter, G. E. Kass, and L. O. Roberts.** 2003. Caspase-mediated cleavage of the feline calicivirus capsid protein. *J Gen Virol* **84**:1237-44.
6. **Angelova, A. L., M. Aprahamian, G. Balboni, H. J. Delecluse, R. Feederle, I. Kiprianova, S. P. Grekova, A. S. Galabov, M. Witzens-Harig, A. D. Ho, J. Rommelaere, and Z. Raykov.** 2009. Oncolytic rat parvovirus H-1PV, a candidate for the treatment of human lymphoma: In vitro and in vivo studies. *Mol Ther* **17**:1164-72.
7. **Angelova, A. L., M. Aprahamian, S. P. Grekova, A. Hajri, B. Leuchs, N. A. Giese, C. Dinsart, A. Herrmann, G. Balboni, J. Rommelaere, and Z. Raykov.** 2009. Improvement of gemcitabine-based therapy of pancreatic carcinoma by means of oncolytic parvovirus H-1PV. *Clin Cancer Res* **15**:511-9.
8. **Ball-Goodrich, L. J., R. D. Moir, and P. Tattersall.** 1991. Parvoviral target cell specificity: acquisition of fibrotropism by a mutant of the lymphotropic strain of minute virus of mice involves multiple amino acid substitutions within the capsid. *Virology* **184**:175-86.
9. **Ball-Goodrich, L. J., and P. Tattersall.** 1992. Two amino acid substitutions within the capsid are coordinately required for acquisition of fibrotropism by the lymphotropic strain of minute virus of mice. *J Virol* **66**:3415-23.
10. **Banos-Lara Mdel, R., and E. Mendez.** Role of individual caspases induced by astrovirus on the processing of its structural protein and its release from the cell through a non-lytic mechanism. *Virology* **401**:322-32.
11. **Barber, G. N.** 2001. Host defense, viruses and apoptosis. *Cell Death Differ* **8**:113-26.
12. **Barkett, M., J. E. Doohar, L. Lemonnier, L. Simmons, J. N. Scarpati, Y. Wang, and T. D. Gilmore.** 2001. Three mutations in v-Rel render it resistant to cleavage by cell-death protease caspase-3. *Biochim Biophys Acta* **1526**:25-36.
13. **Bashir, T., R. Horlein, J. Rommelaere, and K. Willwand.** 2000. Cyclin A activates the DNA polymerase delta -dependent elongation machinery in vitro: A parvovirus DNA replication model. *Proc Natl Acad Sci U S A* **97**:5522-7.
14. **Bashir, T., J. Rommelaere, and C. Cziepluch.** 2001. In vivo accumulation of cyclin A and cellular replication factors in autonomous parvovirus minute virus of mice-associated replication bodies. *J Virol* **75**:4394-8.
15. **Benatti, P., D. Dolfini, A. Vigano, M. Ravo, A. Weisz, and C. Imbriano.** Specific inhibition of NF-Y subunits triggers different cell proliferation defects. *Nucleic Acids Res* **39**:5356-68.
16. **Bertin, J., S. M. Mendrysa, D. J. LaCount, S. Gaur, J. F. Krebs, R. C. Armstrong, K. J. Tomaselli, and P. D. Friesen.** 1996. Apoptotic suppression by baculovirus P35 involves cleavage by and inhibition of a virus-induced CED-3/ICE-like protease. *J Virol* **70**:6251-9.
17. **Best, S. M.** 2008. Viral subversion of apoptotic enzymes: escape from death row. *Annu Rev Microbiol* **62**:171-92.
18. **Best, S. M., and M. E. Bloom.** 2004. Caspase activation during virus infection: more than just the kiss of death? *Virology* **320**:191-4.
19. **Best, S. M., J. F. Shelton, J. M. Pompey, J. B. Wolfenbarger, and M. E. Bloom.** 2003. Caspase cleavage of the nonstructural protein NS1 mediates replication of Aleutian mink disease parvovirus. *J Virol* **77**:5305-12.
20. **Best, S. M., J. B. Wolfenbarger, and M. E. Bloom.** 2002. Caspase activation is required for permissive replication of Aleutian mink disease parvovirus in vitro. *Virology* **292**:224-34.

21. **Bodendorf, U., C. Cziepluch, J. C. Jauniaux, J. Rommelaere, and N. Salome.** 1999. Nuclear export factor CRM1 interacts with nonstructural proteins NS2 from parvovirus minute virus of mice. *J Virol* **73**:7769-79.
22. **Bodnar, J. W.** 1989. Sequence organization in regulatory regions of DNA of minute virus of mice. *Virus Genes* **2**:167-82.
23. **Bohmann, D., T. J. Bos, A. Admon, T. Nishimura, P. K. Vogt, and R. Tjian.** 1987. Human proto-oncogene c-jun encodes a DNA binding protein with structural and functional properties of transcription factor AP-1. *Science* **238**:1386-92.
24. **Brandenburger, A., D. Legendre, B. Avalosse, and J. Rommelaere.** 1990. NS-1 and NS-2 proteins may act synergistically in the cytopathogenicity of parvovirus MVMP. *Virology* **174**:576-84.
25. **Brockhaus, K., S. Plaza, D. J. Pintel, J. Rommelaere, and N. Salome.** 1996. Nonstructural proteins NS2 of minute virus of mice associate in vivo with 14-3-3 protein family members. *J Virol* **70**:7527-34.
26. **Brown, K. E., S. M. Anderson, and N. S. Young.** 1993. Erythrocyte P antigen: cellular receptor for B19 parvovirus. *Science* **262**:114-7.
27. **Brownstein, D. G., A. L. Smith, E. A. Johnson, D. J. Pintel, L. K. Naeger, and P. Tattersall.** 1992. The pathogenesis of infection with minute virus of mice depends on expression of the small nonstructural protein NS2 and on the genotype of the allotropic determinants VP1 and VP2. *J Virol* **66**:3118-24.
28. **Bucher, P.** 1990. Weight matrix descriptions of four eukaryotic RNA polymerase II promoter elements derived from 502 unrelated promoter sequences. *J Mol Biol* **212**:563-78.
29. **Bump, N. J., M. Hackett, M. Hugunin, S. Seshagiri, K. Brady, P. Chen, C. Ferenz, S. Franklin, T. Ghayur, P. Li, and et al.** 1995. Inhibition of ICE family proteases by baculovirus antiapoptotic protein p35. *Science* **269**:1885-8.
30. **Burnett, E., S. F. Cotmore, and P. Tattersall.** 2006. Segregation of a single outboard left-end origin is essential for the viability of parvovirus minute virus of mice. *J Virol* **80**:10879-83.
31. **Caillet-Fauquet, P., M. Perros, A. Brandenburger, P. Spegelaere, and J. Rommelaere.** 1990. Programmed killing of human cells by means of an inducible clone of parvoviral genes encoding non-structural proteins. *Embo J* **9**:2989-95.
32. **Caretti, G., V. Salsi, C. Vecchi, C. Imbriano, and R. Mantovani.** 2003. Dynamic recruitment of NF-Y and histone acetyltransferases on cell-cycle promoters. *J Biol Chem* **278**:30435-40.
33. **Caspar, D. L., and A. Klug.** 1962. Physical principles in the construction of regular viruses. *Cold Spring Harb Symp Quant Biol* **27**:1-24.
34. **Cassel, W. A., D. R. Murray, A. H. Torbin, Z. L. Olkowski, and M. E. Moore.** 1977. Viral oncolysate in the management of malignant melanoma. I. Preparation of the oncolysate and measurement of immunologic responses. *Cancer* **40**:672-9.
35. **Cater, J. E., and D. J. Pintel.** 1992. The small non-structural protein NS2 of the autonomous parvovirus minute virus of mice is required for virus growth in murine cells. *J Gen Virol* **73 (Pt 7)**:1839-43.
36. **Chen, Y. Q., F. de Foresta, J. Hertoghs, B. L. Avalosse, J. J. Cornelis, and J. Rommelaere.** 1986. Selective killing of simian virus 40-transformed human fibroblasts by parvovirus H-1. *Cancer Res* **46**:3574-9.
37. **Chen, Y. Q., M. C. Tuynder, J. J. Cornelis, P. Boukamp, N. E. Fusenig, and J. Rommelaere.** 1989. Sensitization of human keratinocytes to killing by parvovirus H-1 takes place during their malignant transformation but does not require them to be tumorigenic. *Carcinogenesis* **10**:163-7.
38. **Cheng, F., A. Y. Chen, S. M. Best, M. E. Bloom, D. Pintel, and J. Qiu.** The capsid proteins of Aleutian mink disease virus activate caspases and are specifically cleaved during infection. *J Virol* **84**:2687-96.
39. **Christensen, J., S. F. Cotmore, and P. Tattersall.** 2001. Minute virus of mice initiator protein NS1 and a host KDWK family transcription factor must form a precise ternary complex with origin DNA for nicking to occur. *J Virol* **75**:7009-17.

40. **Christensen, J., S. F. Cotmore, and P. Tattersall.** 1995. Minute virus of mice transcriptional activator protein NS1 binds directly to the transactivation region of the viral P38 promoter in a strictly ATP-dependent manner. *J Virol* **69**:5422-30.
41. **Christensen, J., S. F. Cotmore, and P. Tattersall.** 1997. A novel cellular site-specific DNA-binding protein cooperates with the viral NS1 polypeptide to initiate parvovirus DNA replication. *J Virol* **71**:1405-16.
42. **Christensen, J., S. F. Cotmore, and P. Tattersall.** 1997. Parvovirus initiation factor PIF: a novel human DNA-binding factor which coordinately recognizes two ACGT motifs. *J Virol* **71**:5733-41.
43. **Christensen, J., S. F. Cotmore, and P. Tattersall.** 1999. Two new members of the emerging KDWK family of combinatorial transcription modulators bind as a heterodimer to flexibly spaced PuCGPy half-sites. *Mol Cell Biol* **19**:7741-50.
44. **Christensen, J., and P. Tattersall.** 2002. Parvovirus initiator protein NS1 and RPA coordinate replication fork progression in a reconstituted DNA replication system. *J Virol* **76**:6518-31.
45. **Clem, R. J., M. Fechheimer, and L. K. Miller.** 1991. Prevention of apoptosis by a baculovirus gene during infection of insect cells. *Science* **254**:1388-90.
46. **Clemens, K. E., and D. J. Pintel.** 1988. The two transcription units of the autonomous parvovirus minute virus of mice are transcribed in a temporal order. *J Virol* **62**:1448-51.
47. **Cohen, S., A. R. Behzad, J. B. Carroll, and N. Pante.** 2006. Parvoviral nuclear import: bypassing the host nuclear-transport machinery. *J Gen Virol* **87**:3209-13.
48. **Cohen, S., A. K. Marr, P. Garcin, and N. Pante.** Nuclear envelope disruption involving host caspases plays a role in the parvovirus replication cycle. *J Virol* **85**:4863-74.
49. **Cohen, S., and N. Pante.** 2005. Pushing the envelope: microinjection of Minute virus of mice into *Xenopus* oocytes causes damage to the nuclear envelope. *J Gen Virol* **86**:3243-52.
50. **Corbau, R., V. Duverger, J. Rommelaere, and J. P. Nuesch.** 2000. Regulation of MVM NS1 by protein kinase C: impact of mutagenesis at consensus phosphorylation sites on replicative functions and cytopathic effects. *Virology* **278**:151-67.
51. **Corbau, R., N. Salom, J. Rommelaere, and J. P. Nuesch.** 1999. Phosphorylation of the viral nonstructural protein NS1 during MVMP infection of A9 cells. *Virology* **259**:402-15.
52. **Cornelis, J.** 2006. Parvovirus oncosuppression, p. 365-378. *In* B. M. E. Kerr J.R, Linden R.M., Parrish C.R. (ed.), *Parvoviruses*, Hodder Arnold: London.
53. **Cornelis, J. J., P. Becquart, N. Duponchel, N. Salome, B. L. Avalosse, M. Namba, and J. Rommelaere.** 1988. Transformation of human fibroblasts by ionizing radiation, a chemical carcinogen, or simian virus 40 correlates with an increase in susceptibility to the autonomous parvoviruses H-1 virus and minute virus of mice. *J Virol* **62**:1679-86.
54. **Cotmore, S. F., J. Christensen, J. P. Nuesch, and P. Tattersall.** 1995. The NS1 polypeptide of the murine parvovirus minute virus of mice binds to DNA sequences containing the motif [ACCA]₂₋₃. *J Virol* **69**:1652-60.
55. **Cotmore, S. F., M. D'Abramo A, Jr., C. M. Ticknor, and P. Tattersall.** 1999. Controlled conformational transitions in the MVM virion expose the VP1 N-terminus and viral genome without particle disassembly. *Virology* **254**:169-81.
56. **Cotmore, S. F., R. L. Gottlieb, and P. Tattersall.** 2007. Replication initiator protein NS1 of the parvovirus minute virus of mice binds to modular divergent sites distributed throughout duplex viral DNA. *J Virol* **81**:13015-27.
57. **Cotmore, S. F., L. J. Sturzenbecker, and P. Tattersall.** 1983. The autonomous parvovirus MVM encodes two nonstructural proteins in addition to its capsid polypeptides. *Virology* **129**:333-43.
58. **Cotmore, S. F., and P. Tattersall.** 1990. Alternate splicing in a parvoviral nonstructural gene links a common amino-terminal sequence to downstream domains which confer radically different localization and turnover characteristics. *Virology* **177**:477-87.
59. **Cotmore, S. F., and P. Tattersall.** 1994. An asymmetric nucleotide in the parvoviral 3' hairpin directs segregation of a single active origin of DNA replication. *Embo J* **13**:4145-52.
60. **Cotmore, S. F., and P. Tattersall.** 1987. The autonomously replicating parvoviruses of vertebrates. *Adv Virus Res* **33**:91-174.

61. **Cotmore, S. F., and P. Tattersall.** 1989. A genome-linked copy of the NS-1 polypeptide is located on the outside of infectious parvovirus particles. *J Virol* **63**:3902-11.
62. **Cotmore, S. F., and P. Tattersall.** 1998. High-mobility group 1/2 proteins are essential for initiating rolling-circle-type DNA replication at a parvovirus hairpin origin. *J Virol* **72**:8477-84.
63. **Cotmore, S. F., and P. Tattersall.** 1988. The NS-1 polypeptide of minute virus of mice is covalently attached to the 5' termini of duplex replicative-form DNA and progeny single strands. *J Virol* **62**:851-60.
64. **Cotmore, S. F., and P. Tattersall.** 1986. The NS-1 polypeptide of the autonomous parvovirus MVM is a nuclear phosphoprotein. *Virus Res* **4**:243-50.
65. **Cotmore, S. F., and P. Tattersall.** 1986. Organization of nonstructural genes of the autonomous parvovirus minute virus of mice. *J Virol* **58**:724-32.
66. **Crick, F. H., and J. D. Watson.** 1956. Structure of small viruses. *Nature* **177**:473-5.
67. **Critchley-Thorne, R. J., D. L. Simons, N. Yan, A. K. Miyahira, F. M. Dirbas, D. L. Johnson, S. M. Swetter, R. W. Carlson, G. A. Fisher, A. Koong, S. Holmes, and P. P. Lee.** 2009. Impaired interferon signaling is a common immune defect in human cancer. *Proc Natl Acad Sci U S A* **106**:9010-5.
68. **Cziepluch, C., S. Lampel, A. Grewenig, C. Grund, P. Lichter, and J. Rommelaere.** 2000. H-1 parvovirus-associated replication bodies: a distinct virus-induced nuclear structure. *J Virol* **74**:4807-15.
69. **Daeffler, L., R. Horlein, J. Rommelaere, and J. P. Nuesch.** 2003. Modulation of minute virus of mice cytotoxic activities through site-directed mutagenesis within the NS coding region. *J Virol* **77**:12466-78.
70. **Danthi, P.** Enter the kill zone: initiation of death signaling during virus entry. *Virology* **411**:316-24.
71. **Deleu, L., F. Fuks, D. Spitkovsky, R. Horlein, S. Faisst, and J. Rommelaere.** 1998. Opposite transcriptional effects of cyclic AMP-responsive elements in confluent or p27KIP-overexpressing cells versus serum-starved or growing cells. *Mol Cell Biol* **18**:409-19.
72. **Deleu, L., A. Pujol, S. Faisst, and J. Rommelaere.** 1999. Activation of promoter P4 of the autonomous parvovirus minute virus of mice at early S phase is required for productive infection. *J Virol* **73**:3877-85.
73. **Deleu, L., A. Pujol, J. P. Nuesch, and J. Rommelaere.** 2001. Inhibition of transcription-regulating properties of nonstructural protein 1 (NS1) of parvovirus minute virus of mice by a dominant-negative mutant form of NS1. *J Gen Virol* **82**:1929-34.
74. **Dempe, S., A. Y. Stroh-Dege, E. Schwarz, J. Rommelaere, and C. Dinsart.** SMAD4: a predictive marker of PDAC cell permissiveness for oncolytic infection with parvovirus H-1PV. *Int J Cancer* **126**:2914-27.
75. **Der, S. D., Y. L. Yang, C. Weissmann, and B. R. Williams.** 1997. A double-stranded RNA-activated protein kinase-dependent pathway mediating stress-induced apoptosis. *Proc Natl Acad Sci U S A* **94**:3279-83.
76. **Dettwiler, S., J. Rommelaere, and J. P. Nuesch.** 1999. DNA unwinding functions of minute virus of mice NS1 protein are modulated specifically by the lambda isoform of protein kinase C. *J Virol* **73**:7410-20.
77. **Di Piazza, M., C. Mader, K. Geletneky, Y. C. M. Herrero, E. Weber, J. Schlehofer, L. Deleu, and J. Rommelaere.** 2007. Cytosolic activation of cathepsins mediates parvovirus H-1-induced killing of cisplatin and TRAIL-resistant glioma cells. *J Virol* **81**:4186-98.
78. **Diemer, C., M. Schneider, J. Seebach, J. Quaas, G. Frosner, H. M. Schatzl, and S. Gilch.** 2008. Cell type-specific cleavage of nucleocapsid protein by effector caspases during SARS coronavirus infection. *J Mol Biol* **376**:23-34.
79. **Dorn, A., J. Bollekens, A. Staub, C. Benoist, and D. Mathis.** 1987. A multiplicity of CCAAT box-binding proteins. *Cell* **50**:863-72.
80. **Dupressoir, T., J. M. Vanacker, J. J. Cornelis, N. Duponchel, and J. Rommelaere.** 1989. Inhibition by parvovirus H-1 of the formation of tumors in nude mice and colonies in vitro by transformed human mammary epithelial cells. *Cancer Res* **49**:3203-8.

81. **Eichwald, V., L. Daeffler, M. Klein, J. Rommelaere, and N. Salome.** 2002. The NS2 proteins of parvovirus minute virus of mice are required for efficient nuclear egress of progeny virions in mouse cells. *J Virol* **76**:10307-19.
82. **Eleouet, J. F., S. Chilmarczyk, L. Besnardeau, and H. Laude.** 1998. Transmissible gastroenteritis coronavirus induces programmed cell death in infected cells through a caspase-dependent pathway. *J Virol* **72**:4918-24.
83. **Eleouet, J. F., E. A. Slee, F. Saurini, N. Castagne, D. Poncet, C. Garrido, E. Solary, and S. J. Martin.** 2000. The viral nucleocapsid protein of transmissible gastroenteritis coronavirus (TGEV) is cleaved by caspase-6 and -7 during TGEV-induced apoptosis. *J Virol* **74**:3975-83.
84. **Engelsma, D., N. Valle, A. Fish, N. Salome, J. M. Almendral, and M. Fornerod.** 2008. A supraphysiological nuclear export signal is required for parvovirus nuclear export. *Mol Biol Cell* **19**:2544-52.
85. **Faisst, S., S. R. Faisst, T. Dupressoir, S. Plaza, A. Pujol, J. C. Jauniaux, S. L. Rhode, and J. Rommelaere.** 1995. Isolation of a fully infectious variant of parvovirus H-1 supplanting the standard strain in human cells. *J Virol* **69**:4538-43.
86. **Faisst, S., D. Guittard, A. Benner, J. Y. Cesbron, J. R. Schlehofer, J. Rommelaere, and T. Dupressoir.** 1998. Dose-dependent regression of HeLa cell-derived tumours in SCID mice after parvovirus H-1 infection. *Int J Cancer* **75**:584-9.
87. **Faisst, S., M. Perros, L. Deleu, N. Spruyt, and J. Rommelaere.** 1994. Mapping of upstream regulatory elements in the P4 promoter of parvovirus minute virus of mice. *Virology* **202**:466-70.
88. **Faisst, S., J. R. Schlehofer, and H. zur Hausen.** 1989. Transformation of human cells by oncogenic viruses supports permissiveness for parvovirus H-1 propagation. *J Virol* **63**:2152-8.
89. **Faust, E. A., and G. Gloor.** 1984. Characterization of a metastable, partially replicated dimeric intermediate of minute virus of mice. *J Virol* **49**:621-5.
90. **Fei, J. W., and E. M. de Villiers.** 2008. Degradation of HPV20E6 by p53: Delta Np63 alpha and mutant p53R248W protect the wild type p53 mediated caspase-degradation. *Int J Cancer* **123**:108-16.
91. **Fisher, A. J., W. Cruz, S. J. Zoog, C. L. Schneider, and P. D. Friesen.** 1999. Crystal structure of baculovirus P35: role of a novel reactive site loop in apoptotic caspase inhibition. *Embo J* **18**:2031-9.
92. **Forterre, P.** 2006. The origin of viruses and their possible roles in major evolutionary transitions. *Virus Res* **117**:5-16.
93. **Fuks, F., L. Deleu, C. Dinsart, J. Rommelaere, and S. Faisst.** 1996. ras oncogene-dependent activation of the P4 promoter of minute virus of mice through a proximal P4 element interacting with the Ets family of transcription factors. *J Virol* **70**:1331-9.
94. **Galluzzi, L., C. Brenner, E. Morselli, Z. Touat, and G. Kroemer.** 2008. Viral control of mitochondrial apoptosis. *PLoS Pathog* **4**:e1000018.
95. **Gavin, B. J., and D. C. Ward.** 1990. Positive and negative regulation of the minute virus of mice P38 promoter. *J Virol* **64**:2057-63.
96. **Geletneky, K., A. D. Hartkopf, R. Krempien, J. Rommelaere, and J. R. Schlehofer.** Improved killing of human high-grade glioma cells by combining ionizing radiation with oncolytic parvovirus H-1 infection. *J Biomed Biotechnol* **2010**:350748.
97. **Giese, N. A., Z. Raykov, L. DeMartino, A. Vecchi, S. Sozzani, C. Dinsart, J. J. Cornelis, and J. Rommelaere.** 2002. Suppression of metastatic hemangiosarcoma by a parvovirus MVMP vector transducing the IP-10 chemokine into immunocompetent mice. *Cancer Gene Ther* **9**:432-42.
98. **Goh, P. Y., Y. J. Tan, S. P. Lim, S. G. Lim, Y. H. Tan, and W. J. Hong.** 2001. The hepatitis C virus core protein interacts with NS5A and activates its caspase-mediated proteolytic cleavage. *Virology* **290**:224-36.
99. **Grand, R. J., K. Schmeiser, E. M. Gordon, X. Zhang, P. H. Gallimore, and A. S. Turnell.** 2002. Caspase-mediated cleavage of adenovirus early region 1A proteins. *Virology* **301**:255-71.
100. **Green, D. R., T. Ferguson, L. Zitvogel, and G. Kroemer.** 2009. Immunogenic and tolerogenic cell death. *Nat Rev Immunol* **9**:353-63.

101. **Grekova, S., M. Aprahamian, N. Giese, S. Schmitt, T. Giese, C. S. Falk, L. Daeffler, C. Cziepluch, J. Rommelaere, and Z. Raykov.** Immune cells participate in the oncosuppressive activity of parvovirus H-1PV and are activated as a result of their abortive infection with this agent. *Cancer Biol Ther* **10**:1280-9.
102. **Grekova, S., R. Zawatzky, R. Horlein, C. Cziepluch, M. Mincberg, C. Davis, J. Rommelaere, and L. Daeffler.** Activation of an antiviral response in normal but not transformed mouse cells: a new determinant of minute virus of mice oncotropism. *J Virol* **84**:516-31.
103. **Grekova, S. P., M. Aprahamian, L. Daeffler, B. Leuchs, A. Angelova, T. Giese, A. Galabov, A. Heller, N. A. Giese, J. Rommelaere, and Z. Raykov.** Interferon gamma improves the vaccination potential of oncolytic parvovirus H-1PV for the treatment of peritoneal carcinomatosis in pancreatic cancer. *Cancer Biol Ther* **12**.
104. **Gu, M. L., F. X. Chen, and S. L. Rhode.** 1992. Parvovirus H-1 P38 promoter requires the trans-activation region (tar), an SP1 site, and a TATA box for full activity. *Virology* **187**:10-7.
105. **Gu, Z., G. Kuntz-Simon, J. Rommelaere, and J. Cornelis.** 1999. Oncogenic transformation-dependent expression of a transcription factor NF-Y subunit. *Mol Carcinog* **24**:294-9.
106. **Gu, Z., S. Plaza, M. Perros, C. Cziepluch, J. Rommelaere, and J. J. Cornelis.** 1995. NF-Y controls transcription of the minute virus of mice P4 promoter through interaction with an unusual binding site. *J Virol* **69**:239-46.
107. **Guetta, E., Y. Graziani, and J. Tal.** 1986. Suppression of Ehrlich ascites tumors in mice by minute virus of mice. *J Natl Cancer Inst* **76**:1177-80.
108. **Guy, M. P., and P. D. Friesen.** 2008. Reactive-site cleavage residues confer target specificity to baculovirus P49, a dimeric member of the P35 family of caspase inhibitors. *J Virol* **82**:7504-14.
109. **Haag, A., P. Menten, J. Van Damme, C. Dinsart, J. Rommelaere, and J. J. Cornelis.** 2000. Highly efficient transduction and expression of cytokine genes in human tumor cells by means of autonomous parvovirus vectors; generation of antitumor responses in recipient mice. *Hum Gene Ther* **11**:597-609.
110. **Hamilton, G.** 2006. Virology: the gene weavers. *Nature* **441**:683-5.
111. **Hanson, N. D., and S. L. Rhode, 3rd.** 1991. Parvovirus NS1 stimulates P4 expression by interaction with the terminal repeats and through DNA amplification. *J Virol* **65**:4325-33.
112. **Hay, S., and G. Kannourakis.** 2002. A time to kill: viral manipulation of the cell death program. *J Gen Virol* **83**:1547-64.
113. **Hristov, G., M. Kramer, J. Li, N. El-Andaloussi, R. Mora, L. Daeffler, H. Zentgraf, J. Rommelaere, and A. Marchini.** Through its nonstructural protein NS1, parvovirus H-1 induces apoptosis via accumulation of reactive oxygen species. *J Virol* **84**:5909-22.
114. **Hueffer, K., J. S. Parker, W. S. Weichert, R. E. Geisel, J. Y. Sgro, and C. R. Parrish.** 2003. The natural host range shift and subsequent evolution of canine parvovirus resulted from virus-specific binding to the canine transferrin receptor. *J Virol* **77**:1718-26.
115. **Jindal, H. K., C. B. Yong, G. M. Wilson, P. Tam, and C. R. Astell.** 1994. Mutations in the NTP-binding motif of minute virus of mice (MVM) NS-1 protein uncouple ATPase and DNA helicase functions. *J Biol Chem* **269**:3283-9.
116. **Jongeneel, C. V., R. Sahli, G. K. McMaster, and B. Hirt.** 1986. A precise map of splice junctions in the mRNAs of minute virus of mice, an autonomous parvovirus. *J Virol* **59**:564-73.
117. **Kalamvoki, M., U. Georgopoulou, and P. Mavromara.** 2006. The NS5A protein of the hepatitis C virus genotype 1a is cleaved by caspases to produce C-terminal-truncated forms of the protein that reside mainly in the cytosol. *J Biol Chem* **281**:13449-62.
118. **Kalamvoki, M., and P. Mavromara.** 2004. Calcium-dependent calpain proteases are implicated in processing of the hepatitis C virus NS5A protein. *J Virol* **78**:11865-78.
119. **Kaminsky, V., and B. Zhivotovsky.** To kill or be killed: how viruses interact with the cell death machinery. *J Intern Med* **267**:473-82.

120. **Karlberg, H., Y. J. Tan, and A. Mirazimi.** Induction of caspase activation and cleavage of the viral nucleocapsid protein in different cell types during Crimean-Congo hemorrhagic fever virus infection. *J Biol Chem* **286**:3227-34.
121. **Kepp, O., L. Senovilla, L. Galluzzi, T. Panaretakis, A. Tesniere, F. Schlemmer, F. Madeo, L. Zitvogel, and G. Kroemer.** 2009. Viral subversion of immunogenic cell death. *Cell Cycle* **8**:860-9.
122. **Kern, D. H.** 2011. Redemption for oncolytic virotherapy. *Molecular Therapy*.
123. **Kimsey, P. B., H. D. Engers, B. Hirt, and C. V. Jongeneel.** 1986. Pathogenicity of fibroblast- and lymphocyte-specific variants of minute virus of mice. *J Virol* **59**:8-13.
124. **King, J. A., R. Dubielzig, D. Grimm, and J. A. Kleinschmidt.** 2001. DNA helicase-mediated packaging of adeno-associated virus type 2 genomes into preformed capsids. *Embo J* **20**:3282-91.
125. **Kongsvik, J. R., J. F. Gierthy, and S. L. Rhode, 3rd.** 1974. Replication process of the parvovirus H-1. IV. H-1-specific proteins synthesized in synchronized human NB kidney cells. *J Virol* **14**:1600-3.
126. **Krady, J. K., and D. C. Ward.** 1995. Transcriptional activation by the parvoviral nonstructural protein NS-1 is mediated via a direct interaction with Sp1. *Mol Cell Biol* **15**:524-33.
127. **Kuhn, J. H., and P. B. Jahrling.** Clarification and guidance on the proper usage of virus and virus species names. *Arch Virol* **155**:445-53.
128. **Kuntz-Simon, G., T. Bashir, J. Rommelaere, and K. Willwand.** 1999. Neoplastic transformation-associated stimulation of the in vitro resolution of concatemer junction fragments from minute virus of mice DNA. *J Virol* **73**:2552-8.
129. **Labbe, K., and M. Saleh.** 2008. Cell death in the host response to infection. *Cell Death Differ* **15**:1339-49.
130. **Labieniec-Pintel, L., and D. Pintel.** 1986. The minute virus of mice P39 transcription unit can encode both capsid proteins. *J Virol* **57**:1163-7.
131. **Lachmann, S., J. Rommeleare, and J. P. Nuesch.** 2003. Novel PKCeta is required to activate replicative functions of the major nonstructural protein NS1 of minute virus of mice. *J Virol* **77**:8048-60.
132. **Lang, S. I., N. A. Giese, J. Rommelaere, C. Dinsart, and J. J. Cornelis.** 2006. Humoral immune responses against minute virus of mice vectors. *J Gene Med* **8**:1141-50.
133. **Lau, S. K., P. C. Woo, H. Tse, C. T. Fu, W. K. Au, X. C. Chen, H. W. Tsoi, T. H. Tsang, J. S. Chan, D. N. Tsang, K. S. Li, C. W. Tse, T. K. Ng, O. T. Tsang, B. J. Zheng, S. Tam, K. H. Chan, B. Zhou, and K. Y. Yuen.** 2008. Identification of novel porcine and bovine parvoviruses closely related to human parvovirus 4. *J Gen Virol* **89**:1840-8.
134. **Lebovitz, R. M., and R. G. Roeder.** 1986. Parvovirus H-1 expression: mapping of the abundant cytoplasmic transcripts and identification of promoter sites and overlapping transcription units. *J Virol* **58**:271-80.
135. **Legendre, D., and J. Rommelaere.** 1992. Terminal regions of the NS-1 protein of the parvovirus minute virus of mice are involved in cytotoxicity and promoter trans inhibition. *J Virol* **66**:5705-13.
136. **Legrand, C., S. Mousset, N. Salome, and J. Rommelaere.** 1992. Cooperation of oncogenes in cell transformation and sensitization to killing by the parvovirus minute virus of mice. *J Gen Virol* **73 (Pt 8)**:2003-9.
137. **Legrand, C., J. Rommelaere, and P. Caillet-Fauquet.** 1993. MVM(p) NS-2 protein expression is required with NS-1 for maximal cytotoxicity in human transformed cells. *Virology* **195**:149-55.
138. **Leist, M., B. Single, A. F. Castoldi, S. Kuhnle, and P. Nicotera.** 1997. Intracellular adenosine triphosphate (ATP) concentration: a switch in the decision between apoptosis and necrosis. *J Exp Med* **185**:1481-6.
139. **Leu, J. H., L. L. Chen, Y. R. Lin, G. H. Kou, and C. F. Lo.** Molecular mechanism of the interactions between white spot syndrome virus anti-apoptosis protein AAP-1 (WSSV449) and shrimp effector caspase. *Dev Comp Immunol* **34**:1068-74.
140. **Li, J., and J. Yuan.** 2008. Caspases in apoptosis and beyond. *Oncogene* **27**:6194-206.

141. **Li, X., and S. L. Rhode, 3rd.** 1990. Mutation of lysine 405 to serine in the parvovirus H-1 NS1 abolishes its functions for viral DNA replication, late promoter trans activation, and cytotoxicity. *J Virol* **64**:4654-60.
142. **Li, X., and S. L. Rhode, 3rd.** 1991. Nonstructural protein NS2 of parvovirus H-1 is required for efficient viral protein synthesis and virus production in rat cells in vivo and in vitro. *Virology* **184**:117-30.
143. **Li, X., and S. L. Rhode, 3rd.** 1993. The parvovirus H-1 NS2 protein affects viral gene expression through sequences in the 3' untranslated region. *Virology* **194**:10-9.
144. **Lipatov, A. S., H. L. Yen, R. Salomon, H. Ozaki, E. Hoffmann, and R. G. Webster.** 2008. The role of the N-terminal caspase cleavage site in the nucleoprotein of influenza A virus in vitro and in vivo. *Arch Virol* **153**:427-34.
145. **Lombardo, E., J. C. Ramirez, M. Agbandje-McKenna, and J. M. Almendral.** 2000. A beta-stranded motif drives capsid protein oligomers of the parvovirus minute virus of mice into the nucleus for viral assembly. *J Virol* **74**:3804-14.
146. **Lombardo, E., J. C. Ramirez, J. Garcia, and J. M. Almendral.** 2002. Complementary roles of multiple nuclear targeting signals in the capsid proteins of the parvovirus minute virus of mice during assembly and onset of infection. *J Virol* **76**:7049-59.
147. **Lorson, C., L. R. Burger, M. Mouw, and D. J. Pintel.** 1996. Efficient transactivation of the minute virus of mice P38 promoter requires upstream binding of NS1. *J Virol* **70**:834-42.
148. **Lorson, C., J. Pearson, L. Burger, and D. J. Pintel.** 1998. An Sp1-binding site and TATA element are sufficient to support full transactivation by proximally bound NS1 protein of minute virus of mice. *Virology* **240**:326-37.
149. **Lorson, C., and D. J. Pintel.** 1997. Characterization of the minute virus of mice P38 core promoter elements. *J Virol* **71**:6568-75.
150. **Los, M., M. Mozoluk, D. Ferrari, A. Stepczynska, C. Stroh, A. Renz, Z. Herceg, Z. Q. Wang, and K. Schulze-Osthoff.** 2002. Activation and caspase-mediated inhibition of PARP: a molecular switch between fibroblast necrosis and apoptosis in death receptor signaling. *Mol Biol Cell* **13**:978-88.
151. **Luo, M., J. Tsao, M. G. Rossmann, S. Basak, and R. W. Compans.** 1988. Preliminary X-ray crystallographic analysis of canine parvovirus crystals. *J Mol Biol* **200**:209-11.
152. **Majerciak, V., M. Kruhlak, P. K. Dagur, J. P. McCoy, Jr., and Z. M. Zheng.** Caspase-7 cleavage of Kaposi sarcoma-associated herpesvirus ORF57 confers a cellular function against viral lytic gene expression. *J Biol Chem* **285**:11297-307.
153. **Mani, B., C. Baltzer, N. Valle, J. M. Almendral, C. Kempf, and C. Ros.** 2006. Low pH-dependent endosomal processing of the incoming parvovirus minute virus of mice virion leads to externalization of the VP1 N-terminal sequence (N-VP1), N-VP2 cleavage, and uncoating of the full-length genome. *J Virol* **80**:1015-24.
154. **Mantovani, R., X. Y. Li, U. Pessara, R. Hooff van Huisjdijnen, C. Benoist, and D. Mathis.** 1994. Dominant negative analogs of NF-YA. *J Biol Chem* **269**:20340-6.
155. **Maroto, B., J. C. Ramirez, and J. M. Almendral.** 2000. Phosphorylation status of the parvovirus minute virus of mice particle: mapping and biological relevance of the major phosphorylation sites. *J Virol* **74**:10892-902.
156. **Mayo, M. A.** 2005. Changes to virus taxonomy 2004. *Archives of Virology* **150**:189-198.
157. **McKisic, M. D., J. D. Macy, Jr., M. L. Delano, R. O. Jacoby, F. X. Paturzo, and A. L. Smith.** 1998. Mouse parvovirus infection potentiates allogeneic skin graft rejection and induces syngeneic graft rejection. *Transplantation* **65**:1436-46.
158. **McKisic, M. D., F. X. Paturzo, and A. L. Smith.** 1996. Mouse parvovirus infection potentiates rejection of tumor allografts and modulates T cell effector functions. *Transplantation* **61**:292-9.
159. **Meek, D. W.** 2009. Tumour suppression by p53: a role for the DNA damage response? *Nat Rev Cancer* **9**:714-23.
160. **Mendez, E., E. Salas-Ocampo, and C. F. Arias.** 2004. Caspases mediate processing of the capsid precursor and cell release of human astroviruses. *J Virol* **78**:8601-8.
161. **Miller, C. L., and D. J. Pintel.** 2002. Interaction between parvovirus NS2 protein and nuclear export factor Crm1 is important for viral egress from the nucleus of murine cells. *J Virol* **76**:3257-66.

162. **Mincberg, M., J. Gopas, and J. Tal.** Minute virus of mice (MVMp) infection and NS1 expression induce p53 independent apoptosis in transformed rat fibroblast cells. *Virology* **412**:233-43.
163. **Moehler, M., B. Blechacz, N. Weiskopf, M. Zeidler, W. Stremmel, J. Rommelaere, P. R. Galle, and J. J. Cornelis.** 2001. Effective infection, apoptotic cell killing and gene transfer of human hepatoma cells but not primary hepatocytes by parvovirus H1 and derived vectors. *Cancer Gene Ther* **8**:158-67.
164. **Moehler, M. H., M. Zeidler, V. Wilsberg, J. J. Cornelis, T. Woelfel, J. Rommelaere, P. R. Galle, and M. Heike.** 2005. Parvovirus H-1-induced tumor cell death enhances human immune response in vitro via increased phagocytosis, maturation, and cross-presentation by dendritic cells. *Hum Gene Ther* **16**:996-1005.
165. **Moody, C. A., A. Fradet-Turcotte, J. Archambault, and L. A. Laimins.** 2007. Human papillomaviruses activate caspases upon epithelial differentiation to induce viral genome amplification. *Proc Natl Acad Sci U S A* **104**:19541-6.
166. **Moody, C. A., and L. A. Laimins.** 2009. Human papillomaviruses activate the ATM DNA damage pathway for viral genome amplification upon differentiation. *PLoS Pathog* **5**:e1000605.
167. **Mouset, S., J. Cornelis, N. Spruyt, and J. Rommelaere.** 1986. Transformation of established murine fibroblasts with an activated cellular Harvey-ras oncogene or the polyoma virus middle T gene increases cell permissiveness to parvovirus minute-virus-of-mice. *Biochimie* **68**:951-5.
168. **Mouset, S., Y. Ouadrhiri, P. Caillet-Fauquet, and J. Rommelaere.** 1994. The cytotoxicity of the autonomous parvovirus minute virus of mice nonstructural proteins in FR3T3 rat cells depends on oncogene expression. *J Virol* **68**:6446-53.
169. **Muharram, G., E. Le Rhun, I. Loison, P. Wizla, A. Richard, N. Martin, A. Roussel, A. Begue, P. Devos, M. C. Baranzelli, J. Bonnetterre, P. Caillet-Fauquet, and D. Stehelin.** Parvovirus H-1 induces cytopathic effects in breast carcinoma-derived cultures. *Breast Cancer Res Treat* **121**:23-33.
170. **Munger, J., R. Hagglund, and B. Roizman.** 2003. Infected cell protein No. 22 is subject to proteolytic cleavage by caspases activated by a mutant that induces apoptosis. *Virology* **305**:364-70.
171. **Murray, D. R., W. A. Cassel, A. H. Torbin, Z. L. Olkowski, and M. E. Moore.** 1977. Viral oncolysate in the management of malignant melanoma. II. Clinical studies. *Cancer* **40**:680-6.
172. **NA Giese, L. D. M., A Haag, C Dinsart, JJ Cornelis, J Rommelaere.** 2000. Autonomous parvovirus-based vectors: potential for the gene therapy of cancer, p. 34-52. *In* G. Gregoriadis (ed.), *Targeting of drugs: strategies for gene constructs and delivery*, IOS Press: Amsterdam.
173. **Naeger, L. K., J. Cater, and D. J. Pintel.** 1990. The small nonstructural protein (NS2) of the parvovirus minute virus of mice is required for efficient DNA replication and infectious virus production in a cell-type-specific manner. *J Virol* **64**:6166-75.
174. **Naeger, L. K., N. Salome, and D. J. Pintel.** 1993. NS2 is required for efficient translation of viral mRNA in minute virus of mice-infected murine cells. *J Virol* **67**:1034-43.
175. **Nam, H. J., B. Gurda-Whitaker, W. Y. Gan, S. Ilaria, R. McKenna, P. Mehta, R. A. Alvarez, and M. Agbandje-McKenna.** 2006. Identification of the sialic acid structures recognized by minute virus of mice and the role of binding affinity in virulence adaptation. *J Biol Chem* **281**:25670-7.
176. **Nuesch, J. P., S. Bar, S. Lachmann, and J. Rommelaere.** 2009. Ezrin-radixin-moesin family proteins are involved in parvovirus replication and spreading. *J Virol* **83**:5854-63.
177. **Nuesch, J. P., J. Christensen, and J. Rommelaere.** 2001. Initiation of minute virus of mice DNA replication is regulated at the level of origin unwinding by atypical protein kinase C phosphorylation of NS1. *J Virol* **75**:5730-9.
178. **Nuesch, J. P., R. Corbau, P. Tattersall, and J. Rommelaere.** 1998. Biochemical activities of minute virus of mice nonstructural protein NS1 are modulated *In vitro* by the phosphorylation state of the polypeptide. *J Virol* **72**:8002-12.

179. **Nuesch, J. P., S. F. Cotmore, and P. Tattersall.** 1995. Sequence motifs in the replicator protein of parvovirus MVM essential for nicking and covalent attachment to the viral origin: identification of the linking tyrosine. *Virology* **209**:122-35.
180. **Nuesch, J. P., S. Dettwiler, R. Corbau, and J. Rommelaere.** 1998. Replicative functions of minute virus of mice NS1 protein are regulated in vitro by phosphorylation through protein kinase C. *J Virol* **72**:9966-77.
181. **Nuesch, J. P., S. Lachmann, and J. Rommelaere.** 2005. Selective alterations of the host cell architecture upon infection with parvovirus minute virus of mice. *Virology* **331**:159-74.
182. **Nuesch, J. P., and J. Rommelaere.** 2006. NS1 interaction with CKII alpha: novel protein complex mediating parvovirus-induced cytotoxicity. *J Virol* **80**:4729-39.
183. **Nuesch, J. P., and J. Rommelaere.** 2007. A viral adaptor protein modulating casein kinase II activity induces cytopathic effects in permissive cells. *Proc Natl Acad Sci U S A* **104**:12482-7.
184. **Nuesch, J. P., and P. Tattersall.** 1993. Nuclear targeting of the parvoviral replicator molecule NS1: evidence for self-association prior to nuclear transport. *Virology* **196**:637-51.
185. **Nüesch, J. P. F.** 2006. Regulation of non structural protein functions by differential synthesis, modification and trafficking., p. 275-289. *In* B. M. E. Kerr J.R., Linden R.M., Parrish C.R. (ed.), *Parvoviruses*, Hodder Arnold: London.
186. **Nuesch, R., K. Schroeder, T. Dieterle, B. Martina, and E. Battegay.** 2001. Relation between insufficient response to antihypertensive treatment and poor compliance with treatment: a prospective case-control study. *Bmj* **323**:142-6.
187. **Ohshima, T., M. Iwama, Y. Ueno, F. Sugiyama, T. Nakajima, A. Fukamizu, and K. Yagami.** 1998. Induction of apoptosis in vitro and in vivo by H-1 parvovirus infection. *J Gen Virol* **79** (Pt 12):3067-71.
188. **Op De Beeck, A., F. Anouja, S. Mousset, J. Rommelaere, and P. Caillet-Fauquet.** 1995. The nonstructural proteins of the autonomous parvovirus minute virus of mice interfere with the cell cycle, inducing accumulation in G2. *Cell Growth Differ* **6**:781-7.
189. **Op De Beeck, A., and P. Caillet-Fauquet.** 1997. The NS1 protein of the autonomous parvovirus minute virus of mice blocks cellular DNA replication: a consequence of lesions to the chromatin? *J Virol* **71**:5323-9.
190. **Op De Beeck, A., J. Sobczak-Thepot, H. Sirma, F. Bourgain, C. Brechot, and P. Caillet-Fauquet.** 2001. NS1- and minute virus of mice-induced cell cycle arrest: involvement of p53 and p21 (cip1). *J Virol* **75**:11071-8.
191. **Pack, G. T.** 1950. Note on the experimental use of rabies vaccine for melanomatosis. *Arch Derm Syph* **62**:694-695.
192. **Paglino, J., E. Burnett, and P. Tattersall.** 2007. Exploring the contribution of distal P4 promoter elements to the oncosensitivity of Minute Virus of Mice. *Virology* **361**:174-84.
193. **Paradiso, P. R.** 1981. Infectious process of the parvovirus H-1: correlation of protein content, particle density, and viral infectivity. *J Virol* **39**:800-7.
194. **Parker, J. S., W. J. Murphy, D. Wang, S. J. O'Brien, and C. R. Parrish.** 2001. Canine and feline parvoviruses can use human or feline transferrin receptors to bind, enter, and infect cells. *J Virol* **75**:3896-902.
195. **Pennisi, E.** 2004. Evolutionary biology. The birth of the nucleus. *Science* **305**:766-8.
196. **Perros, M., L. Deleu, J. M. Vanacker, Z. Kherrouche, N. Spruyt, S. Faisst, and J. Rommelaere.** 1995. Upstream CREs participate in the basal activity of minute virus of mice promoter P4 and in its stimulation in ras-transformed cells. *J Virol* **69**:5506-15.
197. **Phuangsab, A., R. M. Lorence, K. W. Reichard, M. E. Peoples, and R. J. Walter.** 2001. Newcastle disease virus therapy of human tumor xenografts: antitumor effects of local or systemic administration. *Cancer Lett* **172**:27-36.
198. **Pindel, A., and A. Sadler.** The role of protein kinase R in the interferon response. *J Interferon Cytokine Res* **31**:59-70.
199. **Pitluk, Z. W., and D. C. Ward.** 1991. Unusual Sp1-GC box interaction in a parvovirus promoter. *J Virol* **65**:6661-70.
200. **Plaza, S., A. Boullard, D. Pele, J. J. Cornelis, J. Rommelaere, P. U. Giacomoni, and M. Prunieras.** 1991. Unscheduled DNA synthesis: a quantitative indicator of residual

- immunodetectable pyrimidine dimers in human fibroblasts after ultraviolet-B irradiation. *Photochem Photobiol* **53**:217-27.
201. **Pop, C., and G. S. Salvesen.** 2009. Human caspases: activation, specificity, and regulation. *J Biol Chem* **284**:21777-81.
202. **Pringle, C. R.** 1991. The order Mononegavirales. *Archives of virology* **117**:137-140.
203. **Pujol, A., L. Deleu, J. P. Nuesch, C. Cziepluch, J. C. Jauniaux, and J. Rommelaere.** 1997. Inhibition of parvovirus minute virus of mice replication by a peptide involved in the oligomerization of nonstructural protein NS1. *J Virol* **71**:7393-403.
204. **Ran, Z., B. Rayet, J. Rommelaere, and S. Faisst.** 1999. Parvovirus H-1-induced cell death: influence of intracellular NAD consumption on the regulation of necrosis and apoptosis. *Virus Res* **65**:161-74.
205. **Raykov, Z., P. B. Georgieva, A. Angelova, A. S. Galabov, and J. Rommelaere.** 2009. Anticancer effects of an oncolytic parvovirus combined with non-conventional therapeutics on pancreatic carcinoma cell lines. *Acta Virol* **53**:57-60.
206. **Raykov, Z., S. Grekova, A. S. Galabov, G. Balboni, U. Koch, M. Aprahamian, and J. Rommelaere.** 2007. Combined oncolytic and vaccination activities of parvovirus H-1 in a metastatic tumor model. *Oncol Rep* **17**:1493-9.
207. **Raykov, Z., S. Grekova, B. Leuchs, M. Aprahamian, and J. Rommelaere.** 2008. Arming parvoviruses with CpG motifs to improve their oncosuppressive capacity. *Int J Cancer* **122**:2880-4.
208. **Rhode, S. L., 3rd.** 1989. Both excision and replication of cloned autonomous parvovirus DNA require the NS1 (rep) protein. *J Virol* **63**:4249-56.
209. **Rhode, S. L., 3rd.** 1985. trans-Activation of parvovirus P38 promoter by the 76K noncapsid protein. *J Virol* **55**:886-9.
210. **Rhode, S. L., 3rd, and P. R. Paradiso.** 1983. Parvovirus genome: nucleotide sequence of H-1 and mapping of its genes by hybrid-arrested translation. *J Virol* **45**:173-84.
211. **Rhode, S. L., 3rd, and S. M. Richard.** 1987. Characterization of the trans-activation-responsive element of the parvovirus H-1 P38 promoter. *J Virol* **61**:2807-15.
212. **Richards, R., P. Linser, and R. W. Armentrout.** 1977. Kinetics of assembly of a parvovirus, minute virus of mice, in synchronized rat brain cells. *J Virol* **22**:778-93.
213. **Riolobos, L., J. Reguera, M. G. Mateu, and J. M. Almendral.** 2006. Nuclear transport of trimeric assembly intermediates exerts a morphogenetic control on the icosahedral parvovirus capsid. *J Mol Biol* **357**:1026-38.
214. **Riolobos, L., N. Valle, E. Hernando, B. Maroto, M. Kann, and J. M. Almendral.** Viral oncolysis that targets Raf-1 signaling control of nuclear transport. *J Virol* **84**:2090-9.
215. **Roberts, L. O., N. Al-Molawi, M. J. Carter, and G. E. Kass.** 2003. Apoptosis in cultured cells infected with feline calicivirus. *Ann N Y Acad Sci* **1010**:587-90.
216. **Rommelaere, J., and J. J. Cornelis.** 1991. Antineoplastic activity of parvoviruses. *J Virol Methods* **33**:233-51.
217. **Rommelaere, J., K. Geletneky, A. L. Angelova, L. Daeffler, C. Dinsart, I. Kiprianova, J. R. Schlehofer, and Z. Raykov.** Oncolytic parvoviruses as cancer therapeutics. *Cytokine Growth Factor Rev* **21**:185-95.
218. **Ros, C., C. J. Burckhardt, and C. Kempf.** 2002. Cytoplasmic trafficking of minute virus of mice: low-pH requirement, routing to late endosomes, and proteasome interaction. *J Virol* **76**:12634-45.
219. **Ros, C., and C. Kempf.** 2004. The ubiquitin-proteasome machinery is essential for nuclear translocation of incoming minute virus of mice. *Virology* **324**:350-60.
220. **Ruiz, Z., I. S. Mihaylov, S. F. Cotmore, and P. Tattersall.** Recruitment of DNA replication and damage response proteins to viral replication centers during infection with NS2 mutants of Minute Virus of Mice (MVM). *Virology* **410**:375-84.
221. **Salome, N., B. van Hille, N. Duponchel, G. Meneguzzi, F. Cuzin, J. Rommelaere, and J. J. Cornelis.** 1990. Sensitization of transformed rat cells to parvovirus MVMp is restricted to specific oncogenes. *Oncogene* **5**:123-30.
222. **Salome, N., B. van Hille, M. Geuskens, and J. Rommelaere.** 1989. Partial reversion of conditional transformation correlates with a decrease in the sensitivity of rat cells to killing by the parvovirus minute virus of mice but not in their capacity for virus production: effect of a temperature-sensitive v-src oncogene. *J Virol* **63**:4797-807.

223. **Sanjuan, R., M. R. Nebot, N. Chirico, L. M. Mansky, and R. Belshaw.** Viral mutation rates. *J Virol* **84**:9733-48.
224. **Satoh, S., M. Hirota, T. Noguchi, M. Hijikata, H. Handa, and K. Shimotohno.** 2000. Cleavage of hepatitis C virus nonstructural protein 5A by a caspase-like protease(s) in mammalian cells. *Virology* **270**:476-87.
225. **Schoborg, R. V., and D. J. Pintel.** 1991. Accumulation of MVM gene products is differentially regulated by transcription initiation, RNA processing and protein stability. *Virology* **181**:22-34.
226. **Shisler, J. L., and B. Moss.** 2001. Molluscum contagiosum virus inhibitors of apoptosis: The MC159 v-FLIP protein blocks Fas-induced activation of procaspases and degradation of the related MC160 protein. *Virology* **282**:14-25.
227. **Sieben, M., K. Herzer, M. Zeidler, V. Heinrichs, B. Leuchs, M. Schuler, J. J. Cornelis, P. R. Galle, J. Rommelaere, and M. Moehler.** 2008. Killing of p53-deficient hepatoma cells by parvovirus H-1 and chemotherapeutics requires promyelocytic leukemia protein. *World J Gastroenterol* **14**:3819-28.
228. **Siegl, G.** 1984. Biology and pathogenicity of autonomous parvoviruses, p. 297-362. In K. Bern (ed.), *The Parvoviruses*, Plenum Press: New York.
229. **Sinha, S., S. N. Maity, J. Lu, and B. de Crombrugge.** 1995. Recombinant rat CBF-C, the third subunit of CBF/NFY, allows formation of a protein-DNA complex with CBF-A and CBF-B and with yeast HAP2 and HAP3. *Proc Natl Acad Sci U S A* **92**:1624-8.
230. **Spegelaere, P., B. van Hille, N. Spruyt, S. Faisst, J. J. Cornelis, and J. Rommelaere.** 1991. Initiation of transcription from the minute virus of mice P4 promoter is stimulated in rat cells expressing a c-Ha-ras oncogene. *J Virol* **65**:4919-28.
231. **Stojdl, D. F., B. Lichty, S. Knowles, R. Marius, H. Atkins, N. Sonenberg, and J. C. Bell.** 2000. Exploiting tumor-specific defects in the interferon pathway with a previously unknown oncolytic virus. *Nat Med* **6**:821-5.
232. **Tattersall, P., and J. Bratton.** 1983. Reciprocal productive and restrictive virus-cell interactions of immunosuppressive and prototype strains of minute virus of mice. *J Virol* **46**:944-55.
233. **Tattersall, P., and D. C. Ward.** 1976. Rolling hairpin model for replication of parvovirus and linear chromosomal DNA. *Nature* **263**:106-9.
234. **Telerman, A., M. Tuynder, T. Dupressoir, B. Robaye, F. Sigaux, E. Shaulian, M. Oren, J. Rommelaere, and R. Amson.** 1993. A model for tumor suppression using H-1 parvovirus. *Proc Natl Acad Sci U S A* **90**:8702-6.
235. **Toolan, H. W.** 1965. H-1 Virus Viremia in the Adult Hamster. *Proc Soc Exp Biol Med* **119**:715-7.
236. **Toolan, H. W.** 1967. Lack of oncogenic effect of the H-viruses for hamsters. *Nature* **214**:1036.
237. **Toolan, H. W.** 1978. Maternal role in susceptibility of embryonic and newborn hamsters to H-1 parvovirus in *Replication of Mammalian parvoviruses*, Cold Spring Harbor, NY: Cold Spring Harbor Press, p. 161.
238. **Toolan, H. W., G. Dalldore, M. Barclay, S. Chandra, and A. E. Moore.** 1960. An Unidentified, Filtrable Agent Isolated from Transplanted Human Tumors. *Proc Natl Acad Sci U S A* **46**:1256-8.
239. **Toolan, H. W., E. L. Saunders, C. M. Southam, A. E. Moore, and A. G. Levin.** 1965. H-1 Virus Viremia in the Human. *Proc Soc Exp Biol Med* **119**:711-5.
240. **Tse, H., H. W. Tsoi, J. L. Teng, X. C. Chen, H. Liu, B. Zhou, B. J. Zheng, P. C. Woo, S. K. Lau, and K. Y. Yuen.** Discovery and genomic characterization of a novel ovine parvovirus and a new genotype of bovine parvovirus. *PLoS One* **6**:e25619.
241. **Tullis, G. E., L. R. Burger, and D. J. Pintel.** 1993. The minor capsid protein VP1 of the autonomous parvovirus minute virus of mice is dispensable for encapsidation of progeny single-stranded DNA but is required for infectivity. *J Virol* **67**:131-41.
242. **Tuynder, M., L. Susini, S. Prieur, S. Besse, G. Fiucci, R. Amson, and A. Telerman.** 2002. Biological models and genes of tumor reversion: cellular reprogramming through tpt1/TCTP and SIAH-1. *Proc Natl Acad Sci U S A* **99**:14976-81.

243. **Valle, N. R. A., JM.** 2006. Synthesis, post-translational modification and trafficking of the parvovirus structural polypeptides, p. 291-304. In B. M. E. C. S. F. Kerr J.R., Linden R.M., Parrish C.R. (ed.), *Parvoviruses*, Hodder Arnold: London.
244. **Van Hille, B., N. Duponchel, N. Salome, N. Spruyt, S. F. Cotmore, P. Tattersall, J. J. Cornelis, and J. Rommelaere.** 1989. Limitations to the expression of parvoviral nonstructural proteins may determine the extent of sensitization of EJ-ras-transformed rat cells to minute virus of mice. *Virology* **171**:89-97.
245. **Van Pachterbeke, C., M. Tuynder, A. Brandenburger, G. Leclercq, M. Borrás, and J. Rommelaere.** 1997. Varying sensitivity of human mammary carcinoma cells to the toxic effect of parvovirus H-1. *Eur J Cancer* **33**:1648-53.
246. **Vanacker, J. M., R. Corbau, G. Adelmant, M. Perros, V. Laudet, and J. Rommelaere.** 1996. Transactivation of a cellular promoter by the NS1 protein of the parvovirus minute virus of mice through a putative hormone-responsive element. *J Virol* **70**:2369-77.
247. **Vanacker, J. M., V. Laudet, G. Adelmant, D. Stehelin, and J. Rommelaere.** 1993. Interconnection between thyroid hormone signalling pathways and parvovirus cytotoxic functions. *J Virol* **67**:7668-72.
248. **Ventoso, I., J. J. Berlanga, and J. M. Almendral.** Translation control by protein kinase R restricts minute virus of mice infection: role in parvovirus oncolysis. *J Virol* **84**:5043-51.
249. **Vihinen-Ranta, M., D. Wang, W. S. Weichert, and C. R. Parrish.** 2002. The VP1 N-terminal sequence of canine parvovirus affects nuclear transport of capsids and efficient cell infection. *J Virol* **76**:1884-91.
250. **Wang, F., Y. Wei, C. Zhu, X. Huang, Y. Xu, L. Yu, and X. Yu.** Novel parvovirus sublineage in the family of Parvoviridae. *Virus Genes* **41**:305-8.
251. **Wang, L., B. Zhi, W. Wu, and X. Zhang.** 2008. Requirement for shrimp caspase in apoptosis against virus infection. *Dev Comp Immunol* **32**:706-15.
252. **Whitfield, J.** 2006. Origins of DNA: base invaders. *Nature* **439**:130-1.
253. **Willwand, K., and B. Hirt.** 1991. The minute virus of mice capsid specifically recognizes the 3' hairpin structure of the viral replicative-form DNA: mapping of the binding site by hydroxyl radical footprinting. *J Virol* **65**:4629-35.
254. **Wilson, G. M., H. K. Jindal, D. E. Yeung, W. Chen, and C. R. Astell.** 1991. Expression of minute virus of mice major nonstructural protein in insect cells: purification and identification of ATPase and helicase activities. *Virology* **185**:90-8.
255. **Wizla, P., A. Begue, I. Loison, A. Richard, P. Caillet-Fauquet, and D. Stehelin.** Ectopic expression of H-1 parvovirus NS1 protein induces alterations in actin filaments and cell death in human normal MRC-5 and transformed MRC-5 SV2 cells. *Arch Virol* **155**:771-5.
256. **Wrzesinski, C., L. Tesfay, N. Salome, J. C. Jauniaux, J. Rommelaere, J. Cornelis, and C. Dinsart.** 2003. Chimeric and pseudotyped parvoviruses minimize the contamination of recombinant stocks with replication-competent viruses and identify a DNA sequence that restricts parvovirus H-1 in mouse cells. *J Virol* **77**:3851-8.
257. **Xu, G., M. Cirilli, Y. Huang, R. L. Rich, D. G. Myszka, and H. Wu.** 2001. Covalent inhibition revealed by the crystal structure of the caspase-8/p35 complex. *Nature* **410**:494-7.
258. **Yan, F., D. Xia, S. Lv, Y. Qi, and H. Xu.** Functional analysis of the orf390 gene of the white spot syndrome virus. *Virus Res* **151**:39-44.
259. **Zadori, Z., J. Szelei, M. C. Lacoste, Y. Li, S. Gariépy, P. Raymond, M. Allaire, I. R. Nabi, and P. Tijssen.** 2001. A viral phospholipase A2 is required for parvovirus infectivity. *Dev Cell* **1**:291-302.
260. **Zhirnov, O., and A. G. Bukrinskaya.** 1984. Nucleoproteins of animal influenza viruses, in contrast to those of human strains, are not cleaved in infected cells. *J Gen Virol* **65 (Pt 6)**:1127-34.
261. **Zhirnov, O. P., and H. D. Klenk.** 2009. Alterations in caspase cleavage motifs of NP and M2 proteins attenuate virulence of a highly pathogenic avian influenza virus. *Virology* **394**:57-63.
262. **Zhirnov, O. P., T. E. Konakova, W. Garten, and H. Klenk.** 1999. Caspase-dependent N-terminal cleavage of influenza virus nucleocapsid protein in infected cells. *J Virol* **73**:10158-63.

263. **Zhirnov, O. P., T. E. Konakova, T. Wolff, and H. D. Klenk.** 2002. NS1 protein of influenza A virus down-regulates apoptosis. *J Virol* **76**:1617-25.
264. **Zhirnov, O. P., and V. V. Syrtzev.** 2009. Influenza virus pathogenicity is determined by caspase cleavage motifs located in the viral proteins. *J Mol Genet Med* **3**:124-32.
265. **Zhou, Q., J. F. Krebs, S. J. Snipas, A. Price, E. S. Alnemri, K. J. Tomaselli, and G. S. Salvesen.** 1998. Interaction of the baculovirus anti-apoptotic protein p35 with caspases. Specificity, kinetics, and characterization of the caspase/p35 complex. *Biochemistry* **37**:10757-65.
266. **Zoog, S. J., J. J. Schiller, J. A. Wetter, N. Chejanovsky, and P. D. Friesen.** 2002. Baculovirus apoptotic suppressor P49 is a substrate inhibitor of initiator caspases resistant to P35 in vivo. *Embo J* **21**:5130-40.

ANNEXES

Articles published as co-author

List of oral communications, posters and prize



Quoi d'neuf, Docteur ?

Comme chaque mois, les acteurs de la recherche nous livrent aujourd'hui les découvertes qui feront les traitements de demain.

L'ennemi de ton ennemi est ton ami

Un virus qui rend malade le cancer !

Instinctivement, on associe plutôt les virus à la maladie, et non à la thérapie. Pourtant, parmi les milliers de virus connus, certains sont capables de tuer spécifiquement les cellules cancéreuses. Une propriété qui fascine bien sûr, mais peut inquiéter aussi. Un tel virus pourrait-il un jour rejoindre sans danger l'arsenal thérapeutique des cliniciens ? Enquête sur l'un d'entre eux, le parvovirus H-1.

Virus et cellule, des partenaires particuliers.

Les virus, même s'ils ne sont pas à proprement parler des être vivants, poursuivent cependant le même but que ces derniers : *survivre*. On comprend aisément ce que cela signifie pour les animaux, ou même les plantes. Pour un virus, qui n'est pas indépendant, cela implique de réussir à faire copier son information génétique et fabriquer de nouveaux virus par une cellule dite "cellule-hôte" qui, contrairement à lui, dispose de tout le matériel biologique nécessaire pour le multiplier. Mais tous les virus ne peuvent pas être pris en charge par tous les types de cellules d'un même organisme : on parle de **tropisme viral**. Par exemple, les virus responsables des hépatites dites virales ne vont pouvoir être multipliés que par les cellules du foie (trophisme

hépatique) tandis que le célèbre virus de la grippe préférera quant à lui envahir les cellules du système respiratoire (trophisme respiratoire).

Parvovirus H-1 cherche cellules cancéreuses.

De la même façon, toutes les cellules ne sont pas capables d'assurer la multiplication du parvovirus H-1. Pourtant, chez l'homme, des cellules aussi bien pulmonaires, qu'hépatiques, mammaires, pancréatiques, rénales, ou encore cérébrales, sont connues pour assurer la production de ce virus (Encadré 1). Mais encore faut-il qu'elles soient "transformées", autrement dit cancéreuses. Dans le cas du parvovirus H-1, dont la multiplication est donc favorisée par l'état cancéreux de la cellule-hôte, on parle d'**oncotropisme**. Ces cellules qui "autorisent" la propagation du parvovirus H-1 signifient alors leur arrêt de mort. Le verdict de l'infection d'une population cellulaire cancéreuse est sans appel et la condamnation à une destruction massive (Encadré 2). Le potentiel thérapeutique d'un tel agent est énorme compte tenu de la diversité des cellules cancéreuses sensibles à l'action toxique du parvovirus H-1. Mais sa nature même de virus invite à la prudence car s'il est capable de nuire autant à des cellules aussi dangereuses que des cellules cancéreuses, ne représente-t-il pas un risque ? Son utilisation peut-elle vraiment être envisagée en thérapie ?

Parvovirus H-1 vs. cellules saines : la meilleure défense c'est l'attaque

Contrairement à d'autres virus, l'entrée du parvovirus H-1 est possible aussi bien dans les cellules saines que cancéreuses. Dans ce cas, comment ce virus peut-il être inoffensif pour des cellules saines ? Alors que les fonctions des cellules cancéreuses sont détournées par le virus pour assurer sa multiplication, les cellules saines déclenchent quant à elles un mécanisme de sauvegarde connu pour être l'une des premières défenses immunitaires en cas d'infection, l'**apoptose**.

2. Effet du parvovirus H-1 sur des cellules cancéreuses. Les cellules cancéreuses de l'utérus (à gauche) ont été infectées avec le parvovirus H-1 ou non. Les cellules qui n'ont pas été infectées apparaissent nombreuses (à gauche) alors que l'infection par le virus en a éliminé plus de 90% (à droite) en quelques jours seulement.

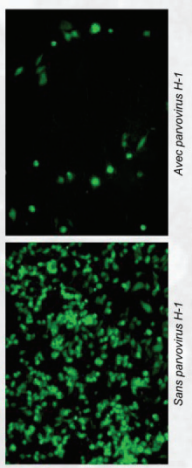

Sans parvovirus H-1

Avec parvovirus H-1

Aussi appelée mort cellulaire programmée, l'apoptose intervient dans de nombreux processus physiologiques et aboutit classiquement à l'activation des caspases, des protéines particulières qui agissent comme de véritables ciseaux moléculaires pour détruire les composants de la cellule. En cas d'infection, le pathogène, indétectable et potentiellement dangereux, doit être éradiqué. «Le déclenchement de ce mécanisme n'a pour ainsi dire jamais été décrit dans le cas d'infection de cellules cancéreuses par le parvovirus H-1. En se plaçant dans des modèles sains, par contre, l'apoptose est observée».

explique-t-on au laboratoire du Pr. Yvan de Launoit (Institut de Biologie de Lille) où l'équipe du Dr. David Tulasne s'intéresse au comportement adopté par le parvovirus H-1 face à l'agression que constitue l'apoptose à son égard. Classiquement, en se suicidant, la cellule empêche non seulement le virus de se multiplier et d'envahir les cellules voisines, mais en plus, elle émet des signaux visant à mettre en place une réponse immunitaire plus spécifique et sophistiquée dirigée contre le virus dont la survie est alors compromise. Que devient alors le parvovirus H-1 ?

3. L'apoptose comme enjeu des interactions entre virus et cellule-hôte



1. Cycle de multiplication du parvovirus H-1. Le virus s'associe à la cellule-hôte (1) et y entre (2). Si elle est cancéreuse, la cellule infectée est capable de multiplier l'information génétique virale et former de nouveaux virus (3) qui sont libérés par la cellule en train de mourir. Les virus libérés peuvent reprendre à l'étape 1 avec les cellules voisines.

2. Même s'il nous reste encore du travail pour pouvoir valider toutes nos hypothèses et être catégorique, ce mécanisme montre que les cellules saines sont capables de faire face au virus qui, en conséquence, fait profil bas, probablement pour éviter d'éveiller tout le système immunitaire. En définitive, nous pensons que le parvovirus H-1 exploite une faiblesse des cellules cancéreuses. Alors, à quand une prescription de parvovirus H-1 ?

(sujet et propos recueillis par ASR).

Association pour le Bonheur des Enfants et des Adultes



Clivage sur les caspases de la protéine NS1 du parvovirus H-1 : Caractérisation et implication dans le cycle viral. Audrey RICHARD.

Articles published as co-author:

1. **Muharram, G., E. Le Rhun, I. Loison, P. Wizla, A. Richard, N. Martin, A. Roussel, A. Begue, P. Devos, M. C. Baranzelli, J. Bonneterre, P. Caillet-Fauquet, and D. Stehelin.** Parvovirus H-1 induces cytopathic effects in breast carcinoma-derived cultures. *Breast Cancer Res Treat* **121**:23-33.
2. **Wizla, P., A. Begue, I. Loison, A. Richard, P. Caillet-Fauquet, and D. Stehelin.** Ectopic expression of H-1 parvovirus NS1 protein induces alterations in actin filaments and cell death in human normal MRC-5 and transformed MRC-5 SV2 cells. *Arch Virol* **155**:771-5.
3. **Moralès O, Richard A, Martin N, Mrizak D, Sénéchal M, Miroux C, Pancré V, Rommelaere J, Caillet-Fauquet P, de Launoit Y, Delhem N.** Activation of a Helper and Not Regulatory Human CD4+ T Cell Response by Oncolytic H-1 Parvovirus. *PLoS One* 2012 ; **7**(2):e32197. Epub 2012 Feb 16.

Oral communications:

• **XIIIth Parvovirus Workshop**, June 20th - 24th 2010, Helsinki, FINLAND.

1. *Caspase-dependent cleavage of H-1PV NS1 protein: characterization and effect on viral oncotropism (in English).*

2. *Impact of a new potential anti-cancer agent on human immune cells: a pre-request before a therapeutic strategy (in English).*

• **9th André Verbert Day**, September 16th 2009, Lille, FRANCE.

Cleavage of H-1 parvovirus NS1 protein by caspases (in French).

Posters:

• **XIIth Parvovirus Workshop**, 1-5 juin 2008, Córdoba, SPAIN.

Richard A, Loison I, Roussel A, Bègue A & Stéhelin D.

Both unconventional Y-boxes within H-1 parvovirus P4 promoter play a synergistic role in viral life cycle.

Prize:

• **ARC (Association pour la Recherche contre le Cancer) Kerner Prize for second best popularization article** (enclosed on the opposite page).