



**HAL**  
open science

**BCG immunotherapy for bladder cancer :  
characterization and modeling of the bladder immune  
response to BCG identify strategies for improving  
anti-tumor activity**

Claire Biot

► **To cite this version:**

Claire Biot. BCG immunotherapy for bladder cancer: characterization and modeling of the bladder immune response to BCG identify strategies for improving anti-tumor activity. Immunology. Université Pierre et Marie Curie - Paris VI, 2012. English. NNT : 2012PA066009 . tel-00827698

**HAL Id: tel-00827698**

**<https://theses.hal.science/tel-00827698>**

Submitted on 29 May 2013

**HAL** is a multi-disciplinary open access archive for the deposit and dissemination of scientific research documents, whether they are published or not. The documents may come from teaching and research institutions in France or abroad, or from public or private research centers.

L'archive ouverte pluridisciplinaire **HAL**, est destinée au dépôt et à la diffusion de documents scientifiques de niveau recherche, publiés ou non, émanant des établissements d'enseignement et de recherche français ou étrangers, des laboratoires publics ou privés.

**Thèse de doctorat de l'Université Pierre et Marie CURIE**

Spécialité : IMMUNOLOGIE

École doctorale Physiologie et Physiopathologie (ED 394)

Présentée par :

**Claire BIOT**

Pour obtenir le grade de Docteur de l'Université Pierre et Marie Curie

Sujet de la thèse :

**BCG-THERAPIE ET CANCER DE LA VESSIE :**

**LA CARACTERISATION ET LA MODELISATION DE LA REPONSE  
IMMUNE AU BCG DANS LA VESSIE REVELENT DES STRATEGIES POUR  
L'AMELIORATION DE LA REPONSE ANTI-TUMORALE**

Soutenue le 15 mars 2012 devant le jury composé de :

Adrien SIX

Président

Andrea COOPER

Rapporteur

Hazel DOCKRELL

Rapporteur

Fabien SAINT

Examineur

Gerard EBERL

Examineur

Ivo GOMPERTS-BONECA

Examineur

Matthew L. ALBERT

Directeur de thèse



Université Pierre et Marie CURIE

Spécialité : IMMUNOLOGIE

École doctorale Physiologie et Physiopathologie (ED 394)

**Claire BIOT**

**BCG IMMUNOTHERAPY FOR BLADDER CANCER:**

**CHARACTERIZATION AND MODELING OF THE BLADDER  
IMMUNE RESPONSE TO BCG IDENTIFY STRATEGIES  
FOR IMPROVING ANTI-TUMOR ACTIVITY**

Thèse de doctorat soutenue le 15 mars 2012 devant le jury composé de :

Adrien SIX	Président
Andrea COOPER	Rapporteur
Hazel DOCKRELL	Rapporteur
Fabien SAINT	Examineur
Gerard EBERL	Examineur
Ivo GOMPERTS-BONECA	Examineur
Matthew L. ALBERT	Directeur de thèse



Intravesical instillation of bacillus Calmette-Guérin (BCG) for non-muscle invasive bladder cancer is one of the few examples of successful immunotherapy in the clinic, with 50-70% treatment response. While success of therapy is known to rely on repeated instillations of live BCG, administered as adjuvant therapy shortly after tumor resection, its precise mechanisms of action remain unclear.

I established an experimental mouse model to study the dynamics of the immune response following intravesical BCG regimen. Based on experimental work in humans, I focused my attention on the establishment of a robust acute inflammatory response, together with the activation and recruitment of T lymphocytes. I demonstrated that BCG dissemination to bladder draining lymph nodes and priming of interferon- $\gamma$ -producing T cells could occur following a single instillation. However, repeated instillations with live BCG were necessary for a robust T cell infiltration into the bladder. Interestingly, subcutaneous immunization with BCG prior to instillation overcame this requirement, triggering a more robust acute inflammatory process following the first intravesical instillation and accelerating T cell entry into the bladder, as compared to the standard protocol. Moreover, subcutaneous immunization with BCG prior to intravesical treatment of an orthotopic tumor dramatically improved response to therapy. These data prompted analysis of clinical data, which showed a significant difference in recurrence-free survival, favoring those patients with sustained pre-existing immunity to BCG.

In parallel, using clinical and *in vitro* experimental data, I contributed to the construction and parameterization of a stochastic mathematical model describing the interactions between BCG, the immune system, the bladder mucosa and tumor cells. First, we could show that tumor extinction mediated by the innate immune system acting on its own is an unlikely occurrence, as it would require a bystander killing capacity per innate effector cell that is much higher than suggested by experimental data. Second, we refined our mathematical model to take into account the adaptive immune response, and evaluated optimal clinical parameters of BCG induction therapy, including (i) duration between resection and the first instillation, (ii) BCG dose, (iii) indwelling time, and (iv) treatment interval of induction therapy, which all had an impact on the probability of tumor extinction. A remarkable finding is that an inter-instillation interval two times longer than the seven-day interval used in the current standard of care would substantially improve treatment outcome.

Together these data provide new insights into a long-standing clinically effective immunotherapeutic regimen and predict strategies that may improve patient management. Most importantly, I suggest that monitoring patients' response to purified protein derivative (PPD) test, and, if negative, boosting BCG responses by parenteral exposure prior to intravesical treatment initiation, may be a safe and effective means of improving intravesical BCG-induced clinical responses.

Key-words: BCG, bladder, immunotherapy, BCG therapy, bladder cancer, inflammation, innate immunity, adaptive immunity, PPD, mathematical modeling.

# Résumé

---

L'instillation intravésicale de bacilles de Calmette et Guérin (BCG) comme traitement adjuvant du cancer de la vessie non invasif du muscle est l'un des seuls exemples de réussite d'une immunothérapie à la clinique, avec des taux de réponse de 50-70 %. S'il est établi que le succès de la thérapie repose sur des injections répétées de BCG vivant, administré peu après la résection chirurgicale de la tumeur, ses mécanismes d'action n'ont pas été définis précisément.

Au cours de ma thèse, j'ai établi un modèle expérimental de souris pour étudier la dynamique de la réponse immune induite par l'administration intravésicale de BCG. Au vu d'un certain nombre de travaux chez l'homme, j'ai concentré mon attention sur l'établissement du processus inflammatoire aigu, ainsi que sur l'activation et le recrutement des lymphocytes T. Je démontre qu'une seule instillation de BCG est suffisante pour induire la dissémination du BCG dans les ganglions lymphatiques drainant la vessie et l'activation de lymphocytes T produisant de l'interféron gamma. Cependant, des instillations répétées de BCG vivant sont nécessaires pour obtenir une robuste infiltration de lymphocytes T dans la vessie. Toutefois, je montre qu'une immunisation préalable des souris par voie sous-cutanée conduit à un processus inflammatoire aigu accentué dès la première instillation et accélère le recrutement des lymphocytes T dans la vessie, par rapport au protocole standard. En outre, l'immunisation préalable des souris par voie sous-cutanée améliore de façon substantielle leur réponse à la BCG-thérapie, dans un modèle d'implantation orthotopique de cellules tumorales. Enfin, l'analyse de données cliniques révèle un avantage statistiquement significatif pour les patients qui ont la signature d'une réponse immune au BCG préalablement à la thérapie intravésicale.

Par ailleurs, utilisant des données cliniques et expérimentales, j'ai contribué à la construction et au paramétrage d'un modèle mathématique stochastique décrivant les interactions entre le BCG, le système immunitaire, la vessie et les cellules tumorales. Nous avons tout d'abord montré qu'il était très improbable que l'extinction tumorale puisse être médiée seulement par l'immunité innée, car cela exigerait une capacité de tuer par effet *bystander* bien plus élevée que celle observée expérimentalement chez les cellules effectrices de l'immunité innée. Nous avons ensuite raffiné notre modèle pour qu'il prenne aussi en compte l'immunité adaptative. Nous avons alors utilisé ce deuxième modèle pour évaluer les paramètres cliniques optimaux pour la BCG thérapie, et parmi eux (i) le délai entre la résection chirurgicale et la première instillation, (ii) la dose de BCG, (iii) le temps de contact du BCG avec la vessie et (iv) l'intervalle de temps entre deux injections répétées de BCG. Tous ces paramètres ont un impact sur la probabilité d'extinction tumorale, et, notablement, la multiplication par deux du délai entre deux instillations améliorerait très favorablement le taux de réponse au traitement.

L'ensemble de ces données contribue à éclairer sous un jour nouveau une immunothérapie utilisée en clinique depuis longtemps et prédit des stratégies qui pourraient contribuer à améliorer le soin des patients. Notamment, je suggère que la pratique d'un test tuberculinique sur les patients préalablement à la thérapie intravésicale, suivie de l'immunisation parentérale par le BCG des patients négatifs pour le test, pourrait être une méthode sûre et efficace pour améliorer la réponse clinique induite par les instillations intravésicales de BCG.

**Mots-clés** : BCG, vessie, immunothérapie, BCG-thérapie, cancer de la vessie, inflammation, immunité innée, immunité adaptative, PPD, modélisation mathématique.

# Table of contents

<b>ABSTRACT</b> .....	<b>5</b>
<b>RÉSUMÉ</b> .....	<b>6</b>
<b>TABLE OF CONTENTS</b> .....	<b>7</b>
<b>LIST OF FIGURES</b> .....	<b>11</b>
<b>LIST OF TABLES</b> .....	<b>13</b>
<b>REMERCIEMENTS</b> .....	<b>15</b>
<b>ABBREVIATIONS</b> .....	<b>19</b>
<b>FOREWORD</b> .....	<b>21</b>
<b>RESEARCH PLAN</b> .....	<b>23</b>
I. DETERMINE THE DYNAMICS OF THE IMMUNE RESPONSE TO INTRAVESICAL BCG .....	24
II. EXPLORE THE MECHANISMS AND DETERMINANTS OF RESPONSE TO BCG THERAPY USING MATHEMATICAL MODELING .....	24
<b>CHAPTER 1. GENERAL INTRODUCTION</b> .....	<b>27</b>
I. BLADDER CANCER .....	30
A. Disease pathogenesis .....	30
1) Bladder anatomy.....	30
2) Bladder cancer is a common cancer, which most often results from exposure to carcinogens.....	32
3) Pathological classification of bladder cancers.....	33
4) Predicting tumor recurrence and progression.....	34
5) Urothelial tumorigenesis, and its implication on tumor recurrence and progression .....	35
6) Mouse models for bladder cancer .....	36
B. Current treatment options .....	38
1) Standard-of-care treatments for non-muscle invasive bladder cancer.....	38
2) Intravesical BCG therapy.....	40
3) Treatments for muscle-invasive tumors (brief description).....	43
4) Emerging therapies against superficial bladder cancer.....	44
II. THE IMMUNOSTIMULATORY PROPERTIES OF BCG .....	46
A. A short general introduction to immunopathogenesis .....	47
1) Epithelial and mucosal barriers .....	47
2) A rapid inflammatory innate immune response .....	48
3) The induction of adaptive immunity by dendritic cells .....	48
4) Cell-mediated adaptive immune responses.....	49
5) Humoral adaptive immune responses .....	53
B. Development of BCG as a vaccine against tuberculosis .....	54
1) BCG, a worldwide used vaccine against Tb.....	54
2) The host immune responses against mycobacteria .....	56
C. BCG as an anti-cancer agent .....	60
1) Seminal experiments in animal models .....	60
2) Early clinical trials using BCG as an anti-cancer therapy in humans.....	63
3) Proposed mechanisms for BCG-induced anti-tumor activity.....	65
4) Qualitative comparison of BCG-derived agents, BCG strains and preparations .....	67
III. CURRENT UNDERSTANDING OF BCG THERAPY AGAINST BLADDER CANCER.....	69
A. The fate of BCG following intravesical injections .....	69
1) What is known about the fate of BCG in patients?.....	69
2) Interaction of BCG with the bladder wall.....	70
3) Does BCG infect urothelial cells? .....	71
B. Involvement of an immune response .....	72
1) The early hours following instillation.....	72
2) Establishment of a Th1 polarized microenvironment.....	76
3) Effective eradication of tumor cells .....	77
4) Immune biomarkers for response to therapy.....	80
<b>CHAPTER 2. CHARACTERIZING THE BLADDER IMMUNE RESPONSE TO INTRAVESICAL BCG IDENTIFIES A STRATEGY FOR IMPROVING ANTI-TUMOR ACTIVITY</b> .....	<b>83</b>



I. INTRODUCTION .....	85
II. OPTIMIZING STRATEGIES TO DEFINE THE DYNAMICS OF THE IMMUNE RESPONSE .....	86
A. Establishment of a mouse model for intravesical instillations .....	86
1) Rationale for working in tumor-free female C57BL/6 mice .....	86
2) Designing an instillation protocol which closely reflects the clinical procedure .....	87
B. Tools to study the cellular signature of the immune response .....	91
1) Flow-based techniques .....	92
2) Histology-based techniques .....	95
C. Tools to study the molecular signature of the immune response .....	96
1) Defining the molecular signature in urine samples .....	97
2) Defining the molecular signature at the RNA level .....	98
D. Monitoring BCG persistence in the bladder .....	99
1) BCG load in the bladder quickly decays .....	99
2) Does BCG infect urothelial cells? .....	100
3) Dendritic cells acquire the capacity to present BCG .....	102
III. THE CHARACTERIZATION OF THE BLADDER IMMUNE RESPONSE IDENTIFIES A STRATEGY FOR IMPROVING ANTI-TUMOR ACTIVITY .....	104
A. Repeated intravesical instillations of live BCG result in a robust, though late, infiltration of activated $\alpha\beta$ T cells into the bladder .....	104
1) Repeated intravesical instillations of BCG result in a robust, though late, infiltration of T cells into the bladder .....	104
2) Bladder infiltrating T cells are mostly activated $\alpha\beta$ T cells .....	106
3) A requirement for repeated instillations and for live BCG .....	107
B. Priming of T cells and their entry into the bladder are uncoupled, following intravesical BCG instillations .....	107
1) BCG can disseminate to the bladder draining lymph nodes following a single instillation .....	108
2) BCG dissemination to the LN correlates with priming of BCG-specific IFN $\gamma$ -producing CD8 $^{+}$ T cells .....	110
3) T cell entry into the bladder is uncoupled from BCG dissemination to the LN .....	110
C. Pre-existing adaptive immunity supports a robust intravesical immune response .....	111
1) Subcutaneous immunization with BCG results in accelerated T cell entry into the bladder, following intravesical challenge with live or HK-BCG .....	111
2) The impact of various BCG regimens on the local acute inflammatory response in the bladder .....	112
3) The boost in inflammation in pre-immunized animals is T-cell mediated .....	116
D. Molecular mechanisms involved in the recruitment of T cells to the bladder .....	117
E. Pre-existing BCG-specific immunity improves the anti-tumor response .....	122
1) Subcutaneous immunization with BCG improves the anti-tumor response in an orthotopic mouse model for bladder cancer .....	122
2) Pre-existing BCG immunity improves the anti-tumor response in patients with high-risk non-muscle invasive bladder cancer .....	124
IV. DISCUSSION .....	125
A. The bladder immune response to BCG .....	126
1) T cell recruitment to the bladder is late to occur .....	126
2) Priming of T cells requires BCG dissemination to the draining lymph nodes but is not sufficient for T cell entry into the bladder .....	127
3) Mechanisms involved in the recruitment of primed T cells to the bladder .....	127
B. Clinical applications of our work .....	128
1) Of PPD responsiveness and response to therapy .....	128
2) Parenteral exposure <i>prior to</i> intravesical regimen: a clinically-testable treatment option .....	129
<b>CHAPTER 3. EXPLORING THE MECHANISMS AND DETERMINANTS OF RESPONSE TO BCG THERAPY USING MATHEMATICAL MODELING .....</b>	<b>131</b>
I. INTRODUCTION .....	133
II. MATHEMATICAL MODELING IDENTIFIES THE LIMITATIONS OF THE INNATE IMMUNE RESPONSE .....	134
A. Modeling BCG-induced response of the innate immune system .....	134
1) Our series of assumptions .....	134
2) Running the model .....	137
3) Calibration of the model .....	139
4) Simulation results .....	142
B. The theoretical condition for tumor elimination by the innate immune system .....	144
1) Model analyses .....	144
2) Validation of the theoretical condition for tumor elimination by the innate immune system .....	146
III. MATHEMATICAL MODELING IDENTIFIES CLINICALLY-RELEVANT DETERMINANTS OF TREATMENT RESPONSE .....	149

A.	Modeling the adaptive immune system.....	150
1)	Two additional assumptions.....	150
2)	Running the model.....	151
3)	Further calibration of the model.....	152
4)	Simulation results.....	154
B.	Testing several key parameters of BCG treatment.....	155
1)	Delay between surgery and initiation of BCG therapy.....	155
2)	BCG dose.....	156
3)	BCG dwell time.....	156
4)	Treatment interval.....	156
IV.	DISCUSSION.....	157
A.	BCG therapy is likely more than a non-specific immunotherapy.....	157
B.	Clinically-relevant determinants of treatment response.....	158
1)	Delay between surgery and initiation of BCG therapy.....	158
2)	BCG dose.....	159
3)	BCG dwell time.....	159
4)	Treatment interval.....	159
C.	Discussion of our modeling.....	160
1)	The novelty of our modeling.....	160
2)	Critical parameters of the model.....	161
<b>CHAPTER 4. GENERAL DISCUSSION .....</b>		<b>163</b>
I.	THE BLADDER IMMUNE RESPONSE TO BCG .....	166
A.	Proposing a model.....	167
1)	The priming of a T cell response: Instillation(s) #1 (and #2).....	167
2)	Enhanced inflammation and local recruitment of T cells (Instillations #3-6).....	169
3)	A progressive return to homeostasis (after the last instillation).....	170
B.	The fate of BCG following repeated instillations.....	170
1)	BCG infects very few urothelial cells, if any.....	171
2)	BCG might infect leukocytes infiltrating the bladder.....	172
3)	Of granulomas in the bladder.....	173
C.	The dynamics of T cell entry into the bladder.....	173
1)	Priming of the T cell response.....	174
2)	Mechanisms involved in the recruitment of primed T cells to the bladder.....	175
3)	HK-BCG fails to induce local T cell infiltration.....	176
D.	The 'prime/boost' pattern of inflammation.....	177
1)	A reaction of delayed-type hypersensitivity.....	177
2)	A DTH reaction might result in increased vascularization of the bladder.....	182
II.	DOES INTRAVESICAL BCG INDUCE A TUMOR-SPECIFIC IMMUNE RESPONSE? .....	184
A.	The innate response is not enough.....	184
B.	Generating tumor-specific immunity, a multistep challenge that could theoretically be achieved by BCG therapy.....	186
1)	Tumor-antigen presentation.....	186
2)	Initiation of effector T-cell responses.....	187
3)	Recruitment of tumor-specific T cells into the tumor.....	187
C.	Some experimental evidence for a tumor-specific response.....	188
1)	Rechallenge of mice with MB49 cells at a distal site.....	188
2)	Mathematical modeling identifies the tumor-specific adaptive response as a crucial parameter.....	190
D.	Perspective.....	191
1)	Strategies for improvement of the MB49 tumor model.....	191
2)	An inducible mouse model of CIS bearing tumor-associated antigens.....	192
III.	A TRANSLATIONAL APPROACH TO BCG THERAPY AND BLADDER CANCER.....	194
A.	Priming/boosting BCG-specific immunity prior to intravesical therapy.....	194
1)	Of prior exposure to BCG and response to therapy.....	195
2)	Triggering a PPD conversion prior to intravesical BCG therapy.....	197
3)	Towards a clinical trial testing the priming of BCG-specific immune response prior to intravesical instillation.....	202
B.	Increasing the inter-instillation interval.....	204
C.	Other treatment options suggested by mathematical modeling.....	206
1)	Leaving tumor cells behind, a double-edge sword.....	206
2)	BCG dose.....	207
IV.	CONCLUSION.....	207

<b>MATERIALS AND METHODS .....</b>	<b>209</b>
I.  INTRAVESICAL INSTILLATIONS.....	211
A.  BCG intravesical instillations.....	211
B.  Orthotopic implantation of MB49 tumours into the bladder.....	212
C.  Intravesical injection of adeno/lenti-virus.....	213
II.  SUBCUTANEOUS INJECTIONS.....	214
III.  BCG PROTOCOLS.....	214
A.  Immucyst reconstitution.....	214
B.  Frozen stocks of BCG.....	215
C.  BCG Titration.....	216
D. <i>In vitro</i> infection of cell-lines with BCG.....	217
E.  Heat-killing of BCG.....	217
IV.  CELL SUSPENSIONS (FOR FLOW CYTOMETRY).....	218
A.  Bladder collagenase digestion.....	218
B.  Other single cell suspensions.....	219
V.  FLOW CYTOMETRY.....	219
A.  Stainings.....	219
1)  Common stainings.....	219
2)  Tetramer stainings.....	221
B.  Determination of absolute cell numbers.....	222
VI.  HISTOLOGY.....	222
A.  Immunofluorescence.....	222
B.  FISH for 16S rRNA.....	225
C.  Acid-fast staining.....	225
VII.  INTERFERON- $\gamma$ ELISPOT.....	226
VIII.  ANTIGENIC PRESENTATION.....	230
IX.  RNA ANALYSIS.....	232
A.  RNA extraction.....	232
1)  RNA extraction of total bladders.....	232
2)  RNA extraction for small number of cells.....	233
3)  Reverse transcription.....	233
4)  qPCR.....	234
X.  URINE ANALYSIS.....	234
A.  Urine collection and processing.....	234
B.  Luminex analysis of urine (Millipore).....	235
C.  Normalization of urine samples by measurement of creatinin concentration.....	237
XI.  DERIVE AND IMMORTALIZE MOUSE EMBRYONIC FIBROBLASTS (MEFs).....	238
<b>MANUSCRIPTS .....</b>	<b>241</b>
I.  MANUSCRIPT 1.....	243
II.  MANUSCRIPT 2.....	243
III.  MANUSCRIPT 3.....	243
<b>REFERENCES.....</b>	<b>325</b>

# List of figures

---

Figure 1: Anatomic structure of the bladder.....	31
Figure 2: Bladder cancer epidemiology.....	32
Figure 3: Schematic representation of urothelial tumors as a function of stage.....	34
Figure 4: The two progression pathways of urothelial carcinoma.....	35
Figure 5: Drawing showing the transurethral resection of a papillary tumor.....	38
Figure 6: Progression-free survival of 48 patients with T1G3 bladder tumors.....	40
Figure 7: Schematic of the current recommended schedule for BCG therapy and follow-up of the patients.....	41
Figure 8: Priming of naïve T cells by resting, mature and activated DCs.....	49
Figure 9: Different subsets of effector CD4 <sup>+</sup> T cells.....	51
Figure 10: Major presentation pathways.....	52
Figure 11: Genealogy of BCG vaccines.....	55
Figure 12: Initiation of the T cell response following low-dose <i>Mtb</i> aerosol infection.....	57
Figure 13: Overview of the immune response to tuberculosis.....	58
Figure 14: The stages of a delayed-type hypersensitivity reaction.....	59
Figure 15: Seminal experiment on guinea pigs, by Zbar and colleagues.....	63
Figure 16: Guinea pigs that receive mixtures of BCG and tumor cells develop specific systemic tumor immunity.....	67
Figure 17: The fate of BCG after intravesical instillations in patients.....	70
Figure 18: BCG might be internalized by normal murine urothelial cells.....	71
Figure 19: The molecular and cellular signature of the inflammatory response following BCG therapy.....	74
Figure 20: First generation map of early innate response to intravesical therapy.....	75
Figure 21: T cell infiltration in the bladder of patients is significantly more pronounced up to 3 months post BCG therapy.....	77
Figure 22: T cells are crucial for BCG-mediated anti-tumor activity in an orthotopic mouse model for bladder cancer.....	78
Figure 23: Our protocol for intravesical instillation of female mice.....	89
Figure 24: Flow cytometric analysis of cells resulting from the collagenase digest of a naïve bladder.....	93
Figure 25: Flow cytometric definition of important leukocyte populations.....	94
Figure 26: Organization of the murine bladder.....	96
Figure 27: A representative picture of a metabolic cage allowing to house up to 5 mice.....	97
Figure 28: The fate of BCG following intravesical BCG instillation(s).....	100
Figure 29: BCG is internalized by urothelial tumor cell-lines after 24 hours of infection <i>in vitro</i> .....	101
Figure 30: <i>In vivo</i> fluorescence imaging of BCG contacting the bladder wall, shortly after removal of the catheter.....	102
Figure 31: CD11c <sup>+</sup> -enriched bladder cells acquire transient antigenic presentation capacities following intravesical BCG.....	103
Figure 32: Repeated intravesical instillation result in a robust, though late, infiltration of T cells in the bladder.....	105
Figure 33: T cells are mostly located within the submucosa.....	106
Figure 34: Bladder infiltrating T cells are mostly activated $\alpha\beta$ T cells.....	106

Figure 35: Repeated instillations and live BCG are required, in order to achieve bladder T cell infiltration. ....	107
Figure 36: BCG dissemination to the bladder draining LN and priming of the T cell response can occur following a single instillation. ....	109
Figure 37: T cell entry into the bladder is uncoupled from BCG dissemination to the LN. ....	111
Figure 38: Subcutaneous immunization with BCG prior to intravesical instillation(s) results in accelerated T cell entry into the bladder, following intravesical challenge with live or HK-BCG. ....	112
Figure 39: The innate inflammatory response is short-lived, and ‘boosted’ after repeated instillations. ....	113
Figure 40: The molecular signature of the inflammatory response, following intravesical BCG. ....	114
Figure 41: Subcutaneous immunization with BCG further enhances the local acute inflammatory process following instillation. ....	115
Figure 42: Intravesical HK-BCG triggers a similar inflammatory response in the bladder. ....	116
Figure 43: The boost in inflammation in pre-immunized animals is T-cell mediated. ....	117
Figure 44: Inflammatory cells are dispensable for T cell recruitment in pre-immunized animals. ....	118
Figure 45: Bladder DCs remain activated and express CXCL-10, following repeated instillations. ....	119
Figure 46: Bladder stromal cells appear activated, following repeated instillations. ....	120
Figure 47: CXCR-3 signaling, if involved, is likely redundant. ....	121
Figure 48: Pre-existing BCG-specific immunity improves anti-tumor response in a mouse model for bladder cancer. ....	123
Figure 49: Pre-existing BCG-specific immunity improves the anti-tumor response in patients with high-risk non-muscle invasive bladder cancer undergoing intravesical BCG therapy. ....	124
Figure 50: Flow diagram of our mathematical model. ....	138
Figure 51: Simulation of logistic tumor growth, resection and tumor re-growth. ....	140
Figure 52: Simulation of population dynamics of cells during a six-week course of BCG therapy. ....	143
Figure 53: Probability of tumor extinction as a function of the number $n$ of bystander cells killed per innate effector mechanisms and the fraction $f(0)$ of tumor cells that associated with BCG during the last instillation. ....	145
Figure 54: Probability of tumor extinction after 6 instillations as a function of the number $n$ of cells killed by bystander mechanisms. ....	147
Figure 55: Estimation of bystander death by measurement of tumor cell apoptosis. ....	148
Figure 56: Flow diagram of the refined mathematical model. ....	151
Figure 57: Simulation of population dynamics of cells during and after a six-week course of intravesical BCG therapy (refined model). ....	154
Figure 58: Timing of BCG therapy, BCG dose and dwell time influence probability of tumor extinction. ....	155
Figure 59: The treatment interval strongly influences the probability of tumor extinction. ....	157
Figure 60: The first instillation results in a moderate inflammatory response and in the priming of BCG-specific T cells in the draining LN (Model part #1). ....	168
Figure 61: The following instillations result in enhanced inflammation and the sustained infiltration of T cells in the bladder (Model part #2). ....	169
Figure 62: Dendritic cells in the resting bladder. ....	172
Figure 63: The acute inflammatory response is further enhanced at the 5 <sup>th</sup> intravesical instillation. ....	180
Figure 64: Representative cytoscopic images of the bladder wall pre vs. post BCG therapy. ....	183
Figure 65: Generating antitumor immunity, a multistep challenge. ....	186
Figure 66: BCG therapy is theoretically capable of achieving specific anti-tumor immunity. ....	188
Figure 67: Most mice that survived the orthotopic tumor challenge are able to reject a subsequent s.c. tumor challenge. ....	189
Figure 68: Targeted gene deletion in bladder urothelium following intravesical delivery of Adeno-Cre. ....	193

# List of tables

---

Table 1: T classification of urothelial tumors.....	34
Table 2: Cell numbers and proportion of various leukocyte populations in the resting bladder. ....	95
Table 3: Stochastic processes and their corresponding rates.....	139
Table 4: Parameters of the model.....	140
Table 5: Stochastic processes and their corresponding rates in the refined model.....	153
Table 6: Parameters of the refined model.....	153
Table 7: Median fold induction of the inflammatory response in patients and mice, following intravesical instillations.....	181
Table 8: Proposal of a schedule for a clinical trial.....	204



# Remerciements

---

Mon projet de thèse a suscité de multiples collaborations avec d'autres équipes, à la fois dans ces murs et en dehors, et j'ai également eu le plaisir de travailler avec de nombreux services et plateformes au sein de l'Institut Pasteur. Je souhaite par conséquent remercier un grand nombre de personnes, et si cette section peut sembler un peu longue, elle me tient néanmoins particulièrement à coeur.

En premier lieu, je remercie vivement Matthew de m'avoir accueillie dans son laboratoire et de m'avoir placée dans un environnement très favorable aux découvertes et au développement scientifique : non seulement j'ai eu accès à des instruments à la pointe de la technologie et j'ai toujours eu les moyens de mener à bien mes expériences, mais j'ai aussi bénéficié d'une grande autonomie pour développer ma propre créativité, tout en appréciant ses conseils tout au long de mon cheminement scientifique. Matthew, j'admire fortement la capacité que tu as de rassembler scientifiques et entrepreneurs autour de projets ambitieux, ainsi que ton enthousiasme pour la recherche clinique. En début de thèse, l'une de mes raisons pour choisir ton laboratoire avait été la façon dont tu considérais la contribution de ton équipe aux sciences et à la médecine : *'from the bedside to the bench; and back to bedside'*. J'ai pu apprécier cela tout au long de ma thèse, et je t'en remercie chaleureusement. Par ailleurs, ton dynamisme et ton optimisme constituent un exemple extrêmement motivant.

Deux autres personnes ont considérablement contribué à mon développement scientifique, Geneviève Milon et Lucie Peduto. Lucie, tu m'as mis le pied à l'étrier, en me donnant des protocoles extrêmement solides qui m'ont permis d'asseoir mon projet sur des bases saines. Mais au-delà de cette contribution cruciale, ta rigueur, ta patience et ton insatiable curiosité ont été une véritable source d'inspiration pour moi, et je te souhaite de continuer à faire de belles découvertes dans tes travaux de recherche. Geneviève, vous êtes un trésor pour l'Institut Pasteur. L'étendue de vos connaissances scientifiques n'est surpassée que par celle de votre gentillesse, et nos petits-déjeuners et autres discussions scientifiques à bâtons rompus me resteront toujours en mémoire. Je dois beaucoup à nos échanges, tant pour la définition et l'aboutissement de mon projet que pour mon développement scientifique

Je remercie vivement les membres de mon jury d'avoir accepté d'évaluer mon travail, et en particulier mes rapporteurs, Andrea Cooper – dont les articles ont été source d'inspiration au cours de ma thèse – et Hazel Dockrell pour leur relecture attentive de mon manuscrit et la richesse de nos discussions. Je remercie aussi vivement Gerard Eberl et Ivo Gomperts-Boneca d'avoir accepté de siéger dans mon Faculty Committee et de m'avoir ainsi suivie et guidée tout au long de mon travail de thèse.

J'ai eu la chance de tomber sur des partenaires de jeu formidables au sein du laboratoire ICD, non seulement pour leurs compétences scientifiques mais aussi pour leur esprit d'équipe. Plus particulièrement, Hélène, je te remercie infiniment pour ta patience et tes enseignements au cours de mes premiers mois au labo, et pour le temps que tu as passé à mettre au point le protocole d'instillations avec moi, étape décisive pour mon projet. Et je te remercie pour ton soutien, et tes encouragements tout au long de ma thèse. Armanda et toi êtes les piliers de ce laboratoire, tout d'abord par votre maîtrise technique de nombreux protocoles mais aussi par votre dévouement pour que le labo fonctionne harmonieusement, et pour lequel on ne vous remerciera jamais assez. J'admire aussi votre rigueur et votre curiosité scientifiques, et je vous souhaite à la paillasse beaucoup de résultats à la hauteur de vos espérances. Armanda, tu



as aussi été une voisine de bureau fantastique, et si j'ai mis du temps à faire la connaissance du 'silent partner' d'ICD, j'ai beaucoup apprécié tes conseils et ton amitié. Isabelle, tu as été la plus géniale des co-thésardes. Nos échanges et encouragements mutuels ont été très importants pour moi, et tu m'as rendu le quotidien au labo plus agréable et facile. Je te souhaite plein de succès pour la suite de tes travaux de recherche, car tu le mérites ! Et puis... merci pour les billes ;-)

Clémentine, j'ai eu une chance immense de t'avoir pour voisine en début de thèse : ta rigueur, ta curiosité et ton dévouement pour le labo ont été un modèle pour moi. Ta tolérance et ta bonne humeur aussi, mais sans doute avec moins de réussite dans l'imitation. Marie-Laure et Stéphanie, vous êtes un rayon de soleil pour le laboratoire. Merci de nous seconder au quotidien avec autant d'énergie et de bonne humeur. Darragh et Briec, merci pour votre intérêt pour mon projet, et pour vos questions qui ont été motivantes pour faire progresser mon raisonnement scientifique. Cécile, bravo pour ce que tu as accompli en master, et je suivrai ton cheminement avec beaucoup d'intérêt, car rarement autant de détermination et d'intelligence n'ont été réunis sous le même front. Charlotte et Huey-Hsuan, merci pour votre contribution au protocole d'instillations.

Relativement tôt dans le projet, s'est initiée une collaboration cruciale avec le service d'urologie de Bale, et j'ai eu la chance d'interagir fortement dans mon projet avec deux médecins de grand talent, Cyrill Rentsch et Joel Gsponer. Cyrill, je me souviendrai toujours de ta première visite au labo, quand nous avons pris des vessies pour des lanternes ! Merci pour ta motivation et ton énergie débordantes. Tu as fait le pari de quitter tes patients pour retrouver la paillasse pendant un an, cela n'a pas dû être toujours facile et j'espère que tu trouveras dans cette collaboration entre la clinique et le fondamental autant que ce que tu y as apporté. Joel, cela a été un immense plaisir de travailler avec toi. Bravo pour ta créativité et ton optimisme ; merci pour ta gentillesse et ton esprit d'équipe.

J'ai mis un peu de temps à comprendre que la majeure partie de mon projet porterait sur le BCG et non sur le cancer. Or, nous manquions d'expertise en la matière dans le labo, mais fort heureusement le campus de l'Institut Pasteur est un vivier de compétences en la matière. Nathalie Winter, Edgar Badell et Caroline Demangel m'ont initiée les premiers au temps long et à l'art de cultiver les mycobactéries. Je remercie aussi vivement Roxane Simeone de m'avoir montré comment 'dompter' les BCG afin de les congeler. Je remercie Roland Brosch et toute son équipe de m'avoir accueillie sous leur hotte pendant bien longtemps. Je remercie aussi Laleh Majlessi et Ludovic Tailleur, dont j'ai fait la connaissance assez tard dans le projet, mais avec qui j'ai eu des échanges très constructifs. En particulier, Laleh, merci pour nos nombreuses discussions cette dernière année et tes précieux conseils. J'admire ta rigueur et ta curiosité scientifiques, et je te souhaite encore de belles découvertes. Ludovic, merci d'avoir créé les meetings mensuels consacrés aux mycobactéries, qui sont un lieu d'échange important. Enfin, j'ai pu me rendre compte de l'étendue des connaissances et de la maîtrise technique de Gilles Marchal et Micheline Lagranderie, que je remercie pour des échanges constructifs et pour leur gentillesse. Je souhaite à leur compagnie et à l'EFD plein de réussite.

Romulus, j'ai pris énormément de plaisir à modéliser la réponse immune au BCG avec toi. Nos discussions m'ont permis de beaucoup mûrir dans mon approche expérimentale, et je demeure impressionnée par ta rapidité de compréhension du système immunitaire.

Philippe (Bouso), j'ai eu beaucoup de plaisir à côtoyer ton laboratoire de près, et l'étendue de tes connaissances et de tes compétences m'impressionne ! Fabrice, un grand merci de m'avoir fourni des réactifs très précieux, qui ont contribué à faire faire un bond en avant à mon projet. Jacques, merci d'avoir été là, tu as mené une thèse exemplaire et je te souhaite pour la suite toute la réussite que tu mérites.

Gerard (Eberl), merci pour la façon exemplaire dont tu mènes tes travaux de recherche. Ton laboratoire a été pour moi un phare dans la tempête.

Je remercie aussi Arnaud Fontanet, Sandrine Leroy et Loic Chartier de m'avoir fourni des outils statistiques précieux pour analyser mes expériences.

L'Institut Pasteur peut s'enorgueillir de la qualité de ses services et plateformes. J'ai eu le plaisir et la chance d'en côtoyer un certain nombre que je remercie vivement ici. Un grand merci à l'animalerie de Metchnikoff, et en particulier à Xavier Montagutelli et Marion Bérard pour leur écoute et leur disponibilité, mais aussi Yohann et Helena pour la qualité de leur travail, essentielle au bon déroulement de nos propres travaux. Merci aux personnels des cuisines de 2<sup>e</sup>, 3<sup>e</sup> et 5<sup>e</sup> étages de Metchnikoff pour leur disponibilité et leur bonne humeur. Merci aux gens de la médiathèque d'avoir trouvé pour moi de multiples vieux articles qui m'ont été très utiles, et ce avec tant d'efficacité et de gentillesse. Merci à la gestion et en particulier à Martine, Sophie, Michel et Christophe. Merci à l'atelier du bâtiment Metchnikoff pour quelques bricolages qui m'ont bien simplifié la vie. Merci au service de reprographie. Merci à Muriel Robert, je me souviendrai de la signature de ma convention ! Merci au service des brevets de m'avoir fait découvrir une autre facette de la R&D, ô combien importante. Merci au CIH, et bravo de réunir autant de beaux équipements avec autant de talent dans la maintenance. En particulier, merci à Helen Law pour son dévouement et son regard critique des FACS plots, et merci à Milena pour quelques FACS-sorts mémorables. Merci à Emmanuelle Perret de m'avoir formée à la microscopie et merci à Patrick Ave et Laurence Fiette de m'avoir ouvert leur labo d'histologie et encadrée efficacement à l'occasion de quelques colorations de Ziehl (Laurence, j'ai bien dit « coloration » et non « marquage » !).

A l'extérieur de l'Institut Pasteur et en dehors de la très proche collaboration avec Bale, déjà mentionnée, je souhaite remercier chaleureusement un certain nombre de personnes à l'Institut Curie. En particulier l'équipe de Clotilde Théry, et notamment Gael Sugano et Sophie Krumeich avec qui j'ai eu l'occasion de faire quelques manip intéressantes. Je remercie aussi Olivier Lantz pour les précieuses souris Pten<sup>flox</sup> x p53<sup>flox</sup>, et Héroïse Flament pour l'initiation aux lentivirus, pour sa gentillesse et sa disponibilité pour la manip d'AdenoCre dans l'animalerie de Curie.

Je remercie aussi le service d'urologie de Berne, et en particulier George Thalmann et Frederic Birkhaeser, de nous avoir donné accès à des données cliniques enthousiasmantes.

Je suis très reconnaissante au Corps des Mines de m'avoir laissée débiter ma carrière par cette formation par la recherche qu'est la thèse. En particulier je remercie Marie-Solange Tissier, ainsi que la Commission Scientifique et Technique du Corps, présidée par Yannick d'Escatha, de m'avoir fait confiance.

Je garde un souvenir ému de mes premières expériences de recherche à Cold Spring Harbor Laboratory, et je remercie en particulier Greg Hannon et Raffaella Sordella de m'avoir donné le goût de la recherche en m'accueillant dans leurs laboratoires respectifs. Je remercie chaleureusement la Watson School of Biological Sciences pour l'excellence de son enseignement, et en particulier mes camarades Claudio Scoppo pour m'avoir montré combien la section M&M des papiers était importante et pour tout ce qu'il m'a appris sur les modèles de cancer, et Eyal Gruntman avant tout pour son amitié, mais aussi pour sa rigueur et sa curiosité scientifique. Enfin je remercie John Inglis pour sa gentillesse et sa disponibilité au cours de mon séjour américain, qui a été un excellent préambule à ma thèse.

Enfin, je tiens à remercier ma famille de m'avoir si bien accompagnée pendant quatre années extrêmement marquantes de ma vie. En particulier, je remercie mon père de m'avoir poussée dans cette voie, et je remercie Philippe pour son soutien quotidien, qui m'a aidée à traverser les périodes difficiles.



# Abbreviations

---

APC	Antigen presenting cell
$\alpha$ -SMA	Alpha smooth muscle actin
AUA	American Urological Association
BBN	N-butyl-N-(4-hydroxybutyl)-nitrosamine
BCG	Bacillus Calmette-Guerin
BSA	Bovine serum albumin
CCL	Chemokine (C-C motif) ligand
CCR	Chemokine (C-C motif) receptor
CFP	Cyan fluorescent protein
CFU	Colony forming unit
CIS	Carcinoma <i>in situ</i>
Cre	Recombinase
CRL	A human urothelial tumor cell-line
CTLA4	Cytotoxic T-Lymphocyte Antigen 4
CXCL	Chemokine (C-X-C motif) ligand
CXCR	Chemokine (C-X-C motif) receptor
DC	Dendritic cell
DTH	Delayed-type hypersensitivity
EAU	European Association for Urology
ELISA	Enzyme-linked immuno-staining assay
ELISPOT	Enzyme-linked immunosorbent spot assay
EORTC	European Organization for Research and Treatment of Cancer
FISH	Fluorescent <i>in situ</i> hybridization
FGFR-3	Fibroblast growth factor receptor 3
flox	Flanked by LoxP sites
FRET	Förster Resonance Energy Transfer
G1/G2/G3	Grade 1/2/3
GFP	Green fluorescent protein
G-CSF	Granulocyte-colony stimulating factor
GM-CSF	Granulocyte-monocyte colony stimulating factor
HK	Heat-killed
IFN	Interferon
IL	Interleukin
IP-10	IFN-induced protein 10, also known as CXCL-10
KC	Also known as CXCL-1
LN	Lymph node
LPS	Lipopolysaccharide
LSL	Lox-STOP-Lox
MB49	A urothelial tumor cell-line derived from Bl/6 mice

MBT-2	A urothelial tumor cell-line derived from C3H mice
MCC	Mycobacterial cell wall - DNA complex
MCP	Monocyte chemotactic protein
MHC	Major histocompatibility complex
MIC-A	MHC-Class I related chain A
MIP	Macrophage inflammatory protein
MMP	Matrix metalloproteinase
MOI	Multiplicity of infection
MPO	Myeloperoxidase
<i>Mtb</i>	<i>Mycobacterium tuberculosis</i>
NK	Natural killer
NKG2	Natural killer receptor group 2
NMIBC	Non-muscle invasive bladder cancer
PBMC	Peripheral blood mononuclear cells
PMN	Polymorphonuclear cells
PPD	Purified protein derivative
PVDF	Polyvinylidene fluoride
qPCR	Quantitative polymerase chain reaction
RANTES	Regulated upon Activation, Normal T-cell Expressed, and Secreted (also known as CCL-5)
Rb	Retinoblastoma
rBCG	Recombinant BCG
RIVM	Name of a BCG strain
rRNA	Ribosomal RNA
s.c.	Subcutaneous
SV40TAg	SV40 T Antigen
Ta/T1/T2/T3	Various grades of primary bladder tumors, according to TNM classification
Tb	Tuberculosis
TCC	Transitional cell carcinoma
Tet	Tetramer
TGF	Transforming growth factor
Th	T helper
TLR	Toll-like receptor
TNF	Tumor necrosis factor
TNM	Tumor, node, metastases
TRAIL	Tumor necrosis factor-related apoptosis-inducing ligand
TUR	Transurethral resection
uroII	Uroplakin II
WHO	World Health Organization
YFP	Yellow fluorescent protein

# Foreword

---

When I joined Matthew's lab as a graduate student, I was very much interested in the interaction between tumors and their microenvironment, including components of the immune system. I was very enthusiastic to join the "bladder cancer" project, as BCG immunotherapy for superficial bladder cancer is one of the few examples of successful immunotherapy. I saw the opportunity to work on very exciting basic scientific questions while remaining close to the clinics and applied science, both of which were major goals for my PhD. I was very happy to undertake the development of an experimental mouse model to explore in detail the mechanisms of a local "prime-boost" immune response to BCG therapy, which our lab had recently reported from an observational clinical study.

Very soon, it seemed to us pretty clear that we had to start by looking at the immune response of a tumor-free bladder to intravesical BCG: indeed there is no perfect mouse model for bladder cancer, and, most importantly, in patients the tumor is removed shortly prior to adjuvant BCG therapy. This study was of course supposed to be a first step, and in parallel we worked hard on the development of pertinent tumor models. However it turned out that this first step was the main core of my PhD. I characterized in much detail the immune response of the tumor-free bladder to intravesical BCG, and in particular, I investigated the mechanisms for priming of BCG-specific T cells, and their entry into the bladder, in response to repeated intravesical BCG instillations. While presenting my work, I very often had to deal with the following question: *"But Claire, what is the use of BCG-specific T cells to clear the tumor? Why wouldn't you focus on tumor-specific T cells instead?"* Obviously, BCG-specific T cells do not perform the whole job themselves, but we still believed that this was an interesting piece in the puzzle.

This is why I was so happy when I came to read that very important scientists involved in the birth of modern immunotherapy, who gathered at the National Cancer Institute late 1972 for a *Conference on the Use of BCG in Therapy of Cancer* had encountered the same kind of doubts and questions. I am transcribing selected pieces of a discussion below (Ribi et al., 1973):

B. H. Waksman: *"I am really quite shocked at what has been going on. Both the Chairman and Dr. Borsos have in essence said that this subject is not scientific but simply empiric. We will test materials at various doses, compare what we can extract from this place, and see what works; but we will not really address ourselves to questions of how they work. I came to*

*this meeting because the word “mechanisms” appeared. When I said to Dr. Borsos that I don’t work on tumors or on BCG, he said, “Come anyway. We need people who are concerned with mechanisms.” [...] If we want to make sense out of what we’re doing, we must understand the mechanisms we are stimulating.”*

*Weiss: “[...] A discussion of mechanism is vital! [...] Our function is to discuss from a mechanistic as well as from a behavioral point of view the effects of BCG and BCG-related compounds in tumor immunotherapy. If we talk in general about the biologic activities of BCG or BCG fractions in many other systems, this certainly would be extremely interesting. But it is not - as I was informed and instructed - within the scope of this meeting.”*

*Borsos: “You have clearly stated my entire position. One purpose of this meeting was indeed to explore the mechanism of how BCG treatment can rid an animal of its cancer. I would very much like to hear a general discussion of how cellular or humoral immunity is stimulated by these various factors. But at this meeting we are addressing ourselves to the question of the use of BCG in the therapy of cancer. The mechanism of this process, for example, may have nothing to do with the delayed reaction of the type Dr. Chase or you describe. **How does one know that, if one studies the mechanism of a nontumor model system, one would indeed study the mechanism of tumor rejection?** [...]”*

I am very proud to report, in this dissertation, how a better understanding of the requirements for priming of BCG-specific T cells and T cell entry into the bladder, led me to optimize a BCG-based regimen, which improved BCG-mediated anti-tumor activity in a mouse model for bladder cancer. Importantly, this data was reinforced by clinical evidence that pre-existing immunity to BCG prior to intravesical therapy significantly improved recurrence-free survival in patients with high-risk bladder tumors, opening an avenue for improvement of the standard-of-care therapy.

# Research Plan

---

BCG therapy of superficial bladder cancer is one of the few examples of successful immunotherapy in the clinic and therefore offers a unique opportunity to define mechanisms by which the immune system may be used to target tumor cells. Carcinoma of the bladder is the most common cancer of the urinary tract and the fourth most common malignant disease in males in the developed world (Jemal et al., 2011). Most tumors are diagnosed at a superficial stage and are surgically removed by transurethral resection. Depending on the stage and grade of the non-muscle invasive tumors, adjuvant therapy is recommended as a strategy for both reducing recurrence and diminishing risk of progression (Babjuk et al., 2011). Since the work of Morales and colleagues in 1976 (Morales et al., 1976), BCG therapy, which consists of 6 weekly intravesical instillations shortly after resection, has been the standard of care for high-risk urothelial carcinoma: carcinoma *in situ*, and high-grade Ta/T1 bladder lesions (Babjuk et al., 2011; Gontero et al., 2010).

BCG is an attenuated strain of *Mycobacterium bovis*, initially developed as a vaccine against *Mycobacterium tuberculosis* (*Mtb*) infection (Guérin, 1980; Zwerling et al., 2011). It is a slow growing bacterium with a doubling-time of about 24 hours. Macrophages are the principal host cells where mycobacteria either multiply or remain latent (Flynn et al., 2011). Several effector lymphocyte subsets are induced upon mycobacterial infection, including multifunctional CD4<sup>+</sup> and cytolytic CD8<sup>+</sup> T cells (Cooper, 2009). Importantly, interferon (IFN)- $\gamma$ -producing CD4<sup>+</sup> T cells are responsible for phagocyte activation, an essential process for controlling mycobacterial infection (Cooper, 2009). While robust, it has been demonstrated that T cell recruitment to the lung mucosa of mice infected with aerosolized mycobacteria occurs late and takes several weeks to establish (Cooper, 2009; Urdahl et al., 2011).

In the context of bladder cancer, BCG therapy is known to trigger a strong innate immune response, followed by the influx of type 1 polarized lymphocyte subsets (Alexandroff et al., 2010; Brandau and Suttmann, 2007). Using orthotopically-transplanted urothelial tumors in mice, several groups have reported that BCG-mediated anti-tumor activity relies on a functional immune system of the tumor-bearing host (Brandau et al., 2001; Ratliff et al., 1987a; Ratliff et al., 1993; Suttmann et al., 2006). In particular, CD4<sup>+</sup> and CD8<sup>+</sup> T lymphocytes seem to be essential effector cells for eliminating the tumor in a mouse model (Ratliff et al., 1993), and correlates have been established between T cell infiltration and



clinical response in patients (Prescott et al., 1992). Our lab recently reported that repeated instillations with BCG were required in order to trigger a robust inflammatory response (Bisiaux et al., 2009).

Based on these findings, I aimed to:

## **I. DETERMINE THE DYNAMICS OF THE IMMUNE RESPONSE TO INTRAVESICAL BCG**

Based on the clinical practice of resecting the tumor shortly prior to adjuvant BCG therapy, I established an experimental mouse model of intravesical BCG instillations into tumor-free animals, and I developed tools to study the dynamics of the immune response following intravesical BCG regimen.

This helped to prepare me to specifically address several important unknowns concerning the local immune response to intravesical BCG, including: the link between bacterial persistence / dissemination and T cell priming; the role of repeated instillations in triggering T cell influx in the bladder; and the temporal relationship between T cell priming and T cell entry into the inflamed bladder microenvironment.

Finally, taking advantage of an orthotopic mouse model for bladder cancer, I translated my understanding of the local dynamics of the immune response into an optimized BCG regimen for triggering an anti-tumor response.

(Manuscript 1, submitted)

## **II. EXPLORE THE MECHANISMS AND DETERMINANTS OF RESPONSE TO BCG THERAPY USING MATHEMATICAL MODELING**

Using clinical and in-vitro experimental data, I collaborated closely with Romulus Breban and other investigators in our Bladder Biology Team to help construct and parameterize a stochastic mathematical model that describes the interactions between BCG, the immune system, the bladder mucosa and tumor cells.

Though the standard-of-care treatment for more than 35 years, the precise mechanisms of action of BCG therapy are not known precisely. Importantly, whether the effective eradication

of tumor cells involves some tumor-specific killing or whether BCG therapy functions as a non-specific immunotherapy is not yet clear. We therefore started by modeling BCG therapy as relying on an innate immune response only, and asked whether the model calibration would fulfill experimental and clinical data (Manuscript 2).

Following this initial work, I contributed to modeling the combined action of innate and adaptive immune effector cells and we sought to define optimal clinical parameters of BCG induction therapy. Specifically, we assessed the impact of (1) duration between resection and the first instillation; (2) BCG dose; (3) indwelling time; and (4) treatment interval of induction therapy – using cure rate as the primary endpoint (Manuscript 3, submitted).



# Chapter 1. General Introduction

---



The use of infectious agents for achieving an anti-tumor effect dates back to the 1700s, but it was William Coley who made the first attempt at extracting an active agent for the purpose of achieving immune-mediated regression of inoperable sarcomas. His extract, called Coley's toxin, was a streptococcal extract that was later supplemented with mycobacterial cell wall preparations. Remarkably, he reported ~10% response rates in patients with advanced stage disease (Wiemann and Starnes, 1994).

Since Coley's studies, it has been well established that cancer cells actively interact with their microenvironment, including components of the immune system (Vesely et al., 2011), and immunologists have better understood which components of the immune system are important for tumor clearance. For example, cytotoxic CD8<sup>+</sup> T cells play a crucial role in tumor elimination, through the cross-priming of a specific immune response to tumor-antigens (Albert, 2004). A compelling evidence of such mechanism came from the study of breast cancer and paraneoplastic diseases: indeed, some antigens that are normally expressed on neurons can become expressed by breast cancer cells, with some patients developing a strong antigen-specific CD8<sup>+</sup> T cell response that controls tumor expansion but concomitantly results in autoimmune cerebellar degeneration (Albert et al., 1998). The molecular identification of human cancer antigens and the discovery of dendritic cells (Nestle et al., 2001; Palucka et al., 2011), potent antigen presenting cells, raised considerable excitement in the field of immunotherapy, with several ways to trigger a specific immune response against tumor cells (passive immunization, vaccine based therapy, adoptive immunotherapy) (Greten and Jaffee, 1999; Old, 1996). However it also became clear that tumors evolved multiple mechanisms to escape from immune attack (Gajewski et al., 2011; Nagaraj and Gaborilovich, 2008), so that strikingly, our advanced knowledge of the immune system has not translated into overwhelming success, and as a result, few clinical studies have reported an effect greater than the 10% rate achieved by Coley (Chamberlain, 1999; Wiemann and Starnes, 1994). Nonetheless, the famous recent FDA approvals of Provenge (sipuleucel-T) – an autologous dendritic-cell-based vaccine (Small et al., 2000), though its therapeutic mechanisms remain unclear (Mellman et al., 2011) – and Yervoy (Ipilimumab) – a monoclonal antibody to CTLA4, a key negative regulator of T cells (Chambers et al., 2001) – have raised a lot of excitement in the field. Cancer immunotherapy is therefore back on the front stage (Lesterhuis et al., 2011; Mellman et al., 2011).

Like Coley and many in the field of tumor immunology, our lab has been concerned with utilizing the immune system to achieve tumor regression and cure. While the current generation of immunologists have focused on the identification of so-called tumor-associated

antigens and the treatment of end-stage cancer patients, our lab has focused its attention on the mechanism of effective tumor immunity and the validation of surrogate markers that would allow for the efficient testing of novel immunotherapy protocols. Therefore, we chose to study patients undergoing intravesical instillation of BCG as therapy for the treatment of superficial bladder cancer (see Section I). Several characteristics make the latter an ideal model for understanding the natural history of clinically effective anti-tumor immune response. (i) There exists a potent, relatively non-toxic immunotherapy for the treatment of TCC, which results in a 50-70% response rate (making it one of the best-known examples of tumor immunotherapy) (Babjuk et al., 2011; Gontero et al., 2010). (ii) Collection of peripheral blood and urine prior to, during and post-BCG therapy permits evaluation of host immunologic and metabolic responses to tumor antigen and immunotherapy. (iii) Patients are often chemo-naïve, thus removing prior exposure to immune modulating agents as a confounding factor, an important issue in the study of tumor immunity. (iv) Bladder cancer and immune response to BCG are amenable, to a certain extent, to modeling in immunocompetent mouse models. (v) BCG can be genetically modified, offering the possibility of improving upon the existing therapy through rational design and introduction of molecules that might overcome the mechanisms of tumor-mediated immune evasion.

In this general introduction, I provide the reader with information about bladder cancer disease pathogenesis and current treatment options. I also review the use of BCG as a vaccine against tuberculosis and highlight its historical use as an anti-cancer agent. Finally I detail the current understanding of BCG-mediated anti-tumor activity, which provided the foundation for my experimental work.

## **I. BLADDER CANCER**

Bladder anatomy and cancer pathogenesis are described, in order to provide a context for understanding the host response to intravesical BCG therapy.

### **A. Disease pathogenesis**

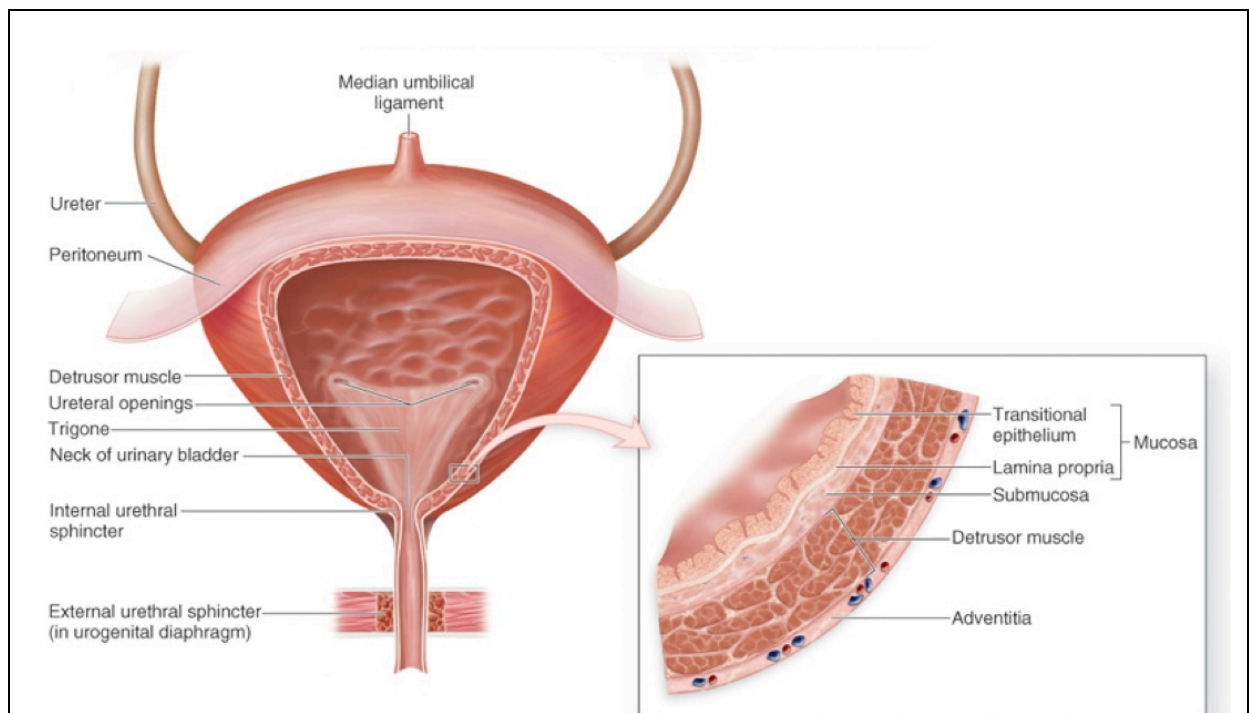
#### 1) Bladder anatomy

The bladder is a hollow muscular organ located in the anterior pelvis, with a lumen that collects liquid waste generated by the kidneys through two ureters (**Figure 1**), and stores it

temporarily prior to excretion via the urethra. The healthy bladder is composed of 3 anatomic structures (**Figure 1**) (Wu et al., 2009):

- A thin mucosa – 3 layers in mice; 4-7 layers in humans –, made of transitional slow-cycling (~200 days) urothelial cells as well as squamous cells;
- A stromal submucosal layer made of connective tissues;
- A thick muscle layer that allows contraction during voiding.

A healthy human bladder can hold up to 300-350mL of urine comfortably for 2-4 hours (200µL for a healthy murine bladder).



**Figure 1: Anatomic structure of the bladder.**

The bladder consists of 3 anatomic structures: (i) a thin mucosa made of transitional urothelium, based on a lamina propria; (ii) a submucosa, made of connective tissue; (iii) a thick muscle layer that allows contraction upon voiding. *Taken from (McKinley and Dean O'Loughlin, 2006).*

Importantly, the urothelium needs to achieve all at once (i) a high degree of size-flexibility (throughout the micturition cycle) and (ii) impermeability (thus providing a constant barrier to protect the blood from toxic urinary substances). These two biophysical properties are met through the fusion of cytoplasmic vesicles to the membrane of the luminal cells and the secretion of uroplakin proteins, which establish an impermeable layer, throughout the micturition cycle (Wu et al., 2009).

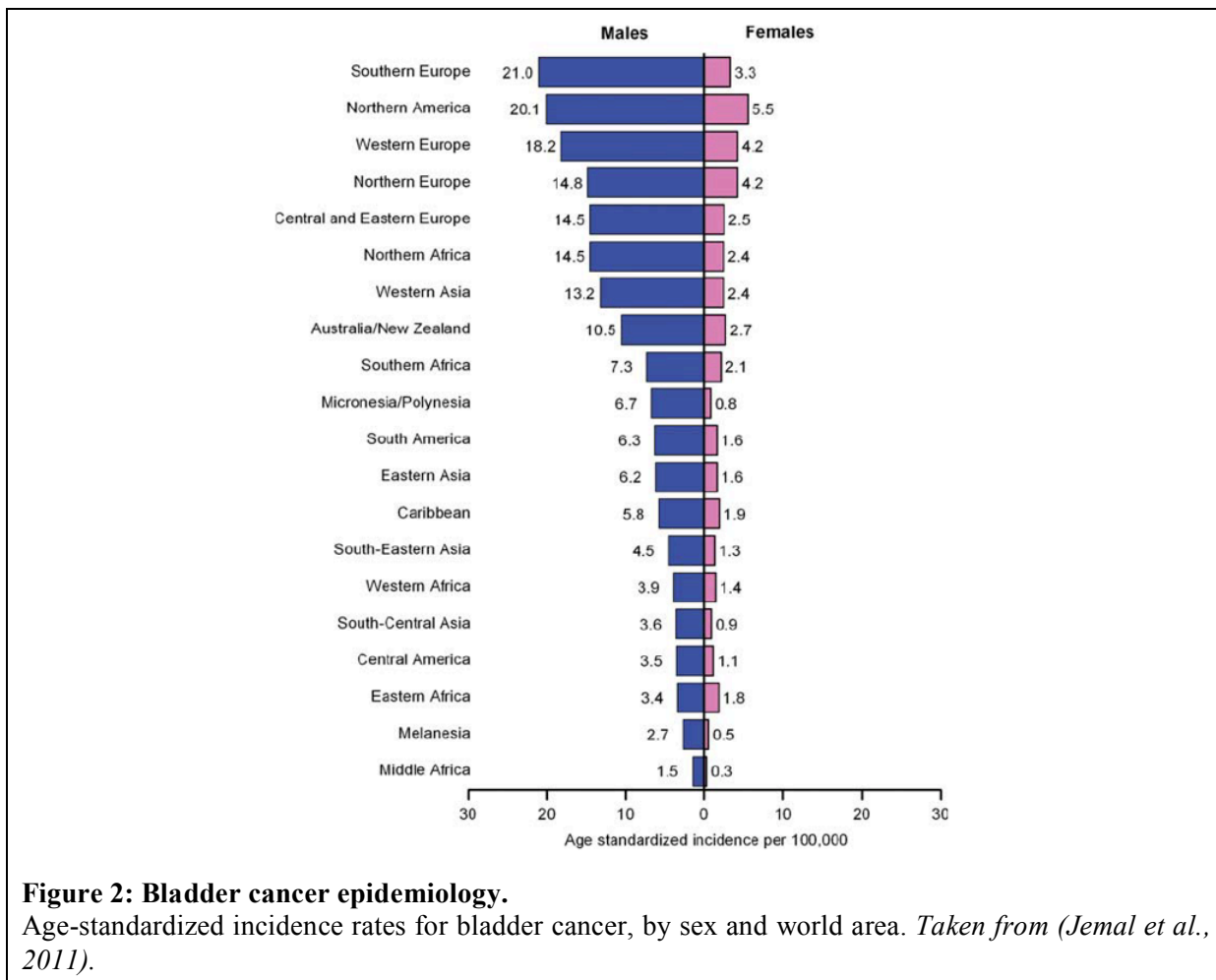
Of note, this makes the bladder a difficult organ for pathogens to invade. One notable exception is the invasion of the bladder by pathogenic *E. coli*, which manages to be



internalized via binding to uroplakins and hijacking of the mechanism of vesicle recycling (Kau et al., 2005). Except for such urinary tract infections, the bladder is relatively unexposed to microbes and has been considered as a sterile organ. These features make the bladder a unique mucosa in the organism and considering the attention to mucosal biology in the last decade, it been under-investigated.

2) Bladder cancer is a common cancer, which most often results from exposure to carcinogens

Worldwide, bladder cancer is the 7<sup>th</sup> most common malignancy in men and the 17<sup>th</sup> in women, with ~300,000 new cases diagnosed and ~100,000 deaths in 2008 (Jemal et al., 2011). In developed countries, bladder cancer is the 4<sup>th</sup> most common cancer among males (Jemal et al., 2011). Bladder cancer is more prevalent in men than women (**Figure 2**). Median age at diagnosis is 68 years, and the incidence increases with age, like most cancers. Ethnically, in the USA, the incidence of bladder cancer is higher in Caucasians than African-Americans or Hispanics (Creel, 2007).



Several risk factors have been identified for bladder cancer, most notably cigarette smoking, which accounts for half of all bladder cancers. Other factors include professional exposure to carcinogens (e.g. printing, aluminium and iron processing, industrial painting, gas manufacturing) (Babjuk et al., 2011; Creel, 2007).

### 3) Pathological classification of bladder cancers

In over 90% patients, bladder cancer occurs as transitional cell carcinoma (TCC); i.e., tumors arise in the transitional cells of the first bladder layer. A small fraction of patients (5-8% in developed countries, but 75% in developing countries!) develop squamous cell carcinoma. The etiology (mostly related to environmental exposure to parasitic organism *Schistosoma haematobium*), treatment and progression of the latter disease are very different from TCC, therefore I focus on TCC for the rest of this dissertation.

Most TCC (75-85%) are diagnosed at an early stage, when the tumor is confined to the mucosa or submucosa, because patients see blood in their urine or feel pain during urination and therefore consult an urologist. The diagnosis and classification of the tumor are made after cystoscopy, histopathological analysis of bladder biopsies, urinary cytology and urinary molecular marker tests.

The classification takes into account several parameters, most importantly including:

- Staging, which measures the extent the cancer has spread, by assessing primary tumor, node and metastasis (TNM system)
- Grading, which measures the cell appearance in tumors (more or less differentiated).

For bladder cancer, the staging of the primary tumor (T) is shown in **Table 1** below (also see **Figure 3**).

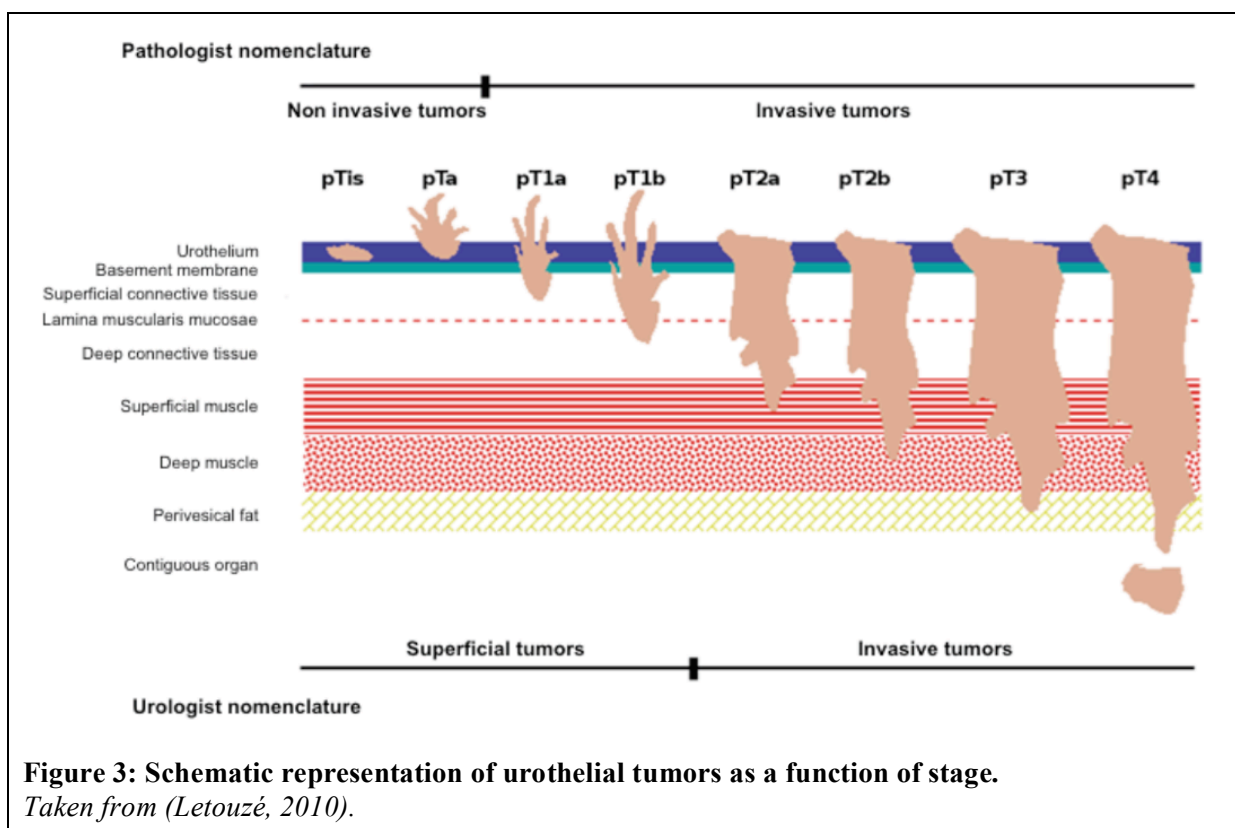
Of note, the staging is completed by evaluation of lymph nodes metastases and distant metastases. Invasion of lymph nodes is noted N0 to N3, as a function of the number and size of invaded nodes identified in the patient, and distant metastases are scored M0 (absence) or M1 (presence).

Bladder tumors are also graded according to specific cytological and architectural criteria. Under the 1973 WHO classification there are 3 grades: G1 tumors are the most differentiated, being similar to normal urothelial cells. By contrast, G3 tumors present various cytologic anomalies, with numerous mitotic figures. More recent classifications of grade have been introduced in 1998 and 2004, but the 1973 classification is still used in clinical practice, alone or in conjunction with others.

Stage	Description
T0	No evidence of primary tumor
Ta	Noninvasive papillary carcinoma
Tis	Carcinoma <i>in situ</i> (“flat tumor”)
T1	Invades subepithelial connective tissues
T2	Invades muscle T2a: invades superficial muscle (inner half) T2b: invades deep muscle (outer half)
T3	Invades perivesical tissue T3a: microscopically T3b: macroscopically
T4	Invades any of the following: prostate, uterus, vagina, pelvic wall, abdominal wall T4a: invades prostate, uterus, vagina T4b: invades pelvic wall, abdominal wall

**Table 1: T classification of urothelial tumors.**

*Adapted from (Babjuk et al., 2011).*



**Figure 3: Schematic representation of urothelial tumors as a function of stage.**

*Taken from (Letouzé, 2010).*

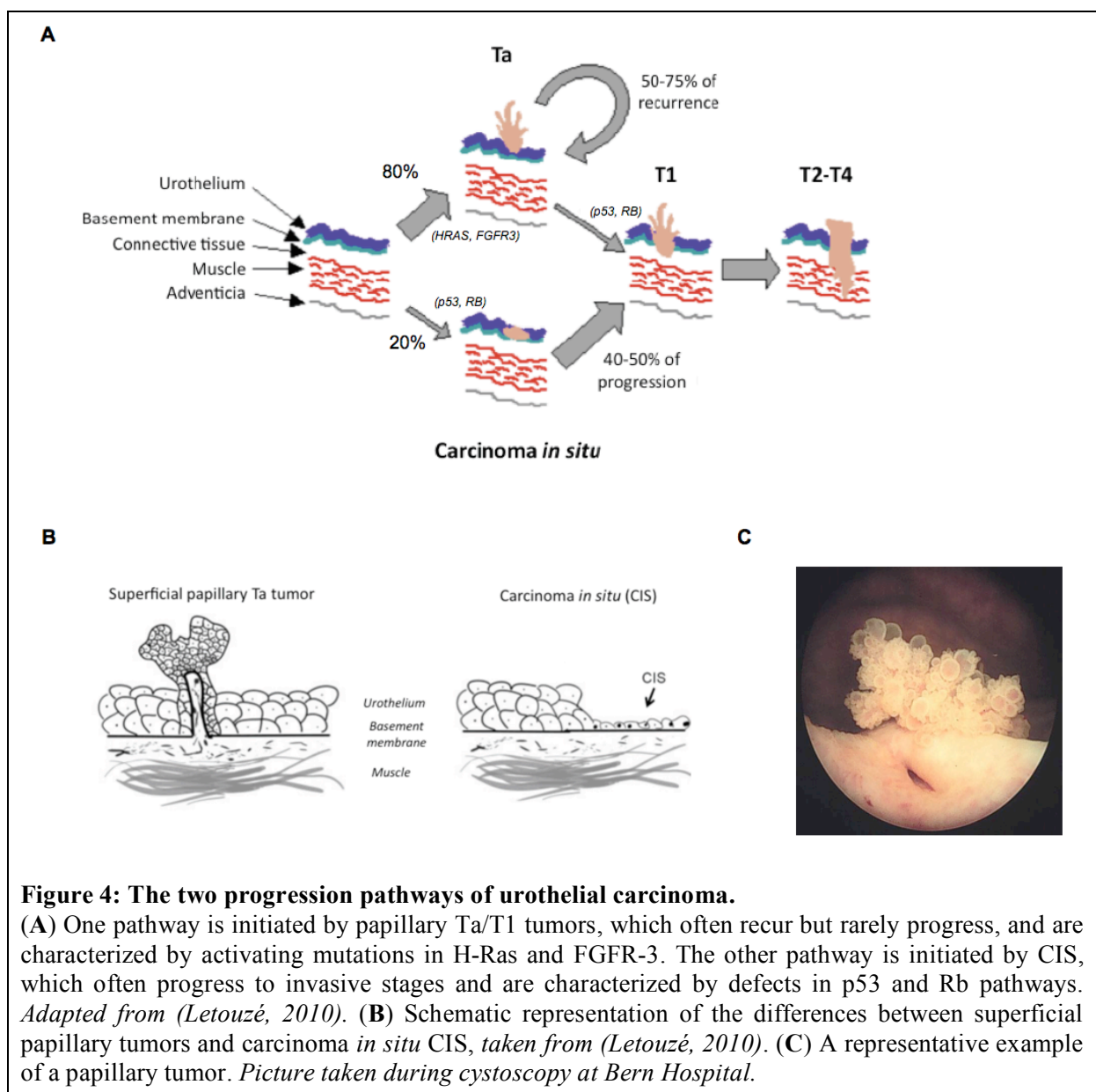
#### 4) Predicting tumor recurrence and progression

Survival prognosis (following treatment according to guidelines, see Section I.B) depends primarily on the stage of the tumor at diagnosis: for patients with localized disease, 5-year survival is 92%, falling to 44% for patients with muscle-invasive disease (T2-T4) and 6% for metastatic diseases (Creel, 2007).

More precisely, the risk of progression (to a more advanced stage/grade) and the risk of recurrence (another occurrence of the same stage/grade of tumor) can be assessed separately by scoring and giving different weights to various clinical and pathological parameters (Babjuk et al., 2011), and dictate the choice of therapy (see Section I.B).

#### 5) Urothelial tumorigenesis, and its implication on tumor recurrence and progression

It is now well accepted that urothelial carcinoma arise by at least 2 separate pathways (**Figure 4A**) (Wu, 2005) and that these two important phenotypic variants exhibit drastically distinct biological behaviors and prognoses in terms of recurrence *versus* progression.



**Figure 4: The two progression pathways of urothelial carcinoma.**

(A) One pathway is initiated by papillary Ta/T1 tumors, which often recur but rarely progress, and are characterized by activating mutations in H-Ras and FGFR-3. The other pathway is initiated by CIS, which often progress to invasive stages and are characterized by defects in p53 and Rb pathways. Adapted from (Letouzé, 2010). (B) Schematic representation of the differences between superficial papillary tumors and carcinoma in situ CIS, taken from (Letouzé, 2010). (C) A representative example of a papillary tumor. Picture taken during cystoscopy at Bern Hospital.

The low-grade papillary variants include urothelial papilloma, papillary urothelial neoplasms of low malignant potential and non-invasive low-grade papillary urothelial carcinoma (**Figure**

**4A-C**). They account for 80% TCC and are often multifocal and recurrent, with limited potential to become muscle-invasive. They are characterized by activating mutations in the *HRAS* gene and fibroblast growth factor receptor 3 (*FGFR-3*) gene (**Figure 4A**).

The second main variant, which accounts for about 20% TCC, presents as an invasive tumor and the patient usually has no previous history of low-grade non-invasive papillary tumors. These tumors arise *de novo* or derive from flat, high-grade carcinoma *in situ* lesions (**Figure 4A-B**). Despite radical cystectomy, most of these variants develop into incurable metastatic disease. They are characterized by structural and functional defects in p53 and retinoblastoma protein (Rb) tumor-suppressor pathways (**Figure 4A**).

#### 6) Mouse models for bladder cancer

Mouse models for bladder cancer in immunocompetent animals can be achieved by several techniques, including the orthotopic transplantation of tumor cells, the use of transgenic animals and the induction of spontaneous tumors by carcinogenic treatment. Importantly, BCG therapy has only been tested in orthotopically-transplanted tumors, to my knowledge.

##### *(a) Orthotopically-transplanted tumors*

Most mouse work in the field of bladder cancer and BCG therapy has been done using orthotopically-transplanted tumors. More specifically, the MB49 cell-line was derived in the 1970s from chemically transformed urothelium of a male C57BL/6 mouse (Summerhayes and Franks, 1979); in C3H mice an equivalent cell-line, called MBT-2, has been established as well.

Efficient seeding of the tumor in the bladder wall is achieved using various methods, many of which include physical or chemical damage to the bladder wall, whereas the use of poly-L-lysine has also been reported (Chan et al., 2009). Tumor take can reach 100%; however the resulting tumor is highly aggressive: it becomes detectable as early as 4 days post implantation and it rapidly becomes muscle-invasive (Chan et al., 2009).

The main caveat of this model is that BCG treatment does not achieve full tumor immunity, even when started on the very first day following tumor instillation (the protocol followed by most groups) (Gunther et al., 1999). Nonetheless, it is the only model, to my knowledge, in which BCG therapy has been tested at all. Another important caveat is the aggressiveness and invasiveness of the tumors, which therefore do not phenocopy an important feature of most human superficial bladder tumors, since papillary tumors rarely progress.

On the other hand, this model presents several advantages, including (i) the relative ease in producing a large cohort of mice with a comparable tumor burden, (ii) the ability to monitor tumor growth directly using non-invasive techniques (e.g., bioluminescence using a luciferase transfected cell-line), (iii) the ability to implant tumors in genetically-manipulated animals and (iv) the presence of male antigens thus permitting the study of anti-male specific T-cell responses when utilizing female hosts. Kinetics of tumor growth is rather fast, which is both an advantage, as it allows testing many parameters in preclinical approaches, and a drawback, as such fast-growing aggressive tumor does not perfectly resemble human lesions.

### *(b) Transgenic models*

Based on the understanding of urothelial pathogenesis, a few transgenic models have been developed, which closer recapitulate features of human non-muscle invasive bladder cancers (NMIBC). One group has taken advantage of the specificity of uroplakin expression to the urothelium (in all 3 layers of murine bladder mucosa) to construct (i) a uroII-HRas mouse that phenocopies a low-grade papillary tumor with 100% penetrance within 6 months (Zhang et al., 2001), and (ii) a uroII-SV40TA<sub>g</sub> mouse that develops CIS with 100% penetrance within 5 months, most of these mice eventually developing an invasive disease within 16 months (Zhang et al., 1999). Though histologically much closer to human bladder tumors, these models have an important caveat, in that it is very difficult to synchronize a large cohort of animals, and to monitor tumor growth using non-invasive techniques.

Alternatively, a conditional model of CIS has been recently reported, where intravesical instillation of an adenovirus encoding expression of the Cre-recombinase locally in the bladder triggers CIS in  $Pten^{flox/flox} \times p53^{flox/flox}$  mice with 100% penetrance within 2.5 months (Puzio-Kuter et al., 2009). The latter model is interesting, as it allows the monitoring of tumor growth and the introduction of tumor-associated antigens (e.g. use of an lentivirus expressing luciferase and membrane-associated ovalbumin).

### *(c) Carcinogen-induced tumors*

An alternative strategy consists in feeding rodents with carcinogens (N-butyl-N-(4-hydroxybutyl)-nitrosamine, BBN) in the drinking water for 14 weeks (McCormick et al., 1981). Mice develop bladder tumors that are histologically similar to the human disease but mostly resemble invasive tumors (Williams et al., 2008), and sometimes seem to be of squamous cell (not transitional cell) origin.

## B. Current treatment options

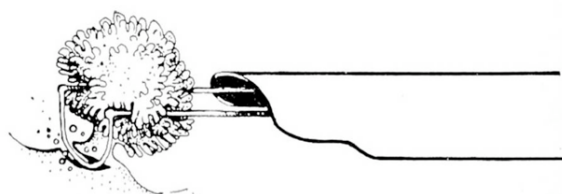
The treatment of bladder cancer is typically dictated by the stage and grade of disease, as well as prior treatments. Of note, because of long-term survival and the need for lifelong routine monitoring and treatment, the cost per patient of bladder cancer from diagnosis to death is the highest of all cancers, ranging from 96,000-187,000 US dollars (2001 values) in the US (Botteman et al., 2003). Overall, bladder cancer is the fifth most expensive cancer in terms of total medical care expenditures, accounting for almost 3.7 billion US dollars (2001 values) in direct costs in the US (Botteman et al., 2003).

Various clinical and pathological parameters such as histology, grade and depth of invasion are used to estimate the risks of recurrence and progression, which in turn influence the choice of treatment. Despite advances in medical oncology, surgery remains the mainstay of the management of bladder cancer, most often accompanied by adjuvant therapies.

### 1) Standard-of-care treatments for non-muscle invasive bladder cancer

#### (a) *Trans-urethral resection (TUR)*

Non-muscle invasive bladder tumors are removed by trans-urethral resection (TUR). More precisely, cystoscope and electrocautery devices are passed through the urethra into the bladder, allowing the visualization and removal of the tumor (**Figure 5**).



**Figure 5: Drawing showing the transurethral resection of a papillary tumor.**

*Courtesy of Bern Hospital.*

Depending on the stage and grade of the tumor, a second TUR might increase the recurrence-free survival. Persistent disease after resection of T1 tumors has been observed in 33-53% of patients. Moreover, the tumor is often under-staged by initial resection. In particular a second TUR should be performed when a high-grade or T1 tumor has been detected at initial TUR (i.e., for those tumors for which BCG therapy is recommended, see the paragraph below). There is no consensus about the timing of second TUR but, to my knowledge, most practitioners recommend resection at 2-6 weeks after initial TUR (Babjuk et al., 2011).

Superficial bladder cancer can be resected with minimal morbidity, but, depending on the stage and the grade of the tumor, some patients are at high risk for tumor recurrence (and progression), therefore an adjuvant therapy may be used, as described in the next section.

Of note, by definition, CIS cannot be fully resected by TUR, and in some centers, they do not perform surgery prior to BCG therapy.

### *(b) Adjuvant intravesical therapies*

By definition, an adjuvant therapy is a treatment that is given in addition to the primary, main or initial treatment. It is commonly used in the field of cancer therapy, where it is usually given after surgery, where all detectable disease has been removed, but where there remains a statistical risk of relapse due to occult disease.

I present here the guidelines for optimizing adjuvant therapy against non-muscle invasive bladder cancer, based on the risk of recurrence and progression of the tumor (Babjuk et al., 2011; Braasch et al., 2008; Gontero et al., 2010). More details about BCG therapy, which is the focus of my work, is provided in the following section.

- Low-risk tumors (single, primary, low-volume papillary lesions) are treated with a single instillation of a chemotherapeutic agent (mitomycin C, epirubicin or doxorubicin) within 6-24 hours of TUR.
- Intermediate-risk tumors (multifocal, large-volume or recurrent, low-grade Ta or T1 lesions) are typically treated with repeated instillations of chemotherapeutic agents. The choice between chemotherapy or BCG immunotherapy (see below) largely depends on the risk that needs to be reduced: recurrence or progression, since retrospective meta-analyses have demonstrated that chemotherapy prevents recurrence but not progression (Babjuk et al., 2011). It is still controversial how long and how frequently instillations of intravesical chemotherapy have to be given. Nevertheless, the available evidence does not support any treatment longer than 1 year.
- Both the American Urological Association (AUA) and the European Association of Urology (EAU) guidelines recommend intravesical BCG therapy for superficial bladder tumors with high risk of progression (high-grade Ta or T1 lesions and/or CIS). Of note, BCG therapy is particularly efficient in patients with CIS, as underlined by a retrospective analysis showing a complete response rate of 48% with intravesical chemotherapy *versus* 72-93% with BCG (Babjuk et al., 2011).

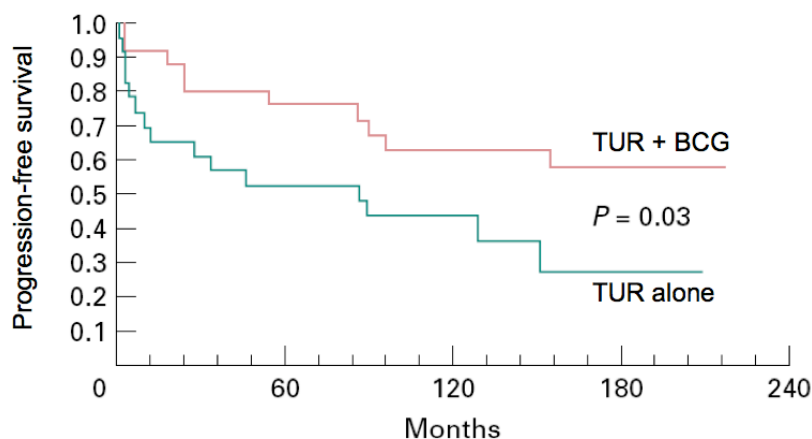


## 2) Intravesical BCG therapy

### (a) *Description of the therapy*

Intravesical BCG therapy mainly consists in 6 weekly intravesical instillations of BCG, the vaccine against tuberculosis, and is initiated shortly after tumor resection, at least 2 weeks after TUR to allow for healing of the bladder wall (Babjuk et al., 2011; Gontero et al., 2010).

Morales and colleagues designed the therapy rather empirically in 1976, based on the work of Zbar, Mathé and others (see Section II.C): 120mg lyophilized BCG Pasteur was reconstituted in 50mL saline and instilled via a catheter into the bladder. Patients were asked to retain the solution for at least 2 hours, and they additionally received 5mg BCG intradermally. Treatments were given weekly over 6 weeks, and altered favorably the pattern of recurrence in 7 patients (Morales et al., 1976). Subsequent studies by Morales, Herr, Lamm and others showed that BCG eradicated CIS of the bladder, delayed stage progression to muscle invasion, improved the survival of the patients with high-risk superficial bladder cancer (**Figure 6**) and proved superior to intravesical chemotherapy (Gontero et al., 2010; Herr and Morales, 2008).

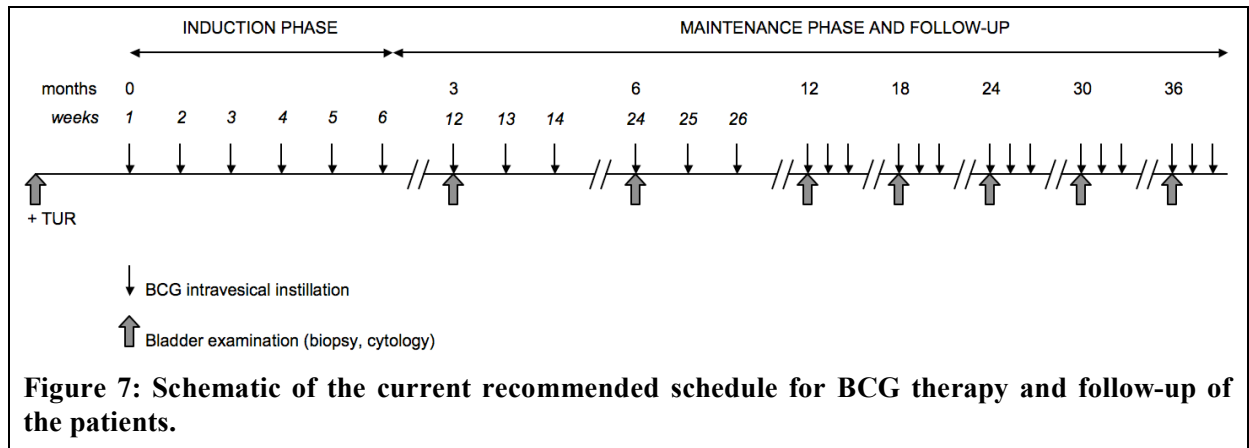


**Figure 6: Progression-free survival of 48 patients with T1G3 bladder tumors.**

Patients were initially randomized to receive either TUR alone (green) or TUR + BCG therapy (red) and followed for 15 years. Of the 23 patients in the TUR group, 14 were treated later with BCG. Of note, T1G3 lesions are the superficial tumors that present the highest risk of recurrence and progression, and in the absence of BCG therapy, the treatment of choice might be cystectomy. Adapted from (Herr, 1997).

In 1990, after local side effects and systemic toxicity were defined in more than 2,500 cases pooled worldwide, the Federal Drug Administration approved the general use of intravesical BCG in patients with superficial bladder tumors. Since then, and as mentioned above, BCG therapy has been the standard of care for high-risk urothelial carcinoma, namely CIS, and high-grade Ta/T1 bladder lesions (Babjuk et al., 2011). Modifications of the initial regimen have mainly focused on the elimination of the concomitant intradermal dose, introduction of

maintenance BCG dosage schedule and introduction of other substrains of BCG. Importantly, two studies performed in the 1990s showed that intravesical therapy alone was not inferior to intravesical + concomitant intradermal administration of BCG (Lamm et al., 1991; Luftenegger et al., 1996), so that nowadays the regimen recommended by the European and American guidelines is as follows (Babjuk et al., 2011; Gontero et al., 2010).



- BCG therapy is usually initiated shortly (2-6 weeks) after transurethral resection of the tumor.
- Use of any of the commercially available BCG strains (see Section II.B.1)(a)) (e.g., Connaught, Tice, RIVM) can be proposed for intravesical therapy. Of note, the current view is that different strains do not differ in efficacy, although only a few comparative studies exist (Brandau and Suttman, 2007; Gontero et al., 2010). However, data from our collaborators in Switzerland suggests that there are indeed strain differences (unpublished results), for reasons that are currently under investigation.
- BCG dose is typically measured in milligrams rather than in number of colony forming units (CFUs – i.e., live bacteria). Depending on the commercial preparation, the dose ranges from 50mg (Tice) to 120mg (Pasteur strain, no more commercialized) and is thought to contain  $10^8$ - $10^9$  CFUs.
- BCG dwell time in the bladder is 2 hours.
- The induction course of 6 weekly intravesical instillations may be followed by maintenance therapy. The recommended maintenance regimen consists in 3 weekly instillations at 3 months, 6 months, and then every 6 months up to 3 year (**Figure 7**). Of note, in several meta-analyses, maintenance therapy has been shown to be a prerequisite for superiority of BCG over mitomycin C (Gontero et al., 2010). But

recently, the benefit of maintenance BCG has been questioned (Gontero et al., 2010; Herr et al., 2011).

*(b) Failure of BCG therapy*

Follow-up of the patients is very important and starts 3 months after the initial TUR, with a cystoscopy (**Figure 7**). Treatment with BCG is considered to have failed in the following situations (Babjuk et al., 2011):

- Whenever muscle-invasive tumor is detected during follow-up.
- If high-grade, non-muscle-invasive tumor is present at both 3 and 6 months. It is worth noting that in patients with tumor present at 3 months, an additional BCG induction course can achieve a complete response in > 50% of cases, both in patients with papillary tumors and CIS, but with increasing risk of progression (Babjuk et al., 2011).
- Worsening of the disease under BCG treatment, such as a higher number of recurrences, higher T stage or higher grade, or appearance of CIS, in spite of an initial response.

In case of a failure, most patients will undergo cystectomy (see Section I.B.3)(a), and some might be involved in clinical trials, testing strategies mentioned in Section I.B.4).

*(c) Side effects*

Although BCG therapy is generally considered safe, it has potential local and systemic side effects, the vast majority of which can be treated effectively. However, BCG toxicity may either lead to treatment cessation (up to 30% patients) or lead to delay or reduction in the number of instillations in 55-83% of patients, which might in turn affect efficiency of therapy (Gontero et al., 2010; van der Meijden et al., 2003).

Local toxicities mostly include cystitis-like symptoms (urinary urgency, frequency and pain), as well as hematuria and bladder contracture. They are generally brief, more frequent and less severe than systemic side effects; however they are more often the cause of treatment cessation (Braasch et al., 2008).

The most common systemic side effects are flu-like symptoms, with fever <38.5C. High, persistent fever is less common but may be the sign of systemic BCG infection. In such cases, BCG therapy should be interrupted until resolution of the symptoms and a prompt antibiotic treatment should be considered. There are rare (1-5%) cases of major systemic BCG reactions, called BCG-itis or BCG-osis, due to active BCG infection in multiple organs,

which can progress to multiple organ failure or sepsis, although very rarely. Finally rare allergic reactions such as arthralgia, skin reactions or anaphylaxis have been reported.

Many attempts have been made to reduce BCG toxicity without compromising its efficacy (Braasch et al., 2008; Gontero et al., 2010). They mostly rely on dose and/or schedule modifications, as well as pharmacological strategies. Approaches dealing with dose and/or schedule modification will be discussed in detail in Chapter 4, and to date long-term efficacy data are lacking to validate such modifications. Briefly they include dose reduction, reducing the dwell time, increasing the inter-instillation interval and reducing the number of instillations (Gontero et al., 2010). Pharmacological approaches include the use of analgesics or anti-inflammatory drugs, which are rather effective against cystitis-like and flu-like symptoms, and the concomitant use of a tuberculostatic agent (ofloxacin has been proven to be effective (Colombel et al., 2006), but not isoniazid (van der Meijden et al., 2001)).

It would be useful to identify, prior to therapy, those patients (<5%) at high risk for severe side effects; however no reliable biomarker has been identified so far. A severe reaction against the purified protein derivative (PPD) test should however alert the physician. And obviously, immunocompromised patients are not eligible for intravesical BCG therapy, because they are at increased risk of systemic infection.

The risk of increased toxicity during maintenance is often questioned (Gontero et al., 2010). An study by the European Organization for Research and Treatment of Cancer (EORTC) has shown that local side effects were not increased during maintenance therapy and that systemic side effects were more frequent during the first 6 months of treatment. Most patients however fail to complete the 3-year course. The high dropout rate is often accounted for by patient choice and/or treatment failure, but true BCG toxicity might be underestimated.

### 3) Treatments for muscle-invasive tumors (brief description)

While outside the scope of my work, I present briefly the options available to patients with muscle-invasive disease (at time of presentation or due to treatment failure and disease progression). Standard-of-care treatment options are discussed as based on a review by (Creel, 2007).

#### *(a) Radical cystectomy*

For patients with tumors infiltrating the muscle but no evidence of metastasis, radical cystectomy with pelvic lymph node dissection is the most common and most effective form

of treatment. Additional indications actually include recurrent high-grade T1 or Ta bladder carcinoma despite repeated endoscopic resection and adjuvant intravesical therapy.

#### *(b) Chemotherapy*

Fewer than 50% of patients with locally advanced or node-positive bladder cancer will survive if treated by cystectomy alone. Several large trials of combination chemotherapy administered before surgery ('neoadjuvant chemotherapy') have suggested a survival benefit. However the neoadjuvant approach is not always practiced. In that case, postoperative adjuvant chemotherapy is then recommended, but its efficacy remains controversial.

#### *(c) Radiotherapy*

Radiation therapy has a long history as a treatment modality for bladder cancer and is sometimes preferred for patients with low performance status. Radiation alone in T2 and T3 tumors can produce response rates of 35-45% but remains inferior to cystectomy in organ-confined disease. Radiotherapy can be combined with chemotherapy and aggressive TUR in a combined-modality bladder sparing approach, with efficiency similar to radical cystectomy. However the patients are at high risk for developing both invasive and superficial recurrences in that case.

### 4) Emerging therapies against superficial bladder cancer

The proven efficiency of standard-of-care treatment translates into patients entering clinical trials being BCG-refractory or BCG-relapsing patients, which creates an inherent challenge for the development of new anti-cancer treatments.

#### *(a) BCG + Interferon- $\alpha$ (IFN- $\alpha$ )*

The high cost and reduced efficacy compared to BCG have prevented IFN $\alpha$  monotherapy to become a viable treatment option. However, noting that BCG owes part of its efficiency to a T-helper 1 (Th1) immune response (see Section III.B.2)), O'Donnell and colleagues have decided to test an approach combining low-dose BCG and IFN- $\alpha$  (50MU). Such treatment has been evaluated in a large, multicentric phase II trial, and yields a good disease-free rate (Joudi et al., 2006).

#### *(b) Mycobacterial cell wall-DNA complex (MCC)*

Mycobacterial cell wall-DNA complex (MCC) is an emulsified preparation containing cell wall extracts from *Mycobacterium phlei* and synthetic oligonucleotides (close to CpG motifs).

Preclinical studies have revealed immunostimulatory properties as well as a direct anticancer activity to MCC. In a recent clinical trial, using a schedule similar to BCG therapy (induction + maintenance) MCC emulsion was well tolerated, with lower side effects than BCG, and yielded encouraging responses (11/21 complete response at week 12, 8/21 at month 18) (Morales et al., 2009). Further studies are ongoing, with a longer follow-up.

Of note this approach is somehow surprising, since extensive work at the National Cancer Institute in the 1970s established that killed preparations of BCG were rather less successful than live BCG at eliciting anti-tumor responses (see Section II.C.4)(a)). In addition, intravesical BCG efficacy in the context of bladder cancer has been correlated to the amount of live bacteria contained in the infusion (Kelley et al., 1985) (also, personal communication from M. Lagranderie and our own observations).

### *(c) Pre-clinical experimental approaches*

Various approaches can be found in the literature but have remained at the pre-clinical stage to date. Most of them utilize the intravesical route (unless otherwise stated), and they involve bacterial, viral or synthetic agents.

One tempting approach consists in enhancing BCG anti-tumoral properties (Th1 skewing e.g.) by genetic manipulation of the bacterium. For example, since BCG in combination with IFN- $\alpha$  has demonstrated improved efficacy, but since IFN- $\alpha$  is expensive and needed in large quantities, it would be of interest to generate a recombinant BCG (rBCG) capable of secreting IFN- $\alpha$ . To date, a number of rBCG strains capable of secreting functional Th1 cytokines (IL2, GM-CSF, IFN- $\alpha_2$ , IFN- $\gamma$ , IL-18, MCP-3, IL-15, TNF- $\alpha$ ) has been developed, and their ability to induce Th1 cytokine production and cellular immunity has been validated, as reviewed by (Luo et al., 2011). However, only rBCG-IFN- $\gamma$  has been demonstrated to be superior to BCG in the MB49 mouse model for bladder cancer (Arnold et al., 2004). An alternative, using a nonpathogenic closely related recombinant *Mycobacterium Smegmatis* has been proposed (Young et al., 2004). Of note, this approach may not be straightforward in terms of drug approval, since it would result in the release of large amounts of genetically modified organisms after voiding and would therefore require heavy environmental risk assessment, as well as removal of the antibiotic-selection cassette before drug approval. We have actually encountered this issue in the lab when studying the possibility of using an rBCG overexpressing listeriolysin (Grode et al., 2005), which is currently in phase 2 clinical trial as a vaccine against Tb (Kaufmann, 2010).

Another approach consists in replacing BCG by another bacterium, which would trigger a similar Th1 environment locally in the bladder, associated to lower toxicity. Two lactobacilli have been tested recently in orthotopically-implanted tumors in mice, the most convincing being *Lactobacillus Rhamnosus*, with similar efficacy to BCG in the MB49 model (Seow et al., 2010).

Based on the potent anti-tumor activity of pro-inflammatory Th1 cytokine IL-12, a group has recently proposed repeated instillations of intravesical IL-12 formulated with chitosan, a mucoadhesive biopolymer and demonstrated efficacy in the MB49 model. They even claimed superiority to BCG therapy, which actually did not result in any anti-tumor response, most probably because the treatment was initiated 7 days post therapy (Zaharoff et al., 2009).

Abate-Shen and colleagues, who developed the inducible model of CIS described in Section I.A.6), have recently reported that intravesical instillations of rapamycin twice weekly prevent progression of CIS to muscle invasive cancer (Seager et al., 2009). They have not tested BCG therapy in such model (Abate-Shen, personal communication).

Others approaches include intravesical gene therapy with cox-2 inducible caspase 3 or 9 complexes, for which some efficacy has been reported in the MB49 model (Zhang and Godbey, 2011) or the intravesical instillation of BCG DNA vaccines + IL12, which yielded some response in the MBT-2 model (Zaharoff et al., 2009). Viral-based therapies are not much developed so far. Some attempts have involved adenovirus-mediated suicide gene therapy (only validated in a subcutaneous model in mice) (Freund et al., 2000) or repeated intravesical instillations of oncolytic vesicular stomatitis viruses, which has shown some efficiency against human urothelial tumors orthotopically implanted in nude mice (Hadaschik et al., 2008).

In summary, non-muscle invasive bladder cancers (or NMIBC) represent the majority of urothelial tumors. They include 2 variants - papillary TaT1 lesions and flat high-grade CIS - with very different biological behavior and prognoses. However, both types of tumors are very responsive to intravesical BCG therapy, which has remained the standard-of-care since 35 years and constitutes one of the few examples of successful immunotherapy.

## **II. THE IMMUNOSTIMULATORY PROPERTIES OF BCG**

The discovery of some anti-cancer properties to mycobacteria dates back to early in the 20<sup>th</sup> century, when tuberculosis (Tb) was noted to have antitumor effects. In 1929, Pearl indeed

reported a lower frequency of cancer in patients with tuberculosis (Pearl, 1929): he was able to show that cancer survivors had a higher incidence of active or latent Tb than individuals dying of cancer (matched for age, sex and race). Conversely he showed a lower incidence of cancer in patients dying of Tb than in matched controls. Though he was unable to explain such mutual antagonism, the link between mycobacterial infection and cancer was made.

Before reviewing the various attempts to harness BCG immunostimulatory properties against cancer, I provide an overview of immunopathogenesis, and describe the development of BCG as a vaccine against tuberculosis, as the field is more developed and will provide a proper introduction to host immune responses upon mycobacteria exposure.

## **A. A short general introduction to immunopathogenesis**

In this general introduction to immunopathogenesis, I focus on the key players and mechanisms involved in the response to intracellular pathogens and/or tumors, as these are the main topics for my dissertation.

Unless otherwise indicated, what is presented below is a textbook understanding of immunopathogenesis, and is therefore not extensively referenced.

### 1) Epithelial and mucosal barriers

When an individual host first encounters a pathogen, the initial defenses against infection are the physical and chemical barrier constituted by the epithelium lining. In particular, the internal epithelial surfaces of the body are called mucosal surfaces, and comprise the gastrointestinal tract, the upper and lower intestinal tracts and the genitourinary tract (including the bladder). Of note, most epithelial surfaces are covered by a layer of protective mucus, though it does not seem to be the case for the bladder, which is protected by an impermeable layer of uroplakins. In addition, most mucosal surfaces are colonized by commensal microorganisms. As already mentioned, it does not seem to be the case for the bladder, though this mucosa has not been investigated in great detail to date.

Beneath the epithelial barrier, in the resting tissue, there are immune cells, which sample the environment and provide a rapid response to infection. These cells are typically myeloid cells such as long-lived phagocytic macrophages and dendritic cells (DCs), but also include resident lymphocytes such as  $\gamma\delta$  T cells, natural killer T cells and mucosal-associated invariant T cells.



## 2) A rapid inflammatory innate immune response

When the epithelial barriers are breached, a rapid inflammatory response is initiated through the recognition of pathogen-derived molecules by pattern recognition receptors expressed on both immune and non-immune cells. Engagement of these receptors triggers the secretion of cytokines, chemokines and other biologically active molecules. The inflammatory cytokines produce changes in the adhesive properties of the endothelial cells, in turn causing circulating inflammatory leukocytes – neutrophils, followed by monocytes that rapidly differentiate into macrophages – to stick and migrate to the site of infection, where they are attracted by chemokines, thereby initiating the process known as inflammation. Of note, inflammation is traditionally defined by heat, redness, swelling, and pain. While heat, redness and swelling can be accounted for by the effects of pro-inflammatory molecules on the local blood vessels, pain is related to the migration and local action of inflammatory cells in the infected tissue.

Ideally, the innate immune response results in limiting the pathogen spread, mostly by engulfment and/or killing of the invading microorganisms by inflammatory cells (e.g., through reactive oxygen and nitrogen species). It also has consequences for the initiation of adaptive immune responses, which are principally mediated by DCs.

## 3) The induction of adaptive immunity by dendritic cells

Like macrophages, immature DCs are highly phagocytic: indeed, they also express a large number of PRRs and, in response to signals from these receptors and antigen capture, they become able to migrate to draining lymph nodes via the afferent lymphatics, to the difference of macrophages that cannot migrate out of inflamed tissues. Migration is controlled by expression of chemokine receptors on DC surface. For example, the chemokine receptor CCR-7 is upregulated on maturing DCs, directing movement along gradients of its chemokines ligands CCL-19 and CCL-21 that are established by high endothelial venules (HEV) and stromal cells within the lymph node.

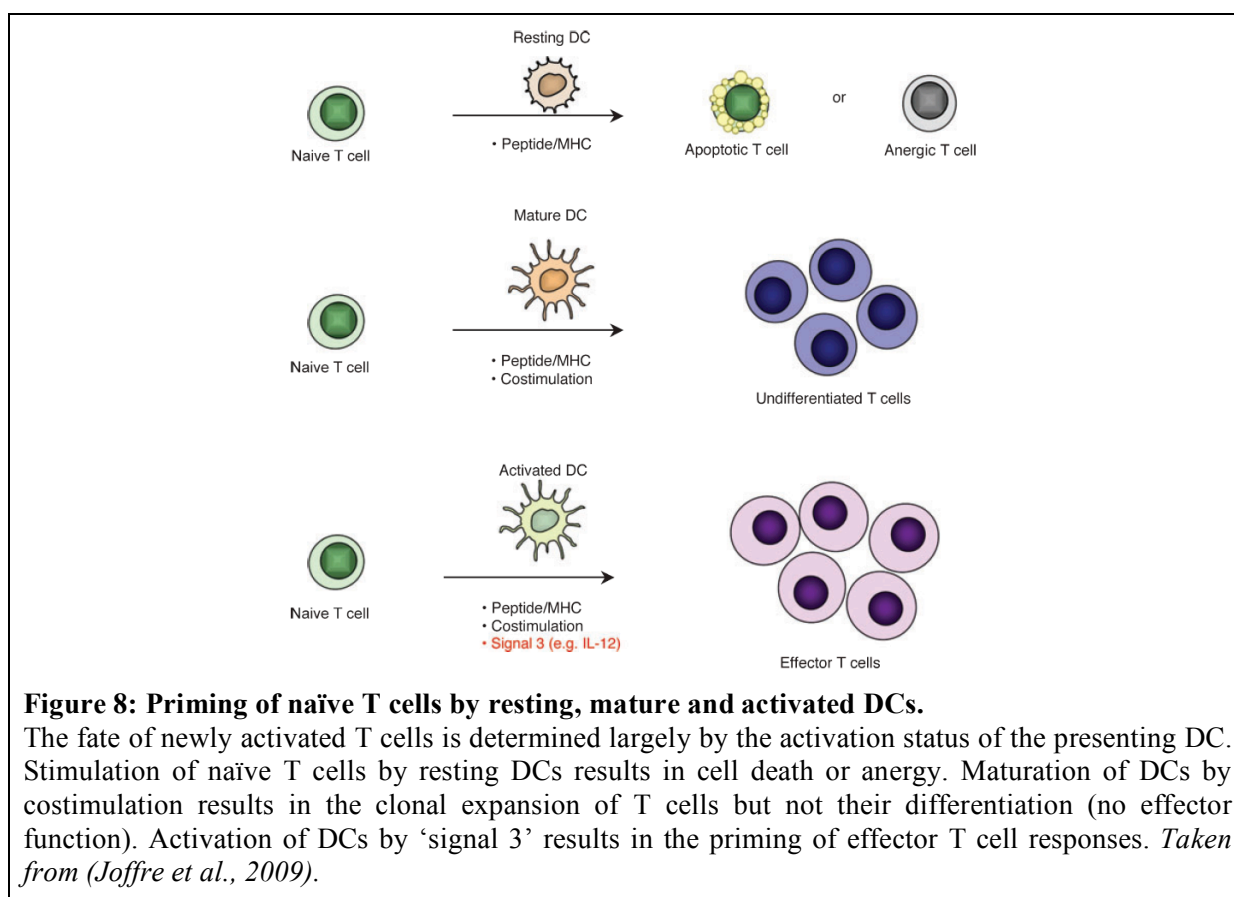
In peripheral lymphoid tissues, DCs undergo a profound phenotypic and functional transformation, called ‘DC activation’, to become ‘professional antigen-presenting cells (APCs)’ competent to sustain the expansion and differentiation of antigen-specific T cells into appropriate effector cells. Of note, this distinguishes DCs from other APCs such as macrophages and B cells, which are capable of presenting antigen and re-stimulating memory T cells but might not be capable of initiating a priming response.

#### 4) Cell-mediated adaptive immune responses

T cell priming is the result of a series of events that occurs in peripheral lymphoid organs and include T-cell receptor (TCR) engagement, cell division and the acquisition of effector functions.

Of note, entry of naïve T cells into the lymph nodes is mediated by non-antigen-specific interactions and requires the expression of selectins – e.g., CD62-L – that mediate rolling of T cells along HEV, integrins – e.g., LFA-1 – that mediate adhesion on the HEV, and chemokine receptors – e.g., CCR-7 – that mediate diapedesis through the HEV and migration to the T-cell zone.

##### *(a) T cell receptor engagement*



DCs activated by pathogen contact will normally present high levels of major histocompatibility complex (MHC) molecules bearing pathogen-derived peptides, which can engage T-cell receptors on naïve pathogen-specific T cells. This delivers the first activating signal to the T cell and is therefore referred to as ‘signal 1’ (**Figure 8**).

DCs activated by pathogen encounter also express a variety of costimulatory molecules (signal 2). For example, the costimulatory molecules CD80 and CD86 are able to engage

CD28 counter-receptor on T cells, thereby transmitting signals that are important for T-cell proliferation and survival – e.g., interleukin (IL)-2 production (**Figure 8**).

Finally, activated DCs also produce mediators that act on the T cell to promote its differentiation into an effector cell (signal 3, **Figure 8**). For example, IL-12 is a typical mediator released by many activated DCs that can instruct the development of type 1 immunity.

The integration of these three classes of signal by the T cell determines its subsequent fate, to a large extent. All signals appear to be required for full effector T-cell generation, whereas signal 1 without signal 2 and/or 3 may be used to drive a naïve T cell into an inactive state, either through anergy, deletion or diversion into a regulatory cell fate. Of note, one of the challenges in the design of immunotherapies is the requirement for immunogenic maturation of DCs, such that the priming of effector – but not anergic or tolerant – tumor-specific T cell can occur (see General Discussion Section II.B).

*(b) Activated lymphocytes proliferate in peripheral lymphoid organs, generating effector cells and immunological memory*

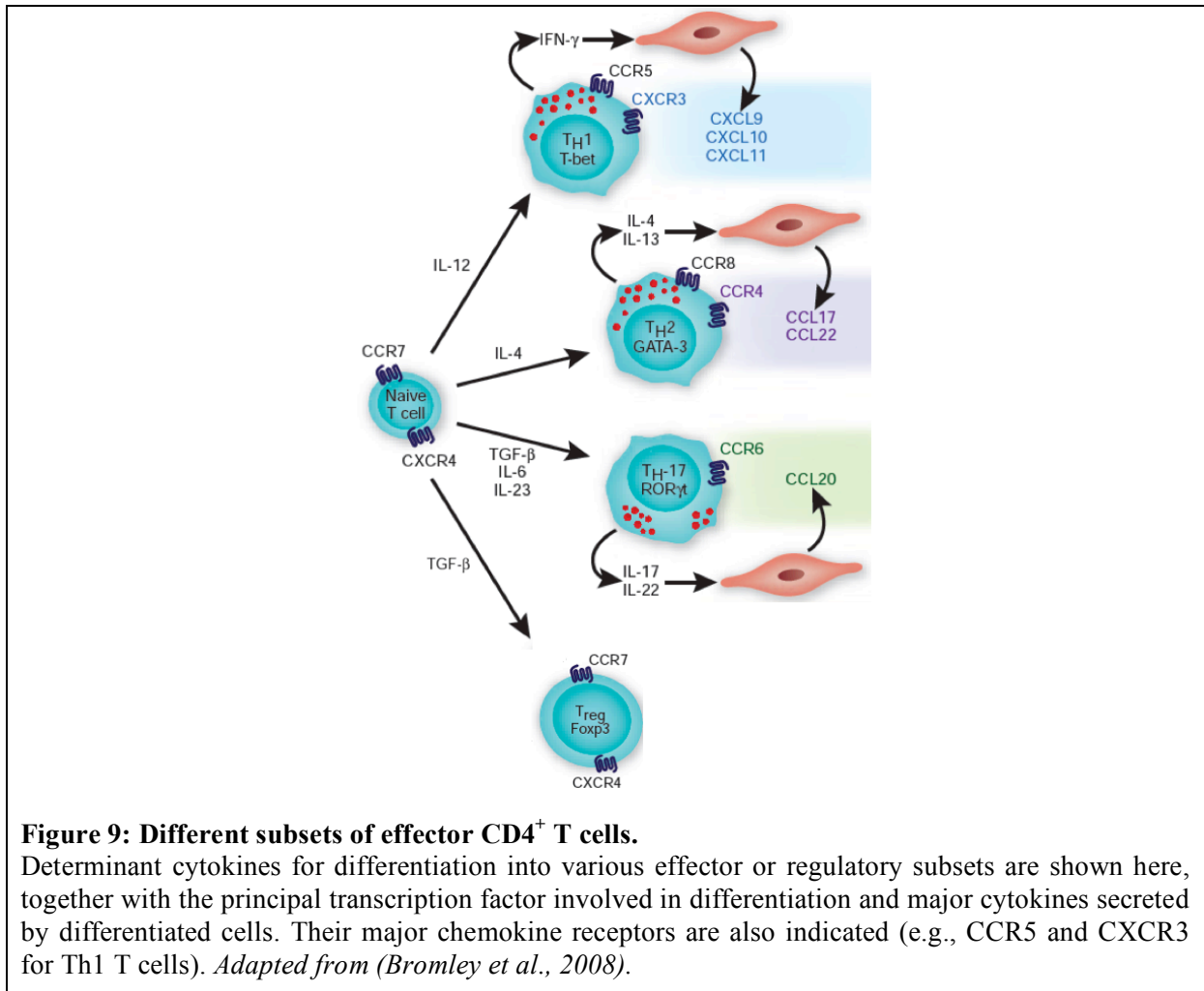
Given the great diversity of the TCR repertoire, only a few lymphocytes are able to bind to a given foreign antigen. In order to generate sufficient numbers to fight an infection, lymphocytes differentiate into lymphoblasts within a few hours upon encounter with the APC, and rapidly divide over 3-5 days, such that one clone gives rise to ~1,000 daughter cells of identical specificity. These then differentiate into effector cells, such as helper T cells or cytotoxic T cells (see below). Of note, this means that the first adaptive response occurs several days after infection has begun and has been detected by the immune system.

Most of the lymphocytes generated by the clonal expansion in any given immune response eventually die. Nonetheless, some long-lived cells persist after antigen has been eliminated. They are named memory cells and form the basis for immunological memory. Indeed, they can be reactivated much more quickly than naïve lymphocytes, which ensures a more rapid and effective response to a second encounter with a pathogen, thereby providing a rationale for vaccination.

*(c) Effector T cell mechanisms*

Naïve CD4<sup>+</sup> T cells can differentiate into different types of effector T cells, depending on the signal 3 they receive. I describe major subsets here (also see **Figure 9**), leaving out more recently discovered and less well-characterized subsets, which are outside the scope of my

dissertation (e.g., Th9, Th22, T<sub>FH</sub>). Of note, the distinct subsets can regulate each other's differentiation.



Th1 differentiation is mostly driven by IL-12 and IFN- $\gamma$ , which stimulate the Jak-STAT intracellular signaling pathway. Th1 polarized cells are capable of stimulating the macrophage's bactericidal activity – e.g., via IFN- $\gamma$  secretion –, which is crucial for killing of intracellular pathogens. In addition Th1 cells can stimulate the production of antibodies (predominantly IgG).

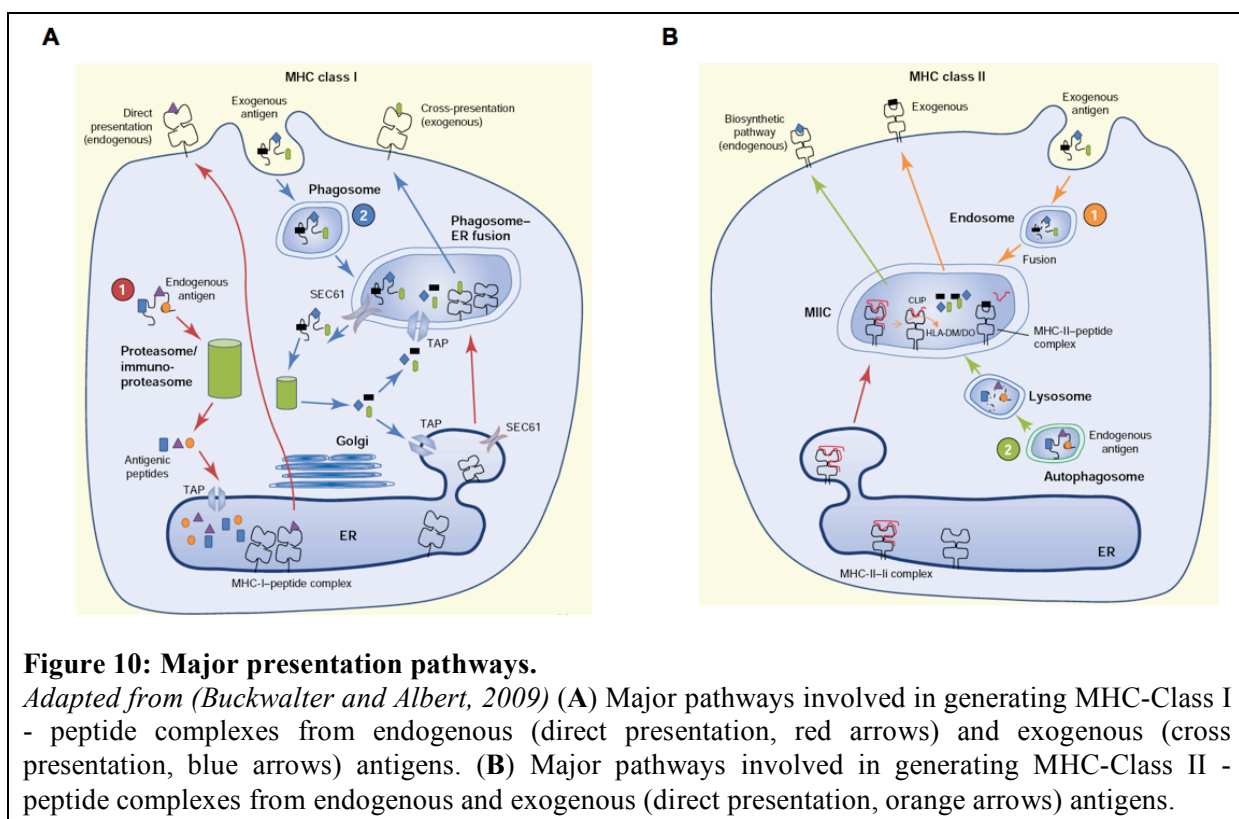
Th2 differentiation is favored by IL-4 signaling and results in helper T cells capable of activating naïve B cells (predominantly of the IgE class). Therefore Th2 responses are particularly relevant to infections by extracellular pathogens (e.g., worms).

A more recently described subset of CD4<sup>+</sup> effector T cells is the subset of Th17 cells. They are induced early in the adaptive response to extracellular bacteria, depending on IL-6 and TGF- $\beta$  for their differentiation and IL-23 for further proliferation, and seem to be involved in stimulating the neutrophil response.

When pathogens are absent, a relative abundance of TGF- $\beta$  and the lack of IL-6, IFN- $\gamma$  and IL-12 favors the development of FoxP3-expressing T regulatory (Treg) cells. Other regulatory subsets require IL-10 signaling during differentiation of CD4<sup>+</sup> T cells. Regulatory T cells restrain the immune response by producing inhibitory cytokines such as IL-10 and TGF- $\beta$ , sparing surrounding tissues from collateral damage.

Naïve CD8<sup>+</sup> T cells differentiate into cytotoxic T cells, which can kill selectively their target cells, via recognition of the cognate peptide presented by MHC-Class I molecules and release of pre-synthesized cytotoxic proteins such as perforin and granzyme B. Cytotoxic T cells kill rapidly and can engage a series of targets in succession. They are important in the defense against intracellular pathogens. Of note, the priming of CD8<sup>+</sup> T cells often requires extra help, which is provided by the ‘licensing’ of DCs by antigen-specific effector CD4<sup>+</sup> T cells (e.g., via the CD40-CD40L binding).

(d) Different presentation pathways



In the ‘direct presentation’ pathways, CD4<sup>+</sup> and CD8<sup>+</sup> T cells recognize peptides bound to two different classes of MHC molecules. APCs are the only ones to harbor MHC-Class II molecules. Endocytosed exogenous antigens are partially degraded in these cells, and, as an outcome, peptides associated to MHC-Class II molecules are presented and recognized by CD4<sup>+</sup> T cells (Figure 10B, pathway 1). On the other hand, all cells express MHC-Class I

molecules (with the exception of red blood cells and a subset of neurons) and are able to present peptides derived from endogenous antigens to CD8<sup>+</sup> T cells (**Figure 10A**, pathway 1). More recently, the ‘cross presentation’ of endocytosed exogenous antigens to CD8<sup>+</sup> T cells was discovered (**Figure 10A**, pathway 2). Several mechanisms have been proposed to explain how such exogenous antigens could be loaded onto MHC-Class I molecules (Burgdorf and Kurts, 2008), one of which being illustrated in **Figure 10A**. Cross-priming is an important mechanism to activate cytotoxic T cells for immune defense against tumors, intracellular pathogens and viruses that do not infect APCs.

#### *(e) Recruitment to the site of inflammation*

Once primed, effector T cells are guided to the site of infection by chemokines and newly expressed adhesion molecules. Most effector T cells cease production of L-selectin, which mediates homing to the lymph nodes, whereas the expression of other adhesion molecules is increased. Expression of particular adhesion molecules can direct different subsets of effector T cells to specific sites (e.g., skin homing T cells).

Of note, in the context of infection by intracellular bacteria (e.g., mycobacterial infection), CXCR-3 and CCR-5 signaling mediate the recruitment of type 1 effector cells to the site of inflammation (**Figure 9**).

#### 5) Humoral adaptive immune responses

As antigens from intracellular pathogens are not accessible to antibodies, humoral adaptive responses are not my primary focus. Very briefly, B cell responses are initiated by certain antigens, with the ‘help’ from activated helper T cells, as mentioned above. Upon activation, B cells differentiate into plasma cells, which proliferate and are able to secrete antibodies, themselves driving protective responses through neutralization, opsonization and complement activation. Activated B cells also give rise to a small pool of memory cells.

With these key players introduced, I now focus on the host immune response to mycobacteria, especially BCG and *Mtb*.

## B. Development of BCG as a vaccine against tuberculosis

### 1) BCG, a worldwide used vaccine against Tb

#### *(a) Generation of BCG as a vaccine against Tb*

Early in the 20<sup>th</sup> century, Albert Calmette, a bacteriologist, and Camille Guérin, a veterinarian, working together at the Pasteur Institute in Lille, began what would become a lifelong quest to develop a vaccine against Tb. The two researchers initially isolated a virulent strain of *Mycobacterium bovis*, closely related to the human pathogen *M. tuberculosis*, and started culturing it in a medium consisting of cow bile, potatoes and glycerin, to prevent clumping of the bacteria. In such medium, they observed a gradual loss of virulence in animals.

In 1921, after 231 passages and 13 years, experiments in guinea pigs showed that the bacterium had attenuated to a nonvirulent form and was protective against Tb challenge. The strain was named after Calmette and Guérin, and the vaccine became known as bacillus Calmette-Guérin, or BCG (Guérin, 1980).

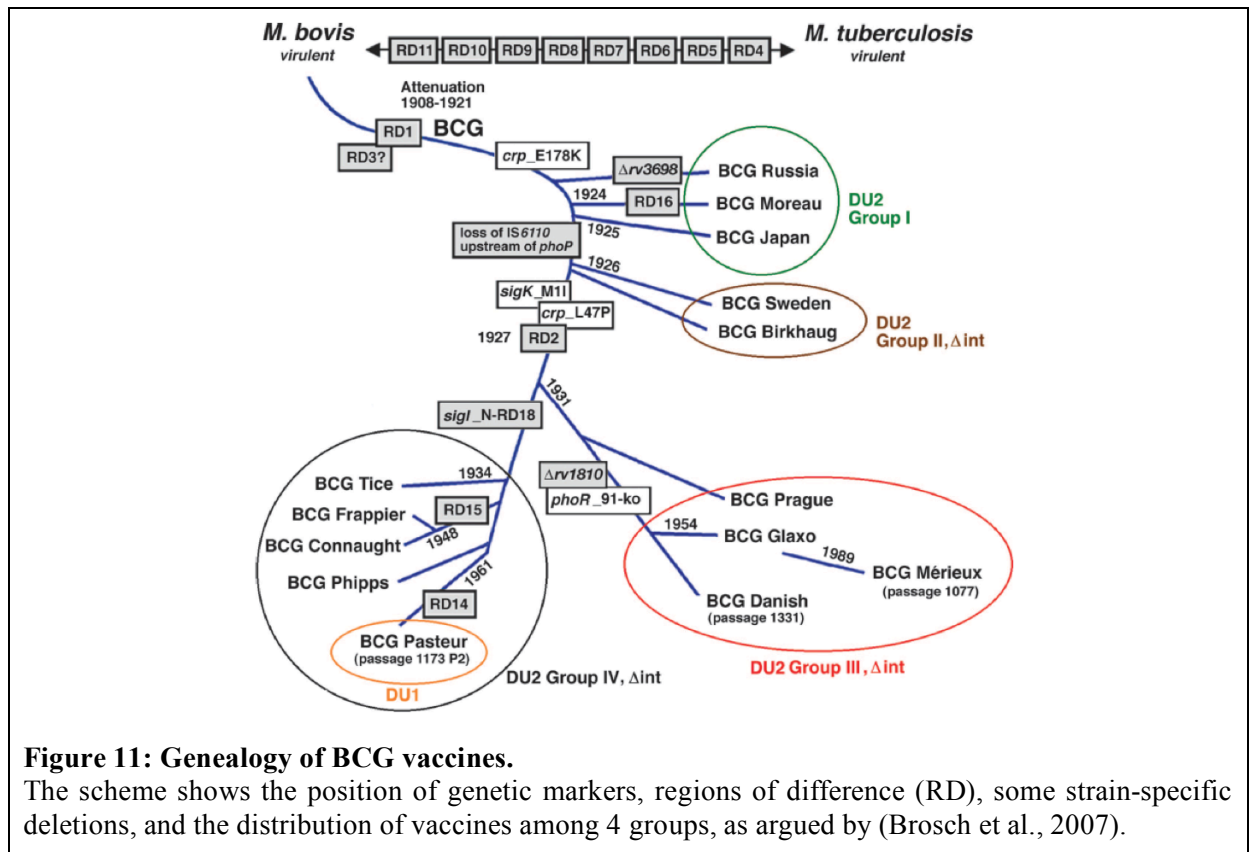
#### *(b) Current practices for BCG vaccination*

Given the success of the vaccine, BCG was distributed all over the world. Interestingly, the inability to cryo-preserve the strain until the 1960s resulted in the need for serial passaging and the emergence of many daughter strains (**Figure 11**) (Behr, 2002; Brosch et al., 2007). In 1990, the World Health Organization (WHO) listed seven substrains used as a vaccine against Tb, made by 16 suppliers (Milstien and Gibson, 1990).

It is worth noting that all vaccines present as a lyophilized stock (Behr, 2002), which is resuspended in saline before inoculation. As such, the inoculated preparation contains considerable amounts of dead material, in a proportion that used to vary greatly from one preparation to the other (Gheorghiu and Lagrange, 1983; Milstien and Gibson, 1990). Nowadays, most preparations contain only 5-10% live material (Behr, 2002). The importance of the ratio of live versus dead has not been formally assessed; however, killed mycobacterial preparations have been reported not to be an effective vaccine against Tb (Orme, 1988; Tuberculosis Program, 1955).

WHO recommends the intradermal route for vaccination. However, the percutaneous route, through multipuncture, is also utilized (e.g., in the US) (Ho et al., 2010). Of note, historically, Calmette and Guérin administered BCG through the oral route (and repeatedly) (Benevolode-Andrade et al., 2005). However, the intradermal route rapidly became more popular than

the oral route for two reasons (Benevolo-de-Andrade et al., 2005): (i) parenteral immunization resulted in much greater frequency of tuberculin skin test conversion, which was seen at that time as a correlate of protection (see Section II.B.2)(c)), and (ii) it allowed using lower doses, therefore opening the way to mass vaccination.



(c) Protective efficacy of BCG as a Tb vaccine

BCG’s efficacy against Tb meningitis and miliary Tb in infancy and in young children is well established, with ~80% protection (Trunz et al., 2006). On the other hand, the vaccine protective efficacy against lung disease is very much debated and ranges from 0% to 70% (Colditz et al., 1994). Reasons for such variable efficacy are not yet clear but might involve vaccine strains, routes of administration, dosage, age at time of vaccination, race and ethnicity of vaccinees, geographical location, previous exposure to environmental mycobacteria, etc. (Dockrell, 2008; Ritz et al., 2008). The duration of BCG’s protective effect is also controversial, but it is generally thought to wane after 20 years or less (Colditz et al., 1994; Sterne et al., 1998; Weir et al., 2008).

The mechanisms of BCG-mediated protective effect are not precisely understood. The current literature is discussed in the following section, after a general introduction to the immune responses against mycobacteria.



## 2) The host immune responses against mycobacteria

In order to understand BCG pro-inflammatory activity (and its potential use as an anti-cancer agent), it is essential to understand the key players (cells, cytokines, etc.) involved in the immune response against BCG, but also against mycobacteria in general. As my experimental model has been the C57BL/6 mouse, I focus on the current knowledge in this animal model, as well as available human data.

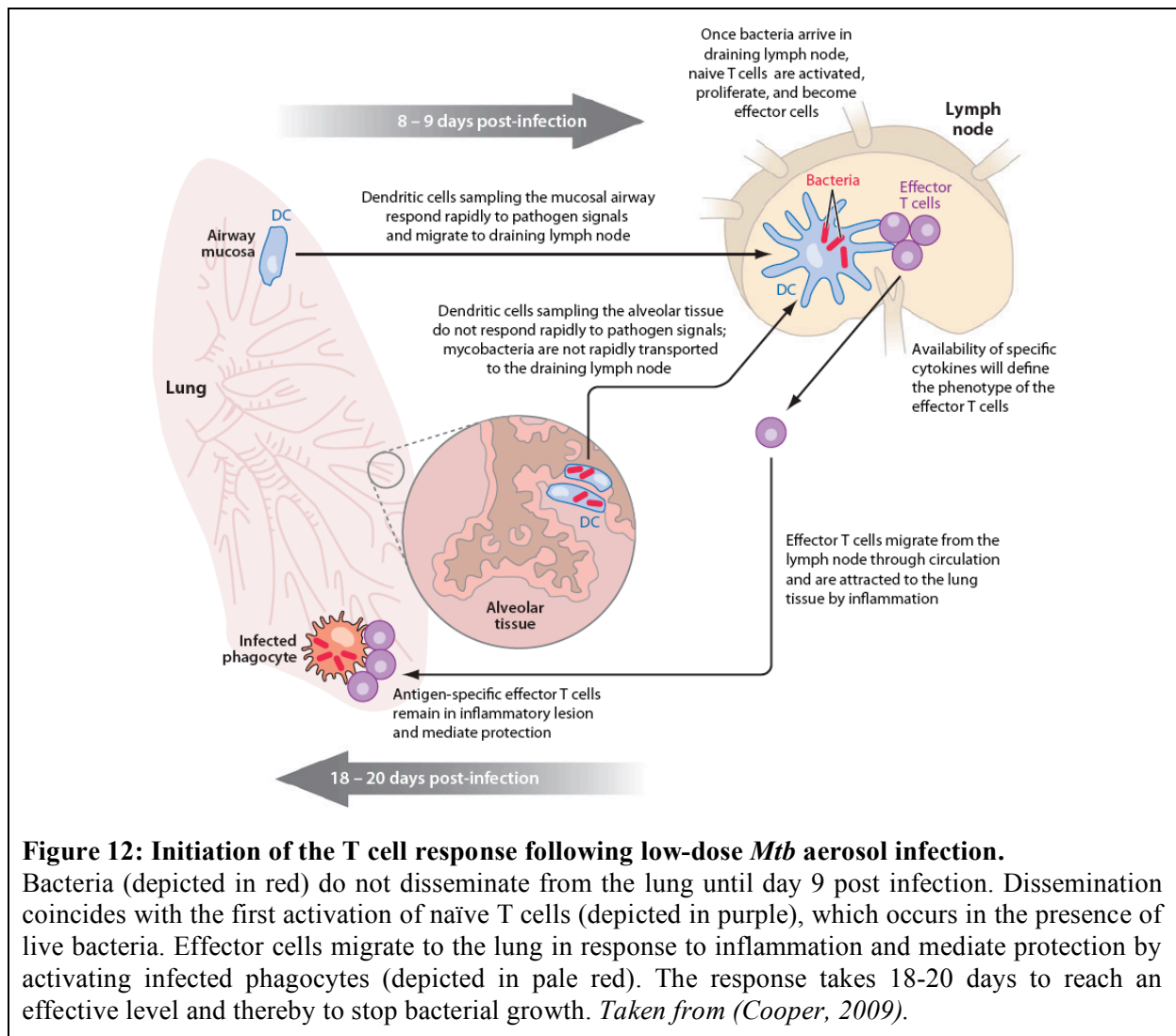
### *(a) The lessons learnt from a mouse model for *Mtb* lung infection*

Though the immunopathological response of mice to *Mtb* infection does not mirror all the features of human Tb, the use of inbred mice has markedly increased the understanding of the immune response to *Mtb*. I briefly describe the kinetics of the response in C57Bl/6 mice, following challenge with low-dose (~100 CFUs) aerosolized *Mtb*, which approximates the natural delivery route for induction of Tb (Cooper, 2009).

In the first stage of immune response to low-dose aerosol infection, bacteria are taken up by resident alveolar macrophages and immature DCs. Chemokine/cytokine gradients established by infected macrophages and surrounding cells initiate the recruitment of inflammatory cells, initially macrophages and neutrophils, to the lung.

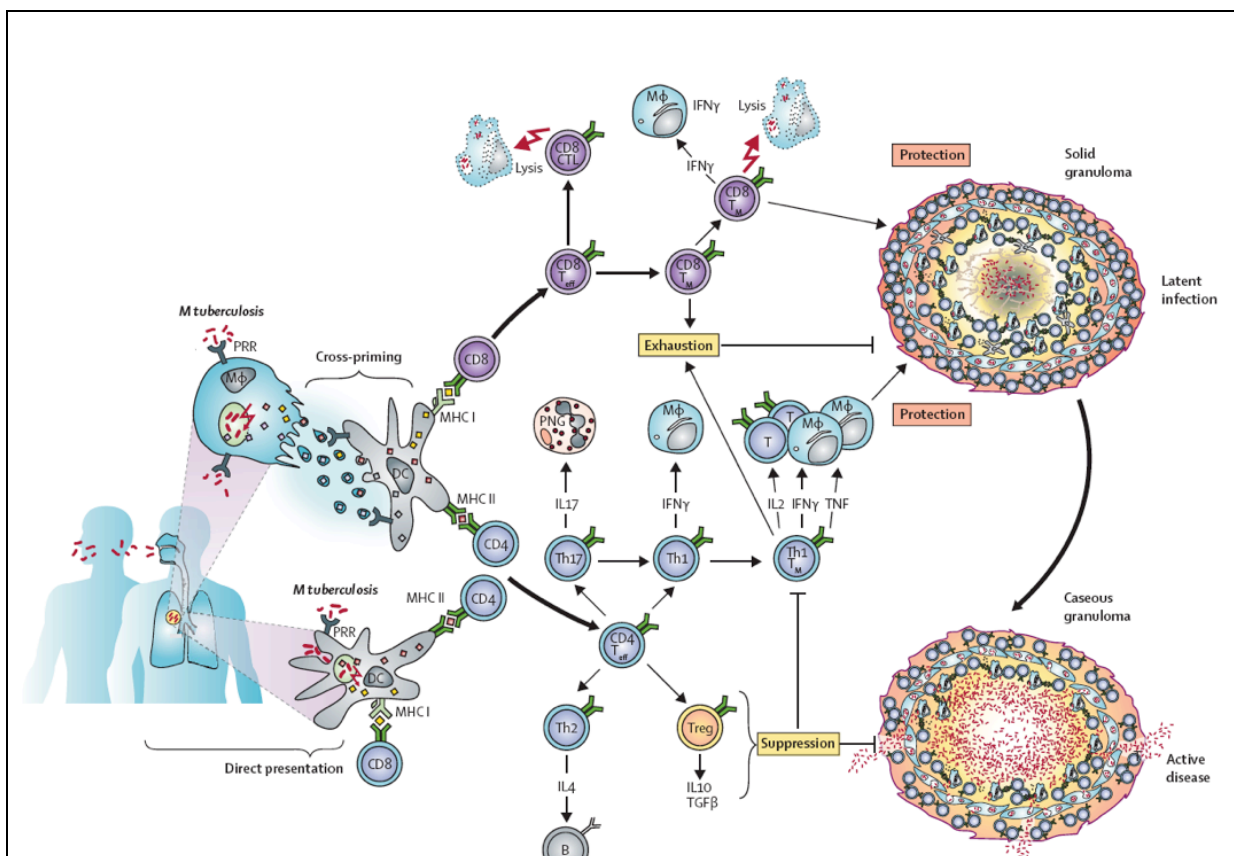
Importantly, bacteria do not disseminate from the lung until day 9 post infection, when they can be detected in the lung draining lymph nodes (**Figure 12**). This dissemination coincides with the first activation of naïve T cells, which occurs in the presence of live bacteria (**Figure 12**). Effector cells develop with expected kinetics and the effector cell phenotype depends on the availability of specific cytokines but is mostly Th1-polarized, and also Th17-polarized. These effector cells migrate to the lung in response to inflammation and mediate protection by activating infected phagocytes (**Figure 12**), through the release of IFN- $\gamma$  and TNF- $\alpha$ . The response takes 18-20 days to reach an effective level and thereby to stop bacterial growth.

While Th1 CD4<sup>+</sup> T cells are known to be essential, other T lymphocytes play important roles in host defense, including  $\gamma\delta$  T cells and CD8<sup>+</sup> T cells. Activation of the latter is mediated either by egression of mycobacterial antigens into the cytosol (van der Wel et al., 2007), and/or by cross priming, induced apoptotic bodies carrying mycobacterial peptides, released by macrophages and taken up by DCs (Winau et al., 2005; Winau et al., 2006). CD8<sup>+</sup> T cells are able to secrete IFN- $\gamma$ , thereby contributing to activation of phagocytes, but also to directly kill mycobacteria-containing macrophages (Cooper, 2009).



Granuloma development occurs between days 14-30. There is a significant influx of inflammatory cells into the lungs and the formation of discrete, defined lesions. By 4 weeks, macrophages and T cells, mostly CD4<sup>+</sup> T cells, are the dominant cell types present and a robust antigen-specific IFN- $\gamma$  producing T cell response is evident in the lungs. Lymphocytes (both T and B cells) aggregate in close apposition to large epithelioid-like macrophages. It is during this phase that activated macrophages contain bacterial growth, eliminating 50-90% bacilli. Despite this robust immune response, mice are unable to completely eliminate the bacilli and the bacterial load stabilizes and remains constant. During that chronic phase, Th1-protective responses are thought to be counter-balanced by Th2 and/or T regulatory (Treg) cells, via cytokines such as IL-4, IL-10 and TGF. Finally, during the later stages of reactivation, granulomas break down, resulting in increased bacterial replication and, without intervention, rapid death of the host by days 200-250 (Saunders et al., 2008).

A model of the immune response to low-dose infection with *Mtb* is proposed in **Figure 13**, and is mostly based on the aforementioned mouse data.



**Figure 13: Overview of the immune response to tuberculosis.**

*Mtb* survives within macrophages and DCs, resulting in the priming of CD4<sup>+</sup> and CD8<sup>+</sup> T cells (see text above for details). The CD4<sup>+</sup> T-helper cells polarize into different subsets: Th1 cells produce IFN- $\gamma$  and/or TNF- $\alpha$  for macrophage activation. Th17 cells, which activate polymorphonuclear granulocytes (PNG), contribute to the early formation of protective immunity in the lung after vaccination. Th2 cells and regulatory T cells (T<sub>reg</sub>) counter-regulate Th1-mediated protection via IL-4, IL-10 and/or TGF- $\beta$ . CD8<sup>+</sup> T cells produce IFN- $\gamma$  and TNF- $\alpha$ , which activate macrophages. They also act as cytolytic T lymphocytes (CTL) by secreting perforin and granulysin, which lyse infected host cells. During active containment in solid granuloma, *Mtb* recesses into a dormant stage and is immune to attack, until its reactivation, which leads to granuloma caseation and active disease. Taken from (Kaufmann, 2010).

(b) Immune responses following BCG vaccination

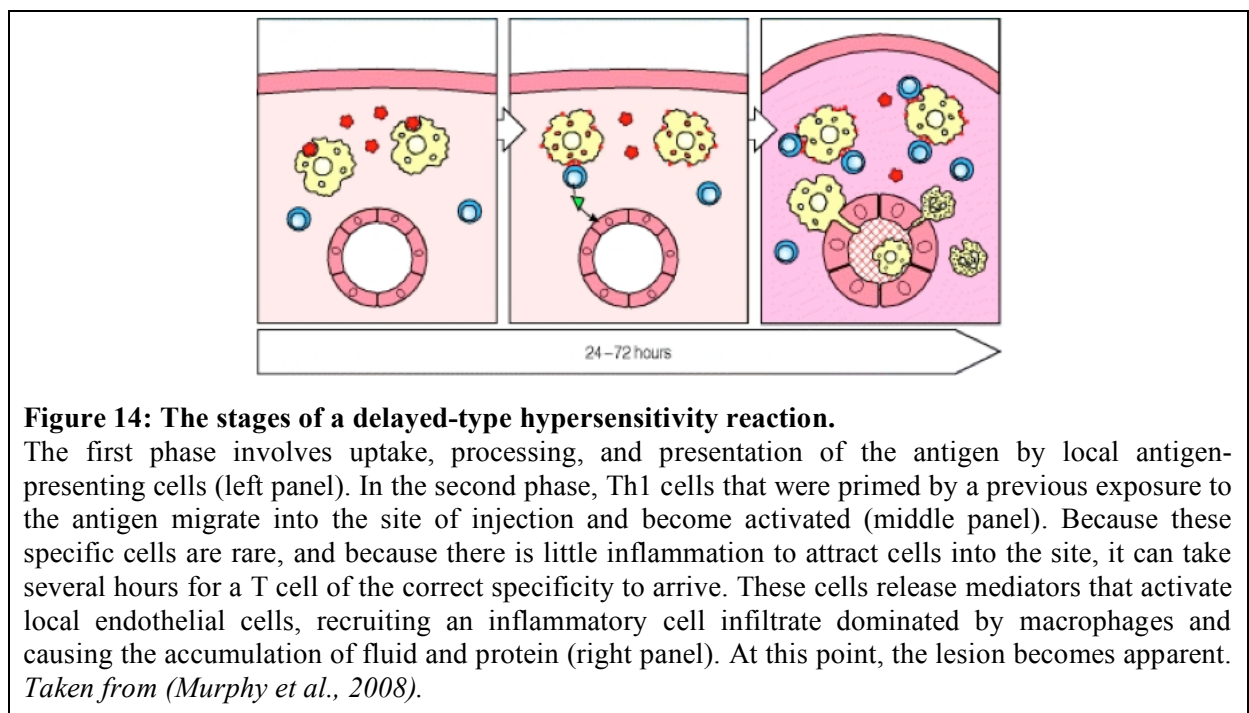
BCG vaccination is known to cause a localized infection (occasionally associated with regional lymphadenitis) and to induce a robust Th1 response at all ages, including in newborns (Marchant et al., 1999). In addition, even though BCG is unable to exit from the phagosome – contrary to *Mtb* – it is able to induce functional CD8<sup>+</sup> T cell responses, both in humans (Murray et al., 2006) and in mice (Ryan et al., 2009), though less efficiently than *Mtb*. Of note, the different priming efficiency has been suggested to be due to a difference in antigen load (Ryan et al., 2009; Weerdenburg et al., 2010).

As already mentioned in Section II.B.1)(c), BCG is only modestly protective against adult lung disease, but is very effective against disseminated disease. What the low dose aerosol

mouse model has taught the field is that T cell recruitment to the lungs of animals previously immunized with BCG is accelerated only by a few days. Therefore this still leaves considerable amount of time to the bacilli to replicate and modulate their environment (Cooper, 2009).

(c) *The immune signature of previous exposure to mycobacteria*

The tuberculin skin test has been commonly used to diagnose previous exposure to mycobacteria: small amounts of protein purified derivative (PPD, a purified and concentrated mixture of proteins and other components present in the growth medium of cultures at the stationary phase of growth) administered intradermally to patients previously exposed to mycobacteria indeed provoke a local inflammatory reaction that evolves over 24-72 hours, and therefore a measurable induration at the site of injection.



This reaction is an example of delayed-type hypersensitivity reaction (DTH), also known as type IV hypersensitivity reaction (**Figure 14**). DTH reactions are known to be mediated by antigen-specific effector Th1 T cells: upon entry at the site of injection and recognition of MHC class II / peptide complexes, these T cells release inflammatory cytokines, which in turn stimulates the expression of adhesion molecules on endothelium and increases local blood vessel permeability, thus allowing the recruitment of inflammatory cells (Murphy et al., 2008). Interestingly, very low numbers of T cells are sufficient to induce such reaction (Marchal et al., 1982). Importantly, this is a regulated reaction: its onset is delayed and it typically attenuates within 48-72 hours.

While the tuberculin reaction was initially considered a surrogate for protection against Tb following BCG vaccination, however current thought suggests that this may be of limited predictive value, based on the absence of correlation between postvaccinal PPD conversion rates and the percentage reduction in tuberculosis attributable to vaccination, across 10 controlled trials (Comstock, 1994).

Importantly, PPD tests display an important cross-reactivity with many other species of mycobacteria, and BCG vaccination is likely to interfere with diagnosis of Tb infection. That said, the use of different cut-offs to define positivity can be used to distinguish infection from exposure to cross-reactive mycobacteria; therefore individuals with a large skin test induration are very likely to be infected with *Mtb* (Centers for Disease Control and Prevention (CDC) - Division of Tuberculosis Elimination).

In summary, exposure to mycobacteria gives rise to an inflammatory immune response that results in the slow-induction – in case of a low-dose infection – of a cellular immune response dominated by type 1 T cells secreting IFN- $\gamma$ .

### **C. BCG as an anti-cancer agent**

In the late 1950s, several factors contributed to the investigation on the possible use of BCG as cancer therapy: the worldwide spread of BCG as a vaccine against Tb; the extension of Coley's seminal work; the development of inbred strains of laboratory animals and the ability to transplant tumors.

I describe here seminal experiments in animal models, which paved the way to clinical trials using BCG as an anti-cancer agent. As documented, such trials were rather disappointing, with the notable exception of bladder cancer.

#### 1) Seminal experiments in animal models

##### *(a) Systemic injections with BCG*

Studies began at the Sloan Kettering Institute, where Old demonstrated that mice intravenously infected with BCG showed increased resistance to subsequent subcutaneous or intraperitoneal challenge with various transplanted tumors (Old et al., 1959).

In parallel, Shear and colleagues had shown that the injection of filtrates from cultures of Gram-negative bacteria induced hemorrhagic necrosis in certain mouse tumors. (Shear et al.,

1943). According to Old, it was generally considered that the action of LPS and BCG was indirect and mediated by the host, owing to general augmentation of immunological reactivity (Old, 1985). Indeed, both LPS and BCG had profound effects on macrophages, activating them to become more phagocytic and bactericidal. In addition, it was known at that time that activated macrophages had the capacity to inhibit or destroy cancer cells *in vitro* through a variety of mechanisms, including the production of active oxygen intermediates (Nathan, 1982).

Old's discovery of tumor necrosis factor (TNF) (Carswell et al., 1975) provided a clue as to how these diverse reactions to microbial products might be linked. His lab went on to show that the serum of BCG-infected mice injected with LPS (but not serum from mice injected with either agent alone) caused hemorrhagic necrosis of an LPS-sensitive mouse sarcoma, thus defining the two events that were necessary for production of the tumor necrotizing and cytotoxic factors (e.g., TNF) (Old, 1985):

- The first event was a priming event that caused activation and proliferation of macrophages and was associated with expansion of reticuloendothelial elements in liver and spleen. Of note, for priming, *C. parvum* and zymosan (yeast cell walls) functioned as well as BCG.
- The second event (elicitation) was required for appearance of the factor in the blood, and LPS turned out to be unique as an eliciting-agent.

Of note, as they rely on systemic effects and do not seem to be uniquely triggered by BCG, these studies might seem pretty far from the local effects mediated by BCG (see Section II.C.1(b)) and the putative mechanisms for BCG therapy (see Sections II.C.3) and III). Nonetheless, Old's study in 1959 provided the first evidence that BCG had anti-tumor effects, and therefore seemed worth mentioning.

#### *(b) Local injection with BCG*

In the 1970s, Burton Zbar conducted seminal studies at the National Cancer Institute, focusing on local anti-tumor properties of BCG, co-injected with transplanted tumors into guinea pigs (Zbar, 1972; Zbar et al., 1970; Zbar et al., 1971; Zbar and Tanaka, 1971). Though the animal model is different from mine, it seems particularly relevant to mention Zbar's studies, as they provided the rationale for BCG therapy in bladder cancer (Herr and Morales, 2008; Morales et al., 1976).

In their experiments, Zbar and colleagues injected ascites tumor cells derived from carcinogen-induced primary hepatomas (called line-10), together with various preparations

and doses of BCG, in guinea pigs previously immunized with BCG, complete Freund adjuvant or unimmunized (Zbar et al., 1971), and followed tumor growth (and inflammation) by recording skin papules size (e.g., **Figure 15A-B**). Their goal was to establish optimal conditions for tumor suppression.

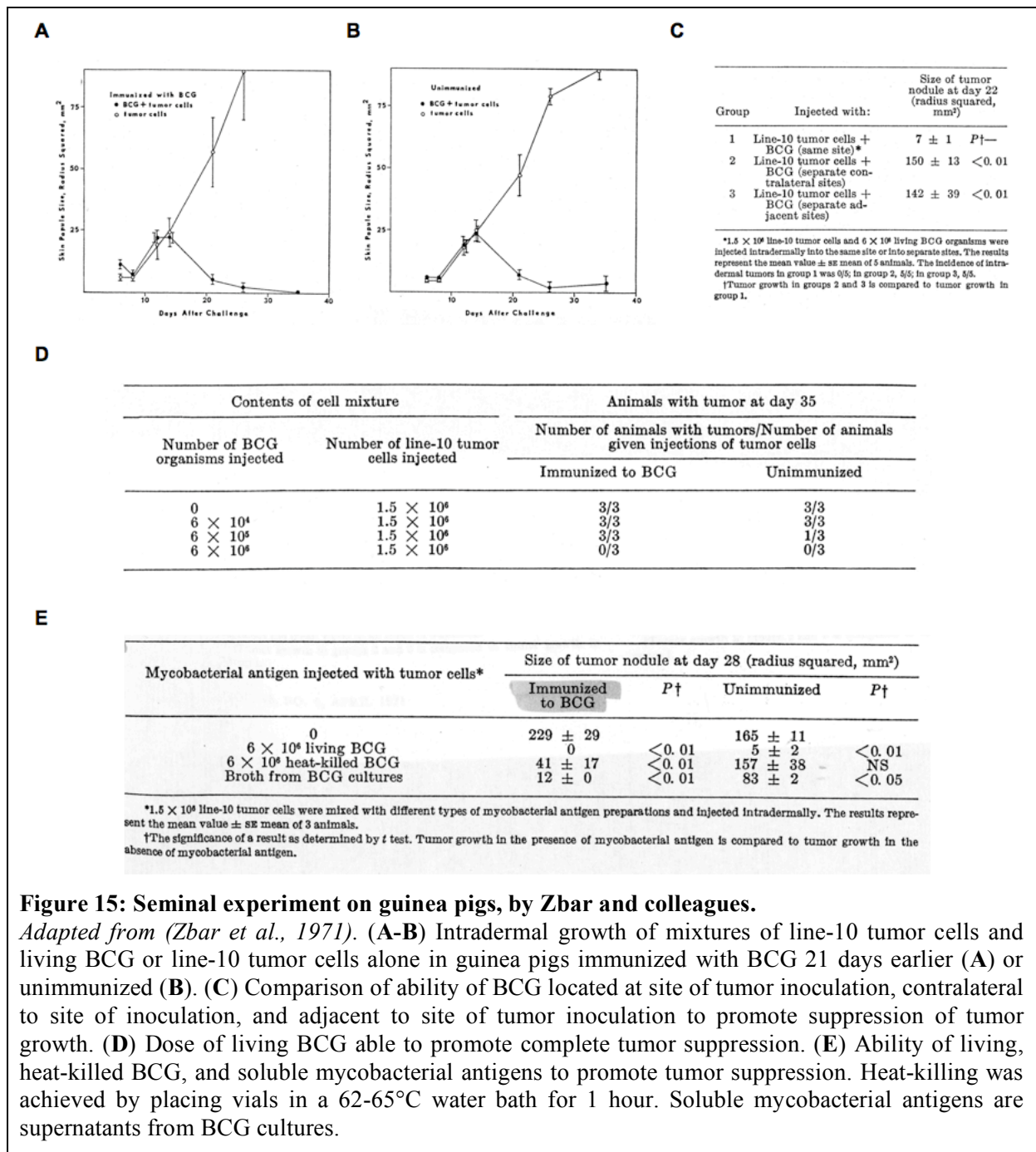
Importantly, tumor growth inhibition was only observed when BCG was inoculated at the tumor site (**Figure 15C**) (Zbar et al., 1971), in an adequate dose (**Figure 15D**) (Zbar et al., 1971), with an adequate tumor burden (Zbar, 1972). Tumor growth inhibition could also occur when BCG was injected into established tumors (~150mm<sup>3</sup> volume) (Zbar and Tanaka, 1971).

Based on *in vitro* data, tumor inhibition was not attributable to a direct cytotoxic effect of BCG (Zbar et al., 1971). On the other hand, it required a chronic inflammatory reaction at the site of tumor suppression, which the author called a “*delayed hypersensitivity type immunological response*” (Zbar et al., 1971). With respect to the results that are presented in this manuscript, it is worth noting that tumor suppression could occur after injection of tumor cells + live BCG in animals that were naïve to BCG (**Figure 15**, compare **A versus B**) (Zbar et al., 1971; Zbar and Tanaka, 1971), therefore not able to mount a delayed-type hypersensitivity (DTH) reaction according to the modern definition (see II.B.2)(c)). What Zbar and colleagues named a “*delayed hypersensitivity type immunological response*” was likely a reflection of chronic inflammatory reaction (Zbar, 1972).

Interestingly, prior immunization of guinea pigs with live BCG allowed for a partial tumor regression in animals subsequently challenged with tumor cells + heat-killed BCG or supernatant from BCG cultures (**Figure 15E**) (Zbar et al., 1971).

This series of seminal experiments allowed Zbar and colleagues to establish the criteria for successful BCG therapy, to which Morales referred in the establishment of BCG therapy for bladder cancer, a few years later (Morales et al., 1976). The requirements were as follows:

- Close contact between tumor cells and BCG;
- A host capable of mounting an immunological reaction to mycobacterial antigens;
- Limited tumor burden;
- Adequate numbers of living BCG.



**Figure 15: Seminal experiment on guinea pigs, by Zbar and colleagues.**

Adapted from (Zbar et al., 1971). (A-B) Intradermal growth of mixtures of line-10 tumor cells and living BCG or line-10 tumor cells alone in guinea pigs immunized with BCG 21 days earlier (A) or unimmunized (B). (C) Comparison of ability of BCG located at site of tumor inoculation, contralateral to site of inoculation, and adjacent to site of tumor inoculation to promote suppression of tumor growth. (D) Dose of living BCG able to promote complete tumor suppression. (E) Ability of living, heat-killed BCG, and soluble mycobacterial antigens to promote tumor suppression. Heat-killing was achieved by placing vials in a 62-65°C water bath for 1 hour. Soluble mycobacterial antigens are supernatants from BCG cultures.

## 2) Early clinical trials using BCG as an anti-cancer therapy in humans

### (a) *Bladder cancer, an exceptional success*

The clinical use of BCG as cancer therapy began in 1969 with George Mathé in France, who reported encouraging results with percutaneous BCG vaccination of patients with acute lymphoblastic leukemia. More precisely, he demonstrated that the remission induced by chemotherapy was prolonged by BCG adjuvant therapy (Mathe et al., 1969). In 1970, Morton in the United States observed temporary regression of malignant metastatic melanoma in 5 out of 8 patients treated with intralesional BCG (Morton et al., 1970).



These reports created enormous interest in BCG as an anticancer agent – of note, “*the use of BCG in therapy of cancer*” was the central topic of a complete conference from the National Cancer Institute in October 1972, and another one “*the present status of BCG in cancer immunotherapy*” in Canada in 1976 – and prompted many clinical trials using BCG against lung, prostate, colon and kidney cancers, which however yielded rather poor results, and BCG was soon replaced by more effective therapy.

The notable exception was bladder cancer. Based on Zbar’s defined criteria (see Section II.C.1)(b)), Alvaro Morales, an urologist in Canada, decided to try intravesical BCG against superficial bladder cancer. Six weekly instillations of a high dose of BCG (120mg, Pasteur strain) were given shortly after tumor resection (i.e. with a limited tumor burden at initiation of therapy) (Herr and Morales, 2008; Morales et al., 1976), concomitantly with intradermal BCG injections. Among the 10 patients with frequent tumor recurrence despite surgery or intravesical thiotepa that were selected for trial, 7 had reduced frequency of tumor recurrence or eradicated existing disease (Morales et al., 1976). The subsequent successful development of BCG therapy as standard of care for high-risk non-muscle invasive bladder carcinoma has been detailed in Section I.B.2)(a).

#### *(b) Repeated injections of BCG*

It is not clear why Morales chose to repeat weekly instillations. One hypothesis, which was suggested by Rosenthal in 1973, is that BCG non-specific effects are “*only of short duration and cannot be stimulated by non-specific agents, e.g., neoplastic cells. Therefore large doses of the specific antigen must be present constantly to achieve and maintain the non-specific effect*” (Rosenthal, 1973). Such reasoning actually led Rosenthal to propose the following schedule for treatment of surgically removable malignant tumors: “*Vaccinate 2 times a week for 1 month; follow by vaccination once every week, 6 months, and once a month for an indefinite period following surgery*”, alternating left and right deltoids and thighs as a site for injection (Rosenthal, 1980a)! He though added that “*the schedule should be modified depending upon local or general reactions*” and that the dose and number of vaccination might be adapted depending on the tuberculin reaction, for which the patient should be tested every 3 months (Rosenthal, 1980a).

Morales himself explained in 2008 (Herr and Morales, 2008) that his choice of therapy regimen was “*because the Frappier strain was packaged in 6 separate vials and it was presumed this schedule would be adequate for a patient to mount an immune response*”. But in the same review he also says that he “*knew that more than 3 weeks of treatment was mandatory to establish a delayed hypersensitivity reaction (which then was the easiest*

*method to assess the success or failure of the immunizations [...]. He also had determined that the adverse effects normally lasted less than 1 week, thus the weekly instillation schedule*". Importantly, there is most likely some confusion between Zbar's definition of delayed hypersensitivity reaction, which does not require prior exposure to mycobacterial antigens, but only persistence of a high dose of BCG, as already underlined above, and what Morales called "*delayed hypersensitivity reaction*", which likely refers to the modern definition of DTH (see Section II.B.2)(c)) and indeed occurs several weeks after start of therapy, as confirmed by our own observations.

*(c) Leaving tumor cells behind?*

Interestingly, Zbar and colleagues insisted that BCG had to be in direct contact with cancer cells to have anti-cancer activity. In particular they "*deplore(d) the implication that (their) work in any way contributed to the design of protocols used in clinical trials of immunotherapy consisting of vaccination with BCG alone following tumor ablation*" (Rapp and Zbar, 1981). They therefore recommended to either directly inject BCG into tumors or, after surgery, to administer a mixture of BCG and attenuated tumor cells (Rapp and Zbar, 1981). Current thought is that, in the context of adjuvant therapy for high-risk non-muscle invasive bladder cancer, it is likely that cancer cells are left behind by surgery.

3) Proposed mechanisms for BCG-induced anti-tumor activity

In this section, I focus on the historical ideas offered to account for tumor immunity, which helped BCG find a place in large numbers of cancer treatment protocols. The current understanding of BCG therapy for bladder cancer will be presented below, in Section III.

*(a) Delayed hypersensitivity to mycobacterial antigens*

In 1980, Rosenthal speculated that the possible mechanism of action of BCG was linked with the host's ability to develop delayed hypersensitivity to mycobacterial antigens. He pointed out that patients with melanoma who had responded to intralesional injection of BCG were either tuberculin positive before therapy or showed positive response after BCG administration, whereas non-responders were usually tuberculin negative (Rosenthal, 1980a). Notably, a similar discussion in the context of BCG therapy for bladder cancer has been going on from the initiation of therapy until late 1990s (see Section III.B.4).

*(b) Bystander killing of tumor cells*

In the guinea pig model, Zbar proposed a mechanism for killing of tumor cells at site of BCG injection that gave a central role to macrophages and was mostly based on histopathologic examination of tumor site (histiocytes): *“Mycobacteria, after injection into the host, migrate to regional LN where they stimulate cells in the paracortical region of the node to become lymphoblasts. These lymphoblasts and their descendants leave the LN and enter the systemic circulation. Able to recognize antigens of the tubercle bacillus, they come in contact by chance with mycobacteria in the tissues. These specifically sensitized lymphocytes, interacting with mycobacterial antigens, then react by producing and secreting soluble molecules. These soluble molecules include factors that immobilize and activate macrophages. As a result of this procedure, macrophages are concentrated at sites of tissues containing living BCG. These activated macrophages are the principal suspects for the cell responsible for tumor cell death at sites of BCG infection.”* (Zbar, 1972)

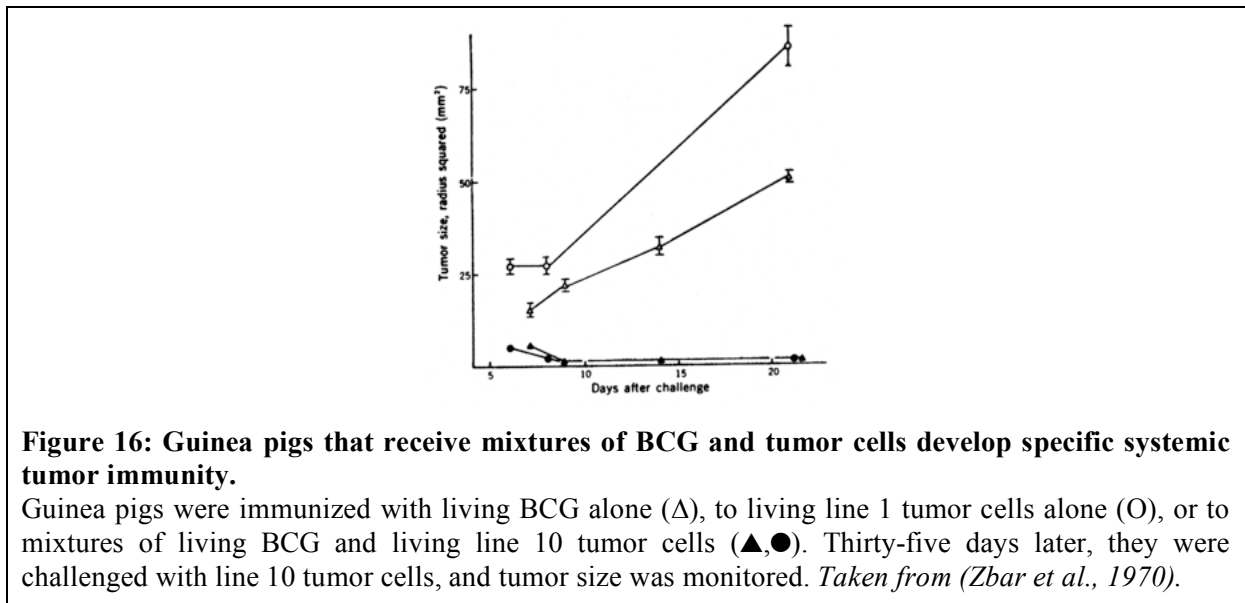
Several years later, Rosenthal noted that tumor cells might be killed as *“innocent bystanders”* at the site of an intense granulomatous reaction evoked by mycobacteria, a hypothesis which we will discuss in the context of bladder cancer in chapter 3. He also mentioned that PPD-stimulated lymphocytes could attract, arrest and activate macrophages. Then, activated macrophages could inhibit tumor growth by direct contact and by release of tumoricidal factor(s). Macrophages from BCG-treated animals could also secrete a lymphocyte activation factor that could enhance the proliferation of lymphocytes, amplifying the entire response (Rosenthal, 1980a). Finally Rosenthal noted that lymphocytes (most probably NK cells) stimulated by mycobacterial antigens could either kill or inhibit growth of tumor cells by direct contact or by release of tumoricidal *“lymphokines”* (Rosenthal, 1980a).

*(c) A role for tumor-specific immunity?*

The role of tumor-specific immunity in producing tumor regression after intralesional injection of BCG was uncertain at that time (and it actually still is, even in the context of bladder cancer, see Section III.B.3)(e) and General Discussion Section II). Indeed, suppression of mouse fibrosarcomas could occur without augmenting tumor immunity (Bartlett et al., 1972).

On the other hand, Zbar and colleagues could demonstrate in their guinea pig model that animals which rejected tumor cells at the site of BCG infection showed suppressed tumor growth and displayed evidence of a *“delayed hypersensitivity reactions”* upon subsequent challenge of tumor cells alone (**Figure 16**) (Zbar et al., 1970; Zbar et al., 1971), suggesting

that specific anti-tumor immunity may develop as a result of BCG-mediated tumor killing. However, in 1973 the group reported evidence that BCG may be antigenically related to tumor line-10 (Borsos and Rapp, 1973).



#### 4) Qualitative comparison of BCG-derived agents, BCG strains and preparations

(a) *Which essential BCG component is responsible for BCG-mediated anti-tumor response?*

Following seminal studies from Zbar, there were considerable efforts to identify components of the bacterium, such as cell wall or lipids (Ribi et al., 1973) or methanol-extraction residues from phenol-killed BCG (Yron et al., 1973), which possessed the same anti-tumor effects. In 1980, Rosenthal listed more than 20 agents derived from BCG, which had been tried in animal models (Rosenthal, 1980a). According to him, BCG remained the most interesting because (Rosenthal, 1980a):

- Experimental screening by the EORTC revealed that BCG was the most efficient among 19 agents submitted (Halle-Pannenko et al., 1976).
- Immunotherapy experiments, particularly in minimal disease following other forms of treatment, found BCG to be the most effective.
- Active immunotherapy by BCG had been demonstrated and confirmed in man.
- The safety of BCG had been established in 500 million vaccinations against tuberculosis.

Of note, there is, to my knowledge, at least one current attempt to use a BCG-derived agent in the clinics for its anti-tumor properties, namely the MCC compound in the treatment of non-muscle invasive bladder cancer (Morales et al., 2009), see Section I.B.4)(b).

*(b) Qualitative comparison of BCG strains and preparations*

Similarly to what was done in the context of Tb vaccination (Ritz et al., 2008)), various BCG strains and preparations (lyophilized commercially-available *versus* freshly made or cryopreserved experimental preparations) were compared by several groups. At that time, commercial preparations were known to differ widely in their proportions of viable units and in bacterial unit / dry weight ratios. In 1973, Mathé and colleagues reported that, among 10 strains (including 9 lyophilized and one freshly made), only the “French fresh” Pasteur Institute preparation yielded significant results in all 5 tests of “*immunity systemic adjuvant screening battery*” in various mouse tumor models (Mathe et al., 1973). In a series of tests by Baldwin and colleagues, the liquid suspension of immuno BCG Pasteur (by the Pasteur Institute) was also found to be superior at inducing tumor suppression after concomitant injection with tumor cell inocula in rats. However, all vaccines tested were effective to a greater or lesser extent (Willmott et al., 1979). Interestingly, in this study, viable organisms were not essential for tumor suppression, as gamma-irradiated preparations of 2 vaccines from the Trudeau Institute were as effective as the preparations containing viable organisms.

In clinical studies run at that time, though variable efficacies were reported using various strains and preparations of BCG, there were differences in doses and methods of administration, such that there was no clinical evidence to claim that a given strain or preparation was more efficient (Rosenthal, 1980a).

As an outcome of such experimental and clinical studies, various BCG strains and various preparations (though mostly lyophilized, as BCG was commercialized that way) continued to be utilized, even for the use of BCG as standard-of-care therapy for bladder cancer (Brandau and Suttmann, 2007).

In summary, based on its immuno-stimulatory properties, such as the induction of a Th1 response and production of TNF- $\alpha$ , BCG has been a good candidate as an anti-cancer agent and extensively studied in the 1960s-1970s. Despite encouraging results in several animal models, it has yielded rather disappointing results in clinical trials, with the notable exception of bladder cancer.

### III. CURRENT UNDERSTANDING OF BCG THERAPY AGAINST BLADDER CANCER

Though BCG therapy has been the standard of care for high-risk non-muscle invasive bladder cancer for more than 35 years, its precise mechanisms of action remain unclear. It is however well established that it involves an immune response from the tumor-bearing host and I review the current knowledge based on human observational trials and experimental studies in mice.

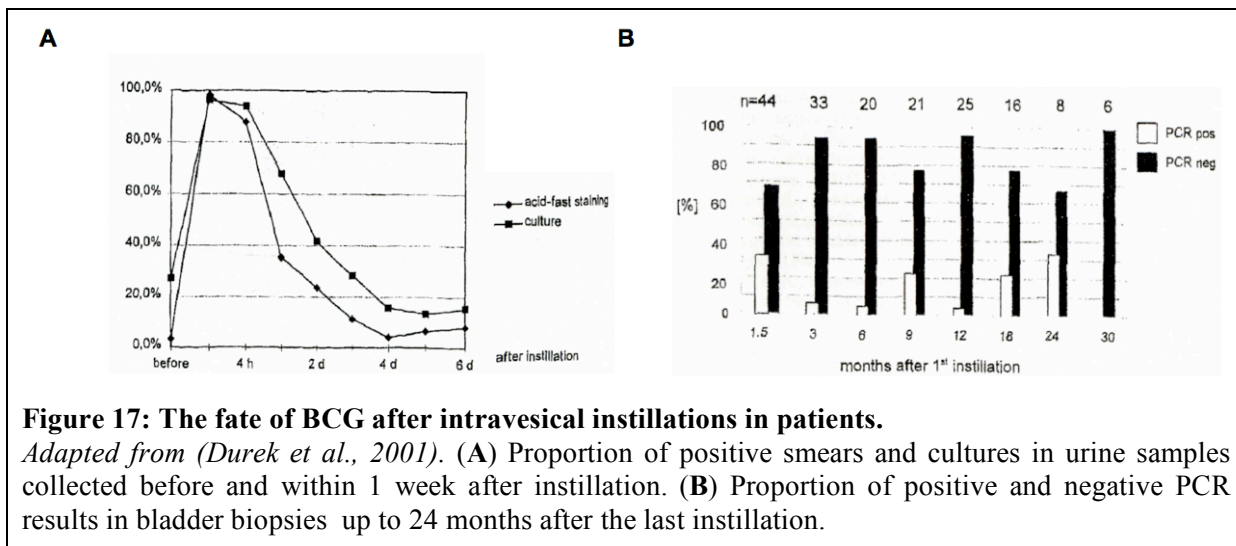
#### A. The fate of BCG following intravesical injections

Considering the success of BCG therapy, it is surprising how little is known about the fate of BCG following intravesical instillation. Little data is available from patients, and in animal models, a systematic analysis of BCG interaction with the bladder wall is still lacking.

##### 1) What is known about the fate of BCG in patients?

There are very few papers investigating the fate of BCG following intravesical injections in patients. In one report (Durek et al., 2001), Böhle and colleagues extensively tracked BCG in urine, sputum and blood samples, as well as in bladder biopsies in 50 patients after uncomplicated induction BCG therapy. Of note the study of urine samples suffers from one caveat, which is that samples from the different weeks of treatment were pooled according to the time point (after last instillation) for analysis. Importantly no systemic mycobacterial spread was observed. The vast majority (95%) of urine samples was culture-positive for BCG at 2hrs, and two thirds (68%) remained positive at 24hrs (**Figure 17A**). The number of positive specimen then quickly decayed to about 25% until the next instillation (**Figure 17A**). A majority of bladder biopsies performed every 3 to 6 months after end of therapy rapidly became PCR negative for BCG (**Figure 17B**).

Such data was confirmed by another study in which only 5 patients out of 125 were found with persisting acid-fast mycobacteria in their urine or bladder up to 16 months post therapy (Bowyer et al., 1995). Finally, a recent report using real-time PCR targeting in specimens collected from 10 patients has shown that all urine samples were positive at 24hrs post instillation, and 24% were positive 7 days later, i.e., prior to the next instillation. In addition BCG DNA was detected in 8.3% of the blood specimens taken 1 day post instillation and its amplification was associated with cases of self-limiting fever (Siatelis et al., 2011).



These data suggest some local persistence of BCG during the instillation course but rather rare long-lasting persistence of BCG in the bladder, and rare systemic mycobacterial spread (associated with systemic side effects, also see Section I.B.2)(c)).

## 2) Interaction of BCG with the bladder wall

Bevens and colleagues point out to the fact that both the bladder wall and BCG cell wall are highly negatively charged, such that BCG bacteria cannot accumulate to the bladder wall without adherence at a close docking distance to the bladder wall (Schamhart et al., 1994). The low abundance of BCG adherence in the uninjured bladder and the dependency of BCG adherence to diluent properties (pH, salt concentration) seem to be in accord with these physicochemical considerations (Hudson et al., 1991; Ratliff et al., 1987b; Teppema et al., 1992).

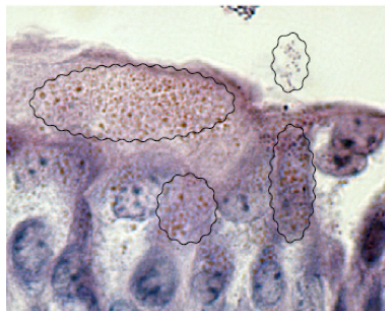
In addition to non-specific interaction, more specific mechanisms seem to be involved in BCG adherence. Binding of BCG to fibronectin in the bladder mucosa has been postulated, based on experiments where Ratliff and colleagues, using radiolabeled BCG, showed that BCG, but not BCG pretreated with fibronectin or BCG preceded by intravesical injection of anti-fibronectin antibodies would persist, as long as 48hrs, in cauterized bladders (Kavoussi et al., 1990; Ratliff et al., 1987b). In addition, they reported that BCG bacteria possess a receptor with high affinity for the collagen domain of fibronectin, the fibronectin attachment protein (FAP). Of note, BCG secretes the antigen 85 complex of antigens, some of which are retained in the cell wall (Wiker and Harboe, 1992), and which are known to bind fibronectin (Naito et al., 1998).

### 3) Does BCG infect urothelial cells?

Several reports show that urothelial cells are capable of internalization of BCG (reviewed by (Bevers et al., 2004)); however most of them relied on *in vitro* experiments.

BCG internalization *in vitro* is time and dose dependant, and can occur pretty fast. In a spheroid 3D-model, internalized BCG was found 4 layers deep, but only in tumor cells, not in normal urothelial cells (Durek et al., 1999). Guinea pig studies have also shown that normal urothelial cells could not internalize BCG (Teppema et al., 1992). In malignant cells, BCG internalization appears to be cell differentiation dependant, based on work with bladder tumor cell lines (Bevers et al., 1998).

In mice, Saban and coworkers have reported histological data showing uptake of BCG by umbrella cells 24hrs post instillation into tumor-naïve animals (Saban et al., 2007). This is, to my knowledge, the only publication dealing with that question in a mouse model, and the ability to conclude that BCG has been internalized based on these photomicrographs remains unclear (**Figure 18**). If this study were to be confirmed, it would be an indication that normal urothelial cells can also internalize BCG.



**Figure 18: BCG might be internalized by normal murine urothelial cells.**

Representative photomicrograph of the acid-fast staining of a murine bladder section (magnification x1000). Tumor-naïve bladders were resected 24 hours after a single instillation with 200 $\mu$ L BCG. The authors have indicated areas containing acid-fast positive bacteria with black wavy lines. Taken from (Saban et al., 2007).

Patient studies, analyzing bladder washings after BCG instillation, have revealed vigorous phagocytosis of BCG by leukocytes. However, concerning internalized BCG in urothelial cells, conflicting data are reported (Teppema et al., 1992), and may be linked with the presence or absence of residual tumor cells in the washings.

Knowledge about the mechanism of BCG internalization (if any) is scarce and controversial (Bevers et al., 2004), and there is no data about the fate of BCG following internalization by urothelial cells (if any).



In summary, the vast majority of BCG is voided after instillation, and, among the few bacteria that persist, their internalization by urothelial cells remains questionable and understudied. Despite this low level of internalization, a strong immune response is triggered following repeated intravesical BCG.

## **B. Involvement of an immune response**

Based on *in vitro* studies, some initial data have suggested a direct antiproliferative or proapoptotic effect of BCG on tumor cells (Brandau and Suttman, 2007). However mechanistic studies in rodent models, mostly using orthotopic implantation of tumor cells, have provided convincing evidence that a functional immune system of the tumor-bearing host is essential for BCG-induced anti-tumor activity (e.g., T cells (Ratliff et al., 1987a; Ratliff et al., 1993), NK cells (Brandau et al., 2001), neutrophils (Suttman et al., 2006), as detailed below in Section III.B.3)). In these studies, intravesical BCG therapy indeed had no therapeutic effect on orthotopically-transplanted tumors in mice bearing various genetic immunodeficiencies.

### 1) The early hours following instillation

#### *(a) Human data*

Multiple studies have reported on cytokine production as a result of BCG therapy. In particular, the pro-inflammatory cytokines IL-1, IL-2, IL-6, IL-8, IL-12, IL-18, GM-CSF and TNF- $\alpha$  are secreted in the early hours following instillation, based on assessment of urine samples from patients (Brandau and Suttman, 2007; De Boer et al., 1992; Jackson et al., 1995). The major cell sources were most often innate immune cells, but some contribution from urothelial cells was also demonstrated, through *in vitro* exposure of bladder cancer cell lines to BCG (de Reijke et al., 1993) and, rarely, immunohistochemistry of tumor biopsies and urinary cytosins (Esuvaranathan et al., 1995).

In the early hours following BCG instillation, some studies in patients (mostly relying on urine samples because bladder biopsies are not available at such early time points) have shown that an influx of various leukocyte subsets occurs in the bladder wall, including neutrophils, monocytes/macrophages and lymphocytes (Brandau and Suttman, 2007; de Boer et al., 1991). These immune cells are likely attracted by a first wave of pro-inflammatory cytokines secreted by urothelial cells contacting BCG; however early recruited neutrophils (and then monocytes/macrophages) likely contribute to the cytokine/chemokine milieu.

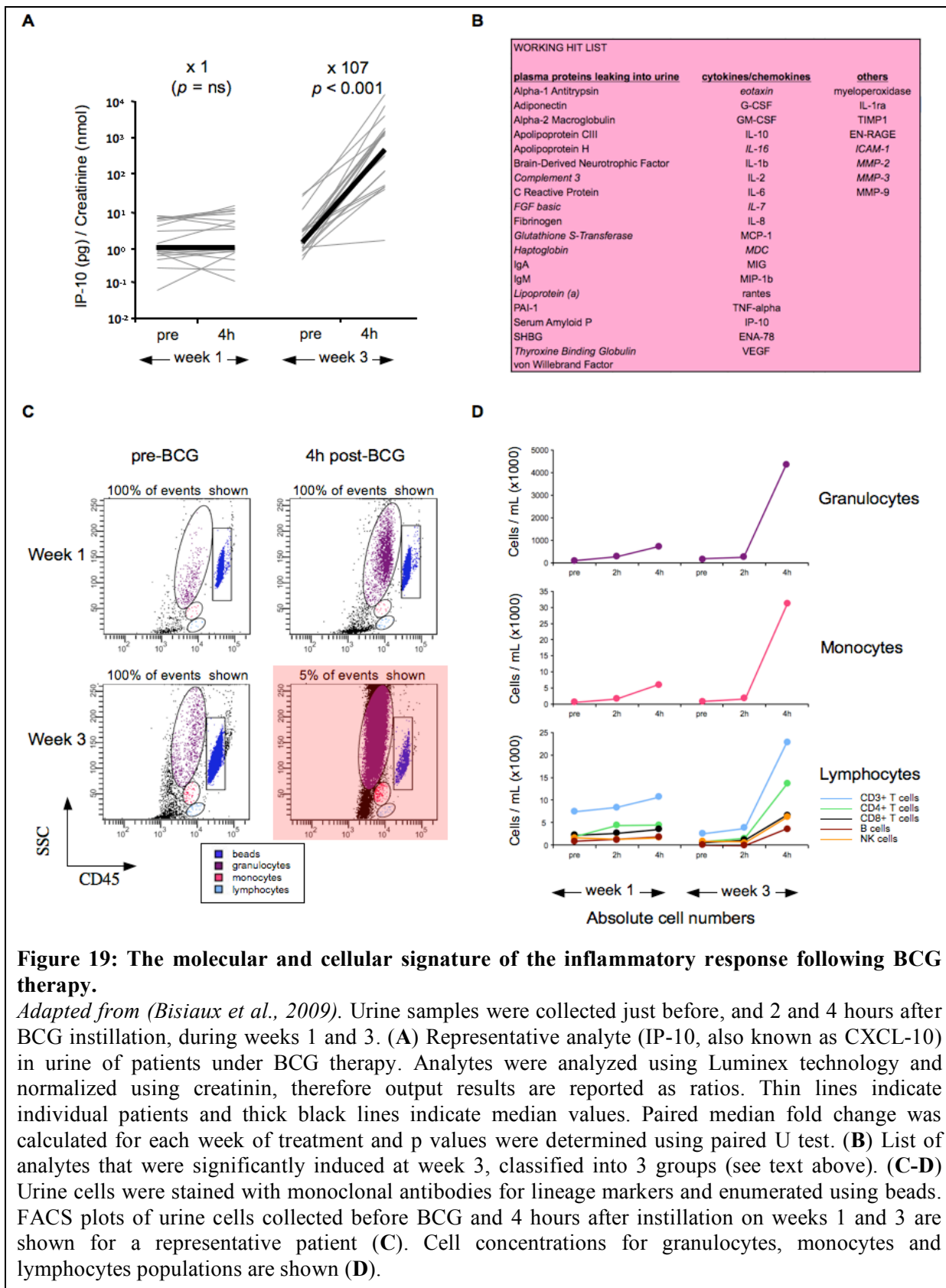
Taking advantage of Luminex technology, our lab recently extended the list of inflammatory analytes that are induced shortly after instillations, and using *ex vivo* stimulation and restimulation experiments, we mapped these analytes to their cell source, thereby providing an integrated view of the early response to BCG therapy (Bisiaux et al., 2009).

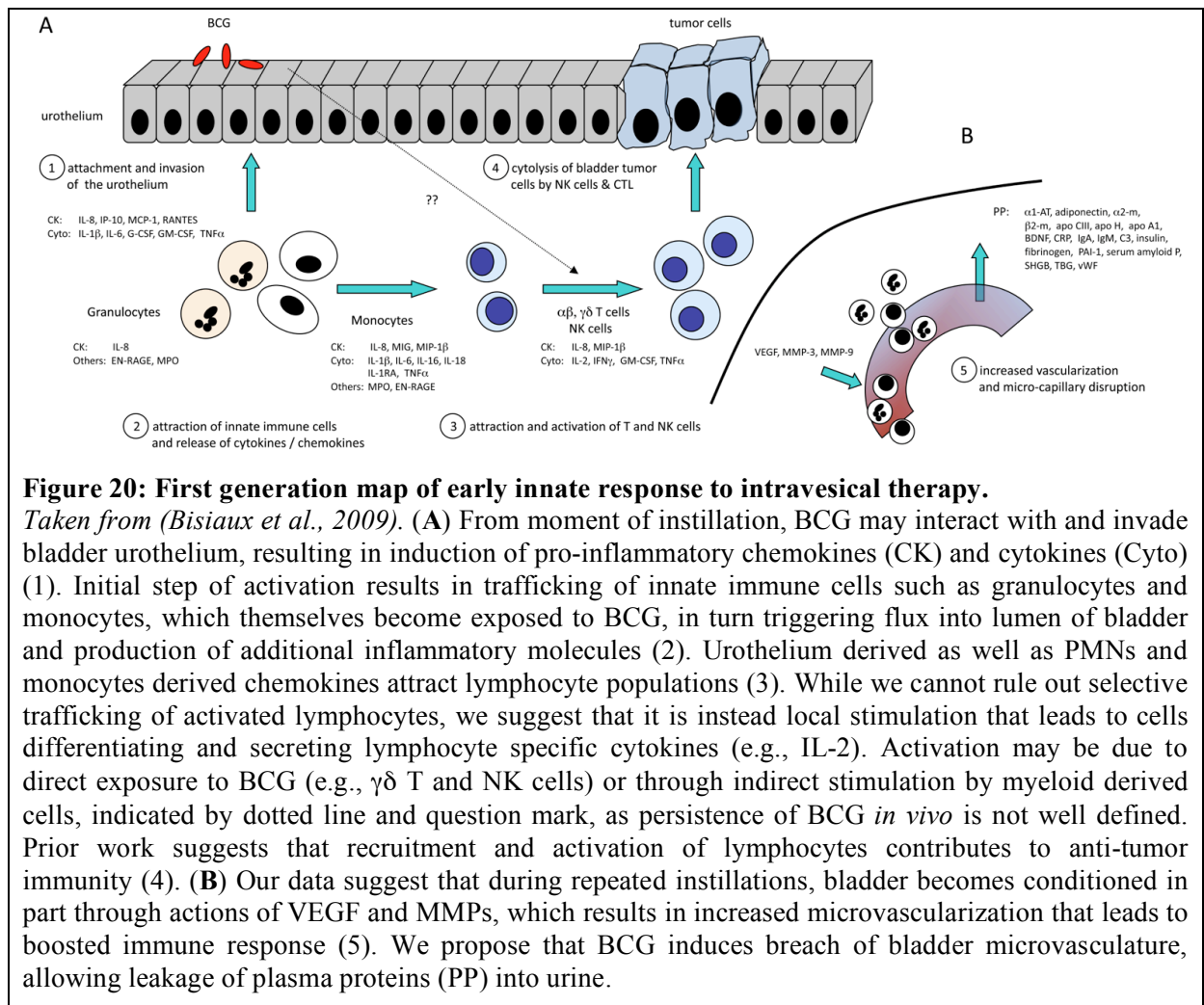
Importantly, we were able to show that repeated instillations of BCG were required to observe a robust inflammatory response (see representative examples in **Figure 19A**), since only MIP-1b was found significantly induced at week 1, 4hrs post instillation, whereas 47 analytes were significantly induced at week 3 during the same 4hr-interval. These analytes were classified in 3 groups (**Figure 19B**):

- Plasma proteins (15) that leaked into the urine (probably via microvascular breaks), e.g. IgM (83x),  $\alpha$ -2m (29x), fibrinogen (28x)
- Chemokines and cytokines (16) that were likely produced locally in response to BCG instillation (since their level in plasma did not increase); e.g. IP-10 (228x), MIP-1 $\beta$  (83x), IL-8 (5x), IL-6 (44x), IL-1 $\beta$  (38x), G-CSF (25x), GM-CSF (23x) and TNF- $\alpha$  (11x).
- Analytes involved in host defense and tissue remodeling, including 2 molecules produced at high levels by neutrophils and monocytes: myeloperoxidase (62x) and EN-RAGE (22x).

The cellular infiltrates (pelleted from urine samples) also followed a similar pattern, as a much higher number of neutrophils (203x), monocytes (126x), NK cells (30x), T cells (17x) and B cells (14x) was observed shortly after the third instillation (**Figure 19C-D**). Strikingly no change in cell numbers was observed in blood, concomitantly.

Interestingly, these analytes were mapped to their potential cell source (mostly immune cells, but also urothelial cells) and led us to combine all these data to provide a first generation map of what occurs during the initial phase of therapy (**Figure 20**). Not only did this study confirm prior reports of the early molecular and cellular signature of the local inflammatory response in the bladder, shortly after instillation (e.g., as reviewed by (Brandau and Suttman, 2007)), but it also highlighted the need of repeated instillations of BCG for a robust innate response.





**Figure 20: First generation map of early innate response to intravesical therapy.**

Taken from (Bisiaux et al., 2009). (A) From moment of instillation, BCG may interact with and invade bladder urothelium, resulting in induction of pro-inflammatory chemokines (CK) and cytokines (Cyto) (1). Initial step of activation results in trafficking of innate immune cells such as granulocytes and monocytes, which themselves become exposed to BCG, in turn triggering flux into lumen of bladder and production of additional inflammatory molecules (2). Urothelium derived as well as PMNs and monocytes derived chemokines attract lymphocyte populations (3). While we cannot rule out selective trafficking of activated lymphocytes, we suggest that it is instead local stimulation that leads to cells differentiating and secreting lymphocyte specific cytokines (e.g., IL-2). Activation may be due to direct exposure to BCG (e.g.,  $\gamma\delta$  T and NK cells) or through indirect stimulation by myeloid derived cells, indicated by dotted line and question mark, as persistence of BCG *in vivo* is not well defined. Prior work suggests that recruitment and activation of lymphocytes contributes to anti-tumor immunity (4). (B) Our data suggest that during repeated instillations, bladder becomes conditioned in part through actions of VEGF and MMPs, which results in increased microvascularization that leads to boosted immune response (5). We propose that BCG induces breach of bladder microvasculature, allowing leakage of plasma proteins (PP) into urine.

### (b) Mouse data

In a mouse model, Saban and coworkers have defined the molecular signature following repeated intravesical instillations with BCG in tumor-naïve mice, through the use of Luminex analysis on buffered urine samples (Saban et al., 2007). The most striking peak urinary cytokines levels were as follows: KC (an IL-8 ortholog; 475x, compared to baseline defined prior to any instillation), MIP- $\alpha$  (73x), IL-1 $\alpha$  (64x), RANTES (47x), IL-6 (46x), G-CSF (22x), IL-1 $\beta$  (22x) and IL-17 (15x). Of note, the paper does not clearly specify when these peak levels were observed.

Using a similar experimental setting (repeated instillations in tumor-naïve mice) another group focused on the expression of Th1 cytokines (IFN-g, IL-2, IL12-p40 and TNF-a) and Th2 cytokines (IL-10 and IL-4) 6 hours after instillations and showed that several instillations resulted in the induction of a local Th1 cytokine response (De Boer et al., 2003).

## 2) Establishment of a Th1 polarized microenvironment

### *(a) Human data*

Compared to the first 24hrs following each instillation, there is relatively little information available about later time points in patients. Several studies on urine samples focusing on this 24-48hrs window after repeated instillations insist on a shift from cytokines towards a T helper type 1 (Th1)-like milieu: the development of a predominant Th1 cytokine profile has indeed been associated by several groups with success of therapy (Kaempfer et al., 1996; Magno et al., 2002; Saint et al., 2002; Watanabe et al., 2003).

Information about cellular infiltrates in the bladder at late time points following BCG therapy is also relatively scarce in patients. In the 1990s, several groups highlighted the presence of numerous T cells, mostly CD4<sup>+</sup>, in bladder biopsies, over 3-6 months following the induction cycle (Leong et al., 1990; Peuchmaur et al., 1989; Prescott et al., 1992).

Of note, immunohistochemical analysis of bladder biopsies has revealed an induction of MHC Class II antigens by urothelial cells up to 6 months after therapy (Jackson et al., 1994b; Prescott et al., 1992) and these findings were backed up by *in vitro* studies (Ikeda et al., 2002). This suggests that urothelial cells may acquire antigen-presenting properties upon BCG therapy.

### *(b) Mouse data*

There is some additional data available from mouse models: following repeated intravesical BCG instillations in tumor-naïve mice, Saban and coworkers have used histochemistry techniques to show a chronic infiltration of polymorphonuclear cells and monocytes-macrophages in the bladder, up to 3 weeks following the last instillation (Saban et al., 2007).

De Boer and coworkers have shown an early induction of Th1 cytokines in the bladder of tumor-naïve mice following repeated instillations (see Section III.B.1)(b)), but reported a rapid decay (as early as 24hrs) in the expression of these cytokines (De Boer et al., 2003).

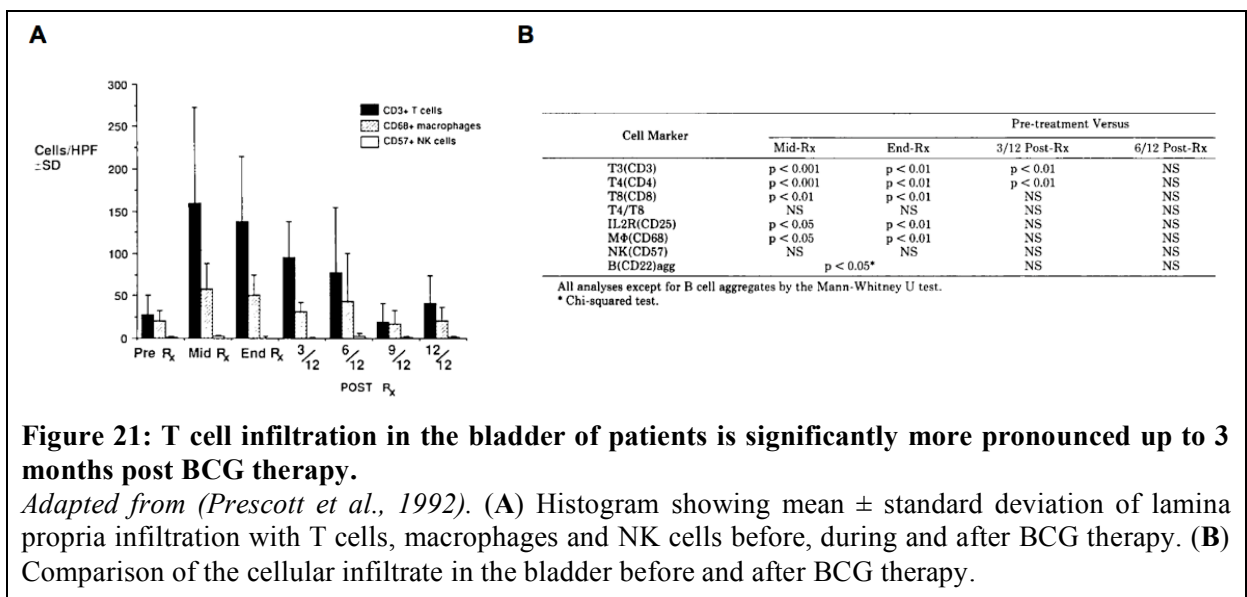
Using orthotopically-transplanted tumors in mice, the requirement for a Th1 polarization of the bladder microenvironment has been highlighted through the use of transgenic animals: a requirement for IFN- $\gamma$  and IL-12 for BCG-mediated anti-tumor activity has indeed been demonstrated (Riemensberger et al., 2002). *In vitro* studies have also shown a role for Th1 cytokines in BCG-induced macrophage cytotoxicity against mouse bladder cancer MBT-2 cells (Luo et al., 2006).

### 3) Effective eradication of tumor cells

#### (a) *A role for T cells*

Human and mouse studies have established a crucial role for T cells in BCG-mediated anti-tumor immunity.

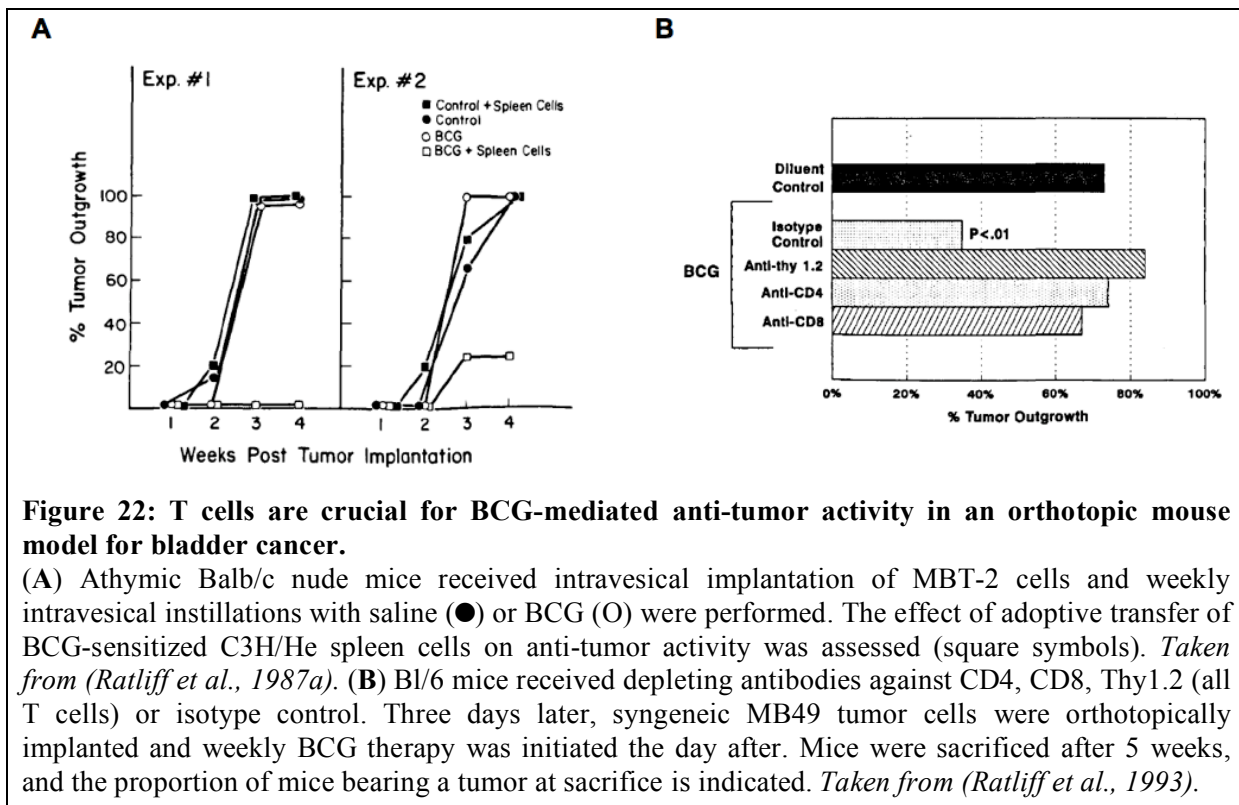
Quantitative immunohistochemical analysis of patient bladder biopsies has indeed demonstrated T cell infiltration - predominantly CD4<sup>+</sup> T cells displaying an activated phenotype - during BCG therapy and up to 3 months post-therapy (**Figure 21A**) (Peuchmaur et al., 1989; Prescott et al., 1992). In addition, the degree of T cell infiltration was reported to correlate with response to therapy (**Figure 21B**) (Prescott et al., 1992).



**Figure 21: T cell infiltration in the bladder of patients is significantly more pronounced up to 3 months post BCG therapy.**

*Adapted from (Prescott et al., 1992).* (A) Histogram showing mean ± standard deviation of lamina propria infiltration with T cells, macrophages and NK cells before, during and after BCG therapy. (B) Comparison of the cellular infiltrate in the bladder before and after BCG therapy.

In an orthotopically-transplanted tumor mouse model, Ratliff and colleagues demonstrated the requirement for a thymus-dependant response (**Figure 22A**, round symbols) (Ratliff et al., 1987a). Importantly, adoptive transfer of BCG-sensitized syngeneic splenocytes transferred delayed hypersensitivity reactivity to BCG antigens and restored the anti-tumor activity of intravesical BCG (**Figure 22A**, square symbols) (Ratliff et al., 1987a). The same group then went on to show that both CD4<sup>+</sup> and CD8<sup>+</sup> T cell subsets were required for BCG-mediated anti-tumor activity, through the use of depleting antibodies (**Figure 22B**) (Ratliff et al., 1993). Of note, footpad delayed type hypersensitivity was aborted only in CD4-depleted animals; however the presence of DTH was not sufficient for induction of BCG-mediated anti-tumor activity (Ratliff et al., 1993).



Importantly, it remains unclear if tumor-specific T cells are primed during BCG therapy.

*(b) A role for NK cells*

Based on mouse data, NK cells have also been established as crucial cells for tumor eradication: an early demonstration was made by Brandau and colleagues, who showed that NK-deficient mice (*beige* mice) and mice treated with anti-NK1.1 antibody did not show any BCG-mediated anti-tumor activity in the MB49 orthotopic model (Brandau et al., 2001). This group performed a series of *in vitro* studies to show that BCG-activated NK cells were of CD3<sup>+</sup>/CD8<sup>+</sup>/CD16<sup>dim</sup>/CD56<sup>+</sup>/NKG2A<sup>+</sup>/perforin<sup>+</sup> phenotype and had the potential to lyse bladder tumor target cells in an MHC-unrestricted manner after appropriate activation by immunostimulatory cytokines, mostly in a perforin-mediated manner (Brandau and Bohle, 2001; Brandau et al., 2000; Brandau et al., 2001; Suttman et al., 2004).

*(c) A role for neutrophils*

More recently neutrophils have been suggested to play a crucial role in tumor eradication, though this role might be indirect. Of note, these neutrophils have most often been defined, in the mouse, by a Gr1 phenotypic staining and it is now clearly established that Gr1<sup>+</sup> cells are mostly inflammatory monocytes, as well as PMNs (Daley et al., 2008).

In 2006, Suttman and colleagues showed that the depletion of Gr1<sup>+</sup> cells completely abrogated BCG-mediated anti-tumor effect in the MB49 orthotopic model (Suttman et al.,

2006). Using tumor-naïve mice, they reported some immunohistochemical evidence that PMN were essential to trigger the influx of CD4<sup>+</sup> T cells to the bladder (8 days following the initiation of instillations). Using transwell experiments, they showed that BCG-stimulated PMN indirectly induced T-cell chemotaxis via the accessory function of activated monocytes.

Another group recently showed that IL-17 production in the bladder upon intravesical BCG preceded the infiltration of Gr1<sup>+</sup> cells and that intravesical BCG therapy had no activity against the growth of orthotopically-transplanted MB49 tumors in IL-17 deficient mice (Takeuchi et al., 2011). Of note, their data also suggested that IL-17 producing  $\gamma\delta$  T cells played a key role in the recruitment of neutrophils to the bladder. The authors did not address the question whether the role of Gr1<sup>+</sup> cells might be direct or indirect.

In patients, tumor necrosis factor-related apoptosis-inducing ligand (TRAIL) becomes detectable in the urine following repeated BCG instillations and correlates with response to therapy (Ludwig et al., 2004). Among the leukocytes pelleted from urine samples, neutrophils displayed high expression of TRAIL, on the contrary to CD3<sup>+</sup>, CD14<sup>+</sup>, CD19<sup>+</sup> and CD56<sup>+</sup> leukocytes (Ludwig et al., 2004). *In vitro* experiments performed by the same group later showed that neutrophils derived from PBMCs of healthy donors expressed surface-bound and released functional soluble TRAIL upon stimulation with live or HK-BCG (Kemp et al., 2005). This group therefore argues for a direct killing of tumor cells by neutrophils.

*(d) A potential role for macrophages*

Several *in vitro* studies has shown that both human and murine macrophages are capable of functioning as tumoricidal cells toward bladder cancer cells upon activation by BCG (Luo et al., 2006; Pryor et al., 1995) and that Th1 cytokines enhance these killing capacities (Luo et al., 2006).

There is some evidence for a role of macrophages *in vivo*, since depletion of Gr1<sup>+</sup> cells abrogates BCG-mediated anti-tumor activity (Suttman et al., 2006), and since Gr1<sup>+</sup> cells comprise a good proportion of inflammatory monocytes ((Daley et al., 2008) and my own observations, see Chapter 2 Section II.B.1)(b)).

*(e) Does the eradication of tumor cells require tumor-specific effector cells?*

It is worth noting that, though the standard of care for more than 35 years, it is still debated whether BCG-mediated anti-cancer activity is tumor-specific. This is to me a question of great interest, which will be further discussed in this dissertation (e.g., see Chapter 3 Section II and General Discussion Section II). Importantly, it is not clear whether the role of the



various cell populations that were mentioned above is direct or indirect, in order to trigger tumor eradication.

#### 4) Immune biomarkers for response to therapy

Given that BCG-induced anti-tumor activity involves an immune response, there have been many attempts to define immune biomarkers that would permit prediction of response to therapy, especially since early cystectomy may save some non-responders to BCG therapy (Herr and Sogani, 2001). To date, there is a lot of controversy about the definition of good prognostic markers, but this is a field of on-going investigation in which our lab is very much involved. I briefly describe the immune biomarkers that have been proposed, based on a recent review (Saint et al., 2003), even though this topic is not directly in the scope of my thesis dissertation. Of note, other types of biomarkers (such as molecular tumor characteristics or host characteristics) have been proposed too, and might be combined with immune biomarkers for better efficacy, but are outside the scope of this introduction and have been very well reviewed recently (Saint et al., 2003; Zuiverloon et al., 2011).

One of the easiest ways to test immune characteristics of the response to intravesical BCG is proteomic analysis on urine samples. In univariate analyses, IL-2, IL-8 and IL-18 seem to be good predictors of the risk of recurrence; IL-8 also being a good predictor of the risk of progression. On the other hand, GM-CSF and IL-6 are poor predictors of the response. In a multivariate analysis of urine samples, leukocyturia also seemed to be a good predictor of the risk of recurrence.

Is previous exposure to mycobacteria - such as BCG vaccination or tuberculosis - a good predictor for response to therapy? This question has been raised in the field for a long time, with controversial answers, and I will come back to such topic in my General Discussion (see chapter 5 Section III.A.1)(a)). Briefly, many groups have linked conversion of PPD test from negative to positive to a lower risk of recurrence in several univariate and multivariate analyses in the past (Kelley et al., 1986; Lamm, 1985; Torrence et al., 1988), whereas some groups only observed a trend (Luftenegger et al., 1996) or did not observe any correlation at all (Bilen et al., 2003; Shinka et al., 1990). Of note, no correlation between PPD responsiveness and progression has been demonstrated until now (Badalament et al., 1987; Herr et al., 1989). As for patients who were PPD positive prior to therapy, there is old controversial data too, as will be discussed later (see Chapter 5 Section III.A.1)(a)). Of note no correlation has been found between previous infection with *Mtb* before BCG treatment and the response to therapy (Okamura et al., 1996).

Finally, BCG effectiveness has often been suggested to be related to its associated side effects (Gontero et al., 2010), and most importantly fever (Luftenegger et al., 1996). An EORTC trial has however shown that although a correlation between BCG toxicity and efficacy did exist, side effects could not be held responsible for an improved outcome to therapy and could not be considered as a prognostic factor for subsequent recurrence (Sylvester et al., 2003).

In summary, BCG-mediated anti-tumor activity involves an immune response that is characterized by waves of inflammatory cells shortly after each repeated instillation, followed by the establishment of a Th1 polarized environment. Whether the effective eradication of tumor cells involves some tumor-specific killing or whether BCG therapy functions as a non-specific immunotherapy is not yet clear.



**Chapter 2.**  
**Characterizing the bladder immune  
response to intravesical BCG identifies a  
strategy for improving anti-tumor activity**

---



# I. INTRODUCTION

BCG therapy of superficial bladder cancer is one of the few examples of successful immunotherapy in the clinic and therefore offers a unique opportunity to define mechanisms by which the immune system may be used to target tumor cells. Carcinoma of the bladder is the most common cancer of the urinary tract and the fourth most common malignant disease in males in the developed world (Jemal et al., 2011). Most tumors are diagnosed at a superficial stage and are surgically removed by transurethral resection. Depending on the stage and grade of the non-muscle invasive tumors, adjuvant therapy is recommended as a strategy for both reducing recurrence and diminishing risk of progression (Babjuk et al., 2011). Since the work of Morales and colleagues in 1976 (Morales et al., 1976), BCG therapy, which consists of 6 weekly intravesical instillations shortly after resection, has been the standard of care for high-risk urothelial carcinoma: carcinoma *in situ*, and high-grade Ta/T1 bladder lesions (Babjuk et al., 2011; Gontero et al., 2010).

BCG is an attenuated strain of *Mycobacterium bovis*, initially developed as a vaccine against *Mycobacterium tuberculosis* (*Mtb*) infection (Guérin, 1980; Zwerling et al., 2011). It is a slow growing bacterium with a doubling-time of about 24 hours. Macrophages are the principal host cells where mycobacteria either multiply or remain latent (Flynn et al., 2011). Several effector lymphocyte subsets are induced upon mycobacterial infection, including multifunctional CD4<sup>+</sup> and cytolytic CD8<sup>+</sup> T cells (Cooper, 2009). Importantly, interferon (IFN)- $\gamma$ -producing CD4<sup>+</sup> T cells are responsible for phagocyte activation, an essential process for controlling mycobacterial infection (Cooper, 2009). While robust, it has been demonstrated that T cell recruitment to the lung mucosa of mice infected with aerosolized mycobacteria occurs late and takes several weeks to establish (Cooper, 2009; Urdahl et al., 2011).

In the context of bladder cancer, BCG therapy is known to trigger a strong innate immune response, followed by the influx of type 1 polarized lymphocyte subsets (Alexandroff et al., 2010; Brandau and Suttman, 2007). Using orthotopically-transplanted urothelial tumors in mice, several groups have reported that BCG-mediated anti-tumor activity relies on a functional immune system of the tumor-bearing host (Brandau et al., 2001; Ratliff et al., 1987a; Ratliff et al., 1993; Suttman et al., 2006). In particular, CD4<sup>+</sup> and CD8<sup>+</sup> T lymphocytes seem to be essential effector cells for eliminating the tumor in a mouse model (Ratliff et al., 1993), and correlates have been established between T cell infiltration and clinical response in patients (Prescott et al., 1992).

Our lab recently reported that repeated instillations with BCG were required in order to trigger a robust inflammatory response (Bisiaux et al., 2009). Based on these findings, our goal was to establish an experimental mouse model to study the dynamics of the immune response following intravesical BCG regimen, and to specifically address several important unknowns, including: the link between bacterial persistence / dissemination and T cell priming; the role of multiple instillations in triggering T cell influx in the bladder; and the temporal relationship between T cell priming and T cell entry into the inflamed bladder microenvironment. I describe here how I sharpened my tools to define the dynamics of the immune response in the bladder, before addressing the aforementioned research questions.

## **II. OPTIMIZING STRATEGIES TO DEFINE THE DYNAMICS OF THE IMMUNE RESPONSE**

The foundations on which this project relied included (i) the establishment of a robust mouse model for intravesical instillations, and (ii) the development of reliable tools to study the dynamics of the immune response. The sharpening of such tools required considerable effort, time and rigor, and I would like to highlight my achievements here.

### **A. Establishment of a mouse model for intravesical instillations**

#### 1) Rationale for working in tumor-free female C57BL/6 mice

##### *(a) Tumor-free mice*

Although mouse studies mentioned in introduction have proven useful to determine cell populations involved in tumor clearance, the use of transplanted tumors does not facilitate detailed mechanistic studies for several reasons:

- The kinetics of tumor growth is very fast – mice die within 30-40 days – which does not mimic kinetics of human NMIBC
- Tumors progress towards muscle-invasive forms, which is not the case of most human NMIBC. Importantly, muscle-invasive tumors are not responsive to BCG.

These two facts might explain the relatively poor efficacy of BCG therapy in the MB49 model, as compared to the clinic. In addition, though useful to track the potential tumor-specific response, the presence of HY antigens (male cells implanted into female hosts) might have an influence on the immune response.

Of note, the other bladder tumor models mentioned in General Introduction also present caveats, including the difficulty to synchronize cohorts of animals, and important time constraints to obtain 100% penetrance, without even being sure if these tumors would respond to BCG therapy.

Therefore, arguing that the tumor is resected a few weeks prior to therapy, making very few tumor cells available for BCG interaction, I decided to study the mechanisms accounting for T cell infiltration in the bladder following repeating intravesical instillations into tumor-free mice.

*(b) The choice of young female C57BL/6 mice*

Given the fact that (i) it is much easier to catheterize female mice than male mice, (ii) current practice in experimental immunology is to work with young adult animals, (iii) most of our knockout strains are in C57BL/6 background, I chose to work with young female C57BL/6 mice (though most bladder cancer patients are old men).

2) Designing an instillation protocol which closely reflects the clinical procedure

My goal, in establishing the instillation protocol, was to reflect, as closely as possible, the clinical procedure of instillation. The final protocol is described in the Material and Methods (see Section I.A), and I acknowledge contribution from other members of the Bladder Biology Team in the lab. I would like to insist here on a series of parameters, which seemed critical to us when we developed this protocol.

*(a) The choice to avoid electrocautery*

Some groups, including famous teams such as Ratliff, O'Donnell, Brandau and others, perform an electrocautery of the mouse bladder wall, straight away prior to BCG instillations (O'Donnell et al., 1999; Ratliff et al., 1987b) or 24 hours prior to the first instillation (due to implantation of tumor cells, also see Section III.E.1)(a)) (Gunther et al., 1999). On the other hand, other teams consider such a practice as unreliable (De Boer et al., 2003) or as not reflecting the clinical procedure (Bevers et al., 2004).

Our rationale to avoid electrocautery was that (i) in patients, resection occurs 2 to 6 weeks prior to initiation of therapy, therefore allowing for some healing of the bladder wall; (ii) it might be much more difficult to practice a reproducible cautery of the murine bladder mucosa, given the available tools and in the absence of concomitant cystoscopy, than in patients.



As a counterpart, a limitation of our model is that the mouse bladder is at homeostasis when BCG therapy is initiated, whereas the bladder of patients is not. Indeed, (i) patients have harbored a tumor for an undetermined period of time, which likely alters bladder homeostasis, though superficial bladder tumors do not display histologic features of inflammation (Prescott et al., 1992; Saint et al., 2001a); (ii) as already mentioned, patients have undergone resection of their tumor by 1 or 2 rounds of electrocautery, 2-6 weeks prior to initiation of BCG therapy. Therefore, the wound in their bladder is probably not fully healed.

Overall, there is no easy experimental model that could avoid such limitations, and I think that our model, though imperfect, can teach us interesting lessons about the bladder immune response to BCG, which could translate into an improvement of BCG-mediated anti-tumor activity.

#### *(b) Water starvation*

Reflecting the clinical practice of patients being asked not to drink prior to therapy, we water starved our mice 6-8 hours prior to instillations. In addition, their bladders were drained of any urine present by application of slight digital pressure to the lower abdomen, prior to insertion of the catheter. Such procedures were aimed at ensuring as little dilution of BCG into urine as possible, during the 2 hours dwell time.

#### *(c) The slow injection of a small volume*

It seemed to us crucial to inject a small volume of liquid into the bladder, reflecting the relatively small volume intravesically instilled in patients (50mL, to compare with the 300-500mL holding capacities of a human bladder). To reflect the scale change from humans to mice, we chose to inject a volume 1000-fold smaller than in patients, i.e., 50 $\mu$ L. In addition, we carefully avoided injecting the air bubble (70-80 $\mu$ L), which corresponds to the dead volume of the catheter, by adjusting the catheter to the syringe and filling in the syringe prior to insertion of the catheter. This makes the catheterization slightly more difficult, but it seemed important to us.

Of note, in the literature, volumes of 50 $\mu$ L (Gunther et al., 1999), 100 $\mu$ L (De Boer et al., 2003; Ratliff et al., 1987b; Zaharoff et al., 2009) and up to 200 $\mu$ L (Saban et al., 2007) are reported and most often, syringes are adapted to the catheter after the urethral insertion of the latter (Gunther et al., 1999). High volumes and injection of an air bubble (due to the dead volume of the catheter) do not seem appropriate to us, as they both lead to distension of the bladder wall, which might be responsible for a qualitatively and quantitatively different interaction of BCG with the urothelium.

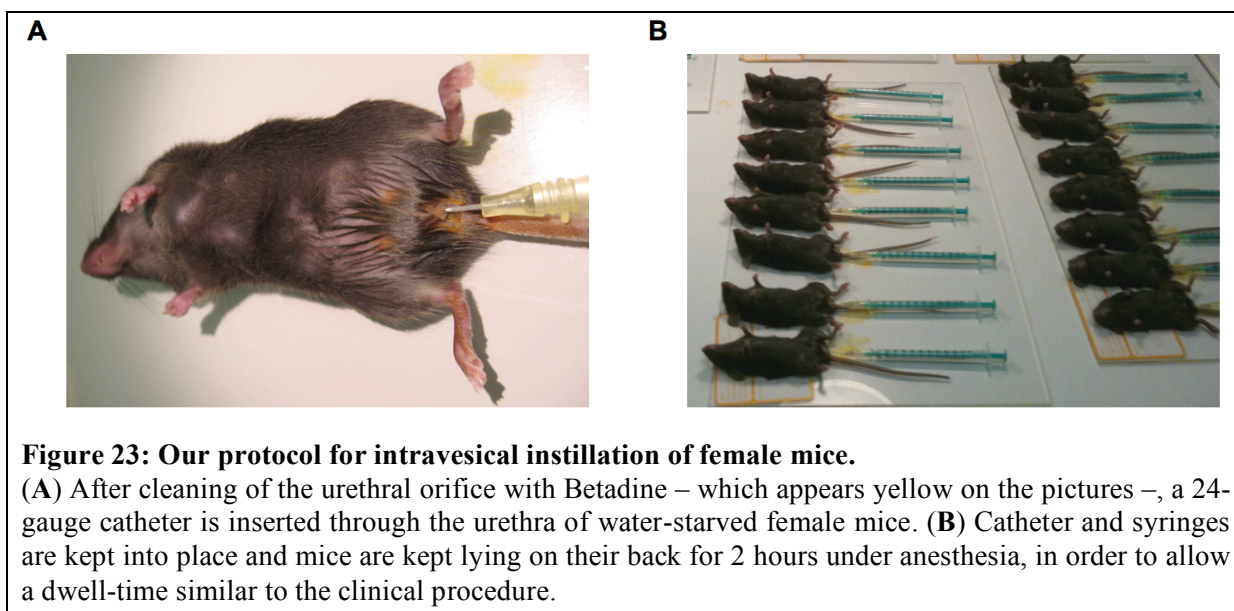
In addition, we made sure to inject the preparation at a slow rate, in order to avoid trauma and vesico-ureteral reflux.

*(d) Strategy for BCG retention*

The clinical procedure is to ask patients not to void during 2 hours. In addition, many urologists ask their patients to move and turn around, so that BCG contacts as much of the bladder mucosal surface as possible.

In the current literature, BCG retention into the bladder is most often achieved by keeping the mice under anesthesia and locking the catheter (e.g., (Gunther et al., 1999)), or maintaining the syringe into place (e.g., (Zaharoff et al., 2009)). Alternatively, but rarely, some groups ligate the opening of the urethra (Nadler et al., 2003; Takeuchi et al., 2011). BCG retention time varies from 30 minutes (Ratliff et al., 1987b) to 45-60 minutes (Zaharoff et al., 2009), “at least 1 hour” (Saban et al.), 2 hours (Nadler et al., 2003) and up to 3 hours (Gunther et al., 1999).

Our own choice was to adopt the BCG retention time used in the clinics, i.e., 2 hours, because the kinetics of the immune response in mice and humans is similar, and therefore there is no reason to increase or decrease the contact time between BCG and the urothelium. To achieve this, we decided to keep our mice under anesthesia, lying on their back with the syringe and catheter maintained into place, to avoid any voiding during the retention time (**Figure 23**).



**Figure 23: Our protocol for intravesical instillation of female mice.**

(A) After cleaning of the urethral orifice with Betadine – which appears yellow on the pictures –, a 24-gauge catheter is inserted through the urethra of water-starved female mice. (B) Catheter and syringes are kept into place and mice are kept lying on their back for 2 hours under anesthesia, in order to allow a dwell-time similar to the clinical procedure.

Of note, we cannot exclude an effect of the anesthetic on the immune response; but we can control it through the use of a control group (instilled with PBS). Actually, for all parameters analyzed in Section III (e.g., cellular infiltrates, antigenic presentation), PBS-treated mice

were very similar to naïve mice, which suggests little to no effect of the anesthetic, as far as these parameters are concerned.

One caveat of keeping the mice on their back is that BCG mostly contacts the backside of the bladder – and indeed we see by histology that the immune infiltration is not similar in all regions of the bladder. However, the other option (ligation of the urethra) is technically not easy to achieve on large cohorts of animals, and might impair blood circulation in the urethra.

*(e) The use of clinical-grade BCG*

The use of various strains and preparations of BCG is reported in the literature. BCG Pasteur (Nadler et al., 2003; O'Donnell et al., 1999) and Connaught (Gunther et al., 1999; Saban et al., 2007; Suttmann et al., 2006; Takeuchi et al., 2011; Zaharoff et al., 2009) are the most used strains. Most groups work with the lyophilized preparation, which they resuspend according to manufacturer's instruction in 3mL saline (e.g., (Gunther et al.; Saban et al., 2007; Takeuchi et al., 2011)), but the O'Donnell group occasionally reported the use of their own exponentially-growing BCG culture (Nadler et al., 2003; O'Donnell et al., 1999). When used as lyophilized, most groups describe the dose in mg rather than in CFUs. In that case, they often report the use of 1.35mg (Gunther et al., 1999; Saban et al., 2007), which corresponds to 1/60<sup>th</sup> of the full vial containing at least  $2 \times 10^8$  CFUs (in the case of Immucyst, Connaught strain). This translates into  $\sim 3 \times 10^6$  CFUs, which correspond to the dose reported in CFUs by other groups (Suttmann et al., 2006; Takeuchi et al., 2011). Therefore, there is a good consensus about the dose among the literature, i.e.  $\sim 3 \times 10^6$  CFUs.

Given that (i) BCG formulation – lyophilized preparations contain only 5-10% live bacteria and a lot of dead bacteria and debris (Behr, 2002) – and (ii) BCG dispersion – BCG might be more or less clumpy according to the culture protocol and/or lyophilization process – likely impact on the immune response (Mathe et al., 1973; Nicolle et al., 2004), our own choice was to work with the clinical-grade BCG used for intravesical therapy in France, i.e., Immucyst (Sanofi-Pasteur, Connaught strain). We resuspended the vial in 3mL phosphate-buffered saline (PBS) according to the manufacturer's instructions, and titrated each vial after use. This allowed us to confirm that the instilled volume of 50 $\mu$ L represents  $\sim 3 \times 10^6$  CFUs. Of note, in our hands, CFUs were very reproducible from 1 vial to the other, and from 1 batch to the other. We also confirmed by reading optical density at 600nm that the preparation contained many more bacteria / debris than revealed by titration, i.e., only a small percentage of bacteria are alive in the preparation. Our own estimation is 2-8%.

#### *(f) Inter-instillation interval*

As the kinetics of the immune response is not different from humans to mice, we chose to keep the inter-instillation interval practiced in the clinics, i.e., weekly instillations.

#### *(g) Number of instillations*

The clinical practice is to perform an induction cycle of 6 weekly instillations, followed by a maintenance cycle, whose schedule is defined by the guidelines, but is more or less strictly followed by urologists (see General Introduction Section I.B.2)(a)).

Our goal with our mouse model was to observe clinically relevant immune responses without increasing too much the overall duration and experimental time-consumption of one experiment. Based on the striking differences that we observed in our observational clinical study between the first and the third instillation (Bisiaux et al., 2009), for all our studies of the dynamics of the immune response in tumor-free animals, we limited the number of instillations to 3. We could show that a 4<sup>th</sup> instillation did not much alter the pattern and dynamics of the immune response (see Section III).

Of note, for survival analyses following orthotopic tumor challenge (see Section III.E.1)), though, we thought it was important to pursue BCG therapy as long as mice were still alive and/or up to 6 instillations. In fact we encountered some problems with anesthetizing tumor-bearing animals as the disease progressed, and therefore we never reached 6 instillations (though mice were still alive); instead, mice received 4 to 5 weekly instillations. That is the best compromise we could find between adequacy with clinical protocols and avoiding to censor too many mice in an experiment – as mice that died from anesthesia had to be excluded from survival analysis.

### **B. Tools to study the cellular signature of the immune response**

As the instillation protocol was well established and allowed working with rather big cohorts of mice, I sought to establish qualitative and quantitative ways of assessing the cellular signature of the immune response. Flow-based techniques allowed me to quantify the response, whereas histology-based techniques allowed me to visualize the distribution of the cells.

## 1) Flow-based techniques

### (a) *Collagenase digest*

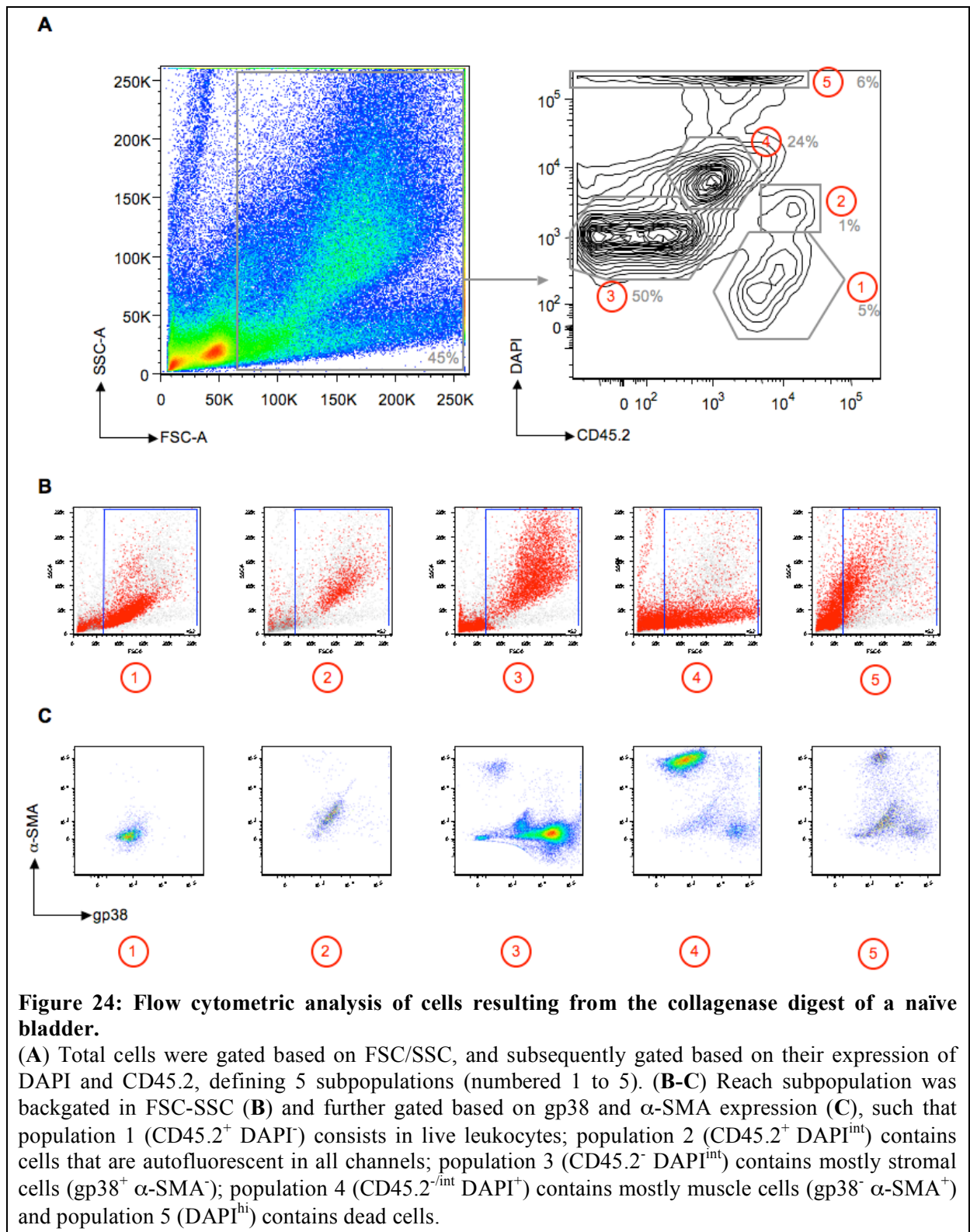
The bladder is mostly a smooth muscle, and is therefore not easy to digest in order to get a single cell suspension amenable to analysis by flow-cytometry. I am very grateful to Lucie Peduto for providing me with a protocol for bladder digest, which triggered very good cell yields (see Materials and Methods Section IV.A), and most importantly relies on the use of liberase TM enzyme (Roche) to digest the bladder.

The total number of cells obtained after collagenase digest were enumerated by flow cytometry, using Accucheck counting beads (Invitrogen, see Materials and Methods Section V.B). I could obtain from  $5 \times 10^5$  to  $2 \times 10^6$  cells, with a median around  $10^6$  cells.

### (b) *Stroma, muscle and leukocyte cell populations*

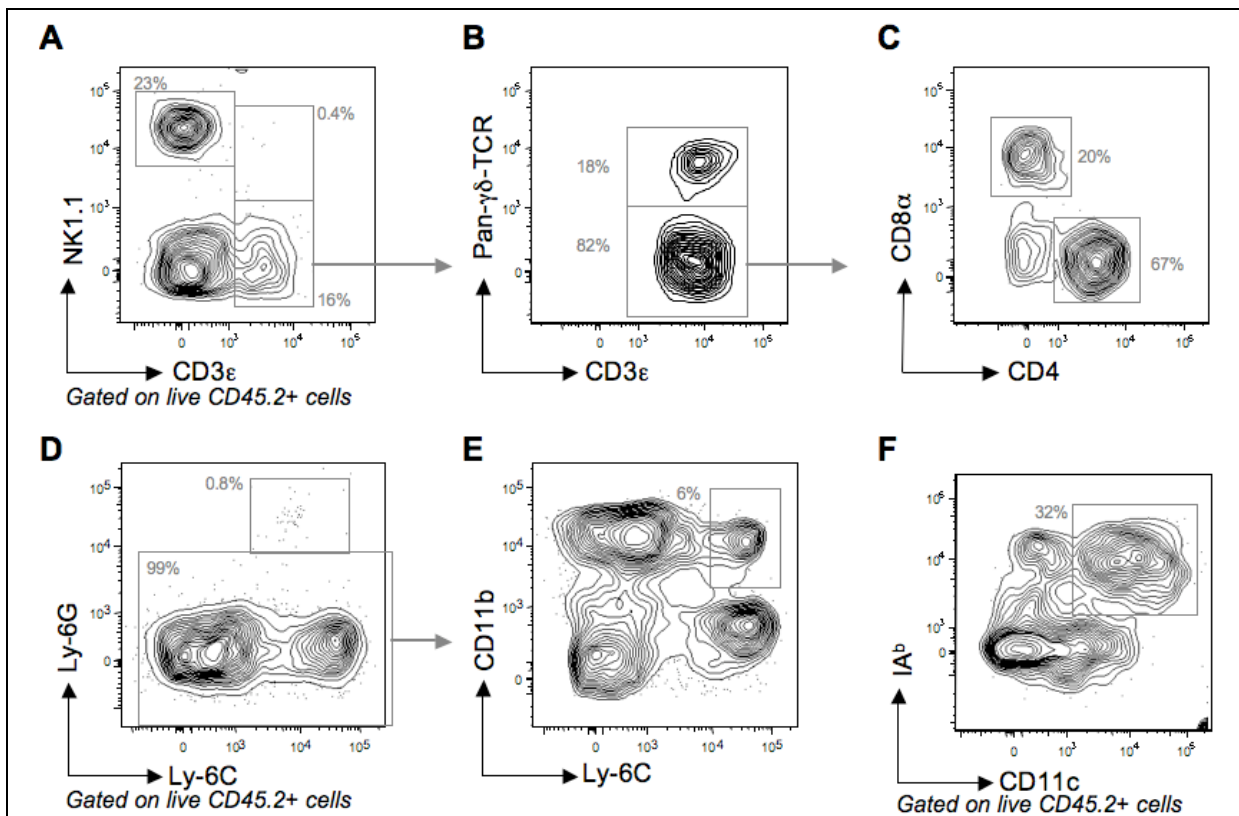
My gating strategy was to stain all leukocytes with a CD45.2 antibody, in order to distinguish them from the mass of muscle and stromal cells. **Figure 24A** shows a plot gating on total cells, and then on CD45.2 *versus* DAPI, such that one can distinguish 5 populations:

- CD45.2<sup>+</sup> DAPI<sup>-</sup> cells (**Figure 24**, population 1) are live leukocytes. This was my main population of interest and I will explain further gating in the next paragraph.
- CD45.2<sup>+</sup> DAPI<sup>int</sup> cells (**Figure 24**, population 2) contain cells that display an intermediate staining for most antibodies tested (e.g., **Figure 24C**), and therefore seem to be dead. It is unclear to me why they do not appear as DAPI<sup>hi</sup>, as most dead cells would. Anyway, I always excluded this population from my analyses.
- CD45.2<sup>-</sup> DAPI<sup>int</sup> cells (**Figure 24**, population 3) are mostly stromal gp38<sup>+</sup> alpha-smooth muscle actin ( $\alpha$ -SMA)<sup>-</sup> cells (**Figure 24C**) and are CD31<sup>-</sup> (data not shown).
- CD45.2<sup>-/int</sup> DAPI<sup>+</sup> cells (**Figure 24**, population 4) are mostly  $\alpha$ -SMA<sup>+</sup> gp38<sup>-</sup> muscle cells (**Figure 24C**), and are autofluorescent for most stainings (data not shown) but can be easily excluded thanks to the CD45.2 / dead cell marker staining.
- DAPI<sup>hi</sup> cells (**Figure 24**, population 5) are dead cells and are excluded from analysis.



*(c) Flow-based definition of a few important cell populations*

All my FACS analyses started by gating on cells based on their FSC/SSC (see above), excluding singlets using a stringent SSC-A *versus* SSC-W plot (data not shown), and further gating on live  $CD45.2^+$  cells (Figure 24A, population 1). I then mostly focused on the following leukocyte populations.



**Figure 25: Flow cytometric definition of important leukocyte populations.**

A representative PBS control (A-C) or naïve (D-F) bladder is shown. Live CD45.2<sup>+</sup> leukocytes were gated based on expression of CD3ε and NK1.1 expression, defining the subsets of T cells (CD3ε<sup>+</sup> NK1.1<sup>-</sup>), NK cells (CD3ε<sup>-</sup> NK1.1<sup>+</sup>) and NKT cells (CD3ε<sup>+</sup> NK1.1<sup>+</sup>) (A). T cells were further gated based on expression of pan-γδ TCR (B) and γδ<sup>-</sup> T cells were further gated based on expression of CD4 and CD8α (C). Live CD45.2<sup>+</sup> leukocytes were alternatively gated based on expression of Ly-6C and Ly-6G, defining the neutrophil subset (Ly-6G<sup>+</sup> Ly-6C<sup>int</sup>) (D) and Ly-6G<sup>-</sup> cells were further gated based on expression of Ly-6C and CD11b, defining the subset of inflammatory monocytes (CD11b<sup>+</sup> Ly-6C<sup>hi</sup>) (E). As a third alternative, live CD45.2<sup>+</sup> leukocytes were gated based on expression of CD11c and IA<sup>b</sup>, defining the DC subset (CD11c<sup>+</sup> IA<sup>b+</sup>) (F).

- T cells were defined as CD3ε<sup>+</sup> NK1.1<sup>-</sup> cells (Figure 25A), and further defined as γδ T cells (Figure 25B), CD4<sup>+</sup> or CD8α<sup>+</sup> T cells (Figure 25C).
- NK cells were defined as NK1.1<sup>+</sup> CD3ε<sup>-</sup> (Figure 25A). They were CD11b<sup>+</sup> (data not shown).
- NKT cells were defined as NK1.1<sup>+</sup> CD3ε<sup>+</sup> (Figure 25A).
- Neutrophils were defined as Ly-6G<sup>+</sup> cells (Figure 25D). They were Ly-6C<sup>int</sup> (Figure 25D), CD11b<sup>+</sup> (data not shown) and high in SSC-A (data not shown). We made sure to avoid the Gr-1 antibody (also called Ly6G/C antibody, clone RB6-8C5) because this antibody recognizes both Ly-6G and Ly-6C and therefore stains both neutrophils and inflammatory monocytes (Daley et al., 2008).

- Inflammatory monocytes were defined as Ly-6G<sup>-</sup> Ly6C<sup>hi</sup> CD11b<sup>hi</sup> cells (**Figure 25E**). They were high in FSC-A, and medium high in SSC-A (data not shown).
- Dendritic cells were defined as CD11c<sup>+</sup> IA<sup>hi</sup> cells (**Figure 25F**). About 85% of them were CD11b<sup>hi</sup> CD103<sup>-</sup> and 15% were CD11b<sup>+</sup> CD103<sup>+</sup> (data not shown).
- B cells were defined as CD19<sup>+</sup> cells (data not shown).

Based on my FACS analyses, a resting bladder is composed of ~15,000 total leukocytes, with the following cell numbers and proportions (**Table 2**):

Cell population	Cell numbers in the resting bladder	Proportion among total leukocytes
Total leukocytes	16,623 ± 1,611	-
T cells	3,067 ± 574	15.2% ± 2.3%
NK cells	3,991 ± 511	20.6% ± 1.5%
NKT cells	223 ± 17	1.2% ± 0.1%
Neutrophils	128 ± 32	0.9% ± 0.1%
Inflammatory monocytes	664 ± 125	4.8% ± 0.6%
Dendritic cells	6,131 ± 687	43% ± 1.8%
Remaining CD11b <sup>+</sup> cells	1,961 ± 336	14.4% ± 1.7%
B cells*	357	2.2%

**Table 2: Cell numbers and proportion of various leukocyte populations in the resting bladder.** Mean ± SEM are shown here. (\*, experiment done only once on pooled bladders; therefore only a mean value is available.)

## 2) Histology-based techniques

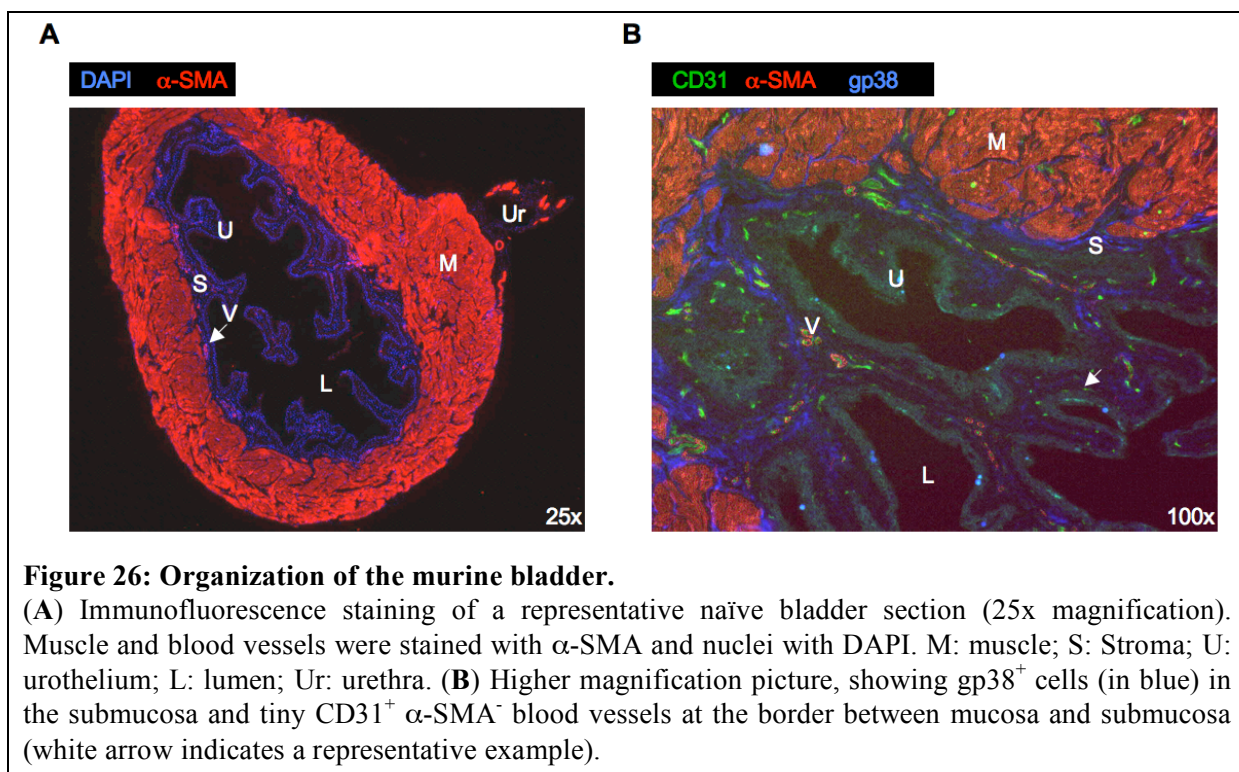
Flow cytometry is much more amenable to quantitative analysis of cell infiltrates in the bladder than histology. On the other hand, histology provides very important information on the localization of the cells and potential crosstalk between the cells. Thanks to Lucie Peduto again, I used protocols based on fixation of the tissue in paraformaldehyde, followed by freezing in OCT compounds, further section in a cryostat, and immunofluorescence staining of the slides (see Material and Methods Section VI.A).

I could observe that indeed, the mouse bladder is composed of:

- A very thin urothelium (U), made of 3 layers of tightly packed cells (**Figure 26A**).



- A stromal submucosa (S) that contains mature blood vessels (V, covered by a layer of  $\alpha$ -SMA, white arrow in **Figure 26A**). Of note, at the border between mucosa and submucosa, there are very tiny blood vessels that stain for CD31 but do not stain for  $\alpha$ -SMA (white arrow in **Figure 26B**). Some stromal cells express gp38 (**Figure 26B**).
- A very thick muscle layer (M), staining for  $\alpha$ -SMA (**Figure 26**).



Of note, from a technical point of view, the staining shown in **Figure 26B** could be improved: (i) gp38 staining was indeed much better with another secondary antibody – which conflicted with the use of  $\alpha$ -SMA, though (data not shown) –, therefore the population of gp38<sup>+</sup> stromal cells is underestimated on this picture; (ii) CD31 staining is very weak. In addition, the urothelium presents with a background staining for this antibody, though it happens to be useful to detect this layer of cells.

In the resting bladder, I could not stain a lot of CD45.2<sup>+</sup> cells per slide. The few leukocytes that we observed were located in the submucosa, as will be described later (**Figure 33**).

### C. Tools to study the molecular signature of the immune response

Based on previous clinical observational study from our lab (Bisiaux et al., 2009), I aimed to define the molecular signature of the local immune response to intravesical BCG, and to use it as a read-out for our further investigation. Such an approach turned out to be much less

successful than looking at the cellular signature of the immune response. I however briefly present the tools that I developed.

### 1) Defining the molecular signature in urine samples

#### *(a) Protocol for urine collection, processing and storage*

To construct parallels with the clinical studies in the lab, I aimed to collect urine from mice. For this purpose I had to pool several mice together in metabolic cages (**Figure 27**), and collected urine over several hours. Actually, in order to collect reliable amounts of urine (mL), mice needed to be 5 per cage, and housed for an average of 10-12 hours (from 8 to 16 hours). One concern was the evaporation of urine on its way to the collection tube in the metabolic cage, which was difficult to control. Another concern was the degradation of proteins in the sample until the urine would be processed. Therefore, I followed standard published protocols (Ludwig et al., 2004; Nadler et al., 2003; O'Donnell et al., 1999; Saban et al., 2007; Zaharoff et al., 2009) to buffer urine, using Tris-HCl 2M pH7.6, 5% BSA and Complete (a protease inhibitor from Roche). I tried to keep urine collection tubes on ice, as published by some groups (Zaharoff et al., 2009), but this was technically too challenging, and this is not the standard protocol followed by most groups.



**Figure 27: A representative picture of a metabolic cage allowing to house up to 5 mice.** Mice are placed on a grid. Urine and feces fall across the grid and are separated thanks to a funnel.

Urine samples were then centrifuged, filtered on a .22 $\mu$  PVDF membrane and stored at -80°C. One concern about the filtration step is that some proteins might be retained on the membrane. However, I was concerned about bacterial contamination (at least by BCG in the early hours) of the urine sample, in the absence of such filtration. Therefore I chose to perform this step and carefully chose a filtering membrane with low retention of proteins.

#### *(b) Urine analysis and normalization of data*

Urine was analyzed using the Luminex technology, which is a high-throughput bead-based ELISA. The standard curve was established using urine from naïve mice (processed as

mentioned above) to dilute our standards. Of note, urine completely impaired the standard curve for IP-10 and IL-5. For the remaining samples, the standard curve looked rather good, but the sensitivity of the assay was most often slightly less good than using a serum matrix.

As the protein concentration might be impacted by the overall concentration of urine, I chose to normalize data using creatinin concentration, as already reported by our lab in our clinical study (Bisiaux et al., 2009). Indeed, creatinin is produced at a fairly constant rate by the kidneys, so, provided the kidney function is not impaired (which we checked by looking at kidney analytes by Luminex, data not shown), its concentration takes into account the overall degree of concentration of urine. Therefore data in Section III.C.2) are reported as pg analyte per mg of creatinin.

But overall, the reproducibility of the data, from one experiment to the other, was not very high, and I will discuss this further below. Of note, based on data published by Hultgren and colleagues (Ingersoll et al., 2008), I tried to use bladder homogenates instead of urine, but with rather disappointing results.

## 2) Defining the molecular signature at the RNA level

As analysis of the immune molecular signature in urine samples was technically challenging, and as, in mice, I had direct access to the tissue (contrary to patients), I aimed to use RNA instead.

### *(a) RNA signature at the bladder level*

Total bladder homogenates were collected at time points of interest and RNA was extracted. RNA quality was checked, using the BioAgilent technology, and qPCR was performed using a chip from SABioscience. However, some candidate genes thought to be positive controls (e.g., IL-6, KC, MMP9) did not show upregulation. And the few upregulations that were observed were about 2-fold, which is very small (data not shown). Of note, de Boer and colleagues have published several studies looking at the Th1-Th2 polarization of the bladder following repeated intravesical BCG instillations by transcriptional analyses, and they also report rather small (from <2-fold up to 10-fold) upregulations (De Boer et al., 2003; de Boer et al., 2005). My interpretation is that muscle cells, which constitute the most part of the bladder, do not respond to intravesical BCG, and therefore dilute out the transcriptional signature of the response in remaining cells (submucosal and mucosal layers). This was my reason to move on to sorted cell populations.

### *(b) RNA on sorted cell populations*

Based on the caveats mentioned above, I decided to sort cell populations (using Miltenyi microbeads or FACS-sorting) prior to analysis of the transcriptional signature. This seems a promising approach, and I will present preliminary data in Section 0); however, given the low cell yield, high-throughput analysis (such as BioMark 48x48 or 96x96 screening or SABioscience 1x96 or 2x48 chips) is more difficult, and I have not yet established protocols for pre-amplification in order to be able to screen large amounts of genes on a small RNA quantity. Therefore, I only performed a few hypothesis-driven “classical” qPCR that will be presented in Section III.D.

## **D. Monitoring BCG persistence in the bladder**

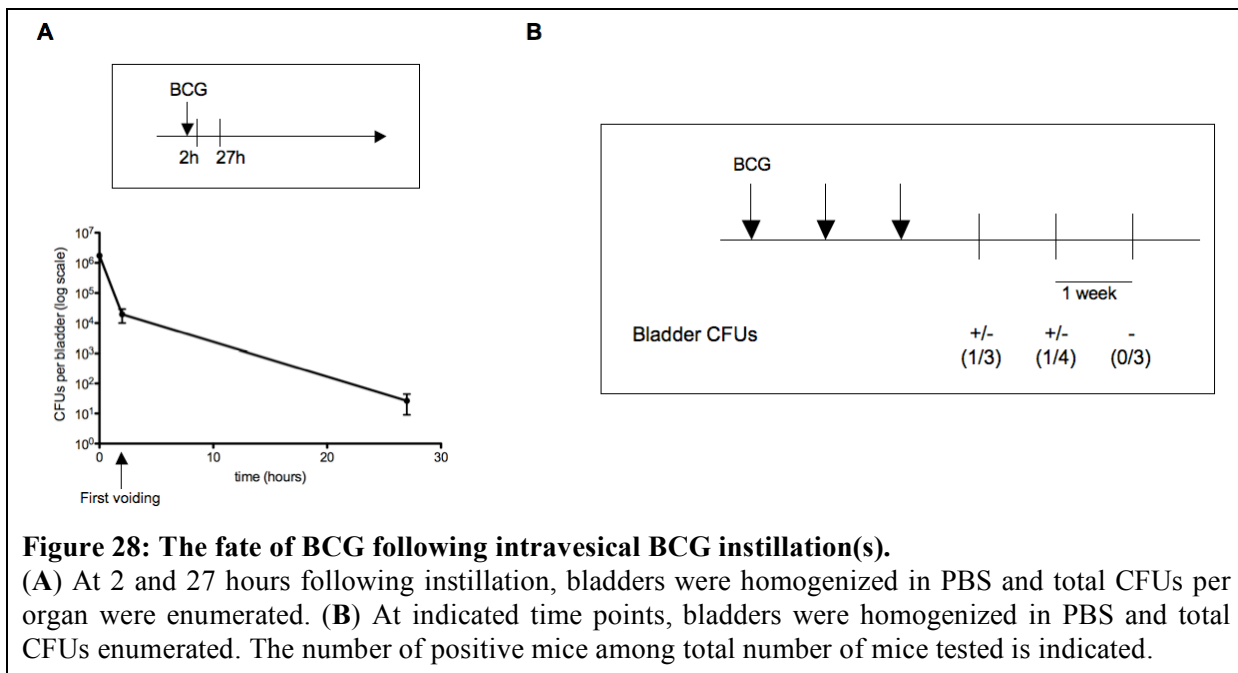
As mentioned in the General Introduction (see Section III.A), very little is known about the fate of BCG following instillations. Using mouse model and *in vitro* experiments, I sought to investigate (i) the persistence of BCG CFUs locally in the bladder, (ii) whether BCG was able to infect urothelial cells, and (iii) whether some immune cells would acquire the capacity to present BCG during instillations.

### 1) BCG load in the bladder quickly decays

The most straightforward approach was to assess the CFUs that remain in the bladder over time. Consistent with what has been suggested for human treatments (Durek et al., 2001; Siatelis et al., 2011), I demonstrated that the BCG load in the bladder rapidly decreased to 1% of the instilled dose, after the first voiding at 2 hours, and was barely detectable by 24h post-instillation (**Figure 28A**).

As BCG is a slow-growing bacterium, I hypothesized that the few persisting bacteria might need time to replicate, and therefore I looked at bladder homogenates at much later time points, up to 3 weeks following the third instillation. However, not all mice were found to be positive for CFUs at such late time points (**Figure 28B**), and, if positive, the number of CFUs was very small (below 100, data not shown). Therefore, BCG does not persist in the bladder, and its dose decays quickly.

Of note, such approach might be well complemented by quantitative PCR, in order to look for the presence of bacterial DNA, but I did not pursue that line of research.



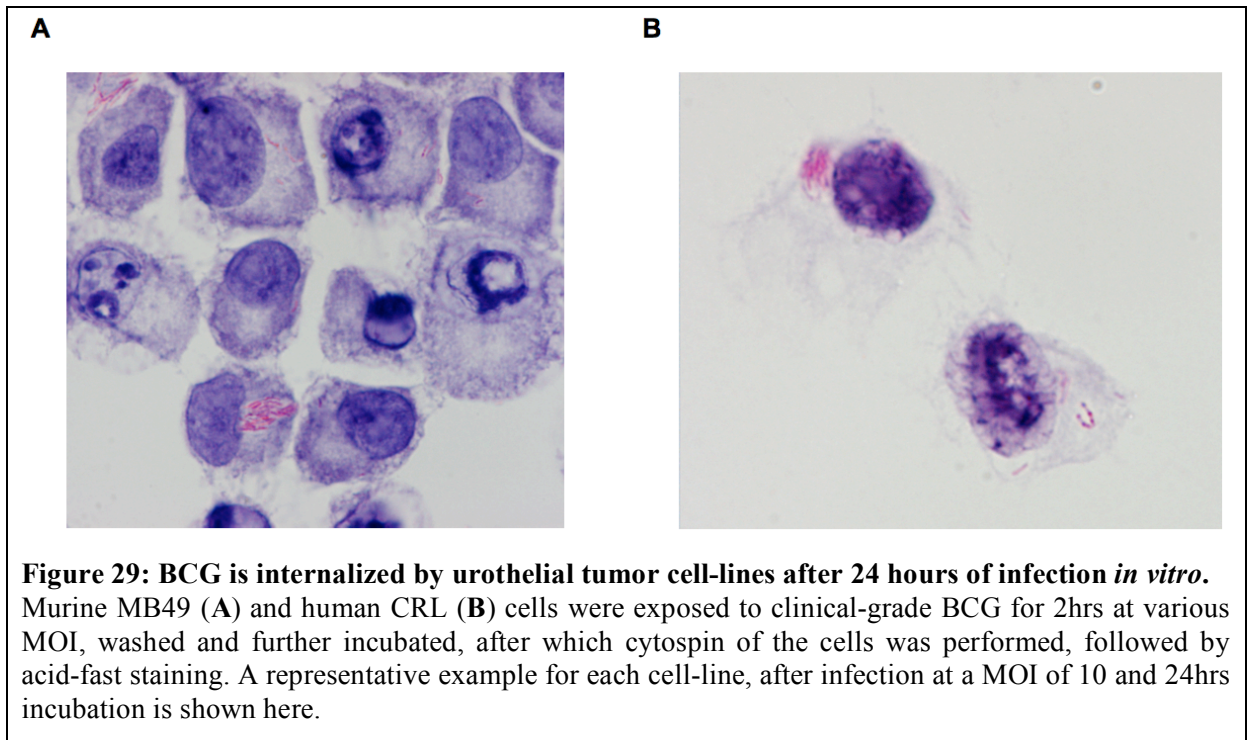
## 2) Does BCG infect urothelial cells?

As mentioned in General Introduction (see Section III.A.3)), there is conflicting data about the ability of BCG to infect normal or transformed urothelial cells (Bevers et al., 2004; Saban et al., 2007). As such, I performed a few experiments to evaluate the question, but a clear answer would require additional experiments.

### (a) *In vitro* analysis

Primary urothelial cultures are difficult to maintain, therefore my *in vitro* experiments only focused on transformed urothelial cell lines (human CRL cells and murine MB49 cells). These cell-lines were exposed to clinical-grade BCG, at various multiplicities of infection (MOI = 10, 1 and 0.1). After various times of incubation, cytopsin was performed on the cells, followed by acid-fast staining, in order to determine if cells had internalized bacteria. Of note, acid-fast staining is effective at revealing live and dead bacteria (which matters a lot in the case of the use of a lyophilized preparation); however, its sensitivity is known to be rather poor, thus reducing confidence in my estimations.

After a 2 hours exposure (corresponding to the *in vivo* dwell time), ~1% of tumor cells were found infected, only at an elevated MOI pf 10 (data not shown). After 24 hours infection, almost all cells were found to contain BCG (most often clumps of bacteria) at the MOI of 10 (**Figure 29**), whereas a low percentage of cells were found to contain BCG at lower MOI (data not shown).

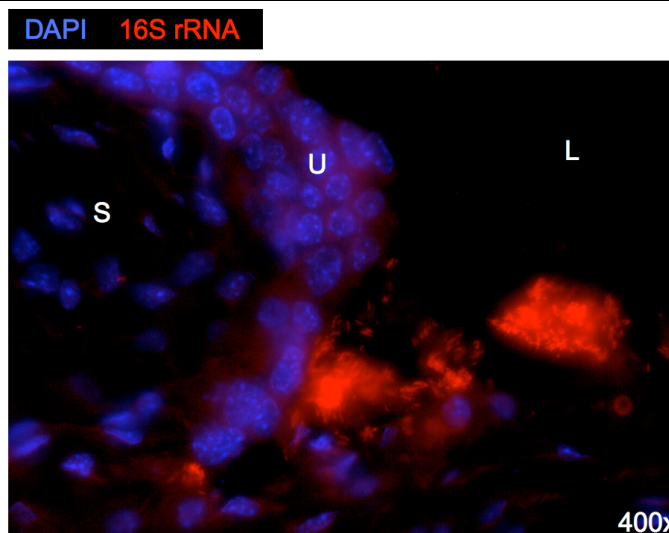


This experiment shows that, *in vitro*, BCG can indeed be internalized by urothelial tumor cell-lines, with rather low efficiency. However, there are 2 main caveats in using *in vitro* systems: first, I am restricted to looking at tumor cell-lines (not primary urothelial cultures); second, it seems to me much easier for the bacteria to be internalized by cells while sitting on top of a layer of cells for an extended period of time (at least, by gravity, they will remain in contact with the cells), rather than *in vivo*, in a 3D empty surface coated by an impermeable layer of uroplakins, during a time period restricted to 2 hours.

(b) *In vivo*

*In vivo*, I made a few unsuccessful attempts to see whether BCG could be found within urothelial cells. Using acid-fast staining or a fluorescent FISH probe against bacterial 16S ribosomal RNA (developed by Eberl and colleagues), I could image BCG at 2 hours, just after voiding: clumps of bacteria were mainly localized in the lumen of the bladder, and some of them were found contacting the mucosal surface (**Figure 30**).

However, I did not have a marker for the plasma membrane of urothelial cells, such that the internalization of bacteria remained questionable: indeed, bacteria might just be sticking to the plasma membrane, or might even only be in close vicinity to the mucosal surface (**Figure 30**). After 4 hours, I could detect very few clumps of bacteria, and again, the precise localization of the bacteria was not clear to me (data not shown).



**Figure 30: *In vivo* fluorescence imaging of BCG contacting the bladder wall, shortly after removal of the catheter.**

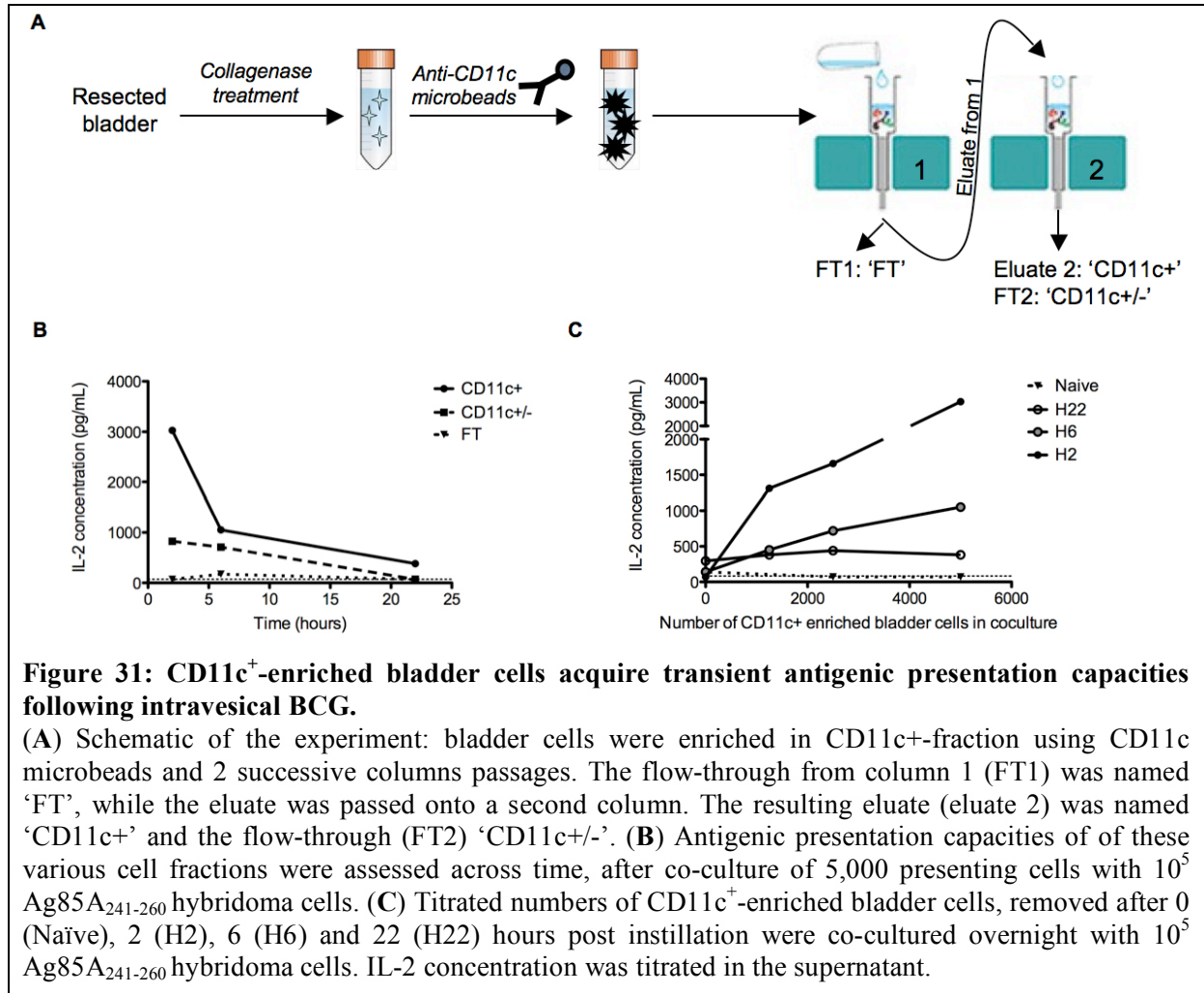
A representative section of the bladder, shortly after removal of the catheter. Cell nuclei are stained with DAPI (blue) and bacteria are stained with a FISH probe against bacterial 16S ribosomal RNA (red). 400x magnification. L: lumen; U: urothelium; S: submucosa.

Of note, it is striking to see that BCG – that was prepared from clinical-grade lyophilized vials – made rather large clumps (**Figure 30**). As already mentioned in Section 0 we chose to work with clinical-grade bacteria, given that BCG formulation and dispersion might both impact on the immune response. Therefore, we did not make use of any tool that is usually employed in mycobacteria labs to dissociate clumps (e.g., glass beads, sedimentation and/or syringe passages, as described in Materials and Methods Sections III.B and III.D). That said, the clinical-grade resuspended preparation could easily pass through 26Ga-syringes (as done prior to titration, see Materials and Methods Section III.C), which indicates that the clumps were much smaller (or much easier to disperse) than the clumps that arise during lab culture of mycobacteria, as described in Materials and Methods (see Section III.B). Indeed the latter do not pass through 26Ga syringes prior to glass beads dispersion and sedimentation.

### 3) Dendritic cells acquire the capacity to present BCG

As it was rather difficult to visualize BCG in the bladder, I decided to ask the question from a different perspective. I asked whether various cell populations from the bladder could acquire the capacity to present a BCG-specific peptide, IA<sup>b</sup>-restricted Ag85A<sub>241-260</sub>, at various time points following an intravesical BCG instillation. For that purpose, I made use of a specific hybridoma CD4<sup>+</sup> T cell-line (kindly provided by Laleh Majlessi, (Majlessi et al., 2006)), which specifically recognizes Ag85A<sub>241-260</sub> if presented by antigen presenting cells in coculture. Titration of IL-2 in the supernatant after overnight coculture of the hybridoma with varying numbers of sorted antigen presenting cells from the bladder would then give an

indication of which bladder cells have acquired the capacity to present a BCG-specific antigen. Positive and negative controls for the experiment involved the use of 5,000 sorted cells spiked with IA<sup>b</sup>-restricted Ag85A<sub>241-260</sub> or an unrelated IA<sup>b</sup>-restricted ESAT6 peptide (data not shown).



In these experiments, at various time points following intravesical BCG instillation, antigen-presenting cells from the bladder were enriched using CD11c microbeads (Miltenyi) and 2 successive column passages (**Figure 31A**). Despite this procedure, cell purity – which was controlled by flow cytometry – was not ideal and in **Figure 31** shown below:

- 'CD11c<sup>+</sup>' fraction (**Figure 31A**) is the eluate from the second column and contains ~60% DCs among leukocytes (and 60% leukocytes among the cell preparation). The remaining cells are mostly MHCII<sup>+</sup> CD11c<sup>-</sup> Ly-6C<sup>int</sup> CD11b<sup>+</sup> cells. Importantly this fraction is the only one to contain DCs (**Figure 31A**).
- 'CD11c<sup>+/-</sup>' fraction (**Figure 31A**) is the flow-through from the second column and contains few leukocytes (10%), which mostly are Ly6C<sup>int</sup> and Ly6C<sup>hi</sup> CD11b<sup>+</sup> monocytes.



- The flow-through fraction from the first column (**Figure 31A**) contains very few leukocytes (3%), which mostly are MHCII<sup>+</sup>, including monocytes and neutrophils.

Despite poor cell purity, I was able to show that the CD11c<sup>+</sup>-enriched fraction was able to efficiently present BCG-specific peptide to the hybridoma (**Figure 31B-C**). Other cell fractions had rather poor presentation capacities (**Figure 31B**). Presentation capacities by the CD11c<sup>+</sup> fraction were transient, as after 24 hours, no IL-2 production was detectable (**Figure 31C**).

If such experiments had to be repeated, FACS-sorting might be a good option to increase purity.

In summary, I developed a protocol for intravesical instillations closely tuned to clinical protocols. Though BCG does not persist a long time in the bladder, and though I am not sure which cells are infected, BCG antigenic presentation can occur.

### **III. THE CHARACTERIZATION OF THE BLADDER IMMUNE RESPONSE IDENTIFIES A STRATEGY FOR IMPROVING ANTI-TUMOR ACTIVITY**

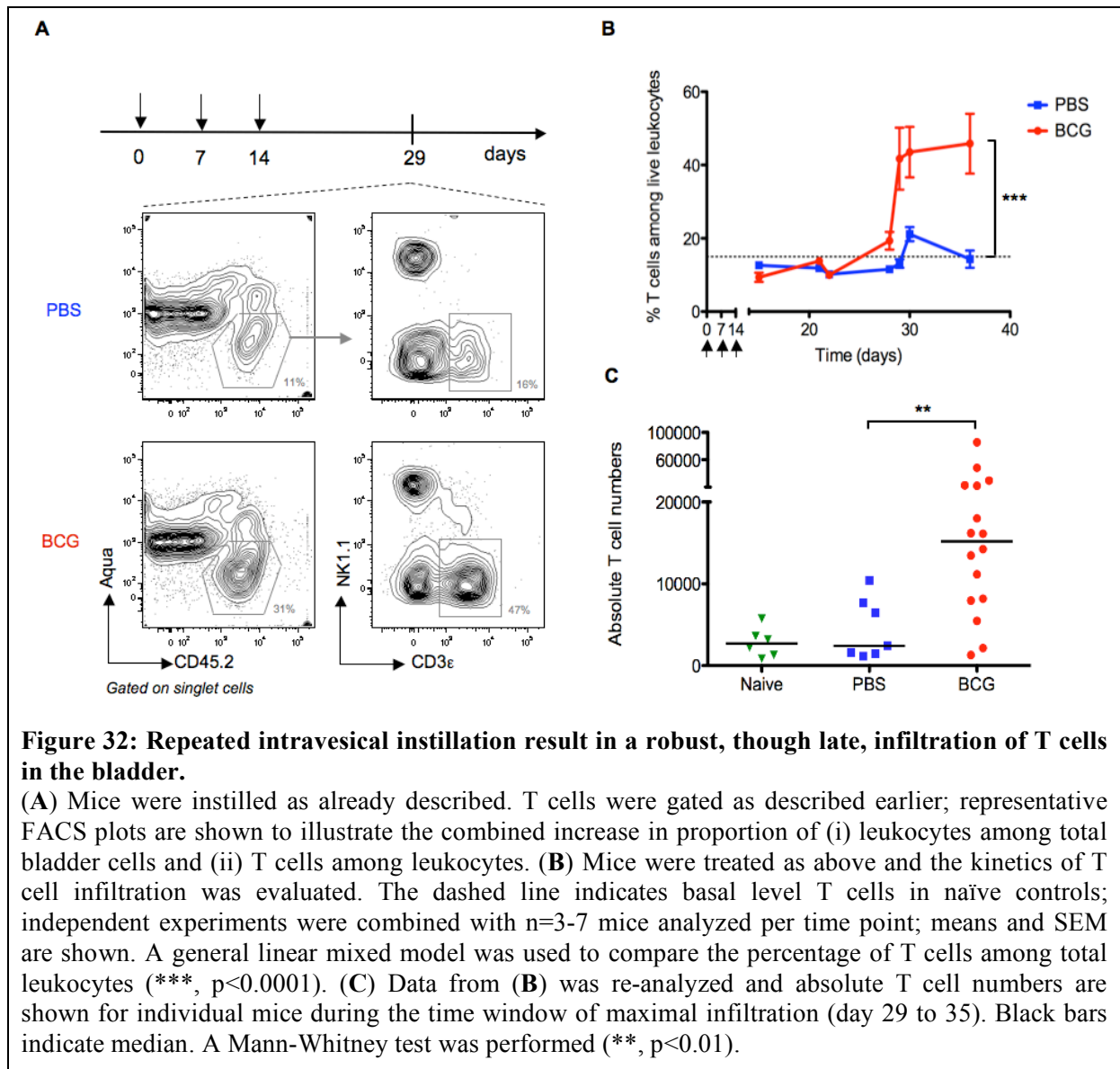
The aforementioned tools allowed me to address several important unknowns about the dynamics of the immune response following intravesical BCG regimen, including: the link between bacterial persistence / dissemination and T cell priming; the role of multiple instillations in triggering T cell influx in the bladder; and the temporal relationship between T cell priming and T cell entry into the inflamed bladder microenvironment. In the course of these studies, I uncovered a strategy that improved BCG-mediated anti-tumor activity.

#### **A. Repeated intravesical instillations of live BCG result in a robust, though late, infiltration of activated $\alpha\beta$ T cells into the bladder**

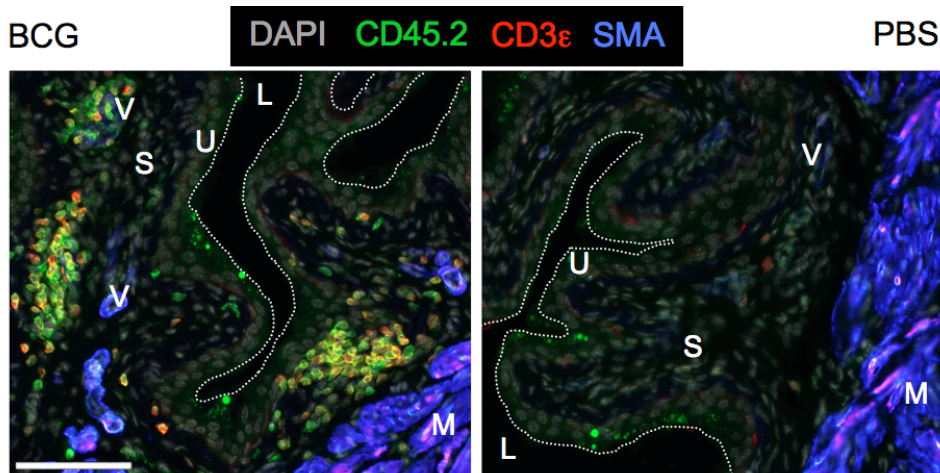
##### 1) Repeated intravesical instillations of BCG result in a robust, though late, infiltration of T cells into the bladder

To determine the dynamics of T cell infiltration into the bladder, I intravesically instilled mice according to the protocols defined above (see Section II.A). At defined time points, bladders were resected, digested as detailed above (see Section II.B.1)), and stained for cytometric analysis. Twenty-nine days after the start of the treatment, there was a robust increase in both the percentage of T cells among total leukocytes infiltrating the bladder (**Figure 32A-B**,

instillation with BCG vs. PBS  $p < 0.001$ ) and their absolute number (**Figure 32C**, instillation with BCG vs. PBS  $p < 0.01$ ).



Once established, this infiltration was sustained in the absence of additional treatments for greater than 10 days (**Figure 32B**). Additionally I demonstrated that administration of a fourth weekly instillation did not alter the kinetics of T cell influx into the bladder (data not shown). Bladder T cells were predominantly found within the submucosa in the vicinity of blood vessels, with some having infiltrated the urothelium (**Figure 33**).

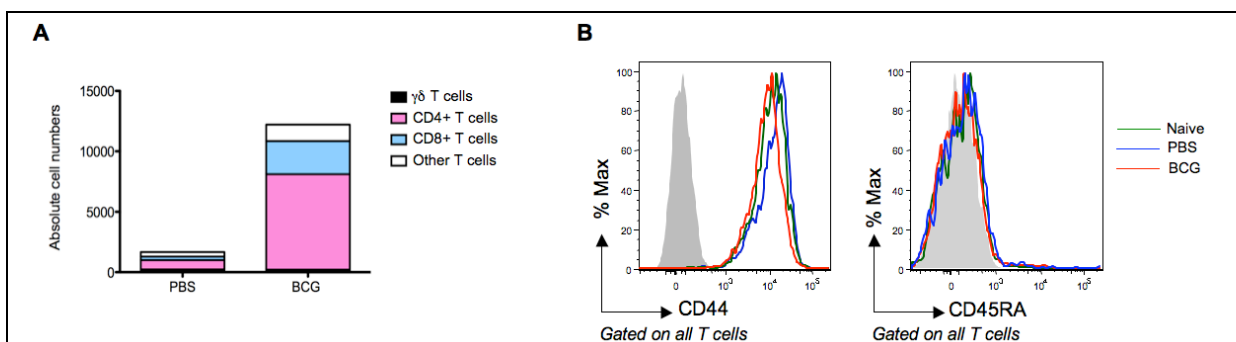


**Figure 33: T cells are mostly located within the submucosa.** Immunofluorescence staining after 3 repeated instillations (days 0,7,14) at day 33 is shown. Nuclei were stained with DAPI (grey), leukocytes with CD45.2 (green) and T cells with CD3ε (red), whereas α-smooth muscle actin (SMA, blue) staining indicates the smooth muscle layer of blood vessels (V) and the bladder muscle layer (M). A dotted white line demarcates the bladder lumen (L), the thin urothelial layer (U) and the submucosa (S) are indicated. Scale bar = 100μm.

2) Bladder infiltrating T cells are mostly activated αβ T cells

Phenotypic assessment demonstrated that greater than 70% of the T cells were αβ CD4<sup>+</sup> and CD8<sup>+</sup> T cells (**Figure 34A**).

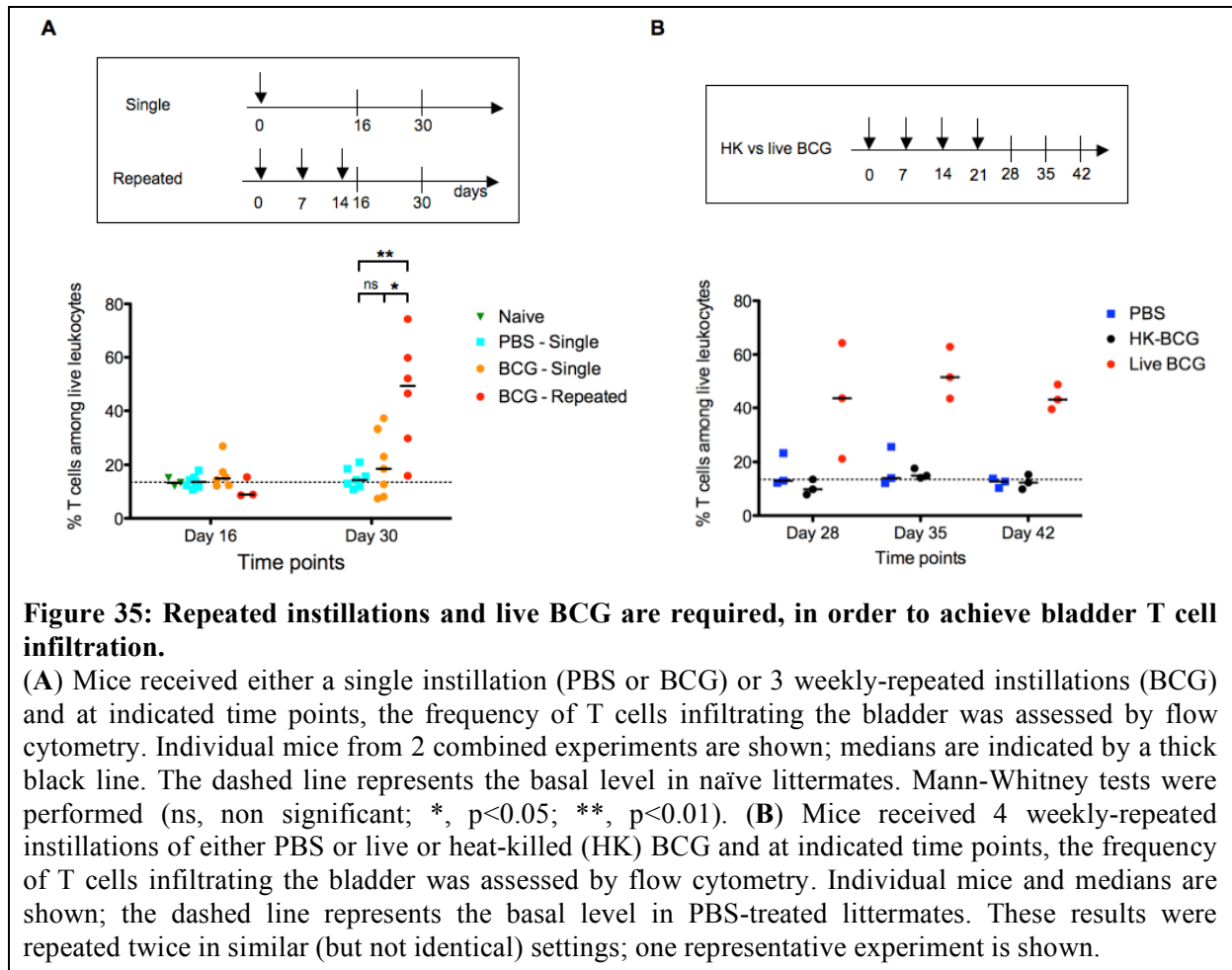
In addition, all bladder T cells had an antigen-experienced phenotype, based on expression of CD44 and absence of CD45RA (**Figure 34B**). That said it should be noted that, while fewer in number, resident T cells were also CD45RA<sup>-</sup> CD44<sup>hi</sup>, suggesting that entry into the submucosa was restricted to previously activated T cells.



**Figure 34: Bladder infiltrating T cells are mostly activated αβ T cells.** (A) T cells infiltrating the bladder were further gated as CD4<sup>+</sup>, CD8<sup>+</sup> and γδ T cells as described above. Average numbers of T cell subpopulations are displayed; n=4 mice per group, from 1 representative experiment (among >10). (B) Bladder infiltrating T cells were assessed by cytometry for an activated phenotype based on CD44 expression and absence of CD45RA. A representative histogram is shown. Shaded histograms indicate fluorescence minus one. This experiment was repeated twice.

### 3) A requirement for repeated instillations and for live BCG

Early attempts to use BCG as an anti-cancer agent have reported anti-tumor activity after a single intratumoral injection with BCG (Zbar et al., 1971). I therefore asked if robust bladder T cell infiltration could be achieved following a single instillation of BCG, but T cell frequency in the bladder never increased much above the basal level (**Figure 35A**).



In addition, early clinical investigation in humans suggested that live BCG was required in order to achieve tumor immunity (Kelley et al., 1985; Zbar, 1972). To establish whether T cell recruitment was indeed dependant on live bacilli, I compared repeated intravesical instillations of clinical-grade BCG (containing live BCG) *versus* heat-killed BCG. As expected, the latter did not result in T cell recruitment to the bladder (**Figure 35B**).

## **B. Priming of T cells and their entry into the bladder are uncoupled, following intravesical BCG instillations**

To assess the requirement for live BCG to activate adaptive immunity components, I evaluated BCG dissemination with the hypothesis that its entry into the bladder draining LN is a pre-requisite for priming and subsequent T cell infiltration of the bladder. Such a

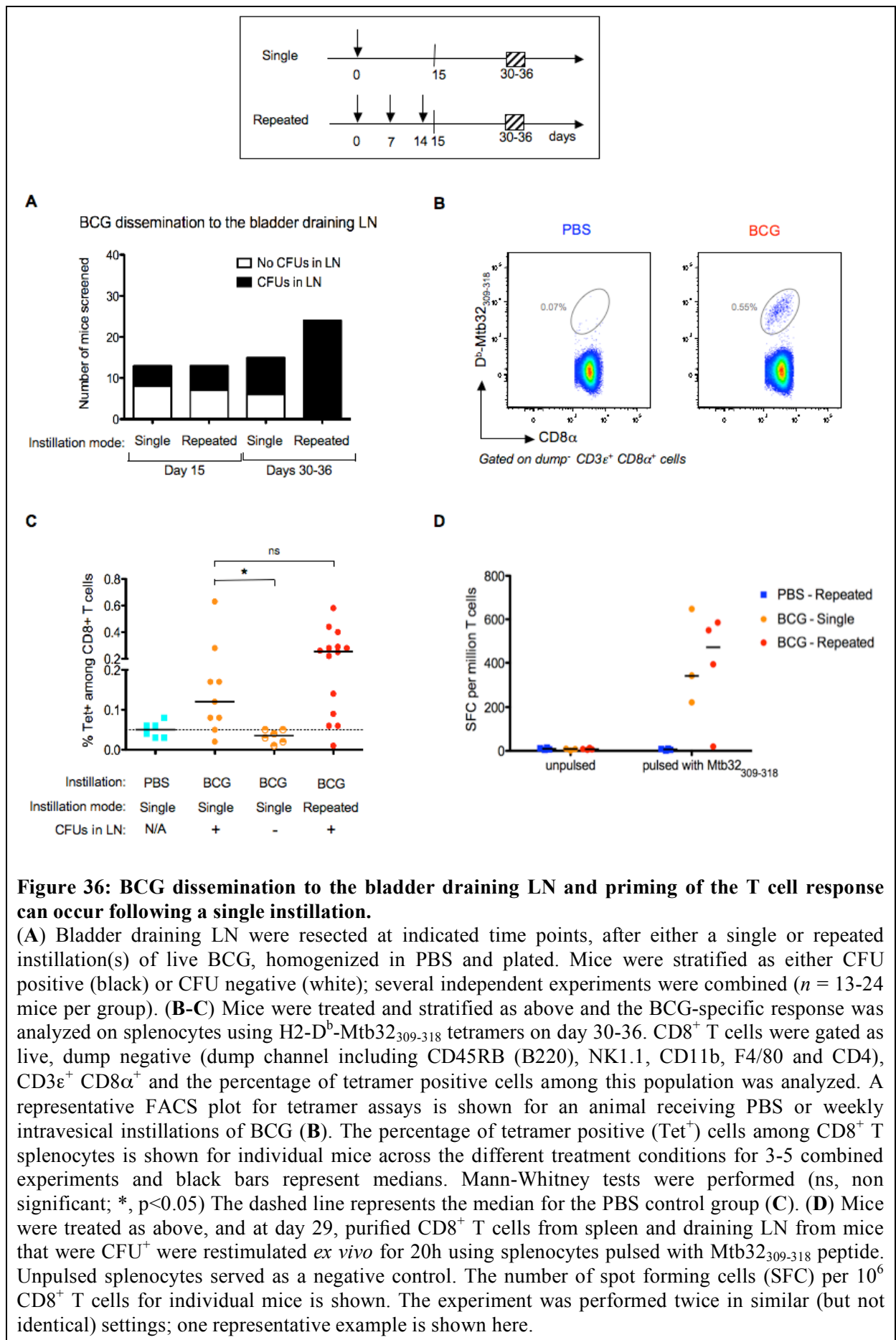
requirement has indeed been well documented in the context of low-dose *Mtb* lung infection (Chackerian et al., 2002; Reiley et al., 2008; Wolf et al., 2008).

1) BCG can disseminate to the bladder draining lymph nodes following a single instillation

As already mentioned, the BCG load in the bladder rapidly decreases to 1% of the instilled dose and is barely detectable by 24h post-instillation (see Section II.D.1) and **Figure 28A**). I investigated the presence of live BCG in the peri-aortic draining LN. As an additional parameter I tested single *versus* weekly-repeated instillation(s), as a single instillation did not result in sustained T cell infiltration in the bladder (**Figure 35A**), which I hypothesized might be linked with a defect in BCG dissemination and priming of the T cell response. Indeed, the rapid decay of BCG load in the bladder led me to hypothesize that repeated doses of live BCG might be required to result in efficient BCG dissemination to the draining LN.

Mice were intravesically instilled with BCG and the peri-aortic LN were homogenized and plated at defined time points. Analysis of early time points (hours) after a single instillation demonstrated no bacterial growth (data not shown), thus indicating that bacilli were not tracking to the LN due to passive processes (e.g., resulting from potential trauma and/or anti-grade pressure during the instillations).

Mice were tested for up to 1 month following single or repeated BCG instillation(s) and when bacterial growth was observed, the total CFUs per LN ranged from 8 to 1,700 colonies (median CFU = 50). Due to the high variance, I scored animals as positive or negative for the presence of live BCG in the LN. Overall, I observed that 40-60% mice harbored BCG in their peri-aortic LN after a single intravesical instillation – this was consistent across a time course of 15 – 36 days (**Figure 36A**). In comparison, mice receiving multiple instillations also showed a mixed response at 15 days, but by day 30-36, BCG could be cultivated from the peri-aortic LN of all mice (**Figure 36A**).



## 2) BCG dissemination to the LN correlates with priming of BCG-specific IFN $\gamma$ -producing CD8<sup>+</sup> T cells

I next evaluated the priming of BCG peptide-specific T cells, assessed using H2-D<sup>b</sup>-Mtb32<sub>309-318</sub> tetramers (also known as PepA or GAP) (Irwin et al., 2005) (**Figure 36B**). Interestingly, when mice were stratified based on the presence of live BCG in their peri-aortic LN, I found that the majority of CFU<sup>+</sup> animals possessed a high frequency of BCG-specific CD8<sup>+</sup> T cells among total splenocytes. In contrast, there was no expansion of D<sup>b</sup>- Mtb32<sub>309-318</sub> reactive T cells in mice for which live BCG was undetectable (**Figure 36C**). When comparing mice that had received single or repeated instillations, the critical parameter was the presence of live BCG (**Figure 36C**).

Of note, time points for analysis were chosen so that the bladder infiltration could be assessed in parallel (days 30 to 36). At such time points, the frequency of Tet<sup>+</sup> cells was measurable in the spleen whereas in the draining LN it was found to be close to the limit of detection (data not shown), most probably because primed T cells had started recirculating. In one preliminary experiment, draining LN were found to contain a measurable proportion of Tet<sup>+</sup> cells from days 25 to 29 (data not shown), i.e., prior to T cell entry into the bladder, and therefore such time points – and thereby analysis of Tet<sup>+</sup> frequency in draining LN – was not carried over.

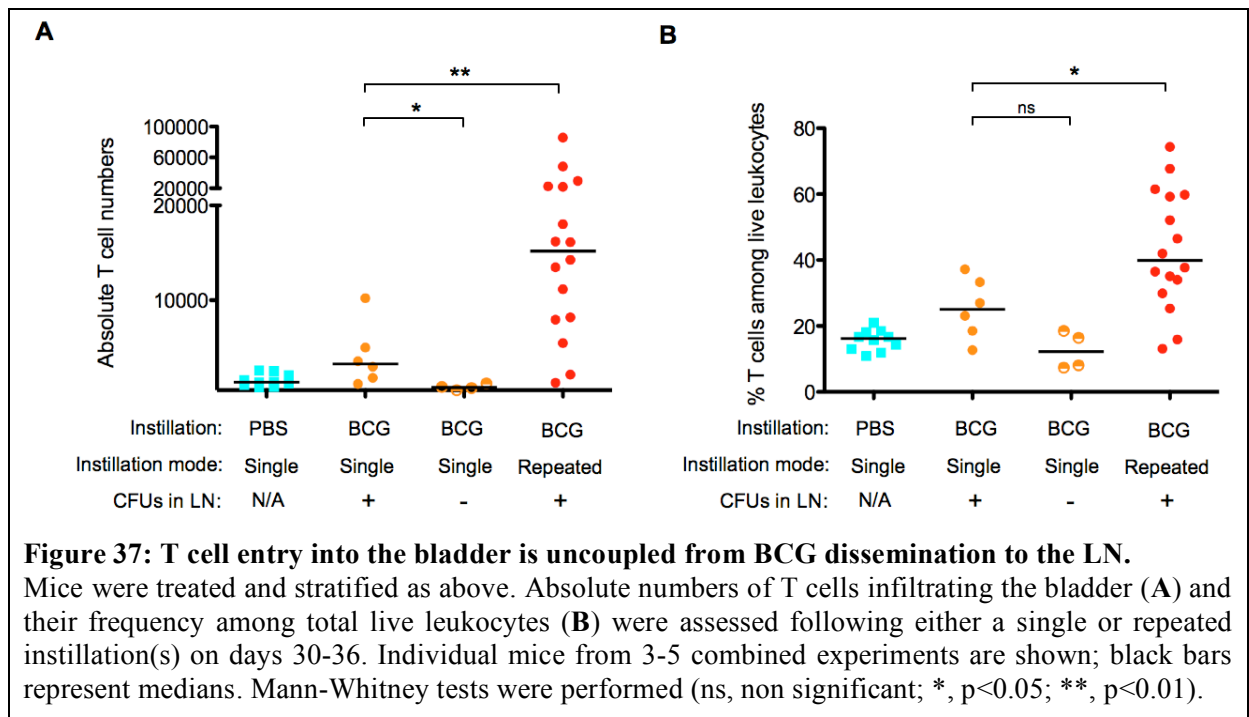
I next assessed the capacity of CD8<sup>+</sup> T cells purified from spleen and peri-aortic LN to produce IFN- $\gamma$  upon restimulation with Mtb32<sub>309-318</sub> peptide in an ELISPOT assay. In mice harboring live BCG within their LNs, I found similar numbers of spot forming cells (SFCs) irrespective of the number of instillations (**Figure 36D**). These data demonstrate that the priming of IFN- $\gamma$  producing BCG-specific T cells can occur following a single instillation and correlates with BCG dissemination to the bladder draining LN.

## 3) T cell entry into the bladder is uncoupled from BCG dissemination to the LN

To investigate if dissemination of BCG also correlated with local adaptive immunity, I examined lymphocyte populations in the bladder.

While I observed low levels of T cell infiltration in CFU<sup>+</sup> animals (**Figure 37**,  $p < 0.05$ ), the level of infiltration was significantly lower in mice that had received single *versus* repeated instillations (**Figure 37**,  $p < 0.01$ ).

Together these data suggest that priming of T cells may be uncoupled from their accumulation in the bladder.



## C. Pre-existing adaptive immunity supports a robust intravesical immune response

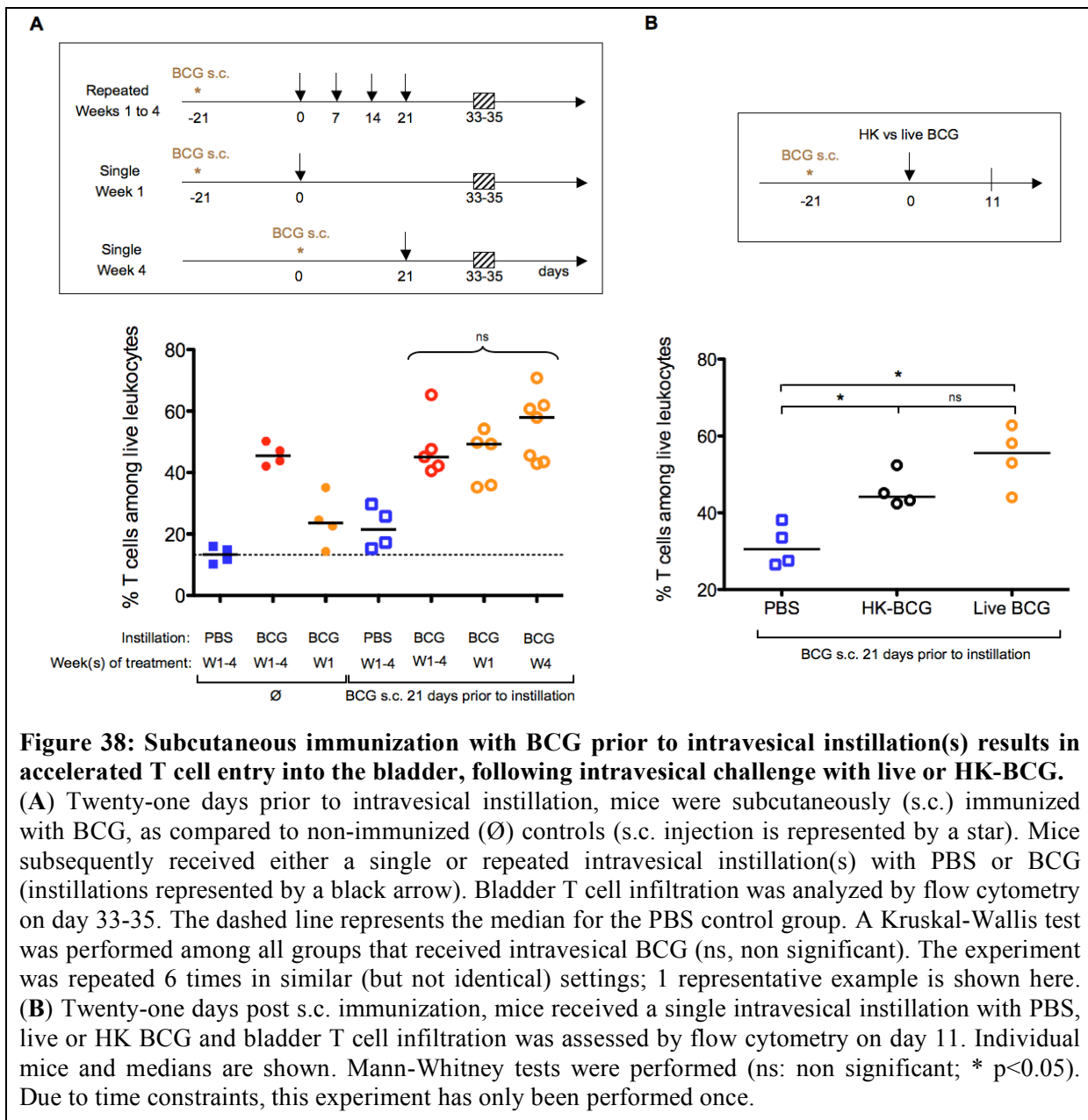
### 1) Subcutaneous immunization with BCG results in accelerated T cell entry into the bladder, following intravesical challenge with live or HK-BCG

#### (a) *Subcutaneous immunization with BCG overcomes the requirement for repeated instillations*

To further test the dissociation of priming from T cell trafficking, I evaluated whether the activation of BCG-specific T cells prior to bladder instillations would impact T cell recruitment during the first intravesical instillation. Mice were injected subcutaneously (s.c.) with BCG, and after 21 days, intravesical instillations were initiated – comparing single vs. repeated BCG challenge.

In mice primed by s.c. BCG, I observed a robust T cell infiltration as early as 12 days following a single instillation (**Figure 38A**, s.c. - BCG W4), which lasted up to 35 days post instillation (**Figure 38A**, s.c. - BCG W1). Of note, the level of T cell accumulation in the bladder was similar to that achieved by multiple intravesical treatments (**Figure 38A**, BCG W1-4). Interestingly, repeated instillations in the s.c. primed group (**Figure 38A**, s.c. - BCG W1-4) did not result in an enhanced accumulation of T cells as compared to other treatment conditions, suggesting that maximal intravesical responses can be achieved by a s.c. injection of BCG followed by a single instillation of BCG.





**Figure 38: Subcutaneous immunization with BCG prior to intravesical instillation(s) results in accelerated T cell entry into the bladder, following intravesical challenge with live or HK-BCG.** (A) Twenty-one days prior to intravesical instillation, mice were subcutaneously (s.c.) immunized with BCG, as compared to non-immunized ( $\emptyset$ ) controls (s.c. injection is represented by a star). Mice subsequently received either a single or repeated intravesical instillation(s) with PBS or BCG (instillations represented by a black arrow). Bladder T cell infiltration was analyzed by flow cytometry on day 33-35. The dashed line represents the median for the PBS control group. A Kruskal-Wallis test was performed among all groups that received intravesical BCG (ns, non significant). The experiment was repeated 6 times in similar (but not identical) settings; 1 representative example is shown here. (B) Twenty-one days post s.c. immunization, mice received a single intravesical instillation with PBS, live or HK BCG and bladder T cell infiltration was assessed by flow cytometry on day 11. Individual mice and medians are shown. Mann-Whitney tests were performed (ns: non significant; \*  $p < 0.05$ ). Due to time constraints, this experiment has only been performed once.

*(b) Subcutaneous immunization with BCG overcomes the requirement for intravesical BCG to be alive*

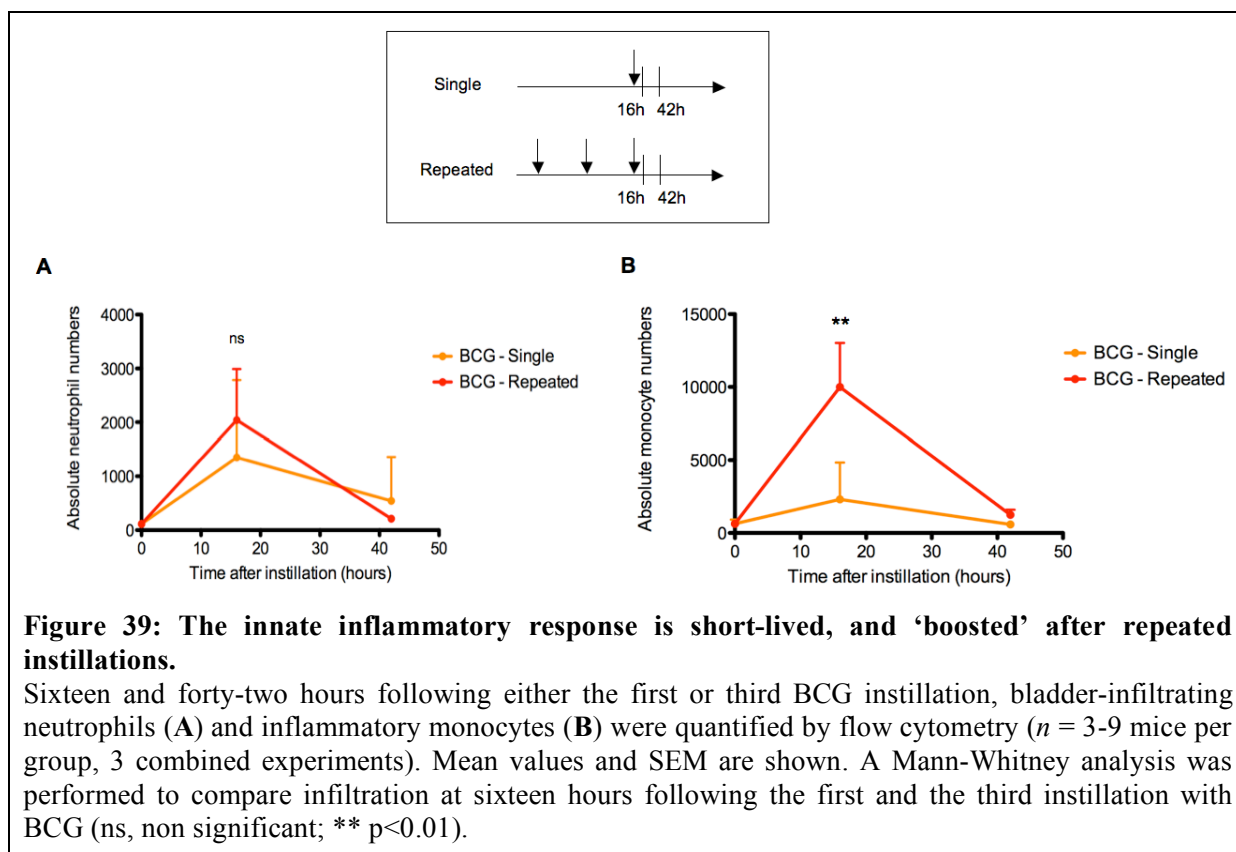
I next asked if s.c. immunization with live BCG prior to bladder instillations could overcome the requirement for live BCG in the intravesical challenge. In a preliminary experiment, this was the case as intravesical HK-BCG resulted in a significant recruitment of T cells in mice previously immunized s.c. with live BCG (**Figure 38B**, comparison to PBS,  $p < 0.05$ ).

2) The impact of various BCG regimens on the local acute inflammatory response in the bladder

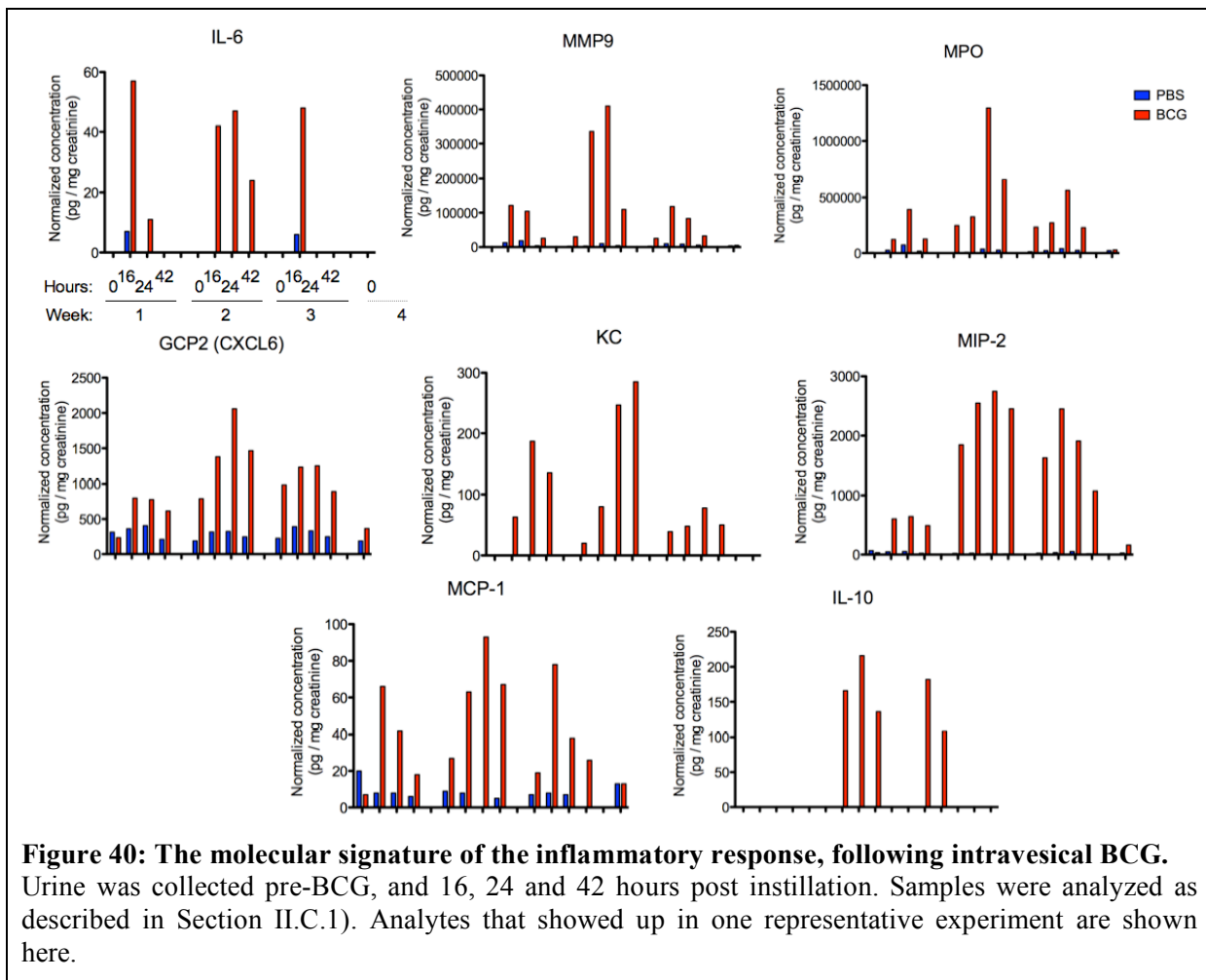
To further characterize the differential bladder T cell trafficking following different BCG regimens, I evaluated the local inflammation of the bladder mucosa.

(a) A 'boosted' inflammatory response following repeated instillations

Shortly after the first and the third instillation, I observed a rapid but short-lived (less than 42 hours post instillation) influx of neutrophils (characterized as Ly-6G<sup>+</sup> leukocytes, as described Section II.B.1)(c)) (**Figure 39A**) and inflammatory monocytes (characterized as Ly-6C<sup>high</sup> CD11b<sup>+</sup> Ly-6G<sup>-</sup> leukocytes, as described Section II.B.1)(c)) (**Figure 39B**). Notably, accumulation of inflammatory monocytes was significantly more pronounced after the third instillation (**Figure 39B**,  $p < 0.01$ ).



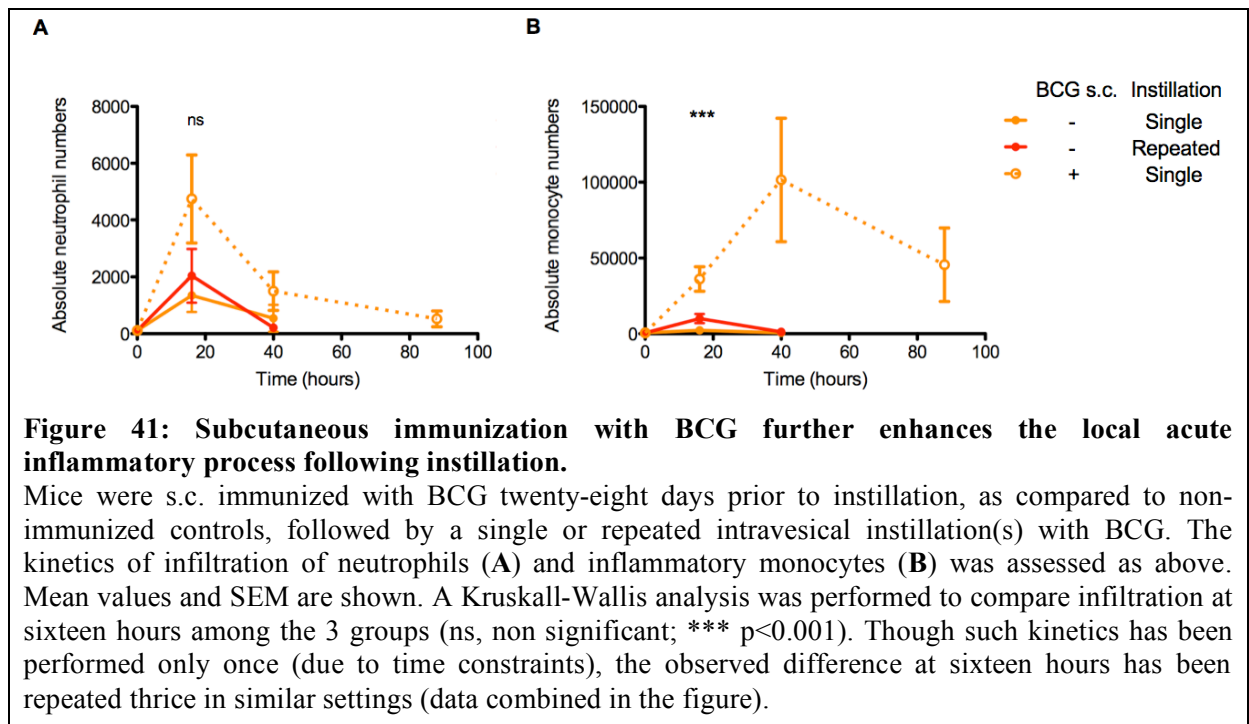
Of note, I tried several times to define the molecular signature in the urine, within 24-42 hours following repeated BCG instillations (see Section II.C.1)). The results that I obtained were rather variable, and I could not consistently observe a boost after the third instillation, nor downregulation of the response after 42 hours (**Figure 40**, compare across analytes, or across weeks for a given analyte; also, my own comparison across experiments, data not shown). The list of analytes that showed up was nonetheless rather consistent, and comprised of IL-6, KC (a mouse ortholog for IL-8), MIP-2 (another mouse ortholog for IL-8), CXCL-6 (a chemoattractant for neutrophils), MCP-1, IL-10, MMP-9 and MPO (**Figure 40**).



*(b) Subcutaneous immunization with BCG further enhances the local acute inflammatory process following instillation*

Interestingly, in animals that had received prior s.c. BCG, the infiltration of neutrophils and inflammatory monocytes after a single dose of intravesical BCG was more pronounced than in non-vaccinated animals, and was actually even stronger than that observed following repeated instillations with no prior s.c. exposure to BCG (**Figure 41**).

Of note, the peak of the response was shifted in time – rather ~40 hours than 16 hours –, but the inflammatory response remained acute, attenuating within 90 hours (**Figure 41**). As this kinetics data was obtained rather late in the project, the remaining of the observations dealing with the acute inflammatory response will focus on the 16-hour time point, based on the kinetics presented in **Figure 39**.

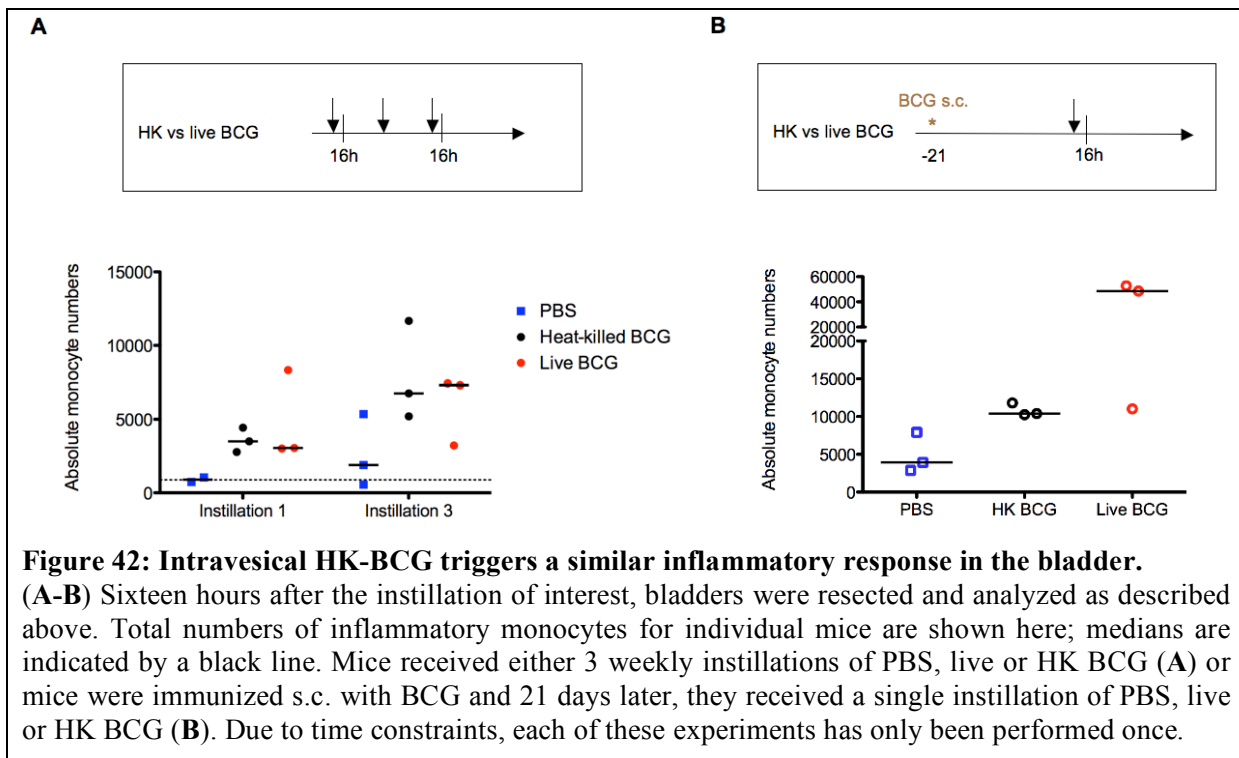


*(c) Intravesical HK-BCG triggers a similar inflammatory response*

Repeated intravesical instillations with HK-BCG do not result in T cell recruitment to the bladder. In a preliminary experiment, I wondered if this could be due to a different inflammatory response, but the influx of inflammatory monocytes was found to be similar after the first and the third instillation with either live (clinical-grade) or HK-BCG (Figure 42A). Whether the response was really boosted after the third instillation (as reported in Section III.C.2)(a)) is a bit uncertain, as the experiment was not repeated (due to time constraints) and contained only 3 mice per group.

Following s.c. immunization with live BCG, I could show that a single intravesical instillation with HK-BCG resulted in a robust inflammatory response, as assessed by the number of inflammatory monocytes infiltrating the bladder shortly after instillation (Figure 42B). The level of the response however seemed lower than that obtained with clinical-grade BCG, but whether this is really significant is unclear as, again, the experiment was done only once with 3 mice per group (again, due to time constraints).

Based on these results, together with data presented in Figure 35B, I suggest that the failure to achieve T cell infiltration of the bladder following intravesical HK-BCG is due to a lack of T cell priming. Indeed, the activation of a local intravesical innate immune response during HK-BCG challenge is sufficient to attract previously primed T cells.



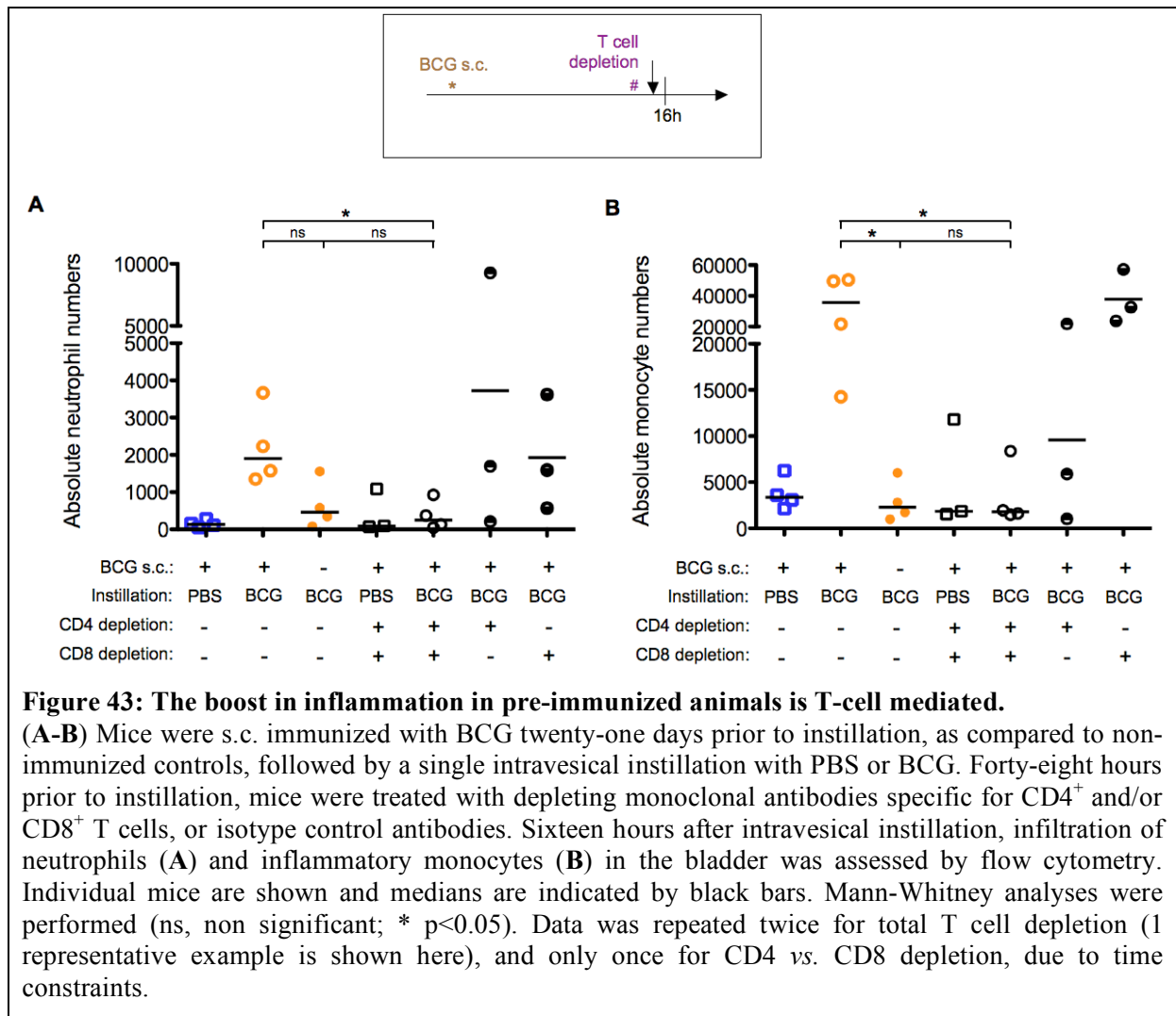
### 3) The boost in inflammation in pre-immunized animals is T-cell mediated

Given the robust inflammatory process observed in mice immunized s.c. with BCG, I hypothesized that the existence of BCG-specific T cells at the time of instillation was impacting upon the acute inflammatory process. To test this possibility, mice previously immunized s.c. with BCG were subjected to anti-CD4 and anti-CD8 depleting antibodies 48h prior to intravesical instillation.

Following T cell depletion, I demonstrated a decrease in the number of neutrophils and inflammatory monocytes infiltrating the bladder (**Figure 43**,  $p < 0.05$ ). Interestingly, the level of the inflammatory response in the group of mice that underwent transient depletion was in the range of what is observed following the first instillation with no prior s.c. BCG exposure (**Figure 43**). Such experiment yielded similar results twice in similar, but not identical, settings (once with semi-purified ascitic fluids, kind gift from Leclerc lab – data not shown – and once with monoclonal antibodies – **Figure 43**).

I further asked whether the boost in inflammation could be attributed to CD4<sup>+</sup> or CD8<sup>+</sup> T cells. From a preliminary experiment – shown in combination with a representative experiment depleting both CD4<sup>+</sup> and CD8<sup>+</sup> T cells –, it seems that CD4<sup>+</sup> T cells are required for the boosted infiltration with inflammatory monocytes, whereas CD8<sup>+</sup> T cells are dispensable (**Figure 43B**). As for neutrophils, both CD4<sup>+</sup> and CD8<sup>+</sup> T cells seem to contribute to the boosted infiltration (**Figure 43A**), though from our own experience, neutrophil numbers

are often more variable, and always much lower, than numbers of inflammatory monocytes. Due to time constraints, this experiment has not been repeated to date.



Together, these data suggest that T cell, primed by s.c. BCG, and most importantly CD4<sup>+</sup> T cells, mediates the ‘boosted’ inflammatory response following intravesical BCG.

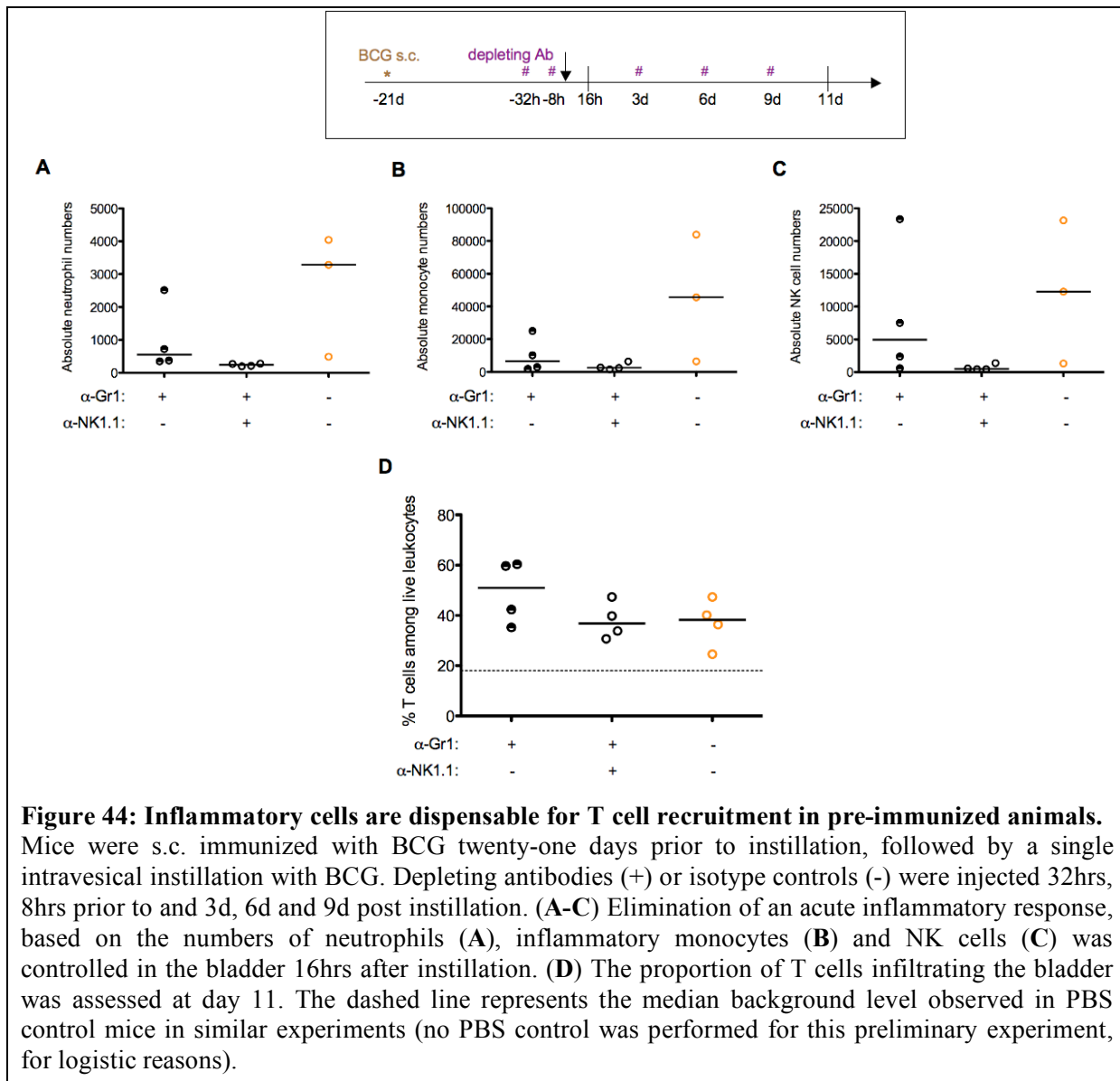
#### D. Molecular mechanisms involved in the recruitment of T cells to the bladder

I was curious to know the molecular mechanisms resulting in T cell entry into the bladder. I made several attempts to try and answer this question, but, at that stage, I am only able to report negative and/or preliminary data.

##### (a) Inflammatory cells are dispensable

As pre-existing immunity to BCG results in (i) a more robust acute inflammatory response and (ii) T cell entry into the bladder, my first hypothesis was that the robust burst of

inflammation, mostly due to high numbers of neutrophils and inflammatory monocytes, had a direct or indirect effect on the recruitment of T cells. To test that hypothesis, I made use of the Gr-1 antibody, which is known to deplete both Ly6G and Ly6C positive cells, i.e., mostly neutrophils and inflammatory monocytes (Daley et al., 2008), in combination or not with a depleting antibody against NK cells, which might play a role in acute inflammation too. Based on blood analyses, depletion with both antibodies is rather transient (data not shown), therefore I injected depleting antibodies every 72 hours over the course of the kinetics.

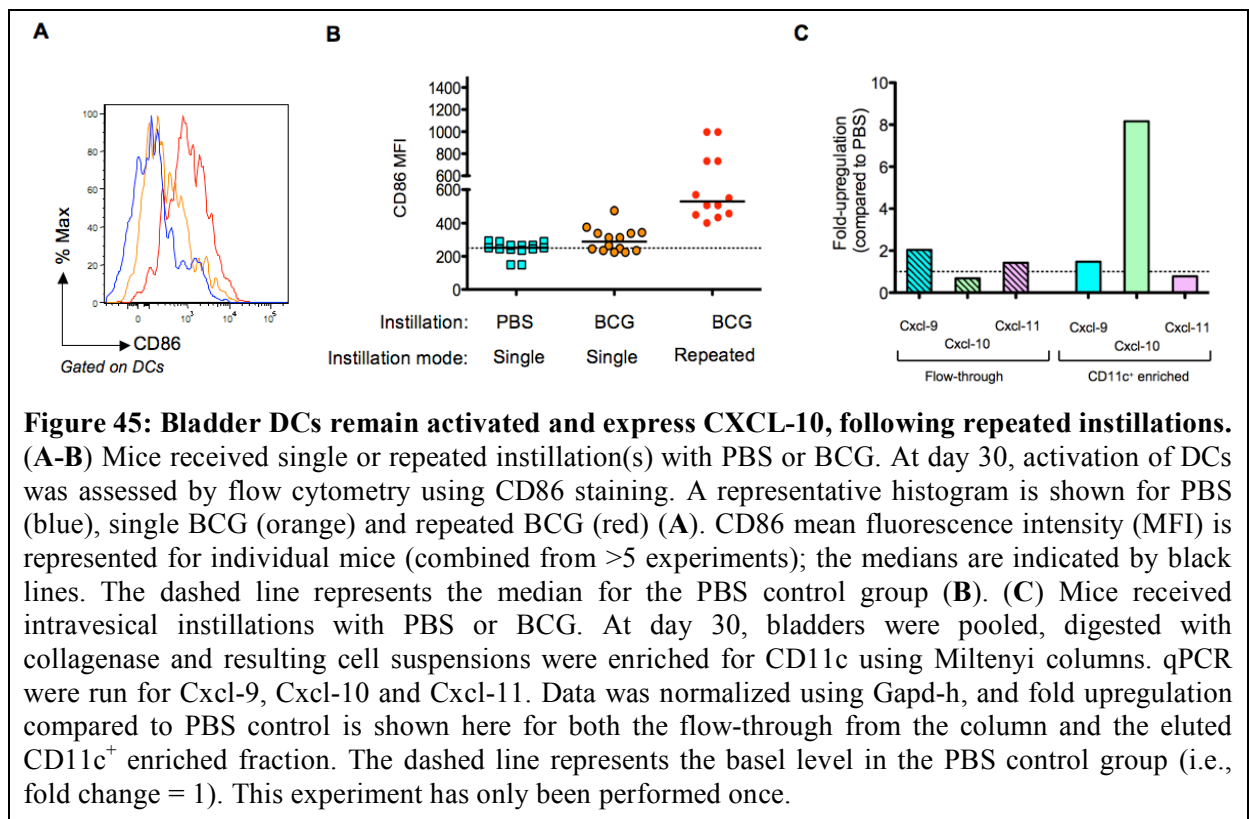


Due to time constraints, the experiment has only been performed once until now, and preliminary results did not validate my hypothesis: if depletion of all inflammatory cells, with Gr-1 antibody alone or Gr-1 together with NK1.1 antibody indeed resulted in the impairment of the robust acute inflammatory response shortly following instillation of mice previously primed with s.c. BCG (Figure 44A-C), it did not impair at all the recruitment of T cells

(**Figure 44D**). Such finding will be discussed in General Discussion (see Chapter 4 Section I.C.2)).

*(b) Bladder dendritic cells (DCs) remain activated and express CXCL-10, following repeated instillations*

Following repeated intravesical instillations, when T cells enter the bladder (15 days following the third instillation), the acute inflammatory response (composed of infiltration of inflammatory monocytes and neutrophils) has resolved for a while. I therefore wanted to know which cell population(s) is (are) responsible for secreting cytokines and chemokines involved in the observed T cell recruitment. I could observe that though the number of dendritic cells (DCs) did not increase much following repeated instillations (data not shown), DCs were activated (as shown by elevated CD86 costimulation molecule) at the time of T cell entry into the bladder (**Figure 45A-B**).

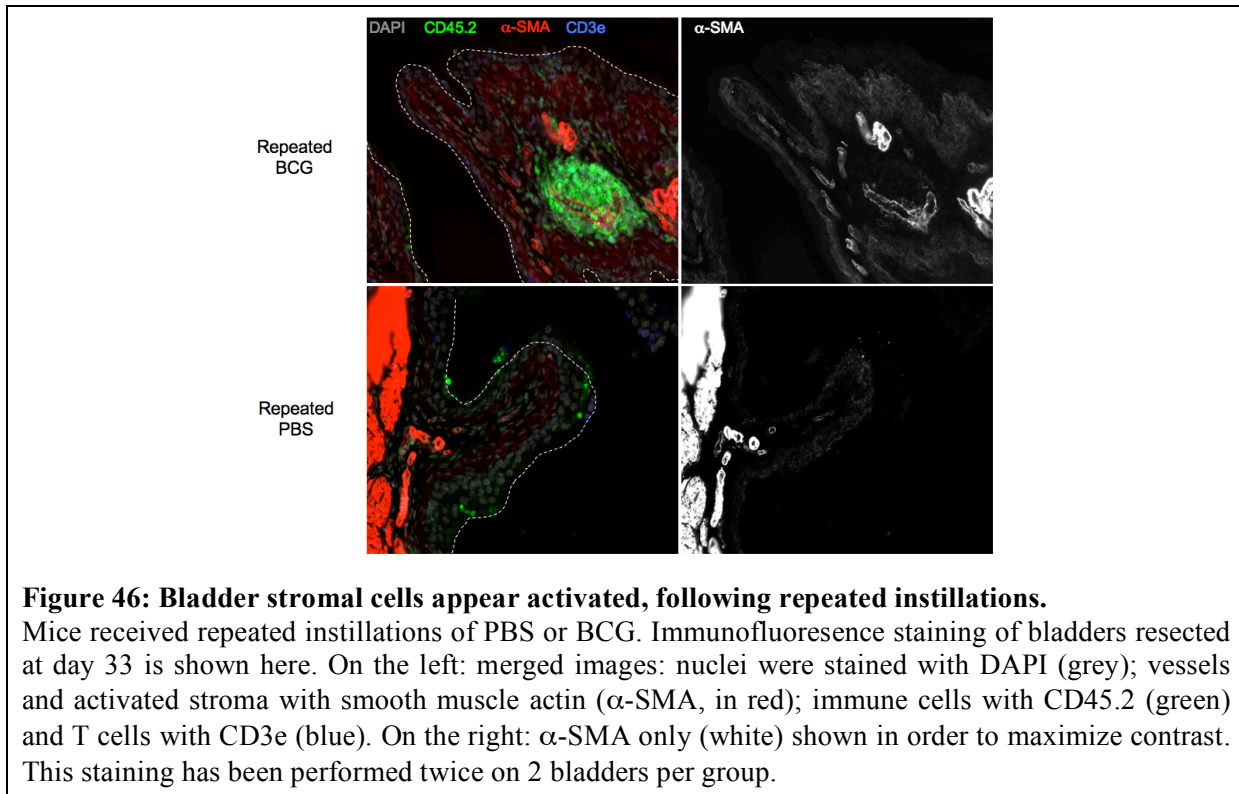


I was curious to know what kind of chemokines DCs might secrete, that could attract T cells. In a preliminary experiment, I digested pooled bladders after repeated instillations and enriched the cell suspension in DCs, using CD11c microbeads (Miltenyi). I looked at the transcriptional profile of this CD11c<sup>+</sup> enriched population and could show that CXCL-10 (but not CXCL-9 and CXCL-11) expression was elevated following repeated instillations with BCG, compared to a PBS control (**Figure 45C**).



*(c) Bladder stromal cells remain activated in the bladder, following repeated instillations*

Another cell population that seemed activated at that time was the stroma, as indicated by the dim expression of  $\alpha$ -SMA (suggestive of fibrosis, though we did not carefully stain for collagen) in some regions of the bladder characterized by high leukocytic infiltration, and the thickening of the submucosa (**Figure 46**).

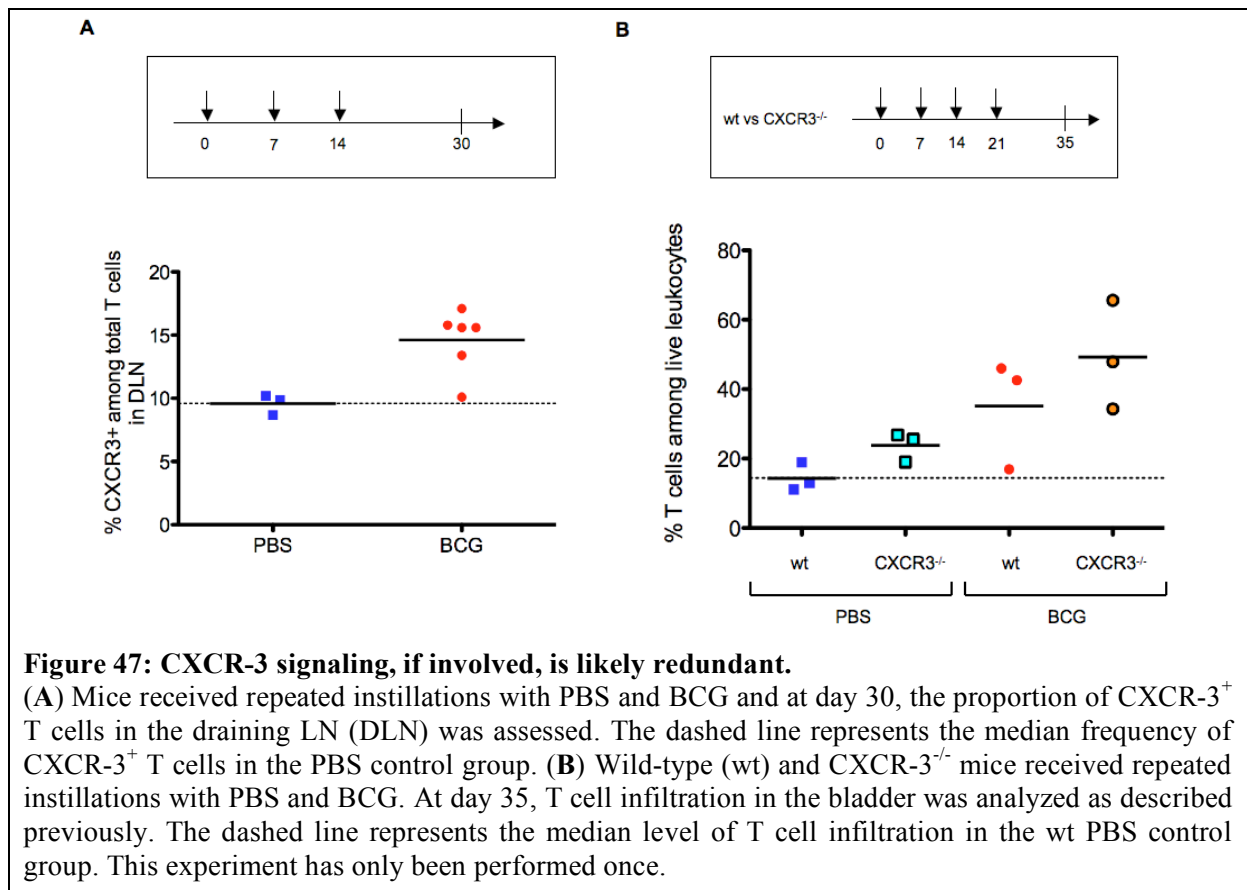


Activated stroma is known to be able to secrete a vast array of inflammatory cytokines and chemokines (Peduto et al., 2009), and I therefore hypothesized that following repeated instillations and the ‘withdrawal’ from inflammatory cells, activated stromal cells might secrete molecules such as CXCL-9/10/11 or CCL2-5 involved in the T cell recruitment. I was able to sort such cells by flow cytometry, defined as CD45.2<sup>-</sup> CD31<sup>-</sup> gp38<sup>+</sup>  $\alpha$ -SMA<sup>int</sup> (data not shown) at various time points following repeated instillations, but I have not yet performed RNA extraction and analysis.

*(d) Redundant mechanisms for T cell recruitment*

Based on the elevated concentration of CXCL-10 in the urine of patients following repeated intravesical BCG instillations (Bisiaux et al., 2009) and on my preliminary results using CD11c<sup>+</sup>-enriched bladder cells (see above), I asked whether CXCR-3 signaling was involved in T cell trafficking.

At the time when T cell entry is initiated (16 days after the third instillation, i.e., at day 30), T cells were isolated from the bladder draining LN and assayed for their expression of various chemokines receptors. A higher proportion of CXCR-3<sup>+</sup> T cells could be observed, as compared to PBS controls (**Figure 47A**). This was my rationale for repeatedly instilling CXCR-3 deficient animals with BCG. However, though the baseline level of T cell infiltration was found to be slightly higher in CXCR-3 deficient animals (**Figure 47B**, second column), a similar fold change was observed following repeated intravesical instillations of BCG (**Figure 47B**).



From this preliminary negative result, I am drawing 3 hypotheses, which await further testing: (i) either CXCR-3 signaling is not involved (which seems unlikely to us, given CXCL-10 data in patients and mice), or (ii) there is some redundancy in the signaling (e.g., involving CCR-5), or (iii) CXCR-3 deficient animals might have evolved compensatory mechanisms.

Hypothesis (ii) is testable in our lab, as we have CCR-5 deficient mice, which are currently been crossed to CXCR-3 deficient animals. Of note, labeling of T cells from the draining LN did not yield any reliable result as for CCR-5 expression, as our clone of antibody is not working (data not shown).

Hypothesis (iii) would be testable, e.g., by creating mouse chimeras, reconstituting irradiated mice with a mixture of wild type and CXCR-3 deficient T cells, in which the patterns of trafficking of these distinct populations would be assessed following repeated BCG instillations.

## **E. Pre-existing BCG-specific immunity improves the anti-tumor response**

### **1) Subcutaneous immunization with BCG improves the anti-tumor response in an orthotopic mouse model for bladder cancer**

Based on the ability to achieve stronger inflammation and earlier T cell recruitment to the bladder microenvironment, I reasoned that s.c. exposure to BCG prior to intravesical BCG therapy might improve the anti-tumor response. To test that hypothesis I partnered with other members of Bladder Biology Team in the lab to employ the MB49 orthotopic tumor model described in General Introduction (see Chapter 1 Section I.A.6)(a)). Although the derived epithelial MB49 tumors grow in an aggressive manner (Chan et al., 2009), this model remains, to my knowledge, the only mouse model in which intravesical BCG treatment has been shown to induce anti-tumor responses, when initiated 1-2 days after tumor implantation (Gunther et al., 1999) (also see I.A.6)).

#### *(a) Designing a protocol for orthotopic implantation of MB49 cells*

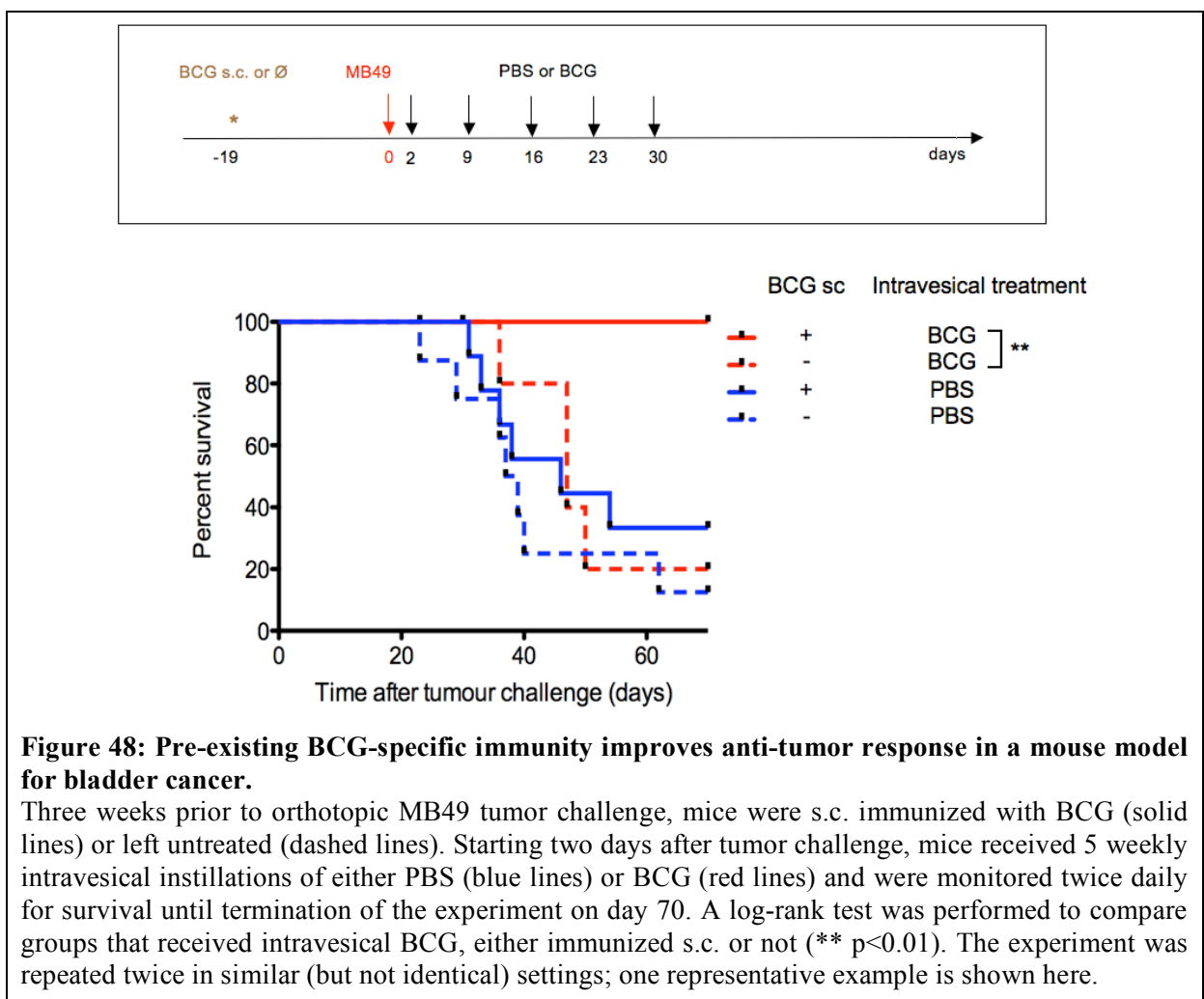
Dr. Cyrill Rentsch, a visiting urologist in our lab, was instrumental in designing the protocol for implanting MB49 tumor cells into the bladder of female mice, based on the existing literature. To foster tumor seeding, there exist two major techniques, namely damage to the bladder wall or pre-treatment of the bladder with poly-L-lysine (which helps tumor cells adhering) (Chan et al., 2009).

The electrocautery to the bladder wall is interesting because one could argue that it mimics resection of the tumor. However, it is rather difficult to practice a reproducible damage to the bladder wall without the help of cystoscopy. Together with Dr. Rentsch, we tried the smallest endoscope we could find (a sialoendoscope from Storz, composed of a Ø1.3mm endoscope, with a camera and a working channel), but this was too large to be inserted without trauma to the urethra of female Bl/6 mice, and the resolution was not great (data not shown). Dr. Rentsch preferred avoiding electrocautery in the absence of cystoscopy, and therefore turned to the poly-L-lysine pre-treatment. The final protocol he established was inspired by (Zaharoff et al., 2009) and consisted in a 20 minutes pretreatment of the bladder with 0.1mg/mL poly-L-

lysin, which is then gently removed from the bladder by slight digital pressure on the abdomen of the mouse, and followed by instillation of tumor cells.

Dr. Rentsch titrated the number of MB49 cells required to trigger a 100% tumor take. We then realized that tumor take (and kinetics of survival) was heavily dependant on the passage number of the cells. Of note, passage number was identical among the few tumor experiments that were performed in this dissertation, but was however different from the initial experiments from Dr. Rentsch and resulted in slightly less than 100% tumor take, and a longer kinetics to death.

*(b) Evaluating the impact of pre-existing BCG-specific immunity*

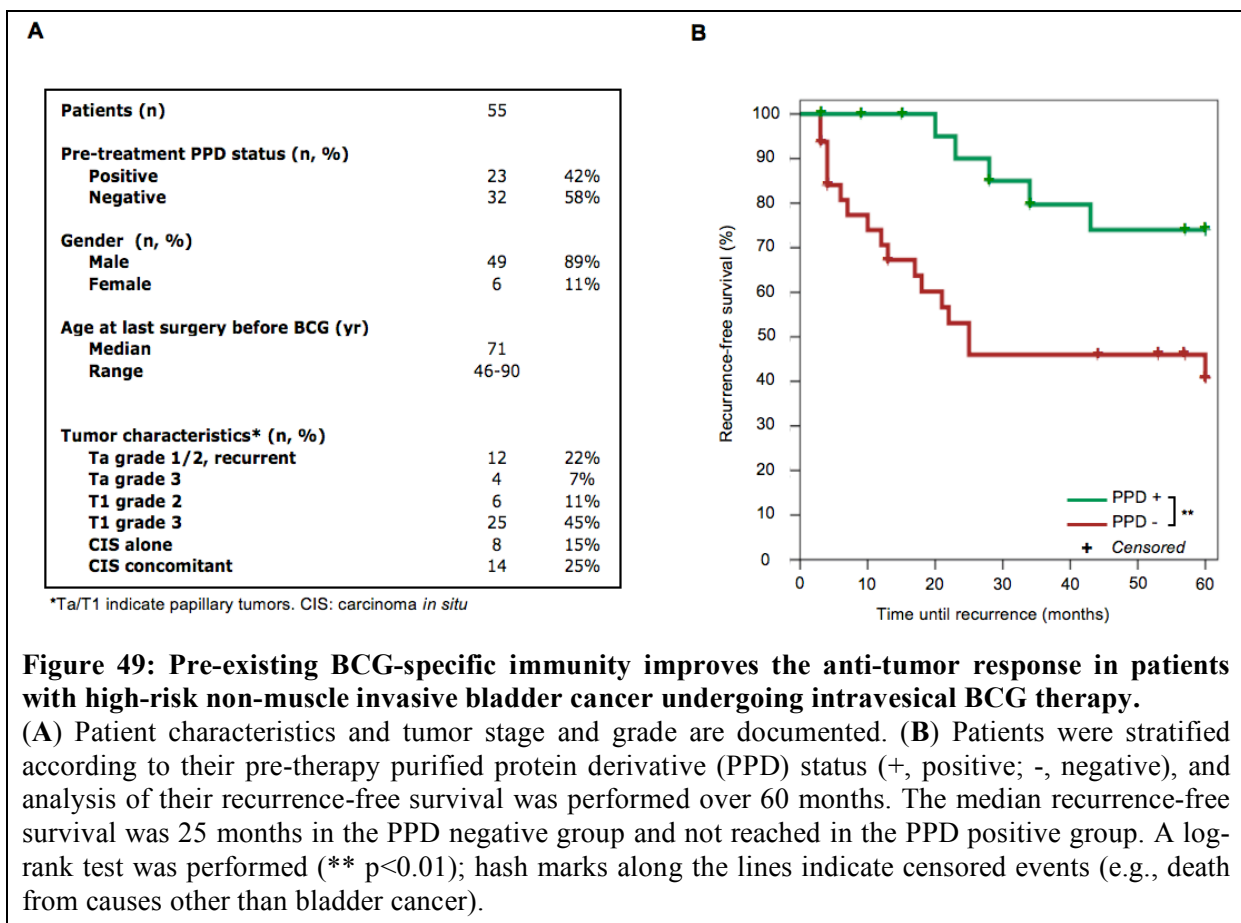


To evaluate the impact of pre-existing BCG-specific T cells, mice were immunized s.c. with BCG and, after 3 weeks, 85,000 MB49 cells were implanted into the bladder mucosa, as described above. Two days later, intravesical BCG therapy was initiated, and mice were monitored twice daily for survival. Strikingly, 100% of mice that received BCG s.c prior to intravesical therapy survived as late as 70 days post tumor challenge; in comparison, 80% of mice with no prior BCG immunization succumbed within 50 days, despite intravesical BCG

therapy (**Figure 48**). As a control, mice received BCG s.c., were challenged with tumors and received intravesical PBS, showing no evidence of delayed tumor growth (**Figure 48**).

2) Pre-existing BCG immunity improves the anti-tumor response in patients with high-risk non-muscle invasive bladder cancer

These results prompted us to investigate the relevance of pre-existing BCG-specific immunity in patients with high-risk non-muscle invasive bladder cancer undergoing BCG therapy. Dr. Rentsch had a long running collaboration with Bern Hospital, and thanks to him, we got access to clinical data from an observational study (principal investigator: George N. Thalmann) in which patients underwent a purified protein derivative (PPD) skin test prior to intravesical therapy (**Figure 49A**). A positive skin test is the signature of previous exposure and active immune response to BCG, *Mtb* or other mycobacteria (see Chapter 1 Section II.B.2)(c)). Skin tests were performed by injection of 2IU tuberculin in the volar forearm. A positive test was defined as an induration of 10mm or more 48-72 hours post injection.



We stratified patient outcome data according to their PPD status prior to treatment, and we observed that patients with a positive PPD had a significantly better recurrence-free survival than patients with a negative PPD skin test (**Figure 49B**,  $p < 0.02$ ). Together these data

suggest that boosting BCG-specific immunity prior to intravesical therapy might improve clinical response and tumor immunity.

In summary, I demonstrated herein that repeated instillations of live BCG were required for robust infiltration of T cells in the bladder. Yet, BCG dissemination to bladder draining LN and T cell priming could occur after a single instillation. Interestingly, the acute inflammatory response following each instillation was short-lived but it was more robust at the third instillation. Prior studies suggested this to be a result of local tissue conditioning by the innate immune system (Bisiaux et al., 2009); I report here that subcutaneous immunization with BCG prior to intravesical regimen facilitated a ‘boosted’ response in the bladder after a single instillation. Based on depletion studies, I provide evidence that pre-existing BCG-specific adaptive immunity enhanced the innate response to intravesical BCG and accelerated T cell infiltration of the bladder. Moreover, subcutaneous exposure to BCG prior to orthotopic tumor challenge dramatically improved response to intravesical BCG therapy. Importantly, analysis of clinical data illustrated a similar finding: patients with pre-existing immunity to BCG had a greater likelihood of achieving recurrence-free survival. Together these data provide new insight into a long-standing clinically effective immunotherapeutic regimen and predict strategies that may improve patient management.

## **IV. DISCUSSION**

*Bacillus Calmette Guérin* was generated by the repetitive passage of a virulent strain of *M. bovis*. This live attenuated strain was developed as a vaccine for tuberculosis and following the work of William Coley (Wiemann and Starnes, 1994), BCG was evaluated for use as an anti-cancer therapeutic vaccine. In fact, it has been injected into many solid tumors and while there were reports of some success, controlled clinical trials did not provide statistical significance (Brandau and Suttman, 2007; Mathe et al., 1969; Morton et al., 1970). Nonetheless, animal studies with BCG continued and it was recognized that long lasting direct contact with the live bacteria resulted in optimal tumor immunity (Zbar et al., 1971). These results prompted Morales et al. to evaluate BCG as an adjuvant intravesical treatment for carcinoma of the bladder (Herr and Morales, 2008; Morales et al., 1976). Since these initial observations, several large prospective studies have been conducted and BCG remains the standard of care for non-muscle invasive disease. While now in use for over 35 years, many questions remain about the mechanism of action by which BCG mediates the observed

clinical response (Brandau and Suttman, 2007); additionally, there is interest in identifying strategies for optimizing therapy (Luo et al., 2011; O'Donnell, 2009).

While prior efforts have evaluated immunologic response during therapy in human observational studies or in experimental mouse models, this study provides the first systematic evaluation of BCG-induced T cell infiltration of the bladder mucosa. Using histological and cytometric analyses, and paying careful attention to mycobacterial persistence and antigen-specific T cell priming, I defined the parameters required for achieving effective adaptive immune responses in the bladder. I identify a requirement for live bacteria that disseminate to local draining lymph nodes in order to achieve T cell priming (**Figure 36**); and repeated instillations are needed to trigger recruitment of T cells to the bladder microenvironment (**Figure 37**). Careful analysis of these parameters has not been previously documented, in part due to inability to access patient material (e.g., bladder mucosa and lymph node) during a clinically approved therapeutic intervention.

Based on experimental work in humans, I focused my attention on the activation and recruitment of T lymphocytes. Immunohistochemical analysis of patient bladder biopsies has indeed demonstrated T cell infiltration during BCG therapy and up to 3 months post-therapy (Peuchmaur et al., 1989; Prescott et al., 1992); and the degree of T cell infiltration correlated with treatment response (Prescott et al., 1992). These findings were consistent with my study of BCG induced inflammation after intravesical instillations in mice. Based on my observations of a delayed influx of T cells, I hypothesized that parenteral exposure to BCG prior to standard-of-care might accelerate the kinetics of bladder inflammation. I demonstrate that such an approach provides an optimized strategy for T cell recruitment and that this treatment protocol improves the host anti-tumor response.

## **A. The bladder immune response to BCG**

### **1) T cell recruitment to the bladder is late to occur**

From the perspective of the host response to infection, one striking observation is that bladder T cell infiltration following repeated BCG instillations occurs only after day 29 (**Figure 32**). There is an important precedent for such an observation – the cellular immune response to aerosolized *Mtb* takes several weeks to initiate, with T cells reaching the lungs only after day 20 post-infection (Cooper, 2009; Urdahl et al., 2011). Several hypotheses have been proposed to explain such a delayed cellular immune response.

One possibility is that *Mycobacteria sp.* regulate T cell activation either by inhibiting antigen-presenting cell (APC) migration and/or function (Cooper, 2009). Alternatively, it has been speculated that slow induction could simply be a consequence of the low number of bacteria used for infection, which could result in insufficient inflammation and antigen load. Arguing against this point, however, is the observation that exponentially increasing the dose of aerosolized bacteria in lung studies does not significantly accelerate T cell recruitment to the mucosa (Reiley et al., 2008). In my bladder instillation model, the number of BCG CFUs decays quickly (**Figure 28A**), however testing the response to higher dose of BCG remains technically challenging. It is worth noting that once established, the response is sustained, lasting at least 21 days following the third instillation.

### 2) Priming of T cells requires BCG dissemination to the draining lymph nodes but is not sufficient for T cell entry into the bladder

I also discovered that BCG dissemination to the regional lymph node is critical for achieving efficient T cell priming, again showing similarity to what has been shown in the lung *Mtb* infection model (Chackerian et al., 2002; Reiley et al., 2008; Wolf et al., 2008). T cell priming, however, was not sufficient to achieve T cell recruitment to the bladder, as shown by the relatively low level of T cell infiltration following a single instillation, even in the presence of measurable live BCG in the draining LN (**Figure 37**).

### 3) Mechanisms involved in the recruitment of primed T cells to the bladder

To further assess the relationship between priming and trafficking to the bladder, I performed studies in mice that were previously primed *via* the subcutaneous route. These data demonstrated that trafficking of T cells to the bladder could be dissociated from the route of priming, in contrast to what has been reported in the context of homing to the gut or central nervous system (Mora and von Andrian, 2006).

Bladder T cell recruitment correlated with a robust, but short-lived innate immune response, which is suggestive of a delayed type-hypersensitivity (DTH) response (also known as type IV hypersensitivity reaction). While not typically attributed to inflammation in the bladder mucosa, DTH reactions are known to be mediated by antigen-specific effector T cells (e.g., induration induced by PPD challenge in the skin of a primed individual). This reaction is defined by antigen-specific T cells mediating the rapid recruitment of inflammatory cells to the site of injection (Marchal et al., 1982). I report here that s.c. immunization 21 days prior to BCG intravesical instillation results in a more robust inflammatory response following



intravesical BCG, which is dependant on T cells (**Figure 43**), thereby suggesting that bladder inflammation should be considered a DTH reaction.

Although I demonstrate a critical role for primed T cells in the BCG-mediated influx of inflammatory innate cells, I was unable to define the cellular mechanism(s) governing T cell entry into the bladder. Notably, depletion of neutrophils, monocytes and NK cells did not result in impaired T cell trafficking to the bladder. Apparently, repeated instillations with BCG take the bladder out of homeostasis for quite some time, as there are activated DCs and signs of fibrosis in the stroma up to 21 days following the third instillation. Activated DCs and stromal cells might be involved in the secretion of chemokines, with CXCL9-11 and CCL2-5 being likely candidates. From my preliminary data, CXCL-10 signaling might be involved, though CXCR-3 seems dispensable for T cell trafficking. Further investigations will be required to understand the cellular and molecular mechanisms governing T cell entry into the bladder.

## **B. Clinical applications of our work**

### **1) Of PPD responsiveness and response to therapy**

To apply my insights into dynamics of bladder inflammation, I teamed with others in the lab to test the aforementioned modified treatment regimen using an orthotopic bladder tumor model. Most strikingly, we demonstrate the ability to achieve up to 100% survival as compared to 80% lethality at day 70 (median survival time being ~45 days) (**Figure 48**). These data are remarkable given the aggressive nature of MB49, but even more so for the ease of translating our results for testing in human clinical trials. Supporting the important role for pre-treatment BCG-specific responses, we conducted a retrospective clinical study and identified absence of a PPD response to be a risk factor for treatment failure (**Figure 49**).

While I assert the novelty of our findings, which emerged from the assessment of parameters dictating T cell recruitment, I acknowledge that there is a historical interest in correlating PPD positivity to treatment response and/or adverse events secondary to intravesical instillation (e.g., fever) (Gontero et al., 2010; Saint et al., 2003). Indeed, several groups have demonstrated that intravesical BCG-induced conversion of PPD test (from negative to positive) during the treatment course significantly correlated with clinical response (Kelley et al., 1986; Lamm et al., 1991; Torrence et al., 1988). Badalament and colleagues reported a related finding in a cohort of USA patients with recurrent superficial bladder cancer: pre-therapy PPD positive patients – likely primed due to their prior intravesical treatment –

showed greater benefit from their subsequent course of treatment (Badalament et al., 1987). In line with this report, it is worthy of mentioning that in patients who fail intravesical therapy, an additional 50% of patients respond to the second cycle of BCG (Gontero et al., 2010; Sylvester et al., 2005). In light of our data, I suggest that the first cycle of BCG might serve to prime patients, thus enhancing bladder inflammation and the chance to achieve tumor clearance during subsequent rounds of intravesical treatment.

## 2) Parenteral exposure *prior to* intravesical regimen: a clinically-testable treatment option

Clinical studies have also investigated the combined use of intravesical and intradermal (or scarification) routes for treating patients with BCG (Lamm et al., 1991; Luftenegger et al., 1996). These trials showed no evidence of enhanced clinical response. Arguably, my findings indicate that treatment protocols combining both routes of injection were well conceived, but misguided with respect to the timing required for achieving systemic BCG-specific immunity. I favor a treatment strategy where patients are exposed parenterally to BCG *prior to* initiation of intravesical therapy. To my knowledge, this has not yet been evaluated and may represent a straightforward approach to improving treatment response.

In summary, I have constructed an experimental mouse model and tools allowing us to address several important questions about the dynamics of the immune response following intravesical BCG therapy. I demonstrated that while BCG dissemination to regional LNs and priming of IFN $\gamma$ -producing T cells could occur following a single instillation, repeated instillations of live BCG are necessary to achieve robust bladder T cell infiltration. Strikingly, parenteral exposure to BCG prior to instillation overcame the requirement for repeated instillations, triggering a more robust acute inflammatory process at the first instillation and accelerating the recruitment of T cells to the bladder. Moreover, parenteral exposure to BCG prior to orthotopic tumor challenge dramatically improved response to BCG therapy. Importantly, patients with pre-existing immunity to BCG responded significantly better to therapy. Together these data suggest that checking patients' immunity to BCG prior to intravesical therapy, and boosting it if necessary, might improve BCG-induced clinical responses.



# **Chapter 3.**

## **Exploring the mechanisms and determinants of response to BCG therapy using mathematical modeling**

---



## I. INTRODUCTION

Carcinoma of the bladder is the most common cancer of the urinary tract and the fourth most common malignant disease in males in the developed world (Jemal et al., 2011). Most tumors are diagnosed at a superficial stage and are surgically removed by transurethral resection. Depending on the stage and grade of the non-muscle invasive tumors, adjuvant therapy is recommended as a strategy for both reducing recurrence and diminishing risk of progression (Babjuk et al., 2011). Since the work of Morales and colleagues in 1976 (Morales et al., 1976), BCG therapy, which consists of 6 weekly intravesical instillations shortly after resection, has been the standard of care for high-risk urothelial carcinoma: carcinoma *in situ*, and high-grade Ta/T1 bladder lesions (Babjuk et al., 2011; Gontero et al., 2010).

The accepted treatment model suggests that, immediately following instillation, interaction of BCG with bladder urothelium results in the induction of pro-inflammatory molecules, which serve to recruit innate immune cells. In particular, neutrophils and monocytes/macrophages are believed to be critical effector cells, capable of mediating the observed tumor immunity (De Boer et al., 1992; Jackson et al., 1995; Suttman et al., 2006). Specifically, innate cells have the capacity to degranulate in response to exposure to BCG, resulting in the bystander killing of tumor cells (Clark and Klebanoff, 1975). In support of this model, it has been demonstrated that BCG treatment induces surface expression of TRAIL on neutrophils, thus arming them with the capacity to induce tumor cell death (Kemp et al., 2005; Ludwig et al., 2004; Rosevear et al., 2009). In addition, monocytes/macrophages and natural killer (NK) cells are stimulated to produce high concentrations of effector cytokines (Bisiaux et al., 2009; Yutkin et al., 2007).

Based on data obtained in our previous observational clinical study as well as published experimental data, we concluded that repeated BCG instillations resulted in a “prime/boost” response of the innate immune system. Intermittent intravesical therapy resulted in tissue remodeling with increased vascularization (Bisiaux et al., 2009; Saban et al., 2008; Saban et al., 2010), and we hypothesized that this accounted for the observed 200-fold increase in neutrophil influx, 125-fold increase in monocyte/macrophage influx and 30-fold increase in NK cell influx (Bisiaux et al., 2009). Using quantitative data from this study as well as our knowledge of the kinetics of bladder tumor growth, we reasoned that it would be possible to establish a mathematical model that could help test the prediction that the innate immune response accounts for the success of bladder cancer immunotherapy (see Section II).

Analysis of the model system showed that the innate immune system was not capable of itself achieving the observed tumor immunity. We went on to parameterize adaptive immunity in our model and, using our refined mathematical model, we assessed the impact of: (1) varying the time from resection to BCG instillation, (2) modulating the BCG dose used during intravesical instillation, (3) the indwelling time of BCG, and (4) the inter-instillation interval (see Section III).

## **II. MATHEMATICAL MODELING IDENTIFIES THE LIMITATIONS OF THE INNATE IMMUNE RESPONSE**

The mathematical modeling of interactions between the innate immune system, BCG and bladder cells during BCG therapy is described, together with the calibration of the model. We then address whether the innate immune system is able by itself to achieve the observed tumor elimination.

Of note, in this Section, I contributed to the design of the flow diagram for the model and to the definition of the assumptions underlying the model, in collaboration with R. Breban, C. Rentsch and M. Albert. I also contributed to produce part of *in vitro* experimental data (infection of urothelial cells with BCG), in collaboration with C. Rentsch.

### **A. Modeling BCG-induced response of the innate immune system**

The instillations are modeled as follows. BCG is instilled into the bladder for a period of 2 hours, resulting in the infection of both healthy urothelial cells and tumor cells. After two hours, the typical duration of one intravesical treatment, 99% of BCG is flushed out (our own observations, please refer to II.D.1)) (Durek et al., 2001; Siatelis et al., 2011). Infected cells provoke an immune response and the influx of effector cells. Engagement of cell-associated BCG or infected bladder cells triggers the activation and/or degranulation of the innate immune cells, thus resulting in the direct and bystander killing of tumor cells.

We describe and justify the series of assumption on which the model relies, before explaining how the model runs.

#### **1) Our series of assumptions**

In order to examine the possibility of the innate immune system as competent in mediating tumor immunity, we developed a mathematical model using parameters that reflect the

biological response to intravesical BCG. Where knowledge of the immunologic system remains uncertain, our assumptions were slanted to favor the immune system's ability to achieve tumor elimination.

*(a) Assumption 1: In absence of therapy, the tumor remains largely undetected by the immune system.*

This assumption is based on histologic assessment of non-muscle invasive tumors as lacking hallmarks of inflammation (Prescott et al., 1992; Saint et al., 2001a).

*(b) Assumption 2: During BCG instillations, free BCG becomes associated with tissue and tumor cells (green arrows in **Figure 50**).*

As the therapeutic mixture contains both live BCG, capable of actively interacting with cells, and dead BCG, that is internalized by cells, we refer to BCG as becoming “cell-associated”. Cells associated with BCG include cells that have BCG adhered to their plasma membrane, cells that have phagocytosed BCG or components of dead bacilli, cells that have upregulated stress molecules (e.g., MIC-A) as a result of contact with BCG and cells that have been actively infected by BCG. Experimental data indicate that BCG can become associated with urothelial cells and transitional carcinoma cell lines (Bevers et al., 2004) (also see Section III.A).

*(c) Assumption 3: BCG instillations result in an increased recruitment of innate effector cells into the bladder tissue (red arrows in **Figure 50**).*

This is well established with quantitative data available from human subject studies and mouse and experimental mouse models (please refer to Section III.B.1)).

*(d) Assumption 4: Innate effector cells engaging with BCG-infected tissue or tumor cells become activated and are induced to secrete effector cytokines and/or degranulate. The activation process is the same whether the trigger is a BCG-associated tissue or tumor cell.*

This assumption is based on the findings of activated innate cells in the urine of patients following intravesical therapy, and experimental work on co-cultures with BCG or BCG-infected cells and innate immune cells (Bisiaux et al., 2009) (also see Section III.B.1)).



(e) *Assumption 5: Activation of an innate effector cell (orange arrow in **Figure 50**) results in bystander death, i.e., tissue and tumor cells in the vicinity of the effector cell may be killed (blue dashed arrows in **Figure 50**). Furthermore, activation in most instances triggers terminal differentiation and death of the innate effector cell.*

In the case of neutrophils and monocytes/macrophages, degranulation is known to result in the release of degradative intracellular proteins (e.g. elastase, heparanase, lipases) having the capacity to induce bystander cell death. In addition, activated innate cells may secrete effector cytokines and/or express cell death inducing proteins (e.g., TRAIL). We acknowledge that the assumption that NK cells die rapidly after engagement of their effector mechanisms results in an underestimation of their killing capacity. In light of the clinical data, however, the relative paucity of NKs recruited to the bladder indicate that even with a high estimate of 10 killing events pr NK, their effector function accounts for <10% of the combined innate response (Bisiaux et al., 2009).

(f) *Assumption 6: Modeling the population dynamics of uninfected tumor cells, we assume that the tumor grows into the bladder lumen and does not impinge on surrounding tissues*

This assumption fits with the use of BCG in the treatment of non-muscle invasive disease, it reflects the anatomy of the bladder, with the lumen being a virtual space, and it is supported by the growth characteristics of the tumor, especially papillary lesions. As such, tumor size is limited only by the blood supply. We therefore chose a logistic model (i.e., the Verhulst model) to describe the dynamics of the tumor cell population in absence of BCG therapy (Bunimovich-Mendrazitsky et al., 2007; Michelson and Leith, 1994) (**Figure 51**).

Notably our model focuses on the description of post-resection BCG immunotherapy where the number of tumor cells is significantly less than the carrying capacity (i.e., the maximum number of tumor cells that the blood supply can sustain). Consequently, the logistic model is used in the regime of exponential growth. Therefore, the results presented here are not restricted by our choice of the logistic model and apply to all models of tumor cell replication in their regime of exponential growth.

(g) *Assumption 7: We consider the population of healthy tissue cells to be very large when compared with other cell populations of interest, and therefore do not use explicit equations to model its dynamic.*

This assumption is based on the knowledge that BCG therapy does not result in the perforation of the bladder wall nor frank disruption of bladder function.

*(h) Assumption 8: We use mass-action to describe the mixing between the cell populations.*

This is supported by BCG dispersion during intravesical therapy, adequate vascularization of all aspects of the bladder wall and non-specific migration patterns of innate immune cells as they enter inflamed tissue.

*(i) Assumption 9: The number of BCG dying during instillation (i.e., 2 hours) is negligible.*

The kinetics of natural cell death of BCG is slow and the host response is minimal within the first 2 hours of BCG instillation (Bisiaux et al., 2009).

*(j) Assumption 10: BCG-associated cells do not undergo local proliferation.*

This is supported by experimental data suggesting that BCG negatively impacts the cell growth of bladder tumor cell lines (Jackson et al., 1994a).

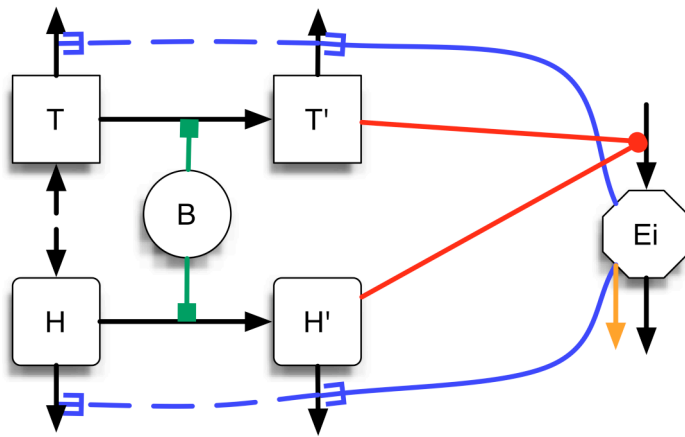
*(k) Assumption 11: Increase in the inflow of immune cells is expressed in a sigmoidal function, induced by the cumulative number of cells destroyed by innate effector cells, but counteracted by homeostatic pressure (i.e., healing of the bladder wall).*

This assumption is supported by the observation that migration of effector cells is linked to the vascularization of the bladder wall, which evolves as a function of inflammation induced cell death (Bisiaux et al., 2009; Saban et al., 2008). Of note, such phenomenon is compatible with the delayed-type hypersensitivity reaction, which we described in chapter 2, in which primed effector T cells mediate a boosted inflammatory response at the following instillations.

As such, the increase in the inflow of immune cells depends on the number of BCG-associated cells present in the bladder, which are triggers for activation and effector activity of innate immune cells.

## 2) Running the model

The model has 6 state variables (see the flow diagram, **Figure 50**). H denotes the number of healthy bladder cells; T denotes the number of tumor cells; and B the number of free BCG bacteria in the bladder. We use prime to denote cell populations that are infected by and/or associated with BCG. We thus use the symbols H' and T' for the number of infected tissue and tumor cells, respectively. E<sub>i</sub> denotes the number of innate effector cells (e.g., neutrophils) that have extravasated into the bladder.



**Figure 50: Flow diagram of our mathematical model.**

H and T denote the number of BCG-unassociated cells of the bladder tissue and tumor cells, respectively.  $E_i$  denotes the number of innate effector cells. B denotes the number of free BCG bacteria in the bladder.  $H'$  and  $T'$  denote the number of BCG-associated tissue and tumor cells, respectively. The model runs as follows. Before immunotherapy, only three of six cell populations are present: H, T and  $E_i$ . The interactions between these cell populations are negligible and their corresponding compartments are disconnected. The processes that take place for each of these independent compartments are ‘birth’ (i.e., cell inflow and/or local proliferation) and ‘death’ (i.e., cell outflow and/or homeostatic programmed cell death); see the vertical arrows. During BCG instillations, three new populations emerge creating dynamic interactions between all the compartments. Free BCG infects tissue and tumor cells (green arrows), inducing transition from H to  $H'$  and T to  $T'$  (horizontal black arrows).  $H'$  and  $T'$  cells activate innate effector cells  $E_i$  (red arrows). In turn,  $E_i$  target  $H'$  and  $T'$ , destroying them (blue continuous arrows) and neighboring H and T cells (blue dashed arrows) by innate effector mechanisms (e.g., cytokines, death receptor agonists, degranulations).

Our model runs as follows.

*(a) Initial state, before immunotherapy*

Before immunotherapy, only 3 of the 6 aforementioned populations are present: H, T and  $E_i$ . Notably, the bladder density of  $E_i$  in the bladder is low, but indeed there do exist resting immune cells in the healthy or tumor-bearing bladder (Prescott et al., 1992; Saint et al., 2001a) (our own observations in mice, please refer to Section II.B).

The interactions between these cell populations are negligible; i.e., their corresponding compartments in **Figure 50** are disconnected. The processes that take place for each of these independent compartments are “birth” (i.e., cell inflow and/or local proliferation) and “death” (i.e., cell outflow and/or homeostatic programmed cell death) (see the vertical black arrows in **Figure 50**).

*(b) Modeling of BCG instillations*

During BCG instillations, 3 new populations of cells emerge, creating dynamic interactions between all the compartments. Free BCG infects and/or associates with tissue and tumor cells (green arrows in **Figure 50**), inducing transition from H to  $H'$  and from T to  $T'$  (horizontal

black arrows in **Figure 50**).  $H'$  and  $T'$  activate innate immune effector cells  $E_i$  (red arrows in **Figure 50**). In turn,  $E_i$  cells target  $H'$  and  $T'$  destroying them (blue continuous arrows in **Figure 50**) as well as  $H$  and  $T$  cells by bystander mechanisms (blue dashed arrows in **Figure 50**). Finally, the presence of  $H'$  and  $T'$  triggers increased migration of  $E_i$  cells into the bladder tissue (see assumption 11).

The model is a continuous-time Markov-chain; its processes and the corresponding rates are listed in **Table 3**.

Process	Definition	Rate
Tumor proliferation	$T \rightarrow T + 1$	$\beta T$
Tumor death	$T \rightarrow T - 1$	$\mu T$
Tumor death due to shortage of blood supply	$T \rightarrow T - 1$	$rT(T + T')/K$
Tumor death due to degranulation	$T \rightarrow T - 1$	$n\kappa ET'$
BCG-infection of tumor cells	$T \rightarrow T - 1,$ $B \rightarrow B - 1,$ $T' \rightarrow T' + 1$	$\rho BT$
Infected tumor death	$T' \rightarrow T' - 1$	$\mu_i T'$
Infected tumor death due to shortage of blood supply	$T' \rightarrow T' - 1$	$rT'(T + T')/K$
Infected tumor death due to degranulation	$T' \rightarrow T' - 1,$ $E \rightarrow E - 1$	$\kappa ET'$
BCG-infection of tissue cells	$H' \rightarrow H' + 1,$ $B \rightarrow B - 1$	$\sigma B$
Infected tissue death	$H' \rightarrow H' - 1$	$\mu_H H'$
Infected tissue death due to degranulation	$H' \rightarrow H' - 1,$ $E \rightarrow E - 1$	$\kappa EH'$
Neutrophil migration at homeostasis	$E \rightarrow E + 1$	$\pi$
Increased neutrophil migration due to BCG-infection <sup>a</sup>	$E \rightarrow E + 1$	$\alpha(t)(T' + H')$
Neutrophil deactivation and loss into the bladder lumen	$E \rightarrow E - 1$	$\mu_E E$

**Table 3: Stochastic processes and their corresponding rates.**

### 3) Calibration of the model

The values for the model parameters were chosen such that cell counts are in agreement with clinical trial data (Bisiaux et al., 2009). As a corollary, where there is some discrepancy between human data (based on published and unpublished observations by Bisiaux, and on the current literature) and mouse data (see Chapter 2), we always favored human data. Such discrepancies (e.g., boost of the inflammatory response on week 3 for humans, but no further boost on week 5, whereas the boost occurs on week 5 for mice) are further discussed in General Discussion (e.g., Section I.D.1)(c)).

We provide details about important parameters below. The remaining parameters were calculated to be in agreement with aforementioned clinical data and with the parameters described below (see **Table 4**).

Parameter	Symbol	Value/Range
Tumor proliferation rate parameter	$\beta$	$0.11 \text{ day}^{-1}$
Tumor death rate parameter	$\mu$	$0.067 \text{ day}^{-1}$
Tumor carrying capacity	$K$	$10^{11}$ cells
Number of cells destroyed per degranulation <sup>a</sup>	$n + 1$	-
Predation coefficient of effector cells	$\kappa$	$5 \times 10^{-8} / \text{cell/day}$
BCG infectiousness of tumor cells	$\rho$	$2 \times 10^{-9} / \text{cell/day}$
Natural death rate of BCG-associated tumor cells	$\mu_i$	$1/3 \text{ days}$
BCG rate of association to tissue cells	$\sigma$	$0.1 \text{ day}^{-1}$
Natural death rate of BCG-associated tissue cells	$\mu_H$	$0.2 \text{ days}$
Inflow of effector cells in the bladder tissue <sup>b</sup>	$\pi$	$345000 \text{ cells/day}$
Deactivation and flushing rate of effector cells	$\mu_E$	$0.345 \text{ day}^{-1}$
Maximum recruitment rate of effectors due to BCG	$\alpha_1$	$1000 \text{ day}^{-1}$
Minimum recruitment rate of effectors due to BCG	$\alpha_1 / (1 + e^{\alpha_2})$	$0.49 \text{ day}^{-1}$
Scale of $C(t)$ for vascularization increase	$\alpha_3$	$10^{11}$ cells
Healing time of the bladder wall	$\tau$	$33.3 \text{ days}$

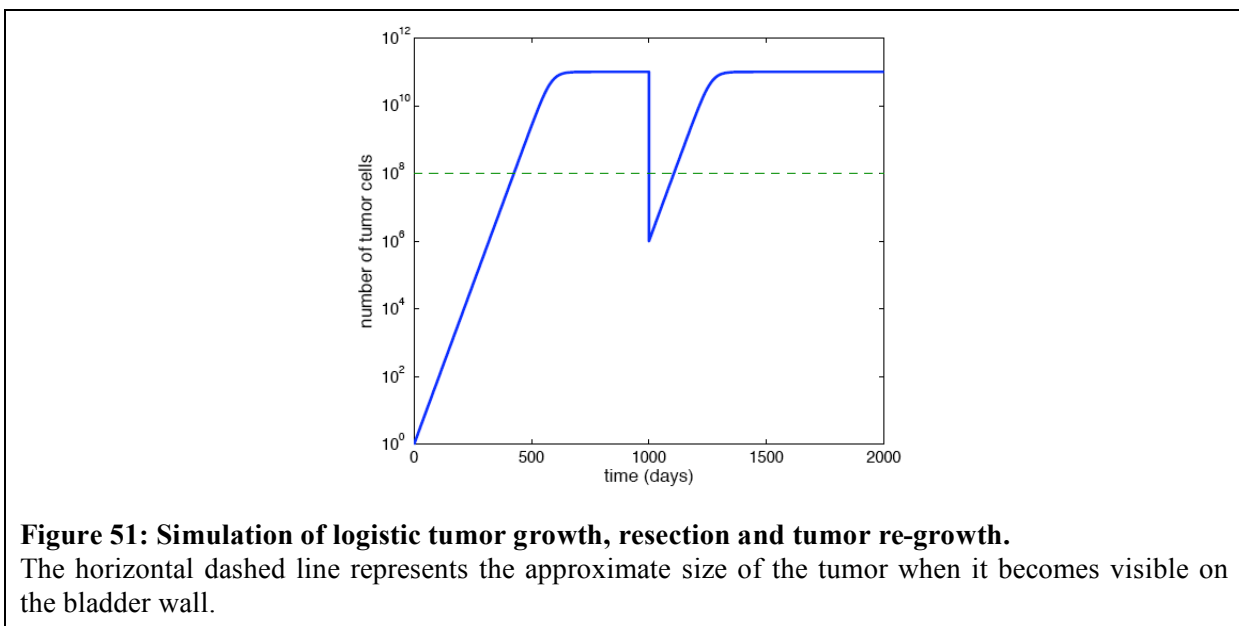
**Table 4: Parameters of the model.**

*(a) Estimation of the number of tumor cells ( $T$ ) at initiation of therapy*

We estimate the post-resection tumor burden to be in the range of  $10^5$ - $10^7$  tumor cells for papillary tumors (i.e., microscopic lesions  $\sim 10^6$  cells, occupying  $\sim 1\text{mm}^3$ ), and  $10^7$ - $10^9$  tumor cells for CIS lesions (n.b., some treatment practices do not resect CIS due to its sessile nature and lesions may reach a tumor burden of  $10^{10}$  cells). As a starting point for our model, we use  $10^6$  cells, but we have evaluated the effect of starting tumor burden as one of the determinants of tumor elimination (data not shown).

The tumor growth rate parameter ( $r=\beta-\mu$ ) is tuned such that the re-growth of the tumor to a visible size (i.e.,  $\sim 10^8$  cells) takes about three months (according to clinical observation).

**Figure 51** shows a simulation of tumor growth, including resection of the tumor to  $10^6$  cells, and in the absence of BCG therapy.



*(b) Estimation of the number of cells in the human bladder (H)*

We start from the fact that the volume of a full human bladder is approximately 0.5 liters. Approximating the shape by a sphere, the surface is approximately  $7.62 \times 10^{-3} \text{ m}^2$ .

On the other hand, the perimeter of a bladder cell is  $80 \mu\text{m}$  (Boon et al., 1981), which yields a surface of section of approximately  $5.09 \times 10^{-10} \text{ m}^2$ .

Dividing the bladder surface by the cell surface of section, we estimate the number of cells per layer of bladder wall to be  $1.5 \times 10^7$ .

*(c) Number of BCG bacteria (B) instilled and retained into the bladder after voiding*

One vial of clinical-grade BCG (Immucyst, Sanofi-Pasteur) is declared to contain  $2 \times 10^8$ - $2 \times 10^9$  colony-forming units (CFUs); i.e., live bacteria. Our own titrations are much closer to  $10^8$  CFUs.

In addition commercially available preparations of BCG are lyophilized and therefore contain a high proportion of dead bacilli, such that vials are thought to contain only 5-10% bacteria. Our own observations confirm that the optical density of the preparation is much stronger than it would be if it contained only the titrated number of live bacteria, confirming that only a small proportion of bacteria in the preparation are live. We approximated this proportion to 10%, such that a vial containing  $10^8$  CFUs actually contains  $10^9$  total bacteria.

In our model, we care about all BCG-associated cells, which include cells actively infected by live BCG but also dead BCG internalized by tissue or tumor cells. Therefore we set B to  $10^9$ .

In addition, our own observations, as well as Brandau's personal communication and evidence from the literature (Durek et al., 2001), led us to set to 1% the fraction of BCG remaining in the bladder after the first voiding, at 2 hours.

*(d) Estimation of the number of innate effector cells ( $E_i$ ) recruited and activated during BCG therapy*

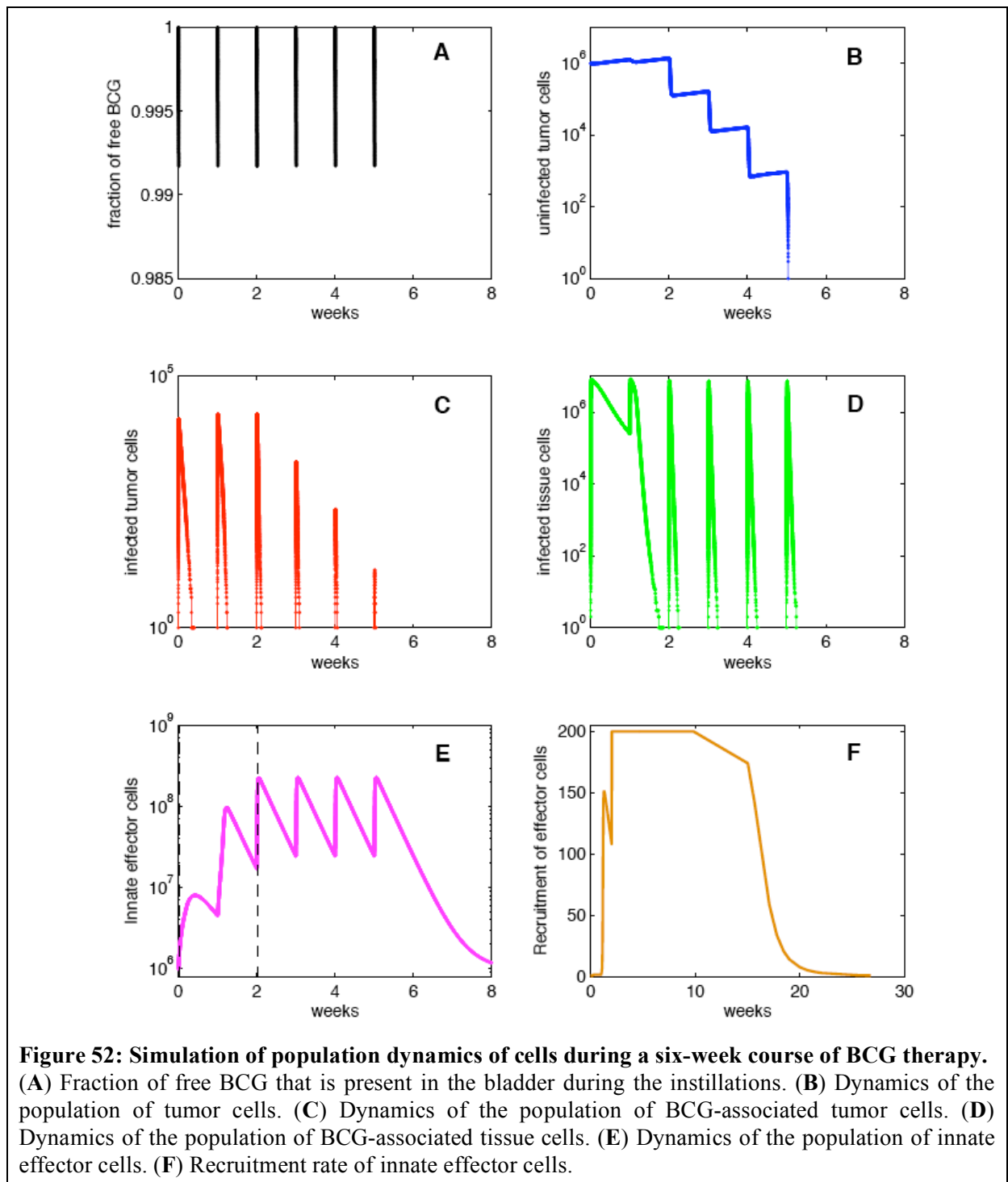
Neutrophils, monocytes/macrophages and NK cells are the main types of effector cells in the innate immune system and their infiltration into the bladder following intravesical BCG therapy is predictive of treatment success (Ayari et al., 2009; Simons et al., 2008; Yutkin et al., 2007). In addition mouse models have revealed their importance for BCG-mediated anti-tumor activity (Brandau et al., 2001; Suttman et al., 2006) (also see General Introduction Section III.B.3)).

For innate immune cells to enter the bladder mucosa, they must undergo activation. This is thought to occur as a result of BCG interacting with urothelial cells, which triggers the secretion of inflammatory cytokines, chemokines and other bioactive molecules. After transmigration into the bladder parenchyma, innate cells migrate in a random manner (Chtanova et al., 2008), until a further activation step is achieved. In the context of BCG-triggered bladder inflammation, neutrophils and monocytes/macrophages will likely engage and adhere to BCG-associated bladder and immune cells, resulting in cytokine production, degranulation and, in the case of neutrophils, their production of extra-cellular structures called neutrophil extra-cellular traps (Brinkmann et al., 2004). NK cells will be activated by stress-induced self-proteins (e.g., MIC-A) resulting in their secretion of effector cytokines and upregulation of cell-death inducing agonists (e.g., TNF-SF molecules) (Cerwenka and Lanier, 2001; Zamai et al., 2007). The processes are aimed at the killing of microorganisms, but they also result in their own death (referred to as “beneficial suicide”) as well as death of bystander cells (Brinkmann and Zychlinsky, 2007; Smith, 1994). Specifically, neutrophils and macrophages possess oxygen-dependant and oxygen-independent mechanisms of triggering cell death. Degranulation also results in the release of lipases, phospholipases and gelatinases, all of which are toxic for neighboring cells.

To provide a first evaluation of whether the innate immune response can account for the observed tumor immunity, we calculated the number of effector cells that are induced upon therapy. Neutrophil degranulation events were used as a surrogate marker based on their abundance and on the possibility to calibrate data based on MPO release. *In vitro* investigations revealed that a neutrophil can release  $\sim 4.5 \times 10^{-4}$  ng of MPO. Our previous clinical study established the concentration of MPO in the urine of patients at different time points following BCG instillation. Thus, we calculated that there are  $0.6-2.8 \times 10^6$  degranulation events during the first instillation and  $3.6-11.3 \times 10^6$  degranulation events during the third instillation. The total number of degranulations during the 6 BCG instillations was estimated to be in the range of  $1.26-4.23 \times 10^7$  events. Of note, these estimates make the assumption that all of the degranulations observed are concentrated in the smallest number of neutrophils. One caveat is that, *in vivo*, neutrophils may be partially degranulated, which would translate into greater population number but weaker killing capacity per neutrophil.

#### 4) Simulation results

**Figure 52** below shows a simulation of the dynamics of cell populations during BCG therapy.



Panel **A** shows the percent of free BCG that is present in the bladder during the instillations. Note that  $\sim 99\%$  of the free BCG is flushed out weekly, after each instillation. The dynamics of the tumor cells (panel **B**) is marked by steep decreases in the cell population numbers due to BCG instillations followed by slight increases due to local proliferation. Panels **C** and **D** represent the dynamics of the population of BCG-associated tumor cells and BCG-associated tissue cells, respectively. The population of BCG-associated tumor cells is fairly small and undergoes extinction in between the BCG instillations. Panel **E** shows the dynamics of the population of innate effector cells. Note the significant growth in the number of effector cells



after the third instillation, corresponding to the “prime-boost” effect (see assumption 11). Panel **F** shows the change in the recruitment rate of innate effector cells due to vascularization and healing of the bladder wall.

## **B. The theoretical condition for tumor elimination by the innate immune system**

Given that the tumor burden following surgical resection of Ta/T1 or CIS lesions is in the range of  $10^6$  tumor cells and that the total number of degranulation is in the order of  $1-4 \times 10^7$  events, it is theoretically possible that the innate immune system can account for the observed tumor immunity. The major caveat, however, concerns the cells from the innate immune system not having the capacity to direct their cytotoxic potential.

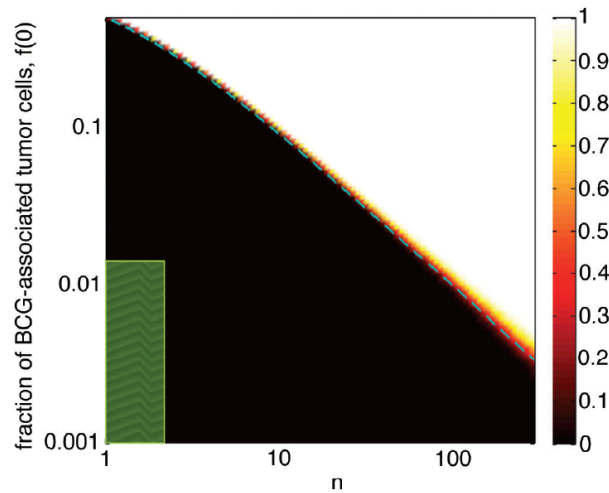
### 1) Model analyses

#### *(a) Analysis of the stochastic model*

We found that 2 quantities play a crucial role in understanding the potential of the innate immune system for tumor elimination.

- The first quantity, which we denoted  $n$ , is the number of bystander cells killed per innate immune cell activated.
- The second quantity, which we denoted  $f(0)$ , is the fraction of tumor cells that associate with BCG during the last instillation.

Numerical simulations of the stochastic model provide the probability of tumor extinction vs.  $n$  and  $f(0)$  (**Figure 53**). The white zone marks the region in the parameter space where tumor goes extinct, while the black zone marks the region in the parameter space where tumor survives immunotherapy. A number of parameters determine this result (see **Table 4**).



**Figure 53: Probability of tumor extinction as a function of the number  $n$  of bystander cells killed per innate effector mechanisms and the fraction  $f(0)$  of tumor cells that associated with BCG during the last instillation.**

The probability map was obtained with the stochastic version of our model (as mentioned in the text above). The blue dashed line represents the necessary condition for tumor elimination that we obtained from the deterministic version of our model (see text below). Note that the stochastic and deterministic results appear to be fairly close. The green shade defines the region of parameter values that are derived from clinical and observational data (see below). The scaled color heat map indicates the probability of tumor extinction.

*(b) Mean-field approximation of the stochastic model*

For a better understanding of the tumor elimination process, we derived the mean-field approximation of our stochastic model. Thus, we obtained a set of ordinary differential equations whose analysis yielded an intuitive result (see supplemental information of manuscript 2): if tumor extinction occurred following completion of therapy, then, following the last instillation, the number of “free” tumor cells  $T(0)$  was smaller than the number of BCG-associated tumor cells  $T'(0)$  multiplied by  $n$ , the average number of bystander tumor cells killed per innate effector cell activation, triggered by a  $T'$  cell:

$$T(0) < n T'(0) \quad (1)$$

Note however that given the growth conditions of tumors within tissues (i.e., most tumor cells neighbor only tumor cells),  $n$  may be thought of as the number of bystander cells killed per innate effector cell activated. For convenience in presentation, we assign this interpretation to  $n$  as for the rest of this subchapter, favoring again the modeling outcome of tumor elimination.

Following from equation (1), infected tumor cells activate and trigger cytokine secretion and/or degranulation of innate effector cells (see Assumption 5). Effector cytokines, engagement of death receptors and/or degranulation causes death of the infected tumor cell that triggered the response, killing in addition - on average - neighboring cells (bystander

death), most of which would be uninfected tumor cells. Therefore equation (1) can also be written as:

$$f(0)(n+1) > 1 \quad (2)$$

where  $f(0) = T'(0) / [T'(0) + T(0)]$  is the fraction of BCG-associated tumor cells after the flush of BCG.

Condition (2) is economic in parameters and provides a good approximation of the results obtained directly from running our stochastic model (see **Figure 53**). It is important to note that condition (2) is necessary, yet insufficient, for tumor elimination for 2 major reasons. First, BCG-associated tumor cells may die and thus not all of the cells present after the last BCG instillation trigger activation of the innate response. Second, tumor cells not associated with BCG undergo local proliferation and thus their number increases during immunotherapy. Both these phenomena suggest that in fact, the number of BCG-associated tumor cells must be greater than  $T(0)/n$  to ensure tumor elimination. Overlaying the results of the deterministic model (represented by the dashed blue line in **Figure 53**) on those from the stochastic version, we find that condition (2) provides a good approximation of the predictions of tumor elimination made by the stochastic model.

## 2) Validation of the theoretical condition for tumor elimination by the innate immune system

To verify whether condition (2) applies in practice, we sought for experimental values for  $f(0)$ , the fraction of BCG-associated tumor cells and  $n$ , the bystander death.

### (a) *Experimental estimation of the fraction of BCG-associated tumor cells, $f(0)$*

To estimate the fraction of BCG-associated tumor cells,  $f(0)$ , we performed *in vitro* exposure of bladder tumor cell cultures to clinical-grade BCG, at a multiplicity of infection (MOI) close to that encountered *in vivo*. To estimate such MOI, we took into consideration the estimated number of urothelial cells per layer, i.e.,  $10^7$  (see Section 0) and the dose of BCG instilled into the bladder, i.e.,  $10^9$  bacteria, including  $10^8$  CFUs (see Section A.3)(c)). Therefore we used a MOI of 10 (taking into account CFUs, which are the measurable parameter on the BCG preparation). Of note, such MOI is an overestimation of the MOI encountered *in vivo*, as all bacteria are very unlikely to contact the urothelium, given that the bladder is a 3D volume and not a flat surface.

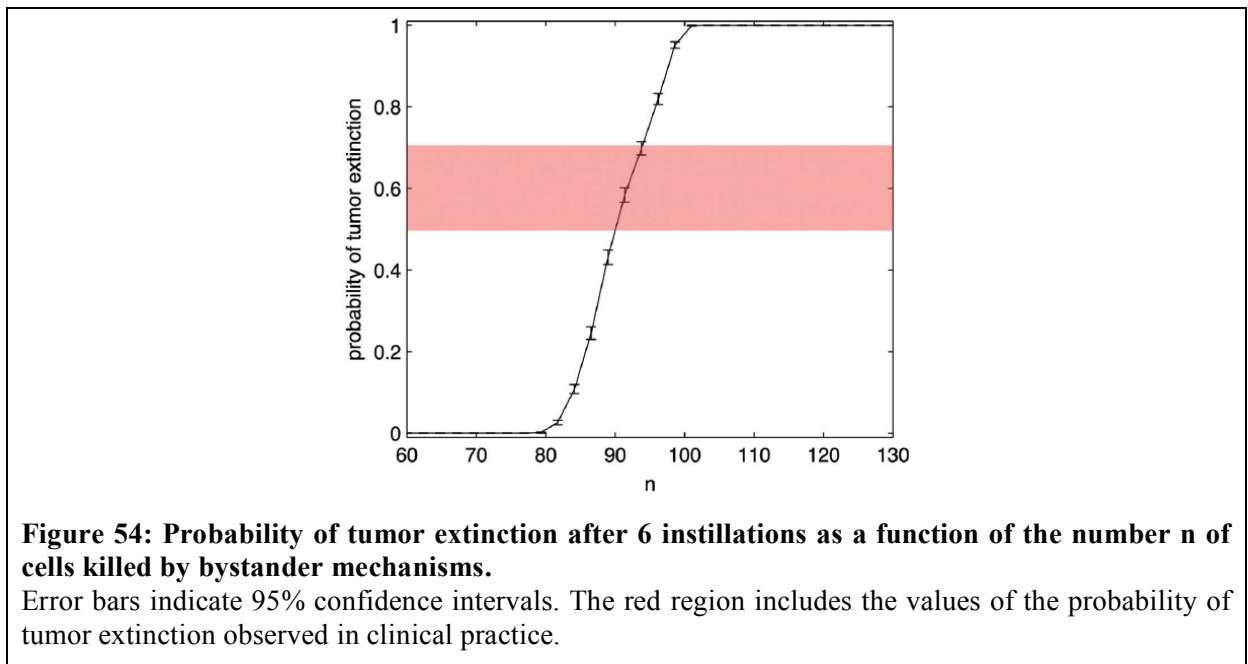
After a 2 hours exposure (corresponding to the *in vivo* dwell time), ~1% of tumor cells were found infected, using acid-fast staining (**Figure 29** is showing a representative staining

example, but after 24 hours infection). If acid-fast staining is effective at revealing live and dead bacteria (which matters a lot in the case of the use of a lyophilized preparation), its sensitivity is known not to be very good, which is a caveat of our estimation. We however argue that such caveat is counterbalanced by the rather elevated MOI that was utilized.

As an alternative strategy, fluorescent GFP-expressing BCG was used. Even with an extended exposure period of up to 48 hours, we observed only 4-15% cell-associated BCG (data not shown).

*(b) Simulation-based calculation of bystander death, n*

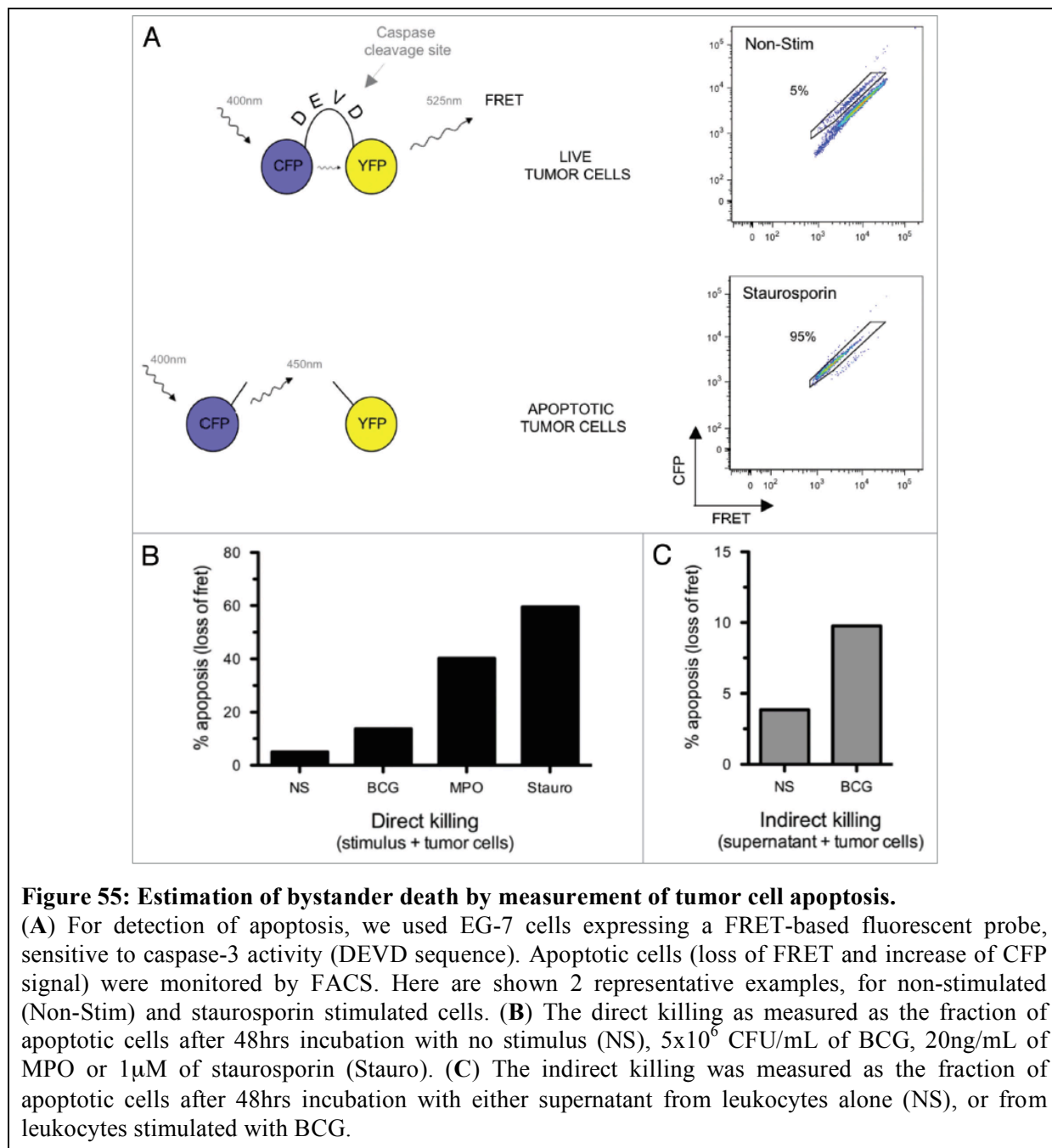
Next we used these *in vitro* findings and simulated the whole regimen of 6 BCG instillations to obtain the number of bystander cells killed per innate cell activated (denoted  $n$ ) that would yield the expected 50-70% cure rate observed in clinical trials. We kept the ratio of the infected tumor cells  $f(0) \sim 1.5\%$ . We thus estimated that 90-95 bystander cells must be killed per innate cell if the innate system is solely responsible for tumor elimination (**Figure 54**).



*(c) Experimental estimation of bystander death, n*

To verify whether this estimate for  $n$  was realistic, we used 2 different approaches. Our first approach was based on clinical observations of bladder anatomy during BCG immunotherapy. There are  $2.4-4.2 \times 10^8$  urothelial cells in the bladder, organized in 4-7 layers ( $\sim 1.5 \times 10^7$  cells per layer of the bladder wall, see Section 0). Since the calculated number of neutrophil degranulations was found to be in the range of  $1.26-4.23 \times 10^7$  events (as detailed above, in Section A.3)(d)), we could imagine sloughing of the outer 1-2 (out of 4-7) layers of the bladder wall. Given our estimate of neutrophil degranulations during immunotherapy, this is

consistent with a killing capacity of  $n < 2$  cells per neutrophil degranulation. Considering that other innate effector cell have the possibility to induce cell death to the transitional urothelium, this is a high estimate of the tolerable bystander damage to the bladder wall.



**Figure 55: Estimation of bystander death by measurement of tumor cell apoptosis.**

(A) For detection of apoptosis, we used EG-7 cells expressing a FRET-based fluorescent probe, sensitive to caspase-3 activity (DEVD sequence). Apoptotic cells (loss of FRET and increase of CFP signal) were monitored by FACS. Here are shown 2 representative examples, for non-stimulated (Non-Stim) and staurosporin stimulated cells. (B) The direct killing as measured as the fraction of apoptotic cells after 48hrs incubation with no stimulus (NS),  $5 \times 10^6$  CFU/mL of BCG, 20ng/mL of MPO or  $1 \mu\text{M}$  of staurosporin (Stauro). (C) The indirect killing was measured as the fraction of apoptotic cells after 48hrs incubation with either supernatant from leukocytes alone (NS), or from leukocytes stimulated with BCG.

In our second approach, we monitored bystander death directly by measuring tumor cell apoptosis based on cleavage of caspase-3 (Myzak and Carr, 2002; Srivastava, 2001). We made use of EG7 cells expressing a FRET-based (Förster Resonance Energy Transfer) fluorescent probe sensitive to caspase-3 activity. CFP and YFP molecules are linked by a peptide containing the sequence DEVD (Asp-Glu-Val-Asp), which is cleaved by activated caspase-3. Cleavage of the probe upon caspase-3 activation resulted in FRET disruption (see **Figure 55A**). EG7 cells were incubated for 48 hours with BCG, myeloperoxidase or

staurosporine for assessing the direct killing (**Figure 55B**). For indirect killing, EG7 cells were incubated for 48 hours with supernatant from leukocytes alone (NS, Non Stimulated), or from leukocytes stimulated with BCG (**Figure 55C**). After incubation, cells were washed twice in PBS and run on a BD FACS Canto II. Apoptotic cells were identified based on their loss of FRET and increase of the CFP signal. Notably, continuous exposure of tumor cells to BCG resulted in >14% of the tumor cells undergoing apoptosis (**Figure 55B**), among which up to 10% being attributed to bystander cell death (**Figure 55C**). These results translate into an experimentally determined bystander killing capacity estimate of only  $n \approx 1$  cell per neutrophil degranulation.

We therefore conclude that the values for  $f(0)$  and  $n$  observed in clinical and experimental data belong to the green shaded region in **Figure 53**, where condition (2) is violated. Hence, tumor extinction mediated by the innate immune system acting on its own is highly improbable.

### **III. MATHEMATICAL MODELING IDENTIFIES CLINICALLY-RELEVANT DETERMINANTS OF TREATMENT RESPONSE**

Based on the analysis that the innate immune system was not capable of itself achieving the observed tumor immunity (see Section II), we went on to parameterize adaptive immunity in our model. Adaptive immune effector cells (e.g., T lymphocytes) are distinct from most innate populations as they are long-lived, possess properties of antigen specificity and immunologic memory, with the possibility of interacting with multiple target cells during a single round of activation. Estimates based on experimental data suggest that a single cytolytic T lymphocyte has the potential to kill ten target cells before it requires re-activation by an antigen-presenting cell (Breart et al., 2008). Moreover, the existence of a memory pool of antigen-specific T cells enables a more robust adaptive immune effector cell response upon secondary re-exposure to BCG.

Specifically, we used clinical and *in-vitro* experimental data to construct and parameterize a new stochastic mathematical model describing the interactions between BCG, the immune system, and tumor cells with the primary endpoint being the probability of tumor extinction. We did not aim for precise quantitative results but rather for a robust qualitative overall understanding that would remain valid for further generations of models including integration of increasing levels of detail. Using our refined mathematical model, we addressed several clinical parameters – (1) varying the time from resection to BCG instillation, (2) modulating

the BCG dose used during intravesical instillation, (3) the indwelling time of BCG, and (4) the inter-instillation interval – in order to ascertain their impact on response to standard therapy, and suggest strategies for an optimal protocol of successful BCG immunotherapy.

Of note, in this Section, I contributed to the conception of the project, to the design of the flow diagram of the model and to the definition of the assumptions underlying the model, in collaboration with R. Breban, M. Albert, C. Rentsch and J. Gsponer. I was involved in data analysis, interpretation and drafting of the manuscript.

## **A. Modeling the adaptive immune system**

We completed our series of assumptions described in Section II.A.1) with 2 additional assumptions dealing with adaptive effector cells, which we describe and justify, before explaining how the updated model runs.

### 1) Two additional assumptions

*(a) Assumption 12: Adaptive effector cells are recruited to the bladder as a direct result of the increased number of innate effector cells. The initial recruitment is however delayed, as the adaptive immune system does not react as fast as the innate immune system.*

For parsimony of the model, we consider a model of signaling by the innate immune system that is based simply on the count of innate effector cells in the bladder. This is meant to embody the activation of migratory dendritic cells that prime adaptive responses, and the local production of chemokines that directly act by attracting lymphocytes into the bladder mucosa. The delay in activation of the adaptive immune system is modeled empirically by simply not allowing adaptive effector cells in the bladder earlier than day 10 after the initiation of BCG immunotherapy, the minimal time required to achieve activation of mycobacterial (based on our clinical observations (Bisiaux et al., 2009)) or tumor antigen specific responses.

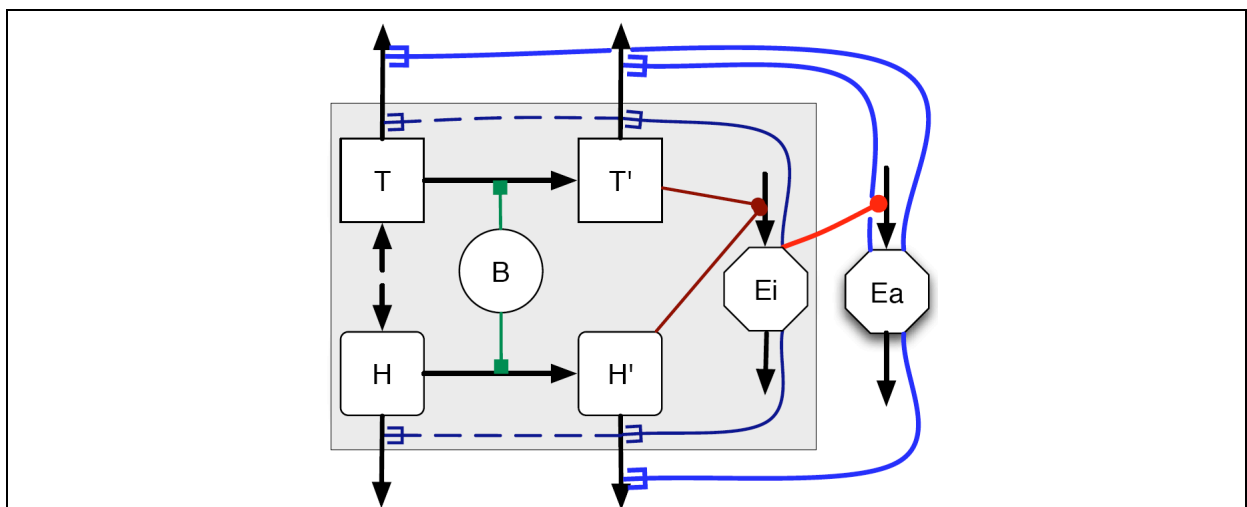
*(b) Assumption 13: Adaptive effector cells engage equally well with BCG-associated tissue and tumor cells. Adaptive effector cells also engage, but less effectively, with BCG-unassociated tumor cells. As a result of the engagement process, only the target cell is destroyed.*

For parsimony of the model, we consider only one population of adaptive effector cells that, on average, fulfills the roles of a heterogeneous mix of lymphocytes that occurs in reality. This assumption considerably reduces the number of parameters needed to describe the adaptive immune system and makes possible the calibration of the model to clinical data.

Based on some theoretical analysis of BCG mode of action together with preliminary results that will both be detailed in General Discussion (see Chapter 4 Section II.B and II.C.1)), we make the assumption that activation and recruitment of tumor-specific adaptive effector cells occurs. By offsetting the potency of engagement of BCG-associated vs. unassociated cells, we may introduce the notion of affinity for antigen, which is expected to be greater for microbial antigen, as compared to tumor antigen (De Visser et al., 2003).

## 2) Running the model

We add a 7<sup>th</sup> state variable to our previous model (see the flow diagram below, **Figure 56**), namely adaptive effector cells that have extravasated into the bladder, which we denote  $E_a$ .



**Figure 56: Flow diagram of the refined mathematical model.**

H and T denote the number of BCG-unassociated cells of the bladder tissue and tumor cells, respectively.  $E_i$  and  $E_a$  denote the number of innate and adaptive effector cells, respectively. B denotes the number of free BCG bacteria in the bladder.  $H'$  and  $T'$  denote the number of BCG-associated tissue and tumor cells, respectively. The model runs as follows. Before immunotherapy, only three of seven cell populations are present: H, T and  $E_i$ . The interactions between these cell populations are negligible and their corresponding compartments are disconnected. The processes that take place for each of these independent compartments are 'birth' (i.e., cell inflow and/or local proliferation) and 'death' (i.e., cell outflow and/or homeostatic programmed cell death); see the vertical arrows. During BCG instillations, the initiation of the response is as described in Section II: three new populations emerge creating dynamic interactions between all the compartments. Free BCG infects tissue and tumor cells (green arrows), inducing transition from H to  $H'$  and T to  $T'$  (horizontal black arrows).  $H'$  and  $T'$  cells activate innate effector cells  $E_i$  (red arrows). In turn,  $E_i$  target  $H'$  and  $T'$ , destroying them (blue continuous arrows) and neighboring H and T cells (blue dashed arrows) by innate effector mechanisms. The presence of  $H'$  and  $T'$  triggers increased migration of  $E_i$  cells into the bladder and such increase in  $E_i$  triggers recruitment of  $E_a$  (red arrow), with a much-enhanced killing capacity.  $E_a$  target  $H'$ ,  $T'$  and T (blue arrows) either by BCG-specific ( $H'$ ,  $T'$ ) or tumor-specific (T) mechanisms.

Our refined model runs as follows.



*(a) Initial state, before therapy*

As explained in Section II, before immunotherapy, only 3 of the 7 populations are present: H, T and  $E_i$  and the interactions between these cell populations are negligible; i.e., their corresponding compartments in **Figure 56** are disconnected. The processes that take place for each of these independent compartments are “birth” (i.e., cell inflow and/or local proliferation) and “death” (i.e., cell outflow and/or homeostatic programmed cell death) (black vertical arrows in **Figure 56**).

Importantly, adaptive immune cells (e.g., antigen-specific T cells) are not present before initiation of therapy, as their entry into the dynamic model requires priming (see Assumption 12).

*(b) Modeling of BCG instillations*

During BCG instillations, the initiation of the response is as described in II; i.e., 3 new populations emerge, creating dynamic interactions between all the compartments. B associates to tissue and tumor cells (green arrows in **Figure 56**), inducing transitions of cells from H to H' and from T to T' (horizontal black arrows in **Figure 56**). The presence of H' and T' cells triggers increased migration and activation of innate effector cells  $E_i$  into the bladder mucosa. In turn,  $E_i$  cells target H' and T', destroying them and neighboring H and T cells (bystander death). Of note, the presence of H' and T' triggers increased migration of  $E_i$  cells into the bladder tissue (see assumption 11 in II).

What is new in the modeling is that now, the increased number of  $E_i$  cells triggers recruitment of adaptive effector cells  $E_a$  (red arrow in **Figure 56**), with a much enhanced killing capacity. As explained in Assumption 13, cells of the adaptive immune system may be specific to BCG antigen, thus targeting BCG associated urothelial and tumor cells; but they may also include tumor antigen-specific effector cells, thus permitting the direct targeting of uninfected tumor cells.

3) Further calibration of the model

From Section II, we set the fraction of infected cells  $f(0)$  to 1.5% and bystander death ( $n$ ) to 1, such that the list of stochastic processes and their corresponding rates is displayed in **Table 5** and the parameters of the models in **Table 6**.

Process	Definition	Rate
Tumor proliferation	$T \rightarrow T + 1$	$\beta T$
Tumor death	$T \rightarrow T - 1$	$\mu_T T$
Tumor death due to shortage of blood supply	$T \rightarrow T - 1$	$rT(T + T')/K$
Tumor death due to degranulation	$T \rightarrow T - 1$	$n\kappa E_i T'$
Tumor death due to adaptive effectors	$T \rightarrow T - 1$	$\lambda E_a T$
BCG-infection of tumor cells	$T \rightarrow T - 1,$ $B \rightarrow B - 1,$ $T' \rightarrow T' + 1$	$\rho B T$
Infected tumor death	$T' \rightarrow T' - 1$	$\mu_{T'} T'$
Infected tumor death due to shortage of blood supply	$T' \rightarrow T' - 1$	$rT'(T + T')/K$
Infected tumor death due to degranulation	$T' \rightarrow T' - 1,$ $E_i \rightarrow E_i - 1$	$\kappa E_i T'$
Infected tumor death due to adaptive effectors	$T' \rightarrow T' - 1$	$\lambda' E_a T'$
BCG-infection of tissue cells	$H' \rightarrow H' + 1,$ $B \rightarrow B - 1$	$\sigma B$
Infected tissue death	$H' \rightarrow H' - 1$	$\mu_{H'} H'$
Infected tissue death due to degranulation	$H' \rightarrow H' - 1,$ $E_i \rightarrow E_i - 1$	$\kappa E_i H'$
Infected tissue death due to adaptive effectors	$H' \rightarrow H' - 1$	$\lambda' E_a H'$
Neutrophil migration at homeostasis	$E_i \rightarrow E_i + 1$	$\pi$
Increased neutrophil migration due to BCG-infection <sup>a</sup>	$E_i \rightarrow E_i + 1$	$\alpha(t)(T' + H')$
Neutrophil deactivation and loss into the bladder lumen	$E_i \rightarrow E_i - 1$	$\mu_{E_i} E - i$
Recruitment of adaptive effectors <sup>b</sup>	$E_a \rightarrow E_a + 1$	$\zeta \alpha(t)[E_i(t) - \pi/\mu_{E_i}]\theta(t - t_a)$
Death and loss of adaptive effectors into the bladder lumen	$E_a \rightarrow E_a - 1$	$\mu_{E_a} E_a$

**Table 5: Stochastic processes and their corresponding rates in the refined model.**

The refined model is parameterized such that the simulated dynamics of the cell populations are in agreement with *in vivo* and experimental data and the observed tumor elimination probability of approximately 50%.

Parameter	Symbol	Value/Range
Tumor proliferation rate parameter	$\beta$	0.11 day <sup>-1</sup>
Tumor death rate parameter	$\mu_T$	0.067 day <sup>-1</sup>
Tumor carrying capacity	$K$	10 <sup>11</sup> cells
Number of cells destroyed per degranulation	$n + 1$	2
Predation coefficient of innate effector cells	$\kappa$	10 <sup>-12</sup> /cell/day
Predation coefficient of adapted effectors on uninfected tumor cells <sup>a</sup>	$\lambda$	3.36 × 10 <sup>-7</sup> /cell/day
Delay in the activation of the adaptive immune responses	$t_a$	10 days
Predation coefficient of adapted effectors on infected cells	$\lambda'$	10 <sup>-6</sup> /cell/day
BCG infectiousness of tumor cells	$\rho$	2 × 10 <sup>-9</sup> /cell/day
Natural death rate of BCG-associated tumor cells	$\mu_{T'}$	1/3 days
BCG rate of association to tissue cells	$\sigma$	0.1 day <sup>-1</sup>
Natural death rate of BCG-associated tissue cells	$\mu_{H'}$	0.2 days
Inflow of effector cells in the bladder tissue <sup>b</sup>	$\pi$	345000 cells/day
Loss parameter of innate effector cells	$\mu_{E_i}$	0.345 day <sup>-1</sup>
Maximum recruitment rate of effectors due to BCG	$\alpha_1$	200 day <sup>-1</sup>
Minimum recruitment rate of effectors due to BCG <sup>c</sup>	$\alpha_1/(1 + e^{\alpha_2})$	0.49 day <sup>-1</sup>
Scale of $C(t)$ for vascularization increase	$\alpha_3$	10 <sup>9</sup> cells
Healing time of the bladder wall	$\tau$	33.3 days
Recruitment parameter of adaptive effectors	$\zeta$	10 <sup>-5</sup>
Loss parameter of adaptive effector cells	$\mu_{E_a}$	0.8 day <sup>-1</sup>

<sup>a</sup>Chosen such that the probability of tumor elimination of the six weekly instillation schedule is ~50%.

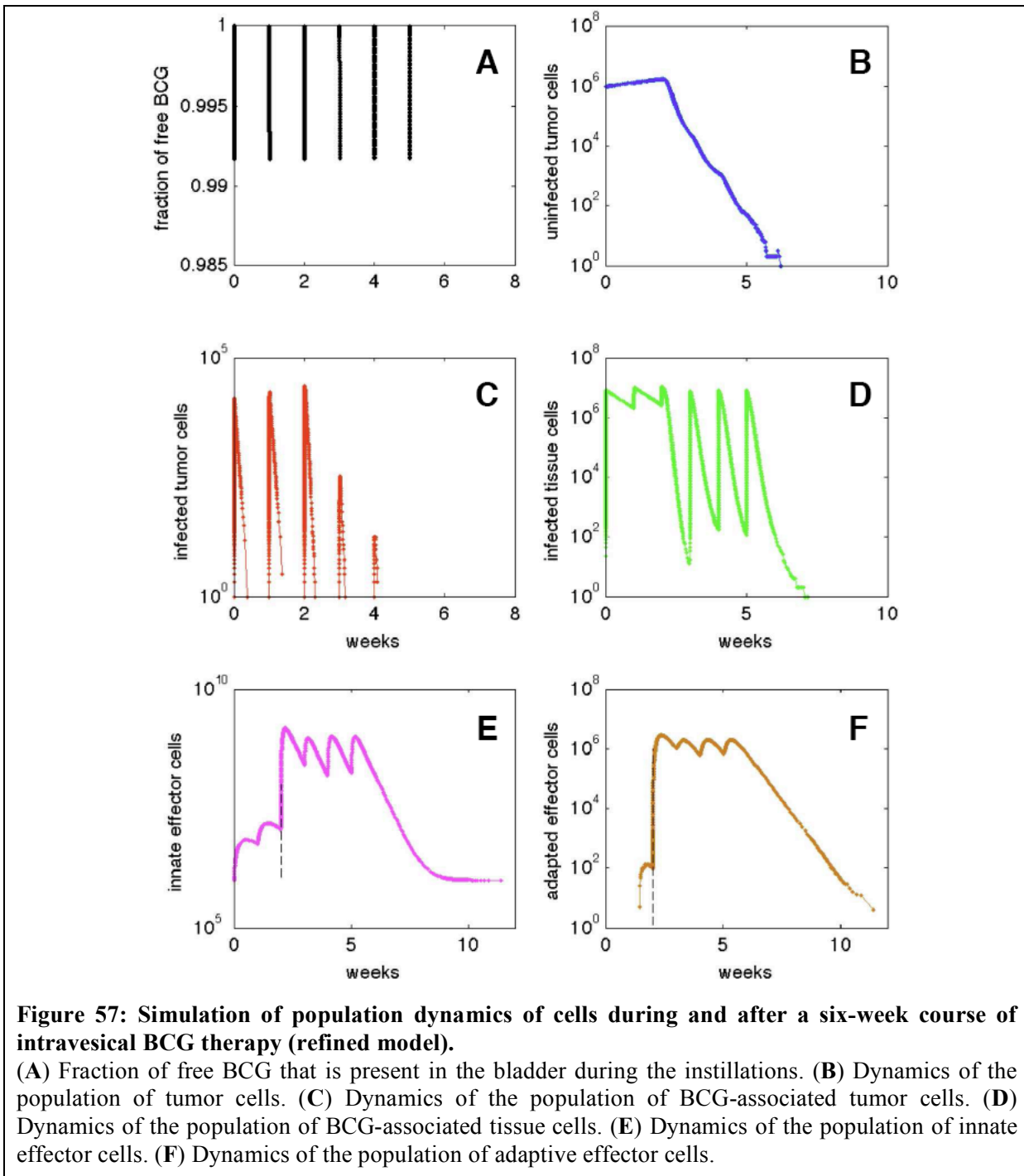
<sup>b</sup>Chosen such that the steady population of effectors in the bladder amounts to 10<sup>6</sup> cells.

<sup>c</sup> $\alpha_2 = 6$ .

**Table 6: Parameters of the refined model.**

#### 4) Simulation results

**Figure 57** shows a simulation of the dynamics of cell populations during and after BCG therapy.



As in Section II, panel A shows the fraction of free BCG during the instillations, with  $\sim 99\%$  of the free BCG being flushed out weekly, after each instillation. The dynamics of the tumor cells (panel B) is marked by steep decreases in the cell population numbers due to BCG instillations followed by slight increases due to local proliferation. Panels C and D represent the dynamics of the population of BCG-associated tumor cells and BCG-associated tissue

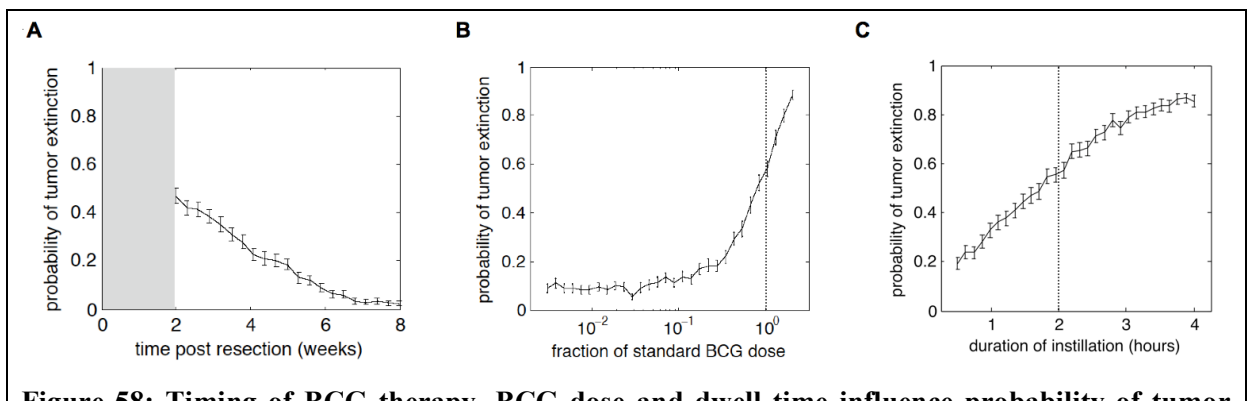
cells, respectively. The population of BCG-associated tumor cells is fairly small and undergoes extinction in between the BCG instillations. Panel **E** shows the dynamics of the population of innate effector cells. Panel **F** now shows the dynamics of the population of adaptive effector cells. As for innate cells (in **E**) we do observe a prime boost effect (since their recruitment is late, and based on the number of innate effector cells, which follow a prime-boost effect).

## B. Testing several key parameters of BCG treatment

Using this refined mathematical model, we evaluated treatment parameters thought to influence clinical response, including (1) varying the time from resection to BCG instillation, (2) modulating the BCG dose used during intravesical instillation, (3) modulating BCG dwell time, and (4) the inter-instillation interval

### 1) Delay between surgery and initiation of BCG therapy

First, we determined the influence of the time interval between surgery and initiation of BCG treatment. The model calculated the probability of tumor extinction after six weekly instillations as a function of the post resection time (**Figure 58A**). The shorter the interval from surgery to BCG therapy, the greater is the chance for achieving clinical response. This result is due to the continued expansion of residual tumor cells post-resection, increasing the burden of disease and challenging the limited kill capacity of the immune system.



**Figure 58: Timing of BCG therapy, BCG dose and dwell time influence probability of tumor extinction.**

(A) Probability of tumor extinction with time from surgery to the start of BCG therapy. The grey shaded area represents the time from surgery to the typical initiation of BCG therapy (i.e., 2 weeks). (B) The probability of tumor extinction after a 6-week course BCG induction cycle was modeled as a function of BCG dose, and (C) BCG dwell time. The dotted lines indicate the treatment outcome for standard protocol.

## 2) BCG dose

The model was further queried to determine impact of BCG dose in the bladder. We noted a clear positive correlation between BCG dose and probability of tumor extinction (**Figure 58B**). Strikingly, small changes in dose are predicted to have a significant impact on therapeutic success.

## 3) BCG dwell time

As a corollary, we examined the dwell time (i.e., the duration of BCG instillation). Again, we find that greater exposure of the bladder mucosa to BCG results in an increased probability of tumor extinction (**Figure 58C**). These results provide a stark reminder of the importance of adhering to, at minimum, the current guidelines for BCG immunotherapy.

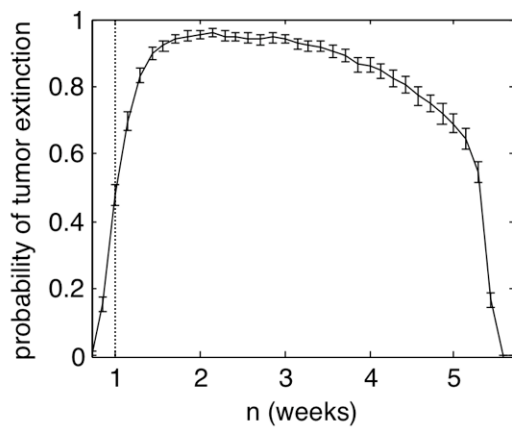
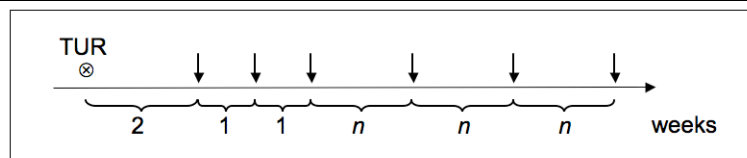
## 4) Treatment interval

Our own data showing late priming and recruitment of T cells to the bladder (see Chapter 2) suggested that the current treatment schedule may not be properly tuned to the kinetics of adaptive immune responses. Therefore, the impact of varying inter-instillation intervals was assessed.

Since our model did not detail the activation of the immune response – due to lack of data and parameters, especially when the model was initiated a few years ago –, we maintained the first three doses at weekly intervals, allowing for priming of adaptive immune responses (our own data in Chapter 2) and enhanced bladder inflammation (Bisiaux et al., 2009).

We then varied the time interval – named  $n$  – between each instillation, from the third to the sixth dose. As already mentioned, the model is parameterized such that if  $n = 1$  (standard protocol), there is a probability of tumor extinction of 50%. The simulation shows that shorter inter-instillation intervals negatively impacted clinical response (**Figure 59**), while extending the treatment intervals remarkably resulted in improved response rates. For example, a treatment interval twice longer than the current standard of care would yield higher tumor extinction rates, with no negative impact if extended up to 30 days, but with abrupt loss of treatment response if further extended (**Figure 59**).

From our modeling perspective, the modified treatment regimen engages the afferent immune response during the early phase of treatment and maximally benefits from the effector potential of the efferent adaptive response. Moreover, the proposed schedule may help lessen some of the side effects seen during conventional therapy.



**Figure 59: The treatment interval strongly influences the probability of tumor extinction.**

The first 3 instillations were maintained on a weekly basis in order to initiate innate and adaptive immune responses (see text above). The time interval between each instillation, from the third to the sixth, was varied and designated  $n$  (weeks);  $\otimes$  indicates the time of transurethral resection (TUR). The probability of tumor extinction is shown here as a function of  $n$ . The dotted line indicates the outcome after the recommended interval of  $n = 1$  week.

## IV. DISCUSSION

William Coley, in the late 1800s, was titrating sepsis and tumor immunity, observing the occasional remission of non-resectable sarcomas and sparking over a century's worth of clinical investigation as to how to harness the immune system for tumor immunotherapy (Old, 1996; Wiemann and Starnes, 1994). The use of BCG as adjuvant therapy in bladder cancer patients follows from Coley's initial findings, and notably, it represents perhaps the only reproducible intervention, resulting in 50-70% clinical response in patients with non-muscle invasive transitional cell carcinoma (Brandau and Suttman, 2007). While this therapy has been the standard of care for more than 35 years, its precise mechanisms remain unclear - including the important question whether BCG only functions as a non-specific immunotherapy, or also involves some tumor-specific mechanisms - and the treatment regimen was designed empirically. We discuss both topics sequentially.

### A. BCG therapy is likely more than a non-specific immunotherapy

One area of research that has yielded important results concerns the innate immune response provoked by intravesical instillation of BCG. Others and we have reported massive influx of

innate effector cells into the bladder (Bisiaux et al., 2009; Brandau and Suttman, 2007); and several studies have illustrated the anti-tumor potential of activated innate immune cells (Rosevear et al., 2009; Yutkin et al.). Furthermore there exist active lines of clinical investigation aimed at enhancing neutrophil cytotoxicity. For example BCG has been combined with type I interferon, with the aim to enhancing TRAIL expression on innate immune cells (Joudi et al., 2006; Kemp et al., 2005).

In Section II, we established a mathematical model to evaluate the capacity of the innate immune system to mediate the observed tumor immunity in patients receiving BCG therapy for non-muscle invasive bladder cancer. Importantly, the model accurately reflected the recruitment and activation of innate immune cells during the 6-week course of BCG treatment. Strikingly, analyses and simulations of our model indicated that a bystander kill rate of  $>90$  cells per innate effector cell would be required to achieve tumor extinction with a 50-70% probability. A kill radius of this magnitude would result in loss of integrity of the bladder wall. Furthermore, experimental data indicated that BCG-stimulated innate cells have only a modest bystander kill capacity. We therefore rejected our hypothesis that the innate immune system is solely responsible for tumor elimination and infer that other effector mechanisms are required to fully account for the clinically observed tumor immunity. We therefore pursued our efforts (see Section III and following discussion) by modeling the adaptive immune response, and its crosstalk with the innate immune response.

## **B. Clinically-relevant determinants of treatment response**

Using our refined mathematical model we evaluated clinically relevant questions of BCG therapy in NMIBC. The model revealed that therapeutic success depends strongly on the timing of the BCG regimen. An early start of BCG therapy after TUR, combined with an optimal dwell time and treatment inter-instillation interval, do, in fact, have profound influence on treatment outcome, according to our model.

### 1) Delay between surgery and initiation of BCG therapy

There are no current guidelines advising when to start BCG therapy after surgery. Delay is considered important for the healing of the bladder wall, and the prevention of systemic complications due to BCG therapy. Therefore, most urologists wait 2-6 weeks prior to starting BCG therapy; however, in some studies intravesical treatment has been initiated as early as 1 week after transurethral resection (Lamm et al., 2000; van der Meijden et al., 2003). To date,

no prospective comparisons of different delays to start of BCG treatment have been performed.

Our model indicates that a prolonged delay in initiating BCG therapy could negatively impact recurrence rates (**Figure 58A**). Analysis of the model suggested that the increased risk for recurrence was related to outgrowth of residual tumor cells.

## 2) BCG dose

Changes in dose and dwell time have been discussed on the basis of reducing side effects. Dose reduction has been assessed in several clinical trials (Agrawal et al., 2007; Losa et al., 2000; Mack and Frick, 1995; Martinez-Pineiro et al., 2002; Ojea et al., 2007; Pagano et al., 1991). Reducing BCG dose to one third was considered as a strategy aimed at lowering side effects. This lower dose remained significantly better than mitomycin; whereas one sixth of the BCG dose was not better than the use of mitomycin alone (Martinez-Pineiro et al., 2002; Ojea et al., 2007).

These findings corroborate our modeling results regarding the influence of dose on the cure rate (**Figure 58B**). Our model also shows that increasing the dose increases therapeutic success. However, this would probably occur at the cost of enhancing side effects.

## 3) BCG dwell time

Reduction of dwell time has been reported as a possibility for improving therapy and as an alternative to dose reduction in patients with severe side effects (Andius et al., 2005) but no prospective study has compared BCG dwell time as a variable.

These results provide a stark reminder of the importance of adhering, as much as possible, to the current guidelines for BCG immunotherapy. In addition, our model indicates that increased dwell time might favorably influence treatment outcome (**Figure 58C**). This could be of special importance in patients with minimal symptoms that may benefit from enhanced BCG-mediated immune activation.

## 4) Treatment interval

Perhaps the most striking finding is the observation that a longer treatment interval – e.g., twice as long as the current schedule – would greatly improve response to therapy (**Figure 59**). This finding is likely related to the kinetics of T and B cell activation, and the persistence of these relatively long-lived effector cells in the bladder. By extending the treatment interval



during the effector phase, we have succeeded in enhancing the time period during which the immune system may exert negative pressure on the residual tumor burden.

Only limited information is available from clinical trials where the treatment interval was modified during BCG induction therapy. Studies in mice indicated that the number and timing of the instillations are important in determining different local cytokine profiles, which in turn may influence the qualitative and quantitative recruitment of adaptive effector cells (de Boer et al., 2005). Such findings in combination with the result of our model support the need for further investigations to determine the optimal timing of BCG instillations. Attention should be paid to the abrupt loss of the treatment effect after a certain interval (**Figure 59**), a finding that may also have implications for the timing of possible maintenance therapy.

These results are encouraging, since an extended course of treatment may be better tolerated by patients (Bassi et al., 2000). Moreover, it is intriguing to consider that extension of the first six doses of BCG could obviate the need for maintenance therapy.

## **C. Discussion of our modeling**

### 1) The novelty of our modeling

The field of mathematical modeling in BCG immunotherapy of bladder cancer has emerged only recently (Bunimovich-Mendrazitsky et al., 2008; Bunimovich-Mendrazitsky et al., 2011; Bunimovich-Mendrazitsky and Goltser, 2011; Bunimovich-Mendrazitsky et al., 2007). Topics addressed so far have been: BCG dose and number of instillations needed to achieve cure and the combined effect of IL-2 and BCG. Previous models (Bunimovich-Mendrazitsky et al., 2008; Bunimovich-Mendrazitsky et al., 2011; Bunimovich-Mendrazitsky and Goltser, 2011; Bunimovich-Mendrazitsky et al., 2007) had a number of limitations that we circumvented in this work.

#### *(a) Mathematical modeling of the tumor*

Instead of ordinary differential equations, where the numbers of cells are real numbers, we have chosen a stochastic model where the numbers of cells are integers, such that the tumor can go extinct.

#### *(b) Modeling of the immune response*

Unlike previous models, our model includes the dynamics of BCG-associated healthy urothelial cells, which are more numerous than BCG-associated tumor cells - serving as initiators of both innate and adaptive immunity.

In addition, we are the first to model the prime-boost response of the immune system, a phenomenon suggested to be of critical importance for BCG immunotherapy (Bisiaux et al., 2009) (see assumption 11, in II). We are also the first to model a tumor-specific response (see assumption 13 in III), which is very likely to occur, through the cross-priming of tumor-specific T cells, given the death of infected tumor cells in a pro-inflammatory microenvironment.

## 2) Critical parameters of the model

Overall, our results rely on a small number of assumptions and key parameters, which we would like to highlight.

On the one hand, the limitations of the innate immune response are mostly linked to the fact that (i) only a small fraction of tumor cells is infected by BCG (in the range of 1%), and (ii) innate effector cells only target infected cells (with very little contribution of bystander death, as  $n \approx 1$ ). Consequently, each instillation results in a short-lived infiltration of innate immune cells, which might be able to clear the bladder from infected tumor cells but are rather unlikely to clear the bladder from uninfected tumor cells, though they make the majority of tumor cells.

On the other hand, the efficiency of adaptive effector cells mostly relies on their capacity to (i) attack uninfected tumor cells, and (ii) serially kill several targets, which relies on their being long-lived cells and not undergoing ‘beneficial suicide’.

In summary, using a mathematical model parsimoniously designed to describe the core biological components and interactions at play during BCG immunotherapy, we were able to argue that such immunotherapeutic regimen is likely more than a non-specific immunotherapy and to identify an altered regimen that may decrease side effects of treatment while improving response to therapy. Clearly, these findings require validation in pre-clinical experimental models and clinical trials prior to their being adopted for patient management. Nonetheless, we are encouraged by the findings and support the use of mathematical models to establish a framework for optimization of treatment practices.



# Chapter 4. General Discussion

---



*Bacillus Calmette-Guérin* was generated by the repetitive passage of a virulent strain of *M. bovis*. This live attenuated strain was developed as a vaccine for tuberculosis and, following historical path begun by William Coley (Wiemann and Starnes, 1994), BCG was evaluated for use as an anti-cancer therapeutic vaccine. In fact, it has been injected into many solid tumors and while there were reports of some success, randomized clinical trials did not provide statistical significance (Brandau and Suttman, 2007; Mathe et al., 1969; Morton et al., 1970). Nonetheless, animal studies with BCG continued and it was recognized that long lasting direct contact with the live bacteria resulted in optimal tumor immunity (Zbar et al., 1971). These results prompted Morales et al. to evaluate BCG as an adjuvant intravesical treatment for carcinoma of the bladder (Herr and Morales, 2008; Morales et al., 1976). Since these initial observations, several large prospective studies have been conducted and BCG remains the standard of care for non-muscle invasive disease. While now in use for over 35 years, many questions remain about the mechanism of action by which BCG mediates the observed clinical response (Brandau and Suttman, 2007); additionally, there is interest in identifying strategies for optimizing therapy (Luo et al., 2011; O'Donnell, 2009).

While prior efforts have evaluated immunologic response during therapy in human observational studies or in experimental mouse models, my experimental study (Chapter 2) provides the first systematic evaluation of BCG-induced T cell infiltration of the bladder mucosa. Using histological and cytometric analyses, and paying careful attention to mycobacterial persistence and antigen-specific T cell priming, I defined the parameters required for achieving effective adaptive immune responses in the bladder. I identify a requirement for live bacteria that disseminate to local draining lymph nodes in order to achieve T cell priming (**Figure 36**); and repeated instillations are needed to trigger recruitment of T cells to the bladder microenvironment (**Figure 37**). Careful analysis of these parameters has not been previously documented, in part due to inability to access patient material (e.g., bladder mucosa and lymph node) during a clinically approved therapeutic intervention.

Based on experimental work in humans, I focused my attention on the activation and recruitment of T lymphocytes. Immunohistochemical analysis of patient bladder biopsies has indeed demonstrated T cell infiltration during BCG therapy and up to 3 months post-therapy (Peuchmaur et al., 1989; Prescott et al., 1992); and the degree of T cell infiltration correlated with treatment response (Prescott et al., 1992). These findings were consistent with my study of BCG induced inflammation after intravesical instillations in mice. Based on my observations of a delayed influx of T cells, I hypothesized that parenteral exposure to BCG

prior to standard-of-care might accelerate the kinetics of bladder inflammation. I demonstrate that such an approach provides an optimized strategy for T cell recruitment and that this treatment protocol improves the host anti-tumor response.

In parallel, using clinical and *in vitro* experimental data, I contributed to the construction and parameterization of a stochastic mathematical model describing the interactions between BCG, the immune system, the bladder mucosa, and tumor cells (Chapter 3). Using this model, we could show that tumor extinction mediated by the innate immune system acting on its own is highly improbable. We thus refined our mathematical model to take into account the adaptive immune response, and evaluated optimal clinical parameters of BCG induction therapy, including (i) duration between resection and the first instillation, (ii) BCG dose, (iii) indwelling time, and (iv) treatment interval of induction therapy, which all had an impact on the probability of tumor extinction. A remarkable finding is that an inter-instillation interval two times longer than the seven-day interval used in the current standard of care would substantially improve treatment outcome.

Overall, careful evaluation of BCG-induced T cell infiltration in the bladder as well as mathematical modeling – definition of the assumptions underlying its construction together with analysis of simulations – fed my thinking about BCG mechanisms of action and, as I try to highlight in this discussion, cross-fertilized each other. I first consider the results I obtained in the mouse experimental model from the perspective of the host response to infection. I then discuss the relevance of a tumor-specific response in BCG therapy for bladder cancer, before adopting a translational approach to BCG therapy, and discussing strategies that I identified along my studies and may improve patient management.

## **I. THE BLADDER IMMUNE RESPONSE TO BCG**

From the perspective of the host response to BCG infection, I mainly focus here on mouse data, though I occasionally refer to clinical, *in vitro* and mathematical modeling data, in order to show how ‘cross-fertilization’ helped me build a model of the mechanisms underlying the inflammatory response and T cell infiltration following repeated intravesical instillations with BCG. I first present the model, before discussing each of its steps.

Of note, the choice of tumor-free mice as my experimental model has been extensively argued in Chapter II Section X and I do not discuss such choice any further.

## A. Proposing a model

Based on the integration of my results (as discussed below in this Section), I propose a model for the dynamics of the immune response, following repeated intravesical instillations of BCG in tumor-free mice, which are naïve to mycobacterial antigens. Of note, I do not mention the interactions with tumor cells here, but I will propose a model for tumor immunity in Section II.

### 1) The priming of a T cell response: Instillation(s) #1 (and #2)

The first instillations of BCG result in the priming of BCG-specific T cell responses, following the steps described below (**Figure 60**).

#### *(a) The first day of instillation: BCG contacts the bladder wall and triggers a moderate inflammatory response*

During the 2-hour dwell-time, BCG (both live and dead) bacilli contact – and stick to – the bladder wall. Most bacteria are voided at 2 hours, but ~1% remain attached to the bladder wall. Whether urothelial cells internalize live bacteria – leading to infection – or any kind of mycobacterial debris is unclear, but they most probably sense the bacilli. In addition, a few DCs and macrophages likely become infected during the first 24 hours – at least, DCs acquire the capacity to present BCG antigens. The interaction between BCG and the bladder mucosa is sufficient to trigger a moderate inflammatory response, which consists in the infiltration of inflammatory monocytes – in majority – and neutrophils during the first day of inflammation (**Figure 60**, left panel).

After 1 day, BCG is almost cleared from the bladder, and the inflammatory response is self-limiting within 2 days.

#### *(b) BCG disseminates to the draining LN*

A single instillation of BCG is enough to result in dissemination of live BCG to the draining LN in a majority of mice. Bacilli might be shuttled to the LN within migratory DCs (**Figure 60**, left panel). The precise kinetics of dissemination has not been assessed, but based on data from the *Mtb* field (Cooper, 2009) and on the delayed priming of T cells, I argue that it requires more than 1 week.

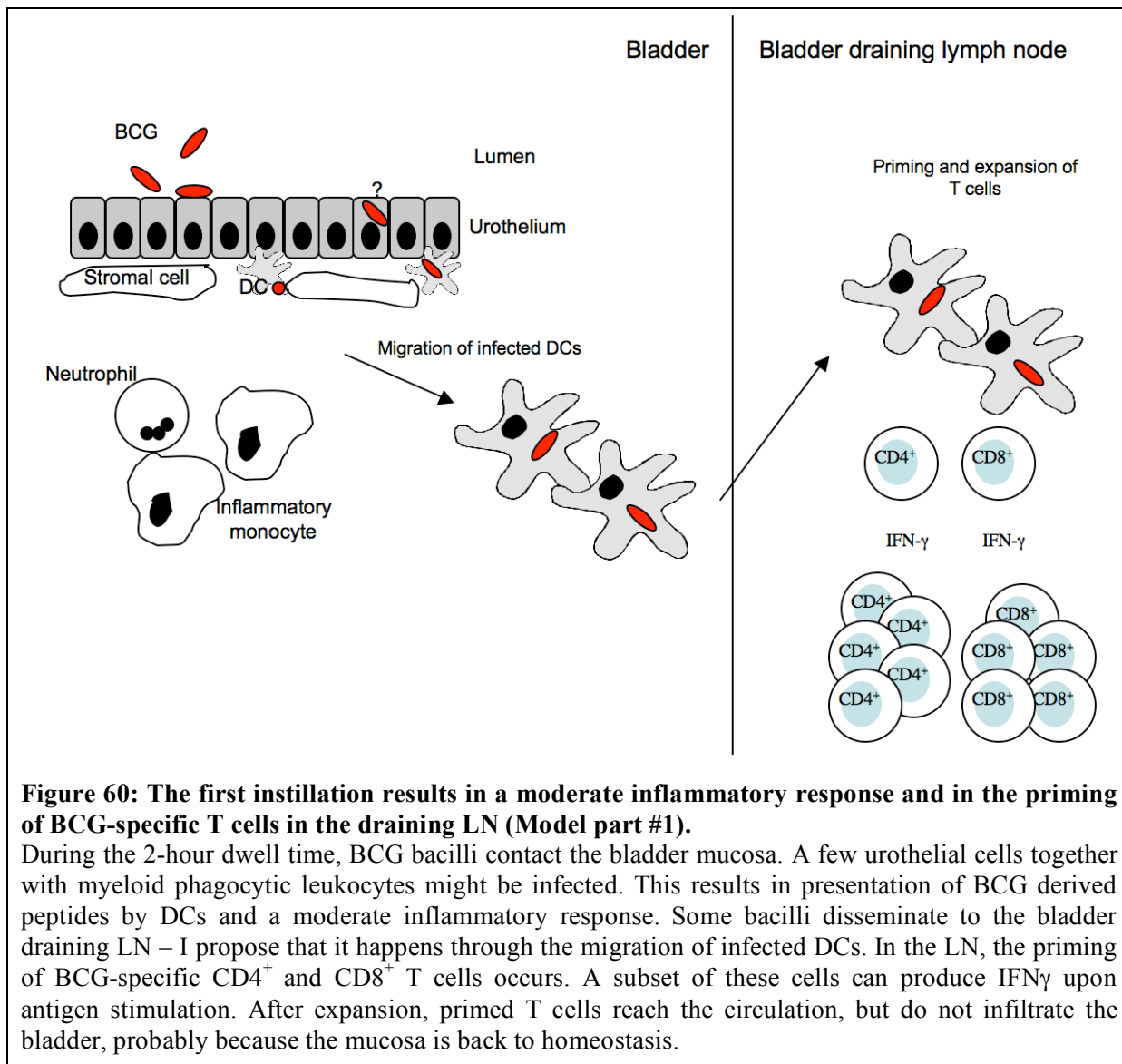
#### *(c) Priming of T cells*

The priming of CD8<sup>+</sup> T cells correlates with BCG dissemination and likely occurs in the LN, as this is the first place where I am able to detect Tet<sup>+</sup> cells (data not shown). As far as CD4<sup>+</sup>



T cells are concerned, I think that their priming is also dependant on dissemination of live BCG to the LN, and occurs there, based on indirect evidence from my own data (no T cell infiltration of the bladder at all if no BCG is found in the LN) together with literature in the *Mtb* field (Cooper, 2009) (**Figure 60**, right panel).

A subset of these primed T cells are able to produce IFN $\gamma$  upon stimulation with mycobacterial antigens.



I did not precisely assess the kinetics of priming of CD8<sup>+</sup> T cells, in particular following a single instillation. Based on some preliminary results, and based on the observation of an enhanced inflammatory response after the 3<sup>rd</sup> instillation, but not after the 2<sup>nd</sup> (data not shown), I suggest that priming of CD4<sup>+</sup> T cells occurs around day 14 (i.e., shortly prior to the 3<sup>rd</sup> instillation), and priming of CD8<sup>+</sup> T cells occurs by days 20-25.

(d) *Primed T cells enter the circulation*

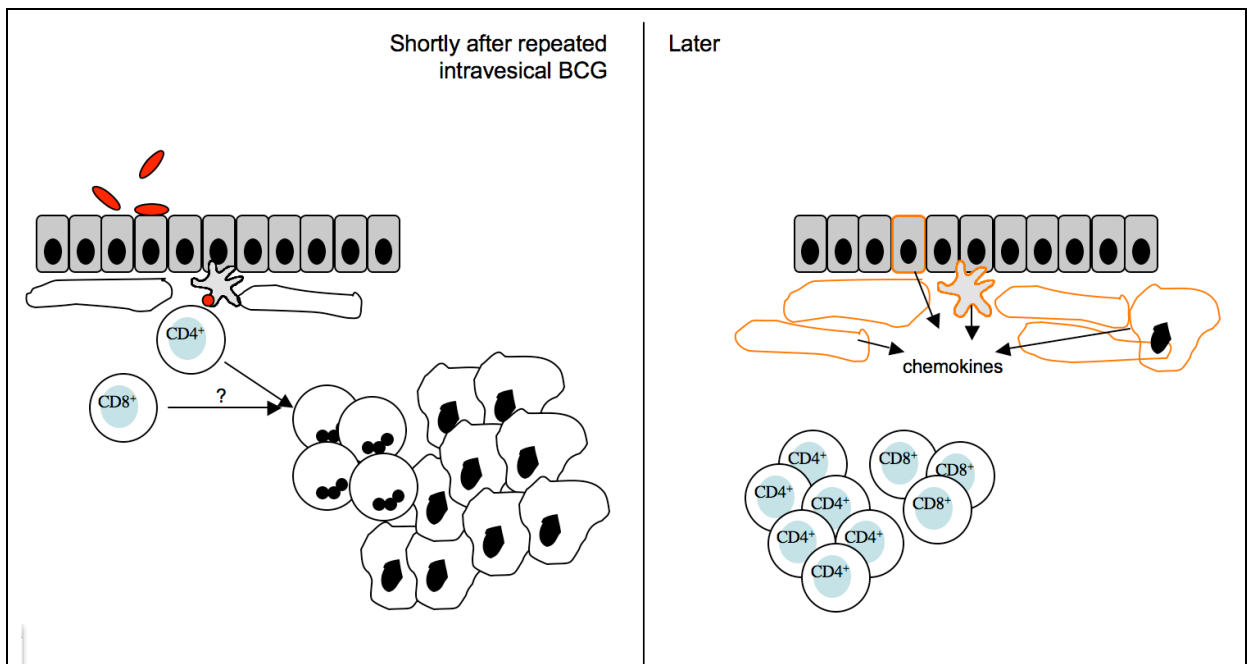
Shortly after their priming in the draining LN, primed T cells enter the circulation. For example, they can be found in the spleen, where a fraction of these cells secrete IFN- $\gamma$  upon restimulation with mycobacterial antigens.

On the other hand, primed T cells do not reach the bladder, probably due to a lack of chemo-attraction. Indeed, given the absence of persistence of BCG and the moderate inflammatory response, the bladder likely returns to homeostasis within a few days.

2) Enhanced inflammation and local recruitment of T cells (Instillations #3-6)

(a) *A DTH reaction enhances the acute inflammatory process*

As soon as BCG-specific CD4<sup>+</sup> T cells circulate – i.e., shortly prior to the 3<sup>rd</sup> instillation – each following instillation triggers a DTH-like reaction in the bladder, resulting in enhanced acute inflammatory response (**Figure 61**, left panel). Inflammation resolves within a few days.



**Figure 61: The following instillations result in enhanced inflammation and the sustained infiltration of T cells in the bladder (Model part #2).**

As soon as BCG-specific CD4<sup>+</sup> T cells enter the circulation, each following instillation results in a DTH reaction (to which CD8<sup>+</sup> T cells might contribute too), thus a robust inflammatory response in the bladder, which resolves after a few days. The bladder does not come back to homeostasis (e.g., stromal cells and DCs remain activated, as depicted by an orange layer in the figure), resulting in potent chemo-attraction of activated T cells to the bladder, which is sustained at least a few weeks, before progressive return to homeostasis.

*(b) T cells are recruited to the bladder*

Likely due to the robust acute inflammatory process, the bladder mucosa remains out of homeostasis for several weeks following the last instillation performed. For example, DCs and stromal cells are activated as late as 3 weeks after the 3<sup>rd</sup> instillation. Though this is work in progress, I think that these activated cells secrete chemokines involved in attracting T cells to the bladder (**Figure 61**, right panel).

Of note, De Boer and colleagues observed a Th1 signature in the bladder if they instilled tumor-free mice only on week 1 and 6 (de Boer et al., 2005), which fits with the model that I am proposing. Indeed, instillation on week 1 would induce the priming of a BCG-specific response (see Section I.A.1)) and then the instillation on week 6 – when the response is primed – would result in a robust immune response, as described in this paragraph.

3) A progressive return to homeostasis (after the last instillation)

After the last instillation has been performed, some bladder cells remain activated during several weeks, and T cells infiltrate the bladder during the same period of time. However, their number progressively goes down (data not shown). The expression of  $\alpha$ -SMA by stromal cells suggests a process of fibrosis, though I have not accurately demonstrated this. Fibrosis is a process of tissue repair, which would suggest that the bladder progressively returns to homeostasis, following a kinetics that remains to be determined. Based on histological analysis of patient biopsies, I suggest that return to homeostasis happens within a few months.

With this model in mind, I now examine each of the steps, placing my results in the context of existing literature, and highlighting perspective for further investigation.

## **B. The fate of BCG following repeated instillations**

Before digging into the dynamics of the local immune response to intravesical BCG, I would like to take a step back, and share a few thoughts about a frequently asked question: what is the fate of BCG following intravesical BCG instillation(s)? Answering this question was not the main goal of my experiments, thus I have only preliminary results to share, but they might be a good complement to the relatively sparse existing literature on that matter.

### 1) BCG infects very few urothelial cells, if any

BCG is known to be most preferentially phagocytosed by macrophages and dendritic cells (Flynn et al., 2011); however infected epithelial cells can be detected after aerosol exposure to *Mtb* (Tailleux, personal communication), and adipocytes can also become infected (Neyrolles et al., 2006).

As far as urothelial cells are concerned, I have mentioned in General Introduction (Section III.A.2)) that there is sparse and conflicting data about the ability of BCG to infect these cells (Bever et al., 2004; Saban et al., 2007). In particular I mentioned some data suggesting that fibronectin (induced by electrocautery) plays a role in BCG attachment to the bladder wall and that such step might be a prerequisite for BCG-mediated anti-tumor activity. Importantly, in the absence of cautery, Ratliff and colleagues reported very little BCG persistence in the bladder at removal of catheter ( $<10^2$  in average, i.e.,  $<0.002\%$  of the instilled dose; BCG not detected at all in 8 of the 10 experimental repeats) (Ratliff et al., 1987b), suggesting that electrocautery is required in order to transiently observe BCG in the bladder following instillation. This observation is in conflict with what I have observed, as I detect 1% of the instilled dose (corresponding to  $\sim 10^4$  CFUs) at removal of catheter (**Figure 28A**), which actually corresponds to the dose of BCG reported by Ratliff and colleagues after electrocautery at removal of catheter. Such discrepancy might be related to differences in the instillation protocol (BCG strain, preparation, dwell time, mouse strain), and I argue here that electrocautery is not required in order to detect BCG in the bladder after instillation. The decrease of BCG load in the bladder is nevertheless rapid, as BCG is barely detectable neither after 24 hours, nor at later time points.

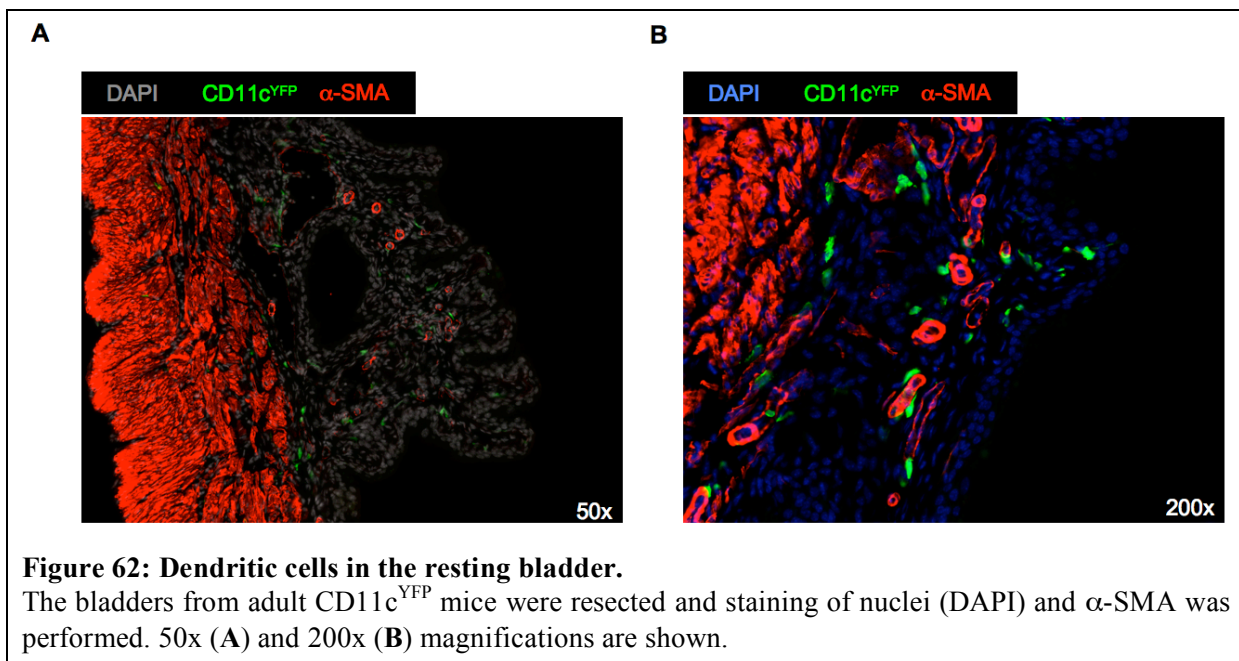
I did not optimize my tools and imaging techniques well enough to argue whether or not urothelial cells are indeed infected by BCG. My data suggest that (i) urothelial cells are exposed to a very low dose of bacteria and (ii) urothelial cells are not easily infected by BCG *in vitro* (See Chapter 2 Section II.D.2)). Therefore, I would like to argue that very few urothelial cells, if any, are infected.

Of note, urothelial tumor cells might be more prone to BCG infection. Indeed, as epithelial tumor cells tend to dedifferentiate, thereby downregulating their tight junctions (Feigin and Muthuswamy, 2009), they might become more easily infected. Experiments performed by Brandau and colleagues and using a 3D culture system with normal and transformed human urothelial cells suggested such a differential resistance to infection (Durek et al., 1999). To my knowledge, there has been no further investigation of that question, though one could think of rather easy experiments – such as MB49 tumor implantation in the bladder followed

by intravesical BCG instillation and histopathological analysis of resected bladders at various time points. If such differential resistance to infection by BCG were true, then BCG might persist better in tumor-bearing bladders and this might impact on the immune response, which is a second limitation to my experimental model.

## 2) BCG might infect leukocytes infiltrating the bladder

To my knowledge, no one has investigated whether leukocytes infiltrating the bladder are infected upon BCG instillation. Indeed, though in low numbers, there are some leukocytes in the resting bladder, and more than 50% of them are macrophages or dendritic cells (see **Table 2**), i.e., cells that could easily phagocytose BCG (Flynn et al., 2011). Though I did not perform extensive histological analysis of the localization of these cells in the bladder, I could see dendritic cells in the submucosa and at the border with the urothelial layer in the resting bladder of CD11c-YFP reporter mice (**Figure 62**). In addition, though it is not a direct proof of infection, I demonstrated that the CD11c<sup>+</sup>-enriched bladder cell population from mice instilled with BCG was able to present a BCG-specific peptide, in the first hours following instillation (**Figure 31**).



Thus, dendritic cells and macrophages infiltrating the resting bladder might very well be infected by BCG, though in low numbers – given the low dose of BCG persisting in the bladder (see previous paragraph), and the relatively low number of leukocytes infiltrating the bladder. The fraction of infected cells might even increase with the number of instillations, given the enhanced leukocyte infiltration following repeated instillations.

### 3) Of granulomas in the bladder

Several groups looking at biopsies from patients following BCG therapy have reported infrequent granulomas (Peuchmaur et al., 1989; Prescott et al., 1992). In a mouse model, following repeated intravesical BCG in tumor-free mice, Saban and colleagues have reported some “granuloma-like” structures during a chronic phase of inflammation (Saban et al., 2007). I am not fully convinced that these structures really resemble granulomas; they instead seem to be massive immune infiltrates surrounding blood vessels. Of note, their observation of the chronic infiltration of polymorphonuclear cells and monocytes-macrophages is in discrepancy with my own observations, since at that time I do not observe any neutrophils and inflammatory monocytes anymore, but rather a very high proportion of T cells (**Figure 32**). This group however used an instillation volume of 200 $\mu$ L, which is close to the maximum capacity of the bladder – for comparison, I inject 50 $\mu$ L without any dead volume in the catheter – and is therefore likely to disrupt the integrity of the bladder wall. This could result in a very different interaction between BCG and the bladder mucosa and a very different immune response.

In my analyses, bladder infiltrating T cells were mostly localized in the submucosa, in the vicinity of blood vessels (**Figure 33**). I also found some T cells contacting and infiltrating the urothelium. Despite the massive infiltrates found in the submucosa, I did not see granulomas; the infiltrates indeed mostly consisted of T cells and dendritic cells, and I was not able to detect BCG in these structures, by acid-fast and FISH staining, which is not surprising, given my CFU data.

In summary, even though it is not clear to me whether any cell in the bladder is infected by BCG, I do find bacilli in the bladder draining LN and I can clearly see a local immune response to BCG in the bladder. I now discuss the kinetics of this response as well as the mechanisms accounting for T cell entry into the bladder and enhanced inflammation following repeated instillations.

### **C. The dynamics of T cell entry into the bladder**

Based on experimental work in humans, I initially focused my attention on the activation and recruitment of T lymphocytes. Immunohistochemical analysis of patient bladder biopsies has indeed demonstrated T cell infiltration during BCG therapy and up to 3 months post-therapy (Peuchmaur et al., 1989; Prescott et al., 1992); and the degree of T cell infiltration correlated with treatment response (Prescott et al., 1992).

## 1) Priming of the T cell response

### *(a) A robust, though late, T cell infiltration of the bladder*

One striking observation in our model of repeated intravesical BCG instillations into tumor-free mice is that bladder T cell infiltration occurs only after day 29 (**Figure 32**). There is an important precedent for such an observation – the cellular immune response to aerosolized *Mtb* takes several weeks to initiate, with T cells reaching the lungs only after day 20 post-infection (Cooper, 2009; Urdahl et al., 2011).

Several hypotheses have been proposed to explain such a delayed cellular immune response. One possibility is that *Mycobacteria sp.* regulate T cell activation either by inhibiting antigen-presenting cell (APC) migration and/or function (Cooper, 2009). Interestingly, DCs from the conducting airways and from lung alveolar space have been reported to have distinct functional properties (von Garnier et al., 2005). It is tempting to speculate that such difference might result from differential exposure to microbes, and an interesting similarity may concern the bladder mucosa and lung alveolar space having relatively little exposure to microbes. In future experiments, the migratory properties of bladder DC subsets might be explored (e.g., using CFSE painting).

Alternatively, it has been speculated that slow induction could simply be a consequence of the low number of bacteria used for infection, which could result in insufficient inflammation and antigen load. Arguing against this point, however, is the observation that exponentially increasing the dose of aerosolized bacteria in lung studies does not significantly accelerate T cell recruitment to the mucosa (Reiley et al., 2008). In my bladder instillation model, the number of BCG CFUs decays quickly, and evaluating the response to higher dose of BCG remains technically challenging. Indeed the current practice involves resuspension of the whole BCG vial in 3mL. Therefore increasing the dose by 1 log would require resuspending the vial in 300 $\mu$ L.

### *(b) Priming of T cells requires BCG dissemination to the draining lymph nodes but is not sufficient for T cell entry into the bladder*

I also discovered that BCG dissemination to the regional lymph node is critical for achieving efficient T cell priming, again showing similarity to what has been shown in the lung *Mtb* infection model (Chackerian et al., 2002; Reiley et al., 2008; Wolf et al., 2008).

Of note, I have not assessed how BCG disseminates to the LN. It is probably transported by cells, rather than freely moving, and given the migratory nature of DCs, together with their capacity to phagocytose BCG, as well as data from *Mtb* infection of the lung (Tian et al.,

2005; Wolf et al., 2007), DCs are good candidates for contributing to bacilli dissemination, and further histologic analyses might provide additional insight into this question, though the low number of CFUs might render the observation of infected DCs challenging.

Importantly, my data show that T cell priming was not sufficient to achieve T cell recruitment to the bladder, as shown by the relatively low level of T cell infiltration following a single instillation, even in the presence of measurable live BCG in the draining LN (**Figure 37**), which suggests that, by the time T cells are primed and enter the circulation, the bladder has returned to homeostasis and is not able to attract T lymphocytes.

## 2) Mechanisms involved in the recruitment of primed T cells to the bladder

It is worth noting that once established, following repeated instillations, T cell infiltration in the bladder is sustained, lasting at least 21 days following the third instillation. I wanted to understand the basis for such a sustained recruitment of primed T cells, and why T cells that were primed after a single instillation would not be recruited to the bladder (see above). For that purpose, I performed studies in mice that were previously primed *via* the subcutaneous route and showed that, in that context, the recruitment of primed T cells could occur rapidly after a single instillation. These data demonstrated that trafficking of T cells to the bladder could be dissociated from the route of priming, in contrast to what has been reported in the context of homing to the gut or central nervous system (Mora and von Andrian, 2006).

### *(a) A robust acute inflammatory response following instillation might be dispensable*

I could link the existence of activated BCG-specific T cells at the time of instillation to an enhanced acute inflammatory response – suggestive of a delayed-type hypersensitivity reaction, as it will be discussed in the next subsection. My hypothesis, then, was that such an acute inflammatory process was taking the bladder out of homeostasis, though live BCG might not persist locally – for example, by activating DCs or stromal cells, that in turn would secrete cytokines and chemokines responsible for attracting primed T cells. Some data from the literature showed that Gr-1<sup>+</sup> cells – i.e., mostly inflammatory monocytes and neutrophils, thus the cells that are involved in the acute phase of inflammation – were required to histologically detect T cells in the bladder (Suttmann et al., 2006) – though 1 day after the second weekly intravesical instillation of BCG, which does not fit with the kinetics I defined, for reasons that I cannot explain, but might highlight the difficulty to be quantitative using histology-based techniques. Using an *in vitro* co-culture system, the authors suggested an



indirect role for Gr-1<sup>+</sup> cells in the recruitment of T cells, through the recruitment of monocytes/macrophages and their release of cytokines/chemokines (Suttman et al., 2006).

In my hands, however, depletion of neutrophils and inflammatory monocytes – together or not with depletion of NK cells – (i.e., depletion of all the cells involved in the acute inflammatory response) did not result in impaired T cell trafficking to the bladder. I have not gone further on this subject, but either there was a technical issue with this preliminary experiment (e.g., depletion was insufficient or not sustained enough) or a single BCG instillation in mice previously primed subcutaneously with BCG is able to disrupt bladder homeostasis (e.g., through the persistence of bacilli or debris in some cells) such that chemokines are secreted that result in T cell recruitment.

### *(b) The molecular basis for T cell recruitment*

My preliminary attempts to narrow down the list of chemokines involved in that recruitment were not that successful either. Based on clinical data from our lab, which showed a robust production of CXCL-10 after the third instillation (Bisiaux et al., 2009), as well as my knowledge that chemo-attraction of type 1 T cells is mostly mediated by receptors CXCR-3 – the 3 agonist chemokines being CXCL-9, -10 and -11 – and CCR-5 – the 4 agonist chemokines being CCL-2, -3, -4, -5 –, I initiated transcriptional analyses of total or sorted cells from the bladder. This has been more challenging than expected, as discussed in Chapter 2 (see Section II.C.2)), and this work remains on-going. Shortly, I was able to show that CXCL-10 signaling might be involved, though CXCR-3 seems dispensable for T cell trafficking. At that stage of the project, I would like to hypothesize that there might be some redundancy in the signaling. Obviously, further investigations will be required to understand the cellular and molecular mechanisms governing T cell entry into the bladder.

### 3) HK-BCG fails to induce local T cell infiltration

Interestingly, the viability of BCG seems important for its anti-tumor activity (Kelley et al., 1985). In particular, heat-killed (HK) BCG does not result in an anti-tumor response (Zbar et al., 1971), nor is it a protective vaccine against tuberculosis (Daugelat et al., 1995; Orme, 1988). Some authors have suggested that T cell priming to mycobacterial antigens requires antigenic secretion (Daugelat et al., 1995; Woodworth et al., 2008), which might explain the old observation that killed mycobacterial vaccines are less efficient than live mycobacteria at eliciting protective immunity.

I show that repeated instillations with HK-BCG result in an acute inflammatory process similar to the one observed following instillations with live-BCG (**Figure 42**) but do not

result in T cell recruitment to the bladder (**Figure 35**). Vaccinating mice with live BCG prior to intravesical instillation with HK-BCG however results in a more robust acute inflammatory process, and subsequently in a robust bladder T cell infiltration (**Figure 38**). In line with this observation, De Boer and coworkers have shown in tumor-free mice that 6 weekly instillations with HK-BCG did not result in the expression of Th1 cytokines in the bladder, whereas 3 instillations with live-BCG followed by 3 instillations with HK-BCG did (De Boer et al., 2003). Based on my model, I speculate that the first 3 instillations with live BCG led to efficient priming of a BCG-specific Th1-polarized immune response, after which instillations with HK-BCG were sufficient to trigger a robust infiltration of the bladder with Th1-polarized T cells. Such observation might be of interest as far as the anti-tumor response is concerned, as discussed later (see Section III.A.2)(f)).

## **D. The ‘prime/boost’ pattern of inflammation**

During the course of my studies, investigation of the dynamics of the T cell response took me back to the ‘prime/boost’ pattern of inflammatory response that our lab had previously described in patients (Bisiaux et al., 2009). From the perspective of our mouse data, I would like to argue that, in mice previously primed subcutaneously to BCG, I observe a reaction of delayed-type hypersensitivity, which might actually relate to the hypothesis of increased vascularization that our lab had proposed, on the basis of our clinical data (Bisiaux et al., 2009) (**Figure 20B**).

### 1) A reaction of delayed-type hypersensitivity

#### *(a) Mice previously immunized subcutaneously with BCG*

A striking observation in mice that were subcutaneously immunized with BCG is that they displayed a much stronger acute inflammatory response to a single BCG intravesical instillation than their un-immunized counterparts (**Figure 41**). While not typically attributed to inflammation in the bladder mucosa, reactions of delayed-type hypersensitivity – also known as type IV hypersensitivity reactions – are known to be mediated by antigen-specific effector Th1 T cells: upon entry at the site of injection and recognition of MHC class II / peptide complexes, these T cells release inflammatory cytokines, which stimulate the expression of adhesion molecules on endothelium and increase local blood vessel permeability, thus allowing the recruitment of inflammatory cells (Murphy et al., 2008). Interestingly, very low numbers of T cells are required to observe such a reaction (Marchal et al., 1982). Importantly, this is a regulated reaction, whose onset is delayed and which

typically attenuates within 48-72 hours. A textbook example of DTH reaction is the induration induced by intradermal PPD challenge of an individual primed to mycobacterial antigens.

I argue that the acute inflammatory intravesical response observed in the bladder of mice previously immunized subcutaneously with BCG fulfills with the definition of a DTH reaction. Indeed, it peaks around 40 hours and is attenuated (**Figure 41**). In addition, it is T-cell dependant (**Figure 43**). Actually, the only parameter that I have not carefully assessed is whether it is delayed. Three reasons explain – but do not justify – why I did not check that point. First and most importantly, the fact that the number of inflammatory cells – especially inflammatory monocytes – is much stronger at 40 hours than at 16 hours suggests that the response is, indeed, delayed. Second, since the instillation procedure, the collagenase digest and the staining of samples for flow cytometry are time-consuming, there is a time window – roughly, from 6 to 15 hours post instillation – during which it is technically challenging to assess the cellular infiltration of the bladder. This does not however prevent me to check whether there is any major inflammation going-on earlier than 6 hours post instillation. But, and this is the third reason, in the urine analysis following repeated instillations – for which I think that a DTH reaction is also going-on, as argued in the next paragraph – inflammatory analytes such as KC, MIP-2, CXCL-6, MIP-1 $\alpha$ , MIP-1 $\beta$  and MPO peaked rather at 24-42 hours than at 6 and 16 hours post instillation, though I could observe some variations from 1 experiment to the other (only 1 experiment is shown in this dissertation, **Figure 40**, and the caveats of urine analysis mentioned in Chapter 2, see II.C.1) should be kept in mind, though).

Overall, the very robust inflammatory response that I observed in mice subcutaneously immunized with BCG, following intravesical instillation, is a recall reaction that is suggestive of a DTH reaction.

*(b) Evidence for DTH following the standard protocol for BCG therapy*

Following standard protocol for BCG therapy, after the third instillation, the inflammatory response is enhanced, as compared to the first instillation, and rapidly attenuated (within 42 hours) – which is actually more rapid than in the regimen involving a prior subcutaneous immunization with BCG. As for the other key parameters of a DTH reaction, I have not carefully assessed whether the phenomenon is delayed. In addition, in the context of weekly instillations, I have not checked the T cell dependency of the inflammatory response.

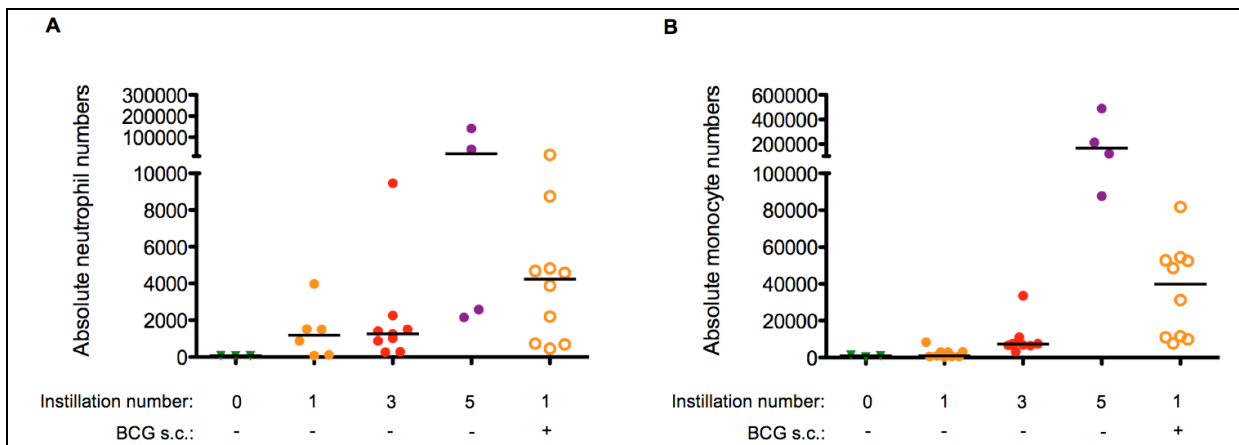
However I have some reasons to argue that there would be primed T cells at the time of the 3<sup>rd</sup> instillation, despite the fact that my analyses of T cell priming focused on CD8<sup>+</sup> T cells,

whereas my preliminary data suggest that the DTH reaction observed in mice primed subcutaneously with BCG is mostly mediated by CD4<sup>+</sup> T cells (**Figure 43**). As I did not have access, on campus, to P25 TCR-transgenic mice – i.e., mice with a TCR that specifically recognizes Ag85A<sub>241-260</sub> peptide – I did not carefully assess the priming of CD4<sup>+</sup> T cells. Even for CD8<sup>+</sup> T cells though, I did not measure accurately when the priming occurred, which would have required tools such as CFSE-dilutions of T cells from a TCR-transgenic animal. The only information I can provide is that I could see a significant number of tetramer positive (Tet<sup>+</sup>) T cells in the draining LN as early as day 25, i.e., 11 days after the 3<sup>rd</sup> instillation (data not shown). This is rather late, but (i) priming of these Tet<sup>+</sup> T cells likely started several days before cells reached a high enough number to be reliably detected by flow cytometry and (ii) priming of CD4<sup>+</sup> T cells is likely to occur several days earlier than priming of CD8<sup>+</sup> T cells. In addition, very low numbers of circulating antigen-specific T cells are known to be sufficient in order to trigger a DTH reaction (Marchal et al., 1982); therefore such reaction might happen very early after priming of CD4<sup>+</sup> T cells has been initiated. Thus, I think that it is possible that there are primed BCG-specific CD4<sup>+</sup> T cells circulating in mice, just prior to the third instillation, which would be able to initiate a DTH reaction.

Of note, if one follows this reasoning, one might hypothesize that a further enhanced inflammatory response might occur in the bladder, following subsequent instillations. I tested this hypothesis in one preliminary experiment, which indeed revealed that the inflammatory response sixteen hours after the 4<sup>th</sup> instillation was rather similar to the 3<sup>rd</sup> instillation (data not shown); but that, sixteen hours following 5<sup>th</sup> instillation, the number of inflammatory cells infiltrating the bladder was strikingly higher than after the 3<sup>rd</sup> one (**Figure 63**).

I did not carefully assess whether such inflammatory response was regulated (i.e., delayed and attenuated) in a short period of time, but 8 days later (i.e., day 36), no more inflammatory cells were found in the bladder, which was mostly infiltrated by T cells – in a similar proportion among leukocytes and in a similar number to what is observed at the same time point, following 3 weekly-repeated instillations (data not shown).

Overall, I argue that the boosted inflammatory response that is observed in the bladder following repeated intravesical BCG instillations is mediated by a DTH reaction.



**Figure 63: The acute inflammatory response is further enhanced at the 5<sup>th</sup> intravesical instillation.**

The inflammatory response (neutrophils shown in (A) and inflammatory monocytes in (B)) 16 hours following either 0, 1, 3 or 5 intravesical BCG instillations, in mice that were immunized s.c. with BCG 21 days earlier (+) or left unimmunized (-). Data from several independent experiments were gathered here. Due to time constraints, this experiment has only been performed once.

*(c) Evidence for DTH in patients*

Does the observation of an acute inflammatory response in the bladder of mice, following repeated instillations, match the previous observations in patients made in our lab (Bisiaux et al., 2009)? In our observational clinical study, we observed an enhanced molecular and cellular inflammatory signature shortly after the 3<sup>rd</sup> instillation, as compared to the 1<sup>st</sup> treatment dose. While keeping in mind that comparing patients with mice involves a comparison of sloughed cells in the urine (patients) with cells in the bladder parenchyma (mice), here are the principle differences between human and patient data, following the standard regimen:

- In the urine of patients, the peak of inflammation is as early as 4-8 hours following instillations. The molecular and cellular signature in urine is indeed much weaker by 24 hours (Bisiaux, unpublished data). As for my observations in mice, preliminary results from urine analysis and FACS observations 5 hours following a single instillation – showing very few inflammatory cells in the bladder (data not shown) – suggest that the peak of the response is later than 4-8 hours.
- In patients, there is limited inflammation after the 1<sup>st</sup> instillation, but a strong boost in inflammation after the 3<sup>rd</sup> one; whereas in mice, I do already observe some inflammation after the first instillation, and, if the boost after the 3<sup>rd</sup> instillation is statistically significant – as far as inflammatory monocytes are concerned – I do not observe a profound shift in median fold change numbers in mice, as compared to

what was observed in patients, both at the cellular and molecular level (see **Table 7**, patients vs. mice Week 3).

I do think that the boosted inflammatory reaction observed in patients is a DTH reaction, i.e., a recall response mediated by activated T cells. From what we see in the urine of patients, the inflammatory reaction does peak earlier than the expected 24-72hrs window, but it is (i) somehow delayed in time, as at 2 hours, no inflammatory signature is observed in the urine of patients (Bisiaux et al., 2009), and (ii) attenuated (less than 24 hours). Now, whether the kinetics is different in the bladder mucosa, as compared to what we observe in the urine, is difficult to assess, because given the intensity of the response, it would be unethical to perform a bladder biopsy in patients at such time points. However, if a profound inflammatory reaction was still going-on in the bladder wall, inflammatory cells would most probably keep sloughing into the urine.

Now, why is the response more “boosted” at the 3<sup>rd</sup> instillation in patients than in mice? I would like to argue that there is indeed such a boost in mice, but only at the 5<sup>th</sup> instillation, not at the 3<sup>rd</sup> one. Indeed, I have evaluated median fold changes in the inflammatory response in mice, focusing on the cellular signature, because urine data was missing for the 5<sup>th</sup> instillation. Though time points were different from patients to mice (4 hours post instillation for patients / 16 hours for mice), I compared these data with our published data for patients. The similarity between week 3 for patients and week 5 for mice is quite striking, as shown in **Table 7** below.

	Patients		Mice			
	Week 1	Week 3	Week 1	Week 3	Week 5	<i>s.c., then Week 1</i>
Neutrophils	8x	203x	12x	13x	226x	46x
Monocytes	4x	125x	1x	11x	261x	76x
NK cells	2x	30x		1x	14x	3x

**Table 7: Median fold induction of the inflammatory response in patients and mice, following intravesical instillations.**

For patients, median fold inductions were calculated by making the ratio of median cell numbers 4 hours post instillation over median cell numbers just before the given instillation. As for mice, median fold inductions were calculated by making the ratio of median cell numbers 16 hours post instillation over median cell numbers in naïve mice. For mice, the last column (*s.c. then Week 1*) represents a regimen of BCG *s.c.* immunization followed, 21 days later, by a single intravesical instillation.

Why then would the response be faster in patients? First, at least 9 out of the 16 patients had previously been exposed to BCG: 8 of them were French – i.e., they had been vaccinated with BCG in their childhood (Zwerling et al., 2011) – and the 9<sup>th</sup> one was American but had already undergone BCG therapy in the past. No PPD test had been performed in this cohort of

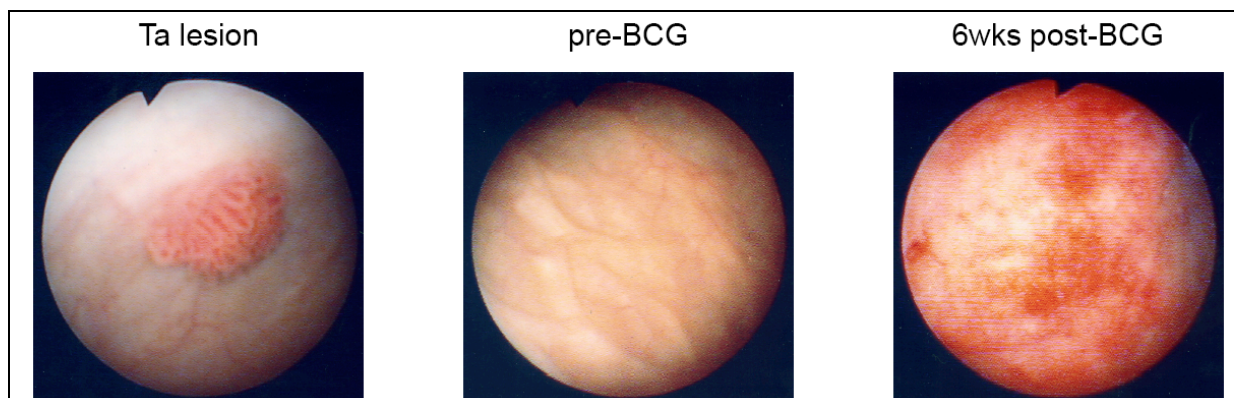
patients, but one might hypothesize that the patients previously exposed to BCG responded faster than patients naïve to mycobacteria. But if this were true, why wouldn't they respond as early as at the 1<sup>st</sup> instillation? I would like to argue that the ability of these patients to react to mycobacterial antigens may have waned over time (Weir et al., 2008). In line with that argument, it is well described that, when given a PPD test years after infection, people may have a false-negative reaction, and it may require a second test for the induration to appear. Such a phenomenon in the context of screening for PPD response – e.g., for healthcare workers – is known as 'Two-step testing' (Centers for Disease Control and Prevention (CDC) - Division of Tuberculosis Elimination, 2011; Menzies, 1999).

Alternatively, the fact that the bladder of patients is out of homeostasis at initiation of BCG therapy – e.g., presence of a higher number of myeloid leukocytes that would be prone to BCG infection, increased concentration of fibronectin, increased number of blood vessels, activated stroma, etc. – might accelerate the dissemination of BCG to the draining LN and the priming of the BCG-specific T cell response, which is required to observe a DTH reaction at the next instillation.

Overall, I would like to argue that the boosted inflammatory response observed in patients after the third instillation (Bisiaux et al., 2009), and probably at each of the following instillations from the induction cycle – as manifested by increased pain caused by instillation – is a recall response suggestive of a DTH reaction, mediated by adaptive cellular response to mycobacterial antigens, which would be due either to memory cells from a previous exposure to mycobacteria, or to priming of the response following the first instillation(s).

## 2) A DTH reaction might result in increased vascularization of the bladder

During the observational clinical study, our lab had access to cystoscopy from patients at their 3 months and 6 months follow-up. At 3 months (i.e., 6 weeks after the last BCG instillation) the bladder mucosa appeared strikingly more vascularized than prior initiation of therapy – which occurred 4 weeks post resection; of note, the bladder wall seems rather well healed (**Figure 64**). The 6 months follow-up could confirm that the inflammation and vascularization observed at 3 months was not due to tumor recurrence. This data, combined with molecular analysis of urine samples from patients, led us to suggest leakage of plasma proteins into the urine, through micro-capillary disruption (**Figure 20B**).



**Figure 64: Representative cystoscopic images of the bladder wall pre vs. post BCG therapy.**

Shown on the left is a lesion from a patient with TaG3 – due to it being multi-focal disease with elements being high grade, this patient received a 6wk course of BCG therapy. Prior to initiation of intravesical therapy (pre-BCG), the individual again underwent cystoscopy, confirm that he had healed from the surgical resection. It is clear from the 6wk post-BCG follow-up that the bladder wall becomes inflamed with significant neo-angiogenesis. While one may not be able to distinguish increased vascularization from CIS at this 6wk post-BCG time point, in this particular patient, we can confidently say that during the subsequent cystoscopic evaluation (12wk post-BCG, not shown), the bladder wall showed decreased inflammation and vascularization.

Increased vascularization of the bladder might very well be compatible with a DTH reaction, as the inflammatory cytokines released by T cells involved in the reaction are known to stimulate the expression of adhesion molecules on endothelium and increase local blood vessel permeability (Murphy et al., 2008).

Of note, the observation of a boosted innate response after the 3<sup>rd</sup> instillation has a direct impact on our mathematical modeling. Indeed, in order to match with our clinical data, assumption 11 stipulates that *“increase in the inflow of immune cells is expressed in a sigmoidal function, induced by the cumulative number of cells destroyed by innate effector cells, but counteracted by homeostatic pressure (i.e., healing of the bladder wall).”* In manuscript 2 (see Manuscripts section at the end), we justified this assumption by the observations listed in the paragraph above. But this assumption would be as well compatible with a DTH reaction. What matters is that the number of innate immune cells recruited to the bladder is not high after the 1<sup>st</sup> instillation, but is considerably enhanced at the 3<sup>rd</sup> instillation, and then plateaus, according to Bisiaux’s observations in patients.

In my mouse model, I have not carefully evaluated vascularization. An elegant study from Saban and coworkers, making use of a fluorescent internalizable tracer, scVEGF/Cy5.5 (Backer et al., 2007) and near-infrared fluorescence imaging, showed increased accumulation of the tracer in the bladder of tumor-free mice following 4 weekly-instillations with BCG (Saban et al., 2010). They also reported a modest increase in the density of blood and lymphatic vessel density at the end of BCG regimen. In my own hands, following a comparable kinetics, preliminary analysis of bladder sections suggested that the mature



endothelial vessels – those surrounded by a layer of  $\alpha$ -SMA – were more dilated following repeated BCG instillations. My observations also suggested a modest – though not quantitatively confirmed – increase in the number of the nascent endothelial vessels depicted in **Figure 26**, that lie at the border between submucosa and mucosa (data not shown). Preliminary analysis of urine samples and RNA from whole bladder early after the 3<sup>rd</sup> instillation did not reveal increased expression of molecules associated with vascularization (e.g., VEGF, angiopoietin, etc.), but based on **Figure 63**, such phenomenon might require 5 repeated instillations, an easily-testable experiment.

In summary, based on my observations of the dynamics of the immune response in the bladder following repeated intravesical instillations into tumor-free mice, and helped by our observations in the clinic as well as our mathematical modeling, I propose a model in which the adaptive response that is primed following the first instillation(s) contributes to boosting the innate inflammatory response to the following instillations, resulting in a sustained T cell infiltration in the bladder mucosa. Now, how does this immune response contribute to elimination of tumor cells? This is the matter for discussion in the following section.

## **II. DOES INTRAVESICAL BCG INDUCE A TUMOR-SPECIFIC IMMUNE RESPONSE?**

Though the standard of care for more than 35 years, it is still debated in the field as to whether or not BCG-mediated anti-cancer activity is tumor-specific. Most of my experimental work was done in tumor-free mice, but I did perform some experiments in tumor-bearing mice, and I would like to use them, together with analysis of mathematical models from Chapter 3, to discuss the question whether BCG induces a tumor-specific immune response.

### **A. The innate response is not enough**

Historically, the mechanisms of action of BCG as an anti-cancer agent have not been clearly defined, but were rather thought to be non-specific. In the context of bladder cancer, it is not clear either. The very striking acute inflammatory reaction following repeated intravesical instillation – leading to very high measurable leukocyturia and proteinuria – as well as the capacity of innate immune cells to kill tumor cells have led part of the community to hypothesize that non-specific inflammation has a more damaging effect on malignant rather than normal epithelium and is enough to result tumor eradication. Therefore BCG adjuvant

therapy is still considered by part of the ‘immunotherapy’ field as a far-off descendant of Coley’s toxins (Mellman et al., 2011).

We made use of our mathematical model to evaluate the capacity of the innate immune system to mediate the observed tumor immunity in patients receiving BCG therapy for non-muscle invasive bladder cancer. Importantly, the model accurately reflected the recruitment and activation of innate immune cells during the 6-week course of BCG treatment. Strikingly, analyses and simulations of our model indicated that a bystander kill rate of  $>90$  cells per innate effector cell would be required to achieve tumor extinction with a 50-70% probability. A kill radius of this magnitude would result in loss of integrity of the bladder wall. Furthermore, experimental data indicated that BCG-stimulated innate cells have only a modest bystander kill capacity. We therefore rejected our hypothesis that the innate immune system is solely responsible for tumor elimination and infer that other effector mechanisms are required to fully account for the clinically observed tumor immunity.

In our analysis of the key parameters in our model, the limitations of the innate immune response are mostly linked to the fact that:

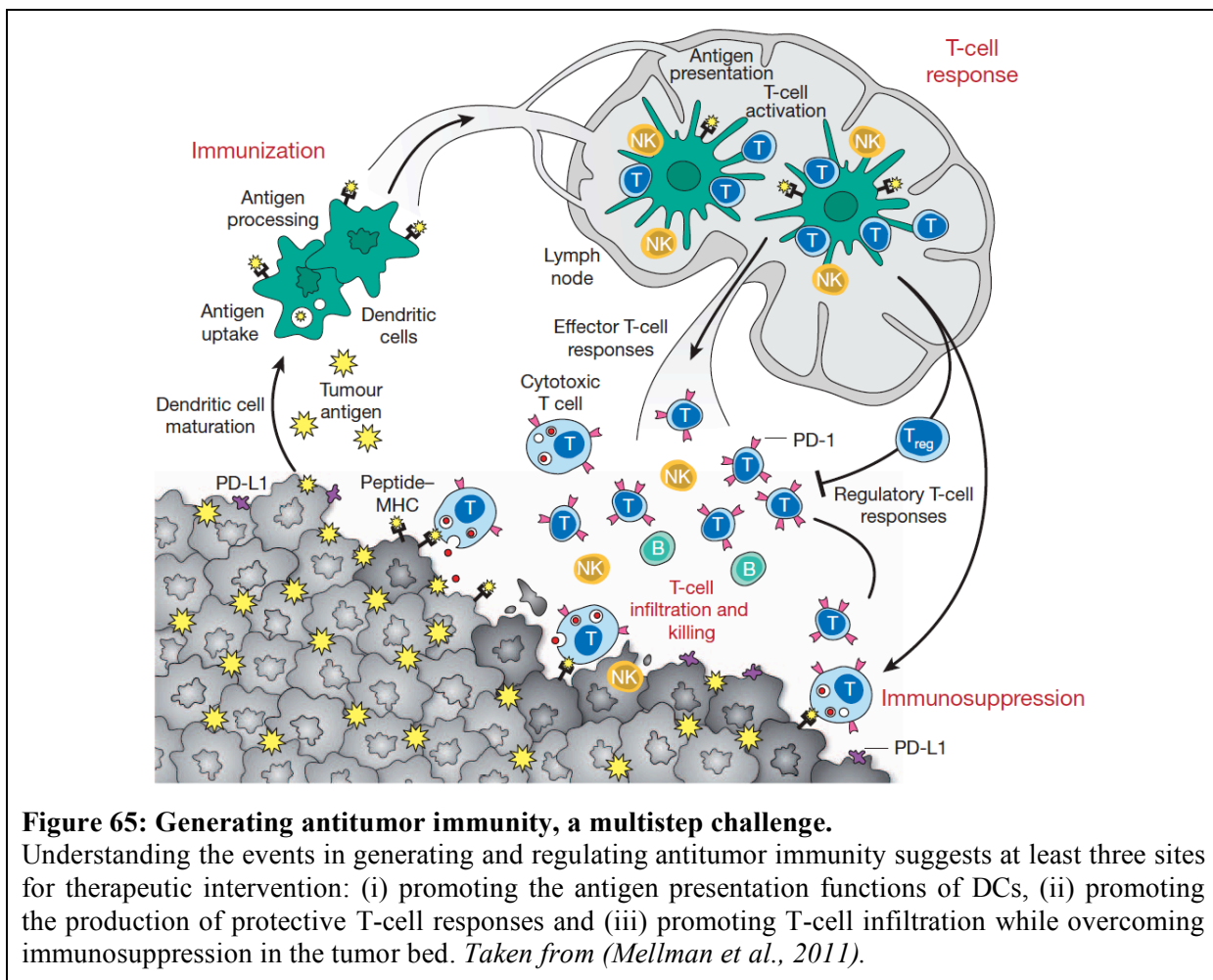
- BCG only infects a small fraction of tumor cells (in the range of 1%).
- Innate effector cells only target infected cells (with very little contribution of bystander death, as  $n \approx 1$ ).
- Innate effector cells are rather short-lived (as most of them will undergo ‘beneficial suicide’ when killing their target cell) and are not attracted to the bladder for a long time (see Section I.A.2)(a)).

Consequently, each instillation results in a short-lived infiltration of innate immune cells, which might be able to clear the bladder from infected tumor cells but are rather unlikely to clear the bladder from uninfected tumor cells, which constitute the vast majority of tumor cells.

Another argument suggesting that the innate immune response may not be sufficient is that non-specific inflammation resulting from other treatments (e.g., radiation, chemotherapy) does not result in similar cure rates.

## B. Generating tumor-specific immunity, a multistep challenge that could theoretically be achieved by BCG therapy

In a recent review, Mellmann et al. reviewed the multiple steps that must be achieved, either spontaneously or therapeutically, to mount effective tumor immunity (Mellman et al., 2011). They listed three distinct steps (**Figure 65**) and I would like to argue that BCG therapy in the bladder could theoretically achieve each of them.



### 1) Tumor-antigen presentation

The first step consists in loading DCs with antigens derived from the tumor (Mellman et al., 2011), which can be either ingested *in situ* or delivered exogenously as part of a therapeutic vaccine (**Figure 65**). Upon antigen encounter, the DCs also need to receive suitable maturation signals so that they promote immunity as opposed to tolerance (see General Introduction Section II.A.3)). Activation signals might be therapeutically supplied exogenously (e.g., Toll-like receptor agonists) or endogenously (e.g., factors released by dying tumor cells). Phagocytosis of tumor cells (e.g., mediated by calreticulin) would enable the presentation of tumor antigens on MHC class I and II molecules.

As far as BCG therapy is concerned, there is very likely death in the tumor cells, for one of the following reasons:

- Infection of tumor cells by BCG likely induces death.
- The acute inflammatory response occurring after each repeated instillation is responsible for direct killing of infected tumor cells and bystander killing of uninfected tumor cells – though rather minimal according to our mathematical model.
- The priming of a BCG-specific adaptive response results in a sustained infiltration of BCG-specific T cells in the bladder that are able to kill infected tumor cells.

Dying tumor cells will be phagocytosed by DCs and other phagocytes (e.g., macrophages). In addition, BCG instillation results in a pro-inflammatory environment locally in the bladder, which likely allows DCs to mature in a way to achieve effector responses (e.g., BCG contains agonists for TLR2, TLR4 and TLR9 (Jo, 2008)).

### 2) Initiation of effector T-cell responses

The second step takes place in lymphoid organs, where tumor-antigen loaded DCs must generate protective T cells responses (**Figure 65**) (Mellman et al., 2011). The precise type of T-cell response needed is unknown, but cytotoxic CD8<sup>+</sup> T cells are likely required. Again, DCs are key players at that stage, since presentation of tumor antigens by DCs at the steady state would promote tolerance.

As far as BCG therapy is concerned, dissemination of bacilli to the bladder draining lymph node likely promotes further activation of the DCs at the site of T cell priming. Furthermore, given that dying tumor cells have likely been phagocytosed, cross presentation of tumor antigens on MHC Class I molecules should occur, therefore allowing for the priming of effector CD8<sup>+</sup> T cells.

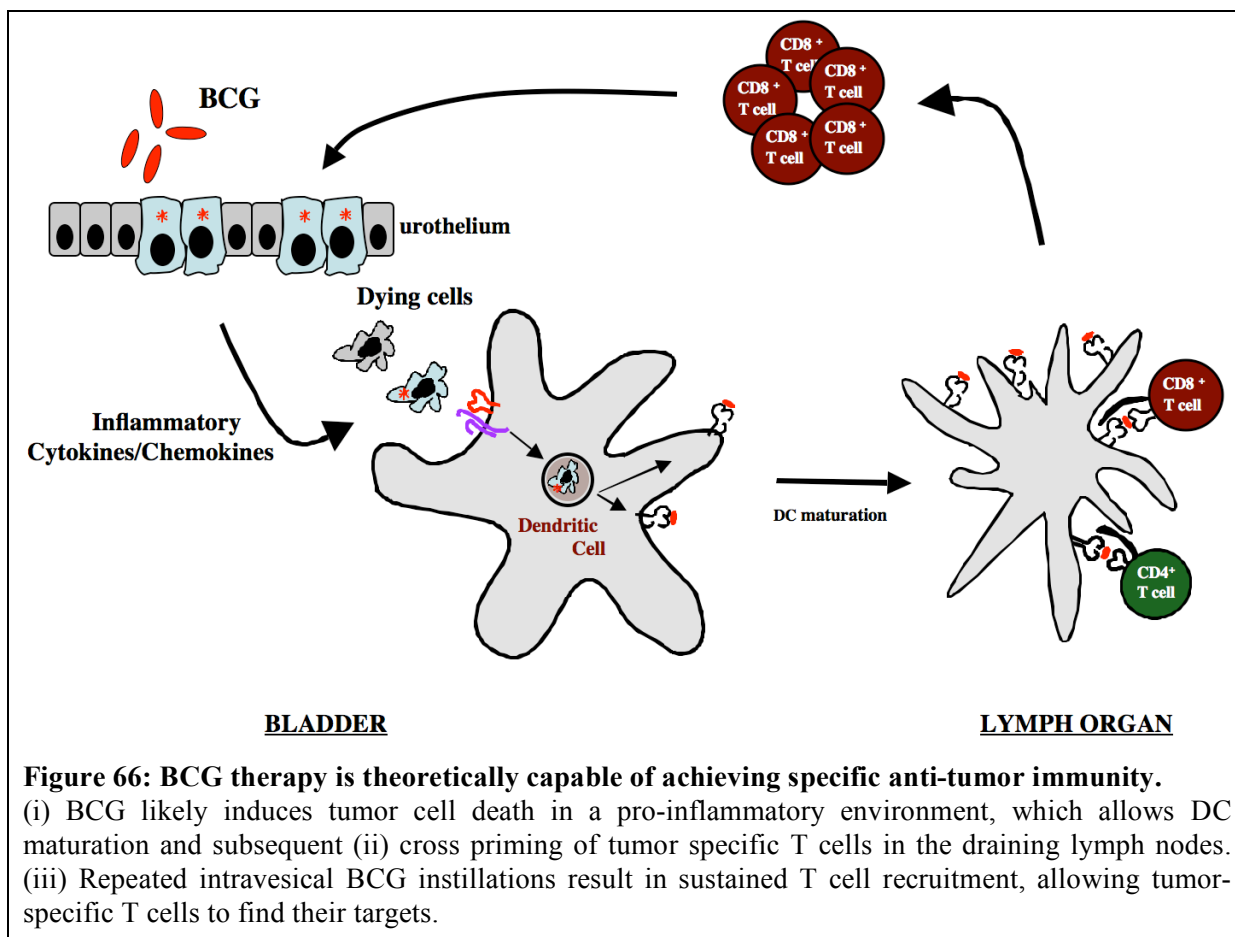
### 3) Recruitment of tumor-specific T cells into the tumor

The third and final step consists in the recruitment of tumor-specific effector cells into the tumor bed so that they can perform their function (**Figure 65**) (Mellman et al., 2011). At that stage, tumor suppression, such as secretion by tumor or stromal cells of immunosuppressive molecules or local accumulation of Treg, may prevent effective tumor immunity (**Figure 65**).

Following repeated intravesical BCG instillations, I have shown in tumor-free mice that the bladder remains for several weeks (at least) out of homeostasis, with activated stromal and

dendritic cells. Though I have not yet determined the molecular signature in the bladder during that time window, I have shown sustained T cell entry into the bladder, such that tumor-specific T cells could likely be recruited into the bladder during that period of time.

In summary, BCG therapy seems capable of achieving specific anti-tumor immunity. Indeed, BCG likely induces cell death in urothelial tumor cells in a pro-inflammatory environment, which results in the cross-priming of tumor-specific CD8<sup>+</sup> T cells (**Figure 66**).



### C. Some experimental evidence for a tumor-specific response

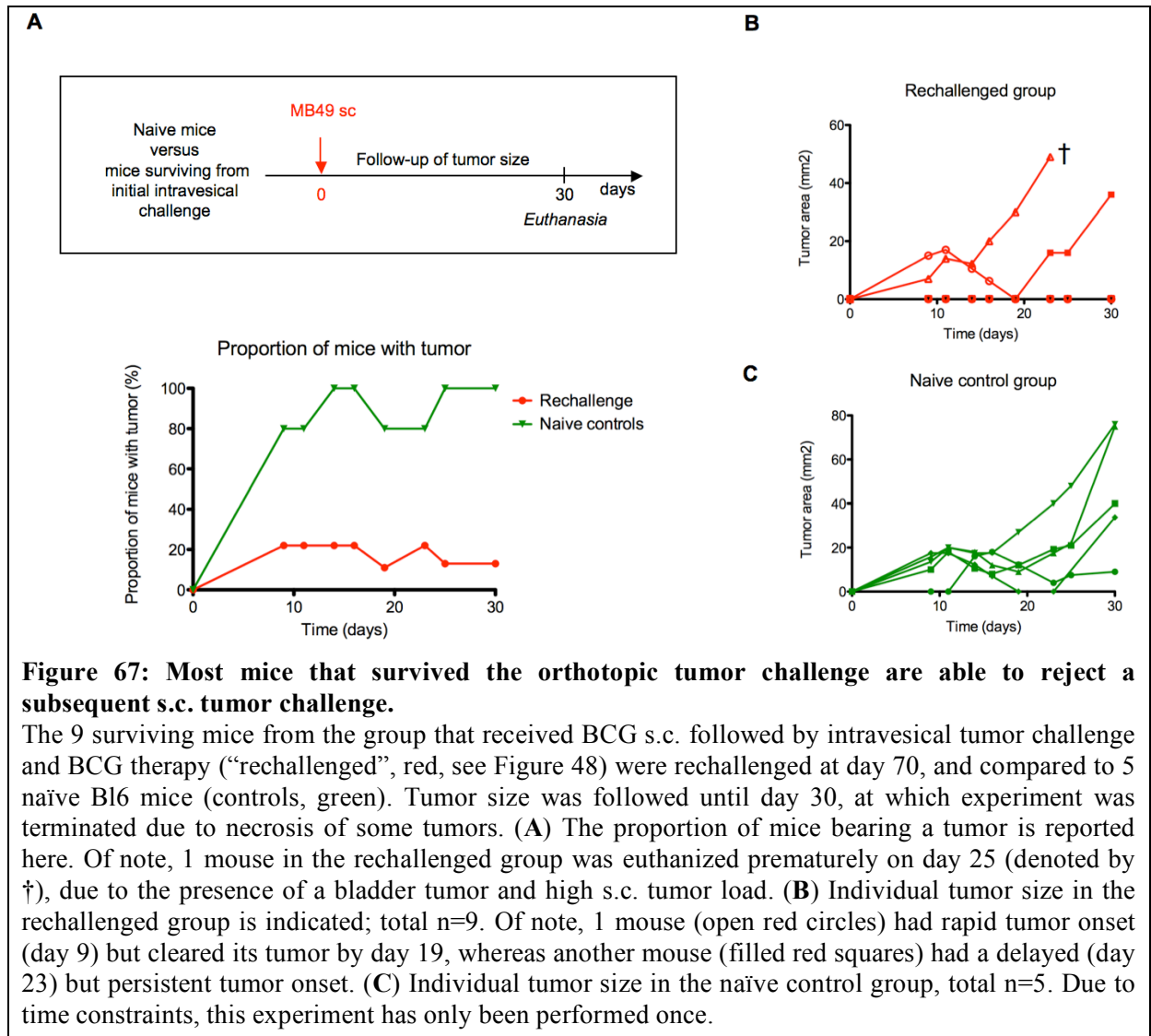
In addition to the theoretical reasoning exposed above, we have some evidence in the lab for a BCG-induced tumor-specific response, based on preliminary experiments in tumor-bearing mice, as well as reasoning about our mathematical modeling.

#### 1) Rechallenge of mice with MB49 cells at a distal site

*(a) A majority of mice survive after MB49 rechallenge at a distal site*

In a preliminary experiment done with mice that controlled their tumor (see Chapter 2 Section III.E.1)(b)), we performed a secondary subcutaneous challenge with MB49 cells. Seven out of

9 mice that had received combination therapy (s.c. BCG followed by intravesical therapy) during the first tumor challenge were protected and showed no evidence of tumor growth (**Figure 67A-B**).



Interestingly, in one of the other 7 protected mice, a tumor started growing rapidly after injection, before shrinking and being completely cleared by day 19 and did not come back (open red circle in **Figure 67B**). Of note, among the 2 mice bearing a tumor by day 30 in the rechallenged group, one had a late subcutaneous tumor onset (filled red squares in **Figure 67B**), and the other one had to be euthanized prematurely due to signs of a bladder tumor.

Of note, all 5 naïve control mice developed a tumor, which most often showed a phase of regression before regrowth (**Figure 67C**). We are not sure why there was such phase of regression – that might be immunoediting of the tumor, but such a phase of regression is usually not reported by groups working with MB49 tumors. Alternatively, we might just need to control more carefully the passage number and the dose of cells that are injected.

*(b) Looking for evidence of an HY-specific response*

As MB49 cells are male cells implanted into a female host, one could expect to see the signature of an HY-specific immune response in mice that survived the MB49 challenge (or even in control mice bearing an MB49 tumor). Thirty days after subcutaneous tumor implantation, we sacrificed the mice and made use of D<sup>b</sup>-uty tetramers to look for the presence of HY-specific CD8<sup>+</sup> T cells in the spleen – following tetramer-based enrichment – as well as in the tumor, but we could not detect any, neither in control naïve mice nor in rechallenged mice. Of note, mice that were previously treated with BCG (subcutaneously then intravesically), we could detect a population of BCG-specific D<sup>b</sup>-Mtb32<sub>309-318</sub> Tet<sup>+</sup> cells.

Understanding why the HY-specific response is not detectable is an on-going work in the lab, and I do not have an explanation now. One hypothesis is that there might be stronger mutated self antigens that might mask the HY response.

Of note, in the context of bladder cancer, it has sometimes been argued that BCG might share some common epitopes with bladder cancer cells, reminiscent of the observation by Zbar and colleagues of BCG being antigenically related to a given hepatocarcinoma cell-line in the guinea pig model (Borsos and Rapp, 1973). However, this seems to me rather unlikely, since BCG induces anti-tumor activity in a broad range of human tumors, with different genetic lesions (Wu, 2005), as well as at least 2 mouse tumor cell-lines (the B16 derived MB49 and the C3H-derived MBT-2).

Overall, my preliminary data suggest that BCG therapy in mice previously primed with BCG results in the priming of MB49-specific responses, as demonstrated by the ability to control tumors during secondary challenge in a distal site, but I do not have mechanistic details for the priming of such response.

2) Mathematical modeling identifies the tumor-specific adaptive response as a crucial parameter

Given that BCG only infects very few tumor cells (in the range of 1%), the ability of the immune system to get rid of all tumor cells heavily relies on:

- Bystander killing – but it is rather minimal, as discussed above;
- Tumor-specific killing.

Therefore, the tumor-specific immune response is a crucial parameter, allowing for eradication of the tumor upon BCG therapy.

## D. Perspective

Whether a tumor-specific response is indeed established awaits further investigation in our lab. To do so, together with our Bladder Biology Team, I have identified several lines of research that are described here. First, in patients, the reactivity of T cells isolated from blood and urine samples to BCG-specific peptides and defined bladder tumor antigens will be assessed. Second, in mice, we are currently trying to improve the MB49 model, while developing an inducible tumor model inspired by (Puzio-Kuter et al., 2009), in collaboration with the Curie Institute. As I have mostly been involved with mouse models during my thesis project, I focus on the second point and discuss a few perspectives.

### 1) Strategies for improvement of the MB49 tumor model

I have already mentioned the advantages of using MB49 transplanted tumors (see General Introduction Section I.A.6)(a)). Briefly:

- They partially respond to BCG therapy;
- They are rather fast and easy to induce;
- They can be transplanted in many knockout or transgenic animals.

However, they rapidly become invasive, which might explain why they only partially respond to BCG therapy, and that might be a very important caveat in order to observe the establishment of a tumor-specific response, as the latter likely takes time to establish. Indeed, based on our model (**Figure 66**), a tumor-specific response requires the priming of a BCG-specific response and the subsequent enhanced inflammatory response in the bladder – at least 14 days, under the assumption that the kinetics of cellular infiltration in the bladder is not much changed by the presence of tumor cells –, as well as T cell recruitment to the bladder – ~30 days, which is also the amount of time required to see further enhanced inflammation, at the 5<sup>th</sup> instillation (**Figure 63**). But 30 days is indeed the time at which mock-treated animals start dying from their tumor... Therefore the aggressiveness of the MB49 tumor might partially mask BCG-mediated anti-tumor activity, as there would be no time for the establishment of a tumor-specific response.

Subcutaneous exposure to BCG prior to MB49 tumor challenge accelerates (i) enhanced inflammation in the bladder and (ii) T cell recruitment to the bladder, and we have demonstrated that mice previously primed subcutaneously with BCG respond much better to tumor challenge followed by BCG therapy. Therefore it is tempting to argue that studying the establishment of the tumor-specific response in this experimental model might be relevant and



worth pursuing, given the advantages of the MB49 model listed above. In that context, other scientists in the lab have undertaken three axes of investigation, in order to improve the MB49 model:

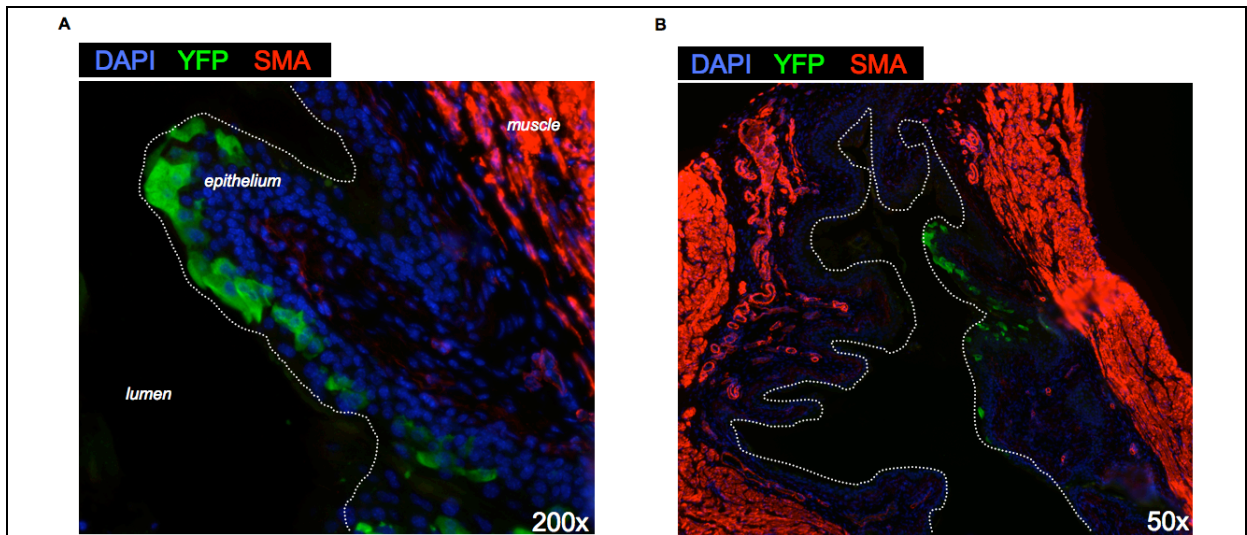
- Standardization of the tumor take and median survival time, by standardization of the passage number for tumor cells.
- The transfection of MB49 cells with OVA, which should allow the tracking of the tumor-specific response.
- The transfection of MB49 cells with luciferase, which should allow better follow-up of the animals, as compared to survival curves.

That said, having a mouse model in which human tumor histology and tumor microenvironment would be better recapitulated remains a worth-pursuing effort, and I have been involved in the first steps of building such model.

## 2) An inducible mouse model of CIS bearing tumor-associated antigens

As published by the Abate-Shen group, our team would like to utilize mice double-floxed for PTEN and p53 (Puzio-Kuter et al., 2009), but we would like to induce recombination with a lentivirus encoding the recombinase (lenti-Cre), which would be delivered intravesically – instead of the Adeno-Cre that was published by Puzio-Kuter and colleagues. The use of a lenti-Cre to induce a tumor has been recently reported (DuPage et al., 2011). Lenti-Cre are interesting, as compared to Adeno-Cre, in that they are more easily amenable to genetic manipulation, and our collaborators at the Curie Institute (Lantz and colleagues) are able to produce a lenti-Cre that also encodes for luciferase and antigens of interest (e.g., dby + uty).

In some preliminary experiments, I have tried to work out a protocol for the intravesical injection of the virus – in order to avoid the surgical manipulation published by (Puzio-Kuter et al., 2009), which seemed to me dispensable in female recipients. In my attempts using Adeno-Cre at the published concentration, and reporter Rosa26-LSL-YFP mice – in which the expression of YFP is under the ubiquitous Rosa26 promoter but depends on the excision of the Lox-Stop-Lox (LSL) cassette, mediated by Cre –, I was able to see YFP<sup>+</sup> cells in a small percentage of urothelial cells (**Figure 68**).



**Figure 68: Targeted gene deletion in bladder urothelium following intravesical delivery of Adeno-Cre.**

Adult Rosa26-LSL-YFP mice (kind gift from G. Eberl) were intravesically instilled with 25 $\mu$ L DMEM containing 10<sup>10</sup> pfu Adeno-Cre + polybrene (800 $\mu$ g/mL final concentration). Five days later, bladders were resected and immunofluorescence performed. A representative section is shown here at 200x (A) and 50x (B) magnifications. The lumen is demarcated by a white dotted line.

However, my first attempt to induce a tumor in mice double-floxed for PTEN and p53 with an Adeno-Cre was not successful, as we could not detect any histologic sign of tumor, three and five months following Adeno-Cre injection (data not shown). One reason might be that we did not reach the basal urothelial layer.

As for now, in the likely perspective that efficient intravesical delivery of virus is achieved in our lab, I remain concerned about the transition from Adeno-Cre to lenti-Cre. Indeed, very high concentrations of Adeno-Cre are required (Puzio-Kuter et al.), probably because most of the virus is voided or diluted in the bladder lumen, and it might be difficult to concentrate the lentivirus high enough.

Though technically challenging, this project is worth pursuing because such model would recapitulate many interesting aspects of human bladder tumors, much better than orthotopically transplanted tumors, namely:

- The induced tumor would have histological features that closely recapitulate human CIS.
- There would be improved modeling of tumor progression (muscle-invasiveness takes several months to occur).
- The tumor microenvironment (stromal cells, and interactions with the immune system) would be better modeled.

- Starting with a high tumor burden might be more relevant in the context of CIS than papillary tumors, since CIS are sometimes not resected in patients.
- The fact that the model is inducible might avoid the induction of central tolerance to mutated tumor suppressors. Therefore one might expect potential similarities in the development of tumor-induced tolerance and immunosuppression.

Finally, all these features might be obtained in a reasonable time-window, as Abate-Shen group reported 2.5 months for 100% penetrance of small CIS in their mice.

Overall, there are a lot of interesting perspectives to investigate the requirement for a tumor-specific response in BCG therapy for bladder cancer, and the interactions between the various components of the immune response, i.e., the innate response, the BCG-specific and – potentially – the tumor-specific adaptive response(s). Obviously, when pursuing such investigations, one should keep in mind their potential therapeutic implications.

Even though I have not pushed my investigations thus far, I have already identified several ways in which standard-of-care BCG therapy might be improved, and that is be my last focus of discussion.

### **III. A TRANSLATIONAL APPROACH TO BCG THERAPY AND BLADDER CANCER**

While I was working on (i) the dynamics of, and the requirements for T cell entry into the bladder in our mouse experimental model and on (ii) the assumptions underlying our mathematical modeling, I realized that playing with the kinetics of bladder T cell infiltration during BCG therapy might allow to improve the response to therapy in patients with superficial bladder cancer. More precisely, I identified two main ways of altering such kinetics in a favorable manner for patients, which are sequentially discussed: (i) accelerating T cell entry into the bladder; (ii) retaining T cells in the bladder for longer. Based on my results with HK-BCG, I also discuss the potential advantages of using killed preparations of BCG as the intravesical agent.

#### **A. Priming/boosting BCG-specific immunity prior to intravesical therapy**

My experimental data show that the priming of BCG-specific cellular immunity – through subcutaneous immunization – prior to intravesical therapy accelerates the recruitment of T

cells into the bladder following intravesical BCG instillation (**Figure 38**). Based on some evidence from the literature that T cells are crucial for the tumor elimination (Prescott et al., 1992; Ratliff et al., 1987a; Ratliff et al., 1993), and based on our mathematical modeling, I reasoned that accelerating the recruitment of T cells would accelerate (i) the killing of infected tumor cells by BCG-specific T cells and (ii) the killing of tumor cells by inflammatory cells, whose recruitment would be enhanced as early as at the first instillation by primed BCG-specific T cells. My reasoning was that accelerating / enhancing tumor cell death early during BCG therapy (as early as at the first instillation, whereas it normally takes at least 3 instillations) would accelerate the cross-priming of tumor-specific T cells, and therefore improve the anti-tumor activity.

I tested such hypothesis in mice and quite strikingly, I demonstrated the ability to achieve up to 100% survival in mice bearing an aggressive orthotopic urothelial tumor, provided they would receive a subcutaneous immunization with BCG prior to tumor challenge and intravesical therapy, as compared to 80% lethality at day 70 in the absence of pre-immunization with BCG (median survival time being ~45 days, **Figure 48**). Supporting the important role for pre-treatment BCG-specific responses, analysis of available clinical data from a recent observational trial identified absence of a PPD response to be a risk factor for treatment failure (**Figure 49**).

Based on these results, I argue that priming/boosting a BCG-specific cellular immune response prior to intravesical therapy may represent a straightforward approach to improving treatment response, and may allow to decrease side effects, through the use of killed BCG preparations as the intravesical agent.

#### 1) Of prior exposure to BCG and response to therapy

##### *(a) PPD responsiveness, an old but controversial predictor of response to therapy*

As early as in 1980, Rosenthal speculated that the possible mechanism of action of BCG was linked with the host's ability to develop delayed hypersensitivity to mycobacterial antigens: he pointed out that patients with melanoma who had responded to intralesional injection of BCG were either tuberculin positive before therapy or showed positive response after BCG administration whereas non-responders usually were tuberculin negative (Rosenthal, 1980a).

In the context of BCG therapy for bladder cancer, many groups have linked conversion of PPD test from negative to positive during induction BCG therapy to a lower risk of recurrence in several univariate and multivariate analyses in the past (Kelley et al., 1986; Lamm et al.,

1991; Torrence et al., 1988), whereas some groups only observed a trend (Luftenegger et al., 1996), or did not observe any correlation at all (Bilen et al., 2003; Shinka et al., 1990). Of note, none of them reported an improved progression-free survival (Saint et al., 2003).

The controversy about PPD conversion being a good predictor of response to therapy might be explained by several factors, including variability in the cohort of patients (prior BCG vaccination, recurrent vs. primary tumor, median grade of tumor, observation window, etc.), delay between surgery and initiation of therapy, BCG strain, the use of maintenance therapy or not, the method chosen for PPD testing, the time at which PPD test was performed, and the delay at which it was read-out, etc. In particular, Luftenegger and colleagues complained about a substantial number of ambiguous results in the PPD testing of their study (especially post intravesical instillation) (Luftenegger et al., 1996). In addition, given that definitive testing with PPD is recommended 8-12 weeks after vaccination (Mandell et al., 1995; Rosenthal, 1980b), one could wonder if the conversion that is observed at the 6<sup>th</sup> instillation, i.e., 5 weeks after initiation of therapy is a true conversion (Luftenegger et al., 1996), or rather a kind of ‘two-step testing’, as defined in Section I.D.1)(c): it is indeed well known that in some persons who were previously exposed to mycobacteria, the ability to react to tuberculin may wane over time and that when given a PPD test years after infection, these persons may have a false-negative reaction. However, the PPD test may stimulate the immune system, causing a positive, or boosted reaction to subsequent tests, while repeated testing cannot produce a positive reaction in previously non-infected or otherwise sensitized persons (Braunwald et al., 1987; Centers for Disease Control and Prevention (CDC) - Division of Tuberculosis Elimination; Menzies, 1999).

As far as PPD status prior to therapy is concerned, I identified two studies prior to our own that looked at its correlation with response to therapy: in 1985, Lamm and colleagues showed that patients who were PPD positive prior to therapy did better than patients who failed to convert but less well than patients who converted during therapy (Lamm, 1985). In 1987, Badalament and colleagues reported that American patients with recurrent superficial bladder cancer had a significantly greater likelihood of recurrence-free survival if they were PPD positive prior to initiation of therapy, as compared to all other PPD statuses (Badalament et al., 1987). In this report, the PPD positive patients have most likely primed a BCG specific response during previous cycle(s) of BCG therapy or Mtb exposure (as American patients do not receive BCG vaccine in their childhood (Zwerling et al., 2011)). And obviously, our own clinical observations in a Swiss cohort of patients with high-risk non-muscle invasive bladder

cancer also showed a significant difference in recurrence-free survival, favoring those patients with a PPD positive test prior to intravesical therapy (**Figure 49**).

Overall, even if some controversy remains in the literature, there is good evidence that immune signatures to BCG in patients with superficial bladder cancer do positively influence the response to intravesical BCG therapy.

*(b) Improved response to further cycles of BCG therapy (maintenance or second induction cycle)*

In line with these results, it is actually worth noting that in the case of failure to therapy, an additional 40-60% of patients respond to a second induction cycle of BCG therapy (Gontero et al., 2010; Sylvester et al., 2005), which suggests that for these patients, the first cycle of BCG might mainly serve as a BCG immunization.

Interestingly, Swiss patients have a high response rate after a single induction cycle and repetitive or maintenance BCG therapy is of little use (Luftenegger et al., 1996; Merz et al., 1995) whereas on the contrary, a second course of BCG or maintenance therapy is of significant value in the American population (Lamm, 1992; Luftenegger et al., 1996). Of note, a clinical study in an American cohort of patients recently reported that a second induction cycle in patients who failed to respond to the first cycle was as efficient as maintenance (Herr et al., 2011). Of note, together with aforementioned data in populations that were vaccinated in their childhood, the latter piece of data might contribute to the current questioning of whether maintenance is really required, with respect to selective retreatment of relapsing patients.

2) Triggering a PPD conversion prior to intravesical BCG therapy

*(a) An important population of patients is PPD negative prior to therapy*

From a clinical point of view, it is worth looking at the impact of pre-existing BCG-specific immunity on the anti-tumor response, as an important population of patients might be concerned by an improvement of therapy, if priming of a BCG-specific cellular immune response happens to be validated in the clinics.

Indeed, there is an important population of patients with bladder cancer who have never been vaccinated with BCG (e.g., in the USA, Canada, Italy) (Zwerling et al., 2011); additionally, among the patients who received BCG vaccine in their childhood, our clinical data show that a good proportion of them (58%, **Figure 49A**) has no more immune signature to BCG, as shown by a negative PPD test prior to intravesical therapy. Given that the mean incidence of

bladder cancer is in the seventh decade, and given that tuberculin reactivity diminishes with age, as mentioned above, this may not be surprising.

*(b) Parenteral exposure to BCG concomitantly with intravesical therapy does not result in improved anti-tumor activity*

To my knowledge, parenteral exposure to BCG shortly prior to BCG therapy has never been evaluated. Initially, BCG therapy was performed through the concomitant intradermal and intravesical routes (Morales et al., 1976). Several groups then showed that there was no improved efficacy in treating patients through the intravesical and concomitant intradermal route, as compared to the intravesical route alone (Herr et al., 1986; Lamm et al., 1991; Luftenegger et al., 1996) and the intradermal route was abandoned from the standard-of-care therapy.

Given my own data, I am not surprised by such results. Indeed, the intradermal injection of BCG at the time of intravesical instillations might not much accelerate the priming and the subsequent recruitment of T cells to the bladder, compared to intravesical alone, therefore not improving the anti-tumor response.

*(c) Inducing a PPD conversion prior to intravesical therapy*

From my data and the aforementioned literature, I predict that inducing – or boosting – BCG-specific cellular immunity in patients with a negative PPD test a few weeks prior to starting BCG therapy is likely to improve their response to therapy. Indeed, provided they receive BCG immunization ahead of time, such that they are able to mount a DTH reaction (and therefore convert their PPD test to positive) prior to initiation of therapy, I hypothesize, based on the reasoning exposed above and the literature, that they will respond better to therapy. It was actually quite striking to read that Luftenegger and colleagues came to the same conclusion in 1996 – however with no precise idea of the mechanism – and concluded from their comparative clinical study of the relevance of concomitant intradermal immunization that “*The possibility of attaining better results by vaccinating PPD negative patients with BCG before bladder instillation may be worth investigation*” (Luftenegger et al., 1996). Quite astonishingly, no one picked up on that, and 15 years later, I provide experimental, clinical and modeling bases for the same conclusion!

Before designing a reasonable schema for a clinical trial allowing to challenge such hypothesis in the near future (see Section III.A.3)), I would like to discuss a bit further the different options to improve therapy that are down the road, based on inducing a PPD conversion in patients prior to intravesical therapy.

As a way to induce, or boost, BCG-specific cellular immunity in patients who are PPD negative at the time of tumor diagnosis, I suggest using the parenteral route. As a reminder, the intradermal route is the recommended route of administration for BCG vaccine, but the percutaneous route is still used, see General Introduction Section II.B.1)(b). Of note, the oral route – which was the initial route of BCG vaccination, see General Introduction Section II.B.1) – has regained interest in the past few years as a Tb vaccine (Benevolo-de-Andrade et al., 2005; Hoft et al., 2000; Lagranderie et al., 2000; Merz et al., 1995; Mittrucker et al., 2007; Palendira et al., 2002; Vipond et al., 2008). Though rather protective against Tb (Lagranderie et al., 2000; Mittrucker et al., 2007; Palendira et al., 2002; Vipond et al., 2008), it is known to trigger only a low proportion of PPD test conversion (Benevolo-de-Andrade et al., 2005; Hoft et al., 2000) and I would therefore not recommend using the oral route as a way to induce BCG-specific immunity in patients with bladder cancer, since DTH reaction at the first instillations seems to be of importance for improving the anti-tumor response.

As far as BCG strain and preparation are concerned, I would suggest using commercially available BCG preparations that are commonly used for vaccination, though the differential efficacy of various strains remains a matter of debate (Aguirre-Blanco et al., 2007; Ritz et al., 2008). Indeed, it seems to me much easier to go on with what is already approved in each country. Alternatively, as soon as subunit and live vector-based vaccines that boost BCG prime reach the market as Tb vaccines (Kaufmann, 2010), one could think of testing such vaccines as a boost in patients who were previously vaccinated with BCG but are PPD negative at the time of tumor diagnosis.

*(d) Should we exclude those patients whose PPD response fails to convert prior to BCG therapy?*

Many studies looking at correlation between PPD conversion and response to therapy report a proportion of patients who fail to convert upon intravesical BCG therapy (Badalament et al., 1987; Bilen et al., 2003; Herr et al., 1989; Kelley et al., 1986; Lamm et al., 1991; Luftenegger et al., 1996; Shinka et al., 1990; Torrence et al., 1988; van der Meijden et al., 1989). Such failure to convert might be attributable to the failure of old patients to mount an efficient immune response.

In that case, one could argue that it might be worth excluding from intravesical BCG therapy those patients who would remain PPD negative after parenteral immunization, as they might not benefit from BCG therapy. Indeed they might better respond to alternative therapy (e.g., cystectomy), if initiated earlier (Herr and Sogani, 2001). However, such practice should be



carefully tested in a clinical trial first, in order to propose to the patients the best treatment strategy for their disease.

*(e) Should we fear a higher dropout rate during induction therapy, if BCG-specific immune responses are boosted prior to intravesical therapy?*

It is very well known by urologists that the tolerance of BCG instillations decreases as the number goes up, i.e. the 6<sup>th</sup> instillation of the induction cycle is the most painful. Notably, if severe side effects are rather rare (see General Introduction Section I.B.2)(c)), its potential local and systemic ‘mild’ side effects may either lead to treatment cessation in up to 30% of patients or lead to a delay or reduction in the number of instillations in 55-83% of patients (van der Meijden et al., 2003); therefore BCG tolerability is an important limitation in its use as a therapy for superficial bladder cancer, and a limitation that needs to be taken into account in any attempt to improve the response rate by modifying the treatment regimen.

On the other hand, BCG effectiveness has often been suggested to be related to its associated side effects. This would match with my own model, since side effects are closely related to bladder inflammation, and since I propose that bladder inflammation is important to (i) result in local T cell recruitment and (ii) induce tumor cell death, leading to cross-priming of a tumor specific response. In line with that, Orihuela and colleagues claimed that patient with a local inflammatory reaction (acute cystitis, inflamed bladder mucosa and/or bladder granulomas) have a better treatment outcome, though the development of systemic symptoms did not appear to be related to treatment efficacy (Orihuela et al., 1987), which contrasts with the study by Luftenegger and colleagues. Indeed, though PPD conversion did not conclusively predict response to treatment, fever  $>37.5^{\circ}\text{C}$  after BCG instillation (i) occurred significantly more frequently in patients with a PPD test before initiation of therapy and (ii) correlated with a lower risk of recurrence (Luftenegger et al., 1996). Whether or not fever correlated with higher inflammation in the bladder is not mentioned. In another study, Saint and colleagues found that a high urinary leukocyte count was related to both improved efficacy and more severe adverse events (Saint et al., 2001b). A trial by the EORTC however showed that *although* a correlation between BCG toxicity and efficacy did exist, side effects could not be held responsible for an improved outcome to therapy. The authors indeed argued that patients with a better outcome remain on study for a longer period of time and receive more BCG, thus increasing their risk to develop side effects. To prove whether toxicity was responsible for improved efficacy, the prognostic importance of toxicity occurring prior to the 6-month instillations was assessed in 487 patients, and neither local nor systemic BCG toxicity prior to 6 months was related to subsequent recurrence (Sylvester et al., 2003).

If PPD conversion is triggered in patients prior to intravesical therapy, and if an enhanced acute inflammatory response now occurs as early as at the first instillation, as expected based on my mouse experimental model (**Figure 41** and **Table 7**), one might fear that the 4<sup>th</sup> instillation is now as painful as the 6<sup>th</sup> used to be, and that a more important proportion of patients fail to complete their induction cycle. (This is without mentioning the direct toxicity of parenteral immunization with BCG, which will be discussed below in Section III.A.3)(a.) Obviously, such a question requires a clinical trial to be solved. To my knowledge, to date, no one has tried to correlate the dropout rate (and/or dose/schedule modification as a result of BCG toxicity) during induction cycle with PPD status prior to therapy.

From my perspective, one way to improve tolerance of therapy for patients might be to increase the inter-instillation interval (see Section III.B), as the periods of acute inflammation in the bladder would be more spaced in time. Alternatively, based on the study of the lymphoproliferative response of PBMCs from patients against BCG related reagents, Zlotta and colleagues argued that 4 weekly instillations might be enough for patients who were previously immune against mycobacterial antigens (Zlotta et al., 2000). Based on our experimental and mathematical modeling results, the long-lasting infiltration of the bladder by T cells (BCG-specific as a first step, but most importantly tumor-specific) is crucial to achieve anti-tumor activity; therefore I do not favor such approach.

*(f) The potential use of killed preparations of BCG as the intravesical agent*

As mentioned in General Introduction (see Chapter 1 Section II.C.4)(a)), the use of killed preparations of BCG as an anti-cancer agent has received a lot of interest in the 1970s, but with rather disappointing results. In Zbar's seminal experiments, co-injection of tumor cells with HK-BCG did not yield tumor regression, but interestingly, if the animals had been previously primed with BCG, the authors could see a partial effect (Zbar et al., 1971).

From my mouse experimental model, instillations with HK-BCG resulted in an acute inflammatory response, which was similar to that obtained with live BCG (**Figure 42**) but did not result in T cell infiltration in the bladder (**Figure 35**). This might explain why such intravesical agent would fail to mediate anti-tumor activity (data not shown).

Provided mice were immunized subcutaneously with BCG, though, I was able to see a robust inflammatory response as early as following the first instillation (**Figure 42**), and T cell infiltration in the bladder could now occur (**Figure 38**). Therefore I speculate that, provided they would have a positive PPD response prior to therapy, patients might be treated with killed BCG preparations as the intravesical agent – and why not MCC (see Chapter 1 Section

I.B.4)(b)? This might decrease the risks of BCG-osis – 1 to 5% of patients indeed suffer from that kind of adverse side effects (Brandau and Suttman, 2007; Gontero et al., 2010).

3) Towards a clinical trial testing the priming of BCG-specific immune response prior to intravesical instillation

It is outside the scope of this dissertation to propose a clinical trial, testing the aforementioned hypotheses, but I would like to briefly discuss the immediate issues that would need to be solved in order to run such a trial any time soon. This discussion is the result of fruitful discussions with Dr. Rentsch and Dr. Gsponer and is a nice illustration of the advantages of a close collaboration between academic laboratories and the clinic.

*(a) Some safety issues to solve*

First of all, some safety issues need to be solved, which concern the potential direct toxicity of parenteral BCG injection into patients that were vaccinated with BCG a long time ago.

It has indeed long been known that repeated exposure to high levels of mycobacterial antigen in *Mtb*-infected hosts can lead to development of a detrimental purulent inflammation, causing necrotic lesions and known as the Koch phenomenon (Rook and Stanford, 1996). Though the definition of such reaction is confined to *Mtb*-infected hosts, the common practice is to avoid repeated BCG vaccination. Of note, this is why current Tb vaccine strategies are turned towards subunit vaccines as a boost for BCG prime or towards the replacement of BCG vaccine itself, but never consider a BCG boost (Kaufmann, 2010).

The concern of a reaction resembling the Koch phenomenon upon parenteral BCG re-immunization is the main reason for me to exclude from the clinical trial those patients who are PPD positive prior to therapy. (Another pragmatic reason is that it would be extremely difficult to prove a significant improvement in therapy in such a population of patients, given their current very high cure rate – see the green curve in **Figure 49**. The sample size would be very high and therefore difficult to reach.)

As far as PPD negative patients are concerned, either they have not been vaccinated in their childhood, and the risk seems to me minimal – though exposure to environmental mycobacterias might need to be taken into consideration in some countries (Dockrell, 2008) – or they have been vaccinated in their childhood, and one might feel concerned about toxicity, or at least, one might argue that toxicity should be tested in a phase 1 trial (especially because standard-of-care treatment yields rather good results, and therefore one should avoid putting patients at risk for severe side effects while testing a new therapeutic regimen).

I have good reasons to expect that toxicity will not be high, though: indeed, up to the late 1990s, the standard treatment practice for bladder cancer involved weekly parenteral (either intradermal or percutaneous) injections of patients concomitantly with intravesical instillations (Luftenegger et al., 1996; Morales et al., 1976) and no toxicity related to the parenteral injections was reported, to my knowledge, even in PPD positive patients. Repeated BCG injections were also recommended by BCG experts such as Rosenthal, in the 1970s, in order to yield good anti-tumor activity (Rosenthal, 1980a) (see General Introduction Section II.C.2)(b)). Finally, BCG revaccination trials – as a way to improve prevention of Tb – have been conducted in the past and did not report high levels of side effects (2001; Rodrigues et al., 2005).

*(b) A reasonable delay for priming*

Another practical question to solve is: when to do the parenteral immunization? Indeed, the common practice in the field of Tb vaccination is to wait 8-12 weeks after BCG injection before performing a PPD test (Centers for Disease Control and Prevention (CDC) - Division of Tuberculosis Elimination). In the context of bladder cancer therapy, the constraints are as follow:

- Based on the reasoning exposed in the previous paragraph, patients' PPD status must be determined prior to the therapeutic decision as to perform parenteral immunization or not. Of note, PPD readout is often done 48-72hrs after tuberculin injection, but it is thought to be more accurate after 7 days, especially in old patients (Rentsch, unpublished observations).
- The delay between diagnosis of a tumor and resection is rather short (1-2 weeks), and the delay between resection and initiation of intravesical therapy (meant to allow bladder healing) is also recommended to be short (Babjuk et al., 2011): though its impact on response to therapy has never been evaluated in the clinics, our mathematical model suggests not to wait more than 2 weeks (see Chapter 4 Section III.B.1)). Of note, the current practice is to wait 2-6 weeks. Therefore, even though 2 resections will likely be required, as one deals with high-risk tumors (with a delay of 2-6 weeks between both of them, see General Introduction Section I.B.1)(a)), the delay from diagnosis to initiation of intravesical therapy can be as short as 4-5 weeks (and up to 14 weeks in the case of 2 successive resections with rather long interval in-between, which appears to me suboptimal).

Given such constraints, it does not seem optimal to wait 8-12 weeks between parenteral immunization of PPD negative patients and initiation of intravesical therapy, as this would likely be beneficial for the tumor to grow in the mean time.

*(c) Proposal for a clinical trial schedule*

Given the constraints that I listed above, Dr. Rentsch and I compromised to propose a schedule for a clinical trial, as illustrated in **Table 8** below. Most importantly, this schedule would involve (i) PPD screening (named PPD1) at the time of diagnosis, (ii) parenteral immunization as soon as the PPD results are known, and (iii) a 2-3 week delay from the second resection until initiation of intravesical therapy.

Of note, testing PPD conversion (named PPD2) prior to initiation of intravesical therapy – as proposed in Section III.A.2)(d) as a way to optimize treatment strategy for the patient – is not possible in such a tight schedule. But we would rather favor short delays at each step, in order to limit tumor growth prior to intravesical therapy.

Days	0	3	7	14		*28/35	35/42	42/49	49/56	56/63	63/70	3m	3mos +3d	3m +7d
Days post vacc.						21-28								
Visual Dx	x													
PPD1	x	r	r											
TUR1			x											
Vaccination			x											
TUR2				x										
PPD2 ?														
standard BCG*						I	II	III	IV	V	VI			
PPD3												x	r	r
controle												for 5 yrs		

x: do; r: read

\*2 or 3 weeks after TUR2

**Table 8: Proposal of a schedule for a clinical trial.**

We propose to perform a first PPD test (PPD1) as early as at the time of diagnosis. Read-out of PPD test would be done both after 72 hours and 7 days. We scheduled 2 TUR, which is rather likely since tumors eligible for BCG therapy are high-risk tumors (see General Introduction Section I.B.1)(a)). Standard BCG therapy would be initiated 2-3 weeks after the second TUR.

## B. Increasing the inter-instillation interval

Another very exciting avenue of therapeutic improvement arose from our mathematical modeling and deals with inter-instillation intervals. Only limited information is available from

clinical trials where the treatment interval was modified during BCG induction therapy. Changing the interval to two weeks seems to improve side effects (Bassi et al., 2000). Studies in mice indicated that the number and timing of the instillations are important in determining different local cytokine profiles (de Boer et al., 2005), which in turn may influence the qualitative and quantitative recruitment of adaptive effector cells.

Results from our mathematical simulations indicate that the treatment interval could be extended by far (**Figure 54**) – up to 30 days in our modeling, but our model does not mean to be quantitative, and the abrupt loss of efficacy by day 30 should be taken into account, therefore 14 days might be a wiser way to start. Such result is related to the facts that the major contributors to tumor cell eradication are adaptive effector cells, which persist for a long time in the bladder and are able to attack uninfected tumor cells, whereas killing of tumor cells by innate effector cells is mostly focused on infected tumor cells (whose proportion is rather low). As a consequence, the acute bursts of inflammation triggered by intravesical instillation seem less important for tumor extinction than long-lasting infiltration of adaptive effector cells. Subsequently, an increase of the inter-instillation interval would increase the overall time period during which effector cells can target and destroy tumor cells, provided such interval would remain lower than the time interval during which adaptive effector cells remain in the bladder. The latter is related to effector cells' lifetime in our mathematical model, but can also be interpreted as the time period during which the bladder is out of homeostasis and secretes cytokines and chemokines that attract activated T cells, i.e., at least several weeks from our experimental studies, see chapter 3 Section III.D).

A beneficial consequence from increasing inter-instillation intervals is that side effects might be reduced, as suggested by published clinical data (Bassi et al., 2000) and by the fact that side effects are mostly linked with the acute inflammatory process that occurs following each intravesical instillation. Increasing treatment interval would give more time to the bladder to recover from one acute phase of inflammation, until the next one.

Of note, the impact of increasing inter-instillation interval on anti-tumor activity is not easily testable in the MB49 model, since the tumors triggered by orthotopic implantation of this tumor cell-line rapidly become aggressive and muscle-invasive (Chan et al., 2009). I would therefore argue that such hypothesis be tested in the clinics, given the encouraging published data (Bassi et al., 2000). Alternatively, one might want to wait for an improved mouse model for bladder cancer, e.g. MB49 implantation in mice previously immunized subcutaneously with BCG.

### C. Other treatment options suggested by mathematical modeling

Our mathematical modeling identified other clinical parameters that likely impact the response to therapy, including the delay from surgery to initiation of therapy, which negatively influences the outcome and is somehow related to the number of tumor cells present at start of therapy, and BCG dose/dwell time. I briefly discuss each of these parameters, though I do not see how to propose an optimized treatment strategy concerning these parameters, except the advice to stick to guidelines as much as possible.

#### 1) Leaving tumor cells behind, a double-edge sword

I discussed in Section II the crucial need for and some experimental evidence of a tumor-specific response in the context of BCG therapy. Obviously, there is a need for tumor cells to be present in order to trigger the cross-priming of tumor specific T cells. This would confirm Zbar's intuition that BCG had to be in direct contact with cancer cells in order to have anti-cancer activity (Rapp and Zbar, 1981; Zbar et al., 1971). At the same time, they reported that the number of tumor cells that were co-injected with BCG limited its anti-tumor efficacy (Zbar et al., 1971), which I interpret as a balance between (i) a high enough number of tumor cells allowing for efficient cross-priming, but (ii) a low enough number of tumor cells so that the immune system is not overwhelmed.

In bladder cancer, though resection is performed once or twice, there are some tumor cells left behind. Urologists, pathologists and scientists argue about their plausible number ( $10^3$ - $10^6$ ), but for sure there are some. In the case of CIS, sometimes, resection is impossible and a very high number of tumor cells are present at initiation of therapy. Intriguingly, BCG therapy is particularly efficient against that type of tumors (72-93% rates) (Babjuk et al., 2011). Therefore, one might ask if there would be an optimal number of tumor cells that should be left behind by surgery. We could not address such question with our mathematical model as it was calibrated to result in 50% tumor extinction with standard therapy and a given number of tumor cells at start; i.e., if one decreases the number of cells at start, the parameters determining the "strength" of the immune system will be tuned such that the probability of tumor extinction is not changed. The only comment I can make is that, for a given number of tumor cells left behind by surgery, it is recommended to initiate therapy early after resection, as recommended by the guidelines.

## 2) BCG dose

In our mathematical modeling, we observed that BCG dose had a strong (exponential) influence on the response to therapy. This is related to the fact that the fraction of BCG-associated tumor cells is determinant for the response to therapy (see Chapter 3 Section IV.C.2)).

In our experimental model, we could not test the influence of increasing BCG dose (see Section I.C.1)(a)), but we could observe that T cell infiltration in the bladder decreased with the dose (Rentsch, unpublished data). As far as BCG commercial preparation is concerned, it would probably be difficult to increase much the dose in one vial, as lyophilizing BCG to the current dose is already quite a challenge (Lagranderie, personal communication).

Therefore, even though the clinical response to BCG seems to be highly dependant on the dose, the relevance of such parameter for the clinical practice is somehow limited to the fact that one should avoid decreasing the instilled dose, as compared to the guidelines.

In summary, our experimental and modeling work opened avenues for improving standard-of-care BCG therapy for patients with non-muscle invasive bladder cancer. I am very happy and proud that these academic results translated into recommendations for current treatment as well as hypotheses that are testable in the clinics. I am looking forward to upcoming clinical trials.

## **IV. CONCLUSION**

In conclusion, I have established an experimental mouse model to study the dynamics of the immune response following intravesical BCG regimen. I have demonstrated that while BCG dissemination to regional LNs and priming of IFN $\gamma$ -producing T cells can occur following a single instillation, repeated instillations of live BCG are necessary to achieve robust bladder T cell infiltration. Strikingly, parenteral exposure to BCG prior to instillation overcomes the requirement for repeated instillations, triggering a more robust acute inflammatory process at the first instillation and accelerating the recruitment of T cells to the bladder. Moreover, parenteral exposure to BCG prior to orthotopic tumor challenge dramatically improves response to BCG therapy. Importantly, patients with pre-existing immunity to BCG responded significantly better to therapy.

In parallel, using clinical and *in vitro* experimental data, I contributed to the construction and parameterization of a stochastic mathematical model describing the interactions between



BCG, the immune system, the bladder mucosa and tumor cells. Using this model, we could show that tumor extinction mediated by the innate immune system acting on its own is highly improbable. We thus refined our mathematical model to take into account the adaptive immune response, and evaluated optimal clinical parameters of BCG induction therapy, including (i) duration between resection and the first instillation, (ii) BCG dose, (iii) indwelling time, and (iv) treatment interval of induction therapy, which all had an impact on the probability of tumor extinction. A remarkable finding is that an inter-instillation interval two times longer than the seven-day interval used in the current standard of care would substantially improve treatment outcome.

Together these data provide new insights into a long-standing clinically effective immunotherapeutic regimen and predict strategies that may improve patient management. Most importantly, I suggest that monitoring patients' response to purified protein derivative (PPD) test, and, if negative, boosting BCG responses by parenteral exposure prior to intravesical treatment initiation, may be a safe and effective means of improving intravesical BCG-induced clinical responses.

# Materials and Methods

---



*(I wrote this section for my fellow lab-members, as I wish that some protocols I developed can be useful in the lab. For the thesis committee, please refer to the manuscripts (below) for usual Materials and Methods)*

## **I. INTRAVESICAL INSTILLATIONS**

### **A. BCG intravesical instillations**

*I established this protocol, with some contribution from H el ene Saklani, Huey-Hsuan Chang, Cyrill Rentsch and Charlotte Auriiau.*

#### Water starvation:

Remove water-bottles 7-8 hours prior to instillation.

If instillation needs to be done in the morning, water-bottles can be removed the evening before, leaving a bit of hydrated food within the cage.

#### Anesthesia:

For 8mL total:

- 1.5mL Imalgen 1000 (ketamine)
- 1mL Rompun 2% (xylazine)
- 5.5mL PBS

The prep can be kept up to 1 month at 4°C, protected from light.

#### Instillation:

Keep the mice under a lamp along the whole manipulation, because they get cold due to anesthesia.

- Anesthetize mice with 100uL ip per 20g mouse; wait 5 minutes to ensure that mice are fully asleep
- Lie the mice on their back on a plate
- Drain their bladders of any urine present by application of slight digital pressure to the lower abdomen
- Clean the urethral orifice with betadine
- Adapt a 24-Ga catheter to a 1mL syringe and fill it in with 50uL PBS or BCG
- Insert the catheter into the bladder, while keeping about 1cm visible (to be sure to remain in the lumen of the bladder)
- Inject at a low rate to avoid trauma and vesicourethral reflux

Keep the mice with catheter inserted for 2 hours.

- 55 minutes after anesthesia, inject additional 50uL of anesthetic diluted 1:2 in PBS intramuscularly to ensure that mice remain asleep over the 2-hour instillation time.
- At the end of instillation time, gently remove the catheter and bring mice in a ventral position, on a paper towel to allow voiding of the infusion.
- Place the mice back into their cage, with normal food and water supply, and keep them under the lamp until they wake up.

Note: all waste that has been in contact with BCG is placed into a special bag, which is sealed before being placed into biological hazard bin.

References/orderings:

Catheters: BD Insyte Autoguard 24GA 0.7 x 19mm. Ref: Apotecnia 381812  
Tuberkulin syringes: 1mL NORm-JECT (Luer) Ref: Dutscher 921036  
Insulin syringes (for anesthesia): VWR 613-4897  
D-PBS (1x) without Ca, Mg, Phenol Red: Invitrogen 14190-169, available from MG 53012  
BCG: Immucyst, Sanofi Pasteur, available from the pharmacy  
Betadine: available from pharmacy  
Imalgen 1000: available from pharmacy  
Rompun 2%: available from pharmacy

## **B. Orthotopic implantation of MB49 tumours into the bladder**

*I am very thankful to Cyrill Rentsch for developing this protocol and to Joel Gsponer for helping me with these heavy experiments.*

MB49 culture medium:

- DMEM
- X% FCS
- 1% Pen/Strep

Prepare cells for orthotopic instillation:

Note: cell culture passage number is an important criterion for tumor take. Late passage cells are highly recommended.

- Thaw cells in a 10cm-plate
- When cells reach 80% confluency (normally 3-4 days), the cells are trypsinized, split and replated.
- Early afternoon on the day of instillation:
  - Trypsinize cells
  - Wash well with PBS
  - Count
  - Resuspend at  $1.7 \times 10^6$  cells/mL in PBS (so that mice receive 85,000 cells in 50uL)
  - Keep on ice until instillation

Instillation of MB49 cells (preceded by coating of bladder wall with poly-L-lysine):

Note: the instillation protocol is more detailed in the BCG instillation section. Below are only listed the specificities of poly-L-lysine and cell instillation.

- Prepare poly-L-lysine at 0.1mg/ml in sterile water
  - Keep on ice until use
- Anesthetize mice (which have been water-starved for 6-8 hours) with 110-120% of the dose used for BCG instillations

Note: it is very important that mice do not wake up during tumor instillation, because otherwise, tumor take might be very variable among littermates. So we are ready here to take the risk of a slight anesthetic overdose. In case a mouse wakes up, it should be discarded from the experiment.

- Lie mice on their back, and clean urethral orifice as for BCG instillation
- Instill 50uL poly-L-lysine
  - Keep it into the bladder for 20'

- Remove catheter
  - Gently press the belly to empty the bladder
- Fill in another syringe with 50uL cell preparation
- Instill mice
  - Keep cell preparation into the bladder for 1hr
- Randomize mice among the different cages and identify them by ear-punching

Note: hematuria should start arising within 12-20 days in the control group.

References/orderings:

D-MEM (1x) 4.5g/L glucose with Glutamax I without Na Pyruvate: Invitrogen 61965-059, available from MG 53005

Fetal calf serum (FCS): Tebubio

Pen/Strep: Gibco 15140-022

Trypsin-EDTA: Invitrogen 25300054, available from MG99637

Instillation material/procedure: see BCG instillation protocol

Poly-L-lysine: Sigma Aldrich P6282

### **C. Intravesical injection of adeno/lenti-virus**

Note: as lentivirus and adenovirus are very concentrated and very precious reagents, I had to adapt BCG instillation protocol to avoid losing 80uL of the preparation per mouse in the dead volume of the catheter.

This protocol was validated using Rosa26-LoxP-STOP-LoxP-YFP mice and Adeno-Cre virus.

For virus concentration/quantities, the protocol below is written for Adeno-Cre and will require further work to adapt to lentiviruses.

- Prepare polybrene at 8mg/mL in PBS (10x stock)
  - Filter it at .22u

Polybrene is reported as stable for at least 1 year at 4°C.

- Clean Hamilton syringe:
  - Remove piston
  - Use a 1mL tuberculin syringe to inject EtOH 70% into the syringe (from its back)
  - Use another 1mL syringe to clean well with PBS
- Prepare the virus mix:
  - Virus: 2x
  - Polybrene: 10x
  - QP: DMEM
- Anesthetize water-starved mice with the regular dose of anesthetic (100uL per 20g)
- Lie mice on their back and tape their legs on the plate (in order to tip up the plate and allow the virus preparation to contact the bladder wall opposite from the urethral orifice)
- Clean the urethral orifice with betadine
- Insert a catheter (with no syringe)
- Fill in Hamilton syringe with 25uL virus preparation

- Pass the needle through the 24Ga-catheter until it cannot go any further

Note: the length of the needle has been designed so that, when the syringe cannot go any further, the tip of the needle goes past the tip of the catheter by 1mm. Therefore the liquid will be able to drop but the risk of piercing the bladder wall and injecting into submucosa or muscle is minimal.

- Slowly inject the virus preparation
- Gently remove the needle
  - Keep the catheter into place to avoid dropping some virus preparation in the urethra while removing the catheter.
  - Clean the Hamilton syringe + needle with (i) PBS, (ii) EtOH70%
- Keep mice under anesthesia for 1hr
- Gently remove catheter

Note: all waste contacting AdCre should be carefully discarded.

References/orderings:

“Regular” instillation material: see BCG instillation protocol

25uL Hamilton syringe: Hamilton 702LT

28Ga 42mm Needles: VWR HAMI7750-19-42-4

D-PBS (1x) without Ca, Mg, Phenol Red: Invitrogen 14190-169, available from MG 53012

1mL tuberculin syringe: BD Plastipak 300015 available from MG 21400

Adeno-Cre: Gene Transfer Vector Core Ad5CMVCre. Titer has to be higher than  $10^{11}$  pfu/mL

Polybrene: Sigma L10768-9

D-MEM (1x) 4.5g/L glucose with Glutamax I without Na Pyruvate: Invitrogen 61965-059, available from MG 53005

## II. SUBCUTANEOUS INJECTIONS

- Adapt a 25-Ga needle to a 1mL syringe
- Place the mouse in the containment
- Gently remove hairs at the root of the tail with a big forceps
- Insert the needle at the root of the tail, just under the skin, for about 1cm
- Inject 100 to 150uL.

One should not feel any resistance to injection.

References/orderings:

Containment made by “Atelier” from Institut Pasteur

25-Ga x 5/8” needles: Terumo NN-2516R

1mL tuberculin syringe: BD Plastipak 300015 available from MG 21400

## III. BCG PROTOCOLS

### A. Immucyst reconstitution

Work under a hood.

- Adapt a 18-Ga needle to a 5mL syringe

- Aspirate 3mL sterile PBS
- Pierce the lid of Immucyst vial with the same needle adapted to the same syringe
- Maintain the vial vertical and move the back of the syringe up to 5mL, in order to create some vacuum in the vial
- Inject the 3mL PBS into the vial and remove the needle
- Gently agitate the vial until full resuspension of the freeze-dried pellet
- Aspirate the whole content of the vial with the same syringe and transfer into a sterile 5mL polypropylene vial
- Remove 40uL for titration

References/orderings:

D-PBS (1x) without Ca, Mg, Phenol Red: Invitrogen 14190-169, available from MG 53012

BCG: Immucyst, Sanofi Pasteur, available from the pharmacy

18-Ga x 1 1/2" needles: Terumo NN-1838R

5mL BD Discardit syringe: Dutscher 309050

5mL polypropylene tubes: BD 352063 available from MG 42105

## **B. Frozen stocks of BCG**

*I am very thankful to Roxane Simeone and Roland Brosch for providing the basis for this protocol.*

Work under a hood.

All cultures are done in flasks, with a close lid to avoid evaporation, in a 37°C shaking incubator (100-120rpm).

BCG-Pasteur (1173P2), BCG-GFP and BCG-dsRed strains were all a kind gift from Nathalie Winter (INRA, Tours).

BCG-GFP and BCG-dsRed selection is done with hygromycin at 50ug/mL.

- Preculture colonies from plates in 10mL 7H9 + 10% ADC +/- antibiotics (25cm<sup>2</sup> flask)

After 1 week:

- Take 1mL of growing bacteria, into 100mL fresh medium (150cm<sup>2</sup> flask)

10 days later:

- Split the culture into 2 vials
- Spin down 4000rpm 15' at room temperature (RT)
- Resuspend each in 40mL PBS
- Spin down 4000rpm 15' at RT
- Repeat 2 more times.
- At the end of the washings, add about 10 glass beads (Ø3 mm) to the pellet and vortex vigorously 1' to get rid of clumps
- Resuspend in 6mL PBS and let sediment for 10' at RT
- Take the supernatant and spin down 1400rpm 10' at RT
- Take the supernatant and aliquot per 500uL in cryovials
- Freeze stock at -80C



Later:

- Titer 1 aliquot.

References/orderings:

7H9 medium: prepared by kitchen from Guérin building, Institut Pasteur  
Middlebrook Albumin Dextrose Catalase (ADC): Ref 211887, available from MG 51518  
Hygromycin: Merck 400052  
25cm<sup>2</sup> flasks: Corning 430168, available from MG 40000  
150cm<sup>2</sup> flasks: Corning 430823, available from MG 40015  
D-PBS (1x) without Ca, Mg, Phenol Red: Invitrogen 14190-169, available from MG 53012  
Glass beads 3mm/ 500g: VWR HECH 1401/3  
Nunc cryovials 1.2mL: Dutscher 55002

## **C. BCG Titration**

*I am very thankful to Caroline Demangel for providing the basis for this protocol.*

Plates:

- Melt pre-autoclaved 7H11 medium
- Cool down to 56°C in a water bath
- Add 10% OADC +/- antibiotics
- Pour plates
- Let dry and store at 4°C. Use within a few months.

BCG titration

- Do 10 syringe passages (26Ga) to avoid/reduce the number of clumps
- Prepare serial 1:5 dilutions of BCG preparation into PBS
- With a multichannel pipette, delicately spread 20uL of dilutions 5-2 to 5-9 onto a square Petri plate, in duplicate
- Wrap the plate to avoid drying
- Let it grow for about 17 days at 37°C

Determination of bacterial load in draining lymph nodes (DLN):

- Resect DLN into 300uL sterile PBS in a 24 well-plate
- Mash with the back of a syringe. Wash the latter with 100uL PBS
- Plate 100uL onto a quarter of Petri dish, in duplicate
- Wrap the plate to avoid drying
- Let it grow for 21-35 days.

Note: Growing time is very variable, mostly around 28 days.

Determination of bacterial load in the bladder:

- Resect the bladder in 500uL PBS in an autoclaved 2mL Eppendorf tube containing a 5mm-stainless steel bead
- Load the tubes in the Tissue Lyzer and lyse 2 minutes at 25Hz
- Prepare serial 1:5 dilutions in PBS
- Plate serial dilutions and/or 100uL pure (depending on the time point), in duplicate

- Let it grow for 21-35 days.

Note: Growing time is very variable, mostly around 28 days.

References/orderings:

7H11 medium: prepared by kitchen from Guérin building, Institut Pasteur  
 Middlebrook Oleic Acid Albumin Dextrose Catalase (OADC): Ref 211886, available from MG 51516  
 Hygromycin: Merck 400052  
 Square Petri plates 120x120x15.8mm: Biorad 50304  
 1mL tuberculin syringe (26Ga): BD Plastipak 300015 available from MG 21400  
 D-PBS (1x) without Ca, Mg, Phenol Red: Invitrogen 14190-169, available from MG 53012  
 5mm-stainless steel beads: Qiagen 69989

## D. *In vitro* infection of cell-lines with BCG

*I am very thankful to Ludovic Tailleux for providing the basis for this protocol.*

Start from a growing culture, in its exponential phase.

- Collect the bacteria into a Falcon 50. Add PBS to the top (to wash)
- Spin down at 4000rpm 15' at room temperature
- Discard the supernatant carefully
- Add about 10 glass beads (Ø3 mm) to the pellet and vortex vigorously 1' to get rid of clumps
- Add 1 to 2 mL of PBS (depending on the volume of culture you started with) and let sediment for 10' at RT
- Carefully take the supernatant.
- Do 50 syringe passages with 1mL-Tuberkulin syringes (26Ga)
- Take 200uL of the prep and dilute it into 800uL PBS to read the OD<sub>600nm</sub> (or any other appropriate dilution). Blank should be done with PBS alone.

1A<sub>600</sub> is equivalent to 10<sup>8</sup> bacteria/mL.

- The prep is ready to use for infection.

Note: if the preparation is not used immediately, vortex well, and redo 20 syringe passages, prior to use.

- Keep a small aliquot for titration on agar (serial 1:5 dilutions).

References/orderings:

D-PBS (1x) without Ca, Mg, Phenol Red: Invitrogen 14190-169, available from MG 53012  
 Glass beads 3mm/ 500g: VWR HECH 1401/3  
 1mL tuberculin syringe (26Ga): BD Plastipak 300015 available from MG 21400

## E. Heat-killing of BCG

*I made use of the protocol utilized by a previous graduate student in the lab. I am aware that many laboratories utilize lower temperatures to heat-kill mycobacteria.*

- Autoclave the BCG preparation 121°C 20 minutes
- Plate 20uL to check that all bacteria are dead.

## IV. CELL SUSPENSIONS (FOR FLOW CYTOMETRY)

### A. Bladder collagenase digestion

*I am very thankful to Lucie Peduto for providing the basis for this very important protocol.*

- Pre-warm DMEM medium at 37C (without enzymes)
- Remove organs and place in DMEM on ice. Remove fat and connective tissue.
- In a 60mm-Petri dish, add 0.5ml of DMEM and the organ. Cut the organ in very small pieces (as small as possible), first with scissors and then with a scalpel.

Note: if working with more than 4 bladders pooled together place them in 1mL DMEM in a 10cm-Petri dish.

- Add 0,17 U/mL Liberase TM, 1mg/mL collagenase D, 1U/mL DNase 1 and to prewarmed DMEM and distribute 5mL per 60mm-Petri dishes (12mL if 10 cm-dish).
- Incubate 30min at 37°C and resuspend vigorously every 10min with a 2-mL pipette
- After 30min, put the prep in a 15ml Falcon and wait until the undigested pieces go to the bottom of the tube.
- Take the supernatant, and wash it in a 50-ml Falcon filled with 18mL (30mL if 10cm-plate) DMEM + 10% FCS (degassed; D10) - Spin 15 min at 1300 rpm 4°C – Let it wait on ice, resuspended in 1-2mL D10
- Put the undigested pieces of tissue back in the Petri dish and add more DMEM+enzymes for 30 additional minutes at 37°C. Repeat the 30' cycles one or two more times if necessary until pieces of tissues are almost invisible.

For single bladders 2 cycles of 30 min are most often enough. For pooled bladders, a third cycle is often necessary. As the digestion goes on, resuspend with P1000 rather than 2mL-pipette.

- Combine all the pellets and press through a 70- $\mu$ m mesh with the back of a syringe, add 30ml PBS 2%FCS (degassed), and spin 15 min at 1300rpm 4°C.
- Resuspend in 2ml of PBS 2%FCS, and filter through 40u-blue cell strainer cap into 5ml FACS tubes.
- Transfer back to 15mL-falcon tube. Spin 7 min at 1300rpm 4°C.
- Resuspend in 200uL FACS buffer and proceed with antibody staining for FACS or cell sorting.

#### References/orderings:

D-MEM (1x) 4.5g/L glucose with Glutamax I without Na Pyruvate: Invitrogen 61965-059, available from MG 53005

Fetal Calf Serum (FCS): Eurobio

Liberase TM 2x50mg: Roche 05 401 127 001

*Make a 150x stock by adding 10mL sterile water to 50mg enzyme. No need to filter. Aliquots can go through 1 cycle of freeze-thaw.*

Collagenase D 2.5g: Roche 11 088 882 001

*Make a 100x stock in PBS, filter .22u and store aliquots at -20°C. Aliquots can go through 1 cycle of freeze-thaw.*

DNase 1: Invitrogen 18047-019

*Warning: concentration varies from lot to lot but is about 200U/uL in average. Prepare a predilution at 1,000x in DMEM.*

500mL Stericup: Millipore SCGPU5RE, available from MG 40720

70u-cell strainer: BD 352350, available from MG 39217

FACS tube with 40u-cell strainer: BD 352235, available from MG 39219

## B. Other single cell suspensions

### Splenocytes:

- Remove organs and place in PBS or DMEM on ice
- Mash with the back of a syringe. Spin down 1250rpm 5' 4°C
- Add 2mL of NH<sub>4</sub>Cl 1.66% (in water). Incubate 5' in the 37°C water bath
- Wash with 13mL PBS. Spin down 1250rpm 5' 4°C
- Resuspend in 2mL PBS + 0.05% FCS (degassed; FACS buffer)
- Filter through a 70u-cell strainer.

### Draining lymph nodes (DLN):

- Remove organs and place in PBS or DMEM on ice
- Mash with the back of a syringe
- Collect and filter through a 70u-cell strainer. Spin down 1250rpm 5' 4°C
- Resuspend in 200uL FACS buffer.

### Blood:

- Collect 25uL blood with into a FACS tube containing 1uL EDTA .5M
- Flush with 1mL NH<sub>4</sub>Cl 1.66%
- Transfer into a new FACS tube. Incubate 10' in the 37°C water bath
- Wash with 2mL PBS. Spin down 1250rpm 5' 4°C
- Proceed with antibody staining

### References/orderings:

D-MEM (1x) 4.5g/L glucose with Glutamax I without Na Pyruvate: Invitrogen 61965-059, available from MG 53005

D-PBS (1x) without Ca, Mg, Phenol Red: Invitrogen 14190-169, available from MG 53012

Fetal Calf Serum (FCS): Eurobio

500mL Stericup: Millipore SCGPU5RE, available from MG 40720

70u-cell strainer: BD 352350, available from MG 39217

NH<sub>4</sub>Cl: Prolabo 21 236 291

UltraPure EDTA .5M: Gibco 15575

Haematocrit capillaries: Hirschmann Labogeräte 9100260

## V. FLOW CYTOMETRY

### A. Stainings

#### 1) Common stainings

### Staining protocol:

- Plate 100uL sample in a 96-well plate. Spin down 2000rpm 2' 4°C
- Resuspend in FACS buffer + Fc block (optional: + Aqua 1000x; + D<sup>b</sup>-GAP tetramer 1:40)

Note: Aqua is very labile. Reconstitute 50uL according to manufacturer instructions; aliquot by 5uL; store at -20°C protected from light and use within 1 month.

Alternatively DAPI (5000x) can be used. In that case, prepare a predilution, and add DAPI just before running the sample through the FACS.

- Incubate 30' at 4°C in the dark
- Wash by adding 100uL FACS buffer
- Resuspend in 100uL antibody cocktail
- Incubate 20' at 4°C in the dark
- Wash twice with FACS buffer
- Resuspend in 300uL FACS buffer and transfer into FACS tubes
- Run on BD FACS CantoII machine.

Note: bladder samples are dirtier than splenocytes, therefore filter each bladder sample through a 40u-cell strainer again, just before run, and clean flow cell every 6 bladder samples.

Common staining panels:

- Bladder - Innate panel:

Specificity	Conjugate	Clone	Dilution	Reference
CD45.2	PE-Cy7	104-2	1:100	Southern Biotech 1800-17
Ly-6G	PE	1A8	1:200	BD 551461
Ly-6C	PerCP-Cy5.5	AL-21	1:800	BD 560525
CD11b	Pac Blue	M1/70	1:200	eBioscience 48-0112
CD11c	APC	HL3	1:100	BD 550261
IA-IE	A700	M5	1:800	eBioscience 56-5321
CD86	FITC	GL1	1:100	BD 553691
Dead cells	Aqua		1000x	Invitrogen L34957

- Bladder - T cell panel:

Specificity	Conjugate	Clone	Dilution	Reference
CD45.2	PE-Cy7	104-2	1:100	Southern Biotech 1800-17
CD3e	PerCP-Cy5.5	145-2C11	1:100	BD 551163
NK1.1	APC	PK136	1:200	BD 550627
CD4	A700	GK1.5	1:400	eBioscience 56-0041
CD8a	PacB	53-6.7	1:100	BD 558106
<i>Open</i>	PE			
<i>Open</i>	FITC			
Dead cells	Aqua		1000x	Invitrogen L34957

## 2) Tetramer stainings

*I am very thankful to Fabrice Lemaître for making the D<sup>b</sup>-GAP monomers.*

Note: D<sup>b</sup>-GAP tetramer should be added first, at the time of Fc block (see above).

For conjugation of D<sup>b</sup>-GAP monomers in PE, here is the rule for 10ug monomer:

- QS PBS: 44.5uL
- Sequentially add 10 times 1.55ug streptavidin-PE every 5 minutes at RT, protected from light (total 15.5ug)

Final volume will be 60uL.

Note that for a better staining, the conjugation should be done at least 24 hours in advance. Tetramers are stable a few months at 4°C (up to 3 months tested to date).

### Additional stainings:

Specificity	Conjugate	Clone	Dilution	Reference
CD3e	PerCP-Cy5.5	145-2C11	1:100	BD 551163
CD4	APC	GK1.5	1:400	eBioscience 17-0041
CD8a	A700	53-6.7	1:400	BD 557959
B220	PacB	RA3-6B2	1:200	BD 558108
NK1.1	PacB	PK136	1:200	BioLegend 108722
CD11b	eF450	M1/70	1:200	eBioscience 48-0112
F4/80	eF450	BM8	1:200	eBioscience 48-4801

Dead cells are stained with DAPI, together with the so-called “dump” channel.

### Other antibodies used:

Specificity	Conjugate	Clone	Dilution	Reference
Pan $\gamma\delta$ -TCR	FITC	GL3	1:200	eBioscience 11-5711
CD44	APC	IM7	1:400	BD 559250
CD45RA	PE	14.8	1:100	BD 553380
CD69	PE	H1.2F3	1:600	BD 553237
CD19	FITC	1D3	1:600	BD 553785

### References/orderings:

Fc block: BD 553142

FACS tube with 40u-cell strainer: BD 352235, available from MG 39219

Aqua LIVE/DEAD Fixable Dead Cell Stain Kits: Invitrogen L34957

DAPI: Invitrogen D3571

Streptavidin-PE Premium Grade: Invitrogen

Db-restricted GAP peptide (GAPINSATAM): Polypeptide SP100713C

Antibodies: see tables above

## B. Determination of absolute cell numbers

*I am very thankful to Isabelle Bouvier for bringing this very useful technique in the lab.*

Aliquots from the samples should be taken prior to any staining or additional washings.

- Prepare FACS tubes with 100uL FACS buffer (PBS + 0.05% FCS, degassed) and 80uL Accucheck counting beads
- Add 20uL bladder sample (10uL if DLN)
- Run 10,000 events on the FACS, adapting the SSC in order to see both the beads and all cell events (beads are higher in SSC), gate on beads and events, and record their respective counts (labeled # in the equation below).
- Check that both subsets of beads (which have different fluorescence intensity in the PE channel) are within 45-55% range (quality control for the beads)
- Calculate the ratio of events versus beads:

$$[Events](/uL) = \frac{\# cells}{\# beads} \times [beads](/uL) \times \frac{Vol_{beads}}{Vol_{events}}$$

Note that the concentration of beads varies from lot to lot.

- Then, express populations of interest as percentage of total, in FlowJo, and multiply by the concentration of events calculated above.

References/orderings:

Accucheck counting beads: Invitrogen PCB100

## VI. HISTOLOGY

### A. Immunofluorescence

*I am very thankful to Lucie Peduto for providing me with this protocol.*

Fix tissues or embryos

- Prepare fresh 4% paraformaldehyde (PFA):

Warning: work under the hood with PFA, because it is really toxic.

- Heat up 60ml distilled H<sub>2</sub>O in erlenmeyer 1min in microwave
- Cool down to 65°C
- Add 4g PFA, a few drops of NaOH 2N, and agitate until PFA dissolves (without heating!) – This shouldn't be immediate (otherwise it means pH changed quite a bit)

Warning: wear a FFP3 mask for the weighing.

- Add 10ml PBS 10x
- Add H<sub>2</sub>O to 100ml
- Adjust to pH7 with HCl 2N (measure with papersticks)
- Filter
- Keep on ice or 4°C until use

PFA can be kept for 2-3 weeks at 4°C.

- Isolate organ or fetus (always add a piece of spleen to the mold, as a control for stains).
- Transfer tissue into excess ice cold PFA (in a tube e.g.) and incubate **O/N** at 4°C.
- Next morning, wash tissue with cold PBS (rinse 2x with 5mL PBS) and incubate in excess PBS **O/N** at 4°C.
- Transfer into sterilely filtered 30% sucrose in PBS (stored at 4°C) and incubate at 4°C until tissue sinks (2-3 hrs for isolated organs, O/N to 1 day for fetuses).
- Transfer tissue into mold filled with OCT (don't forget to label the mold).
- Gently push the organs to the bottom of the mold and group them at the center.  
Watch out bubbles! One can dry tissues a little bit on a Kleenex tissue.
- Freeze in a bath of hexane or isopentane (1-2mm) itself in a bath of liquid nitrogen (2cm).  
Store at -70°C (transfer on dry ice). Might also be stored at -20°C for a few days.  
Isopentane can be recycled.

#### Section tissue in cryostat

Note: if blocks were stored at -80°C let them warm up to -20°C in the freezer or in the cryostat.

- Mount blocks with OCT.
- Set blade / block parallelism
- Cut at 8µm for organs and 12µm for fetuses and collect sections on Superfrost Plus slides
- Let dry 1hr at RT.

Stain or store at -70°C.

#### Staining

Note: if stored at -70°C, slides have to dry 1hr at RT.

- Prepare PBS-TS (0.1% triton-X100 and 1% FCS in Mg<sup>2+</sup>/Ca<sup>2+</sup>-free PBS)
  - Filter
  - Also prepare 10% FCS in PBS-TS.
- Trace a circle around sections with hydrophobic pen and place into humid chamber
- Add enough PBS-TS to cover all sections  
Warning: never let dry the sections once re-hydrated.
- Discard PBS-TS with vacuum Pasteur and replace immediately with 10% FCS in PBS-TS.
- Incubate 1hr at RT in closed humid chamber.
- Wash with PBS-TS.

If using biotinylated antibodies, block with avidin/biotin blocking kit:

- Wash with PBS-TS
- Incubate with avidinD for 15 min in closed humid chamber (5' is ok)
- Wash 2x with PBS-TS for a total of 5 min
- Incubate with biotin for 15 min (5' is ok)
- Wash with PBS-TS for 5 min.
- Add antibody mixes in PBS-TS.

The sections should be comfortably covered to spend O/N without drying, but not too much to avoid leaking.



Warning: centrifuge 30 sec at full speed (14000g) in table-top before adding to the mix.

Incubate **O/N** at 4°C in the dark.

- Wash 3x with PBS-TS for a total of 5'
- Add secondary Abs and/or streptavidin in PBS-TS 1hr at RT and protected from the light.
- Wash with PBS-TS containing 1µg/ml DAPI for 5min (nuclear staining)
- Wash 2x immediately and 3x 10min
- Discard PBS-TS and mount coverslip with 1 drop Fluoromount
- Let dry 2-3hrs before microscope observation and O/N for inverted or oil high magnification observation

Stained slides can be stored in a box at 4°C (in the dark) for a while.

List of commonly used primary or flurochrome-coupled antibodies

Specificity	Conjugate	Clone	Dilution	Reference
CD45.2	FITC	104	1:100	BD 553772
CD3e	Purified	500A2	1:150	BD 550277
α-SMA	Cy3	1A4	1:600	Sigma C6198
GFP	Purified	Polyclonal	1:1,000	Invitrogen A11122
CD11c	PE	HL3	1:100	BD 553802
Gp38	Purified		1:20	SN from Eberl lab

List of commonly used secondary antibodies

Specificity	Conjugate	Clone	Dilution	Reference
Syr. Hamster	A647		1:500	Invitrogen A21451
Rabbit	A488	Polyclonal	1:500	Invitrogen A11034
Arm. Hamster	Cy3		1:500	

#### References/orderings:

PBS (10x) without Ca, Mg, bicarbonate: Invitrogen 14200-083, available from MG 53013  
Paraformaldéhyde: Sigma P6148  
D-PBS (1x) without Ca, Mg, Phenol Red: Invitrogen 14190-169, available from MG 53012  
Sucrose: Sigma 84100  
500mL Stericup: Millipore SCGPU5RE, available from MG 40720  
OCT: TissueTek 4583  
24 x 24 x 5 molds: VWR 60872-490  
15 x 15 x5 molds: VWR 60872-488  
Isopentane: VWR 24872-298  
SuperFrost Plus slides: J1800AMNNZ, available from MG 65630  
Fetal Calf Serum (FCS): Eurobio  
Triton X-100: Sigma T9284  
Filtering paper: Fischer 5171H  
Hydrophobic pen: Cliniscience H4000  
Avidin/biotin blocking kit: Cliniscience SP2001  
DAPI: Invitrogen D3571  
Fluoromount: Southern Biotech 0100-01  
24 x 50 Coverslip: VWR 631-0146

## **B. FISH for 16S rRNA**

*This protocol was kindly provided by Gerard Eberl.*

Tissues have been fixed in 4% PFA O/N, washed and cryopreserved in sucrose 30% in PBS, frozen in OCT, and cut at 6-8 $\mu$ m.

- Dried sections are circled with Immunopen.
- Rehydrate in FISH buffer (20mM Tris-Cl pH8.0, 0.9M NaCl, 0.01% SDS, 30% Formamide) 1 min.
- Change buffer and let 30min at RT.
- Incubate with 50 pmol/ml EUB-338 (Cy3-GCTGCCTCCCGTAGGAGT) O/N at RT and dark. Use the complement primer (Cy3-CGACGG...) as control.
- Wash twice 5 min with SSC 1x (0.15M NaCl, 0.015M Na-Citrate; add 0.01% SDS).
- Stain with antibodies in SSC 1 hr at RT and dark. Wash 3x with SSC and do same with secondary antibodies.
- Stain 5min with DAPI
- Wash with SSC 1x 3x 5min
- Mount.

## **C. Acid-fast staining**

*This protocol was kindly provided by the histopathology platform, who provided bench space and reagents.*

- Incubate the slides 30' in Ziehl fuchsin at 56-60°
- Wash in water
- Differentiate in 5% lactic acid until pink staining
- Wash well with water

- Stain the slides from 5' in methylene blue
- Passage in alcohol baths until xylene
- Mount the slides.

## VII. INTERFERON- $\gamma$ ELISPOT

### R-10 medium:

- 500 mL RPMI 1640 with GlutaMAX I
- 57 mL Fetal calf serum (FCS)
- 5.7 mL HEPES (1M)
- 5.7 mL Sodium pyruvate (100 mM)
- 5.7 mL MEM non-essential amino acids (100x)
- 700  $\mu$ L 2-Mercaptoethanol (50 mM)
- 230  $\mu$ L Gentamicin (50 mg/mL)

### Prepare bone-marrow derived dendritic cells (BM-DCs):

#### Day 0

- Sacrifice mice and remove bones
  - Cut at base of Achilles tendon and pull back skin of each leg up to hip.
  - Dislocate knee joint, and pull tibia from knee.
  - Dislocate foot joint, and pull tibia from foot.
  - Pull femur from knee, cut muscle above and underneath femur by opening scissors, and cut femur from hip.
  - Clean bones with sterile gauze pads.
  - Place bones in 6cm Petri dish filled with 5mL PBS (one per mouse).
  - Move under a hood, in the P2.
- Suck PBS and put 5mL EtOH 70% instead. Wait 5'
- Cut epiphyses and put them in another Petri dish filled with 3mL PBS
  - Cut them with scissors as small as possible
  - Add 8mL PBS
- Put the rest of bones in 5mL Petri dish
  - Flush the BM out with 5mL syringe + 25Ga needle (aspirate 3mL PBS from the plate and flush. Repeat several times).  
The bone turns white when all BM has been flushed out.
  - Aspirate several times with the syringe to well dissociate the cells
  - Add 5mL PBS
- With a 10mL-pipette, pass everything through a 70 $\mu$  cell strainer, into a 50mL Falcon
- Spin down 5' 1250 rpm 4°C
- Lyse red blood cells with 2.5mL NH<sub>4</sub>Cl 1.66% 37°C 5'

- Stop with 10mL PBS
- Spin down 5' 1250 rpm
- Resuspend in 5mL R10
  - Pass through 70u mesh again
  - Count cells
  - Plate at  $10^6$  cells/mL final in R10 + J558 1:30 final into 6well-plates (3mL/well)

### Feeding

Days 2, 4 and 6: feed with fresh R10 + J558 (1:30)

### Mature

It's important to feed 24hrs prior to maturation.

DCs can then be used within 24-72hrs after maturation.

- Well by well, pipette up and down with a 5mL-pipette 5-10 times quite harshly to harvest cells
  - Combine in a 50mL Falcon
  - Spin down 5' 1250 rpm
- Resuspend in 5mL R10
  - Count
- Plate at  $10^6$  cells/mL; 1mL per well
- Add 1mL per well of the following mix: R10 + J558 1:15 + TNFa (12.5uL per mL)
  - Mix gently

### Plate coating

#### Day -1:

- Prepare 50 uL primary antibody (clone AN18) per 10 mL PBS per U-bottom 96-well plate
- With multi-channel pipet, add 100 uL/well of this solution.
- Put overnight (or more) at 4°C wrapped in a Saran film

#### Day 0:

- 4 washes with 200uL PBS (keep sterile!)
- Add 100uL/well of R-10 (saturation). Incubate at least 1hr (until use) at 37°C

### Peptide pulse BM-DCs or SPL

Prepare 10mM peptide aliquots (10uL each) ahead of time in sterile water + 10% DMSO (store at -80°C).

- Add 90uL R-10 to the peptide aliquot (10uL), thus 1mM  
This dilution can be kept at 4°C for up to 1 month.
- Resuspend cells in R-10 at about  $10^7$ /mL  
Don't forget unpulsed cells.
- Add desired amount of peptide (1mM) to attain 10uM final concentration.
- Incubate at room temperature for about 1 hr, shaking (in a 50mL Falcon tube)
- Wash twice in R-10

- Count and resuspend BM-DCs at  $1.4 \times 10^5/\text{mL}$  – SPL at  $4 \times 10^6/\text{mL}$

#### Purify CD8<sup>+</sup> and CD4<sup>+</sup> T cells using MACS columns

MACS buffer = PBS + 5% FCS – Degas

CD8<sup>+</sup> T cells are purified first, and CD4<sup>+</sup> T cells are purified from the CD8 flow-through, following the same process as described below.

- Resuspend cells in cold MACS buffer + microbeads.  
Use 90 uL MACS buffer and 10 uL microbeads per spleen if isolating CD8s.  
Incubate 20 min exactly at 4C.
- Wash with 2 mL cold MACS buffer and spin at 1250 RPM for 5 min at 4C.
- Aspirate supernatant, and resuspend cells in 500uL cold MACS buffer to load onto columns. Do 3-4 up&down with P1000 to break clumps as much as possible.
- Attach MACS columns to MACS magnets. Add a separation filter. Prime columns + filter by adding 500uL cold MACS buffer.  
For collection of the flow-through (for CD4 purification), place 15-mL conical tubes under columns, on the specific Miltenyi holder.
- Load columns with sample.
- Wash columns 4 times with 500uL cold MACS buffer.
- Elute columns by placing in 15-mL or 50-mL conical tube, adding 2.5mL cold MACS buffer, and pushing plunger through column.
- Spin at 1250 RPM for 5 min at 4C. Aspirate supernatant and resuspend in R-10 for Guava count.
- Adjust the cells at  $4 \times 10^6/\text{mL}$  in R10

#### Elispot incubation

- 1) Plate 50uL/well of T cells (at  $4 \times 10^6/\text{mL}$ )
- 2) Plate 50uL/well of peptide-pulsed cells (at  $1.4 \times 10^5/\text{mL}$  for DCs /  $4 \times 10^6/\text{mL}$  for SPL)
- 3) Add 50uL R10
- Wrap in an aluminium foil and incubate at 37°C overnight (16-17hrs) on a horizontal plateau

#### Develop Elispot

Prepare the following solutions:

- 0.05% Tween-20/PBS. Store at room temperature.
- 0.1% Tween-20/PBS. Store at room temperature.
- 1M sodium acetate. Store at room temperature.
- 1N acetic acid. Store at room temperature.
- 0.5% BSA solution in PBS. Keep at 4°C after filtration.

Add 5 uL biotinylated antibody (Mabtech #3420-6 anti-mouse IFN $\gamma$  clone R4-6A2 1 mg/mL) per 10 mL 0.5% BSA solution in boat.

#### Develop Elispot:

- Wash plate 4 times with 0.05% Tween-20/PBS in squirt bottle, squirting liquid into each well. Dab plate upside-down onto paper towel between washes.
- Quick flick plate, and add 100 uL biotinylated antibody solution per well.

- Incubate at 37°C in cell incubator 2 h.

Prepare ABC solution in boat at least 30 min before using by adding 1 drop Reagent A and 1 drop Reagent B to 10 mL 0.1% Tween-20/PBS per plate, and mix. Store at room temperature.

- Wash plate 4 times with 0.05% Tween-20/PBS.
- Quick flick plate, and add 100 uL ABC solution per well. Incubate at room temperature 1 h.

Prepare AEC substrate:

- Dissolve 1 AEC tablet in 2.5mL N,N Dimethyl Formamide (DMF) in 50-mL tube and vortex
- In a graduated cylinder, mix 61 mL sterile water, 0.5 mL 1N acetic acid, and 1 mL 1M sodium acetate. Cover with Parafilm and mix by inverting cylinder.
- Pour 47.5 mL of this solution into the 50 mL tube of AEC/DMF.
- Add 25 uL 30% hydrogen peroxide (H<sub>2</sub>O<sub>2</sub>) and mix.
- Pour this solution into the barrel of a 50 cc syringe attached to a uniflow 0.45 um syringe filter. Filter the solution into a 50-mL tube, and store at room temperature until use.
- Wash plate 3 times with 0.05% Tween-20/PBS.
- Wash plate 3 times with PBS.
- Add 100 uL AEC substrate per well, and incubate at room temperature for 4 min exactly.
- Wash plate 2-3 times with tap water.
- Remove plastic backing and wash back of wells with tap water.
- Blot liquid away with paper towels, and store wrapped in paper towels overnight.

#### Mount ELISPOT

- Place sticky Eli-sheet (Zellnet??) on back of wells, and use Eli-puncher (Zellnet??) to punch out all wells individually onto sticky sheet.
- Pull sticky sheet and well bottoms off of plate, and stick to black & white photocopier transparency.
- Label well A1, label transparency, photocopy plate covers, and send to Zellnet to be read:

Sylvia Janetzki, Zellnet Consulting Inc.

555 North Ave. Ste. 25-S

Fort Lee NJ 07024, USA

#### References/orderings:

RPMI 1640 (1x) with GlutaMAX I: Invitrogen 61870-044, available from MG 53010  
Fetal calf serum (FCS): Tebubio  
HEPES (1M): Sigma H0887, available from MG 52176  
Sodium pyruvate (100 mM): Gibco 11360-039  
MEM non-essential amino acids (100x): Gibco 11140-035  
700 uL 2-Mercaptoethanol (50 mM): Gibco 31350-010  
Gentamicin (50 mg/mL): Gibco 15750-037  
TNF $\alpha$ :  
Multiscreen HTS plate: Millipore MSHAS4510  
Primary IFNg antibody (clone AN18, 1mg/mL): Mabtech 3321-3  
D-PBS (1x) without Ca, Mg, Phenol Red: Invitrogen 14190-169, available from MG 53012  
DMSO: Sigma D2650  
CD8 microbeads: Miltenyi Biotech 130-049-401  
CD4 microbeads: Miltenyi Biotech 130-049-201  
MS columns: Miltenyi Biotech 130-042-201, available from MG 99535  
Separation Filters: Miltenyi Biotech 130-041-407  
Tween-20: Sigma P5927  
Sodium acetate: Sigma S5636  
Acetic acid: VWR 20 104.243  
BSA: PAA K41-012  
Biotinylated IFNg antibody (clone R4-6A2, 1mg/mL): Mabtech 3420-6  
ABC solution: Vectastain PK-6100  
AEC tablet: Sigma A6926  
N,N Dimethyl Formamide (DMF): Sigma 588725  
Hydrogen peroxide: Sigma 95299  
0.45u filter: Sartorius 16555

## **VIII. ANTIGENIC PRESENTATION**

*I am very thankful to Laleh Majlessi for providing me with the hybridoma and protocol.*

#### R-5 medium:

- 500 mL RPMI 1640 with GlutaMAX I
- 25 mL Fetal calf serum (FCS) (ie. 5%)
- 5 mL HEPES (1M)
- 5mL Pen/strep (ie. 1%)
- 500uL 2-Mercaptoethanol (50 mM)

#### IA<sup>b</sup>-Ag85A<sub>241-260</sub> hybridoma (named DE10) culture:

Note: plan about 7-10 days from thawing to using the cells. Do not keep them in culture for too many passages, as they might lose their specificity.

- Thaw in a 24-well plate, with several serial 1:2 dilutions
- 24 hours later, add some more fresh medium
- about 48 hours later, pool confluent (but not overconfluent) wells in a 75cm<sup>2</sup>-flask
- Split 1:2 about every 3 days

#### DC enrichment:

- Prepare single cell suspension according to appropriate protocols (in a sterile fashion)

Note: to get enough DCs for co-culture, pool at least 5 bladders together.

- Use CD11c microbeads to enrich for DCs.
  - Pass the eluted fraction on a second column to improve purity.
- Resuspend in 100uL R5 and count.
- Put at a concentration of  $10^5$  cells/mL

Note purity is not great, though (about 60%?). FACS sorting allows 100% purity, but requires more time, and a schedule adapted to FACS-sorting services!

#### Coculture:

Set up coculture in a flat-bottom 96-well plate.

Note: a total volume of 250uL per well is recommended, in order to be able to repeat IL-2 ELISA twice (100uL each time).

- Plate  $10^5$  DE10 cells per well
- Plate titrated amounts of DCs
  - Do 1:2 dilutions, from 10,000 down to 1,250 cells
- Positive controls:
  - 5,000 DCs + 2uM Ag85A<sub>241-260</sub> peptide
- Negative controls:
  - DE10 alone
  - DCs alone
  - 5,000 DCs + 2uM IAb-restricted ESAT6<sub>1-20</sub> peptide
  - 5,000 DCs +  $10^5$  control hybridoma cells (e.g. ESAT6)

Incubate 20 hours at 37°C

- Freeze down the plate at -20°C for IL-2 ELISA

#### IL-2 ELISA:

- Coating:
  - Dilution at 1ug/mL in Na<sub>2</sub>HPO<sub>4</sub> 50 mM
  - Add 100 µl/well.
  - Incubate 1-4 days at 4°C (sealed or in a humidified box).
- Saturation of the free sites:
  - Wash 4x with PBS-Tween 0,1%
  - Add 150 µl/well of PBS + BSA 1% + 0,1% Tween.
  - Incubate 2h at RT (or >1h30 at 37°C)
- Incubation with the culture supernatants:
  - Wash 4x with PBS-Tween 0,1%
  - Std curve: start at 20ng/mL; serial dilutions of 1:2.
  - Recommended: 1 column of std and 1 column of blank per plate.
  - Add SN (or std or blank) : 100 µl/well
  - Incubate 1h at 37°C (or 2hrs at RT).
- Binding of the biotinylated capture mAb:



- Wash 4x with PBS Tween 0,1%
- Dilute capture-Ab at 1ug/mL in PBS-BSA-Tween
- Add 100 µl/well
- Incubate 1h at 37°C
- Addition of Streptavidine-HRP conjugate:
  - Wash 4x with PBS-Tween 0,1%
  - Streptavidine-HRP diluted to 1/10,000 in PBS-BSA-Tween: 100 µl/well
  - Incubate 30' at RT.
  - Take TMB out of the fridge
- Detection:
  - Wash 5x with PBS-Tween 0,1% - Dry well
  - Substrate: 100uL/well TMB (protect from light, should be at RT)
  - Stop: 100uL/well HCl 1N (when the coloration is appropriate)
- Measure OD 450nm with spectrophotometer.

**References/orderings:**

RPMI 1640 (1x) with GlutaMAX I: Invitrogen 61870-044, available from MG 53010  
 Fetal calf serum (FCS): Tebubio  
 HEPES (1M): Sigma H0887, available from MG 52176  
 Pen/Strep: Gibco 15140-022  
 700 uL 2-Mercaptoethanol (50 mM): Gibco 31350-010  
 500mL Stericup: Millipore SCGPU5RE, available from MG 40720  
 24-well plates: BD 353047, available from MG 42710  
 flat-bottom 96-well plates: BD 353072, available from MG 42720  
 75cm<sup>2</sup> flasks: Corning 430720, available from MG 40010  
 Ag85A<sub>241-260</sub> peptide (QDAYNAGGGHNGVFDFPDSG): Polypeptide  
 ESAT6<sub>1-20</sub> peptide (MTEQQWNFAGIEAAASAIQG): Polypeptide  
 ELISA plate: Nunc F96 Maxisorp  
 Purified IL-2 Ab clone JES6-1A12: BD 554424  
 Capture biotin-IL2 Ab clone JES6-5H4: BD 554426  
 Recombinant mIL-2 standard: BD 550069  
 Tween-20: Sigma P5927  
 BSA: PAA K41-012  
 Streptavidin-HRP: BD 554066  
 Tetramethylbenzidine (TMB): Sigma T0440

## **IX. RNA ANALYSIS**

*I am thankful to Clémentine Schilte for providing the basis of all RNA related protocols.*

### **A. RNA extraction**

#### **1) RNA extraction of total bladders**

If working with total bladder, one can use the QiaSymphony

- Use liquid nitrogen to flash freeze organs in a 2mL-Eppendorf tube containing a 5mm-stainless steel bead
- Store organs at -80°C
- Use the Tissue Lyzer for lysis:
  - Add 350uL RLT+ complemented with DTT 40mM
  - Lyze 2 x 1'30 at 25Hz
  - Spin down full speed 3' RT
  - Transfer into 2mL Sarstedt tubes
- Run QiaSymphony protocol FT400 according manufacturer's instructions
- Check RNA quality using the BioAgilent (pico chip)

## 2) RNA extraction for small number of cells

If working with small number of cells:

- Collect cells in FCS
- Spin down
- Resuspend the pellet in RLT complemented with DTT 40mM
- Vortex well to lyze the cells and store at -80°C
- Extract RNA with Qiagen RNeasy micro kit, following the manufacturer's instructions.
- Check RNA quality using BioAgilent (pico chip)

## 3) Reverse transcription

- Denature RNA, for each tube:
  - Start with 1ug RNA (try to have it in 10uL)
  - 0.5uL RNaseIn
  - 1uL Random Primers at 200ng/mL
  - Add RNase-free water qsp 24uL
  - Denaturation 65°C 5'. At the end put immediately on ice.
- Run the reverse transcription (RT), for each tube:
  - 2.5uL RNase-free water
  - 2uL DTT (from RT kit)
  - 0.5uL RNaseIn
  - 2uL dNTP 10mM
  - 8uL buffer 5x (from RT kit)
  - 1uL RT Superscript enzyme (200U/uL)

Final volume: 16uL

Add this mastermix to the previous 24uL denatured RNA. Final volume: 40uL

Run 1hr 42°C / 15' 94°C / 4°C.

#### 4) qPCR

- Add 160uL RNase-free water (final volume: 200uL / dilution 1:5 of the RT product)
- Prepare the TaqMan qPCR mastermix:
  - 10uL TaqMan PCR mastermix
  - 1uL TaqMan enzyme
- Distribute 10uL primer cocktail per well
- Distribute 10uL cDNA per well (further 1:2 dilution, therefore the RT product is diluted 1:10)
- Cycling:
  - 2' 50°C
  - 10' 95°C
  - 40x (15'' 95°C / 1' 60°C)
- Define threshold and baseline values
- Calculate and export Ct
- Calculate  $\Delta Ct = Ct(GOI) - Ct(HKG)$

#### References/orderings:

DTT: sigma  
Microtubes 2mL with cap: Sarstedt 72693  
Stainless steel beads 5mm: Qiagen 69989  
Elution tubes CL: Qiagen 19588  
QiaSymphony kit: Qiagen 931636  
Tips for QiaSymphony 1500uL: Qiagen 997024  
Tips for QiaSymphony 200uL: Qiagen 990332  
BioAgilent RNA 6000 pico kit: 5067-1513  
RNeasy Micro kit: Qiagen 74004  
Multi-utrip Pro8 strip: Sarstedt 72.991.002  
DNase set: MG 99417  
RT Superscript: MG 90397  
PdN6 (2mg): Mg 96066 (Roche)  
TaqMan PCR mastermix: MG 99082  
RNAsIn: MG 97044 (Promega)

## **X. URINE ANALYSIS**

### **A. Urine collection and processing**

#### Stabilizing buffer:

- Stock of Tris-HCl + BSA 5% + NaAzide 0.1%:
  - Dilute 2.5g of BSA into 50mL Tris-HCl 2M pH=7.6 (thus BSA 5%)
  - Add 500uL of NaAzide 10% (thus NaA 0.1%)
  - Filter .22u
  - Aliquot and freeze at -20°C
- Stock of protease inhibitors (25x, use within 3 months)

- Dissolve 1 tablet of Complete into 2mL water (kitchen bottle)
- Filter .22u
- Aliquot and freeze at -20°C
- Just before use, add Complete (25x) to the stock of Tris-HCl + BSA 5% + NaAzide 0.1%

Setting up metabolic cages:

- Prepare the cage
  - Add powder-food
  - Add autoclaved water-bottle
  - Stabilizing buffer final concentration should be 1/10. Have a rough estimate of the expected urine volume, and add 1/20 of the buffer. (The remaining buffer will be added upon urine processing)
- Combine several mice (up to 5) in the cage

Processing of urine samples:

- Centrifuge urine 2000 rpm 7' 4°C
- Put the supernatant in a new tube
- Adjust the volume of stabilizing buffer to 1/10
- Filter on a PVDF .22µ membrane  
Adapt the size of the filter to the amount of urine collected
- Aliquot and freeze at -80°C

Cleaning of metabolic cages:

- Put the cages in the washing machine (program 1)
- Wrap and take down immediately (to avoid any contamination)

References/orderings:

Metabolic cage: Tecniplast 3700M022  
 Complete: Roche 11 697 498 001  
 Tris-HCl: Sigma  
 BSA: PAA K41-012  
 NaAzide: Sigma S2002  
 Powder-food:  
 PVDF .22µ membrane: Millipore SLGV033RB

## **B. Luminex analysis of urine (Millipore)**

General instructions:

- Shaker: 500-800 rpm
- Use a plate stand
- Allow all reagents to warm to **RT** before use
- Serum: warning, heparin excess might provide falsely high values; keep it <10IU per mL of blood collected.

Wash Buffer:

- Bring the 10x Wash B at RT
- 30 mL into 270 mL deionized water (from the kitchen)

Use WITHIN 1 MONTH

Antibody Beads:

- Sonicate each Ab vial for 30 sec
- Vortex 1 min
- Use each Ab 100x [*protocol says 50x*] and complete the volume with Assay buffer. Mix in the Mixing Bottle
- Vortex well. Vortex again just before use and intermittently during addition

Matrix Solution:

- Use the culture or extraction medium for cell culture SN or tissue extraction
  - Use Serum Matrix provided in the kit for serum/plasma samples that require dilution:
    - Add 2.0mL Assay B into the lyophilized Serum Matrix – Mix well
    - Let it sit  $\geq$  10 min
    - Transfer into polypropylene tube
- Keep 1 month at -20°C or longer at -80°C.

Sample preparation:

- Thaw completely
- Vortex (or pipet up and down)
- (Spin down)
- Prepare in a 96-well plate according to the Luminex map
- Spin down at 2000 rpm for 10'

Standards & Qc:

- Reconstitute the powder by adding 250uL of 'eau ppi'.  
Let the tip touch the side of the vial so that everything goes inside, without foaming
- Mix gently by inverting slowly the vial a few times
- Let it sit for 5-10 minutes
- Transfer to an eppendorf tube (polypropylene)
- Dilutions: in Assay B

Use WITHIN 1 HOUR

Store the leftover of undiluted STD at -80°C.

Protocol:

- Prewet the filter plate with 200uL/well of Wash B  
Shake 10 min at RT
- Vacuum  
Blot the excess Wash B from the bottom of the plate with paper towels
- STD & Qc wells:
  - 25uL/well of Matrix Sol

- 25uL/well of STD
- SPL wells:
  - 25uL/well of Assay B
  - 25uL/well of sample
  - (or whatever dilution of interest)
- Vortex Mixing bottle (containing Ab beads)
  - Add 25uL/well

Note: during addition, shake bead bottle intermittently to avoid settling
- Cover (seal if overnight)
 

Shake 2hrs at RT (or overnight at 4°C)
- Vacuum
 

Blot excess
- Wash twice with 200uL/well of Wash B
 

Vacuum

Blot excess
- Detection Ab: dilute them 1:2 into Assay B [*2x less concentrated than protocol*]
  - Add 25uL/well
- Cover the plate
 

Shake 1hr at RT
- DO NOT VACUUM after incubation
  - Add 25uL/well of Strepta-PE
- Cover
 

Shake 30 min at RT
- Vacuum
 

Blot excess
- Wash twice or thrice with 200uL/well of Wash B
 

Vacuum

Blot excess
- Add 100uL/well of Sheath fluid (from luminex) or Wash B
- Shake 5 min => read out on Luminex 100
 

Note: default dilution = 1:2 for BOTH STD and samples.

<p><u>References/orderings:</u></p>
-------------------------------------

<p>Luminex kit: Linco MPXMCYTO70KPMX32</p>
--

## **C. Normalization of urine samples by measurement of creatinin concentration**

### Procedure

- Transfer 5uL 50mg/dL standard and urine in duplicate into wells of a clear bottom 96-well plate
- Prepare enough working reagent by mixing per well reaction 50uL Reagent A, 50uL Reagent B and 100uL water.
- Add 200uL working reagent quickly to all wells  
Tap briefly to mix
- Read optical density at 490-530nm (peak absorbance at 510nm)
  - At 1min
  - At 5min

#### Calculation

Creatinin concentration of sample is calculated as:

$$\frac{OD_{sample5} - OD_{sample1}}{OD_{std5} - OD_{std1}} \times [std](mg/dL)$$

#### References/orderings:

Quantichrom Creatinin Assay Kit: BioAssays Systems DICT-500

## **XI. DERIVE AND IMMORTALIZE MOUSE EMBRYONIC FIBROBLASTS (MEFs)**

*This method was used to derive and immortalize MEFs as a way to titrate a lentivirus, for my collaborators at Curie Institute. I have grown up reading textbooks about cancer claiming that immortalization of murine cells by serial passaging was rather easy, but I have actually been amazed to be able, myself, to immortalize some cells within a few months! Therefore, even if I do not spend time on the use of the aforementioned lentivirus in my thesis dissertation, because results are too preliminary, I am happy to share this protocol.*

*I am thankful to Clémentine Schilte for providing me with the basis for this protocol.*

#### D-10 medium for MEF culture:

- 500 mL D-MEM
- 57 mL Fetal calf serum (FCS)
- 5.7 mL HEPES (1M)
- 5.7 mL Sodium pyruvate (100 mM)
- 5.7 mL MEM non-essential amino acids (100x)
- 700 uL 2-Mercaptoethanol (50 mM)
- 230 uL Gentamicin (50 mg/mL)

#### Set up mice for mating

- Set up mating cages with one adult male and several female mice, overnight.  
Note: it is better if the male has already reproduced.
- Remove the male the next morning. Either check the plug (but not easy) or increase the number of females in order to be sure to have pregnant females.

Note: The optimal ages of embryos for MEF isolation are E13.5-E15.5. However they can be produced from E8.5.

#### Harvest fetuses

- Euthanize the pregnant female mice one by one. Soak the entire mouse body in 70% ethanol and carefully isolate the uterus

Note: avoid damage to internal organs in order to avoid contamination.

- Transfer the uterus into a 50mL Falcon tube filled with 30mL sterile PBS. Invert the tube a few times to wash the uterus.
- Under a culture hood, transfer the washed uterus on a clean board. Fix the uterus, and cut it open to expose individual embryos
- Dissect out all fetuses intact and transfer each of them into a Petri dish containing 5mL sterile PBS.
- Remove the head, heart, liver and red tissues (muscles). Wash carefully to remove as much blood as possible.

Note: Keep the head (or one of the hind limbs) for genotyping if needed.

#### Prepare MEF suspension

- Transfer the remaining part of each fetus into a new Petri dish containing 0.5mL of 0.25% trypsin-EDTA. Mince the carcasses into thin pieces with a blade.
- Add 2.5mL more trypsin-EDTA and mix by vigorous pipeting.
- Transfer into a 15mL Falcon tube
- Incubate 30' in a 37°C water bath.

Note: *Current Protocols in Molecular Biology* suggests incubating the fetuses in trypsin-EDTA at 4°C overnight (before the 30' 37°C incubation), because trypsin, which had almost no activity at 4°C, will then diffuse into the tissues.

- Add MEF medium to 8mL and pipet vigorously to break up the digested tissues into a cell suspension.
- Allow sedimentation of the cell suspension by gravity for 1'. Transfer the supernatant into a new 50mL Falcon tube. Add more D-10 medium and repeat previous step.
- Mix the cell suspension and plate.

Note: 1 embryo = 1 20cm-plate = 1 162cm<sup>2</sup> flask

- In the next morning, discard medium, wash twice with PBS to remove nonadherent cells and add fresh D-10.

Note: the initial primary culture takes 1 to 3 days to reach confluence.

#### Culture primary MEFs

Each passaging requires a 3-day incubation.

Primary MEFs can be passaged 6-7 times and should be split 1:5 each time (1:3 according to Clem).

Be cautious: confluent MEFs in culture stop proliferating and begin to differentiate. Long-term culture of MEFs at high density causes cellular transformation.

#### Immortalize MEFs (by serial passages)

- Harvest MEFs from primary culture and determine the cell number
- Mix  $3.8 \times 10^5$  cells with 5mL MEF medium and plate in a 25cm<sup>2</sup> flask.  
[My variant:  $2.1 \times 10^6$  cells in a 150mm culture plate with about 20mL medium]



Incubate 3 days.

Note: proliferation of MEFs will dramatically decrease from passage 5 to 14. The number of MEFs harvested from passages 10 to 14 after a 3-day culture may even be less than the number inoculated. It is therefore necessary to set up 5 25cm<sup>2</sup> flasks after passage 3, to ensure there will be enough cells for subsequent passages.

- Repeat the above steps for 20 to 25 passages.

Note: By passage 20-25, the growth rate of MEFs should increase again: cell numbers should increase 2-3x per 3-day passage.

- Expand and freeze.

References/orderings:

D-MEM (1x) 4.5g/L glucose with Glutamax I without Na Pyruvate: Invitrogen 61965-059, available from MG 53005

Fetal calf serum (FCS): Tebubio

HEPES (1M): Sigma H0887, available from MG 52176

Sodium pyruvate (100 mM): Gibco 11360-039

MEM non-essential amino acids (100x): Gibco 11140-035

700 uL 2-Mercaptoethanol (50 mM): Gibco 31350-010

Gentamicin (50 mg/mL): Gibco 15750-037

Trypsin-EDTA: Invitrogen 25300054, available from MG99637

150mm culture plates: Dutscher 353025





## I. MANUSCRIPT 1

**Intravesical BCG immunotherapy: characterization of the bladder immune response identifies a strategy for improving anti-tumor activity.**

Claire Biot, Cyrill A. Rentsch, Joel R. Gsponer, Frédéric D. Birkhaeuser, Hélène Jusforgues-Saklani, Fabrice Lemaître, Alexander Bachmann, Philippe Bousso, Caroline Demangel, Lucie Peduto, George N. Thalmann & Matthew L. Albert

Submitted to *Science Translational Medicine*, Dec 8, 2011.

This manuscript contains a good part of the results presented in Chapter 2.

## II. MANUSCRIPT 2

**Mathematical model of tumor immunotherapy for bladder carcinoma identifies the limitations of the innate immune response.**

Romulus Breban, Aurélie Bisiaux, Claire Biot, Cyrill A. Rentsch, Philippe Bousso & Matthew L. Albert

Published in *OncoImmunology* 1:1, Jan-Feb 2012.

This manuscript contains the results presented in Section II of Chapter 3.

## III. MANUSCRIPT 3

**BCG-mediated bladder cancer immunotherapy: Identifying determinants of treatment response using a calibrated mathematical model.**

Cyrill A. Rentsch, Claire Biot, Joel R. Gsponer, Alexander Bachmann, Matthew L. Albert & Romulus Breban

Submitted to *European Urology*, Jan 10, 2012.

This manuscript contains results presented in Section III of Chapter 3.



# **Intravesical BCG immunotherapy: characterization of the bladder immune response identifies a strategy for improving anti-tumor activity**

Claire Biot<sup>1-3</sup>, Cyrill A. Rentsch<sup>\*,1,2,4</sup>, Joel R. Gsponer<sup>\*,1,2,4</sup>, Frédéric D. Birkhaeuser<sup>5</sup>, Hélène Jusforgues-Saklani<sup>1,2</sup>, Fabrice Lemaître<sup>6,7</sup>, Alexander Bachmann<sup>5</sup>, Philippe Bousso<sup>6,7</sup>, Caroline Demangel<sup>8</sup>, Lucie Peduto<sup>9</sup>, George N. Thalmann<sup>5</sup> & Matthew L. Albert<sup>1,2,10</sup>

## Affiliations

- 1 - Institut Pasteur, Unité d'Immunobiologie des Cellules Dendritiques, Department of Immunology, Paris; France
- 2 - Inserm U818, Paris; France
- 3 - Ecole Nationale Supérieure des Mines de Paris, Paris; France
- 4 - University Hospital of Basel, Department of Urology, Basel; Switzerland
- 5 - University of Bern, Department of Urology, Bern; Switzerland
- 6 - Institut Pasteur, Unité de Dynamique des Réponses Immunes, Department of Immunology, Paris; France
- 7 - Inserm U668, Equipe Avenir, Paris; France
- 8 - Institut Pasteur, Unité de Pathogénomique Mycobactérienne Intégrée, Department of Microbiology, Paris; France
- 9 - Institut Pasteur, Laboratoire de Développement des Tissus Lymphoïdes, Department of Immunology, Paris; France
- 10- Université Paris Descartes, Paris; France

\* Indicates equal contribution.

## Key words

bladder cancer, BCG therapy, adjuvant therapy, bladder inflammation, tumor immunotherapy

## One-sentence summary

Using a pre-clinical experimental model, we defined the dynamics of T cell trafficking to the bladder during intravesical BCG therapy, and identified an optimized strategy for enhancing bladder inflammation and tumor immunity.

## Corresponding author

Matthew L. Albert  
Laboratory of Dendritic Cell Immunobiology  
INSERM U818  
Institut Pasteur  
25 Rue du Dr Roux  
75724, Paris France  
Telephone: +33 1 4568 8552  
Fax: +33 1 4568 8548  
E-mail: [albertm@pasteur.fr](mailto:albertm@pasteur.fr)

## **Abstract**

Therapeutic intravesical instillation of bacillus Calmette-Guérin (BCG) is effective at triggering inflammation and eliciting successful tumor immunity in patients with non-muscle invasive bladder cancer, with 50-70% clinical response. While success of therapy is known to rely on repeated instillations of live BCG, administered as adjuvant therapy shortly after tumor resection, its precise mechanisms of action remain unclear. Using an experimental model, we demonstrate that BCG dissemination to bladder draining lymph nodes and priming of interferon- $\gamma$ -producing T cells could occur following a single instillation. However, repeated instillations with live BCG were necessary for a robust T cell infiltration into the bladder. Surprisingly, parenteral exposure to BCG prior to instillation overcame this requirement, triggering a more robust acute inflammatory process following the first intravesical instillation and accelerating T cell entry into the bladder, as compared to the standard protocol. Moreover, parenteral exposure to BCG prior to intravesical treatment of an orthotopic tumor dramatically improved response to therapy. These data prompted analysis of clinical data, which showed a significant difference in recurrence-free survival, favoring those patients with sustained pre-existing immunity to BCG. Together these data suggest that monitoring patients' response to purified protein derivative (PPD), and, in their absence, boosting BCG responses by parenteral exposure prior to intravesical treatment initiation, may be a safe and effective means of improving intravesical BCG-induced clinical responses.

## INTRODUCTION

BCG therapy of superficial bladder cancer is one of the few examples of successful immunotherapy in the clinic and therefore offers a unique opportunity to define mechanisms by which the immune system may be used to target tumor cells. Carcinoma of the bladder is the most common cancer of the urinary tract and the fourth most common malignant disease in males in the developed world (1). Most tumors are diagnosed at a superficial stage and are surgically removed by transurethral resection. Depending on the stage and grade of the non-muscle invasive tumors, adjuvant therapy is recommended as a strategy for both reducing recurrence and diminishing risk of progression (2). Since the work of Morales and colleagues in 1976 (3), BCG therapy, which consists of 6 weekly intravesical instillations shortly after resection, has been the standard of care for high-risk urothelial carcinoma: carcinoma *in situ*, and high-grade Ta/T1 bladder lesions (2, 4).

BCG is an attenuated strain of *Mycobacterium bovis*, initially developed as a vaccine against *Mycobacterium tuberculosis* (*Mtb*) infection (5). It is a slow growing bacterium with a doubling-time of about 24 hours. Macrophages are the principal host cells where mycobacteria either multiply or remain latent (6). Several effector lymphocyte subsets are induced upon mycobacterial infection, including multifunctional CD4<sup>+</sup> and cytolytic CD8<sup>+</sup> T cells (7). Importantly, interferon (IFN)- $\gamma$ -producing CD4<sup>+</sup> T cells are responsible for phagocyte activation, an essential process for controlling mycobacterial infection (7). While robust, it has been demonstrated that T cell recruitment to the lung mucosa of mice infected with aerosolized mycobacteria occurs late and takes several weeks to establish (7, 8).

In the context of bladder cancer, BCG therapy is known to trigger a strong innate immune response, followed by the influx of type 1 polarized lymphocyte subsets (9, 10). Using orthotopically-transplanted urothelial tumors in mice, several groups have reported that BCG-



mediated anti-tumor activity relies on a functional immune system of the tumor-bearing host (11-14). In particular, CD4<sup>+</sup> and CD8<sup>+</sup> T lymphocytes seem to be essential effector cells for eliminating the tumor in a mouse model (12), and correlates have been established between T cell infiltration and clinical response in patients (15).

We recently reported that repeated instillations with BCG were required in order to trigger a robust inflammatory response (16). Based on these findings, our goal was to establish an experimental mouse model to study the dynamics of the immune response following intravesical BCG regimen, and to specifically address several important unknowns, including: the link between bacterial persistence / dissemination and T cell priming; the role of multiple instillations in triggering T cell influx in the bladder; and the temporal relationship between T cell priming and T cell entry into the inflamed bladder microenvironment. Based on the clinical practice of resecting the tumor shortly prior to adjuvant BCG therapy (4, 10), we began our studies in tumor-free mice and we demonstrate herein that repeated instillations of live BCG were required for robust infiltration of T cells in the bladder. Yet, BCG dissemination to bladder draining lymph nodes (LN) and T cell priming could occur after a single instillation. Interestingly, the acute inflammatory response following each instillation was short-lived but it was more robust at the third instillation. Prior studies suggested this to be a result of local tissue conditioning by the innate immune system (16); we report here that subcutaneous immunization with BCG prior to intravesical regimen facilitated a ‘boosted’ response in the bladder after a single instillation. Based on depletion studies, we provide evidence that pre-existing BCG-specific adaptive immunity enhanced the innate response to intravesical BCG and accelerated T cell infiltration of the bladder. Moreover, subcutaneous exposure to BCG prior to orthotopic tumor challenge dramatically improved response to intravesical BCG therapy. Importantly, analysis of clinical data illustrated a similar finding: patients with pre-existing immunity to BCG

had a greater likelihood of achieving recurrence-free survival. Together these data provide new insight into a long-standing clinically effective immunotherapeutic regimen and predict strategies that may improve patient management.

## RESULTS

### Repeated intravesical instillations of live BCG result in a robust but late infiltration of activated $\alpha\beta$ T cells into the bladder

To determine the dynamics of T cell infiltration into the bladder, we intravesically instilled age-matched female C57BL/6 mice with either phosphate-buffered saline (PBS; control) or clinical-grade BCG (Immucyst, Sanofi-Pasteur) once a week for a total of three instillations (**Fig. 1A**, instillations indicated by black arrow). At defined time points, bladders were resected, digested as detailed in the materials and methods, and stained for cytometric analysis. Infiltrating T cells were defined as  $CD45^+CD3\epsilon^+NK1.1^-$  cells (**Fig. 1A**). Twenty-nine days after the start of the treatment, there was a robust increase in both the percentage of T cells among total leukocytes infiltrating the bladder (**Fig. 1B**, instillation with BCG vs. PBS  $p < 0.01$ ) and their absolute number (**Fig. 1C**, instillation with BCG vs. PBS  $p < 0.01$ ). Once established, this infiltration was sustained in the absence of additional treatments for greater than 10 days (**Fig. 1B**). Additionally we demonstrated that administration of a fourth weekly instillation did not alter the kinetics of T cell influx into the bladder (data not shown). Bladder T cells were predominantly found within the submucosa in the vicinity of blood vessels, with some having infiltrated the urothelium (**Fig. 1D**). All bladder T cells had an antigen-experienced phenotype, based on expression of CD44 and absence of CD45RA (**Fig. 1E**). That said it should be noted that, while fewer in number, resident T cells were also  $CD45RA^-CD44^{hi}$ , suggesting that entry into the submucosa was restricted to previously activated T cells. Phenotypic assessment demonstrated that greater than 70% of the T cells were  $\alpha\beta$   $CD4^+$  and  $CD8^+$  T cells (**Fig. 1F-G**).

## **Priming of T cells and their entry into the bladder are uncoupled, following intravesical BCG instillations**

Interestingly, early clinical investigation in humans suggested that live BCG was required in order to achieve tumor immunity (17, 18). To establish that T cell recruitment was indeed dependant on live bacilli, we compared repeated intravesical instillations of clinical-grade BCG (containing live BCG) *versus* heat-killed BCG. As expected, the latter did not result in T cell recruitment to the bladder (data not shown).

To assess the requirement for live BCG to activate adaptive immunity components, we evaluated BCG dissemination with the hypothesis that its entry into the bladder draining LN is a pre-requisite for priming and subsequent T cell infiltration of the bladder. Such a requirement has indeed been well documented in the context of low-dose *Mtb* lung infection (19-21). We first assessed the decay of BCG after intravesical injection, assaying colony-forming units (CFUs) that remain in the bladder after first voiding (at removal of catheter) at 2 hours, and on day 1 post-instillation. Consistent with what has been suggested for human treatments (22, 23), we demonstrated that the BCG load in the bladder rapidly decreased to 1% of the instilled dose and was barely detectable by 24h post-instillation (**Fig. 2A**). Next, we investigated the presence of live BCG in the peri-aortic draining LN. As an additional parameter we tested single *versus* weekly-repeated instillation(s), as the rapid decay of BCG load in the bladder led us to hypothesize that repeated doses of live BCG might be required to result in efficient BCG dissemination to the draining LN. Mice were intravesically instilled with live BCG and the peri-aortic LN were homogenized and plated at defined time points. Analysis of early time points (hours) after a single instillation demonstrated no bacterial growth (data not shown), thus indicating that bacilli were not tracking to the LN due to passive processes (e.g., resulting from potential trauma and/or anti-grade pressure during the instillations). Mice were tested for up to 1

month following single or repeated BCG instillation(s) and when bacterial growth was observed, the total CFUs per LN ranged from 8 to 1,700 colonies (median CFU = 50). Due to the high variance, we scored animals as positive or negative for the presence of live BCG in the LN. Overall, we observed that 40-60% mice harbored BCG in their peri-aortic LN after a single intravesical instillation – this was consistent across a time course of 15 – 36 days (**Fig. 2B**). In comparison, mice receiving multiple instillations also showed a mixed response at 15 days, but by day 30-36, BCG could be cultivated from the peri-aortic LN of all mice (**Fig. 2B**).

We next evaluated the priming of BCG peptide-specific T cells, assessed using H2-D<sup>b</sup>-Mtb32<sub>309-318</sub> tetramers (also known as PepA or GAP) (24) (**Fig. 2C**). Interestingly, when mice were stratified based on the presence of live BCG in their peri-aortic LN, we found that the majority of CFU<sup>+</sup> animals possessed a high frequency of BCG-specific CD8<sup>+</sup> T cells among total splenocytes. In contrast, there was no expansion of D<sup>b</sup>-Mtb32<sub>309-318</sub> reactive T cells in mice for which live BCG was undetectable (**Fig. 2D**,  $p < 0.05$ ). When comparing mice that had received single or repeated instillations, the critical parameter was the presence of live BCG (**Fig. 2D**, CFU<sup>+</sup> single *versus* repeated  $p = ns$ ). We next assessed the capacity of CD8<sup>+</sup> T cells purified from spleen and peri-aortic LN to produce IFN- $\gamma$  upon restimulation with Mtb32<sub>309-318</sub> peptide in an ELISPOT assay. In mice harboring live BCG within their LNs, we found similar numbers of spot forming cells (SFCs) irrespective of the number of instillations (**Fig. 2E**). These data demonstrate that the priming of IFN- $\gamma$  producing BCG-specific T cells can occur following a single instillation and correlates with BCG dissemination to the bladder draining LN.

To investigate if dissemination of BCG also correlated with local adaptive immunity, we examined lymphocyte populations in the bladder. While we observed low levels of T cell infiltration in CFU<sup>+</sup> animals, the level of infiltration was significantly lower in mice that had

received single *versus* repeated instillations (**Fig. 2F**,  $p < 0.01$ ). Together these data suggest that priming of T cells may be uncoupled from their accumulation in the bladder.

### **Pre-existing adaptive immunity supports a robust intravesical immune response**

To further test the dissociation of priming from T cell trafficking, we evaluated whether the activation of BCG-specific T cells prior to bladder instillations would impact T cell recruitment during the first intravesical instillation. Mice were injected subcutaneously (s.c.) with BCG, and after 21 days, intravesical instillations were initiated – comparing single *vs.* repeated BCG challenge. In mice primed by s.c. BCG, we observed a robust T cell infiltration as early as 12 days following a single instillation (**Fig. 3**, s.c. - BCG W4), which lasted up to 35 days post instillation (**Fig. 3**, s.c. - BCG W1). Of note, the level of T cell accumulation in the bladder was similar to that achieved by multiple intravesical treatments (**Fig. 3**, BCG W1-4). Interestingly, repeated instillations in the s.c. primed group (**Fig. 3**, s.c. - BCG W1-4) did not result in an enhanced accumulation of T cells as compared to other treatment conditions, suggesting that maximal intravesical responses can be achieved by a s.c. injection of BCG followed by a single instillation of BCG.

To further characterize the differential bladder T cell trafficking following different BCG regimens, we evaluated the local inflammation of the bladder mucosa. Shortly after the first and the third instillation, we observed a rapid but short-lived (less than 42 hours post instillation) influx of neutrophils (characterized as Ly-6G<sup>+</sup> leukocytes, **Fig. 4A-B**) and inflammatory monocytes (characterized as Ly-6C<sup>high</sup> CD11b<sup>+</sup> Ly-6G<sup>-</sup> leukocytes, **Fig. 4A-B**). Notably, accumulation of inflammatory monocytes was significantly more pronounced after the third instillation (**Fig. 4B**,  $p < 0.01$ ). Interestingly, in animals that had received prior s.c. BCG, the infiltration of neutrophils and inflammatory monocytes after a single dose of intravesical BCG

was more pronounced than in non-vaccinated animals (**Fig. 4C**, isotype control). The inflammatory response was stronger than that observed following repeated instillations with no prior s.c. exposure to BCG (**Fig. 4B-C**).

Given the robust inflammatory process observed in mice immunized s.c. with BCG, we hypothesized that the existence of BCG-specific T cells at the time of instillation was impacting upon the acute inflammatory process. To test this possibility, mice previously immunized s.c. with BCG were subjected to anti-CD4 and anti-CD8 depleting antibodies 48h prior to intravesical instillation. Following T cell depletion, we demonstrated a decrease in the number of neutrophils and inflammatory monocytes infiltrating the bladder (**Fig. 4C**,  $p < 0.05$ ). Interestingly, the level of the inflammatory response in the group of mice that underwent transient depletion was in the range of what is observed following the first instillation with no prior s.c. BCG exposure (**Fig. 4C**); these data suggest that T cell priming, achieved by s.c. BCG, mediate the ‘boosted’ inflammatory response following intravesical BCG.

### **Pre-existing BCG-specific immunity improves anti-tumor response**

Based on the ability to achieve stronger inflammation and earlier T cell recruitment to the bladder microenvironment, we reasoned that s.c. exposure to BCG prior to intravesical BCG therapy might improve the anti-tumor response. To test that hypothesis we employed an orthotopic tumor model - implantation of syngeneic MB49 tumor cells into the bladders of C57/BL6 mice. Although the derived epithelial MB49 tumors grow in an aggressive manner (25), this model remains, to our knowledge, the only mouse model in which intravesical BCG treatment has been shown to induce anti-tumor responses, when initiated 1-2 days after tumor implantation (26). To evaluate the impact of pre-existing BCG-specific T cells, mice were immunized s.c. with BCG and, after 3 weeks, 85,000 MB49 cells were implanted into the

bladder mucosa, as described in the materials and methods. Two days later, intravesical BCG therapy was initiated, and mice were monitored twice daily for survival. Strikingly, 100% of mice that received BCG s.c prior to intravesical therapy survived as late as 70 days post tumor challenge; in comparison, 80% of mice with no prior BCG immunization succumbed within 50 days, despite intravesical BCG therapy (**Fig. 5**). As a control, mice received BCG s.c., were challenged with tumors and received intravesical PBS, showing no evidence of delayed tumor growth (**Fig. 5**).

These results prompted us to investigate the relevance of pre-existing BCG-specific immunity in patients with high-risk non-muscle invasive bladder cancer undergoing BCG therapy. Analysis of available clinical data was performed, accessing data from an observational study in which patients underwent a purified protein derivative (PPD) skin test prior to intravesical therapy (**Fig. 6A**). A positive skin test is the signature of previous exposure and active immune response to BCG, *Mtb* or other mycobacteria. We therefore stratified patient outcome data according to their PPD status prior to treatment, and observed that patients with a positive PPD had a significantly better recurrence-free survival than patients with a negative PPD skin test (**Fig. 6B**,  $p < 0.02$ ). Together these data suggest that boosting BCG-specific immunity prior to intravesical therapy might improve clinical response and tumor immunity.



## DISCUSSION

Bacillus Calmette Guérin was generated by the repetitive passage of a virulent strain of *M. bovis*. This live attenuated strain was developed as a vaccine for tuberculosis and following the work of William Coley, BCG was evaluated for use as an anti-cancer therapeutic vaccine. In fact, it has been injected into many solid tumors and while there were reports of some success, controlled clinical trials did not provide statistical significance (10, 27, 28). Nonetheless, animal studies with BCG continued and it was recognized that long lasting direct contact with the live bacteria resulted in optimal tumor immunity (29). These results prompted Morales et al. to evaluate BCG as an adjuvant intravesical treatment for carcinoma of the bladder (3, 30). Since these initial observations, several large prospective studies have been conducted and BCG remains the standard of care for non-muscle invasive disease. While now in use for over 35 years, many questions remain about the mechanism of action by which BCG mediates the observed clinical response (10); additionally, there is interest in identifying strategies for optimizing therapy (31, 32).

While prior efforts have evaluated immunologic response during therapy in human observational studies or in experimental mouse models, our study provides the first systematic evaluation of BCG-induced T cell infiltration of the bladder mucosa. Using histological and cytometric analyses, and paying careful attention to mycobacterial persistence and antigen-specific T cell priming, we defined the parameters required for achieving effective adaptive immune responses in the bladder. We identify a requirement for live bacteria that disseminate to local draining lymph nodes in order to achieve T cell priming (**Fig. 2**); and repeated instillations are needed to trigger recruitment of T cells to the bladder microenvironment (**Fig. 1-2**). Careful analysis of these parameters has not been previously documented, in part due to inability to

access patient material (e.g., bladder mucosa and lymph node) during a clinically approved therapeutic intervention.

Based on experimental work in humans, we focused our attention on the activation and recruitment of T lymphocytes. Immunohistochemical analysis of patient bladder biopsies has indeed demonstrated T cell infiltration during BCG therapy and up to 3 months post-therapy (15, 33); and the degree of T cell infiltration correlated with treatment response (15). These findings were consistent with our study of BCG induced inflammation after intravesical instillations in mice. Based on our observations of a delayed influx of T cells, we hypothesized that parenteral exposure to BCG prior to standard-of-care might accelerate the kinetics of bladder inflammation. We demonstrate that such an approach provides an optimized strategy for T cell recruitment and that this treatment protocol improves the host anti-tumor response.

From the perspective of the host response to infection, one striking observation is that bladder T cell infiltration following repeated BCG instillations occurs only after day 29 (**Fig. 1C**). There is an important precedent for such an observation – the cellular immune response to aerosolized *Mtb* takes several weeks to initiate, with T cells reaching the lungs only after day 20 post-infection (7, 8). Several hypotheses have been proposed to explain such a delayed cellular immune response. One possibility is that *Mycobacteria sp.* regulate T cell activation either by inhibiting antigen-presenting cell (APC) migration and/or function (7). Alternatively, it has been speculated that slow induction could simply be a consequence of the low number of bacteria used for infection, which could result in insufficient inflammation and antigen load. Arguing against this point, however, is the observation that exponentially increasing the dose of aerosolized bacteria in lung studies does not significantly accelerate T cell recruitment to the mucosa (20). In our bladder instillation model, the number of BCG CFUs decays quickly (**Fig.**

**2A**), however testing the response to higher dose of BCG remains technically challenging. It is worth noting that once established, the response is sustained, lasting at least 21 days following the third instillation.

We also discovered that BCG dissemination to the regional lymph node is critical for achieving efficient T cell priming, again showing similarity to what has been shown in the lung *Mtb* infection model (19-21). T cell priming, however, was not sufficient to achieve T cell recruitment to the bladder, as shown by the relatively low level of T cell infiltration following a single instillation, even in the presence of measurable BCG-specific T cell responses (**Fig. 2F**). To further assess the relationship between priming and trafficking to the bladder, we performed studies in mice that were previously primed *via* the subcutaneous route. These data demonstrated that trafficking of T cells to the bladder could be dissociated from the route of priming, in contrast to what has been reported in the context of homing to the gut or central nervous system (34). Bladder T cell recruitment correlated with a robust, but short-lived innate immune response, which is suggestive of a delayed type-hypersensitivity (DTH) response (also known as type IV hypersensitivity reaction). While not typically attributed to inflammation in the bladder mucosa, DTH reactions are known to be mediated by antigen-specific effector T cells (e.g., induration induced by PPD challenge in the skin of a primed individual). This reaction is defined by antigen-specific T cells mediating the rapid recruitment of inflammatory cells to the site of injection (35, 36). We report here that s.c. immunization 21 days prior to BCG intravesical instillation results in a more robust inflammatory response following intravesical BCG, which is dependant on T cells (**Fig. 4**), thereby suggesting that bladder inflammation should be considered a DTH reaction. Although we demonstrate a critical role for primed T cells in the BCG-mediated influx of inflammatory innate cells, we were unable to define the cellular mechanism(s)

governing T cell entry into the bladder. Notably, depletion of neutrophils, monocytes and NK cells did not result in impaired T cell trafficking to the bladder (data not shown).

To apply our insights into dynamics of bladder inflammation, we tested our modified treatment regimen using an orthotopic bladder tumor model. Most strikingly, we demonstrate the ability to achieve up to 100% survival as compared to 80% lethality at day 70 (median survival time being ~45 days) (**Fig. 5**). These data are remarkable given the aggressive nature of MB49, but even more so for the ease of translating our results for testing in human clinical trials. Supporting the important role for pre-treatment BCG-specific responses, we analyzed available clinical data from a recent observational trial and identified absence of a PPD response to be a risk factor for treatment failure (**Fig. 6**). While we assert the novelty of our findings, which emerged from the assessment of parameters dictating T cell recruitment, we acknowledge that there is a historical interest in correlating PPD positivity to treatment response and/or adverse events secondary to intravesical instillation (e.g., fever) (4, 37). Indeed, several groups have demonstrated that intravesical BCG-induced conversion of PPD test (from negative to positive) during the treatment course significantly correlated with clinical response (38-40). Badalament and colleagues reported a related finding in a cohort of USA patients with recurrent superficial bladder cancer: pre-therapy PPD positive patients – likely primed due to their prior intravesical treatment – showed greater benefit from their subsequent course of treatment (41). In line with this report, it is worthy of mentioning that in patients who fail intravesical therapy, an additional 50% of patients respond to the second cycle of BCG (42, 43). In light of our data, we suggest that the first cycle of BCG might serve to prime patients, thus enhancing bladder inflammation and the chance to achieve tumor clearance during subsequent rounds of intravesical treatment.

Clinical studies have also investigated the combined use of intravesical and intradermal (or scarification) routes for treating patients with BCG (40, 44). These trials showed no evidence of enhanced clinical response. Arguably, our findings indicate that treatment protocols combining both routes of injection were well conceived, but misguided with respect to the timing required for achieving systemic BCG-specific immunity. We favor a treatment strategy where patients are exposed parenterally to BCG *prior to* initiation of intravesical therapy. To our knowledge, this has not yet been evaluated and may represent a straightforward approach to improving treatment response.

In summary, we have demonstrated that while BCG dissemination to regional LNs and priming of IFN $\gamma$ -producing T cells can occur following a single instillation, repeated instillations of live BCG are necessary to achieve robust bladder T cell infiltration. Strikingly, parenteral exposure to BCG prior to instillation overcomes the requirement for repeated instillations, triggering a more robust acute inflammatory process at the first instillation and accelerating the recruitment of T cells to the bladder. Moreover, parenteral exposure to BCG prior to orthotopic tumor challenge dramatically improves response to BCG therapy. Importantly, patients with pre-existing immunity to BCG responded significantly better to therapy. Together these data suggest that checking patients' immunity to BCG prior to intravesical therapy, and boosting it if necessary, might improve BCG-induced clinical responses.

## **MATERIALS AND METHODS**

### **Mouse intravesical instillations and subcutaneous immunization**

For intravesical instillations, 7-12 week-old C57BL/6 female mice (Charles Rivers) were water starved for 7-8 hours, reflecting the clinical practice of patients being asked not to drink prior to treatment. Mice were anesthetized (125 mg/kg ketamine and 12.5 mg/kg xylazine intraperitoneally) and drained of any urine present by application of slight digital pressure to the lower abdomen. The urethral orifice was disinfected with povidone-iodine and a 24Ga-catheter (BD Insite Autoguard, Becton Dickinson) adapted to a 1mL tuberculin syringe (Braun) containing 50uL of either phosphate-buffered saline (PBS, Invitrogen) or BCG (about  $3 \times 10^6$  CFUs) was carefully inserted through the urethra. The injection was made at a low rate to avoid trauma and vesico-ureteral reflux, and there was no dead volume in the catheter. Mice were kept under anesthesia for 2 hours, with catheter and syringe maintained in place to retain the intravesical solution. For tumor challenge, mouse bladders were pre-treated with 0.1mg/mL poly-L-lysine (Sigma-Aldrich) for 20 minutes, prior to instillation of 85,000 MB49 cells in 50uL PBS, which were retained for 1 hour into the bladder. For subcutaneous (s.c.) immunization, mice received a single injection of  $2-5 \times 10^6$  CFUs BCG. Mice were housed under specific-pathogen free conditions and used under approved protocols.

### **BCG and determination of bacterial load**

For instillations, Immucyst (Sanofi Pasteur) was reconstituted in 3mL PBS following the manufacturer's instructions. For s.c. administration, either Immucyst (once) or frozen aliquots of BCG Pasteur (1137P2) were used with similar results. BCG-Pasteur was grown at 37°C in Middlebrook 7H9 medium supplemented with bovine albumin, dextrose and catalase (ADC, Difco), harvested in exponential growth phase, washed, dispersed with 3mm glass-beads,

resuspended in PBS, aliquoted and then frozen at -80°C. A defrosted aliquot was used to determine the lot titer on 7H11 medium supplemented with oleic acid, albumin dextrose and catalase (OADC, Difco). In addition, all preparations used for intravesical or subcutaneous injections were titrated. For organ bacterial load, bladders were resected in sterile PBS, homogenized 2 min at 25Hz in a Tissue Lyzer II (Qiagen) while draining lymph nodes (LN) were mashed with the back of a syringe in sterile PBS. Five-fold serial dilutions of the homogenates were plated on 7H11 supplemented with OADC and colony forming units (CFUs) were assessed after 17-28 days of growth at 37°C.

### **Antibodies and reagents**

For FACS, CD16/CD32 (clone 2.4G2, Fc block), CD45.2 (clone 104), CD3 $\epsilon$  (clone 145-2C11), NK1.1 (clone PK136), CD8 $\alpha$  (clone 53-6.7), CD44 (clone IM7), CD45RA (clone 14.8), CD45R/B220 (clone RA3-6B2), CD11c (clone HL3), CD86 (clone GL1), Ly-6C (clone AL-21), Ly-6G (clone 1A8) antibodies (Abs) were purchased from BD Pharmingen; CD4 (clone GK1.5), CD11b (clone MAC-1), pan- $\gamma\delta$  TCR (clone GL3), IA<sup>b</sup>-IE<sup>b</sup> (clone M5), F4/80 (clone BM8) Abs were from eBioscience and CD45.2 (clone 104-2) from Southern Biotech. Dead cells were stained either with 4',6-diamidino-2-phenylindole (DAPI, Sigma-Aldrich) or with live/dead fixable Aqua dead cell staining kit (Invitrogen). Cells were enumerated using Accucheck counting beads (Invitrogen). For histology, CD3 $\epsilon$  (clone 500A2) and CD45.2 (clone 104) Abs were obtained from BD Pharmingen;  $\alpha$ -smooth muscle actin ( $\alpha$ -SMA, clone 1A4) from Sigma-Aldrich and syrian-Hamster secondary Ab from Jackson ImmunoResearch Laboratories. Abs used in the IFN- $\gamma$  ELISPOT assays were purchased from Mabtech. H2-D<sup>b</sup>-restricted Mtb32<sub>309-318</sub> peptide (GAPINSATAM) was obtained from PolyPeptide. Depleting anti-CD4 (clone GK1.5) and anti-CD8 (clone YTS169.4) as well as rat IgG2b isotype control mAbs were purchased from

Bio X Cell. MB49 cells were received from the Brandau group and cultured in D-MEM (Invitrogen), complemented with 10% fetal calf serum (FCS, Eurobio) and 1% Penicilin/Streptomycin (Invitrogen). Poly-L-lysin was purchased from Sigma-Aldrich.

### **Tissue processing and flow cytometry**

Bladders were resected and incubated in DMEM (Invitrogen) containing 1mg/mL collagenase D (Roche), 0.17U/mL liberase TM (Roche) and 1U/mL Deoxyribonuclease 1 (Invitrogen) at 37°C for two successive cycles of 30 min. Tissue suspensions were washed in DMEM + 10% FCS, pressed through a 70- $\mu$ m mesh, washed in PBS + 2% FCS, pressed through a 40- $\mu$ m mesh and pelleted for FACS staining. Spleens were mashed, incubated at 37°C in 1.66% ammonium chloride (VWR International) in water for 5 min for red blood cell lysis and filtered through a 70- $\mu$ m mesh. All cells were preincubated with Fc block (and Aqua, if used), washed and incubated with appropriate Abs for 20 min in PBS + 0.5% FCS. Samples were run on a BD FACSCantoII cytometer (BD Biosciences) and analyzed using FlowJo (Treestar) software.

### **Monitoring BCG-specific T cell response**

For IFN- $\gamma$  secretion assays, at indicated time points, spleens and bladder draining LN were harvested and combined, CD8<sup>+</sup> T cells were purified using microbeads and MS columns (Miltenyi Biotec) and ELISPOT assays for IFN- $\gamma$ -producing cells were performed as previously described (45). The ELISPOT plate evaluation was performed in a blinded fashion by an independent evaluation service (Zellnet Consulting). For tetramer staining, soluble D<sup>b</sup>-Mtb32<sub>309-318</sub> monomers were produced using a modified version of that described (46) and conjugated using premium grade streptavidin-PE (Invitrogen), added for 1 hour at room temperature.



### **Immunofluorescence histology**

Tissues were processed as previously described (47). Briefly, samples were fixed overnight at 4°C in a fresh solution of 4% paraformaldehyde (Sigma-Aldrich) in PBS, embedded in OCT compound (Sakura Finetek) and frozen at -80°C. Frozen blocs were cut at 8-µm thickness and sections collected onto Superfrost Plus slides (VWR International). Slides were dried one hour and processed for staining or stored at -80°C. For staining, slides were first hydrated in PBS-XG (PBS containing 0.1% Triton X-100 (Sigma-Aldrich) and 1% FCS) for 5 min and blocked with 10% FCS in PBS-XG for 1 hour at room temperature. Slides were then incubated with primary antibodies in PBS-XG overnight at 4°C, washed, incubated with secondary antibodies for 1 hour at room temperature, incubated with DAPI for 5 min at room temperature, washed and mounted with Fluoromount-G (Southern Biotech). Slides were examined under an AxioImager M1 fluorescence microscope (Zeiss) equipped with a CCD camera and images were processed with AxioVision software (Zeiss).

### **T cell depletion**

Mice were injected intraperitoneally with a mixture of 100ug anti-CD4 and 100ug anti-CD8 antibody, or with 200ug isotype control, 48hrs prior to instillation. Depletion efficiency was controlled on blood and splenocytes.

### **Patients**

We performed analysis of recurrence-free survival stratified to available pre-BCG purified protein derivative (PPD) status in 55 patients with high-risk non-muscle invasive bladder cancer, which were defined as any high-grade tumor or as any low-grade tumor with >2 recurrences within 2 years. Patients underwent transurethral resection of all visible bladder tumors and

random bladder biopsies in case of a positive bladder wash cytology. High-grade tumors underwent a second resection 2-4 weeks after first resection and then, within 2 weeks, BCG therapy was initiated at the Department of Urology, University Hospital of Bern, Switzerland. Patient and tumor characteristics are listed in **Fig. 6A**. Patients were followed as part of an observational clinical trial, in accordance with clinical guidelines. Tumor recurrence was defined based on biopsy and urine cytology. The local ethical commission of Bern, Switzerland, approved the study and all patients provided informed consent.

### **Statistics**

Unless otherwise indicated, two-tailed Mann-Whitney non-parametric tests were employed for statistical analyses using Prism software (Graphpad). Differences with a  $p$  value of 0.05 or less were considered significant. For the mouse tumor challenge (**Fig. 5A**), a log-rank test was performed. For patient data analysis (**Fig. 6B**), a log-rank test was performed using SPSS 18.0 (SPSS Inc.). For kinetic studies (**Fig. 1B**), we employed a general linear mixed model using Stata 11.0 (Stata Corporation).

## References

1. A. Jemal, F. Bray, M. M. Center, J. Ferlay, E. Ward, D. Forman, Global cancer statistics. *CA Cancer J Clin* **61**, 69 (2011).
2. M. Babjuk, W. Oosterlinck, R. Sylvester, E. Kaasinen, A. Bohle, J. Palou-Redorta, M. Roupret, EAU guidelines on non-muscle-invasive urothelial carcinoma of the bladder, the 2011 update. *Eur Urol* **59**, 997 (2011).
3. A. Morales, D. Eidinger, A. W. Bruce, Intracavitary Bacillus Calmette-Guerin in the treatment of superficial bladder tumors. *J Urol* **116**, 180 (1976).
4. P. Gontero, A. Bohle, P. U. Malmstrom, M. A. O'Donnell, M. Oderda, R. Sylvester, F. Witjes, The role of bacillus Calmette-Guerin in the treatment of non-muscle-invasive bladder cancer. *Eur Urol* **57**, 410 (2010).
5. A. Zwerling, M. A. Behr, A. Verma, T. F. Brewer, D. Menzies, M. Pai, The BCG World Atlas: a database of global BCG vaccination policies and practices. *PLoS Med* **8**, e1001012 (2011).
6. J. L. Flynn, J. Chan, P. L. Lin, Macrophages and control of granulomatous inflammation in tuberculosis. *Mucosal Immunol* **4**, 271 (2011).
7. A. M. Cooper, Cell-mediated immune responses in tuberculosis. *Annu Rev Immunol* **27**, 393 (2009).
8. K. B. Urdahl, S. Shafiani, J. D. Ernst, Initiation and regulation of T-cell responses in tuberculosis. *Mucosal Immunol* **4**, 288 (2011).
9. A. B. Alexandroff, S. Nicholson, P. M. Patel, A. M. Jackson, Recent advances in bacillus Calmette-Guerin immunotherapy in bladder cancer. *Immunotherapy* **2**, 551 (2010).
10. S. Brandau, H. Suttman, Thirty years of BCG immunotherapy for non-muscle invasive bladder cancer: a success story with room for improvement. *Biomed Pharmacother* **61**, 299 (2007).
11. T. L. Ratliff, D. Gillen, W. J. Catalona, Requirement of a thymus dependent immune response for BCG-mediated antitumor activity. *J Urol* **137**, 155 (1987).
12. T. L. Ratliff, J. K. Ritchey, J. J. Yuan, G. L. Andriole, W. J. Catalona, T-cell subsets required for intravesical BCG immunotherapy for bladder cancer. *J Urol* **150**, 1018 (1993).
13. S. Brandau, J. Riemensberger, M. Jacobsen, D. Kemp, W. Zhao, X. Zhao, D. Jocham, T. L. Ratliff, A. Bohle, NK cells are essential for effective BCG immunotherapy. *Int J Cancer* **92**, 697 (2001).
14. H. Suttman, J. Riemensberger, G. Bentien, D. Schmaltz, M. Stockle, D. Jocham, A. Bohle, S. Brandau, Neutrophil granulocytes are required for effective Bacillus Calmette-Guerin immunotherapy of bladder cancer and orchestrate local immune responses. *Cancer Res* **66**, 8250 (2006).
15. S. Prescott, K. James, T. B. Hargreave, G. D. Chisholm, J. F. Smyth, Intravesical Evans strain BCG therapy: quantitative immunohistochemical analysis of the immune response within the bladder wall. *J Urol* **147**, 1636 (1992).
16. A. Bisiaux, N. Thiounn, M. O. Timsit, A. Eladaoui, H. H. Chang, J. Mapes, A. Mogenet, J. L. Bresson, D. Prie, S. Bechet, C. Baron, C. Sadorge, S. Thomas, E. B. Albert, P. S. Albert, M. L. Albert, Molecular analyte profiling of the early events and tissue conditioning following intravesical bacillus Calmette-Guerin therapy in patients with superficial bladder cancer. *J Urol* **181**, 1571 (2009).
17. D. R. Kelley, T. L. Ratliff, W. J. Catalona, A. Shapiro, J. M. Lage, W. C. Bauer, E. O. Haaff, S. M. Dresner, Intravesical bacillus Calmette-Guerin therapy for superficial

- bladder cancer: effect of bacillus Calmette-Guerin viability on treatment results. *J Urol* **134**, 48 (1985).
18. B. Zbar, Tumor regression mediated by Mycobacterium bovis (strain BCG). *Natl Cancer Inst Monogr* **35**, 341 (1972).
  19. A. J. Wolf, L. Desvignes, B. Linas, N. Banaiee, T. Tamura, K. Takatsu, J. D. Ernst, Initiation of the adaptive immune response to Mycobacterium tuberculosis depends on antigen production in the local lymph node, not the lungs. *J Exp Med* **205**, 105 (2008).
  20. W. W. Reiley, M. D. Calayag, S. T. Wittmer, J. L. Huntington, J. E. Pearl, J. J. Fountain, C. A. Martino, A. D. Roberts, A. M. Cooper, G. M. Winslow, D. L. Woodland, ESAT-6-specific CD4 T cell responses to aerosol Mycobacterium tuberculosis infection are initiated in the mediastinal lymph nodes. *Proc Natl Acad Sci U S A* **105**, 10961 (2008).
  21. A. A. Chackerian, J. M. Alt, T. V. Perera, C. C. Dascher, S. M. Behar, Dissemination of Mycobacterium tuberculosis is influenced by host factors and precedes the initiation of T-cell immunity. *Infect Immun* **70**, 4501 (2002).
  22. C. Durek, E. Richter, A. Basteck, S. Rusch-Gerdes, J. Gerdes, D. Jocham, A. Bohle, The fate of bacillus Calmette-Guerin after intravesical instillation. *J Urol* **165**, 1765 (2001).
  23. A. Siatelis, D. P. Houhoula, J. Papaparaskevas, D. Delakas, A. Tsakris, Detection of bacillus Calmette-Guerin (Mycobacterium bovis BCG) DNA in urine and blood specimens after intravesical immunotherapy for bladder carcinoma. *J Clin Microbiol* **49**, 1206 (2011).
  24. S. M. Irwin, A. A. Izzo, S. W. Dow, Y. A. Skeiky, S. G. Reed, M. R. Alderson, I. M. Orme, Tracking antigen-specific CD8 T lymphocytes in the lungs of mice vaccinated with the Mtb72F polyprotein. *Infect Immun* **73**, 5809 (2005).
  25. E. Chan, A. Patel, W. Heston, W. Larchian, Mouse orthotopic models for bladder cancer research. *BJU Int* **104**, 1286 (2009).
  26. J. H. Gunther, A. Jurczok, T. Wulf, S. Brandau, I. Deinert, D. Jocham, A. Bohle, Optimizing syngeneic orthotopic murine bladder cancer (MB49). *Cancer Res* **59**, 2834 (1999).
  27. G. Mathe, J. L. Amiel, L. Schwarzenberg, M. Schneider, A. Cattani, J. R. Schlumberger, M. Hayat, F. De Vassal, Active immunotherapy for acute lymphoblastic leukaemia. *Lancet* **1**, 697 (1969).
  28. D. L. Morton, F. R. Eilber, W. L. Joseph, W. C. Wood, E. Trahan, A. S. Ketcham, Immunological factors in human sarcomas and melanomas: a rational basis for immunotherapy. *Ann Surg* **172**, 740 (1970).
  29. B. Zbar, I. D. Bernstein, H. J. Rapp, Suppression of tumor growth at the site of infection with living Bacillus Calmette-Guerin. *J Natl Cancer Inst* **46**, 831 (1971).
  30. H. W. Herr, A. Morales, History of bacillus Calmette-Guerin and bladder cancer: an immunotherapy success story. *J Urol* **179**, 53 (2008).
  31. M. A. O'Donnell, Optimizing BCG therapy. *Urol Oncol* **27**, 325 (2009).
  32. Y. Luo, J. Henning, M. A. O'Donnell, Th1 cytokine-secreting recombinant Mycobacterium bovis bacillus Calmette-Guerin and prospective use in immunotherapy of bladder cancer. *Clin Dev Immunol* **2011**, 728930 (2011).
  33. M. Peuchmaur, G. Benoit, A. Vieillefond, A. Chevalier, G. Lemaigre, E. D. Martin, A. Jardin, Analysis of mucosal bladder leucocyte subpopulations in patients treated with intravesical Bacillus Calmette-Guerin. *Urol Res* **17**, 299 (1989).
  34. J. R. Mora, U. H. von Andrian, T-cell homing specificity and plasticity: new concepts and future challenges. *Trends Immunol* **27**, 235 (2006).

35. G. Marchal, M. Seman, G. Milon, P. Truffa-Bachi, V. Zilberfarb, Local adoptive transfer of skin delayed-type hypersensitivity initiated by a single T lymphocyte. *J Immunol* **129**, 954 (1982).
36. G. Milon, G. Marchal, M. Seman, P. Truffa-Bachi, V. Zilberfarb, Is the delayed-type hypersensitivity observed after a low dose of antigen mediated by helper T cells? *J Immunol* **130**, 1103 (1983).
37. F. Saint, L. Salomon, R. Quintela, A. Cicco, A. Hoznek, C. C. Abbou, D. K. Chopin, Do prognostic parameters of remission versus relapse after Bacillus Calmette-Guerin (BCG) immunotherapy exist?. analysis of a quarter century of literature. *Eur Urol* **43**, 351 (2003).
38. D. R. Kelley, E. O. Haaff, M. Becich, J. Lage, W. C. Bauer, S. M. Dresner, W. J. Catalona, T. L. Ratliff, Prognostic value of purified protein derivative skin test and granuloma formation in patients treated with intravesical bacillus Calmette-Guerin. *J Urol* **135**, 268 (1986).
39. R. J. Torrence, L. R. Kavoussi, W. J. Catalona, T. L. Ratliff, Prognostic factors in patients treated with intravesical bacillus Calmette-Guerin for superficial bladder cancer. *J Urol* **139**, 941 (1988).
40. D. L. Lamm, J. I. DeHaven, J. Shriver, M. F. Sarosdy, Prospective randomized comparison of intravesical with percutaneous bacillus Calmette-Guerin versus intravesical bacillus Calmette-Guerin in superficial bladder cancer. *J Urol* **145**, 738 (1991).
41. R. A. Badalament, H. W. Herr, G. Y. Wong, C. Gnecco, C. M. Pinsky, W. F. Whitmore, Jr., W. R. Fair, H. F. Oettgen, A prospective randomized trial of maintenance versus nonmaintenance intravesical bacillus Calmette-Guerin therapy of superficial bladder cancer. *J Clin Oncol* **5**, 441 (1987).
42. T. T. Bui, P. F. Schellhammer, Additional bacillus Calmette-Guerin therapy for recurrent transitional cell carcinoma after an initial complete response. *Urology* **49**, 687 (1997).
43. T. M. de Reijke, K. H. Kurth, R. J. Sylvester, R. R. Hall, M. Brausi, K. van de Beek, K. E. Landsoght, P. Carpentier, Bacillus Calmette-Guerin versus epirubicin for primary, secondary or concurrent carcinoma in situ of the bladder: results of a European Organization for the Research and Treatment of Cancer--Genito-Urinary Group Phase III Trial (30906). *J Urol* **173**, 405 (2005).
44. W. Luftenegger, D. K. Ackermann, A. Futterlieb, R. Kraft, C. E. Minder, P. Nadelhaft, U. E. Studer, Intravesical versus intravesical plus intradermal bacillus Calmette-Guerin: a prospective randomized study in patients with recurrent superficial bladder tumors. *J Urol* **155**, 483 (1996).
45. N. E. Blachere, R. B. Darnell, M. L. Albert, Apoptotic cells deliver processed antigen to dendritic cells for cross-presentation. *PLoS Biol* **3**, e185 (2005).
46. P. Bousso, A. Casrouge, J. D. Altman, M. Haury, J. Kanellopoulos, J. P. Abastado, P. Kourilsky, Individual variations in the murine T cell response to a specific peptide reflect variability in naive repertoires. *Immunity* **9**, 169 (1998).
47. L. Peduto, S. Dulauroy, M. Lochner, G. F. Spath, M. A. Morales, A. Cumano, G. Eberl, Inflammation recapitulates the ontogeny of lymphoid stromal cells. *J Immunol* **182**, 5789 (2009).
48. Acknowledgements: The authors would like to thank all members of the Albert lab, G. Milon, L. Majlessi, R. Simeone and H. Law for their support and advice. We also thank S. Leroy for assistance with statistical analyses. The Center for Human Immunology and the Animal Facility at Institut Pasteur were instrumental for the studies. Grant support:

Work was funded by La Ligue Contre le Cancer, INCA and through the generosity of the CRPCEN (MLA) and Swiss National Foundation (CAR). Author contributions: CB conceived project, performed all experiments, analyzed data and wrote manuscript; CAR contributed to tumor model development, generated and analyzed clinical data and reviewed manuscript; JRG performed tumor treatment studies; FDB generated and analyzed clinical data and reviewed manuscript; HJS contributed to developing key protocols; FL contibuted critical tools for T cell analysis; AB provided support for the study and reviewed the manuscript; PB provided technical expertise, experimental advice and critical reagents; CD provided support for studies on BCG; LP contributed key protocols for assaying bladder leukocytes; GNT generated and analyzed clinical data and reviewed manuscript; MLA conceived project, analyzed data and wrote manuscript.

## Figure legends

**Fig. 1. Repeated instillations of BCG result in a robust, though late, infiltration of activated  $\alpha\beta$  T cells into the bladder.** (A) Female mice received 3 weekly intravesical instillations of PBS (control) or clinical-grade BCG (ImmuCyst) at days 0, 7, 14 (indicated by black arrows). At day 29, bladders were resected, digested with collagenase and stained for flow cytometry. T cells were gated as live  $CD45.2^+ CD3\epsilon^+ NK1.1^-$  cells. Representative FACS plots are shown. (B) Mice were treated as above and the kinetics of T cell infiltration was evaluated. The dashed line indicates basal level T cells in naïve controls; independent experiments were combined with  $n=3-7$  mice analyzed per time point; means and SEM are shown. A general linear mixed model was used to compare the percentage of T cells among total leukocytes (\*\*\*,  $p<0.0001$ ). (C) Data from (B) was re-analyzed and absolute T cell numbers are shown for individual mice during the time window of maximal infiltration (day 29 to 35). Black bars indicate median. A Mann-Whitney test was performed (\*\*,  $p<0.01$ ). (D) Immunofluorescence staining at day 33 is shown. Nuclei were stained with DAPI (grey), leukocytes with CD45.2 (green) and T cells with CD3 $\epsilon$  (red), whereas  $\alpha$ -smooth muscle actin (SMA, blue) staining indicates the smooth muscle layer of blood vessels (V) and the bladder muscle layer (M). A dotted white line demarcates the bladder lumen (L), the thin urothelial layer (U) and the submucosa (S) are indicated. Scale bar = 100 $\mu$ m. (E) Bladder infiltrating T cells were assessed by cytometry for an activated phenotype based on CD44 expression and absence of CD45RA. A representative histogram is shown. Shaded histograms indicate fluorescence minus one. (F-G) T cells infiltrating the bladder were further gated as  $\gamma\delta$ -TCR positive or negative; and the latter population was assessed for CD4 or CD8 $\alpha$  expression. Representative FACS plots and gating

strategy is shown (F). Average numbers of T cell subpopulations are displayed; n=4 mice per group (G).

**Fig. 2. Priming of T cells and their entry into the bladder are uncoupled, following intravesical BCG instillations.** (A) At 2 and 27 hours following instillation, bladders were homogenized in PBS and total CFUs per organ were enumerated. (B) Bladder draining LN were resected at indicated time points, after either a single or repeated instillation(s) of live BCG, homogenized in PBS and plated. Mice were stratified as either CFU positive (black) or CFU negative (white); several independent experiments were combined ( $n = 13-24$  mice per group). (C-D) Mice were treated and stratified as above and the BCG-specific response was analyzed on splenocytes using H2-D<sup>b</sup>-Mtb32<sub>309-318</sub> tetramers on day 30-36. CD8<sup>+</sup> T cells were gated as live, dump negative (dump channel including CD45RB (B220), NK1.1, CD11b, F4/80 and CD4), CD3ε<sup>+</sup> CD8α<sup>+</sup> and the percentage of tetramer positive cells among this population was analyzed. A representative FACS plot for tetramer assays is shown for an animal receiving PBS or weekly intravesical instillations of BCG (C). The percentage of tetramer positive (Tet<sup>+</sup>) cells among CD8<sup>+</sup> T splenocytes is shown for individual mice across the different treatment conditions and black bars represent medians. Mann-Whitney tests were performed (ns, non significant; \*,  $p < 0.05$ ) (D). (E) Mice were treated as above, and at day 29, purified CD8<sup>+</sup> T cells from spleen and draining LN from mice that were CFU<sup>+</sup> were restimulated *ex vivo* for 20h using splenocytes pulsed with Mtb32<sub>309-318</sub> peptide. Unpulsed splenocytes served as a negative control. The number of spot forming cells (SFC) per 10<sup>6</sup> CD8<sup>+</sup> T cells for individual mice is shown. (F) Mice were treated and stratified as above and absolute numbers of T cells infiltrating the bladder were enumerated following either a single or repeated instillation(s) on day 30-36. Individual mice are shown; black bars represent medians. Mann-Whitney tests were performed (\*\*,  $p < 0.01$ ).



**Fig. 3. Subcutaneous immunization with BCG prior to intravesical instillation(s) results in accelerated T cell entry into the bladder.** Twenty-one days prior to intravesical instillation, mice were subcutaneously (s.c.) immunized with BCG, as compared to non-immunized ( $\emptyset$ ) controls (s.c. injection is represented by a star). Mice subsequently received either a single or repeated intravesical instillation(s) with PBS or BCG (instillations represented by a black arrow). Bladder T cell infiltration was analyzed by flow cytometry on day 33-35. A Kruskal-Wallis test was performed among all groups that received intravesical BCG (ns, non significant).

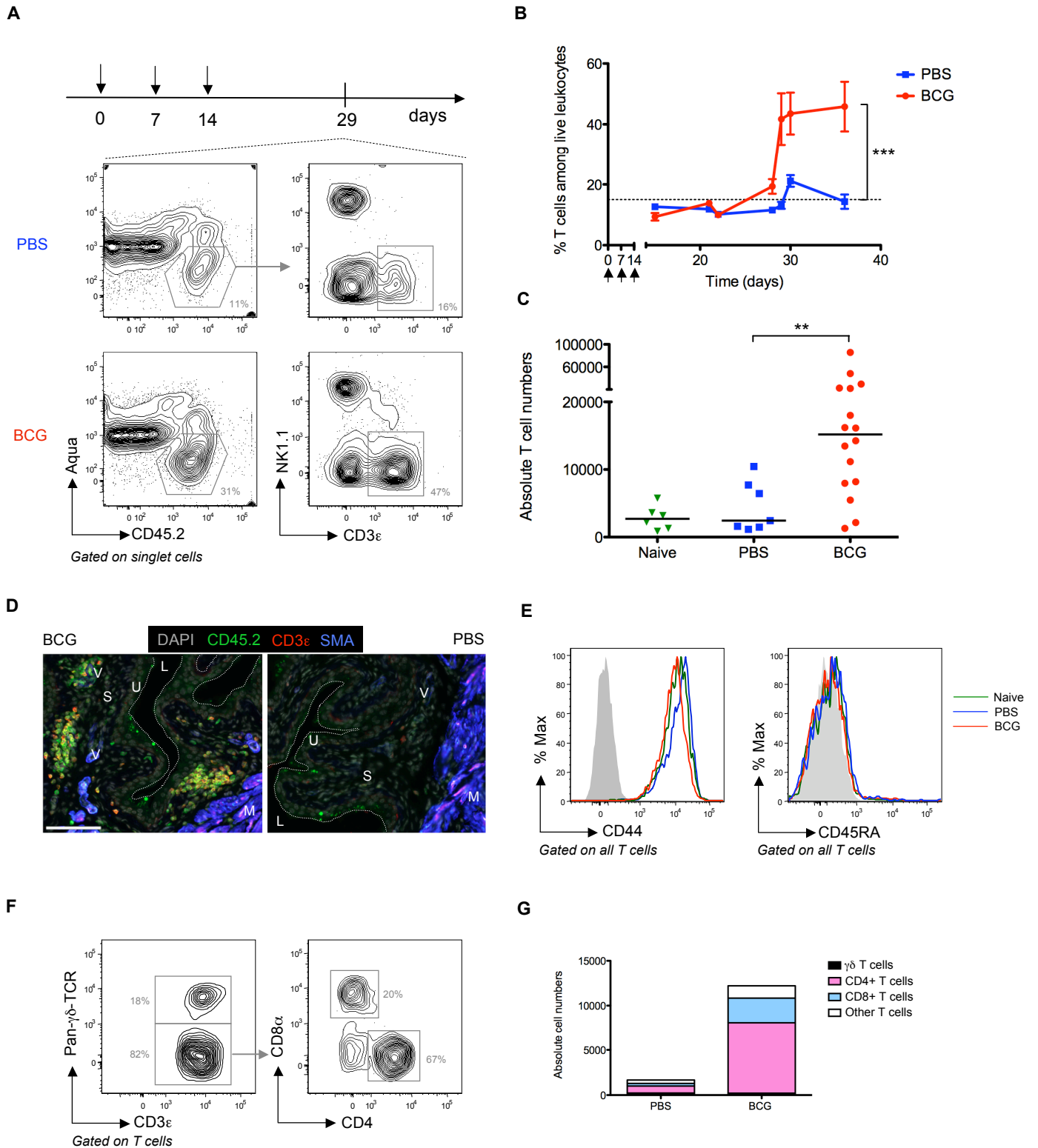
**Fig. 4. Pre-existing adaptive immunity supports a robust, albeit short-lived, innate immune response.** (A) Neutrophils were defined as live CD45.2<sup>+</sup> Ly-6G<sup>+</sup> cells; inflammatory monocytes were defined as live CD45.2<sup>+</sup> Ly-6G<sup>-</sup> Ly-6C<sup>high</sup> CD11b<sup>+</sup> cells. For each cell population, a representative FACS plot is shown (sixteen hours after third BCG instillation). (B) Sixteen and forty-two hours following either the first or third BCG instillation, bladder-infiltrating neutrophils (upper graph) and inflammatory monocytes (lower graph) were quantified by flow cytometry ( $n = 3-9$  mice per group). Mean values and SEM are shown. A Mann-Whitney analysis was performed to compare infiltration at sixteen hours following the first and the third instillation with BCG (ns, non significant; \*\*  $p < 0.01$ ). (C) Mice were s.c. immunized with BCG twenty-one days prior to instillation, as compared to non-immunized controls, followed by a single intravesical instillation with PBS or BCG. Forty-eight hours prior to instillation, mice were treated with depleting monoclonal antibodies specific for CD4<sup>+</sup> and CD8<sup>+</sup> T cells or isotype control antibodies. Sixteen hours after intravesical instillation, infiltration of neutrophils (upper graph) and inflammatory monocytes (lower graph) was assessed by flow cytometry. Individual

mice are shown and medians are indicated by black bars. Mann-Whitney analyses were performed (ns, non significant; \*  $p < 0.05$ ).

**Fig. 5. Pre-existing BCG-specific immunity improves anti-tumor response in a mouse model for bladder cancer.** Three weeks prior to orthotopic MB49 tumor challenge, mice were s.c. immunized with BCG (solid lines) or left untreated (dashed lines). Starting two days after tumor challenge, mice received 5 weekly intravesical instillations of either PBS (blue lines) or BCG (red lines) and were monitored twice daily for survival until termination of the experiment on day 70. A log-rank test was performed to compare groups that received intravesical BCG, either immunized s.c. or not (\*\*  $p < 0.01$ ).

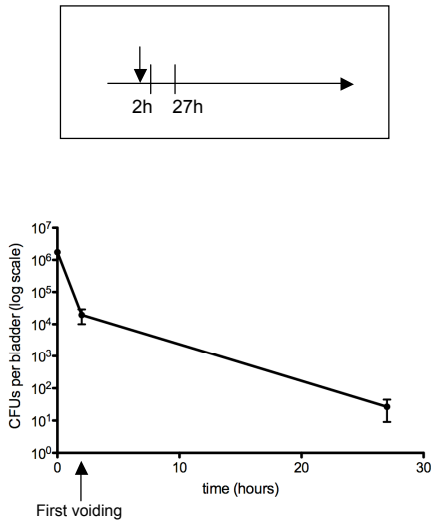
**Fig. 6. Pre-existing BCG-specific immunity improves the anti-tumor response in patients with high-risk non-muscle invasive bladder cancer undergoing intravesical BCG therapy.** (A) Patient characteristics and tumor stage and grade are documented. (B) Patients were stratified according to their pre-therapy purified protein derivative (PPD) status (+, positive; -, negative), and analysis of their recurrence-free survival was performed over 60 months. The median recurrence-free survival was 25 months in the PPD negative group and not reached in the PPD positive group. A log-rank test was performed (\*\*  $p < 0.01$ ); hash marks along the lines indicate censored events (e.g., death from causes other than bladder cancer).

**Fig1. Repeated intravesical instillations of BCG result in a robust, though late, infiltration of activated  $\alpha\beta$  T cells into the bladder**

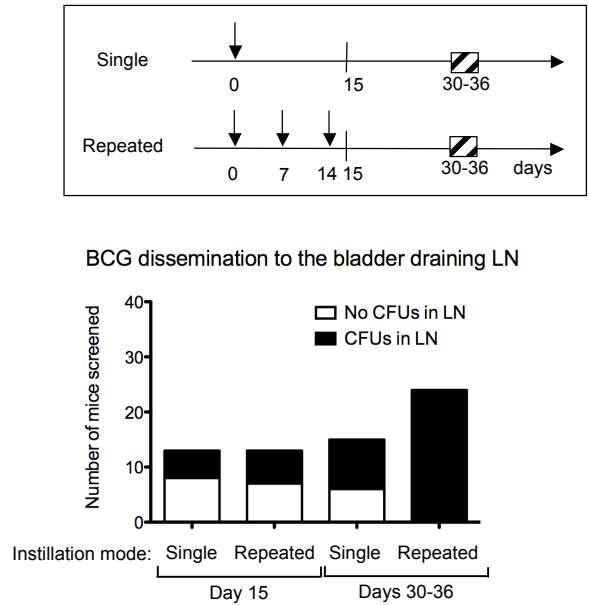


**Fig 2. Priming of T cells and their entry into the bladder are uncoupled, following intravesical BCG instillations**

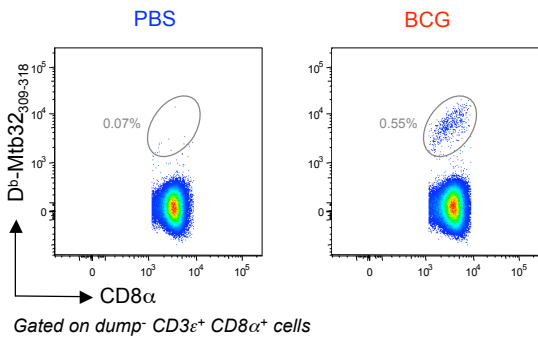
**A**



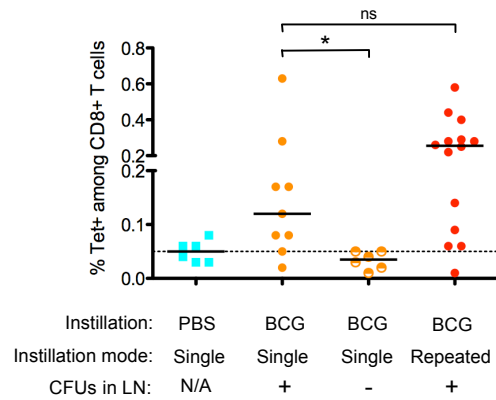
**B**



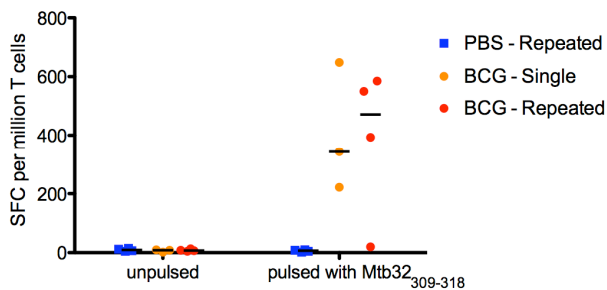
**C**



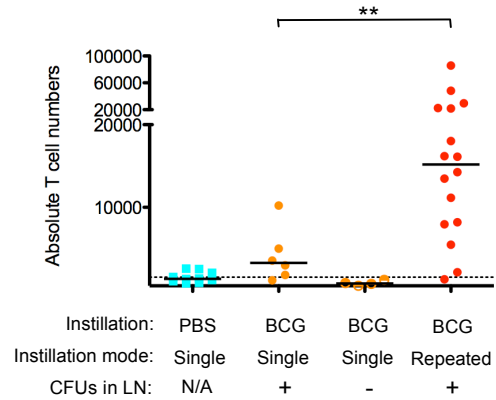
**D**



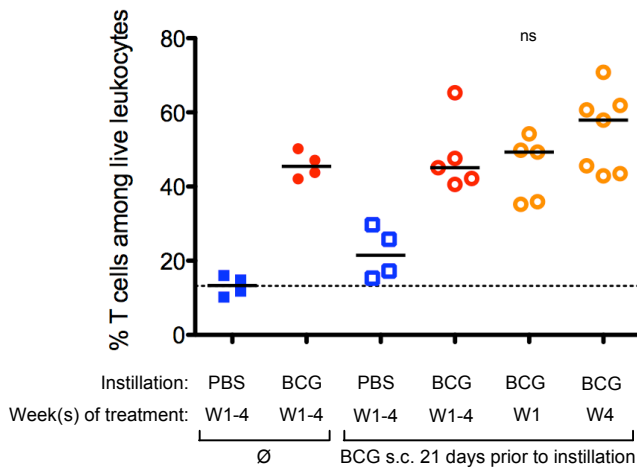
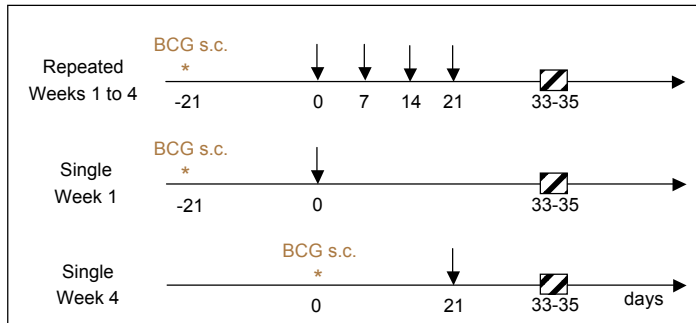
**E**



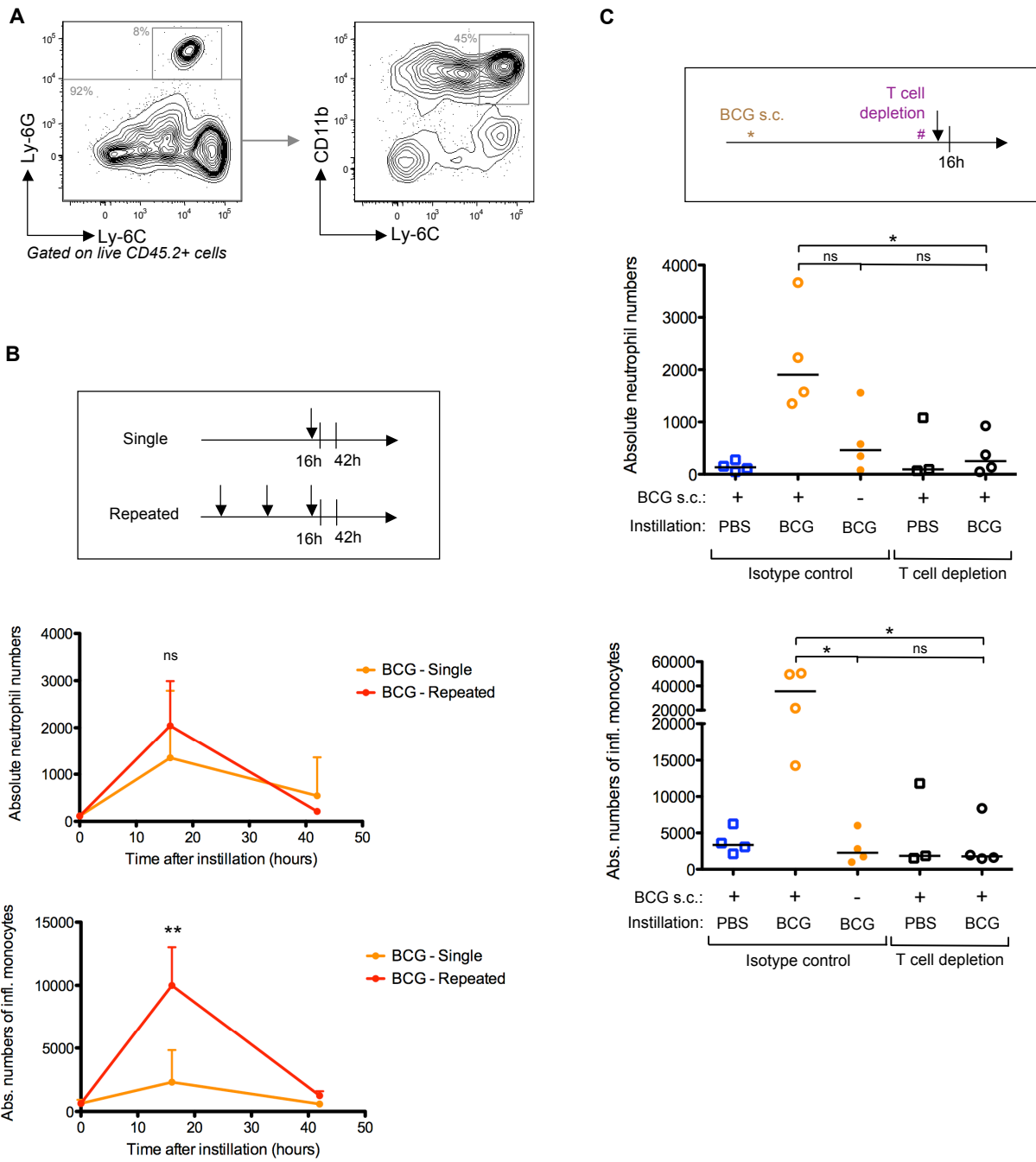
**F**



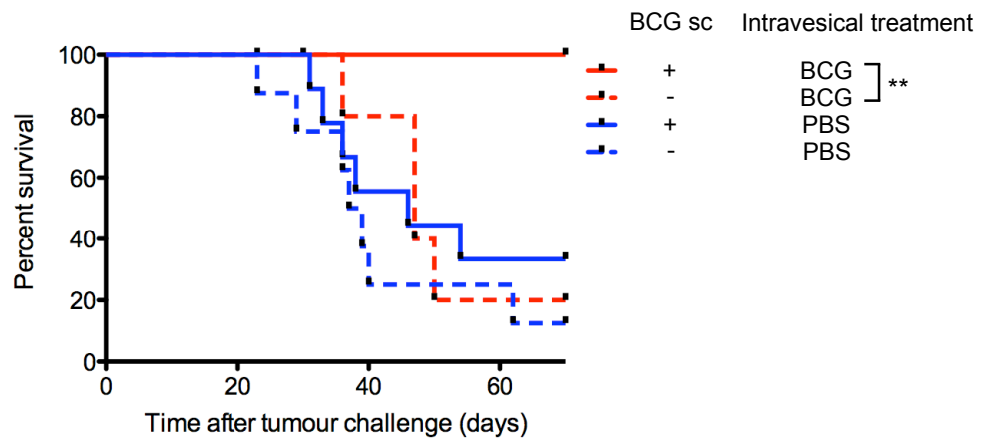
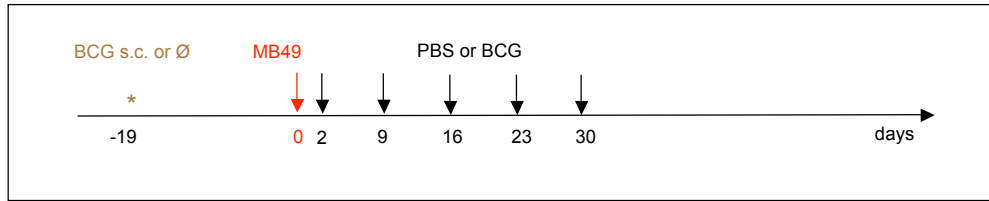
**Fig 3. Subcutaneous immunization with BCG prior to intravesical instillation(s) results in accelerated T cell entry into the bladder**



**Fig 4. Pre-existing adaptive immunity supports a robust, albeit short-lived innate immune response**



**Fig 5. Pre-existing BCG-specific immunity improves the anti-tumor response in a mouse model for bladder cancer**



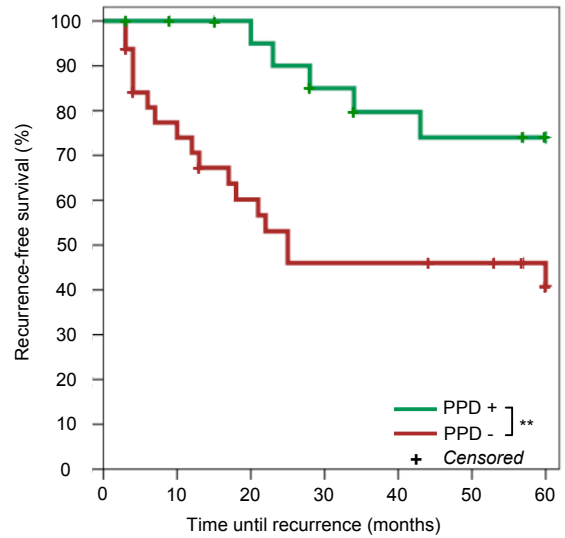
**Fig 6. Pre-existing BCG-specific immunity improves the anti-tumor response in patients with high-risk non-muscle invasive bladder cancer undergoing intravesical BCG therapy**

**A**

<b>Patients (n)</b>	55	
<b>Pre-treatment PPD status (n, %)</b>		
<b>Positive</b>	23	42%
<b>Negative</b>	32	58%
<b>Gender (n, %)</b>		
<b>Male</b>	49	89%
<b>Female</b>	6	11%
<b>Age at last surgery before BCG (yr)</b>		
<b>Median</b>	71	
<b>Range</b>	46-90	
<b>Tumor characteristics* (n, %)</b>		
<b>Ta grade 1/2, recurrent</b>	12	22%
<b>Ta grade 3</b>	4	7%
<b>T1 grade 2</b>	6	11%
<b>T1 grade 3</b>	25	45%
<b>CIS alone</b>	8	15%
<b>CIS concomitant</b>	14	25%

\*Ta/T1 indicate papillary tumors. CIS: carcinoma *in situ*

**B**





# Mathematical model of tumor immunotherapy for bladder carcinoma identifies the limitations of the innate immune response

Romulus Breban,<sup>1</sup> Aurelie Bisiaux,<sup>2,3</sup> Claire Biot,<sup>2-4</sup> Cyrill A. Rentsch,<sup>2,3,5</sup> Philippe Bousoff,<sup>6,7</sup> and Matthew L. Albert<sup>2,3\*</sup>

<sup>1</sup>Institut Pasteur; Unité d'Epidémiologie des Maladies Emergentes; <sup>2</sup>Unité d'Immunologie des Cellules Dendritiques; <sup>3</sup>INSERM U818; <sup>4</sup>Ecole Nationale Supérieure des Mines de Paris; Paris, France; <sup>5</sup>University of Basel; Basel, Switzerland; <sup>6</sup>Institut Pasteur; Unité des Dynamiques des Réponses Immunes; <sup>7</sup>INSERM U668; Equipe Avenir; Paris, France

**Key words:** BCG immunotherapy, bladder carcinoma, innate immunity, bystander death of tumor cell, apoptosis, mathematical model

**Abbreviations:** BCG, bacillus Calmette-Guérin; PMN, polymorphonuclear cell; TCC, transitional cell carcinoma; CIS, carcinoma in situ; TRAIL, TNF-related apoptosis-inducing ligand; NET, neutrophil extracellular traps; MIC-A, MHC-class I polypeptide-related sequence A; TNF-SF, tumor necrosis factor-superfamily; MPO, myeloperoxidase; CFU, colony forming unit; GFP, green fluorescent protein; IFN, interferon; ELISA, enzyme-linked immunosorbent assay; FRET, Förster resonance energy transfer; CFP, cyan fluorescent protein

Treatment for non-muscle invasive carcinoma of the bladder represents one of the few examples of successful tumor immunity. Six weekly intravesical instillations of Bacillus Calmette-Guérin (BCG), often followed by maintenance schedule, result in up to 50–70% clinical response. Current models suggest that the mechanism of action involves the non-specific activation of innate effector cells, which may be capable of acting in the absence of an antigen-specific response. For example, recent evidence suggests that BCG-activated neutrophils possess anti-tumor potential. Moreover, weekly BCG treatment results in a prime-boost pattern with massive influx of innate immune cells ( $10^7$ – $10^8$  PMN/ml urine). Calibrating in-vivo data, we estimate that the number of neutrophil degranulations per instillation is approximately  $10^6$ – $10^7$ , more than sufficient to potentially eliminate  $\sim 10^6$  residual tumor cells. Furthermore, neutrophils, as well as other innate effector cells are not selective in their targeting—thus surrounding cells may be influenced by degranulation and/or cytokine production. To establish if these observed conditions could account for clinically effective tumor immunity, we built a mathematical model reflecting the early events and tissue conditioning in patients undergoing BCG therapy. The model incorporates key features of tumor growth, BCG instillations and the observed prime/boost pattern of the innate immune response. Model calibration established that each innate effector cell must kill 90–95 bystander cells for achieving the expected 50–70% clinical response. This prediction was evaluated both empirically and experimentally and found to vastly exceed the capacity of the innate immune system. We therefore conclude that the innate immune system alone is unable to eliminate the tumor cells. We infer that other aspects of the immune response (e.g., antigen-specific lymphocytes) decisively contribute to the success of BCG immunotherapy.

## Introduction

Carcinoma of the bladder is the most common tumor of the genitourinary tract and transitional cell carcinoma (TCC) accounts for >90% of such malignancies, with peak incidence occurring in the seventh decade.<sup>1-3</sup> Most bladder cancers present as non-muscle invasive disease, in other words, confined to the mucosal or submucosal layer. Non-muscle invasive tumors of the bladder include: papillary or solid tumors restricted to the mucosal layer (Ta), the lamina propria (T1), and carcinoma in situ (CIS), which develops as a flat mucosal dysplasia, can be focal, diffuse or associated with a papillary/sessile tumor.<sup>4</sup> Complete resection is often possible and remains the standard of care for Ta

and T1 diseases. If left unchecked, patients recur and progress to advanced stage disease with invasion of surrounding muscle layers (T2-T3) or adjacent organs (T4). With respect to CIS, its diffuse nature makes surgical resection difficult. Moreover, >80% of patients with untreated CIS progress to invasive disease within 5 y.<sup>5,6</sup> Treatment of advanced disease is based on surgery (cystectomy), chemotherapy and radiotherapy. This has led to aggressive treatment of patients with early stage disease, aimed at preventing tumor recurrence and progression to muscle invasive and metastatic disease. Due to the superficial nature of the tumor and the ease of delivering therapeutic agents into the bladder, intravesical therapy was considered. Several chemotherapy regimens have been tested, but none have shown superiority

\*Correspondence to: Matthew Albert; Email: albertm@pasteur.fr  
Submitted: 08/24/11; Accepted: 08/26/11  
<http://dx.doi.org/10.4161/onci.1.1.17884>

over BCG treatment.<sup>7,8</sup> Moreover, patients with T1 disease who received immunotherapy regimens with intravesical BCG had 32–60% fewer tumor recurrences as compared with controls treated with intravesical chemotherapy.<sup>2,8,9</sup> BCG has been shown to be particularly effective in the eradication of CIS, with >80% of patients achieving cure in some of the reported clinical trials.<sup>3</sup>

Briefly, the benefits of intravesical instillation of BCG were first described by Morales and colleagues in 1976.<sup>10</sup> Controlled studies by the Southwest Oncology Group, reported in 1980, confirmed these findings and showed a clear advantage of BCG immunotherapy for patients with non-muscle invasive disease.<sup>11</sup> Nearly 30 y later, the treatment schedule established by Morales—one BCG instillation per week for 6 weeks—remains the standard of care. The accepted treatment model suggests that, immediately following instillation, interaction of BCG with bladder urothelium results in the induction of pro-inflammatory molecules, which serve to recruit innate immune cells. In particular, neutrophils and inflammatory monocytes are believed to be critical effector cells, capable of mediating the observed tumor immunity.<sup>12–16</sup> Specifically, innate cells have the capacity to degranulate in response to exposure to BCG, resulting in the bystander killing of tumor cells.<sup>17</sup> In support of this model, it has been demonstrated that BCG treatment induces surface expression of TRAIL on neutrophils, thus arming them with the capacity to induce tumor cell death.<sup>18–20</sup> In addition, inflammatory monocytes and natural killer cells are stimulated to produce high concentrations of effector cytokines.<sup>21–23</sup>

Based on data obtained in a previous observational clinical study in bladder cancer patients receiving intravesical BCG therapy as well as published experimental data, we concluded that multiple BCG treatments resulted in a “prime/boost” response for the innate immune system.<sup>21,24,25</sup> Intermittent intravesical therapy resulted in tissue remodeling with increased vascularization, thus accounting for a 200-fold increase in neutrophils influx, a 120-fold increase in inflammatory monocytes and a 30-fold increase in natural killer cells.<sup>21</sup> Using quantitative data from this study as well as our knowledge of the kinetics of bladder tumor growth, we reasoned that it would be possible to establish a mathematical model that could help test the prediction that the innate immune response accounts for the success of bladder cancer immunotherapy.

Here we propose a mathematical model of interactions between the innate immune system, BCG and bladder cells during BCG immunotherapy. The instillations are modeled as follows. BCG is instilled into the bladder for a period of two hours, resulting in the infection of both healthy urothelial cells and tumor cells. After two hours, the typical duration of one intravesical treatment, 99% of the BCG is flushed from the system, modeling micturition by the patient (Ref. 26 and unpublished data, Albert & Biot). Infected cells provoke an immune response and the influx of innate effector cells.<sup>27,28</sup> Engagement of cell-associated BCG or infected bladder cells triggers the activation and/or degranulation of the innate immune cells, thus resulting in the direct and bystander killing of tumor cells. We performed mathematical modeling of successive rounds of BCG therapy including the “prime/boost” response observed in our human subject

studies with peak innate effector cell concentrations reaching  $10^9$  effector cells by the third week of treatment. We assumed that the innate immune system is solely responsible for tumor elimination (i.e., independent of antigen-specific responses), and checked whether the resulting mathematical model withstands all constraints imposed by immunological data.

Analysis of the model system yields that the probability of achieving cure is critically determined by the fraction of tumor cells that are infected by BCG during instillation and the number of bystander cells killed by activated innate effector cells. Using available data on BCG immunotherapy as well as new experimental results, we tested the validity of our model and conclude that the innate immune system is not capable of itself achieving the observed tumor immunity.

## Results

**Estimation of the number of innate effector cells recruited and activated during BCG therapy by calibration of clinical trial data.** Neutrophils, inflammatory monocytes and natural killer cells are the main types of effector cells in the innate immune system and their infiltration into the bladder following intravesical instillation of BCG is predictive of treatment success.<sup>13,23,29,30</sup> Innate immune cells are essential in the defense against invading microorganisms (e.g., BCG), but their entry into peripheral tissue also results in bystander tissue trauma and the initiation of inflammatory cascades.

For innate immune cells to enter the bladder mucosa, they must undergo activation. This is believed to occur as a result of BCG interacting with urothelial cells, which triggers the secretion of inflammatory cytokines, chemokines and other bioactive molecules. After transmigration into the bladder parenchyma, innate cells migrate in a random manner,<sup>31</sup> until a further activation step is achieved. In the context of BCG-triggered bladder inflammation, neutrophils and monocytes/macrophages will likely engage and adhere to BCG-associated bladder and immune cells, resulting in cytokine production, degranulation and in the case of neutrophils, their production of extracellular structures called neutrophil extracellular traps (NETs).<sup>32</sup> Natural killer cells will be activated by stress induced self-proteins (e.g., MIC-A), resulting in their secretion of effector cytokines and upregulation of cell-death inducing agonists (e.g., TNF-SF molecules).<sup>33,34</sup> These processes are aimed at the killing of microorganisms, but they also result in their own death (referred to as “beneficial suicide”) as well as death of bystander cells.<sup>35</sup> Specifically, neutrophils and macrophages possess oxygen-dependent and oxygen-independent mechanisms of triggering cell death. Degranulation also results in the release of lipases, phospholipases and gelatinases, all of which are toxic for neighboring cells. Recent data further implicates cellular proteins, upregulated during inflammation, and in some instances shed from the cell surface into the extracellular milieu.

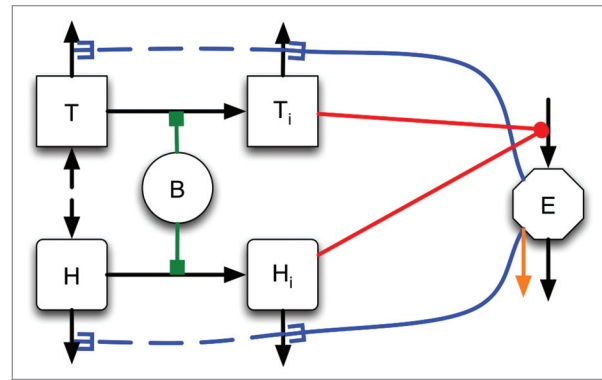
To provide a first evaluation of whether the innate immune response can account for the observed tumor immunity, we calculated the number of effector cells induced by therapy. Neutrophil degranulation events were used as a surrogate marker based on

their abundance and on the possibility to calibrate data based on MPO release. In vitro investigations revealed that a neutrophil can release  $\sim 4.5 \times 10^{-4}$  ng of MPO. Our previous clinical study established the concentration of MPO in the urine of patients at different time points following BCG instillation. Thus, we calculated that there are  $0.6\text{--}2.8 \times 10^6$  degranulation events during the first instillation and  $3.6\text{--}11.3 \times 10^6$  degranulation events during the third instillation. The total number of degranulations during six BCG instillations was estimated to be in the range of  $1.26\text{--}4.23 \times 10^7$  events. These estimates make the assumption that all of the degranulations observed are concentrated in the smallest number of neutrophils. One caveat is that, in vivo, neutrophils may be partially degranulated—this would translate into greater population number but weaker killing capacity per neutrophil.

Given that the tumor burden following surgical resection of T1G3 or CIS tumor is in the range of  $10^5\text{--}10^7$  tumor cells, it is theoretically possible that the innate immune system can account for the observed tumor immunity. The major caveat, however, concerns the innate immune system not having the capacity to direct their cytotoxic potential. In order to examine the possibility of the innate immune system as competent in mediating tumor immunity, we developed a mathematical model using parameters that reflect the biologic response to intravesical BCG. Where knowledge of the immunologic system remains uncertain, our assumptions were slanted to favor the immune system's ability to achieve tumor elimination.

**Modeling the BCG-induced response of the innate immune system.** Our model describes the dynamic interactions between the innate immune system, BCG, tumor and bladder cells during BCG immunotherapy; see the flow diagram in Figure 1. The model has 6 state variables. H denotes the number of healthy cells of the bladder tissue; T denotes the number of tumor cells; and B the number of free BCG bacteria in the bladder. We use the subscript i to denote cell populations that are infected by and/or associated with BCG. We thus use the symbols  $H_i$  and  $T_i$  for the number of infected tissue and tumor cells, respectively. E denotes the number of innate effector cells (e.g., neutrophils) that have extravasated into the bladder.

The model makes the following assumptions. *Assumption 1: In absence of therapy, the tumor remains largely undetected by the immune system.* This is based on the paucity of dendritic cells in the mucosal layer, in the resting bladder mucosa, and the histologic assessment of non-muscle invasive tumors as lacking hallmarks of inflammation. By this assumption, we are also excluding immune tolerance and/or the presence of regulatory immune cells as one of the mechanism that may hamper BCG-induced tumor immunity—again, favoring extinction of the tumor. *Assumption 2: During BCG instillations, free BCG becomes associated with tissue and tumor cells (green arrows in Fig. 1).* As the therapeutic mixture contains both live BCG capable of actively interacting with cells, and dead BCG that is internalized by the cell, we refer to BCG as becoming “cell-associated.” Cells associated with BCG include cells that have BCG adhered to their plasma membrane, cells that have phagocytosed BCG or components of dead bacilli, cells that have upregulated stress molecules (e.g., MIC-A) as a result of contact with BCG and cells that have



**Figure 1.** Diagram of our mathematical model. H and T denote the number of BCG-unassociated cells of the bladder tissue and tumor cells, respectively. E denotes the number of innate effector cells. B denotes the number of free BCG bacteria in the bladder.  $H_i$  and  $T_i$  denote the number of BCG-associated tissue and tumor cells, respectively. The model runs as follows. Before immunotherapy, only three of six cell populations are present: H, T and E. The interactions between these cell populations are negligible and their corresponding compartments are disconnected. The processes that take place for each of these independent compartments are “birth” (i.e., cell inflow and/or local proliferation) and “death” (i.e., cell outflow and/or homeostatic programmed cell death); see the vertical black arrows. During BCG instillations, three new populations of cells emerge creating dynamic interactions between all the compartments. Free BCG infects tissue and tumor cells (green arrows), inducing transitions of cells from H to  $H_i$  and T to  $T_i$  (horizontal black arrows).  $H_i$  and  $T_i$  cells activate innate immune effectors E (red arrows). In turn, E cells target  $H_i$  and  $T_i$  destroying them (blue continuous arrows) and neighboring H and T cells (blue dashed arrows) by innate effector mechanisms (e.g., cytokines, death receptor agonists, degranulations).

been actively infected by BCG. Experimental data indicates that BCG can become associated with urothelial cells and transitional cell carcinoma cell lines; additionally it has been demonstrated in human studies that small quantities of BCG ( $\sim 1\%$  of instilled dose) persist after voiding.<sup>26</sup> *Assumption 3: BCG instillations result in an increased recruitment of innate effector cells into the bladder tissue (red arrows in Fig. 1).* This is well established with quantitative data available from human subject studies and experimental animal models. *Assumption 4: Innate effector cells engaging with BCG-infected tissue or tumor cells become activated, are induced to secrete effector cytokines and in some instances degranulate. The activation process is the same whether the trigger is a BCG-associated tissue or tumor cell.* This assumption is based on findings of activated innate cells in urine following intravesical therapy and experimental work on co-cultures of BCG or BCG-infected cells and innate immune cells.<sup>21</sup> *Assumption 5: Activation of an effector cell (orange arrow in Fig. 1) results in bystander cell death—tissue or tumor cells in the vicinity of the effector cell may be killed (i.e., tissue and tumor cells); see the processes displayed with blue dashed arrows in Fig. 1).* Furthermore, activation in most instances triggers terminal differentiation and death of the effector cell. In the case of neutrophils and inflammatory monocytes, degranulation is known to result in the release of degradative intracellular proteins (e.g., elastase, heparanase, lipases) having the capacity to induce bystander cell death. In addition, activated innate cells

may secrete effector cytokines and/or express cell death inducing proteins (e.g., TRAIL). We acknowledge that the assumption that NK cells die rapidly after engagement of their effector mechanisms results in an underestimation of their killing capacity. In light of the clinical data, however, the relative paucity of NKs recruited to the bladder indicate that even with a high estimate of 10 killing events per NK, their effector function account for <10% of the combined innate response.<sup>21</sup>

Our model runs as follows: Before immunotherapy, only three of six cell populations are present: H, T and E. Notably, the tissue density of E in the bladder is low, but indeed there do exist resting immune cells in the healthy or tumor-bearing bladder. The interactions between these cell populations are negligible; i.e., their corresponding compartments in **Figure 1** are disconnected. The processes that take place for each of these independent compartments are “birth” (i.e., cell inflow and/or local proliferation) and “death” (i.e., cell outflow and/or homeostatic programmed cell death). During BCG instillations, three new populations of cells emerge creating dynamic interactions between all the compartments. Free BCG infects tissue and tumor cells (green arrows in **Fig. 1**), inducing transitions of cells from H to  $H_i$  and from T to  $T_i$  (horizontal black arrows in **Fig. 1**).  $H_i$  and  $T_i$  cells activate innate immune effectors E (red arrows). In turn, E cells target  $H_i$  and  $T_i$  destroying them and as well as H and T cells by bystander mechanisms. Finally, the presence of  $H_i$  and  $T_i$  cells triggers increased migration of effector cells into the bladder tissue. It is known that cellular influx increases significantly from the first to the third BCG instillation after which it plateaus.<sup>21,25</sup>

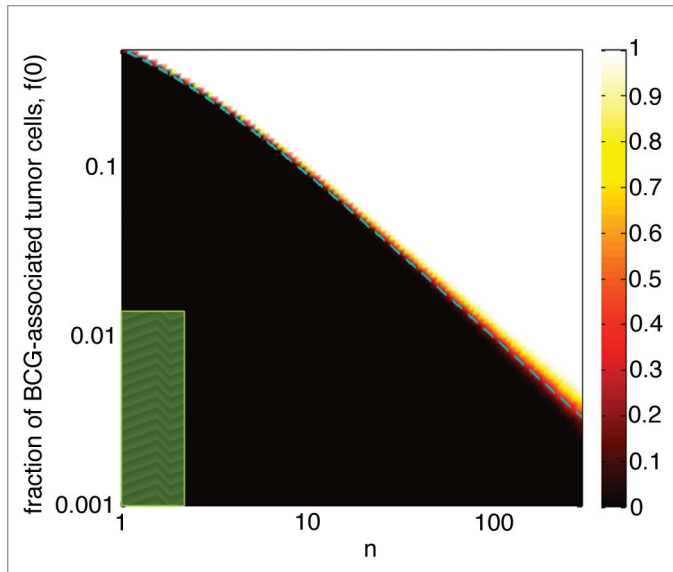
To establish the mathematical structure of our model of BCG immunotherapy, we make further assumptions. *Assumption 6: Modeling the population dynamics of uninfected tumor cells, we assume that the tumor grows into the bladder lumen and does not impinge upon surrounding tissue.* This assumption fits with the use of BCG in the treatment of non-muscle invasive disease, it reflects anatomy of the bladder with the lumen being a virtual space, and it is supported by the growth characteristics of the tumor, especially papillary lesions. As such, tumor size is limited only by the blood supply. We therefore chose a logistic model (i.e., the Verhulst model) to describe the dynamics of the tumor cell population in absence of BCG therapy.<sup>36,37</sup> We estimate the post-resection tumor burden to be in the range of  $10^5$ – $10^7$  tumor cells for papillary tumors (i.e., microscopic lesions  $\sim 10^6$  cells occupying  $\sim 1$  mm<sup>3</sup>) and  $10^7$ – $10^9$  tumor cells for CIS lesions (n.b., some treatment practices do not resect CIS due to its sessile nature and lesions may reach a tumor burden of  $10^{10}$  cells). As a starting point for our model, we use  $10^6$ , but have evaluated the effect of starting tumor burden as one of the determinants of tumor elimination (**Fig. S4**). Notably, our model focuses on post-resection BCG immunotherapy where the number of tumor cells is significantly less than the carrying capacity (i.e., the maximum number of tumor cells that the blood supply can sustain). Consequently, the logistic model will be mainly used in the regime of exponential growth. Therefore, the main results presented in this paper are not restricted by our choice of the logistic model and apply to all models of tumor cell replication in their regime of exponential growth. *Assumption 7: We consider the population of healthy tissue cells to be*

*very large when compared with other cell populations of interest and therefore do not use explicit equations to model the dynamics of H.* This assumption is based on the knowledge that BCG therapy does not result in the perforation of the bladder wall nor frank disruption of bladder function. *Assumption 8: We use mass-action to describe the mixing between the cell populations.* This is supported by BCG dispersion during intravesical therapy, adequate vascularization of all aspects of the bladder wall and non-specific migration patterns of innate immune cells as they enter inflamed tissue. (See discussion in the Model analysis section of the **Sup. Material** on how this assumption can be relaxed). *Assumption 9: The number of BCG dying during instillation (i.e., 2 h) is negligible.* The kinetics of natural cell death of BCG is slow and the host response is minimal within the first hours of BCG instillation. Thus, for the purpose of the model, we do not consider BCG death during the course of instillation therapy. *Assumption 10: BCG-associated cells do not undergo local proliferation.* This is supported by experimental data suggesting that BCG negatively impacts the cell growth of bladder tumor cell lines.<sup>38</sup> As such, local proliferation of BCG-associated cells does not factor into the dynamics of our model. *Assumption 11: Increase in the inflow of immune cells is expressed in a sigmoidal function, induced by the cumulative number of cells destroyed by innate effector cells, but counteracted by homeostatic pressure (i.e., healing of the bladder wall).* This assumption is supported by the observation that migration of effector cells is linked to the vascularization of the bladder wall, which evolves as a function of inflammation induced cell death.<sup>21,25</sup> As such, the increase in the inflow of immune cells depends on the number of BCG-associated cells present in the bladder, which are triggers for activation and effector activity of innate immune cells.

Based on these assumptions we developed a stochastic mathematical model (continuous-time Markov chain) of the cell population dynamics during BCG therapy (see Materials and Methods section).

**Model analyses.** We found that two quantities play a fundamental role in understanding the potential of the innate immune system for tumor elimination. The first quantity, which we denoted by  $n$ , is the number of bystander cells killed per innate immune cell activated and the second quantity, which we denoted by  $f(0)$ , is the fraction of tumor cells that associate with BCG during the last instillation. Numerical simulations of the stochastic model provide the probability of tumor extinction vs.  $n$  and  $f(0)$ ; see **Figure 2**. The white zone marks the region in the parameter space where tumor goes extinct while the black zone marks the region in the parameter space where tumor survives immunotherapy. A number of parameters determine this result; see **Table 1**.

For a better understanding of the tumor extinction process, we derived the mean-field approximation of our stochastic model. Thus, we obtained a set of ordinary differential equations whose analysis yielded an intuitive result (see **Sup. Material**): if tumor extinction occurred following completion of therapy, then, following the last instillation, the number of “free” tumor cells  $T(0)$  was smaller than the number of BCG-associated tumor cells  $T_i(0)$  multiplied by  $n$ , the average number of bystander tumor cells killed per innate effector cell activation, triggered by a  $T_i$  cell



**Figure 2.** Modeling results: The probability of tumor extinction was determined using a stochastic model for tumor growth. The results are bound by the number of bystander cells killed per innate effector mechanisms and the fraction of BCG-infected tumor cells infected by BCG during the last instillation. The probability map was obtained with the stochastic version of our model. The blue dashed line represents the necessary condition for tumor elimination that we obtained from the deterministic version of our model. Note that the stochastic and the deterministic results appear fairly close. The green shade defines the region of parameter values that are derived from clinical and observational data. The scaled color heat map indicates the probability of tumor extinction.

$$T(0) < n T_i(0); (1).$$

Note however that given the growth conditions of tumors within tissue (i.e., most tumor cells neighbor only tumor cells),  $n$  may be thought of as the number of bystander cells killed per innate effector cell activated. For convenience in presentation, we assign this interpretation to  $n$  as for the rest of the paper, favoring again the modeling outcome of tumor elimination; n.b. some BCG-associated tumor cells may neighbor tissue cells.

Following from **equation (1)**, infected tumor cells activate and trigger cytokine secretion and/or degranulation of innate effector cells (Assumption 5). Effector cytokines, engagement of death receptors and/or degranulation causes death of the infected tumor cell that triggered the response, killing in addition—on average— $n$  neighboring cells (bystander death), most of which would be uninfected tumor cells. Note that **equation (1)** can also be written as

$$f(0) (n+1) > 1, (2)$$

where  $f(0) = T_i(0)/[T_i(0) + T(0)]$  is the fraction of BCG-associated tumor cells after the flush of BCG.

Condition (2) is economic in parameters and provides a good approximation of the results obtained directly from running our stochastic model (see **Fig. 2**). It is important to note that condition (2) is necessary yet insufficient for tumor elimination for

**Table 1.** Parameters of the model

Parameter	Symbol	Value	Unit
Tumor proliferation rate parameter	$\beta$	0.11	day <sup>-1</sup>
Tumor death rate parameter	$\mu$	0.067	day <sup>-1</sup>
Tumor carrying capacity	$K$	$10^{11}$	cell
Number of cells destroyed per degranulation <sup>1</sup>	$n$	-	-
Predation coefficient of effector cells	$\kappa$	$5 \times 10^{-8}$	cell <sup>-1</sup> day <sup>-1</sup>
BCG infectiousness of tumor cells	$\rho$	$2 \times 10^{-9}$	cell <sup>-1</sup> day <sup>-1</sup>
Natural death rate of BCG-associated tumor cells	$\mu_i$	1/3	day
BCG rate of association to tissue cells	$\sigma$	0.1	day <sup>-1</sup>
Natural death rate of BCG-associated tissue cells	$\mu_h$	0.2	day
Inflow of effector cells in the bladder tissue <sup>2</sup>	$\pi$	345,000	cell/day
Deactivation and flushing rate of effector cells	$\mu_e$	0.345	day <sup>-1</sup>
Maximum recruitment rate of effectors due to BCG	$\alpha_1$	1000	Day <sup>-1</sup>
Minimum recruitment rate of effectors due to BCG	$\alpha_1/[1 + \exp(\alpha_2)]$	0.49	day <sup>-1</sup>
Scale of $C(t)$ for prime boost	$\alpha_3$	$10^{11}$	cell
Healing time of the bladder wall	$\tau$	33.3	day

<sup>1</sup>Study parameter. <sup>2</sup>Chosen such that the steady population of effectors in the bladder amounts to  $10^6$  cells.

two major reasons. First, BCG-associated tumor cells may die and thus not all of the cells present after the last BCG instillation trigger activation of the innate response. Second, tumor cells not associated with BCG undergo local proliferation and thus their number increases during immunotherapy. Both these phenomena suggest that, in fact, the number of BCG-associated tumor cells must be greater than  $T(0)/n$  to insure tumor elimination. (n.b. condition (1) can be refined as a necessary and sufficient condition within the deterministic framework—see **Sup. Material**). Overlaying the results of the deterministic model (represented by the dashed blue line in **Fig. 2**) on those from the stochastic version, we find that condition (2) provides a good approximation of the predictions of tumor elimination made by the stochastic model (see **Sup. Fig. S3** for sensitivity analysis).

**Table 2.** Stochastic processes and their corresponding rates

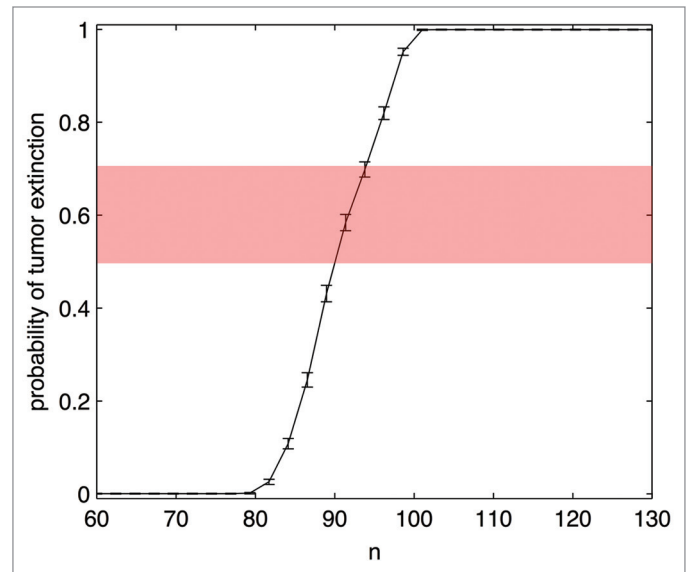
Process	Definition	Rate
Tumor proliferation	$T \rightarrow T + 1$	$\beta T$
Tumor death	$T \rightarrow T - 1$	$\mu T$
Tumor death due to shortage of blood supply	$T \rightarrow T - 1$	$(\beta - \mu)T(T + T_i)/K$
Tumor death due to degranulation	$T \rightarrow T - 1$	$n\kappa E T_i$
BCG-infection of tumor cells	$T \rightarrow T - 1,$	$\rho B T$
	$B \rightarrow B - 1$	
	$T_i \rightarrow T_i + 1$	
Infected tumor death	$T_i \rightarrow T_i - 1$	$\mu_i T_i$
Infected tumor death due to shortage of blood supply	$T_i \rightarrow T_i - 1$	$(\beta - \mu)T_i(T + T_i)/K$
Infected tumor death due to degranulation	$T_i \rightarrow T_i - 1$ $E \rightarrow E - 1$	$\kappa E T_i$
BCG-infection of tissue cells	$B \rightarrow B - 1$	$\sigma_B$
	$H_i \rightarrow H_i + 1$	
Infected tissue death	$H_i \rightarrow H_i - 1$	$\mu_H H_i$
Infected tissue death due to degranulation	$H_i \rightarrow H_i - 1$ $E \rightarrow E - 1$	$\kappa E H_i$
Neutrophil migration at homeostasis	$E \rightarrow E + 1$	$\pi$
Increased neutrophil migration due to BCG infection <sup>1</sup>	$E \rightarrow E + 1$	$\alpha(t)(T_i + H_i)$
Neutrophil deactivation and loss into the bladder lumen	$E \rightarrow E - 1$	$\mu_E E$

<sup>1</sup>See text for the definition of the function  $\alpha(t)$ .

**Validation of the theoretical condition for tumor elimination by the innate immune system.** To verify whether condition (2) applies in practice, we first estimated  $f(0)$ , the fraction of BCG-associated tumor cells. This was accomplished using in vitro exposure of bladder tumor cell cultures to  $10^6$ – $10^7$  CFU of BCG. After a 2 h exposure, ~1% of cells were found infected using acid fast staining (data not shown). One caveat, however, is that not all BCG are detected using acid fast staining, thus risking an underestimation of  $f(0)$ . As an alternate strategy, fluorescent BCG (GFP-expressing bacilli) were used; even with an extended exposure period of up to 48 h, we observed only 4–15% cell-associated BCG (data not shown).

Next, we used these in vitro findings and simulated the whole regimen of six BCG instillations to obtain the number of bystander cells killed per innate cell activated ( $n$ ) that would yield the expected 50–70% cure rate observed in clinical trials. We kept the ratio of the infected tumor cells  $f(0)$  ~1.5%. We thus estimated that 90–95 bystander cells must be killed per innate cell if the innate immune system is solely responsible for tumor elimination (Fig. 3). This number is consistent with condition (2).

To verify whether this estimate for  $n$  is realistic, we used two different approaches. Our first approach is based on clinical observations of bladder anatomy during BCG immunotherapy. There are  $2.4$ – $4.2 \times 10^8$  urothelial cells in the bladder, organized in 4–7 layers (~ $1.5 \times 10^7$  cells per layer of the bladder wall—see **Sup. Material**



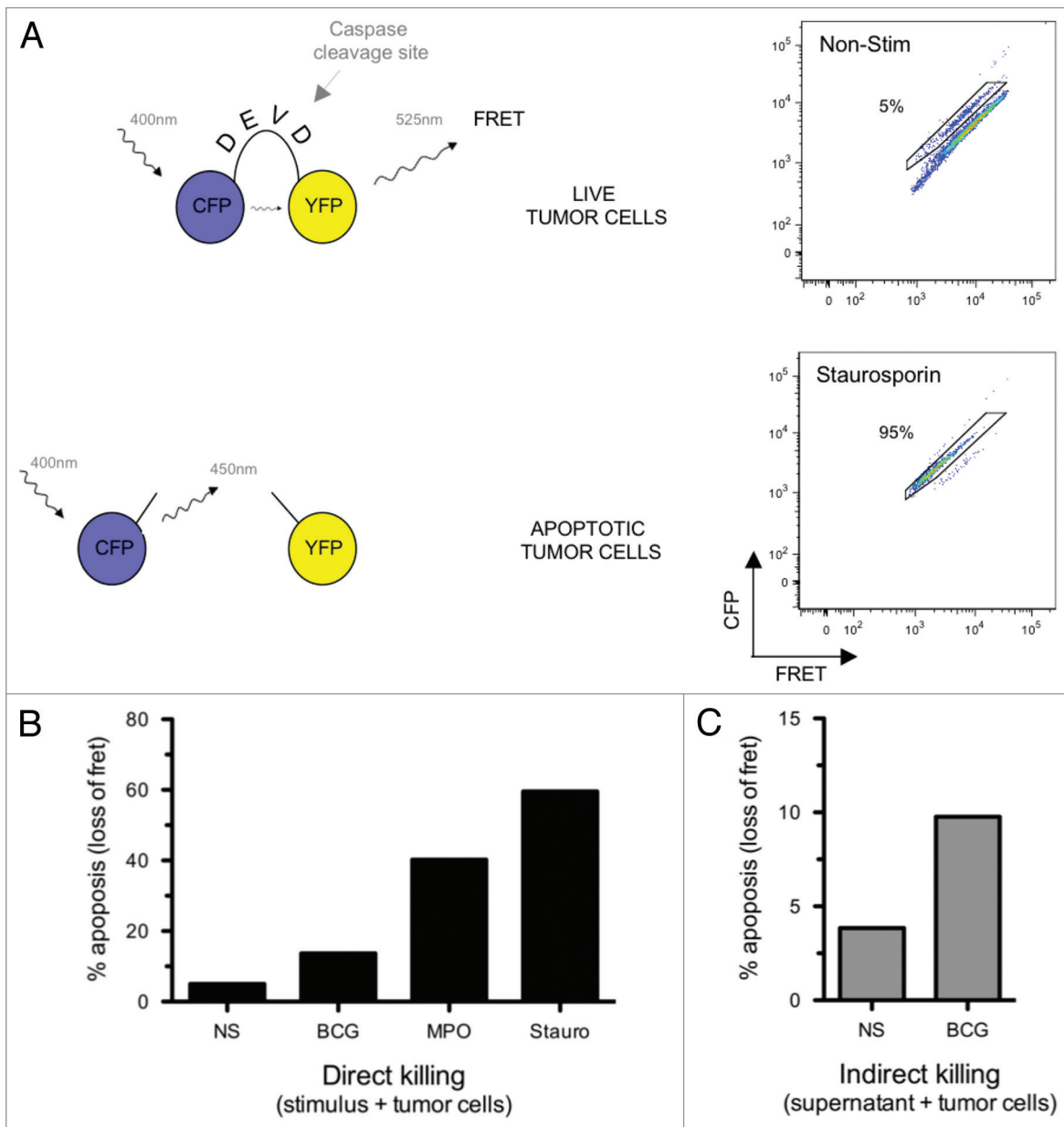
**Figure 3.** Modeling results: The probability of tumor extinction after 6 instillations (error bars indicate 95% confidence intervals) vs. the number of bystander cells killed. The red region includes the values of the probability of tumor extinction observed in clinical practice.

for how the estimation was made). Since on the calculated number of neutrophil degranulations to be in the range of  $1.26$ – $4.23 \times 10^7$  events (as detailed above), we could imagine sloughing of the outer 1–2 (out of 4–7) layers of the bladder wall. Given our estimate of neutrophil degranulations during immunotherapy, this is consistent with a kill capacity of  $n < 2$  cells/neutrophil degranulation. Considering that other innate effector cells have the possibility to induce cell death to the transitional epithelium, this is a high estimate of the tolerable bystander damage to the bladder wall.

In our second approach, we evaluated  $n$  experimentally by monitoring bystander death directly as measured by tumor cell apoptosis. Notably, continuous exposure of tumor cells to BCG resulted in ~14% of the tumor cells undergoing apoptosis among which up to 10% being attributed to bystander cell death mediated by innate immune cell activation (Fig. 4). These results translate into an experimentally determined kill capacity estimate of only  $n \sim 1$  cells/activated innate immune cell. We therefore conclude that the values for  $f(0)$  and  $n$  observed in clinical and experimental data belong to the green shaded region in Figure 2 where condition (2) is violated. Hence, tumor extinction mediated by the innate immune system acting on its own is highly improbable.

## Discussion

William Coley, in the late 1800s, was titrating sepsis and tumor immunity, observing the occasional remission of non-resectable sarcomas and sparking over a century's worth of clinical investigation as to how to harness the immune system for tumor immunotherapy. The use of BCG as adjuvant therapy in bladder cancer patients follows from Coley's initial findings, and notably, it represents perhaps the only reproducible intervention, resulting in 50–70% clinical response in



**Figure 4.** Estimation of bystander death by measurement of tumor cell apoptosis. (A) For detection of caspase-3 activity (apoptosis), we used EG7 cells expressing a FRET-based (Förster Resonance Energy Transfer) fluorescent probe sensitive to caspase-3 activity (see text). Apoptotic cells (loss of FRET and increase of CFP signal) were monitored by FACS. Here are shown two representative examples, for non-stimulated (Non-Stim) and staurosporin-stimulated cells. (B) The direct killing is measured by the percentage of apoptotic cells after 48 h incubation with no stimulus (NS),  $5 \times 10^6$  CFU/ml of BCG, 20 ng/ml of myeloperoxidase (MPO) or  $1 \mu\text{M}$  of staurosporine (Stauro). (C) The indirect killing is measured by the percentage of apoptotic cells after 48 h incubation with either supernatant from leukocytes alone (NS), or from leukocytes stimulated with  $5 \times 10^6$  CFU/ml of BCG. For the data presented in (B and C), more than 1,000 cells were analyzed (CV < 5%). The results are representative of three independent experiments.

patients with non-muscle invasive transitional cell carcinoma. While this therapy has been the standard of care for >30 y, only recently have investigators begun to establish immune correlates of tumor immunity. One area of research that has yielded important results concerns the innate immune response provoked by intravesical instillation of BCG. We and others, have reported massive influx of innate effector cells into the bladder; and several studies have illustrated the anti-tumor potential of activated neutrophils. Furthermore, there exist active lines of

clinical investigation aimed at enhancing neutrophil cytotoxicity. For example, BCG has been combined with type I IFN, with the aim of enhancing TRAIL expression on innate immune cells.<sup>39,40</sup>

Herein, we established a mathematical model to evaluate the capacity of the innate immune system to mediate the observed tumor immunity in patients receiving BCG therapy for their bladder cancer. Importantly, the model accurately reflected the recruitment and activation of innate immune cells during the 6-week course of BCG treatment. Strikingly, analyses and

simulations of our model indicated that a bystander kill rate of >90 cells per innate effector cell would be required to achieve tumor extinction. A kill radius of this magnitude would result in loss of integrity of the bladder wall. Furthermore, experimental data indicated that BCG-stimulated innate cells have only a modest bystander kill capacity. We therefore rejected our hypothesis that the innate immune system is solely responsible for tumor elimination and infer that other effector mechanisms are required to fully account for the clinically observed tumor immunity. Future studies will help establish the importance of the adaptive immune response and define whether antigen specific cells are targeting BCG or tumor derived antigen.

## Material and Methods

**Estimation of the number of innate immune cells recruited and activated during BCG therapy by calibration of clinical trial data.** Neutrophils are the most abundant cell type recruited into the bladder during the early phase of BCG therapy,<sup>21</sup> and there exists a restricted granule protein, myeloperoxidase (MPO), which can be used as a measure of in situ degranulation. As such, we based our initial estimations on neutrophil recruitment and activation. We performed in vitro activation of neutrophils and quantified the amount of MPO per cell. High concentrations of BCG (5 \* 10<sup>6</sup> colony forming units (CFU)) were added to titrated numbers of neutrophils thus achieving maximal stimulation (>70% of neutrophils fully degranulated under these conditions, based on loss of MPO staining by cytometry, data not shown). Culture supernatants were harvested after 6 h and the concentration of MPO was determined by ELISA. Using these data, we determined that a cell can release ~4.5 \* 10<sup>-4</sup> ng of MPO. To calibrate our clinical data, we utilized MPO release as a surrogate for neutrophils degranulation; and extrapolated these data to ascertain the infiltration of other innate cells.<sup>21</sup>

**Definition of stochastic mathematical model.** Based on the biological assumptions discussed in the Results section, we built a stochastic mathematical model of cell populations dynamics. A schematic of the model is the flow diagram in **Figure 1**. The model is a continuous-time Markov chain; its processes and the corresponding rates are defined in **Table 2**. The parameters of the model are listed in **Table 1**. We provide point estimates since most of the parameters are irrelevant for the necessary condition of tumor elimination, see **equation (2)**. The key parameters have been subject of uncertainty analyses (see **Sup. Figs. S3 and S4**). The process of prime/boost is modeled by a sigmoidal function  $\alpha(t)$  given by

$$\alpha(t) = \frac{\alpha_1}{1 + \exp[\alpha_2 - C(t) / \alpha_3]},$$

where  $C(t)$  represents the number of cells destroyed by the innate immune response discounted by an exponential healing factor

$$C(t) = \int_0^t du(n+1)[\kappa E(u)T_i(u) + \kappa E(u)H_i(u)]e^{-u/\tau}.$$

The initial conditions are as follows:  $T(0) = 10^6$ ,  $T_i(0) = 0$ ,  $H_i(0) = 0$  and  $E(0) = 0$ . For each instillation, B starts at 10<sup>9</sup> particles (which translated to ~10<sup>8</sup> CFU), but then it is set to zero at the end of the instillation. We integrated the stochastic model using an efficient tau-leaping method.<sup>41</sup> We tuned the model parameters such that the simulation results match biological data (see **Figs. S1 and S2**). Using mean-field methods, we performed analytical analyses of the model for a robust understanding of the key features of the cell population dynamics.

**Apoptosis measurements.** In order to estimate bystander death of tumor cell apoptosis we utilized EG7 cells expressing a FRET-based (Förster Resonance Energy Transfer) fluorescent probe sensitive to caspase-3 activity. FRET positive cells are scored as living cells. Following cleavage of the DEVD-linker sequence, cells lose FRET and increase their CFP signal, leading them to be scored as apoptotic cells. Assays were monitored by use of a FACS Canto II (Becton Dickinson). Direct killing was measured by the percentage of apoptotic cells after 48 h incubation with BCG. Indirect killing was measured by the percentage of apoptotic cells after 48 h incubation with supernatant from leukocytes stimulated with BCG. See the **Supplemental Material** for additional details.

### Disclosure of Potential Conflicts of Interest

No potential conflicts of interest were disclosed.

### Acknowledgments

This work was supported by La Ligue Contre le Cancer. C.R. acknowledges support from the Swiss National Foundation. The opinions and statements in this Article are those of the authors and do not represent the official policy, endorsement or views of Institut Pasteur.

### Supplementary Materials

Supplementary Material can be found at: [www.landesbioscience.com/journals/oncoimmunology/article/17884](http://www.landesbioscience.com/journals/oncoimmunology/article/17884)

## References

- Patton SE, Hall MC, Ozen H. Bladder cancer. *Curr Opin Oncol* 2002; 14:265-72; PMID:11981270; DOI:10.1097/00001622-200205000-00003.
- Alexandroff AB, Jackson AM, O'Donnell MA, James K. BCG immunotherapy of bladder cancer: 20 years on. *Lancet* 1999; 353:1689-94; PMID:10335805; DOI:10.1016/S0140-6736(98)07422-4.
- Brandau S, Suttman H. Thirty years of BCG immunotherapy for non-muscle invasive bladder cancer: a success story with room for improvement. *Biomed Pharmacother* 2007; 61:299-305; PMID:17604943; DOI:10.1016/j.biopha.2007.05.004.
- Metts MC, Metts JC, Milito SJ, Thomas CR Jr. Bladder cancer: a review of diagnosis and management. *J Natl Med Assoc* 2000; 92:285-94; PMID:10918764.
- Utz DC, Farrow GM. Management of carcinoma in situ of the bladder: the case for surgical management. *Urol Clin North Am* 1980; 7:533-41; PMID:7456165.
- Lamm DL. Carcinoma in situ. *Urol Clin North Am* 1992; 19:499-508; PMID:1636234.
- Lamm DL, Riggs DR, Traynelis CL, Nseyo UO. Apparent failure of current intravesical chemotherapy prophylaxis to influence the long-term course of superficial transitional cell carcinoma of the bladder. *J Urol* 1995; 153:1444-50; PMID:7714962; DOI:10.1016/S0022-5347(01)67427-5.



8. Malmström PU, Sylvester RJ, Crawford DE, Friedrich M, Krega S, Rintala E, et al. An individual patient data meta-analysis of the long-term outcome of randomised studies comparing intravesical mitomycin C versus bacillus Calmette-Guerin for non-muscle-invasive bladder cancer. *Eur Urol* 2009; 56:247-56; PMID:19409692; DOI:10.1016/j.euro.2009.04.038.
9. Meyer JP, Persad R, Gillatt DA. Use of bacille Calmette-Guerin in superficial bladder cancer. *Postgrad Med J* 2002; 78:449-54; PMID:12185215; DOI:10.1136/pmj.78.922.449.
10. Morales A. Intravesical therapy of bladder cancer: an immunotherapy success story. *Int J Urol* 1996; 3:329-33; PMID:8886906; DOI:10.1111/j.1442-2042.1996.tb00548.x.
11. Lamm DL, Thor DE, Harris SC, Reyna JA, Stogdill VD, Radwin HM. Bacillus Calmette-Guerin immunotherapy of superficial bladder cancer. *J Urol* 1980; 124:38-40; PMID:6997513.
12. De Boer EC, De Jong WH, Steerenberg PA, Aarden LA, Tetteroo E, De Groot ER, et al. Induction of urinary interleukin-1 (IL-1), IL-2, IL-6 and tumour necrosis factor during intravesical immunotherapy with bacillus Calmette-Guerin in superficial bladder cancer. *Cancer Immunol Immunother* 1992; 34:306-12; PMID:1540977; DOI:10.1007/BF01741551.
13. Sutmänn H, Riemensberger J, Bentien G, Schmaltz D, Stockle M, Jocham D, et al. Neutrophil granulocytes are required for effective Bacillus Calmette-Guerin immunotherapy of bladder cancer and orchestrate local immune responses. *Cancer Res* 2006; 66:8250-7; PMID:16912205; DOI:10.1158/0008-5472.CAN-06-1416.
14. Taniguchi K, Koga S, Nishikido M, Yamashita S, Sakuragi T, Kanetake H, et al. Systemic immune response after intravesical instillation of bacille Calmette-Guerin (BCG) for superficial bladder cancer. *Clin Exp Immunol* 1999; 115:131-5; PMID:9933432; DOI:10.1046/j.1365-2249.1999.00756.x.
15. Jackson AM, Alexandroff AB, Kelly RW, Skibinska A, Esuvaranathan K, Prescott S, et al. Changes in urinary cytokines and soluble intercellular adhesion molecule-1 (ICAM-1) in bladder cancer patients after bacillus Calmette-Guerin (BCG) immunotherapy. *Clin Exp Immunol* 1995; 99:369-75; PMID:7882559; DOI:10.1111/j.1365-2249.1995.tb05560.x.
16. Siracusano S, Vita F, Abbate R, Ciciliato S, Borelli V, Bernabei M, et al. The role of granulocytes following intravesical BCG prophylaxis. *Eur Urol* 2007; 51:1589-97; PMID:17222501; DOI:10.1016/j.euro.2006.11.045.
17. Clark RA, Klebanoff SJ. Neutrophil-mediated tumor cell cytotoxicity: role of the peroxidase system. *J Exp Med* 1975; 141:1442-7; PMID:165258; DOI:10.1084/jem.141.6.1442.
18. Rosevear HM, Lightfoot AJ, O'Donnell MA, Griffith TS. The role of neutrophils and TNF-related apoptosis-inducing ligand (TRAIL) in bacillus Calmette-Guerin (BCG) immunotherapy for urothelial carcinoma of the bladder. *Cancer Metastasis Rev* 2009; 28:345-53; PMID:19967427; DOI:10.1007/s10555-009-9195-6.
19. Simons MP, Leidal KG, Nauseef WM, Griffith TS. TNF-related apoptosis-inducing ligand (TRAIL) is expressed throughout myeloid development, resulting in a broad distribution among neutrophil granules. *J Leukoc Biol* 2008; 83:621-9; PMID:18063697; DOI:10.1189/jlb.0707452.
20. Griffith TS, Kucaba TA, O'Donnell MA, Burns J, Benetatos C, McKinlay MA, et al. Sensitization of human bladder tumor cells to TNF-related apoptosis-inducing ligand (TRAIL)-induced apoptosis with a small molecule IAP antagonist. *Apoptosis* 2011; 16:13-26; PMID:20734142; DOI:10.1007/s10495-010-0535-3.
21. Bisiaux A, Thioung N, Timsit MO, Eladaoui A, Chang HH, Mapes J, et al. Molecular analyte profiling of the early events and tissue conditioning following intravesical bacillus calmette-guerin therapy in patients with superficial bladder cancer. *J Urol* 2009; 181:1571-80; PMID:19230924; DOI:10.1016/j.juro.2008.11.124.
22. Seow SW, Rahmat JN, Bay BH, Lee YK, Mahendran R. Expression of chemokine/cytokine genes and immune cell recruitment following the instillation of *Mycobacterium bovis*, bacillus Calmette-Guerin or *Lactobacillus rhamnosus* strain GG in the healthy murine bladder. *Immunology* 2008; 124:419-27; PMID:18217952; DOI:10.1111/j.1365-2567.2007.02792.x.
23. Yutkin V, Pode D, Pikarsky E, Mandelboim O. The expression level of ligands for natural killer cell receptors predicts response to bacillus Calmette-Guerin therapy: a pilot study. *J Urol* 2007; 178:2660-4; PMID:17945285; DOI:10.1016/j.juro.2007.07.118.
24. Saban MR, Sferra TJ, Davis CA, Simpson C, Allen AM, Maier J, et al. Neuropilin-VEGF signaling pathway acts as a key modulator of vascular, lymphatic and inflammatory cell responses of the bladder to intravesical BCG treatment. *Am J Physiol Renal Physiol* 2010; 299:1245-56; PMID:20861073; DOI:10.1152/ajprenal.00352.2010.
25. Saban MR, Backer JM, Backer MV, Maier J, Fowler B, Davis CA, et al. VEGF receptors and neuropilins are expressed in the urothelial and neuronal cells in normal mouse urinary bladder and are upregulated in inflammation. *Am J Physiol Renal Physiol* 2008; 295:60-72; PMID:18463314; DOI:10.1152/ajprenal.00618.2007.
26. Durek C, Richter E, Basteck A, Rusch-Gerdes S, Gerdes J, Jocham D, et al. The fate of bacillus Calmette-Guerin after intravesical instillation. *J Urol* 2001; 165:1765-8; PMID:11342972; DOI:10.1016/S0022-5347(05)66410-5.
27. Kavoussi LR, Brown EJ, Ritchey JK, Ratliff TL. Fibronectin-mediated Calmette-Guerin bacillus attachment to murine bladder mucosa. Requirement for the expression of an antitumor response. *J Clin Invest* 1990; 85:62-7; PMID:2404029; DOI:10.1172/JCI114434.
28. Bevers RF, Kurth KH, Schamhart DH. Role of urothelial cells in BCG immunotherapy for superficial bladder cancer. *Br J Cancer* 2004; 91:607-12; PMID:15266312.
29. Simons MP, O'Donnell MA, Griffith TS. Role of neutrophils in BCG immunotherapy for bladder cancer. *Urol Oncol* 2008; 26:341-5; PMID:18593617; DOI:10.1016/j.urolonc.2007.11.031.
30. Ayari C, LaRue H, Hovington H, Decobert M, Harel F, Bergeron A, et al. Bladder tumor infiltrating mature dendritic cells and macrophages as predictors of response to bacillus Calmette-Guerin immunotherapy. *Eur Urol* 2009; 55:1386-95; PMID:19193487; DOI:10.1016/j.euro.2009.01.040.
31. Chtanova T, Schaeffer M, Han SJ, van Dooren GG, Nollmann M, Herzmark P, et al. Dynamics of neutrophil migration in lymph nodes during infection. *Immunity* 2008; 29:487-96; PMID:18718768; DOI:10.1016/j.immuni.2008.07.012.
32. Brinkmann V, Reichard U, Goosmann C, Fauler B, Uhlemann Y, Weiss DS, et al. Neutrophil extracellular traps kill bacteria. *Science* 2004; 303:1532-5; PMID:15001782; DOI:10.1126/science.1092385.
33. Cerwenka A, Lanier LL. Ligands for natural killer cell receptors: redundancy or specificity. *Immunol Rev* 2001; 181:158-69; PMID:11513137; DOI:10.1034/j.1600-065X.2001.1810113.x.
34. Zamai L, Ponti C, Mirandola P, Gobbi G, Papa S, Galeotti L, et al. NK cells and cancer. *J Immunol* 2007; 178:4011-6; PMID:17371953.
35. Smith JA. Neutrophils, host defense and inflammation: a double-edged sword. *J Leukoc Biol* 1994; 56:672-86; PMID:7996043.
36. Michelson S, Leith JT. Dormancy, regression and recurrence: towards a unifying theory of tumor growth control. *J Theor Biol* 1994; 169:327-38; PMID:7967626; DOI:10.1006/jtbi.1994.1155.
37. Bunimovich-Mendrazitsky S, Shochat E, Stone L. Mathematical model of BCG immunotherapy in superficial bladder cancer. *Bull Math Biol* 2007; 69:1847-70; PMID:17457655; DOI:10.1007/s11538-007-9195-z.
38. Jackson A, Alexandroff AB, Fleming D, Prescott S, Chisholm GD, James K. Bacillus-Calmette-Guerin (Bcg) Organisms Directly Alter the Growth of Bladder-Tumor Cells. *Int J Oncol* 1994; 5:697-703; PMID:21559633.
39. Nepple KG, Lightfoot AJ, Rosevear HM, O'Donnell MA, Lamm DL. Bacillus Calmette-Guerin with or without interferon alpha-2b and megadose versus recommended daily allowance vitamins during induction and maintenance intravesical treatment of nonmuscle invasive bladder cancer. *J Urol* 2010; 184:1915-9; PMID:20846688; DOI:10.1016/j.juro.2010.06.147.
40. O'Donnell MA, Krohn J, DeWolf WC. Salvage intravesical therapy with interferon-alpha 2b plus low dose bacillus Calmette-Guerin is effective in patients with superficial bladder cancer in whom bacillus Calmette-Guerin alone previously failed. *J Urol* 2001; 166:1300-4; PMID:11547062; DOI:10.1016/S0022-5347(05)65757-6.
41. Gillespie D, Petzold L. Improved leap-size selection for accelerated stochastic simulation. *J Chem Phys* 2003; 119:8229; DOI:10.1063/1.1613254.

# Mathematical model of tumor immunotherapy for bladder carcinoma identifies the limitations of the innate immune response

## SUPPLEMENTAL MATERIAL

Romulus Breban<sup>1</sup>, Aurelie Bisiaux<sup>2,3</sup>, Claire Biot<sup>2,3,4</sup>, Cyrill Rentsch<sup>2,3,5</sup>,  
Philippe Bouso<sup>6,7</sup> and Matthew Albert<sup>2,3</sup>

<sup>1</sup>*Institut Pasteur, Unité d'Epidémiologie des Maladies Emergentes, 75015 Paris, France*

<sup>2</sup>*Institut Pasteur, Unité d'Immunologie des Cellules Dendritiques, 75015 Paris, France*

<sup>3</sup>*INSERM U818, 75015 Paris, France*

<sup>4</sup>*Ecole Nationale Supérieure des Mines de Paris, 75272 Paris, France*

<sup>5</sup>*University of Basel, Basel, Switzerland*

<sup>6</sup>*Institut Pasteur, Unité des Dynamiques des Réponses Immunes, 75015 Paris, France*

<sup>7</sup>*INSERM U668, Equipe Avenir, 75015 Paris, France*

## Contents

<b>1</b>	<b>Estimation of the number of cells in the human bladder</b>	<b>2</b>
<b>2</b>	<b>Estimation of bystander death by measurement of tumor cell apoptosis</b>	<b>2</b>
<b>3</b>	<b>Simulation results</b>	<b>2</b>
<b>4</b>	<b>Analysis of the mathematical model</b>	<b>5</b>
<b>5</b>	<b>Discussion of the tumor elimination condition</b>	<b>6</b>
<b>6</b>	<b>Uncertainty analyses for Figure 2</b>	<b>7</b>
<b>7</b>	<b>Uncertainty analyses for Figure 3</b>	<b>7</b>

# 1 Estimation of the number of cells in the human bladder

We start from the fact that the volume of a full human bladder is approximately 0.5 liters. Approximating the shape by a sphere, the surface is approximately  $7.62 \times 10^{-3} \text{ m}^2$ . On the other hand, the perimeter of a bladder cell is  $80 \mu\text{m}$  [1] which yields a surface of section of approximately  $5.09 \times 10^{-10} \text{ m}^2$ . Dividing the bladder surface by the cell surface of section, we estimate the number of cells per layer of bladder wall to be  $1.5 \times 10^7$ .

# 2 Estimation of bystander death by measurement of tumor cell apoptosis

We monitored bystander death directly by measuring tumor cell apoptosis based on cleavage of caspase-3 [2,3]. We made use of EG7 cells expressing a FRET-based (Förster Resonance Energy Transfer) fluorescent probe sensitive to caspase-3 activity. CFP and YFP molecules are linked by a peptide containing the sequence DEVD (Asp-Glu-Val-Asp), that is cleaved by activated caspase-3. Cleavage of the probe upon caspase-3 activation resulted in FRET disruption (see Fig. 4A). EG7 cells were incubated for 48 hours in R10 media supplemented with 0.4 mg/ml of G418 and 0.2 mg/ml of hygromycin B with either  $5 \times 10^6$  CFU/ml of BCG, 20 ng/ml of myeloperoxidase or  $1 \mu\text{M}$  of staurosporine for assessing the direct killing. For indirect killing, EG7 cells were incubated for 48 hours with supernatant from leukocytes alone (NS, Non Stimulated), or from leukocytes stimulated with  $5 \times 10^6$  CFU/ml of BCG. After incubation, cells were washed twice in PBS and run on a BD FACS Canto II. Data were analyzed with the FlowJo software making a first gating on YFP+ cells and then measuring the frequency of CFP+ cells among this population (see gate in Fig. 4A). Apoptotic cells indeed show loss of FRET and increase of the CFP signal. Notably, continuous exposure of tumor cells to BCG resulted in  $> 14\%$  of the tumor cells undergoing apoptosis among which up to 10% being attributed to bystander cell death (Figs. 4B, C). These results translate into an experimentally determined kill capacity estimate of only  $n \approx 1$  cell per neutrophil degranulation.

# 3 Simulation results

Figure S1 shows a simulation of tumor growth in absence of BCG therapy. The simulation includes resection of tumor from the carrying capacity of  $\sim 10^{11}$  cells to  $\sim 10^6$  cells. The growth rate parameter  $r = \beta - \mu$  is tuned such that the re-growth of the tumor to a visible size (i.e.,  $\sim 10^8$  cells) takes about three months (according to clinical observation). Figure S2 shows a simulation of the dynamics of cell populations during BCG therapy. Panel **A** shows the percent of free BCG that is present in the bladder during the instillations. Note that  $\sim 99\%$  of the free BCG is flushed out weekly, after each instillation. The dynamics of the tumor cells (panel **B**) is marked by steep decreases in the cell population numbers due to BCG instillations followed by slight increases due to local proliferation. Panels **C** and **D** represent the dynamics of the population of BCG-associated tumor cells and BCG-associated tissue cells, respectively. The population of BCG-associated tumor cells is fairly small and undergoes extinction in between the BCG instillations. Panel **E** shows the dynamics of the population of innate effector cells. Note the significant growth in the number of effector cells after the third instillation, corresponding to the prime-boost effect. Panel **F** shows the change in the recruitment rate of innate effector cells due to vascularization and healing of the bladder wall.

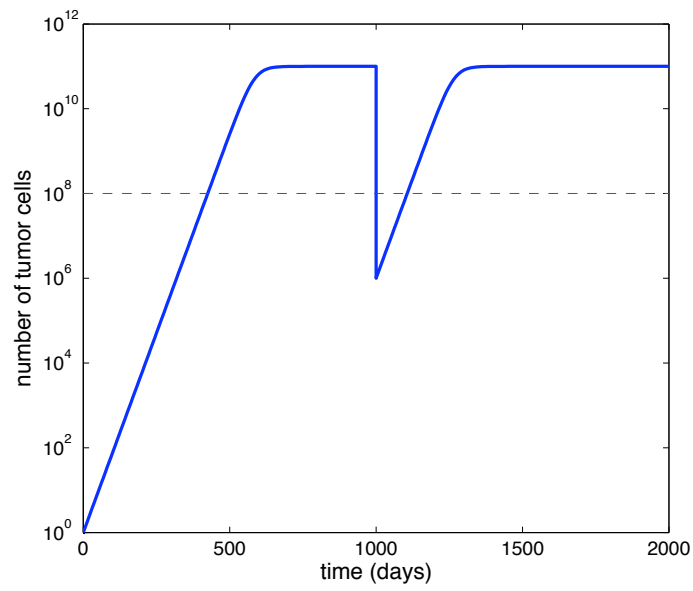


Figure S1: Simulation of logistic tumor growth, resection and tumor re-growth. The horizontal dashed line represents the approximate size of the tumor when the tumor is visible on the bladder wall.

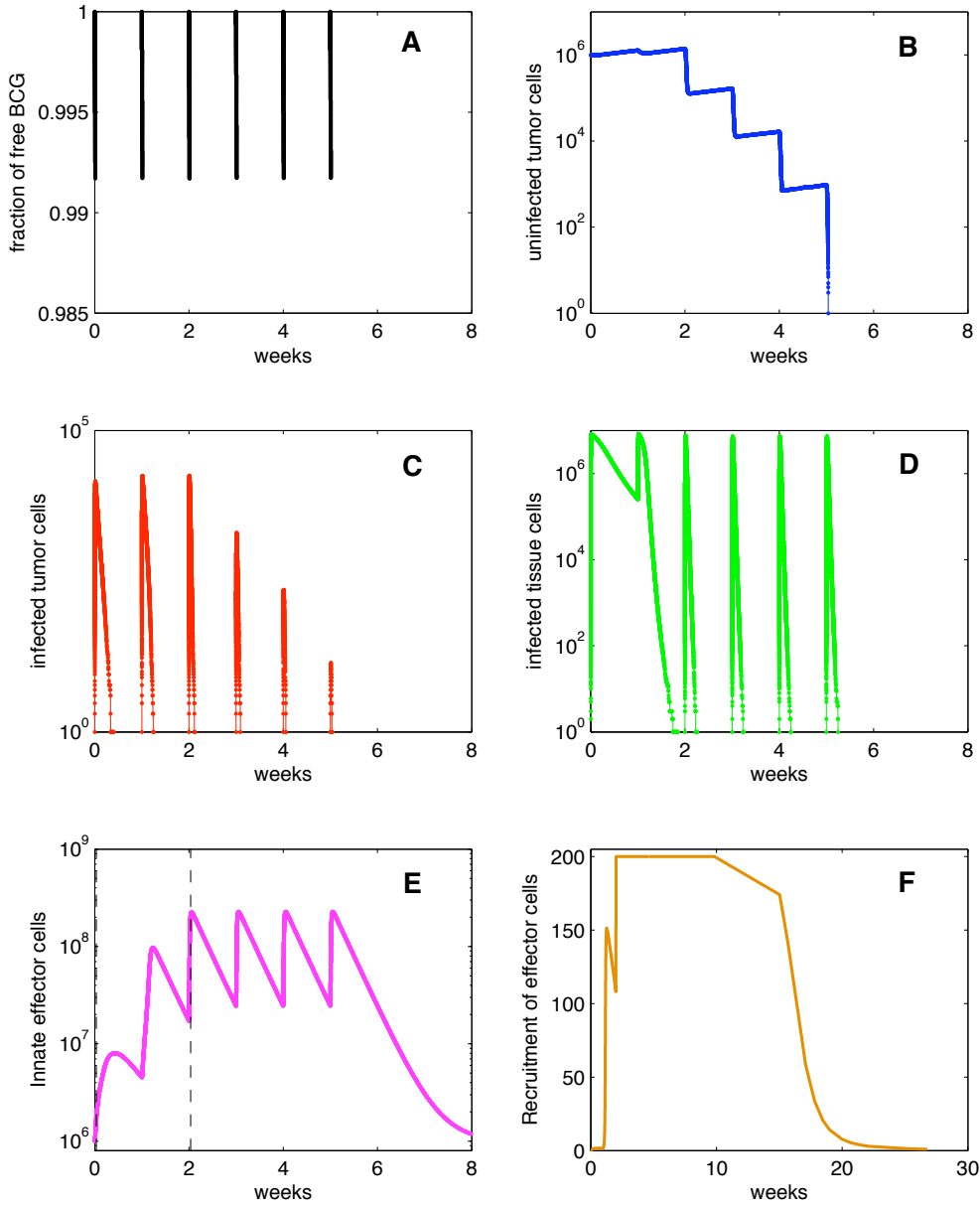


Figure S2: Simulation of population dynamics of cells during a six-week course of intravesical BCG therapy: BCG (panel **A**), tumor cells (panel **B**), BCG-associated tumor cells (panel **C**), BCG-associated tissue cells (panel **D**) and innate effector cells (panel **E**). Panel **F** represents the change in the recruitment rate of innate effector cells due to vascularization and healing of the bladder wall. Note the modeling of the prime boost response of the innate immune system which is clearly illustrated in panels **E** and **F**.

## 4 Analysis of the mathematical model

To obtain an understanding of the dynamics of the stochastic model we derived its mean-field approximation. Standard methodology [4] yields the following set of ordinary differential equations

$$\frac{dT}{dt} = rT \left(1 - \frac{T + T_i}{K}\right) - n\kappa ET_i - \rho BT, \quad (4.1)$$

$$\frac{dT_i}{dt} = \rho BT - \mu_i T_i - rT_i \left(\frac{T + T_i}{K}\right) - \kappa ET_i, \quad (4.2)$$

$$\frac{dH_i}{dt} = \sigma B - \mu_H H_i - \kappa EH_i, \quad (4.3)$$

$$\frac{dB}{dt} = -\rho BT - \sigma B, \quad (4.4)$$

$$\frac{dE}{dt} = \pi + \alpha(t)(T_i + H_i) - \mu_E E - \kappa ET_i - \kappa EH_i. \quad (4.5)$$

Note that we combined the parameters  $\beta$  and  $\mu$  into one by using the formula  $r = \beta - \mu$ ; the parameter  $r$  characterizes tumor growth.

We proceed to analyze the deterministic equations listed above under the following constraints. We consider our mathematical model to describe extinction of microscopic tumors that escaped surgical resection. Therefore, the number of tumor cells is  $\sim 10^6$  ( $\sim 1 \text{ mm}^3$  of tumor), much lower than the carrying capacity of the tumor, which is  $\sim 10^{11}$  cells (i.e.,  $(T + T_i)/K \ll 1$ ). We also focus on the last BCG instillation, when vascularization reached saturation (i.e.,  $\alpha(t) \equiv \alpha$  is approximately constant) and all free BCG has been eliminated (i.e.,  $B = 0$ ). Hence, Eqs. (4.1)-(4.5) become

$$\frac{dT}{dt} = rT - n\kappa ET_i, \quad (4.6)$$

$$\frac{dT_i}{dt} = -\mu_i T_i - \kappa ET_i, \quad (4.7)$$

$$\frac{dH_i}{dt} = -\mu_H H_i - \kappa EH_i, \quad (4.8)$$

$$\frac{dE}{dt} = \pi + \alpha(T_i + H_i) - \mu_E E - \kappa ET_i - \kappa EH_i. \quad (4.9)$$

Note that the variable  $T$  does not occur in Eqs. (4.7)-(4.9). These equations yield the dynamics of the system; once solved,  $T(t)$  can be obtained from the solution by using Eq. (4.6). Thus, we begin our analysis with Eqs. (4.7)-(4.9). It can be shown that these equations (i) yield non-negative solutions for all sets of non-negative initial conditions; and (ii) have a unique fixed-point solution given by  $(T_i, H_i, E) = (0, 0, \pi/\mu_E)$ . The fixed point is stable, having strictly negative eigenvalues for all biologically relevant parameter values. Since the right hand sides of Eqs. (4.7) and (4.8) are strictly negative as long as  $T_i$  and  $H_i$  remain positive, this fixed point represents a global attractor. Analytical characterization of the transients leading to the global attractor remains intractable.

Equation (4.6) can be formally solved using the method of variation of constants; we thus obtain

$$T(t) = T(0)e^{rt} - ne^{rt} \int_0^t du [\kappa E(u)T_i(u)]e^{-ru}, \quad (4.10)$$

where  $t = 0$  represents the moment of time when free BCG is flushed after the last instillation. Since  $T(t)$  is not positively defined, we can formulate a condition that tumor survives immunotherapy

$$T(t)|_{t \rightarrow \infty} > 0. \quad (4.11)$$

Using Eq. (4.10), this condition can be written as

$$\frac{T(0)}{n} > \int_0^\infty du [\kappa E(u)T_i(u)]e^{-ru} \equiv \kappa \mathcal{L}[ET_i](r), \quad (4.12)$$

where  $\mathcal{L}[\cdot]$  denotes the Laplace transform. Since for all solutions of Eqs. (4.7)-(4.9),  $E(t)|_{t \rightarrow \infty} \rightarrow \pi/\mu_E$  and  $T_i(t)|_{t \rightarrow \infty} \rightarrow 0$ ,  $\int_0^\infty du E_i(u) T_i(u) e^{-ru}$  is finite and the Laplace transform exists. Using Eq. (4.7), Eq. (4.12) becomes

$$[T_i(0) - T(0)/n] < (r + \mu_i) \mathcal{L}[T_i](r). \quad (4.13)$$

Note that Eq. (4.13) applies to situations more general than those specified by our assumptions listed in the main text. In fact, Eq. (4.13) can be obtained by simply assuming that the mixing between  $E$  and  $T_i$  is independent of  $T$ ; Assumption 8 is unnecessarily strong.<sup>1</sup> In fact, Assumption 8 is made as such only for concreteness of the model in numerical applications.

## 5 Discussion of the tumor elimination condition

The necessary and sufficient condition for tumor elimination [c.f., Eq. (4.13)] is given by

$$[T_i(0) - T(0)/n] > (r + \mu_i) \mathcal{L}[T_i](r), \quad (5.14)$$

where the right hand side of the inequality depends on the parameters of the tumor and those of the interactions between the innate immune system, BCG and tumor cells (see Table 1 in the main text). Since  $(r + \mu_i) \mathcal{L}[T_i](r) > 0$ , the condition

$$[T_i(0) - T(0)/n] > 0 \quad (5.15)$$

is necessary but not sufficient for tumor elimination. The interpretation of Eq. (5.15) is straightforward. Consider  $T_i(0)$  BCG-associated cells triggering innate effector cell responses. Each innate cell activation event destroys the trigger  $T_i$  cell and  $n$  neighboring  $T$  cells. The necessary condition that all  $T$  cells are destroyed is given by Eq. (5.15). However, in general, this condition is not sufficient because it fails to account for the fact that  $T_i$  cells may die at fairly high rate while  $T$  cells proliferate. Note that in the case where  $T_i$  cells do not die (i.e.,  $\mu_i = 0$ ) and tumor does not grow (i.e.,  $r = 0$ ), the necessary and sufficient condition for tumor elimination Eq. (5.14) is equivalent to Eq. (5.15).

Introducing the variable  $f(0) = T_i(0)/[T(0) + T_i(0)]$  to denote the fraction of BCG-associated tumor cells after the last flush of BCG, Eq. (5.15) can be rewritten as

$$(n + 1)f(0) > 1. \quad (5.16)$$

Although not sufficient for tumor elimination, the virtue of Eq. (5.16) lies in its parsimony and ease of biological interpretation, as most model parameters are irrelevant for this inequality.

We note that BCG immunotherapy is very effective, with a chance of success  $\sim 50$ -70%. Thus, if our model were correct and the innate immune system would be entirely responsible for tumor elimination, Eqs. (5.15) and (5.16) would have necessarily held for more than the fraction of cured patients. (The necessary and sufficient condition, Eq. (5.14), would have held for  $\sim 50$ -70% of the patients.)

---

<sup>1</sup>Replace the mass-action term  $\kappa ET_i$  by an abstract function  $\mathcal{F}(T_i, H_i, E)$ , independent of  $T$ . The derivation of Eq. (4.13) proceeds similarly.

## 6 Uncertainty analyses for Figure 2

In this section we show how the Figure 2 in the main text changes with the number of tumor cells left in the bladder before the sixth BCG instillation.

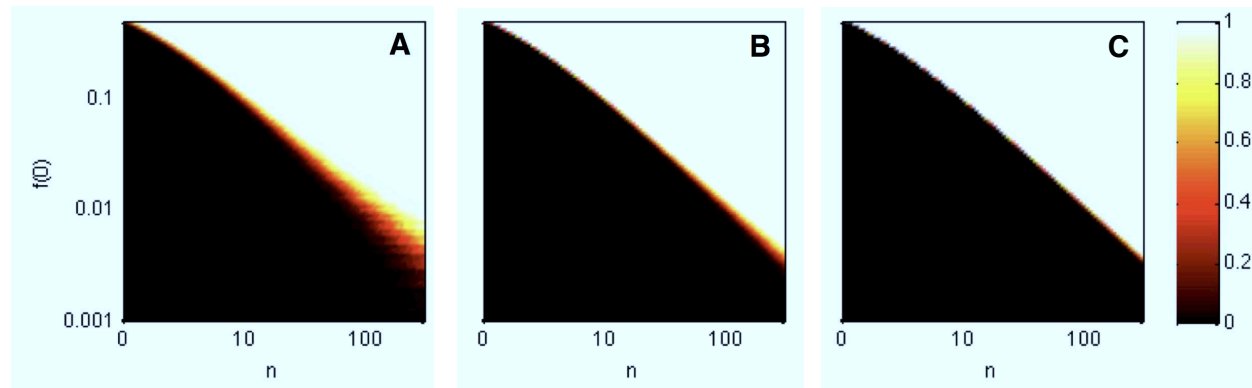


Figure S3: Change in Figure 2 in the main text with the total number tumor cells remained after the last BCG instillation. Panels **A**, **B** and **C** have been obtained using an initial total number of tumor cells (i.e.,  $T(0) + T_i(0)$ ) of  $10^3$ ,  $10^4$  and  $10^5$ , respectively. (Panel **B** corresponds to Fig. 2 in the main text.) With increasing the total number of tumor cells, the width of the border between the region where tumor persist and that where tumor is eliminated becomes narrower. This result is expected since with decreasing the initial number of tumor cells, there is a higher probability that tumor goes extinct simply due to chance. Note however that the main features of the figure do not change with the total number tumor cells.

## 7 Uncertainty analyses for Figure 3

In this section we show how the Figure 3 in the main text changes with the number of tumor cells left in the bladder after resection. The colored curves in Fig. S4 show the probability of tumor extinction after six BCG instillations versus the number of bystander cells killed per innate cell activated and/or triggered to degranulate, for three different numbers of tumor cells:  $10^2$  (purple),  $10^4$  (blue) and  $10^6$  (black). Note that even for  $10^2$  tumor cells, elimination of tumor vastly exceeds the capacity of the innate immune system.

We also note that, while a low initial number of tumor cells would generally favor tumor elimination (especially at high  $n$  values), this is not the case at low values of  $n$ . The explanation of this phenomenon lies in the fact that tumor elimination by the innate immune system critically depends on the ability of BCG to associate with tumor cells during the instillation. With decreasing the initial number of tumor cells, the probability that no tumor cell will be BCG-associated during therapy increases. For example, if 50 tumor cells are left post resection, then the expected number of BCG-associated tumor cells after one instillation is  $\sim 0.5$  since, every instillation, only  $\sim 1\%$  of the tumor cells are expected to become BCG-associated. Thus, some instillations would fail; no tumor cells would become BCG-associated and unassociated tumor cells would not be subject to bystander death. In contrast, if the number of tumor cells is large then instillations do not fail.



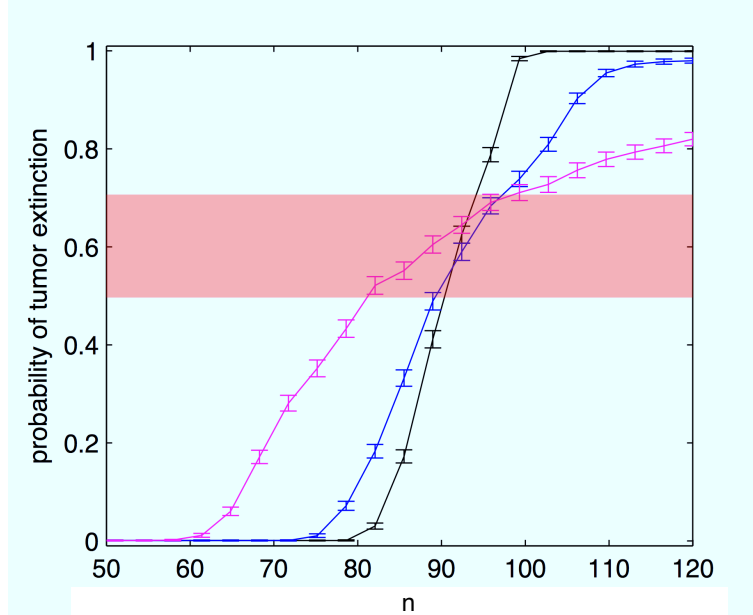


Figure S4: Change in the Figure 3 in the main text with the number tumor cells left after resection. The colored curves show the probability of tumor extinction after six instillations (the error bars indicate 95% confidence intervals) versus the number of bystander cells killed per innate cell activated and/or triggered to degranulate, for three different numbers of tumor cells left after resection:  $10^2$  (purple),  $10^4$  (blue) and  $10^6$  (black). The red region includes the values of the probability of tumor extinction observed in clinical practice. Note that even for  $10^2$  tumor cells left after resection, elimination of tumor by the innate immune system at probability observed in clinical practice requires  $n$  values larger than 80. This vastly exceeds the capacity of the innate immune system.

## References

- [1] M. E. Boon, P. H. Kurver, J. P. Baak, and E. C. Ooms, "Morphometric differences between urothelial cells in voided urine of patients with grade I and grade II bladder tumours," *J Clin Pathol*, vol. 34, pp. 612–5, 1981.
- [2] R. K. Srivastava, "TRAIL/Apo-2L: Mechanisms and clinical applications in cancer," *Neoplasia*, vol. 3, pp. 535–46, 2001.
- [3] M. C. Myzak and A. C. Carr, "Myeloperoxidase-dependent caspase-3 activation and apoptosis in HL-60 cells: protection by the antioxidants ascorbate and (dihydro)lipoic acid," *Redox Rep*, vol. 7, pp. 47–53, 2002.
- [4] N. T. Bailey, *The Mathematical Theory of Infectious Diseases*. Hafner Press/ MacMillian Pub. Co., 1975.

**BCG-mediated bladder cancer immunotherapy: Identifying determinants of treatment response using a calibrated mathematical model**

Cyrill A. Rentsch<sup>1,2</sup>, Claire Biot<sup>2-4</sup>, Joël R. Gsponer<sup>1,2</sup>, Alexander Bachmann<sup>1</sup>,  
Matthew L. Albert<sup>2,4</sup>, and Romulus Breban<sup>5</sup>

**Affiliations:**

<sup>1</sup>*Department of Urology, University Hospital of Basel, University of Basel, CH-4031 Basel, Switzerland*

<sup>2</sup>*Institut Pasteur, Unité d'Immunologie des Cellules Dendritiques, 75015 Paris, France*

<sup>3</sup>*Ecole Nationale Supérieure des Mines de Paris, 75272 Paris, France*

<sup>4</sup>*INSERM U818, 75015 Paris, France*

<sup>5</sup>*Institut Pasteur, Unité d'Epidémiologie des Maladies Emergentes, 75015 Paris, France*

**Key words:** bladder cancer, BCG, mathematical model, adaptive immune response

**Grant Support:** This work was supported by La Ligue Contre le Cancer and Association pour la recherche sur le cancer. CAR acknowledges support from the Swiss National Foundation.

The opinions and statements in this article are those of the authors and do not represent the official policy, endorsement, or views of Institute Pasteur.

Word count abstract: 284

Word count main text: 2121

References: 20

## Abstract

**Background:** Intravesical Bacillus Calmette Guérin (BCG) immunotherapy is considered the standard of care for treatment of non-muscle invasive bladder cancer, however the treatment parameters were established empirically.

**Objective:** To evaluate optimal clinical parameters of BCG induction therapy using an *in silico* approach, we constructed and queried a new mathematical model. Specifically, we assessed the impact of (1) duration between resection and the first instillation; (2) BCG dose; (3) indwelling time; and (4) treatment interval of induction therapy – using cure rate as the primary endpoint.

**Design, Setting, and Participants:** Using clinical and *in vitro* experimental data, we constructed and parameterized a stochastic mathematical model describing the interactions between BCG, the immune system, the bladder mucosa and tumor cells.

**Outcome Measurements and Statistical Analysis:** The primary endpoint of the model was the probability of tumor extinction following BCG induction therapy in patients with high risk for tumor recurrence.

**Results and Limitations:** Our mathematical model incorporates known fundamental concepts of BCG immunotherapy of bladder cancer. We demonstrate that extending the duration between the resection and the first BCG instillation negatively influences treatment outcome. Higher BCG doses and longer indwelling times both improved the probability of tumor extinction. A remarkable finding is that an inter-instillation interval two times longer than the seven-day interval used in the current standard of care would substantially improve treatment outcome. The major limitation of our model lies in its parsimony. Lacking immunological knowledge, is modeled “in bulk”. As such, our model provides robust qualitative predictions, however, its quantitative predictions may be limited.

**Conclusions:** We provide insight into relevant clinical questions using a new mathematical model. Our model predicts an altered regimen that may decrease side effects of treatment while improving response to therapy.

## Introduction

Adjuvant treatment of non-muscle invasive bladder cancer (NMIBC) using intravesical *Bacillus Calmette-Guérin* (BCG) after transurethral resection was established empirically almost 40 years ago [1]. While BCG therapy remains the standard of care, critical parameters influencing treatment outcome are still poorly understood. In a previous study, we constructed a mathematical model that was calibrated to clinical data to evaluate the ability of the innate immune system as the principle effector arm responsible for response to therapy. We demonstrated that the effector function of the innate immune response is not potent enough to yield the cure rates observed in clinical practice [2]. We therefore concluded that components of the adaptive immune system must play a critical role in tumor elimination. Adaptive immune effector cells (e.g., T lymphocytes) are distinct from most innate populations as they are long-lived, possess properties of antigen specificity and immunologic memory, with the possibility of interacting with multiple target cells during a single round of activation. Estimates based on experimental data suggest that a single cytolytic T lymphocyte has the potential to kill ten target cells before it requires re-activation by an antigen presenting cell [3]. Moreover, the existence of a memory pool of antigen-specific T cells enables a more robust adaptive immune effector cell response upon secondary re-exposure to BCG.

Using a refined mathematical model, we address several clinical parameters in order to ascertain their impact for an optimal protocol of successful BCG immunotherapy. Specifically, we used clinical and *in vitro* experimental data to construct and parameterize a new stochastic mathematical model describing the interactions between BCG, the immune system, and tumor cells with the primary endpoint being the probability of tumor extinction. Our model is parsimoniously designed to describe the core biological components and interactions, a complex body of concepts that is otherwise difficult to grasp. We do not aim for precise quantitative results but rather for a robust qualitative understanding that would remain valid for future models that could integrate increasing levels of detail. Herein, we assess the impact of: (1) varying the time from resection to BCG instillation, (2) modulating the BCG dose used during intravesical instillation, (3) the indwelling time of BCG, and (4) the inter-instillation interval.

Our results indicate that all parameters investigated impact the response to treatment. The most surprising result concerned the impact of the inter-instillation interval, where simulations suggested that an interval two times longer than the seven-day interval used in the current standard of care, would substantially improve

treatment outcome. Our study provides useful insight and testable hypotheses that could lead to improved management NMIBC.

## Design and Methods

Our model describes the dynamic interactions triggered by BCG instillation. Prior to initiation of BCG therapy, three cell populations are present: healthy urothelium tissue, tumor and innate immune cells. The interactions between these cell populations are negligible. The processes that take place for each of these cell populations before therapy are cell migration and/or local proliferation and death (**Figure 1** for schematic; and **Figure S1** for simulation of tumor growth). Of note, adaptive immune cells (e.g., antigen-specific T cells) are not present pre-BCG therapy as their entry into the dynamic model requires priming. During BCG instillations, live BCG is capable of actively interacting with cells while dead BCG may be internalized by cells; we refer to BCG as becoming “cell-associated,” to denote either of these two possibilities. As a result of association with BCG, four new cell populations emerge that are linked by dynamic interactions to the previously present cell populations in the bladder: (1) BCG-associated urothelial cells, (2) BCG-associated tumor cells, (3) activated innate immune cells and (4) activated adaptive immune cells. BCG associates to healthy urothelial cells and tumor cells, which in turn triggers increased migration and activation of innate immune cells into the bladder. Innate immune effector cells target BCG associated urothelial and tumor cells, destroying them as well as their neighboring healthy mucosa and uninfected tumor cells [2]. The repeated and boosted inflammation triggers the priming and eventual recruitment of adaptive immune effector cells. Cells of the adaptive immune system may be specific to BCG antigen, thus targeting BCG associated urothelial and tumor cells; but they may also include tumor antigen-specific effector cells, thus permitting the direct targeting of uninfected tumor cells. The model is parameterized such that the simulated dynamics of the cell populations are in agreement with *in vivo* data (**Figure S2**) and the observed probability of tumor elimination being ~50%. Further details on the model and its parameterization are outlined in the supplemental information.

## Results

Using the parameterized mathematical model, we evaluated treatment parameters believed to influence clinical response. First, we determined the influence of the time interval between surgery and initiation of BCG treatment. The model calculated the probability of tumor extinction after six weekly instillations as a function of the post resection time (**Figure 2A**). The shorter the interval from surgery to BCG therapy, the greater is the chance for achieving clinical response. This result is due to the continued expansion of residual tumor cells post-resection, increasing the burden of disease and challenging the limited kill capacity of the immune system.

The model was further queried to determine impact of BCG dose and dwell time in the bladder. We noted a clear positive correlation between BCG dose and probability of tumor extinction (**Figure 2B**). Strikingly, small changes in dose are predicted to have a significant impact on therapeutic success. BCG is commonly delivered at a range between  $10^8$  to  $10^9$  CFUs / vial. According to our model, such a 10-fold difference in dose results in ~40% differential response to treatment. As a corollary, we examined the dwell time (i.e., the duration of BCG instillation). Again, we find that greater exposure of the bladder mucosa to BCG results in an increased probability of tumor extinction (**Figure 2C**). These results provide a stark reminder of the importance of adhering to, at minimum, the current guidelines for BCG immunotherapy.

Recent data regarding the delayed timing of T cell priming following mycobacterial infection [4], or BCG intravesical instillation (unpubl. data, C. Biot et al), suggested that the current treatment schedule may not be properly tuned to the kinetics of adaptive immune responses. Therefore, the impact of varying inter-instillation timing was assessed. We maintained the first three weekly doses, as this is required for priming adaptive immune responses and initiating bladder inflammation [5]; and we modeled the optimal time interval between the third through sixth treatment dose, designated  $n$  (**Figure 3A**). Following from the parameterization conditions, six weekly instillations resulted in the expected cure rate of 50%. Shorter inter-instillation duration negatively impacted clinical response (**Figure 3B**). Remarkably, the model indicates an optimal treatment interval that is twice longer than the current standard of care, with no negative impact if extended up to 30 days (**Figure 3B**). These data are intriguing as the modified treatment regimen engages the afferent immune response during the early phase of treatment and maximally benefits from the effector potential of the efferent adaptive response. Moreover, the proposed schedule may help lessen some of the side effects seen during conventional therapy.

**Discussion:**

Using a mathematical model we evaluated clinically relevant questions of BCG therapy in NMIBC. The model revealed that therapeutic success depends strongly on the timing of the BCG regimen. An early start of BCG therapy after TUR, combined with an optimal dwell time and treatment inter-instillation interval, do, in fact, have profound influence on treatment outcome, according to our model.

There are no current guidelines advising when to start BCG therapy after surgery. Delay is considered important for the healing of the bladder wall, and the prevention of systemic complications due to BCG therapy. Therefore, most urologists wait 2-6 weeks prior to starting BCG therapy; however, in some studies intravesical treatment has been initiated as early as 1 week after transurethral resection [6,7]. To date, no prospective comparisons of different delays to start of BCG treatment have been performed. Our model indicates that a prolonged delay in initiating BCG therapy could negatively impact recurrence rates (**Figure 2A**). Analysis of the model suggested that the increased risk for recurrence was related to outgrowth of residual tumor cells.

Changes in dose and dwell time have been discussed on the basis of reducing side effects. Dose reduction has been assessed in several clinical trials [8-13]. Reducing BCG dose to one third was considered as a strategy aimed at lowering side effects. This lower dose remained significantly better than mitomycin; whereas one sixth of the BCG dose was not better than the use of mitomycin alone [11,13]. These findings corroborate our modeling results regarding the influence of dose on the cure rate (**Figure 2B**). Our model also shows that increasing the dose increases therapeutic success. However, this would probably occur at the cost of enhancing side effects.

Reduction of dwell time has been reported as a possibility for improving therapy and as an alternative to dose reduction in patients with severe side effects [14] but no prospective study has compared BCG dwell time as a variable. Our model indicates that increased dwell time might also influence treatment outcome (**Figure 2C**). This could be of special importance in patients with minimal symptoms that may benefit from enhanced BCG-mediated immune activation.

Perhaps the most striking finding is the observation that the optimal treatment interval is twice as long as the current schedule for managing patients (**Figure 3**). This finding is likely related to the kinetics of T and B cell activation, and the persistence of these relatively long-lived effector cells in the bladder. By



extending the treatment interval during the effector phase, we have succeeded in enhancing the time period in which the immune system may exert negative pressure on the residual tumor burden. Only limited information is available from clinical trials where the treatment interval was modified during BCG induction therapy. Studies in mice indicated that the number and timing of the instillations are important in determining different local cytokine profiles, which in turn may influence the qualitative and quantitative recruitment of adaptive effector cells [15]. Such findings in combination with the result of our model support the need for further investigations to determine the optimal timing of BCG instillations. Finally, attention should be paid to the abrupt loss of the treatment effect after a certain interval (**Figure 3**), a finding that may also have implications for the timing of possible maintenance therapy.

These results are encouraging as an extended course of treatment may be better tolerated by patients [16]. Moreover, it is intriguing to consider that extension of the first six doses of BCG could obviate the need for maintenance therapy. Clearly, these findings require validation in pre-clinical experimental models and clinical trials prior to their being adopted for patient management. Nonetheless, we are encouraged by the findings and support the use of mathematical models to establish a framework for optimization of treatment practices.

The field of mathematical modeling in BCG immunotherapy of bladder cancer has emerged only recently [17-20]. Topics addressed so far have been: BCG dose and number of instillations needed to achieve cure and the combined effect of IL-2 and BCG. Previous models [17-20] had a number of limitations, which have been circumvented in this work. First, instead of ordinary differential equations, where the numbers of cells are given by real numbers, we have chosen a stochastic model where the numbers of cells take integer values. Hence, our model is better suited to describe tumor elimination. Second, unlike previous models [17-20], our model includes the dynamics of BCG-associated healthy urothelial cells, which are more numerous than BCG-associated tumor cells - both serving as initiators of innate and adaptive immunity. Third, we are the first to model the prime boost response of the immune system, a phenomenon believed to be of critical importance for BCG immunotherapy [5]. These findings, in addition to the results presented here, will help advance the use of mathematical models for optimization of immune-based treatment strategies.

**Conclusions**

Although by definition imperfect, mathematical models are useful tools for managing empirical knowledge to extract both qualitative and quantitative information. This new insight into BCG treatment remains to be tested and validated in order to confirm the coherence of the model and its assumptions. A model like the one presented here, may therefore be considered for the design of new therapeutic strategies and clinical studies.

In sum, our model implicates that a rigorous time management of bladder cancer patients is important for successful BCG treatment and that patients may benefit considerably from an instillation plan with extended treatment intervals. This information may be useful for managing patients with increased side effects or patients with relatively low side effects. These results warrant further studies aiming at optimizing BCG therapy in patients with bladder cancer.

## Figure Legends

**Figure 1. Simplified mathematical representation of the model according to supplemental Fig. 1).** The dynamic model represents the interaction between healthy urothelial tissue, tumor cells, and their association with BCG (interaction depicted by green line), which in turn results in the generation of BCG-associated healthy tissue and tumor cells. The latter cell populations possess the capacity to trigger the activation of innate immune effector cells and in turn the priming of adaptive immune effector cells. Red lines ending in circles indicate the input stimuli that influence the recruitment of the indicated immune cell populations. Black arrows indicate either increase (e.g., recruitment or proliferation) or decrease (e.g., death or cell turn-over) of the respective cell population. Lines with blunt ends indicate direct killing of target cell populations (solid lines) or bystander death (dashed lines). The model was parameterized using clinical data and tuned to achieve 50% probability of tumor extinction after six weekly intravesical instillations of BCG.

**Figure 2. Timing of BCG therapy, BCG dose and dwell time influence probability of tumor extinction. (A)** Probability of tumor extinction with time from surgery to the start of BCG therapy as the given variable. The grey shaded area represents the time from surgery to the typical initiation of BCG therapy (= 2 weeks). The cancer growth rate used is based on the clinical observation that high-grade lesions become visible by 3 months in the absence of treatment (detailed definition of tumor dynamics is provided in the supplementary information and figure S2). **(B)** The probability of tumor extinction after six weekly BCG instillations was modeled as a function of BCG dose, and **(C)** BCG dwell time.

**Figure 3. The treatment interval strongly influences the probability of tumor extinction. (A)** Schematic representation of the modeled intravesical treatment time points (arrows). Three weekly instillations are given to initiate innate and adaptive immune responses. The time interval between the third through sixth treatment dose was varied and designated  $n$  (weeks). The symbol \* indicates the time of transurethral resection (TUR) followed by the 2 weeks interval before BCG therapy starts. **(B)** Probability of tumor extinction as a function of  $n$ , the inter-instillation interval during the 3<sup>rd</sup> – 6<sup>th</sup> treatment doses. The dotted line marks the outcome after the recommended interval of  $n = 1$  week.

## References

- [1] Morales A, Eidinger D, Bruce AW. Intracavitary Bacillus Calmette-Guerin in the treatment of superficial bladder tumors. *J Urol.* 1976;116:180-3.
- [2] Breban R, Bisiaux A, Biot C, Rentsch CA, Bouso P, Albert ML. Mathematical model of tumor immunotherapy for bladder carcinoma identifies the limitations of the innate immune response. *Oncol Immunology.* 2012;1:1-9.
- [3] Breart B, Lemaitre F, Celli S, Bouso P. Two-photon imaging of intratumoral CD8+ T cell cytotoxic activity during adoptive T cell therapy in mice. *J Clin Invest.* 2008;118:1390-7.
- [4] Cooper AM. Cell-mediated immune responses in tuberculosis. *Annu Rev Immunol.* 2009;27:393-422.
- [5] Bisiaux A, Thiounn N, Timsit MO, Eladaoui A, Chang HH, Mapes J, et al. Molecular analyte profiling of the early events and tissue conditioning following intravesical bacillus calmette-guerin therapy in patients with superficial bladder cancer. *J Urol.* 2009;181:1571-80.
- [6] Lamm DL, Blumenstein BA, Crissman JD, Montie JE, Gottesman JE, Lowe BA, et al. Maintenance bacillus Calmette-Guerin immunotherapy for recurrent TA, T1 and carcinoma in situ transitional cell carcinoma of the bladder: a randomized Southwest Oncology Group Study. *J Urol.* 2000;163:1124-9.
- [7] van der Meijden AP, Sylvester RJ, Oosterlinck W, Hoeltl W, Bono AV. Maintenance Bacillus Calmette-Guerin for Ta T1 bladder tumors is not associated with increased toxicity: results from a European Organisation for Research and Treatment of Cancer Genito-Urinary Group Phase III Trial. *Eur Urol.* 2003;44:429-34.
- [8] Pagano F, Bassi P, Milani C, Meneghini A, Maruzzi D, Garbeglio A. A low dose bacillus Calmette-Guerin regimen in superficial bladder cancer therapy: is it effective? *J Urol.* 1991;146:32-5.
- [9] Losa A, Hurle R, Lembo A. Low dose bacillus Calmette-Guerin for carcinoma in situ of the bladder: long-term results. *J Urol.* 2000;163:68-71; discussion -2.
- [10] Mack D, Frick J. Low-dose bacille Calmette-Guerin (BCG) therapy in superficial high-risk bladder cancer: a phase II study with the BCG strain Connaught Canada. *Br J Urol.* 1995;75:185-7.
- [11] Martinez-Pineiro JA, Flores N, Isorna S, Solsona E, Sebastian JL, Pertusa C, et al. Long-term follow-up of a randomized prospective trial comparing a standard 81 mg dose of intravesical bacille Calmette-Guerin with a reduced dose of 27 mg in superficial bladder cancer. *BJU Int.* 2002;89:671-80.
- [12] Agrawal MS, Agrawal M, Bansal S, Agarwal M, Lavania P, Goyal J. The safety and efficacy of different doses of bacillus Calmette Guerin in superficial bladder transitional cell carcinoma. *Urology.* 2007;70:1075-8.
- [13] Ojea A, Nogueira JL, Solsona E, Flores N, Gomez JM, Molina JR, et al. A multicentre, randomised prospective trial comparing three intravesical adjuvant therapies for intermediate-risk superficial bladder cancer: low-dose bacillus Calmette-Guerin (27 mg) versus very low-dose bacillus Calmette-Guerin (13.5 mg) versus mitomycin C. *Eur Urol.* 2007;52:1398-406.

- [14] Andius P, Fehrling M, Holmang S. Intravesical bacillus Calmette-Guerin therapy: experience with a reduced dwell-time in patients with pronounced side-effects. *BJU Int.* 2005;96:1290-3.
- [15] de Boer EC, Rooyackers SJ, Schamhart DH, de Reijke TM, Kurth KH. BCG dose reduction by decreasing the instillation frequency: effects on local Th1/Th2 cytokine responses in a mouse model. *Eur Urol.* 2005;48:333-8.
- [16] Bassi P, Spinadin R, Carando R, Balta G, Pagano F. Modified induction course: a solution to side-effects? *Eur Urol.* 2000;37 Suppl 1:31-2.
- [17] Bunimovich-Mendrazitsky S, Goltser Y. Use of quasi-normal form to examine stability of tumor-free equilibrium in a mathematical model of BCG treatment of bladder cancer. *Math Biosci Eng.*8:529-47.
- [18] Bunimovich-Mendrazitsky S, Claude Gluckman J, Chaskalovic J. A mathematical model of combined bacillus Calmette-Guerin (BCG) and interleukin (IL)-2 immunotherapy of superficial bladder cancer. *J Theor Biol.*277:27-40.
- [19] Bunimovich-Mendrazitsky S, Byrne H, Stone L. Mathematical model of pulsed immunotherapy for superficial bladder cancer. *Bull Math Biol.* 2008;70:2055-76.
- [20] Bunimovich-Mendrazitsky S, Shochat E, Stone L. Mathematical model of BCG immunotherapy in superficial bladder cancer. *Bull Math Biol.* 2007;69:1847-70.

BCG-mediated bladder cancer immunotherapy: Identifying  
determinants of treatment response using a calibrated  
mathematical model  
SUPPLEMENTAL MATERIAL

Cyrill A. Rentsch<sup>1,2</sup>, Claire Biot<sup>2-4</sup>, Joël R. Gsponer<sup>1,2</sup>, Alexander Bachmann<sup>1</sup>,  
Matthew L. Albert<sup>2,4</sup>, and Romulus Breban<sup>5</sup>

<sup>1</sup>*Department of Urology, University Hospital of Basel, University of Basel, CH-4031 Basel, Switzerland;*

<sup>2</sup>*Institut Pasteur, Unité d'Immunologie des Cellules Dendritiques, 75015 Paris, France;*

<sup>3</sup>*Ecole Nationale Supérieure des Mines de Paris, 75272 Paris, France;*

<sup>4</sup>*INSERM U818, 75015 Paris, France;*

<sup>5</sup>*Institut Pasteur, Unité d'Epidémiologie des Maladies Emergentes, 75015 Paris, France.*

## Contents

<b>1</b>	<b>Model description</b>	<b>2</b>
<b>2</b>	<b>Stochastic mathematical model</b>	<b>4</b>
<b>3</b>	<b>Simulation results</b>	<b>6</b>
<b>4</b>	<b>Model calibration and parameter uncertainties</b>	<b>9</b>

# 1 Model description

We propose a model of interactions between the immune system, bacillus Calmette-Guérin (BCG), bladder and tumor cells during BCG immunotherapy; see the flow diagram depicted in Fig. S1. We extend our previous work where we described the interactions between the *innate* immune system, BCG, bladder and tumor cells during BCG immunotherapy (the diagram of the prior model is included in the gray box in Fig. S1), appending it using a parsimonious description of the adaptive immune system. Our current model has 7 state variables (see Table S1).  $H$  denotes the number of healthy cells of the bladder tissue.  $T$  denotes the number of tumor cells and  $B$  the number of free BCG bacteria in the bladder. We use primed symbols (i.e.,  $H'$  and  $T'$ ) to denote cell populations that are infected by and/or associated with BCG bacteria. We thus use the symbols  $H'$  and  $T'$  for the number of BCG-associated tissue and tumor cells, respectively.  $E_i$  and  $E_a$  denote the number of innate and adaptive effector cells that have extravasated into the bladder, respectively.

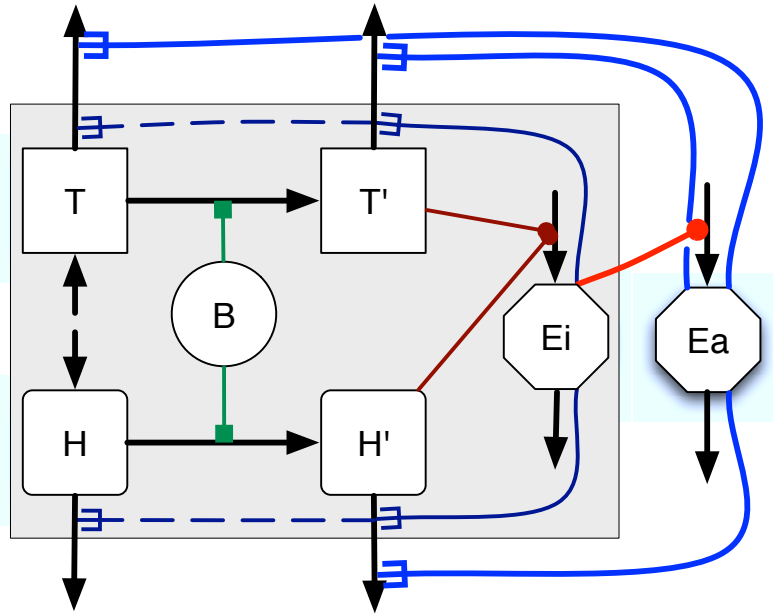


Figure S1: Flow diagram of the model of interactions between the innate immune system and bladder tumor during BCG instillation.

The assumptions of the model are as follows.

*Assumption 1: In absence of therapy, the tumor remains largely undetected by the immune system.* The paucity of dendritic cells in the resting bladder mucosa, and the histologic assessment of non-muscle invasive tumors indicate absence of local inflammation. We exclude immune tolerance and/or the presence of regulatory immune cells as one of the mechanism that may hamper BCG-induced tumor immunity, but this may be inferred within other assigned constraints on immune activation.

*Assumption 2: During BCG instillations, free BCG associates to tissue and tumor cells (green arrows in Fig. S1).* The therapeutic mixture contains both live BCG capable of actively interacting with cells, and dead BCG that is internalized by the cell; hence, we refer to BCG as becoming cell-associated. Cells associated with BCG include cells that have BCG adhered to their plasma membrane, cells that have phagocytosed BCG or components of dead bacilli, cells that have upregulated stress molecules (e.g., MIC-A) as a result of contact with BCG and cells that have been actively infected by BCG. Experimental data indicates that BCG can become associated with urothelial cells and transitional cell carcinoma cell lines; it has been demonstrated

Table S1: State variables of the model along with their biological description. The state variables represent counts of various cell types involved in the interactions between the immune system, tumor cells and BCG.

Variable	Cell type
$H$	Healthy cells of the bladder tissue
$T$	Tumor cells in the bladder
$B$	Free BCG bacteria in the bladder
$H'$	BCG-associated cells of the bladder tissue
$T'$	BCG-associated tumor cells
$E_i$	Innate effector cells in the bladder
$E_a$	Adaptive effector cells in the bladder

in human studies that small quantities of BCG ( $\sim 1\%$  of instilled dose) persist after voiding [1].

*Assumption 3: BCG instillations result in an increased recruitment of innate effector cells into the bladder tissue (dark red arrows in Fig. S1) [2].*

*Assumption 4: Innate effector cells engaging with BCG-associated tissue or tumor cells become activated and degranulate. The degranulation process is the same whether the trigger is a BCG-associated tissue or tumor cell.* This assumption is supported by findings of activated innate cells in urine following intravesical therapy and experimental work on co-cultures of BCG or BCG-infected cells and innate immune cells [3].

*Assumption 5: Degranulation of an innate effector cell results in the death of the effector cell. Furthermore, tissue or tumor cells in the vicinity of the effector cell may be killed (i.e., see the processes displayed with dark blue arrows in Fig. S1).* In the case of neutrophils and inflammatory monocytes, degranulation is known to result in the release of degradative intracellular proteins (e.g., elastase, heparanase, lipases) having the capacity to induce bystander cell death. In addition, activated innate cells may secrete effector cytokines and/or express cell death inducing proteins (e.g., TRAIL). The assumption that NK cells die rapidly after engagement of their effector mechanisms may result in an underestimation of their killing capacity. However, according to clinical data, the relative paucity of NKs recruited to the bladder indicate that even with a high estimate of 10 killing events per NK, their effector function account for  $<10\%$  of the combined innate response [3].

*Assumption 6: Adaptive effector cells are recruited in the bladder as a direct result of the increased number of innate effector cells. However, the initial recruitment is delayed as the adaptive immune system does not react as fast as the innate immune system.* For parsimony of the model, we consider a model of signaling by the innate immune system that is based simply on the count of innate effector cells in the bladder. This is meant to embody the activation of migratory dendritic cells that prime adaptive responses, and the local production of chemokines that directly act by attracting lymphocytes into the bladder mucosa. The delay in activation of the adaptive immune system is modeled empirically by simply not allowing adaptive effectors in the bladder sooner than 10 days after the initiation of BCG immunotherapy - the minimal time required to achieve activation of mycobacterial or tumor antigen-specific responses.

*Assumption 7: Adaptive effector cells engage equally well with BCG-associated tissue or tumor cells. Adaptive effector cell also engage, but less effectively, with BCG-unassociated tumor cells. As a result of the engagement process, only the target cell is destroyed.* For parsimony of the model, we consider only one population of adapted effector cells that, on average, fulfills the roles of a heterogeneous mix of lymphocytes that occurs in reality. This assumption reduces considerably the number of parameters needed to describe the adaptive immune system and makes possible the calibration of the model to clinical data. By offsetting the potency of engagement of BCG-associated vs. unassociated cells, we may introduce the notion of affinity for antigen, which is expected to be greater for microbial antigen as compared to tumor antigen [4].

The model runs as follows. Before immunotherapy, only three of seven cell populations are present:  $H$ ,  $T$  and  $E_i$ . The interactions between these cell populations are negligible and their corresponding compartments are disconnected. The processes that take place for each of these independent compartments are “birth” (i.e., cell migration and/or local proliferation) and death. During BCG instillations, three new populations of cells



emerge creating dynamic interactions between all the compartments.  $B$  associates to tissue and tumor cells (green arrows in Fig. S1), inducing transitions of cells from  $H$  to  $H'$  and from  $T$  to  $T'$  (horizontal black arrows in Fig. S1). The presence of  $H'$  and  $T'$  cells triggers increased migration of effector cells into the bladder tissue.  $H'$  and  $T'$  cells activate innate immune effectors  $E_i$ . In turn,  $E_i$  cells target  $H'$  and  $T'$  destroying them and neighboring  $H$  and  $T$  cells by degranulation. Furthermore, the excess number of  $E_i$  cells triggers recruitment of adaptive effector cells  $E_a$  with a much enhanced killing capacity. Finally, the production of inflammation induced chemattractants, the activation and the exfoliation of bladder endothelium results in an ensemble of phenomena that increase the effector cell migration to the bladder. It is known that effector cell migration increases from the first to the third BCG instillation after which time it starts to plateau [3].

Table S2: Stochastic processes and their corresponding rates.

Process	Definition	Rate
Tumor proliferation	$T \rightarrow T + 1$	$\beta T$
Tumor death	$T \rightarrow T - 1$	$\mu_T T$
Tumor death due to shortage of blood supply	$T \rightarrow T - 1$	$rT(T + T')/K$
Tumor death due to degranulation	$T \rightarrow T - 1$	$n\kappa E_i T'$
Tumor death due to adaptive effectors	$T \rightarrow T - 1$	$\lambda E_a T$
BCG-infection of tumor cells	$T \rightarrow T - 1,$ $B \rightarrow B - 1,$ $T' \rightarrow T' + 1$	$\rho B T$
Infected tumor death	$T' \rightarrow T' - 1$	$\mu_{T'} T'$
Infected tumor death due to shortage of blood supply	$T' \rightarrow T' - 1$	$rT'(T + T')/K$
Infected tumor death due to degranulation	$T' \rightarrow T' - 1,$ $E_i \rightarrow E_i - 1$	$\kappa E_i T'$
Infected tumor death due to adaptive effectors	$T' \rightarrow T' - 1$	$\lambda' E_a T'$
BCG-infection of tissue cells	$H' \rightarrow H' + 1,$ $B \rightarrow B - 1$	$\sigma B$
Infected tissue death	$H' \rightarrow H' - 1$	$\mu_{H'} H'$
Infected tissue death due to degranulation	$H' \rightarrow H' - 1,$ $E_i \rightarrow E_i - 1$	$\kappa E_i H'$
Infected tissue death due to adaptive effectors	$H' \rightarrow H' - 1$	$\lambda' E_a H'$
Neutrophil migration at homeostasis	$E_i \rightarrow E_i + 1$	$\pi$
Increased neutrophil migration due to BCG-infection <sup>a</sup>	$E_i \rightarrow E_i + 1$	$\alpha(t)(T' + H')$
Neutrophil deactivation and loss into the bladder lumen	$E_i \rightarrow E_i - 1$	$\mu_{E_i} E - i$
Recruitment of adaptive effectors <sup>b</sup>	$E_a \rightarrow E_a + 1$	$\zeta \alpha(t)[E_i(t) - \pi/\mu_{E_i}]\theta(t - t_a)$
Death and loss of adaptive effectors into the bladder lumen	$E_a \rightarrow E_a - 1$	$\mu_{E_a} E_a$

<sup>a</sup>See text for the definition of the function  $\alpha(t)$ .

<sup>b</sup> $\theta(\cdot) : \mathbb{R} \rightarrow \mathbb{R}$  is the Heaviside step function defined as follows:  $\theta(x) = 0$  if  $x < 0$  and  $\theta(x) = 1$ , otherwise.

## 2 Stochastic mathematical model

Since we are particularly interested in the phenomenon of tumor elimination, we develop a stochastic mathematical model (i.e., continuous-time Markov chain) where the cell counts are described by integers and

thus can go extinct. We make further assumptions to express the rates of the stochastic model of BCG immunotherapy in a parsimonious way.

Table S3: Parameters of the model.

Parameter	Symbol	Value/Range
Tumor proliferation rate parameter	$\beta$	0.11 day <sup>-1</sup>
Tumor death rate parameter	$\mu_T$	0.067 day <sup>-1</sup>
Tumor carrying capacity	$K$	10 <sup>11</sup> cells
Number of cells destroyed per degranulation	$n + 1$	2
Predation coefficient of innate effector cells	$\kappa$	10 <sup>-12</sup> /cell/day
Predation coefficient of adapted effectors on uninfected tumor cells <sup>a</sup>	$\lambda$	3.36 × 10 <sup>-7</sup> /cell/day
Delay in the activation of the adaptive immune responses	$t_a$	10 days
Predation coefficient of adapted effectors on infected cells	$\lambda'$	10 <sup>-6</sup> /cell/day
BCG infectiousness of tumor cells	$\rho$	2 × 10 <sup>-9</sup> /cell/day
Natural death rate of BCG-associated tumor cells	$\mu_{T'}$	1/3 days
BCG rate of association to tissue cells	$\sigma$	0.1 day <sup>-1</sup>
Natural death rate of BCG-associated tissue cells	$\mu_{H'}$	0.2 days
Inflow of effector cells in the bladder tissue <sup>b</sup>	$\pi$	345000 cells/day
Loss parameter of innate effector cells	$\mu_{E_i}$	0.345 day <sup>-1</sup>
Maximum recruitment rate of effectors due to BCG	$\alpha_1$	200 day <sup>-1</sup>
Minimum recruitment rate of effectors due to BCG <sup>c</sup>	$\alpha_1/(1 + e^{\alpha_2})$	0.49 day <sup>-1</sup>
Scale of $C(t)$ for vascularization increase	$\alpha_3$	10 <sup>9</sup> cells
Healing time of the bladder wall	$\tau$	33.3 days
Recruitment parameter of adaptive effectors	$\zeta$	10 <sup>-5</sup>
Loss parameter of adaptive effector cells	$\mu_{E_a}$	0.8 day <sup>-1</sup>

<sup>a</sup>Chosen such that the probability of tumor elimination of the six weekly instillation schedule is ~50%.

<sup>b</sup>Chosen such that the steady population of effectors in the bladder amounts to 10<sup>6</sup> cells.

<sup>c</sup> $\alpha_2 = 6$ .

*Assumption 8: We assume that tumor undergoes logistic growth.* Modeling the population dynamics of BCG-free tumor cells, we assume that the tumor grows into the bladder lumen and does not impinge upon surrounding tissue. As such, its size is limited only by the blood supply. We choose the logistic model (i.e., the Verhulst model) to describe the dynamics of the tumor cell population in absence of BCG therapy [5,6]. Notably, our model will be applied to the description of post-resection BCG immunotherapy where the number of tumor cells is significantly less than the carrying capacity (i.e., the maximum number of tumor cells that the blood supply can sustain). Consequently, the logistic model will be used in the regime of exponential growth. Therefore, the results presented in this paper are not restricted by our choice of the logistic model and apply to all models of tumor cell replication in their regime of exponential growth.

*Assumption 9: We do not use explicit equations to model the dynamics of the healthy tissue cell population. Rather, we consider that this population is very large when compared with the other cell populations of interest.* This assumption is based on clinical information that BCG therapy does not result in the perforation of the bladder wall nor frank disruption of bladder function.

*Assumption 10: We use mass-action to describe the mixing between the cell populations.* This is supported by BCG dispersion during intravesical therapy, adequate vascularization of all aspects of the bladder wall and non-specific migration patterns of innate immune cells as they enter inflamed tissue.

*Assumption 11: The number of BCG bacteria that die during instillation (i.e., 2 hours) is negligible.* The kinetics of the natural death of BCG is slow and the host response is minimal within the first hours of BCG instillation. Thus, for modeling purposes, we neglect BCG death during the course of instillation therapy.

*Assumption 12: BCG-associated cells do not undergo local proliferation.* This is supported by experimental data suggesting that BCG negatively impacts the cell growth of bladder tumor cell lines [7].

*Assumption 13: The migration of innate effector cells increases due to vascularization of the bladder wall. This increase is proportional to the number of BCG-associated cells present in the bladder. Furthermore, the cumulative number of cells destroyed by degranulation stimulates neo-vascularization in a sigmoidal fashion. This is counteracted by homeostatic pressure (i.e., healing of the bladder wall) which is modeled as a discount factor of the cumulative number of cells destroyed by degranulation.* This assumption is supported by the observation that migration of effector cells is linked to the vascularization of the bladder wall, which evolves as a function of inflammation induced cell death [3, 8]. As such, the increase in the inflow of immune cells depends on the number of BCG-associated cells present in the bladder, which are triggers for activation and effector activity of innate immune cells.

We now define transition rates for each of the processes depicted in the flow diagram (Fig. S1); see Table S2. The parameters of the model are explained in Table S3. The processes of vascularization and healing are modeled by a sigmoidal function  $\alpha(t)$  given by

$$\alpha(t) = \frac{\alpha_1}{1 + \exp[\alpha_2 - C(t)/\alpha_3]}, \quad (2.1)$$

where  $C(t)$  represents the number of destroyed cells discounted by a negative exponential “healing” factor

$$C(t) = \int_0^t du (n+1) \{ \kappa E_i(u) [T'(u) + H'(u)] + \lambda E_a(u) T(u) + \lambda' E_a(u) [T'(u) + H'(u)] \} e^{-u/\tau}. \quad (2.2)$$

### 3 Simulation results

The initial conditions are as follows:  $T(0) = 10^6$ ,  $T_i(0) = 0$ ,  $H_i(0) = 0$  and  $E(0) = 0$ . For each instillation,  $B$  starts at  $10^9$  (of which only  $10^8$  is considered live BCG, corresponding to  $10^8$  CFU) but then it is set to zero at the end of the instillation.

Figure S2 shows a simulation of tumor growth in absence of BCG therapy. The simulation includes resection of tumor from the carrying capacity of  $\sim 10^{11}$  cells to  $\sim 10^6$  cells. The growth rate parameter  $r = \beta - \mu_T$  is tuned such that the re-growth of the tumor to a visible size (i.e.,  $\sim 10^8$  cells) takes about three months.

Figure S3 shows a simulation of the dynamics of cell populations during BCG therapy. Panel **A** shows the percent of free BCG that is present in the bladder during the instillations. Note that  $\sim 99\%$  of the free BCG is flushed out weekly, after each instillation. The dynamics of the tumor cells (panel **B**) is marked by steep decreases in the cell population numbers due to BCG instillations followed by slight increases due to local proliferation. Panels **C** and **D** represent the dynamics of the population of BCG-associated tumor cells and BCG-associated tissue cells, respectively. The population of BCG-associated tumor cells is fairly small and undergoes extinction in between the BCG instillations. Panel **E** shows the dynamics of the population of innate effector cells. Note the significant growth in the number of effector cells after the third instillation, corresponding to the prime-boost effect. Panel **F** shows the dynamics of the population of effector cells of the adapted immune system that is also modulated by the prime-boost effect. Furthermore, the effector cells of the adapted immune system arrive late in the bladder compared to those of the innate immune system.

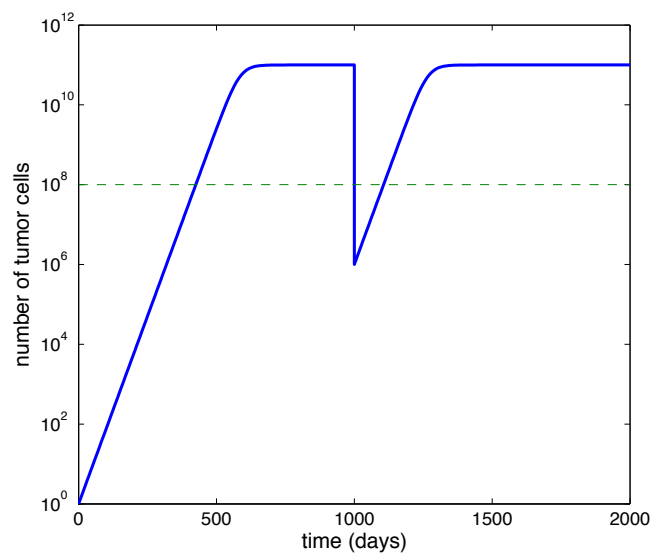


Figure S2: Simulation of logistic tumor growth, resection and tumor re-growth. The horizontal dashed line represents the approximate size of the tumor when the tumor is visible on the bladder wall.

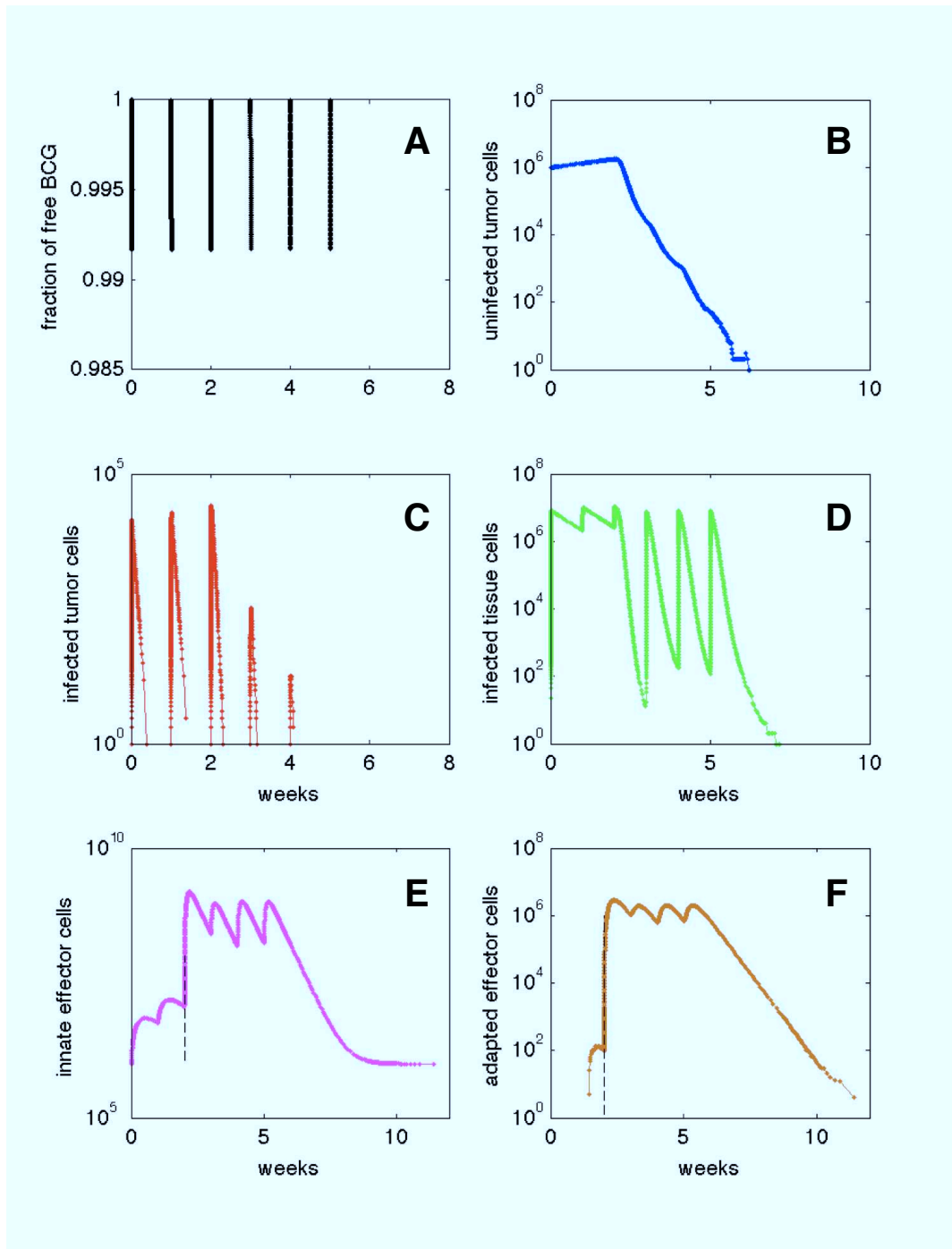


Figure S3: Simulation of population dynamics of cells during and after a six-week course of intravesical BCG therapy: BCG (panel **A**), tumor cells (panel **B**), BCG-associated tumor cells (panel **C**), BCG-associated tissue cells (panel **D**), innate effector cells (panel **E**), adaptive effector cells (panel **F**). Note the modeling of the prime boost response of the innate and adapted immune systems which occurs after the third instillation (in particular, note panels **E** and **F**).

## 4 Model calibration and parameter uncertainties

The values for the model parameters were chosen such that cell counts are in agreement to clinical trial data [3]. One parameter that is critical for the tumor elimination is the predation coefficient of adapted effectors on uninfected tumor cells. It is calibrated such that the probability of tumor elimination of the six weekly instillation schedule is  $\sim 50\%$  where the initial conditions (at time two weeks post-surgical resection, taken as the minimum time delay for initiation of BCG therapy), were chosen as follows  $T(0) = 10^6$ ,  $T_i(0) = 0$ ,  $H_i(0) = 0$  and  $E(0) = 0$ .

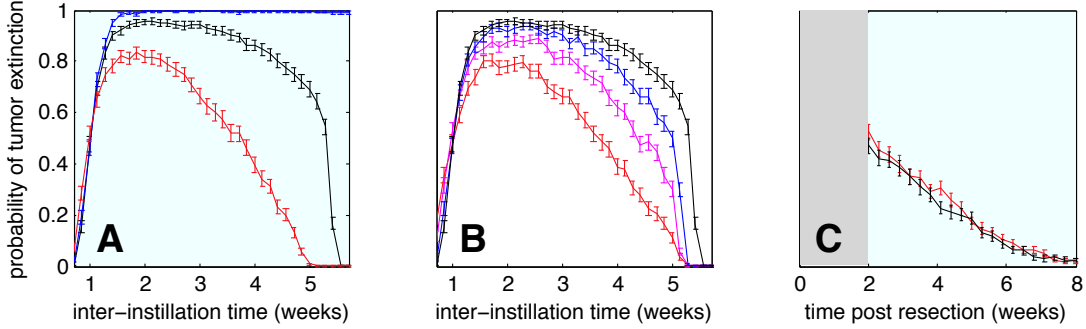


Figure S4: Sensitivity analyses for Figs. 2A and 3 of the main text. **A.** Sensitivity analysis of Fig. 3 with changing the rate of loss of adapted effectors,  $\mu_{E_a}$ . The blue, black (also shown in Fig. 3) and red curves correspond to  $\mu_{E_a} = 0.4, 0.8$  and  $1.6 \text{ day}^{-1}$ , respectively. For every parameter set, the model has been re-calibrated such that six weekly instillation of BCG therapy yield  $\sim 50\%$  chance of cure. **B.** Sensitivity analysis of Fig. 3 with changing the number of tumor cells before initiating BCG therapy,  $T(0)$ . The black (also shown in Fig. 3), blue, magenta and red curves correspond to  $T(0) = 10^6, 10^5, 10^4$  and  $10^3$  tumor cells. The model has been re-calibrated every time, accordingly. These numerics suggest that our prediction that a two-week inter-instillation interval would significantly improve therapeutic outcome is robust. **C.** Sensitivity analysis of Fig. 2A with changing the number of tumor cells before initiating BCG therapy,  $T(0)$ . The black (also shown in Fig. 2A) and red curves correspond to  $T(0) = 10^6$  and  $10^3$  tumor cells.

The BCG amount was chosen as follows. Commercial vials of lyophilized BCG used for immunotherapy contain  $\sim 10^8$  live bacteria (or colony forming units – CFU), representing 5-10% of the total number of bacteria in the preparation [9]. During BCG instillations, live BCG is capable of actively interacting with cells while dead BCG may be internalized by cells. To take into account all these interactions, we assumed that, for each instillation,  $B$  starts at  $10^9$  bacteria (of which only  $10^8$  is considered live BCG) but then it is set to zero at the end of the instillation.

We integrated the stochastic model using an efficient tau-leaping method [10]. It is very important to note that the parameterization of the model yields essentially the same prime boost effect even if the simulation is carried out with no tumor cells in the bladder  $T(0) = 0$ . We consider this to be a realistic feature of the model since the number of BCG associated and unassociated tumor cells is small (compared, for example, with the number of BCG associated and unassociated tissue cells) and does not impact too much on the development of the BCG-triggered prime boost effect.

We performed calibration of the model for other sets of parameters than that given in Table S3. For example, changing the loss parameter  $\mu_{E_a}$  from  $0.8 \text{ day}^{-1}$  to  $1.6 \text{ day}^{-1}$  and  $0.4 \text{ day}^{-1}$ , we obtained  $\lambda$  approximately equal to  $5.52 \times 10^{-7} / \text{cell/day}$  and  $2.17 \times 10^{-7} / \text{cell/day}$ , respectively. We used these parameter sets to run further simulations of BCG regimens with varying the inter-instillation interval. The results are presented in Fig. S4A. We found that the success of BCG immunotherapy is sensitive to the rate of loss of effectors of the adaptive immune system from the bladder. However, our prediction that a two-week inter-instillation interval would significantly improve therapeutic outcome (as compared to a one-week inter-

instillation interval) remains valid with changes in the loss rate.

We performed calibration for other sets of initial conditions that differ in  $T(0)$ , the number of tumor cells left after resection while keeping all the other parameters as given in Table S3. For  $T(0)$  equals  $10^3$ ,  $10^4$  and  $10^5$  cells, we obtained  $\lambda$  approximately equal to  $1.80 \times 10^{-7}$ /cell/day,  $2.35 \times 10^{-7}$ /cell/day and  $2.86 \times 10^{-7}$ /cell/day, respectively. We then ran simulations of BCG regimens with varying the inter-instillation interval (Fig. S4B). Simulation results show similar patterns in all these scenarios. Although the probability of cure is sensitive to the number of tumor cells before immunotherapy, the prediction that a two-week inter-instillation interval would significantly improve therapeutic outcome is robust.

We further used the above parameter sets to investigate how the probability of tumor extinction changes with the duration of time between resection and initiation of therapy (Fig. S4C). In this case, we found that therapeutic success as a function of the time interval between resection and BCG immunotherapy is not very sensitive with changing the number of tumor cells left in the bladder after resection.

## References

- [1] C. Durek, E. Richter, A. Basteck, S. Rüsich-Gerdes, J. Gerdes, D. Jocham, and A. Böhle, “The fate of bacillus Calmette-Guérin after intravesical instillation,” *J Urol*, vol. 165, pp. 1765–8, 2001.
- [2] R. Breban, A. Bisiaux, C. Biot, C. Rentsch, P. Bousso, and M. Albert, “Mathematical model of tumor immunotherapy for bladder carcinoma identifies the limitations of the innate immune response,” *OncoImmunology*, vol. 1, no. 1, 2012.
- [3] A. Bisiaux, N. Thiounn, M. Timsit, A. Eladaoui, H. Chang, J. Mapes, A. Mogenet, J. Bresson, D. Prie, S. Bechet, C. Baron, C. Sadorge, S. Thomas, E. Albert, P. Albert, and M. Albert, “Molecular analyte profiling of the early events and tissue conditioning following intravesical bacillus Calmette-Guérin therapy in patients with superficial bladder cancer,” *J Urol*, vol. 181, pp. 1571–80, 2009.
- [4] K. de Visser, T. Schumacher, and A. Kruisbeek, “CD8(+) T cell tolerance and cancer immunotherapy,” *J Immunother*, vol. 26, no. 1, pp. 1–11, 2003.
- [5] J. Aroesty, T. Lincoln, N. Shapiro, and G. Boccia, “Tumor growth and chemotherapy: Mathematical methods, computer simulations, and experimental foundations,” *Math Biosci*, vol. 17, no. 3-4, pp. 243–300, 1973.
- [6] S. Bunimovich-Mendrazitsky, E. Shochat, and L. Stone, “Mathematical model of bcg immunotherapy in superficial bladder cancer,” *Bull Math Biol*, vol. 69, pp. 1847–70, 2007.
- [7] A. Jackson, A. Alexandroff, D. Fleming, S. Prescott, G. Chisholm, and K. James, “Bacillus-Calmette-Guérin (BCG) organisms directly alter the growth of bladder-tumor cells,” *Int J Oncol*, vol. 5, pp. 697–703, 1994.
- [8] M. R. Saban, J. M. Backer, M. V. Backer, J. Maier, B. Fowler, C. A. Davis, C. Simpson, X.-R. Wu, L. Birder, M. R. Freeman, S. Soker, R. E. Hurst, and R. Saban, “VEGF receptors and neuropilins are expressed in the urothelial and neuronal cells in normal mouse urinary bladder and are upregulated in inflammation,” *Am J Physiol Renal Physiol*, vol. 295, pp. F60–72, 2008.
- [9] M. Behr, “BCG—different strains, different vaccines?,” *The Lancet Infectious Diseases*, vol. 2, no. 2, pp. 86–92, 2002.
- [10] Y. Cao, D. T. Gillespie, and L. R. Petzold, “Efficient step size selection for the tau-leaping simulation method,” *J Chem Phys*, vol. 124, 044109, 2006.

Figure 1

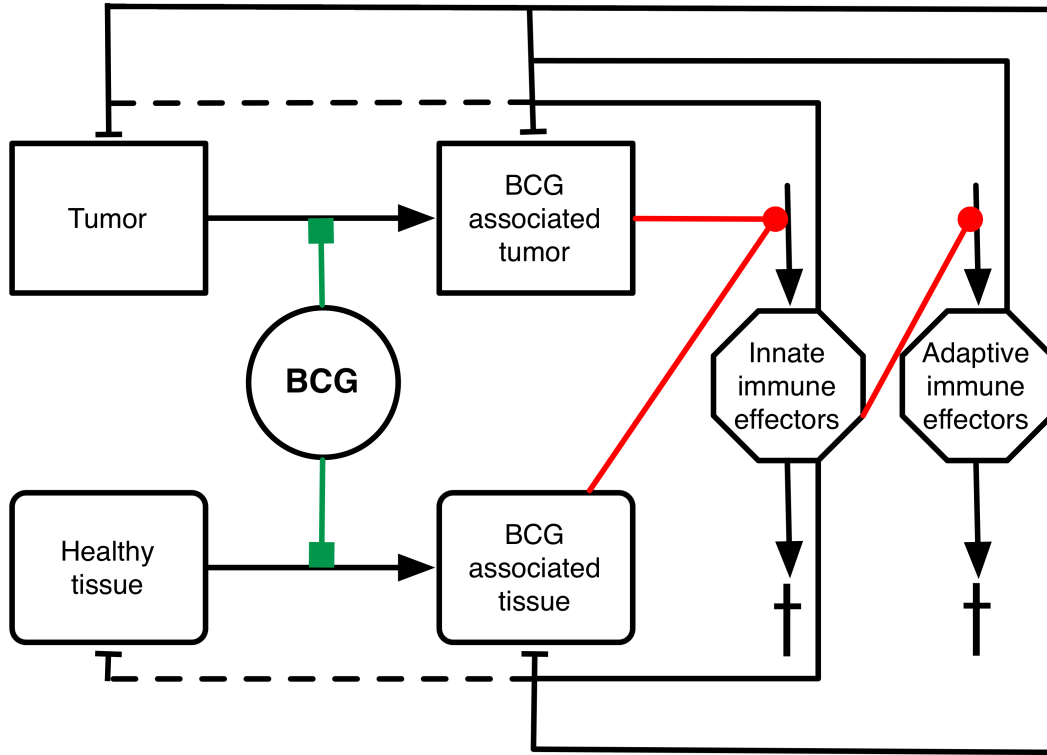
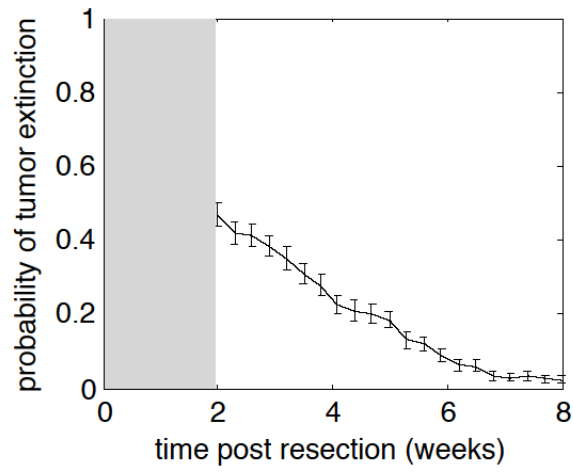


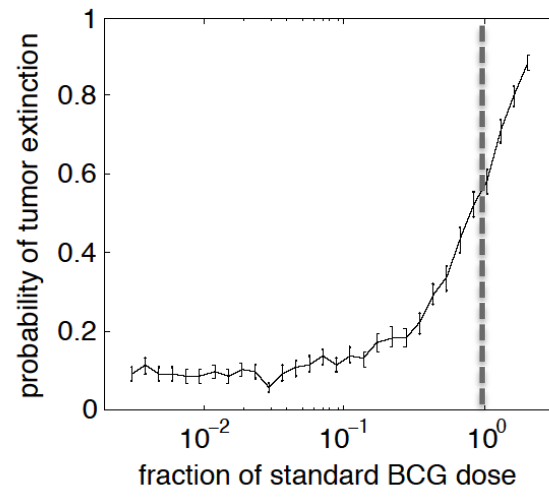


Figure 2

A



B



C

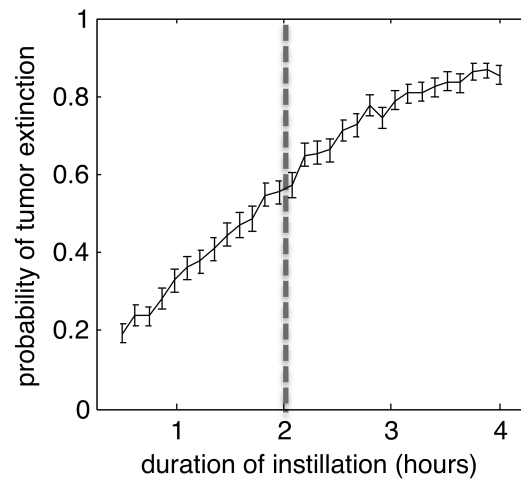
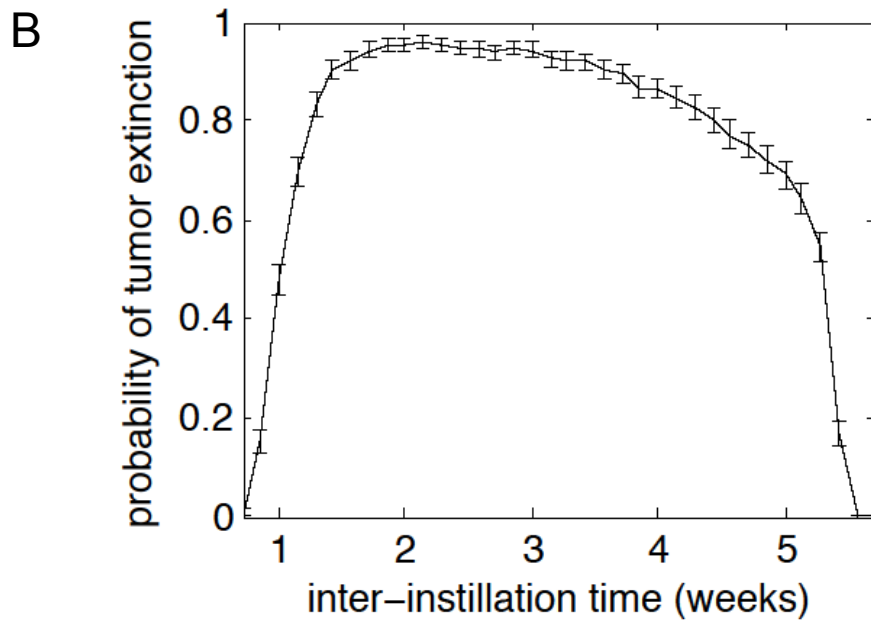
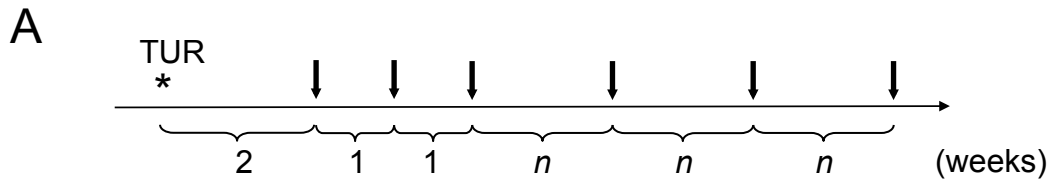


Figure 3



**Take home message**

Applying a new mathematical model of BCG immunotherapy in bladder cancer, we demonstrate that successful therapy depends on a short time from resection to the start of BCG therapy, on a higher BCG dose and a longer dwell time, and most importantly, on an extended treatment interval. Our results identify key parameters that may be tested in prospective clinical trials; and our model may be useful in the optimization of other immune-based cancer treatments.

# References

---



- (2001) BCG in immunization programmes. *Wkly Epidemiol Rec* 76, 33-39.
- Agrawal, M.S., Agrawal, M., Bansal, S., Agarwal, M., Lavania, P., and Goyal, J. (2007) The safety and efficacy of different doses of bacillus Calmette Guerin in superficial bladder transitional cell carcinoma. *Urology* 70, 1075-1078.
- Aguirre-Blanco, A.M., Lukey, P.T., Cliff, J.M., and Dockrell, H.M. (2007) Strain-dependent variation in Mycobacterium bovis BCG-induced human T-cell activation and gamma interferon production in vitro. *Infect Immun* 75, 3197-3201.
- Albert, M.L. (2004) Death-defying immunity: do apoptotic cells influence antigen processing and presentation? *Nat Rev Immunol* 4, 223-231.
- Albert, M.L., Darnell, J.C., Bender, A., Francisco, L.M., Bhardwaj, N., and Darnell, R.B. (1998) Tumor-specific killer cells in paraneoplastic cerebellar degeneration. *Nat Med* 4, 1321-1324.
- Alexandroff, A.B., Nicholson, S., Patel, P.M., and Jackson, A.M. (2010) Recent advances in bacillus Calmette-Guerin immunotherapy in bladder cancer. *Immunotherapy* 2, 551-560.
- Andius, P., Fehrling, M., and Holmang, S. (2005) Intravesical bacillus Calmette-Guerin therapy: experience with a reduced dwell-time in patients with pronounced side-effects. *BJU Int* 96, 1290-1293.
- Arnold, J., de Boer, E.C., O'Donnell, M.A., Bohle, A., and Brandau, S. (2004) Immunotherapy of experimental bladder cancer with recombinant BCG expressing interferon-gamma. *J Immunother* 27, 116-123.
- Ayari, C., LaRue, H., Hovington, H., Decobert, M., Harel, F., Bergeron, A., Tetu, B., Lacombe, L., and Fradet, Y. (2009) Bladder tumor infiltrating mature dendritic cells and macrophages as predictors of response to bacillus Calmette-Guerin immunotherapy. *Eur Urol* 55, 1386-1395.
- Babjuk, M., Oosterlinck, W., Sylvester, R., Kaasinen, E., Bohle, A., Palou-Redorta, J., and Roupret, M. (2011) EAU guidelines on non-muscle-invasive urothelial carcinoma of the bladder, the 2011 update. *Eur Urol* 59, 997-1008.
- Backer, M.V., Levashova, Z., Patel, V., Jehning, B.T., Claffey, K., Blankenberg, F.G., and Backer, J.M. (2007) Molecular imaging of VEGF receptors in angiogenic vasculature with single-chain VEGF-based probes. *Nat Med* 13, 504-509.
- Badalament, R.A., Herr, H.W., Wong, G.Y., Gnecco, C., Pinsky, C.M., Whitmore, W.F., Jr., Fair, W.R., and Oettgen, H.F. (1987) A prospective randomized trial of maintenance versus nonmaintenance intravesical bacillus Calmette-Guerin therapy of superficial bladder cancer. *J Clin Oncol* 5, 441-449.
- Bartlett, G.L., Zbar, B., and Rapp, H.J. (1972) Suppression of murine tumor growth by immune reaction to the Bacillus Calmette-Guerin strain of Mycobacterium bovis. *J Natl Cancer Inst* 48, 245-257.
- Bassi, P., Spinadin, R., Carando, R., Balta, G., and Pagano, F. (2000) Modified induction course: a solution to side-effects? *Eur Urol* 37 Suppl 1, 31-32.
- Behr, M.A. (2002) BCG--different strains, different vaccines? *Lancet Infect Dis* 2, 86-92.

- Benevolo-de-Andrade, T.C., Monteiro-Maia, R., Cosgrove, C., and Castello-Branco, L.R. (2005) BCG Moreau Rio de Janeiro: an oral vaccine against tuberculosis--review. *Mem Inst Oswaldo Cruz* 100, 459-465.
- Bevers, R.F., de Boer, E.C., Kurth, K.H., and Schamhart, D.H. (1998) BCG-induced interleukin-6 upregulation and BCG internalization in well and poorly differentiated human bladder cancer cell lines. *Eur Cytokine Netw* 9, 181-186.
- Bevers, R.F., Kurth, K.H., and Schamhart, D.H. (2004) Role of urothelial cells in BCG immunotherapy for superficial bladder cancer. *Br J Cancer* 91, 607-612.
- Bilen, C.Y., Inci, K., Erkan, I., and Ozen, H. (2003) The predictive value of purified protein derivative results on complications and prognosis in patients with bladder cancer treated with bacillus Calmette-Guerin. *J Urol* 169, 1702-1705.
- Bisiaux, A., Thiounn, N., Timsit, M.O., Eladaoui, A., Chang, H.H., Mapes, J., Mogenet, A., Bresson, J.L., Prie, D., Bechet, S., *et al.* (2009) Molecular analyte profiling of the early events and tissue conditioning following intravesical bacillus calmette-guerin therapy in patients with superficial bladder cancer. *J Urol* 181, 1571-1580.
- Boon, M.E., Kurver, P.H., Baak, J.P., and Ooms, E.C. (1981) Morphometric differences between urothelial cells in voided urine of patients with grade I and grade II bladder tumours. *J Clin Pathol* 34, 612-615.
- Borsos, T., and Rapp, H.J. (1973) Brief communication: antigenic relationship between Mycobacterium bovis (BCG) and a guinea pig hepatoma. *J Natl Cancer Inst* 51, 1085-1086.
- Botteman, M.F., Pashos, C.L., Redaelli, A., Laskin, B., and Hauser, R. (2003) The health economics of bladder cancer: a comprehensive review of the published literature. *Pharmacoeconomics* 21, 1315-1330.
- Bowyer, L., Hall, R.R., Reading, J., and Marsh, M.M. (1995) The persistence of bacille Calmette-Guerin in the bladder after intravesical treatment for bladder cancer. *Br J Urol* 75, 188-192.
- Braasch, M.R., Bohle, A., and O'Donnell, M.A. (2008) Risk-adapted use of intravesical immunotherapy. *BJU Int* 102, 1254-1264.
- Brandau, S., and Bohle, A. (2001) Activation of natural killer cells by Bacillus Calmette-Guerin. *Eur Urol* 39, 518-524.
- Brandau, S., Bohle, A., Thanhauser, A., Ernst, M., Mattern, T., Ulmer, A.J., and Flad, H.D. (2000) In vitro generation of bacillus Calmette-Guerin-activated killer cells. *Clin Infect Dis* 31 Suppl 3, S94-S100.
- Brandau, S., Riemensberger, J., Jacobsen, M., Kemp, D., Zhao, W., Zhao, X., Jocham, D., Ratliff, T.L., and Bohle, A. (2001) NK cells are essential for effective BCG immunotherapy. *Int J Cancer* 92, 697-702.
- Brandau, S., and Suttman, H. (2007) Thirty years of BCG immunotherapy for non-muscle invasive bladder cancer: a success story with room for improvement. *Biomed Pharmacother* 61, 299-305.
- Braunwald, E., Isselbacher, K.J., Petersdorf, R.G., Wilson, J.D., Martin, J.B., and Fauci, A.S., eds. (1987) Harrison's principles of internal medicine, 11th ed. (New York: McGraw-Hill Book Co.).
- Breart, B., Lemaitre, F., Celli, S., and Bousso, P. (2008) Two-photon imaging of intratumoral CD8+ T cell cytotoxic activity during adoptive T cell therapy in mice. *J Clin Invest* 118, 1390-1397.

- Brinkmann, V., Reichard, U., Goosmann, C., Fauler, B., Uhlemann, Y., Weiss, D.S., Weinrauch, Y., and Zychlinsky, A. (2004) Neutrophil extracellular traps kill bacteria. *Science* 303, 1532-1535.
- Brinkmann, V., and Zychlinsky, A. (2007) Beneficial suicide: why neutrophils die to make NETs. *Nat Rev Microbiol* 5, 577-582.
- Bromley, S.K., Mempel, T.R., and Luster, A.D. (2008) Orchestrating the orchestrators: chemokines in control of T cell traffic. *Nat Immunol* 9, 970-980.
- Brosch, R., Gordon, S.V., Garnier, T., Eiglmeier, K., Frigui, W., Valenti, P., Dos Santos, S., Duthoy, S., Lacroix, C., Garcia-Pelayo, C., *et al.* (2007) Genome plasticity of BCG and impact on vaccine efficacy. *Proc Natl Acad Sci U S A* 104, 5596-5601.
- Buckwalter, M.R., and Albert, M.L. (2009) Orchestration of the immune response by dendritic cells. *Curr Biol* 19, R355-361.
- Bunimovich-Mendrazitsky, S., Byrne, H., and Stone, L. (2008) Mathematical model of pulsed immunotherapy for superficial bladder cancer. *Bull Math Biol* 70, 2055-2076.
- Bunimovich-Mendrazitsky, S., Claude Gluckman, J., and Chaskalovic, J. (2011) A mathematical model of combined bacillus Calmette-Guerin (BCG) and interleukin (IL)-2 immunotherapy of superficial bladder cancer. *J Theor Biol* 277, 27-40.
- Bunimovich-Mendrazitsky, S., and Goltser, Y. (2011) Use of quasi-normal form to examine stability of tumor-free equilibrium in a mathematical model of BCG treatment of bladder cancer. *Math Biosci Eng* 8, 529-547.
- Bunimovich-Mendrazitsky, S., Shochat, E., and Stone, L. (2007) Mathematical model of BCG immunotherapy in superficial bladder cancer. *Bull Math Biol* 69, 1847-1870.
- Burgdorf, S., and Kurts, C. (2008) Endocytosis mechanisms and the cell biology of antigen presentation. *Curr Opin Immunol* 20, 89-95.
- Carswell, E.A., Old, L.J., Kassel, R.L., Green, S., Fiore, N., and Williamson, B. (1975) An endotoxin-induced serum factor that causes necrosis of tumors. *Proc Natl Acad Sci U S A* 72, 3666-3670.
- Centers for Disease Control and Prevention (CDC) - Division of Tuberculosis Elimination (2011). Tuberculin Skin Testing. <http://www.cdc.gov/tb/publications/factsheets/testing/skintesting.htm>
- Cerwenka, A., and Lanier, L.L. (2001) Ligands for natural killer cell receptors: redundancy or specificity. *Immunol Rev* 181, 158-169.
- Chackerian, A.A., Alt, J.M., Perera, T.V., Dascher, C.C., and Behar, S.M. (2002) Dissemination of Mycobacterium tuberculosis is influenced by host factors and precedes the initiation of T-cell immunity. *Infect Immun* 70, 4501-4509.
- Chamberlain, R.S. (1999) Prospects for the therapeutic use of anticancer vaccines. *Drugs* 57, 309-325.
- Chambers, C.A., Kuhns, M.S., Egen, J.G., and Allison, J.P. (2001) CTLA-4-mediated inhibition in regulation of T cell responses: mechanisms and manipulation in tumor immunotherapy. *Annu Rev Immunol* 19, 565-594.
- Chan, E., Patel, A., Heston, W., and Larchian, W. (2009) Mouse orthotopic models for bladder cancer research. *BJU Int* 104, 1286-1291.
- Chtanova, T., Schaeffer, M., Han, S.J., van Dooren, G.G., Nollmann, M., Herzmark, P., Chan, S.W., Satija, H., Camfield, K., Aaron, H., *et al.* (2008) Dynamics of neutrophil migration in lymph nodes during infection. *Immunity* 29, 487-496.



- Clark, R.A., and Klebanoff, S.J. (1975) Neutrophil-mediated tumor cell cytotoxicity: role of the peroxidase system. *J Exp Med* 141, 1442-1447.
- Colditz, G.A., Brewer, T.F., Berkey, C.S., Wilson, M.E., Burdick, E., Fineberg, H.V., and Mosteller, F. (1994) Efficacy of BCG vaccine in the prevention of tuberculosis. Meta-analysis of the published literature. *JAMA* 271, 698-702.
- Colombel, M., Saint, F., Chopin, D., Malavaud, B., Nicolas, L., and Rischmann, P. (2006) The effect of ofloxacin on bacillus calmette-guerin induced toxicity in patients with superficial bladder cancer: results of a randomized, prospective, double-blind, placebo controlled, multicenter study. *J Urol* 176, 935-939.
- Comstock, G.W. (1994) Field trials of tuberculosis vaccines: how could we have done them better? *Control Clin Trials* 15, 247-276.
- Cooper, A.M. (2009) Cell-mediated immune responses in tuberculosis. *Annu Rev Immunol* 27, 393-422.
- Creel, P. (2007) Bladder Cancer: Epidemiology, Diagnosis, and Treatment. *Seminars in oncology nursing* 23, S3-S10.
- Daley, J.M., Thomay, A.A., Connolly, M.D., Reichner, J.S., and Albina, J.E. (2008) Use of Ly6G-specific monoclonal antibody to deplete neutrophils in mice. *J Leukoc Biol* 83, 64-70.
- Daugelat, S., Ladel, C.H., and Kaufmann, S.H. (1995) Influence of mouse strain and vaccine viability on T-cell responses induced by Mycobacterium bovis bacillus Calmette-Guerin. *Infect Immun* 63, 2033-2040.
- De Boer, E.C., De Jong, W.H., Steerenberg, P.A., Aarden, L.A., Tetteroo, E., De Groot, E.R., Van der Meijden, A.P., Vegt, P.D., Debruyne, F.M., and Ruitenberg, E.J. (1992) Induction of urinary interleukin-1 (IL-1), IL-2, IL-6, and tumour necrosis factor during intravesical immunotherapy with bacillus Calmette-Guerin in superficial bladder cancer. *Cancer Immunol Immunother* 34, 306-312.
- de Boer, E.C., de Jong, W.H., van der Meijden, A.P., Steerenberg, P.A., Witjes, F., Vegt, P.D., Debruyne, F.M., and Ruitenberg, E.J. (1991) Leukocytes in the urine after intravesical BCG treatment for superficial bladder cancer. A flow cytometric analysis. *Urol Res* 19, 45-50.
- De Boer, E.C., Rooijackers, S.J., Schamhart, D.H., and Kurth, K.H. (2003) Cytokine gene expression in a mouse model: the first instillations with viable bacillus Calmette-Guerin determine the succeeding Th1 response. *J Urol* 170, 2004-2008.
- de Boer, E.C., Rooyackers, S.J., Schamhart, D.H., de Reijke, T.M., and Kurth, K.H. (2005) BCG dose reduction by decreasing the instillation frequency: effects on local Th1/Th2 cytokine responses in a mouse model. *Eur Urol* 48, 333-338.
- de Reijke, T.M., Vos, P.C., de Boer, E.C., Bevers, R.F., de Muinck Keizer, W.H., Kurth, K.H., and Schamhart, D.H. (1993) Cytokine production by the human bladder carcinoma cell line T24 in the presence of bacillus Calmette-Guerin (BCG). *Urol Res* 21, 349-352.
- De Visser, K.E., Schumacher, T.N., and Kruisbeek, A.M. (2003) CD8+ T cell tolerance and cancer immunotherapy. *J Immunother* 26, 1-11.
- Dockrell, H.M. (2008) Real vaccines in the real world: tuberculosis vaccines move south. *Expert Rev Vaccines* 7, 703-707.
- DuPage, M., Cheung, A.F., Mazumdar, C., Winslow, M.M., Bronson, R., Schmidt, L.M., Crowley, D., Chen, J., and Jacks, T. (2011) Endogenous T cell responses to antigens expressed in lung adenocarcinomas delay malignant tumor progression. *Cancer Cell* 19, 72-85.

- Durek, C., Brandau, S., Ulmer, A.J., Flad, H.D., Jocham, D., and Bohle, A. (1999) Bacillus-Calmette-Guerin (BCG) and 3D tumors: an in vitro model for the study of adhesion and invasion. *J Urol* 162, 600-605.
- Durek, C., Richter, E., Basteck, A., Rusch-Gerdes, S., Gerdes, J., Jocham, D., and Bohle, A. (2001) The fate of bacillus Calmette-Guerin after intravesical instillation. *J Urol* 165, 1765-1768.
- Esuvaranathan, K., Alexandroff, A.B., McIntyre, M., Jackson, A.M., Prescott, S., Chisholm, G.D., and James, K. (1995) Interleukin-6 production by bladder tumors is upregulated by BCG immunotherapy. *J Urol* 154, 572-575.
- Feigin, M.E., and Muthuswamy, S.K. (2009) Polarity proteins regulate mammalian cell-cell junctions and cancer pathogenesis. *Curr Opin Cell Biol* 21, 694-700.
- Flynn, J.L., Chan, J., and Lin, P.L. (2011) Macrophages and control of granulomatous inflammation in tuberculosis. *Mucosal Immunol* 4, 271-278.
- Freund, C.T., Tong, X.W., Block, A., Contant, C.F., Kieback, D.G., Rowley, D.R., and Lerner, S.P. (2000) Adenovirus-mediated suicide gene therapy for bladder cancer: comparison of the cytomegalovirus- and Rous sarcoma virus-promoter. *Anticancer Res* 20, 2811-2816.
- Gajewski, T.F., Fuertes, M., Spaapen, R., Zheng, Y., and Kline, J. (2011) Molecular profiling to identify relevant immune resistance mechanisms in the tumor microenvironment. *Curr Opin Immunol* 23, 286-292.
- Gheorghiu, M., and Lagrange, P.H. (1983) Viability, heat stability and immunogenicity of four BCG vaccines prepared from four different BCG strains. *Ann Immunol (Paris)* 134C, 125-147.
- Gontero, P., Bohle, A., Malmstrom, P.U., O'Donnell, M.A., Oderda, M., Sylvester, R., and Witjes, F. (2010) The role of bacillus Calmette-Guerin in the treatment of non-muscle-invasive bladder cancer. *Eur Urol* 57, 410-429.
- Greten, T.F., and Jaffee, E.M. (1999) Cancer vaccines. *J Clin Oncol* 17, 1047-1060.
- Grode, L., Seiler, P., Baumann, S., Hess, J., Brinkmann, V., Nasser Eddine, A., Mann, P., Goosmann, C., Bandermann, S., Smith, D., *et al.* (2005) Increased vaccine efficacy against tuberculosis of recombinant Mycobacterium bovis bacille Calmette-Guerin mutants that secrete listeriolysin. *J Clin Invest* 115, 2472-2479.
- Guérin, C. (1980) The History of BCG - Early History. In BCG Vaccine: Tuberculosis - Cancer, S.R. Rosenthal, ed. (Littleton: PSG Publishing).
- Gunther, J.H., Jurczok, A., Wulf, T., Brandau, S., Deinert, I., Jocham, D., and Bohle, A. (1999) Optimizing syngeneic orthotopic murine bladder cancer (MB49). *Cancer Res* 59, 2834-2837.
- Hadaschik, B.A., Zhang, K., So, A.I., Fazli, L., Jia, W., Bell, J.C., Gleave, M.E., and Rennie, P.S. (2008) Oncolytic vesicular stomatitis viruses are potent agents for intravesical treatment of high-risk bladder cancer. *Cancer Res* 68, 4506-4510.
- Halle-Pannenko, O., Bourut, C., and Kamel, M. (1976) Comparison of various BCG preparations in the EORTC-ICIG experimental screening for systemic immunity adjuvants applicable to cancer immunotherapy. *Cancer Immunol Immunother* 1, 17-23.
- Herr, H.W. (1997) Tumour progression and survival in patients with T1G3 bladder tumours: 15-year outcome. *Br J Urol* 80, 762-765.

- Herr, H.W., Badalament, R.A., Amato, D.A., Laudone, V.P., Fair, W.R., and Whitmore, W.F., Jr. (1989) Superficial bladder cancer treated with bacillus Calmette-Guerin: a multivariate analysis of factors affecting tumor progression. *J Urol* 141, 22-29.
- Herr, H.W., Dalbagni, G., and Donat, S.M. (2011) Bacillus Calmette-Guerin without maintenance therapy for high-risk non-muscle-invasive bladder cancer. *Eur Urol* 60, 32-36.
- Herr, H.W., and Morales, A. (2008) History of bacillus Calmette-Guerin and bladder cancer: an immunotherapy success story. *J Urol* 179, 53-56.
- Herr, H.W., Pinsky, C.M., Whitmore, W.F., Jr., Sogani, P.C., Oettgen, H.F., and Melamed, M.R. (1986) Long-term effect of intravesical bacillus Calmette-Guerin on flat carcinoma in situ of the bladder. *J Urol* 135, 265-267.
- Herr, H.W., and Sogani, P.C. (2001) Does early cystectomy improve the survival of patients with high risk superficial bladder tumors? *J Urol* 166, 1296-1299.
- Ho, M.M., Southern, J., Kang, H.N., and Knezevic, I. (2010) WHO Informal Consultation on standardization and evaluation of BCG vaccines Geneva, Switzerland 22-23 September 2009. *Vaccine* 28, 6945-6950.
- Hoft, D.F., Brown, R.M., and Belshe, R.B. (2000) Mucosal bacille calmette-Guerin vaccination of humans inhibits delayed-type hypersensitivity to purified protein derivative but induces mycobacteria-specific interferon-gamma responses. *Clin Infect Dis* 30 Suppl 3, S217-222.
- Hudson, M.A., Brown, E.J., Ritchey, J.K., and Ratliff, T.L. (1991) Modulation of fibronectin-mediated Bacillus Calmette-Guerin attachment to murine bladder mucosa by drugs influencing the coagulation pathways. *Cancer Res* 51, 3726-3732.
- Ikeda, N., Toida, I., Iwasaki, A., Kawai, K., and Akaza, H. (2002) Surface antigen expression on bladder tumor cells induced by bacillus Calmette-Guerin (BCG): A role of BCG internalization into tumor cells. *Int J Urol* 9, 29-35.
- Ingersoll, M.A., Kline, K.A., Nielsen, H.V., and Hultgren, S.J. (2008) G-CSF induction early in uropathogenic Escherichia coli infection of the urinary tract modulates host immunity. *Cell Microbiol* 10, 2568-2578.
- Irwin, S.M., Izzo, A.A., Dow, S.W., Skeiky, Y.A., Reed, S.G., Alderson, M.R., and Orme, I.M. (2005) Tracking antigen-specific CD8 T lymphocytes in the lungs of mice vaccinated with the Mtb72F polyprotein. *Infect Immun* 73, 5809-5816.
- Jackson, A., Alexandroff, A., Fleming, D., Prescott, S., Chisholm, G., and James, K. (1994a) Bacillus-calmette-guerin (bcg) organisms directly alter the growth of bladder-tumor cells. *Int J Oncol* 5, 697-703.
- Jackson, A.M., Alexandroff, A.B., Kelly, R.W., Skibinska, A., Esuvaranathan, K., Prescott, S., Chisholm, G.D., and James, K. (1995) Changes in urinary cytokines and soluble intercellular adhesion molecule-1 (ICAM-1) in bladder cancer patients after bacillus Calmette-Guerin (BCG) immunotherapy. *Clin Exp Immunol* 99, 369-375.
- Jackson, A.M., Alexandroff, A.B., McIntyre, M., Esuvaranathan, K., James, K., and Chisholm, G.D. (1994b) Induction of ICAM 1 expression on bladder tumours by BCG immunotherapy. *J Clin Pathol* 47, 309-312.
- Jemal, A., Bray, F., Center, M.M., Ferlay, J., Ward, E., and Forman, D. (2011) Global cancer statistics. *CA Cancer J Clin* 61, 69-90.
- Jo, E.K. (2008) Mycobacterial interaction with innate receptors: TLRs, C-type lectins, and NLRs. *Curr Opin Infect Dis* 21, 279-286.

- Joffre, O., Nolte, M.A., Sporri, R., and Reis e Sousa, C. (2009) Inflammatory signals in dendritic cell activation and the induction of adaptive immunity. *Immunol Rev* 227, 234-247.
- Joudi, F.N., Smith, B.J., and O'Donnell, M.A. (2006) Final results from a national multicenter phase II trial of combination bacillus Calmette-Guerin plus interferon alpha-2B for reducing recurrence of superficial bladder cancer. *Urol Oncol* 24, 344-348.
- Kaempfer, R., Gerez, L., Farbstein, H., Madar, L., Hirschman, O., Nussinovich, R., and Shapiro, A. (1996) Prediction of response to treatment in superficial bladder carcinoma through pattern of interleukin-2 gene expression. *J Clin Oncol* 14, 1778-1786.
- Kau, A.L., Hunstad, D.A., and Hultgren, S.J. (2005) Interaction of uropathogenic *Escherichia coli* with host uroepithelium. *Curr Opin Microbiol* 8, 54-59.
- Kaufmann, S.H. (2010) Future vaccination strategies against tuberculosis: thinking outside the box. *Immunity* 33, 567-577.
- Kavoussi, L.R., Brown, E.J., Ritchey, J.K., and Ratliff, T.L. (1990) Fibronectin-mediated Calmette-Guerin bacillus attachment to murine bladder mucosa. Requirement for the expression of an antitumor response. *J Clin Invest* 85, 62-67.
- Kelley, D.R., Haaff, E.O., Becich, M., Lage, J., Bauer, W.C., Dresner, S.M., Catalona, W.J., and Ratliff, T.L. (1986) Prognostic value of purified protein derivative skin test and granuloma formation in patients treated with intravesical bacillus Calmette-Guerin. *J Urol* 135, 268-271.
- Kelley, D.R., Ratliff, T.L., Catalona, W.J., Shapiro, A., Lage, J.M., Bauer, W.C., Haaff, E.O., and Dresner, S.M. (1985) Intravesical bacillus Calmette-Guerin therapy for superficial bladder cancer: effect of bacillus Calmette-Guerin viability on treatment results. *J Urol* 134, 48-53.
- Kemp, T.J., Ludwig, A.T., Earel, J.K., Moore, J.M., Vanoosten, R.L., Moses, B., Leidal, K., Nauseef, W.M., and Griffith, T.S. (2005) Neutrophil stimulation with *Mycobacterium bovis* bacillus Calmette-Guerin (BCG) results in the release of functional soluble TRAIL/Apo-2L. *Blood* 106, 3474-3482.
- Lagranderie, M., Chavarot, P., Balazuc, A.M., and Marchal, G. (2000) Immunogenicity and protective capacity of *Mycobacterium bovis* BCG after oral or intragastric administration in mice. *Vaccine* 18, 1186-1195.
- Lamm, D.L. (1985) Bacillus Calmette-Guerin immunotherapy for bladder cancer. *J Urol* 134, 40-47.
- Lamm, D.L. (1992) Carcinoma in situ. *Urol Clin North Am* 19, 499-508.
- Lamm, D.L., Blumenstein, B.A., Crissman, J.D., Montie, J.E., Gottesman, J.E., Lowe, B.A., Sarosdy, M.F., Bohl, R.D., Grossman, H.B., Beck, T.M., *et al.* (2000) Maintenance bacillus Calmette-Guerin immunotherapy for recurrent TA, T1 and carcinoma in situ transitional cell carcinoma of the bladder: a randomized Southwest Oncology Group Study. *J Urol* 163, 1124-1129.
- Lamm, D.L., DeHaven, J.I., Shriver, J., and Sarosdy, M.F. (1991) Prospective randomized comparison of intravesical with percutaneous bacillus Calmette-Guerin versus intravesical bacillus Calmette-Guerin in superficial bladder cancer. *J Urol* 145, 738-740.
- Leong, A.S., Wannakrairot, P., Jose, J., and Milios, J. (1990) Bacillus Calmette-Guerin-treated superficial bladder cancer: correlation of morphology with immunophenotyping. *J Pathol* 162, 35-41.
- Lesterhuis, W.J., Haanen, J.B., and Punt, C.J. (2011) Cancer immunotherapy--revisited. *Nat Rev Drug Discov* 10, 591-600.

- Letouzé, E. (2010). Bioinformatic analysis of bladder cancer progression pathways (Paris: Paris 7 - Denis Diderot), pp. 172.
- Losa, A., Hurle, R., and Lembo, A. (2000) Low dose bacillus Calmette-Guerin for carcinoma in situ of the bladder: long-term results. *J Urol* 163, 68-71; discussion 71-62.
- Ludwig, A.T., Moore, J.M., Luo, Y., Chen, X., Saltsgaver, N.A., O'Donnell, M.A., and Griffith, T.S. (2004) Tumor necrosis factor-related apoptosis-inducing ligand: a novel mechanism for Bacillus Calmette-Guerin-induced antitumor activity. *Cancer Res* 64, 3386-3390.
- Luftenegger, W., Ackermann, D.K., Futterlieb, A., Kraft, R., Minder, C.E., Nadelhaft, P., and Studer, U.E. (1996) Intravesical versus intravesical plus intradermal bacillus Calmette-Guerin: a prospective randomized study in patients with recurrent superficial bladder tumors. *J Urol* 155, 483-487.
- Luo, Y., Henning, J., and O'Donnell, M.A. (2011) Th1 cytokine-secreting recombinant Mycobacterium bovis bacillus Calmette-Guerin and prospective use in immunotherapy of bladder cancer. *Clin Dev Immunol* 2011, 728930.
- Luo, Y., Yamada, H., Evanoff, D.P., and Chen, X. (2006) Role of Th1-stimulating cytokines in bacillus Calmette-Guerin (BCG)-induced macrophage cytotoxicity against mouse bladder cancer MBT-2 cells. *Clin Exp Immunol* 146, 181-188.
- Mack, D., and Frick, J. (1995) Low-dose bacille Calmette-Guerin (BCG) therapy in superficial high-risk bladder cancer: a phase II study with the BCG strain Connaught Canada. *Br J Urol* 75, 185-187.
- Magno, C., Melloni, D., Gali, A., Mucciardi, G., Nicocia, G., Morandi, B., Melioli, G., and Ferlazzo, G. (2002) The anti-tumor activity of bacillus Calmette-Guerin in bladder cancer is associated with an increase in the circulating level of interleukin-2. *Immunol Lett* 81, 235-238.
- Majlessi, L., Simsova, M., Jarvis, Z., Brodin, P., Rojas, M.J., Bauche, C., Nouze, C., Ladant, D., Cole, S.T., Sebo, P., *et al.* (2006) An increase in antimycobacterial Th1-cell responses by prime-boost protocols of immunization does not enhance protection against tuberculosis. *Infect Immun* 74, 2128-2137.
- Mandell, G.L., Douglas, R.G., and Bennett, J.E. (1995) Mycobacterium Tuberculosis. In Principles and Practice of Infectious Diseases, G.L. Mandell, J.E. Bennett, and R. Dolin, eds. (New York: Churchill Livingstone), p. 2219.
- Marchal, G., Seman, M., Milon, G., Truffa-Bachi, P., and Zilberfarb, V. (1982) Local adoptive transfer of skin delayed-type hypersensitivity initiated by a single T lymphocyte. *J Immunol* 129, 954-958.
- Marchant, A., Goetghebuer, T., Ota, M.O., Wolfe, I., Ceesay, S.J., De Groote, D., Corrah, T., Bennett, S., Wheeler, J., Huygen, K., *et al.* (1999) Newborns develop a Th1-type immune response to Mycobacterium bovis bacillus Calmette-Guerin vaccination. *J Immunol* 163, 2249-2255.
- Martinez-Pineiro, J.A., Flores, N., Isorna, S., Solsona, E., Sebastian, J.L., Pertusa, C., Rioja, L.A., Martinez-Pineiro, L., Vela, R., Camacho, J.E., *et al.* (2002) Long-term follow-up of a randomized prospective trial comparing a standard 81 mg dose of intravesical bacille Calmette-Guerin with a reduced dose of 27 mg in superficial bladder cancer. *BJU Int* 89, 671-680.
- Mathe, G., Amiel, J.L., Schwarzenberg, L., Schneider, M., Cattani, A., Schlumberger, J.R., Hayat, M., and De Vassal, F. (1969) Active immunotherapy for acute lymphoblastic leukaemia. *Lancet* 1, 697-699.

- Mathe, G., Halle-Pannenko, O., and Bourut, C. (1973) BCG in cancer immunotherapy: results obtained with various BCG preparations in a screening study for systemic adjuvants applicable to cancer immunoprophylaxis or immunotherapy. *Natl Cancer Inst Monogr* 39, 107-113.
- McCormick, D.L., Ronan, S.S., Becci, P.J., and Moon, R.C. (1981) Influence of total dose and dose schedule on induction of urinary bladder cancer in the mouse by N-butyl-N-(4-hydroxybutyl)nitrosamine. *Carcinogenesis* 2, 251-254.
- McKinley, M., and Dean O'Loughlin, V. (2006) Human Anatomy (New York: Mc Graw Hill Higher Education).
- Mellman, I., Coukos, G., and Dranoff, G. (2011) Cancer immunotherapy comes of age. *Nature* 480, 480-489.
- Menzies, D. (1999) Interpretation of repeated tuberculin tests. Boosting, conversion, and reversion. *Am J Respir Crit Care Med* 159, 15-21.
- Merz, V.W., Marth, D., Kraft, R., Ackermann, D.K., Zingg, E.J., and Studer, U.E. (1995) Analysis of early failures after intravesical instillation therapy with bacille Calmette-Guerin for carcinoma in situ of the bladder. *Br J Urol* 75, 180-184.
- Michelson, S., and Leith, J.T. (1994) Dormancy, regression, and recurrence: towards a unifying theory of tumor growth control. *J Theor Biol* 169, 327-338.
- Milstien, J.B., and Gibson, J.J. (1990) Quality control of BCG vaccine by WHO: a review of factors that may influence vaccine effectiveness and safety. *Bull World Health Organ* 68, 93-108.
- Mittrucker, H.W., Steinhoff, U., Kohler, A., Krause, M., Lazar, D., Mex, P., Miekley, D., and Kaufmann, S.H. (2007) Poor correlation between BCG vaccination-induced T cell responses and protection against tuberculosis. *Proc Natl Acad Sci U S A* 104, 12434-12439.
- Mora, J.R., and von Andrian, U.H. (2006) T-cell homing specificity and plasticity: new concepts and future challenges. *Trends Immunol* 27, 235-243.
- Morales, A., Eidinger, D., and Bruce, A.W. (1976) Intracavitary Bacillus Calmette-Guerin in the treatment of superficial bladder tumors. *J Urol* 116, 180-183.
- Morales, A., Phadke, K., and Steinhoff, G. (2009) Intravesical mycobacterial cell wall-DNA complex in the treatment of carcinoma in situ of the bladder after standard intravesical therapy has failed. *J Urol* 181, 1040-1045.
- Morton, D.L., Eilber, F.R., Joseph, W.L., Wood, W.C., Trahan, E., and Ketcham, A.S. (1970) Immunological factors in human sarcomas and melanomas: a rational basis for immunotherapy. *Ann Surg* 172, 740-749.
- Murphy, K., Travers, P., and Walport, M., eds. (2008) Janeway's Immunobiology, 7th ed. (New York: Garland Science, Taylor & Francis Group, LLC).
- Murray, R.A., Mansoor, N., Harbacheuski, R., Soler, J., Davids, V., Soares, A., Hawkrigde, A., Hussey, G.D., Maecker, H., Kaplan, G., *et al.* (2006) Bacillus Calmette Guerin vaccination of human newborns induces a specific, functional CD8+ T cell response. *J Immunol* 177, 5647-5651.
- Myzak, M.C., and Carr, A.C. (2002) Myeloperoxidase-dependent caspase-3 activation and apoptosis in HL-60 cells: protection by the antioxidants ascorbate and (dihydro)lipoic acid. *Redox Rep* 7, 47-53.
- Nadler, R., Luo, Y., Zhao, W., Ritchey, J.K., Austin, J.C., Cohen, M.B., O'Donnell, M.A., and Ratliff, T.L. (2003) Interleukin 10 induced augmentation of delayed-type hypersensitivity

(DTH) enhances Mycobacterium bovis bacillus Calmette-Guerin (BCG) mediated antitumour activity. *Clin Exp Immunol* 131, 206-216.

Nagaraj, S., and Gabrilovich, D.I. (2008) Tumor escape mechanism governed by myeloid-derived suppressor cells. *Cancer Res* 68, 2561-2563.

Naito, M., Ohara, N., Matsumoto, S., and Yamada, T. (1998) The novel fibronectin-binding motif and key residues of mycobacteria. *J Biol Chem* 273, 2905-2909.

Nathan, C.F. (1982) Secretion of oxygen intermediates: role in effector functions of activated macrophages. *Fed Proc* 41, 2206-2211.

Nestle, F.O., Banchereau, J., and Hart, D. (2001) Dendritic cells: On the move from bench to bedside. *Nat Med* 7, 761-765.

Neyrolles, O., Hernandez-Pando, R., Pietri-Rouxel, F., Fornes, P., Tailleux, L., Barrios Payan, J.A., Pivert, E., Bordat, Y., Aguilar, D., Prevost, M.C., *et al.* (2006) Is adipose tissue a place for Mycobacterium tuberculosis persistence? *PLoS One* 1, e43.

Nicolle, D., Fremond, C., Pichon, X., Bouchot, A., Maillet, I., Ryffel, B., and Quesniaux, V.J. (2004) Long-term control of Mycobacterium bovis BCG infection in the absence of Toll-like receptors (TLRs): investigation of TLR2-, TLR6-, or TLR2-TLR4-deficient mice. *Infect Immun* 72, 6994-7004.

ODonnell, M.A. (2009) Optimizing BCG therapy. *Urol Oncol* 27, 325-328.

ODonnell, M.A., Luo, Y., Chen, X., Szilvasi, A., Hunter, S.E., and Clinton, S.K. (1999) Role of IL-12 in the induction and potentiation of IFN-gamma in response to bacillus Calmette-Guerin. *J Immunol* 163, 4246-4252.

Ojea, A., Nogueira, J.L., Solsona, E., Flores, N., Gomez, J.M., Molina, J.R., Chantada, V., Camacho, J.E., Pineiro, L.M., Rodriguez, R.H., *et al.* (2007) A multicentre, randomised prospective trial comparing three intravesical adjuvant therapies for intermediate-risk superficial bladder cancer: low-dose bacillus Calmette-Guerin (27 mg) versus very low-dose bacillus Calmette-Guerin (13.5 mg) versus mitomycin C. *Eur Urol* 52, 1398-1406.

Okamura, T., Tozawa, K., Yamada, Y., Sakagami, H., Ueda, K., and Kohri, K. (1996) Clinicopathological evaluation of repeated courses of intravesical bacillus Calmette-Guerin instillation for preventing recurrence of initially resistant superficial bladder cancer. *J Urol* 156, 967-971.

Old, L.J. (1985) Tumor necrosis factor (TNF). *Science* 230, 630-632.

Old, L.J. (1996) Immunotherapy for cancer. *Sci Am* 275, 136-143.

Old, L.J., Clarke, D.A., and Benacerraf, B. (1959) Effect of Bacillus Calmette-Guerin infection on transplanted tumours in the mouse. *Nature* 184(Suppl 5), 291-292.

Orihuela, E., Herr, H.W., Pinsky, C.M., and Whitmore, W.F., Jr. (1987) Toxicity of intravesical BCG and its management in patients with superficial bladder tumors. *Cancer* 60, 326-333.

Orme, I.M. (1988) Induction of nonspecific acquired resistance and delayed-type hypersensitivity, but not specific acquired resistance in mice inoculated with killed mycobacterial vaccines. *Infect Immun* 56, 3310-3312.

Pagano, F., Bassi, P., Milani, C., Meneghini, A., Maruzzi, D., and Garbeglio, A. (1991) A low dose bacillus Calmette-Guerin regimen in superficial bladder cancer therapy: is it effective? *J Urol* 146, 32-35.

- Palendira, U., Bean, A.G., Feng, C.G., and Britton, W.J. (2002) Lymphocyte recruitment and protective efficacy against pulmonary mycobacterial infection are independent of the route of prior *Mycobacterium bovis* BCG immunization. *Infect Immun* 70, 1410-1416.
- Palucka, K., Ueno, H., and Banchereau, J. (2011) Recent developments in cancer vaccines. *J Immunol* 186, 1325-1331.
- Pearl, R. (1929) Cancer and tuberculosis. *Am J Hygiene* 9.
- Peduto, L., Dulauroy, S., Lochner, M., Spath, G.F., Morales, M.A., Cumano, A., and Eberl, G. (2009) Inflammation recapitulates the ontogeny of lymphoid stromal cells. *J Immunol* 182, 5789-5799.
- Peuchmaur, M., Benoit, G., Vieillefond, A., Chevalier, A., Lemaigre, G., Martin, E.D., and Jardin, A. (1989) Analysis of mucosal bladder leucocyte subpopulations in patients treated with intravesical *Bacillus Calmette-Guerin*. *Urol Res* 17, 299-303.
- Prescott, S., James, K., Hargreave, T.B., Chisholm, G.D., and Smyth, J.F. (1992) Intravesical Evans strain BCG therapy: quantitative immunohistochemical analysis of the immune response within the bladder wall. *J Urol* 147, 1636-1642.
- Pryor, K., Goddard, J., Goldstein, D., Stricker, P., Russell, P., Golovsky, D., and Penny, R. (1995) *Bacillus Calmette-Guerin* (BCG) enhances monocyte- and lymphocyte-mediated bladder tumour cell killing. *Br J Cancer* 71, 801-807.
- Puzio-Kuter, A.M., Castillo-Martin, M., Kinkade, C.W., Wang, X., Shen, T.H., Matos, T., Shen, M.M., Cordon-Cardo, C., and Abate-Shen, C. (2009) Inactivation of p53 and Pten promotes invasive bladder cancer. *Genes Dev* 23, 675-680.
- Rapp, H.J., and Zbar, B. (1981) BCG and cancer. *J Natl Cancer Inst* 67, 991.
- Ratliff, T.L., Gillen, D., and Catalona, W.J. (1987a) Requirement of a thymus dependent immune response for BCG-mediated antitumor activity. *J Urol* 137, 155-158.
- Ratliff, T.L., Palmer, J.O., McGarr, J.A., and Brown, E.J. (1987b) Intravesical *Bacillus Calmette-Guerin* therapy for murine bladder tumors: initiation of the response by fibronectin-mediated attachment of *Bacillus Calmette-Guerin*. *Cancer Res* 47, 1762-1766.
- Ratliff, T.L., Ritchey, J.K., Yuan, J.J., Andriole, G.L., and Catalona, W.J. (1993) T-cell subsets required for intravesical BCG immunotherapy for bladder cancer. *J Urol* 150, 1018-1023.
- Reiley, W.W., Calayag, M.D., Wittmer, S.T., Huntington, J.L., Pearl, J.E., Fountain, J.J., Martino, C.A., Roberts, A.D., Cooper, A.M., Winslow, G.M., *et al.* (2008) ESAT-6-specific CD4 T cell responses to aerosol *Mycobacterium tuberculosis* infection are initiated in the mediastinal lymph nodes. *Proc Natl Acad Sci U S A* 105, 10961-10966.
- Ribi, E.E., Meyer, T.J., Azuma, I., and Zbar, B. (1973) Mycobacterial cell wall components in tumor suppression and regression. *Natl Cancer Inst Monogr* 39, 115-119.
- Riemensberger, J., Bohle, A., and Brandau, S. (2002) IFN-gamma and IL-12 but not IL-10 are required for local tumour surveillance in a syngeneic model of orthotopic bladder cancer. *Clin Exp Immunol* 127, 20-26.
- Ritz, N., Hanekom, W.A., Robins-Browne, R., Britton, W.J., and Curtis, N. (2008) Influence of BCG vaccine strain on the immune response and protection against tuberculosis. *FEMS Microbiol Rev* 32, 821-841.
- Rodrigues, L.C., Pereira, S.M., Cunha, S.S., Genser, B., Ichihara, M.Y., de Brito, S.C., Hijjar, M.A., Dourado, I., Cruz, A.A., Sant'Anna, C., *et al.* (2005) Effect of BCG revaccination on



incidence of tuberculosis in school-aged children in Brazil: the BCG-REVAC cluster-randomised trial. *Lancet* 366, 1290-1295.

Rook, G.A., and Stanford, J.L. (1996) The Koch phenomenon and the immunopathology of tuberculosis. *Curr Top Microbiol Immunol* 215, 239-262.

Rosenthal, S.R. (1973) BCG and the lympho-reticuloendothelial system. *Natl Cancer Inst Monogr* 39, 91-106.

Rosenthal, S.R. (1980a) BCG in Cancer and Leukemia. In *BCG Vaccine: Tuberculosis - Cancer*, S.R. Rosenthal, ed. (Littleton: PSG Publishing), p. 295.

Rosenthal, S.R. (1980b) Tuberculin Sensitivity and BCG Vaccination. In *BCG Vaccine: Tuberculosis - Cancer*, S.R. Rosenthal, ed. (Littleton: PSG Publishing), p. 176.

Rosevear, H.M., Lightfoot, A.J., O'Donnell, M.A., and Griffith, T.S. (2009) The role of neutrophils and TNF-related apoptosis-inducing ligand (TRAIL) in bacillus Calmette-Guerin (BCG) immunotherapy for urothelial carcinoma of the bladder. *Cancer Metastasis Rev* 28, 345-353.

Ryan, A.A., Nambiar, J.K., Wozniak, T.M., Roediger, B., Shklovskaya, E., Britton, W.J., Fazekas de St Groth, B., and Triccas, J.A. (2009) Antigen load governs the differential priming of CD8 T cells in response to the bacille Calmette Guerin vaccine or Mycobacterium tuberculosis infection. *J Immunol* 182, 7172-7177.

Saban, M.R., Backer, J.M., Backer, M.V., Maier, J., Fowler, B., Davis, C.A., Simpson, C., Wu, X.R., Birder, L., Freeman, M.R., *et al.* (2008) VEGF receptors and neuropilins are expressed in the urothelial and neuronal cells in normal mouse urinary bladder and are upregulated in inflammation. *Am J Physiol Renal Physiol* 295, F60-72.

Saban, M.R., Sferra, T.J., Davis, C.A., Simpson, C., Allen, A., Maier, J., Fowler, B., Knowlton, N., Birder, L., Wu, X.R., *et al.* (2010) Neuropilin-VEGF signaling pathway acts as a key modulator of vascular, lymphatic, and inflammatory cell responses of the bladder to intravesical BCG treatment. *Am J Physiol Renal Physiol* 299, F1245-1256.

Saban, M.R., Simpson, C., Davis, C., Wallis, G., Knowlton, N., Frank, M.B., Centola, M., Gallucci, R.M., and Saban, R. (2007) Discriminators of mouse bladder response to intravesical Bacillus Calmette-Guerin (BCG). *BMC Immunol* 8, 6.

Saban, R., Gerard, N.P., Saban, M.R., Nguyen, N.B., DeBoer, D.J., and Wershil, B.K. (2002) Mast cells mediate substance P-induced bladder inflammation through an NK(1) receptor-independent mechanism. *Am J Physiol Renal Physiol* 283, F616-629.

Saint, F., Patard, J.J., Groux Muscatelli, B., Lefrere Belda, M.A., Gil Diez de Medina, S., Abbou, C.C., and Chopin, D.K. (2001a) Evaluation of cellular tumour rejection mechanisms in the peritumoral bladder wall after bacillus Calmette-Guerin treatment. *BJU Int* 88, 602-610.

Saint, F., Patard, J.J., Irani, J., Salomon, L., Hoznek, A., Legrand, P., Debois, H., Abbou, C.C., and Chopin, D.K. (2001b) Leukocyturia as a predictor of tolerance and efficacy of intravesical BCG maintenance therapy for superficial bladder cancer. *Urology* 57, 617-621; discussion 621-612.

Saint, F., Patard, J.J., Maille, P., Soyeux, P., Hoznek, A., Salomon, L., Abbou, C.C., and Chopin, D.K. (2002) Prognostic value of a T helper 1 urinary cytokine response after intravesical bacillus Calmette-Guerin treatment for superficial bladder cancer. *J Urol* 167, 364-367.

Saint, F., Salomon, L., Quintela, R., Cicco, A., Hoznek, A., Abbou, C.C., and Chopin, D.K. (2003) Do prognostic parameters of remission versus relapse after Bacillus Calmette-Guerin

- (BCG) immunotherapy exist?. analysis of a quarter century of literature. *Eur Urol* 43, 351-360; discussion 360-351.
- Saunders, B.M., Orme, I.M., and Basaraba, R.J. (2008) Immunopathology of Tuberculosis. In *Handbook of Tuberculosis: Immunology and Cell Biology*, S.H. Kaufmann, and W.J. Britton, eds. (Weinheim: WILEY-VCH Verlag GmbH & Co. KGaA), pp. 245-278.
- Schamhart, D.H., De Boer, E.C., Vleeming, R., and Kurth, K.H. (1994) Theoretical and experimental evidence on the use of glycosaminoglycans in BCG-mediated immunotherapy of superficial bladder cancer. *Semin Thromb Hemost* 20, 301-309.
- Seager, C.M., Puzio-Kuter, A.M., Patel, T., Jain, S., Cordon-Cardo, C., Mc Kiernan, J., and Abate-Shen, C. (2009) Intravesical delivery of rapamycin suppresses tumorigenesis in a mouse model of progressive bladder cancer. *Cancer Prev Res (Phila)* 2, 1008-1014.
- Seow, S.W., Cai, S., Rahmat, J.N., Bay, B.H., Lee, Y.K., Chan, Y.H., and Mahendran, R. (2010) Lactobacillus rhamnosus GG induces tumor regression in mice bearing orthotopic bladder tumors. *Cancer Sci* 101, 751-758.
- Shear, M.J., Turner, F.C., Perrault, A., and Shovelton, T. (1943) Chemical treatment of tumours. V. Isolation of the hemorrhage-producing fraction from *Serratia marcescens* (Bacillus prodigiosus) culture filtrate. *J Natl Cancer Inst* 4, 81-97.
- Shinka, T., Hirano, A., Uekado, Y., and Ohkawa, T. (1990) Clinical study of prognostic factors of superficial bladder cancer treated with intravesical bacillus Calmette-Guerin. *Br J Urol* 66, 35-39.
- Siatelis, A., Houhoula, D.P., Papaparaskevas, J., Delakas, D., and Tsakris, A. (2011) Detection of bacillus Calmette-Guerin (Mycobacterium bovis BCG) DNA in urine and blood specimens after intravesical immunotherapy for bladder carcinoma. *J Clin Microbiol* 49, 1206-1208.
- Simons, M.P., O'Donnell, M.A., and Griffith, T.S. (2008) Role of neutrophils in BCG immunotherapy for bladder cancer. *Urol Oncol* 26, 341-345.
- Small, E.J., Fratesi, P., Reese, D.M., Strang, G., Laus, R., Peshwa, M.V., and Valone, F.H. (2000) Immunotherapy of hormone-refractory prostate cancer with antigen-loaded dendritic cells. *J Clin Oncol* 18, 3894-3903.
- Smith, J.A. (1994) Neutrophils, host defense, and inflammation: a double-edged sword. *J Leukoc Biol* 56, 672-686.
- Srivastava, R.K. (2001) TRAIL/Apo-2L: mechanisms and clinical applications in cancer. *Neoplasia* 3, 535-546.
- Sterne, J.A., Rodrigues, L.C., and Guedes, I.N. (1998) Does the efficacy of BCG decline with time since vaccination? *Int J Tuberc Lung Dis* 2, 200-207.
- Summerhayes, I.C., and Franks, L.M. (1979) Effects of donor age on neoplastic transformation of adult mouse bladder epithelium in vitro. *J Natl Cancer Inst* 62, 1017-1023.
- Suttman, H., Jacobsen, M., Reiss, K., Jocham, D., Bohle, A., and Brandau, S. (2004) Mechanisms of bacillus Calmette-Guerin mediated natural killer cell activation. *J Urol* 172, 1490-1495.
- Suttman, H., Riemensberger, J., Bentien, G., Schmaltz, D., Stockle, M., Jocham, D., Bohle, A., and Brandau, S. (2006) Neutrophil granulocytes are required for effective Bacillus Calmette-Guerin immunotherapy of bladder cancer and orchestrate local immune responses. *Cancer Res* 66, 8250-8257.

Sylvester, R.J., van der Meijden, A., Witjes, J.A., Jakse, G., Nonomura, N., Cheng, C., Torres, A., Watson, R., and Kurth, K.H. (2005) High-grade Ta urothelial carcinoma and carcinoma in situ of the bladder. *Urology* 66, 90-107.

Sylvester, R.J., van der Meijden, A.P., Oosterlinck, W., Hoeltl, W., and Bono, A.V. (2003) The side effects of Bacillus Calmette-Guerin in the treatment of Ta T1 bladder cancer do not predict its efficacy: results from a European Organisation for Research and Treatment of Cancer Genito-Urinary Group Phase III Trial. *Eur Urol* 44, 423-428.

Takeuchi, A., Dejima, T., Yamada, H., Shibata, K., Nakamura, R., Eto, M., Nakatani, T., Naito, S., and Yoshikai, Y. (2011) IL-17 production by gammadelta T cells is important for the antitumor effect of Mycobacterium bovis bacillus Calmette-Guerin treatment against bladder cancer. *Eur J Immunol* 41, 246-251.

Teppema, J.S., de Boer, E.C., Steerenberg, P.A., and van der Meijden, A.P. (1992) Morphological aspects of the interaction of Bacillus Calmette-Guerin with urothelial bladder cells in vivo and in vitro: relevance for antitumor activity? *Urol Res* 20, 219-228.

Tian, T., Woodworth, J., Skold, M., and Behar, S.M. (2005) In vivo depletion of CD11c+ cells delays the CD4+ T cell response to Mycobacterium tuberculosis and exacerbates the outcome of infection. *J Immunol* 175, 3268-3272.

Torrence, R.J., Kavoussi, L.R., Catalona, W.J., and Ratliff, T.L. (1988) Prognostic factors in patients treated with intravesical bacillus Calmette-Guerin for superficial bladder cancer. *J Urol* 139, 941-944.

Trunz, B.B., Fine, P., and Dye, C. (2006) Effect of BCG vaccination on childhood tuberculous meningitis and miliary tuberculosis worldwide: a meta-analysis and assessment of cost-effectiveness. *Lancet* 367, 1173-1180.

Tuberculosis Program, P.H.S. (1955) Experimental studies of vaccination, allergy, and immunity in tuberculosis: 3. Effect of killed BCG vaccine. *Bull World Health Organ* 12, 47-62.

Urdahl, K.B., Shafiani, S., and Ernst, J.D. (2011) Initiation and regulation of T-cell responses in tuberculosis. *Mucosal Immunol* 4, 288-293.

van der Meijden, A.P., Brausi, M., Zambon, V., Kirkels, W., de Balincourt, C., and Sylvester, R. (2001) Intravesical instillation of epirubicin, bacillus Calmette-Guerin and bacillus Calmette-Guerin plus isoniazid for intermediate and high risk Ta, T1 papillary carcinoma of the bladder: a European Organization for Research and Treatment of Cancer genito-urinary group randomized phase III trial. *J Urol* 166, 476-481.

van der Meijden, A.P., Steerenberg, P.A., van Hoogstraaten, I.M., Kerckhaert, J.A., Schreinemachers, L.M., Harthoorn-Lasthuizen, E.J., Hagens, A.M., de Jong, W.H., Debruijne, F.M., and Ruitenberg, E.J. (1989) Immune reactions in patients with superficial bladder cancer after intradermal and intravesical treatment with bacillus Calmette-Guerin. *Cancer Immunol Immunother* 28, 287-295.

van der Meijden, A.P., Sylvester, R.J., Oosterlinck, W., Hoeltl, W., and Bono, A.V. (2003) Maintenance Bacillus Calmette-Guerin for Ta T1 bladder tumors is not associated with increased toxicity: results from a European Organisation for Research and Treatment of Cancer Genito-Urinary Group Phase III Trial. *Eur Urol* 44, 429-434.

van der Wel, N., Hava, D., Houben, D., Fluitsma, D., van Zon, M., Pierson, J., Brenner, M., and Peters, P.J. (2007) M. tuberculosis and M. leprae translocate from the phagolysosome to the cytosol in myeloid cells. *Cell* 129, 1287-1298.

Vesely, M.D., Kershaw, M.H., Schreiber, R.D., and Smyth, M.J. (2011) Natural innate and adaptive immunity to cancer. *Annu Rev Immunol* 29, 235-271.

- Vipond, J., Cross, M.L., Lambeth, M.R., Clark, S., Aldwell, F.E., and Williams, A. (2008) Immunogenicity of orally-delivered lipid-formulated BCG vaccines and protection against Mycobacterium tuberculosis infection. *Microbes Infect* 10, 1577-1581.
- von Garnier, C., Filgueira, L., Wikstrom, M., Smith, M., Thomas, J.A., Strickland, D.H., Holt, P.G., and Stumbles, P.A. (2005) Anatomical location determines the distribution and function of dendritic cells and other APCs in the respiratory tract. *J Immunol* 175, 1609-1618.
- Watanabe, E., Matsuyama, H., Matsuda, K., Ohmi, C., Tei, Y., Yoshihiro, S., Ohmoto, Y., and Naito, K. (2003) Urinary interleukin-2 may predict clinical outcome of intravesical bacillus Calmette-Guerin immunotherapy for carcinoma in situ of the bladder. *Cancer Immunol Immunother* 52, 481-486.
- Weerdenburg, E.M., Peters, P.J., and van der Wel, N.N. (2010) How do mycobacteria activate CD8+ T cells? *Trends Microbiol* 18, 1-10.
- Weir, R.E., Gorak-Stolinska, P., Floyd, S., Lalor, M.K., Stenson, S., Branson, K., Blitz, R., Ben-Smith, A., Fine, P.E., and Dockrell, H.M. (2008) Persistence of the immune response induced by BCG vaccination. *BMC Infect Dis* 8, 9.
- Wiemann, B., and Starnes, C.O. (1994) Coley's toxins, tumor necrosis factor and cancer research: a historical perspective. *Pharmacol Ther* 64, 529-564.
- Wiker, H.G., and Harboe, M. (1992) The antigen 85 complex: a major secretion product of Mycobacterium tuberculosis. *Microbiol Rev* 56, 648-661.
- Williams, P.D., Lee, J.K., and Theodorescu, D. (2008) Molecular credentialing of rodent bladder carcinogenesis models. *Neoplasia* 10, 838-846.
- Willmott, N., Pimm, M.V., and Baldwin, R.W. (1979) Quantitative comparison of BCG strains and preparations in immunotherapy of a rat sarcoma. *J Natl Cancer Inst* 63, 787-795.
- Winau, F., Hegasy, G., Kaufmann, S.H., and Schaible, U.E. (2005) No life without death-apoptosis as prerequisite for T cell activation. *Apoptosis* 10, 707-715.
- Winau, F., Weber, S., Sad, S., de Diego, J., Hoops, S.L., Breiden, B., Sandhoff, K., Brinkmann, V., Kaufmann, S.H., and Schaible, U.E. (2006) Apoptotic vesicles crossprime CD8 T cells and protect against tuberculosis. *Immunity* 24, 105-117.
- Wolf, A.J., Desvignes, L., Linas, B., Banaiee, N., Tamura, T., Takatsu, K., and Ernst, J.D. (2008) Initiation of the adaptive immune response to Mycobacterium tuberculosis depends on antigen production in the local lymph node, not the lungs. *J Exp Med* 205, 105-115.
- Wolf, A.J., Linas, B., Trevejo-Nunez, G.J., Kincaid, E., Tamura, T., Takatsu, K., and Ernst, J.D. (2007) Mycobacterium tuberculosis infects dendritic cells with high frequency and impairs their function in vivo. *J Immunol* 179, 2509-2519.
- Woodworth, J.S., Fortune, S.M., and Behar, S.M. (2008) Bacterial protein secretion is required for priming of CD8+ T cells specific for the Mycobacterium tuberculosis antigen CFP10. *Infect Immun* 76, 4199-4205.
- Wu, X.R. (2005) Urothelial tumorigenesis: a tale of divergent pathways. *Nat Rev Cancer* 5, 713-725.
- Wu, X.R., Kong, X.P., Pellicer, A., Kreibich, G., and Sun, T.T. (2009) Uroplakins in urothelial biology, function, and disease. *Kidney Int* 75, 1153-1165.
- Young, S.L., Murphy, M., Zhu, X.W., Harnden, P., O'Donnell, M.A., James, K., Patel, P.M., Selby, P.J., and Jackson, A.M. (2004) Cytokine-modified Mycobacterium smegmatis as a novel anticancer immunotherapy. *Int J Cancer* 112, 653-660.

- Yron, I., Weiss, D.W., Robinson, E., Cohen, D., Adelberg, M.G., Mekori, T., and Haber, M. (1973) Immunotherapeutic studies in mice with the methanol-extraction residue (mer) fraction of BCG: solid tumors. *Natl Cancer Inst Monogr* 39, 33-55.
- Yutkin, V., Pode, D., Pikarsky, E., and Mandelboim, O. (2007) The expression level of ligands for natural killer cell receptors predicts response to bacillus Calmette-Guerin therapy: a pilot study. *J Urol* 178, 2660-2664.
- Zaharoff, D.A., Hoffman, B.S., Hooper, H.B., Benjamin, C.J., Jr., Khurana, K.K., Hance, K.W., Rogers, C.J., Pinto, P.A., Schlom, J., and Greiner, J.W. (2009) Intravesical immunotherapy of superficial bladder cancer with chitosan/interleukin-12. *Cancer Res* 69, 6192-6199.
- Zamai, L., Ponti, C., Mirandola, P., Gobbi, G., Papa, S., Galeotti, L., Cocco, L., and Vitale, M. (2007) NK cells and cancer. *J Immunol* 178, 4011-4016.
- Zbar, B. (1972) Tumor regression mediated by Mycobacterium bovis (strain BCG). *Natl Cancer Inst Monogr* 35, 341-344.
- Zbar, B., Bernstein, I., Tanaka, T., and Rapp, H.J. (1970) Tumor immunity produced by the intradermal inoculation of living tumor cells and living Mycobacterium bovis (strain BCG). *Science* 170, 1217-1218.
- Zbar, B., Bernstein, I.D., and Rapp, H.J. (1971) Suppression of tumor growth at the site of infection with living Bacillus Calmette-Guerin. *J Natl Cancer Inst* 46, 831-839.
- Zbar, B., and Tanaka, T. (1971) Immunotherapy of cancer: regression of tumors after intralesional injection of living Mycobacterium bovis. *Science* 172, 271-273.
- Zhang, X., and Godbey, W.T. (2011) Preclinical evaluation of a gene therapy treatment for transitional cell carcinoma. *Cancer Gene Ther* 18, 34-41.
- Zhang, Z.T., Pak, J., Huang, H.Y., Shapiro, E., Sun, T.T., Pellicer, A., and Wu, X.R. (2001) Role of Ha-ras activation in superficial papillary pathway of urothelial tumor formation. *Oncogene* 20, 1973-1980.
- Zhang, Z.T., Pak, J., Shapiro, E., Sun, T.T., and Wu, X.R. (1999) Urothelium-specific expression of an oncogene in transgenic mice induced the formation of carcinoma in situ and invasive transitional cell carcinoma. *Cancer Res* 59, 3512-3517.
- Zlotta, A.R., van Vooren, J.P., Huygen, K., Drowart, A., Decock, M., Pirson, M., Jurion, F., Palfliet, K., Denis, O., Simon, J., et al. (2000) What is the optimal regimen for BCG intravesical therapy? Are six weekly instillations necessary? *Eur Urol* 37, 470-477.
- Zuiverloon, T.C., Nieuweboer, A.J., Vekony, H., Kirkels, W.J., Bangma, C.H., and Zwarthoff, E.C. (2011) Markers Predicting Response to Bacillus Calmette-Guerin Immunotherapy in High-Risk Bladder Cancer Patients: A Systematic Review. *Eur Urol*.
- Zwerling, A., Behr, M.A., Verma, A., Brewer, T.F., Menzies, D., and Pai, M. (2011) The BCG World Atlas: a database of global BCG vaccination policies and practices. *PLoS Med* 8, e1001012.

**Abstract:** Intravesical instillation of bacillus Calmette-Guérin (BCG) for non-muscle invasive bladder cancer is one of the few examples of successful immunotherapy in the clinic, with 50-70% treatment response. While success of therapy is known to rely on repeated instillations of live BCG, administered as adjuvant therapy shortly after tumor resection, its precise mechanisms of action remain unclear.

I established an experimental mouse model to study the dynamics of the immune response following intravesical BCG regimen. Based on experimental work in humans, I focused my attention on the establishment of a robust acute inflammatory response, together with the activation and recruitment of T lymphocytes. I demonstrated that BCG dissemination to bladder draining lymph nodes and priming of interferon- $\gamma$ -producing T cells could occur following a single instillation. However, repeated instillations with live BCG were necessary for a robust T cell infiltration into the bladder. Interestingly, subcutaneous immunization with BCG prior to instillation overcame this requirement, triggering a more robust acute inflammatory process following the first intravesical instillation and accelerating T cell entry into the bladder, as compared to the standard protocol. Moreover, subcutaneous immunization with BCG prior to intravesical treatment of an orthotopic tumor dramatically improved response to therapy. These data prompted analysis of clinical data, which showed a significant difference in recurrence-free survival, favoring those patients with sustained pre-existing immunity to BCG.

In parallel, using clinical and *in vitro* experimental data, I contributed to the construction and parameterization of a stochastic mathematical model describing the interactions between BCG, the immune system, the bladder mucosa and tumor cells. First, we could show that tumor extinction mediated by the innate immune system acting on its own is an unlikely occurrence, as it would require a bystander killing capacity per innate effector cell that is much higher than suggested by experimental data. Second, we refined our mathematical model to take into account the adaptive immune response, and evaluated optimal clinical parameters of BCG induction therapy, including (i) duration between resection and the first instillation, (ii) BCG dose, (iii) indwelling time, and (iv) treatment interval of induction therapy, which all had an impact on the probability of tumor extinction. A remarkable finding is that an inter-instillation interval two times longer than the seven-day interval used in the current standard of care would substantially improve treatment outcome.

Together these data provide new insights into a long-standing clinically effective immunotherapeutic regimen and predict strategies that may improve patient management. Most importantly, I suggest that monitoring patients' response to purified protein derivative (PPD) test, and, if negative, boosting BCG responses by parenteral exposure prior to intravesical treatment initiation, may be a safe and effective means of improving intravesical BCG-induced clinical responses.

**Résumé :** L'instillation intravésicale de bacilles de Calmette et Guérin (BCG) comme traitement adjuvant du cancer de la vessie non invasif du muscle est l'un des seuls exemples de réussite d'une immunothérapie à la clinique, avec des taux de réponse de 50-70 %. S'il est établi que le succès de la thérapie repose sur des injections répétées de BCG vivant, administré peu après la résection chirurgicale de la tumeur, ses mécanismes d'action n'ont pas été définis précisément.

Au cours de ma thèse, j'ai établi un modèle expérimental de souris pour étudier la dynamique de la réponse immunitaire induite par l'administration intravésicale de BCG. Au vu d'un certain nombre de travaux chez l'homme, j'ai concentré mon attention sur l'établissement du processus inflammatoire aigu, ainsi que sur l'activation et le recrutement des lymphocytes T. Je démontre qu'une seule instillation de BCG est suffisante pour induire la dissémination du BCG dans les ganglions lymphatiques drainant la vessie et l'activation de lymphocytes T produisant de l'interféron gamma. Cependant, des instillations répétées de BCG vivant sont nécessaires pour obtenir une robuste infiltration de lymphocytes T dans la vessie. Toutefois, je montre qu'une immunisation préalable des souris par voie sous-cutanée conduit à un processus inflammatoire aigu accentué dès la première instillation et accélère le recrutement des lymphocytes T dans la vessie, par rapport au protocole standard. En outre, l'immunisation préalable des souris par voie sous-cutanée améliore de façon substantielle leur réponse à la BCG-thérapie, dans un modèle d'implantation orthotopique de cellules tumorales. Enfin, l'analyse de données cliniques révèle un avantage statistiquement significatif pour les patients qui ont la signature d'une réponse immunitaire au BCG préalablement à la thérapie intravésicale.

Par ailleurs, utilisant des données cliniques et expérimentales, j'ai contribué à la construction et au paramétrage d'un modèle mathématique stochastique décrivant les interactions entre le BCG, le système immunitaire, la vessie et les cellules tumorales. Nous avons tout d'abord montré qu'il était très improbable que l'extinction tumorale puisse être médiée seulement par l'immunité innée, car cela exigerait une capacité de tuer par effet *bystander* bien plus élevée que celle observée expérimentalement chez les cellules effectrices de l'immunité innée. Nous avons ensuite raffiné notre modèle pour qu'il prenne aussi en compte l'immunité adaptative. Nous avons alors utilisé ce deuxième modèle pour évaluer les paramètres cliniques optimaux pour la BCG thérapie, et parmi eux (i) le délai entre la résection chirurgicale et la première instillation, (ii) la dose de BCG, (iii) le temps de contact du BCG avec la vessie et (iv) l'intervalle de temps entre deux injections répétées de BCG. Tous ces paramètres ont un impact sur la probabilité d'extinction tumorale, et, notamment, la multiplication par deux du délai entre deux instillations améliorerait très favorablement le taux de réponse au traitement.

L'ensemble de ces données contribue à éclairer sous un jour nouveau une immunothérapie utilisée en clinique depuis longtemps et prédit des stratégies qui pourraient contribuer à améliorer le soin des patients. Notamment, je suggère que la pratique d'un test tuberculitique sur les patients préalablement à la thérapie intravésicale, suivie de l'immunisation parentérale par le BCG des patients négatifs pour le test, pourrait être une méthode sûre et efficace pour améliorer la réponse clinique induite par les instillations intravésicales de BCG.