



HAL
open science

Design of wideband arrays of spiral antennas.

Israel Hinostroza

► **To cite this version:**

Israel Hinostroza. Design of wideband arrays of spiral antennas.. Other. Supélec, 2013. English.
NNT : 2013SUPL0008 . tel-00830469

HAL Id: tel-00830469

<https://theses.hal.science/tel-00830469>

Submitted on 5 Jun 2013

HAL is a multi-disciplinary open access archive for the deposit and dissemination of scientific research documents, whether they are published or not. The documents may come from teaching and research institutions in France or abroad, or from public or private research centers.

L'archive ouverte pluridisciplinaire **HAL**, est destinée au dépôt et à la diffusion de documents scientifiques de niveau recherche, publiés ou non, émanant des établissements d'enseignement et de recherche français ou étrangers, des laboratoires publics ou privés.



Thèse de Doctorat

DOMAINE : Sciences physiques pour l'ingénieur

Spécialité : Électromagnétisme

École Doctorale « Sciences et Technologies de l'Information des
Télécommunications et des Systèmes »

Présentée par :

Israel HINOSTROZA

Sujet :

Conception de réseaux large bande d'antennes spirales

Soutenue le 5 avril 2013 devant les membres du jury :

Dr. Liliana-Delia Arnaud-Cormos, Université de Limoges
Pr. Raphaël Gillard, INSA Rennes
Pr. Randy L. Haupt, Colorado School of Mines
Pr. Dominique Lesselier, L2S
Pr. Marc Lesturgie, SONDRRA
Dr. Nicolas Ribière-Tharaud, CEA
Pr. Warren L. Stutzman, Virginia Tech
Dr. Régis Guinvarc'h, SONDRRA

Examineur
Rapporteur
Examineur
Examineur
Examineur
Examineur
Rapporteur
Directeur de Thèse

2013-08-TH

ACKNOWLEDGEMENTS

I would like to thank Régis Guinvarc'h for all the support and discussions about this work. He was always trying to put my feet back on the ground. I specially appreciated his guidance about the structure of the work and patience about my systematic errors. I will be forever in his debt. I would also thank Randy Haupt for all his advices. His experience and open-mindedness made a huge difference in my work.

Thanks to Karim Louertani for all the discussions and work we have done together during my work. I also appreciate all the conversations with my colleagues in SONDRALab. It helped me broaden my research work.

I am grateful to my parents, Flor and Pascual, and my sisters, Vicky and Melissa, for all the support to continue in my work, that kind of support that only a very close-knit family gives. I also thank my beloved wife, Cristina, for all the overnight discussions and encouragements, specially in those moments when things appear without solution. And, above all, I thank God, because He gives us the power to think.

TABLE OF CONTENTS

ACKNOWLEDGEMENTS	v
GLOSSARY	ix
RÉSUMÉ ÉTENDU	x
INTRODUCTION	xlix
CHAPTER	
I. General Review	1
1.1 Introduction	1
1.2 Antenna basics	1
1.2.1 Some antenna concepts and definitions	1
1.2.2 Broadband antennas	3
1.3 The Archimedean spiral antenna	5
1.3.1 Type of spirals	9
1.3.2 Feeding system	11
1.3.3 Cavity	14
1.3.4 Miniaturization	17
1.4 Antenna array basics	18
1.4.1 Mutual coupling	18
1.4.2 Array factor	20
1.4.3 Uniformly spaced arrays	21
1.4.4 Non-uniformly spaced arrays	25
1.4.5 Dual polarization capability	26
1.4.6 Array bandwidth	28
1.5 Summary of chapter	32
II. Linear Array of Spiral Antennas	33
2.1 Introduction	33
2.2 Resonances in a linear array	33
2.2.1 An example of a linear array	33

2.2.2	Resonance in arrays without ground plane and in any type of spirals	35
2.2.3	Standing waves found in just one spiral	38
2.2.4	Explanation using transmission line theory	43
2.2.5	Solutions	47
2.3	Mono-polarized uniform linear array	55
2.3.1	Analytical estimation of the bandwidth of linear arrays	55
2.3.2	Simulation of linear arrays of asymmetrical spirals	58
2.4	Dual polarized linear array	63
2.5	Summary of chapter	65
III.	Planar Array of Spiral Antennas	67
3.1	Introduction	67
3.2	Mono polarized planar array of spiral antennas	67
3.2.1	An example of a mono polarized planar array of spiral antennas	67
3.2.2	Analytical estimation of bandwidth of planar spiral arrays	68
3.2.3	Simulations of planar arrays to validate analytical method	70
3.2.4	WAVES technique in uniform planar arrays	76
3.3	Dual polarized planar array (6:1 bandwidth)	84
3.3.1	Design and measurements of one ring array	85
3.3.2	Applying first design trend: Adding more rings	92
3.3.3	Applying second design trend: Connecting the spirals	95
3.4	Summary of chapter	101
IV.	Conclusion	103
4.1	Conclusion	103
BIBLIOGRAPHY		105

GLOSSARY

AR Axial Ratio

VSWR Voltage Standing Wave Ratio

XpolR Rejection of Cross Polarization

RSL Relative Side Lobe Level

RÉSUMÉ ÉTENDU

Introduction

Les télécommunications sans fil utilisant les ondes électromagnétiques remontent à un peu plus d'un siècle. Vers la fin des années 1800s, la télégraphie sans fil utilisait des émetteurs à arc. La bande passante des signaux générés par ces émetteurs était très importante ce qui a obligé à utiliser des antennes large bande (*Lodge*, 1898). À l'époque, la large bande passante de ces systèmes était considérée comme étant une utilisation pas efficace du spectre de fréquences, faisant des systèmes à bande étroite les favoris depuis 1910. À partir des années 1960, les systèmes large bande ont regagné de l'intérêt pour le radar.

Vers 1954, Edwin Turner enroulait les bras d'une antenne dipôle pour lui donner la forme d'une spirale d'Archimède à deux bras, faisant ainsi une nouvelle antenne. Cette antenne possède une bonne polarisation circulaire avec un gain et une impédance d'entrée plus ou moins constants dans une bande passante très large. Ces résultats ont aidé à consolider les travaux théoriques de Victor Rumsey sur l'idée des "antennes indépendantes de la fréquence" (*Corzine and Mosko*, 1990).

Les réseaux d'antennes ont été utilisés depuis le début du 19ème siècle pour augmenter la directivité, mais le balayage était encore fait de façon mécanique. En 1937, l'utilisation des déphaseurs réglables a été proposée pour faire un balayage électronique (*Friis and Feldman*, 1937). En 1958, la première antenne réseau à commande de phase pour balayage tridimensionnel a été présentée (*Spradley*, 1958).

Jusqu'à la fin des années 1960, une des principales applications des réseaux d'antennes était le RADAR. En plus des informations de distance et de vitesse de la cible, le réseau peut être conçu pour obtenir l'information sur la polarisation de l'onde rétrodiffusée par la cible. Cette polarisation change en dépendant de la forme, de l'orientation et de la nature de la cible (*Boerner et al.*, 1981). La polarisation joue aussi un rôle important dans les télécommunications où le récepteur et l'émetteur doivent avoir les bonnes polarisations pour assurer une bonne transmission des données (*Allen et al.*, 2007).

Jusqu'au début des années 2000, la principale tendance de la conception des réseaux d'antennes large bande était d'abord choisir un élément avec la bande passante souhaitée pour en suite optimiser l'élément entouré des autres éléments du réseau (*Munk et al.*, 2003). Dans ce cas-ci, la limite basse de la bande passante dépend de l'antenne choisie, et la limite haute de la bande passante est fixée par l'apparition des lobes de réseau. Pour étendre la bande passante, il est possible d'utiliser une distribution spatiale non-uniforme ainsi qu'un grand nombre d'antennes pour retarder l'apparition des lobes de réseau.

Bien qu'au tour de 1970 une autre façon de concevoir des réseaux large bande fut proposée par Baum (*Hansen*, 2004), une deuxième tendance a gagné de l'impulsion dans la dernière décennie avec les travaux de Munk et d'autres (*Munk et al.*, 2003). Au lieu d'essayer de diminuer les

effets de couplage entre les antennes, ce couplage est plutôt favorisé pour incrémenter la bande passante.

Cette dernière tendance est appliquée principalement aux réseaux à distribution spatiale non uniforme. La bande passante est conçue directement en considérant et favorisant le couplage entre les éléments ce qui va déterminer la limite basse de la bande passante. La limite haute est déterminée, à nouveau, par l'apparition des lobes de réseaux.

Dans ce contexte, le laboratoire SONDRRA s'est intéressé à la recherche de la conception de réseaux d'antennes large bande. SONDRRA est un laboratoire de recherche issu de la collaboration entre 4 institutions de Singapour et de la France. Les instituts sont : SUPELEC et ONERA de la France et NUS (Université Nationale de Singapour) et DSO National Laboratories de Singapour.

Le but de cette recherche était le développement des nouveaux types de maillage (distribution spatiale) pour des réseaux large bande à double polarisation en utilisant les antennes spirales. Les limites des bandes passantes en utilisant les maillages existants devaient être étudiées pour le cas à double polarisation. D'autres problèmes techniques devaient être aussi résolus, comme l'alimentation large bande pour le réseau d'antennes et l'utilisation d'un plan de masse.

Chapitre 1 introduit les définitions et concepts qui seront utilisés tout au long du présent travail. L'antenne spirale d'Archimède est étudiée ainsi comme d'autres variantes de la spirale. Le système d'alimentation de l'antenne est présenté. Les problèmes associés à l'utilisation d'un plan de masse ou cavité dessous l'antenne sont aussi discutés. Quelques concepts importants sur les réseaux d'antennes sont introduits. Pour finir le chapitre, une classification des réseaux d'antennes est présentée en prenant en compte les deux tendances actuelles sur la conception des réseaux d'antennes large bande.

Chapitre 2 est focalisé sur les réseaux linéaires d'antennes spirales. Le problème de résonance dans un réseau d'antennes spirales symétriques est étudié. Il est montré aussi que les résonances sont présentes dans une antenne isolée. Des explications et solutions à ces résonances sont données. Les bandes passantes de ces réseaux sont étudiées. Un exemple d'un réseau à double polarisation montre que dans ce cas les résonances n'apparaissent pas.

Chapitre 3 est centré sur les réseaux planaires. Une méthode analytique pour estimer les bandes passantes des réseaux est présentée et vérifiée par des simulations. Les cas en utilisant la technique WAVES (réseau large bande d'antennes à taille variable) sont aussi étudiés. Il est montré que pour le cas des réseaux à maillage uniforme et double polarisation la bande passante est inexistante. Pour palier le problème des lobes de réseau le maillage non uniforme est proposé et étudié. En connectant les spirales la limite basse de la bande passante est diminuée ce qui élargit encore plus la bande passante.

CHAPITRE 1 : Révision Générale

Dans ce chapitre quelques définitions et concepts liés aux antennes et réseaux d'antennes sont introduits. Quelques exemples d'antennes large bande, en particulier l'antenne spirale d'Archimède, sont présentés. En plus, les tendances actuelles pour la conception des réseaux

large bande sont décrites.

Quelques concepts et définitions sur les antennes

Bande passante des antennes

Les antennes peuvent émettre et recevoir sur une gamme de fréquences, ou bande passante (BW), entre la fréquence de la limite basse (f_{low}) et la fréquence de la limite haute (f_{high}) de la bande passante. En fonction des applications, les antennes sont conçues pour avoir une bande passante large (cas des antennes spirales) ou étroite (cas d'une antenne dipolaire). Il y a trois définitions de bande passante (*Haupt*, 2010) :

- En pourcentage par rapport à la fréquence centrale (f_{center}) :

$$BW = \frac{f_{high} - f_{low}}{f_{center}} \times 100 \quad (1)$$

- Ratio entre la fréquence haute et basse, ($f_{high} : f_{low}$) :

$$BW = \frac{f_{high}}{f_{low}} \quad (2)$$

- Différence entre les limites de la bande passante :

$$BW = f_{high} - f_{low} \quad (3)$$

Les antennes large bande présentent une bande passante d'au moins 25% ($\sim 1.3 : 1$) (*Stutzman and Buxton*, 2000). Les limites de la bande passante (f_{low} , f_{high}) dépendent des paramètres à étudier. Dans ce travail, nous allons considérer principalement deux paramètres des antennes : l'adaptation de l'impédance d'entrée et de la polarisation.

Adaptation de l'impédance d'entrée

Pour une antenne, il est considéré qu'il y a une bonne adaptation de son impédance si le coefficient de réflexion de l'adaptation, $|S_{11}|$, est inférieur à -10 dB. Il est aussi commun d'utiliser le ratio d'ondes stationnaires (ROS et en anglais VSWR) pour exprimer aussi la qualité de l'adaptation d'impédance dont un $VSWR \leq 2$ est équivalent à un $|S_{11}| \leq -10$ dB. Eq. 4 et 5 montrent comment ces paramètres sont obtenus.

$$S_{11} = \frac{Z_{in} - Z_{ref}}{Z_{in} + Z_{ref}} \quad (4)$$

$$VSWR = \frac{1 + |S_{11}|}{1 - |S_{11}|} \quad (5)$$

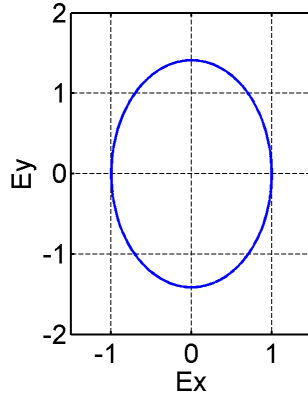

Figure 1: Courbe décrite par une onde avec polarisation circulaire ayant $AR=3$ dB, ou $X_{polR} = 15$ dB.

Polarisation

Dans une onde électromagnétique, le vecteur qui représente le champ électrique change de magnitude et orientation par rapport du temps et de l'espace. La projection spatiale de l'évolution temporelle du champ électrique sur un plan perpendiculaire à la direction de propagation de l'onde peut décrire différentes formes qui vont indiquer le type de polarisation de l'onde. Un segment de droite indiquera une polarisation linéaire, ce qui est le cas pour l'onde rayonnée par une antenne dipolaire. Un cercle ou une ellipse indiqueront une polarisation circulaire, dans ces derniers cas le sens de la rotation ("main gauche" ou "main droite") est important.

Le taux d'ellipticité (en anglais AR) d'une onde est un indicateur de la pureté de sa polarisation circulaire. Valeurs inférieures à 3 dB (ou inférieures à $\sqrt{2}$ en échelle linéaire, cf. 1) indiquent une bonne polarisation circulaire. Un autre paramètre utilisé pour indiquer la pureté de la polarisation circulaire est le taux de réjection de la polarisation croisée (en anglais X_{polR}). Une bonne polarisation donnera une valeur supérieure à 15 dB. Eq. 6 montre le passage d'un paramètre à l'autre.

$$X_{polR} = 20 \log_{10} \frac{10^{\frac{AR}{20}} + 1}{10^{\frac{AR}{20}} - 1} \quad (6)$$

Gain

Le gain d'une antenne (G) est le rapport entre la puissance délivrée par l'antenne vers une certaine direction et la puissance reçue par l'antenne. La directivité de l'antenne est la densité de puissance dans une certaine direction et la moyenne de la densité de puissance créée par l'antenne. La directivité sera toujours supérieure au gain dû aux pertes, prises en compte dans le gain. Le rapport entre le gain et la directivité est "l'efficacité de rayonnement" (δ_e , cf. Eq. 7) (*Haupt*, 2010).

$$D = \delta_e G \quad (7)$$

Le gain maximal théorique qui peut avoir une ouverture rayonnante est présenté dans l'Eq. 8 où G_{max} est le gain maximal, A la surface d'élément rayonnant exprimé en m^2 et λ la longueur d'onde en m . Si l'antenne atteint le gain maximal on dit qu'il y a une efficacité de 100% de

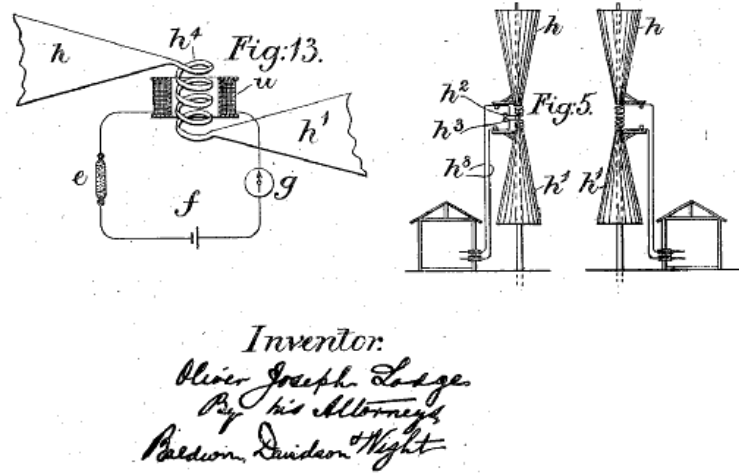

Figure 2: Antenne biconique décrite par Lodge en US Patent 609154. 1898 (Lodge, 1898).

l'ouverture rayonnante.

$$G_{max} = 4\pi \frac{A}{\lambda^2} \quad (8)$$

Antennes large bande

Les antennes large bande ont été présentes depuis les jours de la télégraphie. Vers la fin du 19ème siècle, Lodge mentionnait plusieurs types d'antennes parmi eux "les cônes... ou autres surfaces divergentes..." (Lodge, 1898). La Fig. 2 montre les dessins de Lodge.

Actuellement, on peut trouver plusieurs types d'antennes large bande. Parmi les plus utilisées on trouve les antennes biconiques, cornets, Vivaldi, spirale d'Archimède et "quatre carrés". La Fig. 3 montre une antenne cornet et "quatre carrés". Pour des applications aéroportées, les structures planaires présentent quelques avantages comme la possibilité d'être intégrées dans les parois des avions. Les antennes spirales et "quatre carrés" sont les plus appropriées. En plus, si la polarisation circulaire est cherchée l'antenne spirale la fournit naturellement.

L'antenne spirale d'Archimède

L'antenne spirale a été inventée autour des années 1950 par Edwin Turner. Cette antenne est classifiée comme une antenne indépendante de la fréquence parce que son gain et son impédance d'entrée restent plus au moins constants pendant toute sa bande passante, qui est assez importante. Lorsque les bras de l'antenne sont alimentés avec une différence de phase de 180°, la zone de rayonnement de l'antenne est un anneau ayant une circonférence égal à une longueur d'onde (Kaiser, 1960). Les limites de la bande passante sont dépendantes de la taille de l'antenne (r_{out} , rayon extérieur) et de la précision de fabrication de la zone d'alimentation (r_{in} , rayon intérieur) de l'antenne spirale (cf. Fig. 4). Ces limites théoriques sont présentées dans l'Eq. 9 où c_0 est la vitesse de la lumière dans le vide.

$$f_{low} = \frac{c_0}{2\pi r_{out}}, \quad f_{high} = \frac{c_0}{2\pi r_{in}} \quad (9)$$

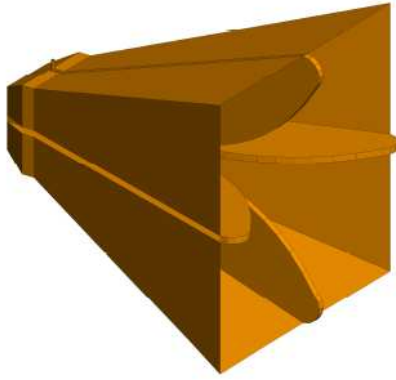

(a) Quad-ridge horn antenna (*Van der Merwe et al., 2012*).

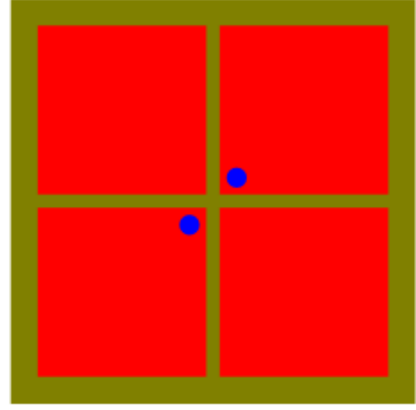

(b) Four square antenna (*Stutzman and Buxton, 2000*).

Figure 3: Exemples d'antennes large bande.

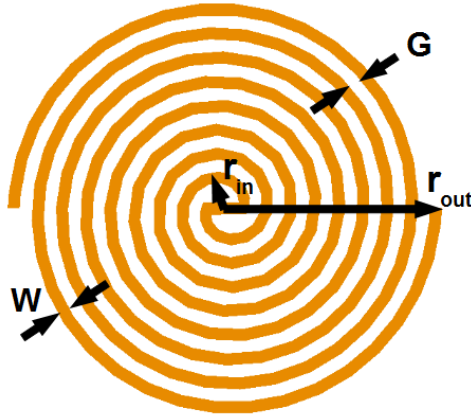

Figure 4: Une antenne spirale auto-complémentaire.

L'impédance d'entrée (Z_{in}) de l'antenne spirale peut être obtenue avec l'extension de Booker au principe de Babinet, exprimé dans l'Eq. 10, pour structures complémentaires.

$$Z_{in} = \sqrt{Z_{microstrip} \times Z_{slot}} = \sqrt{\frac{\eta^2}{4}} \quad (10)$$

où $Z_{microstrip}$ et Z_{slot} sont les impédances des parties micro ruban et slot, respectivement, et η est l'impédance intrinsèque du milieu. Pour une antenne dans le vide son impédance d'entrée devient égale à $120\pi \approx 188.5\Omega$.

Le Tab. 1 présente les dimensions de l'antenne de la Fig. 4. La Fig. 5 montre l'impédance d'entrée et le coefficient de réflexion pour l'antenne de la Fig. 4 dans le vide. Ces grandeurs ont été calculées en utilisant les logiciels FEKO et CST et montrent des différences par rapport à la valeur théorique de 188Ω . Ces différences sont dues à la technique utilisée pour résoudre les

Symbole	Valeur	Description
r_{out}	50 mm	Rayon extérieur
r_{in}	5.5 mm	Rayon intérieur
W	2.8 mm	Largeur des bras
G	2.8 mm	Espace entre les bras
N	4	Nombre de tours

Table 1: Dimensions d'une antenne spirale d'Archimède.

Paramètre	Valeur
r_{out}	50 mm
f_{low} , eq. 9	0.96 GHz
f_{low} , S_{11}	1.1 GHz
f_{low} , AR	1.43 GHz

Table 2: Fréquences de coupure de l'antenne spirale d'Archimède.

équations de Maxwell.

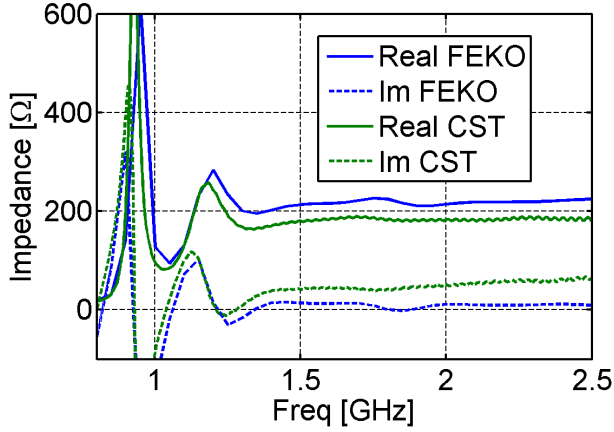

(a) Impédance d'entrée.

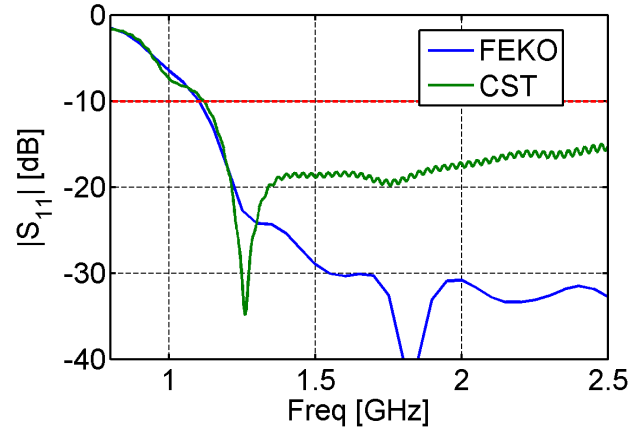

(b) Coefficient de réflexion.

Figure 5: Impédance d'entrée et coefficient de réflexion de l'antenne spirale d'Archimède. L'impédance d'entrée (Z_{ref}) est 220Ω pour la simulation faite avec FEKO et 188Ω pour CST.

D'après la Fig. 0.5(b), dans les deux cas l'antenne est bien adaptée en impédance ($|S_{11}| < -10$ dB) pour fréquences supérieures à 1.1 GHz. Cette fréquence est supérieure à celle théorique de 0.96 GHz (cf. Eq. 9).

Tout au long de ce travail, le logiciel FEKO sera utilisé pour faire les simulations, donc, 220Ω sera l'impédance de référence pour calculer le S_{11} .

Le taux d'ellipticité (AR) de l'antenne spirale de la Fig. 4 est présenté dans la Fig. 6. L'antenne atteint un bon AR pour fréquences supérieures à 1.43 GHz, tandis que la fréquence théorique est 0.96 GHz (cf. Eq. 9).

Le Tab. 2 montre un résumé des fréquences de coupure de l'antenne spirale d'Archimède.

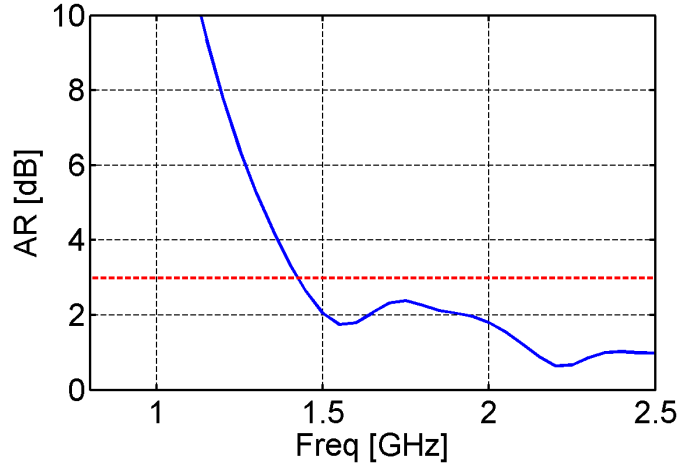

Figure 6: AR de l'antenne spirale d'Archimède.

Forme	$f_{S_{11}}$ (GHz)	$p_{S_{11}}$	f_{AR} (GHz)	p_{AR}	Périmètre (cm)
Archimède	1.1	1.15	1.43	1.5	31.42
Hexagonale	1.18	1.24	1.53	1.6	30
Carrée	1.27	1.33	1.63	1.71	28.28
Étoile	1.03	1.08	1.66	1.74	30.76

Table 3: Résumé des fréquences de coupures.

Types de spirales

D'autres types d'antennes spirales, à part la spirale d'Archimède, se trouvent dans la littérature, comme la spirale carrée (*Kaiser, 1960*), hexagonale (*Bilotti et al., 2005*) et étoile (*Caswell, 2001*). Ces formes sont présentées dans la Fig. 7 où, pour faire une meilleure comparaison, chaque spirale est inscrite dans un cercle de rayon $r_{out}=5$ cm.

Les antennes spirales présentent différentes fréquences de coupure. Nous introduisons un facteur de correction "p" (*Hinostroza et al., 2011*) dans l'Eq. 9 qui devient l'Eq. 11. Évidemment, pour $p = 1$ on retourne à l'Eq. 9, ce qui peut être considéré comme le cas idéal. Pour $p > 1$ nous avons le cas réel. Le Tab. 3 présente un résumé des fréquences de coupure, facteurs "p" et périmètres des antennes spirales.

$$f_{low\ S_{11},AR} = p_{S_{11},AR} \frac{c_0}{2\pi r_{out}} \quad (11)$$

Système d'alimentation

L'antenne spirale est un système symétrique, donc, elle a besoin d'un système d'alimentation balancé (deux signaux avec une différence de phase de 180°), mais le câble coaxial, qui est souvent utilisé pour alimenter les antennes, est un système asymétrique. Le dispositif qui fait l'adaptation entre ces deux systèmes est appelé *balun*. Parmi les baluns utilisés pour les antennes spirales on trouve le balun qui est composé d'un coupleur hybride de 180° de différence de phase et d'une paire de câbles coaxiaux (cf. Fig. 9) (*Dyson and Ginyovsky, 1971*), (*McLean and Schwadron, 2002*). Le coupleur est alimenté par un câble coaxial et la sortie ce sont deux câbles coaxiaux que

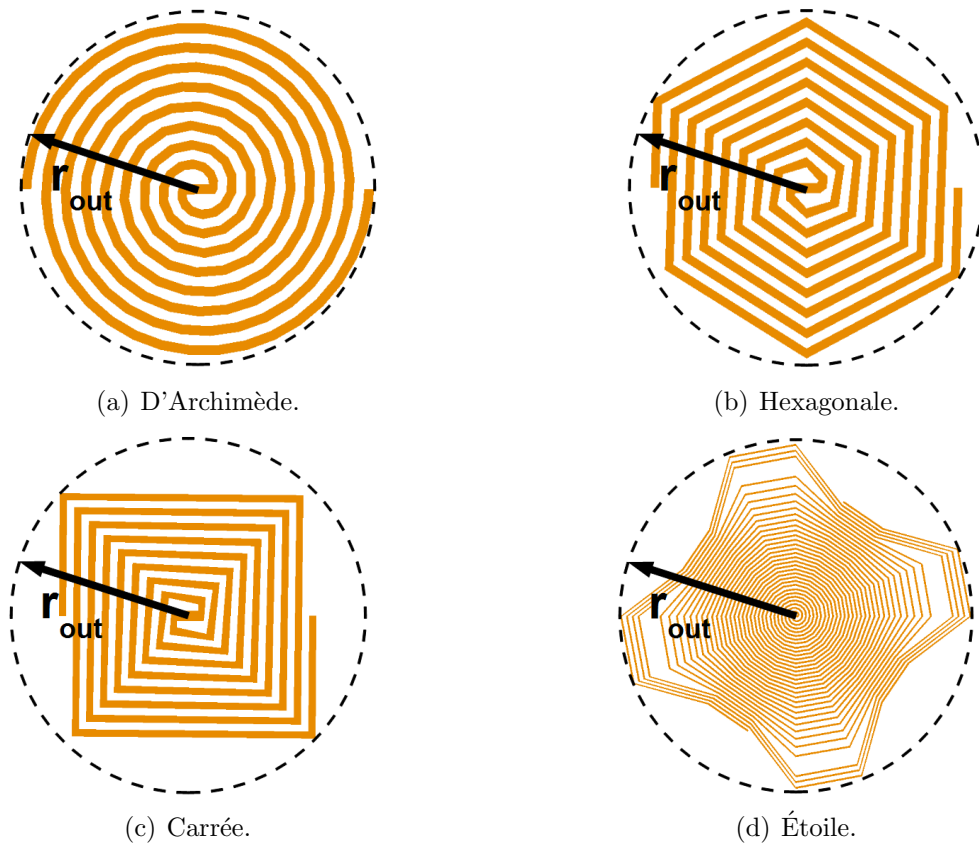

Figure 7: Différentes formes d'antennes spirales.

délivrent deux signaux en opposition de phase (180° de différence de phase). Les blindages des deux lignes coaxiales à la sortie du coupleur hybride sont soudées ce qui fait une impédance deux fois l'impédance caractéristique d'un seul câble. La permittivité du substrat sur lequel l'antenne est fabriquée est choisie de façon à faire descendre l'impédance d'entrée de l'antenne à celle de deux câbles coaxiaux. Les avantages de ce "balun" sont sa simplicité de fabrication, large bande (dépendant des bandes passantes des composants) et la possibilité de mettre le coupleur hybride loin de l'antenne, ce qui est très pratique pour les mesures.

Une antenne spirale de 10.5 cm de diamètre a été fabriquée aux laboratoires de NUS Temasek Lab, Singapour, avec l'aide du Dr. Karim Louertani. Le substrat utilisé a été FR4 d'épaisseur de 0.81 mm (cf. Fig. 10). Les simulations faites avec FEKO et les mesures de cette antenne correspondent.

Cavité

L'antenne spirale possède un rayonnement bidirectionnel. Dans la plupart des applications il est préférable d'avoir un rayonnement unidirectionnel. Pour ce faire, une cavité a été placée dessous la spirale (cf. Fig. 11). Pour toutes les distances "h", la XpolR est mauvaise, même résultat trouvé dans des anciens travaux (*Nakano et al.*, 2008). Le XpolR peut être récupéré avec des techniques au niveau du réseau. Un bon choix est $h = 5 \text{ cm}$ pour obtenir un bon coefficient de réflexion.

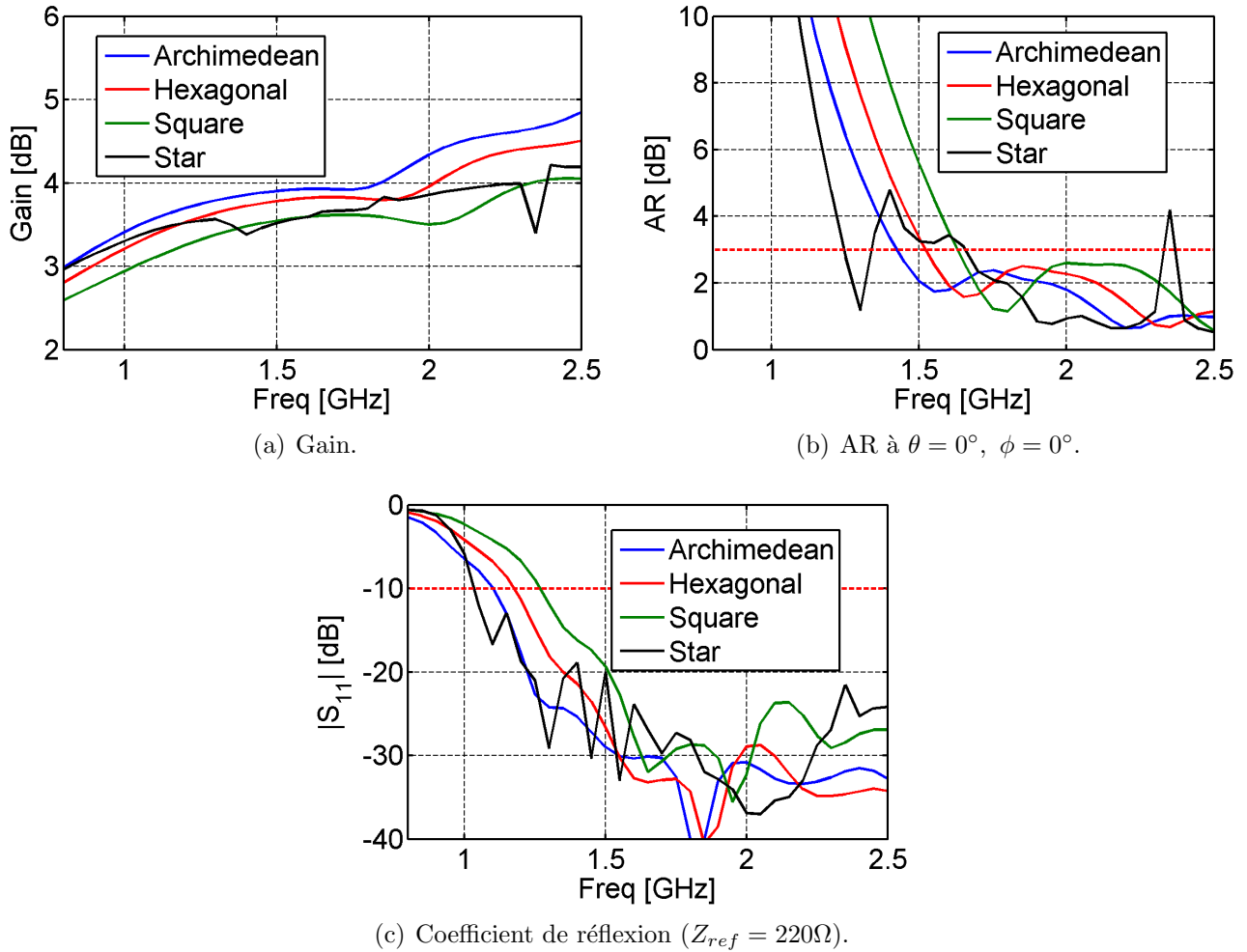

Figure 8: Comparaison des différentes antennes spirales. Les lignes en bleu correspondent à la spirale d'Archimède, en rouge à l'hexagonale, en vert à la carrée et en noir à la spirale en forme d'étoile.

Quelques concepts et définitions sur les réseaux d'antennes

Couplage mutuel

Le comportement d'une antenne seule est différent de celle dans un réseau d'antennes. Il y a trois types de couplages : entre les antennes dans un réseau, entre les antennes et un autre objet proche, et couplage à travers le système d'alimentation (cf. Fig. 12).

Facteur de réseau

Le calcul du champ électrique total d'un réseau d'antennes nécessite de la solution exacte des équations de Maxwell, généralement par de méthodes numériques. Une bonne approximation peut être obtenue en considérant que le diagramme de rayonnement de chaque antenne (\mathbf{f}_i) est le même pour toutes. Dans ce cas-ci le champ électrique total (\mathbf{E}_{array}) peut être exprimé par

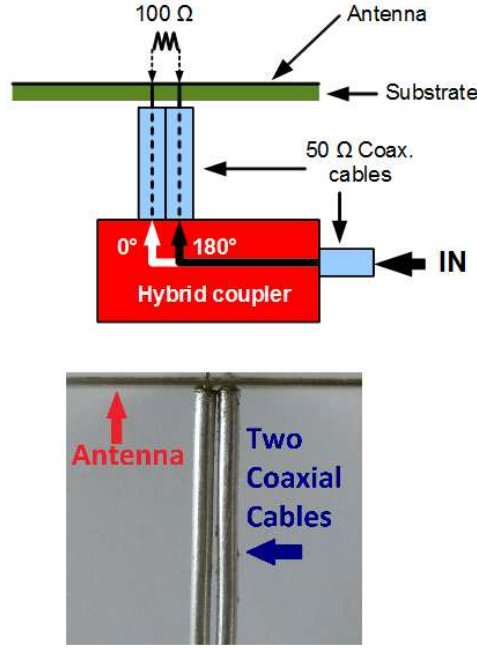

Figure 9: Balun composé d'un coupleur hybride de 180° de différence de phase avec deux câbles coaxiaux.

l'Eq. 12 où \mathbf{r}_i est le vecteur position de la i ème antenne, k est le nombre d'onde dans le vide ($k = 2\pi/\lambda$, λ est la longueur d'onde), a_i est le poids complexe appliqué à l'élément, R est la distance entre l'origine et le point d'évaluation qui a les coordonnées sphériques (r, θ, ϕ) avec le vecteur unitaire $\hat{\mathbf{r}}$.

$$\mathbf{E}_{array} = \mathbf{f}_i(\theta, \phi) \frac{\exp(-jkR)}{R} \sum a_i \exp(+jk\mathbf{r}_i \cdot \hat{\mathbf{r}}) \quad (12)$$

Le factor de réseau ($F(\theta, \phi)$) est alors exprimé par l'Eq. 13 présentée à continuation :

$$F(\theta, \phi) = \sum a_i \exp(jk\mathbf{r}_i \cdot \hat{\mathbf{r}}) \quad (13)$$

Avec le facteur de réseau il est possible de calculer facilement les lobes de réseaux. Pour les réseaux infinis, uniformes, linéaires et planaires, une formule analytique peut être trouvée. Pour les cas de réseaux non-uniformes il est plus utile d'utiliser le niveau relatif du maximum des lobes secondaires par rapport au lobe principal (en anglais RSSL) communément exprimé en dB (cf. Fig. 13). Les réseaux non-uniformes permettent de contrôler mieux les lobes de réseaux et secondaires.

Double polarisation

Il suffit d'une paire de bases orthogonales pour caractériser la polarisation d'une onde : polarisation linéaire verticale et horizontale; ou polarisation circulaire droite et gauche (cf. Fig. 14).

Selon l'IEEE, la polarisation qui est censée être rayonnée est appelée "co-polarisation" et la polarisation orthogonale à la première est appelée "polarisation croisée" (*IEEE Standard*,



(a) Antenne spirale avec substrat FR4.

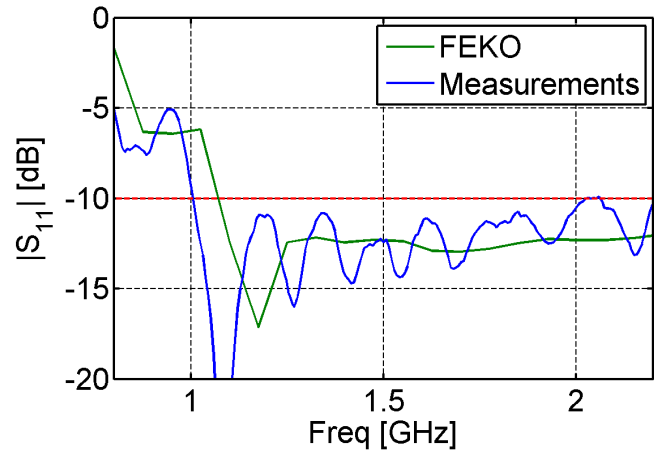

(b) Coefficient de réflexion ($Z_{ref} = 100\Omega$)

Figure 10: Antenne spirale d'Archimède avec substrat FR4 et 10.5 cm de diamètre.

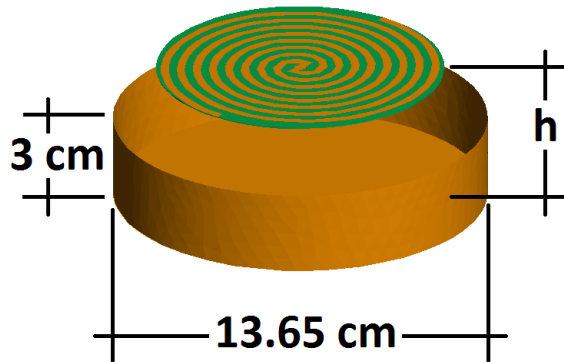

(a) Antenne spirale avec cavité.

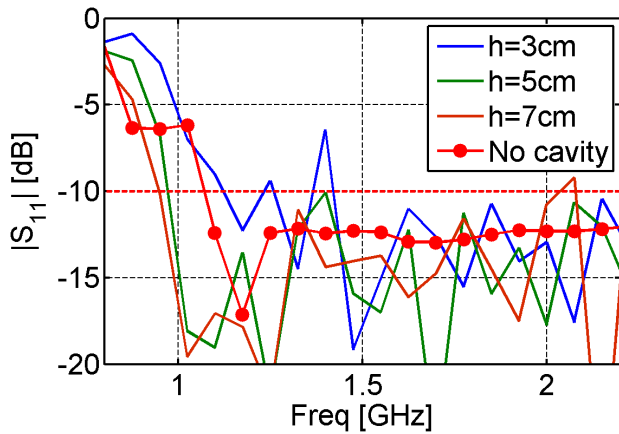

(b) Coefficient de réflexion ($Z_{ref} = 100\Omega$).

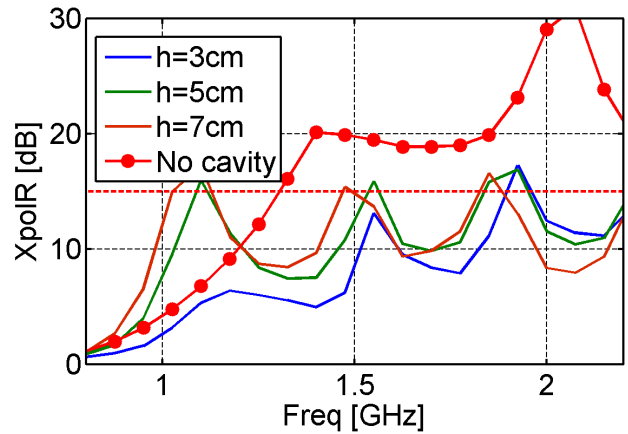

(c) Réjection de la polarisation croisée.

Figure 11: Antenne spirale avec cavité où h est la distance entre la base de la cavité et l'antenne.

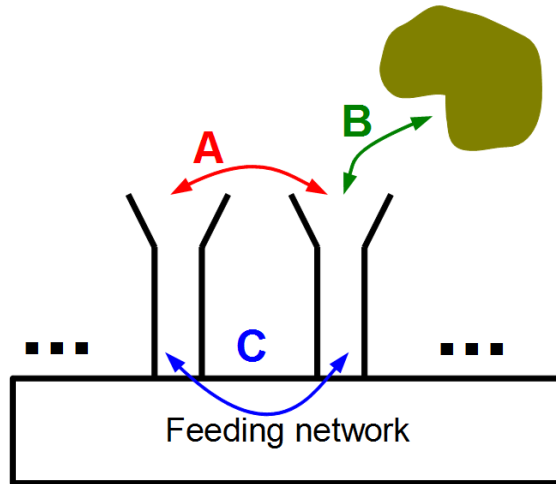

Figure 12: Types de couplage dans un réseau. Couplage entre antennes, en rouge; entre antenne et objets proches, en vert; et à travers le système d'alimentation, en bleu.

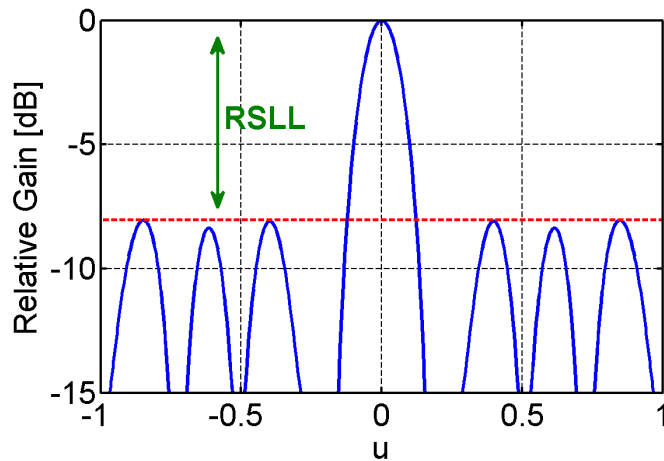

Figure 13: Niveau relatif du maximum des lobes secondaires par rapport au lobe principal (en anglais RSSL) d'un réseau linéaire.

1993). La polarisation du réseau peut être différente de celle des éléments qui la constituent. La polarisation du réseau va changer en fonction de l'angle de balayage, maillage et type d'antenne (*McGrath et al.*, 2003).

Bande passante du réseau d'antennes

Les paramètres utilisés pour définir la bande passante d'une antenne (e.g. S_{11} et XpolR) sont également utilisés pour la bande passante du réseau. En plus, on peut utiliser d'autres paramètres tels que l'apparition de lobes de réseaux, le gain et la possibilité de travailler en double polarisation. La Fig 15 montre un cas typique pour un réseau d'antennes spirales. Dans ce travail nous sommes intéressés par l'intersection des bandes passantes de S_{11} , XpolR et RSSL tout en ayant une double polarisation et un plan de masse.

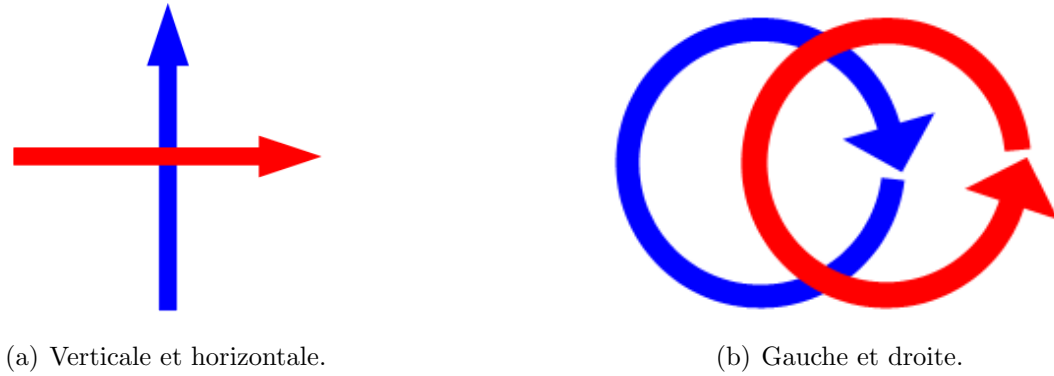

Figure 14: Paires de polarisations orthogonales.

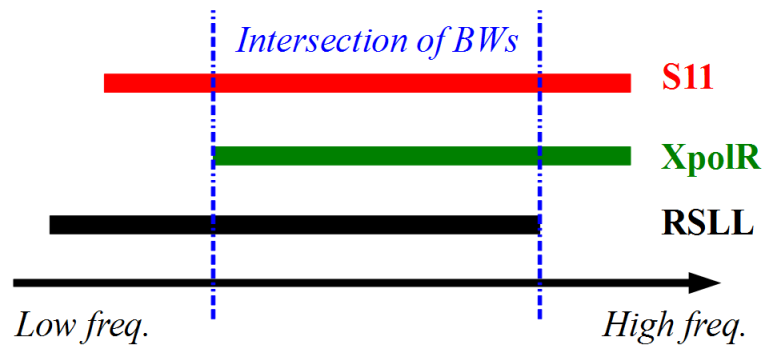

Figure 15: Exemple de bandes passantes pour différents paramètres dans un réseau d'antennes spirales.

Conception des réseaux large bande

Il y a deux courants principaux pour la conception de réseaux large bande (*Munk et al.*, 2003). Le premier prend des antennes qui ont déjà une bande passante large. Le deuxième est basé sur la forte interaction entre les éléments afin d'atteindre une bande passante large, même si la bande passante de l'élément est étroite, suivant le modèle idéal de distribution de courants proposé par Wheeler (*Wheeler*, 1965).

Le Tab. 4 montre un résumé des différents réseaux d'antennes classés par le type de courant de conception utilisé.

Array	Paradigm design	Polar.	$BW_{S_{11}}$ level	$BW_{X_{polR}}$ level	BW_{RSLL} level	f_{GL}	Scan θ	\cap BWs ratio	GND plane
Vivaldi (<i>Hong et al.</i> , 2006)	Wideband element	Mono linear	8-35 GHz -10 dB	10-35 GHz 20 dB	8-35 GHz -6 dB	35 GHz	25°	10-35 GHz 3.5:1	Yes
BOR antenna (<i>Holter</i> , 2007)	Wideband element	Dual linear	4-18 GHz -10 dB	6-18 GHz 15 dB	No spec.	20 GHz	45°	6-18 GHz 3:1	Yes
PUMA array (<i>Holland and Vouvakis</i> , 2012)	Strong interaction	Dual linear	1.1-5.3 GHz -6 dB	1.1-5.3 GHz 15 dB	No spec.	7.2 GHz	45°	1.1-5.3 GHz 5:1	Yes
Connected spirals (<i>Guinvarc'h and Haupt</i> , 2011)	Strong interaction	Dual circular	2-5 GHz -10 dB	2.2-5 GHz 15 dB	2-2.9 GHz -10 dB	2.9 GHz	30°	2.2-2.9 GHz 1.3:1	No
Interleaved spirals (<i>Guinvarc'h and Haupt</i> , 2010)	Wideband element	Dual circular	2-7 GHz -10 dB	3-6.5 GHz 15 dB	2.7-5.9 GHz -10 dB	5.9 GHz	30°	3-5.9 GHz 2:1	No

Table 4: Résumé de réseaux d'antennes large bande classés par le type de courant de conception utilisé.

CHAPITRE 2 : Réseaux linéaires d'antennes spirales

Une grande partie de ce chapitre est dédiée à élargir les travaux des Steyskal et West (*Steyskal et al.*, 2005), (*West and Steyskal*, 2009) dans lesquels ils ont remarqué des résonances dans un réseau planaire d'antennes spirales carrées avec plan de masse. En fait, ces résonances apparaissent aussi dans d'autres types d'antennes spirales et sans avoir plan de masse, comme le montrent les Fig. 16 et 17. Les résonances n'apparaissent que dans les cas de dépointage du réseau et les fréquences de ces résonances sont liées à la longueur des bras de l'antenne spirale, comme le montre l'Eq. 14 où f_{res}^m ce sont les fréquences de résonance, c est la vitesse de la lumière, L est la longueur des bras de la spirale et m un nombre entier. Ces résonances sont des ondes stationnaires que s'installent sur les bras de l'antenne.

$$f_{res}^m = m \frac{c}{2L} \quad (14)$$

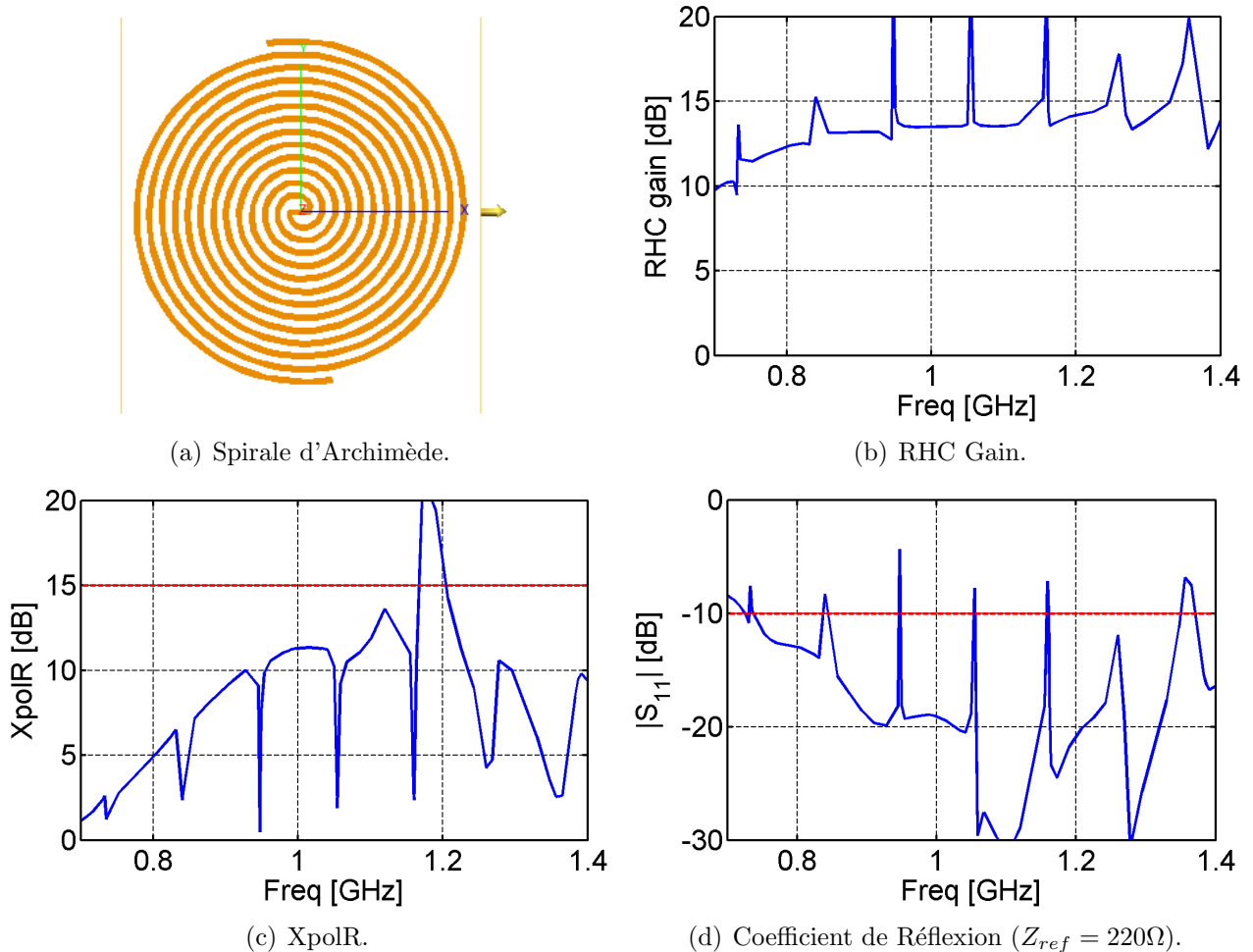

Figure 16: Réseau infini d'antennes de spirales d'Archimède. 30° d'angle de dépointage. Les lobes de réseaux doivent apparaître à 1.36 GHz.

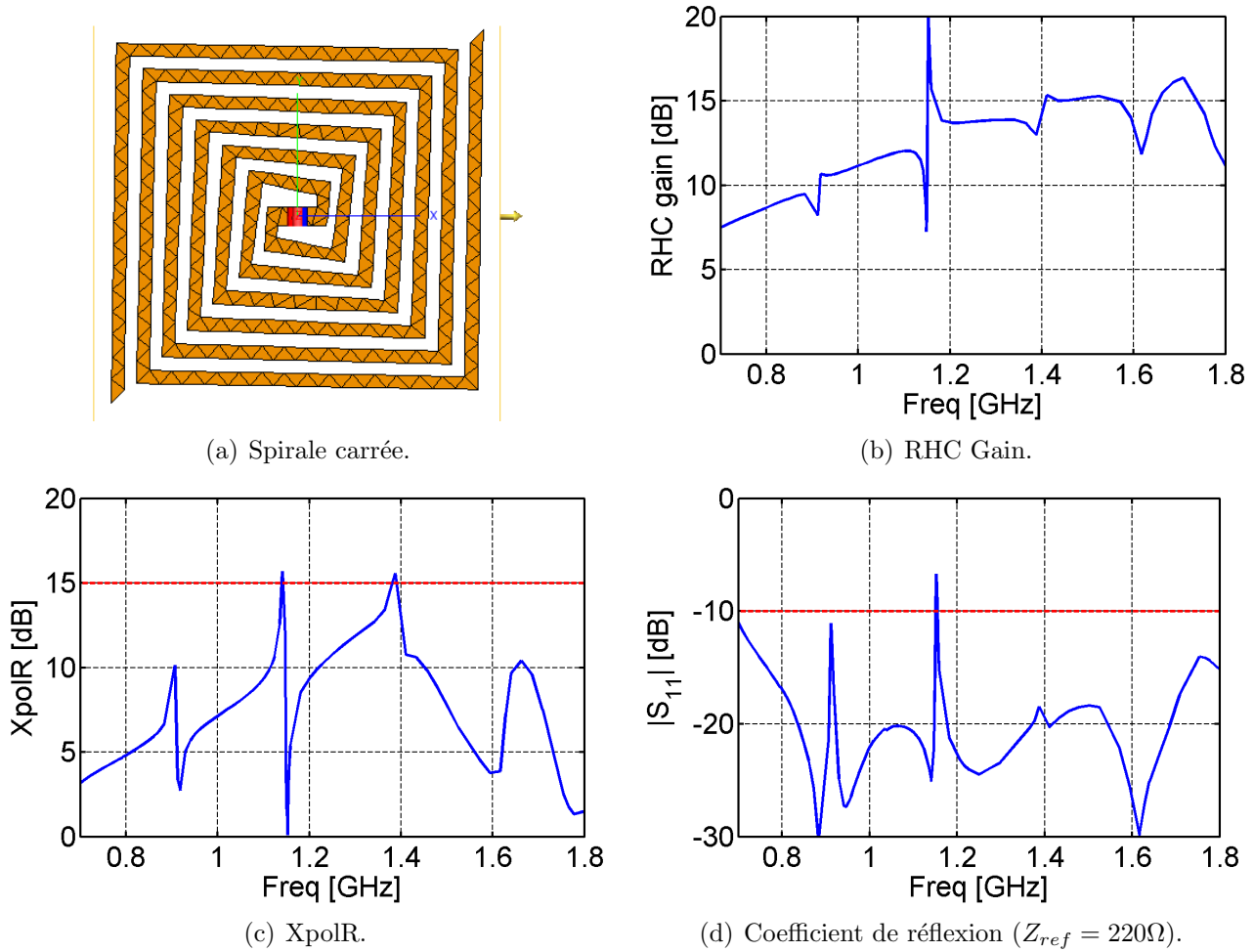
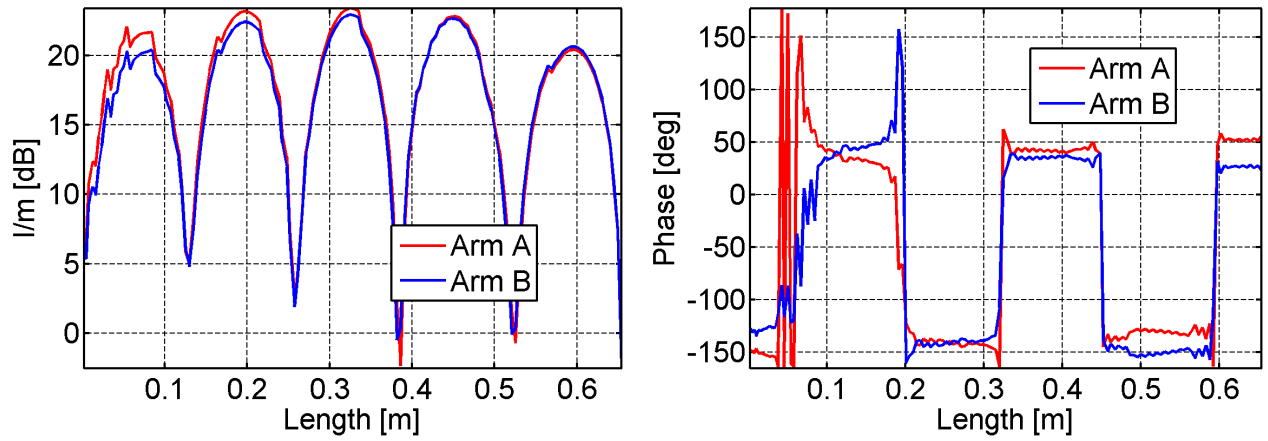

Figure 17: Réseau infini linéaire de spirales carrées. 30° d'angle de dépointage. Les lobes de réseaux doivent apparaître à 1.887 GHz.

La distribution de courants lors d'une résonance est montrée dans la Fig. 18 (1.1526 GHz) pour un réseau linéaire infini d'antennes spirales carrées (cf. Fig. 17) pour un angle de dépointage de $\theta = 30^\circ$. Dans les deux bras l'amplitude de la distribution du courant est presque la même et au centre de l'antenne la valeur du courant est très faible. Dans les deux bras la distribution de phase de charge électrique est la même.

Des ondes stationnaires dans une antenne spirale seule

Dans cette partie, au lieu d'étudier un réseau d'antennes nous allons étudier une seule antenne et une onde avec différents angles d'incidence pour simuler un angle de dépointage. Cette onde va induire des distributions de courants dans les bras de l'antenne spirale. Au centre de la spirale, la différence de phase varie en fonction de l'angle incidence, mesuré à partir de l'axe perpendiculaire au plan de la spirale. La Fig. 19 montre cette variation à la fréquence de résonance de 1.1526 GHz. Pour une onde avec polarisation circulaire ayant une direction de propagation perpendiculaire à l'antenne, la différence de phase induite au centre de la spirale est



(a) Distribution de la densité surfacique de courant dans les bras de l'antenne. (b) Distribution de phase de charge électrique dans les bras de l'antenne.

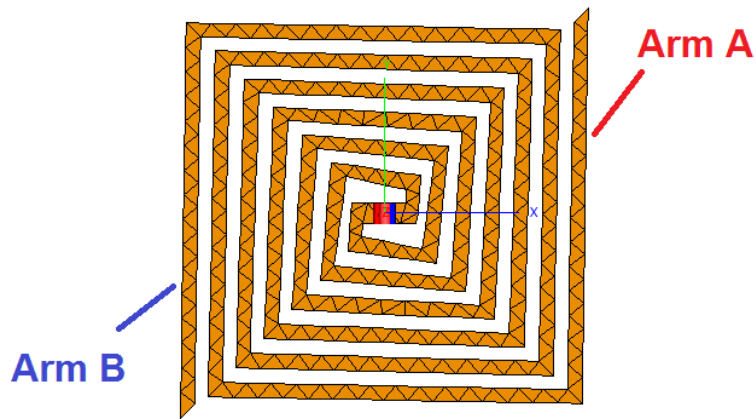

(c) Spirale carrée.

Figure 18: Réseau linéaire infini d'antennes spirales carrées à 1.1526 GHz et pour un angle de dépointage de $\theta = 30^\circ$.

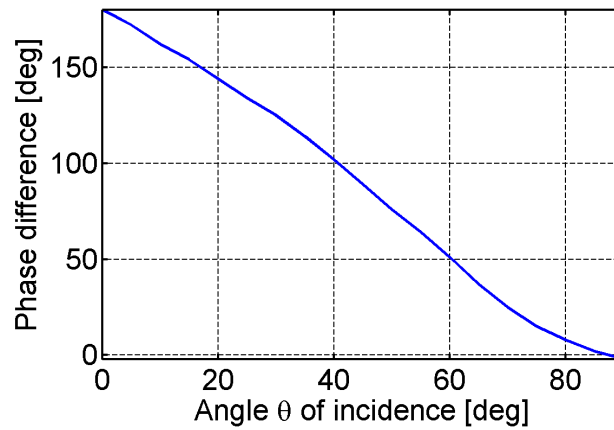

Figure 19: Angle d'incidence vs. différence de phase au centre de la spirale à 1.1526 GHz.

180°, ce qui est le mode normal de fonctionnement de l'antenne spirale. Au contraire, pour une onde ayant une direction de propagation parallèle au plan de la spirale, au centre de la spirale la différence est nulle, qui est le cas dans la résonance.

Lorsque l'angle d'incidence est entre 90° et 0°, l'onde peut être décomposée en deux composantes : une composante perpendiculaire au plan de la spirale, qui va induire le mode normal de fonctionnement; et une autre composante parallèle au plan de la spirale, qui va induire la résonance.

Explication des résonances

L'antenne spirale possède différents modes de fonctionnement. Ces modes ont été mis en évidence par Kaiser (*Kaiser*, 1960) en utilisant un modèle de ligne de transmission. L'antenne spirale peut être représentée par une ligne de transmission qui a été enroulée en forme de spirale.

Lorsque les bras de l'antenne sont alimentés avec un déphasage de 180°, une région annulaire, de longueur égal à la longueur d'onde, est créée où les bras, côte à côte, sont en phase (0° de différence de phase) ce qui fait le rayonnement. Ce mode de fonctionnement est appelé "mode 1". Entre le centre de la spirale et la région de rayonnement, le déphasage entre les bras de la spirale, côte à côte, suit une évolution de 180° à 0° ce qui fait rayonner un peu.

Lorsque les bras de l'antenne sont alimentés en phase, la zone annulaire de rayonnement est 2 fois la longueur d'onde. Ce mode de fonctionnement de l'antenne spirale est appelé "mode 2" par Corzine (*Corzine and Mosko*, 1990). Dans ce cas, la zone de rayonnement du "mode 1" devient une zone où la différence de phase entre les bras de l'antenne, côte à côte, est 180°, donc il n'y a pas de rayonnement. Si la taille de l'antenne ne permet pas d'établir la zone de rayonnement du mode 2 (longueur égal à 2λ), le courant sera reflété au bout des bras sans s'atténuer, ce qui va créer les résonances.

En fait, dû au fort couplage entre les bras de l'antenne, la spirale peut être modélisée comme deux lignes de transmissions (cf. Fig. 20). Pour une spirale symétrique sans charges, les deux bras finissent en circuit ouvert. Ce sont ces deux lignes de transmission qui deviennent résonantes.

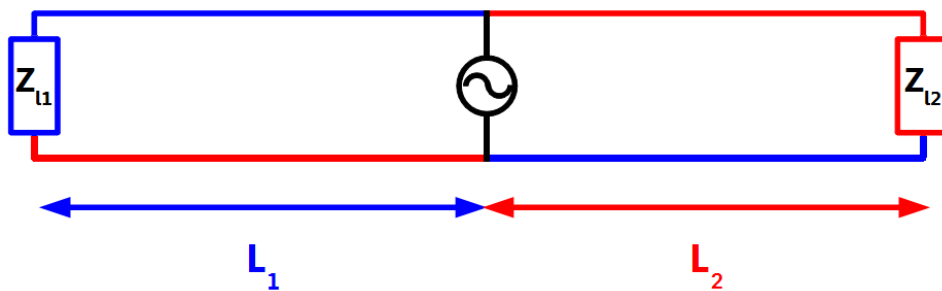
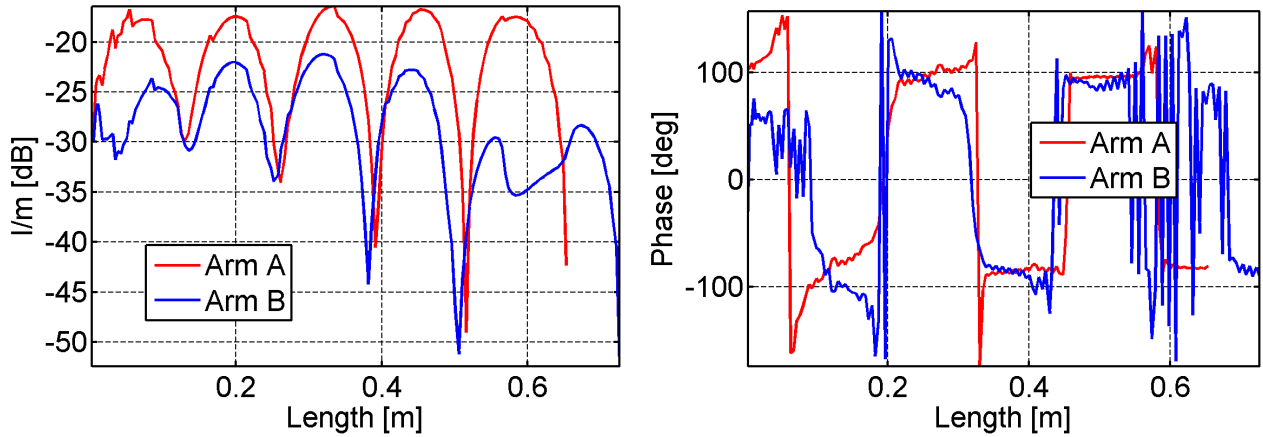

Figure 20: Modèle de double ligne de transmission pour l'antenne spirale. Les couleurs bleue et rouge correspondent aux bras 1 et 2. L et Z sont la longueur des bras et l'impédance de la charge au bout de chaque bras de la spirale.

Solutions pour casser les résonances

Plusieurs méthodes ont été proposées par Steyskal pour casser les résonances. Une de méthodes

est élargir un bras de l'antenne spirale pour casser sa symétrie. De cette façon les deux bras ne pourront pas résonner à la même fréquence. La Fig. 21 montre les effets de cette méthode dans une antenne spirale carrée à la fréquence de résonance de 1.1526 GHz. La distribution de courants n'est plus la même dans les bras de la spirale et la différence de phase induite au centre de l'antenne spirale est 140° , tandis qu'avant elle était 0° .



(a) Distribution de la densité surfacique de courant dans les bras de l'antenne spirale asymétrique.

(b) Distribution de la phase de charge de courant dans les bras de l'antenne spirale asymétrique.

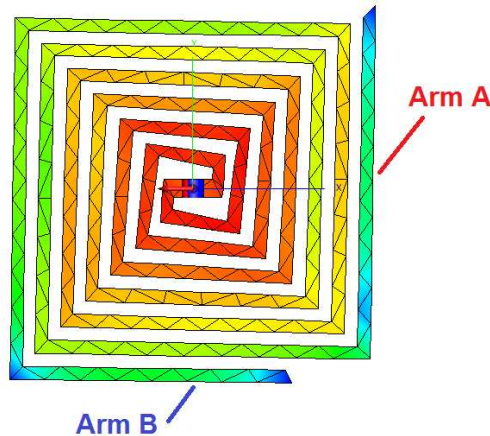

(c) Spirale carrée asymétrique.

Figure 21: Spirale carrée asymétrique avec onde incidente avec direction parallèle au plan de la spirale à 1.1526 GHz.

Nous proposons une autre façon de casser la symétrie, mais au niveau du réseau. Jusqu'à maintenant nous avons étudié des réseaux uniformes ce qui fait apparaître un couplage uniforme entre les antennes. Dans les cas des réseaux non uniformes, le couplage n'est plus uniforme ce qui casse la symétrie du couplage des antennes. Un tel réseau est montré dans la Fig. 22 basé sur les travaux de Guinvarc'h et Haupt (*Guinvarc'h and Haupt, 2010*). Le résultat de simulation de l'antenne 36 montre le cas typique des antennes du réseau composé par 40 éléments. Juste deux antennes montrent des problèmes en basse fréquence, ce qui démontre l'efficacité de cette méthode pour casse les fréquences.

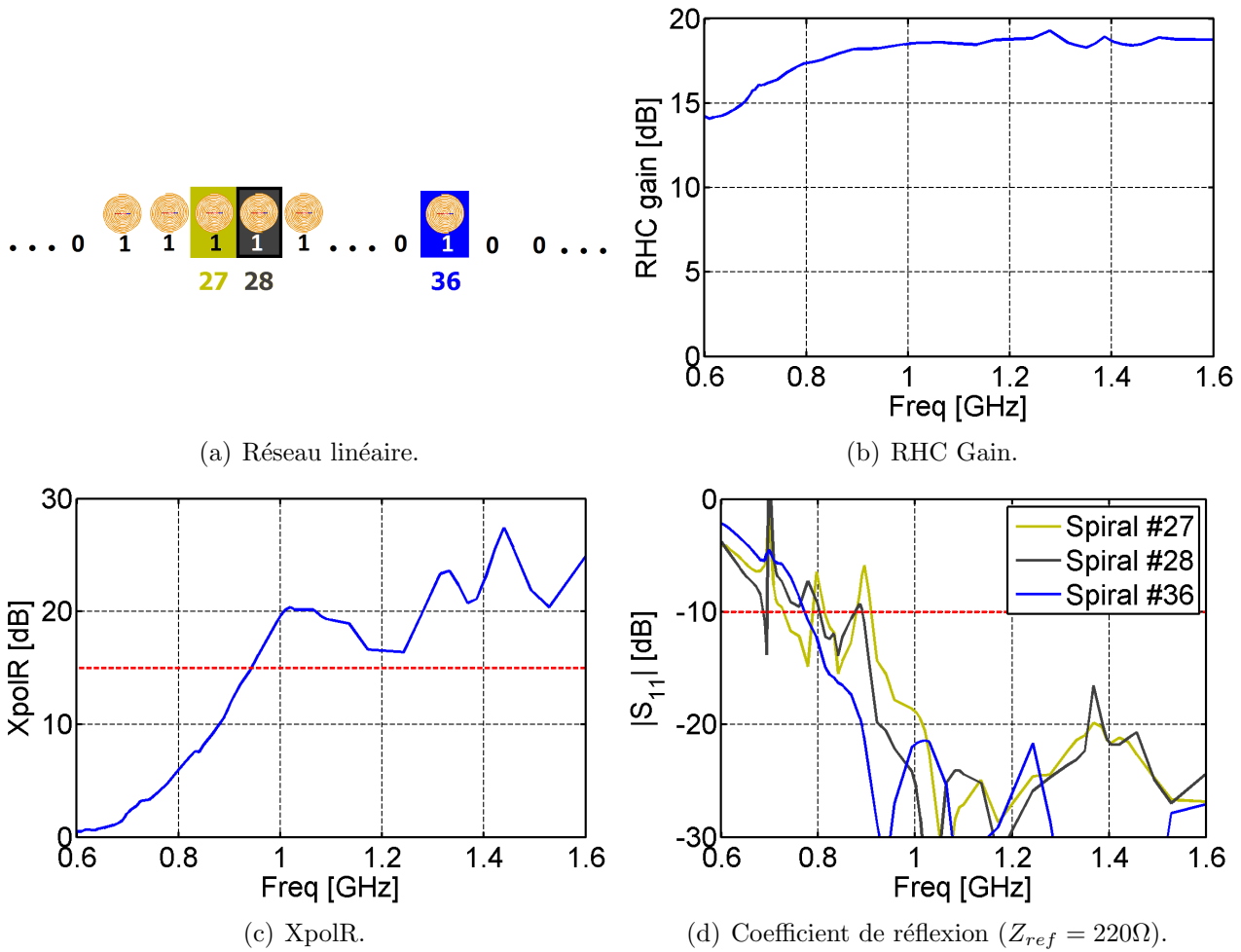

Figure 22: Réseau linéaire d’antennes symétriques spirales d’Archimède basé sur les travaux de Guinvarc’h et Haupt (*Guinvarc’h and Haupt, 2010*). 30° d’angle de dépointage. Les couleurs vert, noir et bleu correspondent aux spirales 27, 28 et 36.

Réseau linéaire à mono polarisation

Nous reprenons la solution des antennes asymétriques pour construire des réseaux linéaires uniformes sans avoir le problème des résonances. La Fig. 23 montre les spirales d’Archimède, hexagonale et carrée asymétriques et ses caractéristiques, lorsqu’elles sont isolées, sont montrées dans la Fig. 24. Le Tab. 5 montre un résumé des fréquences de coupures pour ces antennes ainsi que des nouveaux facteurs “p” (antennes inscrites dans un cercle de rayon de 7 cm).

Forme	$f_{S_{11}}$ (GHz)	$p_{S_{11}}$	$f_{X_{polR}}$ (GHz)	$p_{X_{polR}}$	Perimeter (cm)
D’Archimède	0.74	1.09	0.9	1.32	44
Hexagonale	0.83	1.22	1.07	1.57	42
Carrée	0.92	1.35	1.21	1.77	39.6

Table 5: Résumé des fréquences de coupure des antennes spirales asymétriques.

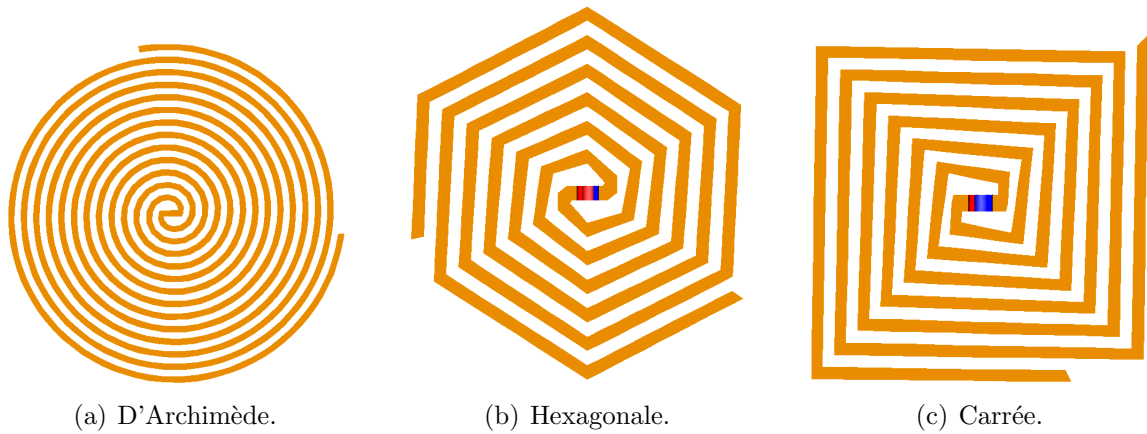

Figure 23: Antennes spirales asymétriques.

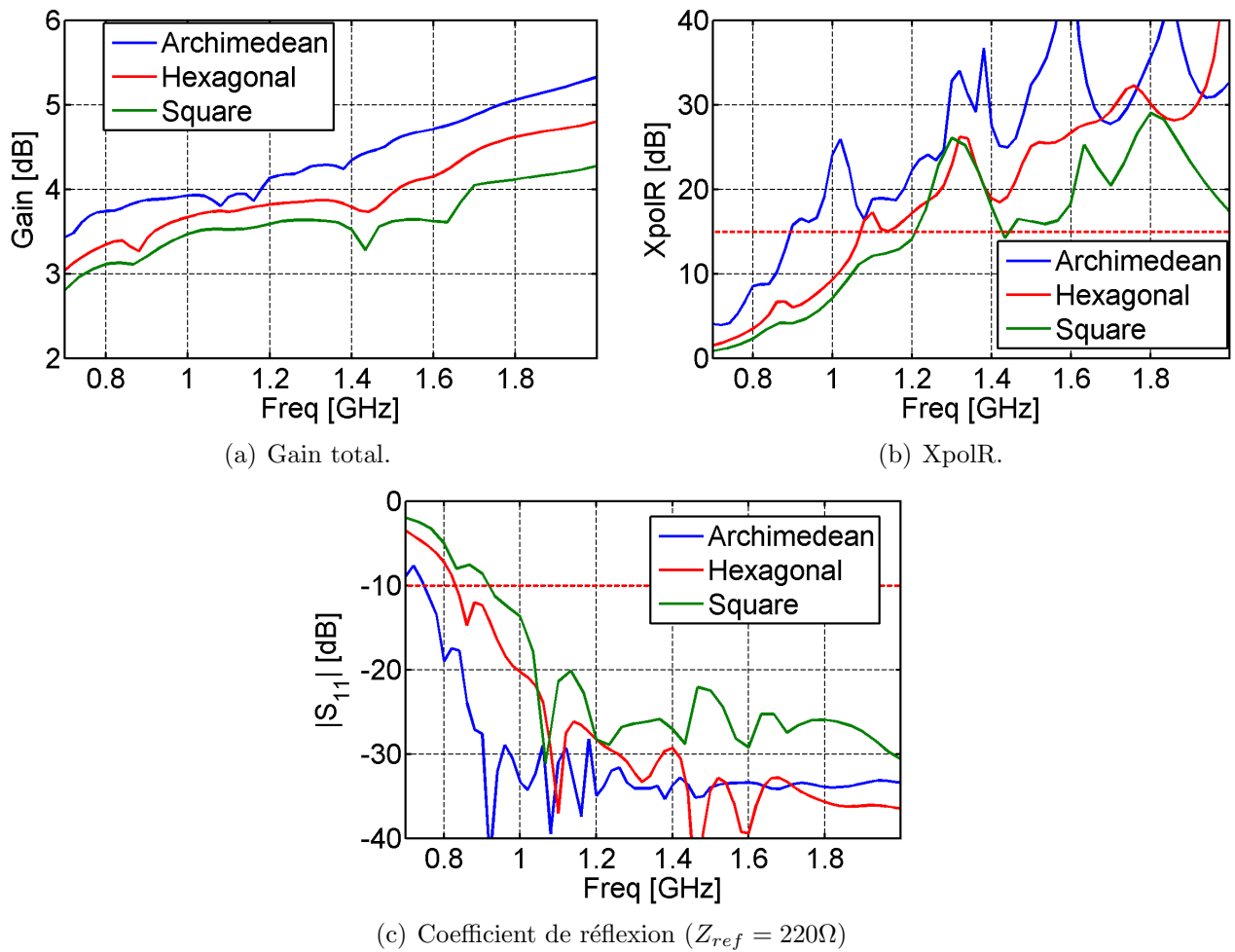

Figure 24: Caractéristiques des antennes spirales asymétriques. Le même code des couleurs est utilisé pour les trois subfigures où la spirale d'Archimède est représenté par la couleur bleue, la spirale hexagonale par le rouge et la spirale carrée par le vert.

Le Tab. 6 montre les limites estimées des bandes passantes des réseaux linéaires, composés par antennes asymétriques, en utilisant les facteurs “p” des antennes asymétriques, pour les fréquences de coupures basse; et les fréquences d’apparition des lobes de réseaux pour un angle de dépointage de 30° , pour les fréquences de coupures haute.

Antenna	d_{elem} (cm)	GL (GHz)	BW_{S11}	BW_{XpolR}
Square	10.6	1.887	2.05	1.56
Archimedean	14.5	1.36	1.83	1.51
Hexagonal	13.18	1.52	1.83	1.42

Table 6: Limites estimées des bandes passantes des réseaux linéaires composés des spirales asymétriques pour un angle de dépointage de 30° .

Les simulations ont montré des différences importantes. Les résultats de ces simulations sont montrés dans le Tab. 7. De tous les cas, seulement la bande passante pour avoir un bon coefficient de réflexion des antennes spirales d’Archimède asymétriques se rapproche à la bande passante estimée.

Antenne	f_{S11} (GHz)	f_{XpolR} (GHz)	f_{GL}	BW_{S11}	BW_{XpolR}
Carrée	1.02	1.24	1.81	1.77	1.46
D’Archimède	0.74	0.95	1.33	1.8	1.4
Hexagonale	0.93	1.12	1.45	1.56	1.3

Table 7: Limites de bandes passantes d’antennes asymétriques montrées dans la Fig. 23. $\theta = 30^\circ$ d’angle de dépointage.

Réseau linéaire à double polarisation

Pour obtenir un réseau à double polarisation en utilisant des spirales à deux bras, on est obligé d’utiliser des spirales de polarisations opposés. La Fig. 25 montre un schéma d’un réseau à double polarisation avec distribution spatiale uniforme. Les disques rouges, marqués avec “RH”, représentent les spirales de polarisation circulaire droite et les disques bleus, “LH”, représentent les spirales de polarisation gauche.

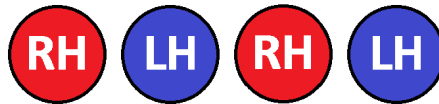

Figure 25: Schéma d’un réseau à double polarisation avec distribution spatiale uniforme.

Nous avons vu que pour le cas à mono polarisation la bande passante d’un réseau ne dépasse pas l’octave, pour un angle de dépointage de 30° , à cause de l’apparition des lobes de réseaux. Au moment d’introduire les antennes de polarisation opposés la distance entre les antennes d’une même polarisation est doublée ce qui fait apparaître les lobes de réseau à moitié de la fréquence pour le cas à mono polarisation. Pour contrôler mieux les lobes de réseaux, Guinvarc’h et Haupt

ont proposé l'utilisation de réseaux non uniformes (*Guinvarc'h and Haupt, 2010*). La Fig. 26 montre un tel réseau composé de 80 spirales, 40 à polarisation gauche et 40 à polarisation droite. Le RSSL est inférieur à -10 dB jusqu'à 1.27 GHz. Deux spirales, 27 et 28, sur un total de 40 par polarisation, ce sont les seules à avoir des problèmes d'adaptation d'impédance en basse fréquence.

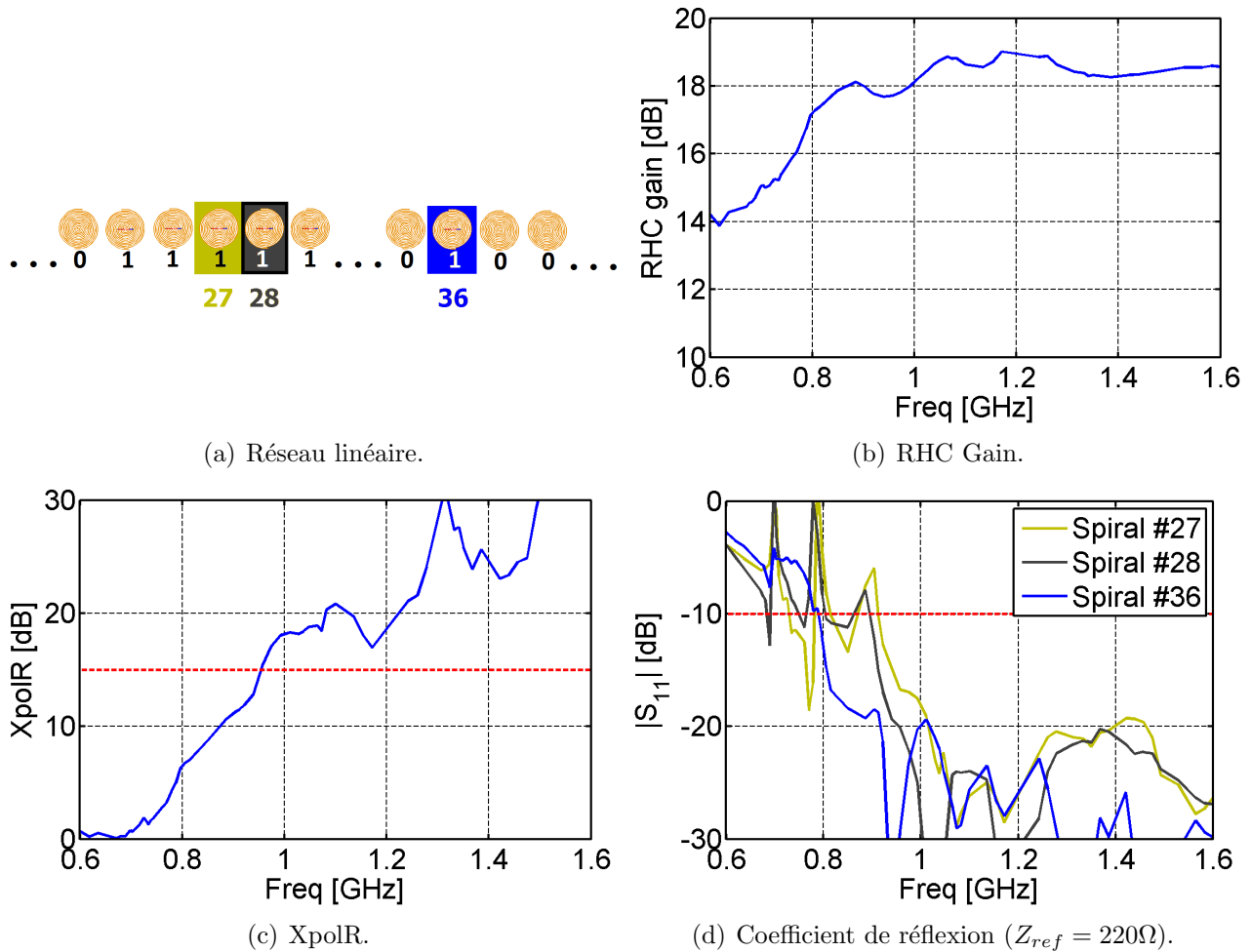

Figure 26: Réseau no uniforme linéaire d'antennes d'Archimède symétriques similaire à (*Guinvarc'h and Haupt, 2010*). 30° d'angle de dépointage. Les couleurs vert, noir et bleu correspondent aux spirales 27, 28 et 36.

CHAPITRE 3 : Réseaux planaires d'antennes spirales

Le but de ce chapitre est la conception d'un réseau planaire à double polarisation ayant une bande passante supérieure à 4:1. Au début, les réseaux à mono polarisation sont étudiés pour déterminer les bandes passantes maximales possibles. En suite, le cas à double polarisation est étudié. L'utilisation de réseaux no uniformes et la connexion entre les antennes spirales vont permettre d'obtenir une bande passante de presque 6:1.

Réseaux planaires à mono polarisation

Il est possible de faire une estimation analytique des bandes passantes des réseaux planaires avec l'aide des facteurs "p", pour déterminer la limite basse, et en déterminant la fréquence d'apparition des lobes de réseaux. Les facteurs "p" sont dépendants de l'élément, (forme, charges additionnelles, etc). L'apparition des lobes de réseaux est dépendante de la distribution spatiale des éléments. L'Eq. 15 montre les fréquences (f_{GL}) d'apparition de lobes de réseaux pour des distributions spatiales, triangulaires (▲) et carrées (■), et une distance entre les éléments d_{ele} où c_0 est la vitesse de la lumière dans le vide.

$$f_{GL, \blacktriangle} = \frac{c_0 4}{3\sqrt{3}d_{ele}} \quad (15a)$$

$$f_{GL, \blacksquare} = \frac{c_0 2}{3d_{ele}} \quad (15b)$$

Pour éviter les résonances, les spirales asymétriques présentées dans la Fig. 23 sont utilisées. Le Tab. 8 montre les facteurs "p" de ces antennes, les fréquences de coupures, la distance entre les éléments pour les différents réseaux et les bandes passantes estimés à partir de ces données.

Ant.,Latt.	Arch.,▲	Arch.,■	Hexag,▲	Hexag,■	Squa,▲	Squa,■
d_{elem} (cm)	14.39	14.39	12.85	12.9	11.7	10.96
$p_{S_{11}}$	1.09	1.09	1.22	1.22	1.35	1.35
$p_{X_{polR}}$	1.32	1.32	1.57	1.57	1.77	1.77
$BW_{S_{11}}$	2.17	1.88	2.24	1.87	2.13	2.13
$BW_{X_{polR}}$	1.8	1.55	1.74	1.45	1.63	1.63

Table 8: Estimation analytique des bandes passantes des réseaux d'antennes spirales asymétriques pour un angle de dépointage de $\theta = 30^\circ$.

Les Fig. 27 et 28 montrent quelques résultats des simulations pour des différents angles de dépointage.

Le Tab. 9 montre le résumé des bandes passantes trouvées par simulation en considérant la fréquence d'apparition de lobes de réseaux comme la limite haute de la bande passante. En comparant avec le Tab. 8 nous pouvons voir que dans tous les réseaux les bandes passantes de coefficient de réflexions n'arrivent pas aux maximums estimés. Par contre, les bandes passantes de XpolR arrivent aux maximums estimés analytiquement. L'estimation analytique des bandes passantes de réseaux d'antennes spirales peut être aussi appliquée pour d'autres configurations spatiales plus complexes et déterminer si elles correspondent aux besoins cherchés, en suite la simulation donnera des résultats plus fins.

Ant.,Latt.	Archi.,▲	Archi.,■	Hexag,▲	Squa,■
$BW_{S_{11}}$	1.93	1.58	1.71	2.03
$BW_{X_{polR}}$	1.82	1.56	1.65	1.56

Table 9: Résumé des bandes passantes trouvées par simulation de réseaux des spirales asymétriques.

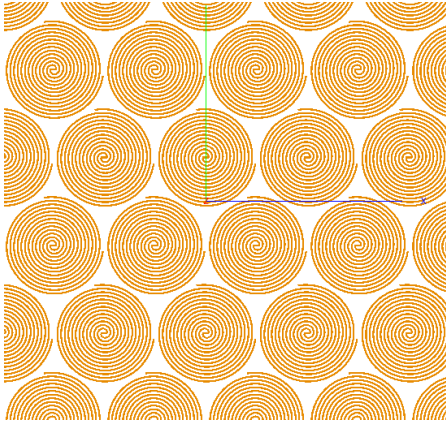

(a) Réseau planaire.

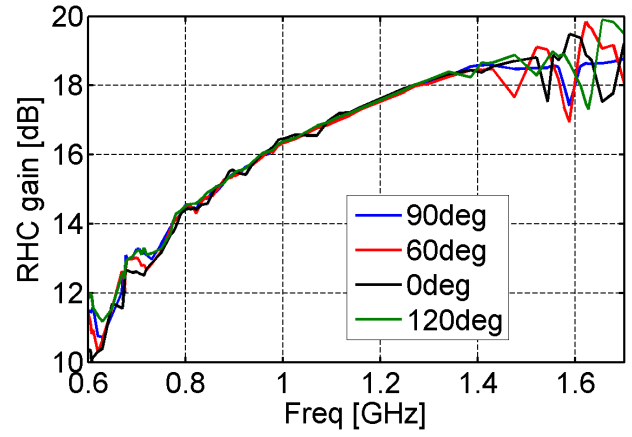

(b) RHC Gain.

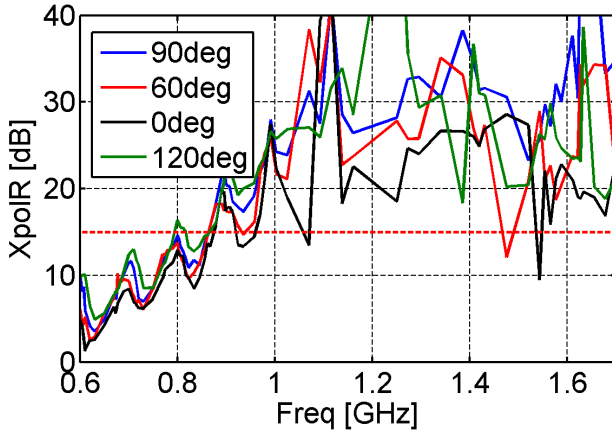

(c) XpolR.

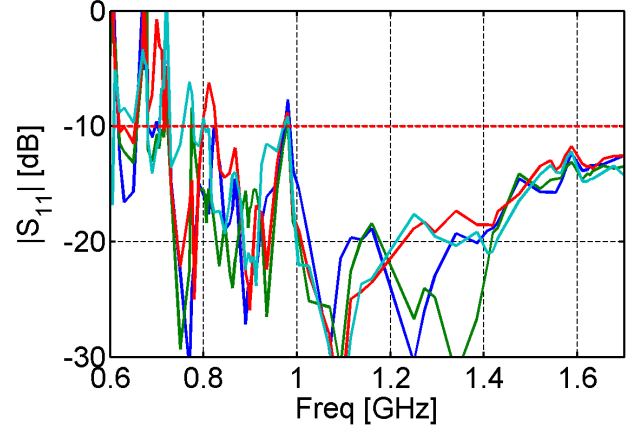

(d) Coeff. de Réf. à $\phi = 90^\circ$.

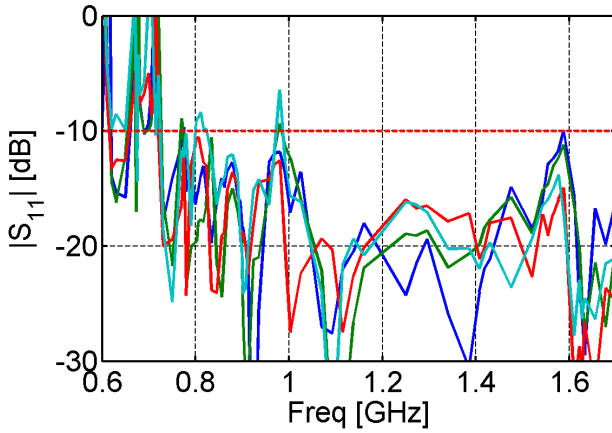

(e) Coeff. de Réf. à $\phi = 60^\circ$.

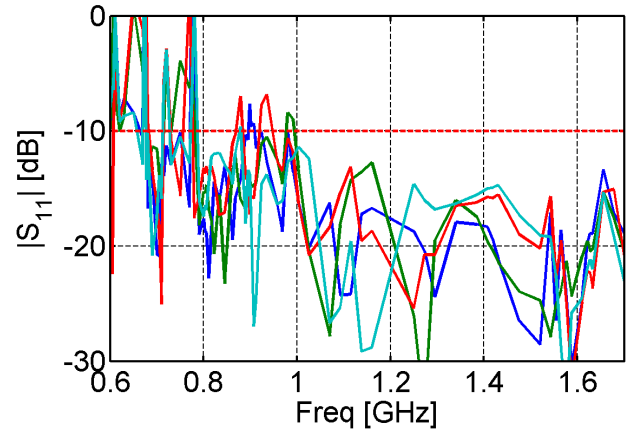

(f) Coeff. de Réf. à $\phi = 0^\circ$.

Figure 27: Réseau planaire de 36 antennes spirales d'Archimède asymétriques avec distribution triangulaire. Angle de dépointage de $\theta = 30^\circ$ pour différents angles ϕ . $Z_{ref} = 220\Omega$ pour calculer les coefficients de réflexion.

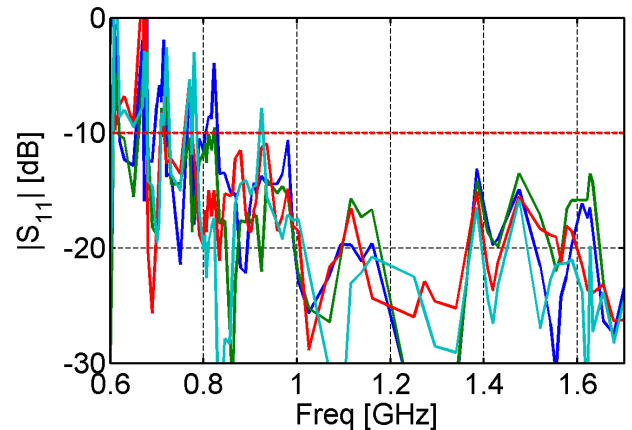

(g) Coeff. de Réf. à $\phi = 120^\circ$.

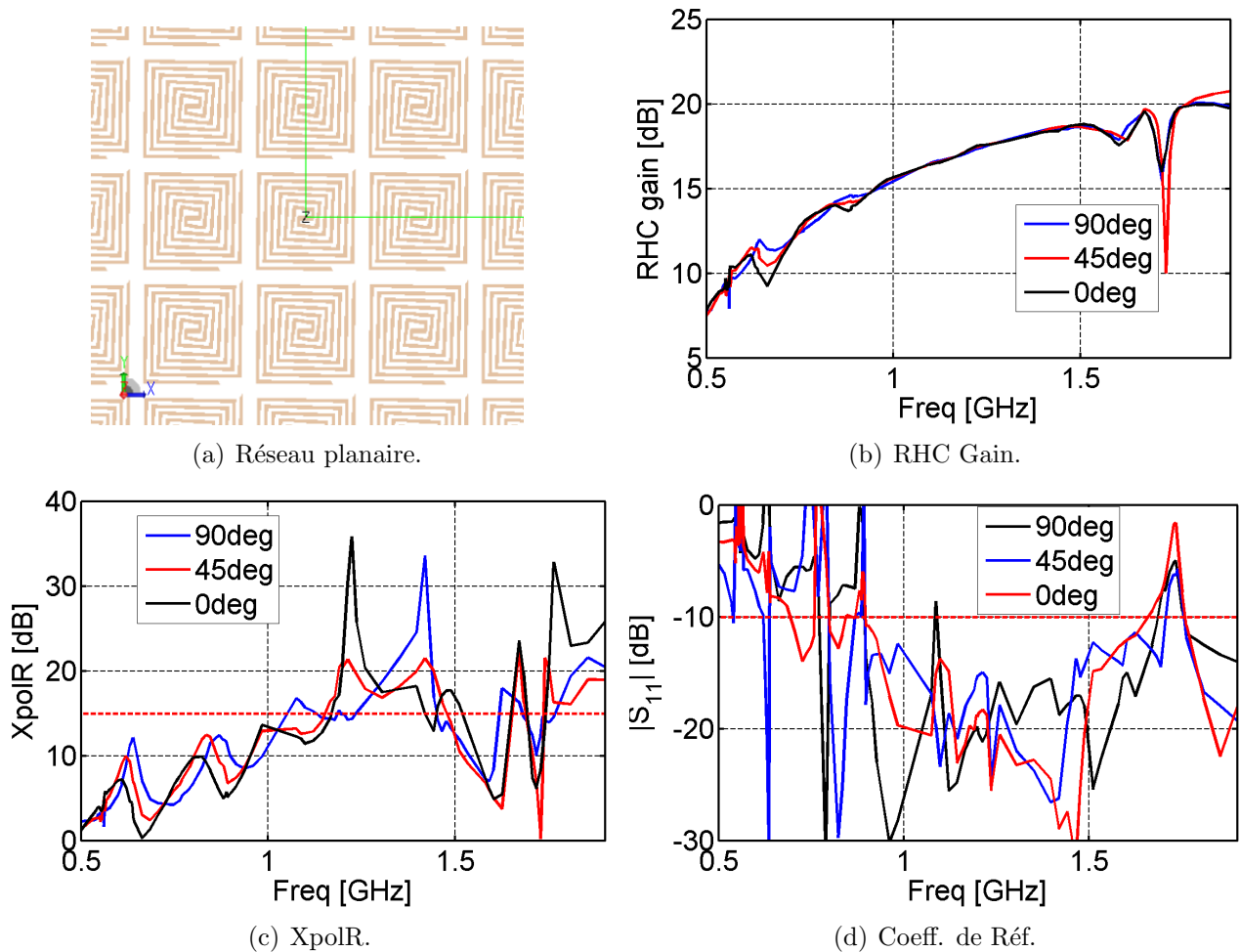

Figure 28: Réseau planaire de 49 antennes spirales carrées asymétriques avec distribution carrée. Angle de dépointage de $\theta = 30^\circ$ pour différents angles ϕ . $Z_{ref} = 220\Omega$ pour calculer les coefficients de réflexion.

Technique WAVES pour réseaux planaires uniformes

La technique WAVES (de l'anglais Wideband Array with Variable Element Sizes) fut proposée par Shively et Stutzman (*Shively and Stutzman, 1990*) et étudiée par Caswell (*Caswell, 2001*). L'idée est d'utiliser des éléments à taille variable pour couvrir une bande passante assez large. Un réseau composé des antennes larges, due à sa taille, peut travailler à des fréquences basses. La limite haute de la bande passante est l'apparition des lobes de réseaux et elle liée à la distance entre les éléments. Pour réduire la distance effective entre les éléments, des antennes de taille plus petites peuvent être introduites entre les antennes grandes et qui seront allumées en même temps que les grandes mais pour les fréquences supérieures (cf. Fig. 29). Nous aurons alors deux bandes passantes, comme le montre la Fig. 30. Pour éliminer le gap entre les deux bandes passantes il est nécessaire faire une optimisation des tailles des antennes. Cette optimisation dépendra de la distribution spatiale, de la forme des antennes et des fréquences des coupures des

antennes. (cf. Fig. 30).

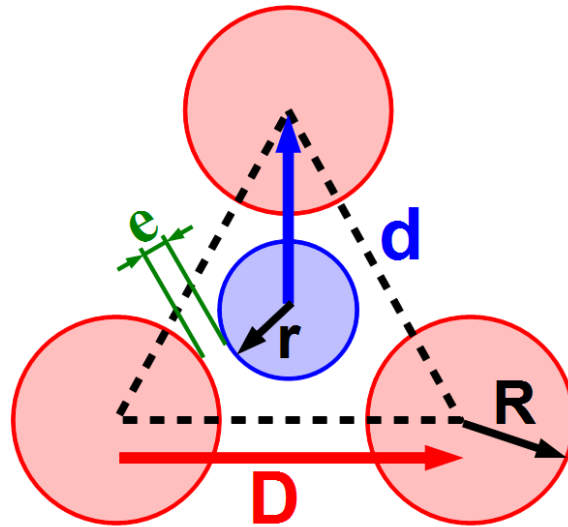

Figure 29: Schéma d'un réseau d'antennes spirales à deux tailles. r est le rayon de l'antenne petite, R est le rayon de l'antenne large. D est l'espacement entre les antennes spirales larges and d est l'espacement entre une antenne large et l'antenne petite la plus proche.

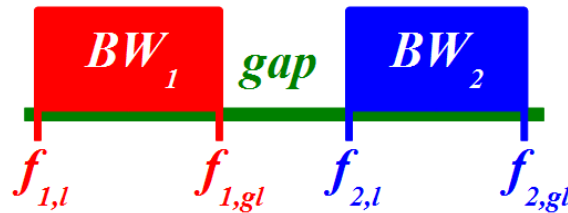

Figure 30: BW_1 est la bande passante lorsque seulement les antennes larges sont utilisées (basses fréquences). BW_2 est la bande passante lorsque les antennes larges et petites sont utilisées en même temps (hautes fréquences). $f_{1,l}$ et $f_{2,l}$ sont les fréquences de coupure basses des bandes passantes BW_1 et BW_2 , respectivement. $f_{1,gl}$ et $f_{2,gl}$ sont les fréquences de coupures hautes (dues aux lobes de réseaux) des bandes passantes BW_1 et BW_2 , respectivement.

En utilisant les facteurs “p” du Tab. 8 pour les antennes asymétriques d’Archimède, hexagonale et carrée, nous pouvons estimer les bandes passantes des réseaux composés par ces antennes et avec différents distributions spatiales, triangulaire et carrée. Ces estimations, après optimisation des tailles pour éliminer le “gap” dans la bande passante, sont présentées dans le Tab. 10 où r est le rayon des antennes petites et R est le rayon des antennes larges. Nous pouvons observer que le rapport r/R est proche à 1 ce qui montre que les antennes doivent avoir de tailles assez proches. Finalement, les bandes passantes estimées de XpolR ne dépassent pas de l’octave pour des angles de dépointage supérieurs à 30° .

Ant.,Latt.	Archi.,▲	r/R	Archi.,■	r/R	Hexag,▲	r/R	Squa,■	r/R
$BW_{S_{11}}$:r/R	2.6	0.67	2.34	0.61	2.74	0.63	2.26	0.88
$BW_{X_{polR}}$:r/R	1.86	0.93	1.69	0.84	1.76	0.99	1.63	1

Table 10: Bandes passantes estimées analytiquement pour réseaux composés par spirales à deux tailles et pour un angle de dépointage de $\theta = 30^\circ$, technique WAVES (*Caswell*, 2001).

Réseaux planaires à double polarisation (bande passante de 6:1)

Cette partie présente le principal but de cette thèse : la conception d'un réseau large bande planaire à double polarisation. Il y a principalement trois problématiques dans la conception des réseaux larges bandes qui sont souvent corrélées. Nous présentons une façon de traiter indépendamment ces problèmes :

1. Obtenir un réseau unidirectionnel avec système d'alimentation large bande. Entre les pages xvii et xviii un système d'alimentation a été utilisé et une cavité a été proposée pour obtenir une bonne adaptation d'impédance, mais la polarisation circulaire a été affectée.
2. Pour améliorer la polarisation circulaire la technique de rotation séquentielle (*Louertani et al.*, 2011) peut être appliquée. La Fig. 31 montre comment cette technique est appliquée. Avec cette technique, même si la polarisation de l'élément n'est pas du tout circulaire, la polarisation du réseau devient circulaire dans l'axe perpendiculaire au plan du réseau.

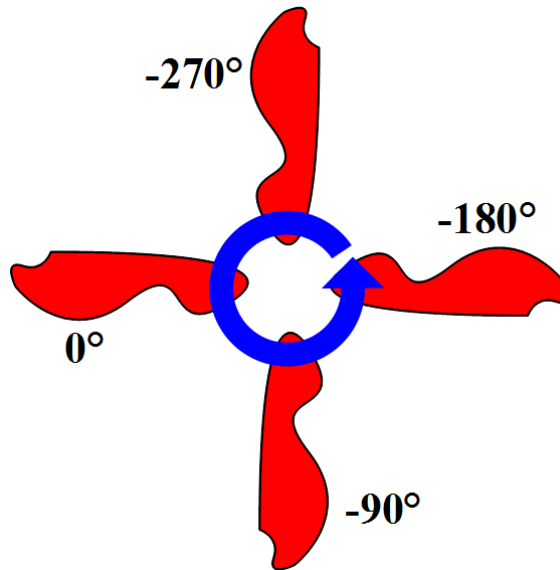

Figure 31: Technique de rotation séquentielle. Les phases qui doivent être additionnées à chaque élément pour obtenir une polarisation circulaire droite sont aussi montrées.

3. Pour traiter le problème des lobes de réseaux, l'utilisation des réseaux non uniformes s'avère importante. Parmi toutes les possibilités, celle qui est compatible avec la technique de rotation séquentielle est le réseau d'anneaux concentriques.

Conception et mesures d'un réseau d'un seul anneau

Dans un réseau linéaire, il a été montré que l'utilisation d'une cavité de la taille du réseau est plus efficace que d'utiliser des cavités sous chaque antenne (*Guinvarc'h et al.*, 2012). Pour le cas d'un anneau, la cavité devient aussi un anneau. La Fig. 32 montre les dimensions d'un réseau d'antennes spirales avec une telle cavité et la Fig. 33 montre le prototype construit à Singapour avec l'aide du Dr. Karim Louertani du NUS Temasek Laboratories.

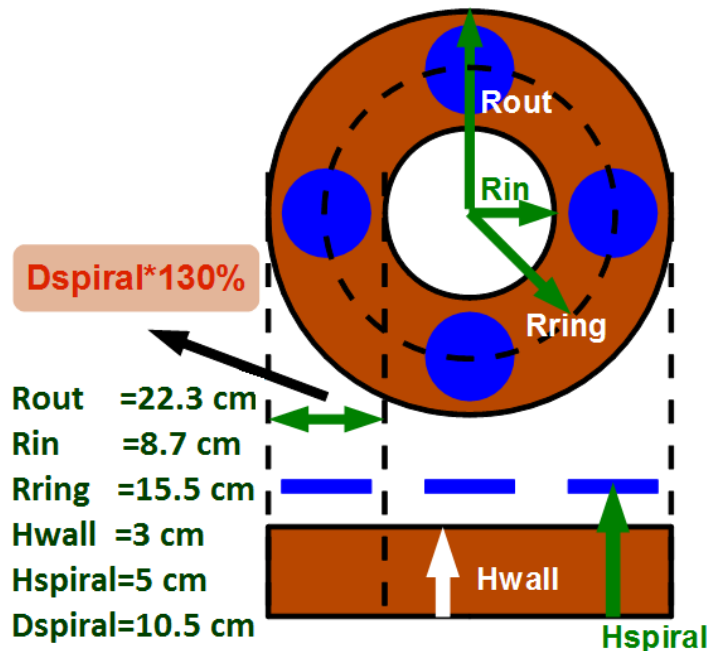

Figure 32: Schéma et dimensions d'un réseau dans un seul anneau d'antennes spirales. Juste les antennes d'une seule polarisation (bleu) sont montrées pour simplifier le schéma.

Les antennes fabriquées ce sont des antennes d'Archimède symétriques sur un substrat FR4 d'épaisseur 0.81 mm, de diamètre de 10.5 cm, 4 antennes de polarisation droite et 4 de polarisation gauche. Le substrat permet de réduire l'impédance d'entrée, originalement d'autour de 188Ω . Les Fig. 34, 35, 36 et 37 montrent le coefficient de réflexion, le gain total avec 2.5 dB de correction pour pertes d'insertion, X_{polR} et le RSSL, respectivement, du réseau d'un seul anneau. La Fig. 38 montre les différentes bandes passantes pour les différents paramètres : S_{11} , X_{polR} et RSSL. L'intersection de ces bandes passantes et le cas le plus intéressant et nous allons le nommer "bande passante utile". Pour l'instant, la bande passante utile est très étroite, entre 1 GHz et 1.1 GHz. Dans les parties suivantes nous allons utiliser des techniques pour élargir cette bande passante.

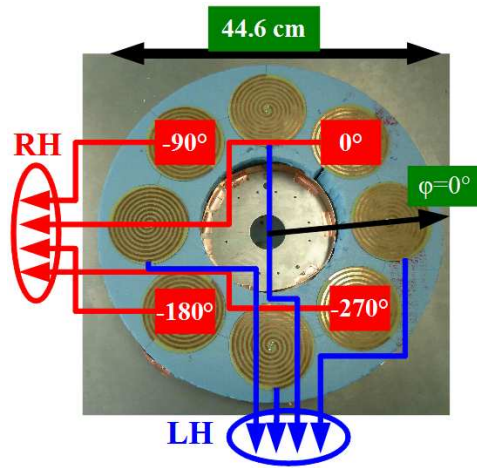

Figure 33: Prototypé du réseau d'un seul anneau.

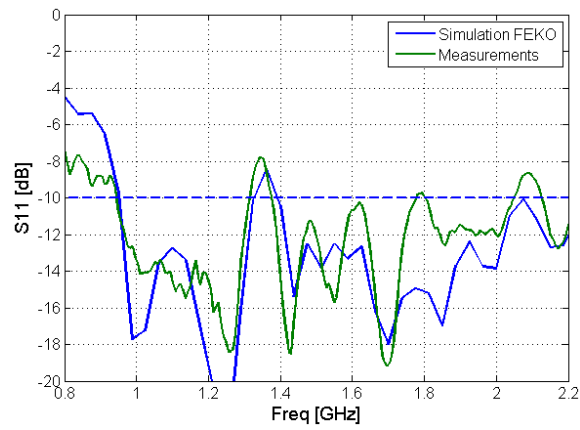

Figure 34: Simulation et mesures de coef. de réf. du réseau d'un anneau ($Z_{ref} = 100\Omega$).

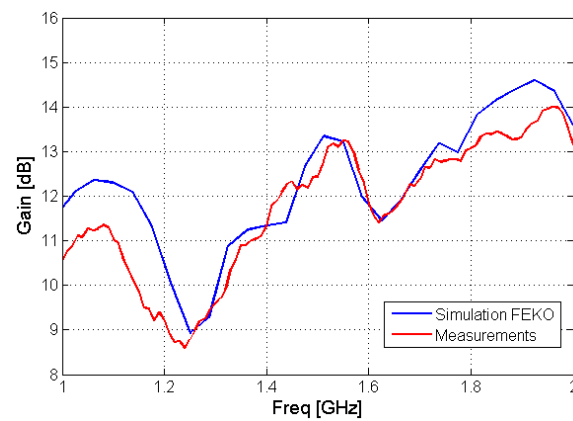

Figure 35: Gain total, mesures avec correction de 2.5 dB, du réseau d'un seul anneau.

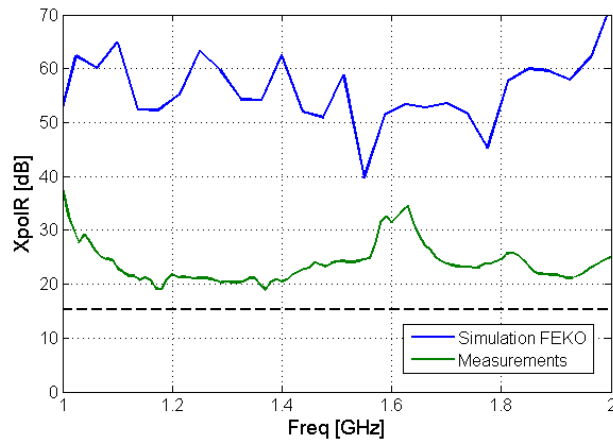

Figure 36: XpolR du réseau d'un anneau.

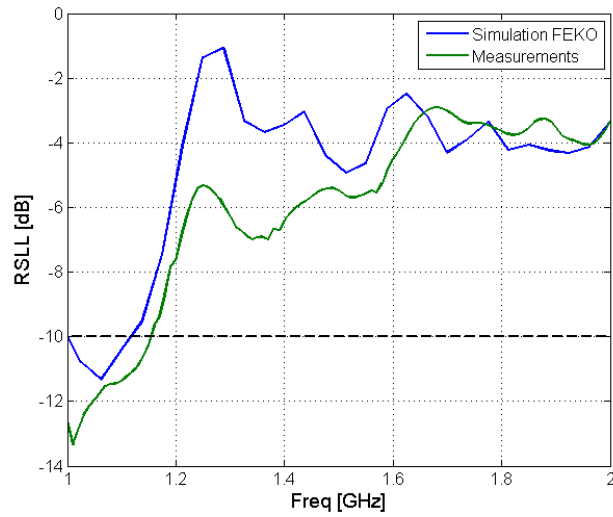

Figure 37: XpolR du réseau d'un anneau.

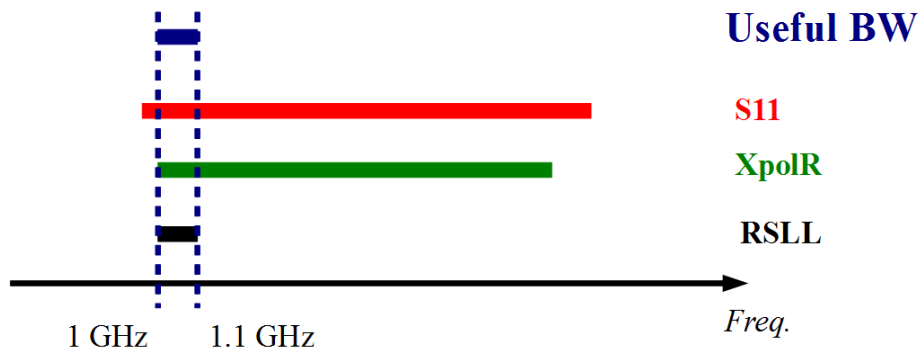

Figure 38: Résumé des bandes passantes du réseau d'un seul anneau.

Addition d'autres anneaux concentriques

Le réseau d'anneaux concentriques peut être conçu pour qu'il soit non uniforme, ce qui nous permettra de contrôler mieux les lobes de réseaux et les niveaux des lobes secondaires. La Fig. 39 montre un schéma d'un réseau à plusieurs anneaux concentriques. Ce réseau doit être optimisé

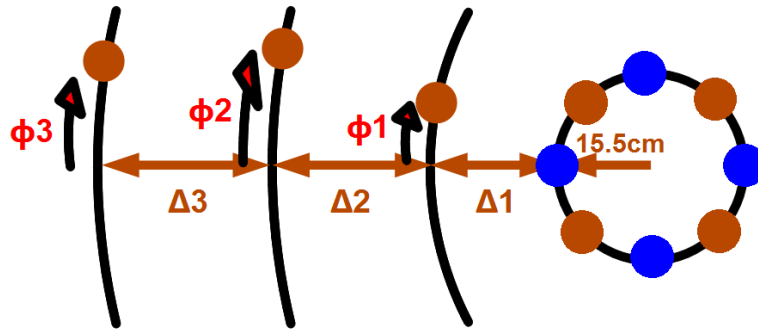

Figure 39: Schéma d'un réseau d'anneaux concentriques à optimiser.

pour avoir une bande passante large. Les variables sont les espacements entre les anneaux (Δ_i) et la position angulaire (ϕ_i) du premier élément de l'anneau. Nous avons choisi d'ajouter seulement 3 anneaux au premier anneau existant (composé de 8 antennes) pour éviter un grand nombre d'éléments. Le but de l'optimisation a été d'avoir un RSLI inférieur à -10 dB entre 1 GHz et 2 GHz pour un angle de dépointage de $\theta = 30^\circ$. L'optimisation a donné un réseau composé des 112 antennes par polarisation. Les algorithmes génétiques ont été utilisés. Les résultats de simulation avec FEKO sont présentés dans les Fig. 40, 41 et 42 for the RSLI, S_{11} , gain and X_{polR} . La Fig. 43 montre les bandes passantes du réseau ainsi que la bande passante utile d'une octave, qui est l'intersection des bandes passantes.

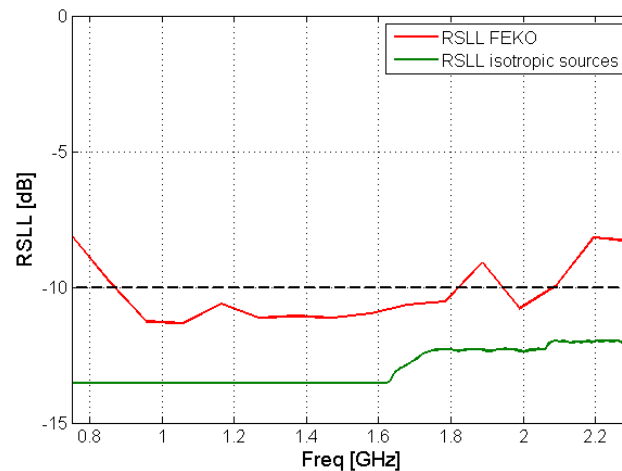

Figure 40: Comparaison de simulations de RSLI entre FEKO (112 antennes par polarisation) et en utilisant des sources isotropiques.

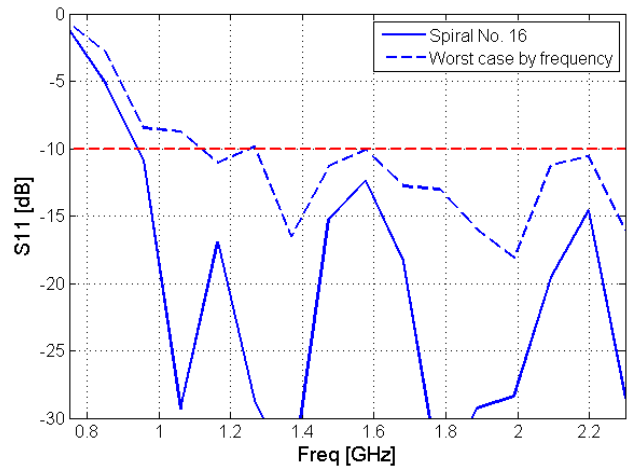

Figure 41: Coefficient de réflexion du réseau d'anneaux concentriques optimisé, 30° d'angle de dépointage. La spirale 16 représente le cas typique ($Z_{ref} = 220\Omega$).

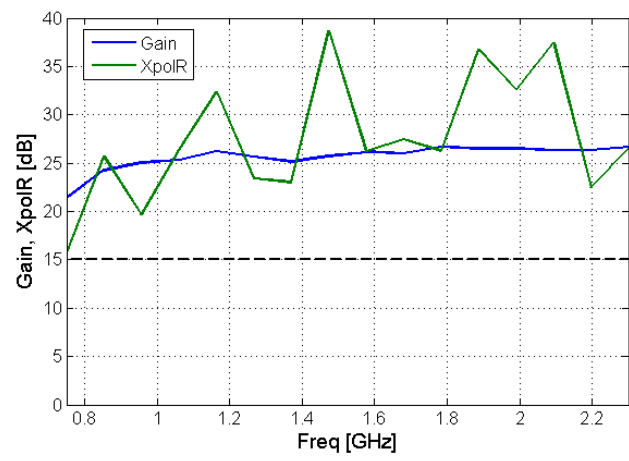

Figure 42: Gain et XpolR du réseau d'anneaux concentriques optimisé, 30° d'angle de dépointage.

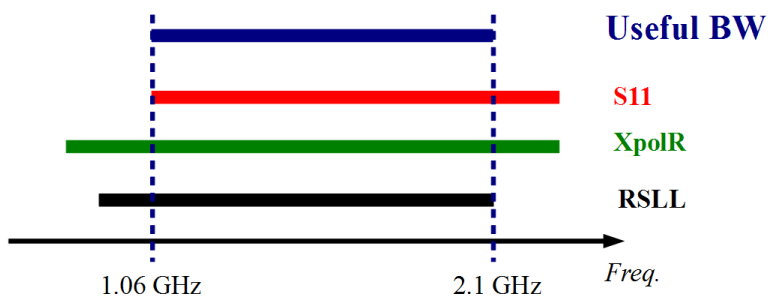

Figure 43: Résumé des bandes passantes du réseau des anneaux concentriques.

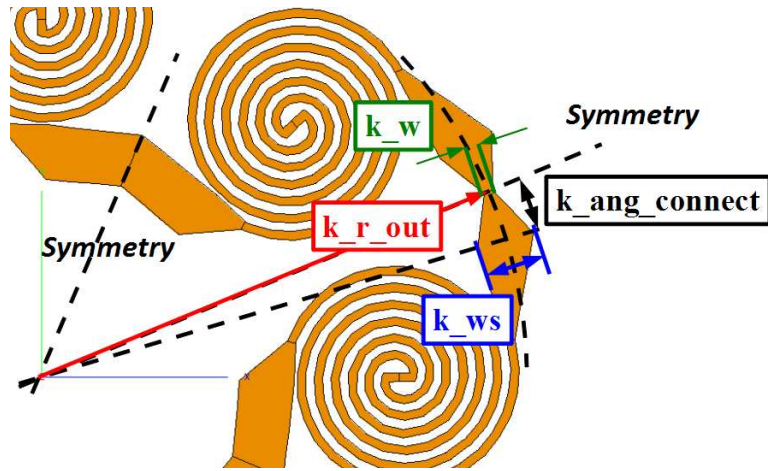

Figure 44: Schéma de connexion entre les antennes spirales d'Archimède.

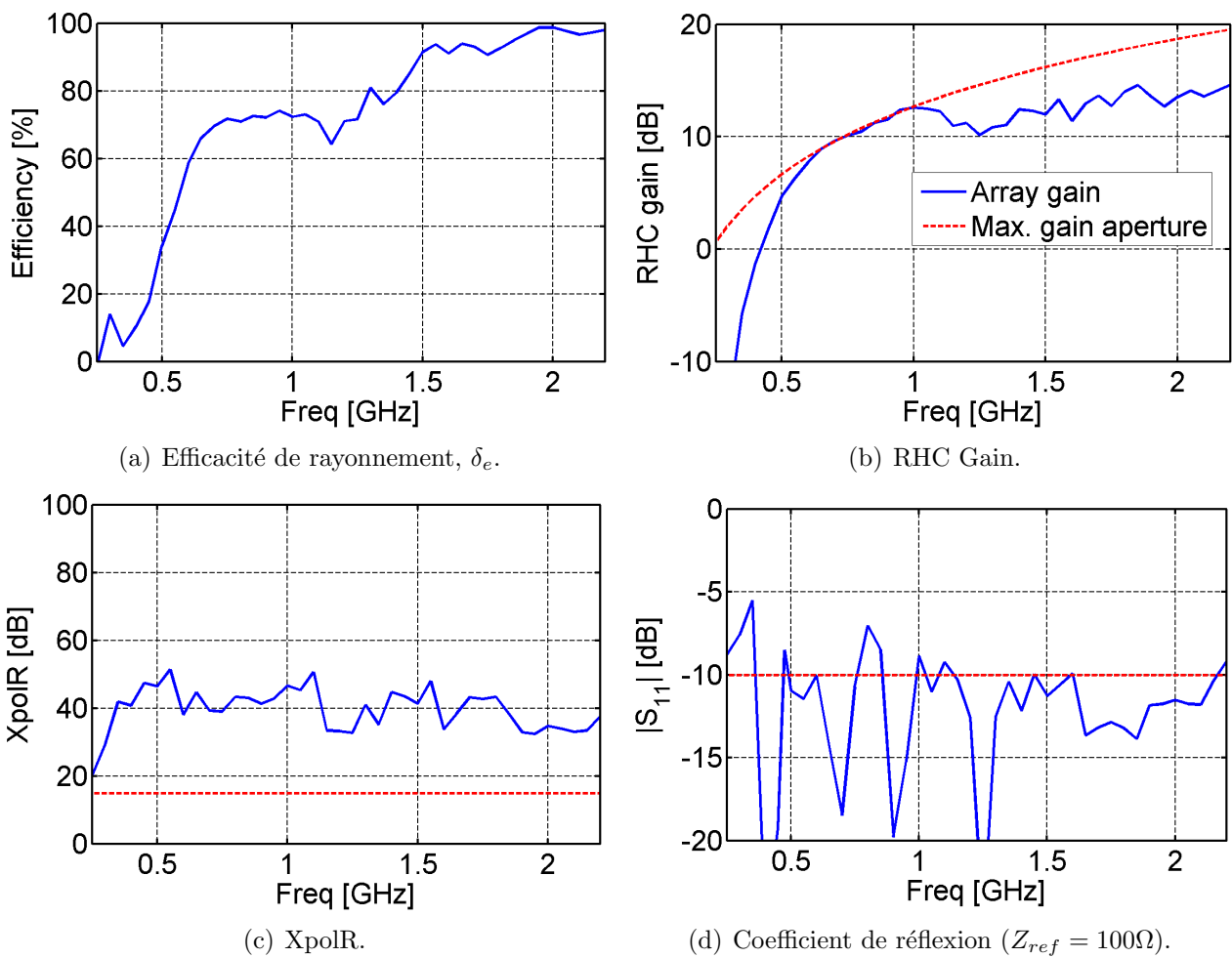

Figure 45: Résultats de simulations du réseau d'un seul anneau avec spirales connectées, substrat FR4, et charges.

Spirales connectées

Le but de cette partie est de diviser au moins par deux la fréquence de coupure basse comme dans (Guinvarc'h and Haupt, 2011). Pour le cas des anneaux concentriques, une optimisation doit être faite en prenant en compte la cavité en forme d'anneau (cf. Fig. 44). Les simulations pendant l'optimisation sont faites sans substrat pour accélérer l'optimisation. La largeur de chaque connexion ainsi que les impédances à utiliser au milieu de chaque connexion sont optimisé avec l'utile OPTFEKO du logiciel FEKO. La Fig. 45 montre les résultats de la simulation du réseau optimisé mais en rajoutant le substrat FR4 de 0.81mm d'épaisseur (cf. Fig. 46). La Fig. 47 montre le coefficient de réflexion obtenu par la simulation et par mesure, les courbes correspondent.

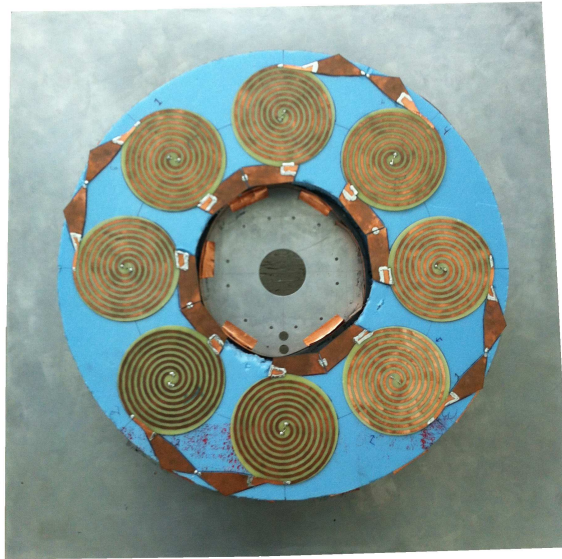

Figure 46: Prototype du réseau d'antennes spirales connectées.

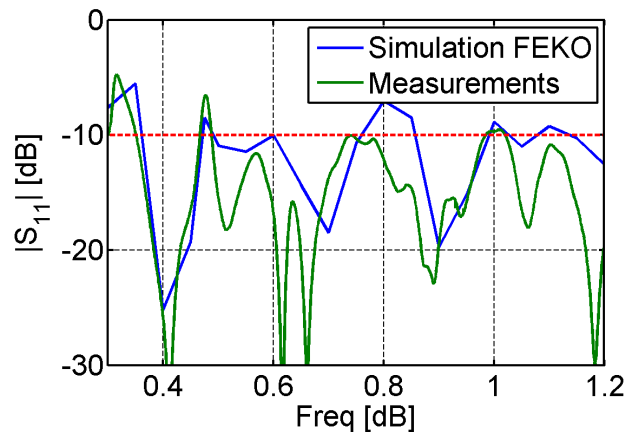

Figure 47: Comparaison entre simulation, avec FEKO, et mesure du coefficient de réflexion ($Z_{ref} = 100\Omega$) d'un réseau d'un seul anneau de spirales connectées.

Le réseau de spirales connectées montre une fréquence de coupure basse autour de 350 MHz. Sans les connexions, la fréquence de coupure basse de la spirale était 1 GHz. La Fig. 48 présente un résumé de l'évolution des bandes passantes utiles du réseau d'anneaux concentriques. Nous pouvons observer que en rajoutant des anneaux il est possible d'élargir la bande passante du réseau au niveau de la limite haute, avec 4 anneaux en total jusqu'à 2.1 GHz. En même temps, si on connecte les spirales la fréquence de coupure basse est 350 MHz, ce qui fait une bande passante totale utile de 6:1. On rappelle que la technique de rotation séquentielle est toujours utilisée pour assurer une excellente polarisation circulaire pendant toute la bande passante.

Le Tab. 11 montre les performances des réseaux planaires qui ont été étudiés dans ce chapitre.

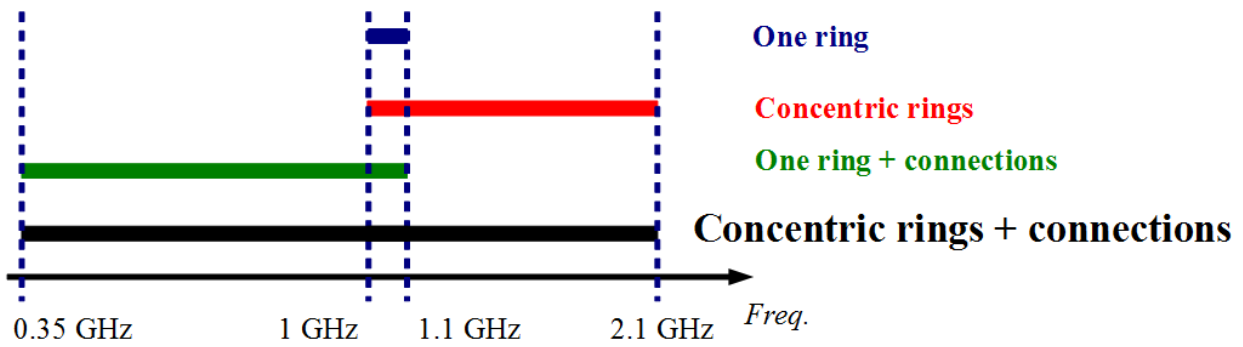

Figure 48: Évolution des bandes passantes utiles du réseau d'anneaux concentriques et avec connexions.

Array	Cavity	Dual Pol.	BW($f_{\text{high}}/f_{\text{low}}$)
Uniform planar spiral antennas	NO	NO	1.82:1
Circular spiral antennas	YES	YES	2:1
Circular spiral antennas + Connections	YES	YES	6:1

Table 11: Résumé de bandes passantes des réseaux pour un angle de dépointage de $\theta = 30^\circ$.

Conclusion

Ce travail de thèse s'est focalisé sur la conception de réseaux planaires larges bandes à double polarisation. Dans la conception, trois principaux paramètres ont été visés : coefficient de réflexion (S_{11}) inférieur à -10 dB, XpolR supérieur à 15 dB et RSSL inférieur à -10 dB. Une cavité sous le réseau a été utilisée pour éliminer la radiation en arrière ainsi que des antennes de polarisation opposées pour obtenir la double polarisation. La contribution de ce travail de thèse peut être synthétisée en trois idées :

- L'analyse des réseaux uniformes avait mis en évidence des résonances. Des travaux précédents avaient montré l'existence de ces résonances dans des réseaux de spirales symétriques carrées avec un plan de masse. Dans nos travaux, nous avons trouvé que ces résonances sont présentes dans toutes les antennes spirales si elles sont symétriques et sans avoir besoin de plan de masse. Nous avons montré, aussi, que ces résonances peuvent être expliquées par les modes d'alimentation de l'antenne spirale. En suite, nous avons proposé l'utilisation de réseaux non-uniformes pour casser ces résonances.
- Une méthode analytique d'estimation de bandes passantes a été aussi présentée. Dans cette méthode une antenne spirale isolée est étudiée pour déterminer les limites basses des bandes passantes des réseaux composés par ces antennes. On a obtenu de bonnes estimations des bandes passantes de XpolR. Cette méthode nous a permis de déterminer que les bandes passantes de réseaux uniformes à mono polarisation ne dépassent pas l'octave pour un angle de dépointage de 30°.
- Nous avons montré aussi qu'un réseau large bande à double polarisation avec des antennes spirales est possible. En utilisant les réseaux non uniformes et en connectant les antennes nous avons pu arriver à obtenir un réseau avec une bande passante de 6:1. En fait, ces deux approches correspondent aux actuelles tendances dans la conception des réseaux non uniformes.

Pour conclure, nous présentons quelques perspectives :

- Le réseau planaire d'anneaux concentriques développé n'utilise pas d'une façon efficace la surface planaire. Il est un réseau lacunaire. La technique WAVES pourrait être utilisée.
- D'autres distributions spatiales pourraient être étudiées qui permettent l'utilisation de la technique de rotation séquentielle et la connexion entre les spirales.
- Dans ce travail de thèse, seulement les réseaux planaires ont été étudiés. On pourrait penser aussi à étudier le cas de réseaux conformes à une surface courbe.

INTRODUCTION

The wireless telecommunications through electromagnetic waves started more than a century ago. By the end of the 1800's the wireless telegraphy used "spark gap" transmitters. These transmitters generated a short pulse and, due to its very broad bandwidth characteristics, wideband antennas were used (*Lodge*, 1898). At that time it was not known how to take advantage of these wideband signals, on the contrary, they were seen as a poor use of the frequency spectrum, therefore narrowband systems gained interest after 1910. It was not until the 1960's that wideband systems were reconsidered with more enthusiasm, in this case in the context of military radar (*Allen et al.*, 2007).

Around 1954, Edwin Turner was winding the arms of a dipole antenna into the shape of a spiral to find out that this new antenna had a good circular polarization with nearly constant gain and input impedance throughout a very wide bandwidth. These findings helped to consolidate the theoretical works of Victor Rumsey on the idea of "frequency independent antennas" (*Corzine and Mosko*, 1990).

Antenna arrays had been used since the beginning of the 19th century in order to improve the directivity, but the scan method was mechanical. In 1937, it was proposed to use adjustable phase shifters in the feeding system of the antenna arrays in order to scan the space instead of moving the whole array (*Friis and Feldman*, 1937). In 1958, the first volume scanning (azimuth and elevation) phased array was presented by Spradley (*Spradley*, 1958).

By that time, one of the main applications of the antenna arrays was in radar. Besides the information on distance and speed of the target, the array could be designed to also recover the polarization of the wave scattered by the target. This polarization changes depending on the shape, orientation and material of the object, which helps in its characterization (*Boerner et al.*, 1981). Polarization also plays an important role in Telecommunications where receiver and transmitter need to match their polarizations to ensure a good transmission (*Allen et al.*, 2007).

There are mainly two paradigms to design wide bandwidth arrays. Up to the beginning of the 2000's, the main paradigm was to choose an element with the desired bandwidth and then to optimize it in the array environment (*Munk et al.*, 2003). In this case, the lowest cutoff frequency of the bandwidth of the array depends on the antenna used and the highest cutoff frequency is determined by the emergence of the grating lobes. In order to expand this bandwidth, a nonuniform array with a high number of elements can be used to reduce the grating lobes.

Although by the 1970's it was already proposed by Baum (*Hansen*, 2004), the second main paradigm to design wideband arrays has gained impetus in the last decade with the work of Munk (*Munk et al.*, 2003) and others. Instead of casting off the mutual coupling between the antennas, this paradigm takes advantage of it to increase the bandwidth of the elements. Since the mutual coupling is a complex phenomenon, the availability of fast computers and efficient

numerical method codes to solve Maxwell's equations was crucial to the development of this design method.

This paradigm is mostly applied to uniform infinite arrays and the bandwidth is designed at the same time with the antenna in the array environment. The highest cutoff frequency of the bandwidth of the array is, again, the presence of the grating lobes. On the other hand, its lowest cutoff frequency will depend on the number of elements.

Nowadays there is a great need for wide bandwidth arrays. For radars, these kind of arrays let to obtain high-resolution images, and, spreading in frequency the transmitted power, it reduces the detection sensibility of a possible intrusive hearing.

In telecommunications, wide bandwidth is needed in the spread spectrum technique which is largely used to reduce the cross-talk interference (*Adamiuk et al.*, 2012), (*Allen et al.*, 2007).

In human detection in debris, low frequencies penetrate easier than high frequencies but the resolution is better for high frequencies, hence frequency agility and wide bandwidths are also needed (*Grazzini et al.*, 2010). The same constraints applied for foliage penetration and ground movement target identification technology (FOPEN GMTI) where low frequencies have less attenuation, due to the foliage, but high frequencies provide better sensitivity to target velocity (*Hellsten and Ulander*, 2000).

Other applications where full polarization detection is additionally needed are local-to-global environment of the terrestrial and planetary covers, crop monitoring and damage assessment, deforestation and burn mapping, land surface structure, biomass, hidrology and ice monitoring, just to mention a few (*Pottier and Ferro-Famil*, 2008).

In this context, SONDRALaboratory decided to launch a research topic on the design of wideband arrays. SONDRAL is a joint research laboratory between Singapore and France made of four partners: SUPELEC and ONERA from France, and the National University of Singapore and DSO National Laboratories from Singapore.

The aim of this research topic was to develop new types of lattices for broadband dual-polarized phased arrays using spiral antennas. In order to obtain a wide bandwidth, the problem of grating lobes and lowest cutoff frequency of the antenna had to be addressed for dual polarization. The existing lattices needed to be investigated in order to define their bandwidth limits. Other technical problems, such as feeding the antenna array for a wide bandwidth and the use of ground plane, had to be addressed as well.

Chapter 1 introduces the definitions and concepts that will be used throughout this work. The Archimedean spiral antenna is studied, as well as other variants of spiral. The feeding system of the antenna is presented and the issues related to the use of a ground plane or cavity behind the antenna are also discussed. Some important antenna array concepts are introduced. Finally, a classification of phased arrays is presented, based on the two paradigms of broadband array design.

Chapter 2 deals with linear arrays of spiral antennas. The resonance issue of symmetrical spiral antennas is addressed in mono-polarized arrays. It is shown that these resonances are also present in a single spiral antenna. Explanations and solutions to these resonances are introduced.

Some solutions are based on the modification of the elements but others, instead, work at the array level. The bandwidth limits of these arrays are also studied. An example of a dual-polarized array is studied showing that the resonance issues are not present in this case.

Chapter 3 focuses on planar arrays. An analytical method to estimate the bandwidths of the arrays is presented and verified by simulations. The bandwidth limits of uniform arrays using the WAVES technique are studied using this method. For the case of uniform dual-polarized arrays, the bandwidth is almost zero due to the early occurrence of grating lobes. To circumvent this problem, the use of nonuniform lattices is proposed and studied, which extends the highest cutoff frequency of the array of the bandwidth. In order to improve the lowest cutoff frequency, a successful technique in spiral linear arrays is adapted and used for planar arrays.

CHAPTER I

General Review

1.1 Introduction

In this chapter some important definitions and concepts related to the antennas and phased arrays that are going to be used throughout this work are introduced, such as bandwidth, reflection coefficient, axial ratio, rejection of cross polarization, mutual coupling, array factor, uniform and nonuniform arrays. Some examples of broadband antennas, in particular the Archimedean spiral antenna, are presented. Additionally, contemporary trends in the design of phased arrays with large bandwidths are described.

1.2 Antenna basics

1.2.1 Some antenna concepts and definitions

Antenna bandwidth

Antennas can transmit and receive over a range of frequencies, or bandwidth (BW), from the lowest frequency (f_{low}) to the highest frequency (f_{high}) of the bandwidth. Depending on their functions, antennas are designed to operate in a narrow or a large bandwidth. An example of a very narrowband antenna is the dipole. On the other hand, there are antennas with a large bandwidth, for instance the helix or spirals. In order to compare them, the bandwidth can be defined in three main ways (*Haupt*, 2010):

- Percent of center frequency (f_{center}):

$$BW = \frac{f_{high} - f_{low}}{f_{center}} \times 100 \quad (1.1)$$

- Ratio of high to low frequencies, ($f_{high} : f_{low}$):

$$BW = \frac{f_{high}}{f_{low}} \quad (1.2)$$

- Range of frequencies:

$$BW = f_{high} - f_{low} \quad (1.3)$$

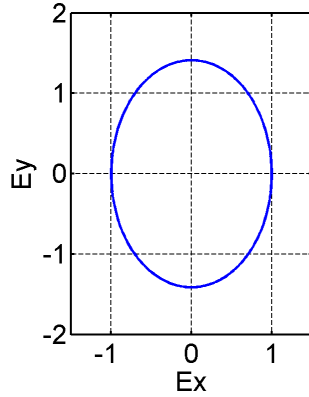

Figure 1.1: Curve described by a circularly polarized wave with AR=3 dB, or XpolR = 15 dB.

Broadband or wideband antennas present a 25% ($\sim 1.3 : 1$) or higher bandwidth (*Stutzman and Buxton, 2000*). The limits of the bandwidth (f_{low} , f_{high}) depend on the parameters considered. In this work we will consider two main parameters of the antenna: impedance matching and polarization.

Impedance matching

For an antenna, usually, good impedance matching means a reflection coefficient, $|S_{11}|$, under -10 dB. This represents a loss in the power driven to the antenna of about 10%. It is also common to find the Voltage Standing Wave Ratio (VSWR) as an indicator of impedance matching. A good impedance matching has a VSWR ≤ 2 . The relations between the S_{11} and the VSWR are presented in Eq. 1.4 and 1.5.

$$S_{11} = \frac{Z_{in} - Z_{ref}}{Z_{in} + Z_{ref}} \quad (1.4)$$

$$VSWR = \frac{1 + |S_{11}|}{1 - |S_{11}|} \quad (1.5)$$

Polarization

For an electromagnetic wave radiated from an antenna, the electric field vector has a magnitude and orientation that depend on time and space. For linearly-polarized antennas, the electric field describes a line, as in a dipole. Other antennas, like spirals, present a circular polarization, which means that the electric field rotates in such a way that it describes a circle, the ideal case, or an ellipse, the most realistic case. This rotation is called “right hand” (“left hand”) if it is clockwise (counterclockwise) when looking at the transmitted wave in the direction of propagation. The Axial Ratio (AR) of a wave is an indicator of the ellipticity of the polarization. According to IEEE (*IEEE Standard, 1993*), the AR is the ratio (expressed in dB) between the major and the minor axes of a polarization ellipse. Usually, good AR values are less than 3 dB (in linear scale $\sqrt{2}$, cf. Fig. 1.1). For the case of a linearly-polarized wave, it is easy to see that the AR will be infinite.

Another common indicator of the AR is the Rejection of Cross Polarization (XpolR), usually expressed in dB. Good XpolR values are larger than 15 dB. Eq. 1.6 shows the relation between

the AR and the XpolR, both expressed in dB.

$$XpolR = 20 \log_{10} \frac{10^{\frac{AR}{20}} + 1}{10^{\frac{AR}{20}} - 1} \quad (1.6)$$

Gain

The gain of an antenna (G) is the ratio between the power delivered by the antenna in a certain direction versus the power delivered to the antenna. The directivity of the antenna (D) is the power density in a certain direction versus the average power density created by the antenna. The directivity will be always larger than the gain since the latter includes the losses, such as losses in the substrate, losses due to loads in the antennas, etc. Eq. 1.7 relates these two parameters by the *radiation efficiency* (δ_e) (Haupt, 2010).

$$D = \delta_e G \quad (1.7)$$

Another interesting parameter is the theoretical maximum gain of an aperture. If the gain of the antenna achieves this value, it is said that it has a 100% *aperture efficiency*. This maximum gain is shown in Eq. 1.8.

$$G_{max} = 4\pi \frac{A}{\lambda^2} \quad (1.8)$$

where G_{max} is the maximum gain, A is the area of the radiant element expressed in m^2 and λ the wavelength expressed in m .

1.2.2 Broadband antennas

The use of broadband antennas can be traced back to the days of telegraphy. By the end of the 19th century, Lodge proposes new improvements to a system known at that time as “Hertzian-wave telegraphy” (Lodge, 1898). In his invention, he explains that the system uses “capacity areas” (antennas) to transmit and receive the signals. Lodge cites many antennas, among them “cones or triangles or other such diverging surfaces with the vertices adjoining and their larger areas spreading out into space”. Fig. 1.2 shows some of his designs. The biconical antenna has been revisited by Carter and Schelkunoff (Schantz, 2004). Many other antennas have been proposed, such as Vivaldi, helix, spiral antennas and four square antennas.

Biconical or conical with ground plane

If the biconical antenna were infinite its bandwidth would also be infinite. But in practice the bandwidth is limited to about 50:1 (Sandler and King, 1994). The input impedance of this antenna is mostly real and it depends on the angular aperture. It can be easily designed to be adapted to an input impedance of 50Ω . The polarization of the antenna is linear, parallel to the axis of the antenna. The radiation pattern is omnidirectional, in the perpendicular plane of the axis of the antenna, as in the case of the dipole.

Horn

By adapting the aperture edges of the horn, it is easy to obtain an octave bandwidth (Burnside and Chuang, 1982). Thanks to its profile aperture, the antenna is easily matched to a 50Ω

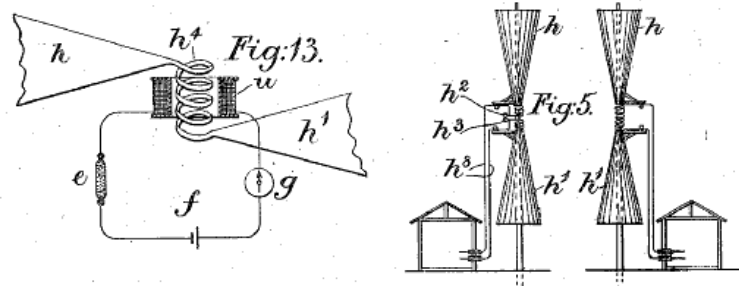

Inventor:
Olivier Joseph Lodge
By his attorney
Richard Davidson Wright

Figure 1.2: Biconical antenna described by Lodge in US Patent 609154 (Lodge, 1898).

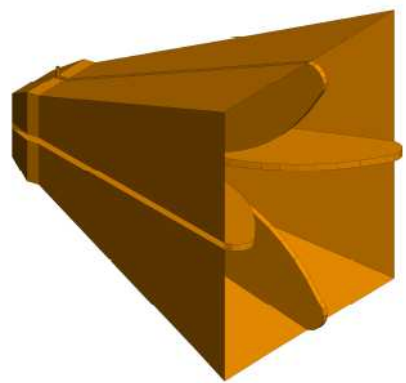

(a) Quad-ridge horn antenna (Van der Merwe et al., 2012).

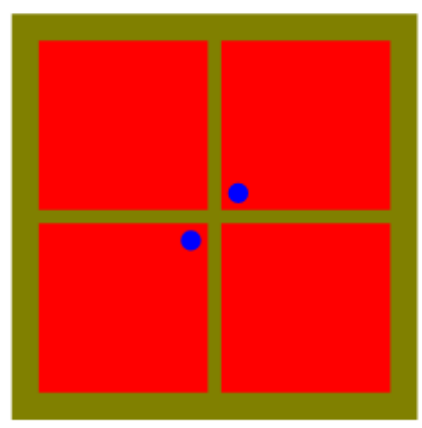

(b) Four square antenna (Stutzman and Buxton, 2000).

Figure 1.3: Examples of broadband antennas.

coaxial cable. With the addition of ridges, this antenna can be dual linearly-polarized and its bandwidth can go up to 15.7:1 of bandwidth (Van der Merwe et al., 2012) (cf. Fig. 1.3(a)).

Vivaldi, tapered slot or flared notch antenna

The Vivaldi antenna produces an endfire directive linearly polarized radiation. This antenna can easily achieve a bandwidth of 20:1 (Gazit, 1988). Its tapered profile provides a good impedance match to a 50Ω coaxial cable.

Archimedean and equiangular spiral

Commercial spiral antennas can achieve bandwidths larger than 20:1. Its input impedance in free space is about 188Ω. An impedance transformer is needed to adapt to a 50Ω coaxial cable. They exhibit excellent circular polarization (Kaiser, 1960), thanks to their rotational symmetry.

Four square

The four square antenna was patented in 1999 by the Virginia Tech Antenna Group (cf. Fig. 1.3(b)). It provides dual orthogonal linear polarization. Its bandwidth goes up to 1.8:1 (*Stutzman and Buxton*, 2000). Its input impedance can be designed to be around 100Ω .

For airborne applications, planar structures have some advantages, such as the possibility to be mounted in the skin of an aircraft. In this case the biconical, horn and Vivaldi antennas can be too cumbersome. Additionally, if we want circular polarization the spiral antenna provides it naturally.

1.3 The Archimedean spiral antenna

The two-arm Archimedean spiral antenna can be seen as a dipole the arms of which have been wrapped into the shape of an Archimedean spiral. This idea came from Edwin Turner around 1954. By that time, Victor Rumsey was already working on the idea of “frequency independent antennas” and the derivation of the logarithmic spiral antenna. Turner’s results helped to impulse Rumsey’s ideas.

The spiral antenna can be classified as a frequency-independent antenna in the sense that its input impedance and gain remain almost constant throughout the bandwidth. When the arms of the antenna are fed with a 180° phase difference, the antenna radiates from an annular ring with a mean circumference of one wavelength. This is known as the *ring theory* and was explained by Kaiser in (*Kaiser*, 1960). At low frequencies the radiation zone is near the outermost part of the spiral, meanwhile at high frequencies it is near the center. Hence, the lowest cutoff frequency (f_{low}) of the spiral antenna is related to its outer radius and the highest cutoff frequency (f_{high}) is related to its inner radius, as shown in Eq. 1.9. This means that the bandwidth of the antenna can be very large, only depending on size and printing accuracy.

$$f_{low} = \frac{c_0}{2\pi r_{out}}, \quad f_{high} = \frac{c_0}{2\pi r_{in}} \quad (1.9)$$

where c_0 is the speed of light in free space.

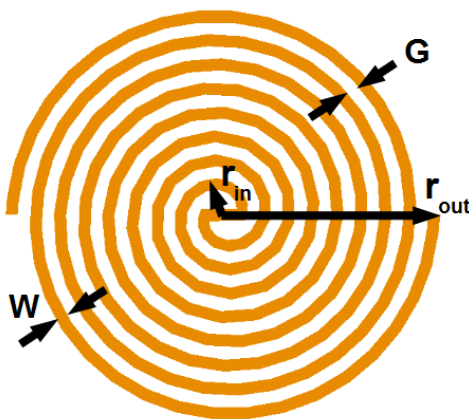

Figure 1.4: A self-complementary right-handed Archimedean spiral antenna.

Symbol	Value	Description
r_{out}	50 mm	Outer radius
r_{in}	5.5 mm	Inner radius
W	2.8 mm	Width of the arms
G	2.8 mm	Gap between arms
N	4	Number of turns

Table 1.1: Geometrical dimensions of the Archimedean spiral antenna.

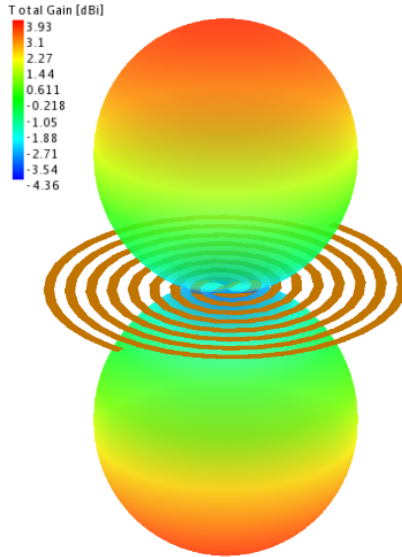

Figure 1.5: Far field of a spiral antenna.

Impedance matching

Fig. 1.4 shows the self-complementary right-handed Archimedean spiral antenna and its dimensions. G is the gap between the arms, W is the width of the arms, r_{in} is the inner radius, and r_{out} is the outer radius. The input impedance of this spiral antenna can be obtained using the Booker's extension of the Babinet's principle for complementary structures (*Balanis, 2005*) and is expressed in Eq. 1.10.

$$Z_{in} = \sqrt{Z_{microstrip} \times Z_{slot}} = \sqrt{\frac{\eta^2}{4}} \quad (1.10)$$

Z_{in} is the input impedance of the structure, $Z_{microstrip}$ and Z_{slot} are the input impedances of the microstrip and slot parts, respectively, and η is the intrinsic impedance of the medium. For an antenna in free space, its input impedance equals $60\pi \approx 188.5\Omega$.

An example of an Archimedean spiral antenna with the dimensions given in Tab. 1.1 was evaluated with simulation codes. Fig. 1.6 shows the input impedance and reflection coefficient calculated with FEKO, a method of moments code (*FEKO, 2004*), and CST, a finite integration in time domain technique (*CST, 2010*), for the spiral in free space shown in Fig. 1.4. The arms of the antenna are fed at the center with a 180° phase difference. The input impedance

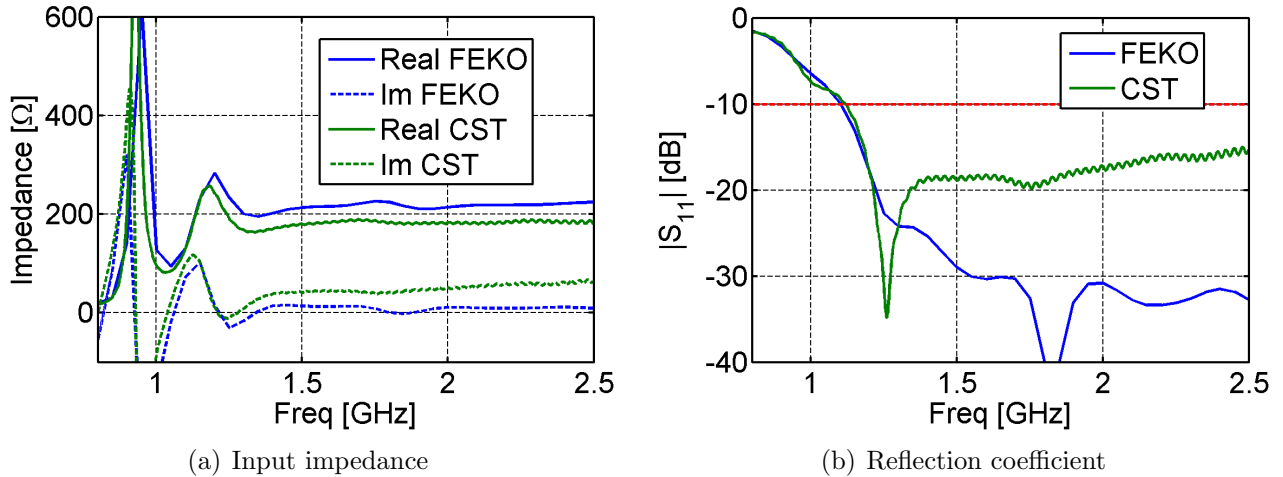

Figure 1.6: Input impedance and reflection coefficient of the Archimedean spiral antenna of Tab. 1.1. Z_{ref} is 220Ω for the simulation done with FEKO and 188Ω for the simulation done with CST.

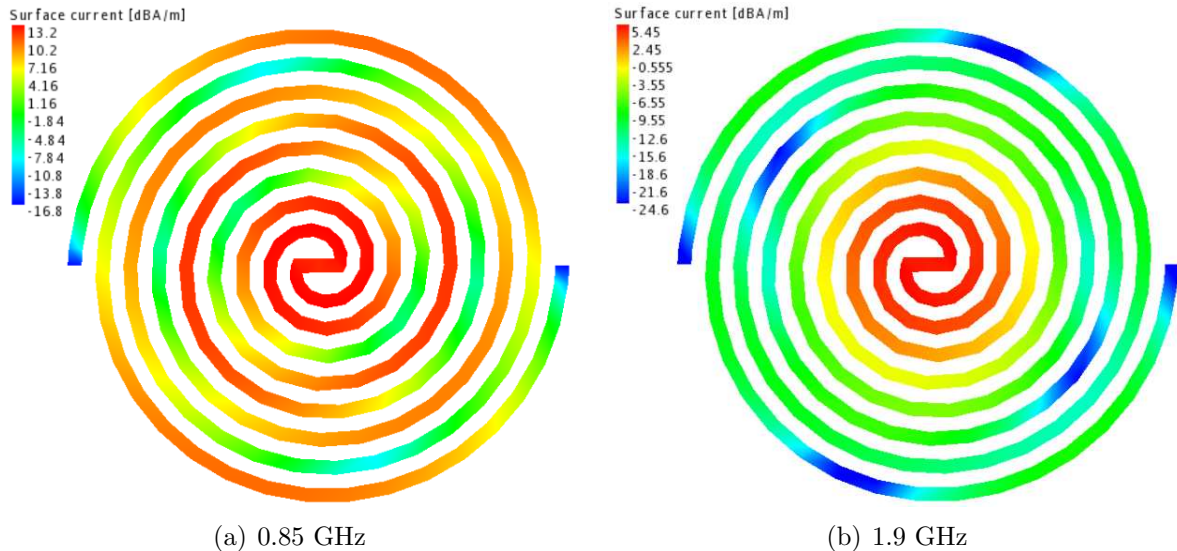

Figure 1.7: Current distributions of the Archimedean spiral antenna.

is about $220 + 10i\Omega$ when the simulation is carried out in FEKO and about $180 + 50i\Omega$ when in CST. The differences between these values and the theoretical value for self-complementary structures ($188 + 0i\Omega$, expected by Eq. 1.10) are due to the technique used to solve the Maxwell's equations. Additionally, as can be seen in Figure 1.4, the spiral used in the simulation is not exactly self-complementary at the center.

The reflection coefficient was calculated using a reference impedance (Z_{ref}) of 220Ω (with FEKO) and 188Ω (with CST), which are, respectively, the approximated absolute values of the impedances found in the simulations. Both reflection coefficients have the same behavior until their values reach -18 dB.

According to Fig. 1.6(b), in both cases we can consider that the antenna is well matched

($|S_{11}| < -10$ dB) for frequencies higher than 1.1 GHz. This frequency is higher than the theoretical frequency of 0.96 GHz (cf. Eq. 1.9), because at this frequency the current is still strongly reflected from the end of the arms. In fact, at low frequencies the currents on the arms of the spiral reach the end of the arm, are reflected and reach again the feed at the center. This contributes to a poor matching, as can be seen in Fig. 1.7(a). At higher frequencies the currents are already dissipated due to the radiation and there is no reflection, as shown in Fig. 1.7(b).

Throughout this work we use FEKO to carry out the simulations, and will use 220Ω as the reference impedance for the calculation of the S_{11} .

Circular polarization

Fig. 1.7 also shows that the current distribution presents a 180° rotational symmetry, which produces a circularly polarized radiated wave. Since the wave is radiated in perpendicular directions to the plane of the antenna (cf. Fig. 1.5), seen from above, the sense of the polarization will be right-handed above the spiral and left-handed below. Throughout this work we will only consider the front radiation of the spiral. The AR at broadside of the spiral antenna from Tab. 1.1 is

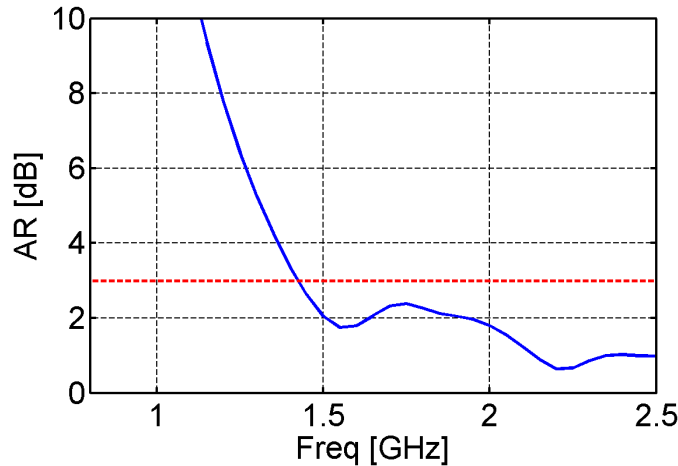

Figure 1.8: AR of the Archimedean spiral antenna.

plotted in Fig. 1.8. It can be seen that the spiral antenna achieves a good circular polarization for frequencies higher than 1.43 GHz, which is almost 50% higher than the theoretical frequency of 0.96 GHz (cf. Eq. 1.9). This difference is due, again, to the reflected currents, as in the case of the impedance matching. At low frequencies the current from the center creates a right-handed polarization while the reflected currents are strong enough to create a non-negligible opposite polarization, destroying the circular polarization of the spiral (cf. Fig. 1.7(a)). Even at 1.1 GHz (where $|S_{11}| < -10$ dB) the reflected currents do not considerably affect the impedance matching, however they generate enough left-hand polarization to disturb the right-hand polarization of the antenna. At high frequencies, thanks to radiation, the reflected current from the end of the arms is very weak, therefore the circular polarization is good (cf. Fig. 1.7(b)).

Tab. 1.2 summarizes the cutoff frequencies found, by the ring theory and by simulation, in the Archimedean spiral antenna.

Parameter	Value
r_{out}	50 mm
f_{low} , eq. 1.9	0.96 GHz
f_{low} , S_{11}	1.1 GHz
f_{low} , AR	1.43 GHz

Table 1.2: Cutoff frequencies of the spiral antenna.

1.3.1 Type of spirals

Besides the Archimedean spiral, other shapes are found in literature. Among them, we mention the square (*Kaiser, 1960*), hexagon (*Bilotti et al., 2005*) and star (*Caswell, 2001*). The latter was optimized in order to obtain the lowest cutoff frequency based on S_{11} and a good packing of array elements. These shapes are sketched in Fig. 1.9. To make a comparison, each spiral is inscribed within a circle of radius $r_{out}=5$ cm.

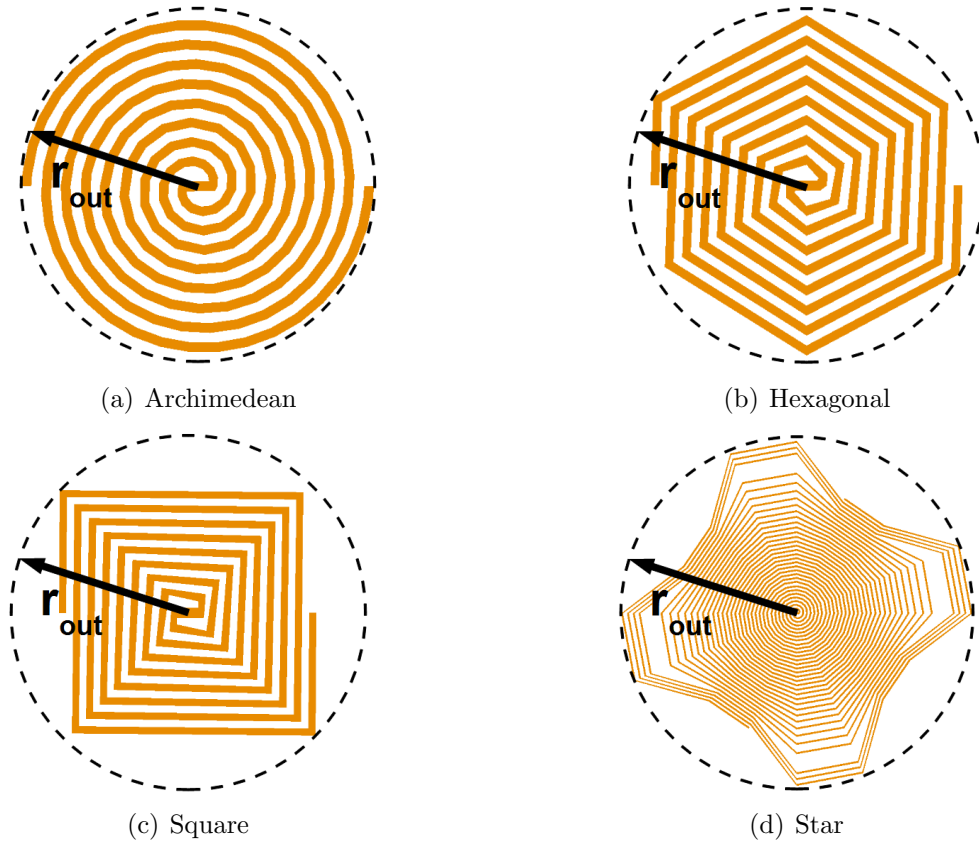

Figure 1.9: Different shapes of spiral antennas.

Fig. 1.10 depicts the gain, axial ratio and reflection coefficient of the spirals with different shapes as found by simulation. The same color code is used in the three subfigures, where the Archimedean spiral is blue, the hexagonal one is red, the square one is green and the star one is black.

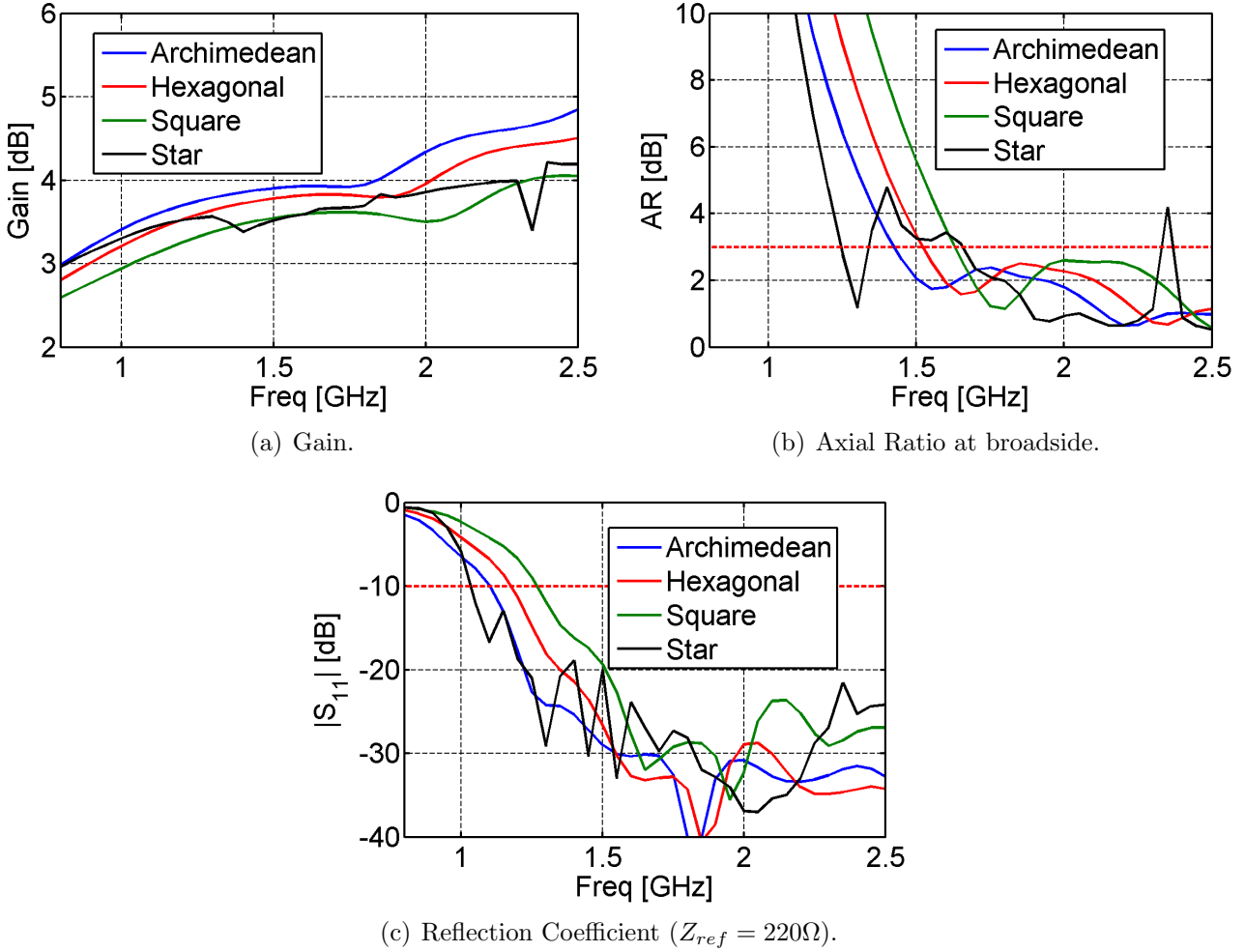

Figure 1.10: Comparison of different spiral antennas. Blue is Archimedean, red is hexagonal, green is square, and black is star spiral.

We will first explain the results of the Archimedean, hexagonal and square spirals. For the same perimeter, a circle presents an aperture area larger than a hexagon and a square, explaining why the gain of the Archimedean spiral is the highest. The Archimedean spiral also presents the minimum cutoff frequency for both parameters, S_{11} and AR. On the other hand, the square spiral has the smallest perimeter, hence, it has the highest S_{11} and AR cutoff frequencies. The results show the relation between perimeter and cutoff frequency of the S_{11} and AR of the spirals: the larger the perimeter, the lower the cutoff frequency. This agrees with the ring theory where the maximum wavelength (minimum frequency) that can be established is about the size of the perimeter of each spiral.

In order to better represent the behavior and make a better comparison between the spirals, we have introduced the correction factor “p” (*Hinostroza et al., 2011*) in Eq. 1.9, which becomes Eq. 1.11. Obviously, for $p = 1$ we obtain again Eq. 1.9, which we can see as the ideal case. For $p > 1$ we have a realistic behavior of the spiral antenna.

Shape	$f_{S_{11}}$ (GHz)	$p_{S_{11}}$	f_{AR} (GHz)	p_{AR}	Perimeter (cm)
Archimedean	1.1	1.15	1.43	1.5	31.42
Hexagonal	1.18	1.24	1.53	1.6	30
Square	1.27	1.33	1.63	1.71	28.28
Star	1.03	1.08	1.66	1.74	30.76

Table 1.3: Summary of “p” factors, perimeters and cutoff frequencies, obtained from Fig. 1.10.

Tab. 1.3 summarizes the cutoff frequencies, “p” factors and perimeters of the spirals.

$$f_{low\ S_{11},AR} = p_{S_{11},AR} \frac{c_0}{2\pi r_{out}} \quad (1.11)$$

The star spiral is a special case. It has the lowest S_{11} cutoff frequency but the highest AR cutoff frequency. It does not take into account the acceptable AR at 1.3 GHz because it is narrowband. There is also a small problem at 2.35 GHz, as seen in its gain. This spiral was optimized, using a Genetic Algorithm (*Caswell, 2001*), to give the star spiral, to get the lowest S_{11} cutoff frequency without taking into account the AR. Due to its geometry, this spiral can be efficiently packed with Archimedean spirals.

1.3.2 Feeding system

Turner originally fed the spiral antenna in the same way as the dipole. The spiral antenna, as well as the dipole antenna, is a symmetrical system, which needs a balanced feed (two signals with a 180° phase difference). A coaxial cable is usually used to deliver the signal between the antenna and the transmitter and/or receiver, but it is an unbalanced system. A device that makes the adaptation between *balanced* to *unbalanced* systems is called *balun*. Since the spiral antenna can achieve a very broad bandwidth, there is a need for a broadband balun.

Infinite balun

The infinite balun was proposed by Dyson (*Dyson, 1959*), and it is fabricated by soldering the shield of the coaxial cable along one of the arms while connecting the inner conductor to the other arm. A dummy cable on the opposite arm can be mounted to keep the symmetry in the radiation pattern. This feed functions over the whole bandwidth of the spiral antenna (cf. Fig. 1.11(a)). A negative point to this balun is that the diameter of the coaxial cable has to be smaller than the inner radius of the spiral, limiting the cutoff high frequency. Improvements to this design can help to overcome this disadvantage. The input impedance of the spiral has to match the characteristic impedance of the coaxial cable, but by using a printed solution this limitation can also be overcome (*Nurnberger and Volakis, 1996*).

Marchand balun

The Marchand balun has been used with the spiral antennas (*Van Tonder and Cloete, 1994*) providing a wide bandwidth, 9:1 or even more (*Morgan, 1985*). Initially designed by using coaxial cables, modern designs propose planar structures (cf. Fig. 1.11(b)) (*Sun et al., 2006*). In its planar version, this balun uses the mutual coupling and characteristic impedance of two

parallel lines. These baluns, like many others, can be as big as the spiral and, usually, they have to be attached as close as possible to the antenna, which can be cumbersome. This balun only provides a balanced signal leaving the input and output impedances of the same value. If another value is needed an impedance transformer has to be used.



(a) Infinite balun (Dyson, 1959).

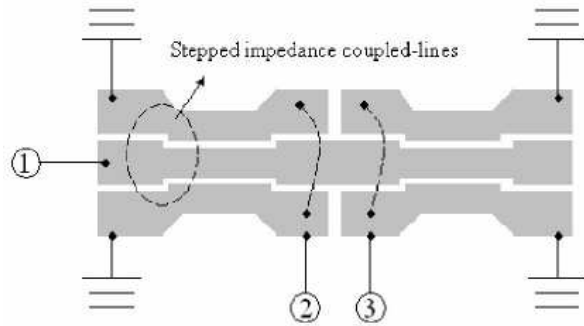

(b) Marchand balun, planar design (Sun et al., 2006).

Figure 1.11: Wideband baluns: left, infinite balun; right, Marchand balun, ports 2 and 3 together form the balanced output and port 1 is the unbalanced input.

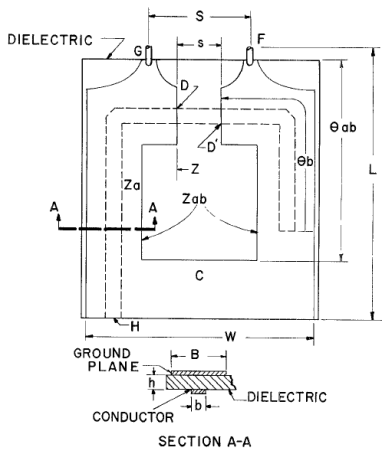

(a) Bawer and Wolfe balun, planar design (Bawer and Wolfe, 1960).

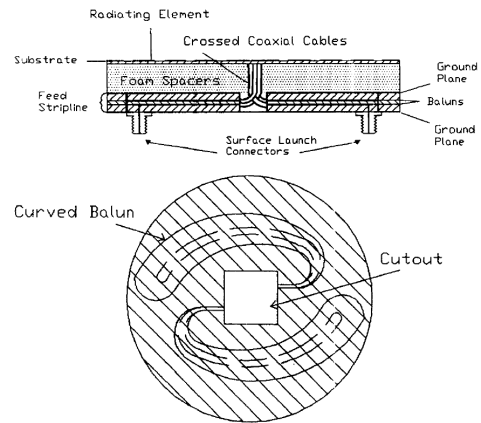

(b) Exponential tapered balun (Hofer and Tripp, 1993).

Figure 1.12: Wideband baluns: left, proposed by Bawer and Wolfe; right, exponential tapered balun.

Bawer and Wolfe balun

The balun proposed by Bawer and Wolfe in (Bawer and Wolfe, 1960) is not as long as those presented before, and it can achieve an octave bandwidth. As in the Marchand balun, it relies on the mutual coupling of two lines. It can be a problem for high frequencies due to its width, which can be comparable or larger than the inner radius of the spiral (cf. Fig. 1.12(a)).

Exponential tapered balun

The exponential tapered balun goes perpendicular to the spiral. It is fabricated by removing the shielding of the coaxial cable following an exponential law. This balun can be larger than the diameter of the spiral antenna. Some authors propose to place the balun parallel to the antenna aperture (*Hofer and Tripp, 1993*). The balun is put between two ground planes, which means that the spiral antenna uses a ground plane below (cf. Fig. 1.12(b)). It can achieve a 9:1 bandwidth. Thanks to its tapered profile, the output impedance of the balun can be adapted.

Tchebycheff balun

The Tchebycheff balun, also known as 100:1 bandwidth balun transformer, is a very impressive balun (*Duncan and Minerva, 1960*). As in the case of the exponential tapered balun, this balun can adapt impedances and is made by tapering a coaxial cable, but its profile is optimized using Tchebycheff polynomials, achieving an extremely wide bandwidth. The main problem with this approach is that the size of the balun can be twice as large as the diameter of the spiral antenna (cf. Fig. 1.13(a)).

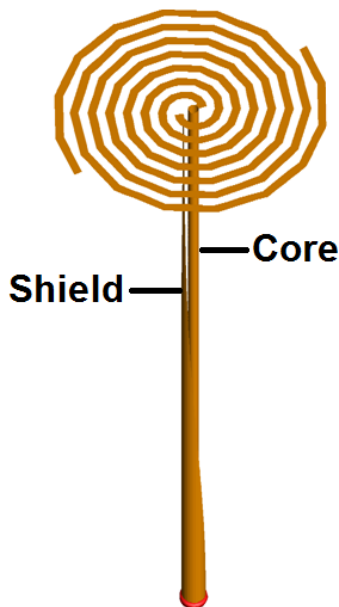

(a) Tchebycheff balun (*Duncan and Minerva, 1960*)

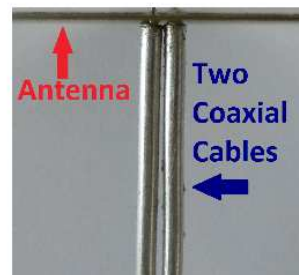
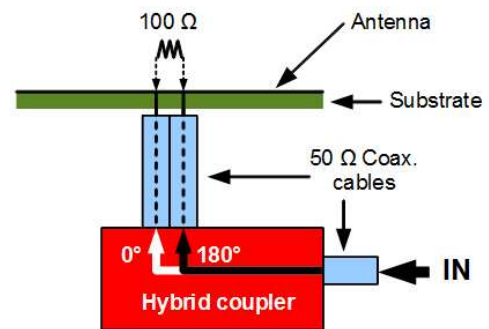

(b) 180° hybrid coupler with two coaxial cables

Figure 1.13: Wideband baluns: left, Tchebycheff balun; right, a 180° hybrid coupler with two coaxial cables acting as a balun.

180° hybrid coupler with two coaxial cables

Another solution is to use a very broadband 180° hybrid coupler (*Dyson and Ginyovsky, 1971*), (*McLean and Schwadron, 2002*). The coupler is fed by a coaxial cable and the output is two coaxial cables delivering two signals in phase opposition (180° phase difference). Then, the coaxial cables feed the spiral in a balanced way. Since the shields of the coaxial cables are put

together, the total impedance of the two coaxial cables is twice the characteristic impedance of one coaxial cable, which can be a disadvantage (cf. Fig. 1.13(b)). We recall that the impedance of the spiral in free space is 188Ω (cf. Eq. 1.10), but the dielectric substrate over which the spiral is etched lowers it. Additionally, according to the Babinet’s principle, by breaking the self-complementarity of the spiral we can obtain a finer adjustment of the impedance. The bandwidth of this feeding system will depend on the bandwidth of the coaxial cables and the hybrid coupler. It is not complicated to find on the market hybrid couplers with an octave bandwidth and more. The advantages of this “balun” are its simplicity in fabrication and the possibility to put the hybrid coupler far from the spiral antenna.

A spiral antenna of 10.5 cm of diameter was constructed over a FR4 substrate (cf. Fig. 1.14) in NUS Temasek Lab with the help of PhD Karim Louertani. The thickness of the substrate was 0.81 mm. This spiral was simulated with FEKO. The antenna was fed using the hybrid coupler balun. We can see that the measurements and the simulations agree. According to Eq. 1.9, the lowest cutoff frequency is 910 MHz. Using the factor “p” (cf. Tab. 1.3) for the S_{11} cutoff frequency, it should be about 1.05 GHz, which is the value obtained in the simulation. The measurements show a cutoff frequency of 1 GHz using a 180° hybrid coupler going from 0.8 to 2.2 GHz.



(a) Hardware model of spiral antenna over FR4 substrate

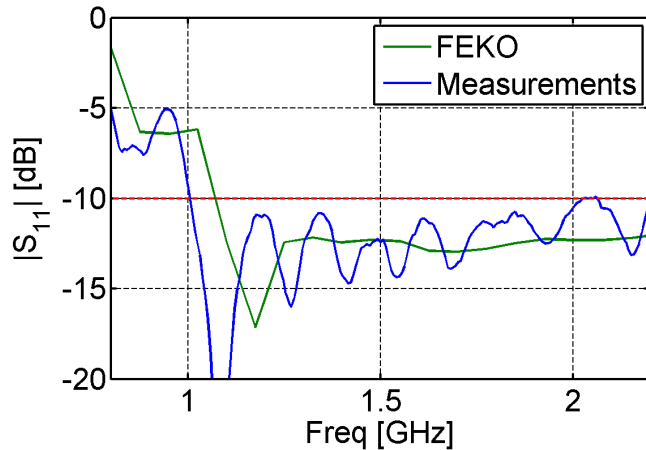

(b) Measured and computed reflection coefficient (Impedance reference 100Ω)

Figure 1.14: Archimedean spiral antenna with 10.5 cm of diameter fed with balun of Fig. 1.13(b).

1.3.3 Cavity

Although the spiral antenna radiates in two directions (cf. Fig. 1.15), most of the time the antenna needs to be uni-directional and as low profile as possible. A backing cavity yields a narrowband device. The optimum distance of a perfect conducting reflector from the antenna is $\lambda/4$. In order to take benefit of the wide bandwidth of the spiral antenna, absorbing materials are often put in the cavity to avoid reflected energy adding destructively (*Morgan, 1985*), although the absorbers lower the gain. The design of these absorbers is usually carried out empirically.

Some people proposed that the main problem with the cavity is the residual energy due to the reflected currents at the end of the arms of the spiral. Including an absorbing material

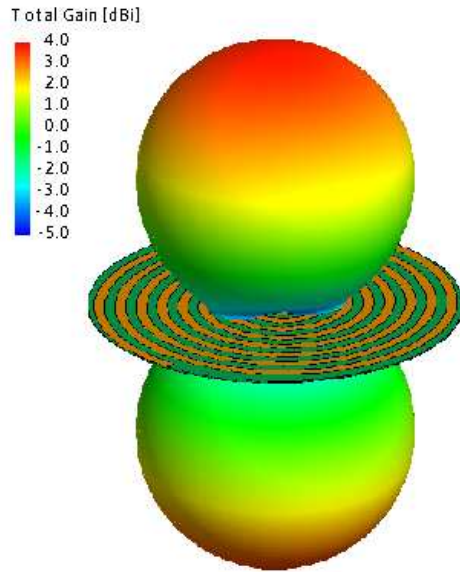

Figure 1.15: Far field of spiral antenna with substrate.

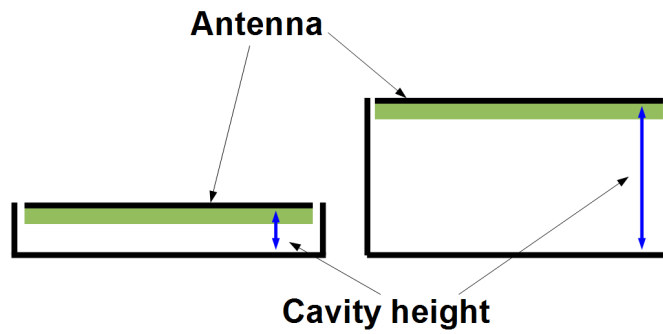

Figure 1.16: Cavity fully enclosing bottom space of the antenna.

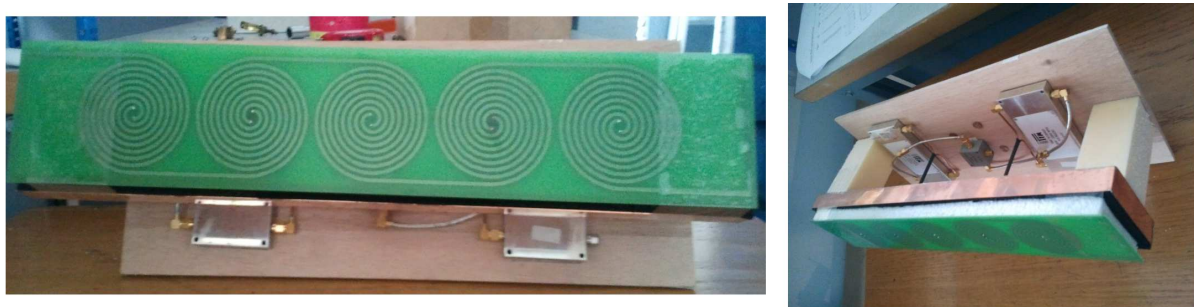
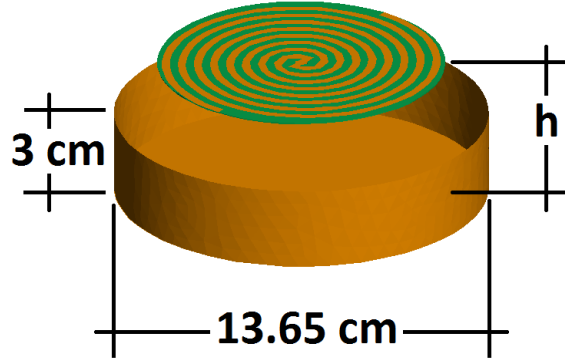

Figure 1.17: Linear array of connected spirals with cavity (*Guinvarc'h et al.*, 2012).

ring dissipates the residual energy. A 6:1 bandwidth of good gain and impedance matching can be achieved for a shallow cavity ($\lambda_{max}/10$), but at the expenses of good circular polarization (*Wang and Tripp*, 1991). A better selection of the absorber can help to obtain an extremely shallow cavity ($\lambda_{max}/20$) and a very good axial ratio (*Nakano et al.*, 2008). The downside of this

technique is the reduction of the gain, also seen as a low radiation efficiency, at low frequencies.

Usually, the cavity is designed to fully enclose the bottom space of the spiral, as shown in Fig. 1.16. Recently, a linear array of connected spiral antennas using a cavity (cf. Fig. 1.17) that partially encloses the bottom space of the array was developed with non absorbent materials (Guinvarc'h et al., 2012). The cavity is much larger than the spirals and the connections between spirals contribute to a good circular polarization at low frequencies. Since it does not use any absorber, the efficiency is high.



(a) Cavity backed spiral

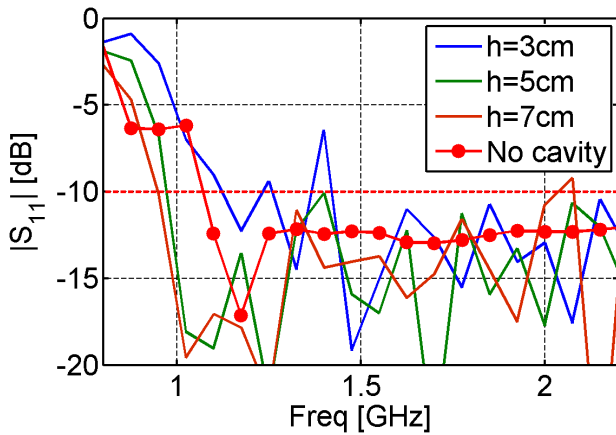

(b) Reflection coefficient ($Z_{ref} = 100\Omega$).

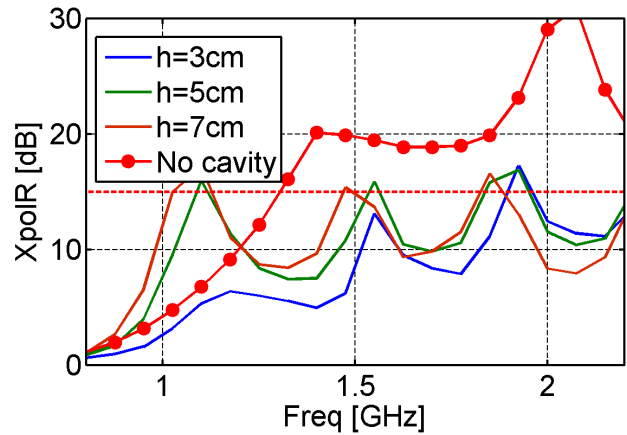

(c) Rejection of cross-polarization.

Figure 1.18: A cavity backed spiral where h represents the distance between the bottom of the cavity and the spiral antenna. The results were obtained by simulation.

Fig. 1.18 shows the effects of a cavity on the characteristics of one spiral, for different distances (h) between the spiral and the bottom of the cavity. The diameter of the cavity is 13.65 cm and its height is 3 cm. We remark that, in this kind of cavity, the effect of the border of the cavity also varies with h .

When the spiral is too close to the cavity ($h = 3$ cm) the cutoff frequency of the reflection coefficient is about 1.1 GHz, with a peak at 1.4 GHz. In the other cases, the cutoff frequency is about 0.95 GHz. If the spiral is too far from the cavity ($h = 7$ cm) the highest cutoff frequency becomes 2.14 GHz, at this frequency the half-wavelength is 7 cm, adding in anti-phase the electric field and the reflected field from the cavity destroys the gain.

Although, for all distances, the XpolR is poor, as in earlier works (*Nakano et al.*, 2008), we can see that $h = 5 \text{ cm}$ is a good choice, regarding the reflection coefficient. We will see later that a good XpolR will be recovered with the use of array techniques.

1.3.4 Miniaturization

Recalling the ring theory, the lowest frequency of the spiral in free space is set by its perimeter, hence, by its size. Making the spiral work at frequencies below this frequency is the aim of the miniaturization. There are two ways to do so: slowing down the phase velocity of the wave, and weakening the current reflections from the end of the arms of the spiral.

Slowing down the phase velocity of the wave

In narrowband antennas it is common to use materials with a high dielectric constant to reduce their physical size (*Kula et al.*, 1959). The main idea behind this technique is to slow down the wavelength phase velocity which, in turn, increases the electrical size of the antenna.

That can be done as follows in a spiral antenna:

- **Using a dielectric with high permittivity**, in other terms, dielectric loading (*Kramer et al.*, 2005). There are some problems related to this technique such as undesirable resonances and surface waves. There are limitations in the availability of materials to achieve the desired reduction. The permittivity of the medium also changes the input impedance of the spiral and, for high permittivity materials, impedance matching can be very difficult. Fabrication of the optimum dielectric shape can be very complex. The gain is reduced, as well as the radiation efficiency, compared to a spiral in free space.
- **Using lumped loads distribution** in the arms of the spiral (*Lee et al.*, 2007). This technique is based on the transmission line concepts of the spiral antenna. It slows down the current velocity in the arm of the spiral adding reactive components, as in a transmission line. It also permits an easier way to match the spiral antenna by changing the characteristic impedance of the arms of the spiral. Problems related to this technique are the use of loads at frequencies where the loads become comparable to the size of the arms of the antenna. Fabrication of this distribution of loads becomes more complicated. Gain and radiation efficiency losses are present if this technique is used in excess.
- **Slow wave spiral**. In this technique the phase velocity is reduced only by changing the outer shape of the spiral (*Caswell*, 2001) or using a greater shape modification. An example is the meanderline concept, such as the zig-zag spiral, or the meanderline spiral (*Filipovic and Volakis*, 2002). The main idea is to introduce an inductive loading using the shape of the arm of the spiral. The impedance matching is improved, but the circular polarization is degraded. Gain and efficiency remain unchanged.

Reduction of reflected currents from the end of the arms of the spiral

Section 1.3 was shown that, for low frequencies, the current can hit the end of the arm of the spiral and return to the feed port, inducing some impedance mismatching. For less severe

Miniaturization	Fabrication	Matching	Efficiency	Axial Ratio
Dielectric load	difficult	difficult	poor	good
Lumped load	moderate	easy	moderate	good
Slow wave	easy	moderate	good	poor
Resistive load, absorbent	moderate	moderate	poor	good

Table 1.4: Types of miniaturization and their properties.

reflections, the current is just strong enough to bounce from the end of the arms of the spiral without reaching the feed port, in this case only the circular polarization is degraded while the impedance matching is acceptable.

A way to reduce end reflections is by using resistive loading (*Morgan, 1979*). When resistive loads are placed at the end of the arm of the spiral the current is absorbed. An outer absorbent ring can be used with the same goal (*Nakano et al., 2008*). The impedance matching and the circular polarization are good. The efficiency of the antenna is degraded at the low end of the bandwidth, as is the gain.

Tab. 1.4 summarizes the different types of miniaturization and their properties.

A final word about miniaturization

These techniques increase the bandwidth of a single antenna. A miniaturized spiral antenna can also be useful in an array. Since the grating lobes depend on the distance between the elements (see next section), using smaller elements would be of great help. It will be shown later that this reasoning corresponds to the first design trend of wideband arrays. Instead of relying on a single element, a second design trend has appeared where the interaction between the elements in an array plays a fundamental role. From this point of view, the second paradigm can be also thought as a miniaturization of the whole array, although it does not reduce the perimeter of the array.

1.4 Antenna array basics

There are many benefits to use an array of antennas instead of using just a single one, but at the expense of more complexity and cost. By applying a complex weight (amplitude and phase) distribution to the antennas that make the array, the far field radiation pattern of the array can be controlled in order to avoid interferences, reduce secondary lobes, steer the main beam etc. The bandwidth and physical dimensions of the array determine its application. Linear (1D) and planar (2D) arrays are widely used. The bandwidth limits of the array are influenced by many factors: bandwidth limits of the antenna element, interaction between the elements, lattice of the array, scan angle, size of the array, etc. (*Haupt, 2010*).

1.4.1 Mutual coupling

The behavior of the antenna in free space is different to that of the antenna in its environment. This interaction between the antenna and its environment is called mutual coupling. There are

three types of coupling: between antennas in an array, between the antenna and other objects nearby, and within the feeding network of the antenna array (*Haupt, 2010*).

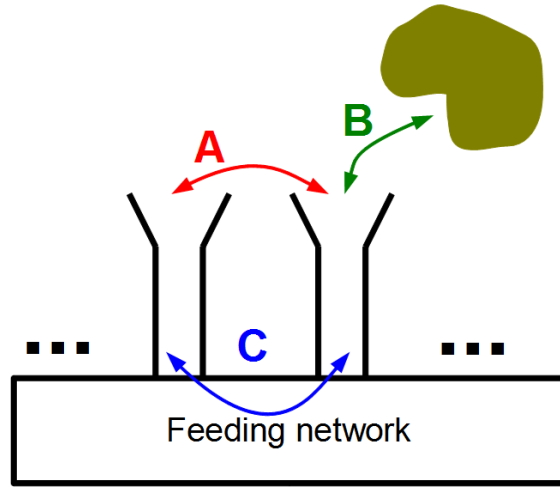

Figure 1.19: Types of mutual coupling in an array in color code. Between antennas, in red; between antenna and objects nearby, in green; and through the feeding network, in blue.

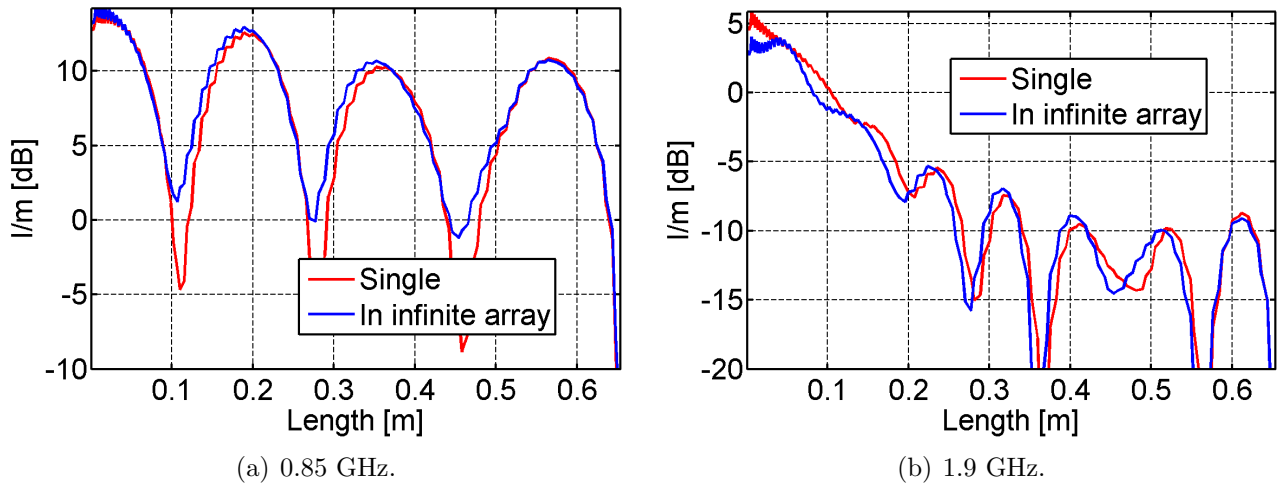

Figure 1.20: Distribution of currents, calculated by simulation in FEKO, along the spiral arm for a single antenna (red) and immersed in an infinite linear array (blue). Diameter of the spiral is 10 cm (cf. Tab. 1.2) and element spacing is 10.23 cm. Frequencies considered are 0.85 GHz and 1.9 GHz. Scan angle is $\theta = 0^\circ$.

Usually, the most important coupling is the one between the closest antennas in the array. We can see in Fig. 1.19 that antennas induce current in the other antennas. This additional current changes the impedance of the antennas. The latter impedance is called “active impedance”. Changing the excitation of the antennas, as in the case of beamforming, will change the induced

currents, by mutual coupling, on the other antennas which, in turn, will change their active impedance.

Fig. 1.20 shows the effect of the presence of other antennas (infinite linear array) on its current distribution along the arm of the spiral of Fig. 1.9(a). The diameter of the spiral is 10 cm and the distance between the center of the spirals is 10.23 cm. We recall that a single spiral of this size should have a $S_{11} < -10$ dB ($Z_{ref} = 220\Omega$) for frequencies higher than 1.1 GHz (cf. Tab. 1.2).

The active input impedance, at 0.85 GHz, of the single spiral is $30.4 + 77.1i\Omega$ ($|S_{11}| = -3.1$ dB) and for the spiral in an infinite linear array, it is $56.6 + 53.7i\Omega$ ($|S_{11}| = -7$ dB), which is an improvement of 4 dB in the reflection coefficient. For certain applications -7 dB can be acceptable. At 1.9 GHz, the active input impedance of the single spiral is $209.3 + 1.8i\Omega$ ($|S_{11}| = -11.3$ dB) and, for the spiral in infinite array, it is $251.4 - 27.8i\Omega$ ($|S_{11}| = -8.9$ dB).

Hence, the mutual coupling can enhance or worsen the input impedance of the antennas. This shows the need for an exact method of computing the mutual coupling.

1.4.2 Array factor

The preceding section showed that the interaction between the elements in an array can be very complex. The calculation of the total electric field of the array would require the exact solutions of the Maxwell's equations, usually via numerical methods. As a good approximation, the array theory gives us some mathematical tools to estimate the electric field of the array in the far zone, called far field, where the radiated wave is considered perfectly spherical (*Mailloux*, 2005).

First, let us consider Eq. 1.12:

$$\mathbf{E}_i(r, \theta, \phi) = \mathbf{f}_i(\theta, \phi) \frac{\exp(-jkR)}{R} \exp(+jk\mathbf{r}_i \cdot \hat{\mathbf{r}}) \quad (1.12)$$

where \mathbf{E}_i , \mathbf{f}_i and \mathbf{r}_i are, respectively, the electric far field, element pattern and vector position of the i th antenna, k is the free space wave number ($k = 2\pi/\lambda$) and R is the distance between the origin and the evaluation point at the spherical coordinates (r, θ, ϕ) with unit vector $\hat{\mathbf{r}}$.

When we have an array we can use the superposition principle to obtain the total radiation pattern (cf. Eq. 1.13) for elements with different complex weights a_i . Most of the time, the element pattern is the same for all antennas, which is the case in this work. This assumption lets us work with the array factor $F(\theta, \phi)$, defined by Eq. 1.14. This expression is a simpler and, sometimes, more useful idea than the total radiation pattern.

$$\mathbf{E}_{array} = \mathbf{f}_i(\theta, \phi) \frac{\exp(-jkR)}{R} \sum a_i \exp(+jk\mathbf{r}_i \cdot \hat{\mathbf{r}}) \quad (1.13)$$

$$F(\theta, \phi) = \sum a_i \exp(jk\mathbf{r}_i \cdot \hat{\mathbf{r}}) \quad (1.14)$$

Changing the phase of each antenna complex amplitude (a_i) according to its position, we can steer the main beam to the direction of unit vector $\hat{\mathbf{r}}_0$.

$$a_i = |a_i| \exp(-jk\mathbf{r}_i \cdot \hat{\mathbf{r}}_0) \quad (1.15)$$

It is useful to consider the antenna array as a sensor that samples the incident signals in time and at discrete locations (*Haupt*, 2010) applying complex weights (a_i) to each sample. The complex weights can also be used to control the maxima and minima of the array factor, therefore, to improve the array factor. In this work we prefer to keep the same amplitude for all the complex weights in order to determine the worst case for the array factor.

1.4.3 Uniformly spaced arrays

Uniform arrays are widely used because it is easy to fabricate the feeding system in a systematic way. The downside of uniform arrays is the presence of grating lobes, due to the spatial periodicity. Grating lobes are other main lobes that appear in the radiation pattern besides the main lobe due to the aliasing. The analysis of the array factor, instead of the total far field array, is straightforward to understand the presence of grating lobes.

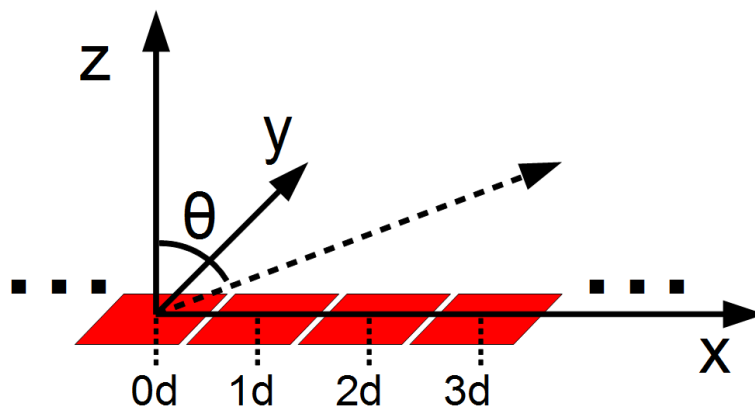

Figure 1.21: Linear array along the x axis.

1.4.3.1 Uniform linear array

For an infinite linear array with elements equally spaced along the x axis with positions $x = nd$, with n being an integer number (cf. Fig. 1.21) and having the same weights ($a_i = 1$), Eq. 1.14 becomes Eq. 1.16, which is simpler.

$$F(\theta) = \sum_{n=-\infty}^{+\infty} \exp(jn(kd \sin \theta)) \quad (1.16)$$

where d is the distance between the elements. It is common to use the variable u instead of $\sin \theta \cos \phi$, but in this case $\phi = 0$. We can also use another variable $b = d/\lambda$ to simplify the equations. Additionally, we can define the position function of the elements relative to the wavelength, as in Eq. 1.17, at the positions $q = nb$:

$$f_{pos}(q) = \sum_{n=-\infty}^{+\infty} \delta(q - nb) \quad (1.17)$$

where $\delta(q)$ is the Dirac delta function. Then, we can rewrite Eq. 1.16 into Eq. 1.18 to show that, in fact, the array factor is a Fourier Transform (\mathcal{F}) of the position function defined before.

$$\begin{aligned}
 F(u) &= \sum_{n=-\infty}^{+\infty} \exp(jn2\pi bu) \\
 &= \int_{-\infty}^{+\infty} \exp(-j2\pi qu) \sum_{n=-\infty}^{+\infty} \delta(q - nb) dq \\
 F(u) &= \mathcal{F}\{f_{pos}(q)\}
 \end{aligned}
 \tag{1.18}$$

Finally, Eq. 1.18 takes the form of Eq. 1.19

$$\begin{aligned}
 F(u) &= \frac{1}{b} \sum_{m=-\infty}^{+\infty} \delta(u - \frac{m}{b}) \\
 F(u) &= \frac{\lambda}{d} \sum_{m=-\infty}^{+\infty} \delta(u - m\frac{\lambda}{d})
 \end{aligned}
 \tag{1.19}$$

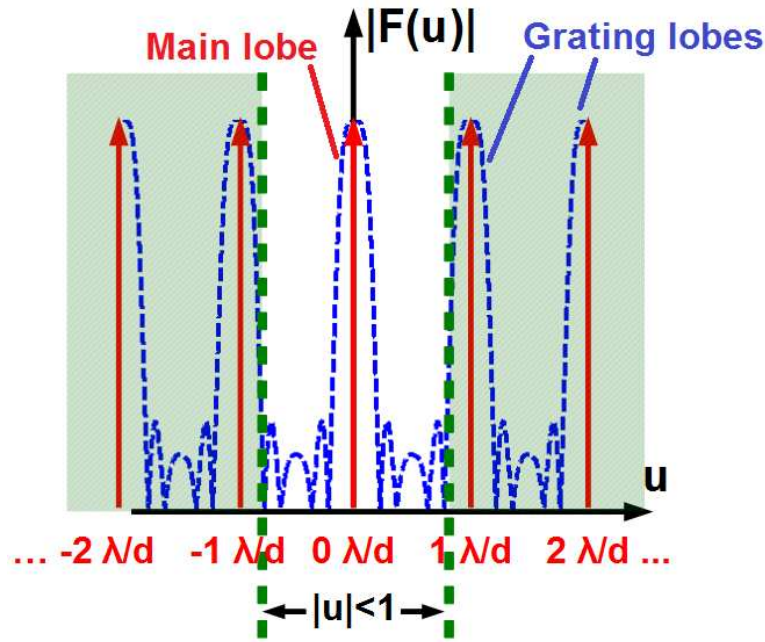

Figure 1.22: Magnitude of the array factor of a linear array in the u -space. In red for infinite arrays and in blue (dashed) for finite arrays.

The positions $\sin \theta = u = m\lambda/d$ in the u -space give the values that maximize Eq. 1.16 through $\exp(jn(kd \sin \theta)) = 1$. These maxima are the grating lobes and for $m=0$ we obtain the main lobe. Since $u = \sin \theta$, the only “visible region” is when $|u| \leq 1$. Fig. 1.22 shows the array

factor of a uniform linear array with distance d between the elements. For an infinite linear array we obtain Dirac deltas, representing the main lobe and grating lobes (red arrows in Fig. 1.22). For a finite linear array we obtain a finite sum of sinc functions (blue dashed line in Fig. 1.22).

When we scan the array in the direction $\hat{\mathbf{r}}_o = \sin \theta_o \hat{\mathbf{x}}$, the array factor in Eq. 1.16 becomes:

$$F(\theta, \phi) = \sum_{n=-\infty}^{+\infty} \exp(jn(kd(\sin \theta - \sin \theta_o))) \quad (1.20)$$

Then, making $u = \sin \theta - \sin \theta_o$, we arrive at the same Eq. 1.19, but this time the origin of the “visible region” is displaced by $u_o = \sin \theta_o$. From here we can deduce the condition to avoid the presence of the maximum of the grating lobes (in this case, the first one, $m = 1$) in the “visible region” (Mailloux, 2005):

$$\begin{aligned} 1 &\leq \frac{\lambda}{d} - u_o \\ 1 &\leq \frac{\lambda}{d} - \sin \theta_o \\ \frac{d}{\lambda} &\leq \frac{1}{1 + \sin \theta_o} \end{aligned} \quad (1.21)$$

1.4.3.2 Uniform planar array

For planar arrays, without losing generality, we can choose to work in the x - y plane, having the variables expressed as in Eq. 1.22.

$$\begin{aligned} (x_i, y_i) &= \text{position of } i\text{th element} \\ u &= \sin \theta \cos \phi; \quad v = \sin \theta \sin \phi \end{aligned} \quad (1.22)$$

Eq. 1.14 can be re-arranged in a two-dimensional discrete Fourier Transform (Haupt, 2010). In fact, the Fourier Transform of the x - y array lattice, divided by λ , is its reciprocal lattice in the u - v space (Kittel, 1995).

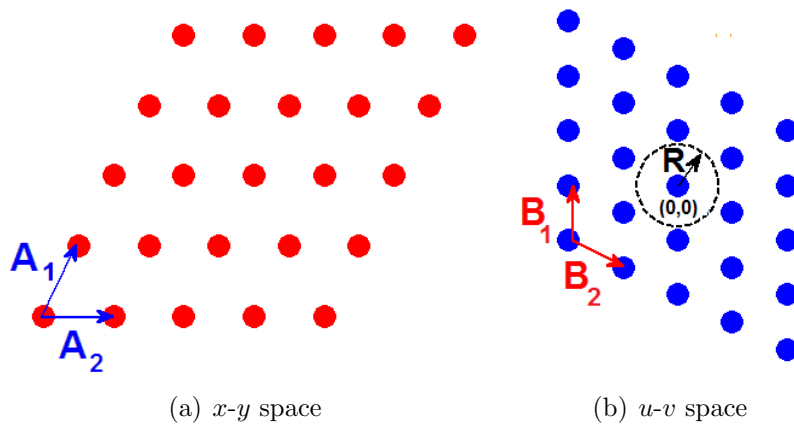

Figure 1.23: Original and reciprocal lattice of a planar array.

Consider the planar array in Fig. 1.23, with lattice basis vectors \mathbf{A}_1 and \mathbf{A}_2 . To obtain the location of the grating lobes in the u - v space for the planar array we obtain the reciprocal basis vectors, \mathbf{B}_1 and \mathbf{B}_2 , according to Eq. 1.23, presented in Eq. 1.23 (Kittel, 1995).

$$\mathbf{B}_1 = \lambda \frac{\mathbf{A}_2 \times \hat{\mathbf{z}}}{\mathbf{A}_1 \cdot (\mathbf{A}_2 \times \hat{\mathbf{z}})}; \quad \mathbf{B}_2 = \lambda \frac{\hat{\mathbf{z}} \times \mathbf{A}_1}{\mathbf{A}_1 \cdot (\mathbf{A}_2 \times \hat{\mathbf{z}})} \quad (1.23)$$

Eq. 1.23 can also be used to find the grating lobe positions for the linear array using $\mathbf{A}_2 = \hat{\mathbf{y}}$ giving the same positions as in Eq. 1.19. We can see in Fig. 1.23 the limit of the “visible region” represented by the circle in black dashed line with $R = 1$ and center $(u, v) = (0, 0)$.

Grating lobes for an equilateral triangular lattice

If we have a planar array with a triangular lattice and distance d between the elements, the position of the grating lobes in the u - v space can be found using the reciprocal basis vectors in Eq. 1.24. Hence, when there is no scan, the first grating lobes enter into the “visible region” when $1 = (\lambda/d)(2/\sqrt{3})$, or, which is the same, when $d = \lambda(2/\sqrt{3})$.

$$\mathbf{A}_1 = d \hat{\mathbf{x}}; \quad \mathbf{A}_2 = \frac{d}{2}(1\hat{\mathbf{x}} + \sqrt{3}\hat{\mathbf{y}}) \quad (1.24a)$$

$$\mathbf{B}_1 = \frac{\lambda}{d}(\hat{\mathbf{x}} - \frac{1}{\sqrt{3}}\hat{\mathbf{y}}); \quad \mathbf{B}_2 = \frac{\lambda}{d}(\frac{2}{\sqrt{3}}\hat{\mathbf{y}}) \quad (1.24b)$$

Now, if the main beam is steered to the angle (θ_o, ϕ_o) , the “visible region” has a center (u_o, v_o) and it becomes expressed by Eq. 1.25.

$$\begin{aligned} (u_o, v_o) &= (\sin\theta_o \cos\phi_o, \sin\theta_o \sin\phi_o) \\ (u - u_o)^2 + (v - v_o)^2 &\leq 1 \end{aligned} \quad (1.25)$$

When the steering angle of the array is $(\theta = 30^\circ, \phi = \phi_o)$, the new center of the “visible region” (unit circle) is $(\cos\phi_o, \sin\phi_o)/2$. Fig. 1.24 shows this case. The red dashed line is the locus of the center of the “visible regions” for the scan angle $(\theta = 30^\circ, \phi = \phi_o)$. The black line is the limit of the “visible region” when the scan angle is $(\theta = 30^\circ, \phi = 90^\circ)$. We can see that the black line shows the case when a grating lobe enters to the “visible region”.

From Fig. 1.24 we can deduce the frequency at which the grating lobes enter into the “visible region” for a scan angle of $\theta = 30^\circ$ and any ϕ (cf. Eq. 1.26), in particular, for $(\theta = 30^\circ, \phi = 90^\circ)$.

$$\frac{2}{\sqrt{3}} \frac{\lambda}{d} = \frac{3}{2} \quad (1.26a)$$

$$f_{GL} = \frac{4c_0}{3\sqrt{3}d} \quad (1.26b)$$

where f_{GL} is the grating lobes frequency, c_0 is the speed of light and d is the inter element spacing of the array.

We have seen that, in uniformly spaced arrays, the grating lobes can be easily predicted according to the array factor. It is important to consider that the scan angle and the element

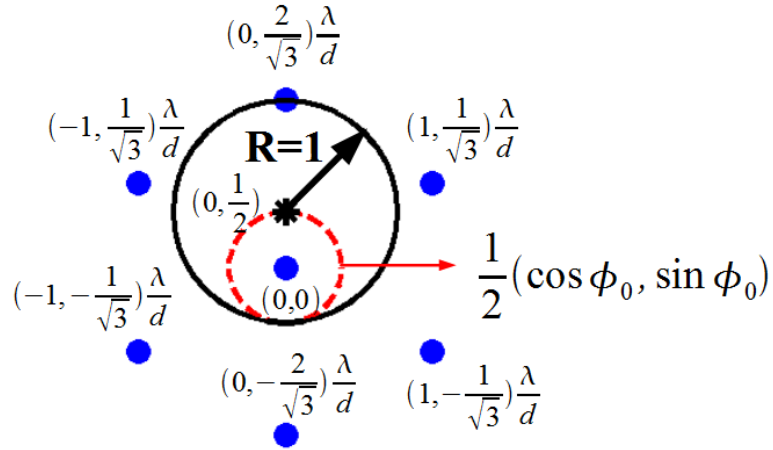

Figure 1.24: Visible region in the $u - v$ space for the case of a triangular lattice. Blue points are the main and grating lobes. Dashed red line is the locus of center of the visible regions for a scan angle ($\theta = 30^\circ, \phi = \phi_0$). Black line is the limit of the visible region for a scan angle of ($\theta = 30^\circ, \phi = 90^\circ$).

pattern will play an important role in the level of the grating lobes.

1.4.4 Non-uniformly spaced arrays

As seen before, the presence of grating lobes in uniform arrays is related to the distance between the elements. In fact, the periodicity creates the grating lobes, then the use of non-uniformly spaced arrays can overcome this problem (*King et al., 1960*). Since there are no grating lobes, we deal with side lobes. An important parameter is the Relative Side Lobe Level (RSL), which is the ratio, usually measured in dB, between the main lobe and the largest side lobe level (cf. Fig. 1.25).

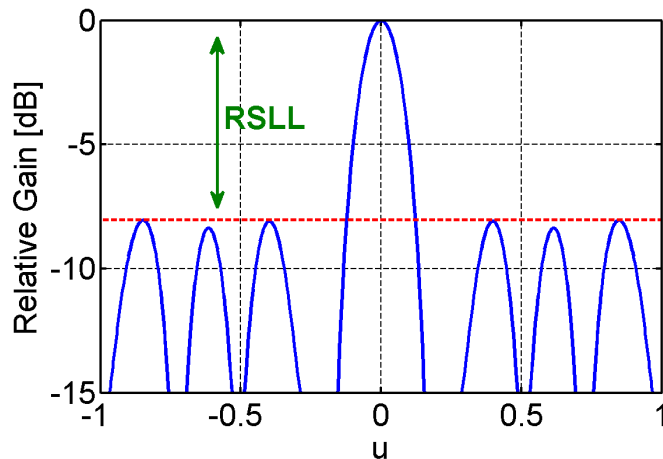
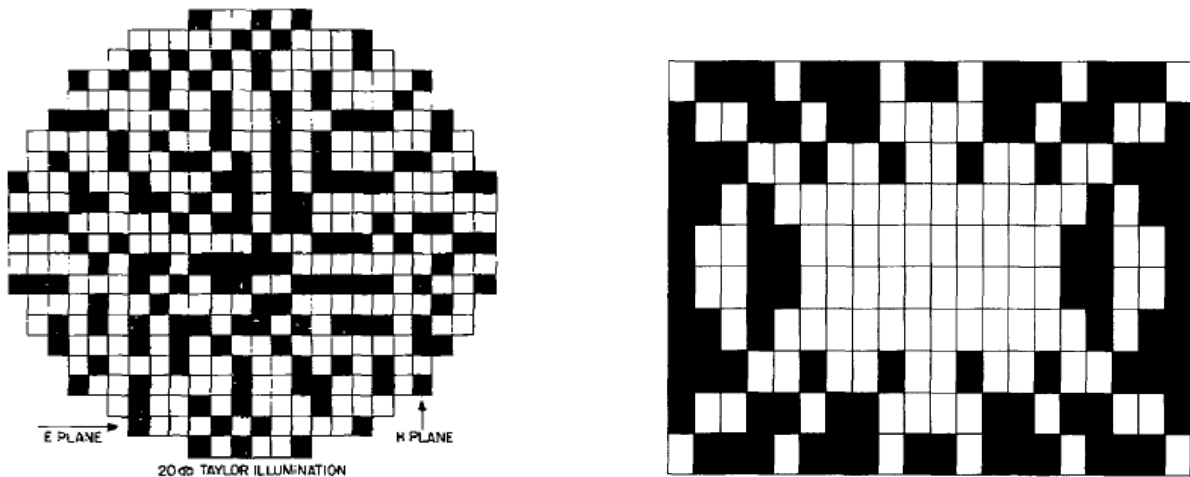

Figure 1.25: Relative side lobe level of a linear array.

There are two techniques to break the periodicity: “thinning” and “sparse arrays”.

Thinning

Thinned arrays are also known as density tapered arrays. A thinned array uses a uniformly spaced array but turns off the elements in such a way that the elements that contribute to the array factor do not present periodicity. There are many ways to select which elements will contribute to the array factor, such as simulating an amplitude taper, as done by Willey using a Taylor distribution (Willey, 1962) (cf. Fig. 1.26(a)); using an amplitude taper as a probability function to switch “on” or “off” the elements of the array (Skolnik et al., 1964b); evolutionary stochastic methods, such as Genetic Algorithms in (Haupt, 1994) (cf. Fig. 1.26(b)), (Haupt, 2008) and others. An advantage of the thinned array approach is that the mutual coupling and the element pattern are the same as in the uniform spaced array.



(a) Space tapering of planar array with a -20 dB sidelobe level Taylor distribution. Black squares represent the elements turned “on” (Willey, 1962).

(b) Optimized thinned 20×10 element planar array using GA. Black squares represent the elements turned “off” (Haupt, 1994).

Figure 1.26: Examples of Thinned arrays.

Sparse arrays

Sparse arrays are a more general way to introduce non-periodicity. In this case the positions of the elements are chosen with more freedom than by using a fixed uniform grid. The distance between the elements can be different, hence the coupling can be considerably different. There are deterministic methods to choose the locations (Galejs, 1964), (Neustadter, 1963), (Ishimaru and Chen, 1965), (Haupt, 1995), (Skolnik et al., 1964a), (Das, 1966), (Caratelli and Vigano, 2011); evolutionary stochastic methods such as simulated annealing (Trucco and Murino, 1999) (cf. Fig. 1.27(a)), Genetic Algorithms (Haupt, 2008) (cf. Fig. 1.27(b)), and others.

1.4.5 Dual polarization capability

In order to characterize the polarization of the wave, only a pair of orthogonal basis is needed: vertical and horizontal linear polarization; or, right and left hand circular polarization. The choice of one pair does not affect the measurement potential of the system (Raney, 2008),

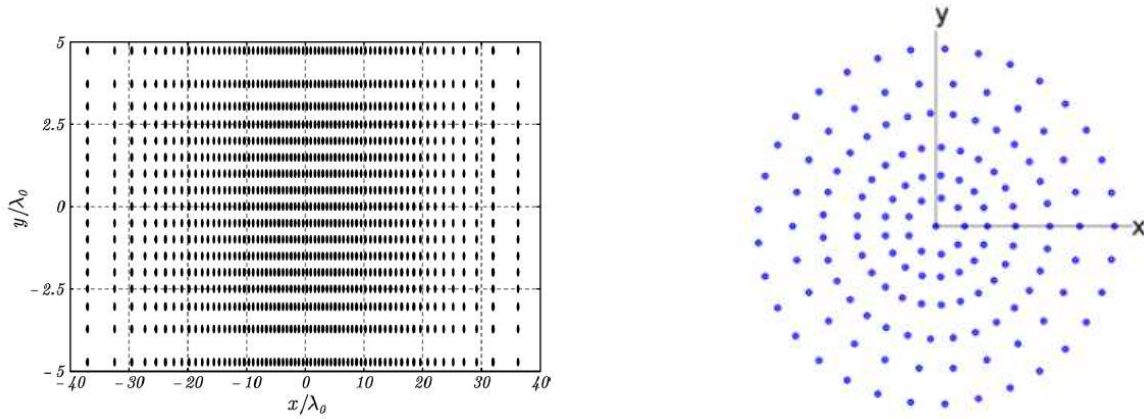

(a) Sparse array of 66×17 elements. The optimization was done with the deterministic method based on the auxiliary array factor function (*Caratelli and Vigano, 2011*).

(b) 6 ring array with optimized radius and number of elements on each ring using GA (*Haupt, 2008*).

Figure 1.27: Examples of sparse arrays.

(*Dinh et al., 2012*). Hence, arrays that handle sets of two orthogonal polarizations are needed. In real life, it is really difficult to obtain a perfectly polarized wave.



(a) Vertical and horizontal

(b) Left and right

Figure 1.28: Orthogonal polarizations.

According to the IEEE, the polarization that the antenna array is intended to radiate is called “co-polarization” and the orthogonal polarization to the intended one is called “cross-polarization” (*IEEE Standard, 1993*). The polarization of the array can be different from the polarization of the element that constitutes it. This polarization will change depending on the scan angle, array lattice and radiator type (*McGrath et al., 2003*).

Taking the ideal model of infinite current sheet array proposed by Wheeler (*Wheeler, 1965*), Boryssenko derived some polarization constraints for a dual polarized array (*Boryssenko, 2009*). For the case of circular polarization the maximum scan angle is $\theta = 45^\circ$, in order to keep the axial ratio below 3 dB. For the case of linear polarization, the D-plane presents great problems. If the radiating aperture lies in the x - y , the plane $\phi = 45^\circ$ defines the D-plane (cf. Fig. 1.29). Boryssenko also proposes an adaptive compensation of amplitude and phase of the antenna

weights to overcome these problems.

As an example, Vivaldi antenna arrays, which are linearly-polarized, can have serious problems of polarization purity, at the point to reach circular polarization when scanning in the D-plane. In mono-polarized linear arrays this problem can be greatly overcome by mirroring the elements in the array (*Hong et al.*, 2006). In dual polarized arrays, this problem can be corrected by adjusting the feeding weights, amplitudes and phases (*Kindt and Taylor*, 2011).

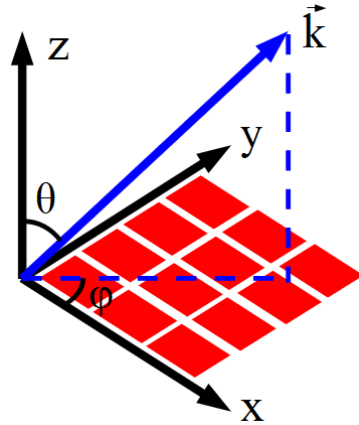

Figure 1.29: Planar array composed of rectangular elements on the x - y plane. The radiated wave has a direction parallel to the vector \vec{k} . D-plane corresponds to $\phi = 45^\circ$.

1.4.6 Array bandwidth

In section 1.2.1 the concept of bandwidth applied to a single antenna was introduced. It is important to clarify that the definition of the bandwidth can depend on a single parameter or a combination of parameters. The parameters used in defining the bandwidth of the antenna (e.g. S_{11} and XpolR) are also used for the bandwidth of the array. In the case of an array, the grating lobes presence, secondary lobes level, gain and dual polarization capabilities are among the parameters that can also be useful. As an example, Fig. 1.30 depicts a common scenario of an array using spiral antennas. Lines represent bandwidths where the parameters respect certain range of values. The intersection of the bandwidths is generally much less than the individual bandwidths.

In this work we are interested in the intersection of the bandwidths of the S_{11} , XpolR and RSSL, while keeping dual polarization capabilities and using a ground plane.

1.4.6.1 Design of large bandwidth arrays

We have shown that the lattice of the array plays an important role in the presence of the grating lobes and the sidelobe levels. Usually, this will set the higher limit of the bandwidth of the array. In order to obtain large bandwidths, we can also improve its lower limit. There are two main trends, or “paradigms” (as presented in (*Munk et al.*, 2003)), while designing wideband arrays. The first one is to take antennas that already have a wide bandwidth. The second one

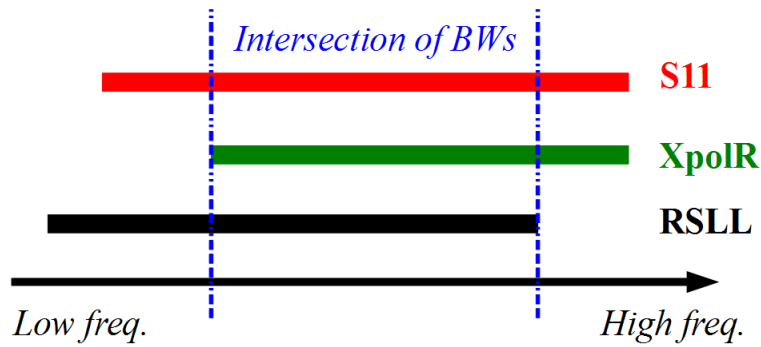
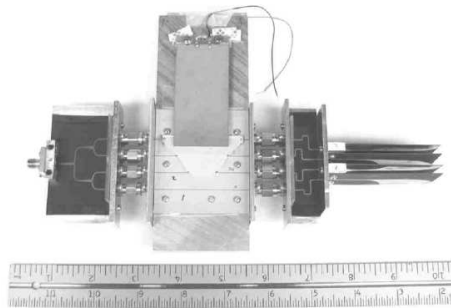
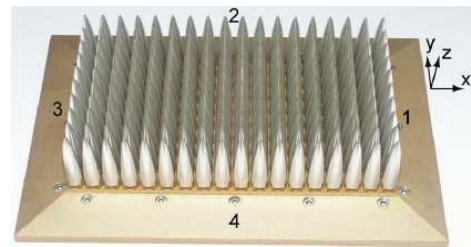

Figure 1.30: Example of bandwidths for different parameters in an array of spiral antennas.

relies on the strong interaction between the elements to achieve very broad bandwidths in order to obtain an idealized current distribution as proposed by Wheeler (*Wheeler, 1965*).



(a) Antenna array using Vivaldi antennas (*Hong et al., 2006*).



(b) Antenna array using BOR antennas (*Holter, 2007*).

Figure 1.31: Examples of wideband arrays using wideband elements.

Arrays composed of wideband elements

To this group belong the arrays composed of wideband antennas such as Vivaldi antennas (*Hong et al., 2006*), spiral antennas (*Stutzman and Buxton, 2000*), and the Wideband Array with Variable Element Sizes (*Caswell, 2001*), for the mono polarized case. Examples of dual polarized arrays are found in (*Guinvarc'h and Haupt, 2010*), using spiral antennas, and in (*Holter, 2007*), using body of revolution antennas. In these cases, the coupling between the elements can increase or degrade the bandwidth of the array. Fig. 1.31 shows some examples of arrays that follow this design trend.

Wideband array with highly coupled or connected elements

To this group belong the long slots array (*Lee et al., 2008*), the fragmented aperture array (*Maloney et al., 2011*) and PUMA array, Planar Ultrawideband Modular Antenna (*Holland and Vouvakis, 2012*). All of them are linearly dual polarized. Spiral antennas can also be connected using resistors, as in the dual polarized array of connected spirals (*Guinvarc'h and Haupt, 2011*); or highly coupled, as in the interwoven mono polarized spiral array with a bandwidth of 10:1

(Tzanidis *et al.*, 2011), although the latter presents a low XpolR (7 dB). Fig. 1.32 presents some arrays that were designed using this trend.

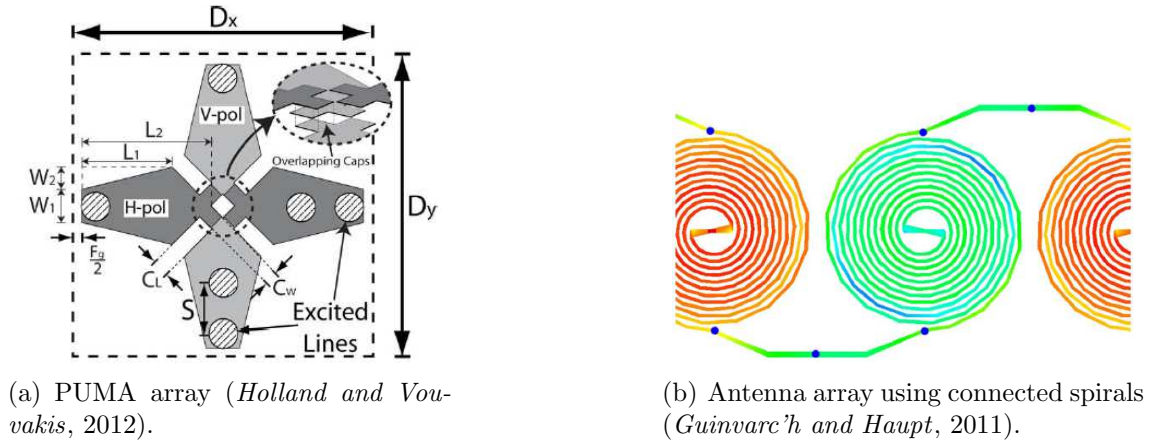

Figure 1.32: Examples of wideband arrays using connected elements.

Discussion about the arrays

Tab. 1.5 shows a summary of the most important antenna arrays mentioned before. It presents the trends used in the design, polarization capabilities, S_{11} and XpolR bandwidths with their respective maximum levels, the RSSL bandwidth where the side lobe level is kept below a certain value stated by the author, the frequency at which the grating lobes (f_{GL}) will appear (computed from the distance between the elements and the maximum scan angle), maximum scan angle from broadside, intersection of bandwidths and presence of ground plane.

It can be seen that the arrays might have different bandwidths for each parameter. Usually, it is the S_{11} which has the largest bandwidth and exhibits the lowest cutoff frequency among the other parameters. At higher frequencies, the presence of grating lobes is the most common limitation.

Some applications need the use of planar arrays. In these cases the only options are the PUMA array and the spirals array. Vivaldi antennas can be very bulky. If a ground plane is considered, sometimes it is beneficial to have a low profile array, as in the case of the BOR antenna array and PUMA Array. A linear array of spiral antennas can be backed by a ground plane or a cavity (cf. section 1.3.3). It will be seen later that a variant of this idea is also applicable to a planar array.

Considering the design process, the most complex case is the PUMA array, which considers the design of the element, solving issues with the feeding system and scan blindness problems due to the configuration of the array. But its main advantage is its great bandwidth. The simplest design can be the spiral arrays, although having not so wide a bandwidth. Furthermore, additional issues can appear when adding the ground plane. Later it will be shown how to increase this bandwidth.

Array	Design trend	Polar.	$BW_{S_{11}}$ level	$BW_{X_{polR}}$ level	BW_{RSLL} level	f_{GL}	Scan θ	\cap BWs ratio	GND plane
Vivaldi antenna (<i>Hong et al.</i> , 2006)	Wideband element	Mono linear	8-35 GHz -10 dB	10-35 GHz 20 dB	8-35 GHz -6 dB	35 GHz	25°	10-35 GHz 3.5:1	Yes
BOR antenna (<i>Holter</i> , 2007)	Wideband element	Dual linear	4-18 GHz -10 dB	6-18 GHz 15 dB	No spec.	20 GHz	45°	6-18 GHz 3:1	Yes
PUMA array (<i>Holland and Vouvakis</i> , 2012)	Strong interaction	Dual linear	1.1-5.3 GHz -6 dB	1.1-5.3 GHz 15 dB	No spec.	7.2 GHz	45°	1.1-5.3 GHz 5:1	Yes
Connected spirals (<i>Guinvarc'h and Haupt</i> , 2011)	Strong interaction	Dual circular	2-5 GHz -10 dB	2.2-5 GHz 15 dB	2-2.9 GHz -10 dB	2.9 GHz	30°	2.2-2.9 GHz 1.3:1	No
Interleaved spirals (<i>Guinvarc'h and Haupt</i> , 2010)	Wideband element	Dual circular	2-7 GHz -10 dB	3-6.5 GHz 15 dB	2.7-5.9 GHz -10 dB	5.9 GHz	30°	3-5.9 GHz 2:1	No

Table 1.5: Summary of wideband antenna arrays.

1.5 Summary of chapter

Some definitions and concepts related to the spiral antennas and antenna arrays were presented. The Archimedean spiral antenna and some variants were studied. It was shown that the shape of the spirals had an influence on its lowest bandwidth limit. A factor “p” was proposed to include these differences. A broadband feeding system was proven to work with the spiral antenna. The simulations also exposed the problems that appear when using a cavity behind the spiral. Some useful concepts were presented to deal with antenna arrays, as well as the two trends used in the design of broadband antenna arrays. The first design trend focuses on the use of wideband antennas to obtain wideband arrays. The second one focuses on the strong interaction between the elements in an array to achieve a widebandwidth.

CHAPTER II

Linear Array of Spiral Antennas

2.1 Introduction

In the previous chapter we have seen the behavior of a single spiral. The next step is the study of mono polarized linear arrays composed of spiral antennas where, due to the mutual coupling, some issues appear. The first part of this chapter is dedicated to extend the works of Steyskal (*Steyskal et al.*, 2005) and West (*West and Steyskal*, 2009) regarding some resonances present in spiral arrays. Then, we move to the dual polarized case.

2.2 Resonances in a linear array

2.2.1 An example of a linear array

Let us first consider an infinite linear array of Archimedean spiral antennas in free space, without a ground plane. The diameter of the spirals is 14 cm and the element spacing is 14.5 cm. These spirals have two arms and are self-complementary. Fig. 2.1 shows the results of the simulation of this array, with FEKO, for a scan angle of $\theta = 30^\circ$. The right hand circular polarization gain (RHC gain), and XpolR were obtained by multiplying the array factor of 14 spirals and the radiation pattern of a single element immersed in an infinite linear array.

According to Eq. 1.9, these spirals (with diameter of 14 cm) should start working at around 0.68 GHz. Using the $p_{S_{11}}$ factor (cf. Tab. 1.3, pg. 11), these antennas should have a good $|S_{11}|$ (below -10 dB) from 0.75 GHz, which corresponds well with the simulations. In the same way, using the p_{AR} factor (cf. Tab. 1.3), we can expect to have a good circular polarization (XpolR > 15 dB, AR < 3dB) starting from 1 GHz, but, in general, the array presents a poor XpolR with an exception at around 1.19 GHz.

We can see periodically-spaced large peaks in the RHC gain (cf. Fig. 2.1(b)), XpolR (cf. Fig. 2.1(c)) and reflection coefficient (cf. Fig. 2.1(d)). These peaks were noticed by Steyskal (*Steyskal et al.*, 2005), and it was shown that they were, in fact, “resonances”. He also proposed a solution to overcome this issue.

Resonance issue

It has been noted that, for off broadside scanning, some “resonances” can appear in a uniformly

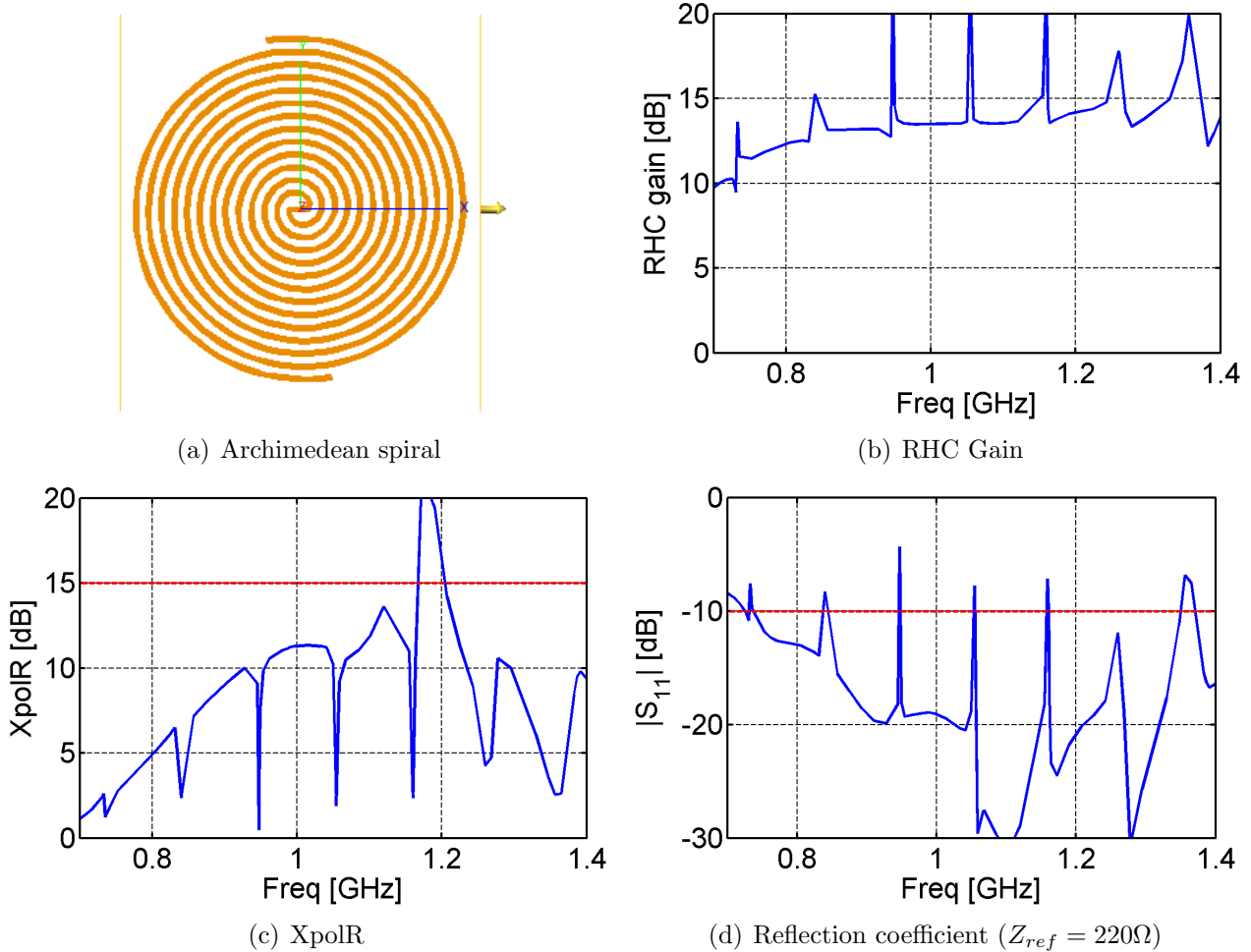

Figure 2.1: Infinite linear array of Archimedean spiral antennas (cf. Tab. 2.1). 30° of scan angle. Diameter of the spirals is 14 cm and element spacing is 14.5 cm. According to Eq. 1.21 grating lobes should appear at 1.36 GHz.

spaced array of spiral antennas (*Steyskal et al.*, 2005). These resonances are related to the length of the arms of the spiral according to Eq. 2.1.

$$f_{res}^m = m \frac{c}{2L} \quad (2.1)$$

where f_{res}^m are the estimated resonance frequencies, c is the speed of light, L is the length of the arm of the spiral and m is an integer number. It has also been shown that these resonances are related to the coupling between the spirals (*West and Steyskal*, 2009). Those works, (*Steyskal et al.*, 2005), (*West and Steyskal*, 2009), studied a planar array of square spiral antennas over a ground plane. Here we extend these works. It will be shown that it is not necessary to have a ground plane to reproduce these resonances, as can be seen in Fig. 2.1.

We will also show that these resonances are present in any type of planar spiral, including Archimedean, hexagonal and logarithmic spiral. Additionally, we will see that the same phenomenon can be reproduced in just one spiral with the incidence of a wave with direction

parallel to the plane of the spiral. An explanation of this phenomenon is presented and some solutions will also be proposed.

The simulations were carried out with FEKO and the adaptive frequency sampling tool provided by the software. Since the solution of Maxwell's equations is made through the method of moments, in the frequency domain, it is complicated to resolve the "narrow spikes" due to the resonances (Steyskal *et al.*, 2005). For the case of infinite arrays, the gain and XpolR were calculated by multiplying the array factor of 14 spirals by the radiation pattern of a single element submersed in the infinite array.

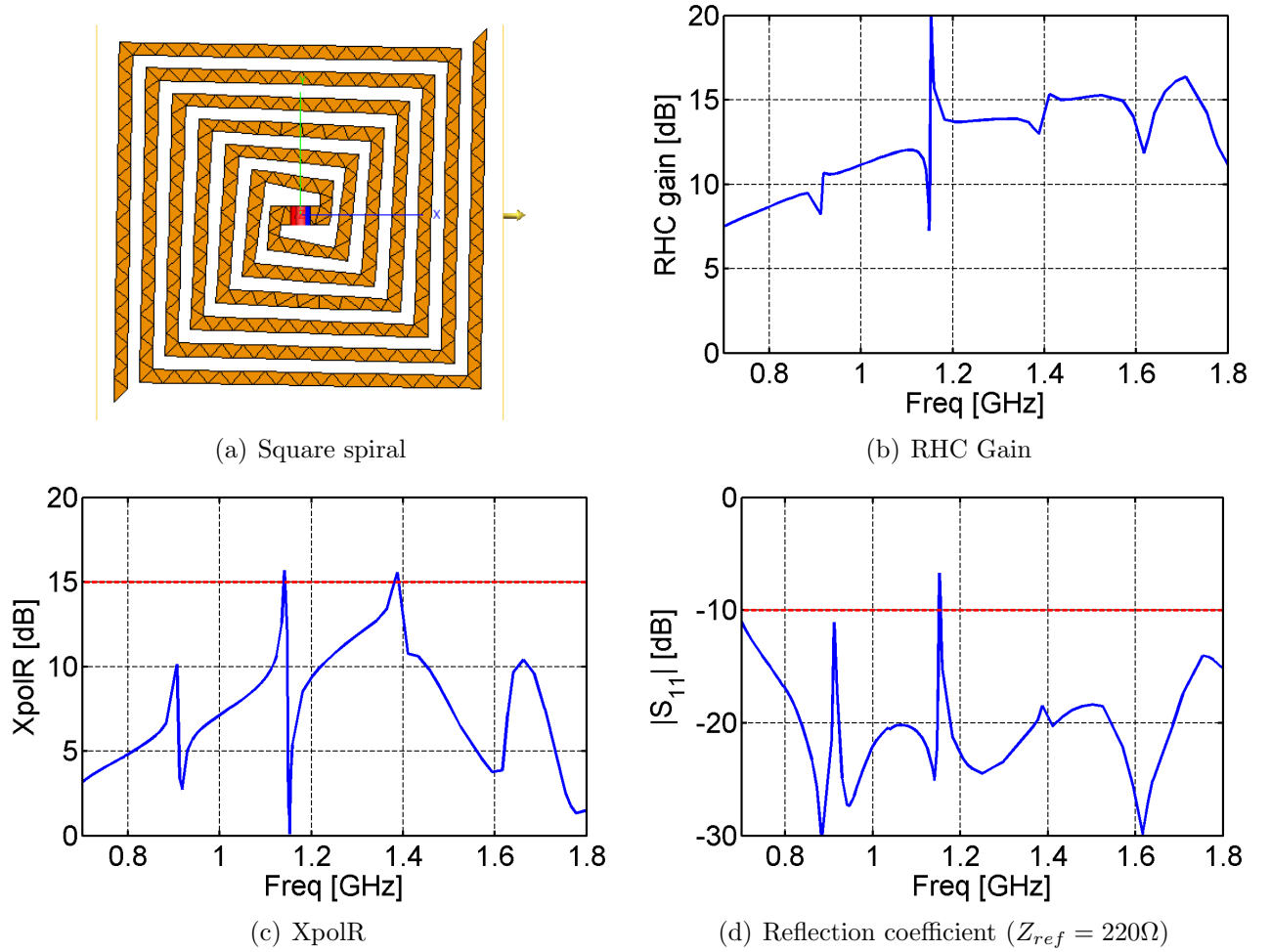

Figure 2.2: Infinite linear array of square spiral antennas (cf. Tab. 2.1). 30° of scan angle.

2.2.2 Resonance in arrays without ground plane and in any type of spirals

In order to analyze these resonances, some simulations of infinite linear arrays have been carried out. No ground plane, substrate or loadings were considered. All the antennas are inscribed in a circle with a radius of 7cm. For all cases the scan angle was $\theta = 30^\circ$. The dimensions and other important parameters of the array are listed in Tab. 2.1 where *Diam* is

Spiral	$Diam$ (cm)	Per (cm)	d_{elem} (cm)	L (cm)	GL (GHz)
Square	14	39.6	10.6	66.78	1.887
Archimedean	14	44	14.5	142.77	1.36
Hexagonal	14	42	13.18	75.85	1.52
Logarithmic	14	44	15.4	52.6	1.3

Table 2.1: Parameters of linear arrays of spirals. Grating lobe frequencies were calculated using Eq. 1.21 for a scan angle of $\theta = 30^\circ$.

the diameter of the spirals, Per is the perimeter of the spiral, d_{elem} is the distance between the elements of the array (spacing), L is the length of the arm of the spiral and GL is the grating lobe frequency of the array.

Resonances present in array without ground plane

Steyskal observed these resonances in planar arrays over ground plane (*Steyskal et al.*, 2005). West presented an explanation using a transmission line model where the ground plane plays an important role (*West and Steyskal*, 2009). However, Fig. 2.2 shows that there are resonances in an infinite linear array of square spirals in free space and *without ground plane*. These resonances are present in the main parameters of the array, circular polarization and reflection coefficient. Since the arm length of the square spiral is 66.78 cm (cf. Tab. 2.1), we can estimate the resonances using Eq. 2.1. Tab. 2.2 shows the expected and observed resonances showing a good agreement.

$\lambda/2$ multiple m	4	5	6	7
Observed (GHz)	0.91	1.15	1.39	1.62
Estimated (GHz)	0.90	1.12	1.35	1.57

Table 2.2: Resonance frequencies for a linear square spiral array.

Resonances present in spiral arrays besides square spiral

The important feature for creating resonances is the symmetry. Hence, we can expect resonances in all kind of spirals. Fig. 2.1, 2.3 and 2.4 show the simulated gain, X_{polR} and $|S_{11}|$ for infinite linear arrays of Archimedean, hexagonal and logarithmic spirals, respectively. For the three types of spirals the resonances are observed. Tab. 2.3, 2.4 and 2.5 show the resonance frequencies estimated by Eq. 2.1 using the lengths of the arms of the spirals presented in Tab. 2.1.

$\lambda/2$ multiple m	7	8	9	10	11	12	13
Observed (GHz)	0.73	0.84	0.95	1.06	1.16	1.26	1.36
Estimated (GHz)	0.74	0.84	0.95	1.05	1.16	1.26	1.37

Table 2.3: Resonance frequencies for a linear array of Archimedean spirals.

It can be seen that, for the case of the Archimedean spiral, the estimated and observed resonance frequencies have an almost perfect agreement. In the case of the logarithmic spirals it

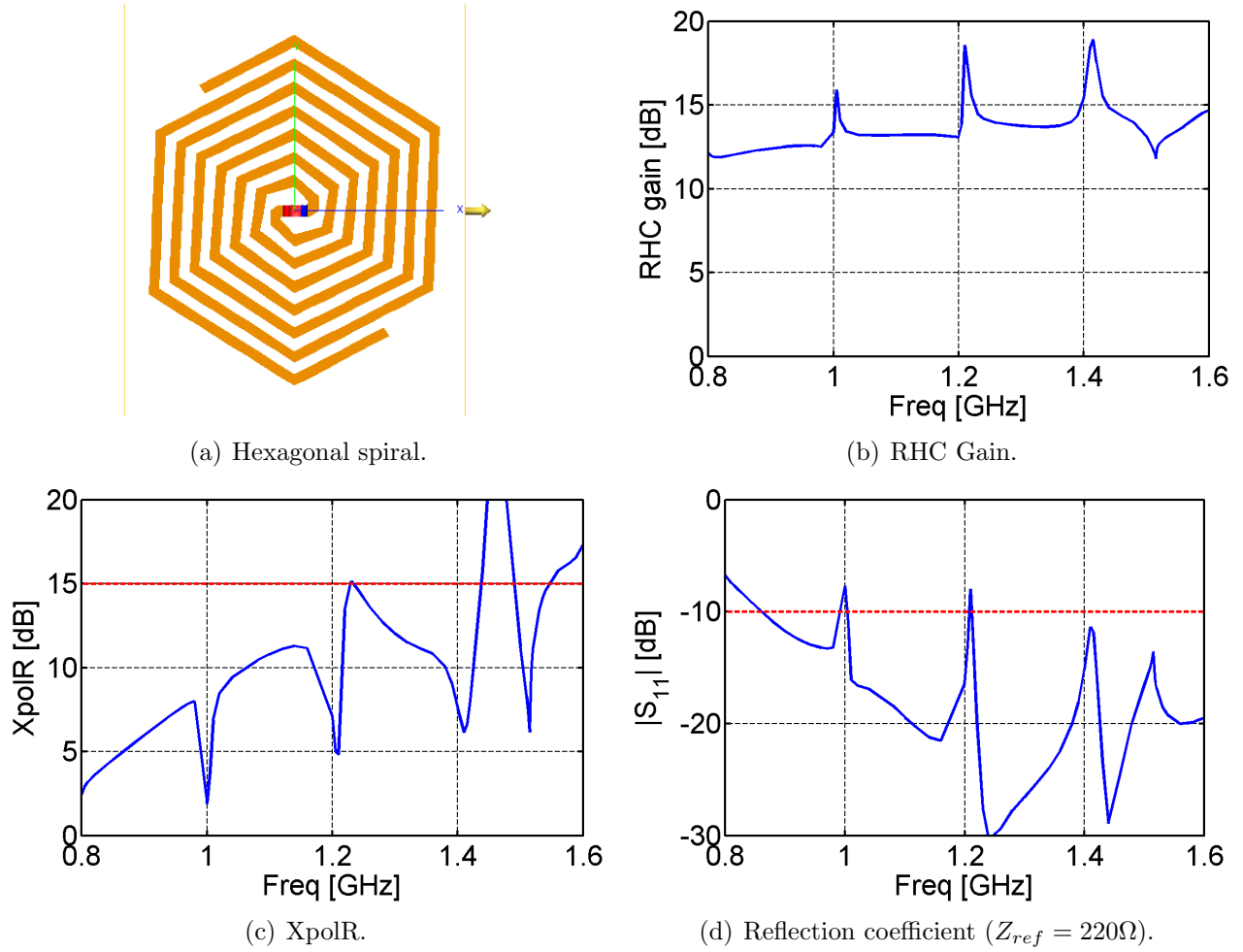

Figure 2.3: Infinite linear array of hexagonal spiral antennas (cf. Tab. 2.1). 30° of scan angle.

$\lambda/2$ multiple m	5	6	7
Observed (GHz)	1.00	1.21	1.41
Estimated (GHz)	0.99	1.19	1.38

Table 2.4: Resonance frequencies for a linear array of hexagonal spirals.

$\lambda/2$ multiple m	3	4	5
Observed (GHz)	0.78	1.04	1.28
Estimated (GHz)	0.86	1.14	1.43
Estimated 10% correc. (GHz)	0.78	1.04	1.3

Table 2.5: Resonance frequencies for a linear array of logarithmic spirals.

is found that the frequencies of resonance can be accurately estimated considering an “electrical arm length” of 57.9 cm, which is 10% longer than the physical length (52.6 cm). This is so since the width of the spiral arms gets wider at the outermost part of the spiral.

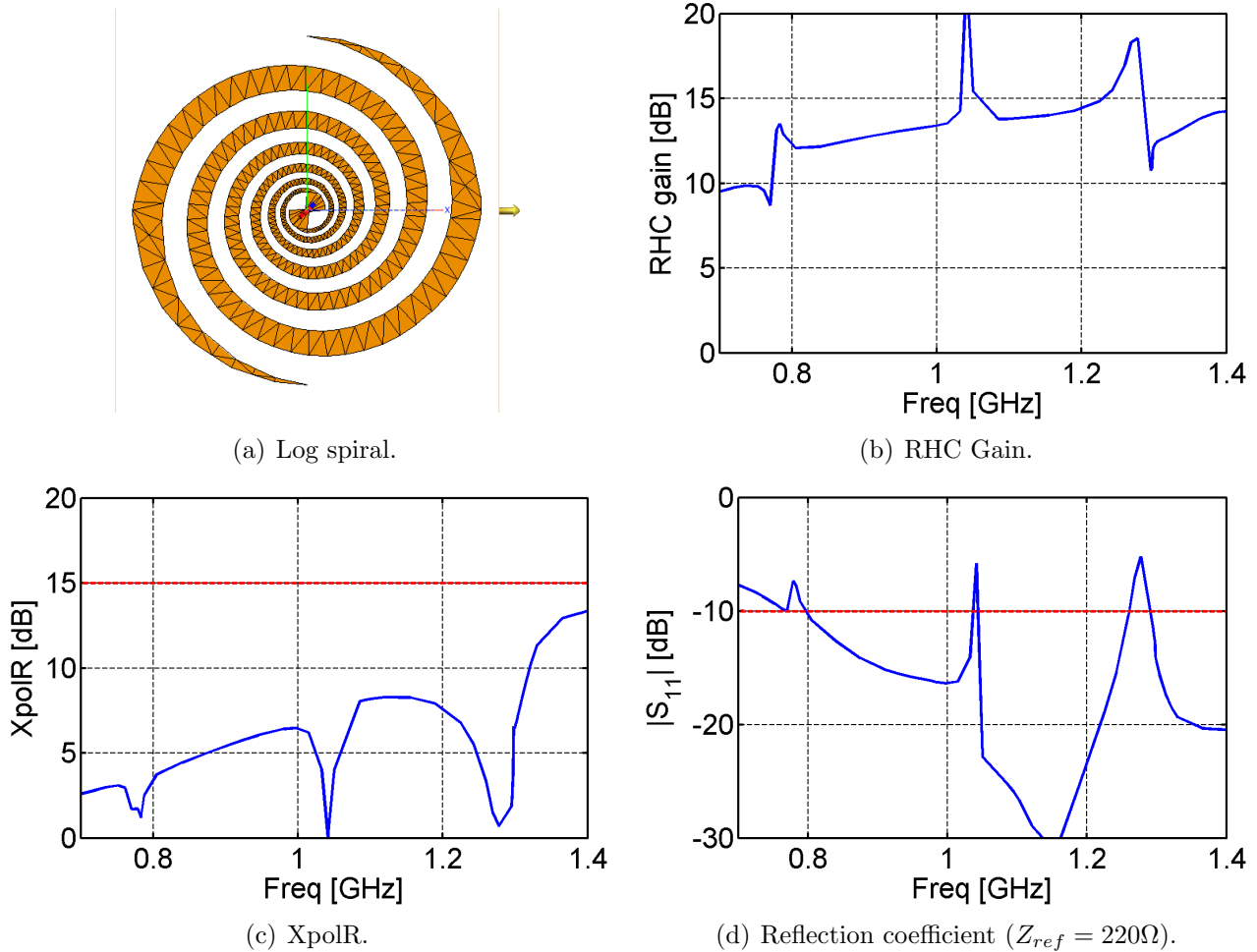

Figure 2.4: Infinite linear array of log spiral antennas (cf. Tab. 2.1). 30° of scan angle.

2.2.3 Standing waves found in just one spiral

So far, we have verified the presence of resonances in arrays, whatever the type of the spiral, as long as the spirals are symmetric. Fig. 2.5 shows the current density distribution at one resonance frequency (1.1526 GHz), of one square spiral in an infinite linear array (cf. Fig. 2.2 and Tab. 2.1) when scanning at $\theta = 30^\circ$. We can see that both arms have almost the same amplitude with nulls at the same locations. The null at the center of the spiral reveals that the current does not reach the center. Both arms have almost the same charge phase distribution.

Steyskal noticed that the resonances occurred only when the array scans off-broadside (*Steyskal et al.*, 2005). The off-broadside radiated wave can be decomposed into a wave travelling perpendicular to the plane of the array and into another wave travelling parallel to the plane of the array. The latter one could be the cause of this resonance.

In this section, *instead of a transmitter antenna array, we will use one spiral antenna receiving a wave at different angles to simulate the scanning.* We will start with perpendicular incidence, then with parallel incidence, and with incidence with angle θ_i from broadside.

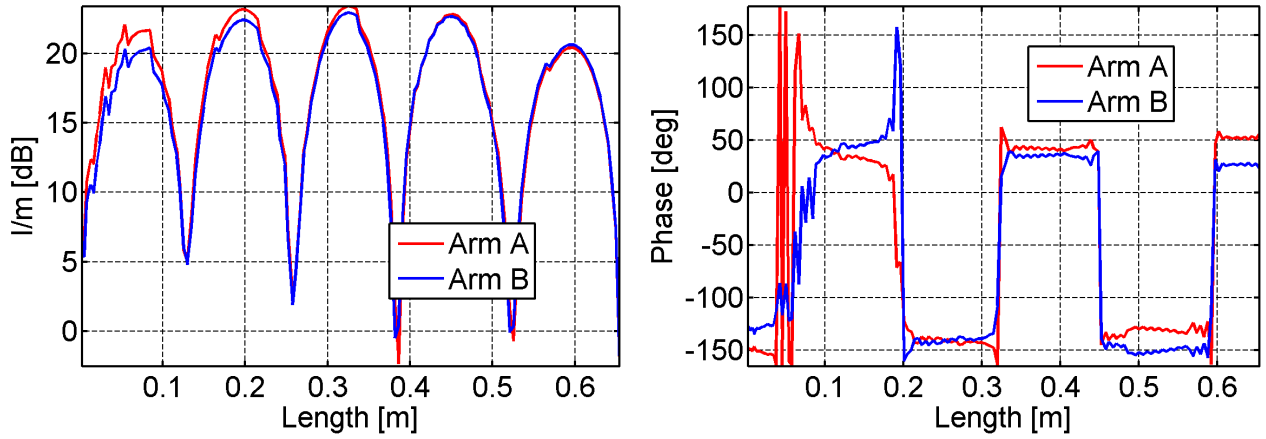

(a) Distribution of surface current density on the spiral (b) Distribution of charge phase on the spiral arms.

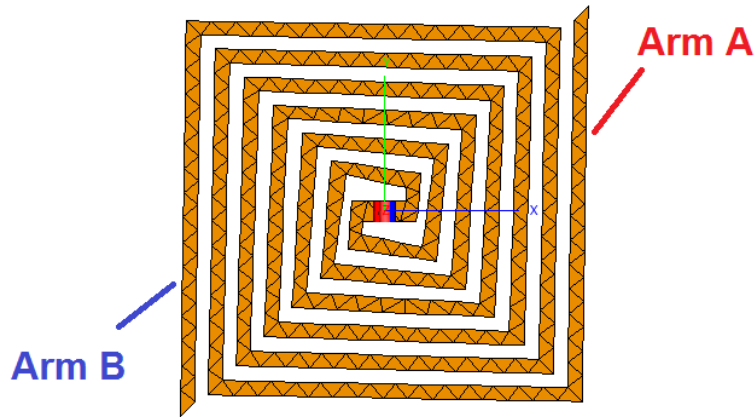

(c) Square spiral.

Figure 2.5: Infinite linear array of square spirals (cf. Tab. 2.1) at 1.1526 GHz and $\theta = 30^\circ$ of scan angle. The arm length is 66.78 cm which corresponds to $5.1 \times (\lambda/2)$.

Incident wave perpendicular to the plane of the antenna

In Fig. 2.6 we can see the current density distribution of a right-handed square spiral antenna, terminated at the center with 220Ω (to represent a perfectly matched feed) for an incident wave perpendicular to the spiral. The wave is right handed circularly polarized at the resonance frequency of 1.1526 GHz.

The simulations show that the induced currents on the arms are symmetric. The amplitude of the current shows a constant and smooth reduction. Near the arm end there is a drop due to radiation. The small peaks correspond to the corners of the spiral arm. The charge phase has a constant 180° phase difference from the center of the spiral up to near the end, where the radiation occurs. This is how the spiral is intended to work. There is no resonance when the wave arrives perpendicular to the spiral.

Incident wave parallel to the plane of the antenna

For waves travelling parallel to the plane of the antenna, the perpendicular component do not

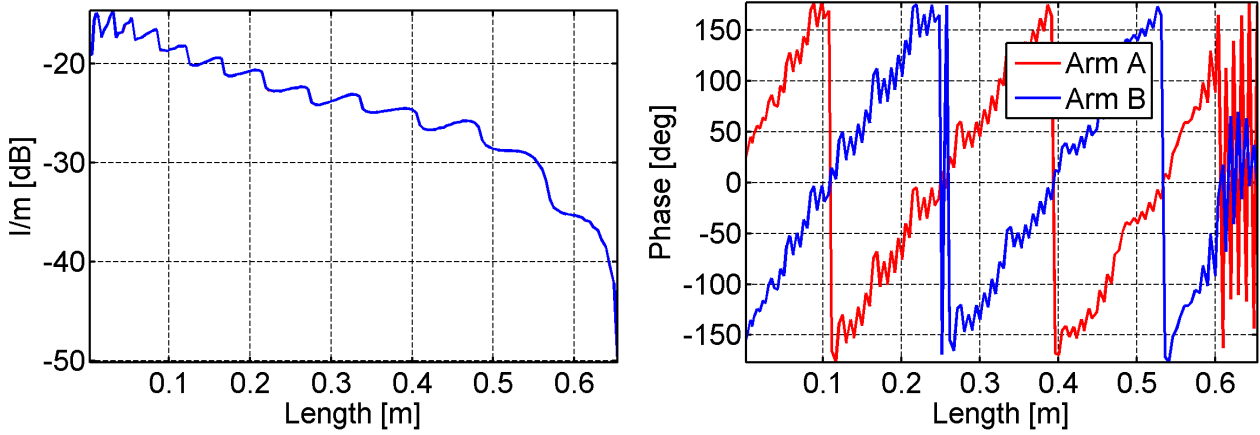

(a) Distribution of surface current density on the spiral arms. (b) Distribution of charge phase on the spiral arms.

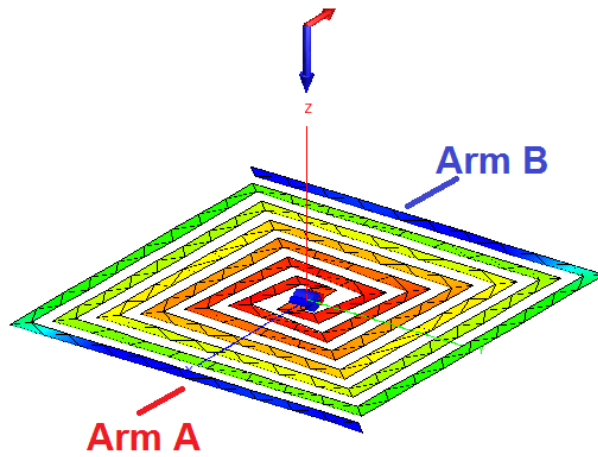

(c) Square spiral with incident right hand circularly polarized wave.

Figure 2.6: Incident circular wave from broadside (along z axis) over square spiral at 1.1526 GHz.

induce any current in the arms of the spiral, hence, we will consider just the component parallel to the plane, which is the same as considering a wave with linear polarization parallel to the plane. Fig. 2.7 shows this case. We can see that a strong standing wave appears on the arms of the spiral, similar to the case of the infinite linear array scanning off-broadside presented in Fig. 2.5. Both arms have the same nulls in the current distribution and have a 0° phase difference at the center. The current amplitude on the arm A is greater than the current amplitude on the arm B, since the wave is coming from the side of the arm A.

Now, consider a left handed circularly polarized wave arriving at an angle off-broadside, as in Fig. 2.8 where the incoming wave makes an angle of 30° with z axis. We can see that the currents on both arms are similar in magnitude and have 0° phase difference at the center. The current amplitude at the center of the spiral is about -28 dB which indicates that the current does not reach the center of the spiral because of the resonance. This can be explained by decomposing the circular wave into two waves with normal and parallel directions to the plane of the spiral, both of them left handed circularly polarized. Since the spiral is right-handed, the

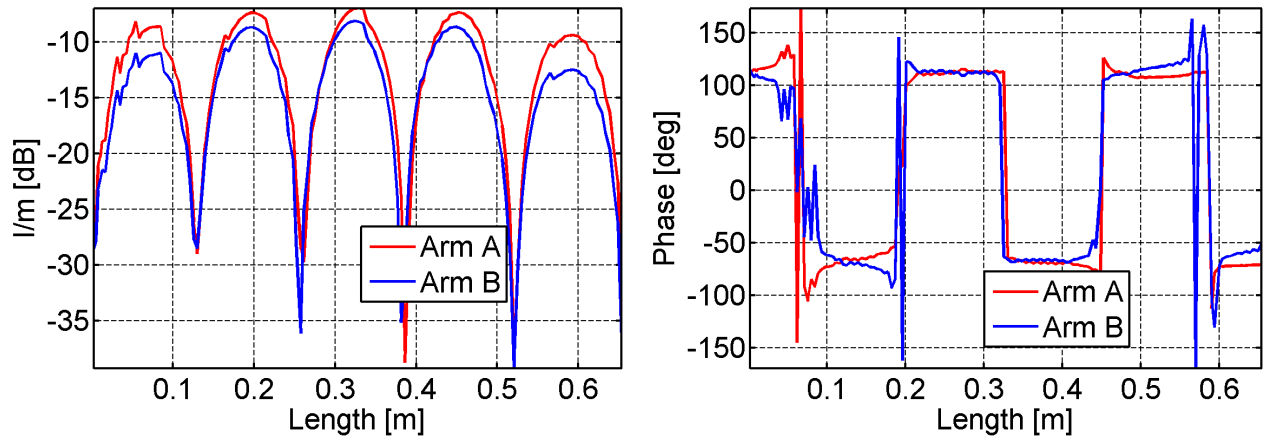

(a) Distribution of surface current density on the spiral (b) Distribution of charge phase on the spiral arms.

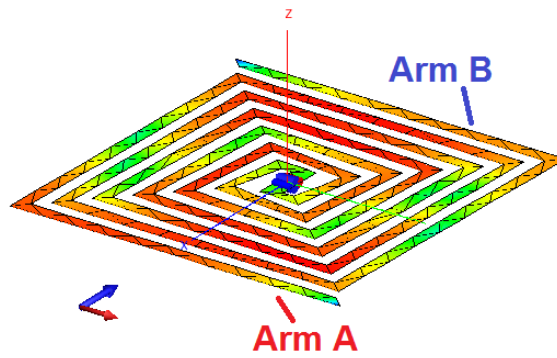

(c) Square spiral with incident wave.

Figure 2.7: Incident wave with linear polarization parallel to the spiral at 1.1526 GHz.

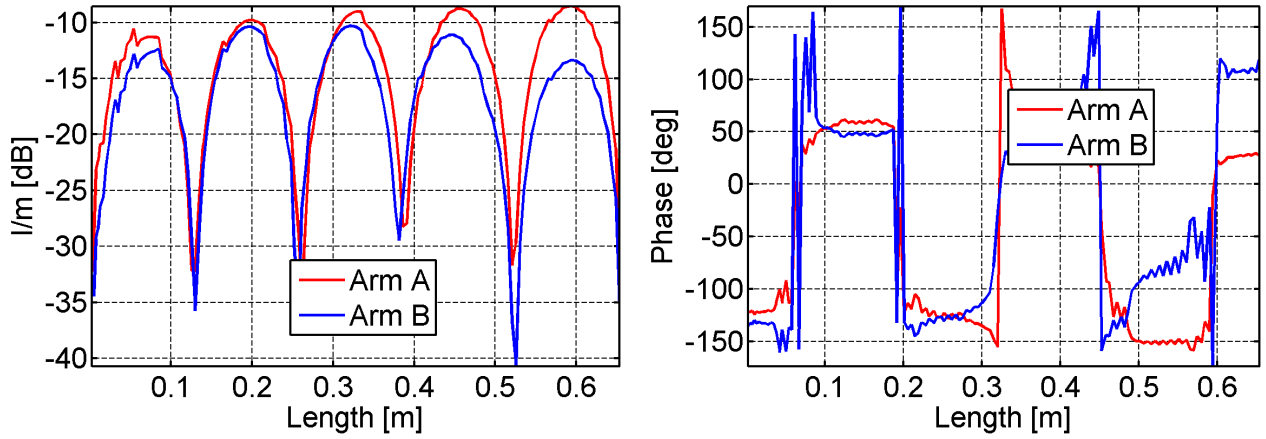

(a) Distr. of surface current density on the spiral arms. (b) Distribution of charge phase on the spiral arms.

Figure 2.8: Incident left-handed circularly polarized wave from $\theta = 30^\circ$ over square spiral at 1.1526 GHz.

perpendicular wave, which is left handed, will be rejected by the spiral. Only the other wave, with direction parallel to the plane of the spiral, induces a strong standing wave in the arm of the spiral. From this wave, only the component parallel to the spiral will induce current, reducing it to the previous case of a linearly polarized wave.

Incident wave coming from off-broadside

We have considered the cases of waves perpendicular and parallel to the plane of the spiral. Now, the combination of both of them is considered, a right-handed circularly polarized wave arriving at an angle θ_i (angle of incidence) off-broadside. Fig. 2.9 shows the current and charge phase distribution in the arms of the spiral for an incoming wave with direction 30° from the z axis.

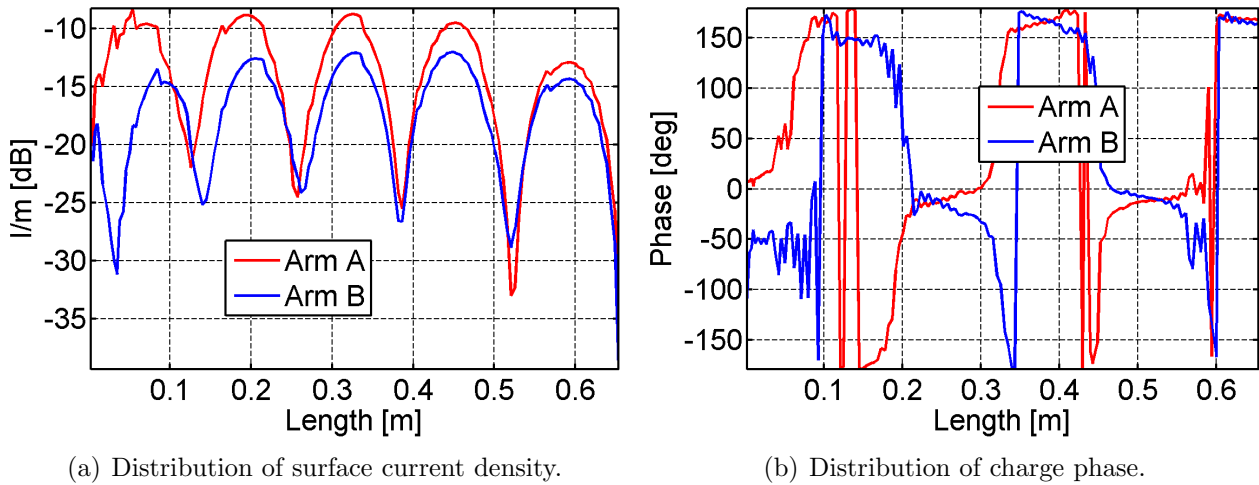

Figure 2.9: Distribution of current and charge phase along the arms of the square spiral induced by an incident right-handed circularly polarized wave from $\theta = 30^\circ$ at 1.1526 GHz.

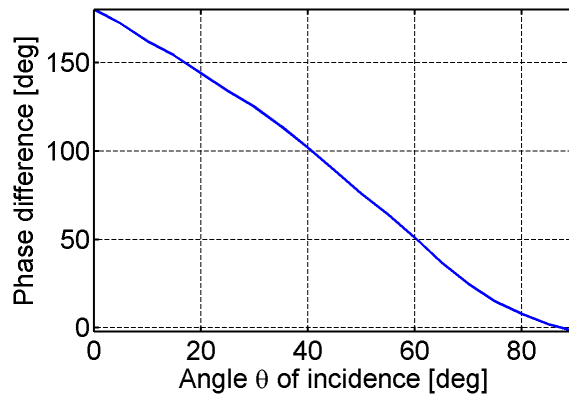

Figure 2.10: Angle of incidence vs. phase difference of arm charges at the center of the spiral at 1.1526 GHz, resonance frequency.

The current density amplitude at the center of the spiral is about -20 dB, which is similar to the case of a perpendicular incident circular wave, but the phase difference at the center of the spiral is now almost 110° , while in Fig. 2.6 the difference is exactly 180° .

Fig. 2.10 shows the phase difference at the center of the spiral for different angles of incidence of a right-handed circularly polarized wave. For an incidence angle of 0° (perpendicular to the spiral) the phase difference is 180° . Increasing the angle of incidence reduces the phase difference, becoming 0° for an angle of incidence of 90° , which is the case of a wave with direction parallel to the plane of the spiral.

When the phase difference is 180° we have the normal behavior of the spiral for all the frequencies. When the phase difference is 0° , at the frequencies provided by Eq. 2.1, the resonance appears. By reciprocity, if the spiral is fed with a 180° phase difference we obtain the normal behavior. But, if we try to feed the spiral with a 0° phase difference, at certain frequencies, the resonance will appear, mismatching the antenna. This mechanism will be explained in the next section.

2.2.4 Explanation using transmission line theory

Excitation modes of the spiral antenna

As explained by Kaiser in (*Kaiser, 1960*), a spiral antenna can be thought as a two-wire transmission line that has been wrapped into a spiral. To see this, a simple model of the change of phase of the current along the arms due to the electrical length, calculated from the center of the spiral, was made using Eq. 2.2, also proposed by Kaiser.

$$\Delta\varphi(\ell)^\circ = \frac{\ell}{\lambda} 360^\circ \quad (2.2)$$

where $\Delta\varphi$ is the phase change at some point of the arm of the spiral, ℓ is the arm length up to this point calculated from the center of the spiral and λ is the current wavelength.

Fig. 2.11 and 2.12 show the current phase distribution along the arms of a symmetrical square spiral at 1 GHz and 1.4211 GHz, respectively. The spiral has 4.6 turns and the length of each arm is 0.95 m. Eq. 2.1 predicts the presence of a resonance at 1.4211 GHz for this spiral. At this frequency the length of the arm is a multiple 9 of the half wavelength which makes appear a 180° phase difference between the center and the end of each arm. When the two arms of the spiral are fed with a 180° phase difference, and with sufficient length, there is an annular region (green region in Fig. 2.11(b) and 2.12(b)) where the two arms, side by side, will be in-phase (0° phase difference), which is the radiation region. This mode of feeding is called “mode 1”. Depending on the shape of the spiral, this radiation region will be a circle, square, hexagon, etc. Between the center of the spiral and the radiation region, the arms of the spiral, side by side, present a phase difference that goes from 180° (center feeding) to almost 0° (radiation region). Since the phase difference is not exactly 180° , there is a small amount of radiation that leaks, making the two-arm spiral acts as a lossy transmission line until the radiation region is attained, where the energy is radiated. This annular ring region has an average length equal to λ .

The arms of the spiral can also be excited in-phase. This mode is called “mode 0”, also known as “mode 2” by Corzine (*Corzine and Mosko, 1990*). In this case, the “radiation region” of “mode 1” becomes a “transmission line region”, 180° phase difference (cf. green region in Fig. 2.11(a) and 2.12(a)). In order to have a radiation region for the “mode 0” the average length of this region should be 2λ .

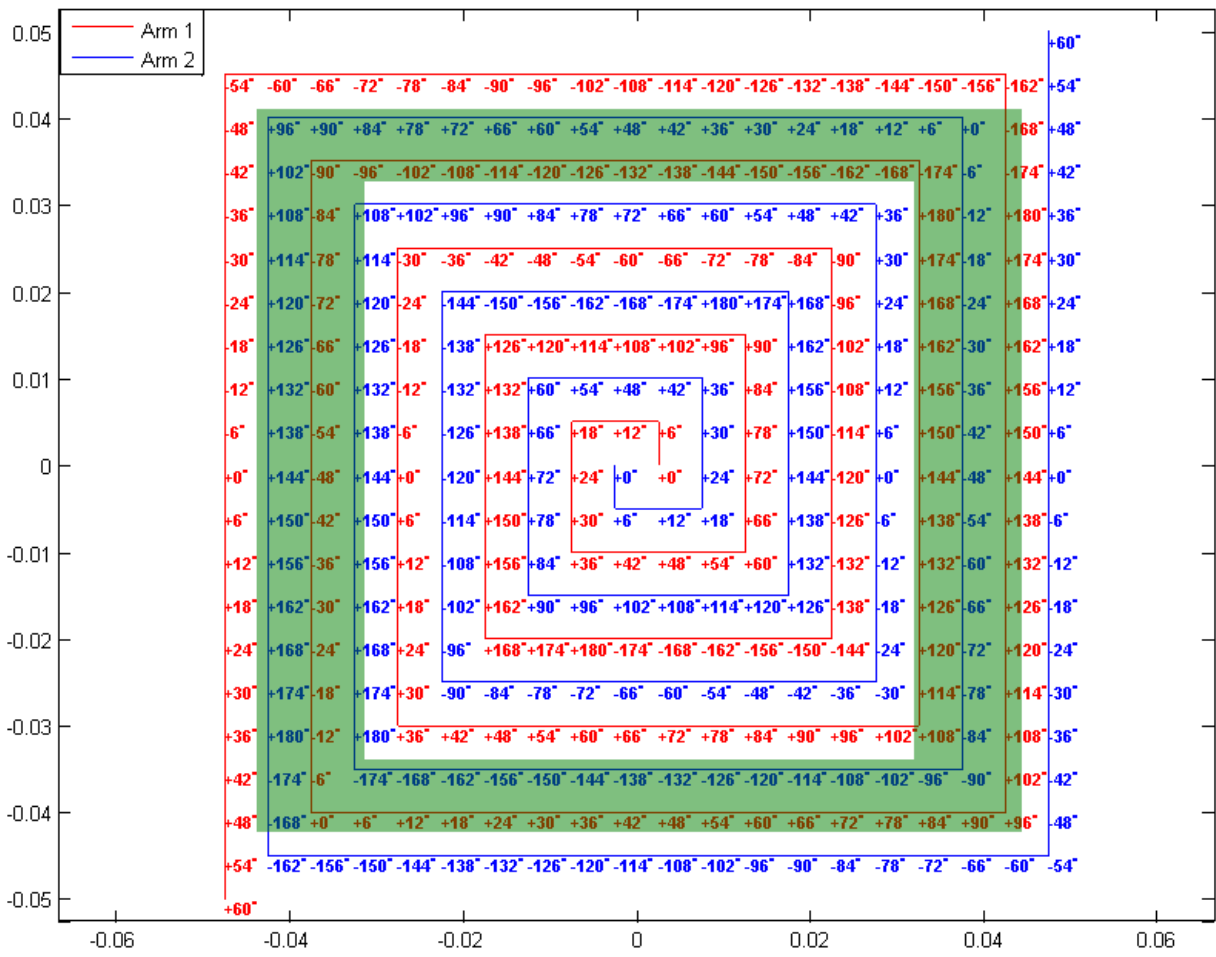

(a) Mode 0, green zone represents the radiation region. Length units in meters.

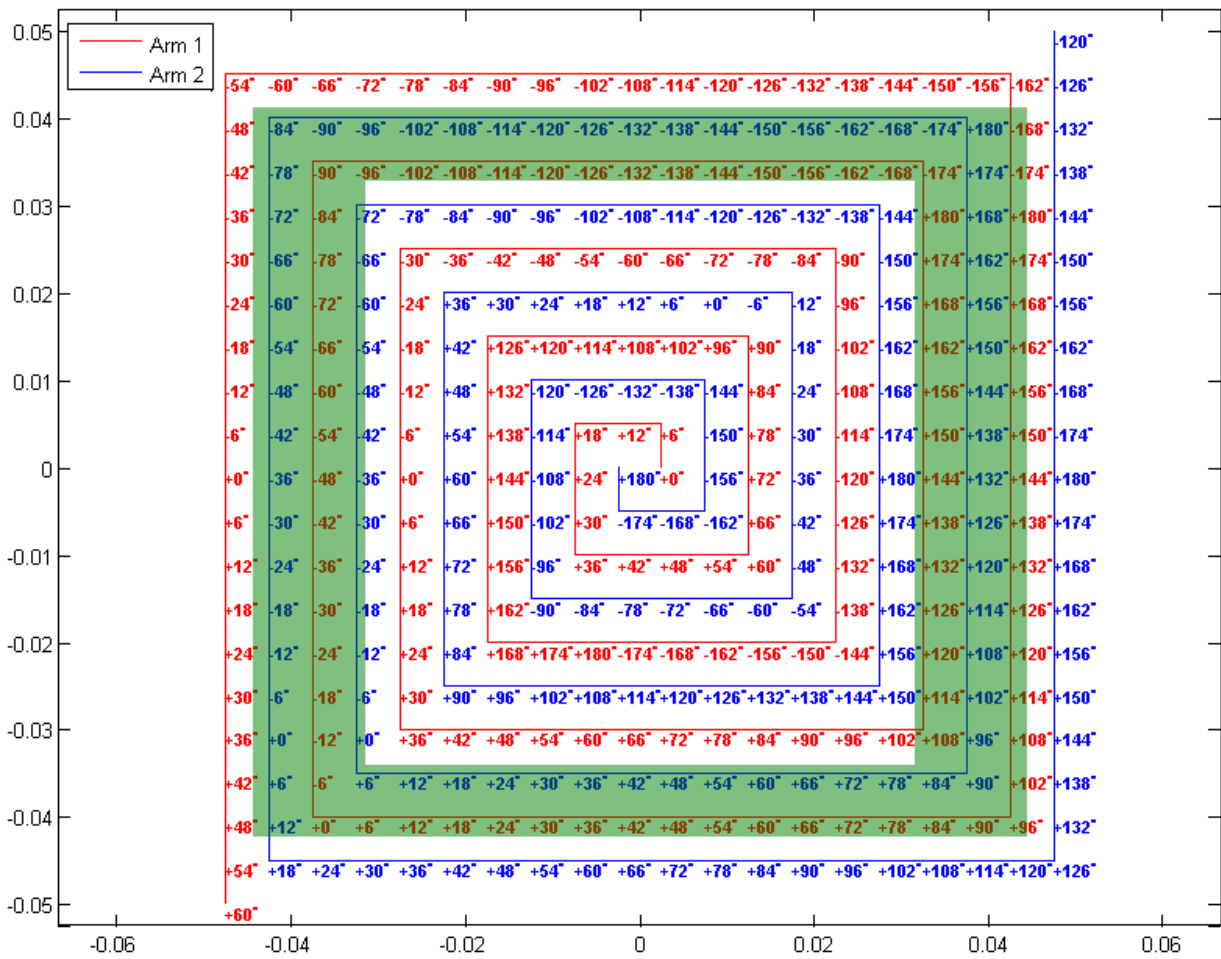

(b) Mode 1, green zone represents a transmission line region. Length units in meters.

Figure 2.11: Current phase ($^{\circ}$) distr. along the arms of a symmetrical square spiral at 1GHz.

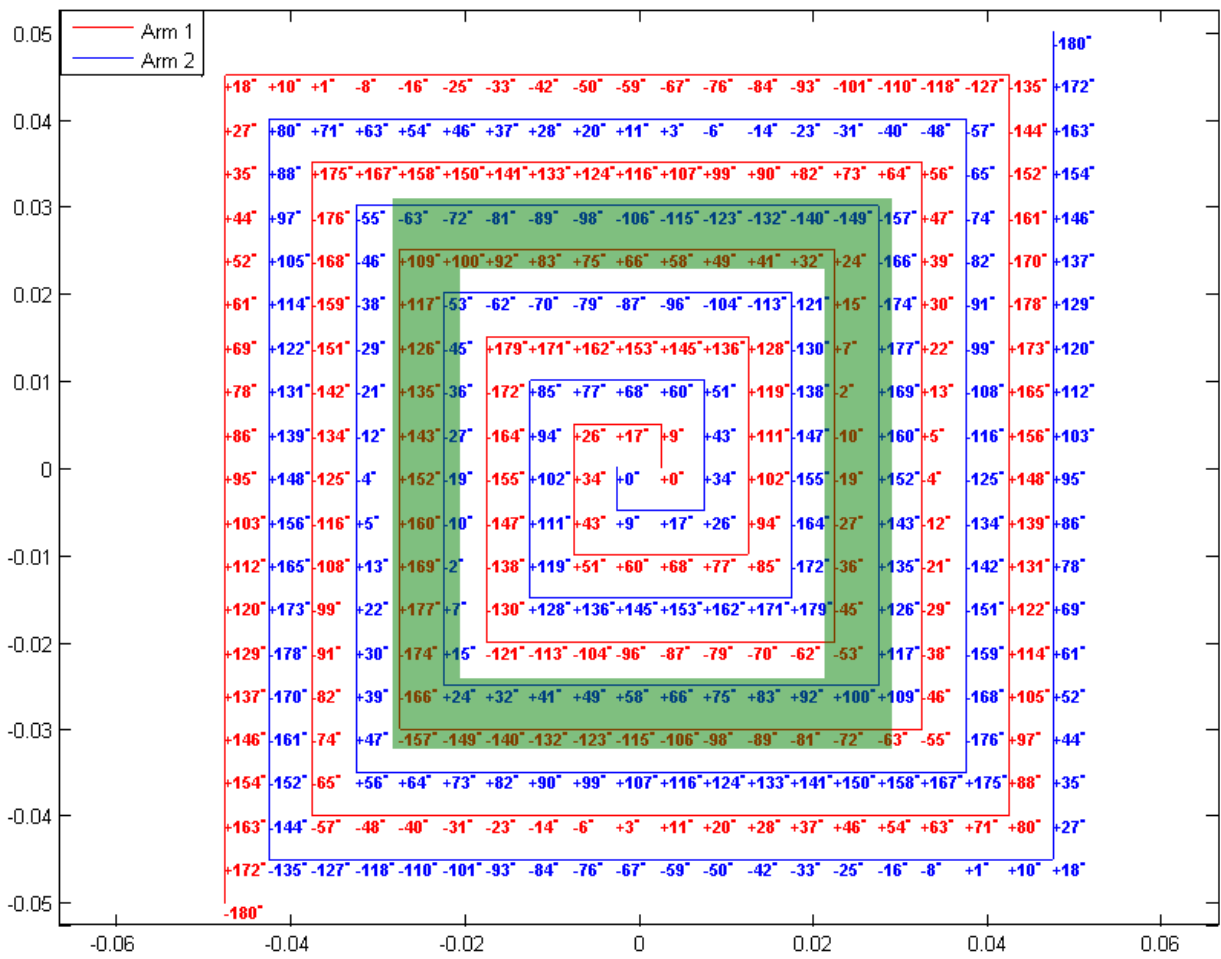

(a) Mode 0, green zone represents the radiation region. Length units in meters.

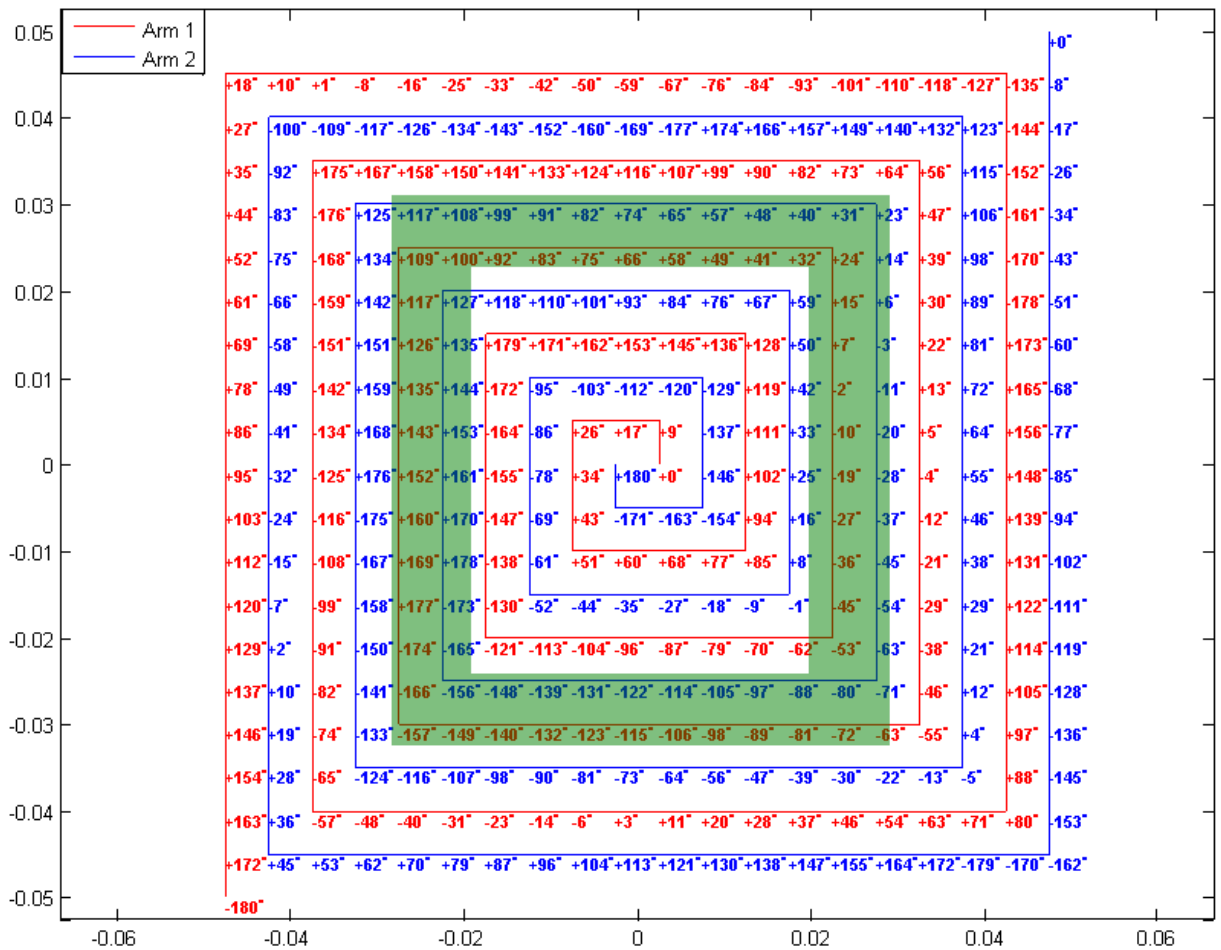

(b) Mode 1, green zone represents a transmission line region. Length units in meters.

Figure 2.12: Current phase ($^{\circ}$) distr. along the arms of a symmetrical square spiral at 1.4211GHz.

Incident wave and excitation modes

When a circularly polarized wave, with direction normal to the plane of the spiral, strikes the spiral antenna, the electromagnetic field is uniform in the plane which induces a symmetric distribution of currents in the spiral arms with a 180° of phase difference (mode 1) at the center. On the other hand, when the direction of the wave is parallel to the spiral plane (only the component parallel to the plane will induce currents, cf. section 2.2.3), the electromagnetic field is no longer uniform in the plane and induces a 0° phase difference (mode 0) at the center, making a strong mismatching.

Resonances and excitation modes

A wave with direction parallel to the spiral plane, already shown in section 2.2.3 (pg. 38), is present when the array scans off-broadside or if a wave strikes the spiral with an angle $\theta \neq 0^\circ$. This wave can be decomposed into two waves with directions perpendicular and parallel to the plane of the spiral.

The wave perpendicular to the plane of the spiral will induce the mode 1, and, provided sufficient arm length, it is possible to find a radiation region where its average length is λ . On the other hand, the wave with direction parallel to the plane of the spiral will induce the mode 0. At low frequencies, apart from a small region at the center, there is no region with a 0° phase difference between the two arms, side by side, which impedes any radiation and, with the proper arm length ($\lambda/2$) (Steyskal et al., 2005), the structure resonates, trapping the wave into the spiral arms.

Double transmission line model

If the arms of the spiral are unwrapped, as in Fig. 2.13, we can reach a clearer idea. Blue and red colors represent the arms 1 and 2. We can see that a transmission line model is formed between the arms of the spiral. For a symmetrical spiral with no loads, the two arms are terminated with an open circuit. It is this transmission line that resonates.

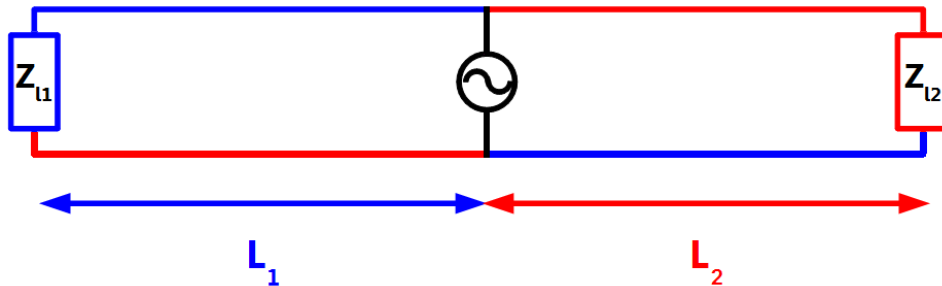

Figure 2.13: Double transmission line model of spiral antenna. Blue and red colors correspond to arm 1 and 2, respectively. L and Z represent the arm length and load impedance at the end of the arm of the spiral.

This model is different from the one proposed by West in (West and Steyskal, 2009) for the case of a spiral over a metallic ground plane. The double transmission line model has the advantage of not needing a ground plane to explain the resonances.

2.2.5 Solutions

In this section we will review, in the light of our previous explanation, the solutions proposed by Steyskal, which all rely on some modifications of the spiral element. We will, then, introduce our new solutions that work at the array level.

Spoiling the symmetry of the spiral

Steyskal proposed to break this symmetry by extending one of the spiral arms in order to have different resonance frequencies on each arm (*Steyskal et al., 2005*). In this section we study the behavior of this antenna at 1.1526 GHz to verify that the resonances disappear.

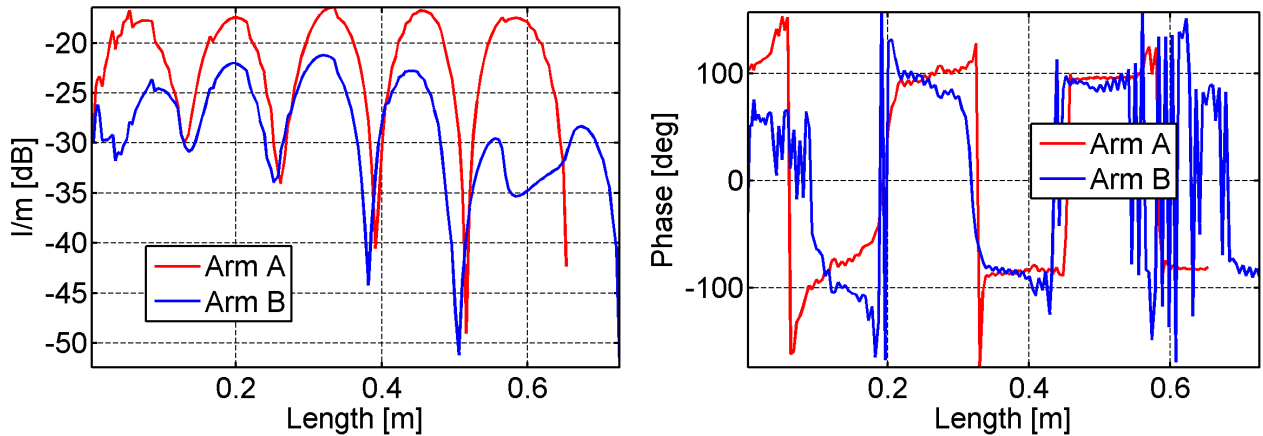

(a) Distribution of surface current density on the spiral arms. (b) Distribution of charge phase on the spiral arms.

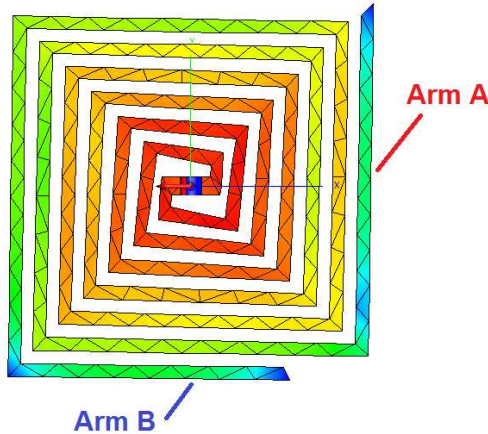

(c) Asymmetrical square spiral.

Figure 2.14: Incident wave with direction parallel to the plane of the square assymetrical spiral at 1.1526 GHz.

First, let us verify that an incident wave cannot induce resonances in the asymmetrical spiral. Fig. 2.14 shows an incident wave with direction parallel to a single asymmetrical spiral. The asymmetrical spiral has arm lengths of 66.78 cm and 74.26 cm. We can see that the resonance is still present in the shorter arm (arm A), but the longer arm does not have exactly a resonance.

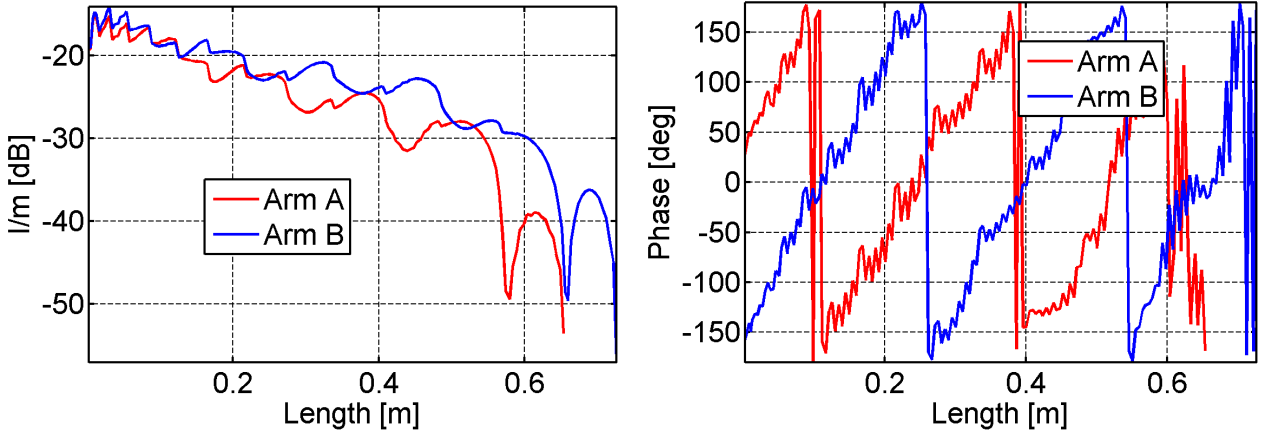

(a) Distr. of surface current density on the spiral arms. (b) Distr. of charge phase on the spiral arms.

Figure 2.15: Incident right hand circularly polarized wave coming from broadside over asymmetrical square spiral at 1.1526 GHz.

The phase difference at the center of the spiral is, then, about 140° and not 0° as in Fig. 2.7(b). This result shows the effectiveness of this technique.

Now, let us consider the behavior of the antenna for an incident right-handed circularly polarized wave perpendicular to the plane of the antenna. Fig. 2.15 shows this case. We verify that there is no resonance. As in the case of the symmetrical spiral (cf. Fig. 2.15), the phase difference is almost 180° up to near the end of the arm.

Finally, the simulation results of the asymmetrical square spiral in an infinite linear array with 30° of scan angle are shown in Fig. 2.16. The spacing of this array is 10.6 cm, same as in the array presented in Fig. 2.2, hence, grating lobes are expected to be present at 1.887 GHz for a scan angle of 30° . We can see that the reflection coefficient was greatly improved, specially at the resonance frequencies (cf. Tab. 2.2). The total gain and co-pol gain (RHC gain) have dips at these frequencies which means that there is no proper radiation. The XpolR at the steering angle is not good at the frequencies of the dips in the co-pol gain, but they are better at frequencies a bit lower.

Fig. 2.17 shows the distribution of surface current of the array at 1.1526 GHz. It appears a weak resonance in the arms of the spiral, but now the phase difference at the center of the spiral is almost 165° , which explains the improvement of reflection coefficient at this frequency. Instead of remaining constant, this phase difference is reduced from the middle of the arms up to the end, spoiling the radiation, seen as a drop in gain, and reducing the XpolR.

Dissipation of current at the end of spiral arm

Another idea, proposed by Steyskal, to eliminate the resonances, was to use a resistance to absorb the current at the end of the arms (*Steyskal et al., 2005*). A symmetrical spiral with absorbers can also play the same role. Nakano presented a spiral antenna with a strip absorber below the spiral and at the end of the arms (*Nakano et al., 2008*).

Fig. 2.18 shows the result of an infinite linear array of such spiral with 30° of scan angle. The dimensions are listed in Tab. 2.6 where r_{out} is the outer radius of the spiral antenna which is the same as the absorber, $r_{in, absorber}$ is the inner radius of the absorber (this make an absorber

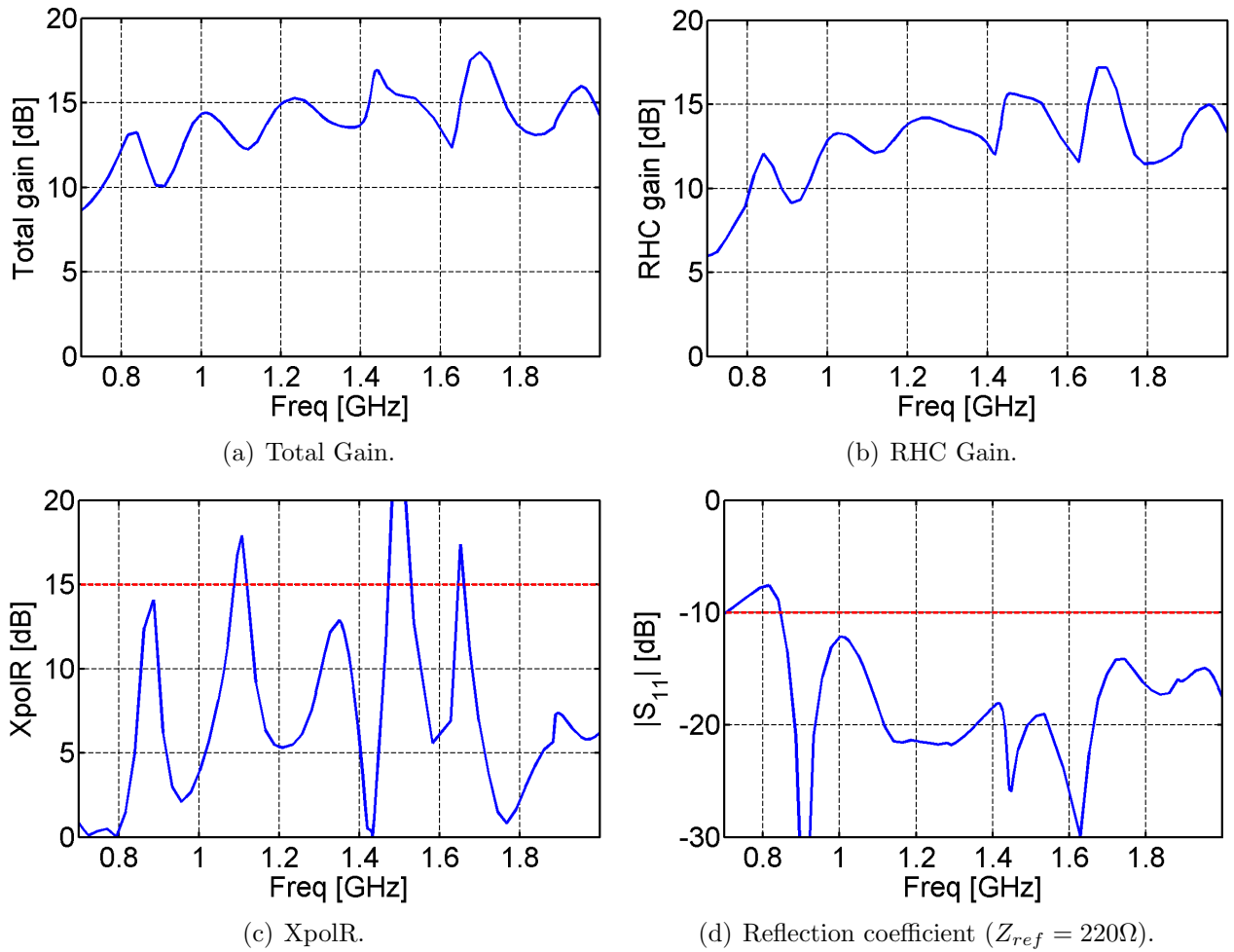

Figure 2.16: Infinite linear array of asymmetrical square spirals with element spacing 10.6 cm. 30° of scan angle. Grating lobes should appear at 1.887 GHz (cf. Eq. 1.21).

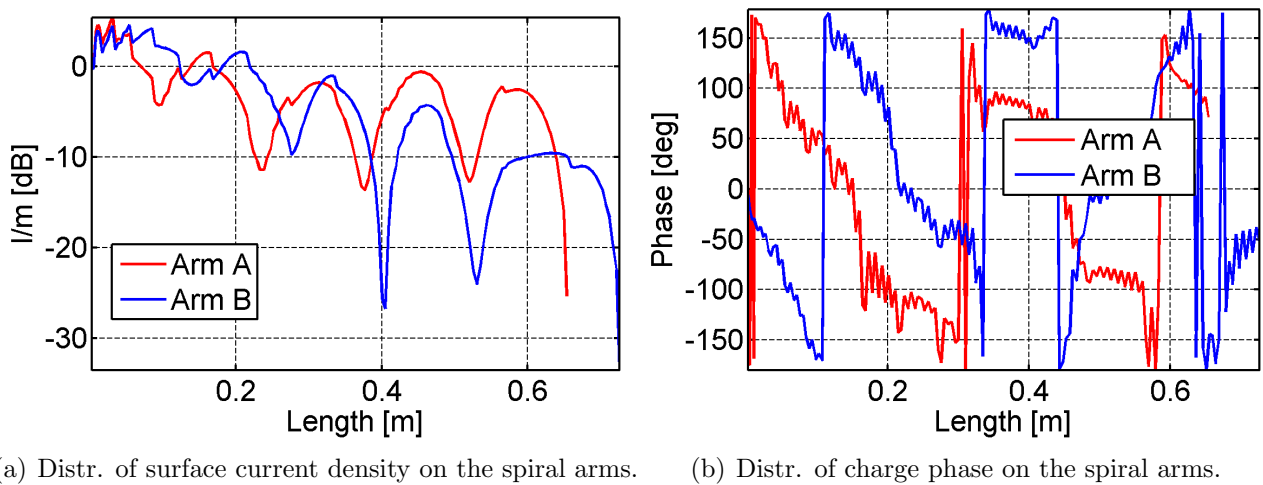

Figure 2.17: Infinite linear array of asymmetrical square spirals at 1.1526 GHz. 30° of scan angle.

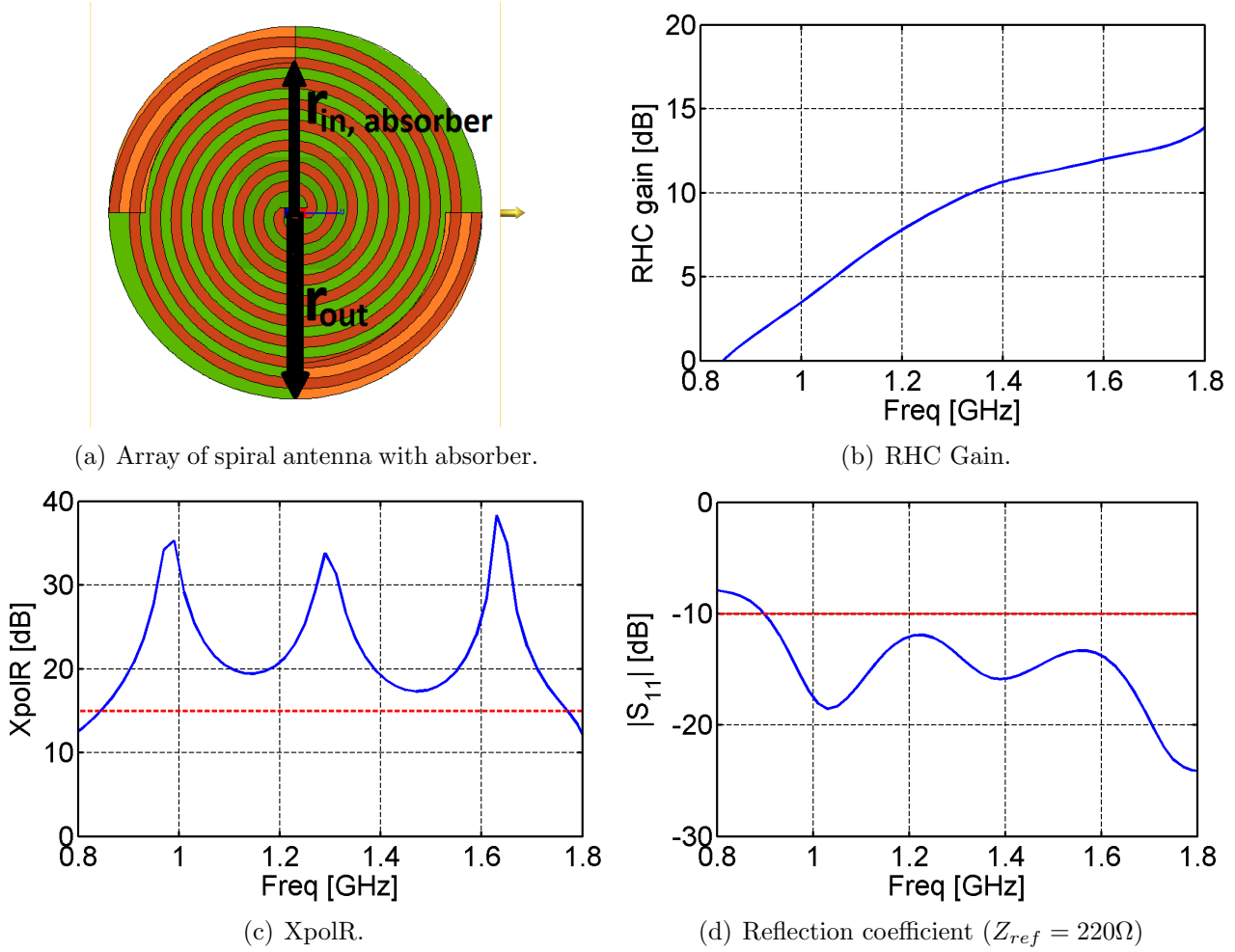

Figure 2.18: Infinite array of self-complementary spiral antenna with absorbers (*Nakano et al.*, 2008). 30° of scan angle. According to Eq. 1.21 grating lobes should appear at 1.82 GHz (cf. Tab. 2.6).

Parameter	Value (cm)
r_{out}	5
$r_{in, absorber}$	4.03
$h_{absorber}$	1.36
d_{elem}	11

Table 2.6: Dimensions of infinite array of self-complementary spiral antenna with strip absorbers below it (*Nakano et al.*, 2008).

strip of 0.97 mm width), $h_{absorber}$ is the height of the absorber which is the same as the distance between the spiral and the plane below the spiral, and d_{elem} is the spacing of the array used in the simulation.

Effectively, the array of spiral antennas with strip absorber does not present resonances. It has good circular polarization for frequencies higher than 0.85 GHz and good reflection coefficient

for frequencies higher than 0.9 GHz. The main problem is the gain, which is very low, since at low frequencies an important fraction of the power is dissipated in the strip absorber.

Breaking the periodicity of the array

So far we have discussed the presence of resonances in uniform arrays. For the case of nonuniform arrays, Guinvarc'h and Haupt have proposed an array where the positions of the antennas are selected by the use of Genetic Algorithms for a dual polarized linear array (*Guinvarc'h and Haupt, 2010*). The optimum distribution is represented by the sequence: "10100111101101001010101101110000011000110011100111110001001010101101001000011010" where "1" represents a spiral of one polarization (RHCP) and "0" represents a spiral of the opposite polarization (LHCP). In our case we will consider only spirals of one polarization (RHCP), hence, the "0" positions will represent the absence of the spiral.

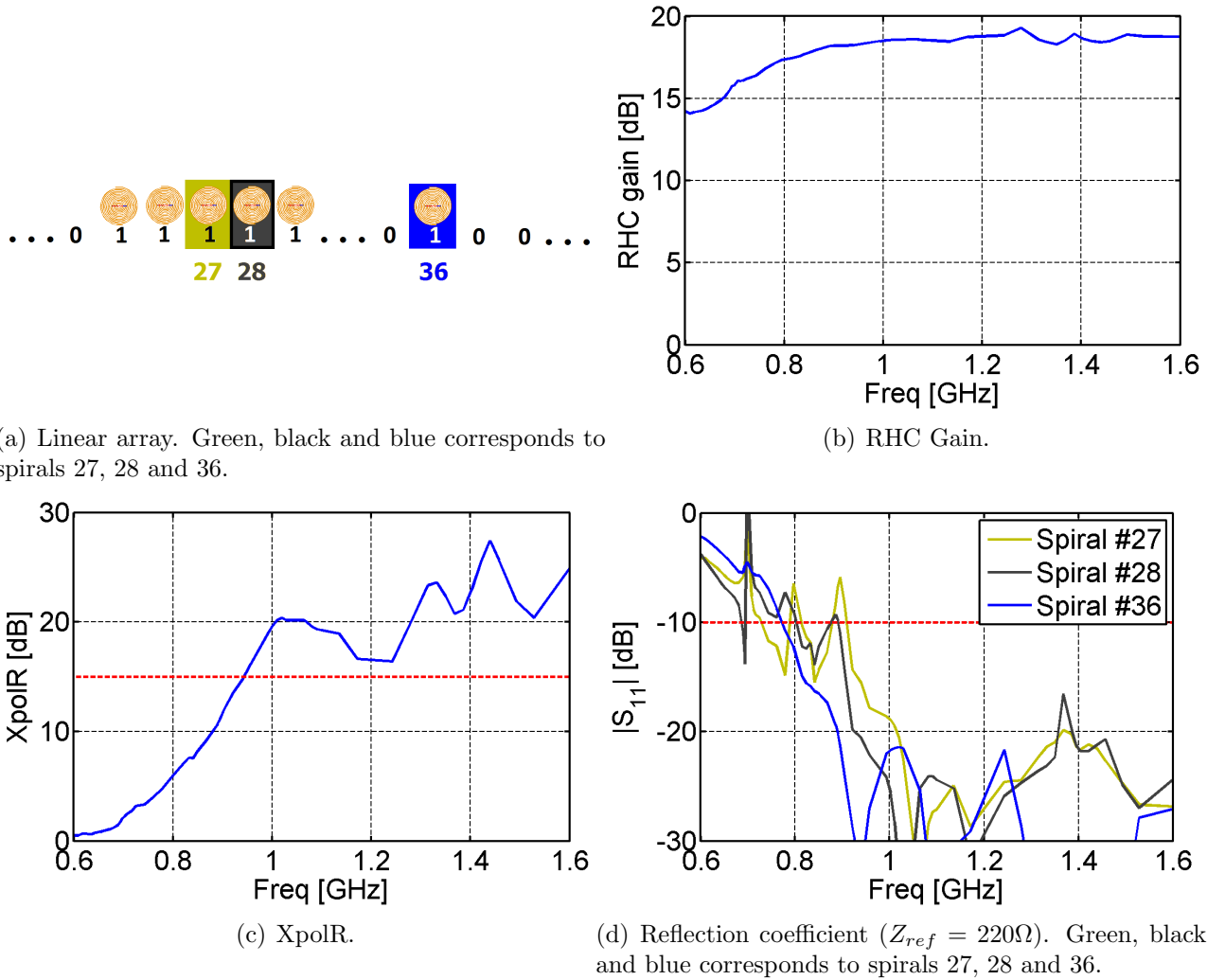

Figure 2.19: Linear array of 40 two-arm symmetrical Archimedean spirals, similar to array presented in (*Guinvarc'h and Haupt, 2010*), but taking just the RHCP subarray. 30° of scan angle. Diameter of spirals is 14 cm and element spacing is 15.65 cm.

Fig. 2.19 presents the simulation results of such mono polarized array. 40 symmetrical spirals, of section 2.2.1 (diameter of 14 cm, pg. 33), was used and the spacing was 15.65 cm. Spiral 36 represents the usual behavior of the spirals of the array, not presenting any peak. Spirals 27 and 28 are the atypical cases. It can be seen that, around 0.79 GHz and 0.9 GHz, there are some peaks in the reflection coefficient of the spirals 27 and 28. These peaks do not necessarily correspond to the Steyskal's resonance frequencies for these spirals which are 0.84 GHz and 0.95 GHz (see Tab. 2.3). The spirals 27 and 28 correspond to a portion of the array where there are five consecutive spirals, which make them act as a small uniform array inducing the resonances. Since only these spirals (2 out of 40) present this problem, the gain and XpolR are not affected.

Then, in general, the resonances are not present when nonuniform arrays are used. This effect can be thought of as having different impedances at the end of the arm of the spiral (see transmission line model of Fig. 2.13). This is so because the coupling at the right side of the spiral is different from the left side, hence, the reflected waves, at the end of the arms, do not have the same phase which reduces the resonance. Besides, the non uniformity of the array does not allow the coupling between the spirals to be reinforced and become stronger.

Connecting the spirals

Fig. 2.20 shows a linear array of 14 adjacent and electrically connected square spirals. Each spiral can be inscribed in a circle with a diameter of 14 cm, has 4 turns and its arm length is 84.2 cm. The spacing is 9.6 cm and the scan angle is $\theta = 30^\circ$ which means that we can expect grating lobes at 2.09 GHz. We will only consider the spirals at the middle of the array to avoid edge effects.

Two strong peaks at 0.87 GHz and 1.12 GHz appear in the reflection coefficient of the spirals placed right in the middle of the array. Since the arms are connected we can consider that the total arm length is 168.4 cm to calculate the Steyskal's resonances (cf. Eq. 2.1). Tab. 2.7 presents the Steyskal's resonances near these two strong peaks showing that they are possibly due to the Steyskal's resonance. The peaks appear just at the lower part of the bandwidth.

$\lambda/2$ multiple m	9	-	10	12	-	13
Observed (GHz)	-	0.87	-	-	1.12	-
Estimated (GHz)	0.8	-	0.89	1.07	-	1.16

Table 2.7: Resonance frequencies for a linear array of connected square spirals. Total arm length is 168.4 cm.

Additionally, we can see that the XpolR is really poor. The large peaks in the XpolR correspond to frequencies a bit lower than the Steyskal's resonances when we consider the arm length as being just 84.2 cm (as in a non connected spiral). The XpolR at the Steyskal's resonance frequencies are well below 15 dB. The dips in the RHC gain corresponds, again, more or less, to the Steyskal's resonance of the non connected square spiral, up to 1.6 GHz. This reveals that the resonances in this array are not completely gone when we connect the square spirals.

Now, consider Fig. 2.21 where there are 14 Archimedean spirals connected. The diameter of each spiral is 14 cm and the arm length is 92.1 cm, before connecting them. This time, there is just a strong peak in the $|S_{11}|$ at around 0.72 GHz in one of the spirals located at the center of the linear array. This would correspond to one of the Steyskal's resonances, considering an

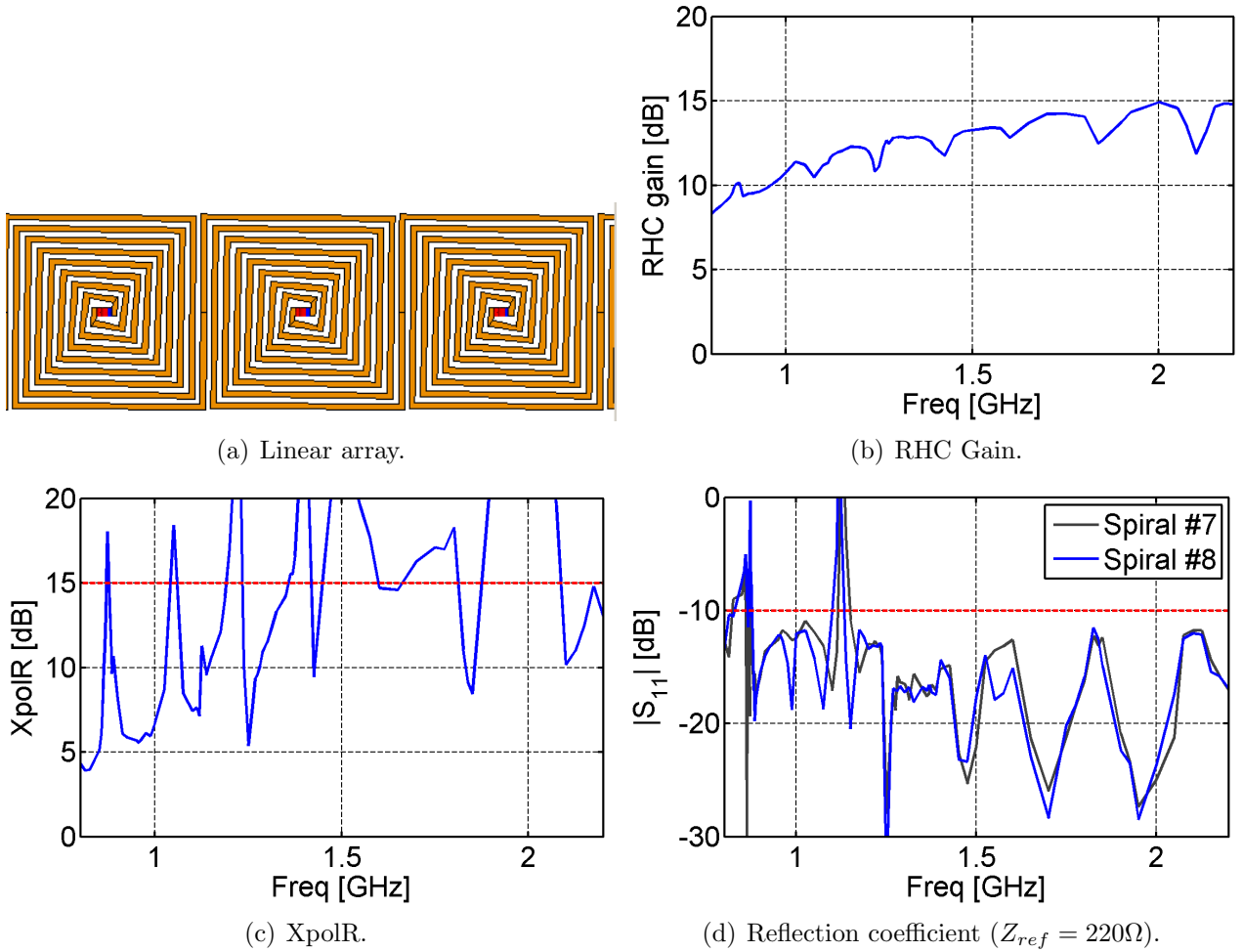

Figure 2.20: Linear array of 14 symmetrical square connected spiral antennas. Diameter of 14 cm and element spacing of 9.6 cm. 30° of scan angle. According to Eq. 1.21 grating lobes should appear at 2.09 GHz. Spirals 7 and 8 are at the middle of the array.

arm length of 184.2 cm (twice, due to the connection) at 0.73 GHz (see Eq. 2.1 for $m=9$). The XpolR of the array is almost everywhere below 15 dB. On the contrary, the RHC gain is more stable than the connected square spirals case.

The effectiveness of the connection is better in the case of the Archimedean spirals where the connection permits a smoother transition from the spiral arms to free space. As in the case of a horn antenna, the progressive transition from the feed point to open space provides a better matching between the transmission line impedance and the free open space. This, in turn, produces reflected waves back to the source with lower intensity and different phases which destroy the possible resonances (see Fig. 2.22). This does not work well at low frequencies because the aperture is too small compared with the wavelength.

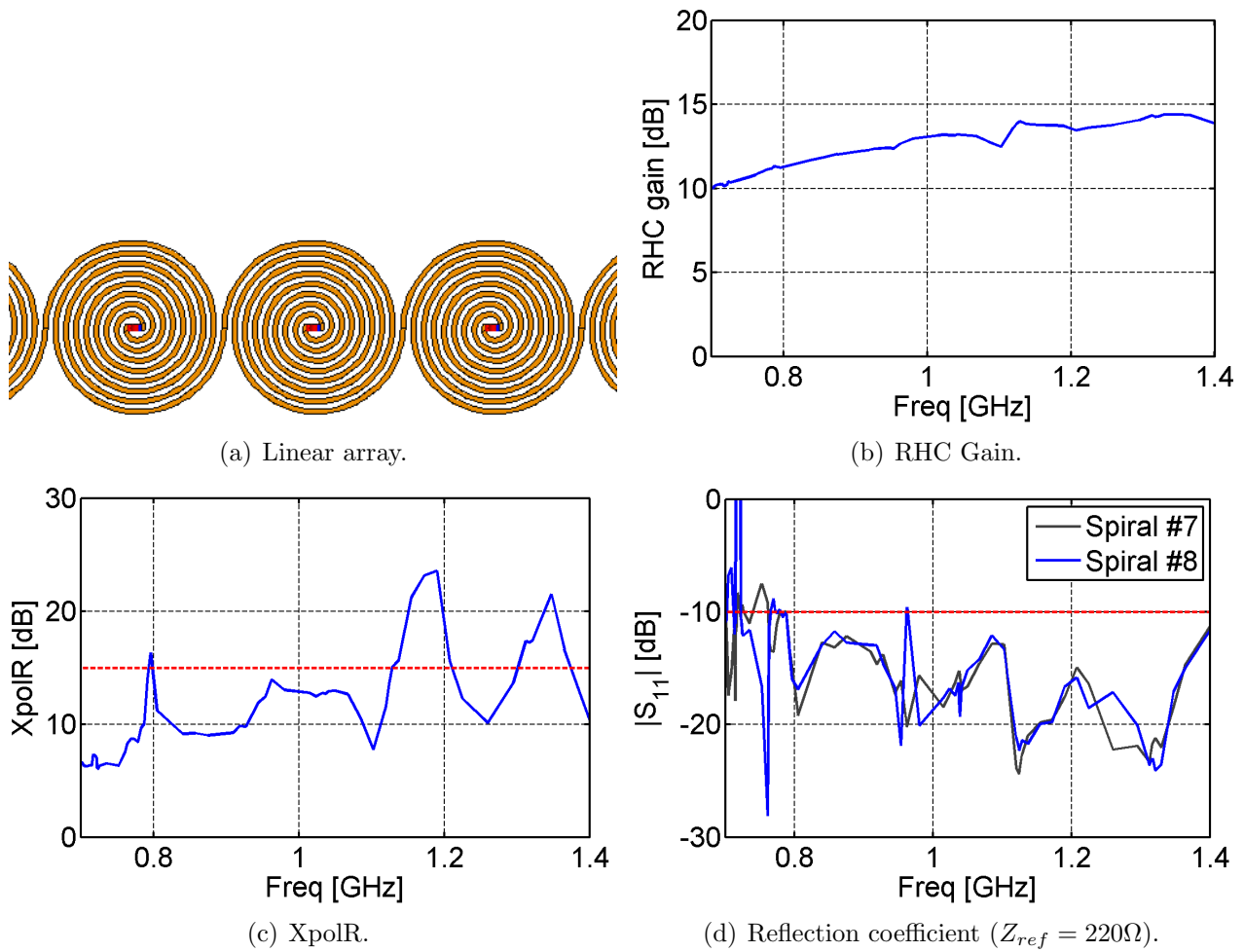

Figure 2.21: Linear array of 14 symmetrical Archimedean connected spirals. 30° of scan angle. Diameter of spirals is 14 cm and element spacing is 13.6 cm. Grating lobes should appear at 1.47 GHz (cf. Eq. 1.21). Spirals 7 and 8 are at the middle of the array.

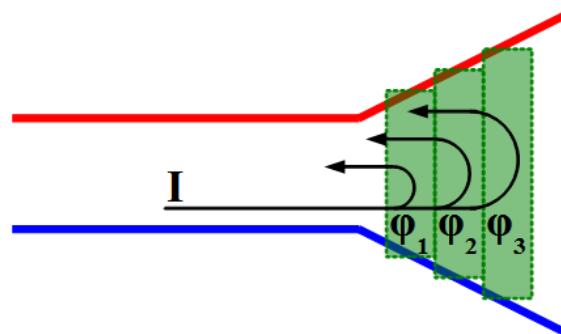

Figure 2.22: Example of a progressive transition to open space. The current is reflected at different parts of the aperture. There is no a strong reflection, since the reflections are not in phase.

2.3 Mono-polarized uniform linear array

Now, we consider again the solution of spoiling the symmetry of the spirals. Although applied to square spirals, it can also be applied to Archimedean and hexagonal spirals. In order to better compare these new spirals we calculate the new “p” factors of *single antennas*, as done in section 1.3.1 (9).

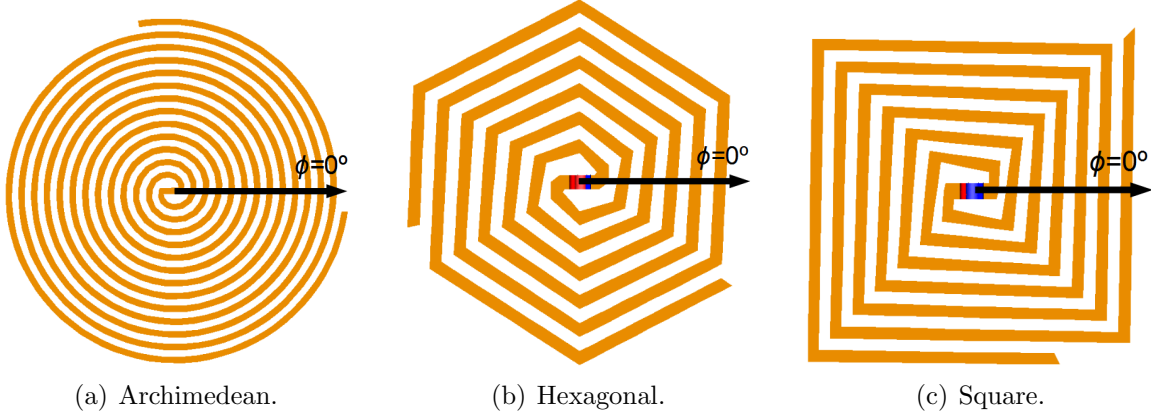

Figure 2.23: Asymmetrical spiral antennas.

“p” factor of asymmetrical spirals

The factor “p” seen in section 1.3.1 applies for symmetrical spirals. Spoiling the symmetry of the spirals and, at the same time, avoiding to have spiral arms with multiples of half a wavelength (i.e. $L_1 = m_1\lambda/2$, $L_2 = m_2\lambda/2$; (Steyskal *et al.*, 2005)) change the characteristics of the spirals. Fig. 2.23 shows the new spirals. Fig. 2.24, 2.25, 2.26 and 2.27 show the simulation results of the asymmetrical spirals. All spirals are inscribed in a circle with radius of 7 cm.

Shape	$f_{S_{11}}$ (GHz)	$p_{S_{11}}$	$f_{X_{polR}}$ (GHz)	$p_{X_{polR}}$	Perimeter (cm)
Archimedean	0.74	1.09	0.9	1.32	44
Hexagonal	0.83	1.22	1.07	1.57	42
Square	0.92	1.35	1.21	1.77	39.6

Table 2.8: Resume of cutoff frequencies for the asymmetrical spirals.

Tab. 2.8 shows the new parameters “p” for the asymmetrical spirals and we can compare them with those found for the symmetrical spirals (see Tab. 1.3, pg. 11). These new “p” parameters are slightly lower for the Archimedean and hexagonal spirals while a bit higher for the square spiral. It is also noted that the circular polarization of the asymmetrical square spiral is unstable having a region between 1.4 GHz and 1.6 GHz where the rejection of cross-polarization is just acceptable ($X_{polR} \approx 15$ dB).

2.3.1 Analytical estimation of the bandwidth of linear arrays

Then, if we use these spirals in a uniform linear array, we can estimate the bandwidths of the arrays using Eq. 1.2, where the high limit is set by the presence of grating lobes and the low limit

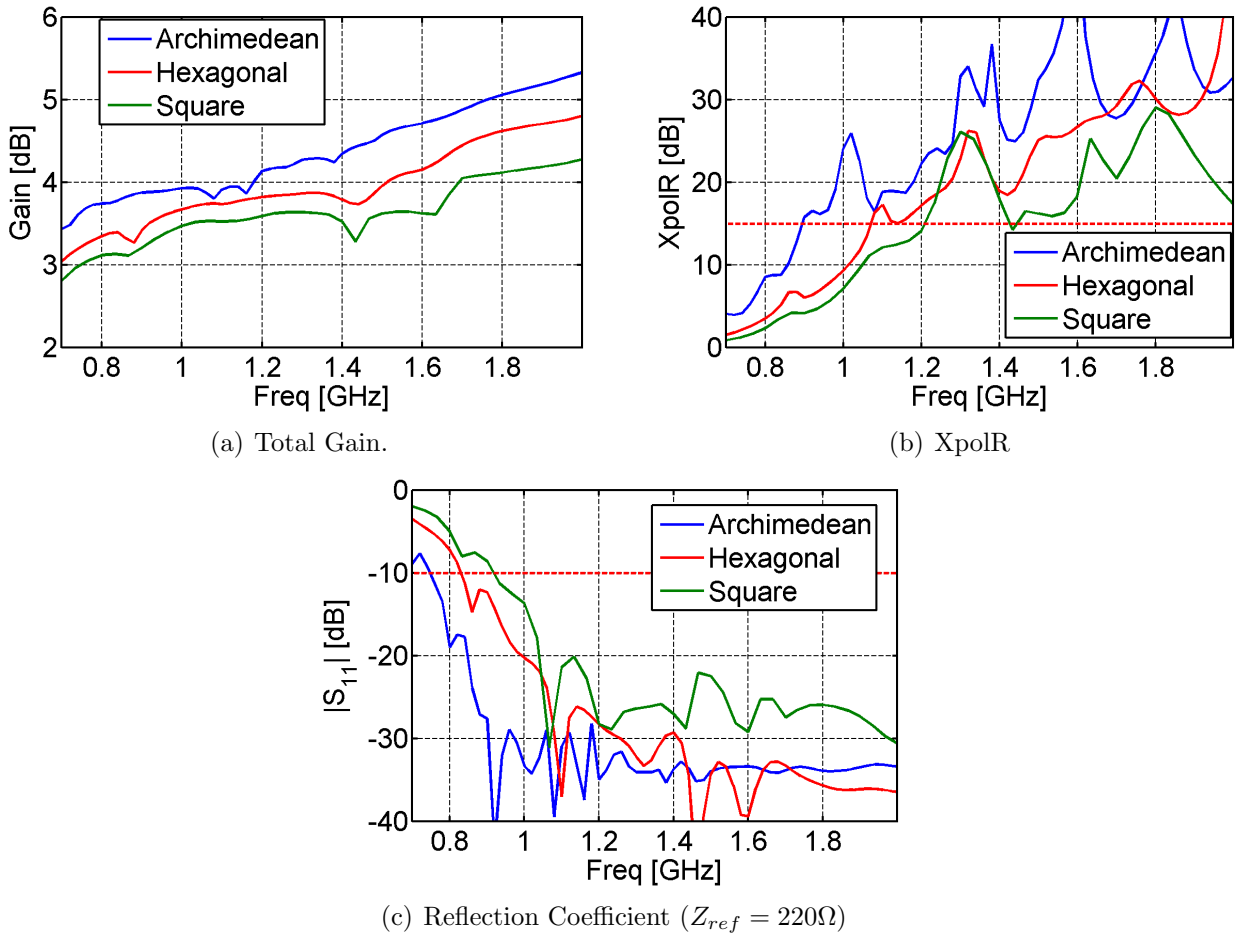

Figure 2.24: Characteristics of the asymmetrical spiral. Same color code is used for the three figures: blue for the Archimedean, red for the hexagonal and green for the square.

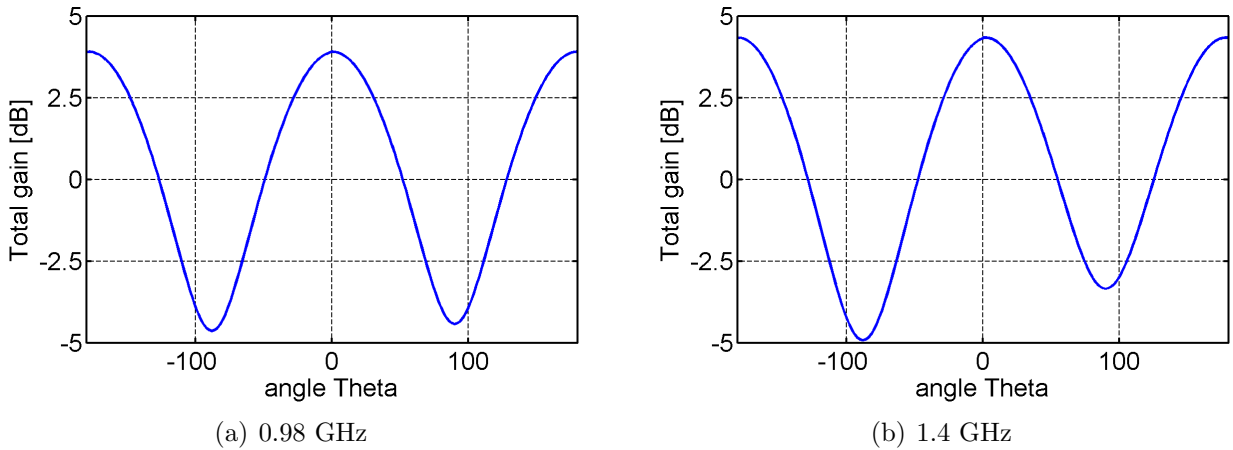

Figure 2.25: Cuts of radiation pattern at $\phi = 0^\circ$ of the asymmetrical Archimedean spiral of Fig. 2.23(a).

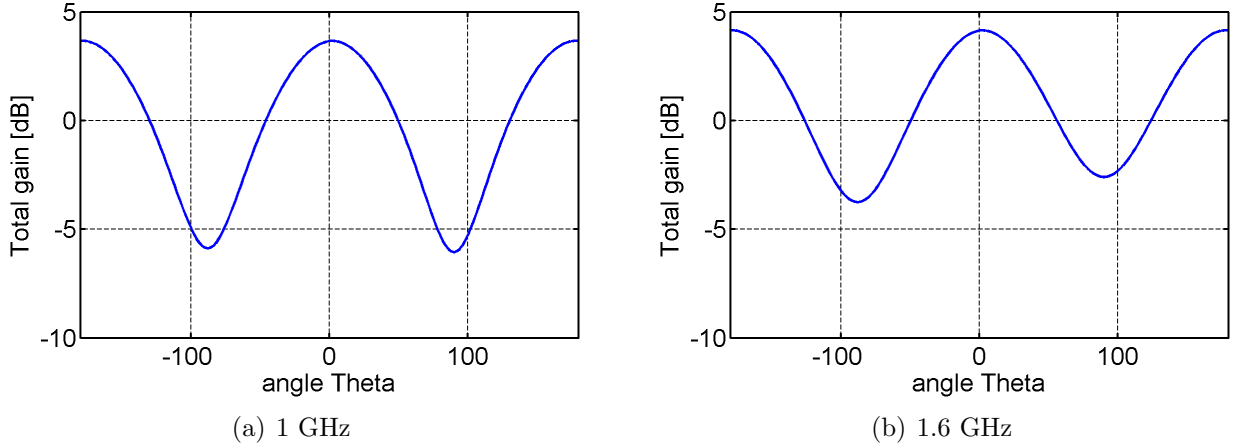

Figure 2.26: Cuts of radiation pattern at $\phi = 0^\circ$ of the asymmetrical hexagonal spiral of Fig. 2.23(b).

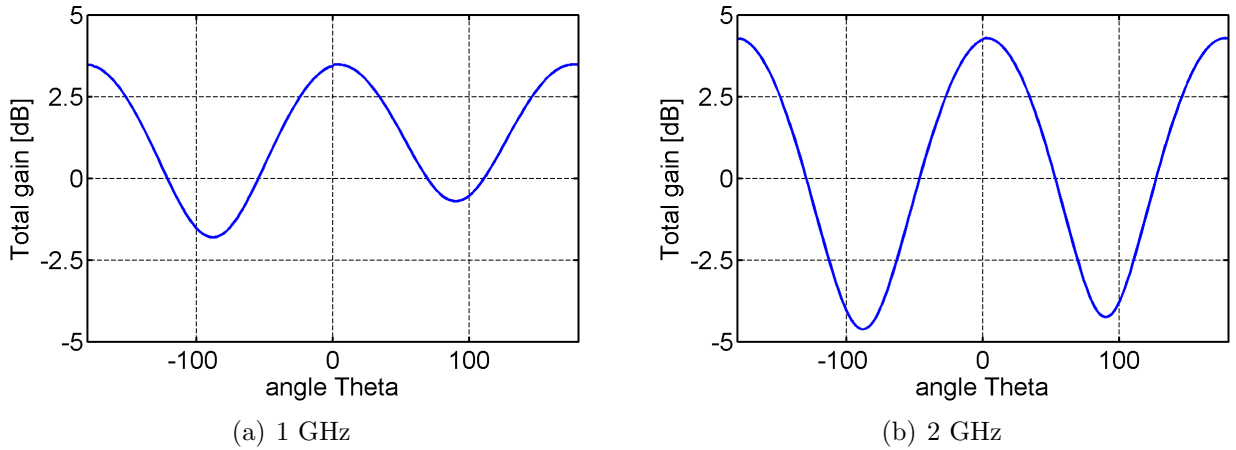

Figure 2.27: Cuts of radiation pattern at $\phi = 0^\circ$ of the asymmetrical square spiral of Fig. 2.23(c).

Antenna	$BW_{S_{11}}$	$BW_{X_{polR}}$
Square	2.05	1.56
Archimedean	1.83	1.51
Hexagonal	1.83	1.42

Table 2.9: Estimated bandwidth limits of linear arrays of asymmetrical spirals of Fig. 2.23 for a scan angle of $\theta = 30^\circ$.

is set by either the reflection coefficient or the rejection of cross-polarization cutoff frequencies. We use, here, the same spacing of the arrays of sections 2.2.1 and 2.2.2 (cf. Tab. 2.1, pg. 36). Using Eq. 1.21 (pg. 23) we analytically estimate the presence of the grating lobes and using the new factor “p” of each spiral (cf. Tab. 2.8) we can estimate the lowest limit of the bandwidth. Tab. 2.9 presents the theoretical bandwidths of the arrays without taking into consideration coupling or resonance effects. $BW_{S_{11}}$ and $BW_{X_{polR}}$ are, respectively, the reflection coefficient

and rejection of cross-polarization bandwidths of the arrays using the cutoff and grating lobes frequencies estimated before.

2.3.2 Simulation of linear arrays of asymmetrical spirals

Circular polarizatton issue

Steyskal's idea of spoiling the symmetry of the spiral was used to overcome the problem of impedance mismatching at the resonance frequencies. Doing so, we obtain a good impedance matching but the circular polarization is not really improved, as can be seen in the results of the linear array of asymmetrical spiral antennas in Fig. 2.16. One way to enhance the circular polarization is to place a spiral antenna next to a 180° rotated element (cf. Fig. 2.28(a)). This technique is known as sequential rotation and it will be revisited later for planar arrays.

Linear arrays of asymmetrical spirals with sequential rotation technique

The gain, XpolR, $|S_{11}|$ and cuts of radiation patterns for these configurations are shown in Fig. 2.28, 2.29, 2.30, 2.31, 2.32 and 2.33. The dimensions of these arrays are the same as those listed in Tab. 2.1 (pg. 36).

- *Linear array of asymmetrical square spirals* (cf. Fig. 2.28). In all the properties (gain, XpolR and S_{11}) there is a problem at low frequencies (0.5 GHz - 0.95 GHz). Roughly, peaks appear at 0.65 GHz, 0.78 GHz, 0.88 GHz and 0.94 GHz. Since the arms lengths of these square spirals are 66.78 cm and 74.26 cm, using Eq. 2.1, we can expect resonances at 0.67 GHz, 0.81 GHz, 0.9 GHz and 1.01 GHz, which would explain the resonances. Since we are not using any load and the gain simulated does not take into account the losses of mismatching, the gain is the same as the directivity. The peaks in the gain near the resonance frequencies are similar to the case of large dipoles, where, near the resonance frequencies, the directivity is increased (cf. section "Finite length dipole" (*Balanis, 2005*)).

Due to the rotation, arms of the same length end up side by side, which creates a strong coupling at low frequencies, hence, reducing and even eliminating, the effectiveness of the use of asymmetrical spirals. For higher frequencies the radiation zone of the spiral gets closer to the center, which reduces the coupling between the spirals. The reflection coefficient of the elements of the array is kept below -10 dB for frequencies higher than 1.02 GHz while for a single spiral it was 0.92 GHz, which means that the S_{11} bandwidth is narrower than the bandwidth of a single spiral. The circular polarization of the array is acceptable for frequencies higher than 1.24 GHz while for a single spiral it was 1.21 GHz. There is a narrow region around 1.11 GHz which presents a good XpolR and another region around 1.5 GHz which does not present an acceptable XpolR.

- *Linear array of asymmetrical Archimedean spirals* (cf. Fig. 2.30). The lengths of the arms of the spiral are 142.765 and 151.52 cm. We can see a peak at 0.73 GHz in the reflection coefficient, which corresponds to the Steyskal's resonance of the smaller arm. Beyond the resonance, the reflection coefficient becomes acceptable, which is the same value for the single asymmetrical Archimedean spiral. There are considerably fewer peaks than in the case of the square spirals. This is due to a lower coupling presented in the Archimedean

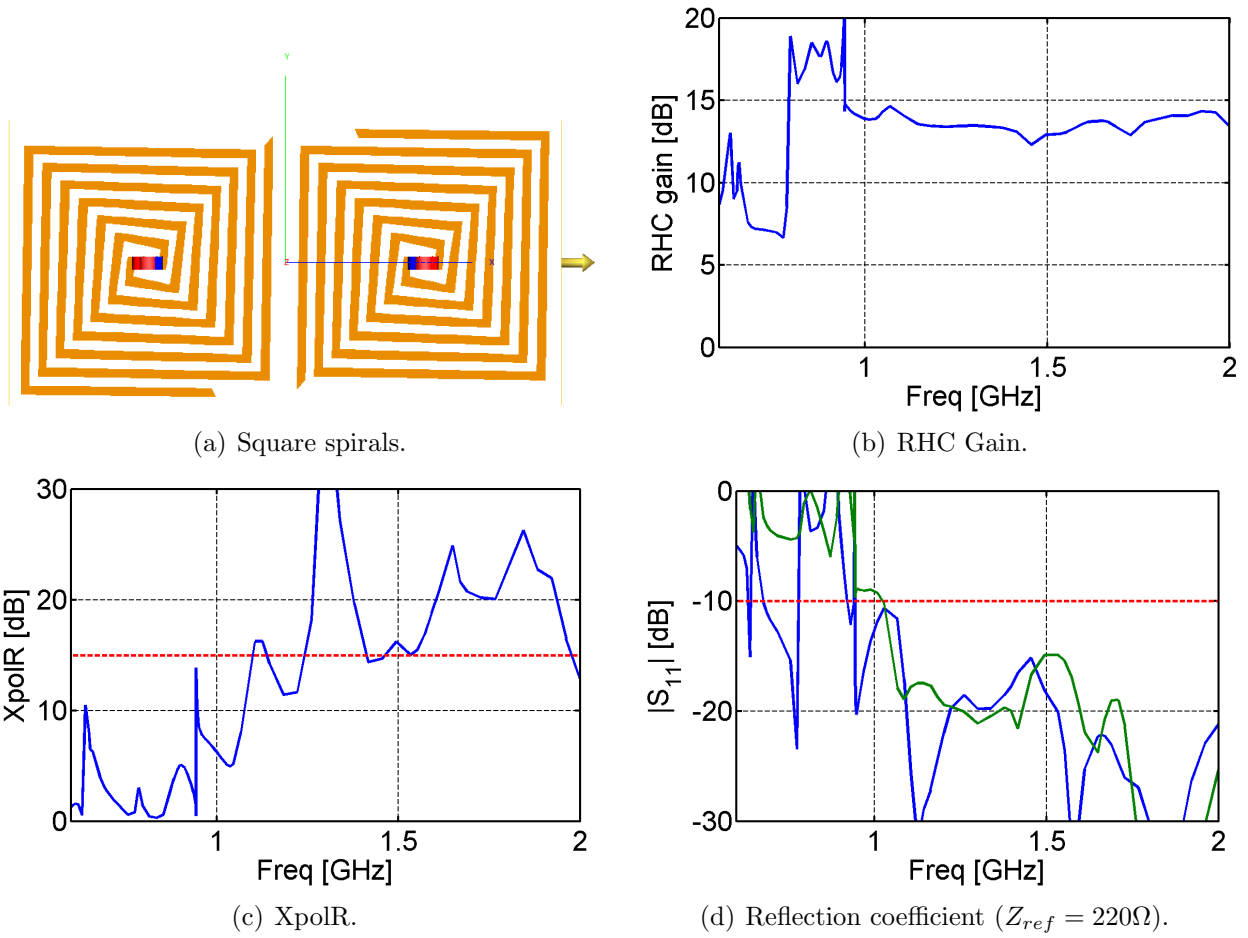

Figure 2.28: Infinite linear array of asymmetrical square spiral antennas. 30° of scan angle. Spacing is 10.6 cm. Grating lobes should appear at 1.887 GHz (cf. Eq. 1.21).

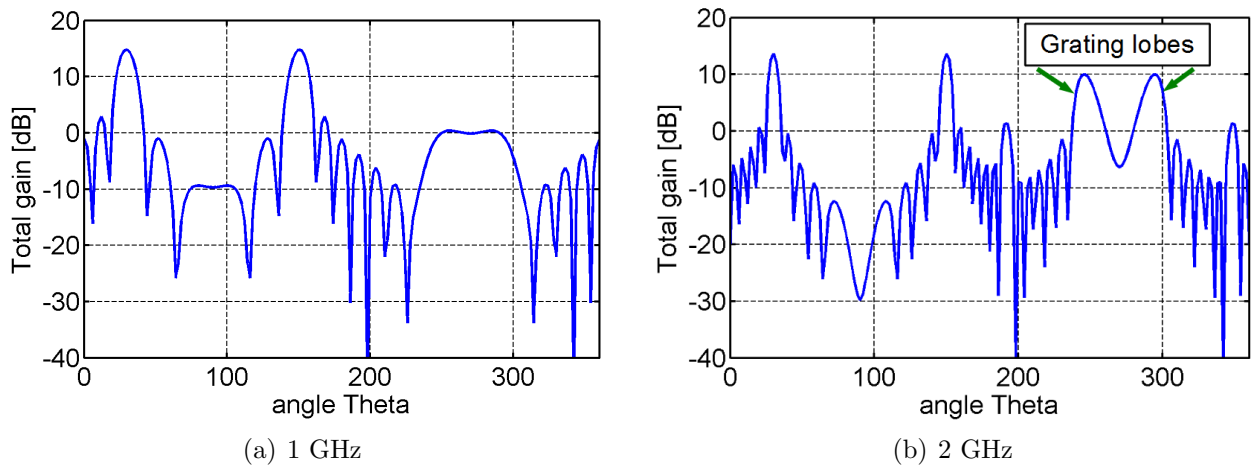

Figure 2.29: Cuts of radiation pattern at $\phi = 0^\circ$ of the infinite linear array of asymmetrical square spirals of Fig. 2.28.

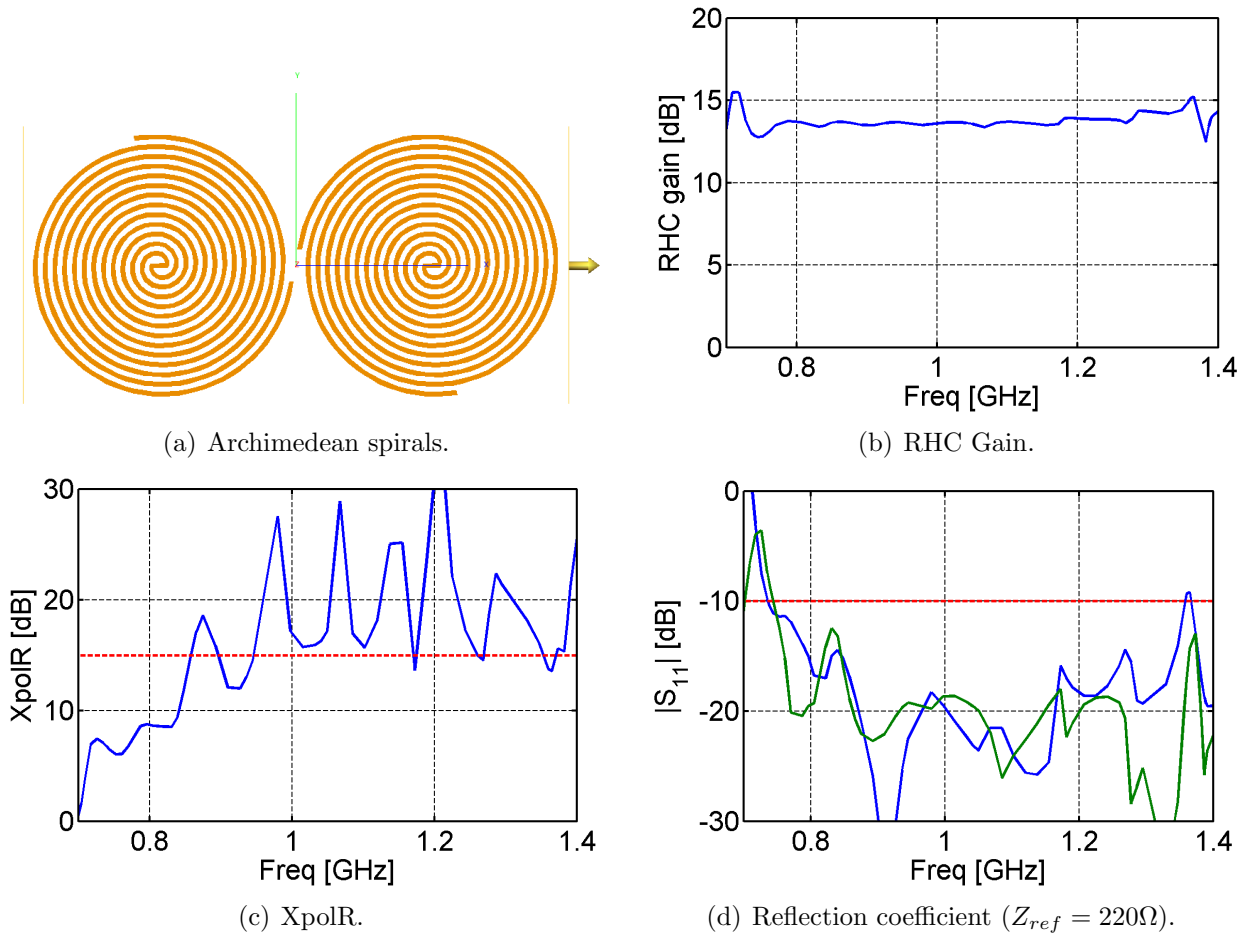

Figure 2.30: Infinite linear array of asymmetrical Archimedean spiral antennas. 30° of scan angle. Spacing is 14.5 cm. Grating lobes should appear at 1.36 GHz (cf. Eq. 1.21).

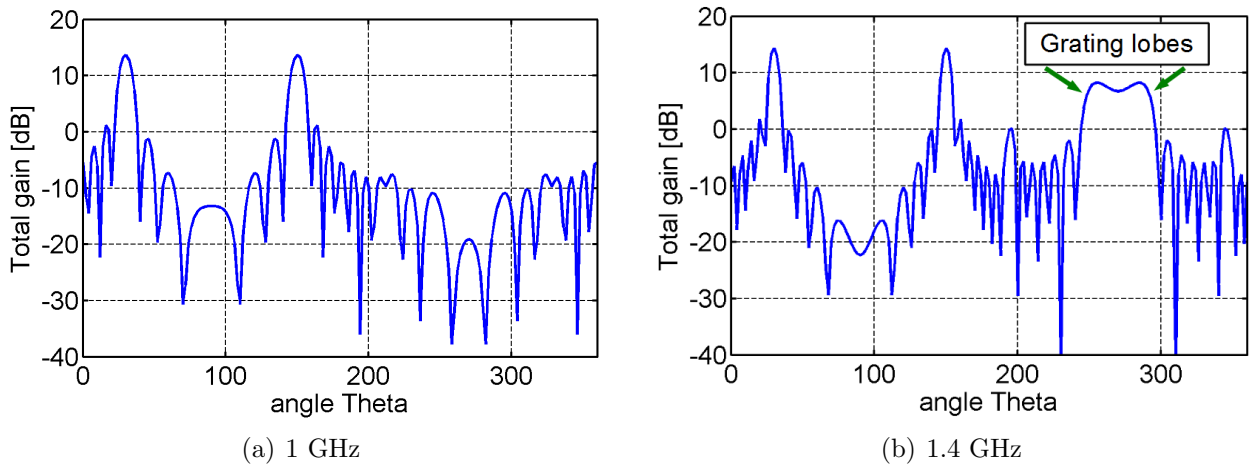

Figure 2.31: Cuts of radiation pattern at $\phi = 0^\circ$ of the infinite linear array of asymmetrical Archimedean spirals of Fig. 2.30.

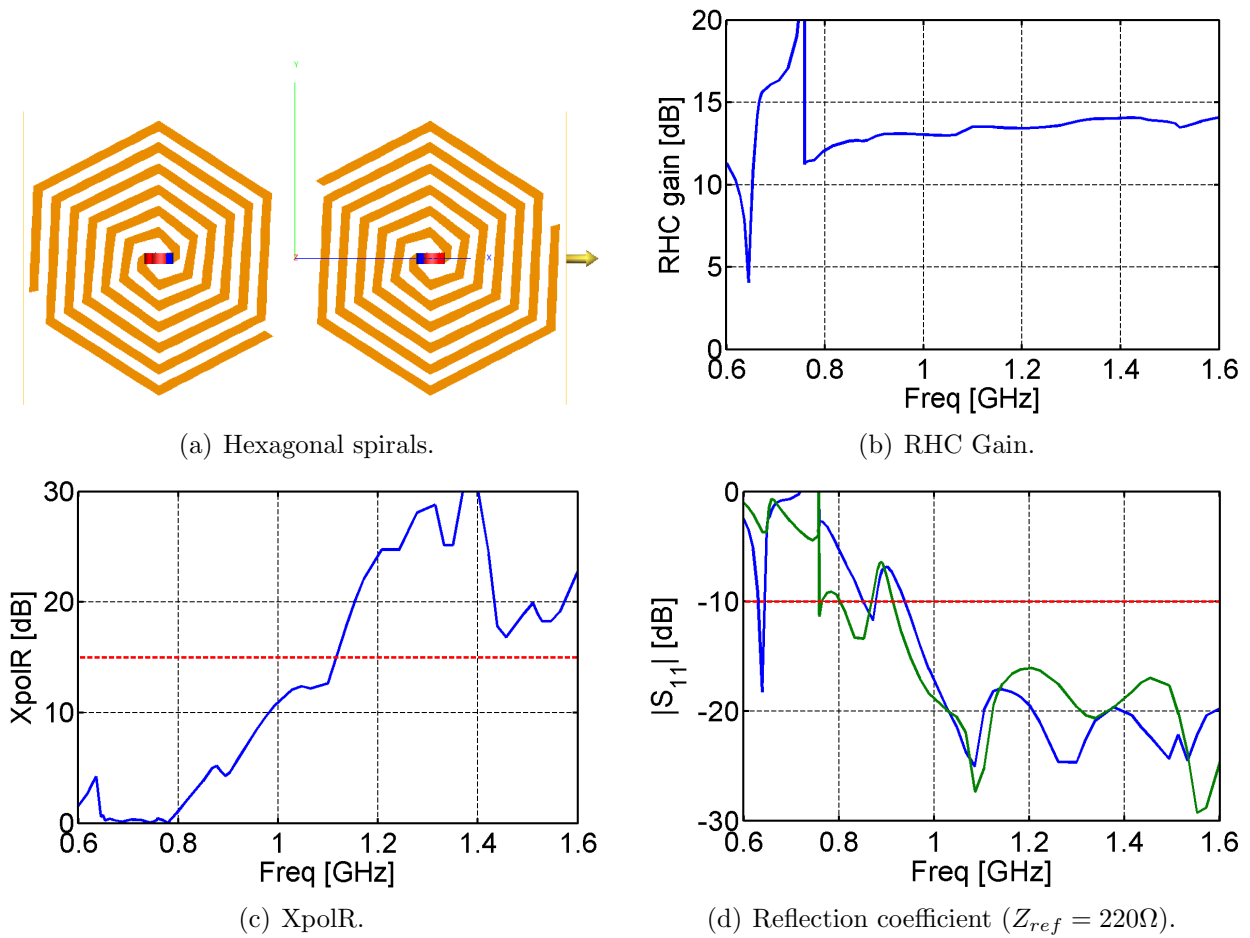

Figure 2.32: Infinite linear array of asymmetrical hexagonal spiral antennas. 30° of scan angle. Spacing is 13.18 cm. Grating lobes should appear at 1.52 GHz (cf. Eq. 1.21).

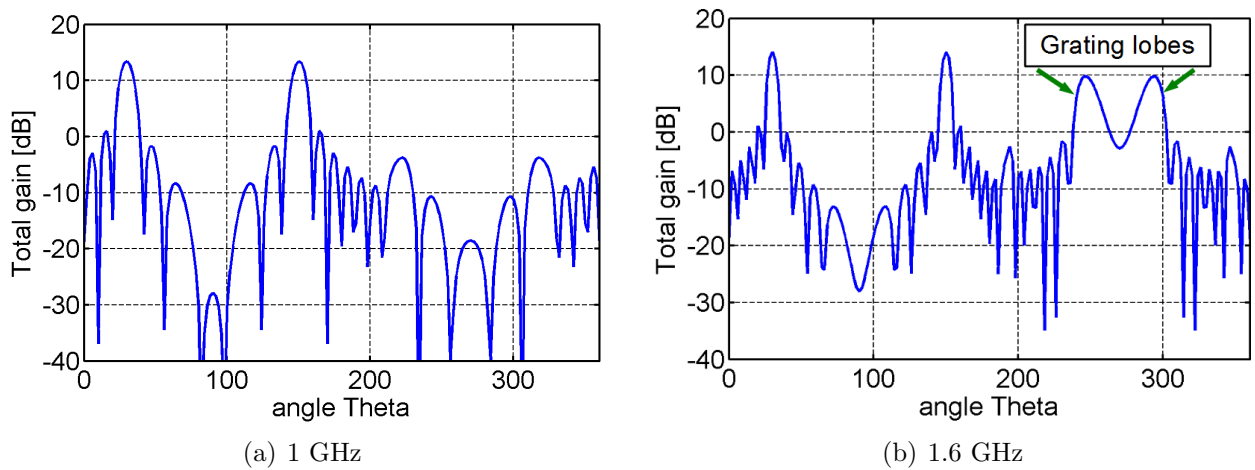

Figure 2.33: Cuts of radiation pattern at $\phi = 0^\circ$ of the infinite linear array of asymmetrical hexagonal spirals of Fig. 2.32.

spirals. The cutoff frequency of the XpolR of the array is 0.95 GHz, roughly the same as for a single asymmetrical spiral (0.9 GHz), although there is a narrow region with acceptable XpolR around 0.88 GHz. The first grating lobe appears at 1.36 GHz.

- *Linear array of asymmetrical hexagonal spirals* (cf. Fig. 2.32). We can see strong peaks in the reflection coefficient between 0.6 GHz and 1 GHz. Since the lengths of the arms are 66.46 cm and 72.03 cm, and using Eq. 2.1, the expected resonances are 0.68 GHz, 0.83 GHz and 0.9 GHz, which are close to those present in the simulations.

As in the case of the square spirals, the sequential rotation technique, in this case, favors the coupling between the arms of same length which induces the resonances at low frequencies. The reflection coefficient of the elements of the array becomes acceptable for frequencies larger than 0.93 GHz, much later than in the case of a single square spiral (0.83 GHz). The cutoff frequency of the XpolR is 1.12 GHz while for a single spiral it is 1.07 GHz. At around 1.5 GHz the rejection of cross-polarization decreases but it is still good. This is due to the presence of the grating lobe, at 1.52 GHz (cf. Eq. 1.21), since the spacing is 13.18 cm and the scan angle is $\theta = 30^\circ$.

Tab. 2.10 summarizes the cutoff frequencies found in the linear arrays of asymmetrical spirals using the sequential rotation technique. $f_{S_{11}}$, f_{XpolR} and f_{GL} are the cutoff frequencies of reflection coefficient, rejection of cross-polarization and grating lobes frequency, respectively. $BW_{S_{11}}$ and BW_{XpolR} are the bandwidths of the arrays using, respectively, the reflection coefficient and rejection of cross-polarization cutoff frequencies and grating lobes frequencies.

Comparing these results, from Tab. 2.10, with the analytical bandwidths presented in Tab. 2.9, we can see that, for the case of S_{11} bandwidths, only the array of asymmetrical Archimedean spirals reach the analytical limit of the bandwidth. On the other hand, the XpolR bandwidths of the arrays reached the analytical limits with a maximum error of 5%. This is so because, although the sequential rotation technique greatly improved the circular polarization, it places arms of the same length side by side which keeps the resonance in the arms at low frequencies which reduces the S_{11} bandwidths at their low end. At higher frequencies the radiation zone is concentrated around the center of the spiral, at this moment the circular polarization of the array is good.

Antenna	$f_{S_{11}}$ (GHz)	f_{XpolR} (GHz)	f_{GL}	$BW_{S_{11}}$	BW_{XpolR}
Square	1.02	1.24	1.887	1.85	1.52
Archimedean	0.74	0.95	1.36	1.84	1.43
Hexagonal	0.93	1.12	1.52	1.63	1.38

Table 2.10: Bandwidth limits found by simulation of linear arrays using asymmetrical spirals and 180° sequential rotation. $\theta = 30^\circ$ of scan angle. Spacings were the same as in Tab. 2.1.

2.4 Dual polarized linear array

So far, we have only considered arrays with one polarization. Since the two-arm spiral is a mono polarization element, the design of dual polarization arrays require two elements of opposite polarization. In this case, there will be two subarrays, one for each polarization. Whenever a specific polarization is needed, we turn “on” the elements of the subarray corresponding to that polarization, and we turn “off” the elements of the other subarray with opposite polarization, terminating them with impedances equal to the input impedance of the spiral. If both subarrays are turned “on” at the same time a linear polarization can be obtained. The straight way to have two subarrays sharing the same aperture would be by uniformly interleaving a right hand polarization spiral (RH) next to a left hand polarization spiral (LH) in a linear array, as shown in Fig. 2.34.

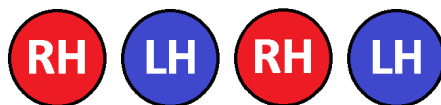

Figure 2.34: Scheme of a uniformly interleaved linear array.

In the uniform interleaving, the spacing between the elements of the same polarization is doubled, compared to a mono polarized array, therefore the frequency at which the grating lobes appear is divided by two for each subarray, greatly reducing the bandwidth. Since all the uniform linear arrays studied in the previous section have less than an octave bandwidth, grating lobes will appear at frequencies lower than their lowest cut-off frequency making the array useless.

In order to overcome this problem, another strategy can be applied to select the position of the elements contributing to the array factor. A nonuniform element spacing eliminates the grating lobes and keeps low the sidelobe level. Guinvarc’h and Haupt proposed the use of Genetic Algorithms to select the position of the elements of each subarray in such a way that both subarrays have the same radiation pattern (*Guinvarc’h and Haupt, 2010*). This array was already presented in section 2.2.5. We present again the optimum distribution which is represented by the sequence: “10100111101101001010101101110000011000110011100111110001001010101101001000011010”. This time, there are two subarrays, corresponding to each polarization, left and right. “1” corresponds to RH spirals and those marked with “0” correspond to LH spirals.

The simulation results of a similar array, but using the spiral of Fig. 2.1(a), are shown in Fig. 2.35. The diameter of the symmetrical spirals is 14 cm, the spacing is 15.65 cm, and the number of turns is 6.28. The sidelobe level relative to the main beam is kept below -10 dB up to 1.27 GHz. The XpolR is good for frequencies larger than 0.96 GHz. The results are very similar with those obtained before in Fig. 2.19, where just one subarray was simulated.

In Fig. 2.35(d) we can observe the reflection coefficient of the spirals 27, 28 and 36. Spiral 36 represents the normal behavior of the spirals in the array. Spirals 27 and 28 are the atypical cases and show three peaks at 0.7 GHz, 0.79 GHz and 0.9 GHz. Since they are among the five consecutive spirals of one kind of polarization, as in the case of the nonuniform array presented in section 2.2.5, they act like a uniform linear array. A priori, these peaks do not correspond to the resonances noticed by Steyskal since, for this spiral, they should be 0.63 GHz, 0.74 GHz, 0.84 GHz and 0.95 GHz (cf. Tab. 2.3). These peaks are just present at low frequencies, showing

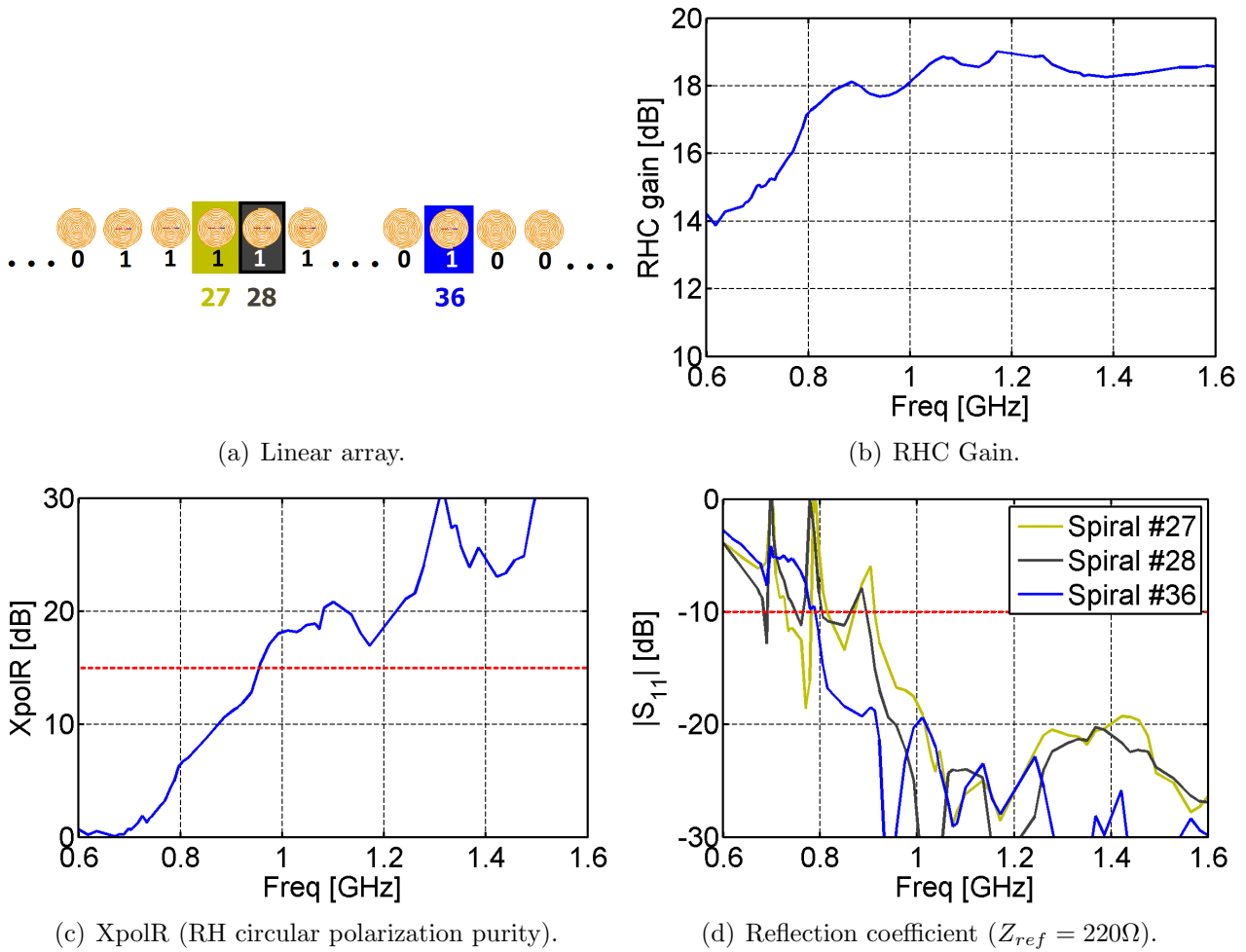

Figure 2.35: Dual-polarized linear array of 80 symmetrical Archimedean spiral antennas (40 antennas per polarization), no uniform interleaving, similar to array of Guinvarc'h and Haupt (*Guinvarc'h and Haupt, 2010*). 30° of scan angle. Spirals marked with green, black and blue correspond to right hand spirals 27, 28 and 36.

that they are due to the strong coupling. This is so since, at higher frequencies, the radiation zone gets closer to the center, hence the current does not reach the outer parts of the arms which lowers the coupling, contrary to what happens at low frequencies. For the rest of the spirals the reflection coefficient becomes acceptable for frequencies higher than 0.81 GHz.

Since just 2 spirals out of 40 for each polarization have problems, we can see that there are no peaks in the XpolR and gain of the array, contrary to the case of uniform linear arrays where the peaks were also present in the XpolR and gain.

2.5 Summary of chapter

We have seen that linear arrays of spiral antennas have some resonances when the array is scanned off-broadside. These resonances are found in any symmetrical spiral (Archimedean, hexagonal, square, etc.) with no loadings, no ground plane and in uniform arrays. The same resonance can appear in a single spiral if there is an incident wave with direction parallel to the plane of the spiral. Breaking the symmetry of the spiral, adding resistive loads or using nonuniform arrays are among the solutions that can be used to avoid this problem. Once solved the problem of the resonances the bandwidth of the array is less than an octave for a scan angle of $\theta = 30^\circ$. A case of a dual polarized linear array was also analyzed. This array does not present the resonances mentioned before (with the exception of 2 spirals out of 40) without loading the arms of the spiral. Adding the loads reduces the mutual coupling, reducing the mismatching of the 2 spirals with problems. Additionally, since the loads at the end of the arms of the spirals reduce the reflected currents (cf. section 1.3.4, pg. 17), adding the loads will increase the bandwidth of the spiral, so will the bandwidth of the array to nearly an octave for a scan angle of $\theta = 30^\circ$ (*Guinvarc'h and Haupt, 2010*).

CHAPTER III

Planar Array of Spiral Antennas

3.1 Introduction

In the previous chapter we have addressed linear arrays of spiral antennas. Using uniform arrays and for the mono polarization case, the bandwidth of the linear arrays of spirals cannot go further than an octave for a maximum scan angle of $\theta = 30^\circ$. Introduction of spirals of opposite polarization, in order to obtain a dual polarized array, reduces the bandwidth of the array. The bandwidth was increased by using nonuniform arrays. So far, only the design trend of wideband arrays, which focuses on using wideband antennas, has been considered.

In this chapter we address the case of planar arrays. Our goal is to obtain a dual polarized array with a large bandwidth, more than 4:1. In the first part of this chapter we will follow, again, the first trend of design. We will analytically estimate and verify the bandwidths of the arrays. Then, we will work with nonuniform arrays, concentric ring arrays, which will help us to enhance the highest bandwidth limit. And finally, we will use the second design trend by connecting the spirals. This will lead us to enhance the lowest limit of the bandwidth of the array. Combining the two trends of design we will achieve a very large bandwidth working with two opposite polarizations. The proposed approach will address each array parameter (S_{11} , XpolR and RSSL) independently.

3.2 Mono polarized planar array of spiral antennas

The goal of this section is to introduce the performance limits of uniform planar arrays. The simplest case is the design of a planar array of spirals of the same polarization in a uniform lattice. An example illustrates the common issues found in this kind of an array. An analytical estimation reveals the bandwidth limits of a uniform array of spiral antennas. The spirals do not have any load or connection.

3.2.1 An example of a mono polarized planar array of spiral antennas

We can see in Fig. 3.1 a planar array of 18 spiral antennas in free space in a equilateral triangular lattice. These antennas have a diameter (D) of 14 cm. The distance between them (d_{ele}) is 14.4 cm. XpolR was calculated, in FEKO, at just 18 frequencies, so the resonances presented in section 2.2.1 were skipped. In the blue area the XpolR is less than 15 dB and this

is due to the mutual coupling between the elements. Grating lobes appear beyond 1.59 GHz, marked by the red area, and this is related to the distance between the elements. XpolR is not good in the green area and this is due to D which determines the lowest cutoff frequency of the bandwidth of the array.

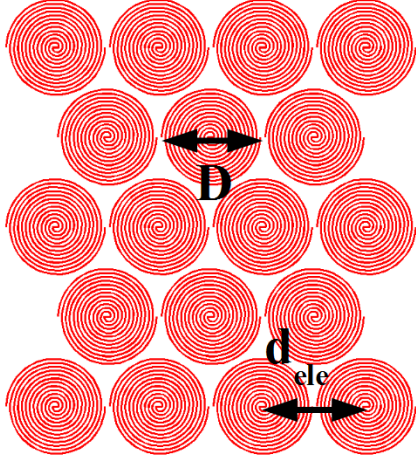

(a) Planar array of 18 spirals.

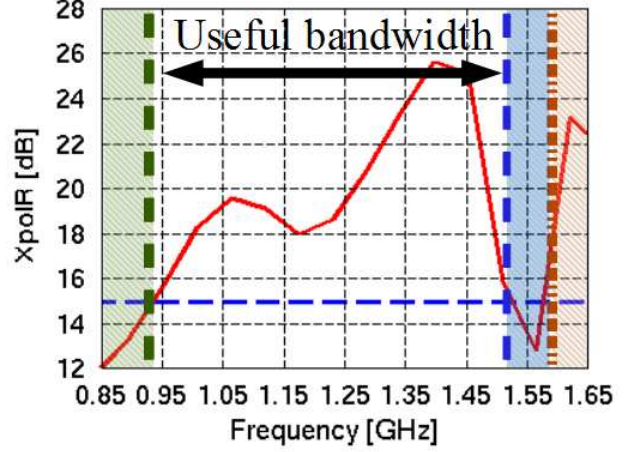

(b) XpolR of planar array for scan angle $\theta = 30^\circ$.

Figure 3.1: Example of a planar array of spiral antennas in a equilateral triangular lattice. Diameter of the spiral (D) is 14 cm. Spacing (d_{ele}) is 14.4 cm. Grating lobes appear after 1.59 GHz (red area). XpolR is not good in green and blue area.

3.2.2 Analytical estimation of bandwidth of planar spiral arrays

Following the reasoning of the first trend of array design, we neglect the mutual coupling. Although an approximation, it will be useful to estimate various parameters, especially for the XpolR bandwidth.

The bandwidths are, then, calculated using the “p” factor of the spirals, for the lowest cutoff frequency (cf. Eq. 1.11, 11) and the grating lobe frequency for the highest cutoff frequency, which depends on the lattice used and the scan angle. Eq. 3.1 explains how the bandwidth is obtained.

$$BW_{S_{11}, XpolR} = \frac{f_{GL}}{f_{S_{11}, XpolR}} \quad (3.1)$$

where $BW_{S_{11}, XpolR}$ stands for the S_{11} or $XpolR$ bandwidth, f_{GL} for grating lobe frequency and $f_{S_{11}, XpolR}$ for the S_{11} or $XpolR$ cutoff frequency.

Eq. 3.2 gives the grating lobe frequencies for scan angles of $\theta = 30^\circ$ (see section 1.4.3.2, pg. 23). We will only consider triangular and square lattices.

$$f_{GL, \blacktriangle} = \frac{c_0 4}{3\sqrt{3}d_{ele}} \quad (3.2a)$$

$$f_{GL, \blacksquare} = \frac{c_0 2}{3d_{ele}} \quad (3.2b)$$

where c_0 is the speed of light in free space, d_{ele} is the spacing and \blacktriangle and \blacksquare stand for the triangular and square lattices, respectively. Though in Fig. 3.1 we have used symmetrical spirals as an introductory example, from now on we will use asymmetrical spirals to avoid the resonances that appear in a uniform array (*Steyskal et al., 2005*), as done in the previous chapter.

Let us consider the asymmetrical spirals of section 2.3 (pg. 55) where the spirals are inscribed in a circle with radius of 7 cm.

Ant.,Latt.	Arch., \blacktriangle	Arch., \blacksquare	Hexag, \blacktriangle	Hexag, \blacksquare	Squa, \blacktriangle	Squa, \blacksquare
d_{elem} (cm)	14.39	14.39	12.85	12.9	11.7	10.96
$p_{S_{11}}$	1.09	1.09	1.22	1.22	1.35	1.35
$p_{X_{polR}}$	1.32	1.32	1.57	1.57	1.77	1.77
$BW_{S_{11}}$	2.17	1.88	2.24	1.87	2.13	2.13
$BW_{X_{polR}}$	1.8	1.55	1.74	1.45	1.63	1.63
$BW_{S_{11}}/BW_{X_{polR}}$	1.21	1.21	1.29	1.29	1.31	1.31

Table 3.1: Analytical estimation of bandwidths of asymmetrical spiral arrays. Scan angle of $\theta = 30^\circ$.

Tab. 3.1 lists the ‘‘p’’ factors of these antennas according to the parameter to characterize; $p_{S_{11}}$ and $p_{X_{polR}}$ for the reflection coefficient and rejection of cross-polarization cutoff frequencies, respectively; they were taken from Tab. 2.8 (pg. 55). \blacktriangle and \blacksquare stand for triangular and square lattices. d_{elem} is the spacing of the arrays. $BW_{S_{11}}$ and $BW_{X_{polR}}$ are the bandwidths of the reflection coefficient and rejection of cross-polarization, respectively, which were calculated according to Eq. 3.1. The last line of the table shows the ratio $BW_{S_{11}}/BW_{X_{polR}}$. It clearly shows that the S_{11} bandwidth is always larger than the X_{polR} bandwidth.

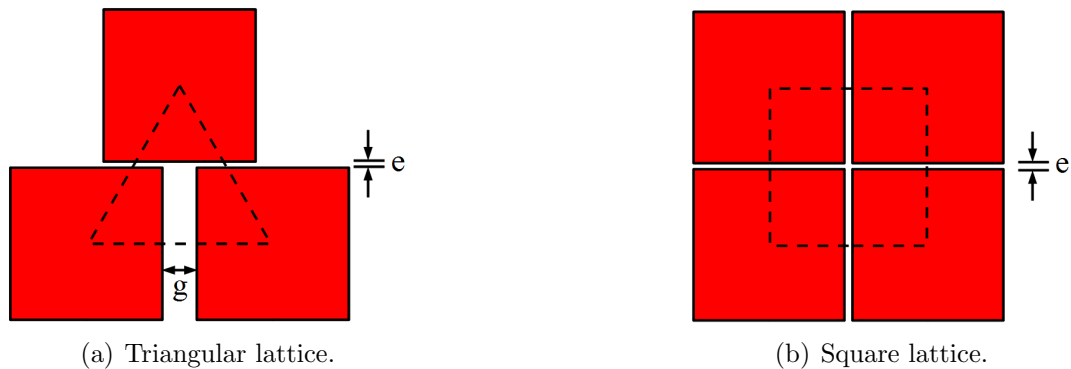

Figure 3.2: Diagram of square spiral in a triangular lattice (left) and in a square lattice (right). e is the minimum space allowed between the spirals. g is the gap, greater than e , that appears when trying to arrange square spirals in a triangular lattice.

For the cases of Archimedean and hexagonal spirals, using a triangular lattice gives larger bandwidths. This was expected as it is known that, for the same spacing, the grating lobes in triangular lattice arrays appear later than in square lattice arrays (*Haupt, 2010*). But for square spirals in a planar array, the bandwidths are similar for both triangular and square lattices. This means that, without taking into account the effects of mutual coupling, there is no advantage

in choosing triangular or square lattice when using square spirals. This is so because of a gap, g , that appears when we try to arrange the square spirals in a triangular lattice (cf. Fig. 3.2). This gap makes the minimum spacing in triangular lattice larger than the minimum spacing in a square lattice, hence, the grating lobes appear earlier in the triangular lattice, which reduces the bandwidth of the array. Since, in a single spiral, the XpolR cutoff frequency is higher than the S_{11} cutoff frequency, the XpolR bandwidth is narrower than the S_{11} bandwidth for all the cases.

3.2.3 Simulations of planar arrays to validate analytical method

In order to verify these assumptions, including the effect of mutual coupling, we carried out the simulations of four cases with FEKO. The array geometries used in the simulations are presented in Tab. 3.2. The arrays were simulated considering the worst case, which is $\theta = 30^\circ$ and different azimuth angles ϕ . In all the cases we only consider the elements that are at the center of the array. The spacings for each array and spiral sizes (diameter of 14 cm) are the same as those used in Tab. 3.1. All of the spirals are in free space, no backing cavity and no substrate. We compare the results of XpolR and S_{11} cutoff frequencies of the array with those obtained for single spirals in Tab. 2.8 (pg. 55), which have the same sizes as those used here.

Ant.,Latt.	Arch.,▲	Arch.,■	Hexag,▲	Squa,■
# total elem.	36	36	36	49
# elem. at center	4	4	4	1
d_{elem}	14.39 cm	14.39 cm	12.85 cm	10.96 cm
Scan $\theta = 30^\circ, \phi = x^\circ$	$90^\circ, 60^\circ, 0^\circ, 120^\circ$	$45^\circ, 90^\circ, 0^\circ$	$90^\circ, 60^\circ, 0^\circ, 120^\circ$	$90^\circ, 45^\circ, 0^\circ$

Table 3.2: Setting for the simulation of the planar arrays with asymmetrical spirals. The main beam is scanned to $\theta = 30^\circ$ for different azimuth scan angles of $\phi = x^\circ$.

Asymmetrical Archimedean spirals in equilateral triangular lattice.

Fig. 3.3 shows the simulation results of the array of Archimedean spirals in free space and equilateral triangular lattice. As showed in Tab. 3.2, the main beam is scanned to $\theta = 30^\circ$ for different azimuth scan angles of $\phi = 90^\circ, 60^\circ, 0^\circ, 120^\circ$. The XpolR lowest cutoff frequency of the array (0.88 GHz) is about the same as that of a single spiral of this size (0.9 GHz). At some frequencies, beyond the cutoff frequency, the XpolR is below 15 dB. In particular, at 1.5 GHz the XpolR reaches 9.5 dB. This frequency is close to the frequency at which the grating lobes appear in this array, 1.6 GHz.

For a single spiral, the S_{11} cutoff frequency is 0.74 GHz, but the reflection coefficients of the spirals of the array present strong mismatches for frequencies below 0.83 GHz. Beyond this frequency, with few exceptions, the S_{11} is good. There is no mismatch at the grating lobe frequency, 1.6 GHz.

The results show that the lowest cutoff frequency of the XpolR is slightly greater than the one of the S_{11} . In comparison with a single spiral, the S_{11} bandwidth is greatly reduced in the array. On the contrary, the XpolR bandwidth is slightly improved.

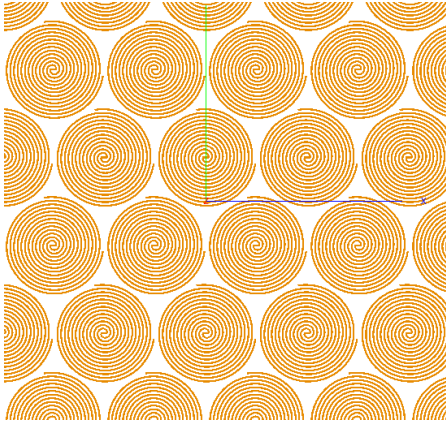

(a) Planar array.

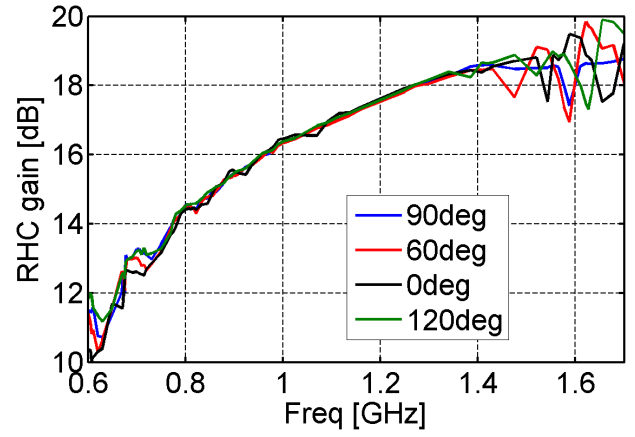

(b) RHC Gain.

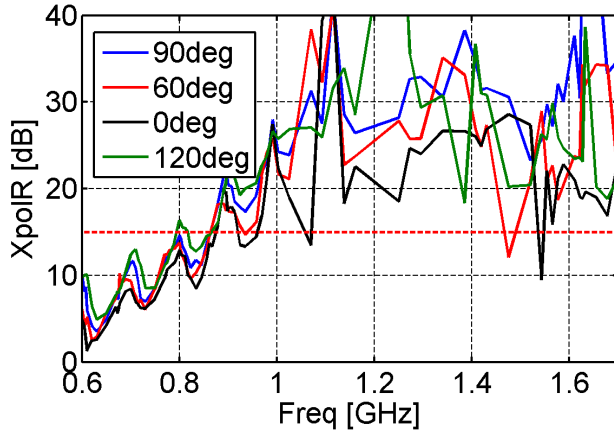

(c) XpolR.

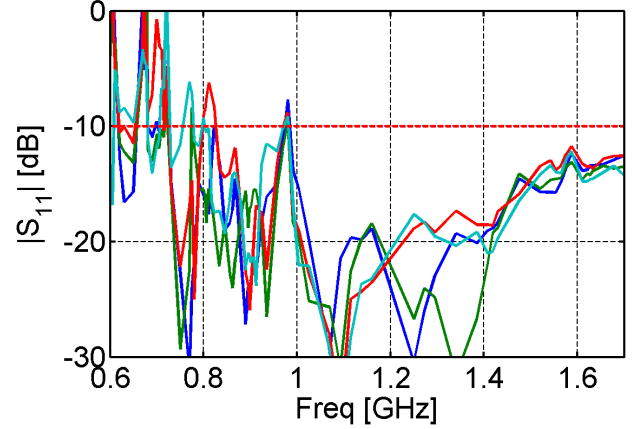

(d) Ref. Coeff. at $\phi = 90^\circ$.

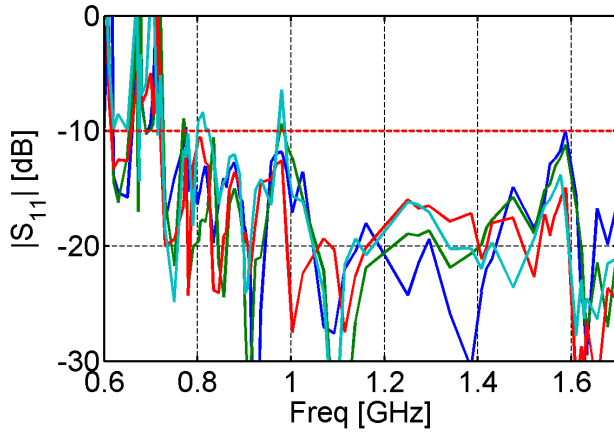

(e) Ref. Coeff. at $\phi = 60^\circ$.

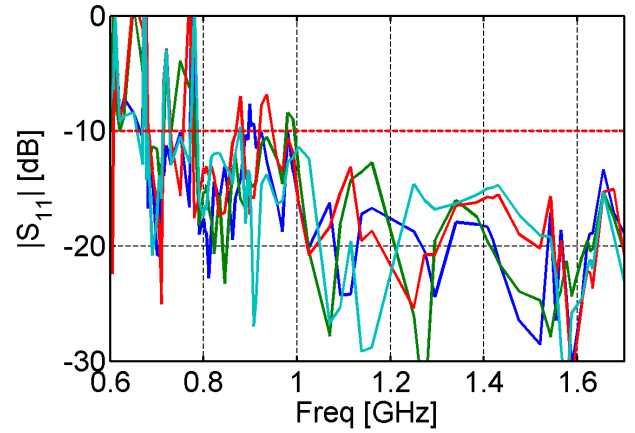

(f) Ref. Coeff. at $\phi = 0^\circ$.

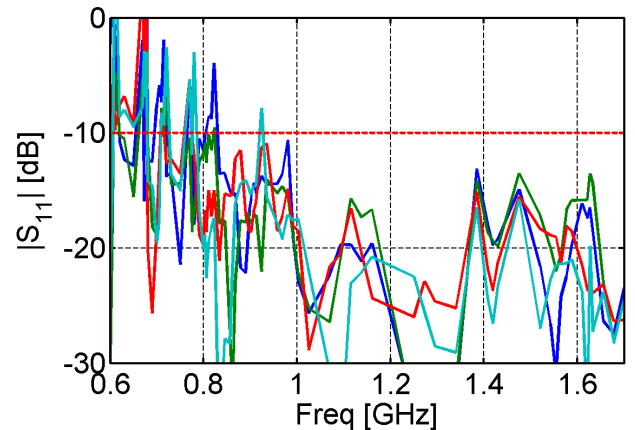

(g) Ref. Coeff. at $\phi = 120^\circ$.

Figure 3.3: Planar array of 36 asymmetrical Archimedean spiral antennas in an equilateral triangular lattice. Scan angle is $\theta = 30^\circ$ and different ϕ angles. $Z_{ref} = 220\Omega$ to calculate the reflection coefficient of center spirals. The earliest grating lobe should appear at 1.6 GHz.

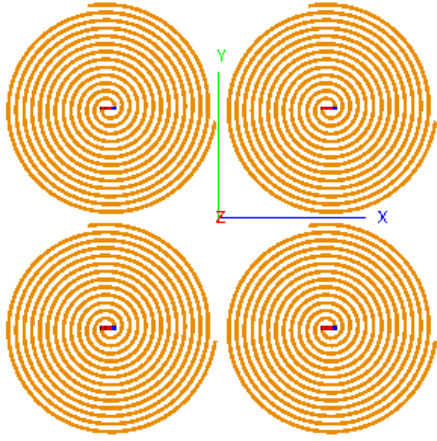

(a) Planar array.

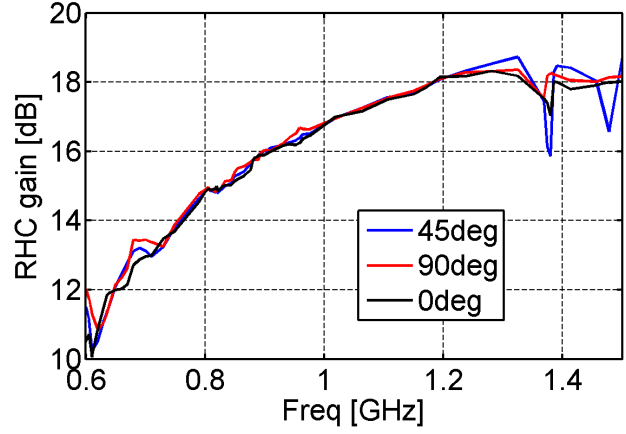

(b) RHC Gain.

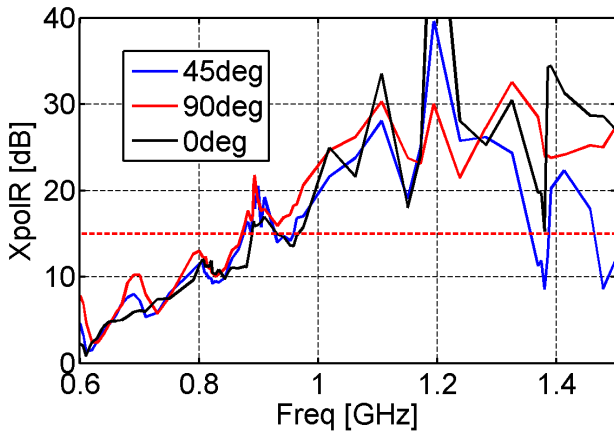

(c) XpolR.

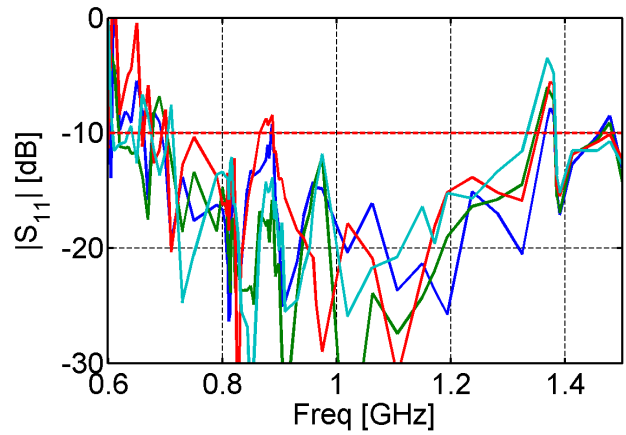

(d) Ref. Coeff. at $\phi = 45^\circ$.

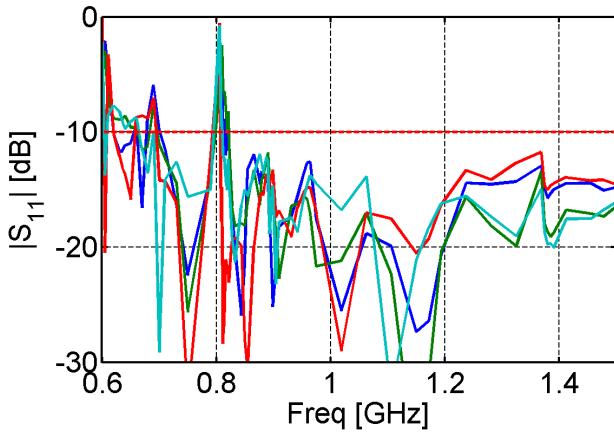

(e) Ref. Coeff. at $\phi = 90^\circ$.

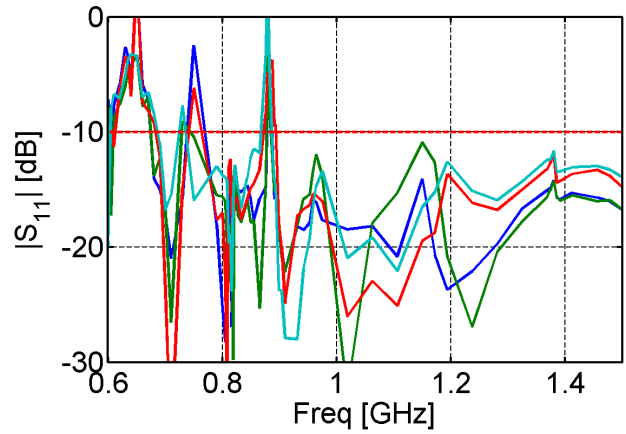

(f) Ref. Coeff. at $\phi = 0^\circ$.

Figure 3.4: Planar array of 36 asymmetrical Archimedean spiral antennas in a square lattice. Scan angle is $\theta = 30^\circ$ and different ϕ angles. $Z_{ref} = 220\Omega$ to calculate reflection coefficient of center spirals. The earliest grating lobe should appear at 1.39 GHz.

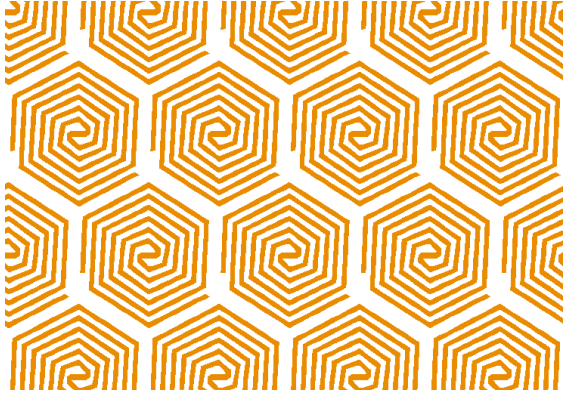

(a) Planar array.

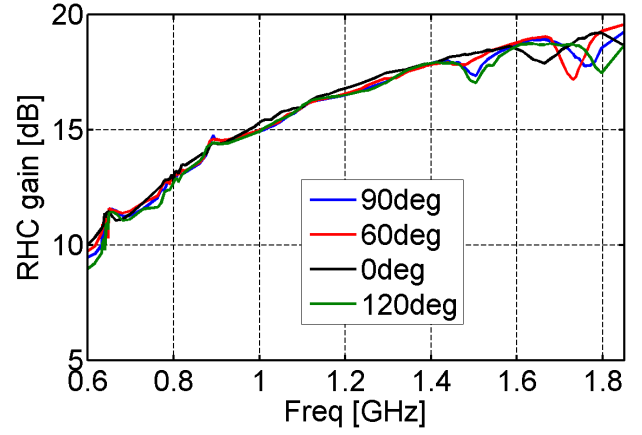

(b) RHC Gain.

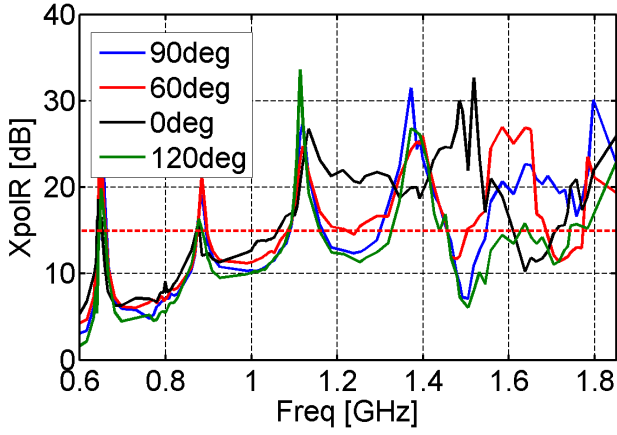

(c) XpolR.

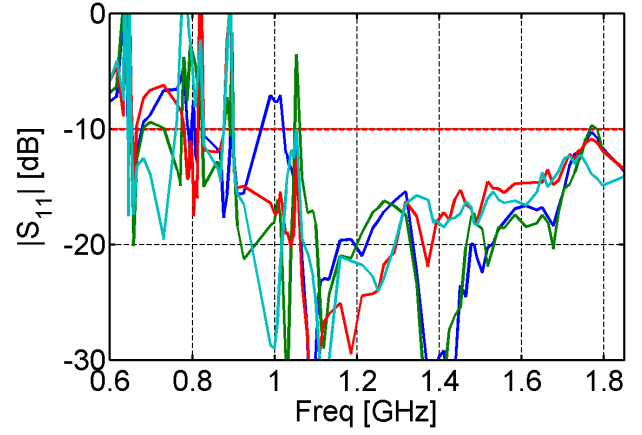

(d) Ref. Coeff. at $\phi = 90^\circ$.

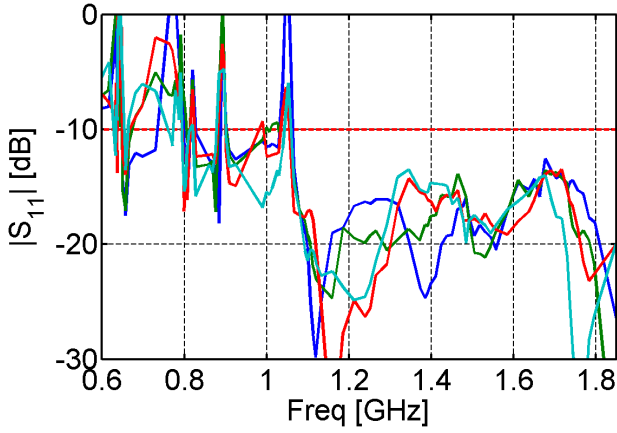

(e) Ref. Coeff. at $\phi = 60^\circ$.

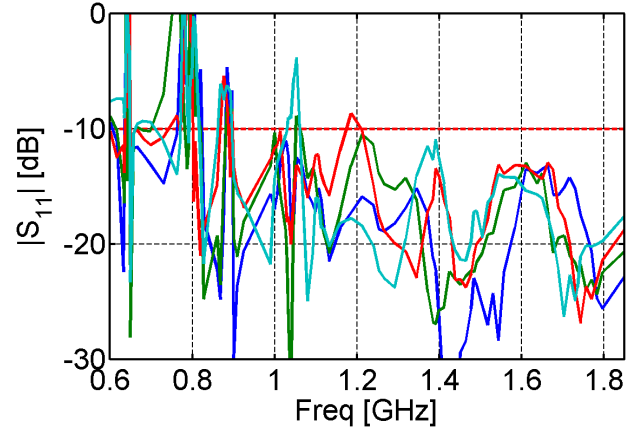

(f) Ref. Coeff. at $\phi = 0^\circ$.

Figure 3.5: Planar array of 36 asymmetrical hexagonal spiral antennas in a equilateral triangular lattice. Scan angle is $\theta = 30^\circ$ and different ϕ angles. $Z_{ref} = 220\Omega$ to calculate reflection coefficient of center spirals. The earliest grating lobe should appear at 1.8 GHz.

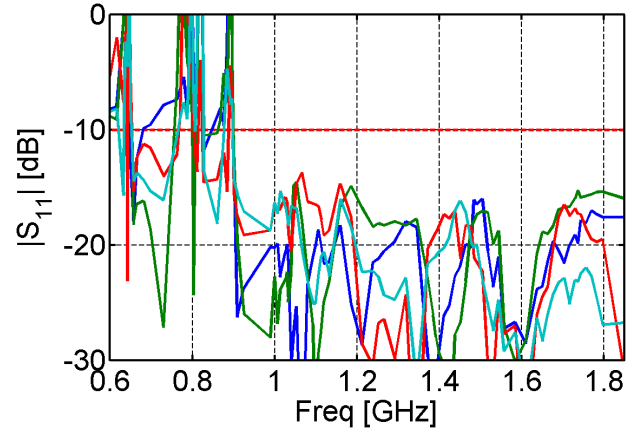

(g) Ref. Coeff. at $\phi = 120^\circ$.

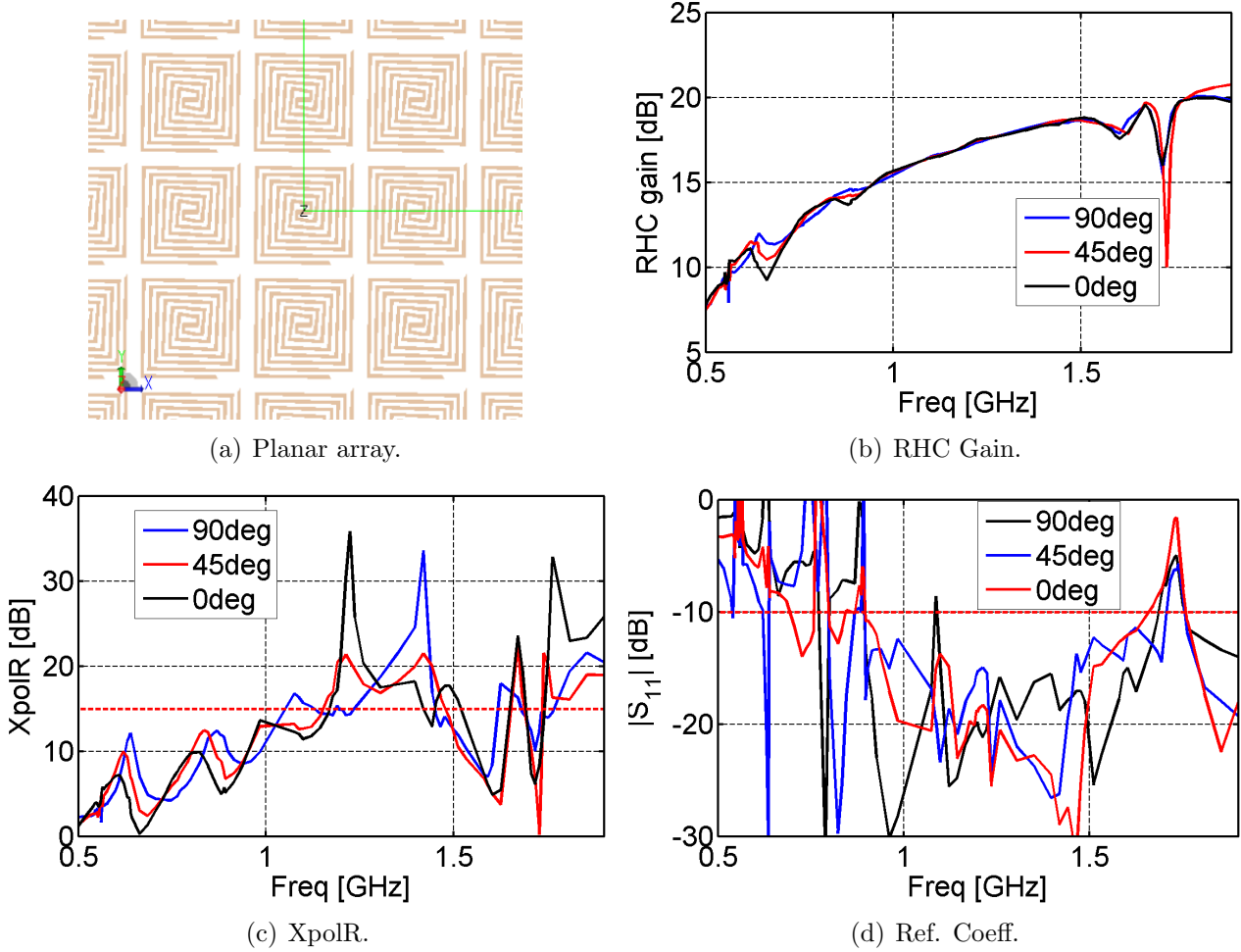

Figure 3.6: Planar array of 49 asymmetrical square spiral antennas in a square lattice. Scan angle is $\theta = 30^\circ$ and different ϕ angles. $Z_{ref} = 220\Omega$ to calculate reflection coefficient of center spirals. The earliest grating lobe should appear at 1.83 GHz.

Asymmetrical Archimedean spirals in a square lattice.

We can see in Fig. 3.4 the simulation results of the Archimedean spirals array. Again, the lowest cutoff frequency of the XpolR is 0.89 GHz which is similar, to a single spiral. At around 1.37 GHz the XpolR is just 8.6 dB. This frequency is very close to the frequency at which the rise of the grating lobes is expected, 1.39 GHz. The mismatching, -3.5 dB, around 1.37 GHz can be explained by the grating lobes presence at 1.39 GHz. This time, the reflection coefficients of the spirals present few, but strong mismatches at low frequencies up to 0.89 GHz, while in the triangular lattice case the peaks ceased at 0.83 GHz. This is so, because in a square lattice each element sees 4 other elements while in a triangular lattice each element sees 6 other elements which makes a more uniform coupling distribution, especially effective at low frequencies, since the radiation zone is closer to the edge of the spirals.

As in the last case, once the array enters the zone of good XpolR, the reflection coefficient no longer presents a strong mismatch.

Asymmetrical hexagonal spirals in a equilateral triangular lattice.

Fig. 3.5 shows the simulation results of an array of asymmetrical hexagonal spirals in a equilateral triangular lattice. In this array the XpolR is less stable than in the two previous cases. Following the tendency of the XpolR, the XpolR cutoff frequency of the array can be considered to be at 1.09 GHz which is very similar to the case of a single spiral (1.07 GHz). In general, the circular polarization of this array is poor, especially above 1.45 GHz.

In order to increase the XpolR of this array at 1.45 GHz, we tried to change the d_{elem} and the number of turns of the spirals with no success. The unacceptable XpolR remains, at the middle of the bandwidth. At the same frequency there is a drop in the gain of the array, revealing an insipient scan blindness phenomenon. A similar problem is observed in the next case. At low frequencies, the reflection coefficients of the spirals present strong mismatches up to 1.05 GHz, afterwards, in general, the reflection coefficient is good. The S_{11} bandwidth is greatly reduced in comparison to a single hexagonal spiral.

Asymmetrical square spirals in rectangular lattice.

Fig. 3.6 shows the simulation results of an array of asymmetrical square spirals. This array is similar to the array presented by Steyskal in (Steyskal *et al.*, 2005), but without ground plane and the square spiral is inscribed in a circle with radius of 7 cm.

As in the previous cases, the XpolR cutoff frequency (1.17 GHz) is close to the cutoff frequency of a single asymmetrical square spiral (1.21 GHz). But at around 1.62 GHz and 1.73 GHz the XpolR is poor. At 1.73 GHz, the $|S_{11}|$ of the central spiral presents a mismatching. A similar problem was pointed out by Steyskal in (Steyskal *et al.*, 2005) naming it a scan blindness phenomenon.

We can consider the S_{11} cutoff frequency of the array at 0.9 GHz, since the $|S_{11}|$ presents strong mismatches below that frequency. Hence, the cutoff frequency of the array is about the same as in the case of a single square spiral (0.92 GHz).

Discussion about the results of the simulations of the planar arrays

Tab. 3.3 summarizes the cutoff frequencies found in the simulations. In general, we can see that the XpolR lowest cutoff frequency of the array is not so different from the one of a single element (cf. Tab. 2.8, pg. 55); although, for the hexagonal and square spiral arrays, the XpolR shows problems beyond this frequency.

Ant. shape, Latt.	Archi.,▲	Archi.,■	Hexag,▲	Squa,■
d_{elem} (cm)	14.39	14.39	12.85	10.96
f_{GL} (GHz)	1.6	1.39	1.8	1.83
$f_{S_{11}}$ (GHz)	0.83	0.88	1.05	0.9
f_{XpolR} (GHz)	0.88	0.89	1.09	1.17

Table 3.3: Parameters and cutoff frequencies found by simulation of asymmetrical spirals array (cf. Fig. 3.3, 3.4, 3.5 and 3.6). Scan angle of $\theta = 30^\circ$.

If we consider the highest cutoff frequency of the bandwidth of the array as being the rising of the grating lobes (as in the case of the analytical estimation), we obtain the bandwidths presented in Tab. 3.4. We can see that, for the case of the S_{11} bandwidths, the analytical bandwidths (cf.

Tab. 3.1) are an over-estimate. Indeed in the analytical estimation, coupling effects were not considered, which reduce the bandwidths.

Ant. shape, Latt.	Archi.,▲	Archi.,■	Hexag,▲	Squa,■
$BW_{S_{11}}$	1.93	1.58	1.71	2.03
$BW_{X_{\text{polR}}}$	1.82	1.56	1.65	1.56

Table 3.4: Summary of bandwidths of arrays found by simulation for asymmetrical spirals array and scan angle of $\theta = 30^\circ$ (cf. Fig. 3.3, 3.4, 3.5 and 3.6).

On the other hand, the XpolR bandwidth of the Archimedean arrays (triangular and square lattices) have been well estimated, and for the cases of the hexagonal and square spirals the errors are around 5%.

Contrary to the case of linear arrays, the circular polarization of the Archimedean spiral arrays is kept inside the range of accepted values ($X_{\text{polR}} > 15$ dB). The results have also shown that once the arrays achieve a good XpolR the peaks observed in the $|S_{11}|$ vanishes. This is the most interesting case, where the array presents good, XpolR and S_{11} at the same time.

This analytical estimation shows that, analyzing a single spiral antenna, we can estimate the maximum bandwidths that can be obtained using this spiral in different lattices. Mutual coupling, in these cases, have offered only problems, reducing the bandwidths, especially in the case of impedance matching.

The results give us confidence to analyze more complex situations like using spirals of different sizes, more complex lattices, etc. The analytical estimation can be used to estimate the maximum bandwidth of these cases and select the one that fits our needs better before starting the simulations, which is time consuming.

3.2.4 WAVES technique in uniform planar arrays

Tab. 3.4 has shown that the XpolR bandwidth of uniform planar arrays for a scan angle $\theta = 30^\circ$ is less than an octave. The XpolR bandwidth is narrower than the S_{11} bandwidth. So far we have been using spirals with the same size. Since the lowest cutoff frequency is related to the size of the spiral, we can use different spirals for different bandwidths. This idea was proposed by Shively and Stutzman (*Shively and Stutzman*, 1990) and studied by Caswell (*Caswell*, 2001). In this technique, it was proposed to use spirals of different sizes and apply different amplitude weights to the spirals in order to obtain a very large bandwidth array with low side lobe levels. We recall that in this work we have been using uniform weight feeding, providing the worst case.

Using the analytical estimation method presented in the last section we can infer the maximum bandwidths that can be achieved for spirals of different sizes and applying a uniform weight feeding to the antennas. Fig. 3.7 presents the scheme of an array that uses Archimedean spirals of different radii in a equilateral triangular lattice, r and R for small and large spirals, respectively. D is the spacing between large spirals and d is the spacing between large and small spirals.

Fig. 3.8 also shows that there is a minimum gap, e , between large and small spirals. This is set to be a $1/25$ of the radius R of the large spiral, to avoid overlapping.

At low frequencies, the large spirals (due to its size) are turned “on” and the small spirals are turned “off”. In this case we are within the bandwidth BW_1 and the grating lobe frequency

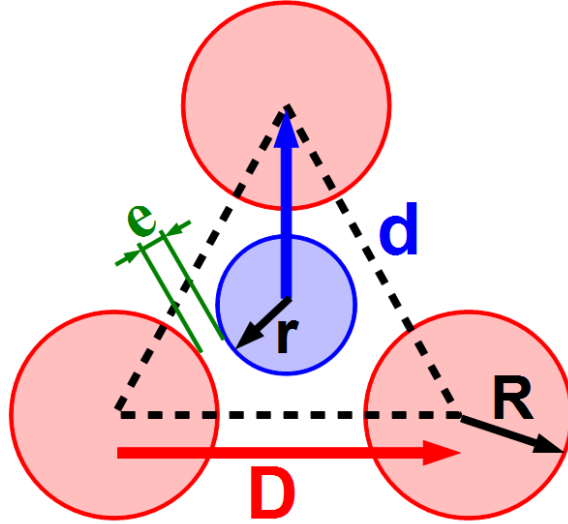

Figure 3.7: Scheme of a two element sizes spiral array. r is the radius of small spiral, R is the radius of large spiral. D is the spacing between large spirals and d is the spacing between large and small spirals.

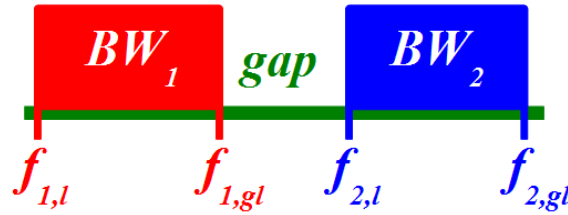

Figure 3.8: BW_1 is the bandwidth when only the large spirals are used (low frequencies). BW_2 is the bandwidth when large and small spirals are used at the same time (high frequencies). $f_{1,l}$ and $f_{2,l}$ are the lowest cutoff frequencies of the bandwidths BW_1 and BW_2 , respectively. $f_{1,gl}$ and $f_{2,gl}$ are the highest cutoff frequencies (grating lobe frequencies) of the bandwidths BW_1 and BW_2 , respectively.

is related to the spacing between large spirals. At high frequencies we turn “on” the large and small spirals at the same time, in this case we are in the bandwidth BW_2 and the grating lobe frequency is related to the spacing between small and large spirals. Since the spacing in the latter is shorter than in the former the grating lobes in the latter appear at frequencies higher than in the former.

Fig. 3.8 presents an example of these two bandwidths. The lowest cutoff frequencies of the bandwidths BW_1 and BW_2 are $f_{1,l}$ and $f_{2,l}$, respectively. These frequencies are the cutoff frequencies of the properties of the elements (S_{11} and X_{polR}). The highest cutoff frequencies of the bandwidths BW_1 and BW_2 are $f_{1,gl}$ and $f_{2,gl}$, respectively, and they are the grating lobe frequencies of each bandwidth.

Usually, there is a gap between the bandwidths, as shown in Fig. 3.8, and it can be eliminated to make a larger bandwidth (we will call it *total bandwidth*) by optimizing the sizes of the spirals and spacings.

Analytical optimization for the Archimedean spiral antennas in a equilateral triangular lattice planar array

We will maximize the total bandwidth of the array of Archimedean spiral antennas with two sizes in a equilateral triangular lattice sketched in Fig. 3.7. We will use a generic “ p ” factor to calculate the S_{11} and XpolR cutoff frequencies of the small and large spirals. Lately, it will be replaced by its corresponding value ($p_{S_{11}}$ or p_{XpolR}) to found the *total S_{11} and XpolR bandwidths*.

Eq. 3.3 gives the cutoff frequencies $f_{1,l}$ and $f_{2,l}$ of the bandwidths BW_1 and BW_2 , respectively.

$$f_{1,l} = p \frac{c_0}{2\pi r} \quad (3.3a)$$

$$f_{2,l} = p \frac{c_0}{2\pi R} \quad (3.3b)$$

where c_0 is the speed of the light in free space, r and R are the radii of the small and large spirals, respectively.

The grating lobe frequencies, $f_{1,gl}$ and $f_{2,gl}$, of the bandwidths BW_1 and BW_2 , respectively, are given in Eq. 3.4 (cf. Eq. 3.2). We recall that, for this configuration $d=D/\sqrt{3}$

$$f_{1,gl} = \frac{c_0^4}{3\sqrt{3}D} \quad (3.4a)$$

$$f_{2,gl} = \frac{c_0^4}{3D} \quad (3.4b)$$

To avoid the gap between the bandwidths (cf. Fig. 3.8), Eq. 3.5 presents the no-bandwidth-gap condition.

$$f_{2,l} - f_{1,gl} \leq 0 \quad (3.5)$$

In particular, for this configuration, the no-bandwidth-gap condition is expressed by:

$$p \frac{c_0}{2\pi r} - \frac{c_0^4}{3\sqrt{3}D} \leq 0 \quad (3.6a)$$

$$p \frac{3\sqrt{3}D}{8\pi} \leq r \quad (3.6b)$$

Best packing increases the grating lobe frequency. Hence, for a minimum gap, $e = R/25$, between the spirals, the condition to be respected is in Eq. 3.7. The measurements are taken along the line that connects the centers of the small spiral with the large spiral.

$$\frac{D}{\sqrt{3}} = R + r + e \quad (3.7a)$$

$$D = \sqrt{3} \left(\frac{26}{25} R + r \right) \quad (3.7b)$$

Hence, using Eq. 3.4, the *total bandwidth* (BW_T) of this configuration is expressed by:

$$BW_T = \frac{f_{2,gl}}{f_{1,l}} \quad (3.8a)$$

$$BW_T = \frac{8\pi R}{3Dp} \quad (3.8b)$$

Combining Eq. 3.7 with 3.8, the *total bandwidth* for the array in a equilateral triangular lattice using two sizes of Archimedean spirals has its final form expressed by:

$$BW_T = \frac{8\pi R}{p3\sqrt{3}(\frac{26}{25}R + r)} \quad (3.9)$$

From the best packing condition (Eq. 3.7) and the no-bandwidth-gap condition (Eq. 3.6), we obtain the relation between the radii of the large and small spirals for a maximum *total bandwidth*:

$$\frac{p\frac{9}{8\pi}(\frac{26}{25})}{1 - p\frac{9}{8\pi}}R \leq r \quad (3.10)$$

Analytical optimization for the Archimedean spiral antennas in a square lattice planar array

Fig. 3.9 shows the case of a uniform planar array of two sizes Archimedean spiral antennas in a square lattice. For this configuration $d = D/\sqrt{2}$.

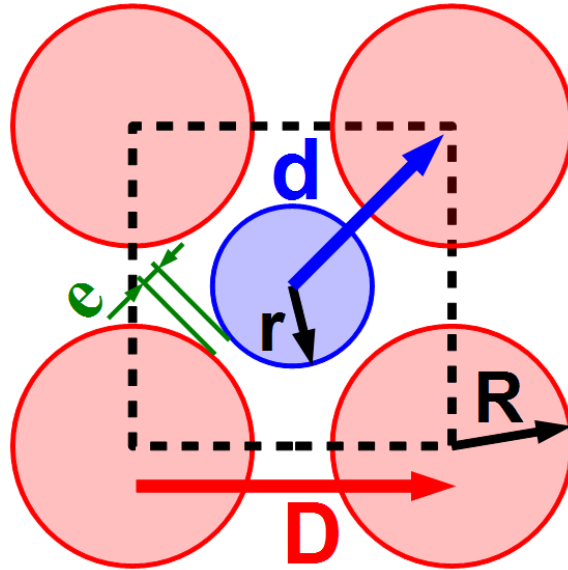

Figure 3.9: An array with two sizes Archimedean spirals in a square lattice. r is the radius of small spiral, R is the radius of large spiral. D is the spacing between large spirals and d is the spacing between large and small spirals.

This time, the grating lobes of the bandwidths for a square lattice are given in Eq. 3.11. The

lowest cutoff frequencies remain the same as in Eq. 3.3.

$$f_{1,gl} = \frac{c_0 2}{3D} \quad (3.11a)$$

$$f_{2,gl} = \frac{c_0 2\sqrt{2}}{3D} \quad (3.11b)$$

The best packing condition, for a minimum gap ($e = R/25$) between the spirals, is, then, given in Eq. 3.12. It is taken along the line that connects the centers of the small spiral with the large spiral.

$$\frac{D}{\sqrt{2}} = R + r + e \quad (3.12a)$$

$$D = \sqrt{2}\left(\frac{26}{25}R + r\right) \quad (3.12b)$$

From Eq. 3.5 we obtain the no-bandwidth-gap condition for this case, and it is given by:

$$p\frac{c_0}{2\pi r} - \frac{c_0 2}{3D} \leq 0 \quad (3.13a)$$

$$p\frac{3D}{4\pi} \leq r \quad (3.13b)$$

The *total bandwidth* for this array is expressed by:

$$\text{BW}_T = \frac{f_{2,gl}}{f_{1,l}} \quad (3.14a)$$

$$\text{BW}_T = \frac{4\sqrt{2}\pi R}{3Dp} \quad (3.14b)$$

From the best packing condition, Eq. 3.12, and no-bandwidth-gap condition, Eq. 3.13, for this array we obtain the ratio of the radii that maximizes the *total bandwidth*:

$$\frac{p\frac{3\sqrt{2}}{4\pi}\left(\frac{26}{25}\right)R}{1 - p\frac{3\sqrt{2}}{4\pi}} \leq r \quad (3.15)$$

Using Eq. 3.12 in 3.14, the maximum *total bandwidth* for this array is expressed by:

$$\text{BW}_T = \frac{4\pi R}{p3\left(\frac{26}{25}R + r\right)} \quad (3.16)$$

Analytical optimization for the hexagonal spiral antennas in a equilateral triangular lattice planar array

Fig. 3.10 shows the case of a uniform planar array of two sizes hexagonal spiral antennas in a equilateral triangular lattice. For this configuration we have again $d = D/\sqrt{3}$.

In this array the equation for the grating lobes are the same as in the case of the Archimedean spirals in triangular lattice (cf. Eq. 3.4), since, the grating lobes only depend on the lattice of

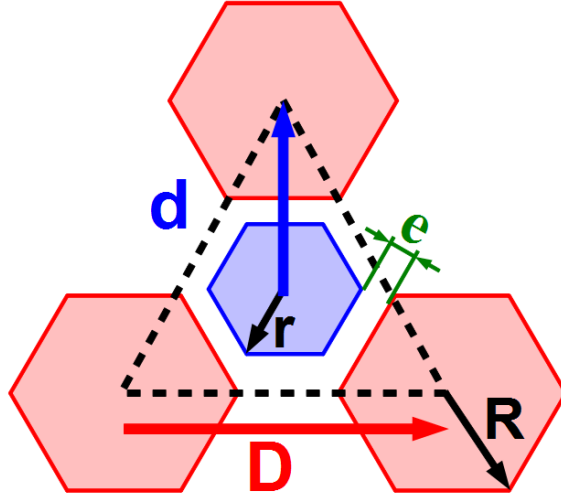

Figure 3.10: An array using hexagonal spirals of two sizes in an equilateral triangular lattice. r is the radius of small spiral, R is the radius of large spiral. D is the spacing between large spirals and d is the spacing between large and small spirals.

the array. The no-bandwidth-gap condition is again the same (cf. Eq. 3.6).

The best packing condition of this array, for $e = R/25$, is given by:

$$D = \frac{3}{2} \left(\frac{26}{25} R + r \right) \quad (3.17)$$

From the best packing condition, Eq. 3.17, and the no-bandwidth-gap condition, Eq. 3.6, we obtain the ratio between the radii of the spirals:

$$\frac{p^{\frac{9\sqrt{3}}{16\pi}} \left(\frac{26}{25} \right) R}{1 - p^{\frac{9\sqrt{3}}{16\pi}}} \leq r \quad (3.18)$$

Finally, the *total bandwidth* of this planar array of two sizes hexagonal spirals is expressed by:

$$\text{BW}_T = \frac{8\pi R}{p^{\frac{9}{2}} \left(\frac{26}{25} R + r \right)} \quad (3.19)$$

Analytical optimization for the square spiral antennas in a square lattice planar array

Fig. 3.11 shows the case of a uniform planar array of two sizes square spiral antennas in a square lattice. For this configuration we have again $d = 2D$.

For this array the grating lobe frequencies are given in:

$$f_{1,gl} = \frac{c_0^2}{3D} \quad (3.20a)$$

$$f_{2,gl} = \frac{c_0^4}{3D} \quad (3.20b)$$

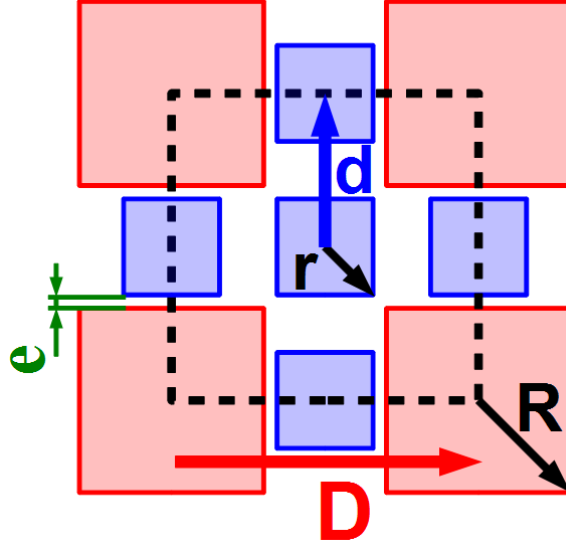

Figure 3.11: An array using two sizes square spirals in square lattice. r is the radius of small spiral, R is the radius of large spiral. D is the spacing between large spirals and d is the vertical spacing between large and small spirals.

The best packing condition, with $e = R/25$, is given in:

$$\frac{D}{2} = \frac{R}{\sqrt{2}} + \frac{r}{\sqrt{2}} + e \quad (3.21a)$$

$$D = \sqrt{2}(1.0566R + r) \quad (3.21b)$$

The no-bandwidth-gap condition (cf. Eq. 3.5) for this array is expressed by:

$$\frac{3Dp}{4\pi} \leq r \quad (3.22)$$

Then, from the best packing condition, Eq. 3.21, and no-bandwidth-gap condition, Eq. 3.22, we obtain the ratio r/R that yields the maximum *total bandwidth* in:

$$\frac{0.75}{\frac{2\pi}{3p} - \frac{1}{\sqrt{2}}} R \leq r \quad (3.23)$$

Finally, the *total bandwidth* of the array of two sizes square spirals is expressed by:

$$BW_T = \frac{8\pi R}{3Dp} \quad (3.24)$$

Summary of the results

Tab. 3.5 shows the different optimized bandwidths, $BW_{S_{11}}$ and $BW_{X_{poIR}}$ (calculated using the “p” factor of each antenna) and the ratio of the radius of the small spiral over the large spiral, r/R , that gives this bandwidth. In order to avoid intersection between the spirals, a minimum

gap, of $1/25$ of the large spiral radius was imposed. $r/R = 1$ means that the optimum case is to use spirals of same size. $r/R < 1$ means that there is an advantage of using spiral of different sizes.

Ant.,Latt.	Archi.,▲	r/R	Archi.,■	r/R	Hexag,▲	r/R	Squa,■	r/R
$BW_{S_{11}}$ and r/R	2.6	0.67	2.34	0.61	2.74	0.63	2.26	0.88
BW_{XpolR} and r/R	1.86	0.93	1.69	0.84	1.76	0.99	1.63	1

Table 3.5: Analytically estimated bandwidths of arrays using two sizes of spirals and scan angle of $\theta = 30^\circ$. WAVES technique (*Caswell*, 2001).

We can see that there is advantage in using WAVES if we want to extend the S_{11} bandwidth. The hexagonal spiral gives the maximum S_{11} bandwidth, 2.74:1.

On the contrary, for the case of XpolR bandwidth, there is little (if using Archimedean spirals) or no advantage at all (if using hexagonal and square spirals). This means that, using elements of same size is the best case if we want to get a large XpolR bandwidth.

Considering the XpolR bandwidth, Tab. 3.5 shows that the maximum bandwidth that can be obtained is less than an octave. We recall that we have been considering mono polarized arrays. If we want to introduce spirals of opposite polarization, in order to obtain a dual polarized array, the bandwidth disappears. This is so because the spacing between elements of the same polarization will be doubled, which means that the grating lobe frequency will be divided by 2, making them appear before the lowest cutoff frequency. That was the same situation as in the uniform linear array case presented in the previous chapter.

3.3 Dual polarized planar array (6:1 bandwidth)

This section presents the main goal of this thesis: the design of a dual polarized wideband planar array. As discussed in the last section, using spirals of opposite polarization produces an array with virtually an inexistent bandwidth. A way to extend this bandwidth, in linear and planar arrays of spirals (*Guinvarc'h*, 2007), was already investigated in section 2.4 (pg. 63), by introduction of nonuniform spacing. This approach corresponds to the first trend in the design of arrays. Another way to extend this bandwidth was proposed by connecting the spirals of opposite polarization in a linear array (*Guinvarc'h and Haupt*, 2011), which corresponds to the second design trend.

The three main issues in the design of a wideband planar array

So far we have been dealing with arrays with no ground plane. In most of the cases, a ground plane behind the spirals is needed to avoid radiation to the feeding system. In order to design a uni-directional phased array, a ground plane or a backing cavity can be used. This ground plane, or cavity, affects the rejection of cross polarization (XpolR), which is a measure of the circular polarization purity of the antenna, reducing its bandwidth. This was shown in section 1.3.3 (pg. 14). For the dual polarization case, we have also seen that, in uniform arrays, the grating lobes appear at frequencies lower than the lowest cutoff frequency making the array unuseful.

Hence, we have three main issues to deal with, usually, inter-correlated to a certain degree:

1. To obtain a uni-directional array over a wide bandwidth and to find a feeding method for such array.
2. To enhance the circular polarization purity.
3. To suppress the grating lobes.

We will show that, in fact, these issues can be addressed almost independently of each other:

1. The issue of feeding a spiral antenna over a wide bandwidth was already addressed in section 1.3.2 (pg. 11).

A cavity for the spiral was studied in section 1.3.3 (pg. 14). The height of the cavity was optimized to have a good S_{11} but the circular polarization of the spiral was lost.

2. To enhance the circular polarization, a sequential rotation technique can be applied (*Huang*, 1986), (*Louertani et al.*, 2011). Fig. 3.12 shows how this technique is used. The original element is copied N times and rotated by $360^\circ/N$, to obtain a structure with rotational symmetry. For right hand circular polarization, the additional relative phase, that needs to be included in the spirals feeding, is the negative of the angle used to rotate it for right hand circular polarization and the converse for left hand polarization. At least three elements are needed to obtain a perfect circular polarization at broadside. Even if the elements have poor reflection coefficients the array has perfect circular polarization.
3. Nonuniform arrays suppress grating lobes. Section 1.4.4 (pg. 25) showed many options. From all of them we have chosen the uniform concentric rings array (*Haupt*, 2008) because it presents rotational symmetry, which let us apply the sequential rotation technique. Besides,

in the concentric rings, for large separations between the rings, there is only interaction between the elements placed in the same ring. The mutual coupling between the elements of different rings is greatly reduced. Additionally, each ring can be thought of as being a linear array wrapped around a circle, so there are no edge issues.

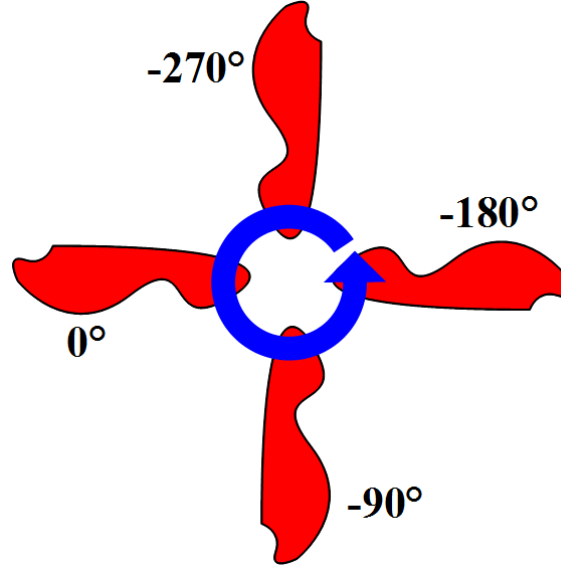

Figure 3.12: Sequential rotation technique showing also the additional phases to be added for a right hand circular polarization.

We will start designing a nonuniform planar array, a concentric rings array of spirals, which corresponds to the use of the first trend of array design. Then, we introduce the second trend by connecting the spirals. We seek good impedance matching ($|S_{11}| < -10$ dB), circular polarization ($X_{\text{polR}} > 15$ dB) and low side lobes level ($\text{RSSL} < -10$ dB). The *useful bandwidth*, then, will be the intersection of the bandwidths of these three parameters.

3.3.1 Design and measurements of one ring array

Design

In a linear array, it was shown that using a single cavity for the whole array is more convenient (*Guinvarc'h et al.*, 2012) than using individual cavities, as presented in Fig. 1.18 (pg. 16). The dimensions and configuration of one ring array with its cavity are shown in Fig. 3.13. Only spirals of one polarization are depicted to simplify the scheme. In fact, there are 8 antennas. 4 antennas of right hand circular polarization were interleaved with the other 4 antennas of left hand circular polarization, in order to obtain dual polarization. The antennas of right hand circular polarization are fed using the sequential rotation technique.

An Archimedean spiral over FR4 substrate of 0.81 mm of thickness was fabricated in coordination with PhD Karim Louertani from NUS Temasek Lab, Singapore. The substrate is used to reduce the input impedance of the spiral. Hence, the antennas of left hand circular polarization are terminated with 100Ω . As in section 1.3.3 (pg. 14), all the antennas have a diameter of 10.5 cm and the width of the cavity ($R_{\text{out}} - R_{\text{in}}$) is 130% larger than the diameter of the antenna to

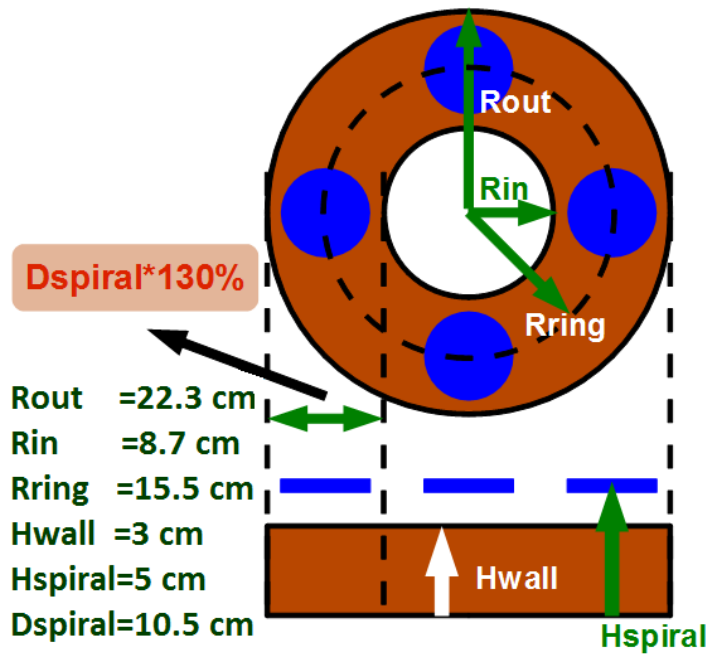

Figure 3.13: Scheme and dimensions of one ring spiral array. Only spirals of one polarization (blue) are depicted to simplify the scheme.

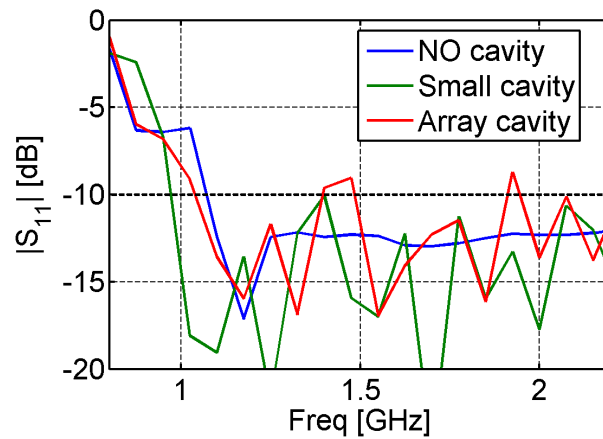

Figure 3.14: Simulation of reflection coefficients of a single Archimedean spiral antenna. In blue with no cavity, in green when using small cavity (cf. Fig. 1.18, pg. 16) and in red when using the large cavity (cf. Fig. 3.13). ($Z_{ref} = 100\Omega$)

reduce the coupling between the border of the cavity and the spiral. The distance between the bottom of the cavity and the spirals was also kept at 5 cm. The distance between the spirals of the same polarization is 21.92 cm.

Effect of the array cavity on the reflection coefficient

Fig. 3.14 depicts the reflection coefficient of a single spiral with different cavities to compare their effect. We observe that the presence of the cavity, small or large, slightly improves the

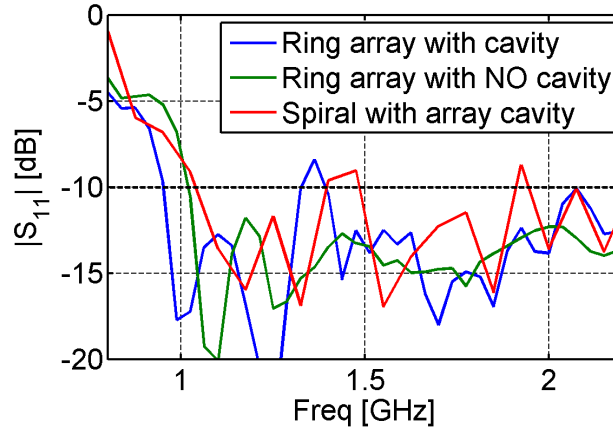

Figure 3.15: Simulations of reflection coefficient of one ring array, with and without large cavity (blue and green, respectively), and a single spiral with large cavity (red). ($Z_{ref} = 100\Omega$)

lower frequency limit of the reflection coefficient, being better when using the small cavity.

Fig. 3.15 shows the simulation results of one ring array of Fig. 3.13, with and without cavity, and compares it with the single spiral backed by the cavity of the array. In the case of the array, the improvement in the reflection coefficient is due to the presence of the cavity and the coupling with the other spirals. But the array cavity also affects the input impedance of the spiral increasing the reflection coefficient slightly over -10 dB at 1.35 GHz and 2.1 GHz. This issue can be overcome by optimizing the matching of the element in the cavity and the feeding system.

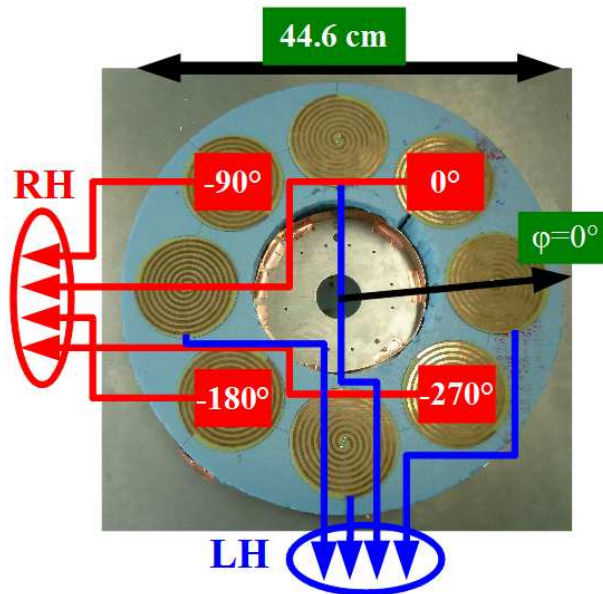

Figure 3.16: Prototype of the one ring array (cf. Fig. 3.13). Right hand spirals are marked with red color, left hand spirals are marked with blue color.

Prototype

As depicted in Fig. 3.16, the Archimedean spirals were placed over a foam of 5 cm height (H_{spiral}). To create the cavity, two strips of copper, with height of 3 cm (H_{wall}), were put around the spiral ring with inner radius of 8.7 cm (R_{in}), outer radius (R_{out}) of 22.3 cm. The left hand polarization spirals were terminated with chip resistors of 100Ω . The feeding system of section 1.3.2 (pg. 11) was used.

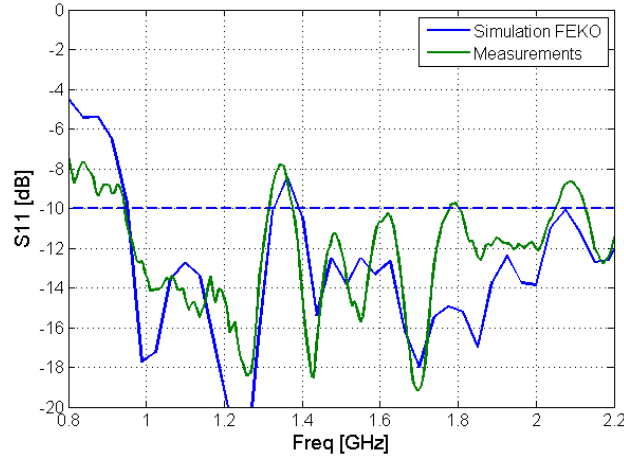

Figure 3.17: Simulation and measurements of ref. coef. of the one ring array of Fig. 3.16 ($Z_{ref} = 100\Omega$).

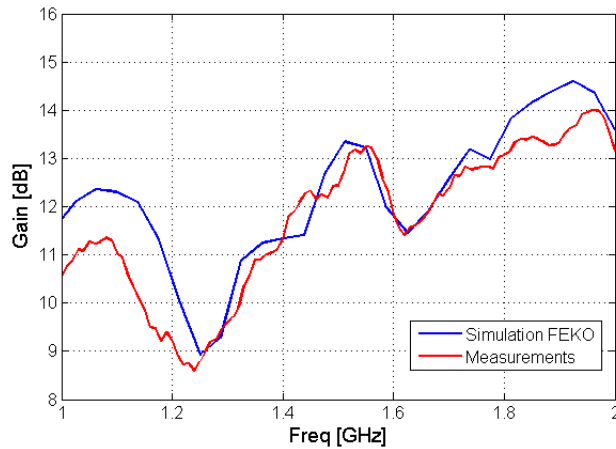

Figure 3.18: Total gain (simulation and measurements with 2.5dB of losses correction) of the one ring array at broadside of Fig. 3.16.

Measurements

Fig. 3.17 compares the reflection coefficient of the measurements and simulations. The measurements also show the mismatch at 1.35 GHz. Since the diameter of the symmetrical spiral antenna is 10.5 cm, using Eq. 1.11 (pg. 11) along with the p_{S11} factor of the Archimedean spiral

antenna with no substrate ($p_{S_{11}} = 1.15$, cf. Tab. 1.3, pg. 11), we expect its S_{11} cutoff frequency at 1.05 GHz.

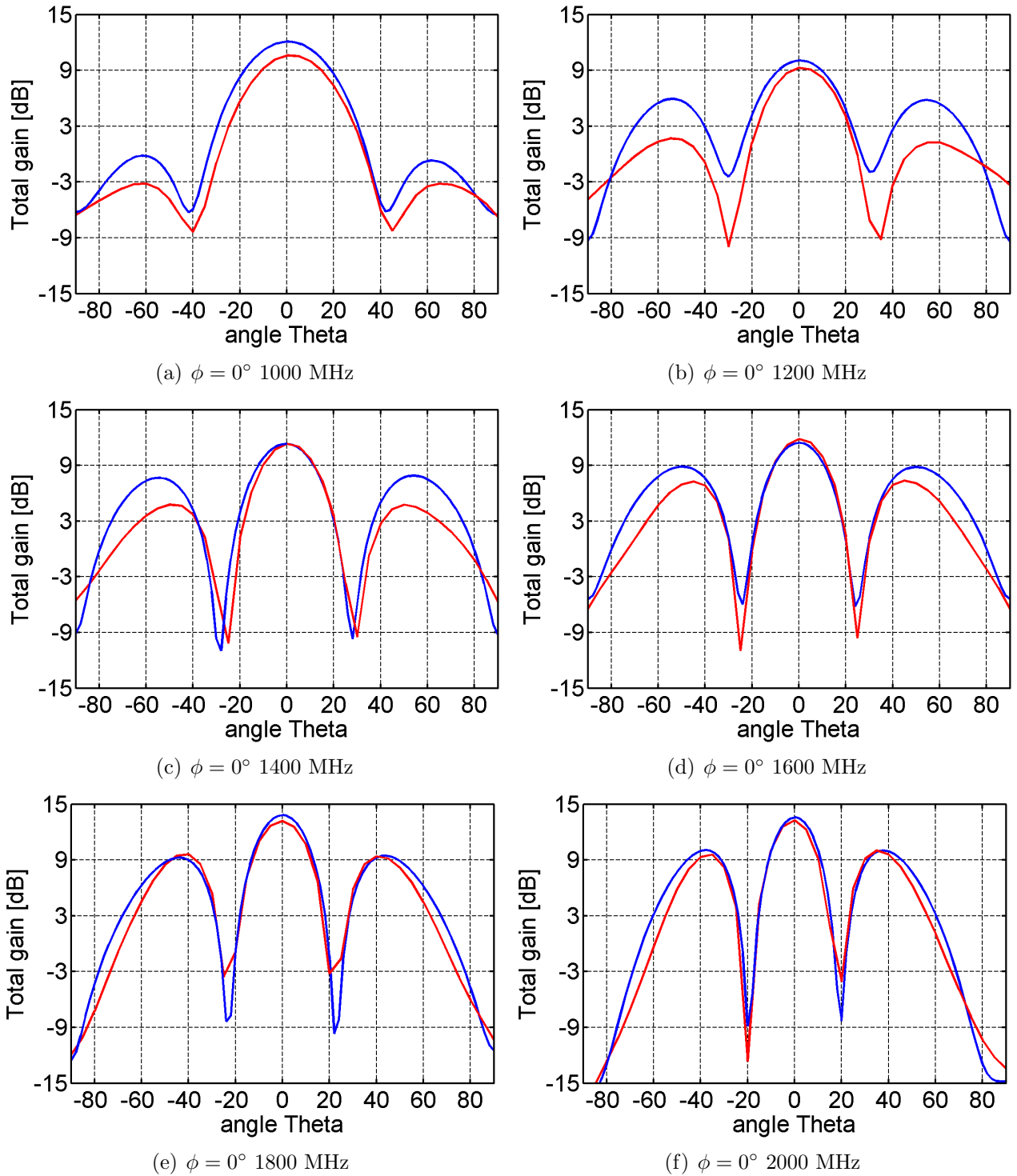

Figure 3.19: Cuts of radiation pattern at $\phi = 0^\circ$ of Fig. 3.16. Simulation results with FEKO in blue. Measurements in red.

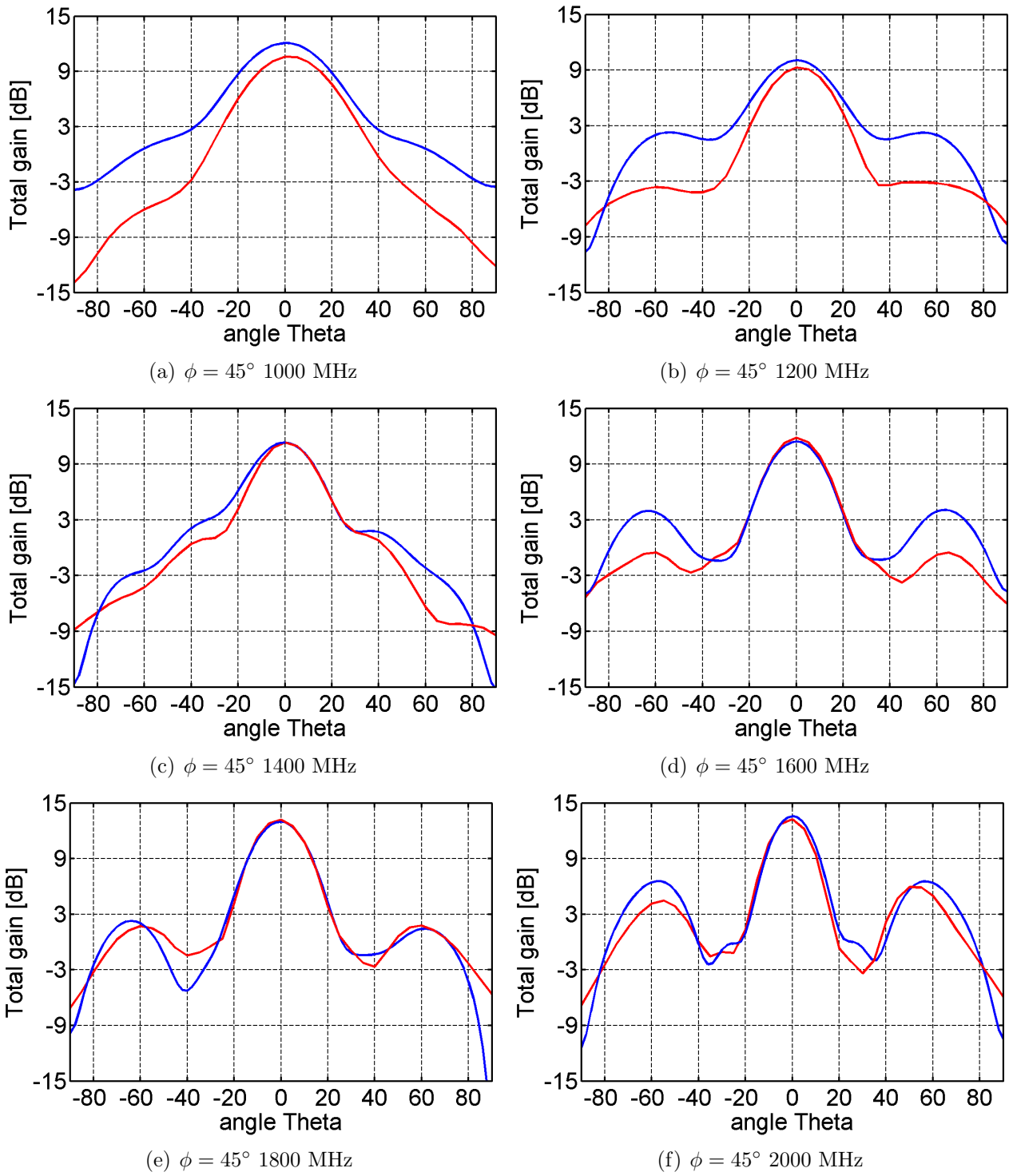

Figure 3.20: Cuts of radiation pattern at $\phi = 45^\circ$ of Fig. 3.16. Simulation results with FEKO in blue. Measurements in red.

In fact, we can see that the reflection coefficient of the spiral with substrate starts a bit earlier. The S_{11} bandwidth goes from 0.96 up to 2.1 GHz. We observe a good agreement of the experimental results with the simulation.

The radiation patterns of the simulations and measurements can be seen in Fig. 3.19 (pg. 89) and 3.20 (pg. 90). The measurements are presented after compensation for the feeding system (about 2.5 dB). The curves agree with some differences in the sidelobes. The total gain in the simulations is about 12 dB (cf. Fig. 3.18). This is expected since the gain of a single Archimedean spiral in free space is about 4 dB (cf. Fig. 1.10, pg. 10), using 4 spirals gives 6 dB more and the cavity gives, at most, 3 dB more.

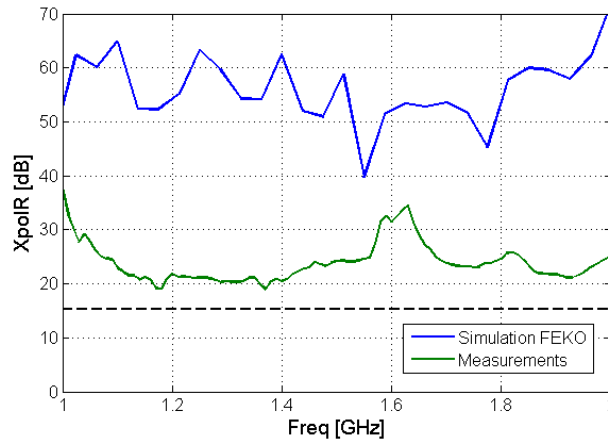

Figure 3.21: XpolR at broadside of one ring array of Fig. 3.16.

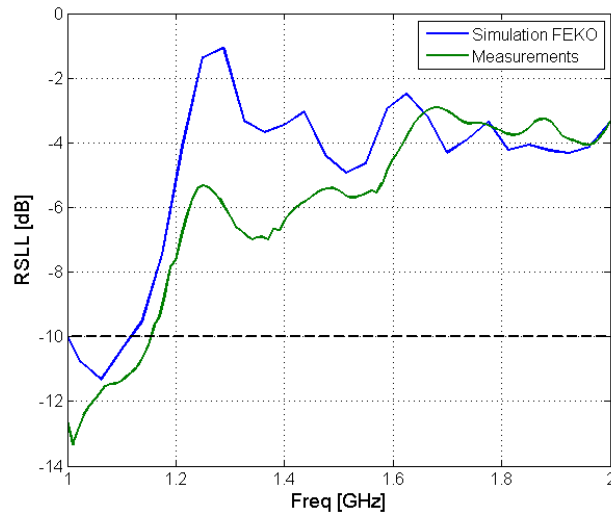

Figure 3.22: Relative side lobe level of the one ring array of Fig. 3.16.

The XpolR at broadside (cf. Fig. 3.21) is very good ($X_{polR} > 15$ dB) between 1 GHz and 2 GHz, as expected. The difference between the simulation and the measurements is due to the errors in phase and amplitude introduced by the hybrid couplers and power dividers used in the

feeding system. Even if the reflection coefficient at 1.35 GHz presents a mismatch, the XpolR is still good thanks to the sequential rotation technique.

Fig. 3.22 shows the relative side lobe level (RSLL) of the ring array. Since the distance between the elements is 21.92 cm and there is no scanning, it is expected to have grating lobes at 1.37 GHz, for a square lattice infinite uniform array. Since in this array there are just 4 antennas per polarization the grating lobes appear earlier. The measurements show that the side lobes reach the limit of -10 dB at 1.1 GHz. Hence, the RSLL bandwidth goes from 1 GHz to 1.1 GHz. In the next section we will see how using more rings reduces the side lobes level to less than -10 dB, relative to the main lobe. In this case, the useful bandwidth is strongly dependent of the RSLL (cf. Fig. 3.23).

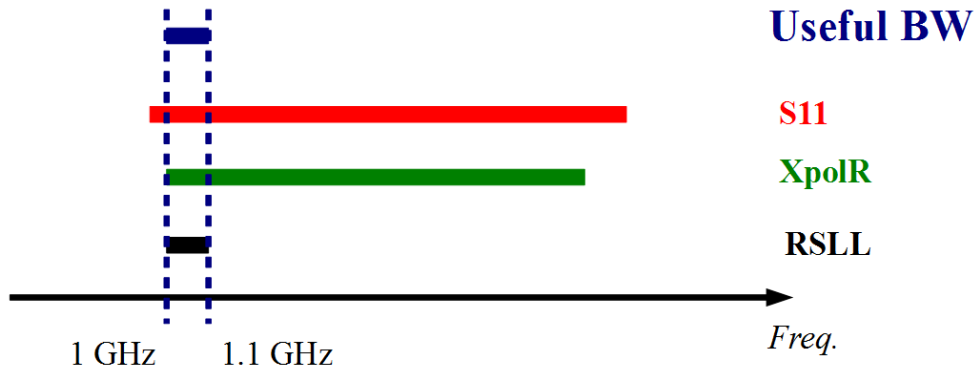

Figure 3.23: Summary of the bandwidths of the one ring array.

The measurements and fabrication of this array were performed in coordination with PhD Karim Louertani, from NUS Temasek Laboratories, Singapore.

3.3.2 Applying first design trend: Adding more rings

Following the reasoning of the first design trend, we will not try to increase the bandwidth of the antenna, instead, we will try to delay the presence of the grating lobes by using nonuniform arrays, in this case a concentric ring array. Since the first ring was already set, we will add more rings to the existing one.

Optimization

Numerical optimization using a Genetic Algorithm (GA) determines the optimum positions of the rings (*Haupt*, 2010). The goal is to achieve an octave bandwidth (1 GHz to 2 GHz) with $RSLL < -10$ dB. Omnidirectional point sources were used in the optimization process, which was done with the optimization tool of Matlab (“optintool”). We kept constant the distance between the sources that are located in the same ring. Only 3 additional rings were used in order to prevent the use of a very large number of elements (cf. Fig. 3.24). The goal was to minimize the RSLL at the highest frequency of the bandwidth, 2 GHz and 30° of steering angle. Tab. 3.6 lists the parameters used in the GA. where d_{elem} is the distance between elements of same ring, Δ_0 is the radius of first ring, Δ_n is the distance between the n th and $(n + 1)$ th ring ($n=1, 2$ and 3) and Φ_m is the fraction of the maximum rotation angle allowed for the $(m + 1)$ th

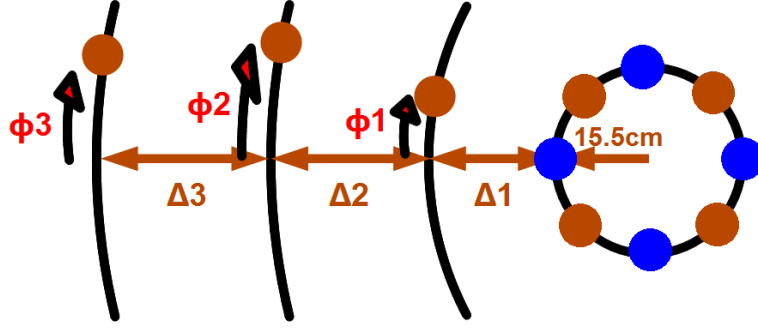

Figure 3.24: Scheme of spiral array to be optimized. Right and left hand spirals are in brown and blue colors, respectively.

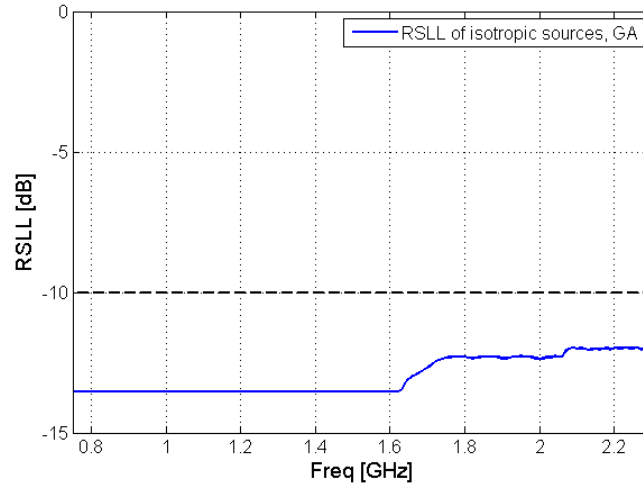

Figure 3.25: RSLL of 112 isotropic sources, 4 rings array using GA and 30° of steering angle. The optimization was done with Matlab.

Param.	Values	Opt. Value
d_{elem}	24.34 cm	24.34 cm
Δ_0	15.5 cm	15.5 cm
Δ_1	$[1;3]d_{elem}$	58.61 cm
Δ_2	$[1;3]d_{elem}$	72.82 cm
Δ_3	$[1;3]d_{elem}$	57.05 cm
Φ_1	$[0;1]$	0.88
Φ_2	$[0;1]$	0.92
Φ_3	$[0;1]$	0.83

Table 3.6: GA Parameters

ring ($m=1, 2$ and 3). This maximum rotation angle is set to be the minimum angular distance between sources in the same $(m + 1)$ th ring. This rotation is done in order to obtain a similar side lobe level distribution for both circular polarizations. With the optimum values we obtained an array of 112 elements per polarization, 224 antennas in total. 8 elements in the first inner

ring, 38 in the second ring, 74 in the third ring and 104 in the outer ring. The values of RSLL of the optimized array, for the case of isotropic sources, are presented in Fig. 3.25 for the worst case, which is a 30° maximum scan angle.

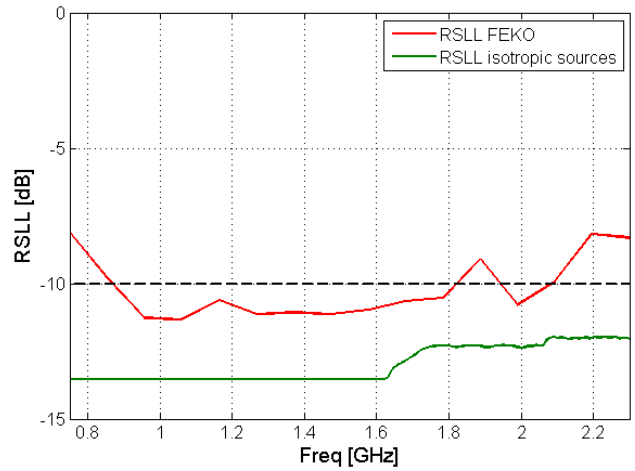

Figure 3.26: Comparison of RSLL between FEKO (112 spirals, per polarization, array) and isotropic sources, Matlab.

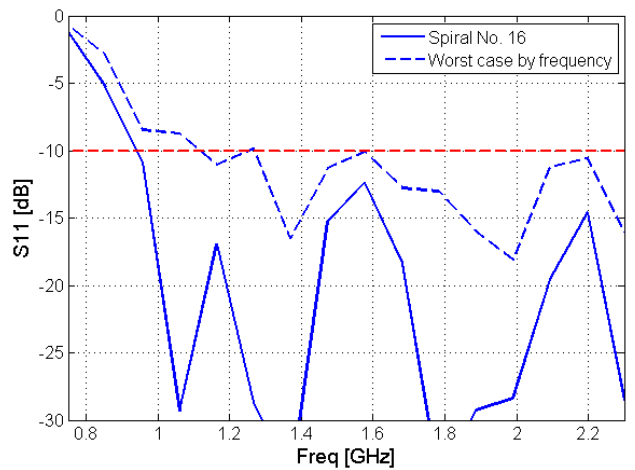

Figure 3.27: Reflection coefficient of spiral array with FEKO, 30° of steering angle. ($Z_{ref} = 220\Omega$).

Simulation of the optimized array

We simulated the array with FEKO using spiral antennas with a cavity under each ring. In order to speed up the optimization process, the substrate of the spirals were not considered. Each ring was provided with a cavity. As in the case of the one ring array, the antennas were located 5 cm above their corresponding cavities and the height of the walls was 3 cm. We also kept a width of 130% larger than the diameter of the spiral.

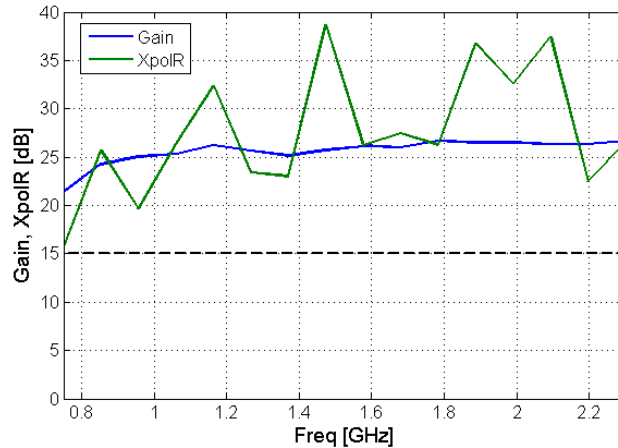

Figure 3.28: Gain and XpolR of 112 spirals, per polarization, array with FEKO. 30° of steering angle.

The results are shown in Fig. 3.26, 3.27 and 3.28. We can see that the RSSL bandwidth starts at 0.9 GHz and goes up to 2.1 GHz, although at 1.9 GHz the RSSL increases up to -9 dB.

The S_{11} bandwidth goes from 1.06 GHz up to 2.3 GHz. There are 3, out of 112, antennas with $|S_{11}|$ of about -9 dB at 1.06 GHz. The reference impedance is 220Ω because the spiral is self-complimentary and was simulated with no substrate.

The XpolR is good over the entire bandwidth. Hence, the *useful bandwidth* of the array goes from 1.06 GHz up to 2.1 GHz which gives an octave bandwidth (cf. Fig. 3.29).

Using more rings has extended the useful bandwidth of the array by reducing the side lobes while affecting neither the XpolR nor the reflection coefficient of the antennas.

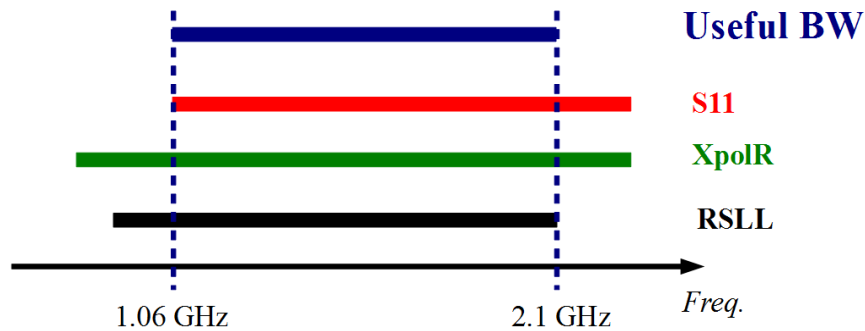

Figure 3.29: Summary of the bandwidths for the concentric rings array.

3.3.3 Applying second design trend: Connecting the spirals

Following the reasoning of the second design trend, we can make the interaction between the elements stronger to enhance the lowest limit of the bandwidth of the array. The goal is to reduce, at least, by half the lowest bandwidth frequency (1 GHz). This was done in (*Guinvarc'h and Haupt, 2011*) by connecting the spirals of opposite polarization for the case of linear arrays. For the case of planar arrays, the concentric ring array presents an additional advantage. Since

the array was optimized for a constant distance between the elements, a similar approach to (Guinvarc'h and Haupt, 2011) can be followed.

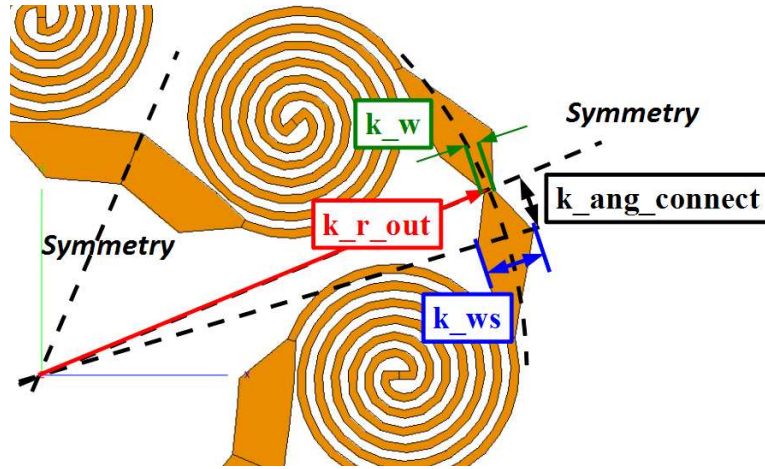

Figure 3.30: Parameters used to optimized spiral connections. k_w and k_{ws} indicates width, k_{r_out} indicates distance from center to connection and $k_{ang_connect}$ indicates angle from symmetry line to next change in arm width of the connection.

Optimization of the connections

A numerical optimization using the OPTFEKO tool is used to optimize these connections with resistive loads in order to get a lower limit of the bandwidth of the array. To speed up the process, the optimization was carried out without substrate and between 0.6 GHz and 1.2 GHz. Fig. 3.30 shows the parameters used to optimize the outer connection: k_w and k_{ws} indicates width, k_{r_out} indicates distance from center to connection, $k_{ang_connect}$ indicates angle from symmetry line to next change in arm width of the connection and $load_out$ indicates the value of the impedance placed in the intersection of the connection and the symmetry line. For the inner connection the parameters are k_{w_in} and k_{ws_in} to indicate width, $k_{r_out_in}$ to indicate distance from center to connection, $k_{ang_connect_in}$ to indicate angle from symmetry line to next change in arm width of the connection and $load_in$ indicates the value of the impedance placed in the intersection of the connection and the symmetry line. Tab. 3.7 shows the optimum parameter values in order to obtain a $|S_{11}|$ lower than -10 dB for a scan angle of $\theta = 30^\circ$.

Optimization results without substrate

Fig. 3.31 shows the simulations results of the one ring array of section 3.3.1 using the optimized connections. We recall that we are using $Z_{ref} = 220\Omega$ because the spiral has no substrate. It can be seen in Fig. 3.31(a) that the gain is around 12.5 dB. This was expected, since there are 4 spirals which give around 9 dB and the cavity which gives the additional 3 dB. The gain is compared with the theoretical maximum gain of the aperture (cf. Eq. 1.8). Between 0.6 GHz and 1 GHz both gains have no difference, meaning that, in this range, the array is achieving 100% of aperture efficiency, thanks to the connections. Another type of connection would be devised to increase its effectiveness below 0.6 GHz. For frequencies higher than 1 GHz the gain

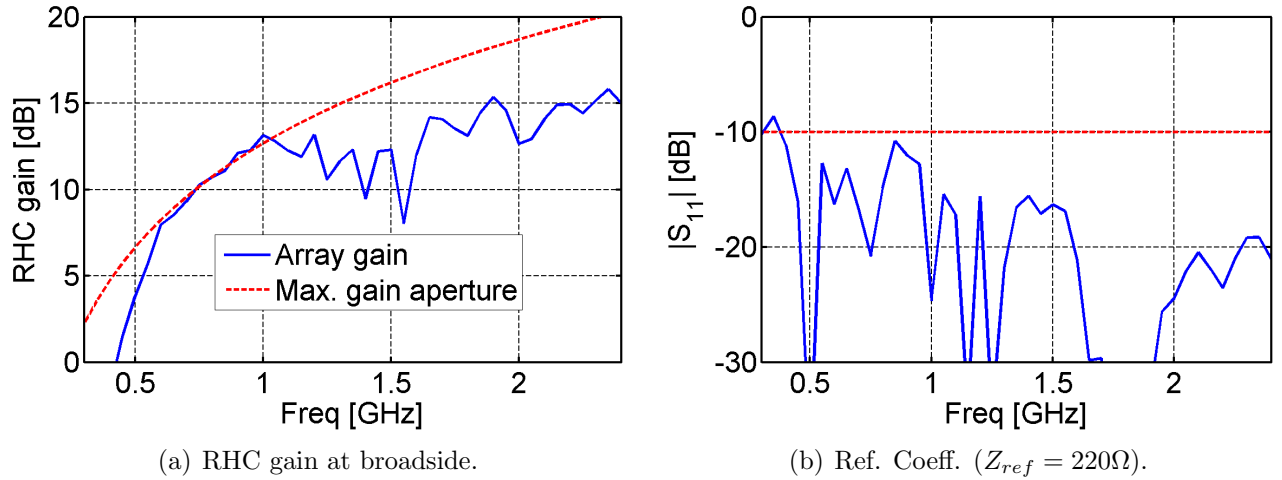

Figure 3.31: Simulation results of one ring array with optimized connections without substrate.

remains stable since the radiation zone of the spiral, compared to the wavelength, is more or less constant (see also Fig. 1.10, pg. 10).

Since the rotation technique was used, the array radiates a perfect circularly polarized wave at broadside ($X_{polR} = \infty$ dB).

Adding the substrate

When adding the substrate we obtain the simulation results shown in Fig. 3.32. Adding the substrate decreases the input impedance of the spiral and introduce losses. In this case we use $Z_{ref} = 100\Omega$. The substrate has produced some mismatches, especially at 0.8 GHz ($|S_{11}| = -7.5$ dB). Besides that, with few small exceptions, the reflection coefficient keeps its value below -10 dB from 0.35 GHz.

Given that we have used the same spacing as in the case of the one ring array, the RSSL is greater than -10 dB from 1.1 GHz (cf. Fig. 3.32). Since the sequential rotation technique is used,

Symbol	Optimum Value	Description
load_in	101 Ω	Load in inner conn.
k_r_in	9.92 cm	Dist. center to middle of inner conn.
k_w_in	2.15 cm	Width at middle of inner conn.
k_ws_in	2 cm	Width, out of middle of inner conn.
k_ang_connect_in	29.2°	Angular distance from symmetry line for inner conn.
load_out	197 Ω	Load in outer conn.
k_r_out	21.45 cm	Dist. center to middle of outer conn.
k_w	0.2 cm	Width at middle of outer conn.
k_ws	2.3 cm	Width, out of middle of outer conn.
k_ang_connect	8.3°	Angular distance from symmetry line for outer conn.

Table 3.7: Optimum dimensions for the connections in one ring array of spiral antennas (cf. Fig. 3.16 and 3.30).

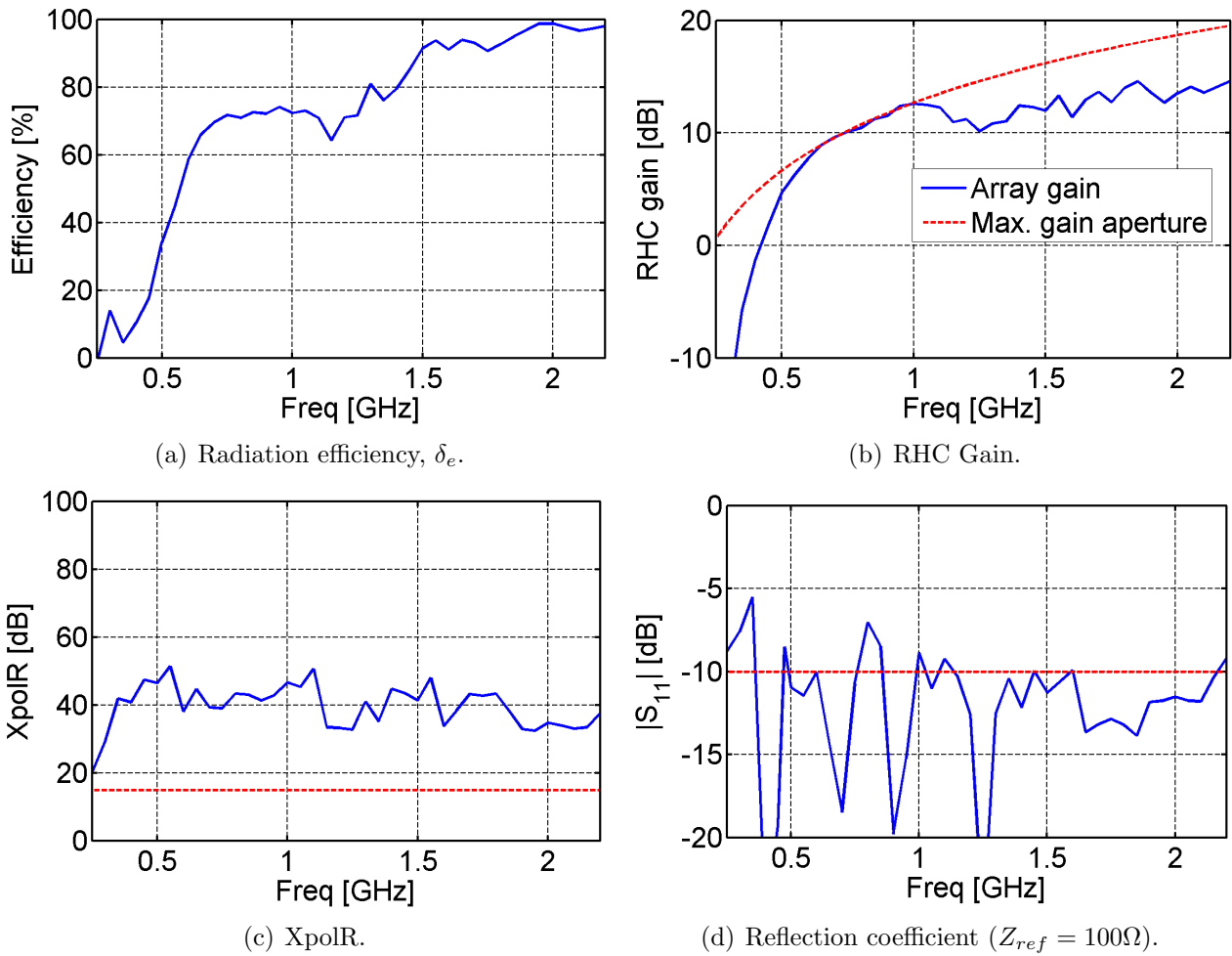

Figure 3.32: Simulations results of the one ring array with optimized connections, loads and FR4 as substrate, for broadside radiation. Sequential rotation technique is used.

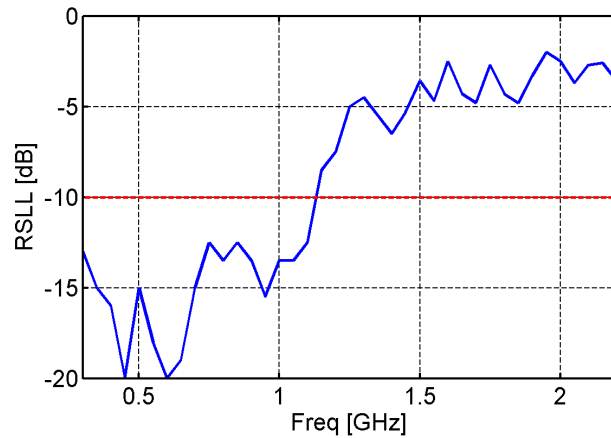

Figure 3.33: RSL of the one ring array with optimized connections, loads and FR4 as substrate, for broadside radiation (cf. Fig. 3.32).

the array produces a perfect circularly polarized wave. We can see, again, that the gain of the array and the theoretical maximum gain of the aperture are very similar between 0.6 GHz and 1 GHz. The radiation efficiency of the array starts dropping too much below 0.6 GHz, meaning that the losses, due to the loads in the connections, have become too high.

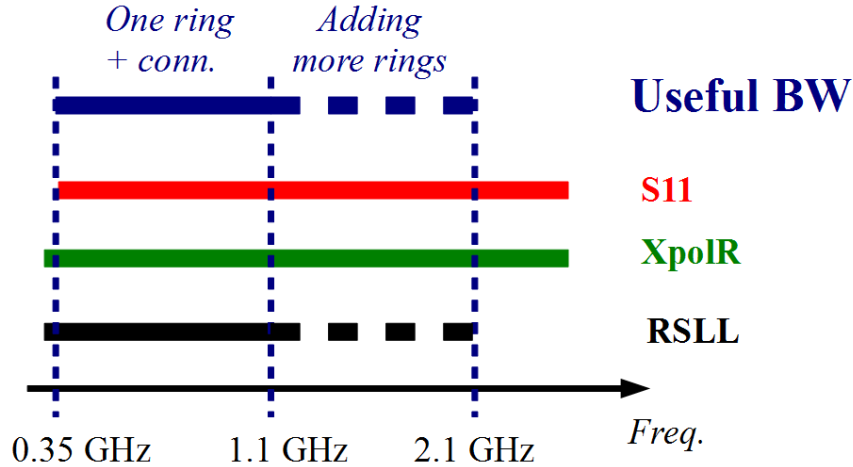

Figure 3.34: Summary of bandwidths for the one ring array with connections.

Prototype and first measurements of the one ring array with connections

The prototype shown in Fig. 3.16 (pg. 87) was used again, but this time the optimized connections were added, as shown in Fig. 3.35.

By the time this work is written, the measurements of the one ring array with the optimized connections are being carried out. Fig. 3.36 shows the reflection coefficient, from 0.3 GHz to 1.2 GHz, of the prototype compared with the simulation result.

The measurements agree with the simulation. There is mismatch at 0.47 GHz. The half of the wavelength at this frequency ($\lambda/2 = 32$ cm) corresponds to the distance between two spirals in diametrical opposition ($2R_{ring} = 31$ cm, cf. Fig. 3.13, pg. 86). This suggests that a cavity mode might be the cause of the mismatching. An adjustment in the height of the walls might work. Apart from that mismatching, the reflection coefficient of the measurement is good, providing a S_{11} cutoff frequency at 0.35 GHz.

Discussion about the bandwidth of the array

As discussed in section 1.4.6, the bandwidth of the array will depend on the application. These applications will impose some restrictions in the parameters of the array. So far, we have just considered a XpolR greater than 15 dB, a $|S_{11}|$ less than -10 dB, a RSSL less than -10 dB as acceptable values.

In the case of the ring of connected spirals, the S_{11} bandwidth can be set to be from around 0.35 GHz to 2.15 GHz and the XpolR bandwidth can be as wide as we want, thanks to the sequential rotation technique. As presented in the section 3.3.2, we can use more rings to increase the RSSL up to 2.1 GHz. With these values, a concentric ring array of connected spirals would go from 0.35 GHz up to 2.1 GHz (6:1 bandwidth) with dual circular polarization capability and

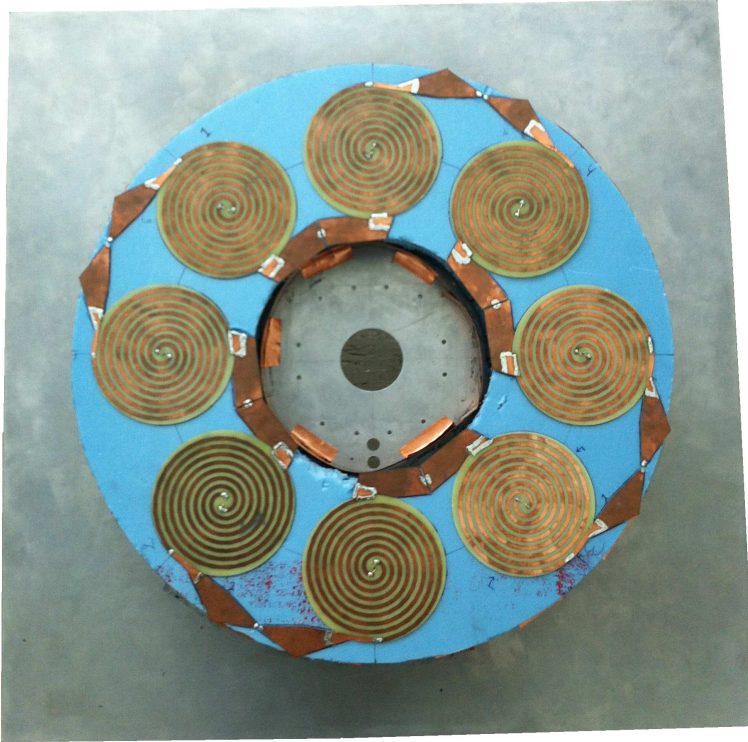

Figure 3.35: One ring array with optimized connections.

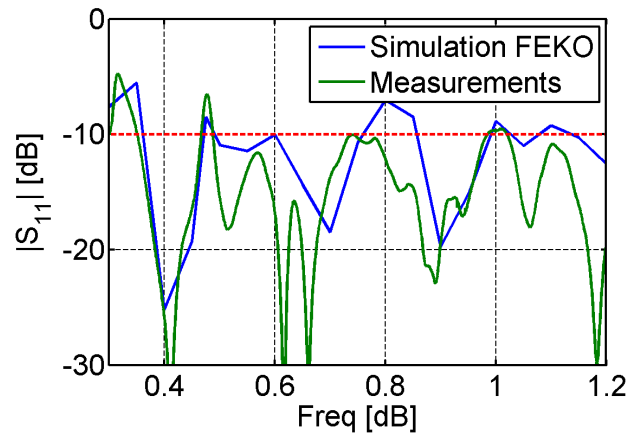

Figure 3.36: Comparison between measurements and simulation with FEKO of reflection coefficients ($Z_{ref} = 100\Omega$) of one ring array with optimized connections.

uni directional radiation for a scan angle up to $\theta = 30^\circ$ from broadside. Fig. 3.34 presents a summary of this results.

But, at 0.35 GHz the radiation efficiency of the array is about 8% and the difference between the maximum theoretical gain (3.6 dB, cf. Eq. 1.8) and the gain obtained by the simulation (-5.7 dB) is 9.3 dB. Since below 0.6 GHz the array does not achieve its maximum gain, there is still a lot of room to optimize the gain of the array at low frequencies.

3.4 Summary of chapter

In this chapter we have seen that the useful bandwidth (for $|S_{11}|$ less than -10 dB, XpolR greater than 15 dB and RSSL less than -10 dB) of a planar array depends strongly on the geometrical array lattice used, the type of the antennas used, and the way they interact between each other.

The first part of this chapter explained the limitations of using a uniform planar array of spiral antennas. This kind of array can achieve a maximum bandwidth of 1.82:1 for the mono polarized case.

The second part focused on the use of circular arrays which helped to address the problem of the presence of the grating lobes achieving a useful bandwidth of 2:1 for the dual polarized case, using the first design trend of wideband arrays.

The second design trend tries to increase the lowest cut off frequency of the bandwidth by controlling and increasing the coupling between the elements. This was successfully achieved by connecting the spirals. It was not necessary to increase the total number of elements and the array area remained the same. Using this technique the array can achieve a total bandwidth of 6:1 for the dual polarized case.

In this chapter we have shown that it is possible to use both design trends in the case of the concentric rings array which addresses the problem of the grating lobes and let us connect the elements. Tab. 3.8 and Fig. 3.37 summarize these results.

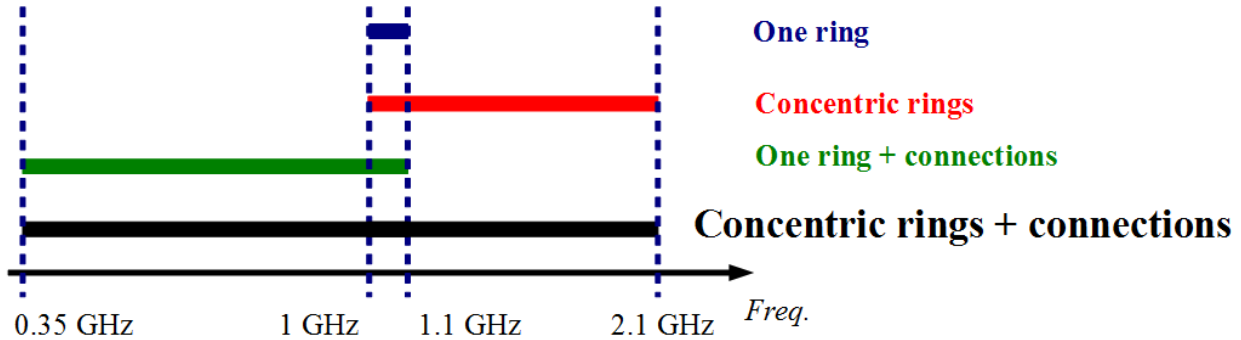

Figure 3.37: Evolution of the useful bandwidth of the concentric rings array with connections.

Array	Cavity	Dual Pol.	BW(f_{high}/f_{low})	# of elem.
Uniform planar array	NO	NO	1.82:1	36
Concentric rings array	YES	YES	2:1	224
Concentric rings array + Connections	YES	YES	6:1	224

Table 3.8: Summary of arrays' bandwidth seen in this chapter for a maximum scan angle of $\theta = 30^\circ$.

CHAPTER IV

Conclusion

4.1 Conclusion

This work dealt with the design of wideband planar phased arrays with dual polarization. Three main goals were aimed: a reflection coefficient (S_{11}) less than -10 dB, a rejection of cross polarization (XpolR) larger than 15 dB and a sidelobe level relative to the main beam (RSL) less than -10 dB. A cavity behind the array was needed to avoid back-radiation and elements of opposite polarization had to be integrated to obtain a dual polarized array. The contributions of this work involve three main concepts.

- As a first approach, a simpler geometrical lattice was presented. Analysis and examples of different cases of uniform linear arrays drove us to a better understanding of the resonance issues presented in uniform arrays of spiral antennas. These resonances do not belong solely to the square spiral antennas over a ground plane, they are present even without ground plane and for different kind of spirals: round, hexagonal, square and logarithmic. The key ideas are the symmetry of these spirals, the impedance change at the end of the spirals and the uniform lattice. Breaking one of these factors helps to decrease this issue. Spoiling the symmetry of the spiral affects the XpolR of the array. Loading the end of the spiral arms affects the efficiency of the antenna. Using non uniform arrays will not affect the XpolR of the array, neither its efficiency. Additionally, it helps to delay the occurrence of grating lobes compared to uniform arrays.
- The development of an analytical method to estimate the bandwidths of uniform planar arrays of spiral antennas without a ground plane was presented. This method is based on the analysis of an isolated spiral, hence, does not take into account the mutual coupling between spirals. It gave good estimations regarding the XpolR bandwidth and it also showed the limits of using uniform arrays of spiral antennas. For a maximum scan angle of $\theta = 30^\circ$ the widest XpolR bandwidth for a mono polarized planar array that we can expect is less than one octave. If we want to design a dual polarized array using two-arm spiral antennas we need to use spirals of opposite polarization, which means that the distance between the elements of the same polarization will be larger. Larger distance is synonym of the appearance of grating lobes closer to the broadside direction. Hence, the XpolR bandwidth becomes nonexistent for the same scan angle conditions.

- It has been shown that a wideband dual polarized planar array of spiral antennas can be developed. The design addresses, independently, the problem of achieving a desired S_{11} , XpolR and RSSL in a cavity backed array. A wideband feeding system to the spiral antenna was also studied. Uniform arrays exhibit serious limitations for dual polarized designs. Nonuniform arrays proved to solve this problem and, at the same time, choosing the lattice that presents rotational symmetry allowed us also to take advantage of the sequential rotation technique in order to enhance the XpolR. Concentric ring arrays permitted us to use also the connecting spirals technique, enhancing the lower bandwidth limit of the array. A 4:1 bandwidth planar array, with scan capability up to $\theta = \pm 30^\circ$, was presented using the combination of the two different paradigms of broadband arrays design.

To conclude, a number of perspective can outlined as follows:

- The planar wideband array obtained by the proposed design does not make efficient use of the area. There are empty spaces that can be filled using spirals of different sizes. The WAVES technique proposed this idea and was used in (*Caswell*, 2001) for uniform arrays. In our case it will be applied to nonuniform arrays. This will let us work in many different bands, or to expand even more the bandwidth of the array. In the last case we still have two possibilities to explore. The first one is to interleave two or more concentric rings arrays with elements of different sizes. The second one is to use many concentric rings, one ring per band and each ring having elements smaller than the other. In this last case we will still obtain a wide bandwidth array but with narrower instantaneous bandwidths. It will depend on the application whether the first or the second approach should be used.
- We can study other lattices that present rotational symmetry and, at the same time, enable us to use the connection technique. Using the sequential rotation technique permits us to use any antenna, as long as the antenna has the desired S_{11} . Consequently, we can investigate other types of spirals that can be connected. One possible approach would be to design many subarrays and then apply a rotation to use the sequential rotation technique.
- So far, only linear and planar arrays have been studied. The presence of grating lobes is related to the minimum distance between the sources, but the size of the antenna limits this distance. Future work might deal with conformal arrays. In this case the effective distance between the sources is less than in the linear and planar cases. This means that the curvature of the surface over which the spirals are positioned will help to delay the presence of grating lobes. The curvature might also play an important role in the mutual coupling between elements and the effect of spirals connection.

BIBLIOGRAPHY

BIBLIOGRAPHY

- Adamiuk, G., T. Zwick, and W. Wiesbeck (2012), UWB antennas for communication systems, *Proceedings of the IEEE*, 100(7), 2308–2321.
- Allen, B., M. Dohler, E. E. Okon, W. Q. Malik, A. K. Brown, and D. J. Edwards (2007), *Ultra-wideband Antennas and Propagation for Communications, Radar and Imaging*, John Wiley & Sons.
- Balanis, C. A. (2005), *Antenna Theory, Analysis and Design*, 698 pp., John Wiley & Sons, New Jersey, USA.
- Bawer, R., and J. J. Wolfe (1960), A Printed Circuit Balun for Use with Spiral Antennas, *IRE Transactions on Microwave Theory and Techniques*, 8(3), 319–325.
- Bilotti, F., A. Alu, L. Vegni, and P. Baldonero (2005), Single Arm Hexagonal Spiral Element for Ultra Wide Band Phased Antenna Arrays, in *18th International Conference on Applied Electromagnetics and Communications. ICECom 2005*.
- Boerner, W.-M., M. El-Arini, C.-Y. Chan, and P. Mastoris (1981), Polarization dependence in electromagnetic inverse problems, *IEEE Trans. Antennas Propagat.*, 29(2), 262–271.
- Boryssenko, A. O. (2009), Polarization constraints in dual-polarized phased arrays derived from an infinite current sheet model, *IEEE Antennas Wireless Propag. Lett.*, 8, 955–958.
- Burnside, W., and C. Chuang (1982), An aperture-matched horn design, *IEEE Trans. Antennas Propagat.*, 30(4), 790–796.
- Caratelli, D., and M. C. Vigano (2011), A novel deterministic synthesis technique for constrained sparse array design problems, *IEEE Trans. Antennas Propagat.*, 59(11), 4085–4093.
- Caswell, E. D. (2001), Design and Analysis of Star Spiral with Application to Wideband Arrays with Variable Element Sizes, Ph.D. thesis, Virginia Polytechnic Institute and State University, Virginia, USA.
- Corzine, R. G., and J. A. Mosko (1990), *Four-arm Spiral Antennas*, Artech House, Massachusetts, USA.
- CST (2010), (Computer Science Technology).
- Das, R. (1966), Concentric ring array, *IEEE Trans. Antennas Propagat.*, 14(3), 398–400.

- Dinh, H. T. M., F. Rocca, S. Tebaldini, M. M. d'Alessandro, and T. Le Toan (2012), Linear and circular polarization p band sar tomography for tropical forest biomass study.
- Duncan, J. W., and V. P. Minerva (1960), 100:1 bandwidth balun transformer, *Proceedings of the IRE*, 48(2), 156–164.
- Dyson, J. D. (1959), The Equiangular Spiral Antenna, *IRE Transaction on Micro Wave Theory and Techniques*, 7(2), 181–187.
- Dyson, J. D., and R. Ginyovsky (1971), Balanced transmission-line measurements using coaxial equipment (correspondence), *IEEE Transactions on Microwave Theory and Techniques*, 19(1), 94–96.
- FEKO (2004), EM Software & Systems-S.A.
- Filipovic, D. S., and J. L. Volakis (2002), Broadband meanderline slot spiral antenna, *IEE Proceedings Microwaves, Antennas and Propagation*, 149(2), 98–105.
- Friis, H., and C. Feldman (1937), A multiple unit steerable antenna for short-wave reception, *Proceedings of the Institute of Radio Engineers*, 25(7), 841–917.
- Galejs, J. (1964), Minimization of sidelobes in space tapered linear arrays, *IEEE Trans. Antennas Propagat.*, 12(4), 497–498.
- Gazit, E. (1988), Improved design of the vivaldi antenna, *IEE Proceedings H Microwaves, Antennas and Propagation*, 135(2), 89–92.
- Grazzini, G., M. Pieraccini, F. Parrini, A. Spinetti, G. Macaluso, D. Dei, and C. Atzeni (2010), An ultra-wideband high-dynamic range gpr for detecting buried people after collapse of buildings, in *13th International Conference on Ground Penetrating Radar (GPR)*, pp. 1–6.
- Guinvarc'h, R. (2007), Dual polarization wide-band interleaved spiral antenna array, in *Proc. IET Int. Radar Systems Conf.*, pp. 1–5.
- Guinvarc'h, R., and R. L. Haupt (2010), Dual polarization interleaved spiral antenna phased array with an octave bandwidth, *IEEE Trans. Antennas Propagat.*, 58(2), 397–403.
- Guinvarc'h, R., and R. L. Haupt (2011), Connecting spirals for wideband dual polarization phased array, *IEEE Trans. Antennas Propagat.*, 59(12), 4534–4541.
- Guinvarc'h, R., M. Serhir, and N. Ribiere-Tharaud (2012), A cavity-backed dual polarized array of connected spiral antennas, in *Proc. IEEE Int. Symp. Antennas and Propagation (APSURSI)*.
- Hansen, R. C. (2004), Linear connected arrays [coupled dipole arrays], *IEEE Antennas Wireless Propagat. Lett.*, 3(1), 154–156.
- Haupt, R. L. (1994), Thinned arrays using genetic algorithms, *IEEE Trans. Antennas Propagat.*, 42(7), 993–999.

- Haupt, R. L. (1995), Unit circle representation of aperiodic arrays, *IEEE Trans. Antennas Propagat.*, *43*(10), 1152–1155.
- Haupt, R. L. (2008), Optimized element spacing for low sidelobe concentric ring arrays, *IEEE Trans. Antennas Propagat.*, *56*(1), 266–268.
- Haupt, R. L. (2010), *Antenna Arrays, A Computational Approach*, John Wiley & Sons, New Jersey, USA.
- Hellsten, H., and L. M. H. Ulander (2000), Airborne array aperture uwb uhf radar-motivation and system considerations, *IEEE Aerospace and Electronic Systems Magazine*, *15*(5), 35–45.
- Hinostroza, I., R. Guinvarc’h, and R. L. Haupt (2011), The design of wide band planar arrays of spiral antennas, in *Proc. IEEE Int. Symp. Antennas and Propagation (APSURSI)*, pp. 609–611.
- Hofer, D., and V. K. Tripp (1993), A low-profile, broadband balun feed, in *Proc. IEEE Int. Symp. Antennas and Propagation (APSURSI)*, pp. 458–461.
- Holland, S. S., and M. N. Vouvakis (2012), The planar ultrawideband modular antenna (puma) array, *IEEE Trans. Antennas Propagat.*, *60*(1), 130–140.
- Holter, H. (2007), Dual-polarized broadband array antenna with bor-elements, mechanical design and measurements, *IEEE Trans. Antennas Propagat.*, *55*(2), 305–312.
- Hong, S., S.-G. Kim, M. R. Coutant, C. T. Rodenbeck, and K. Chang (2006), A multiband, compact, and full-duplex beam scanning antenna transceiver system operating from 10 to 35 ghz, *IEEE Trans. Antennas Propagat.*, *54*(2), 359–367.
- Huang, J. (1986), A technique for an array to generate circular polarization with linearly polarized elements, *IEEE Trans. Antennas Propagat.*, *34*(9), 1113–1124.
- IEEE Standard (1993), Std. 145-1993, IEEE Standards and Definition of Terms for Antennas.
- Ishimaru, A., and Y.-S. Chen (1965), Thinning and broadbanding antenna arrays by unequal spacings, *IEEE Trans. Antennas Propagat.*, *13*(1), 34–42.
- Kaiser, J. A. (1960), The archimedean two-wire spiral antenna, *IRE Transactions on Antennas and Propagation*, *8*(3), 312–323.
- Kindt, R., and D. Taylor (2011), Polarization correction in dual-polarized phased arrays of flared notches, in *Proc. IEEE Int. Symp. Antennas and Propagation (APSURSI)*, pp. 1961–1964.
- King, D., R. Packard, and R. Thomas (1960), Unequally-spaced, broad-band antenna arrays, *IRE Transactions on Antennas and Propagation*, *8*(4), 380–384.
- Kittel, C. (1995), *Introduction to Solid State Physics*, John Wiley & Sons, New York, USA.

- Kramer, B., L. Ming, C. Chi-Chih, and J. Volakis (2005), Design and performance of an ultrawide-band ceramic-loaded slot spiral, *IEEE Trans. Antennas Propagat.*, 53(7), 2193–2199.
- Kula, J., D. Psychoudakis, C.-C. Chen, J. L. Volakis, and J. Halloran (1959), Patch antenna miniaturization using thick truncated textured ceramic substrates, *IRE Transactions on Micro Wave Theory and Techniques*, 4, 3800–3803.
- Lee, J. J., S. Livingston, and D. Nagata (2008), A low profile 10:1 (200–2000 MHz) wide band long slot array, in *Proc. IEEE Int. Symp. Antennas and Propagation (APSURSI)*, pp. 1–4.
- Lee, M., B. A. Kramer, C.-C. Chen, and J. L. Volakis (2007), Distributed lumped loads and lossy transmission line model for wideband spiral antenna miniaturization and characterization, *IEEE Trans. Antennas Propagat.*, 55(10), 2671–2678.
- Lodge, O. J. (1898), *Electric Telegraphy*.
- Louertani, K., R. Guinvarc’h, N. Ribière-Tharaud, and M. Hélier (2011), Study of the Radiated Polarization of an Antenna Array with Circular Geometry, *Progress In Electromagnetics Research C*, 24, 173–183.
- Mailloux, R. J. (2005), *Phased Array Antenna Handbook*, Artech House, Norwood, Massachusetts, USA.
- Maloney, J. G., B. N. Baker, R. T. Lee, G. N. Kiesel, and J. J. Acree (2011), Wide scan, integrated printed circuit board, fragmented aperture array antennas, in *Proc. IEEE Int. Symp. Antennas and Propagation (APSURSI)*, pp. 1965–1968.
- McGrath, D. T., N. Schuneman, T. H. Shively, and I. Irion, J. (2003), Polarization properties of scanning arrays, in *Proc. IEEE Int. Phased Array Systems and Technology Symp.*, pp. 295–299.
- McLean, J. S., and N. A. Schwadron (2002), Balancing Networks for Symmetric Antennas I: Classification and Fundamental Operation, *IEEE Transactions on Electromagnetic Compatibility*, 44(4), 503–514.
- Morgan, T. E. (1979), Reduced size spiral antenna, in *Proc. 9th European Microwave Conf.*, pp. 181–185.
- Morgan, T. E. (1985), Spiral antennas for esm, *IEE Proceedings F Communications, Radar and Signal Processing*, 132(4), 245–251.
- Munk, B., et al. (2003), A low-profile broadband phased array antenna, in *Proc. IEEE Int. Symp. Antennas and Propagation (APSURSI)*, vol. 2, pp. 448–451.
- Nakano, H., S. Sasaki, H. Oyagani, and J. Yamauchi (2008), Cavity-backed Archimedean spiral antenna with strip absorber, *IET Microwaves, Antennas & Propagation*, 2(7), 725–730.
- Neustadter, S. (1963), The second moment sum method and space-tapered arrays, *IEEE Trans. Antennas Propagat.*, 11(6), 706–707.

- Nurnberger, M. W., and J. L. Volakis (1996), A new planar feed for slot spiral antennas, *IEEE Trans. Antennas Propagat.*, 44(1), 130–131.
- Pottier, E., and L. Ferro-Famil (2008), Advances in sar polarimetry applications exploiting polarimetric spaceborne sensors, in *Proc. IEEE Radar Conference, RADAR '08*.
- Raney, R. K. (2008), Hybrid-quad-pol sar, in *Proc. IEEE Int. Geoscience and Remote Sensing Symp. IGARSS 2008*, vol. 4.
- Sandler, S. S., and R. W. P. King (1994), Compact conical antennas for wide-band coverage, *IEEE Trans. Antennas Propagat.*, 42(3), 436–439.
- Schantz, H. G. (2004), A brief history of uwb antennas, *IEEE Aero El Sys Mag*, 19(4), 22–26.
- Shively, D. G., and W. L. Stutzman (1990), Wideband arrays with variable element sizes, *IEEE Proceedings H Microwaves, Antennas and Propagation*, 137(4), 238–240.
- Skolnik, M., G. Nemhauser, and I. Sherman, J. (1964a), Dynamic programming applied to unequally spaced arrays, *IEEE Trans. Antennas Propagat.*, 12(1), 35–43.
- Skolnik, M., I. Sherman, J., and J. Ogg, F. (1964b), Statistically designed density-tapered arrays, *IEEE Trans. Antennas Propagat.*, 12(4), 408–417.
- Spradley, J. (1958), A volumetric electrically scanned two-dimensional microwave antenna array, *IRE International Convention Record*, 6, 204–212.
- Steyskal, H., J. Ramprecht, and H. Holter (2005), Spiral Elements for Broad-Band Phased Arrays, *IEEE Trans. Antennas Propagat.*, 53(8), 2558–2562.
- Stutzman, W. L., and C. G. Buxton (2000), Radiating elements for wideband phased arrays, *Microwave Journal*, 43(2), 130–141.
- Sun, J.-S., G.-Y. Chen, S.-Y. Huang, C.-J. Huang, K.-L. Wu, and Y. Chen (2006), The Wideband Marchand Balun Transition Design, in *International Symposium on Antennas, Propagation & EM Theory, ISAPE '06. 7th*.
- Trucco, A., and V. Murino (1999), Stochastic optimization of linear sparse arrays, *IEEE J. Ocean Engineering*, 24(3), 291–299.
- Tzanidis, I., K. Sertel, and J. L. Volakis (2011), Interwoven spiral array (ispa) with a 10:1 bandwidth on a ground plane, *IEEE Antennas Wireless Propag. Lett.*, 10, 115–118.
- Van der Merwe, P. H., J. W. Odendaal, and J. Joubert (2012), A wide bandwidth compact quad-ridged horn antenna, in *Proc. 15th Int Antenna Technology and Applied Electromagnetics (ANTEM) Symp.*, pp. 1–2.
- Van Tonder, J. J., and J. K. Cloete (1994), A study of an archimedes spiral antenna, in *Proc. IEEE Int. Symp. Antennas and Propagation (APSURSI)*, vol. 2, pp. 1302–1305.

- Wang, J. J. H., and V. K. Tripp (1991), Design of multioctave spiral-mode microstrip antennas, *IEEE Trans. Antennas Propagat.*, 39(3), 332–335.
- West, J. C., and H. Steyskal (2009), Analysis and feeding of a spiral element used in a planar array, *IEEE Trans. Antennas Propagat.*, 57(7), 1931–1935.
- Wheeler, H. (1965), Simple relations derived from a phased-array antenna made of an infinite current sheet, *IEEE Trans. Antennas Propagat.*, 13(4), 506–514.
- Willey, R. (1962), Space tapering of linear and planar arrays, *IRE Transactions on Antennas and Propagation*, 10(4), 369–377.

ABSTRACT

Design of wideband arrays of two-arm spiral antennas
by
Israel David Hinojosa Sáenz

This work focuses on the design of wideband dual polarized arrays using spiral antennas. These antennas are known for having wideband properties. But, due to the presence of the grating lobes, the bandwidth is decreased when using an array instead of a single antenna. In order to obtain a dual polarized array, it is needed to use elements of opposite polarization, which creates great distances between same polarization elements, meaning an earlier presence of the grating lobes. In this work, an analytic method was developed to estimate the bandwidth of the spiral arrays. This method showed that the maximum bandwidth of uniform spiral arrays is about an octave, for the mono-polarized case, and nonexistent for the dual polarized case. Working on the validation of the method, some resonances were observed. Explanations are presented, as well as possible solutions. Trying to expand the bandwidth of the array, it was found that it is possible and suitable to use at the same time the two current design paradigms for wideband arrays. Using this idea, a 6:1 bandwidth concentric rings array using connected spirals was achieved. Perspectives are also presented.

Keywords: Spiral antenna, wideband, circular polarization, antenna array, dual polarization

RÉSUMÉ

Conception de réseaux large bande d'antennes spirales

Ce travail porte sur la conception de réseaux large bande à double polarisation basés sur des antennes spirales d'Archimède. Ces antennes sont connues pour avoir une bande passante très large. Mais, dans un réseau, la bande passante est diminuée du fait de l'apparition de lobes de réseaux. Pour que le réseau fonctionne à double polarisation, il est nécessaire d'utiliser des éléments de polarisations opposées, ce qui accroît encore la distance entre les éléments possédant la même polarisation. Ceci fait ainsi apparaître les lobes de réseaux à des fréquences inférieures par rapport au cas à mono polarisation. Dans ce travail, une méthode analytique a été développée pour estimer la bande passante des réseaux d'antennes spirales. Cette méthode a montré que la bande passante maximale d'un réseau à distribution spatiale uniforme est d'environ une octave pour le cas à mono polarisation et inexistant pour le cas à double polarisation. Pendant la validation de la méthode d'estimation quelques résonances ont été observées. Des explications de ce phénomène sont présentées, ainsi que des possibles solutions. Pour élargir la bande passante du réseau, nous montrons qu'il est possible d'utiliser en même temps les deux tendances actuelles de conception de réseaux d'antennes large bande. En utilisant deux techniques issues de ces deux tendances, nous avons pu réaliser un réseau présentant une bande passante de 6:1. Des perspectives sont aussi présentées.

Mots clé : Antenne spirale, large bande, polarisation circulaire, réseaux d'antennes, double polarisation