



**HAL**  
open science

# Les systèmes microparticulaires pour la libération colonique

Tereza Bautzova

► **To cite this version:**

Tereza Bautzova. Les systèmes microparticulaires pour la libération colonique. Médecine humaine et pathologie. Université de Franche-Comté; Université des sciences vétérinaires et pharmaceutiques de Brno, République tchèque, 2012. Français. NNT : 2012BESA3009 . tel-00830507

**HAL Id: tel-00830507**

**<https://theses.hal.science/tel-00830507>**

Submitted on 5 Jun 2013

**HAL** is a multi-disciplinary open access archive for the deposit and dissemination of scientific research documents, whether they are published or not. The documents may come from teaching and research institutions in France or abroad, or from public or private research centers.

L'archive ouverte pluridisciplinaire **HAL**, est destinée au dépôt et à la diffusion de documents scientifiques de niveau recherche, publiés ou non, émanant des établissements d'enseignement et de recherche français ou étrangers, des laboratoires publics ou privés.

**UNIVERSITE DES SCIENCES VETERINAIRES ET  
PHARMACEUTIQUES DE BRNO**

Faculté de Pharmacie

**ET**

**UNIVERSITE DE FRANCHE-COMTÉ**

Ecole doctorale : Environnement-Santé

**Le systèmes microparticulaires pour la libération colonique**

**THESE en Co-tutelle**

en vue de l'obtention du diplôme de

**Ph.D de l'Université des Sciences Vétérinaires et Pharmaceutiques de Brno**

**/ Docteur de l'Université de Franche-Comté**

présentée et soutenue

par

Tereza BAUTZOVA

le 17 septembre 2012 à Brno

**JURY**

Pr. Miloslava RABISKOVA, Directeur de thèse	Université des Sciences Vétérinaires et Pharmaceutiques de Brno
Pr. Alf LAMPRECHT, Directeur de thèse	Université de Franche-Comté
Pr. Philippe MAINCENT, Rapporteur	Université Henri Poincaré, Nancy
Pr. Pavel KOMÁREK, Rapporteur	Institute of Postgraduate Education in Health Care
Doc. Ruta MASTEIKOVÁ, Juge	Université des Sciences Vétérinaires et Pharmaceutiques de Brno



**UNIVERSITY OF VETERINARY AND PHARMACEUTICAL SCIENCES**

Ph.D. study program: Pharmacy

Speciality: Pharmaceutical Technology

**and**

**UNIVERSITY OF FRANCHE-COMTÉ**

Graduate School: Environment-Health

Speciality: Life and Health Sciences

**Multiparticulate colon drug delivery systems**

**THESIS**

with a view to obtaining the diploma of

**DOKTOR: Ph.D VETERINÁRNÍ A FARMACEUTICKÁ UNIVERZITA BRNO/**

**DOCTEUR DE L'UNIVERSITÉ DE FRANCHE-COMTÉ**

presented and defended

by

Miss Tereza BAUTZOVÁ

on September 17<sup>th</sup>, 2012 in Brno

**JURY**

Pr. Miloslava RABIŠKOVÁ, Supervisor    University of Veterinary and Pharmaceutical  
Sciences Brno

Pr. Alf LAMPRECHT, Supervisor        University of Franche-Comté

Pr. Philippe MAINCENT, Reviewer      Nancy University

Pr. Pavel KOMÁREK, Reviewer         Institute of Postgraduate Education in Health Care

Doc. Ruta MASTEIKOVÁ, Judge         University of Veterinary and Pharmaceutical  
Sciences Brno



Supervisors **Professor Miloslava RABIŠKOVÁ**

Department of Pharmaceutics

Faculty of Pharmacy

University of Veterinary and Pharmaceutical Sciences Brno

Czech Republic

**Professor Alf LAMPRECHT**

Laboratory of Pharmaceutical Engineering

Faculty of Medicine and Pharmacy

University of Franche-Comté Besançon

France

Reviewers **Professor Philippe MAINCENT**

Laboratory of Pharmaceutical Technology

Faculty of Pharmacy

Nancy University

France

**Professor Pavel KOMÁREK**

Department of Pharmaceutical Technology and Drug Control

Institute of Postgraduate Education in Health Care

Prague

Czech Republic



## ACKNOWLEDGEMENTS

The investigations presented in this thesis were performed during the years 2007-2012 in which period my research activity took place at Department of Pharmaceutics, Faculty of Pharmacy in Brno under the supervision of Professor Miloslava Rabišková and Laboratory of Pharmaceutical Engineering, Faculty of Medicine and Pharmacy in Besançon headed by my second director of thesis Professor Alf Lamprecht. I have enjoyed the aid of post-graduate scholarship from The Ministry of Education, Youth and Sports of the Czech Republic and scholarship for PhD students under co-supervision from the French Government (No 201052). Financial support from the Department of Pharmaceutics and Freemovers mobility program of University of Veterinary and Pharmaceutical Sciences Brno is gratefully acknowledged. This research work was generously funded in part by the Research Project Ministry of Health of the Czech Republic - NS10222-2/2009; the Research Project IGA - 253/2009/FaF, the Research Project Ministry of Industry and Trade of the Czech Republic - 2A-1TP1/073. The Institut Universitaire de France co-financed this study.

First of all, I owe my sincere gratitude to Professor Miloslava Rabišková for providing me an opportunity to do my PhD thesis in her department and such an interesting topic. I am particularly thankful for her valuable advice and support. Her idea of pellets based on natural polymers for the treatment of inflammatory bowel disease was in the beginning of this dissertation with kind collaboration of Professor Jiřina Spilková from Faculty of Pharmacy in Hradec Králové and Professor Alf Lamprecht.

I would like to express my deepest appreciation to Professor Alf Lamprecht. I am grateful to him for his professional guidance and his helpful advices. I would also acknowledge for his scientific support. Furthermore, I convey my gratitude to him for the opportunity to do my PhD in his co-supervision and research in very international group.

Special thanks are due to Yann Pellequer for his never-ending patience, valuable advices and willing help during day and night, working week and weekend. I deeply thank him for his insightful suggestions and comments. I am extremely grateful for his continuous encouragement.



I am very thankful to all members of the Department of Pharmaceutics in Brno for their help and technical assistance and especially to Honza Gajdziok who introduced me and guided my initial steps in the field of pharmaceutical technology. I single out for special mention Kateřina Dvořáčková for her encouragement and helping me in solving many problems that this research faced.

My warmest thanks and appreciations also go to all my colleagues in the Laboratory of Pharmaceutical Engineering in Besançon for their hearty reception, friendly atmosphere, pleasant mood at the office and their wonderful help. Arnaud Béduneau deserves a special mention for his mental support and obliging help in my French writing.

I am equally grateful to Hervé Reyssie for his guidance when I was making my first steps in animal experimentation.

I wish to thank my other colleagues, some become very good friends, who have accompanied me during my thesis and owing to them this period will be a wonderful memory.

Further I am much indebted to Doctor Jarmila Klusáková and Gabriela Pražanová for my initiation into the mystery of the histology.

Acknowledgments are also owed to Professor Philippe Maincent and Professor Pavel Komárek who honored me by accepting to review this thesis. I am also very grateful to the other members of the jury Doc. Ruta Masteiková and Yann Pellequer.

I would like to send my thanks out to Linton Corbet for his help with my English in preparing some of the articles and this manuscript.

It is a pleasure to show my gratitude wholeheartedly to Foltete's family for their extraordinary hospitality during my stay in Besançon.

Also, I wish to convey my appreciation to my partner for his continued love, great support, enormous patience and ability to tolerate relationship in distance.

Where would I be without my family? My parents and my brother deserve special mention for their endless love, understanding, encouragement and mental support despite of the distance. Deepest thanks are extended for their patience during all the years of my studies.

Finally, I would like to thank everybody who was important to the successful realisation of this thesis, as well as expressing my apology that I could not mention personally one by one.

Tereza Bautzová

Besançon, June 2012



## SUMMARY

Crohn's disease and ulcerative colitis are two related but distinct chronic inflammatory disorders of gastrointestinal tract (GIT), commonly denoted as inflammatory bowel disease (IBD). The main goal of the anti-inflammatory treatment of this disorder is to achieve maximal drug concentration in inflamed area and reduce systemic adverse effects. For this purpose several colon-specific drug delivery systems have been investigated. In addition, the design of pellets as oral drug delivery systems may provide many advantages over single unit preparations and thus improve patient compliance.

It is well known that most existing treatments of IBD are associated with significant side effects and for this reason the formulation with a "food like" composition was designed. In the first part of our study, therapeutic efficiency of rutin/chitosan pellets with coatings based on natural polysaccharides degraded by colonic microbiota compared to commercialized 5-aminosalicylic acid (5-ASA) pellets was investigated. Release profiles of coated pellets showed a minimal drug release in simulated stomach and small intestine following by rapid drug release upon exposure to the colonic fluid. The results from *in vivo* testing showed that rutin attenuated efficiently inflammation in the colon and coated pellets were as effective as 5-ASA pellets in mitigating experimental colitis. The studies demonstrated that rutin administration via chitosan core coated pellets seems to be a promising approach for colon-specific delivery since they could interact easily with the mucin layer and deliver drug especially to the inflamed colonic area to relieve symptoms of IBD omitting side effects related to conventional treatment.

The second objective of this thesis was to explore the impact of additional mucoadhesive polymer chitosan in the pellets core on the therapeutic efficiency. For this purpose, 5-ASA loaded pellets were produced by extrusion/spheronisation method and subsequently coated with pH-sensitive polymer Eudragit® FS. No drug release at pH 1.2 within 2 h, and release as intended in the simulated distal ileum and colon was observed. Chitosan-core pellets showed efficient mucoadhesive properties in *ex vivo* bioadhesion testing which were also confirmed by increased concentration of 5-ASA metabolite in the colonic tissues in rats. The pellets were tested in preexisting colitis and the results revealed significant attenuation of the colonic inflammation. We can conclude, that bioadhesive chitosan-core pellets showed additional beneficial properties for colonic 5-ASA delivery in the treatment of IBD over marketed dosage formulation.

## SHRNUTÍ

Crohnova choroba patří spolu s ulcerózní kolitidou mezi tzv. nespecifické střevní záněty. Hlavním cílem protizánětlivé léčby je dosažení maximální koncentrace léčivé látky v místě zánětu a snížení výskytu systémových nežádoucích účinků. Za tímto účelem bylo vyvinuto několik lékových transportních systémů pro kolon. Mezi nimi, pelety představují sofistikovanou lékovou formu přinášející nespočet výhod oproti tradičním lékovým formám.

Je všeobecně známo, že většina stávající léčby nespecifických střevních zánětů je spojena s významnými vedlejšími nežádoucími účinky. Z tohoto důvodu se první část experimentu zaměřila na výrobu pelet obsahujících rutin, přírodní flavonoid s protizánětlivými účinky. Taktéž obal pelet byl složen z přírodních polysacharidů degradovatelných enzymy střevní mikroflóry. Disoluční studie ukázaly minimální uvolnění rutinu v prostředí simulujícím žaludek a tenké střevo. Naproti tomu v disolučním médiu napodobujícím podmínky tlustého střeva došlo k rychlému a úplnému uvolnění léčivé látky. Výsledky z *in vivo* testování naznačují, že podání rutinu vede ke znatelnému potlačení experimentálně vyvolané kolitidy a rutinové obalené pelety jsou stejně tak účinné jako komerčně vyráběné pelety obsahující kyselinu 5-aminosalicylovou (5-ASA). Naše studie prokázala, že rutinové pelety s chitosanovým jádrem se zdají být slibným přínosem pro lékové transportní systémy pro kolon a léčbu nespecifických střevních zánětů, neboť zaručující uvolnění léčivé látky v místě zánětu, mají mukoadhezivní vlastnosti a nevykazují závažné vedlejší nežádoucí účinky.

Druhým cílem této práce bylo objasnit vliv mukoadhezivního polymeru chitosanu na terapeutickou účinnost pelet. Pelety obsahující 5-ASA byly připraveny metodou extruze/sferonizace a následně obaleny pH dependentním polyakrylátovým obalem Eudragitem<sup>®</sup> FS. Jádro pelet bylo složeno buď z 5-ASA a mikrokrytalické celulosy nebo byl ještě přidán chitosan. Z výsledků disoluční zkoušky vyplývá, že obal je schopný zabránit uvolnění léčiva v prvních dvou hodinách v prostředí umělé žaludeční šťávy a disoluční profil v prostředí simulujícím tenké střevo a kolon odpovídá požadavkům kladeným na lékové transportní systémy pro kolon. Pelety obsahující chitosan prokázaly výborné mukoadhezivní vlastnosti v *ex vivo* testu, které byly dále potvrzeny zvýšenou koncentrací metabolitu 5-ASA ve tkáni tlustého střeva potkanů. Po podání pelet potkanům s experimentálně vyvolanou kolitidou došlo k významnému potlačení zánětu. Z našich výsledků vyplývá, že pelety s chitosanovým jádrem vykazují několik výhod pro doručení 5-ASA do kolonu oproti registrovaným částicovým lékovým formám.

## RÉSUMÉ

La maladie de Crohn et la rectocolite hémorragique font partie des maladies inflammatoires chroniques de l'intestin (MICI). Le principal objectif des traitements anti-inflammatoires est de favoriser la délivrance du principe actif localement, spécifiquement sur les zones enflammées et de limiter les effets indésirables. Ainsi, plusieurs systèmes à libération colonique de molécules actives ont été développés. Parmi eux, les pellets présentent de nombreux avantages par rapport aux formes solides unitaires conventionnelles.

Dans un premier temps, des pellets contenant une substance anti-inflammatoire naturelle et nutritive, la rutine, ont été développés. L'intérêt de cette molécule est de réduire considérablement les effets secondaires qui constituent un véritable problème dans les traitements actuels des MICI. Les pellets ont été enrobés avec les polysaccharides naturels se dégradant avec la flore colonique. Les études *in vitro* ont démontré une libération minimale du principe actif au niveau de l'estomac et du petit intestin. Par contre, une libération rapide et totale a été observée lors de l'exposition des pellets dans les conditions du milieu colonique. Les résultats des tests *in vivo* ont démontré que la rutine a atténué considérablement l'inflammation au niveau de côlon et les pellets enrobés ont été aussi efficaces que les pellets d'acide 5-aminosalicylique (5-ASA) commercialisés. L'administration orale de rutine via les pellets enrobés et préparés avec le chitosan semble être une approche prometteuse, permettant la libération du principe actif au niveau des zones enflammées, pour le traitement des MICI tout en réduisant les effets secondaires.

Le deuxième but de notre travail était d'élucider l'impact du chitosan, un polymère mucoadhésif, sur l'efficacité thérapeutique. Les pellets de 5-ASA ont été préparés à partir de cellulose microcristalline avec ou sans chitosan. Un enrobage constitué d'un polymère pH-dépendant, l'Eudragit® FS, a ensuite été réalisé autour du noyau. Les tests de dissolution ont montré que le principe actif n'était pas libéré du pellet après 2 h en milieu acide. En revanche, la libération était rapide dans un milieu simulant l'environnement colonique. Les tests *ex vivo* avec les pellets contenant le chitosan ont montré des propriétés mucoadhésives importantes qui ont été confirmées par la concentration élevée du métabolite de 5-ASA dans les tissus coloniques des rats. De plus, nous avons démontré que les pellets permettaient d'atténuer de façon significative l'inflammation du côlon. Ainsi, les pellets bioadhésifs enrobés possèdent des propriétés bénéfiques supplémentaires pour la libération du 5-ASA au niveau du côlon par rapport à des formes multidoses commercialisées pour le traitement des MICI.



## LIST OF ORIGINAL PUBLICATIONS

This thesis is based on the following publications:

- I Rabišková M, Bautzová T, Dvořáčková K, Spilková J. Beneficial effects of rutin, quercitrin and quercetin on inflammatory bowel disease. *Čes Slov Farm.* 2009;58:47-54. Review.
- II Bautzová T, Rabišková M, Lamprecht A. Multiparticulate systems containing 5-aminosalicylic acid for the treatment of inflammatory bowel disease. *Drug Dev Ind Pharm.* 2011;37(9):1100-9. Review.
- III Rabišková M, Bautzová T, Gajdziok J, Dvořáčková K, Lamprecht A, Pellequer Y, Spilková J. Coated chitosan pellets containing rutin intended for the treatment of inflammatory bowel disease: In vitro characteristics and in vivo evaluation. *Int J Pharm.* 2012;422(1-2):151-9.
- IV Bautzová T, Rabišková M, Béduneau A, Pellequer Y, Lamprecht A. Bioadhesive pellets increase local 5-aminosalicylic concentration in experimental colitis. *Eur J Pharm Biopharm.* 2012;81(2):379-85.





# TABLE OF CONTENTS

<b>GENERAL INTRODUCTION</b>	<b>1</b>
<b>I. COLON-SPECIFIC DRUG DELIVERY SYSTEMS</b>	<b>3</b>
1. GENERALITIES	5
1.1. pH-based systems	5
1.2. Time-dependent systems	6
1.3. Microflora-activated systems	7
1.4. Pressure-controlled systems	9
2. PELLETS	9
2.1. Pellets as solid dosage forms	10
2.2. Pellets versus single unit forms	10
2.3. Pelletization techniques	12
2.3.1. Layering	12
2.3.1.1. Dry powder	12
2.3.1.2. Solution/suspension	13
2.3.2. Extrusion/spheronization	14
2.3.3. Rotoagglomeration	20
2.3.4. Spray drying, spray congealing	21
2.4. Characterisation of pellet properties	22
2.4.1. The pellet size, size distribution and shape	22
2.4.2. Density and porosity of pellets	24
2.4.3. Flow properties of pellets	26
2.4.4. Mechanical properties of pellets	27
3. REFERENCES	28
<b>II. CHARACTERISATION OF USED DRUGS AND EXCIPIENTS</b>	<b>35</b>

1. RUTIN	37
2. 5-AMINOSALICYLIC ADIC	39
3. CHITOSAN	41
4. SODIUM ALGINATE	43
5. REFERENCES	45
<b>III. INFLAMMATORY BOWEL DISEASE</b>	<b>53</b>
1. GENERALITIES	55
2. ANATOMY AND HISTOLOGY OF BOWELS	57
2.1. Small intestine	57
2.2. Large intestine	58
2.3. Microscopic structure	59
3. RELATED BUT DISTINCT CHRONIC INFLAMMATORY DISORDERS	61
3.1. Ulcerative colitis	61
3.1.1. History	61
3.1.2. Epidemiology	61
3.1.3. Types	62
3.1.4. Main features	63
3.2. Crohn's disease	65
3.2.1. History	65
3.2.2. Epidemiology	66
3.2.3. Classification	66
3.2.4. Main features	66
4. IMMUNE RESPONSE AND INFLAMMATORY PATHWAYS	69
5. MEDICAL MANAGEMENT	71
5.1. Current therapies	73
5.1.1. 5-aminosalicylates	73

5.1.2. Corticosteroids	74
5.1.3. Immunosuppressive and immunoregulatory agents	74
5.1.4. Biological agents	75
5.1.5. Antibiotics	76
5.1.6. Probiotics	76
5.1.7. OTC and diet	77
6. REFERENCES	78
<b>PURPOSES OF THE THESIS</b>	<b>83</b>
<b>GENERAL DISCUSSION</b>	<b>87</b>
1. PREPARATION OF PELLETS	89
2. EVALUATION OF PELLETS	91
3. COATING OF PELLETS	92
4. DISSOLUTION TESTING	94
5. THERAPEUTIC EFFICIENCY	97
6. REFERENCES	101
<b>ORIGINAL PUBLICATIONS I-IV</b>	<b>105</b>



## LIST OF FIGURES

---

---

Fig. I.1: Enteric coated Pulsincap <sup>®</sup>	6
Fig. I.2: Double coating time-dependent system	7
Fig. I.3: Schematic of the CODES <sup>™</sup> formulation	8
Fig. I.4: Principle of powder layering process	13
Fig. I.5: Principle of suspension layering process	14
Fig. I.6: Marumizer, demonstration of particles moving, indented plate	15
Fig. I.7: Critical factors in extrusion/spheronization	16
Fig. I.8: Schematic view of axial and radial type of screw extruder	17
Fig. I.9: Schematic view of gravity-fed extruders (A) and ram extruder (B)	18
Fig. I.10: Geometry of spheronization plate. Crosshatch (A) and radial (B)	19
Fig. I.11: Pellet-forming mechanisms according to Rowe and Baert	19
Fig. I.12: Principle of direct pelletizing	20
Fig. I.13: Schematic representation of the mechanisms of nucleation, coalescence, layering	21
Fig. II.1: Rutin structure	37
Fig. II.2: Proposed pharmacokinetics of orally administered rutin	38
Fig. II.3: 5-ASA structure, zwitter ion	39
Fig. II.4: Chitosan structure	41
Fig. II.5: Sodium alginate structure	43
Fig. II.6: Schematic representation of the egg-box structure	43
Fig. III.1: Inflammation in CD	55
Fig. III.2: Differences in the localization and distribution of UC and CD with depiction of intestinal complications	55
Fig. III.3: Bulk of the surface area expansion, showing villi (fingerlike and leaflike appearance), epithelial cells that cover the villi and the microvilli of the epithelial cells	57
Fig. III.4: The four main differentiated cell types found in the epithelial lining of the small intestine	58
Fig. III.5: Anatomy of large intestine	59
Fig. III.6: Microanatomy of the digestive tube	60
Fig. III.7: Colonoscopy pictures of colon	61
Fig. III.8: Anatomic extent of UC involvement	63
Fig. III.9: Main macroscopic features in UC	64

Fig. III.10: Spectrum of mucosal abnormalities in UC	64
Fig. III.11: Histologic features in UC	65
Fig. III.12: Main features in CD	67
Fig. III.13: Spectrum of radiologic changes in CD	68
Fig. III.14: Histological features in CD	69
Fig. III.15: Pathogenesis of IBD: antigen recognition and immunoregulation	70
Fig. IV.1: Drug released profiles from uncoated rutin pellets in phosphate buffer of pH 3.0 or pH 6.8	91
Fig. IV.2: Pellet size distribution in the fractions determined by sieve analysis	92
Fig. IV.3: Drug released profiles from uncoated and coated rutin and 5-ASA pellets in 0.1N HCl and rutin in phosphate buffer of pH 3.0 (A); and phosphate buffer of pH 6.8 (B)	95
Fig. IV.4: Drug released profiles from coated rutin and 5-ASA pellets in the continuous dissolution method	97
Fig. IV.5: Determination of colon/body weigh index (A) and myeloperoxidase activity (B) after final drug administration for n = 4 animals	99

## LIST OF TABLES

---

Table I.1: Properties of pellets	22
Table I.2: Definition of various types of volumes and densities	24
Table I.3: Flow properties and corresponding angles of repose	26
Table II.1: Pharmaceutical applications of chitosan	42
Table III.1: Commercialized drugs for the treatment of IBD	72
Table IV.1: Pellet characteristics	92

## LIST OF ABBREVIATIONS

---

---

5-ASA: 5-aminosalicylic acid

AC: alginate/chitosan

CD: Crohn's disease

CD8: Cluster of differentiation 8

CFU: Colony-forming unit

DNA: Deoxyribonucleic acid

EFS: Eudragit<sup>®</sup> FS

E/S: Extrusion/spheronization

GIT: Gastrointestinal tract

HCl: Hydrochloric acid

HPMC: Hypromellose

IBD: Inflammatory bowel disease

Ig: Immunoglobulin

IL: Interleukin

INF: Interferon

IV: Intravenously

kDa : Kilodaltons

MCC: Microcrystalline cellulose

MICI: Maladies inflammatoires chroniques de l'intestin

NF- $\kappa$ B: Nuclear factor-kappa B

NOD2: Nucleotide-binding oligomerization domain containing 2

O: Orally

pH: Potential of hydrogen

PPAR- $\gamma$ : Peroxisome proliferator-activated receptor gamma

R: Rectally

SUB: Subcutaneously

Th: Helper T cells

TNBS: Trinitrobenzene sulfonic acid

TNF: Tumor necrosis factor

UC: Ulcerative colitis





# **GENERAL INTRODUCTION**



## **I. COLON-SPECIFIC DRUG DELIVERY SYSTEMS**



## 1. GENERALITIES

---

---

An oral delivery system that can precisely target drugs to the colon without premature release in the upper GIT is important and advantageous in a number of ways (Shah et al., 2000). Such a delivery system is able to provide more effective local therapy of colon related diseases, because it avoids drug absorption through the upper GIT, minimizes drug concentration in the general circulation and maximizes drug levels in the diseased intestinal tissue (Dahan et al., 2010). On the other hand, the colon is also viewed as the preferred absorption site for orally administered protein and peptides drugs due to the relatively low proteolytic enzyme activities and slow transit, thus such delivery system can be used to increase overall systemic absorption of these drugs (Arhewoh and Okhamafe, 2004).

Because of the distal location of colon in the GIT, a colon-specific drug delivery system should prevent drug release in the stomach and small intestine, and effect an abrupt onset of drug release upon entry into the colon. This necessitates a triggering element in the system that can respond to physiological changes in the colon (Yang et al., 2002). For this purpose, different approaches relied on the pH difference between different parts of the GIT, gastrointestinal transit time, enzymatic activity of the gastrointestinal microflora and increased luminal pressure in the colon for targeted colon delivery have been investigated and are detailed later (Leopold, 2001). Generally, the drug embedded within a polymeric matrix, or a drug reservoir (e.g., drug loaded pellet, capsule or tablet) is surrounded by a polymeric film coating (Karrout et al., 2009).

### 1.1. pH-BASED SYSTEMS

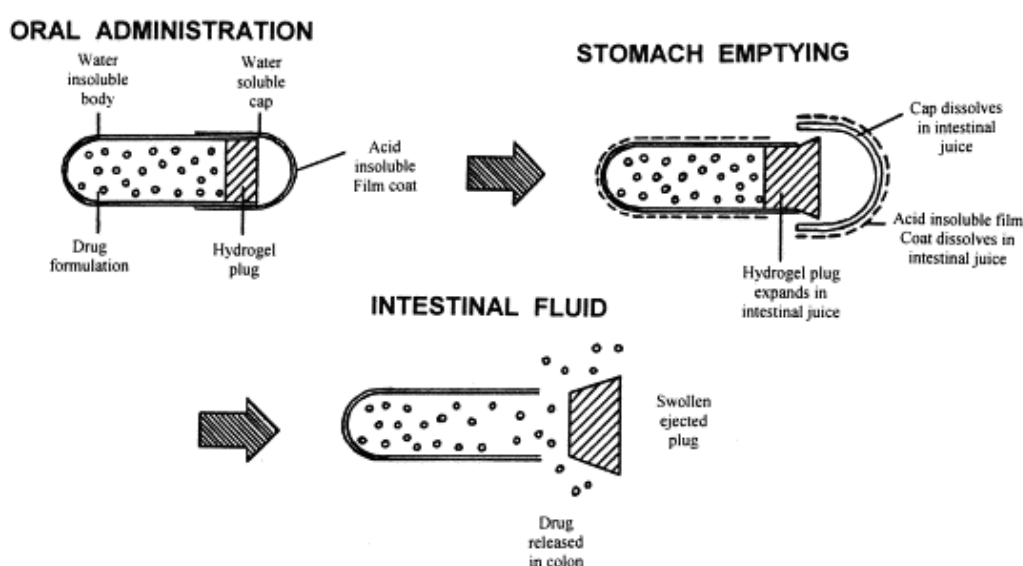
---

The pH-dependent systems exploit the generally accepted view that pH of the human GIT increases progressively from the stomach (pH 2-3), small intestine (pH 6.5-7) to the terminal ileum (7-8) (Ashford and Fell, 1994). However, the pH of the colon drops to 5.5-7 because of the acidification of the colonic contents caused by the products of bacterial fermentation (Guarner and Malagelada, 2003). Most commonly used pH-dependent coating polymers are methacrylic acid copolymers commonly known as Eudragit<sup>®</sup> that are insoluble in the stomach but soluble at pH values ranging between 5.5 and 7.0 (Khan et al., 1999). High individual variability in physiological pH, the similarity in pH between the small intestine and

the colon, and very inconsistent data of the colonic pH in disease state reported in the literature make pH-dependent systems less reliable and thus site-specificity of drug release in the colon more unpredictable (Evans et al., 1988; Nugent et al., 2001; Yang et al., 2002).

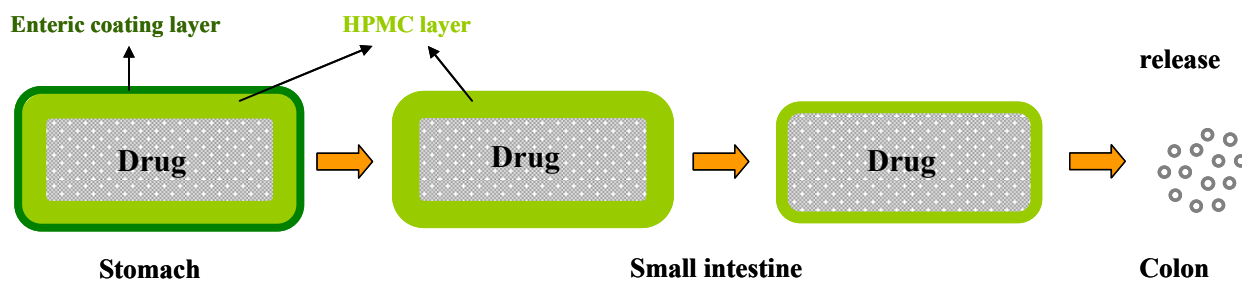
## 1.2. TIME-DEPENDENT SYSTEMS

The location of initial drug release predominantly depends on the transit time of the system in the GIT (Yang et al., 2002). In this respect Pulsincap<sup>®</sup> System (Fig. I.1, Mc Neil and Stevens, 1990) and Time Clock<sup>®</sup> System (Pozzi et al., 1994) have been developed with the programmed lag time. Briefly, Pulsincap<sup>®</sup> System comprises a slowly hydrating hydrogel plug, and insoluble capsule body whose contents are released at times dependent on the dimensions of the plug (Hebden et al., 1999). Whereas, drug release from the tablet core of Time Clock<sup>®</sup> System occurs after a pre-determined lag phase caused by slow hydration of the hydrophobic coating layer and depends mainly on the thickness of this layer (Pozzi et al., 1994). Even though, following gastric emptying, small intestinal transit time is fairly constant at 3-4 h, the retention times in the stomach are highly variable and make this approach complicated in predicting the accurate site of drug release (Davis et al., 1986; Kaniwa et al., 1988). Additionally, the performance of a time-dependent formulation can be significantly affected by accelerated transit through different regions of the colon observed in the patients with IBD (Hebden et al., 2000).



**Fig. I.1: Enteric coated Pulsincap<sup>®</sup>** (adapted from Mc Neil and Stevens, 1990)

Other alternative in time-controlled drug delivery systems involves ethyl cellulose coating: the drug is released in a sustained manner starting from the duodenum and proceeding till rectum (Sandborn, 2010). As mentioned above, transit through the small intestine is relatively uniform. By combining an enteric coating approach to prevent drug dissolution in the stomach and a delayed release element, it is possible to overcome high variability in gastric residence time and target drug liberation in the terminal ileum and colon (Friend, 2005). These systems consist of an outer coating of an enteric polymer (usually Eudragit<sup>®</sup> L, S, or FS) and inner coating based on Eudragit<sup>®</sup> RL and RS, ethylcellulose, or hypromellose (HPMC) (Fig. I.2, Gupta et al., 2001; Lecompte et al., 2005; Chickpetty et al., 2010).



**Fig. I.2: Double coating time-dependent system**

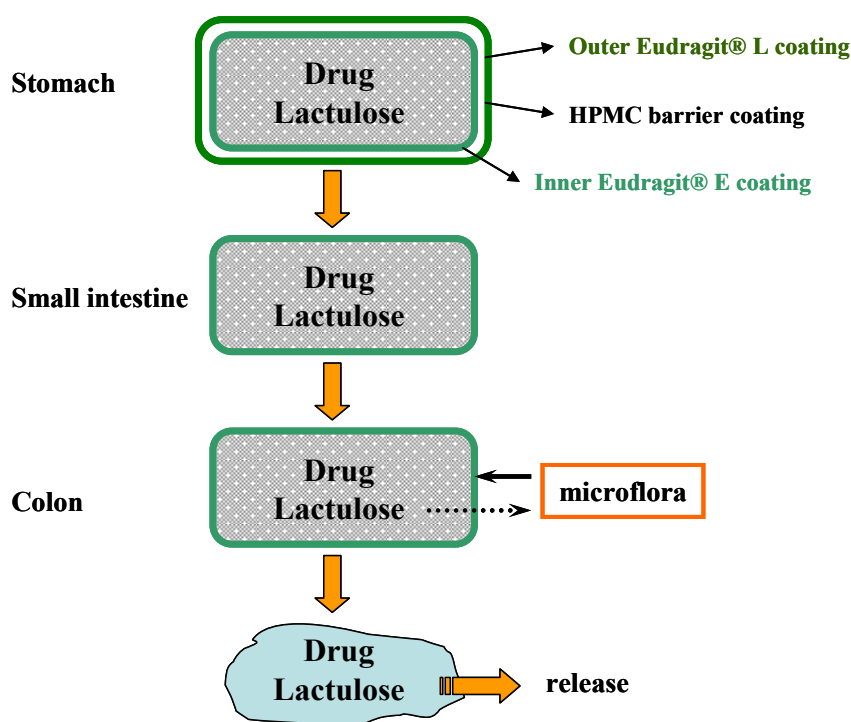
### 1.3. MICROFLORA-ACTIVATED SYSTEMS

The colonic microflora is well recognized as an effective triggering component in the design of colon-specific drug delivery systems since bacteria population increase abruptly in the colon (over 400 distinct species having a population of  $10^{11}$ - $10^{12}$  CFU/ml) and produces a wide range of enzymes that are not present or are different from those in the stomach and the small intestine (Simon and Gorbach, 1984; Basit, 2005; McConnell et al., 2008). Large number of polysaccharides, such as amylose, alginates, dextran, guar gums, inulin, pectins, starch etc., is stable in the upper GIT, however is specifically hydrolysed by colonic bacteria (Hovgaard and Brøndsted, 1996). These polysaccharides can be incorporated into the delivery system via film coating and matrix formation or used as drug-polymer conjugates and prodrugs (Vandamme et al., 2002). Thus, they pass unchanged through the stomach and small intestine and active drug moiety is released after enzymatic bond cleavage in the colon. The enzymatic controlled systems seem to be very promising since they could avoid the



drawbacks inherent in pH- and time- dependent systems. Nevertheless variations in enzymatic activity leading to variability in drug cleavage or drug release in Crohn's disease (CD) patients have been observed (Carrette et al., 1995; Yang et al., 2002).

Codes™ represents another more complex formulation which relies on the conversion of lactulose to organic acids by colonic bacterial enzymes as shown and explained in Fig. I.3 (Watanabe et al., 1998).



**Fig. I.3: Schematic of the CODES™ formulation** (adapted from Katsuma et al., 2002). Typical configuration consists of a core tablet coated with three layers of polymer coatings. CODES™ remains intact in the stomach due to the outer coating (Eudragit® L). Once the unit passes into the duodenum, enteric and barrier (HPMC) coating dissolves exposing the inner Eudragit® E coating which is slightly permeable and swellable in the small intestine. Upon entry into the colon, lactulose inside core tablet dissolves and diffuses through the coating. This disaccharide is enzymatically degraded into short chain fatty acids by colonic bacteria. This lowers the local pH, Eudragit® E dissolves and subsequently drug is released.

## **1.4. PRESSURE-CONTROLLED SYSTEMS**

---

As a result of strong peristaltic waves, increased luminal pressure occurs in the colon than in the small intestine providing a potential triggering mechanism for colon-specific drug delivery (Shameem et al., 1995). Pressure-controlled colon delivery capsule has been introduced by Niwa et al. (1995) and consists of a capsular shape suppositories with an inner ethylcellulose coating. Disintegration of the formulation depends on the thickness of the ethylcellulose film. However, it should be noted that major peristaltic waves occur physiologically only once or twice a day and therefore the exact time of drug release cannot be accurately predicted. Moreover, drug release could be significantly affected by colonic disorders such as diarrhoea (Leopold, 1999).

## **2. PELLETS**

---

---

In the past three decades, multiple unit drug delivery systems like e.g. pellets have gained increasing attention in different pharmacological applications. The pellet based systems have been recognized as an efficient way for IBD treatment compared to single unit forms in order to prolong colonic passage time in patients suffering from diarrhoea (Collnot et al., 2012). As well, delayed-onset sustained-release pellets have been proposed according to the concept of chronotherapy to improve the pharmacotherapy of cardiovascular diseases (Michelson 1991). Besides, pellets as pulsatile drug delivery system present an interesting approach for antidiabetic drugs with short biological half-life requiring multiple dosing or for treating nocturnal bronchial asthma or angina pectoris (Maroni et al., 2005; Piao et al., 2009). Additionally, sustained-release pellets have been developed for drugs with short half-life, for example ambroxol, diclofenac sodium, flucloxacillin, paracetamol, for the purpose of improving patient compliance (Bowyer and Cumberland, 1994; Grassi et al., 2003; Kramar et al., 2003; Chi et al., 2010). Also, pellets offer more flexibility to body weight dose adaptation and therefore represent an alternative to tablet breaking in pediatrics (Kayumba et al., 2007).

## 2.1. PELLETS AS SOLID DOSAGE FORMS

---

Historically, the term “pellet” has been used by a number of industries to describe a variety of agglomerates produced from diverse raw materials using different processing conditions (Ghebre-Sellassie and Knoch, 2002). Pharmaceutical pellets are small, free flowing, spherical or semi-spherical units with a narrow size distribution, typically varying between 500 and 1500  $\mu\text{m}$  in size which can be obtained through agglomeration of fine powders or granulates of active ingredients and excipients using several pelletization methods (Ghebre-Sellassie, 1989). Pellets offer a high degree of flexibility in the design and development of oral dosage forms and are primarily produced for manufacturing of controlled-release dosage forms with gastroresistant or sustained-release properties (Gryczova et al., 2008). For this purpose, they are filled into hard capsules, sachets or stick packs (Chopra et al., 2002). Alternatively, they are combined with suitable excipients and compacted into disintegrating tablets (Bashaiwoldu et al., 2011). They can also be sold in multidose containers and taken with a measuring spoon by the patient (Knop and Kleinebudde, 2005). In order to obtain a controlled release, polymeric film coatings or several types of matrix systems are commonly used (Tapia et al., 1993; Van Savage and Rhodes, 1995). The spherical shape of pellets without any edges is ideal for the application of coatings with respect to the low surface-to-volume ratio for a given particle size (Larsen et al., 2003).

## 2.2. PELLETS VERSUS SINGLE UNIT FORMS

---

The use of pellets in controlled-release oral solid dosage forms provides several advantages over monolithic single-dose units such as tablets:

### PHARMACOLOGICAL

- ✓ After swallowing, the pellets are widely and more uniformly dispersed in the GIT contents with a consequent reduction in local drug concentration and thus less local irritation of the gastrointestinal mucosa on the one hand and increased contact between drug and GIT surface and thus more uniform drug absorption and improved bioavailability on the other hand (Washington et al., 2001; Cheng et al., 2004).
- ✓ The pellets appear to be less influenced by the physiologic factors, such as the gastric emptying and intestinal transit. More predictable and reproducible gastrointestinal

transit time provide more uniform drug release. In addition, pellets are continuously emptied from the stomach during the digestive period compared to the non-disintegrating tablets which are emptied during the interdigestive period (Hardy et al., 1985; Goracinova et al., 2012).

- ✓ Due to smaller particle size, the pellets pass through the GIT easily, leading to less inter- and intra-subject variations in the pharmacokinetic parameters and moreover are retained in the ascending colon for a relatively long period of time (Hardy et al., 1985).
- ✓ The unintentional disintegration of certain single unit formulation (due to manufacturing defects, abrasion with food in the stomach, etc.) and consequently serious problems with dose dumping, risk of side effects and systemic toxicity are considerably less with pellets because the release failure of the individual unit hardly affects the total release behavior of multiparticulate system (Washington et al., 2001; Chopra et al., 2002; Cheng et al., 2004).
- ✓ The pellets can be re-obtained easily by opening the capsule or dispersing the tablet in water. This allows more facile swallowing for children and elders or even administration via nasogastric feeding tubes (Steiner, 2011).

#### TECHNOLOGICAL

- ✓ Pellets possess low friability and narrow particle size distribution. Owing to their smooth surface morphology and spherical shape pellets can be easily coated or are ideal for powder layering. Pellets offer the possibility of accurate volumetric dosing on tablet presses or uniform packing on capsule filling machines due to good flow properties (Reynolds, 1970, Gryczova et al., 2008).
- ✓ Pelletization process results in an improvement of the uniformity of the content thanks to the prevention of segregation of co-agglomerated components (Gu et al., 2004).
- ✓ Manipulation with pellets prevents dust formation resulting in an amelioration of the process safety (Ramaker, 2001).
- ✓ Incompatible drugs can be processed separately and mixed later. Drugs with different release pattern can be combined in the same dosage form or pellets with different release mechanisms can be mixed to give a new modified release profile of a single dose (capsule, sachet) (Steckel and Mindermann-Nogly, 2004).

- ✓ High dose of drug can be incorporated into the pellets (Wesseling and Bodmeier, 2001).
- ✓ Pellets provide improved drug stability against external factors such as moisture, air and light (Fitzpatrick et al., 2006).

## 2.3. PELLETTIZATION TECHNIQUES

---

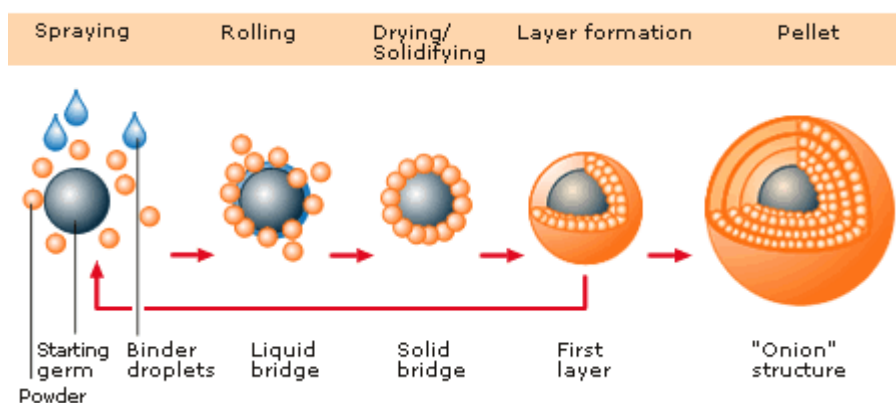
Pelletization is often referred to as a size-enlargement process that involves the manufacture of agglomerates with a relatively narrow size range, and is used in various industries, such as agriculture, mineral processing, food and detergent industry. Several methods in the pharmaceutical industry are used for pellet preparation. The most commonly employed and intensely investigated pelletization processes are layering of the drug solution, suspension or powder on the inactive cores, extrusion/spheronization (E/S) and rotoagglomeration. Extensive research has focused as well as on the development of novel manufacturing approaches that use innovative formulations and processing equipment, such as spray drying, or spray congealing, hot-melt extrusion, cryopelletization, etc. (Ghebre-Sellassie and Knoch, 2002; Dukić-Ott et al., 2009; Hirjau et al., 2011).

### 2.3.1. Layering

#### 2.3.1.1. Dry powder

Formulation of multiparticulates by powder layering process comprises the deposition of successive layers of dry powder of drug, excipients or both on preformed nuclei or cores with the help of a binding liquid. Since finely milled dry powder and binding liquid are applied simultaneously, this process requires specialized equipment. Conventional coating pan, a machine that has been used primarily for sugar coating, was the first equipment utilized to manufacture pellets. However, the degree of mixing is very poor and the drying process is not efficient. Given that tangential spray or centrifugal fluid-bed granulators have been developed to overcome these significant limitations. During a layering process, centrifugal force, fluidization air velocity, and gravity force act in concert to generate a spiral, rope-like motion of the particles in the product bed. Loss in the spiral rope-like motion, caking and severe particle attrition represent the serious problems in this technique. Fig. I.4 shows

principle of powder layering process. In the initial stages, the drug particles are bound to the starter seeds and subsequently to the forming pellets with the help of liquid bridges originated from the sprayed liquid, eventually replaced by solid bridges. Successive layering continues until the desired pellet size is reached. Throughout the process, it is extremely important to maintain equilibrium between the binder liquid application rate and the powder delivery rate in order to avoid overwetting and agglomeration or dust generation. The most attractive features of this technique are the uniform distribution of the powder on cores and the high drying efficiency of the binder solution, as well as the possibility of applying the successive functional film coating using the same equipment. In spite of interesting possibilities, powder layering still presents some drawbacks. This process requires a great deal of repetition of wetting and powdering operations and is thus time consuming. Moreover, undesired agglomeration and adhesion of pellets to the wall of the coating equipment can occur (Nastruzzi et al., 2000; Ghebre-Sellassie and Knoch, 2002; Varshosaz et al., 2009).

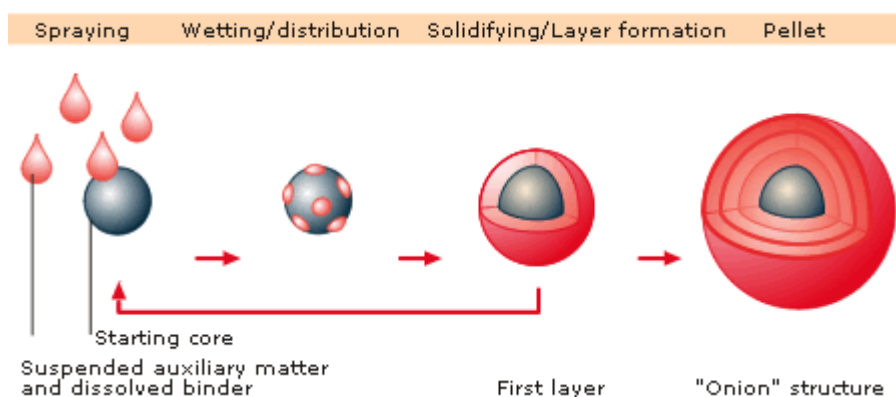


**Fig. I.4: Principle of powder layering process** (downloaded from Glatt®)

### 2.3.1.2. Solution/suspension

Solution/suspension layering involves the deposition of successive layers of solutions and/or suspensions of drug substances and binders on starter seeds, which may be inert materials or crystals/granules of the same drug. The process can be carried out in conventional coating pans, fluid-bed centrifugal granulators, or Wurster coaters. Its efficiency and the quality of manufactured pellets are in part related to the type of equipment used. The Wurster coating process, which was invented about 30 years ago, had evolved into ideal equipment owing to the high drying efficiency, cylindrical partition located in the product

chamber and orifice plate. The obtained pellets are uniform in size distribution and exhibit very good surface morphology. Homogeneous layering of drug substances is consistently achieved using this method nevertheless only low drug loaded pellets can be produced. The quantity of starter cores, the fluidization air volume and the well-organized particle movement are the critical parameters in this process. Besides, the evaporation rate of the application medium should neither impair binder effectiveness nor lead to overwetting and subsequent agglomeration. It is important to keep in mind that with increasing size of the forming pellets, the mass in the bed rises, and so it is necessary to continuously augment the fluidization air volume to provide optimum expansion and mixing of the product bed. During processing (Fig. I.5), all the components of the formulation are first dissolved or suspended in a appropriate quantity of application medium to provide a formulation with the desired viscosity and is then sprayed onto the product bed. The sprayed droplets immediately impinge on the starter seeds and spreads evenly on the surface. In a drying phase, dissolved materials precipitate and form solid bridges that would hold the formulation components together as successive layers on the starter seeds. The process continues until the desired quantity of drug substance are achieved (Ghebre-Sellassie and Knoch, 2002).

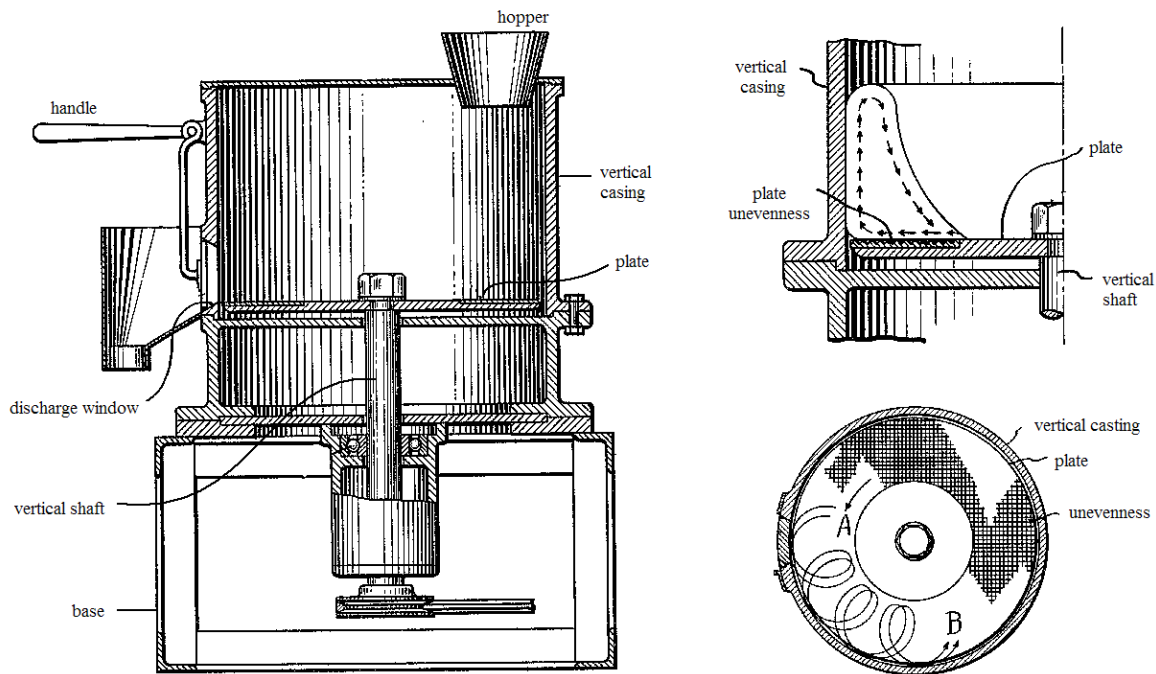


**Fig. I.5: Principle of suspension layering process** (downloaded from Glatt®)

### 2.3.2. Extrusion/spheronization

Historically, the concept of E/S as a pelletization technique has been developed in the early 1960s and widely used in the plastics and food industries. It found its way into the pharmaceutical industry in 1964 with the invention of the spheronizer also known as a marumizer by Nakahara. Marumizer consists of a static cylinder or stator and a rotating

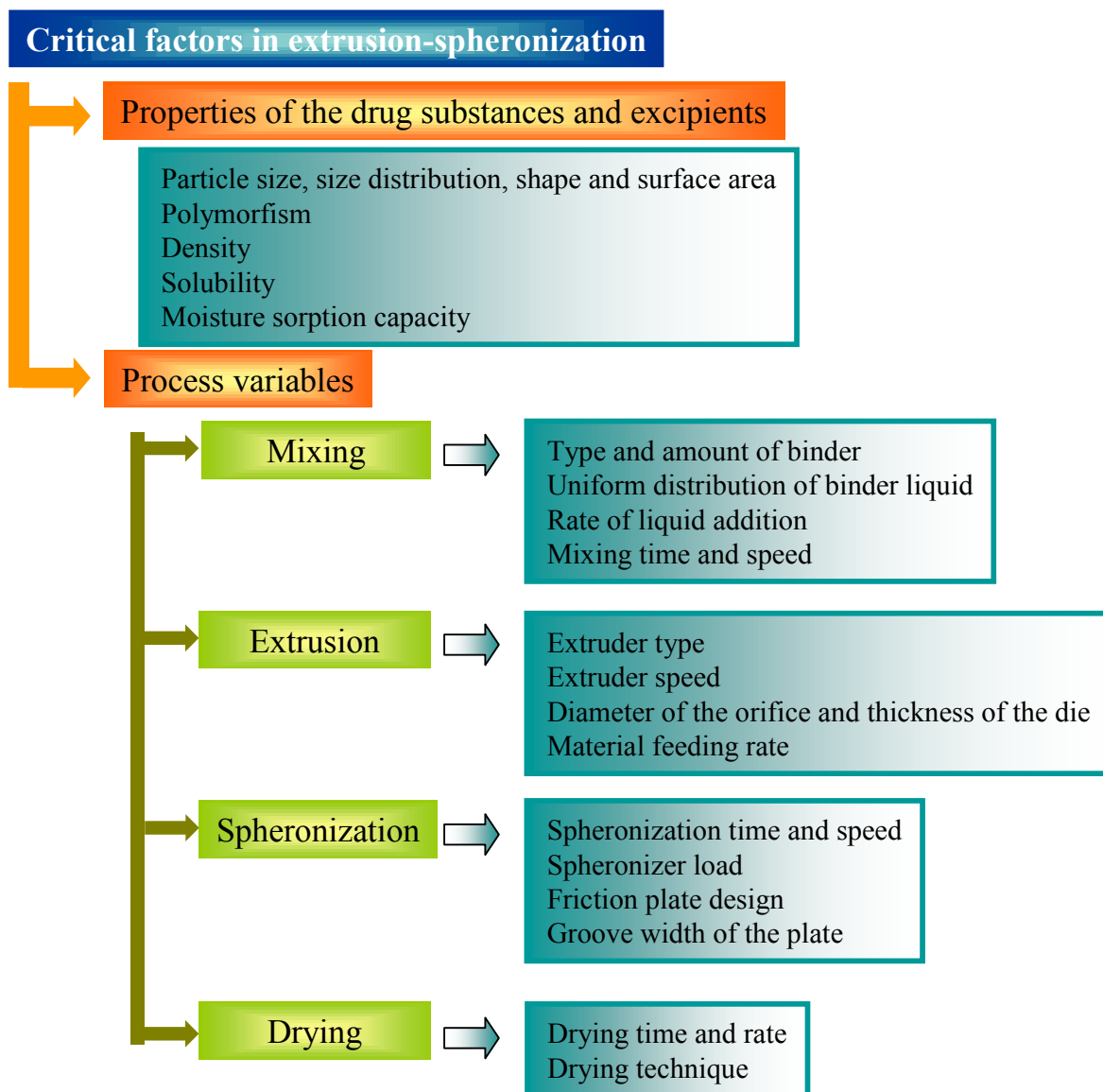
friction plate with a grooved surface at the base (Fig. I.6). The unevenness serves as the means for cutting and rubbing material which travels in the path of arrow B.



**Fig. I.6: Marumizer patented by Nakahara, demonstration of particles moving, indented plate; A-plate turning direction, B-path of material travelling (adapted from Nakahara, 1964)**

E/S is a multistage process allowing production of pellets with uniform size from wet granulates. The method was first reported by Renolds (1970) and by Conine and Hadley (1970) and involves the following main steps: homogenization and wetting, extrusion, spheronization and drying. This technology enables the manufacture of pellets with a high drug loading up to 90 % but it also can be used to produce extended-release matrix type pellets in a single step avoiding subsequent film coating. The produced pellets possess low friability, good flow properties, and a spherical to slightly oval shape. The characteristics and quality of the final pellets are dependent on the physicochemical properties of the active pharmaceutical ingredient, excipients and process variables which are shown in Fig. I.7 (Nakahara, 1964; Ghebre-Sellassie and Knoch, 2002; Trivedi et al., 2007).

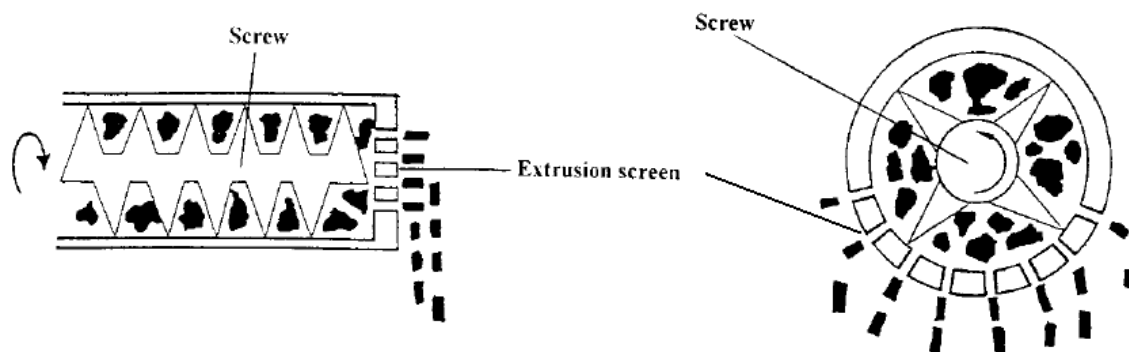




**Fig. I.7: Critical factors in E/S** (adapted from Ghebre-Sellassie and Knoch, 2002; Trivedi et al., 2007)

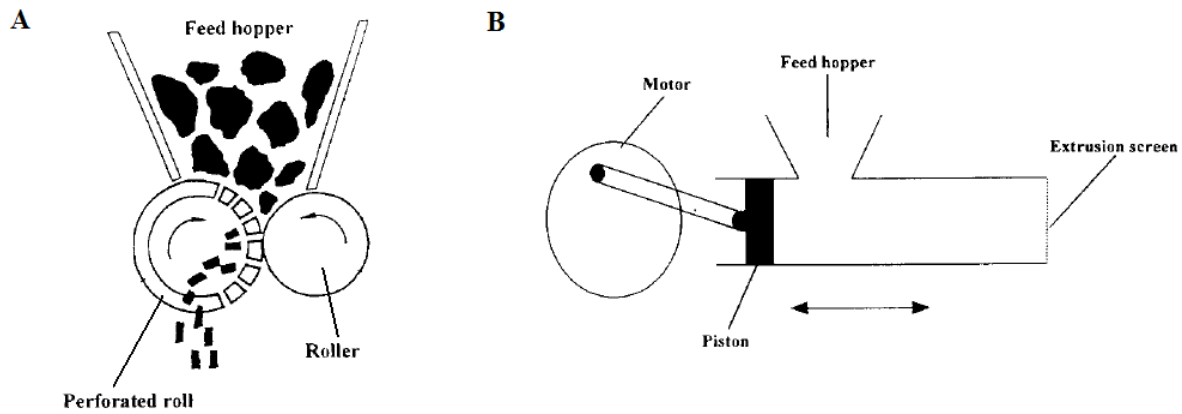
*Mixing* or *blending* of dry powders is the first step of the extrusion/spheronization process when the drug is mixed with one or more excipients in a blender. Subsequently, an adequate amount of binding liquid is added to the dry powder mixture at an appropriate rate to obtain a wet mass. The quantity of liquid should be sufficient to provide plasticity to the resulting extrudates. During this step the evaporation of the fluid phase should be restricted to a minimum and the homogeneous distribution of granulation liquid throughout the wet mass should be achieved. The dry blending and wet mixing are generally carried out in the same equipment, such as a planetary mixer, sigma blade mixer, continuous granulator or a high-shear mixer (Baert and Remon, 1993; Vervaet et al., 1995; Trivedi et al., 2007).

*Extrusion*, the second step, is a continuous process that can be defined as a molding process in which the material is forced to pass through a die or mold with the numerous apertures to create cylinders or rod-shaped masses called extrudates. The granulated mass must be plastic and sufficiently cohesive and self-lubricating during extrusion. The diameter of the extrudate segments and the final size of the spheroids depend on the diameter of the opening in the extruder screen. A variety of extruders exists. In screw-fed extruders (Fig. I.8), screws rotate along the horizontal axis and transport the wet mass from the hopper towards the die. Axial extruders have a die plate positioned perpendicularly at the end of the screw and tend to produce extrudates with slightly higher densities whereas in radial extruders material is extruded radially through screens mounted around the horizontal axis of the screws, they have higher throughput but produce less dense extrudates. Nevertheless, the increase in product temperature is negligible and thus it is a suitable method to extrude thermolabile drug substances. Twin-screw extruders provide better material transport characteristics and higher capacity or throughput than single-screw extruders (Hicks and Freese, 1989; Newton, 2002).



**Fig. I.8: Schematic view of axial and radial type of screw extruder** (adapted from Vervaeet et al., 1995)

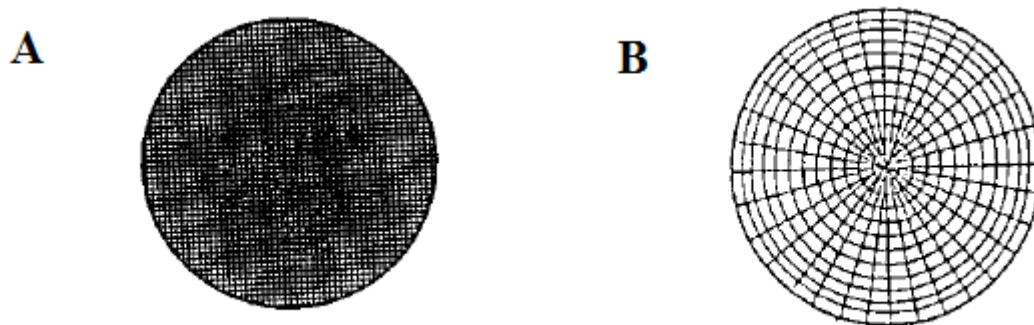
Gravity-fed extruders (Fig. I.9A) are equipped with two rollers that apply pressure on the wet mass which moves through the extruder by gravitational force. In ram extruders (Fig. I.9B), a piston displaces and forces the wet mass through a die at the end. These extruders are used for extrusion of wax-like substances. The ideal extrudate should have sufficient mechanical strength to retain the shape without crumbling into powder, but also be brittle enough to be broken down during spheronization. In addition, it should possess sufficient plasticity to be rolled into spheres (Fielden et al., 1992; Hirjau et al., 2011).



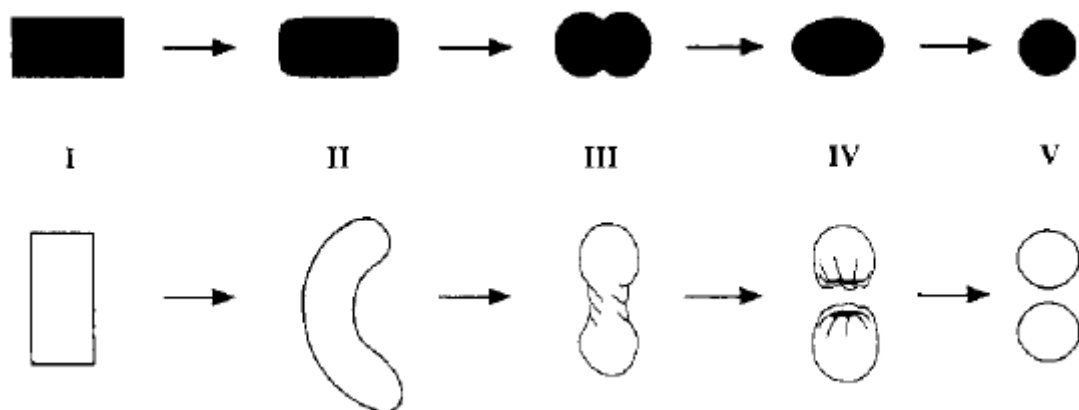
**Fig. I.9: Schematic view of gravity-fed extruders (A) and ram extruder (B)** (adapted from Vervaet et al., 1995)

*Spheronization* takes place in a spheronizer which consists of a cylindrical bowl with a bottom rotating friction plate. Two commonly known groove patterns of plate are crosshatch geometry, in which the grooves intersect each other at  $90^\circ$  angle, and radial geometry, in which the grooves spread out radially from the center (Fig. I.10). The extrudates are spheronized by interparticle collisions and particle-to-wall frictional forces. The grooved plate moves the extrudates in such a way that they scramble back and forth in a spiraling motion onto the rotating bed. The frictional force on the material generated by this movement first breaks the extrudates into small cylinders, which then spheronize into spheres. There are two well-known models that describe this transition mechanism. According to Rowe's model (Fig. I.11), rounding of the cylinders starts with edges to form rounded ends and continues with the conversion into dumbbell-shaped pellets, elliptical shaped pellets and finally into spheres. However, Baert's model (Fig. I.11) describes the transformation of cylindrical extrudates into rope-shaped cylinders and then into dumbbell-shaped pellets. On further twisting, the latter break into two spheres with cavities. The continuous movement of the pellets eventually seals the cavities and forms the spherical pellets. The spheronizing time is usually 2-15 min. During the spheronization step, it is essential that the extrudate break at appropriate length and have sufficient surface moisture to enhance formation of uniform spherical pellets. The degree of liquid saturation is critical factor and needs to be optimized. Wet mass containing low moisture content may generate extrudates that produce large quantities of fines during the spheronization step. If the moisture level is too high, the extrudate may adhere to each other, become sticky and form bundles of strands that fail to rotate. New types of spheronizers, so-called air-assisted, are designed to permit a conditioned air stream to pass from beneath the

rotating disk through the gap or slit between the cylindrical wall and the rotating friction plate into the product bed which improves pellet turnover and brings about a spiral rope-like motion that facilitates spheronization (Rowe, 1985; Baert et al., 1993; Trivedi et al., 2007).



**Fig. I.10: Geometry of crosshatch (A) and radial (B) spheronization plate** (adapted from Vervaet et al., 1995)

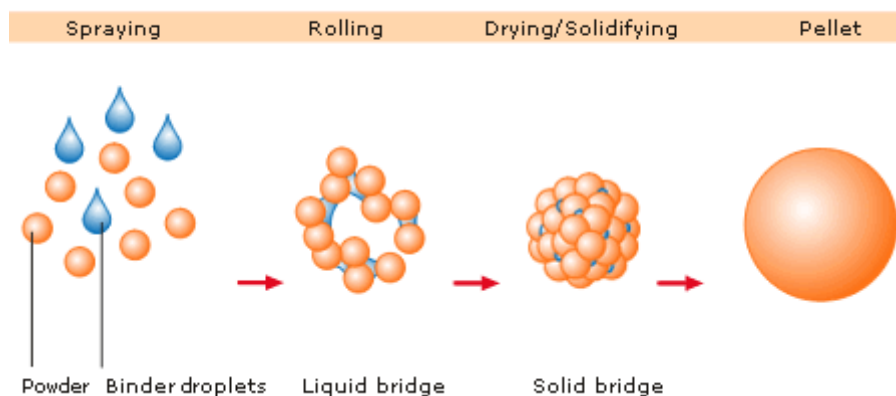


**Fig. I.11: Pellet-forming mechanisms according to Rowe (upper row: I-cylinder; II-cylinder with rounded edges; III-dumbbell; IV-ellipse; V-sphere) and Baert (lower row: I-cylinder; II-rope; III-dumbbell; IV-sphere with a cavity outside; V-spheres)** (adapted from Vervaet et al., 1995)

The final step of the E/S is *drying*. Because relatively large amounts of water or solvent are incorporated into the formulation, the final pellets contain significant quantities of residual moisture and are oven-dried or dried in a fluid-bed dryer or at room temperature before further processing. Porosity of pellets may be affected by different drying techniques depending on the rate of water evaporation (Vervaet et al., 1995; Bashaiwoldu et al., 2004).

### 2.3.3. Rotoagglomeration

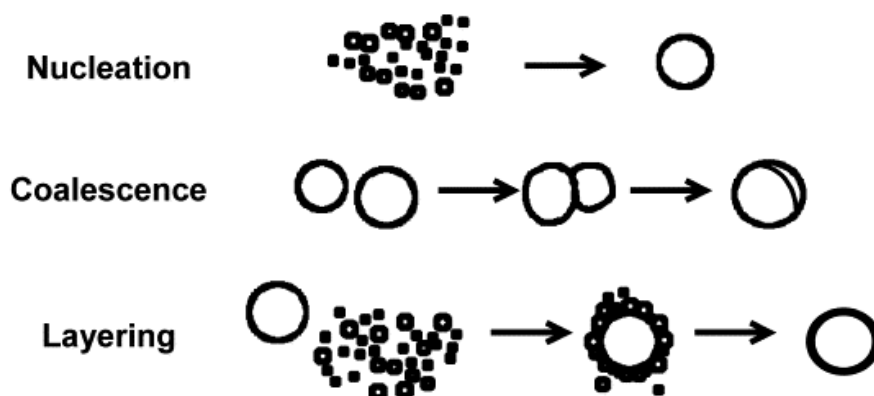
Rotoagglomeration is a newer method of pellet preparation. Homogenized dry powder mixture of the drug and excipients is wetted and due to the centrifugal, fluidization and gravity forces, is turned into the spheres (Fig. I.12). A centrifugal force is provided by a rotating disc, the main piece of the equipment, which throws the pellets towards the wall of processing chamber. Air via a slit between the disc and the wall of the chamber moves the particles in a vertical direction. As the fluidizing force decreases with the distance above the slit, the pellets fall towards the bottom of the disc. The centrifugal force is in relation with the rotation speed of the disc, while the vertical distance for which the particles move is dependent on the air velocity and volume. As powders come in contact with a liquid phase, they form agglomerates or nuclei, which initially are bound together by liquid bridges. These are subsequently replaced by solid bridges, which are derived from the hardening binder. The nuclei formed collide with other adjacent nuclei and coalesce to form larger nuclei or pellets. The coalescence process continues until a condition arises in which bonding forces are overcome by breaking forces. At this point, coalescence is replaced by layering, whereby small particles adhere on much larger particles and increase the size of the latter until pelletization is completed (Vertommen and Kinget, 1997; Kristensen et al., 2000; Ghebre-Sellassie and Knoch, 2002; Hirjau et al., 2011).



**Fig. I.12: Principle of direct pelletizing** (downloaded from Glatt®)

The moisture content is particularly critical because it determines whether nucleation, coalescence or layering occurs (Fig. I.13). Using a rotary processor, it is possible to produce, to dry and, if desired, to coat pellets in the same equipment. It is the main advantage of this technique, because dust problems and the contamination risks can be avoided, and time,

equipment, energy, laboratory space, and machine operators can be saved. Moreover, pellets produced by this method were reported to be of the same quality as pellets produced by the conventional multi-step E/S process. Additionally, pellets of homogeneous matrix structure and high drug loading of up to 65 % can be achieved. The particle size distribution is however broader than that resulting from the above mentioned two methods (Robinson and Hollenbeck, 1991; Vetchý and Rabišková, 2002; Krejčová et al., 2006).



**Fig. I.13: Schematic representation of the mechanisms of nucleation, coalescence and layering** (adapted from Sastry et al., 2003)

#### 2.3.4. Spray drying, spray congealing

Spray drying and congealing are based on globulation. The droplet sizes in both processes is kept small to maximize the rate of evaporation or congealing, and consequently the particle size of the pellets is usually very small. During spray drying, a drug solution or suspension is sprayed, with or without excipients, into a hot air stream to generate dry and highly spherical particles. As the atomized droplets come in contact with hot air, evaporation of the application medium is initiated. This drying process continues through a series of stages whereby the viscosity of the droplets constantly increases until finally almost the entire application medium is driven off and solid particles are formed. Generally, spray-dried pellets are homogenous, approximately spherical, nearly uniform in size and tend to be porous. This technique is usually employed to improve the dissolution rates and hence, the bioavailability of poorly soluble drugs. Spray congealing is a process in which a drug is allowed to melt, disperse or dissolve in hot melts of gums, waxes, fatty acids or other melting solids. The dispersion is then sprayed into a stream of air and other gases with a temperature below the melting point of the formulation components, to provide spherical pellets. Because the

process does not involve evaporation of solvents, the produced pellets are dense and nonporous (Ghebre-Sellassie and Knoch, 2002; Hirjau et al., 2011).

## 2.4. CHARACTERISATION OF PELLET PROPERTIES

The properties of pellets are listed in Table I.1 together with different evaluation methods (Knop and Kleinebudde, 2005).

**Table I.1: Properties of pellets**

Property	Requirements	Analytical methods
Particle shape, sphericity	Like a sphere, aspect ratio close to 1	Image analysis
Surface texture	Smooth	Image analysis, SEM
Mean particle size	Between 0.5 and 1.5	Sieve or image analysis
Particle size distribution	Narrow	Sieve or image analysis
Porosity	Low	Mercury intrusion, true and bulk densities
Density	High	Bulk and tapped density determination
Mechanical strength	High	Friability tests, breaking force tests
Flow properties	(very) good	Angle of repose, flow rate estimation, compressibility index, Hausner's ratio
Drug content	From very low to more than 95 %	Dependent on the drug
Drug release	From immediate to controlled release	Dissolution tests

### 2.4.1. The pellet size, size distribution and shape

Shape and size are important parameters when characterising pellets for modified release film coating. Equally, size has a major effect on drug release from coated pellets due to the natural correlation between size and surface area of pellets (Larsen et al., 2003). The size of pellets can be determined using a variety of parameters: particle size distribution, mean diameter, geometric mean diameter, inter-particle range, mean particle width and length. *The sieve analysis* is the oldest, simplest and best-known method. Despite new developments in

the field of optical particle measuring instruments it remains a proven, reliable and inexpensive method. The particle size distribution is defined via the mass or volume. Sieve analysis is used to divide the particulate material into size fractions and then to determine the weight of these fractions. During sieving the sample is subjected to horizontal or vertical movement carried out with sieve shakers. Depending on the size the individual particles either pass through the sieve mesh or are retained on the sieve surface. The tests sieves are arranged in a stack with the largest mesh openings at the top of the stack and a collector pan at the bottom. The sample is placed on the top sieve. The results are expressed as the percentage of the weight retained on each sieve size. Mean particle diameter can be calculated by applying the following formula (Hazos et al., 1992):

$$\bar{d} = \sum x_i n_i / 100 \text{ } [\mu\text{m}] \quad (1)$$

where  $x_i$  is the mean of the upper and the lower limits of the sieve fraction and  $n_i$  is the weight percentage of the  $i$  sieve fraction.

In this way a relatively broad particle size spectrum can be analyzed quickly and reliably (The Basic Principles of Sieve Analysis).

*The image analysis* represents a common analytical procedure to evaluate simultaneously the size, shape and surface morphology of pellets (Tapia et al., 1993). The main advantage of this technique is that it could describe the non-spherical particle using the longest and shortest diameters, perimeter and projected area. Measuring each particle allows the user unmatched flexibility for calculating and reporting particle size results. Podczek et al. (1999) stated that a minimum of 100 pellets should be analysed for mean pellet size estimation. Particle shape parameters such as roundness, aspect ratio, and compactness are used to describe particle morphology (Horiba Scientific). The filling of pellets into hard gelatin capsules appears generally possible as long as the pellets approach an aspect ratio below 1.2 and do not show large amounts of surface irregularities (Podczek et al., 1999). The equipment consists of a stereomicroscope equipped with black/white video camera. A cold light source is used to illuminate the pellets against a black surface. The captured images are analyzed by computer software. Pellet sphericity is calculated from the determined area and perimeter according to the following formula (Cox, 1927):

$$S = 4\pi \times \text{area} / \text{perimeter}^2 \quad (2)$$

By employing image analysis a relatively large number of pellets can be measured in a limited time (Larsen et al., 2003).



### 2.4.2. Density and porosity of pellets

The density of a material is defined as its mass per unit volume:

$$\rho = m / V \text{ [g/cm}^3\text{]} \quad (3)$$

While the mass is exactly determined by weighing, the volume can vary. This leads to define various types of volumes and densities (Table I.2) (Turchiuli and Castillo-Castaneda, 2009).

**Table I.2: Definition of various types of volumes and densities**

Volume/Density	Volumes included			
	Solid material	Intra-particular pores		Inter-particles voids
Closed pores		Open pores		
True	x			
Apparent	x	x		
Bulk	x	x	x	x
Tapped	x	x	x	x

The *bulk density* of a solid is often very difficult to measure since the slightest disturbance of the bed may result in a new bulk density. Bulk density is determined by measuring the volume ( $V_0$ ) of a known mass of pellets sample (approximately 100 g) that has been passed without compacting into a dry graduated 250 ml cylinder and leveled carefully. Calculated bulk density is expressed in g per ml (USP, 2011).

*Tapped density* is achieved by mechanically tapping a measuring cylinder containing a pellet sample. After observing the initial volume, the cylinder is tapped 500 times initially and the tapped volume ( $V_a$ ) is read to the nearest graduated unit. The tapping an additional 750 times is repeated and  $V_f$  measured. If the difference between the two volumes is less than 2 %,  $V_f$  is the final tapped volume. The tapping is repeated in increments of 1250 taps, until the difference between succeeding measurements is less than 2 % (USP, 2011).

A comparison of the bulk and tapped densities can be used as an index of the ability of pellets to flow which is an important factor during the filling of pellets into hard capsules. *Compressibility index* (4) and *Hausner ratio* (5) are measures of the relative importance of interparticulate interactions. Alternatively, they may be calculated using measured values for

the unsettled apparent volume ( $V_0$ ) and the final tapped volume ( $V_f$ ). Pellets with excellent flowing property are characterised with less significant interactions between the particles, and the bulk and tapped densities will be closer in value. The generally accepted scale of flowability is given in Table I.3 (part 2.4.3.) (USP, 2011).

$$\text{Compressibility index} = 100 (\rho_t - \rho_0) / \rho_0 = 100 (V_0 - V_f) / V_0 \quad [\%] \quad (4)$$

$$\text{Hausner ratio} = \rho_t / \rho_0 = V_0 / V_f \quad (5)$$

The *apparent density* ( $\rho_{app}$ ) includes pores inside the particles and can be determined in a helium pycnometer. Helium has a very small atomic size that can permeate extremely narrow pores in a solid and fill the interparticular spaces, permitting the determination of the real volume occupied by the sample. The ratio of the dried sample weight and the volume measured by pycnometer gives the apparent density. The high thermal conductivity of helium and its ideal gas behavior at room temperature, make this technique extremely reliable and fast. The *true density* ( $\rho_s$ ) corresponds to the density of raw substances or pellets crushed into the powder including also intraparticular spaces-closed pores (Omega Scientific).

The *inter-particular* porosity corresponds to the voids between pellets. The total volume of inter-particle voids depends on the size and shape of pellets and how well they will flow. The inter-particle porosity could be also calculated from the values of bulk and apparent density (Turchiuli and Castillo-Castaneda, 2009):

$$\text{Inter-particular porosity} = (1 - V_{app} / V_0) \times 100 = (1 - \rho_0 / \rho_{app}) \times 100 \quad [\%] \quad (6)$$

The *intra-particular porosity* of pellets can affect the capillary action of the dissolved drug and consequently, influence the rate of release of drugs from the pellets. It also affects film deposition and formation during coating and has an impact on the pellets hardness. The intra-particular porosity is formed by cavities and cracks within the pellets themselves and is defined as the ratio of void volume ( $V_v$ ) and total volume ( $V_{app}$ ) of the pellets. The void volume is the difference between the total volume ( $V_{app}$ ) and the solid volume ( $V_s$ ). It can be also calculated as the difference between the true ( $\rho_s$ ) and apparent density ( $\rho_{app}$ ) (Turchiuli and Castillo-Castaneda, 2009):

$$\text{Intra-particular porosity} = (1 - V_s / V_{app}) \times 100 = (1 - \rho_{app} / \rho_s) \times 100 \quad [\%] \quad (7)$$

### 2.4.3. Flow properties of pellets

Some of the common methods as *angle of repose*, *flow through an orifice* and also *compressibility index* and closely related *Hausner ratio* mentioned above indicate the flow properties of pellets. The *angle of repose*, a static method, is commonly used characteristic related to interparticulate friction or resistance to movement between particles (USP, 2011). The pellets are placed in a conical glass funnel with a stem. The funnel is maintained upright so that the stem terminated 10 cm above a flat solid underlay protected from vibrations. Pellets flow freely out of the funnel and form a cone. Its height (h) and base diameter (d) is measured and the repose angle value ( $\alpha$ ) is calculated using the following equation (Häring et al., 2008):

$$\tan(\alpha) = h / 0.5 d [^\circ] \quad (8)$$

Although there is some variation in the qualitative description of powder flow using the angle of repose, much of the pharmaceutical literature appears to be consistent with the classification by Carr (1965) which is shown in Table I.3. When the angle of repose exceeds 50°, the flow is rarely acceptable for manufacturing purposes (USP, 2011).

**Table I.3: Flow properties and corresponding angles of repose**

Flow property	Angle of repose [°]	Compressibility index [%]	Hausner ratio
Excellent	25 - 30	≤ 10	1.00 - 1.11
Good	31 - 35	11 - 15	1.12 - 1.18
Fair - aid not needed	36 - 40	16 - 20	1.19 - 1.25
Passable - may hang up	41 - 45	21 - 25	1.26 - 1.34
Poor - must agitate, vibrate	46 - 55	26 - 31	1.35 - 1.45
Very poor	56 - 65	32 - 37	1.46 - 1.59
Very, very poor	> 66	> 38	> 1.60

The *flow rate through an orifice* is generally measured as the mass per time flowing from any of a number of types of containers (cylinders, funnels, hoppers). The orifice diameter and shape are critical factors in determining pellets flow rate. Flow rate can be measured continuously using an electronic balance permitting detect momentary flow rate variations or in discrete samples. This method is not useful for cohesive materials. No general scale is

available because flow rate is critically dependent on the method used to measure it (USP, 2011).

#### 2.4.4. Mechanical properties of pellets

Mechanical properties include pellet *friability* and *hardness*. Since most pellets are subjected to coating, it is necessary that they possess good mechanical properties in order to withstand the coating process. Any other handling of particulate materials in manufacturing and shipping, inevitably causes attrition. By determination of friability and hardness of pellets, information about their stability and behavior under mechanical stress can be obtained (Bemrose and Bridgwater, 1987).

The pellets, accurately weighted ( $m_1$ ) and free of dust, are placed into a stainless steel drum of the abrasion tester adapted for pellet testing together with 200 pieces of 4 mm glass beads, and rotated for 10 min. at 20 rpm. Subsequently glass beads are separated from the pellets using a set of sieves, generated fines are removed with the air stream and pellets are reweighed ( $m_2$ ). The *friability*, that is, the weight loss after agitation, is expressed as a percentage and calculated from Eq. 9 The result is the average of three runs (Dreu et al., 2005; Scala-Bertola et al., 2009):

$$\text{Friability} = [(m_1 - m_2) / m_1] \times 100 \text{ [\%]} \quad (9)$$

Tablet hardness and compression tester fitted with 5-kg load cell operated at constant speed is used for the assessment of pellet hardness. The *hardness* is defined as force necessary to crush the pellets under the standard conditions. Individual pellets are placed between two jaws, one moves, the second is fixed. The force needed to fracture is recorded and the hardness is expressed in Newton, kilogram or pound (1 kg = 9.81 N = 2.2 Ib). Measurement is performed ten times in randomly selected pellets and the hardness mean value and the standard deviation are calculated (Gryczová et al., 2008). Otherwise, the hardness may be also expressed as tensile strength ( $\sigma$ ) calculated applying the values for the failure load (F) and the radius of the pellet (R) according to Eq. 10 (Shipway and Hutchings, 1993):

$$\sigma_{f(s)} = 0.4 F / \pi R^2 \text{ [MPa]} \quad (10)$$

### 3. REFERENCES

---

---

Arhewoh IM, Okhamafe AO. An overview of site-specific delivery of orally administered proteins/peptides and modeling considerations. *J Med Biomed Res.* 2004;3(1):7-20.

Ashford M, Fell JT. Targeting drugs to the colon: delivery systems for oral administration. *J Drug Target.* 1994;2(3):241-57.

Baert L, Remon JP. Influence of amount of granulation liquid on the drug release rate from pellets made by extrusion spheronization. *Int J Pharm.* 1993;95(1-3):135-41.

Baert L, Vermeersch H, Remon JP, Smeyers-Verbeke J, Massart DL. Study of parameters important in the spheronisation process. *Int J Pharm.* 1993;96:225-9.

Bashaiwoldu AB, Podczek F, Newton JM. A study on the effect of drying techniques on the mechanical properties of pellets and compacted pellets. *Eur J Pharm Sci.* 2004;21(2-3):119-29.

Bashaiwoldu AB, Podczek F, Newton JM. Compaction of and drug release from coated pellets of different mechanical properties. *Adv Powder Technol.* 2011;22:340-353.

Basit AW. Advances in colonic drug delivery. *Drugs.* 2005;65(14):1991-2007.

Bemrose CR, Bridgwater J. A review of attrition and attrition test methods. *Powder Technol.* 1987;49:97-126.

Bowyer GW, Cumberland N. Antibiotic release from impregnated pellets and beads. *J Trauma.* 1994;36(3):331-5.

Carr RL. Evaluating flow properties of solids. *Chem Eng.* 1965;72:163-8.

Carrette O, Favier C, Mizon C, Neut C, Cortot A, Colombel JF, Mizon J. Bacterial enzymes used for colon-specific drug delivery are decreased in active Crohn's disease. *Dig Dis Sci.* 1995;40(12):2641-6.

Cheng G, An F, Zou MJ, Sun J, Hao XH, He YX. Time- and pH-dependent colon-specific drug delivery for orally administered diclofenac sodium and 5-aminosalicylic acid. *World J Gastroenterol.* 2004;10(12):1769-74.

Chi N, Guo JH, Zhang Y, Zhang W, Tang X. An oral controlled release system for ambroxol hydrochloride containing a wax and a water insoluble polymer. *Pharm Dev Technol.* 2010;15(1):97-104.

Chickpetty SM, Baswaraj R, Nanjwadel BK. Studies on development of novel combined time and pH dependent solventless compression coated delivery systems for colonic delivery of diclofenac sodium. *Asian J Pharm Clin Res.* 2010;3(2):110-3.

Chopra R, Podczeczek F, Newton JM, Alderborn G. The influence of pellet shape and film coating on the filling of pellets into hard shell capsules. *Eur J Pharm Biopharm.* 2002;53(3):327-33.

Collnot EM, Ali H, Lehr CM. Nano- and microparticulate drug carriers for targeting of the inflamed intestinal mucosa. *J Control Release.* 2012. In Press.

Conine JW, Hadley HR. Preparation of small solid pharmaceutical spheres. *Drug Cosmet Ind.* 1970;106:38-41.

Cox EP. A method of assigning numerical and percentage values to the degree of roundness of sand grains. *J Paleontol.* 1927;1:179-83.

Dahan A, Amidon GL, Zimmermann EM. Drug targeting strategies for the treatment of inflammatory bowel disease: a mechanistic update. *Expert Rev Clin Immunol.* 2010;6(4):543-50.

Davis SS, Hardy JG, Fara JW. Transit of pharmaceutical dosage forms through the small intestine. *Gut.* 1986;27:886-92.

Dreu R, Sirca J, Pintye-Hodi K, Burjan T, Planinsek O, Srcic S. Physicochemical properties of granulating liquids and their influence on microcrystalline cellulose pellets obtained by extrusion-spheronisation technology. *Int J Pharm.* 2005;291(1-2):99-111.

Dukić-Ott A, Thommes M, Remon JP, Kleinebudde P, Vervaet C. Production of pellets via extrusion-spheronisation without the incorporation of microcrystalline cellulose: a critical review. *Eur J Pharm Biopharm.* 2009;71(1):38-46.

Evans DF, Pye G, Bramley R, Clark AG, Dyson TJ, Hardcastle JD. Measurement of gastrointestinal pH profiles in normal ambulant human subjects. *Gut.* 1988;29(8):1035-41.

Fielden KE, Newton JM, Rowe RC. A comparison of the extrusion and spheronization behaviour of wet powder masses processed by a ram extruder and a cylinder extruder. *Int J Pharm.* 1992;81(2-3):225-33.

Fitzpatrick S, Taylor S, Booth SW, Newton MJ. The development of a stable, coated pellet formulation of a water-sensitive drug, a case study: development of a stable core formulation. *Pharm Dev Technol.* 2006;11(4):521-8.

Friend DR. New oral delivery systems for treatment of inflammatory bowel disease. *Adv Drug Deliv Rev.* 2005;57(2):247-65.

Ghebre-Sellassie I. Pellets: A General Overview. In: *Pharmaceutical pelletization technology.* Ghebre-Sellassie I (Ed.), Marcel Dekker, Inc., New York, NY. 1989:288p.

Ghebre-Sellassie I, Knoch A. Pelletization techniques. In: *Encyclopedia of pharmaceutical technology.* Swarbrick J, Boylan JC (Eds.), 2nd ed., Marcel Dekker, Inc., New York, NY. 2002:3096p.

Glatt<sup>®</sup>: <http://www.glatt.com/cm/en/process-technologies/pelletizing/directpelletizing.html>, downloaded 13.6.2012.

Glatt<sup>®</sup>: <http://www.glatt.com/cm/en/process-technologies/pelletizing/layering/drypowder.html>, downloaded 7.6.2012.

Glatt<sup>®</sup>: <http://www.glatt.com/cm/en/process-technologies/pelletizing/layering/suspension-solution.html>, downloaded 7.6.2012.

Goracinova K, Glavas-Dodov M, Simonoska-Crcarevska M, Geskovski N. Drug targeting in IBD treatment – existing and new approaches. In: Inflammatory Bowel Disease - Advances in Pathogenesis and Management. Karoui S (Ed.), In Tech, Rijeka, Croatia. 2012:342p.

Grassi M, Voinovich D, Moneghini M, Franceschinis E, Perissutti B, Filipovic-Grcic J. Preparation and evaluation of a melt pelletised paracetamol/stearic acid sustained release delivery system. *J Control Release*. 2003;88(3):381-91.

Gryczová E, Rabišková M, Vetchý D, Krejčová K. Pellet starters in layering technique using concentrated drug solution. *Drug Dev Ind Pharm*. 2008;34(12):1381-7.

Guarner F, Malagelada JR. Gut flora in health and disease. *Lancet*. 2003;361(9356):512-9.

Gu L, Liew CV, Heng PW. Wet spheronization by rotary processing-a multistage single-pot process for producing spheroids. *Drug Dev Ind Pharm*. 2004;30(2):111-23.

Gupta VK, Beckert TE, Price JC. A novel pH- and time-based multi-unit potential colonic drug delivery system. I. Development. *Int J Pharm*. 2001;213(1-2):83-91.

Hardy JG, Wilson CG, Wood E. Drug delivery to the proximal colon. *J Pharm Pharmacol*. 1985;37(12):874-7.

Häring A, Vetchý D, Janovská L, Krejčová K, Rabišková M. Differences in characteristics of pellets prepared by different pelletization methods. *Drug Dev Ind Pharm*. 2008;34(3):289-96.

Hazos L, Langer I, Gyamathy M. Some factors influencing pellet characteristics made by extrusion/spheronization process: effect on size characteristics and moisture content decrease of pellets. *Drug Dev Ind Pharm*. 1992;18:409-438.

Hebden JM, Blackshaw PE, Perkins AC, Wilson CG, Spiller RC. Limited exposure of the healthy distal colon to orally-dosed formulation is further exaggerated in active left-sided ulcerative colitis. *Aliment Pharmacol Ther*. 2000;14(2):155-61.

Hebden JM, Gilchrist PJ, Perkins AC, Wilson CG, Spiller RC. Stool water content and colonic drug absorption: contrasting effects of lactulose and codeine. *Pharm Res*. 1999;16(8):1254-9.

Hicks DC, Freese HL. Extrusion and spheronizing equipment. In: Pharmaceutical pelletization technology. Ghebre-Sellassie I (Ed.), Marcel Dekker, Inc., New York, NY. 1989:288p.

Hirjau M, Nicoara AC, Hirjau V, Lupuleasa D. Pelletization techniques used in pharmaceutical fields. *Pract Farm.* 2011;4(3-4):206-11.

Horiba Scientific. A guidebook to particle size analysis: [http://www.horiba.com/fileadmin/uploads/Scientific/Documents/PSA/PSA\\_Guidebook.pdf](http://www.horiba.com/fileadmin/uploads/Scientific/Documents/PSA/PSA_Guidebook.pdf), downloaded 26.4.2012.

Hovgaard L, Brøndsted H. Current applications of polysaccharides in colon targeting. *Crit Rev Ther Drug Carrier Syst.* 1996;13(3-4):185-223.

Kaniwa N, Aoyagi N, Ogata H, Ejima A, Motoyama H, Yasumi H. Gastric emptying rates of drug preparations. II. Effects of size and density of enteric-coated drug preparations and food on gastric emptying rates in humans. *J Pharmacobiodyn.* 1988;11(8):571-5.

Karrout Y, Neut C, Wils D, Siepmann F, Deremaux L, Flament MP, Dubreuil L, Desreumaux P, Siepmann J. Novel polymeric film coatings for colon targeting: Drug release from coated pellets. *Eur J Pharm Sci.* 2009;37(3-4):427-33.

Katsuma M, Watanabe S, Kawai H, Takemura S, Masuda Y, Fukui M. Studies on lactulose formulations for colon-specific drug delivery. *Int J Pharm.* 2002;249(1-2):33-43.

Kayumba PC, Huyghebaert N, Cordella C, Ntawukuliryayo JD, Vervaeet C, Remon JP. Quinine sulphate pellets for flexible pediatric drug dosing: formulation development and evaluation of taste-masking efficiency using the electronic tongue. *Eur J Pharm Biopharm.* 2007;66(3):460-5.

Khan MZ, Prebeg Z, Kurjaković N. A pH-dependent colon targeted oral drug delivery system using methacrylic acid copolymers. I. Manipulation Of drug release using Eudragit L100-55 and Eudragit S100 combinations. *J Control Release.* 1999;58(2):215-22.

Knop K, Kleinebudde P. Pharmaceutical pellets. Definition, properties, production. *ExAct.* 2005;15:2-5.

Kramar A, Turk S, Vrecer F. Statistical optimisation of diclofenac sustained release pellets coated with polymethacrylic films. *Int J Pharm.* 2003;256(1-2):43-52.

Krejčová K, Rabišková M, Vetchý D, Polášek E, Tomášek V, Prokopová A. The influence of drug solubility and particle size on the pellet formulation in a rotoprocessor. *Drug Dev Ind Pharm.* 2006;32(5):585-93.

Kristensen J, Schaefer T, Kleinebudde P. Direct pelletization in a rotary processor controlled by torque measurements. I. Influence of process variables. *Pharm Dev Technol.* 2000;5(2):247-56.

Larsen CC, Sonnergaard JM, Bertelsen P, Holm P. Validation of an image analysis method for estimating coating thickness on pellets. *Eur J Pharm Sci.* 2003;18(2):191-6.



Lecomte F, Siepmann J, Walther M, MacRae RJ, Bodmeier R. pH-Sensitive polymer blends used as coating materials to control drug release from spherical beads: elucidation of the underlying mass transport mechanisms. *Pharm Res.* 2005;22(7):1129-41.

Leopold CS. Coated dosage forms for colon-specific drug delivery. *Pharm Sci Technol Today.* 1999;2(5):197-204.

Leopold CS. A practical approach in the design of colon-specific drug delivery systems. In: *Drug targeting – Organ-specific strategy.* Molema G, Meijer DKF (Eds.), Wiley-VCH Verlag GmbH, Weinheim, Germany. 2001:382p.

Maroni A, Zema L, Cerea M, Sangalli ME. Oral pulsatile drug delivery systems. *Expert Opin Drug Deliv.* 2005;2(5):855-71.

McConnell EL, Fadda HM, Basit AW. Gut instincts: explorations in intestinal physiology and drug delivery. *Int J Pharm.* 2008;364(2):213-26.

Mc Neil ME, Stevens HNE. Dispensing device. WO Patent 90/09168, 1990.

Michelson EL. Calcium antagonists in cardiology: update on sustained-release drug delivery systems. *Clin Cardiol.* 1991;14(12):947-50.

Nakahara N. Method and apparatus for making spherical granules. US patent 3277520, 1964.

Nastruzzi C, Cortesi R, Esposito E, Genovesi A, Spadoni A, Vecchio C, Menegatti E. Influence of formulation and process parameters on pellet production by powder layering technique. *AAPS Pharm Sci Tech.* 2000;1(2):14-25.

Newton JM. Extrusion and extruders. In: *Encyclopedia of pharmaceutical technology.* Swarbrick J, Boylan JC (Eds.), 2nd ed., Marcel Dekker, Inc., New York, NY. 2002:3096p.

Niwa K, Takaya T, Morimoto T, Takada K. Preparation and evaluation of a time-controlled release capsule made of ethylcellulose for colon delivery of drugs. *J Drug Target.* 1995;3(2):83-9.

Nugent SG, Kumar D, Rampton DS, Evans DF. Intestinal luminal pH in inflammatory bowel disease: possible determinants and implications for therapy with aminosalicylates and other drugs. *Gut.* 2001;48:571-7.

Omega Scientific. True density pycnometer: <http://omegascientific.com.sg/products/particle-characterisation-2/true-density-pycnometer/>, downloaded 27.4.2012

Piao J, Lee JE, Weon KY, Kim DW, Lee JS, Park JD, Nishiyama Y, Fukui I, Kim JS. Development of novel mucoadhesive pellets of metformin hydrochloride. *Arch Pharm Res.* 2009;32(3):391-7.

Podczec F, Rahman SR, Newton JM. Evaluation of a standardised procedure to assess the shape of pellets using image analysis. *Int J Pharm.* 1999;192(2):123-38.

Pozzi F, Furlani P, Gazzaniga A, Davis SS, Wilding IR. The time clock system: A new oral dosage form for fast and complete release of drug after a predetermined lag time. *J Control Release*. 1994;31(1):99-108.

Ramaker JS. Fundamentals of the high-shear pelletisation process. Thesis. Groningen, Netherlands. 2001:144p.

Reynolds AD. A new technique for the production of spherical particles; *Manuf Chem Aerosol News*. 1970;41:40-3.

Rowe RC. Spheronization: a novel pill-making process? *Pharm Int*. 1985;6:119-23.

Robinson RL, Hollenbeck RG. Manufacture of spherical acetaminophen pellets: comparison of rotary processing with multiple-step extrusion and spheronization. *Pharm Technol*. 1991;15:48-56.

Sandborn WJ. Therapeutic Approaches to the treatment of ulcerative colitis. In: *Inflammatory bowel disease*. Targan SR, Shanahan F, Karp LC (Eds.), 5th ed., Blackwell publishing Ltd., West Sussex, UK. 2010:752p.

Sastry KVS, Dontula P, Hosten C. Investigation of the layering mechanism of agglomerate growth during drum pelletization. *Powder Technol*. 2003;130(1):231-7.

Scala-Bertola J, Gajdziok J, Rabišková M, Bonneaux F, Lecompte T, Sapin A, Maincent P. Pellets for oral administration of low-molecular-weight heparin. *Drug Dev Ind Pharm*. 2009;35(12):1503-10.

Simon GL, Gorbach SL. Intestinal flora in health and disease. *Gastroenterology*. 1984;86(1):174-93.

Shah NH, Railkar AM, Phuapradit W. Colon targeted delivery system. US patent 6039975, 2000.

Shameem M, Katori N, Aoyagi N, Kojima S. Oral solid controlled release dosage forms: role of GI-mechanical destructive forces and colonic release in drug absorption under fasted and fed conditions in humans. *Pharm Res*. 1995;12(7):1049-54.

Shipway PH, Hutchings IM. Fracture of brittle spheres under compression and impact loading: I - Elastic stress distributions. *Phil Mag*. 1993;A67:1389-404.

Steiner K. The influence of drug core properties on drug release from extended release reservoir pellets. Thesis. Berlin, Germany. 2011:155p.

Steckel H, Mindermann-Nogly F. Production of chitosan pellets by extrusion/spheronization. *Eur J Pharm Biopharm*. 2004;57(1):107-14.

Tapia C, Buckton G, Newton JM. Factors influencing the mechanism of release from sustained release matrix pellets, produced by extrusion/spheronisation. *Int J Pharm*. 1993;92:211-8.

The Basic Principles of Sieve Analysis: [http://www.ninolab.se/fileadmin/Ninolab/pdf/retsch/documents/af\\_sieving\\_basics\\_2004\\_en.pdf](http://www.ninolab.se/fileadmin/Ninolab/pdf/retsch/documents/af_sieving_basics_2004_en.pdf), downloaded 25.4.2011.

Trivedi NR, Rajan MG, Johnson JR, Shukla AJ. Pharmaceutical approaches to preparing pelletized dosage forms using the extrusion-spheronization process. *Crit Rev Ther Drug Carrier Syst.* 2007;24(1):1-40.

Turchiuli C, Castillo-Castaneda E. Agglomerates structure characterization using 3D-image reconstruction. *Part Part Syst Charact.* 2009;26:25-33.

U.S. Pharmacopeia 34, National formulary 29. United Book Press, Inc., Baltimore, MD. 2011:5489p.

Van Savage G, Rhodes CT. The sustained release coating of solid dosage forms: a historical review. *Drug Dev Ind Pharm.* 1995;21:93-118.

Vandamme ThF, Lenoury A, Charrueau C, Chaumeil J-C. The use of polysaccharides to target drugs to the colon. *Carbohydr Polym.* 2002;48:219-31.

Varshosaz J, Tavakoli N, Serri A. Preparation and in vitro characterization of piroxicam enteric coated pellets using powder layering technique. *Pharm Dev Technol.* 2009;14(3):305-11.

Vertommen J, Kinget R. The influence of five selected processing and formulation variables on the particle size, particle size distribution, and friability of pellets produced in a rotary processor. *Drug Dev Ind Pharm.* 1997;23:39-46.

Vervaet C, Baert L, Remon JP. Extrusion-spheronisation. *Int J Pharm.* 1995;116 :131-46.

Vetchý D, Rabišková M. Some variables influencing rotoagglomeration in the multiprocessor MP-1. *Int J Pharm.* 2002;242(1-2):353-6.

Watanabe S, Kawai H, Katsuma M, Fukui M. Colon specific drug release system. US patent 09183339, 1998.

Washington N, Washington C, Wilson CG, Washington N. *Physiological Pharmaceutics: Biological barriers to drug absorption.* 2nd ed., Taylor and Francis, London, UK. 2001:312p.

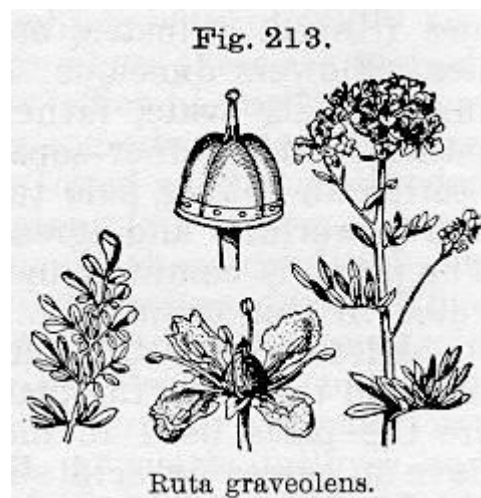
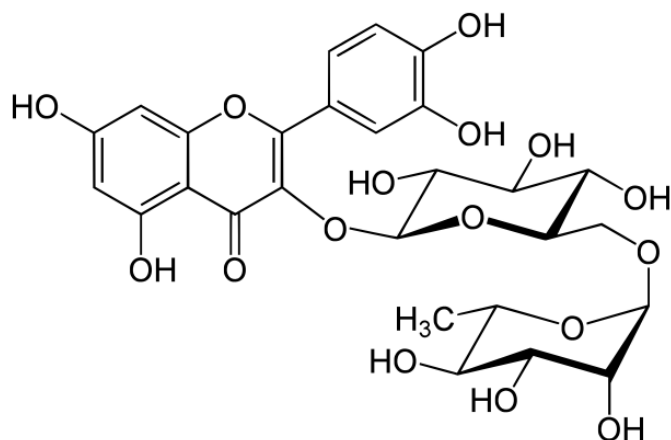
Wesseling M, Bodmeier R. Influence of plasticization time, curing conditions, storage time, and core properties on the drug release from Aquacoat-coated pellets. *Pharm Dev Technol.* 2001;6(3):325-31.

Yang L, Chu JS, Fix JA. Colon-specific drug delivery: new approaches and in vitro/in vivo evaluation. *Int J Pharm.* 2002;235(1-2):1-15.

## **II. CHARACTERISATION OF USED DRUGS AND EXCIPIENTS**



## 1. RUTIN



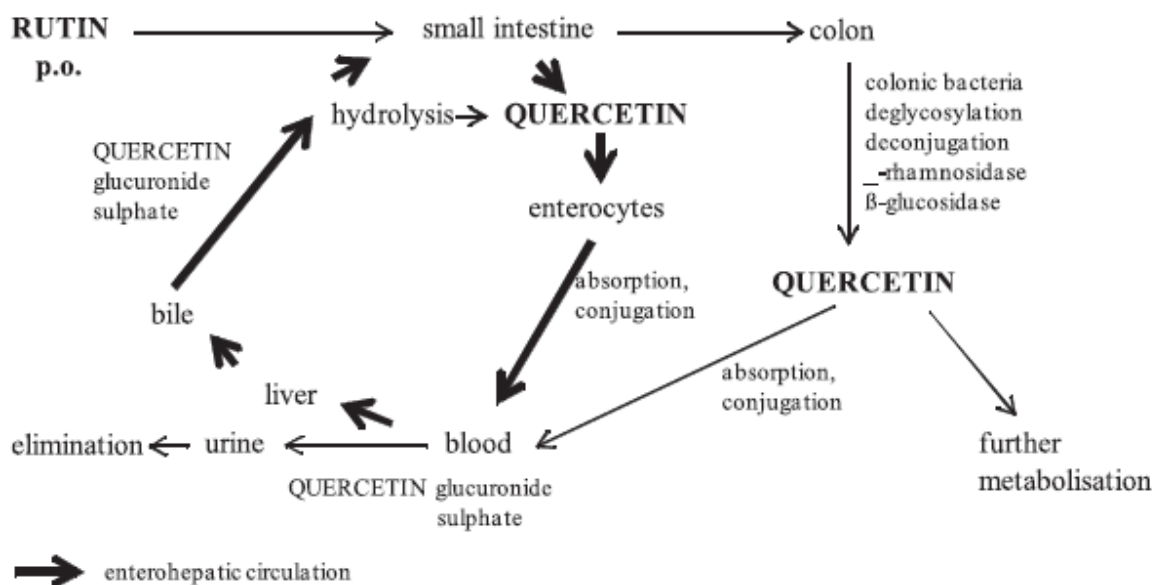
**Fig. II.1: Rutin structure** (downloaded from wikipedia)

Molecular formula:  $C_{27}H_{30}O_{16}$

Molar mass = 610.52 g/mol

Rutin (quercetin 3-*O*-rutinoside) is a flavonol glycoside, composed of quercetin, glucose and rhamnose, widely occurring in the plant kingdom (Abdullah et al., 2008). It was first isolated by the German pharmacist-chemist August Weiss in 1842 from the leaves of the garden rue (*Ruta graveolens*, Rutaceae). Rutin is a yellow crystalline powder only slightly soluble in water (Couch et al., 1946). For pharmaceutical purposes, rutin may be obtained from green buckwheat (*Fagopyrum esculentum*, Polygonaceae) and Japanese Pagoda tree (*Sophora japonica*, Fabaceae) (Lachman et al., 2000). Extensive studies by pharmacologists have shown that rutin is nontoxic (Afanas'eva et al., 2001). After oral administration, rutin is hardly absorbed from the upper GIT owing to its highly hydrophilic sugar moieties (Fig. II.2). Reaching the colon, it is deglycosylated by present microbiota producing  $\alpha$ -rhamnosidase and  $\beta$ -glucosidase, and its aglycone quercetin is liberated. Quercetin can be absorbed easily into epithelial cells and most likely exerts a therapeutic effect of the parent compound. After intestinal absorption, quercetin enters the liver via the portal vein and is biotransformed. Conjugation of the polar hydroxyl groups with glucuronic acid, sulfuric acid, glycine, or possibly glutathione results in water-soluble conjugates. These conjugates are eliminated either from the liver with bile into the duodenum, or renally with the urine. In addition, flavonoid glucuronide and sulfate metabolites secreted into the small intestine could be

hydrolyzed and the liberated aglycones would then pass into enterocytes passively, reabsorbed again, and metabolized forming thus an enterohepatic cycling (Kim et al., 1998; Crespy et al., 1999; Williamson et al., 2000; O'Leary et al., 2001; Spencer et al., 2003; Rechner et al., 2004; Kim et al., 2005).



**Fig. II.2: Proposed pharmacokinetics of orally administered rutin** (downloaded from Rabišková et al., 2009)

The first application of rutin medicinally was in the treatment of increased capillary fragility and permeability (Johnson, 1946). Rutin possess antihemorrhagic activity (Formica and Regelson, 1995). The use of rutin has been studied in many applications, for example, glaucoma (Stocker, 1947), protection from injury by X-ray irradiation (Weiss and Landauer, 2003), telangiectasia (Kushlan, 1946), protecting against cold injury (Fuhrman, 1955), lowering cholesterol levels (da Silva et al., 2001), hemorrhoids treatment (Squadrito et al., 2000), etc. Rutin has antioxidant and anti-inflammatory activity (Guardia et al., 2001).

## 2. 5-AMINOSALICYLIC ACID (MESALAZINE)

---



**Fig. II.3: 5-ASA structure, zwitter ion** (downloaded from wikipedia)

Molecular formula:  $C_7H_7NO_3$

Molar mass = 153.14 g/mol

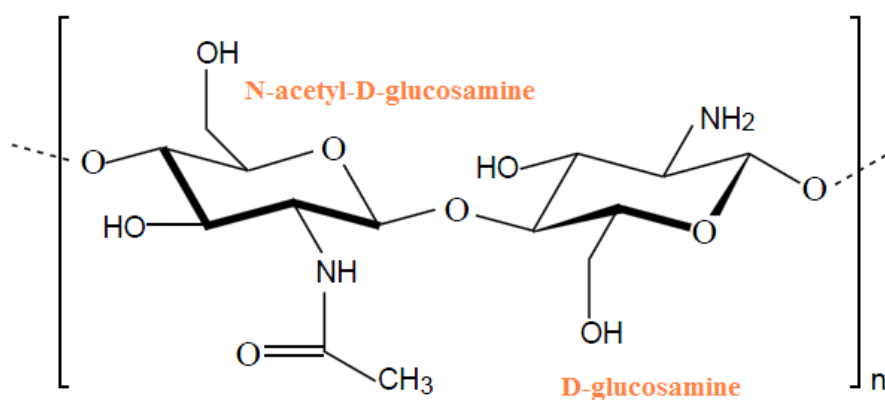
5-ASA, also known as mesalazine, presents light tan to pink needle-shaped odourless crystals. The colour may darken on exposure to air thus the preferable storage is in airtight containers. 5-ASA is very slightly soluble in water and practically insoluble in alcohol (Martindale, 2005). 5-ASA is a zwitterion with determined pKa values of 3.0, 6.0 and 13.9 (Allgayer et al., 1985).

The 5-ASA is the active moiety of sulphasalazine (Williams and Hallett, 1989). For decades, this azo-compound has been a cornerstone in medical treatment of IBD, nevertheless, it is associated with a number of dose-dependent adverse events related to the sulphur in the sulphapyridine moiety (Nielsen, 1982; Shah and Peppercorn, 1995). Sulphasalazine combines an antibiotic sulphapyridine and an anti-inflammatory 5-ASA, and was originally developed by Nana Svartz in 1938 for possible use in rheumatoid arthritis (Svartz, 1948). The drug, however, proved to be effective primarily in the treatment of IBD (Das, 1983). In 1977, Azad Khan et al. studied a mechanism of action of sulphasalazine and discovered that 5-ASA is responsible for therapeutic effect. After, a rapid development in the field of new 5-ASA drug formulations with different principles of sustained release has taken place (Bondesen et al., 1987; Wolf and Lashner, 2002). It has been pointed out that 80 % of patients intolerant to sulfasalazine will tolerate mesalazine without problems (D'Haens and van Bodegraven, 2004). The main goal of the treatment is to maximize delivery of 5-ASA to the affected regions of the colonic mucosa while minimizing systemic absorption which is related with adverse effects (Cohen, 2006). Mesalazine may cause headache and gastrointestinal disturbances, such



as nausea, diarrhoea, and abdominal pain. Hypersensitivity reactions may occasionally occur. There are some reports of pancreatitis and interstitial nephritis. Some patients may experience blood disorders including aplastic anaemia, thrombocytopenia, neutropenia, leucopenia and pancytopenia. It should not be given to patients with severe renal or hepatic impairment, or salicylate hypersensitivity (Martindale, 2005). Following oral administration of conventional formulation, 5-ASA would be extensively absorbed from the upper GIT, with little of drug reaching the colon. Oral preparations are therefore generally formulated to release the drug in the terminal ileum and colon, where it is thought to exert a mainly local action. Absorption from rectal dosage forms is around 10 to 20 % of the dose. The absorbed portion of mesalazine is almost completely acetylated in the gut wall and in the liver to acetyl-5-ASA. The rate of acetylation, and hence the concentration of parent drug and metabolite in the systemic circulation, is dependent of the acetylator status. The acetylated metabolite is excreted mainly in urine by tubular secretion, together with traces of the parent compound. The elimination half-life of mesalazine is reported to be about 1 h and it is 40 to 50 % bound to plasma proteins. The acetylated metabolite has a half-life of up to 10 h and is about 80 % bound to plasma proteins (Klotz, 1985; Zhou et al., 1999; De Vos, 2000).

### 3. CHITOSAN



**Fig. II.4: Chitosan structure** (adapted from wikipedia)

Molecular formula:  $(C_6H_{12}O_4N)_n$      $n \approx 60-6060$     Molar mass between 10 and 1000 kDa

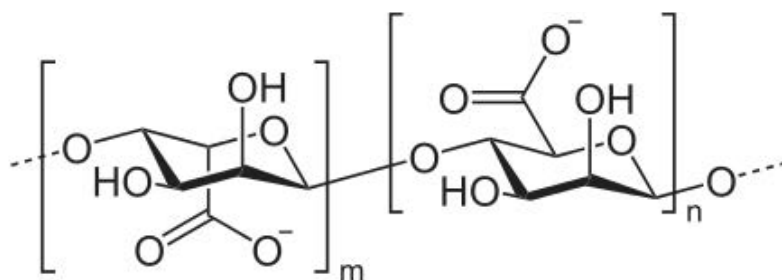
Chitosan is a cationic polymer derived from crustacean chitin, the second most abundant polymer in nature after cellulose (Roberts, 1992). Chitosan is a linear polysaccharide consisting of D-glucosamine and N-acetyl-D-glucosamine units (Kato et al., 2003). The degree of deacetylation of chitosan is usually between 70 and 95 % (Hamman, 2010). It occurs as white or creamy-white powder or flakes. Chitosan is sparingly soluble in water and practically insoluble in organic solvents, however, it dissolves slowly in acidic conditions. It gets precipitated and may look ‘cottonlike’ in alkaline solution, and forms gel at lower pH (Illum, 1998; Jones, 2009). In the  $pH < pK_a$  (6.5), chitosan bears a positive charge and thus in turn reacts with many negatively charged surfaces/polymers. Indeed, mucoadhesive properties are due to molecular attractive forces formed by electrostatic interaction between positively charged amino groups of chitosan and negatively charged sialic acid residues of mucin resulting in potential retention of particles at the mucosal surface which can contribute to extended residence time in the target region (Smart, 2005; Shaikh et al., 2011). On the other hand, it spontaneously associates with negatively charged polyions in solution to form polyelectrolyte complexes useful for the design of different types of dosage forms (Hamman, 2010). Chitosan is digested by the enzymes produced by the colonic bacteria and thus is a favorable candidate for colonic-targeted drug delivery systems (McConnell et al., 2008). Chitosan as biocompatible, biodegradable and non-toxic material is suitable for use in a wide range of biomedical and pharmaceutical applications (Hirano et al., 1990). It has been extensively studied in wound

healing (Dai et al., 2011), as an antacid (Weisberg et al., 1966) and for hypocholesterolemic effects (Moon et al., 2007). Pharmaceutical applications are summarized in Table II.1.

**Table II.1: Pharmaceutical applications of chitosan**

<b>Application</b>	<b>References</b>
Diluent in direct compression of tablets	Sawayanagi et al., 1982; Mir et al., 2008
Tablets and pellets disintegrant	Ritthidy et al., 1994; Goyanes et al., 2011
Binder in wet granulation	Upadrashta et al., 1992; Nunthanid et al., 2004
Drug carrier in hydrocolloids and gels	Kristl et al., 1993; Cheng et al., 2011
Drug carrier in micro and nanoparticle systems	Calija et al., 2012; Hosseinzadeh et al., 2012
Carrier in relation to vaccine delivery or gene therapy	Chua et al., 2012; Klausner et al., 2012
Hydrophilic matrix retarding drug release	Säkkinen et al., 2002; Wong and Nurulaini, 2012
Coating agent	Mohamed et al., 2008; Sahasathian et al., 2010
Film-forming agent	Fernandez-Saiz et al., 2009; Mengatto et al., 2012
Improvement of dissolution of poorly soluble drugs	Portero et al., 1998; Maestrelli et al., 2011
Absorption enhancer	Sadeghi et al., 2008; Rosenthal et al., 2012
Viscosity increasing agent	Felt et al., 1999; Perioli et al., 2008
Mucoadhesive polymer	He et al., 1998; Albertini et al., 2009
Controlled drug delivery	Di Colo et al., 2006; Yeh et al., 2011
Site-specific drug delivery	Keegan et al., 2012; Mura et al., 2012
Improved peptide delivery	Dünnhaupt et al., 2012; Narayanan et al., 2012

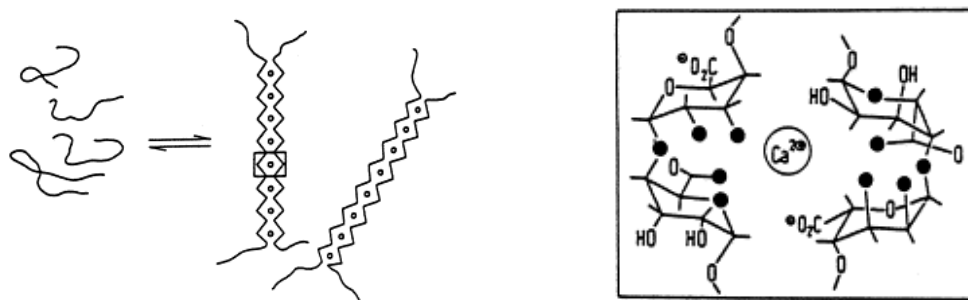
#### 4. SODIUM ALGINATE



**Fig. II.5: Sodium alginate structure** (downloaded from wikipedia)

Molecular formula:  $(C_6H_7 Na O_6)_n$      $n \approx 50-3000$     Molar mass between 10 and 600 kDa

Sodium alginate is obtained by neutralisation of alginic acid extracted from brown seaweed (*Phaeophyceae*). It contains  $\alpha$ -L-guluronic and  $\beta$ -D-mannuronic acids in varying proportions and sequence (Draget, 2000). It is found as white to pale yellowish-brown colored powder which is slowly soluble in water, forming a viscous colloidal solution, and practically insoluble in ethanol (Cable, 2009). It is generally regarded as nontoxic and predominantly metabolized by colonic bacteria (Anderson et al., 1991; Matsubara et al., 1998). Gelation occurs by cross-linking of the uronic acids with divalent cations, such as calcium, strontium and barium ions, resulting in formation of three-dimensional network, which is usually described by egg-box model (Fig.II.6) (Grant et al., 1973). Moreover, it also can form a complex with the cationic polymer chitosan (Florczyk et al., 2011). Therapeutically, it has been used in combination with an H<sub>2</sub>-receptor antagonist in the management of gastroesophageal reflux, as a hemostatic agent in surgical dressings and as a dressing to treat exuding wounds (Qin and Gilding, 1996; Angspatt et al., 2010; Bordin et al., 2010).



**Fig. II.6: Schematic representation of the egg-box structure** (adapted from Rees, 1981)

Sodium alginate is widely utilized in cosmetics, food products, and variety of oral and topical pharmaceutical formulations. For instance, it has been used as a tablet binder and disintegrant (Sakr et al., 1978), as a diluent in capsule formulations (Veski and Marvola, 1993). It can delay the dissolution of a drug from tablets, capsules and aqueous suspensions, thus it is interesting in the preparation of sustained-release oral formulations (Zatz and Woodford, 1987; Veski et al., 1994; Holte et al., 2003). In the same context, it plays a role of carrier in hydrophilic matrix controlled-release dosage forms (Sriamornsak and Sungthongjeen, 2007). It has been investigated for the aqueous microencapsulation of drugs (Chan et al., 2000) and it has also been studied in the formation of nanoparticles (Machado et al., 2012). In topical formulations, sodium alginate is widely used as a thickening and suspending agent in a variety of pastes, creams, and gels, and as stabilizing agent for oil-in-water emulsions (Cable, 2009). Hydrogels, suspensions, oral mucosal, buccal and vaginal tablets, microspheres containing sodium alginate possess bioadhesive properties (Miyazaki et al., 1994; Vennat et al., 1998; Gavini et al., 2002; Mohammed and Khedr, 2003; Richardson et al., 2004; Gavini et al., 2005). *In situ* gel forming formulations for ophthalmic and oral-sustained drug delivery consisting of sodium alginate have been developed (Cohen et al., 1997; Kubo et al., 2003). Hydrogel systems containing alginates have been proposed for delivery of proteins and peptides (Jeon et al., 2011). In addition, sodium alginate microspheres for vaccine delivery have been explored (Mata et al., 2011).

## 5. REFERENCES

---

---

Abdullah Y, Schneider B, Petersen M. Occurrence of rosmarinic acid, chlorogenic acid and rutin in Marantaceae species. *Phytochemistry Letters*. 2008;1(4):199-203.

Afanas'eva IB, Ostrakhovitch EA, Mikhal'chik EV, Ibragimova GA, Korkina LG. Enhancement of antioxidant and anti-inflammatory activities of bioflavonoid rutin by complexation with transition metals. *Biochem Pharmacol*. 2001;61(6):677-84.

Albertini B, Passerini N, Di Sabatino M, Vitali B, Brigidi P, Rodriguez L. Polymer-lipid based mucoadhesive microspheres prepared by spray-congealing for the vaginal delivery of econazole nitrate. *Eur J Pharm Sci*. 2009;36(4-5):591-601.

Allgayer H, Sonnenbichler J, Kruis W, Paumgartner G. Determination of the pK values of 5-aminosalicylic acid and N-acetylamino-salicylic acid and comparison of the pH dependent lipid-water partition coefficients of sulphasalazine and its metabolites. *Arzneimittelforschung*. 1985;35(9):1457-9.

Anderson DM, Brydon WG, Eastwood MA, Sedgwick DM. Dietary effects of sodium alginate in humans. *Food Addit Contam*. 1991;8(3):237-48.

Angspatt A, Tanvatcharaphan P, Channasanon S, Tanodekaew S, Chokrungrvaranont P, Sirimaharaj W. Comparative study between chitin/polyacrylic acid (PAA) dressing, lipido-colloid absorbent dressing and alginate wound dressing: a pilot study in the treatment of partial-thickness wound. *J Med Assoc Thai*. 2010;93(6):694-7.

Azad Khan AK, Piris J, Truelove SC. An experiment to determine the active therapeutic moiety of sulphasalazine. *Lancet*. 1977;2(8044):892-5.

Bondesen S, Rasmussen SN, Rask-Madsen J, Nielsen OH, Lauritsen K, Binder V, Hansen SH, Hvidberg EF. 5-Aminosalicylic acid in the treatment of inflammatory bowel disease. *Acta Med Scand*. 1987;221(3):227-42.

Bordin DS, Masharova AA, Drozdov VN, Firsova LD, Kozhurina TS. Diagnostic value of alginate test in gastroesophageal reflux disease. *Eksp Klin Gastroenterol*. 2010;(12):102-7.

Cable CK. Sodium alginate. In: *Handbook of pharmaceutical excipients*. Rowe RC, Sheskey PJ, Quinn ME (Eds.), 6th ed., Pharmaceutical Press, London, UK. 2009:888p.

Calija B, Milić J, Cekić N, Krajišnik D, Daniels R, Savić S. Chitosan oligosaccharide as prospective cross-linking agent for naproxen-loaded Ca-alginate microparticles with improved pH sensitivity. *Drug Dev Ind Pharm*. 2012, In press.

Chan LW, Lim LT, Heng PW. Microencapsulation of oils using sodium alginate. *J Microencapsul*. 2000;17(6):757-66.

Cheng YH, Yang SH, Lin FH. Thermosensitive chitosan-gelatin-glycerol phosphate hydrogel as a controlled release system of ferulic acid for nucleus pulposus regeneration. *Biomaterials*. 2011;32(29):6953-61.

Chua BY, Al Kobaisi M, Zeng W, Mainwaring D, Jackson DC. Chitosan microparticles and nanoparticles as biocompatible delivery vehicles for peptide and protein-based immunocontraceptive vaccines. *Mol Pharm*. 2012;9(1):81-90.

Cohen RD. Review article: evolutionary advances in the delivery of aminosalicylates for the treatment of ulcerative colitis. *Aliment Pharmacol Ther*. 2006;24(3):465-74.

Cohen S, Lobel E, Trevigoda A, Peled Y. A novel in situ-forming ophthalmic drug delivery system from alginates undergoing gelation in the eye. *J Control Release*. 1997;44(2-3): 201-8.

Couch JF, Naghski J, Krewson CF. Buckwheat as a Source of Rutin. *Science*. 1946;103(2668):197-8.

Crespy V, Morand C, Manach C, Besson C, Demigne C, Remesy C. Part of quercetin absorbed in the small intestine is conjugated and further secreted in the intestinal lumen. *Am J Physiol*. 1999;277(1 Pt 1):G120-6.

D'Haens G, van Bodegraven AA. Mesalazine is safe for the treatment of IBD. *Gut*. 2004;53(1):155.

da Silva RR, de Oliveira TT, Nagem TJ, Pinto AS, Albino LF, de Almeida MR, de Moraes GH, Pinto JG. Hypocholesterolemic effect of naringin and rutin flavonoids. *Arch Latinoam Nutr*. 2001;51(3):258-64.

Dai T, Tanaka M, Huang Y-Y, Hamblin MR. Chitosan preparations for wounds and burns: antimicrobial and wound-healing effects. *Expert Rev Anti Infect Ther*. 2011;9(7):857-79.

Das KM. Pharmacotherapy of inflammatory bowel disease. Part 1. Sulfasalazine. *Postgrad Med*. 1983;74(6):141-8, 150-1.

De Vos M. Clinical pharmacokinetics of slow release mesalazine. *Clin Pharmacokinet*. 2000;39(2):85-97.

Di Colo G, Baggiani A, Zambito Y, Mollica G, Geppi M, Serafini MF. A new hydrogel for the extended and complete prednisolone release in the GI tract. *Int J Pharm*. 2006;310(1-2):154-61.

Draget KI. Alginates. In: *Handbook of hydrocolloids*. Philips GO, Williams PA (Eds.), Woodhead Publishing Ltd, Cambridge, UK. 2000:453p.

Dünnhaupt S, Barthelmes J, Iqbal J, Perera G, Thurner CC, Friedl H, Bernkop-Schnürch A. In vivo evaluation of an oral drug delivery system for peptides based on S-protected thiolated chitosan. *J Control Release*. 2012, In press.

Felt O, Furrer P, Mayer JM, Plazonnet B, Buri P, Gurny R. Topical use of chitosan in ophthalmology: tolerance assessment and evaluation of precorneal retention. *Int J Pharm.* 1999;180(2):185-93.

Fernandez-Saiz P, Lagarón JM, Ocio MJ. Optimization of the film-forming and storage conditions of chitosan as an antimicrobial agent. *J Agric Food Chem.* 2009;57(8):3298-307.

Florezyk SJ, Kim DJ, Wood DL, Zhang M. Influence of processing parameters on pore structure of 3D porous chitosan-alginate polyelectrolyte complex scaffolds. *J Biomed Mater Res A.* 2011;98(4):614-20.

Formica JV, Regelson W. Review of the biology of quercetin and related bioflavonoids. *Food Chem Toxicol.* 1995;33(12):1061-80.

Fuhrman FA. Influence of dietary flavonoids on frostbite in the rat. *Am J Physiol.* 1955;181(1):123-7.

Gavini E, Rassa G, Sanna V, Cossu M, Giunchedi P. Mucoadhesive microspheres for nasal administration of an antiemetic drug, metoclopramide: in-vitro/ex-vivo studies. *J Pharm Pharmacol.* 2005;57(3):287-94.

Gavini E, Sanna V, Juliano C, Bonferoni MC, Giunchedi P. Mucoadhesive vaginal tablets as veterinary delivery system for the controlled release of an antimicrobial drug, acriflavine. *AAPS Pharm Sci Tech.* 2002;3(3):E1-7.

Goyanes A, Souto C, Martínez-Pacheco R. A comparison of chitosan-silica and sodium starch glycolate as disintegrants for spheronized extruded microcrystalline cellulose pellets. *Drug Dev Ind Pharm.* 2011;37(7):825-31.

Grant GT, Morris ER, Rees DA, Smith PCJ, Thom D. Biological interactions between polysaccharides and divalent cations: the egg-box model. *FEBS Lett.* 1973;32:195-8.

Guardia T, Rotelli AE, Juarez AO, Pelzer LE. Anti-inflammatory properties of plant flavonoids. Effects of rutin, quercetin and hesperidin on adjuvant arthritis in rat. *Farmaco.* 2001;56(9):683-7.

[http://en.wikipedia.org/wiki/File:Rutin\\_structure.svg](http://en.wikipedia.org/wiki/File:Rutin_structure.svg), downloaded 27.04.2012

[http://en.wikipedia.org/wiki/File:5-Aminosalicylic\\_acid.svg](http://en.wikipedia.org/wiki/File:5-Aminosalicylic_acid.svg), downloaded 27.04.2012

<http://upload.wikimedia.org/wikipedia/commons/9/99/Chitosan.png>, downloaded 27.04.2012

<http://upload.wikimedia.org/wikipedia/commons/f/f1/Alginat.svg>, downloaded 14.05.2012

Hamman JH. Chitosan based polyelectrolyte complexes as potential carrier materials in drug delivery systems. *Mar Drugs.* 2010;8(4):1305-22.

He P, Davis SS, Illum L. In vitro evaluation of the mucoadhesive properties of chitosan microspheres. *Int J Pharm.* 1998;166(1):75-88.



Hirano S, Seino H, Akiyama Y, Nonaka I. Chitosan: a biocompatible material for oral and intravenous administration. In: Progress in biomedical polymers. Gebelein CG, Dunn RL (Eds.), Plenum Press, New York, NY. 1990:428p.

Holte Ø, Onsøyen E, Myrvold R, Karlsen J. Sustained release of water-soluble drug from directly compressed alginate tablets. *Eur J Pharm Sci.* 2003;20(4-5):403-7.

Hosseinzadeh H, Atyabi F, Dinarvand R, Ostad SN. Chitosan-Pluronic nanoparticles as oral delivery of anticancer gemcitabine: preparation and in vitro study. *Int J Nanomedicine.* 2012;7:1851-63.

Illum L. Chitosan and its use as a pharmaceutical excipient. *Pharm Res.* 1998;15(9):1326-31.

Jeon O, Powell C, Solorio LD, Krebs MD, Alsberg E. Affinity-based growth factor delivery using biodegradable, photocrosslinked heparin-alginate hydrogels. *J Control Release.* 2011;154(3):258-66.

Johnson EF. Rutin and capillary fragility. *Am J Pharm Sci Support Public Health.* 1946;118:164-75.

Jones DS. Chitosan. In: Handbook of pharmaceutical excipients. Rowe RC, Sheskey PJ, Quinn ME (Eds.), 6th ed., Pharmaceutical Press, London, UK. 2009:888p.

Kato Y, Onishi H, Machida Y. Application of chitin and chitosan derivatives in the pharmaceutical field. *Curr Pharm Biotechnol.* 2003;4(5):303-9.

Keegan GM, Smart JD, Ingram MJ, Barnes LM, Burnett GR, Rees GD. Chitosan microparticles for the controlled delivery of fluoride. *J Dent.* 2012;40(3):229-40.

Kim DH, Jung EA, Sohng IS, Han JA, Kim TH, Han MJ. Intestinal bacterial metabolism of flavonoids and its relation to some biological activities. *Arch Pharm Res.* 1998;21(1):17-23.

Kim H, Kong H, Choi B, Yang Y, Kim Y, Lim M-J, Neckers L, Jung Y. Metabolic and pharmacological properties of rutin, a dietary quercetin glycoside, for treatment of inflammatory bowel disease. *Pharmacol Res.* 2005;22:1499-509.

Klausner EA, Zhang Z, Wong SP, Chapman RL, Volin MV, Harbottle RP. Corneal gene delivery: chitosan oligomer as a carrier of CpG rich, CpG free or S/MAR plasmid DNA. *J Gene Med.* 2012;14(2):100-8.

Klotz U. Clinical pharmacokinetics of sulphasalazine, its metabolites and other prodrugs of 5-aminosalicylic acid. *Clin Pharmacokinet.* 1985;10(4):285-302.

Kristl J, Šmid-Korbar J, Štruc E, Schara M, Rupprecht H. Hydrocolloids and gels of chitosan as drug carriers. *Int J Pharm.* 1993;99(1):13-9.

Kubo W, Miyazaki S, Attwood D. Oral sustained delivery of paracetamol from in situ-gelling gellan and sodium alginate formulations. *Int J Pharm.* 2003;258(1-2):55-64.

Kushlan SD. Gastro-intestinal bleeding in hereditary hemorrhagic telangiectasia; historical review and case report with gastroscopic findings and rutin therapy. *Gastroenterology*. 1946;7:199-212.

Lachman J, Orsák M, Pivec V, Faustusová E. Content of rutin in selected plant sources. *SAB*. 2000;31(2):89-99.

Machado AH, Lundberg D, Ribeiro AJ, Veiga FJ, Lindman B, Miguel MG, Olsson U. Preparation of calcium alginate nanoparticles using water-in-oil (W/O) nanoemulsions. *Langmuir*. 2012;28(9):4131-41.

Maestrelli F, Cirri M, Mennini N, Zerrouk N, Mura P. Improvement of oxaprozin solubility and permeability by the combined use of cyclodextrin, chitosan, and bile components. *Eur J Pharm Biopharm*. 2011;78(3):385-93.

Martindale: the complete drug reference. Sweetman SC (Ed.), 34th ed., Pharmaceutical Press, London, UK. 2005:2756p.

Mata E, Igartua M, Patarroyo ME, Pedraz JL, Hernández RM. Enhancing immunogenicity to PLGA microparticulate systems by incorporation of alginate and RGD-modified alginate. *Eur J Pharm Sci*. 2011;44(1-2):32-40.

Matsubara Y, Inoue M, Iwasaki K. Continuous degradation of sodium alginate in bioreactor using immobilized alginate lyase. *FSTI* 1998;4:71-6.

McConnell EL, Murdan S, Basit AW. An investigation into the digestion of chitosan (noncrosslinked and crosslinked) by human colonic bacteria. *J Pharm Sci*. 2008;97(9):3820-9.

Miyazaki S, Nakayama A, Oda M, Takada M, Attwood D. Chitosan and sodium alginate based bioadhesive tablets for intraoral drug delivery. *Biol Pharm Bull*. 1994;17(5):745-7.

Mir VG, Heinämäki J, Antikainen O, Revoredo OB, Colarte AI, Nieto OM, Yliruusi J. Direct compression properties of chitin and chitosan. *Eur J Pharm Biopharm*. 2008;69(3):964-8.

Mengatto LN, Helbling IM, Luna JA. Recent advances in chitosan films for controlled release of drugs. *Recent Pat Drug Deliv Formul*. 2012, In press.

Mohamed SA, Aly AS, Mohamed TM, Salah HA. Immobilization of horseradish peroxidase on nonwoven polyester fabric coated with chitosan. *Appl Biochem Biotechnol*. 2008;144(2):169-79.

Mohammed FA, Khedr H. Preparation and in vitro/in vivo evaluation of the buccal bioadhesive properties of slow-release tablets containing miconazole nitrate. *Drug Dev Ind Pharm*. 2003;29(3):321-37.

Moon M-S, Lee M-S, Kim C-T, Kim Y. Dietary chitosan enhances hepatic CYP7A1 activity and reduces plasma and liver cholesterol concentrations in diet-induced hypercholesterolemia in rats. *Nutr Res Pract*. 2007;1(3):175-9.

Mura C, Nácher A, Merino V, Merino-Sanjuán M, Manconi M, Loy G, Fadda AM, Díez-Sales O. Design, characterization and in vitro evaluation of 5-aminosalicylic acid loaded N-succinyl-chitosan microparticles for colon specific delivery. *Colloids Surf B Biointerfaces*. 2012;94:199-205.

Narayanan D, Anitha A, Jayakumar R, Nair SV, Chennazhi KP. Synthesis, characterization and preliminary in vitro evaluation of PTH 1-34 loaded chitosan nanoparticles for osteoporosis. *J Biomed Nanotechnol*. 2012;8(1):98-106.

Nielsen OH. Sulfasalazine intolerance. A retrospective survey of the reasons for discontinuing treatment with sulfasalazine in patients with chronic inflammatory bowel disease. *Scand J Gastroenterol*. 1982;17(3):389-93.

Nunthanid J, Laungtana-Anan M, Sriamornsak P, Limmatvapirat S, Puttipipatkachorn S, Lim LY, Khor E. Characterization of chitosan acetate as a binder for sustained release tablets. *J Control Release*. 2004;99(1):15-26.

O'Leary KA, Day AJ, Needs PW, Sly WS, O'Brien NM, Williamson G. Flavonoid glucuronides are substrates for human liver beta-glucuronidase. *FEBS Lett*. 2001;503(1):103-6.

Perioli L, Ambroggi V, Venezia L, Pagano C, Ricci M, Rossi C. Chitosan and a modified chitosan as agents to improve performances of mucoadhesive vaginal gels. *Colloids Surf B Biointerfaces*. 2008;66(1):141-5.

Portero A, Remuñán-López C, Vila-Jato JL. Effect of chitosan and chitosan glutamate enhancing the dissolution properties of the poorly water soluble drug nifedipine. *Int J Pharm*. 1998;175(1):75-84.

Qin Y, Gilding DK. Alginate fibres and wound dressings. *Med Device Technol*. 1996;7(9):32-41.

Rabišková M, Bautzová T, Dvořáčková K, Spilková J. Beneficial effects of rutin, quercitrin and quercetin on inflammatory bowel disease. *Čes Slov Farm*. 2009;58:47-54.

Rechner AR, Smith MA, Kuhnle G, Gibson GR, Debnam ES, Srai SK, Moore KP, Rice-Evans CA. Colonic metabolism of dietary polyphenols: influence of structure on microbial fermentation products. *Free Radic Biol Med*. 2004;36(2):212-25.

Rees DA. Polysaccharide shapes and their interactions-some recent advances *Pure Appl Chem*. 1981;53:1-14.

Richardson JC, Dettmar PW, Hampson FC, Melia CD. Oesophageal bioadhesion of sodium alginate suspensions: particle swelling and mucosal retention. *Eur J Pharm Sci*. 2004;23(1):49-56.

Ritthidy GC, Chomto P, Pummangura S, Menasveta P. Chitin and chitosan as disintegrants in paracetamol tablets. *Drug Dev Ind Pharm*. 1994;20(13):2109-34.

- Roberts GAF. Chitin Chemistry. The Macmillan Press, Basingstoke, UK. 1992:365p.
- Rosenthal R, Günzel D, Finger C, Krug SM, Richter JF, Schulzke JD, Fromm M, Amasheh S. The effect of chitosan on transcellular and paracellular mechanisms in the intestinal epithelial barrier. *Biomaterials*. 2012;33(9):2791-800.
- Sadeghi AM, Dorkoosh FA, Avadi MR, Weinhold M, Bayat A, Delie F, Gurny R, Larijani B, Rafiee-Tehrani M, Junginger HE. Permeation enhancer effect of chitosan and chitosan derivatives: comparison of formulations as soluble polymers and nanoparticulate systems on insulin absorption in Caco-2 cells. *Eur J Pharm Biopharm*. 2008;70(1):270-8.
- Sahasathian T, Praphairaksit N, Muangsin N. Mucoadhesive and floating chitosan-coated alginate beads for the controlled gastric release of amoxicillin. *Arch Pharm Res*. 2010;33(6):889-99.
- Säkkinen M, Seppälä U, Heinänen P, Marvola M. In vitro evaluation of microcrystalline chitosan (MCCh) as gel-forming excipient in matrix granules. *Eur J Pharm Biopharm*. 2002;54(1):33-40.
- Sakr A, El Sabbagh H, Shalaby A. Effect of the technique of incorporating sodium alginate on its binding and/or disintegrating effectiveness in sulphathiazole tablets. *Pharm Ind*. 1978;40, 1080-6.
- Sawayanagi Y, Nambu N, Nagai T. Directly compressed tablets containing chitin or chitosan in addition to lactose or potato starch. *Chem Pharm Bull (Tokyo)*. 1982;30(8):2935-40.
- Shah SA, Peppercorn MA. Inflammatory bowel disease therapy: an update. *Compr Ther*. 1995;21(6):296-302.
- Shaikh R, Singh TRR, Garland MJ, Woolfson AD, Donnelly RF. Mucoadhesive drug delivery systems. *J Pharm Bioallied Sci*. 2011; 3(1): 89-100.
- Smart JD. The basics and underlying mechanisms of mucoadhesion. *Adv Drug Deliv Rev*. 2005;57(11):1556-68.
- Spencer JP, Kuhnle GG, Williams RJ, Rice-Evans C. Intracellular metabolism and bioactivity of quercetin and its in vivo metabolites. *Biochem J*. 2003;372(Pt 1):173-81.
- Squadrito F, Altavilla D, Oliaro Bosso S. Double-blind, randomized clinical trial of troxerutin-carbazochrome in patients with hemorrhoids. *Eur Rev Med Pharmacol Sci*. 2000;4(1-2):21-4.
- Sriamornsak P, Sungthongjeen S. Modification of theophylline release with alginate gel formed in hard capsules. *AAPS Pharm Sci Tech*. 2007;8(3):E1-8.
- Stocker FW. Treatment of chronic simple glaucoma. *Postgraduate Course Ophthalmol*. 1947;8:269-84.
- Svartz N. The treatment of rheumatic polyarthritis with acid azo compounds. *Rheumatism*. 1948;4(1):180-5.

Upadrashta SM, Katikaneni PR, Nuessle NO. Chitosan as a tablet binder. *Drug Dev Ind Pharm.* 1992;18(15):1701-8.

Vennat B, Lardy F, Arvouet-Grand A, Pourrat A. Comparative texturometric analysis of hydrogels based on cellulose derivatives, carraghenates, and alginates: evaluation of adhesiveness. *Drug Dev Ind Pharm.* 1998;24(1):27-35.

Veski P, Marvola M. Sodium alginate as diluents in hard gelatin capsules containing ibuprofen as a model drug. *Pharmazie.* 1993;48:757-60.

Veski P, Marvola M, Smal J, Heiskanen I, Jurjenson H. Biopharmaceutical evaluation of pseudoephedrine hydrochloride capsules containing different grades of sodium alginate. *Int J Pharm.* 1994;111:171-9.

Weisberg M, Gubner RS, Kroll H. Chitosan containing antacid composition and method of using same. US Patent 3257275, 1966.

Weiss A. *Pharm Zentralbl.* 1842;13(2):903-5.

Weiss JF, Landauer MR. Protection against ionizing radiation by antioxidant nutrients and phytochemicals. *Toxicology.* 2003;189(1-2):1-20.

Williams JG, Hallett MB. Effect of sulphasalazine and its active metabolite, 5-amino-salicylic acid, on toxic oxygen metabolite production by neutrophils. *Gut.* 1989;30(11):1581-7.

Williamson G, Day AJ, Plumb GW, Couteau D. Human metabolic pathways of dietary flavonoids and cinnamates. *Biochem Soc Trans.* 2000;28(2):16-22.

Wolf JM, Lashner BA. Inflammatory bowel disease: sorting out the treatment options. *Cleve Clin J Med.* 2002;69(8):621-6, 629-31.

Wong TW, Nurulaini H. Sustained-release alginate-chitosan pellets prepared by melt pelletization technique. *Drug Dev Ind Pharm.* 2012, In press.

Yeh MK, Cheng KM, Hu CS, Huang YC, Young JJ. Novel protein-loaded chondroitin sulfate-chitosan nanoparticles: preparation and characterization. *Acta Biomater.* 2011;7(10):3804-12.

Zatz JL, Woodford DW. Prolonged release of theophylline from aqueous suspensions. *Drug Dev Ind Pharm.* 1987;13(12):2159-78.

Zhou SY, Fleisher D, Pao LH, Li C, Winward B, Zimmermann EM. Intestinal metabolism and transport of 5-aminosalicylate. *Drug Metab Dispos.* 1999;27(4):479-85.

### **III. INFLAMMATORY BOWEL DISEASE**



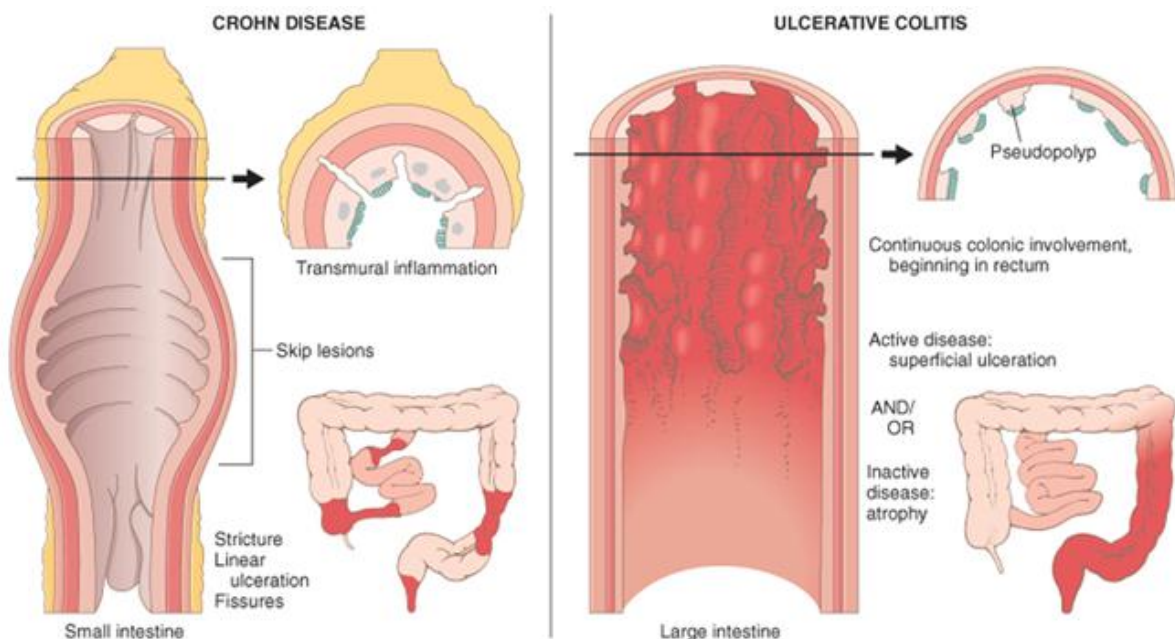
## 1. GENERALITIES

Inflammatory bowel disease (IBD) comprises especially Crohn's disease (CD) and ulcerative colitis (UC), which are defined as chronically relapsing immune-mediated inflammations of the gastrointestinal tract GIT over many years (Podolsky, 2002). Appearing initially as isolated cases in Great Britain and northern Europe during the 19<sup>th</sup> and early 20<sup>th</sup> centuries, they have steadily increased numerically and geographically and today are recognized worldwide (Kirsner, 2001).



UC and CD are similar in many respects, but there are contrasting features. While CD is a multifocal, transmural inflammatory process which includes the presence of granulomas and fissures that can affect any part of the GIT (Fig. III.1), UC is characterized by a continuous, superficial inflammation, which occurs typically in the rectum and lower part of the colon with pseudopolyps as a frequent sequella (Fig. III.2) (Turnbough and Wilson, 2007; Atreya and Neurath, 2008).

**Fig. III.1: Inflammation in CD:** It can appear along the entire GIT, but most commonly the ileum and colon are affected (downloaded from The bowel disease foundation)



**Fig. III.2: Differences in the localization and distribution of UC and CD with depiction of intestinal complications** (adapted from Kumar et al., 2007)



In approximately 10 % of IBD, a definite diagnosis of UC or CD cannot be established due to either insufficient clinical data or prominent overlapping features between these two disorders. Under these circumstances, some pathologists choose to render a diagnosis of indeterminate colitis (Prenzel and Uhlig, 2009).

IBD is a multifactorial disorder whose etiology remains unknown and furthermore the exact pathogenesis is poorly understood. Chronic, recurrent intestinal inflammation is thought to result from inappropriate and ongoing activation of the mucosal immune system driven by the products of commensal bacteria in the lumen. There is evidence of interactions among genetically determined susceptibility to chronic intestinal inflammation (gene encoding nucleotide-binding oligomerization domain containing 2 (NOD2), tumor necrosis factor (TNF), mucin, interleukin-10 (IL-10), etc.), the immune response (T cells, macrophages, active inflammatory cytokines), and the environment, most notably the bacterial flora, but also infection, use of nonsteroidal anti-inflammatory drugs, stress and smoking (in CD; protective role in UC) play an important role. The activation of immune system is eventually accompanied by the production of a wide variety of nonspecific mediators of inflammation. These enhance the inflammatory process and tissue destruction, which eventuate in clinical intestinal and extraintestinal manifestations of the disease. Clinical features of intestinal involvement include abdominal pain, rectal bleeding, nausea, diarrhoea, signs of malnutrition and weight loss. Patients complain of lassitude and recurrent fever. Extraintestinal features are common and represent ocular and dermal manifestations, hepatobiliary and renal disease, bone abnormalities and inflammatory seronegative arthropathies (Kirsner, 2001; Hendrickson et al., 2002; Podolsky, 2002).

The frequency of IBD in industrialized countries contrasts with underdeveloped countries where disease rarely occurred. However, as these nations became industrialized, the incidence of UC and then CD increased (Kaplan et al., 2010). Moreover mechanisms underlying initiation vs. progression and chronicity may well be distinct (Elson et al., 1995). Hence, the treatment does not affect the cause of the illness and is effective only in reducing the inflammation and accompanying symptoms (Oz and Ebersole, 2008).

## 2. ANATOMY AND HISTOLOGY OF BOWELS

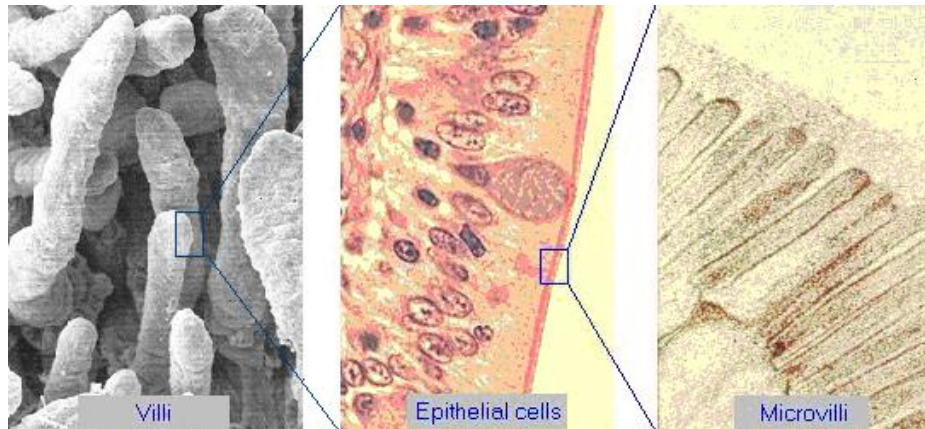
---

---

### 2.1. SMALL INTESTINE

---

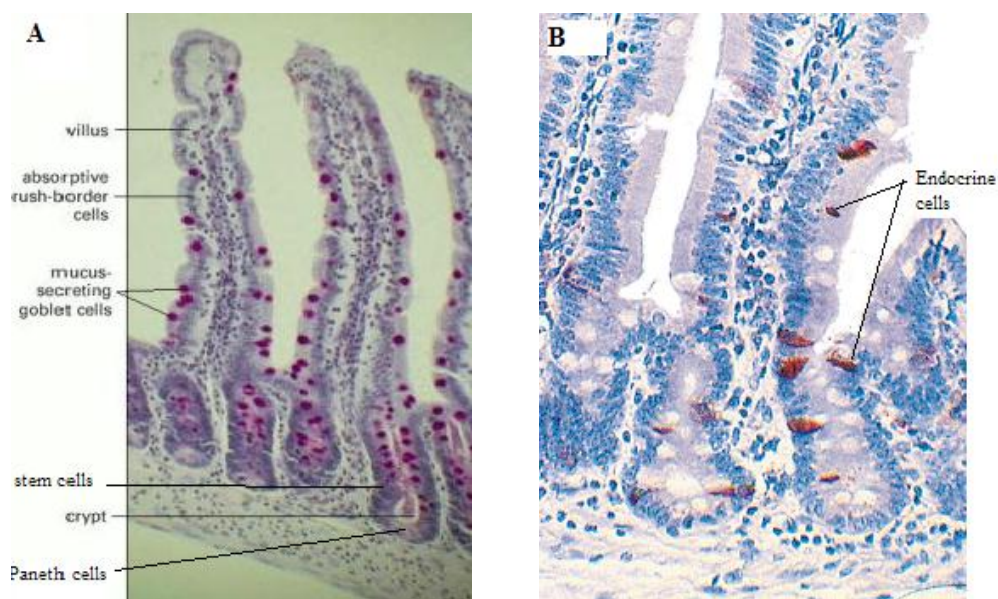
The small intestine, located within the abdominal cavity, is the longest section of the digestive tube and consists of three segments (duodenum, jejunum and ileum) forming a passage from the pyloric sphincter of the stomach to the ileocecal valve of the large intestine. Its average length in the human adult is 6 to 7 m (Rubin, 2009). The inner surface of the small intestine appears similar to velvet due to multiple circular mucosal folds known as **plicae circulares** which are covered by millions of tiny projections, shaped like cactus leaves, called **villi** (Fig. III.3) extended about 1 mm into the lumen and with mature enterocytes on their surface. The luminal plasma membrane of absorptive epithelial cells is studded with densely-packed **microvilli** looking something like a brush. For this reason, the microvillus border of intestinal epithelial cells is referred to as the "brush border". These three related features create the huge absorptive surface area of the small intestine (an area equivalent to a tennis court) (Gramlich and Petras, 2007).



**Fig. III.3: Bulk of the surface area expansion, showing villi (fingerlike and leaflike appearance), epithelial cells that cover the villi and the microvilli of the epithelial cells (adapted from Bowen, 2004)**

Crypts, moat-like invaginations of the epithelium around the villi, house a dynamic self-renewing population of undifferentiated multipotent stem epithelial cells generating mucus-secreting goblet cells, endocrine cells, mature absorptive epithelial cells fulfilling the

basic function of the digestive system and Paneth cells which probably play a role in regulating the intestinal microbial flora and provide defense against microbes by phagocytosis (Fig. III.4). From birth to death, intestinal epithelial cells live some 3 to 4 days, consequently, the turnover of intestinal epithelial cells is high. The crypt epithelium also contains intraepithelial lymphocytes that are predominantly T-suppressor/cytotoxic (cluster of differentiation 8<sup>+</sup> (CD8<sup>+</sup>)) cells. Other inflammatory cell types, such as the neutrophil or the plasma cell, are not normally present within either the crypt or villous epithelial compartments and their presence would indicate a pathologic state (Bowen, 2004; Gramlich and Petras, 2007; Moran and Rowley).

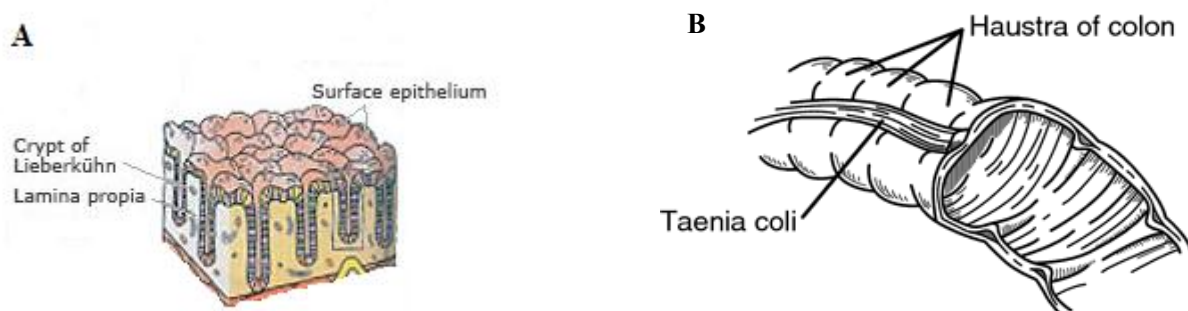


**Fig. III.4: The four main differentiated cell types found in the epithelial lining of the small intestine** (adapted from Alberts et al., 2002 (A); Gramlich and Petras, 2007 (B))

## 2.2. LARGE INTESTINE

The large intestine constitutes the terminal part of the digestive system and is anatomically divided into three main sections: cecum including the vermiform appendix, colon (subclassified into ascending, transversal, descending, sigmoid), and terminal segment of digestive tube - rectum, continuous with the anal canal. In the adult, the large intestine measures approximately 1.5 m (Cohn et al., 2009). The large intestine looks very different from the small intestine. The surface of the mucosa is relatively smooth, because plicae circulares and intestinal villi are absent. On the other hand, **microvilli** are preserved and

greatly increase the surface area (Fig. III.5A). Crypts are usually deeper and straighter than those of the small intestine and mucus-secreting goblet cells are much more abundant in the colonic epithelium. Also the external appearance of the colon differs from that of the small bowel. Outer longitudinal muscle fibers coalesce into three discrete bands - **teniae coli** which start at the base of the appendix and extend continuously to the proximal rectum. Contraction of the teniae coli exerts pressure on the wall and creates a series of pouches, called **haustra**, along the colon (Fig. III.5B) (Dahl and Greenson, 2007; Moran and Rowley).



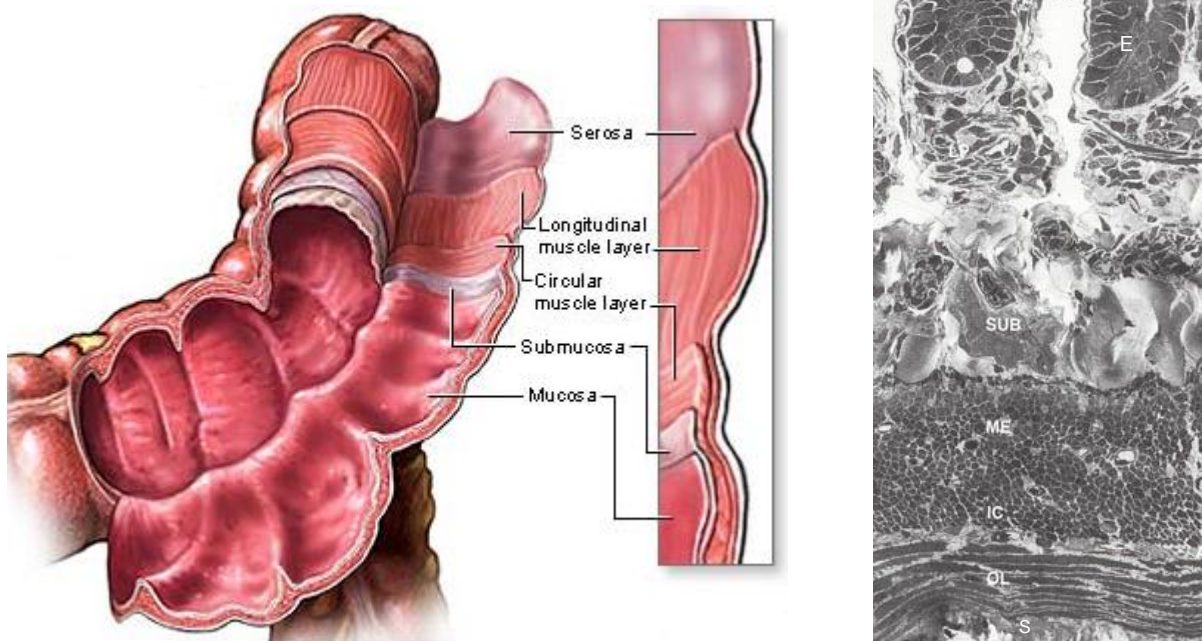
**Fig. III.5: Anatomy of large intestine** (adapted from McPhee and Hammer, 2009 (A); Dorland, 2000 (B))

### 2.3. MICROSCOPIC STRUCTURE

---

Although regional differences exist within the GIT, the general microscopic structure is similar throughout its length. The wall of the digestive tube can be divided into four basic layers: mucosa, submucosa, muscularis externa or propria, and adventicia or serosa (Fig. III.6). **Mucosa** is the innermost layer of the digestive tube and lines the lumen. Among the four tunics, the mucosa is most variable in structure and function, endowing the tube with an ability to perform diverse and specialized digestive tasks along its length. The mucosa is formed by surface epithelium, lamina propria, and muscularis mucosae. The surface epithelium and lamina propria form intraluminal villi and/or crypts. Lamina propria contains a centrally located, blind-ended lymphatic channel (lacteal), an arteriovenous capillary network, and various types of leukocyte populations which control the inflammation. They include T cells, B cells, monocytes, macrophages, eosinofils and mast cells. Muscularis mucosae consists of a thin layer of smooth muscle at the boundary of the mucosa and submucosa. **Submucosa** is a bigger, tougher version of the lamina propria. It is a layer of loose to dense

fibrous connective tissue containing fibroblasts, mast cells, blood and lymphatic vessels, and nerve fiber plexus. **Muscularis propria** consists of two thick powerful layers of smooth muscles set in bidirectional orientations. Muscle fibers in the inner layer are aligned circularly and constrict the lumen, whereas those in the outer longitudinal layer shorten the tube. Together, as in a worm, they cause peristaltic movements and also provide the motive force for venous return of blood from the gut. A prominent nerve fiber plexus is found between these two muscle layers. The entire gut is wrapped in a collagenous bag, the **serosa**. When it covers retroperitoneal portions of the GIT, it is called **adventitia** (Geboes, 2003; Bowen, 2004; Gramlich and Petras, 2007).

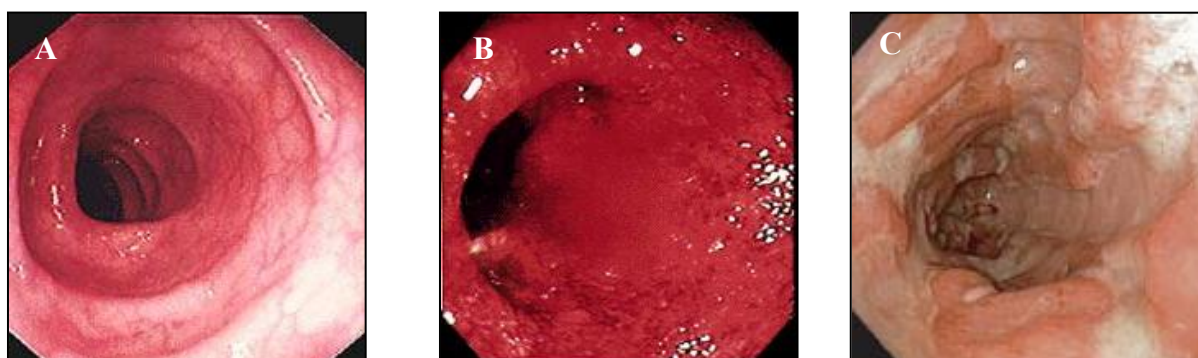


**Fig. III.6: Microanatomy of the digestive tube.** E, epithelium; IC, inner circular layer of muscularis externa; IG, intestinal glands; La, lacteal; LP, lamia propria; ME, muscularis externa; OL, outer longitudinal layer of muscularis externa; S, serosa; SUB, submucosa (adapted from Penn Medicine; Moran and Rowley)

### 3. RELATED BUT DISTINCT CHRONIC INFLAMMATORY DISORDERS

---

Proper clinical separation UC and CD has important therapeutic implications. Accurate diagnosis often requires correlation of clinical, endoscopic and histopathological findings. The diagnostic work-up may also include hematological screening, renal and liver function tests, bile duct problems and inflammatory processes throughout the body. Although CD and UC each carry an increased risk of neoplastic transformation, the risk is higher and surgical intervention is better tolerated in UC (Hendrickson et al., 2002; Ricci et al., 2008; Rendi et al.). Irregular or villous surface, a decrease in mucus content and crypt atrophy is the best combination to distinguish UC. On the other hand, epithelioid granulomas, isolated giant cells and microgranulomas suggest a diagnostic of CD (Le Berre et al., 1995). The main features discriminating between the both diseases are seen in Fig. III.7 and described below.



**Fig. III.7: Colonoscopy pictures of colon in healthy (A), UC (B: wet and glaring mucosal surface with marked hyperemia) and CD patients (C: linear and serpiginous ulcerations and patchy inflammation resulting in cobblestone pattern)** (adapted from Maxwell-Armstrong and Cohen, 2003 (A, B); Baumgart and Sandborn, 2007 (C))

#### 3.1. ULCERATIVE COLITIS

---

##### 3.1.1. History

In all probability we shall never know who first described UC, although Sir Samuel Wilks first referred to the disease by name in 1859 (Hurst, 1923). Prior to that date, as far back as Roman times, various forms of non-contagious diarrhoea were described freely in the literature. The customary name of this disease “UC“ is thoroughly imprecise, since ulceration

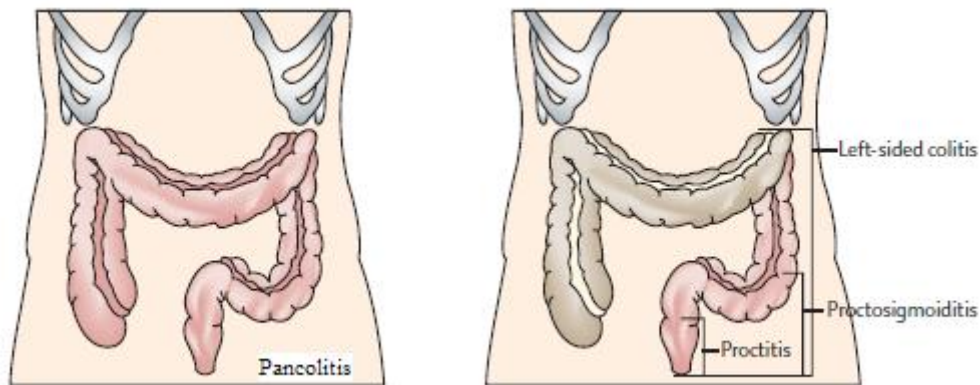
is not a “*sine qua non*” of the disease and since the disease usually involves colonic and rectal mucosa. Undoubtedly “idiopathic diffuse mucosal proctocolitis” would be a more accurate descriptive term. The pathological and clinical features of the disease were closely characterized, notably by Wilks & Moxon (1875), Allchin (1885) and Hale-White (1888). Gradually UC became more widely recognized (De Dombal, 1968). Since then the disease has consistently increased in notoriety. Early in the 20<sup>th</sup> century, the incidence of UC was higher than CD. The number of individuals suffering from UC augmented steadily during the first half of the 20<sup>th</sup> century, after which the number has leveled out. Recent trends indicate a decrease in UC incidence. In the last decade, CD has become the predominating disease, with higher incidence rates than UC in most countries (Kaplan et al., 2010; Ekbom, 2011).

### **3.1.2. Epidemiology**

Figures from France and the Czech Republic show prevalence rates of 70-80 and 40-45 per 100 000 population, respectively. Incidence rates vary between 7 and 4 per 1000 000 population for France and the Czech Republic. All age groups are at risk, and the peak age of onset is between 30 and 40 years (Nerich et al., 2006; Hošek et al, 2008). UC has a slight male predilection (Karlinger et al., 2000). In clinical practice, UC is classified based on its severity being quiescent (remission), mild, moderate or severe attacks (Baumgart and Sandborn, 2007). Severe UC may progress in fulminant colitis and be complicated with toxic megacolon, and perforation (De Iorio, 2006).

### **3.1.3. Types**

UC starts from the rectum, extends proximally and in continuity, involving a variable length of the colon (Fig. III.8). In ulcerative proctitis, the disease is confined to the rectum. In left-sided colitis or rectosigmoiditis, disease extends to the sigmoid colon. In pancolitis, the entire colon is affected, but normally inflammation stops abruptly at the ileocecal valve, nevertheless in some cases a limited distal ileitis, called backwash ileitis, is observed (Friedman and Blumberg, 2008).



**Fig. III.8: Anatomic extent of UC involvement** (adapted from Baumgart and Sandborn, 2007)

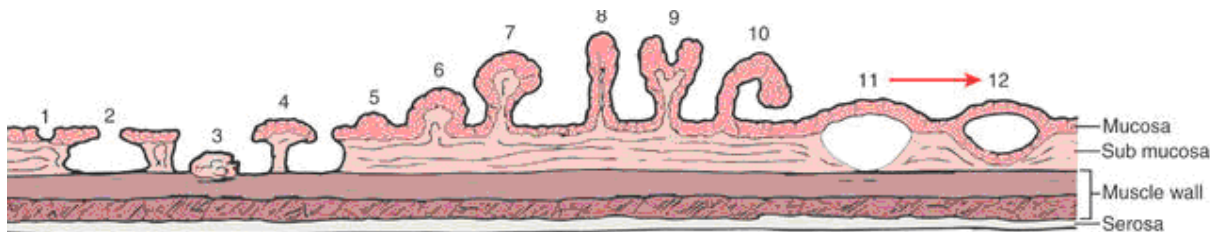
#### 3.1.4. Main features

The general appearance of UC varies with the activity of the disease. Lesions are usually limited to the mucosa. Stenoses, fistulas, well-formed granulomas and significant thickening of the wall are rare. In the acute form, the mucosal surface is wet and glaring from blood and mucus with numerous petechial hemorrhages (Fig. III.9A). Ulcers of various sizes can appear. They may be small, rounded and superficial (rarely extend below the submucosa) or more irregular. Fissuring ulcers are not seen, except in some cases of toxic megacolon. Following healing of mucosal ulcers, islands of regenerating mucosa bulge upward to create pseudopolyps (elevated sessile reddish nodules, Fig. III.9B) which appear on an otherwise flat surface and covered by nonspecific granulation tissue. They are typically small and numerous, but may have a filiform configuration. In the more advanced stages, the entire bowel becomes fibrotic, narrowed, shortened, and mucosa is atrophic (Fig. III.9C). Mucosal abnormalities occurring in UC patients are also depicted in Fig. III.10. During remission, the mucosa may become normal again. Healing often occurs in an irregular way leading to a discontinuous, heterogeneous aspect of the mucosa, which can be confused with CD. In severe active forms the entire colon or a segment may become dilated (toxic megacolon). Inflammation may extend towards the submucosa. In such cases, the wall is thin and perforation can occur. Patients are in a high risk of carcinoma development (Geboes, 2003; Odze, 2003).





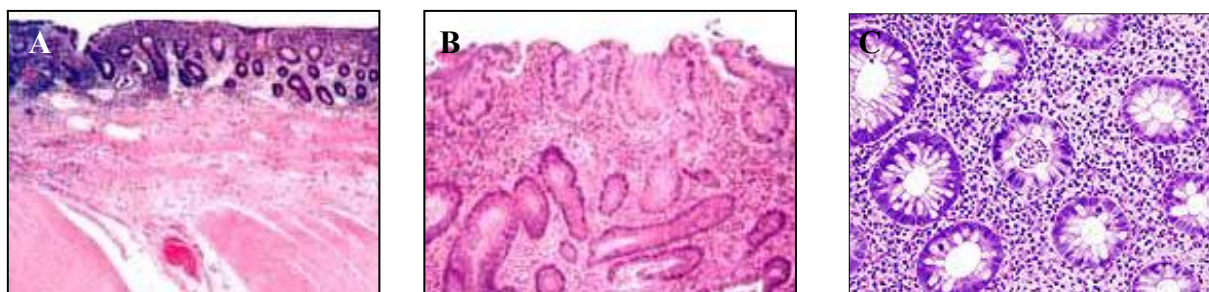
**Fig. III.9: Main macroscopic features in UC: marked hyperemia (A), pseudopolyps (B), total mucosal atrophy (C)** (adapted from Lockhart et al., 2004 (A, C); University of Michigan, Department of surgery (B))



**Fig. III.10: Spectrum of mucosal abnormalities in UC: punctate mucosal ulcer-crypt abscess (1), “collar button” ulcer (2), polypoid accumulation of granulation tissue (3), mucosal remnant forming inflammatory pseudopolyp (4), sessile mucosal polyps (5, 6), pedunculated polyp (7), postinflammatory pseudopolyps of various configurations (8, 9, 10), mucosal remnant bridging area of active undermining ulceration (11), mucosal bridge in quiescent state with previously denuded surfaces covered with new epithelium (12)** (adapted from Lichtenstein, 1987)

The microscopic pattern of UC is characterized by an increase in intensity of the lamina propria cellular infiltrate which extends diffusely towards the deeper parts (transmucosal distribution may be found). Chronic inflammation of the mucosa is accompanied with atrophy of colonic glands and moderate submucosal fibrosis however muscle wall is not usually affected (Fig. III.11A). The presence of neutrophils indicates a change in the composition of the inflammatory infiltrate. Accumulation of neutrophils within epithelial structures results in cryptitis (in the crypt wall) or abscesses (at base of the crypts) (Fig. III.11B,C), which are generally more common in UC, being present in 41 % of the cases while in CD they are found in 19 % of cases. Severe crypt architectural distortion, including

shortened crypts that become widely separated from the underlying muscularis mucosae, crypt drop-out and especially prominent crypt budding (branching crypts, bifid crypts), is helpful feature for diagnosis of UC. Mucosal atrophy is a combination of crypt drop-out and their shortening. An irregular or villiform (reminiscent of small bowel mucosa) surface is present in approximately 60 % of patients. Blood vessels are dilated. Mucosal erosions and widespread surface epithelial damage are more common in UC than in CD. Severe, almost total mucin depletion occurs during the acute phase while mucin secretion returns to normal in quiescent phase. Abnormal mucin production may permit various intraluminal bacterial products and toxins to attack mucosa. (Cook and Dixon, 1973; Scott and Sanders, 1998; Geboes, 2003; Maxwell-Armstrong and Cohen, 2003).



**Fig. III.11: Histologic features in UC: inflammation of the mucosa, normal muscle wall (A), crypt abscess and glandular architectural distortion (B), crypt abscesses (C)** (adapted from Glossary of pathology (A, B); Webster's online dictionary (C))

## 3.2. CROHN'S DISEASE

### 3.2.1. History

CD, originally called *regional ileitis*, takes its name from an American gastroenterologist B.B.Crohn. CD initially came to be known as a medical entity when it was referred to B.B.Crohn and his colleagues, L. Ginzburg and G. Oppenheimer, in 1932 (Blumberg, 2008). It is by virtue of alphabetization rather than contribution that Crohn's name appeared as the first author. The first description of this condition was earlier made by physician G.B.Morgagni in 1769, when he diagnosed a young man with a chronic, debilitating illness and diarrhea. Successive cases of patients suffered from intestinal obstruction were reported in the end of 19<sup>th</sup> century. On close examination, transmural inflammation of the bowel wall was clearly evident. The early history of CD is probably also

linked with the numerous reports of tumor-like granulomas of the small intestine, initially regarded as neoplastic lesions requiring surgical removal (Kirsner, 1988). Before 1950, incidence rates of CD were 0.2 in 100 000 population. Afterwards, a rising incidence during the 1950s through to the 1980s was reported (Logan, 1998; Ekblom 2011).

### **3.2.2. Epidemiology**

The prevalence is 94-110 and 18-22 per 1000 000 population in France and the Czech Republic, respectively. The incidence of CD has significantly increased over the second half of 20<sup>th</sup> century and is higher in France than in the Czech Republic (6 versus 2 cases per 100 000 people). The first peak of CD onset occurs in the teenage years, the second smaller peak during the fifth to seventh decades (Piront et al., 2003; Nerich et al., 2006; Hošek et al., 2008). The condition is marginally more common in females (Podolsky, 2002). In clinical practice, disease activity is typically described as quiescent, mild to moderate, moderate to severe or severe to fulminant (Baumgart and Sandborn, 2007). Frequent complications associated with CD include bowel obstruction, fistulas and abscess formation (Knopp and Hokanson, 2006).

### **3.2.3. Classification**

CD most commonly affects the terminal ileum, ileocecal valve and cecum but has the potential to involve any part of the GIT. Based on the bowel segment it affects, CD has been classified into ileitis (only ileum), colitis (only colon) and ileocolic (involving ileum and colon) (Ruthruff, 2007). Pediatric patients with CD experience failure of linear growth, and delayed puberty caused by disease-induced malnutrition, poor appetite, or medical therapy (Tietjen et al., 2009).

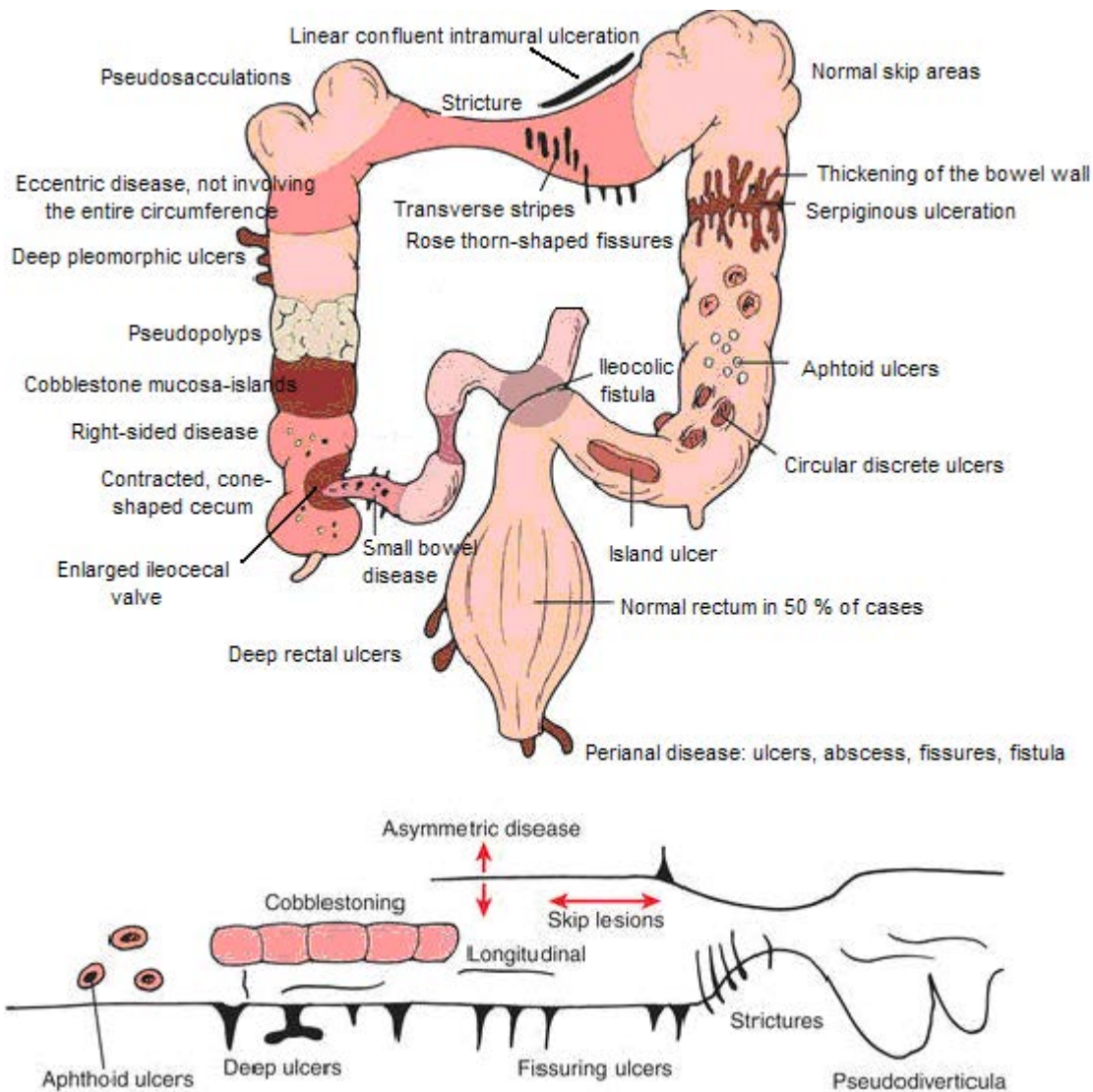
### **3.2.4. Main features**

CD is characterized by a sharply delimited and transmural (full-thickness) inflammation of the bowel with mucosal damage (Fig. III.12A). The intestinal wall is rubbery and thick, due to oedema (mainly in submucosa), inflammation, fibrosis, and hypertrophy of the muscularis propria (Fig. III.12B). Oedema and fibrosis lead to splaying of the muscularis mucosae and distortion of the muscularis propria. The lumen is almost always narrowed, seen

radiographically as the "string sign". The length of the segments involved is variable and the lesions are separated by narrow areas of healthy tissue ("skip" lesions). The affected bowel is oedematous and ulcerated. Over a period of time, the erosions become confluent and give rise to larger longitudinal ulcers, known as serpiginous ulcers, which tend to be oriented along the axis of the bowel. The combination of longitudinal and transverse ulceration in an edematous mucosa induces a characteristic "cobblestone appearance" (Fig. III.12C). Chronic, transmural inflammation can lead to deeply situated fissures reaching the muscularis propria or pass through the muscularis with ensuing abscesses or fistulas (tunnels) between involved segments and adjacent organs or nearby uninvolved loops (developed in almost 25 % of patients). Gut swells inwardly and strictures characterized by luminal narrowing and bowel wall thickening, can occur. Non-necrotizing granulomas composed of epithelioid histiocytes are commonly present. Especially single, long segment strictures are classic. Inflammatory pseudopolyps, tall mucosal outgrowths measuring a few millimeters in length, are often seen on the proximal side of an ulcerated stricture in approximately 20 % of the cases. The mucosa may appear normal or may show multiple small (1-2 mm in size) punctiforms, rounded nodules with white bases or superficial erosion known as "aphthoid ulcers". Fat wrapping characterized by the overgrowth of mesenteric fat is observed in 75 % of the surgical specimens. Spectrum of radiologic changes occurred in patients with CD is shown in Fig. III.13 (Scott and Sanders, 1998; Maxwell-Armstrong and Cohen, 2003; Odze, 2003; Rendi et al.).



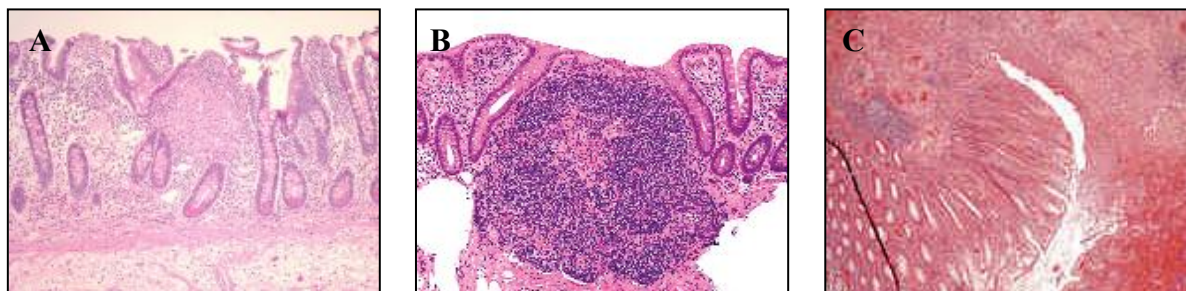
**Fig. III.12: Main features in CD: segmental involvement with transmural spread (A), rigid thickening of bowel wall (B), cobblestone change of the mucosa (C)** (adapted from University of connecticut health center (A); Rendi et al. (B, C))



**Fig. III.13: Spectrum of radiologic changes in CD** (adapted from Simpkins, 1988)

The findings of granulomas in histological sections are a key feature of CD, although they may only be identified in 70 % of cases (Fig. III.14A). A granuloma is defined as a collection of monocyte/macrophages cells and other inflammatory cells (lymphocytes) with or without giant cells. They develop in all layers of the intestines from the mucosa to the serosa but are most frequent in the submucosa. The granuloma has to be distinguished from the microgranuloma, another important marker of CD which is smaller, composed of histiocytes and situated in the upper part of the mucosa. Early mucosal lesions, including epithelial patchy necrosis, the aphthoid ulcer or mucosal microulcerations, occur as focal lesions in a background of normal mucosa in contrast with UC where diffuse epithelial necrosis is seen. The abnormalities of the enteric nervous system called neuromatous lesions are common and

most prominent in the submucosa. Inflammatory cell infiltration of blood vessels, obliterative lesions and lymphangiectasia (pathologic dilatation of lymph vessels) represent other distinguishing features of CD. Lymphoid aggregates and nodules are found ordinarily in the mucosa and even more in the submucosa (Fig. III.14B). Deep fissures which extended into the muscularis propria are often observed (Fig. III.14C) (Kosugi et al., 2002; Geboes, 2003; Fefferman and Farrell, 2005).



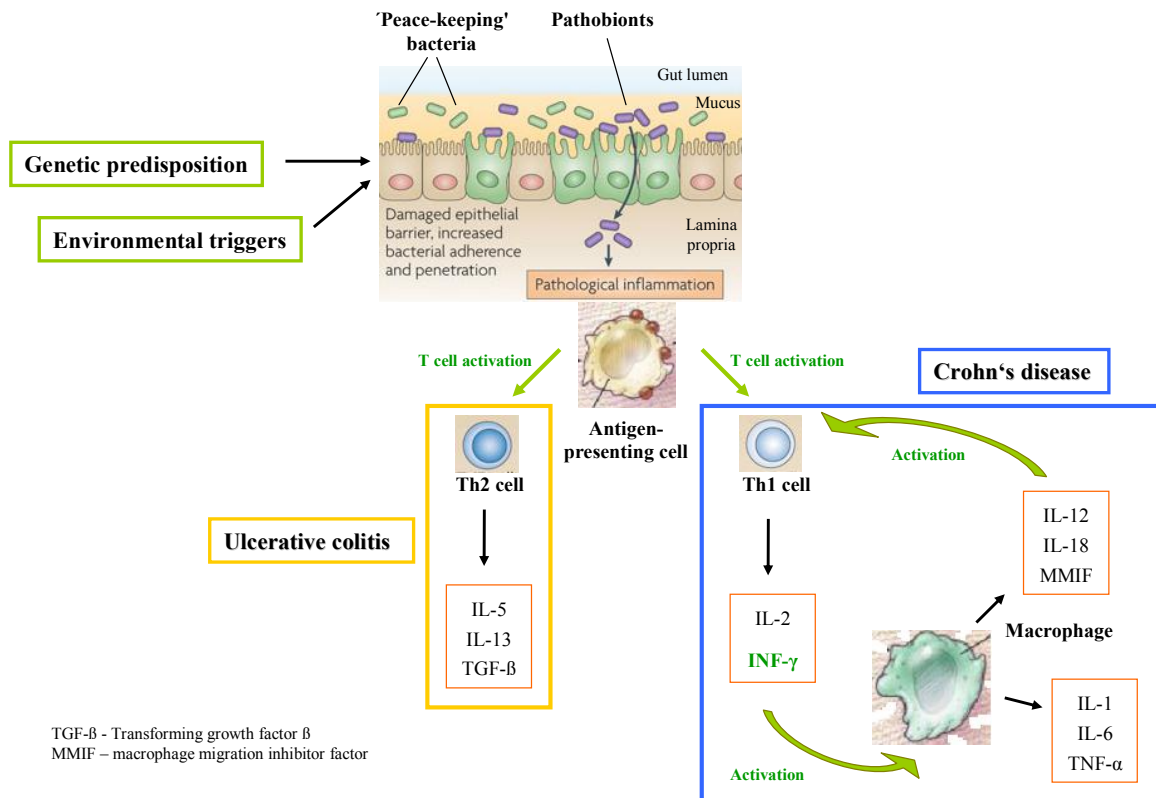
**Fig. III.14: Histological features in CD: granuloma in the mucosa (A), lymphoid aggregate (B), prominent fissuring (C)** (adapted from Rendi et al. (A, C); Dahl and Greenson, 2007 (B))

#### 4. IMMUNE RESPONSE AND INFLAMMATORY PATHWAYS

---

Normal epithelium provides an effective barrier against luminal agents. The integrity of the barrier may be compromised by genetic variations, a diminished reparative response to injury, or exogenous agents, such as nonsteroidal anti-inflammatory drugs. Chronic, recurrent intestinal inflammation appears to result from stimulation of the mucosal immune system by penetrating products of commensal bacteria through the mucosal barrier, and subsequent promotion of a classic adaptive immune response. Alternatively, bacterial products may stimulate the surface epithelium through receptors and the epithelium can, in turn, produce cytokines and chemokines that recruit and activate mucosal immune cells (Podolsky, 2002). Elevated numbers of T cells in the mucosa affected by either form of IBD were detected. Type 1 helper T cells (Th1), secreting interferon- $\gamma$  (INF- $\gamma$ ) and IL-2, are predominantly differentiated in patients with established CD. INF- $\gamma$  leads to activation of macrophages, which in turn, produce IL-12, IL-18 and macrophage migration inhibitor factor and thus

further stimulate Th1 in a self-sustaining cycle. Activated macrophages produce a potent mix of broadly active inflammatory cytokines, including tumor necrosis factor, IL-1 and IL-6. Conversely, atypical Th2 predominate in patients with UC and are characterized by the production of transforming growth factor  $\beta$ , IL-5 and IL-13 (Fiocchi, 1998; Sands, 2000; Podolsky, 2002) (Fig.III.15).



**Fig. III.15: Pathogenesis of IBD: antigen recognition and immunoregulation** (adapted from Martins and Peppercorn, 2004; Cerf-Bensussan and Gaboriau-Routhiau, 2010)

Concerning humoral immunity, an intestine with IBD shows a massive increase in the number of plasma cells with a 2, 5 and 30-fold increase in secretion of immunoglobulin (Ig)A, IgM and IgG, respectively. A selective enhancement of IgG1 synthesis was observed in UC, whereas IgG2 was accentuated in CD (Fiocchi, 1998). Patients with IBD possess a variety of circulating antibodies that may also help in detection of intestinal inflammation and differentiating CD from UC. A high prevalence of perinuclear antineutrophil cytoplasmic

antibodies was reported in patients with UC. Anti-*Saccharomyces cerevisiae* antibodies are frequently present in CD (Israeli et al., 2005).

The activation of central immune-cell populations is eventually accompanied by the production of a wide variety of nonspecific mediators of inflammation including many other cytokines, chemokines and growth factors as well as metabolites of arachidonic acid (e.g., prostaglandins and leukotrienes) and reactive oxygen metabolites such as nitric oxide. Concentration of prostaglandin E<sub>2</sub>, tromboxane B<sub>2</sub>, leukotriene B<sub>4</sub> and platelet-activating factor are markedly elevated in UC compared with CD and this may serve as a distinguishing diagnostic features. An inflamed gut of IBD patients is rich in activated macrophages and neutrophils and these inflammatory cells generate excess amounts of reactive oxygen species with subsequent increase in oxidative stress. Moreover intestinal mucosa is relatively depleted of antioxidant defenses, rendering it more susceptible and contributing to intestinal oxidative injury. All these mentioned mediators enhance the inflammatory process itself and tissue destruction, which eventuate in the clinical manifestations of the disease (Conner et al., 1996; Yang, 1996; Pavlick et al., 2002; Oz and Ebersole, 2008).

## **5. MEDICAL MANAGEMENT**

---

---

IBD presents a problem in public health because of its high incidence in early adulthood and its chronic clinical course. IBD remains largely incurable and commonly requires a lifetime of care. Although not particularly a cause for mortality, IBD is associated with significant morbidity and decreased quality of life is not negligible (Fatahzadeh, 2009; Turnbough and Wilson, 2007). Current drug medication aims to induce and then maintain the patient in remission and ameliorate the disease's secondary effects (Harris et al., 2009). Therapy is individualized, requires time to work, and is often associated with side effects (Fatahzadeh, 2009). Table III.1 provides a summary of current medical therapy for IBD in France and in the Czech Republic. Routine treatment has not changed significantly over the last 40 years and still relies mostly on anti-inflammatory drugs, such as aminosalicylates and corticosteroids (prednisone, prednisolone, budesonide, etc.). In severe disease or in patients who fail conventional therapy immunosuppressive (azathioprine, 6-mercaptopurine, methotrexate, cyclosporine) and biologic agents (infliximab, adalimumab, certolizumab



pegol) are applied (Kozuch and Hanauer, 2008). Antibiotics (metronidazole, ciprofloxacin) are useful in the treatment of subgroups of patients with CD (Lal and Steinhart, 2006).

**Table III.1: Commercialized drugs for the treatment of IBD** (adapted from Vidal® 2012; Kašparová et al., 2012)

Drug	Brade name	
	in France	in the Czech Republic
<i>Aminosalicylates</i>		
Sulfasalazine	Salazopyrine - O*	Salazopyrin - O Sulfasalazin - O
Olsalazine	Dipentum - O	-
Mesalazine	Fivasa - O, R* Pentasa - O, R Rowasa - O, R	Asacol - O, R Pentasa - O, R Salofalk - O, R
<i>Corticosteroids</i>		
Prednisone	Cortancyl - O	Prednison - O
Prednisolone	Solupred - O	-
Methylprednisolone	Médrol - O	Depo-medrol - IV* Solu-medrol - IV Medrol - O
Hydrocortisone	Colofoam - R	-
Budesonide	Entocort - O Rafton - O	Budenofalk - O Entocort - O, R
Betamethasone	Célestène - O Betnesol - R	Diprophos - R
<i>Immunosuppressive drugs</i>		
Azathioprine	Imurel - O	Immunoprin - O
<i>Biological agents</i>		
Infliximab	Remicade - IV	Remicade - IV
Adalimumab	Humira - SUB*	Hunmira - SUB

\* O - orally, R - rectally, IV - intravenously, SUB - subcutaneously

Advances in the understanding of the pathophysiology of IBD, have led to the development of several new treatment strategies which selectively inhibit crucial mediators of the inflammatory process and target specific biomolecules such as human recombinant cytokines IL-10, 11; monoclonal antibodies against IL-12, TNF- $\alpha$  and INF- $\gamma$ ; recombinant growth factors, p38 antagonist, nuclear factor-kappa B (NF- $\kappa$ B) with many more on horizon that may well provide future alternative therapy. Effective antioxidant therapies could be another interesting possibility of treatment because free radicals may be responsible for a great deal of direct injury to the mucosa and may account for increased cancer risk (Sands, 2000; Triantafyllidis et al., 2011).

## **5.1. CURRENT THERAPIES**

---

### **5.1.1. 5-aminosalicylates**

The 5-aminosalicylate based compounds have remained cornerstone of the treatment for patients with mild to moderately active UC and CD since the recognition of the therapeutic efficacy of the prototypical agent sulfasalazine in 1940. Maintenance treatment with 5-aminosalicylate formulations can be effective for sustaining remission induced by 5-aminosalicylates in mild to moderate UC or corticosteroids in severe UC, but is of questionable value in CD. Finally, long term use of 5-aminosalicylate in UC may decrease colorectal cancer risk by 50 %. Their exact mechanism of action is still not fully understood. 5-aminosalicylate may act by blocking the production of prostaglandins and leukotrienes, inhibiting bacterial peptide-induced neutrophil chemotaxis and adenosine-induced secretion, scavenging reactive oxygen metabolites, and perhaps inhibiting the activation of nuclear factor- $\kappa$ B. In general, pharmaceutical forms should be selected principally on the basis of disease location. Proctitis and left-sided UC might respond better to rectal formulations such as suppositories, enemas or foams. Oral prodrug formulations (sulfasalazine, olsalazine and balsalazide), in which 5-aminosalicylic acid (mesalazine) is conjugated to prevent absorption by the small bowel, are appropriate for colonic disease. Mesalazine delayed-release formulations based on ethylcellulose (time-dependent release) or methacrylic acid copolymers (pH-dependent concept) can deliver therapeutic concentrations to the more proximal small bowel or distal ileum to expand the spectrum of patients with CD. Up to 30 % of patients taking sulfasalazine are intolerant and newer 5-aminosalicylate oral formulations avoiding adverse effects principally related to sulfapyridine moiety are useful for treatment. Newer

formulations also reduce pill size and could be taken only once per day which increases patients compliance (Sands 2000; Podolsky, 2002; Cohen 2006; Baumgart and Sandborn, 2007; Harris et al., 2009; Triantafillidis et al., 2011). The available mesalazine formulations are described in detail in review article Bautzová et al. (2011).

### 5.1.2. Corticosteroids

Corticosteroids have been used for over 50 years to treat IBD. Oral corticosteroids are efficacious in decreasing disease activity and inducing remission in most IBD patients not responsive to aminosalicylates or with severe disease activity. They are not recommended for maintenance therapy due to numerous undesirable side effects and not proven benefit. Some patients could become steroid-dependent or steroid resistant. Budesonide, as an enema or a controlled-ileal release formulation, provides markedly reduced side-effects of systemic corticosteroids and hence is ideal for inducing and prolonging remission in mild to moderate CD involving distal ileum and proximal colon. Topical preparations including enemas and foam may reduce symptoms in patients with proctitis and limited distal UC. Intravenous corticosteroids are applied in fulminant UC patients with significant abdominal cramping, bloody diarrhea and abdominal tenderness until symptoms subside. Corticosteroids diminish production of a host proinflammatory cytokines, directly inhibit a variety of leukocytes functions and interfere with metabolism of arachidonic acid causing an alteration in the delicate balance between the cytoprotective prostaglandins and proinflammatory leukotrienes (Sands, 2000; Hendrickson et al., 2002; Kozuch and Hanauer, 2008).

### 5.1.3. Immunosuppressive and immunoregulatory agents

Immunomodulators such as 6-mercaptopurine or its prodrug azathioprine are purine analogs that interfere with nucleic acid synthesis and thereby exerting an antiproliferative effect on mitotically active lymphocyte populations. Widespread use of immunosuppressives agents is minimized due to severe adverse effects (Hendrickson et al., 2002; Baumgart and Sandborn, 2007). Nevertheless, they are suitable for patients with steroid dependency and those who are unresponsive to 5-aminosalicylate or corticosteroid therapy to avoid long term use of corticosteroids. They are slow-acting, steroid-sparing agents best suited for maintenance rather than inductive therapy in IBD. *Azathioprine* and/or *6-mercaptopurine* can also form the basis in of chronic therapy for extensive small bowel disease and as a second-

line treatment of fistulizing CD, for which both aminosalicylates and steroids are ineffective. It must be stressed that the majority of patients relapse when azathioprine and 6-mercaptopurine are withdrawn (Fraser et al., 2002; Hendrickson et al., 2002; Kozuch and Hanauer, 2008). *Methotrexate* is appropriate for the treatment of steroid-dependent or steroid refractory chronically active CD and for maintaining long-term remission. It has not proven effective in patients with UC. Methotrexate, as a folate analog, influences impaired deoxyribonucleic acid (DNA) synthesis, decreases expression of IL-1 and induces apoptosis and must be administered in conjunction with folic acid (Podolsky, 2002; Wolf and Lashner, 2002; Harris et al., 2009). *Cyclosporine*, a lipophilic cyclic polypeptide, is adequate for patients with acute steroid-refractory severe UC in a last attempt to prevent proctocolectomy. In general, it should not be used in the treatment of CD, with the possible exception of patients with symptomatic and severe perianal or cutaneous fistulas. By inhibiting proinflammatory transcription factors, cyclosporine diminishes cytokine production and exerts an antiproliferative effect on lymphocytes (Sands, 2000; Harris et al., 2009). *Tacrolimus* is a calcineurin inhibitor that suppresses proinflammatory cytokine production and T-cell activation. Tacrolimus is adequate for the patients with fistulising CD and refractory UC (Triantafillidis et al., 2011).

#### 5.1.4. Biological agents

Tumor necrosis factor alfa, a product of activated macrophages and a powerful proinflammatory cytokine, plays a pivotal role in the process of the inflammation in IBD patients. Inhibition of this cytokine is expected to be a powerful treatment strategy in patients with both UC and CD. Moreover, anti-TNF- $\alpha$  therapy is a strong inducer of mucosal healing (Pallone and Monteleone, 2001; Triantafillidis et al., 2011). *Infliximab* (a chimeric mouse-human monoclonal IgG1 antibody) or its alternatives as *adalimumab* (a recombinant fully human monoclonal IgG1 antibody) and *certolizumab pergol* (an antigen-binding fragment portion of IgG antibody attached to polyethylene glycol) are beneficial in control of overactive inflammatory process. They have efficacy in induction and maintenance therapy in moderate to severe UC and CD in patients failing or poor tolerating conventional therapies. They have been successfully used as well as for the treatment of fistulas in patients with CD. Adalimumab appears to be a beneficial option for IBD patients who cannot tolerate infliximab or are symptomatic despite receiving infliximab therapy. These agents bind circulating and membrane-bound TNF- $\alpha$ , induce a cell mediated cytotoxic reaction and enhance the

programmed cell death of activated T-cells monocyte (Podolsky, 2002; Baumgart and Sandborn, 2007; Triantafillidis et al., 2011). *Thalidomide*, anti TNF- $\alpha$  antibody blocking the production of TNF- $\alpha$ , inhibiting the formation of superoxide and hydroxyl radicals and stabilizing lysosomal membranes, was found to be efficacious in patients with chronically active, steroid-dependent CD (Evans, 2000; Ginsburg et al., 2001). Although highly effective, these agents are expensive and associated with serious adverse effects, related with powerful immunosuppressive capacity, mandating careful patient selection, counseling and close follow-up (Ricci et al., 2008; Fatahzadeh, 2009).

### 5.1.5. Antibiotics

The rationale for using antibiotics is based on the assumption that intestinal bacteria are involved in the pathogenesis of the disease. Enteric flora is altered and immunological tolerance to commensal bacteria has been lost in patients with IBD. Antibiotic therapy with *metronidazole* or *ciprofloxacin*, possessing also innate immunomodulatory activity, is widely used for the first-line treatment of perianal fistulas in CD and is effective in treating mild to moderate CD. In contrast, antibiotics have very limited use in UC except for hospitalized patients with fulminant colitis at risk for sepsis. Metronidazole ointment could be used as potential treatment for pain and discharge associated with perianal CD with minimal adverse effects. *Ornidazole*, *clarithromycin* and *rifaximin* have been shown efficacious in inducing clinical remission in active CD. The antibiotics treatment is associated with important adverse effects and a risk for *Clostridium difficile* infection (Podolsky, 2002; Baumgart and Sandborn, 2007; Kozuch and Hanauer, 2008; Triantafillidis et al., 2011).

### 5.1.6. Probiotics

Probiotics are live non-pathogenic microorganisms that improve microbial balance in the GIT through various mechanisms, including reduced intestinal pH, decreased colonization and invasion by pathogenic organisms, and modification of the host immune response. They consist of *Saccharomyces boulardii*, *Lactobacillus* and *Bifidobacterium* spp. Use of probiotics appears to be one promising approach free of systemic side effects in achieving clinical response and remissions in patients with mild-to-moderately active distal UC and pouchitis in CD patients (Podolsky, 2002; Triantafillidis et al., 2011).

### **5.1.7. OTC and diet**

Patients afflicted with IBD may also benefit from taking over-the-counter antidiarrheal agents (*codeine, diphenoxylate, loperamide*), laxatives and pain medications for palliation of intestinal symptoms. Although there is little support for a dietary factor in triggering IBD, modifications in the diet (restriction of high-fiber, spicy food, uncooked vegetables and nuts) and lifestyle may also help with bowel syndromes (Evans, 2000).

## 6. REFERENCES

---

---

Alberts B, Johnson A, Lewis J, Raff M, Roberts K, Walter P. Molecular biology of the cell. Gibbs S (Ed.), 4th ed., Garland Science, New York, NY. 2002:1435p.

Atreya R, Neurath MF. New therapeutic strategies for treatment of inflammatory bowel disease. *Mucosal Immunol.* 2008;1(3):175-82.

Baumgart DC, Sandborn WJ. Inflammatory bowel disease: clinical aspects and established and evolving therapies. *Lancet.* 2007;369(9573):1641-57.

Bautzová T, Rabišková M, Lamprecht A. Multiparticulate systems containing 5-aminosalicylic acid for the treatment of inflammatory bowel disease. *Drug Dev Ind Pharm.* 2011;37(9):1100-9.

Blumberg RS. Crohn disease. *JAMA.* 2008;300(4):439-40.

Bowen R. Pathophysiology of the digestive system: <http://www.vivo.colostate.edu/hbooks/pathphys/digestion/index.html>, download 7.6.2011

Cerf-Bensussan N, Gaboriau-Routhiau V. The immune system and the gut microbiota: friends or foes? *Nat Rev Immunol.* 2010;10(10):735-44.

Cohen RD. Review article: evolutionary advances in the delivery of aminosaliculates for the treatment of ulcerative colitis. *Aliment Pharmacol Ther.* 2006;24(3):465-74.

Cohn SM, Birnbaum EH, Friel CM. Colon: Anatomy and structural anomalies. In: *Textbook of gastroenterology.* Yamada T (Ed.), 5th ed., Blackwell publishing Ltd., Oxford, UK. 2009: 3551p.

Conner EM, Brand SJ, Davis JM, Kang DY, Grisham MB. Role of reactive metabolites of oxygen and nitrogen in inflammatory bowel disease: toxins, mediators, and modulators of gene expression. *Inflamm Bowel Dis.* 1996;2:133-47.

Cook MG, Dixon MF. An analysis of the reliability of detection and diagnostic value of various pathological features in Crohn's disease and ulcerative colitis. *Gut.* 1973;14:255-62.

Dahl J, Greenson JK. Colon. In: *Histology for pathologists.* Mills SE (Ed.), 3rd ed., Lippincott Williams & Wilkins, Philadelphia, PA. 2007:1272p.

De Dombal FT. Ulcerative colitis: definition, historical background, aetiology, diagnosis, natural history and local complications. *Postgrad Med J.* 1968;44(515):684-92.

De Ioro N. Large Bowel. In: *Essentials of emergency medicine.* Aghababian RV (Ed.), Jones and Bartlett Publishers, Inc, London, UK. 2006:1069p.

Dorland WAN. Dorland's medical dictionary. 29th ed., WB Saunders Company, Philadelphia, PA: 2000, 1974p.

Ekbom A. The changing epidemiology of IBD. In: Inflammatory bowel disease: diagnosis and therapeutics. Cohen RD (Ed.), 2nd ed., Springer Science+Business Media, New York, NY. 2011:337p.

Elson CO, Sartor RB, Tennyson GS, Riddell RH. Experimental models of inflammatory bowel disease. *Gastroenterology*. 1995;109(4):1344-67.

Evans BK. Inflammatory bowel disease. *Gastrointest disord*. 2000;11: 163-178.

Fatahzadeh M. Inflammatory bowel disease. *Oral Surg Oral Med Oral Pathol Oral Radiol Endod*. 2009;108(5):e1-10.

Fefferman DS, Farrell RJ. Endoscopy in inflammatory bowel disease: indications, surveillance, and use in clinical practice. *Clin Gastroenterol Hepatol*. 2005;3(1):11-24.

Fiocchi C. Inflammatory bowel disease: etiology and pathogenesis. *Gastroenterology*. 1998;115(1):182-205.

Fraser AG, Orchard TR, Jewell DP. The efficacy of azathioprine for the treatment of inflammatory bowel disease: a 30 year review. *Gut* 2002;50:485-9.

Friedman S, Blumberg R. Inflammatory bowel disease. In: Harrison's principles of internal medicine. Fauci AS, Braunwald E, Kasper DL, Hauser SL, Longo DL, Jameson JL, Loscalzo J (Eds.), 17th ed., The McGraw-Hill Companies; New York, NY. 2008:2958p.

Geboes K. Histopathology of Crohn's disease and ulcerative colitis. In: Inflammatory bowel disease. Satsangi J, Sutherland LR (Eds.), 4<sup>th</sup> ed., Churchill Livingstone, Oxford, UK. 2003:856p.

Ginsburg PM, Dassopoulos T, Ehrenpreis ED. Thalidomide for refractory Crohn's disease: a review of the history, pharmacological mechanisms and clinical literature. *Ann Med* 2001;33:516-25.

Glossary of pathology: [http://cueflash.com/decks/Pathology\\_Chapter\\_17\\_and\\_19\\_Images\\*](http://cueflash.com/decks/Pathology_Chapter_17_and_19_Images*), downloaded 27.6.2011

Gramlich TL, Petras RE. Small intestine. In: Histology for pathologists. Mills SE (Ed.), 3rd ed., Lippincott Williams & Wilkins, Philadelphia, PA. 2007:1272p.

Harris A, Feller ER, Shah SA. Medical therapy of IBD in 2009. *Med Health R I*. 2009;92(3):78-81.

Hendrickson BA, Gokhale R, Cho JH. Clinical aspects and pathophysiology of inflammatory bowel disease. *Clin Microbiol Rev*. 2002;15(1):79-94.



Hošek J, Bartošová L, Gregor P, Kolorz M, Dítě P, Bátovský M, Bartoš M. Frequency of representative single nucleotide polymorphisms associated with inflammatory bowel disease in the Czech Republic and Slovak Republic. *Folia Biol (Praha)*. 2008;54(3):88-96.

Hurst AF. Discussion on ulcerative colitis. *Proc R Soc Med*. 1923;16(Surg Sect):106-8.

Israeli E, Grotto I, Gilburd B, Balicer RD, Goldin E, Wiik A, Shoenfeld Y. Anti-*Saccharomyces cerevisiae* and antineutrophil cytoplasmic antibodies as predictors of inflammatory bowel disease. *Gut*. 2005;54:1232-6.

Kaplan GG, Hubbard J, Korzenik J, Sands BE, Panaccione R, Ghosh S, Wheeler AJ, Villeneuve PJ. The inflammatory bowel diseases and ambient air pollution: a novel association. *Am J Gastroenterol*. 2010;105(11):2412-9.

Karlinger K, Gyorko T, Mako E, Mester A, Tarjan Z. The epidemiology and the pathogenesis of inflammatory bowel disease. *Eur J Radiol*. 2000;35:154-67.

Kašparová L, Novotná H, Škopa B, Švihovec J. Breviř. Kučerová H (Ed.), 21th ed., Medical Tribune CZ, Praha, ĀR. 2012:1282p.

Kirsner JB. Historical aspects of inflammatory bowel disease. *J Clin Gastroenterol*. 1988;10(3):286-97.

Kirsner JB. Historical origins of current IBD concepts. *World J Gastroenterol*. 2001;7(2):175-84.

Knopp R, Hokanson J. Small bowel. In: *Essentials of emergency medicine*. Aghababian RV (Ed.), Jones and Bartlett Publishers, Inc, London, UK. 2006:1069p.

Kosugi I, Tada T, Tsutsui Y, Sato Y, Mitsui T, Itazu I. Giant inflammatory polyposis of the descending colon associated with a Crohn's disease-like colitis. *Pathol Int*. 2002;52(4):318-21.

Kozuch PL, Hanauer SB. Treatment of inflammatory bowel disease: a review of medical therapy. *World J Gastroenterol*. 2008;14(3):354-77.

Kumar V, Abbas AK, Fausto N, Mitchell R. *Robbins basic pathology*. Abbas AK, Kumar V, Fausto N (Eds.), 8th ed., WB Saunders Company, Philadelphia, PA. 2007:946p.

Lal S, Steinhart AH. Antibiotic therapy for Crohn's disease: a review. *Can J Gastroenterol*. 2006;20(10):651-5.

Le Berre N, Heresbach D, Kerbaol M, Caulet S, Bretagne JF, Chaperon J, Gosselin M, Ramée MP. Histological discrimination of idiopathic inflammatory bowel disease from other types of colitis. *J Clin Pathol*. 1995;48(8):749-53.

Lichtenstein JE. Radiologic-pathologic correlation of inflammatory bowel disease. *Radiol Clin North Am*. 1987;25(1):3-24.

Lockhart M, Lopez R, Nath H. *Rosai and Ackerman's Surgical Pathology*. Rosai J (Ed.), 9th ed., Mosby, St. Louis, MO. 2004:3080p.

Logan RFA. Inflammatory bowel disease incidence: up, down or unchanged? *Gut*. 1998;42:309-11.

Martins NB, Peppercorn MA. Inflammatory bowel disease. *Am J Manag Care*. 2004;10(8):544-52.

Maxwell-Armstrong C, Cohen R. Inflammatory bowel disease. *Surgery*. 2003;21(2):34-8.

McPhee SJ, Hammer GD. Pathophysiology of disease: An introduction to clinical medicine. In: *Gastrointestinal disease*. McPhee SJ, Hammer GD (Eds.), 6th ed., The McGraw-Hill Companies; New York, NY. 2009:768p.

Milestone AN, Iacucci M, Ghosh S. Is rosiglitazone a promising treatment for ulcerative colitis? *Nat Clin Pract Gastroenterol Hepatol*. 2008;5(9):486-7.

Mirbagheri SA, Nezami BG, Assa S, Hajimahmoodi M. Rectal administration of d-alpha tocopherol for active ulcerative colitis: a preliminary report. *World J Gastroenterol*. 2008;14(39):5990-5.

Moran D, Rowley C. Visual histology: <http://www.visualhistology.com/index.html>, downloaded 27.6.2011

Nerich V, Monnet E, Etienne A, Louafi S, Ramée C, Rican S, Weill A, Vallier N, Vanbockstael V, Auleley GR, Allemand H, Carbonnel F. Geographical variations of inflammatory bowel disease in France: a study based on national health insurance data. *Inflamm Bowel Dis*. 2006;12(3):218-26.

Odze R. Diagnostic problem and advances in inflammatory bowel disease. *Mod Pathol*. 2003;16(4):347-58.

Oz HS, Ebersole JL. Application of prodrugs to inflammatory diseases of the gut. *Molecules*. 2008;13(2):452-74.

Pallone F, Monteleone G. Mechanism of tissue damage in inflammatory bowel disease. *Curr Opin Gastroenterol*. 2001;17:307-12.

Pavlick KP, Laroux FS, Fuseler J, Wolf RE, Gray L, Hoffman J, Grisham MB. Role of reactive metabolites of oxygen and nitrogen in inflammatory bowel disease. *Free Radic Biol Med*. 2002;33(3):311-22.

Penn medicine: <http://www.penncancer.org/patients/cancer-types/gastrointestinal-cancers/colon-cancer/diagnosing-colon-cancer/>, downloaded 14.6.2011

Prenzel F, Uhlig HH. Frequency of indeterminate colitis in children and adults with IBD - a metaanalysis. *J Crohns Colitis*. 2009;3(4):277-81.

Piront P, Belaiche J, Louis E. Epidemiology of Crohn's disease in Europe. *Acta Endoscopica*. 2003;33(2):199-205.

Podolsky DK. Inflammatory bowel disease. *N Engl J Med*. 2002;347(6):417-29.

Rendi M, Swanson PE, Upton MP. Crohn disease Pathology: <http://emedicine.medscape.com/article/1986158-overview#showall>, downloaded 14.6.2011

Ricci C, Lanzarotto F, Lanzini A. The multidisciplinary team for management of inflammatory bowel diseases. *Dig Liver Dis.* 2008;40(Suppl 2):S285-8.

Rubin DC. Small intestine: Anatomy and structural anomalies. In: *Textbook of gastroenterology.* Yamada T (Ed.), 5th ed., Blackwell publishing Ltd., Oxford, UK. 2009:3551p.

Ruthruff B. Clinical review of Crohn's disease. *J Am Acad Nurse Pract.* 2007;19:8:392-7.

Sands BE. Therapy of inflammatory bowel disease. *Gastroenterology.* 2000;118(2 Suppl 1):S68-82.

Simpkins KC. Inflammatory bowel disease: Ulcerative and Crohn's colitis. In: *A Textbook of Radiological Diagnosis, Volume 4, The Alimentary Tract: The Hollow Organs and Salivary Glands.* Simpkins KC (Ed.), 5th ed., H.K. Lewis, London, UK. 1988:754p.

Scott D, Sanders A. The differential diagnosis of Crohn's disease and ulcerative colitis. *Baillieres Clin Gastroenterol.* 1998;12:19-33.

The bowel disease foundation: <http://www.stiftung-darmerkrankungen.de>, downloaded 13.6.2011

Tietjen K, Behrens R, Weimann E. Growth failure in children and adolescents with Crohn's disease. *Turk J Gastroenterol.* 2009;20:13-9.

Triantafyllidis JK, Merikas E, Georgopoulos F. Current and emerging drugs for the treatment of inflammatory bowel disease. *Drug Des Devel Ther.* 2011;5:185-210.

Turnbough L, Wilson L. "Take your medicine": nonadherence issues in patients with ulcerative colitis. *Gastroenterol Nurs.* 2007;30(3):212-7.

University of connecticut health center: <http://radiology.uhc.edu/eAtlas/GI/912.htm>, downloaded 23.6.2011

University of Michigan, Department of surgery: [http://surgery.med.umich.edu/pediatric/clinical/physician\\_content/n-z/ulcerative\\_colitis.shtml](http://surgery.med.umich.edu/pediatric/clinical/physician_content/n-z/ulcerative_colitis.shtml), downloaded 16.6.2011

Vidal<sup>®</sup>. 88th ed., Copyright Vidal, Issy-les-Moulineaux, France, 2012:3199p.

Webster's online dictionary: [http://www.websters-online-dictionary.org/definitions/Ulcerative\\_colitis](http://www.websters-online-dictionary.org/definitions/Ulcerative_colitis), downloaded 16.6.2011

Wolf JM, Lashner BA. Inflammatory bowel disease: sorting out treatment options. *Cleveland Clin J Med.* 2002;69:621-31.

Yang VW. Eicosanoids and inflammatory bowel disease. *Gastroenterol Clin North Am.* 1996;25(2):317-32.

## **PURPOSE OF THE THESIS**



As IBD primarily represents a local inflammation of the mucosa in the colon and in parts of the small bowel, it would be ideal to target the therapeutic principles directly to the affected areas. Topical administration of the drug in form of enemas, foams, gels or suppositories seems to be more effective since the colon or rectosigmoid area are affected. However, patients often dislike rectal formulations. Nowadays, oral delivery represents the most common and preferred route of drug administration. The optimal dosage schedule for 5-ASA range from 2 to 4 g/day which lead to the multiple tablets intake several time a day and lack of patient compliance. Thus multiparticulate dosage forms were introduced to overcome the disadvantages of single unit dosage forms. The main aim of this work was to design multiparticulate system, e.g. pellets in our case, for colon-specific drug delivery intended for the treatment of IBD. It was demonstrated that the pellets are less influenced with diarrhoea in IBD patients and promising in order to reduce the dosage frequency.

Since, IBD affects approximately one in five hundred inhabitants in the Western world and conventional treatment is usually related with more or less serious adverse effects, the first objective of our study was to design multiparticulate system based only on natural substances and efficient in reducing inflammation process. In several *in vivo* studies, rutin, one of the most common naturally occurring flavonoids possessing anti-inflammatory and antioxidant properties, has shown the therapeutic benefit in experimental colitis. The major goal was to identify novel polymeric film coatings for chitosan-core pellets based on natural polysaccharides degraded by colonic microbiota, protecting pellets from the disintegration in the acidic environment of the stomach, allowing for the site-specific delivery of the rutin to the colon and ensuring increased local drug concentration in the site of the inflammation. For this purpose, different types of polymer coatings have been investigated. It was expected that rutin loaded pellets will provide significant mitigating effect in experimental colitis comparable to marketed 5-ASA pellets avoiding side effects related to commonly used treatment and thus could be a promising approach in therapeutic strategy in IBD.

Aminosalicylates belong to the current first-line treatment for mild to moderate IBD which are used to treat active symptoms and to maintain periods of remissions. Two different therapeutic approaches have been employed to target the active 5-ASA to its site of action and to avoid possible adverse effects related with its absorption in the upper intestine. Either inactive azo-prodrugs or special galenic formulations coated with the pH-dependent polymers or semi-permeable membrane have been developed. Nevertheless, for the present bioadhesive formulations able to increase drug concentration in the site of pathology have not been

marketed yet. The second objective of the thesis was to prepared 5-ASA loaded pellets with pH dependent coating containing chitosan, a biodegradable polymer with bioadhesive properties, in their core to ensure longer residence time of multiparticulate system in the target region. It was supposed that this approach will result in lower systemic drug bioavailability, augmented mucosal drug concentration in the colonic tissue and better therapeutic effect.

All pellets were prepared by E/S method and subsequently coated in the fluidized bed coater. Dissolution studies at different pH levels were conducted throughout the study and anti-inflammatory effect of pellets was evaluated *in vivo* in trinitrobenzene sulfonic acid (TNBS)-induced colitis in rats. Also, plasma pharmacokinetic studies provided data on systemic exposure that might be one determinant of side effects, but not on colonic distribution or mucosal uptake was carried out. In addition, biodistribution of N-acetyl-5-ASA in GIT tissues predicted therapeutic efficacy which depends on local drug concentration in the colonic mucosa was assessed. For reasons of comparison, drug release, anti-inflammatory activity and pharmacokinetic parameters of commercially available product was determined.

## **GENERAL DISCUSSION**





## 1. PREPARATION OF PELLETS

---

---

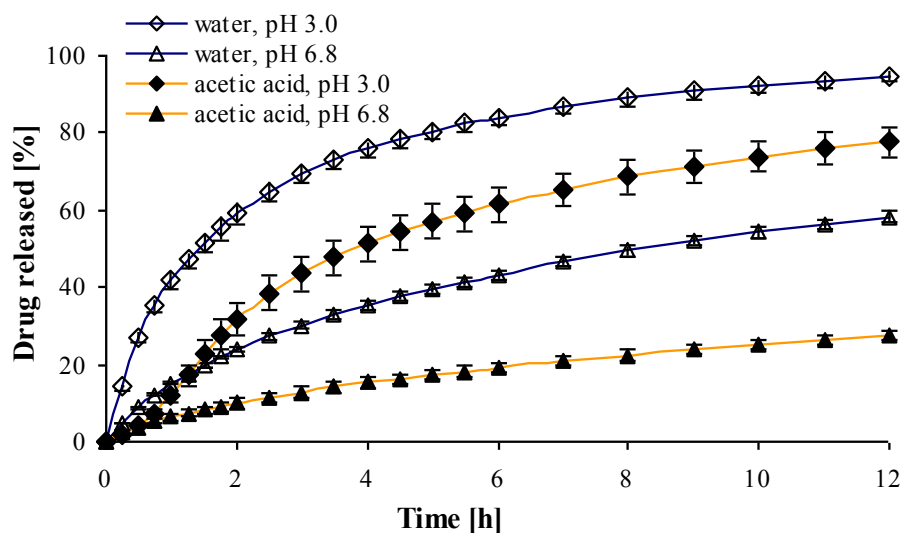
The pelletization process consists of the agglomeration of fine powders of active drug and excipients into small spherical units of acceptable size and size distribution (Ghebre-Sellassie, 1989). Among existing pelletization techniques, E/S represents an established and the most popular method used to produce pharmaceutical pellets (Charoenthai et al., 2007a). In general, this process consists of the compaction of a wet powder mass leading to an intermediate spaghetti-like product, which is promptly spheronised obtaining a final spherical product (Santos et al., 2002). E/S is advantageous method for preparing high drug loading pellets of uniform size and good mechanical properties, but it is time consuming process of several steps (Vervaet et al., 1995; Charoenthai et al., 2007a).

Successful production of pellets by E/S requires the addition of the excipients to aid rheological suitability, i.e. plasticity, rigidity, water absorbing capacity and cohesiveness, of the wet powder mass. To dates, microcrystalline cellulose (MCC) is regarded as the essential excipient to obtain spherical pellets with low friability, high density and smooth surface properties (Charoenthai et al., 2007b). MCC has good binding properties and provides cohesiveness to the wet mass (Dukić-Ott et al., 2009). Furthermore, MCC, acting as a molecular sponge, is able to hold large amounts of freely mobile water in the wet stage, confers the appropriate degree of plasticity to the wet mass, controls the movement of water through this mass during extrusion and enhances spheronisation (Lustig-Gustafsson et al., 1999; Di Pretoro et al., 2010). In the last decade, the use of chitosan in mixtures with MCC for the production of pellets via E/S has been reported by several authors (Santos et al., 2002; Steckel and Mindermann-Nogly, 2004; Charoenthai et al., 2007a). Chitosan, likewise MCC, can act as a molecular sponge (Agrawal et al., 2004). Moreover, this natural polysaccharide is readily degraded by bacteria in the colon, which makes it interesting for colon-specific drug delivery systems (Zhang and Neau, 2002). Recently, Charoenthai et al. (2007a) have demonstrated that pellets produced by E/S with low (190 kDa) instead of high (419 kDa) molecular weight chitosan possess higher mean diameter, sphericity, and crushing force. Taking into account all the above considerations, MCC and low molecular weight chitosan (162 kDa) was used for pellets preparation in our experiment.

Apart from excipients, the moisture of the granulated mass is an extremely important formulation parameter in the E/S process regarding the shape and the size of produced pellets.

Two extremes can be recognized. Moisture content exceeding the optimum quantity leads to an overwettted mass and agglomeration of the pellets during spheronisation due to the excess of water at the surface of the pellets. While a lower limit exists where the wet mass is too dry, resulting in a generation of cylindrical or non-rounded pellets with a lot of quantity of dust (Charoenthai et al., 2007b). Previous works imply that the amount of liquid necessary to obtain a wet mass with the required plasticity is highly dependent on the physical and chemical properties of the active pharmaceutical ingredient and excipients, such as solubility, particle size and morphology, specific surface area and packing behavior (Lustig-Gustafsson et al., 1999; Di Pretoro et al., 2010). Thus, less amount of wetting liquid is needed to produce appropriate extrusion mass in powders containing larger particles of sparingly soluble substances than in fine powders. Furthermore, the amount of liquid is reduced with increasing solubility of the drug and/ or excipients (Krejčová et al., 2006). Therefore, particle size characterization was performed using an optical microscope fitted with a camera and computer for automatic image analysis to estimate the amount of liquid necessary to produce the extrudate and minimize inadequate number of experiments.

In general, water is the most often used granulation liquid in E/S (Vervaet et al., 1995). The results of Steckel and Mindermann-Nogly (2004) have indicated a successful extrusion of chitosan and MCC in a maximum ratio of 1 to 1 using water. Whereas, replacing the water by a 0.1 N (0.6%) acetic acid solution enabled the production of pellets with a chitosan content of up to 70 % due to partial dissolution of chitosan giving sufficient plastic formability to the wet mass. Additionally, previous work in our laboratory focused on preparation of chitosan matrix pellets (Janovská et al., 2009) revealed that 0.25% acetic acid is ideal for production spherical pellets which led us to employ this solution as granulation fluid in present experiment. In fact, the optimal amount of binding liquid was evaluated experimentally in order to achieve acceptable sphericity and required size distribution. It is interesting to note that it was possible to produce spherical pellets when water was added as wetting agent however this formulation showed faster drug release in phosphate buffers of pH 3.0 and 6.8, respectively (Fig. IV.1). On the other hand, drug release rate decreased when dry powder mixture was wetted with acetic acid. It might be speculated that partially dissolved chitosan facilitates viscous gel layer formation controlling drug release.

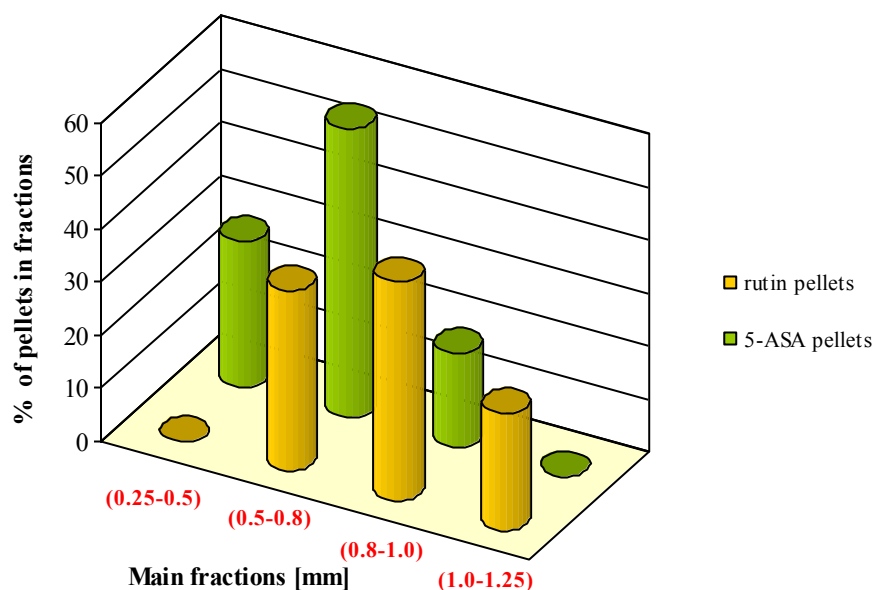


**Fig. IV.1: Drug released profiles from uncoated rutin pellets in phosphate buffer of pH 3.0 (diamond) or pH 6.8 (triangle). The plastic masses were wetted with water (empty symbols) or diluted acetic acid (full symbols). Data are shown as mean  $\pm$  SD.**

## 2. EVALUATION OF PELLETS

---

As seen in Fig. IV.2, pellet size distribution determined prior to the coating process showed three main fractions for 5-ASA pellets as well as for rutin pellets. Main pellets characteristics were evaluated and are summarized in Table IV.1. Both pellet samples presented high drug content and suitable sphericity higher than critical value of 0.80 (Deasy and Law, 1997). Pellets showed good mechanical properties, i.e. pellet hardness and friability, what is typical for extrusion/ spheronization method (Håring et al., 2008). Mean diameter of rutin pellets was bigger than that one of 5-ASA pellets; then pellet fraction of 0.5-1.0 mm was used for the following coating process.



**Fig. IV.2: Pellet size distribution in the fractions determined by sieve analysis**

**Table IV.1: Pellet characteristics**

Pellets	5-ASA	Rutin
Drug content [%]	94.6 ± 1.4	94.6 ± 1.4
Mean diameter [mm]	0.62	0.89
Sphericity	0.8335 ± 0.03	0.8295 ± 0.04
Hardness [N]	10.2 ± 1.7	10.8 ± 1.1
Friability [%]	0.053 ± 0.02	0.051 ± 0.01

### 3. COATING OF PELLETS

---

In the pharmacotherapy of IBD, colon-specific drug delivery systems represent an interesting approach since they prevent drug release in the stomach and small intestine, and provide an abrupt onset of drug release upon entry into the colon (Yang et al., 2002). In order to obtain required controlled release effect and achieve colon specific drug delivery which can significantly improve the efficacy of local treatments of IBD as well as lower distinct adverse effects, different polymers have been investigated. Film coatings with pH-dependent

properties, most commonly based on methacrylic acid copolymers marketed under the trade name Eudragit<sup>®</sup>, substituted polyvinyl acetate or some cellulose derivatives, are well established and commonly used during the past decades (Kietzmann et al., 2010). Besides, ethylcellulose membranes may be applied in order to achieve prolonged drug release in the cases when CD occurs also in upper GIT (Bautzová et al., 2011). Taking into consideration the variations in intestinal and colonic pH, gastrointestinal motility and inherent variability in gastrointestinal transit times in patients with IBD, pH- and time-dependent systems seem to be less reliable and site-specificity of drug release more unpredictable (Nugent et al., 2001; McConnell et al., 2008b). It is noteworthy to mention that over 500 distinct species of bacteria with a population of  $10^{11}$ - $10^{13}$  CFU/ml, greatly outnumbering microbial colonization in the upper parts of GIT, reside in the large intestine and this microbiota is increasingly recognized as a preferable triggering component in the design of colon-specific drug delivery systems (Sousa et al., 2008). In this context, naturally occurring polysaccharides, stable in the upper intestine, but susceptible to hydrolytic degradation by the colonic microbiota, have arisen as an ideal candidate material for enzyme-based systems (McConnell et al., 2008b). In our experiment microbially degradable coating of rutin pellets and pH-dependent coating on the surface of 5-ASA pellets were compared. Both samples contained chitosan in the pellet core. Degradable coating was composed of alginate and chitosan, polysaccharides of natural origin. Chitosan, a cationic polymer should interact with anionic polymer alginate and form water insoluble barrier, which influences the release of drug prior to pellet arrival in the colon where the both undergo microbial degradation and thus ensure colon drug delivery (Mitrevej et al., 2001). In order to prevent 5-ASA release in the upper GIT, Eudragit FS (EFS) was chosen for 5-ASA pellets. EFS dissolves at pH equal or higher than 7 (Potestà, 2001), i.e. this coating can be partially dissolved - depending on the coating thickness - under proximal ileum conditions. pH values differ significantly within the distal gut showing the values of 2.3-7.2. In alkaline pH, EFS coating will dissolve releasing the drug. If pH value would decrease to acidic values in the colon, chitosan in the core will dissolve and help the drug to release through the fissures or pores formed in the coating in previous alkaline environment (Rabišková et al., 2012).

#### 4. DISSOLUTION TESTING

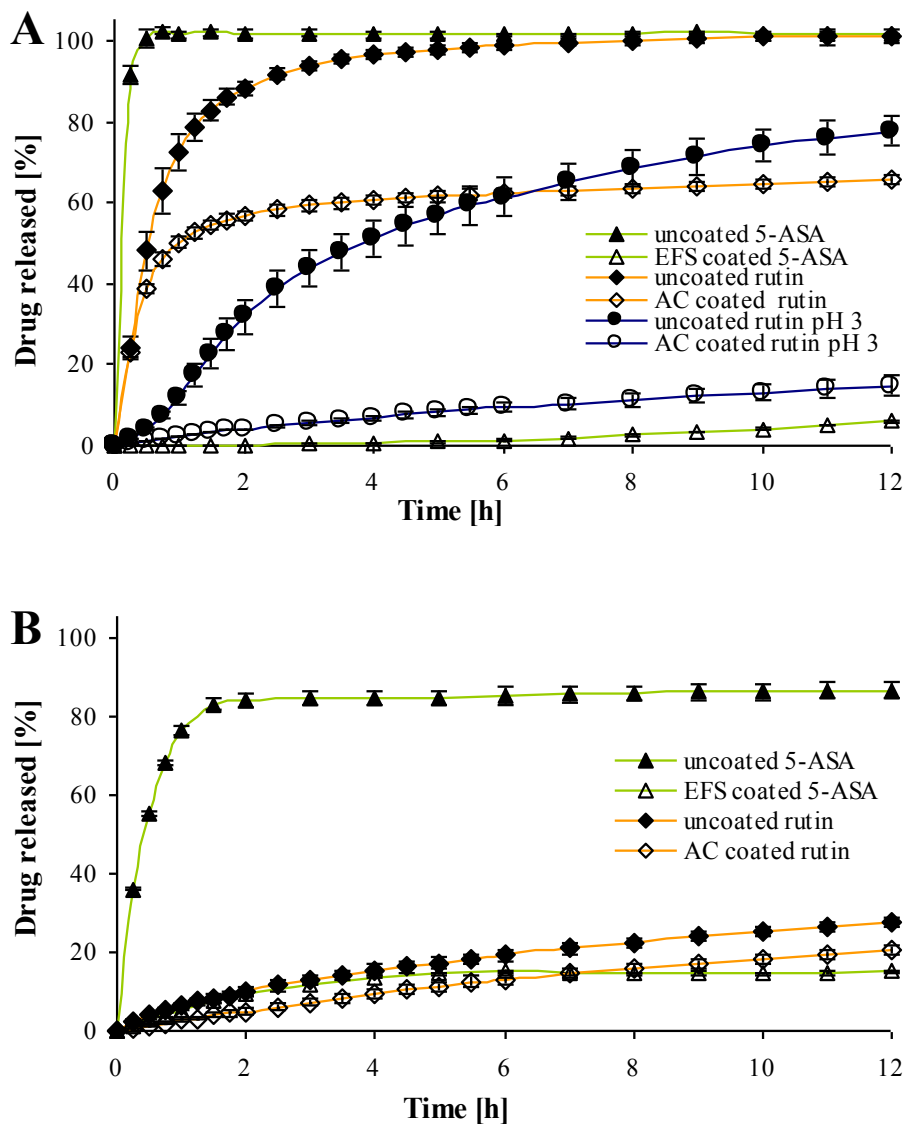
---

---

*In vitro* dissolution testing takes an important role in the development of solid dosage forms, especially those with controlled release, and should be conducted under conditions simulating demanded GIT environment (Yang et al., 2002).

First, conventional dissolution method was applied for assessing the ability of coated pellets to prevent drug release in the stomach and small intestine. Dissolution profiles of uncoated and coated pellets were determined in 0.1N hydrochloric acid (HCl) (5-ASA and rutin pellets) or phosphate buffer of pH 3.0 (rutin pellets) simulating gastric conditions in fasted and fed state in man (McConnell et al., 2008a). Preliminary dissolution tests were carried out also in phosphate buffer of pH 6.8 mimicking conditions in the small intestine (Shimono et al., 2003). At pH 1.2 (Fig. IV.3A), uncoated pellets release both drugs quite fast: immediate 5-ASA release compared to rapid rutin release is probably related to 40 fold higher solubility of 5-ASA at pH 1.2 (French and Mauger, 1993, for rutin determined experimentally). Additionally, rutin release rate at pH 3.0 decreased due to lower solubility of rutin in this medium. Applied coating, either EFS for 5-ASA pellets or alginate/chitosan (AC) for rutin pellets, minimized significantly drug release from the formulations. Coating of 5-ASA pellets is acidoresistant and therefore minimum drug release was observed. AC coated pellets exhibited different rutin dissolution profile in differing acidic media: approximately  $14.8 \pm 2.5$  % of the drug was released at pH 3 at the end of dissolution testing, while significant rutin amount was released in the first hour of the testing at pH 1.2. According to the observations of Elzatahry et al. (2009), it might be speculated that at pH 3.0 the formed polyelectrolyte complex between carboxyl residues of alginate and amino groups of chitosan is denser resulting in lower drug release. As is evident from the dissolution profiles in simulated gastric conditions, an additional outer enteric coating is necessary to prevent drug release from the chitosan-core pellets intended for colon-specific drug delivery. At pH 6.8 (Fig. IV.3B), the higher 5-ASA solubility compared to rutin contributed to the faster drug release from uncoated pellets. Rutin release from uncoated pellets in simulated intestinal fluid is hindered by insoluble chitosan matrix at this pH, while in the body chitosan is decomposed by intestinal microbiota (Zambito and Di Colo, 2003; McConnell et al., 2008c). Slow release of 5-ASA from coated pellets was expected as EFS dissolves at pH=7 and higher (Potestà,

2001). Also rutin release from coated pellets was very slow due to insoluble chitosan matrix and AC coating which *in vivo* are decomposed in the colon (Jain et al., 2007).

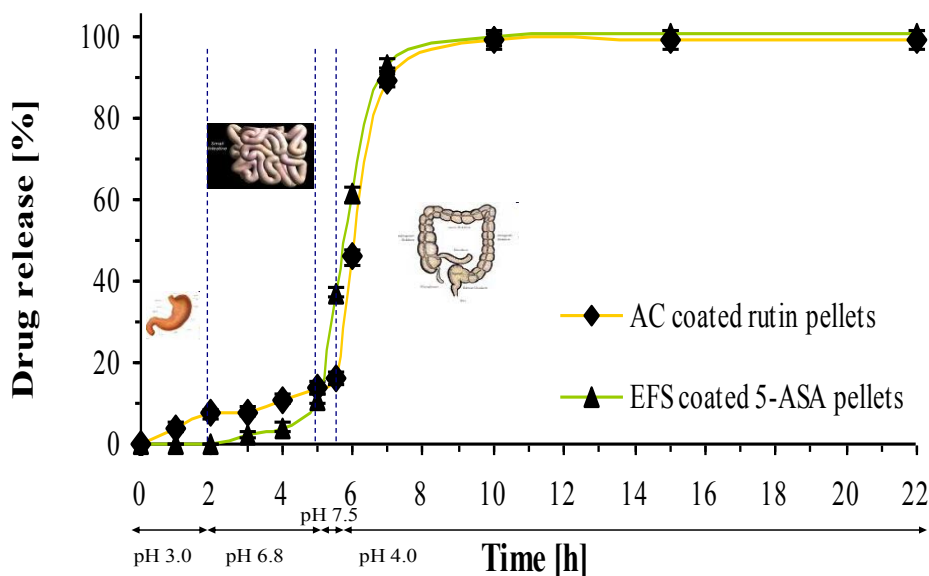


**Fig. IV.3: Drug released profiles from uncoated (full symbols) and coated (empty symbols) rutin (◆) and 5-ASA (▲) pellets in 0.1N HCl and rutin (●) in phosphate buffer of pH 3.0 (A); and phosphate buffer of pH 6.8 (B). Data are shown as mean ± SD.**

For *in vitro* evaluation of colon-specific drug delivery systems, the dissolution testing should closely mimic the *in vivo* conditions. Hence, a continuous dissolution method in buffers of different pH and reflecting residence time was performed in order to simulate



transit of pellets through the GIT. It was demonstrated that upper parts of GIT are hardly influenced by disease state of IBD (Press et al, 1998) and intraluminal pHs showed a similar pH values in proximal (6.1-7.3) and distal small bowel (6.8-8.3). Nonetheless, large pH variability in the caecum and right colon has been reported (2.3-7.3) (Nugent et al., 2001). Time profile of release tests was based on data of Davis et al. (1986) indicating the average gastric emptying time of 2 h and small intestinal transit time of approximately 3 h after oral administration of pellets in healthy humans. Additionally, previous work implies that overall transit time in the disease state is similar to that found in healthy volunteers although transit through the proximal colon is on average slower while accelerated transit through the rectosigmoid region was observed (Davis et al., 1991). Similarly, experimental colitis had no effect on the intestinal transit (De Schepper et al., 2007). According to the literature, no differences were detected in transit profiles of pellets between human and rats (Mori et al., 1989). In fact, release characteristics of coated pellets were examined by four sequential dissolution media with different pH values in order to mimic pH changes along GIT (Fig. IV.4). Dissolution profiles of both drugs are similar indicating insignificant drug release under the upper GIT conditions and fast drug release in the media mimicking distal GIT parts. Being acidoresistant, EFS coating prevented drug release at pH 3.0 and showed minimum drug release at pH 6.8. 5-ASA release was fast after the exposure of EFS coated pellets to pH 7.5 for 30 min. and this trend continued even in the medium of pH 4.0. Rapid drug release through EFS coating was ensured by the supporting effect of dissolved chitosan from the pellet core and fissures in the coating formed previously in the alkaline buffer. Rutin was retained efficiently inside AC coated pellets when tested at pH 3.0, 6.8 and 7.5 where at least 84 % of the initial drug load was still present in the pellets after 5.5 h of dissolution testing. Previous studies indicate that coating consisting of these polymers is able to prolong the drug release efficiently not only at low but also at high pH values, since sodium alginate not dissolves in acidic medium but is soluble under the alkali conditions, while opposite trend is observed for chitosan (Elzatahry et al., 2009). On the opposite, rutin was released rapidly when pellets were subjected to the medium of pH 4.0 which is related to chitosan dissolution (Dvořáčková et al., 2011). From our results, it can be supposed that pellets will pass intact through the stomach and the small intestine, and when they reach the colon, chitosan in the pellets core will be dissolved under low pH conditions or degraded by colonic enzymes, resulting in colon-specific drug delivery.



**Fig. IV.4: Drug released profiles from coated rutin (◆) and 5-ASA (▲) pellets in the continuous dissolution method. Data are shown as mean  $\pm$  SD.**

## 5. THERAPEUTIC EFFICIENCY

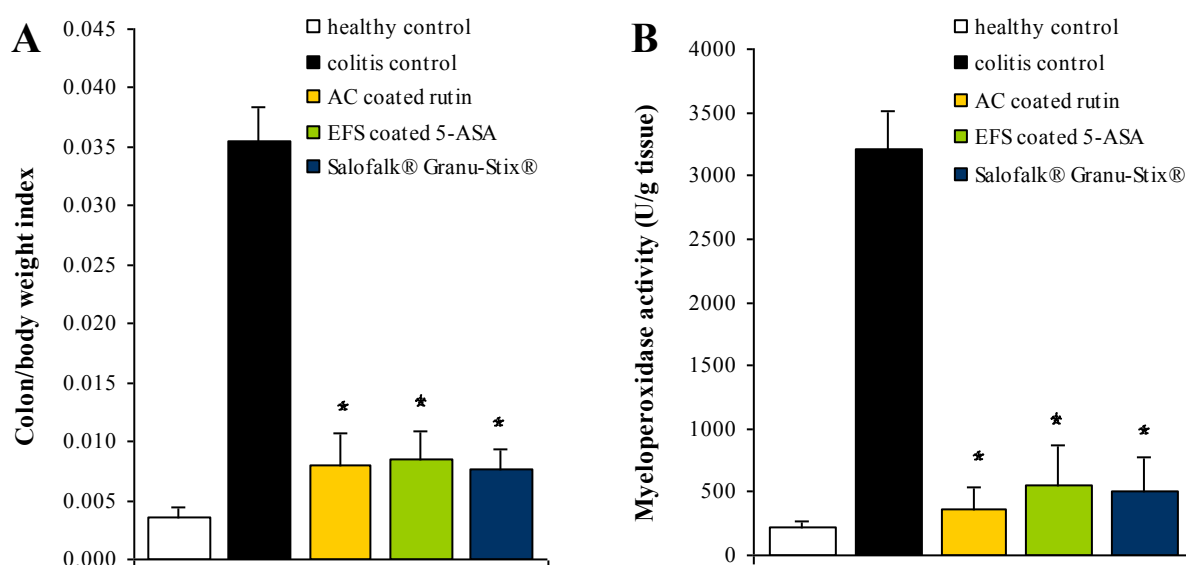
Since IBD represent extremely complex disorders with multiple components overall 63 models have been described to allow the examination of inflammatory processes as well as the evaluation of new therapeutic modalities (Hoffmann et al., 2002). Nevertheless, none of the current animal models may reproduce this human disease completely. In fact, simple and reproducible models involving only nonspecific inflammation exists for the testing of new anti-inflammatory drugs that may be used in patients and acquired findings are very appreciated whereas the cells, cytokines and inflammatory mediators involved in the nonspecific inflammatory phase of colitis seem to be common to multiple models, despite widely divergent mechanism of induction, and also occur in the mucosal lesions of patients with IBD (Elson et al., 1995). Hapten-induced model of colitis by the intraluminal instillation of a solution containing ethanol, e.g. a "barrier breaker" and TNBS, e.g. a contact sensitizing

allergen and covalently reactive compound was originally described by Morris et al. (1989), and is one of the most widely used model for the study of IBD, because of the immediate inflammation, high reproducibility and simplicity of the induction process (Hoffmann et al., 2002). Rectal administration of TNBS results in acute transmural necrosis which is likely caused by oxidative damage and focal basal cryptitis. This is followed by chronic inflammation with a mononuclear infiltrate and marked thickening of the bowel wall. Moreover, in rats, segmental ulceration, focal fibrosis, stenosis and granulomas can occur (Elson et al., 1995). After inflammation induction, tissue damage increases and maximizes on the 2<sup>nd</sup> day, remains high until the 10<sup>th</sup> day when it starts dropping and colitis recovers completely over time. This spontaneous healing and no relapsing nature of inflammation differs this model from human IBD (Luchini et al., 2009). In our study, the TNBS rat model was chosen as well recognized experimental model that allows induction of colitis at an exact location and affords an opportunity to evaluate new treatments potentially applicable to IBD patients (Morris et al., 1989).

It is well known that increased local drug concentration can improve therapeutic efficiency and this highlights the importance of mucoadhesive systems able to retain a dosage form at the site of action in the treatment of IBD (Smart 2005). The most widely investigated group of mucoadhesives is hydrophilic macromolecules containing numerous hydrogen bond forming groups (Smart et al., 1984). Typical example is chitosan, a cationic polymer obtained by alkaline deacetylation of chitin, which is one of the most abundant natural polysaccharides largely available in the exoskeletons of shellfish and insects (Singla and Chawla, 2001). It has attracted much attention in the recent years in the pharmaceutical and medical fields owing to its favorable biological properties such as biodegradability (metabolization by lysozyme and colonic bacteria enzymes), biocompatibility and low toxicity (Pangburn et al., 1982). In addition to hydrogen bonds, free amino groups are available for ionic cross-linking with negatively charged sialic acid residues of mucin which results in mucoadhesion and longer residence time of the dosage form at the site of absorption (He et al., 1998). In the line with this supposition, we incorporated chitosan into the pellets. These chitosan-core pellets showed efficient mucoadhesive properties in *ex vivo* bioadhesion testing and also provided higher drug metabolite concentration in the inflamed colonic tissue compared to chitosan free or Salofalk<sup>®</sup> Granu-Stix<sup>®</sup> pellets. Our results are in good accordance with earlier investigations revealing mucoadhesive properties of formulations containing chitosan. For instance, Takeuchi et al. (2005) observed the highest adhesive % of chitosan-coated among the three

different polymer-coated liposomes. Also, Wittaya-areekul et al. (2006) have demonstrated enhanced mucoadhesivity of chitosan coated alginate microparticles than the uncoated one.

5-ASA has become a standard therapy for mild-to-moderate IBD based on an extensive and long treatment history (Kornbluth and Sachar, 2010). On the other hand, rutin, naturally occurring flavonoid exhibited anti-inflammatory and anti-oxidant properties could be the subject of interest as a possible drug for the treatment of this chronic disorder (Guardia et al., 2001). Therapeutic efficiency of either 5-ASA or rutin loaded pellets was tested in experimental colitis in rats. Administration of pellets markedly decreased the colon/body weight ratio and myeloperoxidase activity in comparison with the colitis control group (Fig. IV.5). However there was no statistical difference among the treated groups.



**Fig. IV.5: Determination of colon/body weigh index (A) and myeloperoxidase activity (B) after final drug administration for n = 4 animals. \*P < 0.05 compared with colitis control group. Data are shown as mean ± SD.**

The results from this study revealed additional beneficial properties of bioadhesive chitosan-core pellets for colonic 5-ASA delivery. In this respect, the potential to increase drug residence time in the inflamed area may be a valuable tool to further optimize the therapy of IBD. Additionally, rutin pellets coated with mixed film composed of chitosan and alginate showed significant healing effect in experimental colitis comparable to 5-ASA pellets. This

could lead us to think that formulations based on natural components may be promising candidates in the treatment of IBD. With regard to the study of Mizoyama et al. (2004) reporting on inhibitory effect of flavonoids on 5-ASA N-acetylation, co-administration of rutin pellets together with 5-ASA preparations could provide increased tissue levels of 5-ASA, decreased dose intake, more appropriate dosage schedule and thus ameliorate patient compliance in the treatment of this enigmatic disease. Likewise 5-ASA-rutin loaded pellets may represent interesting formulation for further investigations.

## 6. REFERENCES

---

---

Agrawal AM, Manek RV, Kolling WM, Neau SH. Water distribution studies within microcrystalline cellulose and chitosan using differential scanning calorimetry and dynamic vapor sorption analysis. *J Pharm Sci.* 2004;93(7):1766-79.

Bautzová T, Rabišková M, Lamprecht A. Multiparticulate systems containing 5-aminosalicylic acid for the treatment of inflammatory bowel disease. *Drug Dev Ind Pharm.* 2011;37(9):1100-9.

Charoenthai N, Kleinebudde P, Puttipipatkachorn S. Influence of chitosan type on the properties of extruded pellets with low amount of microcrystalline cellulose. *AAPS Pharm Sci Tech.* 2007a;8(3):E1-11, <http://www.aapspharmscitech.org/articles/pt0803/pt0803064/pt0803064.pdf>, downloaded 23.08.2011.

Charoenthai N, Kleinebudde P, Puttipipatkachorn S. Use of chitosan-alginate as alternative pelletization aid to microcrystalline cellulose in extrusion/spheronization. *J Pharm Sci.* 2007b;96(9):2469-84.

Davis SS, Hardy JG, Fara JW. Transit of pharmaceutical dosage forms through the small intestine. *Gut.* 1986;27:886-92.

Davis SS, Robertson C, Wilding IR. Gastrointestinal transit of a multiparticulate tablet formulation in patients with active ulcerative colitis. *Int J Pharm.* 1991;68(1-3):199-204.

De Schepper HU, De Man JG, Van Nassauw L, Timmermans JP, Herman AG, Pelckmans PA, De Winter BY. Acute distal colitis impairs gastric emptying in rats via an extrinsic neuronal reflex pathway involving the pelvic nerve. *Gut.* 2007;56(2):195-202.

Deasy PB, Law MFL. Use of extrusion-spheronization to develop an improved oral dosage form of indomethacin. *Int J Pharm.* 1997;148:201-9.

Di Pretoro G, Zema L, Gazzaniga A, Rough SL, Wilson DI. Extrusion-spheronisation of highly loaded 5-ASA multiparticulate dosage forms. *Int J Pharm.* 2010;402(1-2):153-64.

Dukić-Ott A, Thommes M, Remon JP, Kleinebudde P, Vervaet C. Production of pellets via extrusion-spheronisation without the incorporation of microcrystalline cellulose: a critical review. *Eur J Pharm Biopharm.* 2009;71(1):38-46.

Dvořáčková K, Bautzová T, Rabišková M. Dissolution studies in evaluation of oral dosage forms with controlled drug release. *Chem listy.* 2011;105(1):50-54.

Elson CO, Sartor RB, Tennyson GS, Riddell RH. Experimental models of inflammatory bowel disease. *Gastroenterology.* 1995;109(4):1344-67.

Elzatahry AA, Mohy Eldin MS, Soliman EA, Hassan EA. Evaluation of alginate-chitosan bioadhesive beads as a drug delivery system for the controlled release of theophylline. *J Appl Pol Sci.* 2009;111(5):2452-9.

French DL, Mauger JW. Evaluation of the physicochemical properties and dissolution characteristics of mesalamine: relevance to controlled intestinal drug delivery. *Pharm Res.* 1993;10(9):1285-90.

Ghebre-Sellassie I. Pellets: A General Overview. In: *Pharmaceutical pelletization technology.* Ghebre-Sellassie I (Ed.), Marcel Dekker, Inc., New York, NY. 1989:288p.

Guardia T, Rotelli AE, Juarez AO, Pelzer LE. Anti-inflammatory properties of plant flavonoids. Effects of rutin, quercetin and hesperidin on adjuvant arthritis in rat. *Farmaco.* 2001;56(9):683-7.

Häring A, Vetchý D, Janovská L, Krejčová K, Rabišková M. Differences in characteristics of pellets prepared by different pelletization methods. *Drug Dev Ind Pharm.* 2008;34(3):289-96.

He P, Davis SS, Illum L. In vitro evaluation of the mucoadhesive properties of chitosan microspheres. *Int J Pharm.* 1998;166(1):75-88.

Hoffmann JC, Pawlowski NN, Kühl AA, Höhne W, Zeitz M. Animal models of inflammatory bowel disease: an overview. *Pathobiology.* 2002;70(3):121-30.

Jain A, Gupta Y, Jain SK. Perspectives of biodegradable natural polysaccharides for site-specific drug delivery to the colon. *J Pharm Pharm Sci.* 2007;10(1):86-128.

Janovská L, Škrabáková G, Vetchý D, Rabišková M. Pellets containing chitosan prepared by extrusion-spheronization method. *Čes Slov Farm.* 2009;58(1):21-7.

Kietzmann D, Moulari B, Béduneau A, Pellequer Y, Lamprecht A. Colonic delivery of carboxyfluorescein by pH-sensitive microspheres in experimental colitis. *Eur J Pharm Biopharm.* 2010;76:290-5.

Kornbluth A, Sachar DB. Ulcerative colitis practice guidelines in adults: American College of Gastroenterology, Practice Parameters Committee. *Am J Gastroenterol.* 2010;105(3):501-23.

Krejčová K, Rabišková M, Vetchý D, Polášek E, Tomášek V, Prokopová A. The influence of drug solubility and particle size on the pellet formulation in a rotoprocessor. *Drug Dev Ind Pharm.* 2006;32(5):585-93.

Luchini AC, Costa de Oliveira DM, Pellizzon CH, Di Stasi LC, Gomes JC. Relationship between mast cells and the colitis with relapse induced by trinitrobenzenesulphonic acid in Wistar rats. *Mediators Inflamm.* 2009;ID432493:E1-7, <http://www.ncbi.nlm.nih.gov/pmc/articles/PMC2680139/pdf/MI2009-432493.pdf>, downloaded 23.08.2011.

Lustig-Gustafsson C, Kaur Johal H, Podczeck F, Newton JM. The influence of water content and drug solubility on the formulation of pellets by extrusion and spheronisation. *Eur J Pharm Sci.* 1999;8(2):147-52.

McConnell EL, Basit AW, Murdan S. Measurements of rat and mouse gastrointestinal pH, fluid and lymphoid tissue, and implications for in-vivo experiments. *J Pharm Pharmacol*. 2008a;60(1):63-70.

McConnell EL, Fadda HM, Basit AW. Gut instincts: explorations in intestinal physiology and drug delivery. *Int J Pharm*. 2008b;364(2):213-26.

McConnell EL, Murdan S, Basit AW. An investigation into the digestion of chitosan (noncrosslinked and crosslinked) by human colonic bacteria. *J Pharm Sci*. 2008c;97(9):3820-9.

Mitrevej A, Sinchaipanid N, Rungvejhavuttivittaya Y, Kositchaiyong V. Multiunit controlled-release diclofenac sodium capsules using complex of chitosan with sodium alginate or pectin. *Pharm Dev Technol*. 2001;6(3):385-92.

Mizoyama Y, Takaki H, Sugihara N, Furuno K. Inhibitory effect of flavonoids on N-acetylation of 5-aminosalicylic acid in cultured rat hepatocytes. *Biol Pharm Bull*. 2004;27(9):1455-8.

Mori M, Shirai Y, Uezono Y, Takahashi T, Nakamura Y, Makita H, Nakanishi Y, Imasato Y. Influence of specific gravity and food on movement of granules in the gastrointestinal tract of rats. *Chem Pharm Bull (Tokyo)*. 1989;37(3):738-41.

Morris GP, Beck PL, Herridge MS, Depew WT, Szewczuk MR, Wallace JL. Hapten-induced model of chronic inflammation and ulceration in the rat colon. *Gastroenterology*. 1989;96(3):795-803.

Nugent SG, Kumar D, Rampton DS, Evans DF. Intestinal luminal pH in inflammatory bowel disease: possible determinants and implications for therapy with aminosalicylates and other drugs. *Gut*. 2001;48:571-7.

Pangburn SH, Trescony PV, Heller J. Lysozyme degradation of partially deacetylated chitin, its films and hydrogels. *Biomaterials*. 1982;3:105-8.

Potestà P. Eudragit FS 30 D: a new pH-sensitive polymer covering for mesalamine. *Eur Rev Med Pharmacol Sci*. 2001;5:30.

Press AG, Hauptmann IA, Hauptmann L, Fuchs B, Fuchs M, Ewe K, Ramadori G. Gastrointestinal pH profiles in patients with inflammatory bowel disease. *Aliment Pharmacol Ther*. 1998;12:673-8.

Rabišková M, Bautzová T, Gajdziok J, Dvořáčková K, Lamprecht A, Pellequer Y, Spilková J. Coated chitosan pellets containing rutin intended for the treatment of inflammatory bowel disease: In vitro characteristics and in vivo evaluation. *Int J Pharm*. 2012;422(1-2):151-9.

Santos H, Veiga F, Pina M, Podczeczek F, Sousa J. Physical properties of chitosan pellets produced by extrusion-spheronisation: influence of formulation variables. *Int J Pharm*. 2002;246(1-2):153-69.



Shimono N, Takatori T, Ueda M, Mori M, Nakamura, Y. Multiparticulate chitosan-dispersed system for drug delivery. *Chem Pharm Bull.* 2003;51(6):620-4.

Singla AK, Chawla M. Chitosan: some pharmaceutical and biological aspects-an update. *J Pharm Pharmacol.* 2001;53(8):1047-67.

Smart JD. The basics and underlying mechanisms of mucoadhesion. *Adv Drug Deliv Rev.* 2005;57(11):1556-68.

Smart JD, Kellaway IW, Worthington HE. An in-vitro investigation of mucosa-adhesive materials for use in controlled drug delivery. *J Pharm Pharmacol.* 1984;36(5):295-9.

Sousa T, Paterson R, Moore V, Carlsson A, Abrahamsson B, Basit AW. The gastrointestinal microbiota as a site for the biotransformation of drugs. *Int J Pharm.* 2008;363(1-2):1-25.

Steckel H, Mindermann-Nogly F. Production of chitosan pellets by extrusion/spheronization. *Eur J Pharm Biopharm.* 2004;57(1):107-14.

Takeuchi H, Thongborisute J, Matsui Y, Sugihara H, Yamamoto H, Kawashima Y. Novel mucoadhesion tests for polymers and polymer-coated particles to design optimal mucoadhesive drug delivery systems. *Adv Drug Deliv Rev.* 2005;57(11):1583-94.

Vervaet C, Baert L, Remon JP. Extrusion-spheronisation. *Int J Pharm.* 1995;116:131-46.

Wittaya-areekul S, Kruenate J, Prahsarn C. Preparation and in vitro evaluation of mucoadhesive properties of alginate/chitosan microparticles containing prednisolone. *Int J Pharm.* 2006;312(1-2):113-8.

Yang L, Chu J, Fix J. Colon-specific drug delivery: new approaches and in vitro/in vivo evaluation. *Int J Pharm.* 2002;235:1-15.

Zambito Y, Di Colo G. Preparation and in vitro evaluation of chitosan matrices for colonic controlled drug delivery. *J Pharm Pharm Sci.* 2003;6(2):274-81.

Zhang H, Neau SH. In vitro degradation of chitosan by bacterial enzymes from rat cecal and colonic contents. *Biomaterials.* 2002;23(13):2761-6.

## **ORIGINAL PUBLICATIONS**



## PŘEHLEDY A ODBORNÁ SDĚLENÍ

**Beneficial effects of rutin, quercitrin and quercetin on inflammatory bowel disease**RABIŠKOVÁ M.<sup>1</sup>, BAUTZOVÁ T.<sup>1</sup>, DVOŘÁČKOVÁ K.<sup>1</sup>, SPILKOVÁ J.<sup>2</sup><sup>1</sup>University of Veterinary and Pharmaceutical Sciences Brno, Faculty of Pharmacy, Department of Pharmaceutics, Czech Republic<sup>2</sup>Charles University, Faculty of Pharmacy in Hradec Králové, Department of Pharmacognosy, Czech Republic

Received 24 March 2009 / Accepted 8 April 2009

## SUMMARY

**Beneficial effects of rutin, quercitrin and quercetin on inflammatory bowel disease**

The aim of this review article was to obtain a deeper understanding of the reported effects of flavonols, in particular rutin, quercitrin and their aglycone quercetin, with respect to their potential beneficial action on inflammatory bowel disease. Research in the field of flavonoids has increased significantly in recent few years and many new investigations have been performed concerning their absorption, metabolism, and probable mechanisms of action. Recently published results obtained in *in vitro* approaches and *in vivo* experiments on animal models are reported. Further investigation aimed at the clinical effects of rutin may be important for the development of a new therapeutic agent for the treatment of inflammatory bowel disease in humans.

**Key words:** inflammatory bowel disease – flavonols – absorption – metabolism – effects

Čes. a slov. Farm., 2009; 58, 47–54

## SOUHRN

**Příznivé účinky rutinu, kvercitrinu a kvercetinu na nespecifické střevní záněty**

Cílem přehledného článku bylo dosáhnout hlubšího pochopení ve vědeckých časopisech publikovaných účinků flavonolů, zejména rutinu, kvercitrinu a jejich aglykonu kvercetinu, s důrazem na jejich potenciální příznivé působení u nespecifických střevních zánětů. Výzkum v oblasti flavonoidů v několika posledních letech významně vzrostl a objevila se řada nových skutečností týkajících se jejich absorpce, metabolismu a možných mechanismů účinků. Článek uvádí nedávno publikované výsledky získané v pokusech *in vitro* a experimentech *in vivo* na zvířecích modelech. Další výzkum zaměřený na klinické účinky rutinu může být důležitý pro vývoj nové léčivé látky k terapii nespecifických střevních zánětů v humánní medicíně.

**Klíčová slova:** nespecifické střevní záněty – flavonoly – absorpce – metabolismus – účinky

Čes. a slov. Farm., 2009; 58, 47–54

Má

Inflammatory bowel disease (IBD) refers to two major clinical conditions, i.e. ulcerative colitis (UC) and Crohn's disease (CD). UC is a refractory, chronic

recurrent and non-specific inflammatory disease of rectal and colonic mucosa. Clinical manifestations include diarrhea, blood in the stool, abdominal pain, weight loss

**Address for correspondence:**

doc. PharmDr. Miloslava Rabišková, CSc.  
Department of Pharmaceutics University of Veterinary and Pharmaceutical Sciences  
Palackého 1–3, 612 42 Brno  
e-mail: rabiskovam@vfu.cz

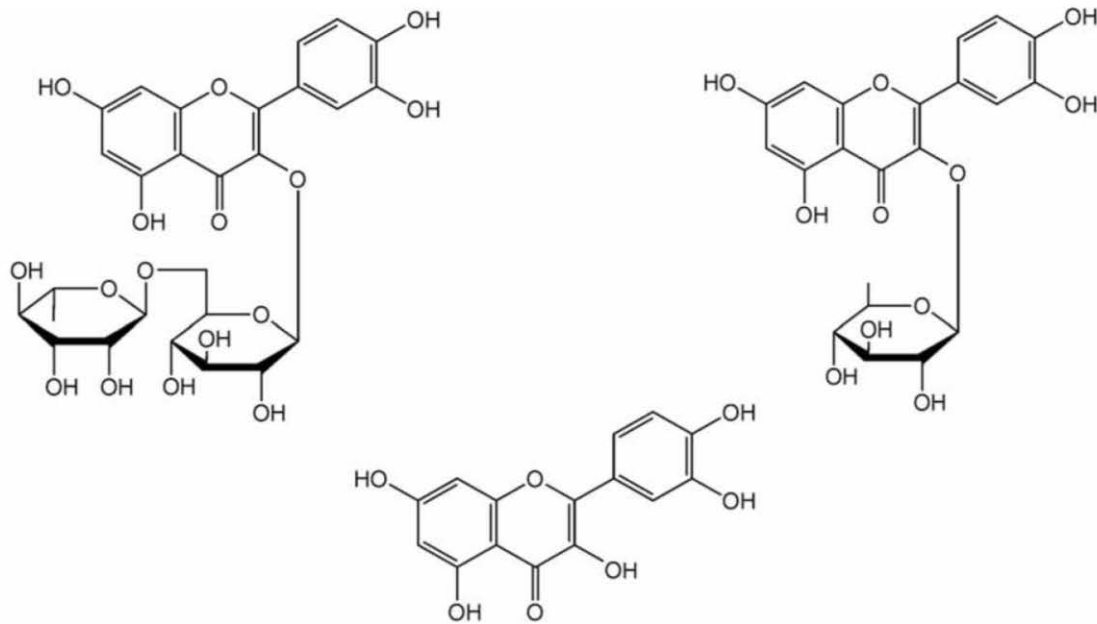


Fig. 1. Rutin (left), quercitrin (right) and their aglycone quercetin (middle)

and mucosal ulceration. CD can involve any part of gastrointestinal tract, but most frequently it involves the distal small intestine and colon. Patients with IBD often receive intense doses, i.e. the dosage schedule with multiple tablets several times a day, and long-term therapy that frequently requires lifelong treatment. The therapy is often accompanied with side effects associated with high dose intake resulting in low patient compliance which has a negative effect on the treatment.

As in other inflammatory processes, IBD is characterized by an up-regulation of the synthesis and release of a variety of pro-inflammatory mediators, such as eicosanoids, platelet activating factor, reactive oxygen and nitrogen metabolites and cytokines, thus influencing mucosal integrity and leading to excessive injury<sup>1)</sup>. The cell types involved in the mucosal inflammatory response are similar to those found at systemic inflammatory sites including macrophages<sup>2)</sup>. These cells have critical functions in the immune system, acting as regulators of homeostasis and as effector cells in infection, wound healing and tumor growth. However, macrophages do not always play a positive role in the homeostasis of the immune system. Under some circumstances, such as septic shock<sup>3)</sup>, rheumatoid arthritis<sup>4)</sup>, atherosclerosis and IBD<sup>5)</sup>, macrophages have been described to have noxious effects, probably due to the non-regulated and excessive secretion of inflammatory modulators such as reactive metabolites from oxygen or nitrogen and pro-inflammatory cytokines, including tumor necrosis factor alpha (TNF- $\alpha$ ), being deleterious to intestinal function. In fact, macrophages are considered to be the main source of these pro-inflammatory mediators in IBD, thus actively contributing to the pathology of these intestinal conditions<sup>2, 6, 7)</sup>.

Considering this, flavonoids are potential anti-inflammatory drugs applicable to IBD because firstly,

these compounds are inhibitors of several enzymes which are activated in inflammation<sup>7)</sup>, secondly, a number of cells of the immune system are down-regulated by certain flavonoids *in vitro*<sup>8)</sup>, and thirdly, most flavonoids show potent antioxidative/radical scavenging effects<sup>9, 10)</sup>.

#### Flavonoids structure

Based on their molecular structure, flavonoids are divided into several groups, e.g. flavonols, flavones, flavanones, flavanols, and anthocyanins. All of them are phenylbenzopyrones with a basic structure formed by two benzene rings united through a heterocyclic pyrane or pyrone. Flavonols (i.e. rutin, quercitrin and quercetin) are characterized by the presence of a double bond in the central ring.

Among flavonoids, quercetin is the most common flavonoid in nature, and it is mainly present as its glycosylated forms such as quercitrin (3-rhamnosylquercetin) or rutin (rutoside, 3-rhamnosyl-glucosyl quercetin)<sup>11)</sup> (Figure 1). *In vitro* studies have clearly shown that quercetin acts as a potent pleiotropic modulator in several physiological functions, showing different activities, such as an anti-proliferative effect in numerous cell lines<sup>12, 13)</sup>, a pro-apoptotic effect in lung carcinoma cell lines<sup>14)</sup>, and an inhibitory effect of osteoclastic differentiation<sup>15)</sup>. It is important to note that when the glycosylated forms of quercetin are assayed, there is usually a loss of activity in these effects in comparison with those obtained with the aglycone, due to the presence of the sugar moiety in the flavonoid structure<sup>16)</sup>. On the contrary, both glycosides quercitrin and rutin have been shown to exert intestinal anti-inflammatory effects in experimental models of rat colitis<sup>7, 17)</sup>. Both flavonoids have been reported to be

helpful on acute and chronic experimental colitis in the rat, acting via a mechanism ascribed to mucosal protection or enhancement of mucosal repair, in which protection against oxidative insult and/ or amelioration of colonic fluid absorption may play a role<sup>6, 16, 18)</sup>.

### **Absorption, Metabolism and Elimination**

Understanding the absorption and metabolism of flavonoids is fundamental in determining their biological activity. In general, naturally occurring flavonoids are attached to sugar residues which affect the mechanism of absorption by altering their physicochemical properties and thus their ability to enter cells, or to interact with transporters and cellular (lipo)proteins<sup>19, 20)</sup>.

It is thought that ingested flavonoid glycosides are not easily absorbed in the gastrointestinal tract due to their hydrophilicity; consequently, a large fraction of them reaches the large intestine where they could be metabolized by microbial glycosidases to liberate their aglycones and affect the (patho)physiology of the large intestine<sup>20)</sup>. A different situation has been observed for aglycones. The rapid absorption of quercetin indicates that it probably takes place in the proximal part of the small intestine<sup>21)</sup>.

Although quercetin glycosides are subject to deglycosylation by enterobacteria for the absorption at large intestine, small intestine acts as an effective absorption site for glucose-bound glycosides (quercetin glycosides). This is because small intestinal cells possess a glucoside-hydrolyzing activity and their glucose transport system is capable of participating in the glucoside absorption<sup>22)</sup>. Thus the first step metabolic change of orally administered flavonoid glycosides seems to be deglycosylation occurring in the small intestinal lumen<sup>23, 24)</sup> as the non-enzymatic deglycosylation of flavonoids such as gastric hydrolysis was not found<sup>25)</sup>. Epithelial cells of the gastrointestinal tract are the only cells of the body in contact with flavonoid glycosides; the other cells are reached only by flavonoid metabolites and degradation products<sup>26)</sup>. Flavonoid glycosides undergo either luminal deglycosylation catalyzed by membrane bound enzymes<sup>26)</sup> or enter the enterocytes in the form of glycosides requiring active transport<sup>27)</sup> followed by intracellular hydrolysis. The transport across the intestinal enterocytes depends on the quality of the flavonoid aglycone moiety and the nature and position of the attached sugar. The mechanism of absorption of quercetin-4'-glucoside was shown to involve both interaction with the sodium-dependent glucose transporter (SGLT1) and luminal hydrolysis by lactase phlorizin hydrolase (LPH), whereas quercetin-3'-glucoside was absorbed only following deglycosylation by LPH<sup>19)</sup>.

After passage into enterocytes, flavonoid glycosides are susceptible to hydrolysis by intracellular  $\beta$ -glucosidases, such as broad-specificity cytosolic  $\beta$ -glucosidase<sup>28)</sup>. After absorption, aglycones are conjugated to glucuronide, sulphate, and/or methyl groups in the intestinal mucosa and inner tissues<sup>29)</sup>. Uridin-diphosphate-glucuronyl transferases are

membrane-bound enzymes, situated in the endoplasmic reticulum, expressed primarily in the liver but also present in the intestinal epithelium<sup>30)</sup>. Quercetin glucuronides can be resecreted from apical surfaces of epithelial cells back to the intestinal lumen<sup>31)</sup>. Quercetin-3-glucuronides were shown to be further metabolized: either by a methylation of the catechol moiety resulting in 3'-methylquercetin- and 4'-methylquercetin-glucuronides or by the deglucuronidation with subsequent sulfation in 3'-position<sup>32)</sup>.

Recently, it has been reported that LPH, located in the brush border of mammalian small intestine, could perform hydrolysis not only for flavonoid glycosides but also for some flavonoid glycosides<sup>33)</sup>. Furthermore, it was observed that absorption of both quercetin and rutin from the small intestine of rat occurred. Rutin appeared to be absorbed much more slowly than quercetin. Both flavonoids were bound to the small intestinal tissue. This binding to the intestinal wall components may significantly limit their absorption from this site<sup>34)</sup>.

The colon is heavily colonized by microorganisms with a strong catalytic and hydrolytic potential against compounds of exogenous and endogenous origin<sup>35)</sup>. Flavonoids neither absorbed in the stomach nor in the small intestine are propelled to the colon. Reaching the colon, they are subjected to deglycosylation and deconjugation by colonic bacteria, and are cleaved giving rise to ring fission products<sup>22, 36)</sup>. Prior to absorption, rutin and quercetin must undergo deglycosylation, what cannot be fully achieved by the small intestinal enzymatic system but is possible by colon microflora. Rutin is transformed to its aglycone by the bacteria producing  $\alpha$ -rhamnosidase and  $\beta$ -glucosidase<sup>24)</sup> (Figure 2).

The type of ring fission depends on the type of flavonoids. Flavonols are degraded to phenylacetic acids and phenylpropionic acids which are finally oxidized (beta-oxidation) to benzoic acids<sup>37)</sup>. These low molecular microbial metabolites of flavonoids exhibit several important biological activities, e.g. anti-platelet activity and cytotoxicity for tumor cell lines<sup>38)</sup>. The arising cleavage products are absorbed from the colon or further metabolized. 3,4-dihydroxyphenylpropionic acid is degraded in the colon to phenylpropionic, 3-hydroxypropionic, and 4-hydroxypropionic acid, which are further metabolized by the liver giving rise to hippuric, 3-hydroxyhippuric, and 4-hydroxyhippuric acids<sup>39)</sup>.

Compounds absorbed from the intestines enter the liver via the portal vein; they are removed from the blood by the liver parenchymal cells and biotransformed<sup>40)</sup>. Conjugation of the polar hydroxyl groups with glucuronic acid, sulfuric acid, glycine, or possibly glutathione<sup>41)</sup> results in water-soluble conjugates. These conjugates are eliminated either from the liver with bile into the duodenum, or renally with the urine (Figure 2). The minimum molecular weight is one of the factors determining whether a compound or a conjugate will undergo biliary excretion. The molecular weight limit depends on particular species; it was reported to be around 500–600 Da in humans<sup>42)</sup>. Human small intestinal microsomes were shown to hydrolyze quercetin glucuronides *in vitro*, but this activity was related to

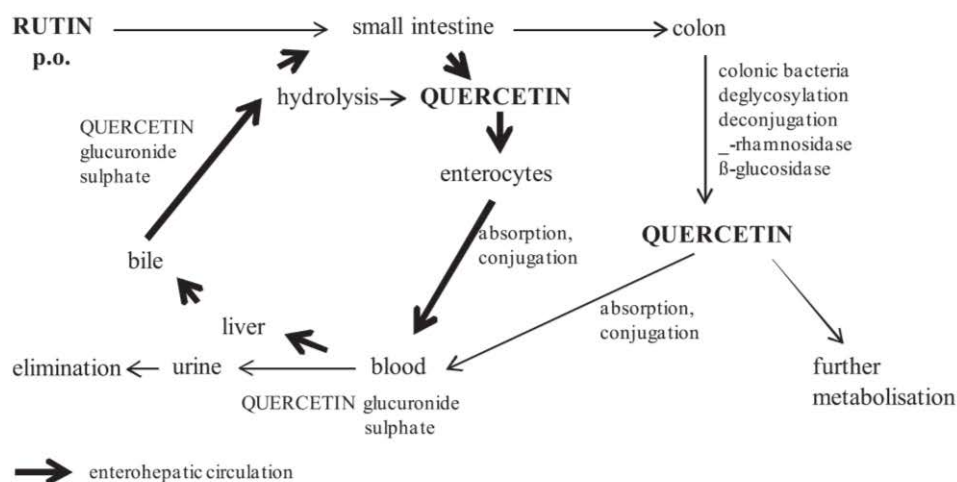


Fig. 2. Proposed pharmacokinetics of orally administered rutin

microsomal  $\beta$ -glucuronidase. Thus deglucuronidation can occur when the flavonoid conjugate reaches the same cellular compartment<sup>43</sup>. So far no transport of glucuronides has been shown across the cell wall which would make them accessible for intracellular  $\beta$ -glucuronidases. Deglucuronidation has not been reported in the gastrointestinal lumen yet due to other than microbial activity. However, deglucuronidation can occur during inflammation.  $\beta$ -glucuronidase released from stimulated neutrophils or certain injured cells can hydrolyze flavonoid glucuronide to free aglycone possessing anti-inflammatory activities as reported for luteolin monoglucuronide<sup>44</sup>. High microbial  $\beta$ -glucuronidase activity in the rat cecum content has also been observed<sup>45</sup>. Deconjugation of flavonoid metabolites coming from biliary clearance is thus possible to occur also in humans. In addition, flavonoid glucuronide and sulfate metabolites secreted with bile or in any other way into the small intestine could be hydrolyzed and the liberated aglycones would then pass into enterocytes passively, reabsorbed again, and metabolized forming thus an enterohepatic cycling<sup>46,47</sup> (Figure 2).

In the plasma, flavonoids are present in conjugated forms as responsible reactions facilitate their excretion<sup>29</sup>. Systemic occurrence of quercetin in the conjugated form only was confirmed<sup>48</sup>, free aglycone or parent glycosides were not detected. Quercetin metabolites have a lower but still significant inhibitory effect on lipid peroxidation and other biological activities as compared to the aglycone and these properties depend on the conjugation pattern<sup>49</sup>. Due to aromatic nucleus and hydroxyl substituents, flavonoids have a great affinity for proteins, particularly for albumin. The binding of quercetin to human albumin was found 70–80%. The presence of the unsaturated bond in the heterocyclic ring of flavonoids is crucial for this effect. Albumin-bound quercetin conjugates retained the antioxidative property.

The distribution of quercetin metabolites in tissues was investigated: high amount of them was observed in the digestive tract, low amount in the blood, liver, kidney,

and lungs. The major metabolites in the intestine were quercetin-3-glucuronide, quercetin glucuronide sulphate, methyl-quercetin glucuronide (probably from biliary clearance) and quercetin<sup>50</sup>.

Several papers report elimination of flavonoid metabolites by the urinary pathway. Quercetin is excreted in the urine in the form of glucuronide or sulphate<sup>51</sup>.

As presented above, flavonoids undergo extensive metabolism after administration resulting in their altered structure. They were found in systemic circulation in the form of (methylated)glucuronide and/ or sulphate conjugates, whereby the hydroxyl groups are not available. Therefore, most of the effects shown in *in vitro* experiments with aglycones cannot be directly extrapolated to *in vivo* systems apart from the digestive tract where the possibility of direct interactions is obvious. This also concerns the antioxidant properties of flavonoids, which can be reduced. Even after being metabolized they may act locally or indirectly influence redox balance by inducing antioxidative enzymes, detoxifying enzymes, or compounds which may be involved in sustaining homeostasis<sup>24</sup>.

#### Possible mechanisms of action – present status

The fundamental property of flavonoids, responsible for many of their beneficial effects, is their antioxidant capacity, allowing them to chelate ions of transition metals such as  $\text{Fe}^{2+}$ ,  $\text{Cu}^{2+}$  or  $\text{Zn}^{2+}$ , to catalyze the electron transport, to scavenger reactive oxygen species (ROS) like the superoxide anion, oxygen singlet and lipidic peroxyradicals, or to stabilize free ROS by means of the hydrogenation or formation of complexes with oxidating species<sup>52</sup>. The antioxidant capacity of flavonoids presents a therapeutic potential in diseases, such as cardiovascular diseases<sup>53</sup>, gastric or duodenal ulcers<sup>54</sup>, cancer<sup>55</sup> or hepatic disorders<sup>56</sup>. Their antiviral and antiallergic actions are also important, as well as their anti-thrombotic and anti-inflammatory properties<sup>52</sup>.

Flavonoids effects on a variety of inflammatory

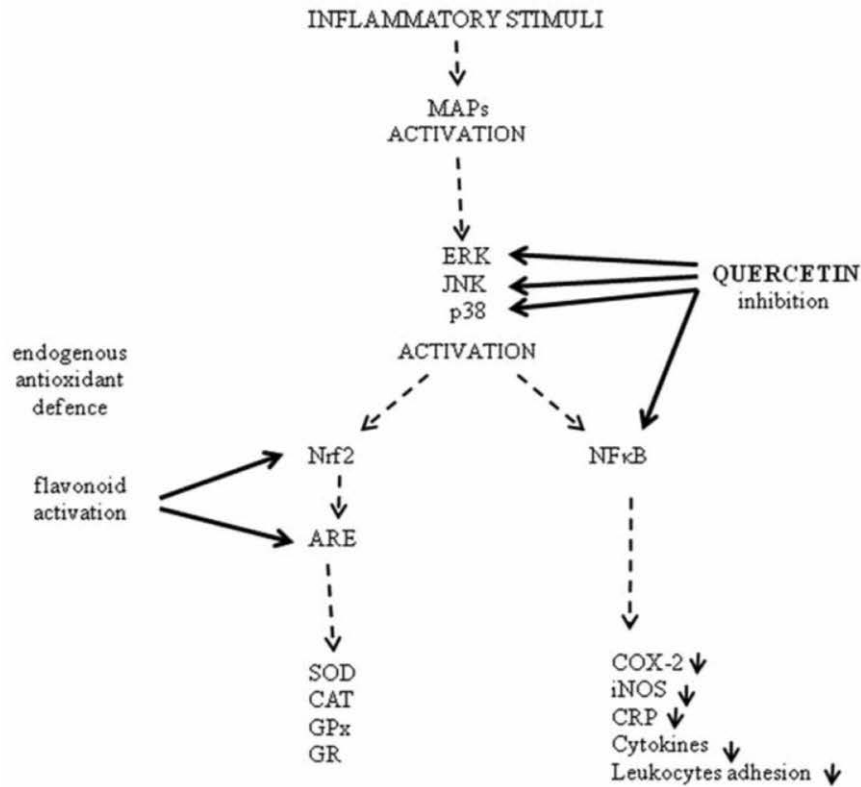


Fig. 3. Some effects of quercetin on the inflammatory cascade (adapted from <sup>60</sup>). In inflammation, three kinds of mitogen-activated proteins (MAPs), i.e. extracellular signal related kinase (ERK), Jun N-terminal kinase (JNK), and p38 kinase are activated. Quercetin (right) was reported to inhibit iNOS expression through inhibition of p38 kinase and JNK, and to suppress pro-inflammatory cytokines and NFκB activation through ERK and p38 kinase. Flavonoids (left) are also reported to increase the endogenous antioxidant defence potential. The NF-E2 related factor 2 (Nrf2) is a redox sensitive factor whose nuclear translocation and binding to the antioxidant response elements (ARE) may result in the induction of antioxidant enzymes, i.e. superoxide dismutase (SOD), catalase (CAT), glutathione peroxidase (GPx), and glutathione reductase (GR).

processes have been an object of diverse recent reviews and experimental studies, and it has been demonstrated that they are able to inhibit a series of enzymes activated during inflammatory process <sup>57</sup>. Prostaglandins and nitric oxide biosynthesis is involved in inflammation, and isoforms of inducible nitric oxide synthase (iNOS) and of cyclooxygenase (COX-2) are responsible for the production of a great amount of these mediators. *In vitro* studies have confirmed that quercetin inhibits nitric oxide production and the expression of iNOS. Some of these studies showed that quercetin down-regulates COX-2 expression in macrophages <sup>58</sup>, human lymphocytes (*in vivo*) <sup>59</sup>, and hepatic cells <sup>60</sup>.

There are several steps at which flavonoids can modulate the cascade of molecular events leading to the over expression of iNOS or COX-2. They include inhibition of protein kinase C, phospholipases and phosphodiesterases <sup>61</sup>, indirect modulation of iNOS by inhibition of the cyclooxygenase and/or lipooxygenase pathways, and some others <sup>62</sup>. Pathways inducing iNOS and COX-2 seem to converge in the activation of a transcription essential for the expression of pro-inflammatory genes, the nuclear factor kappa B (NFκB) <sup>63</sup>. The NFκB is one of the main factors whose modulation triggers a cascade of molecular events, some

of which can constitute potential key targets for the treatment of inflammation. Inflammatory stimuli activate some cells, such as macrophages, which release cytokines (i.e. tumor necrosis factor alpha, TNFκ) and ROS.

In macrophages and other cell types, three kinds of mitogen-activated proteins (MAPs) are activated: extracellular signal related kinase (ERK), Jun N-terminal kinase (JNK), and p38 kinase <sup>60</sup> (Figure 3). Activated NFκB can stimulate the expression of iNOS with an increase in the nitric oxide formation. Its reaction with ROS produces the formation of peroxynitrite which contributes to cellular injury. Quercetin has been reported to inhibit iNOS expression through inhibition of p38 kinase <sup>64</sup> and JNK <sup>65</sup>. Quercetin is also able to suppress pro-inflammatory cytokines and NFκB activation through ERK and p38 kinase <sup>66</sup>. An elevation of reactive C protein (CRP) in serum is considered as the indicator of chronic inflammation. It is known that pro-inflammatory cytokine IL-6 induces CRP through NFκB activation <sup>67</sup>. Recent data demonstrate that flavonoids including quercetin reduce CRP level in some cells <sup>68</sup>. It is therefore probable that these effects on CRP expression could be mediated, at least partly, by the modulation of NFκB dependent pathway <sup>60</sup>.

A variety of antioxidant defense systems as protection



from ROS have been developed in organisms. The major endogenous antioxidant systems include superoxide dismutase (SOD), catalase (CAT), glutathione peroxidase (GPx), and glutathione reductase (GR). SOD catalyzes the dismutation of the superoxide radical anion, CAT and GPx convert  $H_2O_2$  to  $H_2O$ , and GR recycles oxidized glutathione back to reduced form. The NF-E2 related factor 2 (Nrf2) is a redox-sensitive factor whose nuclear translocation and binding to the antioxidant response elements (ARE) may result in induction of antioxidant enzymes<sup>69)</sup> (Figure 3). It has been reported that some flavonoids are Nrf2-ARE activators<sup>70)</sup>. An increase in the endogenous antioxidant defense potential is thus additional mechanism which could contribute to the anti-inflammatory properties of flavonoids.

The immobilization and firm adhesion of leukocytes to the endothelial wall is another major mechanism responsible for the formation of oxygen-derived free radicals, but also for the release of cytotoxic oxidants and inflammatory mediators and further activation of the complement system. Under normal conditions, leukocytes move freely along the endothelial wall. However, during ischemia and inflammation, various mainly endothelium-derived mediators and complement factors may cause adhesion of the leukocytes to the endothelial wall resulting in the injury to tissues<sup>23)</sup>. NF $\kappa$ B activation is a necessary step in the adhesion molecules<sup>71)</sup>. Activated endothelial cells release IL-6 stimulating CRP production<sup>72)</sup> contributing thus to the exacerbation of endothelial dysfunction. Infiltration of leukocytes into the mucosa significantly contributes to tissue necrosis and dysfunction. Neutrophils play crucial roles in the development of gastrointestinal inflammation. Neutrophils are recruited into the tissue by local production of IL-8, which is the primary chemotactic factor of neutrophils, and can then contribute to tissue destruction. In gastrointestinal inflammation, bacterial pathogens or cytokines induce the production of IL-8 by intestinal epithelial cells, and this may be followed by the migration of neutrophils. Some evidence suggests that IL-8 is significantly up-regulated in primary intestinal epithelial cell cultures from patients with IBD<sup>73)</sup>.

### **Beneficial effects on IBD**

Beneficial effects of rutin and quercitrin (in some studies also quercetin) on IBD have been reported in many papers. In some of them, rutin and quercitrin act as quercetin deliverers to the large intestine<sup>20)</sup>.

Rutin, quercitrin, quercetin, and their metabolites can ameliorate conditions in the inflamed intestine through several mechanisms. The most investigated and reported one is their anti-oxidative effect. It can be helpful in scavenging of free radicals by means of interfering with several enzymes such as nitric oxide synthase, thereby resulting in decreased oxidative tissue injury. In addition, the suppression of pro-inflammatory cytokines, i.e. IL-1 $\beta$ , IL-6<sup>57)</sup>, IL-8<sup>73)</sup> and the key mediator for the expression of inflammatory cytokines TNF- $\alpha$  has been demonstrated<sup>74, 75)</sup>. This can improve regulation in immune responses and prevent tissue damage. It is known that expression of TNF- $\alpha$ , which strongly activates NF $\kappa$ B, is

itself up-regulated by NF $\kappa$ B. This provides a positive autoregulatory loop that amplifies the inflammatory response and perpetuates chronic intestinal inflammation<sup>76)</sup>. For this reason, therapeutic intervention against TNF- $\alpha$  or NF $\kappa$ B activation has been used for the treatment of IBD<sup>77)</sup>. In fact, inhibition of NF $\kappa$ B activity has been suggested to be a major component of the anti-inflammatory activity of glucocorticoids and 5-amino-salicylic acid, both of which are frequently used for treatment of chronic intestinal inflammation<sup>78)</sup>. Also an amelioration of water absorption and the disturbances in hydroelectrolytic transport ascribed to early downregulation of the inflammatory cascade by quercitrin and rutin has been recently reported<sup>79)</sup>.

Positive effects of flavonols on the vascular system (antithrombotic and atherosclerotic effects) can be helpful in the inflamed intestine improving its microcirculation.

Protein binding effect of quercetin is the most recently discovered one<sup>80)</sup>. IBD is considered to be an autoimmune disorder (with shared genetic predisposition for IBD and celiac disease), demonstrating increased gut permeability even in unaffected relatives of people with CD<sup>81)</sup>. This increased epithelial permeability may result in a breakdown in the first line of defense against commensal bacteria and this coupled with other genetic factors could lead to an increase in innate and adaptive immune responses to disease-related microbial antigens. MAG12, recently implicated in UC and celiac disease, encodes a scaffolding protein involved in epithelial integrity (enabling protein-protein interactions)<sup>82)</sup>. It is well known that bacterial metabolism of flavonoids occurs in the colon leading to their deglycosylation and further degradation into numerous phenolic and carboxylic acid products, though the biological significance of these products is still poorly understood. Other types of metabolites are those resulting from oxidation by reactive oxygen species as firstly recognized for quercetin<sup>83)</sup>. It was also observed in human cell lines, and covalent binding of oxidized quercetin to DNA, but in particular to cellular protein was demonstrated<sup>84)</sup>. It is proposed that this interaction with proteins might contribute to the biological action of flavonoids<sup>81)</sup>.

In summary, it seems that one of the most important beneficial effects of quercetin glycosides on IBD is their combined anti-inflammatory and immunomodulatory effect on intestinal epithelial cells suggesting that they may be an effective oral preventive and a therapeutic agent for this disease<sup>73)</sup>. Their other effects, i.e. antithrombotic, atherosclerotic and cellular binding effects can contribute to their positive action on the inflamed intestinal tissue. Although the numerous studies published with *in vitro* approaches allow to identify molecular mechanisms of flavonols effects, the data obtained must be verified in humans and it is necessary to be very careful when extrapolating *in vitro* results to *in vivo* situations<sup>60)</sup>. There are also differences between the mouse, rat and human gut with respect to the mechanism by which they utilize or exclude luminal flavonols<sup>57)</sup>. In any case, the data nowadays available make clear the potential utility that flavonols have for the possible treatment of inflammatory

diseases. Considering reported observations, such as high concentration of administered flavonols in the colon, their binding to intestinal tissue, their deglycosylation by colonic bacteria, enterohepatic cycling, biliary excretion of quercetin glucuronides and their deglucuronidation in the inflamed tissue, local and systemic effects of quercetin metabolites and cellular protein binding effect, all these findings make rutin and quercitrin (and also quercetin in appropriate controlled release dosage form) promising candidates for the treatment of IBD. Their natural origin and absence of side effects can even make these substances more interesting with respect to IBD lifelong treatment. Further investigations aimed on clinical effects of flavonols would be a good start point for their therapeutic use in humans.

This work was supported by the Research Project MSM 0021620822 and IGA VFU 253/2009/FaF.

---

## REFERENCES

---

- Katz, J. A., Itoh, J., Fiocchi, C.: *Curr. Opin. Gastroenterol.*, 1999; 15, 291–297.
- Grip, O., Janciauskiene, S., Lindgren, S.: *Curr. Drug Targets Inflamm. Allergy*, 2003; 2, 155–160.
- Bone, R. C.: *Ann. Intern. Med.*, 1991; 114, 332–333.
- Feldmann, M., Brennan, F. M., Maini, R. N.: *Annu. Rev. Immunol.*, 1996; 14, 397–440.
- Schwertschlag, U. S. et al.: *Leukemia*, 1999; 13, 1307–1315.
- Grisham, M. B. et al.: *J. Investig. Med.*, 2002; 50, 272–283.
- Comalada, M. et al.: *Eur. J. Immunol.*, 2005; 35, 584–592.
- Middleton, E., Kandaswami, C.: In: Klurfeld D. M. (Ed): *Nutrition and immunology*. New York: Plenum Press 1993; 239–266.
- Mora, A. et al.: *Biochem. Pharmacol.*, 1990; 40, 793–797.
- Hertog, M. G. et al.: *Lancet*, 1993; 342, 1007–1011.
- Nair, H. K. et al.: *Clin. Diagn. Lab. Immunol.*, 2004; 11, 63–69.
- Fan, P. S. et al.: *Acta Pharmacol. Sin.*, 2003; 24, 1231–1234.
- Nguyen, T. T. et al.: *Carcinogenesis*, 2004; 25, 647–659.
- Wattel, A. et al.: *J. Cell. Biochem.*, 2004; 92, 285–295.
- Shen, S. C. et al.: *J. Cell. Biochem.*, 2003; 89, 1044–1055.
- Cruz, T. et al.: *Life Sci.*, 1998; 62, 687–695.
- Camuesco, D. et al.: *Br. J. Pharmacol.*, 2004; 143, 908–918.
- Gálvez, J. et al.: *Studies in Natural Products Chemistry*, 2001; 25, 607–649.
- Day, A. J. et al.: *Biochem. Pharmacol.*, 2003; 65, 1199–1206.
- Kim H. et al.: *Pharm. Res.*, 2005; 22, 1499–1509.
- Manach, C. et al.: *FEBS Lett.*, 1998; 426, 331–336.
- Murota, K., Terao, J.: *Archives of Biochemistry and Biophysics*, 2003; 417, 12–17.
- Nemeth, K. et al.: *Eur. J. Nutr.*, 2003; 42, 29–42.
- Nemeth K., Piskula M. K.: *Crit. Rev. Food Sci. Nutr.*, 2007; 47, 397–409.
- Gee, J. M. et al.: *Free Radic. Biol. Med.*, 1998; 25, 19–25.
- Depeint, F. et al.: *Proc. Nutr. Soc.*, 2002; 61, 97–103.
- Arts, I. C. W. et al.: *J. Nutr.*, 2002; 132, 2823–2832.
- Berrin, J. G. et al.: *Eur. J. Biochem.*, 2002; 269, 249–258.
- Scalbert, A. et al.: *Biomed. Pharmacother.*, 2002; 56, 276–282.
- Murota, K., Terao, J.: *FEBS Lett.*, 2005; 579, 5343–5346.
- Crespy, V. et al.: *J. Nutr.*, 2001; 131, 2109–2114.
- O'Leary K. A. et al.: *Biochem. Pharmacol.*, 2003; 65, 479–491.
- Day, A. J. et al.: *FEBS Lett.*, 2000; 468, 166–170.
- Carbonaro, M., Grant, G.: *Ann. Nutr. Metab.*, 2005; 49, 178–182.
- Scalbert, A., Williamson, G.: *J. Nutr.*, 2000; 130, 2073S–2085S.
- Hollman, P. C. H.: *Pharm. Biol.*, 2004; 42, 74–83.
- Aura, A. M. et al.: *J. Agric. Food Chem.*, 2002; 50, 1725–1730.
- Kim, D. H. et al.: *Arch. Pharm. Res.*, 1998; 21, 17–23.
- Rechner, A. R. et al.: *Free Radic. Biol. Med.*, 2002; 33, 220–235.
- Williamson, G. et al.: *Biochem. Soc. Trans.*, 2000; 28, 16–22.
- Spencer, J. P. et al.: *Biochem. J.*, 2003; 372, 173–181.
- Hackett, A. M.: In: Cody, V., Middleton, E., Harborne, J. B. (eds.): *Plant flavonoids in biology and medicine*. New York: Liss 1986; 177–194.
- O'Leary, K. A. et al.: *FEBS Lett.*, 2001; 503, 103–106.
- Shimoi, K. et al.: *Drug Metab. Dispos.*, 2001; 29, 1521–1524.
- Sakamoto, H. et al.: *Biochim. Biophys. Acta*, 2002; 1573, 171–176.
- Crespy, V. et al.: *Am. J. Physiol.*, 1999; 277, G120–G126.
- Chen, X. et al.: *Pharm. Res.*, 2005; 22, 892–901.
- Wittig, J. et al.: *J. Chromatogr. B*, 2001; 753, 237–243.
- Janisch, K. M. et al.: *Free Radic. Res.*, 2004; 38, 877–884.
- Mullen, W. et al.: *J. Agric. Food Chem.*, 2002; 50, 6902–6909.
- Clarke, D. B. et al.: *Anal. Biochem.*, 2002; 309, 158–172.
- Nijveldt, R. J. et al.: *Am. J. Clin. Nutr.*, 2001; 74, 418–425.
- Yao, L. H. et al.: *Plant Food Human Nutr.*, 2004; 59, 113–122.
- Moreira, A. et al.: *Biochem Pharmacol.*, 2004; 68, 1939–1946.
- Yang K. et al.: *Carcinogenesis*, 2000; 1, 1655–1660.
- Peres W. et al.: *J. Hepatol.*, 2000; 33, 742–750.
- Kwon, K. H. et al.: *Biochem. Pharmacol.*, 2005; 69, 395–406.
- Banerjee, T., Van der Vliet, A., Ziboh, V. A.: *Prostag. Leukotr. Essent. Fatty Acids*, 2002; 66, 485–492.
- De Pascual, T. S. et al.: *J. Nutr.*, 2004; 134, 552–557.
- González-Gallego, J., Sánchez-Campos, S., Tunón, M. J.: *Nutr. Hosp.*, 2007; 22, 3–15.
- Middleton, E., Kandaswami, C., Theoharides, T. C.: *Pharmacol. Rev.*, 2000; 52, 673–751.
- Ruiz, P. A., Haller, D.: *J. Nutr.*, 2006; 136, 664–671.
- Jiang, B. et al.: *J. Biol. Chem.* 2004; 279, 1323–1329.
- Wadsworth, T. L., Koop, D. R.: *Chem. Biol. Interact.*, 2001; 137, 43–58.
- Wadsworth, T. L., McDonald, T. L., Koop, D. R.: *Biochem. Pharmacol.*, 2001; 62, 963–974.
- Cho, S. Y. et al.: *Mol. Cell Biochem.*, 2003; 243, 153–160.
- Odontuya, G., Hout, J., Houghton, P. J.: *Phytother. Res.*, 2005; 19, 782–786.
- García-Mediavilla, M. V. et al.: *Eur. J. Pharmacol.*, 2007; 557, 221–229.
- Brigelius-Flohe, R., Banning, A.: *Free Radic. Biol. Med.*, 2006; 40, 775–787.

70. **Andreadi, C. K. et al.:** Mol. Pharmacol., 2006; 69, 1033–1040.
71. **Collins, T.:** Lab. Invest. 1993; 68, 499–508.
72. **Mortensen, R. F.:** Immunol. Res., 2001; 24, 163–176.
73. **Yoshioka, Y. et al.:** Int. Immunopharmacol., 2008; 8, 1802–1807.
74. **Ruiz, P. A. et al.:** J. Nutr., 2007; 137, 1208–1215.
75. **Ohkawara, T. et al.:** Immunol. Lett., 2006; 107, 148–154.
76. **Neurath, M. F., Becker, C., Barbulescu, K.:** Gut, 1998; 43, 856–860.
77. **Ogataand, H., Hibi, T.:** Curr. Pharm. Des., 2003; 9, 1107–1113.
78. **Yanand, F. D., Polk, B.:** J. Biol. Chem., 1999; 274, 3631–3636.
79. **Sánchez de Medina, F. et al.:** Life Sci., 2002; 70, 3097–3108.
80. **Walle, T.:** Free Radic. Biol. Med., 2004; 36, 829–837.
81. **Halme, L. et al.:** World J. Gastroenterol. 2006; 12, 3668–3672.
82. **McGovern, D. P. B. et al.:** Inflamm. Bowel Dis. 2009; 15, 75–83.
83. **Galati, G. et al.:** Free Radic. Biol. Med., 2001; 30, 370–382.
84. **Walle, T., Vincent, T. S., Walle, U. K.:** Biochem. Pharmacol., 2003; 65, 1603–1610.

## REVIEW ARTICLE

# Multiparticulate systems containing 5-aminosalicylic acid for the treatment of inflammatory bowel disease

Tereza Bautzová<sup>1,2</sup>, Miloslava Rabišková<sup>1</sup>, and Alf Lamprecht<sup>2</sup>

<sup>1</sup>Department of Pharmaceutics, Faculty of Pharmacy, University of Veterinary and Pharmaceutical Sciences, Czech Republic, and <sup>2</sup>Laboratory of Pharmaceutical Engineering, Faculty of Medicine and Pharmacy, University of Franche-Comté, Besançon Cedex, France

## Abstract

**Background:** In recent years, many achievements have been realized in the therapy of inflammatory bowel disease (IBD) although its etiology remains unknown. Thus IBD treatment is symptomatic and targets general inflammatory mechanisms. Oral formulations containing 5-aminosalicylic acid (5-ASA) have become the standard therapy for mild-to-moderate IBD.

**Objective:** This article is a review of recently published research dealing with new 5-ASA dosage forms. Thus promising candidates for IBD treatment evaluated *in vitro* are reported; systems tested *in vivo* in trinitrobenzene sulfonic acid (TNBS)-induced colitis in rats are mentioned; and 5-ASA formulations used in clinical studies are presented. Moreover, all oral dosage forms containing 5-ASA or its prodrugs are reviewed; their characteristics and utilization in IBD treatment are discussed.

**Conclusion:** In several clinical studies, it has been shown that multiparticulates such as pellets offer more advantages as compared with single unit forms, that is, coated tablets. Prolonged presence close to the site of the action, improved drug bioavailability, and easier administration of large drug doses belong to the benefits of pellets.

**Keywords:** Controlled drug delivery, 5-aminosalicylic acid, pellets, tablets, commercialized products, promising candidates

## Introduction

Inflammatory bowel disease (IBD) comprises two idiopathic inflammatory disorders of the intestinal tract: ulcerative colitis (UC) and Crohn's disease (CD)<sup>1</sup>. Clinical manifestations include bloody diarrhea, fecal urgency, tenesmus, mucosal ulcerations, weight loss, and generally feeling unwell<sup>2</sup>. This pathology is widespread in western countries and, although its exact etiology is poorly understood, individual genetic background, environmental signals such as stress, and immunological influences may all contribute to the disease process<sup>3</sup>. Probably, in hereditarily susceptible population, environmental factors such as water, food, and infection trigger excessive reaction of intestinal immunity. Their action may cause an inflammatory stimulation to the intestinal mucosa and damage it<sup>4</sup>.

UC is a refractory, chronic, and nonspecific inflammatory disease of the rectal and colonic mucosa. Abdominal pain occurs in the lower left part. The colon wall is thinner compared with CD and shows continuous inflammation with no patches of healthy tissue in the diseased section<sup>5,6</sup>. Contrarily, CD can involve any part of the gastrointestinal (GI) tract from the mouth to the anus, but most frequently involves the distal small bowel and colon<sup>7</sup>. CD patients commonly experience pain in the lower right abdomen. Bleeding from the rectum is much less common as in the patients with UC<sup>8</sup>. The inflammation may occur in patches in one or more organs in the digestive system. A diseased section of colon may appear between two healthy sections<sup>9</sup>. The colon wall may be thickened and, because of the intermittent pattern of diseased and healthy tissue may have a "cobblestone"

*Address for Correspondence:* Prof. Miloslava Rabišková, Department of Pharmaceutics, Faculty of Pharmacy, University of Veterinary and Pharmaceutical Sciences, Palackého 1-3, Brno 612 42, Czech Republic. Tel: 0042 54156 2860. E-mail: rabiskovam@vfu.cz

(Received 17 December 2010; revised 28 January 2011; accepted 01 February 2011)

**Abbreviations:**

AUC, area under the curve;  
 CD, Crohn's disease;  
 CMCNa, carmellose sodium;  
 IBD, inflammatory bowel disease;  
 MCC, microcrystalline cellulose;  
 NO, nitric oxide;

PPAR $\gamma$ , peroxisome proliferator-activated receptor gamma;  
 ROS, reactive oxygen species;  
 TNBS, 2,4,6-trinitrobenzenesulfonic acid;  
 TNF, tumor necrosis factor;  
 UC, ulcerative colitis;  
 5-ASA, 5-aminosalicylic acid

appearance<sup>10</sup>. Main features of UC and CD are compared in Table 1<sup>11,12</sup>.

The degree of disease activity of UC and CD can vary from mild to highly severe<sup>13</sup> and acute flare-ups are followed by the periods of remission<sup>14</sup>. In the acute phase, patients often receive intense therapy, that is, the dosage schedule with multiple tablets several times a day. These complicated dosing regimens are inconvenient for patients and negatively affect their compliance<sup>15,16</sup>. On the other hand, patients in the quiescence state of disease with the absence of symptoms are non-adherent too<sup>17</sup>. Precisely, lack of patients' compliance in frequent lifelong treatment greatly increases the risk of clinical relapse and disease activity, and in addition represents an important barrier to the successful management of the patients<sup>18,19</sup>. Thus, new once or twice-daily dosing formulations could improve patient compliance. They are at least as effective as more frequent dosing tablets<sup>6,15,20,21</sup>.

As the etiology of IBD is still not well-known, therapy is symptomatic and targets general inflammatory mechanisms<sup>22</sup>. IBD is considered a chronic inflammatory disorder characterized by the development of intestinal inflammation resulting from the transmural infiltration of neutrophils, macrophages, lymphocytes, and mast cells, ultimately giving rise to mucosal disruption and ulceration<sup>23</sup>. Activated macrophages produce a host of proinflammatory cytokines, including IL-1, tumor necrosis factor- $\alpha$  (TNF- $\alpha$ , i.e. a cytokine involved in systemic inflammation, the member of a group of cytokines that stimulate the acute phase reaction), and the chemokine IL-8<sup>24</sup>. Increased levels of inflammatory cytokines are

secreted in the colonic mucosa of IBD patients, leading to the production of other inflammatory mediators such as nitric oxide (NO), reactive oxygen species (ROS), eicosanoids, and so on. These mediators contribute to tissue necrosis and mucosal dysfunction<sup>25</sup>. Recently, the peroxisome proliferator-activated receptor (PPAR $\gamma$ ) has been described as a regulator of cellular proliferation, apoptosis, and anti-inflammatory response possibly through several signaling pathways<sup>26</sup>.

**Pharmacotherapy of IBD**

Since the precise etiology of IBD is still not clear, the mainstay of medical therapy depends on inhibition of the inflammatory mediators<sup>27</sup>. In past years, available treatments offered both imperfect control of symptoms and the possibility of serious side effects. Today, current treatments include anti-inflammatory drugs, antibiotics, and immunomodulators<sup>28</sup>. 5-Aminosalicylic acid (5-ASA)-related drugs are used under mild or moderate disease conditions, whereas steroids and immunomodulatory drugs are required for the treatment of more severe inflammation. However, the use of latter types of drugs is seriously restricted because of the more serious complications and toxic side effects, which are related to their systemic absorption<sup>29,30</sup>. As both CD and UC remain medically incurable and associated with potentially significant morbidity, the focus of a treatment must be to reduce or eliminate symptoms, optimize nutritional status, prevent complications, and minimize the potential psychological effects of these chronic illnesses<sup>31</sup>.

**5-Aminosalicylic acid: mesalazine (5-ASA), sulfasalazine, olsalazine, and balsalazide**

Formulations containing 5-ASA have become the gold standard of treatment for mild-to-moderate active UC, based on an extensive and long history of their efficacy and safety. They are effective in the induction and maintenance of IBD remission<sup>32,33</sup>. Furthermore, 5-ASA may provide protection against the development of colorectal cancer in patients suffering from IBD<sup>34</sup>. Free 5-ASA is a zwitter ion and when administered orally, it is rapidly and nearly completely systematically absorbed from the proximal small intestine and then extensively metabolized to *N*-acetyl-5-ASA by *N*-acetyltransferase-1 in intestinal epithelial cells and the liver<sup>35,36</sup>. This metabolite is therapeutically inactive<sup>35</sup>. Excretion is primarily

Table 1. Comparison of ulcerative colitis and Crohn's disease (adapted from refs. 11 and 12).

Feature	Ulcerative colitis	Crohn's disease
Distribution	Diffuse, distal predominance	Segmental or diffuse, often proximal predominance
Rectum	Always involved	Often spared
Microscopic distribution	Diffuse	Often focal
Depth of inflammation	Mucosal	Transmural
Sinus tracts and fistulae	Absent	Often present
Strictures	Absent	Often present
Fissures	Absent	Often present
Granulomas	Absent	Often present

through the urine as a mixture of free 5-ASA and *N*-acetyl 5-ASA<sup>37</sup>. From large intestine, 5-ASA and its metabolite are excreted in feces<sup>5,38</sup>.

### Strategies for colon delivery

Optimal delivery of 5-ASA in the treatment of UC demands release in the colon, where 5-ASA acts topically at the inflammatory lesions and can exert anti-inflammatory effects. Therefore, strategies to protect orally administered 5-ASA from its release, absorption, and metabolism until it reaches the colon have been developed to provide effective therapy with minimal side effects<sup>36,39</sup>. In general, four primary approaches have been proposed, namely prodrugs, pH- and time-dependent formulations, and colonic microflora-activated systems<sup>40</sup>. Sulfasalazine, olsalazine, and balsalazide are prodrugs (Table 2). Sulfasalazine consists of 5-ASA linked to sulfapyridine by an azo-bond. Olsalazine comprises two molecules of 5-ASA linked by an azo-bond as a dimer, and balsalazide consists of 5-ASA linked by an azo-bond to inert carrier 4-aminobenzoyl- $\beta$ -alanine<sup>36,38,41</sup>. Due to the azo linkage, the compounds pass unchanged through the small intestine and undergo their metabolism by the bacterial azoreductase enzymes when they reach the colon releasing 5-ASA<sup>42,43</sup>. Prodrugs are available either in a form of tablet or gelatine capsule and are listed in Table 2. Sulfapyridine, the therapeutically inactive moiety of sulfasalazine, is absorbed systemically from the colon and is responsible for most of the hypersensitivity and intolerant side effects<sup>44,45</sup>. Olsalazine is associated particularly with an increased incidence of dose-dependent diarrhea. The azo-bond prodrugs represent dose limitations in the treatment of IBD, rely on their ileic secretory effects, which can lead to diarrhea<sup>43</sup>. Hence, various new concepts for the safer treatment of IBD without these side effects are desirable. The majority of commercial available colon-targeted products containing 5-ASA is based on pH-dependent concept (Table 3). Most commonly used polymers for controlled release preparations are methacrylic acid copolymers—Eudragit® L 100-55, Eudragit® L 100, Eudragit® S 100, which dissolve at pH 5.5, 6.0, and 7.0, respectively<sup>46</sup>. Inter- and intra-individual

variability, the similarity in pH between the small intestine and the colon, and very different data of the colonic pH in patients with IBD in literature make pH-dependent systems less reliable and site-specificity of drug release in colon more unpredictable<sup>47,48</sup>. However, in CD with the inflammation throughout the intestinal tract these forms can be valuable. Controlled release mechanism of mesalazine through semipermeable ethyl cellulose membrane (Pentasa) tends a time-dependent release of the drug, starting in the duodenum and proceeding till rectum. Pentasa is pH-independent formulation containing mesalazine pellets with moisture-sensitive membrane and is available as a tablet, a capsule, or a sachet<sup>3</sup>. Therefore, Pentasa preparation is as well more useful for CD patients who often have inflammation of the small intestine<sup>49</sup>. On the other side, time-dependent systems confront the complication in predicting the accurate location of drug release due to inherent variability in GI transit times. The onset of initial drug release occurred in the small intestine in some subjects, whereas in others the formulations passed ascending colon intact. Moreover, accelerated GI transit in patients with UC has been observed<sup>47,48,50</sup>. Hence, these factors limit time-dependent systems for colon delivery especially in IBD. On the other hand, microflora-activated systems seem to be very promising for specific colon-targeting, because they are independent of pH and transit time variations along the GI tract and the drug release starts upon activation after arrival into the colon<sup>51</sup>. Bacteria population, which is essentially absent from the stomach or the small intestine, increases sharply in the colon<sup>52</sup>. These anaerobic bacteria produce a wide range of degrading enzymes. A number of naturally occurring polysaccharides are stable in the upper GI tract, but they are degraded by the colonic bacteria<sup>51</sup>. Hence, diverse polysaccharides, such as pectin, guar gum, amylose, chitosan, and so on, have been designed and applied for colonic delivery systems<sup>53-57</sup>. Nevertheless, the colonic microflora varies substantially between individuals, reflecting diet, age, and disease and thus microbially triggered drug delivery could be altered<sup>58</sup>. It may be concluded that each of these approaches represents a unique system in terms of design with some advantages, but has certain shortcomings, and

Table 2. Oral 5-ASA prodrugs and their dosage forms (adapted from refs. 35, 36, 38, and 41).

Product	Drug	Dosage form	Formulation	Site of delivery	Drug content
Azulfidine Salazopyrine	Sulfasalazine	Tablet	5-ASA linked to sulfapyridine by azo-bond	Colon	500 mg (200 mg 5-ASA)
Azulfidine EN-tabs Salazopyrine EN-tabs	Sulfasalazine	Tablet coated with cellulose acetate phthalate	5-ASA linked to sulfapyridine by azo-bond	Colon	500 mg (200 mg 5-ASA)
Colo-Pleon	Sulfasalazine	Tablet coated with Eudragit® L 100-55	5-ASA linked to sulfapyridine by azo-bond	Colon	500 mg
Dipentum	Olsalazine	Capsule	5-ASA dimer linked by azo-bond	Colon	250 mg (225 mg 5-ASA)
Colazide	Balsalazide	Capsule	5-ASA linked to 4-amino benzoyl- $\beta$ -alanine (inert carrier) by azo-bond	Colon	750 mg (262 mg 5-ASA)
Colazal		Tablet (clinical testing)			1100 mg (400 mg 5-ASA)

Table 3. Mesalazine preparations used in oral application (adapted from refs. 14, 21, 36, 38, 41, 47, and 76).

Product	Formulation	Release pH	Site of delivery	Drug content
Asacol	Eudragit® S-coated tablets (delayed release)	pH > 7	Terminal ileum	400 mg
Asacolitin			Colon	800 mg
Ipocol	Eudragit® L-coated tablets (delayed release)	pH > 6	Jejunum	250 mg
Mesren			Terminal ileum	500 mg
Pentacol			Colon	
Salofalk				
Mesasal Claversal	Ethyl cellulose-coated pellets available as capsule, tablet, or sachet (slow continuous controlled release, time-dependent release)	Release via diffusion	Duodenum	250 mg
Calitofalk			Jejunum	500 mg tbl, cps
Pentasa			Ileum	1000 mg
			Colon	2000 mg sachet
			Rectum	
Apriso	Eudragit® L-coated matrix granules with polyacrylic polymer in the core available in gelatin capsule (delayed, extended, and continuous release)	pH > 6	Small bowel	375 mg
			Colon	
Salofalk Granu-Stix	Eudragit® L-coated matrix granules with Eudragit® NE 40D in the core, available in a sachet (delayed and sustained release)	pH > 6	Distal small bowel	500 mg
			Colon	1000 mg
				1500 mg
Lialda (USA)	Eudragit® L- and Eudragit® S-coated lipophilic and hydrophilic matrix tablets (delayed release)	pH > 7	Terminal ileum	1200 mg
Mezavant (EU)			Colon	

at present no ideal system for colon-specific drug delivery exists for the treatment of IBD.

### Single unit forms versus multiparticulate systems

Pellets as a multiparticulate drug delivery system offer the benefits as compared with conventional preparations, such as tablets. The size of pellets (~1 mm) guarantees their continuous and unhindered transit through the GI tract and thus they are less influenced by gastric emptying and intestinal transit<sup>42,59</sup>. Hence, the pellets can be taken independently from meals<sup>39</sup>. In addition, in the colon, pellets are slowly diffused over a wide area and are retained longer in the ascending colon than a tablet (28 h compared with 15 h, respectively) that could be favorable in the treatment of IBD, where local concentrations at the sites of inflammation are required<sup>60-62</sup>. Furthermore, pellets that are easier to swallow and as effective as tablets seem to enable a larger dose to be taken comfortably and conveniently, thereby potentially improve patients' compliance, treatment response, and quality of life<sup>63,64</sup>. Moreover, pellets could be widely and uniformly dispersed in the GI tract surfaces, which on the one hand increase the drug-tract contact surface and thus improve drug bioavailability and on the other hand reduce local irritation<sup>47,59,65</sup>. Finally, the release failure of the individual unit hardly affects the total release behavior due to the multiple units, thus risk of systemic toxicity is reduced<sup>47,59</sup>.

### Pellet characteristics and preparation

Pellets are small, free-flowing, spherical particles of drugs and excipients; they possess narrow size distribution and

for pharmaceutical purposes they have a diameter of 0.5–2.0 mm. Pellets are prepared using several pelletization methods such as solution, suspension, or dry powder layering on inactive starters, extrusion/spheronization, rotoagglomeration, spray drying, or spray congealing<sup>66</sup>.

Solution or suspension layering is the oldest pelletization technique in which drug solution or its suspension is sprayed onto inactive spherical particles of sucrose or microcrystalline cellulose (MCC) in fluid bed equipment or coaters. These pellets are uniform in size distribution and exhibit very good surface morphology. In dry powder layering process, inactive starters are wetted with an adhesive solution in a rotating pan, rotoprocessor, or rotoagglomerator, and drug powder is added simultaneously. Lower drug loading up to 50% is main disadvantage of the layering process. Homogeneous particles of matrix structure also cannot be prepared by this method. Mechanical properties of layered pellets, that is, their hardness and friability depend to certain degree on the properties of starter used<sup>67</sup>.

Extrusion/spheronization, which is widely used in pharmaceutical industry, was developed in Japan in 1964. It comprises four main steps: wetting of homogenized dry powder mixture of a drug and excipients; extrusion when the plastic mass is passed through the extruder to form rods of spaghetti-like structure; spheronization including breaking of extrudate to short cylinders, converting them to spheres and smoothing their surface; and drying step using various drying procedures<sup>68,69</sup>. Particles of high drug loading up to 90%, homogeneous matrix structure, uniform size, and good mechanical properties could be achieved. Main disadvantage of this method is a several steps process.

Rotoagglomeration in rotoagglomerators or rotoprocessors is a newer pelletization method starting with

homogenized dry powder mixture that is wetted and turned into the spheres by the action of three forces: centrifugal, fluidization, and gravitational. Pellets are dried and can be coated in the same equipment, and this is main advantage of this method. Particles of homogeneous matrix structure and drug content of 65% can be obtained. Their particle size distribution is however broader than that resulting from the above mentioned two methods<sup>70,71</sup>.

Spray drying is a method of converting solution or suspension droplets into porous spherical particles by hot air in a production chamber. It is used generally to form fast-dissolving particles<sup>72</sup>. Spray congealing involves cold air to solidify droplets of a melted liquid or dispersion. Particles of prolonged drug release can be obtained<sup>73</sup>.

Spherical pellets have ideal shape for coating application. Coated or uncoated particles can easily modify the release profile of drugs and therefore are widely used in controlled drug release. In general, they are semi-products and turn into the final medicament when filled into hard capsules or carefully compressed into disintegrating tablets.

### From promising candidates to commercialized products

The main objective in the treatment of IBD is to deliver drugs to the sites of inflammation to achieve maximal drug concentration and to reduce side effects due to the abrupt release of drug in the upper GI tract. In this context, many research groups have attempted to develop various multiparticulate systems for successful colon-specific drug delivery. First, novel 5-ASA formulations, that is, promising candidates for the treatment of IBD evaluated *in vitro* are reported; second, systems containing 5-ASA tested *in vivo* in trinitrobenzene sulfonic acid (TNBS)-induced rat colitis model are mentioned; and finally, multiparticulate-commercialized 5-ASA formulations administered to healthy volunteers or IBD patients in a clinical trials are presented.

#### In vitro evaluation

Gupta et al.<sup>74</sup> prepared layered 5-ASA pellets and studied the influence of multiple coatings from aqueous dispersions of polymethacrylates on drug release. Inner coating layer consisted of Eudragit<sup>®</sup> RL and RS (2:8), and outer layer of Eudragit<sup>®</sup> FS of different coating levels (15–30%). Eudragit<sup>®</sup> FS 30D is a new polymer resin composed of methacrylic acid, methacrylate, and methylmethacrylate, which dissolves rapidly at pH  $\geq$  7.5. Dissolution testing involved media of two different pH values in each set, that is, first the samples were exposed to 0.1 N hydrochloric acid for 2 h and then they were transferred into the buffers of pH 6.5 or 7.0 or 7.5, respectively, for 12 h. No drug release was observed at pH 6.5. At pH 7.0, prolonged 5-ASA release after a lag time of 15–60 min depending on the coating level was determined. Similarly, at pH 7.5 again prolonged drug release was measured, but without

lag time at any of the coating levels. With respect to the obtained results, this delivery system might prove successful for the drug transport to the ileo-colonic part of GI tract in a sustained-release fashion.

Zambito and Di Colo<sup>75</sup> studied *in vitro* the release of 5-ASA from chitosan matrices of 50 mg weight and 6 mm diameter obtained by the compression of 5-ASA with chitosan or chitosan hydrochloride microspheres. Drug release study was carried out in phosphate-buffered saline (PBS) pH 7.4 after 4 h of incubation in rat cecal contents or in bicarbonate buffer pH 7.0. All (100%) or almost all (90%) the drug amount was released from the chitosan hydrochloride-based matrices after 2.5 h at pH 7.4 depending on the incubation in rat cecal contents or a bicarbonate, respectively. The drug release from chitosan-based matrices was lower (70%) and independent of the incubation buffer used at the same time and conditions. For *in vivo* application, the matrices are supposed to be filled into enteric-coated capsules to prevent the drug release in upper GI tract.

In another study, Rudolph et al.<sup>14</sup> compared the dissolution profiles of 5-ASA pellets prepared by extrusion/spheronization and coated either with Eudragit<sup>®</sup> FS 30D dispersion or with Eudragit<sup>®</sup> S organic solution or aqueous dispersion. Dissolution testing was performed for 6 h in different media of pH 1.2, 6.0, 6.5, 6.8, 7.2, or 7.5, respectively. No drug release was observed at pH 1.2, 6.0, and 6.5 and its release was slow at pH 6.8. The release of 5-ASA from Eudragit<sup>®</sup> FS-coated pellets was in the average about 20% an hour at pH 7.2 and was completed within 2 h at pH 7.5. For pellets coated with Eudragit<sup>®</sup> S, fast release was observed at pH 7.2 and 7.5. The multiunit dosage form coated with Eudragit<sup>®</sup> FS 30D exhibited release pattern more appropriate to the pH profile of the ileum and the colon observed in UC patients and reported in some articles<sup>76,77</sup>.

Milojevic et al.<sup>78</sup> presented 5-ASA pellets prepared using extrusion/spheronization and subsequently coated by amylose-Ethocel<sup>®</sup> coating (1:4). For drug release studies, dissolution medium of 0.1 M HCl with pepsin was used for the first 3 h and the test continued in PBS of pH 7.2 with pancreatin for an additional 21 h. No drug release was observed in pH 1.2, and only 10% of 5-ASA was released after next 21 h in pH 7.2. *In vitro* fermentation studies were performed in batch culture fermenter with mixed fecal bacteria. Gut microflora was capable to degrade amylose-Ethocel<sup>®</sup> coating and the drug release was almost completed after 8 h. These results indicate that this coating could be used for a range of drugs requiring their delivery into the colon.

Calcium alginate beads as core carriers of 5-ASA coated with inner Aquacoat<sup>®</sup> film and outer layer of Eudragit<sup>®</sup> L 30D have also been studied for drug delivery into the lower intestinal tract<sup>79</sup>. Dissolution started in acidic medium of pH 1.4 for 2 h, and afterward the medium was changed with simulated intestinal fluid of pH 7.4 for 22 h. Outer coating prevented 5-ASA dissolution in acidic medium and then the drug release rate was controlled by the inner film and alginate in the core. This dosage form



is reported to deliver a drug to the ileo-colonic part in a sustained released fashion with minimal early release in the upper GI tract.

Cheng et al.<sup>59</sup> reported 5-ASA pellets produced by extrusion/spheronization and coated with Eudragit® L 100 and Eudragit® S 100 (1:4). For drug release, three dissolution media of different pH values 1.2, 6.0, and 7.2 were sequentially used. Drug was released <1.0% in pH 1.2 until 2 h, and <3.0% in pH 6.0 PBS at 1 h after 2 h. When the buffer of pH 7.2 was employed, >80% of 5-ASA was released after 1.5 h. Thus this formulation could achieve pH-specific drug delivery under pH 7.2.

Different coating composed of nutriose:ethyl cellulose (1:3 to 1:5) was studied on pellets with 5-ASA prepared using extrusion/spheronization<sup>60</sup>. Nutriose is a starch derivative, which is preferentially degraded by microflora enzymes in the colon of IBD patients compared with healthy people<sup>61</sup>. Dissolution studies were performed in three media of pH 1.2 (2 h), 6.8 (9 h), and 7.0 containing fresh fecal samples from IBD patients (10 h). The release of 5-ASA was suppressed in pH 1.2 and 6.8 corresponding to the upper GI tract conditions, but the release rate significantly increased in the last medium. Proposed formulation provides an interesting approach of a colon-targeted system.

From the above mentioned experiments, it can be concluded that the appropriate dissolution method using buffers simulating pH values in different GI tract parts of IBD patients as accurately as possible for time intervals corresponding to the residence times in stomach and intestine, and including either fecal bacterial enzymes or  $\beta$ -glucosidase in the medium mimicking colonic compartment<sup>62</sup>, would be crucial for the *in vitro* evaluation of 5-ASA colon-targeted systems.

Nevertheless, the promising candidates for novel developed preparations selected in *in vitro* testing should be considered carefully and necessitate always *in vivo* investigations to verify their efficacy, because *in vitro* data cannot reflect inflammatory state in IBD.

### Preclinical studies in animals

Several models of experimental colitis have been developed to investigate the molecular and cellular mechanisms of inflammation and immunological disorders. Currently, hapten-induced colitis, in which TNBS shares important similarities with human CD such as transmural inflammation, lymphocyte infiltration, Th1-dominated cytokine profile, and stricture formation. This model is suitable to study anti-inflammatory agents and/or their delivery systems during the course of developing and resolving inflammation<sup>63,64</sup>.

Wei et al.<sup>65</sup> reported bacterially triggered film-coated pellets efficient for colonic targeting and effective in the treatment of IBD in rats. 5-ASA pellets were prepared by extrusion/spheronization (the formulation comprised 5-ASA, lactose, and MMC) and coated with chitosan/Kollocoat SR 30D film. The coated pellets were tested for drug release for 2 h in 0.1 M HCl, the study was continued

for 3 h at pH 6.8 and finished in a PBS pH 6.8 with cecal content or  $\beta$ -glucosidase for 10 h. Only a small amount of 5-ASA was released from the coated pellets in the upper GI tract conditions and its release increased in the presence of rat cecal bacterial enzymes or  $\beta$ -glucosidase enzyme. For *in vivo* evaluation, pellets were administered to TNBS-induced colitis in rats. A significant decrease of colonic damage score was observed after oral administration of pellets compared with the untreated colitis control group. Colon/body ratio was found to be lower and level of myeloperoxidase activity in the colon was markedly decreased in comparison with the colitis control. The coated pellets provided an effective and prolonged local therapeutic concentration for the treatment of IBD with a potential of reducing the adverse effects.

Another approach for colon-specific delivery was presented in the study of Mladenovska et al.<sup>66</sup> 5-ASA-loaded alginate microparticles were prepared by spraying of aqueous dispersion of alginate and 5-ASA into the solution of chitosan and CaCl<sub>2</sub> in acetic acid placed in the apparatus collector. Drug release studies were performed in different dissolution media and correspondent residence times were included: stomach—120 min. (pH 1.2, 0.1 M HCl), duodenum—10 min (pH 6.0, PBS), jejunum—120 min (pH 6.8, PBS), and ileum-colon (a suspension of fresh rat cecal content in bicarbonate buffer pH 7.0) until 24 h. In conditions simulating gastric content, the 5-ASA release was about 27%, with increasing pH, slower release was observed (2 h after the pH change to 6.8 only 34% of drug was released). The release was completed in simulated colonic conditions in 24 h. The particles were administered orally to rats with TNBS-induced colitis. The sixth day maximal activity of inflammation was observed. From eighth to the 21st day, the decrease in colonic inflammation was proved (total damage score, colon/body weight ratio, myeloperoxidase activity decrease). For biodistribution studies, radiolabeled [<sup>131</sup>I] 5-ASA microparticles and [<sup>131</sup>I] 5-ASA as an aqueous suspension were compared. Dominant localization of 5-ASA in the colon and smaller amount of systemically absorbed 5-ASA were observed when microparticles were administered. Thus this microparticle system may be promising for clinical treatment of colonic IBD.

Eudragit® FS 30D coating (15% w/w) was applied on 5-ASA pellets prepared using extrusion/spheronization and consisting either of the drug (30%), MCC (25%), and chitosan (45%) or the drug (30%) and MCC (70%)<sup>67</sup>. Three continual dissolution tests using the media of different pH values, that is, 1.2, 4.0, 6.8, and 7.5 were used. First 5 h, the dissolution was performed in the same dissolution media, that is, pH 1.2 for 2 h and pH 6.8 for 3 h, mimicking thus the upper part of GI tract. Then either pH of 7.5 for the remaining 15 h or for 0.5 h following pH 4.0 for the next 14.5 h was used, respectively. Third testing was done in pH 4.0 from fifth to 15th hour simulating the lowest pH value described in the inflamed colon. Very slow drug release has been observed when maximal pH value of dissolution medium reached only

6.8, that is, 31.47% or 9.38% of 5-ASA was released from chitosan containing coated pellets and pellets without chitosan, respectively, at the end of the dissolution test. On the other hand, complete drug release was determined 1 h after the pH change to 7.5 (lag time 5 h) in pellets containing chitosan, and 4–15 h after this pH change in pellets without chitosan depending on the medium used. Pellets were tested *in vivo* on rats with TNBS-induced colitis. Clinical activity score, colon/body weight ratio, and myeloperoxidase activity were determined to quantify the severity of the colitis. In all treated groups, all the observed parameters decreased and reduced significantly the inflammation in colon. Slight anti-inflammatory effect of chitosan was also observed in accordance with recently published data<sup>88,89</sup>. Based on the results obtained *in vitro* and confirmed *in vivo* on rats, this novel Eudragit® FS coating used in a combination of either chitosan/MCC or MCC in the pellet core can control very well 5-ASA colonic release within extended time period from 1 to 15 h.

The results of *in vivo* studies for promising multiparticulate systems developed for the treatment of IBD have to provide the information of therapeutic effects (determination of colon/body weight ratio, assessment of the damage score, measurement of myeloperoxidase activity, TNF- $\alpha$ , etc.), biodistribution data (confirmation of the dominant localization of 5-ASA in the colon), and pharmacokinetic data (demonstration of low systemic bioavailability).

### Clinical studies

Three hundred sixty-two patients with mild-to-moderate UC were enrolled in the randomized-controlled trial to compare the efficacy and the tolerability of 5-ASA pellets with a tablet formulation<sup>63</sup>. Pellets were administered orally as one sachet of 1.5 g, taken twice daily, tablets as two 500 mg dose, taken three times daily, both in the period of 8 weeks. Pellets were as effective as tablets in UC patients, allowed less frequent dosing in an easier to swallow formulation that could improve patient compliance, treatment response, and quality of life.

In another study by Farup et al.<sup>15</sup>, 227 patients with mild-to-moderate UC were randomized to the treatment either with prolonged-release pellets or prolonged-release tablets for 8 weeks. 5-ASA (4 g daily) given as pellets twice and four times daily, supplied in packets of 1 g, was found at least as effective as tablets containing 500 mg of the drug four times daily. In addition, the twice-daily dosing regimen was preferred by the patients.

Thirteen patients with UC and CD were enrolled in the pharmacokinetics study of mesalazine pellets coated with Eudragit® L (Salofalk®) in children<sup>64</sup>. Plasma and urinary concentrations of 5-ASA were determined. It has been demonstrated that about 80% of the parent drug was delivered to the colon that provide a higher local activity in colonic mucosa and lower systemic absorption of 5-ASA as compared with Salofalk® tablets. Salofalk® tablets were examined in earlier multiple

dosing study in children by Klotz<sup>90</sup>. In comparison with previous experience in adults<sup>35</sup>, pharmacokinetics of mesalazine administered as pellets appear to be similar in both populations<sup>64</sup>.

A study of GI spread of oral prolonged-release mesalazine pellets (Pentasa) dosed either as tablets (2 × 500 mg) or sachets (1 g) was undertaken in eight healthy volunteers<sup>62</sup>. *In vitro* dissolution profile at pH 7.5 and *in vivo* disposition of the pellets in terms of gastric emptying, small intestinal transit, and colon arrival was comparable. Sachet with 1 g dose offers the advantage of fewer oral doses and easier swallowing.

Brunner et al.<sup>39</sup> investigated GI transit and release of 5-ASA from pellets versus tablets administered as single dose of 500 mg of 5-ASA in 14 healthy male volunteers. The GI transit of <sup>153</sup>Sm, incorporated into the formulations, was followed by gamma-scintigraphy. The dissolution tests were carried out in buffer at pH 1.2 for 2 h, and then at pH 6.8 for 1 h (tablets) or 5 h (pellets). The lower dissolution rate was measured for pellets (>85% of the drug released after 5 h in pH 6.8) than for tablets (>85% of the drug released after 30 min in pH 6.8). Drug release was verified by assessing 5-ASA plasma pharmacokinetics. The both formulations released active 5-ASA in the same target region and passed through the GI tract under fasting conditions in comparable times (3.3 ± 1 and 3.8 ± 1 h for pellets and tablets, respectively). However, area under the curve (AUC) values of plasma were significantly lower for pellets when compared with tablets (968 ± 629 ng h/mL and 2206 ± 1767 ng h/mL, respectively). This finding was explained by the more prolonged drug release from the pellets found *in vitro* assuming that this release will remain constant also *in vivo*. Slower and more prolonged release of 5-ASA passage through the stomach independent of concomitant food intake and better palatability gets more advantages for pellets compared with tablets.

Roda et al.<sup>76</sup> conducted a randomized study in 23 healthy volunteers comparing pharmacokinetics of new enteric-coated pellet formulation administered in 1.2 g sachets in one dose with an equimolar dose of three separated enteric-coated commercially available tablets (Pentacol, 400 mg). New formulation is composed from 5-ASA pellets (5-ASA, MCC, carmellose sodium [CMCNa]) coated with Eudragit® S 100 and Eudragit® L, which ensure a complete release of the active ingredient at pH 7.5 after 45 min. The  $C_{max}$  and AUC values were similar for both formulations (1554 ± 612 ng/mL, 28120 ± 7820 ng h/mL for pellets and 1471 ± 585 ng/mL, 28770 ± 9770 ng h/mL for the tablets, respectively). The use of pellet formulation allows to reduce the daily dosages and to improve the patients' compliance.

Frequently, clinical studies are conducted in healthy volunteers and do not take in consideration pathophysiological conditions associated with IBD as accelerated transit time, alternation colonic microflora, and so on. Clinical studies carried out in IBD patients showed equal efficacy of multiparticulate formulations and tablets.

Simplified dosage regimen and easier administration make multiparticulate systems preferable in patients and resulting in presumably improved long-term compliance.

### Novel 5-ASA preparations on the market

New mesalazine formulations include coated granules (Apriso and Salofalk Granu-Stix) and multimatrix tablets (Lialda, Mezavant)<sup>5,36,38</sup>.

In Apriso (Table 3), 5-ASA is incorporated in retarding polyacrylate multiparticulate matrix core that allows drug release after a 6- to 7-h period throughout the terminal ileum and colon. The core is protected with Eudragit® L coating that dissolves at pH  $\geq 6$ , which means a benefit for the patients with bowel pH  $< 7$ . These coated granules are filled into gelatin capsule that dissolves quickly in the stomach to disperse particles into the digestive tract. Capsules combine delayed, extended, and continuous-release mechanisms and could be administered as a single dose, with or without a food. A once-a-day dosing encourages compliance in patients<sup>5,32,91</sup>.

Salofalk Granu-Stix® represents mesalazine multiparticulate formulation in a sachet (Table 3). Matrix cores containing 5-ASA and retarding polymer Eudragit® NE 40D are coated with Eudragit® L. Eudragit® NE 40D is aqueous dispersion of a neutral copolymer based on ethyl acrylate and methyl methacrylate. It is insoluble but swellable in water polymer with low permeability independent on pH. Due to its high flexibility, it requires no plasticizer and is suitable for matrix structures<sup>91</sup>. Coated matrix granules enable delayed and prolonged release of the drug from small bowel until the colon or rectum<sup>92</sup>.

MMX mesalazine (Multi Matrix System; Lialda or Mezavant) is based on tablet coated with a gastro-resistant pH-dependent polymer film of Eudragit® L and Eudragit® S that provides drug release at a pH above 7.0, initiating in the terminal ileum and continuing throughout the colon (Table 3). Mesalazine in the amount of 1.2 g is embedded in lipophilic and hydrophilic matrices, which disintegrate slowly over 24 h. This MMX release system permits less frequent dosing (once or twice daily) with fewer tablets and is more appropriate for patients experiencing difficulty with a high pill burden<sup>5,36,38,80,93</sup>.

### Conclusion

It can be concluded that many improvements in drug delivery into the inflamed areas of the gut in IBD patients have been achieved in recent years. Multiparticulate dosage forms such as pellets showed their benefits, that is, prolonged presence close the site of action, improved drug bioavailability, and easier administration of large drug doses, compared with tablets. Furthermore, multiparticulate systems allow once-daily dosing regimen leading to the better patient compliance, therapeutic

efficacy, and diminution in risk of disease relapse. Several new multiparticulates were introduced to the market; others products are undergoing clinical studies; and many of these preparations are investigated. Thus microparticulates proved their great significance in the pharmacotherapy of IBD.

### Declaration of interest

The authors report no conflicts of interest. The authors alone are responsible for the content and writing of this article.

### References

- Hanauer SB. (2006). Inflammatory bowel disease: epidemiology, pathogenesis, and therapeutic opportunities. *Inflamm Bowel Dis*, 12 (Suppl 1):S3-S9.
- Baumgart DC, Sandborn WJ. (2007). Inflammatory bowel disease: clinical aspects and established and evolving therapies. *Lancet*, 369:1641-1657.
- Fiocchi C. (2002). Inflammatory bowel disease. Current concepts of pathogenesis and implications for therapy. *Minerva Gastroenterol Dietol*, 48:215-226.
- Elson CO, Sartor RB, Targan SR, Sandborn WJ. (2003). Challenges in IBD Research: updating the scientific agendas. *Inflamm Bowel Dis*, 9:137-153.
- Lichtenstein GR. (2009). Mesalamine in the treatment of ulcerative colitis: novel therapeutic options. *Gastroenterol Hepatol*, 5:65-73.
- D'Haens G, Hommes D, Engels L, Baert F, van der Waaaj L, Connor P et al. (2006). Once daily MMX mesalazine for the treatment of mild-to-moderate ulcerative colitis: a phase II, dose-ranging study. *Aliment Pharmacol Ther*, 24:1087-1097.
- Ando T, Watanabe O, Nobata K, Ishiguro K, Maeda O, Ishikawa D et al. (2008). Immunological status of the stomach in inflammatory bowel disease—comparison between ulcerative colitis and Crohn's disease. *Digestion*, 77:145-149.
- Gariballa SE, Gunasekera NP. (1994). Bilateral foot drop, weight loss and rectal bleeding as an acute presentation of Crohn's disease. *Postgrad Med J*, 70:762-763.
- Tresca AJ. (2009). The differences between ulcerative colitis and Crohn's disease. *About.com Guide* [Online]. Available at: <http://ibd.crohns.about.com/od/ulcerativecolitis/a/diffucd.htm>. Updated on May 2, 2009.
- Low RN, Sebrecchts CP, Politoske DA, Bennett MT, Flores S, Snyder RJ et al. (2002). Crohn disease with endoscopic correlation: single-shot fast spin-echo and gadolinium-enhanced fat-suppressed spoiled gradient-echo MR imaging. *Radiology*, 222:652-660.
- Guthery SL. (2007). Inflammatory bowel disease as a complex genetic disease [Online]. Available at: [http://jorde-lab.genetics.utah.edu/medstudents\\_2007/Guthery\\_IBD\\_lecture.pdf](http://jorde-lab.genetics.utah.edu/medstudents_2007/Guthery_IBD_lecture.pdf)
- Wijmenga C. (2005). Expressing the differences between Crohn disease and ulcerative colitis. *Plos Med*, 2:e230; quiz e304.
- Frieri G, Giacomelli R, Pimpo M, Palumbo G, Passacantando A, Pantaleoni G et al. (2000). Mucosal 5-aminosalicylic acid concentration inversely correlates with severity of colonic inflammation in patients with ulcerative colitis. *Gut*, 47:410-414.
- Rudolph MW, Klein S, Beckert TE, Petereit H, Dressman JB. (2001). A new 5-aminosalicylic acid multi-unit dosage form for the therapy of ulcerative colitis. *Eur J Pharm Biopharm*, 51:183-190.
- Farup PG, Hinterleitner TA, Lukás M, Hébuterne X, Rachmilewitz D, Campieri M et al. (2001). Mesalazine 4g daily given as prolonged-release granules twice daily and four times daily is at least as effective as prolonged-release tablets four times daily in patients with ulcerative colitis. *Inflamm Bowel Dis*, 7:237-242.

16. Hawthorne AB, Rubin G, Ghosh S. (2008). Review article: medication non-adherence in ulcerative colitis—strategies to improve adherence with mesalazine and other maintenance therapies. *Aliment Pharmacol Ther*, 27:1157–1166.
17. Shale MJ, Riley SA. (2003). Studies of compliance with delayed-release mesalazine therapy in patients with inflammatory bowel disease. *Aliment Pharmacol Ther*, 18:191–198.
18. Han SW, McColl E, Barton JR, James P, Steen IN, Welfare MR. (2005). Predictors of quality of life in ulcerative colitis: the importance of symptoms and illness representations. *Inflamm Bowel Dis*, 11:24–34.
19. Lakatos PL, Lakatos L. (2008). Once daily 5-aminosalicylic acid for the treatment of ulcerative colitis; are we there yet? *Pharmacol Res*, 58:190–195.
20. Prantera C, Rizzi M. (2009). 5-ASA in ulcerative colitis: improving treatment compliance. *World J Gastroenterol*, 15:4353–4355.
21. Sandborn WJ. (2008). Oral 5-ASA therapy in ulcerative colitis: what are the implications of the new formulations? *J Clin Gastroenterol*, 42:338–344.
22. Egan LJ, Sandborn WJ. (1998). Drug therapy of inflammatory bowel disease. *Drugs Today*, 34:431–446.
23. Talero E, Sánchez-Fidalgo S, Calvo JR, Motilva V. (2007). Chronic administration of galanin attenuates the TNBS-induced colitis in rats. *Regul Pept*, 141:96–104.
24. Sands BE. (2000). Therapy of inflammatory bowel disease. *Gastroenterology*, 118:S68–S82.
25. Reinecker HC, Steffen M, Witthoef T, Pflueger I, Schreiber S, MacDermott RP et al. (1993). Enhanced secretion of tumour necrosis factor- $\alpha$ , IL-6, and IL-1 beta by isolated lamina propria mononuclear cells from patients with ulcerative colitis and Crohn's disease. *Clin Exp Immunol*, 94:174–181.
26. Cabrero A, Laguna JC, Vázquez M. (2002). Peroxisome proliferator-activated receptors and the control of inflammation. *Curr Drug Targets Inflamm Allergy*, 1:243–248.
27. Hanauer SB. (2004). Medical therapy for ulcerative colitis 2004. *Gastroenterology*, 126:1582–1592.
28. Kornbluth A, Sachar DB; Practice Parameters Committee of the American College of Gastroenterology. (2004). Ulcerative colitis practice guidelines in adults (update): American College of Gastroenterology, Practice Parameters Committee. *Am J Gastroenterol*, 99:1371–1385.
29. Campieri M, Ferguson A, Doe W, Persson T, Nilsson LG. (1997). Oral budesonide is as effective as oral prednisolone in active Crohn's disease. The Global Budesonide Study Group. *Gut*, 41:209–214.
30. van Dieren JM, Kuipers EJ, Samsom JN, Nieuwenhuis EE, van der Woude CJ. (2006). Revisiting the immunomodulators tacrolimus, methotrexate, and mycophenolate mofetil: their mechanisms of action and role in the treatment of IBD. *Inflamm Bowel Dis*, 12:311–327.
31. Markowitz J. (2008). Current treatment of inflammatory bowel disease in children. *Dig Liver Dis*, 40:16–21.
32. Kruis W, Bar-Meir S, Feher J, Mickisch O, Mlitz H, Faszczuk M et al. (2003). The optimal dose of 5-aminosalicylic acid in active ulcerative colitis: a dose-finding study with newly developed mesalamine. *Clin Gastroenterol Hepatol*, 1:36–43.
33. Sutherland L, Macdonald JK. (2006). Oral 5-aminosalicylic acid for induction of remission in ulcerative colitis. *Cochrane Database Syst Rev*, 4:CD000543.
34. Bernstein CN, Eaden J, Steinhart AH, Munkholm P, Gordon PH. (2002). Cancer prevention in inflammatory bowel disease and the chemoprophylactic potential of 5-aminosalicylic acid. *Inflamm Bowel Dis*, 8:356–361.
35. Sandborn WJ, Hanauer SB. (2003). Systematic review: the pharmacokinetic profiles of oral mesalazine formulations and mesalazine pro-drugs used in the management of ulcerative colitis. *Aliment Pharmacol Ther*, 17:29–42.
36. Sandborn WJ. (2007). New advances in 5-ASA therapy for ulcerative colitis. *Medscape gastroenterology* [Online]. Available at: <http://cme.medscape.com/viewarticle/553568>. Accessed on March 3, 2007.
37. Pierce D, Martin P, Kern M, Homolka R. (2007). MMX™ Mesalazine: a pharmacokinetic evaluation of dose proportionality and the effect of food. *Gut*, 56 (Suppl 3):A158.
38. Ng SC, Kamm MA. (2008). Review article: new drug formulations, chemical entities and therapeutic approaches for the management of ulcerative colitis. *Aliment Pharmacol Ther*, 28:815–829.
39. Brunner M, Greinwald R, Kletter K, Kvaternik H, Corrado ME, Eichler HG et al. (2003). Gastrointestinal transit and release of 5-aminosalicylic acid from <sup>153</sup>Sm-labelled mesalazine pellets vs. tablets in male healthy volunteers. *Aliment Pharmacol Ther*, 17:1163–1169.
40. Chourasia MK, Jain SK. (2003). Pharmaceutical approaches to colon targeted drug delivery systems. *J Pharm Pharm Sci*, 6:33–66.
41. Leopold CS. (1999). Coated dosage forms for colon-specific drug delivery. *Pharm Sci Technol Today*, 2:197–204.
42. Marakhouski Y, Fixa B, Holomán J, Hulek P, Lukas M, Bátorvský M et al.; International Salofalk Study Group. (2005). A double-blind dose-escalating trial comparing novel mesalazine pellets with mesalazine tablets in active ulcerative colitis. *Aliment Pharmacol Ther*, 21:133–140.
43. Kles KA, Vavricka SR, Turner JR, Musch MW, Hanauer SB, Chang EB. (2005). Comparative analysis of the *in vitro* prosecretory effects of balsalazide, sulfasalazine, olsalazine, and mesalamine in rabbit distal ileum. *Inflamm Bowel Dis*, 11:253–257.
44. Loftus EV Jr, Kane SV, Bjorkman D. (2004). Systematic review: short-term adverse effects of 5-aminosalicylic acid agents in the treatment of ulcerative colitis. *Aliment Pharmacol Ther*, 19:179–189.
45. Harrell LE, Hanauer SB. (2004). Mesalamine derivatives in the treatment of Crohn's disease. *Gastroenterol Clin North Am*, 33:303–17, ix.
46. Khan MZ, Prebeg Z, Kurjakovic N. (1999). A pH-dependent colon targeted oral drug delivery system using methacrylic acid copolymers. I. Manipulation of drug release using Eudragit L100-55 and Eudragit S100 combinations. *J Control Release*, 58:215–222.
47. Asghar LF, Chandran S. (2006). Multiparticulate formulation approach to colon specific drug delivery: current perspectives. *J Pharm Pharm Sci*, 9:327–338.
48. Yang L, Chu JS, Fix JA. (2002). Colon-specific drug delivery: new approaches and *in vitro/in vivo* evaluation. *Int J Pharm*, 235:1–15.
49. Burakoff R. (2000). Crohn's disease of the small intestine. *Curr Treat Options Gastroenterol*, 3:59–68.
50. Klotz U. (2005). Colonic targeting of aminosalicylates for the treatment of ulcerative colitis. *Dig Liver Dis*, 37:381–388.
51. Sinha VR, Kumria R. (2004). Polysaccharide matrices for microbially triggered drug delivery to the colon. *Drug Dev Ind Pharm*, 30:143–150.
52. Linskens RK, Huijsdens XW, Savelkoul PH, Vandenbroucke-Grauls CM, Meuwissen SG. (2001). The bacterial flora in inflammatory bowel disease: current insights in pathogenesis and the influence of antibiotics and probiotics. *Scand J Gastroenterol*, 36(Suppl): 29–40.
53. Lee CM, Kim DW, Lee HC, Lee KY. (2004). Pectin microspheres for oral colon delivery: preparation using spray drying method and *in vitro* release of indomethacin. *Biotechnol Bioprocess Eng*, 9:191–195.
54. Ji CM, Xu HN, Wu W. (2009). Guar gum as potential film coating material for colon-specific delivery of fluorouracil. *J Biomater Appl*, 23:311–329.
55. Siew LF, Man SM, Newton JM, Basit AW. (2004). Amylose formulations for drug delivery to the colon: a comparison of two fermentation models to assess colonic targeting performance *in vitro*. *Int J Pharm*, 273:129–134.
56. Ferrari PC, Oliveira GF, Chibebe FCS, Evangelista RC. (2009). *In vitro* characterization of coevaporates containing chitosan for colonic drug delivery. *Carbohydr Polym*, 78:557–563.
57. Zhao W, Song L, Deng H, Yao H. (2009). Hydration, erosion, and release behavior of guar-based hydrophilic matrix tablets

- containing total alkaloids of *Sophora alopecuroides*. Drug Dev Ind Pharm, 35:594-602.
58. Edwards C. (1993). Interactions between nutrition and the intestinal microflora. Proc Nutr Soc, 52:375-382.
  59. Cheng G, An F, Zou MJ, Sun J, Hao XH, He YX. (2004). Time- and pH-dependent colon-specific drug delivery for orally administered diclofenac sodium and 5-aminosalicylic acid. World J Gastroenterol, 10:1769-1774.
  60. Abrahamsson B, Alpsten M, Jonsson UE, Lundberg PJ, Sandberg A, Sundgren M et al. (1996). Gastro-intestinal transit of a multiple-unit formulation (metoprolol CR/ZOK) and a non-disintegrating tablet with the emphasis on colon. Int J Pharm, 140: 229-235.
  61. Zhang H, Alsarra IA, Neau SH. (2002). An *in vitro* evaluation of a chitosan-containing multiparticulate system for macromolecule delivery to the colon. Int J Pharm, 239:197-205.
  62. Wilding IR, Kenyon CJ, Hooper G. (2000). Gastrointestinal spread of oral prolonged-release mesalazine microgranules (Pentasa) dosed as either tablets or sachet. Aliment Pharmacol Ther, 14:163-169.
  63. Raedler A, Behrens C, Bias P. (2004). Mesalazine (5-aminosalicylic acid) micropellets show similar efficacy and tolerability to mesalazine tablets in patients with ulcerative colitis—results from a randomized-controlled trial. Aliment Pharmacol Ther, 20:1353-1363.
  64. Wiersma H, Escher JC, Dilger K, Trenk D, Benninga MA, van Boxtel CJ et al. (2004). Pharmacokinetics of mesalazine pellets in children with inflammatory bowel disease. Inflamm Bowel Dis, 10:626-631.
  65. Kramar A, Turk S, Vrecer F. (2003). Statistical optimisation of diclofenac sustained release pellets coated with polymethacrylic films. Int J Pharm, 256:43-52.
  66. Ghebre-Sellassie I. (1989). Pellets: a general overview. In: Ghebre-Sellassie I, ed. Pharmaceutical Pelletization Technology. New York: Marcel Dekker, pp. 1-13.
  67. Gryczová E, Dvořáčková K, Rabišková M. (2009). Evaluation of pellet friability. Čes Slov Farm, 58:9-13.
  68. Pérez J, Rabišková M. (2002). Influence of the drying technique on theophylline pellets prepared by extrusion-spheronization. Int J Pharm, 242:349-351.
  69. Häring A, Vetchý D, Janovská L, Krejčová K, Rabišková M. (2008). Differences in characteristics of pellets prepared by different pelletization methods. Drug Dev Ind Pharm, 34:289-296.
  70. Krejčová K, Rabišková M, Vetchý D, Polásek E, Tomásek V, Prokopová A. (2006). The influence of drug solubility and particle size on the pellet formulation in a rotoprocessor. Drug Dev Ind Pharm, 32:585-593.
  71. Gu L, Liew CV, Heng PW. (2004). Wet spheronization by rotary processing—a multistage single-pot process for producing spheroids. Drug Dev Ind Pharm, 30:111-123.
  72. Vehring R. (2008). Pharmaceutical particle engineering via spray drying. Pharm Res, 25:999-1022.
  73. Emäs M, Nyqvist H. (2000). Methods of studying aging and stabilization of spray-congealed solid dispersions with carnauba wax. I. Microcalorimetric investigation. Int J Pharm, 197: 117-127.
  74. Gupta VK, Beckert TE, Price JC. (2001). A novel pH- and time-based multi-unit potential colonic drug delivery system. I. Development. Int J Pharm, 213:83-91.
  75. Zambito Y, Di Colo G. (2003). Preparation and *in vitro* evaluation of chitosan matrices for colonic controlled drug delivery. J Pharm Pharm Sci, 6:274-281.
  76. Roda A, Simoni P, Roda G, Caponi A, Pastorini E, Locatelli M et al. (2009). Pharmacokinetics and safety of a new 1200 mg single-dose delayed release mesalazine microgranule formulation. J Bioequiv Bioavail, 1:44-51.
  77. Press AG, Hauptmann IA, Hauptmann L, Fuchs B, Fuchs M, Ewe K et al. (1998). Gastrointestinal pH profiles in patients with inflammatory bowel disease. Aliment Pharmacol Ther, 12:673-678.
  78. Milojevic S, Newton JM, Cummings JH, Gibson GR, Botham RL, Ring SG et al. (1996). Amylose as a coating for drug delivery to the colon: preparation and *in vitro* evaluation using 5-aminosalicylic acid pellets. J Control Release, 38:75-84.
  79. Lin SY, Ayres JW. (1992). Calcium alginate beads as core carriers of 5-aminosalicylic acid. Pharm Res, 9:1128-1131.
  80. Karrouy Y, Neut C, Wils D, Siepmann F, Deremaux L, Flament MP et al. (2009). Novel polymeric film coatings for colon targeting: drug release from coated pellets. Eur J Pharm Sci, 37:427-433.
  81. Karrouy Y, Neut C, Wils D, Siepmann F, Deremaux L, Dubreuil L et al. (2009). Colon targeting with bacteria-sensitive films adapted to the disease state. Eur J Pharm Biopharm, 73:74-81.
  82. Dvořáčková K, Bautzová T, Rabišková M. (2011). Dissolution study in the evaluation of oral preparations with controlled drug release. Chem Listy, 105:50-54.
  83. Strober W, Lúdvíksson BR, Fuss JJ. (1998). The pathogenesis of mucosal inflammation in murine models of inflammatory bowel disease and Crohn disease. Ann Intern Med, 128:848-856.
  84. Lamprecht A, Ubrich N, Yamamoto H, Schäfer U, Takeuchi H, Maincent P et al. (2001). Biodegradable nanoparticles for targeted drug delivery in treatment of inflammatory bowel disease. J Pharmacol Exp Ther, 299:775-781.
  85. Wei H, Li-Fang F, Min B, Yong-Zhen C, Bai X, Qing D et al. (2010). Chitosan/Kollicoat SR 30D film-coated pellets of aminosaliculates for colonic drug delivery. J Pharm Sci, 99:186-195.
  86. Mladenovska K, Raicki RS, Janevik EI, Ristoski T, Pavlova MJ, Kavrakovski Z et al. (2007). Colon-specific delivery of 5-aminosalicylic acid from chitosan-Ca-alginate microparticles. Int J Pharm, 342:124-136.
  87. Bautzová T, Rabišková M, Lamprecht A. (2011). Mucoadhesive pellets for the treatment of inflammatory bowel disease. Int J Pharm, in press.
  88. Seo SB, Jeong HJ, Chung HS, Lee JD, You YO, Kajiuchi T et al. (2003). Inhibitory effect of high molecular weight water-soluble chitosan on hypoxia-induced inflammatory cytokine production. Biol Pharm Bull, 26:717-721.
  89. Kim KW, Thomas RL. (2007). Antioxidative activity of chitosans with varying molecular weights. Food Chem, 101:308-313.
  90. Klotz U. (1995). [5-Aminosalicylic acid and chronic inflammatory bowel diseases in children]. Klin Padiatr, 207:285-287.
  91. Evonik Industries. (2009). Eudragit® Application Guidelines, 11th Ed. Darmstadt: Evonik.
  92. Cohen RD, Lichtenstein GR, Safdi AV. (2008). 5-ASA treatment for ulcerative colitis: what's on the horizon? Gastroenterol Hepatol, 11 (Suppl 24):5-14.
  93. Grosso A. (2009). A review of mesalazine MR formulations in ulcerative colitis. Br J Clin Pharm, 1:333-336.



Contents lists available at SciVerse ScienceDirect

## International Journal of Pharmaceutics

journal homepage: [www.elsevier.com/locate/ijpharm](http://www.elsevier.com/locate/ijpharm)

## Coated chitosan pellets containing rutin intended for the treatment of inflammatory bowel disease: In vitro characteristics and in vivo evaluation

Miloslava Rabišková<sup>a,\*</sup>, Tereza Bautzová<sup>a,b</sup>, Jan Gajdziok<sup>a</sup>, Kateřina Dvořáčková<sup>a</sup>, Alf Lamprecht<sup>b</sup>, Yann Pellequer<sup>b</sup>, Jiřina Spilková<sup>c</sup>

<sup>a</sup> Department of Pharmaceutics, Faculty of Pharmacy, University of Veterinary and Pharmaceutical Sciences, Palackého 1-3, 612 42 Brno, Czech Republic

<sup>b</sup> Laboratory of Pharmaceutical Engineering, Faculty of Medicine and Pharmacy, University of Franche-Comté, Besançon, France

<sup>c</sup> Department of Pharmacognosy, Faculty of Pharmacy, Charles University, Hradec Králové, Czech Republic

## ARTICLE INFO

## Article history:

Received 28 July 2011

Received in revised form 21 October 2011

Accepted 22 October 2011

Available online 3 November 2011

## Keywords:

Colonic delivery

Coated pellets

Rutin

Chitosan

In vitro characteristics

In vivo evaluation

## ABSTRACT

Preparation of coated pellets intended for rutin colon delivery, their evaluation in vitro and in vivo in experimental colitis in rats was the purpose of this study. Pellets were obtained using extrusion/spheronization and coated with three types of coatings (caffeic acid/hypromellose/alginate; sodium alginate/hypromellose/zinc acetate; sodium alginate/chitosan). Dissolution using buffers of pH values,  $\beta$ -glucosidase and times corresponding to gastrointestinal tract (GIT) was provided. Pellets coated with alginate/chitosan showed low rutin dissolution (12–14%) in upper GIT conditions and fast release (87–89%) under colon conditions; that is a good presumption of intended rutin release. After colitis induction and development, the rats were treated with pellets and rutin solution administered orally, solution also rectally. Colon/body weight ratio, myeloperoxidase activity and histological evaluation were performed. Rutin was able to promote colonic healing at the dose of 10 mg/kg: colon/body weight ratio decreased and myeloperoxidase activity was significantly suppressed. Pellets coated with alginate/chitosan applied orally and rutin solution administered rectally showed the best efficacy. The combination of rutin as natural product, mucoadhesive chitosan degraded in the colon and sodium alginate as the main coating substance in the form of pellets create a promising preparation for therapy of this severe illness.

© 2011 Elsevier B.V. All rights reserved.

## 1. Introduction

Inflammatory bowel disease (IBD) comprises two idiopathic inflammatory diseases of intestinal tract: ulcerative colitis and Crohn's disease. IBD is a refractory, chronic, recurrent and non-specific inflammatory disorder characterized by the development of intestinal inflammation resulting from the transmural infiltration of neutrophils, macrophages, lymphocytes and mast cells, ultimately giving rise to mucosal disruption and ulceration (Baumgart and Sandborn, 2007). IBD is a serious illness, its exact etiology is poorly understood, and individual genetic background, heredity, environmental signals such as stress, and immunologic influences, may all contribute to this disease process (Fiocchi, 2002). The therapy is symptomatic and targets general inflammatory mechanisms (Bresci et al., 2002). Patients often receive intense (i.e., the dosage schedule with multiple tablets several times a day) and long-term therapy that frequently requires lifelong treatment and is followed by several side effects associated with high dose

intake (Farup et al., 2001). Drugs currently used in the treatment of IBD include 5-aminosalicylates as a standard therapy, corticosteroids in more severe inflammation, immunosuppressives and biological agents for patients who fail conventional therapy (Sands, 2000). It is well recognized that free radicals, including reactive oxygen metabolites and nitric oxide are produced in excess by the inflamed mucosa in IBD and may be responsible for a great deal of direct injury to the mucosa (Oldenburg et al., 2001). Thus the need of active substances with anti-oxidant activity delivered directly to the inflamed area seems to be an important issue in the treatment of IBD.

As flavonoids such as quercetin, quercitrin or rutin exhibit anti-oxidant and anti-inflammatory effects, they are the subjects of interest as potential drugs for the treatment of several diseases including IBD (Rabiskova et al., 2009). Contrary to quercetin, rutin absorption is limited in upper gastrointestinal (GI) tract due to its highly hydrophilic sugar part. Its use is more advantageous as it reaches the large intestine without significant chemical and biochemical loss. There, rutin is rapidly deglycosylated by colon microbiota to liberate its aglycone quercetin, which is absorbed easily into epithelial cells due to its lipophilicity. Thereafter, it enters the circulation and is subjected to *O*-methylation,

\* Corresponding author. Tel.: +42 5 41562860; fax: +42 5 49240589.  
E-mail address: [rabiskovam@vfu.cz](mailto:rabiskovam@vfu.cz) (M. Rabišková).

**Table 1**  
Pellet composition and characteristics.

Sample	1 <sup>x</sup>	2 <sup>x</sup>	3 <sup>x</sup>	4 <sup>x</sup>	5 <sup>y</sup>
Theoretical content (%)	30	30	30	30	30
Practical content (%)	28.12 ± 0.60	28.37 ± 0.40	28.50 ± 0.38	28.77 ± 0.49	28.55 ± 0.42
Mean diameter (mm)	0.79	0.74	0.77	0.78	0.80
Sphericity	0.83 ± 0.03	0.85 ± 0.04	0.83 ± 0.03	0.83 ± 0.05	0.83 ± 0.04
Porosity (%)	2.82 ± 0.11	3.32 ± 0.09	3.13 ± 0.10	3.06 ± 0.08	2.80 ± 0.01
Hardness (N)	10.54 ± 1.17	11.47 ± 1.16	9.35 ± 1.32	10.71 ± 1.42	18.06 ± 1.69
Friability (%)	0.15 ± 0.02	0.27 ± 0.01	0.21 ± 0.03	0.19 ± 0.02	0.09 ± 0.01
Repose angle	17° 34' ± 0° 40'	17° 28' ± 0° 54'	17° 14' ± 0° 35'	17° 31' ± 0° 48'	23° 18' ± 0° 58'
Hausner ratio	1.07	1.11	1.10	1.08	1.09
Coating <sup>z</sup>	a Caffeic acid 55% Alginic acid 25% HPMC K100M 20%	b – two layers 1. Na alginate 50% 2. HPMC E 25% Zn acetate 25%	c Na alginate 95% Chitosan 5%	d Eudragit® FS 94.1% Polysorbate 80 1.2% Glyceryl monostearate 4.7%	

<sup>x</sup> Composition of uncoated pellets: Rutin 30%, Chitosan 45%, MCC 25%.<sup>y</sup> Composition of uncoated pellets: Rutin 30%, MCC 70%.<sup>z</sup> a, b, c – 18%; d – 15%.

Compression Tester (Engineering System, Nottingham, United Kingdom) equipped with a C5 cell for pellet evaluation. For friability testing, a stainless steel drum of the friabilator (Erweka TAR 10, Ensenstam, Germany) was used. Rutin content in the pellets was determined spectrophotometrically at a wavelength of 360 nm (phosphate buffer pH 6.8; Specord® 205, Analytik Jena, Jena, Germany). Friability and content measurements were repeated three times and the results were expressed as an arithmetic mean ± standard deviation (SD).

### 2.5. *In vitro* drug release

First, samples of uncoated and coated pellets (a, b, c) corresponding to the dose of 30 mg of rutin were placed into 1000 mL of phosphate buffer (pH 3.0 or 6.8) for dissolution studies (Ungell and Abrahamsson, 2004). The test was examined using a basket dissolution method at a rotation speed of 100 rpm at 37.0 ± 0.5 °C (Sotax AT 7 Smart on-line, Donau Lab, Basel, Switzerland). Released drug amount was measured spectrophotometrically at 360 nm (Lambda 25, PerkinElmer Instruments, Shelton, USA). All experiments were performed in triplicate and results are expressed as the mean ± SD of the active substance in %, dissolved at given sampling time.

Second, the pellets were also evaluated in dissolution test under simulated GI transit conditions described in Table 2. The buffers needed to be exchanged after 5.5 h of the testing. Samples were withdrawn every 30 min in 0–3 h and then every hour with the exception between 5–6 h.

### 2.6. Stability testing

Samples of pellets coated with alginate/chitosan were placed into stability boxes (Binder, Tuttlingen, Germany) under 25 °C and 60% of relative humidity (25/60); 30 °C and 65% of relative humidity (30/65); 40 °C and 75% of relative humidity (40/75). Stability tests were provided for 6 months (40/75) and for 12 months (25/60; 30/65), respectively. At the times 0, 3, 6, 9 and 12 months, samples were withdrawn and their dissolution profiles were determined

using pH changing dissolution method described in previous chapter, and compared.

### 2.7. Animal studies

All animal experiments were carried out in accordance with the recommendations of the *Guide for the Care and Use of Laboratory Animals* (Institute of Laboratory Animal Resources, National Research Council and National Academy of Sciences, United States). Male Wistar rats (average weight 175–199 g, 5–6 weeks old;  $n = 4$ /group) were purchased from Société Janvier (Le Genest, St Isle, France). The animals were housed in groups of four and acclimatized to laboratory conditions a week before the experiments, with food and water ad libitum at 23 ± 1 °C, a relative humidity of 60 ± 5% and 12 h light–dark cycle. Animals were randomized into 7 groups according to colitis and drug administration: healthy control group (1); colitis control group – non treated colitis-induced rats (2); rutin solution receiving group per rectum (3); rutin solution receiving group per os (4); rutin pellets receiving group a, b, c: a – coated with caffeic acid/HPMC/alginic acid (5), b – coated with sodium alginate/HPMC/zinc acetate (6), c – coated with sodium alginate/chitosan (7). Twenty-four hours before the experiment the food was withdrawn but free access to tap water was allowed. Colitis was induced according to Morris et al. (1989). Briefly, rats were slightly anesthetized with ether, and then a rubber catheter was inserted into the anus and the tip was advanced to 8 cm to the anus verge. 300 µL of TNBS dissolved in 50% (v/v) ethanol was instilled into the colon through the catheter (dose was 42 mg/kg body weight). The animals were kept in a head-down position for a few minutes to prevent leakage of the intracolonic instillation. Control group received physiological saline instead of the TNBS solution. For 2 days, the rats were housed without treatment to maintain the development of a full inflammatory bowel disease model. Starting day 4, different groups received rutin at the dose 10 mg/kg either as a solution orally or rectally dissolved in phosphate buffer pH 7.4 or as pellet formulation. The rats were treated once daily for 5 continuous days. Colitis controls received physiological saline orally instead. The animals were sacrificed using an

**Table 2**  
Simulating GIT conditions.

Part of GIT	Stomach	Small intestine	Terminal ileum	Colon
pH	3.0	6.8	7.5	4.0/6.0
Dissolution medium	Phosphate buffer	+4.2 g Na <sub>3</sub> PO <sub>4</sub> · 12H <sub>2</sub> O	+6.0 g Na <sub>3</sub> PO <sub>4</sub> · 12H <sub>2</sub> O	Acetate buffer phosphate buffer ± β-glucosidase
Time	2 h	3 h	0.5 h	16.5 h

overdose of anesthetic 24 h after the last drug/particle administration and colons were resected.

### 2.8. Clinical activity score system, colon/body weight ratio, and myeloperoxidase activity

Colitis activity was quantified with a clinical score assessing weight loss, stool consistency, and rectal bleeding. The mean of these score values was giving the clinical score ranging from 0 (healthy) to 4 (maximal activity of colitis) (Lamprecht et al., 2001).

Resected colon tissue samples were opened longitudinally and rinsed with iced physiological saline to remove luminal content and weighed. The colon/body weight ratio was calculated as a quotient of colon wet weight compared to total body weight of each rat (Lamprecht et al., 2005a).

Myeloperoxidase activity measurement was performed to quantify the severity of the colitis. Activities were analyzed according to Krawisz et al. (1984). One unit of myeloperoxidase activity was defined as the amount that degraded 1  $\mu$ L of peroxidase per minute at 25 °C.

### 2.9. Microscopical/histological evaluation

Histologic assessment was carried out by light microscopy of colon tissue samples. Five micrometer thick sections were cut on a rotary microtome (Tissue-Tek®III, Sakura Finetek, Zoeterwoude, Netherlands), and stained with hematoxylin and eosin for histological evaluation of colonic damage and mucus content. All tissue sections were examined by at least two independent investigators with a Leica DMR microscope (Solms Germany) for characterization of histopathological changes and photographed (camera Leica DC500, Solms, Germany).

### 2.10. Statistical analysis

The results were expressed as mean values  $\pm$  SD. For analysis of statistical significance, the Anova test was applied. In all cases,  $P < 0.05$  was considered to be significant.

## 3. Results and discussion

### 3.1. Pellets evaluation

Rutin/chitosan/MCC pellets, i.e., samples 1–4 (or rutin/MCC pellets – sample 5) were prepared by extrusion/spheronization method using acetic acid as the wetting agent and a solvent for partial dissolution of chitosan to obtain matrix pellets (Dvorackova et al., 2009) (or water to prepare sample 5). As moisture content of the extrudate affects pellets shape and size (Perez and Rabiskova, 2002), the optimum amount of acetic acid was evaluated experimentally to be 90 g (or 97.5 g of water in sample 5) for 100 g of the powder mixture, thus forming plastic mass appropriate for extrusion. The size of the pellets produced by extrusion/spheronization was found in narrow interval, i.e., 0.5–1.0 mm (92.15–93.45%), what is typical for this method. Pellet size distribution showed two main fractions: 0.5–0.8 mm and 0.8–1.0 mm giving mean diameter shown in Table 1. These major pellet fractions were used for further evaluation and experiments. Pellets showed shape (Fig. 1A) of suitable sphericity values (Table 1) (Deasy and Law, 1997). Rutin content in pellets was 93.74–95.17% of its theoretical value. Pellet intraparticle porosity was very low indicating good compactness of used substances. Obtained values of pellet friability and their hardness indicated pellet quality sufficient to withstand further processing. Flow properties of pellets showed low repose angle and Hausner ratio close to 1.1 corresponding to excellent flow. For the coated pellets, rutin represented 25% of their total weight. In

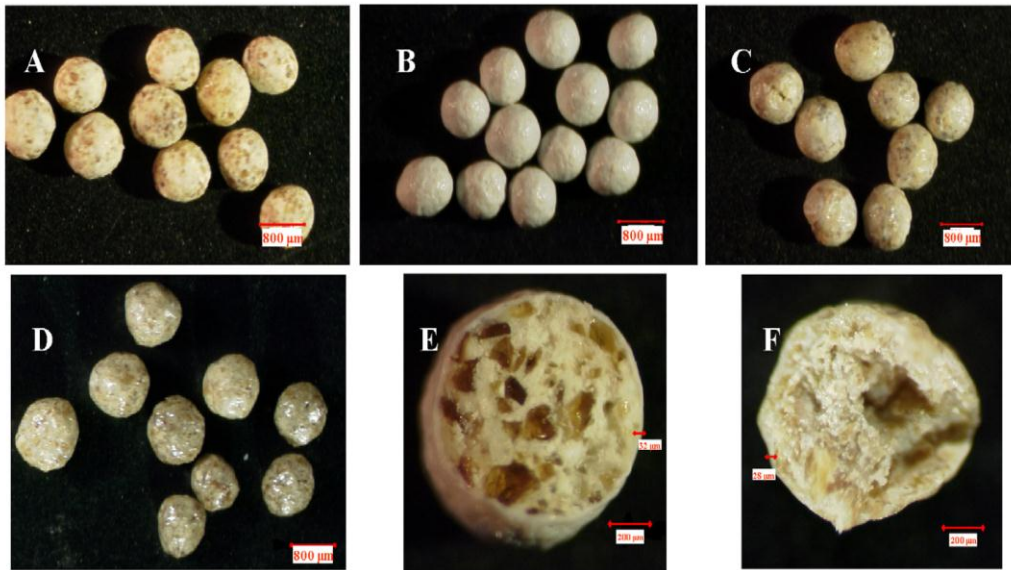
Fig. 1B–D, representative examples of coated pellets are shown. Fig. 1B illustrates the pellets coated with caffeic acid/HPMC/alginate, Fig. 1C with sodium alginate/HPMC/zinc acetate and Fig. 1D with sodium alginate/chitosan. As it can be seen from the cross sections of pellets coated with caffeic acid//HPMC/alginate and with sodium alginate/chitosan (Fig. 1E and F), the thickness of the coat was approximately 30  $\mu$ m. The glinting parts are chitosan particles undissolved in acetic acid. Thus the matrix is composed of rutin, MCC and partially dissolved chitosan particles.

### 3.2. Dissolution tests

After pellets characterization, in vitro dissolution profiles of uncoated and coated (a–c) pellets were determined in phosphate buffers of pH 3.0 or 6.8, respectively. In man, in fasted state pH reaches the values 1.0–3.0, but in fed state pH from 2.0 to 5.0 has been observed (Chuong et al., 2008). Thus, pH 3.0 could be considered as a good compromise of pH values in fed state to simulate gastric conditions. Generally, pH value of 6.8 is used to simulate conditions in the small intestine, therefore pH 6.8 was the second value used in preliminary dissolution tests. Rutin dissolution profiles are presented in Fig. 2. All pellet samples showed prolonged rutin release in media of both pH values. As evident from Fig. 2A the drug release from uncoated pellets was significantly faster ( $77.72 \pm 3.80\%$ ) than that from coated samples due to chitosan dissolution in acidic media (Rowe et al., 2006). Pellets coated with caffeic acid/HPMC/alginate showed faster rutin release ( $38.45 \pm 3.87\%$ ) than two other samples ( $16.55 \pm 3.77\%$  and  $22.19 \pm 3.69\%$ , respectively). This coating consists from two acids and HPMC helping to form a gel layer. Hypromellose K is known for its fast hydration rate and thus, when distributed homogeneously within the layer, could cause higher coating permeability. Second coating b consisted of two layers: sodium alginate, and hypromellose E and zinc acetate. The gelation and crosslinking of the polymers are achieved by the exchange of sodium and zinc ions and stacking of glucuronic groups to form egg-box structure (Gombotz and Wee, 1998) able to control drug release within 24 h (Zeng, 2004). Hypromellose E has slower hydration rate and when used in a different layer, it seems to have less influence on the coating permeability than HPMC K in the previous coating. Third coating c was based on sodium alginate with 5% of chitosan and ensured slow rutin dissolution profile similar to that of coating b. Alginate is a natural, biocompatible, biodegradable and cost acceptable polysaccharide, insoluble in aqueous solutions with pH less than 3 (Rowe et al., 2006). Containing carboxyl end groups, it is classified as an anionic mucoadhesive polymer, resistant to digestive enzymes and fermented by colonic microbiota (Patel et al., 2007). Alginate and chitosan are known to interact and form polyelectrolyte complex decreasing the drug release in low as well as high pH values (Mi et al., 2002). In pH 6.8 (Fig. 2B), rutin release was very slow in all tested samples: 19.8–27.5% after 12 h of dissolution test. These results were expected as chitosan is not soluble at pH values higher than 6.5 (Rowe et al., 2006). In vivo, chitosan degradation takes place in the colon due to the activity of enzymes produced by colonic microbiota. Following the degradation, dosage forms based on chitosan can release the drug included (Jose et al., 2009). In dissolution studies, commercially available  $\beta$ -glucosidase with similar degradation function on chitosan as that of colonic enzymes is used instead (Zhang and Neau, 2001).

Following the above described testing, rutin release from pellets with coat c using buffers with changing pH values and the final buffers of pH 4.0 and 6.0, respectively, was provided (Fallingborg et al., 1993; Nugent et al., 2001). Dissolution medium of pH 6.0 contained  $\beta$ -glucosidase in the concentration of 0.1%. Fig. 3 compares dissolution profiles of rutin/chitosan/MCC pellets with the coating c and d, and rutin/MCC pellets with the same coating d to





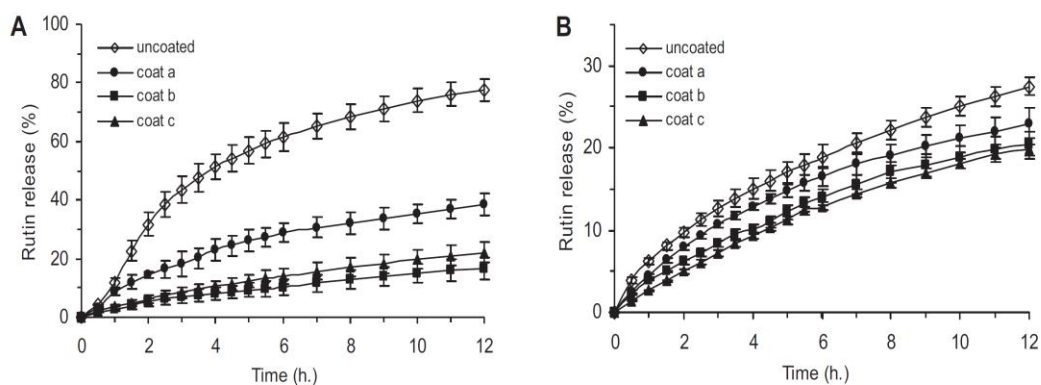
**Fig. 1.** Optical microscopic images showing the general morphology of rutin pellets uncoated (A) and coated with different coatings: caffeic acid/HPMC/alginate (B), sodium alginate/HPMC/zinc acetate (C), sodium alginate/chitosan (D), a cross-section of caffeic acid/HPMC/alginate coated pellet (E) and a cross-section of sodium alginate/chitosan coated pellet (F). The scale bars represent 800  $\mu\text{m}$  (A–D), 200  $\mu\text{m}$  (E–F); 32  $\mu\text{m}$  (E) and 28  $\mu\text{m}$  (F) for the coating thickness, respectively.

see the possible influence of chitosan inside the pellets. No difference was found in promising rutin dissolution profiles from pellets with polysaccharide coating no matter of pH value of the last buffer used: during first 5 h of dissolution test only small amount (<14%) of rutin was released and 90 min after the pH change simulating terminal ileum more than 80% of rutin was determined in the medium. On the other hand, great difference was determined in drug release from pellets coated with polyacrylates depending on the final buffer value. When acetic buffer (pH 4.0) was applied, the course of rutin dissolution profile was more similar to those measured for pellets coated with sodium alginate/chitosan. However in phosphate buffer of pH 6.0, very slow release ending at 27% of rutin was determined. Similar values were found also when  $\beta$ -glucosidase was added into the last medium. It is evident that short period in buffer of pH 7.5 was not sufficient to dissolve coating d and facilitate rutin release. Similar results were recently reported also by Poelvoorde et al. (2008). It seems however that dissolution buffer activity was able to cause some fractures in this coating explaining fast rutin release in acetic buffer of pH 4.0. This buffer passing through the coating could dissolve chitosan inside the coated pellets helping thus the drug release. This finding can be supported by the results obtained from rutin/MCC pellets with coat d, i.e.,

the dissolution profiles ending at 27% of rutin when final pH of 4.0 was applied and 17% in pH 6.0, respectively. These results were expected as inside of these pellets was no excipient promoting drug release through polyacrylic coating and rutin solubility is low, only slightly different in pH 4.0 (219.64 mg/L) and pH 6.0 (90.95 mg/L) at 37 °C. Considering in vitro results, the administration of dosage forms with polyacrylic coating d and intended for IBD treatment need not lead to the drug release in the appropriate site of GI tract in some IBD patients exhibiting lower colonic pH values.

### 3.3. Stability testing

Pellets coated with alginate/chitosan were placed to stability boxes under 25 °C and 60% of relative humidity (25/60); 30 °C and 65% of relative humidity (30/65); 40 °C and 75% of relative humidity (40/75). Stability tests were provided for 6 months (40/75) and for 12 months (25/60; 30/65), respectively. At the times 3, 6, 9 and 12 months, samples were withdrawn and their dissolution profiles were determined using pH changing dissolution method and compared with rutin dissolution profiles at the time 0 (Rabiskova et al., 2011). Differences between obtained results are presented in Table 3. No significant differences in rutin release have been



**Fig. 2.** Dissolution profiles of rutin pellets with different coatings in phosphate buffer systems pH 3.0 (A) and 6.8 (B); coat a: caffeic acid/HPMC/alginate; coat b: sodium alginate/HPMC/zinc acetate; coat c: sodium alginate/chitosan.

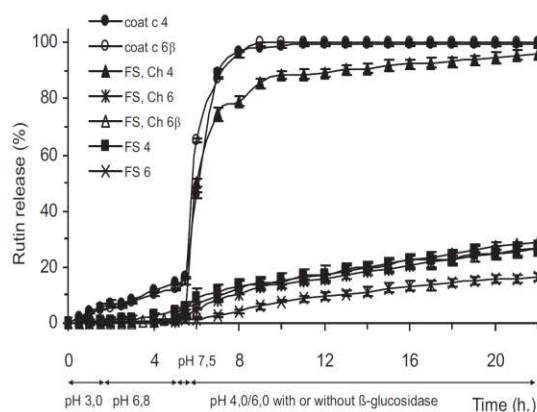
**Table 3**  
Differences in rutin release from pellets coated with sodium alginate/chitosan within stability testing.

Temperature (°C)/RH/t	Differences in rutin release (%)									
	1	3	5	5.5	6	7	8	14	22	
25/60/3M	-0.82	-1.13	-1.41	3.27	5.43	4.27	3.38	2.52	1.97	
25/60/6M	-3.30	-3.84	-4.28	6.87	11.88	10.53	9.21	7.17	7.01	
25/60/9M	0.40	-1.63	-1.98	9.71	12.89	9.92	7.89	5.42	4.39	
25/60/12M	0.76	0.12	-0.32	10.43	12.98	11.12	9.26	6.77	6.50	
30/65/3M	0.39	-0.32	-0.10	0.26	4.66	4.57	4.42	4.15	4.74	
30/65/6M	0.19	-1.26	-2.04	5.01	9.35	9.64	8.61	8.98	10.06	
30/65/9M	0.36	-3.38	-5.55	5.12	7.75	6.05	4.29	3.75	4.39	
30/65/12M	1.14	-1.15	-2.40	6.22	9.67	8.97	7.44	7.10	7.93	
40/75/3M	0.46	-1.25	-1.62	2.92	4.20	3.91	3.46	2.75	2.66	
40/75/6M	1.08	-1.63	1.76	5.77	8.28	6.87	6.01	4.57	4.15	

found; the maximum difference was less than 13%. Nevertheless these small differences indicating excellent stability of the pellets, one can admit the tendency in the dissolution profiles change in all stability regimens, i.e., slowing down of the rutin release within first 5 h and mild acceleration in the release from the 5.5 h of the testing. This tendency is in harmony with the demanded dissolution profile, i.e., no or low amount of the drug released under conditions simulating upper GI tract and fast release of the drug under the conditions mimicking the colon.

### 3.4. Animal studies

Several investigations were realized in order to evaluate the therapeutic value of rutin, on a preexisting colitis model in rats. Cruz et al. (1998) demonstrated the anti-inflammatory effect of rutin in acute and chronic colitis. Rats were treated with aqueous solution of rutin at different doses administered orally with optimal effect at the dose of 10 or 25 mg/kg of rutin. Kwon et al. (2005) reported that rutin ameliorates experimental colitis, presumably by suppressing the induction of pro-inflammatory cytokines. In our study, we investigated the effect of rutin solution or rutin/chitosan/MCC pellets coated with polysaccharides for diminution the inflammation in TNBS-induced colitis. The animals were divided into 7 groups and starved for 24 h before induction of colitis. On day 3, the animals received an intrarectal application of TNBS except the healthy control group. Before this time point, animals showed no clinical problems. After inducing the experimental colitis, the clinical score increased rapidly and consistently for the next 2 days for all groups as represented by clinical activity score (Fig. 4), and the rats developed prostration, piloerection and

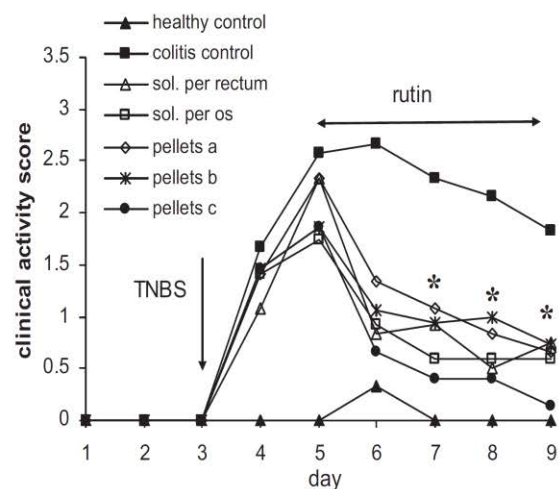


**Fig. 3.** Rutin dissolution profiles from rutin/MCC/chitosan or rutin/MCC pellets with different coatings obtained using dissolution method with continual pH change of buffers: c – sodium alginate/chitosan coat; d – Eudragit® FS coat; Ch – rutin/MCC/chitosan pellets; M – rutin/MCC pellets; 4 – final pH 4.0; 6 – final pH 6.0; 6β – final pH 6 with β-glucosidase. Data are shown as mean ± SD.

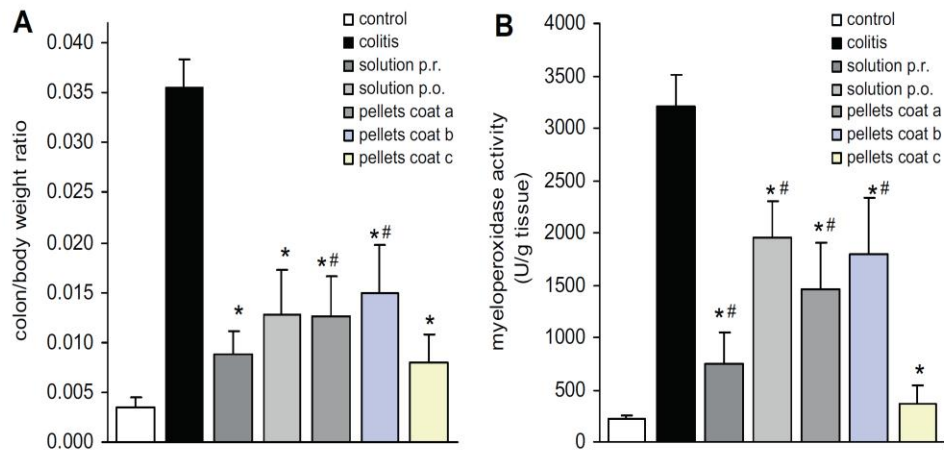
hypomotility. The diarrhea in the majority of TNBS-administrated animals occurred during the first 3–4 days. The inflammatory response showed similar characteristics to those reported elsewhere: experimental animals had anorexia and loss of weight as well as diarrhea (Cruz et al., 1998; Magro et al., 2006).

Starting from day 5, rats received rutin solution either rectally or orally or rutin pellets orally once a day for five following days, with the exception of the colitis control group. Healthy control group received saline instead. The clinical activity score was used to evaluate the severity of the colonic inflammation and the colitis control group proved to be an excellent model of inflammation as evidenced by the highly increased clinical activity. During the whole treatment period, rutin lowered the clinical activity so that all drug-receiving groups showed decreasing index values after a lag time of 24 h. The difference between drug-treated groups and colitis controls became significant on day 7. The treatment with rutin resulted in a diminution of diarrhea compared to the TNBS control group, where we detected diarrhea still at the day of sacrifice. The most pronounced decrease in clinical activity score was observed in group treated with pellets coat c. Other treatment resulted in nearly identical clinical activity score.

On day 10 (24 h after the last drug administration), the animals were sacrificed, and colon/body weight ratio and myeloperoxidase activity were determined to quantify the inflammation. Inflammatory changes of the intestinal tract after intracolonic administration of TNBS are associated with transmural inflammation of the colonic segments and presence of adhesions of the rat colon to adjacent



**Fig. 4.** Clinical activity score in TNBS rat model during the whole experimental period after rectal and oral administration always determined for  $n = 4$  animals. Error bars are not shown for clearness. \* $P < 0.05$  compared with colitis control rats given saline for all treated group, except pellets a at administration on day 7.

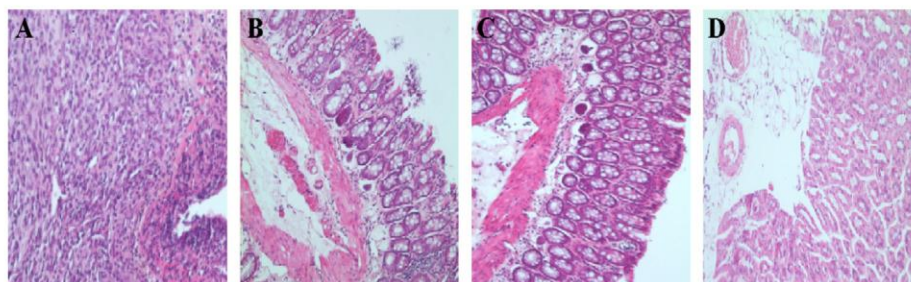


**Fig. 5.** Determination of colon/body weight ratio (A) and myeloperoxidase activity (B) on day 10 in TNBS colitis model after rectal and oral rutin administration at a dose of 10 mg/kg. Data are shown as mean  $\pm$  S.D. for  $n=4$  animals. \* $P<0.05$  compared with colitis control rats given saline, # $P<0.05$  compared with rats given pellets coat c.

organs (Galvez et al., 2000). Macroscopic inspection in colitis control group showed evidence of bowel wall thickening and stiffness, bleeding or intense hyperemia, focal ulceration of the mucosa and diffuse hemorrhagic necrosis of the epithelium. Amelioration in macroscopic changes without the sign of bleeding, ulceration and necrosis, and reduced presence of adhesions to adjacent organs was observed in all treated groups. Only bowel wall thickening and moderate hyperemia were detected in flavonoids receiving groups. In Fig. 5A colon/body weight ratio is depicted. Significant increase of values up to 0.036 was observed in colitis control group and reported also elsewhere (Lamprecht et al., 2005b). Similarly as in the case of clinical activity score, the drug-treated groups showed decreased values in the colon/body weight ratio. The best results were obtained in groups receiving pellets coated with sodium alginate/chitosan (0.008) or rutin solution rectally (0.009). In healthy control group, colon/body weight ratio was also calculated and reached the value of 0.004. A marked increase in myeloperoxidase activity, an indicator of the colonic infiltration with polymorphonuclear leukocytes, characterizes the severity of colitis as well (Cuzzocrea et al., 2005). Rutin administration, either rectally or orally, significantly reduced myeloperoxidase activity when compared to the corresponding colitis control group (Fig. 5B): best results were achieved in group treated with pellets coat c and then the group treated with rutin solution administered rectally. This reduction of neutrophil infiltration seemed to be a consequence of the accelerated healing of colonic ulcers, facilitating the elimination of neutrophil accumulation from the inflamed colon (Cruz et al., 1998). In groups treated with rutin solution administered orally and pellets coated either with caffeic acid/HPMC/alginate

or sodium alginate/HPMC/zinc acetate the decrease in myeloperoxidase activity was less significant. It seems that pellets with coat c pass through the stomach and intestines without the structural changes. Reaching the colon, both coating substances are decomposed by microbiota, uncoated particles adhere to the bowel wall due to bioadhesive properties of chitosan, and released rutin can be effective in the site of inflammation, similarly as after its rectal administration. As mentioned above, the coating based on caffeic acid/alginate, starts to release the small amount of rutin already in pH 3.0, i.e., in the stomach. This can lead to the decomposition of pellets within intestinal transit and thus the same efficacy as after the oral administration of rutin solution was observed. Surprisingly, the pellets coated with sodium alginate/HPMC/zinc acetate possessing better dissolution profiles than pellets coated with caffeic acid/alginate in vitro did not prove an appropriate amelioration of the inflammation in vivo. Taking into consideration the article published by Dhalleine et al. recently (2011), the interaction between  $Zn^{2+}$  ions present in pellet coating and phosphate ions from GI tract could occur forming the insoluble layer on the pellet surface. This zinc phosphate layer can be responsible for minimal drug liberation in the colon and subsequently less important therapeutic effect of rutin.

Histological pictures are shown in Fig. 6. Colonic inflammation of TNBS-induced colitis is characterized by strong damages of intestinal tissue, e.g., crypt destruction, mucosal ulceration, erosions and infiltration of immune related cells into the mucosal tissue. In some sections of ulcerated areas necrotic tissue could be observed. Goblet cells were totally absent at the surface epithelium (A) of colitis group compared to the healthy one (D). The



**Fig. 6.** Microscopic images of a colon section through a tissue sample after hematoxylin and eosin stain of the colitis group (A) showing massive ulceration with disappearance of 3 typical layers and site of necrosis, (B) the group treated with pellets coated with sodium alginate/HPMC/zinc acetate presenting decreased inflammation, still visible erosion of mucosa, (C) group treated with pellets coated with sodium alginate/chitosan showing a rest of focus of inflammation, but without any erosion of mucosa and (D) healthy group without any histological modification. Original magnifications 100 $\times$ .

inflammation extended through three layers of the colon tissue, i.e., mucosa, muscularis mucosae and submucosa. Histological figures confirmed the results presented in previous figures (Figs. 4 and 5), i.e., that the treatment with rutin reduced the morphological alterations associated with TNBS administration showing ulcers in the process of healing (B, C). After the treatment with pellets coated with sodium alginate/HPMC/zinc acetate we observed persisting erosion of mucosa and some focus of inflammation (B). Thanks to favorable effect of rutin to damaged tissue, after the treatment we could anew distinguish three layers of colonic epithelium (mucosa, muscularis mucosae, submucosa), which disappeared during the inflammation. After the application of the pellets coated with sodium alginate/chitosan, histological cut of tissue (C) demonstrates the reconstitution of the mucosa surface with the rest of few focus of inflammation. Histological examination of healthy group represented typical features of the colon and normal structure (D).

#### 4. Conclusions

Rutin pellets based on chitosan and coated with several natural substances were successfully prepared and showed very good characteristics. Pellets coated with sodium alginate/chitosan presented promising rutin dissolution profiles and excellent stability. The results of in vivo study demonstrate that the administration of rutin at the dose of 10 mg/kg daily during 5 days in all groups ameliorated clinical activity score observed in TNBS control rats. In this way, rutin treatment also decreased the colon/body weight ratio. In addition, rutin administrated rectally as solution or orally as pellets coated with sodium alginate/chitosan, significantly reduced the inflammatory response. The beneficial effect exerted by rutin resulted in diminution of myeloperoxidase activity, a marker of neutrophil infiltration into the colon, which has been previously described to be upregulated in experimental colonic inflammation (Cuzzocrea et al., 2005). This reduction of neutrophil infiltration seemed to be a consequence of the accelerated healing of colonic ulcers, facilitating the elimination of neutrophil accumulation from the inflamed colon.

Thus, rutin pellets coated with sodium alginate/chitosan could become the valuable preparation for mild-to-moderate IBD treatment. The combination of rutin as natural product, chitosan as a mucoadhesive excipient degraded in the colon, sodium alginate as the main natural coating substance and pellets as multiparticulate dosage form having numerous advantages in IBD treatment, could form a promising preparation free of side effects for life long therapy of this severe illness.

#### Acknowledgements

The authors would like to thank to Dr. Jarmila Klusakova, Ph.D. from Department of Histopathology, University Hospital Brno, Czech Republic for histological preparations. Financial support for Research Project Ministry of Health, Czech Republic NS10222-2/2009, Research Project MSM 0021620822 and from Institut Universitaire de France are announced.

#### References

- Baumgart, D.C., Sandborn, W.J., 2007. Inflammatory bowel disease: clinical aspects and established and evolving therapies. *Lancet* 369, 1641–1657.
- Bautzova, T., Rabišková, M., Lamprecht, A., 2011. Multiparticulate systems containing 5-ASA for the treatment of inflammatory bowel disease. *Drug Dev. Ind. Pharm.* 37, in print.
- Berthold, A., Cremer, K., Kreuter, J., 1996. Preparation and characterization of chitosan microspheres as drug carrier for prednisolone sodium phosphate as model for anti-inflammatory drugs. *J. Controlled Release* 39, 17–25.
- Bresci, G., Parisi, G., Bertoni, M., Capria, A., 2002. Long-term maintenance treatment in ulcerative colitis: a 10-year follow-up. *Dig. Liver Dis.* 34, 419–423.
- Chuong, M.C., Christensen, J.M., Ayres, J.W., 2008. New dissolution method for mesalamine tablets and capsules. *Dissolution Technol.* 15, 7–14.
- Crespy, V., Morand, C., Manach, C., Besson, C., Demigne, C., Remesy, C., 1999. Part of quercetin absorbed in the small intestine is conjugated and further secreted in the intestinal lumen. *Am. J. Physiol. Gastrointest. Liver Physiol.* 277, 120–126.
- Cruz, T., Galvez, J., Ocete, M.A., Crespo, M.E., Sanchez de Medina, L.H.F., Zarzuelo, A., 1998. Oral administration of rutoside can ameliorate inflammatory bowel disease in rats. *Life Sci.* 62, 687–695.
- Cuzzocrea, S., Rossi, A., Mazzon, E., Di Paola, R., Genovese, T., Muia, C., Caputi, A.P., Sautebin, L., 2005. 5-Lipoxygenase modulates colitis through the regulation of adhesion molecule expression and neutrophil migration. *Lab. Invest.* 85, 808–822.
- Deasy, P.B., Law, M.F.L., 1997. Use of extrusion-spheronization to develop an improved oral dosage form of indomethacin. *Int. J. Pharm.* 148, 201–209.
- Dhallele, C., Assifaoui, A., Moulari, B., Pellequer, Y., Cayot, P., Lamprecht, A., Chamblin, O., 2011. Zinc-pectinate beads as an in vivo self-assembling system for pulsatile drug delivery. *Int. J. Pharm.* 414, 28–34.
- Dvorackova, K., Skrabakova, G., Rabišková, M., 2009. Influence of formulation technology on theophylline release from chitosan-based pellets. *Ces. Slov. Farm.* 58, 216–224.
- Fallingborg, J., Christensen, L.A., Jacobsen, B.A., Rasmussen, S.N., 1993. Very low intraluminal colonic pH in patients with active ulcerative colitis. *Dig. Dis. Sci.* 38, 1989–1993.
- Farup, P.G., Hinterleitner, T.A., Lukas, M., Hebuterne, X., Rachmilewitz, D., Campieri, M., Meier, R., Keller, R., Rathbone, B., Oddsson, E., 2001. Mesalazine 4g daily given as prolonged-release granules twice daily and four times daily is at least as effective as prolonged-release tablets four times daily in patients with ulcerative colitis. *Inflamm. Bowel Dis.* 7, 237–242.
- Fiocchi, C., 2002. Inflammatory bowel disease: current concepts of pathogenesis and implications for therapy. *Minerva Gastroenterol. Dietol.* 48, 215–226.
- Galvez, J., Garrido, M., Merlos, M., Torres, M.L., Zarzuelo, A., 2000. Intestinal anti-inflammatory activity of UR-12746, a novel 5-ASA conjugate, on acute and chronic experimental colitis in the rat. *Br. J. Pharmacol.* 130, 1949–1959.
- Gombotz, W.R., Wee, S.F., 1998. Protein release from alginate matrices. *Adv. Drug Deliv. Rev.* 31, 267–285.
- Illum, L., 1998. Chitosan and its use as a pharmaceutical excipient. *Pharm. Res.* 15, 1326–1331.
- Jose, S., Dhanya, K., Cinu, T.A., Litty, J., Chacko, A.J., 2009. Colon targeted drug delivery: different approaches. *J. Young Pharmacists* 1, 13–19.
- Krawisz, J.E., Sharon, P., Stenson, W.F., 1984. Quantitative assay for acute intestinal inflammation based on myeloperoxidase activity. *Gastroenterology* 87, 1344–1350.
- Kwon, K.H., Murakami, A., Tanaka, T., Ohigashi, H., 2005. Dietary rutin, but not its aglycone quercetin, ameliorates dextran sulfate sodium-induced experimental colitis in mice: attenuation of pro-inflammatory gene expression. *Biochem. Pharmacol.* 69, 395–406.
- Lamprecht, A., Ubrich, N., Yamamoto, H., Schafer, U., Takeuchi, H., Maincent, P., Kawashima, Y., Lehr, C.M., 2001. Biodegradable nanoparticles for targeted drug delivery in treatment of inflammatory bowel disease. *J. Pharmacol. Exp. Ther.* 299, 775–781.
- Lamprecht, A., Yamamoto, H., Ubrich, N., Takeuchi, H., Maincent, P., Kawashima, Y., 2005a. FK506 microparticles mitigate experimental colitis with minor renal calcineurin suppression. *Pharm. Res.* 22, 193–199.
- Lamprecht, A., Yamamoto, H., Takeuchi, H., Kawashima, Y., 2005b. A pH-sensitive microsphere system for the colon delivery of tacrolimus containing nanoparticles. *J. Controlled Release* 104, 337–346.
- Magro, F., Fraga, S., Azevedo, I., Soares-Da-Silva, P., 2006. Intestinal 5-hydroxytryptamine and mast cell infiltration in experimental colitis. *Dig. Dis. Sci.* 51, 495–501.
- Marcussen, J., Brandsborg, E., 2002. Enteric coating, comprising alginate acid, for an oral preparation. US Patent 6455052.
- Mi, F.L., Sung, H.W., Shyu, S.S., 2002. Drug release from chitosan-alginate complex beads reinforced by a naturally occurring crosslinking agent. *Carbohydr. Polym.* 48, 61–72.
- Morris, G.P., Beck, P.L., Herridge, M.S., Depew, W.T., Szewczuk, M.R., Wallace, J.L., 1989. Hapten-induced model of chronic inflammation and ulceration in the rat colon. *Gastroenterology* 96, 795–803.
- Murota, K., Terao, J., 2003. Antioxidative flavonoid quercetin: implication of its intestinal absorption and metabolism. *Arch. Biochem. Biophys.* 417, 12–17.
- Na, K., Bae, Y.H., 2005. pH-sensitive polymers for drug delivery. In: Kwon, G.S. (Ed.), *Polymeric Drug Delivery Systems*. Taylor and Francis, Boca Raton, pp. 129–180.
- Nemeth, K., Piskula, M.K., 2007. Food content, processing, absorption and metabolism of onion flavonoids. *Food Sci. Nutr.* 47, 397–409.
- Nugent, S.G., Kumar, D., Rampton, D.S., Yazaki, E., Evans, D.F., 2001. Intestinal luminal pH in inflammatory bowel disease: possible determinants and implications for therapy with aminosalicylates and other drugs. *Gut* 48, 571–577.
- Oldenburg, B., van Kats-Renaud, H., Koningsberger, J.C., van Berge Henegouwen, G.P., van Asbeck, B.S., 2001. Chemiluminescence in inflammatory bowel disease patients: a parameter of inflammatory activity. *Clin. Chim. Acta* 310, 151–156.
- Patel, G., Patel, R., Patel, J., Bharadia, P., Patel, M., 2007. Sodium alginate: physiological activity, usage and potential applications. *Drug Deliv. Technol.* 7, 28–37.
- Perez, J.P., Rabišková, M., 2002. Influence of the drying technique on theophylline pellets prepared by extrusion-spheronization. *Int. J. Pharm.* 242, 349–351.
- Poelvoorde, N., Huyghebaert, N., Vervaeck, C., Remon, J.P., 2008. Optimisation of an enteric coated, layered multi-particulate formulation for ileal delivery of viable recombinant *Lactococcus lactis*. *Eur. J. Pharm. Biopharm.* 69, 969–976.

- Rabiskova, M., Bautzova, T., Dvorackova, K., Spilkova, J., 2009. Beneficial effects of rutin, quercitrin and quercetin on inflammatory bowel disease. *Ces. Slov. Farm.* 58, 47–54.
- Rabiskova, M., Dvorackova, K., Kofronova, L., 2011. Stability testing of alginate–chitosan films. *Ces. Slov. Farm.* 60, in print.
- Rowe, R.S., Sheskey, P.J., Owen, S.C., 2006. *Handbook of Pharmaceutical Excipients*, fifth ed. Pharmaceutical Press, Washington.
- Sands, B.E., 2000. Therapy of inflammatory bowel disease. *Gastroenterology* 118, 68–82.
- Scala-Bertola, J., Gajdziok, J., Rabiskova, M., Bonneaux, F., Lecompte, T., Sapin, A., Maincent, P., 2009. Pellets for oral administration of low-molecular-weight heparin. *Drug Dev. Ind. Pharm.* 35, 1503–1510.
- Steckel, H., Mindermann-Nogly, F., 2004. Production of chitosan pellets by extrusion/spheronization. *Eur. J. Pharm. Biopharm.* 57, 107–114.
- Ungell, A.L., Abrahamsson, B., 2004. Biopharmaceutical support in candidate drug selection. In: Gibson, M. (Ed.), *Pharmaceutical Formulation and Preformulation: A Practical Guide from Candidate Drug Selection to Commercial Dosage Form*. Informa Healthcare, New York, pp. 129–171.
- Zeng, W.M., 2004. Oral controlled release formulation for highly water-soluble drugs: drug–sodium alginate–xanthan gum–zinc acetate matrix. *Drug Dev. Ind. Pharm.* 30, 491–495.
- Zhang, H., Neau, S.H., 2001. In vitro degradation of chitosan by a commercial enzyme preparation: effect of molecular weight and degree of deacetylation. *Biomaterials* 22, 1653–1658.



Contents lists available at SciVerse ScienceDirect

European Journal of Pharmaceutics and Biopharmaceutics

journal homepage: [www.elsevier.com/locate/ejpb](http://www.elsevier.com/locate/ejpb)

Research paper

## Bioadhesive pellets increase local 5-aminosalicylic acid concentration in experimental colitis

Tereza Bautzová<sup>a,b</sup>, Miloslava Rabišková<sup>a</sup>, Arnaud Béduneau<sup>b</sup>, Yann Pellequer<sup>b</sup>, Alf Lamprecht<sup>b,c,\*</sup><sup>a</sup> Department of Pharmaceutics, University of Veterinary and Pharmaceutical Sciences, Brno, Czech Republic<sup>b</sup> Laboratory of Pharmaceutical Engineering, University of Franche-Comté, Besançon, France<sup>c</sup> Laboratory of Pharmaceutical Engineering, University of Bonn, Germany

## ARTICLE INFO

## Article history:

Received 25 October 2011

Accepted in revised form 14 February 2012

Available online 22 February 2012

## Keywords:

Pellets

5-ASA

Chitosan

Colonic delivery

Experimental colitis

## ABSTRACT

Topical delivery of 5-aminosalicylic acid (5-ASA) to the colonic mucosa is important in order to achieve effective drug concentration in the site of inflammation and to minimize its systemic availability. 5-ASA loaded pellets were prepared by an extrusion/spheronization method. Mucoadhesive biopolymer chitosan was incorporated into the pellets, and drug delivery to the colon was controlled by the pH-sensitive polymer Eudragit® FS. Dissolution profiles of coated pellets revealed no drug release at pH 1.2 within 2 h and release as intended in the simulated distal ileum and colon. In vivo, chitosan-core drug loaded pellets (AMCh) showed 2.5-fold higher drug metabolite concentration than after chitosan free pellets (AM) administration in the inflamed colonic tissue. Additionally, AMCh demonstrated decreased in AUC in colitis group ( $1507 \pm 400$  ng h/ml) compared with AM ( $1907 \pm 122$  ng h/ml). In terms of therapeutic efficiency, administration of pellets markedly decreased the colon/body weight ratio (colitis:  $0.0355 \pm 0.0028$ ; AM  $0.0092 \pm 0.0033$ ; AMCh  $0.0086 \pm 0.0022$ ) and myeloperoxidase activity (colitis:  $3212 \pm 294$  U/g tissue; AM  $796 \pm 211$  U/g; AMCh  $552 \pm 319$  U/g). Bioadhesive chitosan pellets showed additional beneficial properties for colonic 5-ASA delivery in the treatment of inflammatory bowel disease by increasing the drug concentration locally.

© 2012 Elsevier B.V. All rights reserved.

## 1. Introduction

Inflammatory bowel disease (IBD) comprises two idiopathic inflammatory disorders of the intestinal tract, that is, ulcerative colitis and Crohn disease which differ from each other in the inflammation localization and some other symptoms [1]. As the aetiology of IBD is still not well known, therapy is symptomatic and targets general inflammatory mechanisms [2]. Therefore, current treatment includes anti-inflammatory drugs as aminosalicylates and corticosteroids, antibiotics, immunomodulators and antibodies. 5-amino-salicylic acid (5-ASA) is used under mild-to-moderate disease conditions and has become a standard therapy based on an extensive and long treatment history [3].

5-ASA given orally is absorbed in the upper gastrointestinal tract. It exerts a degenerative effect on the gastric mucosa and increases the risk of side effects such as renal toxicity and pancreatitis [4]. Thus, the main objective in the treatment of IBD is to deliver the drug to the sites of inflammation to achieve maximal drug concentration in the distal ileum and colon allowing a local

therapeutic effect and avoiding side effects by minimizing systemic availability. Therefore, different approaches to target the drug to the appropriate site of action were investigated: pH dependent concept, time dependent release, prodrugs and microflora activated systems. The pH-dependent concept is often based on methacrylic acid copolymers coatings that are insoluble in the stomach but soluble at pH values ranging between 5.5 and 7.0 [5].

Additionally, the use of mucoadhesive polymers in pharmaceutical formulations could advantageously improve therapeutic efficiency of administered drug [6]. It has been shown that chitosan, a polyaminosaccharide bearing the positive charge in the  $\text{pH} < \text{pK}_a$  (6.5), possess mucoadhesive properties, and the potential retention of particles at the mucosal surface can contribute to extended residence time in the target region [7]. In recent years, chitosan has received considerable attention as multifunctional biopolymer with a wide range of biomedical and pharmaceutical applications, such as drug delivery, tissue engineering, wound healing and gene therapy. Because of its biodegradability by colonic microflora, chitosan gained a certain importance in colon targeting [8].

The aim of this study was to prepare 5-ASA pellets containing chitosan designated for colonic delivery of the drug with a potential benefit in the treatment of IBD. Prepared pellets with chitosan cores were protected with pH-sensitive coating to deliver 5-ASA into the colon, to minimize drug release in the upper

\* Corresponding author. Laboratory of Pharmaceutical Engineering, Faculty of Medicine and Pharmacy, University of Franche-Comté 19, rue Ambroise Paré, 25000 Besançon, France. Tel.: +33 3 81 66 55 48; fax: +33 3 81 66 52 90.

E-mail address: [alf.lamprecht@univ-fcomte.fr](mailto:alf.lamprecht@univ-fcomte.fr) (A. Lamprecht).

gastrointestinal tract and prevent related side effects. The present work was focused on the mucoadhesion and anti-inflammatory effectiveness of the chitosan pellets. In vivo studies in a colitis model in rats assessed the influence of chitosan on the bioadhesion, pharmacokinetics and therapeutic outcome.

## 2. Materials and methods

### 2.1. Materials

5-ASA, the active substance was purchased from Sigma-Aldrich (Steinheim, Germany). Microcrystalline cellulose (MCC) Avicel® PH 101 as a spheronization enhancer was supplied by FMC (Cork, Ireland), chitosan (91% deacetylation degree, viscosity 11.1 mPa s) by JBiChem (Hangzhou, China). Acetic acid to dissolve chitosan was obtained from Penta (Chrudim, Czech Republic). Eudragit® FS 30D for pellet coatings was received as a donation from Evonik Röhm GmbH (Darmstadt, Germany). 2,4,6-trinitrobenzenesulfonic acid (TNBS) and hexadecyltrimethylammonium bromide were obtained from Fluka Biochemika (Steinheim, Germany), o-dianisidine dihydrochloride as a substrate and hydrogen peroxide as a reagent (starting the reaction) from Sigma-Aldrich (Steinheim, Germany).

### 2.2. Pellet preparation

Pellets of different composition (see Table 1) were prepared by an extrusion/spheronization method. Dry powder mixture was homogenized in a mixer (Tefal Kaleo, Rumilly, France) and then wetted. The plastic mass was fed into a one-screw axial extruder (Pharmex 35T, Wyss & Probst, Ettlingen, Germany). The operating speed was 110 rpm. To form the extrudate, a die 1 mm thick with perforations of 0.8 mm in diameter was used. The extrudate was then placed into the spheronizer (Pharmex 35T, Wyss & Probst, Ettlingen, Germany); spheronization speed was set at 640 rpm for 15 min. The prepared pellets were dried in a ventilated oven (Horo, Ostfildern, Germany) at 40 °C for 3 h.

### 2.3. Coating of pellets

Pellets were coated in a fluidized bed coater (M-100, Medipo, Brno, Czech Republic) with Eudragit® FS 30D (15% of total pellets weight). Preparation of coating dispersions and coating process conditions were adapted from Gupta et al. [9]. 150 g of pellets (each having a size of 0.6–0.8 mm) were charged into a process chamber equipped with a spray nozzle of 0.4 mm diameter, located in the bottom of a Wurster insert. Dispersions were sprayed at a rate of 2 g/min. under an atomization pressure of 100 kPa. The final pellet coating was cured at 40 °C for 24 h in an oven to complete the film formation [9].

### 2.4. Pellet characterization

Pellet size and size distribution were determined prior to the coating process by sieve analysis. Pellet sphericity, hardness, friability and 5-ASA content were evaluated in an uncoated pellet sample fraction of 0.5–0.8 mm. Pellet sphericity was derived using image analysis system (Leco IA, Leco Instruments, St. Joseph, USA). To investigate pellet hardness, ten randomly selected pellets were

crushed in a Tablet Hardness & Compression tester (Engineering System, Nottingham, United Kingdom) equipped with a C5 cell for pellet evaluation. The friability was tested in the friabilator (Erweka TAR 10, Heusenstamm, Germany) equipped with stainless steel drum. Crushed uncoated pellets were dissolved in phosphate buffer of pH 6.8, and their drug content was determined spectrophotometrically at a wavelength of 330 nm (Lambda 25, Perkin Elmer Instruments, Shelton, USA).

### 2.5. Dissolution testing

5-ASA release from coated pellets was determined using the standard basket dissolution method at a rotation speed of 100 rpm in 500 ml of dissolution medium at 37.0 ± 0.5 °C (Sotax AT 7 Smart on-line, Donau Lab, Basel, Switzerland). The dissolution test was performed in changing dissolution media given in Table 2. The amount of drug released was measured by UV/VIS spectrophotometer (Lambda 25, Perkin Elmer Instruments, Shelton, USA) at 330 nm. All experiments were performed in triplicate.

### 2.6. Animal treatment

All animal experiments were carried out in accordance with the recommendations of the *Guide for the Care and Use of Laboratory Animals* (Institute of Laboratory Animal Resources, National Research Council and National Academy of Sciences, United States) and under the French experimentation authorization no. 54–68. The protocol was approved in agreement with the regulations of animal experimentation at the University of Franche-Comté. Male Wistar rats (average weight 175–199 g, 5–6 weeks old;  $n = 4$ /group) were purchased from Janvier (Le Genest-St-Isle, France). The animals were housed in groups of four and acclimatized to laboratory conditions a week prior to the experiments, with food and water *ad libitum*. Twenty-four hours prior to the experiment, the food was withdrawn but free access to tap water was allowed. Colitis was induced with an ethanolic TNBS solution that was instilled into the colon through a catheter at a dose of 42 mg/kg body weight [10]. A healthy control group received physiological saline instead of the TNBS solution. For 2 days, the rats were housed without treatment to maintain the development of a full inflammatory bowel disease model. Starting day 4, the different groups received 5-ASA containing pellets (21.5 mg/kg) or drug free pellets (MCh) at the amount equivalent to the weight of active pellets. The rats were treated once daily for 5 continuous days. The animals were randomly split into 6 groups: healthy control group (1); colitis control group non treated (2); pellets receiving groups (3 – MCh; 4 – AMCh; 5 – AM) and Salofalk® Granu-Stix® (SG) receiving group (6). Colitis controls received physiological saline orally instead of pellets. The animals were sacrificed 24 h after last drug or particle administration and colons were resected.

### 2.7. Clinical activity, colon/body weight ratio, and myeloperoxidase activity

Colitis activity was quantified with a clinical activity score assessing weight loss, stool consistency and rectal bleeding as described earlier [11].

**Table 1**  
Composition of powder mixture and wetting amount.

Sample	5-ASA (g)	MCC (g)	Chitosan (g)	Wetting amount (g)
AMCh	30	25	45	111.1 of 0.25% acetic acid
AM	30	70	0	101.0 of water
MCh	–	55	45	135.0 of 0.25% acetic acid

**Table 2**  
Dissolution media and time progression.

pH	Time	Dissolution medium
1.2	2 h	0.1N-HCl
6.8	3 h	+Na <sub>3</sub> PO <sub>4</sub> ·12 H <sub>2</sub> O
7.5	17/0.5 h	+Na <sub>3</sub> PO <sub>4</sub> ·12 H <sub>2</sub> O
4.0	16.5 h	Acetate buffer

Resected colon tissue samples were opened longitudinally and rinsed with iced physiological saline to remove luminal content and weighed. The colon/body weight ratio was calculated as a quotient of the colon wet weight compared with the total body weight of each rat [12].

The measurement of myeloperoxidase activity was performed to quantify the severity of the colitis. Activities were analysed according to the method described by Krawisz et al. [13] with minor modifications. One unit of myeloperoxidase activity was defined as the amount that degraded 1  $\mu$ l of peroxidase per minute at 25 °C.

### 2.8. In situ bioadhesion testing

Bioadhesion was studied for MCC uncoated, AMCh and AM coated with Eudragit® FS by an in vitro method evaluating the interaction of pellets with excised tissue [14]. Drug loaded pellets were exposed to the dissolution medium (2 h in 0.1 N HCl, 3 h in buffer solution of pH 6.8 and 30 minutes in pH 7.5) before testing. Twenty mg of particles was placed onto an excised segment of healthy rat jejunum. The percentage of particles retained on the tissue was considered as an index of bioadhesion.

### 2.9. N-acetyl 5-ASA tissue concentration and pharmacokinetics studies of 5-ASA

Male Wistar rats (220 g) were fasted for 12 h, and 5-ASA pellets coated with Eudragit® FS (AMCh and AM) were administered in one dose of 21.5 mg/kg to healthy and colitis induced animals.

Blood samples (200  $\mu$ l) were collected from internal jugular vein into heparinized tubes at specific time points after administration (1; 2.5; 4; 5.5; 9.25; 10.25; 13.5; 24 h). Blood samples were centrifuged immediately at 6000 rpm for 10 min (Eppendorf AG, Hamburg, Germany). Plasma samples were transferred into microcentrifuge tubes and frozen prior to HPLC measurement. The extraction procedure was performed according to Bystrowska et al. [15] with some modifications. Twenty microlitres of the sample was injected to the chromatographic column. Following oral administration, 5-ASA is rapidly metabolized to N-acetyl-5-ASA. For this reason, blood and tissue samples were treated with acetic anhydride prior to HPLC analysis (acetylation reaction in vitro), and subsequently, 5-ASA was determined as metabolite N-acetyl-5-ASA.  $C_{max}$  and  $t_{max}$  were extrapolated from the graph, and the area under the plasma concentration versus time curve (AUC) was calculated in GraphPad Prism®.

Twenty-four hours after the administration, rats were sacrificed and gastrointestinal tissue samples, including duodenum, jejunum, ileum and colon, were collected. The tissues were homogenized (Ultra-turrax®, Janke & Kunkel, Staufen, Germany) with 2 ml of physiological saline and centrifuged at 10,000 rpm for 15 min. The same extraction procedure for plasma samples was carried out.

HPLC analysis was carried out using a chromatographic system composed of a liquid chromatography pump (Shimadzu LC-10A, Kyoto, Japan), a fluorescence detector (Shimadzu RF-10A, Kyoto, Japan) operated at an excitation wavelength of 315 nm and an

emission wavelength of 470 nm, an auto sampler (model 360, Kontron Instruments, Milton Keynes, UK). 5-ASA was assayed in an ODS Hypersil column ( $C_{18}$ ,  $4.6 \times 150$  mm, 5  $\mu$ m particle size, Thermo Scientific, Illkirch, France). The mobile phase consisted of a mixture of 5 mM ammonium acetate buffer of pH 3.0 with acetonitrile (85:15% v/v). The flow rate was 1.0 ml/min. and all analyses were performed at 53 °C (oven controller, model 480, Kontron Instruments, Milton Keynes, UK).

### 2.10. Statistical analysis

Data were expressed as means  $\pm$  SD. Statistical significance of the results was determined using a one-way analysis of variance (ANOVA) or Student–Newman–Keuls (SigmaStat® 3.5 software). Data were considered significantly different at a level of  $p < 0.05$ .

## 3. Results

Pellet size distribution, calculated mean diameter and sphericity are shown in Table 3. AMCh pellets exhibited the smallest mean diameter while MCh pellets exhibited the largest. Sphericity was observed to be within the interval of 0.8299–0.8453. Pellets from 0.5 to 0.8 mm interval were used for evaluation of mechanical properties (i.e. hardness and friability) and 5-ASA content. All the samples possessed optimal hardness values from  $9.9 \pm 1.3$  N to  $10.8 \pm 1.9$  N. Moreover, the pellets showed low friability values (AMCh:  $0.05 \pm 0.02\%$ , AM:  $0.04 \pm 0.01\%$ , MCh:  $0.07 \pm 0.01\%$ , respectively). The mean drug content of uncoated pellets was found to be  $94.6 \pm 1.4\%$  for AMCh and  $95.0 \pm 1.0\%$  for AM.

Release profiles of pellets coated with Eudragit® FS (AMCh and AM) were compared with commercially available 5-ASA pellets Salofalk® Granu-Stix® (SG). In all tested samples, no drug release was observed at pH 1.2 within 2 h (Figs. 1 and 2). The drug release from SG pellets set in immediately when pH increased to 6.8, then it became slower and was completed within 10 h at pH 7.5 or 22 h at pH 4.0. In contrast, a slow drug release from Eudragit® FS coated pellets in phosphate buffer at pH 6.8 was observed: a maximum of  $12.5 \pm 1.3\%$  of 5-ASA was released within 3 h. Eudragit® FS coated pellets underwent a fast 5-ASA release at pH 7.5. Complete drug release was achieved within 2 h for chitosan-containing pellets and 5 h for chitosan-free pellets. As evident from Fig. 2, the release of 5-ASA from AMCh was reduced by around 18% after 6 h at pH 4.0, nevertheless equal amount of released drug was found after 7 h in both final media. On the contrary, a comparatively slower 5-ASA release from AM was observed at pH 4.0, that is,  $96 \pm 1\%$  of the incorporated drug within 22 h.

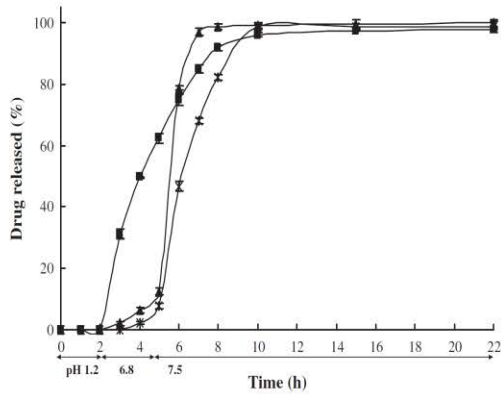
The quantitative adhesion of pellets on excised intestinal tissue is shown in Fig. 3. AMCh pellets exhibited a 3.5-fold higher adhesion than M and AM. No differences in mucoadhesive properties were detected between M and AM pellets ( $p > 0.05$ ).

N-acetyl-5-ASA was absent in the duodenal and jejunal tissues of all experimental animals. It was, however, detected in the ileum of healthy rats (Fig. 4). Ileal concentrations attained after oral administration of AM, AMCh and SG pellets were statistically similar. N-acetyl-5-ASA amounts accumulated in the colonic tissue were significantly higher after AMCh administration. Metabolite

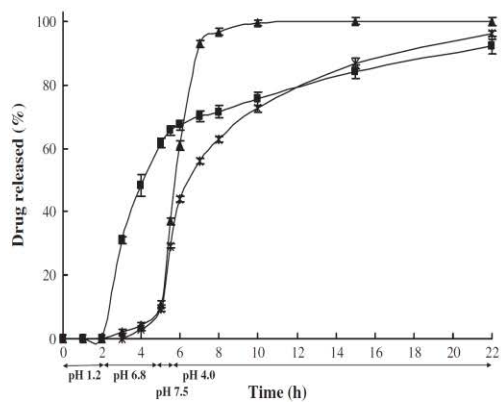
**Table 3**  
Pellet size distribution and sphericity.

Sample	Size distribution (%)				Mean diameter (mm)	Sphericity
	<0.25 mm	0.25–0.5 mm	0.5–0.8 mm	0.8–1.0 mm		
AMCh	0.26	27.58	54.49	17.67	0.617	0.8335
AM	0.00	5.40	94.36	0.24	0.636	0.8453
MCh	0.00	9.65	48.64	41.71	0.728	0.8299

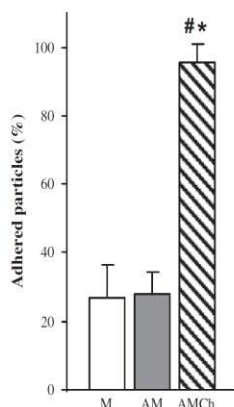




**Fig. 1.** Dissolution profiles of 5-ASA pellets for the first 2 h at pH 1.2, followed for 3 h at pH 6.8 and finished at pH 7.5 for 17 h. (■) SG, (▲) AMCh (X) AM. Data are shown as mean  $\pm$  SD.

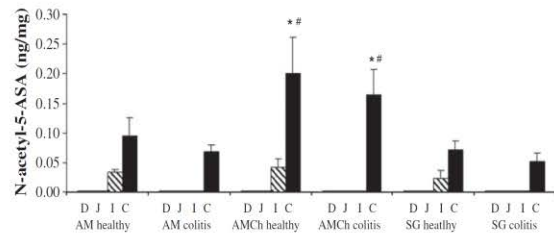


**Fig. 2.** Dissolution profiles of 5-ASA pellets for the first 2 h at pH 1.2, followed for 3 h at pH 6.8, followed for 0.5 h at pH 7.5 and finished at pH 4.0 for 16.5 h. (■) SG, (▲) AMCh, (X) AM. Data are shown as mean  $\pm$  SD.



**Fig. 3.** Determination of the mucoadhesive properties of pellets (nomenclature according to table 1, M – pellet core of MCC), \* $P < 0.05$  compared with M pellets, # $P < 0.05$  compared with AM pellets. Data are shown as mean  $\pm$  SD.

tissue concentrations were slightly lower in colitis group, but the differences were not significant. In general,  $C_{max}$  reached nearly identical values in all tested groups. Administration of AM and AMCh pellets led to a higher  $t_{max}$  value than SG pellet administration; however, an opposite trend was observed in the case of AUC (Table 4). AUC values after AMCh formulations were significantly lower than those after administration of AM and SG pellets.



**Fig. 4.** Determination of N-acetyl-5-ASA in intestinal tissues for  $n = 3$  animals. D – duodenum, J – jejunum, I – ileum, C – colon. \* $P < 0.05$  compared with AM group. # $P < 0.05$  compared with SG group. Data are shown as mean  $\pm$  SD.

**Table 4**

Key pharmacokinetic parameters after oral pellets administration.

	$T_{max}$ (h)	$C_{max}$ (ng/ml)	$AUC_{0-24}$ (ng h/ml)
AM healthy	10.25 $\pm$ 0.13	267.9 $\pm$ 32.2	1800 $\pm$ 194
AM colitis	10.25 $\pm$ 0.09	309.7 $\pm$ 47.3	1907 $\pm$ 122
AMCh healthy	9.25 $\pm$ 0.05	271.6 $\pm$ 36.2	1426 $\pm$ 92 <sup>#</sup>
AMCh colitis	9.25 $\pm$ 0.12	252.4 $\pm$ 65.9	1507 $\pm$ 400 <sup>#</sup>
SG healthy	5.50 $\pm$ 0.11	288.9 $\pm$ 20.1	2277 $\pm$ 124
SG colitis	5.50 $\pm$ 0.14	287.7 $\pm$ 3.4	2172 $\pm$ 429

Data are expressed as mean  $\pm$  SD ( $n = 3$ ).  $T_{max}$ : time of maximum plasma concentration;  $C_{max}$ : maximum plasma concentration;  $AUC_{0-24}$ : area under curve from time of administration to the last measurable concentration. \* $P < 0.05$  healthy group compared with colitis control group.

<sup>#</sup>  $P < 0.05$  compared with SG group.

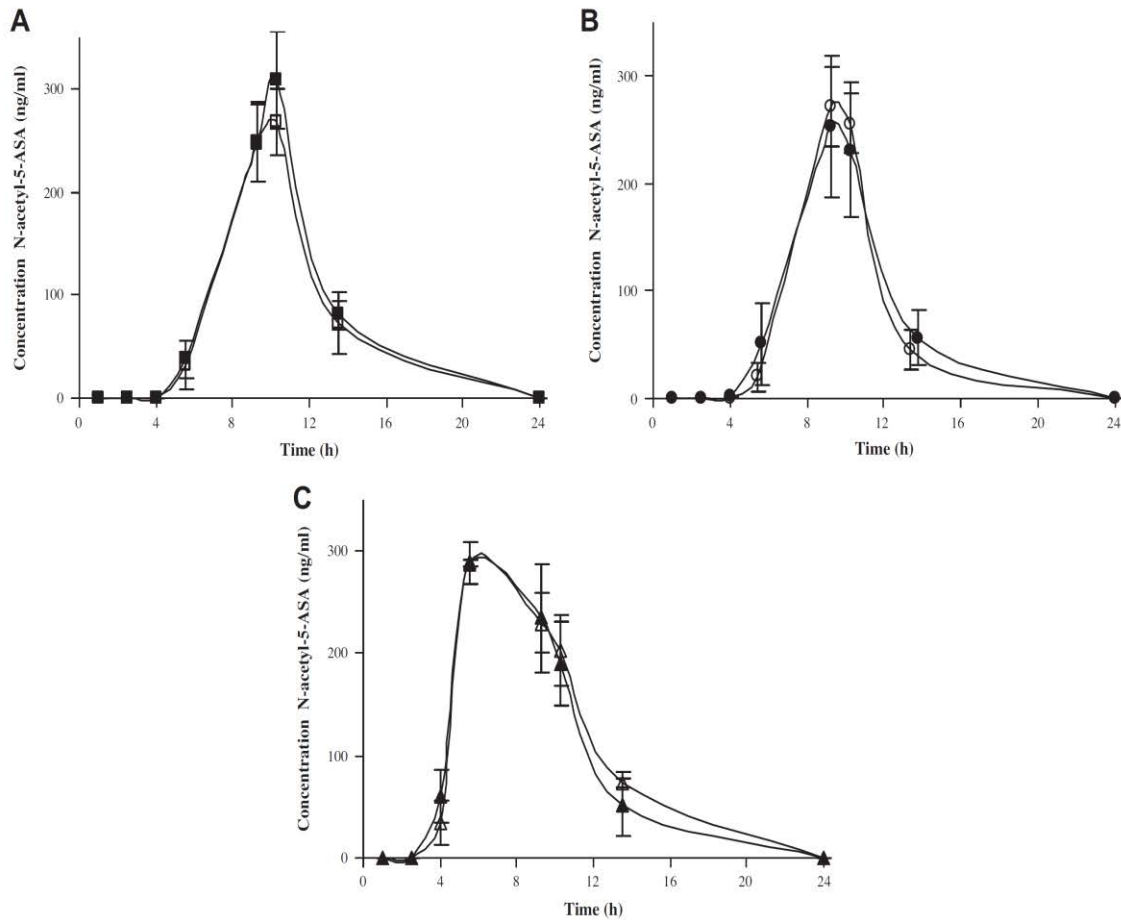
Statistically, differences between AMCh and AM and also between healthy and colitis group analyses were not significant. The plasma concentration of N-acetyl-5-ASA started to increase slowly 4 h after administration of AM and AMCh pellets, while the lag time with SG pellets was around 2.5 h and then its concentration augmented rapidly (Fig. 5).

Clinical activity scores increased rapidly after day 3 and consistently for the next 2 days for all TNBS-treated groups (Fig. 6). Besides, clinical signs like prostration, piloerection and hypomotility were observed in all animals. On day 6, the clinical activity score decreased in all pellet-receiving groups, and the difference between treated groups and the colitis control group became noticeably pronounced. After 5 days, low clinical activity values (0.25–0.33) in 5-ASA treated groups and slightly increased values in the MCh treated group were found. Although only qualitatively, representative images of colonic tissue reveal the anti-inflammatory benefit from AMCh compared MCh and surely versus the untreated colitis control (Fig. 7).

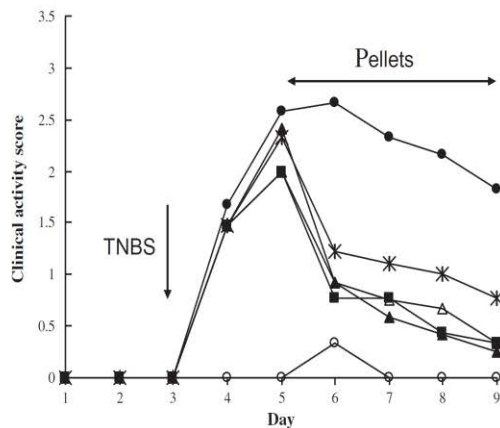
Similarly, colon/body weight ratio markedly decreased in all pellet groups and better therapeutic effect was achieved using 5-ASA containing pellets (Fig. 8). Furthermore, it is remarkable that MCh pellets showed a significant anti-inflammatory effect. 5-ASA pellets significantly reduced MPO activity in all groups (Fig. 9). Results from the groups receiving either AMCh or SG pellets were comparable. The absence of chitosan in pellets led to a lesser anti-inflammatory efficiency that was nonetheless significant compared with colitis group.

#### 4. Discussion

Differences in mean diameter between the different pellet types could be related to limited wetting of the plastic AMCh mass. It has been reported earlier that with increasing chitosan concentration a higher amount of liquid was necessary for successful extrusion [16].



**Fig. 5.** Determination of N-acetyl-5-ASA in plasma after oral pellets administration for  $n = 3$  animals. A – AM treated group; B – AMCh treated group; C – SG treated group; empty symbols – healthy animals; full symbols – colitis animals. Data are shown as mean  $\pm$  SD.



**Fig. 6.** Clinical activity score during the whole experimental period always determined for  $n = 4$  animals. (○) healthy control group, (●) colitis control group, (✱) MCh (▲) AMCh, (△) AM, (■) SG. Error bars were omitted for clarity reasons.

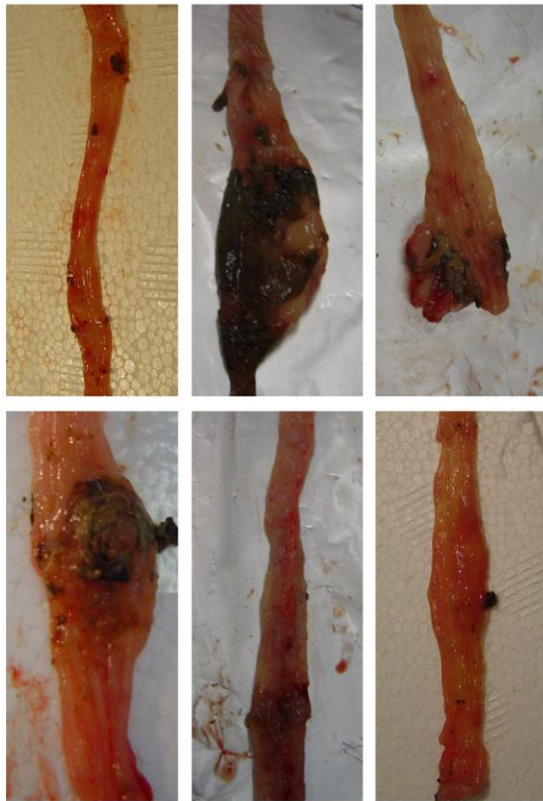
The continuous dissolution method was adapted to best mimic the pH changes in the luminal milieu. While upper parts are hardly influenced by the disease state of IBD [17] as intraluminal pHs in patients with IBD showed a similar pH values in proximal and distal small bowel, large pH variability in the caecum and right colon has been reported [18].

Generally, the increase in MCC content provided slower 5-ASA release that is probably due to a larger mean diameter and

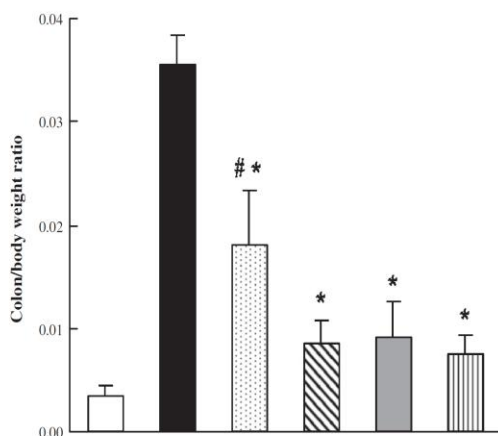
especially the increased hardness of AM compared with AMCh pellets. One issue that needs to be addressed is the solubility of 5-ASA being pH dependent with a minimum between pH 2.0 and pH 5.5 [19]. On the one hand, we can expect that the slower dissolution rate of 5-ASA in a terminal dissolution medium of pH 4.0 is due to lesser drug solubility as noticed from dissolution profiles of AM pellets. On the other hand, we suppose that 5-ASA release from AMCh at pH 4.0 is enhanced owing to the solubility of chitosan in acidic medium and its disintegrant property [8]. Finally, the generally different dissolution profiles of SG are surely related to the presence of Eudragit® NE, a pH-independent sustained release polymer, in the core of these pellets [20].

The incorporation of chitosan into pellet formulation clearly increased mucoadhesive properties on excised rat intestinal tissues. As reported earlier, the positive charge of amino groups will favour binding to negatively charged sialic acid residues of mucin and, on the contrary, nonionic polymers will manifest minimal adhesion to the mucus [6,14]. This statement is in agreement with the observation that AMCh pellets exhibited stronger mucoadhesion properties than M and AM pellets.

Upon oral administration, 5-ASA is rapidly absorbed and pre-systemically metabolized by enteric mucosal enzymes to inactive N-acetyl-5-ASA [21]. This highlights the importance of 5-ASA delivery into the colon, where it could act locally and would result in better efficacy and less adverse effects [4,21]. As found in the dissolution studies, Eudragit® FS coating should lead to minimal absorption of 5-ASA in the jejunum and upper ileum and provide drug release in the distal ileum and colon. 5-ASA metabolites were



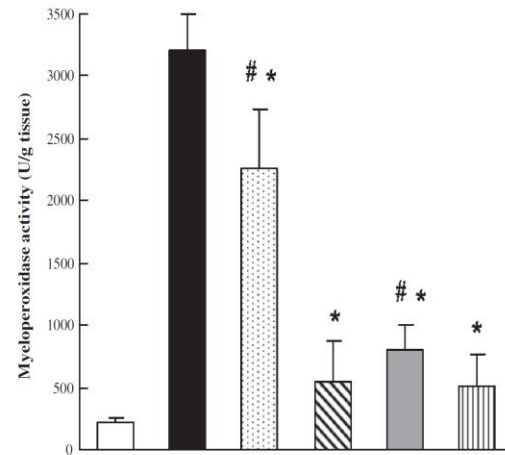
**Fig. 7.** Photographs of representative rat colon show tissue sections from TNBS installation site (upper left to right: healthy control, untreated colitis, MCh, lower left to right: AM, AMCh, SG, equivalent magnification for all images, original size  $5 \times 2.5$  cm). (For interpretation of the references to colour in this figure legend, the reader is referred to the web version of this article.)



**Fig. 8.** Determination of colon/body weight ratio for  $n=4$  animals. (□) healthy control group, (■) colitis control group, (▨) MCh (▩) AMCh, (▧) AM, (▦) SG. \* $P < 0.05$  compared with colitis control group. # $P < 0.05$  compared with SG group. Data are shown as mean  $\pm$  SD.

detected in intestinal tissues, especially in the distal small intestine and colon, that is, the segments mainly affected in IBD, which proved in vivo that Eudragit® FS coating was able to prevent 5-ASA release in the upper gastrointestinal tract.

SG pellets showed a faster onset of drug metabolite in plasma and the AUC data indicated higher systemic bioavailability compared with AMCh that could be related to a faster drug release as observed in vitro as well as augmented mucosal permeability of



**Fig. 9.** Determination of myeloperoxidase activity for  $n=4$  animals. (□) healthy control group, (■) colitis control group, (▨) MCh (▩) AMCh, (▧) AM, (▦) SG. \* $P < 0.05$  compared with colitis control group. # $P < 0.05$  compared with SG group. Data are shown as mean  $\pm$  SD.

the ileum and proximal colon [22]. Estimating a transit time to the colon of about 5–6 h [23], AM and AMCh better correspond to colon-specific release as only a small amount of drug was detected in plasma before 5.5 h. Surprisingly, AMCh pellets led to lower systemic N-acetyl-5-ASA level than chitosan-free formulations. This phenomenon is unclear however a potential interaction between chitosan and drug or chitosan and coating can be rather excluded since no peculiarities have been observed during in vitro dissolution, where usually such phenomena are confirmed. The observed data speak for circumstances, where chitosan influences the passage through the barrier lowering the AUC combined with an increased local tissue concentration of N-acetyl-5-ASA. It has been suggested recently that chitosan is likely to modulate cytochrome P450 3A activity and protein expression which is one possible explanation for our observations [24].

While in healthy rats N-acetyl-5-ASA was found in the ileum and in higher concentration in the colon, in colitis groups the metabolite was present principally in the colon and slightly lower concentrations were achieved. This slight differences between healthy and colitis state can be related to the accelerated transit time in active colitis compared with healthy animals [12], the impaired mucosal uptake during inflammation leading to reduced mucosal concentrations of 5-ASA [25], and the increased intestinal permeability in apparently unaffected parts of intestine [26]. Even though, intestinal permeability studies in the inflamed tissue have so far been contradictory [21,27] it is of interest to note that changes in permeability are related to the physicochemical properties of the active and may vary with each different drug applied in the treatment of IBD [28]. It is well documented that the therapeutic effect of 5-ASA depends directly on the actual mucosal drug concentration in the inflamed area assuming that 5-ASA enters into the epithelial cells from the luminal side of the intestine after delivery to the colon [3,29]. Recently, 5-ASA has shown to be a substrate for the members of the organic anion transporting polypeptide (OATP) family being significantly overexpressed in inflamed tissue which can enhance the intracellular accumulation of 5-ASA [30,31]. On the other hand, the existence of efflux pumps for 5-ASA and N-acetyl-5-ASA was discovered and could be a reason for the observed concentrations being lower in colitis group [32].

Our in vivo data on the therapeutic efficiency of MCh pellets support previous findings in cultured cells hypothesizing that chitosan may modulate increased levels of inflammatory cytokines (IL-6, IL-8, TNF- $\alpha$ ) through inhibition of NF- $\kappa$ B activation and thus

could exert a potentially beneficial effect in the treatment of IBD [33]. Although several polysaccharides have already been observed to possess anti-inflammatory effects [34,35], it is interesting that other studies did not observe such efficiency, where drug free chitosan capsules did not provide a pronounced healing effect compared with 5-ASA loading chitosan capsules [36]. This requires surely further elucidation of the mechanism.

## 5. Conclusion

Chitosan-core 5-ASA pellets seem to be a promising candidate for colonic drug delivery in the therapy of IBD. Release of 5-ASA is concentrated to the distal ileum and colon, resulting in reduced systemic drug exposure. Such pellets provide increased N-acetyl-5-ASA concentration in the colonic tissue and lower systemic availability. Chitosan alone was found to provide a significant anti-inflammatory effect and can increase the intra-tissue drug concentration in inflamed tissue although no synergistic effect on the therapeutic outcome was observed with the combination of chitosan and 5-ASA. Overall, bioadhesive chitosan pellets showed additional beneficial properties for colonic 5-ASA delivery in the treatment of IBD.

## Acknowledgements

Alf Lamprecht is thankful to the “Institut Universitaire de France” for financial support. The project was co-financed by grant from Ministry of Health of the Czech Republic (Project NS10222-2/2009). Financial support for PhD students under co-supervision from the French Government (No 201052) is gratefully acknowledged.

## References

- [1] C. Loddenkemper, Diagnostic standards in the pathology of inflammatory bowel disease, *Dig. Dis.* 27 (2009) 576–583.
- [2] L.J. Egan, W.J. Sandborn, Drug therapy of inflammatory bowel disease, *Drugs Today (Barc)* 34 (1998) 431–446.
- [3] A. Kornbluth, D.B. Sachar, Ulcerative colitis practice guidelines in adults: American college of gastroenterology, practice parameters committee, *Am. J. Gastroenterol.* 105 (2010) 501–523.
- [4] J.D. Lewis, How safe are the safest IBD drugs?, *Gastroenterology* 124 (2003) 1986–1988.
- [5] D.R. Friend, New oral delivery systems for treatment of inflammatory bowel disease, *Adv. Drug Deliv. Rev.* 57 (2005) 247–265.
- [6] J.D. Smart, The basics and underlying mechanisms of mucoadhesion, *Adv. Drug Deliv. Rev.* 57 (2005) 1556–1568.
- [7] A.K. Singla, M. Chawla, Chitosan: some pharmaceutical and biological aspects – an update, *J. Pharm. Pharmacol.* 53 (2001) 1047–1067.
- [8] L. Illum, Chitosan and its use as a pharmaceutical excipient, *Pharm. Res.* 15 (1998) 1326–1331.
- [9] V.K. Gupta, T.E. Beckert, J.C. Price, A novel pH- and time-based multi-unit potential colonic drug delivery system. I. Development, *Int. J. Pharm.* 213 (2001) 83–91.
- [10] G.P. Morris, P.L. Beck, M.S. Herridge, W.T. Depew, M.R. Szwczuk, J.L. Wallace, Hapten-induced model of chronic inflammation and ulceration in the rat colon, *Gastroenterology* 96 (1989) 795–803.
- [11] A. Lamprecht, N. Ubrich, H. Yamamoto, U. Schäfer, H. Takeuchi, P. Maincent, Y. Kawashima, C.M. Lehr, Biodegradable nanoparticles for targeted drug delivery in treatment of inflammatory bowel disease, *J. Pharmacol. Exp. Ther.* 299 (2001) 775–781.
- [12] A. Lamprecht, H. Yamamoto, H. Takeuchi, Y. Kawashima, A pH-sensitive microsphere system for the colon delivery of tacrolimus containing nanoparticles, *J. Control. Release* 104 (2005) 337–346.
- [13] J.E. Krawisz, P. Sharon, W.F. Stenson, Quantitative assay for acute intestinal inflammation based on myeloperoxidase activity. Assessment of inflammation in rat and hamster models, *Gastroenterology* 87 (1984) 1344–1350.
- [14] K.V.R. Rao, P. Buri, A novel in situ method to test polymers and coated microparticles for bioadhesion, *Int. J. Pharm.* 52 (1989) 265–270.
- [15] B. Bystrowska, J. Nowak, J. Brandys, Validation of a LC method for the determination of 5-aminosalicylic acid and its metabolite in plasma and urine, *J. Pharm. Biomed. Anal.* 22 (2000) 341–347.
- [16] H. Steckel, F. Mindermann-Nogly, Production of chitosan pellets by extrusion/spheronization, *Eur. J. Pharm. Biopharm.* 57 (2004) 107–114.
- [17] A.G. Press, L.A. Hauptmann, L. Hauptmann, B. Fuchs, M. Fuchs, K. Ewe, G. Ramadori, Gastrointestinal pH profiles in patients with inflammatory bowel disease, *Aliment. Pharmacol. Ther.* 12 (1998) 673–678.
- [18] S.G. Nugent, D. Kumar, D.S. Rampton, D.F. Evans, Intestinal luminal pH in inflammatory bowel disease: possible determinants and implications for therapy with aminosaliculates and other drugs, *Gut* 48 (2001) 571–577.
- [19] D.L. French, J.W. Mauger, Evaluation of the physicochemical properties and dissolution characteristics of mesalamine: relevance to controlled intestinal drug delivery, *Pharm. Res.* 10 (1993) 1285–1290.
- [20] R.C. Schellekens, F.E. Stuurman, F.H. van der Weert, J.G. Kosterink, H.W. Frijlink, A novel dissolution method relevant to intestinal release behaviour and its application in the evaluation of modified release mesalazine products, *Eur. J. Pharm. Sci.* 30 (2007) 15–20.
- [21] S.Y. Zhou, D. Fleisher, L.H. Pao, C. Li, B. Winward, E.M. Zimmermann, Intestinal metabolism and transport of 5-aminosalicylate, *Drug Metab. Dispos.* 27 (1999) 479–485.
- [22] F.J. Zijlstra, M.E. van Meeteren, I.M. Garredts, M.A. Meijssen, Effect of pharmacologically induced smooth muscle activation on permeability in murine colitis, *Mediators Inflamm.* 12 (2003) 21–27.
- [23] M. Mori, Y. Shirai, Y. Uezono, T. Takahashi, Y. Nakamura, H. Makita, Y. Nakanishi, Y. Imasato, Influence of specific gravity and food on movement of granules in the gastrointestinal tract of rats, *Chem. Pharm. Bull. (Tokyo)* 37 (1989) 738–741.
- [24] H.T. Yao, C.K. Lii, R.H. Chou, J.H. Lin, H.T. Yang, M.T. Chiang, Effect of chitosan on hepatic drug-metabolizing enzymes and oxidative stress in rats fed low and high-fat diets, *J. Agric. Food Chem.* 58 (2010) 5187–5193.
- [25] G. Frieri, R. Giacomelli, M. Pimpo, G. Palumbo, A. Passacantando, G. Pantaleoni, R. Caprilli, Mucosal 5-aminosalicylic acid concentration inversely correlates with severity of colonic inflammation in patients with ulcerative colitis, *Gut* 47 (2000) 410–414.
- [26] D.J. Dawson, R.W. Lobley, P.C. Burrows, J.A. Notman, M. Mahon, R. Holmes, Changes in jejunal permeability and passive permeation of sugars in intestinal biopsies in coeliac disease and Crohn's disease, *Clin. Sci. (Lond.)* 74 (1988) 427–431.
- [27] J.R. Turner, Intestinal mucosal barrier function in health and disease, *Nat. Rev. Immunol.* 9 (2009) 799–809.
- [28] Y. Pellequer, V. Weissenborn, A. Lamprecht, Decreased drug penetration in inflamed tissue related to changed mucosal metabolism in experimental colitis, *J. Pharm. Sci.* 96 (2007) 2145–2153.
- [29] J. König, H. Glaeser, M. Keiser, K. Mandery, U. Klotz, M.F. Fromm, Role of organic anion-transporting polypeptides for cellular mesalazine (5-aminosalicylic acid) uptake, *Drug Metab. Dispos.* 39 (2011) 1097–1102.
- [30] K.A. Wojtal, J.J. Eloranta, P. Hruz, H. Gutmann, J. Drewe, A. Staumann, C. Beglinger, M. Fried, G.A. Kullak-Ublick, S.R. Vavricka, Changes in mRNA expression levels of solute carrier transporters in inflammatory bowel disease patients, *Drug Metab. Dispos.* 37 (2009) 1871–1877.
- [31] D. Kietzmann, B. Moulari, A. Béduneau, Y. Pellequer, A. Lamprecht, Colonic delivery of carboxyfluorescein by pH-sensitive microspheres in experimental colitis, *Eur. J. Pharm. Biopharm.* 76 (2010) 290–295.
- [32] H.W. Xin, M. Schwab, U. Klotz, Transport studies with 5-aminosalicylate, *Eur. J. Clin. Pharmacol.* 62 (2006) 871–875.
- [33] S.B. Seo, H.J. Jeong, H.S. Chung, J.D. Lee, Y.O. You, T. Kajiuchi, H.M. Kim, Inhibitory effect of high molecular weight water-soluble chitosan on hypoxia-induced inflammatory cytokine production, *Biol. Pharm. Bull.* 26 (2003) 717–721.
- [34] A. Mirshafiey, A. Khodadadi, B.H. Rehm, M.R. Khorramizadeh, M.B. Eslami, A. Razavi, F. Saadat, Sodium alginate as a novel therapeutic option in experimental colitis, *Scand. J. Immunol.* 61 (2005) 316–321.
- [35] Y. Pellequer, Y. Meissner, N. Ubrich, A. Lamprecht, Epithelial heparin delivery via microspheres mitigates experimental colitis in mice, *J. Pharmacol. Exp. Ther.* 321 (2007) 726–733.
- [36] H. Tozaki, T. Odoriba, N. Okada, T. Fujita, A. Terabe, T. Suzuki, S. Okabe, S. Muranishi, A. Yamamoto, Chitosan capsules for colon-specific drug delivery: enhanced localization of 5-aminosalicylic acid in the large intestine accelerates healing of TNBS-induced colitis in rats, *J. Control. Release* 82 (2002) 51–61.