



HAL
open science

Ecological significance of the induced tolerance of microbial communities in fluvial biofilms to anthropogenic contaminations

Ahmed Tlili

► **To cite this version:**

Ahmed Tlili. Ecological significance of the induced tolerance of microbial communities in fluvial biofilms to anthropogenic contaminations. Agricultural sciences. Université Claude Bernard - Lyon I, 2010. English. NNT : 2010LYO10293 . tel-00847372

HAL Id: tel-00847372

<https://theses.hal.science/tel-00847372>

Submitted on 23 Jul 2013

HAL is a multi-disciplinary open access archive for the deposit and dissemination of scientific research documents, whether they are published or not. The documents may come from teaching and research institutions in France or abroad, or from public or private research centers.

L'archive ouverte pluridisciplinaire **HAL**, est destinée au dépôt et à la diffusion de documents scientifiques de niveau recherche, publiés ou non, émanant des établissements d'enseignement et de recherche français ou étrangers, des laboratoires publics ou privés.

THESE DE L'UNIVERSITE DE LYON

Délivrée par

L'UNIVERSITÉ CLAUDE BERNARD LYON 1

Ecole doctorale **E2M2**

Spécialité **ÉCOLOGIE MICROBIENNE**

DIPLOME DE DOCTORAT

(arrêté du 7 août 2006)

par **Ahmed TLILI**

**SIGNIFICATION ÉCOLOGIQUE DE LA TOLÉRANCE
ACQUISE DES COMMUNAUTÉS MICROBIENNES DES
BIOFILMS DE RIVIÈRES À UNE CONTAMINATION
D'ORIGINE ANTHROPIQUE**

Soutenue publiquement le 21 décembre 2010 devant le jury composé de :

M. Frédéric GARABETIAN (Rapporteur, Président)

Mme. Nathalie CHEVRE (Rapporteur)

M. Gérard LACROIX (Examineur)

M. Jean-Pierre REBILLARD (Examineur)

M. Franck POLY (Examineur)

M. Bernard MONTUELLE (Directeur de thèse)

Mme. Annette BERARD (Codirectrice de thèse)

UNIVERSITE CLAUDE BERNARD - LYON 1

Président de l'Université

M. le Professeur L. Collet

Vice-président du Conseil Scientifique

M. le Professeur J-F. Mornex

Vice-président du Conseil d'Administration

M. le Professeur G. Annat

Vice-président du Conseil des Etudes et de la Vie Universitaire

M. le Professeur D. Simon

Secrétaire Général

M. G. Gay

COMPOSANTES SANTE

Faculté de Médecine Lyon Est – Claude Bernard

Directeur : M. le Professeur J. Etienne

Faculté de Médecine et de Maïeutique Lyon Sud – Charles Mérieux

Directeur : M. le Professeur F-N. Gilly

UFR d'Odontologie

Directeur : M. le Professeur D. Bourgeois

Institut des Sciences Pharmaceutiques et Biologiques

Directeur : M. le Professeur F. Locher

Institut des Sciences et Techniques de la Réadaptation

Directeur : M. le Professeur Y. Matillon

Département de formation et Centre de Recherche en Biologie Humaine

Directeur : M. le Professeur P. Farge

COMPOSANTES ET DEPARTEMENTS DE SCIENCES ET TECHNOLOGIE

Faculté des Sciences et Technologies

Directeur : M. le Professeur F. Gieres

Département Biologie

Directeur : M. le Professeur F. Fleury

Département Chimie Biochimie

Directeur : Mme le Professeur H. Parrot

Département GEP

Directeur : M. N. Siauve

Département Informatique

Directeur : M. le Professeur S. Akkouche

Département Mathématiques

Directeur : M. le Professeur A. Goldman

Département Mécanique

Directeur : M. le Professeur H. Ben Hadid

Département Physique

Directeur : Mme S. Fleck

Département Sciences de la Terre

Directeur : Mme le Professeur I. Daniel

UFR Sciences et Techniques des Activités Physiques et Sportives

Directeur : M. C. Collignon

Observatoire de Lyon

Directeur : M. B. Guiderdoni

Ecole Polytechnique Universitaire de Lyon 1

Directeur : M. P. Fournier

Institut Universitaire de Technologie de Lyon 1

Directeur : M. le Professeur C. Coulet

Institut de Science Financière et d'Assurances

Directeur : M. le Professeur J-C. Augros

Institut Universitaire de Formation des Maîtres

Directeur : M. R. Bernard

RÉSUMÉ

Les modifications de structure et de diversité des communautés biologiques au sein d'un écosystème soumis à une perturbation, se traduisent généralement par la raréfaction, la disparition d'espèces sensibles et/ou l'apparition de nouvelles espèces tolérantes ou par la prolifération d'autres espèces tolérantes déjà présentes mais à une faible densité. Dans le cas d'une perturbation d'origine toxique, ceci a pour conséquence une diminution de la sensibilité globale de la communauté par rapport à la (aux) substance(s) responsable(s) de cette modification de structure et de diversité. L'évaluation de la tolérance vis-à-vis d'un toxique peut donc nous permettre de révéler a posteriori l'exposition d'une communauté biologique à ce toxique, en mettant en évidence le lien entre pression et impact sur le compartiment biotique d'un écosystème. Malgré de nombreux travaux en ce domaine, il reste cependant de nombreuses lacunes scientifiques dans la compréhension de cette tolérance induite par les pollutions (PICT). Le modèle d'étude retenu est le biofilm aquatique (ou périphyton), dont les spécificités biologiques et écologiques en font un outil d'étude très intéressant.

Ce travail a permis de montrer que l'intégration du concept PICT comme un outil complémentaire dans les systèmes d'évaluation environnementale donnerait plus de pertinence écologique et de spécificité écotoxicologique à la batterie actuelle des bio-indicateurs utilisés.

Par ailleurs, le PICT est aussi une approche conceptuelle, à l'échelle des communautés, très riche et qui confirme l'intérêt d'aborder l'écotoxicologie avec le regard de l'écologue plus holistique que celui du toxicologue. En effet, les mesures de tolérance-induite qui prennent en compte la diversité fonctionnelle du biofilm, ainsi que les analyses taxonomiques associées, nous ont permis une meilleure compréhension de la résistance et de la résilience de cet écosystème suite à des perturbations d'origine chimique. Nos travaux nous ont aussi permis d'aborder le concept des seuils de résistance et de résilience écologiques, et de mettre en évidence le fait qu'une acquisition de tolérance à un stress donné, pourrait se traduire par le déplacement des communautés d'un état initial vers un état « alternatif » stable, même après le retrait du stress. Ces seuils écologiques ainsi que cet état alternatif stable signifient que la disparition des espèces les plus sensibles (comme l'un des processus expliquant le PICT) n'affecte donc pas les fonctions de la communauté dans son ensemble au début et ce seulement jusqu'à un certain seuil de résistance. Le PICT pourrait ainsi se traduire par une réduction de la diversité ou avec des modifications dans la composition spécifique, sans pour

autant qu'il y ait un effet négatif sur le fonctionnement de la communauté. Cependant, la capacité des communautés à devenir tolérantes à une perturbation peut avoir des conséquences négatives sur les capacités de résilience et de résistance des écosystèmes. Nous avons donc abordé dans nos travaux le concept de « co-tolérance négative entre espèces » et de coût de la tolérance.

ABSTRACT

Changes in structure and diversity of biological communities within ecosystems subjected to disturbances, are generally synonymous of the scarcity, loss and/or the emergence of new tolerant species or by the proliferation of other species already present but at low density. This leads to a decrease in the overall sensitivity of the community toward the substance(s) responsible for this change of community structure and diversity. The evaluation (and if possible the quantification) of tolerance towards a toxicant may therefore enable us to reveal *a posteriori* the exposure of a biological community to this toxicant (its exposure history), and demonstrate the specific link between pressure and impact on the biotic compartment of an ecosystem and, more generally, on the ecosystem. Despite numerous studies in this area, there are still many gaps in scientific understanding of the pollution induced-tolerance. The biological model that we used is the lotic biofilm (or periphyton) whose biological and ecological characteristics make it a very interesting tool for study.

This work has shown firstly that the integration of the acquired tolerance concept as a complementary tool in the environmental assessment systems would allow more ecological relevance and ecotoxicological specificity to the current set of used bio-indicators.

Furthermore, the PICT is also a conceptual approach at the community level, which confirms the interest to address ecotoxicology from the viewpoint of the ecologist that is more holistic than the toxicologist one. Indeed, measures of pollution-induced tolerance, by taking into account the functional diversity of biofilms, and the associated taxonomic analysis, allowed to have a better understanding of resistance and resilience of the ecosystem submitted to chemical perturbations. Our works enabled us to tackle the concept of ecological thresholds of resistance and resilience, and to highlight the fact that enhanced tolerance to a given stress, could result in the displacement of communities from an initial state to an « alternative » stable state, even after the stress removal. These ecological thresholds and the alternative stable state mean that the disappearance of the most sensitive species (as a process explaining the PICT) does not affect the functions of the community until reaching a threshold of resistance. Thus the PICT could correspond to a reduction in diversity or changes in species composition, without having a negative effect on the functioning of the community. However, the ability of communities to be tolerant toward disturbance can have negative consequences on the resilience and resistance of ecosystems. Consequently, we addressed in our work the concept of "negative co-tolerance between species" and costs of tolerance

Remerciements

Je voudrais tout d'abord remercier sincèrement les membres du jury d'avoir accepté d'évaluer ce travail. Je tiens également à adresser mes profonds remerciements à mes deux directeurs de thèse Bernard Montuelle et Annette Bérard, qui m'ont fait confiance tout au long de ces 3 années de thèse et qui ont su me transmettre leur passion pour l'écologie aquatique.

Merci aux membres de mon comité de pilotage Agnès Bouchez, Hélène Guasch et Thomas Pelte de m'avoir guidé et empêché de me disperser dans toutes les directions.

Je tiens également à remercier tous les membres de l'équipe «EMHA» du Cemagref de Lyon avec qui j'ai passé d'agréables moments. Mille mercis à Stéphane, Bernard, Christophe, Joan, Jean-Louis, Marjorie et Bernadette pour votre aide précieuse.

Ce travail de thèse est le fruit de nombreuses collaborations. Merci donc à tous ceux qui font partie du Laboratoire de chimie de Lyon, ainsi qu'aux personnes qui m'ont aidé dans mon travail à l'INRA de Thonon les Bains. Merci également aux membres de l'équipe d'Ecologie Aquatique de l'Université de Gérone en Espagne qui m'ont accueilli pendant six mois et qui ont su rendre ce séjour agréable, et en particulier Natalia, Berta, Chloé et Leslie. Mention spéciale à Hélène, qui m'a accueilli et encadré pendant ce séjour. Et enfin merci à Soizic Morin du Cemagref de Bordeaux pour son aide précieuse dans la taxonomie des diatomées.

Merci également à tous mes amis qui ont su être à mes côtés et me soutenir pendant les moments difficiles : Kabil, Myriam, Salma, Nour, Patrice et Amel.

Et enfin je tiens énormément à remercier tous les membres de ma famille, loin par la distance mais pas de mon cœur, et en particulier mes frères Hechem et Skander et ma sœur Sourour pour l'amour qu'ils me portent ainsi que pour leurs encouragements continus.

Je dédie ce travail de thèse à mes chers parents pour tous les sacrifices qu'ils ont fait pour moi, pour leur confiance et leur amour sans limite.

Table des matières

	page
Avant propos	1
CADRE GENERAL ET PROBLEMATIQUE	1
OBJECTIFS ET HYPOTHESES POSEES	3
PRESENTATION DU MANUSCRIT	5
Chapitre A. Introduction générale et synthèse bibliographique	7
A.I. Pollution des milieux aquatiques : contexte réglementaire et scientifique	7
A.I.1. Origines et natures des pollutions	8
A.I.2. Contexte réglementaire	10
A.I.3. Contexte scientifique	12
A.I.3.a. Pollutions et état écologique des cours d'eau : une question de relation entre diversité et fonction	12
A.I.3.b. Outils d'évaluation des pollutions : entre réalisme et réductionnisme ---	13
A.II. Les biofilms de rivières en tant que modèle biologique	16
A.II.1. Définition	16
A.II.2. Structure et formation	17
A.II.3. Rôle du biofilm dans les cours d'eau	19
A.II.4. Pertinence de l'utilisation du biofilm de rivière en tant que modèle biologique de bioindication	20
A.III. Le concept de la tolérance acquise ou de « pollution-induced community tolerance » (Article 1)	21
Chapitre B. Matériel et méthodes	48
B.I. Sites d'études et systèmes expérimentaux	48
B.I.1. Sites d'études	48
B.I.1.a. La rivière Morcille	48
B.I.1.b. La rivière Osor	49
B.I.2. Microcosmes de laboratoire et mésocosmes ex situ	50
B.I.2.a. Microcosmes de laboratoire	50
B.I.2.b. Mésocosmes ex situ	51

B.II. Les paramètres mesurés -----	52
B.II.1. Analyses physico-chimiques -----	52
B.II.1.a. Physico-chimie des eaux -----	53
B.II.1.b. Dosage des micropolluants dans les biofilms -----	53
B.II.2. Analyses biologiques -----	54
B.II.2.a. Mesures de la structure générale du biofilm -----	54
B.II.2.b. Caractérisations de la structure et de la composition des communautés périphytiques -----	55
B.II.2.c. Production primaire par incorporation de ¹⁴ C -----	61
B.II.2.d. Efficacité photosynthétique -----	62
B.II.2.e. Bioessais à court terme pour les mesures de tolérance (article 2) -----	62
Chapitre C. Résultats et Discussion -----	86
C.I. Influence du phosphore sur la tolérance acquise aux polluants des communautés phototrophes et hétérotrophes des biofilms de rivière (article 3) -----	86
C.II. Les Conséquences de l'acquisition de tolérance par les communautés microbiennes du biofilm, dans un contexte de pollution multiple par des métaux lourds (article 4) -----	116
C.III. Influence des chroniques d'exposition aux toxiques sur la tolérance acquise des communautés microbiennes du biofilm -----	142
C.III.1. Impacts d'expositions chroniques et aiguës au diuron sur les communautés autotrophes du biofilm simulant des épisodes de crues (article 5) -	142
C.III.2. Evolution spatio-temporelle de la tolérance acquise au zinc des communautés microbiennes du biofilm (article 6) -----	176
Chapitre D. Conclusions et perspectives -----	210
D.I. CONCLUSIONS GENERALES -----	210
D.I.I. Le concept PICT d'un point de vue écologique -----	210
D.I.II. Le concept PICT et son cadre d'utilisation dans la gestion des milieux aquatiques -----	213
D.II. PERSPECTIVES : du particulier au global -----	217

Références bibliographiques ----- 220

Annexes ----- 244

Tlili, A., Dorigo, U., Montuelle, B., Margoum, C., Carluer, N., Gouy, V., Bouchez, A., Berard, A., 2008. Responses of chronically contaminated biofilms to short pulses of diuron - An experimental study simulating flooding events in a small river. *Aquatic Toxicology*. 87, (4) 252-263.

Pesce, S., Tlili, A., Montuelle, B., 2009. Les biofilms aquatiques : dans quelle mesure permettent-ils de comprendre l'effet des pesticides sur le fonctionnement des cours d'eau ? Exemple en zone de vignoble. *Ingénieries-EAT*. 55-56, 79-91.

Morin, S., Pesce, S., Tlili, A., Coste, M., Montuelle, B., 2010. Recovery potential of periphytic communities in a river impacted by a vineyard watershed. *Ecological Indicators*. 10, (2) 419-426.

Montuelle, B., Dorigo, U., Bérard, A., Bouchez, A., Tlili, A., Gouy, V., Pesce, S., 2010. The periphyton as a multimetric bioindicator to assess the impact of land use on river: an overview on the Ardières-Morcille experimental watershed (France). *Hydriobiologia*. 657, 123-147.

Avant-propos

CADRE GENERAL ET PROBLEMATIQUE

Les écosystèmes assurent de très nombreuses fonctions et processus de transferts et de transformations physico-biochimiques. Face à la dégradation généralisée de l'environnement, conséquence du développement des sociétés humaines, une des manières de quantifier l'utilité des écosystèmes pour ces sociétés a été d'en identifier les « services rendus ». Depuis la conférence de Rio, et avec le *Millennium Ecosystems assessment* (MA, 2005), ces services écologiques ou services écosystémiques commencent à être caractérisés et quantifiés, et certains tentent de leur attribuer une valeur économique (coût de production ou de restauration). Durant les dernières décennies, les activités humaines ont modifié la qualité de ces écosystèmes plus rapidement et plus profondément qu'au cours de toute autre période comparable de l'histoire de l'humanité, menaçant ainsi la capacité des écosystèmes à assurer la pérennité des services écologiques qu'ils fournissent.

En tant qu'écosystèmes récepteurs, les milieux aquatiques sont particulièrement vulnérables aux différentes pressions anthropiques qui ont de graves conséquences sur la biodiversité de ces écosystèmes et sur leur fonctionnement. Depuis quelques années, au-delà du constat de pollution d'un milieu, se sont développées les notions, plus ou moins précises, de « santé des écosystèmes » et de « bon état écologique » (Costanza et Mageau 1999) impliquant une approche plus globale du milieu aquatique. Dans ce contexte, les pouvoirs publics européens se sont intéressés à cette notion d'état écologique des écosystèmes aquatiques, en visant comme objectif final une amélioration nette de leur qualité (ce qui implique leur restauration) ainsi que leur conservation pour les générations futures. De ce fait, de très nombreux travaux de recherche se sont développés sur cette question, en étudiant en particulier les relations entre le niveau de contamination des milieux et les impacts possibles sur les organismes ou les écosystèmes aquatiques (Pelte, 2009). Un des grands enjeux actuels est (1) d'élargir la connaissance de la biodiversité à la connaissance des liens biodiversité-fonctions au sein des communautés et des écosystèmes et (2) de traduire cette connaissance en outil d'aide à la gestion des milieux. Un autre grand enjeu est la prise en compte des changements de nature de la pression polluante, avec la multiplication de composés xénobiotiques actifs à de faibles doses. Ces enjeux, ainsi que celui des indicateurs, ont été

bien analysés dans le n°1 de la revue Sciences Eau et Territoires, (SET, n°1, Pont et Garric Coordonateurs).

Parmi les biocénoses aquatiques, les communautés microbiennes qui se développent en agrégats dénommés biofilms¹ sont des acteurs clés dans le fonctionnement général des cours d'eau. En effet, par leur position à la base du réseau trophique et leurs capacités enzymatiques, les microorganismes eucaryotes et procaryotes les constituant interviennent de manière prépondérante dans différents processus écologiques fondamentaux, tels que la production primaire, assurée par les organismes autotrophes, ou la dégradation de la matière organique et le recyclage des nutriments, assurés par les organismes hétérotrophes. C'est donc une communauté diversifiée particulièrement intéressante à étudier et pertinente pour aborder l'effet de substances polluantes ou toxiques.

Au sein des écosystèmes, les effets toxiques des polluants sur cette biocénose peuvent entraîner des changements au niveau de leur diversité et, en conséquence, des modifications d'interactions entre les organismes d'une communauté et des modifications des processus biologiques qui s'y déroulent (Clements et Newman 2002). En outre, ces changements se traduisent généralement par une adaptation et une sélection des organismes les plus tolérants à ces toxiques, ayant pour conséquence un accroissement de la tolérance globale des communautés. C'est sur cette constatation que le concept PICT (pollution-induced community tolerance ou acquisition de tolérance induite par la pollution) a été proposé (Blanck *et al.* 1988). Le concept PICT est donc basé sur le fait qu'une communauté biologique naturelle est constituée de différents « taxons » (espèces, souches, clones) ayant des sensibilités variables vis-à-vis d'un toxique donné. L'exposition d'une communauté à ce toxique se traduira par la sélection des organismes les plus tolérants ou la mise en place de mécanismes de détoxification. La communauté résultante présentera alors, dans son ensemble, une tolérance spécifique vis-à-vis du toxique supérieure à celle d'une communauté comparable mais n'ayant pas subi de pression de sélection par ce toxique (Bérard *et al.* 2002).

Deux approches complémentaires sont possibles pour évaluer la réponse microbienne à un stress environnemental : une approche orientée vers l'étude structurale des communautés et une approche fonctionnelle basée généralement sur le suivi d'activités métaboliques. Le concept PICT englobe ces deux approches puisqu'il correspond d'abord à des mesures de la sensibilité des communautés biologiques via des tests de toxicité aiguë (mesure de l'inhibition

¹ Voir le chapitre A « Introduction générale et synthèse bibliographique » pour plus de détails sur la définition des biofilms.

d'un paramètre fonctionnel par un toxique) qui vont confirmer l'hypothèse de la tolérance acquise, et ensuite ces mesures sont associées à des analyses structurales qui vont étayer l'hypothèse de sélection exercée par le polluant.

Actuellement, les nombreux outils de bioindication développés pour l'évaluation de la qualité des milieux aquatiques ne permettent pas toujours d'identifier des liens de causalité entre un polluant particulier (en particulier toxique) et un effet. **La démarche PICT serait alors un complément approprié pour mesurer l'importance d'une perturbation de nature toxique subie par les communautés, puisqu'elle permet de renseigner sur un historique d'exposition aux toxiques (non pas sur une contamination ponctuelle du milieu), et d'établir ainsi une causalité entre pression et impact. Finalement, le PICT, tout en restant spécifique au stress d'origine toxique, permet par son approche « communauté et fonction », l'introduction de « plus d'écologie en écotoxicologie ».**

OBJECTIFS ET HYPOTHESES POSEES

En dépit des nombreux avantages que le concept PICT offre dans la compréhension des conséquences de la pollution anthropique des milieux aquatiques, quelques incertitudes subsistent encore quant à son utilisation comme un outil de routine dans l'évaluation de la qualité des milieux.

L'objectif de ce travail de thèse est en premier lieu, d'ordre cognitif en cherchant à **approfondir notre compréhension de la signification écologique de l'acquisition de la tolérance des communautés microbiennes** des biofilms de rivières à une contamination par des xénobiotiques (pesticides et métaux lourds) :

(1) quelles sont les causes (facteurs externes et internes au périphyton) de l'acquisition de tolérance ?

(2) quelles sont les conséquences de l'acquisition de tolérance d'un point de vue structure et fonctions du biofilm ?

e et en second lieu une approche plus pratique qui peut déboucher sur la **mise au point d'un bioindicateur de pollution** des milieux aquatiques basé sur la méthode PICT et l'utilisation des communautés biologiques des biofilms en tant que modèle biologique.

Afin de pouvoir répondre au mieux aux questions posées, différentes hypothèses ont été élaborées, basées en partie sur les connaissances actuelles, acquises dans le domaine de

l'évaluation de la qualité des milieux ainsi que sur les lacunes que peuvent présenter ces connaissances :

(1) la première hypothèse est basée sur le fait que **les changements fonctionnels au sein des communautés microbiennes du biofilm résultant de la tolérance induite par un pesticide ou un métal lourd, ne peuvent pas être caractérisés en ne ciblant qu'une partie des composantes microbiennes du périphyton** (soit autotrophes, soit hétérotrophes). De plus, actuellement non seulement peu d'outils fonctionnels sont proposés dans une approche PICT, mais généralement ces derniers sont basés sur l'incorporation d'éléments radioactifs (i.e. ^{14}C , leucine ou thymidine tritiées) non accessibles à tous les laboratoires. C'est pour cela que différents paramètres fonctionnels, simples d'emploi et qui ciblent les différents groupes fonctionnels du biofilm seront proposés. Ces descripteurs nous permettront en premier lieu, une meilleure compréhension des interactions entre groupes fonctionnels au sein du périphyton pouvant résulter de l'acquisition de tolérance. En second lieu, ils pourront, selon leur pertinence écologique, être éventuellement proposés comme outils d'évaluation du PICT.

(2) la deuxième hypothèse propose que **la tolérance acquise vis-à-vis d'un toxique donné, serait fortement dépendante des facteurs environnementaux**. Nous proposons donc, pour une meilleure compréhension du concept PICT, d'étudier l'interaction de ces facteurs (et dans notre cas nous avons choisi le phosphore, pour des raisons de réalisme avec notre site d'étude), sur les communautés microbiennes du biofilm impactées par des pollutions anthropiques.

(3) la troisième hypothèse suggère que l'acquisition de tolérance vis-à-vis d'un stress par les communautés microbiennes du biofilm pourrait avoir des conséquences sur les capacités de tolérance de ces mêmes communautés à un nouveau stress. En effet, l'exposition à un toxique pourrait induire un élargissement de la gamme de tolérance (i.e. co-tolérance) mais aussi de la sensibilité (i.e. coût de la tolérance) vis-à-vis d'un autre toxique auquel les communautés microbiennes n'ont jamais été exposées. Mieux comprendre ces conséquences de la tolérance induite pourrait nous permettre à plus long terme non seulement d'en évaluer son « coût écologique », mais aussi de proposer un démarche de sélection de molécules modèle pour des applications PICT ultérieures.

(4) les chroniques de flux de pesticides peuvent être extrêmement variables en termes de concentration, nature des polluants, durée des différents épisodes, hydrologie associée (crues notamment). On constate par ailleurs une variabilité temporelle de la tolérance des communautés microbiennes des biofilms aux pesticides. Une quatrième hypothèse a été formulée, et stipule que la nature ainsi que la durée des chroniques d'exposition pourrait

influencer l'intensité de l'impact des phytosanitaires sur la biologie des systèmes et en particulier sur la tolérance induite des communautés microbiennes du biofilm exposées.

PRESENTATION DU MANUSCRIT

Ce mémoire s'organise en quatre chapitres principaux :

◆ Le **CHAPITRE A**, bibliographique, dans le quel nous présentons un aperçu sur l'influence des activités humaines sur la qualité des milieux lotiques (d'un point de vue réglementaire mais aussi scientifique), ainsi que les différents outils mis en place pour la caractériser. Un intérêt tout particulier est porté sur les biofilms de rivières en tant que modèle biologique et sur leur utilisation dans le concept de la tolérance induite par la pollution (PICT). Une synthèse bibliographique sur le concept PICT est présentée à la fin de ce chapitre sous le titre « Microbial pollution-induced community tolerance » (**article 1**). Cette synthèse constitue un des chapitres du livre « Tolerance to Environmental Contaminants » édité pour CRC Press par Amiard-Triquet, C., Rainbow, P.S. et Roméo, M.

◆ Le **CHAPITRE B** est consacré à la présentation du matériel et des méthodes d'analyse utilisés au cours des différentes expériences. Ce chapitre inclut un article intitulé « Use of the MicroRespTM method to assess pollution-induced community tolerance to metals for lotic biofilms » et qui a été publié dans *Environmental Pollution* (**article 2**).

◆ Les résultats obtenus sont ensuite détaillés et discutés dans le **CHAPITRE C** qui s'articule autour de trois parties structurées en fonction de nos hypothèses de travail. La première partie aborde la pertinence des descripteurs fonctionnels du PICT, ainsi que l'influence d'un gradient de phosphore sur cette tolérance acquise des communautés microbiennes des biofilms vis à vis d'un pesticide et d'un métal lourd. Cette section a fait l'objet d'une publication intitulée « PO₄³⁻ dependence of the tolerance of autotrophic and heterotrophic biofilm communities to copper and diuron » et publiée dans *Aquatic Toxicology* (**article 3**).

La deuxième partie de ce chapitre relative aux conséquences de l'acquisition de tolérance par les communautés hétérotrophes et phototrophes des biofilms dans un contexte de pollution multiple par les métaux lourds, est présentée sous la forme d'un article dont le titre est « An experimental study on tolerance patterns to multiple metal exposures of heterotrophic and autotrophic biofilm communities » et soumis à la revue *Science of the Total Environment* (**article 4**).

La troisième partie est consacrée à l'étude de l'influence des chroniques d'exposition aux polluants, en terme d'intensité et de durée, sur la tolérance acquise des communautés microbiennes des biofilms. Cette section a fait l'objet de deux articles : le premier concernant les impacts d'expositions chroniques et aiguës à un herbicide (i.e. diuron) sur les communautés autotrophes du biofilm est intitulé « Impact of chronic and acute pesticide concentrations on autotrophic periphyton communities: testing exposure scenarios and pesticide partitioning » et publié dans la revue *Science of the Total Environment* (**article 5**), et le deuxième concernant l'évolution spatio-temporelle du PICT est intitulé « *In-situ* spatio-temporal evolution of pollution-induced community tolerance to zinc in autotrophic and heterotrophic biofilm communities » et soumis à la revue *Ecotoxicology* (**article 6**).

◆ Le **CHAPITRE D** présente une synthèse des principales conclusions qui reposent sur les résultats obtenus au cours de ce travail, ainsi que les perspectives de recherche qui en découlent.

◆ Les deux dernières parties de ce manuscrit correspondent aux **références bibliographiques**, et à quatre publications présentées en **annexes** : (1) « Responses of chronically contaminated biofilms to short pulses of diuron. An experimental study simulating flooding events in a small river » (Tlili et al. 2008. *Aquatic Toxicology*) ; (2) « Les biofilms aquatiques : dans quelle mesure permettent-ils de comprendre l'effet des pesticides sur le fonctionnement des cours d'eau ? Exemple en zone de vignoble. » (Pesce et al. 2009. *Ingénieries-EAT*) ; (3) « Recovery potential of periphytic communities in a river impacted by a vineyard watershed. » (Morin et al. 2010. *Ecological Indicators*) ; (4) « The periphyton as a multimetric bioindicator to assess the impact of land use on river: an overview on the Ardières-Morcille experimental watershed (France). » (Montuelle et al. 2010. *Hydrobiologia*).

INTRODUCTION GENERALE
ET
SYNTHESE BIBLIOGRAPHIQUE

Chapitre A. Introduction générale et synthèse bibliographique

L'état écologique d'un cours d'eau est caractérisé par ses différentes composantes abiotiques (caractères physiques, hydrologiques et physico-chimiques) et biotiques (diversité et dynamique des biocénoses). Pour évaluer cet état, il faut donc réaliser une analyse multidisciplinaire de cet écosystème et du territoire qu'il traverse (le bassin versant), en étudiant d'une part la géologie et la typographie du milieu ainsi que les caractéristiques physico-chimiques de l'eau et du sol, et d'autre part la biodiversité et les processus bio-géo-écologiques associés. Dans le cadre de cette étude, nous avons abordé l'état écologique des cours d'eau selon une démarche d'écotoxicologie en précisant les effets des perturbations anthropiques (contexte de pollutions) sur la biocénose.

Dans ce chapitre introductif, nous présentons un aperçu sur l'influence des activités humaines sur cet état écologique des milieux lotiques (d'un point de vue réglementaire mais aussi scientifique), ainsi que les différents outils mis en place pour la caractériser. Un intérêt tout particulier est porté sur les biofilms de rivières en tant que modèle biologique et sur leur utilisation dans le concept de la tolérance induite par la pollution (PICT). C'est à travers ce concept que nous avons développé notre étude.

A.I. Pollution des milieux aquatiques : contexte réglementaire et scientifique

Les bassins versants des rivières présentent des composantes physiques, chimiques et biologiques, interconnectées et soumises aux variations des régimes hydrauliques de l'eau. En conséquence, toutes les modifications survenant au niveau de ces bassins versants pourraient avoir des implications néfastes plus en aval, et compromettre ainsi la viabilité des écosystèmes aquatiques récepteurs (Allan et al. 1997). Que ce soit d'une manière consciente, accidentelle ou par manque d'informations, les activités humaines qui se sont intensifiées ces dernière décennies, ont conduit, via des rejets solides et liquides, à des changements importants dans les milieux aquatiques. Ce faisant, ces rejets ont entraîné une dégradation de l'état écologique et chimique de ces milieux et impacté les multiples « services écologiques » fournis par les rivières, tels que leur capacité à approvisionner en eau les besoins domestiques ou industriels, leur capacité à recycler les matières exogènes leur pouvoir auto-épurateur, (Edeline 2001) ou encore leur capacité à soutenir une biodiversité adaptée à leur état initial.

Les activités humaines, présentent donc à l'échelle du paysage, la principale menace pour l'intégrité écologique des rivières, impactant ainsi l'habitat, la qualité de l'eau et les biotas (figure 1, Bernot et al. 2010, Norris et al. 2007). Parmi ces menaces, les pollutions sont susceptibles d'agir directement et indirectement sur les biocénoses aquatiques (Clements et Rohr, 2009).

A.I.1. Origines et natures des pollutions (figure 1)

Les principales sources de la pollution de l'eau peuvent être groupées en deux catégories selon leur type :

(1) Les **pollutions ponctuelles** correspondent à des apports directs et localisés, parfois temporaires de substances chimiques dans les cours d'eau et sont liées par exemple à des rejets d'effluents urbains ou industriels. Une pollution ponctuelle peut être issue de plusieurs sources géographiquement localisables proches les unes des autres, peu nombreuses et parfaitement dénombrables.

(2) Les **pollutions diffuses** sont dues à des rejets issus de toute la surface d'un territoire et transmis aux milieux aquatiques de façon indirecte, par ruissellement ou infiltration, sous l'influence de la force d'entraînement des eaux en provenance des précipitations ou des irrigations. Les pratiques agricoles ou minières peuvent être à l'origine de pollutions diffuses par entraînement de produits polluants dans les eaux qui percolent ou ruissellent. La pollution diffuse est d'autant plus difficile à contrôler que le nombre de sites émetteurs est important et que la collecte des eaux contaminées difficile.

De façon complémentaire, selon la nature des polluants une autre classification de la pollution des milieux aquatiques peut être adoptée. On distingue deux types majeurs de pollution :

(1) **La pollution trophique** (eutrophisation) qui se produit lorsqu'un milieu reçoit trop de matières nutritives assimilables par les algues (et cyanobactéries) et que celles-ci prolifèrent. Les principaux nutriments à l'origine de ce phénomène sont le phosphore (essentiellement sous forme de phosphates) et l'azote (contenu dans l'ammonium, les nitrates, et les nitrites). Leur apport en grande quantité par les effluents agricoles et urbains est responsable de l'eutrophisation, de l'écosystème aquatique conduisant ainsi à sa dégradation (Karaer et Kucukballi, 2006).

(2) **La pollution toxique** : les principaux toxiques rencontrés dans l'environnement lors des pollutions chroniques ou aiguës sont généralement des métaux lourds (plomb, mercure, cadmium, zinc...), des halogènes (chlore, brome, fluor, iode), des molécules organiques

complexes d'origine synthétique (xénobiotiques : pesticides...) ou naturelle (hydrocarbures). La pollution toxique peut provenir des rejets ponctuels (industries, stations d'épuration urbaines,...), et/ou de rejets diffus moins bien connus (épandage de pesticides en agriculture, retombées de micropolluants émis dans l'atmosphère...). Les substances toxiques déversées dans le milieu aquatique, ont des effets dommageables pour l'homme, la faune et la flore. Elles contribuent à l'appauvrissement biologique des écosystèmes aquatiques et en réduisent les usages. Certaines d'entre elles peuvent s'accumuler dans les êtres vivants (bio-concentration), et passer d'un maillon du réseau trophique à un autre (bio-amplification). Elles entraînent des dommages importants pour les équilibres biologiques (Serra 2009, IFEN 2010).

Enfin, pour mémoire, il est juste rappelé ici, les conséquences négatives des changements physiques apportés aux milieux aquatiques (chenalisation, destruction des habitats rivulaires, extraction de granulats,...) qui peuvent amplifier les conséquences des apports chimiques.

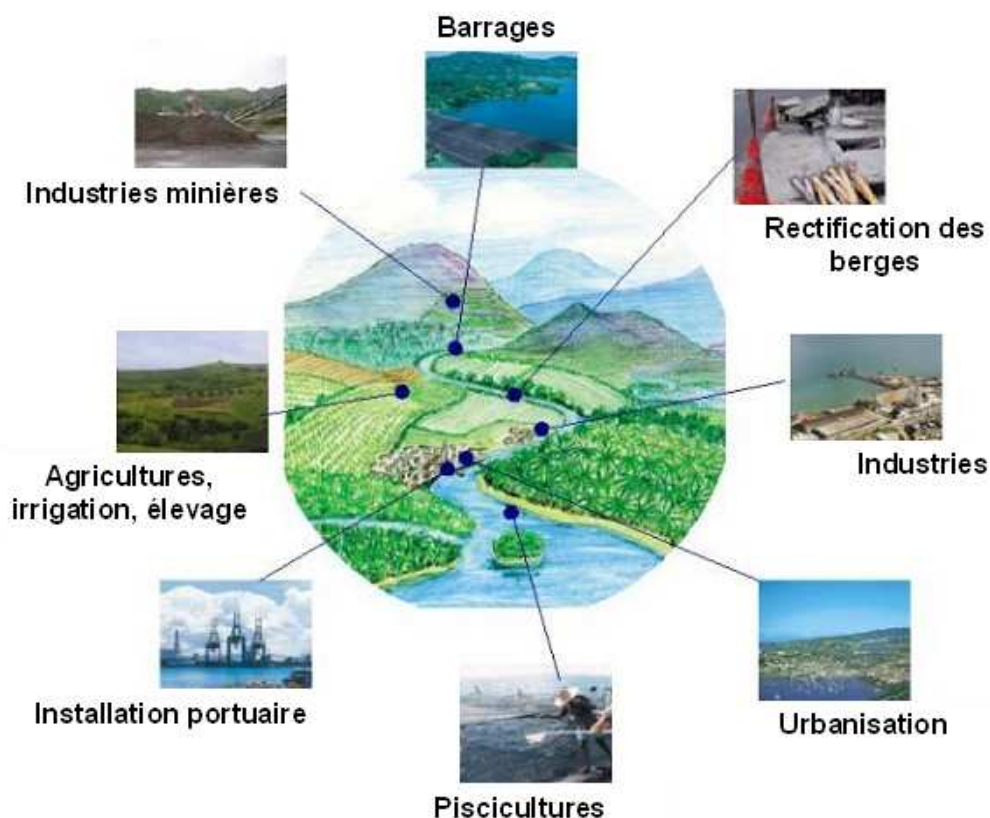

Figure 1 Schéma de la diversité des usages sur un bassin versant et des causes de dégradation possible des milieux aquatiques (source : DIREN)

A.I.2. Contexte réglementaire

Suite au constat relatif à la dégradation généralisée des milieux aquatiques, les pouvoirs publics en Europe ainsi que le Parlement et le Conseil Européen, ont adopté en octobre 2000 la Directive-Cadre sur l'eau (DCE) (2000/60/CE). L'objectif de l'Union Européenne est d'établir ainsi un cadre global pour une politique communautaire dans le domaine de l'eau et d'atteindre à l'horizon 2015 un « bon état écologique » de ses eaux de surfaces, souterraines et côtières. La mise en place de la DCE se traduit principalement en deux phases : établir en premier lieu un diagnostic général de l'état des milieux et mettre en place un réseau de suivi, et ensuite engager des actions de restauration sur les milieux n'ayant pas atteint le « bon état ». Pour tenir compte de la diversité des systèmes aquatiques, la notion de « masses d'eau » a été introduite pour définir des objectifs spécifiques et adaptées aux systèmes considérés (par ex., ruisseaux de têtes de bassin, grands fleuves,... Enfin, une prise en compte des facteurs environnementaux régionaux s'est révélée nécessaire pour définir des objectifs de qualité réalistes (définition d'hydroécorégions).

La phase de diagnostic commence d'abord par la caractérisation typologique des milieux sur des critères purement physiques et qui incluent donc un cadre géographique (géologie, altitude et taille des cours d'eau). Cette première caractérisation a pour objectif d'établir un système de référence par type de cours d'eau, et par hydroécorégion et ceci afin de permettre des comparaisons à l'échelle de l'Europe. La deuxième étape clé dans cette phase de diagnostic, est évidemment l'évaluation de l'état écologique des cours d'eau, via une spatialisation des pressions anthropiques. L'état des cours d'eau sera d'abord déterminé sur la base de deux critères : (1) hydromorphologique et (2) physicochimique, qui vont soutenir par la suite un troisième critère, à savoir la qualité biologique des cours d'eau (Wasson et al. 2001).

(1) L'hydromorphologie des cours d'eau est caractérisée par trois points :

- ◆ Le régime hydrologique (quantité et dynamique du débit d'eau, connexion aux masses d'eau souterraines...).
- ◆ La continuité de la rivière (transfert de sédiments...).
- ◆ Les conditions morphologiques (profondeur et largeur du cours d'eau, structure du lit et de la rive...).

(2) La qualité physicochimique est quant à elle évaluée à partir de la présence de trois éléments :

- ◆ Les macro-polluants, comme par exemple les matières en suspension ou les nutriments (qui ne sont considérés comme néfastes qu'à de fortes doses).

- ◆ Les micro-polluants minéraux, tels que les métaux lourds et qui peuvent être toxiques même à de faibles doses. Ces micro-polluants peuvent être d'origine naturelle ou anthropique.

- ◆ Les micro-polluants synthétiques (xénobiotiques), tels que les pesticides et les biocides et qui ne sont que d'origine anthropiques.

(3) La qualité biologique est évaluée principalement par l'utilisation de bio-indicateurs spécifiques, standardisés et normalisés, calculé par rapport à l'état biologique de peuplements de zones de référence. Ces bio-indicateurs, traduits au format numérique par une note, s'appuient sur des métriques qualitatives et quantitatives (composition taxonomique, abondance et biomasse, taxons sensibles...) et constituent des indices basés sur quatre groupes biologiques : les poissons (Indice Poisson en Rivière, IPR), les invertébrés (Indice Biologique Global Normalisé, IBGN), la flore aquatique (Indice biologique des Macrophytes en Rivières, IBMR) et le phytoplancton (Indice Biologique Diatomique, IBD) (voir section I.I.3.2 pour plus de détails).

Cependant, en plus de l'approche « appliquée », à destination des gestionnaires, la mise en place de la DCE soulève aussi de nombreuses questions d'ordre scientifique et notamment celle de la définition d'un « bon état écologique » de l'écosystème. En effet, cette notion va au-delà d'une simple mesure par paramètre, et devrait englober une vision plus globale de la compréhension des processus complexes impliqués dans le fonctionnement du milieu (Wasson et al. 2003).

Par ailleurs, L'Union européenne (UE) a mis en place en 2006 le système REACH, d'enregistrement, d'évaluation, d'autorisation et de restrictions des substances chimiques. Cette directive REACH (Règlement (CE) n° 1907/2006) complète la directive européenne 91/414 qui prévoit l'évaluation des risques associés aux usages agricoles des pesticides. REACH oblige les entreprises qui fabriquent et importent des substances chimiques à évaluer les risques résultant de leur utilisation et à prendre les mesures nécessaires pour gérer tout risque identifié. Ces substances chimiques, en particulier les pesticides, font donc l'objet d'une évaluation au niveau européen et national, de manière par exemple, à caractériser le risque *à priori* – pour l'agriculteur, le consommateur et l'environnement. Le risque pour l'environnement est évalué en comparant l'exposition et les effets possibles du toxique. C'est sur la base d'essais écotoxiques normalisés que ce risque est caractérisé, mais il est souvent nécessaire de réaliser une évaluation plus approfondie, qui prenne en compte la réactivité des milieux naturels (approches milieux naturels, complétées par des approches expérimentales en cosmes). De plus, une fois la substance chimique (voire sa formulation phytosanitaire commerciale) homologuée, il est nécessaire d'avoir un suivi des impacts du toxique dans les

milieux naturels et en particulier dans les milieux aquatiques réceptacles potentiels de pollutions, afin d'avoir un retour entre risque *à priori* et risque *à posteriori* évalués.

A.I.3. Contexte scientifique

A.I.3.a. Pollutions et état écologique des cours d'eau : une question de relation entre diversité et fonction

Un écosystème, dans ses aspects fondamentaux, implique la transformation, la circulation et l'accumulation d'énergie et de matière par les êtres vivants. La photosynthèse, la phytophagie, la prédation, le parasitisme, la symbiose, les activités de décomposition des matières organiques représentent les principaux processus biologiques responsables du transport et du stockage de la matière et de l'énergie. Les interactions des organismes engagés dans ces activités en fournissent les circuits de distribution. Les écologistes étudient depuis longtemps la fonction (rôle) écologique des différentes espèces. Ces fonctions regroupent l'ensemble des processus liés à l'écologie et à l'évolution, tels que les flux génétiques (dispersion des gènes...), les cycles des éléments nutritifs et la réponse aux perturbations. Leur étude porte sur la manière dont les différentes composantes des écosystèmes, comme par exemple l'énergie, les biomasses et les types d'espèces, évoluent au cours du temps.

Au sein des écosystèmes aquatiques, les effets toxiques des polluants entraînent des changements de la biodiversité et, en conséquence, des modifications d'interactions entre les organismes d'une communauté et les modifications des processus biologiques qui s'y déroulent. Si le concept de la biodiversité, ainsi que celui de réseau trophique, sont assez bien définis dans la littérature (DeLorenzo et al., 1999), il est difficile de mettre en évidence le lien entre la biodiversité d'un milieu naturel et les transferts d'énergie et de matière au sein de ce réseau. D'après de nombreuses études, la biodiversité contribue d'une façon générale à la capacité de résilience ainsi qu'à la stabilité d'un écosystème (Chapin et al., 2000 ; Hooper et al., 2002 ; Loreau et al., 2002). Cette hypothèse de la « diversité-stabilité » considère que la biodiversité constitue une « police d'assurance » pour l'écosystème, en pouvant minimiser ainsi les effets des perturbations qu'il risque de subir (Chapin et al., 2000). Cette capacité est basée sur le fait que dans un milieu donné, il existe de nombreuses espèces qui assurent les mêmes fonctions (redondance fonctionnelle) mais avec des abondances différentes, des capacités de croissance, de compétition et de colonisation variables. Dans le cas où l'une d'entre elles viendrait à disparaître, suite à une perturbation, les autres prendraient le relais pour assurer le maintien du bon fonctionnement de l'écosystème (Hooper et al., 2002 ; Pearce et Moran 1993). Le bon état écologique d'un cours d'eau pourrait donc se caractériser par sa

biodiversité taxonomique ainsi que par une diversité et une stabilité des transferts d'énergie et de matière au sein d'un même niveau trophique et des relations (consommation, compétition, commensalisme,...) entre les niveaux trophiques (Chapin et al., 2000).

A.I.3.b. Outils d'évaluation des pollutions : entre réalisme et réductionnisme

L'évaluation de la qualité des milieux aquatiques repose donc en partie sur des critères chimiques tels que les natures et les concentrations des polluants (IFEN, 2007) et physiques tels que la topographie, la géologie et l'hydrologie (Carluer et De Marsily, 2004 ; Lagacherie et al., 2006). Même si cette approche physico-chimique est incontournable, elle possède de nombreuses limites (informations ponctuelles, pas de renseignement sur les risques écotoxiques liés aux contaminations, de nombreuses contraintes d'un point de vue analytique (nombre de molécules et produits de dégradation de ces molécules à analyser importants, molécules inconnues, limites de détection et de quantification...). Par exemple, dans les années 1990, le Ministère de l'Aménagement du Territoire et de l'Environnement (MATE) et les agences de l'eau ont mis au point des outils d'évaluation de la qualité des milieux aquatiques basés en partie sur ces critères et connus sous le nom de Systèmes d'Évaluation de la Qualité (SEQ). En ce qui concerne les micropolluants, les grilles d'interprétations du SEQ-Eau étaient basées sur des valeurs seuils, elles mêmes basées sur les données écotoxicologiques de la littérature et comparées aux concentrations mesurées dans le milieu. Cette méthode, inspirée de celle de l'évaluation des risques, ayant pour intérêt pratique l'identification d'éventuels problèmes de qualité de l'eau et la définition d'objectifs de gestion, restait donc inféodée aux suivis analytiques du milieu. En résumé, les analyses physico-chimiques, malgré leur importance, ne suffisent donc pas à tirer des conclusions sur l'état des milieux aquatiques soumis à des pressions anthropiques. Les approches biologiques, écologiques et, plus récemment écotoxicologiques, se révèlent indispensables pour une telle évaluation.

Lagadic et Caquet (1998) proposent ainsi trois niveaux stratégiques et chronologiques dans l'évaluation biologique *in situ* de la qualité des milieux aquatiques. Le premier est une mesure chimique des concentrations des substances dans les organismes, suite à leur exposition (absorption, bioaccumulation...). Le second niveau est une mesure de biomarqueurs qui correspondent à des changements biochimiques, physiologiques, immunologiques, histologiques, morphologiques, et de comportement, à l'échelle individuelle, en réponse à au moins une substance toxique (Walker et al., 1998). Enfin, le troisième niveau, est une mesure d'effet sur les communautés avec l'utilisation de bioindicateurs (espèces ou groupes d'espèces) et qui désignent des espèces biologiques ou

animales qui, du fait de leurs particularités écologiques, constituent l'indication précoce de modifications biotiques ou abiotiques de l'environnement dues à des activités humaines (Ham et al., 1997). Actuellement en France, les indicateurs biocénotiques validés par une normalisation AFNOR sont au nombre de 5 :

(1) l'indice biologique global normalisé (**IBGN**, 1992 NF T90-350) qui est un outil de bioindication standardisé, utilisé en écologie et fondé sur l'étude des macro-invertébrés benthiques d'eau douce qui sont récoltés suivant un protocole d'échantillonnage normalisé.

(2) l'indice biologique macrophytique en rivière (**IBMR**, 2003 NF T90-395) est fondé sur l'examen des macrophytes pour déterminer le statut trophique des rivières, et qui traduit essentiellement le degré de trophie lié à des teneurs en ammonium et phosphates, ainsi qu'aux pollutions organiques les plus flagrantes.

(3) l'indice biologique diatomique (**IBD**, 2000 NF T90-354) est un outil d'investigation pratique de l'évaluation de la qualité des eaux mis à la disposition des gestionnaires des milieux aquatiques et applicable à l'ensemble des cours d'eau de France. Cet indice est établi selon la présence de diatomées, organismes particulièrement sensibles aux variations environnementales et notamment aux pollutions organiques, nutritives (azote, phosphore), salines, acides ou thermiques. Cet indice a été élaboré à partir d'une base de données (toujours alimentée) et d'un travail statistique et de modélisation original (réseaux artificiels de neurones).

(4) l'indice oligochètes de bio-indication des sédiments (**IOBS**, 2002 NF T90-390) permettant l'évaluation de la qualité biologique des sédiments fins ou sableux permanents ou stables des cours d'eau. Cet indice est basé sur la description et le comptage de taxons d'oligochètes et fait apparaître les incidences écologiques des rejets polluants (charge organique ; micro-polluants organiques et métalliques).

(5) l'indice poisson en rivière (**IPR**, 2004 NF T90-334) qui mesure sur un linéaire de court d'eau l'écart entre la composition d'un peuplement présent (déterminée après pêche électrique) et la composition du peuplement attendu en condition de référence. Il répond à différentes perturbations concernant la chimie de l'eau mais aussi l'habitat physique.

Du fait qu'ils ont été conçus pour évaluer une communauté par rapport à une référence, l'IBD, l'IBGN et l'IPR sont les trois indices principalement utilisés en France.

Cependant, d'une manière générale ces indices présentent des limites d'utilisation, liés au fait : (1) qu'ils reposent principalement sur l'analyse des caractéristiques structurelles (statistiques taxonomiques et abondance) des communautés, (2) qu'ils ne tiennent pas compte

des modifications physiologiques (croissance, activités métaboliques) que peuvent subir les communautés biologiques suite à des perturbations d'origine anthropiques et (3) qu'ils ne sont pas, en leur état actuel, de bons indicateurs de pollutions toxiques.

En complément à ces informations obtenues sur les organismes et les communautés en place dans le milieu étudié, la mise en œuvre des méthodes et techniques de l'écotoxicologie peut apporter un éclairage très complémentaire, voire déterminant, dans la démarche d'évaluation de la qualité des milieux. On fait ainsi souvent appel aux bio-essais pour déterminer un degré de pollution environnemental et évaluer le risque représenté par les substances toxiques telles que les phytosanitaires (utilisés par exemple dans le cadre de la directive REACH et dans le cadre du SEQ eau). Ces essais d'écotoxicité sont effectués au laboratoire et en conditions contrôlées sur des organismes sélectionnés selon différents critères : sensibilités aux toxiques, facilité de maintenance et de culture *in vitro*, pertinence écologique... Ils consistent à exposer ces organismes à différentes concentrations en toxique et à évaluer l'impact par rapport aux différents paramètres souhaités (survie, mortalité, reproduction...), qui sont mesurés après une courte durée (essais aigus) ou une longue durée (essais chroniques). La plupart de ces bioessais font l'objet de norme telles que les normes AFNOR ou OCDE et garantissent une mesure fiable de la toxicité de la substance active pour l'organisme test. L'ensemble des essais d'écotoxicité pour un groupe d'organismes, sert à définir des valeurs seuils telles que les NOEC¹ ou LOEC², qui sont spécifiques d'un organisme et d'une substance. Parmi ces tests, on peut citer le bioessai algal OCDE 201-1984 96 heures ou le test aigu d'immobilisation des Daphnies qui dure 24h (OCDE 202-1984). Un des défauts majeurs de ces tests est leur manque de représentativité environnementale et l'approche réductionniste des questions d'impact. En effet, les tests d'écotoxicité sont généralement appliqués sur des « souches » élevées depuis longtemps au laboratoire en milieu de culture artificiel, et qui ne sont pas forcément représentatives localement. De plus, cette approche est effectuée en monospécifique et donc on n'intègre pas les interactions interspécifiques (Bérard et Pelte, 1999 ; LeBoulangier, 2004).

¹ « No Observed Effect Concentration » ou concentration sans effet observable. Il s'agit de la plus haute concentration testée pour laquelle l'effet n'est significativement pas différent des contrôles

² « Low Observed Effect Concentration » ou « Plus faible concentration entraînant un effet observable ». Il s'agit de la plus basse concentration pour laquelle l'effet est différent de celui des contrôles. C'est la première concentration testée après la NOEC.

En conclusion, travailler avec différentes approches complémentaires pour la caractérisation de la contamination des milieux est du plus grand intérêt. La mise en évidence d'une relation de causalité entre la présence des polluants et leurs effets impose de réaliser en parallèle l'analyse du niveau de contamination des écosystèmes (approche physico-chimique) et celles des effets biologiques (biomarqueurs, bioindicateurs, bioessais d'écotoxicité...). Cependant, les évaluations de l'effet des pressions anthropiques sur les organismes biologiques dans l'environnement seraient encore plus pertinentes si elles étaient effectuées à l'échelle des communautés (Clements et Rohr, 2009), et c'est cette approche que nous avons privilégié dans cette thèse.

A.II. Les biofilms de rivières en tant que modèle biologique

Parmi les biocénoses aquatiques, les communautés microbiennes qui se développent sous forme d'agrégats dénommés biofilms (ou périphyton) sont des acteurs clés dans le fonctionnement général des écosystèmes aquatiques. En effet, le biofilm joue un rôle essentiel, sinon central, dans le fonctionnement des écosystèmes aquatiques car il est le siège de processus auto- et hétérotrophes intervenant dans les cycles bio-géochimiques majeurs (Kostel *et al.*, 1999).

A.II.1. Définition

Wimpenny (2000), suggère que la définition d'un biofilm naturel doit englober trois points essentiels : (1) la notion de surface ou d'interface, qui servira de support pour le développement des organismes biologiques, (2) la matrice de polymères extracellulaire qui va jouer un rôle de protection pour les organismes qui s'y développent, et enfin (3) la notion de communauté et des propriétés fonctionnelles liées à la structure et la composition des biofilms.

A l'échelle microbienne, le biofilm est un écosystème à part entière, qui désigne un ensemble de populations de microorganismes (algues, bactéries, champignons...) incluses dans une matrice d'exopolymères, généralement fixées sur un support solide (roche, sable, bois...), et qui se développent dans les milieux aquatiques ouverts (lacs, rivières...) (Singh *et al.*, 2006 ; Costerton *et al.* 1994, Jackson *et al.* 2003). Quant au terme périphyton, il désigne à l'origine la couverture biologique recouvrant les macrophytes mais les définitions actuelles les plus communément admises sont moins restrictives et ne limitent pas la nature des substrats colonisés aux macrophytes (Wetzel 1983). De ce fait, nous considérerons comme de nombreux auteurs, les deux terme « biofilms » (avec une composante phototrophe) et « périphyton » comme étant similaires.

A.II.2. Structure et formation

La formation d'un biofilm, est un ensemble de processus complexes où plusieurs facteurs entrent en compte (surface des cellules, nature et rugosité du support, conditions du milieu...) (Singh et al., 2006) (figure 2). La première étape consiste en l'adhésion des cellules bactériennes sous forme planctonique à la surface du support. L'adhésion dépend, de l'entrée en contact des cellules avec le support, mais surtout de la nature de ce dernier ainsi que de celle des cellules microbiennes. Cette étape implique un phénomène de « sensing » (Stanley et Lazazzera, 2004 ; Singh et al., 2006) où les microorganismes perçoivent la surface du support et s'y fixent en premier lieu par adsorption (réversible), suivi d'un attachement (irréversible) influencé par l'hydrophobicité de la surface du microorganisme et par son état physiologique (qui influence la composition de l'enveloppe microbienne) (Landini & Zehnder, 2002). Elle varie selon l'espèce concernée, et les paramètres du milieu tel que la température et la disponibilité des nutriments (Costerton et al., 1994). Cet attachement se fait soit par interaction directe entre les constituants de surface de l'enveloppe bactérienne formée d'exopolymères, soit par adhésion grâce à des structures bactériennes spécialisées comme les fimbriae et les adhésines (Stanley et Lazazzera, 2004). L'étape suivante correspond à la « maturation » du périphyton par la croissance microbienne et l'instauration des différents métabolismes et catabolismes nécessaires à la vie des communautés microbiennes au sein du biofilms (Stanley et Lazazzera, 2004). Les microorganismes se développent alors dans une matrice formée d'exo polysaccharides (EPS) qui joue un rôle protecteur et nutritionnel (Barranguet et al., 2005). Ces EPS sont sécrétés par les organismes du biofilm et correspondent à des composés chimiques très variés tels que des polysaccharides, des protéines, des acides nucléiques, des acides humiques et des phospholipides (Freeman et Lock 1995, Flemming et al. 2000, Nivens et al. 2001). Les premières cellules à se fixer sur le support, sont les bactéries, qui sont suivies par les algues et enfin le reste des microorganismes benthiques (Lyautey et al., 2005).

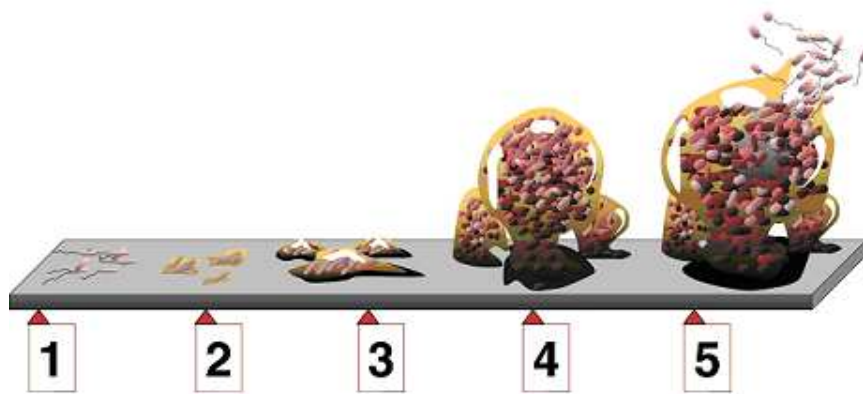

Figure 2. Les 5 étapes du développement d'un biofilm sur une surface dure. Étape 1 : attachement initial; étape 2 : attachement irréversible; étape 3 : maturation I; étape 4 maturation II; étape 5 : dispersion (d'après Monroe, 2007).

La diversité au sein des communautés du biofilm est à l'origine d'interactions intra et inter-spécifiques (symbiose, commensalisme, prédation, compétition...) mais aussi avec le milieu aquatique environnant. L'un des phénomènes d'interaction les plus étudiés entre bactéries est le « quorum-sensing ». Les N-acyl-HomoSerineLactone (N-acyl-HSL) sont des molécules signal, densité dépendantes, synthétisées et secrétées par les bactéries lorsque la densité de la population atteint un seuil précis afin d'arrêter sa croissance (Hammer & Bassler, 2003 ; Stanley et Lazazzera, 2004). Les interactions allélopathiques impliquent, dans le biofilm, en plus des bactéries, les algues, les champignons et les protozoaires... Le phénomène d'allélopathie décrit les interactions biochimiques directes ou indirectes, positives ou négatives, d'un microorganisme sur un autre au moyen de métabolites secondaires tels que les acides phénoliques ou les alcaloïdes... Ces composés allélochimiques jouent un rôle important dans la compétition vis-à-vis des ressources environnementales que sont la lumière et les substances nutritives, mais aussi dans l'armement chimique de défense des microorganismes contre leurs prédateurs, et dans la coopération intra- et interspécifique (Flemming et al. 2000).

Les communautés biologiques des biofilms sont sensibles à de nombreux facteurs abiotiques (température, luminosité, nutriments, hydrologie, oxygène...). Ces derniers influent sur la structure, la diversité ainsi que sur la succession des communautés microbiennes (Barranguet et al., 2005). La pénétration de la lumière est nécessaire aux organismes phototrophes (algues et cyanobactéries). Elle dépend en partie de l'épaisseur du biofilm et vice-versa. Le taux d'éclairement a un effet important du point de vue structural et dans la dynamique de succession des communautés microbiennes dans le biofilm (organismes

phototrophes et indirectement les autres composés hétérotrophes du biofilm) (Tuji, 2000). Le régime hydrologique (vitesse du courant) influence également le mode de développement des microorganismes. Des études menées sur les communautés microbiennes périphtiques, soumises à différentes vitesses de courant, ont montré une différence de composition taxinomique et de croissance algale ainsi que dans l'architecture même du biofilm (adaptation microbienne) (Fayolle et al., 1999). La composition des communautés microbiennes (diversité et abondance), les interactions entre populations au sein de ces communautés (Rier et Stevenson, 2002), mais aussi l'architecture spatiale du biofilm (l'épaisseur d'un biofilm est plus importante dans un milieu riche que pauvre), sont étroitement liées à la disponibilité des éléments nutritifs (Phosphore, Carbone, Azote...) dans le milieu aquatique (Barranguet et al., 2005 ; Van der Grinten et al., 2004).

Le biofilm n'est donc pas une microniche hermétique, mais un système en interactions continues avec ses composantes internes et externes. Il contribue d'une manière fondamentale à la biodiversité et au bon fonctionnement des écosystèmes aquatiques.

A.II.3. Rôle du biofilm dans les cours d'eau

Le biofilm joue plusieurs rôles de base dans le fonctionnement des écosystèmes aquatiques, en particulier en rivière, grâce à la complexité et à la diversité de sa composition taxinomique (Battin et al. 2003, Singh et al. 2006).

Au sein du biofilm, les bactéries hétérotrophes métabolisent la matière organique dissoute (MOD), permettant ainsi son transfert vers des niveaux trophiques supérieurs ce qui limite sa perte (Costerton et al., 1994). Cette matière organique est soit allochtone (provient du bassin versant), soit autochtone (matières organiques produites dans le milieu aquatique) (Romani et al., 2004). Les biofilms sont des sites majeurs d'assimilation et de stockage du carbone organique dissous dans les milieux lotiques, en particulier ceux de petites tailles. Ils contribuent ainsi d'une manière significative au cycle du carbone mais aussi à ceux de l'azote (nitrification, dénitrification...) et du phosphore...(Van der Grinten et al., 2004 ; Singh et al., 2006 ; Romani et al., 2004).

La proximité des différentes communautés microbiennes, ainsi que l'architecture même du biofilm (présence de la matrice d'EPS), facilite les phénomènes de transferts horizontaux de gènes (en particulier ceux impliqués dans l'acquisition de résistance aux antibiotiques, la capacité de dégradation des xénobiotiques, ou la résistance aux métaux lourds...), par rapport à des organismes vivant sous des formes libres, comme par exemple les organismes planctoniques. Cet échange d'ADN mobile peut rendre ainsi les microorganismes plus

tolérants vis-à-vis de changements brusques des conditions environnementales (Singh et al., 2006).

Au final, toutes ces caractéristiques des microorganismes benthiques (contrôle des cycles biogéochimiques, source trophique, plasticité génomique, mais aussi dégradation des polluants...) confèrent aux biofilms un rôle important dans l'équilibre écologique des milieux aquatiques soumis à des apports anthropiques. Les processus microbiens (cycles biogéochimiques...) qui assurent une transformation des composés dissous, présents en grande quantité dans le milieu, peuvent permettre une réduction des charges en éléments nutritifs et contribuer à limiter une hyper-eutrophisation des hydrosystèmes (Abrantes et al., 2006). La dégradation et/ou le blocage des composés xénobiotiques, tels que les phytosanitaires et les métaux lourds, par les communautés périphytiques est un phénomène important pour la détoxification du milieu (Singh et al., 2006), mais cependant difficilement quantifiable.

A.II.4. Pertinence de l'utilisation du biofilm de rivière en tant que modèle biologique de bioindication

La sélection d'outils de bioindication pertinents est la clef pour le succès de tout programme de suivi de la qualité des milieux (que ce soit dans un contexte d'évaluation *in situ* (DCE), ou dans un contexte expérimental d'évaluation du risque lié à l'utilisation de substances chimiques (REACH)). Généralement, un bioindicateur doit être capable d'intégrer la complexité des écosystèmes, tout en restant simple d'application. De plus en plus d'écologistes considèrent le biofilm de rivière comme étant un indicateur pertinent de pollution (Montuelle et al. 2010, Sabater et al. 2007). Outre son importance écologique dans le fonctionnement des cours d'eau, le biofilm de rivière présente de nombreuses caractéristiques indispensables pour la sélection d'un bioindicateur, telles que son ubiquité, son mode de vie sédentaire, son taux de reproduction élevé, son abondance et la simplicité des opérations de collecte et de transport (Culp et al. 2000, Mc Cormick et Cairns 1994). De plus, la grande diversité des communautés microbiennes qui composent les biofilms (procaryotes ou eucaryotes, unicellulaires ou pluricellulaires, autotrophes ou hétérotrophes) et la multitude des processus biologiques et physico-chimiques qui s'y déroulent, induisent une grande complexité structurelle et fonctionnelle. Cette diversité biologique génère des sensibilités variées vis-à-vis des différentes pressions anthropiques que peuvent subir les cours d'eau ainsi que des réponses variables à ces pressions. Cette organisation biologique complexe du biofilm, avec la présence de producteurs, consommateurs et décomposeurs, permet d'intégrer

les relations entre les espèces d'un même niveau trophique ou de niveaux trophiques différents.

Deux approches complémentaires co-existent pour évaluer la réponse microbienne à un stress environnemental : une approche descriptive basée sur l'étude structurale des communautés (biomasse, taxonomie, diversité...) et une approche fonctionnelle portée généralement sur le suivi d'activités métaboliques (photosynthèse, respiration, activités enzymatiques, potentiel de biodégradation...). L'utilisation du biofilm microbien comme modèle biologique permet donc un large choix de descripteurs. Le choix de ces descripteurs se révèle très important afin de pouvoir discriminer les effets des pesticides des effets associés aux facteurs de confusion d'origine naturelle (vitesse de courant, luminosité...) et/ou anthropique (autres composés organiques et inorganiques), et de prendre en considération les spécificités des différentes composantes du biofilms et leur interactions mutuelles (Sabater et al., 2007 ; Villeneuve, 2008).

A.III. Le concept de la tolérance acquise ou de « pollution-induced community tolerance » (Article 1)

Les études concernant les effets des xénobiotiques à long terme sur les communautés biologiques du biofilm, ont généralement montré que les communautés d'organismes étaient susceptibles de développer une tolérance vis-à-vis des polluants. Suite à une perturbation d'origine anthropique, les changements de structures des communautés (diversité, abondance relative), accompagnés d'un quasi-retour à la normale des activités microbiennes globales (photosynthèse, activités métaboliques, croissance microbienne...), tendent à prouver que les microorganismes à l'échelle de la communauté s'adaptent, plus ou moins, rapidement aux nouvelles conditions environnementales (Soldo et Behra, 2000 ; Boivin et al., 2006).

Le concept PICT (Pollution-Induced Community Tolerance) se base sur cette capacité d'adaptation des organismes et considère que des communautés biologiques, déjà exposées à un polluant, acquièrent une tolérance à ce toxique par rapport à d'autres, comparables de point de vue écologique mais qui n'ont pas été exposées (Blanck, 2002). Cette différence de tolérance, que l'on peut évaluer par des bioessais de courte durée et avec des concentrations croissantes en toxique, peut donc révéler *a posteriori* l'exposition d'une communauté biologique à ce toxique (son historique). Cette approche permet la mise en évidence du lien entre la pression et son impact sur le compartiment biotique d'un écosystème et d'une manière plus générale sur l'écosystème dans sa globalité (Millward et Klerks 2002).

L'application du PICT comme méthode de bioindication, basée sur l'utilisation des communautés naturelles du biofilm en tant que modèle biologique, se justifie parce qu'elle satisfait de nombreux critères établis par Dale et Beyeler (2001) pour le choix d'un indicateur de l'état écologique des écosystèmes : (1) spécificité de réponse à un stress particulier (Blanck et al. 1988, Boivin et al. 2002). (2) facilité et rapidité des mesures (Millward et Grant, 2000). (3) intégration de la complexité structurale et fonctionnelle de la composante biotique des écosystèmes (Tlili et al. 2008, Dorigo et al. 2010). (4) spatialisation temporelle des pressions anthropiques, c'est à dire révéler une exposition présente ou passée au toxique (Dorigo et al. 2004, 2010, Pesce et al. 2010). La méthode PICT présente donc un intérêt comme outil de diagnose et d'évaluation du risque écotoxicologique en milieu aquatique (Bérard et al., 2002).

Une synthèse bibliographique relative au concept PICT et réalisée au cours de mon travail de thèse est présentée dans ce chapitre sous le titre « Microbial pollution-induced community tolerance » (Tlili et Montuelle 2010). Cette synthèse constitue un des chapitres du livre « Tolerance to Environmental Contaminants » édité par Amiard-Triquet, C., Rainbow, P.S. et Roméo, M.

Article 1

Microbial Pollution-Induced Community Tolerance

A. TLILI & B. MONTUELLE

**In « Tolerance to Environmental Contaminants » (2010), Amiard-Triquet,
et al. (eds). CRC press. pp 85-108**

Microbial Pollution-Induced Community Tolerance

Ahmed Tlili^a, Bernard Montuelle^{a,b}

a. CEMAGREF, UR MAEP, 3 Quai Chauveau CP 69336 Lyon Cedex 09, France

b. INRA UMR CARTEL, Laboratoire de Microbiologie Aquatique, BP 511, 74203, Thonon Cedex, France

1. Introduction – from the simple to the complex

The assessment of the ecological quality of natural ecosystems is partly based on chemical criteria such as the chemical nature and concentrations of pollutants and physical criteria such as topography, geology and hydrology (Carluer and De Marsily 2004; Lagacherie et al. 2006). Even if such a physico-chemical approach is essential, it has many limitations (specific information, no predictive information on the ecotoxicological risks associated with contamination) and many constraints from an analytical point of view (large number of molecules and degradation products of these molecules to analyze, unknown molecules, detection and quantification limits, etc.). In addition, biological approaches measure the impact of exposure to toxic contaminants on biological communities in natural ecosystems. According to the scheme proposed by Lagadic and Caquet (1998), three strategic levels for the *in-situ* evaluation of the biological quality of ecosystems should be considered. The first is the measurement of the concentrations of chemical substances in organisms after exposure to toxicants (absorption, bioaccumulation...). The second level is a measurement of biomarkers (biochemical and physiological) such as enzyme activities (catalase, glutathione peroxidase...). And finally, the third level is a measure of the effect of the toxic contaminant on populations via the use of bioindicators (species or species groups) such as the diatom biological index or the IPS (pollution sensitivity index) in aquatic ecosystems for example. These indices are based primarily on species characteristics analysis (taxonomy, species abundance statistics and identification of key species), but do not reflect functional changes (growth, metabolic activities) that can develop in biological communities in response to anthropogenic disturbances. In addition to obtaining ecological information from *in-situ* organisms and communities, ecotoxicological methods and techniques have the potential to improve environmental assessment.

Mono-specific bioassays are often used to determine the degree of environmental contamination and the risk associated with toxic substances. These ecotoxicity tests are performed in the laboratory under controlled conditions on selected organisms based on different criteria (sensitivity to toxicants, ease of maintenance and *in-vitro* culture, repeatability), and the impact is assessed by dose-response tests in relation to different parameters (survival, mortality, reproduction...). A major shortcoming of these tests is their lack of environmental representivity and the reductionist approach to effect issues. Indeed, ecotoxicity tests are generally applied to “strains” that are cultivated in artificial culture media

in the laboratory, sometimes using genetically modified strains (e.g. several bacterial tests: Ames, Microtox). Moreover, this approach is performed with single species and therefore does not include interspecific interactions. To overcome this drawback, it is essential to develop ecotoxicological studies that take into account both the biodiversity and functioning of microbial communities. Biological and ecological specificities of microbial communities make them very interesting tools for environmental quality assessment and impact assessment whether at *in-situ* level or using a “cosms” techniques to develop causality studies. The 20 year old concept of Pollution Induced Community Tolerance (PICT), first introduced by Blanck et al. (1988), is an ecotoxicological tool that provides a good alternative for environmental status characterization, useful for assessing not only an immediate impact but also taking into account the contamination history of ecosystem at the community level. It is also a tool that allows a better understanding of the ecological drivers in adaptation processes. Finally the PICT concept allows the introduction of “more ecology in ecotoxicology”.

2. The PICT concept in brief: principle, objectives and application

The large diversity of microbes in natural ecosystems (algae, bacteria, protozoa, fungi, viruses...) and the associated multitude of biological and physico-chemical processes induce high structural and functional complexity into microbial communities. This generates various sensitivities and a highly variable type of response to anthropogenic pressures. The presence of an increasing bioavailability of xenobiotics especially leads to such structural and functional disturbances of microbial communities. One result is adaptation and the selection of the most tolerant species or strains of microorganisms to these toxicants, resulting in an overall increase in tolerance towards the toxicants of the whole exposed communities. This process underlies the concept of Pollution Induced Community Tolerance. Assessing the acquisition of tolerance is a method that tries to establish a cause-effect relationship between one pollutant and its impact on biological communities. Indeed, the PICT approach is primarily a measure of the sensitivity of biological communities to a toxicant, combined with taxonomic analysis (Fig.1). However a lot of issues are still open: is it possible to target the effect of a given compound in an environmental pollutants cocktail? What are the relevant endpoints for PICT studies? What is the threshold to conclude that a community is impacted?

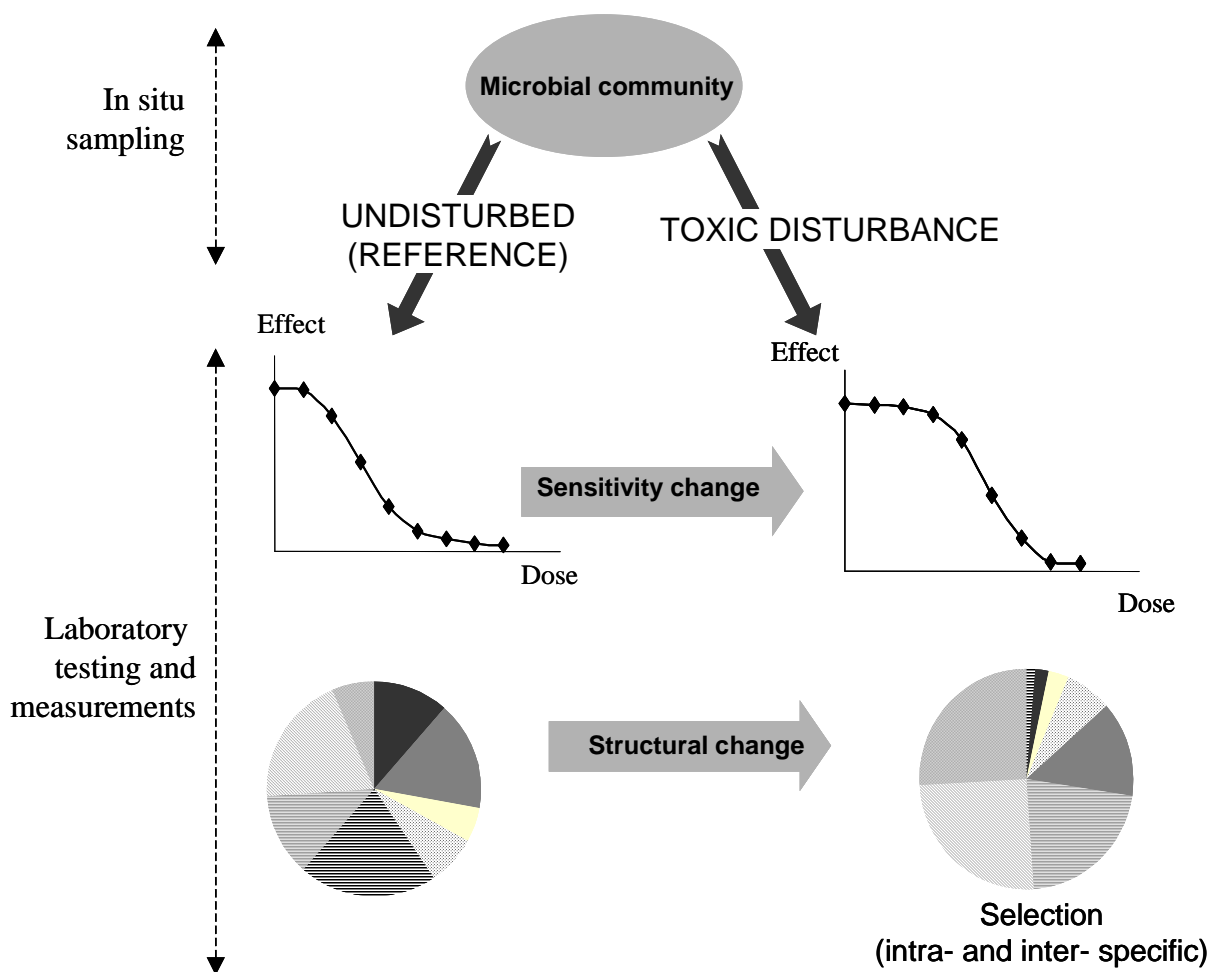

Fig.1 PICT concept is based on the fact that exposure of a biological community to a toxicant, will induce an inter-and intra-specific selection of the most tolerant organisms or the establishment of mechanisms for detoxification. Thus the entire community may be restructured, present physiological alterations and come finally to display an overall increase in tolerance to the toxicant compared to a reference community that has never been exposed. This tolerance difference, which is evaluated by *in-vitro* short-term bioassays and with increasing concentrations of toxicant, may give an indication of past exposure (*in situ*) to toxicant of the different sampled communities.

Basically, the main goal of such a method is to highlight differences in tolerance towards a toxin of two “comparable” biological communities, with one of them being “naïve” with respect to this substance (the reference community). In principle, the PICT concept can be applied to all types of ecosystems, aquatic or terrestrial (Hjorth et al. 2006; Niklinska et al. 2006), and to all microbial communities such as bacteria (Boivin et al. 2005) or photosynthetic microorganisms (Dahl and Blanck 1996). Table.1 summarizes a non-exhaustive list of microbial PICT-studies (in aquatic ecosystems and different targeted organisms).

Table.1 Main characteristics and biological targets of PICT studies in different aquatic ecosystems.

Ecosystems	Targeted organisms	Selection (structural endpoint)	Detection (functional endpoint)	References
Aquatic (river; lake; Estuary; Marine and coastal system...)	Photoautrophic (algae and cyanobacteria) community in periphyton; phytoplankton or sediment	<ul style="list-style-type: none"> - Taxonomic analysis by microscopy - Molecular Biology by DGGE ; TTGE or PFLA. - High-performance liquid chromatographie. 	<ul style="list-style-type: none"> - Photosynthesis: ¹⁴C incorporation and <i>In-vivo</i> induced fluorescence) 	Wangberg et al. 1991; Nyström et al. 2000; Paulsson et al. 2000; Soldo and Behra, 2000; Bérard and Benninghoff, 2001; Schmitt-Jansen and Altenburger, 2005; Hjorth et al. 2006; Dorigo et al. 2007; Navarro et al. 2008; McClellan et al. 2008; Schmitt-Jansen and Altenburger, 2008; Tlili et al. 2008; Eriksson et al. 2009; Blanck et al. 2009; Debenest et al. 2009; Pesce et al. 2010.
	Heterotrophic (bacteria and fungi) community in periphyton; phytoplankton or sediment	<ul style="list-style-type: none"> - Bacterial enumeration (DAPI-FISH, flow cytometry) - Molecular Biology (DGGE ; TTGE or ARISA). - Community-level physiological profiling (CLPP) 	<ul style="list-style-type: none"> - Thymidine (Tdr) and leucine (Leu) incorporation techniques. - Biolog® ECO plates - Respiration (gas chromatography or MicroResp™) - Extracellular enzyme activity. 	Lehmann et al. 1999; Nyström et al. 2000; Barranguet et al. 2003; Blanck et al. 2003; Brandt et al. 2004; Massieux et al. 2004; Boivin et al. 2005; Boivin et al. 2006; Hjorth et al. 2006; Tlili et al. (2010)

Besides impact assessment, and as a result of generation time and microbial dynamics specificity, the PICT approach could also be used for environmental recovery studies. However, this application is less developed than impact studies (Blanck and Dahl 1998;; Larsen et al. 2003; Boivin et al. 2006; Demoling and Baath 2008a,b).

3. Selection process, detection and validation of the PICT

According to Molander and Blanck (1991), the PICT CONCEPT can be summarized in two phases, a selection phase and a detection phase based on the functional response of biological communities. The selection phase is based on how communities adapt to stress conditions, with several levels of biological responses (from strain-specific sensitivity and cell responses with detoxification capacity and contaminant storage to selection of resistant strains and changes in diversity and specific individual numbers). The detection phase concerns the expression of the acquired tolerance and the way to characterize it by short-term bioassays.

3.1. Selection phase or “survival of the fittest”

Basically, exposure of communities to toxicants leads to the selection of the most tolerant species. This tolerance could result from cellular metabolic processes that detoxify the contaminant. As examples, stress proteins are often involved in the tolerance to a metal or changes may occur in the activity of an enzyme that modifies metal speciation (e.g., Cr^{6+} to the less toxic Cr^{3+} resulting from reductase activity in *Methylococcus capsulatus* (Al Hasin et al. 2010).

This section deals with other drivers of tolerance such as selection processes and their role in PICT acquisition. Taken as a whole, tolerance acquisition depends on (1) inter- and intra-specific diversity, and (2) the specific sensitivities of the strains and/or species that comprise the community.

3.1.a. Intra- and inter-specific selection

Selection of a strain by a toxicant can lead to an increased tolerance in the species, population and community concerned. There are many examples demonstrating the phenomenon of intra-specific selection, especially for algal populations in aquatic ecosystems contaminated by metals or xenobiotics (Kasai et al. 1993; Bérard et al. 1998; Debenest et al. 2009). Hersh and Crumpton (1989) isolated and compared Chlorophyceae strains from

different aquatic systems either highly contaminated by atrazine (agricultural areas) or uncontaminated. Chlorophyceae from the contaminated systems exhibited increased tolerance to atrazine compared to the Chlorophyceae isolated from the uncontaminated systems. Bérard et al. (1998) also tested the atrazine tolerance of two strains of *Chlorella vulgaris* (Chlorophyceae) isolated from two limnic systems: Lake Geneva (with low herbicide pollution) and Villaumur barrage (highly polluted by herbicides inhibiting PhotoSystem II). Results showed that the strain from the polluted site was more tolerant to atrazine than the strain from the unpolluted site, suggesting that there has probably been a genotypic selection by herbicides inhibiting photosynthesis, confirming therefore intra-specific selection.

The second selection level is inter-specific and most of the studies on PICT have shown that some species can survive at the expense of others, whether for bacteria (Dorigo et al. 2007; Demoling et al. 2009) or for algae (Schmitt-Janssen and Altenburger 2005; Dorigo et al. 2007; McClellan et al. 2008; Morin et al. 2010). A study conducted by Boivin et al. (2005) showed the selective effect of copper on bacterial communities in river biofilms, by using DGGE analysis of the 16S rDNA gene. McClellan et al. (2008) studied interspecific algal community selection after exposure to diuron. They used *in-vivo* algal induced fluorescence (measured by PhytoPAM) and showed a 45% increase in the cyanobacterial proportion of the community, whereas the relative contribution of diatoms decreased to about 50% in the contaminated microcosms compared to the control microcosms. Serra (2009) also reported changes in the algal biofilm community exposed to copper, with the development of green algae and the decrease of diatoms and cyanobacteria, reflecting the copper tolerance of green algae.

Intra- and inter-specific selection takes place simultaneously. Several contributing factors related to biological interactions and environmental factors (varying according to the studied sites and seasons) may affect the specific response of organisms to different selection pressures (DeLorenzo et al. 1999a,b; Espeland et al. 2001; Dorigo et al. 2004). Rimet et al. (1999) show that algal sensitivity increases with the complexity of the algal communities studied: the EC₅₀ of nicosulfuron was higher for the algae from monocultures than for those studied in microcosms inoculated with phytoplankton collected from Lake Geneva. Hjorth et al. (2006), investigating the role of interaction complexity between marine phytoplankton and zooplankton under stress from the antifouling compound zinc pyrithione, provided evidence of effects on the function and structure of the marine plankton communities. Direct selective effects were observed immediately (such as reduced phytoplankton activity inducing a decrease in grazing rates of zooplankton), leading to cascading indirect effects throughout the

community, such as a change in the algal community structure over time due to the decrease of the zooplankton predation pressure.

3.1.b. Ecosystem characteristics and their role in the selection process

Many studies have shown the influence of environmental factors on the bioavailability of toxicants and therefore on the control of their toxicity (Lock and Janssen, 2005; Brack et al. 2008). PICT reflects the accessibility to environmental chemicals by the local micro-organisms and the bioavailability of these contaminants (metal speciation, adsorption of toxins onto organic matter...). Measures of concentrations of *in-situ* total contaminants are too widely inclusive, and can then appear poorly correlated with the PICT values of impacted communities.

For example, Almas et al. (2005) emphasized that localization in the soil matrix could influence organism exposure to trace metals, either by diffusion constraints, by metal sequestration onto soil colloids (providing a local environment with low chemical activity), or both. Neither of these mechanisms provides permanent protection if high metal concentrations occur in macropores for prolonged periods, but they would protect against transient peaks in macropore concentrations. To confirm this hypothesis, the authors used a set of Zn- and Cd-contaminated soils to explore the relationship between the binding strength of micro-organisms to surfaces and their decreased PICT. They demonstrated that free and loosely attached cells had developed a strong PICT in response to 80 years of Zn and Cd pollution, whereas strongly attached cells were virtually unaffected. It appears that the position of strongly attached cells in biofilms and micropores of soil has effectively protected them against toxic metal selection. In an aquatic ecosystem study, Guasch et al. (2002) evaluated the effects of chronic copper exposure on natural periphyton in a non-polluted calcareous river. In this study, copper exposure for 16 days under variations in pH similar to those observed in the stream (i.e. diurnal changes from 8.2 to 8.6) affected the biomass and community structure of the stream algal community, by the replacement of metal-sensitive species by metal-tolerant ones. The authors concluded that the water alkalinity was important in affecting the bioavailability of the metals and therefore their selection pressure on the biological community. On a broader study scale, Blanck et al. (2003) showed in a study on fifteen European rivers that Zn tolerance of the microbial community was driven by different factors (e.g. pH, calcium or bicarbonate concentration) and that only regional models could describe this tolerance. Variability in Zn tolerances was high, reaching 1.5 to 2.5 orders of magnitude, ranging for example from 25 to 8145 μ M Zn for responses in photosynthesis.

Environmental factors (e.g. temperature, light or nutrient availability) which interact with toxicants, may also influence micro-organism sensitivity and thus the selection process within a community exposed to pollutants (Bérard and Benninghoff 2001; Guasch et al. 2003; Villeneuve et al. 2010). Effects of antibiotics on the PICT of the soil bacterial community could be modulated by the organic matter and nutrient content of soil. Schmitt et al. (2005) studied the microbial induced tolerance in response to increasing sulfonamide sulfachloropyridazine concentrations in bulk soil and in nutrient amended soil. They found that the antibiotic-induced tolerance (measured with the single carbon source microplate Biolog® technique) of the microbial community was increased if the soils were amended with nutrients. In the same way, Guasch et al. (2004) investigated the influence of phosphorus limitation on copper toxicity in periphytic communities, and they observed an enhancement of the phototrophic community tolerance to Cu in the P-enriched microcosm, coupled with a shift in the community structure between the exposed and the non-exposed periphyton communities.

More globally, Brack et al. (2008) considered that an Effect-Directed Analysis (EDA) that combines chemical fractionation, chemical analysis and biotesting could help to identify hazardous compounds in complex environmental mixtures, as this combined approach avoids artefacts in establishing relevant cause-effect relationships. The PICT approach is well adapted to such an EDA approach.

3.1.c. Exposure time and species succession duration

The type and the duration of exposure are obviously of major interest for the development of tolerance. PICT studies have been mainly conducted on small organisms with fast life cycles, mainly algae and bacteria, facilitating the analysis of short-term contamination effects (pulse contamination) (Tlili et al. 2008). The short generation time of bacteria and microalgae is a real advantage for comprehensive studies on the mechanism of tolerance acquisition at the community level. One of the most important parameters for the selection process in a PICT approach is the exposure time to the toxicant, since it must exceed the generation time of a non-exposed community. Moreover, the contact between toxicants and community must be established (Schmitt et al. 2005). The rate at which PICT develops has rarely been directly investigated. However, Ivorra et al. (1999) compared Zn- and Cd- tolerance in young biofilms and old biofilms (2 and 6 weeks old respectively) sampled in a Zn- and Cd-polluted river to the tolerance of naïve biofilms. These authors showed that 2 weeks exposure to Zn and Cd was not sufficient to observe PICT development unlike the 6 weeks exposure. In a field study,

of irgarol tolerance in marine periphyton conducted over a decade, Blanck et al. (2009) showed that, despite the fact that the irgarol concentrations had not changed in the polluted sites, PICT development was observed between the beginning and the end of the study, supporting the hypothesis that the PICT potential was low initially and that a persistent selection pressure was required to favor the development of irgarol-tolerant species. Such time-dependent acquisition of PICT is supported by the generation and growth time of algal or bacterial species, but also by the rate of immigration/emigration of cells in the environment, especially in biofilms.

The taxonomic analysis of biological communities highlights these structural differences and diversity evolution between impacted and non-impacted communities, and subsequently supports the species selection hypothesis, for example in the case of algae, at a global level (Bérard and Benninghoff 2001; Guasch et al. 2004) or more specifically in the case of diatoms (Morin et al. 2008). Non-taxonomic methods also provide interesting evidence for microbial diversity changes. Fatty acid analysis (PLFA) was used especially to detect structural changes in microbial communities in contaminated soils (Baath et al. 1998; Demoling et al. 2009). Molecular biology tools are also used, such as the use of PCR (Polymerase Chain Reaction) on 16S rDNA (prokaryotes) and 18S (eukaryotes), followed by Denaturing Gradient Gel Electrophoresis (DGGE) or Temperature Gradient Gel Electrophoresis (TGGE) (Dorigo et al., 2002, 2007). High-pressure liquid chromatography (HPLC), which allows the identification of photosynthetic pigments of major algal groups, allows investigation of the structural changes of photosynthetic communities (Dorigo et al. 2007).

3.2. Measuring PICT (detection phase)

To detect tolerance acquisition, short-term bioassays are applied, allowing the establishment of a dose-response curve for the toxicant-exposed and reference communities. Tolerance is subsequently expressed as an EC_x applied to the selected endpoint parameter. The difference between the EC_x obtained for the toxicant-exposed and reference communities allows the assessment of PICT (Fig.2).

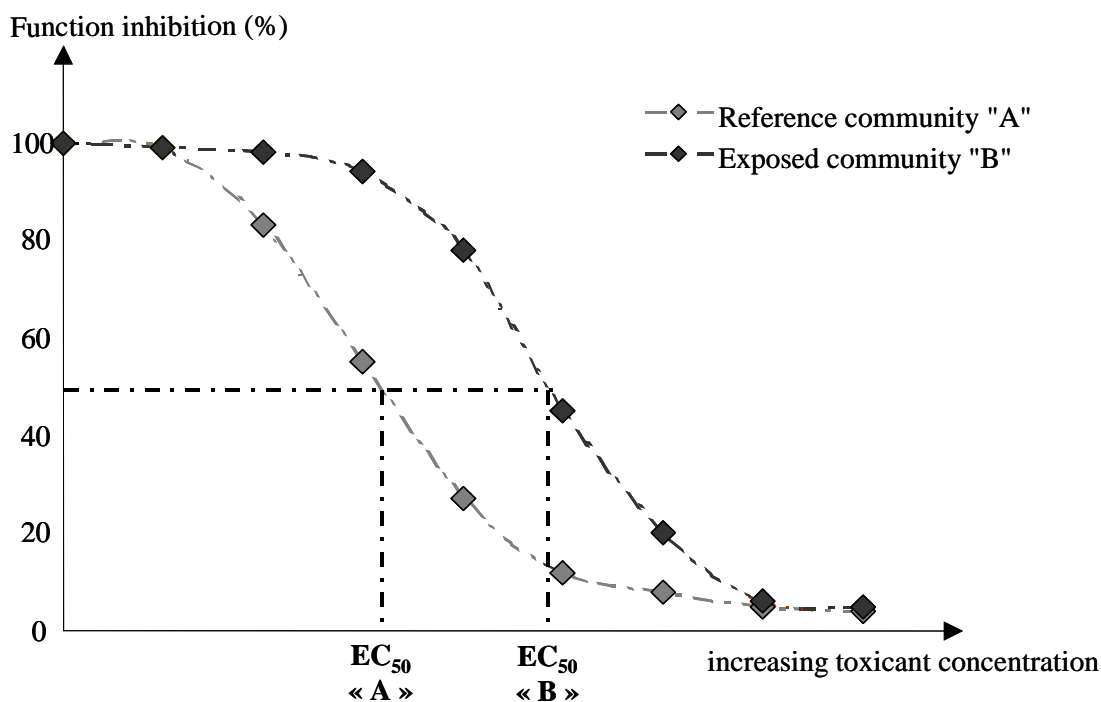

Fig.2 Dose-response curves for PICT characterization. The tolerance level of biological community to a toxicant is measured by estimating the effective concentration of this toxic reducing x % of the selected functional descriptor intensity (EC_x). This estimation is based on the analysis of dose-response curves established by means of short-term bioassays. Comparison of EC_x obtained for different communities allows therefore evaluation of their level of tolerance for a toxicant: the highest EC_x value means a greater resistance to a pollutant. Thus, in the figure, community B is characterized by an EC_{50} higher than the EC_{50} of community A which means that the exposed community is more tolerant than the reference community to the tested pollutant.

The initial composition of a community that reflects environmental conditions before exposure to any stress (time reference) or under reference conditions (spatial reference) should be considered for PICT assessment. This was shown for phytoplankton, particularly in connection with seasonal events and algal succession (Bérard and Benninghoff 2001). Similarly, differences in periphyton microbial diversity between lotic and lentic areas in rivers (an effect of flow speed) resulted in differences in sensitivity and tolerance to a similar toxic exposure (Villeneuve 2010). The choice of the reference community is therefore an important step for the validation of a PICT approach. According to Blanck et al. (1988), a reference

community is a community able to acquire significant tolerance after exposure to a toxicant: the tolerance acquisition depends not only on the community itself but also on its interactions with the toxicant. A highly diversified community with a large range of specific sensitivities towards a toxicant has an important selection potential and thus an important potential for tolerance (so-called “background tolerance”) to toxicants.

The choice of a functional parameter in the induced tolerance assessment is also crucial, because its relevance as an ecotoxicological endpoint depends firstly on the mode of action of the toxicant (and its bioavailability) and secondly on the mechanisms involved in the community tolerance. In a recent study, Tlili et al. (2010) investigated the potential effect of a phosphorus gradient on biofilm tolerance to copper and diuron in indoor microcosms. To assess biofilm sensitivity to Cu and diuron, various physiological parameters were used in short-term inhibition tests, targeting the autotrophic and heterotrophic communities. It was concluded that induced tolerance to Cu or diuron varied according to the considered toxicant and the functional endpoint chosen, confirming the need to focus on functional diversity using complementary indicators for ecotoxicological investigations in river biofilms. Moreover, the combination of assessment tools for different activities (heterotrophic and autotrophic) can highlight possible interactions between different communities. Thus, Nyström (1997) showed a replacement of autotrophic communities by heterotrophic communities in atrazine-contaminated microcosms.

The most commonly used tests (Table.1) are the incorporation of labeled elements, such as carbon as labeled ^{14}C to measure primary production, considered as a relevant endpoint in the tolerance assessment in aquatic photosynthetic organisms in both the phytoplankton and the phytobenthos (Dahl and Blanck 1996; Bérard et al. 2003), and the incorporation of tritiated thymidine or leucine to measure bacterial activity, mainly in soil studies (Almas et al. 2005; Niklinska et al. 2006) and increasingly in aquatic environments (Pesce et al. 2006). Other tests such as the induction of algal fluorescence by photosynthesis inhibitors or the use of Biolog® plates and measures of respiration (concentration of CO_2 or O_2) are also applied (Witter et al. 2000; Niklinska et al. 2006, Tlili et al., 2010).

3.3. Gaps in PICT: Nobody is perfect

As explained above, the advantage of the PICT approach is, on the one hand, to give information about the history of exposure to a toxicant (not an occasional and brief contamination of the environment), focusing then on the link between selection pressure and

impact, and, on the other hand, to generally provide a faster and complementary response than available from a taxonomic analysis of communities. However, to validate the PICT approach as a bioindicator tool of ecosystem pollution, many issues still need to be considered.

3.3.a. Short or long term endpoints: which are the most relevant?

Most of the experimental studies on PICT use and compare the classical parameters of long-term stress (biomass, chlorophyll concentration, bacterial total density...) and primary production (e.g. ^{14}C , bacterial leucine or thymidine incorporation, *in-vivo* algal induced fluorescence) used in short term bioassays. The PICT approach can therefore be well validated, and tolerance results are in agreement with biomass or activity measurements realized during a study. However, in some cases, conventional endpoint measures of long-term stress appear to be more sensitive than those typically used in the PICT approach. Molander and Blanck (1992) showed, in a study on the pollution-induced tolerance in marine periphyton exposed to different concentrations of diuron, that some long-term parameters (increase of diatom species richness and increase in chlorophyll-*a*) were more sensitive than the lowest detection of PICT at 40 nM diuron, while PICT was more sensitive than other long-term parameters such as a decrease of carbon incorporation rate. In a most recent study, Tlili et al. (2008) highlighted the ecotoxicological potential impact of the herbicide diuron on biofilms during flooding events in a small river in the Beaujolais vineyard area (France). The authors investigated the responses of chronically contaminated biofilms exposed to short-term pulses of diuron. Biofilms were grown in indoor microcosms that were either non-contaminated or exposed to low-level chronic contamination ($1 \mu\text{g.L}^{-1}$ of diuron), and not exposed, or exposed to single or double pulses of two environmental concentrations of diuron (7 or $14 \mu\text{g.L}^{-1}$ of diuron). Exposure to pollution and its impact on biofilms were assessed by using a various set of long-term stress parameters, such as biomass parameters (chl *a*, ash-free dry weight (AFDW)), community structure (using 18S and 16S rDNA gene analysis by DGGE, and HPLC pigment analysis to target eukaryotes, bacteria and photoautotrophs, respectively), and also by performing photosynthesis-inhibition bioassays (by ^{14}C assimilation). In this study, long term stress parameters appeared to be more sensitive and discriminatory than PICT measurement. Whatever the exposure situation, no PICT development was observed, whereas biomass, fluorescence and structural analysis showed a diuron pulse effect on biofilms.

Molander and Blanck (1992) proposed a conceptual three-stage model to explain the impact of diuron on marine periphyton as a function of water diuron concentrations. During

the first stage, exposure to diuron has no long-term effect, but during the second stage there is a slight long-term effect on biomass and structure, and during the third and final stage, the diuron stress is so severe that sensitive species are eliminated, resulting in a decline in biomass diversity and chlorophyll-*a* in parallel with an increase in community tolerance, giving an easily detected PICT.

3.3.b. Environmental factors and PICT

In the global context of assessing the impacts of complex pollution on microbial community diversity and function in natural ecosystems, one of the most critical points remains the distinction between the relative effects of selective pressures resulting from xenobiotic pollution and those resulting from environmental factors. As explained above, PICT is detected by comparing the tolerances of a selected community and an unselected “naïve” community, this latter having an initial composition reflecting environmental conditions before application of stress (time reference) or reference conditions (spatial reference) and an original sensitivity (“base-line” tolerance, Molander 1991). This base-line tolerance probably fluctuates with the environmental conditions (such as nutrient, temperature and light) of the reference community, inducing limited variations in biomass, species composition and phenotypic adaptations (Bérard and Benninghoff 2001; Dorigo et al. 2003; Guasch et al. 2003; Schmitt et al. 2005). When there are significant variations of the base-line tolerance, it will be difficult to prove an induced-tolerance exclusively caused by the toxicant selection pressure. It is therefore necessary to have not only a reference site that is globally comparable to the study site, but also a sampling strategy (spatial and temporal) minimizing the interference of environmental factors in the detection of PICT. In a study of the effect of copper and temperature on aquatic bacterial communities, Boivin et al. (2005) showed that the copper tolerance at 10 and 14 °C increased about 3 times, whereas copper tolerance at 20 °C increased about 6 times. Temperature therefore had an effect on tolerance development, indicating that the effect of exposure to copper was enhanced at the higher temperature. In a soil study, Demoling and Baath (2008a) investigated the toxicity of different phenols on bacterial communities at different temperatures, by using leucine incorporation in bioassays as an endpoint, and they observed that the induced tolerance to phenols increased at lower temperature. Some studies have also focused on the effect of nutrients on tolerance acquisition (Ivorra et al. 2002; Brandt et al. 2009). Guasch et al. (2004) observed a clear influence of phosphorus limitation on copper toxicity. Biofilm communities that were previously fertilized for 18 days were three times more tolerant than control communities

indicating that phosphorus limitation enhanced Cu toxicity, and tolerance induction was probably related to the higher phosphorus availability (negative correlation between Cu toxicity and algal biomass which is stimulated by phosphorus supply). On the other hand, in a more recent study, these authors (Guasch et al., 2007) tested the influence of phosphorus on the tolerance of periphytic communities to the herbicide atrazine, and, conversely to copper, tolerance induction to atrazine did not require a phosphorus supply (because of the fast sorption kinetics and low rate of bioaccumulation of atrazine, which make its toxicity independent of the water chemistry and thus of phosphorus enrichment). In contrast, light history seems to influence the sensitivity of periphytic algae to atrazine (Guasch and Sabater 1998).

Finally, considering the variability of terrestrial and aquatic environments, PICT assessment should take into account the mosaic of microhabitats to establish a reliable sampling strategy (Almas et al. 2005 in soil; Dorigo et al. 2009 in watercourses). These small-scale spatial, but also temporal, variabilities are in fact of major concern for population succession during PICT acquisition. They are sometimes considered as “stochastic events” (Brandt et al. 2004).

3.3.c. The phenomenon of co-tolerance

Co-tolerance (Table.2) may occur when communities that have been exposed to one toxicant, but not to another, become tolerant to both toxicants. Occurrence of co-tolerance depends on the means of acquiring tolerance and on the tolerance mechanisms involved (Blanck et al. 1988). This phenomenon is mainly caused by substances having a similar mode of action (Molander and Blanck 1991; Soldo and Behra 2000) or inducing a similar detoxification mechanism (Gustavson and Wängberg 1995). According to Molander (1991), two classes of mechanisms at biochemical level could induce co-tolerance. The first concerns tolerance mechanisms related to the uptake, translocation or metabolization/excretion of the toxicant, while the second is related to modifications of the target site or of by-pass reactions. Co-tolerance is a phenomenon that should not be confused with the “multiple tolerance” of a community subjected to exposure by several toxicants simultaneously.

Table2. Examples of co-tolerance between toxicants as a confounding factor for PICT assessment.

Long exposure term	Community	Endpoint: 1. Selection 2. Detection	Co-tolerance with	References
Diuron	Phototrophic marine periphyton	1. Taxonomic analysis by microscopy 2. Photosynthesis (¹⁴ C incorporation)	- Atrazine - Bromacil - Metribuzin	Molander al. 1991
Zinc	Soil bacteria	1. Plate count method (CFU) 2. Thymidine incorporation	- Copper - Cadmium - Nickel - Lead	Diaz-Ravina et al. 1994
Ultraviolet radiation	Phototrophic periphyton freshwater	1. Taxonomic analysis by microscopy 2. Photosynthesis (fluorimetry by MINI-PAM)	- Cadmium	Navarro et al. 2008
Oxytetracycline	Soil bacteria	1. Plate count method (CFU) 2. Biolog® ECO plates	- Tetracycline - Tylosin	Schmitt et al. 2005
Copper	Freshwater phytoplankton	1. Taxonomic analysis by microscopy 2. Photosynthesis (¹⁴ C incorporation)	- Zinc	Gustavson and Wängberg, 1995
Arsenate	Phototrophic marine periphyton	1. Taxonomic analysis by microscopy 2. Photosynthesis (¹⁴ C incorporation)	- Thiophosphate - Low co-tolerance with Arsenic and diuron	Blanck and Wängberg, 1991
Phenol	Soil bacteria	1. Phospholipid fatty acid pattern 2. Leucine incorporation	- 2-chlorophenol - 2,4-dichlorophenol - 2,3,6-trichlorophenol - No co-tolerance with Copper and Zinc	Demoling and Baath. 2008c
Atrazine	Freshwater phytoplankton	1. Taxonomic analysis by microscopy 2. Photosynthesis (fluorimetry by Toxy PAM)	- Isoproturon - No co-tolerance with diuron	Knauer et al. 2010
Diuron			- Atrazine - Isoproturon	
Copper	Phototrophic periphyton freshwater	1. Taxonomic analysis by microscopy 2. Photosynthesis (¹⁴ C incorporation)	- Zinc - Nickel - Silver	Soldo and Behra, 2000

Some studies have reported a co-tolerance of biofilm communities between copper and some metals such as Zn or Ni (Gustavson and Wängberg 1995; Ivorra et al. 1999). Soldo and Behra (2000) have shown a strong co-tolerance to silver in autotrophic biofilm communities exposed to 5µM of copper. In contrast, Tlili (pers. com) did not detect any co-tolerance between copper and silver in a study based on the use of the MicroRespTM method to assess PICT to metals for lotic biofilms. These contradictory results may be explained by the fact that most of the studies that have detected a co-tolerance were based on photosynthesis as an endpoint to measure PICT (targeting the photoautotroph community in the biofilm), whereas Tlili (pers. com) used the substrate-induced respiration endpoint, targeting the heterotrophic community in the biofilm. Thus, depending on the kind of targeted activities and associated communities (phototrophic or heterotrophic), co-tolerance assessment can be variable, and the combination of different endpoints may provide a better approach. Knauer et al. (2010) examined the specificity of PICT by evaluating the co-tolerance pattern for three photosystem II inhibitors herbicides (atrazine, diuron and isoproturon) to the phytoplankton community, exposed separately over the long-term to these three herbicides. These authors demonstrated that pre-exposure to diuron induced similar tolerance to all three herbicides. While it is difficult to distinguish the specific PICT effect of two toxicants, the PICT method, however, can separate molecule groups with common effects that are associated with different pollution types (herbicides inhibitors of PS II, groups of heavy metals...). The PICT method, used with a particular caution with respect to the phenomenon of co-tolerance, might for example be proposed as a preliminary approach in the assessment of ecosystem pollution, choosing a « model » molecule for each different group of pollutants.

4. The PICT concept and its position in the ecosystem functioning

Even though the PICT concept has been proposed as a methodological approach based on comparative community ecotoxicology, it has the potential also to be integrated into a broader vision of ecosystem functioning. Any investigation of the ecological basis of PICT needs to have a wide knowledge of the ecosystem itself.

4.1 PICT CONCEPT, REDUNDANCY AND RESILIENCE: WHAT IS THE CONNEXION?

One important and up-to-date question in microbial ecology concerns the nature of the relationship that may exist between biodiversity and ecosystem functioning. Several theories attempt to explain the impact of diversity on ecosystem functions, such as matter and energy flows like photosynthesis, gene flow or nutrient cycling. On the basis of assumptions about the functional role of diversity, there is the necessary assessment of the unequal ecological roles of various species in the ecosystem: the concepts of keystone species, guilds or functional redundancy. It is generally admitted that large species richness allows a greater stability of the community, but the link between these two characteristics might vary, thereby leading to applicability of different models (Clements and Newman 2002; Fig.3).

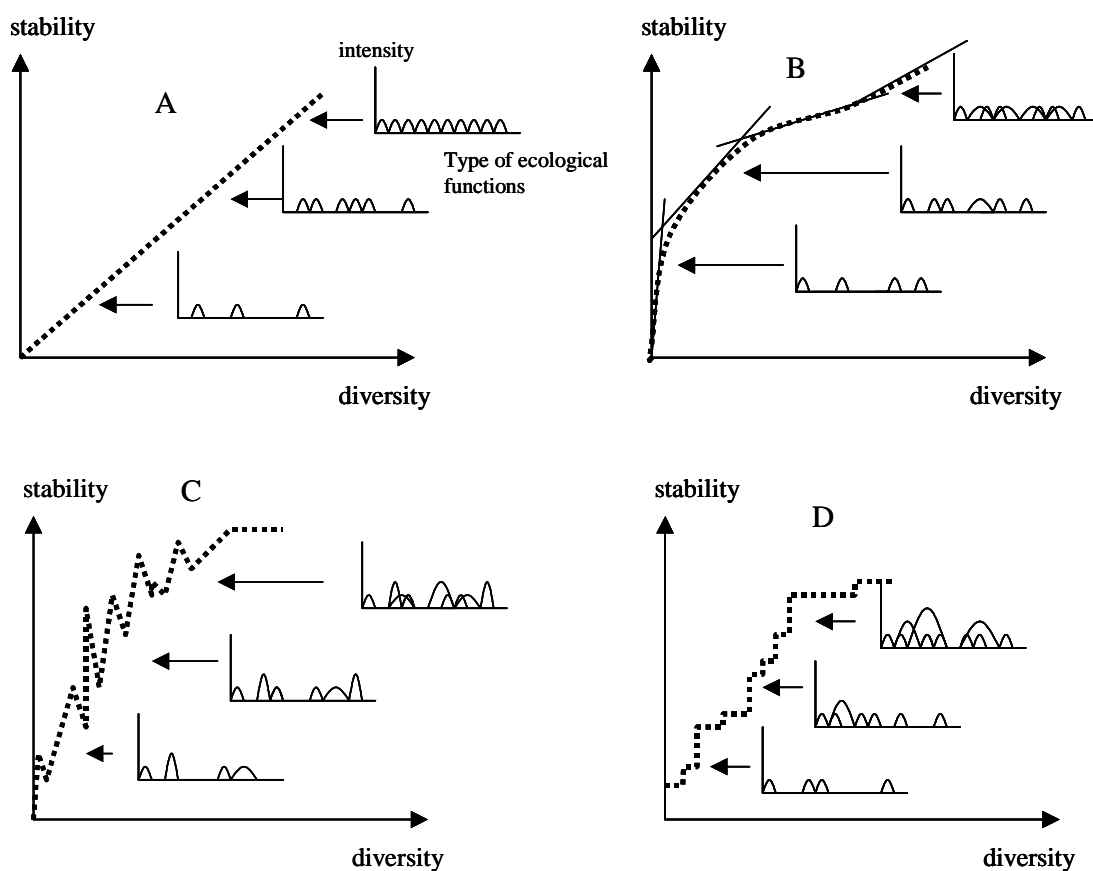

Fig.3 Four models showing the relationship between species richness and functional stability in communities. (A) Linear model: functional stability decreases linearly with the reduction of species number. (B) Rivet model: a functional redundancy protects the system from loss of species until a threshold level. (C) Idiosyncratic model: species disappearance effect is dependent on species interaction and hardly predictive. (D) Drivers and passengers model: stability depends on the species ecological importance. Disappearance of driver species (keystone species) have more effect than disappearance of passenger species. Modified from Figure 6.2 in Clements and Newman 2002.

One of the theories regarding the impact of species number on ecosystem function is based on the assumption of redundancy, which considers that the number of functions in an ecosystem increases with the number of species, but only to a certain threshold. Beyond this threshold, species that are added can be considered superfluous because they do not enrich ecosystem functions. According to this theory, the disappearance of the most sensitive species (as one of the processes underpinning PICT) does not affect ecosystem function as a whole initially, but only beyond a certain threshold of species loss (Schwartz et al. 2000). If this theory assumes that the degree of diversity and ecosystem function are closely related, others estimate that these two entities do not maintain a fixed relationship between them, and that ecosystem functions are a result of interactions between species. In this case, it is not only the number of species that counts, but their relative abundance, their organization in the community and the environment in which they live (Ekschmitt et al. 2001).

Biological diversity appears therefore to have two major roles. The first is to ensure essential ecosystem function, and the second is to allow adaptation to changing environmental conditions (e.g. stress conditions). The concept of an "insurance policy" which stipulates that each species has advantages that enable it to deal successfully with certain environmental circumstances, explains why a more diversified system should be more stable. If a community contains a large number of redundant species, the probability that a functional role can still be exercised even after a strong disturbance is greater, through the survival of at least one of the more tolerant species (Mertz et al. 2007). In this case, PICT could correlate with a reduction of diversity or with changes in species evenness. This restructuring finally leads to changes or losses in ecological functions of the community, and so to a lowering of community stability (Fig.4).

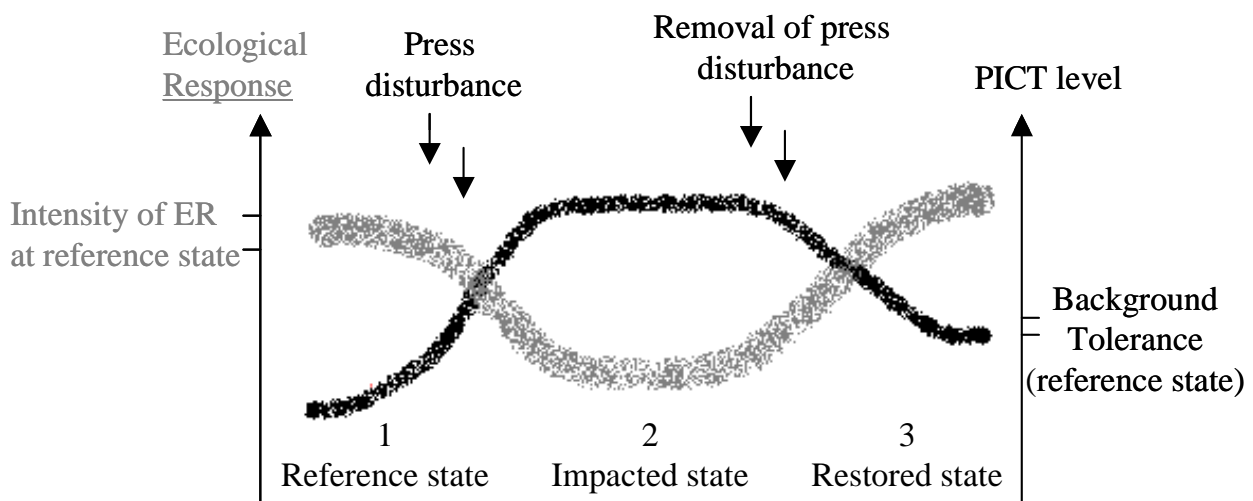

Fig.4 Ecological response and associated PICT response of a community to a stress or a recovery. Modified from Clements and Newman, 2002.

The notion of ecosystem stability is also related to other concepts, which are a matter of discussion: resilience (return of ecosystems to a quasi-initial state following a disturbance), robustness (resistance to interference) and elasticity (ability to restore quickly the biomass to its initial value after disturbance). All these concepts are more or less involved in a comprehensive analysis of PICT. Barbault (1997) highlights “the probable importance of biodiversity to ecosystem resilience, which means not only their recovery ability after disturbance, but also their resistance to invasive species and therefore their long-term persistence”. “Ecophysiological” demands of species are never identical, even when the species provide the same functions (identical ecological niches, redundant species...). The numerical balance (abundance and richness) between these species may vary depending on environmental changes, while the interactions between them remain unchanged.

These phenomena should also be considered for environmental recovery processes after a disturbance, and the PICT approach could also be used for studying the dynamics of environmental recovery. However, this application is less developed than impact studies (Demoling and Baath 2008a; Blanck and Dahl 1998; Larsen et al. 2003; Boivin et al. 2006). Kinetics of recovery at community level after disturbances are variable, and physiological recovery from a chemical stress is generally more efficient at high microbial diversity and at

high functional redundancy. However, recovering a function after a stress does not necessarily mean that a community returns to its original composition and tolerance (Fig.4). Dorigo et al. (2010) studied the structural and functional recovery of bacterial and eukaryote communities in biofilms naturally grown on stones for 9 weeks in a pesticide impacted site, after transferring them from the pesticide-polluted downstream site to a non-contaminated upstream site (Fig.5). Their results revealed that toxicant-induced changes between non-impacted biofilm (NIB) and impacted biofilm (IB) communities remained present after translocation throughout the recovery period. The transfer of biofilm from impacted site to reference site did not break up structural differences between NIB and IB, and brought on only weak functional changes. Several causes could explain the maintained structural and functional differences. It is likely that persistent differences are preserved via long lasting effects of the toxicant on the periphyton communities, particularly of copper, considering its adsorption onto biofilm and its incomplete release from biofilm matrices (Dorigo et al. 2010). This is in accordance with the results of Larsen et al. (2003) indicating that phytoplankton PICT was maintained over more than 2 weeks after the biocide Sea-Nine 211 had been degraded. It is also suggested that the limited recovery could also be due to limited new cell immigration and to the difficulty for microbial species to invade an already established community rather than invade non- or recently colonized substrata.

The use of biofilm recovery capacity assessed by the PICT appears to be an interesting bioindicator of the recovery of freshwater ecosystems; it is ecologically relevant and could potentially be a management tool (Blanck et al. 1988; Demoling and Baath 2008b).

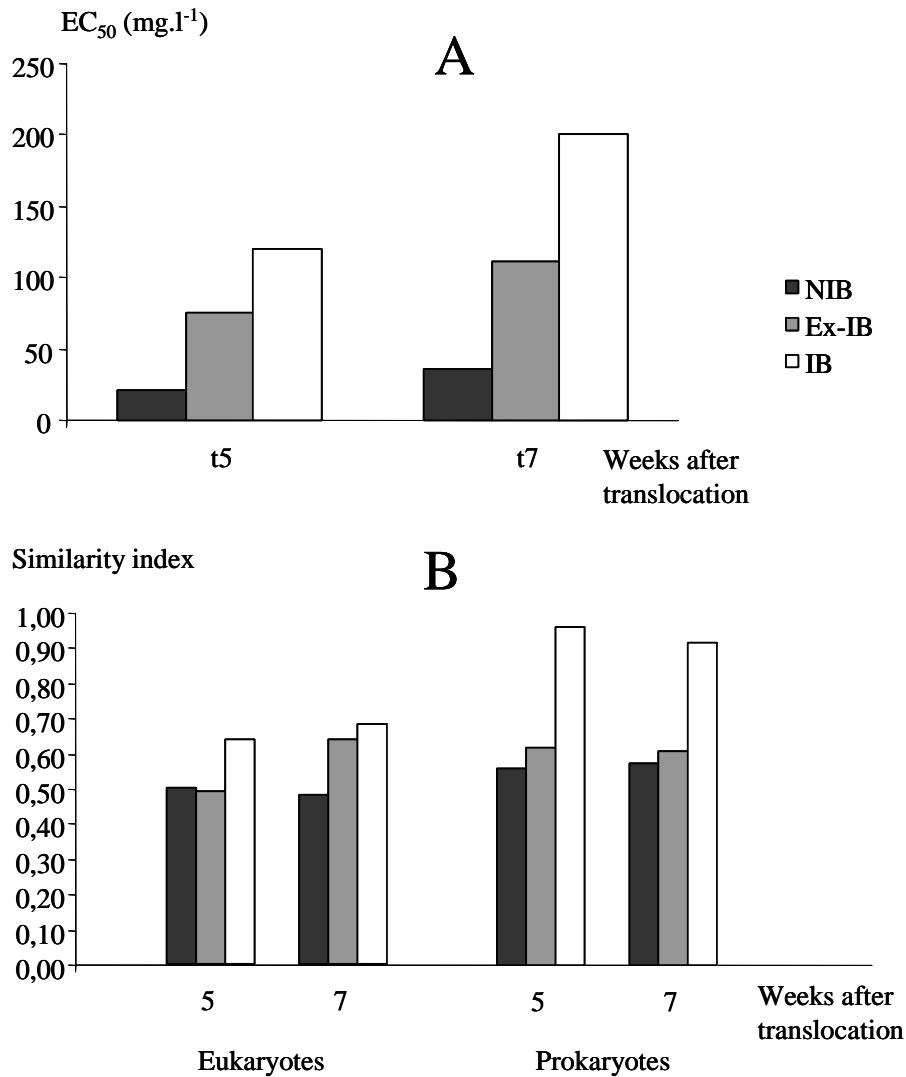

Fig.5 Periphytic community response after translocation for an impacted site (IB) to a non-impacted site (NIB). The translocated biofilm (ex-IB) has a PICT intermediate between NIB tolerance (reference or background PICT) and the IB tolerance. Similarity Indices at 5 and 7 weeks after translocation of IB to the reference site indicate a low similarity with IB diversity for prokaryotes and an incomplete one for eukaryotes (modified from Dorigo et al. 2010).

4.2. Cost of induced tolerance and additional disturbances

The PICT approach has been employed to demonstrate that community structural changes are the direct result of contaminant exposure. However, few studies have investigated the effects of this community restructuring on its sensitivity to other stressors. Acclimating or

adapting to one set of environmental stressors may increase community sensitivity to novel stressors, suggesting a potential cost associated with tolerance acquisition (Wilson 1988; Clements and Rohr 2009). Mature stable ecosystems are characterized by a preponderance of organisms referred to as k-strategists, species that succeed by being well adapted to their environment. Earlier stages in a succession may have a greater proportion of r-strategists, organisms with broad environmental tolerances that do not survive so well in stable habitats where they cannot compete favorably against the more adapted k-species. By contrast, r-strategists have high reproductive rates, flood the environment with their cells, and are ready to colonize opportunistically any habitat space which may become available. In stressful environments, either under man-made stress or naturally harsh conditions, tolerance to abiotic factors becomes a greater determinant of community composition than biotic interactions and r-strategists predominate.

Kashian et al. (2007) showed that benthic communities subjected to long-term metal pollution were generally more tolerant to metals but more sensitive to UV-B radiation than communities from a reference site. The authors speculated that the increase of metal tolerance and the increase of sensitivity to UV-B were probably related to population-level responses (acclimation and adaptation) and shifts in community composition. The elimination of the most sensitive genotypes by pollution in a population, causing a loss of genetic variability, could reduce the ability of these populations to respond to future disturbances. Likewise, the same phenomenon could be possible with elimination of the most sensitive species from a community, inducing an alteration of the ecosystem's functions and augmentation of the sensitivity of the restructured community to additional perturbation (Paine et al. 1998). In 2004, Montuelle (pers. com) showed that the impact of 2,4 D on denitrification and respiration of a microbial soil community was more marked after thermal stress. This loss of functional tolerance due to an additive effect of both stresses, was incidental to a change in diversity, as indicated by 16S rDNA fingerprints.

Most studies dealing with the cost of tolerance have shown that the ability of organisms to tolerate a disturbance has variable consequences if tolerant genotypes are favored and genetic diversity will be reduced (Wilson 1988; Courtney and Clements 2000; Zuellig et al. 2008). Moreover, apparent structural recovery, based on abundance or community composition, does not necessarily mean a functional recovery since similar communities with different histories of exposure can show divergent response trajectories after the removal of the stressors (Kashian et al. 2007). The cost of the induced tolerance may therefore explain the non-return to the initial state of a community after the removal of stress.

4.3. PICT and management implications in ecological risk assessment

Toxicants can disturb the sustainability of natural ecosystems by a variety of effects on species, populations, communities and ecosystem processes. However, such systems have some capacity to absorb potentially toxic substances because of their “dynamic stability”. Toxicity testing has limitations in predicting ecological effects and chemical measurement of environmental toxicant concentrations must be accompanied by ecological monitoring. A complementary approach is needed to distinguish between ecological effects resulting from the pollution and those due to naturally-occurring environmental conditions.

Ecological risk assessment (ERA) is aimed to evaluate the likelihood that adverse ecological effects may occur, or are occurring, as a result of exposure to one or more stressors (U.S. EPA 1992). The process is used to systematically evaluate and organize data, information, assumptions, and uncertainties in order to help understand and predict the relationships between stressors and ecological effects in a way that is useful for environmental decision-making. Such assessment may involve chemical, physical or biological stressors, and one stressor or many stressors may be considered.

The value of risk is obtained by comparing predicted environmental concentrations of the toxic substance in the environment (PEC) with a predicted no-effect concentration (PNEC) on exposed organisms. Whereas the PEC is determined from actual measurement of the toxic substance in the environment or estimated from environmental fate models, the PNEC is commonly derived from concentration–response curves obtained with single-species laboratory species. But PNEC and PEC are not based on a homogenous data set and this risk assessment ratio PEC/PNEC could then be questionable. The PICT approach can be easily integrated into an ERA process and applied as an analytical tool in the analysis phase. In this way, McClellan et al. (2008) showed, for example, that the chronic community-level effects of the herbicide diuron were not predictable from single-species tests. PICT methodology allows the minimizing of such uncertainty in an ERA, because it takes into account the species interactions by working at the community level. Furthermore, Efroymson and Suter (1999) emphasize that the use of small organisms is often omitted in ERA endpoints, and the PICT method is mainly based on small organisms. In their review of the significance of PICT, Boivin et al. (2002) proposed the connection of the PICT method to the conceptual model of the ecosystem (e.g. inclusion of higher trophic levels, community structure analysis and food web modeling) in the planning stage of the ERA to overcome this problem. An active

integration of PICT measurements as a complementary tool and as a microbial community endpoint in environmental assessment schemes would give more ecological relevance to the present battery of bioindicators.

MATERIEL ET METHODES

Chapitre B. Matériel et méthodes

Dans ce chapitre, nous présentons l'ensemble des matériels et méthodes utilisés au cours des études constituant ce travail de thèse. Dans un premier temps, les sites d'études ainsi que les systèmes expérimentaux seront décrits. Ensuite, seront exposées les différentes méthodes d'analyse utilisées pour la caractérisation physico-chimique des écosystèmes étudiés. Enfin, les protocoles des paramètres structurels et fonctionnels des biofilms étudiés seront décrits, avec un intérêt tout particulier pour les bioessais à court-terme, utilisés dans la caractérisation des niveaux de tolérance aux polluants. L'article dans lequel chaque paramètre a été utilisé sera mentionné tout au long de ce chapitre.

B.I. Sites d'études et systèmes expérimentaux

B.I.1. Sites d'études

B.I.1.a. La rivière Morcille

Ce travail de thèse, réalisé au Cemagref de Lyon, s'est appuyé essentiellement sur le site d'étude la rivière Morcille (ordre 1).

Le bassin versant de la Morcille (9,5 km²) est situé au nord du département du Rhône, dans le Haut-Beaujolais, entre la bordure orientale du Massif Central et l'extrémité ouest de la vallée de la Saône (**figure 1**). Il constitue un sous-bassin de l'Ardières (220 km²) avec lequel il compose le Site Atelier Ardières-Morcille (SAAM), intégré dans la Zone Atelier du Bassin du Rhône (ZABR). Le bassin versant de la Morcille est essentiellement forestier en amont et planté de vignes en aval. Ce site atelier est suivi depuis plus de 15 ans d'une manière pluridisciplinaire, qui repose majoritairement sur un couplage chimie - physique - biologie - écologie et, selon le programme implique, la collaboration de nombreux organismes (Cemagref Lyon, INRA (Thonon, Dijon), ENTPE Lyon, Université Claude Bernard Lyon, CNRS, Agence de l'EAU RMC, Université de Bourgogne, ENESAD Dijon). Sur ce cours d'eau, trois sites d'échantillonnage sont généralement privilégiés pour la caractérisation chimique et biologique du cours d'eau: un site amont, dénommé « Saint Joseph » ; un site intermédiaire, dénommé « Versauds » ; et un site aval, dénommé « Saint Ennemond ». Ces trois stations sont représentatives de l'augmentation de la proportion relative de vigne sur la surface de bassin versant drainée par le cours d'eau de la station amont (7%) à la station aval (69%) (**figure 1**). Cette augmentation est associée à un gradient croissant des teneurs en pesticides (majoritairement à action herbicide mais aussi fongicide), en métaux (principalement cuivre, zinc et arsenic) et en nutriments (surtout phosphore) tout au long du

cours d'eau (Dorigo et al. 2007, 2010, Gouy et Nivon 2007, Pesce et al. 2010, Rabiet et al. 2010).

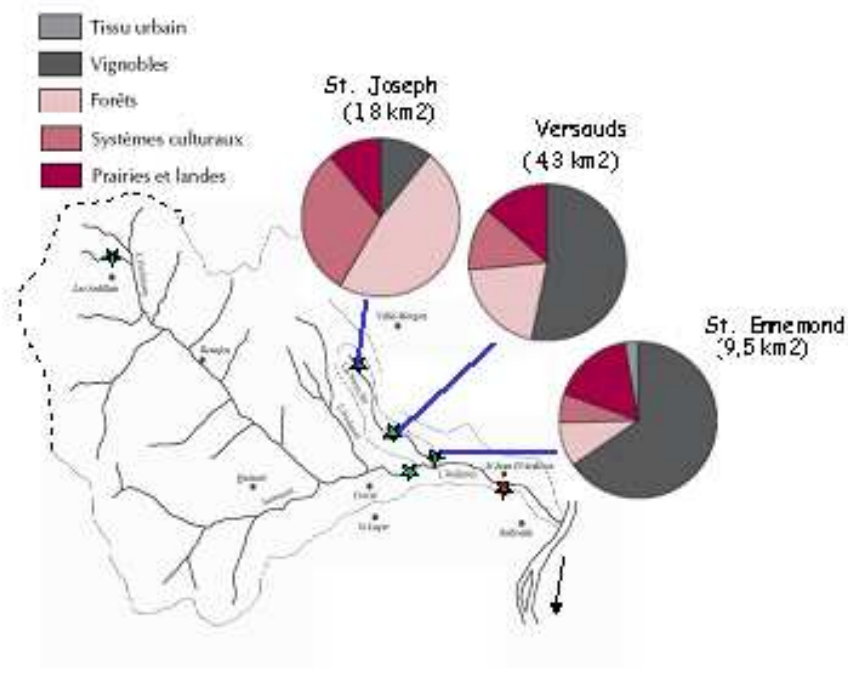

Figure 1 Localisation des trois stations de prélèvements sur le bassin versant de la Morcille. Pour chaque station est indiquée la surface drainée par le cours d'eau et son occupation des sols (Pesce et al. 2009).

B.I.1.b. La rivière Osor

Dans le cadre d'une collaboration avec l'équipe d'écologie microbienne de l'Université de Gérone (Espagne), une étude *in-situ* a été menée dans la rivière Osor (**article 6**). Osor est une rivière d'ordre 2 située en Catalogne (nord-est, Espagne), et est un affluent de la rivière Ter (**figure 2**). Cette rivière de 23,5 km de long draine un bassin versant (depuis les montagnes Guillerries) de 8890 ha. Le lit de la rivière Osor est principalement siliceux, avec une minéralisation modérée ($173 \text{ mg.L}^{-1} \text{ CaCO}_3$, ACA 2009). Cette rivière est relativement bien préservée, et les pressions anthropiques sont essentiellement liées à d'anciennes activités minières (achevées en 1980). Les pressions urbaines sont faibles, avec des apports en quantités faibles d'eaux usées résiduelles du village d'Osor (354 habitants) et d'une usine de traitement des eaux usées située en amont (St. Hilari Sacalm avec 5064 habitants). Cinq sites d'échantillonnage ont été sélectionnés dans cette rivière (**figure 2**) : deux sites sans pollution métallique situés en amont des rejets miniers et dénommés « Colonization site » et « Reference site », et les trois autres sites (listés de l'amont vers l'aval) sont caractérisés par des niveaux de pollutions métalliques différents: (« Mining.1 » est situé avant le principal

effluent minier et reçoit des apports diffus en métaux (pollution intermédiaire), « Mining.2 » se situe juste après l'effluent de la mine et présente donc un taux de contamination par les métaux relativement élevé et enfin « Mining.3 » situé juste après une digue, est caractérisé par une faible contamination due à des phénomènes de précipitation et de stockage des métaux dans les sédiments.

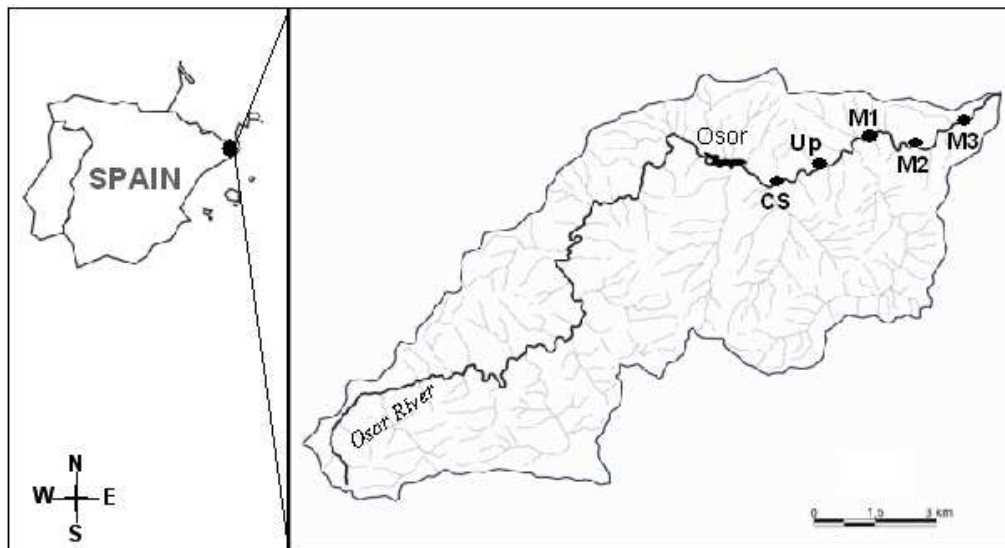

Figure 2 Bassin versant de la rivière Osor (Espagne) et les sites d'échantillonnage (CS: colonization site, Up: Reference site, M1: Mining.1, M2: Mining.2 et M3: Mining.3)

Pour des raisons de réalisme, excepté pour l'étude in situ correspondant à l'article 6 qui a été effectuée en Espagne, toutes les études expérimentales réalisées au cours de ce travail ont été construites en se basant sur les caractéristiques physico-chimiques de la rivière Morcille.

B.I.2. Microcosmes de laboratoire et mésocosmes *ex situ*

B.I.2.a. Microcosmes de laboratoire

Deux dispositifs de microcosmes de laboratoire ont été utilisés au cours de ce travail et nous ont permis d'avoir des biofilms qui se sont développés (sur des lames de verre avec une surface dépolie) sous des conditions physico-chimiques contrôlées (e.g. lumière, température, exposition aux polluants...). Ces systèmes correspondent à :

(i) des aquariums en verre d'une capacité de 40 L remplis avec de l'eau et dans lesquels le biofilm s'est développé sur des substrats artificiels (**figure 3**) (**article 2** et **article 3**). Des

pompes centrifuges ont été plongées dans l'eau de ces aquariums pour simuler un mouvement de l'eau ;



Figure 3 Système expérimental : aquariums installés au laboratoire.

(ii) des petit canaux de laboratoire en verre (**figure 4**) (63 cm de long, 11 cm de large et 4 cm de profondeur) dans lesquels le biofilm s'est développé sur des substrats artificiels (lames de verre sablé) (**article 4**). La circulation de l'eau dans ces canaux était en mode fermé : grâce à des pompes centrifuges, 5 L d'eau étaient mis en circulation avec un débit de 1,2 L / min à partir d'un récipient en verre situé à l'extrémité de chaque canal. Tous les récipients en verre étaient placés dans un bain d'eau thermostatée pour le contrôle de la température, et un robinet à l'amont de chaque canal a permis d'avoir des débits similaires entre tous les canaux.

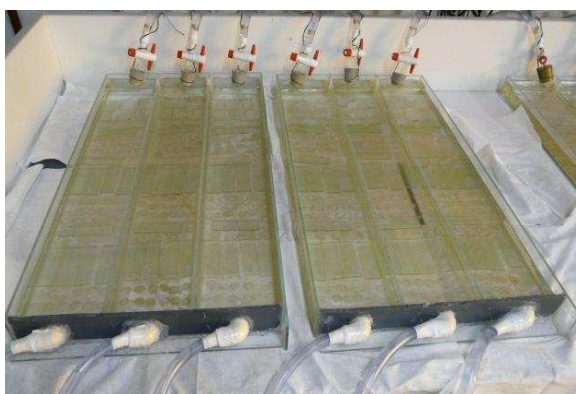

Figure 4 système expérimental : canaux installés au laboratoire

B.I.2.b. Mésocosmes *ex situ*

Un système expérimental de plus grandes dimensions et en extérieur a été utilisé au cours d'une étude simulant des phénomènes de contaminations associées au crues (**article 5**). Ce dispositif consiste en une plate-forme de 4 mésocosmes extérieurs (INRA, Thonon-les-Bains,

France) en acier inoxydable (4 m de long, 0,4 m de large et 0,35 m de profondeur) (**figure 5**). Chaque canal se compose de trois modules indépendants: (1) une partie linéaire, de section rectangulaire constante (la veine d'étude : 400 x 40 x 35 cm) , (2) une cuve située en extrémité amont de la veine d'étude qui joue le rôle de cuve de tranquillisation du flux (70 x 70 x 125 cm) et (3) une cuve aval qui sert essentiellement à la remise en circulation du fluide lorsque l'installation fonctionne en circuit semi-fermé ou fermé (130 x 92 x 124 cm). Les canaux fonctionnent en circuit semi-ouvert grâce à un trop plein et sont alimentés avec l'eau du lac Léman prélevée en continu à 36 m de profondeur. Le volume total d'eau dans le système (2,2 m³ par canal) est remplacé 4 fois par jour. Le débit et la vitesse de l'eau dans les canaux sont contrôlés en utilisant un système de vannes et by-pass. L'eau évacuée par le trop-plein est reversée au lac au travers d'un filtre à charbon actif destiné à piéger les pesticides. Ces canaux ont été initialement mis au point à l'ENTPE (Volatier, 2004).



Figure 5 Mésocosmes extérieurs : 2 des 4 canaux, avec leur déversoir de sortie.

B.II. Les paramètres mesurés

B.II.1. Analyses physico-chimiques

Les analyses physico-chimiques (chimie des majeurs, micropolluants dans l'eau et dans les biofilms) ont représenté une composante relativement importante dans ce travail de thèse. Ceci nous a permis au cours de nos différentes études de faire le lien entre caractéristiques physico-chimiques des milieux et impact des pressions anthropiques sur les communautés microbiennes des biofilms. Ces analyses ont été réalisées par le Laboratoire d'Analyse des

Milieux Aquatiques (LAMA) du Cemagref de Lyon et le laboratoire de chimie de l'INRA de Thonon.

B.II.1.a. Physico-chimie des eaux

Les produits mesurés ainsi que leurs méthodes d'analyses sont les suivant :

- ◆ Les orthophosphates selon la norme NF EN 1189, par la méthode de colorimétrie Murphy et Riley.
- ◆ Le carbone organique dissous (COD) selon la norme FDT 90-102, par la mesure de l'absorbance IR après oxydation chimique du carbone organique en CO₂ par du persulfate de potassium.
- ◆ La conductivité selon la norme NF EN 2788 / ISO 7888, par la méthode de correction de température automatique à une température de 25°C, elle est mesurée par sonde.
- ◆ Le pH par pHmètre (Meter-pH 196).
- ◆ L'irradiance par luxmètre LUX-METER LX-101 (Bioblock Scientific).
- ◆ Les métaux dissous selon la norme NF EN ISO 5667-3, par les méthodes d'analyse par spectrométrie d'absorption atomique (AA) ou spectrométrie de masse avec plasma inductif (ICP-MS).
- ◆ Les polluants organiques par HPLC (SDS, France).

B.II.1.b. Dosage des micropolluants dans les biofilms

- ◆ Les métaux totaux, bioaccumulés dans les biofilms et internalisés dans les cellules, sont dosés selon la norme NF EN ISO 5667-3 par les méthodes d'analyse par spectrométrie d'absorption atomique (AA) ou spectrométrie de masse avec plasma inductif (ICP-MS), après minéralisation des biofilms et traitement des biofilms à l'EDTA pour les mesures d'internalisation dans les cellules.
- ◆ Les polluants organiques, ainsi que leurs principaux produits de dégradation sont dosés par ESI-LC-MS sur une colonne Purospher star RP-18^e (Merck, France).

Remarque : Les protocoles détaillés pour les analyses des micro-polluants organiques (i.e. diuron) sont décrits dans Tlili et al. (2008) (annexe 1).

B.II.2. Analyses biologiques

B.II.2.a. Mesures de la structure générale du biofilm

◆ Estimations de la biomasse totale (tous les articles)

La masse sèche sans cendre est évaluée selon la technique classique de perte au feu (Scholz et Boon, 1993). 2 mL de chaque suspension périphytique est filtré sur un filtre Whatman GF/C (porosité 1.2 μm) pré-séché à 110°C pendant 12 h et pré-pesé (m_0). Ce filtre est alors séché à 110°C pendant 24 h, pesé (m_1), puis calciné pendant 1 h à 480°C (four Ventoux HM, Serlabo) et enfin pesé à nouveau (m_2). Chaque pesée s'effectue à l'aide d'une balance de précision, les échantillons étant sortis du dessiccateur le plus rapidement possible. La masse sèche (MS) (équation 1) et la masse sèche sans cendre (MSSC) (équation 2) se calculent alors de la façon suivante :

$$\boxed{MS = \frac{1}{S} \times (m_1 - m_0) \times \frac{V_{\text{suspension}}}{V_{\text{filtré}}}} \quad \text{Éq (1)} \quad \text{et} \quad \boxed{MSSC = \frac{1}{S} \times (m_1 - m_2) \times \frac{V_{\text{suspension}}}{V_{\text{filtré}}}} \quad \text{Éq (2)}$$

(S = surface analysée du biofilm).

◆ Dénombrement bactérien par cytométrie en flux (CFM) (article 3)

Le protocole suivi est inspiré de Duhamel et Jacquet (2006). Trois réplicats, correspondant chacun à 2 mL de suspension périphytique, sont prélevés par date de prélèvement. 3 mL d'eau du site de référence (filtrée sur 0.02 μm) et du formaldéhyde 2% final sont ajoutés au biofilm. Les échantillons sont par la suite congelés à l'azote liquide puis conservés à -80°C. Le jour de l'analyse, 5 μL de Tween 80 (10%), 1 mL de solution de sodium pyrophosphate (10 mM) et 4 mL d'eau milliQ sont ajoutés, dans le but d'extraire les bactéries de la matrice périphytique. Les échantillons sont ensuite placés dans un sonicateur (3 fois 1 min) puis incubés dans la glace (15 min). Ils sont ensuite centrifugés 1 min à 800g puis filtrés sur 10 μm . Le surnageant est ensuite dilué au 1/25^{ième}. Un microlitre d'une solution de billes calibrées, servant d'étalon interne, (Fluoresbrite Carboxy YG 10 Micron Microsphere [2,57 % Solids-Latex], Polysciences) est ajouté à 1 mL du surnageant dilué. Les bactéries sont marquées avec du SYBR-I à la concentration de 1/10000 dilué dans du TE filtré à travers 0,02 μm . Les échantillons sont incubés 15 min à l'obscurité à température ambiante puis 10 min à 70°C. L'analyse se fait avec un cytomètre FACSCalibur (Becton

Dickinson) possédant un laser d'une capacité de 15 mW à 488 nm avec des filtres standards. L'analyse des résultats a été effectuée avec le logiciel CYTOWIN (Vaulot, 1989).

B.II.2.b. Caractérisations de la structure et de la composition des communautés périphtiques

◆ Analyse de la composition pigmentaire par HPLC (High Performance Liquid Chromatography) (tous les articles)

L'analyse des pigments phototrophes a été réalisée par HPLC, ce qui nous a permis d'une part d'établir un profil de diversité de ces pigments, et d'autre part de déterminer l'abondance relative des principales classes phytobenthiques présentes dans les échantillons, grâce à leurs pigments caractéristiques (i.e. fucoxanthine pour les diatomées, zéaxanthine pour les cyanobactéries et lutéine pour les algues vertes). De plus, cette technique a été utilisée pour la quantification de la chlorophylle-a (considérée comme indicateur de la biomasse phototrophe totale) qui a été réalisée à partir d'une gamme étalon d'une solution chlorophylle-a standard (C55H72MgN4O5, Carl Roth GmbH & Co).

Selon Jeffrey et al. (1996), les pigments sont extraits dans un solvant (98 : 2 méthanol : ammonium acétate 0,5 M). 5 mL de la suspension périphtique sont centrifugés pendant 30 min à 9750 g et à 0°C. Le surnageant est par la suite éliminé et le culot conservé à -80°C. Dans le cas où on travaille avec des pastilles en verre sablé (sur lesquelles le biofilm s'est développé) cette étape de centrifugation est inutile, puisque les pastilles sont directement placées dans les tubes et conservées à -80°C.

Le jour de l'analyse, 4 mL du solvant d'extraction sont rajoutés aux tubes qui sont par la suite passés au sonicateur pendant 1 min à 180W en utilisant un sonicateur équipé avec une sonde de 4 mm de diamètre directement insérée dans le solvant. Après sonication les tubes sont centrifugés pendant 6 min à 6000 g et à 0°C. Les surnageants sont collectés et purifiés à travers un filtre de 0,22 µm de porosité (Cameo 3N-syringe nylon filtre ; Micron Separation Inc.). Les surnageants ainsi purifiés sont injectés dans des tubes ambrés de 2 mL qui seront stockés au congélateur (-20°C) jusqu'à leur analyse HPLC (Chaîne HPLC Waters ; pompe 600, passeur 717 et barrette de diodes 996 ; colonne Phenomenex Luna 5µ-C18(2), 240 mm x 4.6 mm). Les pigments sont identifiés grâce à leur temps de rétention et leur spectre d'absorbance. Des standards sont utilisés afin de confirmer l'identité de divers pigments clés et de les quantifier dans les échantillons.

Le système de solvants utilisé au cours de l'analyse HPLC est constitué d'un ensemble de 3 solvants : **A** (méthanol : 0,5 M ammonium acetate; 80 : 20), **B** (acétonitrile : eau milliQ ; 90 : 10) et **C** (éthyle acétate).

Le programme de passage des solvants dans la colonne est présenté dans le Tableau 1

Tableau 1 Programme HPLC pour l'analyse des pigments phototrophes. **A** (méthanol : 0,5 M ammonium acetate), **B** (acétonitrile : eau milliQ) et **C** (éthyle acétate) correspondent aux trois solvants utilisés).

Temps (min.)	% A	% B	% C	Evénement
0 - 4	100	0	0	injection
4 - 18	0	100	0	Gradient logarithmique
18 - 21	0	20	80	Gradient linéaire
21 - 24	0	100	0	Gradient linéaire
24 - 32	100	0	0	Gradient linéaire
32	100	0	0	Retour à l'équilibre

◆ Analyse taxonomique des diatomées par microscopie (article 6)

Ces analyses ont été effectuées par Soizic Morin du Cemagref de Bordeaux (UR REBX). L'identification des diatomées présentes dans les échantillons de périphyton (préalablement fixé au formol) est réalisée d'après l'examen microscopique de leur squelette siliceux. Le protocole normalisé AFNOR (NF EN 13946) consiste en une première étape de digestion de la matière organique par un traitement des échantillons formolés à l'eau oxygénée (H₂O₂, 30%) bouillante de 10 minutes. Un deuxième traitement, à l'acide chlorhydrique (HCl, 35%) bouillant pendant 5 minutes est parfois nécessaire pour obtenir un nettoyage satisfaisant des frustules. Ensuite, les résidus d'eau oxygénée et d'acide sont éliminés par des cycles successifs de centrifugations (5 minutes à 2500g) et de rinçages à l'eau distillée. Une partie aliquote est déposée sur une lamelle propre et déshydratée par séchage. La lamelle est ensuite

retournée sur une goutte de résine réfringente, le Naphrax[®] (Brunel Microscopes Ltd, UK), déposée au préalable sur une lame, le chauffage permet de chasser les bulles d'air et d'aboutir à la fabrication de lames permanentes.

L'identification des diatomées se fait par l'observation en microscopie photonique (au grossissement x1000) des lames préparées, selon la norme NF EN 14407 (2004). L'effort de détermination porte sur 400 valves au minimum.

◆ Analyses moléculaires

(i) Extraction de l'ADN

Une des étapes clés dans la réalisation des analyses moléculaires est l'extraction de l'ADN génomique des échantillons de biofilm. Pour cela nous avons utilisé le kit DNAeasy Plant kit (QIAGEN). La première étape consiste à centrifuger 2 mL de la suspension périphtyque pendant 30 min à 14.000 g et à 4°C. Ensuite le surnageant est éliminé et le culot est conservé à -80°C jusqu'à l'analyse. Le jour de l'extraction de l'ADN, les cellules sont éclatées par lyse mécanique : broyage à l'aide d'un Fast-Prep avec addition de billes de verre de différentes tailles. Ensuite l'ADN est extrait selon les instructions du fournisseur et dosé par spectrophotométrie à 260nm.

(ii) Amplification de l'ADN par PCR (Polymerase Chain Reaction)

Les réaction d'amplification ont été réalisées dans un thermocycler T-Personal48 (Biometra, France). Les ADNr 18S eucaryotes (à partir de 60 ng d'ADN génomique) ont été amplifiés partiellement par PCR à l'aide des amorces Euk1Af et Euk516r-GC. Les ADNr 16S procaryotes (à partir de 30 ng d'ADN génomique) ont été amplifiés partiellement à l'aide des amorces 341f et 907rM. L'amplification des séquences intergéniques bactériennes 16S-23S a été réalisée avec les amorces S-D-Bact-1522-b-S-20 et L-D-Bact-132-a-A-18, et celle de la région fongique ITS1-5.8S-ITS2, avec les amorces 2234C et 3126T.

L'ensemble des amorces utilisées pour les différentes PCR est présenté dans le Tableau 2 :

Tableau.2 Séquences et cibles des différentes amorces utilisées dans cette étude

Amorce	Séquence	Cible
PCR pour DGGE :		
Euk1Af	5'-CTGGTTGATCCTGCCAG-3'	18S eucaryote (Sogin et Gunderson 1987)
Euk516r-GC	5'- GCCCGGGGCGCGCCCCGGGC GGGGCGGGGGCACGGGGGGAC CAGACTTGCCCTCC-3'	18S eucaryote (Amann et al. 1990)
341f	5'-CGCCCGCCGCGCGGGCGGG CGGGGCGGGGGCACGGGGGGC CTACGGGAGGCAGCAG-3'	16S procaryote (Muyzer et Smalla 1998)
907rM	5'-CCGTCAATTCMTTTGAGTTT- 3'	16S procaryote (Schauer et al. 2003)
PCR pour ARISA :		
S-D-Bact-1522-b-S- 20	5'-TGCGGCTGGATCCCCTCCTT- 3'	16S-23S bactérien (Ranjard et al. 2001)
L-D-Bact-132-a-A- 18	5'-CCGGGTTTCCCCATTCGG-3'	16S-23S bactérien (Ranjard et al. 2001)
2234C	5'- GTTTCCGTAGGTGAACCTGC-3'	ITS1-5.8S-ITS2 fongique (Ranjard et al. 2001)
3126T	5'- ATATGCTTAAGTTCAGCGGGT- 3'	ITS1-5.8S-ITS2 fongique (Ranjard et al. 2001)

Les mélanges réactionnels des réactions de PCRs sont décrits dans le Tableau 3 :

Tableau.3 Réactifs pour les différentes réactions de PCR (les couples d'amorces sont : **a** et **b** = ADNr 18S eucaryote ; **c** et **d** = ADNr 16S procaryote ; **e** et **f** = région 16S-23S bactérienne ; **g** et **h** = région ITS1-5.8S-ITS2 fongique).

Réactif	PCR-DGGE	PCR-ARISA
Taq polymérase (Eurobio)	0.25 µL soit 1.25 U	0.25 µL soit 1.25 U
Tampon 10X	5 µL	5 µL
dNTP (2 mM)	3 µL	3 µL
BSA (10 mg.mL ⁻¹)	2.5 µL	2.5 µL
Euk1Af (12.5 µM)	4 ^a	--
Euk516r-GC (12.5 µM)	4 ^b	--
341f (12.5 µM)	4 ^c	--
907rM (12.5 µM)	4 ^d	--
S-D-Bact-1522-b-S-20 (12.5 µM)	--	4 ^e
L-D-Bact-132-a-A-18 (12.5 µM)	--	4 ^f
2234C (12.5 µM)	--	4 ^g
3126T (12.5 µM)	--	4 ^h
ADN génomique	2 µL	2 µL
Eau ultra pure	qsp 50 µL	qsp 50 µ

Les conditions d'amplification choisies sont présentées dans le Tableau 4 :

Tableau 4 Paramètres de l'amplification par PCR pour la DGGE et pour l'ARISA.

		PCR-DGGE				PCR-ARISA			
		18S eucaryote		16S procaryote		16S-23S bactérien		ITS1-5.8S-ITS2 fongique	
ETAPE		<i>Température</i>	<i>Durée</i>	<i>Température</i>	<i>Durée</i>	<i>Température</i>	<i>Durée</i>	<i>Température</i>	<i>Durée</i>
Dénaturation initiale		94 °C	3 min	94 °C	5 min	94 °C	5 min	94 °C	5 min
Dénaturation	Cycle	94 °C	30 s	94 °C	45 s	94 °C	1 min	94 °C	1 min
Hybridation		57 °C	30 s	57 °C	45 s	55 °C	1 min	57 °C	1 min
Elongation		72 °C	1 min	72 °C	1 min	72 °C	90 s	72 °C	90 s
Elongation finale		72 °C	7 min	72 °C	10 min	72 °C	10 min	72 °C	10 min
Nombre total de cycles		30		35		31		31	

(iii) *Analyse DGGE des ADNr 16S (procaryote) et 18S (eucaryotes) et révélation du gel (article 3, article 4 et article 5)*

L'analyse DGGE est effectuée avec le système DGGE 2001 (CBS Scientific Company) selon le mode opératoire décrit par Muyzer et al. (1998) et les conditions expérimentales de Shauer et al. (2003). La première étape consiste en la préparation d'un gel de 1 mm d'épaisseur contenant 6% de polyacrylamide et un gradient de substance dénaturante allant de 40 à 80% pour l'étude des communautés procaryotes et de 40 à 60 % pour l'étude des communautés eucaryotes (une solution contenant 100% d'agent dénaturant est composée d'une solution d'urée à 7M et de formamide déionisé à 40% (v:v)). Ensuite 30 µL de produits

PCR sont déposés et leur migration se fait pendant 16 h à 100 V dans un bain de TAE 1X (40 mM Tris, 20 mM acétate de sodium, 1 mM d'EDTA) maintenu à 60°C. L'ADN est par la suite coloré avec du SYBR Gold (Molecular Probes) pendant 45 min à l'obscurité et les fragments d'ADN sont révélés sous UV et photographiés (Scion Corporation caméra). Finalement, les OTUs sont identifiées et les profils DGGE eucaryotes et procaryotes sont analysés avec le logiciel GelCompar II (Applied Math NV). Une matrice basée sur la présence/absence ou sur l'intensité relative des bandes est créée à partir de l'analyse du gel.

(iv) Analyse ARISA des régions 16S-23S (bactérie) et ITS1-5.8S-ITS2 (champignons)
(article 6 et article 2)

Les analyses ARISA ont été effectuées avec le système Agilent 2100 Bioanalyzer (Agilent Technology Mfg GmbH & Co. KG) avec le kit « high sensitivity » d'après les instructions du fabricant. Les profils ARISA de diversité bactérienne et fongique obtenus ont été analysés avec le logiciel GelCompar II (Applied Math NV), conduisant à une matrice basée sur la quantification des intensités relatives des bandes.

B.II.2.c. Production primaire par incorporation de ^{14}C **(article 5)**

Ces analyses ont été réalisées à l'INRA de Thonon, d'après le protocole décrit par Dorigo et LeBoulangier (2001). Des pastilles de verre fritté (1.5 cm²), contenant du périphyton, sont placées dans des fioles à scintillation contenant 1 mL d'eau du milieu filtrée à 0.2 µm et auxquels on rajoute 25 µl de NaH¹⁴CO₃ (20 µCi/mL) pour une activité finale proche de 0,25 µCi/mL). Les fioles sont par la suite incubées pendant 2 heures à la même lumière et température du milieu (un contrôle est réalisé avec une pastille placée à l'obscurité). La photosynthèse est par la suite stoppée en ajoutant 100 µl de formol 4% et les échantillons peuvent être par la suite stockés. L'étape suivante consiste à éliminer le carbonate radioactif en rajoutant 100 µL d'acide acétique et les fioles sont ensuite mises à agiter pendant 1 heure à 150 rpm. Les échantillons sont ensuite séchés pendant une heure à 60°C, 1 mL de DMSO est introduit dans chaque fiole et les échantillons sont de nouveau mis à sécher pendant 1h à 60°C afin de solubiliser la matière organique. Enfin, 15 mL de liquide de scintillation (Ultima Gold LLT, Perkin Elmer) sont ajoutés, et après une incubation pendant 48 heures à l'obscurité (pour éviter un phénomène de chimioluminescence), la radioactivité est mesurée avec un compteur à scintillation (2100-TR, Packard Instruments) et est exprimée en DPM (désintégration par minute).

B.II.2.d. Efficacité photosynthétique (**tous les articles**)

L'efficacité photosynthétique est basée sur la mesure du rendement quantique (YII) des communautés phototrophes (Schreiber, 2002). Il reflète le nombre de photosystème-II fonctionnels et par conséquent, plus généralement l'état physiologique des communautés phototrophes. Les mesures ont été effectuées en utilisant un fluorimètre Phyto- ou Mini-PAM (amplitude d'impulsion modulée). Les pastilles de verre fritté contenant les biofilms (ou 3 mL de suspension périphytique) sont incubées pendant 30 min à l'obscurité et ensuite, la fluorescence de la chlorophylle-a est mesurée à 665 nm. Une seule impulsion lumineuse saturante a été appliquée pour calculer le rendement quantique maximal :

$$YII_{665\text{nm}} = \frac{F_m - F_0}{F_m} \quad \text{Éq (3)}$$

où F_m correspond à la fluorescence maximale obtenue après l'impulsion lumineuse saturante, et F_0 correspond à la fluorescence de base en équilibre.

B.II.2.e. Bioessais à court terme pour les mesures de tolérance

Le niveau de tolérance global des communautés microbiennes du biofilm aux différents toxiques étudiés dans ce travail de thèse, a été évalué à partir de tests de toxicité aiguë effectués en laboratoire. Brièvement, les biofilms ont été soumis au laboratoire à des concentrations croissantes en toxique et la réponse microbienne, en fonction du niveau d'exposition, a été appréciée en termes d'efficacité photosynthétique [cible la communauté phototrophe] ainsi que des activités enzymatiques extracellulaires (leucine-aminopeptidase (LAP) et β -glucosidase (β -Glu)) et de la respiration induite par un substrat (SIR) carboné [ciblent la communauté hétérotrophe]. Les courbes doses-réponse (ou doses-effet) établies ont ainsi permis de déterminer la concentration efficace en toxique inhibant 50% (CE_{50}) de l'activité mesurée de chacune des communautés étudiées.

◆ Bioessais basés sur l'efficacité photosynthétique (**tous les articles**)

Les bioessais basés sur l'inhibition de l'efficacité photosynthétique ont été réalisés d'après le protocole décrit par Schmitt-Jansen et Altenburger (2008). Les biofilms (en suspension (2,7 ml) ou sur des pastilles de verre sablé) ont été exposés à des concentrations croissantes de toxique (3 témoins et 3 réplicats pour chacune des 5 concentrations de

toxique). Ensuite les biofilms ont été incubés pendant des durées variables (déterminées au préalable) selon le polluant étudié, à la même intensité lumineuse et température que celles de la croissance du biofilm et sous agitation douce. Après 30 min d'adaptation à l'obscurité, les mesures ont été effectuées grâce un fluorimètre PhytoPAM ou MiniPAM, comme indiqué précédemment pour les mesures de l'efficacité photosynthétique. Le pourcentage d'inhibition du rendement de fluorescence à 665 nm par rapport à celui du témoin a été calculé pour chaque bioessai et une courbe dose-réponse a été tracée afin de calculer les CE₅₀.

Les gammes de concentrations utilisées et les durées d'exposition appliquées pour chaque toxique étudié sont présentées dans le tableau 5.

Tableau 5 Récapitulatif des gammes de concentrations et des durées d'exposition appliquées pour chaque toxique étudié au cours des bioessais basés sur l'efficacité photosynthétique.

Polluant	Gamme de concentration	Durée d'exposition
Diuron	0 M à $3.2 \cdot 10^{-3}$ M	3 heures
Cuivre	0 M à $2 \cdot 10^{-3}$ M	2 heures
Zinc	0 M à $6 \cdot 10^{-2}$ M	4 heures
Arsenic	0 M à 0.2 M	2.5 heures

◆ Bioessais basés sur les activités enzymatiques extra-cellulaires

Ces bioessais ont été réalisés afin de déterminer la tolérance acquise au cuivre des communautés hétérotrophes du biofilm, au cours de l'une de nos études (**article 3**). Les activités enzymatiques sont mesurées par fluorimétrie d'après Chrost et Rai (1993) avec quelques modifications. Le principe de ces mesures est basé sur l'utilisation d'un ensemble non fluorescent composé d'un fluorogène associé à une molécule analogue au substrat de l'enzyme étudiée (substrat-analogue). L'hydrolyse enzymatique casse la liaison de cet ensemble, libérant ainsi le fluorogène qui devient fluorescent. Les activités enzymatiques peuvent être ainsi quantifiées par l'augmentation de la fluorescence, compte tenu du fait que la réaction d'hydrolyse est molaire (1 mole de fluorogène pour une mole de substrat libéré).

Les ensembles substrat-fluorogène pour les deux activités enzymatiques étudiées sont :

- Le 4-methylumbelliféryl- β -D-glucopyranoside (MUF-Glu) pour la β -glucosidase
- Le L-leucine-7-amido-4-methylcoumarin hydrochloride (MCA-LAP) pour la leucine-aminopeptidase.

Les fluorogènes libérés lors de l'hydrolyse enzymatique sont :

- Le 4-methylumbellifénone (MUF) pour la β -glucosidase.
- Le 7-amino-4-methyl-coumarin (MCA) pour la leucine-aminopeptidase.

Remarque : Afin d'éviter un effet limitant de substrat mais aussi pour pouvoir comparer les résultats obtenus entre les échantillons, ainsi qu'à chaque campagne de prélèvement, il faut déterminer la concentration saturante en substrat spécifique pour chaque activité enzymatique. Pour cela, une première étape d'incubation du biofilm avec une gamme de concentrations croissantes de substrat (allant de 0 μ M à 2000 μ M) est nécessaire. La concentration saturante est déterminée en réalisant une courbe : valeur de fluorescence obtenue = f (C_{substrat}). La valeur de cette concentration saturante choisie, correspond à celle où la courbe atteint un plateau

Le protocole employé au cours des bioessais basés sur les deux activités enzymatiques extracellulaires étudiées a été mis au point au cours de mon travail de thèse. Les différentes étapes sont les suivantes : 0.7 mL de la suspension périphytique sont exposés à des concentrations croissantes en cuivre (0.3 mL), allant de 0.2 μ M à 2000 μ M (3 témoins et 3 réplicats pour les 6 concentration testées), pendant une durée de 4 heures. Cette incubation est réalisée à l'obscurité et à température ambiante. Ensuite, 2 mL de substrat-fluorogène (concentration saturante) sont rajoutés et les échantillons sont par la suite incubés à l'obscurité et à température ambiante, sous agitation pendant 20 min. La réaction est arrêtée en rajoutant 0.3 mL d'un tampon glycine (Glycine 0.05 mole.L⁻¹ + NH₄OH 0.2mole.L⁻¹ ; pH = 10.4). Les échantillons sont ensuite centrifugés à 8000g pendant 10 min. L'étape suivant consiste à distribuer les surnageant dans une microplaque à 96 puit (300 μ L par puit) et à lire la fluorescence dans un lecteur de microplaques (longueur d'onde : excitation : 360nm \pm 40nm ; émission : 460nm \pm 40nm). Les quantités de MUF et de MCA sont calculées grâce à des droites étalons établies à partir de dilution de fluorogènes standards, et les résultats sont exprimés en μ mole de MUF ou MCA.g⁻¹MSSC.h⁻¹. Les résultats obtenus servent par la suite à établir des courbes dose-réponse et à calculer les CE₅₀.

- ◆ Bioessais basés sur la respiration induite par un substrat carboné (SIR)

Dans un premier temps, afin de déterminer la tolérance hétérotrophe au cuivre (**article 3**), les mesures de SIR ont été réalisées selon la méthode de Furutani et Rudd (1984) qui a été adaptée par Dorigo *et al.* 2010, et mesurées par chromatographie en phase gazeuse (CPG) avec un microcatharomètre MTI 200 par quantification du CO₂ produit. 7 mL de la suspension de biofilm, placés dans des flacons de 150 mL, sont pré-exposés à des concentrations croissantes en cuivre (1 mL), allant de 0.2 µM à 2000 µM (3 témoins et 3 réplicats pour les 6 concentrations testées), pendant une durée de 2 heures. Ensuite 2 mL d'une solution nutritive (15 g.mL⁻¹ de glucose et 14.6 g.mL⁻¹ d'acide glutamique) sont ajoutés et les flacons scellés (t = 0h) et incubés à l'obscurité sous agitation douce à température ambiante. Le rajout de la solution nutritive permet de mesurer une activité potentielle en s'assurant que les substrats sont toujours saturants. A t = 5h et t = 8h, les aires de pics correspondant au CO₂ produit sont mesurées. Finalement, une droite étalon établie avec des quantités connues et croissantes de CO₂ permet de convertir les aires de pics en ng de CO₂ et les résultats sont exprimés en ng CO₂.g⁻¹MSSC.h⁻¹. Les résultats obtenus servent par la suite à établir des courbes dose-réponse et à calculer les CE₅₀.

Cependant, l'utilisation de la chromatographie en phase gazeuse pour les mesures de respiration reste laborieuse et lente, surtout quand de nombreux échantillons microbiens sont dosés dans une multitude de flacons qui doivent être traités séparément pour mesurer la quantité de CO₂ émise. Les systèmes miniaturisés offrent donc l'avantage de permettre la multiplication des échantillons et des réplicats. Dans les études sur du sol, Campbell et al. (2003) ont développé la technique MicroRespTM, qui est une méthode qui combine les avantages de la technique BiologTM, en utilisant un système de microplaques, et de l'approche SIR avec la capacité de mesurer la production de CO₂ pendant l'incubation à court terme d'une communauté microbienne totale du sol. Nous avons donc au cours de ce travail de thèse développé un protocole basé sur la respiration aérobie des communautés microbiennes des biofilms, en utilisant la technique MicroRespTM dans une approche PICT (**article 4** et **article 6**).

Ce travail a fait l'objet d'un article qui est présenté dans ce chapitre sous le titre «Use of the MicroRespTM method to assess pollution-induced community tolerance to metals for lotic biofilms» et qui a été publié dans la revue « Environmental Pollution » (**article 2**).

Article 2

«Use of the MicroRespTM method to assess pollution-induced community tolerance to metals for lotic biofilms»

**A. TLILI, M. MARECHAL, B. MONTUELLE, B. VOLAT, U. DORIGO &
A. BERARD**

Environmental Pollution 159 (2011) 18-24

Use of the MicroRespTM method to assess pollution-induced community tolerance to metals for lotic biofilms

Ahmed Tlili^a, Marjorie Marechal^a, Bernard Montuelle^a, Bernadette Volat^a, Ursula Dorigo^b, Annette Bérard^c

a. CEMAGREF, UR MAEP, 3 quai Chauveau CP 69336 Lyon Cedex 09, France

b. INRA UMR CARTELE, Laboratoire de Microbiologie Aquatique, BP 511, 74203, Thonon Cedex, France

c. INRA UMR CSE-EMMAH 1114, Domaine Saint-Paul - Site Agroparc 84914 Avignon Cedex 9, France

Abstract

Understanding the ecological status of aquatic ecosystems and the impact of anthropogenic contamination requires correlating exposure to toxicants with impact on biological communities. Several tools exist for assessing the ecotoxicity of substances, but there is still a need for new tools that are ecologically relevant and easy to use. We have developed a protocol based on the substrate-induced respiration of a river biofilm community, using the MicroRespTM technique, in a pollution-induced community tolerance approach. The results show that MicroRespTM can be used in bioassays to assess the toxicity toward biofilm communities of a wide range of metals (Cu, Zn, Cd, Ag, Ni, Fe, Co, Al and As). Moreover, a community-level physiological profile based on the mineralization of different carbon substrates was established. Finally, the utility of MicroRespTM was confirmed in an in-situ study showing gradient of tolerance to copper correlated to a contamination gradient of this metal in a small river.

Capsule: A modified MicroRespTM technique as a tool for measuring induced tolerance to heavy metals of a microbial biofilm community.

Keywords: river biofilm; pollution-induced community tolerance; substrate induced respiration; heavy metals; MicroRespTM.

1. Introduction

In a setting of agricultural land use, small lotic ecosystems (Strahler order below 3) are very sensitive to pollution because of generally low dilution and contiguous contamination sources (spraying of pesticides, run off...) (Dorigo et al., 2003). In these ecosystems, biofilms (attached microbial communities of autotrophic and heterotrophic, eukaryotic and prokaryotic populations) play a fundamental role in the aquatic trophic web and geochemical cycles (Battin et al, 2003). In agricultural watershed rivers, biofilms are exposed directly to toxicants that run off from fields, and their structure and function can be affected. The vast diversity of microbial species and the multitude of biological and physico-chemical processes induce a large structural and functional complexity into the matrix biofilm. Also, species composing the biofilm may have ranging sensitivities and responses towards various anthropogenic pressures (Barranguet et al., 2003). During exposure to toxic agents such as heavy metals, the most sensitive organisms may be overtaken by more resistant or more tolerant ones. Thus the entire community may be restructured, present physiological alterations and come finally to display an overall increase in tolerance to the toxicant. This process underlies the concept of pollution-induced community tolerance (PICT), developed by Blanck et al. (1988) as an ecotoxicological tool to assess xenobiotic impact at the community level.

Diverse approaches to examining the tolerance or resistance of a bacterial community to heavy metals have been developed. For example, Díaz-Raviña et al. (2007) investigated vineyard soil copper contamination inducing bacterial tolerance with growth measurements using thymidine (Tdr) and leucine (Leu) incorporation techniques. In aquatic systems Tdr or Leu incorporation techniques have also been used to assess the tolerance of bacterial communities in biofilm and sediments (Paulsson et al., 2000; Ogilvie and Grant, 2008). Despite good results, these techniques remain difficult to implement and are not possible in all laboratories as they use radio-labelled elements. BiologTM is a conventional approach applied first to obtain catabolic fingerprints of the bacterial communities or a community-level physiological profile (CLPP), and more recently to assess tolerance to metals of the bacterial communities in soil and aquatic biofilms (Boivin et al., 2006; Stefanowicz et al., 2009). However, this microplate technique, based on the analysis of a bacterial community's use of several carbon sources, has major drawbacks: incomplete assessment of the whole microbial community, a long incubation time inducing bacterial selection and growth (Preston-Mafham et al., 2002) and the use of artificial culture media with buffer that may have artificial significant effects on the speciation and in consequence on the bioavailability

and the toxicity of toxicants (Barranguet et al. 2003). A respirometric technique based on the analysis of the substrate-induced respiration (SIR) response (using gas chromatography analysis) was also investigated with a multiple carbon-source substrate for CLPP (Garland and Mills, 1991), and in a few studies, to test microbial tolerance to heavy metals at the community level in soils (Witter et al., 2000; Rajapaksha et al., 2004). More recently this approach was used to assess induced tolerance to copper of bacterial communities in river biofilms (Tlili et al., 2010). However, the method is still tedious, especially when assaying many microbial samples simultaneously in a multitude of bottles that have to be processed separately to measure the amount of released CO₂ (Chapman et al., 2007). Miniaturized systems offer the considerable advantage of allowing sample and replicate multiplication. In soil studies, Campbell et al. (2003) developed the MicroRespTM technique, which is an alternative method that combines the advantages of the BiologTM technique, using the microplate system, and of the SIR approach with ability to measure CO₂ production during short-term incubation from a whole soil microbial community.

We hypothesized that the use of this new microrespirometric technique could be modified and applied to perform ecotoxicological bioassays on river biofilms for metal tolerance comparison purposes. The objectives of our study were thus (i) to test the MicroRespTM technique for a metal-contamination assessment in an aquatic ecosystem, using biofilms as a biological model in a PICT approach, (ii) to take a catabolic fingerprint of the heterotrophic biofilm community, and (iii) to implement an in-situ PICT application of MicroRespTM in a copper contamination context.

2. Materials and methods

1. In-situ biofilm

The biofilm used in our study was taken from the River Morcille, located in the Beaujolais vineyard area. The Morcille is a small first-order stream (7 km long) under strong agricultural pressure, essentially from vineyards, which occupy about 80% of its 8.5 km² catchment area. The Morcille watershed is part of the Long-Term Ecological Research Rhône Basin (ZABR). Regular physico-chemical surveys (hydrology, nutrients, pesticides and metals) and biological monitoring have been conducted on this site (Dorigo et al., 2007; Rabiet et al., 2008; Morin et al., 2010; Montuelle et al., 2010). Three sampling sites were selected along a gradient of increasing percentage contribution of vineyards to the catchment area: Saint-Joseph (vineyard percentage cover 11%), Les Versauds (53%) and Saint-Ennemond (65%) (see Table. 1 for

physico-chemical details). Several annual surveys were performed to characterize metal contamination. In 2009 ($n = 43$ samples), Saint-Joseph was the least polluted site with a mean $0.51 \pm 0.02 \mu\text{g.L}^{-1}$ of Cu, $1.13 \pm 0.21 \mu\text{g.L}^{-1}$ of Zn and $1.94 \pm 0.46 \mu\text{g.L}^{-1}$ of As. By contrast, the two other sites studied were considered polluted: Les Versauds was characterized by a mean $2.05 \pm 0.25 \mu\text{g.L}^{-1}$ of Cu, $0.83 \pm 0.42 \mu\text{g.L}^{-1}$ of Zn and $11.5 \pm 0.46 \mu\text{g.L}^{-1}$ of As, and Saint-Ennemond by a mean $3.93 \pm 0.77 \mu\text{g.L}^{-1}$ of Cu, $7.05 \pm 3.56 \mu\text{g.L}^{-1}$ of Zn and $9.26 \pm 4.99 \mu\text{g.L}^{-1}$ of As. Other metals including Cd, Ni, Fe or Al were also detected at low levels (means near limits of quantification) and there was no gradient of contamination from upstream to downstream.

Table.1 Means (\pm standard deviation, $n = 43$) of selected chemical parameters (pH; cond.: conductivity [$\mu\text{S.cm}^{-1}$]; DOC [mg.L^{-1}]; NH_4^+ [mg.L^{-1}]; NO_2^- [mg.L^{-1}]; NO_3^- [mg.L^{-1}] and PO_4^{3-} [mg.L^{-1}]) obtained from the three sampling areas (J: Saint-Joseph; V: Les Versauds and E: Saint-Ennemond) over two years (2009 and 2010).

Site	pH	cond	DOC	NH_4^+	NO_2^-	NO_3^-	PO_4^{3-}
J	7.27	161.72	2.67	0.04	0.02	6.82	0.07
	± 0.29	± 17.65	± 0.88	± 0.03	± 0.01	± 1.28	± 0.03
V	7.41	201.33	3.28	0.05	0.03	7.58	0.23
	± 0.27	± 18.57	± 0.91	± 0.04	± 0.01	± 3.03	± 0.13
E	7.51	233.61	4.52	0.08	0.06	7.33	0.28
	± 0.24	± 33.52	± 1.82	± 0.04	± 0.06	± 2.69	± 0.17

2. Biofilm microcosm

During the different experiments with the MicroRespTM, a biofilm was grown on artificial substrates (microscope slides previously cleaned in a dilute nitric acid bath and rinsed with milli-Q water before use) in laboratory microcosms under controlled conditions. Fifteen-litter aquariums were filled with river water from the reference site (Saint-Joseph), which had been filtered through a $50 \mu\text{m}$ mesh to remove most of the grazers (water was renewed once a week). The water was kept at a temperature of $18 \pm 2 \text{ }^\circ\text{C}$, and exposed to a light intensity of $260 \mu\text{mol m}^{-2}\text{s}^{-1}$, with a light/dark regime of 18:6 h. Three-week-old biofilms were used for the MicroRespTM assays (Tlili et al., 2008).

3. The MicroRespTM procedure

MicroRespTM system has been described in detail by Campbell et al. (2003), but only a few ecotoxicological applications of the MicroRespTM technique have been investigated on

soils (Kaufmann et al. 2006) and none on aquatic microbial communities. Here we present an adaptation of the procedure of Campbell et al. (2003) to aquatic biofilm suspensions and toxicological bioassays. MicroRespTM is a colorimetric method based on the colour change of a pH indicator dye caused by the release of CO₂ by heterotrophic communities. The system consists of two microplates (96 wells) placed face to face. One of these is a deep-well microplate (1.2 mL capacity, 96-deep-well microplate, NUNC) in which each well contains the microbiological sample (we used a 500 µL biofilm suspension obtained by scraping biofilm off glass substrata using a polypropylene spatula and suspending it in 0.2 µm of Nuclepore-filtered water from the reference site) with the carbon source (30 µL per well, 6.2 mg of C per well). To this deep-well microplate we added the toxicant (50 µL per well). The second microplate contained the detection gel (cresol red dye (12.5 ppm), potassium chloride (150 mM) and sodium bicarbonate (2.5 mM) set in a 1% gel of noble agar (final volume 150 µL per well)). The two microplates were sealed together with a silicone seal, with interconnecting holes between the corresponding wells. The assembly was clamped together and the system was incubated in the dark (to avoid any photosynthesis interference with CO₂ release) at room temperature. CO₂-trap absorbance was measured at 590 nm (Biotek Synergy HT spectrophotometer) immediately before sealing to the deep-well plate (coefficient of variation below 5%), and after incubation. Quantities of CO₂ produced by the microbial samples were calculated using a calibration curve of absorbance values versus CO₂ quantity measured by gas chromatography (MTI 200 microcatharometer). Results were then expressed as µg CO₂.mg⁻¹ of sample.h⁻¹. In our biofilm study, the sample was considered as organic matter (ash-free dry weight, AFDW) of the biofilm suspension tested, and measured using the protocol described by Tlili et al. (2008). Briefly, three aliquots of each homogenized biofilm suspension (2 mL) were filtered through individual 25 mm CF/C Whatman glass fibre filters (1.2 µm pore size). Total dry matter was measured by weighing the filters after drying at 105°C for 24 h. The filters were then combusted in an oven at 480°C (Nabertherm P320) for 1 h, and reweighed to calculate mineral matter. AFDW was calculated by subtracting mineral matter from total dry matter.

4. Development of the MicroResp™ protocol (Table. 2)

Table. 2 Chronological summary of the different experiments and steps performed during the study

	Step No.	Biofilm used
<p><u>Experiment 1</u></p> <p>Development of the MicroResp™ protocol, applied to aquatic ecosystems and using river biofilms.</p>	<p>1. <u>Incubation time</u> To ensure a relevant measure in the well airspace of the CO₂ released from the sample.</p> <p>2. <u>Pre-incubation test with toxicant</u> To cope with artefacts causing a chemical release of CO₂.</p> <p>3. <u>Short-term bioassays</u> To validate the utility of the MicroResp™ method for short-term bioassays with different metals.</p>	<p>Cultivated in laboratory microcosms under controlled conditions</p>
<p><u>Experiment 2</u></p> <p>Application of the microrespirometric method to a field situation</p>	<p>1. <u>PICT approach (short-term bioassays)</u> To validate the relevance of the MicroResp™ technique in a PICT approach, by testing copper, silver and cadmium.</p> <p>2. <u>Catabolic diversity fingerprint</u> To establish a CLPP of the heterotrophic biofilm compartment, using a multiple carbon-source substrate.</p> <p>3. <u>Molecular biology analysis</u> To characterize the diversity of the river biofilm bacterial communities, using the ARISA molecular fingerprint technique.</p>	<p>Collected from the three sampling sites in the Morcille River.</p>

4.1. Incubation time

Campbell et al. (2003) propose an incubation time of 6 h with soil samples. However, in our case, we have to take into account the rate of CO₂ diffusion at the air-water interface, which may be low. To ensure a relevant measure in the well airspace of the CO₂ released from the sample (the biofilm), we tested a range of incubation times: 4, 6, 8, and 15 h. Individual MicroRespTM microplates were used for each incubation time. Eight deep wells of each microplate were filled with 500 µL of biofilm suspension with 50 µL of milli-Q water and 30 µL of D-glucose (Prolabo) (the remaining wells of the microplate were filled with 580 µL of milli-Q water). Quantities of released CO₂ were measured at each incubation period, as described in Section 3.

4.2. Pre-incubation test with toxicant

To enable the toxicant to penetrate into the cells and to cope with artefacts causing a chemical release of CO₂ (Lindsay, 1979), a metal pre-exposure period was necessary before adding the carbon substrate (glucose) and starting the incubation. The different tested times of pre-exposure to Cu were 0, 0.25, 0.5, 1, 2, 3, 4 and 6 h.

4.3. Short-term bioassays

To validate the utility of the MicroRespTM method for short-term bioassays, using biofilms, a wide range of heavy metals was tested: CuSO₄ (Merck KgaA; purity≥99.0%;), ZnSO₄ (Sigma-Aldrich GmbH), CdN₂O₆.7H₂O (Fluka Sigma-Aldrich; purity≥99.0%), AgNO₃ (CARLO ERBA reagenti; purity≥99.8%), N₂NiO₆.6H₂O (Fluka Sigma-Aldrich Chemie GmbH; purity≥97.0%), FeSO₄.7H₂O (Sigma Chemical co.; purity≥99.0%), CoN₂O₆.6H₂O (Fluka Sigma-Aldrich Chemie GmbH; purity≥98.0%), AlN₃O₉.9H₂O (Merck KgaA; purity≥98.5%) and Na₂HAsO₄.7H₂O (Sigma-Aldrich GmbH; purity≥98.0%). Briefly, stock solutions containing 200 mM of each metal were prepared in water and stored at 4 °C, before dilution in the test wells. A semi-logarithmic series of concentrations was freshly prepared by serial dilution of the stock solutions in 0.2 µm-filtered river water. Final nominal test concentrations in the deep wells ranged from 0.5 µM to 17.2 mM (4 blanks and 4 replicates for each of the 9 concentrations). The carbon substrate used for all the SIR toxicological bioassays was D-glucose. Quantities of released CO₂ were measured for each bioassay as described in Section 3. Dose-response curves were plotted using CO₂ values

produced by biofilm at each metal concentration as a percentage of CO₂ produced by a control biofilm (without toxicant).

5. Application of the microrespirometric method to a field situation

5.1. PICT approach (short-term bioassays)

The relevance of the MicroRespTM technique in a PICT approach was tested with biofilms sampled from the River Morcille. Induced tolerances to Cu, Cd and Ag of the heterotrophic biofilm communities were then tested by toxicological bioassay using the MicroRespTM method. Briefly, biofilms were scraped from stones (500 cm² per sample) collected from the three sampling sites described previously (St. Joseph (J), Les Versauds (V) and Saint-Ennemond (E)), and homogenized in 150 mL of 0.22 µm-filtered water from the reference site (J). Biofilm suspensions were placed directly in the deep well (500 µL) and 50 µL of each tested metal (Cu, Cd or Ag) was added separately. After pre-incubation 30 µL of glucose was added to each of the deep wells, and the MicroRespTM system was assembled as described previously and incubated in the dark at room temperature (23 ± 1 °C). After incubation, the absorbance of the detection microplate was measured at 590 nm (Biotek Synergy HT spectrophotometer), the amounts of released CO₂ were calculated and the results were expressed in µg CO₂.mg⁻¹AFDW.h⁻¹. Dose-response curves were plotted using CO₂ values produced by the biofilm at each metal concentration as a percentage of the CO₂ produced by control biofilms (without toxicant). The EC₅₀ values were calculated for each metal and for each site.

5.2. Catabolic diversity fingerprint

With a view to establishing a CLPP of the heterotrophic biofilm compartment, a multiple carbon-source substrate-induced respiration approach (using the MicroRespTM technique) was used. The different carbon substrates used were: D-glucose (Prolabo), D-fructose (Sigma chemical Co.), D-sucrose (Fluka biochemica), D-ribose (Prolabo), D-galactose (Prolabo), D-maltose (Prolabo), L-arginine (Sigma Chimie Fluka), glycine (Sigma Aldrich Chemie), L-lysine hydrochloride (Sigma Chimie, Fluka), L-glutamic acid (Sigma Aldrich Chemie) and citric acid anhydre (Sigma Aldrich Chemie). Stock solutions containing 120 mg.mL⁻¹ of each substrate were prepared in 0.22 µm-filtered milli Q water and stored at 4 °C, until used. The pH of each solution was adjusted to river pH (7) to prevent any substrate-pH effects on microbial communities and minimize chemical artefacts due to carbonate-derived CO₂. Final concentration was 6.2 mg of C per mL in each deep well. The results were expressed in µg

$\text{CO}_2 \cdot \text{mg}^{-1} \text{AFDW} \cdot \text{h}^{-1}$. In addition to the SIR measurements, the basal respiration (without substrate addition) was measured for each biofilm.

6. Biofilm DNA extraction, amplification and automated ribosomal intergenic spacer analysis (ARISA)

To characterize the diversity of the river biofilm bacterial communities, we used the ARISA molecular fingerprint technique. Three replicates of 2 mL of each biofilm suspension were centrifuged at 14,000g for 30 minutes, and the supernatant was discarded and pellet stored at -80°C before extraction. Nucleic acid extraction was performed on biofilm pellets using the FAST DNA kit (QBIogene, Illkirch, France) according to the manufacturer's instructions. The PCR conditions and the PCR template preparation for the ARISA conditions were those described by Ranjard et al. (2003). The primers used were S-D-Bact-1522-b-S-20 (3'end of 16S genes) and L-D-Bact-132-a-A-18 (5'end of 23S genes) (Ranjard et al., 2003).

7. Data treatment

EC_{50} values were calculated using the Regtox model (E. Vindimian, <http://eric.vindimian.9online.fr/>). The CLPP data sets (normalized by the basal respiration values) were subjected to principal component analysis (PCA) (XLSTAT Software Package, 2009 version). The significant level was set to 5% for all the statistical tests with four replicates for each parameter. Bacterial ARISA profiles were compared with regards to the presence or absence of bands, using the Pearson similarity index. Matrices were used to perform Ward's method of hierarchical cluster analysis (HCA) using the XLSTAT Software Package (2009 version).

III. Results and discussion

1. MicroRespTM protocol applied to ecotoxicological bioassays on microbial biofilms

In toxicological bioassays, adding a mineralizable carbon source overcomes a problem that arises when measuring basal respiration, namely mineralization of unknown native organic matter that may be different between sampling stations. Glucose mineralization activity was detected by our MicroRespTM modified design within 8 h incubation time, and net CO_2 production was approximately linear between 8 h and 15 h incubation time, with respiration rates of 160.0 ± 14.9 and $160.6 \pm 12.1 \mu\text{g CO}_2 \cdot \text{mg}^{-1} \text{AFDW} \cdot \text{h}^{-1}$ for 8 h and 15 h incubation time respectively. In addition, analysis of the bacterial community profiles (ARISA) of each of the four incubation times tested showed no change in the diversity of this

community (data not shown). Incubation for 8 h would have sufficed, but for practical reasons we opted to conduct our bioassays with an incubation time of 15 h (overnight).

During preliminary bioassays with Cu, no dose-response curves were obtained (data not shown). The quantities of measured CO₂ corresponding to the well containing the most concentrated Cu solutions were high. The pH measurement of these biofilm solutions showed that the addition of large amounts of Cu to the biofilm suspensions induced a very rapid and marked pH decrease, linked to an abundant release of CO₂, which could not be of biological origin but was probably due to chemical reactions. Oren and Steinberger (2008) suggested that dissolution of CaCO₃ (contained in the biological samples, in their case soil) may follow pH decline, and be accompanied by abiotic CO₂ evolution that may be mistakenly taken for respired CO₂. Fig. 1 shows that 3 h of copper pre-incubation is needed to obtain a dose-response curve and a percentage SIR inhibition below 20% ($19.01 \pm 0.1\%$) with the maximum copper concentration ($17.2 \times 10^2 \mu\text{M}$). This dose-response curve did not change with biofilms pre-incubated for longer times (4 h and 6 h). These results suggest that this chemical artefact has ceased after 3 h. We therefore opted for this time of 3 h pre-incubation with copper.

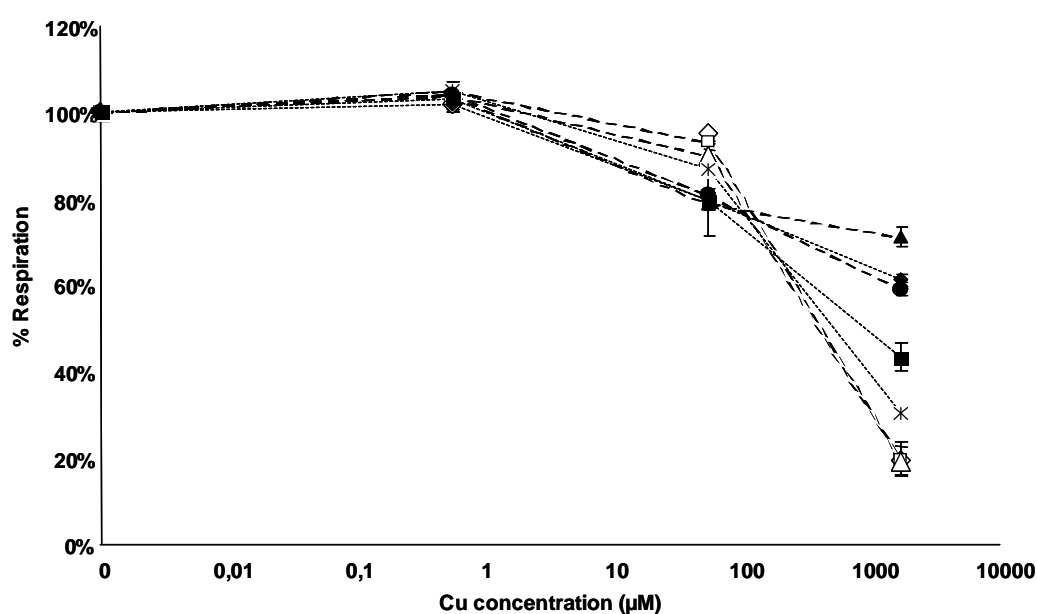

Fig. 1 Respiration values (expressed as a percentage of control) after short-term bioassay with different pre-incubation periods (▲ 0; ◆ 0.25; ● 0.5; ■ 1; * 2; ◇ 3 ; □ 4 and △ 6 h) before addition of the carbon substrate (glucose). Error bars represent standard deviations ($n = 4$).

Finally, the protocol used for short-term bioassays can be summarized as follows: the biofilm suspension was distributed in deep wells (500 μL per well), to which we added 50 μL of the metal solution (increasing nominal concentrations). The microplate was then pre-incubated in the dark at room temperature for 3 h, 30 μL of the glucose solution (120 $\text{mg}\cdot\text{mL}^{-1}$) was added to each well and the detection microplate was positioned. The system was sealed and incubated for 15 h in the dark (without photosynthetic activity, which could induce an increase of the pH and interfere with the CO_2 release) and at room temperature (23 ± 1 $^\circ\text{C}$). CO_2 -trap absorbance was measured at 590 nm (or better at 570 nm, Rowell, 1995) immediately before sealing to the deep well plate, and after 15 h incubation.

The MicroRespTM technique enabled us to plot dose-response curves with all the tested metals. The EC_{50} obtained with the different tested metals in short-term bioassays are shown in Table.3. Compared with the other metals, silver seems to be the most toxic metal to the SIR ($\text{EC}_{50} = 3.96$ μM). Aluminium ($\text{EC}_{50} = 2317.86$ μM) and cobalt ($\text{EC}_{50} = 6170.63$ μM) were the least toxic, while Zn, Cu and Cd had similar intermediate toxicities. However, in our study some of the metal salts used included a nitrogen source (e.g. AgNO_3 , $\text{N}_2\text{NiO}_6\cdot 6\text{H}_2\text{O}$ or $\text{CoN}_2\text{O}_6\cdot 6\text{H}_2\text{O}$) that could interfere with the respiration measurements and so bias the EC_{50} values. A second control using NaNO_3 in addition to glucose might be a good option to overcome this interference. Witter et al., (2000) obtained similar results when testing soil bacteria tolerance (based on SIR) to these three metals (e.g. EC_{50} Zn value of about 250 ppm). EC_{50} values calculated for the percentage of 95 substrates used completely within 8 days of incubation in Cu (0–300 mM)-amended BIOLOG GN plates inoculated with a river biofilm bacteria consortium were in the range 10–30 μM (Barranguet et al. 2003). Sensitivities obtained with other bioassays such as the well-known Microtox[®] (based on bioluminescence reduction of the marine bacterium *Vibrio fischeri*) are also comparable to our range of EC_{50} values (e.g. $\text{EC}_{50}(5 \text{ mn}) = 941$ μM CdCl_2 and 168 μM CuCl_2 and $\text{EC}_{50}(15\text{mn}) = 421$ μM CdCl_2 and 49 μM CuCl_2 , in Macken et al. 2009). Therefore, our dose-response curves and EC_{50} obtained with the SIR, related to heterotrophic organisms, confirm that the MicroRespTM technique could be a useful method to classify heavy metals according to their toxicity toward river biofilms.

Table.3 Sensitivity (expressed as EC₅₀ in µM) of the heterotrophic biofilm community to different tested metals in short-term bioassays using MicroRespTM. C.I. confidence interval ($n = 4$; $\alpha = 0.5$)

Tested metal	EC₅₀ µM	C.I.
Silver	3.96	2.60 – 6.27
Zinc	82.41	15.77 – 323.18
Copper	156.45	122.27 – 196.44
Cadmium	194.95	110.99 – 336.18
Arsenic	244.46	178.52 – 348.43
Nickel	403.53	87.14 – 1184.89
Iron	772.88	392.85 – 1532.95
Aluminium	2317.86	1515.83 – 3731.99
Cobalt	6170.63	4270.30 – 8519.66

2. Application of the microrespirometry method to a field situation

2.1. Copper-induced tolerance

Cu EC₅₀ values were estimated to evaluate tolerance to this pollutant of the biofilm communities sampled at three sites along the River Morcille. EC₅₀ values increased upstream to downstream, ranging from 48.5 to 179.4 µM copper (Table.4, Fig.2).

Table.4 EC₅₀ values (in µM of copper, silver or cadmium) for the three sampling sites (J: Saint-Joseph; V: Les Versauds; E: Saint-Ennemond). C.I. confidence interval ($n = 4$; $\alpha = 0.5$).

Tested metal	Site	EC₅₀ µM	C.I.
Copper	J	48.52	41.02 - 59.13
	V	172.37	133.50 - 227.91
	E	179.42	117.11 - 266.18
Silver	J	31.99	25.99 - 40.67
	V	22.39	17.25 - 31.37
	E	25.52	19.22 - 36.01
Cadmium	J	82.48	65.59 - 103.61
	V	111.15	91.04 - 142.36
	E	82.48	65.59 - 103.61

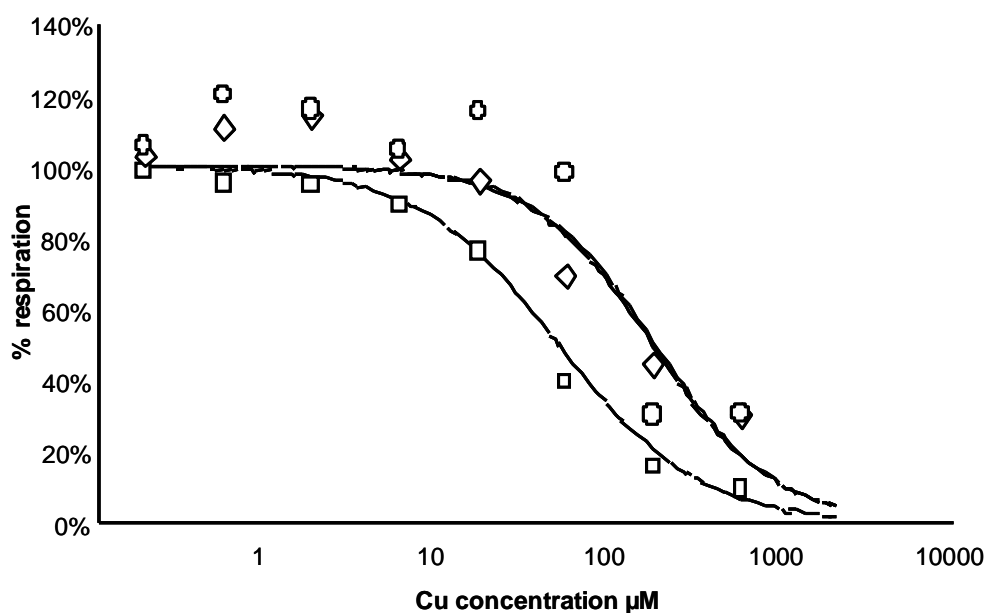

Fig.2 Copper tolerance of heterotrophic communities at three sampling areas along a copper contamination gradient in the River Morcille. Symbols for each area (◆: Saint-Joseph; ■: Les Versauds; ▲: Saint-Ennemond), represent average SIR expressed as a percentage of the corresponding controls and obtained during the MicroRespTM short-term bioassay. Dose-response curves (◇: Saint-Joseph; □: Les Versauds; △: Saint-Ennemond) represent the Hill equation model applied to the same SIR measurements. Parameters were calculated by nonlinear regression and statistics (four replicates) were obtained using a Bootstrap-Monte-Carlo simulation (from Regtox model: <http://eric.vindimian.9online.fr/>) allowing to calculate EC₅₀ values with a confidence interval of 95%.

The most Cu-sensitive communities were from the upstream site “Saint-Joseph” (**J**), while the most Cu-tolerant communities were downstream at “Saint-Ennemond” (**E**). The measured sensitivity at the intermediate site “Les Versauds” (**V**) was closer to **E** than to **J**. Cu concentrations in the water from the three sampling sites, collected in the same period as our study, and the EC₅₀ values measured were closely correlated ($n = 4$, Pearson $R^2 = 0.72$, $p = 0.0004$). Also, diversity analysis by ARISA of bacterial communities showed a differentiation of **J**, **E** and **V**. Bacterial diversity from the intermediate site **V** was more closely similar to the most contaminated site **E** than the pristine area **J** (Fig.3). These results agree with previous studies (Boivin et al., 2006; Dorigo et al., 2007) and are congruent with the predictions of the PICT concept and validation (Blanck, 2002), suggesting that Cu constitutes a selective pressure, at least on the bacterial and heterotrophic portion of the Morcille biofilms, producing changes in species composition, catabolic structure (see paragraph 2.3) and Cu substrate-induced respiration tolerance. However, given the presence of gradient

contaminations with other metals (As and Zn) from the Morcille upstream to downstream, these differences in bacterial structure cannot be attributed to Cu alone.

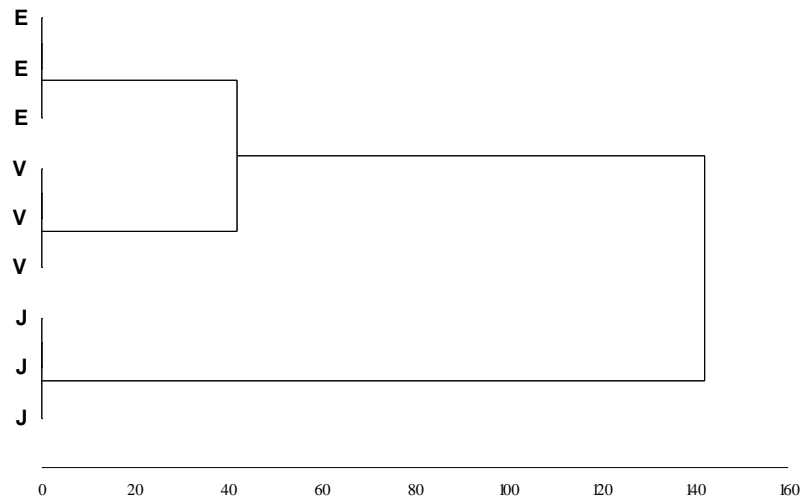

Fig.3 Cluster analysis (hierarchical ascendant classification based on Pearson correlation coefficient) of the bacterial community (ARISA analysis of PCR amplified IGS gene fragments) from three sampling areas (J: Saint-Joseph; V: Les Versauds; E: Saint-Ennemond) on the River Morcille (three replicates per sampling area).

On the other hand, environmental factors such as light, current velocity, temperature or nutrient content could affect toxicant bioavailability and the biofilm tolerance to these toxicants. During long-term exposure, for example, Guasch et al. (2004) and Tlili et al. (2010) showed that phosphorus supply caused an increased induced tolerance of biofilms to copper. Also, Guasch et al. (2002) evaluated the effects of chronic copper exposure on natural periphyton in a non-polluted calcareous river, and they concluded that the water pH in the river was important in affecting the bioavailability of the metals and therefore their toxicity towards the biological community. It is therefore necessary to have not only a reference site that is globally comparable to the study site, but also a sampling strategy (spatial and temporal) that minimizes the interference of environmental factors in the detection of PICT (Dorigo et al., 2009). Care must also be taken in a PICT approach to ascertain that bioassays are controlled and standardized, and that different physicochemical parameters are homogeneous and similar during short-term exposure of the tested communities. Blanck (2002) stipulated that bioavailability may interfere in the PICT detection as a confounding

factor, for example when the waters used in the short-term tests are different. This could then affect the EC_x values obtained and finally the PICT signal may represent a bioavailability gradient. However, this remark concerns a regional survey (Blanck et al., 2003) that compared very different sampling sites (from different rivers and countries) in the context of bioassays that used the filtered natural water from each sampling area. This was not the case in our study, where we used the same filtered water of the upstream sampling area **J** (pH values in the range 7.2–8) for periphytic suspensions and toxic solutions of all bioassays and in the context of a small river basin. In addition, in a previous study we measured pH in the biofilm-river suspension (using water from site **J**), glucose and copper added at the beginning and end of the short-term incubation, and observed no pH changes during the bioassays despite demonstrating an induced tolerance to copper based on the substrate-induced respiration as a functional parameter (measured by gas chromatography, data not shown). Rusk et al. (2004) investigated tolerance of soil biological nitrification to metals using sterilized, metal-treated soils from the reference area reinoculated with a similar soil containing the microbial communities to be tested. Our approach using filtered water from a reference area (upstream) to perform the PICT bioassays, in which we suspended periphyton scraped from the different investigated sites, is comparable to the approach of Rusk et al. (2004), who wanted to exclude the potentially confounding effects of variations in metal bioavailability in their tolerance bioassays. We can conclude that the bioassays conducted during our study were performed under homogeneous standardized conditions and minimized variations in metal bioavailability among the microbial samples tested.

In previous studies, a respirometric technique based on the analysis of the substrate-induced respiration (SIR) response was developed to test the microbial tolerance to toxicants at the community level in soil ecosystems (Witter *et al.*, 2000). These studies demonstrated that microbial tolerance to metals increased as soil metal pollutant concentrations increased. However, there are few studies on the toxicity assessment of contaminants in aquatic ecosystems using the SIR to assess the induced tolerance to metals of heterotrophic biofilm communities. Dorigo et al. (2010), investigated the effects of Cu on heterotrophic biofilm communities collected from the same sampling sites (**J**; **V** and **E**), using the SIR measured by gas chromatography and the 16S rRNA gene DGGE method to highlight induced tolerance to Cu and bacterial diversity respectively. Like ours, her results strongly suggested Cu contamination-driven changes in biofilm community structure and in the tolerance to Cu of the bacterial community, confirming the PICT hypothesis.

This first biofilm ecotoxicological bioassays using MicroRespTM applied in a river contamination assessment context, highlights the efficiency of this technique for measuring the induced tolerance to metals of the heterotrophic biofilm community based on SIR.

2.2. Co-tolerance assessment

Co-tolerance may occur when communities that have been exposed to one toxicant, but not to another, become tolerant to both toxicants. Occurrence of co-tolerance depends on the means of conferring tolerance and on the tolerance mechanisms (Blanck et al., 1988). Tolerance to Ag and Cd was measured for biofilms from the three sampling sites (**J**, **V** and **E**) (Table.4). In contrast to results for copper, no significant changes in tolerance to Ag or Cd were observed from upstream to downstream sites. These results are congruent with Ag and Cd concentrations measured in water from **J**, **V** and **E** sites, which were constantly below the limits of quantification. Therefore, these SIR measurements with MicroRespTM did not reveal any co-tolerance between Cu and Ag or Cd. Some studies have reported a co-tolerance of biofilm communities between copper and some metals such as Zn or Ni (Gustavson and Wängberg, 1995; Ivorra et al., 1999). Soldo and Behra (2000) have shown a strong co-tolerance to silver in autotrophic biofilm communities exposed to 5 μ M of copper. In contrast to our study, all these co-tolerance measurements were based on photosynthetic activity, and therefore especially targeted the phototrophic biofilm compartment. Detection of co-tolerance implies difficulty attributing a tolerance shift to the presence of a particular toxicant in the environment. Our results and those obtained in the above-cited studies show that depending on the kind of targeted activities and associated communities (phototrophic or heterotrophic), co-tolerance linked to specific modes of action of toxicants and detoxification processes (Soldo and Behra, 2000; Knauer et al., 2010) can be variable. MicroRespTM use, in addition to other tolerance measurements based on other activities in the context of co-tolerance studies, could thus offer a complementary approach to investigating mechanisms of tolerance.

2.3. Community-level physiological profiles

Principal component analysis (PCA) was applied to the data set obtained with the various carbon sources, normalized by the basal respiration values for each site (Fig.4). The first two axes of the PCA accounted for more than 80% of the variability. Pristine area **J** and downstream area **E** were separated from the intermediate area **V** on the first axis F1, while the second axis F2 separated area **J** from area **E** (left panel). Biofilms from **V** were characterized by a higher mineralization of the glutamic acid and citric acid substrate and biofilms from **J** and **E** were characterized by a higher mineralization rate of glucose substrate (right panel). Thus multivariate analysis showed a clear discrimination between the biofilms from the

different sampling sites. Several soil studies investigated functional diversity with CLPP measurements and showed the utility of the MicroRespTM method to discriminate different soils or soils submitted to different pressures (Campbell et al., 2003, 2008; Oren and Stenberger, 2008). Applied to an aquatic environment, MicroRespTM seems also to be a useful tool for assessing changes in the functional diversity of the microbial community (CLPPs) in biofilms.

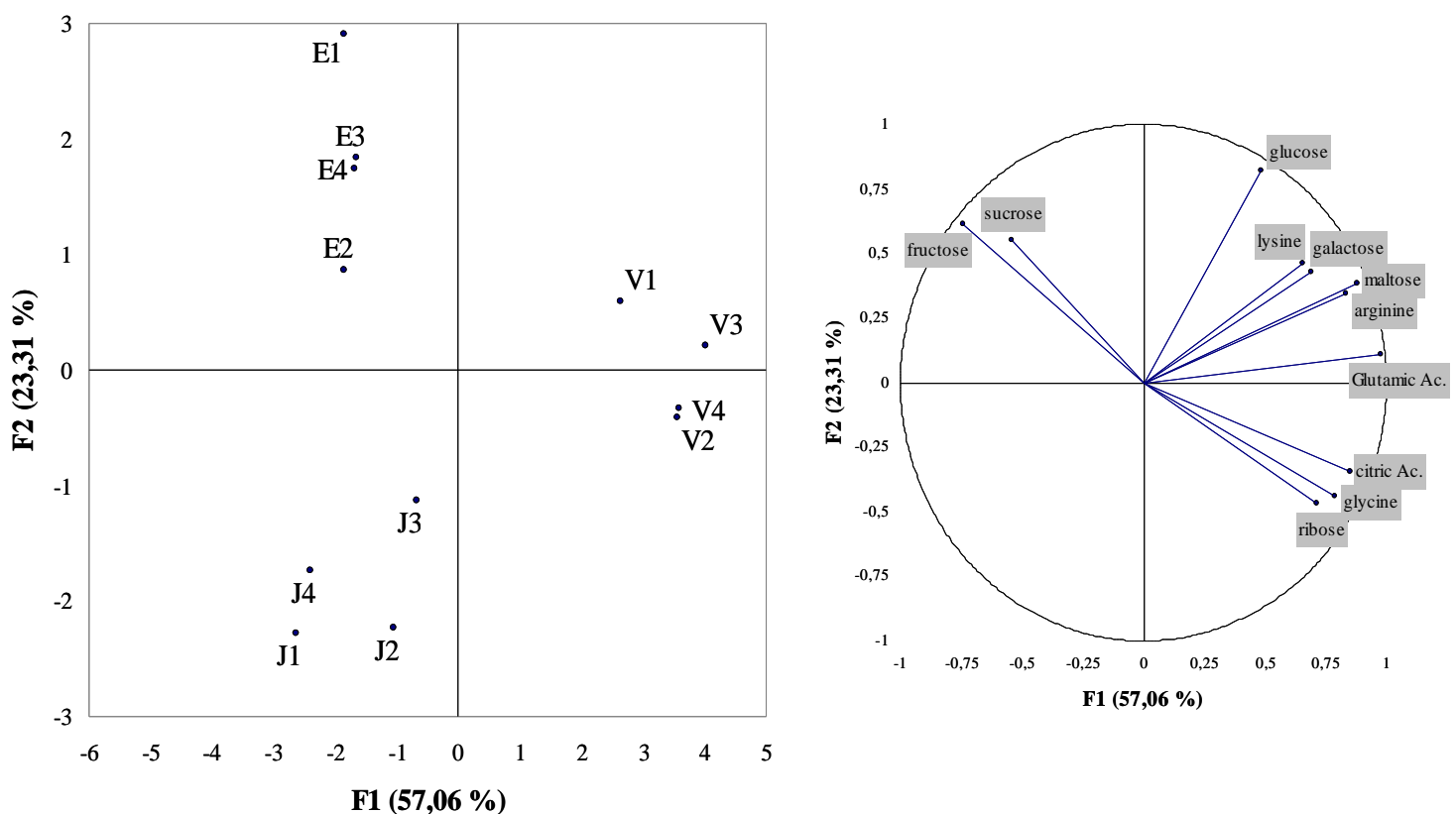

Fig.4 Principal component analysis (PCA) of community-level physiological profiles (CLPP) of biofilms measured with the MicroRespTM method and normalized to basal respiration, from three sampling areas (J: Saint-Joseph; V: Les Versauds; E: Saint-Ennemond) in the River Morcille (four replicates per sampling area).

5. Conclusion and perspectives

In the global context of assessing the impact of pollutants on the diversity and functioning of microbial communities in aquatic ecosystems, a range of diversified indicators for diversified functions and communities is needed (Clements and Rohr, 2009). Among such

indicators, the PICT approach, which offers a good tool for assessing an ecosystem's history of exposure to pollution at the community level, and the establishment of catabolic fingerprint profiles of microbial communities, are now applied in diverse ecosystems (Bérard et al., 2002; Boivin et al., 2006; Kaufmann et al., 2006). However, this study is the first to investigate micro-SIR in a contaminated aquatic system as a tool for measuring induced tolerance in a microbial community and establishing catabolic physiological profiles on the whole heterotrophic biofilm. The purpose of this methodological study was not to make a direct translation of the EC₅₀ obtained in MicroRespTM plates to the situation of the biofilms exposed in the river, but to propose an easy short-term bioassay based on catabolism to detect relative differences in metal tolerance between long-term exposed communities that were sampled (complementary to investigations of their taxonomic composition for PICT methodology). Our results show that the MicroRespTM technique offers a convenient, rapid and sensitive method for assessing metal contamination of aquatic ecosystems. Like for soil microbial micro-SIR measurements, for results to be fully transportable between studies, this method would require inter-laboratory calibration (Creamer et al., 2009). A modified MicroRespTM system could be developed, using microplates with larger wells than those currently used. The method could thus be applied with an in-place biofilm (grown on individual artificial substrates) to minimize disturbances of the microbial communities and be suitable for similar samples of periphyton, and for other measurements of additional activities such as photosynthesis (Dorigo and Leboulanger, 2001).

Acknowledgments

The authors thank G. Sevenier (UMR EMMAH, INRA-UAPV, France) for technical advice on the MicroRespTM technique, M. Coquery, J. Gahou for metal analysis, B. Motte (UR MAEP, CEMAGREF-Lyon, France) for field sampling and ATT for editing the English-language version of the manuscript. We thank Onema (French National Agency for Water and Aquatic Ecosystems) for financial support (Program 26 "Assessment and Remediation of Pesticide Effects").

RESULTATS ET DISCUSSION

Chapitre C. Résultats et Discussion

Ce chapitre est constitué de 3 parties. La première partie aborde la question de l'influence des facteurs environnementaux (dans notre cas un gradient de phosphore) sur la tolérance acquise des communautés microbiennes des biofilms vis à vis d'un pesticide et d'un métal lourd, ainsi que la pertinence de différents descripteurs fonctionnels du PICT pour mettre en évidence cette influence. La deuxième partie est relative aux conséquences de l'acquisition de tolérance par les communautés hétérotrophes et phototrophes des biofilms dans un contexte de pollution multiple par les métaux lourds (i.e. cuivre, zinc et arsenic, et enfin la troisième partie est consacrée à l'étude de l'influence des chroniques d'exposition aux polluants, en terme d'intensité et de durée, sur la tolérance acquise des communautés microbiennes des biofilms.

C.I. Influence du phosphore sur la tolérance acquise aux polluants des communautés phototrophes et hétérotrophes des biofilms de rivière (article 3)

Le concept PICT est basé sur l'hypothèse que la présence d'un toxique donné dans le milieu constituera une pression de sélection sur les communautés biologiques qui va se traduire par l'élimination des espèces les plus sensibles, favorisant ainsi le développement des espèces les plus tolérantes à ce toxique. Toutefois, cette tolérance induite ne peut pas être seulement imputée à la présence des polluants dans les cours d'eau. En effet, différents facteurs environnementaux (e.g. lumière, vitesse du courant, nutriments...) pourraient jouer un rôle important dans l'acquisition de cette tolérance (Bérard et Benninghoff, 2001 ; Guasch, et Sabater, 1998). Par exemple, l'apport de nutriments et en particulier le phosphore peut stimuler la croissance et l'activité algale et les rendre plus tolérantes à des toxiques comme le Cuivre (Guasch et al., 2004). L'objectif, est donc de s'affranchir de la contrainte de ces différents facteurs dit de confusion, en appliquant une stratégie d'échantillonnage favorisant le plus possible l'homogénéité des stations de prélèvement (Dorigo et al. 2009). Toutefois, un gradient de phosphore, couplé à un gradient de contamination au cuivre et au diuron, a été mesuré de l'amont vers l'aval de la Morcille (site d'étude décrit dans le chapitre B). Il pourrait jouer un rôle non négligeable dans le contrôle de l'acquisition de la tolérance des communautés périphytiques mise en évidence par des travaux précédents sur notre site d'étude (Dorigo et al. 2007, 2010, Pesce et al. 2010). D'où la nécessité d'évaluer la part du

phosphore dans l'acquisition de tolérance en prenant en compte la diversité structurelle et fonctionnelle des biofilms (phototrophe, hétérotrophe, procaryote, eucaryote...).

Le contexte du terrain, avec justement la présence de plusieurs contaminants ainsi que de nombreux facteurs de confusion (lumière, température, vitesse du courant, brouteurs, nutriments...), nécessite pour cette étape du travail, d'effectuer une approche expérimentale au laboratoire. Pour cela, nous avons réalisé des expérimentations en microcosmes pour mettre en évidence l'influence potentielle d'un gradient de phosphore sur la sensibilité des communautés microbiennes périphytiques au cuivre et au diuron. Les biofilms ont été exposés chroniquement à des concentrations environnementales (mesurées dans la rivière Morcille) de substances toxiques couplées à un gradient de phosphore. La tolérance acquise des biofilms au diuron et au cuivre a été évaluée via des tests d'inhibition à court-terme, basés sur l'efficacité photosynthétique pour cibler les phototrophes ainsi que sur les activités enzymatiques extracellulaires (β -glucosidase et leucine-aminopeptidase) et la respiration induite par un substrat carboné pour cibler les hétérotrophes. L'impact du gradient de phosphore associé à la pollution a été aussi évalué en mesurant les concentrations des toxiques dans la matrice des biofilms, la biomasse (Chla, AFDW), la densité des cellules bactériennes, l'efficacité photosynthétique et la structure des communautés (en utilisant la technique PCR-DGGE 18S et 16S pour cibler respectivement les eucaryotes et les procaryotes et l'analyse des pigments par HPLC afin de cibler les phototrophes). Les résultats obtenus montrent que, selon la substance toxique étudiée et le paramètre structurel ou fonctionnel utilisé, l'effet du gradient de phosphore a été variable. La prise en compte de la diversité structurelle et fonctionnelle des biofilms de rivière, semble donc une approche nécessaire pour dissocier l'impact réel des substances toxiques de celui des facteurs environnementaux sur la tolérance acquise.

Les résultats et les interprétations de cette partie sont présentés dans l'article 3 intitulé « PO_4^{3-} dependence of the tolerance of autotrophic and heterotrophic biofilm communities to copper and diuron » et publiée dans la revue *Aquatic Toxicology*.

Article 3

PO₄³⁻ dependence of the tolerance of autotrophic and heterotrophic biofilm communities to copper and diuron

A. TLILI, A. BERARD, J.L. ROULIER, B. VOLAT & B. MONTUELLE

PO₄³⁻ dependence of the tolerance of autotrophic and heterotrophic biofilm communities to copper and diuron

Ahmed Tlili^a, Annette Bérard^b, Jean-Louis Roulier^a, Bernadette Volat^a, Bernard Montuelle^a

a. CEMAGREF, UR MAEP, 3 Quai Chauveau CP 69336 Lyon Cedex 09, France

b. INRA UMR CSE-EMMAH 1114, Domaine Saint Paul - Site Agroparc 84914 Avignon Cedex 9, France

Abstract

Pollution-induced community tolerance (PICT) concept is based on the assumption that the toxicant exerts selection pressure on the biological communities when exposure reaches a critical level for a sufficient period of time and therefore sensitive species are eliminated. However, induced tolerance of microbial biofilm communities cannot be attributed solely to the presence of toxics in rivers but also to various environmental factors, such as amount of nutrients. An experimental study was undertaken to highlight the potential impact of a phosphorus gradient on periphytic microbial community sensitivity to Cu and diuron. Biofilms were exposed to real-world levels of chronic environmental contamination of toxicants with a phosphorus-gradient. Biofilm sensitivity to Cu and diuron was assessed by performing short-term inhibition tests based on photosynthetic efficiency to target photoautotrophs, extracellular enzyme activity (β -glucosidase and leucine-aminopeptidase) and substrate-induced respiration activity to target heterotrophs. The impact of P-gradient-associated to pollution was evaluated by measuring pesticide concentrations in biofilms, biomass parameters (*chl**a*, AFDW), bacterial cell density, photosynthetic efficiency and community structure (using 18S and 16S rDNA gene analysis to target eukaryotes and DGGE and HPLC pigment analysis to target bacteria and photoautotrophs). The obtained results show that depending on the studied toxicant and the used structural or functional parameter, the effect of the phosphorus gradient was variable. This highlights the importance of using a range of parameters that target all the biofilm biological communities. The PICT method can be regarded as a good tool for assessing anthropogenic environmental contaminations, but it is necessary to dissociate the real impact of toxicants from environmental factors.

Keywords: river biofilm; pollution-induced community tolerance; copper; diuron; phosphorus gradient.

1. Introduction

The European Water Framework Directive (WFD) sets a framework for the protection of all waters with the aim of achieving “good ecological status” by 2015, but the complexity and intensity of the pollutions faced makes this a tough challenge. The good ecological status of an ecosystem is characterized as high biodiversity and a stable transfer of energy and matter within trophic levels (Chapin *et al.*, 2000; Hooper *et al.*, 2002). Pesticides and heavy metals are two of the main groups of chemical aquatic pollutants that damage aquatic ecosystems (INRA-Cemagref, 2005). In aquatic ecosystems, the toxic effects of pesticides can cause alter biodiversity and consequently species interactions and biological processes (Sabater *et al.*, 2002; Fleeger *et al.*, 2003; Ricart *et al.*, 2009). Biofilm (an attached community of autotrophic and heterotrophic eukaryotic and prokaryotic populations) plays a fundamental role in the trophic web of small lotic ecosystems and in the geochemical cycles within aquatic ecosystems (Battin *et al.*, 2003). Biofilm communities are one of the first collateral victims of pesticide residue runoff from fields, which can affect their structure and function (Dorigo *et al.*, 2007). Structural and functional responses to environmental changes occur within a few weeks, and are thus considered an early-warning pollution indicator (Sabater *et al.*, 2007). Within biofilm, the vast diversity of microbial communities (algae, bacteria, protozoa, fungi, viruses, etc.) and the multitude of biological and physico-chemical processes generates huge structural and functional complexity. Consequently, in-biofilm biodiversity generates varied sensitivities and responses to various anthropogenic pressures (Barranguet *et al.*, 2003; McClellan *et al.*, 2008).

These specificities were used to build the pollution-induced community tolerance (PICT) concept introduced by Blanck *et al.* in 1988. PICT is a useful ecotoxicological tool for assessing the history of environmental exposure to a pollutant, at community level. Assessment of tolerance acquisition is a method used to establish a causal link between a toxic exposure and its impact on biological communities. Indeed, the PICT method is primarily a measure of biological community sensitivity to a given toxicant that is associated with taxonomic analysis and, generally, comparison against an uncontaminated reference.

The reference community already has a baseline tolerance (Bérard *et al.*, 2002) that can be affected by environmental factors such as light, temperature, flow velocity or nutrients (Guasch and Sabater, 1998; Villeuneuve *et al.*, 2010). Nutrient inputs, particularly phosphorus, can also influence microbial biofilm community sensitivity to toxicants (Hall *et al.*, 1989; Ivorra *et al.*, 2002; Kamaya *et al.*, 2004). For example, Guasch *et al.* (2004)

observed a clear influence of phosphorus limitation on copper toxicity. Biofilms communities that were previously fertilised for 18 days were three times more tolerant than control communities indicating that phosphorus limitation enhanced Cu toxicity and tolerance induction were probably related to the higher phosphorus availability. On the other hand, these authors tested, in a more recent study (Guasch et al., 2007), the influence of phosphorus on the tolerance of periphytic communities to the herbicide atrazine. Their results indicate that the process of tolerance induction to atrazine does not require phosphorus supply, supporting the view that phosphorus enrichment will not interact with atrazine toxicity in the long term. Similarly, Pesce et al. (2010) showed in a field study that there was no correlation between tolerance to diuron of phototrophic communities of river biofilms and the amount of phosphorus in water using the photosynthetic activity as endpoint in bioassays.

The purpose of this study was to investigate the potential effect of a phosphorus gradient on biofilm tolerance to diuron and copper in indoor microcosms. To assess biofilm sensitivity to Cu and diuron, various physiological parameters were used in short-term inhibition tests targeting the autotrophic and heterotrophic communities.

Two models of toxic molecules were used: diuron and copper. Diuron (N-(3,4-dichlorophenyl)-N,N-dimethyl-urea) is an herbicide (phenylurea) that inhibits photosynthesis by blocking the chloroplast electron transport chain in Photosystem-II (PSII) of phototrophic microorganisms and plants (Bérard and Pelte, 1999). Diuron is considered a model herbicide with regard to PSII inhibition in plants and algae. Copper is a metal that at high concentration and/or in prolonged exposure can have severe toxic effects. The mechanisms proposed as drivers of copper damage include inhibition of enzymes, inhibition of various PSI sites or PSII reaction centers, and altered uptake of essential microelements (Kuepper et al., 2002).

2. Material and methods

2.1. Sampling site

This study was carried out on a small river (the Morcille river) located in the intensive wine-producing Beaujolais vineyard area. Morcille river is characterized by an increasing and permanent pesticides and nutrient gradient (Gouy and Nivon, 2007) along the river. Diuron and Cu are two of the pesticides most often detected. Sampling was performed during June 2008 for the Cu experiment and September 2008 for the diuron experiment. Water carrying periphyton was collected from the Morcille River at the upstream, unpolluted reference site known as St. Joseph.

2.2. Experimental schedule

For each 3-week experimental series (Cu with P or diuron with P), two groups of four 15-L aquariums were filled with river water sampled from the reference site and filtered through a 50- μm mesh to remove most of the grazers. In each group, one aquarium was not P-enriched, while the three others were supplemented with P, added as $\text{Na}(\text{H}_2\text{PO}_4)\text{H}_2\text{O}$ (final PO_4^{3-} concentrations of 0.2, 0.4 and 0.8 $\text{mg}\cdot\text{L}^{-1}$, respectively). For the series of copper experiments, a group of 4 aquariums was contaminated with a nominal concentration of 30 $\mu\text{g}\cdot\text{L}^{-1}$ of Cu, added as CuSO_4 (Merck, 99% purity) and the 4 others were kept as a control group. The series of diuron experiments followed the same design but with 10 $\mu\text{g}\cdot\text{L}^{-1}$ of diuron (Sigma, high-grade, 99.5% purity). The toxicants (diuron and Cu) and P-gradient concentrations used in our study were similar to the maximum observed at Morcille river in late spring/early summer. Artificial substrates (27 individual microscope slides per aquarium) were fitted vertically in each aquarium (total surface of the artificial substrates: 975 $\text{cm}^2/\text{aquarium}$). During the experiment, the aquarium water was replaced each week with 50- μm mesh-filtered water from the reference site to avoid nutritional deficiency, and, depending on the experimental design, completed with diuron or Cu and P in order to maintain constant exposure.

The water was kept at a temperature of 23°C ($\pm 2^\circ\text{C}$), and exposed to a light intensity of 260 $\mu\text{mol m}^{-2}\text{s}^{-1}$ under an 18:6 h light/dark regime. These physical parameters were checked daily throughout the experiment.

2.3. Periphyton collection for biological analysis

After 3 weeks of growth, the biofilms were sampled and analyses were performed. Biofilm was scraped off (3 glass substrata per aquarium were kept for in-biofilm Cu or diuron analysis) using a Teflon blade for diuron or a polypropylene spatula for Cu, and suspended in 250 mL of 0.2 μm Nuclepore filtered water from the reference site. Total biomass analysis, photosynthetic efficiency and bioassays were performed immediately after sampling, whereas other analyses (bacterial enumeration, chemical, molecular and HPLC pigment analysis) were performed later on the deep-frozen biofilm (- 80°C).

2.4. Water analysis

Two-litre water samples 3 were collected into polyethylene bottles from the Morcille river at the reference site as well as from microcosms just before replacing the water (3 water samples were taken over each experiment duration), in order to assess chemical parameters

including DOC, PO_4^{3-} , conductivity and pH, following French standard operating procedures and protocols (AFNOR, 1999). The laboratory which conducted the chemical analysis is accredited by the French Accreditation Committee (COFRAC) (accreditation number: 1-1238).

Diuron and its main metabolites (3-(3,4-dichlorophenyl)-1-methyl urea (DCMU) and 3,4-dichloroaniline (DCA)) were measured in water by ESI-LC-MS/MS (API 4000, Applied Biosystems). The total dissolved Cu concentrations in the water were measured on a furnace atomic absorption spectrometer (AAAnalyst600, PerkinElmer) with Zeeman background correction. Water samples were taken from each aquarium before and after water renewal.

2.5. Analysis of Cu in biofilm

Biofilm was scraped off the glass substrata using a polypropylene spatula (3 replicates per microcosm) and suspended in 40 mL of 0.2 μm Nuclepore-filtered water from the reference site. This suspension was divided into two fractions. Fraction one (20 mL) was treated with 320 μL of 4.0 mM EDTA (final concentration) to quantify internalized Cu, and fraction two was used to quantify total in-biofilm Cu.

Briefly, the biofilm suspensions were filtered on a pre-weighed filter membrane washed previously in nitric acid (cellulose nitrate 0.45 μm , MILLIPORE). After drying 24 h at 50°C, the filters were weighed, and the filters containing dry biofilm were placed in Teflon vessels. Extra vessels included CRM 414 (PLANCTON) from the European Community Bureau of reference - BCR as references. 3 mL of 65% nitric acid (Merck, Suprapur) was added to all Teflon vessels. The samples were placed in a microwave digestion unit (MARS 5 CEM), and 12 mL Milli-Q was added to dilute the acid concentrate. The water samples were analyzed following the same procedure as for total dissolved Cu concentration in water.

2.6. Analysis of diuron in biofilm

Diuron and its main metabolites (DCMU and DCA) were measured in the biofilm by ESI-LC-MS/MS (API 4000, Applied Biosystems) according to Tlili *et al.* (2008). Briefly, biofilms were first collected from the substrata (3 replicates per microcosm) and suspended in 10 mL of 0.2 μm Nuclepore-filtered water from the reference site. Biofilm suspensions were then freeze-dried in order to prevent any matrix degradation before analysis. 10 to 100 mg of dried biofilm spiked with the analytical control standard (linuron) was extracted with 10 mL organic solvent (acetone/dichloromethane, 20/80, v/v) in an ultrasonic bath for 30 min. 6 mL of ultrapure water was then added to re-dissolve the extract. Purification was carried out on a

solid-phase extraction (SPE) cartridge (Oasis HLB, 60 mg, 3 mL, Waters). 10 μ L of internal standard control (deuteriated diuron) was added to the final extract of 240 μ L water/acetonitrile (80/20, V/V). Biofilm sample extracts were then quantified by ESI-LC-MS/MS. Diuron and its metabolites were separated on a 250 x 2 mm Purospher Star RP-18e column (Merck, France).

2.7. Total and algal biomass

Total organic matter was estimated by calculating ash-free dry weight (AFDW). Three aliquots of each homogenized biofilm suspension (2 mL) were filtered through individual 25-mm CF/C Whatman glass fibre filters (1.2- μ m pore size). Total dry matter was measured by weighing the filters after drying at 105°C for 24 h. The filters were then combusted in an oven at 480°C (Nabertherm P320) for 1 h, and then reweighed to calculate mineral matter. AFDW was calculated by subtracting mineral matter from total dry matter. Results are expressed in $\text{g}\cdot\text{m}^{-2}$ (Tlili et al., 2008).

Chla content in biofilm suspensions was quantified by HPLC analysis. The quantification of identified chla was made from external calibrations on standard chla (C55H72MgN4O5, Carl Roth GmbH & Co). Final concentrations are given as $\mu\text{g}\cdot\text{cm}^{-2}$ (see 2.9 for analytical details).

2.8. Biofilm DNA extraction-amplification and denaturing gradient gel electrophoresis (DGGE) analysis

As it was impossible to load more than 20 samples on the same DGGE gel and difficult to compare samples run on different DGGE gels (due to low reproducibility for the same PCR products on different DGGE gels), a preliminary experiment was run to test the reproducibility of DNA extraction, amplification and DGGE analysis. Six biofilm suspensions randomly chosen from among the various different contamination scenarios were extracted in triplicate (2 mL each). DGGE analyses were done separately on 18S rRNA and 16S rRNA polymerase chain reaction (PCR)-amplified fragments. Replicates produced identical DGGE band patterns (data not shown), which led us to simplify the analysis further by pooling the three biofilm subsamples for each contamination scenario.

Three replicates of 2 mL of each biofilm suspension were centrifuged at 14,000 g for 30 minutes, and the supernatant was removed and kept at -80°C until extraction. Nucleic acid extraction was performed on biofilm pellets using the FAST DNA kit (QBIogene, Illkirch, France) following the manufacturer's instructions.

PCR amplification of eukaryotic 18S rRNA gene fragments and bacterial 16S rRNA gene fragments and their DGGE analysis were performed according to Tlili et al. (2008). Briefly, 60 ng of template DNA and the Euk1Af (Sogin and Gunderson, 1987) and Euk516r-GC (Amann et al., 1990) primers were used to amplify the eukaryotic 18S rRNA gene fragment. PCR amplification of the bacterial 16S rRNA gene fragment was done with 30 ng of template DNA, and the primers 341f (Muyzer and Smalla, 1998), to which a GC-rich fragment was attached, and 907rM (Schauer et al., 2003).

DGGE analyses were performed as described in Dorigo et al. (2007) on a pool of the three PCR-amplified replicates. DGGE profiles were compared for presence or absence of bands, using the Dice dissimilarity index. Matrices were used to perform Ward's method of hierarchical cluster analysis (HCA) using XLSTAT software (2009 version).

2.9. Pigment analysis by high-performance liquid chromatography (HPLC)

Three replicates (5 mL) from each biofilm suspension were centrifuged at 9750 g for 30 min at 0°C, and kept at -80°C until analysis. HPLC pigment analysis was conducted as described in Tlili et al. (2008). Each pigment was identified from its retention time and absorption spectrum using DAD according to SCOR (Jeffrey et al., 1997). We employed a quantitative method resulting from a calculation model based on published ratios (r_w) for monocultures. Diatoms, cyanophytes and green algae were identified from their specific pigment signatures (fucoxanthin for diatoms, zeaxanthin for cyanobacteria, and lutein for green algae). Final concentrations are given as $\mu\text{g}\cdot\text{cm}^{-2}$.

2.10. Bacterial cell counts

Flow cytometry (FCM) was performed on a FACSCalibur platform (Becton Dickinson) to count the bacterial cells in each sample. Three replicates (10 mL) from each biofilm suspension were incubated overnight with paraformaldehyde (3% final concentration) and centrifuged at 8500 g for 25 min. at 4°C. The resulting pellet was washed with 20 mL of sterile PBS 1x, centrifuged at 8500 g for 25 min. at 4°C, dried, re-suspended in 1 mL ethanol 70%/PBS 1x (v/v), and kept at -25°C until analysis.

Samples were treated according to Duhamel and Jacquet (2006). 1 μL of a calibrated bead solution (Fluoresbrite Carboxy YG10 Micron Microsphere, Polysciences) used as an internal standard was added to 1 mL of the sample. Bacterial cells were stained with SYBR Green 1 dye (Invitrogen) at a concentration of 0.01%. On the basis of the cytograms obtained and

analyzed with the CYTOWIN software (Vaulo et al., 1989), cells from bacterial communities were identified and counted.

2.11. Photosynthetic efficiency

Photosynthetic efficiency is based on measurement of maximal quantum yield (YII) of algae (Schreiber et al., 2002). It reflects the number of functional PSII and therefore more generally the physiological state of the phototrophic communities. Measurements were performed using a PhytoPAM (pulse amplitude-modulated) fluorometer (Heinz Walz, GmbH). After 30 min of adaptation to darkness, *chl a* fluorescence of 3 replicates (3 mL) from biofilm suspensions was measured at 665 nm. A single saturation pulse was applied to calculate the maximal quantum yield as:

$$YII_{665\text{nm}} = \frac{F_m - F_0}{F_m}$$

where F_m is the maximum fluorescence after the saturation pulse and F_0 is the steady-state fluorescence.

2.12. Short-term bioassays and tolerance assessment

We monitored the effects of increasing concentrations (semi-logarithmic) of diuron or Cu on biofilm using photosynthetic efficiency, substrate-induced respiration (SIR) and extracellular enzymatic activities (leucine-aminopeptidase (LAP) and β -glucosidase (B-Glu)) as endpoints.

Briefly, stock solutions containing 100 μM (MW = 233.10 g) diuron or 200 mM (MW = 159.5 g) Cu were prepared in water and stored at -20°C and 4°C , respectively, prior to dilution in the test vessels. A semi-logarithmic series of concentrations was freshly prepared by serial dilutions of the stock solutions in 0.2 μm -filtered river water. Final test concentrations in the vessels ranged from 0.0032 μM to 3.2 μM for diuron and 0.2 μM to 2000 μM for Cu (3 blanks and 3 replicates for each of the 6 increasing concentrations).

Photosynthetic efficiency bioassays: biofilm suspensions (2.7 mL) were exposed to increasing concentrations of diuron or Cu for three or two hours, respectively, at the same light intensity and temperature conditions as they were grown in the aquariums, under continuous gentle shaking. Measurements were performed on a PhytoPAM fluorometer. The relative inhibition of fluorescence yield at 665 nm in relation to control was calculated to model concentration-response relationships.

Substrate-induced respiration (SIR) bioassays: biofilm suspensions (7 mL) were placed directly in 150 mL flasks, and diuron or Cu were added. After 2 hrs of preincubation (in the dark, at 20°C, under gentle shaking), 2 mL of feeding solution (15 g.mL⁻¹ glucose and 14.6 g.mL⁻¹ glutamic acid) was added, and the flasks were capped (t = 0 h). At t = 5 h and t = 8 h, the gas (C-CO₂) in the flask headspace was measured by gas chromatography on an MTI 200 microcatharometer. Results are expressed as ng CO₂.g⁻¹AFDW.h⁻¹. Dose-response curves were plotted using CO₂ values produced by biofilm at each diuron or Cu concentration.

Extracellular enzymatic activities bioassays: extracellular enzymes leucine-aminopeptidase and β-glucosidase were measured using fluorescent-linked substrates (aminomethylcoumarin (AMC) and methylumbelliferyl (MUF), respectively; Sigma-Aldrich) according to Romani et al. (2004). First, biofilm suspensions (0.7 mL) were exposed to diuron or Cu for 4 hours (in the dark, at 20°C, under gentle shaking). Each biofilm suspension was then incubated with 2 mL of the specific artificial substrate for each enzyme, at saturation concentration. After 20 min. incubation in the dark and in a shaker, glycine buffer (pH = 10.4, 0.3 mL to each sample) was added to stop the enzyme reaction and reach maximum AMC and MUF fluorescence, which was measured on a Biotek synergyHT fluoremeter at 360/460 nm excitation/emission. Results are expressed in μmol MUF or AMC.g⁻¹AFDW.h⁻¹. Data were fitted to a sigmoid dose-response model.

2.13. Data processing

The effect of P-gradient on biomass, relative autotroph abundance, bacterial cell density and physiological activities were tested by one-way ANOVA on XLSTAT (2009 version). The relationships between exposure conditions (P-gradient and P-gradient with Cu or Diuron) and chemical (Cu and Diuron in biofilms) or biological variables (biomass, relative autotroph abundance, bacterial cell density, photosynthetic efficiency and EC₅₀) were explored by multifactorial 2-way ANOVA on XLSTAT (2009 version). If a main effect was significant, the ANOVA were followed by a Tukey-HSD test. Homogeneity of variances was checked prior to data analysis. EC₅₀ values were calculated using the Regtox model (E. Vindimian, <http://eric.vindimian.9online.fr/>). The biological datasets along with the different exposure conditions (P-gradient and P-gradient with Cu or Diuron) were subjected to separate redundancy data analysis (RDA; XLSTAT, 2009 version). The data correlations between the EC₅₀ values, PO₄³⁻ concentration, in-biofilm quantity of Cu or diuron, total and algal biomass, relative autotroph abundance and bacterial cells density were tested by Pearson product-

moment correlation on XLSTAT (2009 version). Significance level was set at 5% for all statistical tests with three replicates for each parameter.

3. Results

3.1. Physico-chemical data

Conductivity in all microcosms remained relatively stable throughout the experiments ($145 \pm 5 \mu\text{S}\cdot\text{cm}^{-1}$ and $170 \pm 5 \mu\text{S}\cdot\text{cm}^{-1}$ for the Cu and diuron series, respectively. $n = 3$). In all microcosms, pH varied by up to 2.6 pH units compared to river water ($\text{pH} = 7.4 \pm 0.8$). DOC values within microcosms, before water change, from different exposure scenarios are given in Table 1. PO_4^{3-} , Cu, diuron and DCMU concentrations analyzed in microcosm water samples after water renewal are given in Table 2. The Cu concentration in the control microcosms was $1.89 \pm 0.08 \mu\text{g}\cdot\text{L}^{-1}$. In the Cu-exposed microcosms, Cu concentrations ranged from 25.2 to 27.4 $\mu\text{g}\cdot\text{L}^{-1}$. Diuron concentrations in the control microcosm water samples during the experiment were always below the quantification threshold ($< 0.02 \mu\text{g}\cdot\text{L}^{-1}$). Diuron concentrations in contaminated microcosms ranged from 10.77 to 11.18 $\mu\text{g}\cdot\text{L}^{-1}$. DCMU was also detected in water before each water renewal, at concentrations of 0.037 ± 0.001 ; 0.05 ± 0.008 and $0.14 \pm 0.03 \mu\text{g}\cdot\text{L}^{-1}$ after 1, 2 and 3 weeks of biofilm growth respectively. No DCA was detected in the water samples.

Table.1 Quantity of DOC ($\text{mg}\cdot\text{L}^{-1}$) in the microcosms, measured before each water renewal, during the three weeks of biofilm growth. P0: no P-enrichment. P1, P2 and P3: microcosms enriched with 0.2, 0.4 or 0.8 $\text{mg}\cdot\text{L}^{-1}$ of P, respectively.

Treatment		Day 7	Day 14	Day 21
No-Cu	P0	5.2	5.5	7.05
	P1	6.05	10.8	11.2
	P2	5.75	10	11.2
	P3	5.4	9.4	9.1
Cu exposure	P0	5.65	5.4	5.9
	P1	5.95	9.1	11.5
	P2	5.75	9.75	12.3
	P3	5.4	9.2	9.4
No-Diuron	P0	3.6	6.5	6.05
	P1	3.55	6.65	10
	P2	3.5	6.7	8.75
	P3	3.4	5.7	8.5
Diuron exposure	P0	3.65	4.3	8.2
	P1	3.75	4.1	8.9
	P2	3.55	4.3	8.95
	P3	3.4	4.1	8.25

Table.2 Summary of the phosphorus, Cu and diuron concentrations in the microcosms, measured after each water renewal (corresponding to initial conditions), during the three weeks of biofilm growth. P0: no P-enrichment. P1, P2, and P3: microcosms enriched with 0.2, 0.4 or 0.8 mg.L⁻¹ of P, respectively. AVG: average. SE: standard error (n = 3). QL: quantification limit = 0.02 µg.L⁻¹. na: not analyzed (as not matching to a studied contamination scenario).

Treatment		PO ₄ ³⁻ (mg.L ⁻¹)		Cu (µg.L ⁻¹)		diuron (µg.L ⁻¹)	
		AVG	SE	AVG	SE	AVG	SE
No-Cu	P0	0.05	0.01	1.95	0.86	na	na
	P1	0.26	0.04	1.90	0.80	na	na
	P2	0.45	0.03	1.78	0.67	na	na
	P3	0.86	0.03	1.96	0.77	na	na
Cu exposure	P0	0.05	0.02	25.20	2.92	na	na
	P1	0.26	0.02	27.35	3.51	na	na
	P2	0.48	0.03	27.19	3.40	na	na
	P3	0.85	0.01	27.16	3.47	na	na
No-diuron	P0	0.10	0.02	na	na	<QL	<QL
	P1	0.28	0.02	na	na	<QL	<QL
	P2	0.51	0.02	na	na	<QL	<QL
	P3	0.90	0.04	na	na	<QL	<QL
Diuron exposure	P0	0.08	0.02	na	na	11.09	0.99
	P1	0.26	0.03	na	na	11.18	0.44
	P2	0.49	0.01	na	na	10.89	0.52
	P3	0.86	0.04	na	na	10.77	0.97

The Cu (total and % of internalization) and diuron concentrations analyzed in the biofilm matrix are given in Table 3. The amount of total and internalized Cu in biofilms was explained by P-gradient together with dissolved Cu (2-way ANOVA, p<0.0001). Whatever the P concentration added (0.2, 0.4 or 0.8 mg.L⁻¹), total-Cu was always significantly less in exposed biofilms than in non-enriched microcosms (Tukey test p<0.0001). However, percentage Cu internalization was higher in the P-enriched microcosms. Diuron was measured in the biofilm matrix of the contaminated microcosm, but in concentrations there were not significantly different between enriched and non-enriched biofilms (Tukey test p>0.05).

Table.3 Concentrations of total-Cu, diuron and DCMU (μg of Cu or diuron. g^{-1} of biofilm, dry weight) and percentage of Cu internalization within the biofilm matrix in control microcosms and microcosms exposed to Cu or diuron, enriched or not with a P-gradient. P0: no P-enrichment. P1, P2, and P3: microcosms enriched with 0.2, 0.4 or 0.8 mg.L^{-1} of P, respectively. AVG: average. SE: standard error (n=3). QL: quantification limit. nd: not detected.

Treatment		No-Cu				Cu exposure			
		P0	P1	P2	P3	P0	P1	P2	P3
Total Cu	AVG	40.5	22.4	20.0	19.4	484.3	271.9	233.3	249.1
	SE	7.1	3.8	3.8	2.6	3.0	2.9	7.3	2.7
Percentage of Cu internalization	AVG	58.4	72.6	73.8	76.8	41.5	45.9	49.7	51.4
	SE	7.7	4.0	10.9	5.9	2.4	3.8	4.5	2.2
Treatment		No-Diuron				Diuron exposure			
		P0	P1	P2	P3	P0	P1	P2	P3
Diuron	AVG	LQ	LQ	LQ	LQ	1.85	1.48	1.37	1.59
	SE	-	-	-	-	0.06	0.36	0.23	0.17
DCMU	AVG	nd	nd	nd	nd	0.20	0.19	0.20	0.17
	SE	-	-	-	-	0.03	0.03	0.03	0.05

3.2. Biomass parameters

As shown in Fig. 1a, there was no significant difference in AFDW between Cu or diuron-exposed and control biofilms in the P0 microcosms (Tukey test $p > 0.05$). In both experiments (P with Cu and P with diuron), AFDW was influenced by P-gradient (one-way ANOVA, $p < 0.05$). The evolution of AFDW was positively correlated with the P-gradient (Pearson correlation $p < 0.05$). The effect of the interaction of Cu exposure and P-gradient exposure on AFDW was significant (2-way ANOVA, $p < 0.001$). However, there was no interaction between diuron exposure and P-gradient on AFDW (2-way ANOVA, $p > 0.05$).

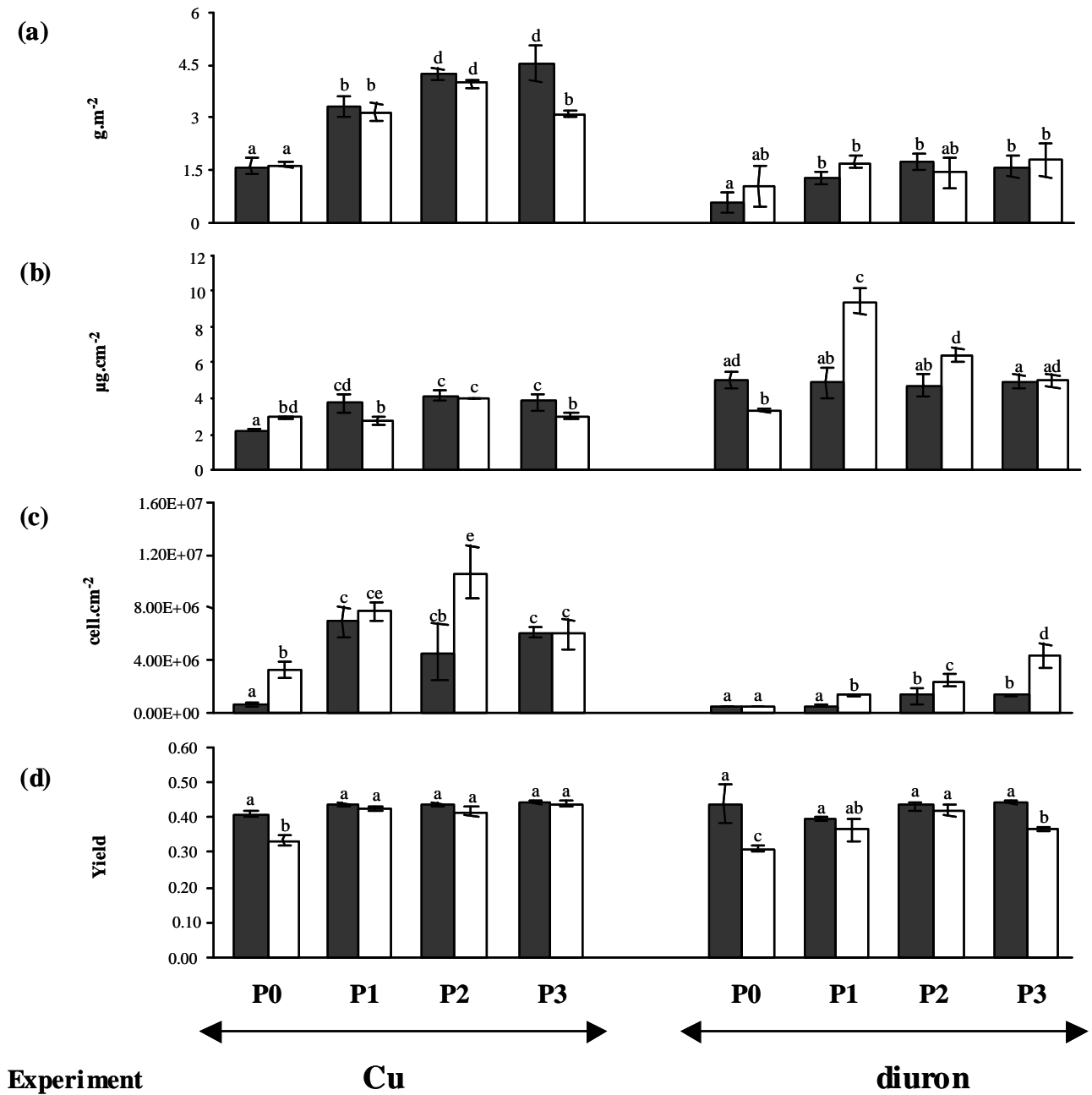

Fig.1 Long-term impact of copper ($30 \mu\text{g.L}^{-1}$) and diuron ($10 \mu\text{g.L}^{-1}$) on control (■) and exposed (□) microcosms. (a) AFDW biomass, (b) chl a , (c) bacterial cell density, and (d) photosynthetic efficiency. P0: non-P-enriched microcosm. P1, P2 and P3: microcosms enriched with 0.2, 0.4 or 0.8 mg.L^{-1} of phosphorus, respectively. Error bars represent standard deviations ($n = 3$). Different lower-case letters next to the bars indicate significant differences ($p < 0.05$) among treatments (Tukey HSD following two-way ANOVA).

In the P0 microcosms, *chl a* concentrations were significantly higher in Cu-exposed biofilm than in control biofilm, but lower in diuron-exposed biofilm than in control biofilm (Fig. 1b, Tukey test $p < 0.05$). In the Cu-experiment, the P addition induced a small but significant *chl a* increase in control microcosms (1-way ANOVA, $p < 0.05$). This increase similar whatever the amount of P added (Tukey test $p > 0.05$). Cu plus P-gradient exposure led to a decrease in *chl a* (Fig. 1b, 2-way ANOVA, $p < 0.01$). In the diuron experiment, *chl a* concentrations were identical in all control (P-enriched or not) microcosms (1-way ANOVA, $p > 0.05$). P concentration had no direct influence on *chl a* (1-way ANOVA, $p > 0.05$);, whereas diuron exposure led to increased *chl a* concentrations, but only in P1, P2 and P3 microcosms (2-way ANOVA, $p < 0.0001$). This increase was strongly and negatively linked to the quantities of P added, (Fig. 1b, Tukey test $p < 0.0001$).

3.3. Bacterial cell count

As shown in Fig. 1c, the number of bacterial cells increased significantly in control P-enriched microcosms (P1, P2 and P3), whatever the experiment (Cu and diuron experiments) (1-way ANOVA, $p < 0.0001$). In the P0 microcosms, Cu exposure led to a significant increase in bacterial density compared to control biofilm (Tukey test $p < 0.0001$), whereas diuron exposure had no effect on bacterial cell counts (Tukey test $p > 0.05$). Multifactorial 2-way ANOVA showed that bacterial cell counts was significantly dependent on both Cu plus P-gradient and diuron exposure plus P-gradient ($p < 0.0001$). In the diuron microcosms, bacterial density increased linearly along the P-gradient (Pearson's correlation $p < 0.05$).

3.4. Photosynthetic efficiency (Fig. 1d)

P-gradient, without exposure to Cu or diuron, had no effect on biofilm photosynthetic efficiency (1-way ANOVA, $p > 0.05$). In the P0 microcosms, exposure to Cu or diuron led to a significant yield decrease (Tukey test, $p < 0.001$). When microcosms were P-enriched, the inhibiting effect of Cu or diuron on the yield was not conserved (2-way ANOVA, $p < 0.0001$).

3.5. HPLC pigment analyses

Fourteen pigments were identified: chlorophyll *c1*, chlorophyll *c2*, chlorophyll *c3*, fucoxanthin, violaxanthin, dinoxanthin, canthaxanthin, zeaxanthin, lutein, antheroxanthin, diadinoxanthin, chlorophyll *b*, beta-carotene and chlorophyll *a*. Diagnostic pigment signatures indicated the presence of diatoms, green algae and cyanobacteria in biofilms, so we calculated the relative percentages of these 3 groups (Fig. 2). Exposure to Cu or diuron (without P-enrichment) led to a significant decrease in diatoms and cyanobacteria but an increase in

green algae (Tukey test, $p < 0.0001$). In the Cu experiment, relative percentages of diatoms, cyanobacteria and green algae were significantly influenced by both factors tested (exposure to toxicant and P-gradient; 2-way ANOVA, $p < 0.001$) whereas in the diuron experiment, the two factors tested only influenced relative percentages of diatoms and cyanobacteria (2-way ANOVA, $p < 0.0001$), and not green algae (2-way ANOVA, $p > 0.05$).

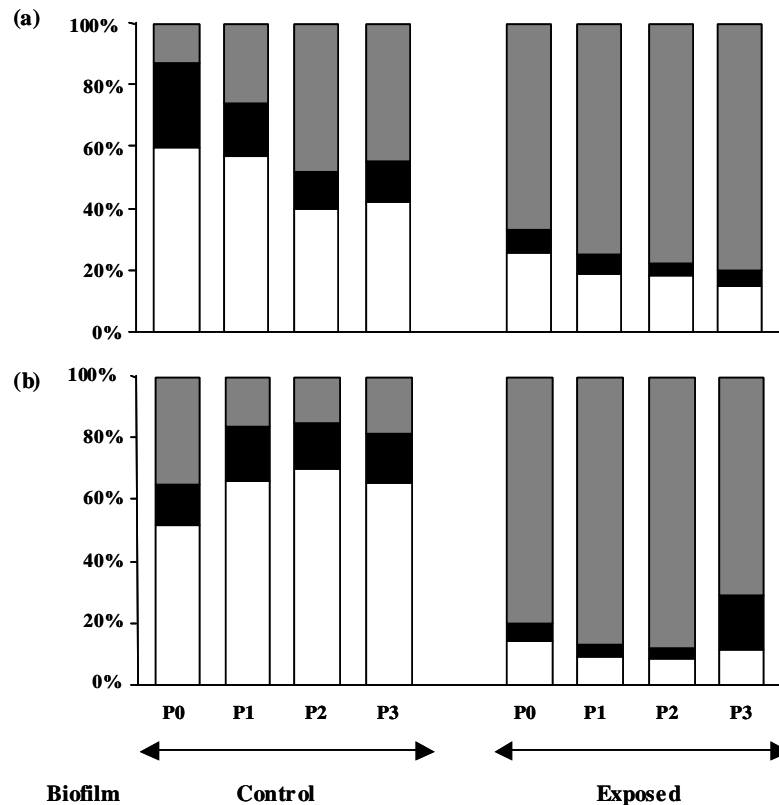

Fig.2 Relative percentages of diatoms (□), cyanobacteria (■) and green algae (▒) (determined by HPLC) in control microcosms and microcosms exposed to (a) copper and (b) diuron. P0: non-P-enriched microcosm. P1, P2 and P3: microcosms enriched with 0.2, 0.4 or 0.8 mg.L⁻¹ of P, respectively.

3.6. Community structures

3.6.1. Bacterial community structures

In the Cu and diuron experiments, 66 and 62 bands were detected, respectively, by the DGGE fingerprints. In the control microcosms, the number of bands detected in each biofilm sample ranged from 24 to 26 (mean: 25) in the Cu experiment and 23 to 25 (mean: 24) in the diuron experiment. In contaminated microcosms, number of bands per profile ranged from 19 to 29 (mean: 26) in the Cu experiment and 25 to 29 (mean: 27) in the diuron experiment.

HCA of the various DGGE profiles based on presence/absence matrix revealed that bacterial community was structured by exposure to toxicants (Cu or diuron) and to a lesser extent by P-gradient (Fig. 3a and b). Two main groups were distinguished: the first group corresponds to the control biofilms and the second to the Cu or diuron-exposed biofilms. Within each group, biofilms are structured according to P-gradient.

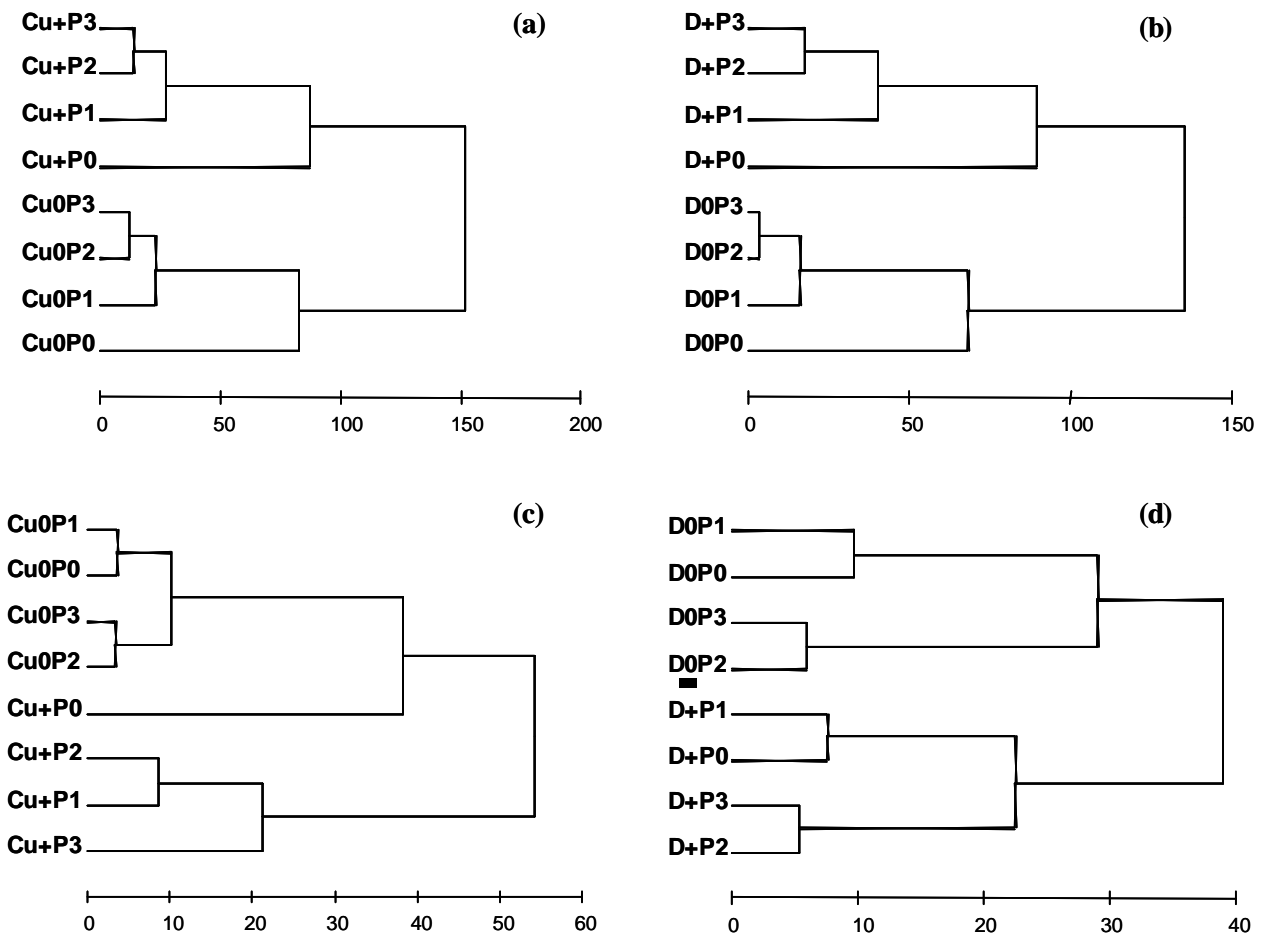

Fig.3 Cluster analysis (hierarchical ascendant classification based on Pearson's correlation coefficients) of the bacterial community (DGGE analysis of PCR-amplified 16S rRNA gene fragments) exposed to (a) copper and (b) diuron, and the eukaryotic community (DGGE analysis of PCR-amplified 18S rRNA gene fragments) exposed to (c) copper and (d) diuron.

3.6.2. Eukaryotic community structure

Over the whole biofilm samples, 27 and 26 different bands were detected in the Cu and diuron series, respectively. In the control microcosms, the number of bands detected in each biofilm sample ranged from 12 to 14 (mean: 13) in the Cu experiment and 17 to 19 (mean: 18) in the diuron experiment. In the contaminated microcosms, the number of bands per

profile ranged from 12 to 21 (mean: 16) in the Cu experiment and from 12 to 15 (mean: 13) in the diuron experiment.

In the Cu experiment, HCA on the 18S gels (Fig. 3c) distinguished two groups: one including biofilms from control microcosms with the P0 from the contaminated microcosms, and the other including biofilms from the enriched and contaminated microcosms (P1, P2 and P3). In the diuron experiment (Fig. 3d), eukaryotic community seemed to have been structured principally by exposure to toxicant, and the P-gradient had little influence.

3.7. Toxicant-induced tolerance

Diuron herbicide is an exclusive inhibitor of photosynthesis and does not therefore act on respiration and extracellular enzymatic activities in the short term. For this reason, it was impossible to use the SIR, LAP and β -glucosidase biological descriptors to highlight biofilm tolerances to diuron. In contrast, Cu acts directly on the heterotrophic microbial compartment, particularly SIR and the tested extracellular enzymatic activities. Thus, these parameters were successfully used to evaluate the induced tolerance to Cu of our biofilms.

3.7.1. Photosynthetic efficiency bioassay

Cu experiment: Exposure to $30 \mu\text{g.L}^{-1}$ of Cu for 3 weeks without P-enrichment led to a significant increase in EC_{50} (fig 4). Without this long-term exposure to Cu, adding 0.2 and 0.4 mg.L^{-1} of P did not change the phototrophic community tolerance to Cu. However, the adding 0.8 mg.L^{-1} of P led to an increase in EC_{50} . Exposure to Cu coupled with P-enrichment appears to influence phototrophic community tolerance to Cu (2-way ANOVA, $p < 0.01$). Indeed, the Cu tolerance of exposed biofilms increased along the P-gradient, particularly in the P3 microcosm.

Diuron experiment: Fig.4a shows that phototrophic communities exposed to diuron $10 \mu\text{g.L}^{-1}$ for three weeks were more diuron-tolerant than control biofilms. However, the P-gradient alone or coupled with exposure to diuron had no effect on EC_{50} .

3.7.2. Substrate-induced respiration (SIR) bioassay

Heterotrophic Communities exposed to Cu for 3 weeks were less sensitive to $30 \mu\text{g.L}^{-1}$ of Cu than control communities (Fig. 4c). SIR bioassays demonstrated a concentration-dependent increase in EC_{50} throughout the P-gradient (Fig. 4c). Long-term exposure to Cu associated with the P-gradient tends to lead to a decrease in biofilm sensitivity to this metal (particularly in P3; 2-way ANOVA, $p < 0.05$; Fig. 4c).

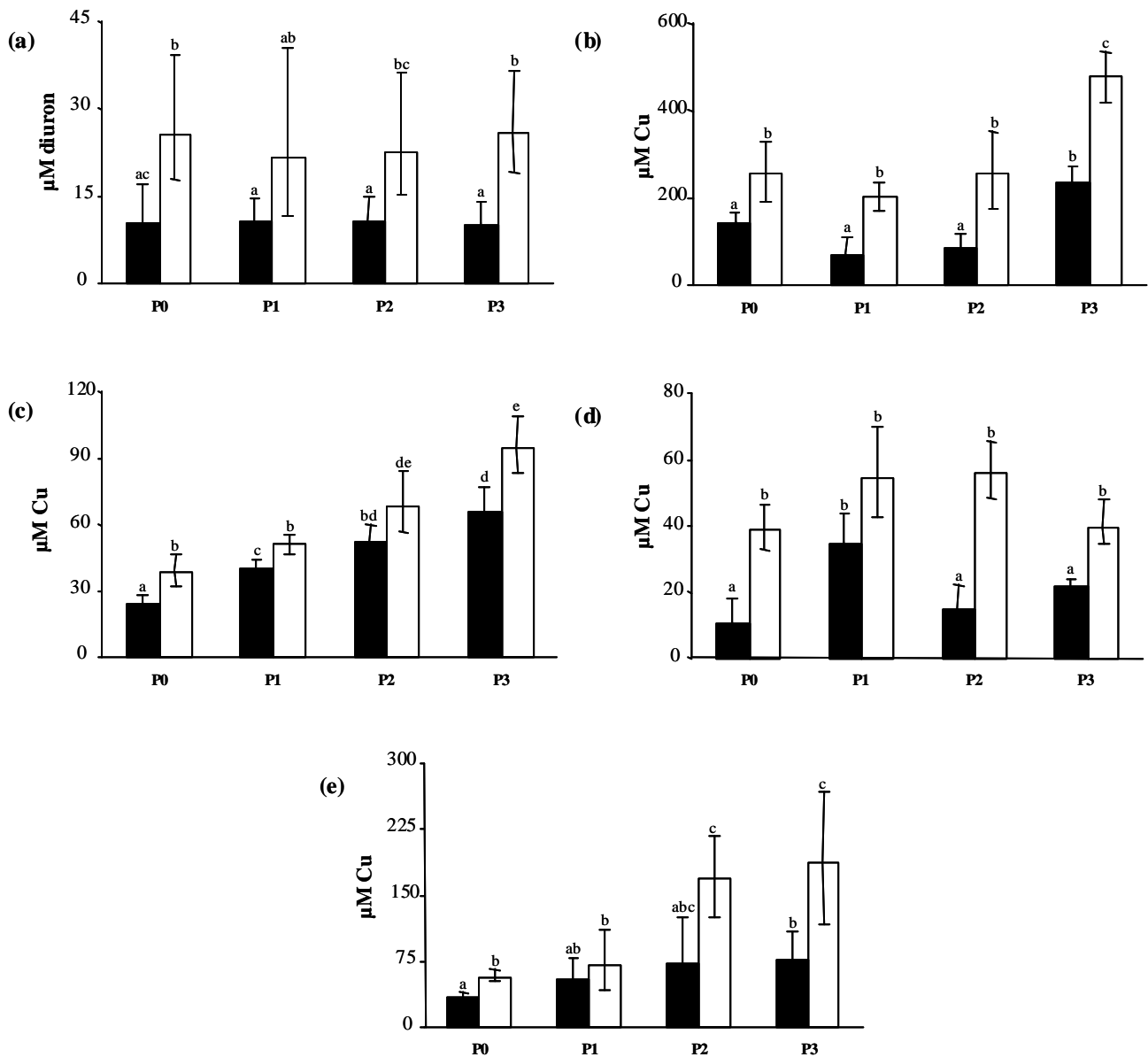

Fig.4 EC₅₀ values (in μM of copper or diuron), in control (■) and exposed (□) microcosms. (a) photosynthetic efficiency bioassay for the P-diuron experiment. (b) photosynthetic efficiency bioassay for the P-Cu experiment, (c) substrate-induced respiration bioassay, (d) leucine-aminopeptidase bioassay, and (e) β-glucosidase bioassay for the P-Cu experiment. P0: non-P-enriched microcosm. P1, P2 and P3: microcosms enriched with 0.2, 0.4 or 0.8 mg.L⁻¹ of P, respectively. Error bars represent confidence intervals. Different lower-case letters next to the bars indicate significant differences (n= 3; p<0.05) among treatments (Tukey HSD following two-way ANOVA).

3.7.3. Extracellular enzymatic activities bioassay

Leucine-aminopeptidase bioassay: In the P0 microcosms, after 3-week exposure to 30 μg.L⁻¹ of Cu, exposed biofilms showed a significantly higher EC₅₀ than control biofilms (Fig.

4d). The P-gradient (without Cu exposure) had no significant effect on biofilm tolerance (based on leucine-aminopeptidase activity; Fig. 4d). Multifactorial ANOVA showed that tolerance of biofilm was not controlled by the combined impact of the two factors (Cu and P-enrichment; 2-way ANOVA, $p > 0.05$).

β -glucosidase bioassay: In the P0 microcosms, long-term Cu-exposed biofilm showed higher EC_{50} than control biofilm (Fig. 4e). Increasing concentrations of P (without exposure to Cu) did not appear to trigger any marked effect biofilm tolerance to Cu. Indeed, biofilms from the P3 microcosm appeared less sensitive to copper than control biofilms (Tukey test, $p < 0.05$; Fig. 4e). Long-term Cu exposure coupled with P-gradient enrichment led to an increase in EC_{50} . Biofilm tolerance to Cu was influenced by the combined effects of the two factors (Cu and P-enrichment; 2-way ANOVA, $p < 0.0001$).

3.8. Multi-parametric analysis

Fig. 5. gives the results of redundancy data analysis (RDA) on biological descriptors constrained by environmental variables. RDA determined that P-gradient and exposure to toxicant explained 71.96% and 63.70% of variability in the Cu- and diuron experiments, respectively. The first RDA axis reflected the distribution of biofilms according principally to P-gradient. Exposure to the pollutant (Cu or diuron) was the environmental variable most correlated with axis 2. The effect of a P-gradient on the individual distributions, as generated by RDA, was more pronounced in the presence of a toxicant.

In the Cu experiment (Fig. 5a), biofilms exposed to Cu were showed greater green algae abundances, bacterial cells densities and EC_{50} values, but also lower diatom and cyanobacteria abundances. Biofilms from P-enriched microcosms showed greater AFDW, *chl a* quantities and photosynthetic efficiency. RDA showed that EC_{50} based on leucine-aminopeptidase bioassay was closely correlated to Cu exposure only, whereas EC_{50} based on SIR bioassay was more tightly correlated to P-gradient more than Cu exposure. EC_{50} values based on photosynthesis and β -glucosidase activity bioassays were correlated to both Cu exposure and P-gradient.

In the diuron experiment (Fig. 5b), RDA showed that exposure to toxicant led to greater green algae abundance, *chl a* counts and EC_{50} values. Biofilms exposed to diuron showed lower abundance of diatoms and less efficient photosynthesis. On the other hand, P-gradient was correlated to greater AFDW, cyanobacteria abundance and bacterial cell density. In contrast to Cu, EC_{50} based on photosynthesis bioassay in the diuron experiment was only related to diuron exposure, and not to P-gradient.

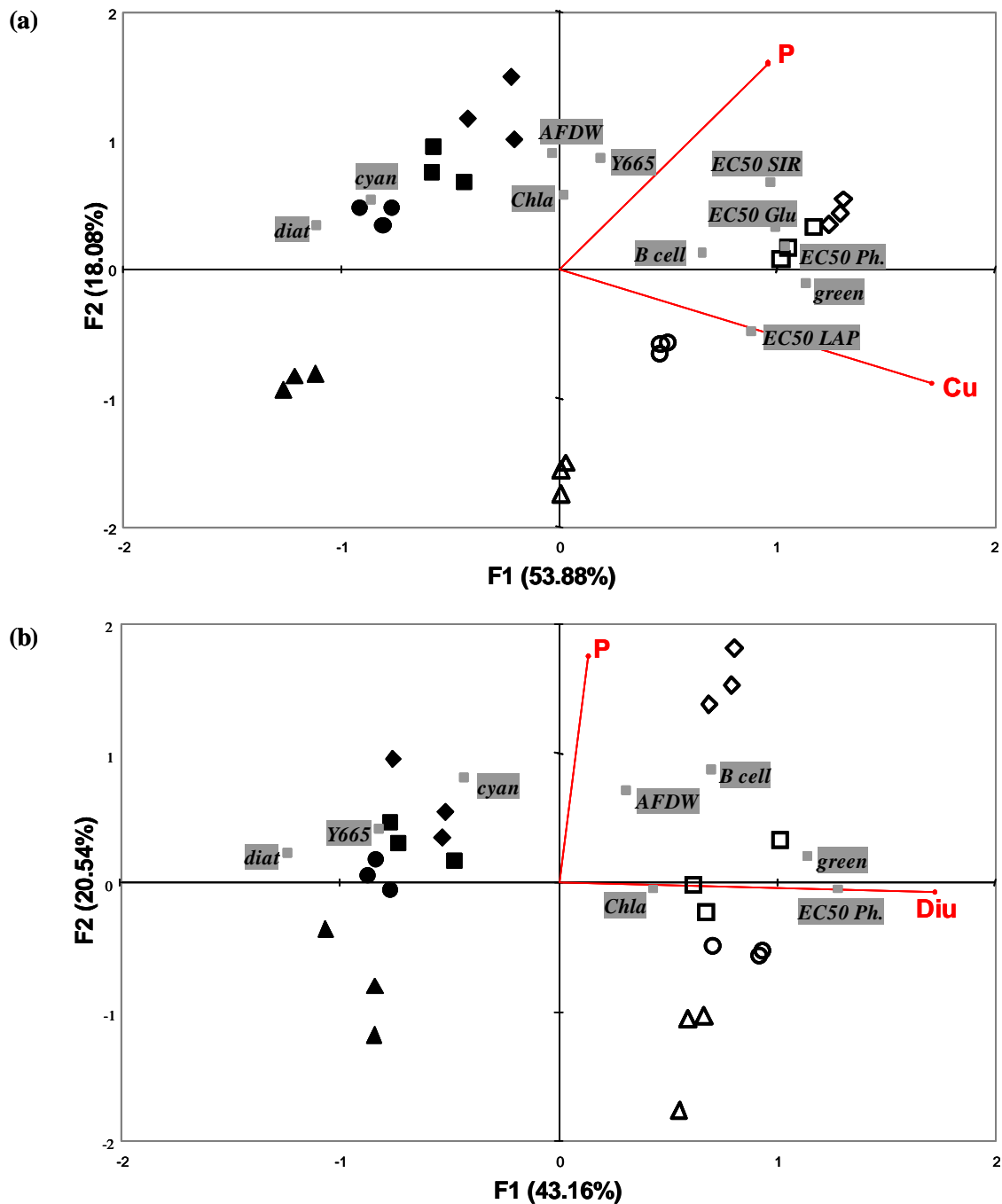

Fig.5 Biplot based on redundancy analysis of control biofilms (in black) and biofilms (n=3) exposed (in white) to (a) copper and (b) diuron. Codes for different conditions of P-addition are: ▲ Non-enriched; ● 0.2 mg.L⁻¹; ■ 0.4 mg.L⁻¹ and ◆ 0.8 mg.L⁻¹ of phosphorus. Arrows representing the constraint variables show P for the phosphorus gradient, Cu for copper and Diu for diuron. Biological variables are: AFDW, Chla, bacterial cells density (Bcell). Relative percentages of cyanobacteria (cyan), diatoms (diat) and green algae (green). Photosynthetic activity (Y665); EC₅₀ photosynthesis (EC₅₀ Ph.); EC₅₀ based on SIR bioassay (EC₅₀ SIR); EC₅₀ based on LAP bioassay (EC₅₀ LAP); EC₅₀ based on β-Glucosidase bioassay (EC₅₀ Glu).

4. Discussion

This study was led on Morcille river. In 2007, Dorigo *et al.* highlighted a gradient of tolerance to Cu and diuron from upstream to downstream in Morcille river, associated with a toxicant and nutrient gradient. *In situ* interactions between xenobiotics and nutrients are difficult to assess due to the many direct and indirect effects that have to be taken into account. To assess potential interaction, we exposed biofilms to Cu or diuron, coupled or not with a P-gradient, in a laboratory experiment.

(i) Phosphorus modulates contaminant effects on autotrophic biofilm communities.

- *Effect of Cu and diuron without P-enrichment*: Our results show that long-term exposure to Cu (without P-enrichment) led to an increase in *chl a* concentrations and an inhibition of photosynthetic efficiency, whereas long-term exposure to diuron (without P-enrichment) led to lower *chl a* concentrations and photosynthetic efficiency compared to control biofilm. These dissimilar effects between Cu and diuron are probably due to the different modes of action. Barranguet *et al.* (2002) hypothesized that the mode of action of Cu was progressive and non-specific. For this reason, an increase in algal biomass after three weeks of Cu exposure does not necessarily signal stimulated photosynthesis. In contrast, diuron (a PII inhibitor) acts quickly and exclusively on photosynthesis by blocking the electron transport chain in the first phase of photosynthesis (Bérard and Pelte, 1999).

Pollution-induced community tolerance (PICT) is based on the assumption that the toxicant exerts selection pressure when exposure reaches a critical level for a sufficient period of time (Bérard *et al.* 2002), inducing a shift in the community structures with the emergence of the most tolerant species (Mølander and Blanck., 1992; Dorigo *et al.*, 2003; Schmitt-Jansen and Altenburger, 2005). In our experiments, community tolerance to diuron and Cu based on EC₅₀ values for photosynthesis was significantly lower in control photoautotrophs than pollutant-challenged photoautotrophs, suggesting pollution-induced community tolerance (PICT) to both of these toxicants. Mølander and Blanck (1992) proposed a conceptual three-stage model of the impact of diuron on marine periphyton as a function of water diuron concentrations. During the first stage, exposure to diuron had no long-term effect, but during the second stage there was a slight long-term effect on biomass and structure and during the final stage, the diuron stress was so severe that sensitive species were eliminated, resulting in a decline in biomass diversity and *chl a* in parallel with an increase in community tolerance, giving an easily-detected PICT. Our chronic exposure conditions could be compared to the

third stage of Mølander and Blank (from 9 µg of diuron per litre for these authors and 10 µg.L⁻¹ in our study). Soldo and Behra (2000) observed the same trend with the effect of Cu on autotrophic river biofilm communities, with PICT detected from 15.5 µg.L⁻¹ of Cu in chronic exposure conditions (30 µg.L⁻¹ in our study). RDA showed that EC₅₀ values were strongly and positively correlated with an increase of green algae and negatively correlated with a decrease in diatoms and cyanobacteria in the exposed biofilms. These results are consistent with other reports (Genter *et al.*, 1987; Soldo and Behra, 2000; Serra, 2009) of a dominance of green algae in Cu or diuron-challenged biofilms.

- *Combined effect of Cu or diuron plus phosphorus*: When biofilms were exposed to toxicant and P together, over a 3-week period, the inhibiting effect of Cu or diuron on photosynthetic efficiency was cancelled. The explanation for these findings could be different depending on the toxicant (Cu or diuron). It was shown that exposure to metals strongly limits access to nutrients by reducing cell membrane permeability (Nalewajko and Olaveson, 1994). The simultaneous addition of toxicants and nutrients may therefore compensate the inhibitory effect on physiological community responses (Guasch *et al.*, 2004; Serra, 2009). On the other hand, the antagonistic effect of P and diuron on photosynthesis could be an indirect intracellular effect. Diuron not only leads to the inhibition of photosynthetic reactions by blocking electron transfer at PSII level, but also consequently stops oxygen release and CO₂ fixation (Bérard and Pelte, 1999). The excited chlorophylls allow the production of singlet oxygen, a highly reactive form. As the inhibition of PSII blocks electron transfer, singlet oxygen will remain active and trigger the oxidative destruction of pigments such as *chl a*. P-enrichment could counteract this negative effect of diuron: Goncharova *et al.* (1997) addressed the possible interaction between the PSII, *chl a* and inorganic phosphate and suggested that the phosphate ions could act as electron donors in the PSII-PSI chain during the photosynthetic reaction. They tested this hypothesis and showed that exposure to high irradiance intensities led to a destruction of PSII (a similar effect to diuron exposure) and a sharp depletion in endogenous P, thereby stopping the electron transfer chain. When P was added in the medium, the reactions resumed and *chl a* increased. In our study, *chl a* also increased in the biofilms exposed to both P and diuron.

HPLC analysis showed that photoautotrophic communities were structured by exposure to both Cu and phosphorus. This is consistent with the DGGE analysis showing that eukaryotic communities were not clearly structured by exposure to Cu (like bacterial communities) but were clustered by the both the phosphorus gradient and exposure to Cu. In contrast, there was no clear combined effect of phosphorus and diuron on eukaryotic community structure but a

strong structuring effect of diuron exposure. Multivariate analyses showed that there was a combined effect of Cu and P on the induced tolerance of photoautotrophs communities to Cu (EC_{50} Ph.), unlike diuron with P.

The physical structure and chemical characteristics of biofilm communities make it possible to modulate the toxic effects of metal pollutants (Barranguet *et al.*, 2000). One of the hypotheses that could explain the antagonistic effect of P against Cu toxicity is related to the decrease in the bioavailability of the metal. This effect could be direct or indirect. The indirect effect may be linked to pH in the microcosms: RDA indicates that photosynthetic efficiency was positively correlated to P-gradient, and the increase in photosynthesis may induce an increase in pH that could modify metal solubility and bioavailability by reducing the concentration of Cu^{2+} ions (Guasch *et al.*, 2002). The pH monitoring conducted throughout our experiment showed an identical pH increase pattern in all microcosms (P-enriched or not), whereas the amount of total-Cu in the biofilms (directly and positively proportional to the concentration of free metal in water) was significantly different. We can therefore exclude the hypothesis of an indirect effect of pH on Cu toxicity. On the other hand, the amount of total-Cu in no-P microcosms was higher than in P1, P2 and P3. A direct effect could be linked to copper speciation in interaction with phosphate. Phosphates can complex and precipitate Cu, decreasing the “free” copper concentration in solution, and may ultimately decrease the Cu available to biofilm (Nalewajko and Paul, 1985; Guasch *et al.*, 2004). The high Cu-tolerance of the autotrophic biofilm communities in presence of P could be explained by another assumption related to the presence of polyphosphate bodies (PPB) that are storage sites for metals acting as a detoxification mechanism. Studies have reported that when the amount of P in the medium increases, the excess intracellular P is stored as PPB (Serra, 2009). In our experiments, increasing P concentrations and increasing percentage of internalized Cu showed the same pattern. Hall *et al.* (1989) suggested a Cu complexation by polyphosphates to explain the cell’s capacity to detoxify Cu. Batch experiments with a macroalgae (*Macrocystis pyrifera*) showed enhanced metal (Cd) uptake from seawater when PPB formation was induced (Walsh and Hunter, 1992).

The induced tolerance of autotrophic biofilm communities to diuron was exclusively related to exposure to the herbicide and was not influenced by P-gradient or biomass. This contrasts with other studies on metals such as Zn or Cu that have clearly demonstrated that their toxicity was inversely linked to biofilm biomass (Guasch *et al.*, 2003, 2004). Indeed, our results show that despite the fact that P-enrichment induces an increase in AFDW, there was no correlation between biomass and diuron tolerance (based on photosynthesis). Considering

the findings of Headley et al. (1998), who showed that it only takes a few minutes for pesticides with a K_{ow} higher than diuron (2.68) to bioconcentrate in biofilms, we could assume that the sorption kinetics are mainly dependent on the physico-chemical properties of the pesticide rather than on the biofilm biomass (enhanced by the P-enrichment; Brown and Lean, 1995). Consequently, there is no indirect physical biofilm structure effect of P on the induced tolerance of phototrophic communities to diuron (Guasch et al., 2003), as we suggest for Cu. In 2007, a laboratory study by Guasch et al. concluded that the process of tolerance induction to atrazine (a PSII-inhibitor herbicide) does not require P-supply. Kamaya et al. (2004) obtained the same results by testing the toxicity of Cu and simazine (PSII-inhibitor herbicide) on *Selenastrum capricornutum* (green algae), depending on the amounts of phosphorus in the medium: in-medium phosphate levels affected Cu toxicity but not simazine toxicity.

(ii) Phosphorus modulates contaminant toxicity to heterotrophic communities.

Studies have investigated the combined toxicity of pollutants and phosphorus, but the main focus has been on the microbial autotrophic compartments of the biofilm (e.g. Guasch et al., 2004; Kamaya et al. 2004). In our experiments, we also focused on the effects on the heterotrophic communities in the freshwater biofilm.

- *Effect of Cu and diuron without P-enrichment*: Cu and diuron can modify bacterial community structure and physiology (Barranguet et al., 2003; Boivin et al., 2005; Pesce et al., 2006; Tlili et al., 2008). In our study, the patterns of bacterial diversity obtained by molecular fingerprinting under the different exposure conditions showed that the bacterial communities were structured mainly by exposure to toxicants, whether Cu or diuron. Massieux et al. (2004) showed that Cu was a strong driver (direct or not) of bacterial structure changes. Long-term exposure to diuron affects both the structure and functioning of microbenthic algae, which may result in changes in the quantity and quality of algal products available to bacteria within the biofilm, subsequently leading to a shift in the composition of the bacterial community (Ricart et al. 2009; Tlili et al., 2008).

These assumptions are confirmed by our results on bacterial cell density. Exposure of biofilms to Cu over a 3-week period caused a significant increase in bacterial cell density, while exposure to diuron (without P-enrichment) had no effect. These differences in effects of Cu and diuron might be related to the different modes of action of these two pollutants. Cu, which acts directly on the bacteria, will cause rapid elimination of the most Cu-sensitive bacteria and consequently promote the development of other taxa not subjected to a strong

competition for nutrients, thus stimulating cell density (Fleeger et al., 2003; Le Jeune et al., 2007). Conversely, diuron acts indirectly on heterotrophic organisms. Its effects could be begin by modifying algal diversity (in agreement with our DGGE results), resulting in changes in interspecies interactions, and consequently changes in bacterial cell densities.

- *Effect of P-enrichment without exposure to Cu or diuron*: P-supply is an important driver of heterotrophic activity in lotic systems (Carr et al., 2005). In our study, P-enrichment increased bacterial cell density. This stimulation of bacterial cell density could be related to a direct effect of P stimulating the bacterial growth or to an indirect effect via an action on algae producing organic matter that is easily assimilated by bacteria. Lyon and Ziegler (2009) suggested that in stream systems, nutrient enrichment decouples the positive relationship between algae and bacteria, inducing an increase in DOC. Our results are in agreement with these observations, as we observed a significant increase (from 40% to 65%) of DOC in the P1, P2 and P3 microcosms compared to the P0 microcosm. If there is coupling of carbon flux between autotrophs and heterotrophs in the biofilm, then DOC would be expected to decrease in the water phase. However, this was not the case in our experiment. The hypothesis of an indirect and positive effect of P on bacterial cell density can therefore be excluded.

When bacterial community is not coupled to algal C-production, heterotrophic bacteria may also compete with algae for inorganic nutrients (Currie and Kalff, 1984; Mohamed et al., 1998). For example, bacteria have shown faster P uptake rates than algae and could be responsible for 97% to 100 % of initial P uptake (Currie and Kalff, 1984). We can therefore assume that the stimulating effect of P on bacterial cell density is directly related to the P assimilation by heterotrophic bacteria.

- *Combined effect of Cu or diuron with phosphorus*: When aquatic ecosystems are contaminated with toxicants, it could disturb the interactions between algae and bacteria, causing structural and physiological changes in heterotrophic communities (Waston and Bollen, 1952; Barranguet et al., 2003). In our experiments, although the bacterial community appeared to be influenced by both toxicant exposure and P-enrichment (see RDA and the 16S DGGE fingerprinting analyses), bacterial community response varied depending on the toxicant (Cu or diuron). When biofilms were exposed to both Cu and P, the stimulating effect of Cu alone on the bacterial cell density was cancelled. In contrast, diuron exposure coupled with P-enrichment induced an increase in bacterial cell density throughout the P-gradient. Moreover, the analysis of water microcosms showed an increase in DOC when biofilms were exposed to Cu + P but no change in DOC when biofilms were exposed to diuron + P. Soil studies have suggested that contaminants may enhance or lower the release of nutrients (like

DOC) to the point that plant or microbe abundances can be affected (Bogomolov et al., 1996; Salminen et al., 2001).

We used three functional bioindicators (SIR, leucine-aminopeptidase (LAP) and β -glucosidase) to evaluate the heterotrophic community tolerance induced by long-term exposure to Cu. Induced tolerance of heterotrophic communities based on SIR bioassay seemed to be positively influenced by exposure to Cu and P-gradient together, with a greater influence of nutrient addition. On the other hand, β -glucosidase activity showed that induced tolerance to Cu was also influenced by exposure to Cu and P-enrichment together, but these two factors had the same weight. However, Cu-induced heterotrophic community tolerance based on LAP showed that the EC₅₀ seemed to be related strictly to long-term exposure to metal. Considering these results, it is interesting to note that the two physiological parameters that are linked to the carbon cycle for the synthesis (SIR) or degradation (β -glucosidase) of polysaccharides showed EC₅₀ correlated with exposure to both Cu and P-enrichment. However, the LAP bioassay, which is more linked to the nitrogen cycle for the degradation of the leucine aminoacid, allowed us to discriminate between the effect of metal contamination and the addition of the nutrient in order to evaluate Cu-induced community tolerance of heterotrophs in the presence of P. This suggests a possible higher interaction of P and C biogeochemical cycles than P and N biogeochemical cycles in a context of Cu contamination.

4. Conclusion

In the global context of assessing the impacts of complex pollution on microbial community diversity and function in natural ecosystems, one of the most critical points remains the distinction between the relative effects of selective pressures resulting from xenobiotic pollution and those resulting from associated nutrients (i.e. eutrophication). Thus, it is crucial to differentiate toxicant effects from phosphorus effects in order to investigate functional diversity in the biofilm, using a set of various physiological parameters targeting autotrophic and heterotrophic microbial communities to discriminate toxicant (Cu and diuron) impacts according to modes of action. Previous studies that have investigated the coupled effects of toxicants and phosphorus have generally reported contradictory results. Although these results are highly dependent on experimental conditions, the inconsistencies probably stem from the fact that most studies have only focused on one microbial compartment of the biofilm (mainly algae) with one single functional descriptor (photosynthesis, algal biomass, etc.). This study highlights that results vary according to the toxicant considered and the

functional descriptor used, confirming the need to focus on functional diversity using complementary indicators for ecotoxicological investigations in river biofilms.

Acknowledgments

The authors thank M. Coquery, C. Margoum, J. Gahou and F. Lahjiouj for chemical analysis, B. Motte for field sampling, S. Jacquet and A Bouchez (INRA) for their help in bacterial enumeration and pigments analysis and the ATT company for english reviewing. We thank the Onema (French National Agency for Water and Aquatic Ecosystems) for providing financial support.

C.II. Les conséquences de l'acquisition de tolérance par les communautés microbiennes du biofilm, dans un contexte de pollution multiple par des métaux lourds (article 4)

Les systèmes lotiques ne sont pas soumis à une seule pression anthropique mais à un ensemble de polluants de nature variable (pesticides, métaux lourds, nutriments...). De ce fait, comprendre les effets interactifs des facteurs multiples de stress sur les écosystèmes est de plus en plus une préoccupation majeure. Notre étude avait pour objectif de vérifier l'hypothèse que l'acquisition de tolérance vis à vis d'un toxique par les communautés microbiennes des biofilms pouvait avoir des conséquences sur la tolérance de ces communautés vis-à-vis d'un autre polluant. Pour cela nous nous sommes basés sur les données obtenues ultérieurement au niveau de notre site d'étude (la rivière Morcille) où des gradients de cuivre, de zinc et d'arsenic ont été observés de l'amont vers l'aval de la rivière. Les biofilms ont donc été exposés chroniquement et séparément à des concentrations environnementales de ces trois métaux dans des canaux installés au laboratoire, alimentés avec de l'eau provenant du site non pollué de la Morcille. La spécificité du PICT a été estimée par l'évaluation des phénomènes de co-tolérance mais aussi du coût de la tolérance qui pourraient exister entre ces différents métaux testés. L'efficacité photosynthétique ainsi que la respiration induite par un substrat carboné, ciblant respectivement les communautés autotrophes et hétérotrophes du biofilm ont été utilisées en tant que descripteurs fonctionnels du PICT dans des bioessais à court terme avec du cuivre, du zinc et de l'arsenic pour évaluer la sensibilité des biofilms pré-exposés à ces trois métaux testés. De plus, les profils de diversité des communautés phototrophes, procaryotes et eucaryotes des biofilms préalablement exposés à ces différents métaux ont été analysés par analyse en composante principale.

Les résultats de notre étude ont montré que la pré-exposition aux métaux a induit des changements structurels des communautés microbiennes des biofilms et conduit à une augmentation de la tolérance-induite de ces communautés (phototrophes et hétérotrophes) vis à vis du métal auquel elles étaient exposées. Par ailleurs, quelque soit le paramètre fonctionnel utilisé, les communautés pré-exposées au cuivre étaient aussi plus tolérantes au zinc, et *vice versa* (confirmant ainsi les données de la littérature). Par contre, seules les communautés phototrophes pré-exposées à l'arsenic ont développé une tolérance vis-à-vis du cuivre et non vis-à-vis du zinc. Enfin, les communautés phototrophes et hétérotrophes pré-exposées au cuivre et au zinc sont devenues plus sensibles à l'arsenic, reflétant ainsi un possible coût de la

tolérance acquise. D'une manière générale, nos résultats confirment le fait que bien que les modes d'action des différents métaux soient des facteurs important pour la structure et donc la tolérance acquise des communautés, il semble que les modes de détoxification mis en place par les organismes, modulent fortement les phénomènes de co-tolérance.

Les résultats et interprétations de cette étude sont présentés dans l'article 4 intitulé « An experimental study on tolerance patterns to multiple metal exposures of heterotrophic and autotrophic biofilm communities » et soumis à la revue *Science of the Total Environment*.

Article 4

**An experimental study on tolerance patterns to multiple
metal exposures of heterotrophic and autotrophic biofilm
communities**

A. TLILI, M. MARECHAL, A. BERARD, B. VOLAT & B. MONTUELLE

Science of the Total Environment (soumis)

An experimental study on tolerance patterns to multiple metal exposures of heterotrophic and autotrophic biofilm communities

Ahmed Tlili^a, Marjorie Maréchal^a, Annette Bérard^b, Bernadette Volat^a, Bernard Montuelle^{a,c}

a. CEMAGREF, UR MAEP, 3 Quai Chauveau CP 69336 Lyon Cedex 09, France

b. INRA UMR CSE-EMMAH 1114, Domaine Saint Paul - Site Agroparc 84914 Avignon Cedex 9, France

c. INRA UMR EMMAH 1114, Domaine Saint-Paul - Site Agroparc 84914 Avignon Cedex 9, France

Abstract

Understanding the interactive effects of multiple stressors on ecosystems has started to become a major concern. The aim of our study was therefore to evaluate the consequences of a long-term exposure to environmental concentrations of Cu, Zn and As on the pollution-induced community tolerance (PICT) of lotic biofilm communities in artificial indoor channels. Moreover, the specificity of the PICT was assessed by evaluating co-tolerance and the cost of tolerance patterns for these metals. Photosynthetic efficiency and substrate-induced respiration (SIR), targeting the autotrophic and heterotrophic communities respectively were used in short-term inhibition bioassays with Cu, Zn and As to assess sensitivities of pre-exposed biofilms to the metals tested. Diversity profiles of a phototrophic, eukaryotic and prokaryotic community in biofilms following the different treatments were determined and analyzed with principal component analysis. The results demonstrated that pre-exposure to metals induced structural shifts in the community and led to tolerance enhancements in the phototrophic and heterotrophic communities. On the other hand, whatever the functional parameter used (i.e. photosynthesis and SIR), communities exposed to Cu were more tolerant to Zn and vice versa. Furthermore, only phototrophic communities pre-exposed to As developed tolerance to Cu but not to Zn, whereas no co-tolerance between Cu and As was observed in the heterotrophic communities. Finally, phototrophic and heterotrophic communities exposed to Cu and Zn became more sensitive to As, reflecting a possible cost of enhanced tolerance. Overall, our findings support the fact that although the mode of action of the different metals is an important driver for the structure and thus the tolerance of the communities, it appears that the detoxification modes are the most important factors for the occurrence of co-tolerance.

Keywords: co-tolerance, ecological cost, river biofilm, metal toxicity.

1. Introduction

Considering the variability of aquatic environments, the multitude of contaminants and the inherent resistance and structural characteristics of communities, which are in turn dependent on species interactions and history of previous exposure, the assessment of the long-term impacts of chemical contamination of an environment is a complex issue. It is essential therefore to apply approaches that take into account biological and chemical complexity and variability of natural ecological systems to deal with the effects of metal pollution, and community ecotoxicology seems to be suitable for that (Clements and Rohr 2009). Lotic biofilms (attached microbial communities of autotrophic and heterotrophic, eukaryotic and prokaryotic populations) play a fundamental role in the aquatic trophic web and geochemical cycles (Battin et al, 2003). Indeed, biofilms are major sites for the uptake, processing and storage of dissolved organic carbon in lotic ecosystems. Because of their structural and functional complexity, biofilms integrate the effects of environmental conditions and are therefore considered as good early warning indicators of toxicants in aquatic ecosystems (Montuelle et al. 2010).

Pollution-induced tolerance could be defined as the capacity of an organism to cope with unfavourable environmental conditions resulting from the anthropogenic input of one or more pollutants into the environment. Previous studies have shown that gaining tolerance to toxicants could be the consequence of physiological acclimations of organisms during exposure, or of genetic adaptations (Bérard et al. 1998, Taylor and Feyereisen 1996). It is well recognized that the genetic adaptation is mainly due to the natural variability of the organisms' resistance toward pollutants (Clements and Rohr, 2009), which leads to the elimination of the most sensitive and the development of the most tolerant ones under chemical stress. Increased adaptation could therefore be analyzed as a consequence of the impact of xenobiotics on the local biodiversity and on the ecological status in general.

Based on these considerations, Blanck et al. (1988) proposed the concept of pollution-induced community tolerance (PICT) as an ecotoxicological tool that provides a good approach for environmental status characterization, useful not only for assessing immediate impact but also for taking into account the contamination history of the ecosystem at the community level. It is also a tool that allows a better understanding of the ecological drivers in adaptation processes. The PICT is based on the fact that pollutants will exert a selection pressure and only the tolerant organisms will resist conferring a high tolerance to the whole community. Assessing the acquisition of tolerance is a method that should also try to establish

a specific cause-effect relationship between one pollutant and its impact on biological communities. Indeed, the PICT approach is primarily a measure of the sensitivity of biological communities to a toxicant based on short-term bioassays, combined with taxonomic analysis (Tlili and Montuelle, 2010). However, some issues still need to be clarified: Is it possible to target the specific effect of a given compound when modes of action and detoxification mechanisms are similar among chemicals thus leading to the same selection pattern? What are the consequences of enhanced tolerance to one stressor in the case of the occurrence of a new and different stressor?

In theory, PICT increase should be related to the selection pressure of one toxicant and thus reflects its presence in the ecosystem. However, this specificity is not absolute, and co-tolerance could occur, which should not be confused with the “multiple tolerance” of a community subjected to exposure by several toxicants simultaneously. Co-tolerance is mainly caused by substances having a similar mode of action (Bérard et al. 2003, Molander 1991, Soldo and Behra 2000) or inducing a similar detoxification mechanism (Gustavson and Wängberg 1995). According to Molander (1991), two classes of mechanisms at biochemical level could induce co-tolerance. The first concerns tolerance mechanisms related to the uptake, translocation or metabolization/excretion of the toxicant, while the second is related to modifications of the target site or of by-pass reactions. Previous studies have reported the occurrence of co-tolerance in biofilm communities between Cu and metals such as Zn or Ni (Gustavson and Wängberg 1995, Ivorra et al. 1999, Soldo and Behra 2000). In soil environments bacterial co-tolerance to toxicants have been studied using thymidine and leucine incorporation techniques (e.g. Diaz-Ravina et al., 1994; Baath et al., 1998; Demolling and Baath, 2008). Nevertheless, co-tolerance is still insufficiently studied, especially since almost studies that have addressed this issue in aquatic environments, were focused on the phototrophic component despite the importance of the heterotrophic one.

In addition to its methodological interest, comparative ecotoxicology that is the basis of the PICT approach is also useful for understanding the consequences of enhanced tolerance. Acclimating or adapting to one set of environmental stressors may increase community susceptibility to novel stressors, suggesting a potential cost associated with greater tolerance (Clements and Rohr 2009, Wilson 1988). Generally there is a consensus about the role of the biological diversity in the adaptation to changing environmental conditions. The concept of "insurance policy" which stipulates that each species has advantages that enable it to deal successfully with certain environmental circumstances, explains why a more diversified system should be more stable (Mertz et al. 2007). The elimination of the most sensitive

genotypes by pollution means the diminution of genetic variability and leads to a population specifically tolerant to that pollution, thus reducing the ability of the populations to cope with future disturbances. Kashian et al. (2007) and Zuelling et al. (2008) both reported that benthic communities pre-exposed to metals were highly tolerant to metals, as predicted by the PICT hypothesis, but significantly more sensitive to UV-B radiation, in comparison to reference communities. Despite the evident advantage of tolerance acquisition for maintaining an ecosystemic process exposed to a given disturbance, it is clear that higher tolerance could also signify an alteration of community's efficiency to tolerate additional disturbances and therefore less ability to insure the ecosystem's recovery (Tobor-Kaplon et al., 2005).

In this experimental study, we tested the hypothesis that long-term exposure of lotic biofilm communities to a metal could lead to specific increased tolerance toward this metal and to an increase (or a decrease) of tolerance towards other metals to which they are naive. To confirm our hypothesis, we investigated the consequences of long-term exposure to environmentally realistic concentrations of Cu, Zn and As on biofilm community structure and their tolerance in artificial indoor channels. Various physiological parameters (targeting the autotrophic and heterotrophic communities) were used in short-term inhibition tests with Cu, Zn and As to assess sensitivities of pre-exposed biofilms to the metals tested.

2. Material and methods

2.1. Sampling site

The study was carried out on a small first-order stream (7 km long) (the Morcille river) which is subjected to strong agricultural pressure, essentially exerted by vineyards that occupy almost 80% of the 8.5 km² catchment area and is characterized by an increasing and permanent heavy metal gradient (Coquery, M. and Gahou, J., pers.com, Dorigo et al., 2010) along the river. Cu, Zn and As are three of the metals most often detected. For the laboratory experiments, water carrying biofilm cells was collected from the Morcille River at the upstream, reference site.

2.2. Experimental design

To conduct this study, we used a total of 12 indoor glass channels (63 cm long, 11 cm wide and 4 cm deep) supplied with river water from the unpolluted reference site, which had been filtered through a 50- μ m mesh to remove most of the grazers. During all the study, the experimental channels were used in recirculating mode: 5 L of water were recirculated at a

rate of 1.2 L/min from a glass beaker located at the end of each channel through centrifugal pumps. All the glass beakers were placed in a refrigerated water bath for temperature control, and a tap at the head of each channel allowed similar flow regulation between all the experimental systems.

Biofilms colonized and grew for 5 weeks on artificial substrates (60 frosted glass disks of 1.5 cm² and 15 frosted glass slides of 18 cm²) installed horizontally in each channel. At the start of the experiment, the three channel replicates were contaminated separately with one of the three tested metals with a nominal concentration of 10 µg.L⁻¹ of Cu, added as CuSO₄ (Merck, 99% purity), 35 µg.L⁻¹ of Zn added as ZnSO₄ (Sigma-Aldrich GmbH, 98% purity) and 15 µg.L⁻¹ of As added as Na₂HAsO₄ (Sigma-Aldrich GmbH; 98% purity). The three remaining channels were used as controls (no metals added). The toxicant (Cu, Zn and As) concentrations used in our study were similar to the maxima observed in Morcille river in late spring/early summer.

The water was kept at a temperature of 18°C (± 1°C), and exposed to a light intensity of 260 µmol m⁻²s⁻¹ under an 18:6 hr light/dark regime. These physical parameters were checked daily throughout the experiment. During the experiment, the channel water was replaced twice a week with 50-µm mesh-filtered water from the reference site to avoid nutritional deficiency, and depending on the experimental design, supplemented with Cu, Zn or As in order to maintain the nominal exposure.

2.3. Biofilm sampling

After five weeks of growth, biofilms were sampled and analyses performed: Total biomass (glass disks), bioassays (photosynthetic efficiency and substrate-induced respiration on glass disk and glass slides respectively) and chemical analysis (glass slides) were performed immediately, whereas others (molecular and pigment analysis on big slides and small disk respectively) were performed subsequently on deep-frozen (-80°C) samples.

2.4. Physico-chemical analysis

Parameters including oxygen (%), pH, conductivity, temperature and light were measured daily in each channel. In addition, 200 mL of water were collected from each channel to measure DOC (dissolved organic carbon), PO₄³⁻ and SiO₂ concentrations just before and 1 hour after water renewal. Measurements were done following French standard operating procedures and protocols (AFNOR). The laboratory which conducted the chemical analysis is

accredited by the French Accreditation Committee (COFRAC) (accreditation number: 1-1238).

In order to measure the total dissolved Cu, Zn and As concentrations in the channels before and after each water renewal, 50 mL from each channel were filtered (Nylon Membrane Filters 0.2 μm , Whatman, Maidstone, UK) and acidified with 1% of Supra pure nitric acid before storage at 4°C until analysis. Filtered samples were analyzed using inductively coupled plasma mass spectrometry (ICP-MS X Series II, Thermo Electron).

For quantification of total and internalized metals in biofilm, 4 pooled big glass slides (total surface area 72 cm^2) per channel were scraped using a polypropylene spatula and the biofilm suspended in 40 mL of 0.2 μm Nuclepore-filtered water from the reference site. This suspension was divided into two fractions. Fraction one (20 mL) was treated with 320 μL of 4.0 mM EDTA (final concentration) to quantify internalized Cu, Zn and As, and fraction two was used to quantify total in-biofilm Cu, Zn and As. Biofilm suspensions were then treated following Tlili et al. (2010a). Briefly, biofilms were filtered (cellulose nitrate 0.45 μm membrane, Millipore) and dried for 24h at 50°C. Dry samples were digested with 3 ml of concentrated nitric acid (Supra pure) and 1 ml of 30% hydrogen peroxide in a high-performance microwave oven (Milestone, Ethos sel) and 25 mL Milli-Q water was added to dilute the acid concentrate. The water samples were analyzed following the same procedure as for total dissolved metal concentrations in water. The percentage internalization for each metal was determined by dividing the concentration of internalized metal in cells (after EDTA treatment) by the total concentration measured in the biofilm matrix (without EDTA treatment).

2.5. Total and phototrophic biomass

The organic matter content in 3 pooled small disks (4.5 cm^2 / channel) was calculated as described in Tlili et al. (2008). Results are expressed as $\text{g}\cdot\text{m}^{-2}$. Chlorophyll-*a* content in biofilm was considered to be an indicator of the phototrophic biomass (Bonin and Travers, 1992) and was quantified by HPLC analysis. The chlorophyll-*a* was quantified using external calibrations of standard chlorophyll-*a* (C55H72MgN4O5, Carl Roth GmbH & Co). Final concentrations are given as $\mu\text{g}\cdot\text{cm}^{-2}$ (see 2.7.1 for analytical details).

2.6. Biofilm function analysis

2.6.1. Photosynthetic efficiency

In order to measure the maximum photosynthetic efficiency, we used the Pulse of Amplitude Modulated fluorometry (PhytoPAM, Heinz Walz, GmbH) technique. Three small disks per channel were sampled and after 30 minutes of dark adaptation, they were submitted to a single saturation pulse allowing the measurement of the maximum quantum yield ($Y_{II_{665nm}}$), which is an indicator of the photosynthetic efficiency, as:

$$Y_{II_{665nm}} = \frac{F_m - F_0}{F_m}$$

where F_m is the maximum fluorescence after the saturation pulse and F_0 is the steady-state fluorescence.

2.6.2 Substrate-induced respiration

The substrate-induced respiration (SIR) of the heterotrophic biofilm communities was measured using the MicroRespTM method according to Tlili et al. (2010b). MicroRespTM system is a colorimetric method well described by Campbell et al. (2003) and consists of two microplates (96 wells) placed face to face. One of these is a deep-well microplate (1.2 mL capacity, 96-deep-well microplate, NUNC) in which each well contains the biofilm sample with the carbon source, and the second microplate (detection microplate) contains a pH indicator dye that changes proportionally to the amounts of CO₂ released by heterotrophic communities.

Biofilm was scraped off substrata (4 pooled glass slides / channel) and suspended in 60 mL of 0.2 µm Nuclepore-filtered water from the reference site. This suspension was divided into two fractions: the first (30 mL) was used for the SIR and basal respiration measurement and the second (30 mL) for the SIR bioassays (see 2.6.3).

Briefly, 500 µL of biofilm suspensions were distributed in the deep-wells and 30 µL of glucose solution (carbon source) were added with final concentration of 6.2 mg of C per mL. After positioning the detection microplate, the system was sealed and incubated for 15 hours in the dark at room temperature (20 ± 1 °C). CO₂-trapped absorbance was measured at 570 nm immediately before sealing to the deep well plate, and after 15 h incubation. The results were expressed in µg CO₂.mg⁻¹AFDW.h⁻¹. In addition to the SIR measurements, the basal respiration (without glucose addition) was measured for each biofilm. Results of induced-respiration with glucose were normalized by the basal respiration to target only the heterotrophic communities (Tlili et al. 2010b).

2.6.3. Biofilm phototrophic and heterotrophic sensitivity measurements to Cu, Zn and As

To investigate sensitivities (pollution-induced community tolerance, PICT) to Cu, Zn and As, acute toxicity tests with pre-exposed and control biofilm samples from all the channels

were performed. Photosynthetic efficiency and substrate-induced respiration (targeting phototrophic and heterotrophic communities respectively) were used as functional parameters in these bioassays.

Stock solutions containing $2 \cdot 10^{-1}$ M Cu (CuSO_4 ; Merck high-purity grade) or 2 M Zn ($\text{ZnSO}_4 \cdot 7\text{H}_2\text{O}$; Sigma high purity grade) or $2 \cdot 10^{-1}$ M As (NaHAsO_4 ; Sigma high-purity grade) were prepared in milli-Q water and stored at 4°C prior to dilution in the test vessels. Semi-logarithmic series of concentrations were freshly prepared by serial dilutions of the stock solutions in $0.2 \mu\text{m}$ -filtered water from the reference site. For photosynthetic bioassays (3 blanks and 3 replicates for each of the 6 increasing concentrations), final test concentrations ranged from 0 to $2 \cdot 10^3 \mu\text{M}$ for Cu, from 0 to $6 \cdot 10^3 \mu\text{M}$ for Zn and from 0 to $2 \cdot 10^5 \mu\text{M}$ for As, whereas for SIR bioassays (3 blanks and 3 replicates for each of the 9 increasing concentrations) they ranged from 0 to $2 \cdot 10^4 \mu\text{M}$ for Cu and As, and from 0 to $2 \cdot 10^5 \mu\text{M}$ for Zn.

- *Short-term photosynthetic bioassays*: Biofilms from each channel (small glass disk) were exposed to increasing concentrations of Cu, Zn and As during 2, 4 and 2.5 hours respectively, under the same light intensity and temperature conditions as their growth. Measurements were performed using a PhytoPAM fluorometer and the relative inhibition of photosynthetic efficiency at 665 nm in relation to the control was calculated using a dose-response relationship to measure the EC_{50} for each bioassay. The durations of the bioassays with the different metals were determined during a previous step to know the minimum of incubation time allowing inhibition of photosynthetic efficiency by 50%.

- *Short-term SIR bioassays*: Biofilm suspensions were distributed in deep wells (500 μL per well), to which we added 50 μL of the metal solutions (increasing concentrations). The microplate was then pre-incubated in the dark at room temperature for 3 hours (to cope with artefacts causing chemical release of CO_2), and then 30 μL of the glucose solution ($120 \text{ mg} \cdot \text{mL}^{-1}$) was added to each well and the detection microplate was positioned. Incubation and CO_2 measurements were processed afterwards as described above (section 2.6.2). EC_{50} values were calculated from dose-response curves by plotting biofilm CO_2 production at each metal concentration.

2.7. Biofilm structure analysis

2.7.1. Phototrophic pigment identification by high-performance liquid chromatography (HPLC)

Three pooled glass disks (4.5 cm² / channel) were selected and processed for HPLC pigment analysis as described in Tlili et al. (2008). Identification of the different pigments was performed depending on their specific retention times and absorption spectrum using DAD according to SCOR (Jeffrey et al., 1997). A table was constructed (with samples as rows and pigments as columns) by taking into account the relative abundance of each pigment in a given sample (expressed as a percentage of the sum of the area of all the pigments in a sample). In addition, a quantitative method from a calculation model based on published ratios for cultures containing a mixture of different algae (Wilhem et al. 1991) was used to determine the relative abundance of diatoms, cyanobacteria and green algae from their specific pigment signatures (fucoxanthin, zeaxanthin and lutein, respectively). Final concentrations are given as µg.cm⁻².

2.7.2. Eukaryotic and prokaryotic community structure assessed by denaturing gradient gel electrophoresis (DGGE)

Determination of the eukaryotic and prokaryotic composition was performed according to Dorigo et al. (2007). Briefly, biofilm from each channel was scraped off 1 big glass substratum, then centrifuged at 14,000 g for 30 minutes at 4°C and the supernatant was removed. Nucleic acid was extracted from the biofilm pellets using the DNAeasy Plant kit (QIAGEN) following the manufacturer's instructions. PCR amplification of eukaryotic 18S rRNA gene fragments, and prokaryotic 16S rRNA gene fragments, and their DGGE analysis were performed according to Tlili et al. (2008). After migration, separated PCR products were stained for 45 min in the dark with SYBRGold (Molecular probes), visualized on a UV transilluminator (Clavision), and photographed (Scion Corporation camera). Prokaryotic- and eukaryotic-DGGE profiles were analyzed by the GelCompar II software (Applied Math NV) leading to a matrix based on the quantification of relative band intensities. Furthermore, diversity based on the Shannon indexes was calculated for all the samples.

2.8. Statistical data processing

EC₅₀ values were calculated by means of the Regtox model (E. Vindimian, <http://eric.vindimian.9online.fr/>).

The effects of long-term exposure to each metal on total and % of internalization of each metal into the biofilm matrices ($n = 3$), AFDW ($n = 3$), algal biomass ($n = 3$), photosynthesis and SIR EC₅₀'s values ($n = 3$), SIR ($n = 3$), photosynthetic efficiency ($n = 3$), and Shannon index ($n = 3$) values were tested by factorial 1-way ANOVA on XLSTAT software (2009 version). If a main effect was significant, the ANOVA was followed by a Tukey-HSD test.

Structural data including DGGE - 18S and 16S rRNA (relative band intensities), and phototrophic pigment identification (relative abundances normalized by chlorophyll-*a*) were used to determine eukaryotic, prokaryotic, and phototrophic pigment diversities respectively. Before their use in the analysis, data were $\log_{10}(x + 1)$ transformed and then submitted to detrended correspondence analysis (DCA). The lengths of all the gradients (1.399; 0.861; 0.789 and for eukaryotes; prokaryotes and phototrophs respectively) indicated that linear methods were also appropriate for all the structural endpoints. Principal component analyses (PCA) were therefore performed, using CANOCO software version 4.5 (ter Braack and Smilauer 1998).

2. Results

2.1. Physico-chemical data

Physico-chemical parameters from the reference site and from channel water samples are given in Table 1. Oxygen concentrations and pH were quite similar between the different treatments, whereas in all the channels compared to the reference site, a decrease in phosphates and silicates and an increase in DOC were detected. Control channels presented lower conductivity than Cu-, Zn- and As-contaminated channels.

The Cu, Zn and As concentrations in the water of the control channels were $2.1 \pm 0.3 \mu\text{g.L}^{-1}$, $7.6 \pm 2.4 \mu\text{g.L}^{-1}$ and $1.2 \pm 0.1 \mu\text{g.L}^{-1}$ respectively. In the water of Cu-contaminated channels, Cu concentration was $10.3 \pm 1.7 \mu\text{g.L}^{-1}$ whereas Zn and As concentrations were similar to those of the controls (6.8 ± 2.6 and $1.2 \pm 0.2 \mu\text{g.L}^{-1}$ respectively). In the Zn-contaminated channels, Zn concentration was $28 \pm 6.7 \mu\text{g.L}^{-1}$ and no difference with the control channels for Cu ($2.6 \pm 0.7 \mu\text{g.L}^{-1}$) or As ($1.2 \pm 0.2 \mu\text{g.L}^{-1}$) concentrations was observed. Arsenic concentrations in the water of As-contaminated channels was $15.8 \pm 1.5 \mu\text{g.L}^{-1}$ whereas Cu and Zn concentrations were similar to those measured in the control channels (2.5 ± 0.8 and $7 \pm 3.1 \mu\text{g.L}^{-1}$ respectively).

Table.1 Mean values (\pm standard deviation, $n = 3$) of selected chemical parameters at the Saint Joseph site (reference), within the control channels and within channels contaminated by Cu, Zn and As, just before replacing water in the channels with water from the saint Joseph site at the sampling date (i.e. week 5).

Channel	pH	Oxy (mg.L ⁻¹)	cond. (μ S.cm ⁻¹)	DOC (mg.L ⁻¹)	PO ₄ ³⁻ (mg.L ⁻¹)	SiO ₂ (mg.L ⁻¹)
Saint-Joseph	7.62 ± 0.04	8.94 ± 0.14	227.44 ± 1.54	2.63 ± 0.12	0.06 ± 0.01	14.67 ± 0.58
Control	7.37 ± 0.09	8.74 ± 0.28	278.00 ± 4.36	6.28 ± 0.52	0.04 ± 0.04	9.30 ± 2.20
Cu	7.49 ± 0.13	8.70 ± 0.12	278.00 ± 6.24	5.65 ± 0.44	0.02 ± 0.02	9.83 ± 2.40
Zn	7.55 ± 0.07	8.72 ± 0.40	287.00 ± 0.40	6.97 ± 0.32	0.03 ± 0.02	6.93 ± 0.76
As	7.55 ± 0.05	8.98 ± 0.08	295.00 ± 3.61	6.15 ± 0.22	0.03 ± 0.00	9.50 ± 3.82

Cu, Zn and As concentrations accumulated (total and % internalization) in biofilms are summarized in Table 2. The amounts of total Cu in the Cu-exposed biofilms were higher than those measured in the controls, and the same trends were observed for Zn and As concentrations in the Zn- and As- exposed biofilms respectively (Tukey test $p < 0.05$). In the Cu- and Zn- exposed biofilms, the % of internalization of Cu and Zn were significantly lower than in the control biofilms (Tukey test $p < 0.05$), whereas no difference was observed for the % of internalization of As, in comparison with the control biofilms. For the As-exposed biofilms, no significant difference was observed in the % internalization of Cu, Zn and As, in comparison with the control biofilms (Tukey test $p > 0.05$).

Table.2 Concentrations in μ g.L⁻¹ total and percentage of internalization within biofilms of metals (Cu, Zn and As) from the control and contaminated channels. Values correspond to the mean (\pm standard deviation) of concentrations obtained at the biofilms sampling date ($n = 3$).

Channel	Total accumulated metals			% of internalization		
	Cu	Zn	As	Cu	Zn	As
Control	104.3 ± 10.8	680.1 ± 20.8	51.6 ± 5.3	50.6 ± 2.3	60.7 ± 0.3	101.8 ± 0.7
Cu	448.9 ± 66.2	626.0 ± 106.1	53.1 ± 12.2	37.9 ± 2.3	57.2 ± 0.7	101.8 ± 2.5
Zn	95.7 ± 14.9	1461.5 ± 136.3	53.5 ± 5.1	42.1 ± 0.4	51.7 ± 4.5	100.6 ± 7.6
As	99.2 ± 18.3	709.1 ± 140.7	153.0 ± 19.6	51.9 ± 0.5	57.7 ± 5.1	99.1 ± 1.8

2.2. Biomass parameters (Table. 3)

There was no significant effect of Cu, Zn and As pre-exposure on the AFDW (1-way ANOVA, $p > 0.05$). Chlorophyll-*a* concentrations were similar between Cu-, Zn-exposed and control biofilms (Tukey test $p > 0.05$), whereas only pre-exposure to As induced a significant and sharp decrease in the chlorophyll-*a* concentrations (Tukey test $p < 0.001$).

Table.3 Long-term impact (mean values \pm standard deviation, $n = 3$) of Cu ($10 \mu\text{g.L}^{-1}$), Zn ($30 \mu\text{g.L}^{-1}$) and As ($15 \mu\text{g.L}^{-1}$) on total biomass (AFDW), chlorophyll-*a* (chl-*a*), photosynthetic efficiency (Yield) and substrate induced respiration (SIR; normalized by the basal respiration) of control, Cu-, Zn-, and As-exposed biofilms.

Channel	AFDW (g.m^{-2})	Chl- <i>a</i> ($\mu\text{g.cm}^{-2}$)	Yield	SIR
Control	10.33 ± 1.02	80.58 ± 13.83	0.42 ± 0.02	135.03 ± 3.88
Cu	11.74 ± 0.73	81.88 ± 19.69	0.47 ± 0.04	118.09 ± 5.04
Zn	9.41 ± 2.20	84.97 ± 13.98	0.45 ± 0.03	115.56 ± 3.43
As	9.63 ± 3.21	17.81 ± 2.85	0.38 ± 0.01	114.25 ± 3.34

2.3. Biofilm activities

2.3.1. Photosynthetic efficiency (Table. 3)

No significant difference was observed for the photosynthetic efficiency between Cu- and Zn-exposed and control biofilms (Tukey test $p > 0.05$). In contrast, pre-exposure to As induced a significant decrease in the photosynthetic efficiency in comparison with the Cu- and Zn-exposed and control biofilms (Tukey test $p < 0.05$).

2.3.2. Heterotrophic SIR (Table. 3)

Exposure to metals had a significant effect on biofilm SIR (1-way ANOVA, $p < 0.001$). Cu-, Zn- and As-exposed biofilms were characterized by lower SIR than the controls (Tukey test $p < 0.001$). No significant SIR differences were observed between biofilms from the different treatments (Tukey test $p > 0.05$).

2.4. Assessment of biofilm sensitivities to Cu, Zn and As

2.4.1. Photosynthetic efficiency bioassay (Table. 4)

- *Specific tolerance measurements*: Overall, in comparison with the control biofilms, phototrophic communities pre-exposed to Cu, Zn or As showed a significantly higher EC_{50}

values of Cu ($R = 2.65$; Tukey test $p < 0.01$), Zn ($R = 2.64$; Tukey test $p < 0.001$) or As ($R = 224.51$; Tukey test $p < 0.0001$) respectively.

- *Cross sensitivities*: Pre-exposure to Cu induced enhanced tolerance of the phototrophic communities to Zn ($R = 2.96$) but an increase in their sensitivity to As ($R = 0.24$). Likewise, biofilms pre-exposed to Zn showed an increased tolerance to Cu ($R = 2.06$) and also a higher sensitivity to As ($R = 0.51$). Pre-exposure to As led to enhanced tolerance to Cu ($R = 2.88$) but not to Zn ($R = 1$).

2.4.2. SIR bioassay (Table. 4)

- *Specific Tolerance measurements*: Pre-exposure to Cu induced a significant increase of the heterotrophic communities' tolerance to Cu itself ($R = 2.12$; Tukey test $p < 0.01$). Similarly, heterotrophic communities pre-exposed to Zn or to As displayed a higher tolerance to Zn ($R = 11.15$; Tukey test $p < 0.001$) and As ($R = 3.44$; Tukey test $p < 0.001$) respectively.

- *Cross sensitivities*: In addition to their enhanced tolerance to Cu, heterotrophic communities pre-exposed to Cu also increased their tolerance to Zn ($R = 2.90$) and similarly, communities pre-exposed to Zn showed an increase of their tolerance to Cu ($R = 2.23$). On the other hand, pre-exposure of heterotrophs to Cu and Zn led to an increase of their sensitivity to As ($R = 0.24$ and 0.61 respectively). Finally, biofilms pre-exposed to As, did not develop any tolerance or sensitivity to Cu and Zn ($R = 1$).

Table.4 Mean tolerance (\pm standard deviation, $n = 3$) and tolerance or sensitivity ratios (R) ($R > 1 =$ induced tolerance and $R < 1 =$ induced sensitivity) determined for phototrophic (based on photosynthesis bioassays) and heterotrophic (based on SIR bioassays) biofilm communities sampled from the control channels and from contaminated channels with Cu, Zn and As. Ratios were calculated by dividing the EC_{50} (pre-exposure) by the corresponding EC_{50} (control).

	Control	Pre-exposure Cu	Pre-exposure Zn	Pre-exposure As
EC_{50} Photosynthesis bioassays (μM)				
Cu	37.6 ± 5.1	99.5 ± 24.8	77.3 ± 7.4	108.2 ± 9.3
R	1	2.65	2.06	2.88
Zn	1085.5 ± 158.4	3216.5 ± 650.1	2862.8 ± 333.1	1094.6 ± 114.9
R	1	2.96	2.64	1
As	14.0 ± 2.1	3.4 ± 0.8	7.2 ± 1.1	3158.4 ± 399.1
R	1	0.24	0.51	224.51
EC_{50} SIR bioassays (μM)				
Cu	92.5 ± 18.1	196.0 ± 58.6	206.1 ± 62.8	69.3 ± 23.6
R	1	2.12	2.23	1
Zn	232.8 ± 34.4	674.8 ± 61.0	2596.3 ± 80.0	275.4 ± 39.3
R	1	2.90	11.15	1
As	1042.7 ± 124.3	245.7 ± 50.4	637.7 ± 35.4	3586.1 ± 130.0
R	1	0.24	0.61	3.44

2.5. Structural analysis

2.5.1. Phototrophic pigment analysis

The relative abundance of diatoms, cyanobacteria and green algae was influenced by their exposure to the different metals (1-way ANOVA, $p < 0.001$, $p < 0.0001$ and $p < 0.0001$ respectively) (Fig.1). Exposure to Cu, Zn or As induced a same and significant decrease in the abundance of diatoms in comparison with the control (Tukey test $p < 0.05$). On the other hand, only exposure to As led to a large and significant increase of the abundance of cyanobacteria (Tukey test $p < 0.0001$). Finally, green algae were significantly more abundant in the Cu- and Zn- exposed biofilms than in the controls (Tukey test $p < 0.05$), whereas they disappeared completely from the As-exposed biofilms (Tukey test $p < 0.0001$).

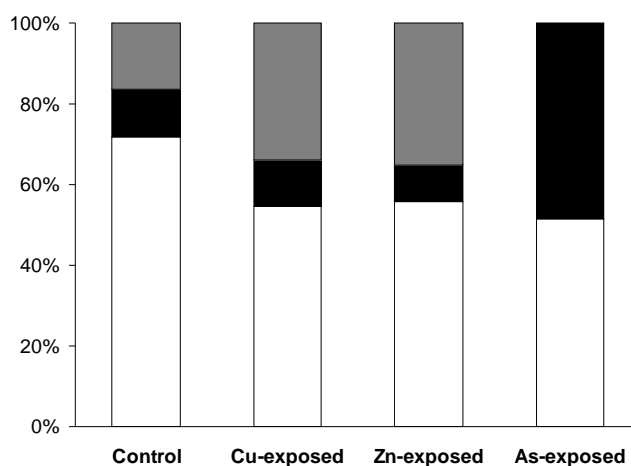

Fig.1 Relative percentages of diatoms (□), cyanobacteria (■) and green algae (▒) (determined by HPLC) in control channels and channels exposed to Cu, Zn and As.

A total of 12 pigments were detected in all samples collected. Among them only 9 (which accounted for at least 2 % in two samples) were included in the PCA (Fig.2). The two first axes (PC1 and PC2) of the PCA accounted for more than 88 % of the total variability. Control biofilms were separated on PC1 from Cu-, Zn- and As- exposed biofilms, whereas PC2 separated As-exposed biofilms from the other ones. PC1 was positively correlated to diadinoxanthin, violaxanthin and carotene, and negatively correlated to the dinoxanthin whereas PC2 was positively correlated to zeaxanthin, and negatively correlated to lutein.

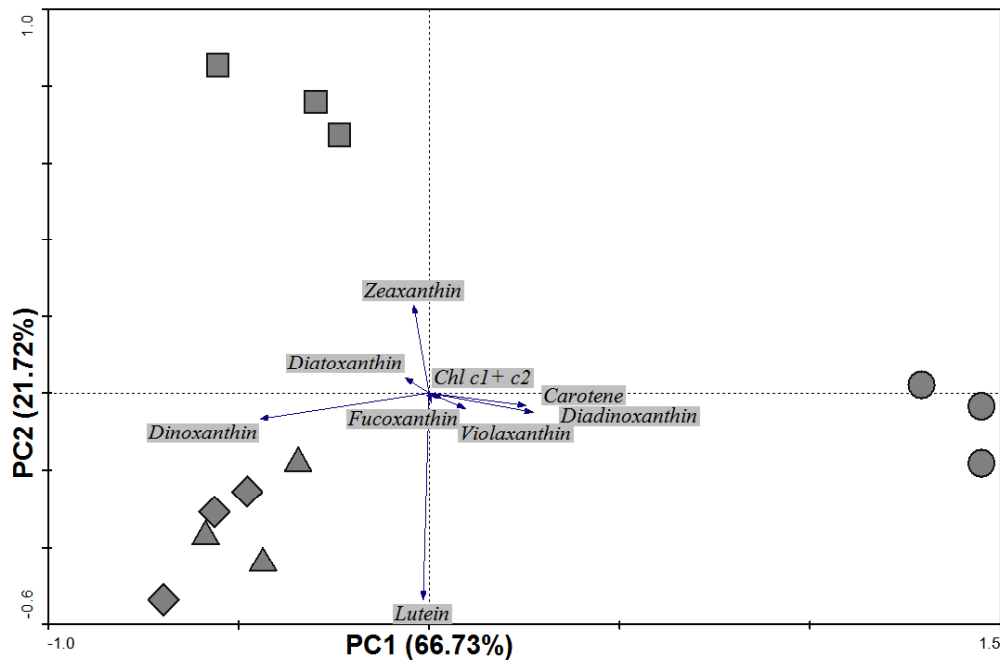

Fig.2 Principal component analysis (PCA) based on the relative abundance of the phototrophic pigments in the collected biofilms from the various channels. Arrows represent the correlation between the PCA axes (PC1 and PC2) and the pigments detected.

2.5.2. Eukaryotic diversity and richness

Table.5 summarizes the Shannon indexes (H) calculated for the eukaryotic community. A total of 41 OTU's were detected after the DGGE analysis. Overall, exposure to metals had a significant effect on "H" (1-way ANOVA, $p < 0.0001$). Eukaryotic communities in the control biofilms showed a significantly higher "H" than Cu-, Zn- and As-exposed ones (Tukey test $p < 0.0001$), and no significant difference was observed between the different exposed biofilms (Tukey test $p > 0.05$).

Table.5 Means (\pm standard deviation, $n = 3$) of Shannon indexes (H) of the eukaryotic (euk) and prokaryotic (prok) biofilm communities sampled from the control channels and from contaminated channels with Cu, Zn and As.

Channel	H. euk	H. prok
Control	4.81 \pm 0.04	4.86 \pm 0.04
Cu	4.35 \pm 0.02	4.44 \pm 0.01
Zn	4.33 \pm 0.02	4.43 \pm 0.02
As	4.36 \pm 0.02	4.34 \pm 0.02

PCA was applied to the bands' relative intensities data for samples from the different channels (Fig.3). The two first axes (PC1 and PC2) explained more than 77 % of the total

variability of eukaryotic diversity. PC1 (39.68%) separated control biofilms very clearly from Cu- Zn- and As-exposed ones, whereas Zn- and Cu-exposed biofilms were separated from control and As-exposed biofilms on PC2 (37.79 %). Overall, in these two projections, there was very low variability between the three replicates in each channel.

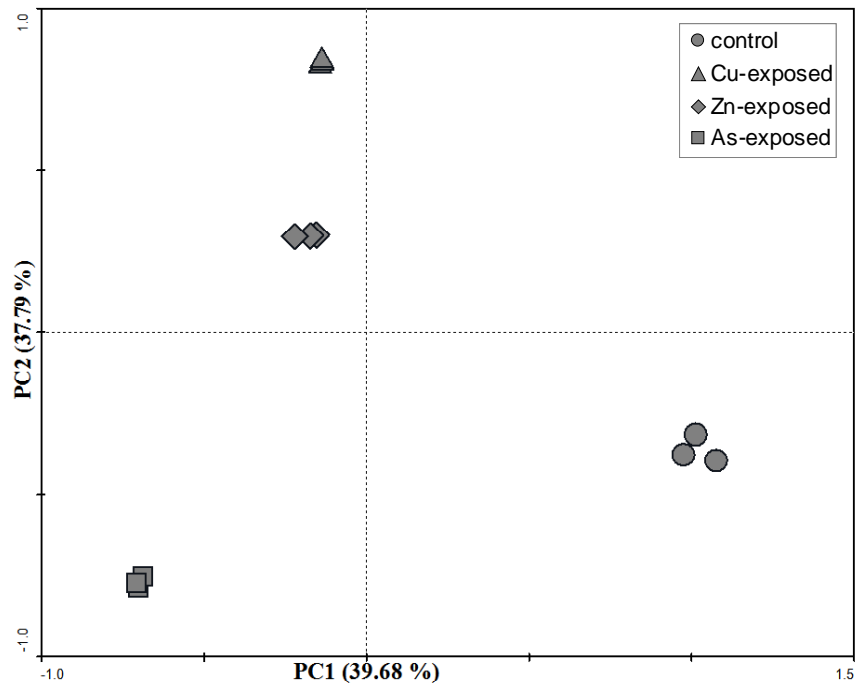

Fig.3 Principal component analysis (PCA) based on the relative band intensities obtained by PCR-DGGE analysis of the 18S rRNA gene fragment of the eukaryotic community in the biofilms collected from the various channels.

2.5.3. Prokaryotic diversity and richness

Table.5 summarizes the Shannon index (H) calculated for the prokaryotic community. Considering overall the biofilm samples, 43 different OTU's were detected after the DGGE analysis. Exposure to Cu, Zn and As induced a significant decrease in the prokaryotic "H" in comparison with the control biofilms (1-way ANOVA, $p < 0.001$). As-exposed biofilms were characterized by the lowest "H" (Tukey test $p < 0.001$), whereas no significant difference was observed between Cu- and Zn-exposed biofilms (Tukey test $p > 0.05$).

PCA performed with the relative band intensity data of samples from different channels (Fig. 4), showed that the first two axes (PC1 and PC2) accounted for more than 69 % of the total variability of the prokaryotic structure. PC1 (37.7 %) separated the As-exposed biofilms very clearly from the control, the Cu- and Zn-exposed biofilms. The second axis, PC2 (31.36 %), separated control and Cu-contaminated channel samples from those taken from the Zn-

and As-contaminated channels. The variability between the three replicates in each channel was also very low.

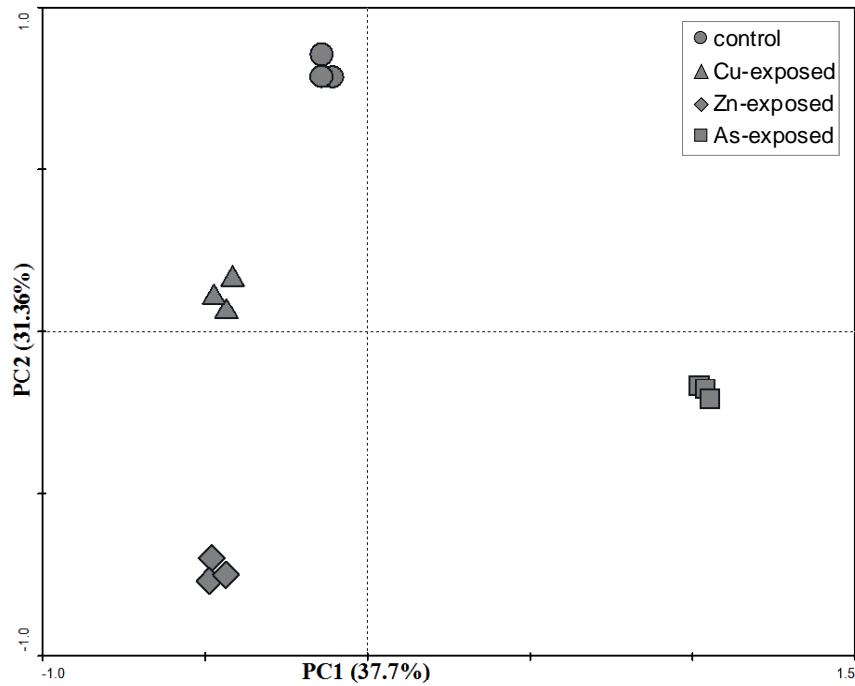

Fig.4 Principal component analysis (PCA) based on the relative band intensities obtained by PCR-DGGE analysis of the 16S rRNA gene fragment of the prokaryotic community in the biofilms collected from the various channels.

4. Discussion

The concentrations of dissolved nutrients, especially PO_4^{3-} and SiO_2 (phosphates are used by all organisms in biofilm, and silicates are principally used by diatoms) at the sampling date in all the channels were very low compared to the initial values (reference site water), suggesting that a rapid uptake of nutrients had occurred in our experimental conditions. The DOC concentrations, however, increased in all the channels, suggesting autochthonous organic matter production by algae. Our physico-chemical measurements also showed a similar increase of the conductivity values in the contaminated channels but not in the control one. These results were expected since the addition of metal ions induces an increase in water conductivity (Guasch et al. 2002). Indeed, conductivity corresponds to the presence of anions and cations in water, and metal inputs in the water generally lead to the increase of these anions and cations (according to the metal speciation) and consequently to increased conductivity.

(i) Exposure to one metal enhances phototrophic and heterotrophic tolerance to this metal but also to others

Some trace metals such as Cu or Zn play indispensable roles in cell growth and maintenance of metabolic functions (De Filippis and Pallaghy 1994). Nevertheless, at high concentrations these trace metals could become toxic (Soldo and Behra 2000). On the other hand, some metals such as As are not required for cell growth and are considered as toxic even at low doses (Hughes and Poole, 1986). Our investigations confirmed the higher toxicity of As than of Cu and Zn, particularly on the phototrophic biofilm component, since they showed that even though there was no difference in total biofilm biomass between the different channels (including the controls), the chlorophyll-*a* content decreased sharply in the biofilms exposed to As, unlike those that were exposed to Cu or Zn, in comparison with the control ones. In addition, the same trend was observed for the photosynthetic activity measurement since only biofilms exposed to As showed lower photosynthesis than the control ones, unlike biofilms exposed to Cu or Zn. It is well known that to counteract the toxic effects of metals, phototrophic cells have evolved various mechanisms to minimize the destructive effects of metals. Previous studies showed that in the presence of Cu or Zn, cells can change their membrane permeability, thus decreasing metal internalization into cells, which is driven chemiosmotically (Soldo 2005, Serra et al. 2009). Nevertheless, As internalization is independent of the membrane permeability, since As is transported into cells actively by two phosphate transporters (Rosen 1996). In our experiment, in comparison with the control biofilms, pre-exposure to Cu and Zn caused a decrease in the percentage of internalization of these two metals, but this was not the case for arsenic. In contrast, pre-exposure to As did not show any significant effects on the percentage of internalization of Cu, Zn or As. These results could therefore explain the negative effects of As on the phototrophic biofilm communities and the lack of effect of Cu and Zn. Conversely, all three metals tested (i.e. Cu, Zn and As) inhibited the heterotrophic activity, based on the SIR measurements, suggesting that only phototrophs could modulate their membrane permeability as a resistance mechanism to metal and not the heterotrophic communities.

In spite of the negative effects, observed on the algal biomass, photosynthetic activity and SIR, enhanced tolerance to the tested metal was observed for all the pre-exposed biofilms. Indeed, over 2-fold increases in the level of tolerance to Cu were observed in phototrophic and heterotrophic communities that were pre-exposed to Cu, when these communities were compared to the controls. Similarly, pre-exposure to Zn also induced more than 2- and 11-fold

enhanced tolerance to this metal in phototrophs and heterotrophs respectively, in comparison with the control communities. On the other hand, As exposure led to a 224-fold higher tolerance to As in phototrophic communities than in control communities, whereas tolerance was enhanced 3-fold in heterotrophs. According to the PICT concept, our results could be related to the fact that these metals provided selection pressure on phototrophs and heterotrophs, inducing a shift in the community structures with the emergence of the most tolerant species (Tlili and Montuelle, 2011). All the structural endpoints in our study, confirmed these assumptions, showing a divergence between all exposed biofilms and the controls. Indeed, HPLC analysis for example, showed that phototrophic communities were structured by exposure to the metals. Overall, even if diatoms were dominant in all the sampled biofilms, Cu, Zn and As exposure induced a decrease in their relative abundance in comparison with the control biofilms. Conversely, the relative abundance of green algae increased after exposure to Cu and Zn and dramatically decreased after As exposure, and the relative abundance of cyanobacteria increased after exposure to As. Numerous studies have also reported the restructuring effect of metals on the phototrophic biofilm communities, with the dominance of green algae in Cu or Zn exposed biofilms (Genter et al. 1987, Serra et al. 2009, Tlili et al. 2010) or the dominance of cyanobacteria after As-exposure (Thiel 1988). Multivariate analysis (PCA) of eukaryotic and prokaryotic diversity and phototrophic pigments analysis also showed that the pre-exposed biofilms were very different from the control ones.

Increases in levels of tolerance to metals other than those that were originally added to the channels were also found for the phototrophic and heterotrophic communities when they were compared with communities obtained from control channels, indicating co-tolerance induction. Indeed, whatever the endpoint used for EC₅₀ measurement (i.e. photosynthesis or SIR), Cu-exposed biofilms showed enhanced tolerance to Zn and vice versa, indicating common tolerance mechanisms for Cu and Zn. Gustavson and Wängberg (1995) or Soldo and Behra (2000) observed such enhanced tolerance to Zn based on photosynthesis bioassays with phytoplankton and periphytic communities respectively after their exposure to Cu. In a soil study, Diaz-Ravina et al. (1994) showed that Zn-exposed or Cu-exposed bacterial communities were characterized by a higher tolerance to both Cu and Zn.

Two hypotheses could explain the co-tolerance induction between Cu and Zn: the first is based on similar modes of action leading to the same selection pressure and thus to the same tolerant species, and the second hypothesis is related to similar modes of detoxification, not necessarily involving the same species.

Our of PCA results for phototrophic pigment and eukaryotic diversity, showed that Cu and Zn exposed biofilms were very similar (following PC2 axis), confirming the hypothesis that Cu and Zn exerted a similar selection pressure on these communities. On the other hand, PCA analysis of the prokaryotic diversity, showed that Cu and Zn exposure did not select a similar community (following PC2 axis), in spite of the occurrence of co-tolerance (based on SIR bioassays). It is well established that even though the exact target sites might differ (Stratton 1987), Cu and Zn share the same modes of action: at high concentrations they could inhibit the photosynthesis reaction by blocking electron transfer at PSI and PSII levels, and consequently stop oxygen release and CO₂ fixation (Serra et al. 2009, Ivorra et al. 1999). Moreover, Zn and Cu could act negatively on the respiratory activities (Nalewajko and Olaveson 1994) or on some enzymes by oxidation of their sulphhydryl groups (Hughes and Poole 1989). Given these similar modes of action, pre-exposure to Cu or Zn could therefore promote the development of the same tolerant organisms (i.e. phototrophs) or different organisms but possessing the same resistance mechanisms (i.e. heterotrophs) against these two metals. Among the different mechanisms that could explain the observed co-tolerance, binding or sequestration of metals by metallothionein and similar proteins are proven. Metallothioneins are small, cysteine-rich proteins that bind heavy metals such as Cu and Zn, and contribute to metal detoxification, homeostasis and metal transfer (Rosen 1996). Cu and Zn share a similar affinity for various metallothioneins such as the Cu-thionein or the metallothionein-like proteins in eukaryotes, and the Cd-BP1 or Cd-BP2 in prokaryotes (Weser et al. 1977, Higham et al. 1984). Overall, we can assume that the occurrence of co-tolerance between Cu and Zn is modulated by similar modes of action and detoxification for phototrophic communities, and mostly by similar detoxification modes for heterotrophic communities.

Interestingly, exposure to As increased the tolerance of phototrophic communities to As and Cu and not their tolerance to Zn, while exposure to Cu or Zn did not induce any enhanced tolerance to As. Our findings are in accordance with those obtained by Blanck and Wängberg (1991) which showed that As specifically selected traits with increased As tolerance in phytoplankton communities, but at the same time also selected species with a large genetic variability that allowed more general tolerance increases. Unlike Cu and Zn exposure, exposure to As was shown here to increase the relative abundance of cyanobacteria . We indicated previously that As may be transported into cells by phosphate carriers and can then interfere with many enzymatic reactions involving phosphate, e.g. oxidative and photosynthetic phosphorylation (Rosen, 1996). According to Thiel (1988), cyanobacteria have

the ability to discriminate between phosphate and As and are therefore tolerant to this metal. Moreover, cyanobacteria are also tolerant to Cu (Barranguet et al. 2000, Roussel et al. 2007). This could explain the enhanced tolerance of phototrophs to Cu after exposure to As.

Conversely, pre-exposure to As in our study, did not enhance tolerance (based on SIR bioassays) of heterotrophic biofilm communities to Cu or Zn. One of the hypotheses that could explain these results is related to the selection pressure that could be exerted differently by the metals tested, leading to completely different heterotrophic communities. Indeed, analysis of prokaryotic diversity, showed that Cu, Zn and As exposure led to dissimilar prokaryotic communities. However, this assumption does not seem to be as important for explaining our results, because in this case, no co-tolerance should be observed between Cu and Zn for the heterotrophic communities, which was not the case in our study. A reasonable interpretation of our findings may be therefore the specificity of the mechanisms involved in As tolerance by heterotrophic communities. Many prokaryotic resistance mechanisms to metals are determined by genes located on plasmids (Rosen 1996). In bacteria, the genes for As detoxification are usually encoded by operons located on plasmid R773 that confer resistance to arsenicals by ATP-coupled extrusion of arsenite from the cells (Baker-Austin et al. 2007). Plasmid p1258 catalyzes Cu and Zn transport, but also Ag, Cd and Pb transport (Solioz and Odermatt 1995, Rensing et al. 2000, Tsai et al. 2002). This may explain the co-tolerance observed between Cu and Zn, and not with As, for heterotrophic communities (e.g. bacteria).

Overall, our findings suggest that the occurrence of co-tolerance does not necessarily follow the same patterns, since it depends on various but interlinked factors such as (i) the metal to which communities were chronically exposed, (ii) the mode of action of the metals, (iii) the detoxification mechanisms implemented by cells, and (iv) the microbial community targeted (e.g. heterotrophs, heterotrophs). Indeed, we showed in this study that, although contamination with different metals could select for Cu phototrophic-tolerance, the tolerance to Cu did not automatically lead to resistance to the other metals. Furthermore, the ubiquitous co-tolerance to Cu that was observed in phototrophs, disappeared in the case of heterotroph tolerance. In ecotoxicological assessment, Cu may be therefore be proposed as a “model” for a given class of toxicant (i.e. heavy metals) in a preliminary PICT approach, aiming to limit the number of suspect pollutants. Afterward, a combination of various tolerance measurements, based on other activities such as SIR, could allow us to refine our investigations into tolerance mechanisms.

(ii) Enhanced tolerance to one metal increases susceptibility to others

The PICT approach was employed to demonstrate that the community restructuring was a direct result of contaminant exposure, but few studies have investigated the effects of community restructuring on their susceptibility to other stressors. As described above, the evolution of tolerance to contaminants may provide benefits via co-tolerance to other stressors by inducing common genes. In our study, when biofilms were exposed to Cu and Zn, we observed enhanced tolerance of phototrophic and heterotrophic communities to these two metals. Nevertheless, we also observed that biofilms tolerant to Cu and Zn became more sensitive to As whatever the targeted community (i.e. heterotrophs or phototrophs), thus reflecting a possible cost for enhanced tolerance. For example, as stated above, it has been shown that microbial communities pre-exposed to metals are more sensitive to UV-B than communities not pre-exposed (Clements et al. 2008, Kashian et al. 2007, Zuellig et al. 2008). Zuellig et al. (2008) concluded that the energetic cost of regulating metals might inhibit the ability of some organisms to efficiently repair DNA damaged by UV-B exposure.

At the community level, the development of enhanced tolerance could be related to the reduction of the global genetic variation in the community due to the strong selective pressure exerted by stressors (e.g. metals) and the elimination of sensitive species, which is the basis of the PICT concept (Kashian et al. 2007). In our study, the calculation of the Shannon index for eukaryotic and prokaryotic communities, confirmed the loss of species diversity after exposure to Cu and Zn, in comparison to control biofilms. In many respects, loss of species diversity is comparable to reduced genetic variation, with similar implications for the ecological functions of ecosystems (Taylor and Feyereisen 1996). Indeed, Paine et al. (1998) stipulated that when an assemblage is already maintained in an altered state (i.e. metal pre-exposure in our case), occurrence of superimposed disturbance may lead to long-term alteration of the community state, therefore impacting the ecosystem's potential for recovery. Furthermore, resistance to additional stressors may depend on tolerances induced by pre-exposure to stress. Initial exposure to a stressor combined with positive species co-tolerance should reduce the impacts of other stressors, which Vinebrooke et al. (2004) terms “stress-induced community tolerance”. Inversely, initial exposure to a stressor combined with negative species co-tolerance should increase the impacts of other stressors, which Vinebrooke et al. (2004) terms “stress-induced community sensitivity”.

In-depth study of the potential biological cost associated to enhancing tolerance to stressors, may therefore help in understanding the role of diversity and positive or negative

species co-tolerance in the maintenance of ecosystem function and the rate of recovery in communities after disturbance removal (Clements and Rohr 2009; Vinebrooke et al., 2004).

5. Conclusion

Multiple stressors in natural aquatic systems could make the establishment of a specific link between a given toxicant and its effects on organisms difficult, even if the concept of pollution-induced community tolerance (PICT) (Blanck et al. 1988) is proposed as a tool to overcome this drawback. Our results support the PICT concept, since we showed that exposure to a given metal led to structural shifts of the community and therefore to enhanced tolerance to this metal. Nevertheless, we also showed that, depending on the chronic stressor and the targeted community (i.e. phototrophs or heterotrophs), the consequences of enhanced tolerance were various, since tolerance increase to one metal was positively (i.e. co-tolerance) or negatively correlated (i.e. cost of tolerance) to tolerance to other metals. Overall, by considering the development of co-tolerance or susceptibility to novel stressors, our study highlights the fact that the PICT concept may improve our ecological understanding of multiple metal contamination and specifically its consequences on diversity and ecosystem functioning.

Acknowledgments

The authors thank the Water Chemistry Laboratory of the CEMAGREF in Lyon who carried out nutrient analyses in water, M. Coquery, and J. Gahou for metal analysis in water and biofilms, B. Motte for field sampling and Peter Winterton for proofreading the English-language version of the manuscript. We thank the ONEMA (French National Agency for Water and Aquatic Ecosystems) for providing financial support.

C.III. Influence des chroniques d'exposition aux toxiques sur la tolérance acquise des communautés microbiennes du biofilm

Cette section s'articule autour de deux articles : le premier concernant les impacts d'expositions chroniques et aiguës à un herbicide (i.e. diuron) sur les communautés autotrophes du biofilm est intitulé « Impact of chronic and acute pesticide concentrations on autotrophic periphyton communities: testing exposure scenarios and pesticide partitioning » et publié dans la revue *Science of the Total Environment* (**article 5**), et le deuxième concernant l'évolution spatio-temporelle du PICT est intitulé « *In-situ* spatio-temporal evolution of pollution-induced community tolerance to zinc in autotrophic and heterotrophic biofilm communities » et soumis à la revue *Ecotoxicology* (**article 6**).

C.III.1. Impacts d'expositions chroniques et aiguës au diuron sur les communautés autotrophes du biofilm simulant des épisodes de crues.

Les systèmes lotiques de petits bassins versants agricoles sont souvent soumis à des chroniques de pollution en pesticides relativement fluctuantes. En particulier, sur le bassin de la Morcille, les épisodes de crues sont toujours associées à de brèves mais importantes augmentations des concentrations de contaminants qui influent sur l'impact sur les communautés biologiques (Rabiet et al. 2010, Tlili et al. 2008). L'objectif de notre étude a donc été d'une part de mettre en évidence l'impact d'un herbicide (diuron) appliqué en mélange avec un fongicide (tébuconazole) sur les communautés périphytiques durant des épisodes de crues, et d'autre part d'approfondir les connaissances sur la relation entre la dynamique des toxiques (dans la colonne d'eau ou dans la matrice du périphyton) et les impacts sur les communautés périphytiques, en particulier sur la tolérance induite des communautés autotrophes. Pour cela, du périphyton s'est développé dans deux séries de deux mésocosmes *ex situ*: une série exposée à une contamination chronique, tandis que l'autre n'a ne l'était pas (canaux témoins). Après quatre semaines, un canal de chaque série a été exposé à trois contaminations aiguës pendant 24 heures avec le même mélange de pesticide que celui de l'exposition chronique, et chaque exposition aiguë a été suivie d'une semaine de récupération. Les concentrations des pesticides pendant les expositions chroniques et aiguës ainsi que la durée des différentes expositions aiguës appliquées lors de notre étude sont caractéristiques de la rivière Morcille (Rabiet et al. 2010). Les impacts des différents scénarios d'exposition sur les périphytons ont été évalués en mesurant les concentrations des pesticides dans la colonne d'eau ainsi que dans la matrice des biofilm et en utilisant la technique de la PCR-DGGE pour déterminer la structure des communautés. Sur un plan

fonctionnel, l'efficacité photosynthétique a été mesurée au cours de chaque exposition aiguë, et la tolérance induite au diuron a été estimée en se basant sur ce paramètre photosynthétique.

Nos résultats ont montré que le diuron s'était adsorbé dans la matrice du périphyton au cours de chaque exposition aiguë. Cependant nos résultats sur les effets écotoxiques et la tolérance étaient variables selon la fréquence de ces expositions aiguës : au cours de la première exposition aiguë, l'inhibition de l'efficacité photosynthétique du biofilm pré-exposé chroniquement était plus importante que celle du biofilm témoin, même si aucune différence dans la tolérance induite n'a été observée. Cependant, au cours de la deuxième et de la troisième exposition aiguë, la tendance s'est inversée par rapport à la première. De même, après la troisième exposition aiguë les communautés phototrophes ont présenté une tolérance au diuron accrue en comparaison avec ces mêmes communautés exposées à seulement deux expositions aiguës. D'une manière générale, notre étude a montré que les expositions aiguës et chroniques ne peuvent pas être considérées séparément pour évaluer les effets des polluants sur les communautés biologiques dans les systèmes lotiques, car les effets d'une exposition aiguë sur les periphytons semblent dépendre du passé d'exposition au même stress.

Les résultats et interprétations de cette étude sont présentés dans l'article 5 intitulé « Impact of chronic and acute pesticide concentrations on autotrophic periphyton communities: testing exposure scenarios and pesticide partitioning » et publié dans la revue *Science of the Total Environment*.

Article 5

Impact of chronic and acute pesticide concentrations on autotrophic periphyton communities: testing exposure scenarios and pesticide partitioning.

A. TLILI, B. MONTUELLE, A. BERARD, & A. BOUCHEZ

Impact of chronic and acute pesticide concentrations on autotrophic periphyton communities: testing exposure scenarios and pesticide partitioning.

Ahmed Tlili^a, Bernard Montuelle^{a,b}, Annette Bérard^c and Agnès Bouchez^b

a. CEMAGREF, UR MAEP, 3 quai Chauveau CP 69336 Lyon Cedex 09, France

b. INRA UMR CARTEL, Laboratoire de Microbiologie Aquatique, BP 511, 74203, Thonon Cedex, France

c. INRA UMR EMMAH 1114, Domaine Saint-Paul - Site Agroparc 84914 Avignon Cedex 9, France

Abstract

Aquatic ecosystems face variable exposure to pesticides, especially during floodings which are associated with short bursts of high contaminant concentrations that influence the impact on biological systems. A study was undertaken to highlight the impact of a herbicide (diuron) applied in mixture with a fungicide (tebuconazole) on natural periphytons in flooding events. Periphytons were grown in two series of two lotic outdoor mesocosms: one series was non-contaminated (control) while the other was exposed to chronic contamination. One channel of each series was exposed to pulses of acute contamination. After 4 weeks, these two channels were exposed to three successive pulses, with each pulse followed by one week of recovery. Impacts on periphytons were assessed by measuring pesticide concentrations in the water column and periphyton matrix and using DGGE to measure community structure. At a functional scale, photosynthetic efficiency was quantified during each pulse, and the induced tolerance to diuron was estimated. Diuron was adsorbed in the periphyton during each pulse and desorbed 13 h after pulse end. During the first pulse, photosynthetic efficiency correlated with pesticide concentration, and there was no difference between periphyton from chronically contaminated channels and control channels. However, during the second and third pulses, the photosynthetic efficiency of periphytons chronically exposed to pesticides appeared to be less impacted by the acute pulsed concentrations of pesticides. These changes were consistent with the acquisition of induced tolerance to diuron. Our experimental study indicates that pulse and chronic exposures cannot be considered separately for assessing the effects of pollutants on non-target organisms in lotic systems, since the effects of pulsed acute exposure on periphytons were dependent on whether or not the periphyton had previously been exposed to the same stressors.

Keywords: chronic exposure; pulse exposure; river periphytons; photosynthetic efficiency; pollution-induced community tolerance; diuron

1. Introduction

Surface waters draining vineyard areas are characterized by high contamination due to the large quantities and broad range of pesticides applied, and by the vulnerability of cultivated land. During rainfall events, fluxes of many pollutants (e.g. nutrients, metals, pesticides) can vary over several orders of magnitude. Rabiet et al. (2010) showed that floods are the dominant pathways for pesticide transport in a small stream in an agricultural watershed characterized by shallow soils and predominantly surface flow pathways. Moreover, environmental pesticide levels increase rapidly during rainfall events, and can reach relatively high concentrations. Floods usually last only a few hours, with discharge increasing then decreasing rapidly. Pesticide concentrations are usually nearly synchronous with discharges, leading to marked changes in exposure levels. Depending on the kind of toxicant exposure in terms of nature, concentration, frequency and duration, its impacts on biological communities can prove highly variable.

At microbial scale, the periphyton is an ecosystem formed by diverse communities of microorganisms (viruses, bacteria, algae, protozoa.) in a matrix of exopolymers fixed on an immersed solid surface (Costerton et al. 1994). In small lotic ecosystems (Strahler number < 3), periphytic communities play fundamental roles in both trophic web and biogeochemical cycles (Battin et al., 2003a). Their structural and functional homology with the initial targets of herbicides together with trophic interactions mean that the primary producers that compose periphyton are vulnerable to these toxicants disrupting the food web from its base. Periphyton may therefore be used to detect the potential early effects of pesticides in aquatic ecosystems (Sabater et al. 2007).

Pollution-induced community tolerance (PICT) is a 20-year-old concept introduced by Blanck et al. back in 1988 (and recently reviewed by Tlili and Montuelle, in press) as an ecotoxicological tool providing a good alternative for environmental status characterization. It is useful not just for assessing immediate impacts but also for integrating the contamination history of an ecosystem at community level. PICT is based on the theory that if a substance is toxic, it will exert a selection pressure on the community, resulting in greater overall tolerance to the toxicant. One of the most important parameters for the selection process in a PICT approach is exposure time to the toxicant, as it has to exceed the generation time of a non-exposed community (Blanck et al. 1988). Flooding events can quickly trigger variations in pesticides concentrations, and toxicant bioavailability may be either reduced or enhanced. To interpret the biological responses, it is important to first identify the toxicant dynamics, i.e.

which fraction (in the water column or accumulated in the biological matrix) is exerting the greatest selection pressure on communities. There are numerous studies on the bioavailability of metal pollutants (Serra et al. 2009, Soldo and Behra 2000) but very few studies on the bioavailability of organic pollutants and the possible link between pollutant dynamics in the water phase or adsorbed in the periphyton matrix and their impacts on microorganisms (Dorigo et al. 2004, 2007, Tlili et al. 2008, 2010). There is an increasing need to study the bioavailability of pesticides to microbenthic periphyton, which can be done by measuring pesticide concentrations and partitioning in the periphyton matrix and the water column (Lawrence et al., 2001).

Most experimental studies of aquatic microbial communities have been done using chronically high pesticide concentrations and only a few have attempted to assess the effect of environmentally realistic pesticide concentrations on microbenthic periphyton (Ricart et al. 2009, Rimet and Bouchez, in press, Tlili et al. 2008). Although there are a handful of studies focused on the effects of flooding on certain aquatic organisms (see Bony et al. 2008 for fish; Zhao and Newman, 2006 for invertebrates; Vallotton et al. 2009 for algal monoculture) in realistic scenarios, there is a lack of information for evaluating biological effects based on real environmental data, particularly at ecologically relevant community level. To our knowledge, only two studies have attempted to gauge the effects of rainfall-driven environmental organic pesticide concentrations on periphytic communities. Both focused on pesticide effects but not on hydrodynamic effects. In the first study, the authors determined pesticide impact during flooding events by testing the effect of short-term pulses of atrazine on autotrophic pristine periphyton (Jurgensen and Hoagland, 1990). In the second experimental study led by Tlili et al. in 2008, acute and short exposures to a high concentration of diuron were applied to periphyton previously-chronically exposed to a low concentration of the same herbicide.

Given that pesticides fluxes can be extremely variable in terms of concentration, type of pollutant and duration of episodes associated with hydrology variations (including flooding), we hypothesized that different exposure scenarios could differentially influence the intensity and type of impacts on biological systems (from the structural and functional point of view), and especially the induced periphytic community tolerance to pesticides.

This study has two aims. The first aim was to evaluate the ecotoxicological effect of a herbicide (diuron) in mixture with a fungicide (tebuconazole) on periphytic communities, and to study the sublethal and long-term effects of successive pulses of the mixture in outdoor lotic mesocosms mimicking different flood-event exposure scenarios. Flood hydrodynamics were not investigated here. The events were simulated by sudden and short increases of the

pesticide mixture in the water. The pulses were applied on previously chronically-exposed periphyton (low doses of the mixture) and on uncontaminated periphyton. The second aim of this study was to gain deeper insight into the relationship between toxicant dynamics (in the water column or in the periphyton matrix) and the impacts on periphytic communities, especially on the autotrophic community tolerance induced. The pesticide mixture and the contamination scenarios tested were characteristic of a vineyard watershed (Rabiet et al. 2010). Given the complexity of this study, the emphasis has been placed on the impacts of the herbicide contained in the mixture on phototrophic target communities and their activities.

This study tackled a specific series of questions: (i) how do autotrophic communities respond to chronic exposure from a structural and functional standpoint? (ii) what are the joint effects of chronic and/or successive pulse exposures on the structure and autotrophic function of the periphyton communities? (iii) is the water/periphyton partition of the contaminant an explanatory factor, and which contaminant fraction represents the most predominant driver of autotrophic periphyton response?

2. Material and methods

2.1. Experimental design and chronic contamination

We used an outdoor mesocosm platform (INRA, Thonon-les-Bains, France) using four stainless steel channels (4 m long, 0.4 m wide and 0.35 m deep) as designed by Volatier (2004) and described in Rimet and Bouchez (in press). The channels were run in a semi-open mode and were continuously supplied with 36 m-deep incoming water from Lake Geneva, ensuring an adequate supply of nutrients and natural seeding of periphytic communities. The entire volume of water in the system (2.2 m³ per channel) was replaced 4 times a day. Water flow and velocity in the channels were controlled using a valves-and-bypass system. Water overflow was decontaminated by activated-carbon filtration before being released. At the start of the experiment, artificial substrates (279 1.5-cm² frosted glass disks and 168 16-cm² frosted glass slides) were installed horizontally in each channel. The outdoor mesocosms were subject to the seasonal variations of the natural environment (light, temperature, day length and water quality input) during the 3-month experiment (June-July-August 2008). These experimental systems are large enough to run monitoring over several weeks (high sample capacity, semi-open system ensuring a constant supply of nutrients).

Two models of toxic molecules, i.e. diuron and tebuconazole, were used in mixture during the chronic and successive pulse exposures. Diuron (N-(3,4-dichlorophenyl)-N,N-dimethyl-

urea) is a herbicide (phenylurea) that inhibits photosynthesis by blocking the chloroplast electron transport chain in Photosystem-II (PSII) of phototrophic microorganisms and plants (Bérard and Pelte, 1999). Tebuconazole (H-1,2,4-triazole-1-ethanol a-[2-(4-chlorophenyl)-ethyl]-a-(1,1-dimethylethyl)) is a fungicide (triazole) that inhibits steroid demethylation (ergosterol biosynthesis in fungi) (Copping and Hewitt, 1998).

Two channels were chronically contaminated with this mixture at a nominal concentration of $1\mu\text{g.L}^{-1}$ of diuron (high-grade pesticide standard, Sigma, 99.6% purity, CAS RN 330-54-1) and $0.5\mu\text{g.L}^{-1}$ of tebuconazole (high-grade pesticide standard, Sigma, 99.5% purity, CAS 107534-96-31). The two remaining channels were used as controls (no pesticides added chronically). During the experiment, chronic contamination of channels was controlled by a peristaltic pump delivering a constant supply of pollutants.

2.2. Environmental pulse scenarios

After 28 days of growth, periphyton from one control and one chronically-contaminated channel were subjected to three successive short-term pulses with the same compositional mixture as for chronic exposure but at higher concentrations ($20\mu\text{g.L}^{-1}$ of diuron and $10\mu\text{g.L}^{-1}$ of tebuconazole) simulating the sudden increase in pesticide concentrations during a flooding event (to simplify our study, impacts of hydrodynamics on periphyton were not considered). Each pulse was followed by a 7-day recovery period (return to initial exposure conditions). These 3 short-term exposures were performed at day 28, day 35 and day 42 of the experiment. Total duration of each pulse was 17 hours, i.e. a 5-hour increase in pesticide concentration, a 6-hour period of peak exposure, and a 6-hour decrease. During pulses, the 4 channels were turned from semi-open to closed systems in order to facilitate the control of pollutant concentrations and pulse exposure periods (see Fig.1).

2.3. Periphyton monitoring

Periphytons were sampled randomly in each mesocosm on day 28 (just before the first pulse), day 35, day 42, day 49 (i.e. 1 week after each pulse) and day 63 (i.e. 3 weeks after the third pulse). Total biomass, carbon incorporation and bioassays (photosynthetic efficiency) were analyzed immediately (on the small frosted-glass disks) while molecular fingerprinting (on big frosted-glass slides) was performed later on using deep-frozen samples (-80°C). Furthermore, periphytons were also sampled during each pulse (at t_0 : just before the pulse, $t_0+5\text{h}$, $t_0+11\text{h}$ and $t_0+24\text{h}$) to monitor photosynthetic efficiency (on the small frosted-glass disks) and pesticide bioaccumulation (on the big-frosted glass slides).

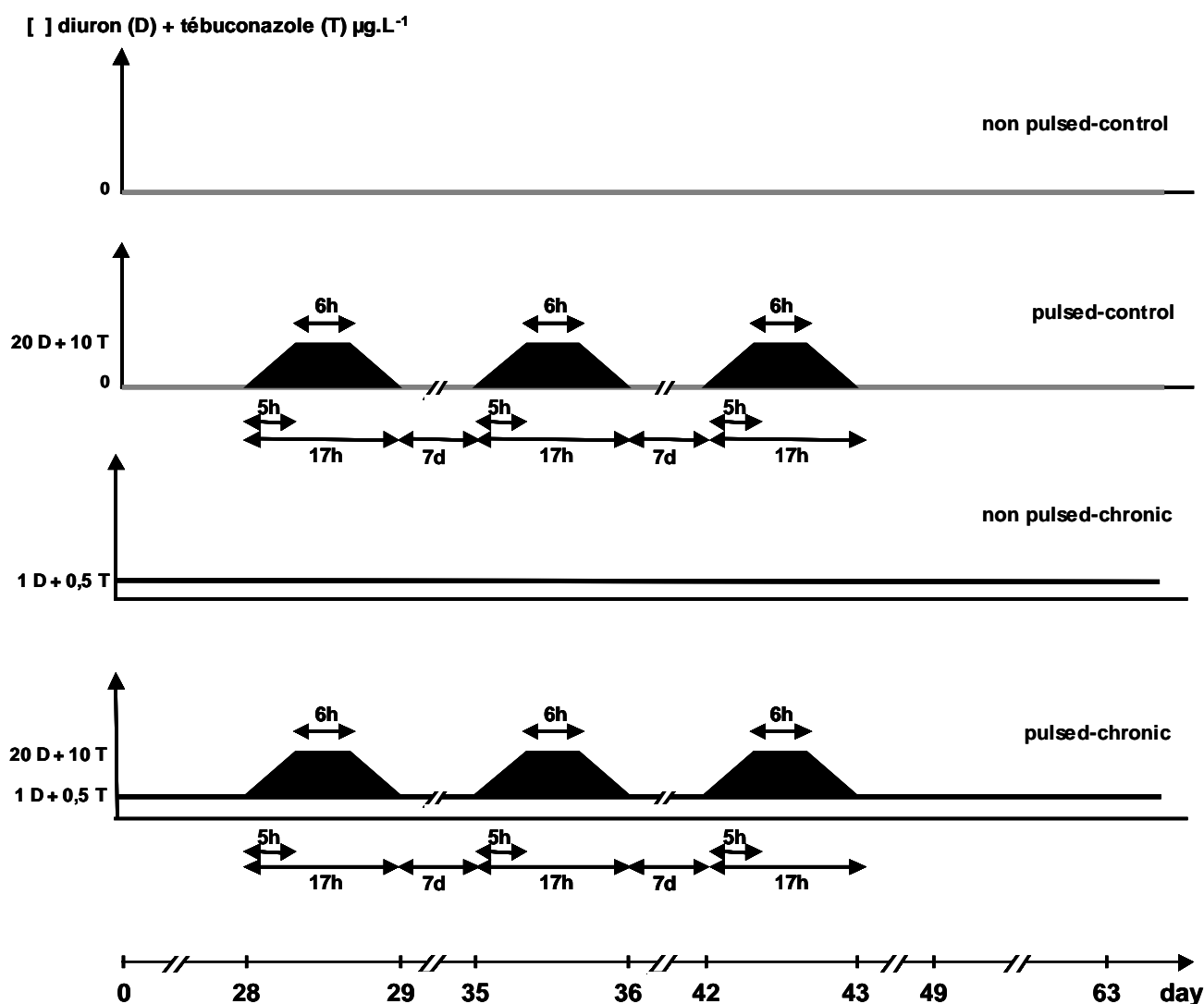

Fig.1 Experimental schedule.

2.4. Chemical analysis

Two-litter water samples from each channel were collected into polyethylene bottles at each sampling date in order to assess chemical parameters including DOC, PO_4^{3-} , SiO_2 , conductivity and pH, following French standard operating protocols (AFNOR).

Tebuconazole, diuron and its main metabolites (3-(3,4-dichlorophenyl)-1-methyl urea (DCMU) and 3,4-dichloroaniline (DCA)) were measured in water and periphyton samples by ESI-LC-MS/MS (API 4000, Applied Biosystems) at day 28, 35, 42, 49, 63 and during each pulse (t_0 , $t_0+6\text{h}$, $t_0+11\text{h}$ and $t_0+24\text{h}$) as described in Tlili et al. (2008).

Briefly, water samples for pesticide analyses were collected into glass bottles from each mesocosm at each sampling date. Samples (250 mL) were first filtered over 0.2- μm polyester filters (Chromafil PET 20/15 MS, Macherey-Nagel, Hoerdt, France) and then spiked with linuron used as analytical control standard. Extraction was performed by solid-phase extraction (SPE) on a 60 mg, 3 mL Oasis HLB cartridge (Waters). Concentration factor was 1000. Deuterated diuron (D6), used as the injection standard, was added to the final extract. Periphyton samples were collected from frosted glass slides (3 pooled replicates per channel) and suspended in 10 mL of 0.2- μm Nuclepore-filtered incoming water in order to quantify the pesticide amounts in the periphyton matrices. Periphyton suspensions were then freeze-dried in order to prevent any matrix degradation before analysis. 10 to 100 mg of freeze-dried periphyton spiked with the analytical control standard (linuron) was extracted with 10 mL organic solvent (acetone/dichloromethane, 20/80, V/V) in an ultrasonic bath for 30 min. 6 mL of ultrapure water was then added to re-dissolve the extract. Purification was carried out on a solid-phase extraction (SPE) cartridge (Oasis HLB, 60 mg, 3 mL, Waters). 10 μL of internal standard control (D6) was added to the final 240 μL water/acetonitrile extract (80/20, V/V).

Tebuconazole, diuron and its metabolites were separated on a 250x2mm Purospher Star RP-18e column (Merck, France). The mobile phase was water/acetonitrile acidified with a 0.3 $\text{mL}\cdot\text{min}^{-1}$ gradient, and injection volume was 10 μL . The limits of quantification ranged from 0.02 to 0.05 $\mu\text{g}\cdot\text{L}^{-1}$ in water and from 0.04 to 0.1 $\mu\text{g}\cdot\text{g}^{-1}$ in periphyton.

2.5. Biological analyses

2.5.1. Periphyton collection

Periphyton analyses were run either directly on frosted glass substrata (primary production, photosynthetic activity, bioassays) or on scraped samples suspended in 2 mL of 0.2- μm filtered incoming water (biomass, molecular fingerprinting).

2.5.2. Total and autotrophic biomass

Total organic matter was estimated by calculating ash-free dry weight (AFDW). Periphyton suspensions ($n = 3$) were filtered through individual 25-mm GF/C Whatman glass microfibre filters (1.2- μm pore size). Total dry matter was measured by weighing the filters after drying at 105°C for 24 h. The filters were then combusted in an oven at 480°C (Nabertherm P320) for 1 h, and reweighed to get mineral matter. AFDW was calculated by subtracting mineral matter from total dry matter, and expressed in $\text{g}\cdot\text{m}^{-2}$.

Chlorophyll-*a*, selected as an indicator of total autotrophic periphyton biomass (Bonin and Travers, 1992), was estimated by high-performance liquid chromatography (HPLC). Periphyton suspensions ($n = 3$) were centrifuged at 9750 *g* for 30 min at 4°C, and kept at -80°C until analysis. HPLC analysis was performed as described in Tlili et al. (2008). Chlorophyll-*a* was identified from its retention time and absorption spectrum using DAD according to SCOR (Jeffrey et al. 1997). The identified chlorophyll-*a* was quantified based on external calibration on standard chlorophyll-*a* (C55H72MgN4O5, Carl Roth GmbH & Co), and final concentrations are given as $\mu\text{g}\cdot\text{cm}^{-2}$.

2.5.3. Periphyton DNA extraction, amplification and denaturing gradient gel electrophoresis (DGGE) analysis

Periphyton suspensions ($n = 3$) were centrifuged at 14,000 *g* for 30 minutes at 4°C after which the supernatant was removed and the pellet was kept at -80°C until extraction. Nucleic acid extraction was performed on periphyton pellets using the DNAeasy Plant kit (Qiagen) according to the manufacturer's instructions.

PCR amplification of eukaryotic 18S rRNA gene fragments was performed according to Tlili et al. (2008). Briefly, 60 ng of template DNA and the primers Euk1Af (Sogin and Gunderson, 1987) and Euk516r-GC (Amann et al. 1990) were used to amplify the eukaryotic 18S rRNA gene fragments.

DGGE analysis was performed as described in Villeneuve et al. (2010). DGGE profiles were analyzed using GelCompar II software (Applied Math NV) leading to a matrix based on the quantification of relative band intensities.

2.5.4. Primary production (carbon incorporation)

Primary production was measured by ^{14}C incorporation rate as described in Dorigo and Leboulanger (2001). Briefly, five periphyton samples ($n = 5$) from each channel were placed separately into 20-mL scintillation vials with 25 μL of $\text{NaH}^{14}\text{CO}_3$ (0.2 μCi per vial), and photosynthesis was allowed to run for two hours under controlled light and temperature conditions (temperature: 18-20°C; luminosity: 100-120 $\mu\text{E}\cdot\text{m}^{-2}\cdot\text{s}^{-1}$). The reaction was stopped by adding formaldehyde (final concentration of 3.7%), followed by 100 μL of glacial acetic acid to remove the inorganic carbon. After stirring for 1 h, 5 mL of scintillation cocktail (Ultima Gold LLT, Perkin Elmer) was added, and the samples were counted after quenching on a 2100-TR (Packard Instruments). Results are expressed in disintegrations per minute (DPM).

2.5.5. Photosynthetic efficiency monitoring during pulses

During each pulse, photosynthetic efficiency was monitored at t_0 (just before the beginning of the pulse), t_0+5h (the beginning of the pulse peak), t_0+11h (at the end of the pulse peak) and t_0+24h (13 hours later) in both pulsed and non-pulsed mesocosms. Photosynthetic efficiency is based on measuring the maximal quantum yield (YII) of algae (Schreiber, 2002). It reflects the number of functional PSII and therefore more generally the physiological state of the phototrophic communities. Measurements were performed using a PhytoPAM (pulse amplitude-modulated) fluorometer (Heinz Walz, GmbH). After 30 min of adaptation to darkness, the chl-*a* fluorescence of sampled periphytons ($n = 3$) was measured at 665 nm. A single saturation pulse was applied to calculate the maximal quantum yield as:

$$YII_{665nm} = \frac{F_m - F_0}{F_m}$$

where F_m is the maximum fluorescence after the saturation pulse and F_0 is the steady-state fluorescence.

2.5.6. Short-term bioassays and PICT assessment for phototrophic communities

The tolerance of phototrophic periphyton communities to diuron was assessed using photosynthetic efficiency as endpoint (Tlili et al. 2010). A stock solution containing 100 mM diuron (MW 233) (Sigma high-grade standard 99.5%) was prepared in water and stored at -20 °C until use. A semi-logarithmic series of concentrations was freshly prepared by serial dilution of the stock solution in 0.2- μ m filtered incoming water. Final test concentrations in the test vessels ranged from 0 μ M to 3.2 μ M (3 blanks and 3 replicates for each of the 5 increasing diuron concentrations). One week after the first and third pulses and 3 weeks after the third pulse, periphyton samples ($n = 3$ per test concentration) were exposed to increasing concentrations of diuron during three hours, under exposure to light and continuous gentle shaking. Measurements were performed on a PhytoPAM fluorometer. The relative inhibition of fluorescence yield at 665 nm in relation to controls was calculated to model concentration-response relationships and plot a dose-response curve to determine photosynthetic EC_{50} values for each channel and period.

2.6. Statistical data analysis

The effects of chronic exposure, pulse exposure and chronic exposure-pulse exposure interaction on AFDW ($n = 3$), algal biomass ($n = 3$), carbon incorporation ($n = 5$), EC_{50} ($n = 3$) and photosynthetic efficiency during each pulse ($n = 3$) were tested by multifactorial 2-way ANOVA using XLSTAT software (2009 version). If a main effect was significant, the ANOVA was followed by a Tukey-HSD test. Student's *t*-tests were run to compare the effects

of chronic contamination on microbenthic periphyton at each sampling date. Homogeneity of variance was checked prior to data analysis. EC₅₀ values were calculated using the Regtox model (E. Vindimian, <http://eric.vindimian.9online.fr/>). Data correlations between the EC₅₀ values, total and algal biomass, primary production, pH, conductivity, PO₄³⁻ concentration, SiO₂, DOC, diuron and tebuconazole in water samples and in periphyton matrices were tested by Pearson product-moment inter-correlation on XLSTAT software (2009 version).

Mean values (three replicates) of data from DGGE–18S rRNA gene analysis were used to determine eukaryotic diversity in the different sampled periphytons. Mean data, based on the relative band intensities, were log₁₀(x + 1)-transformed before being included in the analysis, and then submitted to detrended correspondence analysis (DCA). Maximum length of the gradient (1.062) indicated that linear methods were also appropriate. Consequently, we first carried out a principal component analysis (PCA). Second, in order to determine to which environmental variable PCA-axis and therefore eukaryotic diversity distribution were related, we ran a series of linear regressions between samples-scores of the first two PCA-axes (PC1 and PC2) and physicochemical data (pH, conductivity, PO₄³⁻, SiO₂, DOC, diuron and tebuconazole in water samples and periphyton matrices) and with periphyton age. The coefficient of determination (R²) was calculated for each linear regression, and we tested the significance (based on the Fisher test) of the explanatory variable(s). Significance level was set at 5% for all statistical tests.

3. Results

3.1. Physicochemical data

Physicochemical data for water samples from mesocosms at the different sampling dates are given in Table 1. Conductivity was relatively stable in all mesocosms throughout the experiment. A slight increase in pH and DOC values was observed in water samples from all the channels compared to incoming water, especially from day 35. A decrease in phosphorus and silicate levels was detected from day 28, due to periphyton development.

Table.1 Water chemistry: pH, conductivity, PO₄³⁻, SiO₂ and DOC of samples taken from incoming water (reference), control mesocosms (pulsed or not), and chronically-exposed mesocosms (pulsed or not) throughout the 63 days of the experiment.

Sample	Day	pH	Cond ($\mu\text{S}\cdot\text{cm}^{-1}$)	PO₄³⁻ ($\text{mg}\cdot\text{L}^{-1}$)	SiO₂ ($\text{mg}\cdot\text{L}^{-1}$)	DOC ($\text{mg}\cdot\text{L}^{-1}$)
Incoming water (lake water)	D28	7.75	301	0.007	1.23	1.22
	D35	7.69	287	0.004	1.25	1.17
	D42	7.94	288	0.002	1.83	1.06
	D49	7.9	302	0.01	1.43	1.05
	D63	7.77	298	0.001	1.34	1.14
Non pulsed-control channel	D28	8.1	303	0.003	0.63	1.7
	D35	8.25	300	0.004	1.24	1.24
	D42	8.23	274	0.002	0.62	1.19
	D49	8.1	306	0.003	0.41	1.22
	D63	7.97	302	0.003	1.22	1.25
Pulsed-control channel	D28	7.97	299	0.002	1.18	1.28
	D35	8.3	295	0.003	0.78	1.11
	D42	8.27	282	0.004	0.95	1.2
	D49	8.09	302	0.009	0.92	1.29
	D63	8	302	0.005	1.02	1.28
Non pulsed-chronic channel	D28	8.04	298	0.004	0.77	1.9
	D35	8.44	292	0.004	0.36	1.55
	D42	8.26	284	0.002	0.75	1.43
	D49	8.07	302	0.003	0.89	1.3
	D63	7.98	300	0.005	0.92	1.14
Pulsed-chronic channel	D28	8.01	300	0.002	1.07	1.95
	D35	8.15	298	0.004	0.79	1.34
	D42	8.24	287	0.002	0.91	1.29
	D49	8.08	303	0.005	0.6	1.34
	D63	7.97	301	0.002	1.01	1.17

Except during pulses, diuron and tebuconazole concentrations in control-mesocosm water samples throughout the experiment were always below the limit of quantification ($0.02 \mu\text{g}\cdot\text{L}^{-1}$). Outside pulse periods, diuron and tebuconazole concentrations in the two chronically-contaminated mesocosms ranged from 0.55 to $0.86 \mu\text{g}\cdot\text{L}^{-1}$ and from 0.22 to $0.49 \mu\text{g}\cdot\text{L}^{-1}$, respectively. No metabolites were detected in the water samples. Pesticide concentrations (average of the three pulses) in water during pulse periods are given in Table 2. Between 5 and 11 hours after the pulse start, high pesticide concentrations were constant. Unlike in the non pulsed-chronic channel, one diuron metabolite (DCMU) was detected after 11 hours of acute exposure in the pulsed-control and pulsed-chronic channels. Thirteen hours after pulse

cessation, low pesticide concentrations were still detectable in the pulsed-control and pulsed-chronic channels.

Table.2 Pesticide concentrations (means \pm s.d. in $\mu\text{g.L}^{-1}$) of diuron, DCMU and tebuconazole in water samples from the pulsed-chronic and pulsed-control channels during pulse sequences. Values are the mean concentrations obtained during the three successive pulse exposures at t0 (before pulse start), t0+5h, t0+11h and t0+24h (5, 11 and 24 hours after pulse start, respectively). LQ: limit of quantification ($0.05 \mu\text{g.L}^{-1}$ for diuron; $0.05 \mu\text{g.L}^{-1}$ for DCMU and $0.2 \mu\text{g.L}^{-1}$ for tebuconazole).

Toxicant	Channel	t0	t0+5h	t0+11h	t0+24h
Diuron	Pulsed-control	<LQ --	13.7 ± 1.6	13.3 ± 1.4	0.9 ± 0.0
	Pulsed-chronic	0.69 ± 0.1	15.5 ± 1.2	15.4 ± 1.5	2.13 ± 0.2
DCMU	Pulsed-control	<LQ --	<LQ --	0.08 ± 0.0	<LQ --
	Pulsed-chronic	<LQ --	<LQ --	0.07 ± 0.0	<LQ --
Tebuconazole	Pulsed-control	<LQ --	5.7 ± 1.1	5.8 ± 1.4	0.4 ± 0.0
	Pulsed-chronic	0.5 ± 0.0	7.9 ± 1.1	8.02 ± 1.4	1.22 ± 0.1

Pesticide concentrations in the periphyton matrix in non-pulsed channels (control and chronic) are summarized in Table 3.

Table.3 Pesticide concentrations of diuron and tebuconazole in periphyton samples taken from non pulsed- control and chronic channels at each sampling date (in μg diuron or tebuconazole per g of periphyton dry weight). nd: not detected. <LQ: under the limit of quantification ($0.04 \mu\text{g.g}^{-1}$ for diuron and $0.05 \mu\text{g.g}^{-1}$ for tebuconazole).

Channel	Toxicant	D28	D35	D42	D49	D63
Non pulsed-control	diuron	nd	nd	nd	nd	nd
	tebuconazole	nd	nd	nd	nd	nd
Non pulsed-chronic	diuron	0.17	0.16	0.18	0.26	0.15
	tebuconazole	<LQ	<LQ	<LQ	<LQ	<LQ

Like in water samples, diuron and tebuconazole concentrations in periphyton samples from the non pulsed-control channel were below the limit of quantification, and no

metabolites were detected. In contrast, in the non pulsed-chronic channel, diuron and tebuconazole were found in the periphyton matrix. Table 4 shows the pesticide concentrations in periphyton matrices during each pulse and after the third pulse (1 and 3 weeks after) in the pulsed channels (pulsed-control and pulsed-chronic). Eleven hours after pulse starts, diuron was detected in the periphyton matrices in both pulsed channels, whereas tebuconazole was only found in the pulsed-chronic channel and only during the second and the third pulses. Thirteen hours after pulse cessation, there was a strong decrease in the pesticide amounts accumulated in periphyton matrices during pulses in both pulsed-control and pulsed-chronic channels. On the other hand, accumulated diuron amounts increased as periphyton underwent increasing successive pulse exposures (only in the pulsed-chronic channel). Consequently, one week after the last pulse, diuron concentration in the periphyton was still high ($0.48 \mu\text{g.L}^{-1}$), unlike in the pulsed-control channel (diuron not detected). However, three weeks after the last pulse, diuron concentration decreased back to a more or less similar value to that measured before the pulses started. Conversely, tebuconazole concentrations did not show pulse series-related changes.

Table.4 Pesticide concentrations of diuron and tebuconazole in periphyton samples taken from the pulsed-control and pulsed-chronic channels during each pulse (in μg diuron or tebuconazole per g of periphyton dry weight). P1, P2 and P3: single-, double- and triple- pulsed periphytons, respectively. P3+1w and P3+3w: one and three weeks after the third pulse, respectively. nd: not detected. <LQ: under the limit of quantification ($0.04 \mu\text{g}\cdot\text{g}^{-1}$ for diuron and $0.05 \mu\text{g}\cdot\text{g}^{-1}$ for tebuconazole). ns: not sampled.

Channel	Toxicant	P1 (D28+D29)				P2 (D35+D36)				P3 (D42+D43)				P3+1w (D49)	P3+3w (D63)
		t0	+5h	+11h	+24h	t0	+5h	+11h	+24h	t0	+5h	+11h	+24h	t0	t0
Pulsed-control	diuron	nd	ns	0.14	0.08	nd	ns	0.45	0.14	<LQ	0.37	0.60	0.21	nd	nd
	tebuconazole	nd	ns	<LQ	<LQ	<LQ	ns	<LQ	<LQ	<LQ	<LQ	<LQ	<LQ	nd	nd
Pulsed-chronic	diuron	0.15	ns	0.25	0.14	0.16	ns	0.71	0.34	0.24	0.77	0.90	0.41	0.48	0.16
	tebuconazole	nd	ns	<LQ	<LQ	<LQ	ns	0.06	<LQ	<LQ	0.05	0.08	<LQ	<LQ	<LQ

3.2. Total and autotrophic biomass

As shown in Fig. 2a, AFDW was relatively constant in both non pulsed chronic and control mesocosms throughout the 63 days of the experiment. Control periphytons were characterized by a significantly higher biomass than chronically-contaminated periphytons (Student's t-test, $p < 0.05$), except at days 49 and 63. Otherwise, as shown in Fig. 3a, at day 35 (1 week after the first pulse), the effects of chronic exposure and pulse exposure taken separately were significant (ANOVA, $p < 0.05$). Periphyton from the pulsed-chronic channel showed lower AFDW than periphyton from the non pulsed-chronic channel one week after each pulse (Tukey test $p < 0.05$). At day 42 (one week after the second pulse), the interaction effect of chronic and pulse exposures was significant (ANOVA, $p < 0.01$) and there was no significant effect of chronic or pulse exposure taken separately. After the second pulse, periphyton from the pulsed-chronic channel was characterized by significantly lower biomass than periphyton from the non pulsed-chronic channel (Tukey test $p < 0.01$), whereas biomasses of periphytons from the non pulsed- and double pulsed-control channels were not different (Fig. 3a). At day 49 (one week after the third pulse), there was no significant effect of the different modalities of exposure on the AFDW of the pulsed and non pulsed periphytons, whatever the original channel. However, at day 63 (three weeks after the last pulse), periphytons from the triple pulsed channels (pulsed-control and pulsed-chronic) showed higher biomasses than periphytons from non pulsed channels (control and chronic) (Fig. 3a, Tukey test $p < 0.01$), and the increase was greater for periphytons from the pulsed-chronic channel. Total periphytic biomass was significantly and positively correlated to the PO_4^{3-} (Pearson correlation, $p = 0.009$) and DOC (Pearson correlation, $p = 0.013$) concentrations.

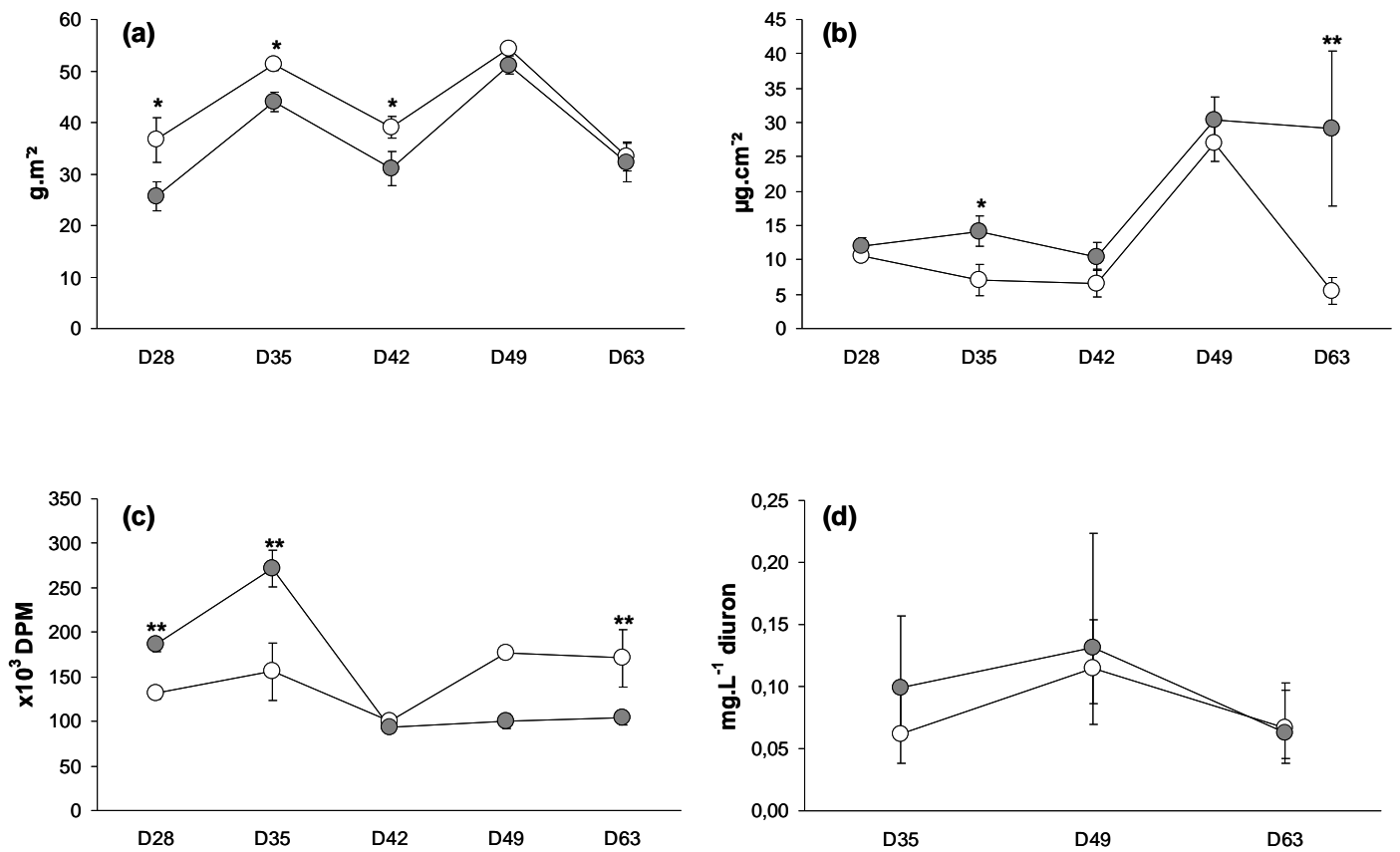

Fig 2 Impact of chronic exposure on periphyton communities in the control (white symbols) and the chronic (grey) channels. (a) AFDW biomass, (b) chlorophyll-*a*, (c) primary production (CO₂ incorporation) and (c) short-term sensitivity to diuron (EC₅₀) during the 63 days of the experiment. Error bars represent standard deviations, except for induced tolerance where they represent the confidence interval (n = 3). Stars represent Student's t-test significance (* *p*<0.05, ** *p*<0.01).

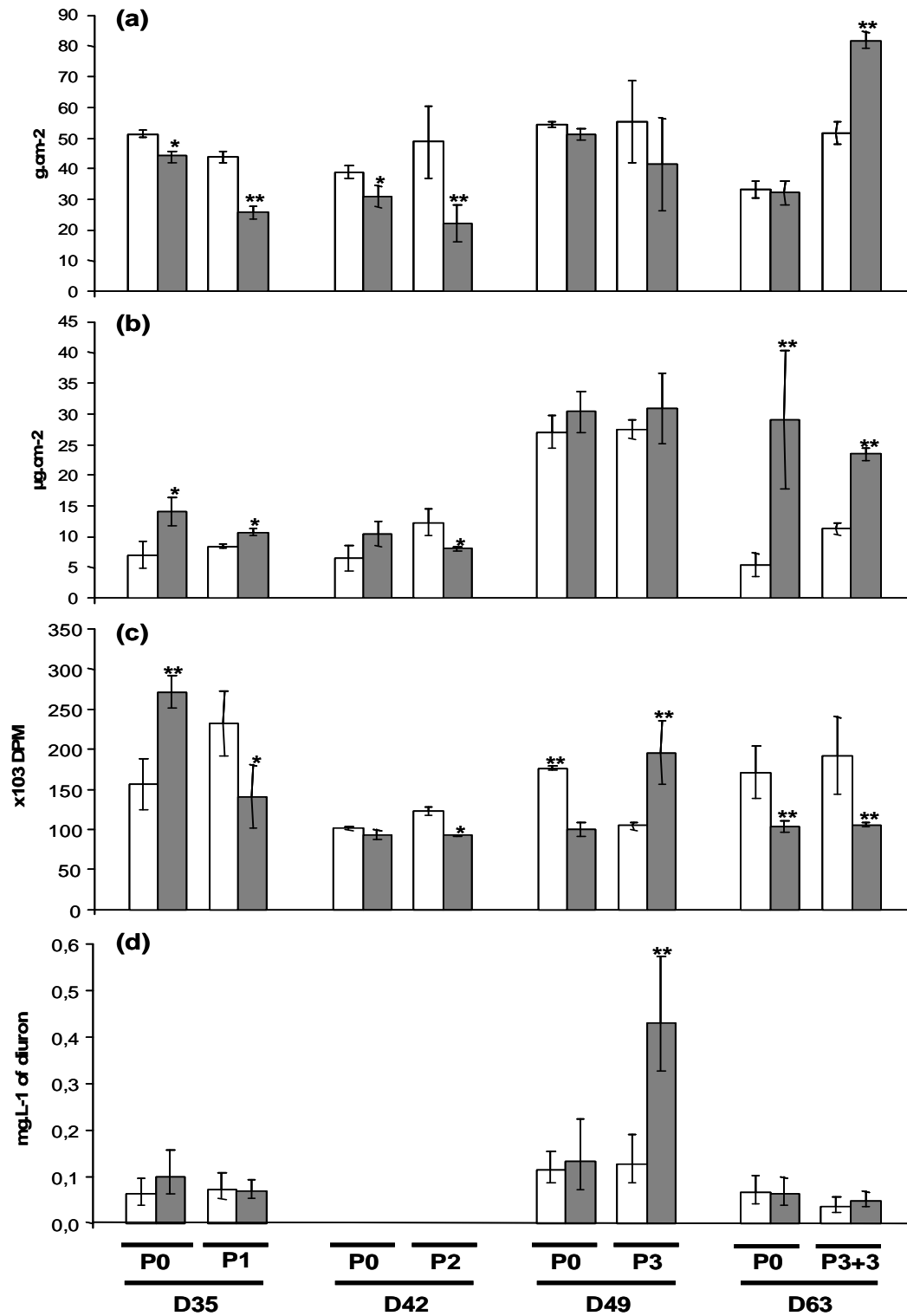

Fig.3 Impact of pulse exposures on periphyton communities in the control and pulsed-control channels (white symbols) and in the chronic and pulsed-chronic channels (grey) one week after each pulse and 3 weeks after the last pulse. (a) AFDW biomass, (b) chlorophyll-*a*, (c) primary production (CO₂ incorporation) and (d) short-term sensitivity to diuron (EC₅₀) during the 63 days of the experiment. P0: non-pulsed periphytons; P1, P2 and P3: single-, double- and triple-pulsed periphytons, respectively, one week after each pulse, and P3+3: triple-pulsed periphytons 3 weeks after the last pulse. Error bars represent standard deviations, except for induced tolerance where they represent the confidence interval ($n = 3$). Stars represent Student's t-test significance (* $p < 0.05$, ** $p < 0.01$).

Chlorophyll-*a* was in general higher in non pulsed chronically-exposed periphyton than in non pulsed control periphyton, especially at days 35 and 63 (Fig. 2b, Student's t-test, $p < 0.01$). At day 35 (after the first pulse), the effects of chronic exposure alone and of the interaction of chronic and pulse exposures were significant (Fig. 3b, ANOVA $p < 0.001$). At day 35, autotrophic biomass was significantly lower in the non pulsed-chronic channel than in the pulsed-chronic channel (Tukey test, $p < 0.05$), but similar between the non pulsed-control and pulsed-control channels. At day 42 (after 2 pulses), the interaction effect of chronic and pulse exposures on the autotrophic biomass was significant (ANOVA, $p < 0.05$). Periphyton from the double pulsed-chronic channel had lower chlorophyll-*a* than periphyton from the non pulsed-chronic channel, whereas periphyton from the double pulsed-control channel had higher chlorophyll-*a* than non pulsed-control periphyton (Fig. 3b, Tukey test $p < 0.01$). At day 49 (after 3 pulses), there were no significant effects of the different exposure modalities on autotrophic periphyton biomass whatever the channel. After 63 days (3 weeks after the third pulse), only the chronic exposure effect was significant (ANOVA, $p < 0.001$) and there were no combined effects of chronic and pulse exposures on the autotrophic biomass. Pearson product-moment correlation showed that autotrophic biomass was positively and significantly correlated to conductivity ($p = 0.039$) and to diuron concentration in periphyton matrices ($p = 0.040$).

3.3. Carbon incorporation

As shown in Fig. 2c, periphytons from the non pulsed-chronic channel were characterized by higher primary production than periphytons from the non pulsed-control channel at the beginning of the experiment (days 28 and 35), and this trend reversed at days 49 and 63 (Student t-test, $p < 0.01$). The effects of pulse exposure on the primary production of autotrophic periphyton communities throughout the experiment are summarized in Fig. 3c. At day 35 and day 42 (after the first and second pulses, respectively), the interaction effect of chronic and pulse exposures was significant (ANOVA $p < 0.01$). Pulses inhibited carbon incorporation by chronically-exposed periphytons (Tukey test, $p < 0.01$) but not by control periphytons. At day 49 (after 3 pulses), chronic exposure, pulse exposure and chronic-pulse exposure interaction all had significant effects on carbon incorporation (ANOVA, $p < 0.001$). Three successive pulses significantly inhibited carbon incorporation by control periphytons but stimulated carbon incorporation by chronically-exposed periphytons (Tukey test, $p < 0.01$). Three weeks after the third pulse (day 63), only the chronic exposure still had a significant

effect on primary production (ANOVA $p < 0.01$), whereas no significant differences were observed between the periphytons from pulsed-chronic and non pulsed-chronic channels or from pulsed-control and non pulsed-control channels.

3.4. Photosynthetic efficiency monitoring during pulses

The time-course pattern of photosynthetic efficiency during each pulse is shown in Fig. 4. Photosynthetic efficiencies (t_0+5h , t_0+11h and t_0+24) were expressed for each mesocosm as percentages of the t_0 baseline reference value ($Yield_{665nm}$ at t_0). This approach allowed us to distinguish between pulse effects and the natural variation in photosynthesis due to diurnal effect. The photosynthetic efficiency of periphyton was first inhibited by each pulse before recovering after pulse cessation. During the first pulse, at peak pulse exposure (from t_0+5h to t_0+11h), the photosynthetic efficiencies of periphytons were significantly inhibited by $43 \pm 6\%$ (pulsed-control channel) and $58 \pm 4\%$ (pulsed-chronic channel) compared to the non pulsed channels (Student's t-test, $p < 0.01$). However, during the second pulse, the pulsed-control periphyton was more affected than the pulsed-chronic periphyton ($58 \pm 4\%$ and $49 \pm 1\%$, respectively; Student's t-test, $p < 0.01$), and during the last pulse this tendency was confirmed ($59 \pm 6\%$ and $39 \pm 5\%$, respectively; Student's t-test, $p < 0.01$). Generally, as pulsed-chronic periphytons were subjected to successive pulse exposures, the inhibition of photosynthetic efficiency progressively weakened compared to non pulsed-control periphytons, especially at the third pulse.

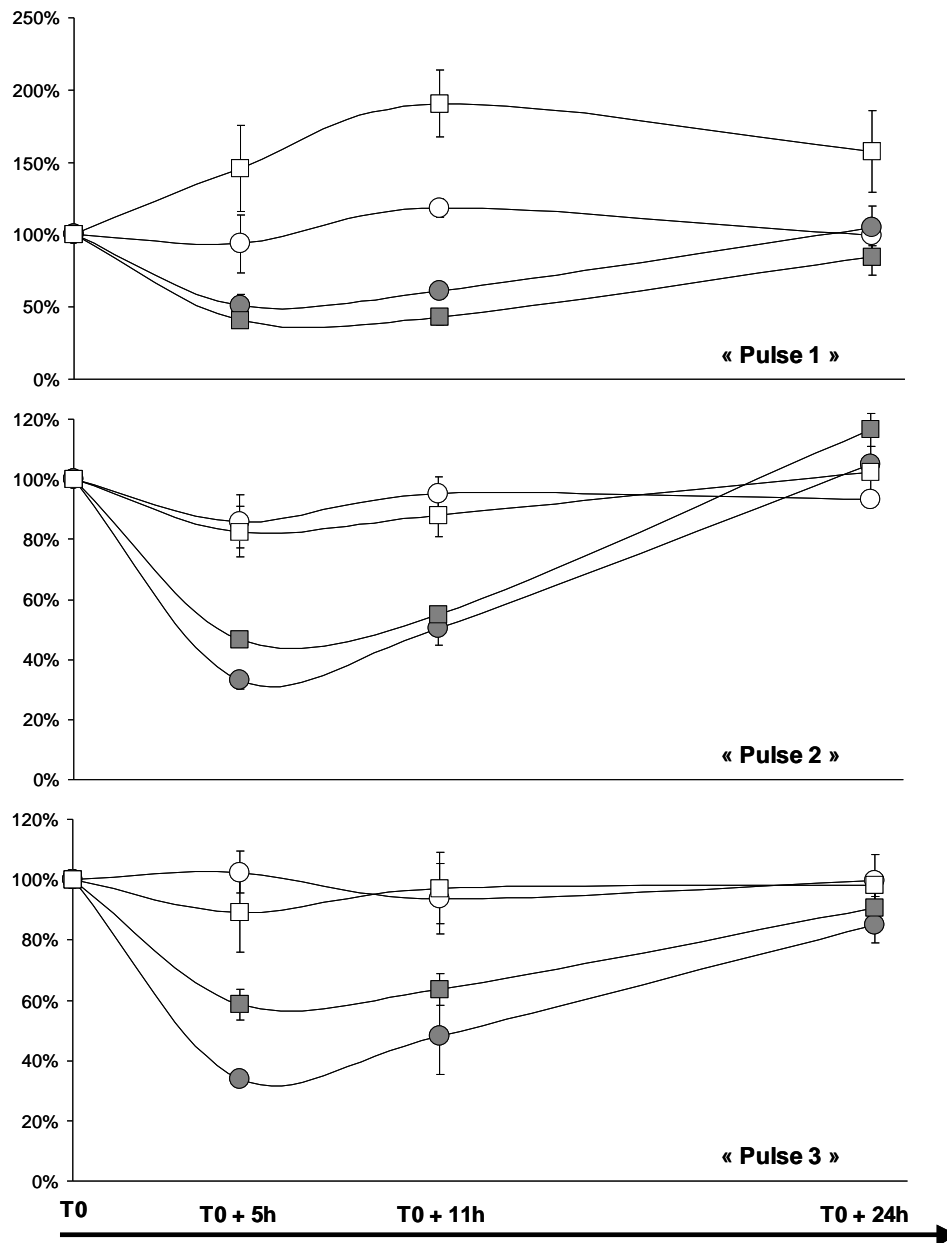

Fig.4 Photosynthetic efficiency monitoring during each pulse exposure in chronic (square symbol) and control (circle symbol) channels, expressed as a percentage of the corresponding reference value (value at t0, just before pulse start) for each channel. Non-pulsed channels: open symbol. Pulsed channels: grey symbol.

3.5. Diuron-induced tolerance

Due to technical problems, the dataset concerning short-term incubations with diuron one week after the second pulse is missing. The short-term bioassays of photosynthetic efficiency gave relatively stable EC_{50} throughout the experiment (Fig. 2d), but were never significantly different between periphytons from non pulsed chronic and control channels. At day 35 (after 1 pulse), the effects of the chronic exposure and pulse exposure taken separately, and interaction effect of both were not significant. Single pulsed periphytons (chronic and control)

showed similar sensitivities to diuron as non-pulsed periphytons (chronic and control) (Fig. 3d). In contrast, after 3 pulses (day 49), only the interaction effect of chronic and pulse exposures was significant (Fig. 3d, ANOVA $p < 0.001$). Periphyton from the triple pulsed-chronic channel showed a significantly higher EC_{50} than periphyton from the triple pulsed-control channel or non pulsed periphyton (chronic and control) (Fig 3d, Student's t-test, $p < 0.001$). At the end of the experiment (three weeks after the third pulse), there were no significant differences between periphyton sensitivities to diuron whatever the previous exposure history (chronic, control, pulsed or non pulsed). Pearson product-moment correlation analysis showed that phototrophic community tolerance to diuron was positively and exclusively correlated to diuron concentration in the periphyton matrices ($p < 0.0001$).

3.7. Eukaryotic community structure

A total of 38 different OTUs were detected during the experiment, averaging 19 and 20 different DGGE-OTUs for control and chronic periphyton samples (pulsed or not), respectively. Figure 5 reports the PCA analysis of eukaryotic diversity showing the ordination of sampling points with respect to the two principal axes. The first axis (PC1) and the second axis (PC2) together explained more than 65% of variance. Linear univariate regression analysis (data not shown) showed a significant relationship between the samples scores on PC1 and diuron concentrations in water ($R = 0.407$, $p = 0.002$), tebuconazole concentrations in water ($R = 0.335$, $p = 0.008$) and diuron concentrations in periphyton matrices ($R = 0.319$, $p = 0.009$) whereas PC2 was only related to the SiO_2^- concentrations ($R = 0.283$, $p = 0.016$). Before pulse exposures, eukaryotic communities were structurally different between control and chronically exposed periphytons according to the first axis. Moreover, the distribution of samples on PC1 showed that periphytons from the pulsed-chronic channel were less affected by the successive series of pulses than periphytons from the pulsed-control channel, even at three weeks after the last pulse. Indeed, the more the control periphytons undergo pulse exposures, the greater their eukaryotic structure diverged from their original composition (just before pulse) towards the eukaryotic composition of periphytons from chronic channel. At the end of the experiment, i.e. three weeks after the third pulse, the eukaryotic community structure of periphytons was fairly similar between pulsed-control and pulsed-chronic channels.

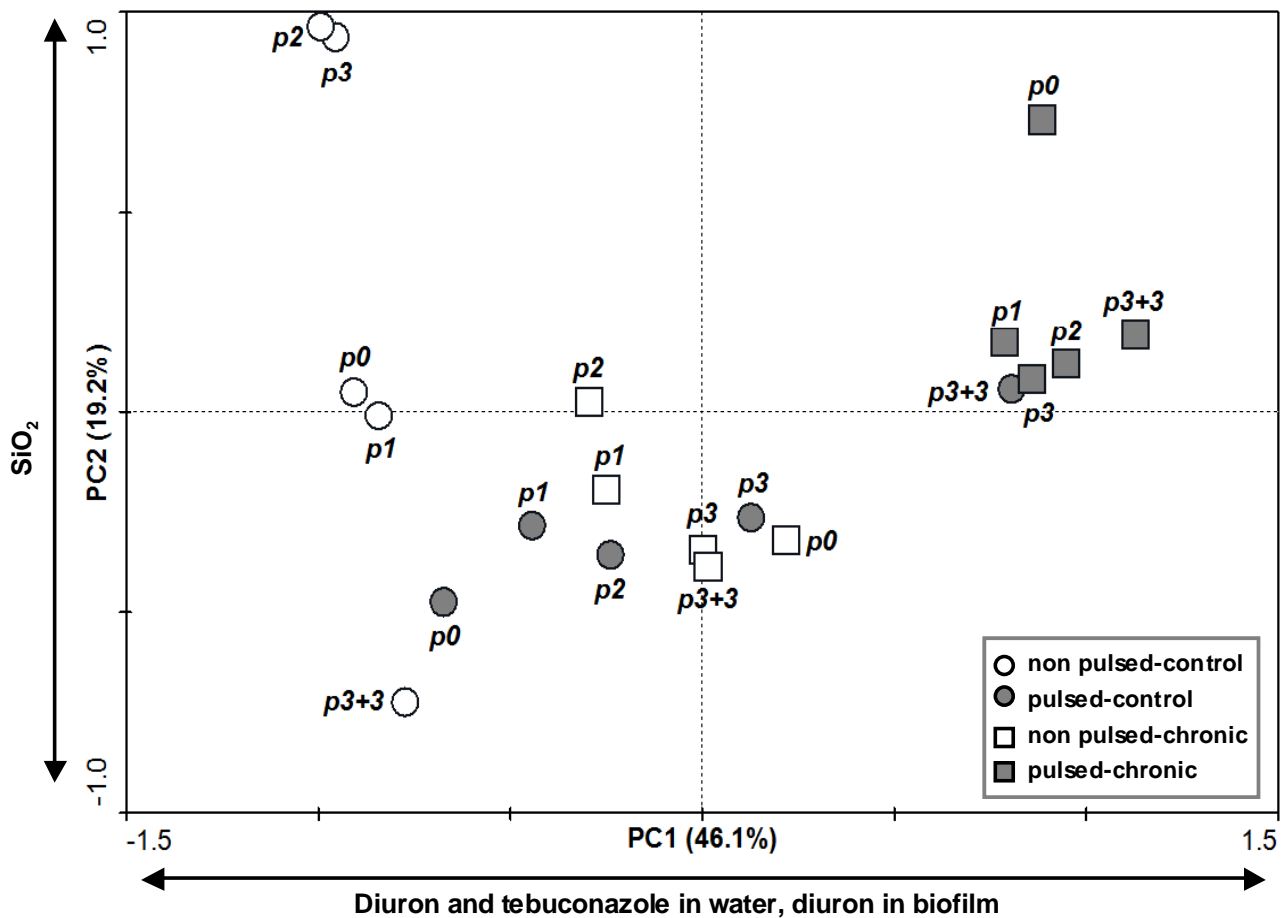

Fig.5 Principal Components Analysis based on DGGE-18S rDNA analysis of eukaryotic periphyton diversity. Physicochemical factors significantly correlated (linear regression) with each PCA axis (with a significance $p < 0.05$) are indicated under an arrow. Op: before pulse. 1p, 2p, 3p: one week after pulse1, pulse2 and pulse3, respectively. 3p+3: three weeks after the last pulse.

4. Discussion

Numerous studies have shown that toxicant effects depend on both concentration and duration of exposure (Pesce et al. 2010; Tlili et al. 2008; Valloton et al. 2009). This means the impact of pesticide exposure during base flow and during flooding or the potential cross-influence of these modes of exposure could be variable. In order to confirm or refute this hypothesis, periphytons that had or had not been chronically exposed to low and realistic concentrations of a pesticide mixture (diuron and tebuconazole) underwent a series of 3 successive pulses (sudden increase in concentration) of this same mixture.

Due to the complexity of our study, this article has principally focused on effects related to diuron, although we are aware that from a chemical dynamics or biological impact standpoint, there may well be indirect effects related to interactions between the two toxicants (diuron and tebuconazole).

(i) Consequences of chronic contamination on autotrophic periphyton communities

Environmentally realistic concentrations of the herbicide diuron produced responses in targeted (phototroph) organisms. In general, chlorophyll-*a*, throughout the experiment, was higher in the chronically-exposed mesocosms than the control mesocosms, whereas total biomass followed the reverse trend. Compared to control periphytons, carbon incorporation by chronically-exposed periphytons was higher from day 28 to 35, at which point this tendency reversed until the end of the experiment. Previous studies have reported similar results after long-term exposure of periphytons to low concentrations of diuron or other similar PSII inhibitor herbicides. Ricart et al. (2009) showed a significant correlation between the autotrophic biomass increase in periphytons, exposure to increasing diuron concentrations, and duration of exposure. They demonstrated that 1 $\mu\text{g.L}^{-1}$ of diuron was sufficient to induce an increase in chlorophyll-*a* content after 29 days of exposure. These results confirmed those obtained by Tlili et al. (2008), who reported that periphytons chronically exposed to 1 $\mu\text{g.L}^{-1}$ of diuron showed higher chlorophyll-*a* pigments and carbon incorporation rates than control periphytons from day 21 to day 32 of their microcosm experiment. The “dynamic balance theory” (Kana et al. 1997), which suggests photosynthetic pigments in phototrophic organisms are environmentally regulated (e.g. by herbicides) by mechanisms of homeostasis, may explain these results. Indeed, the low diuron concentration-induced disruption of electron flow in PSII during the light reaction of photosynthesis induces “shade-type chloroplasts” in a process known as the “greening effect” (Waring et al. 2007). Phototrophs under stress have the ability to adjust their intracellular light-harvesting pigments (e.g. chlorophyll-*a*) to maintain an efficient conversion of light energy to chemical energy, and the loss of functional PSII due to inhibition by the herbicide is therefore counteracted by a gain in the biosynthesis of light-harvesting photosynthetic pigments.

Despite this protective mechanism, phototrophic communities were unable to maintain functional stability (e.g. primary production) after a long period of exposure. Indeed, unlike in the first 5 weeks, compared to the control periphyton, chronically-exposed periphytons showed lower carbon incorporation rates from day 42 to day 63. Thus, despite possessing higher amounts of chlorophyll-*a*, phototrophic organisms appear to be less efficient in

maintaining normal photosynthesis. In fact, primary production declined drastically in the presence of high concentrations of photosynthesis-inhibiting herbicides, even in short-term bursts, and “shade-adaptation” was unable to ensure the functional integrity of phototrophic cells (Cedergreen et al. 2005). In our study, even though periphytons were not exposed to high concentrations of diuron, they were exposed over a long period (63 days) to lower concentrations. In 2004, Chesworth et al. showed that diuron toxicity and its negative effect on photosynthesis was progressive throughout time on the seagrass *Zoostera marina*. In the same way, Vallotton et al. (2008) also showed that the toxicity of atrazine and isoproturon (both PSII inhibitors like diuron) on *Scenedesmus vacuolatus* increased with increasing exposure duration (i.e. 10, 24 and 48 hours). These findings could explain the community-scale decrease in the primary production that had occurred by the end of our experiment.

These observations are in accordance with the measured induced tolerance in our study. Pollution-induced community tolerance (PICT) is based on the assumption that the toxicant exerts a selection pressure once exposure reaches a critical level for a sufficient period of time (Bérard et al. 2002), inducing a shift in the community structure with the emergence of the most tolerant species and/or populations (Dorigo et al. 2004, Tlili et al. 2010). In our case, the eukaryotic DGGE profiles of the control and chronically-contaminated mesocosms showed differences from day 28. However, there was no increase in PICT after a 3-month chronic-exposure, reflecting how phototrophic communities lack long-term adaptation. Numerous studies have reported a structural shift due to toxicant-induced selection pressure on phototrophic organisms, but with no effect on PICT (Nyström et al. 2000, Ricart et al. 2009, Tlili et al. 2008). It is well known that some diatom species may be more tolerant to PSII inhibitors than species of other algal classes (Bérard and Pelte 1999, Guasch et al. 1997), and diatoms are commonly predominant within periphytic layers in lotic systems (Stevenson and Peterson, 1991), as confirmed by our HPLC pigment analyses (data not shown). Therefore, as dominant diatom species occurring in our periphyton communities may have a narrower range of tolerance to PSII inhibitors, this kind of herbicide may have little potential for any increase in periphyton community tolerance in comparison to other algal communities (Bérard and Benninghoff 2001, Nyström et al. 2000).

(ii) Structural and functional “combined” effects of chronic and/or sequential pulsed exposures on autotrophic periphyton communities

This study showed that the phototrophic community responses to pulsed exposures depends not only on the number of pulses they undergo but also on their exposure history (periphytons originating from chronically-polluted or ‘clean’ control mesocosms).

Patterns of change in total and autotrophic biomass and primary production one week after the first and second pulses were different between chronically-contaminated mesocosms and controls. Indeed, chronically-exposed periphytons seem to be functionally more sensitive than controls to the first two pulse exposures. These observations could be explained by the mode of action of the herbicide: diuron binds to the QB-binding niche on the D1 protein of the PSII complex in chloroplast thylakoid membranes, thus blocking electron transport from QA to QB (Jansen et al. 1993). At low herbicide concentrations, a relatively high number of QB niches will be available for the herbicide to bind with, and during pulses there is an additional input of the toxicant molecules leading to an increase in QB-diuron binding and a higher drop in chlorophyll-*a* and primary production than during the chronic exposure to low toxicant concentrations (Chesworth et al. 2004). These assumptions are confirmed by the diuron concentrations measured in the periphyton matrices one week after the first and second pulses. Periphyton from the pulsed-chronic channel contained 0.16 and 0.24 $\mu\text{g diuron g}^{-1}$ dry weight 7 days after the first and second pulse exposures, respectively, whereas diuron concentration in pulsed-control channel periphyton was under the limit of quantification. This suggests a cumulative effect between chronic and pulse exposures. Moreover, the 7 days of the “recovery period” between the first two pulses was not sufficient for chronically-exposed periphytons to reverse the negative-additive effects of chronic and pulse exposures, unlike control periphyton undergoing only pulsed exposure.

On the other hand, the chronically-exposed periphytons seemed to show stimulated primary production after three successive pulses compared to non-pulsed periphytons. Moreover, the decrease in total and algal biomass following the first two pulses was cancelled out, indicating *a priori* that these communities become less sensitive to diuron. Indeed, no tolerance acquisition was observed in short-term bioassays one week after the first pulse. Conversely, 7 days after the third pulse, the chronically-exposed phototrophic communities showed a significantly higher diuron EC_{50} than control communities. Also, photosynthetic efficiency measured at each pulse was in agreement with the tolerance measurements. Indeed, during the first pulse, chronically-exposed communities were more sensitive to pesticide pulse than control communities, whereas during the second and the third pulse this tendency was reversed and photosynthetic inhibition was more pronounced for the control periphytons. Like the other parameters studied (primary production, total and autotrophic biomass), acquisition

of tolerance to diuron seemed to be influenced by a progressive and cumulative effect of both exposure modes (chronic and pulse).

Multivariate analysis of the eukaryotic periphyton communities (PCA based on the DGGE-18S rDNA gene fragments) showed that control communities were restructured by toxic pulses whereas communities chronically-exposed to a low pesticide concentration were only slightly if at all affected by the pesticide pulses. Kashian et al. (2007) showed that compared to a naive community never previously subjected to selective pressure, benthic communities growing under metal pollution pressure were initially structurally impacted, resulting in reduced genetic diversity, but that after exposure to an additional stress (equivalent to the pulse exposure in our case), the pre-exposed communities were less impaired than control communities. Vinebrooke et al. (2004) suggested initially selection-pressured algal communities in a slightly contaminated microcosm lost their potential for selection and were no longer restructured by new pulse contaminations by the toxic agent.

Overall, these results showed that an increase in phototrophic PICT does not necessarily correspond to a detected structural change. According to Kashian et al. (2007), functional acclimation (i.e. EC_{50} measurements) may act at the population level, while species replacement (i.e. eukaryotic diversity) is a community-level response. Indeed, as stated above, the PICT concept is based on the fact that exposure of communities to toxicants leads to the selection, which could be intra- or inter-specific, of the most tolerant individuals. There are many examples demonstrating intra-specific selection, especially for algal populations in aquatic ecosystems contaminated by metals or xenobiotics (Bérard et al. 1998, Debenest et al. 2009, Kasai et al. 1993), which could explain our results.

Another hypothesis linked to the diuron accumulation in the periphyton matrices could explain the decrease in the sensitivity to diuron in chronically-exposed communities after the third pulse. Our study found that not one week after the first and the second pulse but one week after the third and last pulse, diuron concentrations in chronically-exposed periphyton had become significantly higher than in control or non-pulsed periphyton. As explained earlier, at low herbicide concentrations there will be a relatively high number of QB niches available for the herbicide to bind with, and during pulses there is an additional input of the pollutant molecules leading to an increase in QB-diuron binding. However, Chesworth et al. (2004) suggested that as herbicide concentrations increase, there will be fewer QB niche sites available for occupation by the herbicides, meaning binding rate may decrease until there is no more toxicity additive-effect. Thus, we can posit the existence of a concentration threshold

beyond which the harmful toxicant effect is no longer be observed, consequently leading to an increase in photosynthetic efficiency and EC₅₀ values. This was apparent in our investigation.

All the tested endpoints (total biomass, chlorophyll-*a* pigment, primary production and EC₅₀ values) except eukaryotic diversity indicated that three weeks after the last pulse exposure, the pulsed communities (chronically-exposed or not) returned to a similar state to before the start of the pulse exposure, reversing what is found after the one-week recovery periods between successive pulses. However, the eukaryotic diversity of pulsed-control periphytons continued to evolve even three weeks after the last pulse, indicating that structural recovery was slower than functional recovery. Some studies have addressed the link between toxicant pulses and duration of between-pulse recovery period (Macinnis-Ng and Ralph 2004, Vallotton et al. 2009). Vallotton et al. (2009) investigated the effects of various sequential pulsed isoproturon exposure scenarios with various recovery periods on the algae *Scenedesmus vacuolatus* and found no significant difference on photosynthetic efficiency or tolerance to this herbicide. However, Macinnis-Ng and Ralph (2004) assessed the effect of single and multiple exposures to copper and Irgarol 1051 on a seagrass, *Zostera capricorni*. They found that effects and recovery period varied according to toxicant tested and number of pulsed exposures, with copper being more harmful for algae than Irgarol 1051. Dorigo et al. (2010) also reported that periphyton communities recovered less after copper exposure than after diuron exposure. They linked their observations to the difference in accumulation rates between metal (high accumulation) and organic herbicide (low accumulation), adding that diuron was quickly and completely released from periphyton matrices after exposure cessation whereas copper was still detected several weeks later. Our results are in accordance with these findings, since three weeks after the third pulse, the diuron concentrations measured in periphyton matrices were similar to those measured before the pulse.

(iii) Relationships between the toxicant partitioning and periphyton responses linked to chronic and pulsed exposures

The issue of pollutant partitioning and toxicity on periphyton communities has been widely studied for metals contaminations (Guasch et al. 2002, 2003, Serra et al. 2009, Soldo et al. 2005), but to our knowledge only very few cases have focused on organic pesticides during chronic exposure (Dorigo et al. 2010, Tlili et al. 2010), and only one study on pulse exposure (Tlili et al. 2008). Indeed, most of the studies that addressed this issue, whether for chronic or pulsed exposures to pesticides, focused solely on the toxicant fraction in the water

column and not on the fraction adsorbed in the biological matrix (Chesworth et al. 2004, Jurgensen et al. 1990, Vallotton et al. 2008).

Our findings highlighted that functional parameters were generally controlled by the adsorbed fraction of toxicant while structural parameters were mainly linked to the fraction in the water phase. Linear regressions between samples-scores on the PCA-axis (generated based on eukaryotic diversity and physicochemical data) showed that the structural evolution of our communities was influenced mainly by the diuron and tebuconazole concentrations in the water and to a lesser extent by the diuron concentrations adsorbed in periphytons. Conversely, Pearson correlations between other biological endpoints and physicochemical water data indicated that chlorophyll-*a* pigment synthesis, photosynthetic efficiency during pulses and induced tolerance to diuron were significantly and linearly correlated to diuron amounts accumulated in periphytons. Dorigo et al. (2010) showed that shifts in periphyton sensitivities to diuron and copper were correlated to the adsorbed amounts of the corresponding toxicant. Tolerance to diuron, which was released faster than copper from the periphyton matrices, decreased faster than tolerance to copper. Cedergreen et al. (2005) proposed that the effect of pulse exposure could depend on both rate of herbicide accumulation and the organisms' ability to recover. They showed that compounds with high adsorption and desorption kinetics have a stronger functional effect (e.g. induced tolerance and photosynthetic efficiency in our case) but are followed by a rapid recovery, indicating the importance of the fraction accumulated in the biological matrix in showing persistent functional effects.

Here, the different temporal scale on which structural or functional responses occurred could explain the different relationships between toxicant partitioning and periphyton responses: functional responses to xenobiotics usually occur rapidly (e.g. photosynthesis inhibition) and could thus synchronize closely with rapid changes in toxicant concentrations. In contrast, structural changes (e.g. eukaryotic diversity) are usually more long-term responses to perturbations (due to generation time, population development, etc.) and thus cannot be related to the rapid changes in adsorbed herbicide fraction during the pulse. These assumptions may be confirmed by our data on tebuconazole, which cannot directly impact phototrophic communities and has only an indirect effect that occurs later than a direct effect could be detected. According to multivariate analysis (linear regressions), only tebuconazole concentrations in the water influenced the structure of the phototrophic periphyton component, reflecting an indirect effect on this community. Conversely, tebuconazole had no effect on phototrophic functions, thus confirming the time-lag between functional and

structural responses. This bilateral “toxicant partition–exposure” relationship could therefore be a core mechanism in the modulation of periphyton responses, depending on the biological level (structural or functional) considered.

5. Summary and conclusion

The effects of chronic and pulse exposures and of toxicant partition on periphyton can be summarized in a three-stage model scheme (Fig. 6). The first stage (i.e. two pulses) marked the start of a cumulative effect of chronic and pulse exposures. Chronic exposure alone at low diuron concentrations ($1 \mu\text{g.L}^{-1}$) induced a resistance of structural endpoints to additional exposures (pulses), whereas functional endpoints were negatively affected. The combination of chronic and pulse exposures clearly affected the adsorbed fraction of diuron, which increased progressively in the chronically-exposed periphytons that had undergone pulses but not in the control periphytons. In the second stage (i.e. third pulse), the adsorbed fraction of diuron continued to increase in the chronically-exposed periphytons but not in control-channel periphytons. This second stage appears to involve a toxicity threshold, as the cumulative effect of chronic and pulse exposures observed on chronically-exposed periphytons in the first stage was cancelled in this second stage, and these communities showed a higher PICT than all the other periphytons. Conversely, there was an additional effect of successive pulse exposures on control periphyton (CO_2 incorporation and chlorophyll-*a* were reduced by the 3 successive pulse exposures). Moreover, there was a progressive convergence in eukaryotic diversity between control periphyton and chronically-exposed periphyton. The negative effect of long-term exposure at low pollutant concentrations combined with two short-term exposures at high pollutant concentrations (i.e. chronic exposure + 2 pulses), which was observed in the first stage, seemed to be equivalent to three successive short-term but high-concentration exposures (i.e. 3 pulses). Finally, the third stage corresponds to a recovery period and a return to the initial pre-exposure conditions (i.e. before pulse exposure). Phototrophic periphyton community recovery seems to be faster from a functional standpoint than a structural standpoint, whereas the reverse was observed at the first stage, especially for PICT.

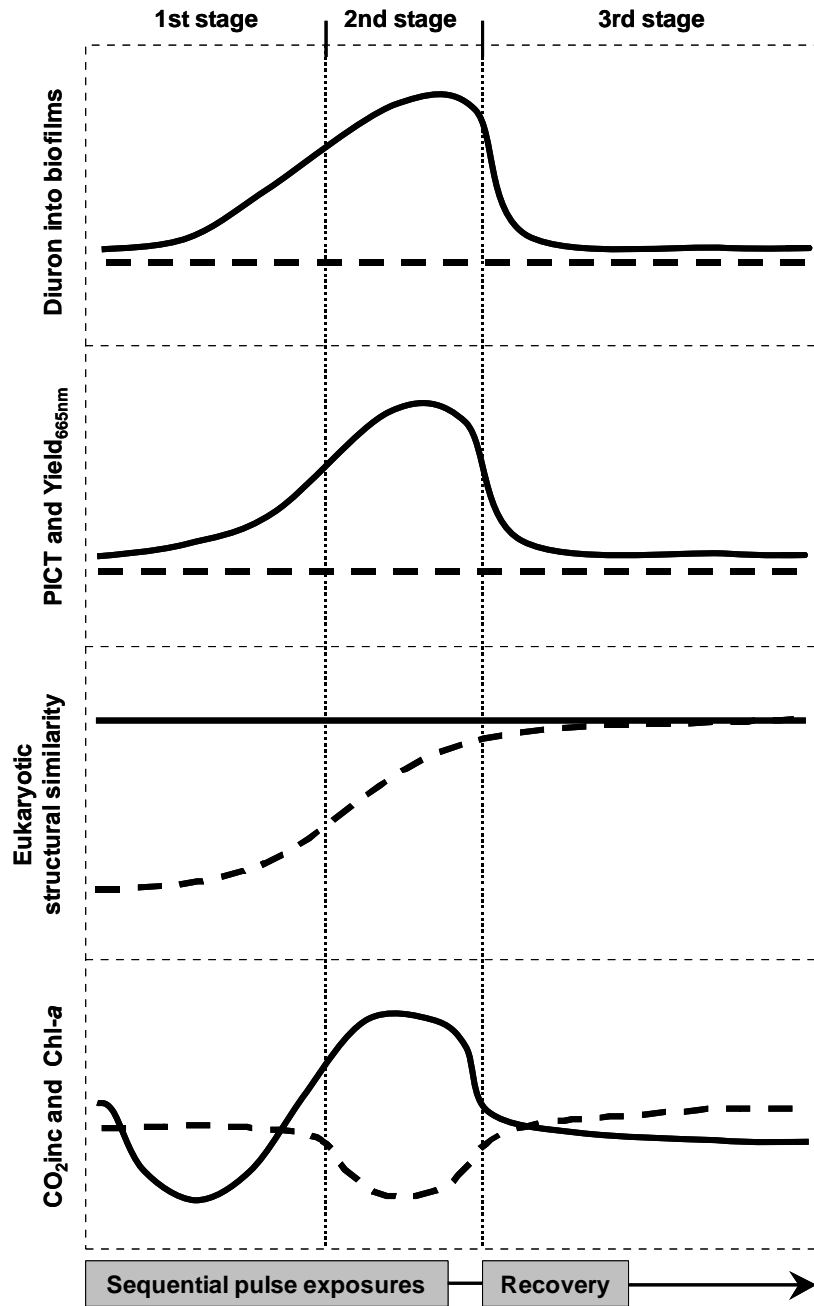

Fig.6 Three-stage model scheme of the effects of sequential pulse exposures on control (dotted line) and chronically pre-exposed (solid line) periphyton (relative to non pulsed-control or chronically-exposed periphyton). This representation of the effects on diuron in periphytons, eukaryotic structural similarity, chlorophyll-*a* pigment (Chl-*a*), PICT, carbon incorporation (CO₂ inc) and photosynthetic efficiency (Yield_{665nm}) does not correspond to a real scale.

Overall, our results showed clear cumulative effects, firstly between chronic and pulse exposures, especially on induced tolerance to diuron, and secondly between the successive pulse exposures. Thus, pulsed and chronic exposures cannot be considered separately for assessing the effects of pollutants on non-target organisms in lotic systems, since *in situ* hydrological dynamics combine both base-flow (chronic) and flood (acute) periods. The next step in toxicity assessment under varying hydraulic conditions would be to consider the joint effect of flow velocity (Battin et al., 2003b, Jurgensen and Hoagland 1990) and changes in organic matter content associated with floods (i.e. the “priming effect” in Guenet et al, 2010), which are liable to modulate periphyton responses to toxic exposure.

Acknowledgments

The authors thank C. Margoum, C. Guillemain and F. Lahjiouj for pesticide analysis, the INRA-Thonon chemistry lab for nutrient analysis, P. Perney, P. Chifflet and B. Le Berre for experimental and laboratory assistance, and ATT for proofreading the English-language version of the paper. This project was supported by funds from the ONEMA (French National Agency for Water and Aquatic Ecosystems), the PADYMA program (French National *Ecosphère Continentale et Côtière* Program), and the IMPALAC Project (Impact of Pesticides on Lakes) sponsored by the French Ministry of Ecology (MEEDAT).

C.III.2. Evolution spatio-temporelle de la tolérance acquise au zinc des communautés microbiennes du biofilm

La Tolérance induite par la pollution (PICT) est une approche qui utilise le phénomène d'accroissement de la tolérance des communautés de sites contaminés, vis-à-vis des pollutions et en comparaison à des sites de référence non contaminés comme un indicateur direct et spécifique de l'exposition et des effets des contaminants. Toutefois, étant donné la vaste complexité structurelle et fonctionnelle qui caractérise les communautés biologiques, l'acquisition de la tolérance aux polluants peut varier avec (i) la communauté cible et sa diversité originelle, (ii) l'intensité de l'exposition au toxique ainsi que sa durée, et (iii) les caractéristiques physico-chimiques du site étudié.

Pour évaluer l'évolution spatio-temporelle de la tolérance induite par le zinc de communautés de biofilms de rivière, une étude *in-situ* a été menée dans la rivière Osor (Nord-Est Catalogne, Espagne). Cette rivière est caractérisée par une pollution multiple aux métaux lourds due à un effluent minier et en particulier par un gradient de contamination en zinc (jusqu'à $600 \mu\text{g.L}^{-1}$). Nous avons mis à développer des biofilms sur des substrats artificiels pendant cinq semaines dans un site de colonisation sans pollution métallique, et les avons ensuite transférés sur des sites du même bassin présentant différents niveaux de contamination par le zinc. L'évolution spatio-temporelle de la tolérance induite par le zinc a été caractérisée via des bioessais d'inhibition de l'efficacité photosynthétique (ciblant les phototrophes) et de la respiration induite par un substrat carboné (ciblant les hétérotrophes) des biofilms provenant des différents sites et à différentes périodes après le transfert (T_0) (i.e. $T_0 + 1$ semaine ; $T_0 + 3$ semaines et $T_0 + 5$ semaines). En outre, une caractérisation physico-chimique des différents sites d'échantillonnage, ainsi qu'une analyse taxonomique des diatomées, de la diversité bactérienne et fongique (en utilisant la technique d'empreintes génétiques ARISA) et des pigments phototrophes ont été effectuées. L'analyse multivariée (à savoir l'analyse en composante principale et l'analyse des données par redondance) des données structurelles et fonctionnelles a montré qu'en plus de la succession naturelle des communautés microbiennes, l'intensité d'exposition au métal a exercé une pression structurelle en sélectionnant les espèces les plus tolérantes au zinc, mais différemment selon le compartiment biologique étudié du biofilm. Les mesures de la tolérance induite par le zinc ont confirmé ces observations et ont indiqué qu'une exposition à d'importantes concentrations en métaux sur le court terme équivaut à une plus longue exposition à de faibles concentrations.

Les résultats et interprétations de cette étude sont présentés dans l'article 6 intitulé « *In-situ* spatio-temporal evolution of pollution-induced community tolerance to zinc in autotrophic and heterotrophic biofilm communities » et soumis à la revue *Ecotoxicology*.

Article 6

***In-situ* spatio-temporal evolution of pollution-induced
community tolerance to zinc in autotrophic and
heterotrophic biofilm communities**

**A. TLILI, N. CORCOLL, B. BONET, S. MORIN, B. MONTUELLE, A.
BERARD & H. GUASCH**

Ecotoxicology (soumis)

***In-situ* spatio-temporal evolution of pollution-induced community tolerance to zinc in autotrophic and heterotrophic biofilm communities.**

Ahmed Tlili^a, Natalia Corcoll^b, Berta Bonet^b, Soizic Morin^c, Bernard Montuelle^a, Annette Bérard^d and Helena Guasch^b.

a. CEMAGREF, UR MAEP, 3 quai Chauveau CP 69336 Lyon Cedex 09, France

b. Department of Environmental Sciences, Institute of Aquatic Ecology, Faculty of Sciences, University of Girona (UdG), Campus Montilivi, 17071 Girona, Spain

c. CEMAGREF, UR REBX, 50 avenue de Verdun, F-33612 Cestas cedex, France

d. INRA UMR EMMAH 1114, Domaine Saint-Paul - Site Agroparc 84914 Avignon Cedex 9, France

Abstract

Pollution-induced community tolerance (PICT) is an approach that employs increased tolerance in populations at contaminated sites as a direct indicator of contaminant effects. However, given the broad structural and functional complexity that characterizes biological communities, the acquisition of tolerance to pollutants could vary with (i) target community, (ii) intensity of toxicant exposure and the species succession stage, and (iii) the physicochemical characteristics of the studied site. To assess the spatio-temporal evolution of zinc-induced tolerance in fluvial biofilm communities, an *in-situ* study was conducted in Osor river (North-East Catalonia, Spain). Osor river is characterized by multi-metal pollution, especially zinc-gradient contamination (reaching $600 \mu\text{g.L}^{-1}$ due to a mining effluent). Biofilms were developed during five weeks in a non-metal-polluted colonization site on artificial substrates, and subsequently transferred to different sites with different levels of zinc contamination. The spatio-temporal evolution of biofilm induced tolerance to zinc was characterized based on photosynthetic activity bioassays (targeting phototrophs) and respiration-induced aerobic bioassays (targeting heterotrophs) in the different sites at different exposure times after the translocation date (T_0), i.e. at $T_0 + 1$ week, $T_0 + 3$ weeks and $T_0 + 5$ weeks. In addition, we ran physicochemical characterization of the sites, taxonomic analysis of diatoms and bacterial and fungal diversity (using the ARISA technique) and pigment profiling of phototrophic communities. The structural and functional results analyzed by multivariate ordination analyses showed that in addition to natural species succession stage, the intensity of metal pollution exerted structural pressure by selecting the most metal-tolerant species, but differently according to the analyzed biofilm component. Zn tolerance measures confirmed these assumptions, and indicated that high metal pollution exposure in the short-term (i.e. 1 week) was equivalent to a longer exposure (i.e. 3 and 5 weeks) to low metal pollution levels.

Keywords: fluvial biofilm, pollution-induced community tolerance, spatio-temporal evolution, zinc, multivariate analysis.

1. Introduction

Fluvial biofilms are an important natural consortium of microorganisms composed by algae, bacteria, fungi and protozoa embedded in a polysaccharide matrix and growing on submerged substrata surfaces. It is well established that in small lotic systems, these communities play fundamental roles in ecosystem function as they are key to most processes, including oxygen production and nutrient cycling (Battin *et al.*, 2003). Moreover, biofilm communities are one of the first collateral victims of metal contamination, which can rapidly affect their structure and function (Soldo and Behra 2000, Dorigo *et al.* 2010, Morin *et al.* 2007). Due to their structural and functional complexity, fluvial biofilms integrate the effects of environmental conditions over extended periods of time, justifying their use as early-warning indicators of toxicant exposure in aquatic ecosystems (Dorigo *et al.* 2004, Sabater *et al.* 2007). The differences in sensitivity to metals between the different species composing biofilm communities forms the basis of the pollution-induced community tolerance (PICT) concept introduced by Blanck *et al.* (1988). PICT was proposed as a sensitive and specific endpoint measure to evaluate the exposure-effects relation of pollutants at community level. The rationale behind the PICT concept is toxicant-tolerant organisms can survive exposure whereas the most toxicant-sensitive organisms will be eliminated, inducing an increased PICT that reflects a globally more tolerant community. The advantage of this concept applied to biofilm communities and their abilities to acquire tolerance is that the PICT approach can establish a cause-effect relationship between a pollutant and its impact on biological communities taking into account the contamination history of the ecosystem at community level (intra- or inter-species) (Tlili and Montuelle, 2010).

In addition to the selective pressure exerted by toxicants, tolerance evolution could also be related to other factors such as the natural population succession process within biofilms (dubbed “baseline tolerance”): mature stable systems (like biofilm) are characterized by a preponderance of organisms known as K-strategists that succeed by being well-adapted to their environment. Earlier successional stages may have a greater proportion of r-strategists – organisms with broad environmental tolerances that struggle to survive in stable habitats where they cannot compete favourably against the better-adapted K-species (Frontier *et al.* 2004). Based on these assumptions, we could suppose that regardless of toxicant-driven selection pressure, mature biofilms are naturally more tolerant to disturbance than younger biofilms. Indeed, during the early stages of formation, biofilm is considered an open system with a little internal cycling of nutrients and carbon. Initial heterotrophic and autotrophic

colonizer populations remain dependent on the availability of nutrients from the water column until they reach a pseudo-steady-state. In the later stages of development, micro-niches are created and biofilms become a closed system as exchanges with the water column decrease. On one hand, the whole-system community is more protected from external stress, yet on the other, there are greater interactions between the different trophic levels within biofilms, since heterotrophic communities (e.g. bacteria and fungi) are more dependent on autotrophic production occurring within the biofilm (e.g. from algae or cyanobacteria) (Jackson, 2003).

The question that presents itself is therefore: how will the tolerance of microbial biofilm communities evolve over time in response to a gradient of selection pressure related to a chemical contamination?

An increasing number of aquatic ecosystems studies in the community ecotoxicology field have explored the PICT concept (Dorigo *et al.* 2007, Pesce *et al.* 2010, Tlili *et al.* 2010a), yet the spatio-temporal evolution of tolerance under metal contamination pressure has rarely been addressed. Moreover, the few previous studies examining this issue failed to account for the specific structural and functional complexity of biofilms, and only one taxonomic component (autotrophic communities) has been studied. Ivorra *et al.* (2000) assessed the toxicity of zinc and cadmium on benthic microalgae after 2 and 6 weeks of biofilm colonization in an extremely polluted site and compared the result to measurements from an upstream community. They found young biofilms were more vulnerable to metal exposure than mature biofilms, confirming that exposure history combined with biofilm age determine tolerance to metals. On the other hand, it is well known that toxicant exposure intensity may modulate the adaptability of microbial biofilm communities and thus their tolerance (Blanck *et al.* 2003, Dorigo *et al.* 2010, Guasch *et al.* 2010). Soldo and Behra (2000) showed that after 12 weeks of biofilm exposure to various copper concentrations, autotrophic community tolerance to copper was higher in pre-exposed communities than control communities, and this tolerance increase was linearly and positively correlated to the metal concentrations.

Given the structural and functional complexity inherent to fluvial biofilms and the vast range of potential interactions that between different microbial components, we hypothesized that induced tolerance to metals in fluvial biofilm communities could vary not just along a spatial gradient but also along a temporal gradient of metal contamination, and that this evolution could be different depending on the biofilm component studied (autotrophs or heterotrophs). The aim of this study was twofold: first, to investigate the temporal evolution of the induced tolerance to zinc in autotrophic and heterotrophic biofilm communities along a zinc gradient in a field context, and second, to link this tolerance evolution to the structural

changes observed in different taxonomic kingdoms that compose biofilms (i.e. bacteria, diatoms, fungi).

2. Material and methods

2.1. Study site

The translocation experiment was conducted in the second-order Osor river in Girona (NE, Spain), a tributary of the Ter River (Fig.1). The Osor is 23.5 km long and drains a catchment area (from the Guilleries Mountains) of 8890 ha. The river's stone-bedded geological substratum is mainly siliceous, with moderate mineralization ($173 \text{ mg.L}^{-1} \text{ CaCO}_3$, ACA 2009). Hydromorphology-wise, it presents riffles and pools. The riparian vegetation is well represented, reaching high cover in spring. This river is relatively well preserved, and the low anthropogenic pressures are essentially continuous (mine effluent) and diffuse metal inputs (mine run-over) from former mining activities (finished in 1980). Urban pressures are low, with small amounts of residual sewage from Osor village (354 inhabitants) and from a wastewater treatment plant located upstream (St. Hilari Sacalm with 5064 inhabitants). Regional climate is Mediterranean. Annual average precipitations are 950 L.m^{-2} , and median temperature is 12°C .

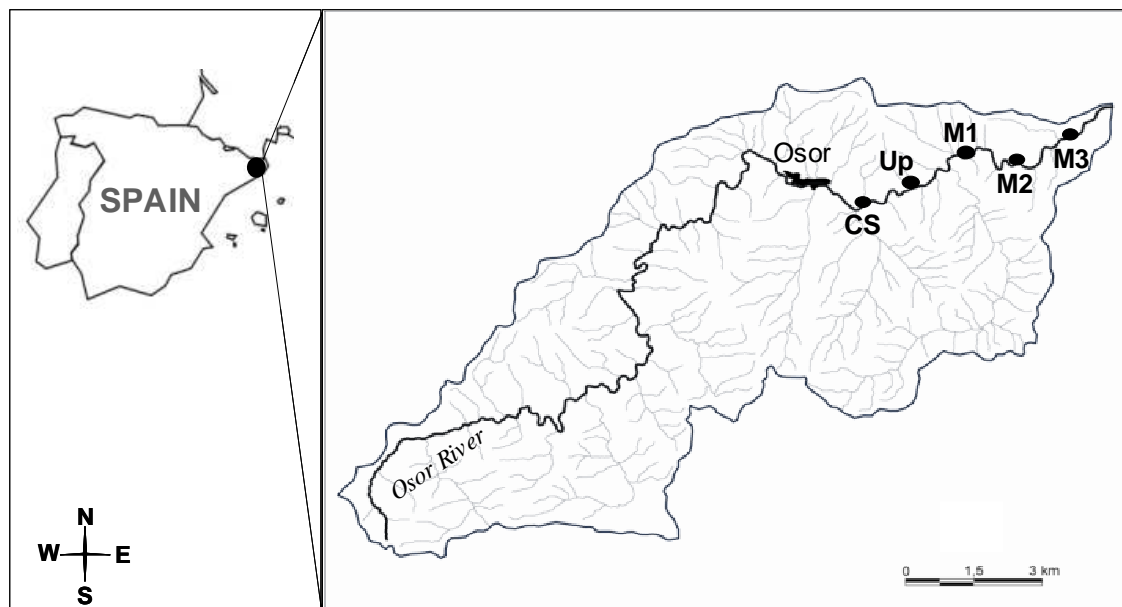

Fig.1 Catchment area of the River Osor (Spain) and the sampling areas (CS: colonization site, Up: Upstream site, M1: Mining.1, M2: Mining.2 and M3: Mining.3).

2.2. Experimental set-up and sample collection

This *in-situ* translocation study was led over April to June 2009. Biofilm was grown on artificial substrates to reduce the heterogeneity that occurs on natural substrates (Cattaneo et al. 1997) by controlling both substrate colonization surface and biofilm maturation level, which is fundamental in the context of this study. Small (1.44cm²) and big (17 cm²) sand-blasted glass slides were glued to 0.16 m² cinder blocks with silicon sealant. 24 blocks were placed horizontally in the colonization site, in the center of the stream. After 5 weeks of growth, mature biofilms were transferred to 4 sampling sites (6 blocks per site) and placed in similar light and water current conditions. To avoid any translocation effect that could be a confounding factor, the colonization site was not considered in our monitoring (since biofilms did not undergo the transfer step). Instead, a downstream site similar to the colonization site and with good ecological status and background metal pollution was used as reference or non-metal-polluted site, hereafter referred to as “upstream” site. Three sites presenting different levels of Zn contamination were chosen from within the mining area (listed from upstream to downstream): the first site, referred to as “Mining.1”, is situated before the main mine effluent and expected to receive diffuse metal inputs. The second site, referred to as “Mining.2”, is located after the mine effluent, leading to continuous metal inputs, and the last site referred to as “Mining.3”, is expected to have the lowest metal concentrations due to metal precipitation and storage in the sediment (Fig.1). Biofilms were collected from each sampling area 1, 3 and 5 weeks after translocation. For chemical, molecular, HPLC-pigment and diatom diversity analyses, biofilms were immediately scraped, whereas for photosynthetic efficiency, total biomass and bioassay analyses, the glass substrata were kept intact and placed in boxes filled with water from the corresponding site. All the samples were then placed in cool-boxes and transported to the laboratory within 5 hours after sampling. Except for diatom analysis (for which samples were preserved in a formalin solution, 4% of final volume), all samples for structural endpoints and chemical analysis were stored at -80°C for further processing. Total biomass, photosynthetic efficiency and bioassay analyses were performed immediately on return to the laboratory.

2.3. Physicochemical analyses

Sampling parameters including oxygen (%), pH, conductivity, temperature (WTW Meters, Weilheim, Germany) and light (LI-COR Inc., Lincoln, Nebraska, USA) were measured *in situ* during each sampling period. Light measurements were performed in the river center and at both banks in order to calculate the percentage of cover. Moreover, in order

to assess chemical parameters including DOC, PO_4^{3-} , nitrate and dissolved metals (Al, Fe, Ni, Cu, Cd, Pb and Zn), water samples were filtered (Nylon Membrane Filters 0.2 μm , Whatman, Maidstone, UK) and frozen in the lab until analysis (water samples for metal analysis were acidified with 1% of Suprapur nitric acid before storage). Phosphate (PO_4^{3-}) concentration was analyzed using the Murphy & Riley (1962) molybdenum blue colorimetric method following standard procedures (APHA 1989). Nitrate was determined by ion chromatography (761 Compact IC, Metrohm, Herisau, Switzerland). Dissolved metal concentrations were analyzed using inductively-coupled plasma mass spectrometry (7500 ICP-MS, Agilent Technologies, Wilmington, DE). Limit of detection was 0.12 $\mu\text{g.L}^{-1}$ for Cu, 2.82 $\mu\text{g.L}^{-1}$ for Zn, 0.72 $\mu\text{g.L}^{-1}$ for Al, 0.40 $\mu\text{g.L}^{-1}$ for Pb, 2.44 $\mu\text{g.L}^{-1}$ for Ni, 17.18 $\mu\text{g.L}^{-1}$ for Fe and 0.32 $\mu\text{g.L}^{-1}$ for Cd.

To measure concentrations of metals accumulated in biofilm matrices, three different slides (17 cm^2/slide) were scraped separately at each sampling area and date. After collection, the biofilms were freeze-dried and weighed. Dry samples (around 200 mg) were digested with 4 ml of concentrated nitric acid (Suprapur) and 1 ml of 30% hydrogen peroxide in a high-performance microwave labstation (Milestone, Ethos sel) and 25 mL Milli-Q water was added to dilute the acid concentrate. The water samples were analyzed following the same procedure as for total dissolved metal concentrations in water.

2.4. Total and phototrophic biomass

The organic matter content of three small substrates was calculated as described in Tlili *et al.* (2008). Results are expressed as g.m^{-2} .

Chlorophyll-*a* content in biofilm was quantified by HPLC analysis. The identified chlorophyll-*a* was quantified from external calibrations on standard chlorophyll-*a* (C55H72MgN4O5, Carl Roth GmbH & Co). Final concentrations are given as $\mu\text{g.cm}^{-2}$ (see 2.5.2 for analytical details).

2.5. Structural analyses

2.5.1. Biofilm DNA extraction, amplification, and automated ribosomal intergenic spacer-analysis (ARISA)

Three biofilm replicates (big frosted-glass slides) per sampling site and period were scraped then centrifuged at 14,000 g for 30 minutes at 4°C. The supernatant was removed, and the biofilm pellets were kept at -80°C until nucleic acid extraction using the DNAeasy Plant kit (QIAGEN) following the manufacturer's instructions.

Amplification and ARISA of the 16S-23S intergenic spacer region from the bacterial rRNA operon and the two internal transcribed spacers plus 5.8S (ITS1-5.8S-ITS2) from the fungal rRNA operon were performed according to Ranjard *et al.* (2003), with modifications. Briefly, the bacterial intergenic spacers were amplified using the primers S-D-Bact-1522-b-S-20 (eubacterial rRNA small subunit, 5'-TGCGGCTGGATCCCCTCCTT-3') and L-D-Bact-132-a-A-18 (eubacterial rRNA large subunit, 5'-CCGGGTTTCCCCATTCGG-3'). The fungal intergenic spacers were amplified using the primers 2234C (5'-GTTTCCGTAGGTGAACCTGC-3') and 3126T (5'-ATATGCTTAAGTTCAGCGGGT-3'). In both cases, PCR amplification was performed on 50 μ L volumes containing a 10x Taq reaction buffer (Sigma), 120 μ M of each deoxynucleotide, 1 μ M of each primer, bovine serum albumin (Sigma, 0.5 mg.mL⁻¹ final concentration) and 1.25U Taq DNA polymerase (Eurobio 1.25U). All amplifications were performed on a TPersonal Thermal Cycler (Whatman Biometra, GmbH Niedersachsen, Germany). Each set of reactions included a negative control in which the template was replaced by an equivalent volume of sterile deionized water.

ARISA analyses were performed on an Agilent 2100 Bioanalyzer (Agilent Technology Mfg GmbH & Co. KG) following the manufacturer's instructions. Bacterial and fungal ARISA profiles were analyzed using GelCompar II software (Applied Math NV) leading to a matrix based on the quantification of relative band intensities.

2.5.2. Phototrophic pigment analysis by high-performance liquid chromatography (HPLC)

Three small glass slides were selected separately at each sampling site and period and processed for HPLC pigment analysis as described in Tlili *et al.* (2008). Pigments were identified according to their specific retention times and absorption spectra using DAD according to SCOR guidelines (Jeffrey *et al.*, 1997). A table was constructed (with samples as rows and pigments as columns) integrating the relative abundance of each pigment in a given sample (expressed as a percentage of the sum of the area of all the pigments in a sample). In addition, diatoms, cyanobacteria and green algae were identified from their specific pigment signatures (fucoxanthin for diatoms, zeaxanthin for cyanobacteria, and lutein for green algae). We employed a quantitative method developed from a calculation model based on published ratios (r_w) for monocultures (Wilhelm *et al.* 1991). Final concentrations are given as μ g.cm⁻².

2.5.3. Diatom community structure

Three replicate small frosted-glass slides per site and sampling period were used for identification of biofilm diatoms. Biofilm samples were cleaned, mounted on permanent slides and observed under microscope according to European standard NF EN 13946.

Diatoms were counted at x1,000 magnification and identified following Krammer & Lange-Bertalot (1986-1991) together with recent nomenclature updates (e.g. Diatoms of Europe, Iconographia Diatomologica, Bibliotheca Diatomologica series).

2.6. Functional analyses

2.6.1. Effective photosynthetic efficiency

The effective photosynthetic efficiency of photosystem II (referred to as “eff. Yield”) was estimated based on the chlorophyll fluorescence signal recorded at 665 nm and given as relative units of fluorescence. Chlorophyll fluorescence was measured on three small frosted-glass slides from each sampling site and period using a MiniPAM (pulse amplitude-modulated) fluorometer (Heinz Walz, GmbH) (Schreiber, 2002).

2.6.2. Basal respiration and substrate-induced respiration

The basal respiration and substrate-induced respiration (SIR) of the heterotrophic biofilm communities were studied using the MicroRespTM method developed by Campbell *et al.* (2003) for soil studies and adapted by Tlili *et al.* (2010b) for aquatic ecosystem studies. This technique is based on miniaturized systems offering the possibility to measure CO₂ production during short-term incubation. MicroRespTM is a colorimetric method based on the color change of a pH indicator dye caused by CO₂ release by heterotrophic communities. The system consists of two 96-well microplates placed face to face. One is a deep-well microplate (1.2 mL capacity, 96-deep-well microplate, NUNC) in which each well contains 500 μ L biofilm suspension (from one big glass slide, n = 3 for each sampling site and period) with 30 μ L of glucose solution (6.2 mg of C per well, pH = 7) to calculate SIR or 30 μ L of water to calculate basal respiration. The second microplate contained the detection gel. The two microplates were sealed together with a silicone seal, with interconnecting holes between the corresponding wells. The assembly was clamped together and the system was incubated in the dark for 15 hours at room temperature. CO₂-trap absorbance was measured at 570 nm (Biotek Synergy HT spectrophotometer) immediately before sealing to the deep-well plate (CoV below 5%) and after incubation. Quantities of CO₂ produced by the microbial samples were calculated using a calibration curve of absorbance values *versus* CO₂ quantity measured by gas chromatography (MTI 200 thermal conductivity detector). Results were then expressed as μ g CO₂.mg⁻¹ of AFDW.h⁻¹.

2.6.3. Short-term bioassays and zinc tolerance assessment

To highlight the induced tolerance to zinc, the sampled biofilms at each studied area and period were subjected to short-term bioassays with a series of increasing concentrations of

zinc. The functional descriptors used in this study to characterize this induced tolerance were photosynthetic efficiency (targeting the phototrophic component) and SIR (targeting the heterotrophic component).

A stock solution containing 2 M zinc ($\text{ZnSO}_4 \cdot 7\text{H}_2\text{O}$; MW = 287.5 g; Sigma high-purity grade) was prepared in Milli-Q water and stored at 4°C prior to dilution in the test vessels. A semi-logarithmic series of concentrations was freshly prepared by serial dilutions of the stock solutions in 0.2 μm -filtered water from the upstream site. Final test concentrations in the vessels ranged from $6 \cdot 10^{-5}$ M to $6 \cdot 10^{-2}$ M for photosynthetic bioassay (3 blanks and 3 replicates for each of the 6 increasing concentrations) and $2 \cdot 10^{-6}$ M to 2 M for SIR bioassay (3 blanks and 3 replicates for each of the 9 increasing concentrations).

- *Short-term photosynthetic bioassay*: the effect of Zn on the phototrophic fraction of the biofilm was assessed one, 3 and 5 weeks after translocation at each sampling site. Small frosted-glass slides were exposed to increasing Zn concentrations over 4 hours at 19°C with a photon flux density of about $120 \mu\text{mol m}^{-2}\text{s}^{-1}$, under continuous gentle shaking. After 30 min of dark adaptation, measurements were performed using a MiniPAM fluorometer. The relative inhibition of the maximum fluorescence yield at 665 nm in relation to control was calculated to model concentration-response relationships, which allowed us to calculate the EC_{50} values (Tlili et al. 2010a).

- *Short-term SIR bioassay*: to assess the effect of Zn on the heterotrophic fraction of the biofilm, 3 big glass substrates from each sampling site and date were scraped and suspended separately in 10 mL of 0.2 μm -filtered water from the upstream site, and bioassays were run using the MicroRespTM method following Tlili et al. (2010b). The biofilm suspension was distributed into deep wells (500 μL per well) in a 96-well microplate to which we added 50 μL of the metal solution (increasing concentrations). The microplate was then pre-incubated in the dark at room temperature for 3 hours (to cope with artefacts causing chemical release of CO_2), then 30 μL of the glucose solution ($120 \text{ mg} \cdot \text{mL}^{-1}$) was added to each well and the detection microplate was positioned. The system was sealed and incubated for 15 hours in the dark at room temperature ($20 \pm 1^\circ\text{C}$). CO_2 -trap absorbance was measured at 570 nm immediately before sealing to the deep well plate and after 15-h incubation. Dose-response curves were plotted using CO_2 values produced by the biofilm at each metal concentration, and the EC_{50} values were calculated for each sampling site and period.

2.7. Statistical data analysis

XLstat software (2009 version) was used to analyze physicochemical data, CANOCO version 4.5 (ter Braack and Smilauer 1998) was used for the ordination methods, and the Regtox model (E. Vindimian, <http://eric.vindimian.9online.fr/>) was used to calculate the EC₅₀ values.

- *Physicochemical data*: to test the significance of differences in physicochemical data from the different sampling sites and verify whether there was any time effect over the study, we applied repeated-measures ANOVA using a mixed model based on the Chi² test. If a significance was confirmed ($p < 0.05$), the ANOVA were followed by a Tukey-HSD test. Homogeneity of variances was checked prior to data analysis.

- *Biofilm diversity data analyses*: data from diatom taxonomy identification, phototrophic pigments and ARISA (fungal and bacterial)-rRNA gene analysis were used to determine the structural evolution of the different biofilm components at each sampling site and date. Metric data, based on relative band intensities for ARISA and relative abundance for diatoms and pigments were $\log_{10}(x + 1)$ -transformed before being included in the analysis, and then submitted to detrended correspondence analysis (DCA). Maximum gradient length was below 3 standard deviation units for all the measured parameters, indicating that linear methods were more appropriate. Consequently, we carried out a principal component analysis (PCA) for all the structural endpoints. Only diatom taxa and phototrophic pigments accounting for at least 2% in two samples were included in the PCA (Guasch *et al.* 2009).

- *Influence of environmental conditions on biofilm metrics*: The relationship between environmental conditions and biofilm metrics was established by multivariate analysis. Variables with a strong inter-correlation (dissolved Cu, Pb and Cd) were eliminated. Except for pH, oxygen (%) and cover (%), all the other data were $\log_{10}(x + 1)$ -transformed before being included in the analysis.

Datasets were analyzed by detrended canonical correspondence analysis (DCCA) to determine the length of the gradient. DCCA revealed that the maximum amount of variation in the data was below 3 standard deviation units (0.805), indicating that linear ordination was more appropriate. We thus ran redundancy data analysis (RDA) in which response variables were constrained by the environmental factors. To select only the explanatory variables that significantly explained the distribution pattern of our samples, a forward selection was done at a cut-off point of $p = 0.1$ and the significance of each variable was tested by the Monte Carlo permutation test (999 unrestricted permutations). Probabilities for multiple comparisons were corrected using Bonferroni correction.

Variance partitioning was performed to distinguish between the effects of two subsets of environmental variables: metal pollution and the other environmental variables (Borcard *et al.* 1992). This approach allowed us to determine the fractions of the explained variance that are related to each data subset or shared by both. To perform the variance partitioning, a series of RDA was done: (1) RDA of response variables constrained by physicochemical variables, (2) RDA of the response variables constrained by metal pollution, (3) partial RDA of the response variables constrained by physicochemical variables with metal pollution as co-variable, and (4) partial RDA of the response variables constrained by metal pollution with physicochemical variables as co-variables.

3. Results

3.1. Physicochemical data

All the physicochemical data including the concentrations of dissolved and bio-accumulated metals measured in our study are summarized in Table. 1.

Results showed that colonization and upstream sites were similar throughout the study in term of their physicochemical characteristics (ANOVA, $p > 0.05$ for all parameters). On the other hand, except for conductivity, percentage cover, dissolved oxygen (%) and phosphate concentrations, all other measured parameters (DOC, temperature, pH and nitrates) were similar across all sampling areas (ANOVA, $p > 0.05$). Percentage cover was significantly lower in the upstream site than the polluted sites (Mining.1, Mining.2 and Mining.3) (Tukey test, $p < 0.0001$) and similar between Mining.2 and Mining.3 (Tukey test $p > 0.05$). Mining.2 was characterized by the highest conductivity (Tukey test $p < 0.0001$), followed by Mining.1 (Tukey test $p < 0.0001$), whereas Mining.3 and the upstream site shared the lowest conductivity (Tukey test $p > 0.05$). PO_4^{3-} concentration was significantly higher in the upstream site than the other sampling sites (Tukey test, $p < 0.0001$), in contrast with Mining.2 which posted the lowest PO_4^{3-} concentration (Tukey test, $p < 0.0001$), whereas Mining.1 and Mining.3 had a similar intermediate PO_4^{3-} concentrations (Tukey test, $p < 0.05$). Finally, dissolved oxygen was similar between the sampling sites but significantly different between sampling dates (ANOVA, $p < 0.05$).

Table.1 Physicochemical variables measured in the studied sites. Mean (n = 9) corresponds to the average of the data obtained throughout the study for each sampling area and all the dates. min and max correspond respectively to the minimum and maximum values obtained for each site, whatever the sampling period. <LQ (under limit of quantification). * : $p < 0.05$, ** : $p < 0.01$ and *** : $p < 0.0001$ based on repeated measures ANOVA. Lower case letters indicate significant differences ($p < 0.05$) among sites (Tukey HSD test).

	Colonization site			Upstream site			Mining. 1			Mining. 2			Mining. 3		
	mean	min	max	mean	min	max	mean	min	Max	mean	min	max	mean	min	max
pH	8.20	8.13	8.28	8.03	7.88	8.15	7.86	7.75	7.96	8.04	7.86	8.2	7.54	7.28	7.79
Conductivity ($\mu\text{S}/\text{cm}$) **	236	227	244	244	231	255	265 ^a	252	286	459 ^b	383	592	218	209	244
Oxygen (%) *	100.5	99.4	102.8	99.60	97.2	101	93.10	83.1	98.8	101.17	97.3	104.8	98.55	95.9	101.2
Temperature ($^{\circ}\text{C}$)	17.40	15.9	20.1	18.07	17	19.3	18.50	16.9	20	19.37	19.1	19.7	18.40	17.8	18.9
Cover (%) ***	10.00	8.37	12.54	2.19	1.36	2.67	14.97 ^a	12.77	17.97	46.66 ^b	37.97	56	55.34 ^b	12.29	74.36
DOC ($\text{mg}\cdot\text{L}^{-1}$)	3.28	2.65	3.86	3.62	2.72	6.51	3.87	2.79	6.75	3.40	2.10	7.11	3.84	2.58	8.30
PO_4^{3-} ($\mu\text{g}\cdot\text{L}^{-1}$) ***	0.47	0.39	0.67	0.47	0.31	0.67	0.39 ^a	0.34	0.44	0.22 ^b	0.16	0.27	0.39 ^a	0.28	0.53
NO_2^- ($\text{mg}\cdot\text{L}^{-1}$)	0.12	0.03	0.28	0.09	0.01	0.23	0.06	0.01	0.18	0.02	0.01	0.04	0.09	0.02	0.19
NO_3^- ($\text{mg}\cdot\text{L}^{-1}$)	3.76	1.96	4.57	3.38	1.68	4.50	2.24	1.49	3.45	1.63	0.17	3.24	3.36	1.95	4.11
NH_4^+ ($\text{mg}\cdot\text{L}^{-1}$)	< LQ	< LQ	< LQ	< LQ	< LQ	< LQ	< LQ	< LQ	< LQ	< LQ	< LQ	< LQ	< LQ	< LQ	< LQ
Dissolved metals:															
Al ($\mu\text{g}\cdot\text{L}^{-1}$) ***	1.97	< LQ	6.75	1.83	< LQ	6.18	7.21 ^a	< LQ	15.02	< LQ	< LQ	< LQ	< LQ	< LQ	< LQ
Fe ($\mu\text{g}\cdot\text{L}^{-1}$) ***	336.0	304.4	358.5	311.4	294.0	320.5	336.9 ^a	321.7	357.9	600.0 ^b	470.1	767.7	185.5 ^c	< LQ	273.4
Ni ($\mu\text{g}\cdot\text{L}^{-1}$) *	1.28	< LQ	3.92	1.39	< LQ	4.45	15.03 ^a	< LQ	54.51	< LQ	< LQ	< LQ	< LQ	< LQ	< LQ
Cu ($\mu\text{g}\cdot\text{L}^{-1}$)	< LQ	< LQ	< LQ	< LQ	< LQ	< LQ	< LQ	< LQ	< LQ	< LQ	< LQ	< LQ	< LQ	< LQ	< LQ
Zn ($\mu\text{g}\cdot\text{L}^{-1}$) ***	45.70	< LQ	146.90	36.03	< LQ	112.90	58.05 ^a	10.53	141.30	454.20 ^b	346.50	620.90	44.69 ^c	< LQ	135.50
Cd ($\mu\text{g}\cdot\text{L}^{-1}$)	< LQ	< LQ	< LQ	< LQ	< LQ	< LQ	< LQ	< LQ	< LQ	< LQ	< LQ	< LQ	< LQ	< LQ	< LQ
Pb ($\mu\text{g}\cdot\text{L}^{-1}$)	< LQ	< LQ	< LQ	< LQ	< LQ	< LQ	< LQ	< LQ	< LQ	< LQ	< LQ	< LQ	< LQ	< LQ	< LQ
Bio-accumulated metals:															
Al ($\mu\text{g}\cdot\text{g}^{-1}\text{DW}$) *	24666	18915	32239	18704	14799	27108	23785 ^a	15580	31322	17003	9528	23368	23341 ^a	16262	31763
Fe ($\mu\text{g}\cdot\text{g}^{-1}\text{DW}$)	23756	19976	34397	17446	11714	27127	17612	12477	23406	14611	7582	21505	19549	15215	24111
Ni ($\mu\text{g}\cdot\text{g}^{-1}\text{DW}$) **	6.98	5.11	9.39	6.14	< LQ	26.24	9.61 ^a	0.58	40.88	29.94 ^b	6.48	52.81	12.33 ^a	10.21	20.83
Cu ($\mu\text{g}\cdot\text{g}^{-1}\text{DW}$) *	17.42	10.47	24.23	2.64	< LQ	7.16	9.47 ^a	1.76	15.24	5.29 ^a	2.03	15.19	13.78 ^b	9.67	18.56
Zn ($\mu\text{g}\cdot\text{g}^{-1}\text{DW}$) ***	137.95	106.78	161.00	97.14	74.71	157.18	748.54 ^a	406.28	1064.6	3408.5 ^b	1631.5	6129.2	549.4 ^c	426.9	727.9
Cd ($\mu\text{g}\cdot\text{g}^{-1}\text{DW}$)	< LQ	< LQ	< LQ	< LQ	< LQ	< LQ	< LQ	< LQ	< LQ	< LQ	< LQ	< LQ	< LQ	< LQ	< LQ
Pb ($\mu\text{g}\cdot\text{g}^{-1}\text{DW}$) ***	33.39	18.88	46.20	19.85	17.16	22.93	135.6 ^a	120.1	160.9	175.7 ^b	90.8	294.4	131.3 ^a	92.84	199.0

Dissolved Cu, Cd and Pb concentrations were always below the limit of quantification in all the studied sites and periods. Repeated-measures ANOVA showed that Al, Fe, Zn and Ni concentrations were significantly different between sites ($p < 0.05$ for Ni and $p < 0.0001$ for the others). Ni and Al concentrations were significantly higher in Mining.1 than in the other sampling sites (Tukey test, $p < 0.05$), which showed similar contaminations of both metals (Tukey test, $p > 0.05$). However, Fe concentration in the upstream site was significantly higher than in Mining.3 but significantly lower than in Mining.1 and Mining.2 (Tukey test, $p < 0.0001$). Conversely, the upstream site was characterized by low Zn contamination whereas Mining.2 showed the highest Zn contamination (Tukey test, $p < 0.0001$). Mining.1 showed intermediate Zn contamination, whereas Mining.3 was slightly more contaminated than the upstream site.

The quantification of accumulated metals within biofilm matrices showed a different pattern than for dissolved metals, except for Cd that was also under the limit of quantification in all the sampled biofilms. Compared to other metals, Al and Fe accumulated most strongly in biofilm matrices. There were no significant between-site differences in Fe (ANOVA, $p > 0.05$), whereas Al was significantly different (ANOVA, $p < 0.05$), with Mining.1 and Mining.3 showing the highest concentrations and Mining.2 and the upstream site showing the lowest concentrations (Tukey test, $p < 0.0001$). Accumulated Pb, Ni, Cu and Zn were significantly lower in the upstream site than the other sampling sites, and Mining.2 biofilms accumulated these metals more than the other sites, except for Cu which was most strongly accumulated in Mining.1 and Mining.3 biofilms (Tukey test, $p < 0.0001$). Biofilms from Mining.1 and Mining.3 showed similar intermediate concentrations of Zn and Ni.

3.2. Structural analyses and principal component analysis (PCA)

3.2.1. Phototrophic communities

- *Phototrophic pigments*: A total of 16 pigments were detected in all the samples collected. Among them, only 10 (accounting for at least 2% in two samples) were included in the PCA (Fig.2). The first two axes (PC1 and PC2) of the PCA accounted for more than 64% of the total variability.

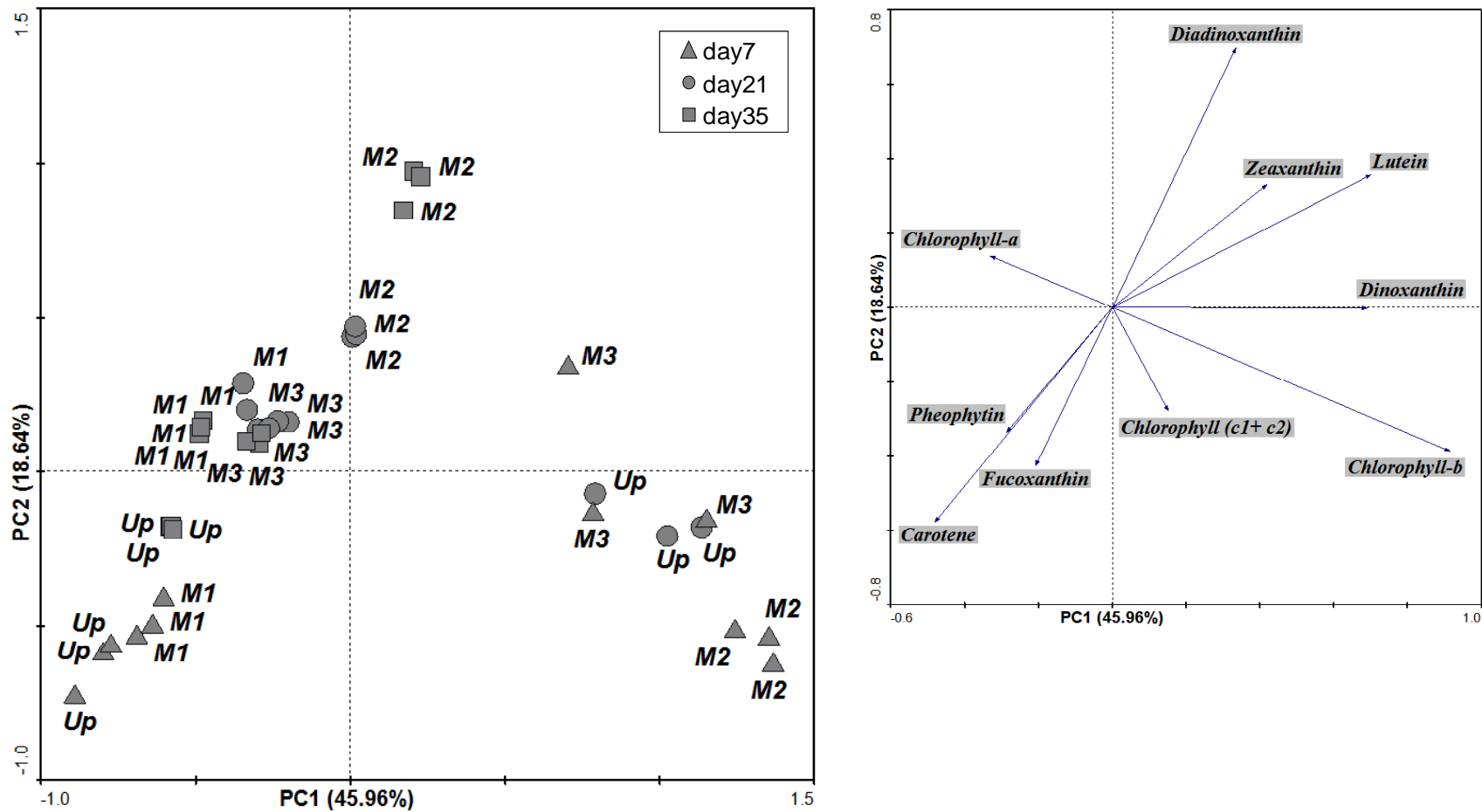

Fig.2 Biplot of the principal component analysis (PCA) based on the relative abundance of phototrophic pigments in the collected biofilms: the left panel represents the ordination of the four Osor river sampling areas (Up: Upstream site, M1: Mining.1, M2: Mining.2 and M3: Mining.3) at one, three and five weeks after translocation according to the PC1 and PC2 axes, and the right panel represents the correlation plot between the PCA axes (PC1 and PC2) and the detected pigments (three replicates per date and sampling area).

Mining.2 (whatever the sampling period), Mining.3 (at one week) and the Upstream site (at three weeks) were separated on PC1 from other sites and periods. PC2 was related to biofilm age and separated sites according to age and contamination intensity. Mining.1 and Mining.3 evolved faster than the Upstream site but slower than Mining.2. PC1 was positively correlated to dinoxanthin and chlorophyll-*b* but negatively correlated to chlorophyll-*a*, whereas PC2 was positively correlated to diadinoxanthin and zeaxanthin but negatively correlated to fucoxanthin, pheophytin and carotene.

- *Diatom taxonomy*: In total, 99 diatom species were found in all the samples collected. Among them, 22 taxa (accounting for at least 2% in two samples) were included in the PCA (Table.2). The first two axes (PC1 and PC2) of the PCA, based on relative abundance of diatom species, accounted for more than 64% of total variability (Fig. 3). PC1 clearly separated Upstream site, Mining.1 and Mining.3 samples from Mining.2 samples, visibly on the basis of metal pollution gradient. Diatom taxa positively associated with PC1 and therefore mainly characterizing Mining.2 at 3 and 5 weeks post-translocation were *Eolimna minima* (EOMI) *Mayamaea permitis* (MAPE), and *Planothidium frequentissimum* (PLFR). In contrast, biofilms collected at 3 and 5 weeks in the Upstream site, Mining.1 and Mining.3 were mostly characterized by *Cocconeis placentula* and its varieties (CPLA, CPLE, CPLI) and *Nitzschia fonticola* (NFON). Biofilms collected one week post-translocation were separated from the others on PC2, meaning that the second PCA axis was clearly related to a temporal evolution in diatom community. Diatom taxa positively associated with PC2 were *Achnanthisidium pyrenaicum* (ADPY), *A. minutissimum* (ADMI), *Eolimna subminuscula* (ESBM), *Melosira varians* (MVAR) and *Nitzschia inconspicua* (NINC).

Table.2 Abbreviations used for diatom taxa.

Code	Diatom taxa
ADMI	<i>Achnantheidium minutissimum</i> (Kützing) Czarnecki
ADPY	<i>Achnantheidium pyrenaicum</i> (Hustedt) Kobayasi
APED	<i>Amphora pediculus</i> (Kützing) Grunow
CPLA	<i>Cocconeis placentula</i> Ehrenberg var. <i>placentula</i>
CPLE	<i>Cocconeis placentula</i> Ehrenberg var. <i>euglypta</i> (Ehrenberg) Grunow
CPLI	<i>Cocconeis placentula</i> Ehrenberg var. <i>lineata</i> (Ehrenberg) Van Heurck
EOMI	<i>Eolimna minima</i> (Grunow) Lange-Bertalot
ESBM	<i>Eolimna subminuscula</i> (Manguin) Moser Lange-Bertalot & Metzeltin
MAPE	<i>Mayamaea permitis</i> (Hustedt) Bruder & Medlin
MVAR	<i>Melosira varians</i> Agardh
NCPR	<i>Navicula capitatoradiata</i> Germain
NGRE	<i>Navicula gregaria</i> Donkin
NLAN	<i>Navicula lanceolata</i> (Agardh) Ehrenberg
NIAR	<i>Nitzschia archibaldii</i> Lange-Bertalot
NDIS	<i>Nitzschia dissipata</i> (Kützing) Grunow var. <i>dissipata</i>
NFON	<i>Nitzschia fonticola</i> Grunow in Cleve et Möller
NIFR	<i>Nitzschia frustulum</i> (Kützing) Grunow var. <i>frustulum</i>
NINC	<i>Nitzschia inconspicua</i> Grunow
NPAL	<i>Nitzschia palea</i> (Kützing) W.Smith
PLFR	<i>Planothidium frequentissimum</i> (Lange-Bertalot) Lange-Bertalot
PTLA	<i>Planothidium lanceolatum</i> (Brebisson ex Kützing) Lange-Bertalot
RSIN	<i>Reimeria sinuata</i> (Gregory) Kociolek & Stoermer

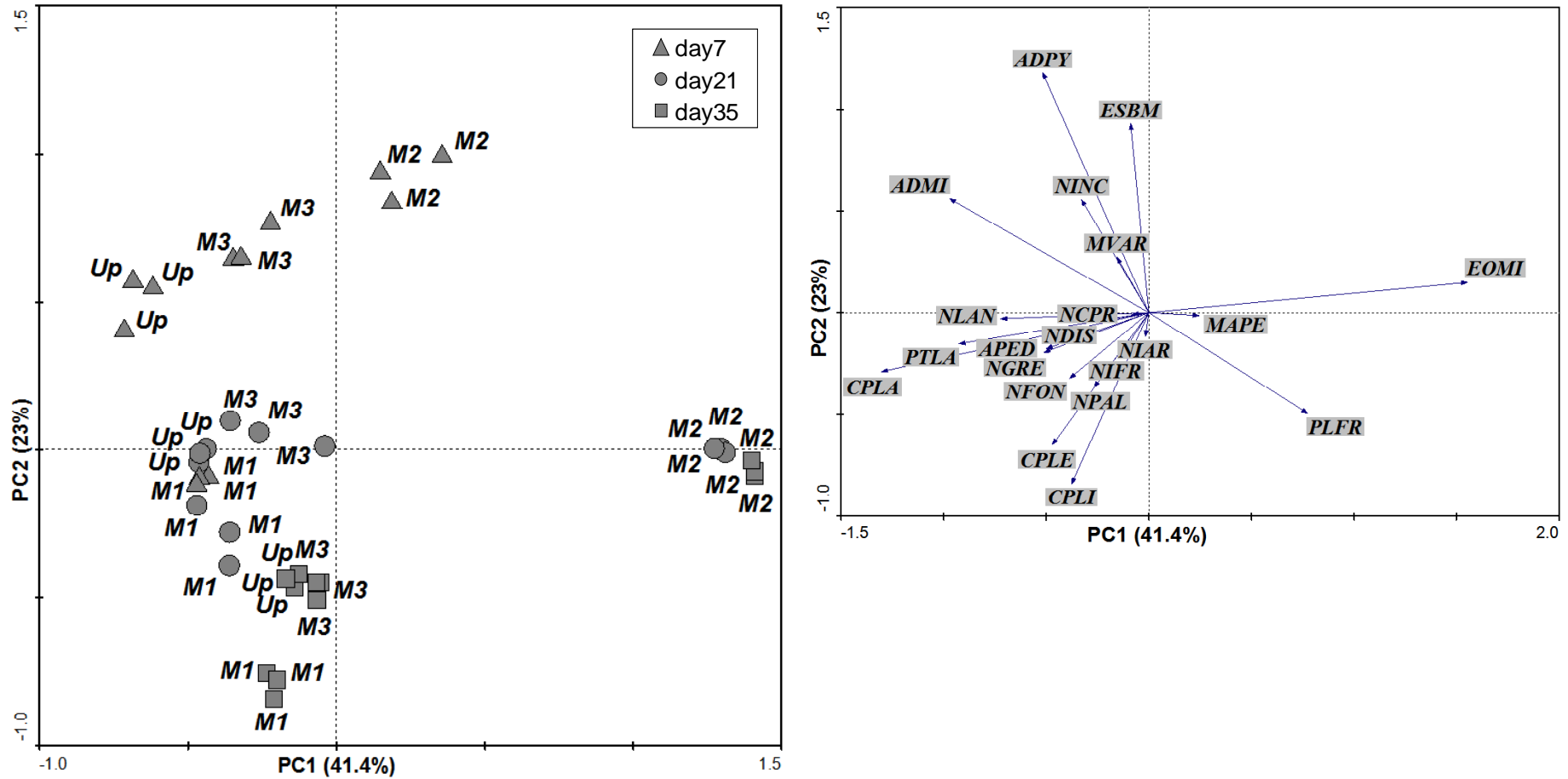

Fig.3 Biplot of the principal component analysis (PCA) based on the relative abundance of diatom species in the collected biofilms: the left panel represents the ordination of the four Osor river sampling areas (Up: Upstream site, M1: Mining.1, M2: Mining.2 and M3: Mining.3) at one, three and five weeks after translocation according to the PC1 and PC2 axes, and the right panel represents the correlation plot between the PCA axes (PC1 and PC2) and the identified diatom taxa (three replicates per date and sampling area).

3.2.2. Heterotrophic communities

- *Bacterial diversity*: Overall, a total of 22 bands were detected after ARISA analysis. The number of bands detected over the course of the study in each sampling area varied from 7 to 14 at the upstream site (mean = 11), from 10 to 14 at Mining.1 (mean = 12), from 8 to 13 at Mining.2 (mean = 11) and from 8 to 16 at Mining.3 (mean = 13). PCA was applied to the relative band intensities data for samples from all the studied areas and sampling dates (Fig.4). The two first axes (PC1 and PC2) explained more than 44% of the total variability in bacterial diversity. PC1 separated the upstream site (whatever the sampling date) and Mining.3 at the first two sampling periods (one and three weeks after translocation) from Mining.1 and Mining.2 at all sampling date and Mining.3 at the last sampling date. PC2 was clearly related to the temporal evolution of the bacterial community, and separated samples from all studied areas at one week after translocation from the other (3 and 5-week) samples. According to PC2, the upstream site seemed to show greater temporal evolution than the other sites. Overall, in these two projections, there was very low variability between the three replicates of sampled biofilms in each sampling area and period.

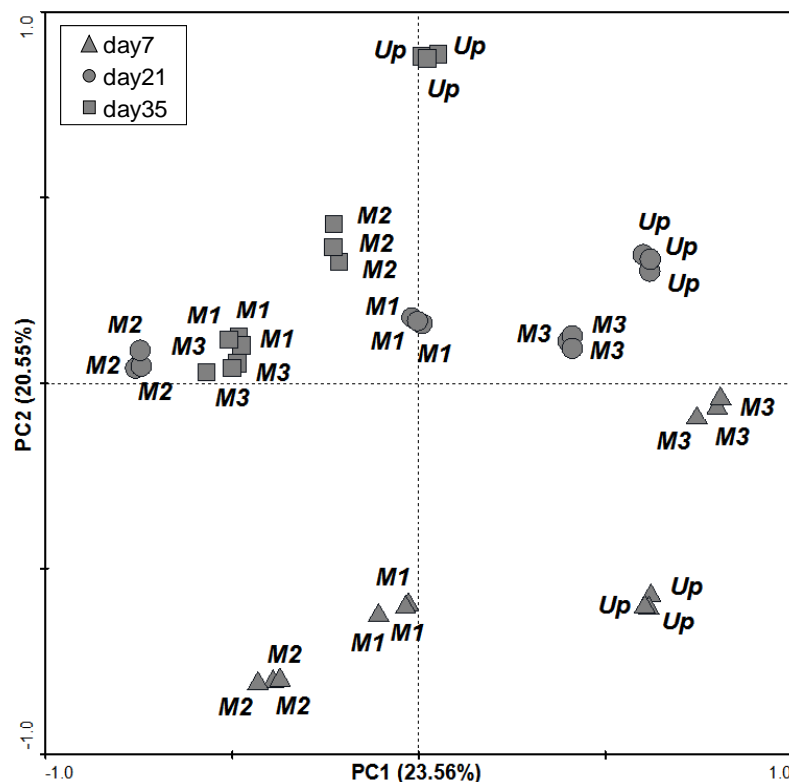

Fig.4 Principal component analysis (PCA) based on the relative band intensities obtained by PCR-ARISA analysis of the 16S-23S intergenic spacer region from the bacterial rRNA operon in biofilms collected from four Osor river sampling areas (Up: Upstream site, M1: Mining.1, M2: Mining.2 and M3: Mining.3) at one, three and five weeks after translocation (three replicates per date and sampling area).

- *Fungal diversity*: Overall, a total of 23 different bands were detected after ARISA analysis. The number of bands detected in each sampling area varied from 12 to 17 in the upstream site (mean = 15), from 14 to 15 at Mining.1 (mean = 15), from 12 to 16 at Mining.2 (mean = 14) and from 12 to 14 at Mining.3 (mean = 13). PCA performed with relative band intensities data for samples from all studied areas and sampling dates (Fig. 5) showed that the first two axes (PC1 and PC2) accounted for more than 56% of the total variability in fungal diversity. PC1 was clearly related to the temporal evolution of the fungal community during our study. Samples collected one week after translocation were separated on PC1 from the other samples collected three and five weeks after translocation. PC2 very clearly separated samples from Mining.2 at 3 and 5 weeks from samples taken at the upstream site, Mining.1 and Mining.3 at the same dates. The variability between the three replicates in each sampling area and period was also very low.

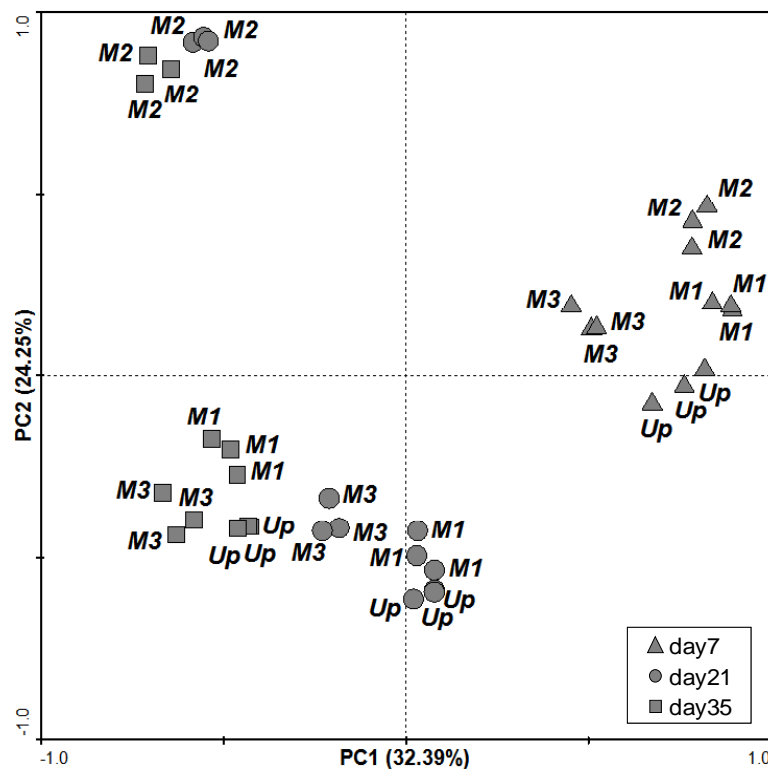

Fig.5 Principal component analysis (PCA) based on the relative band intensities obtained by PCR-ARISA analysis of the ITS1-5.8S-ITS2 intergenic spacer region from the fungal rRNA operon in the biofilms collected from four Osor river sampling areas (Up: Upstream site, M1: Mining.1, M2: Mining.2 and M3: Mining.3) at one, three and five weeks after translocation (three replicates per date and sampling area).

3.4. Redundancy data analysis (RDA) and influence of environmental factors on biofilm metrics

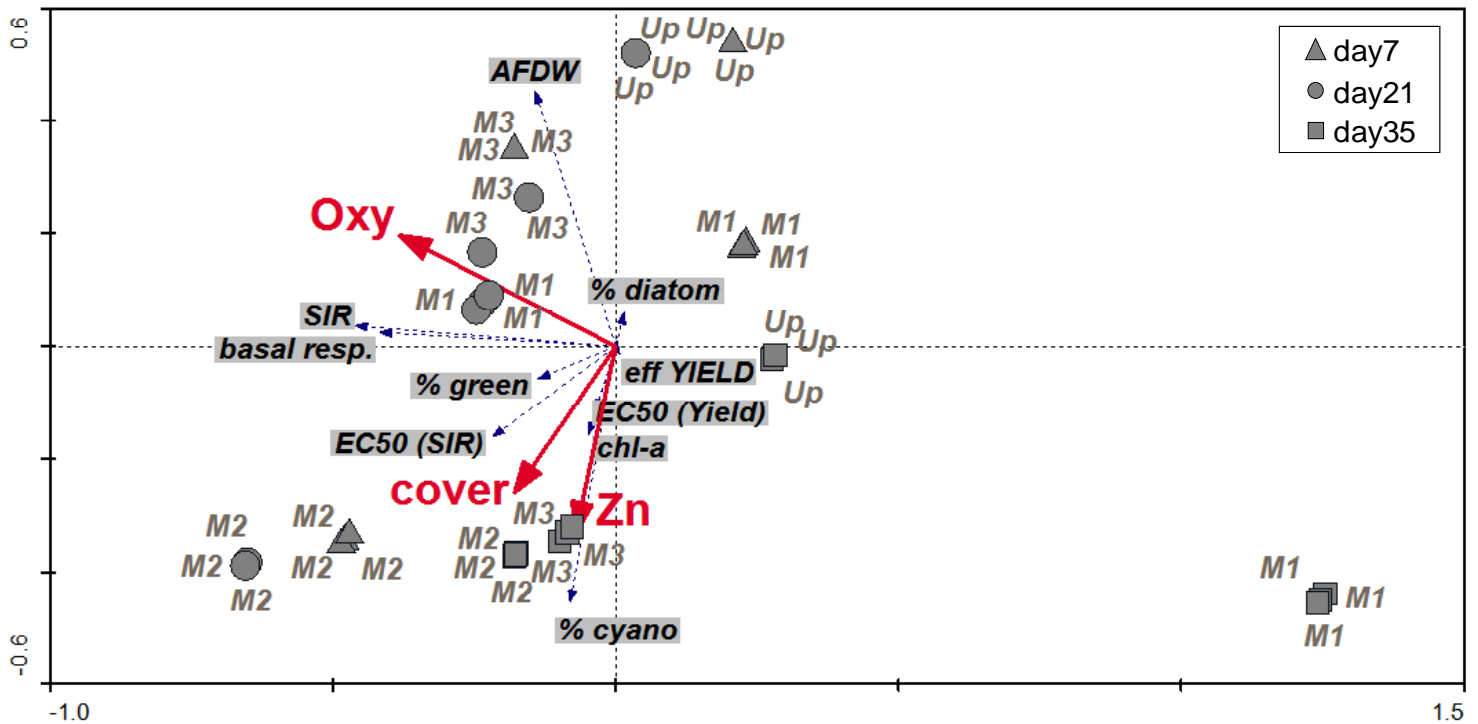

Fig.6 Triplot based on the Redundancy Analysis (RDA) of the biofilms collected from four Osor river sampling areas (Up: Upstream site, M1: Mining.1, M2: Mining.2 and M3: Mining.3) at one, three and five weeks after translocation. Solid arrows representing the constraint variables give Zn for the dissolved zinc concentrations, cover for the percentage of cover and Oxy for the dissolved oxygen. Dotted arrows representing biological variables are: AFDW, chlorophyll-a (chl-a), Relative percentages of cyanobacteria (% cyano), diatoms (% diatom) and green algae (% green), effective photosynthetic efficiency (eff. YIELD), substrate-induced respiration (SIR), basal respiration (basal resp), EC₅₀ based on photosynthesis bioassay (EC₅₀ (Yield)), and EC₅₀ based on SIR bioassay (EC₅₀ (SIR)) (three replicates per date and sampling area).

Table.3 Correlation between environmental variables (dissolved oxygen and percentage of cover) and Zn with the Redundancy Analysis (RDA) axes (RD1 and RD2)

	RD1	RD2
Oxygen	-0.5463	0.4595
Cover	-0.2556	-0.6056
Zinc	-0.1011	-0.7768
Eigenvalues	0.2118	0.1240

RDA analysis (Fig. 6) showed that among all the measured explanatory variables, only dissolved oxygen, percentage cover and dissolved Zn concentrations significantly influenced the measured responses of the sampled biofilms (Table.3). This ordination analysis explained 35.7% of variance. Variance partitioning showed that physicochemical data (oxygen and cover) alone accounted for 29.6% of the total explained variation, whereas Zn pollution alone explained 11.7% of total variation. Results also showed that the shared fraction of total variation between physicochemical and Zn pollution variables was 5.6%, so the unexplained variation was therefore 64.3%. The percentage of variance explained by physicochemical and Zn pollution variables independently, with respect to unconstrained variance, was different between the response variables (Table.4).

Table.4 Results of the partial Redundancy Analysis (RDA) using biofilm metrics, Zn concentrations, and physicochemical variables (dissolved oxygen and percentage of cover). Bold indicates the total variance higher than 10% in the left-side columns while and in the right-side columns (fraction of explained variance), bold indicates values that were clearly biased towards certain groups of variables.

Biofilm metrics	Fraction of total variance		Fraction of explained variance (%)	
	Pysico-chemical variables	Metals	Pysico-chemical variables	Metals
EC50 (yield)	1.86	23.58	7.31	92.69
EC50 (SIR)	18.67	11.99	60.89	39.11
% diatom	18.61	0.01	99.95	0.05
% green	33.71	6.38	84.09	15.91
% cyano	4.26	24.69	14.72	85.28
chl-a	3.59	14.18	20.20	79.80
AFDW	14.36	3.13	82.10	17.90
basal resp.	27.38	2.42	91.88	8.12
SIR	32.18	3.21	90.93	9.07
eff. YIELD	22.44	0.28	98.77	1.23

Percentage of diatoms and green algae, total biofilm biomass, basal respiration, SIR and effective photosynthetic efficiency were mostly explained by physicochemical variables (oxygen and cover). Percentage of cyanobacteria, chlorophyll-*a* concentrations and induced tolerance to Zn based on photosynthesis had their variability mainly explained by Zn pollution, while the induced tolerance to Zn based on SIR was explained by both environmental and Zn pollution variables. Site distribution on the first RDA axis (RD1) followed a gradient of dissolved oxygen, which was variable according to sampling date. Basal respiration and SIR were closely associated with high amounts of oxygen, observed

particularly at Mining.1 and Mining.2 whatever the sampling date and at Mining.3 at 5 weeks, in contrast with effective yield which was associated with the characteristic low oxygen amounts of the upstream site at all the sampling dates. The second RDA axis (RD2) showed a site distribution along a joint gradient of cover with Zn pollution. High chlorophyll-*a* concentrations, percentage of cyanobacteria, and the most Zn-tolerant biofilms were related to the most Zn-polluted and highest-covered sites, while high total biomass concentrations and percentage of diatoms were related to the least Zn-contaminated and lowest-covered sites. However, site ordination on RD2 throughout the different sampling periods followed a different pattern. Mining.2 (the most Zn-polluted) was completely differentiated from the other sites even at one week post-translocation, and its variability remained very low throughout the study. Conversely, according to RD2, the upstream site, Mining.1 and Mining.3 were characterized by high variability between different sampling periods and tended to evolve like Mining.2 but less rapidly. At 5 weeks post-translocation, Mining.1 and Mining.3 were similar to Mining.2, while the upstream site was still different.

4. Discussion

Trace metals have highly complex interactions with biological organisms, and the structural or/and functional responses of these exposed organisms may therefore vary strongly (Tlili et al. 2010a). This *in-situ* study led over five weeks monitored the evolution of the induced tolerance to zinc in biofilms translocated from a clean site to a spatial gradient of Zn-contamination, taking into account their structural and functional complexity.

(i) Uncertainties related to the confounding factors in field studies

The major drawback of *in-situ* approaches assessing the effects of metals on natural communities is the presence of numerous confounding factors. Co-occurrence of metals and the natural variability of sites make it difficult to establish a specific link between a given toxicant and its effects on organisms. Many studies have investigated this issue, and all converge on the same conclusion: metal toxicity could be modulated by the physicochemical characteristics of the ecosystem, which could therefore be considered as confounding factors (Soldo and Behra 2000, Ivorra et al., 2002, Guasch et al. 2003, Duong et al. 2008). As well as providing a good physical and chemical characterization of the studied sites, two different but complementary approaches appear capable of solving this problem: (1) the use of complementary indicators for ecotoxicological investigations in river biofilms targeting

different biological components (Dorigo et al. 2010, Tlili et al. 2010a), and (2) the use of multivariate statistical techniques (Blanck et al. 2003, Guasch et al. 2009).

In general, most of the studies addressing the specificity of metal toxicity and the potential roles of confounding factors have focused solely on one component of the microbial community. For example, in 2002 and 2004 Guasch et al. demonstrated the potential influence of water pH and phosphorous enrichment on Cu toxicity to benthic algae communities, while Boivin et al. (2005) showed the influence of water temperature on Cu toxicity to biofilm bacterial communities. However, Tlili et al. (2010a) showed that, depending on the functional descriptor used and the microbial community targeted, the influence of the confounding factors could be variable or even null. They thus concluded on the need to use a range of parameters that target all the in-biofilm biological kingdoms in order to be able to attribute the measured effect to the toxicant contamination. Here, in addition to a set of functional and structural endpoints, the spatio-temporal evolution of the induced tolerance to Zn was assessed by two functional descriptors that target two different biological biofilm components (i.e. photosynthetic efficiency for phototrophs like algae and cyanobacteria, and SIR for heterotrophs like bacteria and fungi). Our results confirmed those obtained by Tlili et al. (2010a), since phototrophic communities followed a different time-course pattern of induced tolerance to the toxicant (in the present study: Zn) to heterotrophic communities.

These findings were observed by using multivariate ordination analysis (i.e. redundancy data analysis (RDA)). RDA and variance partitioning showed that some descriptors such as SIR, photosynthetic efficiency or total and algal biomass were mainly influenced by physicochemical variables (more than 90% of explained variance for all these descriptors). Moreover, EC_{50} values based on photosynthesis were only linked to metal contamination (92% of explained variance) whereas EC_{50} values based on SIR were related to both metal exposure and physicochemical variables. On the other hand, physicochemical characterization of the Osor river for this study showed the presence of different metals with profiles varying from site to site. One important confounding factor in the assessment of induced tolerance is the “co-tolerance” phenomenon observable in field studies. Co-tolerance may occur when communities that have been exposed to one toxicant but not to another become tolerant to both toxicants (Gustavson and Wängberg 1995, Soldo and Behra 2000). Multivariate analysis and forward selection indicated that among all the metals detected in Osor river, only Zn significantly influenced the measured responses of autotrophic and heterotrophic biofilm communities, enabling us to exclude co-tolerance as a factor.

Overall, the strategy combining good physicochemical characterization of the studied sites with the use of a large set of functional and structural descriptors covering more than one microbial component and the application of multivariate analyses allowed us to discriminate between the direct and specific effects of Zn pollution and the different confounding factors potentially occurring in our field study, and thus to attribute each variable response with the explanatory variable(s) that could influence it.

(ii) Effects of Zn contamination on the induced tolerance of autotrophic biofilm communities

In our *in-situ* study, community tolerance to Zn based on EC₅₀ values for photosynthesis was strictly linked to Zn concentrations and was positively dependant on the intensity of site Zn contamination (92.7% of explained variance), suggesting a pollution-induced community tolerance (PICT) to Zn. On the other hand, RDA indicated that the autotrophic PICT increase was not only modulated by metal concentration levels but also by exposure duration. Indeed, biofilms from Mining.2, which was the most Zn-contaminated site, exhibited higher EC₅₀ values than biofilms from the Upstream site just one week after biofilm translocation, whereas biofilms from the low- and intermediate-polluted sites (Mining.3 and Mining.1, respectively) showed a slower and more progressive increase in induced tolerance over the course of the study, becoming similar to Mining.2 at the end of the experiment.

Different hypotheses could explain the observed spatio-temporal increase in phototrophic induced tolerance to zinc. The physical structure and chemical characteristics of biofilm communities make it possible to modulate the toxic effects of metal pollutants (Barranguet *et al.*, 2000). Indeed, one of the most important parameters influencing metal toxicity is the accessibility of cells to the toxicants, and a thicker biofilm is in theory less vulnerable to inorganic contaminations since the cells are more protected. Previous studies have shown that biofilm thickness (i.e. biofilm biomass), which can increase with biofilm age, is protective against the toxicity of metals such as Cu or Zn (Ivorra *et al.* 1999, Barranguet *al.* 2000). Ivorra *et al.* (2000) demonstrated that mature benthic algae (characterized by highest AFDW) were less affected by Zn contamination than benthic algae exposed at an early development stage. Nevertheless, in our study, RDA showed that the most Zn-tolerant phototrophic biofilms had the lowest total biomass, indicating that the PICT increase was not influenced by biofilm thickness. We can therefore reject this hypothesis to explain our results, and suppose that the PICT increase measured in our study was not linked to spatial biofilm architecture but

to the phenotypic and genotypic characteristics of different phototrophic communities composing the biofilms.

Guasch *et al.* (2003) assessed the responses of algal biofilm communities from different lotic systems to short-term Zn-challenge bioassays and found a negative correlation between Zn toxicity and algal biomass. In an experimental study, Tlili *et al.* (2010a) also found a simultaneous increase in chlorophyll-*a* concentrations and induced tolerance to Cu (based on photosynthetic efficiency) after long-term Zn exposure of biofilms. It is well established that Zn at high concentrations can induce an inhibition of the photosynthesis reaction by blocking electron transfer at PSI and PSII levels, and consequently stopping oxygen release and CO₂ fixation (Ivorra *et al.* 1999). The excited chlorophylls then allow the production of reactive oxygen species (ROS) like singlet oxygen, a highly reactive form causing irreparable damage. Thus, phototrophic organisms have evolved various mechanisms to minimize the destructive effects of this kind of challenge. One demonstrated mechanism is the “greening effect” (especially in shade-adapted organisms) where chlorophyll-*a* pigments biosynthesis is increased to maintain an efficient conversion of light energy to chemical energy (Waring *et al.* 2007). In fact, the highest chlorophyll-*a* concentrations were found in Mining₂, whereas total biomass (AFDW) diverged completely, giving rise to the highest chlorophyll-*a*/AFDW ratio, which argues for the “greening-effect” hypothesis. Our results converge with this assumption, since they indicated that the EC₅₀ values based on photosynthesis were strongly and positively correlated with chlorophyll-*a* concentrations.

Phototrophic organisms growing under low-light conditions are known to have more light-harvesting antennae (i.e. chlorophyll-*a*) (Demmig-Adams and Adams 2006), and our study sites showed progressive more percentage of cover. Nevertheless, variance partitioning indicated that chlorophyll-*a* was mainly linked to metal contamination (79.8% of explained variance) and not lower light intensity, unlike AFDW which was influenced by percentage of cover. Thus, there was more growth in open sites, but shaded sites did not suffer light limitation and did not increase chlorophyll-*a*. We can therefore conclude that the ability to adjust intracellular light-harvesting chlorophyll-*a*, which was proportional to contamination intensity and duration of metal exposure, was one of the mechanisms the phototrophic communities in our study adopted to be more tolerant to the Zn contamination.

The “greening effect” is not the only strategy used by phototrophic organisms to cope with metal toxicity. Different xanthophylls associated with the light-harvesting center of algae are involved in the thermal dissipation of excess excitation energy which reduces the risk of ROS generation (Demmig *et al.*, 1987) by a reaction called the “xanthophylls cycle”. The

xanthophyll cycle involves the enzymatic removal of epoxy groups from xanthophylls (e.g. violaxanthin, antheraxanthin, diadinoxanthin) to create 'de-epoxidized' xanthophylls (e.g. diatoxanthin, zeaxanthin), which are capable of functioning as direct quenchers of energy from excited chlorophyll. For example, in diatoms and dinoflagellates, the xanthophyll cycle consists of the pigment diadinoxanthin, which is transformed into either diatoxanthin (diatoms) or dinoxanthin (dinoflagellates). Moreover, other carotenoids such as lutein or fucoxanthin are known to act as antioxidants (Armstrong and Hearst 1996). Our phototrophic pigment analysis revealed that biofilms from Mining.2, which were the most Zn-tolerant, showed the highest amounts of lutein, diadinoxanthin and zeaxanthin, but low amounts of carotene and fucoxanthin. If the distribution of phototrophic pigments was linked to the xanthophyll cycle, then diadinoxanthin should be negatively correlated to the zeaxanthin, but this was not the case in our study. Moreover, results also showed that zeaxanthin and lutein pigments were negatively correlated to α - and β -carotene pigments, which are the precursor pigments for lutein and zeaxanthin cycle synthesis, respectively, indicating that the observed increase of these two pigments results from a long-term physiological process and not a straightforward de-epoxidation of a pre-existent pigment (Armstrong and Hearst 1996). We can therefore exclude the hypothesis of a xanthophyll cycle activated by phototrophic cells, especially given that such a mechanism usually takes place only a few hours after disturbance.

On the other hand, multivariate analyses (RDA) indicated that biofilm exposure to Zn led to a significant increase in the relative abundance of cyanobacteria, which was dependent on both Zn-contamination intensity and biofilm age, since even biofilms from the upstream site also showed an increase in cyanobacteria over the course of the study. In addition, this increase was strongly and positively correlated with EC_{50} values. It has been established that some pigments are dominant and specific for certain phototrophic organism classes (e.g. fucoxanthin for diatoms, lutein for green algae, or zeaxanthin for cyanobacteria) (Jeffrey and Vesik 1997). We could therefore suppose that the evolution of phototrophic pigments in our study was more related to a selection of their corresponding algal class that was not just exerted by Zn-contamination pressure but also related to a temporal succession of phototrophic communities in our biofilms. Genter *et al.* (1987) observed a shift in phototrophic community composition from diatoms to cyanobacteria and green algae after exposure to Zn. Other studies also reported biofilm community shifts towards a dominance of cyanobacteria after long-term metal exposure, indicating that cyanobacteria are highly tolerant to metal contamination (Barranguet *et al.* 2002, 2003; Serra *et al.* 2009). Cyanobacteria are known to possess no xanthophyll cycle but nevertheless contain significant amounts of

zeaxanthin and other xanthophylls involved in protection of the photosynthetic apparatus (Jeffrey and Vesk 1997), thus explaining their high tolerance to metal contamination. These findings confirm the hypothesis on which the PICT concept was based, i.e. that the toxicant exerts selection pressure when exposure reaches a critical level for a sufficient period of time (Bérard *et al.* 2002), inducing a shift in the community structure with the emergence of the most tolerant species (Mølander and Blanck 1992, Schmitt-Jansen and Altenburger 2005).

The observed changes in diatom structure were also consistent with this assumption. PCA on diatom community structure showed that most of the species found in the upstream and contaminated sites one week post-translocation were typical of early-stage colonization, such as *A. pyrenaicum*, *A. minutissimum* or *M. varians* (Stevenson and Peterson 1989, Duong *et al.* 2008). On the other hand, more mature biofilms (3 and 5 weeks old) from Mining.1, Mining.3 and even the upstream site were characterized by an association of species that are tolerant (e.g. *N. palea*, *N. frustulum*, *N. fonticola*) and sensitive (e.g. *C. placentula*, *A. pediculus*, *N. dissipata*) to metal contaminations (Feurtet-Mazel *et al.* 2003, Morin *et al.* 2008). Higher metal pressure in the most Zn-polluted site (i.e. Mining.2) selected for small diatom species known to be highly metal-tolerant, such as *E. minima*, *M. permitis* and *P. frequentissimum* (Duong *et al.* 2008, Ferreira da Silva *et al.* 2009). Previous studies suggested that communities under chemical stress would tend to be dominated by small species (e.g. *E. minima*) (Pérès *et al.* 1996, Ivorra *et al.* 1999). Khoshmanesh *et al.* (1997) showed that smaller algal cells have proportionally larger surface area and more sites for metal binding than larger algal cells, allowing them to be more tolerant to high concentrations of metals. Our results confirmed these observations, and showed that Zn contamination exerted a selection pressure proportional to both exposure level and biofilm age on the diatom communities, leading to the partial proliferation of some tolerant species in the low and intermediately-polluted sites and total elimination of the sensitive species in the high-pollution sites.

Overall, our assessment of the effects of *in-situ* spatio-temporal Zn-contamination indicated 1) that phototrophic biofilm communities could exhibit constitutive (present in most phenotypes, e.g. “greening effect”) and adaptive (existing only in tolerant phenotypes, e.g. smaller-size cells) mechanisms enabling them to cope with high metal concentrations, and 2) that these mechanisms responsible for tolerance to metals were activated progressively over time and modulated by pollution intensity.

(iii) Effects of Zn contamination on induced tolerance of heterotrophic biofilm communities

Given the broad structural and functional diversity of biofilm composition, it seems natural to also consider the effects of aquatic ecosystem pollutions on the induced tolerance, at different levels of microbial community organization (i.e. phototrophs and heterotrophs). Earlier studies focused on this issue by considering the effects of toxicant contamination-induced tolerance on phototrophic and heterotrophic biofilm communities as a whole (Blank et al. 2003: interregional variability in Zn-tolerance; Dorigo et al. 2010: resilience after disturbance removal; Tlili et al. 2010a: potential interaction between phosphorus gradient and the induced tolerance). However, to our knowledge, this is the first study to focus on the effects of a spatial gradient of Zn contamination combined with a temporal gradient of exposure on the induced tolerance to Zn by taking into account the heterotrophic biofilm component in addition to the phototrophic biofilm component.

Besides its direct effects on phototrophic communities, Zn is also known to have direct or/and indirect effects on heterotrophic communities at functional and structural level (Paulsson et al. 2000). Mahmoud et al. (2005) compared bacterial diversity in biofilms from a high Zn-contaminated stream and a clean one. They found differences between the two study sites, supporting the idea that metal contamination exerts a selection pressure on bacterial community. In our study, patterns of bacterial and fungal community composition obtained by molecular fingerprinting showed that in addition to a temporal evolution of these communities, Zn was also a driver of structural changes. Multivariate analysis (PCA) showed that bacterial community composition was similar between intermediate and higher Zn-polluted sites (Mining.1 and Mining.2, respectively) but completely different to the upstream site, even just one week after translocation, whereas in the low Zn-polluted site (Mining.3) it diverged from the upstream site and only converged with Mining.1 and Mining.2 at five weeks after translocation. However, fungal community composition showed a different pattern. One week after transfer to the different sites, the biofilms showed a similar fungal composition, whereas at three and five weeks only the most Zn-contaminated site (Mining.2) evolved differently from other sites (Mining.1, Mining.3 and the Upstream Site remained similar at 3 and 5 weeks). These results suggest there are different thresholds of the action of Zn contamination on the structures of bacteria and fungi composing biofilms. Bacterial communities seem to be more sensitive to Zn than fungi, since they showed structural changes earlier and at lower Zn concentrations. In a soil study, Zhou et al. (2009) assessed the

effect of increasing Zn concentrations on soil microbial communities including bacteria and fungi, and showed that bacteria were more sensitive than fungi to Zn in agricultural soils, as the Zn concentrations inducing structural shift were higher for fungi than for bacteria. The authors suggested that these observed results could be linked to the reproduction modes of the different microbial communities: sexual growth (characteristic of many fungi), which is more complex, confers a greater ability to resist external disturbance to a certain contamination level than asexual growth (characteristic of bacteria) from a microbial evolution perspective. Our structural analysis were therefore consistent with their findings, and indicated that Zn contamination exerted selection pressure on the different heterotrophic community components by eliminating Zn-sensitive species and promoting Zn-tolerant tolerant species.

Extending on this finding, heterotrophic biofilm communities exposed to Zn should be more Zn-tolerant than non-exposed biofilm communities. Paulsson *et al.* (2000) showed an increase in the induced bacterial tolerance to Zn (measured by Thymidine incorporation) accompanied by a gradual change in their structure after long-term exposure to different Zn concentrations. In a previous *in-situ* study, Lehmann *et al.* (1999) found similar results and concluded that Zn exposure of biofilm communities led to microbial community restructuring that favoured Zn-tolerant bacteria. In our study, based on SIR analysis targeting heterotrophic communities, the assessment of Zn-induced tolerance showed that EC₅₀ values increased along the spatial gradient of Zn contamination but also along a temporal gradient. Nevertheless, unlike autotrophic communities, RDA and variance partitioning showed that the Zn-induced tolerance of the heterotrophic communities was not exclusively linked to metal exposure but was also related to the physicochemical characteristics of our study site (i.e. dissolved oxygen and percentage of cover). In 2010a, a laboratory study by Tlili *et al.* concluded that induced tolerance of heterotrophic biofilm communities based on SIR bioassay was positively influenced by exposure to Cu and phosphorous enrichment together, with a greater influence of nutrient addition, thus confirming our findings.

5. Conclusion

This *in-situ* study provides evidence that level of Zn combined with biofilm age and exposure history has differential affects on the structure and functions of the various communities that compose biofilms. Our results showed that phototrophic communities showed different patterns of response to spatio-temporal Zn contamination than heterotrophic communities. Moreover, in the same microbial biofilm component, Zn effects were different

according to target community (i.e. fungi or bacteria in the heterotrophic component). In more global terms, taken together, our results emphasized firstly that mature biofilms were highly tolerant to metals, even without a history of pre-exposure, since even biofilms from the upstream site showed an increase in temporal EC_{50} values over the course of the study, and secondly that this temporal evolution was modulated by contamination intensity. The short-term effects of high metal pollution on induced tolerance are similar to the effects observed after long-term exposure to low metal pollution levels.

Considering the variability of aquatic environments and the inherent resistance and structural characteristics of the component communities, which in turn are a function of species interactions, succession stage, and previous history of exposure, PICT assessment should take into account the mosaic of these variabilities. Although predicting contaminant effects is a complex task due to the significant spatial and temporal variations in both ecosystems and in community structures, we assume that adopting an appropriate practical approach (e.g. large set of explanatory and response variables) and theoretical approach (e.g. statistical analyses) could give a better picture of ecosystem status.

Acknowledgments

The authors thank C. Rosy for his technical help with the molecular and pigment analyses, Silvia Corcoll for developing the “Osor” Watershed Map by GIS, and the company ATT for proofreading the English-language version of the manuscript. We are grateful to the Onema (French National Agency for Water and Aquatic Ecosystems) and the Rhône-Alpes region (Explora’doc Grant) for providing financial support. This study was also supported by the Spanish Ministry project FLUVIALMULTISTRESS (CTM2009-14111-C02-01) and the EC project KEYBIOEFFECTS (MRTN-CT-2006-035695). The University of Girona “Serveis Tècnics de Recerca” offered their facilities and technical assistance for the metal analyses.

CONCLUSIONS ET PERSPECTIVES

Chapitre D. Conclusions et perspectives

Rappel des objectifs de la thèse :

Ce travail de recherche a visé deux objectifs principaux :

(1) D'un point de vue écologie des milieux aquatiques : notre but a été de contribuer à une meilleure compréhension de la signification écologique de la tolérance acquise des communautés microbiennes des biofilms. Dans ce volet, nous nous sommes focalisés d'une part sur l'étude des causes, qu'elles soient internes ou externes au biofilm, de cette acquisition de tolérance vis à vis des xénobiotiques. D'autre part, nous avons essayé de mieux comprendre les conséquences de la tolérance induite par la pollution sur la diversité mais aussi sur les fonctions des communautés microbiennes du biofilm.

(2) D'un point de vue gestion des milieux aquatiques : l'un des objectifs de ce travail de thèse était d'évaluer la pertinence de la démarche PICT, basée sur l'utilisation des biofilms de rivières comme modèle biologique et en tant qu'outil de bioindication des conséquences de la pollution des cours d'eau.

D.I. CONCLUSIONS GENERALES

D.I.I. Le concept PICT d'un point de vue écologique

Les études qui ont été menées durant ce travail de thèse nous permettent de formuler les quatre conclusions suivantes :

(1) D'après Clements et Newman (2002), la notion de stabilité de l'écosystème est fortement liée à des concepts écologiques , tels que la résistance et la résilience des communautés. La notion de résistance se réfère à la capacité des communautés à se maintenir en l'état suite à une perturbation. Quant à la notion de résilience, elle correspond à la vitesse à laquelle les communautés retournent vers un état (quasi)initial après la perturbation. Une meilleure compréhension des facteurs écologiques qui déterminent la résistance et la résilience permet d'améliorer la capacité de prédire la façon avec laquelle les communautés répondent aux stress. Par exemple, dans l'une de nos études sur les phénomènes de co-tolérance après expositions aux métaux, nous avons constaté que des communautés périphytiques pré-adaptées à un métal donné, devenaient

également résistantes à d'autres métaux (article 4). Dans une autre étude (article 5), nous avons démontré aussi que des communautés microbiennes soumises à un stress chronique (contamination au diuron) devenaient moins sensibles à des stress additifs (pulses de diuron). Dans le cadre de notre démarche PICT, les mesures de tolérance-induite basées sur des paramètres fonctionnels caractérisant certaines fonctions fondamentales du biofilm (photosynthèse, dégradation des MO) et les analyses taxonomiques associées caractérisant les diversités du biofilm, nous ont permis une meilleure compréhension de la résistance et de la résilience (dynamique de restauration) de cet écosystème suite à des perturbations d'origine chimique.

(2) Des études théoriques et empiriques ont suggérés que certaines communautés pouvaient subir des changements imprévus et non linéaires dans leurs structures ou fonctions en réponse à des perturbations (Groffman et al. 2006, Muradian 2001). Ceci introduit le concept de « seuil » ou « discontinuité » écologique. Dans sa définition générale d'après l'académie française, un seuil est considéré comme le point où se produit un changement rapide. Pour les écologistes, il se définit comme des changements significatifs et discontinus dans une variable d'état écologique (e.g. structure des communautés, tolérance-induite...) en raison des changements continus d'une variable environnementale (e.g. pollution chimique, réchauffement climatique...) (Clements et Rohr, 2009). Le seuil écologique est donc étroitement lié aux notions de résistance et de résilience (figure 1). Par exemple, dans le cadre de nos études relatives aux impacts de modalités variées d'exposition aux toxiques (intensité et durée) sur la structure et les fonctions des communautés microbiennes du biofilm (articles 5 et 6), nous avons mis en évidence cette notion de seuils d'expositions mais aussi de seuils de réponses (structure et fonctions). En effet, nous avons montré que des communautés adaptées à une exposition chronique aux polluants avaient un seuil de résistance supérieur à celui des communautés non adaptées. Ce seuil de résistance, correspond aux concentrations de contaminants n'induisant pas de changements dans la réponse écologique des communautés (e.g. structure...). En plus de la notion du seuil de résistance, il existe aussi celle du seuil de résilience, décrite par Clements et Rohr (2009) comme étant l'intervalle entre les points dans le temps où la récupération est d'abord initiée et finalement achevée après le retrait du stress. Nos résultats nous ont montré que ce seuil de résilience est lui aussi variable, selon le niveau de tolérance des communautés à la perturbation. En effet, une communauté déjà adaptée et donc tolérante à un stress donné, semble avoir un seuil de

résilience décalé (i.e. supérieur) par rapport à celui d'une communauté de référence (article 5). Une acquisition de tolérance à un stress donné, pourrait donc se traduire par le déplacement des communautés d'un état (structurel et fonctionnel) initial vers un état « alternatif » stable, même après le retrait du stress (Paine et al 1998).

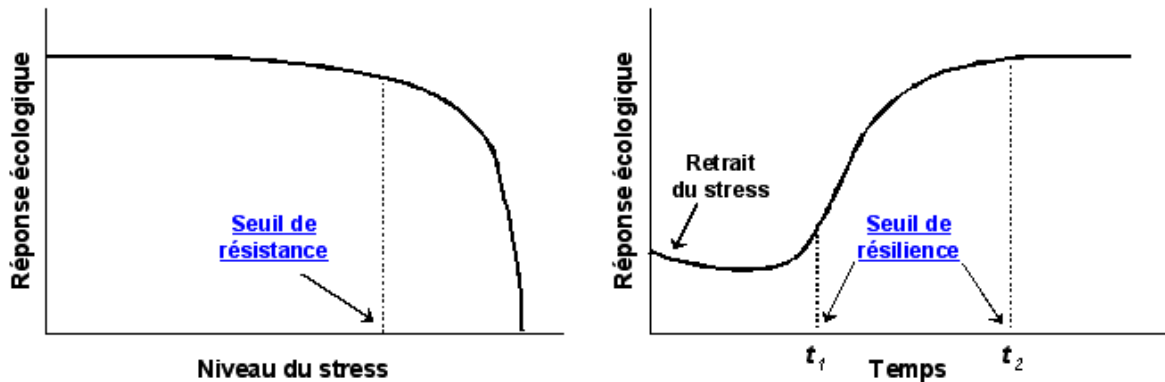

Figure 1 Seuils de résistance et de résilience en écotoxicologie des communautés. Un seuil de résistance correspond à la concentration du contaminant (niveau de stress) après laquelle un changement brutal dans la réponse de la communauté est observé. Le seuil de résilience correspond à l'intervalle de temps entre les deux points où la reprise est amorcée (t_1) et complétée (t_2) après le retrait de stress (modifié d'après Clements et Rohr 2009).

(3) Comme indiqué précédemment, la disparition des espèces les plus sensibles (comme l'un des processus expliquant le PICT) n'affecte donc pas les fonctions de la communauté dans son ensemble au début et ce seulement jusqu'à un certain seuil de résistance. Le PICT pourrait donc se traduire par une réduction de la diversité ou avec des modifications dans la composition spécifique (articles 4 et 6), sans pour autant qu'il y ait un effet négatif sur le fonctionnement de la communauté. La diversité biologique semble donc avoir deux rôles principaux, le premier serait d'assurer les fonctions essentielles de l'écosystème (dans notre cas le biofilm), et le second serait de permettre l'adaptation aux changements environnementaux et aux stress. Chaque espèce posséderait des avantages qui lui permettent d'affronter avec succès certains changements de conditions environnementales (article 4), ce qui expliquerait ainsi pourquoi un système plus diversifié est généralement plus stable (concept de « police d'assurance » Mertz et al, 2007 ; Loreau, 2002). Si une communauté est constituée d'un grand nombre d'espèces redondantes, la probabilité que leur rôle fonctionnel puisse être maintenu, même après une forte perturbation, est plus grande grâce à la survie d'au moins une des espèces plus tolérantes que les autres.

(4) La capacité des communautés à devenir tolérantes à une perturbation peut avoir des conséquences négatives sur les capacités de résilience et de résistance des écosystèmes (Vinebrooke et al. (2004) : concept de « co-tolérance négative entre espèces »). En effet, les communautés ayant une tolérance accrue à un stress donné, malgré leur seuil de résistance qui est plus important à ce stress que celui d'une communauté de référence, peuvent présenter une sensibilité accrue à d'autres perturbations, reflétant ainsi un coût associé à la tolérance acquise (Kashian et al. 2007, Zuellig et al. 2008) (article 4).

Le PICT a été proposé initialement comme méthode d'évaluation de l'exposition des communautés aux polluants et des impacts écotoxiques (Blanck et al. 1988). Nos travaux ont montré que le PICT était aussi une approche conceptuelle, à l'échelle des communautés, très riche et qui confirme l'intérêt d'aborder l'écotoxicologie avec le regard de l'écologue (Cairns 1986, Chapman 2002) plus holistique que celui du toxicologue (Thruhaut 1977). L'écotoxicologie étant maintenant une discipline non plus seulement descriptive mais aussi prédictive (Clements et Rohr 2009).

D.I.II. Le concept PICT et son cadre d'utilisation dans la gestion des milieux aquatiques

La méthode PICT appliquée aux microorganismes pourrait donc complètement satisfaire aux critères établis par Dale et Beyeler (2001) pour le choix d'un bioindicateur de l'état écologique des écosystèmes et que nous rappelons : (1) spécificité de réponse à un stress particulier (Blanck et al. 1988, Boivin et al. 2002). (2) facilité et rapidité des mesures (Millward et Grant, 2000). (3) intégration de la complexité structurale et fonctionnelle de la composante biotique des écosystèmes (Tlili et al. 2008, Dorigo et al. 2010). (4) spatialisation temporelle des pressions anthropiques, c'est à dire capacité à révéler une exposition présente ou passée à un toxique (Dorigo et al. 2004, 2010, Pesce et al. 2010). Cependant beaucoup de questions restent encore ouvertes : Quels sont les paramètres pertinents pour évaluer l'acquisition d'un PICT, en tenant compte de la complexité structurale et fonctionnelle des communautés? Est-il possible de cibler l'effet d'une substance donnée dans un cocktail de polluants sur le PICT ? Quel est le seuil d'exposition aux toxiques qui induit une acquisition de tolérance des communautés, et est ce que ce seuil est modulé uniquement par la présence du polluant dans le milieu ?

Au cours de ce travail de recherche, nous avons contribué à répondre à ces questions au travers des différentes études menées *in situ* et en systèmes expérimentaux. D'une manière générale, ces travaux nous ont permis de formuler les conclusions suivantes :

1- Pertinence des paramètres fonctionnels de la tolérance acquise et diversité fonctionnelle

L'acquisition de la tolérance des communautés microbiennes du biofilm aux xénobiotiques a déjà été abordée par les scientifiques, mais reste complexe à évaluer. Cette complexité réside en partie, d'une part dans la complexité structurelle et fonctionnelle au sein du périphyton et des sensibilités variées (et aux mécanismes variés) des communautés aux différents toxiques, et d'autre part dans le peu d'outils utilisés actuellement pour la caractérisation de cette tolérance acquise. Cependant, nous avons montré que :

(1) Les méthodes basées sur des mesures d'éléments radioactifs (tels que le ^{14}C ou la thymidine et la leucine tritiée), sans remettre en cause leur précision et leur spécificité, ne sont pas incontournables dans une approche PICT. En effet, l'utilisation de nouveaux paramètres fonctionnels tels que les activités enzymatiques (leucine-aminopeptidase et β -glucosidase) ou la respiration induite par un substrat carboné, nous ont permis la réalisation de mesures PICT que ce soit dans des études *ex-situ* ou *in-situ*. De plus une miniaturisation de ces tests apparaît possible comme nous l'avons démontré pour les mesures de respiration avec l'adaptation de la technique MicroRespTM (article 2), ce qui est un atout.

(2) Selon le mode d'action et les caractéristiques chimiques (i.e. organique ou inorganique) du toxique étudié, les facteurs environnementaux (i.e. phosphore) peuvent avoir un effet sur la tolérance acquise (article 3).

(3) Pour un même polluant testé, l'influence des facteurs environnementaux sur la tolérance acquise aux toxiques des biofilm dépend du compartiment microbien ciblé (phototrophe ou hétérotrophe), d'où la nécessité de mettre l'accent sur la diversité fonctionnelle des biofilms de rivière en utilisant des indicateurs complémentaires de la tolérance acquise pour des investigations écotoxicologiques (article 3).

(4) La détection d'une co-tolérance dépend non seulement du polluant auquel les communautés ont été exposées sur le long terme, mais aussi du compartiment microbiens

ciblé (phototrophe ou hétérotrophe, eucaryote ou procaryote) et donc du descripteur fonctionnel utilisé (article 4).

2- Pollution multiple des milieux et spécificité du PICT

Compte tenu de la variabilité des milieux aquatiques, la multitude des contaminants présents ainsi que la complexité structurale et fonctionnelle des communautés, il est difficile d'établir un lien de causalité univoque entre une substance toxique donnée et ses effets sur les organismes. Cependant, nos études ont montré que :

(1) L'exposition chronique à un toxique peut induire une augmentation de la tolérance des communautés phototrophes et hétérotrophes à un autre toxique (co-tolérance) ayant le même mode d'action ou induisant les mêmes modes de détoxification (article 4).

(2) Chez les communautés phototrophes du biofilm, la co-tolérance semble due à des modes d'action similaires des substances chimiques, mais aussi à des modes similaires de détoxification, alors que chez les communautés hétérotrophes la co-tolérance semble principalement liée à des modes de détoxification similaires (article 4).

(3) La détection d'une co-tolérance dépend non seulement du polluant auquel les communautés ont été exposées sur le long terme, mais aussi du compartiment microbiens ciblé (phototrophe ou hétérotrophe, eucaryote ou procaryote) et donc du descripteur fonctionnel utilisé (article 4).

(4) Même si le phénomène de la co-tolérance est souvent décrit comme un inconvénient lors d'une approche PICT (Soldo et Behra 2000), nos résultats ont montré qu'il pourrait être utilisé comme une approche préliminaire dans l'évaluation de l'état des milieux en proposant une molécule « modèle » d'un type de toxique (classification selon les modes d'action et de détoxification). Cette approche aurait pour but de « tester » les classes de polluants « suspects ». Par la suite, une combinaison de différents paramètres fonctionnels de la tolérance acquise, associée à une enquête sur les sources et types de pollutions possibles et des bioessais PICT complémentaires utilisant des molécules soupçonnées, permettrait d'affiner les résultats obtenus et d'être plus discriminant (article 4).

3- Seuil de détection de la tolérance acquise et importance du mode d'exposition

L'intensité et la durée d'exposition sont de toute évidence des facteurs majeurs pour le développement de la tolérance. D'une manière générale, le PICT reflète l'exposition des microorganismes du milieu à des produits chimiques de l'environnement et donc la biodisponibilité de ces contaminants (spéciation des métaux, adsorption des toxiques sur la matière organique...). En effet, nous avons pu démontrer que :

(1) La tolérance acquise aux xénobiotiques des communautés microbiennes du biofilm est fortement modulée par l'historique d'exposition de ces communautés (article 5).

(2) Le mode d'exposition des communautés biologiques aux polluants (chronique ou aigu) est un facteur important dans une démarche PICT puisqu'il peut être déterminant pour le seuil de détection de la tolérance induite (article 5). Les effets de cette variabilité d'exposition sur la tolérance induite des communautés microbiennes sont fonction de la durée d'expositions aux polluants. (article 6).

(3) Selon la caractéristique biologique (structurelle ou fonctionnelle) considérée, la relation entre la partition du toxique (dans la colonne d'eau ou dans la matrice biologique) et l'exposition réelle est un mécanisme essentiel dans la modulation de la réponse du biofilm (article 5).

(4) Le couplage d'une démarche PICT avec une caractérisation physico-chimique précise du milieu, ainsi que l'utilisation d'analyses statistiques multivariées pour la caractérisation des effets possibles de contaminants sur le biofilm dans un système naturel complexe qu'est la rivière, peut permettre d'avoir une meilleure image de l'état écologique de ce système (article 6).

D'une manière plus globale, compte tenu de la variabilité des milieux aquatiques et des caractéristiques structurelles (ainsi que la capacité de résistance aux stress) des communautés biologiques qui y vivent, et des historiques d'exposition aux polluants, l'évaluation PICT doit tenir compte de la mosaïque de ces variabilités. A la lumière de nos résultats, l'intégration des mesures PICT comme un outil complémentaire dans les

systèmes d'évaluation environnementale donnerait plus de pertinence écologique et de spécificité écotoxicologique à la batterie actuelle des bio-indicateurs utilisés.

D.II. PERSPECTIVES : du particulier au global

Les principales perspectives qui découlent de ce travail de recherche s'articulent autour de deux axes complémentaires : (1) des perspectives dont l'objectif est d'approfondir certaines interrogations apparues à la lumière de nos résultats, et (2) des perspectives à plus large échelle, avec une vision systémique du concept PICT.

(1) Perspectives en lien direct avec nos résultats et les questions qui en découlent

Dans le contexte de l'évaluation des impacts des pollutions complexes sur la diversité des communautés microbiennes ou sur les fonctions des écosystèmes naturels, l'un des points critiques reste la distinction entre les effets relatifs des pressions de sélection dues à la pollution par les xénobiotiques et celles résultant des facteurs environnementaux. Un effort doit donc être fait pour multiplier les études sur les facteurs environnementaux, dits de confusion et la caractérisation de la « base-line Tolerance » (Molander 1991). Nos travaux ont montré qu'un gradient en phosphore pouvait interagir avec la présence des polluants dans les milieux lotiques et ainsi influencer la tolérance acquise des communautés microbiennes du biofilm à ces polluants. Cependant, nous avons montré aussi que l'application d'une large gamme de descripteurs fonctionnels du PICT permet une meilleure discrimination de ces effets confondant du phosphore. Il serait donc très intéressant d'adopter la même démarche pour étudier d'autres facteurs environnementaux susceptibles d'influer sur le PICT (e.g. température, lumière, vitesse du courant...).

Par ailleurs, compte tenu du contexte actuel de changements climatiques (réchauffement, modification des régimes de précipitations entraînant sécheresses et inondations accrues...), ces facteurs environnementaux pourraient aussi être (s'ils changeaient) des facteurs de stress supplémentaires. La question qui se pose alors serait : quelles seraient les conséquences de la tolérance acquise dans un environnement soumis à de multiples perturbations ? Nous avons démontré, que des phénomènes « croisés » d'accroissement de la tolérance ou de la sensibilité des communautés microbiennes des biofilm, peuvent être observés entre des métaux qui ont les mêmes modes d'actions ou qui induisent des mécanismes de détoxification cellulaires similaires. L'une des perspectives que nous pourrions donc envisager dans ce genre

d'approche serait de tester ces phénomènes de tolérances croisées, non seulement en s'intéressant aux pollutions toxiques, mais aussi en intégrant d'autres types de stress, tels que par exemple ceux qui sont liés à l'augmentation de la vitesse du courant et des quantités de matière organique pendant les épisodes de crues.

Au cours de l'une des études de ce travail de thèse, nous avons testé l'effet écotoxicologique de différents scénarios d'exposition à un pesticide sur les communautés microbiennes du biofilm, simulant des situations de crues et d'étiage. Cependant, seuls les effets des changements de concentrations des toxiques ont été testés. La prochaine étape dans l'évaluation de la toxicité des polluants, sous différentes conditions hydrauliques, serait donc de considérer les effets conjoints de la vitesse d'écoulement, ainsi que les changements des teneurs en matière organique (associés aux crues) avec les augmentations des concentrations en toxiques.

(2) Le concept PICT et son intégration dans une approche systémique : relation entre diversité et stabilité des écosystèmes

Parmi les questions importantes et d'actualité en écologie microbienne, celles concernant le type de relation qui pourrait exister entre la biodiversité et le fonctionnement des écosystèmes font l'objet de débats (Chapin et al. 1998, Loreau 2002, Schwartz et al. 2000). Il est généralement admis qu'une grande richesse en espèces permet une plus grande stabilité de la communauté, mais le lien entre ces deux caractéristiques pourrait être de nature différente conduisant à des modèles différents (Clements et Newman 2002) (figure 2). Avec le développement d'outils moléculaires de plus en plus performants, la caractérisation de la diversité des communautés devient de plus en plus détaillée et en conséquence de nouvelles compétences telle que la bioinformatique deviennent nécessaires pour traiter les grands jeux de données générés. Le concept PICT pourrait être utilement couplé à ces outils, et permettre de tester les différents modèles cités auparavant. Cette approche, qui se baserait sur la méthode PICT en tant qu'indicateur de la stabilité des communautés nous permettrait de donner un éclairage nouveau entre la biodiversité et l'état écologique des écosystèmes.

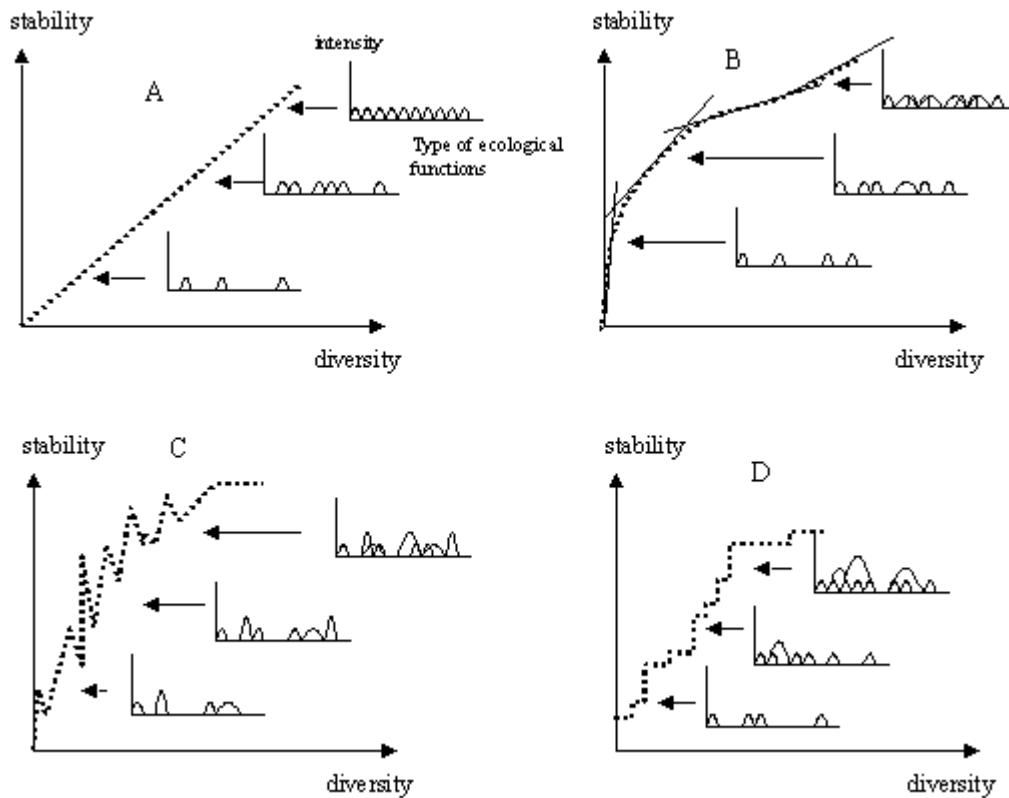

Figure 2 Les quatre modèles montrant la relation entre la diversité et la stabilité fonctionnelle des écosystèmes. (A) le modèle linéaire: la stabilité fonctionnelle décroît linéairement avec la réduction du nombre d'espèces. (B) le modèle rivet: une redondance fonctionnelle protège le système contre la perte d'espèces jusqu'à un certain seuil critique. (C) le modèle idiosyncrasique: l'effet de la disparition des espèces dépend de l'interaction des espèces entre elle et l'évolution du système est donc difficilement prédictive. (D) le modèle des conducteurs et passagers: la stabilité dépend de l'importance écologique des espèces, puisque la disparition des espèces pilotes (espèces clés) a plus d'effet que la disparition des espèces passagers (modifié d'après Clements et Newman 2002).

REFERENCES BIBLIOGRAPHIQUES

A

- Abrantes, N., Pereira, R., Goncalves, F., 2006. First step for an ecological risk assessment to evaluate the impact of diffuse pollution in Lake Vela (Portugal). *Environmental Monitoring and Assessment*. 117, (1-3) 411-431.
- AFNOR, 1999. XP T 90-210. Protocole d'évaluation d'une méthode alternative d'analyse physico-chimique quantitative par rapport à une méthode de référence, 58 p.
- Agencia Catalana de l'Aigua (ACA). <http://aca-web.gencat.cat>
- Al Hasin, A., Gurman, S., Murphy, L., Perry, A., Smith, T., Gardiner, P., 2010. Remediation of Chromium(VI) by a Methane-Oxidizing Bacterium. *ENVIRONMENTAL SCIENCE & TECHNOLOGY*. 44, (1) 400-405.
- Allan, J. D., Erickson, D. L., Fay, J., 1997. The influence of catchment land use on stream integrity across multiple spatial scales. *Freshwater Biology*. 37, (1) 149-161.
- Almas, A.R., Mulder, J., Bakken, L.R., 2005. Trace metal exposure of soil bacteria depends on their position in the soil matrix. *Environmental Science & Technology*. 39, (16) 5927-5932.
- Amann, R.I., Binder, B.J., Olson, R.J., Chisholm, S.W., Devereux, R., Stahl, D.A., 1990. Combination of 16S rRNA-targeted oligonucleotide probes with flow cytometry for analyzing mixed microbial populations. *Appl. Environ. Microbiol.* 56, (6) 1919-1925.
- American Public Health Association, 1989. *Standard Methods for the Examination of Water and Wastewater*. American Public Health Association, Washington.
- Armstrong, G.A., Hearst, J.E., 1996. Genetics and molecular biology of carotenoid pigment biosynthesis. *The FASEB Journal*. 10, 228-237.

B

- Baath, E., Frostegard, A., Diaz-Ravina, M., Tunlid, A., 1998. Microbial community-based measurements to estimate heavy metal effects in soil: The use of phospholipid fatty acid patterns and bacterial community tolerance. *Ambio*. 27, (1) 58-61.
- Baker-Austin, C., Dopson, M., Wexler, M., Sawers, R. G., Stemmler, A., Rosen, B. P., Bond, P. L., 2007. Extreme arsenic resistance by the acidophilic archaeon 'Ferroplasma acidarmanus' Fer1. *Extremophiles*. 11, (3) 425-434.
- Babault, R., 1997. Biodiversité. Introduction à la biologie de la conservation. Paris, Hachette, p 159.
- Barranguet, C., Charantoni, E., Plans, M., Admiraal, W., 2000. Short-term response of monospecific and natural algal biofilms to copper exposure. *European Journal of Phycology*. 35, (4) 397-406.

- Barranguet, C., Plans, M., van der Grinten, E., Sinke, J.J., Admiraal, W., 2002. Development of photosynthetic biofilms affected by dissolved and sorbed copper in a eutrophic river. *Environ. Toxicology and Chemistry*. 21, (9) 1955-1965.
- Barranguet, C., Van den Ende, F.P., Rutgers, M., Breure, A.M., Greijdanus, M., Sinke, J.J., Admiraal, W., 2003. Copper-induced modifications of the trophic relations in riverine algal-bacterial biofilms. *Environmental Toxicology and Chemistry*. 22, (6) 1340-1349.
- Barranguet, C., Admiraal, W., Laanbroek, H.J., Zwart, G., 2004. Analysis of structural and physiological profiles to assess the effects of Cu on biofilm microbial communities. *Appl. Environ. Microbiol.* 70, (8) 4512-4521.
- Barranguet, C., Veuger, B., Van Beusekom, S. A. M., Marvan, P., Sinke, J. J., Admiraal, W., 2005. Divergent composition of algal-bacterial biofilms developing under various external factors. *European Journal of Phycology*. 40, (1) 1-8.
- Battin, T.J., Kaplan, L.A., Newbold, J.D., Hansen, C.M.E., 2003. Contributions of microbial biofilms to ecosystem processes in stream mesocosms. *Nature*. 426, (6965) 439-442.
- Battin, T. J., Kaplan, L. A., Newbold, J. D., Cheng, X. H., Hansen, C., 2003b. Effects of current velocity on the nascent architecture of stream microbial biofilms. *Applied and Environmental Microbiology*. 69, (9) 5443-5452.
- Bérard, A., Pelte, T., Menthon, E., Druart, J. C., Bourrain, X., 1998. Caractérisation du phytoplancton de deux systèmes limniques vis-à-vis d'un herbicide inhibiteur de la photosynthèse. La méthode PICT (Pollution-Induced Community Tolerance): application et signification. *Annls. Limnol.* 34, (3) 269-282.
- Bérard, A., Pelte, T., 1999. Les herbicides inhibiteurs du photo-système II, effets sur les communautés algales et leur dynamique. *Revue des sciences de l'eau*. 12, (2) 333-361.
- Bérard, A., Benninghoff, C., 2001. Pollution-induced community tolerance (PICT) and seasonal variations in the sensitivity of phytoplankton to atrazine in nanocosms. *Chemosphere*. 45, (4-5) 427-437.
- Bérard, A., Dorigo, U., Humbert, J.F., Leboulanger, C., Seguin, F., 2002. Application of the Pollution-Induced Community Tolerance (PICT) method to algal communities: its values as a diagnostic tool for ecotoxicological risk assessment in the aquatic environment. *Annls Limnol- I. J. Limnol.* 38, (3) 247-261.
- Bérard A., Dorigo U., Mercier I., Becker-van Slooten K, Grandjean D., Leboulanger C., 2003. Compared ecotoxicological impact of the two triazines Irgarol 1051 and atrazine to microalgal communities of Lake Geneva. *Chemosphere*. 53, 935-944.
- Bérard, A., Rimet, F., Capowiez, Y., Leboulanger, C., 2004. Procedures for determining the pesticide sensitivity of indigenous soil algae: A possible bioindicator of soil contamination? *Archives of Environmental Contamination and Toxicology*. 46, (1) 24-31.

- Bernot, M. J., Sobota, D. J., Hall, R. O., Mulholland, P. J., Dodds, W. K., Webster, J. R., Tank, J. L., Ashkenas, L. R., Cooper, L. W., Dahm, C. N., Gregory, S. V., Grimm, N. B., Hamilton, S. K., Johnson, S. L., McDowell, W. H., Meyer, J. L., Peterson, B., Poole, G. C., Valett, H. M., Arango, C., Beaulieu, J. J., Burgin, A. J., Crenshaw, C., Helton, A. M., Johnson, L., Merriam, J., Niederlehner, B. R., O'Brien, J. M., Potter, J. D., Sheibley, R. W., Thomas, S. M., Wilson, K., 2010. Inter-regional comparison of land-use effects on stream metabolism. *Freshwater Biology*. 55, (9) 1874-1890.
- Blanck, H., Wangberg, S. A., Molander, S., 1988. Pollution-Induced Community Tolerance - A new ecotoxicological tool, in: Cairns, J., Jr., Pratt, J. R. (Eds.), *Functional Testing of Aquatic Biota for Estimating Hazards of Chemicals*. ASTM STP 988, Philadelphia, pp. 219-230.
- Blanck, H., Wangberg, S. A., 1991. Pattern of cotolerance in marine periphyton communities established under arsenate Stress. *Aquatic Toxicology*. 21, (1-2) 1-14.
- Blanck, H. and Dahl, B., 1998. Recovery of marine periphyton communities around a swedish marina after the ban of TBT use in antifouling paint. *Mar. Pollut. Bull.* 36: 437-442.
- Blanck, H., 2002. A critical review of procedures and approaches used for assessing pollution-induced community tolerance (PICT) in biotic communities. *Human and Ecological Risk Assessment*. 8, (5) 1003-1034.
- Blanck, H., Admiraal, W., Cleven, R.F.M.J., Guasch, H., Van Den Hoop, M.A.G.T., Ivorra, N., Nystrom, B., Paulsson, M., Petterson, R.P., Sabater, S., Tubbing, G.M.J., 2003. Variability in zinc tolerance, measured as incorporation of radio-labeled carbon dioxide and thymidine, in periphyton communities sampled from 15 European river stretches. *Archives of Environmental Contamination and Toxicology*. 44, 17-29.
- Blanck, H. et al. 2009. A retrospective analysis of contamination and periphyton PICT patterns for the antifoulant irgarol 1051, around a small marina on the Swedish west coast. *Mar. Pollut. Bull.* 58: 230-237.
- Bogomolov, D.M., Chen, S.K., Parmelee, R.W., Subler, S., Edwards, C.A., 1996. An ecosystem approach to soil toxicity testing: A study of copper contamination in laboratory soil microcosms. *Applied Soil Ecology*. 4, (2) 95-105.
- Bonin, D. J., Travers, M., 1992. Examen critique des méthodes d'estimation de la biomasse et de l'activité des microorganismes dans les systèmes aquatiques. *Mar. Life*. 2, (1) 1-29.
- Bony, S., Gillet, C., Bouchez, A., Margoum, C., Devaux, A., 2008. Genotoxic pressure of vineyard pesticides in fish: Field and mesocosm surveys. *Aquatic Toxicology*. 89, (197-203).
- Boivin, M. E. Y., Breure, A. M., Posthuma, L., Rutgers, M., 2002. Determination of field effects of contaminants - Significance of pollution-induced community tolerance. *Human and Ecological Risk Assessment*. 8, (5) 1035-1055.
- Boivin, M.Y., Massieux, B., Breure, A.M., Van Den Ende, F.P., Greve, G.D., Rutgers, M., Admiraal, W., 2005. Effects of copper and temperature on aquatic bacterial communities. *Aquatic Toxicology*. 71, (4) 345-356.

- Boivin, M.-E., Massieux, B., Breure, A. M., Greve, G. D., Rutgers, M., Admiraal, W., 2006. Functional recovery of biofilm bacterial communities after copper exposure. *Environmental Pollution*. 140, 239-246.
- Borcard, D., Legendre, P., Drapeau, P., 1992. Partialling out the spatial component of ecological variation. *Ecology*. 73, 1045 - 1055.
- Brack, W., Schmitt-Jansen, M., Machala, M., Brix, R., Barcelo, D., Schymanski, E., Streck, G., Schulze, T., 2008. How to confirm identified toxicants in effect-directed analysis. *Analytical and Bioanalytical Chemistry*. 390, (8) 1959-1973.
- Brandt, K.K., Sjöholm, O.R., Krogh, K.A., Halling-Sorensen, B., Nybroe, O., 2009. Increased Pollution-Induced Bacterial Community Tolerance to Sulfadiazine in Soil Hotspots Amended with Artificial Root Exudates. *Environmental Science & Technology*. 43, (8) 2963-2968.
- Brown, L.S., Lean, D.R.S., 1995. Toxicity of Selected Pesticides to Lake Phytoplankton Measured Using Photosynthetic Inhibition Compared to Maximal Uptake Rates of Phosphate and Ammonium. *Environmental Toxicology and Chemistry*. 14, (1) 93-98.

C

- Cairns, J. J., 1986. What is meant by validation of predictions based on laboratory toxicity tests? *Hydrobiologia*. 137, 271-278.
- Campbell, C. D., Chapman, S. J., Cameron, C. M., Davidson, M. S., Potts, J. M., 2003. A rapid microtiter plate method to measure carbon dioxide evolved from carbon substrate amendments so as to determine the physiological profiles of soil microbial communities by using whole soil. *Applied and Environmental Microbiology*. 69, (6) 3593-3599.
- Campbell, C.D., Cameron, C.M., Bastias, B.A., Chen, C.R., Cairney, J.W.G., 2008. Long term repeated burning in a wet sclerophyll forest reduces fungal and bacterial biomass and responses to carbon substrates. *Soil Biology & Biochemistry*. 40, (9) 2246-2252.
- Carlier, N., De Marsily, G., 2004. Assessment and modelling of the influence of man-made networks on the hydrology of a small watershed: implications for fast flow components, water quality and landscape management. *Journal of Hydrology*. 285, (1-4) 76-95.
- Carr, G.M., Morin, A., Chambers, P.A., 2005. Bacteria and algae in stream periphyton along a nutrient gradient. *Freshwater Biology*. 50, 1337-1350.
- Cattaneo, A., Kerimian, T., Roberge, M., Marty, J., 1997. Periphyton distribution and abundance on substrata of different size along a gradient of stream trophy. *Hydrobiologia*. 354, 101-110.
- Cedergreen, N., Andersen, L., Olesen, C. F., Spliid, H. H., Streibig, J. C., 2005. Does the effect of herbicide pulse exposure on aquatic plants depend on Kow or mode of action? *Aquatic Toxicology*. 71, (3) 261-271.

- Chapin, I.I.I, Stuart, F., Zavaleta, E.S., Eviner, V.T., Naylor, R.L., Vitousek, P.M. Reynolds, H.L., Hooper, D.U., Lavorel, S., Sala, O.E., Hobbie, S.E., Mack, M.C., Diaz, S., 2000. Consequences of changing biodiversity. *Nature*. 405, 234-241.
- Chapman, S.J., Campbell, C.D., Artz, R.R.E., 2007. Assessing CLPPs using MicroRespTM - A comparison with biolog and multi-SIR. *Journal of Soils and Sediments*. 7, (6) 406-410.
- Chesworth, J. C., Donkin, M. E., Brown, M. T., 2004. The interactive effects of the antifouling herbicides Irgarol 1051 and Diuron on the seagrass *Zostera marina* (L.). *Aquatic Toxicology*. 66, (3) 293-305.
- Clements, W.H., M.C. Newman, Eds. 2002. *Community Ecotoxicology*. Chichester UK: J. Wiley & Sons.
- Clements, W. H., Brooks, M. L., Kashian, D. R., Zuellig, R. E., 2008. Changes in dissolved organic material determine exposure of stream benthic communities to UV-B radiation and heavy metals: implications for climate change. *Global Change Biology*. 14, (9) 2201-2214.
- Clements, W. H., Rohr, J. R., 2009. community responses to contaminants: using basic ecological principles to predict ecotoxicological effects. *Environmental Toxicology and Chemistry*. 28, (9) 1789-1800.
- Copping, L., Hewitt, H., 1998. Chemistry and mode of action of crop protection agents. Ed. The Royal Society of Chemistry, Cambridge.
- Costanza, R., Mageau, M., 1999. What is a healthy ecosystem ? *Aquatic Ecology*. 33, 105-115
- Costerton, J. W., Lewandowski, Z., Debeer, D., Caldwell, D., Korber, D., James, G., 1994. Biofilms, the customized microniche. *Journal of Bacteriology*. 176, (8) 2137-2142.
- Courtney, L.A., Clements, W.H., 2000. Sensitivity to acidic pH in benthic invertebrate assemblages with different histories of exposure to metals. *Journal of the North American Benthological Society*. 19, (1) 112-127.
- Creamer, R.E., Bellamy, P., Black, H.I.J., Cameron, C.M., Campbell, C.D., Chamberlain, P., Harris, J., Parekh, N., Pawlett, M., Poskitt, J., Stone, D., Ritz, K., 2009. An inter-laboratory comparison of multi-enzyme and multiple substrate-induced respiration assays to assess method consistency in soil monitoring. *Biology and Fertility of Soils*. 45, (6) 623-633.
- Culp, J. M., Lowell, R. B., Cash, K. J., 2000. Integrating mesocosm experiments with field and laboratory studies to generate weight-of-evidence risk assessments for large rivers. *Environmental Toxicology and Chemistry*. 19, (4) 1167-1173.
- Currie, D.J., Kalff, J., 1984. A comparison of the abilities of freshwater algae and bacteria to acquire and retain phosphorus. *Limnol. Oceanogr.* 29, 298-310.

D

- Dahl, B., Blanck, H., 1996. Toxic effects of the antifouling agent Irgarol 1051 on periphyton communities in coastal water microcosms. *Marine Pollution Bulletin*. 32, (4) 342-350.
- Dale, V. H., H. C. Beyeler, 2001. Challenges in the development and use of biological indicators. *Ecological Indicators* 1: 3–10.
- Davis, M.R.H., Zhao, F.J., Mcgrath, S.P., 2004. Pollution-induced community tolerance of soil microbes in response to a zinc gradient. *Environmental Toxicology and Chemistry*. 23, (11) 2665-2672.
- Debenest, T., Pinelli, E., Coste, M., Silvestre, J., Mazzella, N., Madigou, C., Delmas, F., 2009. Sensitivity of freshwater periphytic diatoms to agricultural herbicides. *Aquatic Toxicology*. 93, (1) 11-17.
- De Filippis, L.F., Pallaghy, C.K., 1994. Heavy metals: Sources and Biological effects, in: Rai, L.C., Gaur, J.P., Soeder, C.J. (Eds.), *Algae and water pollution*. E. Schweizerbart'sche Verlagsbuchhandlung, pp. 31 - 77.
- Delorenzo, M. E., Lauth, J., Pennington, P. L., Scott, G. I., Ross, P. E., 1999. Atrazine effects on the microbial food web in tidal creek mesocosms. *Aquatic Toxicology*. 46, (3-4) 241-251.
- Delorenzo, M.E., Scott, G.I., Ross, P.E., 1999. Effects of the agricultural pesticides atrazine, deethylatrazine, endosulfan, and chlorpyrifos on an estuarine microbial food web. *Environmental Toxicology and Chemistry*. 18, (12) 2824-2835.
- Demoling, L.A., Baath, E., 2008. Use of pollution-induced community tolerance of the bacterial community to detect phenol toxicity in soil. *Environmental Toxicology and Biochemistry*. 27, 334-340.
- Demmig, B., Winter, K., Krüger, A., Czygan, F.C., 1987. Photoinhibition and zeaxanthin formation in intact leaves. A possible role of the xanthophyll cycle in the dissipation of excess light. *Plant Physiology*. 84, 218 - 224.
- Demmig-Adams, B. and Adams, W.W.III, 2006. Photoprotection in an ecological context: the remarkable complexity of thermal energy dissipation. *New Phytol*. 172, 11 - 21.
- Diaz-Ravina, M., Baath, E., Frostegard, A., 1994. multiple heavy-metal tolerance of soil bacterial communities and its measurement by a thymidine incorporation technique. *Applied and Environmental Microbiology*. 60, (7) 2238-2247.
- Diaz-Ravina, M., Calvo De Anta, R., Baath, E., 2007. Tolerance (PICT) of the Bacterial Communities to Copper in Vineyards Soils from Spain. *J. Environ. Qual.* 36, 1760-1764.
- Dorigo, U., Leboulanger, C., 2001. A PAM fluorescence-based method for assessing the effects of photosystem II herbicides on freshwater periphyton. *Journal of Applied Phycology*. 13, (6) 509-515.

- Dorigo, U., Bérard, A., Humbert, J.-F., 2002. Comparison of Eukaryotic Phyto-benthic Community composition in a Polluted River by Partial 18S rRNA Gene Cloning and Sequencing. *Microb. Ecol.* 4, 372-380.
- Dorigo, U., Bourrain, X., A., B., Leboulanger, C., 2003. Seasonal changes in river microalgae sensitivity to atrazine and isoproturon, along a contamination gradient. *The Science of the Total Environment.* 318, 101-114.
- Dorigo, U., Leboulanger, C., Berard, A., Bouchez, A., Humbert, J.F., Montuelle, B., 2007. Lotic biofilm community structure and pesticide tolerance along a contamination gradient in a vineyard area. *Aquatic Microbial Ecology.* 50, (1) 91-102.
- Dorigo U., Lefranc M., Leboulanger C., Montuelle B., Humbert JF., 2009, Influence of sampling strategy on the assessment of the impact of pesticides on periphytic microbial communities in a small river. *FEMS Microbial Ecology*, 67, 491-501.
- Dorigo U., Bérard A., Rimet F., Bouchez A., Montuelle B., 2010. In situ assessment of periphyton recovery in a river contaminated by pesticides. *Aquatic Toxicology.* 98 (4), 396-406.
- Duhamel, S., Jacquet, S., 2006. Flow cytometric analysis of bacteria- and virus-like particles in lake sediments. *Journal of Microbiological Methods.* 64, 316-332.
- Duong, T.T., Morin, S., Herlory, O., Feurtet-Mazel, A., Coste, M., Boudou, A., 2008. Seasonal effects of cadmium accumulation in periphytic diatom communities of freshwater biofilms. *Aquatic Toxicology.* 90, 19-28.
- Duong, T.T., Morin, S., Coste, M., Herlory, O., Feurtet-Mazel, A., Boudou, A., 2010. Experimental toxicity and bioaccumulation of cadmium in freshwater periphytic diatoms in relation with biofilm maturity. *Science of the Total Environment.* 408, 552–562.

E

- Edeline, F., 1998. *le pouvoir autoépurateur des rivières.* ed. Cebedoc, Liège
- Efroymson, R.A., Suter, G.W., 1999. Finding a niche for soil microbial toxicity tests in ecological risk assessment. *Human and Ecological Risk Assessment.* 5, (4) 715-727.
- Ekschmitt, K., Klein, A., Pieper, B., Wolters, V., 2001. Biodiversity and functioning of ecological communities - why is diversity important in some cases and unimportant in others? *Journal of Plant Nutrition and Soil Science-Zeitschrift Fur Pflanzenernahrung Und Bodenkunde.* 164, (3) 239-246.
- Eriksson, K.M., Clarke, A.K., Franzen, L.G., Kuylenstierna, M., Martinez, K., Blanck, H., 2009. Community-Level Analysis of psbA Gene Sequences and Irgarol Tolerance in Marine Periphyton. *Applied and Environmental Microbiology.* 75, (4) 897-906.

Espeland, E.M., Francoeur, S.N., Wetzel, R.G., 2001. Influence of algal photosynthesis on biofilm bacterial production and associated glucosidase and xylosidase activities. *Microbial Ecology*. 42, (4) 524-530.

F

Fayolle, S., Cazaubon, A., Comte, K., 1999. Responses and adaptative strategy of epilithic algae communities to different hydrological regimes. *Comptes Rendus De L Academie Des Sciences Serie Iii-Sciences De La Vie-Life Sciences*. 322, (5) 413-422.

Ferreira Da Silva, E., Almeida, S.F.P., Nunes, M.L., Luís, A.T., Borg, F., Hedlund, M., Marques De Sá, C., Patinha, C., Teixeira, P., 2009. Heavy metal pollution downstream the abandoned Coval da Mó mine (Portugal) and associated effects on epilithic diatom communities. *Science of the Total Environment*. 407, 5620-5636.

Feurtet-Mazel, A., Gold, C., Coste, M., Boudou, A., 2003. Study of periphytic diatom communities exposed to metallic contamination through complementary field and laboratory experiments. *Journal De Physique IV* 107, 467-470.

Fleeger, J.W., Carman, K.R., Nisbet, R.M., 2003. Indirect effects of contaminants in aquatic ecosystems. *Science of the Total Environment*. 317, (1-3) 207-233.

Flemming H.C., Wingender J., Mayer C. et al. 2000, Cohesiveness in biofilm matrix polymers. In : Allison D., Gilbert P., Lappin-Scott H. et al. *Community structure and cooperation in biofilms*. Cambridge University Press, 167-198.

Freeman C. et Lock M.A. The biofilm polysaccharide matrix : a buffer against changing organic substrate supply ? *Limnology and Oceanography*, 1995, vol 40, N°2, pp. 273- 278.

Frontier, S., Pichod-Viale, D., Lepêtre, A., Davoult, D., Luczak, C., 2004. *Ecosystèmes: structure, fonctionnement, évolution*. Ed. DUNOD, Paris.

G

Garland, J.L., Mills, A.L., 1991. Classification and Characterization of Heterotrophic Microbial Communities on the Basis of Patterns of Community-Level Sole-Carbon-Source Utilization. *Applied and Environmental Microbiology*. 57, (8) 2351-2359.

Garric J., Pont D. (coordonateurs), 2010, l'évaluation du risque toxique dans les milieux aquatiques : quels outils, quelles perspectives, *Sciences, Eaux et Territoires*, 1, 1-62.

Genter, R.B., Cherry, D.S., Smith, E.P., Cairns, J.J., 1987. Algal-priphyton population and community changes from zinc stress in stream mesocosms. *Hydriobiologia*. 153, 87-92.

- Goncharova, N.V., Goldfeld, M.G., Chetverikov, A.G., Binyukov, V.I., 1997. Donor function of phosphate ions in photosystem 2. *Photosynthetica*. 34, (1) 77-96.
- Gong, P., Gasparrini, P., Rho, D., Hawari, J., Thiboutot, S., Ampleman, G., Sunahara, G.I., 2000. An *in-Situ* Respirometric Technique to Measure Pollution-Induced Microbial Community Tolerance in Soils Contaminated with 2,4,6-Trinitrotoluene. *Ecotoxicology and Environmental Safety*. 47, 96-103.
- Gouy, V., Nivon, C., 2007. Caractérisation et suivi de la qualité des eaux sur le bassin versant de la Morcille sur la période 2001-2006. Rapport d'étude Cemagref. pp. 59.
- Groffman P, Baron J, Blett T, Gold A, Goodman I, Gunderson L, Levinson B, Palmer M, Paerl H, Peterson G, Poff N, Rejeski D, Reynolds J, Turner M, Weathers K, Wiens J. 2006. Ecological thresholds: The key to successful environmental management or an important concept with no practical application? *Ecosystems* 9:1–13.
- Guasch, H., Muñoz, Roxés, N., Sabater, S., 1997. Changes in atrazine toxicity throughout succession of stream periphyton communities. *Journal of Applied Phycology*. 9, 137-146.
- Guasch, H., Sabater, S., 1998. Light history influences the sensitivity to atrazine in periphytic algae. *J. Phycol.* 34, 233-241.
- Guasch, H., Paulsson, M., Sabater, S., 2002. Effect of copper on algal communities from oligotrophic calcareous streams. *Journal of Phycology*. 38, (2) 241-248.
- Guasch, H., Admiraal, W., Sabater, S., 2003. Contrasting effects of organic and inorganic toxicants on freshwater periphyton. *Aquatic Toxicology*. 64, 165-175.
- Guasch, H., Navarro, E., Serra, A., Sabater, S., 2004. Phosphate limitation influences the sensitivity to copper in periphytic algae. *Freshwater Biology*. 49, (4) 463-473.
- Guasch, H., Lehmann, V., Van Beusekom, B., Sabater, S., Admiraal, W., 2007. Influence of phosphate on the response of periphyton to atrazine exposure. *Archives of Environmental Contamination and Toxicology*. 52, (1) 32-37.
- Guasch, H., Leira, M., Montuelle, B., Geiszinger, A., Roulier, J.L., Tornés, E., Serra, A., 2009. Use of multivariate analyses to investigate the contribution of metal pollution to diatom species composition: search for the most appropriate cases and explanatory variables. *Hydrobiologia*. 627(1), 143 - 158.
- Guasch, H., Atli, G., Bonet, B., Corcoll, N., Leira, M. & Serra, A. (2010). Discharge and the response of biofilms to metal exposure in Mediterranean rivers. *Hydrobiologia*. 657(1), 143 - 157.
- Guenet, B., Danger, M., Abbadie, L., Lacroix, G., *in press*. Priming effect: bridging the gap between terrestrial and aquatic ecology. *Ecological Society of America*.
- Gustavson, K., Wängberg, S.A., 1995. Tolerance induction and succession in microalgae communities exposed to copper and atrazine. *Aquatic Toxicology*. 32, 283-302.

H

- Hall, J., Healey, F.P., Robinson, G.G.C., 1989. The interaction of chronic copper toxicity with nutrient limitation in tow chlorophytes in batch culture. *Aquatic Toxicology*. 14, 1-14.
- Ham, K. D., Adams, S. M., Peterson, M. J., 1997. Application of multiple bioindicators to differentiate spatial and temporal variability from the effects of contaminant exposure on fish. *Ecotoxicology and Environmental Safety*. 37, (1) 53-61.
- Hammer, B. K., Bassler, B. L., 2003. Quorum sensing controls biofilm formation in *Vibrio cholerae*. *Molecular Microbiology*. 50, (1) 101-114.
- Headley, J.V., Gandrass, J., Kuballa, J., Peru, K.M., Gong, Y.L., 1998. Rates of sorption and partitioning of contaminants in river biofilm. *Environmental Science & Technology*. 32, (24) 3968-3973.
- Hersh, C.M., Crumpton, W.G., 1989. Atrazine Tolerance of Algae Isolated from 2 Agricultural Streams. *Environmental Toxicology and Chemistry*. 8, (4) 327-332.
- Higham, D. P., Sadler, P. J., Scawen, M. D., 1984. Cadmium-Resistant *Pseudomonas putida* Synthesizes Novel Cadmium Proteins. *Science*. 225, (4666) 1043-1046.
- Hjorth, M., Dahllof, I., Forbes, V.E., 2006. Effects on the function of three trophic levels in marine plankton communities under stress from the antifouling compound zinc pyrithione. *Aquatic Toxicology*. 77, (1) 105-115.
- Hooper, D.U., Solan, M., Symstad, A., Diaz, S., Gessner, M.O., Buchmann, N., Degrange, V., Grime, P., Hulot, F., Mermillod-Blondin, F., Roy, J., Spehn, E., Van Peer, L., 2002. Species diversity, functional diversity, and ecosystem functioning, in: Loreau, M., Naeem, S., Inchausti, P. (Eds.), *Biodiversity and ecosystem functioning-synthesis and perspectives*. Oxford University Press, pp. 195-208.
- Hughes, M. N., Poole, R. K., 1986. *Metals and Micro-organisms*. ed. Chapman and Hall London.

I

- Ifen, 2004. *Les pesticides dans les eaux. Sixième bilan annuel. Données 2002. Etudes et Travaux n°42*. Institut Français de l'Environnement, Orléans.
- Inra-Cemagref, 2005. *Pesticides, agriculture and the environment: reducing the use of pesticides and limiting their environmental impact*, in: Sabbagh, C.C., De Menthière, N. (Eds.), *Collective Scientific Expert Report, Executive Summary*. pp. 58.

- Ivorra, N., Hettelaar, J., Tubbing, G. M. J., Kraak, M. H. S., Sabater, S., Admiraal, W., 1999. Translocation of microbenthic algal assemblages used for in situ analysis of metal pollution in rivers. *Arch. Environ. Contam. Toxicol.* 37, 19-28.
- Ivorra, N., Bremer, S., Guasch, H., Kraak, M.H.S., Admiraal, W., 2000. Differences in the sensitivity of benthic microalgae to Zn and Cd regarding biofilm development and exposure history. *Environmental Toxicology and Chemistry.* 19(5), 1332-1339.
- Ivorra, N., Barranguet, C., Jonker, M., Kraak, M.H.S., Admiraal, W., 2002. Metal-induced tolerance in the freshwater microbenthic diatom *Gomphonema parvulum*. *Environmental Pollution.* 116, 147-157.
- Ivorra, N., Nystrom, B., Paulsson, M., Petterson, R.P., Sabater, S., Tubbing, G.M.J., 2003. Variability in zinc tolerance, measured as incorporation of radio-labeled carbon dioxide and thymidine, in periphyton communities sampled from 15 European river stretches. *Arch. Environ. Contam. Toxicol.* 44, 17-29.

J

- Jackson, C. R., 2003. Changes in community properties during microbial succession. *Oikos.* 101, (2) 444-448.
- Karaer, F., Kucukballi, A., 2006. Monitoring of water quality and assessment of organic pollution load in the Nilufer Stream, Turkey. *Environmental Monitoring and Assessment.* 114, (1-3) 391-417.
- Jansen, M. A. K., Mattoo, A. K., Malkin, S., Edelman, M., 1993. Direct demonstration of binding-site competition between photosystem-II inhibitors at the Q(B) niche of the D1 protein. *Pesticide Biochemistry and Physiology.* 46, (1) 78-83.
- Jeffrey, S. W., Mantoura, R. F. C., Wright, S. W., 1997. *Phytoplankton pigments in oceanography. Monographs on oceanographic methodologies.* Ed. UNESCO, Paris.
- Jeffrey, S.W., Vesk, M., 1997. Introduction to marine phytoplankton and their pigment signatures. In: Jeffrey, S.W., Mantoura, R.F.C., Wright, S.W. (Eds.), *Phytoplankton pigments in oceanography.* UNESCO Publishing, Paris, pp. 37-84.
- Jurgensen, T. A., Hoagland, K. D., 1990. Effects of short-term pulses of atrazine on attached algal communities in a small stream. *Archives of Environmental Contamination and Toxicology.* 4, 617-623.

K

- Kamaya, Y., Takada, T., Suzuki, K., 2004. Effect of medium phosphate levels on the sensitivity of *Selenastrum capricornutum* to chemicals. *Bull. Environ. Contam. Toxicol.* 73, 995-1000.
- Kamitani, T., Oba, H., Kaneko, N., 2006. Microbial biomass and tolerance of microbial community on an aged heavy metal polluted floodplain in Japan. *Water Air and Soil Pollution.* 172, (1-4) 185-200.
- Kana, T. M., Geider, R. J., Critchley, C., 1997. Regulation of photosynthetic pigments in micro-algae by multiple environmental factors: a dynamic balance. *New Phytologist.* 137, 629-638.
- Kasai, F., Takamura, N., Hatakeyama, S., 1993. Effects of simetryne on growth of various freshwater algal taxa. *Environmental Pollution.* 79, (1) 77-83.
- Kashian, D. R., Zuellig, R. E., Mitchell, K. A., Clements, W. H., 2007. The cost of tolerance: Sensitivity of stream benthic communities to UV-B and metals. *Ecological Applications.* 17, (2) 365-375.
- Kaufmann, K., Chapman, S.J., Campbell, C.D., Harms, H., Hohener, P., 2006. Miniaturized test system for soil respiration induced by volatile pollutants. *Environmental Pollution.* 140, (2) 269-278.
- Khoshmanesh, A., Lawson, F., Prince, I.G., 1997. Cell surface area as a major parameter in the uptake of cadmium by unicellular green microalgae. *Chemical Engineering Journal.* 65, 13-19.
- Knauer, K., Leimgruber, A., Hommen, U., Knauer, S., 2010. Co-tolerance of phytoplankton communities to photosynthesis II inhibitors. *Aquatic Toxicology.* 96, (4) 256-263.
- Knowles, F. C., Benson, A. A., 1983. The Biochemistry of arsenic. *Trends in Biochemical Sciences.* 8, (5) 178-180.
- Kostel, J. A., Wang, H., Amand, A. L. S., Gray, K. A., 1999. 1. Use of a novel laboratory stream system to study the ecological impact of PCB exposure in a periphytic biolayer. *Wat. Res.* 33, (18) 3735-3748.
- Krammer, K. and Lange-Bertalot, H. 1986 - 1991. *Bacillariophyceae* 1. Teil: Naviculaceae, 2. Teil: Bacillariaceae, Epithemiaceae, Surirellaceae, 3. Teil: Centrales, Fragilariaceae, Eunotiaceae, 4. Teil: Achnanthaceae. *Kritische Ergänzungen zu Navicula (Lineolatae) und Gomphonema.* G. Fischer Verlag, Stuttgart.
- Kuepper, H., Setlik, I., Spiller, M., Kuepper, F., Prasil, O., 2002. Heavy metal-induced inhibition of photosynthesis: targets of in vivo heavy metal chlorophyll formation. *J. Phycol.* 38, 429-441.

ℒ

- Lagacherie, P., Diot, O., Domange, N., Gouy, V., Floure, C., Kao, C., Moussa, R., Robbez-Masson, J. M., Szleper, V., 2006. An indicator approach for describing the spatial variability of artificial stream networks with regard to herbicide pollution in cultivated watersheds. *Ecological Indicators.* 6, (2) 265-279.

- Lagadic, L., Caquet, T., 1998. Invertebrates in testing of environmental chemicals: Are they alternatives? *Environmental Health Perspectives*. 106, 593-611.
- Landini, P., Zehnder, A. J. B., 2002. The global regulatory *hns* gene negatively affects adhesion to solid surfaces by anaerobically grown *Escherichia coli* by modulating expression of flagellar genes and lipopolysaccharide production. *Journal of Bacteriology*. 184, (6) 1522-1529.
- Lawrence, J. R., Kopf, G., Headley, J. V., Neu, T. R., 2001. Sorption and metabolism of selected herbicides in river biofilm communities. *Canadian Journal of Microbiology*. 47, (7) 634-641.
- LeBoulanger, C., 2004. Réponses des microalgues d'eaux douces aux pollutions par les pesticides. (Programme : Evaluation et réduction des risques liés à l'emploi des pesticides). Equipe Microbiologie Aquatique. INRA UMR CARTELE. Thonon les Bains.
- Lehmann, V., Tubbing, G.M.J., Admiraal, W., 1999. Induced metal tolerance in microbenthic communities from three lowland rivers with different metal loads. *Archives of Environmental Contamination and Toxicology*. 36(4), 384-391.
- Liang, L. N., He, B., Jiang, G. B., Chen, D. Y., Yao, Z. W., 2004. Evaluation of mollusks as biomonitors to investigate heavy metal contaminations along the Chinese Bohai Sea. *Science of the Total Environment*. 324, (1-3) 105-113.
- Liess, M., Von Der Ohe, P. C., 2005. Analyzing effects of pesticides on invertebrate communities in streams. *Environmental Toxicology and Chemistry*. 24, (4) 954-965.
- Lindsay, W.L., 1979. Carbonate equilibria, in: Lindsay, W.L. (Eds.), *Chemical Equilibria in Soils*. Wiley, M. J, New York, pp. 78-84.
- Le Jeune, A.H., Charpin, M., Sargos, D., Lenain, J.F., Deluchat, V., Ngayila, N., Baudu, M., Amblard, C., 2007. Planktonic microbial community responses to added copper. *Aquatic Toxicology*. 83, (3) 223-237.
- Lesley, A., Ogilvie, A.B., Alistair Grant, B., 2008. Linking pollution induced community tolerance (PICT) and microbial community structure in chronically metal polluted estuarine sediments. *Marine Environmental Research*. 65, 187-198.
- Lock, K., Janssen, C.R., 2005. Influence of soil zinc concentrations on zinc sensitivity and functional diversity of microbial communities. *Environmental Pollution*. 136, (2) 275-281.
- Loreau, M., Naeem, S., Inchausti, P., 2002. Biodiversity and ecosystem functioning, in: (Eds.), Oxford University Press, New York, NY.
- Lyautey, E., Jackson, C. R., Cayrou, J., Rols, J. L., Garabetian, F., 2005. Bacterial community succession in natural river biofilm assemblages. *Microbial Ecology*. 50, (4) 589-601.
- Lyon, D.R., Ziegler, S.E., 2009. Carbon cycling within epilithic biofilm communities across a nutrient gradient of headwater streams. *Limnology and Oceanography*. 54, (2) 439-449.

M

- MA, 2005 Millennium ecosystem assessment. Ecosystems and human well-being: synthesis. Island Press, Washington DC
- Macinnis-Ng, C. M. O., Ralph, P. J., 2004. In situ impact of multiple pulses of metal and herbicide on the seagrass, *Zostera capricorni*. *Aquatic Toxicology*. 67, (3) 227-237.
- Macken, A., Giltrap, M., Ryall, K., Foley, B., MCGovern, E., Mchugh, B., Davoren, M., 2009. A test battery approach to the ecotoxicological evaluation of cadmium and copper employing a battery of marine bioassays. *Ecotoxicology*. 18, (4) 470-480.
- Mahmoud, H.M.A., Goulde, R., Carvalho, G.R., 2005. The response of epilithic bacteria to different metals regime in two upland streams: assessed by conventional microbiological methods and PCR-DGGE. *Archiv für Hydrobiologie*. 163(3), 405-427.
- Massieux, B., Boivin, M.E.Y., Van Den Ende, F.P., Langenskiold, J., Marvan, P., Barranguet, C., Admiraal, W., Laanbroek, H.J., Zwart, G., 2004. Analysis of structural and physiological profiles to assess the effects of Cu on biofilm microbial communities. *Appl. Environ. Microbiol.* 70, (8) 4512-4521.
- McClellan, K., Altenburger, R., Schmitt-Jansen, M., 2008. Pollution-induced community tolerance as a measure of species interaction in toxicity assessment. *Journal of Applied Ecology*. 45, 1514–1522.
- McCormick, P. V., Stevenson, R. J., 1998. Periphyton as a tool for ecological assessment and management in the Florida Everglades. *Journal of Applied Phycology*. 34, 726-733.
- McCormick, P. V., Cairns, J., 1994. Algae as Indicators of Environmental-Change. *Journal of Applied Phycology*. 6, (5-6) 509-526.
- Mertz, O., Ravnborg, H. M., Lovei, G. L., Nielsen, I., Konijnendijk, C. C., 2007. Ecosystem services and biodiversity in developing countries. *Biodiversity and Conservation*. 16, (10) 2729-2737.
- Millward, R. N., Klerks, P. L., 2002. Contaminant-adaptation and community tolerance in ecological risk assessment: Introduction. *Human and Ecological Risk Assessment*. 8, (5) 921-932.
- Millward, R. N., Grant, A., 2000. Pollution-induced tolerance to copper of nematode communities in the severely contaminated restronguet creek and adjacent estuaries, Cornwall, United Kingdom. *Environmental Toxicology and Chemistry*. 19, (2) 454-461.
- Mohamed, M.N., Lawrence, J.R., Robarts, R.D., 1998. Phosphorus limitation of heterotrophic biofilms from the Fraser River, British Columbia, and the effects of pulp mill effluent. *Microbial Ecology*. 36, 121-130.
- Mølander, S., 1991. Detection, validity and specificity of Pollution-Induced Community Tolerance (PICT). PhD thesis (Göteborg (Sweden)).
- Mølander, S., Blanck, H., 1991. Cotolerance pattern of marine periphyton communities restructured by the herbicide diuron. *Departement of Plant Physiology*. University of Göteborg (Sweden).

- Mølander, S., Blanck, H., 1992. Detection of pollution-induced community tolerance (PICT) in marine periphyton communities established under diuron exposure. *Aquatic Toxicology*. 22, 129-144.
- Monroe, D., 2007. Looking for chinks in the armor of bacterial biofilms. *Plos Biology*. 5, (11) 2458-2461.
- Montuelle, B., Dorigo, U., Bérard, A., Bouchez, A., Tlili, A., Gouy, V., Pesce, S., 2010. The periphyton as a multimetric bioindicator to assess the impact of land use on river: an overview on the Ardières-Morcille experimental watershed (France). *Hydrobiologia*. 657, 123-147.
- Morin, S., Vivas-Nogues, M., Duong, T.T., Boudou, A., Coste M., Delmas, F., 2007. Dynamics of benthic diatom colonization in a cadmium/zinc-polluted river (Riou Mort, France). *Fundamental and Applied Limnology*. 168(2), 179–187.
- Morin, S., Duong, T.T., Dabrin, A., Coynel, A., Herlory, O., Baudrimont, M., Delmas, F., Durrieu, G., Schafer, J., Winterton, P., Blanc, G., Coste, M., 2008. Long-term survey of heavy-metal pollution, biofilm contamination and diatom community structure in the Riou Mort watershed, South-West France. *Environmental Pollution*. 151(3), 532-542.
- Morin, S., Pesce, S., Tlili, A., Coste, M., Montuelle, B., 2010. Recovery potential of periphytic communities in a river impacted by a vineyard watershed. *Ecological Indicators*. 10, (2) 419-426.
- Muradian R. 2001. Ecological thresholds: A survey. *Ecol Econ* 38, 7–24.
- Murphy, J. and Riley, J.P., 1992. A modified single solution method for the determination of phosphate in natural waters. *Analytica Chimica Acta*. 27, 31-36.
- Muyzer, G., Smalla, K., 1998. Application of denaturing gradient gel electrophoresis (DGGE) and temperature gradient gel electrophoresis (TGGE) in microbial ecology. *Antonie van Leeuwenhoek*. 73, 127-141.

N

- Nalewajko, C., Paul, B., 1985. Effects of Manipulations of Aluminum Concentrations and Ph on Phosphate-Uptake and Photosynthesis of Planktonic Communities in 2 Precambrian Shield Lakes. *Canadian Journal of Fisheries and Aquatic Sciences*. 42, (12) 1946-1953.
- Nalewajko, C., Olaveson, M., 1994. Differential responses of growth, photosynthesis, respiration, and phosphate uptake to copper in copper-tolerant and copper-intolerant strains of *Scenedesmus acutus* (Chlorophyceae). *Canadian Journal of Botany*. 73, 1295-1303.
- Navarro, E., Robinson, C.T., Behra, R., 2008. Increased tolerance to ultraviolet radiation (UVR) and cotolerance to cadmium in UVR-acclimatized freshwater periphyton. *Limnology and Oceanography*. 53, (3) 1149-1158.

- Niklinska, M., Chodak, M., Laskowski, R., 2006. Pollution-induced community tolerance of microorganisms from forest soil organic layers polluted with Zn or Cu. *Applied Soil Ecology*. 32, (3) 265-272.
- Nivens DE, Ohman DE, Williams J, Franklin MJ. 2001. Role of alginate and its O acetylation in formation of *Pseudomonas aeruginosa* microcolonies and biofilms *J. Bacteriol.* 183:1047-57.
- Norris, R. H., Linke, S., Prosser, I., Young, W. J., Liston, P., Bauer, N., Sloane, N., Dyer, F., Thoms, M., 2007. Very-broad-scale assessment of human impacts on river condition. *Freshwater Biology*. 52, (5) 959-976.
- Pearce, D., Moran, D., 1993. Cash Concerns. *New Scientist*. 140, (1894) 52-52.
- Nyström, B., 1997. Metabolic indicators of ecotoxicological effects in freshwater periphyton communities. PhD thesis. of (Göteborg (Sweden)).
- Nyström, B., Paulsson, M., Almgren, K., Blank, H., 2000. Evaluation of the capacity for development of atrazine tolerance in periphyton from a Swedish freshwater site as determined by inhibition of photosynthesis and sulfolipid synthesis. *Environmental Toxicology and Chemistry*. 19, (5) 1324-1331.

O

- Oren, A., Steinberger, Y., 2008. Coping with artifacts induced by CaCO₃-CO₂-H₂O equilibria in substrate utilization profiling of calcareous soils. *Soil Biology & Biochemistry*. 40, (10) 2569-2577.

P

- Paine, R. T., Tegner, M. J., Johnson, E. A., 1998. Compounded perturbations yield ecological surprises. *Ecosystems*. 1, (6) 535-545.
- Paulsson, M., Nyström, B., Blanck, H., 2000. Long-term toxicity of zinc to bacteria and algae in periphyton communities from the river Gota Alv, based on a microcosm study. *Aquatic Toxicology*. 47(3-4), 243-257.
- Pelte T., 2009. Utilisation de l'écotoxicologie pour la gestion de l'eau et des milieux aquatiques. 5^{ème} journée thématique de la ZABR. 24/09/09, Valence. Présentation orale.
- Peres, F., Lorin, D., Grollier, T., Feurtet-Mazel, A., Coste, M., Ribeyre, F., Ricard, M., Boudou, A., 1996. Effects of the phenylurea herbicide isoproturon on periphytic diatom communities in freshwater indoor microcosms. *Environmental Pollution*, 94(2), 141-152.

- Pesce, S., Fajon, C., Bardot, C., Bonnemoy, F., Portelli, C., Bohatier, J., 2006. Effects of phenylurea herbicide diuron on natural riverine microbial communities in an experimental study. *Aquatic Toxicology*. 78, 303-314.
- Pesce, S., Margoum, C., Montuelle, B., 2010. In situ relationship between spatio-temporal variations in diuron concentrations and phototrophic biofilm tolerance in a contaminated river. *Water Research*. doi:10.1016/j.waters.2009.11.053.
- Preston-Mafham, J., Boddy, L., Randerson, P.F., 2002. Analysis of microbial community functional diversity using sole-carbon-source utilisation profiles - a critique. *Fems Microbiology Ecology*. 42, (1) 1-14.

R

- Rabiet, M., Margoum, C., Gouy, V., Carluer, N., Coquery, M., 2008. Transfert des pesticides dans un petit bassin versant viticole. Influence des conditions hydrologiques sur le transport de ces contaminants. *Ingénieries EAT*.
- Rabiet, M., Margoum, C., Gouy, V., Carluer, N., Coquery, M., 2010. Assessing pesticide concentrations and fluxes in the stream of a small vineyard catchment - Effect of sampling frequency. *Environmental Pollution*. 158, (3) 737-748.
- Rajapaksha, R.M.C.P., Tobor-Kaplon, M.A., Baath, E., 2004. Metal toxicity affects fungal and bacterial activities in soil differently. *Applied and Environmental Microbiology*. 70, (5) 2966-2973.
- Ranjard, L., Lejon, D.P.H., Mougel, C., Schehrer, L., Merdinoglu, D., Chaussod, R., 2003. Sampling strategy in molecular microbial ecology: influence of soil sample size on DNA fingerprinting analysis of fungal and bacterial communities. *Environmental Microbiology*. 5(11), 1111-1120.
- Rensing, C., Fan, B., Sharma, R., Mitra, B., Rosen, B. P., 2000. CopA: An *Escherichia coli* copper(I)-translocating P-type ATPase. *Proceedings of the National Academy of Sciences of the United States of America*. 97, (2) 652-656.
- Ricart, M., Barcelo, D., Geiszinger, A., Guasch, H., Lopez De Alda, M., Romani, A., Vidal, G., Villagrasa, M., Sabater, S., 2009. Effects of low concentrations of the phenylurea herbicide diuron on biofilm algae and bacteria. *Chemosphere*. 76, (10) 1392-1401.
- Rier, S. T., Stevenson, R. J., 2002. Effects of light, dissolved organic carbon, and inorganic nutrients on the relationship between algae and heterotrophic bacteria in stream periphyton. *Hydrobiologia*. 489, (1-3) 179-184.
- Rimet, F., De Lacotte, M.H., Leboulanger, C., Druart, J.C., Bérard, A., 1999. Atrazine and Nicosulfuron effects on phytoplanktonic communities of Lake of Geneva. *Archives Des Sciences*. 52, (2) 111-122.

- Rimet, F., Bouchez, A., in press. Use of diatom life-forms and ecological guilds to assess pesticide contamination in rivers: lotic mesocosm approaches. *Ecological Indicators*.
- Romani, A. M., Guasch, H., Munoz, I., Ruana, J., Vilalta, E., Schwartz, T., Emtiazi, F., Sabater, S., 2004. Biofilm structure and function and possible implications for riverine DOC dynamics. *Microbial Ecology*. 47, (4) 316-328.
- Rosen, B. P., 1996. Bacterial resistance to heavy metals and metalloids. *Journal of Biological Inorganic Chemistry*. 1, (4) 273-277.
- Roussel, H., Ten-Hage, L., Joachim, S., Le Cohu, R., Gauthier, L., Bonzom, J. M., 2007. A long-term copper exposure on freshwater ecosystem using lotic mesocosms: Primary producer community responses. *Aquatic Toxicology*. 81, (2) 168-182.
- Rusk, J.A., Hamon, R.E., Stevens, D.P., Mclaughlin, M.J., 2004. Adaptation of soil biological nitrification to heavy metals. *Environmental Science & Technology*. 38, (11) 3092-3097.
- Rutgers, M., Van't Verlaat, I.M., Wind, B., Posthuma, L., Breure, A.M., 1998. Rapid method for assessing pollution-induced community tolerance in contaminated soil. *Environmental Toxicology and Chemistry*. 17, 2210-2213.

S

- Sabater, S., Guasch, H., Romani, A., Munoz, I., 2002. The effect of biological factors on the efficiency of river biofilms in improving water quality. *Hydrobiologia*. 469, (1-3) 149-156.
- Sabater, S., Guasch, H., Ricart, M., Romani, A., Vidal, G., Klünder, C., Schmitt-Jansen, M., 2007. Monitoring the effect of chemicals on biological communities. The biofilm as an interface. *Anal. Bioanal. Chem*. 387, 1425-1434.
- Salminen, J., Van Gestel, C.A.M., Oksanen, J., 2001. Pollution-Induced community tolerance and functional redundancy in a decomposer food web in metal-stressed soil. *Environmental Toxicology and Chemistry*. 20, (10) 2287-2295.
- Schauer, M., Balagué, V., Pedros-Alio, C., Massana, R., 2003. Seasonal changes in the taxonomic composition of bacterioplankton in a coastal oligotrophic system. *Aquat. Microb. Ecol*. 31, 163-174.
- Schmitt, H., Van Beelen, P., Tolls, J., Van Leeuwen, C.L., 2004. Pollution-induced community tolerance of soil microbial communities caused by the antibiotic sulfachloropyridazine. *Environmental Science & Technology*. 38, (4) 1148-1153.
- Schmitt, H., Haapakangas, H., Van Beelen, P., 2005. Effects of antibiotics on soil microorganisms: time and nutrients influence pollution-induced community tolerance. *Soil Biology & Biochemistry*. 37, (10) 1882-1892.

- Schmitt-Jansen, M., Altenburger, R., 2005. Predicting and observing responses of algal communities to photosystem II-herbicide exposure using pollution-induced community tolerance and species-sensitivity distributions. *Environmental Toxicology and Chemistry*. 24, (2) 304-312.
- Schmitt-Jansen, M., Altenburger, R., 2005. Toxic effects of isoproturon on periphyton communities - a microcosm study. *Estuarine Coastal and Shelf Science*. 62, (3) 539-545.
- Schmitt-Jansen, M., Altenburger, R., 2008. Community-level microalgal toxicity assessment by multiwavelength-excitation PAM fluorometry. *Aquatic Toxicology*. 86, (1) 49-58.
- Schreiber, U., Müller, J.F., Haugg, A., Gademann, R., 2002. New type of dual-channel PAM chlorophyll fluorometer for highly sensitive water toxicity biotests. *Photosynthesis Research*. 74, 317-330.
- Schulz, R., 2004. Field studies on exposure, effects, and risk mitigation of aquatic nonpoint- source insecticide pollution: a review. *J. Environ. Qual.* 33, 419-448.
- Schwartz, M.W., Brigham, C.A., Hoeksema, J.D., Lyons, K.G., Mills, M.H., Van Mantgem, P.J., 2000. Linking biodiversity to ecosystem function: implications for conservation ecology. *Oecologia*. 122, (3) 297-305.
- Seghers, D., Bulcke, R., Reheul, D., Siciliano, S.D., Top, E.M., Verstraete, W., 2003. Pollution induced community tolerance (PICT) and analysis of 16S rRNA genes to evaluate the long-term effects of herbicides on methanotrophic communities in soil. *European Journal of Soil Science*. 54, (4) 679-684.
- Serra, A., 2009. Fate and effects of copper in fluvial ecosystems: the role of periphyton. PhD thesis. Girona (Spain). pp. 110-133.
- Serra, A., Corcoll, N., Guasch, H., 2009. Copper accumulation and toxicity in fluvial periphyton: The influence of exposure history. *Chemosphere*. 74, 633-641.
- Siciliano, S.D., Gong, P., Sunahara, G.I., Greer, C.W., 2000. Assessment of 2,4,6-trinitrotoluene toxicity in field soils by pollution-induced community tolerance, denaturing gradient gel electrophoresis, and seed germination assay. *Environmental Toxicology and Chemistry*. 19, (8) 2154-2160.
- Singh, R., Paul, D., Jain, R. K., 2006. Biofilms: implications in bioremediation. *Trends in Microbiology*. 14, (9) 389-397.
- Smolders, E., Buekers, J., Oliver, I., Mclaughlin, M.J., 2004. Soil properties affecting toxicity of zinc to soil microbial properties in laboratory-spiked and field-contaminated soils. *Environmental Toxicology and Chemistry*. 23, (11) 2633-2640.
- Sogin, M.L., Gunderson, J.H., 1987. Structural diversity of eukaryotic small subunit ribosoma RNAs. *Ann. N.Y.Acad. Sci.* 503: 125-139.
- Soldo, D., Behra, R., 2000. Long-term effects of Cu on the structure of freshwater periphyton communities and their tolerance to Cu, Zn, nickel and silver. *Aquatic Toxicology*. 47, (3-4) 181-189.

- Soldo, D., Hari, R., Sigg, L., Behra, R., 2005. Tolerance of *Oocystis nephrocytioides* to copper: intracellular distribution and extracellular complexation of Cu. *Aquatic Toxicology*. 71, (4) 307-317.
- Sole, J., Garcia-Ladona, E., Ruardij, P., Estrada, M., 2005. Modelling allelopathy among marine algae. *Ecological Modelling*. 183, (4) 373-384.
- Solioz, M., Odermatt, A., 1995. Copper and silver transport by Copb-Atpase in membrane-vesicles of *Enterococcus-Hirae*. *Journal of Biological Chemistry*. 270, (16) 9217-9221.
- Stratton, G. W., 1987. The effects of pesticides and heavy metals towards phototropic microorganisms. *Rev. Environ. Toxicol.* 3, 71-147.
- Stanley, N. R., Lazazzera, B. A., 2004. Environmental signals and regulatory pathways that influence biofilm formation. *Molecular Microbiology*. 52, (4) 917-924.
- Stefanowicz, A.M., Niklinska, M., Laskowski, R., 2009. Pollution-induced tolerance of soil bacterial communities in meadow and forest ecosystems polluted with heavy metals. *European Journal of Soil Biology*. 45, (4) 363-369.
- Stevenson, R.J. and Peterson, C.G., 1989. Variation in benthic diatom (*Bacillariophyceae*) immigration with habitat characteristics and cell morphology. *Journal of Phycology*. 25, 120-129.
- Stevenson, R. J., Peterson, C. G., 1991. Emigration and immigration can be important determinants of benthic diatom assemblages in streams. *Freshwater Biology*. 26, (2) 279-294.

T

- Taylor, M., Feyereisen, R., 1996. Molecular biology and evolution of resistance to toxicants. *Molecular Biology and Evolution*. 13, (6) 719-734.
- Thiel, T., 1988. Phosphate-Transport and arsenate Resistance in the Cyanobacterium *Anabaena-Variabilis*. *Journal of Bacteriology*. 170, (3) 1143-1147.
- Tlili, A., Dorigo, U., Montuelle, B., Margoum, C., Carluer, N., Gouy, V., Bouchez, A., Berard, A., 2008. Responses of chronically contaminated biofilms to short pulses of diuron - An experimental study simulating flooding events in a small river. *Aquatic Toxicology*. 87, (4) 252-263.
- Tlili, A., Montuelle, B., 2011. Microbial pollution-induced community tolerance, in: Amiart-Triquet, C., Rainbow, P. S., Roméo, M. (Eds.), *Tolerance to Environmental Contaminants*. CRCpress.
- Tlili, A., Bérard, A., Roulier, J. L., Volat, B., Montuelle, B., 2010. PO₄³⁻ dependence of the tolerance of autotrophic and heterotrophic biofilm communities to copper and diuron. *Aquatic Toxicology*. 98, 165-177.
- Tlili, A., Marechal, M., Montuelle, B., Volat, B., Dorigo, U., Bérard, A., 2011. Use of the MicroRespTM method to assess pollution-induced community tolerance to metals for lotic biofilms. *Environmental Pollution*. 159, 18-24.

- Tobor-Kaplon, M.A., Bloem, J., Römken, P.F.A.M., de Ruyter, P.C., 2005. Functional stability of microbial communities in contaminated soils. *Oikos*. 111, 119-129.
- Travis, E.R., Bruce, N.C., Rosser, S.J., 2008. Short term exposure to elevated trinitrotoluene concentrations induced structural and functional changes in the soil bacterial community. *Environmental Pollution*. 153, (2) 432-439.
- Tsai, K. J., Lin, Y. F., Wong, M. D., Yang, H. H. C., Fu, H. L., Rosen, B. P., 2002. Membrane topology of the pl258 CadA Cd(II)/Pb(II)/Zn(II)-translocating P-type ATPase. *Journal of Bioenergetics and Biomembranes*. 34, (3) 147-156.
- Tuji, A., 2000. The effect of irradiance on the growth of different forms of freshwater diatoms: Implications for succession in attached diatom communities. *Journal of Phycology*. 36, (4) 659-661.

V

- U.S. Environmental Protection Agency, 1992. Framework for ecological risk assessment. Washington, DC: Risk Assessment Forum, U.S. Environmental Protection Agency. EPA/630/R-92/001.

V

- Vallotton, N., Moser, D., Eggen, R. I. L., Junghans, M., Chevre, N., 2008. S-metolachlor pulse exposure on the alga *Scenedesmus vacuolatus*: effects during exposure and the subsequent recovery. *Chemosphere*. 73, (3) 395-400.
- Vallotton, N., Eggen, R. I. L., Chevre, N., 2009. Effect of sequential isoproturon pulse exposure on *Scenedesmus vacuolatus*. *Archives of Environmental Contamination and Toxicology*. 56, (3) 442-449.
- Van Der Grinten, E., Janssen, M., Simis, S. G. H., Barranguet, C., Admiraal, W., 2004. Phosphate regime structures species composition in cultured phototrophic biofilms. *Freshwater Biology*. 49, (4) 369-381.
- Vaulot, D., Courties, C., Partensky, F., 1989. A simple method to preserve oceanic phytoplankton for flow cytometric analyses. *Cytometry*. 10, 629-635.
- Villeneuve, A., Bouchez, A., Montuelle, B., 2010. Influence of slight differences in environmental conditions (light, hydrodynamics) on the structure and function of the periphyton. *Aquatic Sciences*. 72, (1) 33-44.

Vinebrooke, R. D., Cottingham, K. L., Norberg, J., Scheffer, M., Dodson, S. I., Maberly, S. C., Sommer, U., 2004. Impacts of multiple stressors on biodiversity and ecosystem functioning: the role of species co-tolerance. *OIKOS*. 104, 451-457.

Volatier, L., 2004. Responses of periphytic assemblages exposed to a complex effluent: bioassays and artificial channels. PhD thesis. National Institute of Applied Sciences (Lyon).

W

Walker, C., Kaiser, K., Klein, W., Lagadic, L., Peakall, D., Sheffield, S., Soldan, T., Yasuno, M., 1998. Alternative testing methodologies for ecotoxicity. *Environmental Health Perspectives*. 106, 441-451.

Walsh, R.S., Hunter, K.A., 1992. Influence of Phosphorus Storage on the Uptake of Cadmium by the Marine Alga *Macrocystis-Pyrifera*. *Limnology and Oceanography*. 37, (7) 1361-1369.

Wang, I.-N., Smith, D.L., Young, R., 2000. Holins: the protein clocks of bacteriophage infections. *Ann. Rev. Microbiol.* 54, 799-825.

Wangberg, S.A., Heyman, U., Blanck, H., 1991. Long-Term and Short-Term Arsenate Toxicity to Fresh-Water Phytoplankton and Periphyton in Limnocorrals. *Canadian Journal of Fisheries and Aquatic Sciences*. 48, (2) 173-182.

Waring, J., Baker, N. R., Underwood, G. J. C., 2007. Responses of estuarine intertidal microphytobenthic algal assemblages to enhanced ultraviolet B radiation. *Global Change Biology*. 13, (7) 1398-1413.

Wasson, J. G., 2001. Les questions de recherche posées par la Directive Cadre Européenne sur l'Eau : problématique pour les eaux de surface continentales. *Hydroécologie Appliquée*. 13, (1) 1-19.

Wasson, J. G., Tusseau-Vuillemin, M. H., Andréssian, V., Perrin, C., 2003. What kind of water models are needed for the implementation of the European Water Framework Directive? Examples from France. *Intl. J. River Basin Management*. 1, (2) 125-135.

Waston, G.H., Bollen, W.B., 1952. Effect of copper sulfate weed treatment on bacteria in lake bottoms. *Ecology*. 33, 522-529.

Weser, U., Hartmann, H. J., Fretzdorff, A., Strobel, G. J., 1977. Homologous Cu(I)-(Thiolate)₂-Chromophores in Yeast copper Thionein. *Biochimica Et Biophysica Acta*. 493, (2) 465-477.

Wetzel R.G. Attached algal-substrata interactions : fact or myth, and when and how ? In : Wetzel R.J. Proceedings of the first international workshop on periphyton of freshwater ecosystems, sept. 1982, Växjö, Suède. Dr W. Junk Publishers, 1983, pp. 207-215.

- Wilhelm, C., Rudolph, I., Renner, W., 1991. A quantitative method based on HPLC-aided pigment analysis to monitor structure and dynamics of the phytoplankton assemblage-A study from Lake Meerfelder Maar (Eifel, Germany). *Arch. Hydrobiol.* 123, (1) 21-35.
- Wilson, J. B., 1988. The cost of heavy-metal tolerance - an example. *Evolution.* 42, (2) 408-413.
- Wimpenny J. An overview of biofilms as functional communities. In : ALLISON D., GILBERT P., Lappin-Scott H. et al. *Community structure and co-operation in biofilms.* Cambridge University Press, 2000, pp. 1-24.
- Witter, E., Gong, P., Baath, E., Marstorp, H., 2000. A study of the structure and metal tolerance of the soil microbial community six years after cessation of sewage sludge applications. *Environmental Toxicology and Chemistry.* 19, (8) 1983-1991.

Z

- Zhao, Y., Newman, M. C., 2006. Effects of exposure duration and recovery time during pulsed exposures. *Environmental Toxicology and Chemistry.* 25, 1298-1304.
- Zhou, Y., Yao, J., Choi, M., Chen, Y., Chen, H., Mohammad, R., Zhuang, R., Chen, H., Wang, F., Maskow, T., Zaray, G., 2009. A combination method to study microbial communities and activities in zinc contaminated soil. *Journal of Hazardous Materials.* 169, 875-881.
- Zuellig, R. E., Kashian, D. R., Brooks, M. L., Kiffney, P. M., Clements, W. H., 2008. The influence of metal exposure history and ultraviolet-B radiation on benthic communities in Colorado Rocky Mountain streams. *Journal of the North American Benthological Society.* 27, (1) 120-134.

Annexes

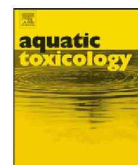

Responses of chronically contaminated biofilms to short pulses of diuron An experimental study simulating flooding events in a small river

Ahmed Tlili^a, Ursula Dorigo^a, Bernard Montuelle^a, Christelle Margoum^a,
Nadia Carluer^a, Véronique Gouy^a, Agnès Bouchez^b, Annette Bérard^{a,b,c,*}

^a CEMAGREF, UR Qualité des Eaux, 3 bis Quai Chauveau CP 220, 69336 Lyon Cedex 09, France

^b INRA UMR CARTEL, Laboratoire de Microbiologie Aquatique, BP 511, 74203 Thonon Cedex, France

^c INRA UMR CSE-EMMAH 1114, Domaine Saint Paul – Site Agroparc, 84914 Avignon Cedex 9, France

ARTICLE INFO

Article history:

Received 13 November 2007

Received in revised form 30 January 2008

Accepted 1 February 2008

Keywords:

River biofilms

Pulsed-exposure

Chronic-exposure

Diuron

Community analysis

Microcosm

ABSTRACT

An experimental study was undertaken to highlight the potential ecotoxicological impact of the herbicide diuron on biofilms during flooding events in a small river (Morcille) in the Beaujolais vineyard area (France). We investigated the responses of chronically contaminated biofilms exposed to short-term pulses (3 h) of diuron. Biofilms were grown in indoor microcosms that were either non-contaminated or exposed to low-level chronic contamination, and not exposed, or exposed to single or double pulses of two environmental concentrations (7 and 14 $\mu\text{g L}^{-1}$) of diuron. Exposure to pollution and its impact on biofilms were assessed by measuring pesticide concentrations in biofilms, biomass parameters (chl *a*, AFDW), community structure (using 18S and 16S rDNA gene analysis by DGGE, and HPLC pigment analysis to target eukaryotes, bacteria and photoautotrophs, respectively) and by performing a physiological test. Control biofilms displayed very low diuron concentrations, whereas the herbicide was found in the contaminated biofilms. Nevertheless, diuron concentrations were not higher in the pulsed biofilms than in the non-pulsed ones. AFDW and chl *a in vivo* fluorescence increased in both microcosms during the experiment and biomass was higher in chronically exposed biofilms than in control ones. The impact on biomass was higher for the control double-pulsed biofilms than for the non-pulsed ones. Carbon incorporation by the chronically exposed biofilms was greater during the first 28 days of growth than during the first 28 days of growth in the control biofilms. Both single and double pulses inhibited carbon incorporation of all biofilm communities, especially of the control ones. Short-term inhibition of photosynthesis was never significantly different in exposed and non-exposed biofilms. Few differences in the pigment structure were found between chronically exposed and control biofilms, but pulses impacted on the pigment structure of all biofilm communities. Bacterial structural differences were observed between single-pulsed and non-pulsed biofilms, but not between double-pulsed and non-pulsed biofilms. The different pulses affected the eukaryotic community structures of the control biofilms, but not of the chronically exposed ones. Unlike the bacterial communities, the control eukaryotic communities were structurally different from the chronically exposed ones. This preliminary experimental study indicates that exposure to environmental concentrations of diuron and other agricultural contaminants and further exposure to diuron can have measurable effects on small river biofilm communities. The effects of a pulsed acute exposure to diuron on biofilms depended on whether the biofilms had previously been exposed to the same stressors or not.

© 2008 Elsevier B.V. All rights reserved.

1. Introduction

The European Water Framework Directive (WFD) and the Registration, Evaluation, Authorisation and Restriction of Chemicals (REACH) programme aims that non-target communities inhabiting water bodies should not be affected by the presence of chemical

substances. Pesticides are one of the main groups of chemicals that could impair aquatic ecosystems (INRA-Cemagref, 2005), and so they have been included in the frame of reference of both WFD (one of the strategies against water pollution is the setting of environmental quality standards (EQS) for pesticides) and REACH. Small lotic ecosystems (Strahler order below 3) are very sensitive to this type of pollution, because little dilution can occur, and because of the proximity of the sources of contamination (spraying of pesticides, run off . . .) (Dorigo et al., 2003). In these ecosystems, microbenthic biofilms (an attached community of autotrophic and heterotrophic, eukaryotic and prokaryotic populations) play a

* Corresponding author at: CEMAGREF, UR Qualité des Eaux, 3 bis Quai Chauveau CP 220, 69336 Lyon Cedex 09, France. Tel.: +33 4 32 72 22 28; fax: +33 4 32 72 22 12.
E-mail address: annette.berard@avignon.inra.fr (A. Bérard).

fundamental role in the trophic web and in the geochemical cycles within aquatic ecosystems (Battin et al., 2003). In rivers, epilithic microbial communities are one of the first organisms exposed to pesticides that run off from fields, and their structure and function can be affected. Structural responses to environmental changes occur within a few weeks (Sabater et al., 2007).

Studying stress effects by investigating changes in community composition is attractive, since the presence and density of different species integrate all the ecological drivers, and reflect inter-species interactions (Bérard et al., 1999). The meta-analysis on 446 measures of biodiversity effects by Balvanera et al. (2006) confirms the importance of biodiversity for ecosystem function and services. This means that it is essential to develop ecotoxicological studies that take into account both the biodiversity and functioning of microbial communities.

Diuron (*N*-(3,4-dichlorophenyl)-*N,N*-dimethyl-urea, MW=233.10 g) is an herbicide (phenylurea) that inhibits photosynthesis by blocking the chloroplast electron transport chain in Photosystem-II (PSII) of phototrophic microorganisms and higher plants (Moreland, 1967). Diuron is considered to be a model herbicide with regard to physiological studies about PSII inhibition in higher plants and algae, but few studies have investigated its ecological impact on the microbial biofilms (Mølander and Blanck, 1992; Pesce et al., 2006). This compound has been used to control a wide variety of annual and perennial broadleaf and grassy weeds, and is used in vineyard husbandry. Due to its persistence in the natural environment (half-life from 56 to 231 days in soil), diuron has been found in streams running through agricultural areas: for example in 2005 in France, diuron was found in 34.6% of surface waters and its concentration in low quality sites ranged from 2.1 to 36 $\mu\text{g L}^{-1}$ (IFEN, 2008).

In small watersheds, the environmental exposure of stream organisms to agricultural pesticides increases very rapidly during rainfall events, and reaches relatively high concentrations (example: 14 $\mu\text{g L}^{-1}$ of diuron during the flood event of 27/07/06 in the Morcille river, France, Rabiet et al., 2008); floods typically last only a few hours, with a discharge that increases and then decreases very rapidly. Pesticide concentrations are usually nearly synchronous with discharges (Rabiet et al., 2007), leading to marked changes in exposure levels. Recent studies have investigated the effects of short and environmentally realistic pulsed toxicant exposures on survival, development, reproduction, latent mortality, and the different life stages of aquatic invertebrates (Cold and Forbes, 2004; Forbes and Cold, 2005; Reynaldi and Liess, 2005; Zhao and Newman, 2006). These studies reflect that increasing attention is being paid to pulsed-exposures resulting from episodic run off events after the application of agrochemicals, and to ecotoxicological questions about how to predict the lethal and sublethal consequences of such exposure on biological populations.

Most experimental studies of aquatic microbial communities have been done using chronically high concentrations of pesticides (see the reviews of Bérard and Pelte, 1999 and DeLorenzo et al., 2001), and only few have attempted to assess the effect of environmentally realistic concentrations of pesticides on microbenthic biofilms (Dorigo et al., 2004, 2007; Mølander and Blanck, 1992; Nyström et al., 2000). To our knowledge, only one study has made any attempt to determine the impact of flooding by testing short-term pulses of herbicides (atrazine) on autotrophic biofilms (Jørgensen and Hoagland, 1990) without having previously exposed the biofilms to chronic herbicide contamination. Nevertheless, in this study pulses lasted for 24 h, which is too long to mimic flood events in small watersheds, which generally last a few hours.

In interpreting the biological impacts of such changing exposure levels, complex and variable interactions between the chemical and the organisms must be taken into account (Guasch et al., 2003). For

example, the bioavailability of pesticides to microbenthic biofilms should be determined, and this can be done by measuring the concentration of the pesticide within the biofilm matrix (Lawrence et al., 2001). The choice of biological endpoints is also a matter of concern, as the effect of a pesticide depends on the type of molecule involved (specific mode of action), and because, as a result of a cascading effect, various populations within the aquatic trophic web could be affected indirectly (Aubertot et al., 2005).

The purpose of this study was to investigate the ecotoxicological impact of the herbicide diuron on river biofilms (autotrophic communities, named as periphyton, and heterotrophic communities), and especially to study the sublethal and long-term effects of diuron pulses on an indoor microcosm mimicking different exposure scenarios resulting from flood events. The impact of diuron on microbenthic biofilm composition and function was observed. To simplify this first study, our lentic microcosms did not take the possible impacts of scouring on the biofilms into account.

The specific questions investigated by this study were: (i) What are the consequences of chronic diuron contamination on biofilms? (ii) What are the consequences of the various different acute diuron exposure scenarios on long-term responses of biofilms? (iii) What influence does previous chronic diuron contamination have on responses to subsequent acute exposures to diuron?

2. Material and methods

2.1. Sampling site

This study was carried out in a small river (the Morcille). The Morcille river is situated in the Beaujolais vineyard area (eastern France, latitude 46.150N; longitude 4.600E), which is a region with high wine-producing activity (70% of the 8 km² of the catchment area), which contributes to the observed gradient of pesticide contamination along the river (Gouy and Nivon, 2007; Rabiet et al., 2007). Diuron is one of the herbicides most often detected in this stream. Water and stones carrying biofilms were collected from the Morcille River at the upstream, unpolluted reference site known as St. Joseph (physical parameters ranged from 3 to 5°C for temperature, 49 to 66 $\mu\text{mol m}^{-2} \text{s}^{-1}$ for irradiance and 0.20 to 0.33 m s^{-1} for stream current). Sampling was performed during January and February 2007, before the pesticide application period. The acute diuron concentrations used in our microcosm study were similar to those at the polluted downstream site of Versauds in late spring or early summer (diuron is usually applied in April) (Rabiet et al., 2008). For experimental and analytical convenience, we used a chronic diuron concentration of 1 $\mu\text{g L}^{-1}$ (on average 1–10 times higher than the concentrations found at the polluted downstream site of the river Morcille during low water periods, which ranged between 0.15 and 1.4 $\mu\text{g L}^{-1}$ in 2006 (Rabiet et al., 2008), which was a realistic chronic concentration for low water periods, especially in the spring and early summer in small rivers in agricultural areas (Pesce et al., 2006).

2.2. Experimental schedule and long-term contamination

Two 35-L aquariums were filled with river water from the reference site, which had been filtered through a 500- μm mesh to remove most of the grazers. Two stones from the same site, which were coated with biofilms, were brought to the laboratory, and one was placed in the bottom of each aquarium to act as a natural biofilm inoculum in the experimental systems. Initially, the aquariums were connected to each other by a system of PVC pipes in order to ensure the homogeneity of the microbial communities in

the two aquaria. After 3 days, this connection was cut off, the stones were removed, and 70 artificial substrates (microscope slides) were installed vertically in each aquarium (total surface of the artificial substrates: 0.2258 m²/aquarium). At this point, one aquarium was contaminated with a nominal concentration of 1 µg L⁻¹ of diuron (high grade pesticide standard, Sigma, 99.5% purity, CAS RN 330-54-1), and the other aquarium was used as a control (no diuron was added). During the experiment (32 days), the aquarium water was replaced each week with filtered (500 µm mesh) water from the reference site. In the chronically contaminated microcosm, this water was once again contaminated with a nominal concentration of 1 µg L⁻¹ of diuron. The two microcosms were not run with replicates. Both aquaria were filled up with water from the upstream site (the reference site) of the river Morcille, whereafter one of the aquaria was contaminated to represent the polluted downstream site of the river and one was kept uncontaminated to represent the reference site.

In order to reduce the heterogeneity that occurs on natural substrates (Cattaneo et al., 1997), we controlled both the colonization surface of the substrate (microscope slides) and the degree of maturation of the biofilm. The water was kept at a temperature of 16 °C (±2 °C), and exposed to a light intensity of 36 µmol m⁻² s⁻¹ of photons, with a light/dark regime of 18:6 h. These physical parameters were checked daily throughout the experiment.

2.3. Short-term contamination scenarios

Two nanocosms were filled with 3.5 L of 500 µm-filtered water from the reference site, and were contaminated with a nominal concentration of either 7 or 14 µg L⁻¹ of diuron. On day 21 of the experiment, biofilm samples from the control and the chronically contaminated microcosms were subjected to short-term pulses of diuron by plunging the colonized microscope slides into the highly contaminated nanocosms. These short-term exposures lasted for 3 h corresponding to the average duration of a flood event (Rabiet et al., 2007), and were performed under the same conditions of temperature and light as those used for microcosms. After each pulse, the slides were gently rinsed by plunging them for 1 min into a third nanocosm filled with 500 µm-filtered river water, and then replaced in their original microcosms. Some slides that had been subjected to the first 7 µg L⁻¹ diuron pulse, were subjected 4 days later to a second 7 µg L⁻¹ diuron pulse (for details see Fig. 1).

2.4. Biofilm collection

On day 21 (just before the first sequence of pulses), day 28, and day 32 (i.e. 1 week after each sequence of pulses), biofilms were sampled, and analyses were performed. Fourteen substrates were collected from each contamination scenario (0.04515 m² surface

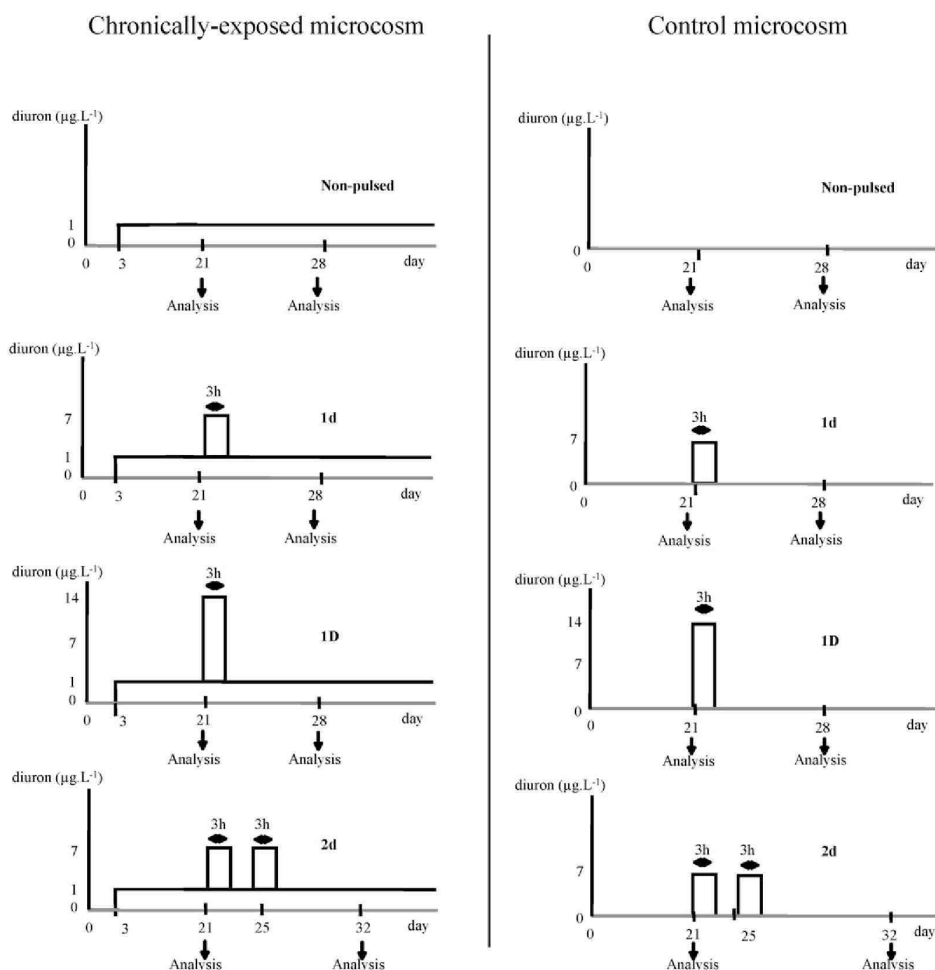

Fig. 1. Experimental schedule. No pulse of diuron: non-pulsed; one pulse of the high concentration of diuron (14 µg L⁻¹): 1D; one pulse of the low concentration of diuron (7 µg L⁻¹): 1d; two pulses of the low concentration of diuron (7 µg L⁻¹): 2d.

area). Biofilms were scraped off the substrates using a Teflon blade, and suspended in 160 mL of 0.2 μm -Nuclepore filtered water from the reference site. Total biomass and *in vivo* chlorophyll *a* fluorescence analysis and bioassays (carbon incorporation) were performed immediately after sampling, whereas others (chemical, molecular and pigment analysis) were performed subsequently on the deep-frozen biofilm (-25°C).

2.5. Chemical analysis

Two-liter water samples were collected in polyethylene bottles from the Morcille river at the St. Joseph reference site and from the microcosms just before replacing the water in order to assess chemical parameters such as DOC, NO_2^- , NO_3^- , NH_4^+ , PO_4^{3-} , SiO_2 , conductivity and pH following French standard operating procedures and protocols (Association Française de Normalisation, AFNOR).

Diuron and its main metabolites (3-(3,4-dichlorophenyl)-1-methyl urea (DCMU) and 3,4-dichloroaniline (DCA)) were measured in the water and biofilm samples by ESI-LC-MS-MS (API 4000, Applied Biosystems).

2.5.1. Pesticide concentrations in the water samples

The pure pesticides used for preparing the standard solutions were of analytical grade and purchased from Dr. Ehrenstorfer (Cluzeau Info Labo, France) or Riedel De Haën (Sigma-Aldrich, France). The organic solvents used for the standard solutions, extraction or chromatographic analysis were HPLC gradient grade (SDS, France). Water samples for pesticide analyses were collected in glass bottles from the microcosms just after they had been contaminated (to verify the homogenisation of the pesticide concentration in the microcosm, data not shown), and just before the weekly replacement of the water. The samples were then filtered over 0.2 μm polyester filters (Chromafil PET 20/15 MS, Macherey-Nagel, Hoerdts, France). Nine hundred and ninety microliters of filtered water was added to 10 μL of deuterated diuron (D6) used as the injection standard. Liquid chromatography was performed on an Agilent Series 1100 HPLC system (Agilent Technologies, Les Ulis, France). Chromatographic separation was done using a Purospher Star RP-18e analytical column (5- μm particle size, 2 mm \times 125 mm) from Merck (France) at a flow rate of 0.3 mL min^{-1} with a mobile phase consisting of water and acetonitrile (62/38, v/v), plus 0.1% (v/v) formic acid. The injection volume was 100 μL . The HPLC system was interfaced to a triple quadrupole mass spectrometer (ABI 4000, Applied Biosystems, Les Ulis, France). The 233/72 and 233/46 *m/z* transitions were used to quantify and confirm diuron, respectively. Quantification was performed by internal calibration using deuterated diuron. The analytical method was validated according to French standard procedure XP-T 90-210 (AFNOR, 1999). The quantification limits (QLs) were 0.02 $\mu\text{g L}^{-1}$ for diuron and DCA, and 0.5 $\mu\text{g L}^{-1}$ for DCMU.

2.5.2. Pesticide concentrations in the biofilm samples

For pesticide analysis on biofilms only one subsample of 75 mL was analyzed, because of limiting biomass, and because the analytical method is quite expensive and time-consuming preventing us from analyzing each sample in triplicate. Nevertheless, a previous methodological study which has been conducted in our laboratory was done on artificial substrate biofilm from the same river assessed the recovery, repeatability and the quantification limit for this analytical method. The quantification limit was established by analyzing sample matrices spiked at the concentration of the estimated limit. Mean recovery and repeatability (assessed by calculating the coefficient of variation, CV in %) were estimated after the analysis of ten replicates. For diuron, the quantification limit was 0.04 $\mu\text{g g}^{-1}$ dry weight and the recovery was 71% (CV 24%), 0.06 $\mu\text{g g}^{-1}$ for DCMU and 0.1 $\mu\text{g g}^{-1}$ for DCA. Biofilms were

first separated from the substrata (Section 2.4), and then 75 mL of biofilm suspension were freeze-dried in order to prevent any matrix degradation before analysis. Ten to hundred milligrams of dried biofilm spiked with the analytical control standard (linuron) was extracted with 10 mL organic solvent (acetone/dichloromethane, 20/80, v/v) in an ultrasonication bath for 30 min. This extraction step was repeated, and the organic extracts were pooled before being evaporated to dryness. Six milliliters of ultrafiltered water was then added to redissolve the extract. Purification was carried out on a solid phase extraction (SPE) cartridge (Oasis HLB, 60 mg, 3 mL, Waters). Ten microliters of internal standard control (deuterated diuron) was added to the final extract of 240 μL water/acetonitrile (80/20, v/v). Biofilm sample extracts were then quantified by ESI-LC-MS-MS. Diuron and its metabolites were separated on a 250 mm \times 2 mm Purospher Star RP-18e column (Merck, France). The mobile phase was water/acetonitrile with a gradient of 0.3 mL min^{-1} , and the injection volume was 10 μL .

2.6. Biological analyses

2.6.1. Total and algal biomass

The organic matter content was evaluated by calculating the ash-free dry weight (AFDW). Three subsamples of each biofilm suspension (2 mL) were filtered through individual, previously dried, 25 mm CF/C Whatman glass fibre filters (1.2- μm pore size). Each filter was weighed, after drying for 24 h at 105 $^\circ\text{C}$ in order to calculate the dry matter. The filters were then combusted in an oven at 480 $^\circ\text{C}$ (Nabertherm P320) for 1 h, and then weighed again to calculate the mineral matter. The AFDW was calculated by subtracting the mineral matter from the total dry matter. Results are expressed as g m^{-2} (Wellnitz and Rader, 2003).

Algal biomass was estimated by *in vivo* chl *a* fluorescence measurements (Leboulanger et al., 2006; Schmitt-Jansen and Altenburger, 2007) using an AquafluorTM Turner micro fluorimeter (excitation and emission wavelengths: 460 and 665 nm, respectively). In previous experiments with similar periphytic suspension samples it has been shown that fluorescence data correlated well with chemically extracted chl *a* concentrations (data not shown). Five replicates of periphytic suspension subsamples (2 mL) were used for the measurements, and the results were expressed as a fluorescence index (FI). From pigment analysis by HPLC, chl *a* was selected as an indicator of the total autotrophic biofilm biomass (Bonin and Travers, 1992). The quantification of identified chl *a* was made from external calibration on standard chl *a*. Final concentrations are given as $\mu\text{g cm}^{-2}$ (see Section 2.6.3 for analysis details).

2.6.2. Biofilm DNA extraction and amplification, and denaturing gradient gel electrophoresis (DGGE) analyses

A preliminary experiment was done to test the reproducibility of DNA extraction, amplification and DGGE analysis. Seven biofilm suspensions, randomly chosen from among the various different contamination scenarios, were extracted in triplicate (2 mL each). DGGE analyses were done separately on 18S rRNA and 16S rRNA polymerase chain reaction (PCR) amplified fragments. Replicates produced identical DGGE band patterns (data not shown), which led us to simplify the analysis further by pooling the three biofilm subsamples for each contamination scenario.

Three replicates of 2 mL of each biofilm suspension were centrifuged at 14,000 $\times g$ for 30 min, and the supernatant was discarded (and kept at -25°C before extraction). Nucleic acid extraction was performed on biofilm pellets using the FAST DNA kit (QBIogene, Illkirch, France) according to manufacturer's instructions. The integrity of the total DNA was checked by agar gel electrophoresis, and quantified by determining the absorbance at 260 nm.

PCR amplification of the eukaryotic 18S rRNA gene fragment was performed using 60 ng of template DNA and the primers Euk1Af (Sogin and Gunderson, 1987) and Euk516r-GC (Amann et al., 1990), leading to a 560-bp fragment. PCR amplification of the bacterial 16S rRNA gene fragment was done with 30 ng of template DNA, and the primers 341f (Muyzer and Smalla, 1998) to which a GC-rich fragment was attached (Muyzer and Smalla, 1998), and 907rM (Schauer et al., 2003), which yielded a fragment of ~590 bp.

In both cases, PCR amplifications were performed on 50 μ L volumes containing a 10 \times Taq reaction buffer (Sigma), 120 μ M of each deoxynucleotide, 1 μ M of each primer, bovine serum albumin (Sigma, 0.5 mg mL⁻¹ final concentration), and 1.25 U Taq DNA polymerase (Eurobio 1.25 U). All amplifications were performed with the same primers and the same PCR reactions as described in Dorigo et al. (2007) using the Thermal Cycler T-Personal (Whatman Biometra, GmbH Niedersachsen, Germany). For each set of reactions, a negative control was included in which the template was replaced by an equivalent volume of sterile deionized water.

DGGE analyses were performed as described in Dorigo et al. (2007) on a pool of the three PCR amplified replicates. Digital images of the gels were obtained using a digital camera (Scion Corporation), subjected to further analysis using Microsoft Photo Editor software, and finally processed as described in Dorigo et al. (2006). The presence or absence of a nucleic acid band at a given height in each lane was scored as 1 or 0, respectively. Matrices were used to perform correspondence analysis and Ward method of cluster analysis using the ADE-4 Software Package (Thioulouse et al., 1997).

2.6.3. Pigment analysis by high pressure liquid chromatography (HPLC)

The introduction of pigment analysis by HPLC facilitated easy and rapid separation, identification and quantification of microalgal pigments. The occurrence of characteristic microalgal pigments within each algal group has favored the use of pigment analysis to investigate microalgal community composition (e.g. Jeffrey et al., 1997). A preliminary experiment was done to test the methodological variability of HPLC analysis. As for DGGE analysis, seven biofilm suspensions, randomly chosen from among the various different contamination scenarios, were extracted in triplicate. HPLC analyses were done separately. The relative variability on the most important pigments found in biofilm samples was estimated as coefficient of variation (CV: ratio of the standard deviation to the mean, in %). The CVs varied between 4.8% (chl *a*), 5.4% (fucoxanthin) and 7.2% (diadinoxanthin). We decided thus to analyze only one subsample of 5 mL for each contamination scenario.

Five milliliters of each biofilm suspension was centrifuged for 30 min (9750 \times g, 0 °C), and kept at -25 °C until analysis. Pellets were placed in individual centrifuge tubes (Corning) and pigments were extracted with 4 mL of methanol/0.5 M ammonium acetate (98/2, v/v) solution as described in Dorigo et al. (2007). An injection volume of 100 μ L of purified biofilm extract was used to determine the lipophilic pigment composition of the biofilm by HPLC. Pigments were separated on a 4.6 mm \times 250 mm column (Waters Spherisorb ODS5 25 μ m). Each pigment was identified from its retentive time and absorption spectrum using DAD according to SCOR (Jeffrey et al., 1997). A table was constructed (with samples as rows and pigments as columns) taking into account the relative abundance of each pigment in each sample (expressed as the percentage of the sum of the areas for all the pigments in the sample). This matrix was used to perform correspondence analysis using the ADE-4 Software Package (Thioulouse et al., 1997).

2.6.4. Short-term photosynthetic bioassay

The concept of pollution-induced community tolerance (PICT) has been developed by Blanck et al. (1988) as an ecotoxicological

tool to determine the impact of toxic chemicals at the community level. PICT is based on the assumption that the toxicant exerts selection pressure when exposure reaches a critical level for a sufficient period of time. This difference in resistance between the unselected and selected communities can be detected by comparing the results of short-term physiological tests performed on the communities.

We monitored the effects of increasing concentrations (semi-logarithmic) of the herbicide diuron on biofilm using ¹⁴C photosynthetic assimilation as the endpoint (Guasch and Sabater, 1998). Briefly, a stock solution containing 100 μ M (MW = 233.10 g) of diuron was prepared in water and stored at -20 °C prior to dilution in the test vessels. A semi-logarithmic series of concentrations was freshly prepared, with a multiplication factor of 10^{0.5}, by serial dilutions of the stock solution in 0.2 μ m-filtered river water. Final test concentrations in the test vessels ranged from 0.00316 to 3.162 μ M (from 0.737 to 737.12 μ g L⁻¹, five blanks and three replicates for each of the seven increasing concentrations of diuron). Photosynthesis activity was measured by ¹⁴C incorporation as described in Dorigo and Leboulanger (2001): biofilm suspensions (2 mL) were directly placed within 20 mL scintillation vials and diuron was added. After 1 h of preincubation (same conditions of temperature and light as those used for microcosms), 25 μ L of NaH¹⁴CO₃ (0.4 μ Ci per vial) was added to each vial, and photosynthesis was allowed to run for 3 h under the same conditions. The reaction was stopped by adding formaldehyde (3.7% final concentration), followed by 200 μ L glacial acetic acid to remove inorganic carbon. Supernatant water was removed after 1 h, and biofilm suspensions were dried at 60 °C under a stream of air. Labelled organic matter was dissolved in 1 mL of dimethylsulfoxide (1 h at 60 °C) and 15 mL of scintillation cocktail was added. The samples were counted after quenching attenuation on a 2100-TR (Packard Instruments). Dose-response curves were traced using gross radioactivity values, as percent of the radioactivity of the control at each diuron concentration.

2.7. Data processing

The effects of chronic-exposure, acute exposure and chronic-acute exposure interaction on AFDW ($n=3$), algal biomass ($n=5$) and carbon incorporation ($n=5$) values were tested by a two-way ANOVA, and a post hoc test (Tukey). Student's *t*-tests were done to compare the effects of chronic diuron contamination on microbenthic biofilms at each sampling date. Prior to data analysis homogeneity of variances was checked. EC50 values were calculated by means of the Regtox model (E. Vindimian, <http://eric.vindimian.9online.fr/>). The significance level was set to 5%.

3. Results

3.1. Physico-chemical data

Physico-chemical parameters found for water samples from the river and microcosms are shown in Table 1. The conductivity in both microcosms was relatively stable throughout the experiment. The pH varies by up to 1.7 pH units in the chronic-exposed microcosm. A decrease in nitrate and silicate levels was detected from day 28 of biofilm growth.

The diuron concentrations found in the control microcosm water samples during the experiment were always below the quantification threshold (0.02 μ g L⁻¹). In the chronically contaminated microcosm, the diuron concentrations ranged from 0.66 to 0.89 μ g L⁻¹. No metabolite was detected in the water samples. The diuron concentrations found in the biofilm matrices are shown in Table 2. Like the water samples, the biofilms in control microcosm

Table 1

Selected chemical parameters (pH; conductivity; DOC; NO₂⁻; NO₃⁻; NH₄⁺; SiO₂ and PO₄³⁻) of water samples collected from the Morcille River at the St Joseph site (reference), within the control microcosm and within the microcosm chronically exposed to diuron (1 µg L⁻¹ diuron, just before replacing the water in the microcosms with water from the Saint Joseph site)

Sample	Day	pH	Conductivity (µS cm ⁻¹)	DOC (mg L ⁻¹)	NO ₂ ⁻ (mg L ⁻¹)	NO ₃ ⁻ (mg L ⁻¹)	NH ₄ ⁺ (mg L ⁻¹)	SiO ₂ (mg L ⁻¹)	PO ₄ ³⁻ (mg L ⁻¹)
Saint Joseph (reference)	D14	7.15	133.3	2.45	<0.02	7.6	0.02	15	0.1
	D21	6.95	136.2	2.4	0.02	7	0.15	15.5	0.08
	D28	7.05	157.4	2.55	<0.02	6.6	0.1	15	0.06
Control microcosm	D21	8.2	185	5.45	0.17	6.7	0.06	15	0.11
	D28	9.3	160	4.9	0.16	2.1	0.07	4	0.08
	D32	8.8	155	5.35	0.08	1.2	0.03	<0.4	0.3
Chronically exposed microcosm	D21	8.2	140	4.35	0.08	5.6	0.07	10.5	0.04
	D28	9.6	155	4.7	0.12	2.7	0.76	3.4	0.36
	D32	7.9	130	5.9	0.05	0.8	0.02	<0.4	0.1

had diuron concentrations below the quantification threshold even after the pulse event, and no metabolites were detected in the biofilms. In contrast, diuron was found in the biofilm matrix of the contaminated microcosm, but interestingly concentrations were no higher in the pulsed biofilms than in the non-pulsed ones.

3.2. Biomass parameters

As shown in Fig. 2a, AFDW increased in both contaminated and control microcosms throughout the 32 days of the experiment. Chronically exposed biofilms were characterized by having higher biomass than the control ones, especially at day 32 (Student's *t*-test, $p < 0.05$). At day 28 of growth, the effects of chronic-exposure or chronic-pulse exposure interaction on AFDW were significant (ANOVA, $p < 0.01$). No significant differences in AFDW biomass were reported between single-pulsed and non-pulsed biofilms at day 28 of growth (apart from the higher diuron pulse on control biofilms, Fig. 3a, Tukey test $p < 0.01$), whereas on day 32 of growth, the effect of chronic and pulsed-exposures on AFDW were significant (ANOVA, $p < 0.01$), and the biomasses of the double-pulsed biofilms were significantly lower than that of the non-pulsed ones (Tukey test, $p < 0.01$).

In vivo fluorescence was significantly higher in chronically exposed biofilms than in control biofilms at the three sampling dates (Fig. 2b, Student's *t*-test, $p < 0.05$). At day 28 of growth, the effect of chronic-exposure, pulses and chronic-pulse exposures on *in vivo* fluorescence were all significant (ANOVA, $p < 0.01$). At the same date, no inhibition of *in vivo* fluorescence was found for single-pulsed and chronically exposed biofilms, but significant inhibition was found for single-pulsed control biofilms (Fig. 3b, Tukey test, $p < 0.01$). The impact on the *in vivo* fluorescence of the control biofilms of the one high concentration pulse was significantly higher than that of the one low concentration pulse (Tukey test, $p < 0.01$). At day 32 of growth, the effect of chronic and pulse expo-

Table 2

Diuron concentrations within the biofilm matrix (µg diuron g⁻¹ of biofilm dry weight) of non-pulsed, single- or double-pulsed biofilms from the control, and from the chronically exposed microcosm (1 µg L⁻¹ diuron)

Microcosm	Biofilm	D21	D28	D32
Control	Non-pulsed	<QL	<QL	<QL
	One pulse of diuron (7 µg L ⁻¹)	na	<QL	na
	One pulse of diuron (14 µg L ⁻¹)	na	<QL	na
	Two pulses of diuron (7 µg L ⁻¹)	na	na	<QL
Chronically exposed	Non-pulsed	0.07	0.41	0.30
	One pulse of diuron (7 µg L ⁻¹)	na	0.27	na
	One pulse of diuron (14 µg L ⁻¹)	na	0.32	na
	Two pulses of diuron (7 µg L ⁻¹)	na	na	0.27

QL: quantification limit = 0.04 µg g⁻¹; na: not analyzed (because not corresponding to a contamination scenario studied).

sure on *in vivo* fluorescence were significant (ANOVA, $p < 0.01$). HPLC-chl *a* data confirm the *in vivo* fluorescence results (Fig. 2c, Fig. 3c).

3.3. Carbon incorporation and EC50 values

As shown in Fig. 2d, carbon incorporation by the biofilm (five replications of control biofilm obtained from the short-term bioassays) was significantly higher in the chronically exposed microcosm during the first 28 days of growth than in the control microcosm (Student's *t*-test, $p < 0.01$ at day 21 and $p < 0.05$ at day 28). At day 28 of growth, chronic-exposure, pulsed-exposure and chronic + pulsed-exposures all had a significant effect on carbon incorporation (ANOVA, $p < 0.01$). Single and double pulses significantly inhibited carbon incorporation by the biofilm communities, especially in the control biofilms (Fig. 3d, Tukey test, $p < 0.01$), except for the chronically exposed biofilms, which were not significantly affected by the low concentration pulse at day 28.

The short-term inhibition of photosynthesis (EC50) fluctuated throughout the experiment (Fig. 2e), but was never significantly different in exposed (chronic and acute exposures) and non-exposed (control and non-pulsed) biofilm (Fig. 2e, Fig. 3e).

3.4. Pigment composition

Twelve pigments were identified: chlorophyll *c1*, chlorophyll *c2*, chlorophyll *c3*, fucoxanthin, neoxanthin, antheroxanthin, diadinoxanthin, diatoxanthin, vaucherixanthin, chlorophyll *b*, beta-carotene and chlorophyll *a* (chl *a*). The most important pigments found in all biofilm samples analyzed (mean >5%) were chl *a*, then fucoxanthin and diadinoxanthin, the latter two being diagnostic pigments of diatoms (Jeffrey et al., 1997). Green algae, which are characterized by the presence of chl *b* (Jeffrey et al., 1997), were found in small amounts within biofilm samples. Correspondence analysis performed by taking into account the relative percentage of each of the 12 pigments identified in a sample (Fig. 4), revealed few differences between chronically exposed biofilm and control ones, except at the end of the experiment (C-D32 and D-D32). However, all of the types of pulses tested impacted on the pigment structure of all biofilm communities.

3.5. Community structures

3.5.1. Bacterial community structure

Up to 38 different DGGE bands were detected in all the biofilm samples. The number of bands detected in each biofilm sample ranged from 24 to 33 in the control microcosm (average 29), and from 24 to 31 in the chronically exposed microcosm (average 29). Cluster analysis was performed using the presence/absence of bands within each sample in the control (Fig. 5a) and chronically

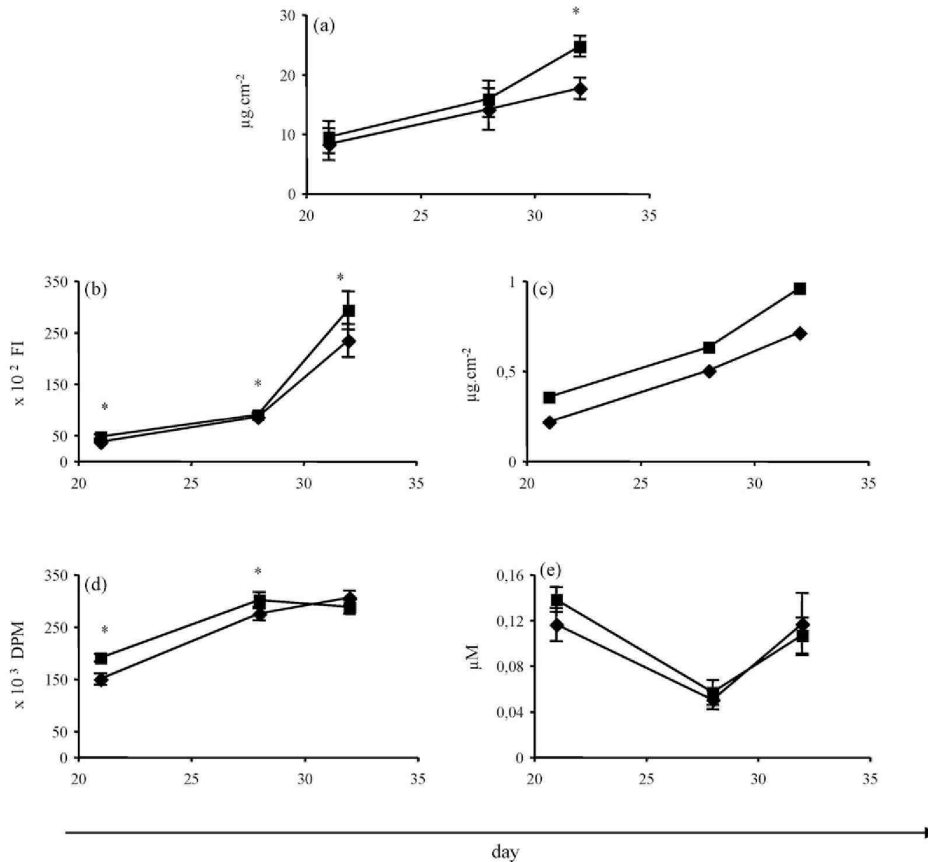

Fig. 2. Long-term chronic impact of diuron ($1 \mu\text{g L}^{-1}$) on biofilms in control (\blacklozenge) and chronically exposed (\blacksquare) microcosms with no diuron pulse. (a) AFDW biomass, (b) *in vivo* chl *a* fluorescence, (c) HPLC-chl *a*, (d) carbon incorporation (CO_2 incorporation), and (e) short-term sensitivity to diuron (EC_{50}) during the 32 days of experiment. Error bars represent standard deviations ($n=3$ for AFDW; $n=5$ for CO_2 incorporation, EC_{50} and *in vivo* fluorescence). (*) Student's *t*-test (5%).

exposed (Fig. 5b) microcosms. Whatever the history of the biofilms, structural differences were always observed between single-pulsed and non-pulsed biofilms (day 28), but not between double-pulsed and non-pulsed ones (day 32). The cluster analysis in Fig. 6a shows considerable similarity between biofilms from control and chronically exposed microcosms for each sampling date.

3.5.2. Eukaryotic community structure

Thirty-seven different bands were detected in the biofilm samples as a whole. The number of bands detected in each biofilm sample ranged from 15 to 25 in the control microcosm (average 22), and from 17 to 22 (average 21) in the chronically exposed microcosm. Cluster analysis was performed using the presence/absence of bands within each sample (Fig. 7). The cluster analysis shows that the different pulses affected the eukaryotic community structures of biofilms from the control microcosm (Fig. 7a), but not of biofilms from the chronically exposed microcosm (Fig. 7b). Unlike the bacterial communities, the eukaryotic communities from the control microcosm were structurally different from those from the chronically exposed microcosm (Fig. 6b).

4. Discussion

During the 32 days of the experiment, epilithic biofilms grew on the artificial substrates within each microcosm (measured from the ash-free dry weight, *in vivo* fluorescence, and carbon incorporation). The three sampling dates were characterized by

changes in both the sensitivity of biofilm photosynthetic activity to diuron (short-term test) and in the community structure (DGGE and pigment analysis). These changes can be explained by successive processes (changes in algal density and community composition) occurring during colonization of the glass plates of the biofilm (Guasch et al., 1997), and by confinement in the microcosm (Schelske, 1984), even though this confinement was reduced by the weekly replacement of the water in the microcosms. The concentrations of dissolved nutrients, especially NO_3^- and SiO_2 (nitrates are used by all algae, and silicates are principally used by diatoms) at the end of the experiment were very low compared to the initial values, suggesting that a rapid uptake of nutrients had occurred. The rapid increase in biofilm biomass may have produced nutrient limitation, and a consequent reduction in biofilm productivity.

4.1. What are the consequences of chronic diuron contamination on biofilm?

Chemical analyses of various different biofilm template forms have shown that diuron is adsorbed by biofilms that have previously been subjected to chronic diuron contamination ($1 \mu\text{g L}^{-1}$). Diuron concentrations within the biofilms were already measurable after 21 days of biofilm development, and increased thereafter up to day 28 of development and of exposure to diuron. Lawrence et al. (2001) studied herbicide adsorption by biofilms, and showed that atrazine and diclofop methyl were absorbed and metabolised

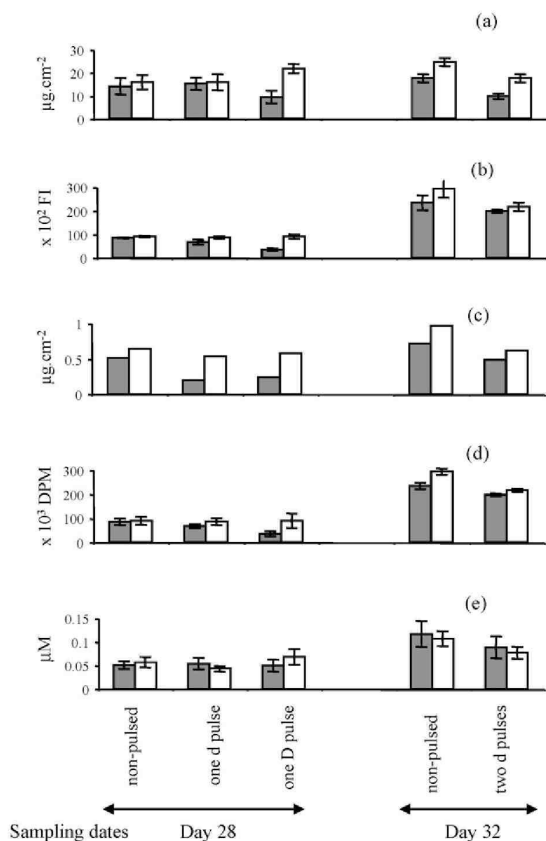

Fig. 3. Impacts of diuron pulses on biofilms in control (■) and chronically exposed (□) microcosms at days 28 and 32 of the experiment. (a) AFDW biomass, (b) *in vivo* chl *a* fluorescence, (c) HPLC-chl *a*, (d) carbon incorporation (CO₂ incorporation), and (e) short-term sensitivity to diuron (EC50) during the 32 days of experiment. One pulse of the low concentration of diuron (7 μg L⁻¹): 1d; one pulse of the high concentration of diuron (14 μg L⁻¹): 1D; two pulses of the low concentration of diuron (7 μg L⁻¹): 2d. Error bars represent standard deviations (n = 3 for AFDW; n = 5 for CO₂ incorporation, EC50 and *in vivo* chl *a* fluorescence).

in the biofilm matrix, which can therefore be viewed as a sink for organic contaminants. All these laboratory experiments confirmed field study findings (Margoum et al., 2007) revealing that the chronic contamination of natural biofilms grown in a small stream was affected by diffuse pesticide pollution. Concentration levels in the biofilms were related to those of the contaminants dissolved in surface water.

Biofilm biomass (quantified by AFDW and fluorescence *in vivo*), and carbon incorporation were both found to be increased in the contaminated microcosm (1 μg L⁻¹ of diuron), and changes were found in community structure (DGGE and pigment analysis). Based on carbon incorporation per biomass (carbon incorporation per AFDW and carbon incorporation per fluorescence units), named specific carbon incorporation was found not to be increased in the contaminated microcosm especially at the end of experiment (data not shown), which may explain a lower pH at the same date. Mølander and Blanck (1992) found an increase in chl *a* content, in specific carbon incorporation (incorporation per chl *a*) and in species richness of the marine periphyton, which had been exposed to low concentrations of diuron for 3–4 weeks. Algae exposed to low concentrations of PSII inhibitors (for example diuron) were shown to increase their light-harvesting pigments (which is known as the greening effect) in order to maintain the conversion of light energy to chemical energy during photosyn-

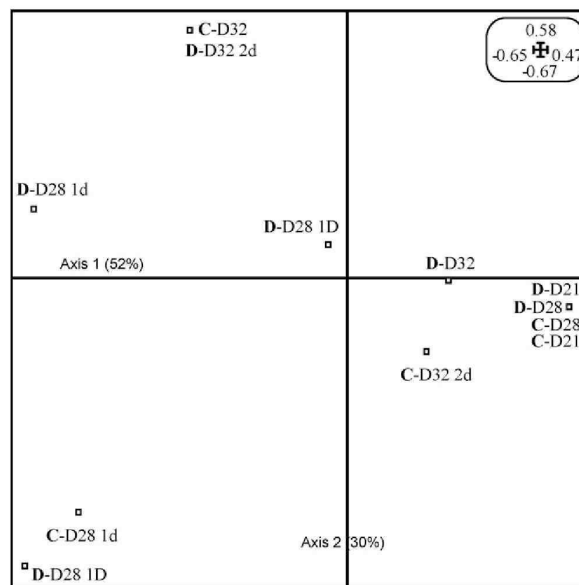

Fig. 4. Correspondence analysis of the biofilm phototroph community structure (pigment analysis by HPLC). C: control microcosm; D: chronically exposed microcosm. Sampling dates; Day 21: D21; Day 28: D28; Day 32: D32; one pulse of the low concentration of diuron (7 μg L⁻¹): 1d; one pulse of the high concentration of diuron (14 μg L⁻¹): 1D; two pulses of the low concentration of diuron (7 μg L⁻¹): 2d.

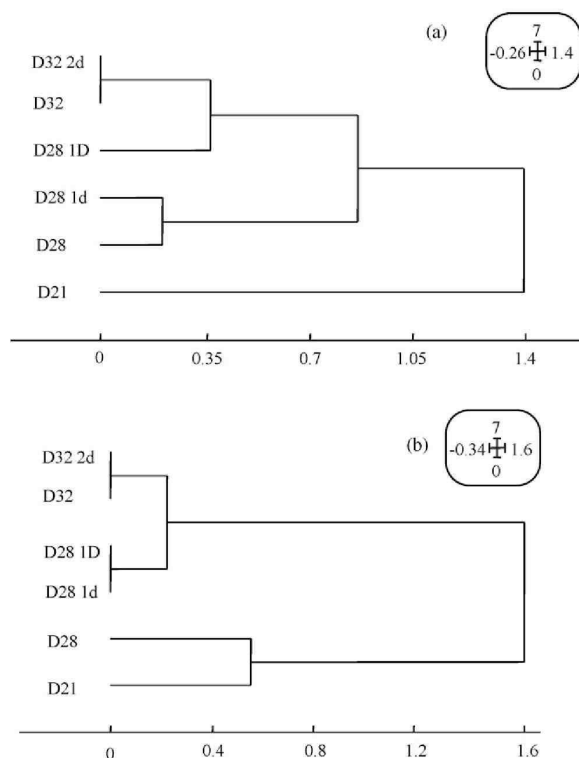

Fig. 5. Cluster analysis (Ward method) of the biofilm bacterial community structure (DGGE analysis on PCR amplified 16S rRNA gene fragments). (a) Control microcosm. (b) Pre-exposed microcosm. Sampling dates; Day 21: D21; Day 28: D28; Day 32: D32; Day 28; one pulse of low diuron concentration (7 μg L⁻¹): D28 1d; Day 28; one pulse of the high concentration of diuron (14 μg L⁻¹): D28 1D; Day 32; two pulses of the low concentration of diuron (7 μg L⁻¹): D32 2d.

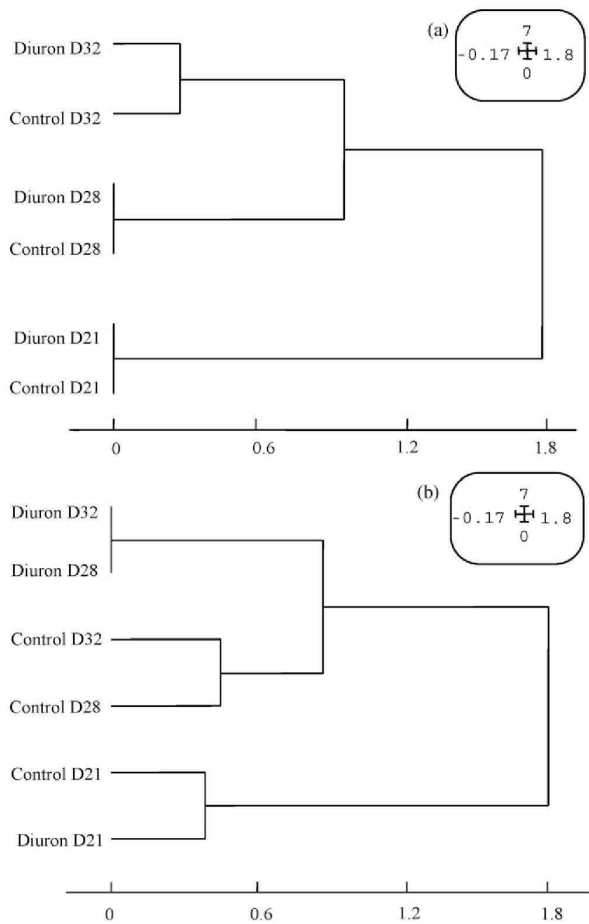

Fig. 6. Cluster analysis (Ward method) of bacterial (a) and eukaryal (b) community structure at three sampling dates. Day 21: D21; Day 28: D28; Day 32: D32. Control: biofilm growth in the control microcosm. Diuron: biofilm growth in the microcosm chronically exposed to $1 \mu\text{g L}^{-1}$ of diuron.

thesis (Bérard and Pelte, 1999). *In vivo* chl *a* fluorescence can be enhanced by PII inhibitors (like diuron) by blocking the electron transport chain in the first phase of photosynthesis (photophosphorylation, Moreland, 1967). This phenomenon has been used to measure photosynthesis inhibition and PICT on phytoplankton after few hours of incubation with the PSII inhibitor (e.g. Seguin et al., 2002). In contrast, fluorescence measurements in our study were done 1–3 weeks after the first exposure of biofilms to diuron, and HPLC-chl *a* data were in concordance with the fluorescence results. François and Robinson (1990) have also shown that low levels of PSII inhibitors can enhance nitrate or nitrite reductase activity and carbon fixation in unicellular algae *Chlamydomonas* cultures, leading to increased protein accumulation in the cells. These phenomena may explain the increase in biofilm chl *a* fluorescence, AFDW and carbon incorporation observed in this study. Our results also suggest that communities may have the capacity to compensate for the inhibition of photosynthesis produced by sublethal herbicide concentrations, which could be explained as a toxicant-induced succession among microbial species resulting in tolerance or hormesis (Schmitt-Jansen and Altenburger, 2005).

Whereas a difference in the eukaryotic DGGE profiles of the control and contaminated microcosms became evident from day 21 of growth, changes in bacterial community structure appeared only at the end of the experiment (D32 of growth). It is well

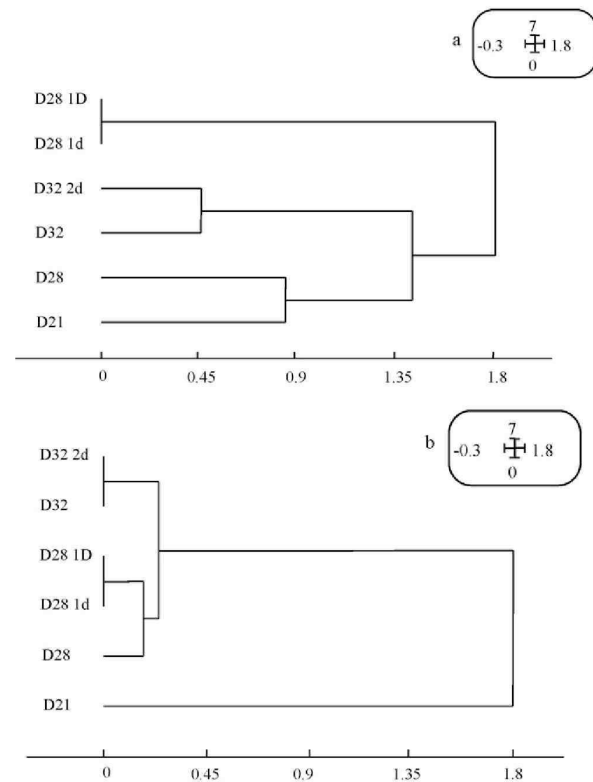

Fig. 7. Cluster analysis (Ward method) of the biofilm eukaryotic community structure (DGGE analysis on PCR amplified 18S rRNA gene fragments) in (a) control microcosm (b) chronically exposed microcosm. Sampling dates; Day 21: D2; Day 28: D28; Day 32: D32; Day 28; one pulse of the low concentration of diuron ($7 \mu\text{g L}^{-1}$): D28 1d; Day 28; one pulse of the high concentration of diuron ($14 \mu\text{g L}^{-1}$): D28 1D; Day 32; two pulses of the low concentration of diuron ($7 \mu\text{g L}^{-1}$): D32 2d.

known that substrates are first colonized by bacteria, and then by microalgae (Liu et al., 1993; Lyautey et al., 2005), and that strong interactions occur between microbenthic algae and heterotrophic bacteria within the biofilm (Romani and Sabater, 1999; Romani et al., 2004). This time-lag between algal and bacterial community restructuring within the biofilm suggests that the impact of a low concentration of diuron on bacteria may be mainly indirect. Long-term exposure to diuron affects both the structure and the functioning of microbenthic algae, which may result in changes in the quantity and quality of algal products available to bacteria within the biofilm, leading to a shift in the composition of the bacterial community (Horner-Devine et al., 2003; Pesce et al., 2006). A shift from autotrophic-dominated to heterotrophic-dominated microbial communities has been highlighted in biofilms exposed to photosynthesis inhibitors, such as atrazine and copper (DeLorenzo et al., 1999; Nyström et al., 2000; Barranguet et al., 2003).

Dorigo et al. (2007) investigated the environmental impact of diffuse pesticide pollution on natural biofilms, at both pristine (upstream) and contaminated stations (downstream) in the Morcille River. The community composition in terms of bacteria, eukaryotes and photoautotrophs as assessed by DGGE and by pigment analysis, respectively, was significantly different in samples from contaminated stations and from uncontaminated ones, which is in accordance with our experimental observations. Community tolerance towards diuron, based on EC50 values for photosynthesis, was significantly lower for upstream photoautotrophic organisms than for those found further downstream, suggesting that there was a pollution-induced gradient in community tolerance (PICT).

In the present experiments, we found differences in microbial community structure, but we did not find any significant difference between the control and the contaminated microcosms in phototrophic biofilm tolerance to diuron. There are several reports of other experimental studies in which no PICT was detected, despite the obvious selection pressure exerted by a given toxicant (Nyström et al., 2000; Mølander and Blanck, 1992). Some diatom species may be more tolerant to PSII inhibitors than species of other algal classes (Bérard and Pelte, 1999; Guasch et al., 1997), and the predominance of diatoms within periphytic layers is a very common situation in lotic systems (Stevenson and Pan, 1999), which was confirmed by our HPLC pigment analyses. Algal species occurring in our biofilm communities may therefore have a narrower range of tolerance to PSII inhibitors, and during our experiments, this kind of herbicide may have little potential for any increase in periphyton community tolerance in comparison to other algal communities (Nyström et al., 2000; Bérard and Benninghoff, 2001). Mølander and Blanck (1992) present a conceptual three-stage model of the impact of diuron on marine periphyton as a function of diuron concentrations in the water. During the first stage, exposure to diuron has no long-term effect, during the second stage, a slight long-term effect on biomass and structure occurs, and during the final stage, the diuron stress is so severe that sensitive species are eliminated resulting, on the one hand, in a decline in the diversity and in chl *a* biomass, and on the other hand, in an increase in community tolerance, giving an easily detected PICT. Our chronic-exposure conditions could be compared to the second stage (between 2 and about 9 µg of diuron per liter for these authors, and 1 µg L⁻¹ in our study). We detected the stimulation of various biomass parameters, changes in structure (but no decrease in diversity) and no PICT. One of the main differences between our experimental study and that of Dorigo et al. (2007) is the surrounding biological environment. Despite an effective contamination of almost 1 µg L⁻¹, the contaminated and reference microcosms were regularly supplied with water, and thus with microorganisms from the upstream station of the Morcille river. In the field, emigration as a result of drift, and immigration of microorganisms onto the substrata can be important processes in regulating biofilm composition and standing crop in streams (Stevenson and Peterson, 1991). At the downstream stations, biofilms are continually interacting with neighboring microbial populations, which are continually exposed to the contaminants, whereas our microcosms were not. This may explain why diuron was detected *in situ* in short-term PICT tests (Dorigo et al., 2007), but not *in vitro* (our study). Another major difference between our experimental study and the study of Dorigo et al. (2007) is, of course, the exposure history of the *in situ* biofilms, which in Dorigo's study may have been exposed to flood events and higher herbicide contamination in the river before the sampling and testing of the study (during flood events concentrations higher than 10 µg L⁻¹ of diuron can be found in the Morcille river, Rabiet et al., 2008), whereas in the context of our experiment, the pulses tested had no significant impacts on biofilm tolerance towards diuron. The small increase in periphyton community tolerance could also be due to protocol artifacts, which may have pre-selected periphyton communities colonizing artificial substrates. For example, temperature was higher within the microcosms than within the sampling site of the Morcille river. Combined effects of diverse stress (physical and chemical) on microbial communities can have synergistic effects or the inverse (Vinebrooke et al., 2004; Sargian et al., 2005).

4.2. What are the consequences of the various acute scenarios on long-term responses of biofilms?

Based on AFDW results, we estimated the increase of biofilm biomass in our microcosms during the length of one pulse (3 h): it

was between 0.8 and 1.7% of the initial biomass, which confirms that the pulses we applied were in the scale of acute impacts. In the context of our *in vitro* experiments, a 24 h pulse (Jurgensen and Hoagland, 1990) would then permit the growth of 6–14% of biofilm biomass.

Single or double 3 h pulses of diuron did not induce diuron accumulation within the biofilm matrix. Considering the findings of Headley et al. (1998), who showed that only a few minutes are needed for pesticides with higher *K_{ow}* to be bioconcentrated in biofilms, we could assume that the sorption kinetics mainly depends on the physico-chemical properties of the pesticide. In our study, diuron (*log K_{ow}* = 2.68) analyses were only performed 1 week after each pesticide pulse so we may not exclude that diuron may have accumulated within the biofilm matrix during the "pulse period", and then have been released during the 7 days of the "recovery period" when they had been transplanted from the nanocosms back into the microcosms. In the light of the adsorption theory, other parameters could also explain these different findings such as the stirring level and varying ratios between the water volume and the substrate mass during experiments (Boesten, 1990; OCDE, 2000).

A single diuron pulse (7 and 14 µg L⁻¹) had no significant effect compared to non-pulsed biofilms on either the ash-free dry weight of the biofilms or the biofilm sensitivity (PICT bioassays, EC50) after 28 days of development (apart from the higher diuron pulse on control biofilms). Some differences were found between pulsed and non-pulsed biofilms for chl *a* fluorescence, carbon incorporation, biomolecular structure (DGGE) and pigment diversity after 28 days of development. We observed that the effects of the short-term pulses displayed very slight, dose-dependency, but except for the chl *a* fluorescence and carbon incorporation, there was little difference between biofilms that have been subjected to the higher diuron pulse (14 µg L⁻¹) and that have been subjected to the lower pulse (7 µg L⁻¹). At the concentrations and experimental conditions that we tested, diuron pulses had only a slight impact on long-term responses of biofilms.

A single pulse (14 µg L⁻¹) lasting 3 h had less impact on biofilms than a double pulse (7 µg L⁻¹), which induced decreases in biomass (AFDW and chl *a* fluorescence) and in photosynthetic activity (carbon incorporation), and an increase in sensitivity towards diuron (EC50, but not significant). Macinnis-Ng and Ralph (2004) examined the impact of double pulses of copper and of the PSII inhibitor Irgarol 1051 on photosynthesis and total chlorophyll concentrations of a seagrass, *Zostera capricorni*. Consistent with our findings for river biofilms, their results indicated that multiple pulses of photosynthetic inhibitors had a greater impact on photosynthesis parameters than a single pulse.

Nevertheless, it should be noted that river biofilms might also be affected by flow velocity and sediment deposition and/or abrasion (Wellnitz and Rader, 2003). For example, in an experimental study with atrazine, Jurgensen and Hoagland (1990) showed that runoff related sediment deposition and the associated fluctuations in the stream flow had more impact on stream periphyton than short-term pulses of the same herbicide. Sabater et al. (2002) proved experimentally that current velocity triggers the effect of copper on biofilms, which more marked at low and high velocities than at intermediate current velocities. Future experimental studies must be designed to take into account the influence of physical parameters and their interaction with pollutants on river biofilms.

4.3. What about the influence of a past chronic diuron contamination on further acute diuron exposures?

When we looked more closely at the impact of diuron pulses on biofilms, we found some differences in the responses of microbial communities originating from the control microcosm and those of

microbial communities originating from the contaminated microcosm.

Biofilm eukaryotic communities (DGGE on 18S rDNA gene fragments) from the control microcosm were restructured by acute exposure to diuron, whereas the eukaryotic community structure of biofilms that have previously been exposed to a low concentration of diuron was not affected by the diuron pulses. In an experimental study, Niederlehner and Cairns (1992) showed that periphytic communities grown under chronic Zn stress were initially impaired in terms of community structure and gross primary productivity, but that they changed less when subsequently subjected to an additional stress. This means that the taxonomic composition changed less in response to a secondary stress of the metal in chronically contaminated communities than in previously contamination-free communities. This suggests that algal communities initially selected in the slightly contaminated microcosm may have lost their potential for selection, and were no longer restructured by fresh acute contamination by the toxic agent (Vinebrooke et al., 2004).

Diuron pulses inhibited the chl *a* fluorescence and carbon incorporation of pre-exposed biofilms less than those of the control ones. This lower inhibition of pre-exposed photosynthetic microbenthic biomass and activity by diuron pulses may be an indirect result of diuron-induced algal community tolerance *via* changes in structure (Bérard and Benninghoff, 2001). No tolerance effect was demonstrated in short-term bioassays, but this effect could be significant under these long-term experimental conditions (algal biomass and carbon incorporation measurements were done 7 days after the pulses).

5. Conclusion

In conclusion, our results indicate that exposure to environmentally realistic concentrations of an herbicide can have measurable effects on freshwater biofilm communities (in terms of biomass, eukaryotic community structure and primary production), and especially on algal communities. Most of the existing effect concentrations used for environmental risk assessment correspond to exposure conditions lasting for more than 1 day, which may not be representative of real exposure conditions in small rivers. For example, the EC₅₀ of 3.3 µg L⁻¹ for diuron in the growth bioassay of the green algae *Scenedesmus subspicatus* corresponds to an exposure lasting 96 h (OECD 201) (Agritox: <http://www.dive.afssa.fr/agritox/index.php>). So far, environmental risk assessment has not taken into account the exposure time, previous exposure and pulse exposure parameters. This is particularly important because the differing mechanisms of action of pesticides mean that the toxic effects produced may be time dependent: for example PSII inhibitors can inhibit the photosynthesis of aquatic microorganisms within a few seconds, but only subsequently induce physiological stress and long-term effects on microbial communities, as we showed 7 days after a short-term exposure to diuron for 3 h.

In our study, the impact of diuron on the composition and function of microbenthic communities were studied under conditions of sequential stresses over time in relation to chronic and acute exposures mimicking flooding events in a small river contaminated by diffuse pesticide pollution. We have shown that the effects of an acute disturbance on biofilm systems depend on whether the biofilms have previously been exposed to these stressors. Given the important environmental implications of these findings, further studies simulating different contamination scenarios (concentration, duration, frequency and mixtures of pesticides) are clearly warranted in order to devise models of the ecotoxicological impacts of flooding on non-target aquatic organisms, such as microbenthic biofilms.

Acknowledgments

The authors wish to thank B. Motte, C. Rosy, C. Guillemain and B. Volat for their support for field sampling and help in laboratory. We would like to thank the Water Chemistry Laboratory of the CEMAGREF station in Lyon who carried out pesticide and nutrient analyses. The project received funding from the National ECCO – Ecodyn Research Program (PADYMA 2006–2007 Program), the National ECCO – Ecodyn Research Program (Périphtyeau 2003–2006 Program), the national programme ECOGER (PAPIER 2006–2008 Program). The project was also supported by the LTER Zone Atelier du Bassin du Rhône (ZABR). English text was edited by Monika Ghosh.

References

- AFNOR, 1999. XP T 90-210. Protocole d'évaluation d'une méthode alternative d'analyse physico-chimique quantitative par rapport à une méthode de référence, 58 p.
- Amann, R.L., Binder, B.J., Olson, R.J., Chisholm, S.W., Devereux, R., Stahl, D.A., 1990. Combination of 16S rRNA-targeted oligonucleotide probes with flow cytometry for analyzing mixed microbial populations. *Appl. Environ. Microbiol.* 56, 1919–1925.
- Aubertot, J.N., Barbier, J.M., Carpentier, A., Grill, J.J., Guichard, L., Lucas, P., Savary, S., Savini, I., Volz, M., 2005. Pesticides, agriculture et environnement. Réduire l'utilisation des pesticides et limiter les impacts environnementaux. Expertise scientifique collective INRA Cemagref, 64 pp.
- Balvanera, P., Pfisterer, A.B., Buchmann, N., He, J.-S., Nakashizuka, T., Raffaelli, D., Schmid, B., 2006. Quantifying the evidence for biodiversity effects on ecosystem functioning and services. *Ecol. Lett.* 9, 1146–1156.
- Barranguet, C., van den Ende, F., Rutgers, M., Breure, A., Greudanus, M., Sinke, J.J., Admiraal, W., 2003. Copper-induced modifications of the trophic relations in riverine algal-bacterial biofilms. *Environ. Toxicol. Chem.* 22 (6), 1340–1349.
- Battin, T.J., Kaplan, L.A., Newbold, J.D., Hansen, C.M.E., 2003. Contributions of microbial biofilms to ecosystem processes in stream mesocosms. *Nature* 426 (6965), 439–442.
- Bérard, A., Pelte, T., 1999. Les herbicides inhibiteurs du photo-système II, effets sur les communautés algales et leur dynamique. *Rev. Sci. Eau* 12, 333–361.
- Bérard, A., Benninghoff, C., 2001. Pollution-induced community tolerance (PICT) and seasonal variations in the sensitivity of phytoplankton to atrazine in microcosms. *Chemosphere* 45 (4–5), 427–437.
- Bérard, A., Pelte, T., Druart, J.C., 1999. Seasonal variations in the sensitivity of Lake Geneva phytoplankton community structure to atrazine. *Arch. Hydrobiol.* 145 (3), 277–295.
- Blanck, H., Wänker, S.A., Molander, S., 1988. Pollution-induced community tolerance—a new ecotoxicological tool. In: Cairns, J., Pratt, J.R. (Eds.), *Functional Testing of Aquatic Biota for Estimating Hazards of Chemicals*. ASTM STP 988, Philadelphia, pp. 219–230.
- Boesten, J.J.T.L., 1990. Influence of solid/liquid ratio on the experimental error of sorption coefficients in pesticide/soil systems. *Pestic. Sci.* 30, 31–41.
- Bonin, D.J., Travers, M., 1992. Examen critique des méthodes d'estimation de la biomasse et de l'activité des microorganismes dans les systèmes aquatiques. *Mar. Life* 2, 1–29.
- Cattaneo, A., Kerimian, T., Roberge, M., Marty, J., 1997. Periphyton distribution and abundance on substrata of different size along a gradient of stream trophy. *Hydrobiologia* 354, 101–110.
- Cold, A., Forbes, V.E., 2004. Consequences of a short pulse of pesticide exposure for survival and reproduction of *Gammarus pulex*. *Aquat. Toxicol.* 67, 287–299.
- DeLorenzo, M.E., Lauth, J., Pennington, P.L., Scott, G.I., Ross, P.E., 1999. Atrazine effects on the microbial food web in tidal creek mesocosms. *Aquat. Toxicol.* 46, 241–251.
- DeLorenzo, M.E., Geoffrey, I., Scott, G.I., Ross, P.E., 2001. Toxicity of pesticides to aquatic microorganisms: a review. *Environ. Toxicol. Chem.* 20 (1), 84–98.
- Dorigo, U., Bourrain, X., Bérard, A., Leboulanger, C., 2004. Seasonal changes in the sensitivity of river microalgae to atrazine and isoproturon along a contamination gradient. *Sci. Total Environ.* 318, 101–104.
- Dorigo, U., Fontvieille, D., Humbert, J.F., 2006. Spatial variability in the dynamic and the composition of the bacterioplankton community of the Lac du Bourget (France). *FEMS Microbiol. Ecol.* 58, 109–119.
- Dorigo, U., Leboulanger, C., 2001. A PAM fluorescence-based method for assessing the effects of photosystem II herbicides on freshwater periphyton. *J. Appl. Phycol.* 13, 509–515.
- Dorigo, U., Leboulanger, C., Bérard, A., Bouchez, A., Humbert, J.F., Montuelle, B., 2007. Lotic biofilm community structure and tolerance along a pesticide contamination gradient in a vineyard area. *Aquat. Microb. Ecol.* 50, 91–102.
- Dorigo, U., Bourrain, X., Bérard, A., Leboulanger, C., 2003. Seasonal changes in river microalgae sensitivity to atrazine and isoproturon, along a contamination gradient. *Sci. Total Environ.* 318, 101–114.
- Forbes, V.E., Cold, A., 2005. Effects of the pyrethroid esfenvalerate on life-cycle traits and population dynamics of *Chironomus reparius*—Importance of exposure scenario. *Environ. Toxicol. Chem.* 24 (1), 78–86.

- François, D.L., Robinson, G.G.C., 1990. Indices of triazine toxicity in *Chlamydomonas geitleri* Ettl. *Aquat. Toxicol.* 16, 205–228.
- Gouy V., Nivon C., 2007. Protection des Eaux en Beaujolais viticole: caractérisation et suivi de la qualité de l'eau sur le bassin versant de la Morcille sur la période 2001–2006, Rapport d'étude Cemagref- Chambre d'Agriculture du Rhône, 81 pp.
- Guasch, H., Muñoz, I., Rosés, N., Sabater, S., 1997. Changes in atrazine toxicity throughout succession of stream periphyton communities. *J. Appl. Phycol.* 9, 137–146.
- Guasch, H., Sabater, S., 1998. Light history influences the sensitivity to atrazine in periphytic algae. *J. Phycol.* 34, 233–241.
- Guasch, H., Admiraal, W., Sabater, S., 2003. Contrasting effects of organics and inorganics toxicants on freshwater periphyton. *Aquat. Toxicol.* 64, 165–175.
- Headley, J.V., Gandrass, J., Kuballa, J., Peru, K.M., Gong, Y., 1998. Rates of sorption and partitioning of contaminants in river biofilm. *Environ. Sci. Technol.* 32, 3968–3973.
- Homer-Devine, M.C., Leibold, M.A., Smith, V.H., Bohannon, B.J.M., 2003. Bacterial diversity patterns along a gradient of primary productivity. *Ecol. Lett.* 6, 613–622.
- IFEN, 2008. Les pesticides dans les eaux. Données 2005. Les dossiers Ifen (Institut Français de l'Environnement, Eds), 36 pp.
- INRA-Cemagref, 2005. Pesticides, agriculture and the environment: reducing the use of pesticides and limiting their environmental impact, Collective Scientific Expert Report, Executive Summary. In: Sabbagh, C.C., De Menthère N. (Eds.) 58 pp.
- Jeffrey, S.W., Mantoura, R.F.C., Wright, S.W., 1997. Phytoplankton Pigments in Oceanography. UNESCO, Paris, France, 661.
- Jurgensen, T.A., Hoagland, K.D., 1990. Effects of short-term pulses of atrazine on attached algal communities in a small stream. *Arch. Environ. Contam. Toxicol.* 19, 617–623.
- Lawrence, J.R., Kopf, G., Headley, J.V., Neu, T.R., 2001. Sorption and metabolism of selected herbicides in river biofilm communities. *Can. J. Microbiol.* 47, 634–641.
- Leboulanger, C., Quiblier, C., Dufour, P., 2006. Rapid assessment of multiple-limiting factors of phytoplankton biomass: bioassays, *in vivo* chlorophyll-*a* fluorescence, and factorial design. *Arch. Hydrobiol.* 166, 433–451.
- Liu, D., Lau, Y.L., Chau, Y.K., Pacepavicius, G.J., 1993. Characterization of biofilm development on artificial substratum in natural water. *Water Res.* 27, 361–367.
- Lyautey, E., Jackson, C.R., Cayrou, J., Rols, J.L., Garabetian, F., 2005. Bacterial community succession in natural river biofilm assemblages. *Microb. Ecol.* 50, 589–601.
- Macinnis-Ng, M.C.O., Ralph, P.J., 2004. In situ impact of multiple pulses of metal and herbicide on the seagrass, *Zostera capricorni*. *Aquat. Toxicol.* 67, 227–237.
- Margoum, C., Guillemain, C., Rabiet, M., Gouy, V., Coquery, M., 2007. Dissipation of pesticides in surface water and biofilms in a small agricultural catchment: development of a methodology for studying environmental impact of pesticides, XIII Symposium in Pesticide Chemistry, 3–6 september 2007, Piacenza, Italy.
- Mølander, S., Blanck, H., 1992. Detection of pollution-induced community tolerance (PCT) in marine periphyton communities established under diuron exposure. *Aquat. Toxicol.* 22, 129–144.
- Moreland, D.E., 1967. Mechanisms of action of herbicides. *Ann. Rev. Plant Physiol.* 18, 365–386.
- Muyzer, G., Smalla, K., 1998. Application of denaturing gradient gel electrophoresis (DGGE) and temperature gradient gel electrophoresis (TGGE) in microbial ecology. *Antonie van Leeuwenhoek* 73, 127–141.
- Niederlehner, B.R., Cairns, J., 1992. Community response to cumulative toxic impact: effects of acclimation on zinc tolerance of Aufwuchs. *Can. J. Fish. Aquat. Sci.* 49, 2155–2163.
- Nyström, B., Paulsson, M., Almgren, K., Blanck, H., 2000. Evaluation of the capacity for development of atrazine tolerance in periphyton from a Swedish freshwater site as determined by inhibition of photosynthesis and sulfolipid synthesis. *Environ. Toxicol. Chem.* 19, 1324–1331.
- OCDE, 2000. 106 - Ligne directrice pour les essais de produits chimiques. Adsorption-désorption selon une méthode d'équilibres successifs.
- Pesce, S., Fajon, C., Bardot, C., Bonnemoy, F., Portelli, C., Bohatier, J., 2006. Effects of the phenylurea herbicide diuron on natural riverine microbial communities in an experimental study. *Aquat. Toxicol.* 78, 303–314.
- Rabiet, M., Margoum, C., Gouy, V., Carluer, N., Coquery, M., 2008. Transfert des pesticides dans un petit bassin versant viticole. Influence des conditions hydrologiques sur le transport de ces contaminants. Ingénieries EAT, in press.
- Rabiet, M., Coquery, M., Margoum, C., Guillemain, C., Carluer, N., Gouy, V., 2007a. Distribution and fate of pesticides and trace metals in a small stream draining and agricultural watershed. Assessing the effect of hydrological conditions on the transport of contaminants. EGU General Assembly, 15–20 april 2007, Vienna, Austria.
- Reynaldi, S., Liess, M., 2005. Influence of duration of exposure to the pyrethroid fenvalerate on sublethal responses and recovery of *Daphnia magna* Straus. *Environ. Toxicol. Chem.* 24, 1160–1164.
- Romani, A.M., Guasch, H., Munoz, I., Ruana, J., Vilalta, E., Schwartz, T., Emtiaz, F., Sabater, S., 2004. Biofilm structure and function and possible implications for riverine DOC dynamics. *Microb. Ecol.* 47, 316–328.
- Romani, A.M., Sabater, S., 1999. Effect of primary producers on the heterotrophic metabolism of a stream biofilm. *Freshwater Biol.* 41, 729–736.
- Sabater, S., Guasch, H., Ricart, M., Romani, A., Vidal, G., Klünder, C., Schmitt-Jansen, M., 2007. Monitoring the effect of chemicals on biological communities. The biofilm as an interface. *Anal. Bioanal. Chem.* 387, 1425–1434.
- Sabater, S., Navarro, E., Guasch, H., 2002. Effects of copper on algal communities at different current velocities. *J. Appl. Phycol.* 14, 391–398.
- Sargian, P., Pelletier, E., Mostajir, B., Ferreyra, G.A., Demers, S., 2005. TBT toxicity on a natural planktonic assemblage exposed to enhanced ultraviolet-B radiation. *Aquat. Toxicol.* 73, 299–314.
- Schauer, M., Balagué, V., Pedros-Alio, C., Massana, R., 2003. Seasonal changes in the taxonomic composition of bacterioplankton in a coastal oligotrophic system. *Aquat. Microb. Ecol.* 31, 163–174.
- Schelske, C.L., 1984. In situ and natural phytoplankton assemblages bioassays. In: Shubert, L.E. (Ed.), *Algae as Ecological Indicators*. Academic Press, London, pp. 15–47.
- Schmitt-Jansen, M., Altenburger, R., 2007. Community-level microalgal toxicity assessment by multiwavelength excitation PAM fluorometry. *Aquat. Toxicol.*, doi:10.1016/j.aquatox.2007.10.001.
- Schmitt-Jansen, M., Altenburger, R., 2005. Toxic effects of isoproturon on periphyton communities—a microcosm study. *Est. Coast. Shelf Sci.* 62, 539–545.
- Seguin, F., Le Bihan, F., Leboulanger, C., Bérard, A., 2002. Risk assessment of pollution: induction of atrazine tolerance in phytoplankton communities in freshwater outdoor mesocosms, using chlorophyll fluorescence as endpoint. *Water Res.* 36, 3239–3248.
- Sogin, M.L., Gunderson, J.H., 1987. Structural diversity of eukaryotic small subunit ribosomal RNAs. *Ann. N. Y. Acad. Sci.* 503, 125–139.
- Stevenson, R.J., Pan, Y.P., 1999. Assessing environmental conditions in rivers and streams with diatoms. In: Stoermer, E.F., Smol, J.P. (Eds.), *The Diatoms: Applications for the Environmental and Earth Sciences*. Cambridge University Press, Cambridge, United Kingdom, pp. 11–40.
- Stevenson, R.J., Peterson, C.G., 1991. Emigration and immigration can be important determinants of benthic diatom assemblages in streams. *Freshwater Biol.* 26, 279–294.
- Thioulouse, J., Chessel, D., Dolédec, D., Olivier, J.M., 1997. Ade-4: a multivariate analysis and graphical display software. *Stat. Comput.* 7, 75–83.
- Vinebrooke, R.D., Cottingham, K.L., Norberg, J., Scheffer, M., Dodson, S.I., Maberly, C., Sommer, U., 2004. Impacts of multiple stressors on biodiversity and ecosystem functioning: the role of species co-tolerance. *Oikos* 104, 451–457.
- Wellnitz, T., Rader, R.B., 2003. Mechanisms influencing community composition and succession in mountain stream periphyton: interactions between scouring history, grazing, and irradiance. *J. North Am. Benthol. Soc.* 22, 528–541.
- Zhao, Y., Newman, M.C., 2006. Effects of exposure duration and recovery time during pulsed exposures. *Environ. Toxicol. Chem.* 25, 1298–1304.

Les biofilms aquatiques : dans quelle mesure permettent-ils de comprendre l'effet des pesticides sur le fonctionnement des cours d'eau ?

Exemple en zone de vignoble

Stéphane Pesce, Ahmed Tlili et Bernard Montuelle

En France, malgré le développement de nouvelles pratiques agricoles plus respectueuses de l'environnement, les pesticides restent les principaux responsables de la pollution chimique des rivières. La compréhension et l'évaluation de l'impact de ces substances sur le fonctionnement des cours d'eau représentent donc un enjeu majeur pour la reconquête de la qualité de l'eau et des milieux aquatiques. À partir des résultats d'études obtenus sur une rivière du Beaujolais, les auteurs de cet article analysent le rôle écologique clé joué par les communautés microbiennes structurées sous forme d'assemblage appelés « biofilms » et proposent leur utilisation comme indicateurs biologiques pour détecter et évaluer les pollutions chimiques par les pesticides ainsi que leurs effets sur le fonctionnement des cours d'eau.

Les diverses pressions anthropiques (rejets domestiques/industriels/agricoles), qu'elles soient ponctuelles ou diffuses, permanentes ou temporaires, entraînent des dégradations parfois fortes et durables des écosystèmes aquatiques. Depuis quelques années, au-delà du constat de pollution d'un milieu, se sont développées les notions de « santé des écosystèmes » et de « bon état écologique » (Costanza et Mageau, 1999) qui considèrent une approche plus globale du milieu aquatique, allant si nécessaire jusqu'à prendre en compte le fonctionnement du bassin versant.

Malgré le développement d'une législation plus protectrice de l'environnement et l'introduction progressive de nouvelles pratiques agricoles pour limiter l'usage et le transfert des pesticides les plus mobiles, de telles substances sont très fréquemment détectées dans les eaux de surface, à des concentrations souvent élevées (IFEN¹, 2007). La directive cadre européenne sur l'eau (DCE, 2000/60/CE), qui établit une politique communautaire en terme de préservation et de gestion des écosystèmes aquatiques, se traduit par une intensification des actions de surveillance des écosystèmes aquatiques et l'élaboration d'actions correctives afin de réduire leur niveau de contamination et atteindre ainsi le « bon état » chimique et écologique des masses d'eau avant 2015.

Les zones viticoles sont des zones bien identifiées de dégradation de qualité des milieux aquatiques (Agence de l'eau Rhône-Méditerranée & Corse, 2008). Elles drainent de petits hydrosystèmes particulièrement exposés aux pesticides qui peuvent être temporairement en fortes concentrations (orages, ruissellement) et souvent en mélange de substances (Rabiet *et al.*, 2008). Les modalités fines de transfert et d'action des pollutions diffuses ne sont pas entièrement connues. Il est cependant indispensable de pouvoir relier, dans ces cours d'eau, les niveaux d'exposition réels aux effets sur les communautés biologiques, en intégrant les aspects de variabilité spatiale et temporelle (Montuelle *et al.*, 2007). De même, la capacité de récupération des communautés (résilience) est un élément de connaissance important pour appréhender le potentiel de retour à un bon état écologique en cas de remédiation du milieu.

Parmi les biocénoses aquatiques, les communautés microbiennes sont des acteurs clés dans le fonctionnement général des écosystèmes aquatiques. En effet, par leur position à la base du réseau trophique et leurs capacités enzymatiques, les micro-organismes eucaryotes (possédant un noyau : microalgues, champignons, levures...) et procaryotes (sans noyaux : bactéries, cyanobactéries...) interviennent de manière prépondérante dans différents processus écologiques fondamentaux : la production primaire, assurée par les orga-

1. Institut français de l'environnement.

Les contacts

Cemagref, UR QELY,
Qualité des eaux
et prévention des
pollutions, 3 bis quai
Chauveau, CP 220,
69336 Lyon Cedex 09

nismes autotrophes, capables de synthétiser du carbone organique par photosynthèse (microalgues et cyanobactéries), ou la dégradation de la matière organique et le recyclage des nutriments, assurés par les organismes hétérotrophes, qui ne sont pas capables d'effectuer la photosynthèse (bactéries, champignons...).

Sur des supports immergés, ces communautés microbiennes se structurent sous forme d'agrégats dénommés biofilms ou périphyton (encadré 1). Dans les petits cours d'eau, tels que ceux drai-

nant les surfaces agricoles, l'importance relative de ces biofilms est grande et ils assurent un rôle fonctionnel majeur pour l'écosystème (Dorigo *et al.*, 2008 ; Villeneuve *et al.*, 2009). De plus, ces assemblages microbiens interagissent précocement avec les substances dissoutes (Sabater *et al.*, 2007) et notamment avec les pesticides. La contamination des milieux aquatiques par ce type de polluants est donc susceptible de modifier leur structure et leur fonctionnement par des effets directs et/ou indirects (Pesce *et al.*, 2006 ;

Encadré 1

Formation et cycle de développement d'un biofilm (Othoniel, 2006)

Les biofilms se développent selon un schéma maintenant bien connu. Les espèces microbiennes sont entraînées par le courant et colonisent les surfaces immergées, selon une succession qui dépend des temps de génération spécifiques des espèces (bactéries ; champignons filamenteux ; algues de type diatomées, algues vertes et bleues). L'atteinte d'un climax (biofilm mature, A) dépend des conditions environnementales (teneurs en nutriments contrôlant la croissance des micro-organismes, régime hydraulique entraînant ou non de l'abrasion, température...). Les dynamiques de croissance et le calcul d'un taux de croissance en phase exponentielle (B) permettent de caractériser des situations chimiques différentes.

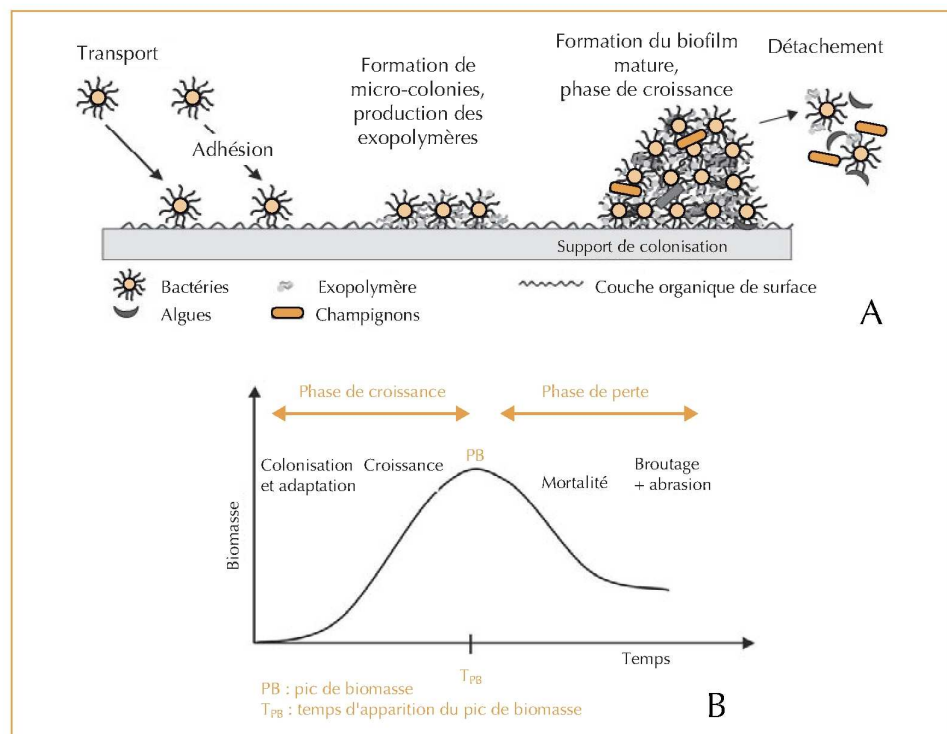

▲ Figure 1 – Formation et cycle de développement d'un biofilm (Othoniel, 2006 ; d'après (A) Mozes, 1995 ; (A) et (B) Biggs, 1996).

Tlili *et al.*, 2008). En outre, les micro-organismes présentent une forte capacité à répondre rapidement à des changements environnementaux et à s'y adapter de manière transitoire ou irréversible (Sabater *et al.*, 2007). C'est pourquoi les biofilms microbiens constituent des indicateurs de perturbation (ou bio-indicateurs) particulièrement pertinents qui peuvent offrir un signal précoce de stress environnemental suite à une pollution chimique (Sabater *et al.*, 2007) et notamment par des pesticides.

Deux approches complémentaires co-existent pour évaluer la réponse microbienne à un stress environnemental :

- une approche basée sur l'étude structurale des communautés (biomasse, taxonomie, diversité...). C'est la méthode la plus connue qui a donné des indicateurs normalisés comme l'indice biologique diatomique (IBD) ou l'indice de polluosensibilité spécifique (IPS), basés sur la taxonomie des algues appartenant au groupe des diatomées (Coste, 1982 ; Morin *et al.*, 2007). Pour l'instant ces méthodes sont cependant limitées à une bio-indication essentiellement trophique ;

- une approche fonctionnelle portée généralement sur le suivi d'activités métaboliques (photosynthèse, respiration, activités enzymatiques, potentiel de biodégradation...).

L'utilisation du biofilm microbien comme bio-indicateur permet donc un large choix de descripteurs, plus ou moins adaptés aux différents types de contaminants. Le choix de ces descripteurs est également très important afin de pouvoir discriminer les effets liés aux pesticides de ceux associés aux facteurs environnementaux (vitesse de courant, luminosité, autres composés organiques et inorganiques) et de prendre en considération les spécificités et les interactions des différentes composantes biologiques du biofilm (Sabater *et al.*, 2007 ; Villeneuve, 2008).

Dans cet article, nous proposons ainsi de discuter le potentiel offert par les biofilms aquatiques pour évaluer l'impact des pesticides sur le fonctionnement d'un cours d'eau, en se basant sur des résultats obtenus au cours de différentes études menées sur un site atelier du Beaujolais. Après une présentation du site d'étude et une brève description des différents descripteurs microbiens utilisés, nous exposerons et commenterons les résultats obtenus pour chacun d'entre eux afin d'en discuter la pertinence comme bio-indicateurs d'une pollution par des pesticides.

Matériels et méthodes

Le site d'étude (la rivière Morcille) : description et mise en place du recueil des données

Le bassin versant de la Morcille (9,5 km²) est situé au nord du département du Rhône, dans le Haut-Beaujolais, entre la bordure orientale du Massif Central et l'extrémité ouest de la vallée de la Saône (figure 2). Il constitue un sous-bassin de l'Ardières (220 km²) avec lequel il compose le site atelier Ardières-Morcille (SAAM), intégré dans la zone atelier du bassin du Rhône (ZABR). Le bassin versant de la Morcille est essentiellement forestier en amont et planté de vignes en aval. Trois sites d'échantillonnage sont généralement privilégiés par le Cemagref pour la caractérisation chimique du cours d'eau : un site amont, dénommé « Saint-Joseph » ; un site intermédiaire, dénommé « Versauds » ; et un site aval, dénommé « Saint-Ennemond ». Ces trois stations sont représentatives de l'augmentation de la proportion relative de vigne sur la surface de bassin versant drainée par le cours d'eau de la station amont (7 %) à la station aval (69 %) (figure 2). Cette augmentation est associée à un gradient croissant des teneurs en pesticides (majoritairement à action herbicide) tout au long du cours d'eau avec une prédominance du diuron (Dorigo *et al.*, 2007 ; Gouy et Nivon, 2007 ; Rabiet *et al.*, 2008 ; Pesce *et al.*, 2009). Cette matière active, largement utilisée comme herbicide sur les vignes ces dernières années, est interdite d'utilisation par les viticulteurs depuis le 13 décembre 2008.

Les caractéristiques de ce bassin versant en font un site de choix pour évaluer l'impact de ce type de polluants sur les communautés microbiennes. La principale période de pollution du cours d'eau par les pesticides s'étend d'avril à août, durant les différents traitements des vignes par les produits phytosanitaires, mais le gradient de contamination est également mesuré en période hivernale. Comme souvent dans le cas de bassins versants agricoles (Pesce *et al.*, 2008), un gradient similaire amont-aval est également observé avec les métaux lourds, notamment l'arsenic et le cuivre (Rabiet *et al.*, 2008), le carbone organique dissous et les composés inorganiques azotés et phosphorés (Dorigo *et al.*, 2007). Les micro-organismes étant également très sensibles à ces composés, ces derniers peuvent donc représenter des facteurs de confusion importants dans l'évaluation de la réponse des communautés microbiennes

► Figure 2 – Localisation des trois stations de prélèvements sur le bassin versant de la Morcille. Pour chaque station est indiquée la surface drainée par le cours d'eau et son occupation des sols.

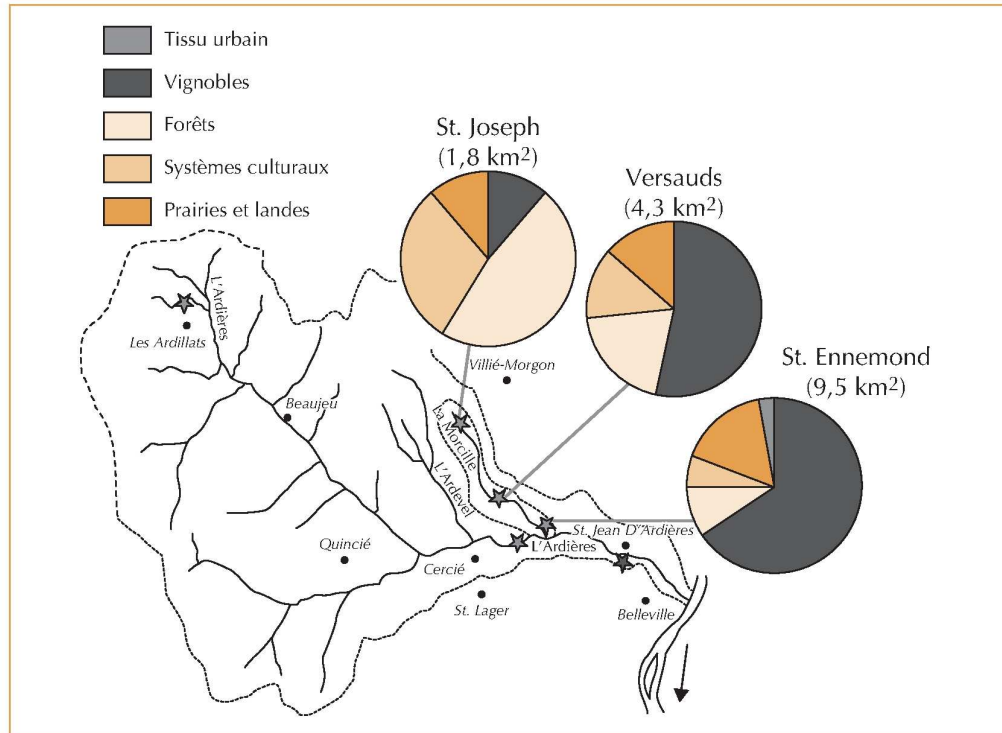

aux pesticides (Dorigo *et al.*, 2007 ; Pesce *et al.*, 2008 ; Villeneuve, 2008).

2. En anglais : *High-Performance Liquid Chromatography*.

3. En anglais : *Polymerase Chain Reaction – Denaturing Gradient Gel Electrophoresis*.

LES RÉSULTATS ISSUS DES CAMPAGNES D'ÉCHANTILLONNAGE

Les résultats présentés dans cet article sont issus de différentes campagnes d'échantillonnage effectuées sur la Morcille au cours de la période 2004-2008. Les biofilms ont été collectés au niveau des trois stations décrites précédemment sur des substrats artificiels immergés pendant deux mois (supports de verre) ou des substrats naturels prélevés dans le lit de la rivière (cailloux). Les périodes de prélèvement et les substrats utilisés seront précisés pour chacun des résultats présentés ci-après.

LES DESCRIPTEURS MICROBIENS UTILISÉS

Plusieurs types de descripteurs ont été utilisés pour caractériser les propriétés fonctionnelles et structurales des biofilms de la Morcille lors des travaux présentés dans cet article. La biomasse totale, qui permet d'appréhender la structure générale du biofilm, a été estimée par mesure de la matière sèche. La distribution des différentes classes de micro-organismes photosynthétiques

(microalgues et cyanobactéries) au sein du biofilm a été appréciée par analyse des pigments photosynthétiques par chromatographie liquide haute performance (HPLC²). La diversité microbienne a également été appréhendée de manière plus fine à l'aide d'une méthode moléculaire dite « d'empreinte génétique » : la PCR-DGGE³ (encadré 2).

Le niveau de tolérance global des communautés photosynthétiques (algues et cyanobactéries) du biofilm au diuron, principal herbicide détecté dans la Morcille, a été apprécié à partir de tests de toxicité aiguë effectués en laboratoire. Brièvement, les biofilms ont été soumis au laboratoire à des concentrations croissantes en diuron et la réponse microbienne, en fonction du niveau d'exposition, a été appréciée en terme d'activité photosynthétique par mesure du taux d'incorporation de ¹⁴C. Les courbes dose-réponse (ou dose-effet) établies ont ainsi permis de déterminer la concentration efficace en diuron inhibant 50 % (CE50) de l'activité photosynthétique de chacune des communautés étudiées (encadré 3).

Le potentiel de dégradation du diuron par les communautés microbiennes bactériennes et

Encadré 2

Principe de la méthode PCR-DGGE

Initialement, la DGGE (électrophorèse en gradient de gel dénaturant) a été développée dans le domaine médical pour détecter des mutations impliquées dans des maladies génétiques. Aujourd'hui elle est largement utilisée pour distinguer les différentes populations de micro-organismes dans des échantillons naturels après amplification par PCR (réactions de polymérase en chaîne) de région de gènes codant pour l'ARN^r 16S pour les procaryotes ou 18S pour les eucaryotes. Cette technique est basée sur le fait qu'un ADN⁵ double brin se dissocie, lorsqu'il est soumis à des dénaturants chimiques, en fonction de sa séquence nucléique. Après amplification, les molécules d'ADN de même taille, différant d'un ou plusieurs nucléotides, vont donc migrer différemment tout au long du gradient dénaturant. Lors de l'analyse d'une communauté complexe, des profils multibandes sont obtenus et chaque bande est théoriquement représentative d'une séquence et donc d'un phylotype, permettant ainsi de visualiser la richesse spécifique des communautés.

4. Acide ribonucléique ribosomique.

5. Acide désoxyribonucléique.

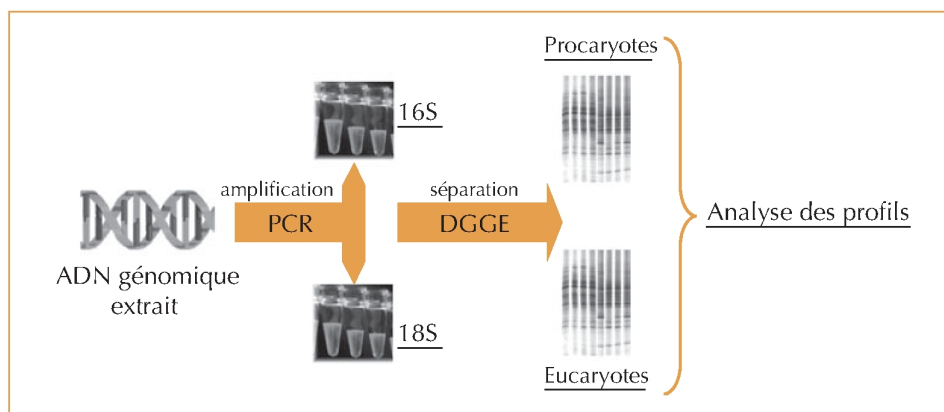

▲ Figure 3 – Principe de la méthode PCR-DGGE.

fungiques du biofilm a été évalué par la méthode de radiorespirométrie (qui permet de mesurer la quantité de CO₂ issue de l'activité microbienne), couplée à l'utilisation de diuron marqué radioactivement (¹⁴C-diuron). Brièvement, les biofilms ont été incubés en enceinte radiorespirométrique étanche pendant seize semaines en présence de ¹⁴C-diuron et le suivi de la cinétique de biodégradation complète de la molécule (minéralisation) a été réalisé par un dosage régulier du CO₂ radioactif (¹⁴CO₂) produit par les micro-organismes suite à cette minéralisation.

Résultats

Structure et composition du biofilm

La variabilité spatiale et temporelle de la biomasse totale, estimée par mesure du poids sec, a été appréciée à partir de biofilms collectés

mensuellement sur des cailloux prélevés aux trois stations d'échantillonnage entre juin 2007 et mai 2008 (figure 5). Les résultats obtenus au cours de ce suivi d'un an semblent faire apparaître une légère tendance saisonnière avec des biomasses plus importantes en hiver qu'en été. Les variations spatiales inter-sites sont quant à elles très limitées, y compris durant le printemps et l'été, principales périodes de contamination de la Morcille par les pesticides.

Deux campagnes réalisées sur les trois stations d'échantillonnage au printemps 2004 et en hiver 2005 ont également permis d'appréhender les variations spatiales et saisonnières de la composition du biofilm (Dorigo *et al.*, 2007, 2009). Ces variations sont illustrées sur la figure 6 sous forme d'une analyse en composantes principales (ACP) représentant les individus (échantillons) dans un espace en deux dimensions en fonc-

6. Dioxyde de carbone.

Encadré 3

Mesure et comparaison du niveau de tolérance de communautés biologiques

Le niveau de tolérance d'une communauté biologique à un toxique peut être mesuré par estimation de la concentration efficace de ce toxique réduisant de x % l'intensité d'un processus biologique choisi (CE_x). Cette estimation s'effectue par l'analyse de courbes dose-réponse qui permet de représenter le niveau d'activité biologique en fonction du niveau d'exposition au toxique choisi et de déterminer la valeur de la CE_x recherchée (généralement la CE₅₀, comme sur l'exemple présenté sur la figure 4). La confrontation des CE_x obtenues pour différentes communautés permet ainsi de comparer leur niveau de tolérance pour un toxique : plus la valeur de la CE_x augmente, et plus la communauté présente des capacités de résistance importante vis-à-vis du polluant. Ainsi sur la figure 4, la communauté B est caractérisée par une CE₅₀ supérieure à la communauté A, ce qui signifie qu'elle est plus tolérante que celle-ci au toxique auquel elles ont été exposées.

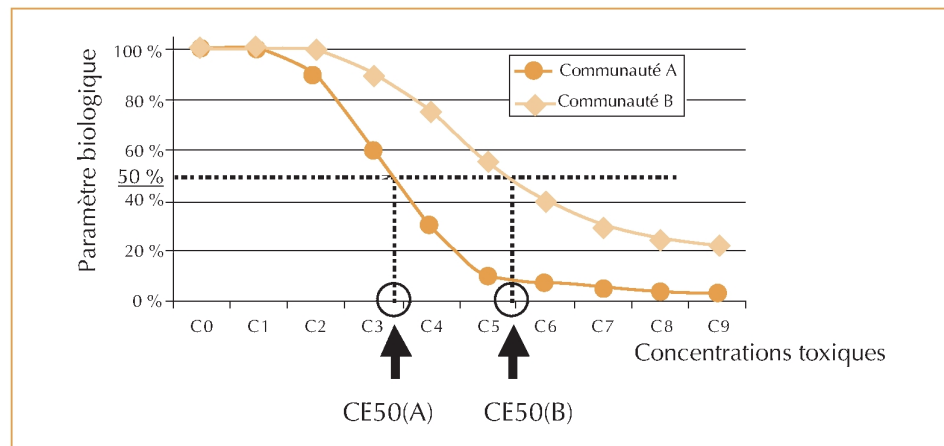

▲ Figure 4 – Mesure et comparaison du niveau de tolérance de communautés biologiques.

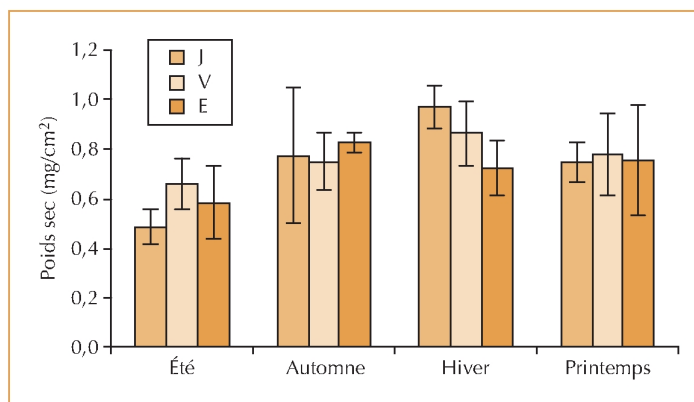

▲ Figure 5 – Évolution saisonnière moyenne (et écarts-types) du poids sec de biofilms collectés mensuellement sur substrats naturels aux trois stations (J : Saint-Joseph ; V : Versauds ; E : Saint-Ennemd) entre juin 2007 et mai 2008.

tion des coordonnées définies par une matrice obtenue par comparaison des profils de diversité génétique observés par DGGE (figure 6B et 6C) ou par analyse de la composition en pigments photosynthétiques (figure 6A). Cette représentation graphique permet ainsi de visualiser les variations suivant les deux axes majeurs qui expliquent la majorité des différences inter-échantillons observées (56 % à 99 % dans les ACP représentées). Les analyses effectuées sur les biofilms printaniers montrent une distinction très nette entre les trois sites en période de pollution par les pesticides, tant au niveau de la répartition pigmentaire des organismes photosynthétiques (microalgues et cyanobactéries) au sein de la communauté (figure 6A), que des diversités eucaryotes (figure 6B) et procaryotes (figure 6C), évaluées par PCR-DGGE. En hiver, cette distinction entre les trois sites reste bien marquée

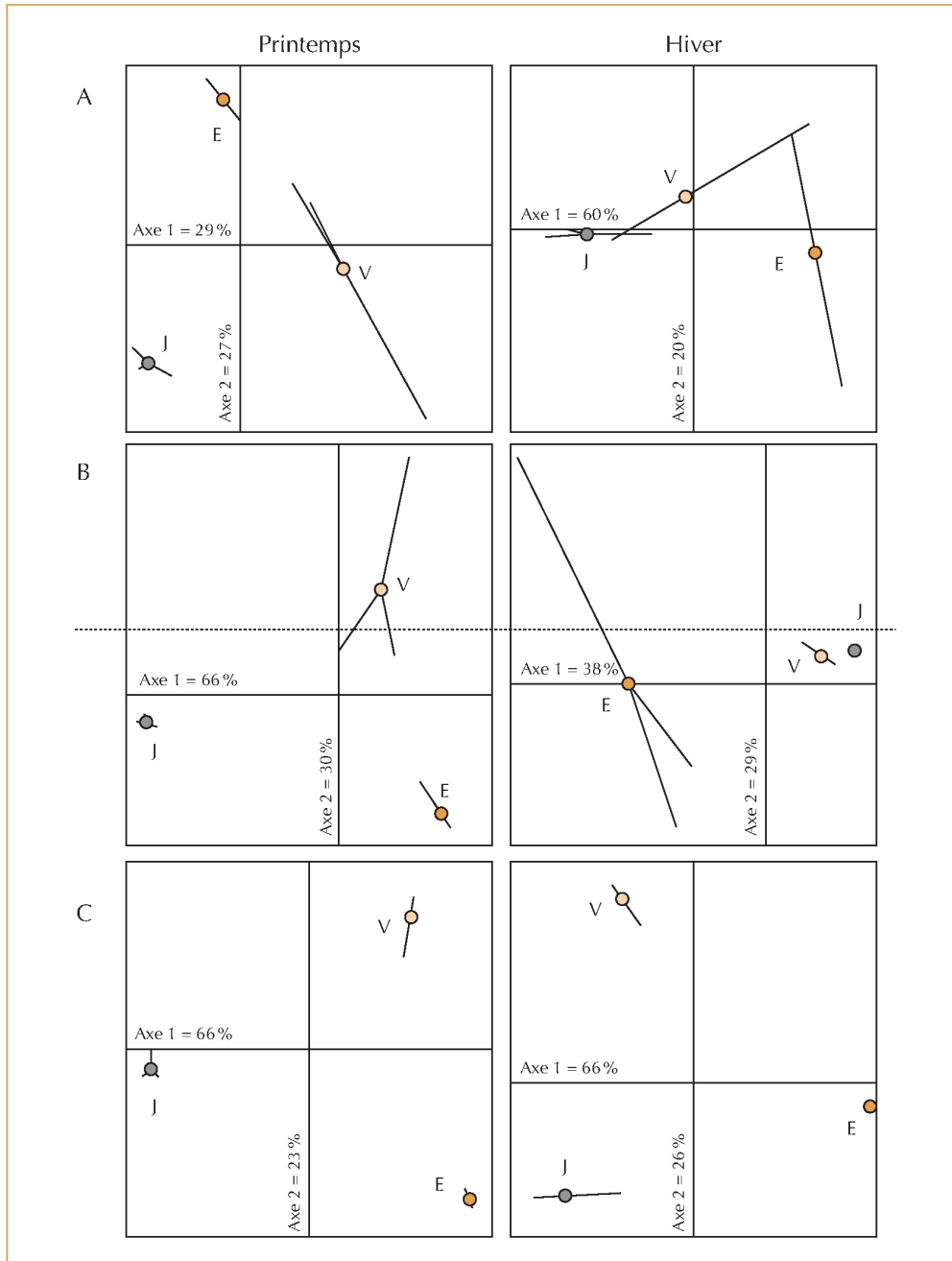

▲ Figure 6 – Analyse en correspondance principale (ACP) de la répartition des différents pigments photosynthétiques (A), des profils de diversité eucaryote obtenus par PCR-DGGE sur ADNr 18S (B) et des profils de diversité procaryote obtenus par PCR-DGGE sur ADNr 16S (C) dans des biofilms collectés sur substrats artificiels (triplicats) immergés durant deux mois au printemps (mi-avril à mi-juin 2004) et en hiver (février-mars 2005) aux trois stations (J : Saint-Joseph ; V : Versaids ; E : Saint-Ennemond) d'après Dorigo *et al.* (2007, 2009). Pour chaque échantillon, les symboles représentent la position médiane des profils de diversité et les traits la variation observée entre les triplicats.

pour la diversité procaryote (figure 6C), mais de fortes similitudes sont observées entre la station amont et la station intermédiaire au niveau de la diversité eucaryote (figure 6B). Ceci est confirmé par l'analyse pigmentaire de la communauté photosynthétique (essentiellement composée d'organismes eucaryotes) qui fait apparaître un fort rapprochement de la composition des biofilms de chaque station en hiver par rapport au printemps (figure 6A).

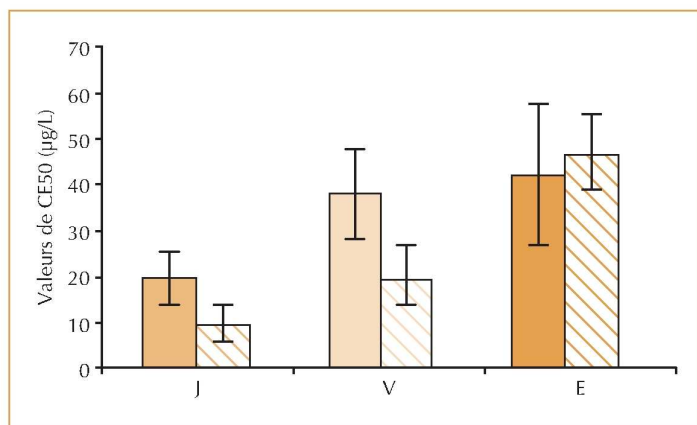

▲ Figure 7 – Tolérance moyenne (et écarts-types) au diuron (exprimée sous forme de concentration efficace inhibant 50 % de l'activité photosynthétique : CE50) de biofilms collectés sur substrats artificiels (triplicats) immergés durant deux mois au printemps (mi-avril à mi-juin 2004) et en hiver (février-mars 2005) aux trois stations (J : Saint-Joseph ; V : Versauds ; E : Saint-Ennemond) d'après Dorigo *et al.* (2007). Couleurs pleines : printemps ; couleurs hachurées : hiver.

Tolérance du biofilm au diuron

Les deux campagnes d'échantillonnage décrites précédemment ont également permis d'apprécier le niveau de tolérance des communautés photosynthétiques printanières et hivernales à une exposition aiguë à l'herbicide diuron (Dorigo *et al.*, 2007). Les résultats présentés sur la figure 7 mettent en évidence une augmentation des CE50 entre les trois stations. Ceci traduit donc une plus grande résistance des communautés à ce produit d'amont en aval, au printemps comme en hiver. Des variations saisonnières sont également observées pour les biofilms situés en amont et surtout pour ceux de la station intermédiaire (Versauds), qui sont caractérisés par une CE50 proche de la station aval durant la principale période de pollution par le diuron (printemps) alors qu'elle diminue et se rapproche de celle mesurée en amont durant l'hiver.

Potentiel de biodégradation du diuron par le biofilm

Le potentiel de biodégradation des communautés microbiennes hétérotrophes de la Morcille a été apprécié à partir de biofilms collectés aux stations Saint-Joseph et Saint-Ennemond, en juin 2007 (Pesce *et al.*, 2009). Les courbes obtenues lors du suivi radiorespirométrique (figure 8) mettent clairement en évidence une augmentation du potentiel de biodégradation totale (minéralisation) du diuron entre la station amont et la station aval durant une période de forte contamination du cours d'eau par cette molécule.

► Figure 8 – Cinétique moyenne (et écarts-types) de minéralisation de ^{14}C -diuron par des biofilms collectés sur substrats naturels (triplicats) aux stations amont (J : Saint-Joseph) et aval (E : Saint-Ennemond) en juin 2007 d'après Pesce *et al.* (2009).

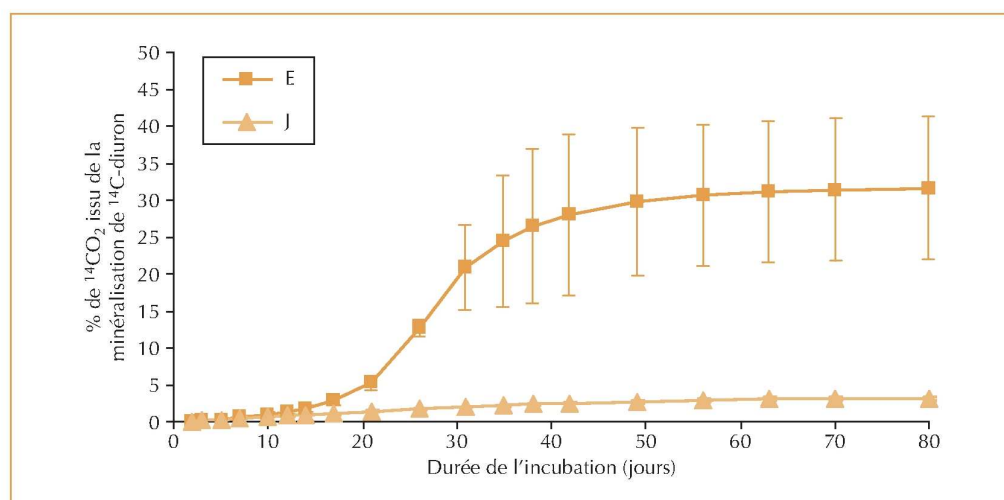

Conséquences et conclusions opérationnelles pour la bio-indication

Nécessité et pertinence de complémentarité des descripteurs microbiens

Les résultats décrits précédemment mettent en évidence une modification nette du biofilm d'amont en aval de la Morcille, tant d'un point de vue structural que fonctionnel. Cependant, certains descripteurs ne permettent pas d'appréhender la spécificité microbienne de chacun des sites étudiés. Ainsi, l'absence de différence inter-sites pour le poids sec des biofilms (figure 5), et ce, quelle que soit la saison, confirme clairement que ce type de descripteur global de la structure générale du biofilm s'avère peu adapté pour étudier la réponse des communautés microbiennes à des modifications environnementales (Othoniel, 2006 ; Villeneuve, 2008). Les changements structuraux des biofilms d'amont en aval sont néanmoins perceptibles à l'aide de descripteurs plus spécifiques, tels que la caractérisation de la composition pigmentaire ou des diversités eucaryotes et procaryotes (figure 6). Les variations inter-sites sont beaucoup plus marquées en période printanière et estivale de forte pollution de la Morcille par les pesticides, en particulier pour les communautés autotrophes, majoritairement eucaryotes (microalgues). Ces communautés sont particulièrement sensibles aux herbicides et notamment au diuron (Pesce et al., 2006 ; Tlili et al., 2008), prédominant dans le cours d'eau à cette période de l'année (Dorigo et al., 2007 ; Rabiet et al., 2008). Les variations spatiales, entre les trois sites présentant un gradient croissant en herbicides, et temporelles, entre le printemps et l'hiver, suggèrent donc un lien fort entre le contexte de contamination par les pesticides et la composition du biofilm. Cependant, ces paramètres structuraux sont aussi conditionnés par de nombreux facteurs physiques (température, vitesse de courant, lumière...) et chimiques (teneurs en nutriments, présence de polluants organiques et inorganiques...) qui évoluent fortement d'amont en aval de la Morcille (Dorigo et al., 2007 ; Rabiet et al., 2008). C'est pourquoi les approches structurales ne peuvent, à elles seules, constituer un outil suffisant pour utiliser les biofilms comme bio-indicateurs d'une pollution par des pesticides.

Le niveau de résistance des biofilms au diuron a été apprécié au moyen d'un descripteur fonc-

tionnel spécifique de la communauté autotrophe : l'activité photosynthétique (figure 7). Cette double démarche d'évaluation des effets de polluants sur la diversité microbienne et sur l'acquisition d'une tolérance/résistance se place dans le cadre conceptuel de la méthode PICT⁷ (Blanck, 1998) qui postule qu'une communauté exposée à un contaminant s'adapte et devient tolérante à cette substance (encadré 4). Elle est fondée sur l'hypothèse qu'une communauté biologique naturelle est constituée de différents composants ayant des sensibilités variables vis-à-vis d'un toxique donné. Ainsi, suite à une exposition à un toxique, les organismes les plus sensibles ne sont plus concurrentiels et sont remplacés par des organismes plus tolérants. La communauté résultante présente alors une tolérance vis-à-vis du toxique, supérieure à celle observée pour une communauté semblable mais n'ayant pas connu de pression de sélection par ce toxique (Bérard et al., 2002). L'utilisation de la démarche PICT a ainsi permis de mettre en évidence une forte adaptation de la communauté autotrophe au diuron dans la Morcille, engendrant alors une augmentation notable de leurs capacités de résistance à ce polluant d'amont en aval (figure 7 et Dorigo et al., 2007). Ce type d'approche s'avère donc particulièrement utile dans une démarche de bio-indication puisqu'elle témoigne, pour un pesticide donné, du niveau d'exposition préalable des communautés à celui-ci dans le milieu.

La complémentarité entre la caractérisation de la composante autotrophe, par analyse pigmentaire et par analyse de la diversité de la communauté eucaryote (essentiellement composée de microalgues photosynthétiques), d'une part, et la mesure de son niveau de tolérance au diuron, d'autre part, est clairement mise en évidence par les résultats décrits. En effet, si les biofilms prélevés respectivement aux stations amont et intermédiaire sont bien différenciés au printemps, tant au niveau de leur structure que de leur capacité de résistance au diuron, on constate en période hivernal un fort rapprochement des communautés pour ces deux critères. Cela confirme donc que le contexte de contamination par les pesticides conditionne fortement la composition du biofilm, en particulier pour sa composante autotrophe, favorisant ainsi les espèces les plus tolérantes au sein du biofilm.

En cas d'exposition prolongée à des polluants organiques, les processus d'adaptation microbienne peuvent également conduire à la stimu-

7. En anglais :
*Pollution Induced
Community Tolerance.*

Encadré 4

Le concept PICT

Le concept PICT ou l'acquisition de tolérance induite proposé par Blanck *et al.*, en 1988, est basé sur le fait qu'une communauté biologique naturelle est constituée de différents « composants » (espèces, souches, clones) ayant des sensibilités variables vis-à-vis d'un toxique donné. L'exposition d'une communauté à ce toxique se traduira par la sélection des organismes les plus tolérants ou la mise en place de mécanismes de détoxification. La communauté résultante présentera alors, dans son ensemble, une tolérance vis-à-vis du toxique supérieure à celle d'une communauté n'ayant pas subi de pression de sélection par ce toxique. Cette différence de tolérance, que l'on peut évaluer *in vitro* par des bio-essais à courte durée en laboratoire et avec des concentrations croissantes en toxique, peut donner une indication sur l'exposition préalable (*in situ*) au toxique des différentes communautés échantillonnées.

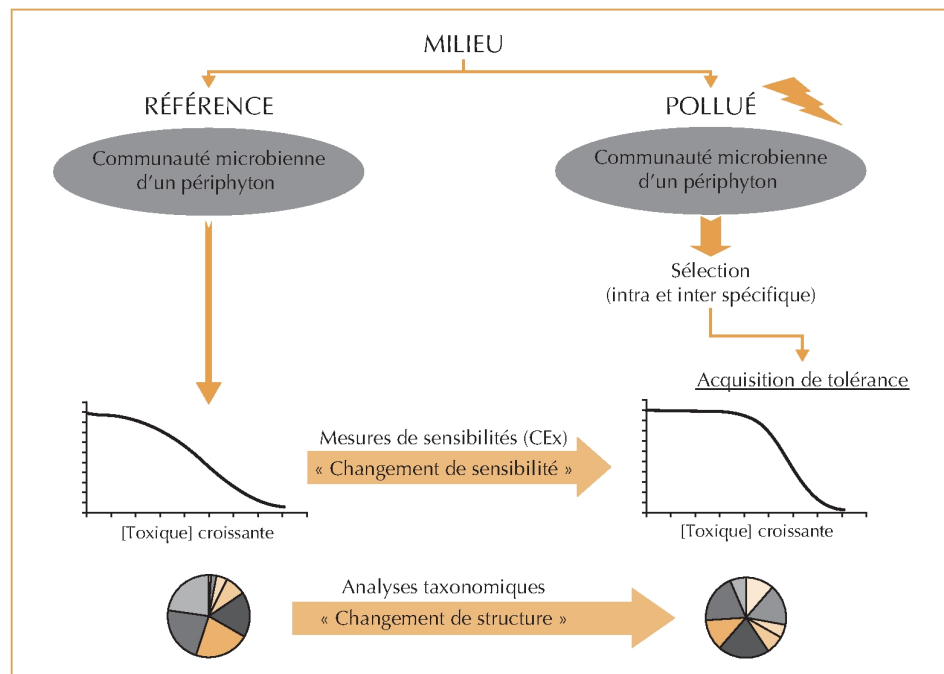

▲ Figure 9 – Le concept PICT.

lation des capacités de biodégradation de ces composés. Cette fonctionnalité concerne les micro-organismes hétérotrophes (essentiellement les bactéries et les champignons) capables de dégrader les polluants (totalement ou partiellement) en les utilisant comme source énergétique. Elle a principalement été étudiée jusqu'à présent pour des communautés provenant de sols agricoles. Les résultats obtenus lors du suivi mené sur la Morcille (figure 8) confirment que les communautés hétérotrophes de biofilms aquatiques possèdent également cette capacité d'adaptation

(Pesce *et al.*, 2009). Dans une période majeure de contamination de la Morcille (fin du printemps), le potentiel de biodégradation du diuron (allant jusqu'à la minéralisation totale du composé) par les communautés microbiennes est très élevé en zone aval et quasi nul en amont, et semble donc refléter une adaptation au niveau d'exposition à ce polluant dans le cours d'eau. Ce type d'approche fonctionnelle, ciblée sur les activités hétérotrophes de biodégradation, semble donc particulièrement bien adapté à une démarche de bio-indication.

Avantages et limites inhérents à l'utilisation des biofilms

De par son rôle écologique et sa sensibilité aux modifications environnementales, l'utilisation du biofilm comme indicateur précoce d'un stress chimique est largement admise par la communauté scientifique (Dorigo *et al.*, 2007 ; Sabater *et al.*, 2007 ; Villeneuve, 2008). Nous avons vu précédemment qu'une des étapes les plus importantes dans une démarche de bio-indication réside dans le choix des descripteurs microbiens considérés. Pour caractériser la réponse microbienne à une pollution aux pesticides, il semble nécessaire de coupler les approches structurales et fonctionnelles (Sabater *et al.*, 2007 ; Villeneuve, 2008), en ciblant des fonctions spécifiques aux molécules étudiées (ex. : activité photosynthétique pour les herbicides inhibiteurs du photosystème II, tels que le diuron). La méthode PICT se révèle donc particulièrement bien adaptée à ce type de démarche et a déjà été utilisée avec succès dans des rivières contaminées par divers pesticides (Dorigo *et al.*, 2004 ; Dorigo *et al.*, 2007 ; Sabater *et al.*, 2007). Elle présente toutefois encore quelques limites puisque les capacités de tolérance microbienne à un pesticide donné peuvent être conditionnées par des facteurs externes (autres que son seul niveau d'exposition à cette molécule), tels que le contexte nutritif ou la présence d'autres pesticides (Sabater *et al.*, 2007) qui peut engendrer des phénomènes de co-tolérance (Blanck *et al.*, 2002). Cette co-tolérance s'observe généralement en présence de molécules ayant des modes d'action comparables envers les communautés microbiennes.

Si elle n'est pas encore très développée en milieu aquatique, l'approche fonctionnelle ciblée sur les activités hétérotrophes de biodégradation des pesticides offre des perspectives prometteuses pour une démarche de bio-indication puisque ces activités sont généralement ciblées sur des molécules ou des groupes de molécules spécifiques. Elle pourrait notamment être enrichie par des mesures *in situ* d'expression de gènes codant des enzymes impliquées dans les mécanismes de dégradation (quand ils sont connus) et des études de diversité pour identifier les organismes impliqués dans ces processus.

Cependant, et quel que soit le type de descripteur utilisé, il est nécessaire d'intégrer dans une approche de type bio-indication, la variabilité naturelle du biofilm et sa sensibilité à l'ensemble des facteurs environnementaux (physiques, chimiques et biologiques) qui agissent en tant que facteurs de confusion dans l'appréciation de la réponse des communautés microbiennes aux pesticides (Dorigo *et al.*, 2009). Cette variabilité naturelle rend également difficile la comparaison inter-sites et la définition d'un état microbien de référence qui pourrait permettre de généraliser et standardiser l'utilisation des biofilms comme bio-indicateurs au sens strict du terme, sans nécessairement nécessiter la comparaison entre des communautés exposées et non exposées dans un même milieu. Il apparaît ainsi nécessaire de multiplier les études visant à hiérarchiser les effets des différents facteurs environnementaux afin d'apprécier leur réel poids dans la réponse microbienne (Villeneuve *et al.*, 2009). D'autre part, plusieurs auteurs ont récemment souligné la nécessité de développer une méthode standardisée pour l'utilisation de biofilms comme bio-indicateurs (Sabater *et al.*, 2007 ; Villeneuve, 2008). Le premier niveau de standardisation devra concerner le mode d'échantillonnage *in situ* (Sabater *et al.*, 2007 ; Dorigo *et al.*, 2009). Le questionnement devra notamment porter sur le choix de la zone de prélèvement, afin d'uniformiser au maximum les caractéristiques physiques (vitesse du courant, éclairage, profondeur...) de la section dont sont issus les différents échantillons à comparer (Dorigo *et al.*, 2009), mais également sur la nécessité ou non d'utiliser des substrats artificiels et la durée optimale de colonisation des biofilms avant analyses (Sabater *et al.*, 2007). Cette problématique a également été soulevée récemment par Morin *et al.* (2007) dans le cadre de l'utilisation des diatomées comme indicateur de qualité des eaux. Les efforts devront également être poursuivis pour améliorer la pertinence des descripteurs biologiques existants et développer de nouvelles méthodologies adaptées afin de tendre également vers une standardisation des méthodes d'analyses du biofilm (Sabater *et al.*, 2007). □

Remerciements

Cette synthèse a été réalisée dans le cadre de la coopération ONEMA⁸ -Cemagref, Action 26 « Évaluation et remédiation des effets des pesticides ».

8. Office national de l'eau et des milieux aquatiques.

Résumé

Fixés sur des substrats immergés, les biofilms microbiens assurent un rôle écologique majeur dans les petits cours d'eau. Ils interagissent avec les substances dissoutes et les contaminants (et notamment avec les pesticides) qui peuvent modifier leur structure et leur fonctionnement par des effets directs ou indirects. Les biofilms peuvent être utilisés comme indicateurs biologiques d'une pollution (bio-indicateurs) grâce à une grande variété de descripteurs microbiens, taxonomiques ou fonctionnels. Ils apportent des informations complémentaires aux indices biologiques normalisés mis en œuvre pour évaluer le bon état écologique des masses d'eau, au sens de la directive cadre sur l'eau. À partir de résultats obtenus dans une rivière située en zone viticole, nous proposons ici de discuter dans quelle mesure les biofilms permettent de comprendre l'effet des pesticides sur le fonctionnement des cours d'eau.

Abstract

Biofilms are attached microbial assemblages on immersed substrates and play a major ecological role in stream ecosystems. Biofilms interact with dissolved substances and contaminants (such as pesticides), which can directly or indirectly affect their structure and functions. A variety of taxonomic and functional microbial indicators exist for considering biofilm as biological indicators of pollution (bio-indicators). They can provide complementary information to normalized biological indices, which are used to assess the ecological status of waters, as defined by the European Water Framework Directive. Synthesizing results obtained in a river draining a vineyard area, we propose here to assess to what extent biofilms can be used to characterize pesticide effects on lotic ecosystems.

Bibliographie

- AGENCE DE L'EAU RHÔNE-MÉDITERRANÉE & CORSE, 2008, *Pesticides dans les eaux superficielles et souterraines des bassins Rhône-Méditerranée et Corse : Données 2006 et 2007, Document de synthèse*, 20 p.
- BÉRARD, A., DORIGO, U., HUMBERT, J.-F., LÉBOULANGER, C., SEGUIN, F., 2002, La méthode PICT (Pollution-Induced Community Tolerance) appliquée aux communautés algales : intérêt comme outil de diagnose et d'évaluation du risque écotoxicologique en milieu, *Annales de Limnologie*, vol. 38, p. 247-261.
- BIGGS, B.-J.-F., 1996, Patterns in benthic algae of streams, in : *Algal Ecology - Freshwater Benthic Ecosystems*, STEVENSON, R.-J., BOTHWELL, M.-L., LOWE, R.-L., p. 31-56.
- BLANCK, H., WANGBERG, S.-A., MOLANDER, S., 1998, Pollution-induced community tolerance. A new ecotoxicological tool, in : *Functional testing of aquatic biota for estimating hazards of chemicals ASTM STP 988*, CAIRNS, J., PRATT, J.-R., p. 219-230.
- BLANCK, H., 2002, A Critical Review of Procedures and Approaches Used for Assessing Pollution-Induced Community Tolerance (PICT) in Biotic Communities, *Human and Ecological Risk Assessment*, vol. 8, p. 1003-1034.
- COSTE, M., 1982, *Étude des méthodes biologiques d'appréciation quantitative de la qualité des eaux*, Rapport Q.E. Lyon A.F., Bassin Rhône-Méditerranée-Corse, Cemagref, 218 p.
- COSTANZA, R., MAGEAU, M., 1999, What is a healthy ecosystem ?, *Aquatic Ecology*, vol. 33, p. 105-115.
- DORIGO, U., BOURRAIN, X., BÉRARD, A., LÉBOULANGER, C., 2004, Seasonal changes in the sensitivity of river microalgae to atrazine and isoproturon along a contamination gradient, *The Science of the Total Environment*, vol. 318, p. 101-114.

DORIGO, U., LÉBOULANGER, C., BÉRARD, A., BOUCHEZ, A., HUMBERT, J.-F., MONTUELLE, B., 2007, Lotic biofilm community structure and pesticide tolerance along a contamination gradient in a vineyard area, *Aquatic Microbial Ecology*, vol. 50, p. 91-102.

DORIGO, U., LEFRANC, M., LÉBOULANGER, C., MONTUELLE, B., HUMBERT, J.-F., 2009, Influence of sampling strategy on the assessment of the impact of pesticides on periphytic microbial communities in a small river, *FEMS Microbial Ecology*, sous presse.

GOUY, V., NIVON, C., 2007, *Caractérisation et suivi de la qualité des eaux sur le bassin versant de la Morcille sur la période 2001-2006*, Rapport d'étude Cemagref, Chambre d'agriculture du Rhône, 59 p.

INSTITUT FRANÇAIS DE L'ENVIRONNEMENT, 2007, *Les pesticides dans les eaux : données 2005*, www.ifen.fr

MONTUELLE, B., BÉRARD, A., LAGADIC, L., CAQUET, T., 2007, Évaluation de l'impact écologique lié à la présence de pesticides dans les eaux, *Mer et Littoral, Lacs et Cours d'eau*, vol. 73, p. 40-46.

MORIN, S., COSTE, M., DELMAS, F., 2007, Substrats artificiels : dans quelle limite permettent-ils de décrire les peuplements diatomiques des cours d'eau ?, *Ingénieries-EAT*, n° 52, p. 3-12.

MOZES, N., 1995, The ways we study interfacial phenomena of living cells, in : *Adhésion des micro-organismes aux surfaces. Biofilms – Nettoyage – Désinfection*, BELLON-FONTAINE, M.-N., FOURNIAT, J., Paris, Lavoisier Tec & Doc, p. 3-13.

OTHONIEL, C., 2006, *La croissance du biofilm photosynthétique : un indicateur du statut trophique des rivières ?*, thèse de doctorat spécialité Biogéochimie de l'environnement, Université Bordeaux 1, 277 p.

PESCE, S., FAJON, C., BARDOT, C., BONNEMOY, F., PORTELLI, C., BOHATIER, J., 2006, Effects of the phenylurea herbicide diuron on natural riverine microbial communities in an experimental study, *Aquatic Toxicology*, vol. 78, p. 303-314.

PESCE, S., FAJON, C., BARDOT, C., BONNEMOY, F., PORTELLI, C., BOHATIER, J., 2008, Longitudinal changes in microbial planktonic communities of a French river in relation to pesticide and nutrient inputs, *Aquatic Toxicology*, vol. 86, p. 352-360.

PESCE, S., MARTIN-LAURENT, F., ROUARD, N., MONTUELLE, B., 2009, Potential for microbial diuron mineralisation in a small wine-growing watershed : from treated plots to lotic receiver hydrosystem, *Pest Management Science*, sous presse, doi 10.100 ps-1729.

RABIET, M., MARGOUM, C., GOUY, V., CARLUER, N., COQUERY, M., 2008, Transfert des pesticides et métaux dans un petit bassin versant viticole. Étude préliminaire de l'influence des conditions hydrologiques sur le transport de ces contaminants, *Ingénieries-EAT*, numéro spécial Azote, phosphore et pesticides. Stratégies et perspectives de réduction des flux, p. 65-75.

SABATER, S., GUASCH, H., RICART, M., ROMANÍ, A., VIDAL, G., KLÜNDER, C., SCHMITT-JANSEN, M., 2007, Monitoring the effect of chemicals on biological communities. The biofilm as an interface, *Analytical and Bioanalytical Chemistry*, vol. 387, p. 1425-1434.

TLILI, A., DORIGO, U., MONTUELLE, B., MARGOUM, C., CARLUER, N., GOUY, V., BOUCHEZ, A., BÉRARD, A., 2008, Responses of chronically contaminated biofilms to short pulses of diuron. An experimental study simulating flooding events in a small river, *Aquatic Toxicology*, vol. 87, p. 252-263.

VILLENEUVE, A., 2008, *Effets conjoints de facteurs physiques (lumière et vitesse du courant) sur la structure et la composition du périphyton : une approche multi-échelles*, thèse de doctorat spécialité Biologie des populations et des écosystèmes, Université de Savoie, 223 p.

VILLENEUVE, A., BOUCHEZ, A., MONTUELLE, B., 2009, Influence of slight differences in environmental conditions (light, hydrodynamics) on the structure and function of the periphyton, *Aquatic Sciences*, sous presse.

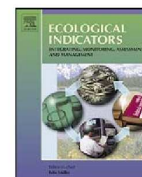

Recovery potential of periphytic communities in a river impacted by a vineyard watershed

S. Morin^{a,*}, S. Pesce^b, A. Tlili^b, M. Coste^a, B. Montuelle^b

^a Cemagref, UR REBX, 50 avenue de Verdun, F-33612 Cestas cedex, France

^b Cemagref, UR QELY, 3 bis quai Chauveau – CP 220, F-69366 Lyon, France

ARTICLE INFO

Article history:

Received 27 February 2009

Received in revised form 15 May 2009

Accepted 18 July 2009

Keywords:

River biofilms

Diatoms

Pesticides

Biological Diatom Index

Community analysis

Diuron

Recovery

ABSTRACT

Vineyard areas are important causes of water contamination, especially by pesticides and residues. These compounds can markedly disturb aquatic communities particularly photosynthetic organisms that are targeted by herbicides. Biofilms and diatoms were used as bioindicators for quality assessment in the Morcille watershed, an area impacted by Beaujolais vineyards (SE France), during the pesticide spreading period (April–May 2008). Biofilms were allowed to settle on glass slides for 4 or 8 weeks at three sites along a 7-km long gradient of trophic (mainly orthophosphate) and pesticide pollution. After a 4-week colonization, samples from the two contaminated downstream sites were transferred upstream to the clean site for 4 weeks while others were left in the same place.

In vivo fluorescence measurements indicated that the periphytic communities were dominated by diatoms. Going downstream, biofilm biomass and diatom species richness decreased; normalized diatom indices (including the French standard BDI) expressed the increase in trophic status quite well. The species composition of the assemblages was used to discriminate between the effects of nutrients and toxicants, which increased simultaneously as the river continued downstream.

The way in which the biofilm samples transferred upstream recovered was quite different depending on the location of the original site in the contamination gradient. Most of the quantitative descriptors reached a level comparable to that of the reference communities, but the diatom assemblages (cell density per surface unit, taxonomic composition) varied between dates and along the gradient. These communities did not entirely recover a reference structure but the increase in diversity, associated with the settlement of sensitive species, suggested an elevated recovery potential.

© 2009 Elsevier Ltd. All rights reserved.

1. Introduction

Aquatic life constitutes the ultimate indicator of conditions in aquatic systems, and many studies undertaken to assess the degradation of habitats and water quality have been based on key organisms (primary producers, benthic invertebrates and fishes). In particular, periphytic diatoms are widely used for monitoring purposes because of their value as indicators of organic pollution, eutrophication and acidification (the major diatom-based indices are reviewed in Prygiel et al., 1999). More recently, *in situ* surveys of toxic pollutants like heavy metals (Ivorra et al., 2002; Gold et al., 2003; Morin et al., 2008a) or pesticides (De Jonge et al., 2008; Morin et al., 2009) have provided data in favour of an extension of the application domain of diatoms indices.

Reaching a 'good ecological status' (i.e. close to reference conditions) for most surface waters by 2015, as imposed by the European Water Framework Directive (2000/60/EC), should lead to

the rehabilitation of many impacted sites. In this context, growing interest is now given to studying recovery trajectories and community resilience in aquatic environments. Due to their key ecological role in streams and rivers, studying and understanding biofilm resilience is a matter of importance. Since polluted sites are difficult to remediate and generally necessitate long-term surveillance, the assessment of the consequences of site rehabilitation on periphytic communities could be helped by rapid alternative methods. The use of translocation approaches (from up- to downstream of a point source of contamination and vice versa) has thus been proposed to provide an *in situ* assessment of the impacts on un-exposed microbenthic communities or of the resilience of chronically exposed communities after mimicking a reduction of pollution pressure by biofilm translocation (Ivorra et al., 1999; Tolcach and Gómez, 2002).

Considering the lack of knowledge about the recovery trajectory of microbenthic communities moved from contaminated sites, we propose here an *in situ* survey for studying biofilm and diatom recovery potential in the Morcille River (France) which exhibits increasing pesticide contamination with vineyard pressure (Gouy et al., 1998; Lagacherie et al., 2006; Rabiet et al., 2008),

* Corresponding author. Tel.: +33 557 892721; fax: +33 557 890801.
E-mail address: soizic.morin@cemagref.fr (S. Morin).

accompanied by an elevation in nutrients (Dorigo et al., 2007) and metals (Rabiet et al., 2008). Along this gradient, microbial biofilms differ in structure (Montuelle et al., 2006; Dorigo et al., 2007, 2009) as well as in tolerance to pesticides, notably diuron (Dorigo et al., 2007) and in diuron-mineralization potential (Pesce et al., 2009).

We studied the structural changes in assemblages induced by the transfer of periphytic communities from 2 contaminated sites on the Morcille River, respectively draining areas of 51.6 and 79% of vineyard cover, to a clean site upstream. We expected a recovery of the translocated communities, either in structure or in diversity. Biofilm biomass, diatom taxonomic composition, and commonly used indices were used to characterize their response to the gradient of agricultural contamination and to the simulated improvement of water quality.

2. Materials and methods

2.1. Location of the study sites

The translocation experiments were conducted in Spring (April and May) 2008 along the Morcille River, located in the Beaujolais vineyard area, eastern France (46.150°N, 4.600°E, belonging to national river type 3 “Massif Central sud”, Fig. 1). The Morcille River is a small first-order stream (7 km long) subjected to strong agricultural pressure, essentially exerted by vineyards that occupy almost 80% of the 8.5 km² catchment area. Three sites were selected along the gradient of increasing percentage contribution of vineyards to the catchment area: Saint-Joseph (vineyard percentage cover: 6.7%), Les Versauds (51.6%) and Saint-Ennemond (79%).

With pesticide concentrations below the quantification limits in 2007, Saint-Joseph was considered as a “clean” site, whereas total pesticide concentrations at Les Versauds and Saint-Ennemond in Spring sometimes exceeded 2 µg/L and 5 µg/L, respectively (Rabiet et al., 2008).

2.2. Stream water physicochemical characteristics of the sites

Sampling was performed in Spring 2008, during the intense pesticide application period. During the experiment, pH, electrical conductivity and dissolved oxygen were measured *in situ* (WTW, Weilheim, Germany). Water samples were taken, cooled to 4 °C and brought back to the laboratory for nutrient (bimonthly) and pesticide analyses, twice a month at Saint-Joseph and Les Versauds and mid-survey at Saint-Ennemond. Nitrite, nitrate, ammonia, orthophosphate and suspended solids concentrations were determined following French standard operating procedures and protocols (Association Française de Normalisation, AFNOR).

Using standardized protocols, the 8 most frequently found pesticides and some of their degradation products were analyzed

in the water samples by ESI-LC-MS/MS (API 4000, Applied Biosystems) at the Water Chemistry Laboratory in Cemagref (Lyon). An exhaustive, complementary, screening of 379 substances was also performed at Les Versauds on the 30th May by the Laboratoire Départemental d'Analyses de la Drôme (LDA, Valence, France).

2.3. Collection of periphytic communities

At each site, large glass slides (300 cm² area for both slides) fixed in perforated plastic boxes were used as artificial substrates allowing algal colonization. After a 4-week immersion (2 April–6 May), slides were removed (i) for collection to characterize the 4-week-old communities (3 slides per site, called “1 month April”), (ii) for a 4-week translocation to the site Saint-Joseph (2 slides per site, called “translocated slides”), and (iii) 3 slides remained for 4 more weeks at their respective sites (2 April–29 May; called “2 months”). Simultaneously, new slides were caged to characterize the 4-week-old communities settling between 6 and 29 May at the three sites (called “1 month May”).

2.4. Biofilm analyses and diatom species composition

The proportions of the different algal groups (i.e. green algae, diatoms and cyanobacteria) were estimated by *in vivo* chlorophyll *a* fluorescence measurements (Leboulanger et al., 2006) using a Phyto-PAM (Phytoplankton analyzer Phyto-PAM, Heinz Walz GmbH, Effeltrich, Germany) directly on randomly selected points of the colonized slides. Then the biofilm was scraped off each replicate slide, suspended in a standard volume of mineral water and subsampled for further analyses.

A 20-mL aliquot was used to determine the dry weight (DW) and ash-free dry mass (AFDM) of the biofilm, expressed as mg/cm². After filtration of the suspension through individual, previously dried and weighed, glass fibre filters (pore size: 1.2 µm; Sartorius, Göttingen, Germany), the samples were dried for 1 h at 105 °C for DW calculations. Then the filters were ashed at 500 °C for 1 h (Nabertherm P320 furnace) and weighed to determine the mineral content. AFDM was calculated by subtracting the mineral matter from the total dry weight.

Ten milliliters of the suspension were filtered through a Whatman GF/C filter, then extracted with acetone for 24 h before spectrophotometric analyses. Chlorophyll *a* concentrations were calculated after Lorenzen (1967).

An aliquot of 5 mL was preserved with 1 mL of formalin solution for diatom cell density enumeration and taxonomic identification. Enumeration was done from 125 µL of each preserved sample using a Nageotte counting chamber: the total number of cells counted in 10 fields (1.25 mL each, 0.5 mm depth) using light microscopy at 400× magnification (photomicroscope Leica DMRB, Wetzlar, Germany) was then recorded as cells per unit area of substrate (number of diatom cells/cm²). Subsamples assigned to taxonomic analyses were prepared according to Charles et al. (2002), i.e. digestion in boiling hydrogen peroxide (30% H₂O₂) and hydrochloric acid (35%) followed by three cycles of centrifugation of the sample and pellet rinsing with distilled water. After the last treatment, the pellet was once again resuspended in distilled water, and the suspension deposited onto coverslips then mounted onto slides after air drying, using the high refractive index (1.74) medium Naphrax (Brunel Microscopes Ltd., UK). Diatom counts were conducted at a magnification of 1000×; individual fields were scanned until at least 400 valves had been identified using taxonomic literature from central Europe (Krammer and Lange-Bertalot, 1986–1991). From the specific composition of each sample, the indices BDI v.2006 (Biological Diatom Index, Coste et al., 2009) and SPI (Specific Polluosensitivity Index, Coste in

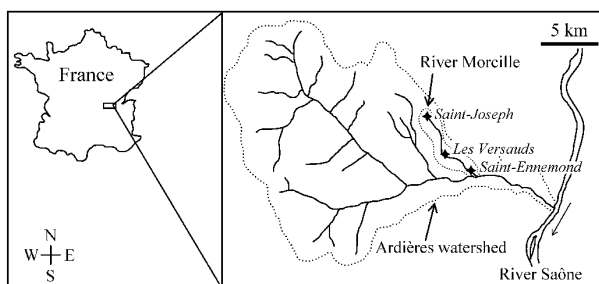

Fig. 1. Location of the study sites along the Morcille River.

Table 1

Mean values and standard errors (SE) corresponding to physical and chemical parameters of the 3 sites of the Morcille River during the experimental period (5 samplings per site, except from Saint-Ennemond where pesticides were sampled once).

Parameter	Saint-Joseph		Les Versauds		Saint-Ennemond	
	Mean	SE	Mean	SE	Mean	SE
pH	7.1	0.3	7.3	0.1	7.3	0.2
Conductivity ($\mu\text{S}/\text{cm}$)	128.8	3.6	190.9	15.5	210.5	10.9
Temperature ($^{\circ}\text{C}$)	n.m.		12.0	0.7	12.6	0.8
DOC (mg/L)	2.3	0.6	2.9	0.1	3.8	0.2
Nitrite (mg/L)	<0.02		0.030	0.005	0.059	0.011
Nitrate (mg/l)	5.9	0.2	7.5	0.3	6.5	0.4
Ammonium (mg/L)	0.07	0.05	0.05	0.01	0.07	0.01
Orthophosphate (mg/L)	0.12	0.02	0.23	0.02	0.29	0.02
Suspended solids (mg/L)	16.0	2.0	10.0	3.0	8.7	3.7
Diuron (DIU) ($\mu\text{g}/\text{L}$)	<q.l.		1.00	0.52	6.65	–
3-(3'-Dichlorophenyl)-1 methylurea (DCMU) ($\mu\text{g}/\text{L}$)	<q.l.		0.22	0.07	1.22	–
Azoxystrobin (AZS) ($\mu\text{g}/\text{L}$)	<q.l.		0.04	0.02	<q.l.	–
Tebuconazole (TBZ) ($\mu\text{g}/\text{L}$)	<q.l.		0.18	0.05	0.05	–
Dimethomorphe (DMM) ($\mu\text{g}/\text{L}$)	<q.l.		1.31	0.80	0.32	–
Procymidone (PCM) ($\mu\text{g}/\text{L}$)	<q.l.		0.09	0.01	0.18	–

n.m. not measured; q.l. quantification limit = 0.02 $\mu\text{g}/\text{L}$ for DIU and DCMU, 0.025 $\mu\text{g}/\text{L}$ for AZS, 0.04 $\mu\text{g}/\text{L}$ for DMM and TBZ, 0.08 for PCM.

Cemagref, 1982) were calculated using Ominidia software (Lecointe et al., 1993).

2.5. Data treatment

Biofilm characteristics and diatom index values were checked for normality and variance equality before analyzing the dataset using one-way ANOVA with STATISTICA software (v. 5.1, StatSoft, 1998). After having completed ANOVA, Tukey's post hoc tests were performed in order to determine which groups of data significantly differed from each other.

Non-metric multi-dimensional scaling (NMDS), an indirect ordination method based on the dissimilarities in species community structure of the samples, was performed using the labdsv package (<http://ecology.msu.montana.edu/labdsv/R/labdsv>) for the R statistical environment (Ihaka and Gentleman, 1996).

3. Results

3.1. Physical and chemical characteristics of the sites (Table 1)

During the survey, pH was quite stable over time and between sites. From up- to downstream, there was a longitudinal increase in conductivity, DOC, nitrite, orthophosphate and pesticides. Conductivity, DOC, nitrite and orthophosphate indicate the progres-

sive increase of human inhabitants from up- to downstream in the watershed and pesticides are connected to the vineyard area.

Routine analyses gave pesticide concentrations that were always below the quantification limits at Saint-Joseph; they increased downstream to reach the value of 8.4 $\mu\text{g}/\text{L}$ at Saint-Ennemond. Differences were observed between April and May at Les Versauds (1.9 $\mu\text{g}/\text{L}$ and 2.6 $\mu\text{g}/\text{L}$). The contamination of the water was mainly due to herbicides (diuron and its metabolite DCMU) and, to a lesser extent, by fungicides (azoxystrobin, dimethomorph, procymidone, tebuconazole). At the half-course of the experiment, the complementary survey performed by the LDA at Les Versauds recorded 21 substances reaching a total concentration of 8.2 $\mu\text{g}/\text{L}$, mainly herbicides (90%, data not shown). Among the compounds found were high concentrations of diuron (4.1 $\mu\text{g}/\text{L}$) as well as the substances routinely analyzed, but also the pyridazinone herbicide norflurazon (0.3 $\mu\text{g}/\text{L}$) together with its breakdown product norflurazon desmethyl (2.6 $\mu\text{g}/\text{L}$), terbumeton desethyl (0.4 $\mu\text{g}/\text{L}$) and dichlorobenzamide (0.2 $\mu\text{g}/\text{L}$).

3.2. Global descriptors of the biofilm (Table 2)

Significant differences were observed between DW ($p < 0.01$) and AFDM ($p < 0.05$) along the gradient and between April and May. Both indicators of biomass established in a 1-month period

Table 2

Mean (\pm SE) values of biofilm descriptors and diatom indices. * $p < 0.05$, ** $p < 0.01$, the superscript letters indicate statistically different groups according to the HSD Tukey test.

	Dry weight** (mg/cm^2)	Ash-free dry matter* (mg/cm^2)	Chlorophyll a** ($\mu\text{g}/\text{cm}^2$)	Cell density** (cell/cm^2)	BDI**	SPI**
<i>Colonization: 1 month (April)</i>						
Saint-Joseph	0.78 \pm 0.12 ^c	0.15 \pm 0.03 ^c	0.76 \pm 0.10 ^{a,b}	46 600 \pm 2500 ^a	15.1 \pm 0.3 ^c	16.4 \pm 0.1 ^c
Les Versauds	0.27 \pm 0.02 ^{a,b}	0.06 \pm 0.00 ^{a,b}	0.98 \pm 0.15 ^b	172 700 \pm 12 400 ^c	14.1 \pm 0.2 ^{a,b}	16.0 \pm 0.5 ^{b,c}
Saint-Ennemond	0.15 \pm 0.00 ^a	0.03 \pm 0.00 ^a	0.12 \pm 0.01 ^a	10 800 \pm 1200 ^a	13.4 \pm 0.1 ^a	14.9 \pm 0.3 ^a
<i>Colonization: 1 month (May)</i>						
Saint-Joseph	0.34 \pm 0.14 ^a	0.07 \pm 0.03 ^{a,b}	0.04 \pm 0.02 ^a	7100 \pm 1500 ^a	14.7 \pm 0.1 ^{b,c}	17.1 \pm 0.2 ^c
Les Versauds	0.26 \pm 0.04 ^{a,b}	0.06 \pm 0.01 ^{a,b}	0.04 \pm 0.00 ^a	4300 \pm 200 ^a	13.5 \pm 0.4 ^a	13.5 \pm 0.4 ^a
Saint-Ennemond	0.38 \pm 0.03 ^{a,b,c}	0.06 \pm 0.00 ^{a,b}	0.04 \pm 0.01 ^a	4200 \pm 300 ^a	11.2 \pm 0.4 ^a	9.1 \pm 0.5 ^a
<i>Colonization: 2 months</i>						
Saint-Joseph	0.57 \pm 0.03 ^{a,b,c}	0.16 \pm 0.01 ^c	0.83 \pm 0.46 ^{a,b}	122 000 \pm 20 700 ^b	14.7 \pm 0.1 ^{b,c}	17.1 \pm 0.3 ^c
Les Versauds	0.21 \pm 0.01 ^{a,b}	0.07 \pm 0.00 ^{a,b}	0.21 \pm 0.06 ^{a,b}	30 000 \pm 900 ^a	13.8 \pm 0.2 ^{a,b}	16.4 \pm 0.2 ^{b,c}
Saint-Ennemond	0.62 \pm 0.17 ^{b,c}	0.10 \pm 0.03 ^{a,b,c}	0.06 \pm 0.01 ^a	24 000 \pm 4700 ^a	13.1 \pm 0.1 ^a	13.7 \pm 0.0 ^a
<i>Translocation</i>						
Les Versauds \rightarrow Saint-Joseph	0.36 \pm 0.08 ^{a,b,c}	0.11 \pm 0.02 ^{b,c}	0.80 \pm 0.16 ^{a,b}	153 700 \pm 12 700 ^{b,c}	14.3 \pm 0.1 ^{a,b,c}	17.0 \pm 0.2 ^c
Saint-Ennemond \rightarrow Saint-Joseph	0.41 \pm 0.00 ^{a,b,c}	0.12 \pm 0.01 ^{b,c}	0.14 \pm 0.05 ^{a,b}	37 000 \pm 500 ^a	14.2 \pm 0.3 ^{a,b,c}	16.2 \pm 0.3 ^{b,c}

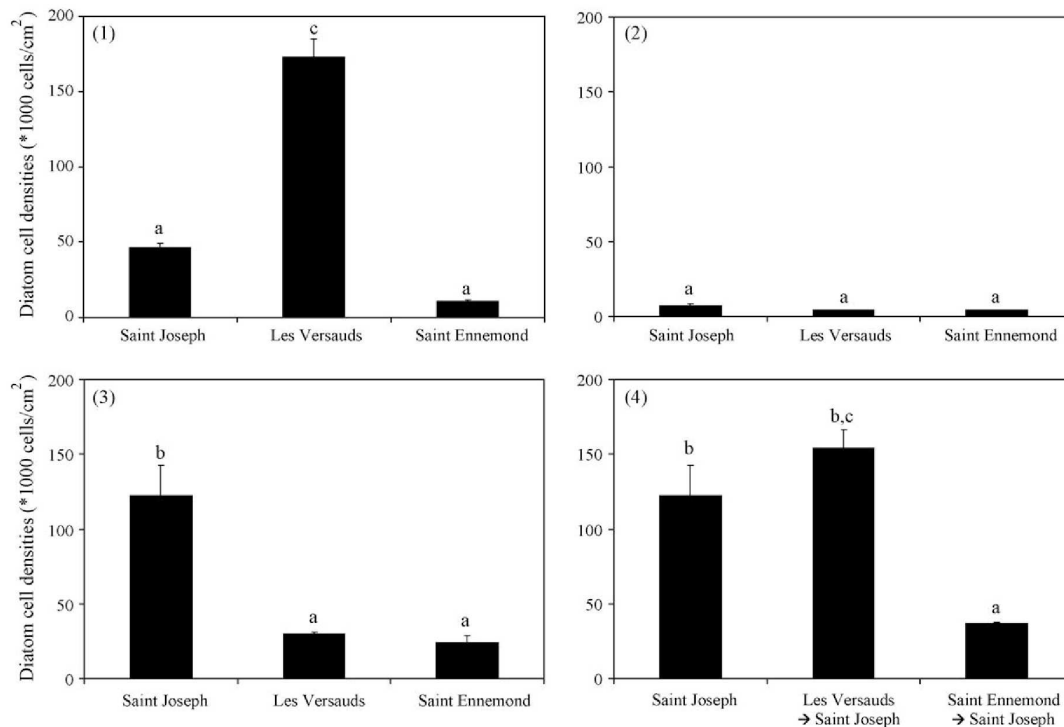

Fig. 2. Diatom cell densities corresponding to 1-month-old biofilms grown in April (1), in May (2), 2-month-old biofilms (3) and translocated biofilms (4). The letters refer to the different groups defined in Table 2.

showed a significant decrease along the gradient in April. In May DW and AFDM were lower at Saint-Joseph, and no statistical difference was observed between sites. The translocated samples presented intermediate values of biomass between Saint-Joseph and the site from which they were transferred.

The PhytoPAM measurements indicated that the biofilms were almost exclusively made up of the pigment class corresponding to diatoms (average 90% of the photosynthetic activity). Chlorophyll *a* concentrations and diatom cell densities were strongly correlated ($R^2 = 0.934$, $p < 0.01$) and their variations closely paralleled those of DW and AFDM. The cell densities after a 1-month colonization, and 2 months at the same site or after translocation, are given in Fig. 2.

3.3. Diatom communities

A total number of 120 species representing 40 genera were identified, but the assemblages were always dominated by *Planorhynchium lanceolatum* (Brébisson ex Kützing) Lange-Bertalot, this species representing about 60% of the relative abundances in all samples. From the NMDS performed using the 40 species occurring at more than 1% relative abundance in at least one sample (Fig. 3), samples presenting strong similarities in community structure were grouped.

Clear differences were observed between the assemblages collected in both April and May (noted 1m/April and 1m/May in Fig. 3). April samples from Les Versauds and Saint-Ennemond were characterized by increasing abundances of *P. lanceolatum*, *P. frequentissimum* (Lange-Bertalot) Lange-Bertalot, *Cocconeis placentula* Ehrenberg var. *placentula* and by decreasing proportions of *Achnanthes minutissimum* (Kützing) Czarnecki and *Rhoicosphenia abbreviata* (C. Agardh) Lange-Bertalot, in comparison with the communities grown at Saint-Joseph (see Table 3). In May,

higher relative abundances (in decreasing order of abundance) of *Nitzschia linearis* (Agardh) W.M. Smith var. *linearis*, *Hantzschia amphioxys* (Ehrenberg) Grunow, *Luticola cohnii* (Hilse) D.G. Mann, *Suirella angusta* Kützing and *Nitzschia palea* (Kützing) W. Smith were found downstream. The communities translocated from Saint-Ennemond to the upstream site tended to shift towards typical Saint-Joseph community structure (with higher proportions of *A. minutissimum* and *R. abbreviata*), whereas the composition of the biofilms translocated from Les Versauds did not diverge as much from the assemblages that settled in April or during the 2-month colonization.

Whatever the sampling date and the duration of colonization, BDI and SPI values decreased significantly from up- to downstream ($p < 0.01$, see Table 2). In cases of translocation, the values returned to levels comparable to those of Saint-Joseph.

4. Discussion

4.1. Potential of diatoms in the assessment of multi-contamination

The BDI (Lenoir and Coste, 1996; Coste et al., 2009) and SPI (Coste in Cemagref, 1982) indices were originally designed to assess alterations in trophic status. The values of diatom indices along the gradient for 1-month-old communities in April and May indicate the efficiency of the index for the diagnosis of trophic pollution, with significant differences between the index values along the stream (Table 2) and changes in water quality class (as defined by the WFD; good/moderate boundary: BDI = 14 for this national type and stream order) between Saint Joseph (good status), Les Versauds (good to moderate) and Saint Ennemond (moderate). This was confirmed by the organic pollution tolerance scales of the species in the assemblages. According to Lange-Bertalot (1979), larger proportions of "pollution-sensitive" species

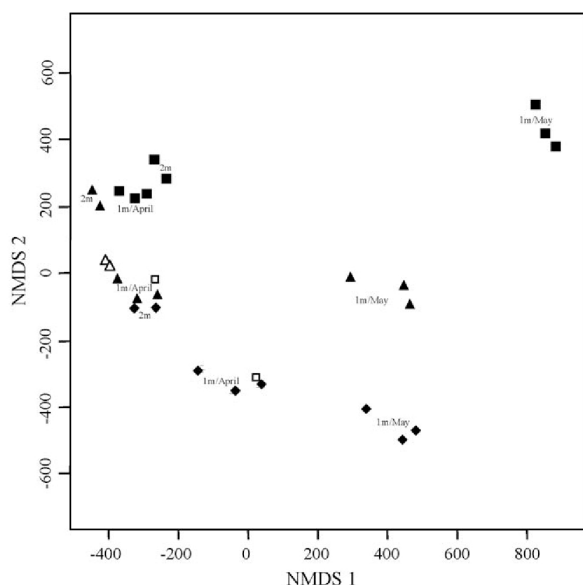

Fig. 3. Plot of the non-metric multi-dimensional scaling. (●) Saint-Joseph, (▲) Versauds, (■) Saint-Ennemond, (△) Versauds → Saint-Joseph, (□) Saint-Ennemond → Saint-Joseph. The labels refer to the colonization period (1m: 1 month, 2m: 2 months).

were found at Saint-Joseph (25.4%), as compared to Les Versauds (18.2%) or Saint-Ennemond (15.9%). Comparably, the trophic conditions as assessed by Steinberg and Schiefele's method (1988) or the saprobity state (van Dam et al., 1994), confirmed the gradient of both organic and inorganic pollution along the Morcille River with 14.1 down to 6.2% of species sensitive to trophic conditions and 8.9–16.4% of α meso- to polysaprobous species between up- and downstream. In the present context of multi-contamination (nutrients and chemicals increasing simultaneously along the gradient) of the Morcille River, it is difficult to determine whether the changes in periphytic community structure are due to effects of pesticides or to other factors like organic or inorganic nutrients. Indeed, Dorigo et al. (2007) were unable to unambiguously distinguish between the effects of nutrients and xenobiotics on the community structure of both prokaryotic and

eukaryotic microorganisms in biofilms. The shift in community structure they observed was concomitant with an increased diuron-induced tolerance, revealing that pesticide contamination was probably a major driving factor. In the present study, we prove that the BDI was able to demonstrate the specific effects of increasing trophic status along the gradient, whereas it was almost impossible for Dorigo to unequivocally explain the changes in microbial assemblages using non-taxonomic methods.

Complementary ecological information was obtained by a precise study of diatom species. Indeed, most of the taxa present in the Morcille River have already been described as metal-tolerant (Gold et al., 2002; Ivorra et al., 2002; Szabó et al., 2005; Morin et al., 2008a,b). This may result from the chronic contamination of the stream by As and Cu, already found at Saint-Joseph in significant concentrations (e.g. in Spring 2006, total As was around 4 $\mu\text{g/L}$ and total Cu around 2 $\mu\text{g/L}$, see Rabiet et al., 2008). Among the diatoms recorded, several subdominant species (e.g. *A. minutissimum*, *Eolimna minima* (Grunow) Lange-Bertalot, *Navicula lanceolata* (Agardh) Ehrenberg) found at Saint-Joseph but not downstream have already been described as pesticide-sensitive (Hamilton et al., 1987; Pérès et al., 1996; Morin et al., 2009), as well as less abundant ones like *Eunotia minor* (Kützing) Grunow in Van Heurck or *Encyonema minutum* (Hilse in Rabenhorst) D.G. Mann (Morin et al., 2009). Their extinction could not have resulted from the trophic gradient, as they are known to tolerate quite elevated organic and inorganic nutrient concentrations (van Dam et al., 1994). In contrast, some of the species that preferentially developed at Les Versauds (especially in May) and Saint-Ennemond (*P. lanceolatum*, *P. frequentissimum*, *C. placentula*) have already been recorded under herbicide concentrations >5 $\mu\text{g/L}$ (Kosinski, 1984; Pérès et al., 1996; Morin et al., 2009). To date, only few studies have provided data about diatom sensitivity or tolerance to pesticides, but substantial evidence has been given by these works in favour of diatom use for the assessment of pesticide contamination. Hamilton et al. (1988), Pérès et al. (1996) and Schmitt-Jansen and Altenburger (2005) found a remarkable decrease in diatom numbers under atrazine and isoproturon contamination. Growth inhibition of the periphytic communities exposed to pesticides has also been observed by Kasai and Hanazato (1995), Tang et al. (1997) and Leboulanger et al. (2001). However, the nature and the intensity of interactions between the various xenobiotics in this environment are quite difficult to determine precisely: antagonistic effects were observed between nutrients (favouring the development of the community) and

Table 3

Mean relative abundances of the 15 dominant species (i.e. representing more than 3% relative abundances in at least one sample).

	PTLA	RABB	ADMI	NLJN	PLFR	HAMP	SBRE	NLAN	NGRE	SANG	APED	LCOH	CPLA	NPAL	EOMI	
<i>Colonization: 1 month (April)</i>																
Saint-Joseph	42.8	4.9	14.3	1.1	5.5	–	0.1	6.6	1.8	0.1	0.6	–	0.1	0.1	1.5	
Les Versauds	51.4	0.3	13.8	0.2	11.3	–	–	1.1	1.9	0.1	1.7	–	1.4	0.1	3.6	
Saint-Ennemond	60.7	0.3	0.6	0.3	13.5	0.1	0.1	1.0	1.8	1.2	5.7	0.2	1.1	1.0	1.6	
<i>Colonization: 1 month (May)</i>																
Saint-Joseph	22.3	14.7	8.0	3.0	2.9	0.1	0.1	7.3	3.6	0.1	0.8	0.1	3.7	0.6	3.1	
Les Versauds	26.9	3.4	3.1	7.7	6.7	0.4	0.1	6.2	5.9	0.7	2.8	0.1	2.5	2.3	2.0	
Saint-Ennemond	11.0	0.7	0.4	13.9	2.0	11.2	0.6	3.5	2.9	5.8	2.4	5.6	3.6	4.5	0.8	
<i>Colonization: 2 months</i>																
Saint-Joseph	60.3	3.8	7.7	0.6	5.7	–	–	1.7	1.2	0.1	2.1	–	0.4	–	1.4	
Les Versauds	68.0	0.1	1.4	0.7	12.9	–	0.1	0.5	0.7	0.5	1.4	–	5.5	0.3	1.2	
Saint-Ennemond	57.6	0.1	0.9	2.6	9.1	2.0	7.7	0.2	1.2	0.7	1.5	2.0	5.3	0.5	1.1	
<i>Translocation</i>																
Les Versauds → Saint-Joseph	67.2	4.0	5.3	0.6	9.5	–	–	0.7	0.4	–	1.4	–	2.4	0.1	1.4	
Saint-Ennemond → Saint-Joseph	50.2	10.1	5.5	1.2	8.3	–	0.1	3.3	2.1	0.1	2.1	–	1.2	0.2	1.0	

Species abbreviations: ADMI: *Achnanthes minutissimum*, APED: *Amphora pediculus*, CPLA: *Cocconeis placentula*, EOMI: *Eolimna minima*, HAMP: *Hantzschia amphyoaxis*, LCOH: *Luticola cohni*, NGRE: *Navicula gregaria*, NLAN: *N. lanceolata*, NLJN: *Nitzschia linearis*, NPAL: *N. palea*, PLFR: *Planothidium frequentissimum*, PTLA: *Planothidium lanceolatum*, RABB: *Rhoicosphenia abbreviata*, SANG: *Surirella angusta*, SBRE: *S. brebissonii*.

toxics (drastically reducing diatom biomass) (Lozano and Pratt, 1994). An improved identification of pesticide specific effects, based on more precise indicators is needed, such as PICT approaches (Blanck et al., 1988; Dorigo et al., 2007). Globally, further studies in environments with various xenobiotic loads, in different hydro-ecoregions (*sensu* Tison et al., 2005), would be necessary to implement diatom-based indices for such pollution.

Other characteristics of diatom communities like quantitative estimates (e.g. diatom cell densities, AFDM or chlorophyll *a* as global indicators of periphytic biomass), the impacts of the toxicants were underlined (see Fig. 2 and Table 2). Finally, not only the thickness of biofilm, but also its adhesion to the substrate, differed between the sites. When scraping the glass slides, the biofilms from Les Versauds and Saint-Ennemond appeared to be much more tightly attached to the substrates than those from Saint-Joseph. This could also be considered as a response of the biofilm to pesticide exposure. Indeed, Guasch et al. (2003) demonstrated the influence of the physiognomy of the communities on their tolerance to atrazine pollution, the loosely attached algae being more sensitive than compact periphyton from the same reach.

4.2. Temporal variability of water contamination and periphytic community responses

In this study, the example of the site Les Versauds underlined the limits of spot measurements of pesticides to analyse dose/response effects. Here the bimonthly frequency of sampling is maybe not sufficient and we might have missed high contamination events, especially during floods, as described by Rabiet et al. (2008). The exhaustive pesticide analysis on this particular site by the LDA also proved that a wider range of chemicals should be tested to assess the diatoms exposure to the toxics. In particular, the high concentrations of norflurazon desmethyl that were measured should be considered: no data are available in the literature concerning its effect on biofilms, but its parent compound norflurazon has been previously shown to affect the growth of freshwater benthic algal species (Blanck et al., 1984). For these reasons, we were not able to characterize precisely the real exposure of benthic microorganisms.

However, the assemblages developed at Les Versauds in April and May were quite different in terms of community structure and SPI values, diatom cell densities and even chlorophyll *a* concentrations. The decrease of these last estimates in May suggests that pesticide contamination, which only increased slightly from April (average total pesticides: 5.7 µg/L) to May (7.5 µg/L), reached a threshold above which the effect became noticeable. As nutrient availability has been shown to mitigate the effects of toxicants (Lozano and Pratt, 1994), the trophic level is likely to reduce the sensitivity of the biofilms towards xenobiotics, until contamination reaches a critical level. It is difficult to establish whether the increase in trophic level affects sensitivity by interfering with the bioavailability of the toxicant, or by protecting the algae in some way from herbicide exposure. The shift in diatom community structure from up- to downstream may partly contribute to a protective effect towards contamination. Guasch et al. (1998) underlined the fact that the diatom taxa occurring under different levels of eutrophication have different sensitivities to pesticides, which can be linked to species' tolerance to high trophic levels, but also to physiological and structural parameters of the biofilms. Inverse correlations also occur between the sensitivity to toxicants and biomass accrual (age, succession stage as well as thickness) (e.g. Sabater et al., 2007), but environmental factors like irradiance are important as well (Guasch et al., 1997).

Assuming that pesticide contamination was too low in April would also mean that the translocation experiment of the

communities was probably done too prematurely in the pesticide treatment season, so the periphytic communities of Les Versauds and Saint-Ennemond had not had the time to adapt to the prevailing levels of pesticides. The dramatic cell loss between 1-month-old (April) samples and 2-month-old biofilms could be the result of this increase in pesticide contamination, but other processes could have taken place simultaneously, such as suspended sediment scour (Francoeur and Biggs, 2006) or self-generated detachment (Boulêtreau et al., 2006) due to senescence, especially in the context of the Morcille River where discharge can undergo great variations. However, the use of artificial, caged samplers that decreased local flow velocity (divided 10 times inside the plastic racks) may have severely limited the abrasive effects of the current.

4.3. Recovery potential of diatom assemblages

The samples transferred from Les Versauds and Saint-Ennemond to the upstream site recovered at different rates, particularly depending on the descriptors taken into consideration. Most of the quantitative parameters (DW, AFDM, chlorophyll *a*) of the translocated biofilms showed rapid recovery, with values close to those of Saint-Joseph after a 2-month colonization. Using the cell density data, the samples originating from the less contaminated Les Versauds site proved to have quicker recovery trajectories than those transferred from Saint-Ennemond.

The intermediate values of BDI for the translocated biofilms between Saint-Joseph and the downstream sites, as well as the shift in diatom community structure towards the "reference" assemblages, indicate the occurrence of a recovery process. However, recovery was not attained within 1 month and a longer translocation time would be necessary. Dorigo et al. (unpublished data) observed that translocation over comparable periods of time was too short to recover a reference community structure analyzed by molecular finger print (PCR-DGGE), whether for eukaryote or for prokaryote assemblages. They also found with PICT assays, in the transferred biofilms, EC50 values intermediate between those obtained with up- and downstream biofilms. This seemed to indicate the persistence of a toxic pressure. It was shown that detectable concentrations of xenobiotics were still adsorbed in the biofilms even after several weeks of translocation, which would have affected the cells exposed to this residual internal contamination. Ivorra et al. (1999) and Dorigo et al. (unpublished data) have in fact demonstrated that transferred biofilms did not completely release metals accumulated after 2–9 weeks of translocation to a new environment. We cannot exclude that such accumulations are possible with pesticides, but in their attempt to measure diuron accumulation in biofilms from the Morcille River, Tlili et al. (2008) did not observe any accumulation of pesticide within the matrix. They hypothesized that the sorption depended on the physicochemical properties of the chemical (log Kow) or that accumulation was followed by rapid release from the biofilm to the water phase when replaced in uncontaminated water.

Whatever the age of the biofilms, immigration and emigration of diatoms play an important role in diatom accumulation (Stevenson and Peterson, 1989; Stevenson and Peterson, 1991), and certainly took place in our translocation experiment. Therefore, the trajectories of structure assemblage recovery observed in the present study are partly due to immigration and emigration of species and not only to the new water conditions. At Saint-Ennemond in particular, diatom cell densities in April were outstandingly low and 3-fold higher after translocation with higher proportions of the rapid colonizer *A. minutissimum* (that was rather found in Saint-Joseph). In this case, immigration may have prevailed over multiplication rates of pre-established species in the process of translocated community development.

Complementary experiments are needed to assess the real importance of cell import and export in the evolution of diatom community structure. However, especially in the context of small rivers like the Morcille River the effects of diatom immigration and emigration cannot be dissociated from the recovery potential of the ecosystem. Indeed, as the distance between the up- and downstream sites is no longer than 7 km, an improvement of the water physicochemical quality following stream restoration associated to the drift of species usually found upstream, would probably result in comparable shifts in community structure as observed by our translocation experiment.

Acknowledgements

The authors would like to thank Muriel Bonnet, Maryse Boudigues, Bernard Motte and Luc Fiat for their technical assistance, the Water Chemistry Laboratory of the Cemagref in Lyon for pesticide and nutrient analysis and Sébastien Boutry for performing the statistical analysis. This study was partly funded by the Cemagref "PestExpo" program and carried out in the frame of the "Rhône Basin" Long-Term Ecological Research (LTER).

References

- Blanck, H., Wallin, G., Wängberg, S.A., 1984. Species-dependent variation in algal sensitivity to chemical compounds. *Ecotoxicol. Environ. Saf.* 8, 339–351.
- Blanck, H., Wängberg, S.A., Molander, S., 1988. Pollution-induced community tolerance—a new ecotoxicological tool. In: Cairns, J., Pratt, J.R. (Eds.), *Functional Testing of Aquatic Biota for Estimating Hazards of Chemicals*. Philadelphia, pp. 219–230.
- Boulétreau, S., Garabétian, F., Sauvage, S., Sánchez-Pérez, J.-M., 2006. Assessing the importance of a self-generated detachment process in river biofilm models. *Freshwat. Biol.* 51, 901–912.
- Cemagref, 1982. Etude des méthodes biologiques d'appréciation quantitative de la qualité des eaux. In: Rapport, Q.E., Lyon, A.F. (Eds.), *Bassin Rhône-Méditerranée-Corse*, p. 218.
- Charles, D.F., Knowles, C., Davies, R.S., 2002. Protocols for the analysis of algal samples collected as part of the U.S. In: *Geological Survey National Water-Quality Assessment Program*. Patrick Center for Environmental Research, The Academy of Natural Sciences, Philadelphia, p. 124.
- Coste, M., Boutry, S., Tison-Rosebery, J., Delmas, F., 2009. Improvements of the Biological Diatom Index (BDI): description and efficiency of the new version (BDI-2006). *Ecol. Indicators* 9, 621–650.
- De Jonge, M., Van de Vijver, B., Blust, R., Bervoets, L., 2008. Responses of aquatic organisms to metal pollution in a lowland river in Flanders: a comparison of diatoms and macroinvertebrates. *Sci. Total Environ.* 407, 615–629.
- Dorigo, U., Leboulanger, C., Bérard, A., Bouchez, A., Humbert, J.F., Montuelle, B., 2007. Lotic biofilm community structure and pesticide tolerance along a contamination gradient in a vineyard area. *Aquat. Microb. Ecol.* 50, 91–102.
- Dorigo, U., Lefranc, M., Leboulanger, C., Montuelle, B., Humbert, J.F., 2009. Spatial heterogeneity of periphytic microbial communities in a small pesticide-polluted river. *FEMS Microbiol. Ecol.* 67, 491–501.
- Francoeur, S.N., Biggs, B.J.F., 2006. Short-term effects of elevated velocity and sediment abrasion on benthic algal communities. *Hydrobiologia* 561, 59–69.
- Gold, C., Feurtet-Mazel, A., Coste, M., Boudou, A., 2002. Field transfer of periphytic diatom communities to assess short-term structural effects of metals (Cd, Zn) in rivers. *Water Res.* 36, 3654–3664.
- Gold, C., Feurtet-Mazel, A., Coste, M., Boudou, A., 2003. Impacts of Cd and Zn on the development of periphytic diatom communities in artificial streams located along a river pollution gradient. *Arch. Environ. Contam. Toxicol.* 44, 189–197.
- Gouy, V., Gril, J.J., Laillet, B., Garon-Boucher, C., Dubernet, F., Cann, C., 1998. Suivi du transfert des produits phytosanitaires sur les bassins versants et exemple de modélisation globale. *Ingénieries* 13, 3–14.
- Guasch, H., Muñoz, I., Rosés, N., Sabater, S., 1997. Changes in atrazine toxicity throughout succession of stream periphyton communities. *J. Appl. Phycol.* 9, 132–146.
- Guasch, H., Ivorra, N., Lehmann, V., Paulsson, M., Real, M., Sabater, S., 1998. Community composition and sensitivity of periphyton to atrazine in flowing waters: the role of environmental factors. *J. Appl. Phycol.* 10, 203–213.
- Guasch, H., Admiraal, W., Sabater, S., 2003. Contrasting effects of organic and inorganic toxicants on freshwater periphyton. *Aquat. Toxicol.* 64, 165–175.
- Hamilton, P.B., Jackson, G.S., Kaushik, N.K., Solomon, K.R., 1987. The impact of atrazine on lake periphyton communities, including carbon uptake dynamics using track autoradiography. *Environ. Pollut.* 46, 83–103.
- Hamilton, P.B., Jackson, G.S., Kaushik, N.K., Solomon, K.R., Stephenson, G.L., 1988. The impact of two applications of atrazine on the plankton communities of *in situ* enclosures. *Aquat. Toxicol.* 13, 123–140.
- Ihaka, R., Gentleman, R., 1996. R: A language for data analysis and graphics. *J. Comput. Graph. Stat.* 5, 299–314.
- Ivorra, N., Hettelaar, J., Kraak, M.H.S., Sabater, S., Admiraal, W., 2002. Responses of biofilms to combined nutrient and metal exposure. *Environ. Toxicol. Chem.* 21, 626–632.
- Ivorra, N., Hettelaar, J., Tubbing, G.M.J., Kraak, M.H.S., Sabater, S., Admiraal, W., 1999. Translocation of microbenthic algal assemblages used for *in situ* analysis of metal pollution in rivers. *Arch. Environ. Contam. Toxicol.* 37, 19–28.
- Kasai, F., Hanazato, T., 1995. Effects of the triazine herbicide, simetryn, on freshwater plankton communities in experimental ponds. *Environ. Pollut.* 89, 197–202.
- Kosinski, R.J., 1984. The effect of terrestrial herbicides on the community structure of stream periphyton. *Environ. Pollut. Ser. A: Ecol. Biol.* 36, 165–189.
- Krammer, K., Lange-Bertalot, H., 1986–1991. *Bacillariophyceae* 1. Teil: Naviculaceae. 876 p.; 2. Teil: Bacillariaceae, Epithemiaceae, Surirellaceae, 596 p.; 3. Teil: Centrales, Fragilariaceae, Eunotiaceae, 576 p.; 4. Teil: Achmanthaceae. *Kritische Ergänzungen zu Navicula (Lineolatae) und Gomphonema*. G. Fischer Verlag, Stuttgart, 437 p.
- Lagacherie, P., Diot, O., Domange, N., Gouy, V., Floure, C., Kao, C., Moussa, R., Robbez-Masson, J.M., Szeleper, V., 2006. An indicator approach for describing the spatial variability of artificial stream networks with regard to herbicide pollution in cultivated watersheds. *Ecol. Indicators* 6, 265–279.
- Lange-Bertalot, H., 1979. Pollution tolerance of diatoms as a criterion for water quality estimation. *Nova Hedw.* 64, 285–304.
- Leboulanger, C., Quiblier, C., Dufour, P., 2006. Rapid assessment of multiple-limiting factors of phytoplankton biomass: bioassays, *in vivo* chlorophyll-a fluorescence, and factorial design. *Arch. Hydrobiol.* 166, 433–451.
- Leboulanger, C., Rimet, F., Heme de Lacotte, M., Bérard, A., 2001. Effects of atrazine and nicosulfuron on freshwater microalgae. *Environ. Int.* 26, 131–135.
- Lecointe, C., Coste, M., Prygiel, J., 1993. Omnidia—software for taxonomy, calculation of diatom indices and inventories management. *Hydrobiologia* 269/270, 509–513.
- Lenoir, A., Coste, M., 1996. Development of a practical diatom index of overall water quality applicable to the French national water Board network. In: Whitton, B.A., Rott, E. (Eds.), *Use of Algae for Monitoring Rivers II*. Studia Student. G.m.b.H., Innsbruck, Austria, pp. 29–43.
- Lorenzen, C.J., 1967. Determination of chlorophyll and pheopigments: spectrophotometric equations. *Limnol. Oceanogr.* 12, 343–346.
- Lozano, R.B., Pratt, J.R., 1994. Interaction of toxicants and communities—the role of nutrients. *Environ. Toxicol. Chem.* 13, 361–368.
- Montuelle, B., Gouy, V., Roger, M.C., Margoum, C., Besson, M., Guillard, C., Chovelon, J.M., Devaux, A., Durrieux, C., Tran Minh, C., Gillet, C., Leboulanger, C., Faure, R., Herbretau, B., Marote, P., Clemens, A., 2006. Evaluation de gains biologique et écologique associés à une réduction d'intrants polluants en milieu aquatique. In: *Rapport Final Cemagref - CPER 2003–2006, Région Rhône Alpes*. Cemagref, Fresnes.
- Morin, S., Bottin, M., Mazzella, N., Macary, F., Delmas, F., Winterton, P., Coste, M., 2009. Linking diatom community structure to pesticide input as evaluated through a spatial contamination potential (Phytopixal): a case study in the Neste system (South-West France). *Aquat. Toxicol.* 94, 28–39.
- Morin, S., Duong, T.T., Dabrin, A., Coynel, A., Herlory, O., Baudrimont, M., Delmas, F., Durrieux, G., Schäfer, J., Winterton, P., Blanc, G., Coste, M., 2008a. Long term survey of heavy metal pollution, biofilm contamination and diatom community structure in the Riou-Mort watershed, South West France. *Environ. Pollut.* 151, 532–542.
- Morin, S., Duong, T.T., Herlory, O., Feurtet-Mazel, A., Coste, M., 2008b. Cadmium toxicity and bioaccumulation in freshwater biofilms. *Arch. Environ. Contam. Toxicol.* 54, 173–186.
- Péres, F., Florin, D., Grollier, T., Feurtet-Mazel, A., Coste, M., Ribeyre, F., Ricard, M., Boudou, A., 1996. Effects of the phenylurea herbicide isoproturon on periphytic diatom communities in freshwater indoor microcosm. *Environ. Pollut.* 94, 141–152.
- Pesce, S., Martin-Laurent, F., Rouard, N., Montuelle, B., 2009. Potential for microbial diuron mineralisation in a small wine-growing watershed: from treated plots to lotic receiver hydrosystem. *Pest. Manag. Sci.* 65, 651–657.
- Prygiel, J., Coste, M., Bukowska, J., 1999. Review of the major diatom-based techniques for the quality assessment in rivers – state of the art in Europe. In: Prygiel, J., Whitton, B.A., Bukowska, J. (Eds.), *Use of Algae for Monitoring Rivers*, vol. III. Agence de l'Eau Artois-Picardie, pp. 224–238.
- Rabiet, M., Margoum, C., Gouy, V., Carlier, N., Coquery, M., 2008. Transfert des pesticides et métaux dans un petit bassin versant viticole. Étude préliminaire de l'influence des conditions hydrologiques sur le transport de ces contaminants. In: *Ingénieries Special issue "Azote, phosphore et pesticides Stratégies et perspectives de réduction des flux"*, pp. 65–75.
- Sabater, S., Guasch, H., Ricart, M., Romani, A., Vidal, G., Klünder, C., Schmitt-Jansen, M., 2007. Monitoring the effect of chemicals on biological communities. The biofilm as an interface. *Anal. Bioanal. Chem.* 387, 1425–1434.
- Schmitt-Jansen, M., Altenburger, R., 2005. Toxic effects of isoproturon on periphyton communities—a microcosm study. *Estuar. Coast. Shelf Sci.* 62, 539–545.
- Steinberg, C., Schiefele, S., 1988. Biological indication of trophy and pollution of running waters. *Z. Wasser Abwasser Forsch.* 21, 227–234.

- Stevenson, R.J., Peterson, C.G., 1989. Variation in benthic diatom (Bacillariophyceae) immigration with habitat characteristics and cell morphology. *J. Phycol.* 25, 120–129.
- Stevenson, R.J., Peterson, C.G., 1991. Emigration and immigration can be important determinants of benthic diatom assemblages in streams. *Freshwat. Biol.* 26, 279–294.
- Szabó, K., Kiss, K.T., Taba, G., Ács, É., 2005. Epiphytic diatoms of the Tisza River. Kisköre Reservoir and some oxbows of the Tisza River after the cyanide and heavy metal pollution in 2000. *Acta Bot. Croat.* 64, 1–46.
- Tang, J.X., Hoagland, K.D., Siegfried, B.D., 1997. Differential toxicity of atrazine to selected freshwater algae. *Bull. Environ. Contam. Toxicol.* 59, 631–637.
- Tison, J., Park, Y.S., Coste, M., Wasson, J.G., Ector, L., Rimet, F., Delmas, F., 2005. Typology of diatom communities and the influence of hydro-ecoregions: A study on the French hydrosystem scale. *Water Res.* 39, 3177–3188.
- Tlili, A., Dorigo, U., Montuelle, B., Margoum, C., Carlier, N., Gouy, V., Bouchez, A., Bérard, A., 2008. Responses of chronically contaminated biofilms to short pulses of diuron. An experimental study simulating flooding events in a small river. *Aquat. Toxicol.* 87, 252–263.
- Tolcach, E.R., Gómez, N., 2002. The effect of translocation of microbenthic communities in a polluted lowland stream. *Verh. Internat. Verein. Limnol.* 28, 254–258.
- van Dam, H., Mertens, A., Sinkeldam, J., 1994. A coded checklist and ecological indicator values of freshwater diatoms from the Netherlands. *Neth. J. Aquat. Ecol.* 28, 117–133.

The periphyton as a multimetric bioindicator for assessing the impact of land use on rivers: an overview of the Ardières-Morcille experimental watershed (France)

B. Montuelle · U. Dorigo · A. Bérard ·
B. Volat · A. Bouchez · A. Tlili · V. Gouy ·
S. Pesce

Received: 28 July 2009 / Accepted: 18 January 2010 / Published online: 4 February 2010
© Springer Science+Business Media B.V. 2010

Abstract Developing new biological indicators for monitoring toxic substances is a major environmental challenge. Intensive agricultural areas are generally pesticide-dependent and generate water pollution due to transfer of pesticide residues through spray-drift, run-off and leaching. The ecological effects of these pollutants in aquatic ecosystems are broad-ranging owing to the variety of substances present (herbicides, fungicides, insecticides, etc.). Biofilms (or periphyton) are considered to be early warning systems for contamination detection and their ability to reveal effects of pollutants led researchers to propose a variety of methods to detect and assess the impact of pesticides. The present article sought to provide new insights into the ecological significance of biofilm

microbial communities and to discuss their bioindication potential for water quality and land use by reporting on 4 years of research performed on the French Ardières-Morcille experimental watershed (AMEW). Various biological indicators have been applied during several surveys on AMEW, allowing the characterisation of (i) the structure and diversity of biofilm communities [community level finger printing (CLFP) such as PCR–DGGE and pigment classes], (ii) functions associated with biofilm [community level physiological profiles (CLPP) such as extracellular enzymes, pesticides biodegradation or carbon sources biodegradation] and (iii) biofilm tolerance assessment (pollution-induced community tolerance, PICT) of the main contaminant in the AMEW (copper and diuron). Approaches based on CLFPs and PICT were consistent with each other and indicated the upstream–downstream impact due to the increasing land use by vineyards and the adaptation of algal and bacterial communities to the pollution gradient. CLPPs gave a contrasted bioindication because some parameters (most of the tested extracellular enzymes activities) did not detect a pollution gradient. Such CLPPs, CLFPs and PICT methods applied to biofilm could constitute the basis for a relevant in situ assessment both for chemical effects and aquatic ecosystem resilience.

Guest editors: R. J. Stevenson, S. Sabater / Global Change and River Ecosystems – Implications for Structure, Function and Ecosystem Services

B. Montuelle (✉) · B. Volat · A. Tlili ·
V. Gouy · S. Pesce
Cemagref, UR MALY, 3 quai Chauveau CP220,
Lyon 69336 Cedex 09, France
e-mail: bernard.montuelle@cemagref.fr

U. Dorigo · A. Bouchez
INRA UMR CARRTEL, Laboratoire RITOXE, BP 511,
74203 Thonon Cedex, France

A. Bérard
INRA, UMR INRA/UAPV Climat Sol Environnement,
Site Agroparc, 84914 Avignon Cedex, France

Keywords Biofilms · River · Biological indication · Pollution · Community level physiological profile · Finger prints · Pollution-induced community tolerance

Introduction

In setting objectives for achieving a 'good ecological status' for aquatic systems, the European Water Framework Directive (WFD 2000/60/EC) has raised numerous scientific questions: What is a 'good ecological status'? How can we improve the chemical and biological quality of aquatic environments? Some authors doubt that these objectives can be reached for priority substances or persistent organic pollutants (Fuerhacker, 2009). This aim requires in particular being able to identify causal relationships between contaminants and biological effects: a difficult task in situ, because of multiple co-occurring pollutants and confounding factors, etc. Bioindicators supporting French and European legislation (invertebrates, fishes macrophytes and diatoms) have been defined to characterise trophic pressure: the macrophytes biological index for rivers (Haury et al., 2006), the biological diatom index (BDI) (Lenoir and Coste, 1996) and the standardised global biological index (AFNOR NF T 90 350, 2004). These three standardised indicators are used to evaluate water quality in France. However, much research work is in progress to design or propose new bioindicators appropriate for toxic substances or newly emerging contaminants like drugs and hormones, to allow early warning of such pollution.

In low-order streams (Strahler order below 3 or 4) draining rural watersheds, domestic and agricultural discharges often result in eutrophication (N and P inputs) and toxic contamination through point or diffuse pollution (e.g. pesticides). Because of the generally low dilution in small rivers, such discharges may temporarily or permanently impair biodiversity and dynamics in aquatic ecosystems. Intensive agricultural areas that are generally pesticide-dependent generate water pollution due to transfer of organic or mineral pesticide residues through spray-drift, run-off and leaching (Landry et al., 2004; Vu et al., 2006). Their ecological effects in aquatic ecosystems are broad-ranging owing to the variety of substances present (herbicides, fungicides, insecticides, etc.) (DeLorenzo et al., 2001).

In small aquatic systems, trophic webs are generally reduced and most microorganisms live on submerged substrates such as biofilms (periphyton). These biofilms are complex assemblies of microbial communities embedded in a polysaccharide and protein matrix.

In such environments, living organisms, both prokaryotic (bacteria) and eukaryotic (mostly microalgae, but also fungi), interact strongly (Rier & Stevenson, 2002; Barranguet et al., 2003) and are responsible for most of the energy input through primary production and nutrient cycling (Battin et al., 2003a, b). They play a marked ecological role in biochemical processes such as organic matter degradation (Romani et al., 2004) or nitrogen biotransformation (Teissier & Torre, 2002).

The ability of biofilms to reveal the effect of pollutants has been the subject of research for some years (Admiraal et al., 1999; Sabater, 2000). As reviewed by Sabater et al. (2007), there is a variety of current methods to detect and assess the impact of pesticides on functional and structural targets, and periphyton is considered as an early warning system for contamination detection. Benthic algae have been the subject of a great deal of work in this area, based on taxonomy (e.g. diatoms: Stevenson & Pan, 1999; Gold et al., 2003; Morin et al., 2007), algal pigments or their photosynthetic capacity (Dorigo et al., 2007; Schmitt-Jansen & Altenburger, 2008; Villeneuve, 2008). Conversely, little work has been published on periphytic bacterial communities (Lyautey et al., 2003; Pesce et al., 2006, 2008; Dorigo et al., 2007, 2009). The ability of microbenthic communities to adapt to pollutants (short generation time, high taxonomic and functional diversity) has produced the concept of pollution-induced community tolerance (PICT; Blanck et al., 1988). PICT is based on the principle that an ecosystem in contact with a toxicant results in changes at the community level due to various toxicant-induced phenomena. These latter include individual acclimation, physiological or genetic adaptation, and loss of sensitive species. Overall, this adaptation results in a lowered sensitivity to this contaminant and higher effective concentration (EC_x) values. This approach has already been successfully applied to evaluating the tolerance of algal communities to pesticides (Dorigo et al., 2004; Bérard et al., 2003) and of bacterial communities to metals (Boivin et al., 2005), demonstrating upstream–downstream gradients in a wine-growing drainage basin (Dorigo et al., 2007; Pesce et al., 2010) and differentiating between chronic and acute effects (Tlili et al., 2008). Such methods, associated with molecular tools for biodiversity studies, have lent new perspectives to bioindication based on microbial communities. These methods allow a better understanding

of ecological responses of rivers, as global change effects are often confused because of the complexity of interactions among anthropic drivers acting on a mosaic of natural hydrogeomorphological and climatic settings. With this aim, the work reported here sought to provide new insight into the ecological significance of benthic microbial communities (biofilms), and discuss their bioindication potential for water quality and land use. We report here on 4 years of research performed on the French Ardières-Morcille experimental watershed (AMEW) (part of the Rhône Basin long-term ecological research watershed <http://www.graie.org/zabr/index.tm>). Several chemical and biological surveys were carried out to give a comprehensive overview of the microbial dynamics in play along this impacted river and to provide tools for assessing the effects of intense agriculture (as a particular element of global change) on freshwater ecological services.

Materials and methods

Field site and sampling

The Morcille River is located in the Beaujolais wine-growing area of eastern France (46.150°N, 4.600°E). Its watershed consists of three nested sub-watersheds (Fig. 1), defined by three sampling stations: St Joseph, Versauds and St Ennemond (upstream to downstream). In this region, which is characterised by an intensive wine-producing activity (vineyards occupy 79% of the catchment area), the routine application of pesticides to the vineyards generates a pesticide contamination gradient from the upstream section of the river down to its mouth (Collectif, 2008).

Most of the samples analysed and discussed here were taken in 2007 except for CLLP measurements (2009). Other surveys with some of these parameters and with specific objectives were performed between 2006 and 2009 (cf. Dorigo et al., 2007, 2009; Tlili et al., 2008; Rabiet et al., 2008; Pesce et al., 2009a, b, 2010; Villeneuve et al., 2010).

Physical characteristics and land use

General characteristics of the soils, slopes, crops and climate were acquired through various sources such as the 1: 25,000 topographical map of IGN (French

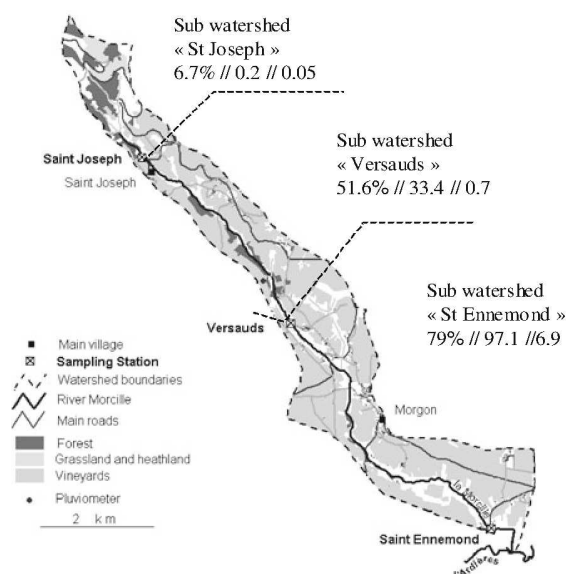

Fig. 1 GIS of Morcille watershed and its three sub-basins with the main land uses. Data indicate, respectively: vineyard area as % of sub-basin surface/length of ditches connected to the river (km)/surface area of housing (ha)

Institute of Geography), a digitized map of the agricultural field boundaries, soil maps, local measurements of soil characteristics, rainfall and water flow and field identification of the main surface water pathways from the plots to the stream, especially the numerous ditches originally dug to limit erosion. Complementary inquiries among the farmers with the support of agricultural advisers (Chambre d'Agriculture du Rhône) were compiled to make an inventory of the commonly used pesticides and periods of application.

Chemistry

Chemical variables were regularly analysed in the course of annual surveys. The data presented here are those from 2007 and are typical of the water chemical quality of the river Morcille ($n = 33$ for pesticides, $n = 33$ for metals and $n = 45$ for nutrients).

Nutrients

DOC, NO_2^- , NO_3^- , NH_4^+ , PO_4^{3-} , conductivity and pH were analysed using French standard operating procedures and protocols (Association Française de Normalisation, AFNOR).

Pesticides

Using standardised protocols, the eight most frequently found pesticides and some of their degradation products were analysed in the water samples by ESI–LC–MS/MS (API 4000, Applied Biosystems) at the Water Chemistry Laboratory in Cemagref (Lyon). The herbicide diuron together with two of its breakdown products (DCPMU and 3,4-DCA) and fungicides azoxystrobin, carbendazim, tebuconazole, procymidone and dimetomorph were analysed and quantified. The quantification thresholds of the method ranged between 0.02 and 0.08 $\mu\text{g/l}$ according to the compound analysed.

Metals

Cu and As were analysed by filtration on PVDF membrane (0.2 μm), and then acidification with HNO_3 SUPRAPUR 0.5%. The analyses were performed by ICP-MS (THERMO ELECTRON X7 Series 2) to meet the standard NF EN ISO 17294-2. The quantification threshold was 0.05 $\mu\text{g/l}$ for both compounds.

Biological variables

Biofilms were generally sampled on non-embedded stones (diameter 1–4 cm) in the river bottom, but artificial substrata in the form of glass discs immersed in the river Morcille for 8 weeks were also used for PCR–DGGE and pigment analysis. Sample triplicates were made and several microbial variables were measured to describe the biological and functional quality of the periphyton and its responses to changes in the chemical quality of the river water. All the measurements were made on periphyton suspensions after scraping and dilution in 0.2 μm filtered river water.

Biomass

Periphytic biomass was evaluated by calculating ash-free dry weight (AFDW). Suspensions (2 ml) of biofilm replicates were filtered through individual, previously dried, 25 mm CF/C Whatman glass fibre filters (pore size 1.2 μm). Each filter was dried for 24 h at 105°C and weighed to calculate dry matter.

The filters were then burned to ash at 480°C (Nabertherm P320) for 1 h and weighed again. The AFDW was calculated by subtracting the mineral matter from the total dry matter. Results were expressed in g m^{-2} .

Community level finger printing: pigment analysis

For each biofilm sample, one glass disc was placed in a centrifuge tube (Corning) containing 4 ml of methanol/0.5 M ammonium acetate (98/2 v/v) solution and sonicated by means of a 4 mm probe for 1 min at 180 W and at 50% activity (Vibracell, Bioblock Scientific 375W). The tubes were then centrifuged for 6 min at $6\times g$ and 0°C. The supernatant was collected and filtered through a 0.2 μm filter syringe (Cameo 3N-syringe nylon filter; Micron Separation Inc.); 100 μl of this extract was injected to determine the lipophilic pigment composition by high pressure liquid chromatography. Pigments were separated on a 4.6 \times 250 mm column (Waters Spherisorb ODS5 25 μm) and identified from retention time and absorption spectrum using DAD according to SCOR.

Chlorophyll *a* can be considered as a proxy of the total periphyton biomass beside the AFDW. In this case, biomasses are given as μg of chl *a* per cm^2 . A quantitative method was used, obtained from a calculation model based on published ratios for monocultures (Dorigo et al., 2004). A table was constructed, taking into account the relative abundance of each pigment in a given sample (expressed as the percentage of the sum of the area of all pigments in a sample) (see Dorigo et al., 2007 for detailed method and data). Furthermore, the total number of pigments and the total number of degraded pigments per sample were counted.

Community level finger printing: PCR–DGGE

Each biofilm sample was collected by scraping six glass discs and was suspended in 2 ml of 0.2 μm filtered river water. Biofilm suspensions were centrifuged at $14,000\times g$ for 30 min and nucleic acid extraction was performed on the biofilm pellets (Dorigo et al., 2009). The integrity of the total DNA was checked by agarose gel electrophoresis and the nucleic acid concentration determined by 260 nm

absorbance. PCR amplification of eukaryotic 18S rRNA gene fragments, bacterial 16S rRNA gene fragments and their DGGE analysis was performed according to Tlili et al. (2008). After migration, separated PCR products were stained for 45 min in the dark with SYBRGold (molecular probes), visualised on a UV transilluminator (Claravision), then photographed and digitalized using Microsoft Photo Editor software. Each band at a given height in each lane was scored 1 or 0 (presence or absence). This data set was used to perform correspondence analysis (COA) using ADE-4 software. A similarity index (Jaccard index) was also built using DGGE fingerprints based on presence/absence data. A similarity value of 1 indicates that two DGGE banding patterns are identical, whereas a value of 0 indicates that there are no common bands.

Community level physiological profile

Two variables were used to describe the community level physiological profiles (CLPPs) based on organic matter degradation: extracellular enzyme activities and carbon mineralisation (substrate-induced respiration method).

The three extracellular enzymes β -D-glucosidase (β Glu), β -xylosidase (β Xyl) involved in cellulose degradation, and leucine aminopeptidase (Lap) involved in amino acid degradation, were analysed as in Romani et al. (2004). Activities were analysed by fluorimetry, using substrate analogues (4-methyl-umbelliferyl- β -D-glucopyranoside (750 μ M), 4-methyl-umbelliferyl-xylopyranoside (1,000 μ M) and L-leucine-4-methylcoumarinyl-7-amide HCl (1,000 μ M), respectively) to predetermine saturation curves and for experimental measurements. For all enzyme assays 6 ml of substrate solution was added to triplicate biofilm samples (non-disrupted biofilm in place on stone) and formaldehyde-killed control samples incubated for 30 min with formol 40% before assay. Incubation was performed at 20°C for 20 min under continuous shaking in the dark. Substrate blanks were also prepared with filter-sterilised stream water. The reaction was stopped in boiling water and each tube was then centrifuged for 10 min at 5,000 \times g. The fluorescent products released by enzyme activities were measured after adding 0.05 M glycine buffer pH 10.4, using a microplate reader (SAFIRE, TECAN Group Ltd, Switzerland) with excitation and emission

wavelengths of 363 and 441 nm, respectively, for MethylUmbelliferyl (MUF) and with 343 nm (excitation) and 436 nm (emission) for MethylCoumarine-Acid (MCA). Quantification was achieved using a standard solution of MUF and MCA. The intensity of fluorescence of the blanks was subtracted from all samples to correct for non-enzymatic hydrolysis. Activity in formaldehyde-killed controls was subtracted to correct for abiotic activity. Results were expressed in nmol of hydrolysed compound per hour and per cm² surface area.

Basal (BR) and substrate-induced respiration (SIR) were assessed using the MicroRespTM system of Campbell et al. (2003), consisting of a 96-deep-wells microplate (Nunc 278012) housing periphyton suspension and aqueous carbon sources, sealed individually to a colorimetric CO₂-trap microplate. Mineralisation of 11 carbon sources was tested (glucose, fructose, sucrose, ribose, galactose, maltose, arginine, glycine, lysine, glutamic acid and citric acid). The carbon stock solutions were prepared at 120 mg/ml and adjusted to river pH (7) to avoid any substrate-pH effects on microbial communities and minimise chemical artefacts due to carbonate-derived CO₂. Colorimetric CO₂ traps were prepared in 96 microplate wells. The indicator dye with the gel detector plate consisted of cresol red dye (12.5 ppm), potassium chloride (150 mM) and sodium bicarbonate (2.5 mM) set in a 1% gel of noble agar (150 ml per well). Periphyton suspension (500 μ l) was added to the 96-deep-well plate after 30 μ l of each C source had been dispensed (four wells per substrate = SIR plus four water per plate = BR). Each deep-well microplate was sealed to the CO₂-trap microplate with a silicone seal and incubated in the dark at 25°C. CO₂-trap absorbance was measured at 570 nm (Biotek Synergy HT spectrophotometer) immediately prior to sealing to the soil deep-well plate, and after 15 h incubation. A calibration curve of absorbance against headspace equilibrium CO₂ concentration (measured on a gas chromatograph) was fitted to a regression model.

Organic pesticide biodegradation

The ability of aquatic microbial communities to mineralise diuron was determined by radiorespirometry as described by Pesce et al. (2009a). Samples were treated with 1.45 kBq of ¹⁴C uniformly (ring)-labelled diuron [specific activity 567 MBq/mmol;

99% radiochemical purity (Sigma-Aldrich)]. An epilithon suspension was prepared with the collected stones using filtered river water. Final concentration was adjusted to approximately 5 cm² of stone biofilm per millilitre of suspension and 50 ml was used for each sample. Epilithon samples were supplemented with 0.5 µg of diuron to reach a final concentration of 10 µg per litre of river water. They were processed in triplicate and incubated under artificial light (13 h photoperiod) at 20°C for 16 weeks; ¹⁴C₂O₂ resulting from the mineralisation of ¹⁴C-diuron was trapped in 5 ml of 0.2 M NaOH solution and analysed by liquid scintillation counting using ACS II (Amersham) scintillation fluid.

Tolerance assessment

Short-term laboratory experiments were performed to assess the natural tolerance of the photoautotrophic communities to the main toxicants found in the river, namely Cu and diuron. The PICT concept makes the assumption that communities exposed to contaminants become tolerant to these contaminants by adaptation or species changes (Blanck et al., 1988; Bérard et al., 2002). During laboratory toxicity assays, exposed communities will be characterised by higher EC₅₀ values than reference communities with respect to the toxicant tested. The effects of contaminants on periphyton were assessed using ¹⁴C photosynthetic assimilation as the endpoint (Guasch & Sabater, 1998). A stock solution containing 100 µM diuron (MW 233 g/mole) (Sigma high grade standard 99.5%) was prepared in water and stored at -20°C prior to use. A semi-logarithmic series of concentrations was freshly prepared by serial dilution of the stock solution in 0.2 µm filtered river water. Final test concentrations ranged from 0 to 10 µM of diuron (one blank and nine increasing concentrations, i.e. from 0 to 2.3 mg/l). For copper bioassays, final concentrations in the test vessels ranged from 0 to 100 µM (five blanks and nine increasing concentrations, i.e. from 0 to 6.3 mg Cu), starting from a stock solution of 1,000 µM Cu (CuSO₄, Merck high purity grade). The measurements of photosynthesis activity by ¹⁴C incorporation were made as described in Dorigo et al. (2007). Data were fitted to a logistic equation using the least squares method, and used to plot a dose–response curve and determine photosynthetic EC₅₀ values for each biofilm and period.

Results

Description of land uses

Description of land uses is summarised in a geographic information system (GIS) (Fig. 1, Gouy, unpublished data). The three sampling points are associated with a specific sub-watershed, with vineyards occupying an increasing percentage of the catchment area along the upstream to downstream gradient (from ca. 7% to nearly 80%). Different land use indicators allowed a better characterisation of the landscape features involved in the formation of pollution flows (Collectif, 2008). In these, allowance was made for drainage channels (sum total of drainage ditches collecting run-off water, helping the rapid transfer of pesticides from treated plots to waterways), and the building surface areas measuring the potential upstream/downstream increase in domestic pressure. Hence, these two indicators could help to understand the changes in chemical quality of the river Morcille, as they indicate a level of anthropogenic pressure.

Water chemistry

A fairly strong upstream/downstream increase (Fig. 2) was significant for most of the variables (DOC, PO₄, conductivity), very likely indicating domestic wastewater inputs. Median values of DOC, PO₄ and conductivity increased by about 125, 300 and 150%, respectively, from upstream to downstream. All the chemical parameters were significantly different between sites (ANOVA 1; $P > 0.001$), except for pH and nitrates (ANOVA 1; $P = 0.569$ and 0.106, respectively). However, the chemical quality of the upstream water (St Joseph) was more stable, and the variability more marked at St Ennemond. Overall the water quality was in line with French standards of good chemical status for the nutrients (DCE, 2005).

Copper and arsenic concentrations increased gradually from upstream to downstream, irrespective of season (Fig. 3, yearly data), with maxima also strongly increasing (more than 16 µg/l for Cu and more than 40 µg/l for As). The annual median values (out of 33 analyses) rose, respectively, between St Joseph and St Ennemond, six-fold for Cu and five-fold for As. The French water quality standards specify 'probable no-effect concentrations' (PNEC)

Fig. 2 Boxplot of water chemistry from upstream to downstream in the river Morcille (date 2007; $n = 44$ for each parameters). Boxplots indicate mean value, first and third quartile, mini and maxi. J: St Joseph; V: Versauds; E: St Ennemon

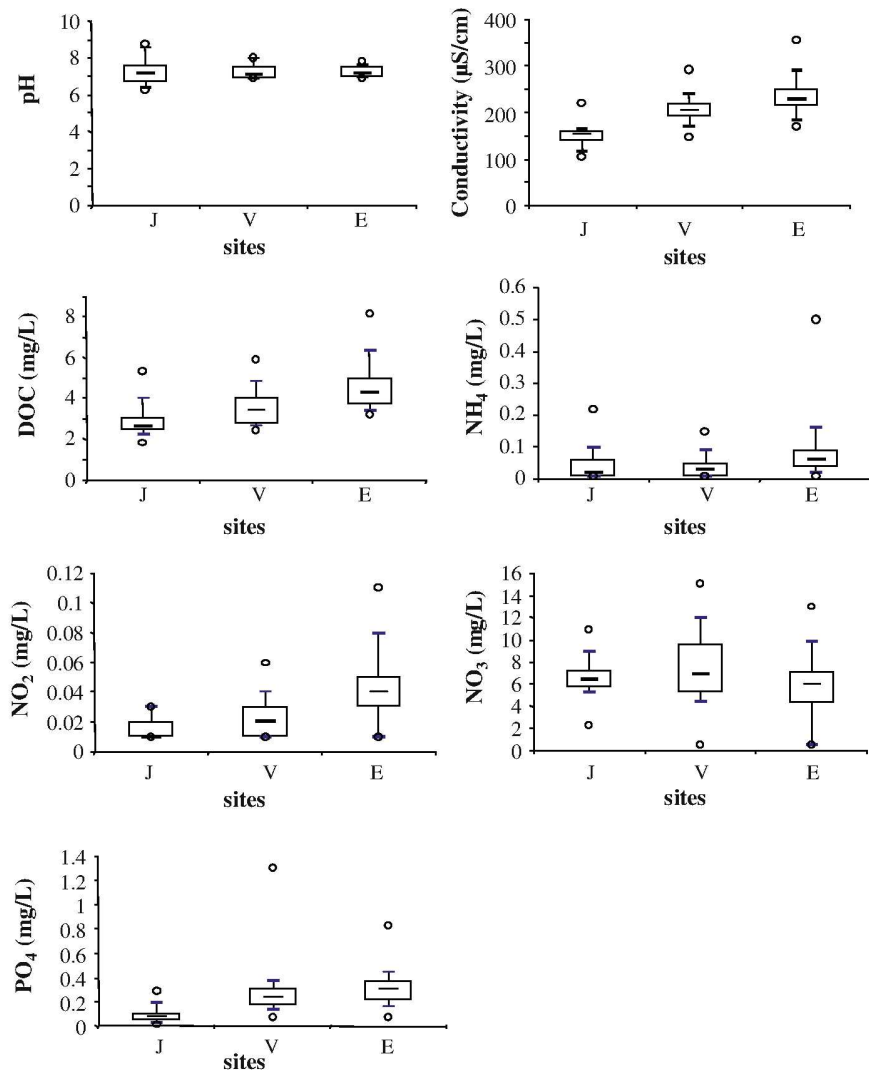

in freshwater for these two metals of 1.6 and 4.4 $\mu\text{g/l}$, indicating a good quality upstream and a poorer quality (given the hardness) at St Ennemon, with a potential toxic effect.

On average some 20 different organic pesticides were found in water, both at Versauds and St Ennemon (Collectif, 2008). However, only the products most frequently used in the drainage basin and found in the water were taken into consideration here (Rabiet et al., 2008, 2010). They were grouped into two activity families (herbicides: diuron and its breakdown products DCPMU and DCA; fungicides: azoxystrobin, carbendazim, tebuconazole, procymidone

and dimetomorph). St Joseph was relatively free of contamination: no substance was found in winter, while diuron was found only three times and fungicides twice in 22 summer samples (Table 1). Versauds and St Ennemon showed a marked occurrence of both herbicide and fungicide (86–100%).

Biomass

Periphytic biomasses were not different between sites ($n = 12$; $P > 0.05$) and between seasons (Fig. 4) and kept a mean value of 0.8 mg AFDW cm^{-2} .

Fig. 3 Boxplot of the concentrations of the main chemicals in the river Morcille (date 2007; $n = 33$). *H*: herbicide; *F*: fungicide—J: St Joseph; V: Versauds; E: St Ennemond. Boxplots indicate mean value, first and third quartile, mini and maxi

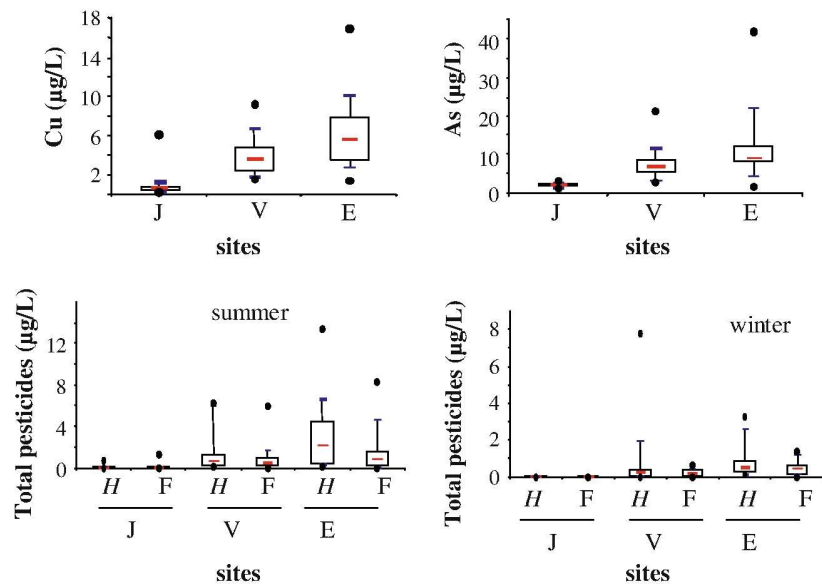

Table 1 Occurrence of pesticides during 2007 survey: A/B: A: presence (with analytical quantification); B: number of analyses

	St Joseph	Versauds	St Ennemond
Winter	H: 0/11 F: 0/11	H: 13/14 F: 13/14	H: 11/11 F: 10/11
Summer	H: 3/22 F: 2/22	H: 21/21 F: 18/21	H: 22/22 F: 19/22

H herbicides, *F* fungicides

Community level finger printing

The microbial community was structured along the upstream–downstream gradient (Fig. 5). For the prokaryotic community, the first two axes of each correspondence analysis accounted globally for 88% of the variability in spring and for 87.7% in winter. For the eukaryotic community, the first two axes of each correspondence analysis accounted for 96 and 67% of the variability in spring and in winter, respectively. For both communities, in spring (Fig. 5, left panel) the first axis separates the pristine St Joseph from Versauds and St Ennemond, and the second axis separates these two last stations. In winter for the eukaryotic community (Fig. 5b, right panel) St Joseph and Versauds are very close to each other and separated from St Ennemond by the first axis. In winter, there was a very high dispersion in the

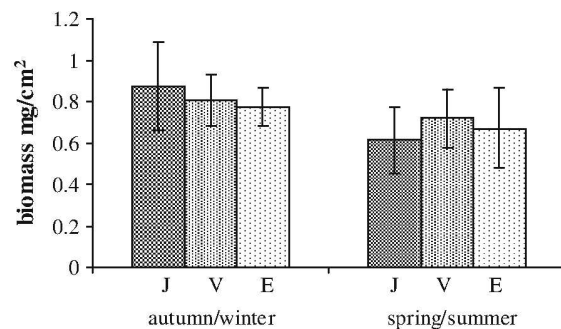
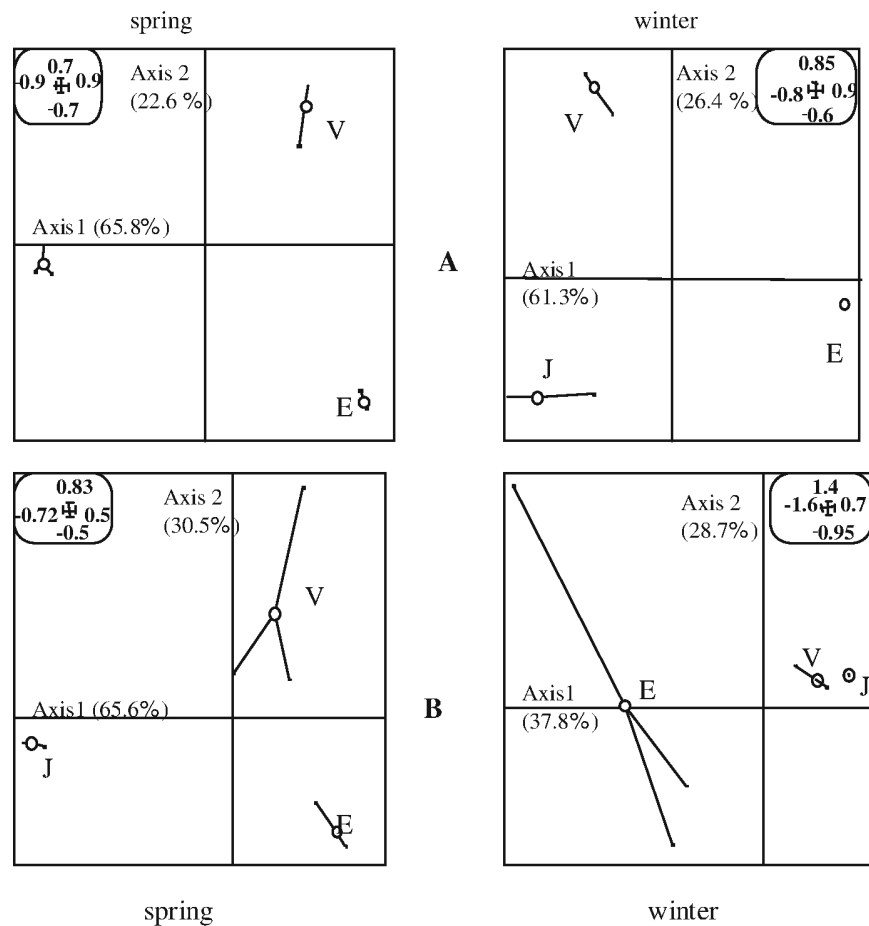

Fig. 4 Periphytic biomass on the three study sites. Spring/summer: during pesticide treatment on the watershed. Autumn/winter: outside pesticide spreading time (mean values \pm SD; $n = 3$). J: St Joseph; V: Versauds; E: St Ennemond

eukaryotic diversity between the three plates from the St Ennemond sampling area.

The correspondence analysis based on the relative percentage of the pigments detected in all sampling sites in winter and spring (see Dorigo et al., 2007), depicts the adaptation of the microalgal community pigment structure (Fig. 6). The projection of the plane defined by the first two axes indicates a clear separation between spring and winter samples. The second axis allowed the differentiation in spring of the pristine St Joseph area from the other two, and in winter the separation of the St Ennemond area from Versauds and St Joseph.

Fig. 5 Correspondence analysis of prokaryotic DGGE bands (A) and eukaryotic DGGE bands (B) of each sampling site and area (J, St Joseph; V, Versauds; E, St Ennemond) in spring (*left panel*) and in winter (*right panel*) (from Dorigo et al., 2007). Dots are mean value of triplicates and bars indicate the variability of triplicates



Community level physiological profiles

Extracellular enzyme activities

Extracellular enzyme activities of the river Morcille biofilms were analysed using a two-way ANOVA to test for spatial effect (upstream to downstream), temporal effect, and their interaction (all data were logarithmically transformed to stabilize the variance and when significant differences were detected by using Scheffé post hoc comparisons were used). No clear spatial or temporal pattern was found (Fig. 7). Between-site differences were generally not significant, except for Lap, which significantly but slightly increased from upstream to downstream in June. Temporal effect was significant for β Xyl and Lap activities (ANOVA2 $P = 0.0115$ and $P = 0.0006$,

respectively), with June values higher than May values (Scheffé $P = 0.0135$ and $P = 0.0006$, respectively). The only observed pattern was the activity level of the enzymes, with Lap > β Glu > β Xyl.

Aerobic respiration

Aerobic respiration was described by MicroResp for bacteria and fungi (heterotrophic microorganisms) as well as the capacity to mineralise different carbon sources. A spatial pattern appears with a marked lowering (mean value: 40%) in the respiration at St Ennemond (Fig. 8), whatever the carbon source (e.g. carbohydrate, amino acids, acids). Finally, substrate-induced respiration is only weakly greater than biofilm respiration on natural DOC (0–15%), whatever the sites.

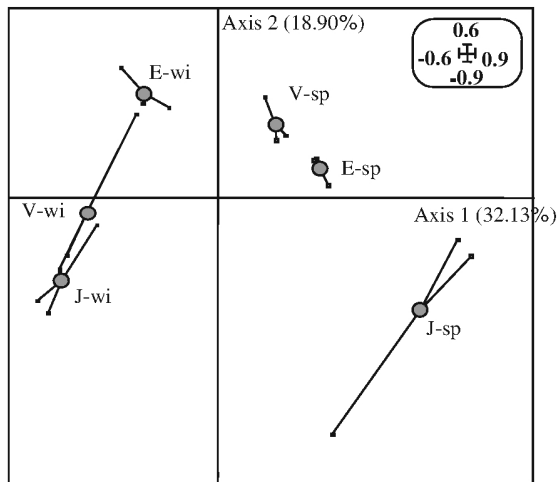

Fig. 6 Correspondence analysis of the percentage contribution of each pigment of the three biofilm samples at the sampling areas (J, St Joseph; V, Versaids; E, St Ennemond) in spring (sp) and in winter (wi). ADE-4 Software Package (from Dorigo et al., 2007)

Diuron mineralisation potential

Diuron mineralisation potential increased significantly from the upstream to the downstream sampling stations (Fig. 8). After a short lag phase of about 10 days, downstream samples exhibited a high biodegradation potential. Diuron mineralisation was then fast (the mean mineralisation rate was about 1.56% per day) and reached a plateau (sixth week) with a mean value of 25% of the initially applied diuron. Conversely, diuron mineralisation obtained with the upstream epilithon was very limited (about 3.3%) and remained close to that observed in autoclaved samples (<4%, data not shown).

Tolerance of periphyton (Table 2)

Photosynthesis EC_{50} values increased from upstream to downstream in both spring and winter, with values ranging from 19.71 to 42.23 and from 9.17 to 50.66 $\mu\text{g l}^{-1}$ of diuron, respectively. Except for St Ennemond, EC_{50} values were higher in summer than in winter. At each season, the lowest EC_{50} values (thus lowest tolerance to diuron) were recorded at the upstream area of St Joseph. Copper effects had the same pattern and tolerance of biofilm also increased from upstream to downstream.

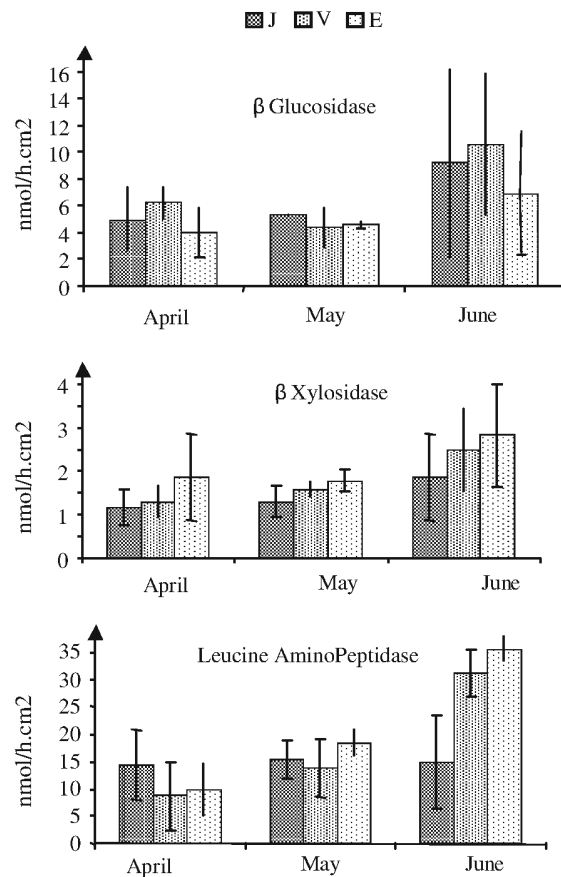

Fig. 7 Exoenzyme activity gradient in early spring at the three sampling sites. J: St Joseph; V: Versaids; E: St Ennemond (mean values \pm SD; $n = 3$)

Discussion

Relationships between land use and water quality

The characterisation of land use in the Morcille drainage basin identified the possible main causes of the observed nature and dynamics of water quality. One cause is the preponderant use of land for wine growing, but with a very small presence at the first sub-basin (St Joseph). The identification of drainage ditches (respectively, 0.2, 33.4 and 97.1 km for the St Joseph, Versaids and St Ennemond sub-basins) shows the importance of run-off collection (Lagacherie et al., 2006) and its contribution to the pollutant flow entering the river Morcille. Indeed, the land is characterised by a sandy, modified granite shallow soil, easily eroded and poor in organic

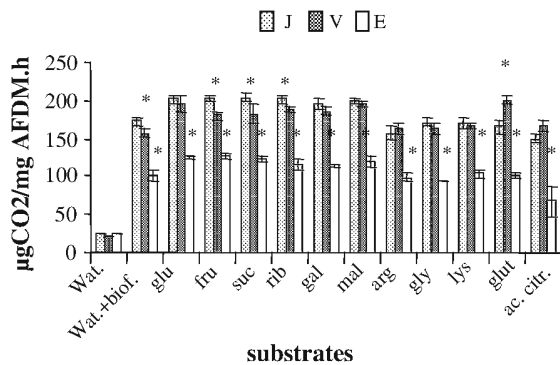

Fig. 8 Potential of carbon substrate mineralisation of biofilms sampled at the three sites. Mean values \pm SD; *significant difference with St Joseph (reference site)—Kruskall–Wallis test, $n = 4$, $P = 0.05$. Wat: water alone (blank); Wat + biof: river water + biofilm; glu: glucose; fru: fructose; suc: succinate; rib: ribose; gal: galactose; mal: maltose; arg: arginin; gly: glycine; glut: glutamic acid; ac citr: citric acid. J: St Joseph; V: Versauds; E: St Ennemond

material. Rainfall intensities as well as sloping relief favour rapid transfer by run-off. This sensitivity to rainfall effects results in high MES levels when the river is in flood (up to 1 g/l, Rabiet et al., 2008). In general, the rainfall pattern is of the ‘continental’ type, with frequent sudden rainstorms in spring and summer. There can be as many as 3–4 river floods during the summer (Rabiet et al., 2008). The drainage ditches and domestic wastewater flow directly into the river Morcille, shunting the wooded or grassy riverbank areas, whose important role in water self-purification is then limited at this site. This pattern of land use explains the upstream/downstream gradient in levels of both organic chemicals, metals (Cu and As) and nutrients. The surface area covered by farm buildings or dwellings is a good indicator of domestic pressure; its gradual increase along the three sub-basins (respectively, 0.05, 2.2 and 6.9 ha) probably

results in the level increase of some organic and inorganic nutrients (PO_4 in particular), whatever the season.

These characteristics account for the flows of pollutants into the Morcille, their gradient and their seasonal pattern. The intensive use of pest-control chemicals in vineyards [mostly herbicides (such as diuron, isoproturon or diflufenicanil in early spring) and fungicides (such as tebuconazol, linuron or fenitrothion in spring and summer)] causes rising downstream contamination of the waterway with both organic residues and metals (essentially Cu and As from vineyard treatment). This contamination persists all year, but with a seasonal peak in the spring and part of the summer (generally late March to early August). Its variability is due to (i) differences in the use of herbicides (mostly early in the growing season) and fungicides (mostly in summer), with a predominance of the herbicide diuron and (ii) the pattern of rainfall and run-off, the intensity of which is an important controlling factor in pollutant flow. At peaks of flooding the concentrations of certain phytochemicals can reach several $\mu\text{g/l}$, or even tens of $\mu\text{g/l}$ (Rabiet et al., 2008), thus profoundly modifying the conditions of exposure of aquatic organisms. As an example, the average concentration of diuron largely exceeds the European environmental quality standard (EQS) of 0.2 $\mu\text{g/l}$ expressed as annual average.

Periphyton biomass, structure and diversity as bioindicators

Global indicators, such as periphytic ash-free dry mass or chlorophyll *a*, have been and are still frequently used to characterise the status of a biofilm or a plankton community in response to environmental changes (Rosemond et al., 2000). This global approach does not always respond clearly to levels of

Table 2 Sensitivity of periphyton to copper and diuron (expressed as EC_{50} measured as primary productivity for periphyton samples from the three sampling sites on the river Morcille)

	St Joseph	Versauds	St Ennemond	Chemicals
Survey 1 (winter)	9.7 \pm 3.8	20 \pm 6.6	47 \pm 8.4	Diuron ($\mu\text{g/l}^{-1}$)
Survey 2 (summer)	20 \pm 6.5	38 \pm 10.2	42 \pm 15.8	Diuron ($\mu\text{g/l}^{-1}$)
Survey 3 (summer)	4.53 \pm 1.54	7.8 \pm 2.2	–	Diuron ($\mu\text{g/l}^{-1}$)
Survey 4 (summer)	32 \pm 7.5	160 \pm 40	–	Copper (μM)

Mean value \pm SD ($n = 3$); –, non determined

nitrogen- and phosphorus-containing nutrients (Bernhard & Likens, 2004). This limitation is seen here for our data on the river Morcille (Fig. 4). Given the intra-site variability of periphytic biomass, and despite a tendency towards a fall in periphyton biomass, no clear-cut upstream/downstream spatial gradient is discernable, in spite of the permanent increase in PO_4 levels at Versauds and St Ennemond. Three hypotheses can be advanced: (i) an effect of reduced light (Villeneuve et al., 2010) due to canopy growth in summer, (ii) physical constraints (biofilm abrasion) due to the turbulences of water on small pebbles and (iii) the presence of diuron (and its breakdown product DCMU) and copper, both inhibitors of algal photosynthesis, which antagonise the growth stimulus provided by PO_4 (Guasch et al., 2007). These authors showed that PO_4 did not modify the inhibiting effect of atrazine (at 100 $\mu\text{g/l}$) on the periphyton biomass, and did not modify the tolerance of the biofilm to this herbicide. The biomass (expressed in AFDM or chlorophyll) does not therefore seem to be a very reliable indicator of the chemical quality of the ecosystem, especially as this depends also on hydraulic and light conditions (Battin et al., 2003a, b; Villeneuve, 2008). Accordingly, some authors have proposed growth rate rather than biomass as an indicator of eutrophication (Othoniel, 2007).

Most works on biofilms take into account algal communities and their taxonomic diversity. Because of their physiological characteristics, photoautotrophic biofilm communities (microalgae and cyanobacteria) and the taxa that compose them can be good indicators of environmental changes. They also represent a potential target for herbicide residues in the aquatic ecosystems. Herbicides acting on the photosynthetic system (such as Photosystem II) have already been identified as a cause of impairment of these communities (Guasch et al., 2003; Dorigo et al., 2004, 2007).

Taxonomic approaches, especially those based on diatoms or on microalgae, are regularly used. The predominance of diatoms in periphyton is a very common situation in lotic systems (Stevenson & Pan, 1999) and allows the design of a specific index. The BDI was originally designed to assess alterations in trophic status (Lenoir & Coste, 1996). For the river Morcille, as shown by Morin et al. (2010), the BDI values along the gradient for 1-month-old communities indicated a trophic pollution and changes in water

quality classes, as defined by the European Water Framework Directive and with a good/moderate boundary: $\text{BDI} = 14$, for this national type and stream order between St Joseph ($\text{BDI} = 14.7 \pm 0.1$, good ecological quality), Versauds ($\text{BDI} = 13.8 \pm 0.2$, good to moderate) and St Ennemond ($\text{BDI} = 13.1 \pm 0.1$, moderate). Morin et al. (2010) identified larger proportions of pollution-sensitive species at St Joseph (25.4%) than at Les Versauds (18.2%) or St Ennemond (15.9%). In addition to these approaches based on global indices, some of the species that preferentially developed at Les Versauds (especially in May) and St Ennemond have already been recorded under herbicide concentrations $>5 \mu\text{g/l}$ (*Planothidium lanceolatum*, *Planothidium frequentissimum* and *Cocconeis placentula*); Pérès et al., 1996; S. Morin, pers. comm.). Only a few studies have addressed diatom sensitivity or tolerance to pesticides, but this work in favour of diatom use for the assessment of pesticide contamination has yielded important findings. Pérès et al. (1996) and Schmitt-Jansen & Altenburger (2005) found a remarkable decrease in diatom numbers under atrazine and isoproturon contamination. The shift in diatom community diversity observed in the river Morcille was concomitant with increased diuron-induced tolerance (see below), revealing that pesticide contamination was probably one of the major driving factors, even if the trophic level bioindicator BDI expressed the increasing OM and nutrient gradient in the Morcille (Morin et al., 2010).

Community level finger printings (CLFPs) are now widely used to assess the diversity of microbial communities and their responses to environmental changes. Fingerprinting techniques based on PCR-DGGE or on pigment abundances have often been used to describe the effect of pollutants (Dorigo et al., 2004; Boivin et al., 2007; Pesce et al., 2009b) or spatio-temporal changes (Lyautey et al., 2005), whatever the biases of these methods (see Dorigo et al., 2007; Marzorati et al., 2008). To obtain ecologically relevant information, fingerprint data are often transformed by statistical treatments such as principal component analysis or other multivariate statistical treatment, but some other straightforward processing methods can be used to obtain a relevant ecological interpretation of fingerprinting patterns (Marzorati et al., 2008). For the river Morcille, correspondence analysis performed on prokaryote and eukaryote fingerprints and on pigment

analysis revealed a structured pattern depending on the season (Dorigo et al., 2007, 2009).

More specifically, correspondence analysis, relative to pigment analysis, separated the spring from the winter communities, and communities inhabiting less contaminated areas from those in more contaminated ones (Fig. 6). However, these differences were not linear because of in situ confounding factors (see above). DGGE analyses also allowed a differentiation of prokaryotic and eukaryotic communities, separating those inhabiting less contaminated sampling areas from more contaminated ones (Fig. 5). Thus, the two methods used to assess the structure of these communities (DGGE or HPLC) prove to be useful bioindicators of the ecological status of biofilms, allowing seasonal and spatial differentiations. In spring, the St Joseph reference area was differentiated from the two other sampling areas (i) by the structure of their prokaryotic, eukaryotic and photoautotrophic communities and (ii) by its level of pollution, which was significantly reduced in comparison with Versauds and St Ennemonde (Fig. 3). In the same way, and only in winter, the St Joseph and Versauds sampling areas were more similar to each other than to St Ennemonde, by both their level of pollution and the structure of their microbial communities. In addition, microcosm studies conducted elsewhere have also shown that environmentally realistic diuron exposure levels can affect aquatic bacterial diversity (Pesce et al., 2006, 2008; Ricart et al., 2009) and it appears that chronic long-term exposure (1 µg/l) can lead to changes in bacterial community structure, more than acute (14 µg/l) and short-term exposure, suggesting a progressive adaptation in microbial communities (Tlili et al., 2008).

Calculating an index such as Jaccard's similarity index yields additional, quantitative indications concerning the differentiation of sites which are therefore more easily exploitable as bioindicators. For example, summer monitoring of the diversity of biofilms grown on artificial supports has shown the low degree of similarity among communities of bacteria (16S) or algae (18S) in the three study sites and according to the season (Table 3) (Montuelle, unpublished data). This index can thus be considered as an indicator of disturbance, by quantifying the intensity of a change in composition of a microbenthic community.

However, these structural changes related to environmental variables or to the toxic contamination

Table 3 Eukaryotes and prokaryotes similarity index (Jaccard Index) between three sampling sites during a summer survey

		St Joseph	Versauds	St Ennemonde
16 S rRNA	St Joseph	100	23	15
	Versauds		100	26.7
	St Ennemonde			100
18S rRNA	St Joseph	100	13.9	23.4
	Versauds		100	64.7
	St Ennemonde			100

present in the river Morcille should be associated with function changes to assess the disturbance of ecological (biochemical) processes and identify the relationship between structure and function.

Functional changes along the pollution gradient

Several functional variables were active on the river Morcille for both autotrophic communities (photosynthesis) and heterotrophic communities (biodegradation).

Photosynthesis and PICT approach

To verify that structural changes were related to pesticide contamination of the river Morcille, we applied the PICT concept proposed by Blanck et al. (1988) and used since by several authors (see Bérard et al. 2002, for a review). The PICT concept states that the tolerance of a community to a toxicant is related to the previous exposure of that community to the toxicant or to another toxicant so long as both belong to the same toxicant family (same chemical composition and/or similar mode of action). In our studies, diuron and Cu were taken, respectively, as models of organic and inorganic pesticides inhibiting photosynthetic organisms in biofilms. The most diuron- and Cu-sensitive communities were found in the upstream area at St Joseph, in both winter and spring. On the other hand, the most diuron-tolerant communities were found both in spring and in winter at the St Ennemonde sampling area, which was also the most severely contaminated one. These results fit well with the predictions of the PICT concept and suggest that pesticide concentrations constitute a selective pressure on the photoautotrophic communities of the Morcille biofilms, resulting in changes in species composition

and in pesticide tolerance. However, nutrients increased concomitantly with the in situ pesticide concentrations (Collectif, 2008), and they could also have driven structural and functional changes in eukaryotic and photoautotrophic communities (deNicola et al., 2006). In such a specific situation, the application of the PICT concept enables us to attribute observed changes to pesticides and not directly to nutrients. In the case of multiple toxic contaminations (diuron and copper), a co-tolerance effect may occur, with a risk of error in the estimation of causality of the effect observed in the biofilms. No co-tolerance between copper and a PSII-inhibiting herbicide (Irgarol) was observed on phytoplankton in Lake Lemán (Bérard, unpublished data).

It should also be emphasised that P content could also modify the tolerance of biofilm to Cu (Guasch et al., 2004): an increase in P could induce an increase in the tolerance to copper and care must be taken to sample sites where P and Cu increase together (as in the Morcille River). However, a recent field survey performed in the river Morcille confirmed that despite the possible influence of identified co-varying variables (such as nitrates, conductivity and temperature), the main factor explaining spatio-temporal variation in diuron sensitivity within photoautotrophic biofilm communities was the mean in situ diuron exposure level during their colonisation period (Pesce et al., 2010).

Biodegradation of pesticides

The increase in tolerance is also accompanied by a greater capacity for the biodegradation of toxicants by biofilms. This type of adaptative response by heterotrophic communities to exposure to toxicants has not been much studied in aquatic environments (Toräng et al., 2003). In the river Morcille, an in situ microbial adaptation to diuron mineralisation following previous diuron exposure was clearly highlighted in aquatic biofilm communities (Fig. 9). For downstream epilithon, a short lag phase was observed, probably reflecting the time required by the diuron-degrading populations to acclimatise to the experimental conditions. Despite a non-negligible variation between replicates, biofilm samples collected at the downstream diuron-impacted station exhibited higher mineralisation percentages than the samples collected at the upstream station, thus evidencing an increasing

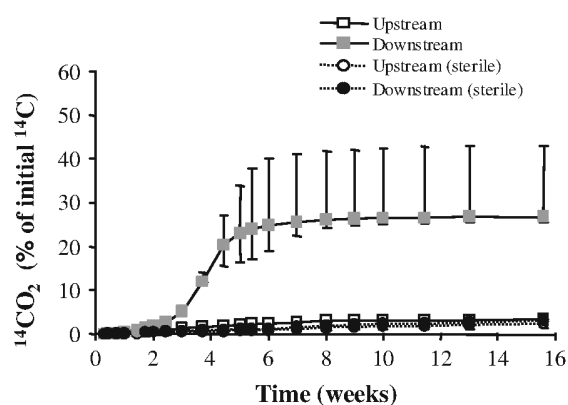

Fig. 9 Biodegradation potential of ¹⁴C-diuron by periphyton in the river Morcille (modified from Pesce et al., 2009a, b)

natural breakdown potential of diuron along the contamination gradient (Pesce et al., 2009a). From a functional point of view, this potential is quite different from an estimation of the real in-field biodegradation processes of pesticides in biofilms. Given the short residence time of water in the river Morcille and the diffuse input in the watershed, most diuron residues are exported to the downstream rivers. However, this bioassay offers interesting perspectives for assessing the adaptation of heterotrophic microbial communities following pollutant exposure.

Community level physiological profiles

Parallel to changes in diversity, the heterotrophic degradation functions exerted by the biofilm also adapted along the gradient. They also provide an integrated response to overall modifications in chemical composition, and can be considered as reflecting the composition of the organic matter in the system (Sinsabaugh et al., 2002; Romani et al., 2004). The cellulases (e.g., glucosidase and xylosidase) that break down plant fibres and peptidases are the key enzymes involved, for example, in the leaf conversion of polymeric compounds into smaller molecules that can be assimilated by microorganisms (Sinsabaugh et al., 2002). No general adaptation pattern was detected in enzymes activity whether temporal or spatial because of a large variability in activity (up to 75%), which prevented characterisation of the increasing tendency of the mean activity values from upstream to downstream as statistically significant.

If increasing concentration in DOC and nutrients could explain such a tendency, many reasons can be offered to explain the high variability. Microbial extracellular enzymes and their activity respond to many environmental variables that can vary rapidly, such as temperature, dissolved oxygen, nycthemeral cycle, microbial biomass and organic matter content (Montuelle & Volat, 1998; Boshker & Cappenberg, 1998). Seasonal or temporal variations in extracellular enzymes activity are well documented (Chappel & Goulder, 1994; Harbott & Grace, 2005), as well as spatial variability (Romani & Sabater, 2000). As expounded by Chrost (1990), the regulation system in extracellular enzymes results from a balance between directly available substrates (low molecular weight molecules inhibit enzyme synthesis and expression), and substrates that are not directly bioavailable but are biodegradable (high molecular weight molecules stimulate enzyme synthesis and activity). Finally, toxicants such as pesticides or heavy metals could have impaired extracellular activity (Lopez et al., 2009; Hussain et al., 2009). On the river Morcille, it is then plausible that these antagonistic factors, linked to the chemistry of water, co-exist and account for the variability of these activities. However, the observed increase in LAP from upstream to downstream in April and May could be a consequence of the increasing housing in the watershed and its greater discharge of protein-rich wastewater.

The degradation of carbon-containing substrates by heterotrophic microbial communities is part of the self-purifying process, in particular pathways that produce CO₂ (or CH₄ in anaerobiosis), which is then exported from the aqueous ecosystem into the atmosphere. The study of the respiratory capacity of microbial communities based on patterns of use of carbon-containing substrates (SIR), has prompted the development of kits such as Biolog[®] (Garland, 1996) or MicroResp[®] (Campbell et al., 2003), which have been used to characterise the status of a community or as a bioindicator of the effect of toxicants (Rutgers et al., 1998; Boivin et al., 2007). The application of this last technique on the river Morcille showed a fall in the overall mineralisation capacity (CO₂ production) of downstream biofilms (St Ennemon) (Fig. 8), although DOC levels were higher. Two hypotheses can be advanced: (i) the DOC is less biodegradable downstream than upstream (unlikely, because some hydrolysis activity tends to increase from upstream to

downstream) and (ii) the toxicants present modify the expression of the enzymes involved in the mineralisation of the carbon compounds as shown for soil microbial community (Hussain et al., 2009). Enhancement of SIR is likely associated with the high biodegradability level of the C source tested, more important than the natural DOC in the Morcille River. However, the observed lowering of biodegradation capacity reduces the self-purification capacity of the river.

Towards a microbial bioindication tool

The different research carried out on the LTER Morcille River allowed the testing of several parameters describing the periphyton and its different functional or structural responses to a specific land use and to a contamination gradient. Putting into practice periphytic microbial indicators to characterise the ecological state of aquatic environments has progressed greatly during recent years. Their sensitivity to pollution and their early response is now well identified (Sabater et al., 2007). However, much progress is needed to meet the indicator criteria defined by Dale & Beyeler (2001).

Be easily measured; be sensitive to stresses on the system; respond to stress in a predictable manner; be anticipatory; predict changes that can be averted by management actions; be integrative; have a known response to disturbances, anthropogenic stresses and changes over times; have a low variability in response.

It is not reasonable to assume that only one biological indicator, whatever its integration level, could be enough to capture the complexity of an ecological system. Development of a multimetric index is essential. It should be composed of metrics for structure, diversity and functions (Eisman & Montuelle, 1999) to reflect the multiple dimensions of ecosystem services. In our work on the river Morcille, the use of these three categories of ecosystems response allowed us to take into account the different functions assumed by microbial communities and to identify sensitive biological indicators for ecosystem functions.

The complexity in the choice and in the identification of relevant microbial indicators is a

consequence of the action of environmental factors that are likely to interfere with the toxicants actions and then to limit the identification of univocal causality relationships. For example, tolerance of biofilm community to one stressor can be modified by natural abiotic factors, such as light or flow speed (Guasch & Sabater, 1998; Villeneuve, 2008), chemical conditions favouring co-tolerance phenomena (Schmitt-Jansen et al., 2008) or changing exposure to toxicants (chronic or acute; Tlili et al., 2008). Biofilm internal parameters, such initial community composition and species interactions, could also control the biological response of biofilm microbial communities to a contaminant (Guasch et al., 1998).

However, community level approaches are a necessity, since single-species tests are not ecologically relevant. Specific methodology such as PICT may then serve as a diagnostic tool in chemical hazard assessment (McClellan et al., 2008). PICT methodology provides information on the sensitivity of a community to a toxicant, integrating in its response changes in species diversity and cell physiology. Applied to complex environmental contamination (in the field or experimentally tested in 'cosms'), the PICT method allows reducing uncertainty on the causes of an ecological impairment to be reduced. However, care should be taken of the possibility of co-tolerance to different substances (Schmitt et al., 2006).

The technique of dose–response bioassays used in the PICT method allows a rather easy screening of substances, even for emerging molecules such as pharmaceuticals (Franz et al., 2008). The validity domain of PICT methods could then be broadened to the calculation of Environmental Quality Standards (EQS) for the European Priority Substances to obtain more relevant threshold characterisation for risk assessment (McClellan et al., 2008).

New functional parameters suitable for PICT studies and for individualising the responses of autotrophic and heterotrophic communities will strengthen the use of PICT-based bioindicators (e.g. respiration, denitrification and nitrification). However, not all metabolic activities could be used to group CLPP and PICT (for example, extracellular activities seemed to be worse in situ bioindicators, in our case study), but research in this field should continue.

Finally, the analysis of biofilm diversity by the CLFP supplements the information given by the PICT method allowing characterisation of the specific changes

of biofilm eukaryote and prokaryote communities exposed to contaminants. Techniques such as DGGE fingerprinting used to assess the structure of eukaryotes and eukaryote communities on the river Morcille have appeared globally in good agreement with pigment analysis and have discriminated the pollution gradient (Dorigo et al., 2007, 2009). In the same way, more classical taxonomic approaches have given relevant insights into the effect of chemicals (Hill et al., 2000; Morin et al., 2010). Other fingerprinting methods (e.g. ARISA and t-RFLP) are also well adapted to such analysis; more powerful molecular methods (sequencing) seem still to be excluded for the construction of bioindication tools because they do not fit with the criteria underlined by Dale & Beyeler (2001). However, it is likely that, in the future, microarray (taxonomic and functional) techniques will give a new insight into bioindication.

The coupling of PICT–CLPPs–CLFPs constitutes a multimetric assessment tool and allows a thorough assessment of biofilm response (function, diversity and tolerance level) to contaminants. The complementarity of such methods allowed in situ characterisation of the individual effects of pollutants in a cocktail of contaminants in a vineyard-dominated watershed. Such multimetric assessment tools give a comprehensive overview of ecosystem impairments and could be applied to different anthropogenic pressures (urban, peri-urban and agricultural). In the perspective of goals defined by the European WFD, our next step will be the use of PICT–CLPPs–CLFPs for studying community resilience and characterising the trajectory of aquatic ecosystem restoration.

Acknowledgements The authors thank the two anonymous reviewers for improving the manuscript. They also thank Marjorie Maréchal for Microresp[®] assays; Laurence Blanc for extracellular enzymes measurements; Bernard Motte for field surveys; Christelle Margoum, Josiane Gahou, Céline Guillemain and Marina Coquery for chemical analysis and for the Morcille river database. The Ardieres-Morcille experimental watershed is supported by the LTER Rhône Basin (ZABR). English was checked by ATT Scientific and Technical Translation.

References

- Admiraal, W., H. Blanck, M. Buckert De Jong, H. Guasch, N. Ivorra, V. Lehman, B. A. H. Nyström, M. Paulsson & S. Sabater, 1999. Short term toxicity of zinc to microbenthic algae and bacteria in a metal polluted stream. *Water Research* 33: 1989–1996.

- AFNOR, 2004. Détermination de l'Indice Biotique Global Normalisé (IBGN). NF T 90-350, Association française de normalisation.
- Barranguet, C., F. P. van den Ende, M. Rutgers, A. M. Breure, M. Greijdanus, J. J. Sinke & W. Admiraal, 2003. Copper-induced modifications of the trophic relations in riverine algalbacterial biofilms. *Environmental Toxicology and Chemistry* 22: 1340–1349.
- Battin, T. J., L. A. Kaplan, D. Newbold & C. M. E. Hansen, 2003a. Contributions of microbial biofilms to ecosystem processes in stream mesocosms. *Nature* 426: 439–442.
- Battin, T. J., L. A. Kaplan, D. Newbold, J. D. Cheng & C. M. E. Hansen, 2003b. Effects of current velocity on the nascent architecture of stream microbial biofilms. *Applied and Environmental Microbiology* 69: 5443–5452.
- Bérard, A., U. Dorigo, J. F. Humbert, C. Leboulanger & F. Seguin, 2002. La méthode PICT (Pollution-Induced Community Tolerance) appliquée aux communautés algales. Intérêt comme outil de diagnose et d'évaluation du risque écotoxicologique en milieu aquatique. *Annales de Limnologie* 38: 247–261.
- Bérard, A., U. Dorigo, I. Mercier, K. Becker van-Slooten & C. Leboulanger, 2003. Comparison of the ecotoxicological impact of triazines Irgarol 1051 and atrazine on microalgal cultures and natural microalgal communities in Lake Geneva. *Chemosphere* 53: 935–944.
- Bernhard, E. & G. E. Likens, 2004. Controls on periphyton biomass in heterotrophic streams. *Freshwater Biology* 49: 14–27.
- Blanck, H., S. A. Wängberg & S. Molander, 1988. Pollution-induced community tolerance—a new ecotoxicological tool. In Cairns, J. & J. R. Pratt (eds), *Functional Testing of Aquatic Biota for Estimating Hazards of Chemicals*. ASTM S/T, Philadelphia: 219–230.
- Boivin, M. E. Y., B. Massieux, A. M. Breure, F. P. van den Ende, G. D. Greve, M. Rutgers & W. Admiraal, 2005. Effects of copper and temperature on aquatic bacterial communities. *Aquatic Toxicology* 71: 345–356.
- Boivin, M. E. Y., G. D. Greve, J. V. Garcia-Meza, B. Massieux, W. Sprenger, M. H. S. Kraak, A. M. Breure, M. Rutgers & W. Admiraal, 2007. Algal-bacterial interactions in metal contaminated floodplain sediments. *Environmental Pollution* 145(3): 884–894.
- Boshker, H. T. S. & T. E. Cappenberg, 1998. Patterns of extracellular enzyme activities in littoral sediments of Lake Gooimeer, The Netherlands. *FEMS Microbial Ecology* 25(1): 79–86.
- Campbell, C. D., S. J. Chapman, C. M. Cameron, M. S. Davidson & J. M. Potts, 2003. A rapid microtiter plate method to measure carbon dioxide evolved from carbon substrate amendments so as to determine the physiological profiles of soil microbial communities by using whole soil. *Applied and Environmental Microbiology* 69(6): 3593–3599.
- Chappel, K. R. & R. Goulder, 1994. Enzymes as river pollutants and the response of native epilithic extracellular-enzyme activity. *Environmental Pollution* 86: 161–169.
- Chrost, R. J., 1990. Microbial ectoenzymes in aquatic environments. In Overbeck, J. (ed.), *Aquatic Microbial Ecology, Biochemical and Molecular Approach*. Brock/Springer Series in Contemporary BioScience.
- Collectif, 2008. Relations entre structures paysagères, transferts hydriques et flux géochimiques, état écologique des milieux aquatiques, Rapport final du programme ECOGER-Papier, INRA-Cemagref, Coord: Grimaldi, C. & B. Montuelle: 33 pp.
- Dale, V. H. & H. C. Beyeler, 2001. Challenges in the development and use of biological indicators. *Ecological Indicators* 1: 3–10.
- DCE, 2005. Définition du bon état des eaux, constitution des nouveaux référentiels et des modalités d'évaluation de l'état des eaux douces de surface. Ministère de l'Ecologie et du Développement Durable (ed.): 17 pp.
- DeLorenzo, M. E., P. Scott & P. E. Ross, 2001. Toxicity of pesticides to aquatic microorganisms: a review. *Environmental Toxicology and Chemistry* 20(1): 84–98.
- deNicola, D. M., E. de Eyto, A. Wemaere & K. Irvine, 2006. Periphyton response to nutrient addition in 3 lakes of different benthic productivity. *Journal of North American Benthological Society* 25: 616–631.
- Dorigo, U., X. Bourrain, A. Berard & C. Leboulanger, 2004. Seasonal changes in the sensitivity of river microalgae to atrazine and isoproturon along a contamination gradient. *Science of Total Environment* 318: 101–104.
- Dorigo, U., C. Leboulanger, A. Bérard, A. Bouchez, J. F. Humbert & B. Montuelle, 2007. Lotic biofilm community structure and pesticide tolerance along a contamination gradient in a vineyard area. *Aquatic Microbial Ecology* 50: 91–102.
- Dorigo, U., M. Lefranc, C. Leboulanger, B. Montuelle & J. F. Humbert, 2009. Influence of sampling strategy on the assessment of the impact of pesticides on periphytic microbial communities in a small river. *FEMS Microbial Ecology* 67: 491–501.
- Eisman, F. & B. Montuelle, 1999. Microbial methods for contaminants effects assessment in sediment. *Reviews of Environmental Contamination and Toxicology* 159: 41–93.
- Franz, S., R. Altenburger, H. Heilmeyer & M. Schmitt-Janssen, 2008. What contributes to the sensitivity of microalgae to triclosan? *Aquatic Toxicology* 90: 102–108.
- Fuerhacker, M., 2009. EU Water Framework Directive and Stockholm Convention: can we reach the targets for priority substances and persistent organic pollutants? *Environmental Science and Pollution Research* 16: 92–97.
- Garland, J. L., 1996. Analytical approaches to the characterization of samples of microbial communities using patterns of potential C source utilization. *Soil Biology and Biochemistry* 28: 213–221.
- Gold, C., A. Feurtet-Mazel, M. Coste & A. Boudou, 2003. Impacts of Cd and Zn on the development of periphytic diatom communities in artificial streams located along a river pollution gradient. *Archives of Environmental Contamination and Toxicology* 44: 189–197.
- Guasch, H. & S. Sabater, 1998. Light history influences the sensitivity to atrazine in periphytic algae. *Journal of Phycology* 34: 233–241.
- Guasch, H., N. Ivorra, V. Lehmann, M. Paulsson, M. Real & S. Sabater, 1998. Community composition and sensitivity of periphyton to atrazine in flowing waters: the role of environmental factors. *Journal of Applied Phycology* 10: 203–213.

- Guasch, H., W. Admiraal & S. Sabater, 2003. Contrasting effects of organic and inorganic toxicants on freshwater periphyton. *Aquatic Toxicology* 64: 165–175.
- Guasch, H., E. Navarro, A. Serra & S. Sabater, 2004. Phosphate limitation influences the sensitivity to copper in periphytic algae. *Freshwater Biology* 49: 463–473.
- Guasch, H., V. Lehmann, B. van Beusekom, S. Sabater & W. Admiraal, 2007. Influence of phosphate on the response of periphyton to atrazine exposure. *Archives of Environmental Contamination and Toxicity* 52: 32–37.
- Harbott, E. L. & M. R. Grace, 2005. Extracellular enzyme response to bioavailability of dissolved organic C in streams of varying catchment urbanization. *Journal of the North American Benthological Society* 24: 588–601.
- Haury, J., M. C. Peltre, M. Trémolières, J. Barbe, G. Thiébaud, I. Bernez, H. Daniel, P. Chatenet, G. Haan-Archipof, S. Muller, A. Dutartre, C. Laplace-Treuture, A. Cazaubon & E. Lambert-Servien, 2006. A new method to assess water trophy and organic pollution—the Macrophytes Biological Index for Rivers (IBMR): its application to different types of river and pollution. *Hydrobiologia* 570: 153–158.
- Hill, B. H., A. T. Herlihy, P. R. Kaufmann, R. J. Stevenson, F. H. McCormick & C. Burch Johnson, 2000. Use of periphyton assemblage data as an index of biotic integrity. *Journal of North American Benthological Society* 19: 50–67.
- Hussain, S., T. Siddique, M. Saalem, M. Arshad & A. Khalid, 2009. Impact of pesticides on soil microbial diversity, enzymes and biochemical reactions. *Advances in Agronomy* 102: 159–200.
- Lagacherie, P., O. Diot, N. Domange, V. Gouy, C. Floure, C. Kao, R. Moussa, J. M. Robbez-Masson & V. Szleper, 2006. An indicator approach for describing the spatial variability of artificial stream networks in regard with herbicide pollution in cultivated watersheds. *Ecological Indicators* 6: 265–279.
- Landry, D., S. Dousset & F. Andreux, 2004. Laboratory leaching studies of oryzalin and diuron through three undisturbed vineyard soil columns. *Chemosphere* 54: 734–742.
- Lenoir, A. & M. Coste, 1996. Development of a practical diatom index of overall water quality applicable to the French national water Board network. In Whitton, B. A. & E. Rott (eds), *Use of Algae for Monitoring Rivers II*. Studia Student. G.m.b.H, Innsbruck, Austria: 29–43.
- Lopez, L., C. Pozo, B. Rodelas, C. Calvo & J. Gonzalez-Lopez, 2009. Influence of pesticides and herbicides presence on phosphatase activity and selected bacterial microbiota of a natural lake system. *Ecotoxicology* 15: 487–493.
- Lyautey, E., S. Tessier, J. Y. Charcosset, J. L. Rols & F. Garabetian, 2003. Bacterial diversity of epilithic biofilm assemblages of an anthropised river section, assessed by DGGE analysis of a 16S rDNA fragment. *Aquatic Microbial Ecology* 33: 217–224.
- Lyautey, E., C. R. Jackson, J. Cayrou, J. L. J. Rols & F. Garabetian, 2005. Bacterial community succession in natural river biofilm assemblages. *Microbial Ecology* 50: 589–601.
- Marzorati, M., L. Wittebolle, N. Boon, D. Dofonchio & W. Verstraete, 2008. How to get more out of molecular fingerprints: practical tools for microbial ecology. *Environmental Microbiology* 10: 1571–1581.
- McClellan, K., R. Altenburger & M. Schmitt-Janssen, 2008. Pollution-induced community tolerance as a measure of species interaction in toxicity assessment. *Journal of Applied Ecology* 45: 1514–1522.
- Montuelle, B. & B. Volat, 1998. Impact of wastewater treatment plant discharge on enzyme activity in sediments. *Ecotoxicology and Environmental Safety* 40: 154–159.
- Morin, S., M. Vivas-Nogues, T. T. Duong, A. Boudou, M. Coste & F. Delmas, 2007. Dynamics of benthic diatom colonization in a cadmium/zinc-polluted river (Riou-Mort, France). *Fundamental and Applied Limnology* 168: 179–187.
- Morin, S., S. Pesce, A. Thili, M. Coste & B. Montuelle, 2010. Recovery potential of periphytic communities in a river impacted by a vineyard watershed. *Ecological Indicators* 10: 419–426.
- Othoniel, C., 2007. La croissance du biofilm photosynthétique: un indicateur du statut trophique des rivières? PhD Thesis, University of Bordeaux I: 245 pp.
- Pèrès, F., D. Florin, T. Grollier, A. Feurtet-Mazel, M. Coste, F. Ribeyre, M. Ricard & A. Boudou, 1996. Effects of the phenylurea herbicide isoproturon on periphytic diatom communities in freshwater indoor microcosm. *Environmental Pollution* 94: 141–152.
- Pesce, S., C. Fajon, C. Bardot, F. Bonnemoy, C. Portelli & J. Bohatier, 2006. Effects of the phenylurea herbicide diuron on natural riverine microbial communities in an experimental study. *Aquatic Toxicology* 78: 303–314.
- Pesce, S., C. Bardot, A. C. Lehours, I. Batisson, J. Bohatier & C. Fajon, 2008. Effects of diuron in microcosms on natural riverine bacterial community composition: new insight into phylogenetic approaches using PCR-TTGE analysis. *Aquatic Sciences* 70: 410–418.
- Pesce, S., F. Martin-Laurent, N. Rouard & B. Montuelle, 2009a. Potential for microbial diuron mineralisation in a small wine-growing watershed: from treated plots to lotic receiver hydrosystem. *Pest Management Science* 65: 651–657.
- Pesce, S., I. Batisson, C. Bardot, C. Fajon, C. Portelli, B. Montuelle & J. Bohatier, 2009b. Response of spring and summer riverine microbial communities following glyphosate exposure. *Ecotoxicology and Environmental Safety* 72: 1905–1912.
- Pesce, S., C. Margoum & B. Montuelle, 2010. In situ relationships between spatio-temporal variations in diuron concentrations and phototrophic biofilm tolerance in a contaminated river. *Water Research*. doi:10.1016/j.watres.2009.11.053.
- Rabiet, M., C. Margoum, V. Gouy, N. Carluet & M. Coquery, 2008. Transfert des pesticides et métaux dans un petit bassin versant viticole. Etude préliminaire de l'influence des conditions hydrologiques sur le transport de ces contaminants. *Ingénieries EAT«Azote, phosphore et pesticides: stratégies et perspectives de réduction des flux»*: 65–76.
- Rabiet, M., C. Margoum, V. Gouy, N. Carluet & M. Coquery, 2010. Assessing pesticide concentrations and fluxes in the stream of a small vineyard catchment—effect of sampling frequency. *Environmental Pollution* 158: 737–748.
- Ricart, M., H. Guasch, D. Barcelo, A. Geiszinger, M. Lopez de Alda, A. M. Romani, G. Vidal, M. Villagras & S. Sabater,

2009. Effects of low concentrations of the phenylurea herbicide diuron on biofilm algae and bacteria. *Chemosphere* 76: 1392–1401.
- Rier, S. T. & R. J. Stevenson, 2002. Effects of light, dissolved organic carbon, and inorganic nutrients on the relationship between algae and heterotrophic bacteria in stream periphyton. *Hydrobiologia* 489: 179–194.
- Romani, A. M. & S. Sabater, 2000. Variability of heterotrophic activity in Mediterranean stream biofilms: a multivariate analysis of physical–chemical and biological factors. *Aquatic Sciences* 6: 205–215.
- Romani, A. M., H. Guasch, I. Munoz, J. Ruana, E. Vilalta, T. Schwartz, F. Emlazi & S. Sabater, 2004. Biofilm structure and function and possible implications for riverine DOC dynamics. *Microbial Ecology* 47: 316–328.
- Rosemond, A. D., P. Mulholland & S. Brawley, 2000. Seasonally shifting limitation of stream periphyton: response of algal populations and assemblage biomass and productivity to variation in light, nutrients and herbivores. *Canadian Journal of Fisheries and Aquatic Science* 57: 66–75.
- Rutgers, M., I. M. Van't Verlaat, B. Wind, L. Posthuma & A. M. Breure, 1998. Rapid method for assessing pollution-induced community tolerance in contaminated soil. *Environmental Toxicology and Chemistry* 17: 2210–2213.
- Sabater, S., 2000. Diatom communities are indicators of environmental stress in the Guadiamar river, S-W Spain, following a major mine tailings spill. *Journal of Applied Phycology* 12: 113–124.
- Sabater, S., H. Guasch, M. Ricart, A. Romani, G. Vidal, C. Klünder & M. Schmitt-Jansen, 2007. Monitoring the effect of chemical on biological communities: the biofilm as an interface. *Analytical and Bioanalytical Chemistry* 387: 1425–1434.
- Schmitt, H., B. Martinali, P. Van Beelen & W. Seinen, 2006. On the limits of toxicant-induced tolerance testing: co tolerance and response variation of antibiotic effects. *Environmental Toxicology and Chemistry* 25: 1961–1968.
- Schmitt-Jansen, M. & R. Altenburger, 2005. Community-level microalgal toxicity assessment by multiwavelength-excitation PAM fluorometry. *Aquatic Toxicology* 86: 49–58.
- Schmitt-Jansen, M., U. Veit, G. Dudel & R. Altenburger, 2008. An ecological perspective in aquatic ecotoxicology: approaches and challenges. *Basic and Applied Ecology* 9: 337–345.
- Sinsabaugh, R. L., M. M. Carreiro & D. A. Repert, 2002. Allocation of extracellular enzymatic activity in relation to litter composition, N deposition, and mass loss. *Biogeochemistry* 60: 1–24.
- Stevenson, R. J. & Y. P. Pan, 1999. Assessing environmental conditions in rivers and streams with diatoms. In Stoermer, E. F. & J. P. Smol (eds), *The Diatoms: Applications for the Environmental and Earth Sciences*. Cambridge University Press, UK: 11–40.
- Teissier, S. & M. Torre, 2002. Simultaneous assessment of nitrification and denitrification on freshwater epilithic biofilms by acetylene block method. *Water Research* 36: 3803–3811.
- Tlili, A., U. Dorigo, B. Montuelle, C. Margoum, N. Carluer, V. Gouy, A. Bouchez & A. Bérard, 2008. Responses of chronically contaminated biofilms to short pulses of diuron. An experimental study simulating flooding events in a small river. *Aquatic Toxicology* 87: 252–263.
- Toräng, L., N. Nyholm & H. J. Albrechtsen, 2003. Shifts in biodegradation kinetics of the herbicide MCPP and 2, 4-D at low concentrations in aerobic aquifer materials. *Environmental Science and Technology* 37: 3095–3103.
- Villeneuve, A., 2008. Effets conjoints de facteurs physiques et chimiques sur la structure et la composition du périphyton: une approche multi échelle, PhD Thesis, U. de Savoie: 223 pp.
- Villeneuve, A., B. Montuelle & A. Bouchez, 2010. Effect of minor changes in light intensity, current velocity and turbulence on the structure and function of the periphyton. *Aquatic Sciences* 72: 33–44.
- Vu, S. H., S. Ishihara & K. Watanabe, 2006. Exposure risk assessment and evaluation of the best management practice for controlling pesticide runoff from paddy fields. Part 1: paddy watershed monitoring. *Pesticides Management Science* 62: 1193–1206.