



HAL
open science

Vers le futur Internet d'objets au travers d'une optimisation inter-couches des protocoles standardisés

Bogdan Pavkovic

► **To cite this version:**

Bogdan Pavkovic. Vers le futur Internet d'objets au travers d'une optimisation inter-couches des protocoles standardisés. Autre [cs.OH]. Université de Grenoble, 2012. Français. NNT : 2012GRENM096 . tel-00849136

HAL Id: tel-00849136

<https://theses.hal.science/tel-00849136>

Submitted on 30 Jul 2013

HAL is a multi-disciplinary open access archive for the deposit and dissemination of scientific research documents, whether they are published or not. The documents may come from teaching and research institutions in France or abroad, or from public or private research centers.

L'archive ouverte pluridisciplinaire **HAL**, est destinée au dépôt et à la diffusion de documents scientifiques de niveau recherche, publiés ou non, émanant des établissements d'enseignement et de recherche français ou étrangers, des laboratoires publics ou privés.

THÈSE

Pour obtenir le grade de

DOCTEUR DE L'UNIVERSITÉ DE GRENOBLE

Spécialité : **Informatique**

Arrêté ministériel : 7 août 2006

Présentée par

Bogdan PAVKOVIĆ

Thèse dirigée par **Andrzej DUDA**
et codirigée par **Fabrice Theoleyre**

préparée au sein **UMR 5217 - LIG - Laboratoire d'Informatique de Grenoble**
et de **École Doctorale Mathématiques, Sciences et Technologies de l'Information, Informatique**

Going towards the future Internet of Things through a cross-layer optimization of the standard protocol suite

Thèse soutenue publiquement le ,
devant le jury composé de :

M. Thomas Noël

Professeur, Université de Strasbourg, Rapporteur

M. Fabrice Valois

Professeur, Université de Lyon, Rapporteur

M. Michel Misson

Professeur, Université de Clermont-Ferrand, Examineur

M. Andrzej Duda

Professeur, Grenoble INP – Ensimag, Directeur de thèse

M. Fabrice Theoleyre

Chargé de Recherche CNRS, Université de Strasbourg, Co-Directeur de thèse



Acknowledgments

Firstly, I would sincerely like to thank to Nathalie Mitton who initiated me to the world of research and recommended me for the PhD position in Grenoble.

I want to thank to Dominique Barthel and Giyyarpuram Madhusudan from Orange Labs/ France Telecom, Meylan, for providing experimental data and advices that allowed me to successfully start my PhD journey.

I would like to thank Thomas Noël and Fabrice Vallois for their time to evaluate my thesis manuscript, and along with Michel Misson for being in the jury for my thesis defense.

I owe deep gratitude to my supervisor Fabrice Theoleyre who knowledgeably guided me along the waters of PhD odyssey, through active weekly meetings, technical and scientific advices. His personal qualities made my doctoral journey a worthwhile and pleasant experience. Special thanks goes to my thesis director Andrzej Duda for having given me the opportunity to study in the LIG laboratory and actively present my work in the worldwide conferences. His high level guidance assured that my research addresses interesting scientific challenges that lead to publications.

I thank all the permanent members of Drakkar team - Franck Rousseau, Martin Heusse, and Olivier Alphand - for being constantly available to discuss and challenge my ideas. All the PhD candidates from Drakkar team, and other fellow PhD travelers, showed me what a great colleagues should be alike - friendly, supportive, ready to help, discuss, and share. And I am not talking only about the countless hours we spent in the lab. Maciej, Nazim, Isabel, Maru, Ana, Carina, Reinaldo, Sofia, Azzeddine, and Fabian - you are great. I have to bring to a special light Maciej, the person of infinite smiles, and Nazim, the great provocative teacher of French language.

My personal differences and struggles with French bureaucracy would resemble to Don Quixote fight with windmills if our paperwork angels, Pascale and Ghislaine, were not around.

I dedicate this line to uncountable number of persons that I have met in Grenoble over the last 3 years - all of them made me grow as a person.

My journey would not be the same without my new family - my own personal *Auberge Espagnol* - all of 19 people who created the unique atmosphere in the mythical apartment of 20, avenue Alsace-Lorraine. A potluck of bon vivants from around the world, with whom I shared my daily life. I will cherish our stories over the cooking sessions followed by delicious meals. Show must go on dedication goes to my beloved Dominik, Cécile, Gaëtan, Bjorn, and Cédric - who continue carrying the AL torch. I owe a deep gratitude to Dominik and Antoine for initiating me in the world of mountaineering and tree loving.

Big ups for my friend at first sight, bearded companion, and a fellow photography aficionado - Kristoforos. Special thanks to Nathalie and Axelle for bringing so much creative and positive energy throughout our Sunday cinema sessions and disguised parties.

I am grateful to my Serbian friends that have not forgot about me and that were always ready to open their arms each time I went back home in Serbia (Cveja, Sanja, Jeca, Miša, Panjko, Vlada, Brena, Sloba, Komša, Nidža, Djole, Plavi, Šljiva, Tića, Radak, Steva, Anđa,...).

Special thought goes to my dear, loving, and busy (no, they are not doing thesis, "just" having or waiting for kids) best-mans Miljan and Danijel for keeping the trinity going.

I want to make sure to leave a written trace of my recognition for "the" man at the same wave length and with the perfect mutual synchronization - Jovanče. Almost day-to-day friendly chitchats, shared PhD delights, literature exchanges and debates, perfect travel companion (hope more travels to come) and mucho mas.

Any of this would not be possible without my family - my parents Rastko and Novka, and my sister Milica offered me a constant love, care, support, and advices when needed. Finally, I accomplish this chapter by thanking my fiancée (good opportunity) Ivana for giving me more than enough love, understanding, and strength necessary to close this part of the life journey.

Abstract

Internet of Things (IoT) paradigm envisages to expand the current Internet with a huge number of intelligent communicating devices. Wireless Sensor Networks (WSN) deploys the devices running on meager energy supplies and measuring environmental phenomena (like temperature, radioactivity, or CO_2). WSN popular applications include monitoring, telemetry, and natural disaster prevention. Major WSN challenges are how to allow energy efficiency, overcome impairments of wireless medium, and operate in the self-organized manner. The WSN integrating IoT will rely on a set of the open standards striving to offer scalability and reliability in a variety of the operating scenarios and conditions. Nevertheless, the current state of the standards have interoperability issues and can benefit from further improvements.

The contributions of the thesis work are:

- We conducted an experimental analysis and characterization of a WSN environment. Our analysis included the link characterization, correlation with environmental parameters, as well as network dynamics. Analytical study allowed us to identify the key weaknesses of the WSN environment as well to get a better understanding of the dynamics—both link and node neighborhood related.
- We confront the interoperability issue of the leading IEEE 802.15.4 standard on the Medium Access Control layer and RPL standard on the transport layer. We propose to accommodate the original cluster-tree structure and to build an elegant framework for collision free multi-hop operation of the IEEE 802.15.4 that allows RPL to run on top of it. Furthermore, we evaluate through extensive simulations two distributed self-organization schemes that achieve near collision free operation.
- The choice of MAC parents within a directed acyclic graph has a crucial impact on the quality of possible end-to-end routes on the transport layer. Therefore, we propose a distributed algorithm for efficient parent selection based on multiple metrics. We obtain a convergecast topology structure enabling the load balancing and limiting the congestion, while using the radio links of good quality. Extensive simulations demonstrate the advantages of the resulting structure in terms of convergence time, stability, and energy efficiency in a long term.
- We propose a set of new mechanisms that improve RPL performances and enable Quality of Service operation for delay sensitive traffic. Our extension for multi-path opportunistic routing helps to improve packet

delivery before a deadline, while minimizing overhead and energy consumption compared to the original version of RPL.

Key words: wireless sensor network, standardization, RPL, 802.15.4, MAC protocol, routing, self-organization, cross-layer, statistical analysis, experimental study

Résumé

Le paradigme de l'Internet des Objets (IoT) envisage d'enrichir l'Internet actuel avec un grand nombre de dispositifs intelligents communicants. Les réseaux de capteurs sans fil (RCF) exploitent des appareils avec des ressources énergétiques limitées équipés de capteurs afin de récupérer en temps réel des mesures (comme la température, la radioactivité, ou le CO₂).

Les réseaux de capteurs sont particulièrement pertinents pour la surveillance, la télémétrie ou la prévention des catastrophes naturelles. Cependant, ce type de réseau pose des problèmes majeurs tels que l'utilisation efficace de ressources énergétiques limitées, la prise en charge transparente de nœuds défaillants, sans intervention humaine.

L'Internet des Objets ne permettra d'intégrer des réseaux de capteurs autonomes que si les protocoles sont standards et passent à l'échelle.

Les contributions de cette thèse sont les suivantes :

- nous avons caractérisé expérimentalement un réseau radio multisaut en exploitant statistiquement un grand volume de mesures provenant d'une plate-forme expérimentale opérée par Orange. Notre analyse porte sur la caractérisation d'un lien et de sa qualité ainsi que de la dynamique du réseau.
- nous avons proposé de modifier le standard IEEE 802.15.4 afin qu'il puisse cohabiter efficacement avec le protocole de routage actuellement standard de l'Internet des Objets, RPL. En particulier, nous proposons d'exploiter une structure de graphe dirigé acyclique afin d'exploiter une topologie maillée et pallier à la déficience éventuelle d'un nœud. Nous avons proposé également des algorithmes simples d'ordonnancement distribué des supertrames adaptés à cette topologie.
- le choix des pères au niveau MAC dans une structure de graphe dirigé acyclique est déterminant dans la qualité des routes possibles dans la couche réseau. Nous avons ainsi proposé un algorithme de choix des pères basé sur plusieurs métriques. Nous aboutissons à une structure permettant d'équilibrer la charge, limitant les points de congestion, utilisant des liens radio de bonne qualité, limitant la congestion au niveau MAC.
- nous avons enfin présenté des mécanismes permettant d'offrir une qualité de service dans une pile s'appuyant sur IEEE 802.15.4 et RPL. Notre extension de routage opportuniste et multi-chemin contribue à améliorer la livraison des paquets avant une date limite, tout en minimisant le

surcout et la consommation d'énergie par rapport à la version originale de RPL.

Les mots clefs: réseaux de capteurs sans fil, standardisation, RPL, 802.15.4, MAC, routage, auto-organisation, inter-couche, analyse statistique, étude expérimentale

Contents

I	Introduction	1
	1 Wireless Sensor Networks—a long way from the start line	1
	2 Internet of Things—the new research challenges for WSN	3
	3 Outline	5
II	State of the art	7
	1 Medium Access Control Techniques for Wireless Sensor Networks	7
	1.1 MAC guidelines for Wireless Sensor Networks	7
	1.2 Classes of MAC methods	10
	1.3 Standardization of the IEEE 802.15.4	15
	2 Routing in Wireless Sensor Networks	23
	2.1 Basic concepts	23
	2.2 General families	24
	2.3 Emerging IPv6 routing standards for WSN	32
	3 Cross-Layer Techniques for Wireless Sensor Networks	39
	3.1 Classical layered paradigm in WSN in the light of IoT	39
	3.2 Idea of cross-layer in WSN	40
	3.3 Cross-layer approaches	41
III	Experimental analysis and characterization of a Wireless Sensor Network environment	45
	1 Methodology	46
	1.1 Testbed description	46
	1.2 Database description	47
	1.3 Bidirectional and unidirectional links	48
	1.4 Filtering data	49
	2 Experimental testbed data analysis	50
	2.1 Link quality	50
	2.2 Network dynamics	55
	3 Conclusions	59
	4 Recommendations for experimental testbed	59
IV	IoT standards - how to make them work together	63
	1 Problem statement	63
	2 New superframe collision free organization	64
	3 BOP and superframe slot attribution algorithm	65
	3.1 Necessary neighborhood information	65
	3.2 BOP slot assignment	66
	3.3 Superframe slot assignment	66
	4 New topological structure: cluster-DAG	67
	4.1 Multiple parent association	68

5	Performance evaluation	70
5.1	Traffic model and routing	70
5.2	Cluster-DAG properties	71
5.3	Impact of the BO/SO values	72
5.4	Scalability	75
6	Conclusions	75
V	Multipath opportunistic routing with RPL	79
1	Problem statement	79
2	QoS considerations with RPL	80
2.1	Race against the time: beat the deadline	81
2.2	Multi-path opportunistic forwarding algorithm	83
3	Performance evaluation	84
3.1	Simulation setup	84
3.2	Result analysis	85
4	Conclusions	89
VI	Fuzzy logic cluster-DAG topology construction	91
1	Problem statement	91
1.1	Global recommendations for convergecast tree	91
1.2	Parent selection metrics	92
1.3	Modified IEEE 802.15.4 beacon format	97
2	Methods for combining multiple metric	98
2.1	Hierarchical succession	98
2.2	Linear combination	99
2.3	Fuzzy logic	99
3	Parent selection with fuzzy logic	101
3.1	Fuzzy decision rule	101
3.2	Fuzzification of the input variables	101
4	Performance evaluation	103
4.1	Simulation setup	104
4.2	Structural properties	105
4.3	Convergence and stability	108
4.4	Energy concerns	112
4.5	Impact of the bootstrap strategy	112
5	Conclusions	114
VII	Conclusions and Future work	115
1	Summary of the thesis contributions	115
2	New research perspectives	117
	Publications	119
	List of Abbreviations	121
	List of Figures	125
	List of Tables	127

Bibliography 129

CHAPTER I

Introduction

1 Wireless Sensor Networks—a long way from the start line

Wireless Sensor Networks (WSN) became very popular thanks to their driving idea during the past decade. A large amount of tiny wireless devices reliably running on a meager energy resources and providing a valuable measurements of the observed environment. The sensor readings (such as temperature, vibrations, sounds, movements etc.) are collected in a (set of) sink node(s) for further processing, analysis, and possible action issued as a response to sensed phenomena. Durable wireless sensors measuring the environment alleviate the need to use wires and human intervention, thus offering a low intrusive approach.

Intended large scale deployments (we can even read about hundred thousands or millions of devices) will be made possible by a small price of WSN devices. Wireless sensors are embedded system with limited resources—a low-power (up to couple 10 mW), a low-range (few hundreds of meters), the low-bandwidth communication (250 kbit/s), a small memory (few MB), and finally, a small battery (few thousands mAh). Obviously, the characteristic of WSN radio chips are far inferior compared to a concurrent WiFi technology, especially when it comes to the emitted power. The original idea to deploy nodes over a large area combined with a small radio range lead to multihop functioning of WSN.

WSN owe their success to the abundance of envisioned applications leading to the improved quality of life, a better products, or a cleaner environment. We can name some of them: the environmental, habitat, or structural monitoring, as well the surveillance systems, a home automation, or a natural disaster prevention [60]. The near future have also stored for us smart homes, buildings, cities and industrial plants, that will offer the energy savings and the control over the distance [34]. WorldSensing company offers the perfect running example of a WSN application. A network of small magnetic wireless sensors integrated in the road, combined with a mobile phone application help citizens to save time finding a free parking spot in a busy city center. Implemented solution brings positive effects on the traffic flow regulation, decreasing

the pollution, and increasing the general well-being in large cities.

WSN applications can be roughly divided into two classes according to their data collection pattern: time driven and event driven. The former one represents the class of periodic reporting of observed environmental or habitat phenomena. The later one aims at recording as much as possible data measures after an interesting event has triggered sensor nodes. Obviously, the initial application scenario deeply impacts all consequent choices for used WSN protocols.

In parallel with the application choice, the intrinsic wireless medium impairments (volatile (lossy) nature of radio links—the unpredictable packet losses due to interference, path loss, shadowing or multi-path fading [112]) as well influence the most of the communication layers. A reliable WSN protocol should incorporate mechanisms that account and leverage on the wireless medium downfalls. It is a hard and a non trivial task to analyze and afterwards create a trustworthy model of the wireless link that can be used to improve the network protocols. For example, Packet Delivery Ratio in function of the link quality indicator measured at the radio chip [109]. In this light, we believe that the research in the WSN domain should be inspired by a real world observations and feedback. Some research advices already exist on how to conceive a running testbed [15] or how to simplify some of the research assumptions by critically observing what really matters in design goals [17].

WSN represent a flat collection of sensors nodes with no fixed infrastructure support. Self-organization is thus a huge challenge for WSN—a set of individual sensors need to independently create a fully autonomous network without human intervention nor a specific network knowledge. Nevertheless, the node positions can be optimized in advance to provide improved connectivity and coverage, while using a minimal number of deployed nodes. Similarly to the plug-and-play concept from personal computers, WSN should offer a deploy-and-forget experience to the final users. Self-organization over the long operational periods should account for the link breakage, appearance of new nodes, and dying out of nodes due to the battery exhaustion or malfunctioning. Therefore, WSN should be self-healing.

The classical WSN paradigm of nodes running on the limited battery power got extended by the recent development of the Power Line Communication (PLC) and energy scavenging devices. A new type of hybrid WSN networks can be considered where nodes can be either battery or line powered, or can use small amounts of recovered (scavenged) energy from the environment (sun, vibrations, magnetic waves, temperature gradient, etc.). Such energy heterogeneity should be taken into account when conceiving new application scenarios and protocols for self-organization. Nevertheless, the energy efficiency remains of the utmost importance when entire WSN runs on the batteries.

2 Internet of Things—the new research challenges for WSN

WSN are like isolated islands of wireless smart objects that need to be merged with a huge continent of already interconnected machines belonging to nowadays Internet. The existing real world WSN deployments still operate independently from the rest of the world. The collected data is held inside the closed network not allowing outside access and sharing.

WSN real world deployments exist mainly in two forms—as small trial testbeds preceding a launch of a large running industrial deployment, or in a form of research testbed used to verify theoretical assumptions or newly conceived protocols. Deployments steadily grow in size and soon will be reaching the promised goal that was set in the early WSN projections. The progress is due to the valuable research done in the previous decade that lead to the conception of reliable, scalable, and energy efficient WSN protocols, necessary for large deployments.

The driving idea behind the Internet of Things (IoT) is to revolutionize the current Internet by expanding it with a large number of smart communicating objects (sensor, tags, embedded systems, modern mobile phones). Communication between devices should be transparent regardless to the underlying technology. The development of the new IPv6 protocol will make possible to interconnect a huge number of smart devices (approximately 3.4×10^{38}), solving the long-anticipated problem of IPv4 running out of addresses. Each smart object will be reachable through an unique attributed address (128 bits).

Security of WSN in the interconnected IoT paradigm is a delicate aspect. A smart devices will be in charge of monitoring people's health, critical scenarios, or providing telemetric measures. A breach of security might have disastrous consequences on people's lives, important structures, or future of cities, and as well important economic losses. Smart devices need to offer a high level of security robustness to shield potential users from outside attacks and misconduct.

WSN operate in the unlicensed band densely populated with various devices leading to a radio polluted environment. A surrounding interferer can obstruct data availability since both emit at the same time. Additionally, a simple microwaves can behave as jammers, easily leading to packet drops and energy waste. Some of these issues can be either handled at radio link layer and higher layers [126] or by secure channel hopping mechanism [86].

Standardization is a critical success factor for smart objects, notably for WSN. Existing abundance of proprietary solutions hinder the wider acceptance of the technology at the market. Vendors control the future develop-

ment of the technology thus making users, customers, manufacturers, and developers (contributors) dependent. With the use of standards, the technology is independent of any of the aforementioned actors. Customers (final users) benefit from a wider range of services, without being attached to any particular service provider or technology vendor. **IoT** promotes the use of open standards—unburdened by any form of intellectual property, such as patents, sometimes freely licensed, and most of them openly published [34]. A large community can scrutinize / provide valuable feedback, compared to smaller engineering teams employed by particular vendor.

Standardization efforts relevant to WSNs are the IEEE (link and physical layer solutions), ETSI (complete machine-to-machine solutions), ISA (regulation for control systems) and the IETF (routing and network solutions).

IEEE generally standardizes the physical layer and medium access protocols. The IEEE 802.15.4 proposes a widely accepted WSN global standard at **MAC** and **PHY** level for interconnecting low-power/data-rate/cost sensor and actuator networks. The IEEE 802.15.4 standard for ubiquitous networks responds to a wide range of application scenarios [136] (e.g. interactive toys, health monitoring, building surveillance, home automation [45]).

The Internet Engineering Task Force (**IETF**) comprises more than 120 active working groups organized in 8 areas. IETF working groups related to WSNs are IETF 6LoWPAN (focusing on end-to-end IPv6 connectivity in WSNs) and IETF **ROLL** (Routing Over Low-power Lossy links) (focusing on routing and self-organization). **ROLL** working group aim to cover a comprehensive number of various use cases: Home automation [18], Commercial building automation [78], Industrial automation [92], Urban environments [33]. RPL (Routing Protocol for **LLN**) is built over a traditional distance vector (gradient) routing paradigm in order to support the variety of network traffic patterns (multi-point to point, point to multi-point, and point to point).

These two WSN building stone standards (IEEE 802.15.4 and RPL) are conceived as general wide use protocols, independent from the rest of the protocol stack. However, some particular decisions from two standardization groups make the interoperability of two standards impossible in the default version. Additionally, the both standards propose a self-organization mechanism. Maintaining two different topology structure is not only redundant but also highly energy inefficient.

3 Outline

Work covered in this thesis considers the **WSN** supporting IP connectivity and running over the low-duty IEEE 802.15.4 wireless links. Such networks will lead to the development of the future Internet of Things and enable large deployments of sensors in various domains (smart homes, smart cities, smart grids, environmental sensing, critical infrastructure surveillance, etc.).

We propose a cross-layer approach that will allow joint operation of two emerging **WSN** standard protocols—IEEE 802.15.4 at the **MAC** layer and RPL at the network layer. Therefrom, we offer a set improvements for both protocols as well as an efficient topology construction algorithm that strive for distributed self-organization, self-healing and energy efficiency in a long term. Feasibility and effectiveness of all proposed schemes have been verified through detailed simulation studies.

The second chapter presents the state of the art, according to a studied communication layer. The **MAC** techniques available in the literature (synchronized, preamble sampling and hybrid) are presented before an overview of routing protocols in WSNs, focusing notably on distance-vector (gradient) routing. We conclude the chapter by a detailed discussion on the utility of the cross-layer approach and its application to solving challenges in the light of the **IoT** paradigm.

The third chapter offers an experimental analysis and characterization of a **WSN** environment. We wanted to gain a valuable real-world motivated standpoint before considering the problematic of protocol design. The analytical study allowed us to identify the key weaknesses of the **WSN** environment as well obtain a better understanding of the dynamics—both link and node neighborhood related. We terminate this chapter with a set of recommendations for an experimental testbed for characterizing **WSN** environment motivated by the difficulties we have encountered during our study.

The fourth chapter describes the building stone for the rest of the thesis. The joint operation of the IEEE 802.15.4 and RPL standards is being considered by accommodating the original cluster-tree topological structure. Then, we propose an elegant framework for a collision free multi-hop operation of the IEEE 802.15.4 that accommodates RPL on top of it. Furthermore, we evaluate through extensive simulations two distributed schemes that achieve near collision free self-organization of the nodes. The pros and cons of both schemes are evaluated against the existing IEEE 802.15.4 standard.

The fifth chapter examines how to further capitalize on the joint RPL and IEEE 802.15.4 resulting topological structure, from the view point of routing. Our objective is to enhance the RPL mechanism that will enable Quality of Service (**QoS**) multi-path opportunistic routing and improve packet delivery

before a deadline, while minimizing overhead and energy consumption. We compare our opportunistic version of RPL to its basic version through detailed simulations in terms of packet delivery ratio, incurred delay, and overhead.

The sixth chapter focuses on the distributed cross-layer convergecast topology construction within the joint IEEE 802.15.4 and RPL framework. We start with elaborating a set of global recommendations that an efficient convergecast structure should attain. Thereafter, we correspondingly propose a set of locally measured metrics that would help achieve these goals. Finally, we adopt a practical method to combine them in a single output metric used for efficient parent selection. We evaluate the proposed method by measuring the properties of the resulting structures (convergence time, stability, energy efficiency) and its impact on routing performance.

The seventh chapter completes this thesis by summarizing the main contributions. The final remarks motivate further possible research directions that could stem out from our work.

CHAPTER II

State of the art

The goal of this chapter is to give a general overview of the tremendous research efforts in **WSN** that lead to the standardization of the protocols that will become the building stone of the Internet of Things (**IoT**). We will focus our attention in particular on the Medium Access Control (**MAC**), and routing protocols. We will give some consideration to the topology construction, not exclusively belonging to **MAC** nor routing layer. These two protocol layers have precisely defined goals and serve for a particular purpose, but still in our opinion they are mutually dependent. We cannot consider the design either of them without the back thought how this will impact the other one. This is why we would like to discuss the philosophy of cross-layer protocols in the light of **IoT** where the classical layered philosophy is predominant.

1 Medium Access Control Techniques for Wireless Sensor Networks

We can freely say that the **MAC** layer is a basic building block in **WSN**. Hence, it has been thoroughly studied in details over the last decade (more than 100 distinct solutions) [5]. This section is meant to recall the purpose of the **MAC** layer, state the most important design guidelines based on the particularities of **WSN** environment, followed by an overview of the important classes of **MAC** as well as of the IEEE 802.15.4 standard. We will discuss some of the un-answered question and challenges in the light of the IEEE 802.15.4 standard that this thesis addresses.

1.1 MAC guidelines for Wireless Sensor Networks

The two general roles of a **MAC** method consist of providing the **MAC** addresses to nodes and enabling mechanisms for channel access in a situation where multiple nodes should simultaneously share medium. Putting it simply, it decides when a particular node should transmit packets, when it should listen for incoming packets, and finally when it should go to sleep mode, potentially saving the energy. Obviously, a coordination between a potentially large number of nodes becomes highly important.

WSN environment particularities impose on MAC mechanisms some additional constraints—half-duplex radio (cannot transmit and receive simultaneously), broadcast nature of wireless medium (packets are received by all nodes located in the radio neighborhood of the transmitter), volatile (lossy) nature of radio links (unpredictable packet losses due to interference, path loss, shadowing or multi-path fading) [112], limited battery supply in contrast to long demanded autonomy, low-cost low-power WSN radio chips and antennas not offering large communication ranges.

Energy being the most valuable resource, the goal of any WSN protocol, especially MAC will be to spend it wisely and prevent its wastage. We identify the main guidelines for energy efficient MAC that should be taken in account [131]:

- *Idle listening*—when a node does not know when the reception will occur, radio chip is uselessly kept in the listening state for a long time in order not to miss an incoming packet. Idle listening presents the largest source of energy wastage since the radio chip consumption stays almost constant, whether the carrier is sensed occupied or free. When a network traffic is low, idle listening becomes even bigger problem since actual transmissions are quite rare.

A MAC protocol can turn off the radio in order to save energy. Duty-cycle (the ratio between the time spent in sleeping and being awake) should be kept as low as possible. On the other hand, long sleep times should not hinder the normal network operation i.e. nodes should be ready to react and participate in network operation anytime needed. The deafness effect manifests in packet losses occurring due to inappropriate radio state (sleep) of supposed packet destination. It should be avoided while still preserving energy efficient network operation, that is to say, putting nodes to sleep as often as possible.

- *Overhead*—control packets (not carrying any useful application data) are considered as protocol overhead. Control packets are usually necessary for a better node coordination and efficient operation of protocols underneath the application layer. For example, the use of RTS/CTS control packets (cf. Figure 2.1) alleviate the hidden terminal problem. Centralized solutions are out of the question—flooding the control information from centralized source over multiple hops is highly energetically expensive. Multi-hop network topology and restrained energy resources make it even more important to use distributed solutions. Energy consumption due to control packet propagation could be additionally reduced by decreasing the packet size and generation frequency. Extra

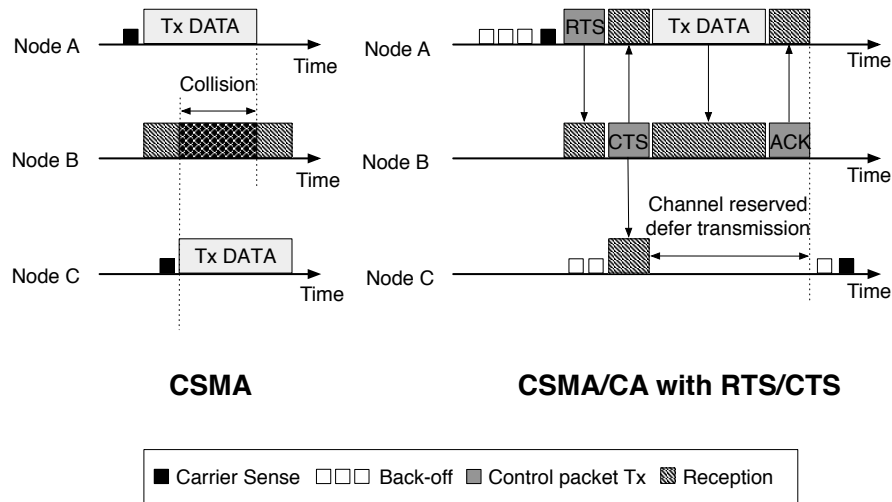

Figure 2.1: Illustration of the basic CSMA (Carrier Sense Multiple Access) principle and CSMA/CA (Collision Avoidance) with RTS/CTS mechanism. The use of the additional RTS/CTS control packets remedies the hidden terminal problem. Node *B* CTS response will reserve the radio channel till the end of the node *A* packet transmission

energy savings can be achieved on a lower scale—redundant bits (not carrying any useful information) inside the packets can be compressed or removed to decrease the overall packet size.

- *Overhearing*—the wireless medium being broadcast, all unintentional receivers uselessly waste radio and energy resources by overhearing the packets not meant for them. As a consequence, throughput decreases, delay increases, which is even more accentuated in dense deployments.
- *Collisions*—two concurrent transmissions collide producing a jammed signal at the receiving node, while transmitters are not able to detect it. All nodes involved in communication waste energy, since a packet is finally discarded being unable to decode. More energy is spent on eventual re-transmissions, followed by reduced channel availability, and potentially leading to more collisions and energy waste.

An efficient **MAC** should follow these guidelines. Additionally to fundamental requirement of decreased energy consumption, some particular **WSN** scenarios impose supplementary ones. We can briefly mention some of them: a mobile **WSN**, where the node movements should be taken into account; scenarios with only mobile sinks, where the trajectory of collecting nodes plays important role; heterogeneous networks in terms of node type or density, where

the difference in node characteristics or local node degree should be incorporated in the **MAC** behavior; networks with the energy harvesting devices, where the periodicity and the amount of recuperated energy modify the **MAC** standard operation.

1.2 Classes of **MAC** methods

This section gives a global overview of main classes of the **WSN MAC** protocols that have emerged in the previous years—synchronized, preamble sampling and hybrid. All classes are briefly introduced with short description and a figure explaining the general idea. Each subsection offers the comments on the advantages, defaults, specific use cases of each general class.

1.2.1 Synchronized

The synchronized **MAC** class characterizes the need to organize the nodes around a common timing schedule. Accurate active (transmission and reception) and sleep periods will be established prior to any network communication. Depending on how precise and flexible these periods are, we can differentiate between: slotted and common active/sleep period schemes.

Time synchronization Before we present the state of the art on synchronized **MAC** schemes, we would like to give a brief overview on the challenges of time synchronization in **WSN** [50]. Each node gets a local notion of time through its internal clock based on a quartz oscillator. Cheap oscillators used in **WSN** usually introduce a drift between 30 and 100 ppm. A drift is gradually changing according to the external temperature, battery voltage, and on oscillator aging. Having the common notion of time in **WSN** can be achieved on a global scale [77] or between a local group of nodes [108]. Either way, nodes should periodically exchange packets announcing their local timer state and logical clock rate in order to achieve drift and offset compensation.

The global schemes strive to minimize the skew between any two nodes in the network, regardless how distant they are in the radio topology. Usually, only a sink node possesses an accurate source of time (atomic clock or GPS) that propagates to other network nodes through the exchange of control packets. The control packet dissemination induces the cumulative synchronization errors due to different propagation times over multiple hops. This error has to be taken into account, additionally to drift and offset errors.

Having a global synchronization is a noble and challenging goal, but is it really necessary that distant nodes maintain tight and precise synchronization? Most of the **MAC** proposals only require a precise schedule between 1-hop

transmitters and receivers to result in efficient operation. This observation motivated researchers to rather concentrate on a local (also called *gradient*) synchronization where a clock skew needs to be corrected among 1-hop neighbors. Obviously, the control overhead decreases since the packet propagation is limited to imminent radio neighbors. The lack of global notion of time does not impair the normal protocol operation.

Regardless of the selected synchronization approach (global or local skew), it is almost impossible that system achieves perfect synchronization due the imperfections of quartz oscillator [50] and impairments of the wireless channel [112]. Time synchronization schemes rather strive to guarantee a more or less tight upper bound on the clock offset. Due to a clock imprecision, a *guard time* is used prior to any scheduled event. Nodes will turn on their radio at least a guard time before actual communication takes place. A guard time accounts for the uncertainties of the exact time estimation. The use of a guard time increases the nominal duty cycle, since nodes are obliged to stay awake for a bit longer time. Smaller upper bounds can be achieved at the cost of more frequent control traffic necessary for the time synchronization.

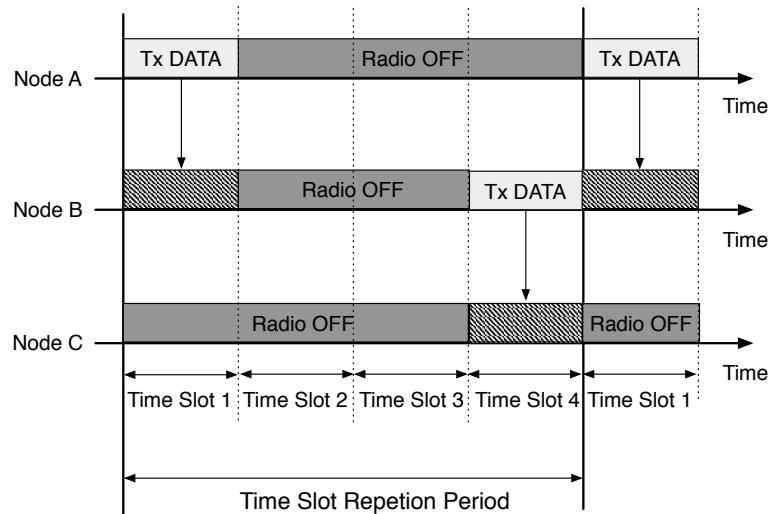

Figure 2.2: General idea of slotted synchronized MAC scheme - a TDMA (Time Division Multiple Access) style time slot division

Slotted schemes Slotted schemes rely on tight synchronization of TDMA (Time Division Multiple Access) [118] time slots. Each pair of communicating nodes is dedicated a unique time slot for its own needs. The general idea is illustrated in Figure 2.2. For example nodes *A* and *B* are attributed Time Slot 1 for their packet exchange. Time Slot communication can be unidirectional

($A \rightarrow B$) [11], if sufficient number of slots are vacant, or bidirectional ($A \leftrightarrow B$) [99], if a protocol tries to minimize the number of used slots.

While the protocol is running, existing Time Slots duplicate each Repetition Period, the nodes taking turns to carry out traffic exchange. When a node is not transmitting nor receiving, it can turn off his radio and sleep the rest of the time slots. A node duty-cycle depends on its network activity e.g. node B will have duty-cycle of 50% where node A will have only 25%. Additionally, the duty cycle also depends on a network topology. In dense networks, a slotted scheme needs more unique time slots to efficiently schedule all interfering nodes. As a result, a smaller duty cycle is obtained, and potentially, a larger routing delay. To decrease the total number of attributed time slots, a slotted MAC scheme can combine FDMA solution in parallel with TDMA [93].

The slotted scheme reduces overhearing and idle listening by making a collision-free schedule. As a result, a lower number of necessary re-transmissions is achieved.

Time slots can be established in three different ways:

- *Centralized*—A sink decides on an overall schedule and distributes it to all nodes. The network wide information about a topology needs to be collected at the sink. The schedule can be efficiently maintained in a single hop network, whereas in multi-hop topologies the control information is being flooded. **Arisha** [11] proposes two slot centralized attribution algorithms: a graph breadth and depth search. The former one attributes consecutive transmission slots to nodes sharing the same ancestor node. The approach favors data aggregation since the ancestor node continuously listen to all slots of its descendant nodes, but incurs a higher delay. The later one starts the slot attribution from a single leaf node until it reaches a sink. The process is repeated for all leaf nodes and their paths. This approach optimizes a delay but forces parent nodes to frequently change radio states. TSMP [93] additionally collects the traffic generation requirements to elaborate a better time schedule.
- *Clustered*—a schedule is more flexibly elaborated with the help of elected cluster-head nodes. Instead of collecting the global information, cluster-heads perform a time slot coordination in a 1-hop neighborhood. PACT (Power Aware Clustered TDMA) [89] dedicates control slots prior to data slots so that nodes can declare upcoming transmissions, later on scheduled by the cluster-heads. The energy consumption is equally spread over all nodes, taking turns to act as a cluster-head. BMA (Bit-Map Assisted) [73] offers a similar approach, where, as the title says, the time slot schedule is communicated in the form of bit-maps.

- *Distributed*—each node locally chooses a collision free slot, only based on the available neighborhood information. TRAMA (TRAffic Adaptive Medium Access protocol) [96] determines a collision-free schedule and assigns the link time slots according to the expected traffic and local neighborhood information. DRAND (Distributed Randomized TDMA Scheduling) [99] goes one step further. A time schedule avoids the hidden terminal collisions that might occur between nodes in a two-hop neighborhood sharing the same time slot.

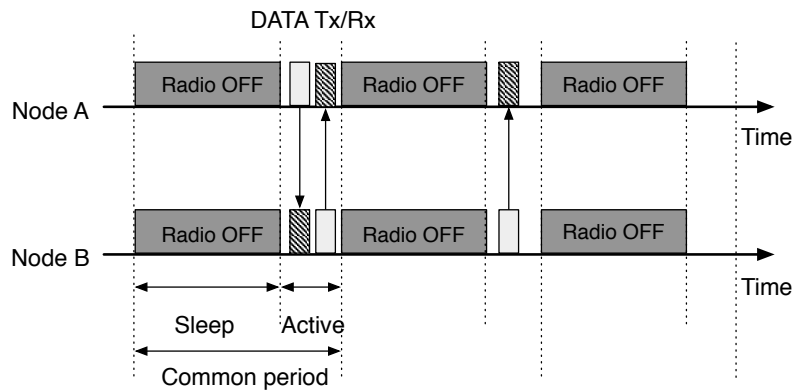

Figure 2.3: General idea of the common active/sleep period MAC scheme - all the nodes follow the same active period

Common active/sleep period schemes Protocols from this class organize all network nodes around the same global common active/sleep schedule (cf. Figure 2.3) [130]. While nodes are running, a succession of active (radio turned on) and sleep (radio turned off, thus saving energy) periods is repeatedly put in place. Nodes execute synchronization and as well packet transmissions and receptions during the active periods. Access to channel becomes contention based leading naturally to more collisions and overhearing compared to synchronized schemes. The basic scheme chooses at network bootstrap a fixed duty-cycle prone to idle listening [130]. This is solved by sending nodes to sleep state once they become idle for a timeout period [116]. Finally, solutions from this class are sensible to exposed and hidden terminal problem, due to the fact that all the nodes mutually share active periods.

1.2.2 Preamble Sampling

Nodes deploying preamble sampling MAC solutions leave out the need to use time synchronization. Receiving nodes sleep most of the time, periodically waking up for short periods to sample the channel for possible transmis-

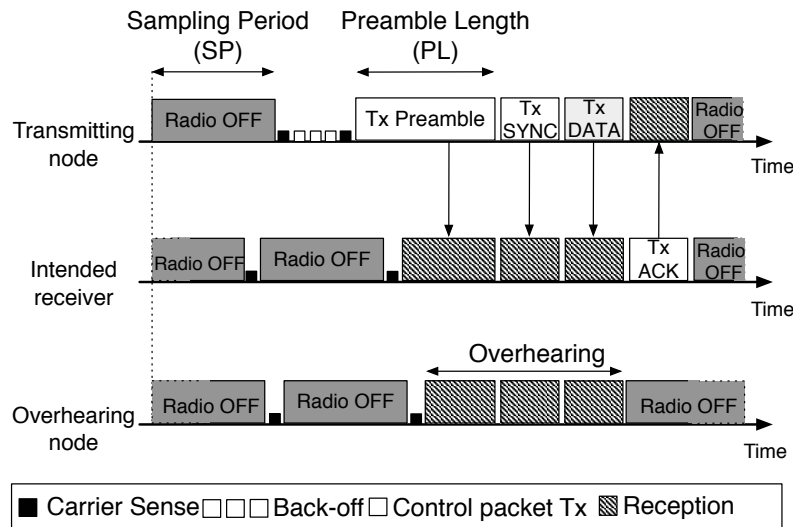

Figure 2.4: General idea of the preamble sampling MAC scheme

sions [94]. Communication becomes resilient to clock drifts by sending long preambles. Communication cost shifts to the transmitting side. The preamble length (PL) must be at least the sampling period (SP) long. A transmitter ascertains that all of the potential receivers are awake, have sampled the channel and are ready for the communication (cf. Figure 2.4). Broadcast transmissions will always use the maximum size PL, while unicast can minimize the PL by knowing the wake-up time of potential receivers [35].

Preamble sampling schemes reduce the idle listening problem while overhearing becomes more accentuated. Overhearing node stays awake, uselessly receiving the entire preamble and data packet. It realizes only at the end that the current transmission was meant for an other node. Dividing the preamble into smaller packets — *strokes* — containing the information on an intentional receiver can reduce this problem [20]. The overhearing node receives a small stroke, realizes that following transmission does not concern it and goes to sleep.

To resume, preamble sampling schemes are mostly adapted for light traffic schemes; the main cost comes from the rare transmissions. For the case of periodic traffic, preamble sampling schemes easily experience channel capacity problems. They are not able to handle the increased channel pressure [70].

1.2.3 Hybrid

Protocols from the hybrid class attempt to combine efficient mechanisms from both above mentioned classes. Hybrid protocols respond to some particular scenarios e.g. convergecast, variable traffic, or mobility support. The *fun-*

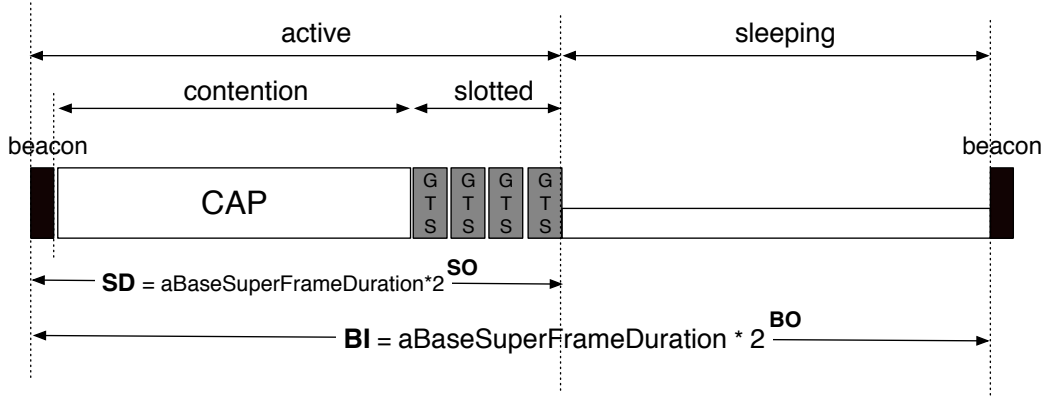

Figure 2.5: Superframe structure in IEEE 802.15.4

neling effect—a convergecast scenario leads to more congestion and energy dissipation in the zone close to the sink. The nodes closer to a sink forward all the accumulated traffic from their descending nodes.

Funneling-MAC [7] combines the principles of preamble sampling [94] [35] in the low congestion zones further away from the sink, and hybrid combination of CSMA/TDMA around the sink where congestion reaches important levels.

1.3 Standardization of the IEEE 802.15.4

IEEE 802.15.4 proposes a global standard at the MAC and PHY layer for interconnecting low-power/data-rate/cost sensor and actuator networks. The IEEE 802.15.4 standard is meant for ubiquitous networks aiming to respond to a wide range of application scenarios [136] (e.g. interactive toys, health monitoring, building surveillance, home automation [45]). On the contrary, the aforementioned MAC solutions are generally being optimized for a particular application scenario. Having an operational standardized solution would also bring faster technology development in WSN, as it already happened with classical wired networks.

1.3.1 Operating modes

The IEEE 802.15.4 standard offers two operating modes. In the **non-beacon mode**, all the nodes use classical CSMA/CA solution to access the medium: since no synchronization is required, nodes have to remain awake to exchange frames and thus cannot save energy.

In the **beacon-enabled mode**, the standard introduces the concept of superframes (cf. Figure 2.5): the PAN (Personal Area Network) coordinator (the IEEE 802.15.4 term for the sink node) starts to periodically send

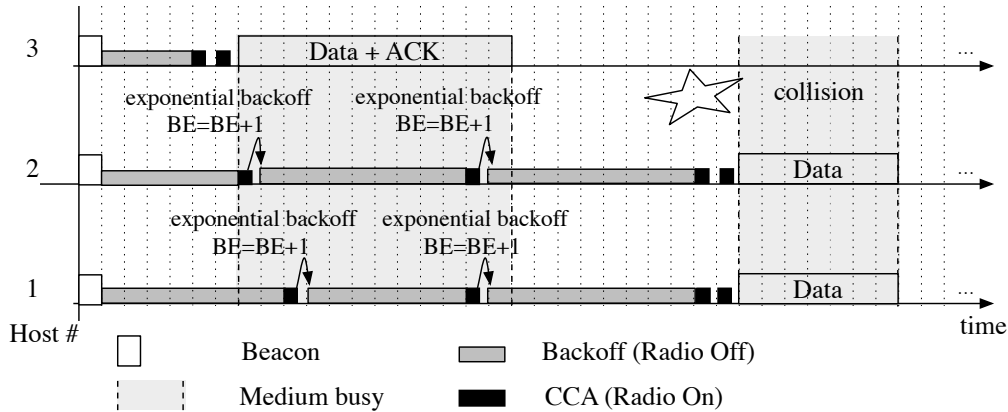

Figure 2.6: IEEE 802.15.4 slotted CSMA/CA method

short beacon frames to delimit the beginning of its superframe. Then, all the children nodes participating to superframe can access the medium using the slotted CSMA/CA during the Contention Access Period (CAP) (part of the active period of the superframe). Compared to preamble sampling, the use of short delimiter beacon packet and synchronization decreases the occurrence of the overhearing and blocked nodes. The idea of slotted channel access lays on the division of time in small chunks. A backoff period or simply a unit, is 20 radio symbols wide. Operations related to the medium access should align to the start of this elementary unit of time.

We illustrate the slotted CSMA/CA in Figure 2.6. Node holding a packet to send will first initialize a list of necessary protocol variables; the contention window size ($CW = 2$), the number of backoff stages ($NB = 0$), and the backoff exponent (set to the default minimum value, $BE = \text{macMinBE}$). Next, the node detects the next start of the unit period and waits for a random backoff issued from the interval $(0, 2^{BE}) \cdot \text{backoff period}$. Once the backoff timer expires the node will perform a CCA (Clear Channel Assessment). If the channel is free, $CW = CW - 1$ and another consecutive CCA is performed after 2 backoff units. CW is decremented again (reaches 0) if the channel was free and the packet is immediately sent. When the channel is detected occupied, state variables are updated: $CW = 2$ (reset to original value), $NB = NB + 1$, $BE = \min(BE+1, \text{macMaxBE})$.

When the number of backoff stages (BE) exceeds the maximum allowed value ($\text{macMaxCSMABackoffs}$), the packet is dropped. Otherwise, the node repeats the process of getting the new backoff and afterwards performs a CCA. Sometimes, a generated backoff value exceeds the remaining CAP duration. The backoff timer is paused at the end of the CAP and resumed at the beginning of the next superframe.

The IEEE 802.15.4 standard offers an optional retransmission scheme based on the acknowledgment frames (ACK). The protocol limits the maximum number of retransmissions with the configurable state variable *macMaxFrameRetries*.

Children may also reserve a Guaranteed Time Slot (GTS) located at the end of the active period of the superframe for real-time periodic transmissions. GTS are contention free periods, thus offering privileged access to the nodes forwarding the data of higher importance. It makes the IEEE 802.15.4 standard elegantly adapted for both regular and on demand sensitive traffic. When a active period of the superframe is finished, all the nodes may sleep until the next beacon.

The whole concept undoubtedly reminds the common active/sleep period scheme merged with eventual TDMA slots. The duty cycle (ratio between BI (Beacon Interval) and SD (Superframe Duration)) can be adapted by conveniently setting the parameters BO (Beacon Order) and SO (Superframe Order). These parameters can be flexibly set either prior to the deployment (static manner) [40] or during the runtime (dynamical manner) [107] [41] [88].

1.3.2 Analysis and improvements of the IEEE 802.15.4 mechanisms

Anastasi et al. [40] offer an exhaustive analytical study of the IEEE 802.15.4 CSMA/CA mechanism and propose a method to improve its efficiency. They observe the behavior of a single hop network (varying the number of nodes) with the idealized UDG (Unit Disk Graph) propagation model. The IEEE 802.15.4 standard leads to unsatisfactory performance even with a low number of nodes when the default parameter set is used (*macMaxFrameRetries* = 3, *macMaxCSMABackoffs* = 4, *macMinBE* = 3, *macMaxBE* = 5).

The authors demonstrate that using a non-authorized value set can easily lead to almost perfect delivery rates (close to 100%) and minimized contention. The increase of the reliability is paid by the increased packet latency. Nevertheless, the IEEE 802.15.4 achieves better energy efficiency. The average energy consumed per correctly delivered packet reduces significantly.

The authors refine their findings by using the realistic radio propagation model and extend it to multihop communication [9]. The gains of increasing the default parameter values do not apply equally to multihop topologies. The nodes close to the network edge do not experience high contention and thus are uselessly penalized with the increased delay.

Parameter adaptation can be done in the dynamic fashion, relative to the type of traffic, targeted reliability or energy constraints.

Severino et al. [107] propose a real testbed verification of an effective add-on for the IEEE 802.15.4 standard. A traffic differentiation is ensured by

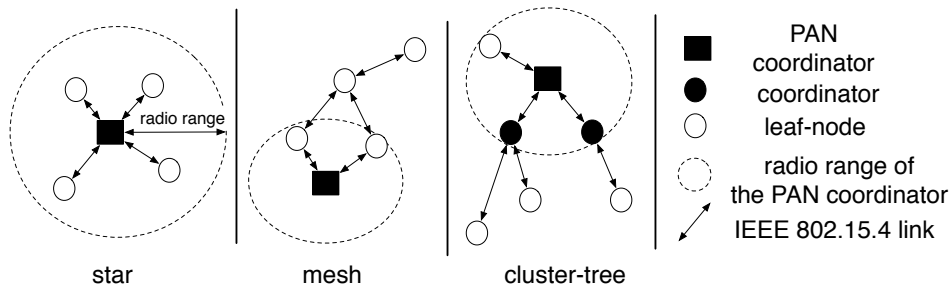

Figure 2.7: The IEEE 802.15.4 supported topologies: star, mesh, and cluster-tree. The star is for 1-hop networks, while mesh and cluster-tree topologies support multihop operation.

assigning different **MAC** parameter sets for time-critical control traffic and regular data packets. ADAPT [41] dynamically adapts the **MAC** parameters at each node (linearly increments or decrements). A change is done according to the difference between targeted and experienced data packet reliability.

Park et al. [88] achieve parameter adaptation through a constrained optimization problem. A minimization of total energy consumption is the objective. The problem is constrained by the packet delivery ratio (reliability) and average delay experienced by a transmitting node. Each node distributively solves a simplified approximation of the optimization problem and accordingly sets the IEEE 802.15.4 **MAC** parameters. The proposed algorithm results in a longer network lifetime under both stationary and transient conditions while reliability and delay constraints are respected.

1.3.3 Supported topologies and association process

The IEEE 802.15.4 standard supports three distinct topology types that can be seen in Figure 2.7. The standard was initially mainly designed for a single hop networks: the **PAN** coordinator is directly connected to end-devices, forming a star topology. The multihop mesh topology authorizes any pair of the IEEE 802.15.4 nodes to communicate directly. Nevertheless, the mesh topology was mainly conceived for the energy inefficient non-beacon mode. Then, the cluster-tree topology [32] permits to forward packets along a tree rooted at the **PAN** coordinator. We will focus on the beacon-enabled mode with a cluster-tree. It is the only way to deploy a multihop WSN while saving energy in the IEEE 802.15.4.

The cluster-tree formation process is initiated by a **PAN** coordinator which starts to periodically send beacon frames containing the **PAN** control information. An unassociated node must discover a **PAN** coordinator either by performing a passive (listening for a beacon) or active scan (transmitting a

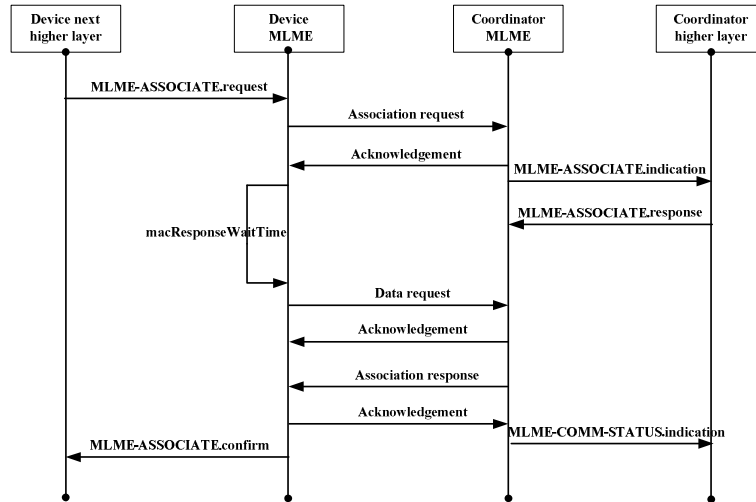

Figure 2.8: The IEEE 802.15.4 association process: an explicit way to learn about PAN control parameters and to establish bi-directional link with a selected parent[1]

beacon request). Either way, a node first scans all available channels (16 in the 2.4GHz frequency band). Once a PAN coordinator is discovered, a node initiates the association procedure illustrated in Figure 2.8.

A node transmits an *association-request* during the CAP, acknowledged by the coordinator. A node has then to retrieve its *association-reply* after *macResponseWaitTime* by using the data-request primitive. This 6-way (handshake) process allows a node to discover PAN control parameters and to explicitly establish a bi-directional link with a selected coordinator (parent) node.

Once a node associates with a coordinator, it begins to periodically send beacons to maintain its own superframe. Possibly, some nodes (Reduced Function Devices - RFD) may refuse to forward packets, becoming leaves in the cluster-tree. In a cluster-tree, all non-leaf nodes must maintain a superframe to exchange packets with their children. For a node, the superframe of its parent is designated as incoming and the superframe maintained by the node itself as outgoing.

In order to account for real-time traffic, Meng et al. [79] propose an optimized association scheme. A scan is stopped as soon as one of the discovered PAN coordinators is estimated worthy to initiate the association process. The association scheme itself excludes the *data-request* primitive and *macResponseWaitTime* to finally result in accelerated convergence time by 90%.

A node becomes an orphan when it loses synchronization with its parent i.e. when it misses 4 consecutive beacon frames. An orphan initiates the re-association with the previous parent or a new parent discovery process. An

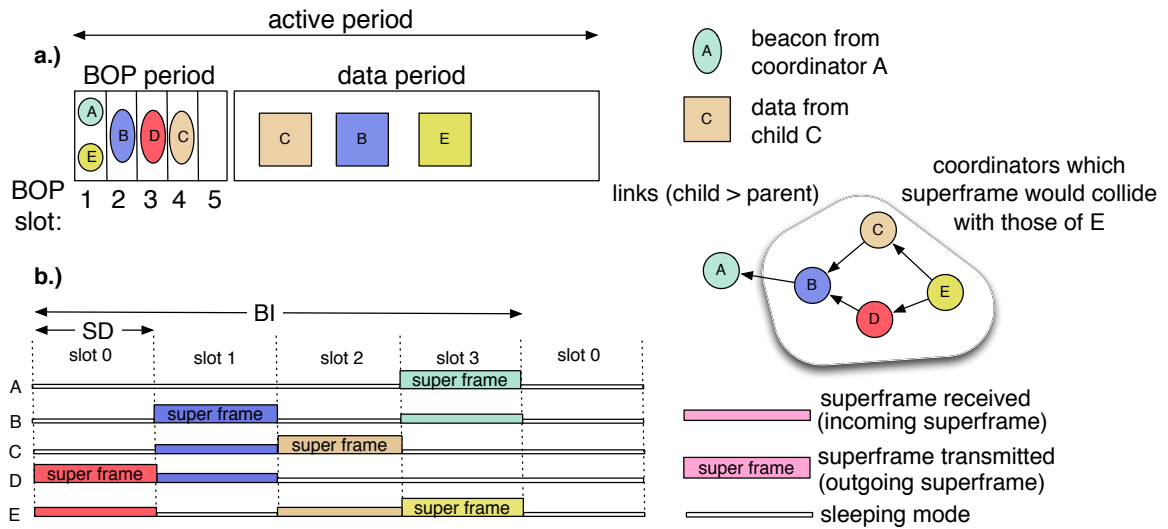

Figure 2.9: Two main solutions for collision avoidance in the IEEE 802.15.4 multi-hop cluster-tree configuration: a.) Beacon-Only Period — solves only beacon collision by reserving slots at the beginning of the active part of the superframe b.) Superframe Scheduling — solves both beacon and data collisions by organizing the active parts of superframes in form of non-overlapping TDMA slots

orphan eventually can stay disconnected for a long time, especially when a node is running on a low duty-cycle. A cluster-tree lacks robustness since a node relies on a single parent node. Selecting a stable parent with a good link quality becomes highly important. Moreover, the IEEE 802.15.4 standard does not specify any parent selection mechanism.

Cuomo et al. [32] gave thorough insight on the IEEE 802.15.4 cluster-tree formation process. In a nutshell, the resulting trees tend to grow in depth when only link quality is used. Whereas, when depth is limited in advance, a parent obtain a higher number of children. Long paths might lead to an increased energy consumption and delivery delay. On the other side, a large number of children per parent implies a high probability of MAC collisions during the CAP [40]. Additionally, high cluster-trees (unbounded in depth) lead to better connectivity and coverage [31]. Obviously, the network depth has to be chosen as a trade-off among competing needs. The authors do not offer appropriate (eventually combined) metric that actually achieves this compromise.

1.3.4 Efficient multihop operation

The IEEE 802.15.4 standard suggests that the superframe of a child and its parent are inter-spaced by *StartTime*. If the *StartTime* value is constant, the superframes of nodes with the same depth are overlapping. Practically, beacons collide, making the protocol inefficient. Two main approaches to reduce collisions exist in the literature (cf. Figure 2.9):

- Beacon-Only Period (BOP) [1]: nodes implement a TDMA approach to send their beacons: at the beginning of each superframe a few slots are dedicated to beacons. Interfering coordinators should choose different BOP slots. While collisions are avoided during the BOP, data frames may still collide during the rest of the shared active period.
- Superframe Scheduling: the solution consists of using a variable *StartTime*. The nodes sharing the same parent should not use the same *StartTime*. As a result, their active parts of a superframe do not overlap, so both data frame and beacon collisions are reduced [83] [66]. Finding the adequate *StartTime* for network nodes that use the same BO and SO values, is equivalent to scheduling the active part of superframes with a TDMA approach. For the sake of simplicity, in the rest of the manuscript we will interchangeably use the following terms: active part of the superframe, superframe, and superframe slot. The number of necessary superframe slots (determined by BO/SO ratio) depends on the number of interfering coordinators (network density). TDMA performance tightly depends on the accuracy of the topological information (neighboring and interference relations) and synchronization. Nevertheless, TDMA can offer very good performance especially under high contention when the provided information is fairly accurate. The optimal time slot scheduling is NP-hard [98].

An experimental comparison of both techniques [119] showed that the Superframe Scheduling outperforms the BOP in terms of the number of delivered packets since the number of both beacon and data collisions drastically decreases. The BOP method is only suitable for low-intensity traffic since its performance quickly degrades and hidden terminals are frequent. A superframe collision-free scheduling is more complex and results in better capacity. Nevertheless, its parameters (BO and SO) should be carefully set to avoid excessive battery consumption.

Koubaa et al. [66] proposed a centralized algorithm to schedule superframes with variable superframe duration (the problem corresponds to a classical knapsack formulation). In each round, a single node is attributed the

first free slot of a sufficient size to accommodate its superframe SD_i . The centralized algorithm terminates with success if it was possible to schedule all superframe slots. Otherwise, an error message is returned, meaning that local SD and BI should be revised. Muthukumaran et al. [83] proposed a greedy distributed algorithm. During the initialization phase, nodes gather the localized 2-hop knowledge. Each node chooses the first free slot (not occupied by its neighbors) and advertise its decision. Greedy slot selection leads to a lot of initial collisions among the children of the same parent since they simultaneously choose the same free superframe slot.

1.3.5 6LoWPAN and IEEE 802.15.4

6LoWPAN (IPv6 over Low power WPAN) Working Group [82] was formed to define an IPv6 compliant operation over the IEEE 802.15.4 networks. 6LoWPAN implements an adaptation layer between the data link and the network layer in the TCP/IP protocol stacks. 6LoWPAN offers bootstrapping capabilities (neighborhood discovery (ND)) and the transmission of IPv6 packets over the IEEE 802.15.4 networks:

- *Header compression*—large IPv6 packets should be reduced to fit 127B offered by the IEEE 802.15.4 standard. The 6LoWPAN adaptation layer dramatically reduces the IPv6 transmission overhead. All unnecessary fields are completely eliminated from the original packet and the remaining fields are resized. Basically, all fields of the IPv6 header can be compressed except the hop limit (8 bits) field. Shorter link local addresses replace long source and destination IPv6 addresses. We can also eliminate the packet length field since it can be derived from the MAC header.
- *Fragmentation*—the IPv6 data payload exceeding the available size of the IEEE 802.15.4 payload results in fragmentation. 6LoWPAN ensures that fragments transmitted over multiple hops are re-assembled at the destination..
- *Routing*—optionally 6LoWPAN offers a routing scheme in the form of mesh-under (hop-by-hop packet retransmissions) or route-over (each node behaves as a router).

Bootstrapping of 6LoWPAN tries to define an alternative to ND proposed by the IEEE 802.15.4 standard. Additionally, in the light of IPv6 adaptation, it should also provide address resolution capabilities (64-bit long addresses are used for link layer addressing in parallel with 16-bit short node addresses).

6LoWPAN ND presents an effort to translate existing ND for wired networks to low-power, low-rate, low-duty cycle, and low-range WSN. In order to do so, excessive overhead caused by multicast should be completely avoided. 6LoWPAN ND solves this issue by registering a new node with an edge router (sink) using (multihop) unicast *Node Registration* and *Node Confirmation* packets.

2 Routing in Wireless Sensor Networks

2.1 Basic concepts

Routing directs the packet forwarding decision at each intermediate node from the source to the destination. In the case of WSN, the source of packets can be a substantial number of nodes deployed over the large area sensing the selected environmental phenomena (e.g. temperature, radiation, object position tracking). In the majority of scenarios, the destination is one or a group of more centralized collecting stations called sink nodes. Sink nodes collect and process gathered packets to mainly provide better understanding of the observed environment to the final user. Sink can react to the anticipated event (e.g. a fire, a burglary, degradation of the building over the tolerated level) and accordingly produce a reaction. WSN radio communication radius being limited, direct delivery to sink nodes is replaced with multi-hop routing. We can say that the routing decides on the succession of intermediate nodes that a packet should traverse to reach a sink node.

Routing protocols for WSN must follow several specific requirements:

- Save energy by reduced control messaging
- Save bandwidth since the WSN radio transmissions offer a low bitrate (nominally 250 kbps);
- Be scalable to deal with a large collection of sensors. Protocols should work efficiently with small number of sensors as well on a big sample.

The classical network paradigm used in Internet relates as well to the WSN (IoT) case—information is retrieved by referencing a specific, physical location where the data is created. Each node is attributed a network address to uniquely identify it.

Contrary to the classical paradigm, we can mention an alternative approach called **data-centric networking** (also referenced as content-based networking). Putting it simply, a final user (sink node) generates a specific

data query and floods it in the network. A user's query concerns a specific occurrence in the sensed environment (e.g. a number of water readers (households) spending more than Y liters in the last hour). A subset of WSN nodes concerned by the user query reacts and produces an answer. Practically, only a network nodes sensing the data matching requested criteria initiate packet generation and routing.

Directed Diffusion [53] presents a pioneering work on data-centric based routing in WSN. Authors combine the data centric approach and data aggregation along the paths leading from the sources of similar information. Basically, more similar packets are merged in a single packet along the path to save the energy.

2.2 General families

This section will introduce state of the art WSN routing protocols divided into two general classes. We chose to classify them according whether they explicitly construct routing path between the source and the destination. When no paths are explicitly constructed the main challenge is how to find precise local information that will allow to forward the packet till the destination. Otherwise, the main challenges are how to reduce the control packet overhead and to find the optimal paths from the global point of view.

2.2.1 Routing without paths

Random walk (hot potato) routing in WSN can serve as the simplest, and fully local strategy. Upon a packet reception, a node forwards it to a random neighboring node. Random walk has the zero control packet overhead. Nevertheless, the protocol incur the high latency and long unoptimized routes (possible high number of packet retransmissions) [10].

Geographical routing requires that a node has to be aware of its own geographical coordinates, its 1-hop neighbors, and of the destination. At each step, a node forwards a packet to the neighboring node making the positive progress towards the final destination. When the average node degree (number of 1-hop neighbors) drop down below a certain critical level, the greedy routing starts to fail immanently [111]. The face phase overcomes the impairments of the pure greedy routing, but it requires a planar graph. The planar graphs can be defined as a subset of general graphs whose edges intersect only at their endpoints i.e. no overlapping edges exist. The link unidirectionality and the miscalculations of a node geographical position can lead to a disconnected graphs after the planarization process [55]. Finally, impracticality to obtain geographical coordinates (high energy cost, or impressions) [87] makes the

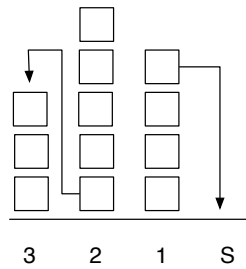

Figure 2.10: Back-pressure routing principle: packets will be forwarded to a node offering the highest difference in the size of routing queues (back-log gradient)

geographical routing unfeasible in WSN.

Back-pressure routing exploits the difference in the routing queues (back-log) to opportunistically forward on a packet basis (cf. Figure 2.10). Sink always announces a packet queue of 0 making the data to flow towards it. Back-pressure Collection Protocol (BCP) [81] is inspired on the fundamental work on back-pressure routing theory [114] (dynamic queuing and scheduling). BCP offers an experimental verification on a real testbed taking into account the realistic radio link qualities and finite queue lengths to refine the theoretical model. The back-pressure routing only supports a convergecast traffic model.

2.2.2 Routing along the constructed paths

The protocols from the "routing along the constructed paths" class use the network wide control packet dissemination (flooding) to explicitly discover and establish paths prior to any packet forwarding. First challenge is how to optimize the control packet overhead i.e. a number and frequency of packet dissemination. Second of the challenges is how to establish the most efficient routes taking into account more design metrics (e.g. link quality, spent energy, number of necessary messages, or remaining node battery).

We traditionally oppose the proactive and reactive approaches inside the "routing along the constructed paths" family: while the former one creates routes a priori and maintain them afterwards, the second approach constructs a route only when a packet has to be transmitted.

Reactive protocols are suited for scenarios where the network topology is highly dynamic, traffic is sporadic, and/or bursty, and destination may change along the time [122]. They permit to reduce overhead in similar scenarios since no routes are maintained over the long duration. A rare packet generation triggers the construction of an one-time use path, followed by packet routing

over it. Nevertheless, the reactive protocols are not suited for the periodic traffic since they incur large control overhead. The initial time necessary to establish a route should not be neglected in the case of time sensitive traffic. This time additionally increases when the network grows in size (the longer paths). A route repair may be expensive in terms of time and control packets since nodes do not maintain any information about alternative paths.

AODV (Ad hoc On-Demand Distance Vector) [90] is a seminal work, initially built for mobile ad hoc networks, that inspired reactive protocols for WSN. LOAD[58] and LOADng[28] (new generation with small additional improvements) proposed a set of simplifications to the original AODV protocol to cope with the constraints of LLN (Low Power and Lossy Networks) sensor devices. LOADng was recently proposed to IETF as a RFC (Request For Comments). Default traffic pattern supported by LOAD(ng) is bi-directional point-to-point (P2P) traffic.

Basic operation of AODV and LOAD(ng) can be resumed as follows. The bi-directional path construction starts on demand by issuing a route-request (RREQ) packet. A RREQ packet eventually reaches the destination after being flooded in the whole network. Upon receiving a RREQ packet, the destination node replies to the originator of the demand with a route-reply (RREP) packet. A RREP packet follows the previously installed reverse route. Reception of the RREP packet at the originator node installs a bi-directional path, making it available for immediate use. When a node detects a broken link on the installed path, a route-repair may be evoked. Basically a new RREQ/RREP cycle will start to re-discover the destination.

Apart minor differences like a simplified packet format (reduced size), and support for IPv6 packets over the IEEE 802.15.4 networks, LOAD(ng) have three main simplifications compared to AODV:

- A destination node communicates only with a single source node at a time.
- Intermediate devices do not respond with a RREP even if they previously have installed an active route to the intended destination.
- Intermediate devices do not attempt to transmit the route-error (RERR) packet to recently used forwarders as part of the route repair mechanism. Any link breakage will be remediated with a new route-request cycle.

Simulation results [29] showed that LOAD(ng) provides a reasonably high data delivery rates in the networks with up to 1000 nodes randomly distributed on a square. LOAD(ng) achieves a low control data overhead in scenarios of sporadic P2P data packet exchange. Bi-directional path establishment works

efficiently and it is invariant to the underlying network topology type. Simulation results lack findings on the LOAD(ng) performance for other types of traffic as well for periodic data exchanges.

Proactive protocols construct routes towards a set of designated destinations before their use and maintain them afterwards [122]. The routes are immediately available on a packet generation. The proactive approach is particularly suited for convergecast traffic: a single destination has to be announced in the network. Otherwise, the generated routing overhead increases with the number of routes being created. The incurred path maintenance overhead pays off for the case of periodic traffic from more collecting nodes and/or delay sensitive traffic. When network topology changes are sporadic but not drastic, route inconsistency has to be repaired only locally. A protocol avoids the huge cost of network wide flooding.

The protocols from the "routing along the constructed paths" family can be further divided into three classes. We divide protocols according to how strong the constructed path guides the forwarding process. The source end-to-end routing embeds the full path to the packet, the hierarchical routing forward always the packets through the configured cluster backbone, where gradient routing implements a hop-by-hop forwarding decisions.

Source end-to-end routing Dynamic Source Routing (DSR) [63] presents a seminal work of the source end-to-end routing in WSN. In a nutshell, a packet carries the complete ordered list of nodes through which the packet will pass. The fresh routing information is not maintained by intermediate nodes. All the routing information is contained in the packet itself. The path discovery and repair in the case of failure of a single hop, are performed through the network wide flooding. Source end-to-end routing is not flexible, nor scalable since the large paths are hardly to fit the small packet load [63]. Furthermore, it is not possible to achieve load balancing since a single path is used until it fails.

Hierarchical routing strives at energy efficient and scalable multi-hop operation. A subset of nodes forms a network backbone of connected cluster heads. A cluster head collects packets from its cluster and performs data aggregation in order to decrease the number of transmitted packets to the sink. The main challenge is how to select the cluster heads in distributed fashion to allow most energy efficient routes. LEACH [47] presents a seminal work. The cluster heads are randomly elected, and announced at each round, then

periodically changed to balance the energy dissipation of nodes. Several improvements of LEACH have been proposed [8]. Nevertheless, the hierarchical routing class never managed to achieve efficient operation in the multi-hop topologies larger than several hops.

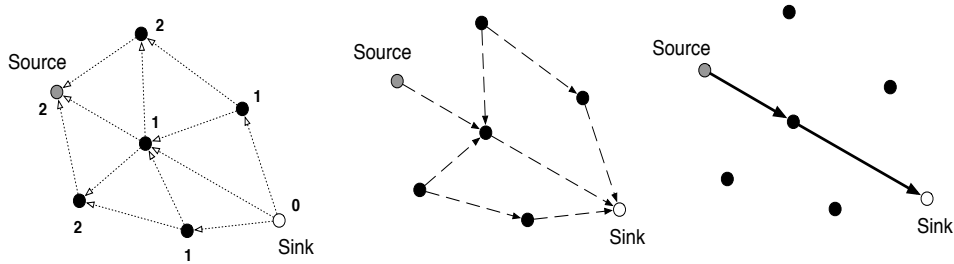

Figure 2.11: Gradient routing: route discovery, gradient establishment, routing

Gradient based routing is founded on the basic concept inherited from Internet—distance vector routing [113]. Gradient based routing (GBR) protocol [104] is a seminal work. We will use a simple example to illustrate the basic functioning of the protocol (cf. Figure 2.11). A protocol executes three distinct operations: route propagation, gradient establishing, and shortest-path routing.

A sink node starts the *route propagation* by sending a control packet with a field *cost* set to 0. In general, a node announces its *cost* to reach the sink in terms of some chosen metric. In our example, the necessary number of hops. A node applies a feasibility condition to verify whether it can create the routing gradient towards the originator of the control packet. A feasibility condition avoids the creation of the routing loops. Basically, a node verifies if the neighbor's *cost* is strictly smaller than its actual *cost* [91].

A node establishes a gradient toward a feasible neighbor. Analogous to vectors, each gradient holds the information on two vector components—a *magnitude* - a *cost* to reach the sink and a *direction* - the forwarding neighbor (parent) that offers a progress towards the destination. A node updates its *cost* to the value of the parent's *cost* plus the cost to reach it (in our example +1 hop). Thereafter, a node starts sending control packets with its updated *cost*.

A source node might start the routing towards the sink as soon as it has at least one established gradient. A packet is forwarded along the path following the gradients offering the lowest *cost*. It can be compared to a mountain torrent rushing down the hill following the most steepest rocks. The gradients can be established by the use of timers, where each node would send only one

packet [129]. This can be a promising solution for WSN, thanks to its reduced control overhead.

When only a simple hop count is used as gradient metric, a smaller subset of network nodes (offering the shortest paths) is overused. A network nodes might suffer of possible congestion and premature battery exhaustion. A gradient can incorporate the volume of forwarded traffic at each node to improve the load balancing [132]. Similarly, a more equal battery consumption among all nodes can be achieved with gradients using the node remaining battery level [95]. A recent real world implementation uses the link quality as gradient metric [85]. Volatile radio links should not be reinforced by gradients, rather the stable and reliable ones offering a high delivery rates. Specific scenarios like fire prevention, might opt to use the *natural type* [39] of gradients. Information flows onwards the nodes measuring a higher temperature, activating the fire extinguishers closer to the source of the fire.

All aforementioned proposals introduce a single metric and do not optimize more goals. Such gradient solutions are based on the assumption that a single metric is sufficient to build gradients that will optimize both local (reliability, energy) and global (e.g. load balancing) network properties. Zhou *et al.* [137] present four simple parent-selection metrics for convergecast topology formation (earliest-first, randomized, nearest-first, and weighted-randomized). They give straightforward and clear insights on impact of each separate metric choice on global properties of constructed topology. However, they do not propose any method to combine positive effects of separate metrics.

Whatever the nature of the gradients might be, a special care should be taken in the case of dynamic networks. A network connectivity graph change since links and/or nodes (dis)appear. A feasibility condition can produce the node starvation when the parent nodes disappear. A node have available neighbors but they do not satisfy the feasibility condition. The starvation can be solved through a mechanism of the sequenced routes [91]. A sink increments a route version number, allowing all nodes to reset their *cost* and rebuild from zero their gradients. A global repair is performed either in periodical fashion [91] or by the means of triggered updates [26]. The remaining challenge is to find an efficient, and energy inexpensively local mechanism, adapted to work in the networks with volatile links.

Multi-path routing So far we presented a routing strategy where a data packet follows a single end-to-end path from a source to a destination. We can introduce the concept of multi-path routing by opposing two approaches: *a.) Redundancy*—a routing protocol sends multiple copies of the same packet on different paths towards the destination. *b.) Diversity*—a routing protocol forwards packets from a stream of the same source along multiple different

paths. In principle, we can speak about the primary path and certain number of alternative (or back-up) paths. The main path is usually optimal, while alternative ones are often longer or consume more energy.

The advantages of multi-path routing can be multi-fold [115]:

- **Robustness**—accidental node breakdowns due to hardware malfunction or battery exhaustion can take time to repair or replace them. Similarly, a node is not able to momentarily re-establish a link that went down due to obstacles, interference, or harsh atmospheric conditions. During the time of maintenance, a part of the network might become disconnected, leading to packet losses and drops. In the case of multi-path routing the time to repair a broken route is zero. The alternative paths momentarily replace the primary one.
- **Load balancing**—the load is spread over different nodes (*diversity* approach). A protocol achieves uniform battery consumption and decreases congestion in the hot spots.
- **Bandwidth accumulation**—a multi-path routing protocol can meet the higher bandwidth demand from the application layer by reuniting the low bandwidth provision of more WSN links. A source-destination pairs achieve effective bandwidth accumulation by routing packets from a stream on multiple paths.
- **Quality of Service (QoS)**—original idea comes from the need to differentiate packets coming from the various application layers and offer different processing. A simple example opposing two extreme cases would be: delay-sensitive fire alarms and low-intensity periodic temperature measurements. We can agree that alarms should be processed with higher priority, since missing to accordingly react on time would have disastrous consequences. Missing a monitoring data report or two can be generally tolerated, since values can be either interpolated or simply neglected in most of the cases. WSN QoS provisioning of multi-path routing protocols can be mainly interesting in the time-critical and reliability domains. The QoS requirements can be hard (must be met at all cost) or best-effort type (should be met in a high percentage of cases). The application generating an alarm would impose that it is delivered before a short deadline. On the other hand, QoS requirements can be loose for the case of periodic environmental data reporting.

All aforementioned advantages come with a certain cost. Maintaining more parallel paths between a single source-destination pair comes with an addi-

tional overhead in terms of control packets, computation, and memory. Having more copies of the same packet will easily deplete the battery at higher rates. We should not easily neglect the issue of generating the interference between more concurrent paths. Contrary to wired solutions, the interference in wireless systems operating in a single radio channel is unavoidable.

Multiple paths can be generated by following four different basic types (cf. Figure 2.12):

- **Node disjoint** [44]—multiple paths from the same source-destination pair have to go through different network nodes. The idea behind is to generate a robust topology with a single main path and several alternative back-up paths in the case of a failure of a node or a link on the main path. The positive side effect of this topology is that load balancing is achieved as soon as we pass to the alternative paths. The downfall is that even though the main path is optimal, the alternative paths are often long and energy inefficient. Additionally, the node disjoint paths are complex to compute and realize in distributed manner.
- **Link disjoint** [44]—multiple paths can share the same nodes but are forbidden to use the same links. Link disjoint paths come as a less complex alternative since they relax the node disjointness criterion. Paths from this type still can offer a fair level of robustness. Node failures can be considered as less common compared to those that affect the links. The maintenance cost for link disjoint is several times lower than that for the node disjoint paths [44].
- **Interleaved**—this approach goes one step further in relaxing the node disjointness criterion with a considerable loss in robustness. Different paths can interchangeably use the same nodes and/or links. Novelty in this approach is that forwarding mesh, that is to say, the number of parallel paths between a source-destination pair is not set in advance. Rather, we expand it to the necessary number, according to a global reliability requirement. QoS reliability requirements leverages on the broadcast nature of the radio medium. The routing protocol implicitly decides how many nodes from the interleaved path will forward the same packet in the each routing step [37]. On the other side, the forwarder might also explicitly decide on how many paths will send the same packet [19]. Either way, the forwarders locally measure packet reception rate to estimate the link quality towards the neighbors.
- **Opportunistic** [38]—no multi-path structure is made prior to routing, thus making it impossible to make hard QoS guaranties. The service

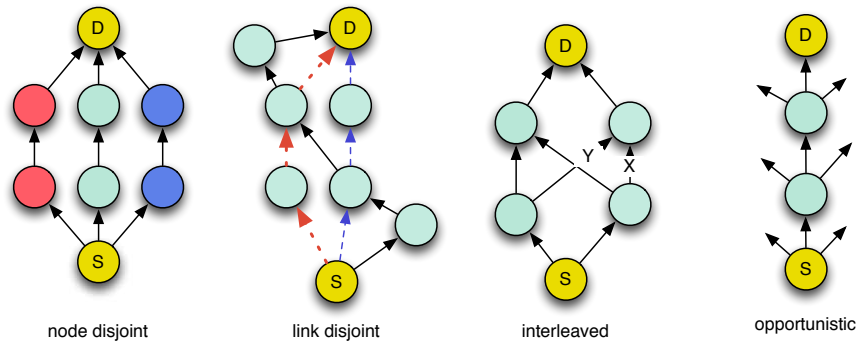

Figure 2.12: Multi-path types: node and link disjoint, interleaved, and opportunistic

becomes a best-effort type, since routing philosophy shifts to packet basis decisions. At each hop, the packet holder locally aggregates the power of available links to match the end-to-end QoS reliability criteria, eventually replicating more copies to same neighbors. An intuitive step-by-step adaptation takes away all the complexity of the multi-path generation and maintenance with the cost of degrading the QoS. The approach can be combined with geographical routing to propose QoS in time domain [36]. Each packet is labeled with a delivery deadline when created. The packet forwarder chooses only a subset of neighbors that offer the sufficient packet speed (geographical progress towards the destination divided by the necessary time to receive it) to meet the packet deadline at the destination.

2.3 Emerging IPv6 routing standards for WSN

The RPL routing protocol A special IETF working group - ROLL has been established in the beginning of 2007. The main goal was to elaborate a new routing and self-organization protocol suitable for LLN in the light of the new IoT paradigm. The ROLL working group strives to cover a comprehensive number of various use cases: Home automation [18], Commercial building automation [78], Industrial automation [92], Urban environments [33]. RPL (Routing Protocol for LLN) is built as a gradient routing to support a variety of network traffic patterns (cf. Figure 2.13):

- Multi-point-to-point (MP2P)—the most common WSN traffic pattern in the vast number of cases, also know as convergecast or upward routing. A large amount of sensing devices report their readings to a centralized processing and storing unit called sink.

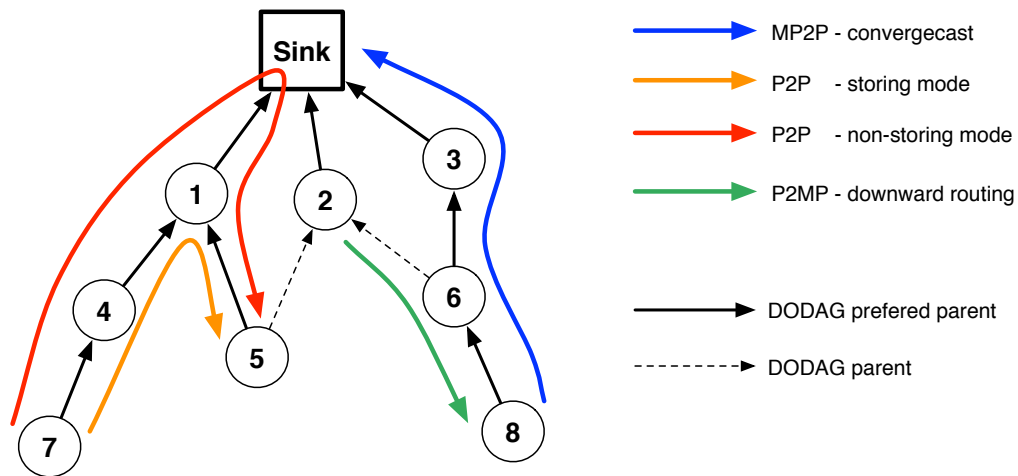

Figure 2.13: RPL supported traffic types

- Point-to-Multi-point (P2MP)—downward routing that can be seen as a form of data polling where the sink unit requests specific data or control readings from a single or a group of nodes corresponding to the same shared quest (data centric approach).
- Point-to-point (P2P)—an arbitrary pair of nodes is enabled to communicate. An example from building automation networks might illustrates the case: a sensor detecting a particular car at the building entrance can turn on the lights at the corresponding parking space.

Anticipating the new IoT, ROLL requires the interoperability with IPv6 and 6LoWPAN as well the compliance with a variety of link layers, supporting both wireless and PLC (Power Line Communication). So far the ROLL working group has produced numerous RFC documents describing in details everything that concerns routing and self organization—from the requirements of the final protocol, supported scenarios, details on the RPL protocol functioning, a list of supported metrics, energy optimizations and stability mechanisms, and some preliminary test results. Nevertheless, there is still a lot of space left for improvements, especially when it comes to practical mechanisms, and P2MP / P2P traffic pattern [30]. We will detail about it in the rest of the section.

2.3.1 Upward routing topological structure

The underlying topological structure belongs to a specific sub-class of DAG (Directed Acyclic Graphs) called a DODAG (Destination Oriented DAG). A DAG builds a directed relation (gradients) between nodes. Data packets flow

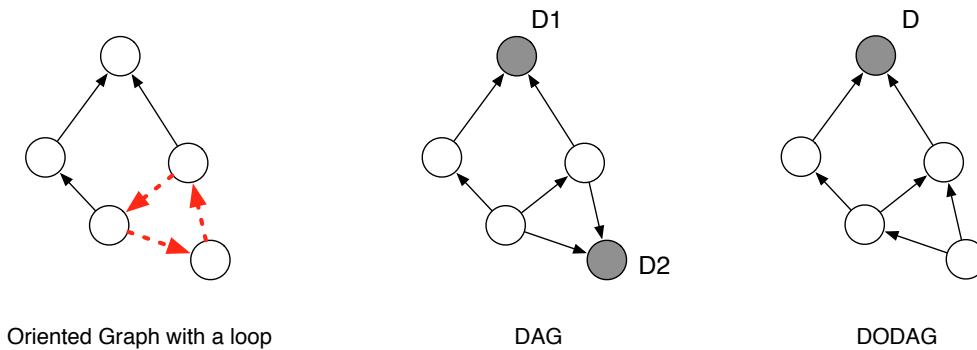

Figure 2.14: Difference between various directed graph structures: oriented graph with a loop, DAG, and DODAG

towards a small set of root nodes without the risk to form a closed cycles (loops) (cf. Figure 2.14). The node gradient points in the direction of its selected parent node. DAG roots do not have outgoing edges while other nodes can freely have more outgoing and incoming edges. A DAG result in a more robust structure compared to a classical tree structure where each node has a single outgoing edge. A DODAG defines a DAG that forms oriented paths to a single root (cf. Figure 2.14). The RPL choice of DODAG stems from the observation that a majority of the supported traffic patterns belongs to the [MP2P](#) class.

2.3.2 A DODAG rank

RPL was designed as a generic protocol, thus the [DODAG](#) structure is built on the concept of the node rank. The rank scalar value represents the node distance to the DODAG root, used to establish the node relative position to others. RPL implements the following feasibility criterion: a rank value must monotonically decrease as gradients flow towards the DODAG root. The Objective Function ([OF](#)) defines a set of optimization objectives used to actually calculate a rank value and accordingly select parent nodes.

DODAG rank types The node rank can serve as a routing constraint (a way of pruning potential forwarders not satisfying specific properties e.g. use only paths traversing main powered nodes). It can also serve as an accumulative metric (a way of estimating the route cost e.g. use the path that minimize the energy consumption). [OF](#) classifies rank metrics/constraints into two classes:

1. **Node type** reflects the node internal properties into a rank value. A rank can be either a *hop count* distance to the DODAG root ([OF0](#));

a node *remaining energy* (in percentage if all nodes use the same battery model or in absolute units); *energy source type* (battery, scavenger, main); a node *capacity to aggregate traffic*; or a node *workload state* (a single constraint bit indicating if node is saturated and cannot handle more traffic).

2. **Link type** reflects the properties of a link between a node and its neighbor into a rank value. Depending on a scenario, nodes can announce the available *link throughput* (higher bit rates can be traded for higher power consumption); observed *delay* (the MAC layer can decrease the duty cycle causing the delay to grow); link *reliability* (proportional to the Packet Delivery Rate (PDR)); or a link *color* (an implementation open flag (discrete value) to indicate a supplementary link property e.g. whether the link is encrypted or not). Link reliability (OF1) is expressed in ETX (Expected Transmission Count), that is to say, the number of re-transmissions of a packet before the successful reception.

Network sink (DODAG root) can construct several different DODAGs optimized according to a specific OF choice. Conversely, the RPL Instance holds disjoint DODAGs built by different sink nodes using the same OF. Each DODAG is identified with an unique DODAG Id (usually a IPv6 address of the root). Network nodes can belong only to a single DODAG inside the same RPL Instance.

2.3.3 The DODAG construction process

starts when a root sends a DIO (Destination Information Object) control packet as a link-local multi-cast. DIO packets contain, among other control information, a unique RPLInstanceId, DODAGId, Version number (as part of the loop removal technique) and a type of the used rank defined by the OF. Nodes receiving the DIO packet will create an entry in the candidate neighborhood list. Node neighbors from a parent set must have a strictly lower rank (loop avoidance). Finally, a neighbor optimizing the OF goal (usually minimizing the path cost) will be elected as a preferred parent. RPL, similarly to IEEE 802.15.4, exploits a single preferred parent to forward packets until it exhausts battery, experience malfunction, the radio link becomes unavailable, or his rank changes discarding it as a preferred parent.

Preferred parent selection should be performed each time a rank changes in the parent set or a new candidate is inserted. Once a preferred parent is elected, the node will start sending the DIO packets. A node announces its new rank set to the sum of the preferred parent rank and the cost to reach it. RPL suggest the use of hysteresis to limit the frequent changes of

the preferred parent due to the unstable nature of LLN links. The originally elected preferred parent will be replaced with a new one if a difference in the announced rank goes over a hysteresis threshold.

Gaddour et al. [42] have recently evaluated the process of DODAG construction. The convergence time (the time necessary to find a preferred parent by all nodes) does not depend on the number of network nodes, but rather on the size of the deployed area and the communication radius. The authors notice that the resulting DODAG has a lower depth (distance to root in hops) when OF0 is used, especially when the DODAG root is placed in center of the deployed topology. OF1 helps to increase the network throughput since the link quality is considered when choosing parents. Finally, the network performance improves with the increase of the number of created DODAGs with same OF. Now, a node belongs to a smaller DAG.

2.3.4 A DODAG maintenance

RPL relies on the bi-directionality property of links that should be verified prior to the preferred parent final election. RPL suggests the use of 6LoWPAN ND (Neighbor Discovery) as the default solution for the neighbor reachability maintenance. When a preferred parent is detected unavailable, 6LoWPAN ND will initiate measures to replace it with a backup one. 6LoWPAN ND is based on observing the data packet progress, thus leading to inefficient and slow link breakage detection. Whenever available, level 2 mechanisms should be preferably used [62].

If the parent set is detected empty, a node will announce its unavailability to behave as a parent. A disconnected node poisons its sub-DODAG routes with a DIO packet of the infinite rank. A sub-DODAG nodes not receiving the poisoned DIO with the infinite rank continue to treat the disconnected node as a preferred parent. A (disconnected) node can safely add a parent of any rank with a newer DODAG version number without the risk of forming a loop. A network sink either periodically issues a new DODAG version number or triggers it on an event. A disconnected node can safely add as parents nodes from its previous sub-DODAG if they passed to the new version number. This would mean that they have found an alternative parent that evolved to the new version. Nevertheless, a simulation study [54] suggested that a local route repair mechanism would be more suitable for LLN environments.

Each node belonging to a DODAG periodically sends DIO packets to announce its rank and to maintain the routing paths. To reduce control overhead, RPL sends DIO packets using the Trickle timer [72]. A node starts sending DIO packets with default minimal period I_{min} when it joins a new (version of) DODAG. While the network is stable (no inconsistencies detected), the DIO

period is doubled until the maximal period value I_{max} is attained. Trickle period resets to I_{min} as a quick response to repair topological pathologies. For instance, on detecting a transitory loop that appears due to a loss of control packets. Trickle resets as well when a DIS (DODAG Information Solicitation) control packet is received. These packets are issued as a part of the active DODAG discovery. DIS can be the efficient way to reduce a waiting time for a DIO reception when the trickle period reaches high values (I_{max}).

2.3.5 Downward paths

are optional part of RPL that enables P2MP and P2P traffic patterns. RPL builds them by explicitly sending DAO (Destination Advertisement Object) control packets from a particular destination node to the DODAG root. The destination advertises its presence by issuing DAO packets to a subset of parent set, preferably as multi-cast. Contrary to the clear definition of the Trickle timer that triggers a DIO packet, DAO packets lack this kind of specification. One possibility would be to send them periodically just before a downward route expires. Otherwise, several times in a row to increase the route establishment probability [30]. Even when periodic DAO transmissions are well parametrized, they account for the majority of RPL control traffic [6]. They have to be conveyed over the multi-hops to a DODAG root, whereas DIO are only locally sent.

RPL supports two modes of downward routing:

- **Storing**—a fully stateful mode where each node memorizes the next best hop to reach an advertised destination. Obviously, this efficient downward routing requires more memory capacity on each node to store multiple paths.
- **Non-storing**—a stateless mode where paths are only stored at the network root. All traffic firstly reaches the root and it is then source routed to the destination. Obviously, this is highly inefficient both energy, and control traffic wise [127]. Routing is performed following sub-optimal paths. It generates an unnecessary traffic overload around DODAG root. Additionally, storing large paths can be cumbersome due to the small packet size.

Contrary to efficient, simple and well detailed (all necessary IPv6 compatible mechanisms are described) upward routing, RPL lacks in maturity when it comes to P2P and P2MP routing. Additional effort have to be made in order to promote RPL in omnipotent routing solution for IoT that it strives to be.

Babel routing Recently, RPL got an alternative for MP2P routing—Babel protocol was introduced to IETF [26]. The motivation was to offer a clear, well defined, and short description (46 pages contrary to 164 pages of RPL main RFC) of all necessary mechanisms specific only to the most dominant MP2P traffic. Babel belongs to a distance vector routing protocols. It is designed to be robust and efficient both in wired and dynamic mesh wireless networks. Babel (unlike RIP [46]) disallows the appearance of routing loops for the case of a single sink convergecast even with the dynamic link changes. When dealing with multi-sink scenarios, Babel highly limits the loop duration during the convergence time.

Babel assures a loop free functioning for arbitrary metrics that are strictly monotonic. Babel supports a simple hop count metric, and also describes an explicit method for link quality estimation. Nodes periodically (period can vary) broadcast a sequenced *hello* packet. For the case of WSN, the surrounding nodes should wake up at the right time to receive *hello* packet. According to the sequence number, a receiving node can calculate the *hello* PDR. A node eventually acknowledges *hello* as unicast with a IHU (I Heard You) packet. IHU contains the PDR measured over the last N received *hello* packets. Open challenge is to estimate how many (N) *hello* packets node should wait before acknowledging it. A clear compromise between reactivity and incurred control overhead. The originator node A can calculate the bi-directional quality (C) upon receiving the IHU packet. $C = \frac{1}{\alpha \cdot \beta}$, where α is *hello* PDR, measured over the packets sent from the node B to A and β stands for PDR obtained from the IHU packet.

Babel avoids loop creation by applying a conservative feasibility rule. A node considers only the neighbors with a rank strictly smaller than all the ranks that node has previously declared in route announcements. A feasibility condition guarantees loop avoidance, but can cause the starvation. A node resolves the starvation by explicitly notifying the sink, who in turn increments the global sequence number (similar to DODAG Version number). In conclusion, Babel offers a simple but yet effective distance vector routing protocol, readily available in form of an open-source implementation [27].

3 Cross-Layer Techniques for Wireless Sensor Networks

3.1 Classical layered paradigm in WSN in the light of IoT

For a few years, the 6lowPAN and ROLL working groups have been promoting the IP vision for the WSN. They consider that IoT must support IPv6 to enable new applications—this constitutes a sine qua non condition to its development. The ROLL working group advocates that the M2M (Machine to Machine) market has not yet known the expected growth mainly because it is currently a world of proprietary solutions. Thus, we witnessed a huge standardization efforts to eliminate the unnecessary abundance of proprietary solutions.

The classical layered philosophy reside on the divide and conquer strategy—the complexity of a large unique problem is reduced by splitting it into smaller manageable pieces. The system becomes modular where each layer becomes responsible for a limited and well-defined set of tasks. For the case of WSN supporting the IoT we have to clearly differentiate between:

- MAC layer in charge of radio bandwidth sharing: which node has the right to transmit a packet at a given instant. 6lowPAN assumes, for instance, that IEEE 802.15.4 is used for the transmissions.
- IP layer for interoperability: how a node should route packets, which protocol it uses for exchanging packets with the Internet. ROLL promotes RPL as a potential routing candidate.

Each module only communicates with adjacent modules by offering them a limited and well defined set of services. The implementation details are hidden behind the abstract interfaces. The layered model removes all the dependencies and assumptions between the separate layers. Such design leads to a simplified system architecture. Also, the implementation of one layer is easily interchanged and replaced with a new different one.

We can remark that experiments in WSN research field often adopt the layered approach. Sensorscope project [15] designed a very simple solution where 7 nodes weather-monitoring testbed is deployed. Although the authors faced a simple testbed, they chose to keep the layered architecture of the OSI model. In Zebranet, the authors also implemented a classical stack of protocols for monitoring zebras in their natural environment [57].

Keeping the standardized layered framework with distinct responsibilities of each layer offers a better focus on design challenges and would lead to faster

development of IoT [34].

3.2 Idea of cross-layer in WSN

Over the decade the classical layered structure served well proving to be an efficient and flexible solution. Nevertheless, the classical layered model allows us only to optimize different layers separately. In other words, the local optima for adjacent layers (e.g. MAC and transport (routing)) may be antagonist and would not lead to a global optimum. Solving problems locally inside the layers and optimizing them independently might lead to unsatisfactory results.

Additionally, certain particular functions of WSN cannot be easily allocated to a single specific layer. We can clearly see this on the example of topology construction. It could be arbitrary attributed either to MAC (closer knowledge of link characteristics), or routing (having different global delivery goals in mind). Both, the IEEE 802.15.4 and RPL standards maintain a separate topological structure, a cluster-tree and a DODAG, respectively.

Wireless channel characteristics generally affect all the layers, potentially leading to even more important optimization mismatch between different layers [110]. Wireless channel impairments (interference, path loss, shadowing and multi-path fading) [112] lead to indeterministic behavior of wireless link making it impossible to match wired link characteristics. Wireless link instability highly affects the layered model. Some assumptions do not hold anymore e.g. the routing layer cannot count on bimodal links that are either up and functioning or down.

CPU (Central Processing Unit) and memory constraints typical to WSN make the integration of different layers (e.g. MAC and routing) vital [43]. For instance, mutualizing MAC and routing information permits to reduce the memory fingerprint. A careful co-design of different layers also permits to achieve more easily the energy efficiency [117]. Finally, routing depends heavily on the underlying MAC layer. For instance, a low duty-cycle MAC decreases the node battery consumption but also has the impact on routing decisions. A decreased routing delay can be achieved if a node chooses the next hop according to the scheduled MAC wake up time of each neighbor.

A cross-layer architecture strives to account for some of these problems by adapting the OSI model. Layers should interact and exploit the dependencies to achieve better global system performance. We can imagine that not only adjacent layers interact but basically any arbitrary two layers e.g. MAC→APP [23], or TRANSP↔PHY [120].

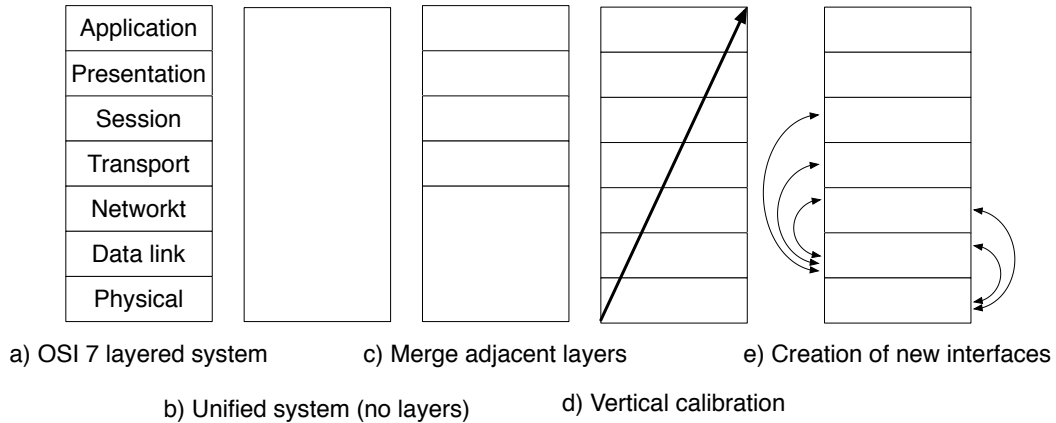

Figure 2.15: Overview of cross-layer approaches: a) OSI 7 layered system b) Creation of new interfaces c) Vertical calibration d) Merge adjacent layers e) Unified system (no more layers)

3.3 Cross-layer approaches

When using the cross-layer philosophy we may adopt several approaches (cf. Figure 2.15) [110]: either we merge all (several) layers to create a single protocol, either we perform vertical calibration, or we maintain more separate layers, that interact with each other.

Unified single layer (merged layers) goes with the principle that the layered approach must be completely eliminated, thus all layers must be integrated and jointly optimized. This permits to explore all the solutions, finding the jointly optimal cross-layered one. We can loosen up this requirement by only merging some layers while leaving the rest of the layered system unchanged.

For instance, Kulkarni et al. proposed a simple joint opportunistic MAC and routing solution for convergecast networks [68]. During the configuration phase each node is attributed to a tier, spreading from the sink node in the form of concentric circles. The joint MAC/routing protocol then follows the classical RTS/CTS/DATA/ACK paradigm. A node asks for a candidate with a RTS: an overhearing node belonging to a tier closer to the sink replies with a CTS and the data transmission takes place. Zeng et al. aim at tackling the same problem with an optimization approach [135]. They proposed to find the optimal MAC scheduling and routing schemes in a centralized way. Removing the classical layered architecture also permits to reduce complexity. If the solution is very simple, it may be implemented in FPGA (Field-programmable Gate Array) [84]. We can in this way largely reduce energy consumption.

Such an approach has clear benefits, but also presents severe drawbacks:

- *Non-flexibility*—since the solutions are monolithic, one modification may require a possible redesign from scratch of new protocol. Having all the protocols tied together is clearly impractical and can easily lead to spaghetti design. The consequences could be disastrous in regard of changes, upgrading, and standardization.
- *Re-usability*—a new application requires a new ad hoc solution. On the contrary, a modular (layered) solution, would have permitted to choose the most accurate protocols we need for a particular use.
- *Interoperability*—The new Internet of Things strongly relies on the standardized layered stack. A monolithic solution would not be interoperable and would not allow seamless integration with the rest of the network running on the layered stack.

Vertical calibration All protocol layers mutually collaborate to find the optimal set of parameters from the global point of view. The performance seen at the level of the application is a function of the parameters at all the layers below it. Vertical calibration can be done in a static manner. The optimal global set of parameters is calculated prior to the node deployment. It can also be done dynamically at runtime. A flexible protocol stack will decide to change parameters in a response to the observed changes in the wireless environment and overall network performance.

As an intuitive example we can take the work of Liu et al. [74]. The proposed MAC protocol decides on an appropriate channel-adaptive modulation scheme according to the persistence of the link-layer automatic repeat request, which in turn is being dictated by the global application delay requirements. The requirements of the higher level become the input optimization goal for the lower level.

Creating new interfaces —Instead of completely abandoning the classical layered model, this approach loosens it up. It allows a new types of interaction between adjacent layers, outside those defined in advance. In other words, creating new interfaces means embracing and exploiting the dependencies and interaction between layers. Additionally, layers can share the knowledge about the their current state and condition. Creating new interfaces has been shown to increase the performance in certain scenarios of wireless networking [49]. For example, providing the knowledge about channel conditions (PHY and MAC) to routing, transport, and application layers allows to design more sophisticated allocation and optimization algorithms [23].

Hurni et al. [49] proposed a cross-layer routing solution for real-time traffic capitalizing on more advanced MAC knowledge. Instead of simply taking the link quality as a routing metric, a node additionally uses the neighboring nodes wake up time. Each node collects the WiseMAC scheduling information on the wake up time of the n-hop neighbors. Thereafter, a node can select the best path towards the sink that optimizes the delay. Similarly, Vanhoesel et al. [117] advocate the use of cross-layer routing and MAC framework for a TDMA-based scheme. Nodes select appropriate time slots in distributed fashion, based on the local topology information, to induce delay optimized routing. In other words, a node chooses the time slot that precedes the one of its parents to decrease the delay for convergecast traffic pattern. The authors demonstrate the benefits of cross-layer interactions over a strict layered approach through a comparative simulations.

Supporting the classical IP building blocks such as the UDP and TCP mechanism over WSN, will enable transparency to existing infrastructure and faster development. Wagenknecht et al. [121] propose a cross-layer approach by exploiting the hop-by-hop re-transmission scheme additionally to the IEEE 802.15.4 mechanisms. The authors aim to offer a pure end-to-end reliability of TCP in the lossy WSN environment. The end-to-end retransmissions are replaced by the reliable hop-by-hop mechanism. The IEEE 802.15.4 MAC layer was modified to locally store and re-transmit the dropped packets. The proposed solution achieves considerable energy savings compared to the original TCP end-to-end re-transmission scheme [121].

Experimental analysis and characterization of a Wireless Sensor Network environment

The primary goal of this chapter is to provide an insight to the characteristics of the real world environment that are often neglected when an experimental testbed is deployed. These observations will serve as a real world feedback and reference point when designing protocols for IoT.

The research community has quickly become aware that models of wireless multihop networks are too simplistic and lead to misleading conclusions. In particular, different simulators have been proven to provide different results [21]. Especially, the radio model has a strong impact on performance [112]. To improve the evaluation of various protocols, we can set-up an *ad hoc* testbed to compare simulation results with measurements gathered on the testbed [12] [100]. However, the collected experimental measurements usually concern only a limited number of specific tested aspects [22] [14]. Setting up operational testbeds requires a large human effort. Furthermore, existing testbeds, even though rare and specialized, are not often exploited to their full potential.

A testbed commendable efforts usually do not provide generic results to the networking research community. For instance, they do not consider many important aspects such as: What are the characteristics of the WSN radio topology? What is the reliability of a WSN? Are the properties stable or do they exhibit some variability or periodicity?

Recently, Raman et al. analyzed the problem of interference and radio link modeling in IEEE 802.11 wireless mesh networks [97]. Their results are experimental, but only concern the wireless mesh networks. Nevertheless, the authors gave an overview of what concerns may arise in WSN.

We propose here to address one part of these fundamental concerns in WSN. To further benefit from the knowledge gathered on a testbed and to obtain the insight into the WSN environment itself, we perform a thorough statistical analysis. In the past, statistical analysis has been applied to traffic analysis [69] or anomaly detection [101] to extract some correlations and salient features. Our analysis includes in particular:

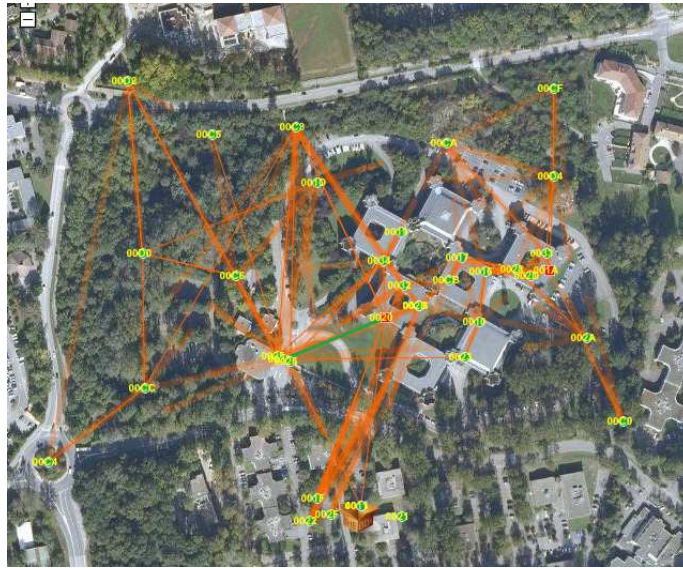

Figure 3.1: Deployed topology in an urban environment

- characterization of radio links in a WSN: their reliability and the correlation between their properties;
- analysis of the network dynamics: how does a WSN change in time?
- how can we predict the quality of a radio link with a local and simple measure?
- how can we discard measurement errors (i.e. artifacts)?

We will close this chapter by discussing how testbeds should be designed or improved to provide more detailed information necessary for an advanced analysis.

1 Methodology

1.1 Testbed description

We used a testbed originally designed for validating a routing protocol [124]. It was composed of 36 Coronis nodes implementing the Wavenis technology [2]: they use fast frequency hopping for robustness and narrowing band interference. Nodes operate in the 868 MHz license-free band, emitting at 25 mW with maximum transmission rate of 19200 bps. The MAC layer follows a CSMA-CA approach for medium access contention. Besides, two nodes acted as sinks with a direct connection to the Internet and a database for storing

Environment type	Urban
Node position	Indoor & outdoor
Sensor type	Coronis Wavenis
Number of nodes (sinks)	36(2)
Duration of the experiment	18 days
Neigh. discovery period	13 min.
Data packet generation period	17 min.

Table 3.1: Wireless sensor network testbed parameters used for collecting data used for statistical analysis

received packets. Nodes were deployed over the area of the technical park of Orange Labs in Meylan, France, both indoor and outdoor. Their location is diversified enough (e.g. walls, barrier, trees, ceiling) so that a wide range of situations is observed. We analyzed the measurements of 18 days of operation. Figure 3.1 presents the deployed topology in the urban environment.

The testbed was mainly used to validate a routing protocol based on virtual coordinates: each node maintains a metric related to its virtual distance to the sink [123]. The next hop is chosen as the neighbor that is virtually the closest to the sink.

Nodes discover neighborhood every 13 minutes and maintain a proactive neighborhood table including the virtual distance and RSSI of each neighbor.

Each node generates a new data packet every 17 minutes. This packet is transmitted in anycast: any sink can be used to reach the wired part of the network. In order to select the next hop (the node that has the lowest virtual distance), a node only has to look up its neighborhood table.

The routed packets, aside from the control fields (source and destination ID, sequence number, etc.), contain debug information consisting of complete neighborhood tables (the neighbor ID and the received RSSI value: 32 possible levels between -108 dBm and -60 dBm in 1.5 dBm increments) and the application payload consisting of measurements of the temperature, humidity, and light sensors at the instant just before sending the packet. Packets successfully received at sink nodes were labeled with a timestamp and stored in a database. Table 3.1 sums-up the important testbed information.

1.2 Database description

To allow meaningful interpretation and easy use of different types of measured values contained in the received routing packets, the database is divided into few tables (cf. Figure 3.2):

- the node ID and its geographical position (known prior to deployment)

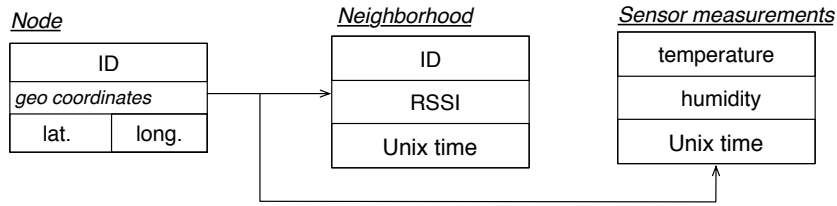

Figure 3.2: Wireless Sensor Network experimental testbed database—an overview of the obtained information

to obtain the geographical topology. We can compare it to the radio topology;

- neighborhood information (neighbor ID and a RSSI value). We can observe in particular duration and quality of the links;
- sensor measurements (e.g. humidity, temperature).

On the average, each node sent 1,500 data packets (maximum sample size) to sinks, where just the ones successfully arrived were saved in the database. To perform an accurate statistical analysis, we need to discard received data samples with insufficient cardinality. Thus, we have removed all the data samples that count less than 1% of the maximum size (i.e. 15 entries). They correspond to isolated or faulty nodes.

1.3 Bidirectional and unidirectional links

We can distinguish between unidirectional and bidirectional links (RSSI measures are available for one or for both directions). We obtained 16 unidirectional links and 280 bidirectional links.

We define as *link occurrence ratio* the number of appearances of a candidate node in the neighborhood table of a reference node divided by the total number of tables for that reference node. In other words, it represents the percentage of the cases where a link between two nodes was detected and qualified with an RSSI value. We can note in Figure 3.3 that a significant number of links (20%) exist less than 1% of the time. By filtering these sets with too small cardinality, we eliminated in particular all the unidirectional links: their data sets accounted only for 1 to 4 occurrences. Thus, one of our first results is that the testbed did not have any unidirectional links. However, some of the bidirectional links can be asymmetrical (i.e. their quality is different for both directions), as explained in one of the following section.

Unidirectional links may appear when antennas are not perfectly omnidirectional [105], filters are not well-designed [75] or when nodes do not use

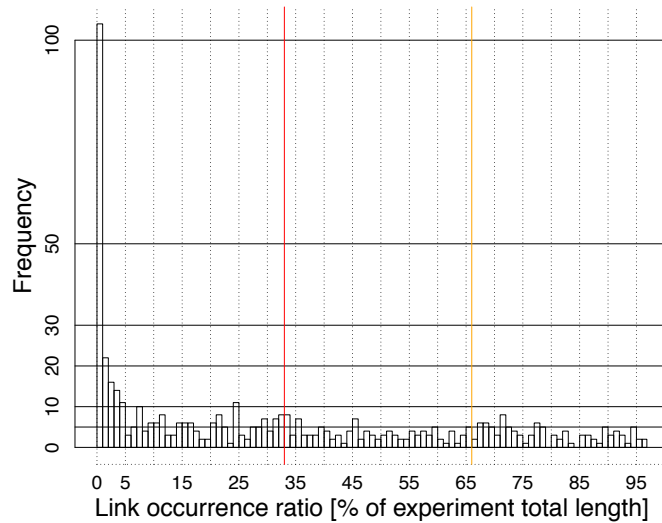

Figure 3.3: Distribution of link occurrence ratio

the same transmission power [103]. Consequently, we can conclude that the Coronis nodes are robust and the hardware is well designed and manufactured (i.e. different nodes have the same characteristics).

1.4 Filtering data

Since we focus on experimental data, we have to discard ambiguous measures (i.e. possible outliers or impracticable values) to obtain unbiased results. We propose to detect and discard this kind of values.

Formally, we consider that a value is an outlier, if it conforms to the following condition:

$$x < Q1 - 1.5 \cdot IQR \quad \vee \quad x > Q3 + 1.5 \cdot IQR \quad (3.1)$$

where $Q1$ represents first quantile of observed data set, $Q3$ third quantile and IQR difference between them i.e. inter-quantile range.

We discard all the values that are single isolated outliers: only one value is extreme, corresponding surely to a transient behavior. On the contrary, multiple consecutive outliers could arise from temporary obstacles (e.g. a delivery truck, a car) for radio propagation, climatological changes (heavy rain that disturbs radio transmissions and increases the humidity measures). Thus, we keep all multiple consecutive outliers. In other words, we consider that the extreme values that last for more than 17 minutes are valid. We will give more attention to multiple consecutive outliers later in the article to infer the main causes and consequences.

After filtering our experimental dataset, we proceed with the analysis.

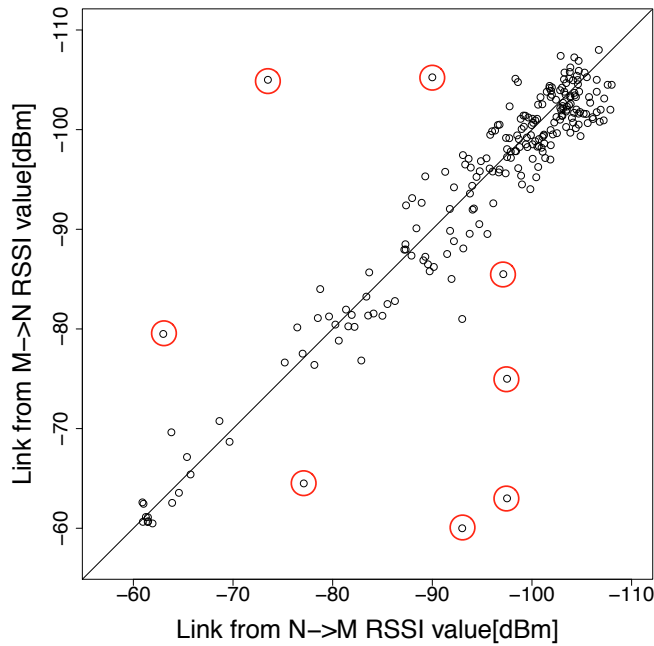

Figure 3.4: Symmetry of existing bidirectional links

2 Experimental testbed data analysis

2.1 Link quality

The progress in the radio chip design positively impacted the performance and reliability of WSNs [109]. This motivated us to further investigate the possibility to use the RSSI value as a reliable link quality indicator.

2.1.1 Radio link symmetry

We measured the RSSI value in both directions for each radio link (Figure 3.4). In this graph, we did not remove the links with a very small number of values (as explained in Section 1.4), because we aim here at analyzing the reason of their existence.

When the points are close to the diagonal, the links are symmetrical: the quality is identical in both directions. The reader can remark that contrary to the literature, symmetry is predominant.

This means that nodes use the same transmission power. Besides, they are also homogeneous: the radio hardware behaves identically. For instance, the radio chips of two different radio modules follow the same frequency selectivity (i.e. filters are identical).

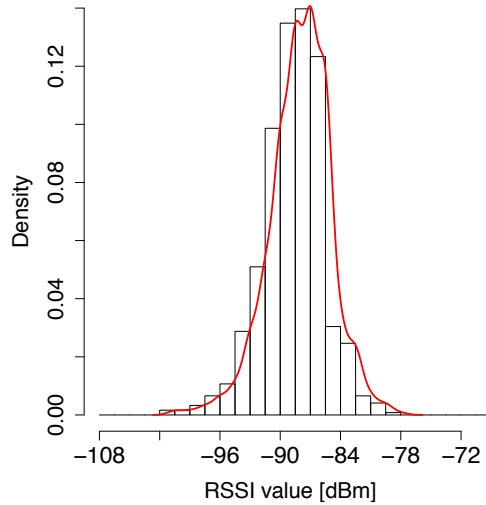

Figure 3.5: Distribution of RSSI value for one of the representative links

Radio links are seldom asymmetrical (cf. points highlighted with red circles in Figure 3.4): these outliers appear for links with a duration less than 1% of total length of the experiment. For these rare cases, the quality in one direction is significantly different, i.e. greater than 10%, sometimes even 55%. This *unbalanced* representation justifies the removing of links with too small cardinalities.

2.1.2 RSSI distribution

To predict the link behavior with a local and simple metric, the measure should follow a known probability distribution model: we would be able to accurately infer the average quality of the link by analyzing the measured values in real-time.

The Normal (or Gaussian) distribution is extensively used since it models well many natural phenomena, especially for radio propagation (e.g. the Additive White Gaussian Noise). We aim here at verifying if the RSSI measured for each of the existing links follows this distribution.

We applied the Shapiro-Wilk test [48], to the measured RSSI samples. For 92% of the links, the p-value of the Shapiro-Wilk test was significantly less than 0.05 and for the rest barely over this value. This signifies that we need to reject the null-hypothesis meaning that the RSSI does not follow a normal distribution. This corroborates some indoor results [59] and even in outdoor conditions for LOS radio links, the RSSI does not follow a normal distribution.

We compared also these RSSI samples to other two well-known distributions: Logistic and Cauchy. These distributions are the only ones that may have this kind of values (close to a log-normal law, but with minor variations).

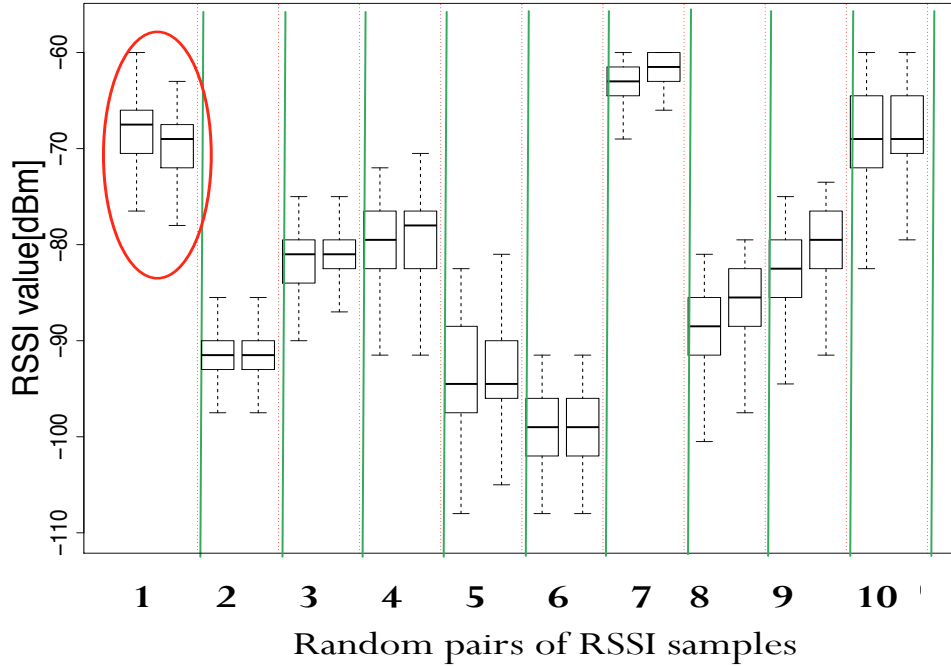

Figure 3.6: Box plots of RSSI values for ten representative node pairs. Link quality in both direction follow the same distribution, even though in some cases box plots are not perfectly symmetrical.

We used a Kolmogorov-Smirnov test to compare a well-known distribution to a collection of samples. More precisely, a collection of values is generated according to the tested distribution with the same cardinality as the set we want to compare to. Then, the Kolmogorov-Smirnov test lets us know if two collections of values follow the same distribution. For both distribution cases and for all of the links the resulting p-value was always close to, meaning that we have to drop null-hypothesis i.e. RSSI samples do not follow neither Logistic neither Cauchy distribution. Nevertheless, RSSI distribution that we tried to describe, has bell shape with high central peak, but it is slightly skewed to one side (Figure 3.5). Thus, no well-known distribution can act as a generic model for such RSSI values.

We now aim at demonstrating that the RSSI of different links follows the same distribution. Since they do not follow the Normal distribution, we have chosen one of the most familiar non-parametric test—the Wilcoxon-Mann-Whitney Test [48]. Now the null-hypothesis is that values from the two independent samples come from the same distribution. The average of p-value for this test was 0.0416 while 89% of values were smaller than 0.05. The null-hypothesis is valid since this p-value is lower than alpha level 0.05. In other words, we conclude that the corresponding pairs of samples do follow the same distribution.

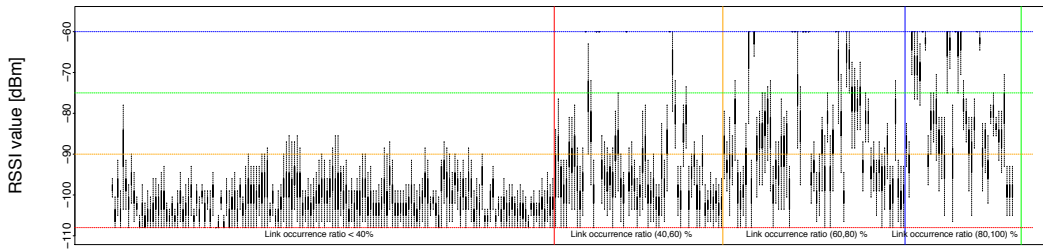

Figure 3.7: Impact of the RSSI value on the link occurrence ratio

We also illustrated this observation in Figure 3.6. We plotted the Box Plots of link RSSI quality in both direction for ten node pairs. Even though median values are not perfectly aligned, we can note that inter quantile ranges are similar as well as the skewness of data and max/min values.

2.1.3 RSSI periodicity

We also analyzed the difference in radio link quality during working hours (8am-7pm) and night periods (9pm-6am). We determined that in the 97% of the link cases, the difference between the RSSI levels was less than 10%. In the remaining 3% of the links, the maximal difference did not rise above 35%. Additionally, plotting the values we obtained almost the same graph as the one plotted in Figure 3.4 showing that links did not change their properties during different periods of day. Thus, movements of people and vehicles in the technical park during working hours do not have any significant impact on the RSSI. RSSI is stable and transmissions are quite robust to some changes in environment properties.

In other words, the PHY layer in the Wavenis nodes is robust to interference, because it uses frequency hopping. Moreover, the PHY channel is stable.

2.1.4 RSSI vs. Link occurrence ratio

To have a more detailed insight into the link occurrence ratio property shown in Figure 3.3, we tried to observe whether it can be correlated with the RSSI value.

Figure 3.7 shows Box Plots for all recognized links in the testbed separated in 4 groups according to the range of their link occurrence ratio without sorting them in ascending order by the same criteria.

Looking at this figure we can notice that there is no evident correlation between RSSI value and link occurrence ratio since Box Plot of RSSI covers whole extent of possible values in different link occurrence ratio ranges. However, we can remark the following points:

- a single RSSI distribution for a particular link does not permit to conclude on the occurrence ratio for this link. Individual conclusions are not possible;
- if we take a closer look at the graph, we can remark that each *category* exhibits different RSSI spreads. In other words, we could derive a probability of link occurrence ratio for different RSSI values. However, this corresponds to a global (and not individual) behavior, i.e. RSSI is not directly a good quality estimator;
- for the first range of link occurrence ratio (1-40%), the mean value of the RSSI for all of the links do not pass above -90 dBm. Thus, a poor link obligatorily means low RSSI;
- the largest RSSI values mean in most cases that we benefit from stable links.

2.1.5 RSSI vs. sensor measurements

First, we checked the correlation between the measured humidity and the RSSI. During the experiments, nodes happened to be exposed to humidity levels between 0 and 100% relative humidity (RH). We computed the Pearson's correlation factors [48] for all bidirectional links. In all cases, the value did not exceed 0.5, moreover we have neither a negative nor a positive correlation between the two variables. In the same way, the correlation is not significant if we only focus on outdoor radio links.

The second test was an attempt at further exploring the correlation between humidity and RSSI values, but just taking into account the impact of the extreme (maximum) values of humidity measurements. We extracted subset of top 25% of all humidity values (more than 75% of RH) measured during the experiment. Afterward, we computed the difference between the mean value of RSSI for the observed link and the current value of RSSI at the same instant as the measured extreme value of humidity.

If the humidity does not impact the RSSI, we would have an average difference equal to 0. This means that the RSSI value has the same chance to be greater or lower than the average RSSI value. Since we observed this behavior (values are very closed to 0 with a varying sign), we can for sure say that humidity has no impact on the RSSI measurements.

In conclusion, the fast frequency hopping technique is efficient to avoid interference and frequency-selective fading.

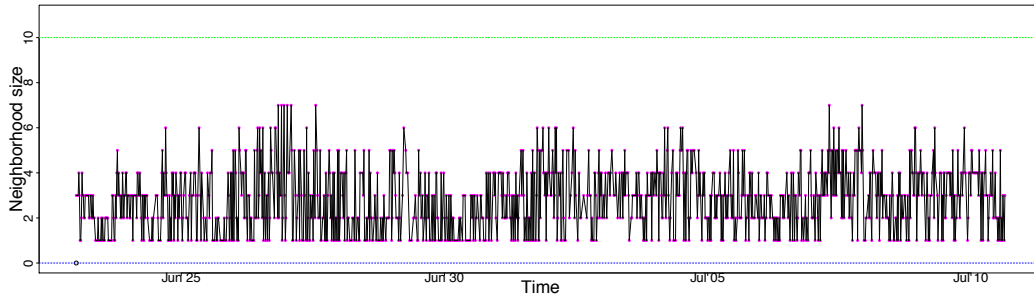

Figure 3.8: Variation in the neighborhood size for one of the nodes

2.2 Network dynamics

The radio channel is intrinsically unstable, since it is easily influenced by various environmental parameters. This implies certain dynamism in the network in which links can easily disappear or re-appear. To optimize the performance, the deployed MAC, topology control, and routing protocols should self-adapt to changes. We will now focus on the network dynamics to understand how it could further impact higher layers.

2.2.1 Neighborhood variation

We first studied the variation in the neighborhood table. The same remarks hold for all the nodes and we focus here on one randomly selected node. We plotted in Figure 3.8 the variation of its neighborhood size.

In the current testbed, there is no `hello` packets, because it implements an *all-reactive* solution. When a node wants to transmit a `data packet`, it sends a `RTS`. All its neighbors reply with a `CTS` including the received RSSI. Thus, a node is able to reconstruct the list of its neighbors and the corresponding RSSI.

It varies most of the time with rare stable periods that last at most few samples. We have recognized this behavior as a general trend for all the nodes. This raises the question of whether a proactive approach is the most accurate solution for discovering its neighbors. Indeed, proactive maintenance may result in inefficient routing decisions when choosing unreliable nodes: they can be chosen as a next hop, because a `hello` was previously received although they will not correctly receive the next data packet. Although RSSI may be stable, the radio link may not be. This result tends to conclude that opportunistic solutions in which the next hop is chosen only when the data packet is transmitted, are more relevant in this environment. Since the next hop is reactively chosen among the nodes that received a data packet, the unreliability problem is reduced.

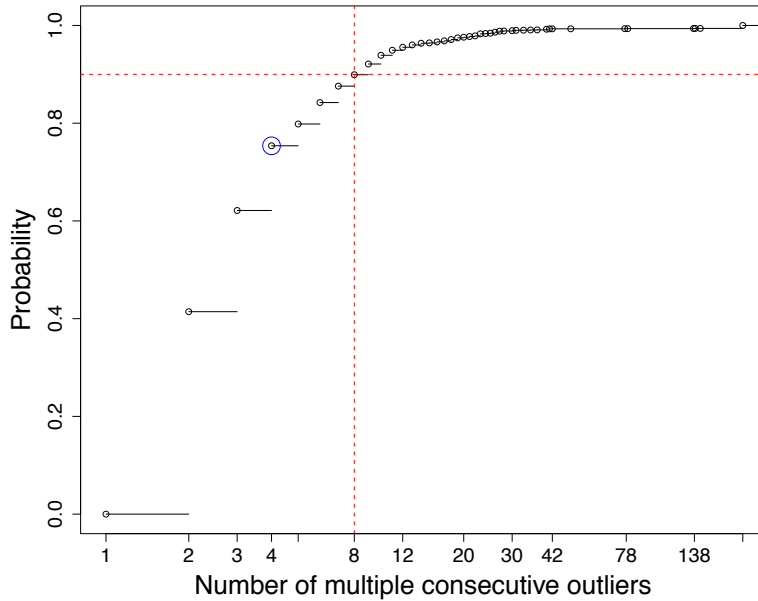

Figure 3.9: CDF of multiple consecutive outlier

2.2.2 Link evolution

Although the neighborhood table continuously changes, a group of stable neighbors may practically exist. In particular, is the stability of neighborhood correlated with e.g. the RSSI or the distance between the transmitter and the receiver?

We have noted that stable radio links have one of the following properties:

- a high RSSI value (superior to -75 dBm);
- a pair of nodes within one fifth of the radio range (≈ 70 m) and having a medium value of RSSI (between -75 dBm and -90 dBm).

By combining distance and RSSI information, we should be able to predict link stability. Moreover, there was no single case in which neighbors with a high value of RSSI were not among most stable neighbors.

High RSSI could be used as reliable indicator of link stability when using Wavenis chips [2]. Geographical information is an additional element to cope with medium RSSI values. Similar observation was made by other authors [109] for a different type of radio chips. Nevertheless, there is still substantial free space in order to make tighter conclusions about the link behavior with RSSI in a gray zone (low levels close to the threshold) since it is influenced by various effects (multipath, fading, interference, etc.) for which the impact varies over time and according to the situation.

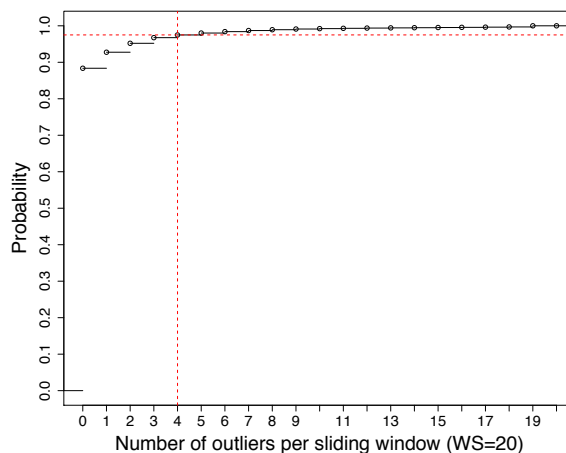

Figure 3.10: CDF of number of outliers per sliding window of size 20 samples

2.2.3 Multiple consecutive outlier distribution

As previously stated in Section 1.4, we have kept multiple consecutive outliers since they depict transitory effect that influence the quality of radio channel for a short period. An outlier will introduce a bias in the average and median values if we do not discard them.

We aim here at analyzing this phenomenon in a more global way, i.e. for all observed links in the network. Thus, we extracted the Cumulative distribution function (CDF) of the number of multiple consecutive outliers. We plotted the results in Figure 3.9.

In our static testbed we have 4 or less consecutive outliers in 75% of the cases (the blue circle in Figure 3.9). In the same way, for 90% of the cases, we have 8 or less multiple consecutive outliers (dashed line in the figure). This means that we can consider multiple consecutive outliers lasting up to 8 periods as transient effects that interrupt stable radio link for a short period. Since observing more than 8 consecutive outliers is very rare in a static testbed, we can consider that this phenomenon is related to a permanent topology change in a mobile/changing testbed (e.g. building modification).

Let us still focus on the 4 consecutive outliers case. We have approximately 12% of the samples that last for exactly 4 outliers (75% - 63%), and only 5% of the samples that last for exactly 5 outliers (80% - 75%). In other words, when a node experiences 4 consecutive outliers, it is more likely that the next sample will be *normal* than it will still be an outlier. We can remark that this observation holds for all cases: we have a strictly larger probability to have k consecutive outliers than $k + 1$. In other words, outliers have a limited impact and the average and mean values would be well estimated if they are properly detected and discarded (i.e. they will not introduce a large bias).

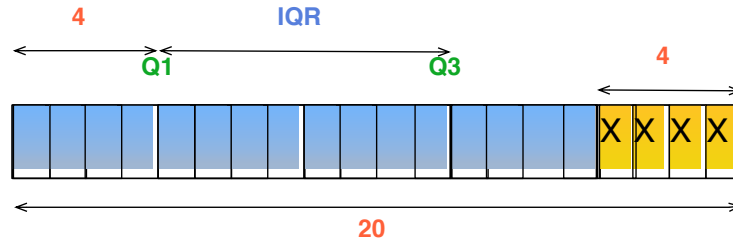

Figure 3.11: Sliding window example with 4 values tagged as outliers

2.2.4 Number of outliers in a sliding window

A problem occurs when we want to practically detect outliers. It is almost impossible to keep the whole history in the node memory to precisely compute IQR and accurately remove outliers. We assume we may only save last few samples. We chose here to implement a sliding window of 20 samples. Furthermore, we have computed the Cumulative Distribution Function of the number of outliers per sliding window (Figure 3.10) to justify our choice.

In 97.5% of cases, we have 4 or less outliers per sliding window (cf. the dashed line). We aim here at limiting the memory consumption while still well estimating the average value to be able to accurately detect the outlier values. Moreover, the method must not be too conservative since testbeds are not static and the environment can change. In particular, the quality should sometimes be re-estimated, even if new values are far from the previous average values.

We propose the following approach to reach this objective. At most 4 slots will be used to store outlier values (yellow fields in Figure 3.11). These values will be tagged and will not be used to compute the IQR value (Eq. 3.1) since we consider that these values are *abnormal*. Possibly, a new value could be detected as outlier although 4 values were already tagged as outliers. In this case, we remove the tag for the outlier closest to the median value. IQR are updated and possibly the outliers could be considered as *normal* if they belong, after the update, in the correct range.

Let us consider Figure 3.11. We can see that the extreme 4 values on the right are tagged as outliers and thus are not used to compute IQR, Q1, etc. Using this approach, we *smooth* the quality metric and discard inaccurate measures. Moreover, we are also reactive: we efficiently detect changing radio links and update their associated quality metric accordingly.

In conclusion, if each value can be coded in $size_{sample}$, a node has to reserve only $20 * size_{sample}$ bits to compute an accurate average metric. The reader can note that such a statistical approach could be easily applied to any metric measuring the quality of a radio link.

3 Conclusions

In this chapter, we have proposed a way to further benefit from the experimental data collected over the implemented testbed in a urban environment. We have carried out thorough statistical analysis on a collected dataset to obtain an insight on the WSN environment and to emphasize its most distinguished properties.

Our analysis considered the aspects of WSNs such as the link characterization, correlation with environmental parameters as well as network dynamics.

First, we showed that, contrary to the literature, there were no unidirectional links in our observed testbed and moreover, that all bidirectional links are highly symmetrical when comparing their mean RSSI values. Furthermore, we have shown that RSSI values do not follow any basic distributions (Normal-Gaussian, Logistic and Cauchy): a fitting distribution is still to propose. Even though, we have demonstrated that the RSSI values from the corresponding pairs of bidirectional links follow the same (unknown) distribution.

Although it is well-known that high humidity may cause a decrease in link quality, we have shown that there is no correlation between humidity and RSSI in our experiments. Even extreme maximum values of humidity do not cause significant changes in link quality measurements. This result probably comes from the MAC and PHY layers used in our nodes.

We have highlighted that a proactive approach in neighborhood discovery may cause imprecise routing decisions, which favors reactive solutions. Besides, although the RSSI exhibits large variations and does not correlate well with link quality, we could characterize stable links. In particular, high RSSI (more than -75 dBm) or a combination of both the distance less than 70 m and RSSI between -75 and -90 dBm permit to conclude that we benefit from stable links.

Finally, we have also presented a reactive, but still flexible mechanism for detecting and discarding transient outlier values in measured RSSI values.

4 Recommendations for experimental testbed

Before we close this chapter, we would like to elaborate a set of recommendations for an experimental testbed, derived from our experience. Originally, the testbed from our study was conceived specifically for the evaluation of the geographical routing protocol [124]. The authors [124] have obtained a rich feedback on the various aspects of the routing protocol. Nevertheless, the collected testbed data was not initially meant to characterize WSN environment itself. Naturally, during our statistical analysis efforts, we were missing some

pieces of the puzzle that prevented us to deduce deeper conclusions.

We would like to share some of our findings, so the researchers who aim at deploying a testbed for characterizing WSN environments do not arrive in the same situation:

- The network should be tightly and globally synchronized to allow chronological organization of the events. Notably, we would be able to reconstruct events at MAC level: for example, retransmissions, losses due to buffer overflows, or interference from concurrent transmissions. We would have been able to also compute average delays and give upper bounds on delays. Also a tighter correlation of local events could have been deduced. Instead of relying on the timestamps of received packets at the sink node, each separate node could order time events. For example, how instantaneous humidity readings affect the number of lost packets. To be clear, even not so tight (less energy consuming) synchronization would provide necessary precision and allowed us to get a better insight.
- In order to provide the fine grained analysis of the WSN environment, one should adapt the frequency of control packet exchange according to the dynamic of the observed phenomenon. Link quality variations can be detected with higher precision if the control packets are exchanged more often. Similar goes for the neighborhood table changes. A node can measure more accurately the disconnection time if the neighborhood discovery *hello* strobes are sent more frequently. A larger batteries should accommodate a higher incurred control overhead to allow a reasonable experimental network autonomy.
- Each single generated and transmitted packet should be saved locally at the node handling it. Thus, appropriate larger storage medium should be provided for a data backup at each node. Collected data would be used posteriori for the offline analysis. Locally saved data would provide richer information on the WSN environment and functioning, compared to the information derived from periodic reports centrally collected at the sink node. Periodic reports can be lost due to the lossy nature of WSN, leaving us with the incomplete information. One could infer what exactly have happened with lost packets, by simply storing the packet drop reason at a corresponding node. Similarly, all maintenance related operations (reboot, firmware version, or battery replacement, etc) should be saved in order to provide a clearer idea on the functioning of the WSN testbed.

- Neighborhood discovery should gather the RSSI and the Packet Delivery Rate (PDR) in both directions. In this way, the originator node has the instant bidirectional knowledge of the link quality indicator towards all of its neighboring nodes. In our analysis, we derived RSSI and PDR from successfully received packets at the sink.

IoT standards - how to make them work together

1 Problem statement

The primary goal of this chapter is to propose a set of improvements to the basic version of the IEEE 802.15.4 and RPL protocols. We will first examine how to allow an efficient multi-hop operation of the IEEE 802.15.4 standard. Then, on this basis, we propose to create a joint operation of the both protocols.

Let us briefly examine the multihop issues of the IEEE 802.15.4 standard itself. In fact, in the basic version of IEEE 802.15.4, beacon collisions are frequent among the children sharing the same parent, leading to inefficient operation. Two main approaches exist in the literature to reduce collisions: BOP [1] and superframe scheduling [66] [83].

We propose to further improve the IEEE 802.15.4 multihop operation by combining the advantages of the both approaches. The first contribution of this chapter is the adequate organization of the IEEE 802.15.4 superframes that reduces collisions and limit bandwidth waste. Thereafter, we propose two distributed and effective algorithms for superframe slot attribution that lead to close to collision free operation. Extensive simulations confirm viability and effectiveness of our method.

Our next objective is to allow running RPL on top of our efficient multi-hop IEEE 802.15.4. The main problem lies in the difference of the topological structures maintained by each respective protocol. Moreover, building and maintaining the redundant structures is useless and present a huge unnecessary energy overhead.

The IEEE 802.15.4 MAC layer maintains a *cluster-tree*—a hierarchical structure. A node can only select and associate with a single parent node (coordinator). Whereas, RPL maintains a **DODAG** topological structure. Each node selects at most three parent nodes while avoiding to create the loops. Alternate parents provide backup routes in case of failure of the preferred parent. The network becomes more robust to unexpected changes in radio connectivity. Nevertheless, all traffic is forwarded through a single preferred parent.

We propose to build and maintain new cluster-DAG structure uniquely at the MAC layer. A IEEE 802.15.4 node can associate with more parent nodes. We allow the nodes to forward their traffic to any of the available parents. Extensive simulations demonstrate that such forwarding scheme achieves better performances in the terms of PDR and packet delay.

2 New superframe collision free organization

Existing algorithms schedule the superframes while trying to avoid the collisions [66] [83]. They allocate one whole superframe per coordinator. A total number of superframe slots is limited and dictated by the ratio between BI and SD. This ratio determines the IEEE 802.15.4 duty-cycle ($\frac{SD}{BI}$). A limited number of superframe slots may be an issue in dense deployments or in the situation where we need a specific duty-cycle. A node without the children (a leaf node) uselessly waste the bandwidth of an entire superframe slot. We aim at eliminating the bandwidth waste, while still allowing leaf nodes to periodically wake up and send short beacon frames.

We strive at improving the existing solutions by adopting the combined approach depicted in Figure 4.1:

1. a Beacon-Only-Period is reserved at the beginning of each superframe. When several coordinators interfere but only one has children, they can use different **BOP slots** in the same superframe;
2. we schedule the superframe slots such that two interfering coordinators with children do not maintain their superframe simultaneously, i.e. they use different **superframe slots**.

With our solution, a node without children can share its superframe with another coordinator. Simply, it has to maintain a different BOP slot. In this way, we waste only one BOP slot and not a whole superframe. After sending a beacon frame, a leaf node can save energy by turning off its radio. On the other hand, a coordinator with children continue on with a data exchange in the active part of the superframe.

We maintain a constant BOP slot duration, long enough to accommodate one beacon of the maximal frame size. The more BOP slots we reserve in the beginning of the superframe, the less time remains for data exchange. Thus, the number of BOP slots should be carefully selected.

The two non-interfering coordinators with children can simultaneously use the same superframe slot (the slot spatial reuse). Otherwise, the solution automatically reacts to interference (self-healing property): when two interfering

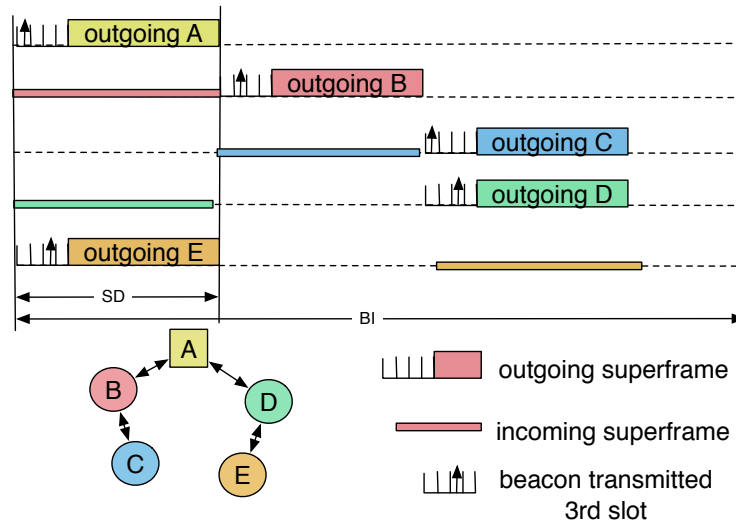

Figure 4.1: Proposed superframe collision free organization: we combine Beacon-Only-Period with superframe scheduling

coordinators have children and share the same BOP and superframe slot, beacon and data packets may collide. At least one of them chooses another slot to avoid collisions among data frames.

3 BOP and superframe slot attribution algorithm

We aim at assigning the BOP and superframe slots in distributed manner while avoiding collisions. Thus, each node maintains the local list of interfering nodes and their slot choice.

3.1 Necessary neighborhood information

In the IEEE 802.15.4 standard, a node only participates to the superframes maintained by its associated coordinator node. A node is not aware of the slot choice of interfering nodes. We propose that a node must follow all the superframes maintained by neighboring coordinators, regardless to their role (parent, child, simple neighbor). We incur a small additional energy overhead by listening the surrounding beacons. It is necessary to allow distributed operation of our slot attribution algorithm. On the other hand, a node may go to sleep as soon as it has received the short **beacon** frame, if it does not aim to participate to that superframe.

Additionally, we include supplementary information in the IEEE 802.15.4 beacons:

- the depth: a distance to the PAN coordinator in the terms of some metric;
- the number of children;
- a list of 1-neighbors with its short address, the BOP and superframe slots they use.

A node receiving a **beacon** frame complements its locally derived list of interfering neighbors. A more complete information allows each node to better chooses an interference free slot.

If the list of 1-neighbors does not fit in the **beacon** payload (maximally 116 B, when other optional fields are not used), a node creates a separate **hello** packet transmitted during the CAP. Besides, the periodicity of these **hellos** may reduce when the network is stable. We consider that the network is stable when the neighborhood information changes with a periodicity several time higher that the **beacon** interval (BI). We may adopt an approach similar to the trickle timer [72], or TAP [52], aiming to adapt the period of control packets according to the dynamic of the network.

3.2 BOP slot assignment

Prior to any slot assignment, a node learns the occupancy of slots by the neighboring coordinators. A slot map is created over the collected **beacon** and **hello** frames. A new coordinator randomly selects one BOP slot, among those not already occupied by the coordinators in the same superframe. Before sending a **beacon**, a new coordinator listens to the medium to detect a possible coordinator already owning this BOP slot. If it is free, it transmits its **beacon**, else it chooses an another BOP slot. Otherwise, if all BOP slots are occupied, a node changes to a new superframe slot.

3.3 Superframe slot assignment

We propose two different algorithms to assign superframe slots: random and greedy.

The random approach is very simple: a node randomly (uniform distribution) chooses one slot while discarding the slots used by its parents to avoid imminent collisions with them. The random approach performance depends on the number of the available superframe slots. The more slots are available, the probability that several coordinators simultaneously choose the same slot

decreases. We denote with a slot load, the number of coordinators simultaneously using the same superframe slot.

For the greedy solution, node N applies the following rules:

1. if several superframe slots with no interfering node exist, N randomly chooses one of them;
2. if there is no empty slot, N sorts them according to the number of interfering nodes with children. Then, it randomly chooses one among the least loaded slots.
3. the coordinator with children never changes its superframe slot since its children are synchronized to it. Other coordinators can freely change slot.

Even though our algorithms tries to limit collisions, two nodes might simultaneously choose the same slot. The collision can be detected and the algorithms try to attribute a new collision free slot (the self-healing and self-stabilization properties).

Two interfering coordinators with the same superframe but different BOP slots, would be able to detect a problem after having received their respective **beacons**. As a response, each coordinator selects another superframe slot with a probability of 50%.

When two interfering coordinators have the same superframe and BOP slots, their **beacons** collide. Thus, the neighboring nodes might not be able to associate with these coordinators. We consider that a coordinator is without a child, if it did not receive any **association-request** and has no **association-reply** in its buffer. Such coordinator can freely re-selects another superframe slot.

4 New topological structure: cluster-DAG

We aim at running RPL on top of the IEEE 802.15.4 without a huge unnecessary energy overhead. We propose to build and maintain a new cluster-DAG structure only at the **MAC** layer. We decrease the control overhead incurred by uselessly maintaining the redundant multihop structures at both protocols.

Our collision free organization of the IEEE 802.15.4 superframes has a positive side effect. Each IEEE 802.15.4 node can associate with more coordinators. In a cluster-DAG structure, a node equally participates in multiple coordinator superframes. The result, the network becomes robust to unexpected changes in radio connectivity. A loss of connectivity towards one of the coordinators can be immediately compensated with other available parents.

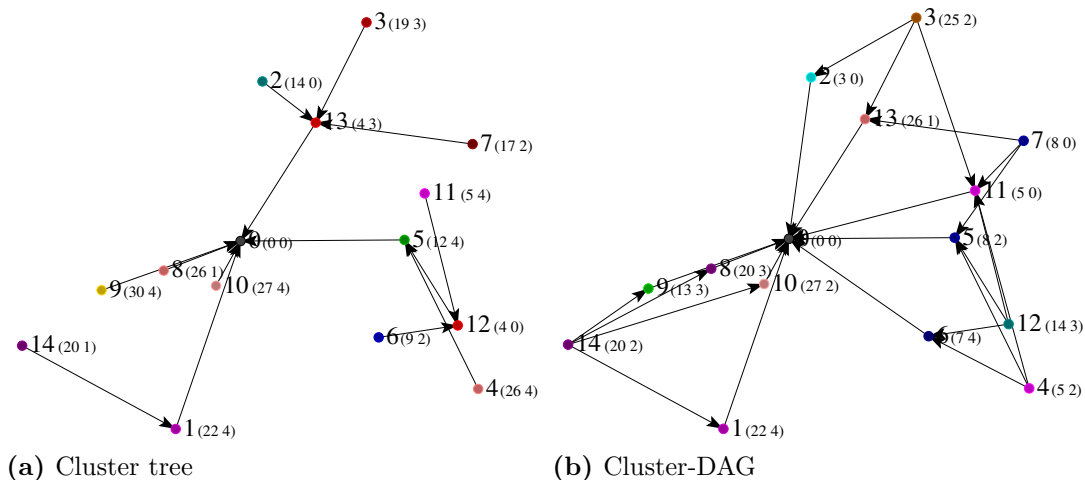

Figure 4.2: Illustration of the topology constructed by the IEEE 802.15.4–original cluster-tree and cluster-DAG improved version

As a proof of concept, we present in Figure 4.2 the resulting cluster-DAG. We simulated a simple IEEE 802.15.4 network with 10 nodes, randomly distributed on a square. In each label $X(Y, Z)$, X denotes the node ID, Y the superframe slot and Z the BOP slot. Node 0 is selected to act as PAN coordinator. We can remark that the cluster-DAG structure permits to introduce more redundancy, even in a such simple topology with a low node degree.

Finally, contrary to a DODAG, a node belonging to a cluster-DAG can forward its traffic to any of the available parents. Actual forwarding strategy will depend on the adopted routing algorithm.

4.1 Multiple parent association

We chose to favor the IEEE 802.15.4 neighborhood discovery (ND) scheme over the 6LowPAN ND suggested by RPL. Whenever available, level 2 mechanisms should be preferably used [62].

We adopt the passive scan method of the IEEE 802.15.4: a node waits for a beacon to become aware of the already associated neighboring coordinators. Once a passive scan is done, a node holds a list of the available potential parents. A node chooses a parent by applying the feasibility rule. A parent has to have a strictly lower depth than a node itself. A depth can be expressed in terms of some available metric (for example: hop count, delay, link quality, or throughput). Such parent selection criterion simply ensures the loop free cluster-DAG structure. A detailed discussion and a practical method of how to choose parents by taking into account more elaborate criteria will be presented in Chapter VI.

Thereafter, a node initiates the association procedure towards the selected candidate parent. The IEEE 802.15.4 association scheme offers a simple, efficient, and explicit method for probing and establishing a bidirectional link with the selected parent. Indeed, we can intermittently receive **beacons** through a low quality link: the association will be successful only if the quality is sufficient in both directions. A 6-way (handshake) process can be summarized as follows: a node sends an **association-request** during the CAP, acknowledged by a coordinator. The node has to wait before transmitting a **data-request** during the next CAP, and the coordinator replies with an **ack** followed by a **association-reply** specifying its short address (16 bits).

The cluster-DAG aims at authorizing multiple parents. After a node transmits its **association-request**, it does not go to sleep as defined in the IEEE 802.15.4 standard. A node keeps on listening to incoming **beacons** to find alternative candidates.

Node N receiving a **beacon** applies the following rules:

1. **beacon** is received from an already associated parent, but its depth is strictly superior to the minimum depth of the rest of its associated parents: N initiates a disassociation since we aim at using the shortest path routes;
2. **beacon** comes from a non-associated parent and its depth is strictly inferior to the minimum depth of all N 's associated parents: N engages an association by immediately sending an **association-request**. When the corresponding **ack** is received, the source is inserted in the parents list and tagged as **on-going association**;
3. **beacon** comes from a non-associated parent and its depth is strictly equal to the minimum depth of all my associated **and** non-associated parents: N engages an association. In this way, we avoid associating with a new parent if an association is already on-going with a better parent: we should reduce the number of disassociations.

A sub-optimal parent is removed and a disassociation procedure is engaged only when the association with a better parent is concluded. We aim at maintaining a connected network, despite the sub-optimal parents.

In conclusion, a node always maintain a list of parents that are strictly closer to the PAN coordinator than itself. In other words, we forbid any loop by maintaining the shortest paths.

Table 4.1: Cluster-DAG collision avoidance - default parameters values

Radio range	30 m	Inter packet time	100s
Interference range	60 m	SO	2
avg. nb of neighbors	8	BO	7
nb nodes	50	BOP slots	4

5 Performance evaluation

We have implemented the beacon-enabled mode of IEEE 802.15.4 in the WSNets simulator [24]. We use a fixed radio range and to limit side effects. The nodes are placed randomly in a disk. The default simulation parameters are represented in Table 4.1. We simulated a duty-cycle comprised between 1% (2^{2-9}) and 25% (2^{2-4}). We evaluated low-density topologies since we consider that a power control solution should limit interference.

We implemented 3 solutions for comparison (all combining BOP and different superframe slot scheduling):

1. 802.15.4 BOP: the superframe slot used by a coordinator follows directly the superframe slot of its parent;
2. random: a coordinator chooses a random superframe slot, except the superframe slot(s) used by its parent(s);
3. greedy: a coordinator selects a superframe slot not used in its neighborhood and tries to detect and solve collisions, as highlighted in Section 3.3.

We obtain a loop free cluster-DAG structure by adopting a simple hop count as a depth metric. A depth field in the IEEE 802.15.4 **beacons** is coded in 6 bits since a diameter of 63 hops seems to be a realistic upper bound for the IEEE 802.15.4 network. We implemented a simple parent selection criterion: when a node receives a **beacon** and is not yet associated, it chooses the source as a parent. We privilege in this way the convergence time. Besides, a coordinator that has a smaller depth in the cluster-tree often transmits first its **beacons**.

We mainly measured the Packet Delivery Ratio (ratio between the number of transmitted packets and the number of received packets), the end-to-end delay and the BOP/superframe collision ratio (the ratio of coordinators that have an interfering coordinator sending a beacon at the same instant).

5.1 Traffic model and routing

We model a bidirectional traffic: a node generates one packet for the PAN coordinator every $T_{interpk}$. Inversely, the PAN coordinator generates packets

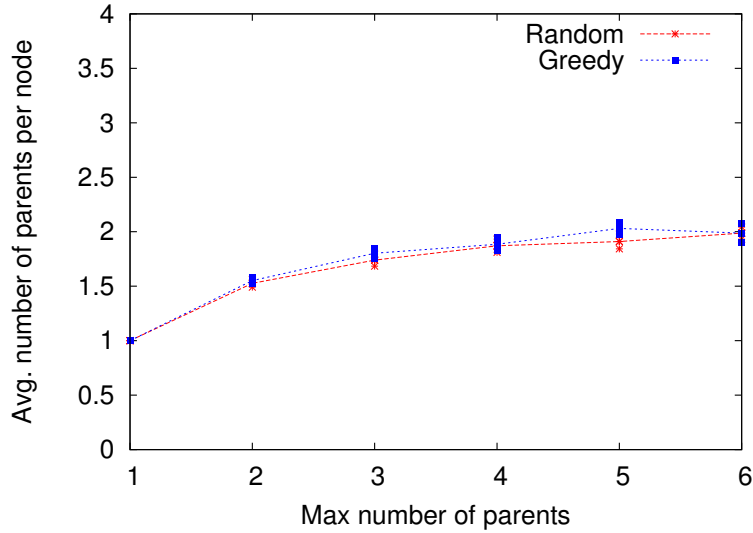

Figure 4.3: A cluster-DAG structural property—redundancy: density being low, after the initial increase, a node quickly reaches a maximum of 2 parents on average

toward a random destination in the network with a rate $\frac{T_{interpk}}{nb_nodes-1}$ to obtain the same rate in the upload and download directions.

Each node maintains two FIFO (First In First Out) buffers. The first one is dedicated to packets toward the PAN coordinator. A packet is pulled from the buffer when the node is in the idle state, during the CAP of the superframe of its parent. The second buffer is dedicated to the download direction: packets are extracted from the buffer after the reception of a `data-request` from the destination. A procedure periodically removes packets that exceeded their timeout (`macTransactionPersistenceTime` as defined in the IEEE 802.15.4 standard).

We implemented two routing strategies according to the corresponding topological structure and slot attribution algorithm. When the original cluster-tree is used (802.15.4 BOP slot attribution algorithm), a node forwards all its traffic to a single parent (similarly to RPL, unicast to a preferred parent). When a cluster-DAG is used (greedy and random approach), we chose to implement an opportunistic anycast strategy: a node forwards packets in its upload buffer to the next awake parent.

5.2 Cluster-DAG properties

We first evaluated the structural properties of the cluster-DAG. The cluster-DAG authorizes a node to maintain multiple parents. We can remark in Fig-

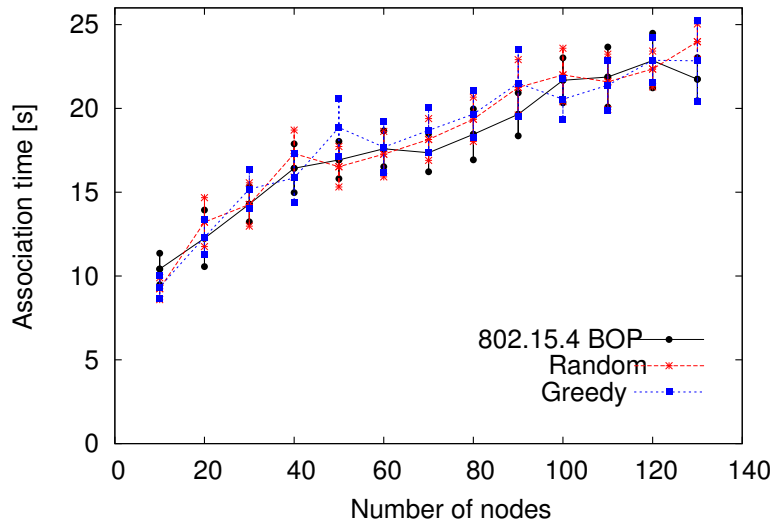

Figure 4.4: Convergence time: similar performance for all algorithms. The association time grows with the number of nodes since we maintain the density constant

ure 4.3 that the redundancy obviously increases when we increase the number of allowed parents. However, it reaches quickly a maximum of 2 parents on average, the density being low.

Then, we measured the time required before the last node becomes associated (it has a valid parent and it gets a short 16 bits address). We increased the number of deployed nodes while maintaining the density constant. The surface of the deployed topology correspondingly increases and thus, the maximal number of radio hops. The association time consequently grows with the increase of the total number of nodes (cf. Figure 4.4). However, it is similar regardless the superframe scheduling algorithm.

We have finally measured the impact of the number of BOP slots (cf. Figure 4.5). While the random and greedy strategies are not impacted by the number of BOP slots, 802.15.4 BOP requires at least 4 BOP slots to increase the PDR performance. On the other hand, too many BOP slots degrade the performance since not enough time is left for data packets. (cf. BOP=7 in Figure 4.5)

5.3 Impact of the BO/SO values

We measured the impact of the number of superframe slots on the performance of the scheduling algorithms (cf. Figure 4.6). The total number of superframe slots is equal to 2^{BO-SO} . We kept $SO = 2$ while we varied the value of BO. The

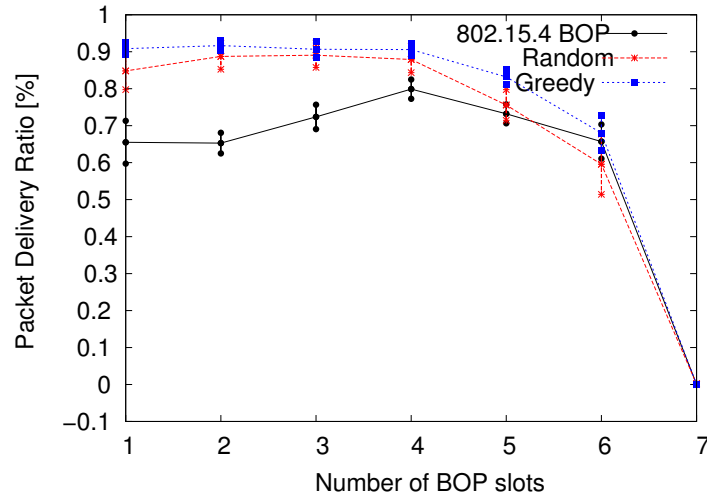
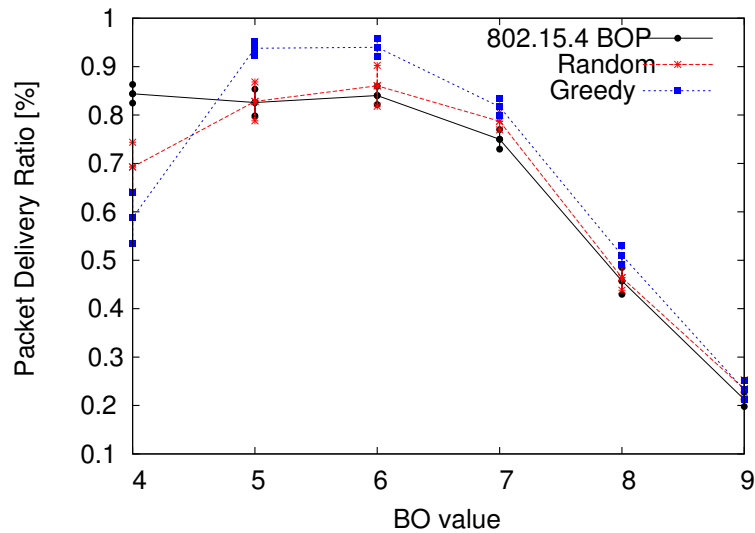

Figure 4.5: Greedy and random schemes outperform 802.15.4 BOP in terms of PDR. When too many BOP slots (cf. BOP=7) are attributed, the performance drops since not enough time is left for active part of the superframe

increase of the BO value results in a higher number of available superframe slots and conversely, a lower duty-cycle. Equally, the inter-beacon period increases.

We measured the impact of the BO/SO values on the resulting PDR (cf. Figure 4.6a). Using only 4 superframe slots (BO = 4, SO = 2) is not sufficient to avoid collisions between interfering coordinators: the random and greedy algorithms perform worse than the simple 802.15.4 BOP solution. However, as soon as we increase the number of available superframe slots, greedy and random perform better. The number of slots become sufficient to schedule all interfering neighbors. A packet collision reduces drastically, leading to the PDR increase of around 30%. On the contrary, PDR decreases when BO further increases. The inter-beacon period increases, becoming closer to *macPersistenceTime*. A node losing few beacons will eventually drop a packet due to the exceeded timeout.

We may also remark that the delay increases with BO (cf. Figure 4.6b): a coordinator has on the average more time before being in the active part of its superframe. Finally, we can also verify that maintaining a cluster-DAG in the IEEE 802.15.4 layer helps to reduce the delay: a coordinator has on average less time to wait before entering the active part of any of its multiple parents.



(a) Greedy scheme improves the network PDR. Initial glitch comes from the fact that we have only 4 slots, thus superframe collision occur quite often.

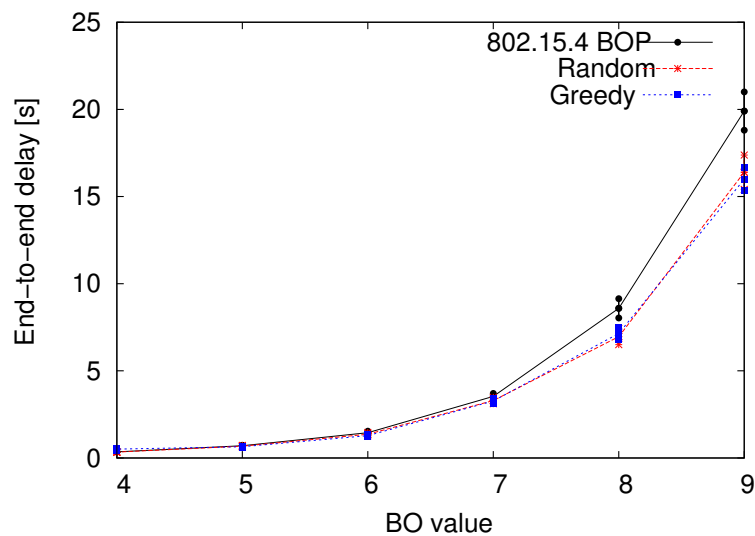

(b) Delay increases with the BO increase (duty cycle decreases). Cluster-DAG structure (greedy and random) helps to decrease the delay i.e. a coordinator waits less before the active part of any of its multiple parents

Figure 4.6: Impact of the number of available slots (duty-cycle) on performance metrics: BO varies while SO=2

5.4 Scalability

Finally, we observed the scalability (impact of the network size on the performance) (cf. Figure 4.7). We measured the superframe collision ratio: the proportion of coordinators that may suffer from collisions from an interfering coordinator. Reducing this ratio means that we reduce interference induced collisions. 802.15.4 BOP performs poorly: since the superframe slot depends directly on the depth, almost all the frames collide. The superframe collision ratio is above 95%, regardless to the number of deployed nodes. The 802.15.4 BOP performance will quickly drop when the traffic increases. The random solution (avoiding collisions with parents) permits to significantly reduce the collision ratio. However, the greedy solution performs better: we reduce the number of collisions by one half compared to a random strategy. The greedy scheme obtains in the worst case 25% of superframe collision ratio. Thus, most packet drops will be mainly caused by the IEEE 802.15.4 MAC mechanisms (e.g. too many CCA) and not by interference: a coordinator is often alone to maintain a superframe at a given instant.

We also measured PDR: it decreases when the number of nodes increases regardless of the used slot attribution algorithm. However, we can remark the greedy is the least affected. The greedy scheme benefits from the reduced number of collisions. The initial PDR of 88% remains above 80% while we increase the number of nodes. Inversely, the simple 802.15.4 BOP scheduling performs poorly: after a quick initial PDR drop below 80%, it reaches the lowest value of 70% for 130 deployed nodes.

6 Conclusions

We proposed to modify the topology of the IEEE 802.15.4: adopting a DAG structure. A cluster-DAG permits to improve the robustness and the delay since a node may choose to have more parents simultaneously. A cluster-DAG allows the adoption of an opportunistic routing approach: a node forwards packets to the next awake parent. Indeed, the resulting cluster-DAG helps to decrease the delay. A coordinator waits on average less time before the active part of any of its available multiple parents. The average number of associated parents per node is limited by the topology density: observed sparse networks allowed only 1 additional parent.

Besides, combining the Beacon-Only Period and the superframe scheduling reduces collisions while limiting bandwidth waste when some coordinators have no child in a superframe. Still, the number of the used BOP slots has to be carefully chosen to avoid the backfire. Maintaining too many BOP slots unnecessary occupies a large amount of the active part of the superframe.

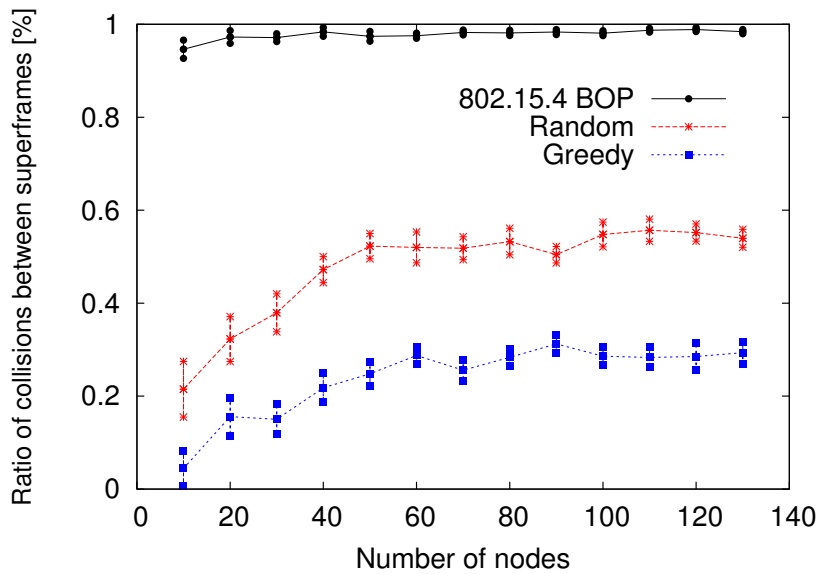

(a) 802.15.4 BOP performs poorly since almost all the frames collide. The greedy outperforms the random solution: we reduce the number of collisions by one half. The greedy obtains in the worst case 25% of superframe collision ratio.

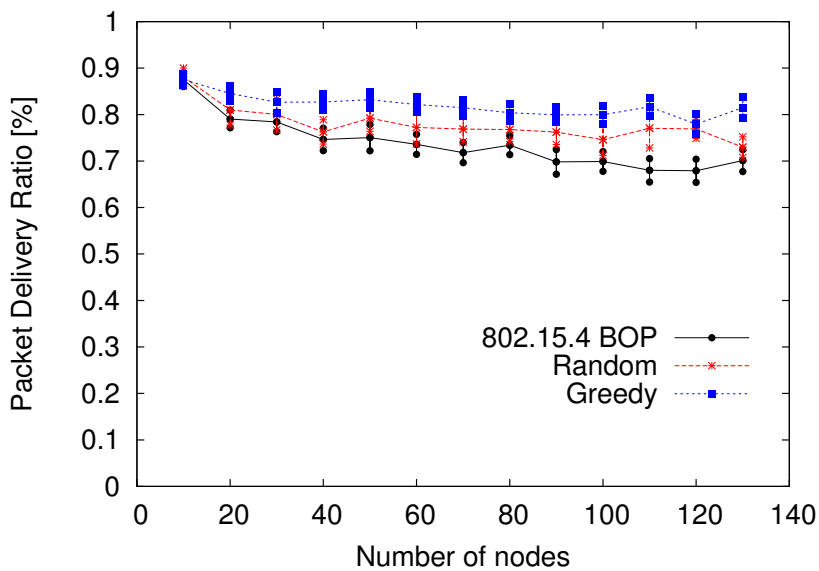

(b) PDR decreases with the node number increase regardless of the used slot attribution algorithm. However, the greedy solution is the least affected.

Figure 4.7: Scalability of proposed solutions: greedy slot attribution scheme is least affected by the increase of the number of nodes. After the initial change performance remains almost constantly stable.

Not enough time is left for data exchange, and thus, result in imminent performance drop (PDR and delay).

Our slot assignment algorithm is very simple, localized, and converges quickly to a stable and accurate assignment. To fully benefit from the solution, initial care should be taken to choose sufficient number of superframe slots (dictated by the duty cycle i.e. ratio of BO and SO). If there are less available superframe slots than the size of the local 2 – *hop* neighborhood, superframe collisions occur quite often leading to poor protocol performance.

Another observed positive side of proposed solutions is that they are scalable. PDR performance of our greedy slot assignment algorithm is the least affected by the increase of the number of deployed nodes: it remains above the level of 80%. Finally, simulations have proved that modifying the IEEE 802.15.4 topology reduces the **beacons** and **data** collisions. Our slot attribution algorithm obtains the lowest percentage of colliding slots regardless of the increase of nodes in the observed topology.

Multipath opportunistic routing with RPL

1 Problem statement

This chapter examines how to further capitalize on the resulting cluster-DAG structure built at IEEE 802.15.4 layer, in order to enhance the RPL routing mechanism.

A cluster-DAG structure has an interesting property: a node can access the channel during the several superframes coordinated by different parent nodes, which provides the basis for multipath forwarding supported by RPL. Instead of always using a preferred parent, a node opportunistically forwards packets through other parents. Other forwarders are used as long as their routes towards the sink conform to the routing strategy.

Our objective is to enhance RPL mechanism by enabling the QoS multipath routing. We want to improve the packet delivery before a deadline, while minimizing overhead and energy consumption.

We assume that there are two types of traffic in the network:

1. **low-intensity monitoring data** that can be considered as best-effort;
2. **higher-priority delay-sensitive alarms** that need to arrive at sink before a given deadline.

We want to provide a support for such service differentiation over RPL, by taking the advantage of multiple paths. Potential forwarders are selected on the basis of their link quality, a quality of the paths to the sink that they provide, and as well on the estimated delay that they will incur. We compare our opportunistic version of RPL to the basic version of RPL, through detailed simulations in the terms of packet delivery ratio, incurred delay, and overhead. Our scheme results in improved packet delivery, shorter delays, while keeping almost the same overhead.

2 QoS considerations with RPL

We focus on service differentiation of best-effort and time-sensitive traffic. We propose to accordingly adapt RPL so that it can take into account a delay before a deadline combined with the energy expenditure concerns. Putting it simply, according to a specific traffic type, a data packet is attributed more or less critical time deadline. A packet should be delivered at the destination before the assigned deadline, otherwise packet is discarded. The time-sensitive traffic is attributed a short deadline according to the urgency of reported phenomena, whereas the best-effort traffic has a virtually unlimited deadline. On the other hand, the energy consumption also should be taken into account when routing a packet. When a node has more available paths to the sink, it should choose the most energy efficient one. The energy consumption of a path could be estimated through a total number of packet retransmissions necessary to deliver data packet to the sink.

We only consider convergecast (multipoint-to-point) traffic following three classes of service:

min-delay: time critical packets for which we need to minimize the end-to-end delay without the energy efficiency concerns.

deadline: alarm packets to deliver before a deadline D , while minimizing energy consumption.

best effort: packets that do not require any delay guarantee, but their forwarding needs to take into account energy consumption.

N	a node that just received a beacon and that afterwards forwards a packet p
$deadline(p)$	a deadline associated with the packet p
t	a beacon reception time at the node N
$d(N)$	a hop distance between the node N and the sink
$slot(t)$	a superframe slot where the node N received a beacon
$slot(NH)$	a superframe slot used by the parent NH
$PDR_{bcn}(NH)$	a beacon packet delivery ratio for the parent NH
$PDR_{data}(NH)$	a data packet delivery ratio over the link to the parent NH
$t_{tx_{data+ACK}}$	a time needed for data and acknowledgment transmissions
$queue(NH)$	a queue of packets scheduled for transmission during the superframe of the parent NH

Table 5.1: Specific notation used for the multi-path opportunistic routing algorithm

2.1 Race against the time: beat the deadline

Before we proceed to elaborate the QoS improvements of the RPL protocol, we would like to introduce the adopted notation (cf. Table 5.1). When a node generates a packet, it assigns a deadline according to the class of service it belongs to. Nodes maintain a queue of packets ordered by their deadlines. When a node has a packet to forward, it waits for a successful **beacon** reception from one of its parents (Algorithm 1, line 1). Then, it needs to decide to transmit each of its packets during the current superframe or later if another parent offers better performance (e.g. smaller energy consumption, better reliability).

The node extracts the first packet from its queue: if the deadline is elapsed, the packet is simply dropped and the next packet is extracted (Algorithm 1, lines 3 through 11). Then, a node must find the forwarder that guarantees the deadline. A protocol assumes that the time before the deadline can be uniformly shared among the nodes in the route. Thus, the transmission has to meet the local *time budget* constraint (Algorithm 1, line 12):

$$budget = \frac{deadline(p) - t}{d(N)} \quad (5.1)$$

When a packet is at node N , the delay before the packet is correctly received by the forwarding parent NH depends on:

1. the delay until the superframe of NH starts while taking into account the average number of superframes to wait in case of beacon losses (Algorithm 1, line 16):

$$D_{sframe} = SD * |slot(NH) - slot(t)| + BI * max \left(0, \frac{1}{PDR_{bcn}(NH)} - 1 \right) \quad (5.2)$$

where SD denotes the superframe duration while BI represents the time separating two beacons. For the currently received beacon, this delay is zero, since the node can immediately try to send the packet.

2. the average delay until NH correctly receives the packet, it is estimated through the packet probability delivery ratio (Algorithm 1, line 17):

$$D_{tx} = \frac{t_{txdata+ACK}}{PDR_{data}(NH)} \quad (5.3)$$

Algorithm 1: Does a packet has to be transmitted in the current superframe?

```

1: src  $\leftarrow$  waitBeacon();
2: nexthopcandidate  $\leftarrow$   $\emptyset$ 
3: if empty(queue) or end(superframe, src) then
4:   return false
5: else
6:   repeat
7:     p  $\leftarrow$  getFirstPacket(queue);
8:     if (p.deadline  $\leq$  t) then
9:       DropPacket(p);
10:    end if
11:   until (p.deadline > t)
12:   budget  $\leftarrow$  computeHopBudget(p, src.hops + 1);
13:   relax  $\leftarrow$  0;
14:   while (nexthopcandidate =  $\emptyset$ ) and (relax < 2 * budget) do
15:     for neigh NH do
16:       Dsframe  $\leftarrow$  computeDelaySuperframe(NH.sframe, NH.pdr);
17:       Dtx  $\leftarrow$  computeExpectedTransmissionTime(NH.pdr);
18:       if (budget + relax > Dsframe + Dtx) then
19:         nexthopcandidate  $\leftarrow$  nexthopcandidate + {NH}
20:       end if
21:     end for
22:     relax += budget * STEP;
23:   end while
24:   if (src = getBestETX(nexthopcandidate)) then
25:     return true
26:   else
27:     return false
28:   end if
29: end if

```

Finally, a forwarding parent *NH* need to satisfy the following deadline constraint (Algorithm 1, line 18):

$$budget \geq D_{sframe} + D_{tx} \quad (5.4)$$

If there is not a single parent node that satisfies the budget constraint, a node *N* reconsiders all the parents for an increased time budget. Variable *relax* (Algorithm 1, line 22) serves to extend the time budget over the originally calculated by Eq 5.1. The budget is extended up to three times from the initial value in small steps (a constant $STEP \in (0,1)$). A packet could recover

from the previous budget increase with eventual shorter delays further in the network.

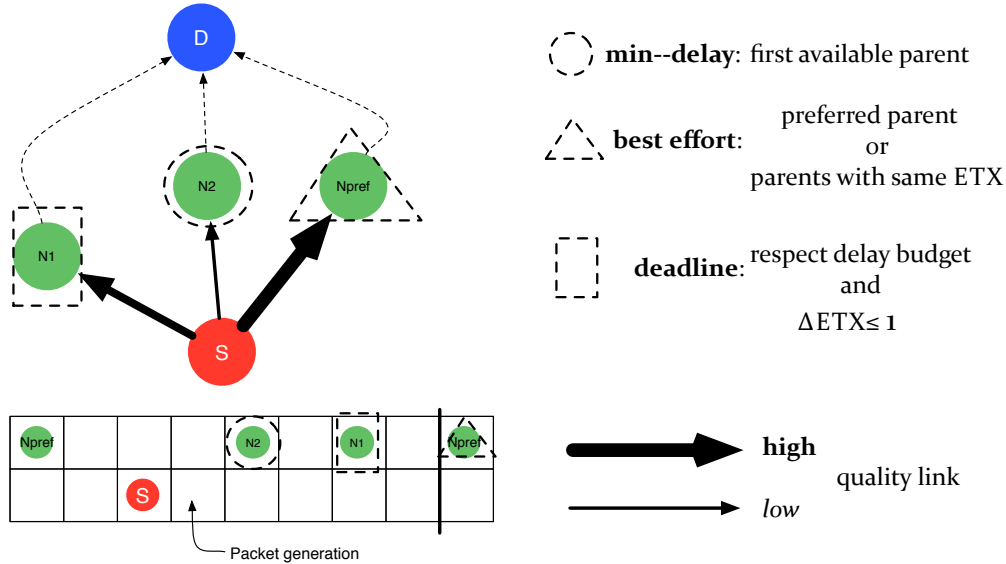

Figure 5.1: An example to illustrate a routing algorithm—**min-delay** traffic type favors the first available parent regardless to his link quality; **deadline** makes a compromise between the delay and the energy consumption, while **best effort** unburdened with delay criterion waits long enough for a parent offering a high quality path.

2.2 Multi-path opportunistic forwarding algorithm

The previous section offered us a detailed description of the algorithm for selecting the available parents complying to the delay criterion. Now, we want to complete the description of the QoS multi-path opportunistic forwarding algorithm by incorporating the energy efficiency aspect.

We convey to the intuition in Figure 5.1, three forwarding algorithms and their impact on the forwarding parent selection. The forwarding algorithms differ according to the traffic class of service:

- **Best effort** A node forwards the **best effort** traffic independently from the delay criterion. Only a path quality of the potential parent counts. A node minimizes the necessary re-transmission cost by choosing the parents with the lowest cumulative ETX: it represents the cumulative number of packet transmissions required to reach the sink, also used as the node *rank* in the DODAG. It should be noted that per link ETX is simply calculated as inverse value of measured $PDR_{bcn}(NH)$ (link to neighbor NH).

- **Min-delay** A traffic belonging to the **min-delay** class is attributed extremely short deadline corresponding to a critical alarm situations. The urgency influences the decision of the next forwarder: a node selects the next available parent (first beacon reception), regardless to his ETX metric. The protocol achieves a short packet delays at the detriment of a possible higher number of re-transmissions through the lower quality links (cf. a parent node $N2$ in Figure 5.1).
- **Deadline** Finally, when a node deals with the **deadline** traffic type, both delay and cumulative ETX should be jointly considered. Node first makes a list of parent nodes that offer a cumulative ETX that differs at most by 1 from preferred parent ($\Delta\text{ETX} \leq 1$). From this list, the protocol selects a parent offering the lowest delay to forward the packet (cf. a parent node $N1$ in Figure 5.1).

3 Performance evaluation

We have compared by the means of detailed simulations, our opportunistic version of RPL and the original RPL (unicast forwarding to the preferred parent), in terms of packet delivery ratio, incurred delay, and overhead. Both protocols take advantage of the 802.15.4 superframe scheduling.

For the sake of simplicity, we implemented a centralized coloring solution to assign slots. However, we may use any scheduling algorithm such as the distributed version described in Chapter IV.

3.1 Simulation setup

We have used the WSNNet/Worldsens event-driven simulator for the large scale wireless sensor networks [24]. We have ported the Contiki RPL implementation [65] to WSNNet. We used the IEEE 802.15.4 implementation in the beacon-enabled mode [4].

We have simulated 10 different topologies. Each of the topologies contained up to 256 randomly deployed nodes in the square area of 400 x 400 m. To make the simulations as close as possible to the reality, we have not adopted the Unit Disk Graph assumptions commonly used in the literature, but rather the Rayleigh propagation model and the parameters of the IEEE 802.15.4 radio. Rayleigh propagation model used the following parameters: the frequency from the Friis formula $f = 868$ MHz, path-loss = 2.5, deviation = 2, $\text{dist0} = 2$, $\text{Pr_dBm0} = -54$ dBm.

We have only considered a low intensity traffic with the average interval between the data packets of 7.5 minutes. We have empirically established

Simulated area	400m x 400m
Number of nodes	up to 256
Traffic type, rate	periodic, 1/7.5 minutes
Simulation duration	50000 s
SO	3, 4, 5
Deadline	360s, 180s

Table 5.2: RPL opportunistic multi-path simulation parameters

this value to avoid performance degradation of the IEEE 802.15.4 under a heavy traffic. The traffic was divided into three classes (best-effort, min-delay, deadline) according to the respective proportions: 70%-20%-10%. We vary the SO parameter from 3 to 5 and choose the BO parameter so that the number of superframe slots is sufficient to avoid superframe collisions. We assume that 2 – hop neighbors interfere so number of slots should be higher than the largest size of 2 – hop neighborhood in the network. We run a single simulation for each of the topologies during 50.000 s. We average the results over multiple runs to obtain 95% confidence interval. Table 5.2 summarizes the important simulation parameters.

3.2 Result analysis

Figure 5.2a presents the total number of transmitted packets for the original (unicast) and opportunistic RPL. We measure the raw number of packets transmitted by the MAC layer, i.e. a data frame transmitted for the first time or retransmitted after a failure. The IEEE 802.15.4 MAC standard drops a frame when the number of retransmissions exceeds 3 or the number of Clear Chanel Assessments exceeds 4. Additionally, a packet is dropped if the deadline is missed. At the end of the simulation, we sum up the number of transmitted packets for all packet sources. Both protocols generate the same fixed amount of application data packets and none of them is destroyed before the end of the simulation.

We can notice that our opportunistic solution results in a slightly greater number of transmitted packets (9%). This increase may come from better performance: since less packets are dropped, this mechanically results in more transmissions at the MAC layer. A larger overhead also comes from the forwarding rule: if the deadline is short, the node will privilege the forwarding delay compared to minimizing the number of transmissions (ETX). This aggressive decision would privilege short deadlines, but also negatively impacts the number of transmissions.

Figure 5.2b presents the packet delivery ratio for all packet types. As soon

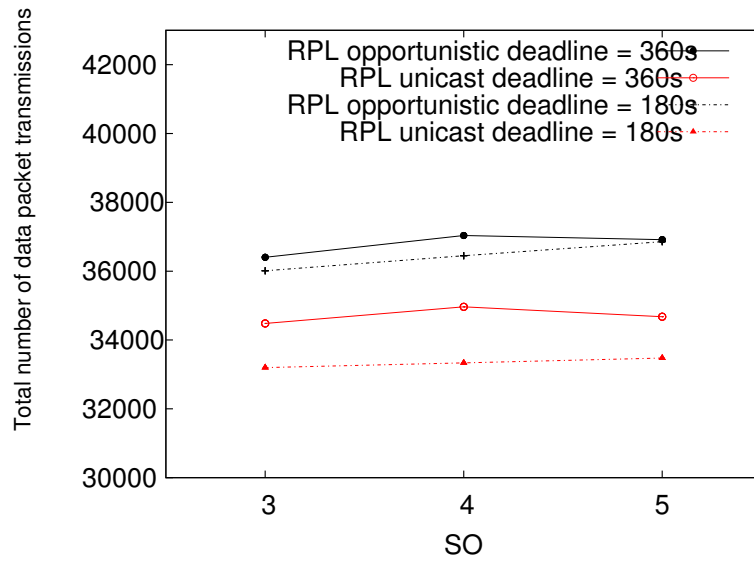

(a) total number of transmitted packets

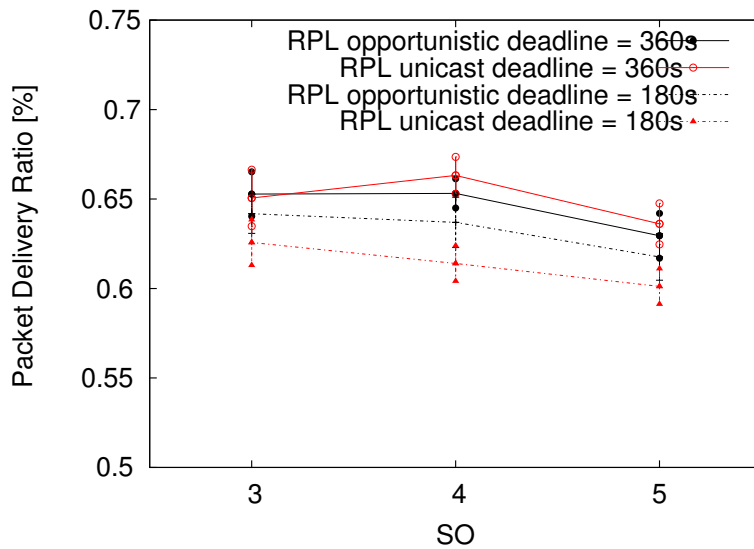
(b) PDR for *all* packet types**Figure 5.2:** General comparison of original (unicast) and opportunistic RPL

as the deadline becomes more critical, the fact that opportunistic RPL use alternative parents results in a higher PDR. Less packets get dropped due to the short packet deadline—a missed beacon from the preferred parent is caught up with the beacon reception from some of the alternative parents. In the same situation, the original (unicast) RPL needs to wait for the whole inter-beacon period (BI), thus risking more packet drops due to the short packet deadline.

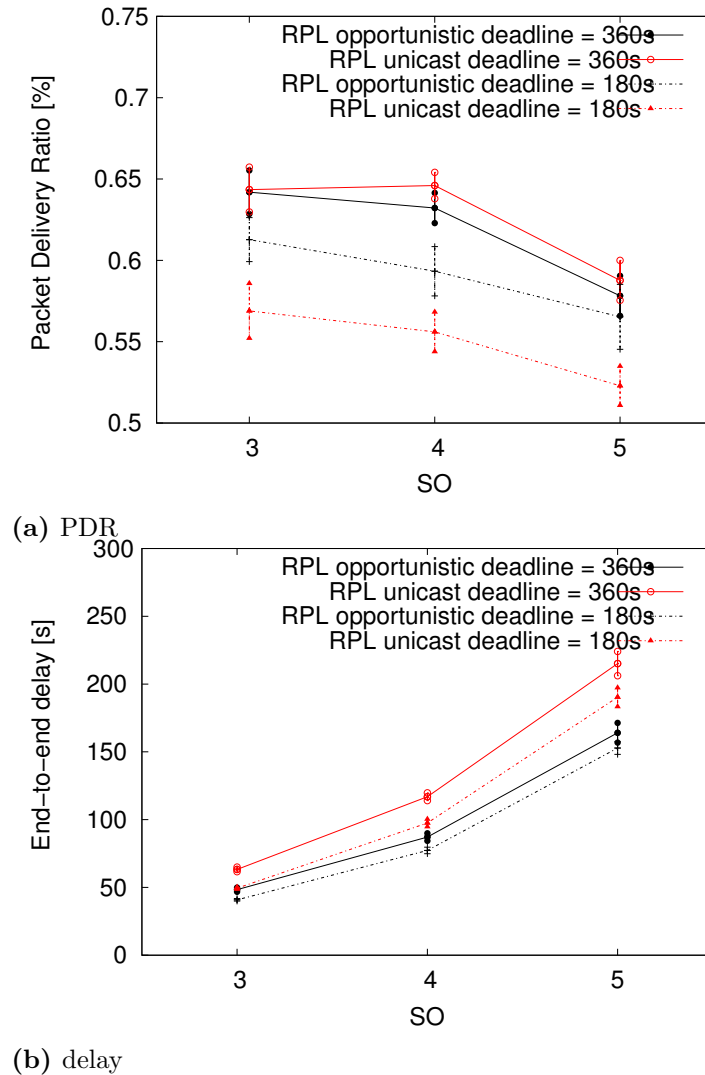

Figure 5.3: Comparison of the original (unicast) and opportunistic RPL, *deadline* traffic

For now, we have considered the RPL (unicast and opportunistic) performance from the global point of view. Let us analyze performance with the respect to the QoS delay requirements of *min-delay* and *deadline* data packet types.

As previously, we can notice the similar behavior for both types of traffic when it comes to PDR (Figures 5.3a and 5.4a) and for the experienced delay (Figures 5.3b and 5.4b). If we consider the delay performance, it is clear that our opportunistic scheme exhibits much shorter delay than the original RPL thanks to the interchangeable use of alternative parents. With the respect to the PDR performance, our opportunistic scheme presents a real gain when we deal with harsh deadline constraints.

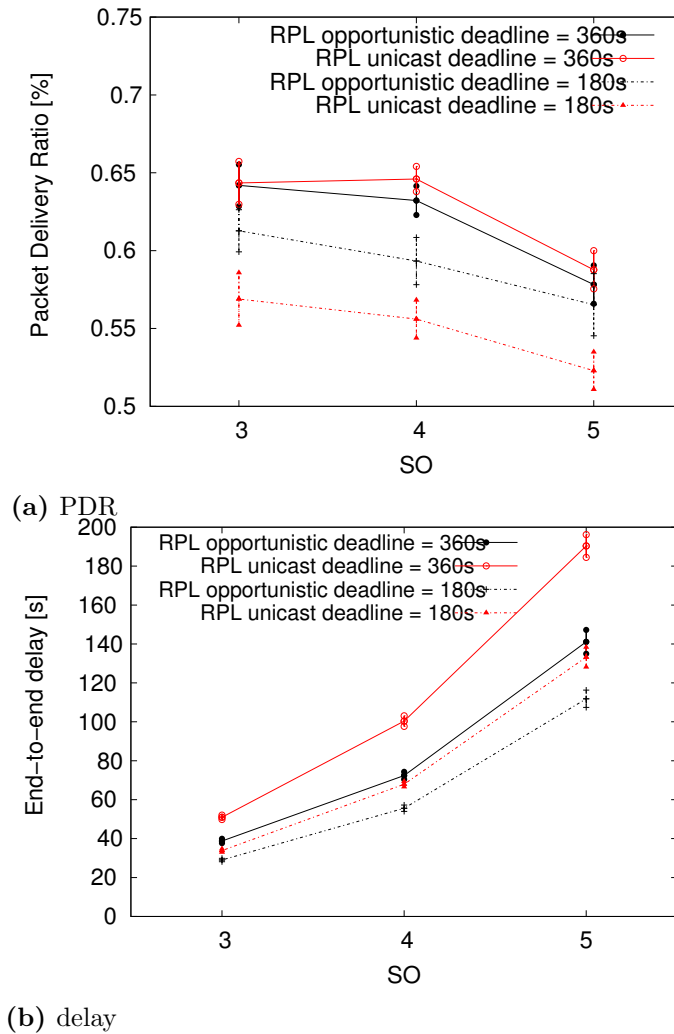

Figure 5.4: Comparison of original (unicast) and opportunistic RPL, *min-delay* traffic

Finally, we can notice an interesting property of our opportunistic approach. It directly stems from our forwarding policy even if it is not expressed in the numerical results. Whereas original (unicast) RPL overuses a single preferred parent, our opportunistic scheme spreads traffic over multiple (preferred and alternative) parents. The energy expenditure is spread over the available parents with opportunistic scheme.

In realistic scenarios with a limited battery capacity and limited queue lengths, this may appear as the primary concern. Spreading the traffic over more nodes would increase the overall network lifetime and prevent packet drops due to full queues. We plan to include this kind of realistic constraints in the future work.

4 Conclusions

We proposed in this chapter to capitalize on the advantages of the cluster-DAG topology in order to support QoS routing at the network layer. A cluster-DAG permits to improve robustness and delay, since a node may have more parents simultaneously. In this way, we can adopt an opportunistic routing approach with the RPL standard: a node forwards packets to a next awake parent. Indeed, the resulting cluster-DAG helps to decrease delay. A coordinator waits on the average less time before the active part of any of its available multiple parents.

From the general point of view, our opportunistic multi-path routing stand shoulder to shoulder with the original (unicast) RPL regarding the PDR and delay performance. Yet, it shows a real advantage when we deal with QoS differentiation of delay sensitive traffic. As soon as the deadline becomes more critical, the fact that we use alternative parents results in a higher PDR and lower incurred delay.

Nevertheless, our opportunistic solution pays a small price for a QoS provision. It results in a slightly higher total number of transmitted packets on the MAC level (9%). A larger overhead partially comes from the forwarding rule: the critical traffic privileges the parents minimizing the packet delay. A sub-optimal parents (a lower ETX link quality) are used in order to respect the short deadlines. The other part of overhead simply comes from a better performance in terms of PDR. The fact that more packets are delivered to the sink, mechanically results in more transmissions at the MAC layer. Delivered packets need to be retransmitted over the multiple hops.

Additionally, our simple opportunistic routing scheme benefits from an interesting feature: traffic is spread more uniformly over all possible parents instead of solely going through the preferred one. We plan to verify how it impacts the network lifetime and fairness.

Fuzzy logic cluster-DAG topology construction

1 Problem statement

We notice that the existing work on convergecast topology construction often favors local optimization goals from the perspective of a single node. Each node greedily strives to obtain the best parent from the point of a single adopted metric. The impact on the global topology, its performance and negative effects that results from such a choice, are often neglected.

Let us take an example where nodes select as a parent, the neighbor that offers the best quality path to the sink. The path quality can be expressed in the total number of transmissions to reach the sink. More neighboring nodes would select the same parent based on the greedy criterion. Such a choice leads to a possible increase of load and congestion experienced on this route, and finally to a premature battery exhaustion. We do not strive to exclude the link quality metric from the observation with this example, but rather argue that it should be jointly considered with other metrics.

In Chapter IV we have proposed a convergecast structure that would allow joint functioning of the IEEE 802.15.4 and RPL standards in multihop networks—a cluster-DAG. In this chapter we would like to go one step further by elaborating a set of global recommendations that an efficient convergecast structure should attain. Thereafter, we correspondingly propose a set of locally measured metrics that would help achieve these goals. Finally, we adopt a practical method to combine them in a single output metric used for efficient parent selection. Extensive simulations confirm viability and effectiveness of our method.

1.1 Global recommendations for convergecast tree

We aim at describing a set of primary global objectives that each node should strive to during the convergecast tree formation. We are convinced that these objectives will lead to a better functioning of the resulting convergecast tree from the global and long-term point of view. Experimental results confirm our believes.

- **Link quality considerations:** obviously, a node should choose a parent with a stable and efficient radio link. A good radio link saves energy that would be otherwise unnecessarily spent on additional contention and packet re-transmissions.
- **Balance between accurate link quality estimation and convergence time:** nodes should favor proper link quality estimation of surrounding potential parents rather than prematurely associating to sub-optimal parents.
- **Convergence and stability:** a node should avoid making decisions that would end up in oscillatory behavior i.e. disconnections and frequent changes of parents. The IEEE 802.15.4 nodes uselessly spend additional energy and time to explicitly disassociate (control packet exchange) from inviable parents. This cost should be minimized by only maintaining stable parents.
- **Bottleneck effect:** the convergecast traffic often lead to the funneling effect [7]: the zone around the PAN coordinator must transmit more packets, creating congestion. To limit this phenomenon, the direct PAN coordinator descendants (1st rank nodes) should all have the same volume of traffic to forward.
- **Avoid congested zones:** nodes should avoid associating to parents offering paths leading through high density network zones i.e. high congestion zones. Contrary to the funneling effect, a high density zone also can appear further from the PAN coordinator. Opting for other parents would alleviate unnecessary delay and extra traffic accumulation in this already congested zones.
- **Self-healing:** a node detects and corrects inconsistencies so that the global objectives stay preserved. For instance, a node should monitor the link quality and change its parent selection if it changes significantly. Also, a resulting convergecast structure should incorporate the new arrival nodes or react to disappearing nodes (battery exhaustion, link failures, etc).

1.2 Parent selection metrics

1.2.1 Link quality

A link of low quality means more retransmissions, which are energy inefficient. Moreover, a low quality link also negatively impacts the bandwidth: the transmitter prevents neighbors to transmit their own packets. In the slotted IEEE

802.15.4, we may estimate the link quality through the packet delivery ratio of beacons. If a node misses a beacon, it must wait the next superframe. Thus, the beacon reception ratio is strongly related to the capacity a node may obtain from a parent. Besides, the passive IEEE 802.15.4 association tightly depends on the successful beacon reception. A node needs to receive a beacon to trigger the association process.

We chose to use the *Expected Beacon Count (EBX)*, the inverse of the beacon delivery ratio. In other words, EBX reflects the number of superframes a node must wait on the average before transmitting its data frames. We measure the EBX over a sliding window to smooth variability while limiting memory use.

Let us consider node N . For each possible parent P_j , N computes a cumulative EBX ($EBX_{cumul_{N \rightarrow P_j}}$) in the following manner:

$$EBX_{cumul_N}(P_j) = EBX_{cumul_{P_j}} + EBX_{link_{N \rightarrow P_j}} \quad (6.1)$$

An already associated node N_i piggybacks in its beacons the minimal cumulative EBX among all its parents. Since the cumulative EBX is a strictly increasing monotonic metric, we may use this metric to avoid loop creation. Thus, a node has just to choose as a parent the node that has a strictly inferior cumulative EBX compared to its own.

Link quality based on EBX can be accurately estimated over a large packet sample. Due to the convergence time concerns, 802.15.4 nodes need a faster estimator before associating to a parent. Inversely, an inaccurate EBX estimation based on few samples can show disastrous effects in the terms of the time spent to associate, data packet PDR during the active period, and finally the stability of the association. Furthermore, a node can successfully receive all the beacons through a low quality link during a short sampling period. Nevertheless, such an EBX estimation would not show the true link quality. Parent metric is biased since the following beacons would be easily lost.

Hence, we propose to reinforce the EBX measure with Received Signal Strength Indicator (RSSI) value. RSSI is readily available at the most radio chips and offers the instantaneous link quality estimation [109]: a link with RSSI close to the radio sensitivity level can be highly volatile due to the radio imperfections (gray zone). Inversely, a link with RSSI far away from the sensitivity level demonstrates the stability of EBX (connected zone). RSSI will serve to predict how probable is that a link quality degrades over the larger packet sample.

We propose to increasingly penalize links as their average RSSI approaches to the radio sensitivity level. We can implement a simple strategy: we multiply the beacon delivery ratio with the linearly decreasing coefficient, and then

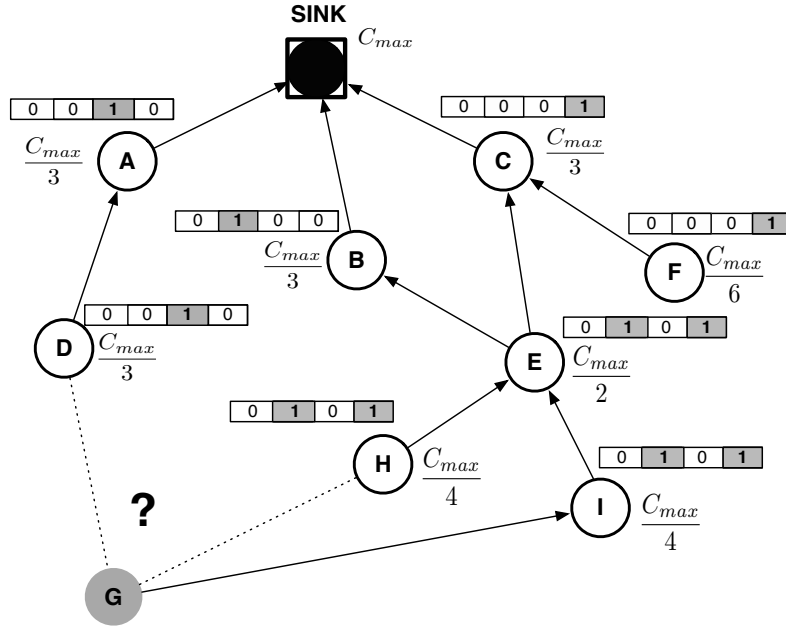

Figure 6.1: Simple network with ideal packet reception (PDR = 100 %) to illustrate capacity and diversity parent selection metric

correspondingly calculate EBX value. The coefficient has a value of 1 at the connected zone and it reaches the 0 at the radio sensitivity level.

1.2.2 Capacity

The slotted IEEE 802.15.4 fairly shares the bandwidth and we can expect long-term fairness [102]. In particular, each node will receive the same amount of bandwidth in the saturated mode, regardless of their buffer size: nodes with more packets will probably drop them if the amount of bandwidth they may use is too restricted.

In particular, the amount of bandwidth a node may receive does not depend on its subtree size. For instance, a node with a large number of descendants will have the same probability to gain medium access than another coordinator without children.

Let us consider the topology illustrated in Figure 6.1. The sink offers capacity (i.e. bandwidth) C_{max} . If we consider ideal fairness, its direct descendants (1st nodes) will share C_{max} in even parts. Thus, these descendants will extract from the **beacons** the capacity offered by their new parent (C_{max}) and the number of children (in this case, $|\{A, B, C\}| = 3$). They finally have to make the ratio to obtain their individual capacity ($\frac{C_{max}}{3}$).

When searching a parent, a node may use this capacity metric to compare different coordinators. A coordinator with a larger capacity should be

preferred. In this way, we balance the load in the cluster-DAG.

Capacity defined in this manner is an upper bound of what a node could obtain from this parent. Actual capacity will have to take into account link quality from corresponding parents. In other words, a node can reach this upper bound only if it successfully receives each single beacon from this parent. On the contrary, missing a beacon will decrease the actual capacity experienced in a long term. Moreover, we practically have a cluster-DAG: a node has several parents and should sum the bandwidth it obtains through each parent. Finally, the capacity can be expressed as following:

$$capa_N = \sum_{P_j} \frac{capa_{P_j}}{EBX_{link_{N \rightarrow P_j}}} \quad (6.2)$$

In Figure 6.1, node F receives a half of the capacity of C (2 children). Node E sums the capacity through C ($C_{max}/6$) and through B ($C_{max}/3$). Finally, we may remark that G should choose D as a parent since it maximizes the capacity. This selfish choice will produce a globally balanced cluster-DAG: a heavily loaded subtrees will not be chosen by newly associating nodes. Possibly, G will choose later several other parents if viable candidates still exist.

1.2.3 Diversity improvement

When a node chooses several parents, they must offer *diverse* properties, e.g. the different paths to the PAN coordinator should be node-disjoint. Since convergecast traffic is very common, we should rather consider only the most heavily loaded zone: the set of links forming the maximum clique in the contention graph [61]. In other words, the neighbors of the PAN coordinator are the most important nodes in the path. By balancing the load among these nodes, the routing protocol will be able to balance the energy consumption and increase the network lifetime.

Besides, the diversity metric also denotes the ability of the cluster-DAG to deal with node failures. If several paths exist toward the PAN coordinator, a node will probably have a backup path if an ancestor runs out of energy. The routing protocol (e.g. RPL) will detect the failure and redirect the traffic to other paths.

We chose to represent the diversity metric as the number of different 1st rank nodes contained in the set of paths toward the PAN coordinator. We denote the node N diversity by div_N : a node includes in its beacons the list of 1st rank nodes it may reach through all the paths with its parents. For example, in Figure 6.1 the traffic forwarded through parent node I would be possibly distributed among 1st rank nodes B and C .

We can update the diversity metric hop by hop in the cluster-DAG. Indeed, a node has just to make the union of the diversity metric of its parents:

$$div_N = \bigcup_{P_j} div_{P_j} \quad (6.3)$$

We define the **diversity improvement** as the diversity a new parent brings compared to the diversity a node had before. More formally, the diversity improvement is denoted as:

$$divIm(P_j) = |(div_N \cup div_{P_j}) \setminus div_N| \quad (6.4)$$

We can note that an unassociated node has initially a null diversity ($div_N = \emptyset$). Thus, the initial diversity of a node is simply the diversity of the corresponding parent ($|div(P_j)|$). This initial diversity is used to choose the first parent.

To simplify the calculations, we chose a straightforward binary formulation. The set of 1st rank nodes is practically limited: if we have n such nodes, we can encode this information in a variable of n bits. A node sets the k^{th} bit to 1 if it can reach the k^{th} 1st rank node. Conversely, to reduce the transmission overhead necessary to signal this information to surrounding nodes, we choose to encode diversity information in a packet field that is $\log_2(n) + 1$ bits large. The PAN coordinator is in charge of fixing the ordering of the list of its associated children nodes, i.e. each child receives its 1st rank ID.

Each node calculates the diversity by simply executing the equivalent bitwise operations of those described in Equations 6.3 and 6.4. For instance, the norm is the number of non null bits in binary diversity variable, \cup is equivalent to bitwise **or** of two variables and \setminus is replaced by bitwise **and not**.

Let us focus on the example illustrated in Figure 6.1. The PAN coordinator have 3 children and the diversity is encoded in 4 bits. The diversity of E is **0101** since it belongs to the subtree of B and C . Obviously, the diversity is minimal for children of the PAN coordinator: we forbid the creation of any loop. Thus, only the bit corresponding to their ID is non null in the diversity metric.

The diversity metric will help to choose a parent maximizing the diversity of the paths toward the PAN coordinator. This helps both to balance the load and to improve the fault-tolerance.

1.2.4 Inter beacon reception delay

To estimate the end-to-end delay, we should consider the superframe slots used along the path to the PAN coordinator. In particular, a node should consider the delay between its own superframe slot and the slot of its potential parent.

We can often neglect the transmission delay since it is commonly much smaller than the inter-superframe slot delay.

For example, in Figure 4.1, the superframe slots of each node is very close to the superframe slot of its parent. Thus, the end-to-delay will be minimized.

The delay incurred by superframe scheduling may be estimated similarly to Equation 5.2:

$$delay_{bcn}(P_j) = SD * | slot(P_j) - slot(N) | + BI * (EBX_{link_{N \rightarrow P_j}} - 1) \quad (6.5)$$

Intuitively, the delay depends on the number of superframe a node must wait before correctly receiving the beacon (second part of the equation) and the time separating its superframe and one of its parent (first part).

A node chooses its superframe slot just after having associated to the cluster-DAG. Thus, this delay will be integrated in the parent choice starting from the 2^{nd} parent.

To decrease the delay while maintaining the same duty cycle, we have to decrease in the same proportion both SD and BI values in Equation 6.5. Thus, the ability of a cluster-DAG to minimize the delay should be expressed independently from the real BO and SO values. In conclusion, we chose to represent a normalized delay, expressed in number of Beacon Intervals (BI):

$$delay_{bcn-norm}(P_j) = \frac{delay_{bcn}(P_j)}{BI} \quad (6.6)$$

1.3 Modified IEEE 802.15.4 beacon format

We propose to modify the IEEE 802.15.4 beacon format by adding more fields containing, among others, parent selection metrics defined above:

- Slot number
- Depth (hop distance)
- Rank
- Capacity
- Number of nodes associated with it
- Diversity

After the deployment, each node listens to incoming beacons until $c \times BI$ (Beacon Interval) after the first received beacon from the neighbor not creating loops. The first received beacon from each new potential neighbor will extend

once more this period for $c \times \text{BI}$. In this way, nodes will have for all potential parents same minimal level of precision and accuracy on measured selection metrics. Constant c can be chosen as a compromise between the precision for estimating the initial EBX and topology formation convergence time. Once convergence period expires, each node makes a decision with which parents to associate.

2 Methods for combining multiple metric

We believe that the biggest challenge in efficient convergecast construction is to find a single (locally measured) criterion (metric) for parent selection. This is a non-trivial task, especially when we take into account the list of global recommendations for efficient convergecast tree (cf. Subsection 1.1). Following these guidelines, we elaborated the set of metrics seeking to satisfy different goals. Neither one of them is able to address the totality of global recommendations since they aim for confronted properties. For example a parent with a good link quality will attract a lot of interest, directly leading to its capacity degradation and increased contention.

We propose an overview of available methods for combining multiple metrics to generate a single output decision value that will be used for parent selection. We will argue the reasons that lead us to adopt fuzzy logic as a preferred method.

2.1 Hierarchical succession

In a nutshell, hierarchical succession is basically using a single metric until a tie situation occurs. When two potential parents offer the same value of the primary metric, the secondary one is evoked to break the ties. Further eventual ties can be solved with some additional metric if available, otherwise the preferred parent is selected randomly. We can find the use of this method in RPL preferred parent selection.

The method has several downfalls that discouraged us from using it: very often ties will not even occur, leading to a single metric dominating the choice. Other metrics are not being used for parent selection most of the time, except in rare occurrences of the ties. Even when ties appear, the method is basically shifting the decision to a new single criterion opposed to jointly combining them. For example, a parent offering slightly worse link quality will be directly eliminated in the first round even though it offers extremely good capacity. It will not be possible to make a joint decision taking into account all available metrics.

2.2 Linear combination

Some of the impairments from the previous method are remediated with a linear combination. Contrary to hierarchical succession, all input variables are taken into account by combining them in a linear rule (it should be noticed that this is a most straightforward case. Basically any polynomial function would exhibit closely similar properties). We can represent it with a simple formula:

$$R_{out} = \alpha_1 * m_1 + \alpha_2 * m_2 + \dots + \alpha_n * m_n \quad (6.7)$$

where R_{out} is output resulting single metric for parent selection, m_i are various input variables and α_i corresponding coefficients.

Different coefficients α_i are weights for the input variables according to a predetermined overall importance on the output. This means that a larger coefficient attributed to a certain variable will result in its higher impact on the result. To allow proper functioning of the method, all input variables m_i should be reduced to the same scale. Otherwise, having the input variables represented on a different absolute scale would possibly produce a large mismatch in the resulting metric R_{out} . A single large absolute value could easily overwhelm all other input metrics, not allowing them to accordingly influence output value. The complexity of the linear combination containing a large number of input variables can be reduced if variables are mutually dependent. Basically, one variable is expressed as a function of another one, thus reducing complexity.

The drawback of linear combination is that the coefficients are constant for all the values of an input variable. We do not rely on the domain knowledge, since an input variable can behave differently over the different ranges (e.g. a link quality has its gray zone).

2.3 Fuzzy logic

Fuzzy logic, a form of many-valued logic, dates back to 1965 [134] and was complemented later by L. Zadeh [71]. Opposed to the traditional logic theory (uniquely true or false values), it offers a way to consider the concept of partial truth where variables can take continuous values between complete true (1) and false (0). Thanks to its similarity to human reasoning it has been widely exploited in various fields. We may use fuzzy logic in WSN for e.g. routing [64] [80], estimating the link quality in the MAC layer [13], cluster-head election [56], or detecting events [67].

Fuzzy logic supplies an algebra to express human reasoning and a concept of partial truth in a precise mathematical notation. We start by defining

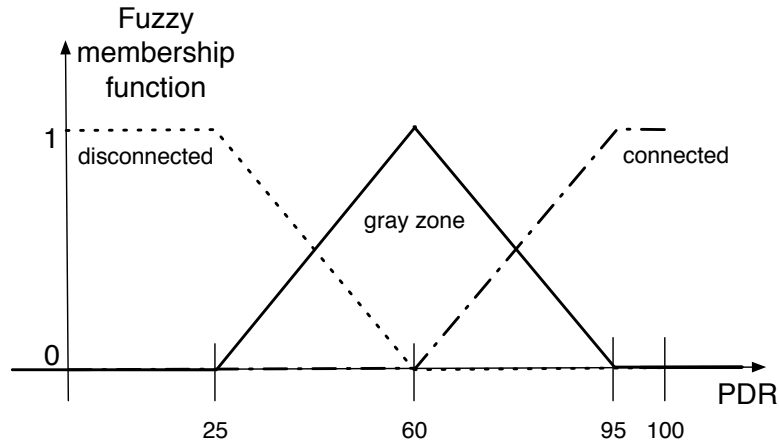

Figure 6.2: Example fuzzy membership function: Link can be described as connected, disconnected or belonging to the gray zone where its quality is uncertain to precisely predict.

a linguistic variable - a variable whose values are not numbers but words or sentences in natural or artificial language [134]. Packet delivery ratio (PDR) provides a classical WSN example: an input crisp variable is translated into multiple linguistic variables i.e. connected, gray zone, disconnected. Afterwards, we proceed by describing a membership function that determines the level of belonging (association) of a input (crisp) to a specific linguistic variable on a continuous scale from 0 to 1. Figure 6.2 illustrates a simple trapezoidal function. Membership functions may have any form, mostly used ones being triangular, trapezoidal and Gaussian-shaped, due to their computational simplicity.

Fuzzy logic offers a solution to combine confronted input variables for decision making. We create rules to determine the result of a final decision. A rule is written as **IF** *premise* **THEN** *consequence*. We form a premise by combining different linguistic variables with logical operators like AND, OR and NOT. Consequence is basically our decision. We can imagine example rule for parent selection: **IF** PDR is *connected* **AND** throughput is *high* **THEN** Associate to this parent.

Fuzzy logic for clustering [51, 56] tried to make optimized decisions by combining several variables. However, a decision does only depends on node properties (energy, concentration and centrality), not necessarily sufficient to achieve global topology goals.

3 Parent selection with fuzzy logic

The fuzzy logic offers a precise mathematical solution to combine confronted input variables used for decision making, producing a single output value. We will show how expertise and insights from the WSN domain can be used to capitalize on fuzzy logic positive properties for parent selection.

3.1 Fuzzy decision rule

For each potential parent (not creating loops), a node estimates corresponding goodness for association by evaluating a following fuzzy rule combining the previously stated linguistic variables in a single output value:

IF beacon PDR is high **AND** capacity is high **AND** diversity improvement is high **THEN** parent is *highly* suitable for association.

This fuzzy rule can be translated to the numerical form by using the following formula [128]:

$$\begin{aligned} \mu(i) = & \beta * \min(\mu_{bcn_{PDR}}, \mu_{capa}, \mu_{div-impr}) + \\ & (1 - \beta) * \text{mean}(\mu_{bcn_{PDR}}, \mu_{capa}, \mu_{div-impr}) \end{aligned} \quad (6.8)$$

where $\mu(i)$ is the fuzzy output value of neighbor i . The fuzzy logic literature [133] suggests that $\beta \in (0.5, 0.8)$, where generally 0.6 obtains the best results in any case. For each parent selection metric we create a fuzzy input variable μ by applying the fuzzy membership function. A more detailed practical explanation of this conversion will be offered in the following subsection. Finally, a node always chooses to associate with the neighbor i with the highest value of fuzzy output $\mu(i)$.

The fuzzy rule slightly changes for the selection of the 2nd and consecutive parents. Once the association with the first parent is done, a node selects one available slot and starts sending beacons. Now, a node is capable to favor the neighbors that optimize time critical traffic (small difference in time slots, cf. Equation 6.5). The original fuzzy rule stated above is expanded with the operator **AND** and another linguistic variable—inter beacon reception delay is low. We correspondingly expand Equation 6.8 with the variable $\mu_{delay_{bcn}}$.

3.2 Fuzzification of the input variables

Before applying the fuzzy decision rule, we first have to perform the fuzzification of all necessary input metric variables i.e. a crisp value of the variable is always converted to the same scale (from 0 to 1) by the use of the membership function. It can take the form of any of the available mathematical functions

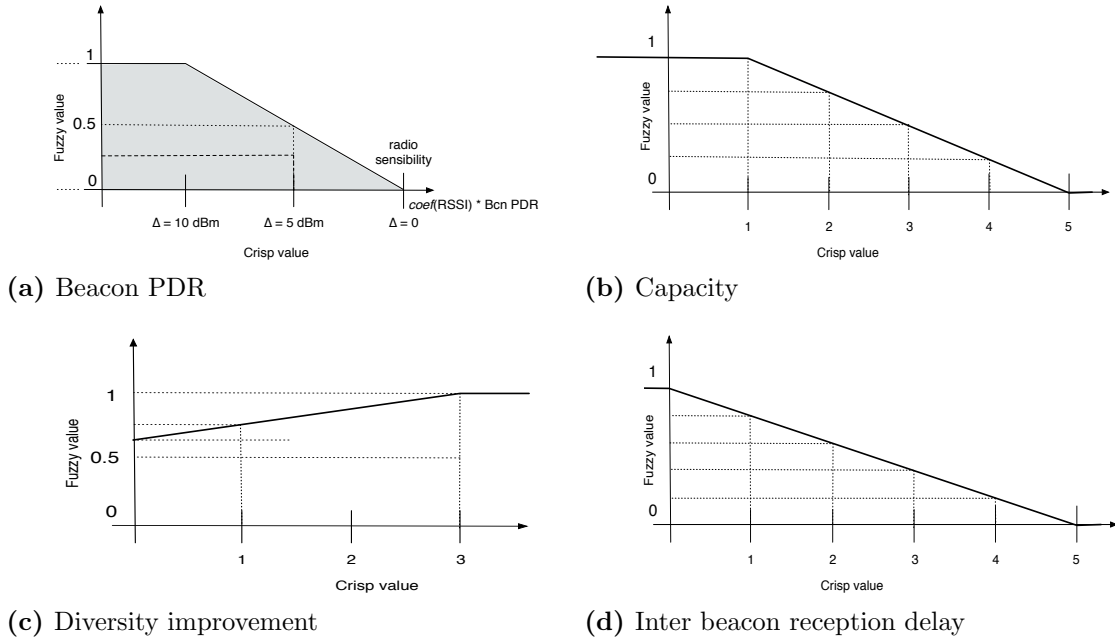

Figure 6.3: Fuzzy membership function of four variables: Beacon PDR, capacity, diversity improvement, and inter beacon reception delay

(triangular, trapezoidal and Gaussian-shaped, logarithmic, exponential, etc.) that best describes the translation of a crisp value to an abstract fuzzy value. Choice of the membership function should rely on the domain expertise i.e. various ranges of input crisp values often need to be attributed different importance.

We decided to use a trapezoidal form (piece-by-piece linear characteristic) since its computational simplicity suits well WSN nodes. Additionally, for the case of link quality, it offers the first approximation for the gray zone effect (two stable areas interrupted by a transient zone).

For each of the input variable (parent metric) we define only one linguistic variable (*high* beacon PDR, *high* capacity, *high* diversity improvement and *low* inter beacon reception delay) and corresponding membership function (denoted respectively with μ_{bcn_PDR} , μ_{capa} , $\mu_{div-impr}$ and $\mu_{delay_{bcn}}$) (cf. Figure 6.3). Using more linguistic variables would only increase the rule set (computationally more demanding) with no real gain in refining the decision making.

We can adapt the form of the membership function according to a different environment or empiric measures. We simply regulate the inclination of the ramp or adjusting the knee points (common points between the linear segments). In this way, we as well tune the importance (weight) that each metric will have on the final decision.

For example, depending on whether we optimize our topological struc-

ture for time critical traffic or not, we would make the relative slot position membership function ramp more or less oblique.

Finally, we would like to explain in more details the specificities of the beacon PDR membership function. Contrary to other functions, we combine two input variables (product of beacon PDR and penalizing coefficient that depends on the average RSSI value).

We measure the average RSSI value of all received beacon frames and accordingly establish the penalizing coefficient (cf. trapezoidal function in Figure 6.3a). We penalize the links up to 10 dBm from the radio sensitivity level (gray zone) according to the findings of Srinivasan et al. [109]. We can see the coefficient as the upper bound of the fuzzy output value. Actual fuzzy output value belongs to the area below the line (shaded area in Figure 6.3a).

For example, when the average RSSI value is 5 dBm away from the radio sensitivity ($\Delta=5$ dBm), the penalizing coefficient is equal to 0.5 (as well the maximum fuzzy output marked with the dotted line in Figure 6.3a). For this case, when $PDR = 0.5$, fuzzy output value is equal to 0.25 (dashed line).

4 Performance evaluation

We have compared four parent selection strategies for cluster-DAG construction:

- **First choice**—a node associate to the first detected parent
- **Random**—a node associate to the random parent from the candidate list
- **EBX**—a node associate to the parent offering the best link quality in the terms of EBX
- **fuzzy**—a node associate to the neighbor maximizing the fuzzy output value (cf. Equation 6.8).

For the sake of simplicity, we implemented a centralized solution that achieves a collision free scheduling. We wanted to isolated the impact of parent selection on the resulting topological structure. However, we may use any scheduling algorithm such as the distributed version described in Chapter IV. Then, the link quality estimation should incorporate the interference and collisions. Nevertheless, such a simplification does not diminish the usefulness of our combined *Fuzzy* approach for parent selection.

We have as well implemented three bootstrap strategies for comparison: a.) *All together*—nodes start running at the same moment. b.) *Random*

Simulated area	200m x 200m	path loss	1.97
Topology type	square grid	standard deviation	2.0
Packet period	30 s	Pr(2m)	-61.4dBm
Simulated time	1200 s	SO, BO, BOP slots	2, 8, 4

Table 6.1: A cluster-DAG topology construction: General simulation parameters

circle—nodes are divided in the concentric circles (tiers) centered at the sink node. Each following circle increases the radius for one approximative radio transmission range. A sink node starts the bootstrap procedure. Then, we randomly bootstrap the nodes in the circle closest to the sink node. Once all nodes from the first tier are running, we proceed with the tiers further away from the sink until all the nodes are running. c.) *Random chain*—Again, a sink node starts the bootstrap procedure. Next, we select a random radio neighbor of the sink. In each following step, we bootstrap a random neighbor of already running nodes.

Most of the work in the literature explicitly assumes the first strategy. Nevertheless, such a strategy is technically challenging and limited to highly specific scenarios such as the networks with a global notion of time (the testbeds wired with a control backbone or the nodes equipped with GPS). Our goal here was not to propose an optimal strategy, rather to observe the impact of different bootstrap strategies on the topology formation process.

We evaluated the structural properties of a cluster-DAG when different strategies are used: the average number of parents (children) per node, and the percentage of coordinator nodes with children. We compared the strategies in the terms of association time (the time necessary until the last node associate), and the stability (percentage of associations that did not end up in a disassociation). We examine the energy overhead necessary for cluster-DAG construction, and the reasons of energy consumption. Finally, we offer an analysis of the parent selection performance when different bootstrap strategies are used.

4.1 Simulation setup

We have used the WSNNet/Worldsens event-driven simulator for large scale wireless sensor networks [24]. The simulator has been already thoroughly evaluated [16]. We used the IEEE 802.15.4 implementation in bacon-enabled mode [4].

To make the simulations as close as possible to the reality, we have not adopted the Unit Disk Graph assumptions commonly used in the literature. We rather use the Rayleigh propagation model and the parameters of the IEEE

Number of beacon to wait	1, 2, 4
Number of nodes (density)	25, 81, 225
Maximum number of parents	1, 2, 3 , unlimited
Rank type	hop count, EBX
Node bootstrap strategy	all, random circle , random chain

Table 6.2: A cluster-DAG topology construction: Varied parameters, default marked in bold typeface

802.15.4 radio. The model has been calibrated with the scenario FB6 (indoor real deployment) as presented in [25].

We used the square grid topologies ($N \times N$ nodes) placed in the square of 200 x 200 m. As we increase the number of nodes, the node density simultaneously increases as well. The grid topology has an interesting property for analysis purposes: almost all the nodes (except those situated at the border) keep the constant radio neighborhood in terms of size, placement, and density. In such scenarios, only the parent selection algorithm impacts the quality of the final topological structure.

We run a simulation for 1200 s and average the results over multiple runs to obtain 95% confidence intervals. State that association ratio was 100 % in all cases.

The general simulation parameters are represented in Table 6.1.

We observed the cluster-DAG formation process while varying independently several design parameters. We present them in Table 6.2. We vary a single parameter a time while others are kept constant at a default value (marked in bold in Table 6.2).

4.2 Structural properties

We start the performance evaluation by examining the structural properties of the obtained cluster-DAG topology.

4.2.1 Average number of children per coordinator

Average number of children per coordinator can be a good indicator on how well the resulting topology structure can handle the data traffic [40]. Basically, in the IEEE 802.15.4 networks the PDR performance drastically drops when the number of the children per coordinator rises over 5. A larger number of nodes compete during an active period of a superframe. The IEEE 802.15.4 node drops packets since the channel is often sensed occupied (i.e. a node is unable to obtain a CCA (Clear Channel Assessment)).

We can observe in Figure 6.4a that our *Fuzzy* approach manages to keep the number of children below the critical level of 5. Less children per active period means less contention and better performance [40]. Other approaches (*First choice*, *Random*, and *EBX*) are unable to limit the number of contending children.

We can observe the variability in the number of children for *Fuzzy* scheme when a single beacon is used to estimate the parent selection metric. A node is unable to properly estimate all parent metrics over a single beacon frame.

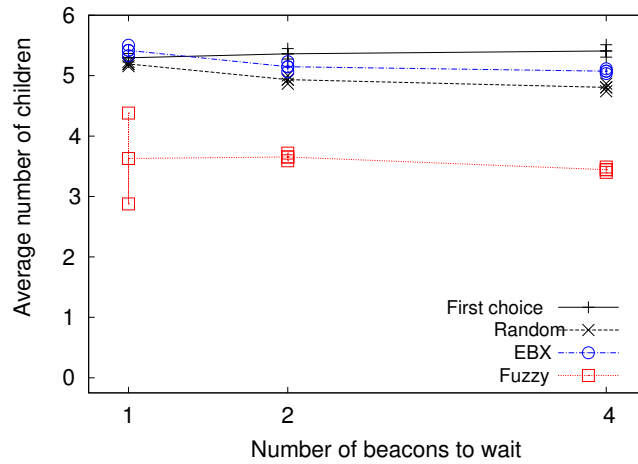

(a) Number of beacons to wait: *Fuzzy* approach constantly manages to keep the number of children below the critical level of 5

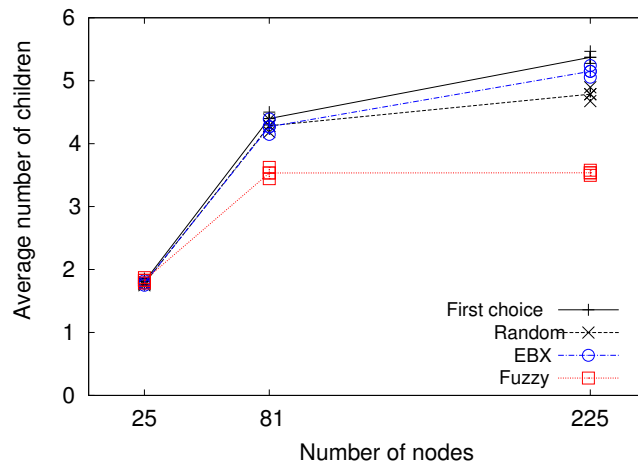

(b) *Fuzzy* manages to keep the low number of children per parent regardless to the topology density (total number of nodes)

Figure 6.4: A cluster-DAG topology construction: Average number of children per coordinator

Figure 6.4b represents the protocol conduct when the number of deployed nodes (density) is varied. For a sparse network (25 nodes), all schemes reach the limit due to the insufficient density. Whereas, the number of children almost linearly rises with the density for the case of *First choice*, *Random* and *EBX* schemes. On the other hand, the *Fuzzy* scheme manages to keep the constant number of children. The contention remains low even in denser networks.

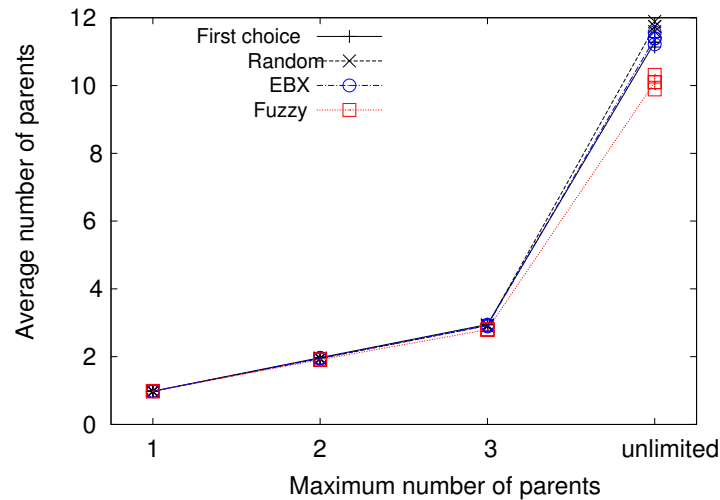

Figure 6.5: A cluster-DAG topology construction: Average number of parents per node

4.2.2 Average number of parents per node

Having more parent nodes can be beneficial to obtain a robust topology, and/or as we have demonstrated in the previous chapter, and for QoS routing. Nevertheless, the maximum number of parents has to be limited since not all parents are useful for the routing. For example, a parent with low link quality, or with too many children nodes.

We examine in Figure 6.5 the impact of the maximum allowed number of parents. With no limits, a node keeps on adding new parents in the decreasing order of preference until there are no more available candidates. Thus, none of the parent selection metrics is able to limit the number of parents. Even when a number of parents is fixed, a node quickly reaches a maximum value.

Ideally, a node should dynamically decide when to stop adding the new parents. For example, when there is no increase in robustness or when it will start to degrade the routing performances. Nevertheless, such a mechanism is still to be proposed.

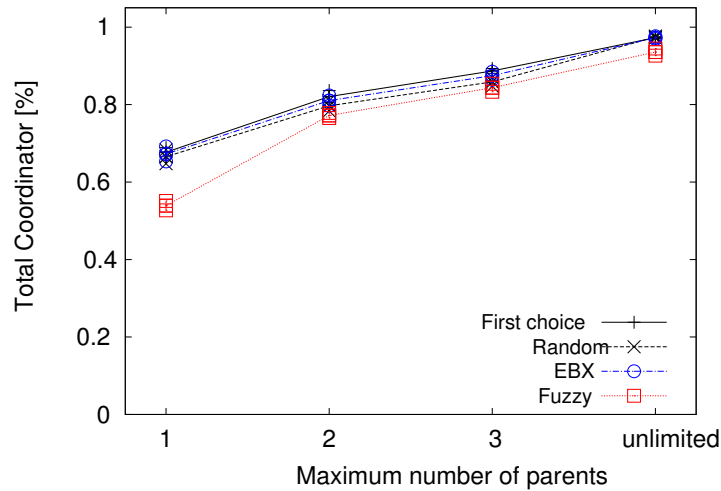

Figure 6.6: A cluster-DAG topology construction: *Fuzzy* minimizes (maximizes) the percentage of coordinators (leaf nodes)

4.2.3 Percentage of the coordinator nodes with children

We can observe in Figure 6.6 the percentage of the coordinator nodes with children. The remaining nodes are the leaf nodes. Maximizing the number of the leaf nodes can be beneficial for the overall network energy consumption. A leaf node can turn off its radio in the beginning of the active period, once it is sure that there will be no eventual association requests.

We can see that the *Fuzzy* scheme constantly keeps the lowest percentage of the coordinators with children (highest number of leaf nodes). We can as well notice the importance of limiting the maximum number of parent nodes. Authorizing more parent per node, reduces the percentage of leaf nodes and accordingly, a possibility to save more energy.

4.3 Convergence and stability

4.3.1 Association time

We present in Figure 6.7 the association time for all parent selection schemes. We measure the time necessary until the last node associate to the network.

In Figure 6.7b we can observe the impact of the number of beacons before a node selects a parent, on the association time. We would expect that the association time rises with the necessary number of beacons. Nevertheless, it is only true for the case of *Fuzzy* and *Random* scheme.

EBX and *First choice* suffer from the long association times. They have the tendency to group more nodes to the parents with the lowest EBX or to

the parents first sending their beacons. Higher contention during the active period causes the 6-way association process to be inefficient and long. A better link quality estimation (more beacon frames to wait) seems to help the *EBX* scheme.

The *Fuzzy* schemes obtains the best association time since the parent selection takes into account the capacity. The capacity incorporates the number of contending nodes in a superframe.

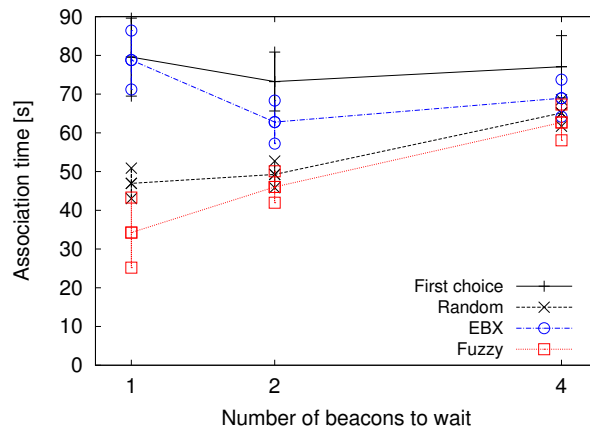

(a) Impact of the number of beacons on the association time

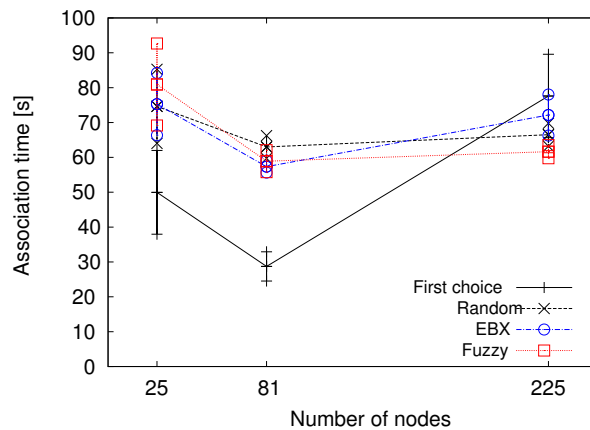

(b) Impact of the number of nodes (density) on the association time

Figure 6.7: A cluster-DAG topology construction: Association time

In Figure 6.7b we can observe the impact of the topology density (number of nodes) to the association time. We recall that the *First choice* scheme immediately initiates the association procedure after a single received beacon, while others have to wait the default 4 beacons.

When the density is kept low (topologies with 25, and 81 nodes) the *First choice* scheme performs rapidly. For high density (225 nodes), the contention level rises since nodes group to the first available parent, and thus, the association process takes a longer time.

The *Fuzzy* scheme performs well except for the lowest density (25 nodes).

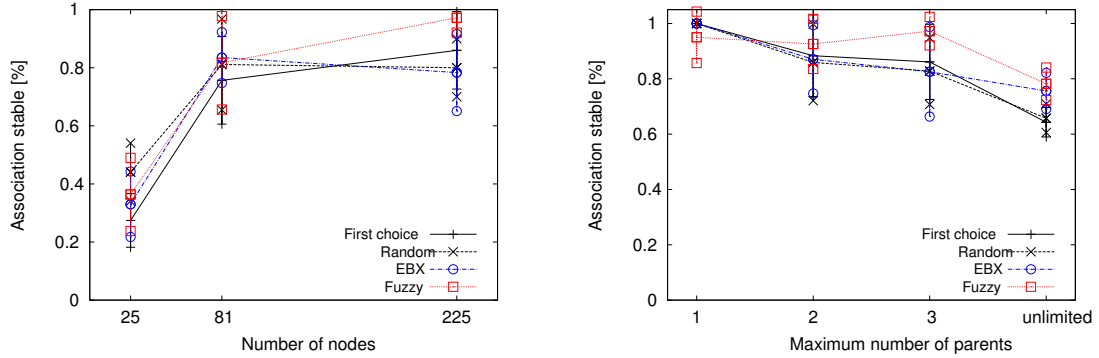

(a) Impact of the number of nodes (density) (b) Impact of the maximum number of parents

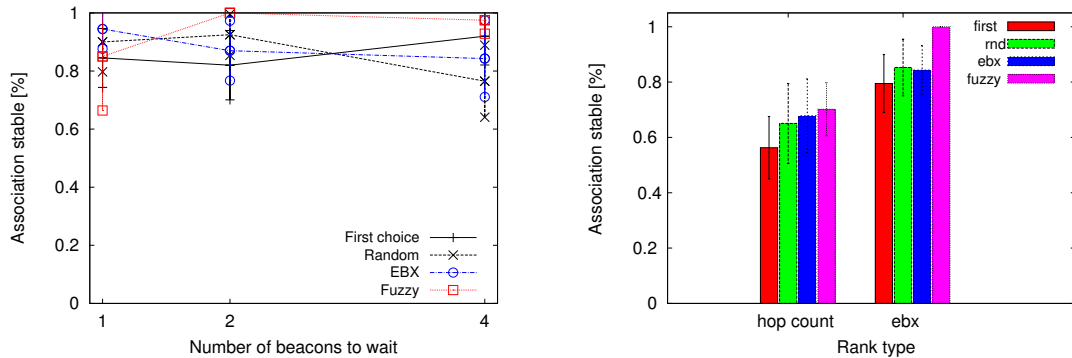

(c) Impact of the number of beacons to wait (d) Impact of the rank

Figure 6.8: Stability of the cluster-DAG structure: the percentage of associated parents that were not afterwards removed with a disassociation process

4.3.2 Association stability

Figure 6.8 presents the stability of the cluster-DAG structure according to the different design parameters and the parent selection algorithms. We define a stable parent as the parent that was not removed with a disassociation process. A node disassociate from a parent when it loses the synchronization (a loss of 4 consecutive beacons) or when it detect the routing loop (due to a change in the rank (EBX used by default)). We measured the percentage of the stable parents.

We notice in Figure 6.8a the general trend of stability increase with the

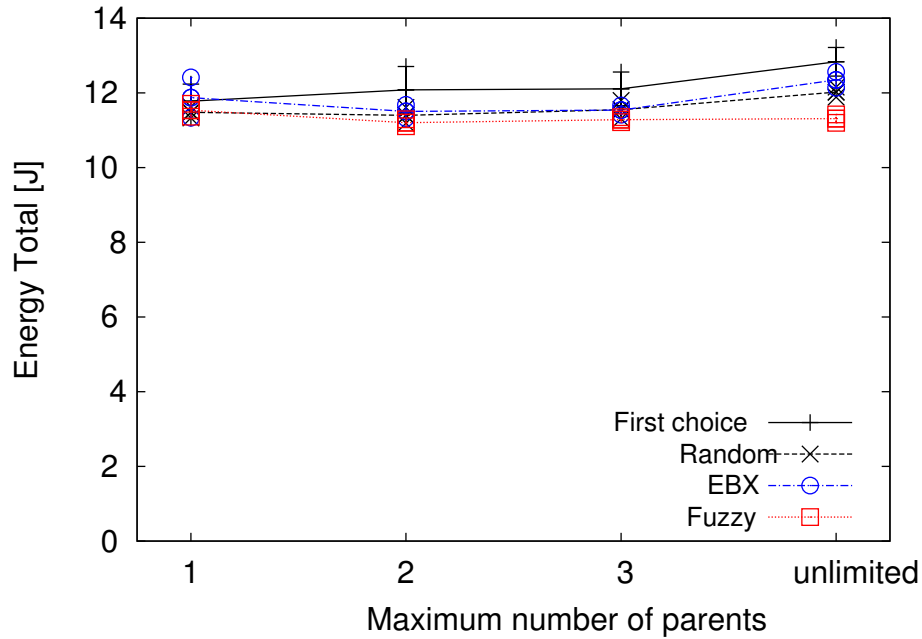

Figure 6.9: Energy spent for cluster-DAG topology construction and maintenance. Impact of the maximum allowed number of parents

density. For the topology with 25 nodes, the links operate close to the sensitivity level, leading to a frequent beacon losses. The nodes become closer to each other in denser topologies. It generally positively impacts the link quality. A node has more choices of the parents with a high quality link.

Associating to more parents is beneficial for the structure robustness, but evidently degrades the stability (cf. Figure 6.8b). Parents are generally added in the order of the decreasing quality (*Fuzzy* and *EBX*). Yet another reason to intelligently limit the number of parents.

Spending more beacon can be beneficial to properly evaluate all the elements of fuzzy parent quality. Obtained stability slightly increases when a node waits more than a single beacon frame (cf. Figure 6.8c. Surprisingly, this is not the case for the *EBX* strategy.

A hop count should be obviously avoided as parent rank metric (cf. Figure 6.8d). During the convergence time, a node's hop count changes are frequent, causing the high level of disassociations. On the other hand, a cumulative EBX offers a more stable rank for the cluster-DAG loop avoidance.

Prevailing conclusion from Figure 6.8 is that *Fuzzy* performs very well in the variety of parameter choices. Apart from some extreme cases, *Fuzzy* outperforms the rest of the algorithms.

4.4 Energy concerns

We evaluated in Figure 6.9 the energy consumption necessary to build and maintain a cluster-DAG. We measured the network wide spent energy used for the radio communication.

We consider the radio chip as the most important energy consumer, thus we neglect the other WSN node components. Our energy model is based on the specification of the CC2420 radio chip [3]. Total energy spent is expressed in Joules.

We can remark an interesting feature in Figure 6.9: the energy consumption of the *Fuzzy* scheme remains almost constant regardless the number of parents. A node following an additional superframe just requires to wake-up and to receive a **beacon** frame. Afterwards, a node can freely turn off its radio during the active period. The energy necessary to receive a short beacon frame (100 μ s) represents approximately 0.16% of the energy that node spends during its own superframe (e.g. 61.44 ms for $SO = 2$).

On the other hand, other approaches consume slightly more energy when the number of parents is not bounded. We can attribute this overhead to the joint effect of less stable parents, longer association time, and higher percent of coordinator nodes.

4.5 Impact of the bootstrap strategy

Finally, we examined the impact of the bootstrap strategy on the performance of parent selection mechanisms (cf. Figure 6.10).

As we suspected, the choice of a bootstrap strategy strongly influences the performance. We can notice in Figure 6.10a and 6.10b that widely accepted *All together* bootstrap strategy negatively affects the association time and the total spent energy. Nodes start running at the same moment, thus creating the contention at the parents offering the best quality. Using the *Random circle* seems to help to reduce this problem, while *Random chain* is the clear winner. The *Random chain* strategy spreads the node wake up during the parent discovery phase. The 6-way association is performed efficiently since the level of contention decreases when a lower number of nodes is active.

The bootstrap strategy seems not to influence to much the percentage of stable association (cf. Figure 6.10c). Nevertheless, when the *Random chain* bootstrap is used, the *EBX* strategy is unable to cope with disassociations caused by rank loops.

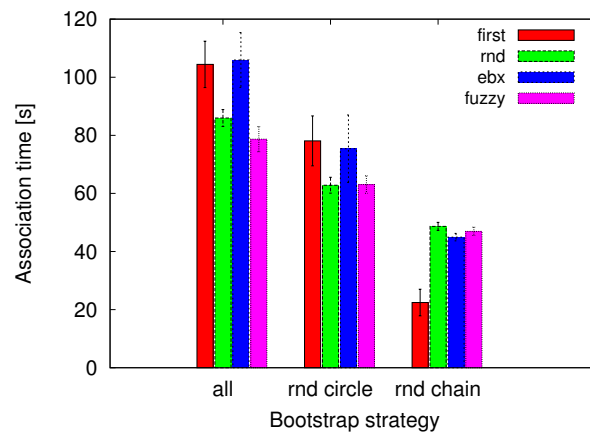

(a) Association time

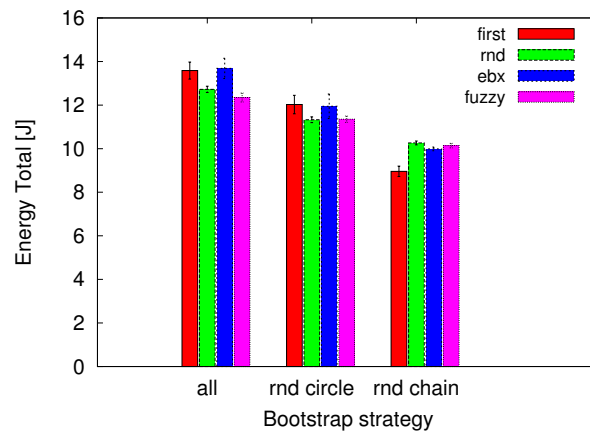

(b) Energy spent for cluster-DAG topology construction and maintenance.

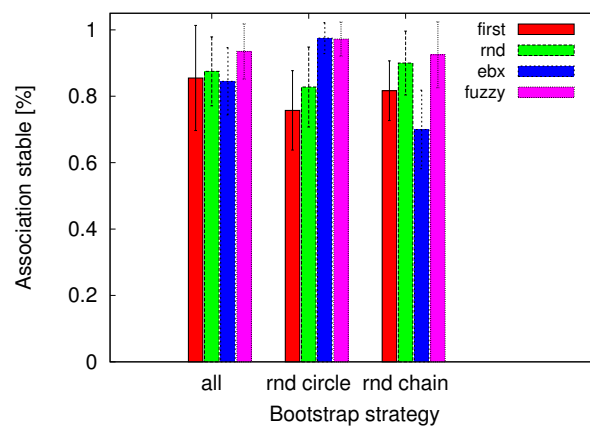

(c) Percentage of the stable associations

Figure 6.10: Impact of the bootstrap strategy on the cluster-DAG performance

5 Conclusions

We have presented a cross-layer approach to construct an efficient cluster-DAG. We started by analyzing the global requirements for an efficient convergecast topological structure. Then, we elaborated a list of locally measured metrics which estimate the potential of the candidate parents. Thereafter, we proposed to use the fuzzy logic to normalize and jointly use the positive sides of all the metrics. Simulation results prove the relevance of our approach: a node locally selects the parents based on the multiple criteria while optimizing the global cluster-DAG properties.

The resulting cluster-DAG structure obtains a low average number of children per coordinator. Our approach prevents the performance degradation by keeping the number of children below the critical level of 5. Our *Fuzzy* scheme as well keeps the high percentage of the leaf nodes. A leaf node potentially can turn off its radio in the beginning of the active period, thus saving the energy.

When using our *Fuzzy* parent selection scheme, all the nodes rapidly manage to associate to the network, while guaranteeing the stability. By taking more selection criteria (notably the capacity), the *Fuzzy* scheme avoids initiating 6-way association to a potentially overcrowded parents. *Fuzzy* performs very well in the terms of stability over the different parameters. Only a small percent of nodes is removed due to the disassociation. As a joint result of short association time and high percentage of stable parents, we improve the network lifetime (lowest energy consumption).

Even though not part of the parent selection scheme, we stress the importance of a proper bootstrap strategy. In order to limit the association time and spent energy, the nodes should bootstrap at different moments. On contrary, starting all the nodes at the same time creates a wave of simultaneous association request. A node is not able to efficiently associate to a parent in the presence of many competing nodes.

Finally, we raise a question on how to dynamically limit the maximum number of parents per node. The unlimited number of parents negatively impacts the cluster-DAG performance.

Conclusions and Future work

1 Summary of the thesis contributions

The aim of this dissertation is to contribute to the better understanding of the real world WSN behavior and performance improvement of the WSN striving for the Internet of Things paradigm. In particular, the dissertation contributes in the following fundamental areas of WSN: the statistical analysis and characterization of the real world WSN behavior, the collision free MAC scheduling and a distributed TDMA slot attribution algorithms, the routing algorithms providing a QoS differentiation for the time critical traffic, the analysis of the global requirements for an efficient convergecast traffic leading to a cross-layer approach for the topology construction.

The first contribution consists in a thorough statistical analysis on a collected dataset from an experimental testbed in the urban environment. We emphasize the most distinguished WSN properties, such as the link characterization, correlation with environmental parameters as well as network dynamics.

Contrary to the literature, we demonstrated that there were no unidirectional links in our observed testbed. Moreover, all the links are highly symmetrical when comparing their mean RSSI values. Nevertheless, the RSSI value does not present a suitable choice to model the link quality. A fitting physical parameter is still to be proposed. We have highlighted that a proactive neighborhood discovery may cause imprecise routing decisions, which favors reactive solutions. We have also presented a reactive, but still flexible mechanism for detecting and discarding transient outlier values in measured RSSI values. Finally, we have offered a list of recommendation to the research community on how an experimental WSN testbed serving to provide a deeper analysis of WSN behavior might be conceived.

The following contributions concerns the performance improvements of the standardized protocol suite aiming for the IoT paradigm: the IEEE 802.15.4 and RPL standards. Our proposed improvements concern MAC, routing and a cross-layer solution for topology construction.

The second contribution corresponds to a superframe scheduling framework in the IEEE 802.15.4 standard. We combine positive aspects of two

existing solutions to reduce collisions while limiting bandwidth waste. Additionally, we propose a practical slot assignment algorithm which is very simple, localized, and converges quickly to a stable and accurate assignment. Our proposed algorithm is also scalable. The percentage of colliding slots is kept low regardless of the number of nodes in the observed networks. A positive side effect of our collision free framework is that it allow joined operation of IEEE 802.15.4 and RPL. We proposed to modify the topology of the IEEE 802.15.4: adopting a cluster-DAG structure. A node chooses to maintain more parents simultaneously—it helps to improve the robustness and the delay.

The third contribution capitalize on the advantages created by the cluster-DAG topology structure. We adopted an opportunistic routing approach in order to provide QoS routing with the RPL standard: a node forwards the packets to the next awake parent. A coordinator waits on the average less time before the active part of any of its available multiple parents.

From the general point of view, our opportunistic multi-path routing stand shoulder to shoulder with RPL regarding the PDR and delay performance. Yet, it shows a real advantage when we deal with QoS differentiation of delay sensitive traffic. As soon as the deadline becomes more critical, the fact that we use alternative parents results in a higher PDR and lower incurred delay. Finally, our simple opportunistic routing scheme benefits from an interesting feature: a traffic is spread across all possible parents instead of going through the preferred one. Nevertheless, an effective load balancing routing is still to be proposed.

The fourth contribution is twofold: first, we analyzed the global requirements for an efficient convergecast topological structure. We referenced all the metrics which estimate the *quality* of candidate parents. Second, on this basis, we have proposed a cross-layer approach for the topology construction that targeted to achieve global goals.

By normalizing and combining all the metrics with fuzzy logic rules, we simultaneously optimize multiple criteria. Simulation results prove the relevance of this approach: a node selects the parents based on the locally computed metrics while optimizing globally the cluster-DAG properties.

The resulting cluster-DAG structure obtains a low average number of nodes per coordinator. A parent benefits from the low contention preparing a good base for an efficient data packet transfer.

All the nodes rapidly manage to associate to the network, while guaranteeing the stability. Only a small percent of nodes is removed due to the disassociation. Thus, we improve the network lifetime by achieving the energy efficient topology construction.

Finally, we stress the importance of a proper bootstrap strategy, as well as the necessity to dynamically limit the maximum number of associated parents.

2 New research perspectives

We would like to lay out some of the perspective research challenges that might originate from this dissertation. We might highlight the following directions (a non-exhaustive list):

WSN analysis and modeling Our WSN analysis concerned a specific hardware platform in the urban scenario. We could extend the findings from our study to some other environment and/or another type of nodes. An exhaustive analysis could provide more general results to the research community. We should follow the advices on how conceive an experimental testbed in order to maximize the outcome value of such study. Additionally, one could enrich the list with the advices specific to these new conditions. We would like to mention some of the readily available open testbed platforms: Senslab [106], Wisebed [125], GreenOrbs [76]. Currently, they could offer a starting point to perform a detailed analysis in variety of topologies, scenarios, and wireless environments.

A wireless link uncertainties affect deeply the entire WSN protocol stack. Providing an accurate model of the wireless link behavior would improve the WSN protocols. Currently, we are not able to efficiently model the link behavior. We believe that more closer collaboration should be established between the domains of WSN hardware conception and WSN research. Joint efforts could lead to more precise link quality estimation, either readily available in the new version of the WSN hardware, either through algorithms capitalizing on more refined knowledge on the existing WSN radio devices.

Routing supporting load balancing and other traffic models In this thesis, we have described and evaluated improvements of the RPL standard aiming to provide QoS in time and reliability domain. Our algorithm only supports the soft QoS requirement. A possible extension of our work would be to provide QoS hard requirements. This is a challenging task due to the unreliable nature of wireless links and resource limitations.

Furthermore, it is intuitively clear that an opportunistic forwarding could be beneficial to distribute the traffic over more available parent nodes. Nevertheless, such a strategy does not provide a deterministic load balancing. Further improvements could be to consider the load balancing either separately, or in parallel with soft QoS requirements. A starting point could be

to investigate how the link quality influence the load balancing in the case of opportunistic forwarding.

Topology construction 2 We believe that we raised more new questions regarding the topology construction, than we actually answered them. We showed the benefits of using the fuzzy logic, but as well demonstrated where the parent selection process can be further improved.

In the near future, we plan to validate the proposed scheme on some other topologies different than the grid. Also, being able to incorporate the interference in the link quality estimation would be crucial.

We showed the importance of an appropriate bootstrap strategy. We could elaborate more realistic bootstrapping scheme that would support and improve the topology construction itself.

Yet another possibility is to investigate how to dynamically limit the number of associated parents. For example, a node should stop adding parents when there is no increase in robustness or when it will start to degrade the routing performances.

Finally, we aim also at designing an efficient routing strategy to fully exploit the cluster-DAG structure: several paths exist, we must efficiently distribute the load the network layer. In particular, should an opportunistic routing approach use the same metrics to select the best next hop at a given instant?

Publications

- 1 Bogdan Pavković, Fabrice Theoleyre, Dominique Barthel, Andrzej Duda, *Experimental Analysis and Characterization of a Wireless Sensor Network Environment*, In proceedings of ACM PE-WASUN (International Symposium on Performance Evaluation of Wireless Ad Hoc, Sensor, and Ubiquitous Networks), Bodrum, Turkey, October 17-21, 2010
- 2 Bogdan Pavković, Fabrice Theoleyre, Andrzej Duda, *Multipath Opportunistic RPL Routing over IEEE 802.15.4*, In proceedings of ACM MSWiM (International Conference on Modeling, Analysis and Simulation of Wireless and Mobile Systems), Miami, Florida, USA, 31st October - 4th November, 2011
- 3 Bogdan Pavković, Won-Joo Hwang, Fabrice Theoleyre, *Cluster-Directed Acyclic Graph Formation for IEEE 802.15.4 in Multihop Topologies*, In proceedings of 5th IFIP NTMS (International Conference on New Technologies, Mobility and Security), Istanbul, Turkey, 7th - 10th May, 2012
- 4 Bogdan Pavković and Fabrice Theoleyre, *MAC and Routing Integration in Wireless Sensor Networks* in Using Cross-Layer Techniques for Communication Systems: Techniques and Applications, by IGI Global, Release date April, 2012
- 5 Bogdan Pavković , Andrzej Duda, Won-Joo Hwang, Fabrice Theoleyre, *Efficient Topology Construction for RPL over IEEE 802.15.4 in Wireless Sensor Networks*, Ad Hoc Networks Journal, 2012, submitted
- 6 Bogdan Pavković, Fabrice Theoleyre, Andrzej Duda, *Fuzzy Logic Cluster-Directed Acyclic Graph Formation for Beacon-Enabled IEEE 802.15.4 in Multihop Topologies*, Networking, 2013, submitted

List of Abbreviations

<i>AODV</i> Ad hoc On-Demand Distance Vector, page 28	<i>OF</i> Objective Function, page 36
<i>BI</i> Beacon Interval, page 19	<i>P2MP</i> Point-to-Multi-Point, page 35
<i>BO</i> Beacon Order, page 19	<i>P2P</i> Point-to-Point, page 28
<i>BOP</i> Beacon-Only Period, page 23	<i>PAN</i> Personal Area Network, page 16
<i>CAP</i> Contention Access Period, page 16	<i>PDR</i> Packet Delivery Rates, page 37
<i>DAG</i> Directed Acyclic Graph, page 36	<i>QoS</i> Quality of Service, page 5
<i>DODAG</i> Destination Oriented Directed Acyclic Graph, page 36	<i>RFD</i> Reduced Function Devices, page 22
<i>GTS</i> Guaranteed Time Slot, page 18	<i>ROLL</i> Routing Over Low-power Lossy links, page 4
<i>IETF</i> Internet Engineering Task Force, page 4	<i>RPL</i> Routing Protocol for LLN, page 34
<i>IoT</i> Internet of Things, page 3	<i>SD</i> Superframe Duration, page 19
<i>LLN</i> Low Power and Lossy Networks, page 28	<i>SO</i> Superframe Order, page 19
<i>MAC</i> Medium Access Control, page 7	<i>TDMA</i> Time Division Multiple Access, page 11
<i>MP2P</i> Multi-point-to-Point, page 35	<i>UDG</i> Unit Disk Graph, page 19
	<i>WSN</i> Wireless Sensor Networks, page 1

List of Figures

2.1	Illustration of the basic CSMA (Carrier Sense Multiple Access) principle and CSMA/CA (Collision Avoidance) with RTS/CTS mechanism. The use of the additional RTS/CTS control packets remedies the hidden terminal problem. Node <i>B</i> CTS response will reserve the radio channel till the end of the node <i>A</i> packet transmission	9
2.2	General idea of slotted synchronized MAC scheme - a TDMA (Time Division Multiple Access) style time slot division	11
2.3	General idea of the common active/sleep period MAC scheme - all the nodes follow the same active period	13
2.4	General idea of the preamble sampling MAC scheme	14
2.5	Superframe structure in IEEE 802.15.4	15
2.6	IEEE 802.15.4 slotted CSMA/CA method	16
2.7	The IEEE 802.15.4 supported topologies: star, mesh, and cluster-tree. The star is for 1-hop networks, while mesh and cluster-tree topologies support multihop operation.	18
2.8	The IEEE 802.15.4 association process: an explicit way to learn about PAN control parameters and to establish bi-directional link with a selected parent[1]	19
2.9	Two main solutions for collision avoidance in the IEEE 802.15.4 multi-hop cluster-tree configuration: a.) Beacon-Only Period — solves only beacon collision by reserving slots at the beginning of the active part of the superframe b.) Superframe Scheduling — solves both beacon and data collisions by organizing the active parts of superframes in form of non-overlapping TDMA slots	20
2.10	Back-pressure routing principle: packets will be forwarded to a node offering the highest difference in the size of routing queues (back-log gradient)	25
2.11	Gradient routing: route discovery, gradient establishment, routing	28
2.12	Multi-path types: node and link disjoint, interleaved, and opportunistic	32
2.13	RPL supported traffic types	33
2.14	Difference between various directed graph structures: oriented graph with a loop, DAG, and DODAG	34

2.15	Overview of cross-layer approaches: a) OSI 7 layered system b) Creation of new interfaces c) Vertical calibration d) Merge adjacent layers e) Unified system (no more layers)	41
3.1	Deployed topology in an urban environment	46
3.2	Wireless Sensor Network experimental testbed database—an overview of the obtained information	48
3.3	Distribution of link occurrence ratio	49
3.4	Symmetry of existing bidirectional links	50
3.5	Distribution of RSSI value for one of the representative links .	51
3.6	Box plots of RSSI values for ten representative node pairs. Link quality in both direction follow the same distribution, even though in some cases box plots are not perfectly symmetrical.	52
3.7	Impact of the RSSI value on the link occurrence ratio	53
3.8	Variation in the neighborhood size for one of the nodes	55
3.9	CDF of multiple consecutive outlier	56
3.10	CDF of number of outliers per sliding window of size 20 samples	57
3.11	Sliding window example with 4 values tagged as outliers	58
4.1	Proposed superframe collision free organization: we combine Beacon-Only-Period with superframe scheduling	65
4.2	Illustration of the topology constructed by the IEEE 802.15.4– original cluster-tree and cluster-DAG improved version	68
4.3	A cluster-DAG structural property—redundancy: density be- ing low, after the initial increase, a node quickly reaches a max- imum of 2 parents on average	71
4.4	Convergence time: similar performance for all algorithms. The association time grows with the number of nodes since we main- tain the density constant	72
4.5	Greedy and random schemes outperform 802.15.4 BOP in terms of PDR. When too many BOP slots (cf. BOP=7) are at- tributed, the performance drops since not enough time is left for active part of the superframe	73
4.6	Impact of the number of available slots (duty-cycle) on perfor- mance metrics: BO varies while SO=2	74
4.7	Scalability of proposed solutions: greedy slot attribution scheme is least affected by the increase of the number of nodes. After the initial change performance remains almost constantly stable.	76

5.1	An example to illustrate a routing algorithm— min-delay traffic type favors the first available parent regardless to his link quality; deadline makes a compromise between the delay and the energy consumption, while best effort unburdened with delay criterion waits long enough for a parent offering a high quality path.	83
5.2	General comparison of original (unicast) and opportunistic RPL	86
5.3	Comparison of the original (unicast) and opportunistic RPL, <i>deadline</i> traffic	87
5.4	Comparison of original (unicast) and opportunistic RPL, <i>min-delay</i> traffic	88
6.1	Simple network with ideal packet reception (PDR = 100 %) to illustrate capacity and diversity parent selection metric	94
6.2	Example fuzzy membership function: Link can be described as connected, disconnected or belonging to the gray zone where its quality is uncertain to precisely predict.	100
6.3	Fuzzy membership function of four variables: Beacon PDR, capacity, diversity improvement, and inter beacon reception delay	102
6.4	A cluster-DAG topology construction: Average number of children per coordinator	106
6.5	A cluster-DAG topology construction: Average number of parents per node	107
6.6	A cluster-DAG topology construction: <i>Fuzzy</i> minimizes (maximizes) the percentage of coordinators (leaf nodes)	108
6.7	A cluster-DAG topology construction: Association time	109
6.8	Stability of the cluster-DAG structure: the percentage of associated parents that were not afterwards removed with a disassociation process	110
6.9	Energy spent for cluster-DAG topology construction and maintenance. Impact of the maximum allowed number of parents .	111
6.10	Impact of the bootstrap strategy on the cluster-DAG performance	113

List of Tables

3.1	Wireless sensor network testbed parameters used for collecting data used for statistical analysis	47
4.1	Cluster-DAG collision avoidance - default parameters values . .	70
5.1	Specific notation used for the multi-path opportunistic routing algorithm	80
5.2	RPL opportunistic multi-path simulation parameters	85
6.1	A cluster-DAG topology construction: General simulation parameters	104
6.2	A cluster-DAG topology construction: Varied parameters, default marked in bold typeface	105

Bibliography

- [1] IEEE 802.15.4-2006 standard, <http://www.ieee802.org/15/pub/04>. 19, 21, 63, 123
- [2] <http://www.wavenis-osa.org>. 46, 56
- [3] Chipcon CC2420 Datasheet: <http://focus.ti.com/lit/ds/symlink/cc2420.pdf>, Texas Instruments, 2007. 112
- [4] Nazim Abdeddaim and Fabrice Theoleyre. Implementation of a wsn module to simulate the IEEE 802.15.4 beacon-enabled mode in multihop topologies. Research Report 00590853 <http://hal.archives-ouvertes.fr/hal-00590853>, HAL, May 2011. 84, 104
- [5] Thomas Watteyne Abdelmalik Bachir, Mischa Dohler and Kin K. Leung. Mac essentials for wireless sensor networks. *IEEE COMMUNICATIONS SURVEYS and TUTORIALS*, 12(2), 2010. 7
- [6] N. Accettura, L.A. Grieco, G. Boggia, and P. Camarda. Performance analysis of the rpl routing protocol. In *Mechatronics (ICM), 2011 IEEE International Conference on*, pages 767–772, april 2011. 37
- [7] Gahng-Seop Ahn, Se Gi Hong, Emiliano Miluzzo, Andrew T. Campbell, and Francesca Cuomo. Funneling-mac: a localized, sink-oriented mac for boosting fidelity in sensor networks. In *Proceedings of the 4th international conference on Embedded networked sensor systems*, SenSys '06, pages 293–306, New York, NY, USA, 2006. ACM. 15, 92
- [8] Kemal Akkaya and Mohamed Younis. A survey on routing protocols for wireless sensor networks. *Ad Hoc Networks*, 3:325–349, 2005. 28
- [9] Giuseppe Anastasi, Marco Conti, Mario Di Francesco, and Vincenzo Neri. Reliability and energy efficiency in multi-hop ieee 802.15.4/zigbee wireless sensor networks. In *Proceedings of the The IEEE symposium on Computers and Communications*, ISCC '10, pages 336–341, Washington, DC, USA, 2010. IEEE Computer Society. 17
- [10] Constantinos Marios Angelopoulos, Sotiris Nikolettseas, Dimitra Patroump, and Christoforos Raptopoulos. A new random walk for efficient data collection in sensor networks. In *Proceedings of the 9th ACM international symposium on Mobility management and wireless access*, MobiWac '11, pages 53–60, New York, NY, USA, 2011. ACM. 24

-
- [11] Khaled Arisha, Moustafa Youssef, and Mohamed Younis. Energy-aware tdma-based mac for sensor networks. In *System-Level Power Optimization for Wireless Multimedia Communication*, pages 21–40. Springer US, 2002. 12
- [12] Adel Aziz, Alaeddine El Fawal, Jean-Yves Le Boudec, and Patrick Thiran. Aziala-net: Deploying a scalable multi-hop wireless testbed platform for research purposes. In *MobiHoc S3*, New Orleans, USA, May 2009. ACM. 45
- [13] Nouha Baccour, Habib Youssef Anis Koubaa, Denis do Rosario Maissa Ben Jamaa, Mario Alves, and Leandro B. Becker. F-lqe - a fuzzy link quality estimator for wireless sensor networks. *EWSN*, 2010. 99
- [14] G. Barrenetxea, F. Ingelrest, G. Schaefer, M. Vetterli, O. Couach, and M. Parlange. Sensorscope: Out-of-the-box environmental monitoring. In *IPSN*, St. Louis, Missouri, USA, April 2008. IEEE/ACM. 45
- [15] Guillermo Barrenetxea, François Ingelrest, Gunnar Schaefer, and Martin Vetterli. The hitchhiker’s guide to successful wireless sensor network deployments. In *Proceedings of the 6th ACM conference on Embedded network sensor systems*, SenSys ’08, pages 43–56, New York, NY, USA, 2008. ACM. 2, 39
- [16] E. Ben Hamida, G. Chelius, and J-M. Gorce. On the complexity of an accurate and precise performance evaluation of wireless networks using simulations. In *MSWiM*, Vancouver, Canada, 2008. ACM. 104
- [17] Kameswari Chebrolu Bhaskaran Raman. Sensor networks: A critique of “sensor networks” from a systems perspective. *SIGCOMM*, 2008. 2
- [18] A. Brandt, J. Buron, and G. Porcu. Home Automation Routing Requirements in Low-Power and Lossy Networks. RFC 5826 (Informational), April 2010. 4, 32
- [19] Sudeept Bhatnagar Budhaditya Deb and Badri Nath. Reinform: Reliable information forwarding using multiple paths in sensor networks. *Local Computer Networks, LCN*, 2003. 31
- [20] Michael Buettner, Gary V. Yee, Eric Anderson, and Richard Han. X-mac: a short preamble mac protocol for duty-cycled wireless sensor networks. In *Proceedings of the 4th international conference on Embedded networked sensor systems*, SenSys ’06, pages 307–320, New York, NY, USA, 2006. ACM. 14

-
- [21] David Cavin, Yoav Sasson, and Andre Schiper. On the accuracy of manet simulators. In *POMC*, pages 38–43, Toulouse, France, October 2002. ACM. 45
- [22] Matteo Ceriotti, Luca Mottola, Gian Pietro Picco, Amy L. Murphy, Stefan Guna, Michele Corra, Matteo Pozzi, Daniele Zonta, and Paolo Zanon. Monitoring heritage buildings with wireless sensor networks: The torre aquila deployment. In *IPSN*, San Francisco, USA, April 2009. ACM/IEEE. 45
- [23] S. Chatterjea and P.J.M. Havinga. Pushing the frontiers of cross-layer optimization in wireless sensor networks right up to the application layer. In *ISSNIP 2007 : 3rd International Conference on Intelligent Sensors, Sensor Networks and Information Processing*, pages 19–24, 2007. 40, 42
- [24] G. Chelius, A. Fraboulet, and E. Fleury. Wsnnet: a modular event-driven wireless network simulator. <http://www.worldsens.net/>, 2011. 70, 84, 104
- [25] Y. Chen and A. Terzis. On the implications of the log-normal path loss model: an efficient method to deploy and move sensor motes. In *SenSys*, Seattle, Washington, 2011. ACM. 105
- [26] J. Chroboczek. The Babel Routing Protocol. RFC 6126 (Experimental), April 2011. 29, 38
- [27] J. Chroboczek. Babel — a loop-avoiding distance-vector routing protocol, 2012. 38
- [28] T. Clausen, A. Colin de Verdiere, J. Yi, A. Niktash, Y. Igarashi, and U. Herberg. The LLN On-demand Ad hoc Distance-vector Routing Protocol - Next Generation (LOADng). Internet draft, IETF, April 2012. 26
- [29] Thomas Clausen and Ulrich Herberg. A comparative performance study of the routing protocols LOAD and RPL with bi-directional traffic in low-power and lossy networks (LLN). Technical Report No. 7637, INRIA, June 2011. 26
- [30] Thomas Clausen, Ulrich Herberg, and Matthias Philipp. A critical evaluation of the ipv6 routing protocol for low power and lossy networks (rpl). In *Proceedings of the 2011 IEEE 7th International Conference on Wireless and Mobile Computing, Networking and Communications, WIMOB '11*, pages 365–372, Washington, DC, USA, 2011. IEEE Computer Society. 33, 37

-
- [31] Francesca Cuomo, Emanuele Cipollone, and Anna Abbagnale. Performance analysis of ieee 802.15.4 wireless sensor networks: An insight into the topology formation process. *Comput. Netw.*, 53(18):3057–3075, December 2009. 20
- [32] Francesca Cuomo, Sara Della Luna, Petia Todorova, and Tapio Suihko. Topology formation in ieee 802.15.4: Cluster-tree characterization. In *Proceedings of the 2008 Sixth Annual IEEE International Conference on Pervasive Computing and Communications*, PERCOM '08, pages 276–281, Washington, DC, USA, 2008. IEEE Computer Society. 18, 20
- [33] M. Dohler, T. Watteyne, T. Winter, and D. Barthel. Routing Requirements for Urban Low-Power and Lossy Networks. RFC 5548 (Informational), May 2009. 4, 32
- [34] A. Dunkels and J-P Vasseur. IP for Smart Objects, September 2008. IPSO Alliance White Paper 1, available from www.ipso-alliance.org. 1, 4, 40
- [35] Amre El-Hoiydi and Jean-Dominique Decotignie. Low power downlink mac protocols for infrastructure wireless sensor networks. *Mob. Netw. Appl.*, 10(5):675–690, October 2005. 14, 15
- [36] Chang-Gun Lee Emad Felemban and Eylem Ekici. Mmspeed: Multipath multi-speed protocol for qos guarantee of reliability and timeliness in wireless sensor networks. *IEEE TRANSACTIONS ON MOBILE COMPUTING*, 2006. 32
- [37] SONGWU LU FAN YE, GARY ZHONG and LIXIA ZHANG. Gradient broadcast: A robust data delivery protocol for large scale sensor networks. *Springer Wireless Networks*, 11:285–298, 2005. 31
- [38] Xiaoxia Huang · Yuguang Fang. Multiconstrained qos multipath routing in wireless sensor networks. *LLC*, 2007. 31
- [39] Jabed Faruque and Ahmed Helmy. Gradient-based routing in sensor networks. *Mobile Computing and Communications Review*, 2, 2003. 29
- [40] Mario Di Francesco, Giuseppe Anastasi, Marco Conti, Sajal K. Das, and Vincenzo Neri. An adaptive algorithm for dynamic tuning of mac parameters in ieee 802.15.4/zigbee sensor networks. In *PerCom Workshops*, pages 400–405, 2010. 17, 20, 105, 106

- [41] Mario Di Francesco, Giuseppe Anastasi, Marco Conti, Sajal K. Das, and Vincenzo Neri. An adaptive algorithm for dynamic tuning of mac parameters in iee 802.15.4/zigbee sensor networks. In *PerCom Workshops*, pages 400–405, 2010. 17, 18
- [42] Olfa Gaddour, Anis Koubaa, Shafique Chaudhry, Miled Tezeghdanti, and Mohamed Abid. Simulation and Performance Evaluation of DAG Construction with RPL. In *Third International Conference on Communications and Networking (COMNET'2012), Hammamet, Tunisia, 29 Mars, 1 April*, April 2012. 36
- [43] Sachin Gajjar, Shrikant N. Pradhan, and Kankar Dasgupta. Performance analysis of cross layer protocols for wireless sensor networks. In *Proceedings of the International Conference on Advances in Computing, Communications and Informatics, ICACCI '12*, pages 348–354, New York, NY, USA, 2012. ACM. 40
- [44] Deepak Ganesan, Ramesh Govindan, Scott Shenker, and Deborah Estrin. Highly-resilient, energy-efficient multipath routing in wireless sensor networks. *SIGMOBILE Mob. Comput. Commun. Rev.*, 5(4):11–25, October 2001. 31
- [45] C. Gomez and J. Paradells. Wireless home automation networks: A survey of architectures and technologies. *Communications Magazine, IEEE*, 48(6):92–101, june 2010. 4, 15
- [46] C.L. Hedrick. Routing Information Protocol. RFC 1058 (Historic), June 1988. Updated by RFCs 1388, 1723. 38
- [47] Wendi Rabiner Heinzelman, Anantha Chandrakasan, and Hari Balakrishnan. Energy-efficient communication protocol for wireless microsensor networks. In *Proceedings of the 33rd Hawaii International Conference on System Sciences-Volume 8 - Volume 8, HICSS '00*, pages 8020–, Washington, DC, USA, 2000. IEEE Computer Society. 27
- [48] Peter. J. Huber. *Robust Statistics*. Wiley, 2004. 51, 52, 54
- [49] Philipp Hurni, Torsten Braun, Bharat K. Bhargava, and Yu Zhang. Multi-hop cross-layer design in wireless sensor networks: A case study. In *Proceedings of the 2008 IEEE International Conference on Wireless & Mobile Computing, Networking & Communication, WIMOB '08*, pages 291–296, Washington, DC, USA, 2008. IEEE Computer Society. 42, 43

- [50] Jangsub Kim Erchin Serpedin Ill-Keun Rhee, Jaehan Lee and Yik-Chung Wu. Clock synchronization in wireless sensor networks: An overview. *Open Access Sensors*, 9:56–85, 2009. 10, 11
- [51] Srinivas Sampalli Indranil Gupta, Denis Riordan. Cluster-head election using fuzzy logic for wireless sensor networks. *CNSR*, 2005. 100
- [52] F. Ingelrest, N. Mitton, and D. Simplot-Ryl. A turnover based adaptive hello protocol for mobile ad hoc and sensor networks. In *Proceedings of the 2007 15th International Symposium on Modeling, Analysis, and Simulation of Computer and Telecommunication Systems, MASCOTS '07*, pages 9–14, Washington, DC, USA, 2007. IEEE Computer Society. 66
- [53] Chalermek Intanagonwiwat, Ramesh Govindan, Deborah Estrin, John Heidemann, and Fabio Silva. Directed diffusion for wireless sensor networking. *IEEE/ACM Trans. Netw.*, 11(1):2–16, February 2003. 24
- [54] J. P. Vasseur J. Tripathi, J. C. de Oliveira. A performance evaluation study of rpl: Routing protocol for low power and lossy networks. *Conference on Information Sciences and Systems (CISS)*, 2010. 36
- [55] Young jin Kim, Ramesh Govindan, Brad Karp, and Scott Shenker. On the pitfalls of geographic face routing. In *in Proc. of DIALM-POMC*, pages 34–43. ACM Press, 2005. 24
- [56] Young-Ju Han Jong-Myoung Kim, Seon-Ho Park and Tai-Myoung Chung. Chef: Cluster head election mechanism using fuzzy logic in wireless sensor networks. *ICACT*, 2008. 99, 100
- [57] Philo Juang, Hidekazu Oki, Yong Wang, Margaret Martonosi, Li-Shiuan Peh, and Daniel Rubenstein. Energy-efficient computing for wildlife tracking design tradeoffs and early experiences with zebranet. *ACM SIGOPS Operating Systems Review*, pages 96–107, 2002. 39
- [58] G. Montenegro-S. Yoo K. Kim, S. D. Park and N. Kushalnagar. Internet Draft, work in progress - 6LoW- PAN Ad Hoc On-Demand Distance Vector Routing (LOAD), 2007. 26
- [59] K. Kaemarungsi. Distribution of wlan received signal strength indication for indoor location determination. In *ISWPC*, Phuket, Thailand, January 2006. IEEE. 51
- [60] Holger Karl and Andreas Willig. *Protocols and Architectures for Wireless Sensor Networks*. John Wiley & Sons, 2005. 1

- [61] A. Karnik, A. Iyer, and C. Rosenberg. Throughput-optimal configuration of fixed wireless networks. *IEEE/ACM Transactions on Networking*, 16(5):1161–1174, oct. 2008. 95
- [62] H.R. Kermajani and C. Gomez. Route change latency in low-power and lossy wireless networks using rpl and 6lowpan neighbor discovery. In *Computers and Communications (ISCC), 2011 IEEE Symposium on*, pages 937–942, 28 2011-july 1 2011. 36, 68
- [63] Rizwan Ahmed Khan and Shoab A. Khan. Performance evaluation of aodv and dsr for wireless sensor networks. In *Proceedings of the 10th WSEAS international conference on Communications, ICCOM'06*, pages 268–273, Stevens Point, Wisconsin, USA, 2006. World Scientific and Engineering Academy and Society (WSEAS). 27
- [64] Jin Kim and Tae Cho. Routing path generation for reliable transmission in sensor networks using ga with fuzzy logic based fitness function. In *ICCSA, 2007*. 99
- [65] Jeonggil Ko, Joakim Eriksson, Nicolas Tsiftes, Stephen Dawson-Haggerty, Andreas Terzis, Adam Dunkels, and David Culler. ContikiRPL and TinyRPL: Happy Together. In *Proceedings of the workshop on Extending the Internet to Low power and Lossy Networks (IPSN 2011)*, Chicago, IL, USA, April 2011. 84
- [66] Anis Koubâa, André Cunha, Mário Alves, and Eduardo Tovar. TDBS: a Time Division Beacon Scheduling Mechanism for ZigBee Cluster-Tree Wireless Sensor Networks. *Real-Time Systems*, 40(3):321–354, 2008. 21, 63, 64
- [67] Kyoung-Don Kang Krasimira Kapitanova, Sang H. Son. Using fuzzy logic for robust event detection in wireless sensor networks. *Ad Hoc Networks*, 2011. 99
- [68] Sunil Kulkarni, Aravind Iyer, and Catherine Rosenberg. An address-light, integrated mac and routing protocol for wireless sensor networks. *IEEE/ACM Trans. Netw.*, 14(4):793–806, August 2006. 41
- [69] Anukool Lakhina, Konstantina Papagiannaki, Mark Crovella, Christophe Diot, Eric D. Kolaczyk, and Nina Taft. Structural analysis of network traffic flows. In *SIGMETRICS*, pages 61–72, New York, NY, USA, 2004. ACM. 45

- [70] Koen Langendoen and Andreas Meier. Analyzing mac protocols for low data-rate applications. *ACM Trans. Sen. Netw.*, 7(1):10:1–10:34, August 2010. 14
- [71] L.A.Zadeh. The concept of a linguistic variable and its application to approximate reasoning. *Information Sciences*, 8:199–249, 1975. 99
- [72] P. Levis, T. Clausen, J. Hui, O. Gnawali, and J. Ko. The Trickle Algorithm. RFC 6206 (Proposed Standard), March 2011. 36, 66
- [73] Jing Li and G.Y. Lazarou. A bit-map-assisted energy-efficient mac scheme for wireless sensor networks. In *Information Processing in Sensor Networks, 2004. IPSN 2004. Third International Symposium on*, pages 55 – 60, april 2004. 12
- [74] Qingwen Liu, Shengli Zhou, and G. B. Giannakis. Cross-layer combining of adaptive modulation and coding with truncated arq over wireless links. *Trans. Wireless. Comm.*, 3(5):1746–1755, September 2004. 42
- [75] R.P. Liu, Z. Rosberg, I.B. Collings, C. Wilson, A.Y. Dong, and S. Jha. Overcoming radio link asymmetry in wireless sensor networks. In *PIMRC*, pages 1–5. IEEE, 2008. 48
- [76] Yunhao Liu, Yuan He, Mo Li, Jiliang Wang, Kebin Liu, Lufeng Mo, Wei Dong, Zheng Yang, Min Xi, Jizhong Zhao, and Xiang-Yang Li. Does Wireless Sensor Network Scale? A Measurement Study on GreenOrbs. In *INFOCOM, 2011 Proceedings IEEE*, pages 873 –881, april 2011. 117
- [77] Miklós Maróti, Branislav Kusy, Gyula Simon, and Ákos Lédeczi. The flooding time synchronization protocol. In *Proceedings of the 2nd international conference on Embedded networked sensor systems, SenSys '04*, pages 39–49, New York, NY, USA, 2004. ACM. 10
- [78] J. Martocci, P. De Mil, N. Riou, and W. Vermeylen. Building Automation Routing Requirements in Low-Power and Lossy Networks. RFC 5867 (Informational), June 2010. 4, 32
- [79] Fanliang Meng and Yigang Han. A new association scheme of iee 802.15.4 for real-time applications. In *Proceedings of the 5th International Conference on Wireless communications, networking and mobile computing, WiCOM'09*, pages 3432–3436, Piscataway, NJ, USA, 2009. IEEE Press. 19

- [80] M.R. Minhas, S. Gopalakrishnan, and V. Leung. Fuzzy algorithms for maximum lifetime routing in wireless sensor networks. In *GLOBECOM*. IEEE, 2008. 99
- [81] Scott Moeller, Avinash Sridharan, Bhaskar Krishnamachari, and Omprakash Gnawali. Routing without routes: the backpressure collection protocol. In *Proceedings of the 9th ACM/IEEE International Conference on Information Processing in Sensor Networks*, IPSN '10, pages 279–290, New York, NY, USA, 2010. ACM. 25
- [82] G. Montenegro, N. Kushalnagar, J. Hui, and D. Culler. Transmission of IPv6 Packets over IEEE 802.15.4 Networks. RFC 4944 (Proposed Standard), September 2007. Updated by RFC 6282. 22
- [83] Panneer Selvan Muthukumar, Rodolfo de Paz, Rostislav Špinar, and Dirk Pesch. MeshMAC: Enabling Mesh Networking over IEEE802.15.4 through Distributed Beacon Scheduling. In *International Conference on Ad Hoc Networks (AdHocNets)*, Niagara Falls, Ontario, Canada, September 2009. 21, 22, 63, 64
- [84] Brendan O'Flynn, S. Bellis, K. Delaney, J. Barton, S. C. O'Mathuna, Andre Melon Barroso, J. Benson, U. Roedig, and C. Sreenan. The development of a novel miniaturized modular platform for wireless sensor networks. In *Proceedings of the 4th international symposium on Information processing in sensor networks*, IPSN '05, Piscataway, NJ, USA, 2005. IEEE Press. 41
- [85] Kyle Jamieson-David Moss Philip Levis Omprakash Gnawali, Rodrigo Fonseca. Collection tree protocol. *Sensys*, 2009. 29
- [86] Miroslav Pajic and Rahul Mangharam. Anti-jamming for embedded wireless networks. In *Proceedings of the 2009 International Conference on Information Processing in Sensor Networks*, IPSN '09, pages 301–312, Washington, DC, USA, 2009. IEEE Computer Society. 3
- [87] Anita Panwar and Sh. Ashok Kumar. Localization schemes in wireless sensor networks. In *Proceedings of the 2012 Second International Conference on Advanced Computing & Communication Technologies*, ACCT '12, pages 443–449, Washington, DC, USA, 2012. IEEE Computer Society. 24
- [88] Pangun Park, Carlo Fischione, and Karl Henrik Johansson. Adaptive ieee 802.15.4 protocol for energy efficient, reliable and timely communications. In *International Conference on Information Processing in*

- Sensor Networks (IPSN)*, pages 327–338, Stockholm, Sweden, 2010. ACM/IEEE. 17, 18
- [89] Guangyu Pei and C. Chien. Low power tdma in large wireless sensor networks. In *Military Communications Conference, 2001. MILCOM 2001. Communications for Network-Centric Operations: Creating the Information Force. IEEE*, volume 1, pages 347 – 351 vol.1, 2001. 12
- [90] C. Perkins, E. Royer, and S. Das. RFC 3561 Ad hoc On-Demand Distance Vector (AODV) Routing, 2003. 26
- [91] Charles E. Perkins and Pravin Bhagwat. Highly dynamic destination-sequenced distance-vector routing (dsv) for mobile computers. *SIGCOMM Comput. Commun. Rev.*, 24(4):234–244, October 1994. 28, 29
- [92] K. Pister, P. Thubert, S. Dwars, and T. Phinney. Industrial Routing Requirements in Low-Power and Lossy Networks. RFC 5673 (Informational), October 2009. 4, 32
- [93] Kristofer S. J. Pister and Lance Doherty. Tsmpt: Time synchronized mesh protocol. In *In Proceedings of the IASTED International Symposium on Distributed Sensor Networks (DSN08, 2008)*. 12
- [94] Joseph Polastre, Jason Hill, and David Culler. Versatile low power media access for wireless sensor networks. In *Proceedings of the 2nd international conference on Embedded networked sensor systems, SenSys '04*, pages 95–107, New York, NY, USA, 2004. ACM. 14, 15
- [95] Olivier Powell, Aubin Jarry, Pierre Leone, and José D. P. Rolim. Gradient based routing in wireless sensor networks: a mixed strategy. *CoRR*, abs/cs/0511083, 2005. 29
- [96] V. Rajendran, J.J. Garcia-Luna-Aveces, and K. Obraczka. Energy-efficient, application-aware medium access for sensor networks. In *Mobile Adhoc and Sensor Systems Conference, 2005. IEEE International Conference on*, pages 8 pp. –630, nov. 2005. 13
- [97] Bhaskaran Raman, Kameswari Chebrolu, Dattatraya Gokhale, and Sayandeep Sen. On the feasibility of the link abstraction in wireless mesh networks. *IEEE Transactions on Networking*, 17(2):528–541, April 2009. 45
- [98] S. Ramanathan. A unified framework and algorithm for (t/f/c)dma channel assignment in wireless networks. In *Proceedings of the INFOCOM '97. Sixteenth Annual Joint Conference of the IEEE Computer*

- and Communications Societies. Driving the Information Revolution*, INFOCOM '97, pages 900–, Washington, DC, USA, 1997. IEEE Computer Society. 21
- [99] Injong Rhee, Ajit Warrier, Jeongki Min, and Lisong Xu. Drand: distributed randomized tdma scheduling for wireless ad-hoc networks. In *Proceedings of the 7th ACM international symposium on Mobile ad hoc networking and computing*, MobiHoc '06, pages 190–201, New York, NY, USA, 2006. ACM. 12, 13
- [100] R. Riggio, D. Miorandi, I. Chlamtac, N. Scalabrino, E. Gregori, F. Granelli, and Yuguang Fang. Hardware and software solutions for wireless mesh network testbeds. *IEEE Communications Magazine*, 46(6):156–162, June 2008. 45
- [101] Haakon Ringberg, Augustin Soule, Jennifer Rexford, and Christophe Diot. Sensitivity of pca for traffic anomaly detection. *SIGMETRICS Performance Evaluation Review*, 35(1):109–120, 2007. 45
- [102] S. Pollin et al. Performance analysis of slotted carrier sense ieee 802.15.4 medium access layer. *IEEE Transactions on Wireless Communications*, 7(9):3359–3371, September 2008. 94
- [103] Lifeng Sang, Anish Arora, and Hongwei Zhang. On link asymmetry and one-way estimation in wireless sensor networks. *ACM Transactions on Sensor Networks*, 6(2):1–25, February 2010. 49
- [104] C. Schurgers and M.B. Srivastava. Energy efficient routing in wireless sensor networks. In *Military Communications Conference, 2001. MILCOM 2001. Communications for Network-Centric Operations: Creating the Information Force. IEEE*, volume 1, pages 357 – 361 vol.1, 2001. 28
- [105] Tereus Scott, Kui Wu, and Daniel Hoffman. Radio propagation patterns in wireless sensor networks: new experimental results. In *IWCMC*, pages 857–862, Vancouver, British Columbia, Canada, 2006. ACM. 48
- [106] Senslab. Very large scale open wireless sensor network testbed. <http://www.senslab.info/>. 117
- [107] Ricardo Severino, Manish Batsa, Mario Alves, and Anis Koubaa. A traffic differentiation add-on to the ieee 802.15.4 protocol: Implementation and experimental validation over a real-time operating system. In *Proceedings of the 2010 13th Euromicro Conference on Digital System Design: Architectures, Methods and Tools*, DSD '10, pages 501–508, Washington, DC, USA, 2010. IEEE Computer Society. 17

- [108] Philipp Sommer and Roger Wattenhofer. Gradient clock synchronization in wireless sensor networks. In *Proceedings of the 2009 International Conference on Information Processing in Sensor Networks*, IPSN '09, pages 37–48, Washington, DC, USA, 2009. IEEE Computer Society. 10
- [109] K. Srinivasan and P. Levis. RSSI is Under Appreciated. *Proceedings of the Third Workshop on Embedded Networked Sensors*, 2006. 2, 50, 56, 93, 103
- [110] V. Srivastava and M. Motani. Cross-layer design: a survey and the road ahead. *Comm. Mag.*, 43(12):112–119, December 2005. 40, 41
- [111] I. Stojmenovic. Position-based routing in ad hoc networks. *Comm. Mag.*, 40(7):128–134, July 2002. 24
- [112] Mineo Takai, Jay Martin, and Rajive Bagrodia. Effects of wireless physical layer modeling in mobile ad hoc networks. In *MobiHoc*, pages 87–94. ACM, Long Beach, CA, USA, 2001. 2, 8, 11, 40, 45
- [113] Andrew S. Tanenbaum. *Computer Networks (International Edition)*. Prentice Hall, fourth edition, December 2008. 28
- [114] Leandros Tassiulas and Anthony Ephremides. Stability properties of constrained queueing systems and scheduling policies for maximum throughput in multihop radio networks. *IEEE TRANSACTIONSON AUTOMATIC CONTROL*, 31(12):1936–1948, DECEMBER 1992. 25
- [115] Jack Tsai and Tim Moors. A review of multipath routing protocols: From wireless ad hoc to mesh networks. *ACoRN Early Career Researcher Workshop on Wireless Multihop Networking*, 2006. 30
- [116] Tijs van Dam and Koen Langendoen. An adaptive energy-efficient mac protocol for wireless sensor networks. In *Proceedings of the 1st international conference on Embedded networked sensor systems*, SenSys '03, pages 171–180, New York, NY, USA, 2003. ACM. 13
- [117] L. van Hoesel, T. Nieberg, Jian Wu, and P. J.M. Havinga. Prolonging the lifetime of wireless sensor networks by cross-layer interaction. *Wireless Commun.*, 11(6):78–86, December 2004. 40, 43
- [118] L.F.W. van Hoesel, T. Nieberg, H.J. Kip, and P.J.M. Havinga. Advantages of a tdma based, energy-efficient, self-organizing mac protocol for wsns. In *Vehicular Technology Conference, 2004. VTC 2004-Spring. 2004 IEEE 59th*, volume 3, pages 1598 – 1602 Vol.3, may 2004. 11

- [119] B.C. Villaverde, R. De Paz Alberola, S. Rea, and D. Pesch. Experimental Evaluation of Beacon Scheduling Mechanisms for Multihop IEEE 802.15.4 Wireless Sensor Networks. In *International Conference on Sensor Technologies and Applications (SENSORCOMM)*, pages 226–231. IARIA, July 2010. 21
- [120] Mehmet C. Vuran and Ian F. Akyildiz. Xlp: A cross-layer protocol for efficient communication in wireless sensor networks. *IEEE Transactions on Mobile Computing*, 9(11):1578–1591, November 2010. 40
- [121] Gerald Wagenknecht, Markus Anwander, and Torsten Braun. Hop-to-hop reliability in ip-based wireless sensor networks - a cross-layer approach. In *Proceedings of the 7th International Conference on Wired/Wireless Internet Communications, WWIC 2009*, pages 61–72, Berlin, Heidelberg, 2009. Springer-Verlag. 43
- [122] Dorothea Wagner and Roger Wattenhofer. *Algorithms for sensor and ad hoc networks: advanced lectures*. Springer-Verlag, Berlin, Heidelberg, 2007. 25, 27
- [123] Thomas Watteyne, Isabelle Augé-Blum, Mischa Dohler, Stéphane Ubéda, and Dominique Barthel. Centroid virtual coordinates - a novel near-shortest path routing paradigm. *Computer Networks.*, 53(10):1697–1711, 2009. 47
- [124] Thomas Watteyne, David Simplot-Ryl, Isabelle Augé-Blum, and Mischa Dohler. On using virtual coordinates for routing in the context of wireless sensor networks. *PIMRC*, 2007. 46, 59
- [125] WISEBED. Wireless Sensor Network Testbeds. <http://www.wisebed.eu/>. 117
- [126] A.D. Wood, J.A. Stankovic, and Gang Zhou. Deejam: Defeating energy-efficient jamming in ieee 802.15.4-based wireless networks. In *Sensor, Mesh and Ad Hoc Communications and Networks, 2007. SECON '07*, pages 60–69, june 2007. 3
- [127] W. Xie, M. Goyal, H. Hosseini, J. Martocci, Y. Bashir, E. Baccelli, and A. Durresi. A performance analysis of point-to-point routing along a directed acyclic graph in low power and lossy networks. In *Proceedings of the 2010 13th International Conference on Network-Based Information Systems, NBIS '10*, pages 111–116, Washington, DC, USA, 2010. IEEE Computer Society. 37

- [128] R. R. Yager. On ordered weighted averaging aggregation operators in multicriteria decisionmaking. *IEEE Transaction on System, Man and Cybernetics*, vol. 18(no. 1):pp. 183 – 190, 1988. 101
- [129] Fan Ye, Alvin Chen, Songwu Lu, Lixia Zhang, and Fan Ye Alvin Chen. A scalable solution to minimum cost forwarding in large sensor networks. pages 304–309, 2001. 29
- [130] Wei Ye, John Heidemann, and Deborah Estrin. An energy-efficient mac protocol for wireless sensor networks. In *Proceedings 21st International Annual Joint Conference of the IEEE Computer and Communications Societies*, New York, New York, USA, 2002. 13
- [131] Jennifer Yick, Biswanath Mukherjee, and Dipak Ghosal. Wireless sensor network survey. *Comput. Netw.*, 52(12):2292–2330, August 2008. 8
- [132] Hongseok Yoo, Moonjoo Shim, Dongkyun Kim, and Kyu Hyung Kim. Global: A gradient-based routing protocol for load-balancing in large-scale wireless sensor networks with multiple sinks. In *Proceedings of the The IEEE symposium on Computers and Communications, ISCC '10*, pages 556–562, Washington, DC, USA, 2010. IEEE Computer Society. 29
- [133] Habib Youssef, Sadiq M. Sait, and Salman A. Khan. Fuzzy evolutionary hybrid metaheuristic for network topology design. In *EMO*, 2001. 101
- [134] L.A. Zadeh. Fuzzy sets. *Information and Control*, vol. 8:p. 338–353, 1965. 99, 100
- [135] Wenjie Zeng, Anish Arora, and Ness Shroff. Maximizing energy efficiency for convergecast via joint duty cycle and route optimization. In *Proceedings of the 29th conference on Information communications, INFOCOM'10*, pages 16–20, Piscataway, NJ, USA, 2010. IEEE Press. 41
- [136] Jianliang Zheng and M.J. Lee. Will iee 802.15.4 make ubiquitous networking a reality?: a discussion on a potential low power, low bit rate standard. *Communications Magazine, IEEE*, 42(6):140 – 146, june 2004. 4, 15
- [137] C. Zhou and Bhaskar Krishnamachari. Localized topology generation mechanisms for wireless sensor networks. In *Global Telecommunications Conference (GLOBECOM)*, San Francisco, USA, December 2003. IEEE. 29

