



HAL
open science

Rôles des NADPH oxydases lors de pathologies humaines à l'aide de modèles murins transgéniques

Christine Deffert, Bernard Lardy, Françoise Morel

► **To cite this version:**

Christine Deffert, Bernard Lardy, Françoise Morel. Rôles des NADPH oxydases lors de pathologies humaines à l'aide de modèles murins transgéniques. Biologie cellulaire. Université de Grenoble, 2009. Français. NNT: . tel-00862905

HAL Id: tel-00862905

<https://theses.hal.science/tel-00862905>

Submitted on 17 Sep 2013

HAL is a multi-disciplinary open access archive for the deposit and dissemination of scientific research documents, whether they are published or not. The documents may come from teaching and research institutions in France or abroad, or from public or private research centers.

L'archive ouverte pluridisciplinaire **HAL**, est destinée au dépôt et à la diffusion de documents scientifiques de niveau recherche, publiés ou non, émanant des établissements d'enseignement et de recherche français ou étrangers, des laboratoires publics ou privés.

UNIVERSITE JOSEPH FOURIER - GRENOBLE 1

Ecole Doctorale Chimie et Sciences du Vivant

THESE

pour obtenir le grade de

Docteur de l'Université Joseph Fourier - Grenoble 1

Discipline : Biologie cellulaire

Présentée et soutenue publiquement par

Christine DEFFERT DELBOUILLE

Le 16 Décembre 2009

Modèles murins déficients en NOX1 ou NOX2 : Applications physiopathologiques

Composition du jury :

Président : Professeur Jacques DEMONGEOT

Rapporteurs : Docteur Corinne DUPUY
Professeur Christian DROUET

Examineur : Docteur Michela SCHÄPPI

Directeurs de thèse : Professeur Françoise MOREL
Professeur Karl-Heinz KRAUSE

Thèse préparée au sein du laboratoire du Pr. KRAUSE (Département de Pathologie et Immunologie, Centre Médical Universitaire de Genève, Suisse) et du Groupe de Recherche et d'Etude du Processus Inflammatoire (Laboratoire TIMC-Imag UMR CNRS 5525-CHU Grenoble, France)

Résumé

Les espèces réactives de l'oxygène ou ROS sont des molécules dérivées de l'oxygène produites « de manière professionnelle » par les NADPH oxydases (NOX). Ces enzymes utilisent l'oxygène comme accepteur d'électrons afin de les transférer à travers les membranes. Le produit de cette réaction est l'anion superoxyde et ses dérivés : les espèces réactives de l'oxygène (ROS). La famille des NADPH oxydases est composée chez l'Homme de 7 membres : NOX1 à NOX5, DUOX1 et DUOX2. Bien que les structures des différentes isoformes des NOX soient très homologues, leurs mécanismes d'activation et leurs distributions tissulaires, cellulaires et subcellulaires et en conséquence, leurs fonctions physiologiques sont très différents. Leurs rôles physiologiques mais aussi pathologiques ont été très souvent déterminés à l'aide de modèles murins transgéniques.

Le travail présenté dans cette thèse a eu pour but de déterminer deux nouveaux rôles de NOX1 dans des pathologies humaines : l'hypertension artérielle et le syndrome de détresse respiratoire. Dans un second temps, nous avons également évalué le rôle anti-inflammatoire de NOX2 en utilisant comme modèle des souris déficientes en Nox2.

NOX1 a été impliqué dans l'hypertension artérielle induite par l'angiotensine II. Dans cette étude, il a été démontré que les ROS générés par NOX1 sont impliqués dans la formation des anévrismes aortiques induits par l'angiotensine II. Alors que l'activation de NOX1 par l'angiotensine II via son récepteur AT1 est un phénomène bien connu, nous avons démontré que NOX1 est capable également de réguler la présence du récepteur AT1 à la membrane plasmique.

Les poumons soumis à des conditions d'hyperoxie vont être exposés à des concentrations importantes de ROS favorisant et exacerbant les lésions pulmonaires. Lors de cette étude, nous avons démontré à l'aide de souris déficientes en Nox1 que cette NADPH oxydase uniquement est impliquée dans la génération des ROS induite par l'hyperoxie.

La maladie granulomateuse septique ou CGD est un syndrome d'immunodéficience dû à la présence de mutations au niveau du gène codant pour NOX2. Associées aux infections, des réactions inflammatoires exacerbées sont observées chez les patients CGD et ont un impact sur la morbidité. Dans cette étude, nous avons déterminé qu'une des origines possibles de l'inflammation en l'absence de NOX2 est le β -glycan. Cette hyperinflammation observée dans un modèle inflammatoire cutané chez les souris déficientes en Nox2 est associée à de fortes quantités de TNF α , l'augmentation de cette cytokine pro-inflammatoire n'est pas le principal médiateur des lésions inflammatoires induites par les β -glycans et l'absence de Nox2. Le traitement des patients CGD par des bloqueurs du TNF α ne semblent donc pas recommandés. D'un autre côté, il semble que les molécules capables de bloquer les effets des β -glycans sont à considérer comme des cibles potentielles pour la recherche de molécules anti-inflammatoires spécifiques et le développement de nouvelles stratégies thérapeutiques et préventives pour les patients CGD.

Mots-Clés : NOX1, NOX2, Hypertension artérielle, Poumons et Inflammation.

Résumé en anglais

Reactive oxygen species (ROS) are molecules derived from oxygen. They are generated by professional NADPH oxidases (NOX). The NOX family is proteins that transfer electrons across biological membranes. In general, the electron acceptor is oxygen and the product of the electron transfer reaction is superoxide. Seven NOXs protein has been described and all of them generate or ROS. Despite their similar structure and enzymatic function, NOX family enzymes differ in their mechanism of activation, their tissue, cellular and subcellular localizations and in consequence their physiological functions. Physiological and pathological roles of NOX enzymes are usually discovered in transgenic mouse models.

The goal of this thesis was to determine two new roles of NOX1 in human diseases: Hypertension and respiratory distress syndrome using Nox1-deficient mice. Secondly, we have evaluated the anti-inflammatory role of NOX2 using Nox2-deficient mice.

NOX1 has been involved in angiotensin II-induced hypertension. In this study, it has been demonstrated that NOX1-generated ROS have also implicated in angiotensin II-induced aneurysms. They can regulate the metallo-protease activity and fibrosis. NOX1 is activated by angiotensin II receptor (AT1) engagement. We have demonstrated that NOX1 also regulates the AT1 expression to the plasma membrane. NOX1 seems to be a possible therapeutical target in hypertension and aneurysm formation.

The respiratory distress syndrome especially in premature babies is characterized by immature lung development. During respiratory distress syndrome treatment with mechanical ventilation and high oxygen concentration, the lungs are exposed to increased oxidative stress leading to pulmonary injury. During this study, we have demonstrated that Nox1 but not Nox2 participates to hyperoxie-induced lung injury. In Nox1-deficient mice, decreased ROS generation reduce cell death in alveolar epithelial and endothelial cells. NOX1 seems also to be a possible therapeutical target in respiratory distress syndrome.

Chronic granulomatous disease (CGD) is an immunodeficiency syndrome due to mutations in gene $gp91^{phox}$ coding for NOX2 protein. In consequence, CGD patients suffer from severe and recurrent infections. Indeed, they present hyperinflammatory response which plays a role in the morbidity of the disease. During this study, we have demonstrated that a possible stimulus of this CGD inflammatory complication is the β -glucans, in Nox2-deficient mice. These glucose polymers induce inflammation that cannot be resolved in absence of NOX2. Also, CGD hyperinflammation is characterized by important TNF α production. But the blockage of TNF α has not dampened CGD hyperinflammation. In the other hand, the blockage of the principal β -glucans receptor, dectin-1 pharmacologically or genetically, has reduced significantly CGD hyperinflammation. These data constitute new therapeutical target in CGD inflammatory syndrome.

Key-words :NOX1, NOX2, Hypertension, Lung, Inflammation.

Remerciements

Je remercie tous les membres de mon jury de thèse –

Merci au **Professeur Jacques Demongeot** d’avoir accepté la présidence de ce jury

Merci au **Docteur Corinne Dupuy** et au **Professeur Christian Drouet** d’avoir accepté d’être les rapporteurs de ce travail

Merci au **Docteur Michela Schäppi** d’avoir accepté de juger ce travail

Un grand merci à mes directeurs de thèse :

Professeur Françoise Morel pour son chaleureux accueil, son soutien et ses conseils durant toute cette thèse. J’espère que cette collaboration franco-suisse sera toujours aussi enrichissante.

Professeur Karl-Heinz Krause pour m’avoir permis d’effectuer cette thèse dans son laboratoire et pour son enthousiasme et ses immenses compétences.

Mes remerciements vont également à tous ceux qui ont jalonné cette aventure :

Laurence Fiette qui par ses immenses compétences nous a appris énormément et a participé activement au début de l'expérience.

Annelise Wohlwend, Danielle Ben Nasr et Marie Ebrahim Malek pour leurs compétences et leurs gentilleses.

Mylène Docquier, Didier Cholet, Céline Delucinge et Patrick Descombes pour leurs compétences et leurs gentilleses.

Les animaliers de la zootechnie du CMU qui ont permis que tout cela soit possible.

Huiping Yuan et Olivier Plastre pour leur aide technique et amicale.

Olivier Basset pour m'avoir permis de faire encore un peu partie de l'expérience « NOX1 et vasculaire ».

Les autres membres du laboratoire du Professeur Krause présents et passés : Karen Bedard, Li Bin, Jérôme Bonnefont, Aurélie Caillon, Graziella Chakroun-Martinello, Michel Dubois-Dauphin, Laeticia Fioraso-Cartier, Chantal Genet, Hélène Gfeller-Tillmann, Angelo Gradia, Cécile Guichard, Térése Laforge, Vincent Jaquet, Stéphanie Julien, Yannick Martinez, Laura Ndompetelo, Olivier Preynat-Seauve, Stefania Schiavone,, Lena Serrander, Silvia Sorce, Michaël Stouffs, Diderik Tirefort, Laura Trigui.

Un remerciement spécial pour :

Gaëtan Gavazzi, Bernard Lardy et Stéphanie Carnesecchi-Acker. Ils ont d'abord été mes collègues, ils sont devenus des amis très chers. Je les remercie de leur soutien, de leur enthousiasme et de leurs amitiés.

Remerciements

Michela Tempia-Caliera pour son soutien immuable, son sourire en toute circonstance. Que notre duo continue.

Et puis les inconnus de la science mais chers à mon cœur : **Alexandra, Annie, Nathalie, Nelly, Océane, Malaury, Frédéric, Laurent et Michel.**

Et puis si tout ceci a un sens, c'est pour eux :

MANON et EMMANUEL

Mes parents

TABLE DES MATIERES

TABLE DES MATIERES	9
TABLE DES FIGURES ET TABLEAUX	13
LISTE DES ABREVIATIONS	15

PREMIERE PARTIE= INTRODUCTION BIBLIOGRAPHIQUE	17-77
--	--------------

A. Les espèces réactives de l'oxygène ou ROS	19
---	-----------

B. Les sources de génération de ROS	21
--	-----------

C. Les NADPH oxydases	21
------------------------------	-----------

I. Structure	22
---------------------	-----------

II. Génération de ROS par les NADPH oxydases	23
---	-----------

II.1 par la NADPH oxydase des phagocytes	24
--	-----------

II.2 par les homologues de NADPH oxydase des phagocytes	26
---	-----------

2.1 NOX1	26
----------	-----------

2.2 NOX3	27
----------	-----------

2.3 NOX4	28
----------	-----------

2.4 NOX5 et DUOX1/2	29
---------------------	-----------

III. Fonctions communes des NADPH oxydase	30
--	-----------

IV. Localisation des NADPH oxydases	32
--	-----------

IV.1 Localisation tissulaire	32
------------------------------	-----------

IV.2 Localisation cellulaire et subcellulaire	33
---	-----------

V. Régulation des NADPH oxydases et de la production des ROS	33
---	-----------

V.1 Par les systèmes antioxydants	33
V.2 Par les sous-unités cytosoliques régulatrices	37
V.3 Par la sous-unité membranaire p22 ^{phox}	37
V.4 Régulation transcriptionnelle	38
4.1 par des stimuli	38
4.2 par des variants d'épissage alternatif	40
V.5 Régulation post-traductionnelle	40
V.6 Par les microARNs	40
V.7 Par les récepteurs PRRs	41
7.1 Les récepteurs Toll (TLRs)	42
7.2 Le récepteur dectine-1	42
V.8 Par compartimentalisation	45
VI. Comparaison des NADPH oxydases chez l'Homme et la souris	47
VI.1 Comparaison des séquences au niveau des ARN messagers et des protéines	47
VI.2 Au niveau de la localisation tissulaire	47
VII. Fonctions physiologiques et pathologiques liés à NOX1	49
VII.1 Dans le système vasculaire	50
1.1 Rôle dans la régulation de la pression artérielle	51
1.2 Rôle dans le remodelage vasculaire	56
1.3 Rôle dans l'angiogénèse	56
VII.2 Dans le système pulmonaire	57
2.1 Rôles physiologiques	58
2.2 Rôles pathologiques	59
VIII. Fonctions physiologiques et pathologiques liés à NOX2	60

VIII.1 Rôles physiologiques dans le système immunitaire	60
1.1 Rôles dans les polynucléaires neutrophiles	61
1.2 Rôles dans les macrophages	64
1.3 Rôles dans les cellules dendritiques	66
1.4 Rôles dans les lymphocytes B	67
VIII.2 Rôles pathologiques dans la maladie granulomateuse septique	67
D. Modèles murins d'étude du rôle des NADPH oxydases	72
I. Souris déficientes en Nox1	72
II. Souris déficientes en Nox2	73
III. Autres modèles de rongeurs de la CGD	76
DEUXIEME PARTIE = TRAVAUX DE RECHERCHE	77-196
A. Introduction et buts des travaux de recherche	79
B. Rôles de NOX1 dans la régulation de la pression artérielle	81
I. Article 1 L'absence de NOX1 protège des dissections aortiques induites par l'angiotensine II (<i>Hypertension</i> 2007. 50:189-196).	82
II. Article 2 L'absence de NOX1 altère la phosphorylation de la cavéoline et la localisation du récepteur de l'angiotensine II dans les cellules musculaires lisses (<i>Antioxid Redox Signal.</i> 2009. 11:2371-2384).	95

C. Implications de NOX1 dans les lésions tissulaires pulmonaires induites par l'hyperoxie **111**

III. Article 3 NOX1 joue un rôle crucial dans les lésions pulmonaires aiguës induites par l'hyperoxie (*Am J Respir Crit Care Med.* 2009. 180:972-981) **112**

D. Maladie granulomateuse septique et inflammation **123**

IV. Article 4 Les β -glycans branchés d'origine fongique induisent une hyperinflammation et une nécrose chez les souris déficientes en NADPH oxydase du phagocyte (*J Pathol.* 2008. 214:434-444). **125**

V. Article 5 L'hyperinflammation observée dans la maladie granulomateuse septique en réponse aux β -glycans est dépendante du récepteur dectine-1 mais pas du TNF α (En soumission) **139**

E. Discussion générale et perspectives **177**

REFERENCES BIBLIOGRAPHIQUES	197-222
------------------------------------	----------------

ANNEXE	223
---------------	------------

FIGURES

Figure 1. Formation des dérivés réactifs de l'oxygène	20
Figure 2. Structure proposée des NADPH oxydases	23
Figure 3. Modèle d'activation de NOX2	25
Figure 4. Topologie et activation des différentes isoformes des NADPH oxydases	30
Figure 5. Localisations tissulaires des NADPH oxydases chez l'homme	34
Figure 6. Systèmes antioxydants	36
Figure 7. Le récepteur dectine-1 et sa signalisation	45
Figure 8. Localisations des NADPH oxydases au niveau de la paroi vasculaire	50
Figure 9. Voies de synthèse et effets physiopathologiques de l'angiotensine II dus à la stimulation de ses récepteurs AT ₁ et AT ₂	52
Figure 10. Rôles possibles des ROS dans la contraction des cellules musculaires lisses induite par l'angiotensine II	55
Figure 11. Expressions cellulaires des NADPH oxydases dans le système respiratoire	58
Figure 12. Production de ROS par les cellules du système immunitaire	60
Figure 13. Mécanismes microbicides de la NADPH oxydase phagocytaire	63
Figure 14. Rôles possibles des ROS dans la synapse immunologique	65
Figure 15. Construction de la souris déficiente en Nox1	72
Figure 16. Génotypage des souris déficientes en Nox1	73
Figure 17. Construction de la souris déficiente en Nox2	74
Figure 18. Génotypage de la souris déficiente en Nox2	75

TABLEAUX

Tableau I. Localisations cellulaires et subcellulaires des NADPH oxydases chez l'Homme	35
Tableau II. Régulation des NADPH oxydases par différents stimuli	39
Tableau III. Localisations cellulaires et ligands des récepteurs Toll-like	43
Tableau IV. Relation entre les récepteurs Toll-like et les NADPH oxydases	44
Tableau V. Comparaison des séquences codantes des ARN des NADPH oxydases chez l'Homme et la souris	48
Tableau VI. Comparaison des séquences protéiques des NADPH oxydases chez l'Homme et la souris	48
Tableau VII. Syndromes inflammatoires développés par les patients CGD et les souris déficientes en Nox2 (CGD)	69

LISTE DES ABREVIATIONS

AA	Acide arachidonique
AP-1	Activator protein 1
ARNm	Acide ribonucléique messenger
AT1/2	Récepteur de l'angiotensine II de type 1 ou 2
CARD9	caspase recrutement domain protein 9
CD	Cluster de différenciation
CGD	Chronic Granulomatous Disease (Maladie Granulomateuse Septique)
DAG	Diacylglycérol
DD	Dead Domain
DPI	Diphényliodonium
DUOX	Dual oxidase
DUOXA	Dual oxidase activator
FAD	Flavine adénine dinucléotide
fMLP	N-formyl-methionyl-leucyl-phenylalanine
GM-CSF	Granulocyte Monocyte- Colony Stimulating Factor
GSH/GSSG	Glutathion réduit/oxydé
GTP	Guanosine triphosphate
HEK	Cellules humaines rénales d'embryon
HIF	Hypoxia Inducible Factor
HL-60	Human leukemia (lignée cellulaire de promyélocytes)
H ₂ O ₂	Peroxyde d'hydrogène
IL-	Interleukine
ITAM	I mmunoreceptor T yrosine-based A ctivation M otif
LPS	Lipopolysaccharide
LRR	Leucin-Rich Repeats

LTA	Lipotechoic acid (acide lipotechoïque)
MLE-12	lignée humaine de cellules épithéliales pulmonaires
MMP	Métalloprotéase matricielle
MPO	Myéloperoxydase
MRP	Myeloid related protein
NADPH	Nicotinamide Adénosine Dinucléotide Phosphate
NCF1	Neutrophil cytosolic factor 1
NETs	Neutrophil Extracellular Traps (pièges extracellulaires des neutrophiles)
NF-κB	Nuclear factor kappa B
NO	Oxyde nitrique
NOX	NADPH oxydase humaine
Nox	NADPH oxydase murine
NOXA1	NADPH oxidase Activator
NOXO1	NADPH oxidase Organizer
O ₂ ⁻	Anion superoxyde
PAMP	Pathogen associated molecular pattern
PCR	Polymerase Chain reaction
Phox	Phagocyte oxydase
PK	Protéine kinase
PLC	Phospholipase C
PMA	4β-Phorbol 12-myristate 13-acétate
Poldip2	Polymerase delta-interacting protein 2
PRR	Pattern Recognition Receptor
PTP	protéines tyrosine phosphatases
Ra2	Lignée murine microgliale
ROS	Reactive oxygen species (espèces réactives de l'oxygène)
SOD	Superoxyde dismutase

Src	Sarcoma
Syk	spleen tyrosine kinase
TCR	T cell receptor (récepteur des lymphocytes T)
TIR	Toll-interleukine 1 receptor
Tks	T yrosine k inase s ubstrat with SH3 domains
TLR	Toll-like receptor
TNF α	Tumor necrosis factor α
ZAP-70	Zeta-chain-associated protein kinase 70

PREMIERE PARTIE :
INTRODUCTION BIBLIOGRAPHIQUE

A. Les espèces réactives de l'oxygène ou ROS

Les espèces réactives de l'oxygène ou ROS (**R**eactive **O**xygen **S**pecies) sont de petites molécules dérivées de l'oxygène comprenant des radicaux oxygénés : les anions superoxydes ($O_2^{\cdot-}$), les radicaux hydroxyles (OH^{\cdot}), hydroperoxydes (HOO^{\cdot}), peroxydes (RO_2^{\cdot}) et alkoxydes (RO^{\cdot}) mais également des composés non radicalaires comme l'acide hypochlorique (HOCl), l'ozone (O_3), l'oxygène singulet (1O_2) et le peroxyde d'hydrogène (H_2O_2) (Genestra 2007). Ces ROS sont générées à partir de transfert d'électrons entre les molécules selon un mécanisme de réactions en cascade, enzymatiques ou non.

L'anion superoxyde ($O_2^{\cdot-}$) est généré à partir de l'oxygène selon des sources variables. Deux molécules d' $O_2^{\cdot-}$ peuvent réagir pour produire du peroxyde d'hydrogène (H_2O_2) par une réaction de dismutation spontanée (en particulier à pH acide) ou catalysée par le superoxyde dismutase (SOD). En présence de fer, $O_2^{\cdot-}$ et H_2O_2 réagissent pour générer des radicaux hydroxyles (OH^{\cdot}).

Dans les zones inflammatoires au sein du neutrophile, la myéloperoxydase (MPO) catalyse la formation d'acide hypochlorique (HOCl) à partir d' H_2O_2 et d'ions chlorures (Cl^-).

L'oxygène singulet (1O_2) peut être formé, en cas d'inflammation, en présence d'oxygène et de MPO, cette dernière catalyse l'oxydation d'ions halogénés mais également à partir d'acide hypochlorique et d'ions superoxydes. Au contact de molécules d'anticorps, l'oxygène singulet donne naissance à l'ozone (O_3).

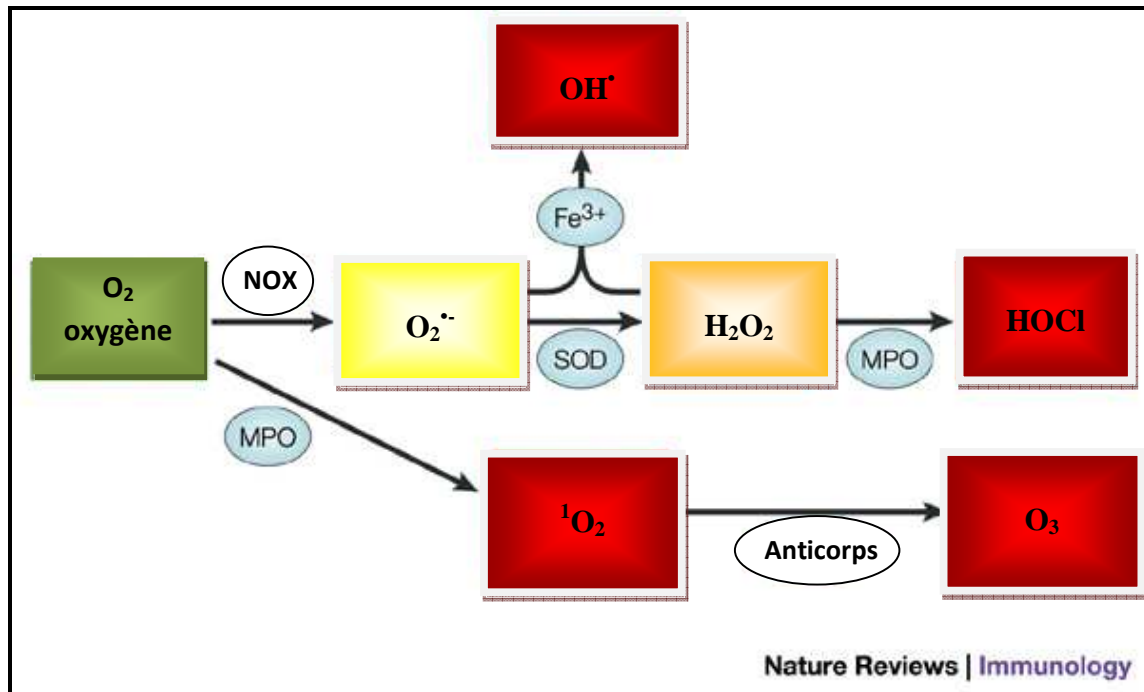

Figure 1. Formation des dérivés réactifs de l'oxygène. Les couleurs des boîtes varient en fonction de la réactivité des molécules ; les boîtes vertes: relativement non réactive, jaune : réactivité limitée, orange : réactivité modérée et rouge : forte réactivité et non spécifique. $O_2^{\cdot-}$: anions superoxydes, OH^{\cdot} : radical hydroxyle, $HOCl$: acide hypochlorique, O_3 : ozone, 1O_2 : oxygène singulet, H_2O_2 : peroxyde d'hydrogène, MPO : myélopéroxydase. D'après Lambeth 2004.

La réactivité de ces molécules dérivées de l'oxygène diffère énormément :

- ✓ Les anions superoxydes ont une réactivité limitée et peuvent être oxydants ou réducteurs en fonction de la molécule avec laquelle ils vont réagir. Cette molécule est très instable, ne diffuse pas à travers les membranes et se dismute rapidement en peroxyde d'hydrogène entraînant un nombre limité de molécules cibles.

✓ Sous l'action de la MPO ou d'anticorps, ces molécules de réactivité modérée vont générer des molécules hautement oxydantes (HOCl, O₃ et ¹O₂) envers de nombreuses molécules comme les lipides, les protéines et les acides nucléiques.

B. Les sources de génération des ROS

Les ROS dans les cellules mammifères sont essentiellement des sous-produits générés de manière fortuite par la chaîne respiratoire mitochondriale, la lipoxigénase, la gamma glutamyl transférase, le cytochrome *P*-450, et la xanthine oxydoréductase ou par le fonctionnement détourné de certaines enzymes comme la NO synthase. La NADPH oxydase phagocytaire a été le premier exemple d'enzymes ayant pour fonction primaire et unique de générer des ROS. Cette caractéristique a été confirmée pour les autres membres de la famille des NADPH oxydases.

C. Les NADPH oxydases

Le prototype de la famille des NADPH oxydases est l'enzyme gp91^{phox}, identifié au niveau des cellules phagocytaires. Puis, 3 groupes ont découvert que la production des ROS n'était pas exclusivement phagocytaire. Ils ont alors identifié le premier homologue de la gp91^{phox}, nommé Mox1 (**mitogenic oxidase 1**) par (Suh, Arnold et al. 1999), NOH-1 (**NADPH Oxidase Homolog-1**) par (Banfi, A et al. 2000) et gp-91-2 par (Kikuchi, Hikage et al. 2000). Dans la nouvelle nomenclature, les NADPH oxydases sont regroupées sous le terme NOX où la NADPH phagocytaire gp91^{phox} devient NOX2 et Mox1, NOH-1 et gp-91-2 deviennent NOX1. L'identification de NOX1 a été rapidement suivie par le clonage de nouveaux homologues :

NOX3 (Kikuchi, Hikage et al. 2000), NOX4 (Geiszt, Kopp et al. 2000) et NOX5 (Banfi, Molnar et al. 2001). En parallèle, 2 nouveaux membres nommés DUOX1 et DUOX2 (**DU**al **OX**idase) (Dupuy, Ohayon et al. 1999; De Deken, Wang et al. 2000) ont été identifiés au niveau de la thyroïde.

A ce jour, la famille des NADPH oxydases comprend 7 membres chez l'Homme : NOX1 à NOX5, DUOX1 et DUOX2.

I. Structure

Les NADPH oxydases sont des protéines transmembranaires dont la structure est bien conservée entre les différents membres de la famille (de 39% à 60% d'homologie par rapport à NOX2). Ces protéines débutent par une partie C-terminale cytosolique contenant les sites de fixation hautement conservés du FAD (**F**lavine **a**dénine **d**inucléotide) et du NADPH (**N**icotinamide **a**dénine **d**inucléotide **p**hosphate), suivi de 6 hélices transmembranaires. La 3^{ème} et 5^{ème} hélices transmembranaires contiennent respectivement 2 résidus histidine reliant 2 hèmes.

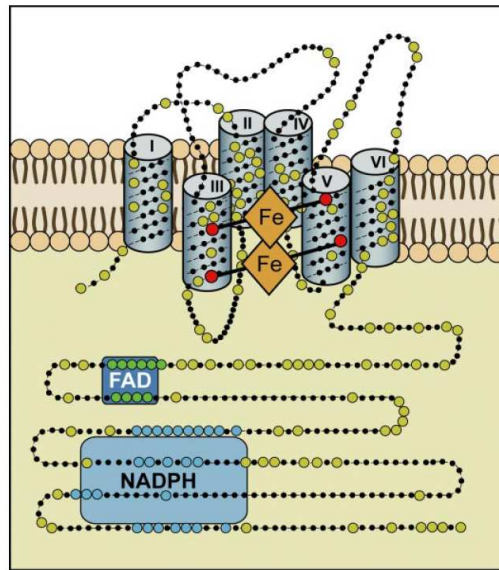

Figure 2. Structure proposée des NADPH oxydases. Les 6 domaines transmembranaires sont numérotés de I à VI. Les domaines transmembranaires III et V contiennent chacun 2 résidus histidine (points rouges) coordonnant les 2 domaines hèmes (Fe). Le domaine C-terminal cytoplasmique comprend 2 motifs (points verts foncés) de fixation pour le FAD et 4 motifs de fixation (points bleus) pour une molécule de NADPH (Bedard and Krause 2007).

En plus, de cette structure commune à NOX1-4, NOX5 possède une longue partie N-terminale intracellulaire contenant un EF-hand domaine capable de fixer le Ca^{2+} . DUOX1 et DUOX2 présentent également une longue partie N-terminale intracellulaire contenant un EF-hand domaine capable de fixer le Ca^{2+} , ainsi qu'un domaine transmembranaire additionnel puis un domaine *peroxydase-like* extracellulaire.

II. Génération des ROS par les NADPH oxydases

Bien que leur structure soit très proche, chaque membre de la famille des NADPH oxydases présente des particularités pour produire les ROS.

II.1 Par la NADPH des phagocytes

La NADPH phagocytaire ou NOX2 est un complexe multimérique constitué au repos de protéines membranaires (gp91^{phox} et p22^{phox}, formant le cytochrome *b₅₅₈*) et de protéines cytosoliques (p40^{phox}, p47^{phox}, p67^{phox} et une petite protéine G de type Rac2). La désignation « phox » accompagnant chaque composant de l'oxydase correspond à « **phagocyte oxidase** ». L'activation de la NADPH oxydase met en jeu différentes voies de signalisation aboutissant à la phosphorylation des sous-unités cytosoliques p47^{phox} et p67^{phox} et conduit à un regroupement de manière coordonnée des différents composants à la membrane des granulations et à la membrane plasmique des phagocytes. Cette activation n'est pas constitutive mais inductible sous l'effet d'une stimulation extracellulaire. La fixation d'une bactérie opsonisée ou d'un élément soluble tel que le N-formyl-méthionyl-leucyl-phenylalanine (fMLP) sur leur récepteur de surface couplé à une protéine G, sont les événements principaux qui permettent l'activation de la cascade spécifique de la protéine G α . La phospholipase C (PLC) membranaire clive le phosphatidyl inositol 4-5 diphosphate (PIP₂) en diacylglycérol (DAG) et en inositol triphosphate (IP₃). Ces deux seconds messagers agissent à leur tour comme des effecteurs : L'IP₃ formé induit le relargage du Ca²⁺ des vésicules de stockage, et le Ca²⁺ libéré facilite la migration de la protéine kinase C (PKC) cytosolique à la membrane plasmique où le DAG peut l'activer. La phospholipase D (PLD) membranaire, qui déphosphoryle l'acide phosphatidique (PA) produit aussi du DAG qui entretient la réaction d'activation de la PKC. *In vitro*, les esters de phorbol tel que le phorbol myristate acétate (PMA) peuvent activer directement la PKC. Cette enzyme activée va permettre la phosphorylation du facteur cytosolique de l'oxydase p47^{phox} provoquant la

translocation à la membrane des sous-unités cytosoliques. La PKC active également la phospholipase A2 (PLA2) catalysant la formation d'acide arachidonique (AA) à partir des phospholipides membranaires. En parallèle, la protéine Rac migre à la membrane de manière indépendante et participe à l'activation de la NADPH oxydase. La liaison de la sous-unité p67^{phox} avec le cytochrome *b*₅₅₈ induit la transition d'une conformation inactive à active de ce dernier, permettant ainsi le transfert d'électrons à travers les hèmes et la formation d'anions superoxydes.

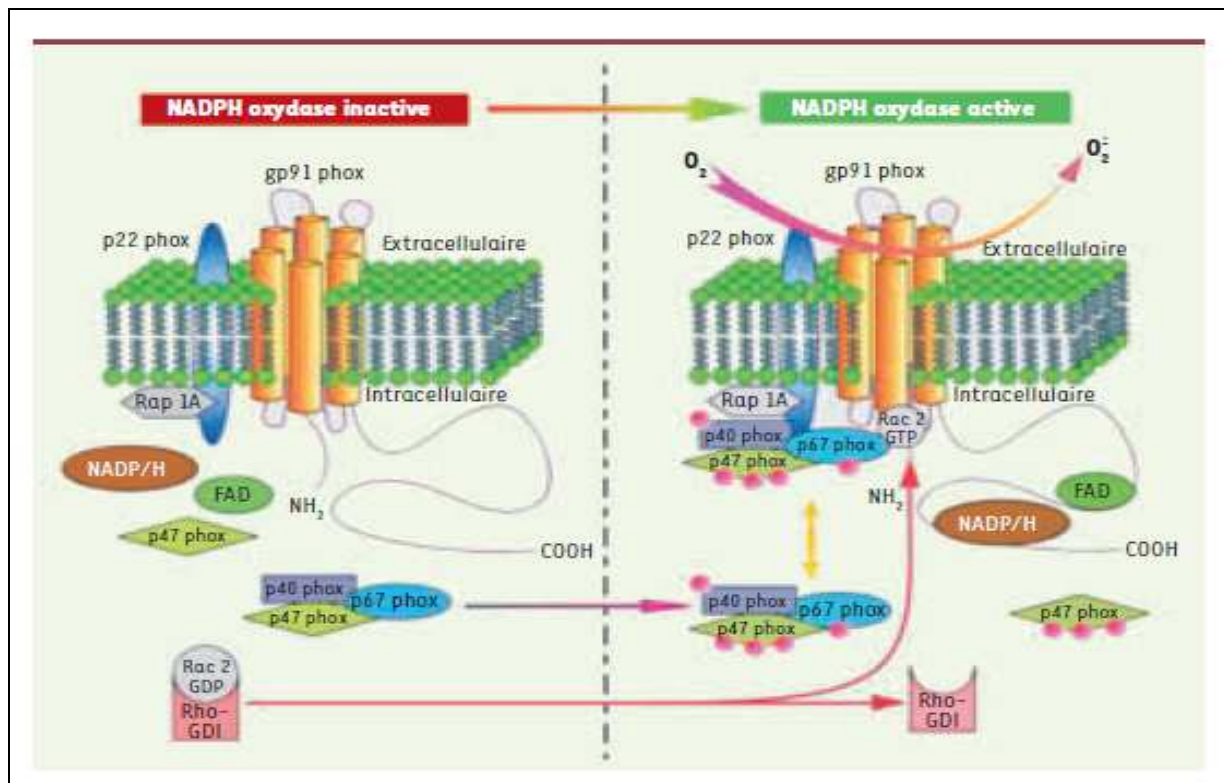

Figure 3. Modèle d'activation de NOX2. Au repos, la NADPH oxydase est inactive et caractérisée par une localisation membranaire (gp91^{phox} et p22^{phox}) et cytosolique de l'hétérotrimère (p40^{phox}, p47^{phox} et p67^{phox}) et du complexe Rac2-GDP/Rho-GDI. Lors du passage de la NADPH oxydase à la forme active pour produire l'anion superoxyde d'O₂⁻, les trois sous-unités p40^{phox}, p47^{phox} et p67^{phox} subissent des phosphorylations (points roses) et sont transloquées à la membrane plasmique pour s'associer au gp91^{phox} et p22^{phox}. La protéine Rac2 est libérée de Rho-GPI et échange sa molécule de GDP pour du GTP. Cette protéine migre alors à la membrane pour participer à la production d'O₂⁻. (Guichard, Pedruzzi et al. 2006).

II.2 Par les homologues de la NADPH oxydase des phagocytes

2.1 NOX1

La NADPH non phagocytaire NOX1, comme NOX2, requiert l'association avec la sous-unité membranaire p22^{phox} puisque la déplétion de p22^{phox} inhibe l'activation de NOX1 (Kawahara, Ritsick et al. 2005). Les facteurs cytosoliques NOXO1 (**NOX Organizer 1**) analogue fonctionnel de p47^{phox} et NOXA1 (**NOX Activator 1**) analogue fonctionnel de p67^{phox} sont essentiels à une activation maximale de NOX1 et sont localisés dans les mêmes tissus que NOX1 (Geiszt, Lekstrom et al. 2003).

Très récemment, deux substrats de Src (**Sarcoma**) : Tks4 et Tks5 (**Tyrosine kinase substrat with 4/5 SH3 domains**), présentant comme p47^{phox} et NOXO1, un domaine Px et des domaines SH3, ont montré qu'ils étaient capables d'induire la production de ROS dans des systèmes cellulaires (HEK293) reconstitués avec NOX1 (ou NOX3) (Gianni, Diaz et al. 2009; Weaver 2009). Ces Tks fixeraient NOXA1 par ses domaines SH3 indépendamment de la présence de Rac. Ces protéines sont localisées au niveau des podosomes des macrophages, des ostéoclastes, des cellules endothéliales et des cellules musculaires lisses. Les podosomes sont des microdomaines d'adhésion constitués à partir d'invaginations de la membrane plasmique et organisés en structures cylindriques à base d'actine, localisés exclusivement à la face ventrale des cellules et polymérisant perpendiculairement. Ces microdomaines regroupent des composants structuraux et des protéines de signalisation comme Src, PKC et des métalloprotéases (MMP-2). Les podosomes découverts dans certaines cellules tumorales métastatiques sont alors appelés invadopodes. La formation de ces structures dans les cellules endothéliales humaines peut-être

induite par le PMA (Tatin, Varon et al. 2006) et donc certainement par l'activation de la NADPH oxydase.

Contrairement à p47^{phox}, NOXO1 ne possède pas de région auto-inhibitrice et donc ne nécessite pas d'être phosphorylé pour être actif (Bedard and Krause 2007). L'absence de cette région auto-inhibitrice permettrait une activité constitutive du complexe NOX1/NOXO1/NOXA1. Cette activité constitutive de NOX1 par NOXO1/NOXA1 n'est clairement démontrée que dans les systèmes d'expression utilisant des protéines murines (Banfi, Clark et al. 2002; Banfi, Malgrange et al. 2004) alors qu'elle est très faible dans les systèmes d'expression utilisant des protéines humaines. L'activation à un niveau optimal du complexe NOX1/NOXO1/NOXA1 humain nécessite le PMA (Geiszt, Lekstrom et al. 2003; Cheng, Diebold et al. 2006). Cet activateur de la PKC, au contraire, n'a aucun effet sur la production de ROS par Nox1 murin (Banfi, Clark et al. 2002). A ce jour, il n'est pas encore clairement établi si cette différence de dépendance au PMA est réellement due à une différence entre NOXO1 humaine et murine.

A l'inverse de NOX2, l'activation de NOX1 par Rac n'est nécessaire que lorsque les taux de NOXO1 et NOXA1 sont faibles (Cheng, Diebold et al. 2006).

2.2 NOX3

NOX3 requiert l'association avec la sous-unité membranaire p22^{phox} pour sa maturation et son adressage au niveau subcellulaire (Nakano, Banfi et al. 2007). Son activation nécessite

l'assemblage avec NOXO1 (Kiss, Knisz et al. 2006). Le rôle crucial de NOXO1 dans l'activation de NOX3 provient d'études *in vivo* démontrant que l'inactivation de NOXO1 dans des souris mutantes pour ce gène (Kiss, Knisz et al. 2006) présente le même phénotype que les souris mutantes pour NOX3 (Paffenholz, Bergstrom et al. 2004). La sous-unité NOXA1 semble être essentielle pour l'activation de Nox3 murin (Banfi, Malgrange et al. 2004) alors que son absence ne diminue pas l'activation de NOX3 humaine (Cheng, Ritsick et al. 2004).

L'activation de NOX3 semble être constitutive dans des systèmes cellulaires reconstitués (Banfi, Malgrange et al. 2004; Ueno, Takeya et al. 2005).

2.3 NOX4

L'activation de NOX4 requiert l'association avec la sous-unité membranaire p22^{phox} (Ambasta, Kumar et al. 2004; Martyn, Frederick et al. 2006). Son expression seule est suffisante pour induire une production de ROS (Serrander, Cartier et al. 2007) et n'est pas augmentée par la co-expression de NOX4 avec les facteurs cytosoliques connus (p47^{phox}, p67^{phox}, NOXO1 et NOXA1) (Martyn, Frederick et al. 2006). Cependant, très récemment, par criblage double-hybride en levure, un polypeptide, nommé Poldip2 (**p**olymerase **d**elta-**i**nteracting **p**rotein **2**) a été identifié comme interagissant avec la région riche en proline de p22^{phox}. Il ne présente pas d'homologie avec les autres facteurs cytosoliques classiques (p47^{phox}, p67^{phox}, NOXO1 et NOXA1) et co-localise avec p22^{phox} et NOX4 au niveau des cellules musculaires lisses des vaisseaux de rat (Lyle, Deshpande et al. 2009).

L'association de NOX4 avec Rac ne semble pas, non plus, nécessaire à son activation (Martyn, Frederick et al. 2006; Kao, Gianni et al. 2008). Mais l'indépendance de NOX4 vis-à-vis de Rac est encore controversée (Gorin, Ricono et al. 2003).

NOX4 présente une activité constitutive importante lorsqu'elle est surexprimée dans des modèles cellulaires en l'absence d'activateurs comme le PMA (Martyn, Frederick et al. 2006) ou le Ca^{2+} (Lambeth, Kawahara et al. 2007). Un modèle cellulaire exprimant constitutivement NOX4 a également démontré une activité constitutive (Li, Bedard et al. 2009). A ce jour, les augmentations d'activité de NOX4 décrites étaient essentiellement liées à une augmentation de l'expression de la protéine (Serrander, Cartier et al. 2007). Poldip2 en s'associant à p22^{phox} , est la première protéine endogène régulant positivement l'activité de NOX4 au niveau des cellules musculaires lisses des vaisseaux chez l'Homme et chez le rat sans augmenter l'expression de la protéine (Lyle, Deshpande et al. 2009).

2.4 NOX5 et DUOXs

NOX5 et DUOX1/2 possèdent, contrairement aux autres NOX, un domaine EF-hand capable de fixer le Ca^{2+} . En conséquence, leur activation est sous la dépendance du Ca^{2+} et ne nécessite aucune association avec p22^{phox} et les autres facteurs cytosoliques régulateurs (Banfi, Tirone et al. 2004; Ameziane-El-Hassani, Morand et al. 2005).

De façon analogue au rôle stabilisateur de p22^{phox} pour NOX2, les enzymes DUOX1 et DUOX2 se lient à des protéines DUOXA1 ou DUOXA2 respectivement afin de former un complexe stable (Morand, Ueyama et al. 2009)

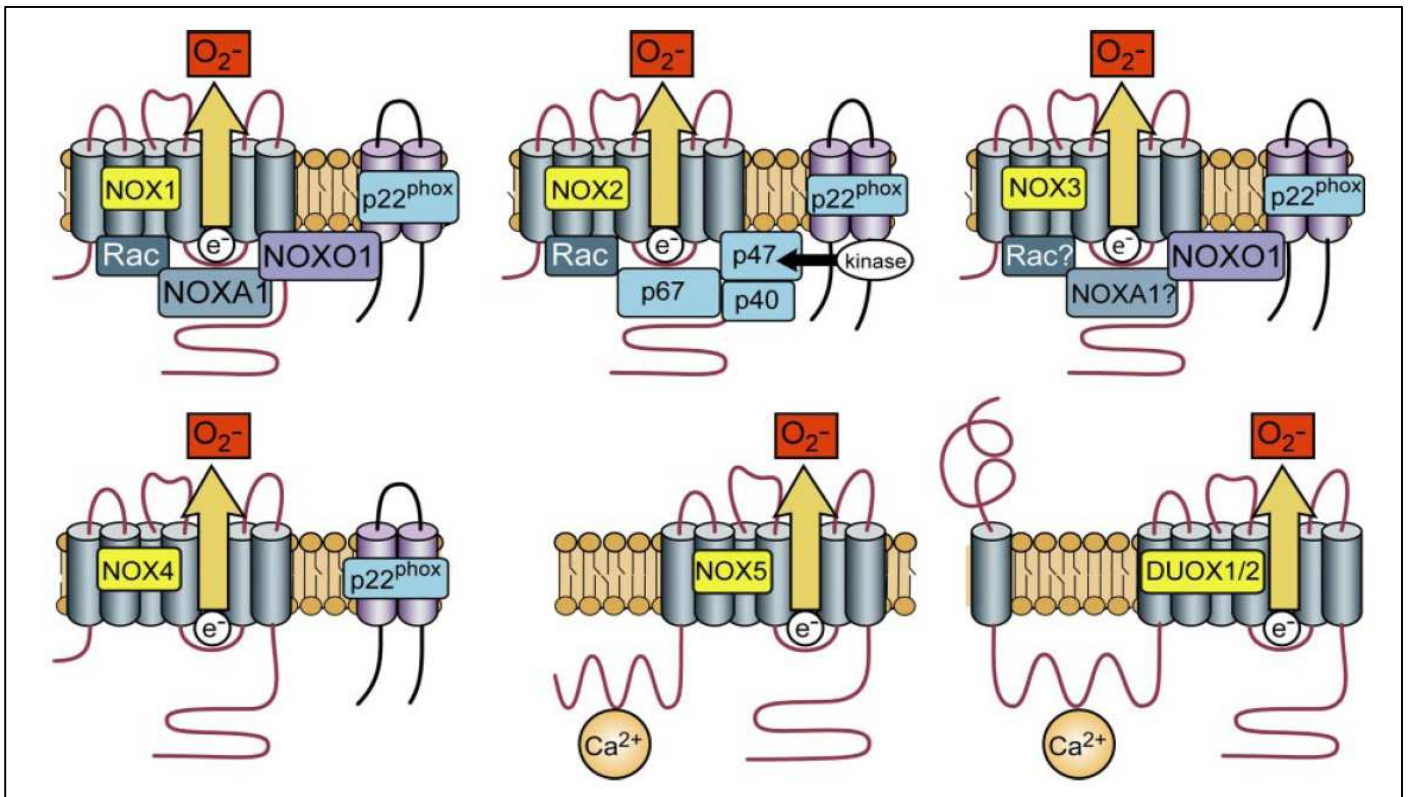

Figure 4. Topologie et activation des différentes isoformes des NADPH oxydases. Représentations graphiques des différentes NADPH oxydases et de leurs sous-unités respectives. NOX1, NOX2, NOX3 et NOX4 requièrent l'association avec la sous-unité p22^{phox} à la membrane. A l'exception de NOX4, ces NADPH oxydases ont besoin de sous-unités cytosoliques (p47^{phox}, p67^{phox} ou NOXO1 et NOXA1) pour leur activation. NOX5 ne nécessite pas de sous-unités lors de son activation mais possède un domaine N-terminale liant le Ca²⁺. Les DUOX1/2 présentent également ce domaine fixant le Ca²⁺ relié à une région transmembranaire suivie d'un domaine homologue aux peroxydases. (Bedard and Krause 2007).

III. Fonctions communes des NADPH oxydases

La fonction primaire des enzymes NOX est de produire des espèces réactives de l'oxygène (ROS). Le produit immédiat formé par les NOX est l'anion superoxyde (O₂^{•-}) à l'intérieur des organelles ou dans le milieu extracellulaire. La charge négative ne permet pas au superoxyde de traverser les bicouches lipidiques des membranes biologiques. Dans certains cas, les anions

superoxydes peuvent traverser les membranes grâce aux canaux d'anions. Les effets biologiques des anions superoxydes dérivés des NOX sont :

- ✓ La réaction avec l'oxyde nitrique (NO) amenant à (i) la dégradation du NO, (ii) la formation de peroxyde nitrique, (iii) la nitrosylation des protéines et (iv) l'addition de glutathion réduit sur les groupements thiols.
- ✓ La réduction des hèmes ferriques à l'intérieur de l'enzyme.
- ✓ Et finalement à l'alcalinisation des organelles intracellulaires.

Le peroxyde d'hydrogène (H_2O_2) est rapidement formé par dismutation spontanée ou catalysé par la SOD de 2 anions superoxydes. H_2O_2 sécrété à l'intérieur des organelles ou dans le milieu extracellulaire est une molécule capable de traverser les membranes biologiques par diffusion. Ces effets biologiques sont les suivants :

- ✓ L'oxydation de résidus cystéine conduisant à (i) l'inactivation des tyrosines phosphatases assurant les déphosphorylations, (ii) la formation de ponts disulfures et (iii) l'activation de nombreux facteurs transcriptionnels (NF- κ B, AP-1 etc...) ainsi que les GTPases comme Ras.
- ✓ Une réaction avec les peroxydases (phénomène important lors de la défense antimicrobienne et lors de l'iodation des hormones thyroïdiennes)
- ✓ Une toxicité par des oxydations non spécifiques de composés cellulaires, essentiellement à fortes concentrations.

Les ROS jouent donc un rôle important dans de nombreux processus physiologiques et pathologiques. Leur rôle délétère sur les composants cellulaires (protéines, lipides, ADN) est bien

caractérisé. Cependant, ces ROS ont des effets positifs dans la défense contre les agents pathogènes et sont considérées comme des seconds messagers intracellulaires. Ces molécules vont donc avoir des effets et des propriétés différentes en fonction de leur lieu d'émission et de la concentration à laquelle elles sont produites. En effet, les ROS, toxiques à forte dose, peuvent être bénéfiques voire indispensables à faible concentration.

De plus, elles doivent posséder à la fois une haute réactivité envers une cible spécifique sur une courte durée et la potentialité de l'atteindre. Cela nécessite par leur faible diffusion une proximité cellulaire voire subcellulaire avec leurs cibles.

Les NOX apparaissent donc comme des enzymes dont les rôles physiologiques sont susceptibles d'être divers et variés du fait de leur localisation différente et de leur régulation complexe. Ainsi, toute modification de leur expression ou toute production trop intense et maintenue dans le temps sont susceptibles d'être impliquées dans différentes maladies humaines.

IV. Localisation des NADPH oxydases

IV.1 Localisation tissulaire

Bien que les différentes NOX présentent des structures très analogues et la fonction commune de produire des ROS, leurs distributions tissulaires diffèrent. Il existe deux niveaux d'expression tissulaire des NOX, une expression principale et une secondaire (figure 5).

IV.2 Localisation cellulaire et subcellulaire

Les localisations cellulaires et subcellulaires des NOX vont intervenir au niveau de la régulation des ROS. Les données de la littérature concernant les localisations cellulaires et subcellulaires des NOX sont listées dans le tableau I. Dans la plupart des cas, les localisations subcellulaires sont encore controversées. Le manque d'anticorps anti- NADPH oxydase commercialisés d'excellente qualité est en partie responsable de ces divergences.

V. Régulation des NADPH oxydases et de la production des ROS

Les mécanismes de régulation de la production des ROS sont donc multiples et variés. Ils peuvent être divisés en plusieurs groupes : i) Les mécanismes qui régulent l'activité négativement en bloquant ou diminuant les ROS : les systèmes antioxydants et ii) les mécanismes qui régulent l'activité en modulant l'expression ou l'activité des NOX : les facteurs cytosoliques, la sous-unité membranaire p22^{phox}, les molécules régulant les transcrits, les modifications post-traductionnelles, de façon encore anecdotique, les micro-ARNs et les récepteurs des pathogènes et finalement iii) les mécanismes qui permettent de localiser la production des ROS et de la limiter dans le temps : la compartimentalisation.

V.1 Régulation « négative » par les systèmes antioxydants

Afin de maintenir l'homéostasie redox au sein d'une cellule et donc réduire le stress oxydatif engendré par des taux élevés de ROS, les cellules ont développé des systèmes antioxydants. Ces molécules sont des substances capables de diminuer ou de prévenir l'oxydation des substrats. Ces systèmes antioxydants vont agir pour contrôler « l'homéostasie » redox

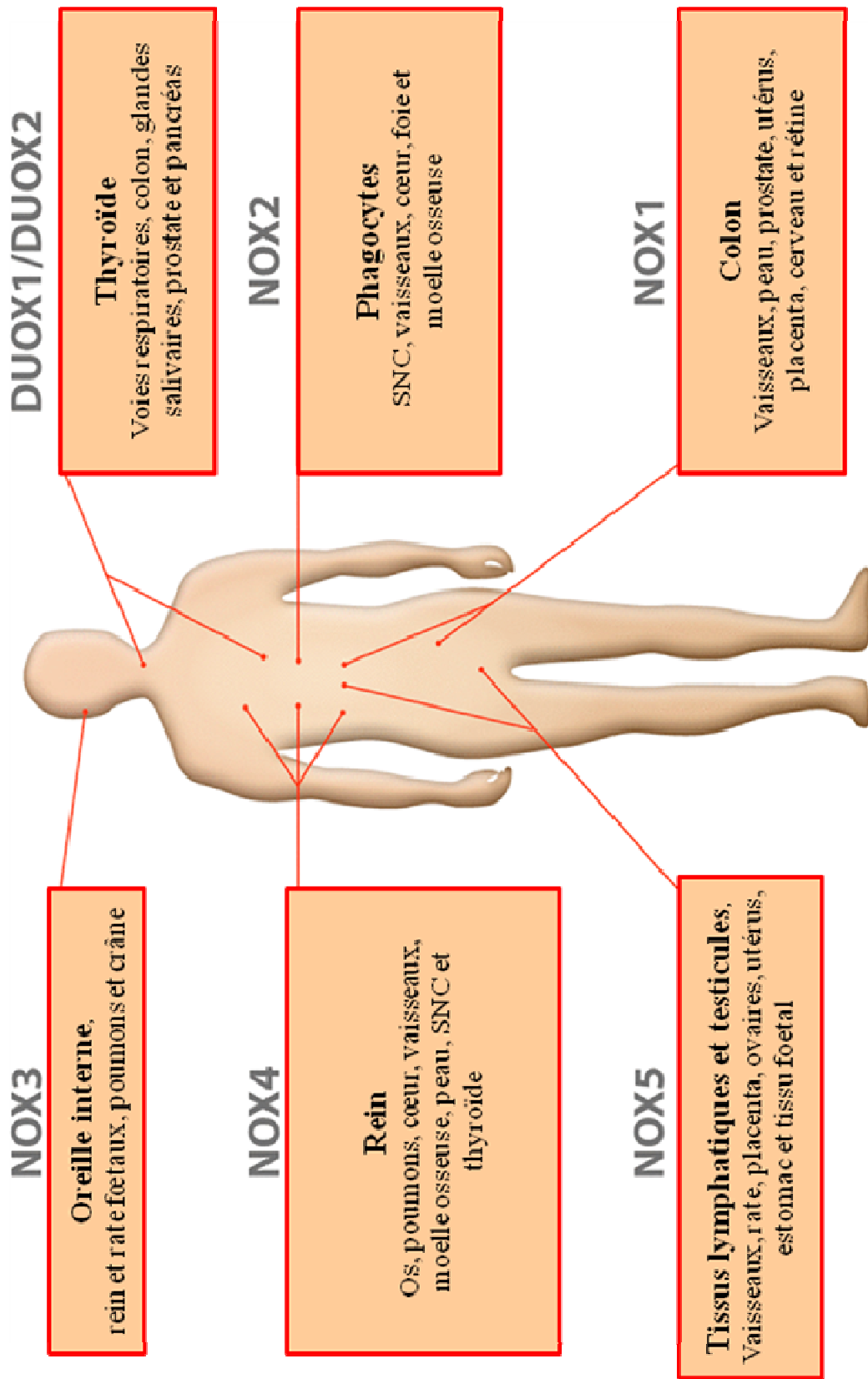

Figure 5. Localisations tissulaires des NADPH oxydases chez l'Homme. Les organes en gras correspondent aux localisations principales. Les organes en non-gras correspondent aux localisations secondaires. SNC: système nerveux central. D'après Quinn, Ammons et al. 2006.

Les NADPH oxydases

Tableau I. Localisations cellulaires et subcellulaires des NADPH oxydases. RE: réticulum endoplasmique. D'après (Bedard and Krause 2007; Brown and Griendling 2009)

NADPH Oxydase	Localisation tissulaire	Localisation cellulaire	Localisation subcellulaire
NOX1	Colon distal Vaisseaux Rétine Os Cerveau Peau	Cellules épithéliales Cellules musculaires lisses/ endothéliales Péricytes Ostéoclastes Neurons/Astrocytes/Microglie Kératinocytes	Endosome/Cavéoline Noyau et cytoplasme
	Phagocytes	Neutrophiles, monocytes, macrophages, cellules dendritiques et lymphocytes B	Microdomaines, membrane phagosomes
NOX2	SNC Vaisseaux Cœur Foie Moelle osseuse	Microglie, neurones et astrocytes Cellules musculaires lisses et striées Cardiomyocytes Hépatocytes Cellules souches hématopoïétiques	
	Oreille interne Poumons	?	?
NOX4	Rein Vaisseaux Peau Poumons Os SNC Foie Thyroïde	Cellules tubulaires et mésangiales du glomérule Cellules musculaires lisses/ endothéliales Kératinocytes Fibroblastes Ostéoclastes et ostéoblastes Neurons Hépatocytes Thyrocytes activés	Complexe d'adhérence, noyau et RE
	Tissu lymphatique Organes sexuels	?	?
DUOX1	Thyroïde Voies respiratoire	Thyrocytes Cellules épithéliales bronchiques	Membrane plasmique
DUOX2	Thyroïde Colon distal	Thyrocytes	Membrane plasmique

intracellulaire, soit en se comportant comme des molécules tampon (vitamines C et E, coenzyme Q, glutathion, acides aminés...), soit en faisant appel à des processus enzymatiques (SOD, catalase, glutathion peroxydase, peroxyrédoxines).

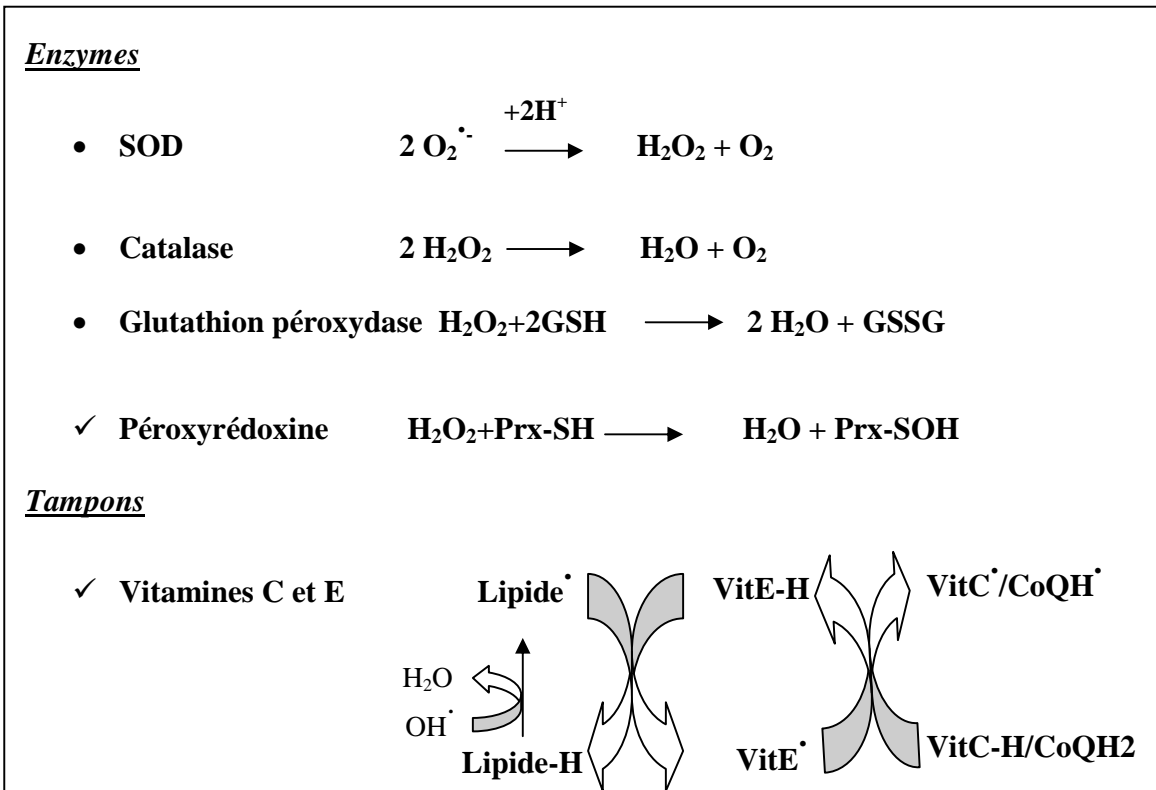

Figure 6. Les systèmes antioxydants. Les systèmes de défense antioxydants agissent comme des enzymes ou comme des tampons. Certaines enzymes (SOD: superoxyde dismutase, catalase, la glutathion peroxydase et les peroxyrédoxines) dégradent les dérivés réactifs de l’oxygène en composés non toxiques. La vitamine E va piéger les radicaux formés sous l’action des ROS et sera régénérée par la vitamine C ou le coenzyme Q.

On parle de « *stress oxydant* » lorsque cette homéostasie redox est perturbée, soit par une surproduction de ROS, soit par une défaillance des systèmes antioxydants. Pour exemple, les souris mutantes pour le gène SOD1 présente une augmentation de la production de ROS au niveau de la microglie contribuant à la pathogénèse de la sclérose latérale amyotrophique (Marden, Harraz et al. 2007).

V.2 Régulation « positive » par les sous-unités cytosoliques

L'activité NADPH oxydase est régulée par l'efficacité de l'assemblage des facteurs de régulation (voir chapitre II). Pour exemple, les cellules transfectées uniquement avec NOX1 produisent de faibles quantités d'ions superoxydes. Une fois, co-exprimée avec la p47^{phox} et la p67^{phox}, la production d'ions superoxydes se trouve significativement augmentée. Cette production est encore augmentée lorsque les cellules sont transfectées avec NOXO1 (analogue de la p47^{phox}) et NOXA1 (analogue de la p67^{phox}) (Banfi, Clark et al. 2003). Les facteurs cytosoliques sont donc substituables. Cependant, l'efficacité de l'activité des NADPH oxydases sera plus ou moins importante selon le couple de facteurs cytosoliques utilisés.

V.3 Régulation « positive » par p22^{phox}

La production de ROS par les NADPH oxydases, exceptés NOX5 et DUOX1 et 2, est sous la dépendance de la sous-unité membranaire p22^{phox} (voir aussi chapitre II.1 et 2). En effet, la déplétion de p22^{phox} (surexpression ou inhibition par ARN interférence) inhibe l'activation de NOX1, NOX2, NOX4 (Kawahara, Ritsick et al. 2005) et NOX3 (Ueno, Takeya et al. 2005). De façon plus physiologique, un haplotype formé par l'association de 3 polymorphismes du gène de p22^{phox} (nommé CYBA) est associé à une diminution de la production des ROS par NOX2 dans les lymphocytes B (Bedard, Attar et al. 2009).

p22^{phox} permet la stabilité des protéines NOX sous forme d'hétérodimères alors que les monomères sont dégradés par le protéasome (DeLeo, Burritt et al. 2000). L'absence protéique de NOX2 dans les phagocytes des patients atteints de granulomatose septique chronique, due à une mutation de NOX2, est associée à un taux indétectable de protéine p22^{phox} et inversement, l'absence protéique de p22^{phox} dans les phagocytes des patients atteints de granulomatose

septique chronique, due à une mutation de $p22^{\text{phox}}$, est associée à un taux indétectable de protéine NOX2 (Parkos, Dinauer et al. 1988).

V.4 Régulation « positive » transcriptionnelle

4.1 Par des stimuli

La régulation des transcrits des NOX par différents stimuli (tableau II) est très souvent décrite et impliquée dans les mécanismes pathologiques. Certains de ces stimuli vont induire des facteurs de transcription (éléments trans-régulateurs) qui se fixent au niveau de séquences cis-régulatrices spécifiques classiquement appelées éléments de réponse des promoteurs des NOX. Les éléments de réponse des promoteurs de NOX1 et NOX2 sont les mieux connus (Kuwano, Kawahara et al. 2006; Lambeth, Kawahara et al. 2007).

Au niveau des polynucléaires, certains de ces stimuli peuvent aussi jouer un rôle dans le « priming » ou l'amorçage défini par le fait qu'un prétraitement de ces cellules par un agoniste augmente la réponse oxydative à un 2^{ème} agoniste ajouté ultérieurement. Le $\text{TNF}\alpha$, le GM-CSF (Gougerot-Pocidallo, el Benna et al. 2002), IL-18 (Elbim, Guichard et al. 2005) et l'IL-8 (Guichard, Pedruzzi et al. 2005) sont les cytokines qui possèdent l'effet « primant » le plus important afin d'induire une forte production de ROS par les polynucléaires.

Tableau II. Regulation des NADPH oxydases par different stimuli.

uPA: urokinase Plasminogen Activator, PDGF: Platelet-Derived Growth Factor, EGF: Epidermal Growth Factor, BMP-4: Bone Morphogenic Protein, IFN- γ : Interferon γ , GM-CSF: Granulocyte Macrophage-Colony Stimulating Factor, G-CSF: Granulocyte-Colony Stimulating Factor, TNF α : Tumor Necrosis Factor α , RE: Reticulum Endoplasmic.

Stimulus	NADPH oxydase	Cellules (origine)	Références
Angiotensine II	Nox1, Nox4	Cellules musculaires lisses aortique (rat)	(Wingler, Wunsch et al. 2001)
uPA	Nox1, Nox4	Cellules musculaires lisses aortique (rat)	(Menshikov, Plekhanova et al. 2006)
PDGF	Nox1	Cellules musculaires lisses aortique (rat)	(Katsuyama, Fan et al. 2005)
	Nox4	Cellules musculaires lisses aortique (souris)	(Ellmark, Dusting et al. 2005)
EGF	Nox1	Cellules musculaires lisses aortique (rat)	(Fan, Katsuyama et al. 2005)
BMP-4	Nox1	Cellules endothéliales aortiques (souris)	(Sorescu, Song et al. 2004)
PGF2α	Nox1	Cellules musculaires lisses aortique (rat)	(Katsuyama, Fan et al. 2002)
Phorbol ester	Nox1	Cellules musculaires lisses aortique (rat)	(Katsuyama, Fan et al. 2005)
K-Ras G12V	Nox1	Lignée fibroblastique (rat et souris)	(Mitsushita, Lambeth et al. 2004)
Vitamine D3	NOX1	Lignée cancéreuse colique (Homme)	(Geiszt, Lekstrom et al. 2003)
IFN-γ	NOX1	Lignée cancéreuse colique (Homme)	(Geiszt, Lekstrom et al. 2003)
	NOX2	Macrophages, granulocytes (Homme)	(Newburger, Dai et al. 1991)
Hypoxie	NOX1	Cellules épithéliales pulmonaires (Homme)	(Goyal, Weissmann et al. 2004)
	Nox4	Cellules musculaires lisses artérielle (souris)	(Mittal, Roth et al. 2007)
GM-CSF	NOX2	Macrophages, granulocytes (Homme)	(Newburger, Dai et al. 1991)
M-CSF	NOX2	Macrophages (Homme)	(Newburger, Dai et al. 1991)
TGF-β	NOX4	Fibroblastes cardiaque(Homme)	(Cucoranu, Clempus et al. 2005)
		Fibroblastes pulmonaires (Homme)	(Hecker, Vittal et al. 2009)
		Hépatocytes (Rat et Homme)	(Carmona-Cuenca, Roncero et al. 2008)
IL-1β	NOX4	Cellules synoviales (Homme)	(Chenevier-Gobeaux, Lemarechal et al. 2006)
TNFα	NOX4	Cellules musculaires lisses aortique (Homme)	(Moe, Aulia et al. 2006)
Stress du RE	NOX4	Cellules musculaires lisses (Homme)	(Pedruzzi, Guichard et al. 2004)
TSH	NOX4	Tissu thyroïdien (Homme)	(Weyemi, Caillou et al. 2009)
Cytokines Th-2 (IL-4, IL-13)	DUOX1	Cellules épithéliales bronchiques et trachéales (Homme)	(Harper, Xu et al. 2005)
Cytokines Th-1 (IFN-γ, IL-1)	DUOX2	Cellules épithéliales bronchiques et trachéales (Homme)	(Harper, Xu et al. 2005)

4.2 Par des variants d'épissage alternatif

De plus, un épissage alternatif des ARNm de certaines NOX est possible. Les différents variants obtenus peuvent présenter des activités différentes. Par exemple, les isoformes B et C de NOX4, déléetées de leur domaine de liaison NADPH/FAD, produisent des ROS en quantité diminuée et régulent l'activité de NOX4 par un effet dominant négatif (Goyal, Weissmann et al. 2005).

V. 5 Régulation post-traductionnelle

La maturation de NOX2, NOX3, DUOX1, DUOX2 et du variant NOX4-D par glycosylation de ces protéines pourrait être un mécanisme de régulation (Ameziane-El-Hassani, Morand et al. 2005; Goyal, Weissmann et al. 2005; Raad, Paclet et al. 2009).

V. 6 Régulation par les microARNs

Les microARNs sont des petites molécules (≈22nucléotides) endogènes d'ARN capables de réprimer la traduction des ARN en protéine. Peu de données sont encore disponibles mais quelques études essentiellement au niveau des plantes ont décrit une régulation du stress oxydant par un microARN (mi398) (Phillips, Dalmay et al. 2007). Un article très récent a démontré que les souris déficientes en Dicer (enzyme impliquée dans la maturation des microARNs) produisent des taux plus faibles de ROS et que la cible potentielle de ces microARNs serait p47^{phox} (Shilo, Roy et al. 2008).

De plus, la réciproque serait également possible puisque NOX4 serait capable de diminuer l'expression du microARN : mi-188 après stimulation par l'homocystéine (Mishra, Tyagi et al. 2009).

V.7 Régulation par les récepteurs PRRs

Afin de tuer les pathogènes, les cellules de l'immunité doivent d'abord les reconnaître de façon spécifique. Cette identification est assurée par les récepteurs appartenant à la famille des PRRs (**P**attern-**R**ecognition **R**eceptors) qui reconnaissent des « *motifs moléculaires conservés* » chez de nombreux pathogènes. Ceci va amener à la mise en place de voies de signalisation nécessaires à la microbicidie. Une des voies sera la production des ROS par les NADPH oxydases. Ces enzymes vont donc être activées ou inhibées par l'activation de ces récepteurs afin d'exercer leur pouvoir microbicide directement au sein du phagosome mais également en participant dans les voies de signalisation médiées par les récepteurs PRRs. Les récepteurs PRRs comprennent : les récepteurs de type Toll (ou *Toll-like receptors* ou TLRs), les lectines, les scavengers receptors et les intégrines.

De nombreux récepteurs des phagocytes sont impliqués dans l'activation de la NADPH oxydase, comme les récepteurs-Fc dans les macrophages et les neutrophiles (Sakata, Ida et al. 1987; Gresham, McGarr et al. 1988), les TLRs (Ogier-Denis, Mkaddem et al. 2008) ainsi que les lectines (Underhill, Rossnagle et al. 2005). A l'inverse, l'activation des récepteurs C3 du complément n'est pas accompagnée par une activation des NOX (Wright and Silverstein 1983), bien que l'opsonisation des particules par le complément active les NOX (Lofgren, Serrander et al. 1999; Serrander, Larsson et al. 1999). De même, les récepteurs des mannanes n'induisent pas la production de ROS par les NOX (Astarie-Dequeker, N'Diaye et al. 1999).

7.1 Les récepteurs Toll (TLRs)

Les TLRs sont des protéines transmembranaires de type I comportant : Un domaine extracellulaire récepteur du signal de danger et composé de nombreux motifs riches en leucine, les LRRs (**L**eucin-**R**ich **R**epeats), un domaine transmembranaire et un domaine intracellulaire contenant un domaine DD (**D**eath **D**omain) permettant la transduction du signal d'activation. Chez l'Homme, 10 TLRs différents ont été identifiés (TLR1-10). La plupart des ces récepteurs reconnaissent spécifiquement des motifs particuliers d'origine diverse : bactéries, virus, champignons et de nature variée : protéine, sucre, acide nucléique (Tableau III). Plusieurs études ont démontré l'existence de lien entre l'activation de TLR et la production des ROS par une isoforme spécifique des NOX. Ces relations sont décrites dans le tableau IV. L'activation des TLRs va augmenter l'expression des NOX via les molécules de transduction du signal ou dans certains cas, un contact direct entre le TLR et la NADPH oxidase. Pour exemple, la partie C-terminale de NOX4 interagit directement avec le domaine TIR (**T**oll-**i**nterleukine1 **r**eceptor) de TLR4 (Park, Chun et al. 2006).

7.2 Le récepteur dectine-1

La dectine-1 est un récepteur de la famille des lectines de type C contenant un motif ITAM (**I**mmunoreceptor **T**yrosine-based **A**ctivation **M**otif) au niveau de son extrémité cytoplasmique (Brown 2006). Ce motif est impliqué dans l'activation cellulaire consécutive à la phagocytose des ligands spécifiques de la dectine-1. Ce récepteur est exprimé à la surface des neutrophiles, des

Tableau III. Localisations cellulaires et ligands des récepteurs Toll-like.

TLR	Localisation	Motifs de reconnaissance	Origine du motif de reconnaissance
TLR1	Ubiquitaire	Triacyl des lipoprotéines facteurs solubles	Bactéries et Mycobactéries <i>Neisseria meningitidis</i>
TLR2	Neutrophiles Monocytes/Macrophages Cellules dendritiques	Heat Shock protein 70 Peptidoglycane Lipoprotéine/lipopeptides Glycoprotéine	Le « soi » Bactéries gram positive Bactéries et champignons Virus de l'hépatite C
TLR3	Cellules dendritiques Cellules NK Cellules épithéliales Cellules endothéliales	ARN double brin	Virus
TLR4	Neutrophiles Monocytes/Macrophages Cellules dendritiques	Lipopolysaccharides Protéine d'enveloppe Taxol	Bactéries gram négative Virus oncogènes Plantes
TLR5	Monocytes Cellules dendritiques immatures Cellules NK Neutrophiles Cellules épithéliales Lymphocytes T	Flagelline	Bactéries à flagelles
TLR6	Lymphocytes B	Zymosan Acide lipotechoïque Lipopeptides diacylés	Champignons Bactéries gram positive Mycoplasmes
TLR7	Lymphocytes B Cellules dendritiques Neutrophiles	ARN simple brin	Virus
TLR8	Monocytes	ARN simple brin	Virus
TLR9	Cellules dendritiques Lymphocytes B Macrophages (microglie) Cellules NK Neutrophiles	ADN CpG-non méthylé	Virus Bactéries Parasites
TLR10	Cellules dendritiques Lymphocytes B	Non déterminé	

Tableau IV. Relation entre les récepteurs Toll-like et les NADPH oxydases.

Ligand	TLR	NOX	Localisation	Référence
LPS (<i>H.pylori</i>)	TLR4	Nox1	Cellules gastriques (cobaye)	(Kawahara, Kohjima et al. 2005)
Flagelline	TLR5	NOX1	Lignée cancéreuse colique (Homme)	(Kawahara, Kuwano et al. 2004)
Endotoxine	TLR9	Nox1	Lignée murine de macrophages	(Lee, Lee et al. 2008)
LPS	TLR4	NOX2	Neutrophiles (Homme)	(Pacquelet, Johnson et al. 2007)
BCG	TLR2	Nox2	Macrophages (souris)	(Laroux, Romero et al. 2005)
Aucun	TLR4	Nox3	Macrophages (souris)	(Yang, Shin et al. 2009)
Aucun	TLR4	Nox3	Cellules endothéliales pulmonaires	(Zhang, Shan et al. 2006)
LPS	TLR4	NOX4	Cellules endothéliales aortiques (Homme)	(Park, Jung et al. 2004)
Poly (I:C)	TLR3	DUOX2	Cellules épithéliales trachéo-bronchiques (Homme)	(Harper, Xu et al. 2005)

monocytes, des macrophages et des cellules dendritiques. Il est également exprimé par des cellules non immunitaires comme les kératinocytes (Kobayashi, Yoshiki et al. 2009). Comme les autres récepteurs lectines de type C, la dectine-1 reconnaît les hydrates de carbone de la membrane des pathogènes et plus spécifiquement les β -glycans. Ces polysaccharides sont les constituants principaux de la membrane ($\approx 60\%$) des champignons comme les levures mais également de certaines bactéries et plantes. La dectine-1 est donc impliquée dans la défense antifongique. Pour cela, après phagocytose du pathogène, le motif ITAM activé va engendrer, via Syk (spleen tyrosine kinase) et CARD9 (caspase recruitment domain protein 9), la production de cytokines pro-inflammatoires comme l'interleukine 6 (IL-6) et l'interleukine 17 (IL-17) et anti-inflammatoires comme l'interleukine 10 (IL-10). En fonction du type cellulaire, la dectine-1 est capable d'activer le récepteur TLR2 afin d'augmenter la réponse inflammatoire (Gantner, Simmons et al. 2003; Goodridge, Shimada et al. 2009).

De plus, l'activation de la dectine-1 va également, par l'intermédiaire de Syk, induire la production de ROS par activation de la NADPH oxydase (Underhill, Rossmagale et al. 2005) par un mécanisme partiellement dépendant de TLR2 (Yang and Marshall 2009). Les ROS induits par l'activation de la dectine-1 dans les macrophages ont été essentiellement impliqués dans la dégradation du matériel phagocyté puisqu'en l'absence de β -glycanase chez les mammifères, les β -glycans, principaux ligands de la dectine-1, subiront une dégradation oxydative par les ROS (Miura, Miura et al. 1998).

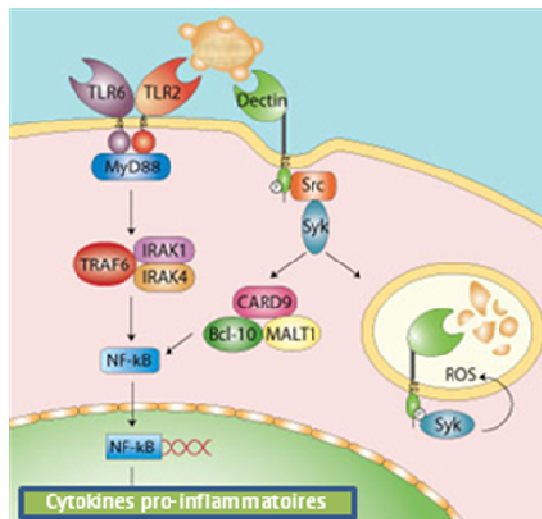

Figure 7. Le récepteur dectine-1 et sa signalisation. Les β -glycans sont capables de se fixer au récepteur dectine-1 et d'induire ainsi l'activation de voies de signalisation qui mèneront pour la plupart à l'activation de NF- κ B et également à la production de ROS.

V.8 Régulation par la compartimentalisation

La localisation cellulaire voire subcellulaire des différentes NOX semble jouer un rôle important dans leur activité afin de générer des ROS de manière localisée au niveau de cibles spécifiques et durant un temps court. Le rôle des différentes NOX sera donc dépendant de la co-localisation avec leurs sous-unités régulatrices et leurs cibles potentielles.

Les radeaux ou microdomaines lipidiques ou « lipids rafts » sont des structures membranaires spécialisées qui vont concentrer au même endroit des molécules de signalisation. Les cavéoles sont une sous-classe de ces microdomaines lipidiques, caractérisées par une invagination membranaire non-tapissée de clathrine, mais riche en cavéolines. Les radeaux lipidiques et les cavéoles vont réguler la signalisation d'un certain nombre de récepteurs en ségréant les différents acteurs pour les activer ou en les séparant physiquement pour les inhiber. Ces microdomaines de la membrane plasmique jouent un rôle important dans l'activation des NADPH oxydases (Ushio-Fukai 2009). Pour exemple, dans des cellules Ra2 (lignée murine de microglie) et HL-60 *neutrophile-like*, le cytochrome b_{558} et ses sous-unités cytosoliques sont spécifiquement ségréés dans les « radeaux lipidiques » après stimulation par le PMA (Vilhardt and van Deurs 2004). Dans les cellules musculaires lisses, NOX1 est exprimée au niveau de ces cavéoles (Hilenski, Clempus et al. 2004). Lors de la fixation de l'angiotensine II à son récepteur AT1, ce complexe migre dans la cavéole, engendrant le recrutement de Rac1. Au sein de la cavéole, NOX1 présente va être alors activée, générant des ROS de manière localisée. Les protéines cibles, sensibles à l'état redox, présentes dans la cavéole vont être ainsi activées.

D'autres études effectuées au niveau des cellules endothéliales ont montré que les radeaux lipidiques, présents dans ces cellules, permettent d'obtenir une production focalisée de ROS par NOX2 après stimulation par le TNF α (Yang and Rizzo 2007).

Les zones de contact matrice-cellules, cellule-cellule, les complexes focaux des lamellipodes, les endosomes et le noyau sont également des domaines spécialisés où les NOX en fonction de leur expression subcellulaire pourront être activer (Ushio-Fukai 2009).

Ces études sur les localisations subcellulaires restent à confirmer en l'absence d'anticorps réellement spécifiques pour certaines NOX, essentiellement NOX1.

VI. Comparaison des NADPH oxydases chez l'Homme et la souris

Les NADPH oxydases sont présentes chez tous les mammifères et également chez les plantes. La grande différence entre l'Homme et la souris au niveau des NADPH oxydases est l'absence de NOX5 chez les rongeurs.

VI.1 Comparaison des séquences des ARN messagers et des protéines

Les pourcentages d'homologie pour les ARN et les pourcentages d'identité peptidique entre l'Homme et la souris sont représentés dans les tableaux V. et VI. Cette étude préliminaire, à l'aide du logiciel Blast (NCBI) permet de supposer que :

- ✓ Les NADPH oxydases humaines et murines présentent une identité peptidique importante.
- ✓ NOX2, NOX4 et DUOX1 présentent des homologies de séquences codantes supérieures à leurs identités peptidiques. Ceci peut être expliqué par la dégénérescence du code génétique.
- ✓ Les séquences promotrices des gènes codant pour les NADPH oxydases sont de plus en plus impliquées dans la régulation de ces protéines. Une comparaison entre les régions promotrices humaines et murines pourrait apporter de nouveaux éléments.

VI.2 Au niveau de la localisation tissulaire et cellulaire

Les NADPH oxydases humaines et murines sont donc très homologues au niveau de la structure des ARN et des protéines. Mais, la localisation est un phénomène très important dans la régulation de ces NADPH oxydases, il est donc important de savoir si les localisations tissulaires, cellulaires voire subcellulaires des NOX sont équivalentes entre l'Homme et la souris. Les données comparatives entre l'Homme et la souris sont rares bien que de nombreuses études sur

Les NADPH oxydases

les modèles murins extrapolent les données provenant de la souris à l'Homme. Une revue comparative des NADPH chez l'Homme et la souris serait souhaitable. Quelques exemples existent :

Tableau V. Comparaison des séquences codantes des ARN des NADPH oxydases chez l'Homme et chez la souris

NADPH oxydase	Espèce	Localisation génique	Longueur séquence codante (pb)	% homologie séquence codante	Référence GenBank (CDS)
NOX1	Homme	Chr.X(q22)	1695	86	NM_007052
Nox1	Souris	Chr.X	1692		NM_172203(Balb/C)
NOX2	Homme	Chr.X(p21.1)	1713	87	NM_000397
Nox2	Souris	Chr.X	1713		NM_007807 (C57Bl/6)
NOX3	Homme	Chr.6(q25.1-q26)	1707	82	NM_015718
Nox3	Souris	Chr.17	1767		NM_198958(C57Bl/6)
NOX4	Homme	Chr.11(q14.2-q21)	1737	87	NM_016931
Nox4	Souris	Chr.7	1737		NM_015760(C57Bl/6)
DUOX1	Homme	Chr.15(q15.3)	4656	87	NM_017434
Duox1	Souris	Chr.2	4656		NM_001099297
DUOX2	Homme	Chr.15(q15.3)	4647	84	NM_014080
Duox2	Souris	Chr.2	4584		NM_177610

Tableau VI. Comparaison des protéines des NADPH oxydases chez l'Homme et chez la souris

NADPH oxydase	Espèce	Longueur (nombre AA)	% d'identité peptidique	Référence (Uniprot)
NOX1	Homme	563	84	Q9Y5S8
Nox1	Souris	564		Q8CIZ9
NOX2	Homme	570	93	P04839
Nox2	Souris	570		Q3U6G0
NOX3	Homme	568	80	Q9HBY0
Nox3	Souris	568		Q672J9
NOX4	Homme	578	90	Q9NPH
Nox4	Souris	578		Q9JHI
DUOX1	Homme	1551	93	Q9NRD9
Duox1	Souris	1058		Q8BZO2
DUOX2	Homme	1548	84	Q9NRD8
Duox2	Souris	1545		Q7ZWM4

✓ L'estomac des rongeurs tel que le cobaye exprime NOX1 (Kawahara, Kohjima et al.

2005) et les ARNm de NOXA1 et NOXO1 sont présents dans l'estomac et l'intestin des

souris (Banfi, Clark et al. 2002) mais à ce jour, NOX1 n'a pas été retrouvé dans l'estomac des hommes.

✓ Les cellules épithéliales du système respiratoire chez l'Homme, mais également chez le rat ou la vache expriment les DUOXs. Cette expression est absente chez la souris (Moskwa, Lorentzen et al. 2007).

Les différences de localisation des NADPH oxydases entre l'Homme et la souris sont à prendre en compte mais les partenaires de ces enzymes peuvent être également différents et importants. Pour exemples, les neutrophiles chez l'Homme représentent environ 65% des globules blancs alors que ce pourcentage est de 29% chez la souris (Mouse Phenome Database Jackson Laboratory). Le récepteur dectine-1 est exprimé par les lymphocytes B et les polynucléaires éosinophiles chez l'Homme alors que l'expression de ce récepteur « fongique » sur ces cellules est absente chez la souris (Willment, Marshall et al. 2005).

VII. Fonctions physiologiques et physiopathologies liées à NOX1

Depuis sa découverte, en tenant compte de son expression prépondérante au niveau colique et son haut degré d'homologie de séquence avec NOX2 (60%), des études se sont focalisées sur le rôle de défense antimicrobienne de NOX1 au niveau colique. Pourtant à ce jour, aucun rôle prépondérant de NOX1 n'a été mis en évidence dans cet organe. Les effets physiologiques de NOX1 ont émané d'études décrivant une diminution d'un phénotype pathologique après délétion du gène *Nox1* chez la souris ou dans des lignées cellulaires. Aucune mutation de NOX1 générant une pathologie n'a été mise en évidence chez l'Homme.

VII.1 Dans le système vasculaire

Le rôle de NOX1 au niveau vasculaire a suscité beaucoup d'enthousiasme et de nouvelles fonctions physiologiques prépondérantes de NOX1 y ont été découvertes malgré une expression faible. La production de ROS au niveau des vaisseaux a été suspectée depuis très longtemps. La mitochondrie puis NOX2 et la xanthine oxydase ont été les premiers suspects. Des mesures directes de l'activité des NADPH/NADH ont démontré, dans le milieu des années 1990, que la production de ROS au sein des vaisseaux était générée par une NADPH oxydase nommée alors la « NADPH oxydase vasculaire ». Il s'est avéré après la découverte des homologues de NOX2 que cette « NADPH oxydase vasculaire » n'était pas unique mais correspondait à plusieurs NADPH oxydases avec différentes localisations cellulaires (figure. 9). Il est à noter que l'expression d'ARNm des NOX a essentiellement été étudiée au niveau des artères et peu de choses sont connues au niveau des vaisseaux. Une étude y suggère un rôle prépondérant de NOX2 (Guzik, Sadowski et al. 2004)

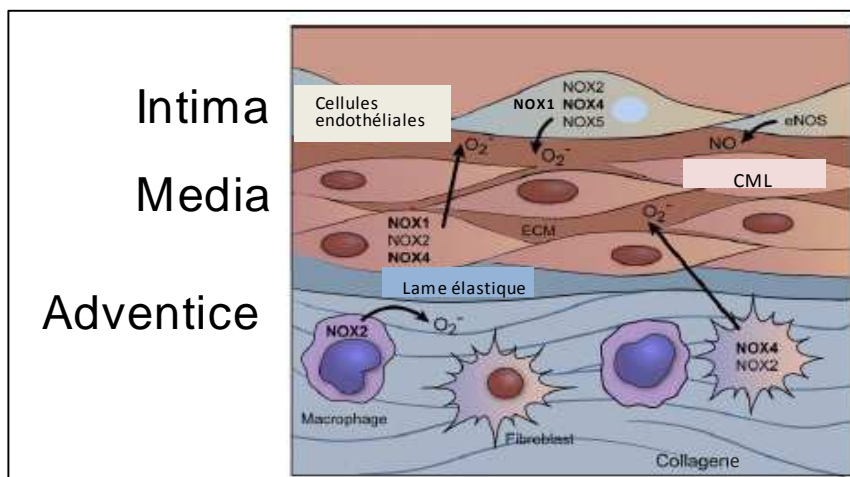

Figure 8. Localisations des NADPH oxydases au niveau de la paroi vasculaire. Les différentes NOX sont présentes de façon spécifique dans les différentes cellules composant les couches de la paroi vasculaire : les cellules endothéliales pour l'intima, les CML (cellules musculaires lisses) pour la média ainsi que les fibroblastes et macrophages pour l'adventice (Bedard and Krause 2007).

1.1 Rôle dans la régulation de la pression artérielle

Les fonctions des NOX au niveau vasculaire sont complexes et dépendent non seulement de l'isoforme de NOX impliquée mais également du type cellulaire. Plusieurs études ont suggéré que NOX1 pouvait jouer un rôle important au niveau vasculaire puisque les taux d'ARNm de cette isoforme dans les cellules musculaires lisses des vaisseaux de rat étaient augmentés après stimulation *ex vivo* par l'angiotensine II (Lassegue, Sorescu et al. 2001) et également chez les rats hypertendus surexprimant un précurseur de l'angiotensine II, la rénine (Wingler, Wunsch et al. 2001). L'angiotensine II est un des acteurs clés des augmentations de pression artérielle avec des effets au niveau du système nerveux central, du système vasculaire et des reins. Son administration chez la souris est un modèle reconnu d'hypertension (Ruiz-Ortega, Lorenzo et al. 2001). Ce polypeptide produit ses effets en stimulant ses récepteurs spécifiques : AT1 et AT2. La vasoconstriction engendrée est responsable de son effet hypertenseur (figure 9).

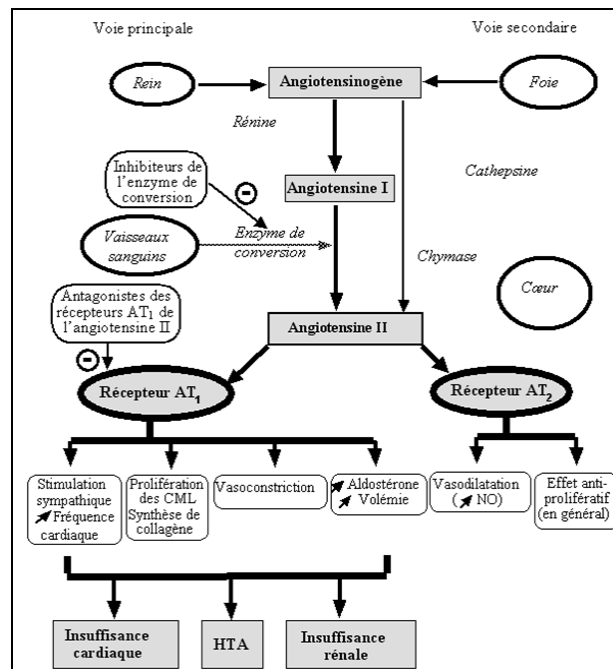

Figure 9. Voies de synthèse et effets physiopathologiques de l'angiotensine II dus à la stimulation de ses récepteurs AT₁ et AT₂. Les sites d'action des 2 classes d'anti-hypertenseurs: inhibiteurs de l'enzyme de conversion et antagonistes des récepteurs AT₁ de l'angiotensine II sont également indiqués. HTA : hypertension artérielle, CML : cellules musculaires lisses.

L'implication de NOX1 dans la régulation de la pression artérielle de base ainsi que sous l'action de l'angiotensine II a clairement été démontrée de façon indirecte dans des modèles murins :

✓ Des souris sauvages, recevant 3mg/kg/jour d'angiotensine II en continu durant 7 jours à l'aide de mini pompes Azlet, présentaient une forte augmentation de la production des ROS au niveau de la média de l'aorte. A l'inverse, cette augmentation était faible chez les souris déficientes en NOX1. L'angiotensine II accroît donc la génération de ROS sous la dépendance de NOX1. La diminution de production de ROS sous angiotensine II est associée, chez les souris déficientes en NOX1, à une augmentation de la pression systolique inférieure à celle observée

avec les souris contrôles durant les 3 premiers jours de l'infusion (Gavazzi, Banfi et al. 2006). A partir du 5^{ème} jour, alors que la pression systolique des souris sauvages continue à augmenter, celle des souris déficientes en Nox1 retournent à des valeurs de pression artérielle systolique basale (Matsuno, Yamada et al. 2005; Gavazzi, Banfi et al. 2006). De plus, la pression systolique basale effectuée sur un grand nombre de souris (n=25) avant traitement par l'angiotensine II, dans l'étude de Gavazzi et coll., était inférieure chez les souris déficientes en Nox1 en comparaison de celle mesurée chez les souris sauvages.

✓ A l'inverse, un modèle de souris surexprimant NOX1 au niveau des cellules musculaires lisses des vaisseaux présentaient après infusion d'angiotensine II une augmentation de la pression artérielle supérieure à celle observée chez les souris contrôles (Dikalova, Clempus et al. 2005).

✓ Il est à noter que bien que les informations concernant la pression artérielle données dans l'article soient succinctes, un modèle de souris surexprimant l'angiotensine II de façon chronique (TTRhRen) et déficientes en Nox1 n'a pas montré de diminution de la pression artérielle par rapport aux souris hypertendues possédant Nox1 (Yogi, Mercure et al. 2008). Il est possible que Nox1 soit essentielle dans les phases d'instauration de l'hypertension artérielle sous angiotensine II, mais que son rôle soit négligeable dans les phases de maintenance.

Les ROS vont moduler la pression artérielle en régulant essentiellement la contraction des cellules musculaires lisses mais également les fonctions des cellules endothéliales vasculaires (Rajagopalan, Kurz et al. 1996). Les cellules musculaires lisses stimulées par l'angiotensine II se contractent à travers des mécanismes sensibles à l'état redox. La phosphorylation de la chaîne légère de la myosine (CLM) est une étape cruciale de cette contraction des cellules musculaires lisses vasculaires. La quantité de CLM phosphorylée est fonction de la balance entre les CLM-kinases et les CML-phosphatases (Somlyo and Somlyo 2000). Les CML-kinases sont sous la

dépendance de la concentration de Ca^{2+} intracellulaire. En effet, un des signaux très précoce de l'effet de l'angiotensine II est une augmentation de Ca^{2+} intracellulaire qui semble médiée par l'augmentation de la production de ROS (Torrecillas, Boyano-Adanez et al. 2001). Les ROS peuvent augmenter la concentration de Ca^{2+} par 3 mécanismes distincts (figure 10):

- ✓ Une augmentation de l'affinité du récepteur de l' IP_3 (Rodriguez-Puyol, Griera-Merino et al. 2002).
- ✓ Une régulation des canaux calciques (Wang, Anrather et al. 2006).
- ✓ Et finalement, une inhibition de SERCA (Sarcoendoplasmic reticulum Ca^{2+} -ATPase) (Redondo, Salido et al. 2004). Pour ce dernier, la source des ROS n'est pas encore clairement définie.

Les CML-phosphatases peuvent être également régulées par les ROS. Les RhoA/RhoAkinases (ROCK) inhibent les CML-phosphatases et donc empêchent la déphosphorylation des CML sous stimulation par l'angiotensine II (Uehata, Ishizaki et al. 1997). Or il a été démontré que l'activation de ces ROCK dépendrait des NADPH oxydases (Higashi, Shimokawa et al. 2003). De nombreux arguments sont donc en faveur d'un rôle des ROS et de NOX1 dans la transduction du signal du récepteur AT1 après stimulation par l'angiotensine II.

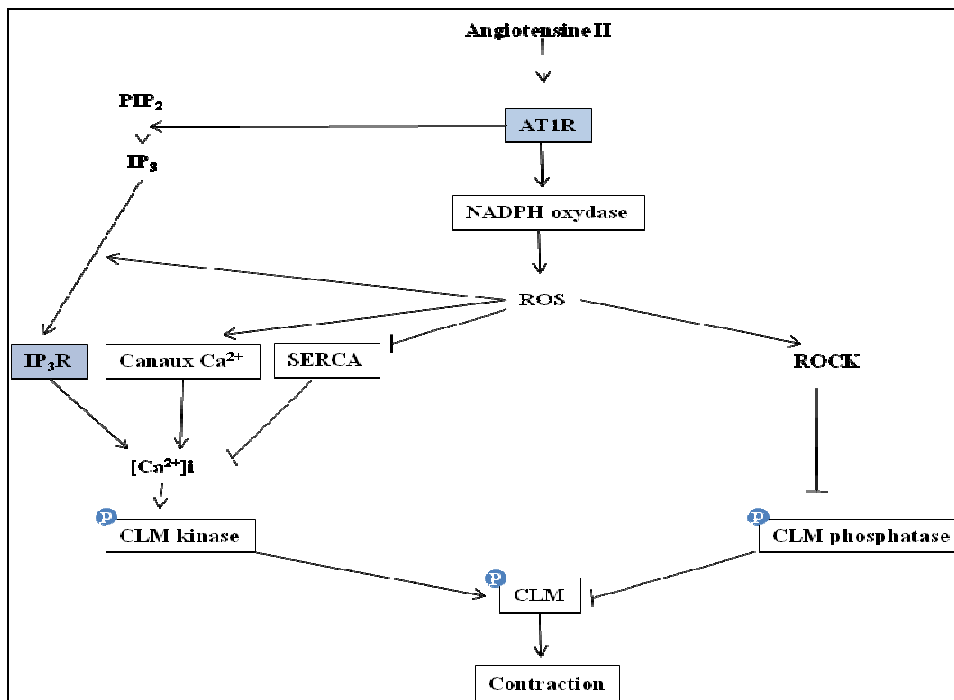

Figure 10. Rôles possibles des ROS dans la contraction des cellules musculaires lisses induite par l'angiotensine II. Les ROS sont impliqués dans des mécanismes dépendants (IP₃R, canaux Ca²⁺ et SERCA) et indépendants du Ca²⁺ (ROCK). AT1R : récepteur de l'angiotensine II de type I, PIP₂ : phosphatidyl inositol biphosphate, IP₃ : inositol triphosphate, IP₃R : récepteur de l'inositol triphosphate, SERCA : Sarcoendoplasmic reticulum Ca²⁺-ATPase, ROCK : Rho-associated kinase et CML : Chaîne légère de la myosine. Le symbole P correspond à l'état phosphorylé. D'après (Garrido and Griendling 2009).

Devant le rôle maintenant bien étayé de NOX1 dans la régulation de la pression artérielle, des études thérapeutiques ont été effectuées chez l'Homme. En l'absence d'inhibiteurs spécifiques de NOX1, des antioxydants ont été administrés. Mais bien que ces antioxydants aient montré une efficacité dans l'hypertension lors d'études cliniques de petite taille (30 à 110 patients) (Czernichow, Bertrais et al. 2006; Plantinga, Ghiadoni et al. 2007; Rodrigo, Prat et al. 2008), les résultats avec des cohortes plus grandes évaluées sur plusieurs années ont été décevants (Maxwell and Greig 2001; McQueen, Lonn et al. 2005; Czernichow, Bertrais et al. 2006).

1.2 Rôle dans le remodelage vasculaire

L'angiotensine II entraîne une augmentation de l'épaisseur de la média des vaisseaux par 3 mécanismes bien déterminés : la prolifération cellulaire, l'hypertrophie des cellules musculaires lisses et l'accumulation de matrice extracellulaire (Ruiz-Ortega, Lorenzo et al. 2001). Des mécanismes dépendants de Nox1 conduisent à cette hypertrophie médiale puisque les souris déficientes en Nox1 traitées par angiotensine II présentent une augmentation de la média de l'aorte mais moins importante que celle observée chez les souris sauvages (Gavazzi, Banfi et al. 2006). Des données *in vitro* ont suggéré l'implication de Nox1 dans la prolifération cellulaire des cellules musculaires lisses (Lassegue, Sorescu et al. 2001). Mais ce rôle de Nox1 est controversé et n'a pas été retrouvé dans les études *in vivo* (Dikalova, Clempus et al. 2005; Gavazzi, Banfi et al. 2006). Ces dernières ont plutôt impliqué Nox1 dans l'induction de l'hypertrophie médiale via l'accumulation de la matrice extracellulaire.

1.3 Rôle dans l'angiogénèse

De nombreuses situations pathologiques présentant une néo-vascularisation sont associées à une augmentation de la production de ROS (Shono, Ono et al. 1996; Lelkes, Hahn et al. 1998). NOX1 a été plus spécifiquement impliqué comme jouant un rôle dans l'angiogénèse observée dans les modèles tumoraux (Arbiser, Petros et al. 2002). Bien que ce rôle soit encore controversé, le rôle de NOX1 dans la prolifération cellulaire a été le premier décrit, expliquant l'un des premiers noms de NOX1 : MOH-1 pour mitogenic oxydase 1. La surexpression de cette protéine dans les cellules NIH 3T3, entraîne un phénotype proche des cellules transformées par l'oncogène Ras et ces cellules transformées par NOX1 greffées sur des souris athymiques provoquent des

fibrosarcomes très agressifs présentant une augmentation importante de l'angiogenèse (Arbiser et al, 2002, Ushio-Fukai, 2004). Les ROS générés par NOX1 augmentent l'expression d'un facteur de croissance des cellules endothéliales, le VEGF (Vascular Endothelial Growth Factor) impliqué dans les mécanismes de l'angiogenèse (Ushio-Fukai 2007; Komatsu, Kato et al. 2008).

VII.2 Dans le système pulmonaire

Le tractus respiratoire est un système unique dévolu à fournir une zone de contact optimale avec l'environnement extérieur afin d'assurer une oxygénation maximale et optimale des tissus. En conséquence, ce système est fortement exposé et vulnérable aux facteurs environnementaux comme les bactéries et virus aéroportés, les irritants chimiques et les allergènes. Il possède donc des systèmes de défense rapides et efficaces mais hautement régulés afin de combattre les pathogènes sans compromettre la fonction pulmonaire. Dans ce contexte, il n'est donc pas étonnant que les NADPH oxydases soient très présentes au niveau du système respiratoire (Pour revue, (van der Vliet 2008). L'analyse des ARNm dans le poumon total a révélé la présence de NOX2, DUOX1 et DUOX2 en grande quantité, et également de NOX1 et NOX4 en quantité moins importante (Edens, Sharling et al. 2001; Geiszt, Witta et al. 2003; Mittal, Roth et al. 2007).

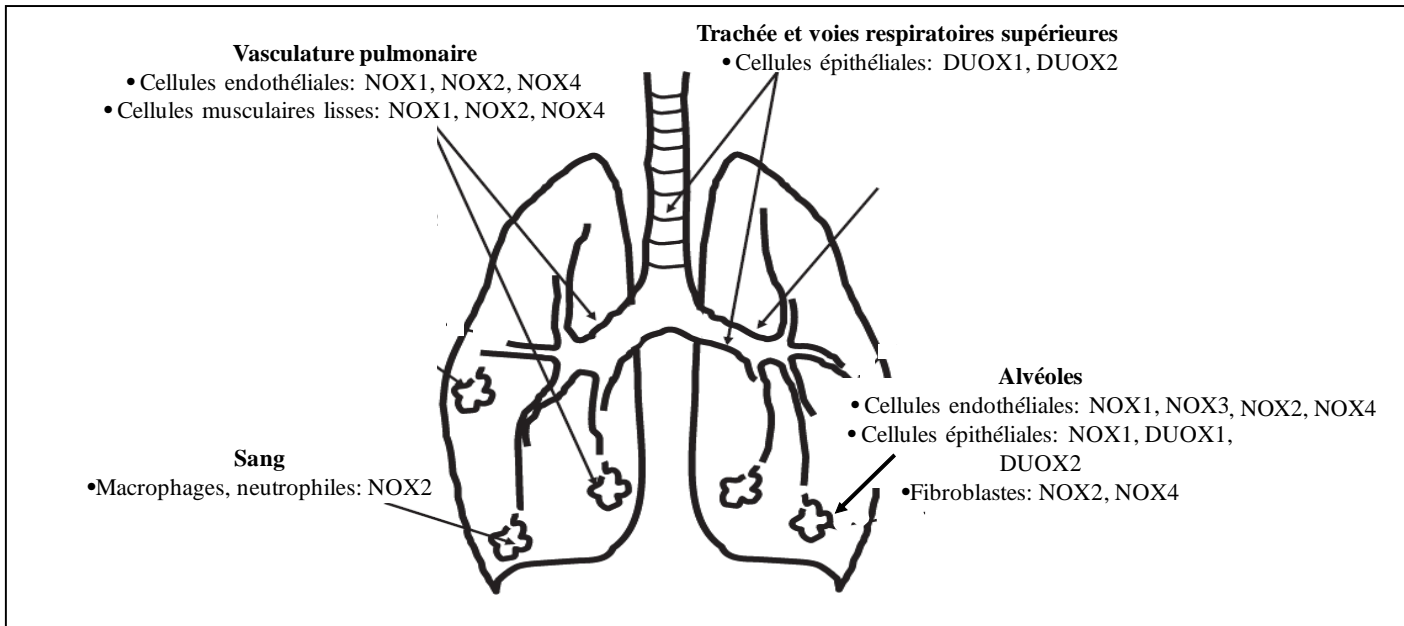

Figure 11. Expressions cellulaires des NADPH oxydases dans le système respiratoire. Les différentes isoformes des NOX, excepté NOX5, sont exprimées dans les différents compartiments pulmonaires (vasculature et alvéoles) ainsi que la trachée et les voies respiratoires supérieures. Cette expression est spécifique du type cellulaire. D'après (Griffith, Pendyala et al. 2009)

2.1 Rôles physiologiques

Les NOX présentes au niveau pulmonaire jouent un rôle essentiel dans la maturation du poumon foetal (Fischer, Gonzales et al. 2007) (essentiellement DUOX1) et dans les défenses antimicrobiennes (Geiszt, Witta et al. 2003) (essentiellement les DUOX et NOX2).

Cependant, peu d'études se sont intéressées au rôle physiologique de NOX1 au niveau pulmonaire. En effet, NOX1 a été détecté dans les cellules épithéliales (Goyal, Weissmann et al. 2004) et endothéliales alvéolaires (Mittal, Roth et al. 2007). De plus, une surexpression de NOX1, associée à une augmentation des ROS, au cours de l'hypoxie a été décrite dans une lignée humaine de cellules épithéliales cancéreuses alvéolaires (A549) (Goyal, Weissmann et al. 2004). L'augmentation des taux de ROS s'accompagne d'une activation de gènes dépendants de HIF-1

(Hypoxia-Inducible Factor 1) dont le rôle est d'induire les mécanismes de régulation de l'hypoxie. Mais la spécificité de NOX1 dans la détection des variations des taux d'oxygène lors de l'hypoxie est controversée puisque NOX2 et NOX4 ont également été impliquées (Mittal, Roth et al. 2007; Cutz, Pan et al. 2009).

2.2 Rôles pathologiques

L'augmentation de l'expression des NOX engendrant des taux élevés de ROS ont été fortement incriminés dans des pathologies pulmonaires chroniques (van der Vliet, Eiserich et al. 1997; Barnes, Shapiro et al. 2003). NOXO1, la sous-unité régulatrice de NOX1 (et de NOX3) est surexprimée dans les poumons de souris présentant une maladie pulmonaire obstructive chronique (Meng, Gideon et al. 2006).

Le rôle des ROS a également été évoqué lors de pathologies pulmonaires aiguës. Des études *in vitro* ont démontré l'efficacité du diphénylénéthidium (DPI), un inhibiteur des NADPH oxydases, sur l'induction des ROS ainsi que sur la mort cellulaire induite par l'hyperoxie. Ces phénotypes ont été observés au niveau d'une lignée murine de cellules épithéliales pulmonaires (MLE-12) (Zhang, Shan et al. 2003) mais également au niveau de cellules humaines endothéliales pulmonaires (Parinandi, Kleinberg et al. 2003). Dans la mesure où ces 2 types cellulaires expriment NOX1, il pourrait donc jouer un rôle important dans l'induction des dommages pulmonaires engendrés par l'hyperoxie conduisant au syndrome de détresse respiratoire.

VIII. Fonctions physiologiques et physiopathologies liées à NOX2

VIII.1 Rôles physiologiques de NOX2 dans le système immunitaire

NOX2, exprimée dans les cellules du système immunitaire, génère des quantités croissantes en fonction de sa localisation respective dans les cellules dendritiques (Gelderman, Hultqvist et al. 2007) ainsi que les lymphocytes B (Morel, Cohen Tanugi Cholley et al. 1993), les macrophages et les polynucléaires neutrophiles. Ces différences de quantité de ROS produits vont engendrer des rôles de NOX2 distincts dans les cellules du système immunitaire.

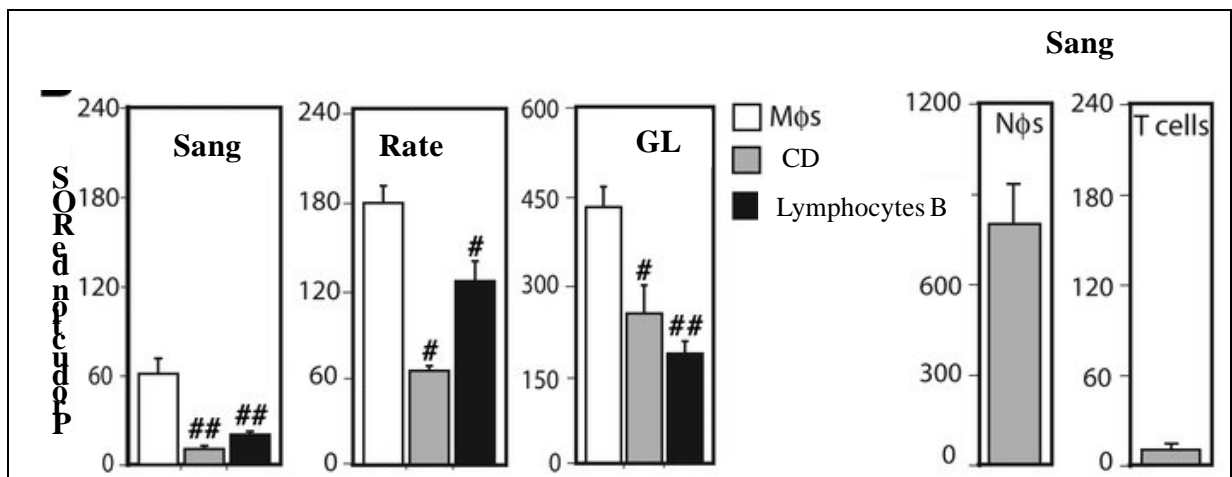

Figure 12. Production de ROS par les cellules du système immunitaire. Après stimulation par le PMA, les macrophages (Mφ) produisent des quantités de ROS, supérieures à celles produites par les cellules dendritiques (CD) et par les lymphocytes B présents dans le sang, la rate, les ganglions inguinaux (GL) de souris sauvages. Les neutrophiles (Nφ) du sang, produisent des quantités très importantes après stimulation par le PMA alors que les lymphocytes T n'en produisent pas. Les astérisques indiquent les niveaux de significativité par rapport aux macrophages: # $P < 0.05$; ## $P < 0.01$. Après marquage par le DHR123 (Dihydrorhodamine 123), la production des ROS a été quantifiée par cytométrie en flux (Gelderman, Hultqvist et al. 2007).

1.1 Rôles dans les polynucléaires neutrophiles

*** Microbicidie:**

NOX2 ou gp91^{phox} ainsi que ses sous-unités régulatrices sont fortement exprimées dans les polynucléaires neutrophiles d'où son nom de « NADPH phagocytaire » et est responsable d'une forte augmentation de la production de ROS appelée « explosion respiration » ou « burst oxydatif » dans ces cellules. Ce mécanisme dépendant de l'oxygène est impliqué, en association avec les mécanismes indépendants de l'oxygène (protéases, peptides et protéines bactéricides), dans la destruction des micro-organismes phagocytés par les neutrophiles. L'activation de NOX2 (voir chapitre II.1) permet la production d'anions superoxydes, peu microbicides mais qui génèrent du peroxyde d'hydrogène avec un pouvoir bactéricide direct plus important. La formation d'acide hypochlorique par la MPO à partir du peroxyde d'hydrogène présente également un pouvoir bactéricide direct important (Jiang, Griffin et al. 1997).

L'activité microbicide de NOX2 au niveau du neutrophile est également indirecte par une modulation du pH et de l'homéostasie ionique du phagosome : i) La réaction de dismutation des ions superoxydes en peroxyde d'hydrogène au sein du phagosome est consommatrice d'ions d'hydrogène (H⁺) (Maturana, Krause et al. 2002). L'alcalinisation créée permettrait d'obtenir un pH phagosomal optimum pour l'activité des protéases neutres bactéricides comme la cathepsine G et l'élastase. ii) L'activation de NOX2 va amener une accumulation de charges négatives au sein du phagosome qui sera compensée par les canaux protons mais également par les canaux potassiques (K⁺) (Ahluwalia, Tinker et al. 2004; Rada, Geiszt et al. 2005). Ceci va engendrer un changement de l'osmolarité phagosomale optimisant l'activité des protéases cationiques.

Récemment, un nouveau mécanisme de destruction des micro-organismes par les polynucléaires neutrophiles a été décrit. Lors de leur activation, ces cellules libèrent des protéines granulaires et de la chromatine qui forment des fibres extracellulaires qui lient les bactéries (Brinkmann, Reichard et al. 2004) et les champignons (Urban, Reichard et al. 2006). Ces structures portent le nom de « pièges extracellulaires des neutrophiles » ou «NETs» (**N**eutrophil **E**xtracellular **T**raps). Les protéases immobilisées sur les NETs dégradent les facteurs de virulence des micro-organismes fixés. La stimulation des neutrophiles par des activateurs de NOX2 (PMA et micro-organismes) induiraient la formation des NETs alors que l'ajout préalable, avant stimulation, d'un inhibiteur des NOX, le diphényliodonium (DPI) la bloquerait. De plus, les neutrophiles des patients atteints de granulomatose septique chronique déficients en NOX2 sont incapables de produire des NETs. La formation de ces NETs serait donc dépendante des ROS produits par le neutrophile (Fuchs, Abed et al. 2007; Bianchi, Hakkim et al. 2009).

La fonction microbicide de NOX2 dans les polynucléaires neutrophiles est également décrite dans les polynucléaires éosinophiles dans la défense contre les parasites (Nagata 2005).

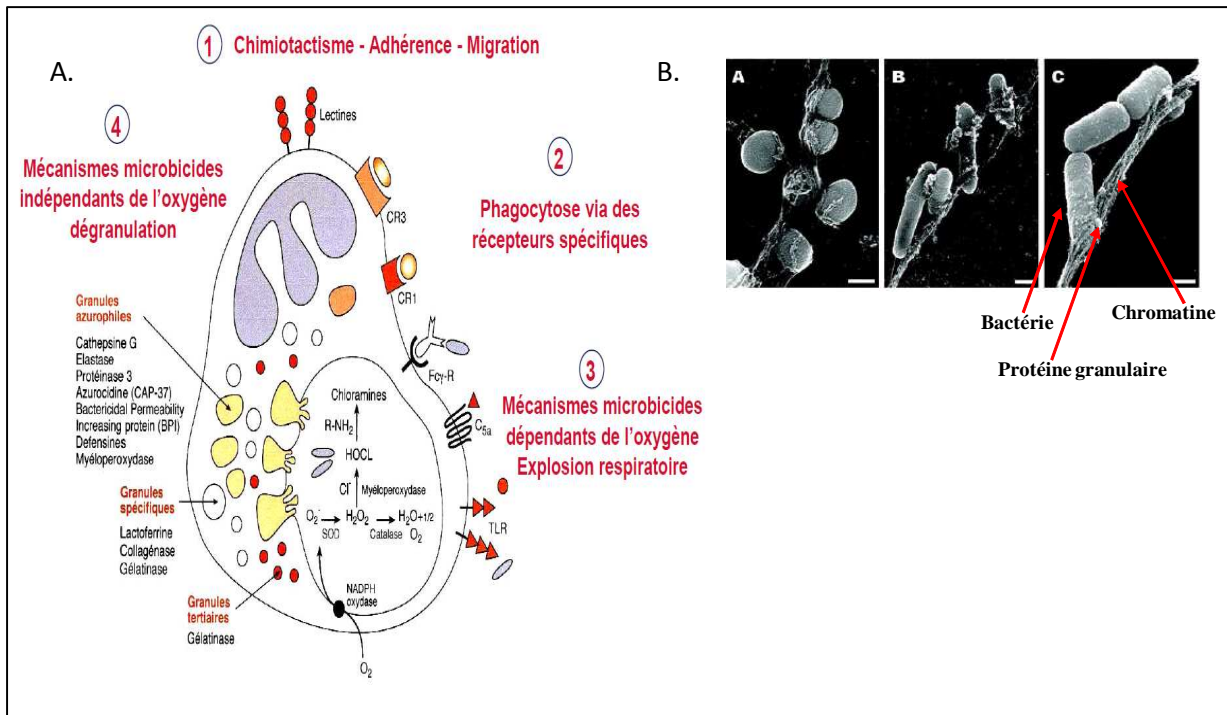

Figure 13. Mécanismes microbicidies de la NADPH oxydase phagocytaire. A. Mécanismes dépendants (3) et indépendants (1, 2 et 4) de l'oxygène responsables de la microbicidie au sein des neutrophiles. B. Illustrations des NETs (Neutrophil Extracellular Traps).

*** Rôle anti-inflammatoire:**

Bien qu'une augmentation de l'activité de NOX2 soit très souvent associée à de nombreuses pathologies inflammatoires (pour revue (Lambeth, Krause et al. 2008)), un nombre croissant de publications présente les ROS produits par NOX2 comme des molécules ayant une activité anti-inflammatoire. Ceci est en accord avec les complications inflammatoires observées en l'absence de NOX2 soit chez les patients atteints de granulomatose septique chronique donc déficients en NOX2, soit chez les souris déficientes en NOX2 (Schappi, Jaquet et al. 2008). Plutôt que d'une contradiction, on peut parler d'un effet biphasique des ROS en fonction de leur concentration. Les ROS produits à forte dose ou de façon prolongée sont toxiques et génèrent des composés pro-inflammatoires. L'absence de ROS engendre également un phénotype pro-

inflammatoire indiquant que les ROS sont des régulateurs importants de l'inflammation et sont essentiels dans des voies de signalisation limitant la réponse inflammatoire lorsqu'ils sont produits à faibles doses.

De nombreux mécanismes de résolution de l'inflammation dépendants des ROS ont été décrits.: i) flip-flop des phosphatidylsérines à la surface des neutrophiles apoptiques (Frasch, Berry et al. 2008; Sanmun, Witasp et al. 2009), ii) dégradation du matériel phagocyté (Metcalf, Thompson et al. 1990), iii) inhibition de la sécrétion et dégradation des cytokines pro-inflammatoires (Clark and Klebanoff 1979; Selmezy, Szelenyi et al. 2003; Lekstrom-Himes, Kuhns et al. 2005) et iv) diminution du flux calcique (Geiszt, Kapus et al. 1997). Mais il est encore difficile d'évaluer leur impact physiologique chez l'Homme.

1.2 Rôles dans les macrophages

Les macrophages sont les phagocytes localisés dans les tissus et dérivés des monocytes circulants. Comme les neutrophiles, les macrophages expriment NOX2 et ses sous-unités régulatrices. Ils ont un pouvoir microbicide dépendant de l'oxygène sur les pathogènes phagocytés.

Par rapport aux polynucléaires neutrophiles, les ROS produits par NOX2 dans les macrophages sont à des taux plus faibles. Ils agiraient donc plus comme des messagers intracellulaires. Leurs rôles dans la transduction du signal (Lee, Lee et al. 2008; Yang, Shin et al. 2009) et dans l'activation de facteurs de transcription (NF- κ B et AP-1) qui vont contrôler l'expression de gènes impliqués dans l'inflammation comme TNF α , IL1- β , IL-6 et IL-18, ont été suggérés.

Les NADPH oxydases

De plus, les macrophages sont des cellules présentatrices d'antigènes aux lymphocytes T. Or, NOX2 est transporté à la membrane cellulaire des macrophages, lieu de contact avec les lymphocytes T lors de la présentation de l'antigène. Au sein de cette « synapse immunologique » formée entre le macrophage et le lymphocyte T, de nombreuses molécules interagissent pour transduire le signal et certaines comme les protéines tyrosine phosphatases (PTP) ou les protéines kinases (PK) vont être sensibles à l'état redox. Les PTP, gouvernant la déphosphorylation, possèdent un résidu cystéine au niveau de leur site catalytique. Les ROS oxydent le groupement thiol de cette cystéine en groupement acide sulfénique, rendant alors non fonctionnelles les PTP (Denu and Tanner 1998; Chiarugi 2005). Inversement à cette inhibition des PTP, les ROS vont activer les protéines kinases comme la protéine Lck responsable de la phosphorylation de ZAP-70, indispensable à la transduction du signal du récepteur des lymphocytes T, le TCR (Nakamura, Hori et al. 1993).

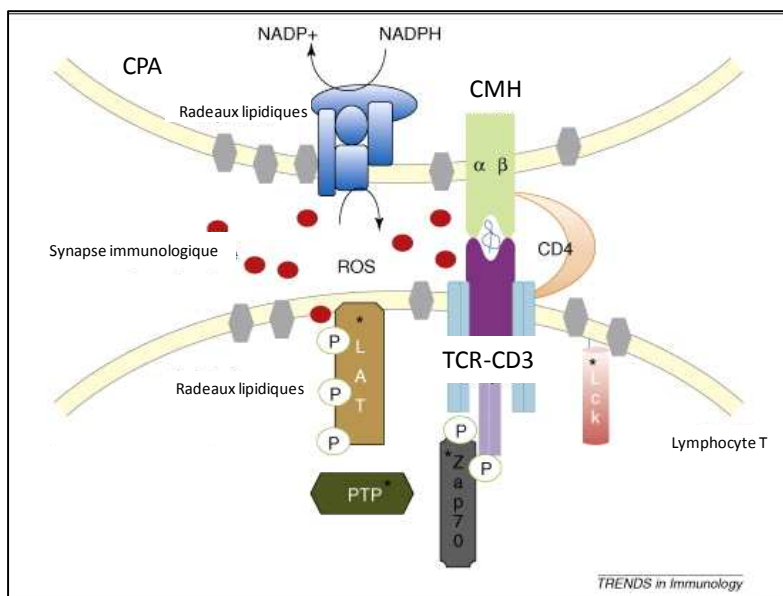

Figure 14. Rôles possibles des ROS dans la synapse immunologique. Les ROS produits par NOX2 localisé au niveau des radeaux lipidiques des cellules présentatrices de l'antigène (CPA) vont pouvoir agir sur les protéines sensibles à l'état redox de la cascade de signalisation du TCR (récepteur des lymphocytes T) : Lck, LAT (linker of activation of Tcells) (Hultqvist, Olsson et al. 2009)

1.3 Rôles dans les cellules dendritiques

Les cellules dendritiques sont des cellules myéloïdes dont le rôle principal est de détecter les pathogènes et de les apprêter correctement afin d'initier une réponse cellulaire T efficace. Ces cellules expriment NOX2 ainsi que ses sous-unités régulatrices mais les ROS produits le sont à des taux très faibles par rapport à ceux des polynucléaires neutrophiles (Elsen, Doussiere et al. 2004; Gelderman, Hultqvist et al. 2007). Cette faible «explosion respiratoire» ainsi que la fonction cellulaire des cellules dendritiques suggèrent que NOX2 n'a pas de rôle microbicide au sein de cette cellule. Il est à noter également que les cellules dendritiques sont dépourvues de MPO et ne pourront donc pas, à partir du peroxyde d'hydrogène, créer des dérivés de l'oxygène hautement réactifs.

A l'inverse, NOX2 semble indispensable à la régulation du pH phagosomal de la cellule dendritique. Afin d'être reconnu par les lymphocytes T (CD8), les antigènes phagocytés par les cellules dendritiques doivent être dégradés sous forme de peptides d'environ 8-9 acides aminés. Cette dégradation est médiée par des protéases lysosomales dont l'activité optimale est obtenue aux pHs 5.5-6.5. Cet apprêtement de l'antigène est soumis à une régulation précise puisqu'une activité diminuée des protéases empêche la dégradation de l'antigène en peptide reconnu mais à l'inverse, une activité augmentée engendre la destruction du peptide. Ces deux phénomènes conduisent à une non-reconnaissance du peptide par les lymphocytes T. Les ROS produits par NOX2, en consommant des protons, permettent une alcalinisation du phagosome et donc assurent une diminution de l'activité des protéases au moment voulu. Les cellules dendritiques humaines ou murines, déficientes en NOX2, présentent une acidification permanente de leur phagosome et donc une dégradation trop importante des antigènes empêchant la reconnaissance du peptide par les lymphocytes T (Savina, Jancic et al. 2006; Mantegazza, Savina et al. 2008).

1.4 Rôles dans les lymphocytes B

Les lymphocytes B sont capables de générer des ROS en faible quantité (5% de la quantité produite par les polynucléaires neutrophiles) par l'activation de NOX2 (Morel, Cohen Tanugi Cholley et al. 1993; Batot, Paquet et al. 1998). Le rôle physiologique de NOX2 au niveau des lymphocytes B n'est pas encore clairement défini, même si les faibles taux de ROS produits évoqueraient plutôt un rôle dans la transduction du signal plutôt qu'une activité microbicide. Deux études ont suggéré un rôle dans la prolifération des lymphocytes B (Hunt, Cook et al. 1991) et dans la régulation de la phosphorylation des tyrosines (Suzuki and Ono 1999).

VIII.2 Rôles pathologiques de NOX2 : La granulomatose septique chronique

L'activité microbicide de NOX2 dans les polynucléaires neutrophiles est primordiale dans la réponse de l'hôte aux infections puisqu'un dysfonctionnement de cette enzyme, causé par des mutations affectant les composants de ce complexe protéique, est à l'origine de la granulomatose septique chronique ou CGD (chronic granulomatous disease) caractérisée par des infections sévères et récidivantes. La CGD est un déficit immunitaire héréditaire rare (incidence de 1/200 000 à 1/250 000 par an) transmis sur un mode lié au chromosome X lorsqu'il est causé par des mutations au niveau du gène CYBB codant pour NOX2 (60% des cas) ou sur un mode autosomique récessif lorsqu'il est causé par des mutations du gène NCF1 codant pour p47^{phox} (20% des cas) ou du gène CYBA codant pour p22^{phox} (5% des cas) ou du gène NCF2 codant pour p67^{phox} (5% des cas). Très récemment, une mutation du gène NCF4 codant pour p40^{phox} a été mise en évidence chez un patient CGD (Matute, Arias et al. 2009).

Le tableau clinique classique de la CGD est un enfant de moins de 5 ans présentant des infections récurrentes dues à des germes « catalase positive » comme *Staphylococcus aureus*, *Pseudomonas spp.*, *Salmonella spp.*, *Serratia marcescens* et *Nocardia spp.*, et à des agents infectieux fongiques essentiellement *Aspergillus spp.* mais aussi *Candida spp.* (van den Berg, van Koppen et al. 2009) au niveau des tissus superficiels (peau et ganglions) mais aussi profonds (poumons, foie, os et sang).

Associées à ces infections, des complications inflammatoires ont été largement décrites (Schappi, Jaquet et al. 2008). Une des réponses inflammatoires typiques de la CGD est la formation de granulomes dont l'origine est non-infectieuse malgré l'idée préalable que les pathogènes, en persistant par absence de ROS, étaient à l'origine d'une inflammation persistante. Trois faits sont en faveur d'une origine stérile: i) dans la plupart des cas, aucun microbe n'a été retrouvé au sein des granulomes (Schäppi, Smith et al. 1999; Levine, Smith et al. 2005), ii) ces lésions inflammatoires sont résistantes aux antibiotiques (Chin, Stiehm et al. 1987; Schappi, Smith et al. 2001) mais répondent aux immuno-modulateurs type corticoïdes (Marciano, Rosenzweig et al. 2004), salazopyrine (Schäppi, Smith et al. 1999), cyclosporine A ou azathioprine (Rosh, Tang et al. 1995) et finalement, iii) ces lésions ont pu être reproduites par injection d'*Aspergillus fumigatus* inactivé par la chaleur chez la souris déficiente en Nox2 (Morgenstern, Gifford et al. 1997; Petersen, Hiran et al. 2002). Les localisations des sites inflammatoires sont ubiquitaires et représentées chez le patient atteint de CGD et la souris déficiente en Nox2 dans le tableau VII. Ces complications inflammatoires ont un retentissement important sur la morbidité. Au niveau digestif, la colite va être à l'origine d'une cassure staturo-pondérale, d'une anémie, de douleurs abdominales, de diarrhées et vomissements ainsi que d'une constipation.

Tableau VII. Syndromes inflammatoires développés par les patients CGD et les souris déficientes en Nox2 (CGD). D'après Schappi, Jaquet et al. 2008.

Organe	Patients CGD	Souris CGD
Système digestif		Pas de phénotype spontané
✓ Colon	Colite (33%)	
✓ Oesophage	Obstruction	
✓ Iléon	Inflammation	
Tractus urogénital	Obstruction urinaire (10%)	
Peau	Rash cutané Lupus (3.8%)	Syndrome inflammatoire après injection d' <i>Aspergillus fumigatus</i> inactivé
Os	Arthrite rhumatoïde	Arthrite induite
Yeux	Choriorétinite (30%)	

Les mécanismes ainsi que les étiologies déterminants les complications inflammatoires dans la CGD ne sont pas encore clairement identifiés. Cette hyperinflammation est due à l'absence d'une NADPH oxydase des phagocytes puisque les patients CGD ayant reçu une transplantation de moelle osseuse ne présentent plus de symptômes inflammatoires. De plus, la correction partielle de l'activité de la NADPH oxydase des phagocytes dans une minorité de cellules souches de la moelle osseuse prévient les réponses inflammatoires exacerbées des souris déficientes en NOX2 (Goebel, Mark et al. 2005). Et finalement, les mères porteuses de la mutation du gène gp91^{phox} présentent avec une forte incidence des pathologies évocatrices de lupus comme des rashes cutanés photosensibles (58%), des ulcères buccaux (42%) ainsi que des douleurs articulaires (37%) associés à une recherche d'auto-anticorps le plus souvent négatives (Cale, Morton et al. 2007).

De nombreux mécanismes ont été avancés mais basés le plus souvent sur des données *in vitro*. Ces modèles d'études ont permis de déterminer de nouveaux rôles de NOX2 dans les voies de signalisation mais n'ont pas permis d'obtenir de nouvelles cibles thérapeutiques potentielles. Le traitement actuel des ces lésions inflammatoires est basé sur les corticoïdes au long court dont le pouvoir immunosuppresseur est difficilement compatible avec un syndrome

d'immunodéficience. Les mécanismes impliqués dans l'induction de l'inflammation en l'absence des NOX2 sont :

✓ Diminution de la dégradation du matériel phagocyté

L'absence de dégradation du matériel phagocyté par absence de ROS engendrerait une activation permanente du système inflammatoire (Petersen, Hiran et al. 2002). Mais aucune donnée *in vivo* n'est disponible.

✓ Absence d'apoptose

De nombreuses études ont montré que les ROS induisaient une apoptose des polynucléaires neutrophiles (Kasahara, Iwai et al. 1997; Ottonello, Frumento et al. 2002; Yamamoto, Tanuichi et al. 2002). En conséquence, il a été suggéré que l'inflammation observée dans la CGD était due à une diminution de l'apoptose des neutrophiles (Hampton, Fadeel et al. 1998; Hiraoka, Vazquez et al. 1998; Lundqvist-Gustafsson and Bengtsson 1999; Petersen, Hiran et al. 2002). Des études à partir de neutrophiles de patients CGD ont démontré que l'absence de NOX2 n'inhibait pas les voies de signalisations apoptotiques mais empêchait plutôt l'élimination des corps apoptotiques neutrophiliques par les macrophages (Brown, Goldblatt et al. 2003; Frasch, Berry et al. 2008; Fernandez-Boyanapalli, Frasch et al. 2009). Cette absence d'élimination des cellules en apoptose pourrait correspondre aux débris de neutrophiles retrouvés sous la forme de cristaux éosinophiliques au niveau des lésions inflammatoires des patients CGD (Schappi, Smith et al. 2001; Harbord, Novelli et al. 2002; Liu, Cheng et al. 2009).

✓ Altération des signaux intracellulaires

Les neutrophiles de patients CGD ou de souris déficientes en NOX2 présentent, après stimulation, un déséquilibre de la balance cytokines pro-inflammatoires/cytokines anti-inflammatoires en faveur des cytokines pro-inflammatoires comme le TNF α et l'IL-8 (Hatanaka, Carvalho et al. 2004). Il n'est pas clairement établi, à ce jour, si cette augmentation de production des cytokines est une des causes de l'inflammation ou la conséquence d'une inflammation persistante.

✓ Absence d'inhibition des médiateurs pro-inflammatoires

Les protéines S100A8/A9 (MRP8/MRP14) ainsi que les leukotriènes sont des médiateurs pro-inflammatoires dont le catabolisme est dépendant de la production des ROS (Henderson and Klebanoff 1983; Hamasaki, Sakano et al. 1989; Harrison, Raftery et al. 1999). Une autre explication possible de cette inflammation pourrait donc être l'absence d'inhibition des médiateurs pro-inflammatoires en l'absence de ROS.

Ces nombreux mécanismes impliquent le plus souvent la NADPH des neutrophiles mais les autres cellules de l'inflammation possédant NOX2, comme les macrophages et les cellules dendritiques, sont certainement également impliqués dans les mécanismes inflammatoires de la CGD.

D. Modèles murins d'étude du rôle des NADPH oxydases

I. Souris déficientes en NOX1 (*Nox1^{tm1Kkr}*)

La souris déficiente en NOX1 utilisée dans les travaux de cette thèse a été créée par le groupe du Pr.Krause en 2002 (Gavazzi, Banfi et al. 2006). Une zone de 1.9kilobases (kb) comprenant l'exon III à l'exon VI du gène de NOX1 a été remplacée par le gène de résistance à la néomycine (RNeo). Ce vecteur a ensuite été transféré par électroporation dans des cellules souches embryonnaires issues de souris de souche 129SvJ. Les clones sélectionnés par PCR et Southern Blot ont été injectés dans des blastocystes de souris de souche 129SvJ. Ces derniers ont été implantés dans des souris pseudo-gravidiques afin d'obtenir les premières souris chimères déficientes pour NOX1. Après plusieurs croisements avec des souris sauvages de souche C57Bl/6, la colonie de souris déficientes en NOX1 avec un fond génétique C57Bl/6 a été créée. Les souris contrôles utilisées sont des souris sauvages de souche C57Bl/6.

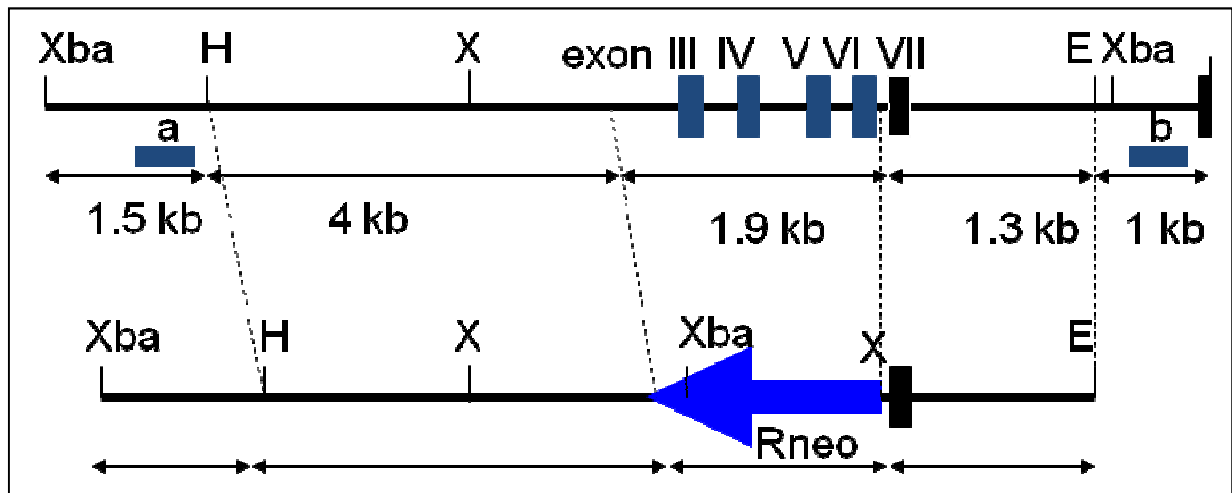

Figure 15. Construction de la souris déficiente en *Nox1*. Représentation du gène NOX1 et du vecteur cible. X et Xba correspondent aux sites de restriction. a et b correspondent aux sondes utilisées pour le Southern blot. Elles ont été choisies en dehors de la séquence du gène *Nox1* afin de s'assurer de l'introduction du vecteur au niveau du chromosome X. La flèche bleue située sur le vecteur cible correspond au gène de résistance à la néomycine (Rneo) inséré.

Le génotype des souris est déterminé à partir de l'ADN extrait des queues de souris. Une amorce sens commune en amont de la délétion reconnaît l'ADN des souris contrôles et déficientes en NOX1. Une amorce anti-sens est spécifique de l'ADN contrôle et une autre amorce anti-sens est spécifique du gène de résistance à la néomycine.

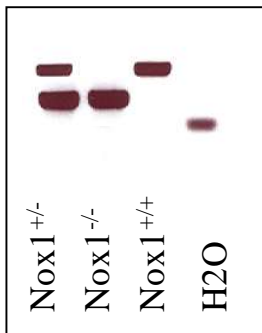

Figure 16. Génotypage des souris déficientes en Nox1. Représentation du gel d'agarose révélant les produits de PCR. L'ADN des souris sauvages ($Nox1^{+/+}$) présente une bande unique à 300 paires de base, alors que celui des souris déficientes en Nox1 présente une bande unique à 140 paires de base et celui des souris femelles hétérozygotes présente les 2 bandes.

Nox1 étant situé sur le chromosome X, les souris femelles pourront avoir comme génotype : sauvage ($Nox1^{+/+}$), hétérozygote pour l'allèle nul ($Nox1^{+/-}$) ou homozygote pour l'allèle nul ($Nox1^{-/-}$). Les souris mâles ne pourront avoir comme génotype : sauvage ($Nox1^{+Y}$), ou hémizygote pour l'allèle nul ($Nox1^{-Y}$).

Ces souris déficientes en NOX1 n'ont, à ce jour, présenté aucun phénotype spontané.

II. Souris déficientes en NOX2 ($Cybb^{tm1Din}$)

La souris déficiente en NOX2 a été créée en 1995 par le groupe du Pr. Dinauer (Pollock, Williams et al. 1995). Un fragment génomique de 4.8kilobases (kb) contenant l'exon II et III du gène de NOX2 a été utilisé pour construire un vecteur cible dans lequel le gène de résistance à la néomycine a été inséré afin de remplacer l'exon III.

Ce vecteur a ensuite été transféré par électroporation dans des cellules souches embryonnaires issues de souris de souche 129SvJ. Les clones sélectionnés par PCR et Southern Blot ont été injectés dans des blastocystes de souris de souche 129SvJ. Ces derniers ont été implantés dans des souris pseudo-gravidiques afin d'obtenir les premières souris chimères déficientes pour NOX2. Après plusieurs croisements avec des souris sauvages de souche C57Bl/6, la colonie de souris déficientes en NOX2 avec un fond génétique C57Bl/6 a été créée. Les souris contrôles utilisées sont des souris sauvages de souche C57Bl/6.

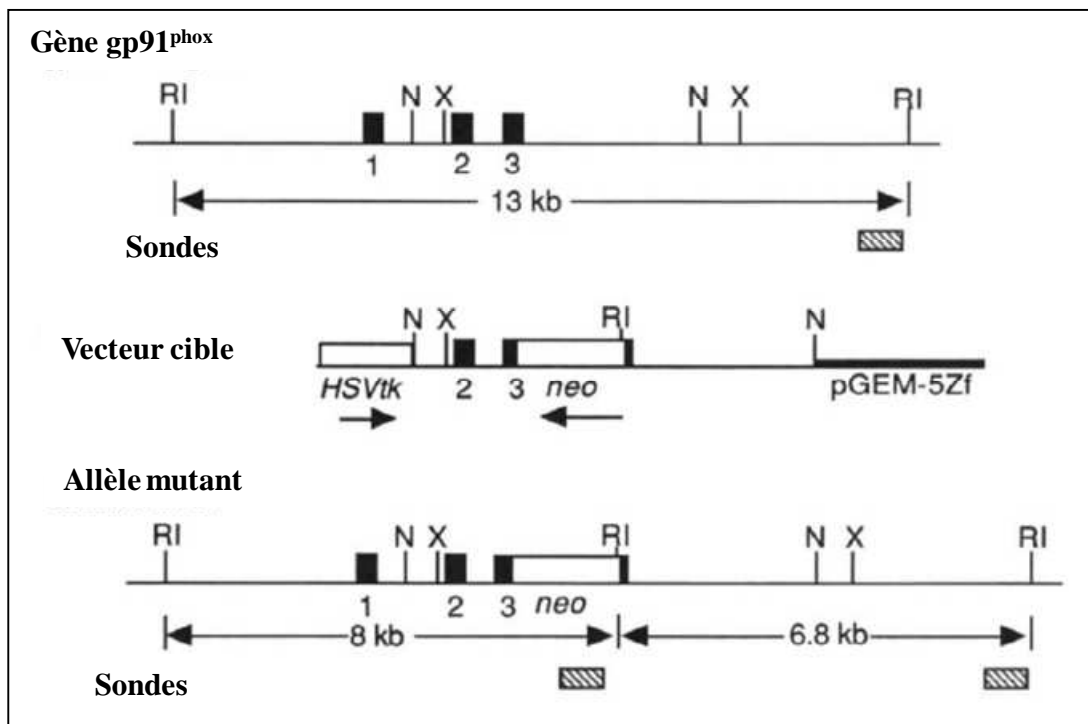

Figure 17. Construction de la souris déficiente en Nox2. Représentation du gène gp91^{phox} codant pour la protéine Nox2, du vecteur cible et l'allèle mutant obtenu. X, N et RI correspondent aux sites de restriction. Le vecteur cible contient le gène de résistance à la néomycine (neo).

Le génotype des souris est déterminé à partir de l'ADN extrait des queues de souris. Une amorce sens commune en amont de la délétion reconnaît l'ADN des souris contrôles et

déficientes en NOX2. Une amorce anti-sens est spécifique de l'ADN contrôle et une autre amorce anti-sens est spécifique du gène de résistance à la néomycine.



Figure 18. Génotypage de la souris déficiente en Nox2. Représentation du gel d'agarose révélant les produits de PCR. L'ADN des souris sauvages ($Nox2^{+/+}$) présente une bande à 240 paires de base, alors que celui des souris déficientes en Nox2 présente une bande unique à 195 paires de base et celui des souris femelles hétérozygotes présentera les 2 bandes.

$Nox2^{+/-}$
 $Nox2^{+/-}$
 $Nox2^{+/-}$
H₂O

Comme Nox1, Nox2 est situé sur le chromosome X, les souris femelles pourront avoir comme génotype : sauvage ($Nox2^{+/+}$), hétérozygote pour l'allèle nul ($Nox2^{+/-}$) ou homozygote pour l'allèle nul ($Nox2^{-/-}$). Les souris mâles ne pourront avoir comme génotype : sauvage ($Nox2^{+/Y}$), ou hémizyote pour l'allèle nul ($Nox2^{-/Y}$).

Ces souris déficientes en Nox2 sont viables et ne présentent, la plupart du temps, aucun phénotype spontané lorsqu'elles sont élevées dans un environnement sans pathogènes spécifiques des souris. Mais lorsque ces souris sont en contact avec *Staphylococcus aureus* ou *Aspergillus fumigatus*, elles présentent une susceptibilité accrue aux agents infectieux. Ces souris déficientes en Nox2 peuvent présenter des gonflements sévères au niveau des pattes ou du museau. Ces lésions contiennent du *Staphylococcus species* (Bingel 2002).

Ce sont des modèles d'études de la maladie granulomateuse septique mais également du rôle de NOX2 dans l'inflammation.

III. Autres rongeurs utilisés comme modèle de la CGD

- ✓ Souris déficiente en p40^{phox}: Les neutrophiles de ces souris produisent des quantités de ROS inférieure à celles produites par des souris sauvages (Ellson, Davidson et al. 2006).
- ✓ Souris déficiente en p47^{phox}: créée par Jackson (Jackson, Gallin et al. 1995) par remplacement de l'exon III à l'exon VII du gène p47^{phox} par un vecteur contenant le gène de résistance à la néomycine. Les souris déficientes en p47^{phox} présentent une susceptibilité accrue aux agents infectieux ainsi que des granulomes inflammatoires.
- ✓ Souris et rats mutants pour Ncf1: Des mutations spontanées du gène Ncf1 (p47^{phox}) affectant la production de ROS ont été découvertes chez ces rongeurs (Olofsson, Holmberg et al. 2003; Hultqvist and Holmdahl 2005). Ces mutations sont responsables d'une susceptibilité accrue aux phénomènes inflammatoires comme l'arthrite.
- ✓ Rats MES: Une mutation spontanée du gène Cyba (p22^{phox}) empêche la production de ROS par les leucocytes de ces rats. Ces rongeurs présentent une hyperéosinophilie sévère engendrant des lésions inflammatoires (Mori, Li et al. 2009).

DEUXIEME PARTIE
TRAVAUX DE RECHERCHE

A. Introduction et buts des travaux de recherche

Depuis l'identification et le clonage des différentes NADPH oxydases, de nombreuses études ont contribué à la connaissance du rôle biologique, de la signalisation et de la régulation des NOX. Ils ont également permis la construction de modèles murins transgéniques. Ces modèles ont participé, en grande partie, à la découverte de nombreux mécanismes pathophysiologiques des différentes NOX. L'absence d'une isoforme spécifique des NOX par invalidation de gène dans les souris a permis de pallier au manque de spécificité envers une isoforme des molécules inhibitrices des NOX.

Le but de ce travail a été d'étudier, à l'aide de modèles murins transgéniques, les rôles de NOX1 et NOX2 susceptibles de participer à des mécanismes physiopathologiques. NOX1 a particulièrement été étudié aux niveaux vasculaire et pulmonaire et NOX2 au niveau cutané dans un contexte inflammatoire.

La partie bibliographique de ce document nous a permis de souligner le rôle essentiel de NOX1 au niveau vasculaire. En effet, NOX1 est impliquée dans l'hypertension artérielle et l'augmentation de la média de l'aorte induites par l'angiotensine II. Ce rôle prépondérant a été clairement défini par la mise en évidence d'une diminution du phénotype chez les souris déficientes en NOX1 par 2 groupes dont celui du Professeur Krause. Mais des questions sur le rôle physiologique de NOX1 dans la régulation de la pression artérielle restaient en suspens : i) Le rôle de NOX1 dans la régulation de la pression artérielle est-il uniquement lié à l'angiotensine II? ii) Quel est ou quels sont les mécanismes par le(s)quel(s) NOX1 module l'activité de l'angiotensine II ?

En parallèle et en collaboration avec le groupe du Professeur Barrazone, pneumologue, nous nous sommes intéressés aux rôles des ROS dans l'induction des dommages pulmonaires engendrés par l'hyperoxie. Les quantités importantes de ROS produites lors de l'hyperventilation mécanique sont responsables des lésions pulmonaires graves. Il semble donc indispensable de bloquer cette production de ROS. Pour cela, une meilleure compréhension de la physiopathologie et la détermination de la NADPH oxydase impliquées dans cette production excessive lors de l'hyperoxie sont essentielles.

Finalement, nous avons investigué les complications hyperinflammatoires observées chez les patients atteints de maladie granulomateuse septique (CGD). Ces réponses inflammatoires exacerbées ont un retentissement important sur la morbidité et le traitement actuel repose sur les corticoïdes au long court dont le pouvoir immunosuppresseur est difficilement compatible avec une pathologie d'immunodéficience. Afin d'assurer une meilleure prise en charge des patients CGD, l'origine et la compréhension des mécanismes initiant ces lésions inflammatoires en l'absence de NOX2 semblent indispensables.

B. Rôles de NOX1 dans la régulation de la pression artérielle

L'hypertension artérielle (pression artérielle supérieure à 140/90 mm de Hg) dans le monde constitue un problème de santé publique avec en France une prévalence de 41,8% pour les hommes et de 27,8% pour les femmes (Etude Mona Lisa 2007). Une des molécules importantes dans la survenue de l'hypertension artérielle est l'angiotensine II et 2 classes d'antihypertenseurs sont capables de bloquer, entre autres, ses effets vasoconstricteurs. Ce sont les inhibiteurs de l'enzyme de conversion et les antagonistes des récepteurs de l'angiotensine II de type 1 (AT1). Ce polypeptide impliqué depuis de nombreuses années comme un stimulus capable d'activer la production de ROS (Griendling, Sorescu et al. 2000) augmente l'expression des transcrits de NOX1 et NOX4 (Lassegue, Sorescu et al. 2001; Wingler, Wunsch et al. 2001). Le lien entre hypertension artérielle, angiotensine II et stress oxydatif a donc été fortement suggéré (Sowers 2002). L'importance grandissante des ROS dans la survenue et l'évolution des pathologies cardio-vasculaires ainsi que le rôle prédominant de NOX1 dans la survenue d'hypertension artérielle systémique induite par l'angiotensine II occupe la littérature depuis quelques années.

I. Article 1 L'absence de NOX1 protège des dissections aortiques induites par l'angiotensine II

NOX1 DEFICIENCY PROTECTS FROM AORTIC DISSECTION IN RESPONSE TO ANGIOTENSIN II. Gaetan Gavazzi, Christine Deffert, Candice Trocme, Michela Schäppi, François R. Hermann and Karl-Heinz Krause. *Hypertension*. 2007. 50:189-196.

La perfusion d'angiotensine II chez les rongeurs est un modèle d'études reconnu de l'hypertension artérielle (Ruiz-Ortega, Lorenzo et al. 2001). Ce modèle est également utilisé dans lors des études de la formation des anévrismes et la survenue des dissections aortiques (Daugherty and Cassis 2004) ce qui n'est pas le cas avec d'autres molécules hypertensives comme la norépinéphrine (ou noradrénaline). L'angiotensine II serait donc une molécule hypertensive majeure également impliquée dans la formation des anévrismes bien que ces phénomènes semblent indépendants (Cassis, Gupte et al. 2009). Les mécanismes conduisant à la formation des lésions de dilation sous angiotensine II sont :i) une infiltration de monocytes et de macrophages de la média en réponse à des ruptures des fibres élastiques, ii) une activation des protéases, en particulier par un déséquilibre de la balance entre les métalloprotéases (MMP) et leurs inhibiteurs, les TIMPs (Tissue Inhibitors of Matrix Métalloprotéinases), et iii) une réponse fibrotique. Un rôle possible des NADPH oxydases a été évoqué dans la survenue d'anévrismes aortiques. Ces derniers sont associés à une augmentation de la sous-unité p22^{phox} chez l'Homme (Ejiri, Inoue et al. 2003; Gavrilu, Li et al. 2005; Thomas, Gavrilu et al. 2006). La délétion génique de p47^{phox} dans un modèle murin (Thomas, Gavrilu et al. 2006) ainsi que l'"inhibition" pharmacologique par l'administration de vitamine E (Gavrilu, Li et al. 2005) ont démontré un effet protecteur vis-à-vis de la survenue des anévrismes.

Lors de cet article, devant le rôle maintenant bien étayé de NOX1 dans l'hypertension artérielle, nous nous sommes demandé si l'activité de NOX1 était uniquement dépendante de l'angiotensine II ? Et si, NOX1 pouvait également jouer un rôle dans d'autres effets de l'angiotensine II comme la formation d'anévrismes ?

Mon travail dans cet article a consisté à mesurer les pressions artérielles systoliques des souris sauvages et déficientes en Nox1, à effectuer le microarray et son analyse ainsi que les PCR quantitatives de confirmation, à participer aux discussions de travail ainsi qu'à l'élaboration du manuscrit. La gestion des animaux transgéniques a également fait partie de ce travail.

Hypertension

JOURNAL OF THE AMERICAN HEART ASSOCIATION



*Learn and Live*SM

NOX1 Deficiency Protects From Aortic Dissection in Response to Angiotensin II

Gaetan Gavazzi, Christine Deffert, Candice Trocme, Michela Schäppi, François R. Herrmann and Karl-Heinz Krause

Hypertension 2007;50;189-196; originally published online May 14, 2007;

DOI: 10.1161/HYPERTENSIONAHA.107.089706

Hypertension is published by the American Heart Association, 7272 Greenville Avenue, Dallas, TX 75214

Copyright © 2007 American Heart Association. All rights reserved. Print ISSN: 0194-911X. Online ISSN: 1524-4563

The online version of this article, along with updated information and services, is located on the World Wide Web at:

<http://hyper.ahajournals.org/cgi/content/full/50/1/189>

Subscriptions: Information about subscribing to Hypertension is online at
<http://hyper.ahajournals.org/subscriptions/>

Permissions: Permissions & Rights Desk, Lippincott Williams & Wilkins, a division of Wolters Kluwer Health, 351 West Camden Street, Baltimore, MD 21202-2436. Phone: 410-528-4050. Fax: 410-528-8550. E-mail:
journalpermissions@lww.com

Reprints: Information about reprints can be found online at
<http://www.lww.com/reprints>

NOX1 Deficiency Protects From Aortic Dissection in Response to Angiotensin II

Gaetan Gavazzi, Christine Deffert, Candice Trocme, Michela Schäppi, François R. Herrmann, Karl-Heinz Krause

Abstract—Oxidative stress leads to vascular damage and participates in the pathomechanisms of aortic dissection and aneurysm formation. Here we study aortic dissection in mice deficient in the superoxide-generating reduced nicotinamide-adenine dinucleotide phosphate oxidase NOX1. Seven days of treatment with the hypertensive agent angiotensin II (3 mg/kg per day) led to aortic dissection in 23% of wild-type C57BL/6J mice but in only 4% of NOX1-deficient mice ($P=0.05$). In contrast, treatment of wild-type C57BL/6J mice with the hypertensive agent norepinephrine (12 mg/kg per day), did not lead to aortic dissection or sudden death, suggesting that hypertension is not sufficient to cause aortic dissection. Interestingly, norepinephrine-dependent blood pressure elevations were conserved in NOX1-deficient mice, demonstrating that, different from angiotensin II, it acts through NOX1-independent hypertensive mechanisms. The resistance of NOX1-deficient mice to angiotensin II–induced aortic dissection suggests a role for NOX1-dependent alterations of the vascular wall. We, therefore, studied gene expression and protease/inhibitor equilibrium. cDNA array analysis demonstrated differential effects of angiotensin II on gene expression in wild-type and NOX1-deficient mice. Tissue inhibitor of metalloproteinase 1 was increased both on the mRNA and the protein level in aortas from NOX1-deficient mice. Thus, our results demonstrate that NOX1 is involved in the mechanisms of angiotensin II–dependent aortic dissection. As one underlying mechanism, we have identified NOX1-dependent suppression of tissue inhibitor of metalloproteinase 1 expression, which could lead to tissue damage through an altered protease/inhibitor balance. (*Hypertension*. 2007;50:189-196.)

Key Words: NOX1 ■ nicotinamide-adenine dinucleotide phosphate oxidase ■ blood pressure ■ aortic dissection ■ angiotensin II

Aortic dissections and formation of aneurysms are serious and frequent medical conditions that are the consequence of damage to the vascular wall. Animals model play a key role in understanding their pathomechanisms.¹ Angiotensin II perfusion in mice has become a particularly valuable model for this pathological process.^{2–5} Angiotensin II–induced vascular alterations include the following: (1) sustained blood pressure elevations; (2) increase in the thickness of the aortic media through mechanisms including smooth muscle hyperplasia, smooth muscle proliferation, and accumulation of extracellular matrix (ECM) proteins; (3) markers of inflammation, including oxidative damage to the vascular tissue, infiltration of monocytes/macrophages, and activation of matrix metalloproteinases; and (4) formation of aortic dissection and aneurysms.^{1,4} Angiotensin II–dependent signal transduction is complex and involves ≥ 2 different receptors and the activation of multiple intracellular signaling pathways.^{6,7} There is now increasing evidence that reactive oxygen species (ROS) are an important

part of angiotensin II–dependent signal transduction^{8–12} involved in the pathogenesis of aortic aneurysms.^{13–17}

Investigations on the source of ROS generation in the vascular system suggest an important role for the NOX family of ROS-generating reduced nicotinamide-adenine dinucleotide phosphate oxidases.^{8–12,18} More specifically, a role for NOX enzymes in aortic dissection and aneurysm formation is suggested by an increased expression of the p22^{phox} NOX subunit in human aneurysmal aortas¹⁹ and by the decreased aortic aneurysm formation in p47^{phox}-deficient mice.²⁰ However, it is not clear which NOX enzyme is relevant for aortic dissection and aneurysm formation. In mice, 6 NOX family members are known: NOX1 to 4 and DUOX1 and 2.¹² In the vascular system, NOX1 is expressed in smooth muscle; NOX2 in macrophages, adventitial fibroblasts, and to some extent also in endothelium; and NOX4 in endothelium and smooth muscle.^{11,21} The role of NOX1 in angiotensin II–induced hypertension has

Received February 21, 2007; first decision March 19, 2007; revision accepted April 20, 2007.

From the Department of Geriatrics (G.G.) and Groupe de Recherche et d'Etude du Processus Inflammatoire Techniques de l'Ingénierie Médicale et de la Complexité-Imag Unité Mixte de Recherche-Centre National de la Recherche Scientifique 5525 (G.G., C.T.), University Hospital of Grenoble, Grenoble, France; and the Departments of Pathology, Immunology, and Clinical Pathology (C.D., M.S., K-H.K.), Pediatrics (C.D.), and Rehabilitation and Geriatrics (F.R.H.), Geneva Medical Faculty, Geneva, Switzerland.

Correspondence to Karl-Heinz Krause, Departments of Pathology, Immunology, and Clinical Pathology, 2 Chemin Petit Bel-Air, 1225 Geneva/Chêne-Bourg, Switzerland. E-mail karl-heinz.krause@medecine.unige.ch

© 2007 American Heart Association, Inc.

Hypertension is available at <http://www.hypertensionaha.org>

DOI: 10.1161/HYPERTENSIONAHA.107.089706

been demonstrated recently.^{22–24} Here we demonstrate that NOX1 is critically involved in angiotensin II–induced aortic dissection.

Methods

All of the reagents were from standard suppliers and of highest available grade.

Animals

Generation of NOX1-deficient mice has been described previously in detail.²³ Animals were back crossed with C57BL/6J mice, and results shown in this study were obtained with F6-generation animals. Wild-type controls were either littermates or wild-type C57BL/6J mice. For our experiments, only males from 12 to 30 weeks of age (weight: 25 to 35 g) were used.

All of the mice were housed in a quiet room at 25°C with a 12-hour light/dark cycle and free access to food and water. This study and the animal procedures described below were approved by the Ethics Committee of Animal Care in Geneva and the Cantonal Veterinary Office (No. 31.1.1033/3168/3).

Definition of Sudden Death

Mice that were found dead without any preceding signs of suffering were defined as sudden death. Signs of suffering in mice were actively searched for by the following criteria: weight, activity, and fur appearance (during the course of the study, no sign of suffering in any of the mice was detected).

Implantation of Minipumps

For implantation of subcutaneous minipump (Azlet model 1007D), mice were anesthetized with inhaled isoflurane (5% at induction followed by an 2%). Minipumps were implanted through an incision in the midscapular region under sterile conditions. Angiotensin II (Sigma) was dissolved in 0.154 mol/L of NaCl for infusion at 3 mg/kg per day.⁵ Norepinephrine (Sigma) was dissolved in 0.154 mol/L of NaCl for infusion at 12 mg/kg per day. Sham-treated animals underwent an identical surgical procedure, except that osmotic minipumps containing 0.9% NaCl were implanted. Mice were euthanized at day 7 after implantation of minipumps and after aortic tissue was removed.

Tail Cuff Blood Pressure Measurements

Tail cuff blood pressure (TCBP) was measured in awake mice by tail cuff plethysmography (RTBP 200, Kent Scientific, ADI Instrument).²⁵ Baseline measurements were performed on ≥ 3 different days before the implantation of minipumps. Animals were considered well trained if TCBP variability was $\leq 40 \pm 20$ mm Hg. All of the reported TCBP values represent an average of 10 to 20 repeated measurements per time point and animal.

Histochemistry

For histology, specimens were fixed in formal, embedded in paraffin, and subsequently sectioned at 5 μ m. Three different parts of each aorta were analyzed with optic microscopy after hematoxylin/eosin staining, performed according to standard procedures. Aortic dissection was defined histologically as a splitting of the middle layer (media) from the outer layer of the aorta and/or blood accumulation within the aortic wall. The analysis was performed blinded by an experienced staff member of our histology core facility.

Oligonucleotide Microarray

The total aorta of 3 wild-type mice and 3 NOX1-deficient mice were collected after a 7-day angiotensin II infusion. The total RNA was extracted from 10 to 15 mg of aorta, using the RNeasy Protect mini kit (Qiagen). A total of 0.2 μ g of RNA was converted into double-stranded cDNA using a cDNA synthesis kit (Superscript Choice, Invitrogen) with a special oligo(dT)₂₄ primer containing a T7 RNA promoter site added 3' to the poly-T tract. Biotinylated

cRNAs were generated from cDNAs using the GeneChip IVT labeling kit (Affymetrix) and subsequently purified with the RNeasy kit (Qiagen).

All of the amplification started with 100 ng of total RNA for each sample. Two rounds of amplifications were performed for each replicate to synthesize biotinylated cRNA according to the Affymetrix protocol. A total of 17.5 μ g of biotinylated cRNA was hybridized to mouse Affymetrix 430 2.0 chips, containing probe features for 45101 transcripts. The chips were washed and scanned and the fluorescence signals analyzed with Affymetrix software GCOS.^{26,27} To identify differentially expressed transcripts, pairwise comparison analyses were carried out with Affymetrix software. Each of the NOX1-deficient aorta samples (knockout) was compared with each of the wild-type aorta, resulting in 9 pairwise comparisons (knockout \times wild-type).

Real-Time PCR

Thoracic aorta samples were placed in RNA later (Qiagen). After homogenization with polytron PT 1200E (Kinematica AG) in RNA, RNA was then extracted by the RNeasy Protect mini kit (Qiagen) and reverse transcribed using the superscript reverse transcriptase (Superscript Choice, Invitrogen). A total of 200 ng of sample was used as a template for the real-time PCR. Based on preliminary experiments, 2 constitutively expressed reference genes were selected for normalization of candidate gene expression levels. These genes were EEF1A1 (eukaryotic elongation factor 1A1) and TBP (Tata box binding protein). For PCR primers see the data supplement available online at <http://hyper.ahajournals.org>.

Metalloproteinases and Tissue Inhibitor of Metalloproteinase 1 Measurement

The explants of whole thoracic aortas from wild-type and NOX1-deficient mice were first homogenized with polytron PT 1200E (Kinematica AG). Gelatinase matrix metalloproteinase (MMP)-9 were evaluated by zymography as described previously.²⁸ Band intensity was quantified by scanning densitometry (CD 60, Desaga, Sarstedt Gruppe), and gelatinase levels were calculated by reference to the scanning values obtained from known amounts of purified MMP-9. This technique allows us to determine levels of latent and activated MMP-9 that migrate at 92 and 82 kDa, respectively, on the gel and degrade gelatin identically after electrophoresis. Specific activity was expressed in picomoles of gelatinase per microgram of protein.

Tissue inhibitor of metalloproteinase 1 (TIMP-1) levels were determined by a commercial ELISA assay (R&D Systems), of which sensitivity is 2.1 pg/mL according to the manufacturer. Results were expressed in picomoles of TIMP-1 per microgram of protein to calculate the molar MMP-9/TIMP-1 ratio.

Statistical Analysis

Differences in blood pressure values were assessed using ANOVA with a repeated-measures design. For the comparison of quantitative PCR, nonparametric tests were used because of the smaller sample size. Fisher's exact test was used to compare the percentage of aortic dissections. All of the data were reported as mean \pm SD. Null hypotheses were rejected when $P < 0.05$. Analyses were performed with the Stata 9.2, statistical package (Stata Corporation).

Results

Susceptibility of NOX1-Deficient Mice to Angiotensin II–Induced Aortic Dissection

We have previously described decreased blood pressure elevations of NOX1-deficient mice in response to angiotensin II.²³ During these initial studies, we have observed in wild-type mice cases of sudden death (see Methods section for definition of sudden death). Because angiotensin II may lead to aortic dissection and aneurysms in C57BL/6 mice,^{1,29,30} we decided to study to what extent NOX1 might be involved in

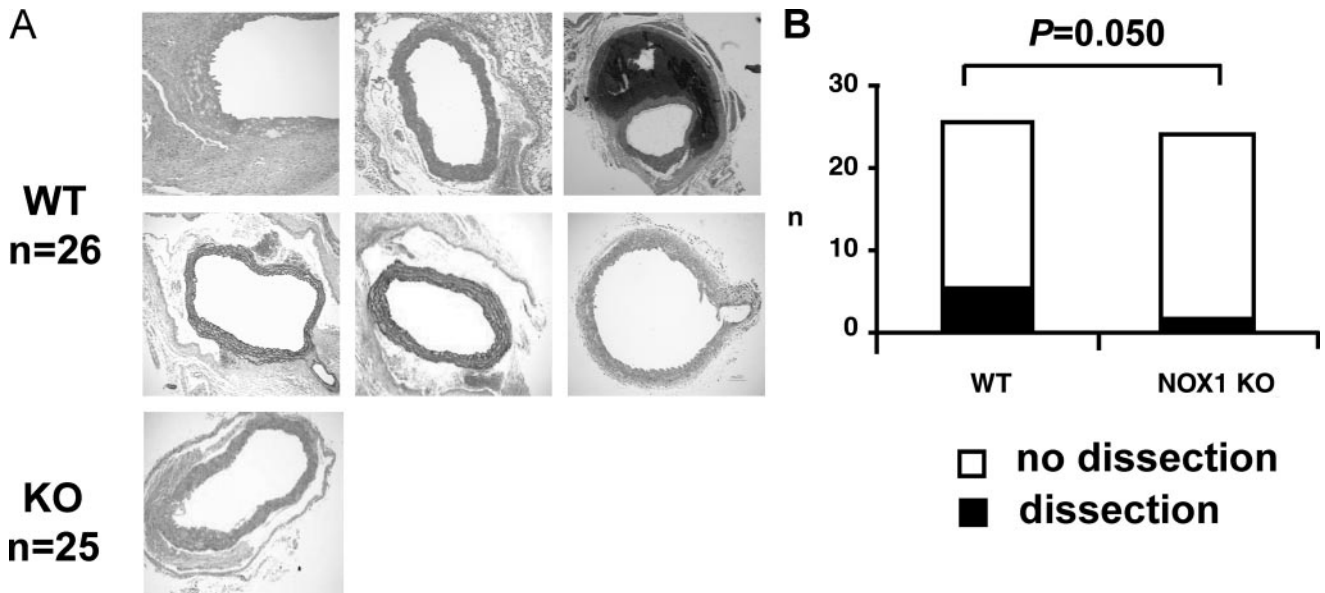

Figure 1. Decreased susceptibility of NOX1-deficient mice to angiotensin II-induced aortic dissection. Wild-type ($n=28$) and NOX1-deficient ($n=24$) mice were continuously infused with angiotensin II (3 mg/kg per day) through implanted minipumps for a 7-day period. Two of 28 wild-type mice, but 0 of 25 NOX1-deficient mice, succumbed to sudden death. Surviving mice were euthanized at day 7, and explanted thoracic aortas were sectioned and stained by hematoxylin/eosin. A, Aortic dissection was detected in 6 (of 26) wild-type mice but in only 1 (of 25) NOX1-deficient mice. B, Number of aortic dissection in wild-type and NOX1-deficient mice.

the development of this pathology. Over a 7-day period of angiotensin II perfusion, 2 (ie, $\approx 7\%$) of the wild-type mice, but none of the NOX1-deficient mice, succumbed to sudden death. In surviving mice, systematic analysis of hematoxylin/eosin-stained aortic sections revealed aortic dissections or aneurysm with thrombi in 6 (of 26) wild-type C57BL/6 mice. In contrast, we found aortic dissection in only 1 (of 25) NOX1-deficient mice (Figure 1A). The difference in the occurrence of aortic dissections in wild-type versus NOX1-deficient mice was statistically significant (Figure 1B; $P=0.05$). Thus, NOX1-deficient mice are protected from angiotensin II-dependent aortic dissection, and we conclude that NOX1 is involved in the underlying pathomechanism.

Norepinephrine-Induced Blood Pressure Elevations in NOX1-Deficient Mice

Angiotensin II-induced blood pressure elevations were blunted in NOX1-deficient mice.²³ Therefore, prevention of dissection may be simply because of decreased blood pressure. To study this question, we used norepinephrine, which acts through hypertensive mechanisms distinct from angiotensin II.³¹ Norepinephrine infusion (12 mg/kg per day) over a 7-day period induced comparable blood pressure elevations in wild-type and NOX1-deficient mice on days 1, 3, and 6 (Figure 2A). Note that the blood pressure increases in response to the selected norepinephrine concentrations were equal or even slightly higher than those observed in wild-type mice with angiotensin II.²³ Thus, we conclude that norepinephrine causes substantial blood pressure elevations in the absence of NOX1 and that NOX1 activation is, therefore, not involved in hypertensive signaling by norepinephrine.

Norepinephrine-Induced Blood Pressure Elevations and Aortic Dissection

No sudden death was observed after treatment with norepinephrine. Histological sections of explanted aortas after

norepinephrine treatment did not reveal aortic dissections in either wild-type or NOX1-deficient mice (data not shown). Figure 2B compares the results obtained with angiotensin II and norepinephrine. There was a significant reduction in angiotensin II-induced blood pressure elevations and aortic dissection in NOX1-deficient mice. Norepinephrine-induced blood pressure elevations were conserved in NOX1-deficient mice, and despite high blood pressure elevations, there were no aortic dissections in norepinephrine-treated mice. This strongly suggests that blood pressure elevations are not sufficient for the induction of aortic dissection and that angiotensin II damages the vascular wall through additional mechanisms, including activation of NOX1.

NOX1 and Angiotensin II-Dependent Regulation of Gene Expression

NOX1 might be involved in the mediation of angiotensin II effects through ROS-dependent regulation of gene expression. We, therefore, performed oligonucleotide array analysis in aortic samples from angiotensin II-treated wild-type and NOX1-deficient mice. As shown in the Table, numerous genes were differentially expressed in NOX1-deficient mice. Based on paired analysis (7 of 9 concordant pairs) and a 2-fold increase as cutoff, a total of 185 genes were upregulated, and >576 genes were downregulated in NOX1-deficient mice, as compared with wild-type mice. The 50 genes with the most important changes are shown in the Table. In terms of function gene analysis (GeneSpring, former Silicon Genetics, now Agilent Technologies), these 50 genes repartitioned as follows: cell structure, 15; metabolism, 11; cell DNA function, 6; cell organism defenses, 9; and unclassified, 9. Thus, we conclude that NOX1 is involved in the regulation of gene expression in response to angiotensin II. For this article, we have followed up by real-time PCR

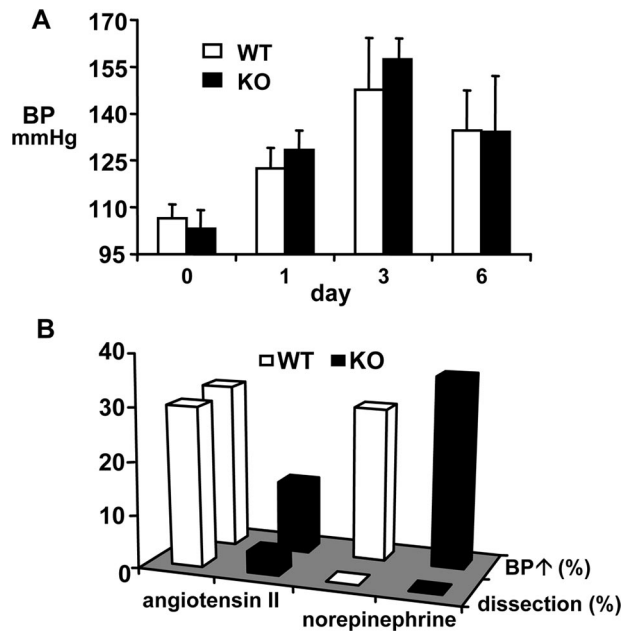

Figure 2. Norepinephrine-induced blood pressure elevations are NOX1 independent and do not lead to aortic dissection. Wild-type ($n=9$) and NOX1-deficient ($n=9$) mice were continuously infused with norepinephrine (12 mg/kg per day) through implanted minipumps for a 7-day period. TCBP was measured using tail cuff plethysmography (see Methods section). No sudden death occurred after norepinephrine treatment. Mice were euthanized at day 7, and explanted thoracic aortas were sectioned and stained by hematoxylin/eosin. A, Blood pressure changes in norepinephrine-treated wild-type and NOX1-deficient (knockout) mice. Days of measurement are indicated with respect to pump implantation; day 0=basal blood pressure before pump implantation. B, Comparisons of TCBP elevations (BP \uparrow) and aortic dissections in angiotensin II- and norepinephrine-treated mice. Blood pressure elevations are shown as percent increase; aortic dissections are shown as percent of total number of mice. Blood pressure elevations and number of dissection in response to angiotensin II are significantly diminished in NOX1-deficient mice ($P=0.001$ and 0.010 , respectively). There were no aortic dissections in norepinephrine-treated wild-type and NOX1-deficient mice despite similar increases in blood pressure.

several genes that appeared of importance for mechanisms of aortic dissection (Figure 3).

The ECM plays an important role in the vascular health and disease. The oligonucleotide array suggested that thrombospondin 4 was increased in angiotensin II-treated NOX1-deficient mice, as compared with wild-type mice. Real-time PCR demonstrated that angiotensin II did not lead to increased thrombospondin 4 levels in wild-type mice. In contrast, angiotensin II caused a massive increase (>10 -fold) in thrombospondin 4 mRNA levels in the NOX1-deficient mice (Figure 3A). Thus, NOX1-derived ROS appear to suppress the angiotensin II induction of thrombospondin 4 expression. Relatively little is known about thrombospondin 4. Thrombospondin 4 polymorphisms are associated with cardiovascular disease in epidemiological studies,^{32–34} and there are some indications that it might act as an “adaptor protein in ECM assembly.”^{35,36} More studies on this interesting protein will be needed to investigate whether it might indeed be involved in the pathophysiology of aortic dissection.

In previous studies, we have observed that NOX1 deficiency diminishes the angiotensin II-induced accumulation of ECM proteins in the aortic media.²³ Collagen I and III are the main components of the aortic ECM, and a protein named CTHRC1 (collagen triple helix repeat containing 1) is thought to inhibit collagen expression.³⁷ The results of the oligonucleotide array suggested that NOX1 deficiency might decrease procollagen type III mRNA levels and increase CTHRC1. We, therefore, measured mRNA levels of procollagen III of CTHRC1 by real-time PCR (Figure 3B and 3C). Thus, there were no statistically significant differences. However, because of the small sample size, we cannot exclude a moderate effect of NOX1 on the expression of procollagen type III and CTHRC1.

NOX1 and MMPs

The balance of protease and antiprotease activity in the aortic tissue is thought to play an important role in pathogenesis of aortic dissection and aneurysm. More specifically, the MMPs MMP-2 and MMP-9 are thought to favor the pathogenesis, whereas the specific inhibitor TIMP-1 is thought to be preventive.^{1,4,38,39}

The results of the oligonucleotide array suggested a possible increase in mRNA levels of TIMP-1, whereas there were no apparent differences in MMP levels. These results were confirmed by real-time PCR: NOX1 deficiency had no effect on MMP-2 and MMP-9 mRNA levels (Figure 3D and 3E). Angiotensin II increased TIMP-1 mRNA levels ≈ 6 -fold in wild-type mice but ≈ 10 -fold in NOX1-deficient mice. This suggests that NOX1 attenuates angiotensin II-induced TIMP-1 gene expression (Figure 3F).

These results raise the possibility that NOX1 alters the protease/antiprotease equilibrium. Indeed, an increase of the MMP-9/TIMP-1 ratio has been associated with aortic aneurysm and dissection.³⁸ We, therefore, measured MMP9 gelatinolytic activity, as well as MMP-9 and TIMP-1 protein levels, in aortic tissue homogenates (Figure 4A through 4C). The levels of latent and activated MMP-9 were slightly increased after angiotensin II infusion, but there was no apparent difference between wild-type and NOX1-deficient mice (Figure 4A and 4B). In contrast, there was a marked effect of NOX1 deficiency on angiotensin II-induced changes in TIMP-1 protein levels. Angiotensin II did not lead to a statistically significant increase in TIMP-1 protein levels in wild-type mice but to a massive increase of ≈ 70 -fold ($P=0.01$) in NOX1-deficient mice (Figure 4C). Taken together, these results demonstrate that NOX1 is an inhibitor of angiotensin II-induced TIMP-1 expression and thereby alters the proteolytic balance in the vascular wall.

Discussion

The finding that NOX1 is of crucial importance for the formation of aortic dissection is novel and unexpected. Mechanisms that lead to angiotensin II-induced aortic dissection include monocyte/macrophage infiltration, activation of proteases (in particular, MMPs), and fibrotic response (reviewed in Reference 4). Because several of these processes involved oxidative stress, there is a mechanistic basis for a potential involvement of NOX enzymes in the pathogenesis

The 50 Most Important Changes of Gene Expression in Aortic Samples of NOX1-Deficient Mice Versus Wild-Type Mice (n=3)

Affimetrix Probe Set Number	Gene Name	Gene Symbol	Fold Change
Cell structure			
1449388_at	Thrombospondin 4	Thbs4	36.20
1451203_at	Myoglobin	Mb	48.13
1417290_at	Leucine-rich α -2-glycoprotein 1	Lrg1	5.08
1418769_at	Myozenin 2	Myoz2	4.00
1452968_at	Collagen triple helix repeat containing 1	Cthrc1	3.97
1435115_at	Fibronectin type III domain containing 5	Fndc5	21.44
1449204_at	Gap junction membrane channel protein β 5	Gjb5	5.16
1424599_at	Fibrinogen-like protein 1	Fgl1	4.03
1423049_a_at	Tropomyosin 1, α	Tpm1	3.94
1460227_at	TIMP-1	Timp1	2.44
1439300_at	Cysteine-rich hydrophobic domain 1	Chic1	-6.02
1421429_a_at	Nephronectin	Npnt	-6.30
1442569_at	Chaperonin subunit 4 (δ)	Cct4	-5.70
1444765_at	RNA binding protein gene with multiple splicing	Rbpms	-6.06
1442977_at	Procollagen, type III, α 1	Col3a1	-2.32
Metabolism			
1454995_at	Dimethylarginine dimethylaminohydrolase 1	Ddah1	5.74
1450033_a_at	Signal transducer and activator of transcription 1	Stat1	3.03
1427747_a_at	Lipocalin 2	Lcn2	20.31
1417951_at	Enolase 3, β muscle	Eno3	6.81
1422206_at	UDP-Gal:betaGlcNAc beta 1,3-galactosyltransferase, polypeptide 1	B3galt1	-13.00
1425339_at	Phospholipase C, β 4	Plcb4	-5.74
1425338_at	Phospholipase C, β 4	Plcb4	-5.20
1422671_s_at	N-acetylated α -linked acidic dipeptidase 2	Naalad2	-10.56
1421403_at	Protease inhibitor 15	Pi15	-7.70
1445723_at	Aldo-keto reductase family 1, member B3 (aldose reductase)	Akr1b3	-4.74
1455361_at	Diacylglycerol kinase, β	Dgkb	-4.63
Cell DNA function			
1429947_a_at	Z-DNA binding protein 1	Zbp1	7.58
1451426_at	DNA segment, Chr 11, Lothar Hennighausen 2, expressed	D11Lgp2e	3.94
1417595_at	Mesenchyme homeobox 1	Meox1	3.88
1418191_at	Ubiquitin specific protease 18	Usp18	3.79
1458512_at	Transducin-like enhancer of split 3, homolog of Drosophila E(spl)	Tle3	-6.70
1438482_at	WW domain containing E3 ubiquitin protein ligase 2	Wwp2	-4.85
Cell/organism defences			
1450783_at	Interferon-induced protein with tetratricopeptide repeats 1	Ifit1	5.04
1419569_a_at	Interferon-stimulated protein	Isg20	4.29
1449401_at	Complement component 1, q subcomponent, γ	C1qg	3.88
1451651_at	V-set and immunoglobulin domain containing 4	Vsig4	3.79
1417851_at	Chemokine (C-X-C motif) ligand 13	Cxcl13	9.19
1417244_a_at	Interferon regulatory factor 7	Irf7	4.13
1423555_a_at	Interferon-induced protein 44	Ifi44	4.13
1453196_a_at	2'-5' Oligoadenylate synthetase-like 2	Oasl2	3.94
1427351_s_at	Immunoglobulin heavy chain 6 (heavy chain of IgM)	Igh-6	6.91
Unclassified			
1438575_a_at	EST	...	-8.77
1420517_at	EST	...	-6.50
1456214_at	Protocadherin 7	Pcdh7	-5.36
1438989_s_at	EST	...	-4.70
1459316_at	EST	...	-8.98
1430436_at	EST	...	-8.71
1457169_at	Protein phosphatase 1, regulatory (inhibitor) subunit 12B	Ppp1r12b	-5.79
1434951_at	Armadillo repeat containing 8	Armc8	-5.49
1457692_at	EST	...	-8.84

Positive numbers in the Fold Change column mean an increased expression and negative numbers a decreased expression in NOX-deficient mice.

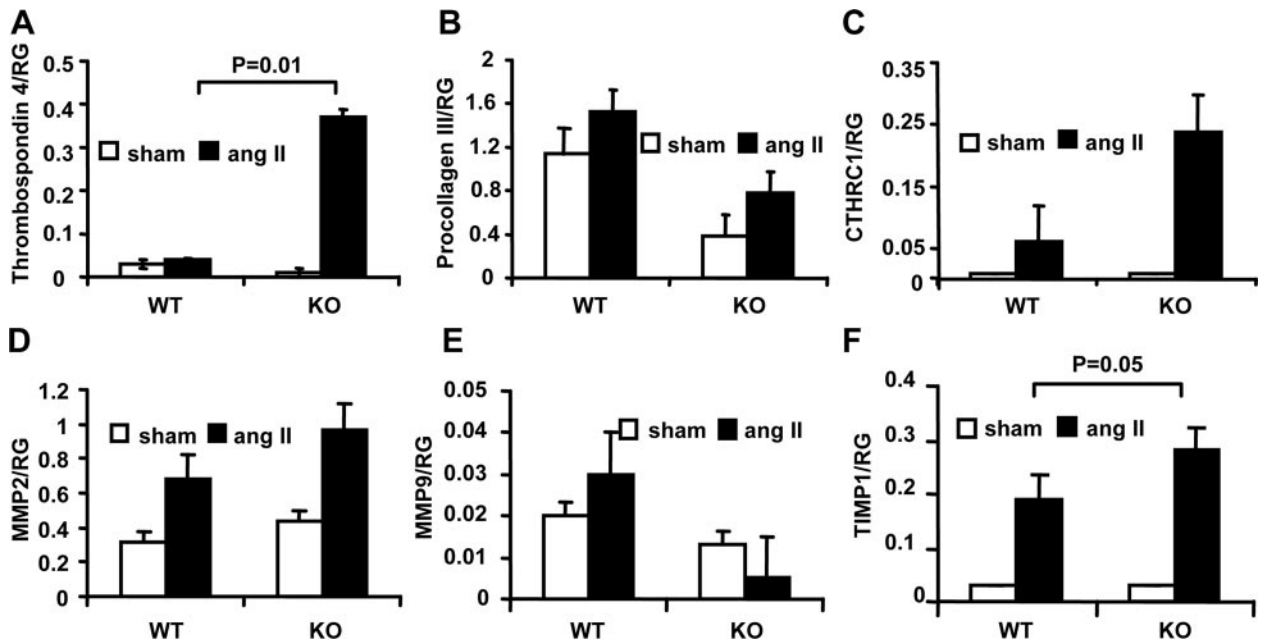

Figure 3. Angiotensin II–induced gene expression in wild-type and NOX1-deficient mice. Mice were treated with angiotensin II (ang II) as described in Figure 1 and euthanized at day 7. mRNA levels of MMPs 2 and 9, TIMP-1, thrombospondin-4, procollagen III, and collagen triple helix type 1 (CTHRC1) were determined by real-time PCR; values shown are normalized with respect to 2 reference genes (RG). n=8 (A); n=4 (B through F).

of aortic dissection.^{14–16,19,20} However, our observation that NOX1 is a key player is unexpected. Indeed, the marked macrophage infiltration in early aortic dissection and aneurysm argues for a role of the phagocyte nicotinamide-adenine dinucleotide phosphate oxidase NOX2. More stringently, deficiency in the phagocyte nicotinamide-adenine dinucleotide phosphate oxidase subunit p47^{phox} was shown to prevent angiotensin II–dependent aneurysm formation.²⁰ Two explanations can account for the apparently diverging results: concomitant activation of NOX1 and NOX2 is necessary for development of aortic dissection and aneurysms, and p47^{phox} might be used by NOX1 as an organizer subunit in the

vascular wall.¹² Studies with NOX2-deficient mice will be necessary to distinguish between the 2 possibilities.

Because NOX1-deficient mice have a decreased blood pressure response to angiotensin II,^{23,24} it was conceivable that the prevention of aortic dissection in NOX1-deficient mice was simply explained by the decreased blood pressure. We, therefore, used norepinephrine, a hypertensive agent thought to act through different pathways than angiotensin II.^{24,31} Interestingly, norepinephrine caused a full blood pressure increase in NOX1-deficient mice. Yet, no sudden death or aortic dissections were observed in either wild-type or NOX1-deficient mice treated with norepinephrine. This

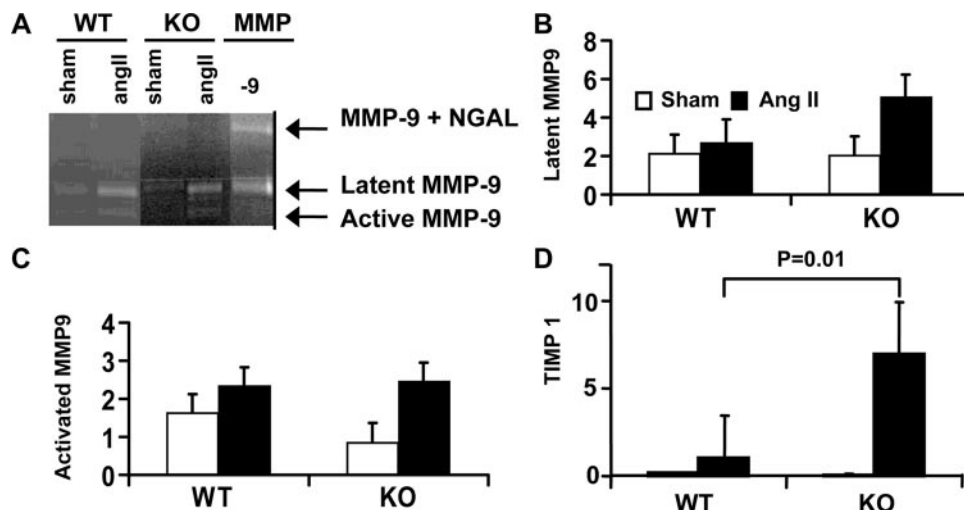

Figure 4. Effect of NOX1 deficiency on MMP-9 and TIMP-1 levels. Mice were treated with angiotensin II (ang II) as described in Figure 1 and euthanized at day 7. Thoracic aortas were explanted and homogenized. Representative zymogram of MMP-9 in sham and angiotensin II–infused wild-type and NOX1-deficient mice (A), levels of latent MMP-9 (B), levels of activated MMP-9 (C), and TIMP-1 (D) were measured as described in the Methods section.

clearly demonstrates that blood pressure elevations are not sufficient to induced aortic dissection in wild-type mice and that NOX1 activation is an important factor in this process. Our observation that blood pressure increase by itself is not sufficient for aortic dissection, and aneurysm formation is in line with observations by other groups.^{20,40}

Through which mechanisms does NOX1-derived ROS participate in the formation of aortic dissection and aneurysm? Our results demonstrate an exquisite sensitivity of TIMP-1 mRNA and protein levels to NOX1. This observation is corroborated by the recent demonstration that ROS induce downregulation of the TIMP-1 protein.⁴¹ In our study, there is an obvious difference between the strong effects of NOX1 deficiency on the TIMP-1 protein level (Figure 4C) and the more moderate effects on TIMP-1 mRNA levels (Figure 3F). Because the relationship between mRNA levels and protein levels is not linear, we cannot exclude that NOX1 exerts its effect solely through transcriptional regulation. However, it is tempting to speculate that, in addition, there is a direct effect of NOX1-derived ROS on TIMP-1 protein synthesis or stability.

TIMP-1 inhibits MMPs, in particular, the proform of MMP-9.^{38,42} There are several lines of arguments suggesting that TIMP-1 plays an important role in the development of aortic dissection and aneurysms. TIMP-1 is secreted by vascular smooth muscle cells.³⁸ TIMP1-deficient mice have an increased risk of aneurysm formation in different mouse models of aneurysm,^{43–45} and TIMP-1 polymorphisms are linked to human risk for aortic aneurysm.⁴⁶ Thus, together with the published information, our results provide a strong argument in favor of TIMP-1 as an important downstream mediator of NOX1-derived oxidative stress in the pathogenesis of aortic dissection and aneurysm.

NOX1-dependent downregulation of TIMP-1 in wild-type mice is expected to enhance the proteolytic activity in the vascular wall. However, we have previously documented an increased accumulation of collagen-type ECM in angiotensin II-stimulated wild-type mice, as compared with NOX1-deficient animals.²³ At first glance, this is counterintuitive, because an increase in MMP activity should lead to an increased degradation of collagen. So, how can this be conceptualized and how is the high protease/antiprotease ratio in wild-type mice linked to aortic dissection? We consider several not virtually exclusive possibilities: (1) MMPs might preferentially degrade elastin, a key matrix protein for the aortic stability, and collagen accumulation might only be a secondary compensatory phenomenon^{1,38}; (2) MMPs promote basement membrane degradation, phenotypic modulation, migration, and proliferation of vascular smooth muscle cells and might thereby destabilize the aortic wall⁴⁷; and (3) the proteolytic activity of MMPs might also be involved in the activation of signaling molecules, such as transforming growth factor- β .⁴⁸

Is there a direct effect of NOX-derived ROS on MMPs in addition to the indirect effect via TIMP-1 described in this study? Angiotensin II clearly activates MMPs.^{13,14,20} Several in vitro studies indeed point toward a role of oxidative stress in this process.^{49,50} However, the in vivo evidence for a role of oxidative stress in angiotensin II-dependent MMP activa-

tion is relatively weak. Vitamin E had a protective effect on aneurysm formation but did not prevent activation of MMPs.^{13,14,20} p47^{phox} deletion diminished, to some extent, MMP-2 (but not MMP-9) activity in the vascular wall.²⁰ Note, however, that these effects were relatively small as compared with the effects on TIMP-1 described in this study. Indeed, angiotensin II appears to double the activity of MMP-2 and MMP-9 in the vascular wall,^{13,14,20} whereas p47^{phox} deletion diminishes MMP-2 activation by $\approx 20\%$.²⁰ For comparison, NOX1 deletion leads to a 6-fold increase in TIMP-1 protein levels.

Perspectives

Our study documents a new role of NOX1 in vascular pathology. The link between NOX1 activation and TIMP-1 suppression also provides new evidence for the protective role of TIMP-1. The essential role of NOX1 in aneurysm formation opens interesting therapeutic avenues. NOX1 might become a prime drug target for prevention and early treatment of aortic aneurysms. Indeed, NOX1 inhibition would target both high blood pressure^{23,24} and blood pressure-independent modifications within the vascular wall. In addition, as opposed to NOX2, NOX1 inhibition is not expected to lead to immunodeficiency. Thus, a long-term treatment with NOX1 inhibitors, which would be needed to prevent progression of aneurysms, is a realistic perspective.

Acknowledgments

We thank Angelo Gradia for skilled technical assistance; Drs Didier Cholet, Céline Delucinge, Mylène Docquier, and Patrick Descombes from the Genomics Platform, NCCR Frontiers in Genetics (Swiss National Science Foundation); and Dr Laurence Fiette for his implication in the animal model.

Sources of Funding

This work was supported by grants from the Swiss National Science Foundation to K-H.K. (3100A0-103725) and the French grant to G.G. from Groupe d'Intérêt Scientifique Longevité (GISL0414).

Disclosures

None.

References

- Daugherty A, Cassis LA. Mouse models of abdominal aortic aneurysms. *Arterioscler Thromb Vasc Biol.* 2004;24:429–434.
- Ruiz-Ortega M, Lorenzo O, Ruperez M, Esteban V, Suzuki Y, Mezzano S, Plaza JJ, Egido J. Role of the renin-angiotensin system in vascular diseases: expanding the field. *Hypertension.* 2001;38:1382–1387.
- Kon V, Jabs K. Angiotensin in atherosclerosis. *Curr Opin Nephrol Hypertens.* 2004;13:291–297.
- Daugherty A, Cassis L. Angiotensin II-mediated development of vascular diseases. *Trends Cardiovasc Med.* 2004;14:117–120.
- Wang HD, Xu S, Johns DG, Du Y, Quinn MT, Cayatte AJ, Cohen RA. Role of NADPH oxidase in the vascular hypertrophic and oxidative stress response to angiotensin II in mice. *Circ Res.* 2001;88:947–953.
- Saito Y, Berk BC. Angiotensin II-mediated signal transduction pathways. *Curr Hypertens Rep.* 2002;4:167–171.
- Dinh DT, Frauman AG, Johnston CI, Fabiani ME. Angiotensin receptors: distribution, signalling and function. *Clin Sci (Lond).* 2001;100:481–492.
- Griendling KK. Novel NAD(P)H oxidases in the cardiovascular system. *Heart.* 2004;90:491–493.
- Ray R, Shah AM. NADPH oxidase and endothelial cell function. *Clin Sci (Lond).* 2005;109:217–226.

10. Mueller CF, Laude K, McNally JS, Harrison DG. ATVB in focus: redox mechanisms in blood vessels. *Arterioscler Thromb Vasc Biol.* 2005;25:274–278.
11. Bengtsson SH, Gulluyan LM, Dusting GJ, Drummond GR. Novel isoforms of NADPH oxidase in vascular physiology and pathophysiology. *Clin Exp Pharmacol Physiol.* 2003;30:849–854.
12. Bedard K, Krause KH. The NOX family of ROS-generating NADPH oxidases: physiology and pathophysiology. *Physiol Rev.* 2007;87:245–313.
13. McCormick ML, Gavrilu D, Weintraub NL. Role of oxidative stress in the pathogenesis of abdominal aortic aneurysms. *Arterioscler Thromb Vasc Biol.* 2007 27:461–469.
14. Gavrilu D, Li WG, McCormick ML, Thomas M, Daugherty A, Cassis LA, Miller FJ Jr, Oberley LW, Dellsperger KC, Weintraub NL. Vitamin E inhibits abdominal aortic aneurysm formation in angiotensin II-infused apolipoprotein E-deficient mice. *Arterioscler Thromb Vasc Biol.* 2005; 25:1671–1677.
15. Miller FJ Jr, Sharp WJ, Fang X, Oberley LW, Oberley TD, Weintraub NL. Oxidative stress in human abdominal aortic aneurysms: a potential mediator of aneurysmal remodeling. *Arterioscler Thromb Vasc Biol.* 2002;22:560–565.
16. Miller FJ Jr. Aortic aneurysms: it's all about the stress. *Arterioscler Thromb Vasc Biol.* 2002;22:1948–1949.
17. Yajima N, Masuda M, Miyazaki M, Nakajima N, Chien S, Shyy JY. Oxidative stress is involved in the development of experimental abdominal aortic aneurysm: a study of the transcription profile with complementary DNA microarray. *J Vasc Surg.* 2002;36:379–385.
18. Lambeth JD. NOX enzymes and the biology of reactive oxygen. *Nat Rev Immunol.* 2004;4:181–189.
19. Ejiri J, Inoue N, Tsukube T, Munezane T, Hino Y, Kobayashi S, Hirata K, Kawashima S, Imajoh-Ohmi S, Hayashi Y, Yokozaki H, Okita Y, Yokoyama M. Oxidative stress in the pathogenesis of thoracic aortic aneurysm: protective role of statin and angiotensin II type 1 receptor blocker. *Cardiovasc Res.* 2003;59:988–996.
20. Thomas M, Gavrilu D, McCormick ML, Miller FJ Jr, Daugherty A, Cassis LA, Dellsperger KC, Weintraub NL. Deletion of p47phox attenuates angiotensin II-induced abdominal aortic aneurysm formation in apolipoprotein E-deficient mice. *Circulation.* 2006;114:404–413.
21. Rey FE, Pagano PJ. The reactive adventitia: fibroblast oxidase in vascular function. *Arterioscler Thromb Vasc Biol.* 2002;22:1962–1971.
22. Dikalova A, Clemens R, Lassègue B, Cheng G, McCoy JW, Dikalov S, San Martin A, Lyle A, Weber DS, Weiss D, Taylor WR, Schmidt HH, Owens GK, Lambeth JD, Griendling KK. Nox1 overexpression potentiates angiotensin II-induced hypertension and vascular smooth muscle hypertrophy in transgenic mice. *Circ Res.* 2005;112:2668–2672.
23. Gavazzi G, Banfi B, Deffert C, Fiette L, Schappi M, Herrmann F, Krause KH. Decreased blood pressure in NOX1-deficient mice. *FEBS Lett.* 2006;580:497–504.
24. Matsuno K, Yamada H, Iwata K, Jin D, Katsuyama M, Matsuki M, Takai S, Yamanishi K, Miyazaki M, Matsubara H, Yabe-Nishimura C. Nox1 is involved in angiotensin II-mediated hypertension: a study in Nox1-deficient mice. *Circulation.* 2005;112:2677–2685.
25. Johns C, Gavras I, Handy DE, Salomao A, Gavras H. Models of experimental hypertension in mice. *Hypertension.* 1996;28:1064–1069.
26. Hubbell E, Liu WM, Mei R. Robust estimators for expression analysis. *Bioinformatics.* 2002;18:1585–1592.
27. Liu WM, Mei R, Di X, Ryder TB, Hubbell E, Dee S, Webster TA, Harrington CA, Ho MH, Baid J, Smeekens SP. Analysis of high density expression microarrays with signed-rank call algorithms. *Bioinformatics.* 2002;18:1593–1599.
28. Gaudin P, Trocme C, Berthier S, Kieffer S, Boutonnat J, Lamy C, Surla A, Garin J, Morel F. TIMP-1/MMP-9 imbalance in an EBV-immortalized B lymphocyte cellular model: evidence for TIMP-1 multifunctional properties. *Biochim Biophys Acta.* 2000;1499:19–33.
29. Deng GG, Martin-McNulty B, Sukovich DA, Freay A, Halks-Miller M, Thinnes T, Loskutoff DJ, Carmeliet P, Dole WP, Wang YX. Urokinase-type plasminogen activator plays a critical role in angiotensin II-induced abdominal aortic aneurysm. *Circ Res.* 2003;92:510–517.
30. Daugherty A, Manning MW, Cassis LA. Antagonism of AT2 receptors augments angiotensin II-induced abdominal aortic aneurysms and atherosclerosis. *Br J Pharmacol.* 2001;134:865–870.
31. Rajagopalan S, Kurz S, Munzel T, Tarpey M, Freeman BA, Griendling KK, Harrison DG. Angiotensin II-mediated hypertension in the rat increases vascular superoxide production via membrane NADH/NADPH oxidase activation. Contribution to alterations of vasomotor tone. *J Clin Invest.* 1996;97:1916–1923.
32. Wessel J, Topol EJ, Ji M, Meyer J, McCarthy JJ. Replication of the association between the thrombospondin-4 A387P polymorphism and myocardial infarction. *Am Heart J.* 2004;147:905–909.
33. McCarthy JJ, Parker A, Salem R, Moliterno DJ, Wang Q, Plow EF, Rao S, Shen G, Rogers WJ, Newby LK, Cannata R, Glatt K, Topol EJ. Large scale association analysis for identification of genes underlying premature coronary heart disease: cumulative perspective from analysis of 111 candidate genes. *J Med Genet.* 2004;41:334–341.
34. Stenina OI, Byzova TV, Adams JC, McCarthy JJ, Topol EJ, Plow EF. Coronary artery disease and the thrombospondin single nucleotide polymorphisms. *Int J Biochem Cell Biol.* 2004;36:1013–1030.
35. Hamsten A, Eriksson P. Thrombospondins and premature coronary artery disease: time to go beyond genotype-phenotype association studies. *Arterioscler Thromb Vasc Biol.* 2003;23:6–7.
36. Narouz-Ott L, Maurer P, Nitsche DP, Smyth N, Paulsson M. Thrombospondin-4 binds specifically to both collagenous and non-collagenous extracellular matrix proteins via its C-terminal domains. *J Biol Chem.* 2000;275:37110–37117.
37. Pyagay P, Heroult M, Wang Q, Lehnert W, Belden J, Liaw L, Friesel RE, Lindner V. Collagen triple helix repeat containing 1, a novel secreted protein in injured and diseased arteries, inhibits collagen expression and promotes cell migration. *Circ Res.* 2005;96:261–268.
38. Kadoglou NP, Liapis CD. Matrix metalloproteinases: contribution to pathogenesis, diagnosis, surveillance and treatment of abdominal aortic aneurysms. *Curr Med Res Opin.* 2004;20:419–432.
39. Ishii T, Asuwa N. Collagen and elastin degradation by matrix metalloproteinases and tissue inhibitors of matrix metalloproteinase in aortic dissection. *Hum Pathol.* 2000;31:640–646.
40. Chen J, Kuhlencordt PJ, Astern J, Gyurko R, Huang PL. Hypertension does not account for the accelerated atherosclerosis and development of aneurysms in male apolipoprotein e/endothelial nitric oxide synthase double knockout mice. *Circulation.* 2001;104:2391–2394.
41. Deem TL, Cook-Mills JM. Vascular cell adhesion molecule 1 (VCAM-1) activation of endothelial cell matrix metalloproteinases: role of reactive oxygen species. *Blood.* 2004;104:2385–2393.
42. Sundstrom J, Vasani RS. Circulating biomarkers of extracellular matrix remodeling and risk of atherosclerotic events. *Curr Opin Lipidol.* 2006; 17:45–53.
43. Eskandari MK, Vijungco JD, Flores A, Borensztajn J, Shively V, Pearce WH. Enhanced abdominal aortic aneurysm in TIMP-1-deficient mice. *J Surg Res.* 2005;123:289–293.
44. Lemaitre V, Soloway PD, D'Armiento J. Increased medial degradation with pseudo-aneurysm formation in apolipoprotein E-knockout mice deficient in tissue inhibitor of metalloproteinases-1. *Circulation.* 2003; 107:333–338.
45. Silence J, Collen D, Lijnen HR. Reduced atherosclerotic plaque but enhanced aneurysm formation in mice with inactivation of the tissue inhibitor of metalloproteinase-1 (TIMP-1) gene. *Circ Res.* 2002;90: 897–903.
46. Ogata T, Shibamura H, Tromp G, Sinha M, Goddard KA, Sakalihan N, Limet R, MacKean GL, Arthur C, Sueda T, Land S, Kuivaniemi H. Genetic analysis of polymorphisms in biologically relevant candidate genes in patients with abdominal aortic aneurysms. *J Vasc Surg.* 2005; 41:1036–1042.
47. Newby AC. Dual role of matrix metalloproteinases (matrixins) in intimal thickening and atherosclerotic plaque rupture. *Physiol Rev.* 2005;85:1–31.
48. Wang M, Zhao D, Spinetti G, Zhang J, Jiang LQ, Pintus G, Monticone R, Lakatta EG. Matrix metalloproteinase 2 activation of transforming growth factor-beta1 (TGF-beta1) and TGF-beta1-type II receptor signaling within the aged arterial wall. *Arterioscler Thromb Vasc Biol.* 2006;26: 1503–1509.
49. Luchtefeld M, Grote K, Grothusen C, Bley S, Bandlow N, Selle T, Struber M, Haverich A, Bavendiek U, Drexler H, Schieffer B. Angiotensin II induces MMP-2 in a p47phox-dependent manner. *Biochem Biophys Res Commun.* 2005;328:183–188.
50. Rajagopalan S, Meng XP, Ramasamy S, Harrison DG, Galis ZS. Reactive oxygen species produced by macrophage-derived foam cells regulate the activity of vascular matrix metalloproteinases in vitro. Implications for atherosclerotic plaque stability. *J Clin Invest.* 1996;98:2572–2579.

II. Article 2 L'absence de NOX1 altère la phosphorylation de la cavéoline et la localisation du récepteur de l'angiotensine II dans les cellules musculaires lisses vasculaires

NADPH OXIDASE 1 DEFICIENCY ALTERS CAVEOLIN PHOSPHORYLATION AND ANGIOTENSIN II-RECEPTOR LOCALIZATION IN VASCULAR SMOOTH MUSCLE.

Olivier Basset, Christine Deffert, Michelangelo Foti, Karen Bedard, Vincent Jaquet, Eric Ogier-Denis and Karl-Heinz Krause. *Antioxid Redox Signal*. 2009. 11:2371-2384.

Au niveau des cellules musculaires lisses, les effets de l'angiotensine II sont médiés essentiellement par le récepteur de l'angiotensine II de type 1 : AT1. Les ROS sont impliqués dans la transduction du signal du récepteur AT1 à travers de nombreuses voies comme, par exemple l'inhibition des tyrosines kinases (Ushio-Fukai, Zuo et al. 2005), des MAP kinases (Touyz, He et al. 1999), les flux calciques (Fellner and Arendshorst 2005) ou de l'inactivation de l'oxyde nitrique (Rubanyi and Vanhoutte 1986).

En parallèle, des études ont démontré que les cavéoles intervenaient dans les signaux de transduction du récepteur AT1 (Zuo, Ushio-Fukai et al. 2005). Les cavéoles sont une sous-classe des microdomaines lipidiques, caractérisés par une invagination membranaire non-tapissée de clathrine, mais riche en cavéoline. Elles sont impliquées, entre autres, dans l'adressage d'un certain nombre de récepteurs vers la membrane plasmique, dont le récepteur AT1. Il a été montré que le récepteur AT1 contient un domaine cavéoline-like (Leclerc, Auger-Messier et al. 2002). De plus, la formation de ROS est indispensable à l'adressage du récepteur AT1 à la membrane plasmique (Ushio-Fukai, Zuo et al. 2005). Or NOX1 est également localisée au sein de ces cavéoles (Hilenski, Clempus et al. 2004).

Dans cet article, nous nous sommes demandé si NOX1 était impliqué dans la signalisation du récepteur AT1 ? Est-ce que NOX1, co-localisée avec le récepteur AT1 au

sein des cavéoles, pourrait être la NADPH oxydase responsable de la formation des ROS impliqués dans l'adressage du récepteur AT1 à la membrane par les cavéolines ? Et ainsi expliquer les mécanismes impliquant NOX1 dans l'hypertension artérielle, l'hypertrophie de la média et la formation d'anévrismes induites par l'angiotensine II.

Mon travail dans cet article a consisté à effectuer les PCR quantitatives, à participer aux discussions de travail ainsi qu'à la correction du manuscrit. La gestion des animaux transgéniques a également fait partie de ce travail.

NADPH Oxidase 1 Deficiency Alters Caveolin Phosphorylation and Angiotensin II–Receptor Localization in Vascular Smooth Muscle

Olivier Basset,¹ Christine Deffert,¹ Michelangelo Foti,² Karen Bedard,¹
Vincent Jaquet,¹ Eric Ogier-Denis,³ and Karl-Heinz Krause¹

Abstract

The superoxide-generating NADPH oxidase NOX1 is thought to be involved in signaling by the angiotensin II–receptor AT1R. However, underlying signaling steps are poorly understood. In this study, we investigated the effect of AngII on aortic smooth muscle from wild-type and NOX1-deficient mice. NOX1-deficient cells showed decreased basal ROS generation and did not produce ROS in response to AngII. Unexpectedly, AngII-dependent Ca²⁺ signaling was markedly decreased in NOX1-deficient cells. Immunostaining demonstrated that AT1R was localized on the plasma membrane in wild-type, but intracellularly in NOX1-deficient cells. Immunohistochemistry and immunoblotting showed a decreased expression of AT1R in the aorta of NOX1-deficient mice. To investigate the basis of the abnormal AT1R targeting, we studied caveolin expression and phosphorylation. The amounts of total caveolin and of caveolae were not different in NOX1-deficient mice, but a marked decrease occurred in the phosphorylated form of caveolin. Exogenous H₂O₂ or transfection of a NOX1 plasmid restored AngII responses in NOX1-deficient cells. Based on these findings, we propose that NOX1-derived reactive oxygen species regulate cell-surface expression of AT1R through mechanisms including caveolin phosphorylation. The lack cell-surface AT1R expression in smooth muscle could be involved in the decreased blood pressure in NOX1-deficient mice. *Antioxid. Redox Signal.* 11, 2371–2384.

Introduction

ANGIOTENSIN II (AngII) is a peptide of the renin–angiotensin system that plays a major role in cardiovascular homeostasis, in particular, in the regulation of blood pressure (8). In vascular smooth muscle, biologic actions of AngII (cell contraction, proliferation, and migration) are mediated mainly through the AngII type 1 receptor (AT1R). Reactive oxygen species (ROS) play an important role in vascular biology. Many of the biologic effects of AngII involve the release of ROS (20, 27, 44). At physiologic concentrations, ROS mediate various responses such as cell migration, cell proliferation, or vasoconstriction, which are necessary processes for cells (36, 42). At higher concentrations, ROS are involved in cardiovascular pathology (26, 34). Thus, decoding pathways involving AngII and ROS is important to the understanding of physiologic and pathologic events in the cardiovascular system and ultimately to finding pharmacologic

tools to treat widespread diseases, including hypertension and atherosclerosis (38, 46).

A major source of ROS is the NOX family of superoxide-generating NADPH oxidases (3). To date, seven members are known in mammals. At least two NOX enzymes, NOX1 and NOX4, are found in vascular smooth muscle (18). Recently, we developed NOX1-deficient mice and showed that in response to AngII, NOX1-deficient mice have an almost complete loss of the sustained blood-pressure response, whereas the initial increase was conserved. In addition, NOX1-deficient mice have a marked reduction in aortic media hypertrophy (16). Activation of the AT1R through AngII is intimately linked with ROS generation (15, 20). ROS trigger downstream signaling of AT1R through various mediators, such as inhibition of tyrosine kinases (29, 45), MAP kinases (39, 40), Ca²⁺ fluxes (12, 33), or nitric oxide inactivation (35).

Recent evidence points to a role of caveolae in AT1R processing and signaling. Caveolae are specialized regions of the

Departments of ¹Pathology and Immunology and ²Cellular Physiology and Metabolism, Centre Medical Universitaire, University of Geneva, Geneva, Switzerland.

³INSERM, U773, Centre de Recherche Biomedicale Bichat-Beaujon CRB3, Paris, France.

plasma membrane, composed mainly of caveolins (31). They have been implicated in endocytosis, transcytosis, Ca^{2+} signaling, and numerous other signal-transduction events. Caveolae are very abundant in smooth muscle cells (32). AT1R depend on caveolae for efficient surface localization (19, 22, 47) and present a caveolin-binding-like domain in their cytoplasmic tail (28). NOX1 colocalizes with caveolin1 (21). Phosphorylation of caveolin has been shown to be related to budding and fusion of caveolae and thus could be responsible for the transport of proteins (1, 31).

In this work, we used aortic primary smooth muscle cells derived from wild-type and NOX1-deficient mice to study the role of NOX1-derived ROS on AngII signaling and on the AT1R expression and localization. AngII-induced ROS formation and Ca^{2+} release is blunted in NOX1-deficient mice. Immunostaining showed that AT1R is not properly targeted to the plasma membrane in NOX1-deficient cells. Our data suggest that decreased phosphorylation of caveolin contributes to the lack of plasma-membrane targeting of the receptor and the subsequent decrease in the Ca^{2+} release in response to AngII. Thus, NOX1-derived ROS play an important role in AT1R sorting and hence represent a novel cellular mechanism to explain how oxidative stress sensitizes the vascular system to the effects of AngII.

Materials and Methods

NOX1-deficient mice

NOX1-deficient mice were generated as described previously (16).

Tissue preparation

Two-month-old C57BL/6J wild-type mice and C57BL/6J NOX1-deficient mice were used. Thoracic aortas were removed, placed in Hank's Balanced Saline Solution (HBSS; Gibco, CA), and connective and fat tissues were removed. For *ex vivo* studies, harvested aortas were directly stimulated for 1 h with H_2O_2 diluted in HBSS.

Cell culture

Primary smooth muscle cells were isolated with enzymatic dissociation. In brief, cleaned aortas were transferred in HBSS containing trypsin (Sigma, Buchs, Switzerland; 1.25 mg/ml), elastase (Sigma; 0.5 mg/ml), and collagenase type 2 (Sigma; 1 mg/ml) to remove the adventitia. Then tissues were incubated in HBSS containing papain (Sigma; 0.3 mg/ml) and dithioerythritol (Sigma; 1 mg/ml) and then transferred to HBSS containing collagenase. Isolated primary smooth muscle cells were plated and cultured in DMEM containing 10% fetal calf serum and used directly for each experiment after 7–10 days.

For H_2O_2 treatment, cells were incubated overnight at 37°C with the indicated concentrations.

Cell transfection

Isolated NOX1-deficient primary smooth muscle cells were cultured for 7 days and then transfected by using JetPEI (Polyplus Transfection, Polyplus, Illkirch, France) with a pCDNA3.1 plasmid-expressing mouse NOX1 (mNOX1) (2)

by following the manufacturer's protocol. Transfected cells were selected with 0.5 mg/ml G418 and were used 3 days after transfection.

SDS-PAGE and immunoblotting

Cleaned aortas (see tissue preparation) were mechanically dissociated by using Tissue Lyser (frequency, 30 Hz; Qiagen, CA). Once dissociated, the resulting mix was further digested on ice in lysis buffer containing 1% Triton X-100 in 50 mM NaCl, 10 mM MgCl_2 , 1 mM EGTA, 50 mM Tris-HCl, pH 7.4, supplemented with a protease inhibitor cocktail (Complete mini; Boehringer-Mannheim, Mannheim, Germany) for 30 min and sonicated. Protein concentration was determined with protein assay (BioRad, CA). Proteins were separated on a 12% SDS-PAGE gel. Immunoblotting was conducted according to standard techniques and probed with rabbit polyclonal AT1R (Santa Cruz Biotechnology, Heidelberg, Germany; sc-1173), total caveolin, and phospho (Y-14)-caveolin antibodies (BD Transduction Laboratories, Allschwill, Switzerland). Antibody binding was visualized with horseradish peroxidase (HRP)-labeled antibodies and chemiluminescence reagents (ECL reagent; Amersham Biosciences, PA). α -Tubulin (Santa Cruz Biotechnology) was used as a standard.

Cytosolic Ca^{2+} measurement

The cytosolic Ca^{2+} concentration was monitored with the fluorescent Ca^{2+} indicator Fura-2 (Invitrogen) as previously described (14). In brief, after 7–10 days in culture, cells were incubated for 1 h in HBSS containing 2 μM Fura-2 AM (Invitrogen) and 0.1% pluronic acid (Sigma). To minimize compartmentalization of the dye, loading and experimentation were performed at room temperature. Fluorescence was processed by calculating 340:380-nm fluorescence ratios by using the Metafluor system (MDS Analytical Technologies, CA).

RT-PCR

RNA was extracted from purified primary smooth muscle cells with Qiagen RNA Micro kit (Qiagen). After standard reverse transcriptase reactions, specific smooth muscle markers were examined with PCR. Primers are described in Table 1.

Quantitative real-time PCR

RT-PCR was conducted as described (17). AT1R primers were as follows, forward: 5'-CCA TTG TCC ACC CGA TGA AG-3' and reverse: 5'-TGC AGG TGA CTT TGG CCA C-3'. Two constitutively expressed reference genes, *EEF1A1* (eukaryotic elongation factor 1A1) and TBP (Tata box-binding protein) were selected for normalization of candidate gene-expression levels.

ROS production

We used DHE (Invitrogen), a widely used probe, to detect ROS generation (48). After 7–10 days in culture, primary smooth muscle cells were loaded in HBSS containing 5 μM DHE for 30 min at 37°C. Nuclear ethidium fluorescent signal (excitation, 480 nm; emission, 590 nm) was detected and analyzed with Metafluor.

TABLE 1. RT-PCR PRIMERS

NOX1	Sense	5'-GAAATTCCTGGGACTGCCTTGG-3'
	Antisense	5'-GCTGGAGAGAACAGAAGCGAGA-3'
NOX2	Sense	5'-TCAACTACTATAAGGTTTATGTATGTAGG-3'
	Antisense	5'-CAGATATCTAAATTATGCTCTTCCAAA-3'
NOX4	Sense	5'-CCTGCTCATTGGCTGTCCCTA-3'
	Antisense	5'-CGGCTACATGCACACCTGAGAAA-3'
AT1R	Sense	5'-AGGGGCTCAGCCTAAGTAGC-3'
	Antisense	5'-CTGCCTCTAGGGCATGTCTC-3'
SM22	Sense	5'-GCTGCTAAACAAGGCACTCC-3'
	Antisense	5'-AACCAGGCACTATCCAAACG-3'
Actin	Sense	5'-CTGACAGAGGCCACTG-3'
	Antisense	5'-CATCTCCAGAGTCCAGACA-3'
GAPDH	Sense	5'-CTCGTCTCATAGACAAGATGGTGAAG-3'
	Antisense	5'-AGACTCCACGACATACTCAGCACC-3'

Immunostaining

For histology, aortas were used in a free-floating tissue configuration. In brief, cleaned aortas were opened and fixed with 4% paraformaldehyde for 2 h. AT1R was stained with a rabbit polyclonal anti-AT1R diluted in saline solution containing 0.3% Triton X-100. An HRP-coupled antibody (Cappel, OH) was used for the revelation. Specific staining was revealed by addition of 3,3'-diaminobenzidine (DAB, Dako, Glostrup, Denmark) to produce a brown coloration, and nuclei were counterstained with cresyl violet. Primary smooth muscle cells were fixed with 2% paraformaldehyde and permeabilized with 0.25% Triton. Antibody raised against AT1R was added and revealed by Alexa Fluor 488-conjugated antibody (Invitrogen). For calreticulin (primary antibody gift of Prof. M. Michalak, University of Alberta, Calgary, Alberta, Canada), revelation was conducted with Alexa Fluor 555-conjugated antibody (Invitrogen). Specific AT1R-blocking peptide (Santa Cruz Biotechnology; sc-1173P) was used for each technique to assess the quality and reliability of the signal obtained with the AT1R antibody. The concentration of the peptide was 5 times the antibody concentration, and they were incubated for 2 h at room temperature for absorption. Confocal imaging was performed on a LSM 510 Meta confocal scanner mounted on an Axio Imager Z1 microscope (Carl Zeiss, Feldbach, Switzerland).

Electron microscopy

Thoracic aortas from 2-month-old wild-type and NOX1-deficient mice were fixed for 2 h in 3% glutaraldehyde (Sigma). The fixed tissues were embedded in epoxy resin and processed for electron microscopy, as described previously (13).

Statistical analysis

Data analysis was performed by using the software GraphPad Prism 4 (GraphPad Software, San Diego, CA). Results are expressed as mean \pm SEM. The p values >0.05 were considered not significant; p values ≤ 0.05 were considered significant.

Results

Given the strong evidence for a role of NOX1 in vascular AngII responses (7, 16, 17, 20, 30), we decided to investigate cultured aortic smooth muscle cells. Purification of smooth muscle cells from aortae of wild-type and NOX1-deficient mice revealed no apparent differences in their number or in

their morphologic appearance. These cells were tested with PCR for specific smooth muscle markers, smooth muscle actin, and the calponin-related protein SM22 (10), and with AT1R and GAPDH as a control. Corresponding mRNA were found in both cell preparations (Fig. 1A). Thus, we concluded that we had obtained high-quality aortic smooth muscle cells from both wild-type and NOX1-deficient mice.

Unfortunately in our hands, none of the commercially available NOX1 antibodies gave satisfying results in Western blots or in immunostaining (data not shown). We therefore analyzed our samples with RT-PCR. In agreement with previous observations (18), we found abundant NOX4 and NOX1 mRNA in wild-type cells, whereas only NOX4 mRNA was detected in NOX1-deficient cells (Fig. 1A).

AngII-induced ROS production is abolished in NOX1-deficient cells

We proceeded to measure ROS generation in the cultured cells. Basal ROS accumulation was $\sim 30\%$ lower in NOX1-deficient, as compared with wild-type mice ($p = 0.0092$) (Fig. 1B and C, left panel). We then investigated stimulated ROS generation. Adenosine triphosphate (ATP) did not stimulate ROS production in wild-type aortic smooth muscle cells (data not shown), whereas AngII clearly did. This ROS production was inhibited by the flavoprotein inhibitor diphenylene iodonium (DPI). Importantly, AngII-dependent ROS generation was almost completely absent in NOX1-deficient cells (Fig. 1B and C). Allopurinol (inhibitor of xanthine oxidase) or carbonyl cyanide 3-chlorophenylhydrazone (CCCP, inhibitor of mitochondrial respiratory chain) did not have any effect on the AngII-induced ROS generation in wild-type cells (Fig. 1C, right panel). Thus, the AngII-induced ROS formation is mediated predominantly by NOX1. These data demonstrate that NOX1 deficiency decreases basal ROS generation and almost completely abolishes AngII-stimulated ROS generation in aortic smooth muscle cells.

AngII-induced Ca^{2+} responses are blunted in NOX1-deficient cells

The absence of AngII-induced ROS generation in NOX1-deficient cells might indicate that NOX1 is the only superoxide-generating system activated by the AngII receptor. It might, however, also be due to a lack of signaling through the AngII receptor in NOX1-deficient smooth muscle cells. We therefore

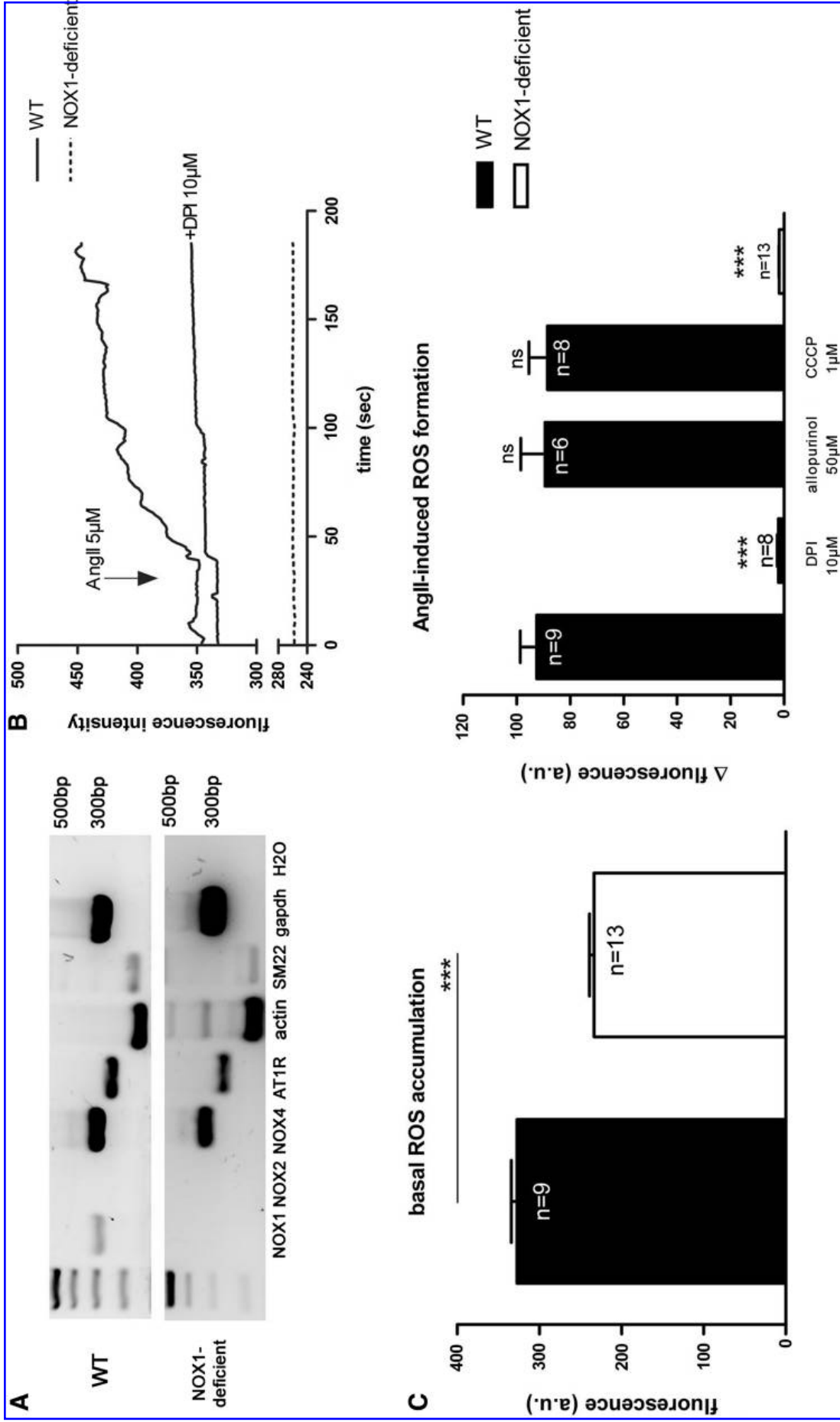

FIG. 1. (A) Characterization of the primary smooth muscle cells. Primary cells were purified from aortae of wild-type and NOX1-deficient mice, and RNA was extracted. PCR was used to determine the presence of specific smooth muscle cell markers. **(B, C)** Role of NOX1 in basal and AngII-stimulated ROS generation in vascular smooth muscle cells. Primary cells were purified from aortae of wild-type and NOX1-deficient mice and exposed to 100 µM ATP or 5 µM AngII and the indicated inhibitors. ROS generation was detected with DHE. **(B)** Representative curves. **(C)** For histograms, values are shown as mean of DHE fluorescence ± SEM; ns, nonsignificant; *** $p < 0.001$ with one-way analysis of variance followed by a Dunnett *post hoc* test with nontreated wild-type cells as control.

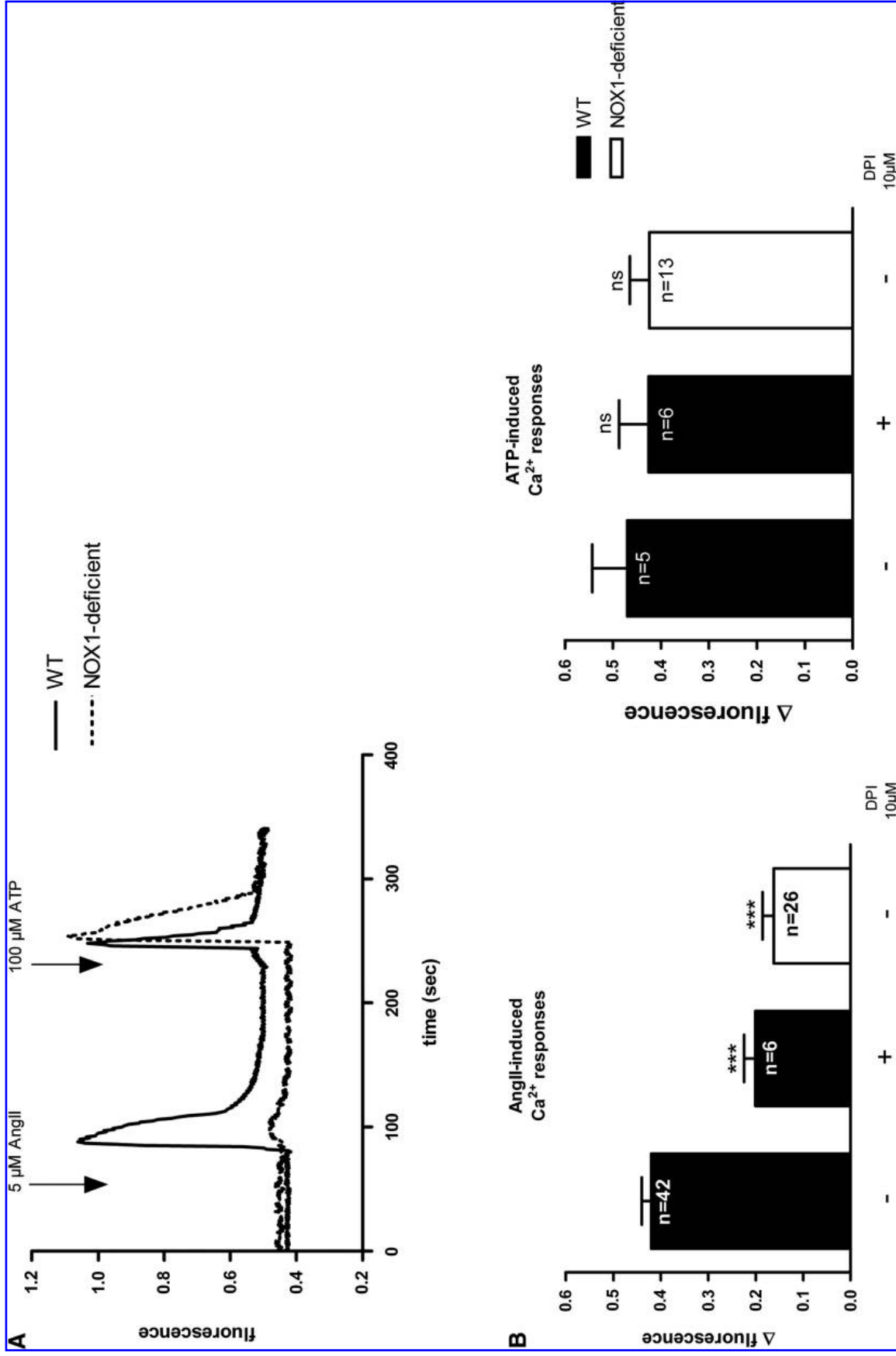

FIG. 2. Role of NOX1 in AngII-stimulated Ca^{2+} release in vascular smooth muscle cells. Ca^{2+} release was detected with Fura-2. Primary smooth muscle cells were purified from aortae of wild-type and NOX1-deficient mice and exposed to 5 μ M AngII. (A) Representative curves (wild-type cells, *plain curve*; NOX1-deficient cells, *hatched curve*). (B) Histograms show comparison of maximal amplitude in fluorescence; data are shown as mean \pm SEM. *ns*, nonsignificant; ****p* < 0.001 with one-way ANOVA followed by a Dunnett *post hoc* test with nontreated wild-type cells as control.

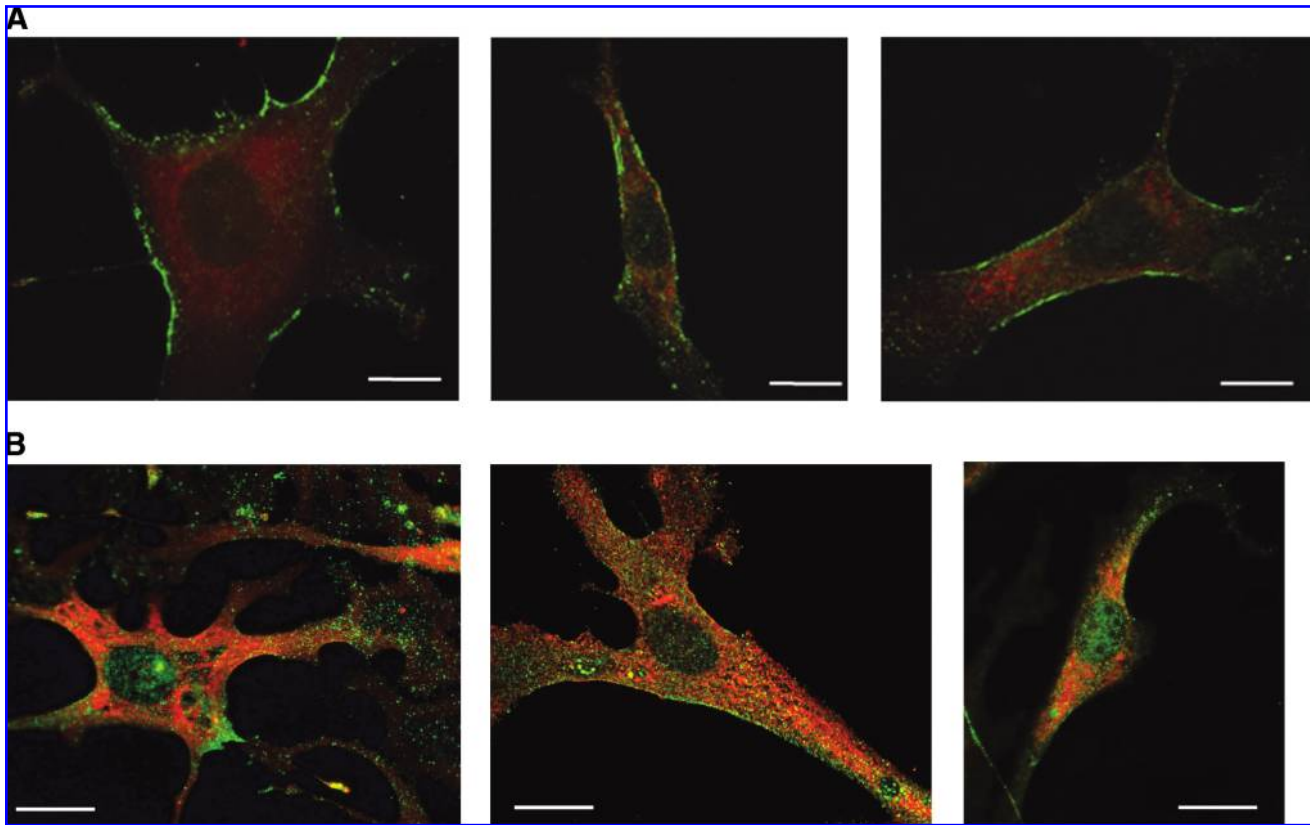

FIG. 3. AT1R localization in vascular smooth muscle cells. Primary smooth muscle cells purified from aortae of wild-type and NOX1-deficient mice were stained for confocal imaging. AT1R appeared in green fluorescence, and calreticulin, in red. (A) Wild-type cells and (B) NOX-1 deficient cells. Similar distribution was observed from primary cultures derived from three independent wild-type and four independent NOX1-deficient animals. Bar, 20 μm . (For interpretation of the references to color in this figure legend, the reader is referred to the web version of this article at www.liebertonline.com/ars).

measured the cytosolic free Ca^{2+} concentration, which is an important second messenger for AngII responses. Changes in intracellular Ca^{2+} were reported by the fluorescence ratio (F_{340}/F_{380}) of the Ca^{2+} indicator, Fura-2.

ATP induced comparable Ca^{2+} elevations in both types of cells (Fig. 2). This suggests that the Ca^{2+} signaling and Ca^{2+} stores are intact in NOX1-deficient cells. However, on stimulation with AngII, a marked increase in cytosolic Ca^{2+} was observed only in wild-type, but not in NOX1-deficient cells (Fig. 2). AngII-induced Ca^{2+} responses in wild-type cells were inhibited by DPI, whereas the ATP-induced Ca^{2+} responses were not (Fig. 2B). These data demonstrate that in NOX1-deficient cells, not only ROS generation, but also AngII-induced Ca^{2+} signaling were greatly diminished. Thus, a global AT1R signaling defect, rather than a selective lack of AngII-induced ROS generation was observed.

Expression and localization of the type 1 angiotensin II receptor

AT1R is the major AngII receptor in vascular smooth muscle cells (8). We therefore investigated the localization of the AT1R in wild-type and NOX1-deficient cells. AT1R antibody specificity was tested by using a specific blocking peptide. The addition of blocking peptide suppressed the signal in both immunohistochemistry and Western blot, demonstrating the specificity of the staining (supplementary Fig. 1). In wild-type cells, AT1R was almost exclusively observed in regions corresponding to the plasma membrane (Fig. 3A, green). In contrast, in NOX1-deficient cells (Fig. 3B), AT1R did not localize to the cell-surface region, but was diffusely found in the cell. AT1R only partially colocalized with the endoplasmic reticulum marker calreticulin (red fluorescence, Fig. 3)

FIG. 4. AT1R localization and expression in aortae. Whole aortae were incubated in an anti-AT1R antiserum, and immunoreactivity for AT1R was revealed with DAB. AT1R was detected in wild-type animals (A, B), but only a very weak signal was detected in NOX1-deficient animals (C, D) (arrows). (B, D) Display at a high magnification of smooth muscle cells. Nuclei were counterstained with cresyl violet. Four wild-type and four NOX1-deficient animals were used. (E) Quantitative real-time PCR (values were normalized with respect to two reference genes (see experimental procedures); *ns*, no statistical difference with Student's *t* test and (F) Western blot ($*0.01 < p < 0.001$ with Student's *t* test). Tubulin was used as a control; bar, 20 μm . (For interpretation of the references to color in this figure legend, the reader is referred to the web version of this article at www.liebertonline.com/ars).

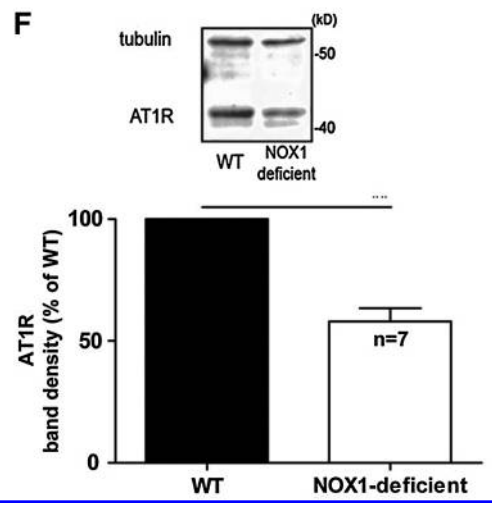
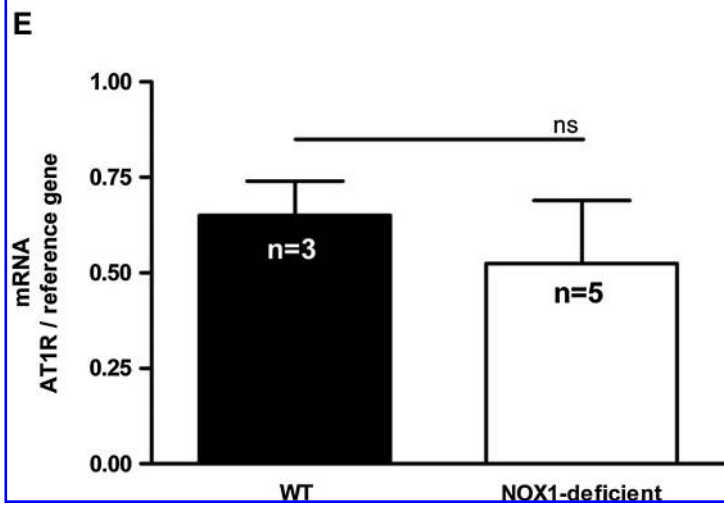
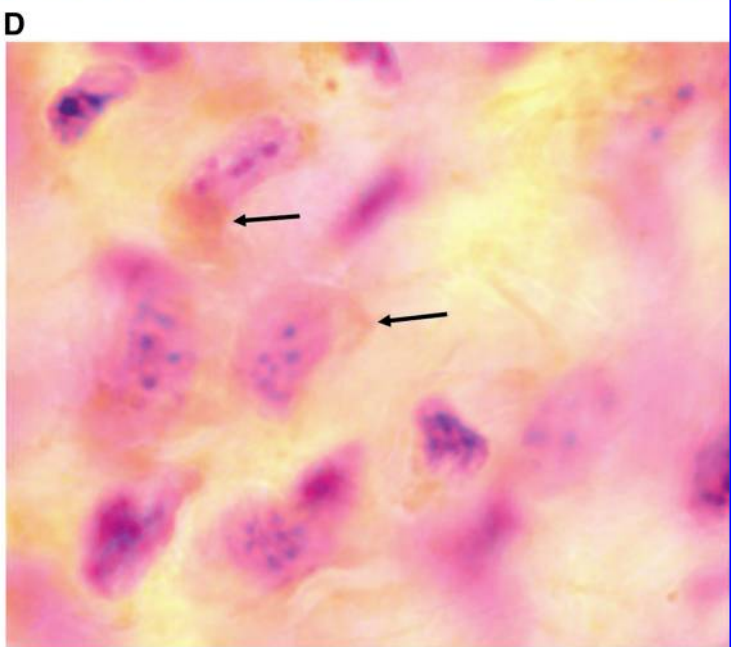
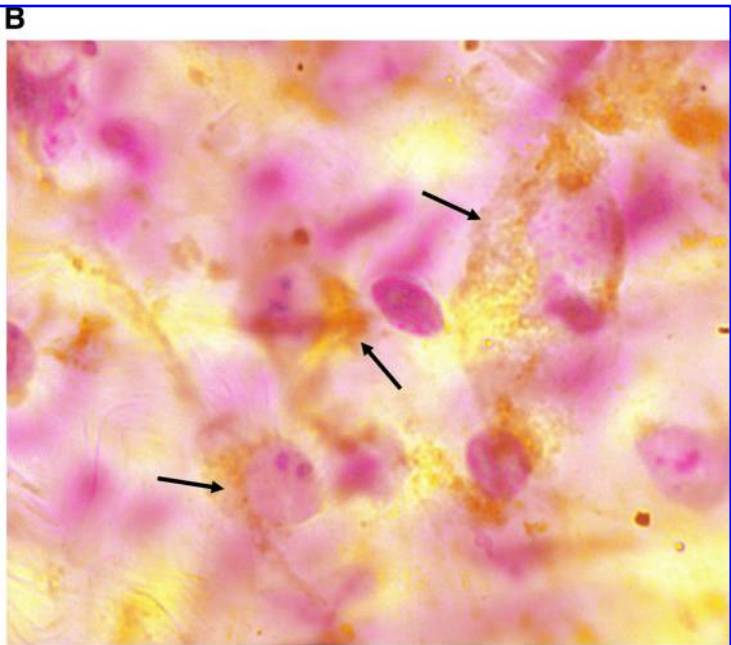
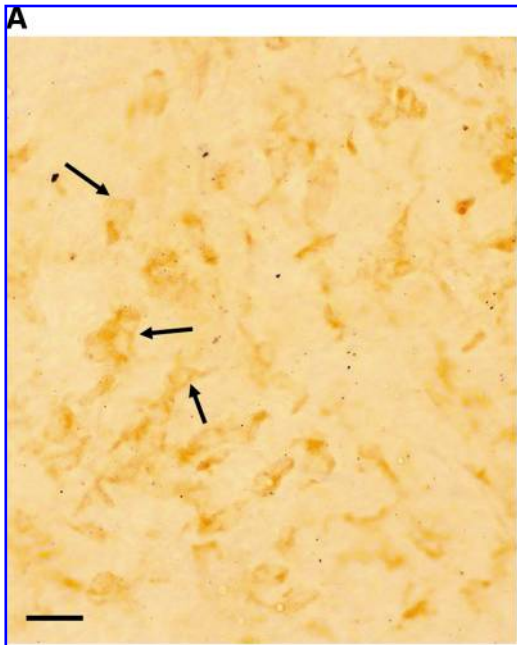

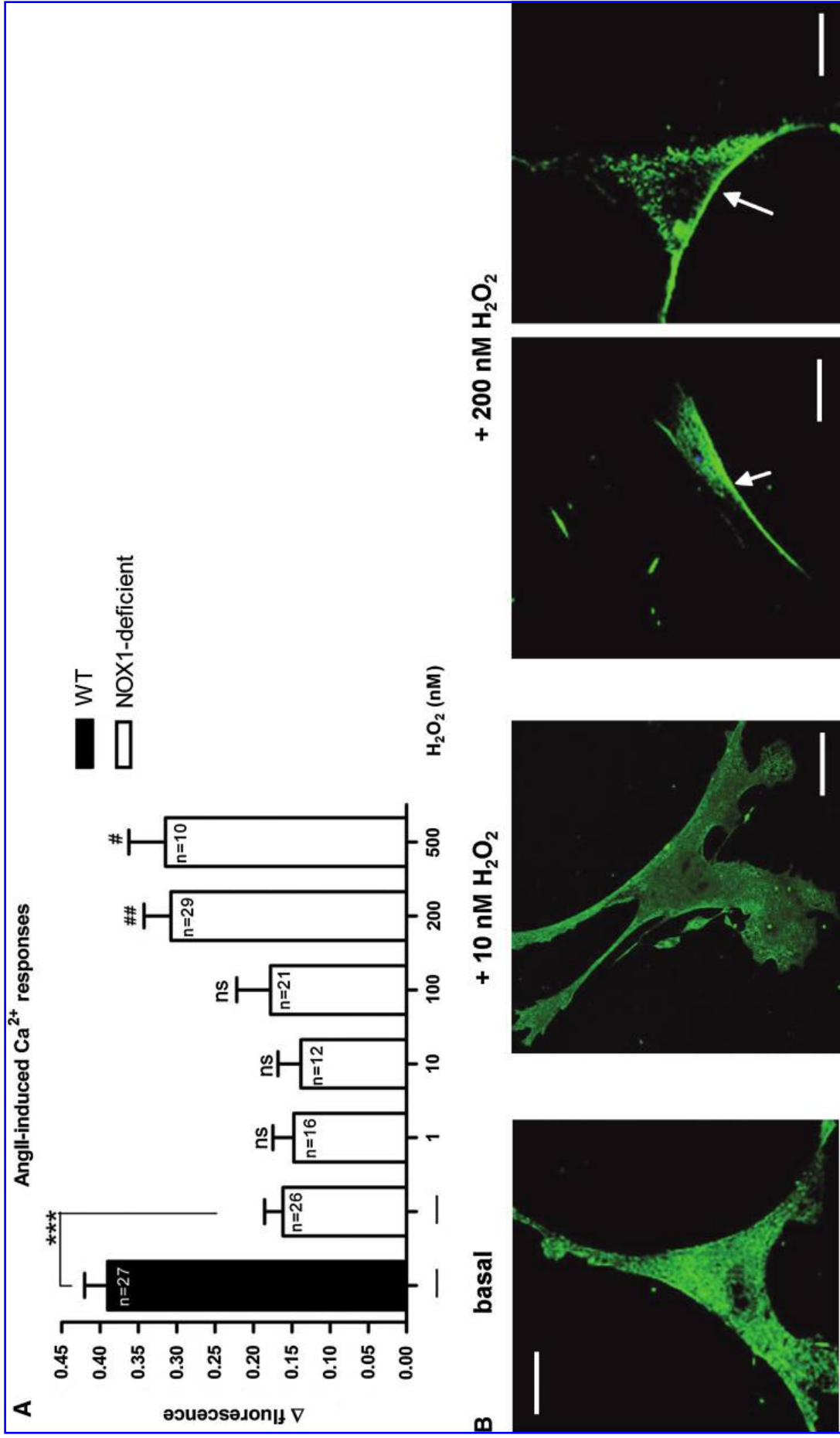

FIG. 5. Exogenous ROS rescue AngII responses and AT1R cell-surface expression in NOX1-deficient cells. NOX1-deficient vascular smooth muscle cells were incubated with different H_2O_2 concentrations (from 1 to 500 nM). (A) AngII-induced cytosolic Ca^{2+} fluxes and (B) AT1R localization (green) were assessed (ns, nonsignificant; ##0.01 < p < 0.001; # p < 0.05 with one-way ANOVA followed by a Dunnett *post hoc* test with nontreated NOX1-deficient cells as control; *** p < 0.001 with Student's *t* test). Bar, 20 μ m. (For interpretation of the references to color in this figure legend, the reader is referred to the web version of this article at www.liebertonline.com/ars).

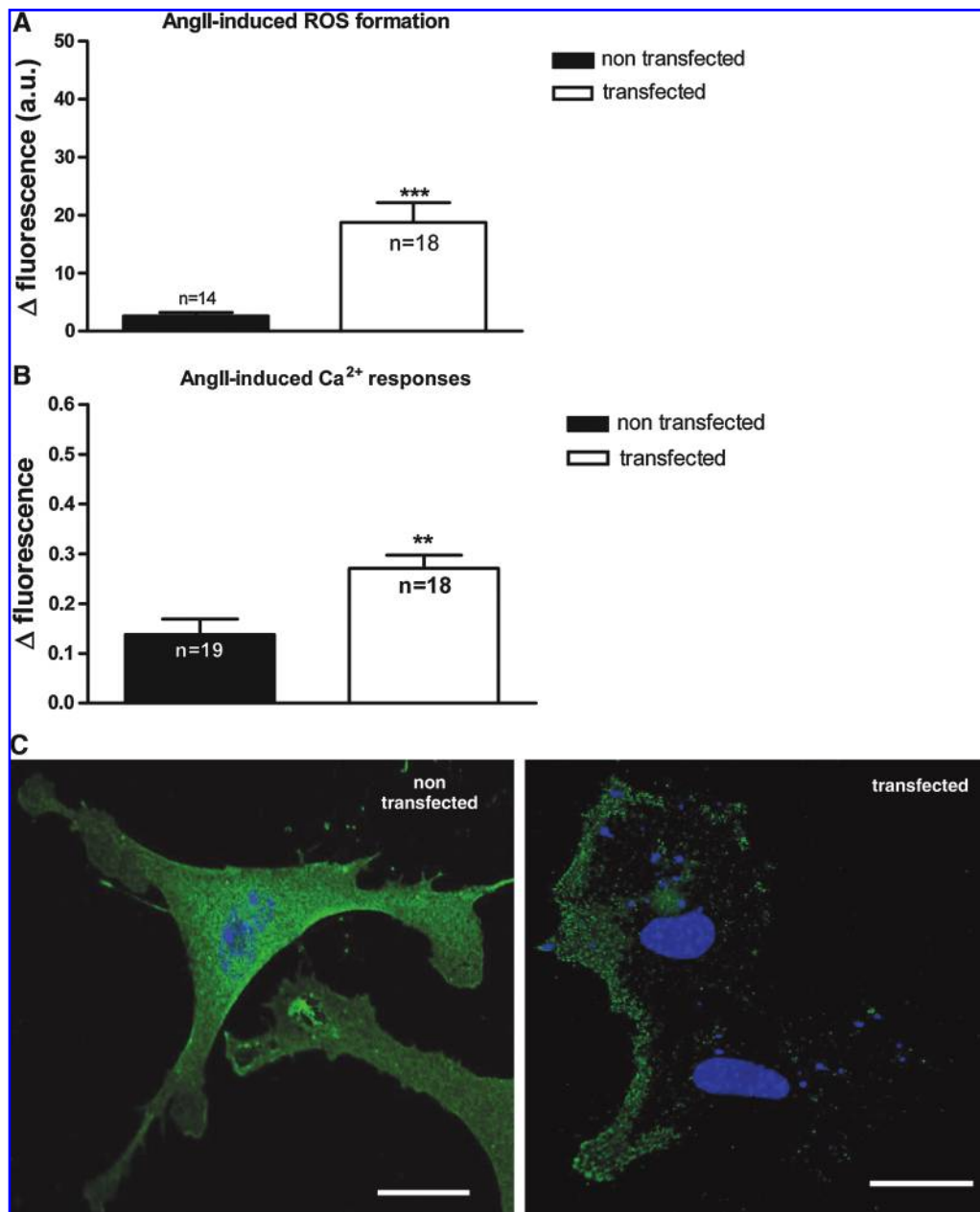
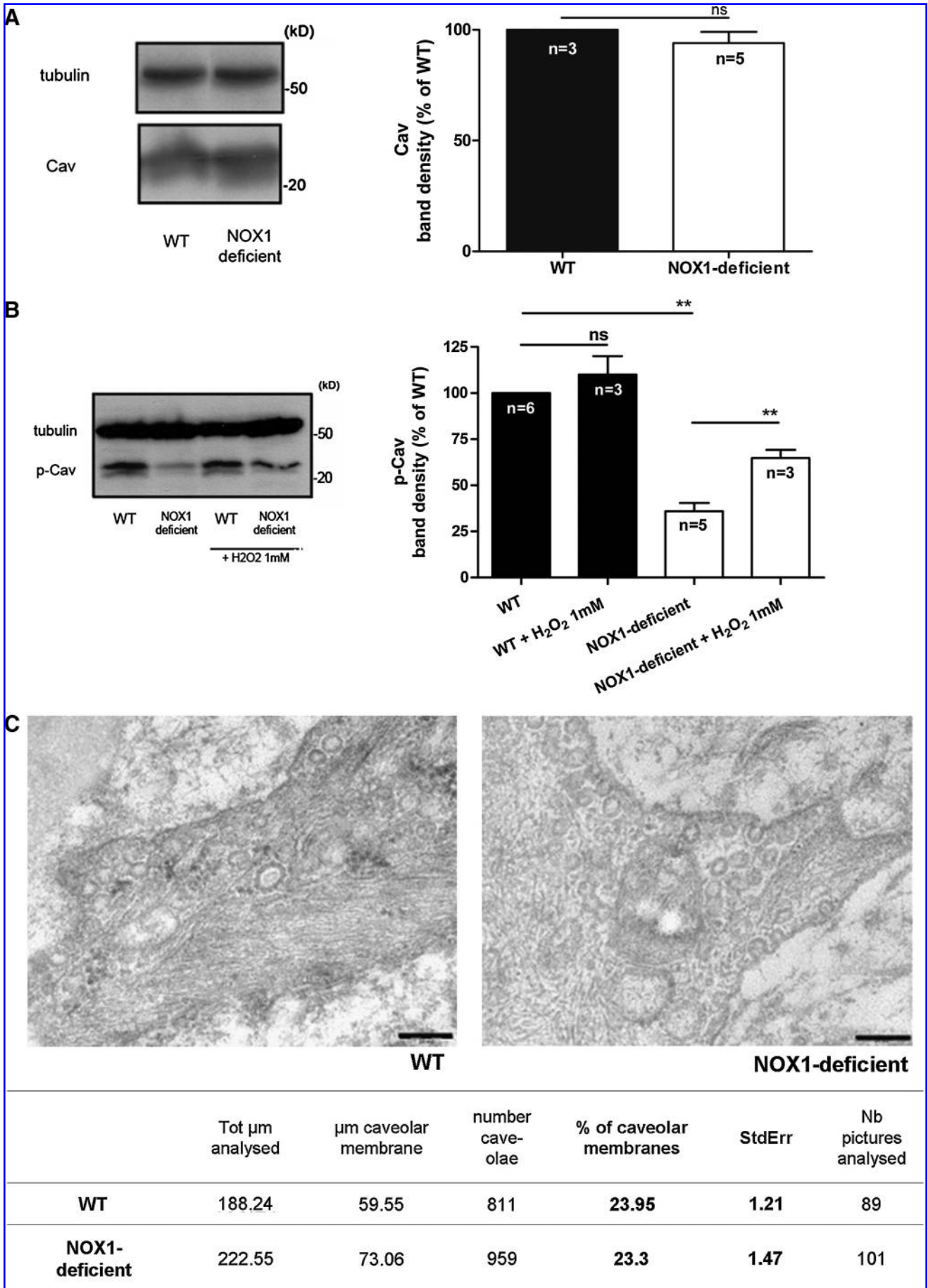

FIG. 6. Reexpression of NOX1 rescues AngII responses and AT1R cell-surface expression in NOX1-deficient cells. NOX1-deficient vascular smooth muscle cells were transfected with mNOX1. (A) AngII-induced ROS generation; (B) AngII-induced Ca²⁺ responses; and (C) AT1R localization (green) were assessed. Nuclei were counterstained with DAPI (blue). **0.01 < *p* < 0.001; ****p* < 0.001 with Student's *t* test. Bar, 20 μm. (For interpretation of the references to color in this figure legend, the reader is referred to the web version of this article at www.liebertonline.com/ars).

and with the Golgi marker GM130 (data not shown). The observed pattern demonstrates an increased intracellular localization of AT1R in NOX1-deficient smooth muscle cells. This altered localization might be, in part, due to retention in the endoplasmic reticulum and the Golgi. Interestingly, nuclear staining also was observed in NOX1-deficient cells, but not in wild-type cells. We have not further investigated this point, but nuclear translocation of AT1R has been described previously (5, 11).

Thus, isolated vascular smooth muscle cells from NOX1-deficient mice show an intracellular localization of AT1R, which is likely to explain the signaling deficit shown earlier.

To investigate AT1R localization *in vivo*, we investigated AT1R in explanted aortas from wild-type and NOX1-deficient mice with immunohistochemistry. An intense immunoreactivity for AT1R was observed in wild-type aortas (Fig. 4A and B, arrows). In NOX1-deficient aortas, almost no signal was observed (Fig. 4C and D, arrows). We therefore applied quantitative methods to investigate AT1R expression. AT1R mRNA levels, as detected by real-time PCR, were not changed in NOX1-deficient mice (Fig. 4E). In contrast, AT1R protein levels, as detected with Western blotting, were markedly decreased in NOX1-deficient mice (Fig. 4F). These data demonstrate that, in addition to the decreased cell-surface



AT1R expression, decreased protein levels are present. The latter was not due to decreased mRNA synthesis.

Low levels of exogenous hydrogen peroxide rescue AngII responses and AT1R cell-surface expression in NOX1-deficient cells

If the cell-surface localization of AT1R depends on NOX1-dependent ROS generation, it might be possible to rescue the phenotype by exogenous addition of ROS. We therefore treated NOX1-deficient vascular smooth muscle cells with increasing H₂O₂ concentrations (from 1 to 500 nM) and measured AngII-induced Ca²⁺ responses. A dose-dependent rescue of AngII-induced Ca²⁺ responses occurred on addition of H₂O₂ (Fig. 5A); the amplitude of the recovered Ca²⁺ responses reached roughly two thirds of the one observed in wild-type cells. To investigate whether this rescue was due to a retargeting of AT1R to the cell surface, we performed immunofluorescence experiments. As shown in Fig. 5B, a partial retargeting to the plasma membrane was observed when cells were treated with 200 nM H₂O₂. These experiments indicate the importance of ROS in the AT1R localization.

Transfection of NOX1 rescues AngII responses and AT1R cell-surface expression in NOX1-deficient cells

Exogenous H₂O₂ has been shown to rescue AngII responses and AT1R cell-surface expression in NOX1-deficient cells. This result suggests that ROS are involved in the AT1R localization and AngII signaling. To investigate this point further, we transfected NOX1-deficient primary smooth muscle cells with a mouse NOX1 plasmid and performed ROS and Ca²⁺ measurements. As shown in Fig. 6A, reexpression of NOX1 in NOX1-deficient cells lead to a reappearance of AngII-induced ROS formation. AngII-induced Ca²⁺ responses were doubled, compared with nontransfected NOX1-deficient cells (Fig. 6B). Similarly, increased targeting of AT1R to the membranes was observed in the NOX1-transfected cells (Fig. 6C). These results might indicate that NOX1 transfection allows the rescue of the phenotype of NOX1-deficient smooth muscle cells.

Expression of caveolin, phosphorylated caveolin, and caveolae number

Caveolae and caveolin have been shown to be involved in AT1R plasma membrane sorting and in AT1R signaling (43). To investigate possible disorders in the anchoring of the AT1R to the plasma membrane, we studied with Western blot the expression of the major component of caveolae, caveolin, and phosphorylated caveolin. The expression of total caveolin (Cav) in whole lysate of aortae from wild-type and NOX1-deficient mice was comparable in both types of mouse (Fig. 7A). Electron microscopy suggested that the integrity and total number of caveolae were not changed in aorta from

both mice (Fig. 7C). However, phosphorylated caveolin (p-Cav) expression was drastically reduced in aorta from NOX1-deficient mice, and addition of H₂O₂ increased the phosphorylation of caveolin in these mice, suggesting a role of NOX1-derived ROS in this reaction (Fig. 7B). Altogether, these results suggest that caveolin phosphorylation is altered in NOX1-deficient mice. This could be involved in the altered localization of the AT1R.

Discussion

Our study investigated the relation between AngII signaling and NOX1-dependent ROS generation in vascular smooth muscle. NOX1 deficiency prevented AngII-induced ROS generation and Ca²⁺ responses. We demonstrated that the lack of AngII responses in NOX1-deficient cells is due to a lack of plasma-membrane localization of the AngII receptor AT1R. The mechanism by which NOX1 determines plasma membrane localization of AT1R may include ROS-dependent phosphorylation of caveolin.

To our knowledge, this is the first description of ROS-dependent regulation of AT1R targeting. This mechanism is clearly demonstrated by the lack of plasma membrane localization of AT1R in NOX1-deficient cells and the rescue through incubation with exogenous H₂O₂ or reexpression of NOX1. However, although exogenous H₂O₂ is able to target AT1R to the membrane, it appears that NOX4, which is abundantly expressed in vascular smooth muscle, is not able to do so. Thus, NOX4 is not able to compensate for the absence of NOX1. This could be explained by a localized site of action of NOX enzymes. It has been suggested that NOX1 localizes to caveolae and/or lipid rafts within the plasma membrane (21, 41), whereas for NOX4, a number of distinct localizations have been suggested (4, 21, 24, 37). The proposed association of NOX1 with caveolae provides a possible explanation for how the relatively low basal ROS generation by NOX1 may be sufficient to drive the association of AT1R with the plasma membrane. A local "ROS signaling cloud" generated by basal NOX1 activity around the region of the caveolae might be sufficient to maintain the anchoring of AT1R at the plasma membrane.

The intracellular AT1R in NOX1-deficient mice did not fully colocalize with calreticulin (Fig. 3) or Golgi (data not shown). Based on these observations, we think that the loss of plasma-membrane localization in the absence of NOX1 is more likely due to altered trafficking. However, we cannot exclude a deficient maturation process, because immunoreactivity for AT1R was found in the ER. Electron microscopy showed that NOX1 deficiency does not change the number of caveolae in the cell. Thus, it appears that the decreased caveolin phosphorylation in NOX1-deficient cells does not lead to global changes in the number of caveolae. The phospho-caveolin-dependent association of AT1R with the plasma membrane does not prove a direct association with caveolae.

FIG. 7. Caveolins, but not phosphorylated caveolin, have comparable protein-expression levels. Western blot analysis of whole aortae lysate with (A) anticaveolin (Cav) and (B) anti-phosphocaveolin (p-Cav) antibodies. For histograms, data are shown as means of band density \pm SEM. $**0.01 < p < 0.001$ with Student's *t* test. (C) Electron microscopy was used to estimate caveolae number in aortae. The percentage of caveolar membrane between aortae from wild-type and NOX1-deficient mice was not statistically different. Bar, 500 nm.

A previous study suggested that AT1R requires receptor occupation for the association with caveolae (22, 43). Thus, it is possible that, in a first step, phospho-caveolin is important for the association of AT1R with the plasma membrane, and in a second step, AngII is necessary for its association with caveolae. Previous studies suggested that phosphorylation of caveolin is required for the formation of caveolae (1, 31). The magnitude of the reduction in caveolin phosphorylation observed in NOX1-deficient mice did not decrease the total number of caveolae; however, it was sufficient to alter the localization of AT1R. Thus, whereas our data do not exclude a role of caveolin phosphorylation in the formation of caveolae, they favor the concept of its involvement in protein trafficking (1, 23). AT1R has a caveolin-binding-like site, and mutations of this motif considerably reduce the plasma-membrane expression of the receptor and lead to its accumulation in intracellular compartments (28). Note also that caveolin1-deficient mice show a decrease in AngII-induced contractile responses in the vascular system (9), but AT1R localization in caveolin1-deficient vascular smooth muscle has so far not been studied.

Recently, Ritsick *et al.* (33) showed that, in *Drosophila* ovarian smooth muscle, NOX5 is required for agonist-induced Ca^{2+} release and subsequent contraction; the same group mentioned unpublished data showing that NOX1 suppression interferes with Ca^{2+} signaling in human smooth muscle cells (25). These data have been interpreted as a role of NOX-derived ROS in the regulation of Ca^{2+} fluxes.

Redox-sensitive regulation of intracellular and plasma membrane Ca^{2+} channels has been described (3). In our system, the lack of Ca^{2+} signaling is, however, due to a different mechanism: ROS indirectly influence AngII-mediated Ca^{2+} signaling through regulation of receptor localization.

The mechanism described (ROS-dependent regulation of plasma membrane localization of AT1R) has potential physiological implication for the AngII response and for blood-pressure regulation. Under stress conditions, one would expect an increased AngII response of the organism. In acute stress situations, this could be considered a beneficial physiologic response. In chronic stress, however, that should contribute to development of hypertension and vascular disease. Thus, the intracellular AT1R localization might contribute to the decreased blood-pressure response in NOX1-deficient mice (16, 30).

It also should be mentioned that the main function of AT1R in aortic vascular smooth muscle is probably not blood-pressure regulation. Key players in blood-pressure regulation are peripheral resistance vessels, the kidneys, and the central nervous system (6). Thus, the mechanisms described here should not be extrapolated to the overall blood-pressure response, but only to the AngII responses in the aortic vascular wall, as, for example, cell proliferation and gene expression.

Taken together, NOX1 is an important modulator of AT1R in aortic smooth muscle, and NOX1 represents an interesting drug target for the treatment of vascular diseases (25, 46).

Acknowledgments

We thank Dr. Michel Dubois-Dauphin for excellent technical assistance and Drs. Daniel Hössli and Pierre Cosson for

helpful discussions. This work was supported by Swiss National Foundation grant 100A0-103725 awarded to K.H.K. and 310000-120280/1 to M.F.

Author Disclosure Statement

K.H.K. and V.J. own stock in the start-up company Gen-KyoTex, which is developing NOX inhibitors.

References

1. Aoki T, Nomura R, and Fujimoto T. Tyrosine phosphorylation of caveolin-1 in the endothelium. *Exp Cell Res* 253: 629–636, 1999.
2. Banfi B, Clark RA, Steger K, and Krause K-H. Two novel proteins activate superoxide generation by the NADPH oxidase NOX1. *J Biol Chem* 278: 3510–3513, 2003.
3. Bedard K and Krause K-H. The NOX family of ROS-generating NADPH oxidases: physiology and pathophysiology. *Physiol Rev* 87: 245–313, 2007.
4. Chen K, Kirber MT, Xiao H, Yang Y, and Keaney JF Jr. Regulation of ROS signal transduction by NADPH oxidase 4 localization. *J Cell Biol* 181: 1129–1139, 2008.
5. Cook JL, Mills SJ, Naquin RT, Alam J, and Re RN. Cleavage of the angiotensin II type 1 receptor and nuclear accumulation of the cytoplasmic carboxy-terminal fragment. *Am J Physiol Cell Physiol* 292: C1313–C1322, 2007.
6. Cowley AW Jr. Long-term control of arterial blood pressure. *Physiol Rev* 72: 231–300, 1992.
7. Dikalova A, Clempus R, Lassegue B, Cheng G, McCoy J, Dikalov S, Martin AS, Lyle A, Weber DS, Weiss D, Taylor WR, Schmidt HHHW, Owens GK, Lambeth JD, and Griendling KK. Nox1 overexpression potentiates angiotensin ii-induced hypertension and vascular smooth muscle hypertrophy in transgenic mice. *Circulation* 112: 2668–2676, 2005.
8. Dinh D, Frauman A, Johnston C, and Fabiani M. Angiotensin receptors: distribution, signalling and function. *Clin Sci (London)* 100: 481–492, 2001.
9. Drab M, Verkade P, Elger M, Kasper M, Lohn M, Lauterbach B, Menne J, Lindschau C, Mende F, Luft F, Schedl A, Haller H, and Kurzchalia T. Loss of caveolae, vascular dysfunction, and pulmonary defects in caveolin-1 gene-disrupted mice. *Science* 293: 2449–2452, 2001.
10. Duband J, Gimona M, Scatena M, Sartore S, and Small J. Calponin and SM 22 as differentiation markers of smooth muscle: spatiotemporal distribution during avian embryonic development. *Differentiation* 55: 1–11, 1993.
11. Eggena P, Zhu JH, Clegg K, and Barrett JD. Nuclear angiotensin receptors induce transcription of renin and angiotensinogen mRNA. *Hypertension* 22: 496–501, 1993.
12. Fellner SK and Arendshorst WJ. Angiotensin II, reactive oxygen species, and Ca^{2+} signaling in afferent arterioles. *Am J Physiol Renal Physiol* 289: F1012–F1019, 2005.
13. Foti M, Phelouzat M-A, Holm A, Rasmussen BJ, and Carpentier J-L. p56Lck anchors CD4 to distinct microdomains on microvilli. *Proc Natl Acad Sci U S A* 99: 2008–2013, 2002.
14. Foyouzi-Youssefi R, Arnaudeau S, Borner C, Kelley WL, Tschoop J, Lew DP, Demaurex N, and Krause K-H. Bcl-2 decreases the free Ca^{2+} concentration within the endoplasmic reticulum. *Proc Natl Acad Sci U S A* 97: 5723–5728, 2000.

15. Garrido A and Griendling K. NADPH oxidases and angiotensin II receptor signaling. *Mol Cell Endocrinol* doi: 10.1016/j.mce. 2008.11.003, 2008.
16. Gavazzi G, Banfi B, Deffert C, Fiette L, Schappi M, Herrmann F, and Krause K. Decreased blood pressure in NOX1-deficient mice. *FEBS Lett* 580: 497–504, 2006.
17. Gavazzi G, Deffert C, Trocme C, Schappi M, Herrmann FR, and Krause K-H. NOX1 deficiency protects from aortic dissection in response to angiotensin II. *Hypertension* 50: 189–196, 2007.
18. Griendling K. Novel NAD(P)H oxidases in the cardiovascular system. *Heart* 90: 491–493, 2004.
19. Griendling K, Delafontaine P, Rittenhouse S, Gimbrone M Jr, and Alexander R. Correlation of receptor sequestration with sustained diacylglycerol accumulation in angiotensin II-stimulated cultured vascular smooth muscle cells. *J Biol Chem* 262: 14555–14562, 1987.
20. Griendling K, Minieri C, Ollerenshaw J, and Alexander R. Angiotensin II stimulates NADH and NADPH oxidase activity in cultured vascular smooth muscle cells. *Circ Res* 74: 1141–1148, 1994.
21. Hilenski LL, Clempus RE, Quinn MT, Lambeth JD, and Griendling KK. Distinct subcellular localizations of Nox1 and Nox4 in vascular smooth muscle cells. *Arterioscler Thromb Vasc Biol* 24: 677–683, 2004.
22. Ishizaka N, Griendling KK, Lassegue B, and Alexander RW. Angiotensin II type 1 receptor: relationship with caveolae and caveolin after initial agonist stimulation. *Hypertension* 32: 459–466, 1998.
23. Kimura A, Mora S, Shigematsu S, Pessin JE, and Saltiel AR. The insulin receptor catalyzes the tyrosine phosphorylation of caveolin-1. *J Biol Chem* 277: 30153–30158, 2002.
24. Kuroda J, Nakagawa K, Yamasaki T, Nakamura K, Takeya R, Kuribayashi F, Imajoh-Ohmi S, Igarashi K, Shibata Y, Sueishi K, and Sumimoto H. The superoxide-producing NAD(P)H oxidase Nox4 in the nucleus of human vascular endothelial cells. *Genes Cells* 10: 1139–1151, 2005.
25. Lambeth JD. Nox enzymes, ROS, and chronic disease: an example of antagonistic pleiotropy. *Free Radic Biol Med* 43: 332–347, 2007.
26. Lassegue B and Griendling KK. Reactive oxygen species in hypertension: an update. *Am J Hypertens* 17: 852–860, 2004.
27. Lassegue B, Sorescu D, Szocs K, Yin Q, Akers M, Zhang Y, Grant SL, Lambeth JD, and Griendling KK. Novel gp91phox homologues in vascular smooth muscle cells: nox1 mediates angiotensin II-induced superoxide formation and redox-sensitive signaling pathways. *Circ Res* 88: 888–894, 2001.
28. Leclerc PC, Auger-Messier M, Lanctot PM, Escher E, Leduc R, and Guillemette G. A polyaromatic caveolin-binding-like motif in the cytoplasmic tail of the type 1 receptor for angiotensin II plays an important role in receptor trafficking and signaling. *Endocrinology* 143: 4702–4710, 2002.
29. Lyle AN and Griendling KK. Modulation of vascular smooth muscle signaling by reactive oxygen species. *Physiology* 21: 269–280, 2006.
30. Matsuno K, Yamada H, Iwata K, Jin D, Katsuyama M, Matsuki M, Takai S, Yamanishi K, Miyazaki M, Matsubara H, and Yabe-Nishimura C. Nox1 is involved in angiotensin ii-mediated hypertension: a study in Nox1-deficient mice. *Circulation* 112: 2677–2685, 2005.
31. Parton RG, Hanzal-Bayer M, and Hancock JF. Biogenesis of caveolae: a structural model for caveolin-induced domain formation. *J Cell Sci* 119: 787–796, 2006.
32. Parton RG and Simons K. The multiple faces of caveolae. *Nat Rev Mol Cell Biol* 8: 185–194, 2007.
33. Ritsick D, Edens W, Finnerty V, and Lambeth J. Nox regulation of smooth muscle contraction. *Free Radic Biol Med* 43: 31–8, 2007.
34. Rojas A, Figueroa H, Re L, and Morales MA. Oxidative stress at the vascular wall. mechanistic and pharmacological aspects. *Arch Med Res* 37: 436–448, 2006.
35. Rubanyi GM and Vanhoutte PM. Superoxide anions and hyperoxia inactivate endothelium-derived relaxing factor. *Am J Physiol Heart Circ Physiol* 250: H822–H827, 1986.
36. Schmelzer M, Ateghang B, Helmig S, Wartenberg M, and Sauer H. Embryonic stem cells utilize reactive oxygen species as transducers of mechanical strain-induced cardiovascular differentiation. *FASEB J* 20: 1182–1184, 2006.
37. Serrander L, Cartier L, Bedard K, Banfi B, Lardy B, Plastre O, Sienkiewicz A, Forro L, Schlegel W, and Krause K. NOX4 activity is determined by mRNA levels and reveals a unique pattern of ROS generation. *Biochem J* 406: 105–114, 2007.
38. Sorescu D, Weiss D, Lassegue B, Clempus RE, Szocs K, Sorescu GP, Valppu L, Quinn MT, Lambeth JD, Vega JD, Taylor WR, and Griendling KK. Superoxide production and expression of Nox family proteins in human atherosclerosis. *Circulation* 105: 1429–1435, 2002.
39. Taniyama Y, Ushio-Fukai M, Hitomi H, Rocic P, Kingsley MJ, Pfahl C, Weber DS, Alexander RW, and Griendling KK. Role of p38 MAPK and MAPKAPK-2 in angiotensin II-induced Akt activation in vascular smooth muscle cells. *Am J Physiol Cell Physiol* 287: C494–C499, 2004.
40. Touyz RM, He G, Deng L-Y, and Schiffrin EL. Role of extracellular signal-regulated kinases in angiotensin II-stimulated contraction of smooth muscle cells from human resistance arteries. *Circulation* 99: 392–399, 1999.
41. Ushio-Fukai M. Localizing NADPH oxidase-derived ROS. *Sci STKE* 2006: re8, 2006.
42. Ushio-Fukai M and Alexander R. Reactive oxygen species as mediators of angiogenesis signaling: role of NAD(P)H oxidase. *Mol Cell Biochem* 264: 85–97, 2004.
43. Ushio-Fukai M and Alexander RW. Caveolin-dependent angiotensin II type 1 receptor signaling in vascular smooth muscle. *Hypertension* 48: 797–803, 2006.
44. Ushio-Fukai M, Griendling KK, Becker PL, Hilenski L, Halleran S, and Alexander RW. Epidermal growth factor receptor transactivation by angiotensin II requires reactive oxygen species in vascular smooth muscle cells. *Arterioscler Thromb Vasc Biol* 21: 489–495, 2001.
45. Ushio-Fukai M, Zuo L, Ikeda S, Tojo T, Patrushev NA, and Alexander RW. cAbl tyrosine kinase mediates reactive oxygen species- and caveolin-dependent AT1 receptor signaling in vascular smooth muscle: role in vascular hypertrophy. *Circ Res* 97: 829–836, 2005.
46. Williams H and Griendling K. NADPH oxidase inhibitors: new antihypertensive agents? *J Cardiovasc Pharmacol* 50: 9–16, 2007.
47. Wyse BD, Prior IA, Qian H, Morrow IC, Nixon S, Muncke C, Kurzchalia TV, Thomas WG, Parton RG, and Hancock JF. Caveolin interacts with the angiotensin II type 1 receptor during exocytic transport but not at the plasma membrane. *J Biol Chem* 278: 23738–23746, 2003.
48. Zhao H, Kalivendi S, Zhang H, Joseph J, Nithipatikom K, Vásquez-Vivar J, and Kalyanaraman B. Superoxide reacts with hydroethidine but forms a fluorescent product that is

distinctly different from ethidium: potential implications in intracellular fluorescence detection of superoxide. *Free Radic Biol Med* 34: 1359–1368, 2003.

Address correspondence to:

*Karl-Heinz Krause
Department of Pathology and Immunology
Centre Medical Universitaire
University of Geneva
Geneva, Switzerland*

E-mail: Karl-Heinz.Krause@unige.ch

Date of first submission to ARS Central, March 16, 2009; date of acceptance, March 22, 2009.

Abbreviations Used

AngII = angiotensin II
AT1R = angiotensin receptor type 1
Cav = caveolin
CCCP = carbonyl cyanide 3-chlorophenylhydrazone
DAB = 3,3'-diaminobenzidine
DHE = dihydroethidium
DPI = diphenylene iodonium
HBSS = Hank's Balanced Saline Solution
mNOX1 = mouse NOX1
NOX1 = NADPH oxidase type 1
p-Cav = phosphorylated caveolin
ROS = reactive oxygen species

Implications de NOX1 dans les lésions tissulaires pulmonaires induites par l'hyperoxie

Le syndrome de détresse respiratoire des prématurés est caractérisé par une immaturité pulmonaire et une production insuffisante de surfactant par les cellules épithéliales alvéolaires de type II. Le traitement de cette pathologie comprend une ventilation mécanique et de fortes concentrations d'oxygène (>95% d'oxygène). Les poumons soumis à des conditions d'hyperoxie sont alors exposés à des concentrations importantes de ROS favorisant et exacerbant les lésions pulmonaires. Cette production de ROS est particulièrement délétère chez les prématurés puisque les lésions engendrées sur des poumons en développement peuvent être irréversibles. De plus, l'expression de nombreux antioxydants est régulée par le développement si bien qu'avant terme, les poumons immatures ne surexpriment pas les systèmes antioxydants en réponse à une quantité excessive de ROS (Asikainen and White 2004).

Les souris exposées à des conditions d'hyperoxie (100% d'oxygène) pendant 72 heures présentent des caractéristiques de dommages pulmonaires sévères ainsi qu'une augmentation de la mort des cellules pulmonaires épithéliales et endothéliales. Ces lésions se caractérisent par une faible inflammation, une rupture de la barrière alvéolo-capillaire, un œdème pulmonaire et des dysfonctionnements de la fonction pulmonaire (Crapo 1986). Il a été clairement démontré que la production excessive de ROS lors des conditions d'hyperoxie induit une augmentation de la mort cellulaire (Barazzone, Horowitz et al. 1998) impliquant l'activation des MAPK (Mitogen-activated protein kinase) (Zaher, Miller et al. 2007) et des caspases (Lee and Choi 2003). Ces phénotypes ont été observés au niveau d'une lignée de cellules murines épithéliales pulmonaires (MLE-12) (Zhang, Shan et al. 2003) mais également au niveau de cellules humaines endothéliales pulmonaires (Parinandi, Kleinberg et al. 2003).

Dans la mesure où NOX1 et NOX2 sont exprimées dans les cellules épithéliales et endothéliales pulmonaires, est-ce que ces deux isoformes peuvent être responsable de la production de ROS et des lésions pulmonaires aiguës induites par l'hyperoxie ?

Cet article correspond à une collaboration entre le groupe du Professeur Barrazone Constance et celui du Professeur Krause Karl-Heinz. Mon travail dans cet article a consisté à effectuer les PCR, à participer aux discussions de travail ainsi qu'à l'élaboration du manuscrit. La gestion des animaux transgéniques a également fait partie de ce travail

Article 3 NOX1 joue un rôle crucial dans les lésions pulmonaires aiguës induites par l'hyperoxie

NOX1 PLAYS A CRUCIAL ROLE IN HYPEROXIA-INDUCED ACUTE LUNG INJURY IN MICE. Stéphanie Carnesecchi, Christine Deffert, Alessandra Pagano, Sarah Garrido-Urbani, Isabelle Métrailler-Ruchonnet, Michela Schäppi, Yves Donati, Michael A. Matthay, Karl-Heinz Krause and Constance Barazzone Argiroffo. *Am J Respir Crit Care Med.* 2009. 180:972-981.

NADPH Oxidase-1 Plays a Crucial Role in Hyperoxia-induced Acute Lung Injury in Mice

Stéphanie Carnesecci^{1,2}, Christine Deffert^{1,2}, Alessandra Pagano^{1,2}, Sarah Garrido-Urbani², Isabelle Métrailler-Ruchonnet^{1,2}, Michela Schäppi^{1,2}, Yves Donati^{1,2}, Michael A. Matthay³, Karl-Heinz Krause^{2,4}, and Constance Barazzone Argiroffo^{1,2}

¹Department of Pediatrics and ²Department of Pathology and Immunology, Medical School, University of Geneva, Geneva, Switzerland;

³Department of Anesthesia, University of California, San Francisco, San Francisco, California; and ⁴Department of Genetic and Laboratory Medicine, Geneva University Hospitals, Geneva, Switzerland

Rationale: Hyperoxia-induced acute lung injury has been used for many years as a model of oxidative stress mimicking clinical acute lung injury and the acute respiratory distress syndrome. Excess quantities of reactive oxygen species (ROS) are responsible for oxidative stress-induced lung injury. ROS are produced by mitochondrial chain transport, but also by NADPH oxidase (NOX) family members. Although NOX1 and NOX2 are expressed in the lungs, their precise function has not been determined until now.

Objectives: To determine whether NOX1 and NOX2 contribute *in vivo* to hyperoxia-induced acute lung injury.

Methods: Wild-type and NOX1- and NOX2-deficient mice, as well as primary lung epithelial and endothelial cells, were exposed to room air or 100% O₂ for 72 hours.

Measurements and Main Results: Lung injury was significantly prevented in NOX1-deficient mice, but not in NOX2-deficient mice. Hyperoxia-dependent ROS production was strongly reduced in lung sections, in isolated epithelial type II cells, and lung endothelial cells from NOX1-deficient mice. Concomitantly, lung cell death *in situ* and in primary cells was markedly decreased in NOX1-deficient mice. In wild-type mice, hyperoxia led to phosphorylation of c-Jun N-terminal kinase (JNK) and extracellular signal-regulated kinase (ERK), two mitogen-activated protein kinases involved in cell death signaling, and to caspase-3 activation. In NOX1-deficient mice, JNK phosphorylation was blunted, and ERK phosphorylation and caspase-3 activation were decreased.

Conclusions: NOX1 is an important contributor to ROS production and cell death of the alveolocapillary barrier during hyperoxia and is an upstream actor in oxidative stress-induced acute lung injury involving JNK and ERK pathways in mice.

Keywords: NADPH oxidase; reactive oxygen species; hyperoxia; apoptosis; mitogen-activated protein kinases

Respiratory distress syndrome (RDS) of premature babies is characterized by immature lung development and insufficient surfactant production by alveolar type II cells. During RDS treatment with mechanical ventilation and high oxygen concentration, the lungs are exposed to increased oxidative stress leading to pulmonary injury (1). The damage to both endothe-

AT A GLANCE COMMENTARY

Scientific Knowledge on the Subject

Oxidative stress is a major feature of acute lung injury and the acute respiratory distress syndrome (ARDS) and may be responsible for pulmonary cell damage.

What This Study Adds to the Field

Targeting the NADPH oxidase NOX1 during hyperoxia-induced lung injury in mice inhibits oxidative-induced cell death pathway and lung damage, providing a new therapeutic approach in the treatment of acute lung injury.

lial and epithelial cells leads to the loss of alveolocapillary barrier integrity, resulting in interstitial edema and gas exchange impairment. We and others have previously shown that reactive oxygen species (ROS) are able to induce a cell death response with features of both apoptosis and necrosis during oxygen exposure (2, 3). The mechanisms of cell death are not completely defined in hyperoxia-mediated lung epithelial and endothelial cell death, but involve the activation of mitogen-activated protein kinase (MAPK) (4) and the caspase cascade (5). Inhibition of the c-Jun N-terminal kinase (JNK) or extracellular signal-regulated kinase (ERK) pathway, using dominant negative constructs or chemical inhibitors, prevents cell death in an epithelial cell line (MLE-12) and in human pulmonary artery endothelial cells during hyperoxia (6–9).

During supplemental oxygen therapy, ROS can be generated by a variety of enzymes such as mitochondrial chain transport and NADPH oxidase enzymes (10, 11). The well-known phagocyte NADPH oxidase complex includes a catalytic subunit, NOX2/gp91^{phox}, which is associated with regulatory subunits (11). This complex is required for NOX activation and generation of superoxide (11, 12). The NOX2 complex plays an essential role in nonspecific host defense against pathogens (13). Several additional homologs of NOX2 have been identified: NOX1–NOX5, dual oxidase-1 (DUOX1), and DUOX2. Despite their similar structure and enzymatic function, NOX enzymes differ in their mechanism of activation. The NOX isoforms are expressed in several tissues and cell types, where they serve various physiological functions, including posttranslational modifications of proteins and cellular signal transduction (12, 14, 15). NOX enzymes are also involved in a variety of pathologies, including amyotrophic lateral sclerosis, hypertension, and lung emphysema (16–19).

A study demonstrated that both NOX1 and NOX2 are expressed in mouse lung, and NOX1 has been detected in a human alveolar epithelial cell line (A549) and in endothelial

(Received in original form February 24, 2009; accepted in final form August 5, 2009)

Supported by Swiss National Research Foundation grant 3100A0-109339, by the Eagle Foundation and the Von Meissner Foundation (C.B.A.), and by NHLBI R01 HL51854 (M.A.M.).

Correspondence and requests for reprints should be addressed to Stéphanie Carnesecci, Ph.D., Department of Pediatrics and Department of Pathology and Immunology, Centre Médical Universitaire, 1, rue Michel Servet, 1211 Geneva 4, Switzerland. E-mail: Stephanie.Carnesecci@unige.ch

This article has an online supplement, which is accessible from this issue's table of contents at www.atsjournals.org

Am J Respir Crit Care Med Vol 180, pp 972–981, 2009

Originally Published in Press as DOI: 10.1164/rccm.200902-0296OC on August 6, 2009

Internet address: www.atsjournals.org

cells (20, 21). However, until now, no precise function of NOX1 and NOX2 in the lungs has been determined. *In vitro* studies demonstrated that diphenylenethidium (DPI), a wide inhibitor of NADPH oxidases, was effective in reducing hyperoxia-induced ROS generation and cell death in MLE-12 cells and in pulmonary endothelial cells (6, 9, 22). Using NOX1- and NOX2-deficient mice, we determined their specific contribution in hyperoxia-induced acute lung injury.

This study demonstrates for the first time that NOX1, but not NOX2, is an important mediator of acute lung injury mediated by oxidative stress, particularly in alveolar cells. NOX1-generated ROS are largely responsible for alveolar cell death and subsequent lung injury through JNK and ERK pathways

during hyperoxia in mice. Some of these data have been reported in the form of an abstract (23).

METHODS

See the online supplement for additional details on reagents and methods.

Animals

NOX1-deficient mice, NOX2 (gp91^{phox})-deficient mice, and wild-type (WT) mice were inbred on the C57BL/6J background (17, 24). Animals were kept under specific pathogen-free conditions. The animal procedure was performed in accordance with the Institutional Ethics

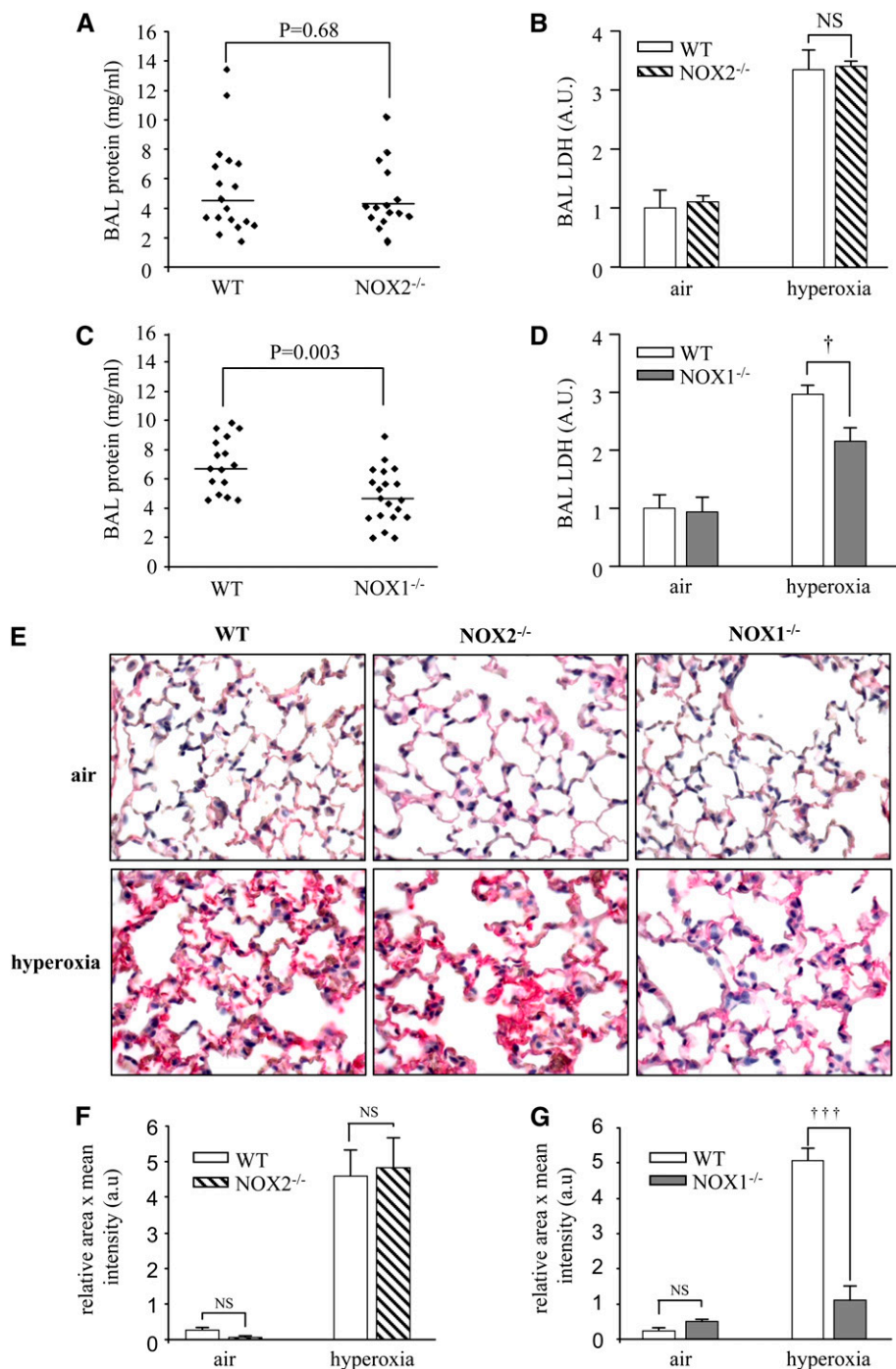

Figure 1. Lung injury is decreased in NADPH oxidase-1 (NOX1)-deficient but not in NADPH oxidase-2 (NOX2)-deficient mice. NOX1^{-/-}, NOX2^{-/-}, and wild-type (WT) mice were exposed to 100% hyperoxia for 72 hours. (A) Bronchoalveolar lavage (BAL) protein content (n ≥ 15 in each group; P = 0.68 compared with WT) and (B) BAL lactate dehydrogenase (LDH) content in NOX2^{-/-} mice (n = 5 or 6 for each group; P = not significant [NS], NOX2^{-/-} mice vs. WT in hyperoxia). (C) BAL protein content (n > 15 for each group; P = 0.003 compared with WT mice) and (D) BAL LDH content in NOX1^{-/-} mice (n = 10 in each group; †P < 0.05, NOX1^{-/-} mice vs. WT in hyperoxia). Columns and error bars represent the mean ± SEM. (E) Immunochemical detection of fibrin in paraffin-embedded lung sections. Lung sections were stained with a polyclonal anti-fibrin antibody (red) and visualized by optical microscopy. Original magnification, ×40. (F) Quantification of fibrin deposition in NOX2^{-/-} mice and their WT control. Values represent the mean of the relative area × mean of intensity ± SEM of 10 different fields (n = 3 mice in each group); P = NS, NOX2^{-/-} mice versus WT in hyperoxia. (G) Quantification of fibrin deposition in NOX1^{-/-} mice and their WT control; †††P < 0.001, NOX1^{-/-} mice versus WT in hyperoxia.

Committee on Animal Care (Geneva, Switzerland) and the Cantonal Veterinary Office.

Hyperoxia Exposure

Eight- to 10-week-old female mice (deficient and WT) were exposed to room air or 100% O₂ for 72 hours. Bronchoalveolar lavage (BAL) was performed as described (25). The total cell count was determined with a cell counter and protein concentration was measured. BAL fluid cell distribution was quantified in Cytospin preparations (Perbio Science, Lausanne, Switzerland) after staining with Diff-Quik dye (Dade Behring, Paris, France).

Lung Histology and Immunohistochemistry

Paraffin-embedded sections of lung fixed in 4% paraformaldehyde were stained with hematoxylin-eosin or with anti-fibrin polyclonal antibody followed by EnVision G2 System/AP (Dako, Glostrup, Denmark), or with an anti-cleaved caspase-3 polyclonal antibody followed by Texas red-conjugated secondary antibody. Double immunostaining was performed with anti-pJNK (phosphorylated JNK) or anti-pERK (phosphorylated ERK) monoclonal antibody combined with anti-SP-C (Chemicon, Zug, Switzerland) or anti-von Willebrand factor (VWF) followed by fluorescein isothiocyanate-conjugated secondary antibody before counterstaining with 4',6-diamidino-2-phenylindole (DAPI). Slides were mounted with Fluor Save (Calbiochem, Darmstadt, Germany) and analyzed by confocal microscopy.

Alveolar Macrophage, Epithelial Type II Cell, and Endothelial Cell Isolation

Alveolar macrophages were isolated from the BAL fluid of adult mice, and alveolar epithelial type II cells (type II AECs) and endothelial cells (MLECs) were isolated from adult mouse (8- to 14-wk-old) lungs as described with minor modifications (26–28). Hyperoxic conditions (24–72 h) were achieved by placing type II AECs and MLECs in a sealed glass chamber filled with 95% O₂–5% CO₂ at 37°C.

Real-time Polymerase Chain Reaction

RNA was extracted with a total RNA isolation NucleoSpin RNA II kit (Macherey-Nagel, Düren, Germany) and reverse transcribed with SuperScript reverse transcriptase (SuperScript choice system; Invitrogen, Carlsbad, CA). We used the primers for NOX1, NOX2, and NOX4 and the reference genes encoding EEF1A1 (eukaryotic elongation factor-1A1) and HPRT (hypoxanthine-guanine phosphoribosyltransferase). For polymerase chain reaction primer sequences and details, see the online supplement.

Detection of Superoxide

Frozen lung tissues were cryosectioned (20 μm) and collected onto SuperFrost Plus slides (Perbio Science). To detect the various cell types that generated ROS, lung sections from all mouse strains were double immunostained with dihydroethidium (DHE) and anti-SP-C or with DHE and anti-VWF. Images were captured with an inverted microscope and analyzed with Metafluor imaging software (Molecular Devices, Basel, Switzerland). Quantification was performed by measuring the fluorescence intensity of all cells counted in the lung sections and of isolated type II and endothelial cells (>50 for each mouse) from three different mice.

Western Blot Analysis

Total lung protein extracts were performed as previously described (29). Total protein extracts were loaded and nitrocellulose membranes were blocked overnight in Tris-buffered saline-Tween buffer, 5% milk, followed by hybridization with anti-pJNK, anti-JNK, anti-pERK, anti-ERK, anti-actin, anti-cleaved caspase-3, or anti-poly(ADP-ribose) polymerase (PARP)-1 in the same buffer. The proteins were detected with enhanced chemiluminescence (ECL) reagents (Interchim, Montluçon, France). Densitometric evaluation was performed with Quantity One software (Bio-Rad, Reinach, Switzerland).

Measures of Cell Death

Lactate dehydrogenase was measured in BAL supernatant as described (30). For sections of fixed lung, terminal deoxynucleotidyl-

transferase-mediated dUTP nick end labeling (TUNEL) was performed with an *in situ* apoptosis detection kit according to the protocol of the manufacturer (Chemicon, Temecula, CA); and for primary cells, TUNEL was performed as described by the manufacturer (Roche, Indianapolis, IN). Slides were mounted with polyvinyl alcohol (Mowiol) and analyzed by confocal microscopy (LSM 510 Meta; Zeiss, Oberkochen, Germany). Quantification of positive staining was performed with Metamorph analysis software (Molecular Devices) (20 images per mouse, 3 mice per group, and 3 independent experiments).

Statistical Analysis

For all parameters measured, the values for all samples under different experimental conditions were averaged and the SEM of the mean was calculated. The significance of differences between the values of the groups was determined by two-way analysis of variance with multiple comparisons followed by unpaired *t* test. The Wilcoxon rank sum test for unpaired data was also used. Significance levels were set at *P* < 0.05.

RESULTS

NOX1, But Not NOX2, Participates in Hyperoxia-induced Lung Injury

To address the role of NOX1 and NOX2 in hyperoxia-induced lung injury, we exposed NOX1- and NOX2-deficient mice, as well as WT mice, to 100% oxygen. In accordance with previous studies from our laboratory and others, WT mice exhibited features of severe lung damage after 72 hours of oxygen exposure. The extent of lung injury was not significantly different in NOX2-deficient mice compared with WT mice as measured by BAL protein content reflecting vascular leakage (Figure 1A); BAL lactate dehydrogenase release, an indicator of tissue injury (Figure 1B); and fibrin deposition in the alveolar spaces (Figures 1E–1G). In contrast, the absence of NOX1 significantly reduced hyperoxia-induced lung injury compared with WT mice (Figures 1C–1E and 1G). Most of the *in vivo*

TABLE 1. EFFECT OF NADPH OXIDASE-1 AND NADPH OXIDASE-2 DEFICIENCY ON INFLAMMATORY CELL RESPONSE DURING HYPEROXIA

	Cell Number (× 10 ⁴)		<i>P</i> Values
	Air	Hyperoxia	
WT	6.77 ± 0.85	17.14 ± 2.10*] NS] NS
NOX1 ^{-/-}	7.97 ± 0.71	16.81 ± 1.66*	
NOX2 ^{-/-}	6.78 ± 1.09	19.63 ± 3.51*	
Macrophages] NS] NS
WT	6.23 ± 0.67	15.30 ± 1.83*	
NOX1 ^{-/-}	7.17 ± 0.65	11.81 ± 1.14*	
NOX2 ^{-/-}	5.47 ± 0.73	11.61 ± 1.09*	
Lymphocytes] NS] NS
WT	0.59 ± 0.12	1.56 ± 0.25*	
NOX1 ^{-/-}	0.74 ± 0.09	1.51 ± 0.21*	
NOX2 ^{-/-}	0.47 ± 0.06	2.76 ± 1.09†	
Neutrophils] †] ‡
WT	0.05 ± 0.01	0.76 ± 0.22*	
NOX1 ^{-/-}	0.06 ± 0.01	3.47 ± 0.77*	
NOX2 ^{-/-}	0.23 ± 0.06	4.53 ± 0.62*	

Definition of abbreviations: NOX1 = NADPH oxidase-1; NOX2 = NADPH oxidase-2; NS = not significant; WT = wild type.

NOX1^{-/-}, NOX2^{-/-}, and WT mice were exposed to air or to hyperoxia for 72 hours. Cells recovered from bronchoalveolar lavage were counted and Cytospin preparations on microscope slides were made and stained for cellular differentials. Results represent the mean value ± SEM for each group (n = 10 animals per group).

* *P* < 0.001, hyperoxia versus air.

† *P* < 0.05, NOX1^{-/-} mice versus WT mice in hyperoxia.

‡ *P* < 0.001, NOX2^{-/-} mice versus WT mice in hyperoxia.

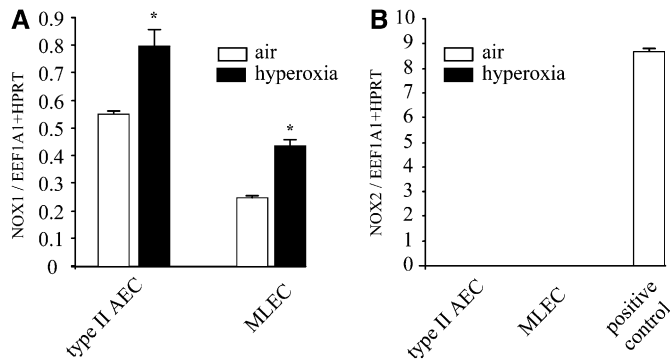

Figure 2. Hyperoxia up-regulates NADPH oxidase-1 (NOX1) mRNA expression in type II alveolar epithelial cells (AECs) and in mouse lung endothelial cells (MLECs). Expression of (A) NOX1 mRNA and (B) NADPH oxidase-2 (NOX2) mRNA in primary type II AECs and MLECs was measured by real-time polymerase chain reaction before and after 72 hours of hyperoxia ($n = 3$). * $P < 0.05$ in type II AECs and MLECs exposed to air (*open columns*) versus hyperoxia (*solid columns*). Note that primary alveolar macrophages were used as positive control for the detection of NOX2 mRNA expression. EEF1A1 = eukaryotic elongation factor-1A1; HPRT = hypoxanthine-guanine phosphoribosyltransferase.

experiments with NOX1- and NOX2-deficient mice were performed independently, each of them with their respective WT control. Under normal conditions, lungs of NOX1- and NOX2-deficient mice displayed no morphological abnormalities and were similar to those of WT mice (data not shown).

We then evaluated hyperoxia-induced lung inflammatory responses in NOX1- and NOX2-deficient mice. Hyperoxia caused a significant increase in BAL total cell count (macrophages, lymphocytes, and neutrophils) that was similar in the three mouse strains (Table 1). BAL neutrophil counts of NOX1- and NOX2-deficient mice were higher compared with those from WT mice in hyperoxia, but the neutrophil count was similar in air-breathing animals (Table 1). These results indicate that NOX1, but not NOX2, participates in oxidative stress-induced acute lung injury independently of the acute lung inflammatory response.

NOX1 Expression Is Increased in Primary Type II Alveolar Epithelial Cells and Lung Endothelial Cells in Hyperoxia

To determine whether NOX1 and NOX2 are regulated by hyperoxia in type II AECs and in MLECs, we measured NOX1 and NOX2 expression. At baseline, NOX1 mRNA was expressed in type II AECs and MLECs (Figure 2A), in contrast to NOX2 mRNA, which was undetectable compared with the positive control. As positive control, we used alveolar macrophages in which NOX2 is strongly expressed, as expected (Figure 2B). After hyperoxia, NOX1 mRNA expression was increased in both type II AECs and MLECs whereas NOX2 was still undetectable in these primary cells (Figures 2A and 2B).

NOX1 Deficiency Markedly Reduces Hyperoxia-induced ROS Production in Lungs and in Primary Pulmonary Cells

To determine the contribution of NOX1 in hyperoxia-induced superoxide formation, we measured ROS production in the lungs

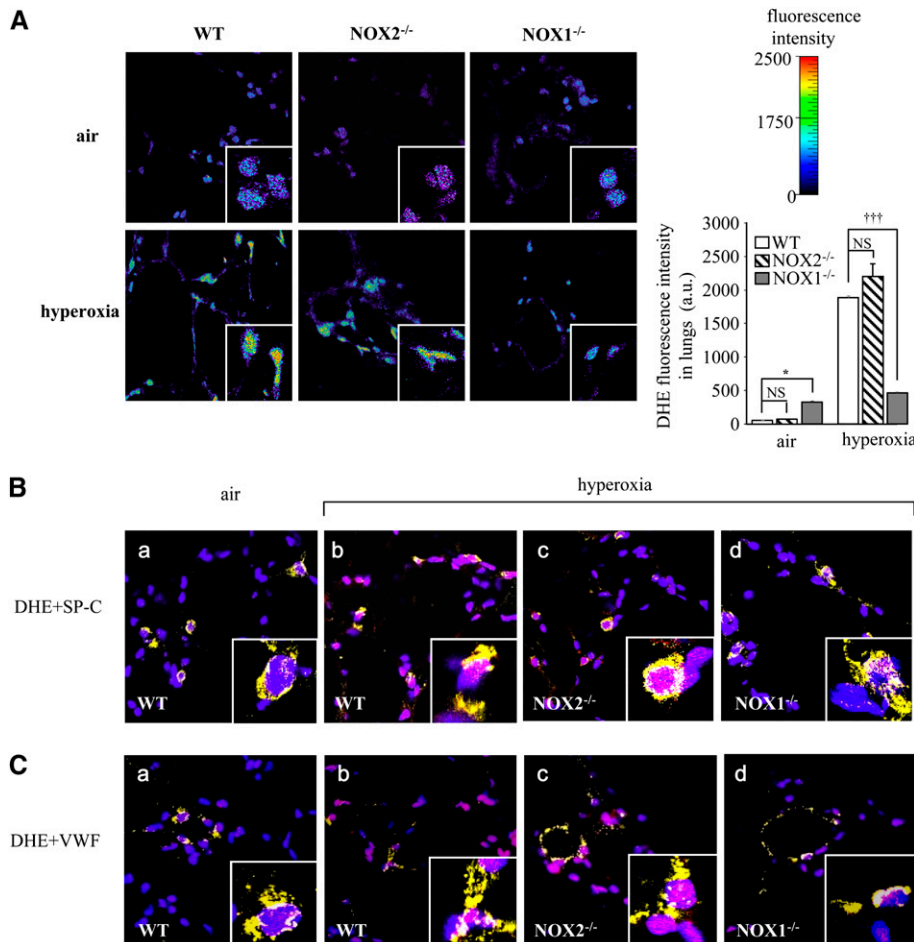

Figure 3. Absence of NADPH oxidase-1 (NOX1) decreased reactive oxygen species generation induced by hyperoxia in lungs. (A) Representative fluorescence images of dihydroethidium (DHE)-loaded lung sections. Frozen lung sections (20 μm) were prepared from NOX1^{-/-}, NOX2^{-/-}, and wild-type (WT) mice after exposure to air or hyperoxia for 72 hours. Lung sections were loaded with DHE (10 μM) and visualized by confocal microscopy (*pseudocolor*). Original magnification, $\times 63$. DHE fluorescence intensity was quantified in whole lung sections ($n = 3$; * $P < 0.05$, NOX1^{-/-} vs. WT mice, and $P = \text{NS}$, NOX2^{-/-} vs. WT mice in air; $+++P < 0.001$, NOX1^{-/-} vs. WT; and $P = \text{NS}$, NOX2^{-/-} vs. WT mice in hyperoxia). (B) Representative merged images of lung sections stained with DHE (*pink*), 4',6-diamidino-2-phenylindole (*blue*), and marker for type II epithelial cells (prosurfactant protein-C [SP-C]: *yellow*, panels a–d), or (C) marker for endothelial cells (von Willebrand factor [VWF]: *yellow*, panels a–d). DHE-positive nuclei appear *pink* and staining for both type II epithelial and endothelial markers appears *yellow*. Note that some cells were positive for DHE and cell-specific marker. Original magnification, $\times 63$. NS = not significant.

of WT and NOX1-deficient mice. Mice were exposed to air or hyperoxia for 72 hours and frozen lungs were cryosectioned. Lung sections were stained with DHE for ROS detection. ROS were markedly increased in the lungs of hyperoxia-exposed WT mice compared with air-exposed WT mice. This hyperoxia-induced increase in ROS was significantly attenuated in NOX1-deficient mice but not in NOX2-deficient mice (Figure 3A).

To detect the various cell types generating ROS, we stained lung sections from WT and NOX2- and NOX1-deficient mice with DHE and an anti-SP-C antibody, or with DHE and an anti-VWF antibody. In wild-type mice, type II epithelial and endothelial cells were positive for DHE staining during hyperoxia in comparison with air-exposed WT mice (respectively: Figure 3B, panels a and b and Figure 3C, panels a and b). Hyperoxia-induced ROS in epithelial type II and endothelial cells were markedly decreased in NOX1-deficient mice, but were not modified in NOX2-deficient mice compared with WT mice (respectively: Figure 3B, panels c and d, and Figure 3C, panels c and d).

Similar results were found for isolated type II AECs (Figures 4A and 4C) and primary MLECs (Figures 4B and 4D) derived from WT and NOX1-deficient mice exposed to hyperoxia. In contrast, primary type II AECs and MLECs isolated from NOX2-deficient mice produced an equal amount of ROS compared with cells isolated from WT mice during hyperoxia stimulation (Figures 4A–4D).

Interestingly, under normoxic conditions, lungs of NOX1-deficient mice exhibited a small, but significant increase in ROS generation as compared with WT mice, possibly because of a compensatory effect of ROS produced by other NOX enzymes or NOX-independent enzymes (Figure 3A; and *see* Figure E1 in the online supplement). Indeed, we analyzed the expression of NOX enzymes (NOX1, NOX2, and NOX4) in

deficient mice and we did not find any up-regulation (Figure E1). This increase was not found in primary type II AECs and in primary MLECs isolated from NOX1-deficient mice (Figures 4C and 4D). These results indicate that NOX1 but not NOX2 is mainly responsible for ROS formation in lungs and in primary type II AECs and MLECs.

NOX1 Deficiency But Not NOX2 Prevents Cell Death in Lungs and in Primary Alveolar Cells

Because ROS contribute to oxidant-induced cell death in several animal models and in humans, we investigated whether NOX1 and NOX2 participate in alveolar cell death during hyperoxia through ROS generation. First, we examined *in situ* DNA strand breaks by fluorescence TUNEL staining. Hyperoxia increased significantly the number of TUNEL-positive cells in the lungs of WT mice and NOX2-deficient mice. By contrast, a much lower number of cells was positive when derived from NOX1-deficient mice under hyperoxia (Figures 5A and 5B). These results were supported by those obtained with primary type II AECs and MLECs isolated from hyperoxia-exposed WT mice and from NOX2- and NOX1-deficient mice (Figures 5C and 5D).

Zhang and colleagues reported that caspase-3 activation participated in oxidant-induced DNA fragmentation and cell death in MLE-12 cells (6). We therefore examined whether ROS-induced cell death *in situ* involved caspase-3 activation and subsequent PARP-1 cleavage. In hyperoxic lungs, there was a significant increase in the amount of cleaved caspase-3 (17 kD) and cleaved PARP-1 (85 kD) in WT mice, whereas in NOX1-deficient mice only small increases were observed (Figures 6A–6C). Indeed, the cleavage of procaspase-3 (32 kD) resulted in two fragments: a 19-kD fragment and a 17-kD fragment, with the 17-kD fragment being the active form of

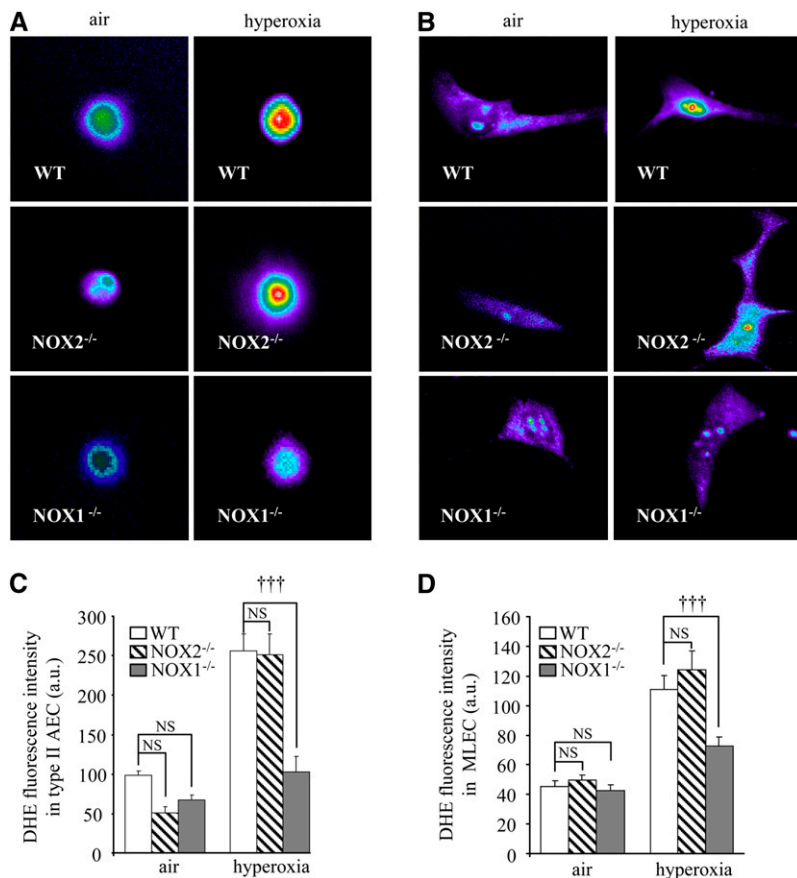

Figure 4. Absence of NADPH oxidase-1 (NOX1) decreased reactive oxygen species generation induced by hyperoxia in primary pulmonary type II alveolar epithelial cells (AECs) and in mouse lung endothelial cells (MLECs). (A) Isolated type II AECs and (B) MLECs from NOX1^{-/-}, NOX2^{-/-}, and wild-type (WT) mice were exposed to hyperoxia for 24 hours and loaded with dihydroethidium (DHE, 5 μ M) and visualized by confocal microscopy (*pseudocolor*). Original magnification, $\times 100$. (C and D) Quantification of DHE fluorescence intensity of type II AECs and MLECs. Values represent means and SEM (n = 3 mice for each group; †††P < 0.001, NOX1^{-/-} vs. WT mice in hyperoxia; and P = not significant [NS], NOX2^{-/-} vs. WT mice in hyperoxia).

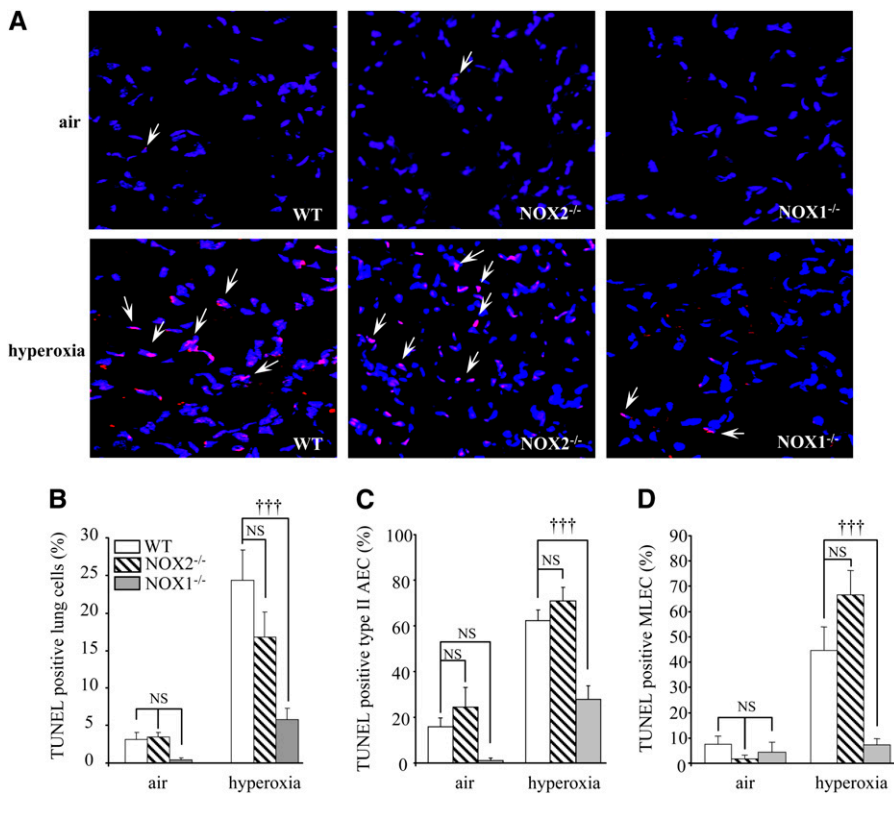

Figure 5. Cell death is decreased in lung cells of NADPH oxidase-1 (NOX1)-deficient mice but not in those of NADPH oxidase-2 (NOX2)-deficient mice. (A) Representative merged images of lung sections stained with terminal deoxynucleotidyltransferase-mediated dUTP nick end labeling (TUNEL) stain (red) and with 4',6-diamidino-2-phenylindole (blue) from NOX1^{-/-}, NOX2^{-/-}, and wild-type (WT) mouse lungs. Original magnification, $\times 40$. Arrows indicate representative TUNEL-positive cells, which appear pink. (B) Quantification of TUNEL-positive cells was performed by counting the number of TUNEL-positive cells (appearing pink) related to the total number of nuclei (appearing blue). Columns and error bars represent means and SEM (10 fields/mouse, $n = 3$ mice for each group; $^{\dagger\dagger\dagger}P < 0.001$, NOX1^{-/-} vs. WT mouse lung sections; $P = \text{NS}$, NOX2^{-/-} vs. WT mouse lung sections in hyperoxia). (C and D) Primary type II alveolar epithelial cells (AECs) and mouse lung endothelial cells (MLECs) isolated from NOX1^{-/-}, NOX2^{-/-}, and WT mice were exposed to air or hyperoxia for 72 hours. Quantification of TUNEL-positive cells was performed by counting the number of TUNEL-positive AECs and MLECs relative to the total number of nuclei. Columns and error bars represent means and SEM (isolation of three different mice for each group; $^{\dagger\dagger\dagger}P < 0.001$, NOX1^{-/-} vs. WT hyperoxia-exposed cells; and $P = \text{NS}$, NOX2^{-/-} vs. WT hyperoxia-exposed cells).

caspace-3 responsible for PARP-1 cleavage (31). We confirmed these results on lung sections from air- and hyperoxia-exposed WT and NOX1-deficient mice, using cleaved caspase-3 immunofluorescence staining (Figure 6D). In hyperoxia, there was a fivefold increase in caspase-3-positive cells compared with air in WT mice, whereas only a few positive cells were found in NOX1-deficient lungs: $5.6 \pm 0.7\%$ for WT mice versus $1.1 \pm 0.2\%$ for NOX1-deficient mice (the values are expressed as the mean percentage \pm SEM; $P < 0.001$, $n = 3$). These data

demonstrate that under hyperoxic conditions, NOX1-generated ROS but not NOX2-generated ROS mediate lung cell death, and NOX1 modulates the caspase-3-dependent apoptotic process.

ROS Generated by NOX1 Mediate JNK and ERK Phosphorylation in Mouse Lungs during Hyperoxia

To determine the mechanisms by which NOX1-derived ROS are responsible for lung alveolar cell death, we examined ROS-

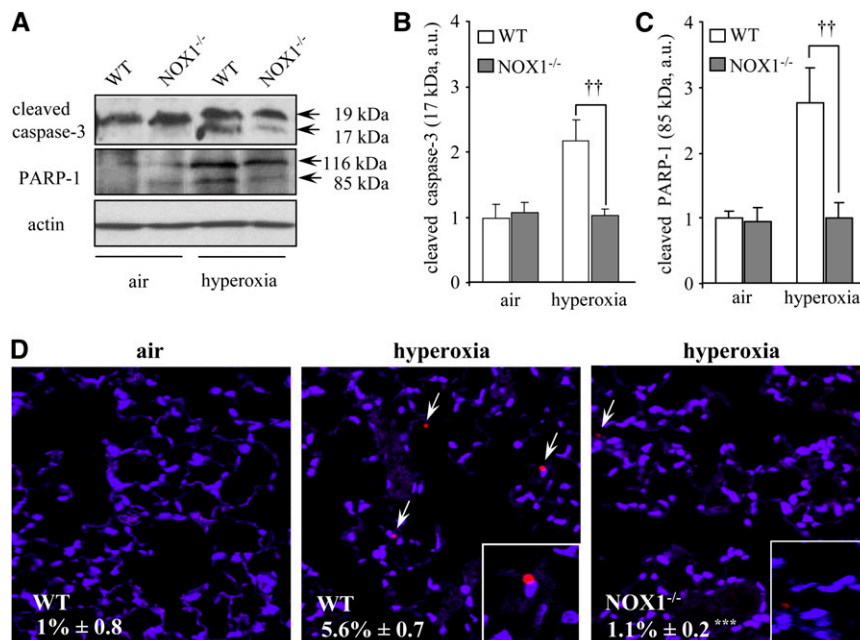

Figure 6. Active caspase-3 and poly(ADP-ribose) polymerase (PARP)-1 cleavage are reduced in the lungs of hyperoxia-exposed NADPH oxidase-1 (NOX1)-deficient mice. (A) Cleaved caspase-3 (17 kD) and cleaved PARP-1 (85 kD) proteins were detected in lung homogenates of NOX1^{-/-} and wild-type (WT) mice exposed to air or hyperoxia for 72 hours. β -Actin-immunoreactive bands were used to demonstrate equal loading. These gels were representative of all samples analyzed ($n = 5$ per group). (B and C) Densitometric quantification of cleaved caspase-3 and cleaved PARP-1 protein levels was expressed as fold increase compared with WT air sample (set as 1). Each sample was normalized with β -actin loading. Columns and error bars represent means and SEM ($n = 5$; $^{\dagger\dagger}P < 0.01$, NOX1^{-/-} vs. WT mice in hyperoxia). (D) Representative merged images of lung sections stained with anti-cleaved caspase-3 (red) and 4',6-diamidino-2-phenylindole (blue) from WT and NOX1^{-/-} mice ($n = 3$). Original magnification, $\times 40$. $^{\ast\ast\ast}P < 0.001$, NOX1^{-/-} vs. WT mice in hyperoxia.

involved MAPK (JNK and ERK) pathways. Hyperoxia was associated with a significant increase in pJNKs and pERKs in WT mice as seen by Western blot. NOX1, but not NOX2, deficiency decreased ERK and JNK phosphorylation without modification of JNK and ERK protein levels (Figures 7A–7F).

To identify cell types involved in ERK and JNK activation in hyperoxia, lung sections from WT and NOX1-deficient mice were immunostained with an anti-pERK or pJNK antibody combined with an anti-SP-C antibody or an anti-VWF antibody. pERK staining was associated with type II pneumocytes and endothelial cell markers during hyperoxia (Figure 8A), whereas pJNK staining was detected mainly in endothelial cells (Figure 8B). The staining for pERKs and pJNKs was attenuated in lungs from NOX1-deficient mice (Figure 8A, panels b and c and panels e and f, respectively; and Figure 8B, panels b and c and panels e and f, respectively), confirming the results obtained by Western blotting (Figures 7D–7F). Some cells were positive for pJNK in hyperoxia that were neither SP-C- nor VWF-positive cells. Therefore, according to their localization and the absence of staining, we concluded that these cells were most probably alveolar macrophages (Figure 8B, panels c–f). These data demonstrate that NOX1 participates in oxidative stress-induced acute lung injury, involving ERK and JNK phosphorylation of pulmonary endothelial and epithelial type II cells.

DISCUSSION

NOX enzymes are considered critical contributors to a variety of diseases including cancers, cardiovascular disease, and diabetes. NOX1 has been shown to be expressed in a large number of tissues, including the lung, but its precise function has not been determined yet (20, 32). Several studies have demonstrated a role for NOX1 in the vascular system: NOX1 deficiency decreased blood pressure and provided protection from aortic dissection and aneurysm formation in response to angiotensin II (17, 18, 33).

In the present study, we found that NOX1, but not NOX2, participates in hyperoxia-induced lung injury through decreased ROS generation and cell death in alveolar epithelial and endothelial cells. Cell death prevention was associated with decreased phosphorylation of two main components of MAPK pathways: pERK and pJNK, two enzymes involved in the cell death pathway. In NOX1- and NOX2-deficient mice, exposure to hyperoxia leads to a huge neutrophil influx in BAL fluid, higher than in WT mice. Our results are supported by previous studies (34). Indeed, NOX2-deficient mice exposed to 48 hours of hyperoxia after acid aspiration, and p47^{phox}- or NOX2-deficient mice infected with *Escherichia coli*, showed a greater amount of neutrophils compared with WT mice, without modification of lung injury (35). Moreover, a similar increased lung inflammatory response was noticed after influenza virus infection in NOX2-deficient mice, but in this case it was associated with reduced lung damage and improved lung function (36). Our data are also consistent with previous studies showing that neutrophil or macrophage depletion did not change lung damage in hyperoxic lung injury (37, 38). Indeed, hyperoxia-induced acute lung injury is one of the most established models of oxidative stress and alveolar cell death, which is not closely linked to the magnitude of the inflammatory response; in this way it is different from most cases of human acute respiratory distress syndrome (39). However, in another study, hyperoxia-exposed NOX2-deficient mice produced a lower number of neutrophils in BAL fluid compared with WT mice (22). In that study, mice exposed to acute hyperoxia developed lung fibrosis that was accompanied by a large inflammatory response. Because fibrosis is not a classical pattern of acute hyperoxic lesions,

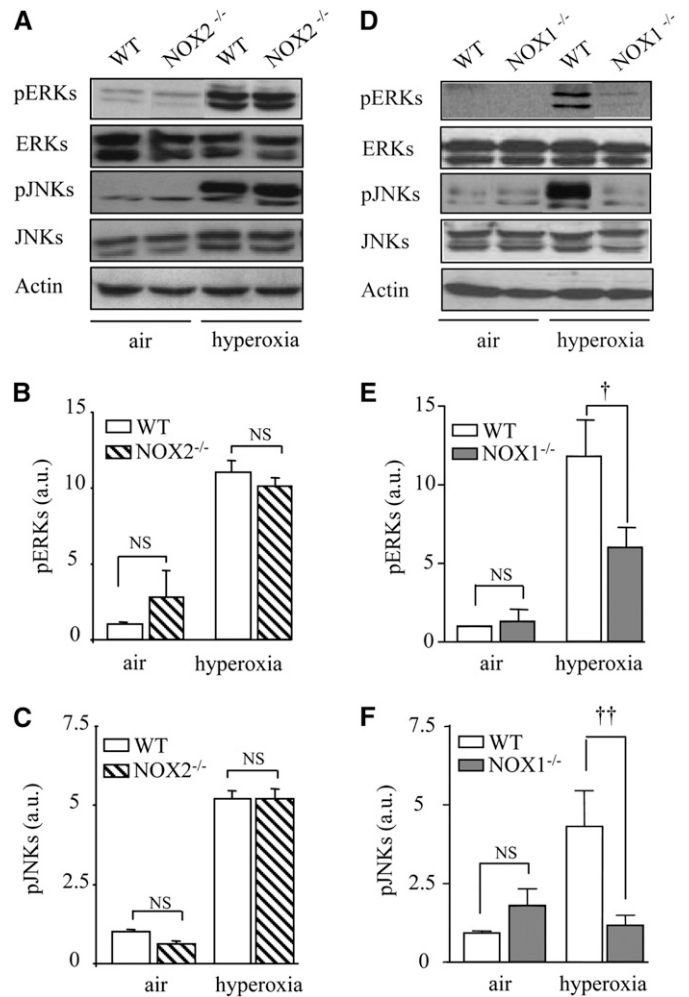

Figure 7. NADPH oxidase-1 (NOX1) mediates the phosphorylation of extracellular signal-regulated kinases (ERKs) and c-Jun N-terminal kinases (JNKs). (A and D) Western blots for phosphorylated ERKs (pERKs), phosphorylated JNKs (pJNKs), and total ERKs and JNKs. Lung lysates (50 μ g) from NOX1^{-/-}, NOX2^{-/-}, or wild-type (WT) mice were loaded. β -Actin-immunoreactive bands were used to demonstrate equal loading. These gels were representative of all samples analyzed (n = 5 per group). (B, C, E, and F) Densitometric quantifications of pERKs and pJNKs were determined by comparing experimental sample with WT air sample. Each sample was normalized for β -actin loading. Columns and error bars represent means and SEM (n = 5 mice; ††P < 0.01, NOX1^{-/-} vs. WT mice in hyperoxia; †P < 0.05, NOX1^{-/-} vs. WT mice in hyperoxia; and P = NS, NOX2^{-/-} vs. WT mice in hyperoxia).

we cannot compare our data with these results. Our study suggests that protection provided by NOX1 deficiency during hyperoxia is not due to decreased ROS production by lung inflammatory cells, where NOX2 is preferentially expressed.

The results of this study demonstrate that hyperoxia-induced oxidative stress and tissue damage is, at least in part, mediated by NOX1. One of the reasons for the important role of NOX1 in hyperoxia might lie in the spatial localization of NOX1 in the lung. Primary pulmonary epithelial type II and lung endothelial cells expressed NOX1. Therefore, NOX1 is strategically located to be exposed to high oxygen concentration and to cause damage to the alveolocapillary barrier. A biochemical feature that distinguishes NOX1 from NOX2 might also play an important role. NOXO1, the organizer subunit of the NOX1 enzyme complex, lacks an autoinhibitory domain (40) and a basal NOX1

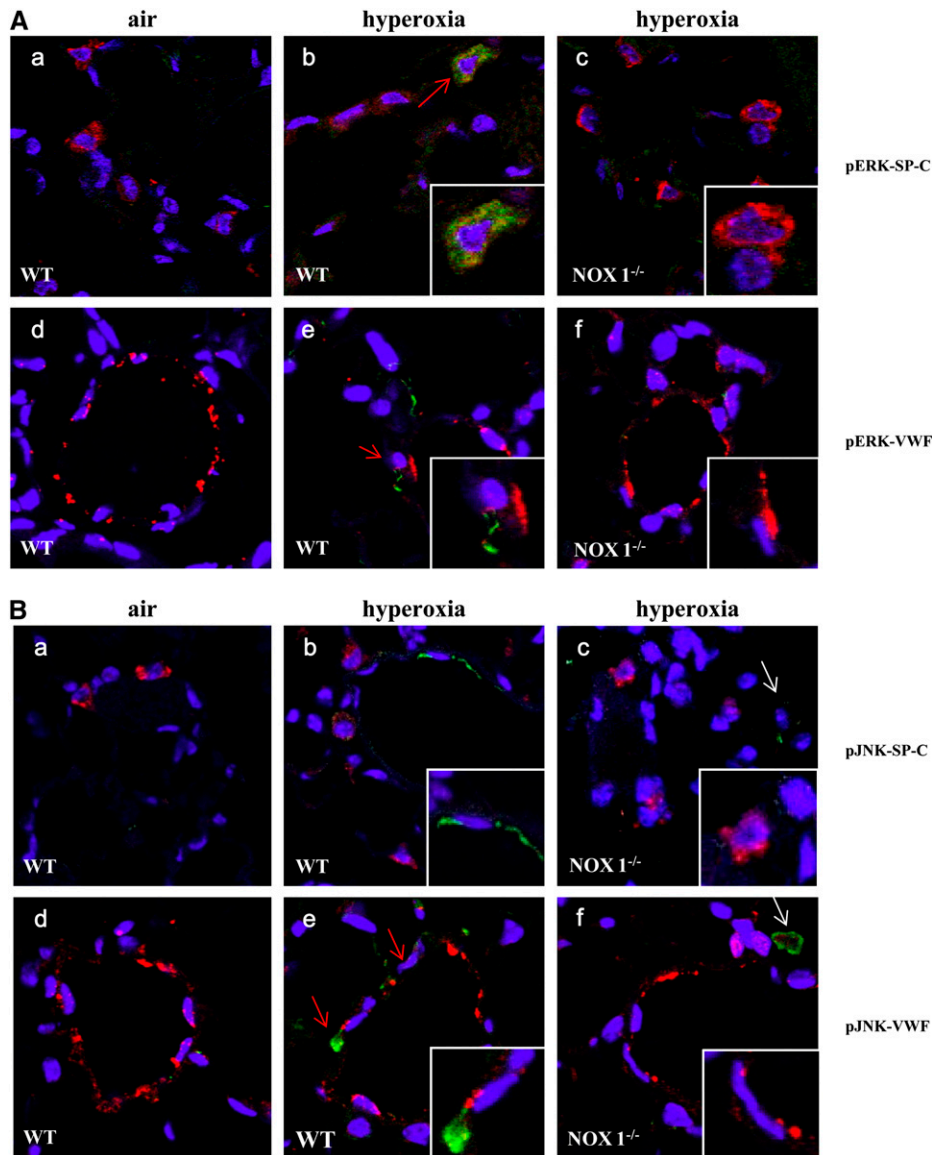

Figure 8. NADPH oxidase-1 (NOX1) mediates the phosphorylation of extracellular signal-regulated kinases (pERKs) and c-Jun N-terminal kinases (pJNKs) in alveolar type II epithelial cells and in endothelial cells. (A) Representative merged images of lung sections stained with anti-pERKs (green), 4',6-diamidino-2-phenylindole (DAPI, blue), and anti-prosurfactant protein-C (SP-C, red; panels a–c) or anti-von Willebrand factor (VWF, red; panels d–f) (original magnification, $\times 63$). Note that pERK staining was colocalized with the marker for type II epithelial cells and endothelial cells (red arrows, panels b and e). (B) Representative merged images of lung sections stained with anti-pJNK (green), DAPI (blue), and anti-SP-C (red, panels a–c) or anti-VWF (red; panels d–f) (original magnification, $\times 63$). Note that pJNK staining is not exclusively restricted to endothelial cells but is also present in macrophages (white arrows). pJNK and pERK cytoplasmic staining is attenuated in $\text{NOX1}^{-/-}$ lungs compared with wild-type (WT) lungs.

activity level has therefore been consistently reported (11). Thus, in contrast to NOX2, which is basically inactive in the absence of cell activation, we found that NOX1 is able to directly increase its ROS generation in response to the elevation of its substrate oxygen in murine alveolar epithelial type II and endothelial cells. In addition to increased substrate, that is, oxygen concentration, other mechanisms might contribute to the increased NOX1 activation under hyperoxic conditions, for example, kinase activation and/or activation of Rac GTPases (41).

NOX1 expression was increased in both epithelial and endothelial cells during hyperoxia. Specific absence of NOX1 decreased hyperoxia-induced ROS generation within the lung and specifically in pulmonary epithelial and endothelial cells. Decreased ROS production was significantly associated with less alveolar cell death as shown by DNA fragmentation markers, such as TUNEL staining and decreased active caspase-3 (17 kD) and PARP-1 cleavage. Also, DPI treatment, a nonspecific inhibitor of NOX enzymes and other electron transporters, decreased hyperoxia-induced ROS generation in human artery endothelial cells and oxidant-induced cell death in MLE-12 cells (6, 9). This cell death reduction was associated

with decreased caspase-3 activation and PARP-1 cleavage in MLE-12 cells (6).

In the present study, hyperoxia activated both pERK and pJNK in mouse lungs as already reported (42) and particularly in pulmonary type II epithelial and endothelial cells. Interestingly, pJNK was found mostly in lung endothelial cells during hyperoxia, suggesting differential MAPK activation *in vivo*. The absence of NOX1 but not NOX2 decreased hyperoxia-induced JNK and ERK phosphorylation in alveolar cells. In accordance with these observations, treatment with DPI completely inhibited hyperoxia-induced ERK1/2 activation and subsequent cell death in alveolar epithelial cells (6, 43). Furthermore, the response to tumor necrosis factor-induced JNK activity and cell death was inhibited in alveolar epithelial cells transfected with NOX1-specific small interfering RNA (44, 45). It is interesting to note that JNK activation was similarly detectable in alveolar macrophages during hyperoxia in NOX1-deficient mice and in WT mice, thus attesting to the specificity of JNK activation by NOX1 in alveolar cells (46). The precise redox-sensible step involved in kinase activation in response to NOX-dependent ROS production is presently unknown. It may be due to inhibition of MAPK tyrosine phosphatase activity or activation of

apoptosis signal-regulating kinase-1 (ASK1)-dependent or -independent pathways (44, 47, 48). It has been proposed that ROS, via the oxidation of thioredoxin, a redox regulatory protein, leads to ASK1 liberation and to tumor necrosis factor-induced JNK activation in MLE-12 cells (44). We also explored Akt phosphorylation (pAkt), because the instillation of the constitutively active form of Akt in mice before exposure to hyperoxia protected lung from oxidant-induced lung damage (49). Our results did not favor the hypothesis that a change in pAkt could mediate lung cell protection in NOX1-deficient mice (data not shown), but they strongly suggest that ROS generated by NOX1 participate specifically in the signaling of hyperoxia-induced ERK and JNK activation and thereby induce alveolar cell death in mouse lung.

Our data are the first direct demonstration that NOX1 activation promotes apoptosis *in vivo* and especially in the cells that comprise the alveolocapillary barrier. The results are not compatible with the hypothesis that ROS released by mitochondria are the *primum movens* of hyperoxic oxidative stress. We also found that NOX-derived ROS cause DNA strand breaks *in vivo*. However, it is not clear at this point whether NOX1-derived ROS are responsible for direct genotoxic stress or whether the DNA strand breaks are also due to caspase activation by redox-sensitive cell death pathways (e.g., JNK and ERK). Indeed, it is likely that caspase activation is not sufficient to fully account for the DNA strand breaks observed in response to hyperoxia because (1) in this study, we observed a smaller number of caspase-3-positive cells, as compared with TUNEL-positive cells; and (2) in previous studies we found that administration of pan-caspase inhibitor (Z-VAD) was not sufficient to rescue hyperoxia-induced cell death (3, 50). If direct genotoxic stress through NOX1-derived ROS is a contributor to hyperoxic lung damage, it is essential to inhibit ROS formation at a significantly upstream level. This approach could have an important impact on future therapeutic developments, potentially favoring the targeting of NOX1-specific inhibitors over inhibition of redox-sensitive cell death pathways in the treatment of acute lung injury.

Conflict of Interest Statement: None of the authors has a financial relationship with a commercial entity that has an interest in the subject of this manuscript.

Acknowledgment: The authors thank Philippe Henchoz, Camille Bron, Karim Hamad, Olivier Basset, Christian Vesin, and Angela Baia for technical assistance, and Karen Bedard and Olivier Preynat-Sauve for scientific help and discussion. The authors also express gratitude to Hal Chapman (Department of Medicine, UCSF) for helpful technical advice in alveolar type II epithelial cell isolation and stimulating scientific discussions.

References

- Tasaka S, Amaya F, Hashimoto S, Ishizaka A. Roles of oxidants and redox signaling in the pathogenesis of acute respiratory distress syndrome. *Antioxid Redox Signal* 2008;10:739–753.
- Roper JM, Mazzatti DJ, Watkins RH, Maniscalco WM, Keng PC, O'Reilly MA. *In vivo* exposure to hyperoxia induces DNA damage in a population of alveolar type II epithelial cells. *Am J Physiol Lung Cell Mol Physiol* 2004;286:L1045–L1054.
- Barazzone C, Horowitz S, Donati YR, Rodriguez I, Piguet PF. Oxygen toxicity in mouse lung: pathways to cell death. *Am J Respir Cell Mol Biol* 1998;19:573–581.
- Zaher TE, Miller EJ, Morrow DM, Javdan M, Mantell LL. Hyperoxia-induced signal transduction pathways in pulmonary epithelial cells. *Free Radic Biol Med* 2007;42:897–908.
- Lee PJ, Choi AM. Pathways of cell signaling in hyperoxia. *Free Radic Biol Med* 2003;35:341–350.
- Zhang X, Shan P, Sasidhar M, Chupp GL, Flavell RA, Choi AM, Lee PJ. Reactive oxygen species and extracellular signal-regulated kinase 1/2 mitogen-activated protein kinase mediate hyperoxia-induced cell death in lung epithelium. *Am J Respir Cell Mol Biol* 2003;28:305–315.
- Romashko J III, Horowitz S, Franek WR, Palaia T, Miller EJ, Lin A, Birrer MJ, Scott W, Mantell LL. MAPK pathways mediate hyperoxia-induced oncotic cell death in lung epithelial cells. *Free Radic Biol Med* 2003;35:978–993.
- Li Y, Arita Y, Koo HC, Davis JM, Kazzaz JA. Inhibition of c-Jun N-terminal kinase pathway improves cell viability in response to oxidant injury. *Am J Respir Cell Mol Biol* 2003;29:779–783.
- Parinandi NL, Kleinberg MA, Usatyuk PV, Cummings RJ, Pennathur A, Cardounel AJ, Zweier JL, Garcia JG, Natarajan V. Hyperoxia-induced NAD(P)H oxidase activation and regulation by MAP kinases in human lung endothelial cells. *Am J Physiol Lung Cell Mol Physiol* 2003;284:L26–L38.
- Li J, Gao X, Qian M, Eaton JW. Mitochondrial metabolism underlies hyperoxic cell damage. *Free Radic Biol Med* 2004;36:1460–1470.
- Lambeth JD. NOX enzymes and the biology of reactive oxygen. *Nat Rev Immunol* 2004;4:181–189.
- Bedard K, Krause KH. The NOX family of ROS-generating NADPH oxidases: physiology and pathophysiology. *Physiol Rev* 2007;87:245–313.
- Babior BM. The leukocyte NADPH oxidase. *Isr Med Assoc J* 2002;4:1023–1024.
- Carneseccchi S, Carpentier JL, Foti M, Szanto I. Insulin-induced vascular endothelial growth factor expression is mediated by the NADPH oxidase NOX3. *Exp Cell Res* 2006;312:3413–3424.
- Ameziane-El-Hassani R, Morand S, Boucher JL, Frapart YM, Apostolou D, Agnandji D, Gnidehou S, Ohayon R, Noel-Hudson MS, Francon J, et al. Dual oxidase-2 has an intrinsic Ca²⁺-dependent H₂O₂-generating activity. *J Biol Chem* 2005;280:30046–30054.
- Wu DC, Re DB, Nagai M, Ischiropoulos H, Przedborski S. The inflammatory NADPH oxidase enzyme modulates motor neuron degeneration in amyotrophic lateral sclerosis mice. *Proc Natl Acad Sci USA* 2006;103:12132–12137.
- Gavazzi G, Banfi B, Deffert C, Fiette L, Schappi M, Herrmann F, Krause KH. Decreased blood pressure in NOX1-deficient mice. *FEBS Lett* 2006;580:497–504.
- Gavazzi G, Deffert C, Trocme C, Schappi M, Herrmann FR, Krause KH. NOX1 deficiency protects from aortic dissection in response to angiotensin II. *Hypertension* 2007;50:189–196.
- Zhang X, Shan P, Jiang G, Cohn L, Lee PJ. Toll-like receptor 4 deficiency causes pulmonary emphysema. *J Clin Invest* 2006;116:3050–3059.
- Mittal M, Roth M, Konig P, Hofmann S, Dony E, Goyal P, Selbitz AC, Schermuly RT, Ghofrani HA, Kwapiszewska G, et al. Hypoxia-dependent regulation of nonphagocytic NADPH oxidase subunit NOX4 in the pulmonary vasculature. *Circ Res* 2007;101:258–267.
- Goyal P, Weissmann N, Grimminger F, Hegel C, Bader L, Rose F, Fink L, Ghofrani HA, Schermuly RT, Schmidt HH, et al. Upregulation of NAD(P)H oxidase 1 in hypoxia activates hypoxia-inducible factor 1 via increase in reactive oxygen species. *Free Radic Biol Med* 2004;36:1279–1288.
- Natarajan V, Pendyala S, Gorshkova IA, Usatyuk P, He D, Pennathur A, Lambeth JD, Thannickal VJ. Role of Nox4 and Nox2 in hyperoxia-induced reactive oxygen species generation and migration of human lung endothelial cells. *Antioxid Redox Signal* 2009;11:747–764.
- Carneseccchi S, Deffert C, Pagano A, Metrailler-Ruchonnet I, Donati Y, Matthay M, Krause KH, Barazzone-Argiroffo C. NADPH oxidase (NOX1) is essential in hyperoxia-induced lung damage [abstract]. *Am J Respir Crit Care Med* 2009;179:A5364.
- Pollock JD, Williams DA, Gifford MA, Li LL, Du X, Fisherman J, Orkin SH, Doerschuk CM, Dinauer MC. Mouse model of X-linked chronic granulomatous disease, an inherited defect in phagocyte superoxide production. *Nat Genet* 1995;9:202–209.
- Barazzone C, Belin D, Piguet PF, Vassalli JD, Sappino AP. Plasminogen activator inhibitor-1 in acute hyperoxic mouse lung injury. *J Clin Invest* 1996;98:2666–2673.
- Zhou H, Imrich A, Kobzik L. Characterization of immortalized MARCO and SR-AI/II-deficient murine alveolar macrophage cell lines. *Part Fibre Toxicol* 2008;5:7.
- Reynolds LE, Hodivala-Dilke KM. Primary mouse endothelial cell culture for assays of angiogenesis. *Methods Mol Med* 2006;120:503–509.
- Corti M, Brody AR, Harrison JH. Isolation and primary culture of murine alveolar type II cells. *Am J Respir Cell Mol Biol* 1996;14:309–315.
- Pagano A, Donati Y, Metrailler I, Barazzone Argiroffo C. Mitochondrial cytochrome c release is a key event in hyperoxia-induced lung injury: protection by cyclosporin A. *Am J Physiol Lung Cell Mol Physiol* 2004;286:L275–L283.

30. Chu SJ, Perng WC, Hung CM, Chang DM, Lin SH, Huang KL. Effects of various body temperatures after lipopolysaccharide-induced lung injury in rats. *Chest* 2005;128:327–336.
31. Zhan Y, van de Water B, Wang Y, Stevens JL. The roles of caspase-3 and bcl-2 in chemically-induced apoptosis but not necrosis of renal epithelial cells. *Oncogene* 1999;18:6505–6512.
32. Cheng G, Cao Z, Xu X, van Meir EG, Lambeth JD. Homologs of gp91phox: cloning and tissue expression of Nox3, Nox4, and Nox5. *Gene* 2001;269:131–140.
33. Matsuno K, Yamada H, Iwata K, Jin D, Katsuyama M, Matsuki M, Takai S, Yamanishi K, Miyazaki M, Matsubara H, *et al.* Nox1 is involved in angiotensin II-mediated hypertension: a study in Nox1-deficient mice. *Circulation* 2005;112:2677–2685.
34. Schappi M, Deffert C, Fiette L, Gavazzi G, Herrmann F, Belli D, Krause KH. Branched fungal β -glucan causes hyperinflammation and necrosis in phagocyte NADPH oxidase-deficient mice. *J Pathol* 2008;214:434–444.
35. Gao XP, Standiford TJ, Rahman A, Newstead M, Holland SM, Dinauer MC, Liu QH, Malik AB. Role of NADPH oxidase in the mechanism of lung neutrophil sequestration and microvessel injury induced by gram-negative sepsis: studies in p47phox^{-/-} and gp91phox^{-/-} mice. *J Immunol* 2002;168:3974–3982.
36. Snelgrove RJ, Edwards L, Rae AJ, Hussell T. An absence of reactive oxygen species improves the resolution of lung influenza infection. *Eur J Immunol* 2006;36:1364–1373.
37. Berg JT, White JE, Tsan MF. Response of alveolar macrophage-depleted rats to hyperoxia. *Exp Lung Res* 1995;21:175–185.
38. Boyce NW, Campbell D, Holdsworth SR. Granulocyte independence of pulmonary oxygen toxicity in the rat. *Exp Lung Res* 1989;15:491–498.
39. Martin TR, Pistoresse BP, Chi EY, Goodman RB, Matthay MA. Effects of leukotriene B₄ in the human lung: recruitment of neutrophils into the alveolar spaces without a change in protein permeability. *J Clin Invest* 1989;84:1609–1619.
40. Banfi B, Clark RA, Steger K, Krause KH. Two novel proteins activate superoxide generation by the NADPH oxidase NOX1. *J Biol Chem* 2003;278:3510–3513.
41. Werner E, Werb Z. Integrins engage mitochondrial function for signal transduction by a mechanism dependent on Rho GTPases. *J Cell Biol* 2002;158:357–368.
42. Yang G, Abate A, George AG, Weng YH, Dennery PA. Maturation differences in lung NF- κ B activation and their role in tolerance to hyperoxia. *J Clin Invest* 2004;114:669–678.
43. Papaiahgari S, Kleeberger SR, Cho HY, Kalvakolanu DV, Reddy SP. NADPH oxidase and ERK signaling regulates hyperoxia-induced Nrf2-ARE transcriptional response in pulmonary epithelial cells. *J Biol Chem* 2004;279:42302–42312.
44. Pantano C, Anathy V, Ranjan P, Heintz NH, Janssen-Heininger YM. Nonphagocytic oxidase 1 causes death in lung epithelial cells via a TNF-RI–JNK signaling axis. *Am J Respir Cell Mol Biol* 2007;36:473–479.
45. Kim YS, Morgan MJ, Choksi S, Liu ZG. TNF-induced activation of the Nox1 NADPH oxidase and its role in the induction of necrotic cell death. *Mol Cell* 2007;26:675–687.
46. Iles KE, Forman HJ. Macrophage signaling and respiratory burst. *Immunol Res* 2002;26:95–105.
47. Chowdhury AK, Watkins T, Parinandi NL, Saatian B, Kleinberg ME, Usatyuk PV, Natarajan V. Src-mediated tyrosine phosphorylation of p47^{phox} in hyperoxia-induced activation of NADPH oxidase and generation of reactive oxygen species in lung endothelial cells. *J Biol Chem* 2005;280:20700–20711.
48. Kamata H, Honda S, Maeda S, Chang L, Hirata H, Karin M. Reactive oxygen species promote TNF α -induced death and sustained JNK activation by inhibiting MAP kinase phosphatases. *Cell* 2005;120:649–661.
49. Lu Y, Parkyn L, Otterbein LE, Kureishi Y, Walsh K, Ray A, Ray P. Activated Akt protects the lung from oxidant-induced injury and delays death of mice. *J Exp Med* 2001;193:545–549.
50. Metrailler-Ruchonnet I, Pagano A, Carnesecci S, Ody C, Donati Y, Barazzone Argiroffo C. Bcl-2 protects against hyperoxia-induced apoptosis through inhibition of the mitochondria-dependent pathway. *Free Radic Biol Med* 2007;42:1062–1074.

D. Maladie granulomateuse septique et inflammation

La maladie granulomateuse septique ou CGD est causée par la perte de fonction de la NADPH des phagocytes générant des ROS. En l'absence de cette enzyme, les patients atteints de CGD souffrent d'infections récurrentes. De plus, ils présentent également une réponse inflammatoire exacerbée au sein de plusieurs organes, comme la peau, les poumons, le tractus digestif et le foie. Ces lésions inflammatoires que l'on peut qualifier « d'hyperinflammation » jouent un rôle essentiel dans la morbidité de la maladie. Les granulomes au niveau de nombreux organes ainsi que la colite constituent les manifestations cliniques classiques de l'hyperinflammation.

Dans le contexte d'immunodéficience de la CGD, ces lésions hyperinflammatoires ont initialement été assimilées à des granulomes septiques. Mais l'origine de cette réponse inflammatoire s'est avérée être non infectieuse. Pour exemple, les parois d'*Aspergillus fumigatus* inactivées par la chaleur induisent une hyperinflammation chez les souris déficientes en NOX2 (Petersen, Hiran et al. 2002). Les parois des champignons semblent donc impliquées dans l'induction de cette inflammation mais la ou les causes exactes sont inconnues. Cette méconnaissance amène, lors des études sur les mécanismes de ces complications en l'absence de NOX2, à l'utilisation de stimuli divers et donc à des conclusions diverses et variées, voire contradictoires.

Un des mécanismes le plus souvent évoqué est une augmentation excessive des cytokines pro-inflammatoires comme le TNF α et l'IL-8 (Hatanaka, Carvalho et al. 2004) par les neutrophiles ou monocytes de patients CGD après stimulation. Il n'est pas clairement établi, à ce jour, si cette augmentation de production des cytokines est une des causes de l'inflammation ou la conséquence d'une inflammation persistante. Ces données sont le plus souvent basées sur des

expériences *in vitro* ou *ex vivo* et impliquent la NADPH des neutrophiles mais les autres cellules du système immunitaire possédant également NOX2, comme les macrophages et les cellules dendritiques, jouent certainement également un rôle dans les mécanismes inflammatoires de la CGD.

Article 4 Les β -glycans branchés d'origine fongique induisent une hyperinflammation et une nécrose chez les souris déficientes en NADPH oxydase du phagocyte

BRANCHED FUNGAL β -GLUCAN CAUSES HYPERINFLAMMATION AND NECROSIS IN PHAGOCYTE NADPH OXIDASE-DEFICIENT MICE. Michela G. Schäppi, Deffert Christine, Laurence Fiette, Gaetan Gavazzi, François R. Hermann, Dominique C. Belli and Karl-Heinz Krause. *J Pathol.* 2008. 214:434-444.

Les granulomes cutanés sont une complication fréquente de la CGD (Segal, Leto et al. 2000). En 2002, Marie Dinuer a établi un modèle cutané inflammatoire de la CGD en injectant des parois d'*Aspergillus fumigatus* inactivées par la chaleur dans les oreilles dans un modèle murin de la CGD liée à l'X (Petersen, Hiran et al. 2002). Ces souris ont été créées par invalidation du gène gp91^{phox}. Lors de cette étude, il a été démontré que les pathogènes inactivés étaient capable d'induire une inflammation exacerbée en l'absence d'une NADPH oxydase du phagocyte fonctionnelle.

Mais des questions restaient en suspens : Est-ce que cette réaction inflammatoire est spécifique des champignons ? Et est-ce que certains composés des parois des pathogènes comme les PAMPS pouvaient être à l'origine de cette inflammation ?

Les PAMPs (*Pathogen-Associated Molecular Patterns*) sont d'origine très diverses (bactérie, virus, parasite) et de natures variées (protéine, ose, acide nucléique). Ce sont des motifs moléculaires hautement conservés reconnus de façon spécifique par les récepteurs PRRs (voir Chapitre V.7). Le PAMP majoritaire des bactéries gram négative est le lipopolysaccharide (LPS), celui des bactéries gram positive est l'acide lipotechoïque (LTA) et celui des champignons est le β -glycan. Ce dernier de découverte récente est le moins connu. Ce sont des polysaccharides retrouvés dans les champignons, les plantes et quelques bactéries. Chez les champignons, comme

les levures, les β -glycans sont les constituants majoritaires de la paroi où ils forment des polymères de glucose entre les β -(1-3) et les β -(1-6) glycans. Les β -glycans d'origine végétale sont retrouvés dans les parois cellulaires et dans d'autres structures et correspondent plutôt à des polymères de glucose entre les β -(1-3) et les β -(1-4) glycans. Les plantes céréalières, comme l'orge, sont très riches en β -glycans (Hrmova, Harvey et al. 1996). Un nombre limité de bactéries, comme les Agrobactéries ou les Streptocoques, peuvent produire des β -glycans au niveau du périplasme ou de leur capsule (McIntosh, Stone et al. 2005).

Ces hydrates de carbone vont être reconnus de façon spécifique par un récepteur de type C-lectin : la dectine-1 (Brown, Herre et al. 2003) présente au niveau des polynucléaires neutrophiles, éosinophiles, des monocytes/macrophages, des cellules dendritiques et de certaines sous-classes de lymphocytes T.

Mon travail dans cet article a consisté à assurer la gestion des animaux transgéniques, à effectuer les injections intradermiques, les différentes immuno-histochimies, les explants ainsi que les mesures au cytomètre de flux. L'élaboration du projet, les discussions de travail ainsi que l'élaboration du manuscrit ont également fait partie de ce travail.

Original Paper

Branched fungal β -glucan causes hyperinflammation and necrosis in phagocyte NADPH oxidase-deficient mice

MG Schappi,^{1*} C Deffert,^{1,2} L Fiette,³ G Gavazzi,⁴ FR Herrmann,⁴ DC Belli¹ and K-H Krause²

¹Paediatric Gastroenterology and Transplantation Division, Department of Paediatrics, Geneva University Hospitals, 1211 Geneva 4, Switzerland

²Departments of Pathology and Immunology, and Genetic and Laboratory Medicine, Geneva Medical Faculty and University Hospitals, 1211 Geneva 4, Switzerland

³Platform of Veterinary Diagnosis, Geneva Medical Faculty, 1211 Geneva 4, Switzerland

⁴Department of Rehabilitation and Geriatrics, Geneva University Hospitals and Medical School, 1211 Geneva 4, Switzerland

*Correspondence to:

MG Schappi, Paediatric Gastroenterology and Transplantation Division, Department of Paediatrics, Geneva University Hospitals, 1211 Geneva 4, Switzerland.

E-mail:

michela.schaepi@hcuge.ch

No conflicts of interest were declared.

Abstract

Chronic granulomatous disease (CGD), a genetic disorder characterized by the absence of a functional phagocyte NADPH oxidase, is a severe immune deficiency. However, non-infectious hyperinflammation is a second hallmark of the disease. In CGD mouse models, sterile hyperinflammation can be induced by *A. fumigatus* cell wall preparations. In this study, we used subcutaneous injection of microbial cell walls and cell wall components to identify causes of CGD hyperinflammation and to characterize its histological features. Sterile cell wall preparations from fungi (*A. fumigatus*, *C. albicans*, *S. cerevisiae*), but not from bacteria (*S. aureus*, *P. aeruginosa*, *E. coli*), caused prolonged and severe skin inflammation in CGD mice. To identify fungal cell wall elements responsible for this process, we investigated microbial cell wall-derived monosubstances. Injection of $\beta(1-3)(1-6)$ -glucan induced severe hyperinflammation in CGD mice, while other fungal cell components [mannan, $(1-3)$ β -glucan] or bacterial cell wall components (lipopolysaccharide, lipoteichoic acid) caused no or only moderate inflammation. β -glucan-induced hyperinflammation was predominantly due to a defect in termination of inflammation, as in the initial stage (2 days), the severity of inflammation and the extent of cell death were comparable in wild-type and CGD mice. At later stages (7 days), $\beta(1-3)(1-6)$ -glucan-induced inflammation had subsided in wild-type mice. In contrast, CGD mice showed persistent severe inflammation with central necrosis, containing abundant apoptotic and necrotic cells. In summary, branched fungal β -glucan induces a severe inflammatory reaction in the absence of phagocyte NADPH oxidase. As opposed to the commonly perceived notion that reactive oxygen species are the cause of cell death, our results demonstrate that tissue necrosis can be caused by the absence of a superoxide-producing enzyme.

Copyright  2008 Pathological Society of Great Britain and Ireland. Published by John Wiley & Sons, Ltd.

Keywords: chronic granulomatous disease; NOX2; ROS; sterile inflammation; neutrophil; fungal cell wall; skin explant; leukocyte egression; $\beta(1-3)(1-6)$ -glucans; apoptosis

Received: 13 April 2007

Revised: 16 August 2007

Accepted: 24 October 2007

Introduction

Chronic granulomatous disease (CGD) is a severe genetic disease caused by lack of function of the phagocyte NADPH oxidase. The latter enzyme generates reactive oxygen species (ROS), which participate in the microbicidal activity of phagocytes [1–4]. The phagocyte NADPH oxidase is a multi-subunit enzyme consisting of two membranous subunits, NOX2/gp91^{phox} and p22^{phox}, as well as three cytoplasmic subunits, p67^{phox}, p47^{phox}, and p40^{phox}. Mutations in all subunits except p40^{phox} have been described as a cause of CGD [5–9].

CGD patients are prone to recurrent life-threatening infections. However, they also suffer from increased

inflammatory responses, which are found in many organs, including the skin, lungs, gastrointestinal tract, liver, and lymphoreticular system [10], and play an important role in morbidity. Although the genetic defects of CGD are now well understood, many aspects of the pathophysiology of the disease remain unclear. This is particularly true with respect to the hyperinflammatory complications, such as granuloma formation and colitis.

Hyperinflammatory lesions in CGD patients have initially been interpreted as chronic infections [11]. However, several recent studies suggest that these lesions are not due to infections: (i) in many instances, no microbes can be recovered from the lesions [10]; (ii) colitis in CGD patients is invariably culture-

negative and responds to immunosuppression rather than to antibiotics [12–14]; and (iii) data from NOX2-deficient mice demonstrate that non-infectious *Aspergillus fumigatus* cell wall preparations can induce a hyperinflammatory reaction (see below).

Mice deficient in the cytochrome subunit of the phagocyte NADPH oxidase (NOX2) represent a good model of CGD. These CGD mice show susceptibility to infections similar to that of their human counterparts [15,16] and also suffer from sterile complications. Models of non-infectious inflammation have been established using intratracheal instillation or intradermal injection of heat-inactivated *A. fumigatus* wall [16,17]. They show that CGD mice are prone to develop exuberant and persistent inflammatory lesions compared with wild-type mice. Inflammatory lesions observed in CGD mice in response to *Aspergillus* cell wall preparations closely resemble those observed in CGD patients.

It was the aim of this study to investigate the response of CGD mice to sterile cell wall extracts from various fungi and/or bacteria, to identify microbial cell wall components that cause hyperinflammation, and to characterize the histological features of this hyperinflammation.

Materials and methods

Mice

NOX2-deficient CGD mice in a C57Bl6/J background, generated in the laboratory of Mary Dinauer, were used [15,18]. Wild-type C57Bl6/J mice were used as controls. Handling and manipulations of the animals were carried out in accordance with the European Community guidelines. All experiments were approved by the Ethics Committee of the University of Geneva and the Cantonal Veterinary Office. Mice (males of 13–17 weeks of age) were maintained in a specific pathogen-free (SPF) environment (microisolator cages, autoclaved food, and acidified water) at the animal house of the Geneva Medical Faculty. Food and water were supplied *ad libitum* in a quiet room at 25 °C with a 12-h light/dark cycle.

Microbial extracts

Clinical strains of yeast *Candida albicans*, *Aspergillus fumigatus*, and *Saccharomyces cerevisiae*; Gram-positive bacteria *Staphylococcus aureus* and *Pseudomonas aeruginosa*; and Gram-negative bacteria *Escherichia coli* were used. Solubilized sterile cell wall preparations were carried out as follows: cultures were grown overnight and inactivated by autoclaving (120 °C, 20 min) followed by sonication. The preparation was lyophilized and the powder obtained re-suspended at a known concentration. The sterility of the solutions was assessed by growth over 3 days at 37 °C (standard and Sabouraud's dextrose agar). β (1–3)(1–6)-glucan from *S. cerevisiae*, mannan

from *S. cerevisiae*, laminarin from *Laminaria digitata*, lipopolysaccharide (LPS) from *E. coli*, and lipoteichoic acid (LTA) from *S. aureus* were from Sigma Aldrich, Schnellendorf, Germany.

Intradermal injection and histology

For intradermal injections, mice (wild type and CGD) were anaesthetized with isoflurane (Forene, Abbott, Baar, Switzerland). We inoculated intradermally into the ear dorsum 50 μ l of a solution containing the cell wall or monosubstance preparation, while the contralateral ear was injected with 50 μ l of PBS vehicle. The quality of the injection was visually assessed and mice that showed a back-leak of the injected solution to the skin surface were excluded from further analysis. Mice were sacrificed (isoflurane anaesthesia followed by cervical dislocation) at the indicated time after injection (2 or 7 days). Ears were removed, fixed in formalin, and embedded along their great axis in paraffin, to systematically include epidermis and dermis in each section. Each paraffin block was sectioned (5 μ m) at two different levels distant by 50 sections. Haematoxylin and eosin (H&E) staining was performed according to standard procedures. Gram, Grocott, and PAS stains were performed and were consistently negative.

Histopathological scoring

Microscopic evaluation was performed blindly on H&E-stained slides. The following items were assessed: inflammatory infiltrate, ulcers, and necrosis. On each slide analysed, a semi-quantitative severity score was given for each of the following items: absent, minimal (+), moderate (++), severe (+++) or very severe (++++)). Using the elements of the semi-quantitative score, a histological grade between 0 and 4 was assigned:

- grade 0: no inflammatory infiltrate;
- grade 1: minimal inflammatory infiltrate;
- grade 2: moderate inflammatory infiltrate or minimal inflammatory infiltrate associated with at least moderate ulcers;
- grade 3: severe inflammatory infiltrate or moderate inflammatory infiltrate associated with at least moderate ulcers, or moderate inflammatory infiltrate associated with at least moderate necrosis;
- grade 4: very severe inflammatory infiltrate or severe inflammatory infiltrate associated with at least moderate ulcers, or severe inflammatory infiltrate associated with at least moderate necrosis.

Two slides were assessed per animal. If there was a discrepancy in the grade, the most severe result was taken into account.

Immunohistochemistry

For immunohistochemistry, 4 µm thick sections were deparaffinized and incubated overnight with primary antibodies followed by 2 h incubation with an appropriate biotinylated secondary antibody. A peroxidase-based system (Dako Cytomation, Glostrup, Denmark) was used for detection. Negative controls in the absence of the primary antibody were performed for each experiment (data not shown). The primary antibodies used were monoclonal antibodies against myeloperoxidase (titre of 1/1000; Dako, Glostrup, Denmark), F4/80 (titre of 1/40; RM 2915, Caltag, Basel, Switzerland), goat anti-rat (titre of 1/400; Dako), and goat anti-rabbit (titre of 1/200; Vector Laboratories, Peterborough, UK).

TUNEL staining

Staining was performed according to the manufacturer's instructions (Roche Molecular Biochemicals, Mannheim, Germany). Negative controls (absence of terminal deoxynucleotidyl transferase or injection of PBS) did not yield any staining.

Skin explants

A skin explant assay was performed as described previously [19]. At the indicated time after $\beta(1-3)(1-6)$ -glucan injection, mice were sacrificed and ears were removed. Dorsal and ventral halves were split and incubated in RPMI medium supplemented with 10% fetal bovine serum, 100 mM HEPES (*N*-2-hydroxyethylpiperazine-*N'*-2-ethane-sulphonic acid), and penicillin-streptomycin (Gibco BRL, Paisley, UK) at 37 °C in 5% CO₂. After the indicated time (3 or 18 h, see the figure legends), egressed cells were analysed.

Flow cytometry

Conjugated antibodies against F4/80-fluorescein isothiocyanate (FITC), MHCII-phycoerythrin-Cy5 (PE-Cy5), Gr-1-PE, CD40-allophycocyanin (APC), CD11c-FITC, and CD3-APC were purchased from eBioscience (Vienna, Austria). After 15 min of incubation with antibodies in RPMI-FCS, fluorescence was analysed on FACSCalibur and CellQuest Software (BD Biosciences, Erembodegem, Belgium).

For the apoptosis assay, we used an Annexin V-FITC apoptosis detection kit I according to the manufacturer's instructions (BD Pharmingen, Erembodegem, Belgium). Analysis was performed using 10⁵ cells with FACSCalibur and CellQuest Software (BD Biosciences).

Statistics

As the histological scoring of inflammation is coded on an ordinal scale (ie the distance between each level of the scale is arbitrary), non-parametric tests (Mann-Whitney *U* and Kruskal-Wallis) were used.

These tests compare the shape of distribution (by ranking each observation) between two, respectively, among more than two groups. In the case of multiple comparisons, appropriate significance levels were adjusted according to Bonferroni's correction. All analyses were performed with the Stata statistical software package (version 9.2; Stata Corporation, College Station, TX, USA).

Results

Severe inflammation in CGD mice 7 days after injection of fungal cell wall extracts

In wild-type mice, intradermal injection of sterile cell wall extracts from three different fungi (*A. fumigatus*, *C. albicans*, *S. cerevisiae*), Gram-positive bacteria (*S. aureus*), and Gram-negative bacteria (*P. aeruginosa*, *E. coli*) caused no visible lesions. On the other hand, in CGD mice, injection of fungal cell wall preparations caused swelling, redness, and ulcerations of the skin (data not shown). These differences corresponded to the observations at microscopic level (Figures 1 and 2). Cell wall extracts from *P. aeruginosa* and *E. coli* induced only minimal or mild inflammatory infiltration of the skin and there was no difference between wild-type and CGD mice. Cell wall products from *S. aureus* led to moderate inflammation in CGD mice, which was slightly enhanced compared with wild type. Finally, fungal extracts produced very severe inflammation in CGD mice, while only mild to moderate inflammation was seen in wild type. Injection of PBS alone caused no or only minimal inflammation in either wild-type or CGD mice (data not shown). When the histopathological scores of lesions induced by bacterial extracts were compared with those induced by fungal extracts in CGD mice, the difference was even more striking ($p < 0.000005$).

Identification of monosubstances that cause hyperinflammation in CGD mice

In an attempt to identify cell wall components responsible for CGD hyperinflammation, we tested selected monosubstances from microbial cell walls: $\beta(1-3)(1-6)$ -glucan and mannan from *S. cerevisiae*; unbranched $\beta(1-3)$ -glucan laminarin from *Laminaria digitata* (algae); lipoteichoic acid (LTA) from *S. aureus*; and lipopolysaccharide (LPS) from *E. coli*. The respective compounds were injected as described above.

Mannan, $\beta(1-3)$ -glucan (laminarin), LTA, and LPS caused mild to moderate inflammation after 7 days, which was not or only slightly enhanced in CGD mice (Figures 3 and 4). However, $\beta(1-3)(1-6)$ -glucan caused severe hyperinflammation in CGD mice. These lesions were usually very necrotic, leading to a histopathology score of 4. A severity score of 4 was never observed with microbial monosubstances other than $\beta(1-3)(1-6)$ -glucan in CGD mice. It should also

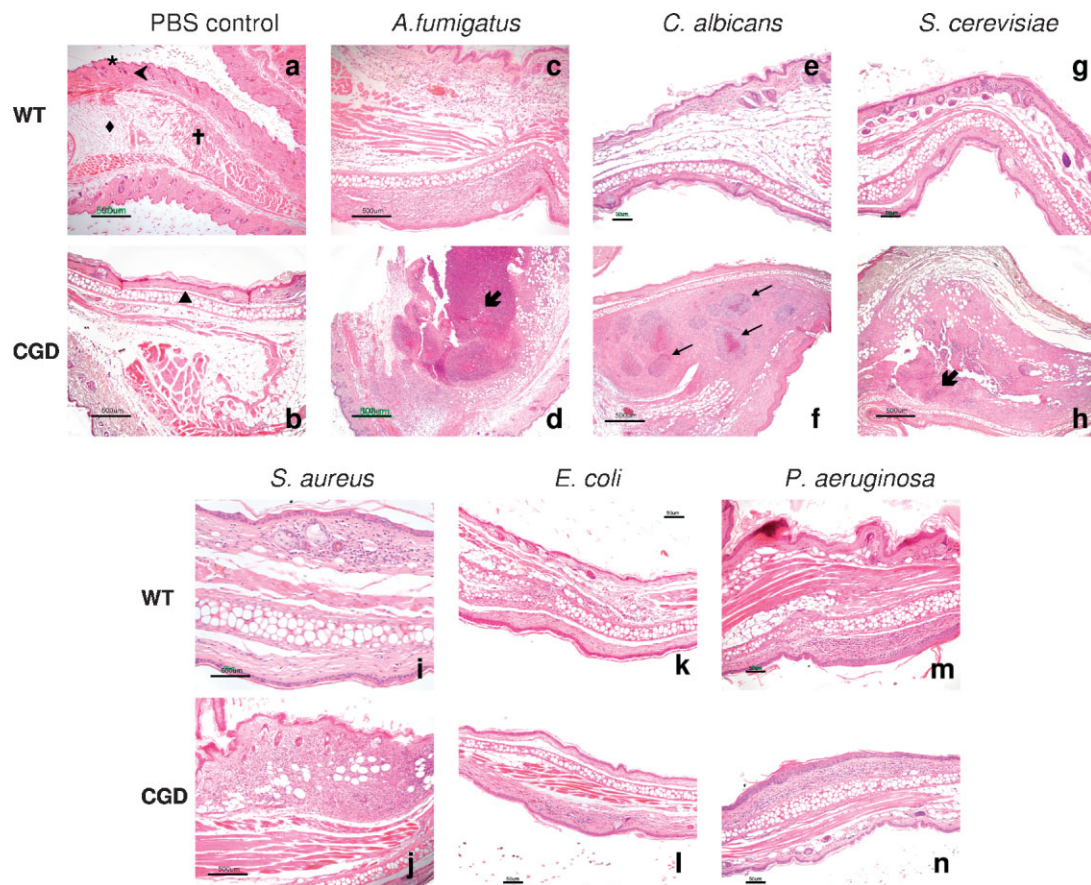

Figure 1. Skin histology (H&E staining) 7 days after injection of fungal and bacterial cell wall extracts. Wild-type (WT) and CGD mice were injected intradermally with microbial cell wall extracts (concentration 20 or 40 $\mu\text{g}/50\ \mu\text{l}$). Cell wall extracts were from fungi (*Aspergillus fumigatus* 20 $\mu\text{g}/50\ \mu\text{l}$, *Candida albicans* 20 $\mu\text{g}/50\ \mu\text{l}$, and *Saccharomyces cerevisiae* 20 $\mu\text{g}/50\ \mu\text{l}$) or bacteria (*Staphylococcus aureus* 20 $\mu\text{g}/50\ \mu\text{l}$, *Escherichia coli* 40 $\mu\text{g}/50\ \mu\text{l}$, and *Pseudomonas aeruginosa* 40 $\mu\text{g}/50\ \mu\text{l}$). Phosphate-buffered saline (PBS) was used as a control. Similar results were obtained with at least six mice (three to four independent experiments). WT: (a) Normal features: epidermis (*), dermis (\blacktriangleleft), cartilage (\blacktriangle), hypodermis (\blacklozenge), subcutaneous muscle (\blackplus). (c) Moderate diffuse inflammation of the dermis, hypodermis, and subcutaneous muscle. (e, g, i, k, m) Focal minimal dermal inflammation. CGD: (b) Normal features. (d) Deep severe inflammation, mainly affecting the hypodermis with a large central area of necrosis (\blacklozenge). (f) Very severe deep inflammation of the hypodermis and muscle. A few micro-abscesses (\blackleftarrow) are distributed within diffuse inflammation. (h) Deep severe inflammation in the hypodermis and muscle with central necrosis (\blacklozenge). (j) Diffuse moderate inflammation of the dermis and hypodermis. (l, n) Focal minimal dermal inflammation

be noted that an increase in dosage of mannan up to 500 $\mu\text{g}/\text{injection}$ did not lead to apoptotic lesions with a severity score of 4. Thus, our experiments demonstrate that severe CGD hyperinflammation is caused by $\beta(1-3)(1-6)$ -glucan.

Time course of inflammation induced by branched β -glucan

To understand whether the difference between wild-type and CGD mice resides in the initiation or rather the termination of inflammation, we studied an early time point after injection. Macroscopic inspection (Figure 5A) 2 days after injection demonstrated inflammation in both wild-type and knock-out mice. In contrast, 7 days after injection, the inflammation in wild-type mice had mostly resolved, while signs of inflammation persisted or progressed in CGD mice. Injected ears of CGD mice were red and swollen at the injection site and — less visible in the figure — had lost their natural shape, with swelling

all over and a ‘cauliflower’ appearance. Microscopic analysis (Figures 5B and 5C) confirmed an essentially identical degree of inflammation 2 days after injection. However, the inflammation had mostly resolved after 7 days in the wild-type mice ($p = 0.02$, day 2 versus day 7), while it was sustained in CGD mice ($p = 0.39$, day 2 versus day 7). When the inflammation score was compared between wild-type (WT) and CGD mice on day 2, there was no difference ($p = 0.220$; WT versus CGD), while there was a major difference on day 7 ($p = 0.0008$; WT versus CGD). Thus, impaired termination rather than enhanced initiation of inflammation appears to cause hyperinflammation in CGD mice.

Characterization of hyperinflammation induced by branched β -glucan

Two days after $\beta(1-3)(1-6)$ -glucan injection, the histopathological appearance of the inflammatory lesions did not differ between wild-type and CGD mice (Figure 5B). The lesions were focal and involved

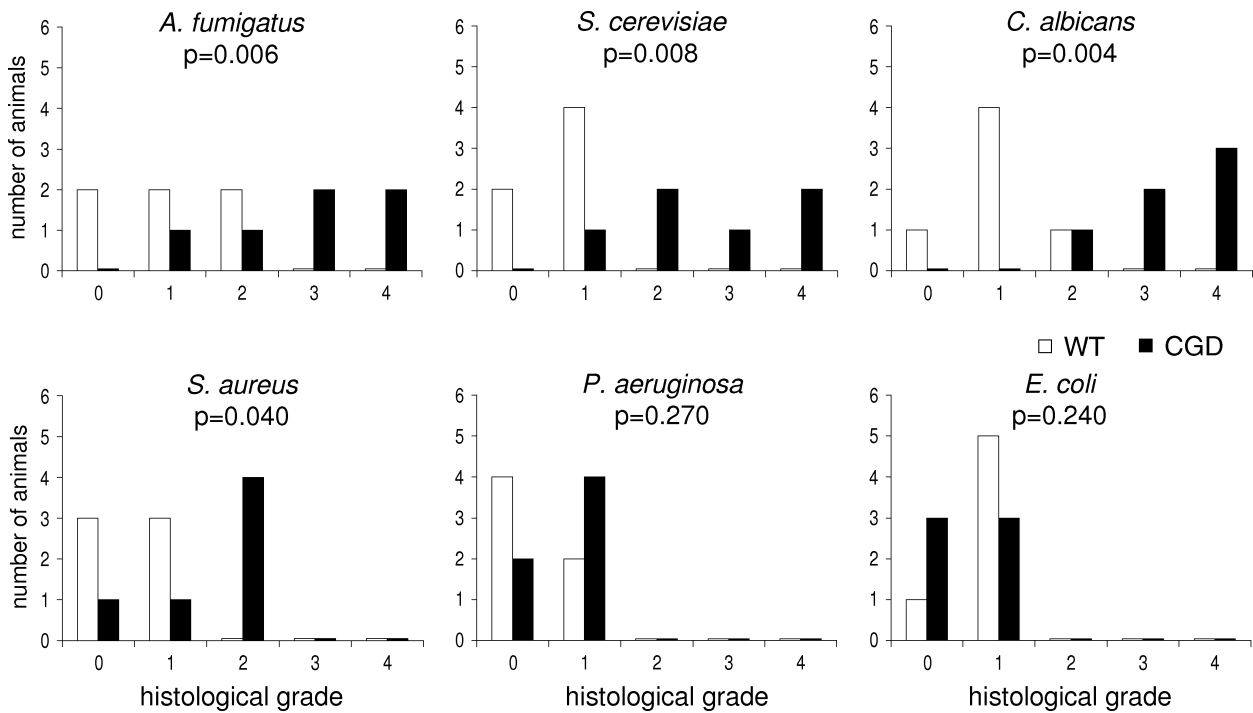

Figure 2. Histology score 7 days after injection of fungal and bacterial cell wall extracts. Histology results from experiments in Figure 1 were quantified by a histological score (grade 0, no inflammation; grade 4, severe inflammation with necrosis). Data are presented as the number of mice (y-axis) that exhibited a given histology score (x-axis). White and black bars represent wild-type and CGD mice, respectively. *p* values, as directly shown in the respective panels, were obtained using Mann–Whitney *U*-tests

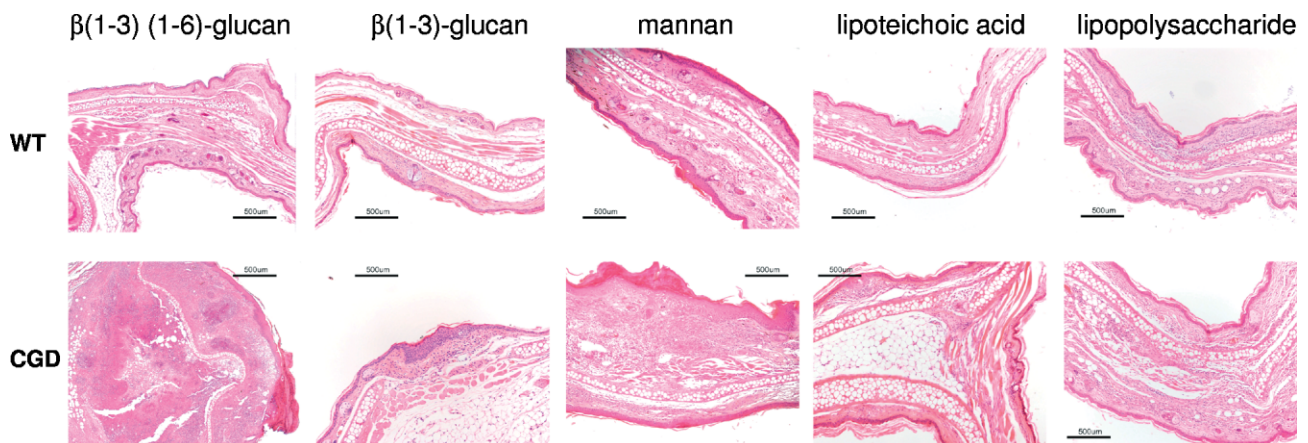

Figure 3. Skin histology (H&E staining) 7 days after injection of cell wall-derived monosubstances. Wild-type (WT) and CGD mice were injected intradermally with monosubstances derived from microbial cell walls. The origin of monosubstances and the injected quantities were as follows: $\beta(1-3)(1-6)$ -glucan (from *Saccharomyces cerevisiae*, 200 $\mu\text{g}/50 \mu\text{l}$), $\beta(1-3)$ -glucan (from *Laminaria digitata*, 500 $\mu\text{g}/50 \mu\text{l}$), mannan (from *Saccharomyces cerevisiae*, 200 $\mu\text{g}/50 \mu\text{l}$), lipoteichoic acid (from *Staphylococcus aureus*, 200 $\mu\text{g}/50 \mu\text{l}$), lipopolysaccharide (from *Escherichia coli*, 50 $\mu\text{g}/50 \mu\text{l}$). Similar results were obtained with at least six mice (three to four independent experiments)

the dermis, hypodermis, and muscle layers. All lesions appeared oedematous. Microscopic ulcers of the epidermis and dermis were frequent. The hypodermis showed a prominent inflammatory infiltrate consisting essentially of neutrophils. Neither central necrosis nor fibrosis was observed in the lesions 2 days after injection.

Seven days after $\beta(1-3)(1-6)$ -glucan injection, 10/10 samples from CGD mice but 1/10 samples from wild-type mice displayed moderate to severe ulcers of the epidermis and dermis. Unlike the lesions observed

2 days after injection, the centre of the lesion showed severe or very severe necrosis (8/10) in CGD mice, while this was never the case in wild-type mice (0/10). H&E staining suggested moderate to severe fibrosis around the necrotic foci in CGD mice (10/10), while in wild-type mice, there was only one case of moderate fibrosis. Thus, central necrosis and fibrosis developed in CGD, but not in wild-type mice.

On H&E slides, numerous neutrophils were seen in the CGD lesions 7 days after $\beta(1-3)(1-6)$ -glucan injection. This was confirmed by immunohisto-

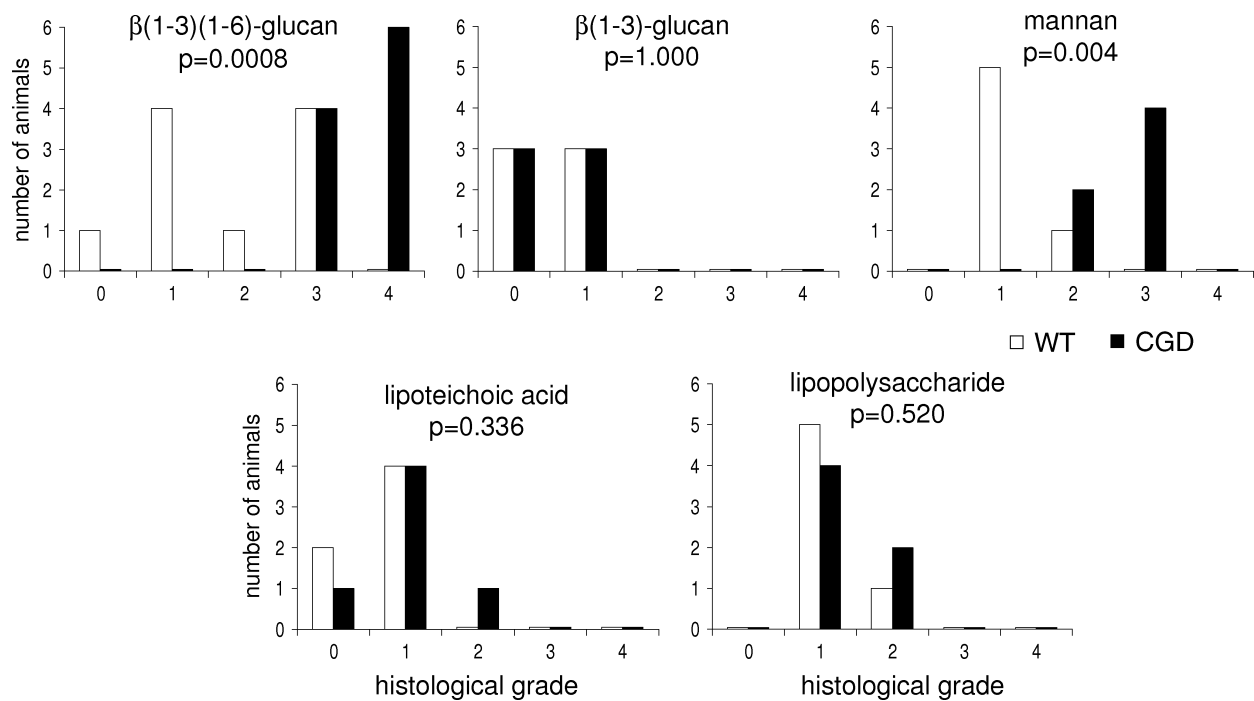

Figure 4. Histology score 7 days after injection of cell wall-derived monosubstances. Histology results from the experiments in Figure 3 were quantified by a histological score. Data are presented as the number of mice (y-axis) that exhibited a given histology score (x-axis). White and black bars represent wild-type and CGD mice, respectively. *p* values, as directly shown in the respective panels, were obtained using Mann–Whitney *U*-tests

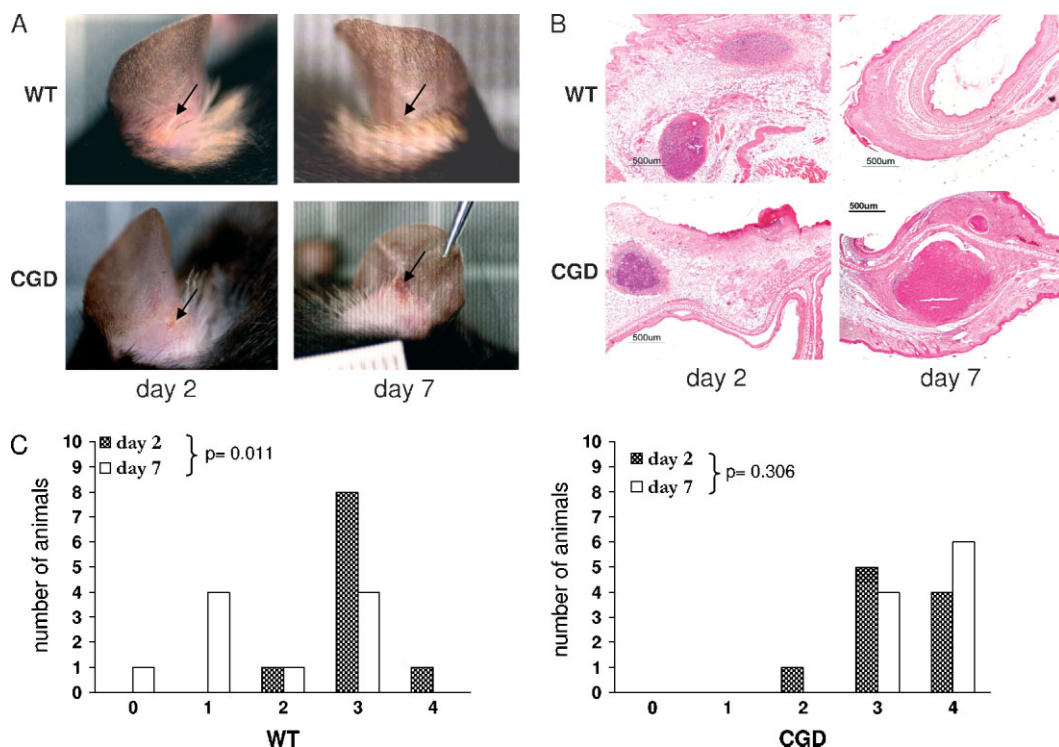

Figure 5. Time course of $\beta(1-3)(1-6)$ -glucan-induced inflammation in wild-type and CGD mice. Wild-type (WT) and CGD mice were injected intradermally with $\beta(1-3)(1-6)$ -glucan (from *Saccharomyces cerevisiae*, 200 μ g) and analysed at days 2 and 7. (A) Macroscopic pictures; injection sites are indicated by arrows. (B) H&E-stained sections of the injection sites. (C) Histology scores of the same experiments ($n = 10$ for both, WT and CGD mice)

chemistry (Figure 6A), which demonstrated abundant myeloperoxidase (MPO)-positive neutrophils in the centre of the CGD lesions, but virtually no MPO staining in wild-type mice. In contrast, F4/80-positive

macrophages were few and — surprisingly — found in the same quantities in CGD and wild-type mice.

To explore the inflammatory cells in CGD lesions further, we analysed a skin explant assay [19].

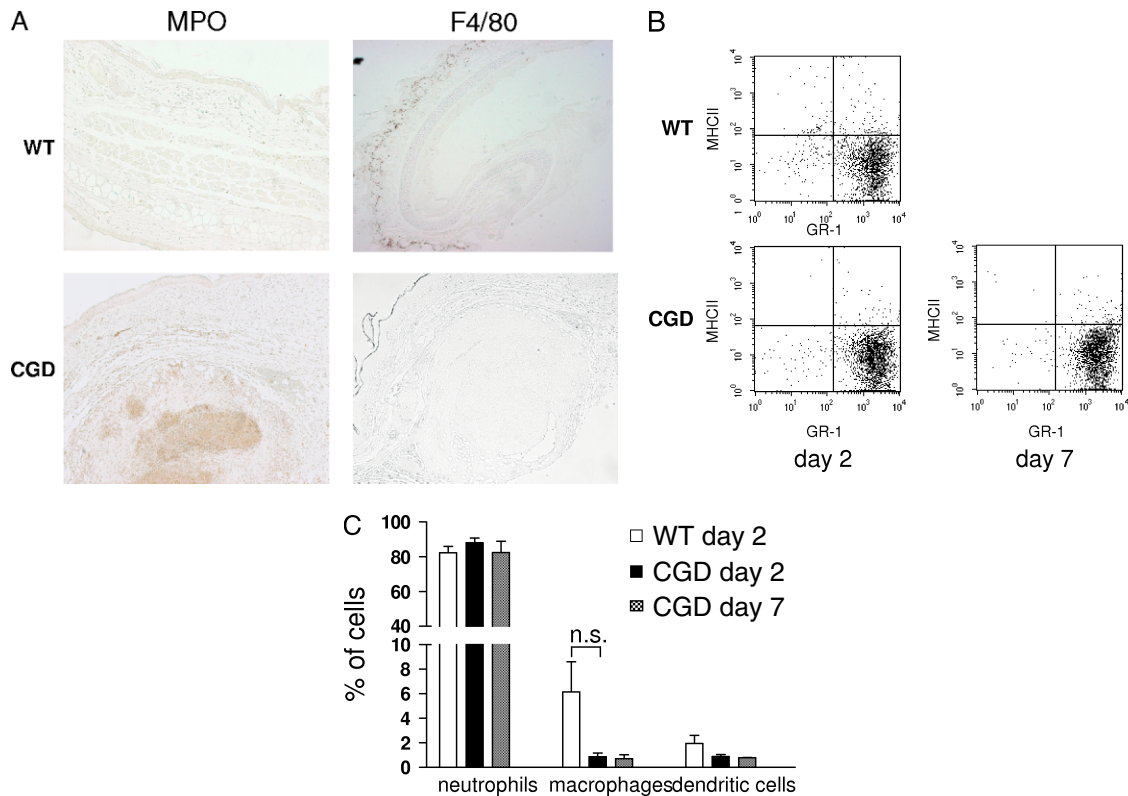

Figure 6. Leukocytes in $\beta(1-3)(1-6)$ -glucan-induced hyperinflammatory lesions. (A) Immunohistological staining of sections from $\beta(1-3)(1-6)$ -glucan-injected mice using antibodies specific for PMN (myeloperoxidase), monocyte/macrophages (F4/80). (B) Ear explants from WT and CGD mice 2 or 7 days after $\beta(1-3)(1-6)$ -glucan injection were incubated for 18 h in culture medium. Egressed cells were stained by Gr-1, MHCII and analysed by flow cytometry. (C) Percentage of egressed neutrophils, macrophages (F4/80^{high}), and dendritic cells (CD11c^{high}, MHCII^{high}) from ear skin explants at days 2 and 7 analysed by flow cytometry

Cells emigrating from skin explants were analysed by flow cytometry (Figures 6B and 6C). On day 2 after injection, egressed cells were mostly neutrophils (MHCII^{low}, Gr-1^{high}), both in wild-type and in CGD samples. The predominance of neutrophils persisted in CGD lesions 7 days after injection, with no discernible augmentation in the number of macrophages. Wild-type tissue 7 days after injection could not be analysed by this method as the inflammation had resolved and virtually no inflammatory cells egressed to the medium.

Cell death in β -glucan-induced CGD hyperinflammation

Two days after $\beta(1-3)(1-6)$ -glucan injection, the majority of cells that egressed from skin explants were apoptotic or necrotic (Figure 7A). There was no difference in the number of apoptotic and necrotic cells between cells from wild-type and CGD mice.

We next investigated whether cell death occurs in the lesions *in vivo* (Figure 7B; black staining shows DNA breaks). The low magnification insets show moderate staining 2 days after $\beta(1-3)(1-6)$ -glucan injection in both wild-type and CGD mice. In contrast, after 7 days, massive staining was observed in the CGD mice, while the staining in the wild-type mice had completely disappeared. High magnification pictures allowed us to assess nuclear morphology and

thereby to distinguish apoptotic and necrotic cells: TUNEL-stained nuclei are small and condensed in apoptotic cells (arrows), but are large and swollen in necrotic cells (arrowheads). Two days after injection, apoptotic together with necrotic nuclei were observed; there was no obvious difference between wild-type and CGD mice. In contrast, 7 days after $\beta(1-3)(1-6)$ -glucan injection, only CGD mice showed massive numbers of apoptotic and necrotic nuclei.

Discussion

The results of this study demonstrate that induction of hyperinflammation is a group effect of fungal cell wall preparations in NOX2-deficient mice. They also show that branched $\beta(1-3)(1-6)$ -glucan, one of the main constituents of fungal cell walls, is the principal culprit. The difference between wild-type and CGD mice resides in the resolution of inflammation, rather than in its initiation. This suggests that ROS play a role in the termination of the inflammatory response.

In our study, hyperinflammation was induced by the cell wall constituents and not by the infectious agents themselves. The preparations used for injection were properly inactivated, as living micro-organisms were never recovered. Staining of the histological sections never showed the presence of pathogens. In addition, the observed inflammatory response depended on the

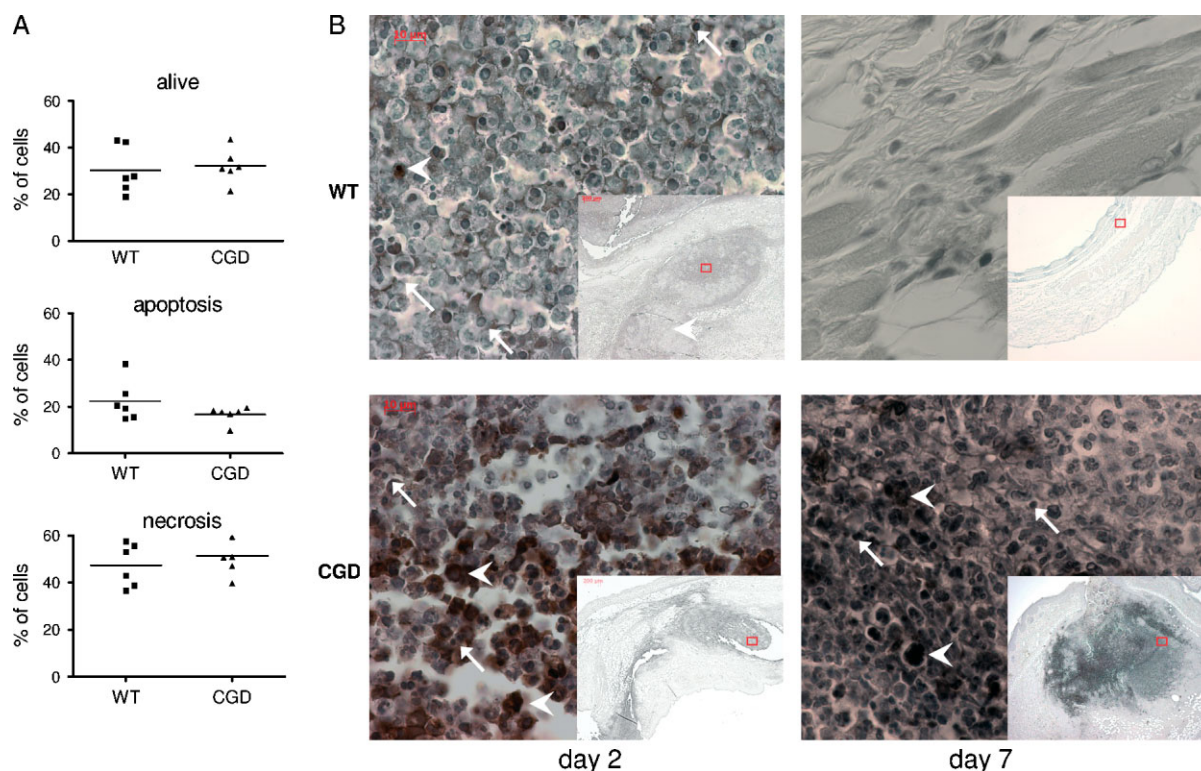

Figure 7. Analysis of cell death. (A) Apoptosis in leukocytes egressed from skin explants (2 days after $\beta(1-3)(1-6)$ -glucan injection; 3 h incubation in culture medium) was analysed by flow cytometry after annexin V and propidium iodide (PI) staining. The percentage of alive (annexin V^{low} and PI^{low}), apoptotic (annexin V^{high} and PI^{low}), and necrotic (annexin V^{high} and PI^{high}) cells is shown. (B) Apoptosis in tissue sections was assessed by TUNEL staining. Left panels show TUNEL-stained sections 2 days and right panels 7 days after $\beta(1-3)(1-6)$ -glucan injection. The boxed areas in the low-magnification insets identify regions shown in the high-magnification pictures. Representative apoptotic nuclei are marked by an arrow; necrotic nuclei by an arrowhead. Scale bars are shown

type of cell wall material injected, which argues against infection with skin contaminants as the cause of inflammation.

Hyperinflammation in CGD mice has been studied with *A. fumigatus* extracts. However, injection of *Saccharomyces cerevisiae* extracts (zymosan) has been widely studied in wild-type (C57Bl6/J) mice as a model of granuloma formation. Typically, a single intraperitoneal injection of zymosan causes progressive accumulation of macrophages and other mononuclear cells, which with time develop into numerous granuloma-like structures [20,21]. Thus, fungal membranes in defined circumstances may cause severe chronic inflammation in wild-type mice, but they did not under our experimental conditions (even at later time points; data not shown). This apparent discrepancy might be explained by the lower doses used in our experiments (0.1–0.2 mg versus 1 mg) [22] and the different site of injection (skin versus peritoneum). Interestingly, central necrosis, characteristic of CGD hyperinflammation, has not been described in granulomatous lesions after high-dose β -glucan injection in wild-type mice. It should be noted that we injected 200 μ g of purified β -glucan, but only 40 μ g of fungal cell wall extract to induce hyperinflammation. Thus, either the configuration of the purified β -glucan leads to a loss in potency or other cell wall components contribute to the magnitude of the inflammatory response.

The development of arthritis has been described in response to intra-articular injection of fungal cell wall [23–27] and is enhanced in mice and rats with deficient phagocyte NADPH oxidase [2,28,29]. It should be noted, however, that only crude fungal cell walls and not purified $\beta(1-3)(1-6)$ -glucans have been investigated in the models. In general, it appears that induction of CGD hyperinflammation and of arthritis by fungal cell walls have different pathomechanisms: non-branched (1–3) β -glucan (laminarin) induces arthritis [30], but not CGD skin hyperinflammation (our study).

Thus, what could be the mechanisms of $\beta(1-3)(1-6)$ -glucan-induced CGD hyperinflammation? The key receptors for the induction of inflammatory responses by $\beta(1-3)(1-6)$ -glucan are dectin-1 and TLR2 (Figure 8) [31–34]. Activation of these receptors leads to pro-inflammatory signals and neutrophil recruitment. Termination of inflammation is thought to include neutrophil apoptosis and clearance by macrophages.

Dectin-1 activation also triggers ROS production [33,35], presumably through the phagocyte NADPH oxidase NOX2. Our results clearly demonstrate that NOX2 activation is not required for activation of pro-inflammatory signals and neutrophil recruitment through $\beta(1-3)(1-6)$ -glucan. On the contrary, NOX2-derived ROS appear to limit the duration of the

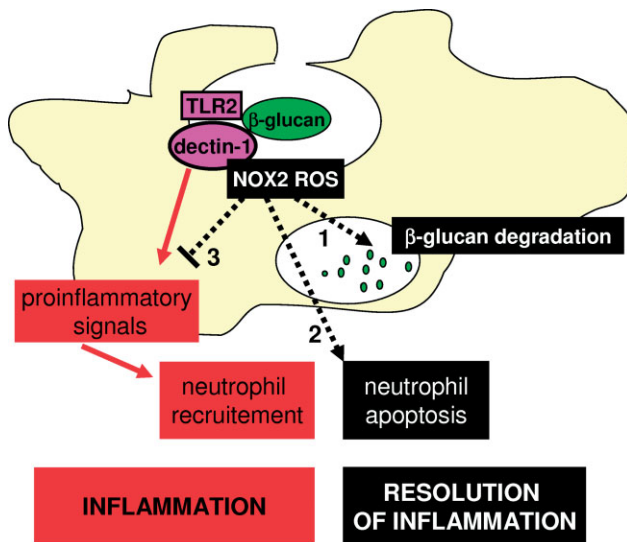

Figure 8. Model of $\beta(1-3)(1-6)$ -glucan-induced CGD hyperinflammation. $\beta(1-3)(1-6)$ -glucan activates dectin-1/TLR2, inducing pro-inflammatory signals and ROS generation through the phagocyte NADPH oxidase NOX2. A phagocyte (neutrophil, macrophage, dendritic cell) generates pro-inflammatory signals in response to $\beta(1-3)(1-6)$ -glucan and thereby causes the recruitment of neutrophils. NOX2-dependent ROS generation may limit inflammation at different levels: (1) degradation of $\beta(1-3)(1-6)$ -glucan; (2) induction of neutrophil apoptosis; and (3) inhibition/destruction of pro-inflammatory signals. Our results favour option (1) and/or (3) over option (2)

inflammation. We found that this hyperinflammation still persisted after 21 days, as described previously with *Aspergillus* cell wall [17]. The strong predominance of neutrophils in $\beta(1-3)(1-6)$ -glucan-induced inflammation might suggest that neutrophil NOX2 is crucial for termination of inflammation, but we cannot formally exclude a role for NOX2 in macrophages.

Three, not mutually exclusive, mechanisms might contribute to the anti-inflammatory activity of NOX2. These three hypotheses — $\beta(1-3)(1-6)$ -glucan degradation, induction of apoptosis of inflammatory cells, and pro-inflammatory signalling — are shown in Figure 8.

$\beta(1-3)(1-6)$ -glucan degradation

Branched $\beta(1-3)(1-6)$ -glucan is known to be resistant to degradation. Plants and fungi have developed β -glucanases, which hydrolyse the 1,3 and 1,6 linkages of the molecule and thereby allow solubilization. In mammals, no enzymes capable of degrading branched β -glucan are known. Consistent with this concept, it has been observed that $\beta(1-3)(1-6)$ -glucan persists up to 6 months after injection in mice [36]. The only hitherto described mechanism of $\beta(1-3)(1-6)$ -glucan removal in mammals is oxidative degradation leading to the generation of $\beta(1-3)$ -glucan (eg laminarin) [36]. $\beta(1-3)$ -glucan has little pro-inflammatory effect (our study) and may even block inflammation in response to $\beta(1-3)(1-6)$ -glucan [33]. Thus, decreased degradation of $\beta(1-3)(1-6)$ -glucan to $\beta(1-3)$ -glucan due to deficient ROS generation in CGD phagocytes

provides a potential mechanism for CGD hyperinflammation. However, given the absence of specific $\beta(1-3)(1-6)$ -glucan antibodies and/or reliable fluorescence labelling techniques for these polysaccharide compounds, a definitive answer will require novel experimental tools.

Induction of apoptosis of inflammatory cells

Apoptosis of inflammatory cells is a potential mechanism to limit inflammation. As opposed to necrosis, apoptosis minimizes activation of inflammatory pathways. There is abundant evidence suggesting that ROS might induce neutrophil apoptosis [37–41]. Consequently, it has been suggested that decreased neutrophil apoptosis is one of the mechanisms of CGD hyperinflammation [4,37,42,43] and arthritis [2]. Our results do not favour this hypothesis. Actually, 2 days after $\beta(1-3)(1-6)$ -glucan injection, there was no difference in the number of apoptotic cells between wild-type and CGD mice. Seven days after injection, the results even went in the opposite direction. Thus, as opposed to the commonly perceived notion that ROS induce cell death, our results demonstrate a massive increase in cell death due to the absence of ROS generation. This could be seen as evidence for a pro-survival function of ROS and NOX enzymes [44–46]. However, it is also possible that ROS-independent pathways towards apoptosis are preferentially stimulated in CGD mice. Indeed, ROS-dependent and ROS-independent pathways both appear to regulate neutrophil apoptosis [3,47].

Pro-inflammatory signalling

NOX2 activity may modulate intracellular signalling pathways. This might occur through regulation of membrane potential and it has indeed been suggested that the more negative membrane potential in CGD granulocytes allows increased Ca^{2+} influx and thereby an enhanced inflammatory response [48]. However, ROS themselves are the most likely candidates to modulate signalling: ROS modulate intracellular signalling molecules, such as kinases, phosphatases, and transcription factors [46], and may either degrade pro-inflammatory mediators (eg S100A8 [49]) or dampen cytokine production [50,51]. Such mechanisms are well documented, but they do not yet explain why CGD hyperinflammation is specific to $\beta(1-3)(1-6)$ -glucan and does not occur in response to pro-inflammatory bacterial cell wall components. The likely answer lies in the nature of the receptor signalling activated by fungal cell walls. $\beta(1-3)(1-6)$ -glucan signals through dectin-1 in cooperation with TLR2 [31,32]. As lipoteichoic acid also signals through TLR2 [52,53] but does not cause CGD hyperinflammation, signalling through dectin-1 is a prime suspect. Further studies will be necessary to understand to what extent and how ROS block pro-inflammatory signalling by dectin-1.

To what extent might the results presented here be relevant for CGD patients? β -glucans are commonly found in the environment [54,55] and in food [56]. It is therefore conceivable that they cause hyperinflammatory symptoms in CGD patients such as lung granuloma and colitis. This might be the first step to integrate the colitis as a disease's manifestations itself and not just as a complication. Such a change in view might improve its diagnosis and clear recommendations for its treatment.

Thus, the mechanisms described in this paper provide new insights into the pathogenesis of CGD and could help us to develop new preventive and therapeutic strategies.

Acknowledgements

We would like to thank Véronique Jacomo of the Geneva Clinical Microbiology Laboratory for help with the microbial cultures; Danielle Ben Nasr, Marie Ebrahim-Malek, and Gorana Perrelet for their excellent technical work in histology; and Karen Bedard, Angelo Gradia, Olivier Preynat-Seauve, and Cécile Guichard for helpful discussions. This work was supported by a grant from the Swiss National Foundation to KHK (3100A0-103725).

References

- Geiszt M, Kapus A, Ligeti E. Chronic granulomatous disease: more than the lack of superoxide? *J Leukoc Biol* 2001;**69**:191–196.
- van de Loo FAJ, Bennink MB, Arntz OJ, Smeets RL, Lubberts E, Joosten LAB, *et al.* Deficiency of NADPH oxidase components p47phox and gp91phox caused granulomatous synovitis and increased connective tissue destruction in experimental arthritis models. *Am J Pathol* 2003;**163**:1525–1537.
- Yamamoto A, Taniuchi S, Tsuji S, Hasui M, Kobayashi Y. Role of reactive oxygen species in neutrophil apoptosis following ingestion of heat-killed *Staphylococcus aureus*. *Clin Exp Immunol* 2002;**129**:479–484.
- Brown JR, Goldblatt D, Buddle J, Morton L, Thrasher AJ. Diminished production of anti-inflammatory mediators during neutrophil apoptosis and macrophage phagocytosis in chronic granulomatous disease (CGD). *J Leukoc Biol* 2003;**73**:591–599.
- Segal A. Absence of both cytochrome b-245 subunits from neutrophils in X-linked chronic granulomatous disease. *Nature* 1987;**326**:88–91.
- Volpp B, Nauseef W, Clark R. Two cytosolic neutrophil oxidase components absent in autosomal chronic granulomatous disease. *Science* 1988;**242**:1295–1296.
- Parkos CA, Dinauer MC, Jesaitis AJ, Orkin SH, Curnutte JT. Absence of both the 91 kD and 22 kD subunits of human neutrophil cytochrome b in two genetic forms of chronic granulomatous disease. *Blood* 1989;**73**:1416–1420.
- Dinauer MC, Pierce EA, Bruns GA, Curnutte JT, Orkin SH. Human neutrophil cytochrome b light chain (p22-phox). Gene structure, chromosomal location, and mutations in cytochrome-negative autosomal recessive chronic granulomatous disease. *J Clin Invest* 1990;**86**:1729–1737.
- Gorlach A, Lee PL, Roesler J, Hopkins PJ, Christensen B, Green ED, *et al.* A p47-phox pseudogene carries the most common mutation causing p47-phox-deficient chronic granulomatous disease. *J Clin Invest* 1997;**100**:1907–1918.
- Levine S, Smith VV, Malone M, Sebire NJ. Histopathological features of chronic granulomatous disease (CGD) in childhood. *Histopathology* 2005;**47**:508–516.
- Harris B, Boles E. Intestinal lesions in chronic granulomatous disease of childhood. *J Pediatr Surg* 1973;**8**:955.
- Schäppi MG, Smith VV, Goldblatt D, Lindley KJ, Milla PJ. Colitis in chronic granulomatous disease. *Arch Dis Child* 2001;**84**:147–151.
- Schäppi MG, Klein NJ, Lindley KJ, Rampling D, Smith VV, Goldblatt D, *et al.* The nature of colitis in chronic granulomatous disease. *J Pediatr Gastro Nutr* 2003;**36**:623–631.
- Chin T, Stiehm E, Falloon J, Gallin J. Corticosteroids in treatment of obstructive lesions of chronic granulomatous disease. *J Pediatr* 1987;**111**:349–350.
- Pollock J, Williams D, Gifford M, Li L, Du X, Fisherman J, *et al.* Mouse model of X-linked chronic granulomatous disease, an inherited defect in phagocyte superoxide production. *Nature Genet* 1995;**9**:202–209.
- Morgenstern DE, Gifford MA, Li LL, Doerschuk CM, Dinauer MC. Absence of respiratory burst in X-linked chronic granulomatous disease mice leads to abnormalities in both host defense and inflammatory response to *Aspergillus fumigatus*. *J Exp Med* 1997;**185**:207–218.
- Petersen JE, Hiran TS, Goebel WS, Johnson C, Murphy RC, Azmi FH, *et al.* Enhanced cutaneous inflammatory reactions to *Aspergillus fumigatus* in a murine model of chronic granulomatous disease. *J Invest Dermatol* 2002;**118**:424–429.
- Goebel WS, Pech NK, Dinauer MC. Stable long-term gene correction with low-dose radiation conditioning in murine X-linked chronic granulomatous disease. *Blood Cells Mol Dis* 2004;**33**:365–371.
- Belkaid Y, Jouin H, Milon G. A method to recover, enumerate and identify lymphomyeloid cells present in an inflammatory dermal site: a study in laboratory mice. *J Immunol Methods* 1996;**199**:5–25.
- Jansen MJ, Hendriks T, Verhofstad AA, Lange W, Geeraedts LM Jr, Goris RJ. Gradual development of organ damage in the murine zymosan-induced multiple organ dysfunction syndrome. *Shock* 1997;**8**:261–267.
- Jinnouchi K, Terasaki Y, Fujiyama S, Tomita K, Kuziel WA, Maeda N, *et al.* Impaired hepatic granuloma formation in mice deficient in C-C chemokine receptor 2. *J Pathol* 2003;**200**:406–416.
- Volman TJ, Hendriks T, Goris RJ. Zymosan-induced generalized inflammation: experimental studies into mechanisms leading to multiple organ dysfunction syndrome. *Shock* 2005;**23**:291–297.
- Keystone EC, Schorlemmer HU, Pope C, Allison AC. Zymosan-induced arthritis: a model of chronic proliferative arthritis following activation of the alternative pathway of complement. *Arthritis Rheum* 1977;**20**:1396–1401.
- Schalkwijk J, van den Berg WB, van de Putte LB, Joosten LA, van den Bersselaar L. Cationization of catalase, peroxidase, and superoxide dismutase. Effect of improved intraarticular retention on experimental arthritis in mice. *J Clin Invest* 1985;**76**:198–205.
- van de Loo FA, Joosten LA, van Lent PL, Arntz OJ, van den Berg WB. Role of interleukin-1, tumor necrosis factor alpha, and interleukin-6 in cartilage proteoglycan metabolism and destruction. Effect of *in situ* blocking in murine antigen- and zymosan-induced arthritis. *Arthritis Rheum* 1995;**38**:164–172.
- van de Loo FA, Arntz OJ, van Enkevort FH, van Lent PL, van den Berg WB. Reduced cartilage proteoglycan loss during zymosan-induced gonarthritis in NOS2-deficient mice and in anti-interleukin-1-treated wild-type mice with unabated joint inflammation. *Arthritis Rheum* 1998;**41**:634–646.
- Weinberger A, Halpern M, Zahalka MA, Quintana F, Traub L, Moroz C. Placental immunomodulator ferritin, a novel immunoregulator, suppresses experimental arthritis. *Arthritis Rheum* 2003;**48**:846–853.
- Hultqvist M, Olofsson P, Holmberg J, Backstrom BT, Tordsson J, Holmdahl R. Enhanced autoimmunity, arthritis, and encephalomyelitis in mice with a reduced oxidative burst due to a mutation in the Ncf1 gene. *PNAS* 2004;**101**:12646–12651.
- Hultqvist M, Holmdahl R. Ncf1 (p47phox) polymorphism determines oxidative burst and the severity of arthritis in rats and mice. *Cell Immunol* 2005;**233**:97–101.
- Yoshitomi H, Sakaguchi N, Kobayashi K, Brown GD, Tagami T, Sakihama T, *et al.* A role for fungal beta-glucans and their receptor

- dectin-1 in the induction of autoimmune arthritis in genetically susceptible mice. *J Exp Med* 2005;**201**:949–960.
31. Brown GD, Gordon S. Immune recognition. A new receptor for beta-glucans. *Nature* 2001;**413**:36–37.
 32. Brown GD, Taylor PR, Reid DM, Willment JA, Williams DL, Martinez-Pomares L, et al. Dectin-1 is a major beta-glucan receptor on macrophages. *J Exp Med* 2002;**196**:407–412.
 33. Gantner BN, Simmons RM, Canavera SJ, Akira S, Underhill DM. Collaborative induction of inflammatory responses by dectin-1 and Toll-like receptor 2. *J Exp Med* 2003;**197**:1107–1117.
 34. Gantner BN, Simmons RM, Underhill DM. Dectin-1 mediates macrophage recognition of *Candida albicans* yeast but not filaments. *EMBO J* 2005;**24**:1277–1286.
 35. Saijo S, Fujikado N, Furuta T, Chung SH, Kotaki H, Seki K, et al. Dectin-1 is required for host defense against *Pneumocystis carinii* but not against *Candida albicans*. *Nature Immunol* 2007;**8**:39–46.
 36. Miura NN, Miura T, Ohno N, Adachi Y, Watanabe M, Tamura H, et al. Gradual solubilization of *Candida* cell wall [beta]-glucan by oxidative degradation in mice. *FEMS Immunol Med Microbiol* 1998;**21**:123–129.
 37. Kasahara Y, Iwai K, Yachie A, Ohta K, Konno A, Seki H, et al. Involvement of reactive oxygen intermediates in spontaneous and CD95 (Fas/APO-1)-mediated apoptosis of neutrophils. *Blood* 1997;**89**:1748–1753.
 38. Gamberale R, Giordano M, Trevani AS, Andonegui G, Geffner JR. Modulation of human neutrophil apoptosis by immune complexes. *J Immunol* 1998;**161**:3666–3674.
 39. Hiraoka W, Vazquez N, Nieves-Neira W, Chanock SJ, Pommer Y. Role of oxygen radicals generated by NADPH oxidase in apoptosis induced in human leukemia cells. *J Clin Invest* 1998;**102**:1961–1968.
 40. Kobayashi SD, Voyich JM, Braughton KR, Whitney AR, Nauseef WM, Malech HL, et al. Gene expression profiling provides insight into the pathophysiology of chronic granulomatous disease. *J Immunol* 2004;**172**:636–643.
 41. Coxon A, Rieu P, Barkalow FJ, Askari S, Sharpe AH, von Andrian UH, et al. A novel role for the beta 2 integrin CD11b/CD18 in neutrophil apoptosis: a homeostatic mechanism in inflammation. *Immunity* 1996;**5**:653–666.
 42. Fadeel B, Ahlin A, Henter JI, Orrenius S, Hampton MB. Involvement of caspases in neutrophil apoptosis: regulation by reactive oxygen species. *Blood* 1998;**92**:4808–4818.
 43. Hampton MB, Vissers MC, Keenan JI, Winterbourn CC. Oxidant-mediated phosphatidylserine exposure and macrophage uptake of activated neutrophils: possible impairment in chronic granulomatous disease. *J Leukoc Biol* 2002;**71**:775–781.
 44. Mochizuki T, Furuta S, Mitsushita J, Shang WH, Ito M, Yokoo Y, et al. Inhibition of NADPH oxidase 4 activates apoptosis via the AKT/apoptosis signal-regulating kinase 1 pathway in pancreatic cancer PANC-1 cells. *Oncogene* 2006;**25**:3699–3707.
 45. Deshpande SS, Angkeow P, Huang J, Ozaki M, Irani K. Rac1 inhibits TNF-alpha-induced endothelial cell apoptosis: dual regulation by reactive oxygen species. *FASEB J* 2000;**14**:1705–1714.
 46. Bedard K, Krause KH. The NOX family of ROS-generating NADPH oxidases: physiology and pathophysiology. *Physiol Rev* 2007;**87**:245–313.
 47. Ottonello L, Frumento G, Arduino N, Bertolotto M, Dapino P, Mancini M, et al. Differential regulation of spontaneous and immune complex-induced neutrophil apoptosis by proinflammatory cytokines. Role of oxidants, Bax and caspase-3. *J Leukoc Biol* 2002;**72**:125–132.
 48. Geiszt M, Kapus A, Nemet K, Farkas L, Ligeti E. Regulation of capacitative Ca²⁺ influx in human neutrophil granulocytes. Alterations in chronic granulomatous disease. *J Biol Chem* 1997;**272**:26471–26478.
 49. Harrison CA, Raftery MJ, Walsh J, Alewood P, Iismaa SE, Thliveris S, et al. Oxidation regulates the inflammatory properties of the murine S100 protein S100A8. *J Biol Chem* 1999;**274**:8561–8569.
 50. Lektstrom-Himes JA, Kuhns DB, Alvord WG, Gallin JI. Inhibition of human neutrophil IL-8 production by hydrogen peroxide and dysregulation in chronic granulomatous disease. *J Immunol* 2005;**174**:411–417.
 51. Bylund J, MacDonald K, Brown K, Mydel P, Collins L, Hancock R, et al. Enhanced inflammatory responses of chronic granulomatous disease leukocytes involve ROS-independent activation of NF-kappaB. *Eur J Immunol* 2007;**37**:1087–1096.
 52. Yoshimura A, Lien E, Ingalls RR, Tuomanen E, Dziarski R, Golenbock D. Cutting edge: recognition of Gram-positive bacterial cell wall components by the innate immune system occurs via Toll-like receptor 2. *J Immunol* 1999;**163**:1–5.
 53. Schwandner R, Dziarski R, Wesche H, Rothe M, Kirschning CJ. Peptidoglycan- and lipoteichoic acid-induced cell activation is mediated by toll-like receptor 2. *J Biol Chem* 1999;**274**:17406–17409.
 54. Milton DK, Alwis KU, Fiset L, Muilenberg M. Enzyme-linked immunosorbent assay specific for (1 → 6) branched, (1 → 3)-beta-D-glucan detection in environmental samples. *Appl Environ Microbiol* 2001;**67**:5420–5424.
 55. Rylander R, Norrhall M, Engdahl U, Tunsater A, Holt PG. Airways inflammation, atopy, and (1 → 3)-beta-D-glucan exposures in two schools. *Am J Respir Crit Care Med* 1998;**158**:1685–1687.
 56. Ko YT, Lin YL. 1,3-beta-glucan quantification by a fluorescence microassay and analysis of its distribution in foods. *J Agric Food Chem* 2004;**52**:3313–3318.

Article 5 L'hyperinflammation observée dans la maladie granulomateuse septique en réponse aux β -glycans est dépendante du récepteur dectine-1 mais pas du TNF α

HYPERINFLAMMATION IN CHRONIC GRANULOMATOUS DISEASE IN RESPONSE TO β -GLUCAN DEPENDS ON DECTIN-1, BUT NOT ON TNF α . Christine Deffert, Maria L. Olleros, Yuan Huiping, Anne-Laure Rougemont, Vincent Jaquet, Y Iwakura, Dominique C. Belli, Irene Garcia*, Karl-Heinz Krause*, Michela G. Schäppi. (En soumission)

Depuis de nombreuses années, les taux élevés de ROS générés par NOX2 sont impliqués dans de divers phénotypes inflammatoires comme les pathologies chroniques pulmonaires (Rahman 2002), les maladies cardio-vasculaires (Heymes, Bendall et al. 2003) et les maladies neuro-dégénératives (Sorce and Krause 2009). Or, l'absence de ROS générés par NOX2, dans les cellules des patients CGD (Schappi, Jaquet et al. 2008) ou dans les souris déficientes en NOX2 (Schappi, Deffert et al. 2008), engendrent également un phénotype inflammatoire. Il est donc de plus en plus communément admis que les ROS générés par NOX2 exercent un effet anti-inflammatoire lorsqu'ils sont produits dans des quantités physiologiques.

Dans ce contexte, il semble assez contradictoire que les taux importants de ROS produits dans les phagosomes des polynucléaires neutrophiles soient impliqués dans les voies de signalisations anti-inflammatoires dépendantes des ROS. A l'inverse, les macrophages et les cellules dendritiques possédant NOX2 et produisant des quantités plus faibles de ROS, pourraient être impliqués dans ces mécanismes anti-inflammatoires. Les macrophages et les cellules dendritiques seraient donc capables de jouer un rôle important dans l'apparition des symptômes inflammatoires observés dans la CGD. L'importance du rôle des macrophages dans les

phénomènes inflammatoires observés dans l'arthrite rhumatoïde en l'absence de p47phox a été démontré (Gelderman, Hultqvist et al. 2007).

En l'absence de NOX2, une production accrue de cytokines pro-inflammatoires, en particulier le TNF α (Petersen, Hiran et al. 2002), a été décrite (Selmeczy, Szelenyi et al. 2003; Hatanaka, Carvalho et al. 2004; Kobayashi, Voyich et al. 2004). Ces études ont essentiellement été effectuées dans des systèmes *in vitro* ou *ex vivo* de neutrophiles ou de monocytes provenant de patients CGD. Il serait donc intéressant de regarder ce mécanisme dans les macrophages ou les cellules dendritiques. De plus, il n'est pas clairement établi, à ce jour, si cette augmentation de production des cytokines est une des causes de l'inflammation ou la conséquence d'une inflammation persistante.

Dans cet article, nous avons cherché à déterminer le rôle des β -glycans dans l'apparition des symptômes inflammatoires de la CGD ainsi que le lien avec la production de TNF α à l'aide de modèles murins doublement déficients : dectine-1/Nox2 et TNF α /Nox2.

**Hyperinflammation in Chronic Granulomatous Disease in response to
 β -glucan depends on dectin-1, but not on TNF α**

Christine Deffert^{*†}; Maria L. Olleros[†]; Huiping Yuan[†]; Anne-Laure Rougemont[‡]; Vincent Jaquet[†]; Shinobu Saijo[§]; Irene Garcia[†]; Karl-Heinz Krause[†]; Michela G. Schäppi^{**†}

^{*}Pediatric Gastroenterology and Transplantation Division, Department of Paediatrics; Geneva University Hospitals, 1211 Geneva 4, Switzerland

[†]Departments of Pathology and Immunology; Medical Faculty and University Hospitals, 1211 Geneva 4, Switzerland

[‡]Departments of Pathology and Immunology; Division of clinical pathology; Medical Faculty and University Hospitals, 1211 Geneva 4, Switzerland

[§]Center for Experimental Medicine, The Institute of Medical Science, The University of Tokyo, Minato-ku, Tokyo 108-8639, Japan.

Corresponding author:

Christine Deffert
Tel: +41 22 379 41 37
Fax: +41 22 379 41 32
email: christine.deffert@unige.ch

ABSTRACT

NOX2 deficiency leads to chronic granulomatous disease (CGD), a genetic disease characterized by impaired killing of microbes and by hyperinflammatory responses. Mechanisms leading to CGD hyperinflammation remain poorly understood. Here we demonstrate that the non-branched bacterial β -glucan curdlan, widely used as a food additive, induces exaggerated skin infiltration and thickening upon intradermal injection in NOX2-deficient mice. This exacerbated inflammation was accompanied by an increased TNF α -release *in vivo*. *In vitro* experiments showed that this response is cell specific, with enhanced TNF α secretion in NOX2-deficient dendritic cells, but surprisingly not in macrophages. To study the potential role of TNF α as a mediator of CGD hyperinflammation, we generated mice double-deficient in NOX2 and TNF α . Interestingly, TNF α deficiency did not protect from CGD hyperinflammation. These results were confirmed by pharmacological inhibition with etanercept. To understand whether receptor-mediated mechanisms play a role in CGD hyperinflammation, we generated mice double-deficient in NOX2 and dectin-1, a key receptor for β -glucan. Dectin-1 deficiency strongly diminished hyperinflammation in NOX2-deficient mice, without entirely abolishing it. We conclude that dectin-1 is the principal receptor mediating β -glucan-induced CGD hyperinflammation. Dectin-1 activation induces the release of inflammatory mediators, which is dampened by concomitant NOX2 activation. NOX2 deficiency is associated with increased TNF α secretion in response to β -glucan, but TNF α appears to be a witness, rather than a mediator of CGD hyperinflammation. Our results also suggest that it will be necessary to verify whether curdlan-containing food is safe for CGD patients.

Keywords:

Hyperinflammation; β -glucan; TNF α ; etanercept; dectin-1.

Introduction

Following microbial infection, leukocytes are recruited to the site of infection in order to destroy invading pathogens by phagocytosis and production of anti-microbial peptides, reactive oxygen (ROS) and nitrogen species (1). It is well established that the killing of specific pathogens such as *Staphylococcus aureus* or specific fungi (2, 3) depends on the generation of large amounts of ROS by the NOX2 (NADPH oxidase) as the genetic alteration of the NOX2 complex results in chronic granulomatous disease (CGD) due to impairment of microbial killing. Although ROS deficiency explain the high susceptibility to infections presented by CGD patients, the link with the inflammatory state is less understood (for review, see (4)).

It is increasingly accepted that the role of NOX2 in inflammation is dual: when NOX2-generated ROS are expressed at high level, a so-called ROS^{high} inflammatory response, the observed phenotype is an inflammatory effect illustrated in several diseases such as chronic lung disorders (5), cardiovascular diseases (6) and neurodegenerative diseases (7). On the other hand, in the case of CGD (4) or in NOX2-deficient mice (8), NOX2-generated ROS are absent, a situation also associated with inflammatory phenotype (9). While in the first case, the high level of ROS is toxic and generates pro-inflammatory components, in the second case, up to now, the mechanism of CGD sterile chronic hyperinflammation is not elucidated (for review, see (4)).

The mechanism leading to hyperinflammation in CGD has been attributed to the overexpression of pro-inflammatory cytokines, in particular TNF α (10, 11). Some studies looked into the NOX2–hyperinflammation relationship, mostly using neutrophils (11-13) as they express large amount of NOX2. Nevertheless, NOX2 is expressed in all phagocytes, including macrophages and dendritic cells (14) producing lower levels of ROS. This low

production may be involved in other cellular signaling functions than microbicidal activity. However TNF α regulation by ROS in dendritic cells has not been well studied.

Hyperinflammatory response upon β -glucan stimulation has been demonstrated in various organs in NOX2- and p47^{phox}-deficient mice (8, 15). β -glucans, major component of fungi cell walls are also present in some bacteria. These carbohydrates are either branched, as β -(1,3)(1,6)-glucan from *Saccharomyces cerevisiae* or linear, as curdlan. This non-branched β -glucan of bacterial origin, is widely used since a decade as texture modifier in the food industry. Recognition of β -glucans is mainly mediated by dectin-1. This receptor is known to mediate ROS (16) and cytokines production in macrophages and dendritic cells (17, 18). However the exact link between dectin-1 and CGD hyperinflammation has never been investigated.

We demonstrated that β -glucan-induced inflammation in absence of NOX2 is associated with high amount of TNF α . However this hyperinflammation does not depend on the enhancement of this pro-inflammatory cytokine. In contrary, dectin-1 involvement is a required step of the β -glucan-induced CGD hyperinflammation.

Materials and Methods

Mice

Wild-type, NOX2- (19), TNF α -(20) and dectin-1- (21) deficient mice were used. All mice were in C57Bl6/J background. Handling and manipulations of the animals were carried out in accordance with the European Community guidelines. All experiments were approved by the ethical committee of the University of Geneva and the Cantonal Veterinary Office. Mice (males or females of 8-12 weeks of age) were maintained in a specific pathogen free (SPF) environment (micro isolator cages, autoclaved food and acidified water) at the animal house of the Geneva Medical Faculty. Food and water were supplied *ad libitum* in a quiet room at 25°C with a 12h light/dark cycle.

NOX2/TNF α and NOX2/dectin-1 double-deficient mice have been generated by a backcross and second generation was used.

Reagents

Curdlan, a β -1,3-glucan preparation from *Alcaligenes faecalis* and lipopolysaccharide (LPS) from *Escherichia coli* (O55:B5), Apocynin (acetovanillone) were purchased from Sigma Aldrich, Schnellendorf, Germany. Etanercept, (Enbrel, Wyeth) a human TNFR2-IgG1 Fc fusion protein that sequesters mouse soluble TNF α , transmembrane TNF α and lymphotoxin- α was obtained at the hospital pharmacy. It was injected intraperitoneally at the dose of 30mg/kg as reported before (22), 1 day before and 2 and 7 days after curdlan intradermal injection.

ROS evaluation

The production of ROS by NOX was measured using Amplex Red (Invitrogen) fluorescence as described previously (23). Total bone marrow cells from wild-type and NOX2-deficient

mice in duplicate were stimulated with 100µg/mL of curdlan and fluorescence was recorded for 60 minutes at 37°C with excitation and emission wavelengths of 550nm and 600nm, respectively. A hydrogen peroxide standard curve was included ranging from 1 to 5000nM. The rate of ROS generation was normalized to the peroxide standard curve.

ROS production by NOX2 in peritoneal macrophages and dendritic cells was performed by luminol-assay (24). Dendritic cells (0.5×10^6) or naïve peritoneal macrophages (0.2×10^6) were resuspended in 100µL HBSS containing 10µg luminol (Sigma) and 5U of horseradish peroxidase (Sigma). Cells were stimulated with PBS or with 100µg/mL curdlan and chemiluminiscence (RLU) was measured over 80 minutes.

Cytokine measurement by ELISA

TNFα and sTNFR2 levels were evaluated by ELISA (Ready&System, Abingdon, United Kingdom) with a sensitivity of 2 to 1000 pg/mL. They were measured on primary cell culture supernatants and on ear-homogenate supernatants at different time-points. Ear homogenate preparation was adapted from previous study (25).

Intradermal injection, ear swelling

For intradermal injections, mice were anaesthetized with isoflurane (Forene, Abbott, Baar, Switzerland) and inoculated intradermally into the ear dorsum. Mice were sacrificed at the indicated time after injection (day 2 or 7).

Ear thickness was measured with a digital gauge (Mitsutoyo, Kanagawa, Japan) before and after intradermal injection on day 1, 2, 3 and 7. The ear swelling (mm) correspond to (ear thickness at day x) – (ear thickness before injection).

Histopathological scoring and immunohistochemistry

Mice were sacrificed (isoflurane anaesthesia followed by cervical dislocation) at 7 days after curdlan injection. Ears were removed, fixed in formalin, and embedded along their great axis in paraffin, to systematically include epidermis and dermis. The microscopic evaluation was performed blindly by an experienced pathologist on HE-stained slides as previously described (8) and a histological grade between 0 and 4 attributed. Score **grade 0**: no inflammatory infiltrate, **grade 1**: minimal inflammatory infiltrate, **grade 2**: moderate inflammatory infiltrate, **grade 3**: severe inflammatory infiltrate and **grade 4**: very severe inflammatory infiltrate or severe inflammatory infiltrate, associated with at least moderate necrosis.

Sections were deparaffinized through graded alcohols, subjected to heat-induced epitope retrieval in 0.01 mol/L citrate buffer (pH 6.0), and incubated overnight at 4°C in PBS-.3% Triton-X100 buffer containing antibody raised against 8-hydroxy-2'-deoxyguanosine (8-OHdG, 1:10, JaICA, Shizuoka, Japan). Sections were then incubated with goat anti-mouse biotinylated secondary antibody (1:100, Vector Laboratories, Burlingame, California) and in Horseradish peroxidase-avidin/biotin complex solution (1:100, Vector Laboratories). Horseradish peroxidase was visualized using 3,3'-diaminobenzidinetetrahydrochloride hydrate (DAB, Sigma-Aldrich). Counterstaining with cresyl violet was performed to visualize cell nuclei.

Isolation and culture of primary mouse macrophages and dendritic cells

Bone-marrow primary cells were obtained from NOX2-deficient and WT mice after bone marrow flushing from the femur and tibia. Cells were collected in DMEM supplemented with 10% FBS and 5% antibiotics at 37°C and 5%CO₂ and were stimulated with medium or curdlan (100ug/mL). Supernatants were collected on day 1, 2 and 7.

Bone-marrow-derived macrophages (BMDM) and bone marrow-derived dendritic cells (BMDC) were obtained from NOX2-deficient and WT mice after bone marrow flushing from the femur and tibia. Cells were collected in DMEM supplemented with 10% FBS, 20% supernatant from L929 cells as source of M-CSF for the BMDM and 0.5% GM-CSF for the BMDC at 37°C and 5%CO₂.

Seven days after L929-conditioned medium for the BMDM, the non-adherent cells were removed, and the remaining adherent macrophages were stimulated with medium, curdlan (10 to 200ug/mL) or LPS (1ug/mL). Supernatants were collected on day 1, 2 and 5.

Seven to 10 days after GM-CSF-complemented medium for the BMDC, the cells were stimulated with medium, curdlan or LPS (1ug/mL). Supernatants were collected on day 1, 2 and 5.

Peritoneal macrophages from naïve (without thioglycollate stimulation) NOX2-deficient and WT mice were isolated by peritoneal washing with 10mL of PBS. After overnight culture at 37°C, medium was removed and the adherent cells were stimulated with medium or curdlan. Supernatants were collected on day 1, 2.

Statistics

Parametric (t-tests) and non parametric tests (Mann-Whitney U) were used. In case of multiple comparisons, Two-way ANOVA test was used and appropriate significance levels were adjusted according to the Bonferroni's correction. Spearman's rank correlation coefficient is used to compare ear swelling measurement and inflammatory grading.

Results

Intradermal injection of the non-branched β -glucan curdlan induces hyperinflammation in NOX2-deficient mice

In a previous study, we have demonstrated that injection of branched β -glucan from fungal cell walls induces hyperinflammation in NOX2-deficient mice (8). In this study, a non-branched β -glucan curdlan was injected intradermally into the ears of wild-type and NOX2-deficient mice. Inflammation was evaluated by measuring locally the ear swelling and histological inflammatory score. The ear swelling increased similarly in response to curdlan injection in both wild-type and NOX2-deficient mice during the first three days. However, at day 7, the swelling had stabilized in wild-type mice, while it was five times larger in NOX2-deficient animals (Fig. 1A). Injection of PBS into the ear caused no or only minimal ear swelling in both types of mice (data not shown).

The histological inflammatory score at day 7 after curdlan injection confirmed that NOX2-deficient mice presented severe, necrotic inflammatory lesions while the inflammation was milder in wild-type mice (Fig. 1B and 1C). The measure of the thickness and the inflammatory score correlated well estimated by Spearman non-parametric correlation test ($p < 0.001$).

To verify whether NOX2 deficiency was associated with absence of oxidative stress in the curdlan-injected ears, immunohistochemical detection was performed on wild-type and NOX2-deficient, using an antibody raised against 8-OHdG, one of the most abundant marker of DNA oxidation (26). While there was no staining in NOX2-deficient inflammatory lesions, wild-type cells in inflammatory lesions stained positively for 8-OHdG antibody (Fig. 1D).

These results show that, in the absence of NOX2-generated ROS, curdlan induces a severe inflammation. Thus, similar to branched β -glucan from fungal cell wall, a non-branched β -glucan of bacterial origin has also the capacity to induce CGD hyperinflammation.

In vivo TNF α production in response to curdlan is increased in NOX2-deficient mice

To characterize the inflammation induced by curdlan, TNF α and the soluble receptor 2 of TNF α (sTNFR2) were measured in the supernatant of ear homogenates (Fig. 2A and B). Seven days after curdlan injection, the levels of TNF α and sTNFR2 were increased, reaching statistical significance in NOX2-deficient mice compared to wild-type. Curdlan injection induced higher amount of TNF α and sTNFR2 compared to PBS injection. We conclude that, under *in vivo* conditions, curdlan-induced release of TNF α and its soluble receptor is negatively regulated by NOX2-generated ROS.

NOX2-deficient bone marrow cells show enhanced TNF α production in response to curdlan

Next, we wanted to investigate whether CGD hyperinflammation could be reproduced in an *in vitro* system using TNF α production as read-out. For this purpose, bone-marrow cells from wild-type and NOX2-deficient mice were isolated and TNF α release was measured at different time points following curdlan stimulation (Fig. 3A). No difference in viability was observed in wild-type and NOX2-deficient bone marrow cells up to seven days in culture and no spontaneous TNF α secretion was detected (data not shown). Upon curdlan stimulation, NOX2-deficient bone-marrow cells released higher amounts of TNF α at all time points measured. Activation of NOX2 by curdlan in bone-marrow cells was confirmed by measuring hydrogen peroxide (H₂O₂) generation using the fluorescent probe Amplex Red. The absence of fluorescence detection in NOX2-deficient cells indicates that NOX2 is indeed the source of hydrogen peroxide generation (Fig. 3B). These experiments show that curdlan can induce H₂O₂ and TNF α release in bone-marrow cells. NOX2-deficient cells are deficient in H₂O₂ release, but secrete markedly enhanced quantities of TNF α .

NOX2-dependent induction of TNF α is cell specific

Bone-marrow is a mixture of different hematopoietic cell types. In order to investigate the cell types involved in the overproduction of TNF α by NOX2-deficient phagocytes, macrophages and dendritic cells were tested separately. Bone-marrow macrophages (BMDM) were derived from wild-type and NOX2-deficient bone-marrow using L929 conditioned-medium. This medium was chosen for its capacity to generate macrophages, which expressed more dectin-1 than those obtained with G-CSF (27), overexpression linked to enhanced TNF α production (28, 29). Subsequently, BMDM were stimulated with different curdlan concentrations for 1 and 2 days.

In day 1, TNF α secretion by BMDM was enhanced by curdlan in a dose dependent manner (Fig. 4A). In response to curdlan stimulation, TNF α was slightly decreased in NOX2-deficient compared to wild-type BMDM. In day 2, TNF α production in response to curdlan decreased and no difference between wild-type and NOX2-deficient mice were observed for all curdlan concentrations used. To verify whether these results (in apparent contradiction with the data obtained *in vivo* and in bone marrow cells) were due to the method of preparation of macrophages, naïve peritoneal macrophages were also tested. No difference in TNF α secretion between NOX2-deficient and wild-type peritoneal macrophages stimulated with 100 μ g/mL curdlan was observed (Fig. 4B). In order to verify the capacity of macrophages to produce ROS, NOX2-deficient and wild-type naïve peritoneal macrophages were stimulated with PBS or curdlan. NOX2 present in wild-type dendritic cells produced ROS upon stimulation with curdlan (Fig. 4C). Similarly to curdlan, NOX2-deficient and wild-type BMDM stimulated with LPS produce comparable amounts of TNF α (Fig. 4D). Thus, as opposed to *in vivo* system and *ex vivo* bone-marrow cells, the presence of NOX2 in isolated macrophages did not affect the release of TNF α induced by curdlan. Therefore macrophages

appear to be not responsible for the increase of TNF α seen in full bone-marrow *in vitro* culture and in the *in vivo* experiments.

We next investigated bone-marrow-derived dendritic cells (BMDC). BMDC from NOX2-deficient mice produced a much higher amount of TNF α compared to wild-type mice, at all curdlan concentrations tested (Fig. 5A). These results were corroborated by experiments using a NOX2 inhibitor/anti-oxidant compound, apocynin: TNF α level with apocynin treatment in wild-type BMDC also led to a moderate increase in TNF α generation (from 3.4 to 4.8 ng/mL; $p=0.03$). In order to verify the capacity of the BMDC to produce ROS, NOX2-deficient and wild-type BMDC were stimulated with PBS or curdlan. NOX2 present in wild-type dendritic cells produced ROS upon stimulation with curdlan (Fig. 5B). As seen for BMDM, LPS-induced TNF α production by BMDC was comparable in wild-type and NOX2-deficient BMDC (Fig. 5C). These results confirm that TNF α production is enhanced in NOX2-deficient dendritic cells by curdlan, but not by LPS. The NOX2 inhibition depends on the stimulus used (no difference for LPS), suggesting that the cellular machinery for TNF α production is normal and that signaling pathways elicited by curdlan are subject to feed-back inhibition by NOX2.

Curdlan-induced CGD hyperinflammation is TNF α -independent

As TNF α release appears to be an indicator of CGD hyperinflammation *in vivo* (as seen in Fig. 2), we tested the hypothesis that increased TNF α is the cause of CGD hyperinflammation through pharmacological and genetic inhibition of TNF α . Etanercept, a TNF α -blocker was administered to mice following curdlan injection.

As expected, vehicle injection showed moderate inflammation in wild-type and severe response in NOX2-deficient mice ($p<0.001$) (Fig. 6A). However, etanercept treatment

remained without effect on inflammation in NOX2-deficient mice as shown by the extent of ear swelling (Fig. 6A) and histology (Fig. 6B).

A conclusive analysis of the role of this cytokine had been obtained by the generation of TNF α /NOX2 double-deficient mice. As reported previously in Figure 1, NOX2-deficient mice showed a massive inflammation compared to wild-type mice. Ears of TNF α -deficient mice presented moderate increase in thickness, comparable to the one observed in wild-type mice (Fig. 6C and 6D). However TNF α /NOX2 double-deficient mice showed no decrease in inflammation compared to NOX2-deficient mice for both ear swelling (Fig. 6C) and histology (Fig. 6D). Injection of PBS caused no or minimal ear swelling in each mice type without any statistical difference (data not shown).

These results show that, in absence of NOX2, pharmacological inhibition or genetic deletion of TNF α is not sufficient to dampen the increased inflammation in NOX2-deficient mice. Thus, TNF α is not a major cause of CGD hyperinflammation.

Hyperinflammation in response to curdlan involves dectin-1

It is possible that a combination of many cytokines, rather than a single player is crucial for CGD hyperinflammation. Thus, an intervention on a more proximal element of the β -glucan-induced cascade might be more efficient. For this purpose, we investigated the principal β -glucan receptor, dectin-1, by generating dectin-1/NOX2 double-deficient mice.

As previously seen, the response was moderate in wild-type mice compared to the massive inflammation observed in NOX2-deficient mice after curdlan stimulation, as shown by ear swelling and histology (Fig. 7A and 7B). Wild-type mice showed a slightly enhanced response compared to dectin-1-deficient mice upon curdlan stimulation (Fig. 7A, 7B and 7C). Both ear swelling and the inflammatory score were markedly reduced in dectin-1/NOX2-deficient compared to NOX2-deficient mice. However, the absence in dectin-1 receptor in

NOX2-deficient was not sufficient to completely abolish curdlan-induced inflammation, as dectin-1/NOX2 showed an increase in ear swelling compared to dectin-1 deficient mice ($p < 0.05$).

In order to determine the role of ROS, H_2O_2 production was measured in bone-marrow from wild-type, NOX2-deficient and dectin-1-deficient mice upon curdlan stimulation. H_2O_2 production was significantly decreased in dectin-1-deficient bone-marrow cells compared to wild-type. However a residual H_2O_2 production was still detected in dectin-1-deficient cells compared to NOX2-deficient cells after curdlan stimulation (Fig. 7D). Thus, β -glucan induces NOX2 activation to produce ROS essentially via the dectin-1 receptor, but not exclusively. Therefore, the difference in inflammatory response observed between dectin-1-deficient and dectin-1/NOX2-deficient, along with small ROS production in dectin-1-deficient mice suggest the presence of additional receptors, which react with curdlan and promote ROS generation.

Discussion

TNF α , a major player in inflammation, has often been cited as a possible culprit in CGD inflammatory states (10, 11, 15). In this study, we show that, although curdlan-induced CGD hyperinflammation is associated with TNF α over production, especially in dendritic cells, this exacerbated inflammatory response is not TNF α -dependent. An essential step in the CGD inflammatory cascade is the presence of dectin-1, which absence leads to a dampened inflammatory response. Yet our results seem to reveal the presence of other(s) receptor(s) involved in CGD hyperinflammation.

In a previous study (8), we showed that hyperinflammation in NOX2-deficient mice is not an universal response to all type of pathogen-associated molecular patterns (PAMPs), but predominantly observed with fungal β -glucan. For example, laminarin, a β -glucan from brown algae did not induce hyperinflammation. Here, we have further investigated the relationship between β -glucan and increased inflammation in NOX2-deficient mice. We demonstrate that CGD hyperinflammation is also observed with branched β -glucan from barley (data not shown), as well as with curdlan, a non-branched β -glucan from the bacterium *Alcaligenes faecalis*. Thus, β -glucan structure, rather than fungal origin determines the hyperinflammatory response. This is important for their potential role in pathogenesis of granuloma and exaggerated inflammation in CGD patients. Indeed various β -glucans are commonly found in air (30, 31) and food (32, 33). This might be particularly relevant with respect to curdlan, investigated more in-depth in this study. Named after its capacity to curdle, curdlan is of interest for the food industry as stabilizer, thickener and texture modifier. Thought to be non-toxic and nutritionally inert, curdlan has obtained acceptance as a food modifier by the FDA in 1996. Since, it is widely used by the food industry, either in small amount as food additive (~1% in sausages, noodles etc) or in large amount as an essential

ingredient (up to 100% in low fat foods or jellies), the impact of such a high nutritional uptake on the health of CGD patient remains to be investigated.

There is increasing evidence for a genetic variability of ROS generation in the general population (23) and NOX polymorphisms leading to low ROS production have been implicated in inflammatory pathologies, such as Crohn's disease (34). Thus, might low ROS generating individuals also respond to curdlan with exaggerated inflammation and might this contribute to the increase in Crohn's incidence observed over the last decades (35)?

The literature on the role of NOX2 in TNF α generation is - at a first glance - difficult to reconcile. While certain studies using NOX2-deficient neutrophils have shown an increased release of TNF α upon various stimuli (11, 36, 37), other results using monocytes/macrophages found no effect (36, 38). Our study demonstrates that the role of NOX2 in TNF α secretion depends on the stimulus and on the cell type. LPS stimulated TNF α secretion is in general not such an enhancing by NOX2 deficiency (36, 38, 39) & our study). And, while β -glucan-induced TNF α release is enhanced in NOX2-deficient dendritic cells, there is no such an enhancing effect of NOX2 deficiency in macrophages. The differing role of NOX2 in macrophages and in dendritic cells is of interest. Differences between these two cell types have been described before with respect to antigen cross presentation, which requires NOX2 in dendritic cells, but not in macrophages (24). Obviously, the sterile inflammatory response studied in our paper, and antigen cross presentation are very different cell functions. Yet, taken together, the two studies suggest that dendritic cells possess NADPH oxidase-sensitive signaling pathways distinct from those found in macrophages. Interestingly, mechanisms leading to zymosan-stimulated TNF α secretion in dendritic cells include the formation of a Card9-Bcl10-Malt1 complex (40), a mechanism not functional in

macrophages (28). Thus, NOX2 appears to negatively regulate cell-specific signaling pathways of dendritic cells, rather than TNF α secretion itself.

Despite being extensively studied, TNF α is still a puzzling cytokine with apparently conflicting multiple functions. This is particularly true in the context of inflammation, where TNF α may trigger inflammatory cascades, but also arrest them. Anti-inflammatory capacities of TNF α include limitation of neutrophils inflammatory response (41) and maintenance of granuloma structure (42, 43). These observations suggest that an antiinflammatory role of TNF α blockade is not universal, but rather pathology-dependent. Initially, TNF α blockers were used for septic shock (44, 45), in which massive release of TNF α was observed, but failed to improve the inflammatory tissue damage in this pathology (46, 47). In contrast, in rheumatoid arthritis and in inflammatory bowel disease, TNF α blockers have become a mainstay of treatment. Of interest is also a genetic immune defect called "common variable immunodeficiency", which, similarly to CGD, presents with a paradoxal association of recurrent infections and autoimmunity (48). There is limited evidence that sterile granulomas in these patients improved after administration of the TNF α -blocker etanercept (49, 50). Thus, our working hypothesis that CGD hyperinflammation might respond to this therapeutic approach was pertinent. However, our results clearly demonstrate that neither neutralization of TNF α by genetic deletion nor its pharmacological inhibition damped hyperinflammation in NOX2-deficient mice. These data suggest that, in CGD, TNF α release is not an inflammatory mediator, but rather it may be secreted as an attempt to resolve the inflammation. Consequently, at this point, there is no rationale for a treatment with TNF α blockers in CGD patients.

The principal receptor for β -glucan is dectin-1. In this study, the decrease in inflammation observed in dectin-1/NOX2-deficient compared to NOX2-deficient mice demonstrate that dectin-1 is a crucial receptor involved in β -glucan-induced CGD inflammation. However, our results also clearly show a dectin-1 independent activity of curdlan (compare dectin-1 and dectin-1/NOX2-deficient mice, Fig. 7A and 7D). Further studies will be necessary to identify this additional curdlan receptor(s); possible candidates include TLR2 (51), complement receptor 3 (CR3) (52), or lactosylceramide. The latter recognizes β -glucan (53) and increases ROS production (54). Whatever its nature is, this second receptor also leads to an increase in TNF α release in the absence of NOX2. Thus, a decrease in the inflammatory response through NOX2-derived ROS is not limited to dectin-1 and may also occur with other types of β -glucan receptors.

A remaining question is the importance of β -glucan in CGD hyperinflammation. Two points should be considered: i) *In vivo* studies on NOX2-deficient mice mainly used sterile stimuli, to create inflammation in different organs (2, 8, 10, 55), substances all containing β -glucans. ii) β -glucan's degradation is dependent on ROS generation in species lacking β -glucanases, such as humans and mice (56).

Better understanding on trigger of CGD hyperinflammation will help us to define specific therapies for patients. In this study, we show that TNF α -blocker seems unlikely to work, while dectin-1 blockers should be considered as new therapeutical perspective in CGD hyperinflammation treatment.

Acknowledgments

We would like to thank Dominique Vesin, Olivier Plastre, Dr Olivier Gaide, Stéphanie Roques, and Annelise Wohlwend, Marie Ebrahim-Malek and Danielle Ben Nasr for excellent technical help and work.

Disclosures

KHK and VJ are founding members of the startup company GenKyoTex (<http://www.genkyotex.com>), which develops NOX inhibitors. The other authors declare no biomedical financial interests or potential conflicts of interest relevant to the subject matter of this work.

References

1. Underhill, D. M., and A. Ozinsky. 2002. Phagocytosis of microbes: complexity in action. *Annu Rev Immunol* 20:825-852.
2. Morgenstern, D. E., M. A. Gifford, L. L. Li, C. M. Doerschuk, and M. C. Dinauer. 1997. Absence of respiratory burst in X-linked chronic granulomatous disease mice leads to abnormalities in both host defense and inflammatory response to *Aspergillus fumigatus*. *J Exp Med* 185:207-218.
3. Winkelstein, J. A., M. C. Marino, R. B. Johnston, Jr., J. Boyle, J. Curnutte, J. I. Gallin, H. L. Malech, S. M. Holland, H. Ochs, P. Quie, R. H. Buckley, C. B. Foster, S. J. Chanock, and H. Dickler. 2000. Chronic granulomatous disease. Report on a national registry of 368 patients. *Medicine (Baltimore)* 79:155-169.
4. Schappi, M. G., V. Jaquet, D. C. Belli, and K. H. Krause. 2008. Hyperinflammation in chronic granulomatous disease and anti-inflammatory role of the phagocyte NADPH oxidase. *Semin Immunopathol* 30:255-271.
5. Rahman, I. 2002. Oxidative stress and gene transcription in asthma and chronic obstructive pulmonary disease: antioxidant therapeutic targets. *Curr Drug Targets Inflamm Allergy* 1:291-315.
6. Heymes, C., J. K. Bendall, P. Ratajczak, A. C. Cave, J. L. Samuel, G. Hasenfuss, and A. M. Shah. 2003. Increased myocardial NADPH oxidase activity in human heart failure. *J Am Coll Cardiol* 41:2164-2171.
7. Sorce, S., and K. H. Krause. 2009. NOX enzymes in the central nervous system: from signaling to disease. *Antioxid Redox Signal* 11:2481-2504.
8. Schappi, M., C. Deffert, L. Fiette, G. Gavazzi, F. Herrmann, D. Belli, and K. H. Krause. 2008. Branched fungal beta-glucan causes hyperinflammation and necrosis in phagocyte NADPH oxidase-deficient mice. *J Pathol* 214:434-444.
9. Schappi, M. G., N. J. Klein, K. J. Lindley, D. Rampling, V. V. Smith, D. Goldblatt, and P. J. Milla. 2003. The nature of colitis in chronic granulomatous disease. *J Pediatr Gastroenterol Nutr* 36:623-631.
10. Petersen, J. E., T. S. Hiran, W. S. Goebel, C. Johnson, R. C. Murphy, F. H. Azmi, A. F. Hood, J. B. Travers, and M. C. Dinauer. 2002. Enhanced cutaneous inflammatory reactions to *Aspergillus fumigatus* in a murine model of chronic granulomatous disease. *J Invest Dermatol* 118:424-429.
11. Hatanaka, E., B. T. Carvalho, A. Condino-Neto, and A. Campa. 2004. Hyperresponsiveness of neutrophils from gp 91phox deficient patients to lipopolysaccharide and serum amyloid A. *Immunol Lett* 94:43-46.
12. Selmezy, Z., J. Szelenyi, K. Nemet, and E. S. Vizi. 2003. The inducibility of TNF-alpha production is different in the granulocytic and monocytic differentiated forms of wild type and CGD-mutant PLB-985 cells. *Immunol Cell Biol* 81:472-479.
13. Kobayashi, S. D., J. M. Voyich, K. R. Braughton, A. R. Whitney, W. M. Nauseef, H. L. Malech, and F. R. DeLeo. 2004. Gene expression profiling provides insight into the pathophysiology of chronic granulomatous disease. *J Immunol* 172:636-643.
14. Gelderman, K. A., M. Hultqvist, A. Pizzolla, M. Zhao, K. S. Nandakumar, R. Mattsson, and R. Holmdahl. 2007. Macrophages suppress T cell responses and arthritis development in mice by producing reactive oxygen species. *J Clin Invest* 117:3020-3028.
15. van de Loo, F. A. J., M. B. Bennink, O. J. Arntz, R. L. Smeets, E. Lubberts, L. A. B. Joosten, P. L. E. M. van Lent, C. J. J. Coenen-de Roo, S. Cuzzocrea, B. H. Segal, S. M. Holland, and W. B. van den Berg. 2003. Deficiency of NADPH Oxidase Components p47phox and gp91phox Caused Granulomatous Synovitis and Increased

- Connective Tissue Destruction in Experimental Arthritis Models. *Am J Pathol* 163:1525-1537.
16. Underhill, D. M., E. Rossnagle, C. A. Lowell, and R. M. Simmons. 2005. Dectin-1 activates Syk tyrosine kinase in a dynamic subset of macrophages for reactive oxygen production. *Blood* 106:2543-2550.
 17. Brown, G. D., J. Herre, D. L. Williams, J. A. Willment, A. S. Marshall, and S. Gordon. 2003. Dectin-1 mediates the biological effects of beta-glucans. *J Exp Med* 197:1119-1124.
 18. Saijo, S., N. Fujikado, T. Furuta, S. H. Chung, H. Kotaki, K. Seki, K. Sudo, S. Akira, Y. Adachi, N. Ohno, T. Kinjo, K. Nakamura, K. Kawakami, and Y. Iwakura. 2007. Dectin-1 is required for host defense against *Pneumocystis carinii* but not against *Candida albicans*. *Nat Immunol* 8:39-46.
 19. Pollock, J., D. Williams, M. Gifford, L. Li, X. Du, J. Fisherman, S. Orkin, C. Doerschuk, and M. Dinauer. 1995. Mouse model of X-linked chronic granulomatous disease, an inherited defect in phagocyte superoxide production. *Nat Gen* 9:202-209.
 20. Marino, M. W., A. Dunn, D. Grail, M. Inglese, Y. Noguchi, E. Richards, A. Jungbluth, H. Wada, M. Moore, B. Williamson, S. Basu, and L. J. Old. 1997. Characterization of tumor necrosis factor-deficient mice. *Proceedings of the National Academy of Sciences* 94:8093-8098.
 21. Nakamura, K., T. Kinjo, S. Saijo, A. Miyazato, Y. Adachi, N. Ohno, J. Fujita, M. Kaku, Y. Iwakura, and K. Kawakami. 2007. Dectin-1 is not required for the host defense to *Cryptococcus neoformans*. *Microbiol Immunol* 51:1115-1119.
 22. Olleros, M. L., D. Vesin, A. F. Lambou, J. P. Janssens, B. Ryffel, S. Rose, C. Fremont, V. F. Quesniaux, D. E. Szymkowski, and I. Garcia. 2009. Dominant-negative tumor necrosis factor protects from *Mycobacterium bovis* Bacillus Calmette Guerin (BCG) and endotoxin-induced liver injury without compromising host immunity to BCG and *Mycobacterium tuberculosis*. *J Infect Dis* 199:1053-1063.
 23. Bedard, K., H. Attar, J. Bonnefont, V. Jaquet, C. Borel, O. Plastre, M. J. Stasia, S. E. Antonarakis, and K. H. Krause. 2009. Three common polymorphisms in the CYBA gene form a haplotype associated with decreased ROS generation. *Hum Mutat* 30:1123-1133.
 24. Savina, A., C. Jancic, S. Hugues, P. Guermonprez, P. Vargas, I. C. Moura, A. M. Lennon-Dumenil, M. C. Seabra, G. Raposo, and S. Amigorena. 2006. NOX2 controls phagosomal pH to regulate antigen processing during crosspresentation by dendritic cells. *Cell* 126:205-218.
 25. Olleros, M. L., R. Guler, D. Vesin, R. Parapanov, G. Marchal, E. Martinez-Soria, N. Corazza, J. C. Pache, C. Mueller, and I. Garcia. 2005. Contribution of transmembrane tumor necrosis factor to host defense against *Mycobacterium bovis* bacillus Calmette-guerin and *Mycobacterium tuberculosis* infections. *Am J Pathol* 166:1109-1120.
 26. Breen, A. P., and J. A. Murphy. 1995. Reactions of oxyl radicals with DNA. *Free Radic Biol Med* 18:1033-1077.
 27. Gersuk, G. M., L. W. Razai, and K. A. Marr. 2008. Methods of in vitro macrophage maturation confer variable inflammatory responses in association with altered expression of cell surface dectin-1. *J Immunol Methods* 329:157-166.
 28. Goodridge, H. S., T. Shimada, A. J. Wolf, Y. M. Hsu, C. A. Becker, X. Lin, and D. M. Underhill. 2009. Differential use of CARD9 by dectin-1 in macrophages and dendritic cells. *J Immunol* 182:1146-1154.
 29. Gantner, B. N., R. M. Simmons, S. J. Canavera, S. Akira, and D. M. Underhill. 2003. Collaborative induction of inflammatory responses by dectin-1 and Toll-like receptor 2. *J Exp Med* 197:1107-1117.

30. Milton, D. K., K. U. Alwis, L. Fiset, and M. Muilenberg. 2001. Enzyme-linked immunosorbent assay specific for (1->6) branched, (1->3)-beta-D-glucan detection in environmental samples. *Appl Environ Microbiol* 67:5420-5424.
31. Thorn, J., and R. Rylander. 1998. Airways inflammation and glucan in a rowhouse area. *Am J Respir Crit Care Med* 157:1798-1803.
32. Ko, Y. T., and Y. L. Lin. 2004. 1,3-beta-glucan quantification by a fluorescence microassay and analysis of its distribution in foods. *J Agric Food Chem* 52:3313-3318.
33. McIntosh, M., B. A. Stone, and V. A. Stanisich. 2005. Curdlan and other bacterial (1->3)-beta-D-glucans. *Appl Microbiol Biotechnol* 68:163-173.
34. Roberts, R. L., J. E. Hollis-Moffatt, R. B. Geary, M. A. Kennedy, M. L. Barclay, and T. R. Merriman. 2008. Confirmation of association of IRGM and NCF4 with ileal Crohn's disease in a population-based cohort. *Genes Immun* 9:561-565.
35. Shanahan, F., and C. N. Bernstein. 2009. The evolving epidemiology of inflammatory bowel disease. *Curr Opin Gastroenterol* 25:301-305.
36. Yang, C. S., D. M. Shin, K. H. Kim, Z. W. Lee, C. H. Lee, S. G. Park, Y. S. Bae, and E. K. Jo. 2009. NADPH oxidase 2 interaction with TLR2 is required for efficient innate immune responses to mycobacteria via cathelicidin expression. *J Immunol* 182:3696-3705.
37. Warris, A., M. G. Netea, J. E. Wang, P. Gaustad, B.-j. Kullberg, P. E. Verweij, and T. G. Abrahamsen. 2003. Cytokine Release in Healthy Donors and Patients with Chronic Granulomatous Disease upon Stimulation with *Aspergillus fumigatus*. *Scandinavian Journal of Infectious Diseases* 35:482-487.
38. Brown, J. R., D. Goldblatt, J. Buddle, L. Morton, and A. J. Thrasher. 2003. Diminished production of anti-inflammatory mediators during neutrophil apoptosis and macrophage phagocytosis in chronic granulomatous disease (CGD). *J Leukoc Biol* 73:591-599.
39. Bylund, J., K. L. MacDonald, K. L. Brown, P. Mydel, L. V. Collins, R. E. Hancock, and D. P. Speert. 2007. Enhanced inflammatory responses of chronic granulomatous disease leukocytes involve ROS-independent activation of NF-kappa B. *Eur J Immunol* 37:1087-1096.
40. Hara, H., C. Ishihara, A. Takeuchi, T. Imanishi, L. Xue, S. W. Morris, M. Inui, T. Takai, A. Shibuya, S. Saijo, Y. Iwakura, N. Ohno, H. Koseki, H. Yoshida, J. M. Penninger, and T. Saito. 2007. The adaptor protein CARD9 is essential for the activation of myeloid cells through ITAM-associated and Toll-like receptors. *Nat Immunol* 8:619-629.
41. Reiling, N., C. Holscher, A. Fehrenbach, S. Kroger, C. J. Kirschning, S. Goyert, and S. Ehlers. 2002. Cutting edge: Toll-like receptor (TLR)2- and TLR4-mediated pathogen recognition in resistance to airborne infection with *Mycobacterium tuberculosis*. *J Immunol* 169:3480-3484.
42. Chakravarty, S. D., G. Zhu, M. C. Tsai, V. P. Mohan, S. Marino, D. E. Kirschner, L. Huang, J. Flynn, and J. Chan. 2008. Tumor necrosis factor blockade in chronic murine tuberculosis enhances granulomatous inflammation and disorganizes granulomas in the lungs. *Infect Immun* 76:916-926.
43. Garcia, I., Y. Miyazaki, G. Marchal, W. Lesslauer, and P. Vassalli. 1997. High sensitivity of transgenic mice expressing soluble TNFR1 fusion protein to mycobacterial infections: synergistic action of TNF and IFN-gamma in the differentiation of protective granulomas. *Eur J Immunol* 27:3182-3190.
44. Abraham, E., R. Wunderink, H. Silverman, T. M. Perl, S. Nasraway, H. Levy, R. Bone, R. P. Wenzel, R. Balk, R. Allred, and et al. 1995. Efficacy and safety of monoclonal antibody to human tumor necrosis factor alpha in patients with sepsis

- syndrome. A randomized, controlled, double-blind, multicenter clinical trial. TNF-alpha MAb Sepsis Study Group. *JAMA* 273:934-941.
45. Cohen, J., and J. Carlet. 1996. INTERSEPT: an international, multicenter, placebo-controlled trial of monoclonal antibody to human tumor necrosis factor-alpha in patients with sepsis. International Sepsis Trial Study Group. *Crit Care Med* 24:1431-1440.
 46. Abraham, E., A. Anzueto, G. Gutierrez, S. Tessler, G. San Pedro, R. Wunderink, A. Dal Nogare, S. Nasraway, S. Berman, R. Cooney, H. Levy, R. Baughman, M. Rumbak, R. B. Light, L. Poole, R. Allred, J. Constant, J. Pennington, and S. Porter. 1998. Double-blind randomised controlled trial of monoclonal antibody to human tumour necrosis factor in treatment of septic shock. NORASEPT II Study Group. *Lancet* 351:929-933.
 47. Reinhart, K., C. Wiegand-Lohnert, F. Grimminger, M. Kaul, S. Withington, D. Treacher, J. Eckart, S. Willatts, C. Bouza, D. Krausch, F. Stockenhuber, J. Eiselstein, L. Daum, and J. Kempeni. 1996. Assessment of the safety and efficacy of the monoclonal anti-tumor necrosis factor antibody-fragment, MAK 195F, in patients with sepsis and septic shock: a multicenter, randomized, placebo-controlled, dose-ranging study. *Crit Care Med* 24:733-742.
 48. Lopes-da-Silva, S., and L. V. Rizzo. 2008. Autoimmunity in common variable immunodeficiency. *J Clin Immunol* 28 Suppl 1:S46-55.
 49. Lin, J. H., M. Liebhaber, R. L. Roberts, Z. Dyer, and E. R. Stiehm. 2006. Etanercept treatment of cutaneous granulomas in common variable immunodeficiency. *J Allergy Clin Immunol* 117:878-882.
 50. Medlicott, S. A., S. Coderre, G. Horne, and R. Panaccione. 2006. Multimodal immunosuppressant therapy in steroid-refractory common variable immunodeficiency sprue: a case report complicating cytomegalovirus infection. *Int J Surg Pathol* 14:101-106.
 51. Yang, Z., and J. S. Marshall. 2009. Zymosan treatment of mouse mast cells enhances dectin-1 expression and induces dectin-1-dependent reactive oxygen species (ROS) generation. *Immunobiology* 214:321-330.
 52. van Bruggen R, D. A., Jansen M, van Houdt M, Roos D, Chapel H, Verhoeven AJ, Kuijpers TW. 2009. Complement receptor 3, not Dectin-1, is the major receptor on human neutrophils for beta-glucan-bearing particles. *Mol Immunol*.
 53. Zimmerman, J. W., J. Linderthum, P. A. Fish, G. P. Palace, T. T. Stevenson, and D. E. DeMong. 1998. A novel carbohydrate-glycosphingolipid interaction between a beta-(1-3)-glucan immunomodulator, PGG-glucan, and lactosylceramide of human leukocytes. *J Biol Chem* 273:22014-22020.
 54. Iwabuchi, K., and I. Nagaoka. 2002. Lactosylceramide-enriched glycosphingolipid signaling domain mediates superoxide generation from human neutrophils. *Blood* 100:1454-1464.
 55. Rajakariar, R., J. Newson, E. K. Jackson, P. Sawmynaden, A. Smith, F. Rahman, M. M. Yaqoob, and D. W. Gilroy. 2009. Nonresolving inflammation in gp91phox^{-/-} mice, a model of human chronic granulomatous disease, has lower adenosine and cyclic adenosine 5'-monophosphate. *J Immunol* 182:3262-3269.
 56. Miura, N. N., T. Miura, N. Ohno, Y. Adachi, M. Watanabe, H. Tamura, S. Tanaka, and T. Yadomae. 1998. Gradual solubilization of Candida cell wall [beta]-glucan by oxidative degradation in mice. *FEMS Immunology and Medical Microbiology* 21:123-129.

Footnotes

1. This work was supported by a grant from Gertrude von Meissner Foundation (ME_8193) and the Swiss National Foundation to KHK (320030_125115).
2. Address correspondence to Dr. Deffert Christine, Departments of Pathology and Immunology, Medical Faculty and University Hospitals, 1211 Geneva 4, Switzerland
E-mail address: christine.deffert@unige.ch
3. Abbreviations used in this paper: sTNF, soluble TNF; BMDM, bone-marrow-derived macrophages; BMDC, bone-marrow-derived dendritic cells; ROS, reactive oxygen species; NOX, NADPH oxidase; CGD, chronic granulomatous disease.

Figure Legends

FIGURE 1. Absence of ROS and hyperinflammation correlate in CGD mice after curdlan injection. NOX2-deficient and wild-type (WT) mice were injected with 200 μ g/50 μ l of curdlan intradermally at the basis of the ear. *A.* The swelling of the ear was measured at day 1, 2, 3 and 7 after injection. Each point represents the mean \pm SEM of 5 different mice. Each inflammatory score is represented as a dot (n=5), median score =4mm for NOX2 versus 2mm for WT (p<0.01). *B.* The severity of the lesions was graded using a histological inflammatory score on H/E stained slides of ears 7 days after curdlan injection. Each inflammatory score is represented as a dot and medians are shown (n=5). *C.* Representative pictures of H/E staining of the injection site in WT and NOX2 at day 7 (Original magnification x20, x200 in magnified views). Pictures a. and b. correspond to grade 0, picture c. to grade 2 and picture d. to grade 4. *D.* Representative pictures of immunohistochemical staining for oxidized nucleic acid 8-hydroxy-2'-deoxyguanosine (8-OHdG) in wild-type and NOX2-deficient inflammatory lesions 7 days after curdlan injection (Original magnification x100). ***=p<0.001; **=p<0.01.

FIGURE 2. Increase of TNF α secretion is correlated with CGD hyperinflammation *in vivo*. NOX2-deficient and wild-type (WT) mice were injected with 200 μ g/50 μ l of curdlan or PBS intradermally at the basis of the ear. *A.* TNF α production was evaluated by ELISA in the supernatants of ear homogenates of mice injected with curdlan or PBS at day 2 and 7. The histograms represent the means \pm SEM of 6-9 samples per mouse group. *B.* Similarly, the type II soluble receptor of TNF α (sTNFR2) was quantified by ELISA. The histograms represent the means \pm SEM of 4 samples per mouse group, of 2 independent experiments. ***=p<0.001; **=p<0.01; *=p<0.05.

FIGURE 3. NOX2-deficient total bone marrow cells have increased TNF α production.

A. Bone-marrow cells from NOX2-deficient and wild-type (WT) mice were cultured in the presence of curdlan (100 $\mu\text{g}/\text{mL}$) during 1, 2 and 7 days. The supernatants were harvested at the time indicated for ELISA quantification of secreted $\text{TNF}\alpha$. The dots represent means $\pm\text{SEM}$ of duplicates in three independent experiments. B. NOX2-deficient and WT freshly isolated bone marrow cells were stimulated with curdlan (100 $\mu\text{g}/\text{mL}$), and ROS production was measured by Amplex Red assay. Results are expressed as the rate of hydrogen peroxide production after PBS or curdlan stimulation, the histograms represent the means $\pm\text{SEM}$ of three independent experiments performed in duplicates. ***= $p<0.001$.

FIGURE 4. $\text{TNF}\alpha$ production by macrophages is independent of NOX2-generated ROS.

Macrophages from wild-type (WT) and NOX2-deficient mice were stimulated by PBS, curdlan or LPS during 1 and 2 days. Supernatants were harvested at each time point for quantification of secreted $\text{TNF}\alpha$ by ELISA. A. Increasing concentrations of curdlan were used to stimulate BMDM from WT (open circles) and NOX2-deficient (full circles) macrophages for 1 or 2 days. Data represent means $\pm\text{SEM}$ of three independent experiments performed in triplicates. *= $p<0.05$. B. $\text{TNF}\alpha$ secretion was evaluated in supernatants from naïve peritoneal macrophages from WT (white bars) and NOX2-deficient (black bars) mice, upon curdlan stimulation (100 $\mu\text{g}/\text{mL}$) during 1 and 2 days. Day 0 corresponds to non stimulated cells. Data represent means $\pm\text{SEM}$ of triplicates in three independent experiments. C. ROS production generated from WT and NOX2-deficient peritoneal macrophages was measured using luminol-dependent chemiluminescence. Results are expressed as the rate of ROS production after PBS or curdlan stimulation, the histograms represent the means $\pm\text{SEM}$ of three independent experiments performed in duplicates. D. $\text{TNF}\alpha$ secretion was evaluated on WT (white bars) and NOX2-deficient (black bars) BMDM stimulated with LPS (1 $\mu\text{g}/\text{mL}$) during

1 and 2 days. Day 0 corresponds to non-stimulated cells. Data represent mean \pm SEM of three independent experiments performed in triplicates.

FIGURE 5. TNF α production by bone-marrow dendritic cells is dependent of NOX2-generated ROS. Dendritic cells from wild-type (WT) and NOX2-deficient mice were stimulated by PBS, curdlan or LPS during 1 and 2 days. Supernatants were harvested at each time point for quantification of secreted TNF α by ELISA. *A.* Increasing concentrations of curdlan were used to stimulate BMDC from WT (open circles) and NOX2-deficient (full circles) mice for 1 or 2 days. Data represent means \pm SEM of 3 to 6 independent experiments performed in triplicates. ***= p <0.001, **= p <0.01, *= p <0.05. *B.* ROS production from WT and NOX2-deficient BMDC was measured using luminol-dependent chemiluminescence. Results are expressed as the rate of ROS production after PBS or curdlan stimulation. The histograms represent the means \pm SEM of three independent experiments performed in triplicates. *C.* TNF α secretion was evaluated on BMDC from WT (white bars) and NOX2-deficient (black bars) in culture stimulated with LPS (1 μ g/mL) during 1 and 2 days.

FIGURE 6. TNF α is not the mediator of CGD hyperinflammation. Mice were injected with 200 μ g/50 μ l of curdlan intradermally at the basis of the ear. The ear swelling was measured at day 1, 2, 3 and 7 following injection. *A.* NOX2-deficient and WT (wild-type) mice treated by etanercept or vehicle were injected with curdlan. Each point represents mean \pm SEM of 4 to 9 mice in each group at indicated time-points. ***= p <0.001 (NOX2-deficient treated by etanercept vs. WT mice treated by etanercept). *B.* Representative pictures of day 7 post-injection with H/E staining of WT (grade 1) and NOX2-deficient (grade 4) mice treated with sTNFR2-Fc, etanercept (Original magnification x20). *C.* TNF α -deficient, TNF α /NOX2 double-deficient, NOX2-deficient and wild-type (WT) mice were injected by curdlan. Each point represents mean \pm SEM of 4 to 9 mice in each group at indicated time-points. ***= p <0.001 (deficient mice vs. WT). *D.* Representative H/E pictures of TNF α (grade 1)

and TNF α /NOX2-deficient (grade 4) mice at the injection site at day 7 (Original magnification x20).

FIGURE 7. The inflammation triggered by curdlan in CGD mice is dectin-1-dependent.

Mice were injected with 200 μ g/50 μ l of curdlan intradermally at the basis of the ear. The ear swelling was measured at day 1, 2, 3 and 7 following injection. *A.* Dectin-1-deficient, NOX2-deficient, dectin-1/NOX2 double-deficient and wild-type (WT) mice were injected. Each point represents mean \pm SEM of 3 different mice. *= p <0.05, ***= p <0.001 (deficient mice vs. WT). *B.* The severity of the lesions was graded using a histological inflammatory score using H/E staining of the ears 7 days after curdlan injection. Each inflammatory score is represented as a dot and medians are shown. **= p <0.01, ***= p <0.001. *C.* Representative pictures of H/E staining of ears sections of dectin-1 (grade 1) and dectin-1/NOX2-deficient (grade 2) mice at day 7 after curdlan injection (Original magnification x20, x200 in magnified views). *D.* NOX2-deficient and wild-type (WT) freshly isolated bone-marrow cells were stimulated with curdlan (100 μ g/mL) and ROS production was measured by Amplex Red assay. Results are expressed as the rate of peroxide production, the histograms representing means \pm SEM of 3 independent experiments performed in duplicates. **= p <0.01, ***= p <0.001.

FIGURE 1

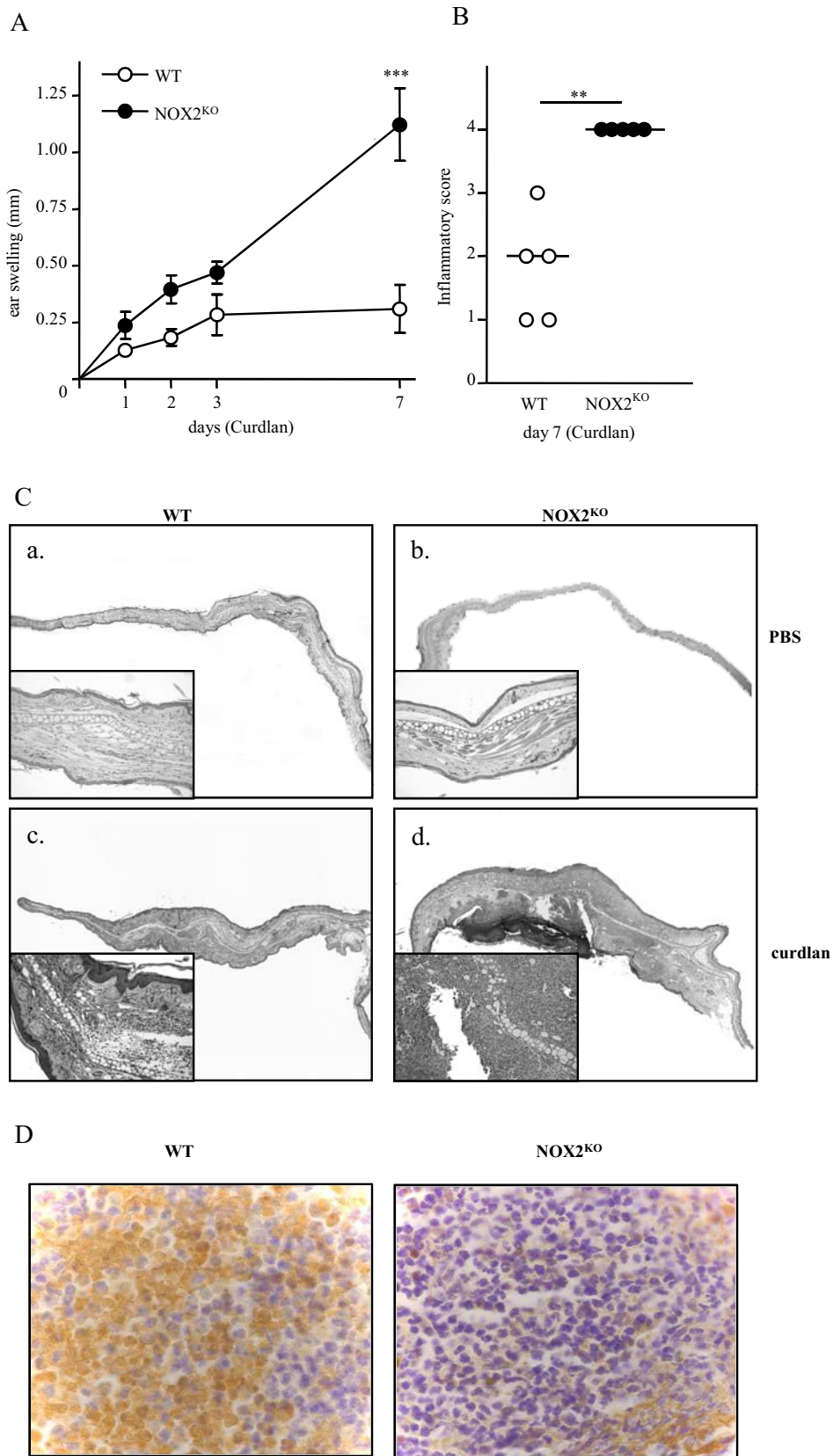

FIGURE 2

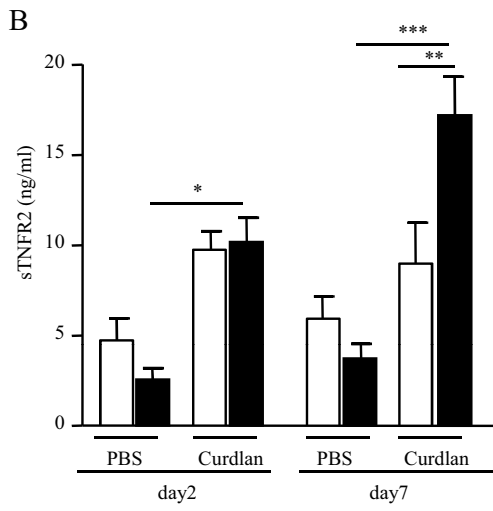
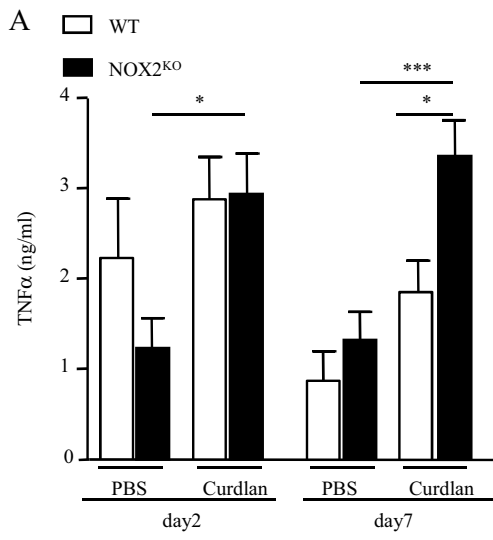

FIGURE 3

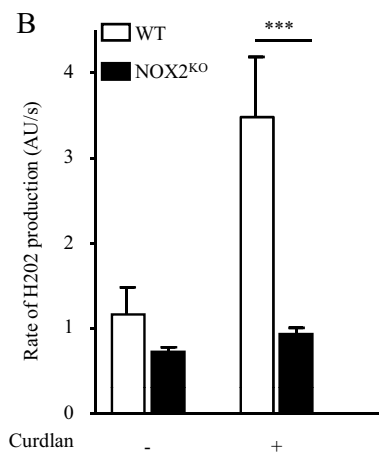
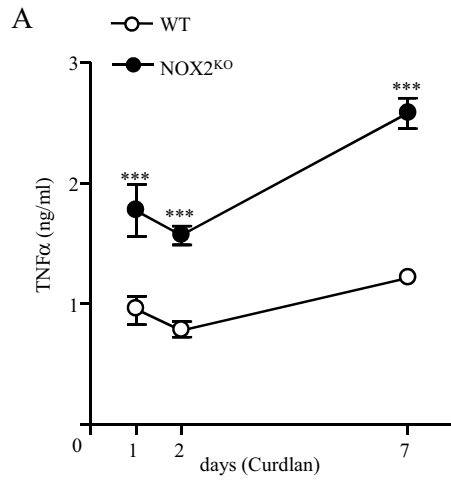
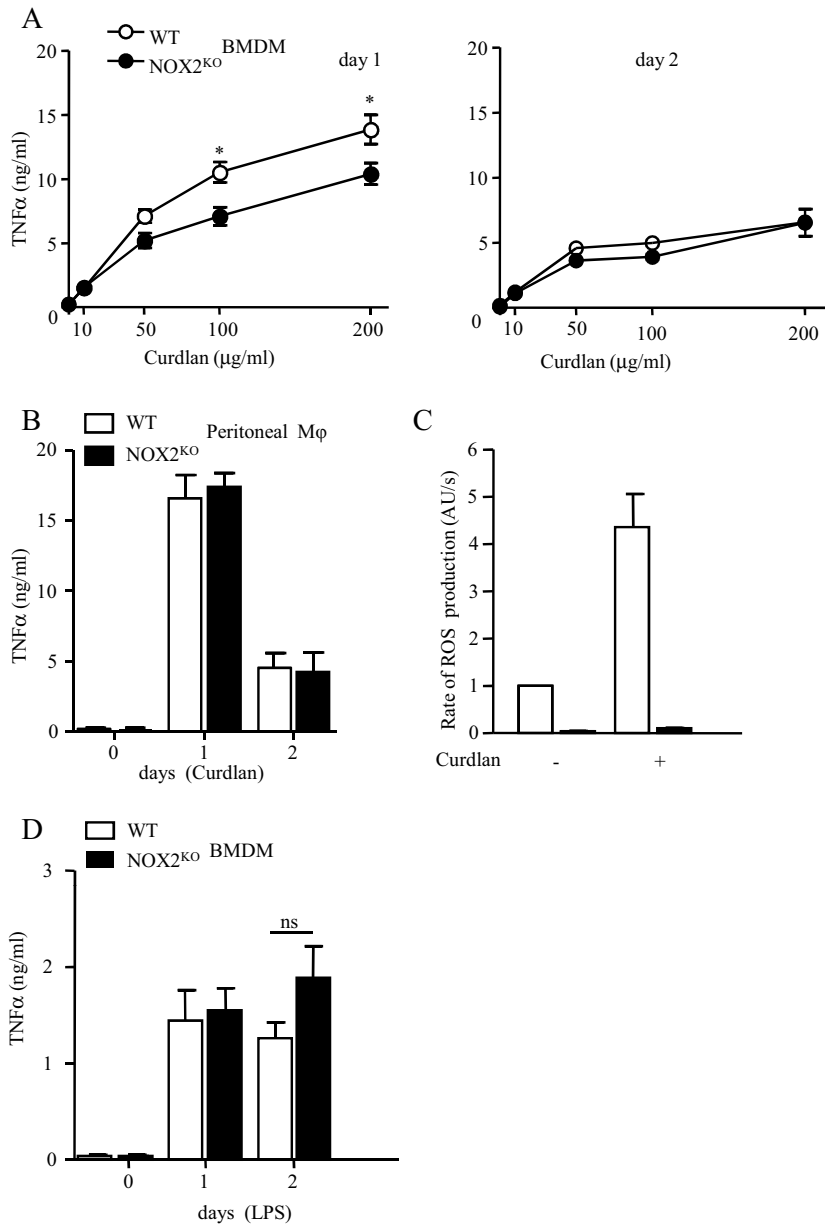

FIGURE 4



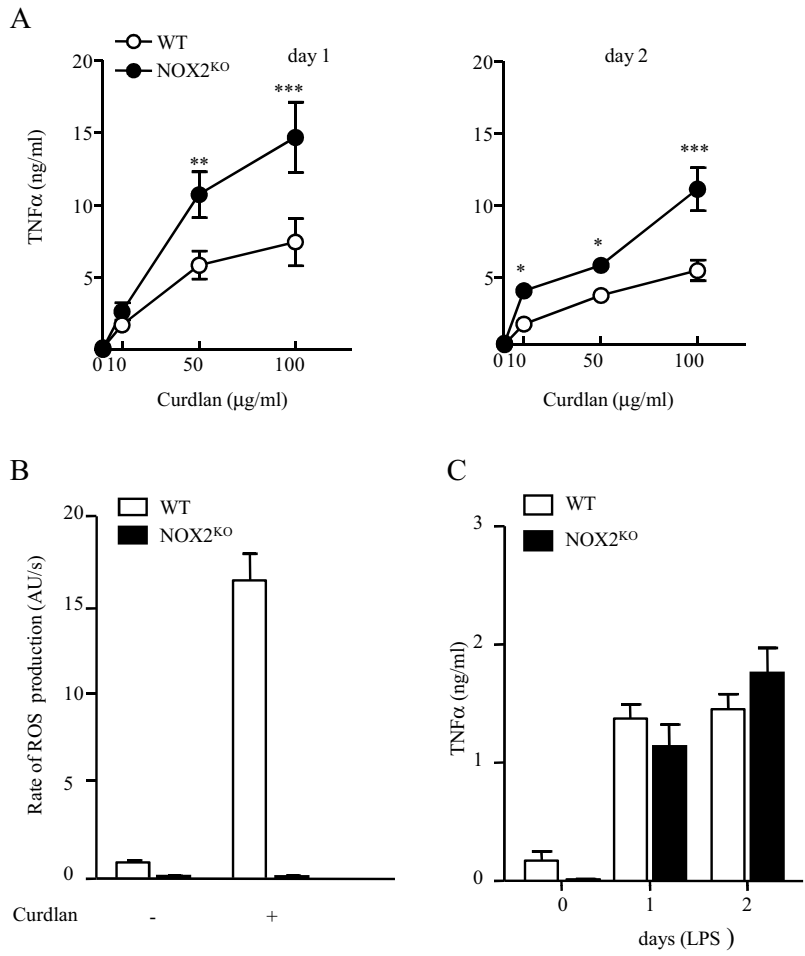

FIGURE 6

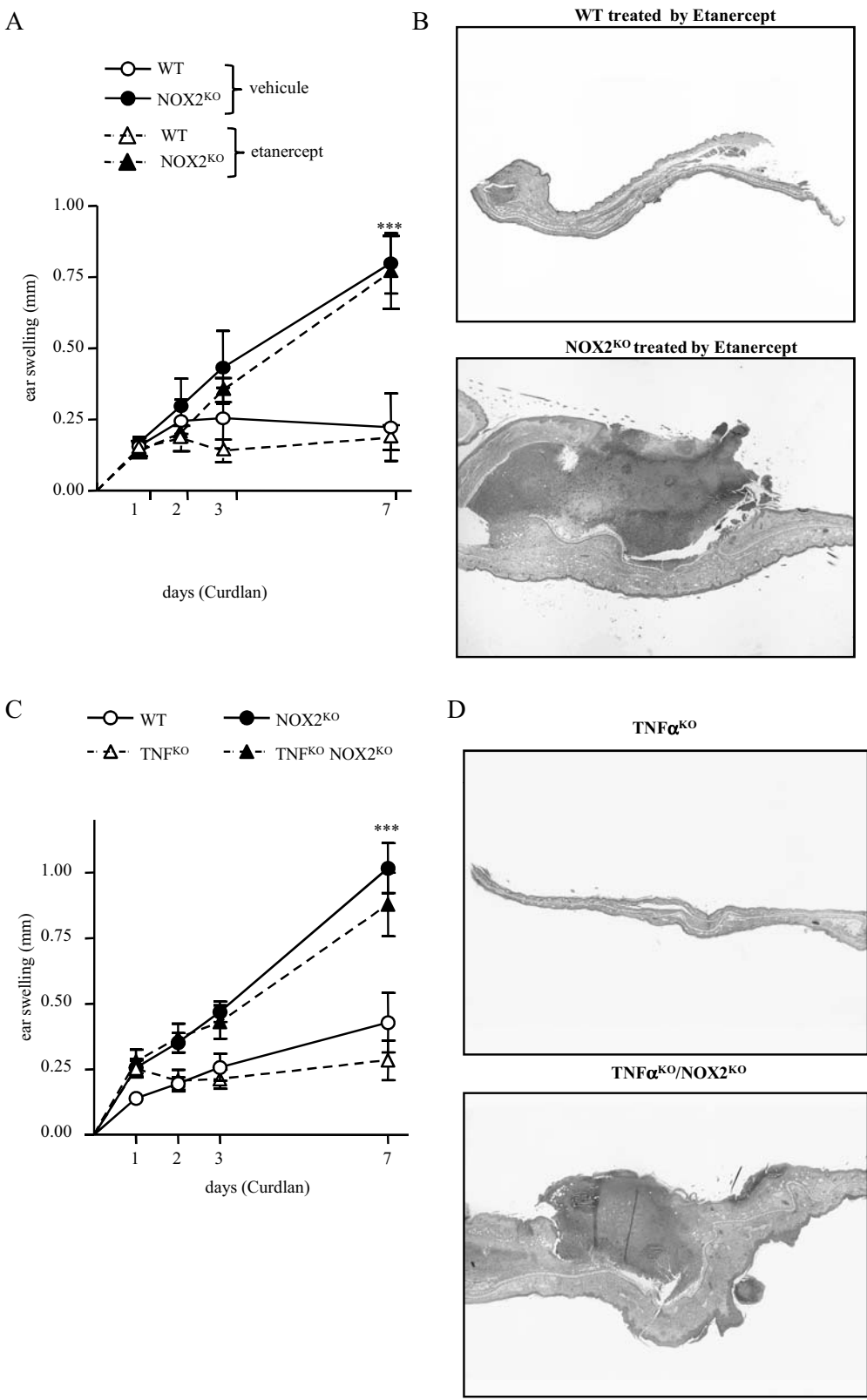
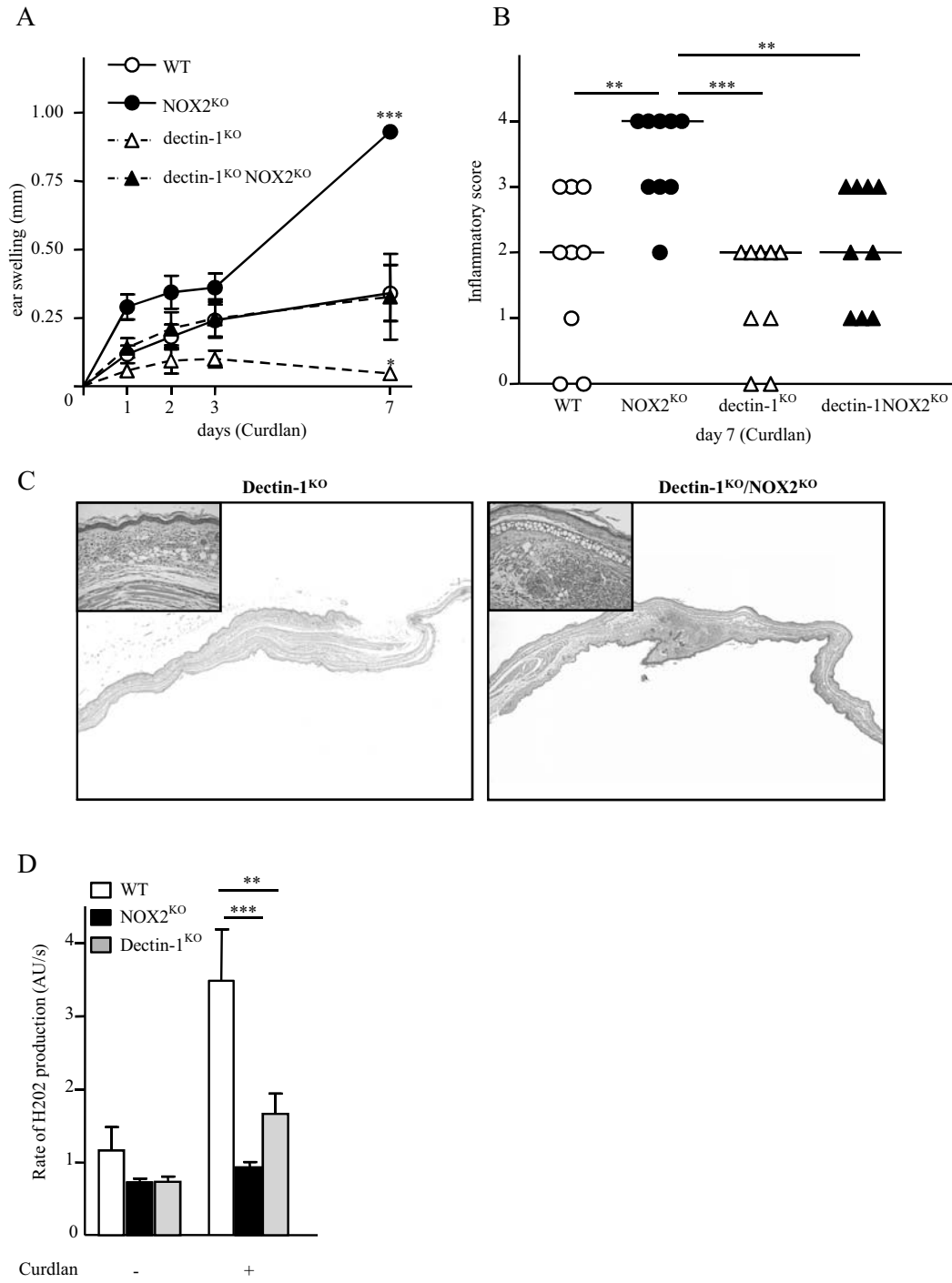

FIGURE 7



DISCUSSION GENERALE ET PERSPECTIVES

Discussion générale et perspectives

Depuis l'identification en 1978 et le clonage de NOX2 en 1980, de nombreuses études ont contribué à la connaissance du rôle biologique, de la signalisation intracellulaire et de la régulation des différentes isoformes des NOX. Leurs rôles physiologiques s'étendent à présent au-delà du simple pouvoir microbicide contre les pathogènes. La littérature scientifique impliquant les différentes NADPH oxydases est en plein essor : 10 414 articles concernent les NADPH oxydases dont 204 articles depuis janvier 2009 (le 16/09/09). Nous avons utilisé 2 approches opposées : soit la production de ROS est délétère et en l'inhibant le phénotype observé chez les souris déficientes est amélioré, soit inversement, l'absence de ROS est délétère et les souris déficientes présentent un phénotype pathologique. Ceci reflète la dualité des rôles des ROS produits par les NOX. Les fortes concentrations de ROS sont toujours délétères mais leur absence n'est pas toujours bénéfique. L'activation des NADPH oxydases est finement régulée afin d'éviter l'apparition de lésions tissulaires et/ou vasculaires.

NOX1 et Angiotensine II

Le lien entre NOX1 et hypertension artérielle induite par l'angiotensine II est maintenant bien établi. A l'inverse, le rôle de NOX1 lors de l'hypertension artérielle induite par d'autres molécules hypertensives était peu connu. La dopamine et essentiellement son récepteur D2 jouent un rôle important dans l'hypertension et celle-ci semble être dépendante de la production des ROS sans que l'on sache exactement quelle isoforme de NOX est impliquée (Armando, Wang et al. 2007). Lors de notre étude, une autre catécholamine, la norépinéphrine (noradrénaline), utilisée lors des chutes de tension artérielle, a engendré une augmentation de la pression artérielle chez les souris sauvages mais également, et avec la même intensité, chez les souris déficientes en Nox1 (article 1). La norépinéphrine induit une vasoconstriction par des mécanismes distincts de

Discussion générale et perspectives

l'angiotensine II (Schiffrin 1994). Il semble donc que le rôle de Nox1 dans la régulation de la pression soit essentiellement impliqué dans l'hypertension artérielle induite par l'angiotensine II.

De plus, nous avons démontré dans cet article que le lien entre Nox1 et l'angiotensine II était plus large que la seule régulation de la pression artérielle. En effet, les souris déficientes en Nox1 semblent protégées de la survenue d'anévrismes ou de dissections aortiques par rapport aux souris sauvages lors de l'infusion par angiotensine II. Ce rôle de Nox1 dans la survenue de ces lésions de dilatation semble contre-intuitif puisqu'un des mécanismes majeurs de ces lésions est une infiltration précoce de la média des vaisseaux par les monocytes et macrophages évoquant plutôt un rôle de NOX2. La diminution de la formation d'anévrisme chez les souris déficientes en $p47^{\text{phox}}$ abonde également dans ce sens. Plusieurs hypothèses peuvent expliquer cette divergence. i) La diminution de pression artérielle induite par l'angiotensine II chez les souris déficientes en Nox1 pourrait les protéger de la survenue d'anévrisme. Or lors de l'administration de norépinéphrine, les souris déficientes en Nox1 n'étaient pas protégées de l'hypertension artérielle et ne présentaient pas pour autant d'anévrisme ou de dissection aortique. Cette observation suggérant que l'hypertension n'est pas un mécanisme suffisant à lui seul pour induire un anévrisme corrèle avec une étude récente (Cassis, Gupte et al. 2009). ii) Certains sous-types de macrophages tissulaires comme la microglie (Sorce and Krause 2009) et les ostéoclastes (Sasaki, Yamamoto et al. 2009) expriment, en plus de NOX2, NOX1 voire NOX4. Il est possible que les macrophages des vaisseaux expriment également NOX1. iii) Les sous-unités régulatrices de NOX1 sont préférentiellement NOXO1 et NOXA1. Or la production de ROS par NOX1 peut également être activée par $p47^{\text{phox}}$ et $p67^{\text{phox}}$ avec une efficacité moindre. iv) Cette divergence n'en est peut être pas une et l'association NOX1-NOX2 est indispensable à la formation d'anévrisme.

Discussion générale et perspectives

TIMP-1 (Tissue inhibitors of matrix metalloproteinases), un inhibiteur des matrix métalloprotéases (MMP) et en particulier de la MMP-9 joue également un rôle important dans la prévention du développement de dissections aortiques et d'anévrismes puisque les souris déficientes en TIMP-1 présentent un risque accru à la formation de ces lésions (Eskandari, Vijungco et al. 2005). Il existe également une corrélation entre la présence de polymorphismes de TIMP-1 et un risque accru d'anévrisme chez l'Homme (Ogata, Shibamura et al. 2005). Au contraire, nous avons observé que l'expression d'ARN messenger et de protéine de TIMP-1 était augmentée chez les souris déficientes en Nox1 sous angiotensine II, comparativement aux souris sauvages. Cette augmentation ne s'accompagnait pas d'une diminution de la MMP-9 mais engendrait un déséquilibre important de l'équilibre protéases/antiprotéases en faveur des antiprotéases. Le déséquilibre de cette balance MMP-9/TIMP-1 en faveur des protéases, plus que leurs taux respectifs, a été impliqué dans la survenue de dissections aortiques (Kadoglou and Liapis 2004). Ces résultats démontrent que l'induction de TIMP-1 par l'angiotensine II, est régulée négativement par Nox1. Ceci pourrait expliquer l'augmentation d'anévrismes chez les souris sauvages par rapport aux souris déficientes en Nox1.

De plus, les aortes des souris sauvages infusées avec l'angiotensine II présentaient une accumulation de collagène au niveau de la matrice extracellulaire (Gavazzi, Banfi et al. 2006) avec une augmentation sensible de l'ARNm du procollagène III par rapport aux aortes de souris déficientes en Nox1. Ces dernières présentaient aussi une forte augmentation de l'ARNm de Cthrc1 (Collagen triple helix repeat containing 1) par rapport aux souris sauvages. Cette protéine inhibe les effets du TGF- β (tumor growth factor β) et induit la diminution du collagène I et III (LeClair, Durmus et al. 2007). La résultante de ces effets est une diminution de la fibrose.

L'augmentation de cette molécule anti-fibrotique chez les souris déficientes en Nox1 pourrait également être impliqué dans la prévention des anévrismes.

En conclusion, un nouveau rôle des ROS générés par Nox1 dans la formation des anévrismes aortiques induits par l'angiotensine II a été démontré. Parmi les nombreux évènements intervenant dans la formation de ces lésions, Nox1 pourrait jouer un rôle dans la régulation de l'activité des métallo-protéases ainsi que dans la fibrose, essentiellement en régulant négativement les facteurs inhibiteurs comme TIMP-1 et Cthrc1.

Ce nouveau rôle renforce la relation entre les ROS générés par Nox1 et l'angiotensine II, correspondant à une littérature scientifique déjà bien étoffée. En réponse à l'angiotensine II, Nox1 va être à l'origine d'une génération de ROS associée à une augmentation de la réponse calcique. Ces 2 phénomènes sont inhibés dans les cellules musculaires lisses déficientes en Nox1. De nombreuses revues (Lassegue and Clempus 2003; Garrido and Griendling 2009) ont expliqué les diminutions des phénotypes induits par l'angiotensine II en l'absence de Nox1 en considérant cette NADPH oxydase comme agissant en aval du stimulus. Mais il se peut également que Nox1 joue un rôle direct sur l'angiotensine II ou sur son récepteur AT1. Dans l'article 2, nous avons démontré que l'absence de réponse à l'angiotensine II dans les cellules musculaires lisses déficientes en Nox1 était également due à une absence du récepteur AT1 à la membrane plasmique. La localisation à la membrane de ce récepteur a pu être retrouvée lors d'ajout de H₂O₂ et lors de la réexpression de Nox1 dans les cellules déficitaires. L'adressage du récepteur AT1, qui possède un domaine cavéoline-like (Leclerc, Auger-Messier et al. 2002), à la membrane est sous la dépendance des cavéolines (Ishizaka, Griendling et al. 1998) ainsi que sous celle des ROS (Ushio-Fukai, Zuo et al. 2005). De plus, une étude a décrit une localisation de NOX1 au niveau

des cavéoles riches en cavéolines (Hilenski, Clempus et al. 2004). Cette compartimentalisation permettrait d'expliquer le fait que de faibles quantités de ROS générées basalement par NOX1 puissent être responsables de l'adressage d'un récepteur à la membrane plasmique.

NOX4 présente en quantité importante dans les cellules musculaires lisses mais pas au niveau des cavéoles, ne compense pas l'absence de NOX1 dans l'adressage du récepteur AT1 à la membrane plasmique.

Mais est-ce que l'absence du récepteur AT1 à la membrane des cellules musculaires lisses peut expliquer les effets sur la pression artérielle? Il semble difficile d'extrapoler ces données obtenues à partir d'aortes et de cellules musculaires lisses des vaisseaux puisque les effets de l'angiotensine II s'exercent également au niveau du système nerveux central et des reins. Plusieurs hypothèses peuvent quand même être émises :

✓ L'angiotensine II en se fixant à son récepteur AT1 stimulerait la production de ROS par Nox1 qui agirait alors sur la concentration intracellulaire de Ca^{2+} pour induire la contraction des cellules musculaires lisses. De plus, Nox1 serait impliqué dans l'amplification de la réponse en augmentant le nombre de récepteurs AT1 à la membrane.

✓ Nox1 pourrait également n'agir qu'en amont du récepteur AT1. Les diminutions des phénotypes dans les souris, les tissus ou les cellules musculaires lisses observés en l'absence de Nox1 ne seraient finalement dues qu'à l'absence du récepteur AT1 à la membrane. L'augmentation du transcrit de Nox1 après stimulation par l'angiotensine II serait induite afin d'augmenter le nombre de récepteurs à la membrane et amplifier la réponse.

En conclusion, cette différence majeure de l'expression à la membrane plasmique du récepteur AT1 en fonction de la présence de Nox1 ne peut-être anodine et reflète sans doute un mécanisme important dans la régulation des effets de l'angiotensine II. Ces données font de Nox1 une cible thérapeutique de plus en plus importante dans l'hypertension ainsi que dans les anévrismes aortiques.

Nox1 n'est pas la NADPH oxydase la plus abondante au niveau de la paroi des vaisseaux et pourtant nous avons démontré que sa présence est essentielle. Nous aimerions nous focaliser ensuite sur les voies de transduction du signal spécifique de NOX1 au niveau des vaisseaux et essentiellement le lien qui pourrait exister entre les ROS générés par NOX1 et le NO (monoxyde d'azote). Un concept de plus en plus admis est la production d'ions superoxydes par découplage de la NO synthase endothéliale (eNOS). Réciproquement, il semblerait également que les ions superoxydes provoquent le découplage de la eNOS directement mais également par diminution de la DDAH1 (diméthylarginine diméthylaminohydrolase 1) et augmentation l'ADMA (asymétrical diméthylarginine,). L'ADMA, analogue de la L-arginine, est le principal inhibiteur endogène des NO synthases (NOS), enzymes clés impliquées dans l'homéostasie vasculaire, puisqu'elles sont responsables de la synthèse du NO. L'ADMA est principalement métabolisée par voie enzymatique impliquant la DDAH1, enzyme particulièrement sensibles à l'état rédox du milieu environnant. Les augmentations d'ADMA par diminution de la DDAH1 engendrent donc des diminutions de NO. Or lors de l'analyse du microarray, nous avons observé une augmentation très importante de la DDAH1 induite par l'angiotensine II chez les souris déficientes en Nox1 par rapport aux souris sauvages. Les ROS produits par Nox1 aurait-il un rôle spécifique dans la régulation de la production du NO par une inhibition de l'expression de

la DDAH1 en réponse à l'angiotensine II, mais également sur la balance NO/O₂⁻ par découplage de l'eNOS ?

NOX1 et dommages pulmonaires induits par l'hyperoxie

La production excessive de ROS lors des conditions d'hyperoxie induit une exacerbation des dommages pulmonaires (Tasaka, Amaya et al. 2008) au niveau d'une lignée de cellules murines épithéliales pulmonaires (MLE-12) (Zhang, Shan et al. 2003) mais également au niveau de cellules humaines endothéliales pulmonaires (Parinandi, Kleinberg et al. 2003). Le rôle des ROS produits par la mitochondrie (Brown, Harris et al. 2001) a été évoqué mais n'était pas compatible avec les mécanismes impliqués comme l'augmentation de la mort cellulaire (Barazzone, Horowitz et al. 1998) due, essentiellement, à l'activation des MAPK (Mitogen-activated protein kinase) (Zaher, Miller et al. 2007) et des caspases (Lee and Choi 2003). NOX1 et NOX2 exprimées dans les cellules épithéliales et endothéliales pulmonaires, en faisait des candidats potentiels.

Nous avons démontré dans l'article 3 que Nox1 participait à la production de ROS impliqués dans les dommages pulmonaires et la mort cellulaire induits par l'hyperoxie mais pas Nox2. Les souris déficientes en Nox1 étaient protégées des fortes concentrations d'oxygène par rapport aux souris sauvages et déficientes en Nox2. De plus, l'expression de l'ARNm de Nox1 est augmentée en condition hyperoxique aussi bien dans les cellules épithéliales que les cellules endothéliales pulmonaires. A l'inverse, Nox2 est très faiblement exprimée dans ces 2 types de cellules en condition basale et cette expression n'est pas augmentée après hyperoxie. Et finalement, la production de ROS induite par l'hyperoxie dans les poumons, les cellules épithéliales et endothéliales pulmonaires est largement diminuée en l'absence de Nox1 mais inchangée en l'absence de Nox2.

La mort cellulaire est un des mécanismes majeurs des lésions pulmonaires induites par l'hyperoxie. Elle est dépendante des ROS produits puisque le traitement par un inhibiteur non spécifique des NOX, le DPI, diminue la mort cellulaire dans les MLE-12 (Parinandi, Kleinberg et al. 2003; Zhang, Shan et al. 2003). Nox1 joue un rôle important dans cette mort cellulaire puisque les poumons des souris déficientes en cette NADPH oxydase présentent des marquages de l'ADN fragmenté (TUNEL), de la caspase-3 activée et du clivage de PARP-1 (Poly (ADP-ribose) polymerase family, member 1) diminués par rapport aux souris sauvages et déficientes en Nox2. La diminution des phénomènes de mort a été observée également dans les cultures primaires de cellules épithéliales et endothéliales déficientes en Nox1.

Cette diminution de la mort cellulaire en l'absence de Nox1 est associée à une diminution de la phosphorylation des kinases ERK (Extracellular signal-regulated kinase) et JNK (c-Jun N-terminal kinases) dans les homogénats de poumons des souris déficientes en Nox1 soumises à une hyperoxie. L'implication de Nox1 dans la phosphorylation de JNK et la mort cellulaire induites par le TNF α avaient déjà été suggérées lors d'études *in vitro* dans les cellules épithéliales alvéolaires murines transfectées par un siRNA de Nox1 (Kim, Morgan et al. 2007; Pantano, Anathy et al. 2007). L'induction de la mort cellulaire par activation des kinases n'est certainement pas le seul mécanisme impliqué puisque les voies apoptotiques des caspases évaluées par le marquage des cellules par un anticorps anti-caspase-3 activée étaient moins nombreuses que les cellules présentant une fragmentation de l'ADN (TUNEL). Ces résultats semblent corrélés avec l'absence d'efficacité complète sur la mort cellulaire induite par l'hyperoxie lors de l'administration d'un inhibiteur de plusieurs caspases, le Z-VAD (Metrailler-Ruchonnet, Pagano et al. 2007).

En conclusion, Nox1, mais pas Nox2, est impliqué dans la génération des ROS au niveau des cellules épithéliales et endothéliales pulmonaires induite par l'hyperoxie. Cette production est responsable de la mort cellulaire, en partie par une activation des kinases ERK et JNK mais certainement aussi par une toxicité par oxydation non spécifique de composés cellulaires. Nox1 est à nouveau une cible potentielle thérapeutique lors des syndromes respiratoires des prématurés particulièrement sensibles aux fortes concentrations de ROS.

Nous aimerions maintenant définir plus précisément les rôles des cellules épithéliales et endothéliales dans ce modèle d'hyperoxie. Pour cela, une approche in vivo est en cours, la création de souris par mutagenèse conditionnelle. En l'occurrence, il s'agit d'utiliser des souris qui portent le gène Nox1 dont une partie essentielle est entourée par 2 séquences loxP (locus of X-over of P1). Une seconde lignée de souris exprimera la recombinaise Cre dans un type cellulaire déterminé. Dans les cellules qui exprimeront cette recombinaise, il y aura excision des séquences lox-P et donc d'une partie du gène Nox1. Le croisement des souris loxP-Nox1 avec les souris Cre nous permettra d'obtenir des souris déficientes en Nox1 uniquement dans les cellules épithéliales pulmonaires lorsque l'expression de la recombinaise Cre sera sous la dépendance du gène SP-C et des souris déficientes en Nox1 uniquement dans les cellules endothéliales pulmonaires lorsque l'expression de la recombinaise Cre sera sous la dépendance du gène ve-cadherine. Ces souris déficientes en Nox1 uniquement dans les cellules cibles nous permettront de définir le ou les rôles de Nox1 spécifique(s) au niveau des cellules épithéliales et endothéliales.

NOX2 et Inflammation

Les patients atteints de maladie granulomateuse septique présentent en association avec les infections bactériennes et fongiques récurrentes, des lésions inflammatoires sévères. L'origine de ces dernières est dépendante du déficit en NOX2 mais indépendante des infections. L'injection intradermique de parois d'*Aspergillus fumigatus* inactivées par la chaleur dans les oreilles de souris déficientes en Nox2 a été capable d'induire une inflammation exacerbée alors que les souris sauvages ayant reçu le même traitement ne présentaient plus d'inflammation 10 jours après l'injection (Petersen, Hiran et al. 2002). Dans l'article 4, nous avons injecté, selon le même protocole, différentes parois de champignons (*Aspergillus fumigatus*, *Saccharomyces cerevisiae* et *Candida albicans*), de bactéries gram négative (*Pseudomonas aeruginosa* et *Escherichia coli*) et de bactérie gram positive (*Staphylococcus aureus*) dans les oreilles de souris sauvages et déficientes en Nox2. Sept jours après l'injection des ces parois stériles, seuls les champignons avaient été capables d'induire une inflammation persistante en l'absence de Nox2. Aucune différence entre les 2 types de souris n'a été observée après l'injection des parois bactériennes à l'exception d'une légère différence après l'injection de *S. aureus*. Un composé commun aux parois des champignons devait être à l'origine de l'induction de cette inflammation en l'absence de Nox2. Deux des composés majeurs de la paroi des champignons sont les β -glycans et les mannanes. Le zymosan, un extrait de paroi de *Saccharomyces cerevisiae* contenant ces deux polysides, a été impliqué dans des phénomènes inflammatoires caractérisés par la formation de granulomes (Jansen, Hendriks et al. 1997; Jinnouchi, Terasaki et al. 2003). De plus, l'injection intra-articulaire de zymosan induit une arthrite sévère chez les souris déficientes en Nox2, en p47^{phox} (van de Loo, Bennink et al. 2003; Hultqvist, Olofsson et al. 2004) et chez les rats présentant une mutation spontanée du gène Ncf1 (Hultqvist and Holmdahl 2005). L'injection de

Discussion générale et perspectives

ces composés séparément dans notre modèle d'inflammation cutanée à permis de déterminer le rôle prédominant des β -glycans par rapport aux mannanes dans l'induction de l'inflammation en l'absence de Nox2. Les mannanes induisent une inflammation plus sévère chez les souris déficientes en Nox2 par rapport aux souris sauvages mais le grade inflammatoire 4 correspondant à la gravité maximale n'a jamais été atteint. Les β -glycans ont, quant à eux, généré le plus souvent des scores inflammatoires de 4 chez les souris déficientes en Nox2.

Les injections de LPS (lipopolysaccharide) et de LTA (acide lipotechoïque), PAMPs des différentes bactéries injectées, ont confirmé les résultats obtenus avec les parois inactivées par la chaleur. Elles ont également permis d'éliminer le rôle possible d'une contamination par le LPS de nos préparations de β -glycans ou de mannanes dans l'induction de l'inflammation en l'absence de Nox2. Le LPS n'induirait donc pas une réponse inflammatoire via Nox2. Ces résultats sont en accord avec le fait que les macrophages provenant de souris sauvages ou déficientes en Nox2 stimulés par le LPS produisent les mêmes quantités d'une cytokine pro-inflammatoire majeure, le TNF α (Yang, Shin et al. 2009) mais également, de façon surprenante les mêmes quantités de ROS. Ces résultats sont en accord avec les données impliquant TLR4, principal récepteur du LPS, dans l'activation de NOX4 au niveau de plusieurs types cellulaires (Park, Jung et al. 2004; Park, Chun et al. 2006; Patel, Bailey et al. 2006; Maloney, Sweet et al. 2009).

Les lésions cutanées inflammatoires induites par les β -glycans provenant de *S. cerevisiae*, très exacerbées en l'absence de Nox2 7 jours après l'injection, étaient au contraire identiques entre les souris sauvages et déficientes en Nox2 2 jours après l'injection. Il semble donc que la résolution de l'inflammation soit dépendante de Nox2 alors que l'induction de la réponse inflammatoire par les β -glycans ne le soit pas.

Un phénomène important de la résolution de l'inflammation est l'apoptose des cellules inflammatoires (Serhan, Brain et al. 2007), phénomène qui semble dépendant de Nox2 pour les neutrophiles (Fadeel, Ahlin et al. 1998; Hampton, Fadeel et al. 1998; Hiraoka, Vazquez et al. 1998). Nous n'avons pu retrouver lors de nos expériences *in vivo* ou *ex vivo* une différence d'apoptose entre les souris sauvages et déficientes en Nox2. Mais ces résultats ne permettent pas d'exclure qu'une absence d'élimination du matériel apoptotique voire nécrotique par les macrophages soit dépendante de Nox2 comme il l'a été décrit (Brown, Goldblatt et al. 2003; Frasch, Berry et al. 2008; Fernandez-Boyanapalli, Frasch et al. 2009). Ce phénomène est peut être à relier à la forte nécrose tissulaire observée chez les souris déficientes en Nox2.

En conclusion, une des origines possibles de l'inflammation en l'absence de Nox2 est les β -glycans. Ils induisent une inflammation qui ne peut se résoudre en l'absence de Nox2. De plus, la nécrose tissulaire générée par les β -glycans ne dépend pas d'un retard ou d'une absence d'apoptose des neutrophiles déficients en Nox2.

Dans l'article 5, nous avons évalué un autre mécanisme impliqué dans l'hyperinflammation de la CGD, le déséquilibre de la balance cytokines pro-inflammatoires/anti-inflammatoires. Les cytokines pro-inflammatoires produites en quantité plus importante lors du déficit en NOX2 sont l'IL-8 (Hatanaka, Carvalho et al. 2004) et essentiellement le TNF α (Petersen, Hiran et al. 2002; Selmezy, Szelenyi et al. 2003). Mais il n'est pas clairement établi, à ce jour, si cette augmentation de production de TNF α est une des causes de l'inflammation ou la conséquence d'une inflammation persistante.

Discussion générale et perspectives

En injectant les β -glycans comme stimulus connu pour induire une inflammation dépendante de Nox2, nous avons observé que cette hyperinflammation était associée à un taux très élevé de TNF α dans les souris déficientes en Nox2. A l'inverse, ce taux de TNF α était identique chez les souris déficientes en Nox2 et sauvages lorsque ces dernières présentaient une inflammation équivalente, c'est-à-dire 2 jours après l'injection de β -glycans. En parallèle, la stimulation par les β -glycans a induit une forte production de TNF α dans les cellules de moelle osseuse déficientes en Nox2 par rapport aux cellules sauvages, quelque soit la durée de la stimulation. Ces résultats démontrent qu'il existe une augmentation de TNF α en l'absence de Nox2 en parallèle de la persistance de l'inflammation et suggèrent que Nox2 pourrait réguler la production de TNF α .

Il est de plus en plus admis que les fortes concentrations de ROS sont dédiées à la microbicidie ainsi qu'à l'oxydation non spécifique de molécules diverses dans les conditions pathologiques. A l'inverse, les faibles taux de ROS seraient plutôt impliqués dans la transduction des voies de signalisation aidée par la compartimentalisation des NADPH oxydases. Or, la mesure du TNF α n'avait jamais été effectuée dans les macrophages et les cellules dendritiques qui produisent des taux de ROS beaucoup plus faibles que les neutrophiles. Nous avons démontré que les ROS générés par Nox2 sont capables de moduler la production de TNF α dans les cellules dendritiques mais pas dans les macrophages que ces derniers soit dérivés de la moelle osseuse ou péritonéaux. Il est d'ailleurs troublant, mais peut-être pas sans pertinence physiologique que la production de TNF α soit dépendante de Nox2 uniquement dans les cellules dendritiques présentes en grande quantité sous le nom de cellules de Langerhans dans la peau, lieu de notre inflammation. Ces résultats constituent la seconde voie de signalisation sensible à l'état redox uniquement dans les cellules dendritiques et pas dans les macrophages. Savina et coll. ont

récemment démontré que le pH phagosomal des cellules dendritiques était régulé par Nox2 dans les cellules dendritiques mais indépendant de Nox2 dans les macrophages (Savina, Jancic et al. 2006). Plus précisément, Goodridge *et coll.* ont décrit une voie de production du TNF α spécifique dans les cellules dendritiques et pas des macrophages après stimulation du récepteur des β -glycans : la dectine-1. Celle-ci est caractérisée par la formation du complexe Card9-Bcl10-Malt1 sous l'effet du Ca^{2+} (Xu, Huo et al. 2009). Or, les granulocytes déficients en NOX2 présentent une augmentation de leur flux calcique (Geiszt, Kapus et al. 2001). Une hypothèse serait que la formation du complexe Card9-Bcl10-Malt1 serait donc facilitée par l'absence de Nox2 expliquant l'augmentation de TNF α dans les cellules dendritiques déficientes en Nox2.

L'augmentation de la production de TNF α observée dans les oreilles des souris déficientes en Nox2 associée à une hyperinflammation suggérait un lien entre le TNF α et l'inflammation chez les patients CGD. De plus, un autre déficit immunitaire, l'immunodéficiences commune variable caractérisée, comme la CGD, par des infections récurrentes associées à des granulomes stériles ainsi qu'à une augmentation du TNF α par les cellules de l'immunité (Medlicott, Coderre et al. 2006; Lopes-da-Silva and Rizzo 2008). Le traitement de ces lésions granulomateuses cutanées par un bloqueur du TNF α , l'éta nercept, a présenté une efficacité importante chez les patients atteints de CVID (Thatayatikom, Thatayatikom et al. 2005; Lin, Liebhaber et al. 2006). Nous avons donc injecté des β -glycans dans les oreilles de souris déficientes en Nox2 soit traitées avec l'éta nercept, soit doublement déficientes pour Nox2 et TNF α . Mais contrairement aux patients CVID, la neutralisation du TNF α par inhibition pharmacologique ou délétion génétique a été incapable d'atténuer l'inflammation engendrée par

Discussion générale et perspectives

les β -glycans et l'absence de Nox2. Le TNF α n'est donc pas essentiel pour l'induction de l'inflammation observée dans la CGD.

Lors de cette étude, nous avons également injecté un β -glycan différent de celui utilisé dans l'article 4. Lors de notre précédente étude, le β -glycan injecté provenait de *S.cerevisiae* donc d'un champignon. Lors de cette étude, nous avons injecté le curdlan, un β -glycan provenant d'une bactérie, *Alcaligenes faecalis* et nous avons retrouvé la même inflammation chez les souris déficientes en Nox2 que précédemment. Ceci démontre que l'inflammation induite par l'absence de Nox2 est dépendante des β -glycans et non des champignons. La présence ubiquitaire des β -glycans dans l'environnement (Rylander, Norrhall et al. 1998; Thorn, Beijer et al. 1998; Thorn and Rylander 1998) et la nourriture (Plat and Mensink 2005) est relevant pour les patients atteints de la CGD. Devant cette spécificité des β -glycans, nous nous sommes intéressés à leur récepteur principal : la dectine-1 et avons créé une souris déficiente en Nox2 et en dectine-1. Cette souris a présenté une inflammation remarquablement diminuée par rapport à la souris uniquement déficiente en Nox2. L'inflammation due à l'absence de Nox2 induite par les β -glycans est donc dépendante de l'activation du récepteur dectine-1. Mais les souris uniquement déficientes en dectine-1 présentaient une diminution encore plus importante de l'inflammation induite par le curdlan. Il semble donc que l'inflammation observée dans la CGD soit essentiellement dépendante de la dectine-1 mais également d'un ou de plusieurs autres récepteurs. TLR2 est un candidat possible puisqu'il a été décrit comme un autre récepteur des β -glycans (Underhill and Ozinsky 2002) ou en tant que récepteur activé par la dectine-1 (Gantner, Simmons et al. 2003). De plus, récemment il a été démontré que les mastocytes utilisaient TLR2 en coopération avec la dectine-1 pour produire des ROS (Yang and Marshall 2009). Le récepteur C3 du complément ainsi que d'autres récepteurs lectines pourraient également être impliqués.

En conclusion, bien que la production de TNF α soit augmentée en l'absence de NOX2 au niveau des cellules dendritiques, les lésions inflammatoires induites par les β -glycans ne cèdent pas en l'absence de TNF α chez les souris déficientes en Nox2. Le traitement des patients CGD par des bloqueurs du TNF α ne semblent donc pas recommandés. D'un autre côté, il semble que les molécules capables de bloquer le récepteur dectine-1 sont à considérer comme des cibles potentielles pour la recherche de molécules anti-inflammatoires spécifiques et le développement de nouvelles stratégies thérapeutiques et préventives pour les patients CGD.

La suite de notre travail va se focaliser sur l'étude du rôle d'autres cytokines pro-inflammatoires jouant un rôle important dans les pathologies inflammatoires et plus précisément l'interleukine 1 β (IL-1 β). La création de souris déficientes en NOX2 et transgéniques pour l'antagoniste endogène du récepteur de l'IL-1 β : l'IL1-Ra, est en cours. L'injection de β -glucan dans les oreilles de ces souris nous permettra rapidement de définir si l'absence d'activité de l'IL-1 β est capable de diminuer l'inflammation induite par l'absence de NOX2.

Par ailleurs, les patients atteints de CGD souffrent également de colite ayant un retentissement important sur la morbidité. Nous aimerions donc créer un modèle de colite après injection rectale de β -glucan chez les souris déficientes en NOX2. Les premières injections rectales ont été encourageantes (photos ci-dessous) bien que des mises au point sur le nombre d'injections et les durées d'expérience soient nécessaires pour augmenter la reproductibilité.

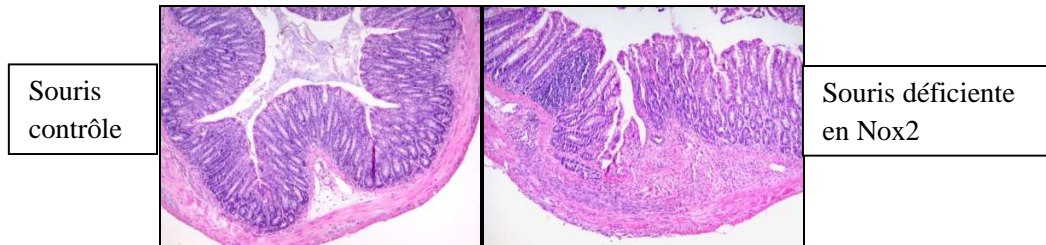

L'induction d'une colite chez la souris déficiente en Nox2 nous permettra de vérifier que les β -glycans sont également capables d'induire une inflammation au niveau du colon. Mais également, que le curdlan, utilisé comme additif alimentaire, pourrait être un facteur important d'induction de la colite observée chez les patients CGD.

CONCLUSION GENERALE

Ce travail a permis de définir ou d'approfondir certains rôles des NOX par 2 approches différentes :

-Soit les ROS produits par les NOX sont délétères et leur absence dans les modèles murins déficients en cette NOX améliore le phénotype observé (Etudes concernant Nox1).

-Soit les ROS produits sont nécessaires à des mécanismes physiologiques et leur absence dans les modèles murins déficients en cette NOX entraîne un phénotype pathologique (Etudes concernant Nox2).

Nox1 contribue de façon essentielle aux effets délétères comme l'hypertension artérielle ou la survenue d'anévrismes aortiques induits par l'angiotensine II en régulant au niveau transcriptionnel certains gènes et également en ciblant le récepteur AT1 de l'angiotensine II à la membrane plasmique des cellules musculaires lisses des vaisseaux.

Nox2 contribue aux mécanismes anti-inflammatoires mis en jeu après activation du récepteur dectine-1 essentiellement dans les cellules dendritiques et certainement les macrophages.

REFERENCES BIBLIOGRAPHIQUES

A

Ahluwalia, J., Tinker, A., Clapp, L. H., Duchon, M. R., Abramov, A. Y., Pope, S., Nobles, M. and Segal, A. W., The large-conductance Ca²⁺-activated K⁺ channel is essential for innate immunity. *Nature* 2004. 427: 853-858.

Ambasta, R. K., Kumar, P., Griendling, K. K., Schmidt, H. H., Busse, R. and Brandes, R. P., Direct interaction of the novel Nox proteins with p22phox is required for the formation of a functionally active NADPH oxidase. *J Biol Chem* 2004. 279: 45935-45941.

Ameziane-El-Hassani, R., Morand, S., Boucher, J. L., Frapart, Y. M., Apostolou, D., Agnandji, D., Gnidehou, S., Ohayon, R., Noel-Hudson, M. S., Francon, J., Lalaoui, K., Virion, A. and Dupuy, C., Dual oxidase-2 has an intrinsic Ca²⁺-dependent H₂O₂-generating activity. *J Biol Chem* 2005. 280: 30046-30054.

Arbiser, J. L., Petros, J., Klafter, R., Govindajaran, B., McLaughlin, E. R., Brown, L. F., Cohen, C., Moses, M., Kilroy, S., Arnold, R. S. and Lambeth, J. D., Reactive oxygen generated by Nox1 triggers the angiogenic switch. *Proc Natl Acad Sci U S A* 2002. 99: 715-720.

Armando, I., Wang, X., Villar, V. A., Jones, J. E., Asico, L. D., Escano, C. and Jose, P. A., Reactive oxygen species-dependent hypertension in dopamine D2 receptor-deficient mice. *Hypertension* 2007. 49: 672-678.

Asikainen, T. M. and White, C. W., Pulmonary antioxidant defenses in the preterm newborn with respiratory distress and bronchopulmonary dysplasia in evolution: implications for antioxidant therapy. *Antioxid Redox Signal* 2004. 6: 155-167.

Astarie-Dequeker, C., N'Diaye, E. N., Le Cabec, V., Rittig, M. G., Prandi, J. and Maridonneau-Parini, I., The mannose receptor mediates uptake of pathogenic and nonpathogenic mycobacteria and bypasses bactericidal responses in human macrophages. *Infect Immun* 1999. 67: 469-477.

B

Banfi, B., Maturana, A., Jaconi, S., Arnaudeau, S., Laforge, T., Sinha, B., Ligeti, E., Demaurex, N. and Krause, K. H., A mammalian H⁺ channel generated through alternative splicing of the NADPH oxidase homolog NOH-1. *Science* 2000. 287: 138-142.

Banfi, B., Molnar, G., Maturana, A., Steger, K., Hegedus, B., Demaurex, N. and Krause, K. H., A Ca(2+)-activated NADPH oxidase in testis, spleen, and lymph nodes 2001. 276: 37594-37601.

Banfi, B., Clark, R., Steger, K. and Krause, K., Two novel proteins activate superoxide generation by the NADPH oxidase NOX1. *Journal of Biological Chemistry* 2002. 278: 3510-3513.

- Banfi, B., Tirone, F., Durussel, I., Knisz, J., Moskwa, P., Molnar, G. Z., Krause, K. H. and Cox, J. A., Mechanism of Ca²⁺ activation of the NADPH oxidase 5 (NOX5). *J Biol Chem* 2004. 279: 18583-18591.
- Banfi, B., Malgrange, B., Knisz, J., Steger, K., Dubois-Dauphin, M. and Krause, K. H., NOX3, a Superoxide-generating NADPH Oxidase of the Inner Ear. *Journal of Biological Chemistry* 2004. 279: 46065-46072.
- Barazzone, C., Horowitz, S., Donati, Y. R., Rodriguez, I. and Piguet, P. F., Oxygen toxicity in mouse lung: pathways to cell death. *Am J Respir Cell Mol Biol* 1998. 19: 573-581.
- Barnes, P. J., Shapiro, S. D. and Pauwels, R. A., Chronic obstructive pulmonary disease: molecular and cellular mechanisms. *Eur Respir J* 2003. 22: 672-688.
- Batot, G., Paclet, M. H., Doussiere, J., Vergnaud, S., Martel, C., Vignais, P. V. and Morel, F., Biochemical and immunochemical properties of B lymphocyte cytochrome b558. *Biochim Biophys Acta* 1998. 1406: 188-202.
- Bedard, K. and Krause, K. H., The NOX family of ROS-generating NADPH oxidases: physiology and pathophysiology. *Physiol Rev* 2007. 87: 245-313.
- Bedard, K., Attar, H., Bonnefont, J., Jaquet, V., Borel, C., Plastre, O., Stasia, M. J., Antonarakis, S. E. and Krause, K. H., Three common polymorphisms in the CYBA gene form a haplotype associated with decreased ROS generation. *Hum Mutat* 2009. 30: 1123-1133.
- Bianchi, M., Hakkim, A., Brinkmann, V., Siler, U., Seger, R. A., Zychlinsky, A. and Reichenbach, J., Restoration of NET formation by gene therapy in CGD controls aspergillosis. *Blood* 2009. 114: 2619-2622.
- Bingel, S. A., Pathology of a mouse model of x-linked chronic granulomatous disease. *Contemp Top Lab Anim Sci* 2002. 41: 33-38.
- Brinkmann, V., Reichard, U., Goosmann, C., Fauler, B., Uhlemann, Y., Weiss, D. S., Weinrauch, Y. and Zychlinsky, A., Neutrophil extracellular traps kill bacteria. *Science* 2004. 303: 1532-1535.
- Brown, G. D., Herre, J., Williams, D. L., Willment, J. A., Marshall, A. S. and Gordon, S., Dectin-1 mediates the biological effects of beta-glucans. *J Exp Med* 2003. 197: 1119-1124.
- Brown, G. D., Dectin-1: a signalling non-TLR pattern-recognition receptor. *Nat Rev Immunol* 2006. 6: 33-43.

Brown, J. R., Goldblatt, D., Buddle, J., Morton, L. and Thrasher, A. J., Diminished production of anti-inflammatory mediators during neutrophil apoptosis and macrophage phagocytosis in chronic granulomatous disease (CGD). *J Leukoc Biol* 2003. 73: 591-599.

Brown, L. A., Harris, F. L. and Guidot, D. M., Chronic ethanol ingestion potentiates TNF-alpha-mediated oxidative stress and apoptosis in rat type II cells. *Am J Physiol Lung Cell Mol Physiol* 2001. 281: L377-386.

C

Cale, C. M., Morton, L. and Goldblatt, D., Cutaneous and other lupus-like symptoms in carriers of X-linked chronic granulomatous disease: incidence and autoimmune serology. *Clin Exp Immunol* 2007. 148: 79-84.

Carmona-Cuenca, I., Roncero, C., Sancho, P., Caja, L., Fausto, N., Fernandez, M. and Fabregat, I., Upregulation of the NADPH oxidase NOX4 by TGF-beta in hepatocytes is required for its pro-apoptotic activity. *J Hepatol* 2008. 49: 965-976.

Cassis, L. A., Gupte, M., Thayer, S., Zhang, X., Charnigo, R., Howatt, D. A., Rateri, D. L. and Daugherty, A., ANG II infusion promotes abdominal aortic aneurysms independent of increased blood pressure in hypercholesterolemic mice. *Am J Physiol Heart Circ Physiol* 2009. 296: H1660-1665.

Chenevier-Gobeaux, C., Lemarechal, H., Bonnefont-Rousselot, D., Poiraudau, S., Ekindjian, O. G. and Borderie, D., Superoxide production and NADPH oxidase expression in human rheumatoid synovial cells: regulation by interleukin-1beta and tumour necrosis factor-alpha. *Inflamm Res* 2006. 55: 483-490.

Cheng, G., Ritsick, D. and Lambeth, J. D., Nox3 regulation by NOXO1, p47phox, and p67phox. *J Biol Chem* 2004. 279: 34250-34255.

Cheng, G., Diebold, B. A., Hughes, Y. and Lambeth, J. D., Nox1-dependent reactive oxygen generation is regulated by Rac1. *J Biol Chem* 2006. 281: 17718-17726.

Chiarugi, P., PTPs versus PTKs: the redox side of the coin. *Free Radic Res* 2005. 39: 353-364.

Chin, T., Stiehm, E., Falloon, J. and Gallin, J., Corticosteroids in treatment of obstructive lesions of chronic granulomatous disease. *J Ped* 1987. 111(3): 349-350.

Clark, R. A. and Klebanoff, S. J., Chemotactic factor inactivation by the myeloperoxidase-hydrogen peroxide-halide system. *J Clin Invest* 1979. 64: 913-920.

Crapo, J. D., Morphologic changes in pulmonary oxygen toxicity. *Annu Rev Physiol* 1986. 48: 721-731.

Cucoranu, I., Clempus, R., Dikalova, A., Phelan, P. J., Ariyan, S., Dikalov, S. and Sorescu, D., NAD(P)H oxidase 4 mediates transforming growth factor-beta1-induced differentiation of cardiac fibroblasts into myofibroblasts. *Circ Res* 2005. 97: 900-907.

Cutz, E., Pan, J. and Yeger, H., The role of NOX2 and "novel oxidases" in airway chemoreceptor O(2) sensing. *Adv Exp Med Biol* 2009. 648: 427-438.

Czernichow, S., Bertrais, S., Blacher, J., Galan, P., Briancon, S., Favier, A., Safar, M. and Hercberg, S., Antioxidant supplements and risk of hypertension in the SU.VI.MAX trial: relationship to plasma antioxidants. *Arch Mal Coeur Vaiss* 2006. 99: 665-668.

D

Daugherty, A. and Cassis, L. A., Mouse models of abdominal aortic aneurysms. *Arterioscler Thromb Vasc Biol* 2004. 24: 429-434.

De Deken, X., Wang, D., Many, M. C., Costagliola, S., Libert, F., Vassart, G., Dumont, J. E. and Miot, F., Cloning of Two Human Thyroid cDNAs Encoding New Members of the NADPH Oxidase Family. *Journal of Biological Chemistry* 2000. 275: 23227-23233.

DeLeo, F. R., Burritt, J. B., Yu, L., Jesaitis, A. J., Dinauer, M. C. and Nauseef, W. M., Processing and maturation of flavocytochrome b558 include incorporation of heme as a prerequisite for heterodimer assembly. *J Biol Chem* 2000. 275: 13986-13993.

Denu, J. M. and Tanner, K. G., Specific and reversible inactivation of protein tyrosine phosphatases by hydrogen peroxide: evidence for a sulfenic acid intermediate and implications for redox regulation. *Biochemistry* 1998. 37: 5633-5642.

Dikalova, A., Clempus, R., Lassegue, B., Cheng, G., McCoy, J., Dikalov, S., San Martin, A., Lyle, A., Weber, D. S., Weiss, D., Taylor, W. R., Schmidt, H. H., Owens, G. K.,

Dupuy, C., Ohayon, R., Valent, A., Noel-Hudson, M. S., Deme, D. and Virion, A., Purification of a novel flavoprotein involved in the thyroid NADPH oxidase. Cloning of the porcine and human cdnas. *J Biol Chem* 1999. 274: 37265-37269.

E

Edens, W. A., Sharling, L., Cheng, G., Shapira, R., Kinkade, J. M., Lee, T., Edens, H. A., Tang, X., Sullards, C., Flaherty, D. B., Benian, G. M. and Lambeth, J. D., Tyrosine cross-linking of extracellular matrix is catalyzed by Duox, a multidomain oxidase/peroxidase with homology to the phagocyte oxidase subunit gp91phox. *The Journal of Cell Biology* 2001. 154: 879-892.

Ejiri, J., Inoue, N., Tsukube, T., Munezane, T., Hino, Y., Kobayashi, S., Hirata, K., Kawashima, S., Imajoh-Ohmi, S., Hayashi, Y., Yokozaki, H., Okita, Y. and Yokoyama, M., Oxidative stress in the pathogenesis of thoracic aortic aneurysm: protective role of statin and angiotensin II type 1 receptor blocker. *Cardiovasc Res* 2003. 59: 988-996.

Elbim, C., Guichard, C., Dang, P. M., Fay, M., Pedruzzi, E., Demur, H., Pouzet, C., El Benna, J. and Gougerot-Pocidalò, M. A., Interleukin-18 primes the oxidative burst of neutrophils in response to formyl-peptides: role of cytochrome b558 translocation and N-formyl peptide receptor endocytosis. *Clin Diagn Lab Immunol* 2005. 12: 436-446.

Ellmark, S. H., Dusting, G. J., Fui, M. N., Guzzo-Pernell, N. and Drummond, G. R., The contribution of Nox4 to NADPH oxidase activity in mouse vascular smooth muscle. *Cardiovasc Res* 2005. 65: 495-504.

Ellson, C. D., Davidson K., Ferguson G. J., O'Connor R., Stephens L. R., and Hawkins P. T., Neutrophils from p40^{phox}^{-/-} mice exhibit severe defects in NADPH oxidase regulation and oxidant-dependent bacterial killing. *JEM* 2006. 203: 1927-1937

Elsen, S., Doussiere, J., Villiers, C. L., Faure, M., Berthier, R., Papaioannou, A., Grandvaux, N., Marche, P. N. and Vignais, P. V., Cryptic O₂⁻-generating NADPH oxidase in dendritic cells. *J Cell Sci* 2004. 117: 2215-2226.

Eskandari, M. K., Vijungco, J. D., Flores, A., Borensztajn, J., Shively, V. and Pearce, W. H., Enhanced abdominal aortic aneurysm in TIMP-1-deficient mice. *J Surg Res* 2005. 123: 289-293.

F

Fadeel, B., Ahlin, A., Henter, J. I., Orrenius, S. and Hampton, M. B., Involvement of caspases in neutrophil apoptosis: regulation by reactive oxygen species. *Blood* 1998. 92: 4808-4818.

Fan, C., Katsuyama, M., Nishinaka, T. and Yabe-Nishimura, C., Transactivation of the EGF receptor and a PI3 kinase-ATF-1 pathway is involved in the upregulation of NOX1, a catalytic subunit of NADPH oxidase. *FEBS Lett* 2005. 579: 1301-1305.

Fellner, S. K. and Arendshorst, W. J., Angiotensin II, reactive oxygen species, and Ca²⁺ signaling in afferent arterioles. *Am J Physiol Renal Physiol* 2005. 289: F1012-1019.

Fernandez-Boyanapalli, R. F., Frasch, S. C., McPhillips, K., Vandivier, R. W., Harry, B. L., Riches, D. W., Henson, P. M. and Bratton, D. L., Impaired apoptotic cell clearance in CGD due to altered macrophage programming is reversed by phosphatidylserine-dependent production of IL-4. *Blood* 2009. 113: 2047-2055.

Fischer, H., Gonzales, L. K., Kolla, V., Schwarzer, C., Miot, F., Illek, B. and Ballard, P. L., Developmental regulation of DUOX1 expression and function in human fetal lung epithelial cells. *Am J Physiol Lung Cell Mol Physiol* 2007. 292: L1506-1514.

Frasch, S. C., Berry, K. Z., Fernandez-Boyanapalli, R., Jin, H. S., Leslie, C., Henson, P. M., Murphy, R. C. and Bratton, D. L., NADPH oxidase-dependent generation of lysophosphatidylserine enhances clearance of activated and dying neutrophils via G2A. *J Biol Chem* 2008. 283: 33736-33749.

Fuchs, T. A., Abed, U., Goosmann, C., Hurwitz, R., Schulze, I., Wahn, V., Weinrauch, Y., Brinkmann, V. and Zychlinsky, A., Novel cell death program leads to neutrophil extracellular traps. *J Cell Biol* 2007. 176: 231-241.

G

Gantner, B. N., Simmons, R. M., Canavera, S. J., Akira, S. and Underhill, D. M., Collaborative induction of inflammatory responses by dectin-1 and Toll-like receptor 2. *J Exp Med* 2003. 197: 1107-1117.

Garrido, A. M. and Griendling, K. K., NADPH oxidases and angiotensin II receptor signaling. *Mol Cell Endocrinol* 2009. 302: 148-158.

Gavazzi, G., Banfi, B., Deffert, C., Fiette, L., Schappi, M., Herrmann, F. and Krause, K. H., Decreased blood pressure in NOX1-deficient mice. *FEBS Lett* 2006. 580: 497-504.

Gavrila, D., Li, W. G., McCormick, M. L., Thomas, M., Daugherty, A., Cassis, L. A., Miller, F. J., Jr., Oberley, L. W., Dellsperger, K. C. and Weintraub, N. L., Vitamin E inhibits abdominal aortic aneurysm formation in angiotensin II-infused apolipoprotein E-deficient mice. *Arterioscler Thromb Vasc Biol* 2005. 25: 1671-1677.

Geiszt, M., Kapus, A., Nemet, K., Farkas, L. and Ligeti, E., Regulation of capacitative Ca²⁺ influx in human neutrophil granulocytes. Alterations in chronic granulomatous disease. *J Biol Chem* 1997. 272: 26471-26478.

Geiszt, M., Kopp, J. B., Varnai, P. and Leto, T. L., Identification of renox, an NAD(P)H oxidase in kidney. 2000. 97: 8010-8014.

Geiszt, M., Kapus, A. and Ligeti, E., Chronic granulomatous disease: more than the lack of superoxide? *J Leukoc Biol* 2001. 69: 191-196.

Geiszt, M., Lekstrom, K., Witta, J. and Leto, T. L., Proteins homologous to p47phox and p67phox support superoxide production by NAD(P)H oxidase 1 in colon epithelial cells. *J Biol Chem* 2003. 278: 20006-20012.

Geiszt, M., Lekstrom, K., Brenner, S., Hewitt, S. M., Dana, R., Malech, H. L. and Leto, T. L., NAD(P)H oxidase 1, a product of differentiated colon epithelial cells, can partially replace glycoprotein 91phox in the regulated production of superoxide by phagocytes. *J Immunol* 2003. 171: 299-306.

Geiszt, M., Witta, J., Baffi, J., Lekstrom, K. and Leto, T. L., Dual oxidases represent novel hydrogen peroxide sources supporting mucosal surface host defense. *FASEB J* 2003. 17: 1502-1504.

Genestra, M., Oxyl radicals, redox-sensitive signalling cascades and antioxidants. *Cell Signal* 2007. 19: 1807-1819.

- Gianni, D., Diaz, B., Taulet, N., Fowler, B., Courtneidge, S. A. and Bokoch, G. M., Novel p47(phox)-related organizers regulate localized NADPH oxidase 1 (Nox1) activity. *Sci Signal* 2009. 2: ra54.
- Goebel, W. S., Mark, L. A., Billings, S. D., Meyers, J. L., Pech, N., Travers, J. B. and Dinauer, M. C., Gene Correction Reduces Cutaneous Inflammation and Granuloma Formation in Murine X-Linked Chronic Granulomatous Disease 2005. 125: 705-710.
- Goodridge, H. S., Shimada, T., Wolf, A. J., Hsu, Y. M., Becker, C. A., Lin, X. and Underhill, D. M., Differential use of CARD9 by dectin-1 in macrophages and dendritic cells. *J Immunol* 2009. 182: 1146-1154.
- Gorin, Y., Ricono, J. M., Kim, N. H., Bhandari, B., Choudhury, G. G. and Abboud, H. E., Nox4 mediates angiotensin II-induced activation of Akt/protein kinase B in mesangial cells. *Am J Physiol Renal Physiol* 2003. 285: F219-229.
- Gougerot-Pocidalo, M. A., el Benna, J., Elbim, C., Chollet-Martin, S. and Dang, M. C., Regulation of human neutrophil oxidative burst by pro- and anti-inflammatory cytokines. *J Soc Biol* 2002. 196: 37-46.
- Goyal, P., Weissmann, N., Rose, F., Grimminger, F., Schafers, H. J., Seeger, W. and Hanze, J., Identification of novel Nox4 splice variants with impact on ROS levels in A549 cells. *Biochem Biophys Res Commun* 2005. 329: 32-39.
- Gresham, H. D., McGarr, J. A., Shackelford, P. G. and Brown, E. J., Studies on the molecular mechanisms of human Fc receptor-mediated phagocytosis. Amplification of ingestion is dependent on the generation of reactive oxygen metabolites and is deficient in polymorphonuclear leukocytes from patients with chronic granulomatous disease. *J Clin Invest* 1988. 82: 1192-1201.
- Griendling, K. K., Sorescu, D. and Ushio-Fukai, M., NAD(P)H oxidase: role in cardiovascular biology and disease. *Circ Res* 2000. 86: 494-501.
- Guichard, C., Pedruzzi, E., Dewas, C., Fay, M., Pouzet, C., Bens, M., Vandewalle, A., Ogier-Denis, E., Gougerot-Pocidalo, M. A. and Elbim, C., Interleukin-8-induced priming of neutrophil oxidative burst requires sequential recruitment of NADPH oxidase components into lipid rafts. *J Biol Chem* 2005. 280: 37021-37032.
- Guichard, C., Pedruzzi, E., Fay, M., Ben Mkaddem, S., Coant, N., Daniel, F. and Ogier-Denis, E., The Nox/Duox family of ROS-generating NADPH oxidases. *Med Sci (Paris)* 2006. 22: 953-959.
- Guzik, T. J., Sadowski, J., Kapelak, B., Jopek, A., Rudzinski, P., Pillai, R., Korbust, R. and Channon, K. M., Systemic regulation of vascular NAD(P)H oxidase activity and nox isoform expression in human arteries and veins. *Arterioscler Thromb Vasc Biol* 2004. 24: 1614-1620.

H

Hamasaki, T., Sakano, T., Kobayashi, M., Sakura, N., Ueda, K. and Usui, T., Leukotriene B4 metabolism in neutrophils of patients with chronic granulomatous disease: phorbol myristate acetate decreases endogenous leukotriene B4 via NADPH oxidase-dependent mechanism. *Eur J Clin Invest* 1989. 19: 404-411.

Hampton, M. B., Fadeel, B. and Orrenius, S., Redox regulation of the caspases during apoptosis. *Ann N Y Acad Sci* 1998. 854: 328-335.

Harbord, M., Novelli, M., Canas, B., Power, D., Davis, C., Godovac-Zimmermann, J., Roes, J. and Segal, A. W., Yml is a neutrophil granule protein that crystallizes in p47phox-deficient mice. *J Biol Chem* 2002. 277: 5468-5475.

Harper, R. W., Xu, C., Eiserich, J. P., Chen, Y., Kao, C. Y., Thai, P., Setiadi, H. and Wu, R., Differential regulation of dual NADPH oxidases/peroxidases, Duox1 and Duox2, by Th1 and Th2 cytokines in respiratory tract epithelium. *FEBS Lett* 2005. 579: 4911-4917.

Harrison, C. A., Raftery, M. J., Walsh, J., Alewood, P., Iismaa, S. E., Thliveris, S. and Geczy, C. L., Oxidation regulates the inflammatory properties of the murine S100 protein S100A8. *J Biol Chem* 1999. 274: 8561-8569.

Hatanaka, E., Carvalho, B. T. C., Condino-Neto, A. and Campa, A., Hyperresponsiveness of neutrophils from gp 91phox deficient patients to lipopolysaccharide and serum amyloid A. *Immunology Letters* 2004. 94: 43-46.

Hecker, L., Vittal, R., Jones, T., Jagirdar, R., Luckhardt, T. R., Horowitz, J. C., Pennathur, S., Martinez, F. J. and Thannickal, V. J., NADPH oxidase-4 mediates myofibroblast activation and fibrogenic responses to lung injury. *Nat Med* 2009. 15: 1077-1081.

Henderson, W. R. and Klebanoff, S. J., Leukotriene production and inactivation by normal, chronic granulomatous disease and myeloperoxidase-deficient neutrophils. *J Biol Chem* 1983. 258: 13522-13527.

Heymes, C., Bendall, J. K., Ratajczak, P., Cave, A. C., Samuel, J. L., Hasenfuss, G. and Shah, A. M., Increased myocardial NADPH oxidase activity in human heart failure. *J Am Coll Cardiol* 2003. 41: 2164-2171.

Higashi, M., Shimokawa, H., Hattori, T., Hiroki, J., Mukai, Y., Morikawa, K., Ichiki, T., Takahashi, S. and Takeshita, A., Long-term inhibition of Rho-kinase suppresses angiotensin II-induced cardiovascular hypertrophy in rats in vivo: effect on endothelial NAD(P)H oxidase system. *Circ Res* 2003. 93: 767-775.

Hilenski, L. L., Clempus, R. E., Quinn, M. T., Lambeth, J. D. and Griendling, K. K., Distinct subcellular localizations of Nox1 and Nox4 in vascular smooth muscle cells. *Arterioscler Thromb Vasc Biol* 2004. 24: 677-683.

Hiraoka, W., Vazquez, N., Nieves-Neira, W., Chanock, S. J. and Pommier, Y., Role of oxygen radicals generated by NADPH oxidase in apoptosis induced in human leukemia cells. *J Clin Invest* 1998. 102: 1961-1968.

Hrmova, M., Harvey, A. J., Wang, J., Shirley, N. J., Jones, G. P., Stone, B. A., Hoj, P. B. and Fincher, G. B., Barley beta-D-glucan exohydrolases with beta-D-glucosidase activity. Purification, characterization, and determination of primary structure from a cDNA clone. *J Biol Chem* 1996. 271: 5277-5286.

Hultqvist, M. and Holmdahl, R., Ncf1 (p47phox) polymorphism determines oxidative burst and the severity of arthritis in rats and mice. *Cellular Immunology* 2005. 233: 97-101.

Hultqvist, M., Olsson, L. M., Gelderman, K. A. and Holmdahl, R., The protective role of ROS in autoimmune disease. *Trends Immunol* 2009. 30: 201-208.

Hunt, N. H., Cook, E. P. and Fragonas, J. C., Interference with oxidative processes inhibits proliferation of human peripheral blood lymphocytes and murine B-lymphocytes. *Int J Immunopharmacol* 1991. 13: 1019-1026.

I

Ishizaka, N., Griendling, K. K., Lassegue, B. and Alexander, R. W., Angiotensin II type 1 receptor: relationship with caveolae and caveolin after initial agonist stimulation. *Hypertension* 1998. 32: 459-466.

J

Jackson, S. H., Gallin, J. I. and Holland, S. M., The p47phox mouse knock-out model of chronic granulomatous disease. *J Exp Med* 1995. 182: 751-758.

Jansen, M. J., Hendriks, T., Verhofstad, A. A., Lange, W., Geeraedts, L. M., Jr. and Goris, R. J., Gradual development of organ damage in the murine zymosan-induced multiple organ dysfunction syndrome. *Shock* 1997. 8: 261-267.

Jiang, Q., Griffin, D. A., Barofsky, D. F. and Hurst, J. K., Intraphagosomal chlorination dynamics and yields determined using unique fluorescent bacterial mimics. *Chem Res Toxicol* 1997. 10: 1080-1089.

Jinnouchi, K., Terasaki, Y., Fujiyama, S., Tomita, K., Kuziel, W. A., Maeda, N., Takahashi, K. and Takeya, M., Impaired hepatic granuloma formation in mice deficient in C-C chemokine receptor 2. *J Pathol* 2003. 200: 406-416.

K

Kao, Y. Y., Gianni, D., Bohl, B., Taylor, R. M. and Bokoch, G. M., Identification of a conserved Rac-binding site on NADPH oxidases supports a direct GTPase regulatory mechanism. *J Biol Chem* 2008. 283: 12736-12746.

- Kadoglou, N. P. and Liapis, C. D., Matrix metalloproteinases: contribution to pathogenesis, diagnosis, surveillance and treatment of abdominal aortic aneurysms. *Curr Med Res Opin* 2004. 20: 419-432.
- Kasahara, Y., Iwai, K., Yachie, A., Ohta, K., Konno, A., Seki, H., Miyawaki, T. and Taniguchi, N., Involvement of reactive oxygen intermediates in spontaneous and CD95 (Fas/APO-1)-mediated apoptosis of neutrophils. *Blood* 1997. 89: 1748-1753.
- Katsuyama, M., Fan, C. and Yabe-Nishimura, C., NADPH oxidase is involved in prostaglandin F₂α-induced hypertrophy of vascular smooth muscle cells: induction of NOX1 by PGF₂α. *J Biol Chem* 2002. 277: 13438-13442.
- Katsuyama, M., Fan, C., Arakawa, N., Nishinaka, T., Miyagishi, M., Taira, K. and Yabe-Nishimura, C., Essential role of ATF-1 in induction of NOX1, a catalytic subunit of NADPH oxidase: involvement of mitochondrial respiratory chain. *Biochem J* 2005. 386: 255-261.
- Kawahara, T., Kuwano, Y., Teshima-Kondo, S., Takeya, R., Sumimoto, H., Kishi, K., Tsunawaki, S., Hirayama, T. and Rokutan, K., Role of nicotinamide adenine dinucleotide phosphate oxidase 1 in oxidative burst response to Toll-like receptor 5 signaling in large intestinal epithelial cells. *J Immunol* 2004. 172: 3051-3058.
- Kawahara, T., Ritsick, D., Cheng, G. and Lambeth, J. D., Point mutations in the proline-rich region of p22phox are dominant inhibitors of Nox1- and Nox2-dependent reactive oxygen generation. *J Biol Chem* 2005. 280: 31859-31869.
- Kawahara, T., Kohjima, M., Kuwano, Y., Mino, H., Teshima-Kondo, S., Takeya, R., Tsunawaki, S., Wada, A., Sumimoto, H. and Rokutan, K., Helicobacter pylori lipopolysaccharide activates Rac1 and transcription of NADPH oxidase Nox1 and its organizer NOXO1 in guinea pig gastric mucosal cells. *Am J Physiol Cell Physiol* 2005. 288: C450-457.
- Kikuchi, H., Hikage, M., Miyashita, H. and Fukumoto, M., NADPH oxidase subunit, gp91(phox) homologue, preferentially expressed in human colon epithelial cells. *Gene* 2000. 254: 237-243.
- Kim, Y. S., Morgan, M. J., Choksi, S. and Liu, Z. G., TNF-induced activation of the Nox1 NADPH oxidase and its role in the induction of necrotic cell death. *Mol Cell* 2007. 26: 675-687.
- Kiss, P. J., Knisz, J., Zhang, Y., Baltrusaitis, J., Sigmund, C. D., Thalmann, R., Smith, R. J., Verpy, E. and Banfi, B., Inactivation of NADPH oxidase organizer 1 results in severe imbalance. *Curr Biol* 2006. 16: 208-213.
- Kobayashi, M., Yoshiki, R., Sakabe, J., Kabashima, K., Nakamura, M. and Tokura, Y., Expression of toll-like receptor 2, NOD2 and dectin-1 and stimulatory effects of their ligands and histamine in normal human keratinocytes. *Br J Dermatol* 2009. 160: 297-304.

Kobayashi, S. D., Voyich, J. M., Braughton, K. R., Whitney, A. R., Nauseef, W. M., Malech, H. L. and DeLeo, F. R., Gene Expression Profiling Provides Insight into the Pathophysiology of Chronic Granulomatous Disease. *J Immunol* 2004. 172: 636-643.

Komatsu, D., Kato, M., Nakayama, J., Miyagawa, S. and Kamata, T., NADPH oxidase 1 plays a critical mediating role in oncogenic Ras-induced vascular endothelial growth factor expression. *Oncogene* 2008. 27: 4724-4732.

Kuwano, Y., Kawahara, T., Yamamoto, H., Teshima-Kondo, S., Tominaga, K., Masuda, K., Kishi, K., Morita, K. and Rokutan, K., Interferon-gamma activates transcription of NADPH oxidase 1 gene and upregulates production of superoxide anion by human large intestinal epithelial cells. *Am J Physiol Cell Physiol* 2006. 290: C433-443.

L

Lambeth, J. D., NOX enzymes and the biology of reactive oxygen. *Nat Rev Immunol* 2004. 4: 181-189.

Lambeth, J. D. and Griendling, K. K., Nox1 overexpression potentiates angiotensin II-induced hypertension and vascular smooth muscle hypertrophy in transgenic mice. *Circulation* 2005. 112: 2668-2676.

Lambeth, J. D., Kawahara, T. and Diebold, B., Regulation of Nox and Duox enzymatic activity and expression. *Free Radic Biol Med* 2007. 43: 319-331.

Lambeth, J. D., Krause, K. H. and Clark, R. A., NOX enzymes as novel targets for drug development. *Semin Immunopathol* 2008. 30: 339-363.

Laroux, F. S., Romero, X., Wetzler, L., Engel, P. and Terhorst, C., Cutting edge: MyD88 controls phagocyte NADPH oxidase function and killing of gram-negative bacteria. *J Immunol* 2005. 175: 5596-5600.

Lassegue, B., Sorescu, D., Szocs, K., Yin, Q., Akers, M., Zhang, Y., Grant, S. L., Lambeth, J. D. and Griendling, K. K., Novel gp91phox Homologues in Vascular Smooth Muscle Cells : nox1 Mediates Angiotensin II-Induced Superoxide Formation and Redox-Sensitive Signaling Pathways. *Circulation Research* 2001. 88: 888-894.

Lassegue, B. and Clempus, R. E., Vascular NAD(P)H oxidases: specific features, expression, and regulation. *Am J Physiol Regul Integr Comp Physiol* 2003. 285: R277-297.

LeClair, R. J., Durmus, T., Wang, Q., Pygay, P., Terzic, A. and Lindner, V., Cthrc1 is a novel inhibitor of transforming growth factor-beta signaling and neointimal lesion formation. *Circ Res* 2007. 100: 826-833.

- Leclerc, P. C., Auger-Messier, M., Lanctot, P. M., Escher, E., Leduc, R. and Guillemette, G., A polyaromatic caveolin-binding-like motif in the cytoplasmic tail of the type 1 receptor for angiotensin II plays an important role in receptor trafficking and signaling. *Endocrinology* 2002. 143: 4702-4710.
- Lee, J. G., Lee, S. H., Park, D. W., Yoon, H. S., Chin, B. R., Kim, J. H., Kim, J. R. and Baek, S. H., Toll-like receptor 9-stimulated monocyte chemoattractant protein-1 is mediated via JNK-cytosolic phospholipase A2-ROS signaling. *Cell Signal* 2008. 20: 105-111.
- Lee, P. J. and Choi, A. M., Pathways of cell signaling in hyperoxia. *Free Radic Biol Med* 2003. 35: 341-350.
- Lekstrom-Himes, J. A., Kuhns, D. B., Alvord, W. G. and Gallin, J. I., Inhibition of Human Neutrophil IL-8 Production by Hydrogen Peroxide and Dysregulation in Chronic Granulomatous Disease. *J Immunol* 2005. 174: 411-417.
- Lelkes, P. I., Hahn, K. L., Sukovich, D. A., Karmioli, S. and Schmidt, D. H., On the possible role of reactive oxygen species in angiogenesis. *Adv Exp Med Biol* 1998. 454: 295-310.
- Levine, S., Smith, V. V., Malone, M. and Sebire, N. J., Histopathological features of chronic granulomatous disease (CGD) in childhood. *Histopathology* 2005. 47: 508-516.
- Li, B., Bedard, K., Sorce, S., Hinz, B., Dubois-dauphin, M. and Krause, K. H., NOX4 Expression in Human Microglia Leads to Constitutive Generation of Reactive Oxygen Species and to Constitutive IL-6 Expression. *J Innate Immun* 2009. 1: 20-24.
- Lin, J. H., Liebhaber, M., Roberts, R. L., Dyer, Z. and Stiehm, E. R., Etanercept treatment of cutaneous granulomas in common variable immunodeficiency. *J Allergy Clin Immunol* 2006. 117: 878-882.
- Liu, Q., Cheng, L. I., Yi, L., Zhu, N., Wood, A., Changpriroa, C. M., Ward, J. M. and Jackson, S. H., p47phox deficiency induces macrophage dysfunction resulting in progressive crystalline macrophage pneumonia. *Am J Pathol* 2009. 174: 153-163.
- Lofgren, R., Serrander, L., Forsberg, M., Wilsson, A., Wasteson, A. and Stendahl, O., CR3, FcγRIIA and FcγRIIIB induce activation of the respiratory burst in human neutrophils: the role of intracellular Ca²⁺, phospholipase D and tyrosine phosphorylation. *Biochim Biophys Acta* 1999. 1452: 46-59.
- Lopes-da-Silva, S. and Rizzo, L. V., Autoimmunity in common variable immunodeficiency. *J Clin Immunol* 2008. 28 Suppl 1: S46-55.
- Lundqvist-Gustafsson, H. and Bengtsson, T., Activation of the granule pool of the NADPH oxidase accelerates apoptosis in human neutrophils. *J Leukoc Biol* 1999. 65: 196-204.

Lyle, A. N., Deshpande, N. N., Taniyama, Y., Seidel-Rogol, B., Pounkova, L., Du, P., Papaharalambus, C., Lassegue, B. and Griendling, K. K., Poldip2, a novel regulator of Nox4 and cytoskeletal integrity in vascular smooth muscle cells. *Circ Res* 2009. 105: 249-259.

M

Maloney, E., Sweet, I. R., Hockenbery, D. M., Pham, M., Rizzo, N. O., Tateya, S., Handa, P., Schwartz, M. W. and Kim, F., Activation of NF-kappaB by palmitate in endothelial cells: a key role for NADPH oxidase-derived superoxide in response to TLR4 activation. *Arterioscler Thromb Vasc Biol* 2009. 29: 1370-1375.

Mantegazza, A. R., Savina, A., Vermeulen, M., Perez, L., Geffner, J., Hermine, O., Rosenzweig, S. D., Faure, F. and Amigorena, S., NADPH oxidase controls phagosomal pH and antigen cross-presentation in human dendritic cells. *Blood* 2008. 112: 4712-4722.

Marciano, B. E., Rosenzweig, S. D., Kleiner, D. E., Anderson, V. L., Darnell, D. N., Anaya-O'Brien, S., Hilligoss, D. M., Malech, H. L., Gallin, J. I. and Holland, S. M., Gastrointestinal involvement in chronic granulomatous disease. *Pediatrics* 2004. 114: 462-468.

Marden, J. J., Harraz, M. M., Williams, A. J., Nelson, K., Luo, M., Paulson, H. and Engelhardt, J. F., Redox modifier genes in amyotrophic lateral sclerosis in mice. *J Clin Invest* 2007. 117: 2913-2919.

Martyn, K. D., Frederick, L. M., von Loehneysen, K., Dinauer, M. C. and Knaus, U. G., Functional analysis of Nox4 reveals unique characteristics compared to other NADPH oxidases. *Cell Signal* 2006. 18: 69-82.

Matsuno, K., Yamada, H., Iwata, K., Jin, D., Katsuyama, M., Matsuki, M., Takai, S., Yamanishi, K., Miyazaki, M., Matsubara, H. and Yabe-Nishimura, C., Nox1 is involved in angiotensin II-mediated hypertension: a study in Nox1-deficient mice. *Circulation* 2005. 112: 2677-2685.

Maturana, A., Krause, K. H. and Demaurex, N., NOX family NADPH oxidases: do they have built-in proton channels? *J Gen Physiol* 2002. 120: 781-786.

Matute, J. D., Arias, A. A., Wright, N. A., Wrobel, I., Waterhouse, C. C., Li, X. J., Marchal, C. C., Stull, N. D., Lewis, D. B., Steele, M., Kellner, J. D., Yu, W., Meroueh, S. O., Nauseef, W. M. and Dinauer, M. C., A new genetic subgroup of chronic granulomatous disease with autosomal recessive mutations in p40 phox and selective defects in neutrophil NADPH oxidase activity. *Blood* 2009. 114: 3309-3315.

Maxwell, S. and Greig, L., Anti-oxidants-- a protective role in cardiovascular disease? *Expert Opin Pharmacother* 2001. 2: 1737-1750.

McIntosh, M., Stone, B. A. and Stanisich, V. A., Curdlan and other bacterial (1-->3)-beta-D-glucans. *Appl Microbiol Biotechnol* 2005. 68: 163-173.

- McQueen, M. J., Lonn, E., Gerstein, H. C., Bosch, J. and Yusuf, S., The HOPE (Heart Outcomes Prevention Evaluation) Study and its consequences. *Scand J Clin Lab Invest Suppl* 2005. 240: 143-156.
- Medlicott, S. A., Coderre, S., Horne, G. and Panaccione, R., Multimodal immunosuppressant therapy in steroid-refractory common variable immunodeficiency sprue: a case report complicating cytomegalovirus infection. *Int J Surg Pathol* 2006. 14: 101-106.
- Meng, Q. R., Gideon, K. M., Harbo, S. J., Renne, R. A., Lee, M. K., Brys, A. M. and Jones, R., Gene expression profiling in lung tissues from mice exposed to cigarette smoke, lipopolysaccharide, or smoke plus lipopolysaccharide by inhalation. *Inhal Toxicol* 2006. 18: 555-568.
- Menshikov, M., Plekhanova, O., Cai, H., Chalupsky, K., Parfyonova, Y., Bashtrikov, P., Tkachuk, V. and Berk, B. C., Urokinase plasminogen activator stimulates vascular smooth muscle cell proliferation via redox-dependent pathways. *Arterioscler Thromb Vasc Biol* 2006. 26: 801-807.
- Metcalf, D. D., Thompson, H. L., Klebanoff, S. J. and Henderson, W. R., Jr., Oxidative degradation of rat mast-cell heparin proteoglycan. *Biochem J* 1990. 272: 51-57.
- Metrailler-Ruchonnet, I., Pagano, A., Carnesecchi, S., Ody, C., Donati, Y. and Barazzone Argiroffo, C., Bcl-2 protects against hyperoxia-induced apoptosis through inhibition of the mitochondria-dependent pathway. *Free Radic Biol Med* 2007. 42: 1062-1074.
- Mishra, P. K., Tyagi, N., Kundu, S. and Tyagi, S. C., MicroRNAs Are Involved in Homocysteine-Induced Cardiac Remodeling. *Cell Biochem Biophys* 2009.
- Mitsushita, J., Lambeth, J. D. and Kamata, T., The superoxide-generating oxidase Nox1 is functionally required for Ras oncogene transformation. *Cancer Res* 2004. 64: 3580-3585.
- Mittal, M., Roth, M., Konig, P., Hofmann, S., Dony, E., Goyal, P., Selbitz, A. C., Schermuly, R. T., Ghofrani, H. A., Kwapiszewska, G., Kummer, W., Klepetko, W., Hoda, M. A., Fink, L., Hanze, J., Seeger, W., Grimminger, F., Schmidt, H. H. and Weissmann, N., Hypoxia-dependent regulation of nonphagocytic NADPH oxidase subunit NOX4 in the pulmonary vasculature. *Circ Res* 2007. 101: 258-267.
- Miura, N. N., Miura, T., Ohno, N., Adachi, Y., Watanabe, M., Tamura, H., Tanaka, S. and Yadomae, T., Gradual solubilization of Candida cell wall [beta]-glucan by oxidative degradation in mice. *FEMS Immunology and Medical Microbiology* 1998. 21: 123-129.
- Moe, K. T., Aulia, S., Jiang, F., Chua, Y. L., Koh, T. H., Wong, M. C. and Dusting, G. J., Differential upregulation of Nox homologues of NADPH oxidase by tumor necrosis factor-alpha in human aortic smooth muscle and embryonic kidney cells. *J Cell Mol Med* 2006. 10: 231-239.

Morand, S., Ueyama, T., Tsujibe, S., Saito, N., Korzeniowska, A. and Leto, T. L., Duox maturation factors form cell surface complexes with Duox affecting the specificity of reactive oxygen species generation. *FASEB J* 2009. 23: 1205-1218.

Morel, F., Cohen Tanugi Cholley, L., Brandolin, G., Dianoux, A. C., Martel, C., Champelovier, P., Seigneurin, J. M., Francois, P., Bost, M. and Vignais, P. V., The O₂-generating oxidase of B lymphocytes: Epstein-Barr virus-immortalized B lymphocytes as a tool for the identification of defective components of the oxidase in chronic granulomatous disease. *Biochim Biophys Acta* 1993. 1182: 101-109.

Morgenstern, D. E., Gifford, M. A., Li, L. L., Doerschuk, C. M. and Dinauer, M. C., Absence of respiratory burst in X-linked chronic granulomatous disease mice leads to abnormalities in both host defense and inflammatory response to *Aspergillus fumigatus*. *J Exp Med* 1997. 185: 207-218.

Mori, M., Li, G., Hashimoto, M., Nishio, A., Tomozawa, H., Suzuki, N., Usami, S., Higuchi, K. and Matsumoto, K., Pivotal Advance: Eosinophilia in the MES rat strain is caused by a loss-of-function mutation in the gene for cytochrome b(-245), alpha polypeptide (Cyba). *J Leukoc Biol* 2009. 86: 473-478.

Moskwa, P., Lorentzen, D., Excoffon, K. J., Zabner, J., McCray, P. B., Jr., Nauseef, W. M., Dupuy, C. and Banfi, B., A novel host defense system of airways is defective in cystic fibrosis. *Am J Respir Crit Care Med* 2007. 175: 174-183.

N

Nagata, M., Inflammatory cells and oxygen radicals. *Curr Drug Targets Inflamm Allergy* 2005. 4: 503-504.

Nakamura, K., Hori, T., Sato, N., Sugie, K., Kawakami, T. and Yodoi, J., Redox regulation of a src family protein tyrosine kinase p56lck in T cells. *Oncogene* 1993. 8: 3133-3139.

Nakano, Y., Banfi, B., Jesaitis, A. J., Dinauer, M. C., Allen, L. A. and Nauseef, W. M., Critical roles for p22phox in the structural maturation and subcellular targeting of Nox3. *Biochem J* 2007. 403: 97-108.

Newburger, P. E., Dai, Q. and Whitney, C., In vitro regulation of human phagocyte cytochrome b heavy and light chain gene expression by bacterial lipopolysaccharide and recombinant human cytokines. *J Biol Chem* 1991. 266: 16171-16177.

O

Ogata, T., Shibamura, H., Tromp, G., Sinha, M., Goddard, K. A., Sakalihan, N., Limet, R., MacKean, G. L., Arthur, C., Sueda, T., Land, S. and Kuivaniemi, H., Genetic analysis of polymorphisms in biologically relevant candidate genes in patients with abdominal aortic aneurysms. *J Vasc Surg* 2005. 41: 1036-1042.

Ogier-Denis, E., Mkaddem, S. B. and Vandewalle, A., NOX enzymes and Toll-like receptor signaling. *Semin Immunopathol* 2008. 30: 291-300.

Olofsson, P., Holmberg, J., Tordsson, J., Lu, S., Akerstrom, B. and Holmdahl, R., Positional identification of Ncf1 as a gene that regulates arthritis severity in rats. *Nat Genet* 2003. 33: 25-32.

Ottonello, L., Frumento, G., Arduino, N., Bertolotto, M., Dapino, P., Mancini, M. and Dallegri, F., Differential regulation of spontaneous and immune complex-induced neutrophil apoptosis by proinflammatory cytokines. Role of oxidants, Bax and caspase-3. *J Leukoc Biol* 2002. 72: 125-132.

P

Pacquelet, S., Johnson, J. L., Ellis, B. A., Brzezinska, A. A., Lane, W. S., Munafo, D. B. and Catz, S. D., Cross-talk between IRAK-4 and the NADPH oxidase. *Biochem J* 2007. 403: 451-461.

Paffenholz, R., Bergstrom, R. A., Pasutto, F., Wabnitz, P., Munroe, R. J., Jagla, W., Heinzmann, U., Marquardt, A., Bareiss, A., Laufs, J., Russ, A., Stumm, G., Schimenti, J. C. and Bergstrom, D. E., Vestibular defects in head-tilt mice result from mutations in Nox3, encoding an NADPH oxidase. *Genes Dev* 2004. 18: 486-491.

Pantano, C., Anathy, V., Ranjan, P., Heintz, N. H. and Janssen-Heininger, Y. M., Nonphagocytic oxidase 1 causes death in lung epithelial cells via a TNF-RI-JNK signaling axis. *Am J Respir Cell Mol Biol* 2007. 36: 473-479.

Parinandi, N. L., Kleinberg, M. A., Usatyuk, P. V., Cummings, R. J., Pennathur, A., Cardounel, A. J., Zweier, J. L., Garcia, J. G. and Natarajan, V., Hyperoxia-induced NAD(P)H oxidase activation and regulation by MAP kinases in human lung endothelial cells. *Am J Physiol Lung Cell Mol Physiol* 2003. 284: L26-38.

Park, H. S., Jung, H. Y., Park, E. Y., Kim, J., Lee, W. J. and Bae, Y. S., Cutting edge: direct interaction of TLR4 with NAD(P)H oxidase 4 isozyme is essential for lipopolysaccharide-induced production of reactive oxygen species and activation of NF-kappa B. *J Immunol* 2004. 173: 3589-3593.

Park, H. S., Chun, J. N., Jung, H. Y., Choi, C. and Bae, Y. S., Role of NADPH oxidase 4 in lipopolysaccharide-induced proinflammatory responses by human aortic endothelial cells. *Cardiovasc Res* 2006. 72: 447-455.

Parkos, C., Dinauer, M., Walker, L., Allen, R., Jesaitis, A. and Orkin, S., Primary structure and unique expression of the 22-kilodalton chain of human neutrophil cytochrome b. *Proc Natl Acad Sci* 1988. 85: 3319-3323.

Patel, D. N., Bailey, S. R., Gresham, J. K., Schuchman, D. B., Shelhamer, J. H., Goldstein, B. J., Foxwell, B. M., Stemerman, M. B., Maranchie, J. K., Valente, A. J., Mummidi, S. and Chandrasekar, B., TLR4-NOX4-AP-1 signaling mediates lipopolysaccharide-induced CXCR6 expression in human aortic smooth muscle cells. *Biochem Biophys Res Commun* 2006. 347: 1113-1120.

Pedruzzi, E., Guichard, C., Ollivier, V., Driss, F., Fay, M., Prunet, C., Marie, J. C., Pouzet, C., Samadi, M., Elbim, C., O'Dowd, Y., Bens, M., Vandewalle, A., Gougerot-Pocidalò, M. A., Lizard, G. and Ogier-Denis, E., NAD(P)H oxidase Nox-4 mediates 7-ketocholesterol-induced endoplasmic reticulum stress and apoptosis in human aortic smooth muscle cells. *Mol Cell Biol* 2004. 24: 10703-10717.

Petersen, J. E., Hiran, T. S., Goebel, W. S., Johnson, C., Murphy, R. C., Azmi, F. H., Hood, A. F., Travers, J. B. and Dinauer, M. C., Enhanced cutaneous inflammatory reactions to *Aspergillus fumigatus* in a murine model of chronic granulomatous disease. *J Invest Dermatol* 2002. 118: 424-429.

Phillips, J. R., Dalmay, T. and Bartels, D., The role of small RNAs in abiotic stress. *FEBS Lett* 2007. 581: 3592-3597.

Plantinga, Y., Ghiadoni, L., Magagna, A., Giannarelli, C., Franzoni, F., Taddei, S. and Salvetti, A., Supplementation with vitamins C and E improves arterial stiffness and endothelial function in essential hypertensive patients. *Am J Hypertens* 2007. 20: 392-397.

Plat, J. and Mensink, R. P., Food components and immune function. *Curr Opin Lipidol* 2005. 16: 31-37.

Pollock, J., Williams, D., Gifford, M., Li, L., Du, X., Fisherman, J., Orkin, S., Doerschuk, C. and Dinauer, M., Mouse model of X-linked chronic granulomatous disease, an inherited defect in phagocyte superoxide production. *Nat Gen* 1995. 9: 202-209.

R

Raad, H., Paclet, M. H., Boussetta, T., Kroviarski, Y., Morel, F., Quinn, M. T., Gougerot-Pocidalò, M. A., Dang, P. M. and El-Benna, J., Regulation of the phagocyte NADPH oxidase activity: phosphorylation of gp91phox/NOX2 by protein kinase C enhances its diaphorase activity and binding to Rac2, p67phox, and p47phox. *FASEB J* 2009. 23: 1011-1022.

Rada, B. K., Geiszt, M., Hably, C. and Ligeti, E., Consequences of the electrogenic function of the phagocytic NADPH oxidase. *Philos Trans R Soc Lond B Biol Sci* 2005. 360: 2293-2300.

Rahman, I., Oxidative stress and gene transcription in asthma and chronic obstructive pulmonary disease: antioxidant therapeutic targets. *Curr Drug Targets Inflamm Allergy* 2002. 1: 291-315.

Rajagopalan, S., Kurz, S., Munzel, T., Tarpey, M., Freeman, B. A., Griendling, K. K. and Harrison, D. G., Angiotensin II-mediated hypertension in the rat increases vascular superoxide production via membrane NADH/NADPH oxidase activation. Contribution to alterations of vasomotor tone. *J Clin Invest* 1996. 97: 1916-1923.

Redondo, P. C., Salido, G. M., Rosado, J. A. and Pariente, J. A., Effect of hydrogen peroxide on Ca²⁺ mobilisation in human platelets through sulphhydryl oxidation dependent and independent mechanisms. *Biochem Pharmacol* 2004. 67: 491-502.

Rodrigo, R., Prat, H., Passalacqua, W., Araya, J. and Bachler, J. P., Decrease in oxidative stress through supplementation of vitamins C and E is associated with a reduction in blood pressure in patients with essential hypertension. *Clin Sci (Lond)* 2008. 114: 625-634.

Rodriguez-Puyol, M., Griera-Merino, M., Perez-Rivero, G., Diez-Marques, M. L., Ruiz-Torres, M. P. and Rodriguez-Puyol, D., Angiotensin II induces a rapid and transient increase of reactive oxygen species. *Antioxid Redox Signal* 2002. 4: 869-875.

Rosh, J. R., Tang, H. B., Mayer, L., Groisman, G., Abraham, S. K. and Prince, A., Treatment of intractable gastrointestinal manifestations of chronic granulomatous disease with cyclosporine. *J Pediatr* 1995. 126: 143-145.

Rubanyi, G. M. and Vanhoutte, P. M., Superoxide anions and hyperoxia inactivate endothelium-derived relaxing factor. *Am J Physiol* 1986. 250: H822-827.

Ruiz-Ortega, M., Lorenzo, O., Ruperez, M., Blanco, J. and Egido, J., Systemic infusion of angiotensin II into normal rats activates nuclear factor-kappaB and AP-1 in the kidney: role of AT(1) and AT(2) receptors. *Am J Pathol* 2001. 158: 1743-1756.

Ruiz-Ortega, M., Lorenzo, O., Ruperez, M., Esteban, V., Suzuki, Y., Mezzano, S., Plaza, J. J. and Egido, J., Role of the renin-angiotensin system in vascular diseases: expanding the field. *Hypertension* 2001. 38: 1382-1387.

Rylander, R., Norrhall, M., Engdahl, U., Tunsater, A. and Holt, P. G., Airways inflammation, atopy, and (1->3)-beta-D-glucan exposures in two schools. *Am J Respir Crit Care Med* 1998. 158: 1685-1687.

S

Sakata, A., Ida, E., Tominaga, M. and Onoue, K., Arachidonic acid acts as an intracellular activator of NADPH-oxidase in Fc gamma receptor-mediated superoxide generation in macrophages. *J Immunol* 1987. 138: 4353-4359.

Sanmun, D., Witasap, E., Jitkaew, S., Tyurina, Y. Y., Kagan, V. E., Ahlin, A., Palmblad, J. and Fadeel, B., Involvement of a functional NADPH oxidase in neutrophils and macrophages during programmed cell clearance: implications for chronic granulomatous disease. *Am J Physiol Cell Physiol* 2009. 297: C621-631.

Sasaki, H., Yamamoto, H., Tominaga, K., Masuda, K., Kawai, T., Teshima-Kondo, S., Matsuno, K., Yabe-Nishimura, C. and Rokutan, K., Receptor activator of nuclear factor-kappaB ligand-induced mouse osteoclast differentiation is associated with switching between NADPH oxidase homologues. *Free Radic Biol Med* 2009. 47: 189-199.

Savina, A., Jancic, C., Hugues, S., Guermonprez, P., Vargas, P., Moura, I. C., Lennon-Dumenil, A. M., Seabra, M. C., Raposo, G. and Amigorena, S., NOX2 controls phagosomal pH to regulate antigen processing during crosspresentation by dendritic cells. *Cell* 2006. 126: 205-218.

Schäppi, M., Smith, V., Goldblatt, D., Lindley, K. and Milla, P., Colitis is common in CGD. *J Ped Gastro Nut* 1999. 28: 569.

Schäppi, M., Smith, V., Lindley, K. and Milla, P., Heterogeneity of crypt function in childhood colitis. *J Ped Gastro Nut* 2001. 32: 373.

Schappi, M., Deffert, C., Fiette, L., Gavazzi, G., Herrmann, F., Belli, D. and Krause, K. H., Branched fungal beta-glucan causes hyperinflammation and necrosis in phagocyte NADPH oxidase-deficient mice. *J Pathol* 2008. 214: 434-444.

Schappi, M. G., Jaquet, V., Belli, D. C. and Krause, K. H., Hyperinflammation in chronic granulomatous disease and anti-inflammatory role of the phagocyte NADPH oxidase. *Semin Immunopathol* 2008. 30: 255-271.

Schiffrin, E. L., Intracellular signal transduction for vasoactive peptides in hypertension. *Can J Physiol Pharmacol* 1994. 72: 954-962.

Segal, B. H., Leto, T. L., Gallin, J. I., Malech, H. L. and Holland, S. M., Genetic, biochemical, and clinical features of chronic granulomatous disease. *Medicine (Baltimore)* 2000. 79: 170-200.

Selmeczy, Z., Szelenyi, J., Nemet, K. and Vizi, E. S., The inducibility of TNF-alpha production is different in the granulocytic and monocytic differentiated forms of wild type and CGD-mutant PLB-985 cells. *Immunol Cell Biol* 2003. 81: 472-479.

Serhan, C. N., Brain, S. D., Buckley, C. D., Gilroy, D. W., Haslett, C., O'Neill, L. A., Perretti, M., Rossi, A. G. and Wallace, J. L., Resolution of inflammation: state of the art, definitions and terms. *FASEB J* 2007. 21: 325-332.

Serrander, L., Larsson, J., Lundqvist, H., Lindmark, M., Fallman, M., Dahlgren, C. and Stendahl, O., Particles binding beta(2)-integrins mediate intracellular production of oxidative metabolites in human neutrophils independently of phagocytosis. *Biochim Biophys Acta* 1999. 1452: 133-144.

Serrander, L., Cartier, L., Bedard, K., Banfi, B., Lardy, B., Plastre, O., Sienkiewicz, A., Forro, L., Schlegel, W. and Krause, K. H., NOX4 activity is determined by mRNA levels and reveals a unique pattern of ROS generation. *Biochem J* 2007. 406: 105-114.

Shilo, S., Roy, S., Khanna, S. and Sen, C. K., Evidence for the involvement of miRNA in redox regulated angiogenic response of human microvascular endothelial cells. *Arterioscler Thromb Vasc Biol* 2008. 28: 471-477.

Shono, T., Ono, M., Izumi, H., Jimi, S. I., Matsushima, K., Okamoto, T., Kohno, K. and Kuwano, M., Involvement of the transcription factor NF-kappaB in tubular morphogenesis of human microvascular endothelial cells by oxidative stress. *Mol Cell Biol* 1996. 16: 4231-4239.

Somlyo, A. P. and Somlyo, A. V., Signal transduction by G-proteins, rho-kinase and protein phosphatase to smooth muscle and non-muscle myosin II. *J Physiol* 2000. 522 Pt 2: 177-185.

Sorce, S. and Krause, K. H., NOX enzymes in the central nervous system: from signaling to disease. *Antioxid Redox Signal* 2009. 11: 2481-2504.

Sorescu, G. P., Song, H., Tressel, S. L., Hwang, J., Dikalov, S., Smith, D. A., Boyd, N. L., Platt, M. O., Lassegue, B., Griendling, K. K. and Jo, H., Bone morphogenic protein 4 produced in endothelial cells by oscillatory shear stress induces monocyte adhesion by stimulating reactive oxygen species production from a nox1-based NADPH oxidase. *Circ Res* 2004. 95: 773-779.

Sowers, J. R., Hypertension, angiotensin II, and oxidative stress. *N Engl J Med* 2002. 346: 1999-2001.

Suh, Y.-A., Arnold, R., Lassegue, B., Shi, J., XU, X., Sorescu, D., Chung, A., Griendling, K. and Lambeth, J., Cell transformation by the superoxide-generating oxidase Mox1. *Nat* 1999. 401: 79-82.

Suzuki, Y. and Ono, Y., Involvement of reactive oxygen species produced via NADPH oxidase in tyrosine phosphorylation in human B- and T-lineage lymphoid cells. *Biochem Biophys Res Commun* 1999. 255: 262-267.

T

Tasaka, S., Amaya, F., Hashimoto, S. and Ishizaka, A., Roles of oxidants and redox signaling in the pathogenesis of acute respiratory distress syndrome. *Antioxid Redox Signal* 2008. 10: 739-753.

Tatin, F., Varon, C., Genot, E. and Moreau, V., A signalling cascade involving PKC, Src and Cdc42 regulates podosome assembly in cultured endothelial cells in response to phorbol ester. *J Cell Sci* 2006. 119: 769-781.

Thatayatikom, A., Thatayatikom, S. and White, A. J., Infliximab treatment for severe granulomatous disease in common variable immunodeficiency: a case report and review of the literature. *Ann Allergy Asthma Immunol* 2005. 95: 293-300.

Thomas, M., Gavrila, D., McCormick, M. L., Miller, F. J., Jr., Daugherty, A., Cassis, L. A., Dellsperger, K. C. and Weintraub, N. L., Deletion of p47phox attenuates angiotensin II-induced abdominal aortic aneurysm formation in apolipoprotein E-deficient mice. *Circulation* 2006. 114: 404-413.

Thorn, J., Beijer, L. and Rylander, R., Airways inflammation and glucan exposure among household waste collectors. *Am J Ind Med* 1998. 33: 463-470.

Torrecillas, G., Boyano-Adanez, M. C., Medina, J., Parra, T., Griera, M., Lopez-Ongil, S., Arilla, E., Rodriguez-Puyol, M. and Rodriguez-Puyol, D., The role of hydrogen peroxide in the contractile response to angiotensin II. *Mol Pharmacol* 2001. 59: 104-112.

Touyz, R. M., He, G., Deng, L. Y. and Schiffrin, E. L., Role of extracellular signal-regulated kinases in angiotensin II-stimulated contraction of smooth muscle cells from human resistance arteries. *Circulation* 1999. 99: 392-399.

U

Uehata, M., Ishizaki, T., Satoh, H., Ono, T., Kawahara, T., Morishita, T., Tamakawa, H., Yamagami, K., Inui, J., Maekawa, M. and Narumiya, S., Calcium sensitization of smooth muscle mediated by a Rho-associated protein kinase in hypertension. *Nature* 1997. 389: 990-994.

Ueno, N., Takeya, R., Miyano, K., Kikuchi, H. and Sumimoto, H., The NADPH oxidase Nox3 constitutively produces superoxide in a p22phox-dependent manner: its regulation by oxidase organizers and activators. *J Biol Chem* 2005. 280: 23328-23339.

Underhill, D. M. and Ozinsky, A., Phagocytosis of microbes: complexity in action. *Annu Rev Immunol* 2002. 20: 825-852.

Underhill, D. M., Rossnagle, E., Lowell, C. A. and Simmons, R. M., Dectin-1 activates Syk tyrosine kinase in a dynamic subset of macrophages for reactive oxygen production. *Blood* 2005. 106: 2543-2550.

Urban, C. F., Reichard, U., Brinkmann, V. and Zychlinsky, A., Neutrophil extracellular traps capture and kill *Candida albicans* yeast and hyphal forms. *Cell Microbiol* 2006. 8: 668-676.

Ushio-Fukai, M., Zuo, L., Ikeda, S., Tojo, T., Patrushev, N. A. and Alexander, R. W., cAbl tyrosine kinase mediates reactive oxygen species- and caveolin-dependent AT1 receptor signaling in vascular smooth muscle: role in vascular hypertrophy. *Circ Res* 2005. 97: 829-836.

Ushio-Fukai, M., VEGF signaling through NADPH oxidase-derived ROS. *Antioxid Redox Signal* 2007. 9: 731-739.

Ushio-Fukai, M., Compartmentalization of redox signaling through NADPH oxidase-derived ROS. *Antioxid Redox Signal* 2009. 11: 1289-1299.

V

Van Bruggen, R., Drewniak, A., Jansen, M., van Houdt, M., Roos, D., Chapel, H., Verhoeven, A. J. and Kuijpers, T. W., Complement receptor 3, not Dectin-1, is the major receptor on human neutrophils for beta-glucan-bearing particles. *Mol Immunol* 2009.

Van de Loo, F. A. J., Bennink, M. B., Arntz, O. J., Smeets, R. L., Lubberts, E., Joosten, L. A. B., van Lent, P. L. E. M., Coenen-de Roo, C. J. J., Cuzzocrea, S., Segal, B. H., Holland, S. M. and van den Berg, W. B., Deficiency of NADPH Oxidase Components p47phox and gp91phox Caused Granulomatous Synovitis and Increased Connective Tissue Destruction in Experimental Arthritis Models. *Am J Pathol* 2003. 163: 1525-1537.

Van den Berg, J. M., van Koppen, E., Ahlin, A., Belohradsky, B. H., Bernatowska, E., Corbeel, L., Espanol, T., Fischer, A., Kurenko-Deptuch, M., Mouy, R., Petropoulou, T., Roesler, J., Seger, R., Stasia, M. J., Valerius, N. H., Weening, R. S., Wolach, B., Roos, D. and Kuijpers, T. W., Chronic granulomatous disease: the European experience. *PLoS One* 2009. 4: e5234.

Van der Vliet, A., Eiserich, J. P., Marelich, G. P., Halliwell, B. and Cross, C. E., Oxidative stress in cystic fibrosis: does it occur and does it matter? *Adv Pharmacol* 1997. 38: 491-513.

Van der Vliet, A., NADPH oxidases in lung biology and pathology: host defense enzymes, and more. *Free Radic Biol Med* 2008. 44: 938-955.

Vilhardt, F. and van Deurs, B., The phagocyte NADPH oxidase depends on cholesterol-enriched membrane microdomains for assembly. *EMBO J* 2004. 23: 739-748.

W

Wang, G., Anrather, J., Glass, M. J., Tarsitano, M. J., Zhou, P., Frys, K. A., Pickel, V. M. and Iadecola, C., Nox2, Ca²⁺, and protein kinase C play a role in angiotensin II-induced free radical production in nucleus tractus solitarius. *Hypertension* 2006. 48: 482-489.

Weaver, A. M., Regulation of cancer invasion by reactive oxygen species and Tks family scaffold proteins. *Sci Signal* 2009. 2: pe56.

Weyemi, U., Caillou, B., Talbot, M., Ameziane-El-Hassani, R., Lacroix, L., Laget-Chevallier, O., Al Ghuzlan, A., Roos, D., Bidart, J. M., Virion, A., Schlumberger, M. and Dupuy, C., Intracellular expression of ROS-generating NADPH oxidase NOX4 in normal and cancer thyroid tissues. *Endocr Relat Cancer* 2009.

Willment, J. A., Marshall, A. S., Reid, D. M., Williams, D. L., Wong, S. Y., Gordon, S. and Brown, G. D., The human beta-glucan receptor is widely expressed and functionally equivalent to murine Dectin-1 on primary cells. *Eur J Immunol* 2005. 35: 1539-1547.

Wingler, K., Wunsch, S., Kreutz, R., Rothermund, L., Paul, M. and Schmidt, H. H., Upregulation of the vascular NAD(P)H-oxidase isoforms Nox1 and Nox4 by the renin-angiotensin system in vitro and in vivo. *Free Radic Biol Med* 2001. 31: 1456-1464.

Wright, S. D. and Silverstein, S. C., Receptors for C3b and C3bi promote phagocytosis but not the release of toxic oxygen from human phagocytes. *J Exp Med* 1983. 158: 2016-2023.

X

Xu, S., Huo, J., Lee, K. G., Kurosaki, T. and Lam, K. P., Phospholipase Cgamma2 is critical for Dectin-1-mediated Ca²⁺ flux and cytokine production in dendritic cells. *J Biol Chem* 2009. 284: 7038-7046.

Y

Yamamoto, A., Tanuichi, S., Tsuji, S., Kobayashi, M. H. Y. and Kobayashi, Y., Role of reactive oxygen species in neutrophil apoptosis following ingestion of heat-killed *Staphylococcus aureus*. *Clinical and Experimental Immunology* 2002. 129: 479-484.

Yang, B. and Rizzo, V., TNF-alpha potentiates protein-tyrosine nitration through activation of NADPH oxidase and eNOS localized in membrane rafts and caveolae of bovine aortic endothelial cells. *Am J Physiol Heart Circ Physiol* 2007. 292: H954-962.

Yang, C. S., Shin, D. M., Kim, K. H., Lee, Z. W., Lee, C. H., Park, S. G., Bae, Y. S. and Jo, E. K., NADPH oxidase 2 interaction with TLR2 is required for efficient innate immune responses to mycobacteria via cathelicidin expression. *J Immunol* 2009. 182: 3696-3705.

Yang, Z. and Marshall, J. S., Zymosan treatment of mouse mast cells enhances dectin-1 expression and induces dectin-1-dependent reactive oxygen species (ROS) generation. *Immunobiology* 2009. 214: 321-330.

Yogi, A., Mercure, C., Touyz, J., Callera, G. E., Montezano, A. C., Aranha, A. B., Tostes, R. C., Reudelhuber, T. and Touyz, R. M., Renal redox-sensitive signaling, but not blood pressure, is attenuated by Nox1 knockout in angiotensin II-dependent chronic hypertension. *Hypertension* 2008. 51: 500-506.

Z

Zaher, T. E., Miller, E. J., Morrow, D. M., Javdan, M. and Mantell, L. L., Hyperoxia-induced signal transduction pathways in pulmonary epithelial cells. *Free Radic Biol Med* 2007. 42: 897-908.

Zhang, X., Shan, P., Sasidhar, M., Chupp, G. L., Flavell, R. A., Choi, A. M. and Lee, P. J., Reactive oxygen species and extracellular signal-regulated kinase 1/2 mitogen-activated protein kinase mediate hyperoxia-induced cell death in lung epithelium. *Am J Respir Cell Mol Biol* 2003. 28: 305-315.

Références bibliographiques

Zhang, X., Shan, P., Jiang, G., Cohn, L. and Lee, P. J., Toll-like receptor 4 deficiency causes pulmonary emphysema. *J Clin Invest* 2006. 116: 3050-3059.

Zuo, L., Ushio-Fukai, M., Ikeda, S., Hilenski, L., Patrushev, N. and Alexander, R. W., Caveolin-1 is essential for activation of Rac1 and NAD(P)H oxidase after angiotensin II type 1 receptor stimulation in vascular smooth muscle cells: role in redox signaling and vascular hypertrophy. *Arterioscler Thromb Vasc Biol* 2005. 25: 1824-1830.

ANNEXE

LISTE DE PUBLICATIONS et COMMUNICATIONS ORALES

ARTICLES ORIGINAUX PUBLIES OU ACCEPTES

Deffert C, Chouraqui J.P, Girardet J.P, Hubert D, Pressac M. Intérêt du dosage de l'élastase pancréatique fécale chez les sujets mucoviscidiques. *Immuno-analyse et biologie spécialisée* 2000. 15: 427- 431

Deffert C, Esteve F, Grimaux M, Gouault-Heilmann M. A direct, automated, immuno-turbidimetric assay of free Protein S antigen in plasma. *Blood Coagulation and Fibrinolysis* 2001. 12: 1-5.

Metz C, Cave H, Bertrand AM, Deffert C, Gueguen-Giroux B, Czernichow P, Polak M. Neonatal diabetes mellitus : chromosomal analysis in transient and permanent cases. *J Pediatr* 2002. 141: 483-489.

Gavazzi G, Banfi B, Deffert C, Fiette L, Schappi M, Herrmann F, Krause KH. Decreased blood pressure in NOX1-deficient mice. *FEBS Lett* 2006. 23: 497-504.

Gavazzi G, Deffert C, Trocme C, Schappi M, Herrmann FR, Krause KH. NOX1 deficiency protects from aortic dissection in response to angiotensin II. *Hypertension* 2007. 50:189-196.

Deffert C, Niel F, Mochel F, Barrey C, Romana C, Souied E, Stoetzel C, Goossens M, Dollfus H, Verloes A, Girodon E, Gerard-Blanluet M. Recurrent insertional polydactyly and situs inversus in a Bardet-Biedl syndrome family. *Am J Med Genet A* 2007. 15: 208-213.

Schappi MG, Deffert C, Fiette L, Herrman F, Belli DC, Krause KH. Fungal branched β -glucan cause hyperinflammation and necrosis in phagocyte NADPH oxidase deficient mice. *J Pathol.* 2008.214: 434-444.

Basset O, Deffert C, Foti M, Bedard K, Jaquet V, Ogier-Denis E, Krause KH. NADPH oxidase 1 deficiency alters caveolin phosphorylation and angiotensin II-receptor localization in vascular smooth muscle. *Antioxid Redox Signal.* 2009.11: 2371-2384.

Carnesecchi S, Deffert C, Pagano A, Garrido-Urbani S, Métrailler-Ruchonnet I, Schappi M, Donati Y, Matthay MA, Krause KH, Barazzone Argiroffo C. NOX1 Plays a Crucial Role in Hyperoxia-Induced Acute Lung Injury in Mice. *Am J Respir Crit Care Med.* 2009. 180: 972-981.

POSTERS ET COMMUNICATIONS ORALES

- Poster et communication « Intérêt de l'Elastase pancréatique fécale chez des enfants mucoviscidosiques ». Congrès CORATA, Liège (1999).
- Communication « Modèle de colite dans la souris déficiente en NOX2 ». 4ème Réunion du Club oxydase, Grenoble (2005).
- Communication et poster « NOX1 et glandes mammaires ». 5ème Réunion du Club oxydase, Grenoble (2007).
- Poster Gordon conférence, Boston (2008).
- Poster « TNF α dans l'inflammation en l'absence de NOX2 ». 6ème Réunion du Club oxydase. Paris (2009).