



HAL
open science

Toward a methodology of structuring the interactions dynamic within the Multi-Domains and Multi-Views design model: Application to the design of modular product families

Aurélie Robert

► To cite this version:

Aurélie Robert. Toward a methodology of structuring the interactions dynamic within the Multi-Domains and Multi-Views design model: Application to the design of modular product families. Other. Université de Technologie de Belfort-Montbeliard, 2012. English. NNT: 2012BELF0189 . tel-00863788

HAL Id: tel-00863788

<https://theses.hal.science/tel-00863788>

Submitted on 19 Sep 2013

HAL is a multi-disciplinary open access archive for the deposit and dissemination of scientific research documents, whether they are published or not. The documents may come from teaching and research institutions in France or abroad, or from public or private research centers.

L'archive ouverte pluridisciplinaire **HAL**, est destinée au dépôt et à la diffusion de documents scientifiques de niveau recherche, publiés ou non, émanant des établissements d'enseignement et de recherche français ou étrangers, des laboratoires publics ou privés.

Thèse de doctorat

Université de Technologie de Belfort-Montbéliard

École doctorale Sciences Pour l'Ingénieur et Microtechniques – SPIM

Pour l'obtention du grade de

**Docteur de l'Université de Technologie de Belfort-
Montbéliard en Sciences pour l'Ingénieur**

Spécialité : Mécanique

**Vers une méthodologie de structuration de la dynamique des
interactions au sein du modèle de conception Multi-Domains et
Multi-Vues - Application à la conception de familles de produits
modulaires**

Toward a methodology of structuring the interactions dynamic within the Multi-Domains and Multi-Views design model - Application to the design of modular product families

Présentée et soutenue publiquement par

Aurélie ROBERT

Le 27 novembre 2012 devant le jury d'examen :

Prof. Chris MCMAHON	University of Bristol, Angleterre - Rapporteur
Prof. Peggy ZWOLINSKI	Institut Polytechnique de Grenoble, France - Rapporteur
Prof. Bernard YANNOU	Ecole Centrale de Paris, France – Président du jury
Dr. Karine DESCHINKEL	Université de Franche-Comté, France - Examineur
Prof. Samuel GOMES	Université de Technologie de Belfort - Montbéliard, France - Directeur de thèse
Dr. Sébastien ROTH	Université de Technologie de Belfort-Montbéliard, France - Co-encadrant
Prof. Xiu Tian YAN	University of Strathclyde, Ecosse - Co-encadrant
Olivier BIDAUX	Directeur Général, entreprise MABI, France - Industriel invité

Remerciements

Je tenais à remercier tout d'abord les rapporteurs de ma thèse, à savoir Madame Peggy ZWOLINSKI, Professeur des Universités à l'Institut Polytechnique de Grenoble, et Monsieur Chris MCMAHON, Professeur à l'Université de Bristol (Angleterre), pour avoir accepté d'être rapporteur sur les travaux de ma thèse.

Je remercie également les examinateurs, Madame Karine DESCHINKEL, Maître de Conférences à l'Université de Franche-Comté, et Monsieur Bernard YANNOU, Professeur des Universités à l'Ecole Centrale de Paris, pour m'avoir fait l'honneur de bien vouloir évaluer mes travaux de recherche.

J'adresse toute ma reconnaissance à mon directeur de thèse, Monsieur Samuel GOMES, Professeur des Universités à l'Université de Technologie de Belfort-Montbéliard, pour ses conseils scientifiques, ses encouragements et sa foi indéfectible en mon égard.

Je remercie également mes encadrants de thèse à savoir, Monsieur Sébastien ROTH, Maître de Conférences à l'Université de Technologie de Belfort-Montbéliard, pour son suivi et son encadrement, ainsi que Monsieur Xiu Tian Yan, Professeur à l'Université de Strathclyde (Écosse), pour ses conseils et son soutien malgré la distance qui nous sépare.

Je remercie l'ensemble du laboratoire IRTES-M3M de l'Université de Technologie de Belfort-Montbéliard, et plus particulièrement l'équipe INCIS, pour m'avoir accueilli et fourni un cadre intellectuel et matériel, adéquat pour réaliser mes travaux de recherche.

J'exprime toute ma gratitude envers la société MABI, et plus particulièrement, Monsieur Olivier BIDAUX, Directeur Général de MABI, pour m'avoir accueilli et m'avoir accordé sa totale confiance tout au long de ces trois années de thèse.

Je remercie également tous mes collaborateurs MABI, Christopher, Jérôme, Jean-Marc, Valérie, Romain, Gaëtan, Philippe, Muriel, Virginie, Stéphane, Uwe, Aurélien, Damien, Nathalie et Sylvie, pour leur accueil et les bons moments partagés ensemble.

Je souhaite également remercier tous les acteurs du consortium du projet INGÉPROD pour nos riches débats.

Je n'oublierai pas les personnes « de l'ombre », principalement Olivier et Sébastien, qui ont permis la réalisation des différents prototypes de recherche exposés dans la thèse, conduisant à améliorer et valider une partie de la méthode proposée, ainsi que les étudiants de l'UTBM avec qui nous avons fait des tests, pour leur regard critique sur la méthode proposée.

J'ai également une pensée toute particulière à Oliver DEAN pour avoir corrigé mon manuscrit.

Je ne manquerai pas de remercier les personnes m'ayant apporté un soutien, et pour leur disponibilité, à savoir Emilie, Béatrice R., François P., Frédéric, Toufik, Nadhir, Said, Dominique, Béatrice B., Régis, Mathieu W., Pierre, Alban, Claudine, François J., Jean-Michel, Danielle, Catherine, Pascal et mes collègues doctorants, passés et présents, à

savoir principalement Estelle, Cyrille, Jérémy, Mathieu L., Julien, Nizar et Anh Tuan, à qui je souhaite une bonne continuation et bon courage.

Enfin une dernière pensée, à toute ma famille et mes proches pour leur soutien indéfectible et leur encouragement durant ces trois années, que ce soit dans les bons moments comme dans les plus difficiles.

Aurélié.

Résumé

Dans le contexte économique actuel, il faut proposer des produits personnalisés de qualité, à faible coût et dans des délais de plus en plus courts. La société MABI a choisi de voir chacune de ces contraintes comme une opportunité de repenser ses produits en misant sur l'innovation. Il faut alors optimiser certaines tâches routinières d'ingénierie afin de dégager du temps pour la conception des nouveaux produits. Le travail de recherche réalisé s'inscrit dans le cadre d'une thèse en convention CIFRE en partenariat entre la société MABI et le laboratoire IRTES-M3M de l'UTBM. MABI conçoit, assemble, commercialise et assure le service après-vente de produits propres dans le domaine de la protection et la rénovation des bâtiments. Ses besoins d'amélioration concernent le processus de développement de produits qui doivent répondre aux besoins des clients tout en respectant des contraintes d'assemblage spécifiques à l'entreprise.

La finalité industrielle de la thèse consiste à décliner au niveau du domaine du « Produit », la méthodologie générique élaborée sur la base de notre travail de recherche scientifique. A ce niveau, notre problématique scientifique consiste à rendre opérationnel et dynamique le modèle Multi-Domains et Multi-Vues (MD-MV), structuré de manière « plutôt statique », en y apportant des éléments de raisonnement contribuant à créer des interactions inter-domaines et inter-points de vue. Pour ce qui est du domaine du « Produit », il en découle la méthodologie FARD (Functional And Robust Design) qui vise à concevoir et à générer rapidement l'ensemble des variantes de produits d'une même famille modulaire tout en assurant le respect des besoins clients (conception fonctionnelle) et des contraintes d'assemblage à travers une aide à la décision pour le choix de la séquence d'assemblage, contribuant ainsi à créer une interaction dynamique avec le domaine du « Process ». Quatre thèmes de recherche sont abordés : la modularité, la conception fonctionnelle, la conception pour l'assemblage (dès les phases amont du processus de conception) et la simulation (accélérée grâce au paramétrage du maillage). Habituellement, le domaine de la modularité est souvent associé à celui de la conception fonctionnelle ou encore à celui de la conception pour l'assemblage, mais rarement les trois ensemble, ce qui constitue la spécificité de nos travaux. Enfin, l'aspect paramétrique de la méthodologie FARD, à travers les liens établis entre les quatre thèmes de recherche évoqués précédemment, rend possible la génération rapide des produits d'une même famille à partir d'un produit générique et ainsi de gagner du temps de conception, en vue d'atteindre nos objectifs de conception routinière « Hautement Productive ». Trois cas d'études industriels et académiques illustrent l'application et la faisabilité la méthodologie FARD.

Afin de rendre opérationnelle la méthodologie FARD, un nouvel outil logiciel « ORASSE Produit » a été développé. Il permet de guider pas à pas l'utilisateur dans certaines étapes complexes et difficiles à mettre en œuvre manuellement (par exemple : utilisation d'algorithmes spécifiques nécessitant une expertise de la part des acteurs). Mais il permet surtout des gains de temps hautement significatifs (jusqu'à 60%) pour l'architecte produit. Ce nouvel outil logiciel peut être utilisé de manière isolée et ponctuelle ou en lien avec la plateforme collaborative ACSP (système de PLM de réalisation et de gestion de projets de conception collaboratifs). ORASSE Produit, limité au domaine Produit, constitue donc une déclinaison particulière du logiciel ORASSE, au niveau du domaine « Produit », ce qui illustre le caractère générique de la méthodologie FARD proposée, à travers son applicabilité à d'autres domaines de conception (comme celui du Process ou du Projet, voire celui de la conception et de la gestion des connaissances). A ce jour, seule la version « ORASSE Produit » a été développée, d'autres déclinaisons sont en cours.

Mots clés : modularité, conception fonctionnelle, conception pour l'assemblage, séquence d'assemblage, modélisation et simulation paramétrique.

Abstract

In current economic context, enterprises must provide quality custom products at a lower cost and a shorter delay. MABI Company chose to consider these constraints as an opportunity to rethink its products through innovation. Then certain routine tasks must be optimized to free up time in order to have more time to innovate and design new products. This thesis is part of a CIFRE partnership between the MABI Company and the IRTES-M3M laboratory at UTBM. MABI designs, assembles, sells and provides after-sales service of products in the field of the protection and the renovation of buildings. MABI needs of improvement are in the development process of its products that must meet customer needs, while respecting its assembly constraints.

The industrial purpose of the thesis is to decline in the Product domain, the generic methodology developed on the basis of our scientific research work. At this level, our scientific problematic is to make operational and dynamic the Multi-Domains and Multi-Views design model (MD-MV), structured in a "rather static" way, and to enriched these models by adding reasoning procedures. It follows the FARD methodology (Functional And Robust Design) which aims to design and quickly generate variants of a modular product family while ensuring compliance with customer requirements (functional design) and assembly constraints. Four domains are covered: modularity, functional design, design for assembly (at the early stages of the design process) and simulation (accelerated through the parameterisation of the mesh). Usually the domain of modularity is often associated with functional design or with the design for assembly, but rarely the three together, that constitutes one of our added values. Finally, the parametric aspect of the FARD methodology, that is the link between the four domains, allows accelerated the generation of products of the same family from a generic product and thus saving design time to achieve our goal of "High Productive" routine design. Three industrial and academic case studies illustrate the application and the feasibility of the FARD methodology.

To facilitate the application of the FARD methodology, the new ORASSE Product software tool guide the user step by step in some manually complex steps (using specific algorithms that require expertise from the users). But it allows to save time especially highly significant (up to 60%). It can be used isolated and punctually or in connection with the ACSP collaborative platform (PLM system of realization and management of collaborative design projects). ORASSE Product, limited to the Product domain, is a variation of the ORASSE software which illustrates the generic nature of the FARD methodology by the application to other design domains (such as the Process or the Project, or the design and knowledge management). Currently, only the "ORASSE Product" version has been developed, other versions are in progress.

Keywords: modularity, functional design, design for assembly, assembly sequence, simulation.

Table of content

General introduction.....	9
Chapter 1 Context and research problematic	13
1 Introduction of the state of art.....	14
2 Product design	14
3 Our research topics.....	26
4 Problematic and research hypothesis.....	45
Chapter 2 Our approach: Functional And Robust Design methodology.....	49
1 Functional And Robust Design (FARD) methodology.....	51
2 Functional design approach	57
3 A new approach of modular design based on DFA.....	62
4 A new approach of multi-physics simulation in HP Design	88
5 Second and next loops of the FARD methodology	93
6 Synopsis	94
Chapter 3 Academics and industrial experimentations	97
1 Introduction	99
2 The Scrap’Air range	99
3 A family of biomimetic spy systems.....	121
4 The “High Productive” simulation of a mountain bike.....	130
5 Conclusion	139
Chapter 4 Our application tool: ORASSE.....	141
1 Introduction to Orasse tool	142
2 Introduction to Orasse Product tool	142
3 Link of Orasse Product with the PLM tool: ACSP	144
4 Tool development.....	146
5 Orasse Product Man – Machine interface illustrated with the Scrap’Air experimentation	153
6 Efficiency of Orasse Product	161
7 Conclusion and perspectives.....	163
Chapter 5 General conclusion and perspectives	167
1 Conclusion	168
2 Research perspectives.....	173
Bibliography	179

1	Valorisation of research work	179
2	External references	181
	Table of figures	193
	Table of tables	197

General introduction

In current economic environment, the customer becomes practically an outsourcer [Tollenaere 1998]. He needs personalized products that have a good quality, at a low cost and a shorter delay. The decrease in demand due to the current economic crisis is forcing companies to rethink their design process to meet the customers needs, which are more and more restrictive. MABI Company is not an exception to these challenges and chose to see these constraints as an opportunity to rethink its products through innovation. For this, certain routine tasks must to be optimized in order to save time and energy to focus on the design of new products.

This thesis is an industrial thesis (Conventions Industrielles de Formation par la REcherche - CIFRE) in partnership between a SME (small and medium enterprise) MABI Company and the IRTES-M3M laboratory at UTBM. MABI Company designs, assembles, sells and provides after-sales service of products in the field of the protection and renovation of buildings. Manufacturing of components is sub-contracted to other companies. MABI Company therefore needs improvements in the design process for developing its own products that must meet customer needs while being consistent with the assembly constraints of the company. MABI wants to renew its product family of pneumatic scraper by bringing new functionalities while controlling production costs. Then, it is necessary to consider a method to create a new improved product family and to reduce costs. MABI Company is located in Botans (90), France. It is a Family Company created in 1967 by Marc BIDAUX. This Company has 12 employees for a turnover of 2 million Euros, including 45% of international sales. The integration of a PhD student, specialized in mechanical engineering and design in a company without any design office, constitutes a real effort toward research and development activities in order to deploy a real strategy for innovation and competition. Existing products were mainly developed by the Chief Executive and the mechanical foreman during their free time. In 2002, Olivier BIDAUX Chief Executive wanted to adopt a new product development strategy. From 2001, the MABI did not submit any new patent. The new Chief Executive wanted to revive the MABI product innovation strategy and decided that MABI Company must be differentiated thanks to new innovative products with their own patents in order to make the difference with concurrent products. The sustainability of the MABI Company will depend on its ability to develop innovative products.

The industrial purpose of this thesis is therefore to decline in the Product field, a generic methodology based on our developed scientific research work, in order to generate all the variants of a complete family of modular products that meet the needs of the MABI Company as mentioned above. To reach this aim, we relied on the Multi-Domains and Multi-Views (MD-MV [Gomes et al. 2002]) model, which proposed a “rather static” information storage structure of the Project-Product-Process-Use data, of their different aspects (functional, structural, dynamic, geometric, etc. aspects) and of their interactions. At this level, our scientific problematic is therefore the Multi-Domains and Multi-Views model to make operational and dynamic, and formalize processes to establish links between the various interactions of the targeted domains, but also between the different aspects within each domain by providing reasoning elements in the interfaces. Finally, in order to understand the generic nature of the developed approach, experimented initially in the

product domain, we propose to verify its applicability to other areas, such as the Process domain, Project domain, or the Knowledge domain.

This thesis focuses on a fast generation of modular products in the same family, as proposed by the “High Productive” routine design approach. The MABI Company developed a lot of similar products belonging to the same family but their components are all independent and different from each other. In order to decrease the number of components and therefore the stocks, MABI Company, as with many other enterprises, needs to develop common product parts shared among the various products of the same family, or with the other products of the enterprise. Modularity seems to be the best way to explore for developing products in a family. The modularity concept is based on the definition of functions for each module. For instance, a small test of the component decomposition among the various functions of a product was done on the head component of a product. The initial component allowed a tool to be adapted and specified the power of the product. This initial component fulfilled two different functions. But in the modularity principles, a component belongs to only one function. This component can be divided into two components that each fulfils one of the two initial functions. This modification of the component allowed a common component for a product family to be created and simplified the initial component. One component became sharable between all the products of the same family and the second component became specific to each product of the family. Then, the two new components are cheaper to manufacture compared to the complex initial component. Moreover, the common component is now bought in larger quantity that reduces significantly the manufacturing costs. This example from the MABI Company shows the importance to affect only one function per component and the impacts on the products of a family and the manufacturing costs. Moreover, this justifies our position on the modularity principle that consists in affecting only one function per module.

Another industrial problematic is the respect of the constant evolution of the customer needs and to be able to follow them as fast as possible. An approach based on functional design is then deployed. It allows verification that the developed products fit as well as possible to the requirements. Moreover, this aspect could be used to develop new product variants in a product family. In this thesis manuscript, the functional analysis aims to have two objectives that are: ensure that the products respect the customer needs and create in a “High Productive” way new products from a common product basis. Moreover, our modularity approach will be based on a functional design approach as explained previously.

The last industrial considered constraint concerns the assembly phase of the products. Indeed, MABI Company does not manufacture its components but operates only the assembly phases in their workshop. A better attention to products design, during preliminary design phase, can impact and bring majors benefits for the manufacturing and assembly phase and then can reduce significantly products manufacturing costs. This subject is important for the MABI Company that mainly integrates these preliminary design and assembly phases (manufacturing operations are operated by sub-contractors) and then can directly keep control of all the manufacturing costs of its products. Moreover, in a modern manufacturing enterprise, assembly costs are significant compared to the overall production costs as they can represent more than a half of the direct manufacturing costs. Assembly work represents between 20 and 70% of the total production cost, with an average of around 45% as summarized by [Abdullah et al. 2003]. This argument strengthens the necessity to operated improvements and optimization during this phase of the manufacturing process.

According to this research and industrial context, the application of the proposed concepts is limited to the Product design domain and especially to the design domain of modular product families. Applied to the Product design domain, it follows the FARD methodology (Functional And Robust Design). This methodology helps to design and generate in a “High Productive” way, products of the same modular family while ensuring compliance with the customer requirements and the assembly constraints. Four research topics are then considered and discussed: modularity, functional design, design for assembly (DFA) and digital modelling and simulation. Usually, scientific research in the domain of modularity is often associated with scientific contributions in functional design area or with design for assembly approach, but rarely all three together. Modularity, through application of our FARD methodology defines the product architecture as a set of functional modules that are independent. The functional design ensures compliance with the customer requirements for the final product. Design for assembly includes assembly constraints at the early stages of the design process and is used in order to define optimal design and assembly sequence of products. This assembly sequence helps to generate the modular product architecture used for modelling the parametric and generic CAD model (basis for a fast and easy creation of the other products within the same family). Then, modelling and simulation step of the final design verifies their good behaviour in accordance with various physical phenomena (mechanical, thermal, vibration, etc.). At this level, a parametric mesh is proposed in order to operate fast and easy update, based on changes made to the original and generic CAD model. Finally, the parametric aspect of the FARD methodology (functional parameters, geometric parameters and simulation parameters) allows the “High Productive” generation of various products of the same family starting from a generic product and saves design time to achieve our overall goal of "High Productive" routine design process.

Some specific steps of the FARD methodology are too complex to be manually applied because they require specifically developed algorithms for matrix-based and graph-based reasoning procedures and therefore a certain level of expertise from the design stakeholders (designers, assembly planners, product architects). In order to guide them, the specifically developed Orasse Product software (as a variation of the ORASSE generic software, but limited to the Product design domain) was developed. Orasse Product allows the application step by step of the most complex part of the FARD methodology. Its efficiency will be tested with various use cases in order to determine the time and quality improvements that Orasse Product can help the design stakeholders to obtain compared to a manual application of the same steps of the FARD global methodology. This new tool can be used stand-alone, with import-export files, based on xml format, or in direct connection with various database (Product Data Management - PDM, Product Lifecycle Management – PLM, Manufacturing Process Management – MPM, or also Enterprise Resource Planning – ERP). In our case, we will investigate a direct connection with the ACSP collaborative platform database. ACSP collaborative platform is a PLM system, developed at UTBM since 1996 [Gomes et al., 1999], for the implementation and management of data and information for collaborative design projects.

In summary, in the context of this research work, the FARD methodology is applied to the development of modular products of the same product family and is used to illustrate a way to make operational and dynamic links between data within the MD-MV design model. The concepts are related to functions, product, process and project. Various viewpoints are coming from the diversity of the involved actors (designer, product architect, assembly

planner and expert in simulation). Three industrial and academic case studies are operated in order to illustrate the feasibility of the FARD methodology. The final objective is to promote the application of the FARD methodology, supported by the new Orasse Product software which guides step by step the user in some complex matrix-based and graph-based reasoning steps, but also allows highly significant time and quality improvements.

The thesis manuscript is divided into five chapters as summarized in Figure 1 below.

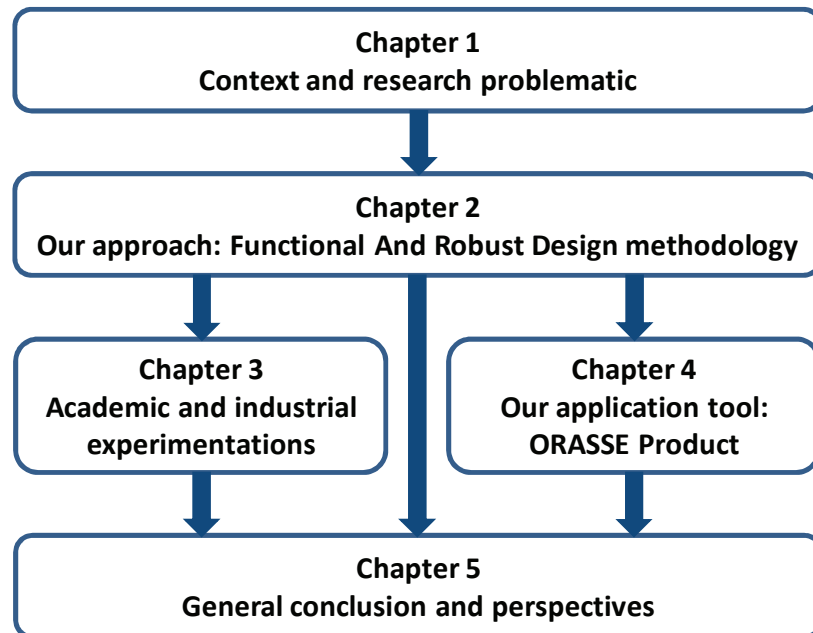

Figure 1. Schema of the chapter organization of our manuscript

The first chapter describes the research context and offers a short review of the main scientific topics considered in this research work. The second chapter describes the proposed FARD methodology. Then, the two following chapters propose experimentations that are manually performed in chapter 3, and handled with our Orasse Product specifically developed software in chapter 4. An industrial use case is used in both chapters in order to compare the results when performing manual and software based application on a part of the FARD methodology. Finally, the last chapter concludes and presents some perspectives for this research work.

Chapter 1

Context and research problematic

Chapter contents:

1	Introduction of the state of art	14
2	Product design.....	14
2.1	Product design typology	15
2.2	Design process and models proposed in the literature.....	16
2.3	“High Productive” routine design methodology.....	24
3	Our research topics	26
3.1	Modularity	26
3.2	Functional Design.....	32
3.3	From Design For X (DFX) to Design For Assembly (DFA)	35
3.4	Simulation.....	45
4	Problematic and research hypothesis	45

1 INTRODUCTION OF THE STATE OF ART

This chapter describes research works, done or still under consideration, linked with our research work focused on this thesis. The first section is dedicated to product design and more specifically to product design process and design models. The goal of our proposed methodology is to validate the dynamic aspect of the Multi-Domains and Multi-Views model [Gomes et al., 2002]. However, this model is mainly developed on the Product design domain which is linked with the problematic of the MABI Company. The second section of this chapter presents the research works according to the company needs on modularity, functional design and design for assembly that are the three main topics developed in the proposed methodology in this thesis. The context of this research work is the modularity that corresponds to a direct need of the MABI Company for developing product families. The functional design is the basis of the proposed methodology in order to ensure compliance with the customer needs of the developed products. The MABI Company does not manufacture its components but assemblies all its products. Then, the MABI Company has an assembly problematic. This literature survey aims to position our research work compared to the other research works.

2 PRODUCT DESIGN

What does design mean? The word “design” has different meanings depending on the context. For many peoples, and particularly in a French context, design is considered as “Industrial design” focused on the “aesthetic” aspects of a product such as the external shapes, surfaces, volumes, colour, textures, etc. But in our context, we prefer to consider product design as a process of defining a product architecture, detailing product parts, establishing a set of basic parameters which can be functional parameters (key characteristics requested by the customer) or specific parameters (defined by the designer). [Boothroyd et al. 2001]. As presented by [Evbuomwan et al. 1996], several designers, engineers and researchers try to give a definition to design according to their own knowledge and experience. The authors make a synthesis and proposed a general definition of design based on keywords extracted from various definitions:

Design can be defined as “The process of establishing requirements based on human needs, transforming them into performance specification and functions, which are then mapped and converted (subject to constraints) into design solutions (using creativity, scientific principles and technical knowledge) that can be economically manufactured and produced.”

In traditional craft-based societies, making or designing are not well separated. There is no real priority between the activity of designing (drawing or modelling) and the activity of making an artefact. But in industrial societies these activities are quite separate. The activity of making (or manufacturing) an artefact cannot begin as the designing activity was not complete. Then, the goal of the design process is to describe the artefact that is to be made [Cross 2000]. So the end of the design process is the transfer of a designed artefact that is ready to be manufactured.

Design comes from the Latin word “designare” that means to define, to describe, to indicate or to mark out. Two kind of design have been developed separately: “design as art” and “design as engineering” [Von Stamm 2003]. There are a lot of definitions as highlighted by [Sun 2012]. However, there is an universal agreement that “design”, as a noun, refers to a plan for a system construction and “to design”, the verb, refers to making the plan. This

thesis focuses on the engineering design field. According to [Pahl et al. 2007], the application of scientific and engineering knowledge constitutes the main task of design in order to find and optimize the solution in accordance with the customer requirements. From [Suh 1990], design in engineering field facilitates the creation of new physical and/or informational structures (for example products, processes, software, systems and organization) which satisfy the needs and aspirations of the society. In an industrial context, typically design aims to specify a product responding to customer needs that are not always clearly and all identified [Ben Sta 2006]. All these approaches are part of the design theory, as we can consider that a theory is an analytical tool defined in order to understand, explain and predict a specific problem [Sun 2012].

The next sections present different types of product design, design process and models, product development models and finally the “High Productive” routine design model that constitutes the framework of our research activity. A lot of design process, models, methods and systems have been developed in the literature and used in industry [Evbuomwan et al. 1996] [Tollenaere 1998]. But we will focus on the most used or most important for the product design field.

2.1 Product design typology

There are various definitions for product design typology. For [Sriram et al. 1989], the design activity can be considered as a problem resolution activity that can be classified into four types of design activities: routine design, redesign, innovative design and creative design. From [Brown and Chandrasekaran 1985], there are three classes of design activities: the same types listed before, except for the redesign. These classes depend on the knowledge resources and the strategy of resolution for the engineering problem. But it is possible to group all these types of design activities into two design typologies (redesign and initial design). Some authors [Serrafero et al. 2006] also define new types of design activities, such as parametric design.

Concerning the design typology, it is possible to distinguish two different types of engineering problems: the redesign (i.e. predefined or variational design) and the initial design or new design. In redesign, the concept of the product (architecture, physical principles, etc.) is well known by designers. For example, designing a ballpoint pen can be classified as redesign. The ballpoint principle is well known but the colour or the external shape of a “new” pen can change. In contrast, in an initial design context, the question can be considered as totally new for the designer and he/she has no design experience on the subject or on similar products. However, redesign is often linked with initial design for some parts or sub-functions of the product. For instance, new sub-functions or sub-systems have been added in order to transform a cellphone (designers know the architecture) into a smartphone such as cameras, internet access, flash memory, music player, etc. Short definitions of typology of engineering problems are given in the following paragraphs.

Redesign (i.e. predefined or variational design) includes mainly two sub-types of design activities: routine design and parametric design [Serrafero et al. 2006]. In routine design, the concept and its architecture or subparts are known but their alternatives, product configurations, must be adapted or improved to satisfy context constraints such as new functional requirements [[Sriram et al. 1989]. The goal is to define various configurations of a product from a wide variety of possibilities in order to create a range or to improve old products, for instance: an ultra-thin laptop with a high degree of autonomy [Gomes 2008]. As

an adaptation of one or more current products, the objective of parametric design is to develop a product respecting new requirements where concepts, architecture and products configuration are known. It is just an adaptation of an old product to new constraints, considering the evolution of some design parameters (dimensions, volume, weight, costs, performance, optimisation, etc). Moreover, this is facilitated by softwares which allow 3D parametric models to be created.

In this context, [Visser 1996] and [Gero 2000] consider the routine character of a project thanks to its similarity with old projects or like a small variation of existing products, in opposite to initial design which is a major variation on the existing one.

The initial or new design or first design includes mainly two types of design activities: the creative design and the innovative design. In this way, the goal is to design a new product or process for the first time without any references to an existing product or process. Creative design is the most uncertain design because knowledge's, fundamental principles or concepts are unknown at the beginning. This is a new product design whose purpose is to lead to a major innovation. In innovative design, the decomposition of the problem is known but not the alternatives for sub-parts. Fundamental principles or concepts are used to develop alternatives in a novel combination such as a new combination of existing components. There is a certain amount of creativity in innovative design. However, we talk about innovative design rather than creative design when a product is a commercial success. For us, invention is a part of an innovative product and innovation is part of an application perspective unlike an invention. In short, an innovation converts an invention into an economic and industrial reality.

Our positioning

Although in companies these two typologies of design are used, most of time they develop routine product. 80% of their time is dedicated to the routine design and just 20% (Pareto's law) for creative and innovative products [Gomes 2008], [Prasad 1996]. However, with better organization, they should be able to reduce their routine design time to free up time for innovation which is attractive for a company.

We propose a methodology to structure redesign activities in order to reduce time devoted to routine design process. Redesign, including the combination of routine and parametric activities, allows a range of products to be developed. However, innovative design, not creative design, is also supported by our approach to develop directly a new product range without similar existing product in a company.

2.2 Design process and models proposed in the literature

As the adage states: "If we know what the problem is, we can find a solution". From Pugh, a solution exists for each design problem and design process allows defining the solution of the initial problem by a new product.

Design process corresponds to the procedure used to create a new product which will be sold to customers. A design process allows a new product to be generated and developed from ideas with efficiency. Design methods, within the framework of engineering process, have been described by many authors in order to reach a solution by starting from a

problem, or in order to provide to a detailed product definition by starting from a concept. These methods try to build various sequences of design activities to be performed by different design actors (marketing, industrial design, design office, quality - methods, production...) to achieve a final goal: a marketable product that meets the customer needs. Design processes are represented by design models that aim to guide the users to know what to do at each step during the process.

Design models show how design may be done. At the beginning, they are divided into three main philosophies: the prescriptive, the descriptive and the computational models. The prescriptive model tends to consider the design process as a global perspective. It suggests the best way that something should be done. The descriptive model is focused on the actions of the designers and their activities during the design process. It is more interested in things involved in designing and how they are done. The computational models focus on the use of numerical and qualitative computational techniques, such as artificial intelligence techniques, combined with modern computing technologies.

Among many models of product-process lifecycle design in the literature, it is possible to identify two types of models that can be described: sequential models and concurrent models. [Deneux 2002] agrees that these two trends emerge from definitions of the design process. This is highlighted by some definitions of the design process below.

- One or more approaches for analyzing and design, retro design or redesign systems of objects. An approach is an ordered set of tasks which are sequential or parallel [Castellani 1993];
- Design means conceiving of objects, of processes, of ideas for accomplishing goals. The designer begins with some primitives (components known to be available or that can be produced) and design is a game of combinations played with these primitives [Simon 1995];
- A wide process of “change-creation” in a dynamic structure [Sobiech, 1995];
- Design approaches operate on information fed into them. Each one behaves as a computer following a planned sequence of analytical, synthetic and evaluative steps and cycles until the designer recognizes the best solution [Nadler 1995].

A sequential model is based on the sequential decomposition of the product-process lifecycle design into phases or tasks that follow one another, sometimes connected with a Work Breakdown Structure [Haugan 2002]. It is a decomposition process that corresponds to a version of the traditional engineering activity organization, inheritance of Taylor's concepts classically applied to manufacturing process. Generally, each phase or task starts only if the previous task is completed. These phases or tasks will allow each life actor to deal with its part of the problem before transferring the project data to the next business unit. Sequential models of the product-process lifecycle design contribute also to maintaining a boundary between the various engineering services company.

The simplest model is a four-stage model consisting of: exploration, generation, evaluation and communication [Cross 2000]. But sometimes these stages are not directly realized during the communication stage. Indeed, there may be iterative feedback loops from the evaluation stage to the exploration stage if the concept is not satisfying enough. This simple four-stage model was developed. For instance, French proposed a more detailed model of the design process (Figure 2) [French 1985]. The analysis of problems aims to

define the design brief with the goal, constraints and criteria of the product. This is the most important stage of the process. The conceptual design stage requires the most effort of reflexion from the designer. In this phase, engineering science, knowledge, production constraints, commercial aspects and so on are implemented together in order to have the most satisfying scheme or concept. In this phase, the most important decisions are taken. In embodiment of schemes, schemes are worked up and a final choice is made. The end product is usually an arrangement of different drawings. Finally, in the detailing phase, the product is detailed in order to be manufactured. Moreover, the feedback loops allow the most satisfying solution to be defined.

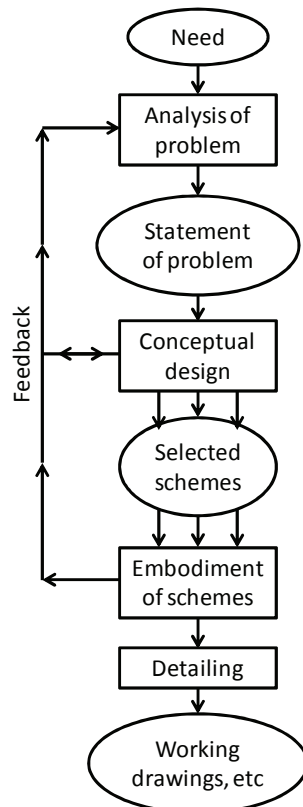

Figure 2. Block diagram of French's design process

One of the well known sequential models is the Systematic Design model [Pahl et al. 2007]. This model (Figure 3) is based on the succession of four phases mainly focused on product definition: Clarification of the task, Conceptual Design, Embodiment design and Detail Design. In the Clarification of the task, the problem and information about the product are collected. The specification of functions and properties for the new product are defined. So all next phases of the design process will be based on these specifications. During the Conceptual Design phase, solution principles are founded according to specifications defined in the previous phases of the Systematic Design model, in order to build a concept, including the product architecture. During the Embodiment design phase the chosen concept and its architecture are refined and transformed into a definitive Product design. During the Detail Design phase the product and all its individual components are fully specified. In the end, all product documents for manufacturing and assembly are produced. In each phase, one or more documents are expected, for example: specifications, concept, preliminary layout, definitive layout...

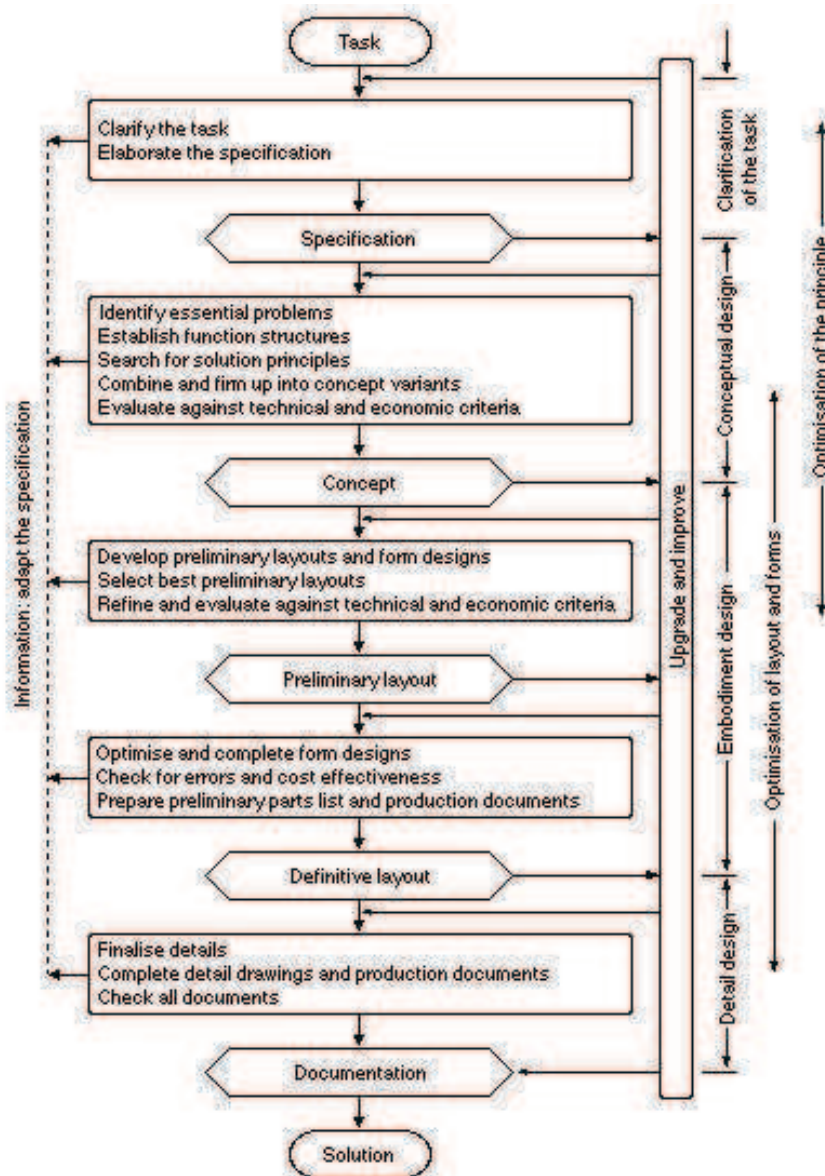

Figure 3. Systematic Design model (Pahl and Beitz, 1992)

In Germany, academics and practitioners worked heavily on engineering design process. The Verein Deutscher Ingenieure society, a German professional engineers' society, defined guidelines in this area. The Guideline VDI 2221, Systematic Approach to the Design of Technical Systems and Products [VDI 2221 1987], is more recent than the Pahl and Beitz model. This model aims for a systematic approach applicable to different branches of industry. It is based on seven stages with a specific output for each (Figure 4). The first stage is the same than in the Systematic Design model of Pahl and Beitz. The specification is also very important because it constitutes a reference for all the next stages which are subsequent. The VDI 2221 model is close to Pahl and Beitz model. The two next stages try to create principle solution through the combination of solutions from solutions of all sub-functions which are defined in the function structure. Then, a module structure is established representing the solution into fundamental assemblies. This stage is not proposed in the Systematic Design model. Next stages are recognizable in the Pahl and Beitz model. Stage four constitutes the main difference. The highlight of the module structure is that it is more adaptable for designing a complex system. Then, the VDI Guidelines allow a systematic

approach to problems breaking them into sub-problems to find sub-solutions which are combined into an overall solution. But this approach was criticised by the design world because it seems to be more a problem-focused than a solution-focused approach contrary to the traditional designer thinking.

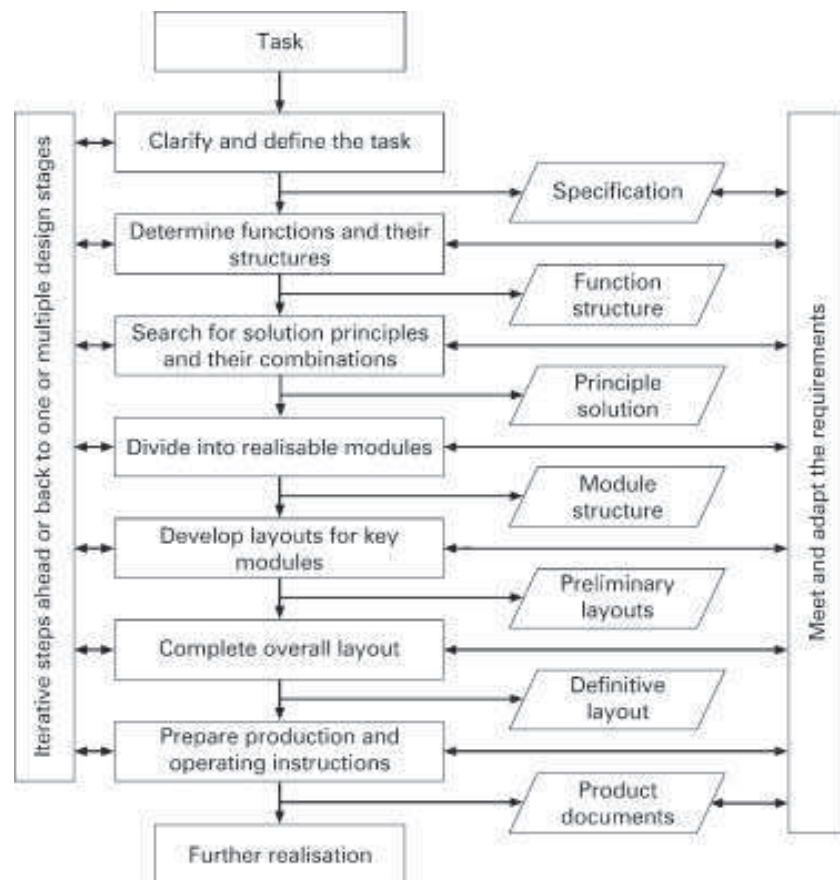

Figure 4. VDI 2221 model of the design process

Other sequential models such as the Ullman design process [Ullman 2002] or the Total Design process, proposed by [Pugh 1990], have their own specificities and add, for instance, various feedback loops, at different levels of the model.

With the evolution of industrial constraints such as the objective to increase quality while reducing costs and time, sequential design process models have been questioned. The evolutions of digital tools and communication infrastructures have contributed to the development of new design organizations and models. These new models of design process have also been called concurrent [Solehnius 1992], integrated [Brissaud and Tichkiewitch 2001], distributed [Brissaud and Garro 1996], or collaborative engineering. The main characteristics of these various methods of concurrent models are:

- the earlier integration of constraints related to the product entire lifecycle,
- a concurrent implementation of the product development and its manufacturing process,
- a parallel realization of the tasks required to perform the design process,
- the reduction of design delays and collaboration improvement between the various design contributors, involved in a single integrated design team.

This collaboration between various stakeholders within the same team has contributed to the evolution of industrial habits. Therefore, the design process has also been improved towards a multi-dimensional and multi-domains design process because project managers can consider many points of view coming from various domains. Axiomatic design is a prescriptive engineering design theory that provides a basis for making good design decisions. This basis is formulated using two design axioms: the independence axiom, and the information axiom [Suh 1990], [Suh 2001]. Generally, the design process begins with defining design objectives called functional requirements (FRs). Then, to satisfy these requirements, a physical structure characterised by design parameters (DPs) is created. Hence, there is a mapping between the functional space where FRs are defined and the physical space where DPs are specified. This mapping is realized using a design matrix (DM). The first axiom states that in this mapping a disruption in a particular DP must only affect its correspondent FR. The second axiom states that, among all the design solutions that satisfy the independence axiom, the one with minimum information content is the best design. One of the limitations of axiomatic design is that it is focused on structural design without a vision of the system design context. Hence, other factors and constraints such as cost, time, and physical integration are not taken into account.

Among the models of concurrent engineering, and through the "axiomatic design" approach, another way of improving the product design process has been identified, if designers decide to respect specific rules, also called axioms. This axiomatic approach is based on various axioms (example: axiom of independence, axiom of minimum information, etc.) applied in four Design domains (Customer Domain, Functional Domain, Physical Domain and Process Domain). Then, design is considered as an iterative process, also called "mapping" or "zig-zagging", of these four domains. Figure 5 shows an example of model proposed by Solehnius.

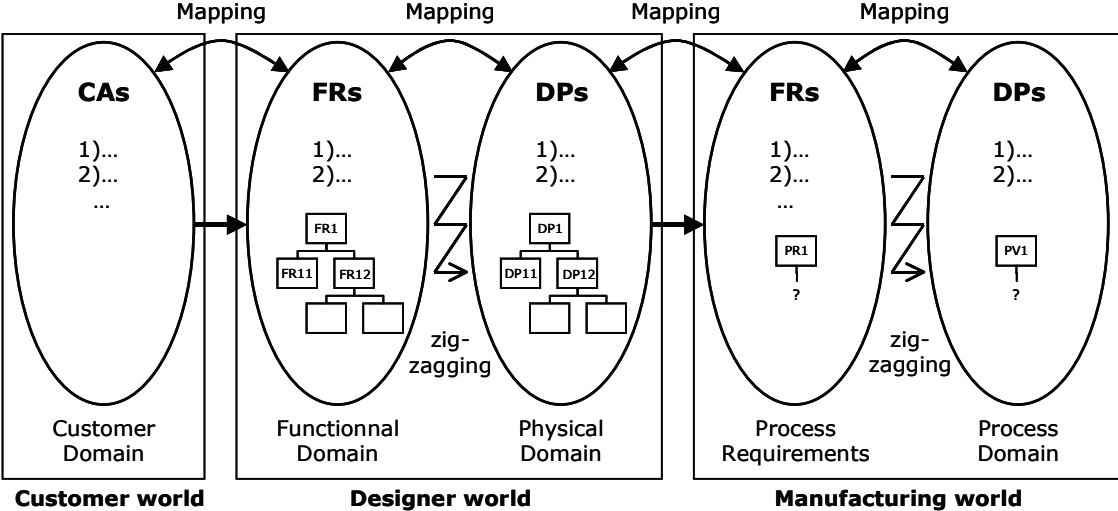

Figure 5. Concurrent engineering model of Solehnius

Another approach concerns also the multi-viewpoints model of the product considered as an integrated design method of products or mechanical systems [Brissaud and Tichkiewitch 2001]. This multi-viewpoints model is used, in particular, to define the interfaces with the external elements or components of a mechanical system. This approach is based on the product architecture and on the combination of various viewpoints of the system: functional, structural, geometrical, machining, assembly, etc.

Finally, the design process model based on Andreasen's Theory of Domains (ToD) [Andreasen and Hein 1987] was proposed. However, this model is based on four domains, each of them representing a level of abstraction of the product going from a global to a more detailed product definition. The domains are realized gradually as the design progresses.

Our design process model, based on the research work on systemic design model proposed by [Gomes et al., 2002], and called Multi-Domain and Multi-Viewpoints (i.e. MD-MV) design model (Figure 6), can be described as a collaborative design process model, integrating concepts coming from Axiomatic design and multi-viewpoints model. This model uses the transverse view of design model decomposed into worlds and domains (Axiomatic design) with the global and generic view of the multi-viewpoints model. Then, this model considers design as a network of design domains interacting with each other.

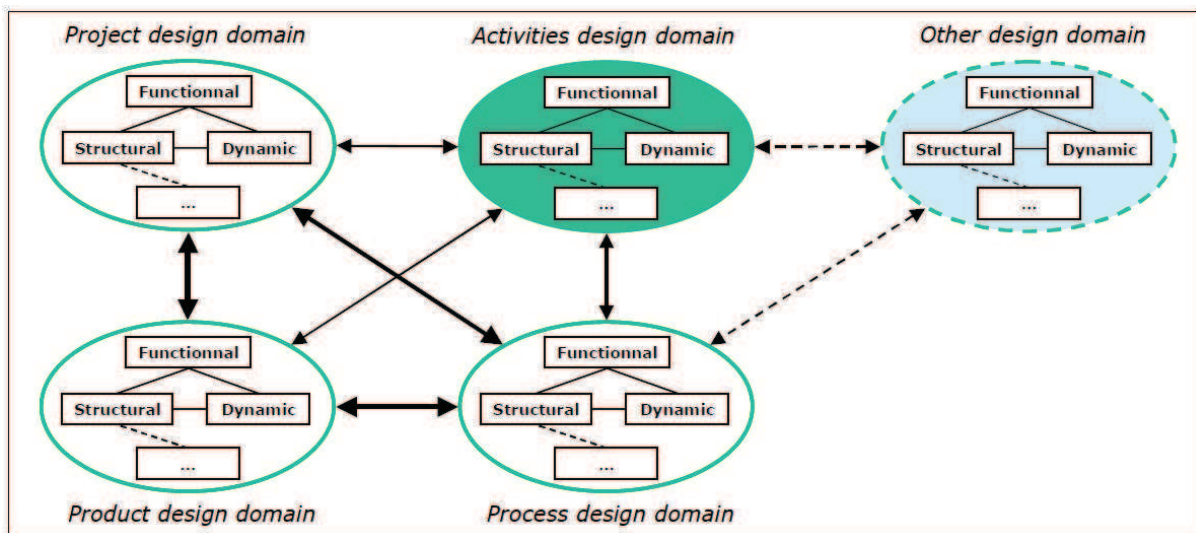

Figure 6. Multi-domain and Multi-viewpoints design model [Gomes et al. 2002]: functional, structural and dynamic aspects considered in each design domain

This model considers that a design project, in the field of mechanical system engineering, is a network of various interacting design domains such as Project, Product, Process, Usage, etc. Each of these design domains can be examined from several viewpoints (or aspects) in interaction such as:

- functional viewpoint, which describes the main objectives and goals of the system. It considers the function of the system (what should do the system);
- structural viewpoint, defining the system elements and architecture. It regards the structure of the system, as a set of objects constituting the system;
- dynamic viewpoint, which describes the chronological behaviour of the system. It studies the evolution of system over time, the system is considered to be changing over time.

Other points of view can be considered like the geometrical aspect (characteristics and spatial positioning of the system), the physical aspect (behaviour laws of the system) in specific design domains, for example Product or Process domain. However, in this configuration, other design viewpoints, such as the physical or the geometrical one, are directly linked to the structural aspect of the system.

The particularity of this design methodology is that it considers human activities (users, manufacturers, etc., activities), as an effective design domain (usage domain), linked to the other Product, Process and Project domains. This usage dimension is integrated into our approach in order to have a better integration of human factors in the early steps of the design process.

One of the interests of this model is the possibility to work on different domains interacting with each other and at the same time released in parallel. Moreover, in a PLM environment it is easier to recognize design knowledge of each domain. Then, process of knowledge extraction can be used to capitalize expert knowledge in order to reuse it. This process of knowledge based engineering (KBE) contributes to accelerating the productivity of routine design [Toussaint 2010]. This idea constitutes the foundation of the High Productive Design methodology proposed by [Gomes 2008]. This methodology tries to streamline routine engineering design to free up designer times and resources from routine design so that they can focus on innovation to improve their competitive edge.

Our positioning

Our research work is based on the MD-MV design model that is a concurrent engineering approach. Concurrent engineering aims to guide the approaches to team work with multi-functional and multi-disciplinary teams [Abdalla 1999]. We rely on it to define our own model to meet a particular case of generation of modular product ranges. The MD-MV design model structures design data for information management systems. Our goal is to make operational and dynamic this design model by activating the various links between design data in each domain and between domains. These links will be enriched by adding reasoning procedures.

Our general goal is to accelerate the routine design of generation product ranges in order to free up time to devote more time to innovation thanks to modular constraints, functional constraints and assembly constraints.

Concerning the theoretical models underlying the design process, three kinds of models can be used: the perspective models, the computational models and the knowledge based models [Bahrami and Dagli 1993]. Our approach is located in the scope of computational models, requiring the use of computers to determine the best feasible values of design variables, using Constraints Problem Solving, when considering expert knowledge (parameters, rules, etc.) linked with modelling, simulation and optimization approaches, when analyzing the impact of Multi-physics solicitations on the product. The objective of such an approach is to maximize or minimize various objective functions using either multi-objectives optimization or simulation techniques.

Our research work is part of a product design process focused on the preliminary design phase with a conceptual design (from the customer needs to the beginning of the definition of the detailed product). It is more interesting to work on this part because the product is not yet frozen and it is easier to change anything. Moreover, this is an important phase for a product. According to [Perrin 2001], the product design, represents only 5% of the total product cost but it determines 75% of this cost. Then, decisions and choices made during the product design phase are determinant for the next steps of the product life cycle,

hence the importance of taking into account a maximum of constraints (customer needs, assembly phase...) during the early steps of the design process.

2.3 “High Productive” routine design methodology

“High Productive” (HP) routine design methodology shown in Figure 7 is a systematic and ordered approach for the design and development process of optimized products [Gomes et al. 2009]. This methodology is termed as “High Productive” and collaborative design methodology because it is based on knowledge that is semi-automatically extracted from a Product Lifecycle Management (PLM) platform in order to generate optimized parametric CAD models (4D CAD) constraint by functional parameters that ensure a good integration of requirements (from customer needs) during the whole design process. This methodology is like a functional, knowledge based engineering and optimization design methodology dedicated to routine design or redesign. Its goal is to reduce routine design time in order to improve time for creativity or innovation.

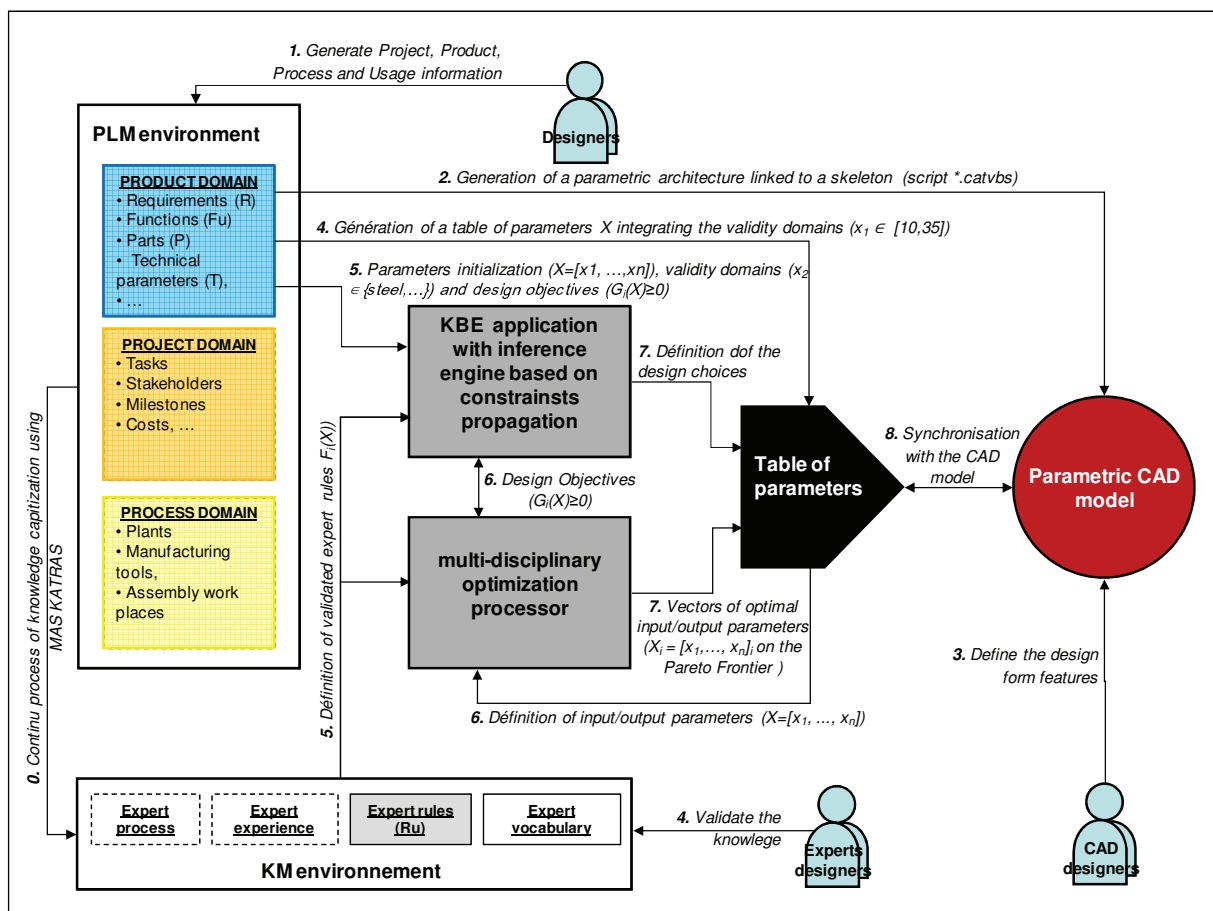

Figure 7. “High Productive” routine design methodology [Gomes et al. 2009]

Figure 7 illustrates the HP routine design methodology that tries to connect various tools and ensure traceability of the multi-views (functional, structural, geometric...) of the product. As shown in Figure 7, there are seven main steps:

- Step 1: Designers generate Project, Product, Process and Usability information in the PLM system thanks to the integration of knowledge engineering features. During the whole process, knowledge in the PLM environment are capitalized in

the Knowledge Management (KM) environment thanks to KATRAS Multi-Agent society [Monticolo 2008].

- Step 2: In the PLM environment, the product architect creates a parametric product architecture and skeleton that are automatically generated in the CAD software. In parallel, a table of parameters X that can be continuous or discrete, is created.
- Step 3: From the information the previous step 2, the CAD designer begins the creation of solid features and links parameters with the CAD model in order to create a parametric CAD model.
- Step 4: Expert knowledge is validated by Expert Designers in the KM environment thanks to a specific process of validation. It allows the validation of domains of the table of parameters X that can then be generated.
- Step 5: A Knowledge Based Engineering (KBE) platform regroups design parameters linked by expert rules in a KBE application. Expert designers set up design parameters in accordance with customer needs that are computed by the inference engine for constraints propagation.
- Step 6: From the table of parameters, expert designers define the input / output parameters according to the design constraints and objective functions (in order to ensure quality-cost-time requirements). Then, they proceed to optimization loops on the product design thanks to a multi-disciplinary optimization processor.
- Step 7: Product architects and expert designers choose various optimal vectors of input / output parameters proposed by the optimization loops in order to define optimal design alternatives. These alternatives are stored in the CAD model table of parameters.
- Step 8: The last step consists of the visualization by CAD designers, expert designers and product architects of the various optimal design alternatives defined previously. For the visualization of the update CAD model, they must open the CAD model that is synchronised with the table of parameters.

As explained previously, our research work is within the scope of the HP routine design methodology. In this methodology promoted by the IRTES-M3M laboratory at UTBM, customer needs are stored as functional parameters that allow geometrical parameters and simulation parameters to be created. All these parameters are linked together thanks to expert rules. The geometrical parameters are also linked with the CAD model in order to quickly create design alternatives. In another part of our methodology, the product architecture is defined thanks to some specific previous steps. Moreover, this research work links simulation parameters with the simulation CAD model.

To sum up, our research work is integrated in the scope of this HP routine design methodology and it adds a contribution. As the HP routine design philosophy, our research work tries to reduce significantly routine time and tries to accelerate requested time for generating new products in a family. In our methodology, there is also management of various parameters with various optimisation loops. Finally, the definition of the product architecture, in accordance with some functional and assembly constraints, is a contribution to the HP routine design methodology.

Moreover, the traditional design processes are based on a Taylor point of view that is similar to a sequential approach. But the main disadvantage of this type of approach is the lack created between services of companies that produce situations named “over-the-wall”. It

means that there is no communication between design stakeholders as if a wall was built between an engineer of the design office and an assembly planner. Our research goal is to establish communication channels between customers, designers and assembly planners in order to design a product family that respects customer needs and have an ease of assembly.

3 OUR RESEARCH TOPICS

In the current economic context impacted by the diversification of needs, customers want a specific product that fulfils all his/her needs without optional functions (not needed by this customer). Designers have various product development strategy alternatives from the unique product that fulfils “as well as possible” all the customer needs to the individualized products that fulfil “perfectly” all specific customer need. It is then normal that designers try to design intermediate products. The ideal solution aims to develop a marketing diversification that has a poor technique diversification. In the last years, a large number of research activities have tried to reduce the internal complexity and variety and at the same time conserve an external variety and range of product portfolio [Daniilidis et al. 2011]. Our objective is to develop product families or product platforms. According to [Simpson et al. 2011], a product family is a group of products derived from a common set of components, modules and/or sub-systems where the product platform is constituted by the common part [Meyer and Lehnerd 1997]. Some product design strategies have been developed such as: delayed differentiation, modular design and standardisation. But modularisation and standardization are not the same concepts as described by [Börjesson 2012]. Modularisation is more dedicated to variation focused on customer needs while standardisation tries to reduce product variety but with an average satisfaction of customer needs. In our research work, we choose to modularize the product architecture in order to reduce the internal variety. Therefore, modular design consists of the decomposition of the product architecture into modules that are linked with the customer needs thanks to functions. A product architecture is like a scheme where the product is decomposed into physical blocks that interact together [Huang 2000]. Then, a modular architecture is defined by [Ulrich 1995] like a scheme where the physical components are associated to functional elements in order to form different products. That is why in this section, an overview of the modular design and the functional design are presented.

According to our industrial context, and during our research work, we try to combine modularity with delayed differentiation. To sum up, the delayed differentiation consists of delaying the point of differentiation or production process in order to supply semi-finished products rather than finished products [Lee and Tang 1998]. The point of product differentiation is the point from which a product acquires its own identity or specificity. For this, Design For Assembly (DFA) approaches have been chosen to develop modular product from which modules are the most independently buildable and at the end of the assembly phase. An overview of the literature focused on DFA is described in this section.

The last point studied on product development is its behaviour validation. For this, a short overview of the product numerical simulation is proposed at the end of this section.

3.1 Modularity

The evolution of the industrial world, with more and more competition (the global competition) and the mass customization, has led to a paradigm shift in which the focus has

moved from the design of single products to the design of product families. So designers must create product families and not only independent products. They must change their mind on this subject [Rai and Allada 2003]. From our point of view, modular design and associated tools have attracted the interests of engineering design practitioners in recent years due to market competition and its potential. Modularity is an important cornerstone of the proposed methodology because it fits the aim of the research by realising a family of modular products. Let's define some basic concepts.

Variety is the origin of our research context, but what is variety? From the Oxford dictionary [<http://oxforddictionaries.com/definition/variety>], the definition of the noun variety (according to our context and not biology or television or theatre entertainment) is:

- *[mass noun] the quality or state of being different or diverse; the absence of uniformity or monotony*
 - *(a **variety of**) a number or range of things of the same general class that are distinct in character or quality*
 - *[count noun] a thing which differs in some way from others of the same general class or sort; a type*
- Origin: late 15th century: from French *variété* or Latin *varietas*, from *varius* (different from one another; of different kinds or sorts)*

From this one and with a more technical point of view, it is possible to define variety as a family of things generally similar but distinct in terms of characteristics. The variety of a family is due to functions, and their resulting characteristics, desired by customers. In contrast, there are unique or unitary products. Most of the time, they are manufactured for a specific customer.

After the Second World War, the “Thirty Glorious years” or “Trente Glorieuses” make the standard of living better. This improvement created an increase in demand. But this demand had to be varied and personalized. These increases forced manufacturers to adapt and produce more variety. Markets were developing and changing very fast during this period. The concept of product variety was born during this period. Nowadays, product variety is mainly used in order to produce just enough in a flexible and reactive way and at the same time respond to a personalized request.

As explained in the introduction of the Our research topics, our research work tries to use modularity for the generation of families of modular products in order to propose variety to the customers. According to [Miguel 2005], a modularity or modularization approach tries to organize complex products and/or processes efficiently [Baldwin and Clark 1997] by decomposing complex systems and/or tasks into simpler portions that can be managed independently. In generic terms, module is similar to group or building block. Modularity is usually grouped into four mains domains: the modularity in design, the modularity in production and the modularity in organization. The modularity in design is the more coherent domain according to our research work positioning and the product architecture is an important aspect. However, modular design is different from a simple decomposition of a product into subassemblies or groups of components. In modular design, modules correspond to one or more well defined functions or sub-functions which are fulfilled by the

components of the corresponding module. Moreover, modules are independent and a variation of their combination can achieve different products [Miguel 2005].

Appropriate combinations and product architectures of modules can allow the creation of a large number of different products for customers and can comprise of a product family from which products have common functionalities and specific functionalities for the creation of the variety [Langlois and Robertson 1992], [Ward et al. 1995], [Harmel 2007]. Thus a well defined modular architecture is an architecture where each functional elements of the product is implemented into exactly one physical building block which has few well-defined interactions with the other physical building blocks [Ulrich and Eppinger 2007]. Modular architecture is opposed to integral architecture which increases knowledge sharing and is dedicated to optimizing product structure [Ulrich, 1995], [Pandremenos et al. 2009], [Sako and Murray 2000]. A list of benefits for modular product design is proposed by [Jose Flores and Tollenaere 2005]. They include specialization of tasks per module, potentials to reproduce a large number of diverse products from the same modules and increase the product variants number, a flexibility of reused components, an easy assembly process of modules, and therefore assembly time is reduced and costs lowered. These potential benefits may help to understand the interest of these last twenty years of research in this field. But the terms “module” or “modularity” are often used with confusion as confirmed by [Börjesson 2012], [Harmel 2007].

In the literature, there is some agreement to define a modular product as a group of modules or building blocks as confirmed by [Gershenson et al 2003]. This is confirmed by a literature review made by [Jose Flores and Tollenaere 2005] that define more generally the product architecture as an arrangement of building blocks of functional elements with a functional and physical mapping of components or modules. Several authors define the concept of “module”, as identified in various literature reviews [Gershenson et al 2003], [Jose Flores and Tollenaere 2005], [Salvador 2007], [Daniilidis et al. 2011]. A module is defined as:

- an interchangeable group of standard components [Galsworth 1994] or independent group that assigns a function to a product [Wilhelm 1997],
- independent units [Baldwin and Clark 1997] to create varieties of product [Huang and Kusiak 1998],
- a unitary correspondence with a subset of functional model of product [Otto and Wood 2000],
- a building block with specific and well defined interfaces [Hölttä-Otto 2005],
- groups with minimal interactions between them [Sosa et al. 2003] but maximal interactions between components inside [Chen and Li 2005], from different lifecycle viewpoints [Newcomb et al. 1998], etc.

Our positioning

In our research work, we have decided to define a module as an independent function group of components that can be assembled independently of the other modules and which are the most independent as possible from each others.

Several authors have worked on measurements and indicators of product modularity as shown in the following literature survey [Gershenson et al. 2004], [Newcomb et al. 1998], [Jose Flores and Tollenaere 2005], [Jose Flores 2005]. The degree of modularity tries to define the efficiency of a modular design. It could be used to compare the improvement of a modular design after some design decisions. Two main types of measurements are proposed: methods based on the calculation of ratio and methods based on specific algorithms. The methods based on ratio propose the most common and simple definition of the degree of modularity. Some of them define the degree of modularity from the study of intra- and inter-module interactions. But the information used to define the degree of modularity is very limited. No method takes into account:

- interactions inside and between modules and which are at the same time common or specific modules,
- assembly independence aspects and fulfilled functions.

The main disadvantage of the algorithms for measuring the degree of modularity comes from the specificity of the context. It is as if each algorithm was dedicated to only one type of use case. There is no real generic algorithm. It can be explained by the diversity of modularity applications. The specificity of our context of modularity is also too singular to find an existing method or algorithm for the definition of the degree of modularity that integrates our constraints (function design constraints, design for assembly constraints, design of modular products from a same family, etc.).

[Salvador 2007] explains that the concept of modular product has evolved from five different perspectives which are, in chronological order: Component commonality, Component combinability, Function binding, Interface standardization and Loose coupling. In component commonality studies, two module notions are discerned: a module is a kit of components usable in different product parts, and a part or subassembly as a stand alone. Component combinability refers to the possible mixing and matching of components in order to obtain different product configurations. Function binding relates product modularity to product functions that are performed by the product and they are described into a product function structure. Interface standardization in modularity refers to the interaction between modules. Loose coupling refers to the degree of independence links (couplings) between components of a system that can be broken into smaller units or modules.

As described by [Jose Flores and Tollenaere 2005] [Fixson 2007], [Huang 2000], there are a lot of modular design methods. But some authors [Harmel 2007], [Daniilidis et al. 2011] are agreed to define three most common methods of identifying modules:

- Heuristics Module method;
- Modular Function Deployment method (MFD);
- Design Structure Matrix method (DSM).

The Heuristics Module method [Stone et al. 2000], [Dahmus et al. 2001] introduces a systematic approach to identifying modules on a functional model description of the product. It is based on the Pahl and Beitz's functional structures [Pahl and Beitz 2007]. [Stone et al. 2000] propose some rules or heuristics in order to identify modules. For instance, dominant flow, branching flow and conversion-transmission pair are function structure heuristics. In the Heuristics Module method, a module is a subset of the physical product structure with a mapping unit, with a unitary correspondence, with a sub-function of the product functional

model. As with the Modular Function Deployment method (MFD), the main disadvantage of this method is the poor repeatability and the varying of its application results.

The Modular Function Deployment method (MFD) [Ericsson and Erixon 1999] is a more strategic and management method than an engineering method. MFD is appropriate for the modularization of one singular product [Daniilidis et al. 2011]. It is based on functional decomposition such as the Heuristics Module method. But the difference comes from the addition of modularity drivers that are initially twelve [Ericsson and Erixon 1999]. MFD is similar to Quality Function Deployment (QFD) [Akao 1990]. The difference is that modularity drivers are not mapped with customer requirements but with functions. The identification of modules is done from a classification of the functions. Dominant functions into a modularity driver have a strong probability to be grouped and to be candidates for a module. But the main disadvantage of this method is the poor repeatability of the results of its application.

[Stake 2000], [Blakenfelt 2001] show how MFD and Design Structure Matrix (DSM) can be coupled during the grouping phase.

Design Structure Matrix (DSM) is a powerful tool and technique used in systems engineering of products, processes and organizations to support new solutions relative to decomposition and integration problems. In DSM, the elements of complex systems and their information dependencies are encapsulated within a compact matrix representation. DSM is typically used to organize and group product development tasks or teams in order to minimize iterations for speed up the development process. But it can also be used for product architecture on components or functions.

The original DSM method was proposed by [Steward 1981]. It does not contain quantitative information about the strength of interaction between the matrix elements. Several extensions have been therefore developed to allow quantitative analysis [Eppinger et al. 1994]. It is possible to use coefficients like -2, -1, 0, 1, 2 for representing the strength of the interactions between elements of the matrix. Based on appropriate algorithms, the coupling relations between the DSM elements can be optimised.

Over recent years, DSM was used in different domains, including product design, systems engineering, project planning, and organization design. This led to the emergence of different types of DSMs. [Browning 2001] proposes a classification of DSMs into two categories: time-based DSMs and static DSMs. Time-based DSMs are used to model the flow through time of the interactions between the matrix elements which are either design tasks or design parameters. Time-based DSMs are often analysed using sequencing algorithms and partitioning algorithms (originally proposed by [Kusiak et al. 1994]). Static DSMs are used to represent elements existing simultaneously, such as the components of a product or groups in an organization. Static DSMs are usually analysed with clustering algorithms. Clustering algorithms can be applied to group elements of a matrix as functions or components in order to have a strong interaction within clusters and minimize the interactions between clusters. Then, the clusters formed by the algorithm represent groups of components that can be considered as possible modules. It is possible by reordering rows and columns in the matrix in order to put the current interactions as close as possible of the matrix diagonal. The computerized algorithm from [Thebeau 2001] is well defined and then regularly used.

From these categories, four main applications represent the research focus of the use of DSM techniques:

- Component-Based or Architecture DSM: Used for modelling interactions among product components or subsystems. It can be useful for appropriate modularisation of complex systems. Matrix-components DSM which was originally proposed by [Kusiak 1999].
- Team-Based or Organization DSM: Used for modelling and depicting interactions among organization structures such as design teams.
- Activity-Based or Schedule DSM: Used for modelling processes and activity networks based on information dependencies among design activities.
- Parameter-Based (or Low-Level Schedule) DSM: Used for modelling relationships between design decisions and parameters.

Our positioning on these various methods dedicated to modules identification

One weakness of these three most common methods for identifying modules is the problem in designing multiple products [Höltta-Otto 2005]. These methods optimize each product of a family but not the family as a whole. To solve this problem, the family can be reduced to a generic product that is used in order to create product variants in a same family thanks to a set of geometric parameters. These geometric parameters can change the dimensions of each variant without any modification of the product architecture. Then, there is a family of products based on the same architecture that can differ from their dimensions.

Our positioning is then to define a functional architecture from a functional analysis combined with the use of a DSM method in order to assign components in each module. Then, independent functional modules can be obtained.

Although a lot of research involving modularising the product architecture has been carried out at the detailed design stage, very few methodologies were found in the literature dealing with modularity at the conceptual design stage [Gupta and Okudan 2007].

Our positioning on modularity

According to our definition of a module, it could be considered as an independent functional module which is independent in terms of assembly and which corresponds to only one function. Moreover, a component can be in only one module (simplification hypothesis) and so meets only one function. In order to define the components in each module, our methodology approaches the definition of modules by different aspects to create a variety of products by the combination of instances (the same module with different parameter values) of each module. Our approach tries to link requirements with modules by employing a functional analysis. Each specific modular product is obtained by the combination of various “functional modules”. Each module represents a function and each product component denotes a specific function, combined with the assembly aspect.

Our definition of the modularity is based on the functional design and coupled with the design for assembly. This modular approach is considered in the preliminary phase

of the design process, on a conceptual design of product. This offers more flexibility for the product but requires a better anticipation of the common and specific modules of the products family.

3.2 Functional Design

One of the constraints implemented to the final products of the family that we aim to generate, is the respect of customer needs. For this, our design methodology begins with a functional design and more specifically with an External Functional Analysis (EFA) followed by an Internal Functional Analysis (IFA). This section will mainly focus on methods and tools, popularized by the APTE Company [Tollenaere. 1998], that are used in our approach.

The customer needs are the needs or desires experienced by the user [Delafollie 1996]. At the beginning of the Functional Analysis, more specifically during the External Functional Analysis, the need is expressed in terms of finality and not in terms of physical or concrete design solution, thanks to functions.

The Functional Analysis (FA) focuses on functions expected by the users [AFNOR 1991]. This approach can be applied on initial design or redesign of a product or system. It ensures that the final product requirements as defined, meet the customer needs. The FA encompasses the External Functional Analysis (EFA) that identifies the context of the study and above all the functions to be fulfilled by products and expected by customers. EFA aims to express what the complete product must do [AFNOR 1996a]. It is also named Functional Analysis of the Need but EFA is chosen for the next steps of our approach. In this context, two types of functions are considered: Service Functions (SF) and CONStraints (CONS). SFs allow the product to satisfy the customer needs and CONS represent an obligation or constraint that limits the designer [AFNOR 1996b]. From the EFA, the functional requirements are established and are integrated in a document [AFNOR 1990a], [AFNOR 1990b], [AFNOR 1997]. This document describes the lifecycle of the future product with the environment of each phase and it identifies, organizes, prioritizes and characterizes the functions. This functional requirements document must be understood by each actor of a development project such as customers, designers, manufacturer, etc. This is a document for exchange established in order to validate the comprehension by the design stakeholders of the customer needs. The customers express their needs in terms of functions and constraints which are then detailed with value criteria (parameters, values, units, etc.) and classified in terms of priority [AFNOR 2007].

For each phase of the lifecycle, a functional diagram can be created to illustrate interactions between functions of the future product and components of the environment (Figure 8).

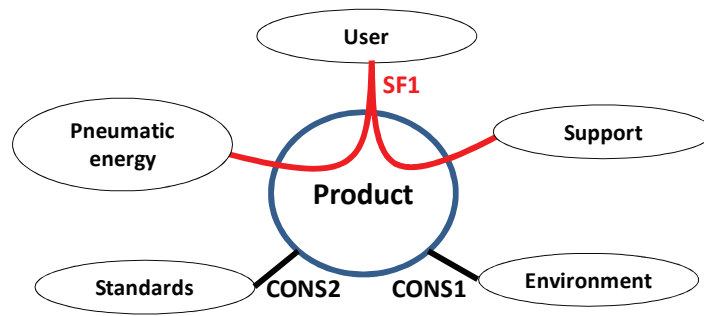

Figure 8. Illustration of a diagram for the use phase of a product

Figure 8 presents the two types of functions (SF and CONS). The environment of the product is composed from five components also named interactors [AFNOR 2007].

From this EFA, a Functional Analysis System Technique [Bytheway 2007] diagram can be used in order to split the functions into Technical Functions (TF), and then into Technical sub-Functions, and so on, in order to achieve formalization of possible solutions [Delafollie 1996]. It is like a creativity tool for searching solution principles, based on design the stakeholders own experience, and recombine them into global solutions in order to obtain a whole design concept, in a morphological design approach. The construction of this FAST diagram is based on three main questions: “Why”, “When” and “How”. In order to detail a function, the designer asks: “How can I do this function?” It is built and read from the left to the right. To decompose a function, two connections are possible by binding “AND” (combined solution) or “OR” (alternative solution). This is an evolution of the initial FAST diagram (Figure 9).

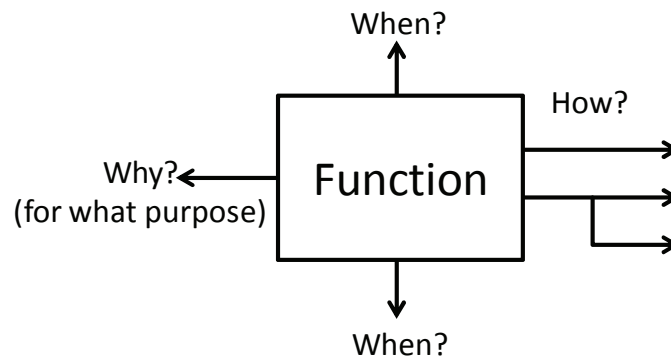

Figure 9. Scheme for illustrating a FAST diagram structure

From the EFA, an Internal Functional Analysis (IFA) is applied in order to contribute to formalizing the product structure by identification of technical functions (TF) of subsets or components [AFNOR 2007] [AFNOR 1990b]. IFA can also be named Technical Functional Analysis but IFA will be used in the future. A product can be thought of in both functional and physical terms. The functional elements of a product are like individual operations and transformations that contribute to the overall performance of the product [Ulrich and Eppinger 2007]. Then, Technical Functions represent an action between components of the product to ensure Service Functions [AFNOR 1996b]. Indeed, TF are only subdivisions of SF and most of the product components may be affected to end-level TF. A TF is qualified as “end level” if this TF is not divided again into sub-TF. There are some parts that do not contribute to a Service Function or Constraint, and we have made previously the hypothesis that each part

can be affected to only one end-level TF. So the functional analysis describes the internal architecture of the concept and components involved in the implementation of one or more Service Functions (or Constraints).

In order to represent the IFA, [De La Bretesche 2000] created a graphical tool: the Functional Block Diagram (FBD) as shown in Figure 10. The FBD allows components of a product with their contacts that are basic functions of contact (boxes in Figure 10) to be represented and also contacts with the external elements of the environment (circles in Figure 10). It also highlights contacts between interactors and components that allow definitions whose components fulfil the Service Function(s). A FBD must be done for each phase of the lifecycle defined in the EFA. In Figure 10, two SF are represented. Another interesting aspect of the FBD is the definition of some specific technical functions, that correspond to design choices (green lines or loops in Figure 10).

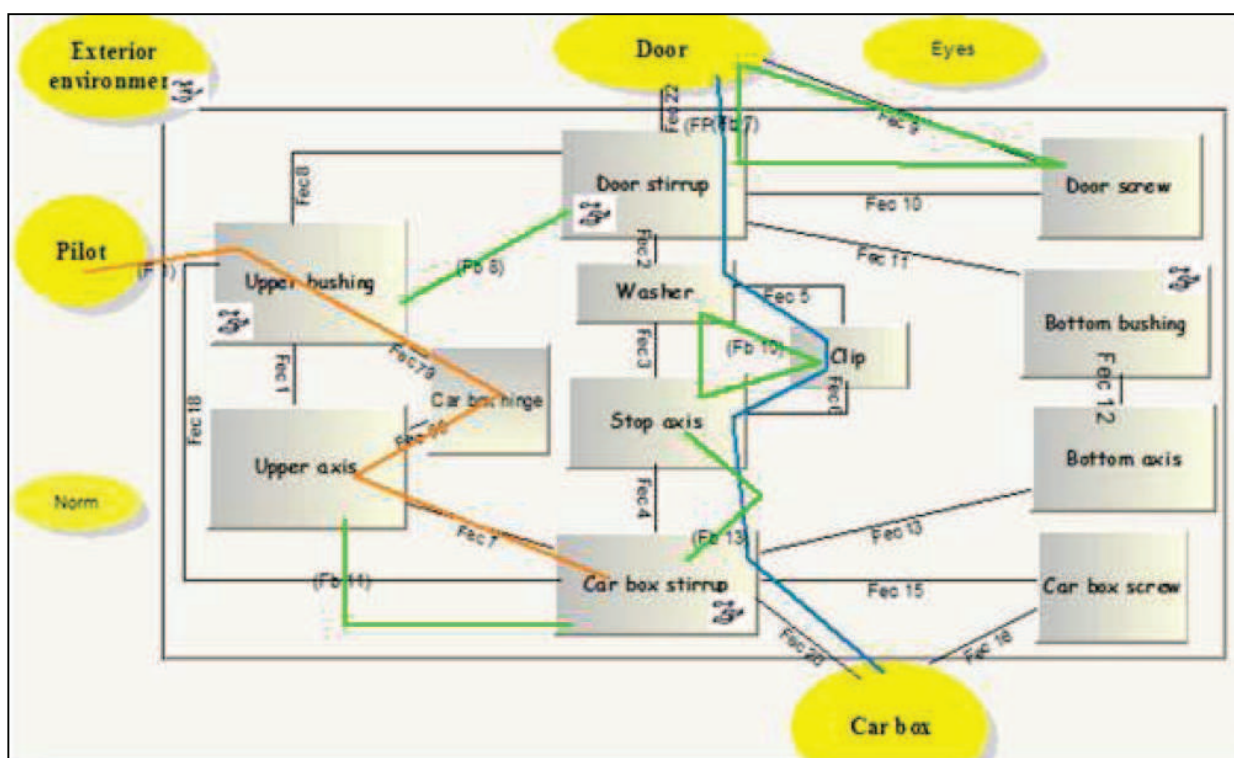

Figure 10. Illustration of a Functional Block Diagram extract from [Frey et al. 2010]

The FBD can be illustrated by a Functional Analysis Table (FAT) or also named products – functions matrix [AFNOR 2009] which regroups all information of the FBD. It is possible to synthesize all types of functions in a table with more or less details. But this FAT is mainly used for value analysis because it simplifies the cost analysis of components and functions.

Our positioning

Our research work is based on Functional Analysis but just on a part that correspond to our needs. Indeed, in our research work the definition of the product or the value analysis is not detailed. However, these methods can be used in parallel by users of our approach.

For instance, we focus on the use phase of the product that is in direct link with the needed modularity aspect. Indeed, our definition of the modularity of a product is based on the customer needs and functions that fulfil them. So these functions are centralized in the use phase of the lifecycle of the product.

The Functional Analysis System Technique (FAST) diagram aims to detailed functions into technical functions in order to define some possible solutions principles for a product concept, using a morphological approach. For the definition of concept or to find possible solutions, many method and tools exist. But develop a new method for the definition of concepts is not the purpose of our research work. So we focus on just a part of the FAST diagram that allows the product functions to be decomposed into technical functions or sub-functions in order to define the modular product structure. However, the user can also use the FAST diagram to define his/her product concept without any disadvantage for the proposed methodology. Limits of the FAST diagram are the lack of links between components and its restriction on the functions.

3.3 From Design For X (DFX) to Design For Assembly (DFA)

The Design For X (DFX) approach has emerged in the late 1950s in order to better take into account the trade constraints downstream from the design and development process of the product [Deng and Yu 2006], [Peck 1973]. Indeed, the goal of the DFX approach, which is composed of a set of design methodologies, is to improve product development by taking into account various concerns. In DFX, the “X” represents a point of view linked with a phase of the product life cycle such as the assembly (Design For Assembly), the manufacturing (Design For Manufacturing), the recyclability (Design For Recyclability), etc. or linked with a factor of competitiveness like the quality (Design For Quality), the cost (Design For Cost), etc. A list of various DFX methods with their purposes is proposed by Holt and Barnes [Holt and Barnes 2009]. They address a particular issue that is caused by or affects the product characteristics. Each DFX aims to guide the designer during the development of a product thanks to a lot of information, knowledge, analysis and recommendations for a better understanding of the impact of the X aspect considered [Kuo et al. 2001]. They are usually composed from design guidelines that propose approaches and corresponding methods in order to help designers apply technical knowledge.

Each DFX focuses on just one aspect of the product but they must be brought together for a holistic approach required by concurrent engineering [Holt and Barnes 2009]. Some new directions appear: applying multiple DFX as soon as possible in the product design process, strengthen the design process thanks to new constraints like from the supply chain, and consider all the DFX as a set by coupling some of them like the DFMA (Design For Manufacturing and Assembly).

This section focuses on the Design For Assembly (DFA) approach which corresponds to the X aspect chosen for our research work in accordance with the MABI Company problematic. Design For Assembly (DFA) is dedicated to the integration of assembly knowledge during design phases. DFA means the design of the product for ease of assembly and “to assemble” refers to the addition or joining of parts in order to form the completed product. The objective of the DFA approach is to reduce production costs by preparing the best production solution with an easy assembly plan. DFA is based on two basic principles that are the reduction of the number of assembly operations by reducing the number of parts

and by making the assembly operations easier to execute. The product must be suitable for an assembly engineering process. DFA helps designers to anticipate future assembly problems for a product. The original development of DFA method emerged in the 1960s on automatic handling [Boothroyd 1974]. This original approach was extended to general areas of DFM and DFA by the U.S. National Science Foundation in the mid-1970s [Boothroyd et al. 2001].

Another main goal of DFA is also to reduce assembly product costs. In accordance with the cost formula [De Lit 2001], the three reduction objectives can lead to a reduction of the assembly product cost: the number of assembly operations, the operation times and the ratio cost/second of the operator who executes the assembly operation. In order to achieve these objectives, three axes can be developed: the reduction of the number of components, the development of standard components and assembly process, and the simplification of the assembly operations.

According to various literature reviews [Stone et al. 2004], [Defaux 1989], [Redford and Chal 1994], [Schepacz 1989], all the DFA approaches can be grouped into three categories known as:

- Qualitative approaches,
- Quantitative approaches,
- Integrated approaches and knowledge-based approaches.

Methods based on qualitative approaches help the designer with rules and guidelines based on examples drawn from experience. These approaches are based on qualitative evaluation using Best Practices or DFA guidelines in order to standardize, simplify and structure the product. [Andreasen, et al. 1983], [Andreasen and Hein 1985] was the first to propose a guide for designing product components with rules for structuring the product and selecting the assembly process. These design rules were extended in order to improve the assembly product from the detailed phase of the design process [Pahlet al. 2007], [Otto and Wood 2000]. But these methods are considered too general for practical application [Abdullah et al. 2003]. Moreover, they intervene on detailed or finished products. Then, [Redford and Chal 1994] evokes the possibility of introducing these guidelines in the preliminary phase of the design process in order to work on concepts of the product not yet too detailed.

Methods based on quantitative approaches are associated to time periods, costs and numerical codes dedicated to characterize parts and assembly operations. In this category, there are a lot of proposed methods. The most popular methods are summarized in this overview:

- The Assembly Evaluation Method of HITACHI [Miyakawa and Ohashi 1986] aims to identify and evaluate the design difficulties for the assembly phase (manual, automatic and robotic) thanks to two indicators based on assemblability and assembly cost. The main principle of this method is “one motion for one component” during the assembly phase or else a penalization is applied on the component. But only the insertion and attachment operations are taken into account by this method.
- The Boothroyd and Dewhurst Method [Boothroyd and Dewhurst 1983], [Boothroyd et al. 2001] is currently widely used in an industrial or scientific context. It takes

into account various aspects such as manual manipulation or machine components, including the assembly time, cost and difficulties in assembling components together. It is based on empirical information extracted from industrial experiences and this method is used during the detailed design phase of the design process. The most important factor for reducing assembly costs is the minimization of the number of components in a product. For this, the evaluation of the product is about the functional analysis of the components in order to verify their need and eliminate some components, the analysis of the geometrical characteristics in order to estimate the assembly time of each component, and the calculation of the DFA Index in order to check the design efficiency. An effective design ("ideal") contains only minimum components and all candidate components for elimination (c.f. the functional analysis) have been eliminated or combined with others. The assembly time can be defined thanks to tables of factors for assembly time estimation from Methods-Time Measurement (MTM).

- The Lucas method [Swift 1989] is the result of the collaboration between Lucas Corporation and the University of Hull in the early 1980's. Its objectives are similar to those of the Boothroyd and Dewhurst Method: the reduction of the number of components in a product and the analysis the geometry of each component in order to facilitate the assembly phase. It is based on three analyses (the functional analysis, the feeding analysis and the fitting analysis), each corresponding to one of the three ratios (the design efficiency ratio, the feeding/handling ration and the fitting ratio). They are described in an Assembly sequence Flowchart (ASF).

Other Methods based on quantitative approaches exist like the SONY Design for Assembly Cost-effectiveness method [Yamagawa 1988], the House of DFA introduced by [Rampersad 1994], [Rampersad 1995], etc. An improvement of the quantitative DFA index is proposed by [Hsu et al. 1998] that can be generated for each component involved in the assembly of the whole product. This DFA index is calculated based on the ranking system developed by Rampersad and the quantification is also partly based on the classification system from Boothroyd and Dewhurst.

Integrated approaches and knowledge-based approaches aim to have a better integration in the design process and to define assembly sequence. The knowledge-based approaches bring some suggestions to the designer [Chang 1990], [Daahub and Abdalla 1999] and allow a better integration of assembly knowledge and assembly constraints in the design. They are linked with expert systems [O'Grady et al. 1992] and allow manufacturing and assembly point of views to be taken into account during the design phase. Their integration into CAD environment allows the extraction and use of information in the product component CAD model thanks to the recognition of features, etc. A lot of approaches are applied in the integrated design and in the Product-Process domains. Here is a summary of a non-exhaustive list of main approaches [Demoly 2010]:

- The Assembly-Oriented Design (AOD) approach proposed by Mantripragada comes originally from the D.E. Whitney team work (CAD LAB laboratory in the Massachusetts Institute of Technology). His team was the first interested in the integration of assembly problems in the design process [Whitney 2004]. The first works were in collaboration with the Charles Stark Draper Laboratory (CSDL) [De Fazio 1999]. They try to delete the precedence assembly constraints between

components thanks to an analysis of the assembly sequence of the product and the use of a genetic algorithm to generate sub-assemblies. Then, the AOD approach aims to create a methodology framework of top-down design [Mantripragada 1998]. This approach uses key characteristics for modelling and controlling variation propagation in assemblies using State Transition models [Mantripragada and Whitney 1999].

- The Systematic Concurrent design of Products, Equipment and control Systems (SCOPEs) approach comes from an European project [Delchambre 1996] and supports a concurrent engineering approach for assembled products. The SCOPEs solution aims to bridge the gap between product design and the production processes. This integrated method is divided into various analysis modules (ease of assembly, assembly order, design of an assembly workshop and the simulation of the workshop) with automatic, semi-automatic and manual utilisations. DFA and assembly sequence are considered but the assembly sequence is defined on a detailed product.
- The Assembly-Oriented Design Expert System (AODES) approach integrates the product design and its assembly sequence definition and is based on costs and productivity criteria. The methodology is based on algorithms for generating assembly sequences and selecting the most optimal assembly sequence and authors develop an expert system [Zha et al. 1999]. Thereafter, it was adapted in order to propose a decision support for helping the designer to define, analyse and modify the product during the whole design process [Zha et al. 2001].
- The projects OPHIR & THE DESIGNER 'S SANDPIT lead by G. Jared and K. Swift consider that most of the DFA approaches are reactive because they impact need modifications on detailed products. Then, these projects aim to be proactive and try to evaluate the product in preliminary design phase [Barnes 1999]. In the OPHIR project, [Barnes et al. 2004] propose an integration of the DFA in a CAD environment to take into account assembly problems during the modelling of the product. This integration leads to the creation of methodology for generating assembly sequence from a CAD model [Barnes et al. 1997] and to geometric reasoning. In THE DESIGNER 'S SANDPIT project [Tate et al. 2000], [Rodriguez-Toro et al. 2004] aims to integrate an assembly problematic in preliminary design phase in order to act before the whole specification of the product. An interactive decision support system SPADE (Sequence Planning And Design Environment) based on knowledge was developed for structuring the product, generating the assembly sequences and applying assembly constraints in the design process. This is a real improvement compared to the previous approaches because of the proactive evaluation.
- [Mathieu and Marguet 2001] proposes to improve the productibility thanks an integrated design method based on product key characteristics and assembly sequences. Their method is composed of seven main steps in order to ensure the robustness of the product assembly phase from the definition of an optimal assembly sequence [Marguet 2001]. Their method is based on the principle that modification of the geometry and dimensions can impact the assembly order of the components of a product. Then, they try to check the fittability of the product in accordance with some functional criteria. But this is applied to detailed products and there is no optimization of definition of eligible assembly sequences.

- The assembly design approach, based on connections between components, comes from a collaboration between the Shanghai Jiao-Tong University and General Motors [Chen et al. 2006], [Wang et al. 2005], [Zhang et al. 2002]. They tried to develop an intelligent system for automotive industry. The approach automatically generates the physical relationships between components and then the assembly sequence of the product. This approach is based on case-based reasoning or case database that contains designs and their information on the assembly entity used. From an assembly input, algorithms of similarity search similar cases in the case database. Then, the approach enters in the case revision where the assembly sequence is generated from an assembly connection diagram, leading to a tolerance analysis. If the proposal is satisfactory, this new case is stored in the case database. Despite the quality of algorithms used and the extent of the method, there is a lack of evaluation criteria for the assembly sequences and of a model for a better connection between all information used in order to have a better integration.

In conclusion, most of these approaches evaluate the product through its components [Eskilander 2001] that are analyzed according to assembly criteria such as assembly type (manual, automatic and robotic), insertion operation, attachment operation, etc. Some methods try to automate the definition of the assembly sequence thanks to algorithms or case-based reasoning. But the main disadvantage of the above approaches are that they are applied and limited mainly to the detailed design phase of the design process. They require fairly detailed levels of product definition. As a consequence, these approaches may require design changes after assembly analysis if certain design features are not suitable for assembly operations. This can lead to significant rework, including redesign, reanalysis through modelling and simulation and even re-prototyping. But it becomes more difficult to modify the product, in the case of problems detected at assembly stage. This rework will increase the product development cost and lead time. Therefore, this highlights the importance of working in a preliminary phase of the design process in order to act on a concept of product not yet detailed.

Our positioning

As stated above, the main goal of DFA approach is to reduce production costs. We propose in our research work to combine a proactive DFA approach with other traditional design methods in order to achieve a better integration of DFA constraints in the design process. Thanks to our proposal, it will be possible to take assembly constraints into account earlier in the design phase. Moreover, DFA approach is then combined with modular approach in order to reduce the number of components of family products and develop standard components shared between the various products of the same family.

In this research, DFA is developed to reduce production costs by optimizing the production of modules. Furthermore, DFA approach is used early in the design life-cycle, just after the definition of the concept. At this stage, there is more flexibility to define the assembly sequence for a product. The proposed approach generates an assembly sequence respecting modular constraints for a family of modular products. The goal is to obtain optimal combinations between functional modular products and assembly sequences. Then, the family of modular products could be obtained by combination of different instances of “function modules” that meets the customer requirements.

The above approaches emphasize the fact that the assembly sequence is very important in design for assembly. However, few research works are about the development of the product and its assembly sequence in a concurrent approach. This integration early in the design process can help increase efficiency and flexibility [Lin et al. 2008]. Any design decisions leading to significant negative assembly consequence can be eliminated at early design stage. The changes are then easier to manage in an early stage of development rather than at the end of detailed study.

It is necessary to have a proactive and integrated approach of DFA in the product development process in order to design a product and at the same time its assembly sequence so right the first time. The objective of this work is to start to use assembly knowledge in design process from the earliest stages of the development process and thus act on a product concept in a preliminary design phase. In this context, [Whitney et al. 1988] were among the first to focus on assembly problems in the early embodiment design phase of the design process. More recently [Demoly 2010] proposes a Proactive ASsembly-Oriented DDesign methodology in the field of mechanical product development. The main objective of this approach was to integrate assembly sequence into the preliminary design stages, by introducing assembly knowledge for product structuring [Demoly et al. 2011].

Assembly sequences are based on connectivity between components from which a product is assembled [Wang and Li 1991] and should help the product assemblability. As explained by [Tseng and Liou 2000], an assembly sequence represents a way in which components can be grouped and fixed together in order to form a product. Several research works have been proposed for generating assembly sequences but this is a non polynomial problem. Some literature reviews [Delchambre 1996], [Homem de Mello and Sanderson 1991], [Lim et al. 1995], [Zha et al. 1998], [Wang et al. 2009] provide an overview of methodologies on assembly process planning. Several methodologies for representing assembly sequences are used such as binary matrices, functional diagrams, directed graphs, AND/OR graphs, precedence relationships, etc. Thereafter, the methodologies presented are classified in accordance with the classification [Wang et al. 2009]: the exact methods and heuristic methods. Exact (or enumerative) methods such as tree search or graph search can find exactly the best result. Heuristic methods aims to converge faster to a result compare to exact methods. All these methods are based on component information and physical relationships between components of a product.

Here is a non exhaustive overview of previous work on exact methods for assembly sequence generation of a product:

- [Bourjault 1984] is considered as the first researcher in the assembly sequence definition domain through a representation using direct graphs and recurring questions. He proposed a method that generates all the eligible assembly sequences from information of a detailed product. A procedure composed by a set of structured questions allows all the precedence knowledge about the liaisons of a product assembly to be obtained. The product is represented by a graph, a liaison model, where nodes are components and edges are functional liaison between components. The main disadvantage of this method is the number of questions that are more and more important, more the number of product components are great.

- [De Fazio and Whitney 1987] have simplified the proposed procedure of Bourjault by reducing the number of asked questions (n), from 2^n to $2n$. But their questions need more reasoning from the user. An advantage of this approach is to generate more compact trees than the Bourjault's approach.
- The Homem de Mello and Sanderson approach [Homem de Mello and Sanderson 1988], [Homem de Mello and Sanderson 1991] proposes an improvement of the Bourjault model thanks to an AND/OR graph describing the assembly. They work on the assembly sequence generation from a disassembly approach. For this, they establish two hypotheses: no component physical distortion is needed for the assembly operation and the disassembly sequence is the inverse of the assembly sequence. All the eligible disassembly sequences are generated and are represented by an AND/OR graph.
- [Santochi and Dini 1992] propose an approach based on three matrices (the interference matrix, the contact matrix and the connection matrix in the Cartesian coordinate system) describing the constraints between components of the product. This allows assembly and subassembly sequences to be generated. The introduction of matrices used for the generation of assembly sequences is very interesting but the number of matrices could be very tedious according to the number of components of a product.
- [Gu et al. 2008] propose an Ordered Binary Decision Diagram (OBDD) that represents all the feasible assembly sequences. An advantage is that the representation does not increase with the components number of assembly compare to direct graph and AND/OR graph. This highlights the interest of using graph-based and matrix-based approaches.
- [Laperrière and ElMaraghy 1996] propose a dynamic approach based on a direct graph and starting from CAD model (a detailed product geometry is needed). An algorithm evaluates the graph, and at the same time, it evolves by selecting of components for the assembly sequence. The algorithm is based on four criteria in order to define the optimal assembly sequence but filling these criteria need well product knowledge from the user.
- [Gottipolu and Ghosh 1997], [Gottipolu and Ghosh 2003] propose a matrix-based methodology used to generate all the feasible assembly sequences thanks to an algorithm from two functions: the contact and the translational functions, in order to analyze the generated assembly sequences for determining the final sequence choice.
- [Zhang et al. 2002] propose a procedure based on a mathematical model to automatically define all the feasible assembly sequences for an automobile body assembly. The mathematical model is based on the definition of the connection matrix and the contracted matrix that represent the precedence constraint knowledge between components of a product and its subassemblies. These authors define a directed graph with two types of connections: direct physical connection and dummy connection (without physical contact) between components. This directed graph is mapped into a connection matrix that represents the both type of connections. From this matrix, a contracted matrix is generated that tries to detect subassemblies according to basic assembly configurations: serial and parallel assembly. Then, the assembly sequences for each subassembly and for the final product are generated. This approach brings

new information of connection between components in the graph and the corresponding matrix.

- Finally, [Lin et al. 2008] propose a contact relation matrix approach based on four rules to generate assembly sequences. They try to assist designers with the assembly issue by recommendation of design alternatives.

In the other hand, heuristic methods with algorithms have been largely studied for the generation, the evaluation and the selection of assembly sequences as shown in [Wang et al. 2009]. These algorithms were developed in order to reduce the time needed for calculation with exact methods. Indeed, the algorithm complexity increases widely the time for generating assembly sequences as the number of components of a product increases. The most common algorithms are genetic algorithms [Bonneville et al. 1995], [De Lit et al. 2001], [Smith and Smith 2002], [Tseng et al. 2004], [Marian et al. 2006], [Su 2009] and then come the simulated annealing and ant colony algorithms. But the simulated annealing algorithms are more used for assembly line balancing than assembly sequence generation, such as ant colony algorithms.

Exact (or enumerative) methods are slow and limited because of the algorithms used in order to find the global optimum and the combinational nature of the problem. But they are relevant to find an optimal assembly sequence result of a product with a large number of components. The heuristic methods have been developed to overcome this complexity but they do not guarantee a global optimum result. However, the literature review of [Wang et al. 2009] shows an evolution towards the genetic algorithms that are a good compromise according to their disadvantages and advantages compare to the exact methods. It is possible to highlight that defining the optimal assembly sequence as early as possible in the design process is needed. It means that a compromise between the exact methods and the heuristic methods is necessary.

Some authors propose to work with a graph representing a product and its components and especially the relationships between components by introducing the precedence constraint on the liaisons graph. The nodes and the edges of the liaisons graph represent the components and the mechanical liaisons that connect pairs of components. In this context, [Demoly 2010] proposed a Proactive ASsembly-Oriented Design (PASODE) approach (an example is shown in Figure 11) based on a direct graph used for generating the connection matrix on which an Assembly Sequence Definition Algorithm (ASDA) is applied. PASODE approach aims to generate assembly sequences in preliminary design phase by the application of process knowledge in a product assembly, which is still in a concept state.

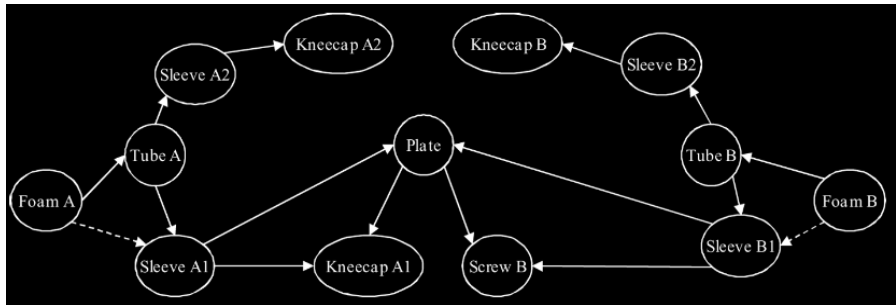
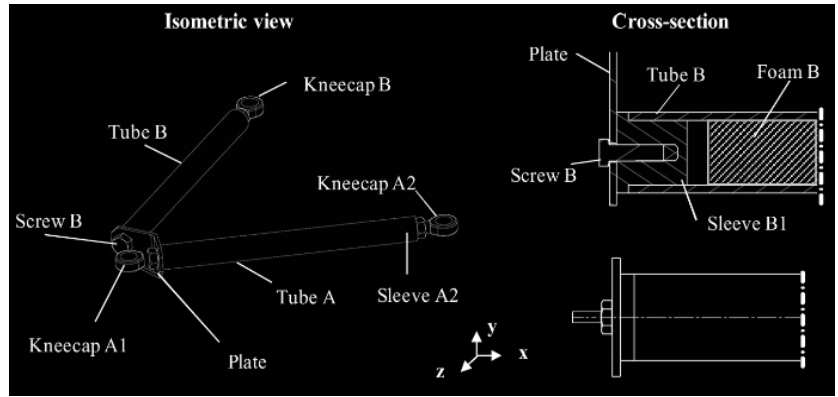

Tube A	Sleeve A2	Kneecap A2	Foam A	Sleeve A1	Plate	Kneecap A1	Tube B	Sleeve B2	Kneecap B	Foam B	Sleeve B1	Screw	
0	1	0	-1	1	0	0	0	0	0	0	0	0	Tube A
-1	0	1	0	0	0	0	0	0	0	0	0	0	Sleeve A2
0	-1	0	0	0	0	0	0	0	0	0	0	0	Kneecap A2
1	0	0	0	λ	0	0	0	0	0	0	0	0	Foam A
-1	0	0	-λ	0	1	1	0	0	0	0	0	0	Sleeve A1
0	0	0	0	-1	0	1	0	0	0	0	-1	1	Plate
0	0	0	0	-1	-1	0	0	0	0	0	0	0	Kneecap A1
0	0	0	0	0	0	0	0	1	0	-1	1	0	Tube B
0	0	0	0	0	0	0	-1	0	1	0	0	0	Sleeve B2
0	0	0	0	0	0	0	0	-1	0	0	0	0	Kneecap B
0	0	0	0	0	0	0	1	0	0	0	λ	0	Foam B
0	0	0	0	0	1	0	-1	0	0	-λ	0	1	Sleeve B1
0	0	0	0	0	-1	0	0	0	0	0	-1	0	Screw

1 Contact connection,
the component *i* can be assembled before component *j* is assembled

-1 Contact connection
the component *i* must be assembled after component *j* is assembled

λ Dummy connection
the component *i* must be assembled before component *j* is assembled

-λ Dummy connection,
the component *i* must be assembled after component *j* is assembled

0 No connection
No connection between two components or self-relationship

Figure 11. Example of direct graph and its corresponding connection matrix according to the PASODE approach and based on the concept of a suspension triangle for automobile

As proposed by [Zhang et al. 2002] the direct graph represents two types of relationships between components: assembly precedence with physical contact and assembly precedence without physical contact (dummy connection). Then, this graph is exactly mapped into a connection matrix representing all the connections between components. From this matrix, some contracted matrices are generated by recognition of specific sub-assemblies patterns like serial, parallel, interconnected and inclusive. Step by step several assembly sequence possibilities are created with sub-assemblies and their own sub-assembly sequence.

One advantage of this approach is the proactive aspect that allows a concept of product to be worked on, during the preliminary design phase, very early in the product lifecycle. However, the direct graph must be fulfilled manually by connections that represent

contact information between components and at the same time assembly precedence relationships. Moreover, the sense of the edges in this graph is inconsistent with the assembly sense that is to say that the assembly sense is opposite to the path of the assembly sequence. For instance, an example of two components (Component 1 and Component 2), for a precedence relationship from 1 to 2, the Component 2 is assembly on the Component 1. This complicates the filling process of the direct graph and it increases the possible human errors. Another point to improve is the results proposed to the user. As all assembly sequences are generated with classical methods, it could be interesting if a decision support system can guide the assembly planner for choosing, step by step, the optimal assembly sequence [Barnes et al. 2004], as an help to the assembly planner when he monitors the generation of some optimized assembly sequences. But the approach developed by [Barnes et al. 2004] generates assembly sequences in parallel to the design process of the product (before the detailed product) with a very high level of detail.

Our positioning

Nowadays it is widely accepted that over 70% of final product costs are determined during the product design [Boothroyd et al. 2001], that is why assembly must be considered as early as possible in the design lifecycle. Our position is situated in the direct continuity of Dr. Frédéric Demoly's research work, with nevertheless some specificities. By considering the applicability of these results to our industrial context, we have identified that some improvement aspects can be highlighted. By applying Dr. Demoly's results to our industrial products, we find that it was difficult to fulfil directly a direct graph without any human errors. Both types of information manually added in the direct graph by the user could be divided into two steps in order to simplify the method.

His approach proposes the creation of a direct graph, and then maps into a connection matrix from which an algorithm is applied in order to generate all assembly sequences with sub-assemblies. Fulfilling a matrix can be completed in a more methodical way compared to a graph. Then, if the order of building the matrix and then the graph are inversed, it could be easier for the user to fulfil them. Moreover, the contact information and the assembly precedence information can be divided into two representations. For instance, the contacts between components can be defined easily in a binary matrix and the directions of assembly precedence relationships seem easier to determine on a graph of components. In this way, the matrix can be first completed, and generate a contact graph to improve using assembly information. This proposal simplifies the information for the user and allows a methodical approach.

In our previous proposal of design for assembly, DFA is considered to further modular product development by incorporating the definition of assembly sequences. A novel aspect can be proposed in adding functional analysis information in the direct graph for taking into account the correspondence of certain components to technical function and then obtain modules that can assembled independently.

It is well known that designers prefer using computers rather than manual calculations in order to analyse their designs with DFA guidelines, such as the DFA software developed by IBM and Digital [Boothroyd et al. 2001]. Then, the development of a new DFA method needs corresponding software to have a good acceptance and use by the designers. Moreover, a decision support system for choosing the optimal assembly sequence can avoid having to generate all the eligible assembly sequences for a product. The more components there are in a product, the more the algorithm calculation time increases. Then, a decision support system that guides the user step by step can be a good compromise.

This section and the two previous sections have focused on the state of art in product design domain with functional design approach, modular product design and design for assembly. But product simulations are also more and more used for the validation of a product design. For this reason, the modelling and simulation aspect of a product is strongly linked with product design process and is studied in this research work. However, this is considered in a “High Productive” routine design context which brings a new point of view and a new approach.

3.4 Simulation

In recent years, with the imperatives of reducing the cost of product development, numerical simulation tools tend to decrease the experimentations and prototype testings. Currently, numerical simulation tools are widely used and have an important place in the product development process. Modelled and simulated phenomena are varied, such as acoustic, vibration, thermal phenomena, without forgetting those related to the product structure (mechanical behaviour). Simulation methods of finite elements are the most common [Bathe 1996], [Belytschko et al. 2000]. These simulation methods can be applied according to various objectives [Troussier et al. 1999], [Lafon 2007]: validation analysis, decision support analysis and analysis for understanding (not taken into account because it is out of preliminary design context). The validation analysis consists in verifying that the chosen solution meets the criteria of the functional requirements. The analysis of decision support aims to evaluate, in a global manner, various design alternatives and then to help the designer in his/her choices [Gardan and Gardan 2003], [Assouroko et al. 2009]. But this analysis is less precise. Whatever the first two types of analysis, it is often necessary to perform multiple simulations from slightly different models. In order to simplify the modelling stage, some approaches of simulation, generating automatically meshed models by finite elements, have been developed as shown in [Badin 2011]. However, some authors such as [Kurowski 1995] have noted that these models contain errors due to the automation of the computational model generation. That is why we propose to manually generate an initial meshed model for the simulation, and then a parametric evolution of this initial model. Thus, the model is specific to the developed product and will evolve without all the meshing phase that is time-consuming and rather complex having to be done again at each modification of the model.

In conclusion, few research works combining modular design with numerical simulation modelling, for the acceleration of routine engineering process, seem to exist in the relevant literature. The use of parametric meshing models seems to be an interesting direction in order to reduce the number of iterations for dimensioning the various product geometry possibilities, involved during the exploration of the solution space. This is the purpose of our proposed methodology to develop a parametric, remeshing process applied to a “High Productive” design process of modular products.

4 PROBLEMATIC AND RESEARCH HYPOTHESIS

As presented previously in this chapter, a lot of design methods and design models exist. Despite all these methods, improvements are always possible for instance thanks to the evolution of the CAD software or the evolution of the customer needs as the appearance of the tryptic Quality-Cost-Delay. Our research work fits into the “High Productive” design routine methodology. The designers must propose more and more new products and

innovation. But they do not have enough time because they are hampered by the multiplication of the routine design tasks and their associated loss of time [Vernadat 1996]. The philosophy of the “High Productive” design routine methodology is to aim to reduce time needed for routine design tasks to have more time for innovation and new products. Then, our research work is in this context and will try to accelerate the routine design of product family.

Our proposed research work is also based on the MD-MV model proposed by [Gomes et al., 2002]. This model is implemented into a collaborative platform that proposes a structure of the various domains. But the dynamic aspect is not developed. We propose to work on an operational and dynamic methodology. This proposed methodology must develop the links inside each domain with reasoning and between the various domains. According to the MABI Company needs, our methodology will firstly focus on the Product design domain. However, the proposed methodology must be generic in order to apply it to other design domains. Then, the global goal of our research work is to propose a methodology, based on the MD-MV model with a dynamic aspect, dedicated to the Product design domain with a generic part that could be applied to other domains.

Customers always want more: better functions, lower cost, higher quality, shorter delays... The never-ending demands have made the industrial world more difficult and companies must evolve in order to face competitiveness. [Gupta and Okudan 2008] propose the generation of a modularised conceptual design from different methodologies in five steps based on customer needs. They think that the modularity passes through the mixing of methodologies and then points of view in order to match the current needs. We propose to base the modularity on the functional design and to mix it with the design for assembly in order to fulfil the MABI Company problematic. This problematic can be generalized to other companies that design, assemble and sale their products without internal manufacturing. Despite all the methods developed in the modularity domain, no methodologies combine the same aspects. Moreover, one of our hypotheses is that it is possible to design a well modularized product to generate other products in order to create a family. It is like creating a generic product and declining it in several variants that constitute a modular product family. This approach can accelerate the generation of new products based on customer needs in order to ensure the requirements are well respected. The design for assembly combined with the modularity can anticipate possible future assembly problems by forming groups of components that are either specific or common to the product family. Then, these groups, assembled independently, can be prepared in the assembly workshop and wait for the final assembly of a product.

To sum up, our modular hypothesis is that a module behaves as an independent functional component or group of components which correspond to a technical function and these modules can be assembled independently. They are like separate functional modules. So a modular product is a product constituted of modules. And more generally, a family of modular products consists of modular products that share the most common modules. Changing or omitting one or two specific modules, according to customer needs, can make the difference between two products of the same family. DFA is used to improve the independency between modules in an assembly context in addition to the independence of modules in a product's structure context. To identify modules which respect the assembly order of components, functional module structure and independence between modules, a specific algorithm can be used. This algorithm can be applied on a coloured and ordered

graph to generate assembly sequences in harmony with the modularity of the products. The final objective is that functional modules can be assembled in various places and then assembled together at the last time to constitute a product satisfying specific customer needs.

For this, a well-structured approach is necessary with best practices in order to satisfy the multiple objectives simultaneously. In this context, we think that it is important to rely on tools and software in order to guide the users and help them to save time by a faster application of the proposed methodology. Moreover, this software can contribute to improve the famous triptych quality/cost/delays. Another interesting point could be the link or the integration of this software based on reasoning processes on various design domains with the ACSP collaborative platform [Gomes et al., 1999] which proposes a data and information structure of various design domains.

The reasoning features included in this software on the Product design domain, based on the proposed methodology, could be generic in order to have a meta-model that could be applied to various design domains. It could contribute to the operational aspect of the MD-MV model with reasoning on the links inside each domain. Moreover, this brings a dynamic aspect to the MD-MV model not yet developed.

A last goal of the proposed methodology is to apply the “High Productive” design method to the simulation domain. Developing a product needs multiple tests, but physical prototypes cost too much. Numerical simulations of phenomena are solutions for simulating the behaviour of products. Then, it allows the number of physical prototypes to be decreased. In the proposed methodology, products of a family are generated from a generic product. It is then possible to think that their numerical simulations are similar. It could be possible to reuse the numerical simulation of the generic product to launch the simulation of the others variants of products and save time.

To summarize, the questions that our research work tries to answer in this thesis are:

- Is it possible to create in a very fast way new products in the same family in a routine design context and ensure that the new developed products respect the customer needs?
- How can the organization of the assembly phase of the products be simplified in order to decrease the stocks while assembling the products as fast as possible?
- Is it possible to reuse the numerical simulation for the validation of the behaviour of the generic product of the family in order to accelerate the physical phenomena simulations of all the other variants of products and finally to save time?
- Is it possible to create a new software for guiding the users during the application of the proposed methodology taking into account multiple objectives and doing it faster?
- Is it possible to link this software with the design domain structured in the collaborative platform ACSP?
- Is it possible to make the interactions between data and information within the MD-MV model operational and dynamic with a generic methodology based on reasoning processes that could be applied to various design domains?

As an answer to our research problematic, our approach can be described and structured into three levels, from the more general to the more detailed one:

- First, at the upper level, our approach globally aims to develop dynamics links and interactions inside and between the various domains of the MD-MV design model thanks to reasoning mechanisms based on graphs and matrices in order to drive a decision support system.
- Then, the dynamic links and interactions are more specifically detailed and developed between the Product Domain and the Process Domain.
- Finally, at the more detailed level, our approach focuses on the specific context of modular products design, according to the industrial framework of the thesis.

Chapter 2

Our approach: Functional And Robust Design methodology

Chapter contents:

1	Functional And Robust Design (FARD) methodology	51
2	Functional design approach.....	57
3	A new approach of modular design based on DFA	62
3.1	Definition of the best assembly sequence of the generic product of the family	62
3.2	Algorithms for creating groups of components from the PP matrix.....	68
3.2.1	Algorithm to gather elements around the matrix diagonal	68
3.2.2	Algorithm of clustering.....	70
3.2.3	Combination of the two algorithms for creating groups of components from the PP matrix	72
3.3	Algorithm of the decision support system for generating the best assembly sequence according to the context.....	73
3.3.1	First algorithm for generating eligible assembly sequences.....	74

3.3.2	Decision support system to define the best assembly sequence	75
3.4	Structure of the generic product of the modular family	78
3.5	Algorithm for structuring the generic product of the modular product's family	81
3.5.1	Step 1: distribution of components into modules	81
3.5.2	Step 2: distribution of components into sub-modules.....	83
3.5.3	Step 3: end of the algorithm for structuring the product	83
3.6	Configuration management of module variants and new products of the modular family	84
3.7	Indicators to validate the improvement of the modular product development thanks to the FARD methodology	87
4	A new approach of multi-physics simulation in HP Design	88
5	Second and next loops of the FARD methodology.....	93
6	Synopsis.....	94

1 FUNCTIONAL AND ROBUST DESIGN (FARD) METHODOLOGY

The proposed Functional And Robust Design methodology aims to develop a new approach for generating families of modular products integrated in a "Highly Productive" design method (HP design method) context characterised by:

- fulfilling customer needs defined through a functional analysis applied at the beginning of a project,
- being consistent with the product family, the relationships between components and the assembly constraints initiated during the preliminary design phase,
- physical verification using multi-physics modelling and simulation methods and tools to understand the behaviour of products when exposed to various physical phenomena (for instance: mechanical stress, fluid-structure interaction, acoustic, impact, etc.),
- a modelling consisting of a set of parameter configuration management, a functional analysis, a comprehensive geometrical representation of the product through 3D parametric features and models, and finally a Finite Elements' modelling and simulation approach.

As explained in chapter 1, our definition of a module is an independent functional component or group of components which correspond to a technical function and which can be assembled independently, as separate and independent "functional modules". That means that each module carries out a function and is assembled in a most independent manner from the others. The goal is to have complete sets of modules, ready to be assembled like building blocks, in order to create various configurations of products with a limited number of modules. So a modular product is a product constituted of "interchangeable" modules. And more generally, a family of modular products consists of modular products that share a significant number of common modules. Changing or omitting one or two specific modules, according to the customer needs, can make the difference between two products of the same family. Then, one objective of our FARD methodology is that "functional modules" can be built in various places and then finally assembled together at the end in order to easily manufacture a product which satisfies specific customer needs.

The FARD methodology is then considered as robust due to its ability to be reused on different use-cases and in various other domains (building industry, transport field...). The model is robust in use (same steps whatever the product or application case) but not necessary for the final results which depend on the knowledge of the users and the use context (who defines product functions, which company, which manufacturing possibilities...). But there is another aspect that can also qualified as robust inside the methodology. Parameters are defined during the first steps of the FARD methodology. Then, they are used to create variants of modules in order to generate new products from the same family. In the same manner, parameters are used in simulation aspects in order to accelerate the simulation phase of the project by developing some parametric meshing features in order to model and simulate, in a very short time, various parts of the family of product.

In summary, the goal is to refine and optimize, in a modular product design context, the collaborative and High Productive design methodology, originally developed for the automotive industry (Front-end systems, Exhaust systems, air-ducts systems for thermal engines [Toussaint et al. 2010], etc.) and test its adaptation to a building equipment context. This methodology is developed to streamline routine engineering design to free up designers'

time, effort and resources from routine design activities, so they can focus on innovation and improve competitive edge.

The family of products is generally defined, driven by marketing requests, at the beginning of a project, before the detailed design phase of the product life cycle. There are two typologies of projects that can be considered in order to apply the proposed methodology:

- Re-design: This first type of project consists in starting with a previously designed product, for which the designer must develop a new version in order to extend the family of product. In this case, he/she will create a new family of products based on a current reference of product or various old products that can be grouped into a common family. A company may want to rejuvenate one of its entire product families. This is a routine design project which can have a small part of new design activities. This kind of project can be considered to take a morphological modular approach because the shape of products is analysed to find some commonalities between them to create an entire family of product.
- First design: In this second case, the designer will directly generate a complete family of products or a new generation of products at the beginning of the project, without any reference to an existing product. This is a new design project type that will be transformed into a routine design one when applying in a second loop the FARD methodology. This project can be considered to take an integrated modular approach because the modularity of the family of product is thought out from the beginning of the product life cycle.

Whatever the project topology, the first loop consists of defining a modular base of product which will be used later to generate all the other products of the family. It is from the generic product of the family that the other products of the same family will be deduced. The first loop of the design process is generally longer than the first steps of classical projects. But the later generation steps of the other products in the same family will be accelerated. Then, at the end of the design process, there will be time savings on the overall products creation process of a whole product's family. The first loop can be considered as an innovative design process, for the entire product or just for a part of the product. But the second and following loops concern a routine design activity. In the specific context of routine design process, the product architecture and their components are well known. These engineering loops aim to generate variants for various modules in order to create new products which will constitute the family of modular products. As product specifications and functions have been defined, it is then possible and easy to bring variations in value criteria (functional parameters). Then, a variant of a value criterion, defined in order to meet new customer needs, can create a variant of a module, and consequently, a new product of the family. After this first reflexion, there is no major modification or improvement possible on the various products of the family. If a company wants to improve or innovate on products of the family, the methodology must be updated on the first loop level, before generating new products in the same family.

The aim of this chapter is to describe the FARD methodology as a whole. The next sections will present each main step independently for a better understanding of our approach. Figure 12 shows the whole FARD methodology which is dedicated to being applied to the specific context of the "modular products' design process". It addresses three

main topics: functional design, modular design approach based on design for assembly (DFA) principles, and finally parametric modelling and multi-physics simulation. In this Figure, numbers link each step of the FARD methodology to a corresponding description, which is more precisely detailed in the next sections of this chapter.

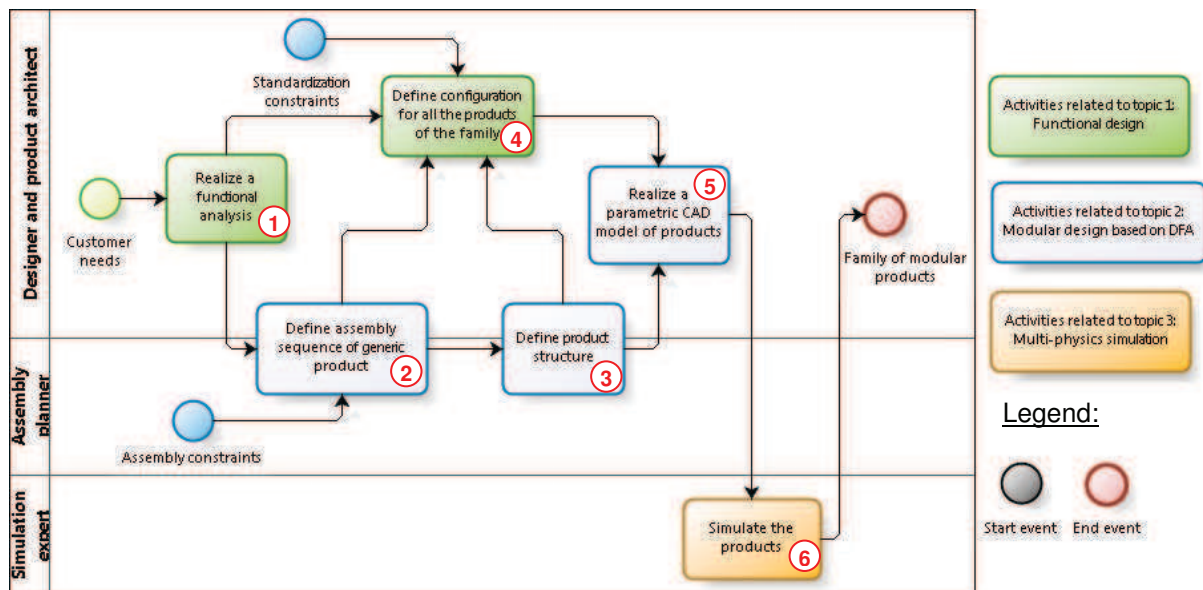

Figure 12. Whole FARD (Functional And Robust Design) methodology built with a BPMN format (Business Process Modelling Notation [Bissay 2009])

The first part of our FARD methodology is applied to a concept of product during the early stages of the design process, and particularly, during the preliminary phase of the design process ([Pahl et al. 2007]). From our viewpoint, a product concept, defined during the preliminary phase of the design process, is sufficiently described in order to know its composition (Bill Of Material, contact between components, number of parts...) and its functioning. But, on the other hand, the product is not sufficiently detailed in order to be manufactured, assembled, recycled, for example (dimensions, material, supplier components etc. are not well defined).

As illustrated in Figure 12, four main business profiles are involved in the FARD methodology. Definitions proposed by [Demoly 2010] are considered in order to explain their roles and goals:

- The designer aims to define the product geometry (with the 3D CAD model for instance) based on functional specifications and process constraints. His/her goal is first to define the best concept that meets as well as possible the customer needs. Then, he/she must ensure that the product and his components are respecting the process constraints in order to be manufactured. The designer can also be helped by the product architect to define the product architecture of a family of product, for instance.
- The product architect is responsible for the product architecture. He/she checks the best correspondence between functions and technical functions from the customer's specifications and the product itself. Moreover, he/she manages product configurations in order to offer some choice to the customer or end-user. In our modular context, the product architect must validate the modular product

architecture that should match as well as possible with our definition of modular product, and the product alternatives in the same family.

- The assembly planner is concerned by the industrial and manufacturing process aspects of the product. He/she defines and plans the industrialisation of the product by defining the assembly sequence and the corresponding process operations.
- The expert in simulation possesses design, modelling and simulation knowledge and skills, but he/she is not necessary expert in one of these fields. He/she can be considered as an integrator. His/her goal is to validate by simulation the design choices for a product, and in our case, for all the products of the family [Badin et al. 2012].

As explained previously, three main topics are considered in the proposed FARD methodology. The functional design changes customer needs into functions that all products within the family must respect. The modular design topic, based on DFA principles, tries to define the best assembly sequence for the entire family of modular products according to the modular architecture, the assembly constraints and the detailed product structure. Then, the DFA concepts are used to improve the independency between modules in “an assembly context” in addition to the independence of modules in “a product’s structure context”. In order to define the best assembly sequence according to the context of the company (knowledge and skills of the assembly planner, assembly tools, assembly workplaces, architecture of the plant...), a decision support system based on our specific algorithm is defined. This algorithm is applied to a coloured and direct graph in order to generate assembly sequences in harmony with the modularity of the products. It helps the assembly planner to identify modules which respect the assembly order of components, the functional module structure and the independence between modules. In this part of the FARD methodology, the modular structure is defined by decomposing functions that products must fulfil into technical functions or sub-functions. In our research work a module is considered as an independent functional component or group of components which correspond to a technical function and which can be assembled independently. So a modular product is a product composed of independent functional modules. Then, the product architecture is finally defined as a combination of the modular structure, the contacts between components and the assembly sequence of the product. This global research work is developed in order to combine functional analysis techniques with DFA principles in order to improve the modularity of the product. Another algorithm that distributes a maximum of components into identified modules and which respects the previously described constraints in terms of functions, modularity and assembly, is proposed. After using this algorithm, the designer, with the product architect finalize the product’s structure by attributing the non-assigned components into already identified modules. They can also adjust the assignment of some components. If the solution can not generate the required modular functional structure, the concept must be modified and re-adapted without too much modification and time lost. Then, all components are distributed into modules. The product architecture is used to generate parametric 3D CAD models to apply multi-physics simulation. The last topic (multi-physics modelling and simulation) on the product behaviour tries to ensure that products fulfil the technical requirements using a simulation validation, in addition to just behaviour limits. It allows evaluation of the performance of the product.

To sum up, at the end of the FARD methodology, the output “Family of modular products” includes:

- a generic assembly sequence for the generic product and for all the components included in each module,
- a parametric 3D CAD model that allows new products of the family to be generated thanks to parameters that drive the geometry,
- a simulation loop to size quickly the various configurations of products of the family thanks to a parametric re-meshing process,
- a generic product that constitutes the basis for generating all the other products of the family. The generic product is obtained from the first loop of the FARD methodology.

The proposed FARD methodology is explained in the next sections step by step, in a more detailed way. Figure 13 illustrates the distribution of the various steps of the FARD methodology in association with the various sections in this chapter, giving more explanations on the various activities, events and results of the model. The next section is dedicated to the other loops of the FARD methodology for generating other products in a same family.

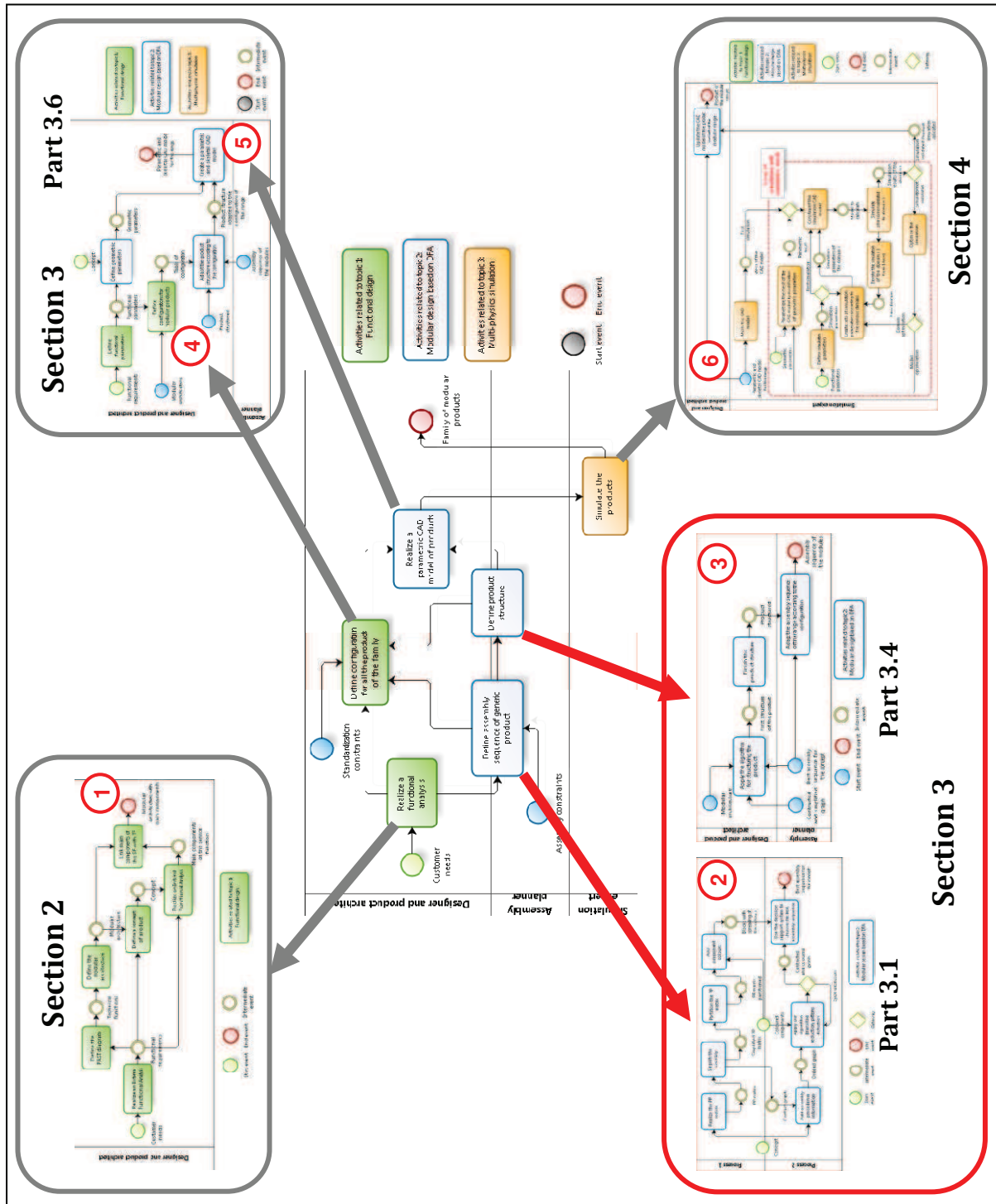

Figure 13. Repartition of the various steps of the FARD methodology in association with the next sections of this chapter

The section 3 of this chapter highlights the most important added value of the FARD methodology. This part is a generic methodology that can be applied on various other design domains such as the Project domain, the Process domain, etc. This generic part of the FARD methodology is named “ORASSE” (ORDERed ActivitieS Sequence). It aims to organize entities or activities according to the domain context constraints based on specific algorithms, that can be considered as generic for the various design domains (Product, Process, Project,

etc.), using matrix-based and graph-based reasoning procedure. However, in this current research work, as we consider our industrial context, the ORASSE part of the FARD methodology is dedicated to the Product design domain as the whole methodology.

2 FUNCTIONAL DESIGN APPROACH

The functional design approach changes customer needs into functions that all the products of the family must respect. This topic begins on classical and well known functional analysis methods and tools. This is a cornerstone for the next steps and for the generation of variants of modules and products. Indeed, a classical viewpoint of functional analysis method is applied to start our methodology. Some functional analysis tools are reajusted in order to match our specific research context. For instance, the traditional external functional analysis method is limited to only use cases of the product's life cycle [Stark 2004]. Currently design, production, manufacturing, recycling, etc., use cases are not integrated into the FARD methodology. But, in the perspective of future work, these other aspects can be implemented to have a better integration of the product's life cycle into the proposed FARD methodology.

In this section, the step 1 defined at Figure 12 and Figure 13 is detailed at Figure 14. It represents the functional design component of the FARD methodology.

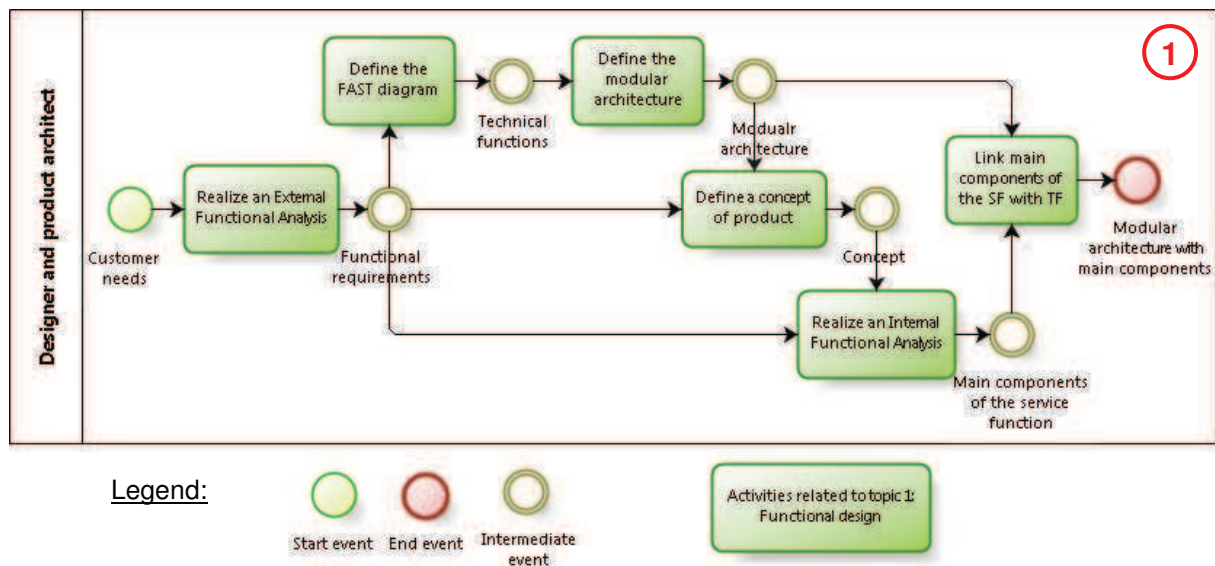

Figure 14. Functional design approach of the FARD methodology

This part of the FARD methodology concerns the modular architecture of the product that fulfil the final product requirements that respect the customer needs, the starting point of the FARD methodology. During the first step, an External Functional Analysis (EFA) is applied, with the main objective of identifying the context of the study and above all the functions, expected by customers, to be fulfilled by products. EFA aims to express what the whole product must do [AFNOR 1996a]. Two types of functions [AFNOR 1996b] are used in the FARD methodology:

- Service functions (SF): SFs are performed by the product in order to satisfy the customer needs. These are the most important functions for the customers. Most of the time, SFs represent what customers need to do with the product, in

interaction with some components of the external environment (Energy, Physical objects, Air, etc.). Usually, they relate to the use phase of the product's life cycle.

- Constraints (CONS): CONS represent an obligation from the context. For instance, if the product must respect standards, this function is considered as a constraint. Another constraint can come from the environment of use of the product, for example dusty air could require some adjustments of the product to not be degraded or fail too fast.

From the EFA, various steps are able to be applied such as the FAST diagram (Functional Analysis System Technique [Bytheway 2007]). FAST diagrams help the designers to define technical functions of the future product. This kind of diagram splits functions into sub-functions also called technical functions (TF) [AFNOR 2007]. Each TF is connected to the "parent" by binding "AND" (both TF) or "OR" (alternative TF). If the project context consists of developing a product without any previous version, the FAST diagram can help the designer to decompose the product into global parts, like in a systemic approach. It allows the global architecture of the product to be define and the concept reflexion to be started. FAST diagram contributes to formalize the product structure and architecture by TF identification. It is then possible to detail each global sub-system with components in order to detail the concept of the product. From the FAST diagram, the designer can work on the definition of a concept.

In our research context, from the FAST diagram and while considering our definition of a module ("functional module"), the functional architecture and then further the modular architecture of the family of products can be defined (Figure 15). This modular architecture diagram is like a simplified FAST diagram that is adapted to the future product modularity. If there is more than only one SF, the architecture must be reorganized. SFs are then merged in order to create the modular architecture with only one origin for all the functions (modules) that should fulfil the product.

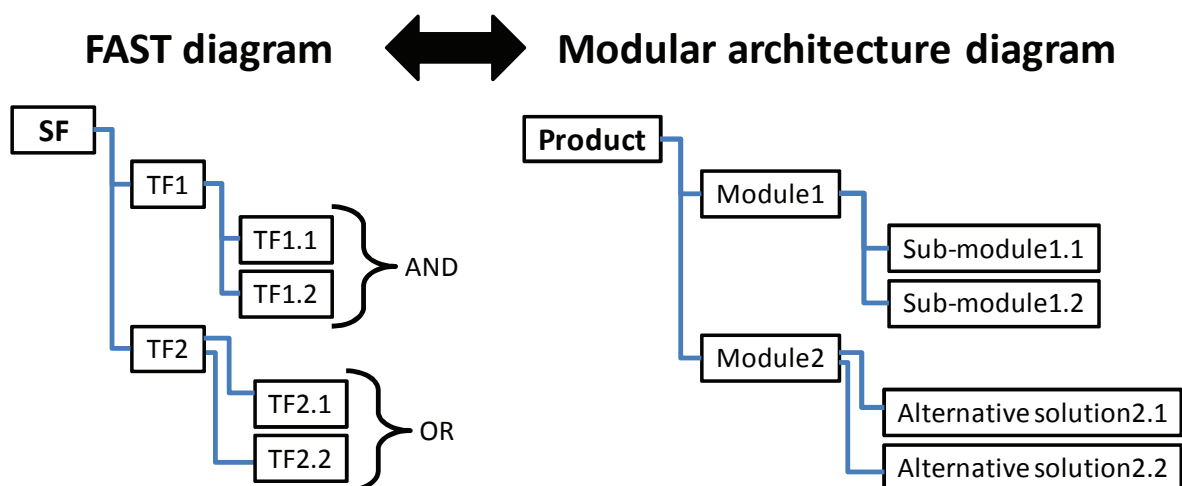

Figure 15. Equivalence between FAST diagram and modular architecture of the products

The objective of this step is to define interchangeable subsets or modules of products from the product's family. In the FAST diagram, SF corresponds to the product and TF is associated to modules or sub-modules. "AND" connections represents future modules or subsets and "OR" connections introduce alternative solutions, which can be considered when building various configurations of products. If there are "OR" in the FAST diagram, the FARD

methodology is firstly applied to the product with one alternative solution, as defined in a specific configuration of the product. The designer must choose a first version as a generic product for the family. Then, for the other alternative solutions, an update of the generic product with another alternative solution is required. In this way the designer does not need to do all the redesign work again. To sum up, if there are some “OR” connections (alternative solutions) in the FAST diagram, the designer must choose a first concept (i.e. generic product) to start the development process and then he has to update this concept with the other alternative solutions in order to create all the other products of the family. However, it is not possible to have only one sub-TF in a parent TF, they must be merged together. In this context, the parent TF can be redefined if necessary.

Constraints are not systematically considered directly in the FAST diagram because most of time, they are shared among various components of the product. However, they must be taken into account in the EFA and the product must at least respect them. If there are constraints that concern some specific or limited components, they can be integrated into the simplified FAST diagram and/or modular architecture diagram (as shown in Figure 15) as a TF of the main SF and then as a module or sub-module.

At this stage, the FAST diagram and the concept of product, with all the components and the kinematic connections are known. An Internal Functional Analysis (IFA) is applied to the concept, during the preliminary design phase of the design process, i.e. at the beginning of the product's design life cycle. The goal of the IFA is to verify if the selected concept meets the customer needs, with a limited number of parts. This approach aims to reduce costs and increase the “Value” of the product, in accordance with “Value Analysis” principles [Miles 1961]. The IFA allows the definition of which components of the product or concept contribute to SF. Then, it is possible to know which components are directly addressing the customer needs. In order to define the components of the product linked with the SF, a Functional Block Diagram (FBD) is proposed, according with the APTE[®] method (APplication des Techniques d'Entreprise) proposed by the APTE office [De La Bretesche 2000]. This diagram represents contacts between components and links them with external elements, such as user, environmental elements, ground, air, dust, etc. Another tool can be used in order to represent the functional aspect of a product: the IDEF0 or SADT diagram (Structured Analysis and Design Technic [Ross 1985]) which do not need to know all the components of a product to be applied.

So, the concept is developed while considering the modular architecture defined from the FAST diagram. It is a very important aspect for the definition of the concept. For a better understanding of the link between IFA and the modular architecture, it is possible to illustrate our proposal through a new graph shown in Figure 16. This graph represents the FBD with modules that can also be decomposed into sub-modules. It allows the links between modules to be seen and then the “structure of the modules” (analogy to the product structure that represents the components organization in a product: contacts and positions among them).

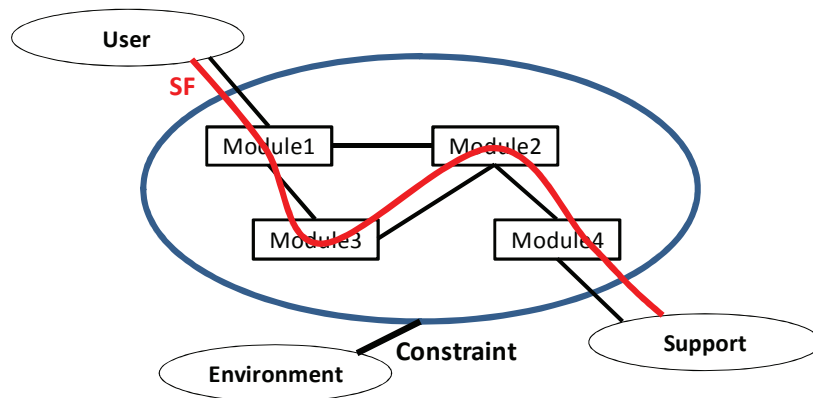

Figure 16. Representation of the modular architecture as a FBD. Black lines represent contacts between modules and the red lines illustrates how the Service Function (SF) crosses the product's architecture

In Figure 16, a red line represents the main service function (SF) of the product that links the user with a support through the product. This graph relies on the FBD representation but using modules instead of components.

From the previous graph, it is possible to directly link components of the SF with modules. In order to help the designer, FBD can be matched with our previous graph (the FBD and the modular architecture as a FBD, Figure 16) as presented on Figure 17.

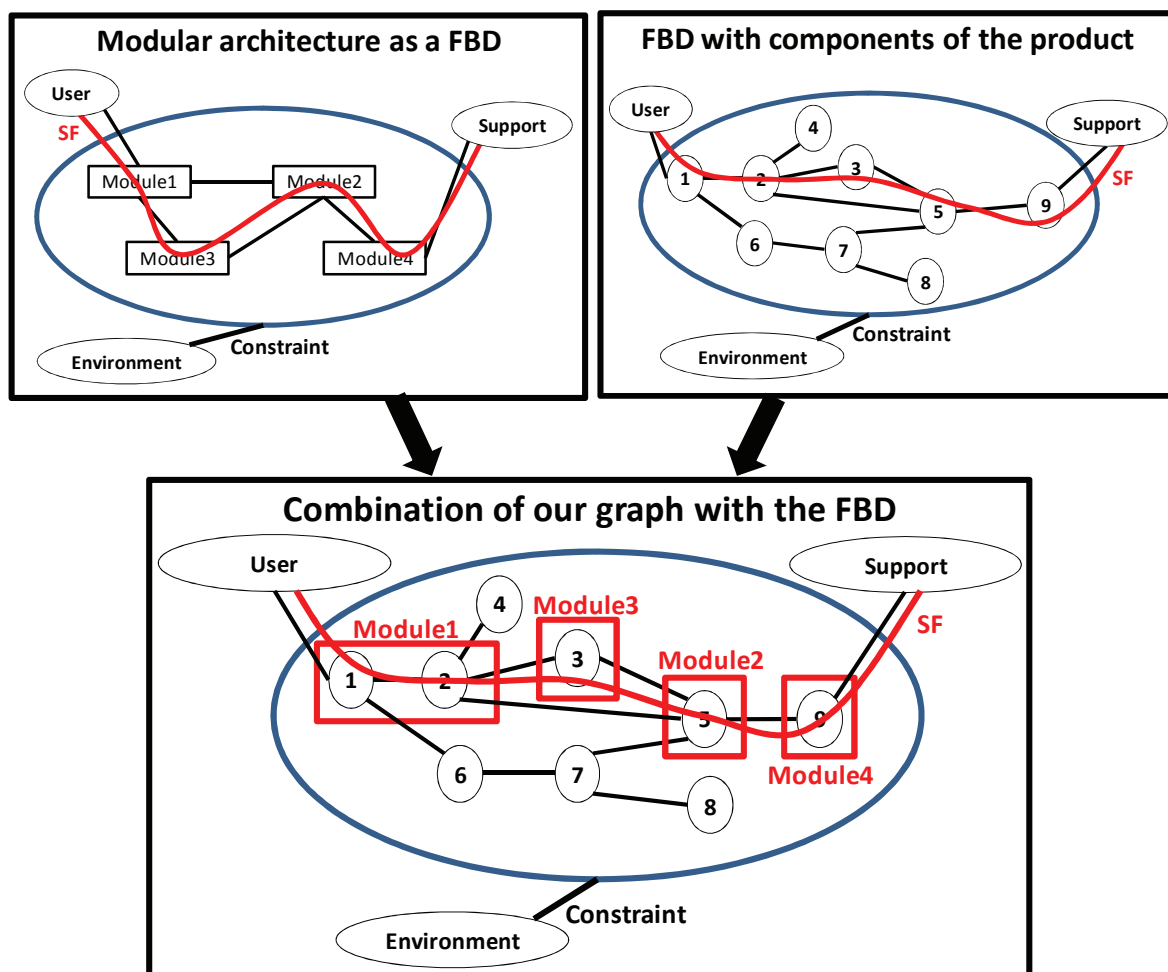

Figure 17. Combination of our graph representing the modular architecture in a FBD format with the FBD of a product.

Considering that technical functions described in the FAST diagram, as decomposition of service functions, and considering the links between product's components and service functions through FBD diagram, it is possible to assign components to TF. Components are distributed on the lower-level of TF in the FAST diagram (Figure 18). If a TF is decomposed into sub-functions, no components can be assigned to this TF. However, there is an indirect assignment mechanism through the structure of the FAST diagram.

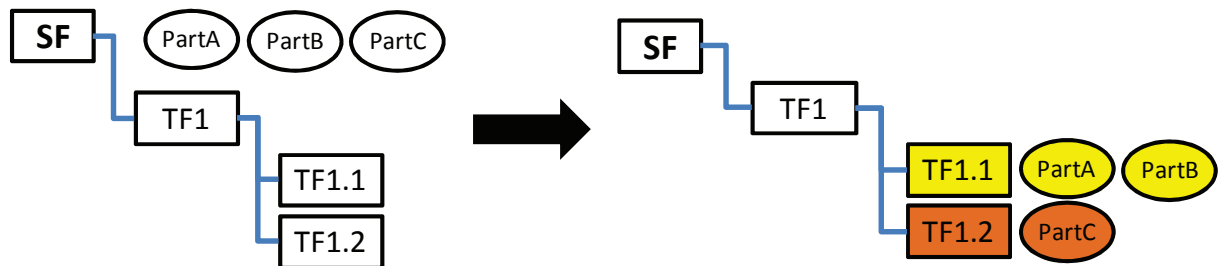

Figure 18. Distributions of parts of the SF into the lower-level TF in the FAST diagram

During the repartition of components among the different technical functions, if the product architect finds some components that are shared into various technical functions, he/she must work again on the product concept. Indeed, in our context of modularity, the following hypotheses are defined: a component must fulfil only one technical function. Otherwise this component will be a problem for the next steps of our method and it does not respect our definition of the modularity (a module is an independent group of components that fulfils a function).

At this stage of the FARD methodology, the main components of each module or sub-module are known thanks to the correspondence between FAST diagram (functional aspect of the product) and modular architecture (structural aspect of the product). A TF represents an action between components of the product, which is performed in order to ensure a specific SF [AFNOR 1996b]. Indeed, Technical Functions -TF are only subdivisions of Service Functions - SF (Figure 15). All the product's components of the SF are shared between TF. In order to maintain the link between components and TF in the following steps of our approach, a specific colour is assigned to each TF and, consequently to its components. In order to help the quick visualisation of colour links, variants of colours are used. For instance, when there are a large number of modules, each module has a specific and distinguishable colour from the others. Then, all sub-modules have a variation of colour of the distinguishable colour of the parent module. During the next steps of the methodology, the user will have an interesting indication of the membership of various sub-modules of the same module due to the variation of colour.

However, some parts of the concept do not contribute directly to a SF and they are not integrated into a module. They also do not have any colour. These parts do not contribute directly to the customer needs but they can be necessary for the designer of the product, or for fulfilling the functional constraints – CONS, which represent obligations coming from the external context, such as “respect norms and standards”. Therefore, these parts are not allocated to a functional module. So the functional analysis describes the internal architecture of the concept and components involved in the implementation of one or more service functions - SF.

3 A NEW APPROACH OF MODULAR DESIGN BASED ON DFA

The part of the proposed methodology in this section is a generic approach namely “ORASSE” (ORdered ActivitieS Sequence) which will be only focused in this current research work, as explained previously, on the Product design domain. ORASSE is developed as a “meta-model” for bringing reasoning mechanisms on data and information concerning the Product domain, but it has been defined in order to be adapted and generalized to other design domains such as Process domain, Project domain, Knowledge domain, etc.

In the context of the ORASSE meta-model applied to the Product design domain, it uses the requirements (developed in the previous section) and the product concept in order to establish the eligible assembly sequence of the modular product and the product structure itself. Its objective is to define a family of modular products respecting the best assembly sequence for the product’s family while checking the correspondence with the functions of the product and the proper assembly relationships of this family. In this section, the numbered steps from 2 to 5 of the Figure 12 are detailed and illustrated on page 53.

3.1 Definition of the best assembly sequence of the generic product of the family

The definition of the best assembly sequence of the generic product of the modular products family uses two parallel processes that interact together. Both processes and their interactions are summarized in Figure 19 using a BPMN format. It corresponds to the step number 2 described in Figure 12, page 53.

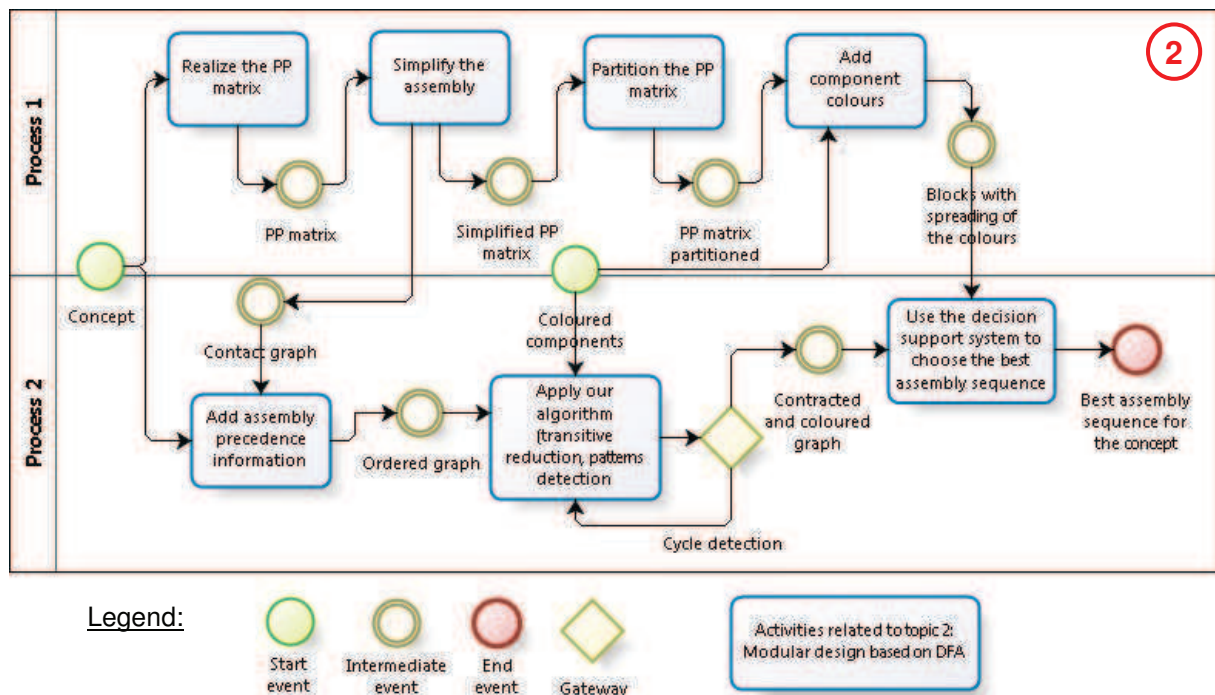

Figure 19. Definition of the best assembly sequence of modular products of the family, as a part of the FARD modular design approach based on DFA principles

The first process described in this BPMN diagram is based on the interactions between components through a PP matrix (i.e. Parts-Parts matrix). From the concept it is possible to determine the product’s parts list, defined as P vector (or Parts vector), and

create the PP matrix which crosses the P vector with itself. The list of components can be considered as a P vector or E-BOM (Engineering Bill Of Material) or P-BOM (Product Bill Of Material) [Frey 2010]. From this list, all parts are represented by a number in order to simplify the next steps of the methodology.

The PP matrix can be generated from the IFA, more specifically from the Functional Block Diagram (FBD). The FBD help the designer to visualize which components participate in the SF. It represents contacts between components and also kinematic links. However, if the PP matrix is created earlier in the FARD methodology, it can be used to generate the FBD of the IFA approach. It is a possibility but not an obligation, because the FBD is not necessarily used. In IFA, the FBD can be replaced by a SADT approach. For these reasons, the PP matrix is not integrated in the FARD methodology before the Functional Block Diagram of the Internal Functional Analysis.

The PP matrix can be seen as a matrix-components DSM (Design Structure Matrix) originally proposed by [Kusiak 1999] and also developed for a long time at the Massachusetts Institute of Technology – MIT [Kusiak et al. 1994]. DSM provides a compact and clear representation of a complex system and illustrates interactions between system elements [Thebeau 2001]. In our case, the matrix layout is as follows: names of the elements (or their corresponding numbers) are placed in the same order in row headings and column headings of the matrix. Our PP matrix is completed with contacts between parts of the concept. If a physical contact between two components i and j exists, the value of element p_{ij} (row i , column j) is 1 (or replaced with an X). Otherwise, the value of the element is zero (or the box stays empty). Moreover, the components of the SF are highlighted thanks to the colours assigned to the components and their TF in the FAST diagram. A weakness of the PP matrix is the consideration of soft components like wires, and moving components. The designer that fills in the PP matrix must be careful. All the wires must be considered into the P vector and their contacts with the other components must be integrated in the PP matrix. Flux contact must not be considered like the flux between a remote control and its receiver.

On this PP matrix, the assembly planner can simplify some groups of two specific components. For instance, an axis with an O-ring around its periphery will be considered as a single component. In fact there is no real assembly order between these parts, or even between just two parts of the same sub-module or subset. However, they have to be assembled before being placed in a set. All these simplifications are replaced by a single component in the next steps of the process and the PP matrix with the assembly planner simplifications is obtained.

The next step of Process 1 consists of the PP matrix partitioning in order to define sets and subsets of components of the product. Here, a combination of two algorithms is used. These algorithms are detailed in the next section 3.2 of this chapter. The overall goal of these algorithms is to form sets of components with minimal interaction between them. A new arrangement of the components is produced so that blocks representing sets of components are as close as possible to the diagonal of the matrix. It is used to group components that are interacting strongly with one another but very little with other component groups. Thereafter, a block represents a group of components.

The second process is also based on a representation of interaction modelling between components. But in this process, interactions are modelled by a contact graph. In

this graph, a vertex/node represents a component or a group of components. An edge joins two nodes to describe the assembly presence of the relationship between two elements. It is easy to switch from one model to another (matrix \Leftrightarrow graph) by the following relation. For a PP matrix of coefficients (p_{ij}) and a graph $G=(V,E)$ where V is the set of nodes (a node for each component) and E the set of edges, there is an edge between Node i and Node j if and only if $p_{ij}=1$. Each change in the matrix of Process 1 is automatically taken into consideration in the graph of Process 2, as in the example shown in Figure 20. In the PP matrix, when there is a contact between two components, there a “1” in the box that crosses the two components considered and the box is coloured. In the graph, when there is a contact between two components, there is an edge between the nodes that represent the components considered. In the graph, each component is replaced by a number in a node in order to facilitate the representation of the overall product.

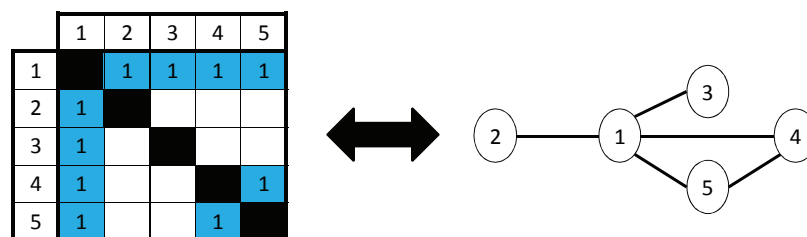

Figure 20. Correspondence between a PP matrix and a contact graph

As soon as the graph is generated from the PP-matrix with assembly planner simplifications, the designer can add precedence information between components resulting in a direct graph. The contact graph is automatically generated from the PP matrix, which can prevent human errors when the designer defines contacts with precedence directly on the graph. In fact, it is easier to complete a matrix rigorously row by row and component by component than a graph. This has been confirmed by tests where manual graph creation was revealed to be more subject to errors. There are two types of links between two components:

- contact relationships with precedence constraint. An arrow represented by a solid line from a Component i to a Component j means the Component i must be assembled before Component j is assembled.
- relationships with precedence without physical contact. An arrow represented by a dashed line from a Component i to a Component j means: there is a precedence relation between Component i and Component j but i and j are not in contact. In addition Component i must also be assembled before the assembly of Component j .

The resultant graph (contact graph with precedence) is a direct graph. Figure 21 gives an example of a direct graph with five components. Edge (1,2) represents a contact relationship where Component 1 must be assembled before Component 2 is assembled. The dotted edge (3,4) represents a constraint of order of assembly despite the lack of contact between these two components.

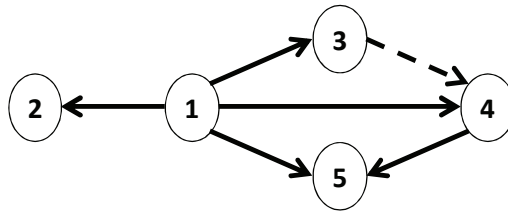

Figure 21. Example of a direct graph with 5 components

To ensure that the designer does not make a mistake on the directions of edges, a cycle detection algorithm based on depth-first search is applied. If the algorithm reveals a cycle, it lists the edges participating in this cycle and the designer has to make changes until the cycle is eliminated. Note that the absence of any cycle is required to produce at least one eligible assembly sequence (respecting all precedence constraints).

A cycle is well defined in graph theory [Cormen 2009]. In a direct graph, it is also called a directed cycle (Figure 22). It is a closed path or a loop between components in which no node except the first (which is also the last) appears more than once. Then, it is not possible to define an assembly sequence.

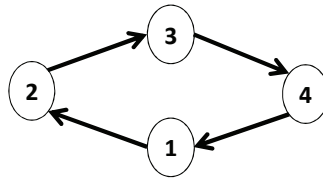

Figure 22. Example of a direct cycle in a direct graph of 4 components

In Figure 22, it only needs one change of precedence sense to delete the cycle in the graph and to allow the definition of one or more assembly sequences.

The next step of the Process 2 consists in performing the transitive reduction of the directed graph. In graph theory the transitive reduction of a graph is sometimes referred to as its minimal representation. Several authors (for instance [Gries et al. 1989]) have studied how to build the transitive reduction. Usually this is done by constructing the transitive closure. It consists of removing edges implied by transitivity. For each edge (i,j) , if another path between i and j exists, the edge (i,j) is removed. For example, in the graph of Figure 21, the arcs $(1,4)$ and $(1,5)$ can be deleted because the precedence constraints between 1 and 4 and between 1 and 5 are obtained by transitivity. The Component 4 must be assembled after Component 3, which itself must be assembled after Component 1. It consists of deleting some "redundant" edges of the graph [Abdennadher and Frühwirth 2003].

In contrast to other works, the novel aspect of our approach lies in the consideration of the memberships of some components to technical functions. As explained in this chapter, in the FARD methodology, the Internal Function Analysis (IFA) highlights the components involved in the implementation of the service functions (SF). It is possible from a product concept still in preliminary design stage. The SF are performed by the product in order to satisfy the customer needs. Then, designers define technical functions (TF), by using a FAST diagram (Function Analysis System Technique), as the result of decomposition of SF. In this way, it is possible to define the distribution of the components among TF using the FAST diagram. So the main components fulfilling the TF defined in the FAST diagram are

known. Then, a procedure of colouring components based on the principle of membership between TF and their linked components is set up (same colour for all major components of the same TF). This coloration of some components in the FARD methodology impacts the two processes, described in the BPMN diagram at Figure 19, and triggers further steps.

At this stage, the coloration of components supplements the PP partitioned matrix from the Process 1 and the simplified precedence graph of the Process 2. So the next step of Process 1 is to apply the same colour to other uncoloured components of the same block. Indeed, a block contains some coloured and some uncoloured components. The goal of this spread of colours is to colour some components not yet coloured, at this stage, and reduce the number of uncoloured components. In order to reach this objective, some specific rules are defined. Once some components are coloured according to their memberships to one technical function, the partitioned matrix contains some blocks with coloured components. A block is considered as “coloured” if all coloured components in this block have the same colour (Figure 23, matrix titled “After”). Two main rules are applied to spread colours to other components:

- Rule 1: an uncoloured component (not at the interface between two blocks) of a coloured block (Figure 23, matrix titled Before), like Part 1, is assigned to the colour of the block (Figure 23, matrix titled After).
- Rule 2: an uncoloured component at the interface of two coloured blocks of the same colour (Figure 24, matrix titled Before), like Part 3, is assigned to this colour (Figure 24, matrix titled After).

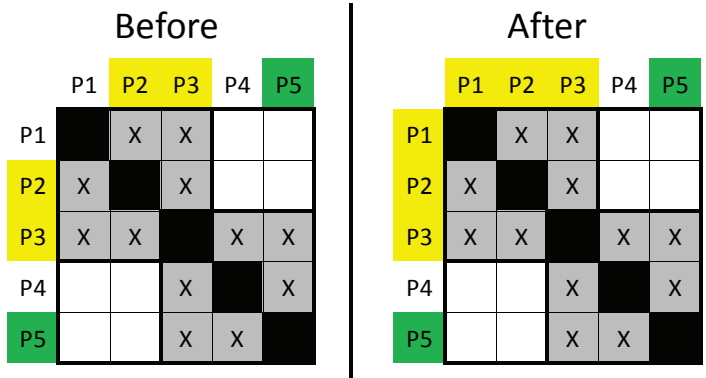

Figure 23. Assignment from one colour to an uncoloured part

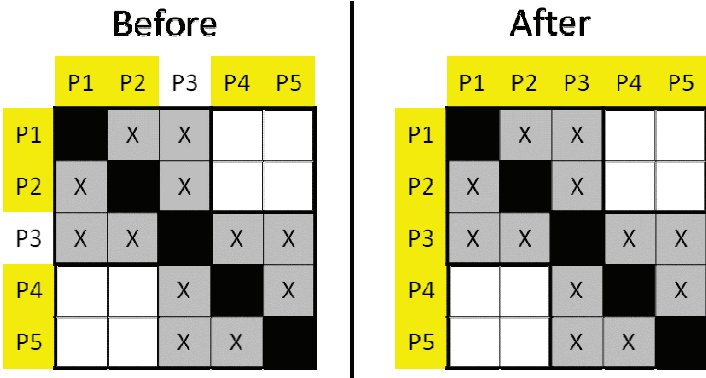

Figure 24. Assignment from one colour to an uncoloured part

At the end of this step, there are some new coloured components. But at this stage of the methodology, not all the components of the concept are necessarily coloured. The coloration process, resulting from the distribution of colours across a matrix block, is reported in the direct graph of the Process 2 (described in the BPMN diagram at Figure 19).

Then, the next step of Process 2 is to identify some sub-assemblies by searching specific patterns in the graph. Our approach is inspired from the work of [Demoly et al. 2011] in the ASDA algorithm where the objective is to detect some sub-assemblies of specific assembly types (for example: serial, interconnected, constrained or parallel). But in our work, we focus more specifically on coloured patterns in order to identify sub-assembly regroupings as much as possible components of the same colour, in other words involved in the same TF, which creates the modular character of the product. Colouring and contraction of graphs, used to colour with the same colour components associated with the same technical function and to aggregate components corresponding to some specific patterns, are conventional operations in graph theory [Gondran 1995]. The originality of our approach is to take into account the functional aspect of components to reduce the number of eligible assembly sequences by focusing our research on coloured patterns. A coloured pattern is a set of components with the same colour, and possible components without any colour. Our research for identifying patterns is also guided by the precedence constraints. Coloured patterns of two or three components satisfying some specific properties are examined. To formulate these properties, notations are adopted, as below:

- M represents the set of components of a pattern.
- For a Component i, $\Gamma^+(i)$ (respectively $\Gamma^-(i)$) represents the set of successors (respectively the set of predecessors) of the Node i. By extension, $\Gamma^+(M)$ (respectively $\Gamma^-(M)$) describes the set of successors (predecessors respectively) of a pattern $\Gamma^+(M)=\bigcup_{i \in M} \Gamma^+(i)$ and $\Gamma^-(M)=\bigcup_{i \in M} \Gamma^-(i)$. In Figure 21, we have, for example, $\Gamma^+(4)=\{5\}$ and $\Gamma^-(4)=\{1,3\}$.

We are looking for colourful patterns that fulfil the following criteria:

- the first component of the pattern is coloured,
- the other components of the pattern are coloured or not,
- $\Gamma^+(M) \cap \Gamma^-(M) \subseteq M$.

Whenever a coloured pattern is identified, all nodes and their adjacent edges constituting the pattern are replaced in the graph by a single node labelled with the ordered nodes of the pattern as shown in Figure 25. This labelled node is then a sub-sequence in the overall sequence assembly. In addition edges between this node and other nodes of the graph are created if there is a precedence relationship (with or without physical contact) between one of the components of the pattern and another node. The criterion 3 prevents the creation of a cycle in the graph. This patterns searching operation is repeated as many times as it is possible in order to reduce the graph.

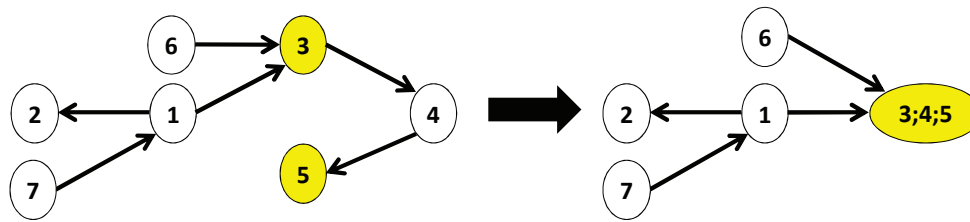

Figure 25. Detection and substitution of a specific pattern between components 3, 4 and 5 in a direct graph of 7 components

Our algorithm proposes some specific patterns to the designer who finally decides to validate the pattern or not. When all patterns have been validated, a coloured and “contracted” direct graph is obtained.

Then, the last step of the process 2 is the generation of eligible assembly sequences based on the coloured and “contracted” direct graph. To help the assembly planner in his/her choice of the most appropriate assembly sequence for products, a decision support system is built. This system offers, step by step, all the possibilities in terms of a component’s choice. This system respects some rules for highlighting preferred choices in order to guide the assembly planner during the constitution of the best assembly sequence. The overall goal of this decision support system is to help the assembly planner to take into account the combination of:

- the customer needs, thanks to colours of components which link some components with TF or with modules of the product;
- the product structure, thanks to the parts’ blocks;
- the assembly constraints, thanks to the precedence relationships (with or without physical contact) between components.

At the end of the use of our decision support system, the best assembly sequence for the concept of generic product for the modular family is defined. This assembly sequence will be updated for the next variants of products but will not radically change, since it is a constant.

3.2 Algorithms for creating groups of components from the PP matrix

The PP matrix, or component-based DSM (Design Structure Matrix), is partitioned in order to define sets and subsets of components of a product. The objective is to produce a new arrangement of the elements of the matrix so that blocks representing sets of components are as close as possible to the diagonal of the matrix. In order to have an efficient partitioning process applied to the PP matrix, two specific algorithms are combined. The first one aims to bring the elements near the diagonal of the matrix. It allows the matrix for the cluster research process to be prepared. The second one aims to form blocks of components (clusters). However, the partitioning process proposed by the first algorithm is efficient enough, and most of time the user is not obliged to use the second algorithm.

3.2.1 Algorithm to gather elements around the matrix diagonal

The objective of this algorithm is to gather around the matrix diagonal, elements (components in our case study) that are tightly coupled. To sum up, each element tries to group elements with strong interactions.

A quadratic assignment problem is applied to propose a new arrangement of elements in the matrix from which high interactions are as close as possible to the matrix diagonal. A DSM matrix of n elements and coefficients d_{ij} that measure the degree of interaction between elements (i,j) is considered. The goal is to assign each element i to a new position k in a new corresponding matrix in order to put high coefficients as close as possible to the diagonal of this new matrix.

For each pair of positions (k,l) , a distance a_{kl} is specified and for the corresponding pair of elements (i,j) , the interaction coefficient d_{ij} is specified. The interaction coefficient d_{ij} is equivalent to a weight. The distance a_{kl} increases when the numerical distance between a position pair (k,l) increases. Therefore, the weight coefficient d_{ij} increases, the more the interaction is strong. The problem consists of assigning all elements to a new position in the corresponding new matrix in order to minimize the sum of distances multiplied by the corresponding weight coefficients. In our study, d_{ij} is a simple binary weight to specify if components are in contact or not.

The formulation of this algorithm corresponds to a classical formulation of a quadratic assignment problem [Burkard 1998]. The quadratic assignment problem (QAP) is one of the most difficult combinatorial optimisation problems. Most exact solution methods for the QAP have been of the branch and bound (B&B) type. While some NP-hard [Cormen 2009] combinatorial optimisation problems can be solved exactly for relatively large instances, QAP instances of size larger than 30 are considered intractable. So a large number of heuristic methods which intend to find near-optimal solution within acceptable computational time, have been developed for solving the QAP, using various techniques (simulated annealing, tabu search, genetic algorithms) [Luke 2009], [Yang 2010]. The performance of different heuristics tends to vary with certain problem characteristics [Drezner et al. 2005]. In the experimentations of the next chapter, there is a problem of 40 components. Due to the symmetry of the PP matrix, it can be solved exactly with a B&B method.

The term "quadratic" comes from the objective function of the optimization problem which is quadratic. Then, the objective function is:

$$\text{Minimize } \sum_k \sum_i \sum_l \sum_j a_{kl} d_{ij} x_{ik} x_{jl}$$

Where:

- a_{kl} refers to the distance between two positions (k,l) ;
- d_{ij} is the weight that corresponds to the measure of the interaction between two elements (i,j) ;
- x_{ik} is a binary variable that refers to the position of the element i at position k , knowing that the matrix is symmetric;
- x_{jl} is a binary variable that refers to the position of the element j at position l , knowing that the matrix is symmetric.

This objective function is subject to the following conditions:

- $\sum_k x_{ik} = 1$: each element is assigned to one and only one position;
- $\sum_i x_{ik} = 1$: each position k receives one and only one element.

Where x_{ik} is a binary variable which is equal to 1 if element i is placed on position k in the new matrix, otherwise it is 0. It is the same for x_{jl} (1 if element j in on position l in the new matrix, otherwise it is 0).

3.2.2 Algorithm of clustering

The goal of a clustering algorithm application is to find subsets of DSM elements (named clusters or modules). These clusters are only a little connected between them, or the rest of the system, but they have a strong interconnection between their own elements (components in our approach). To sum up, a cluster tries to absorb most of internal interactions and minimize or eliminate the external interactions with the other clusters. Thereafter, a cluster represents a group of components that are strongly interacting together.

In our approach, a clustering algorithm originally proposed by [Idicula 1995] and improved by [Fernandez 1998] and [Thebeau 2001] (MIT researchers) is used. Idicula and Fernandez worked on design teams. But this algorithm is also available for components systems as performed by Thebeau. The methodology and corresponding steps is detailed in the flowchart Figure 26. The algorithm tries to minimize the total coordination cost between clusters in an iterative manner.

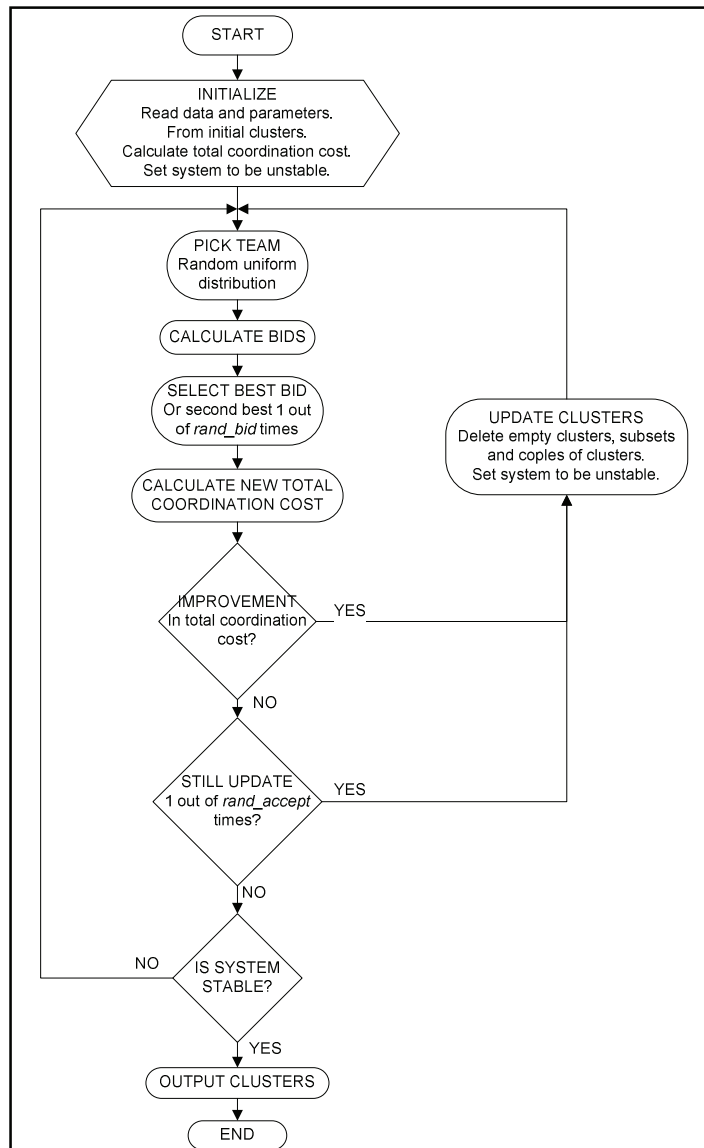

Figure 26. Flowchart of the clustering algorithm [Fernandez 1998]

In this algorithm flowchart, there are two parameters that prevent it from being blocked in a local optima:

- *rand_bid* parameter: it takes into account the second highest bid rather than the first highest bid;
- *rand_accep* parameter: it accepts the change even if there is no improvement of the coordinate cost calculated.

The first step consists of defining clusters (or modules) by the assignment of elements (or components) and calculates their total coordinate cost. To begin, one component is assigned in each cluster. At the beginning of the algorithm, there are as many clusters as elements.

Then, an element is randomly chosen (each element has the same probability of being chosen) in order to be included in another cluster which has the most important total coordinate cost for this element. This is the cluster that has the highest interaction with this element. If the total coordinate cost of this new cluster decreases, this cluster is accepted and the change is permanent. The other empty clusters, duplicated clusters and clusters integrated into others are deleted. This process is repeated until there is no other improvement of the total possible coordinate cost, and after several attempts. In order to improve the ability of this algorithm to obtain the final solution with the lower total coordinate cost, some random features are implemented inner. This maximizes the eligible solutions that are tested in order to not be blocked by local optimum.

In this algorithm commonly applied in Design Structure (DSM) Matrix approach, there are two main functions (they are detailed in the next sections):

- Bid function;
- Total coordinate cost function.

3.2.2.1 Bid function

After choosing an element, the level of interaction between strong elements of a cluster with this element is calculated by a bid function:

$$Bid(cluster_k, element_i) = \sum_{j=1}^{size} \frac{((DSM(i, j) + DSM(j, i))^{pow_dep} \times CL_MAT(k, j))}{cl_size(k)^{pow_bid}}$$

Where:

- $Bid(cluster_k, element_i)$ refers to the bid from cluster k for element i
- Size is the size of the DSM (number of elements in the DSM)
- $DSM(i, j)$ is the value of the interaction or dependency between the randomly selected element i and element j
- $cl_size(k)$ is the number of elements contained in cluster k
- pow_dep controls the importance given to strong interactions over weak ones. A large value increases this difference, and vice versa.

- pow_bid controls the value of a bid depending on the size of the cluster. A large value discourages the formation of large clusters and encourages the formation of similar cluster sizes, and vice versa.
- $CL_MAT(k,j)$ is a binary variable that takes 1 when the element j is present in cluster k .

3.2.2.2 Total coordinate cost function

The total coordinate cost function represents the addition of the coordinate cost of each element. Two cases are distinguished:

If both elements i and j are in the same cluster k (elements i and j interact together and this interaction belongs to the same cluster), then:

$$\begin{aligned} \text{Coordinate cost}(\text{element}_i, \text{element}_j) \\ = (DSM(i, j) + DSM(j, i)) \times (\text{cluster}(i, j)^{pow_cc}) \end{aligned}$$

Else (if elements i and j are not in the same cluster, the entire DSM acts as cluster containing elements i and j):

$$\begin{aligned} \text{Coordinate cost}(\text{element}_i, \text{element}_j) \\ = (DSM(i, j) + DSM(j, i)) \times (\text{size}(i, j)^{pow_cc}) \end{aligned}$$

Where:

- $\text{cluster}(i, j)$ is the size of the cluster that contains elements i and j (number of elements in the cluster)
- $\text{size}(i, j)$ is the size of the DSM (number of elements in the DSM)
- pow_cc is a parameter that controls the type of penalty assigned to the size of the cluster in the coordinate cost

Then, the total coordinate cost is:

$$\text{Total coordinate cost} = \sum_{i=1}^{\text{size}} \sum_{j=1}^{\text{size}} \text{Coordinate cost}(\text{element}_i, \text{element}_j)$$

3.2.3 Combination of the two algorithms for creating groups of components from the PP matrix

The two algorithms presented in this section for proposing groups of components to the users are combined in our methodology. The first algorithm to gather elements around of the matrix diagonal aims at approximating components according their interactions. Grouping contacts near the diagonal of the PP matrix represents the components that have strong contacts with each other. But this first algorithm does not propose any clusters or groups of components. The goal of the second algorithm of clustering is to create and highlight clusters that are groups of components with strong interactions inside and low interactions with other components or clusters. Using a combination of these two algorithms allows good solutions of clusters from a PP matrix to try to be achieved. For this, the first algorithm is used to constrain the second one thanks to a comparison of their results. The first algorithm is used to generate an ordered list of components that correspond to the position defined for each

component in the result matrix. This is suggested in order to use this information to guide the construction of clusters in the second algorithm. For this purpose, a penalty in the formulation of the coordinate cost is added to increase the cost when the distance (expressed as the difference of positions) between two components in the same cluster increases. Then, the calculating of the coordinate cost of two components in the clustering algorithm is compared to the calculating of the coordinate cost of the same components in the result matrix of the first algorithm. If there is a big difference between both calculations, the proposal of the clustering algorithm is not relevant. So the calculations of the second algorithm of clustering are guided by the results of the first algorithm in order to achieve the best solution.

3.3 Algorithm of the decision support system for generating the best assembly sequence according to the context

Firstly, an assembly sequence gives the order of assembly of components of a product according to the preliminary design phase. An assembly sequence is said to be eligible or valid if all precedence constraints are satisfied. The product is a concept and the design details are not known. In the detailed design phase, it is possible to consider more information (like assembly directions, positions of components, tools necessary to operate the assembly process, etc.) into the assembly sequence and interact with the assembly process to organize it and prepare the assembly workstations. This definition is related to an assembly sequence and not to an assembly sequence planning (assembly sequence with information for tools and assembly workstations, etc.).

For the definition of the assembly sequence of the products, two approaches were adopted. The first approach (section 3.3.1 of this chapter) consists of the proposition of all eligible assembly sequences according to some specific constraints of our context. But this approach requires too much work thereafter for the assembly planner. Indeed, he/she must select the best assembly sequence from a large number of proposals. This step is not easy to execute and it can be very long to perform. But adding one or more criteria to compare solutions does not constitute, from our point of view, a solution that simplifies enough the task of the assembly planner. With various criteria, the assembly planner must always search through a large scale of potential solutions, although they are sorted from each other.

From these observations, we decide not to directly offer eligible assembly sequences but to help the assembly planner to build his/her best assembly sequence. Then, our decision support system is proposed. The originality of this support comes from the need of helping the assembly planner to combine the customer needs, the product structure and the assembly constraints in order to define an eligible assembly sequence. The assembly planner is guided step by step during all the definition and he/she does not need to select from a list of possibilities.

During the definition of the assembly sequence, the assembly planner focuses on components and his/her knowledge. The assembly planner will try to choose first the more stable or bigger components or the frame component of the product before the others. His/her goal is to add components that make the assembly process easier with some specific criteria such as “easy to hold” or “fixed together”. Then, the decision support system for choosing the best assembly sequence helps the assembly planner to take into account other constraints (mainly functional and modular constraints), not directly linked with the assembly constraints.

3.3.1 First algorithm for generating eligible assembly sequences

The overall goal of this algorithm is to generate all the eligible assembly sequences for the generic product from the reduced graph. To achieve this objective, a CSP model (Constraint Satisfaction Problem) [Vareilles 2012], [Tsang 1993], [Yannou 2006], [Yvars 2008] is developed. A CSP [Abdennadher and Frühwirth 2003] is a problem modelled as a set of constraints imposed on variables, each of these variables are taking various values in a field. More formally, a CSP is defined by a triplet (X, D, C) where:

- $X = \{X_1, X_2, \dots, X_n\}$ is the set of variables (unknown parameters) of the problem;
- D is the function that maps each variable X with its domain $D(X)$, that is to say all the possible values of X_i ;
- $C = \{C_1, C_2, \dots, C_k\}$ is the set of constraints. Each constraint C_j is a relationship between certain variables X , restricting the values that these variables can take simultaneously.

In our case, the CSP (X, D, C) is defined as a direct graph $G = (V, E)$ where V represents all nodes in the graph ($|V| = n$) and E all edges ($|E| = m$):

- $X = \{X_1, X_2, \dots, X_n\}$;
- $D(X_1) = D(X_2) = \dots = D(X_n) = \{1, n\}$;
- $C_1 = \{X_i \neq X_j \text{ for any pair of nodes } i \text{ and } j \text{ in } V\}$;
- $C_2 = \{X_j \geq X_i + 1 \text{ for every arc } (i, j) \text{ in } E\}$.

Solving a CSP (X, D, C) consists of assigning values to variables, so that all constraints are satisfied. Here, solving the CSP provides us with all the ordered lists of nodes in the graph. To obtain the corresponding assembly sequences, the node is just replaced by its label, the latter corresponding to the number of a component or ordered components sub-sequence.

The number of provided solutions may be huge. For this reason, the blocks of components resulting from the partition of the matrix PP are taken into account in order to limit the number of eligible sequences. The graph is decomposed into several induced sub-graphs; each induced subgraph $H_k = (V_k, E_k)$ corresponding to a block k such as:

- components of V_k are in the same block ;
- $\Gamma^-(V_0) \subseteq V_0$;
- $\Gamma^-(V_k) \subseteq \bigcup_{l=0}^{l=k} V_l$, for $k=1$ to $b-1$.

A CSP model is defined for each sub-graph and the final sequence is formed by linking together all the various ordered sequences: $S_0 S_1 \dots S_{b-1}$ (for a matrix with b blocks). All the generated assembly sequences are eligible, i.e. ordered and that best fit the knowledge of the assembly planner.

This algorithm for generating eligible sequences was tested on some examples of products. Subsequently, we wish to affirm the relevance of our approach on a graph with all the components of a product and expand our search for coloured patterns to more complex patterns (other than series and with more components). Notwithstanding this, the obtained list of assembly sequences is not sorted and does not take into account enough the component blocks. In our future research, efforts will be made towards a better consideration

of the blocks in order to select an assembly sequence by helping the assembly planner during his/her choice with a decision support system.

3.3.2 Decision support system to define the best assembly sequence

Our algorithm aims to guide the assembly planner during the definition of the best assembly sequence according to various constraints such as modularity of the generic product (represented by a coloured link between a module (or a function) and a component). Our decision support system is designed in order to help the assembly planner step by step.

Firstly the system gives a layered drawing of the direct graph where the first layer corresponds to nodes without predecessors, the second layer addresses nodes with predecessors belonging to a previous layer, and so on. This representation of the graph will guide the decision of the assembly planner. Then, some possible choices are suggested in an interactive way in order to build the best assembly sequence. These suggestions are defined using the following algorithm:

```
L <- list of nodes of the graph
while (L is not empty)
  construction of the list W of nodes without predecessor
  if W contains only one Node u
    parts of Node u are added to the sequence
  else
    accept <- 0
    while (not accept)
      u <- W.pop()
      parts of Node u are proposed to the planner
      if the assembly planner confirms this choice
        accept <- 1
        parts of Node u are added to the sequence
      end if
    end while
  end if
  L <- L \ {u}
  remove edges whose tail is u
end while
```

The main step of this algorithm is the construction of the list of nodes (W) without predecessors. In fact, nodes without predecessors are easily identifiable but they are sorted in a specific manner in order to guide the decisions of the assembly planner.

Nodes are sorted in a lexicographic order by considering three criteria, with a priority given to the first criterion. Assume that v is the last node introduced in the sequence, the criteria are:

- Criterion 1: Node u is of the same colour as v ;
- Criterion 2: Node u is in the same block as v ;
- Criterion 3: Node u and Node v are linked by a precedence constraint.

Nodes of the List W are provided in that order (instruction $u \leftarrow W.pop()$ of the algorithm) to the assembly planner until he/she chooses one to complete the sequence.

To explain how nodes are sorted in list W , the following notations are suggested:

- sequence of nodes $seq=e_1, e_2, e_3, \dots, v$
- $c_{u,v} = 1$ if u and v have the same colour, 0 otherwise
- $b_{u,v} = 1$ if u and v belong to the same block, 0 otherwise
- $l_{u,v} = 1$ if u and v are linked by a precedence constraint, 0 otherwise
- w_c : weight related to colour
- w_b : weight related to block
- w_l : weight related to precedence constraint

The weight associated to the couple (u,v) is given by $w_{u,v} = w_c c_{u,v} + w_b b_{u,v} + w_l l_{u,v}$.

Given the last node v of the sequence, nodes u of the list W are sorted in decreasing order of their weight $w_{u,v}$.

For instance, to describe a lexicographic order, we set: $w_c = 4, w_b = 2, w_l = 1$

The first node of the graph is an atypical node. When there is only one possibility to begin the assembly sequence, this node is automatically added in the assembly sequence without any validation process from the assembly planner. But sometimes there is more than one first node to begin the assembly sequence. In this second case, there is an exception in the definition of the priority node that is named initial component. An initial component is a node without any precedent node like Component 1 or Component 6 in Figure 27. The priority is given to the node with the bigger number of successor nodes. The term “successor node” is used here to denote one node reachable by a path starting from the initial node. Indeed, this is the component that is able to prevent the most the selection of future components in the sequence. To begin the assembly sequence, the assembly planner must select an initial component. Among the two possible initial components (Component 1 and Component 6) in Figure 27, the Component 1 is prioritized by the algorithm and highlights for the assembly planner. Indeed, the Component 1 has more successor nodes than the Component 6.

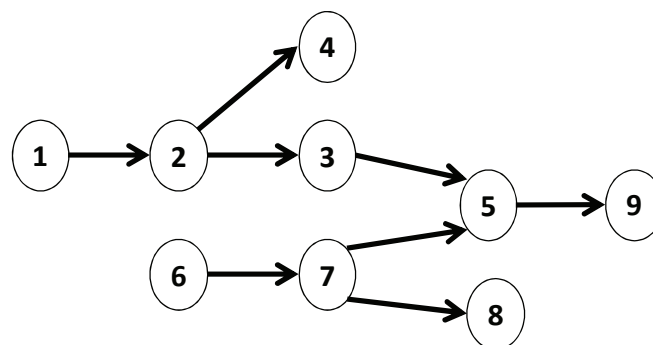

Figure 27. A direct graph with 9 components.

To illustrate the operation, an illustrative example is given. In this example, there are six parts which can be described as follows: two parts of the same colour (Part 3 and Part 6) and two main Blocks A and B with one sub-block of the Block A (Figure 28(a)).

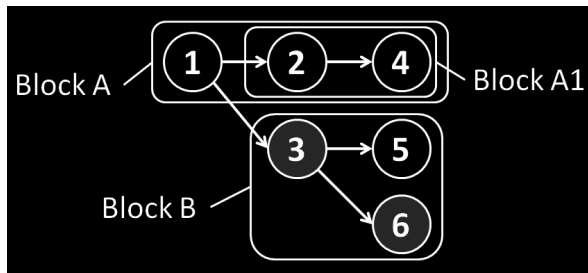

Figure 28(a)

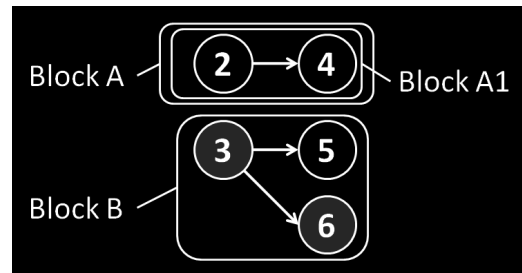

Figure 28(b)

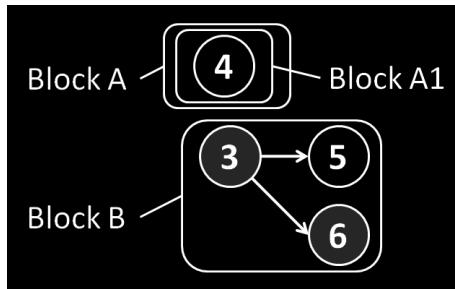

Figure 28(c)

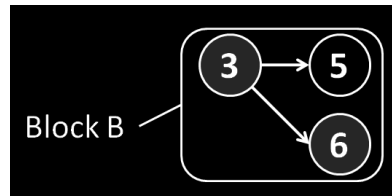

Figure 28(d)

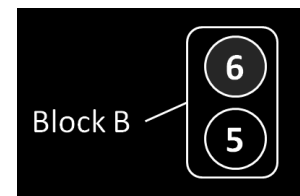

Figure 28(e)

Figure 28. Example with 6 parts of the use of the decision support system for defining the best assembly sequence according to our three constraints

At the beginning of the process, only the Part 1 is automatically added in the assembly sequence because it is the only component without any component of precedence. In the next step, there are two possibilities between Part 2 and Part 3 (Figure 28(b)). But the best option is on the top of the graph; it is the Part 2 because this part belongs to the same Block A as Part 1. In fact, it is better to select parts of the same block before beginning the assembly of parts of another block. So the assembly planner can choose Part 2, as suggested by the decision support system, but he/she can also choose Part 3 if this is the best solution according to his/her specific knowledge. As shown in Figure 28(c), there are also two possibilities for the next assembly steps. Part 4 is on the top of the graph because this part is in the same Block A and in the same Sub-block A1 as the previous chosen part. The assembly planner can choose Part 4 but it is also possible to select Part 3. Assuming that Part 4 is chosen, the remaining possibility is the Part 3 on Figure 28(d). For the two last parts (Figure 28(e)), according to the colour, Part 6 is preferable to Part 5, in the same Block B.

Finally, the generated assembly sequence can be listed as follow: {1;2;4;3;6;5}. This assembly sequence must be read from left to right. The following notations are selected to describe an assembly sequence:

- “{ }” indicates respectively the beginning and the end of the assembly sequence,
- “;” indicates a precedence relationship between two parts;
- “()” represents a group of components made by a simplification of two specific components selected by the assembly planner or a pattern detected by our algorithm;
- “-” is used when two specific components are selected by the assembly planner and there is no assembly precedence between them (it can only be used with “()”).

In order to illustrate this notation, here is a small example of assembly sequence {1;(2-3);8;(4;5;6);7} with its corresponding direct and coloured graph (Figure 29).

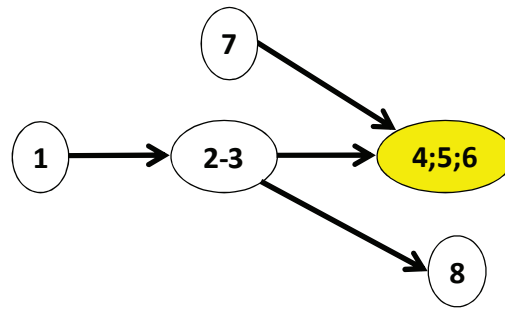

Figure 29. Illustration of our notation for assembly sequences

In the Figure 29, the node 2-3 represents a simplification of two components from the assembly planner. The yellow node 4;5;6 represents a pattern detected by our algorithm that regroups three independent components assembled in this order. The other nodes (1, 7 and 8) are independent components without any colour.

3.4 Structure of the generic product of the modular family

The whole goal of this section is to define the best product structure for the generic product of the modular family. Functional modules that can be independently assembled are defined. The final goal is to have definitive variants of modules ready to be assembled in order to create a family of products that meets a range of customer needs. It is possible to make an analogy with “Bic” pens. Some components are standards for all the family of pens like the body / tube and some other specific to each colour. For instance, there are various pen caps in accordance with the colours of the family and they can be considered as a functional module. When there is a need for blue pens, the right variant of this module is selected and the product is created by assembling all modules that constitute a pen. Moreover, some modules can have a standard sub-module and a specific sub-module. For instance the sub-module of a ball mechanism and the sub-module of ink reservoir can constitute the writing system module of a pen. The ball mechanism is the same for all pens but the ink reservoir depends on the colours. Moreover, it is possible to have some options or optional sub-modules. For instance, some pens have a specific gum in place of the cap. The gum and the cap can be placed in the same place but the choice between these two possibilities is done depending the customer need. Therefore, a pen is a group of independent functional modules that can be assembled together according to the order.

Our methodology of structuring products is detailed in Figure 30 with a BPMN format. It corresponds to the step number 3 of the Figure 12 page 53.

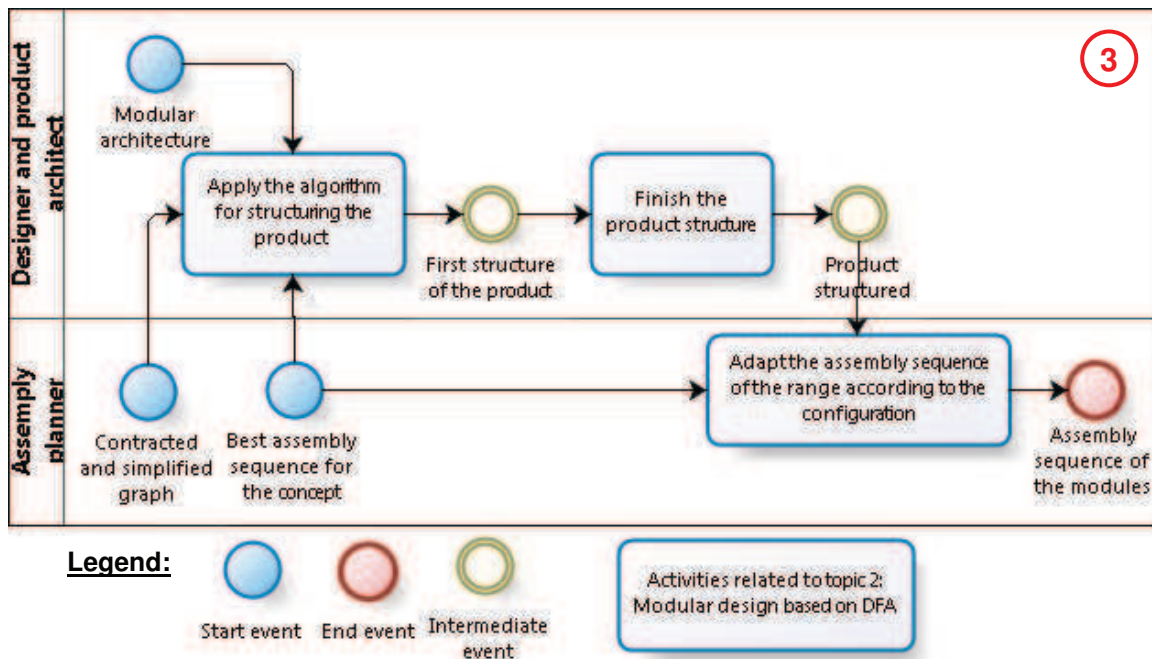

Figure 30. Definition of the structure of the products from the modular family, part of the modular design approach based on DFA principles of the FARD methodology

From the step number 1 of the FARD methodology (Figure 12), modular architecture with main components is known and then main components of each module and sub-module has to be defined. In order to represent this link, colours are used and variations of colours are defined in order to take into account the membership of sub-modules to modules. This information is used in our algorithm to separate components in order to assign them into modules and sub-modules.

From the step number 2 of the FARD methodology (Figure 12), links between components and their colours are summarized in the contracted and coloured graph. Moreover, this step allows the best assembly sequence for the generic product of the family of modular products to be defined.

At this stage of the demonstration, some components are coloured but not all of them. Our algorithm, which is detailed in the next section 3.5, tries to define the distribution of the components without any colour while taking into account constraints of modularity, contacts between components and assembly constraints.

After the application of our algorithm, a first proposal of a product structure is generated. The product is not totally structured due to some components without any colour and which cannot be assigned into a module or sub-module in spite of the reasoning of the algorithm. Then, the user can manually assign components to modules and sub-modules in order to complete the structure of the generic product. An alternative for the user is to allocate a component to a module and use the algorithm to try to assign it to a sub-module of the considered module. Moreover, if the assignment of a component is not considered acceptable for the user, he/she can move the component into another module and/or sub-module. According to his/her knowledge, the user can alter the algorithm proposition. Finally, the generic product structure is obtained. This structure can be reused for the other products of the family because they are only a single variant of the generic product. However, if a

product of the family is composed differently, the assembly sequence and the product structure must be updated.

In order to go further in the combination of DFA principles with a modularity approach, a new assembly sequence, which corresponds to the assembly sequence of modules in modular products, is created. This new module assembly sequence comes from the combination of the best assembly sequence for the concept of generic product for the modular family and the structured product. Then, it is possible to form groups of components that match as well as possible to the modules. This module assembly sequence represents the last product assembly released to quickly create a product that satisfies the customers needs. This approach aims to have a delayed differentiation strategy, which is with modular design, a useful tactic for mass customization [Da Silveira et al. 2001].

In order to illustrate this approach, a product of six components is used. Its assembly sequence is: {1;2;3;4;5;6}. The product is decomposed into two main modules and one of them is also decomposed into two sub-modules. By the combination of the assembly sequence with the product structure, it is possible to define the module assembly sequence. There are two possibilities:

- The component order corresponds to the module order (Figure 31). Then, the module’s assembly sequence is: {Sub-module1.1;Module2;Sub-module1.2}.

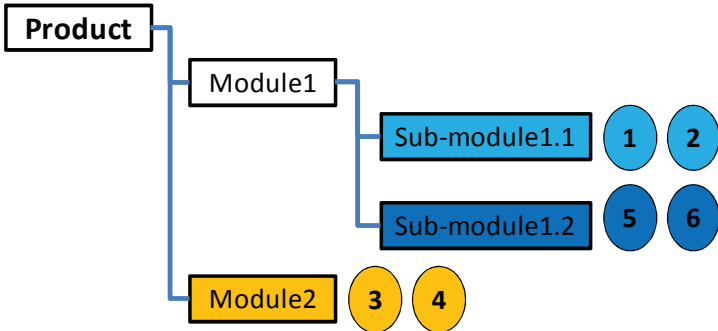

Figure 31. Example of product structure with six components and two mains modules with sub-modules

- Some modules are divided in the component assembly order (Figure 32). In this configuration, groups of assembly components are created in the product structure in order to create the module assembly sequence. Then, the module assembly sequence is: {Sub-module1.1;Group2.1;Sub-module1.2;Group2.2}. This module assembly sequence requires the creation of two groups of components into the module 2. These groups allow taking into account the decomposition of the module 2 into the assembly sequence. Indeed, a “functional module” or “product module” is not necessarily equivalent to an “assembly module”. That is why some arrangements can be necessary to optimize the assembly phase of the products. To continue this development, it is also possible to divide these groups into assembly sets which are stable for the assembly process (fixed components related to each other). Our groups are only groups of components that are assembled one after the other, but which are not necessary stable during the assembly process.

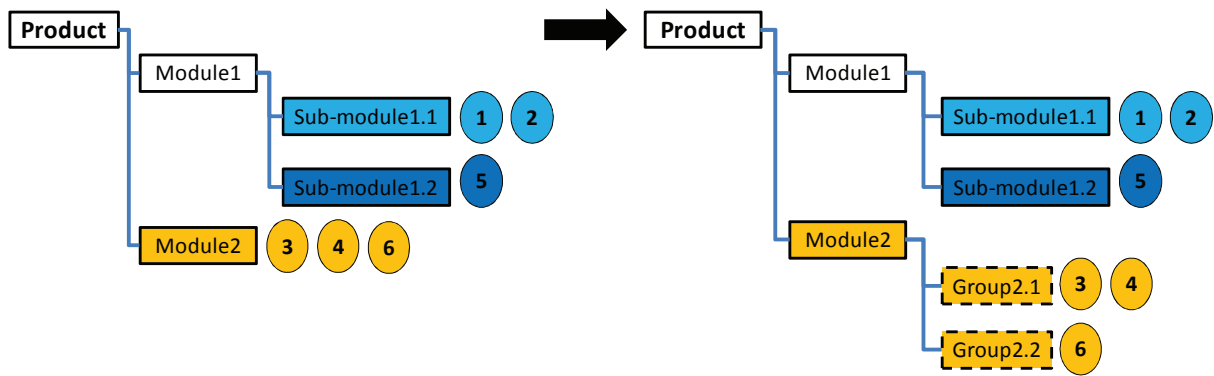

Figure 32. Example of product structure with six components and two main modules with sub-modules

The interest of this new module assembly sequence is the possibility of preparing the schedule for the assembly operations. Then, it will be easier to plan the schedule for products by various assembly workstations in a plant. To go further, this kind of schedule can be represented in a Gantt chart as a project flow diagram. The critical path to assemble components in parallel can be highlighted and then optimised. But this approach is typically a connection to the process design domain.

3.5 Algorithm for structuring the generic product of the modular product's family

Our algorithm aims to define the product architecture from some previously obtained information and especially from the modular architecture. It relies on three criteria and priority is given to the first criterion:

- Criterion 1: the coloured components, this criterion comes from the contracted and simplified graph combined with the modular architecture (and implied the FAST diagram and the link between modules/sub-modules and some components);
- Criterion 2: the path of the chosen assembly sequence for the generic product;
- Criterion 3: the contacts between components, this criterion comes from the contracted and simplified graph.

An assumption is made that all components belong to at least a module. There is no component at the root of the modular architecture of the product. Then, all components must be distributed. Our algorithm works step by step from these criteria and according to the modular architecture of the product. It tries to allocate the components among the modules and sub-modules of the modular architecture. Three main steps are considered.

3.5.1 Step 1: distribution of components into modules

The distribution of components into modules and sub-modules begins at the first level of the product's modular architecture which is denominated as the "module level". Then, the maximum of components are allocated to a module thanks to our three criteria described previously. Criteria 1 and 2 must be considered first. It allows an initial distribution of the components into the module level. The goal is to put in the same module components that follow the way of the assembly sequence (criterion 2). The criterion 3 is mainly to decide the membership of the components without any colour.

If between two components of different colour or assigned to different modules there are components without any colours, contacts between these coloured components and the colourless ones must be considered. So a component without colour in between two coloured components will go in the module that has the coloured component which is in direct contact with the colourless component (an example is detailed in Figure 33). If the part has a direct contact with the other two parts or no contact with them, this component will be waiting for a decision from the product architect (an example is shown at Figure 34 and Figure 35). The product architect must then manually decide its allocation among the two possible modules. Indeed, the algorithm can be made to not assign a component to a module. This component (without any colour) is then placed in a new module without any colour and without any function (example in Figure 36) especially created to wait for a manual component allocation.

At the end of this step, the product structure in the module level is generated with a possible waiting module without any function. Then, the step 2 of our algorithm can start.

In Figure 33, Figure 34 and Figure 35, each node in these graphs shows a component and each edge a contact with precedence constraint. The red arrow represents the path of the assembly sequence.

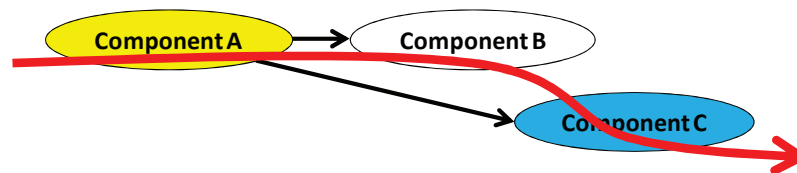

Figure 33. Allocation of the Component A to the yellow module with the Component B by our algorithm

In Figure 33, the Component B can be allocated to the yellow module because of the combination of:

- the contact between Component A and Component B,
- the absence of contact between Component B and Component C,
- the way of the assembly sequence from the Component A to Component B to Component C.

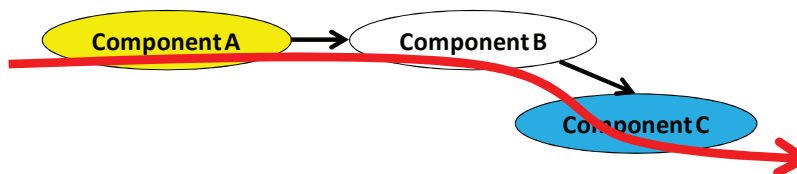

Figure 34. No allocation of the Component B by our algorithm in this first example

In Figure 34, the Component B is not allocated to any module because of the combination of:

- both the contact between Component A and Component B, and the contact between Component B and Component C,
- the way of the assembly sequence from the Component A to Component B to Component C.

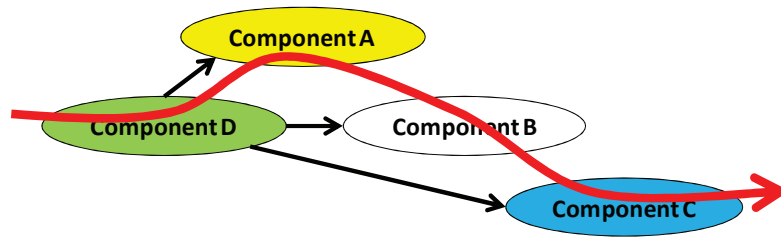

Figure 35. No allocation of the Component B by our algorithm in this second example

In Figure 35, the Component B is not allocated to any module because of the combination of:

- the absence of contact between Component A and Component B,
- the absence of contact between Component B and Component C,
- the way of the assembly sequence from the Component A to Component B to Component C.

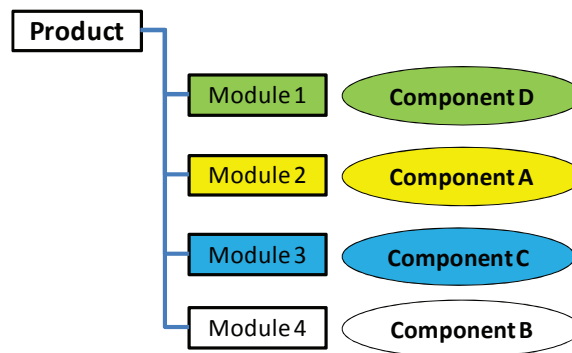

Figure 36. Component B is allocated to a module without any function

Figure 36 shows an example of product architecture generated on step 1 with our algorithm. Whether in the examples given in Figure 34 or Figure 35, the Component B is placed in a waiting module without any function and so without colour.

3.5.2 Step 2: distribution of components into sub-modules

This step consists of the same procedure as the previous one but applied to each module. In step 1, the maximum of components were allocated into the modules of the product's architecture. Then, for each module with sub-modules, the algorithm allocates components of a module into its sub-modules. It can also create a sub-module without any function and consequently without colour.

This step must be repeated as many times as necessary, that is to say, until the lowest level of each module is reached, corresponding to the end elements of the FAST diagram. Indeed, it is done for each module that contains sub-modules but also recursively for each sub-module that contains sub-modules. Each module or sub-module is considered locally in this step.

3.5.3 Step 3: end of the algorithm for structuring the product

This step is the synthesis step of the algorithm procedure. The objective consists in building (or rebuilding) the product structure by highlighting the components remaining to be assigned manually among the different modules. If there is a mix of colours or functions among different components, the product structure can be rebuilt. A module or sub-module

can be integrated into another as a group of components or a sub-module inside. The goal is to have the maximum of set of components of the same colour together, even if they are in another sub-module than initially defined. It still allows a function to be isolated to create a variant.

Following the manual distribution of certain components, the algorithm may propose a new distribution among sub-modules of the selected module. If the algorithm still cannot automatically assign the component, the expertise of the product architect is then requested again.

At the end of this step, the product structure is known. All components are assigned into a module and/or a sub-module and so they are all coloured.

3.6 Configuration management of module variants and new products of the modular family

The goal of this section is to create the products of the family in a modular manner. To succeed, variants of specific modules must be generated in order to fulfil the customer needs. Then, by the combination of variants, new modular products will be created to form the product's family. This work corresponds to the step number 4 of the Figure 12 (page 53).

The next step consists in the creation of the CAD model of the generic product and of all the products of the family which will be parametric in order to be quickly adapted to each product of the product's family. All the products of the family have the same cornerstone. The specificity of each product of the same family comes mainly from their parameters. Then, a parametric CAD model aims to quickly finalise each CAD model of detailing the products of the same family. At this stage, the design process moves from the preliminary phase to the detailed phase. This step corresponds to the number 5 of the Figure 12 on page 53.

Both steps are detailed in the Figure 37, with a BPMN format.

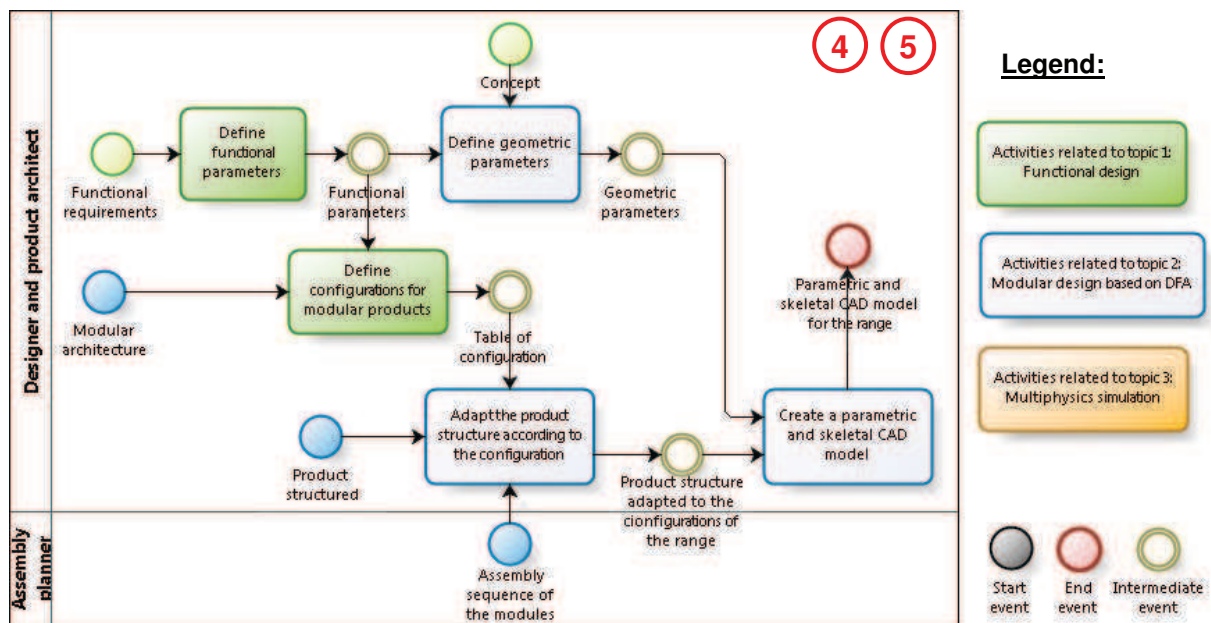

Figure 37. Configuration management of the products of the same family and creation of the parametric and skeletal CAD model for the product's modular family, parts of the modular design approach based on DFA methodology

The first step in this section consists in defining the variants of modules according to customer needs. For this, functional parameters are detailed from the customer needs. They allow specific modules and standard modules to be highlighted. Moreover, some management decisions can decide which variant of module can be matched with which other variant of module. Some module's variants can be unsuited to others because of use cases. For instance, some use contexts impose specific constraints thanks to standards like the ATEX areas that refers to explosive atmospheres [European Directive 94/9/EC 1994], [European Directive 1999/92/EC 2000]. An explosive atmosphere means a mixture with air, under atmospheric conditions, of flammable substances in the form of gases, vapours, mists or dusts in which, after ignition has occurred, combustion spreads to the entire unburned mixture. In this case, some options or modules must be adapted to respect their specific constraints (no risk of ignition is allows). For instance, the head of a hammer must have a specific material in ATEX areas.

The designer lists the variants for each module in accordance with the customer needs (in a table form, as proposed in Table 1, or in a graph form). He/she can also anticipate and add variants that are not yet requested by customers. This list of variants is used to create a table of configuration management. This table details the composition of a product configuration (which variant of all modules is used to create a new product).

		Functional parameters	
		Output power (Watt)	Rotational speed (tr/min)
Variant	Module 1, A	5	2000
	Module 1, B	7	2500
	Module 2, C	9	3000

Table 1. List of variants of a module for defining a power

For instance in Table 2, a list of variants of a module considering various powers of a tool is illustrated. This list is presented as a table with corresponding values for each functional parameter of the module. Then, each variant of a module is associated to a set of values linked with functional parameters. These sets of values are equivalent to instance sets of the module's configurations.

		Modules of the modular family				
		Module 1	Module 2	Module 3	Module 4	Module 5
Product configuration	Product configuration n°1	Module 1, A	Module 2, A	Module 3, C		Module 5, B
	Product configuration n°2	Module 1, B	Module 2, A	Module 3, A		Module 5, B
	Product configuration n°3	Module 2, C	Module 2, B	Module 3, B		Module 5, B

Table 2. Example of the definition of the three first product of a modular family including four specific modules for the creation of variants. Module 4 is a standard module and is necessarily used in all the products of the family

Table 2 shows the beginning of the definition of the products' families, other product configuration can be added later. This family of product includes four modules that allow the

creation of new products thanks to instance sets of module configurations. In each box, the module configuration selected for the product configuration is indicated. Moreover, some standard modules can be added to these specific modules in order to create an entire product. In Table 2, the module 4 is standard and its column is different from those of the specific modules. This module is the same for all the family of products, there is no possible variant. Module 5 has the same variant for each product configuration in this example of a beginning of family.

To facilitate the design of the product, it is possible to adapt the product structure according to the configuration of the products. This adaptation mainly concerns the detail level of the structure. For instance, if a module has sub-modules which have more than two levels of sub-modules and some of them are standard, these standard sub-modules can be regrouped into only one. The goal of this adaptation is to simplify the product structure in terms of module variants. However, this step requires a very precise knowledge of the future family. Indeed, if some sub-modules or modules are grouped together, it will be harder to divide them later in order to convert a standard module into some specific modules or sub-modules.

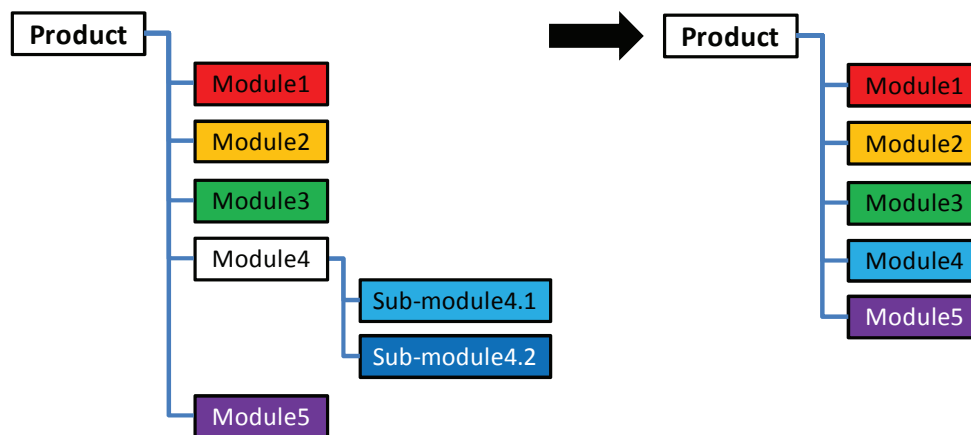

Figure 38. Simplification of the product structure according to configuration information

In Table 2, module 4 has been defined as a standard module without any variant. Then, its sub-modules, each with a correspondence to a technical function in order to realize the function of the module 4, can be regrouped into the same module. As the sub-modules do not have variants, it is not necessary to identify them as independent sub-modules. This will simplify the design of the product and the number of components thanks to the disappearance of interface components.

From the product structure (modules and sub-modules with their components), the designer can design the generic CAD model which is parametric and skeletal. From the functional parameters, he/she defines geometric parameters that allow functional parameters to be adapted in order to manage the CAD model. This is like a translation of parameters from one domain to another. The definition of the geometric parameters is based on the concept of product.

The geometric parameters are linked with a geometrical skeleton model. This allows the CAD model to be managed from parameters. By changing values of parameters it is possible to generate or adapt quickly a new 3D model. A geometrical skeleton model

[Demoly 2010], [Varret 2012] allows the link between parameters and 3D geometry model to be prepared. It is a simplified geometry (line, circle, etc) of the 3D model.

From this skeleton, the geometrical 3D CAD model is created. Then, a generic parametric and skeletal CAD model is obtained for all the products of the family. This model will allow all the products of the family to be generated.

3.7 Indicators to validate the improvement of the modular product development thanks to the FARD methodology

In order to validate the influence of the FARD methodology on the development of modular products, two indicators are proposed. According to the literature review, there are no current indicators that combine our selected aspects: modularity in connexion with assembly sequence and functional structure.

The first indicator we propose is the **Csapm** indicator (in french: “Capacité de la Séquence d’Assemblage à générer un Produit Modulaire”). The **Csapm** indicator measures the capacity of the assembly sequence to generate modular product thanks the application of the FARD methodology:

Csapm

$$C_{sapm} = \frac{N_f : \text{number of functions in the lower level of the modular product structure (equivalent to the number of colours in the modular product structure)}}{N_{cc} : \text{number of colour changes according to the direction of the assembly order of the components in the assembly sequence} + 1}$$

The second indicator is the **Imp** indicator (“Indice de Modularité d’un Produit”). The **Imp** indicator measures the modular index of a product thanks to the application of the FARD methodology:

$$Imp = \frac{N_f : \text{number of functions in the lower level of the modular product structure (equivalent to the number of colours in the modular product structure)}}{N_m : \text{number of modules, submodules and groups of components in the lower level of the product structure}}$$

In order to establish a reference, the Imp indicator of the initial product (which is supposed not to be a modular product) can be measured. In this case, the Nm represents the number of all the components of the product.

Two rules are defined with these indicators:

- The more Csapm and Imp are close to 1, the better the results are (better degree of modularity according to the criteria of the FARD methodology).
- Csapm >= Imp because of some technical constraints of the product that can lead to the creation of groups of components into modules or sub-modules (as shown in Figure 32).

For a better understanding of these indicators, Figure 39 illustrates a simplified and illustrative product composed by three components (a bottle numbered 1, a liquid numbered 2 and a bottle cap numbered 3).

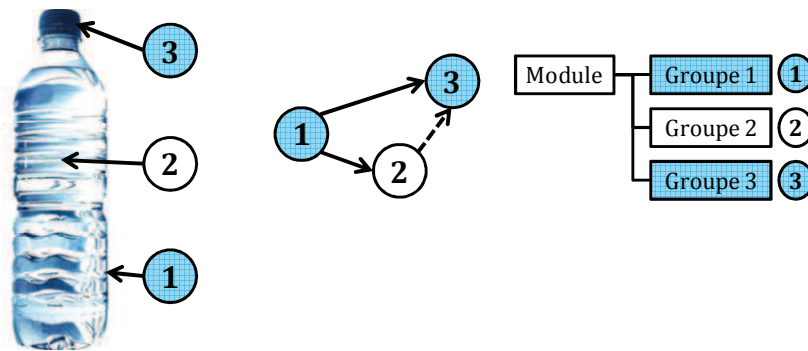

Figure 39. Illustrative example of product with three components: the product and its components, the direct graph of the product and its product structure

According to the direct graph of the product, the assembly sequence is {1;2;3}. Then the C_{sapm} is 1 ($C_{sapm}=1/1$ because there is only one colour and there is no colour changes).

From the product structure of the bottle, the I_{mp} can be measured. $I_{mp}=0,33$ ($I_{mp}=1/3$ because there is three different groups of modules in the product structure).

Then the rule $C_{sapm} \geq I_{mp}$ is confirmed. The I_{mp} decreases because of the assembly constraints that separate the liquid from the bottle and the bottle cap during the assembly process. This is important if the modules “Group 1” and “Group 3” are modular and allow generating a range of products, for instance: a range of products with the same liquid and with various bottle forms. In this case, it is important to divide the product into groups of modules and not considered directly the whole product.

4 A NEW APPROACH OF MULTI-PHYSICS SIMULATION IN HP DESIGN

In order to continue further in our “High Productive” design methodology dedicated to modular products High Productive design, we have decided to discuss the dimensioning aspect and propose a new modelling and simulation approach. This is a continuation of the product’s development process. Multi-physics simulation is deployed to evaluate the performance of the product in its life cycle and if products respect limit values imposed by the functional requirements (such as norms and standards, customer needs, etc). Nowadays, respecting standards or directives is becoming more and more important for competitive companies. If a product doesn’t respect them, its sales can be severely compromised.

This section is concerned with the “robust” character of our design approach, based on modelling and simulation loops in the product mechanical structure. This approach is performed in order to check and validate constraint levels. These levels are defined during the functional analysis phase and detailed through design parameters, which can be directly connected to a parametric CAD model.

Multi-physics simulation is mainly used to validate the complete physical behaviour of the product developed. For instance, products developed must resist, transmit or absorb

various physical loads such as mechanical structural solicitation, vibration generation and transmission, shocks absorption, etc. First goal of our study is to define an optimal design that can satisfy constraints like reducing mechanical vibration levels transmitted to the users in order to decrease some musculoskeletal risks and disorders for the users. The other goal is to ensure that all variants of the product respect the requirements of the functional analysis.

Figure 40 shows details of the step number 6 of the Figure 12 on page 53. It represents the multi-physics simulation aspect of the FARD methodology with a loop of modelling and simulation process with a specific parametric meshing procedure.

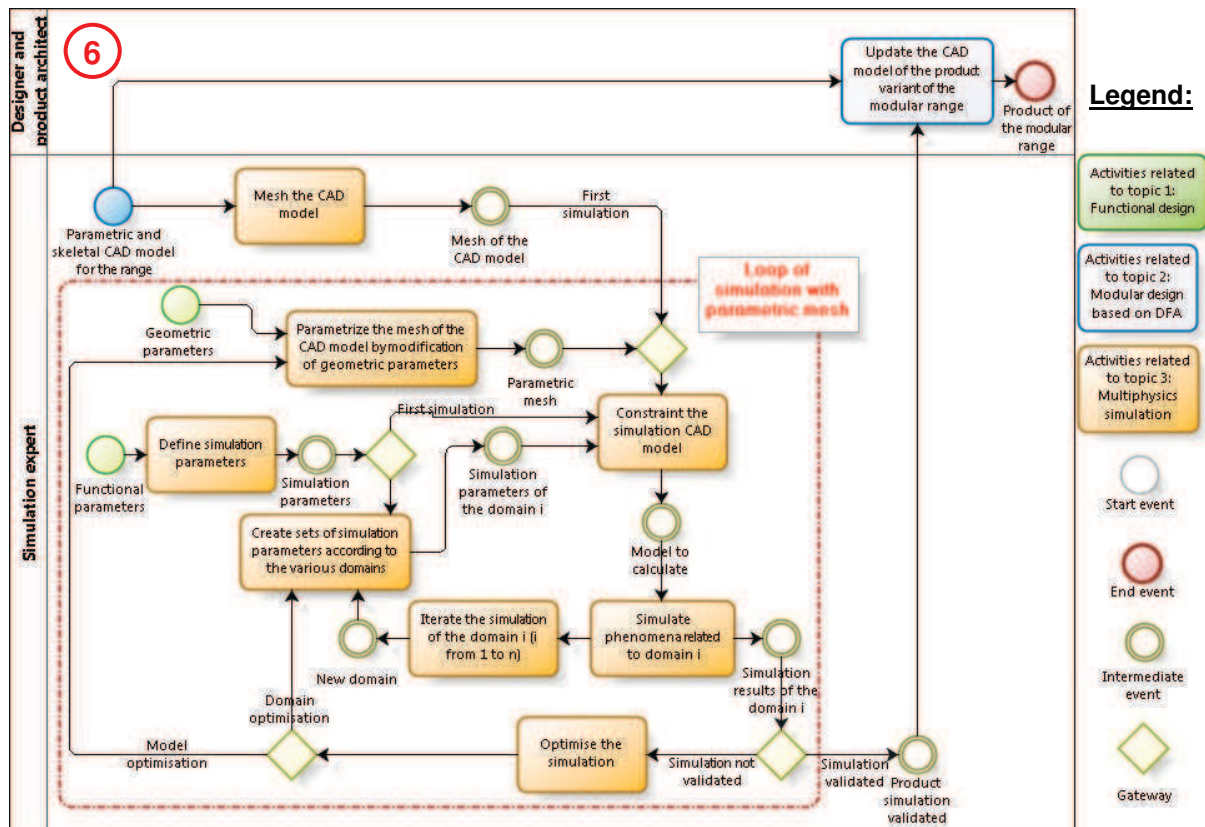

Figure 40. Multi-physics simulation approach applied to products variants in the product's family, as the product's dimensioning aspect of the FARD methodology. The colour of start events depends on the origin of the previous activities.

From the parametric and skeletal CAD model, a product is generated. This geometrical model of the product is used to create the corresponding mesh developed as a finite element model. Then, the simulation expert adds specific constraints which represent the physical solicitations applied to the product in a specific domain and use case. The next steps are the simulation and interpretation on the results. Depending to the results, the simulation expert can:

- stop the computing process when: simulation objectives and results are satisfied;
- Continue the simulation process within a new loop: new simulation with or without optimisation of geometrical parameters (linked with the CAD model) or simulation parameters (linked with the simulation constraints). Then, the process enters properly in the simulation loop.

The first simulation or initial simulation represents a classical process of simulation as illustrated in Figure 41. At the end of the interpretation in a classical simulation procedure, if results are not satisfied, the simulation expert modifies the CAD model, and redoes again the same steps.

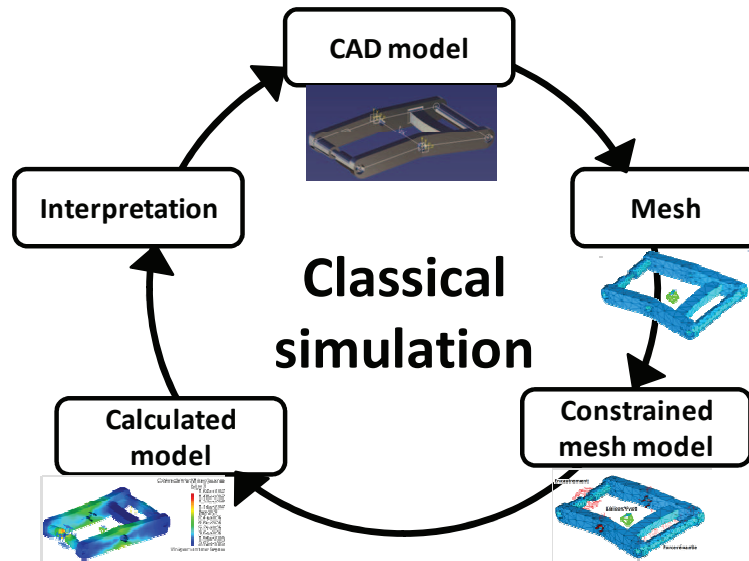

Figure 41. Simplified representation of a classical loop of a modelling and simulation process

But in our methodology, at the second simulation loop, when the validation of another variant of the product’s family is requested, some classical steps (Figure 42) can be shunted in order to fasten the next simulation loops. Our methodology proposed to use our self-developed VBA macro “Paramesh” (i.e. parametric mesh) to update the mesh model without any CAD model modification during the simulation loop. This macro is based on the first generation of the mesh. The first mesh is classically generated and if necessary adjusted manually. This mesh is exported in order to be introduced in our Paramesh macro that modifies directly the mesh. Then, the new mesh generated by the macro is imported in the simulation software and the classical process is reused. The mesh is updated, simulation constraints applied to the mesh do not change usually and the simulation phase can begin. Our macro does not interact with the simulation constraints which stay in the simulation file. Then, their values can vary or a new set of simulation parameters can be used.

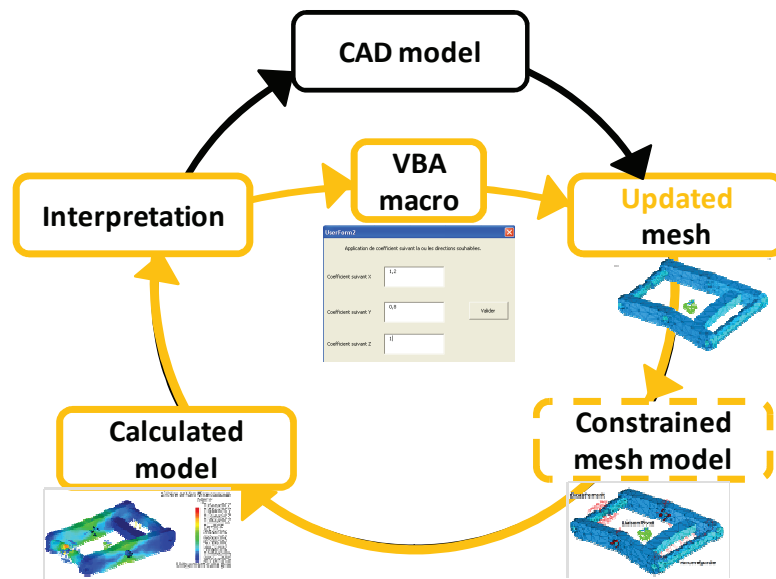

Figure 42. Loop of simulation with the Paramesh macro and a parametric mesh proposed in the FARD methodology

The use of the Paramesh macro allows the parametric mesh to be made/adjusted/modified. Then, it is possible to modify or optimise the geometry of the product without direct modification of the CAD model. An optimisation on geometric parameters can be used to find the best instance configurations. These configurations aim to fulfil both customer needs and technique requirements that allow the product's behaviour to be validated. Moreover, it is possible to test various mesh of the CAD models with the same simulation constraint configuration.

Another optimisation loop consists in creating sets of simulation parameters that are not modified by our macro. This loop can be used to find the behavioural limits of the product. With the same mesh, it is possible to test various sets of simulation parameters. For instance a product that has two possible positions (a horizontal and a vertical position) must be simulate in the both. However, the mesh is the same for the both simulations, only the simulation parameters and simulation constraints are different. Moreover, it is possible to simulate different sets of simulation parameters from various simulation domains with the same mesh. That is why a loop on the domains has been created. This loop represents all the domains by the "domain i" with i from 1 to n. "n" is the maximum number of domains simulated on a product.

Once the simulation results for a product are satisfactorily compared to the requirements, the 3D CAD model of the product can be updated, taking into account various homothety coefficients applied during the different simulation loops. Then, the geometry of all the products of the modular family can be defined with their corresponding validated behaviour.

The contribution of our FARD methodology in the multi-physics simulation topic is the parameterization of the meshed model. The classical simulation process needs to mesh again a CAD model every time the geometry change while our Paramesh macro allows using sets of geometric parameters to update the mesh model without a new meshing phase, after the geometrical modification in the CAD tool. Moreover, the simulation constraints are not

deleted during the update process of the mesh model. The simulation expert does not have to re-assign the simulation constraints (efforts, boundary conditions, etc).

Currently our VBA macro was developed in MS Excel software. A mesh file is imported by the macro in excel in a “dat” format from the 3D software CATIA. Our Paramesh macro allows the application of homotheties according to x, y and z axes. It is like a deformation of the mesh in three directions. The simulation expert indicates its three coefficient values in the macro window. The macro varies only the coordinates of the mesh nodes. The number of mesh cells is constant and is not modified. After the update of the coordinates, the user can save the new file in the same “dat” format or in a “Nastran” format which is a standard simulation format. The “Nastran” format can be used in all modelling and simulation software. Then, the mesh file can be imported into all simulation software.

In order to apply coefficients in the Paramesh macro, some rules must be respected depending on the geometry of the product or of a part of the product (if the product is not entirely simulated). Rules must be respected mainly when the geometry has symmetry features. For instance, the mesh is globally circular like a cylinder (Figure 43). The circle is on the plane of the axes x and y. Then, the coefficients applied on x and y must have the same value. This ensures a minimum of deformation of the circularity of the geometry. Otherwise the circle will turn into oval form. This is the same rule for a pipe or any similar geometry.

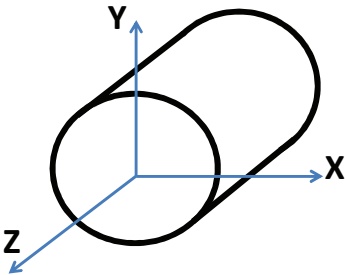

Figure 43. Circular geometry with a circle in the axes x and y

As a cylinder, a parallelepiped must respect some rules not to be deformed. In the form shown in Figure 44, x and y coefficients must have the same value to conserve the initial square form.

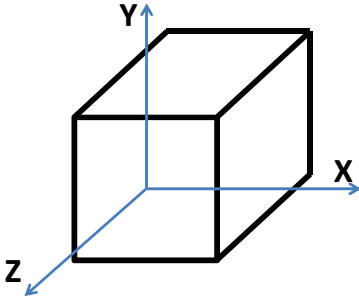

Figure 44. Parallelepiped geometry with a square in the axes x and y

This kind of rule requesting the same value into two coefficients is also available for every symmetrical or circular geometry like a pipe, a mechanical beam, etc.

Our approach with a macro is limited to some very simple products and to some specific use cases. But with these cases, the simulation expert can free up time. He/she is not obliged to mesh again his/her geometry for each modification of the geometry before a new simulation. However, this approach requires specific preparatory work. The geometry must be designed according to the axes x, y and z. It is on these axes that the homothetic coefficients are applied. Currently it is not possible to apply a coefficient on another axis.

Another benefit of this macro consists in its multi-context of application. In our FARD methodology, our Paramesh macro can be applied to refine a CAD model in a modular family context. But this macro can be used independently of our methodology. Indeed, our macro can help a simulation expert in pre-dimensioning process of various types of product. It could be a unique product, without family context. But the simulation expert must be careful not to apply too large coefficients. In this case, the mesh will not be suitable to a new simulation because it will be too distorted or too large. The mesh dimension has an important influence on the simulation results.

Our macro for mesh parameterization allows time to be free up by the direct modification of the mesh without modification of the CAD model and meshing it again. Moreover, this macro can be used in other contexts (not a modular context with parametric CAD model). For instance it can be used to optimise a simulation that requires small variation of the simulation model. This is also possible thanks to the file format which is standard. Moreover, our Paramesh macro can modify every type of meshing cells such as linear, parabolic, tetrahedral... because of the modification of only the node position of the mesh. But our macro for parameterization of the mesh is limited to some use cases. For instance, coefficients applied cannot be too large because the model will be too distorted.

5 SECOND AND NEXT LOOPS OF THE FARD METHODOLOGY

As explained, the FARD methodology aims to develop modular products in the same family products. Then, the first application of the methodology allows defining a generic product which is the base for designing the next products of the family. Afterwards the next loops of the methodology generate the new modular products of the same family as the first generic product. To generate new products in the family, there are two possible cases:

- The new product has a geometry identical to the generic product with only a new set of instance parameters for one or more specific modules in order to fulfil new customer needs. These new parameters create a new variant of the product. In this case, the new customer needs to update the functional parameters that act on geometric parameters of some modules. Then, the steps number 1, 2 and 3 of the FARD methodology (Figure 12) can be avoided. New variants of specific modules are highlighted in the step number 4 of the FARD methodology and the CAD model is quickly updated thanks to its parameterization (step number 5). Finally, the step number 6 can be applied for validating the behaviour of this new version of the product.
- The new product has globally the same geometry as the generic product of the family but to fulfil new customer needs a specific module must be slightly different. Then, it is not possible to go directly to the step number 4 of the FARD methodology (Figure 12) insofar as some adjustments are necessary. In this case, the methodology must take the first step. But this is not like the first loop of the

model. It is more like an update of the first loop. Each step must be updated in accordance with the necessary modifications of the new product. But this work will be faster than for the first generic product. Indeed, just one part of the product changes, the other parts are identical. Finally, at the end of the loop, this new variant of product can be considered as a new generic product that is slightly different from the first generic product of the family.

6 SYNOPSIS

Our proposed FARD methodology is broken down into three main parts summarized as:

- A functional approach based on classical functional analysis combined with a modularity approach,
- A modular approach that takes into account assembly and functional constraints in order to create the most suitable generic product for the generation of modular product family,
- A simulation approach that aims to quickly simulate the behaviour of products.

The main objective of the FARD methodology is to generate in a “High Productive” way new products of a modular family. The design of new products must be created as fast as possible from a product considered to be a generic product (the basis of the product family design). Each module of the generic product must fulfil a function and should be as independent as possible from other modules. There are two types of modules: specific modules (to the origin of variants of the family) and standard modules (identical for all the products of the family). Then, a benefit is the delayed differentiation of the products applied for a mass customization strategy. A company that uses this methodology can prepare modules and finally operates the assembly operation at the last time, when a customer order is received. This allows a limitation of the number of components in the company and increases the number of standard components. Finally, there is a reduction of manufacturing costs for the products of the same family, a simplification of the administrative management of components (references, technical drawings, manufacturers for each component...) and a reduction of response time for a new order.

The main contribution of our work is the definition of a generic product for a modular family that respects as much as possible customer needs, assembly constraints and product structure. Our approach is a systematic design approach that combines two domains:

- The product domain (functional aspect and structural aspect) with the designer;
- The process domain (dynamic aspect) with the assembly planner.

At the crossing of the two domains, the product architect realizes the structuring of the product's architecture. Figure 45 summarizes schematically the various detailed aspects treated in this chapter with their interactions. This approach differs significantly from traditional DFA approaches used during the detailed phase of the design process. The strength of this early consideration is the time saved in modifying the design in order to better respect the assembly process. Moreover, the combination of DFA principles with functional design methods and tools, constitutes a novel approach for designing modular products in a High Productive design context.

PRODUCT DOMAIN

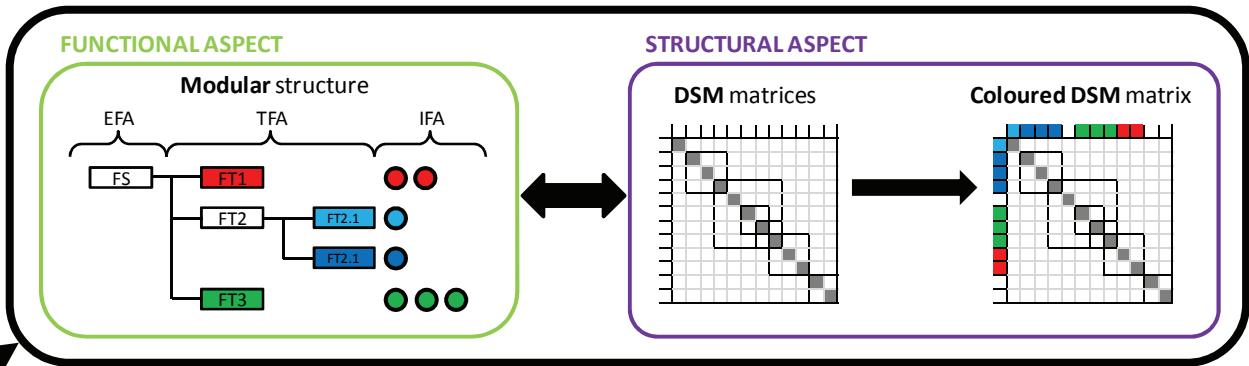

PROCESS DOMAIN

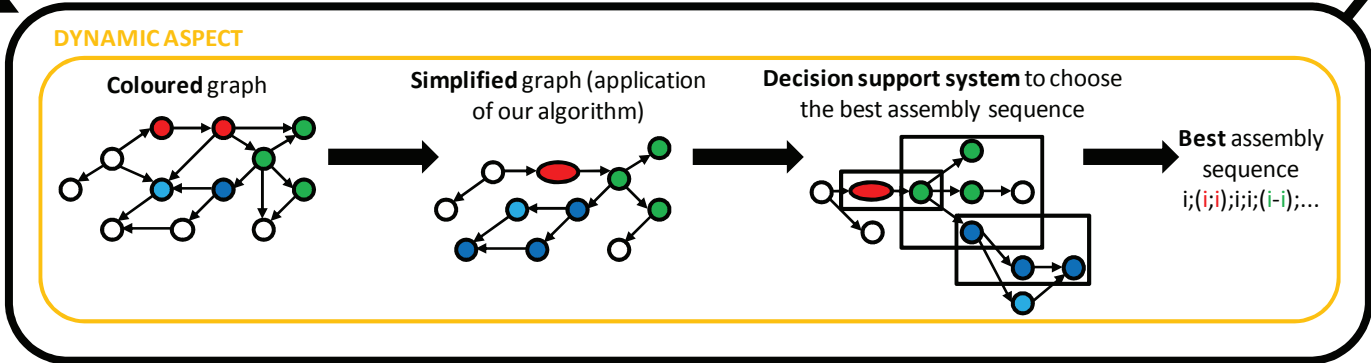

Initial structure for the Concept of the product (list of parts)



New Structure of the product

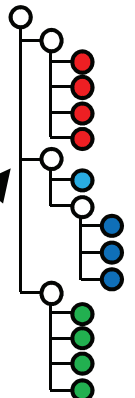

Figure 45. Scheme of our systematic approach for defining the product structure from a concept with a list of components

As shown in Figure 45, many concepts are considered in our approach. There are various steps that require technical knowledge specific to each concept. Then, the design stakeholders (designer, assembly planner and product architect) need a good level of expertise to apply our FARD methodology. The application of this methodology is manually possible by experts or users that are very well guided. So the automation of specific tasks is necessary and a software tool can provide assistance to users of the methodology. Moreover, some advice must be considered such as:

- From the beginning of the application of the External Functional Analysis -EFA and then the Internal Functional Analysis -IFA methods, the designer must keep in mind that his/her new product must be modular, following our definition of the “modular product” concept. This aspect is very important for the future design of the modular product. The design of a modular product is not performed in the same manner as the design of an integrated product.
- Only physical contact must be considered in the PP matrix. Non physical contact, like a flow between a transmitter and its receiver, must not appear in the PP matrix. Moreover, the designer must be careful of the soft components. We advise integrating soft components like wire into the list of components used for the generation of the PP matrix.
- Etc.

On the other hand, it is envisaged that all stages of the product design, modelling and simulation steps will be integrated to create robust understanding of a life-cycle oriented product solution for project team members that enables them to have all the required information (specifications, constraints, parameters...). The multi-physics simulation will be developed and tested through the definition of analytical models and also Finite Elements models, in order to validate the compliance with various standards (noise, vibration, etc...) and the robustness of the product family.

To sum up, our new FARD methodology will help to optimize the time spent in product design, modelling and simulation phases [Toussaint 2010] to foster innovation and increase the productivity of engineering teams, and consequently the competitiveness of companies.

The next chapter proposes some application cases in order to have a better understanding of our FARD methodology. The selected use cases present various levels of product complexity in terms of number of parts, type of project (two types are identified for our methodology), domains, etc. to validate the robustness of our approach whatever the use case.

Chapter 3

Academics and industrial experimentations

Chapter contents:

1	Introduction.....	99
2	The Scrap'Air range.....	99
2.1	Functional design approach.....	100
2.2	A new approach of modular design based on DFA.....	105
2.2.1	Definition of the best assembly sequence of the generic product of the range	105
2.2.2	Structure of the generic product of the product family.....	110
2.3	Configuration management of module variants and new products of the modular family	114
2.4	Towards a multi-physics design of the product	119
2.5	Comparison of results from the FARD methodology with the old product family	120
3	A family of biomimetic spy systems.....	121

3.1	Functional design approach.....	122
3.2	A new approach of modular based on DFA	125
3.2.1	Definition of the best assembly sequence of the generic product of the range	125
3.2.2	Structure of the generic product of the family	126
3.3	Configuration management of module variants and new products of the modular family	128
3.4	Conclusion.....	128
4	The “High Productive” simulation of a mountain bike	130
4.1	Summary of functional design approach elements necessary.....	131
4.2	Parametric and skeletal CAD model	133
4.3	The new approach of simulation proposed in the FARD methodology	134
4.4	Conclusion.....	138
5	Conclusion.....	139

1 INTRODUCTION

In this chapter, implementation of the FARD methodology is undertaken and secondly the validation of FARD is then conducted and described through the application of FARD in two types of design projects (redesign and first design as explained in the previous chapter). With three experiments (industrial and academic) the whole FARD methodology will be implemented. Figure 46 shows the relative scope covered within FARD and the design types of each case study experimentation.

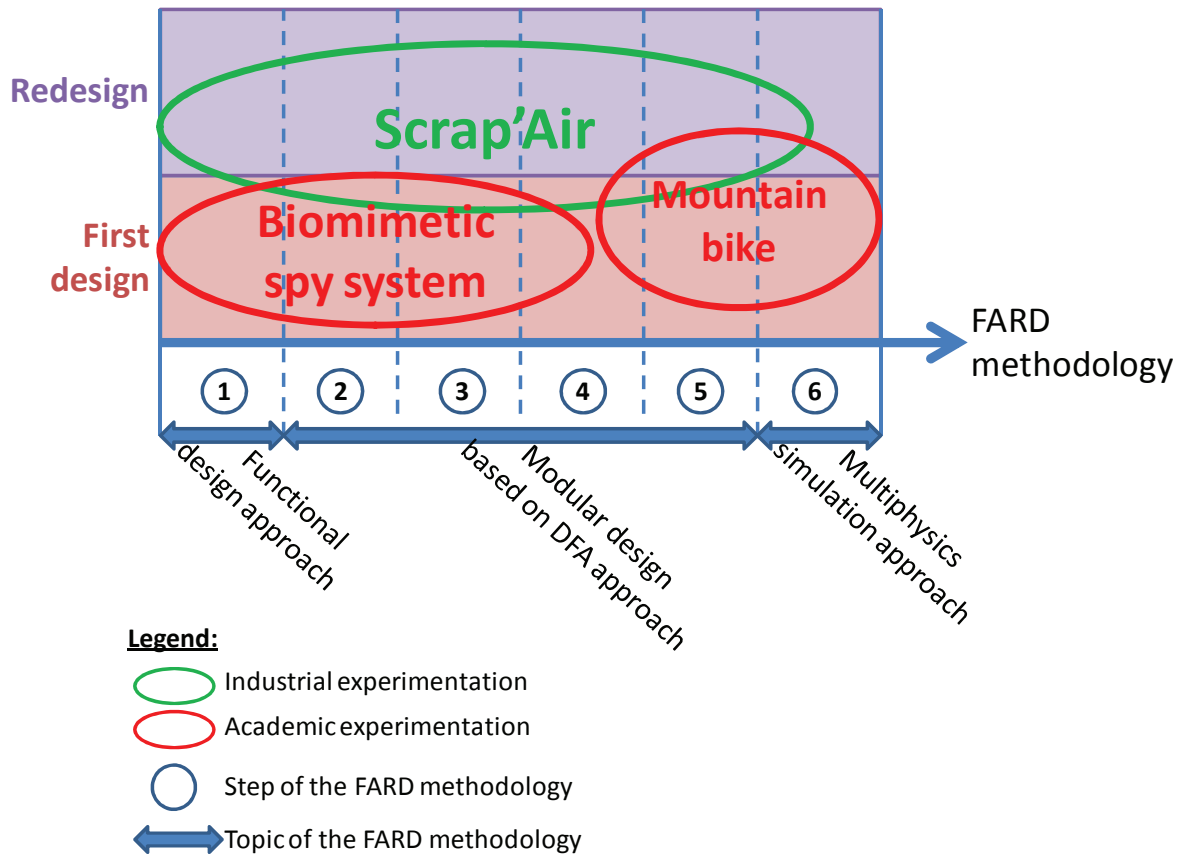

Figure 46. Positioning of the various experimentations

The number of the steps refers to the Figure 12 of the Chapter 2.

In the next section, the three experimentations are presented independently following the steps defined in the previous figure.

2 THE SCRAP' AIR RANGE

As explained previously, this case study is an industrial experimentation from the MABI Company. This product is within the scope of a redesign project with a small part of the product requiring a new design. The goal of this project is to design a range of modular products from various initial existing products shown in Figure 47 and to improve their performance, conditions of use and to reduce manufacturing complexity.



Figure 47. Old versions of products

The products used in this industrial case study experimentation are the Scrap'Air range of the MABI Company. The Scrap'Air products are pneumatic scraper. Depending on the force of the Scrap'Air, these tools are used for the removal of materials like walls or bitumen, commonly found in the renovation of facades, wood work, demolition, and other civil engineering work.

This case study is of a routine design nature, where there is a requirement for a partial new design, e.g. innovation on an anti-vibration system. Referring to the FARD methodology, the following process, shown in Figure 48, can be developed in this case study experimentation illustrating all the steps of the proposed methodology, except the multi-physics simulation aspect which is not very detailed.

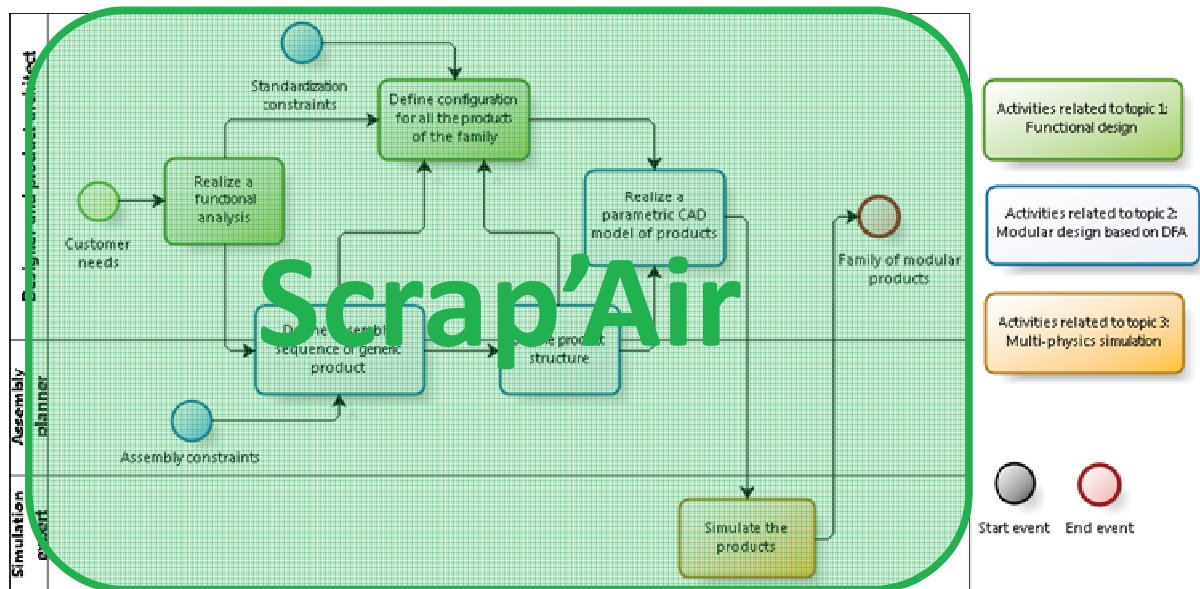

Figure 48. Positioning of the Scrap'Air experimentation according to the FARD methodology steps

2.1 Functional design approach

As described in Chapter 2, the first step of the FARD methodology consists of the definition of the functional design approach. This step begins with an External Functional Analysis (EFA) that allows the context of the design to be defined. Only the “use” phase of

the lifecycle of the products is studied because it is the most representative of the functions desired by customers. These pneumatic scrapers are used to take off any type of coating on floors or walls. They operate with compressed air and must comply with European standards. With all this information, the service functions (SF) and constraints (CONS) of the use can therefore be defined and developed as:

- SF1: allow the user to scrape off the coating with pneumatic power
- CONS1: protect the environment
- CONS2: respect the standards

These functions are defined by the EFA with a graph shown in Figure 49. This graph positions the product in its environment and represents interactions with it. For instance, in this case study, the user is in interaction with the product, especially since the “use” phase is the only one considered here. It is the phase during which the user uses the product.

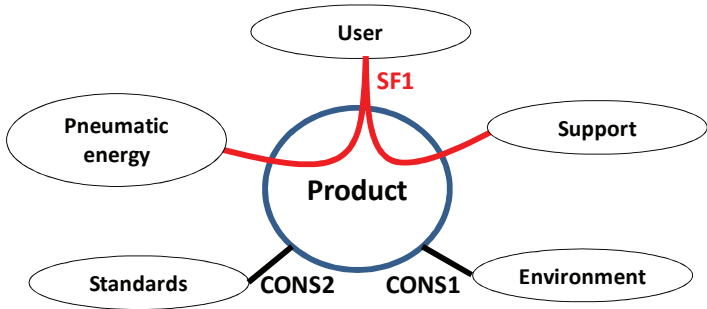

Figure 49. Graph for positioning the product in its environment

The next step of the proposed model is to break down each service function into technical functions (TF), using a FAST diagram. The results of such decomposition are illustrated in Figure 50.

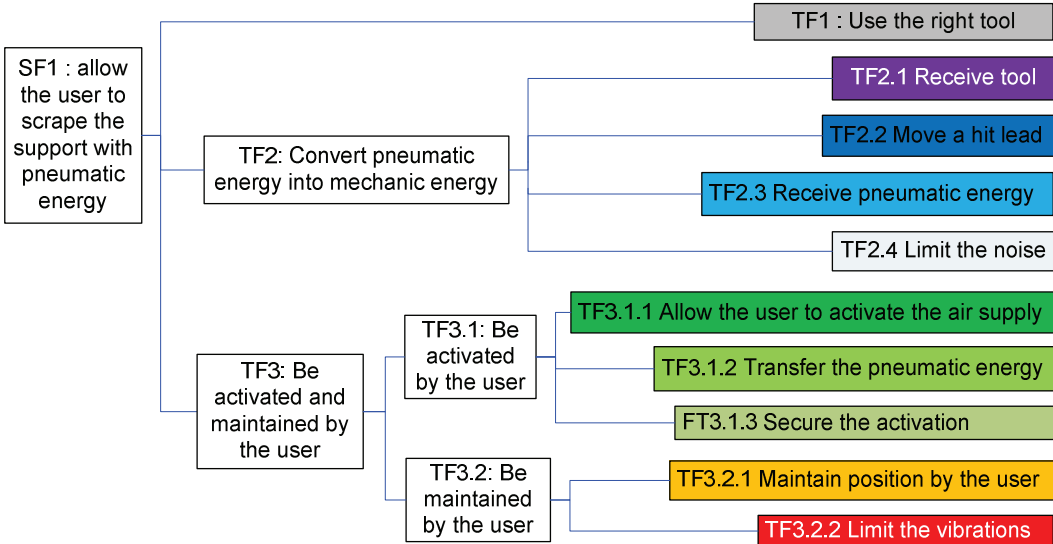

Figure 50. FAST diagram of the main function of a pneumatic scraper

This diagram should be formulated after consulting an expert on this type of product because this step is very important for the product modularity. It should also be checked by the entire team during the project. This diagram allows the architecture of the modular

product range to be sketched. The Function SF1 is decomposed into technical functions which are further decomposed into sub-technical functions. Each function and sub-function then corresponds to a set or subset of the product. While modules are defined as matching units with the technical functions of the FAST diagram, the modular architecture begins to take shape. If the diagram has more than one SF, it is necessary to reinvestigate the diagram in order to adapt it so that it has only one main function by regrouping all the other functions. Moreover, constraints are not specific to certain parts of the product but are applicable globally. Following the above process, the first FAST diagram corresponding directly to the modular architecture of the product range can be generated as shown in Figure 51.

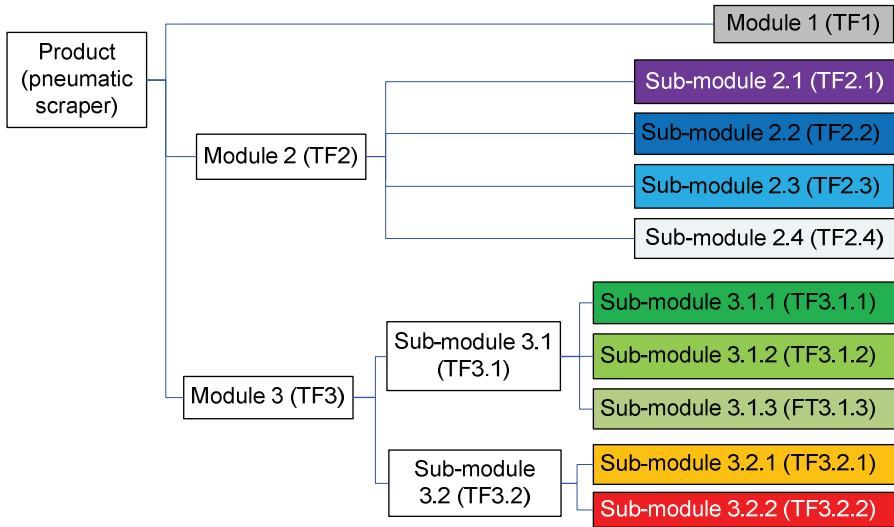

Figure 51. Modular architecture for new products of the modular range of pneumatic scrapers

From this modular architecture, a designer can begin his/her reflexion on the product design. To help him/her, a graph is proposed and depicted in Figure 52 where modules relative to each other are positioned in the product environment which is defined by the EFA. Figure 52 shows the parallel between the three sub-functions of the SF defined in the FAST or the three modules, TF1, TF2 and TF3 defined in the modular architecture in Figure 51 and the EFA in Figure 49. This is the result of the combination of these modules.

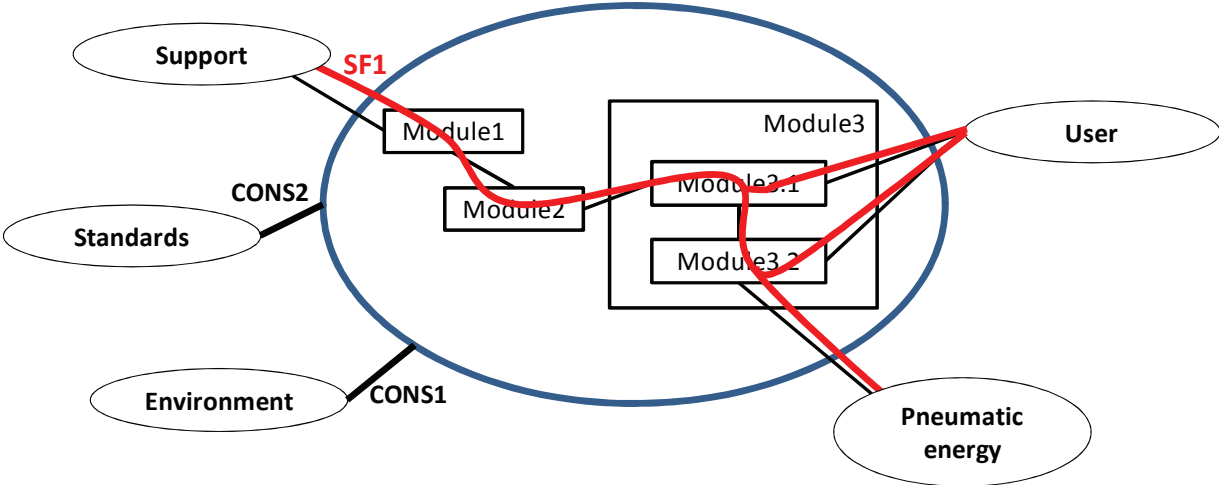

Figure 52. Representation of the modular architecture of a product like its FBD

From the previous information, in the FARD method context, designers work on concepts to develop new products. From this concept, it is possible to determine the product structure with the Engineering Bill Of Materials (E BOM) of product components. However, geometry, the material choice for each part, and dimensions are not yet well defined. A concept represents a high level definition and idea of the product, but it doesn't detail all required information for full product description. Specific for this case study, it is required that this concept take into account the modular goal of the range. This product concept should therefore simply be a sketch drawn freehand as shown in Figure 53. This first sketch of the concept can be completed by another detailed sketch of specific parts like Figure 54 or a kinematic scheme or description from the author or etc.

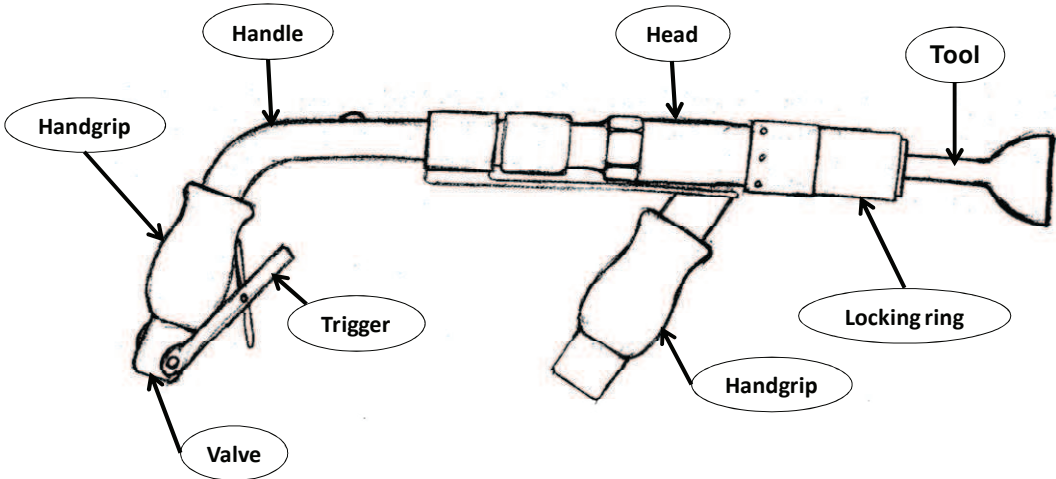

Figure 53. Sketch of a product concept of a pneumatic scraper

In this previous sketch, some components are not sufficiently detailed and for instance the valve part and the components inside are not fully specified. For a better understanding, Figure 54 shows a sectional view of the valve part.

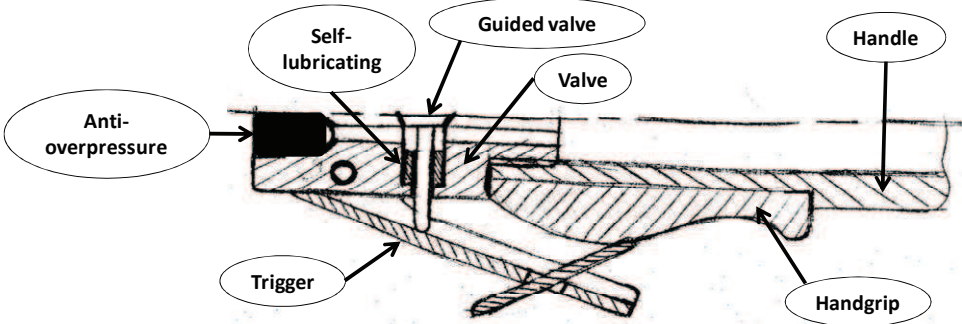

Figure 54. Details of the components of the valve part of the concept

To simplify the sketches which follow, all parts are replaced by a number as presented in the Table 3 below.

N°	Name	N°	Name	N°	Name
1	Tool	14	Head fitting	27	Valve handgrip
2	Support ring	15	Head axis	28	Trigger screw
3	Head ring	16	Self-lubrication	29	Valve handgrip
4	Locking ring	17	Anti-vibration system	30	Trigger spring
5	Head spring	18	Handle O-ring	31	Trigger security
6	Head O-ring	19	Handle screw	32	Guided valve
7	Pin	20	Handle screw O-ring	33	Self-lubricating bushing
8	Balls	21	Handgrip support	34	Guided valve O-ring
9	Clip	22	Handgrip	35	Guided valve spring
10	Tool fitting	23	Tip	36	Stopper
11	Head	24	Screw	37	Cuff
12	Lead	25	Handle	38	Anti-overpressure
13	Noise reduction system	26	Valve	39	Stopper O-ring

Table 3. List of all components of the pneumatic scraper concept considered in this case study

In the previous section, an external functional analysis was conducted. The functions to be fulfilled by different products of the range are identified. At this stage, a product concept has been defined. It is then possible to define which parts contribute to the realisation of the main function for the desired range which is shown in Figure 55.

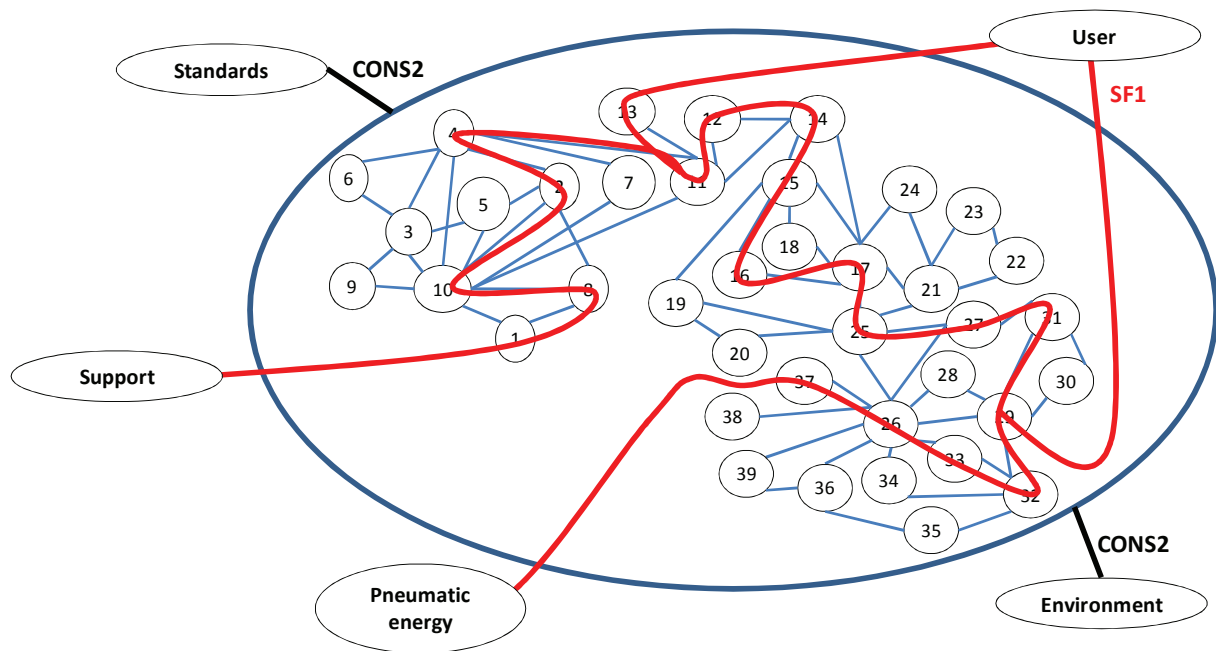

Figure 55. IFA of the concept of pneumatic scraper according to the SF defined in the EFA

Starting from the concept definition, it is then possible to link, with a colour, the TFs and components which represent the contribution of individual parts to the main function. This is possible because all components that participate in the contribution to the realisation of the SF are known and shown in Figure 55. The distribution of parts into different technical functions of the FAST diagram can also be executed. It is the result of gradual decomposition and function mapping. This is possible because a modular structure is developed, where each part can contribute to only one TF as opposed to an integrated design. Figure 56 below shows the attribution of colour to some components which participate in a TF. By using colours, they are linked for the next steps of the methodology proposed.

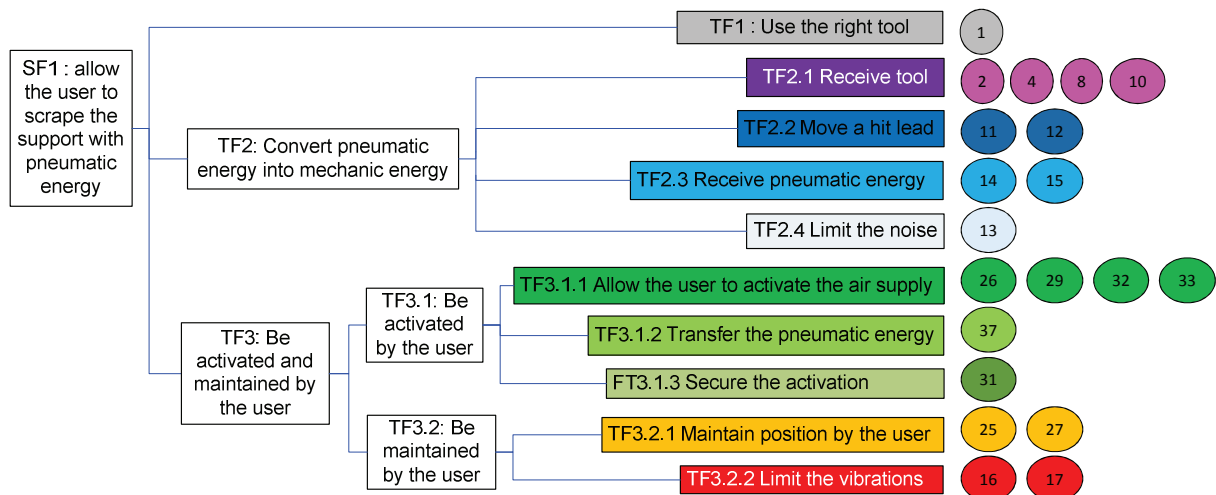

Figure 56. Some coloured components linked by a TF using an IFA of the product

The defined colouration guides the choice of the most suitable assembly sequence for the valve part of the range of products in the next steps.

2.2 A new approach of modular design based on DFA

2.2.1 Definition of the best assembly sequence of the generic product of the range

As described in section 3.1 of Chapter 2, the definition of the best assembly sequence of the generic product of the range uses two parallel processes that interact together. The next sections present these processes applied to the case study.

2.2.1.1 Process 1 of the methodology for generating eligible assembly sequences

From the concept and its E BOM it is possible to generate the PP matrix. This matrix represents physical contacts between parts of a product. When a contact is detected between two parts, the corresponding boxes of the matrix are coloured. This identification is manually done by the designer to show the process and can be automated. Figure 57 shows the PP matrix of the pneumatic scraper.

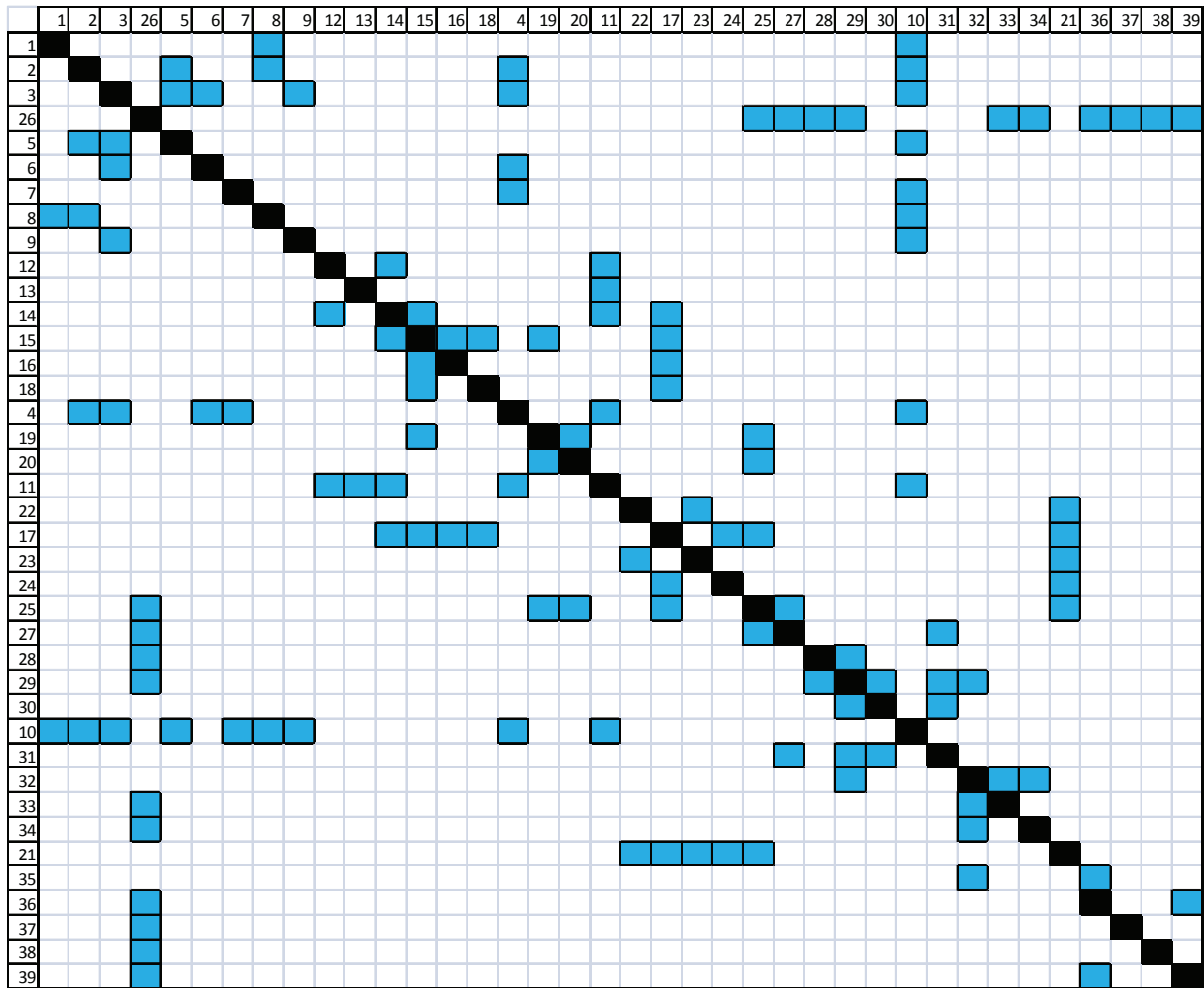

Figure 57. PP matrix of all components of the pneumatic scraper used for this case study

As described in section 3.1 of Chapter 2, the next step of Process 1 is to simplify the PP matrix with assembly planner information. This involves the definition of groups of two specific components to be considered as only one component during the next steps. For instance Components 3 and 6, respectively the head ring and the head O-ring, are considered as one component. There is no real assembly precedence between them. It is the same for singular examples of two parts such as:

- Parts 17 and 18 (Part 18 takes the colour of Part 17);
- Parts 30 and 31 (Part 30 takes the colour of Part 31);
- Parts 32 and 34 (Part 34 takes the colour of Part 32);
- Parts 19 and 20; 36 and 39.

Moreover, the PP matrix is partitioned to create blocks of components which are the most independent of each other. Blocks represent sets or subsets of components with one or more interface parts linking different blocks together. Finally, the colour information defined previously is implemented in this matrix and colours of some components are spread to some non-coloured components according to well defined rules (refer to the explanation of the methodology). The results of this partitioning are presented in Figure 58.

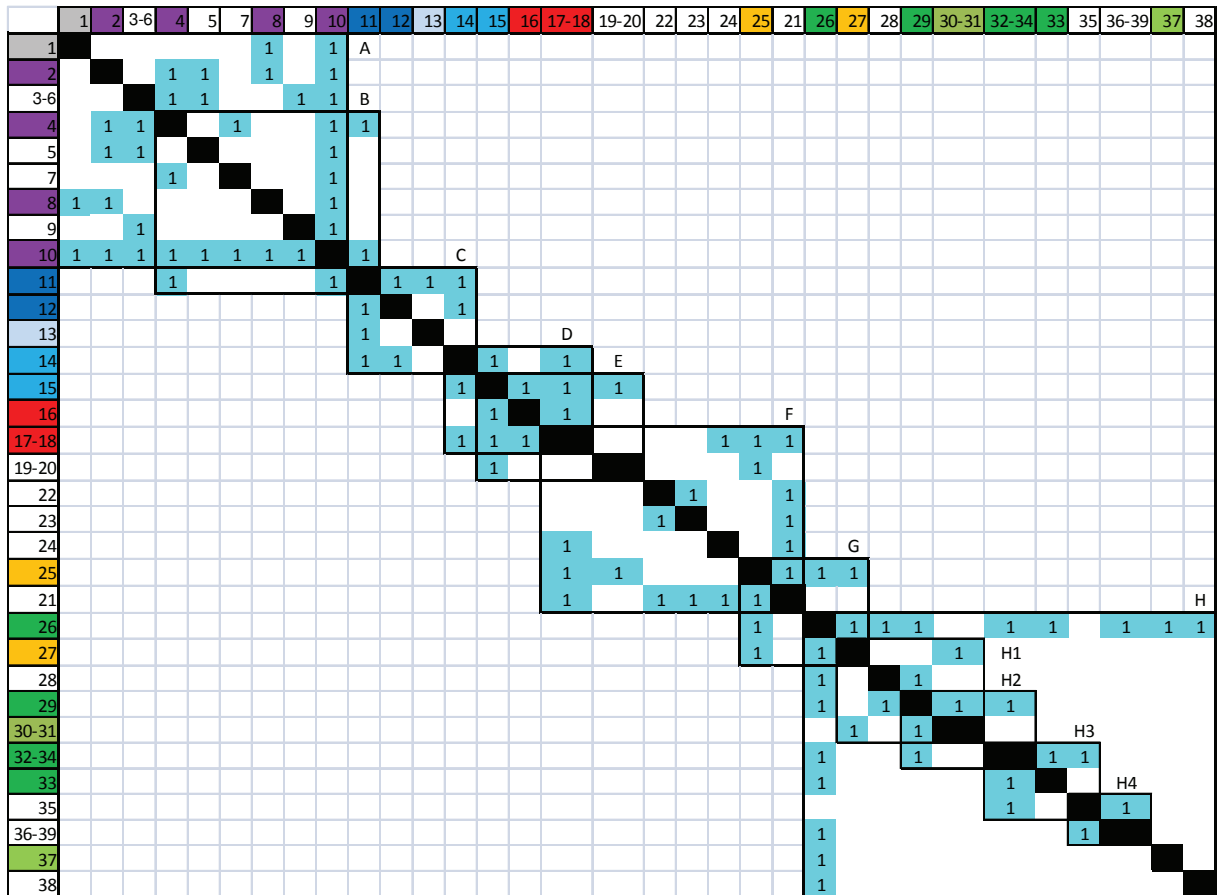

Figure 58. Partitioned PP matrix with assembly planner simplifications and blocks with spreading of the colour

To simplify the next steps, a name (a letter, with a number if it is a sub-block like the sub-block H1 that is a sub-block of the block H) is attributed to each block.

At the end of this step, it is possible to move to Process 2. All necessary information such as assembly planner simplifications, colours of components and links between them is already known.

2.2.1.2 Process 2 of the methodology for generating eligible assembly sequences

Due to the simplification of the partitioned PP matrix, the contact graph depicted in Figure 59, can be automatically generated. Each node represents a component or a group of two singular components and each solid line represents a physical contact between two of them. Colour information and assembly planner simplifications are also affected in this new graph. This graph is similar to the FBD in the IFA. However, there is no information about the use context of the product and colours and assembly simplification are added.

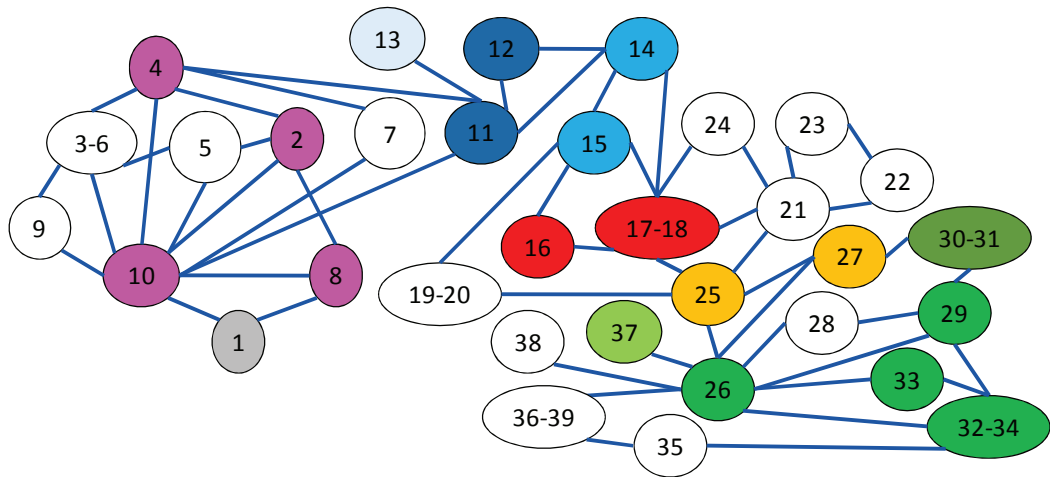

Figure 59. Contact graph from the PP matrix with assembly planner simplifications

On this contact graph, the assembly planner can add the assembly order between components which are already in contact and precedence relationships without physical contact. The graph obtained is a direct graph with coloration and assembly planner simplifications (Figure 60).

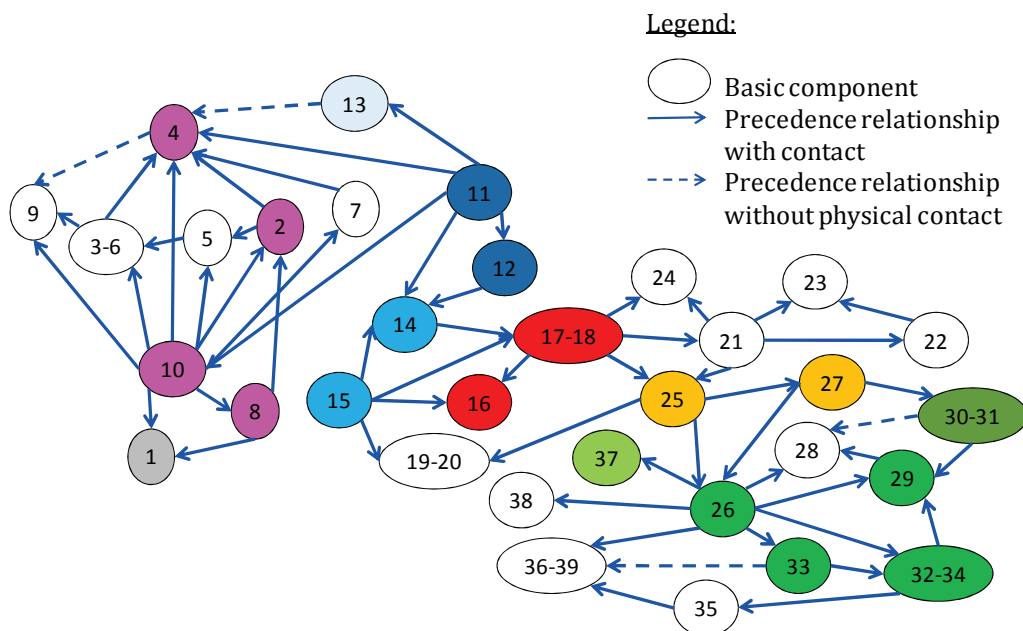

Figure 60. Direct graph with coloured components and assembly planner simplifications, of the concept of pneumatic scraper

An algorithm is used on this last graph with assembly information. After cycle detection, transitive reduction and patterns detection and the precedence graph, Figure 61 is obtained. During this process, the assembly sequence is generated by applying the algorithm. For instance, Part 11 must be assembled before Parts 12 and 14. But Part 14 cannot be assembled if Part 12 has not been assembled before. So the relationship between Parts 11 and 14 is redundant with the relationship between Parts 11 and 12 and the relationship between Parts 12 and 14. So the relationship between Parts 11 and 14 can be deleted. The next step of the algorithm consists in the identification of patterns according to the criteria defined in the methodology section. For instance, the Pattern (15;14) is detected.

It is a serial assembly pattern. It is composed of two parts of the same colour corresponding to the technical function TF2.3. Then, Parts 15 and 14 are contracted in the same node of the graph with a new label (15;14) which respect the precedence link between the two parts, and the graph is simplified.

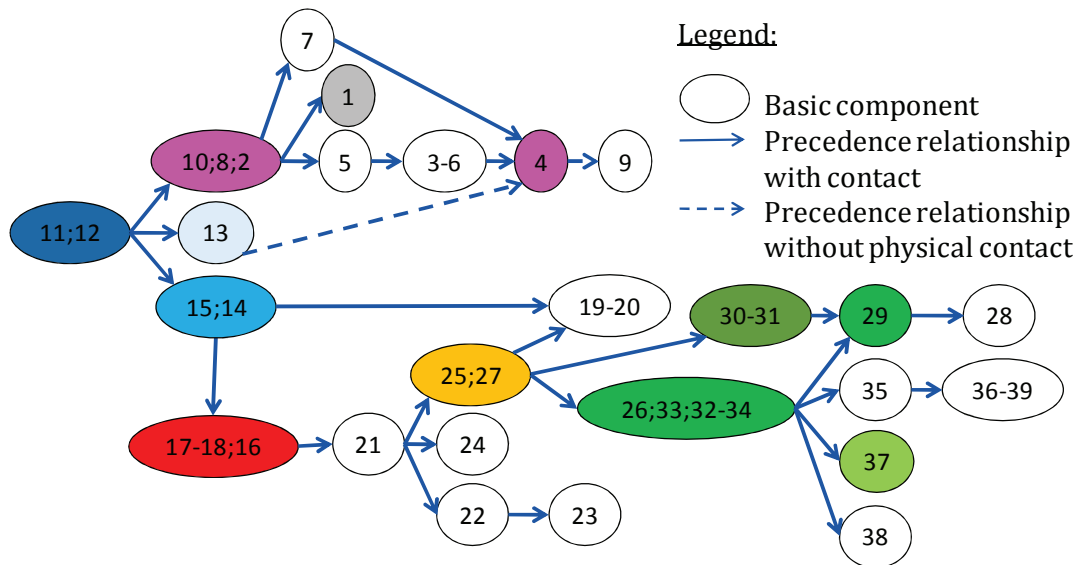

Figure 61. Direct graph with simplifications of the graph generated by the algorithm

From this last graph, it is possible to generate all the eligible assembly sequences. But to help the assembly planner in the definition of the best assembly sequence for the product, a decision support system is proposed. Figure 62 shows the beginning.

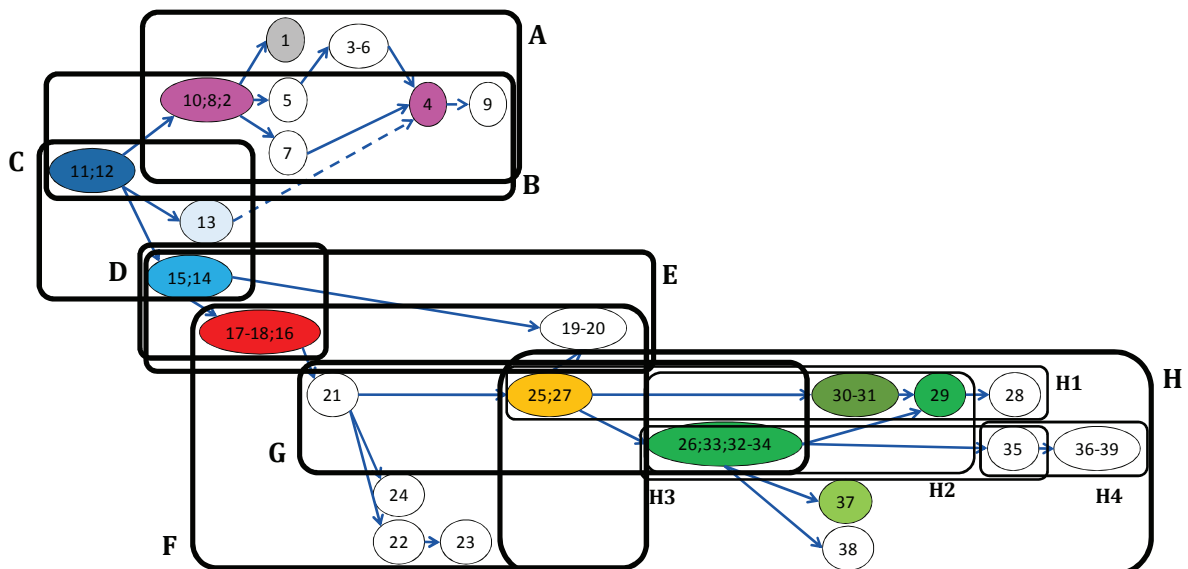

Figure 62. Graph with blocks to start the decision support system for the definition of the best assembly sequence

Here is the description of the first steps of the decision support system:

- Parts (11;12) are not proposed because they represent the only possibility for beginning. Then, the system directly proposes the next choice.

- Step 0: 3 possibilities between Parts (10;8;2), 13 and (15;14). These three possibilities have the same weight according to the decision criteria. Indeed, they are all in a block with (11;12) and all have their own colour.
- Decision 0 of the assembly planner: Parts (15;14).
- Step 1: Three possibilities between Parts ((17-18);16), 13 and (10;8;2). Parts ((17-18);16) are proposed first because they are in the same Block D as Parts (15;14) and there is a precedence relationship with contact with (15;14). Secondly Part 13 is in Block C (the same as (15;14)). Finally, Parts (10;8;2) are proposed because they do not share a block and they are not directly linked.
- Decision 1 of the assembly planner: Part 13.
- Step 2: 2 possibilities between Parts (10;8;2) and ((17-18);16). There is no preference between them.
- Decision 2 of the assembly planner: Parts (10;8;2).
- Step 3: 4 possibilities between Parts 1, 7, 5 and ((17-18);16), etc.

The assembly planner uses his/her knowledge and the decision support system to choose the best assembly sequence: {(11;12);(15;14);13;(10;8;2);5;(3-6);7;4;9;1;((17-18);16);21;22;23;24;(25;27);(19-20);(26;33;(32-34));35;(36-39);(30-31);29;28;38;37}.

As one can see, the assembly sequence of the products has a good degree of modularity because few colours are mixed together. This degree of modularity is very important for the next steps. It allows separating modules from each other during the assembly phase in order to have modules that can be assembled independently and then assembled together for the last time (when there is a sale).

Finally, an assembly sequence is generated, which is the most suitable for the product under consideration in this case study and according to the knowledge of the assembly planner. The assembly planner is guided during his/her choice by the decision support system. Using the algorithm, this system informs the assembly planner of three main constraints:

- The functional architecture to respect modular structure of the product by a link of colours;
- The product structure with blocks of components defined with the DSM matrix;
- The assembly constraints with relationships between components and assembly planner knowledge.

The decision support system guides the assembly planner by proposing choices ranked in accordance with these constraints for selecting the most suitable assembly sequence. But, at any time, he/she can also choose another more suitable solution according to his/her knowledge of the assembly process of the particular company.

2.2.2 Structure of the generic product of the product family

From the assembly sequence of the generic product for the modular family, the FARD methodology proposes to define the product structure. This structure aims to define groups of components that correspond to modules and sub-modules and can be assembled independently. As presented in section 3.4 of the chapter 2, the algorithm for structuring the product is used. It relies on the assembly sequence, the coloured and direct graph and the modular architecture. It tries to divide components into the first level of the modular architecture in accordance with the way of the assembly sequence and the contacts between

components. To illustrate the first step of the algorithm, the coloured and direct graph is adapted in Figure 63 to show the path of the assemble sequence and each coloured components is linked to its module by a specific node geometry. In Figure 63, the way of the assembly sequence is represented by a red arrow (order to assemble the components and indication of the first and the last components). The links between coloured components and modules come from the graph Figure 56 defined during the previous steps of the FARD methodology. The following figure shows the combination between these various constraints.

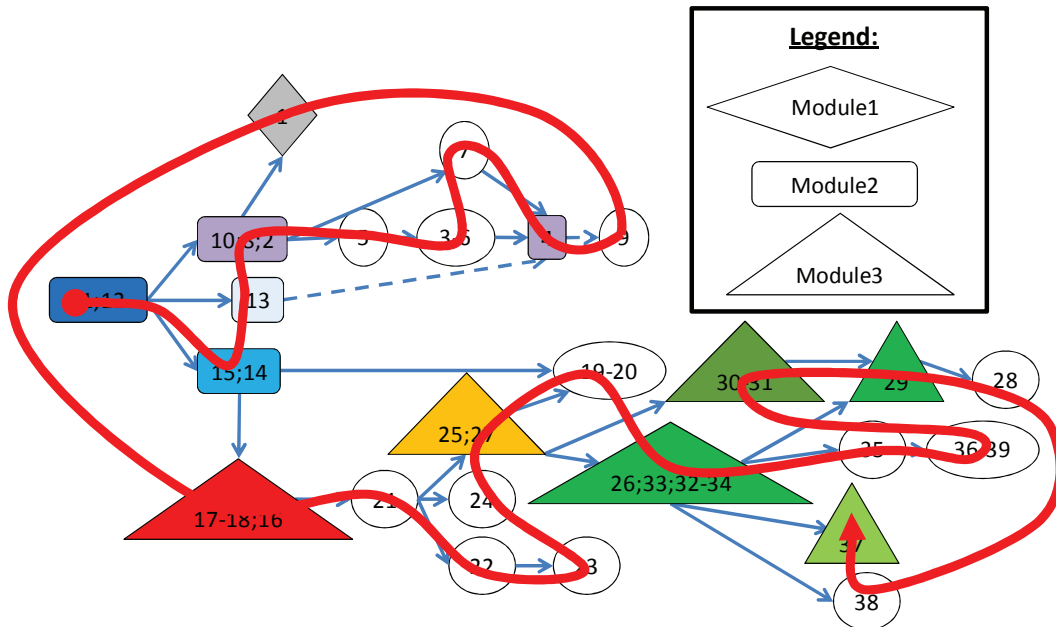

Figure 63. First step of the algorithm for structuring the product

From this first step, it is possible to attribute components to each module (Figure 64). If it is not possible to attribute a component to a specific module, according to the rules defined in section 3.5 of the chapter 2, it is attributed to a module without colour (named “Components without module link” in Figure 64).

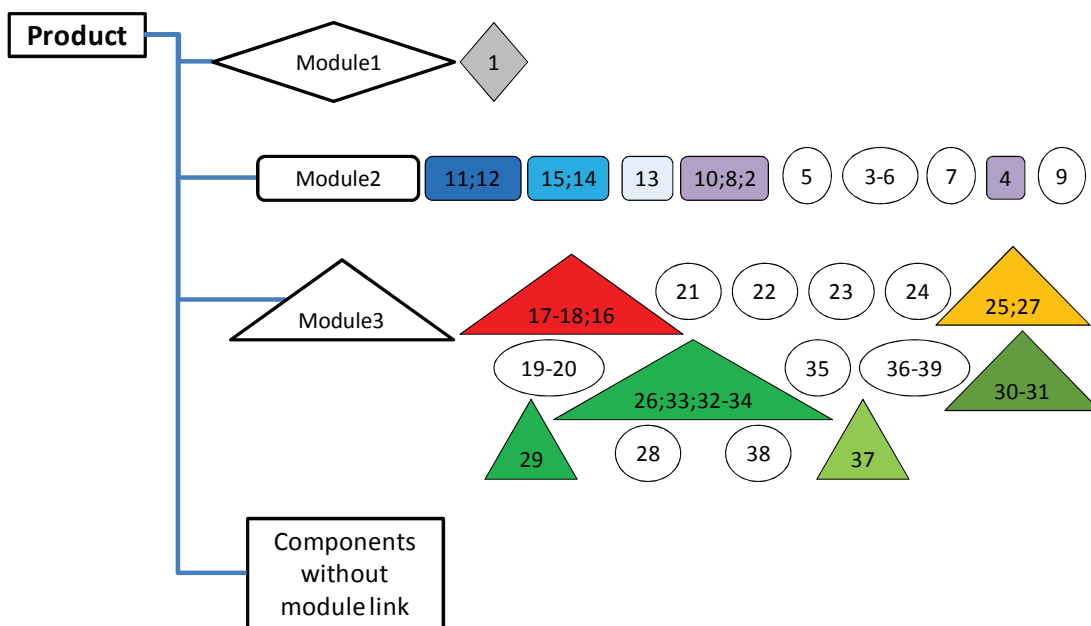

Figure 64. Beginning of the product structure with components allocated to modules (first level of the modular architecture)

In the first step of the product structuring, all components are divided into the three modules. Then, the algorithm repeats the same procedure in each module to share the components of each module into their sub-modules.

If a focus is placed on the module 3, components are divided into the two sub-modules 3.1 and 3.2. In this case, all components are shared to a module and so in the lower level of the modular architecture. So there are no non-assigned components and in the sub-module without colour, in the same level of the sub-modules 3.1 and 3.2 of the module 3. But in the sub-modules of the sub-module 3.2, components are not assignable to a sub-module. Then, there are some non-assigned components and so in the sub-module without colour (Figure 65).

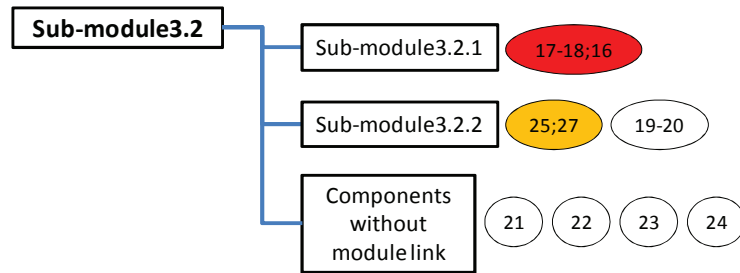

Figure 65. Example of components not assignable to a sub-module and without colour

The algorithm does the same with all modules and their sub-modules until the lower level of the modular architecture of the product. Then, a proposal is made (Figure 66) to the product architect. In this proposal, all components are not allocated to a lower level sub-module. The product architect will decide where to assign them.

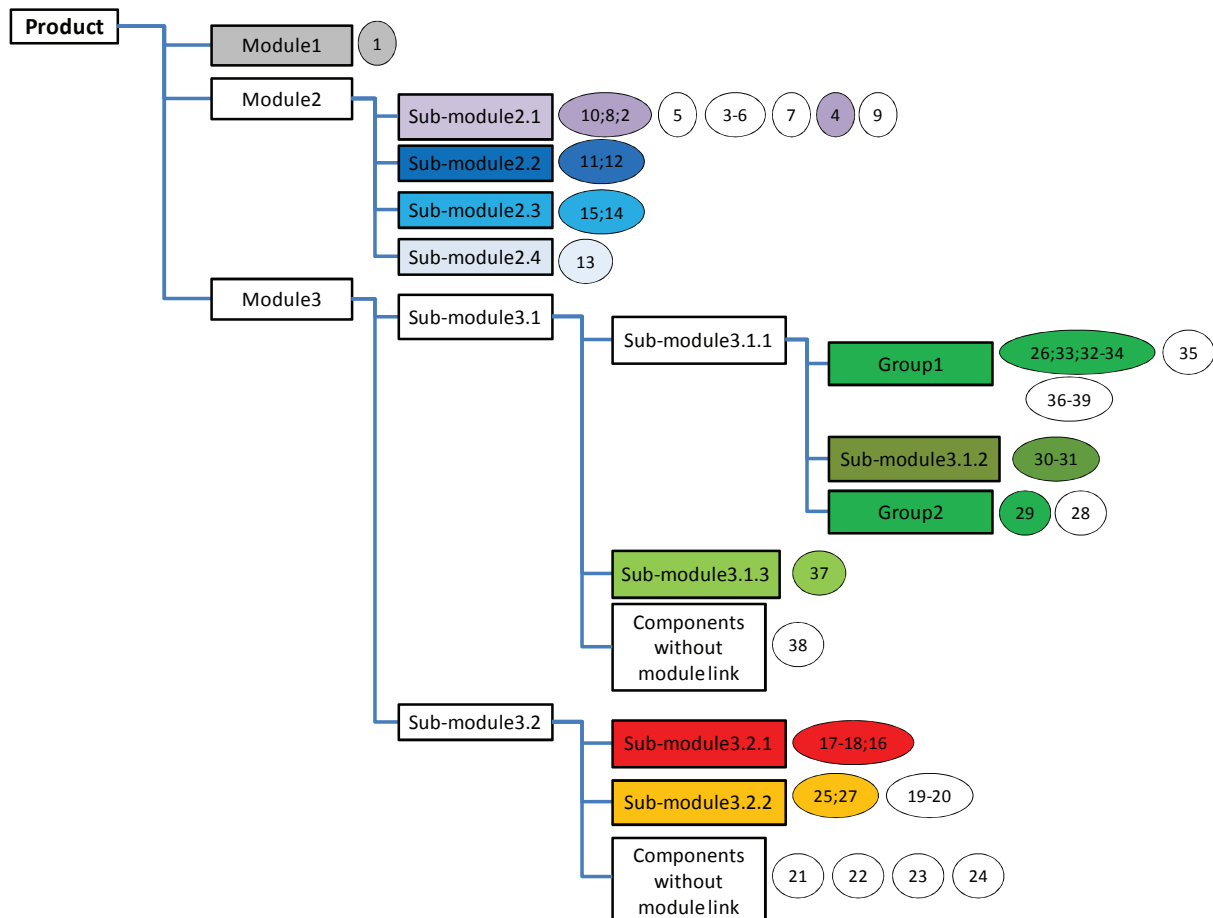

Figure 66. Product structure proposal of the algorithm for the product architect

As shown in Figure 66, some sub-modules are repositioned in another sub-module. This happens when two sub-modules are intermixed together for instance. Then, a sub-module can contain another sub-module and its components are grouped into one or more component sets inside. The displaced sub-module and the component sets are well separated from each other. Moreover, some groups of components can be added in order to simplify the manufacturing or the assembly phase or etc like in the Sub-module3.2.2.

From the previous proposal, the product architect defines the position of components not assigned to a sub-module. Finally, the product architecture is obtained in Figure 67.

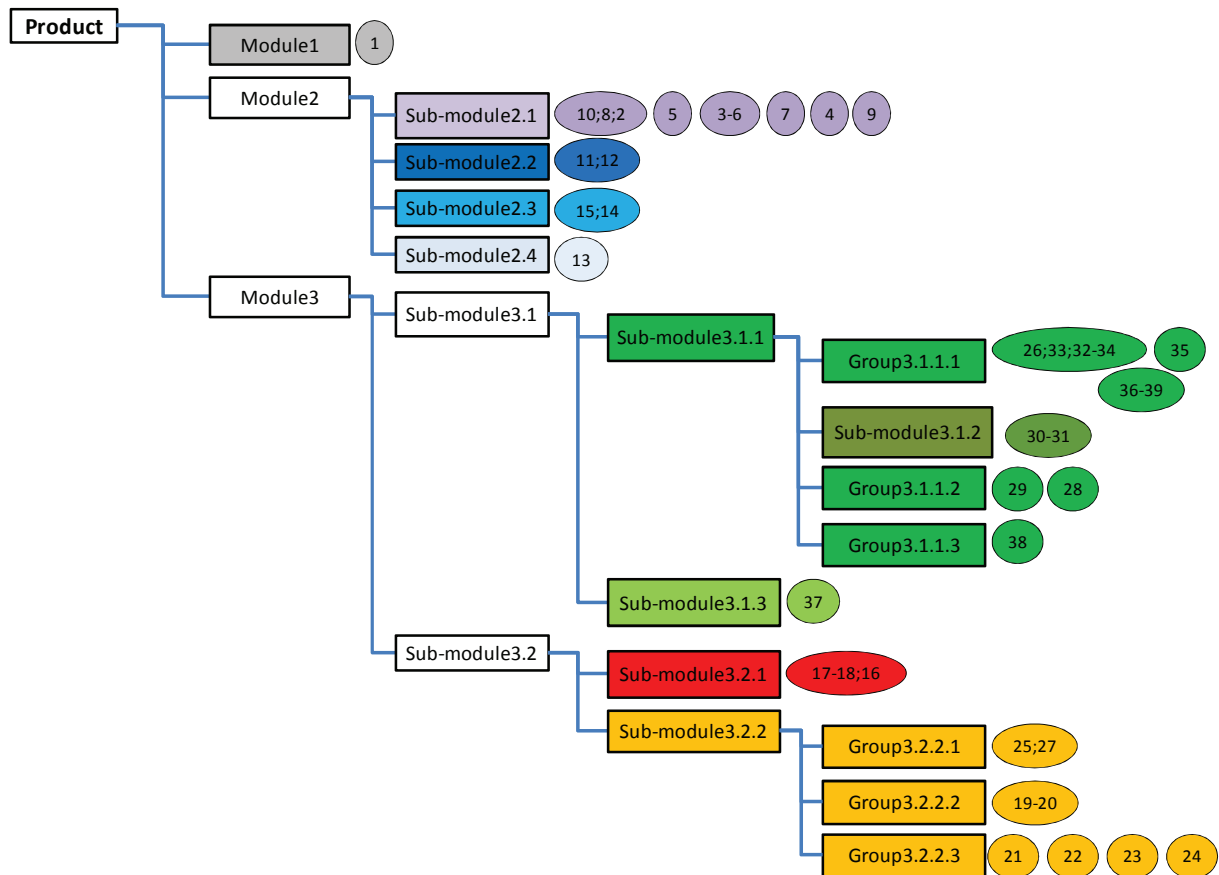

Figure 67. Final product architecture of a pneumatic scraper

From this product architecture, the assembly sequence of the modules and sub-modules can be generated. In this case study, it is: {Module2; Module1; Module3}. Each module of the product is well separated from the other, so an assembly sequence of each module can be generated independently:

- Assembly sequence of the module2: Sub-module2.2; Sub-module2.3; Sub-module2.4; Sub-module2.1.
- Assembly sequence of the module3: Sub-module3.2; Sub-module3.1 with new sub-assembly sequences:
 - Assembly sequence of the sub-module3.2: Sub-module3.2.1; Sub-module3.2.2 with another sub-assembly sequence:
 - Assembly sequence of the sub-module3.2.2: Group3.2.2.3; Group3.2.2.2; Group3.2.2.1.

- Assembly sequence of the sub-module3.1: Sub-module3.1.1; Sub-module3.1.3 with another sub-assembly sequence:
 - Assembly sequence of the sub-module3.1.1: Group3.1.1.1; Sub-module3.1.2; Group3.1.1.2; Group3.1.1.3.

The whole detailed module assembly sequence is: {Sub-module2.2; Sub-module2.3; Sub-module2.4; Sub-module2.1; Module1; Sub-module3.2.1; Group3.2.2.3; Group3.2.2.2; Group3.2.2.1; Group3.1.1.1; Sub-module3.1.2; Group3.1.1.2; Group3.1.1.3; Sub-module3.1.3}.

The main interest of this decomposition of the assembly sequence of the product into module assembly sequence is the parallelization of the assembly tasks. It is possible to define parallel assembly stations that can work at the same time on various modules and sub-modules that are assembled at the end to create a product according to customer needs. This module assembly sequence must be examined by the assembly planner to define exactly which module and/or sub-module can be assembled separately from the other. This step needs assembly expert knowledge. The assembly planner can use the direct graph to determine parallel tasks.

In this case study, the assembly planner considers that Module1, Module2 and Module3 can be prepared separately before being assembled together. Other sub-modules in each module can be assembled separately. To define the separation between modules, he/she can use the direct graph that represents contact between components. If there is no direct contact between the last component of a module or sub-module with the first components of the next, he/she may consider making these modules or sub-modules parallel. This operation can be done automatically but needs verification from the user to be sure it is quite possible. For instance Sub-module2.2 and Sub-module2.3 can be prepared separately before being assembled together. More generally, it is possible to assemble all modules and sub-modules independently except Sub-module2.1, Group3.2.2.2, Sub-module3.1.2 and Group3.1.1.2 that are too connected with the other modules and sub-modules and must be assembled during the product assembly. They are mainly linked components.

2.3 Configuration management of module variants and new products of the modular family

To help the designer and the product architect, a table is used to highlight specific elements of the product. For each lower level of the modular architecture of the product, they define if it is a standard or specific element of the family, as shown in Table 4. To fulfil this table, they rely on customer needs and their future evolutions.

				Standard/common	Specific
Module1					X
Module2		Sub-Module2.1		X	
		Sub-Module2.2			X
		Sub-Module2.3		X	
		Sub-Module2.4		X	
Module3	Sub-Module3.1	Sub-Module3.1.1	Group3.1.1.1	X	
			Sub-Module3.1.2	X	
			Group3.1.1.2	X	
			Group3.1.1.3	X	
	Sub-Module3.1.3		X		
	Sub-Module3.2.1		X		
	Sub-Module3.2	Sub-Module3.2.2	Group3.2.2.1		X
			Group3.2.2.2	X	
Group3.2.2.3				X	

Table 4. Definition of standard and specific elements of the family to create variants of products

From this previous table, it is then possible to highlight the standard or common and specific modules and sub-modules. In this case study, Module1, Sub-Module2.2 and Sub-Module3.2.2 can be considered as specific for the family. Variants of these elements will allow the creation of the various products of the modular range. Moreover, if all the sub-modules or groups of a module or sub-module are common, this module or sub-module may not require subsequent decomposition. It could be generalized and its sub-modules merge. But this is possible even if there is no need for this decomposition during the assembly phase or other phase.

As specific elements are known, it is possible to create variants of each of them in accordance with the functional parameters. Main functional parameters of the family are: product energy (15 to 35 Joules), total lengths (500, 800, 1000 and 1500 mm), weight (< 10 kg), costs (< 500 euros), noise (< 85 dBA), vibrations (< 5 m/s²), etc.

For instance, the Sub-Module2.2 “Move a hit lead” is included in the Module2 “Convert pneumatic energy into mechanical energy”. Module2 corresponds to the definition of the energy, the noise level, etc. But noise level is not variable, compared to the energy that could be specific to each product of the family. Sub-Module2.2 allows the variation of the energy as shown in Table 5.

		Functional parameter
		Energy (Joules)
Variants	Sub-Module2.2, A	15
	Sub-Module2.2, B	25
	Sub-Module2.2, C	30
	Sub-Module2.2, D	35

Table 5. Variants of the Sub-Module2.2

The same procedure must be done with all the other specific modules and sub-modules of the family. Then, a configuration management table is obtained (Table 6). In this table, only specific elements are implemented because the other modules and sub-modules of the modular architecture are common to all the products of the family.

		Specific module and sub-modules		
		Module1	Sub-Module2.2	Sub-Module3.2.2
Product variants of the modular family	Product A	Module1,A	Sub-Module2.2, A	Sub-Module3.2.2,A
	Product B	Module1,A	Sub-Module2.2, B	Sub-Module3.2.2,B
	Product C	Module1,A	Sub-Module2.2, C	Sub-Module3.2.2,B
	Product D	Module1,A	Sub-Module2.2, D	Sub-Module3.2.2,B
	Product E	Module1,B	Sub-Module2.2, A	Sub-Module3.2.2,A
	Product F	Module1,B	Sub-Module2.2, B	Sub-Module3.2.2,B

Table 6. Configuration management of the products of the modular family with definition of each variant of specific elements for every product

The global definition of the family is done. The next step consists of the designing of the products from a parametric and skeletal CAD model. This model relies on geometric parameters linked with functional parameters. For instance, the main functional parameter of the Sub-Module2.2 is the product energy expected by users. After a study of components of this sub-module, two main influential geometric parameters are the hole diameter within the lead and the length of the shoulder inside the head. These geometric parameters are implemented in the parametric and skeletal CAD model in order to generate quickly the various versions of the Sub-Module2.2. The link between functional parameters and the geometric parameters that fulfil them, is assured by rules. However, some other rules are added to link geometric parameters with each other. For instance the diameter of a hole is linked with the external diameter of an axe that is inserted inside the hole. Therefore, sets of parameters are created and each of them is equivalent to the value(s) of functional parameter(s). For instance, to have an energy of 15 Joules, there is a set of geometric parameters that control the lead and the head, and this set is different from the set of an energy of 25 Joules.

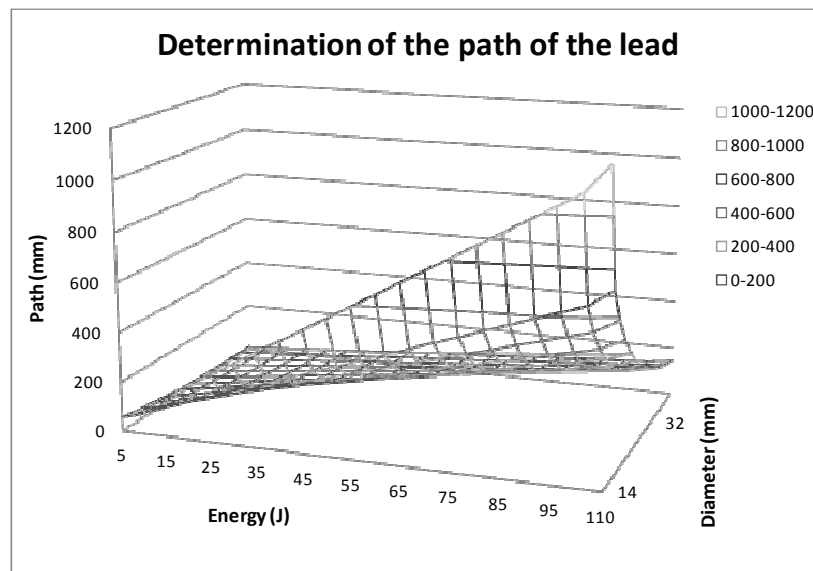
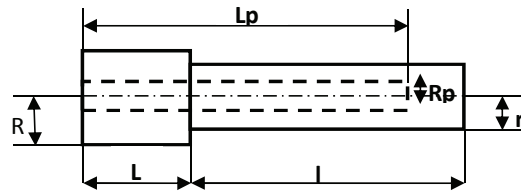

Figure 68. An abacus for calculating a dimension of the lead

Using an abacus (Figure 68) linking some dimensions and table-based mathematical formulas (Figure 69), it is possible to define the dimensions of the lead and the head to achieve the desired impact energy. Indeed, the interior dimensions of the components of the head are directly related to those of the lead.



	Diameter (mm)	Path (mm)	rp (mm)	L (mm)
Definition of the lead	28	68	10	22
	R (mm)	l (mm)	r (mm)	Lp (mm)
	14	68	11,7	57
Definition of the head	Dc (mm)	dc (mm)		
	28	23,3		
	Lc (mm)	lc (mm)	Pc (mm)	
	95	40,5	82	

Figure 69. A table for calculating dimensions of the lead and the head

Here is an example of the rule used in the previous table: $\text{Diameter} = 2 \times R$.

Thus, the parameterization of the lead is implemented in the CAD model. Figure 70 shows a sectional view of the lead with its CAD construction tree.

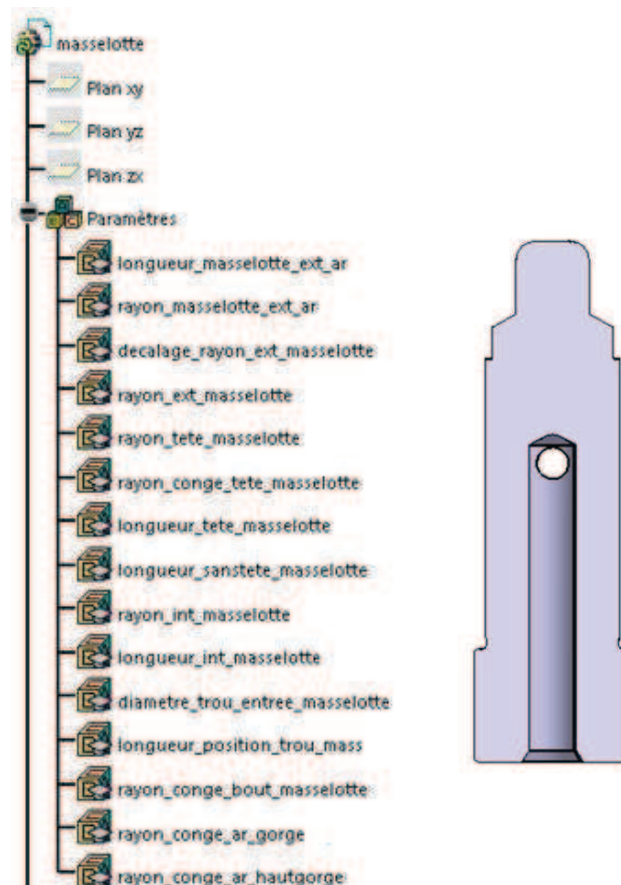

Figure 70. Lead parameterization

According to the list of parameters for a small component, this work of parameterization of all specific components is quite tedious. But this step consistently allows time saving in the future, when new products will be designed.

The same approach is taken for every specific module or sub-module and their specific functional parameters. Finally, a parametric and skeletal CAD model (Figure 71) controlled by functional parameters thanks to rules is created. This model allows the quick generation of designs for each variant of the product family. The skeleton ensures a good propagation of the rules and parameter values without geometric problem and with a good position for each component in the CAD model.



Figure 71. Parametric and skeletal CAD model of a generic pneumatic scraper

From this design, all products of the modular family are generated in this way:

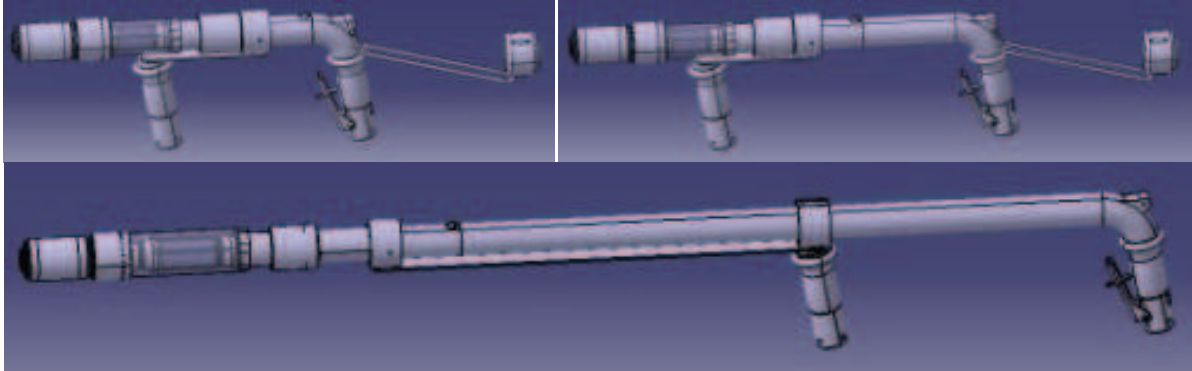

Figure 72. Example of product design generated from the parametric and skeletal CAD model

It is possible on the geometry to highlight the different modules and their sub-modules as shown in Figure 73.

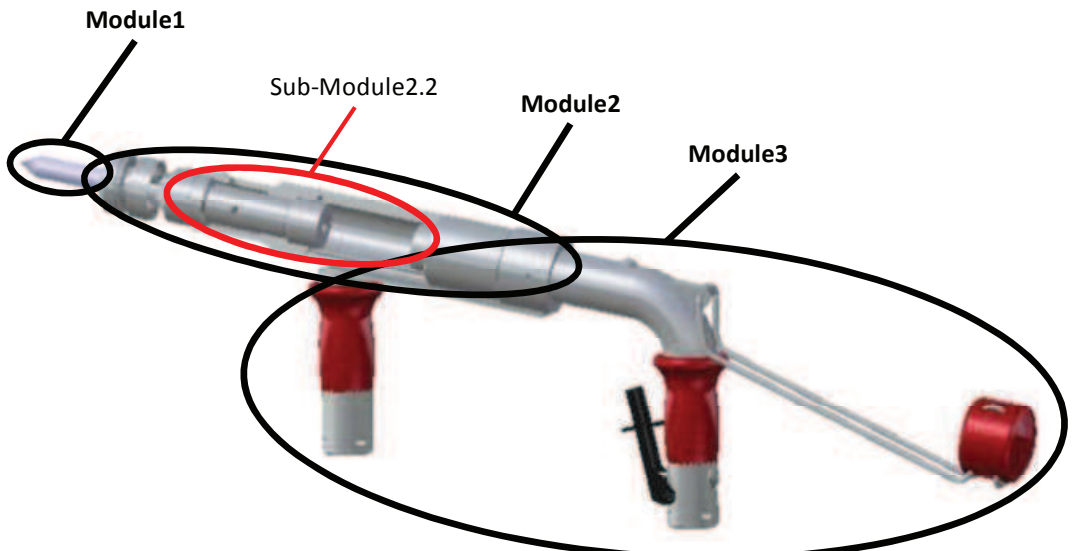

Figure 73. Visualization of the modules on the product design

Here are some examples of products generated to create the pneumatic scraper family. But these designs need behaviour validations. This is the next step of the FARD methodology.

2.4 Towards a multi-physics design of the product

This last step of the FARD methodology aims to validate the behaviour of products of a family and helps simulation experts during their optimisation. In this case study, only a quick presentation of this step is presented without an optimisation loop. The goal is to present the articulation between functional, geometric and simulation parameters. The power part of the head of pneumatic scrapers is limited, as shown in Figure 74. This step will be shown in more detail with another use case in section 4.

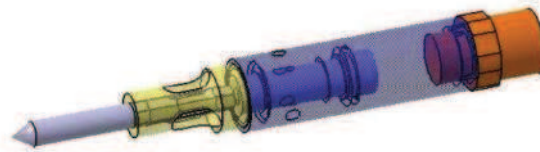

Figure 74 : Power part of the head of a pneumatic scraper

This part needs a multi-physics simulation because of the various physical phenomena like mechanical structure, vibrations, impact, etc. However, to simplify this step, each phenomena is simulated independently.

To validate the behaviour of this power part for a variant of the Module2 (a criterion set is linked with it), the first step is the definition of the impact energy of the lead inside the power part of the head. It is this lead that moves the tool through pneumatic power.

To verify the reliability of the design solution, the geometry is simulated with various phenomena, as shown in Figure 75. The impact resistance simulation aims to determine the impact force which is applied on the lead in a mechanical static simulation. Then, the resistance of the lead is validated. Otherwise, the dimensions or materials or etc. must be changed. However, if the simulation expert changes the dimensions of the lead, he/she must take care of the impact on the energy.

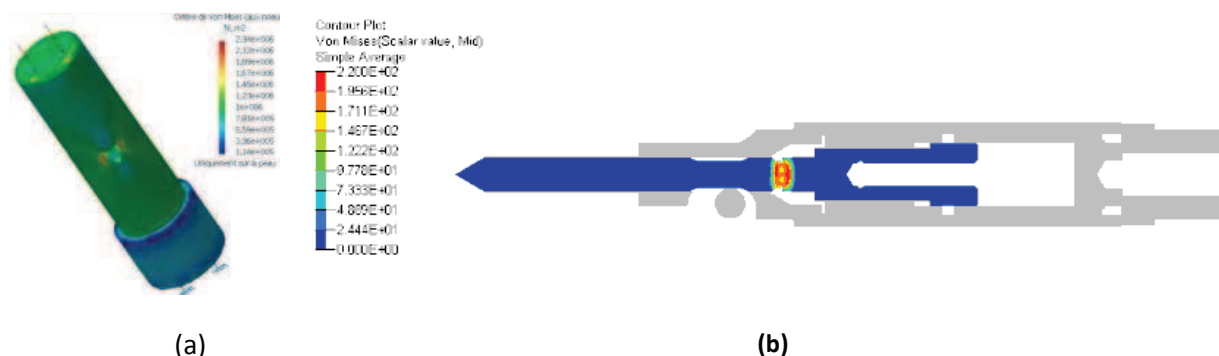

Figure 75 : Multi-physics calculations: mechanical static created with CATIA© (a) and impact resistance achieved with the software RADIOSS© (b)

The loop of optimisation in the FARD methodology allows faster dimensioning of components or groups of components. But optimisation is not the objective of this industrial experimentation. That will be developed in another use case. Indeed, this experimentation

illustrates the link between all parameters and the parametric CAD model and simulation phase.

2.5 Comparison of results from the FARD methodology with the old product family

This industrial experimentation is a redesign project. An old pneumatic scraper family exists. The new products use the same mechanical principles to activate the tool thanks to a lead that is set in motion by air pressure. There is no innovation of the basic functions of the type of product.

Then, it is possible to compare the design of the old products with the new product family. The old products were designed using a traditional design approach. With the evolution of customer needs, new products were created with a similar architecture to previous product design but with their own components. That is why the old products are visually similar.

The main goal of the new product family is to improve the old products with new functions and same manufacturing costs. These functions improve the ergonomic aspect of the products and limit the level of mechanical vibrations in order to protect users from musculoskeletal disorders. Thanks to a modular approach and a functional approach there are more common components. Then, the new product family (same number of products possibilities as in the old family) has the same number of components as the old product family, but products of the new family possess more functions.

The old products do not share a lot of components compared to the new product family. Moreover, it was not easy to store products in groups of components. Old products were stored assembled. In opposition, the new product family share some modules like hand part or valve part of the product. These parts can be assembled independently and kept separately to be added together to create a whole product. This is possible thanks to a good degree of modularity of the assembly sequence of products of the same family.

Moreover, the design of the new products is optimized to be quickly adapted to new customer needs thanks to a parametric and skeletal CAD model. The parameterization of the CAD model is controlled by geometric parameters linked with functional parameters thanks to some rules. Then, it is possible to enter new requirements and quickly adapt the design to create a new product of a new module. Indeed, the interest of the parameterization of a CAD model was demonstrated by [Toussaint 2010] with a strong link with knowledge.

Thanks to the application of the FARD methodology, it is possible to calculate the C_{sapm} that measures the capacity of the assembly sequence to generate modular product according to the FARD principles. For the Scrap'Air product family, the C_{sapm} is 0,91 (10 functions in the lower level of the modular product structure / 11 colour changes according to the assembly order of the added product = 0,91). The goal of the new product family is to reach as much as possible to this value. This is equivalent to the best modular product possible thanks to the chosen assembly sequence.

According to the I_{mp} indicator, the old products have an I_{mp} of 0,26 ($10/39=0,26$) that measures the modular index of a product. The value of this indicator confirms the lack of modularity of the old products. This initial I_{mp} represents around of 29% of the C_{sapm} defined for this family. Thanks to the application of the FARD methodology for developing our

new family of modular products, the Imp increases from 0,26 to 0,67 (10 functions in the lower level of the modular product structure / 15 modules and sub-modules in the lower levels of the product structure = 0,67). Finally, after a manual adaptation of the final product structure we obtain an Imp of 0,71 (10/14=0,71) which represents the last improvement for the modularity of the new product family thanks to the application of the FARD principles. This last Imp corresponds to around 78% of the Csapm. To sum up, the FARD methodology allows improving by 49% the modularity of the product family according to the defined assembly sequence. The evolution of the various Imp compared to the Csapm is illustrated in Figure 76.

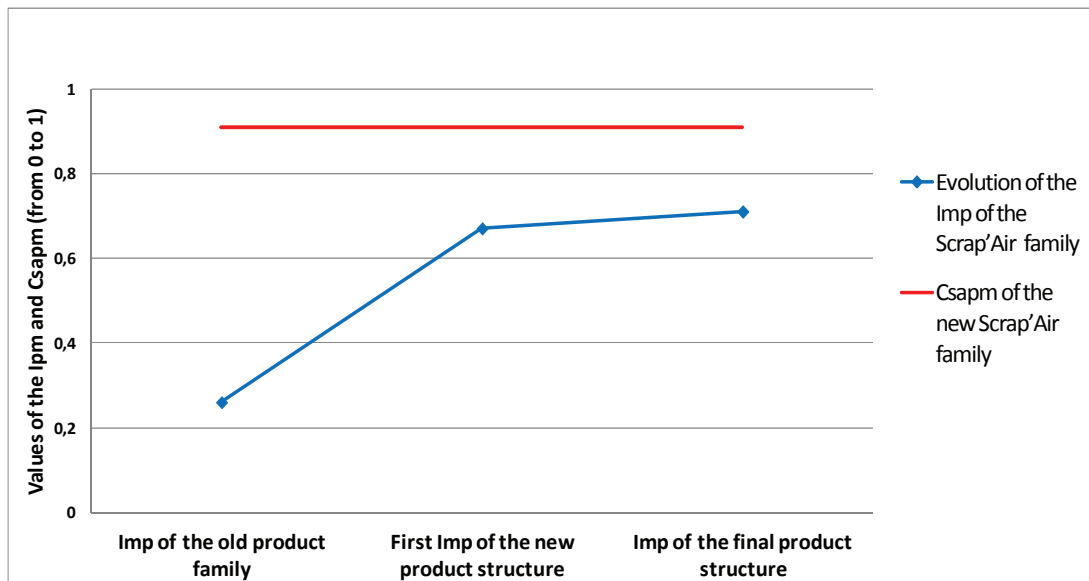

Figure 76. Evolution of the indicators (Imp and Csapm) of the old and the new product family of Scrap'Air

To sum up, products of the new family represent an improvement of the old products family in terms of functions, modularity, number of components and common components, ease of new product or module creation, assembly phase, etc. thanks to the FARD methodology approach.

3 A FAMILY OF BIOMIMETIC SPY SYSTEMS

This use case is an academic experimentation carried out with a group of students from the University of Technology of Belfort-Montbéliard, in the Mechanical and Design department. This experimentation is a first design, an innovative project, without existing products that fulfil the need exactly. Referring to the FARD methodology, this experimentation illustrates the steps from 1 to 4 of the proposed methodology (as shown in Figure 77). This academic experimentation illustrates mainly the functional design approach and the modular design based on the DFA approach.

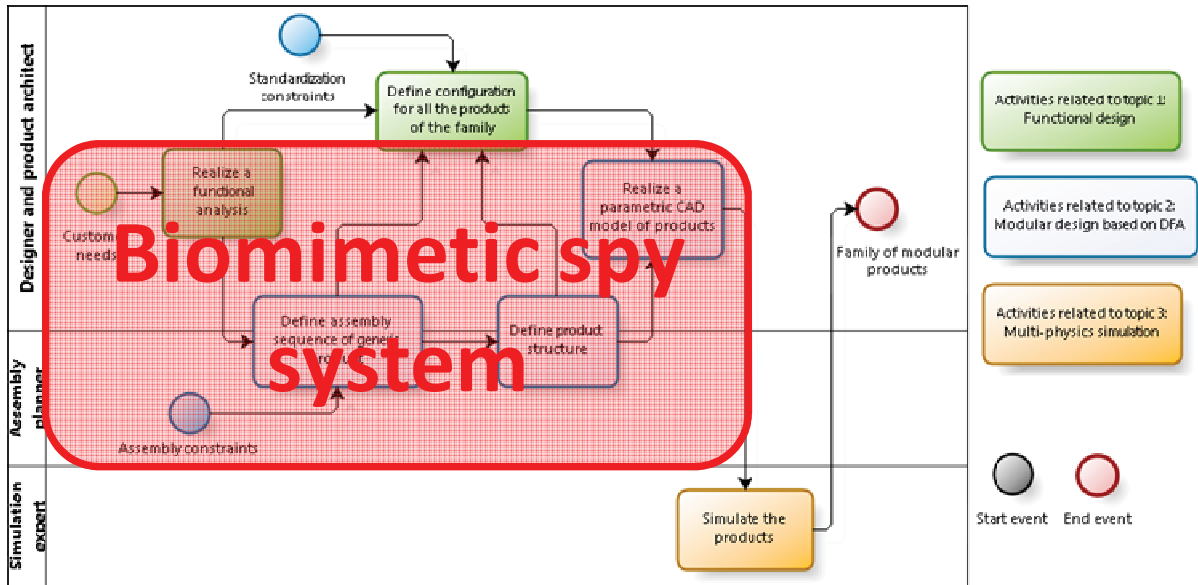

Figure 77. Positioning of the Biomimetic spy system experimentation according to the FARD methodology steps

The project comes from a customer need that consists of developing a biomimetic system of spying for military applications in the inquiry field. It must be declined into a product family adapted to the needs of various recognition missions. Indeed, this system is dedicated to Special Forces units during the phases of recognition before each intervention. It collects the desired information about a hostile environment to better understand its environment, its protagonists, and its dangers. Thus, this stealthy system of information capture allows a safer and better organized tactical attack plan to be planned for the intervention team. Biomimetics is called organic chemistry that tries to imitate the processes of nature in living organisms. The product must meet the needs to accommodate multiple uses. That is why this product, the BioSpy, consists of two main parts: a spying system BioZard (like a lizard) and a transport system BioBird (like a drone in the form of a bird).

This simple presentation of the project justifies the need to maintain a link with the specifications throughout the application of the FARD methodology. The system can also serve to gather information like audio, visual, presence of living organisms or mapping. At this level the importance of designing this type of product in a modular way is shown. This application will focus on BioZard, the spying system in the form of lizard.

The presentation of this experimentation will be simplified compared to the previous section on the pneumatic scraper family. The previous experimentation is very detailed for a better understanding of the FARD methodology. This experimentation aims to demonstrate the feasibility of the FARD methodology on an innovative design project.

3.1 Functional design approach

As explained in the FARD methodology, the first step is the conversion of customer needs into functions by an EFA (Figure 78).

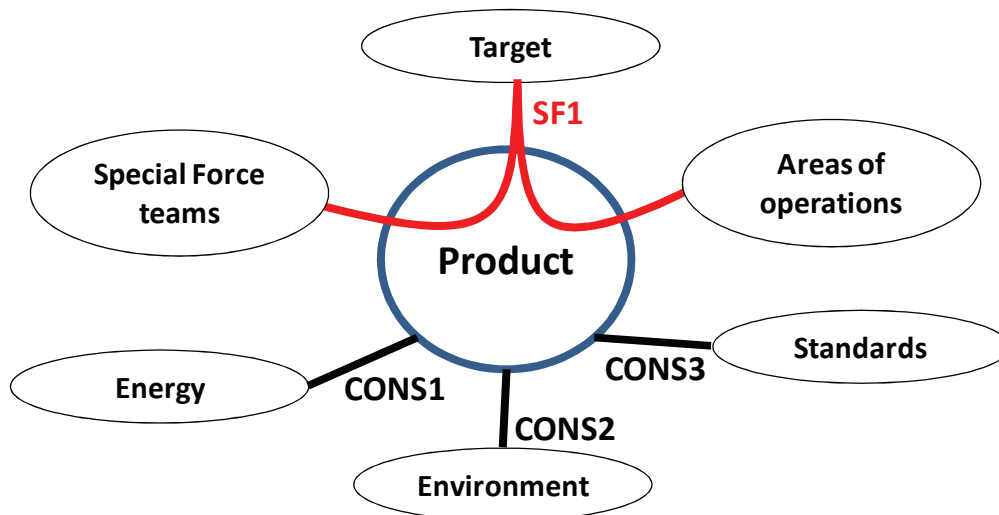

Figure 78. EFA of the product

Here is the list of functions:

- SF1: allow the Special Force teams to spy on their target and evolve in areas of operations
- CONS1: be self-powered
- CONS2: resist its environment
- CONS3: respect the applicable standards

From this EFA, a FAST diagram (Figure 79) is created to develop technical functions that the BioZard (spying part of the whole system) must fulfil. This FAST diagram is important for the definition the concept of the product (Figure 79). However, the designer must keep in mind the modularity needed for the product during the definition of its FAST diagram and the concept. The final goal of the methodology is to create a product composed from modules. The concept presented was selected by the team among various proposals.

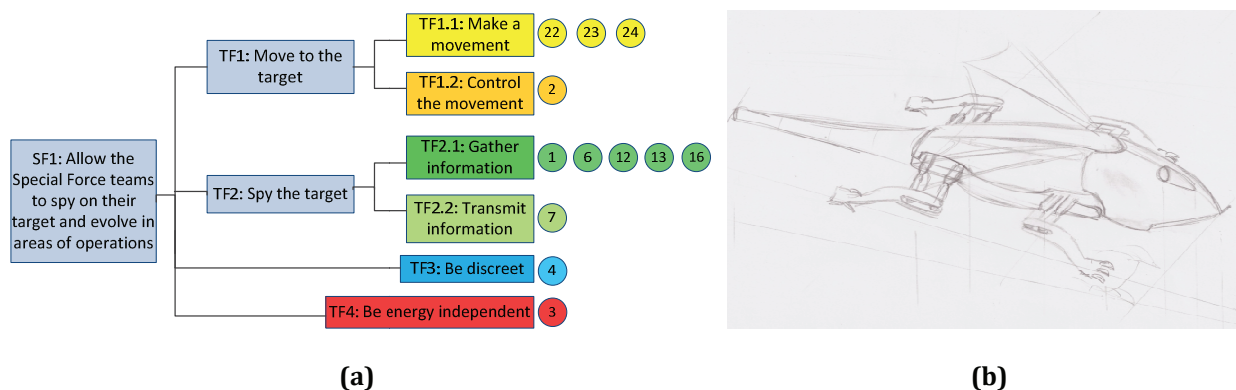

Figure 79. Concept of the BioZard (b) based on the FAST diagram (a) defined from the SF of the EFA

From the concept, the list of components, also called E BOM or P vector, can be defined. To simplify the next steps of the FARD methodology, all components will be replaced by a number as presented in Table 7.

N°	Name	N°	Name
1	Body	14	Arm 2
2	Motherboard	15	Arm 3
3	Battery	16	Specific sensor
4	Outer body	17	Servo-motor
5	Wings	18	Outer tail
6	Interface with the tail	19	Steel cable
7	Transmitter/Receiver	20	Piezoelectric actuators
8	Head servo-motor	21	Rods
9	Head body	22	Led body
10	Outer head	23	Small claws
11	Camera	24	Big claw
12	Interface with the head	25	Outer leg
13	Arm 1		

Table 7. List of components of the concept and their number assigned

All this information allows the designer to create the IFA of the product (Figure 80). The IFA highlights the components that participate in the SF1 that is determined in the EFA. These components are very important to satisfy the customer needs. Some components do not participate in the SF1 of the BioZard. They are not necessary to fulfil the main function of the BioZard but they can be necessary for the product structure. For instance they can assure a good maintenance of the components together.

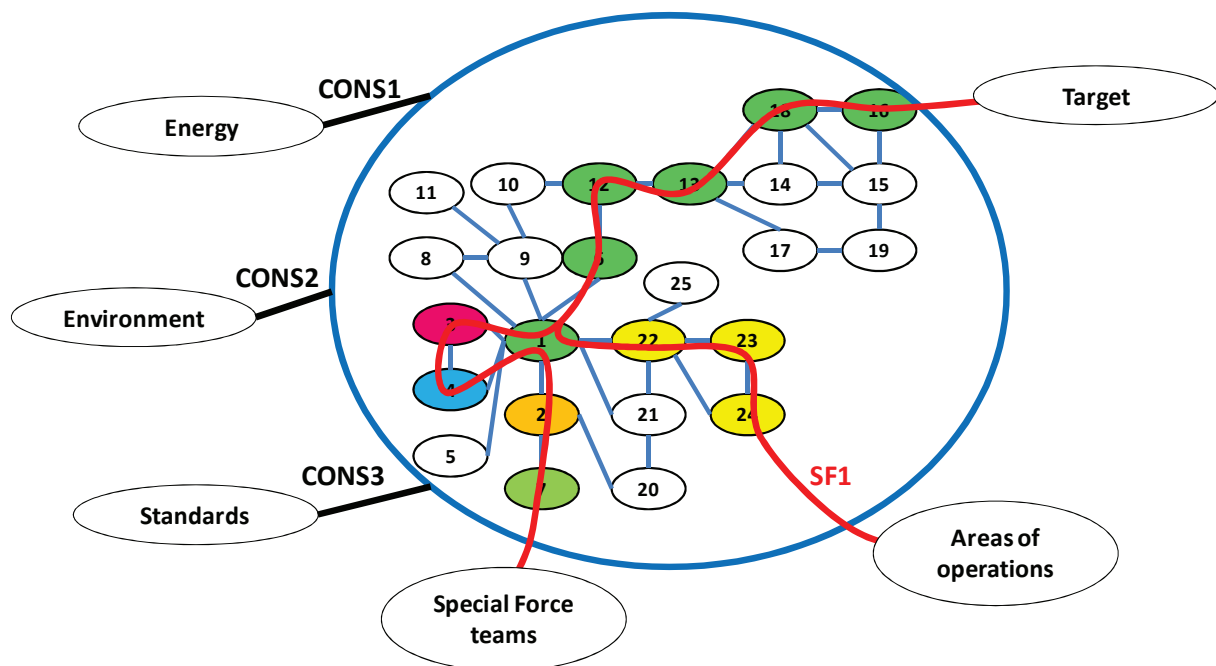

Figure 80. IFA of the BioZard represented by a FBD

The FAST diagram of the product decomposes the SF1 into TF. From the previous graph, components of the SF1 are known. Then, these components can be shared among the various TF until the last level of the FAST diagram as shown in Figure 81.

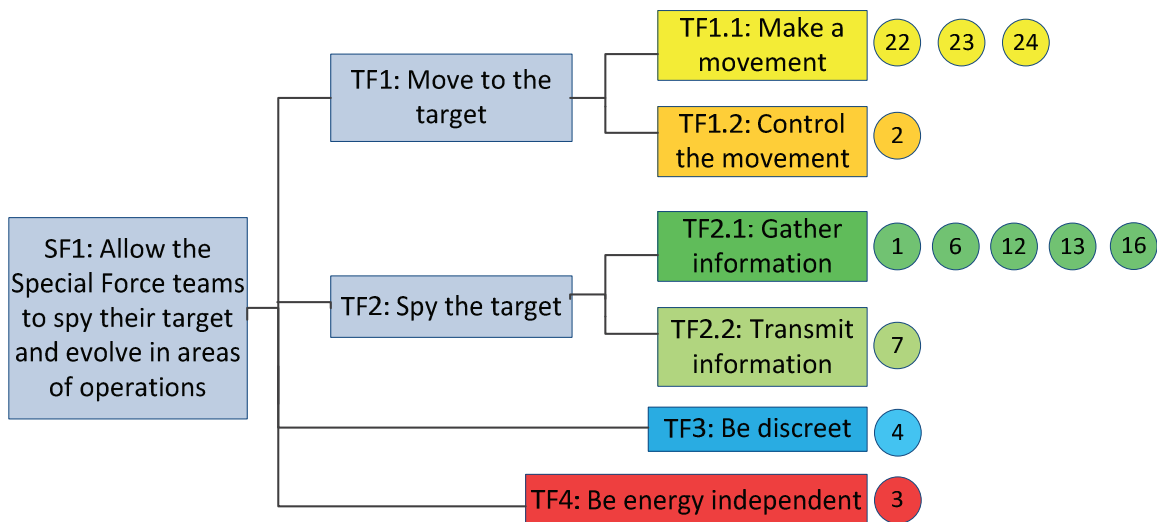

Figure 81. Diagram of the BioZard with the repartition of components among TFs

On this diagram, a colour link is created between some components and TF. This link is used during the next steps of the FARD methodology.

3.2 A new approach of modular based on DFA

3.2.1 Definition of the best assembly sequence of the generic product of the range

The first step of this part of the FARD methodology is the creation of the PP matrix with coloured links and assembly planner simplification. In this case study, there is no assembly planner simplification. This PP matrix is partitioned to define blocks of components (clusters) from which components have a high level of interaction together and clusters with a lower level of interaction together. Figure 82 shows the matrix with its blocks of components.

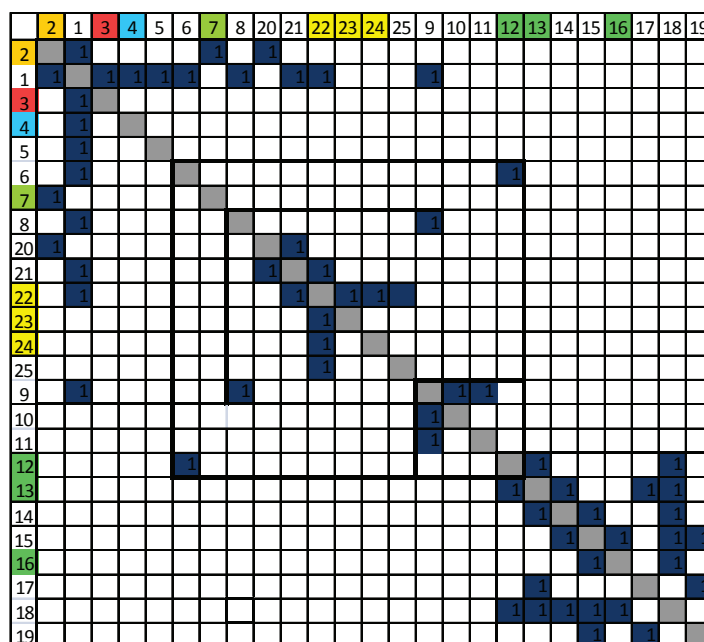

Figure 82. Coloured PP matrix with blocks of components (clusters)

From this matrix, the basis of the contact graph is generated. This is a contact graph with some coloured components (coloured nodes). Then, the assembly planner adds assembly order information between components for each contact between two components generated from the PP matrix. He/she also creates precedence relationships without physical contact. But in this case study, there is not this type of link between components. Figure 83 shows the direct graph of the BioZard concept.

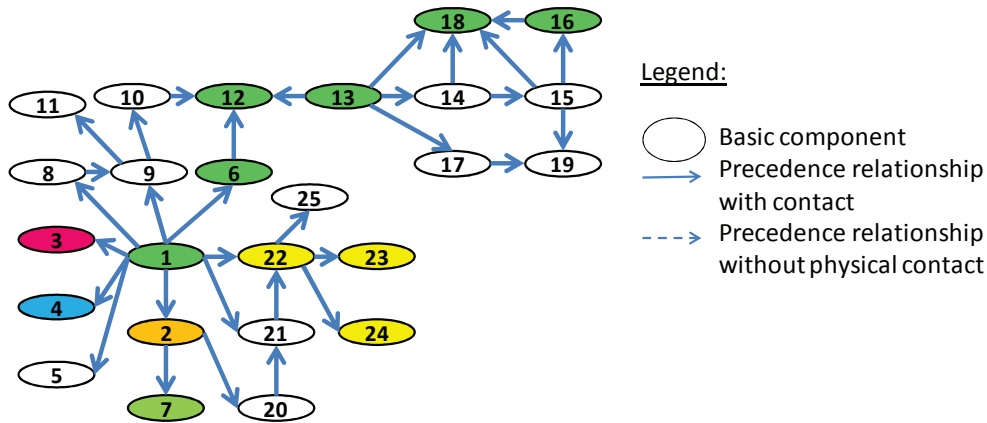

Figure 83. Direct graph with coloured components of the generic product

From this direct graph, the algorithm for generating the assembly sequence of the BioZard is applied by the assembly planner. The assembly sequence defined is: {1;3;4;5;(8;9;(11;10));(2;7);20;21;(22;(23;24;25));6;13;12;14;15;16;18;17;19}. The various steps of the algorithm are not described because they are similar to the previous experimentation.

For us a good degree of modularity of an assembly sequence is represented by the colours that link some components to the various functions (or modules and sub-modules) of the product. As you can see in this previous assembly sequence, only one colour is mixed with the other. In this way, this assembly sequence has a good degree of modularity. This is important for the next steps that try to separate each function or module from each other.

3.2.2 Structure of the generic product of the family

From the assembly sequence of the product, the structure of the product is defined, according to the FARD methodology proposed. The algorithm for structuring the product is used. It allows the position of each component among the modules and sub-modules of the product to be defined in accordance with the assembly sequence, the link of some components with a TF and the contact between components. All constraints come from the coloured and direct graph with the assembly sequence (contact between components and path of the assembly sequence) and the diagram of SF and TF with some components (the FAST diagram of the product with the repartition of components that participate to the SF1), as shown in Figure 84.

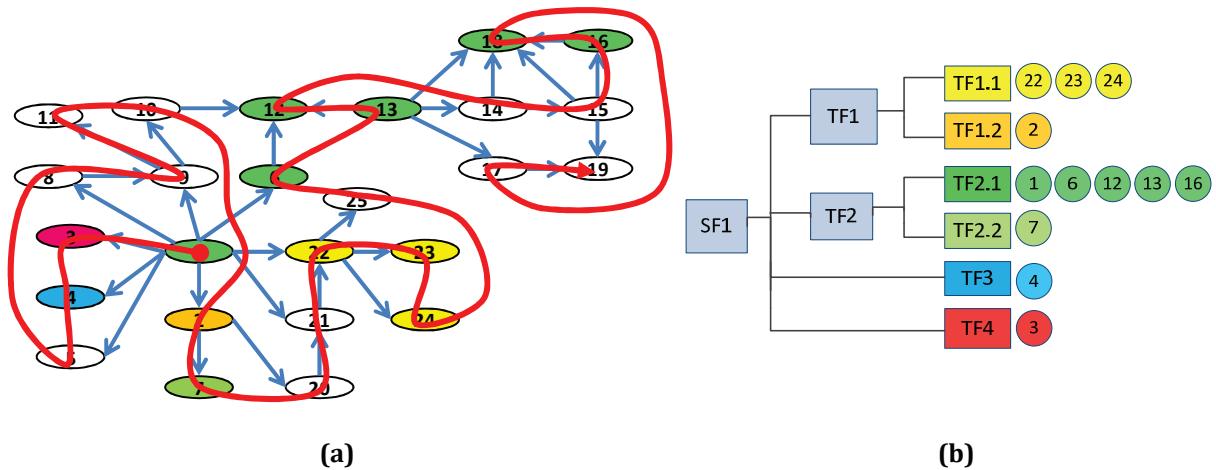

Figure 84. Coloured and direct graph with the representation of the path of the assembly sequence (a) and diagram of the link between some components and lower level of TF of the FAST diagram (b)

The algorithm for structuring the product generates a first proposal of product structure. In this proposal some components are not assigned to a module or sub-module. They are stored in a box without any colour that has no correspondence with a technical function of the product. These components are manually assigned to a module or sub-module by the product architect. Finally, the product structure is obtained and every component belongs to a module or a sub-module as shown in Figure 85.

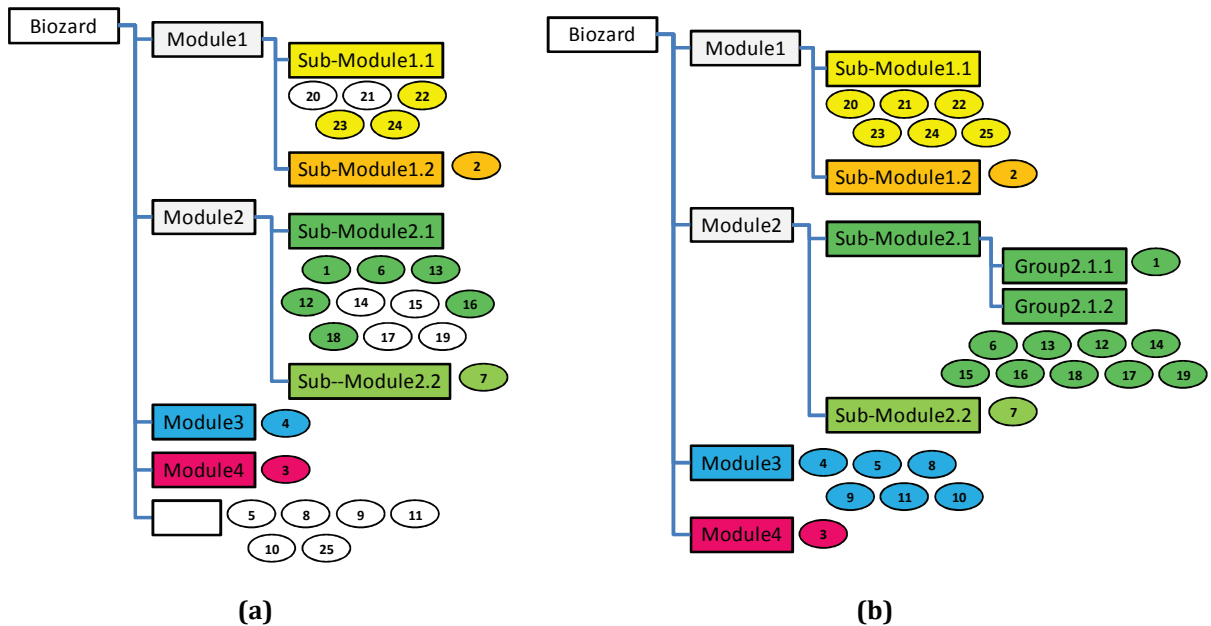

Figure 85. Product structure initially generated by the algorithm for structuring the product (a) and final product structure adapted by the product architect (b)

The product structure generated by the algorithm is not complete and requires some adjustments from the product architect. For instance, components 5, 8, 9, 11, 10 and 25 have no link by the algorithm to a module or sub-module. The product architect, thanks to his/her knowledge of the product and the modularity context, correctly positions these components among the various modules and sub-modules.

Finally, all components are coloured in the product structure. Components initially without any colour (they do not participate to the SF1) are assigned to a TF thanks to the definition of the product structure.

The last step of this part of the FARD methodology is the definition of the module assembly sequence of the BioZard: {Group2.1.1; Module4; Module3; Sub-Module1.2; Sub-Module2.2; Sub-Module1.1; Group2.1.2}.

Sub-Module2.1 is divided into two independent groups because Component 1 and the other of the Group2.1.2 are assembled separately. This division is mainly useful during the assembly phase as highlighted in the module assembly sequence. It is not very important for the design.

3.3 Configuration management of module variants and new products of the modular family

As proposed in the previous experimentation, a table (Table 8) that represents specific parts of the product can be used.

		Standard/common	Specific
Module 1	Sub-Module1.1	X	
	Sub-Module1.2	X	
Module2	Sub-Module2.1	Group2.1.1	X
		Group2.1.2	
	Sub-Module2.2	X	
Module3		X	
Module4		X	

Table 8. Definition of standard and common parts of the family used to create variants of product

This Table 8 highlights the common modules 1, 3 and 4 that are standard for the family. While Sub-module2.1, more precisely Group2.1.2, is specific and allows creation of variants in accordance with customer needs. This sub-module represents the type of information spying done by the Special Force team. Depending on the type of information spying, the sensor, Component 16, needs to be adapted. Finally, the BioZard could be assembled into two separate groups: on one side Module1 with Module3 and Module4, and on the other side the Group2.1.2.

3.4 Conclusion

The application of the FARD methodology allows a modular design of the BioZard spying system to be achieved. The BioZard is composed of four main modules that each responds to a specific function and the assembly of all these modules creates the BioZard. Modules are assembled separately and can be interchanged in order to fulfil various customer needs. The FARD methodology helped to highlight the Group2.1.2's specifics and is the key to create variants of BioZard. This group of components that belongs to the Sub-Module2.1, allows spying on different types of information that requires specific sensors for each one. Then, the BioZard can be considered as two sets of components. The first set of components is common whatever the customer needs and regroups Module1, Module3, Module4, Group2.1.1 and Sub-Module2.2. The second set is the specific group of components that fulfils customer needs without completely changing the product design. Moreover, this specific function is contained into a group of components that is sufficiently independent so that the customer changes himself/herself the function. Indeed, the

Groups2.1.2 is located in the tail of the BioZard and this part can be considered to be an interchangeable option by the user. This specific part can be constituted by various sensors that are proposed independently to the user as an option.

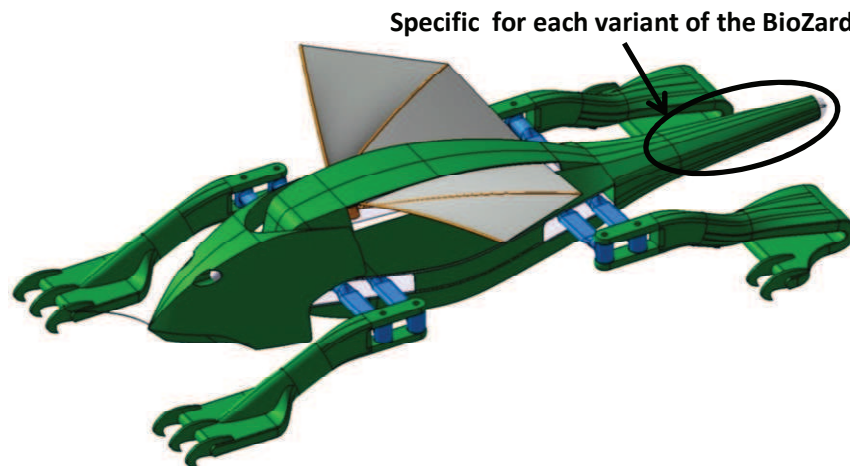

Figure 86. BioZard developed thanks the FARD methodology

On the BioZard system, it is possible to calculate the Csapm indicator that measures the capacity of the assembly sequence to generate modular product according to the FARD methodology. In this case, the Csapm is 0,86 (6 functions in the lower level of the modular product structure / 7 colour change according to the assembly order of the added product = 0,86). The goal of the new developed BioZard is to reach as much as possible this value. This is equivalent to the best possible modular product thanks to the chosen assembly sequence.

Without the application of our modular methodology, the initial Imp of the BioZard is 0,25 (6/25=0,25). This initial Imp represents around of 28% of the Csapm of the BioZard. Thanks to the application of the FARD methodology in order to develop a new modular product, the Imp increases from 0,24 to 0,5 (6 functions in the lower level of the modular product structure / 12 modules and sub-modules in the lower levels of the product structure = 0,5). Finally, a manual improvement of the final product structure allows us to obtain an Imp of 0,86 (6/7=0,86) which represents the last possible improvement for the modularity of the new BioZard thanks the application of the FARD methodology. This last Imp corresponds to the Csapm. To sum up, the FARD methodology allows us to improve the modularity of the product until we can obtain the best possible and theoretical modular product according to the chosen assembly sequence. The evolution of the various Imp compared to the Csapm is illustrated by the Figure 87Figure 76.

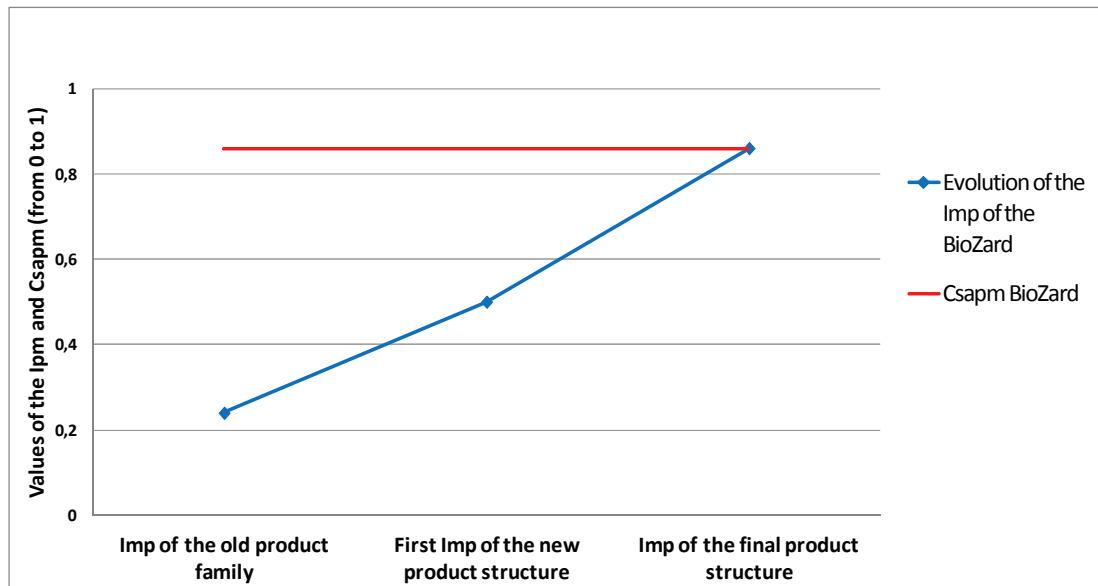

Figure 87. Evolution of the indicators (Imp and Csapm) of the BioZard

The specific part of the BioZard is very useful to quickly adapt to the conditions of each spying mission and to limit the financial investment of customers. With one body part of the BioZard and some tail part options, customer can spy in various conditions with a quick and useful adaptability. For instance, if a Special Force team wants to perform their reconnaissance mission at night, it just has to equip the tail with the infrared camera on the body of the BioZard and start the mission. However, this design does not prevent modifying function included in the body part at all times. Then, the body part will be divided again in accordance with the decomposition defined from the FAST diagram.

Another advantage of the application of the FARD methodology to this experimentation is the separation of the two main functions of the whole system. This use case focuses on the spying system, but there is also a transport system. It allows the spying system to be carried to the point of observation. Without the FARD methodology, designer creates only one system and not two separate systems that allow a smaller spying system to be had for instance. The FARD methodology guides designers in a modular context and helps them to design products in a modular manner.

To sum up, on first design project, the FARD methodology guides designers to develop modular products that will anticipate changes in customer needs. The modular design allows a good reactivity for adapting the product without redesigning all the product but just with module variants.

4 THE “HIGH PRODUCTIVE” SIMULATION OF A MOUNTAIN BIKE

This case study will focus on the new approach of multi-physics simulation proposed in the FARD methodology. This experimentation is limited to this part but some previous necessary elements of the FARD methodology are briefly presented. This experimentation illustrates the steps from 4 to 6 of the proposed FARD methodology (as shown in Figure 88) with a brief presentation of results from the previous steps (needed for the last steps of the FARD methodology). This academic experimentation illustrates mainly the multi-physics simulation aspect.

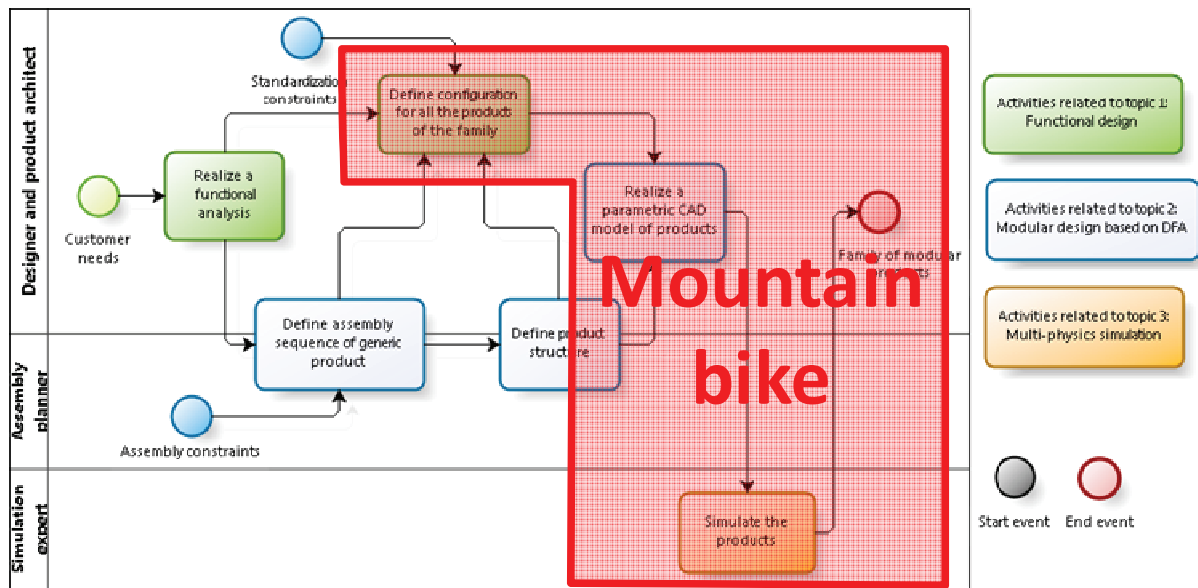

Figure 88. Positioning of the Mountain bike experimentation according to the FARD methodology steps

This academic project is a first design. A team worked on the development of a new generation of mountain bike with an innovation goal. A mountain bike is an alternative bike from which the goal is to use it on a specially designed track. The track has a steep incline and is rugged, dotted with jumps, roots or stones. A mountain bike should also be particularly handy and relatively effective in the phases of raises (pedalling).

Numerical simulation aims to reproduce, numerically, the real physical behaviour of a system subjected to mechanical, thermal, acoustic, etc phenomena. It is increasingly implemented in the design process because it allows saving time and especially money (less need for physical prototypes). This section will demonstrate the time saved thanks to the proposed simulation approach.

This experimentation focuses on the mechanical behaviour of the frame of a mountain bike considered in various geometric configurations that require the use of parametric mesh in order to automate its validation thanks to a numerical simulation.

4.1 Summary of functional design approach elements necessary

The first step of the FARD methodology is the EFA that defines functions of the product. Only the use phase is detailed. It is dedicated to the use of the product, the mountain bike used by the athlete on a specific track. In addition to traverse a track, this sport activity must be practiced safely and must therefore respect European standards. Functions of a mountain bike are:

- SF1: allow the user to evolve on a track
- CONS1: resist the environment
- CONS2: respect the other users
- CONS3: respect standards

From this EFA and especially the SF1, a FAST diagram is developed for the whole mountain bike. This case study concerns only the frame of the mountain bike that is a little

part of the FAST diagram. But from all the FAST diagram, the designers design a concept of mountain bike. The frame part obtained is presented in Figure 89.

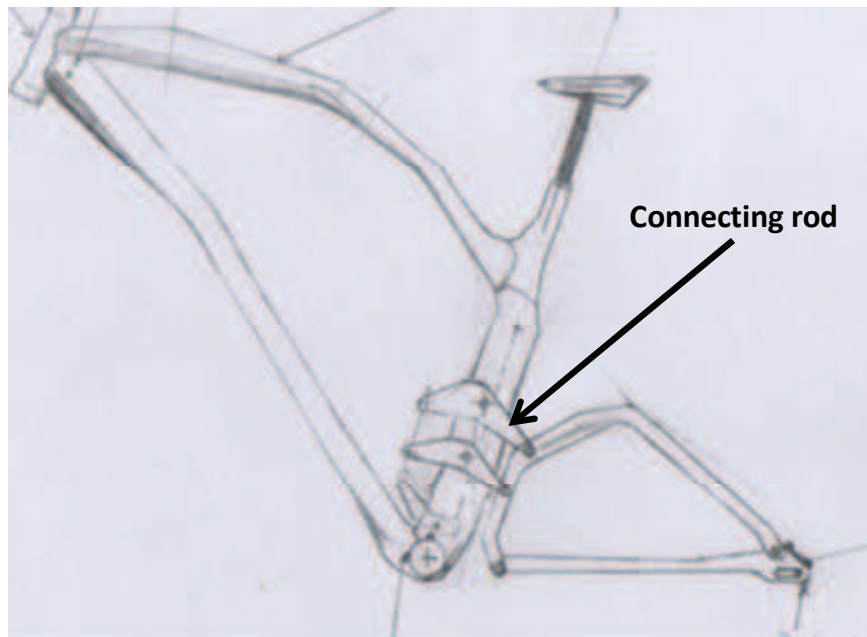

Figure 89. Sketch of the frame of the mountain bike developed in this use case

The components focused on for the next mechanical simulation is the connecting rod. The two connecting rods of the frame of the mountain bike are the main components of the frame and so are very important for this bike.

For the simulation approach, functional parameters of a connecting rod must then be defined. These parameters are used to specify both qualitative and quantitative some key functions of the EFA applied on the connecting rod.

Here is a list of some initial functional parameters (FP):

- FP1: forces transmitted to the connections on the ground below 6000N
- FP2: constraints exercised within the connecting rod: $0N < \sigma < 5000N$
- FP3: weight less than 17 kg
- FP4: operation temperature: $-20^{\circ}C < Temp. < 70^{\circ}C$

These functional parameters are not directly linking to the components of the mountain bike. Then, geometric parameters derived from FP applied to the connecting rod are defined. These new parameters are like the geometric expression of functional parameters, since they are dependent. During the modification of functional parameters, the corresponding geometry can be updated through the geometric parameters that are directly related to the functional parameters modified, in particular with expert rules. These rules can be logical or mathematical. However, the reverse is also possible. It is possible to modify the geometry using the geometric parameters and validate if this new geometry still continues to meet the customer needs well, thanks in particular to the use of functional parameters affected by these geometric parameters.

Here is a list of geometric parameters (GP) of the connecting rod:

- GP1: thickness of the arms of the connecting rod
- GP2: width of the arms of the connecting rod
- GP3: diameter of the fixing tube
- GP4: angle of the connecting rod
- GP5: arm length (front triangle)
- GP6: arm length (back triangle)
- GP7: centre distance of the connecting rod (front triangle)
- GP8: centre distance of the connecting rod (back triangle)
- GP9: diameter of the connecting rod bearing
- GP10: diameter of the bearing binding the axis

From this list of geometric parameters, the designer can create the parametric CAD model that is controllable by functional parameters (FP) thanks to corresponding geometric parameters (GP).

4.2 Parametric and skeletal CAD model

Thanks to the definition of GP, the parametric and skeletal CAD model is created. The first step is the creation of the skeleton for the CAD model (Figure 90). This is a simplified representation of the geometry by lines, circles, points, etc. It allows the changes of geometry to be controlled and limits CAD model modification problems related to the updating of the CAD model with a 3D software. It is on the skeleton that the geometry is built (Figure 90) like the flesh on the bones of the human body.

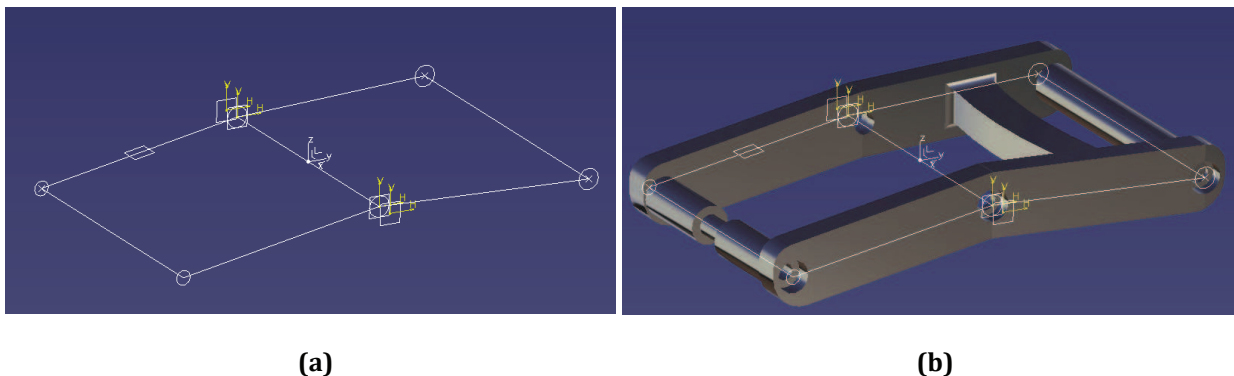

Figure 90. Skeleton (a) with geometry (b) of the connecting rod

On this skeleton with geometry, geometric parameters are applied. It is possible to change the values of GP in order to obtain expected customer needs, in terms of functional parameters associated with them. However, these GP must follow certain rules and constraints so that all functional parameter values are respected and consistent in terms of limits imposed by the requirements. For these reasons, it is important to apply certain rules in the CAD model geometry. These rules can link FP together, FP with GP and GP together.

FP directly applied on the CAD model or through the GP, GP defined previously and rules are applied to the skeletal and parametric CAD model. The skeletal and parametric CAD model is then defined.

4.3 The new approach of simulation proposed in the FARD methodology

As presented in the section 4 of the Chapter 2, the simulation approach of the FARD methodology begins like a traditional simulation process. The difference comes at the time to change the geometry to a new simulation. Then, the loop of simulation starts.

The initial mesh of the connecting rod is created (Figure 91).

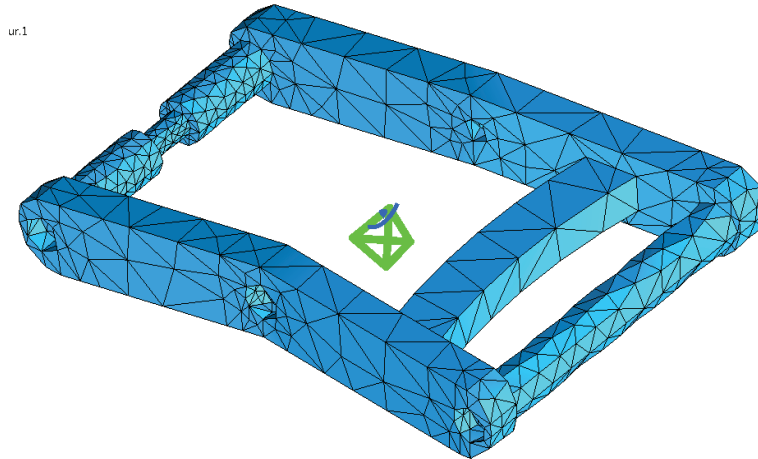

Figure 91. Mesh of the connecting rod

On this mesh, simulation constraints are applied (Figure 92). They act out the physical phenomena defined by simulation parameters like forces, types of fixation, etc. On this connecting rod, two boundary conditions and one force are applied to its:

- a connection pivot at its centre,
- an embedding at its grip on the frame of the mountain bike,
- a distributed force estimated at 1000N on the axis of binding of the back arm on the frame.

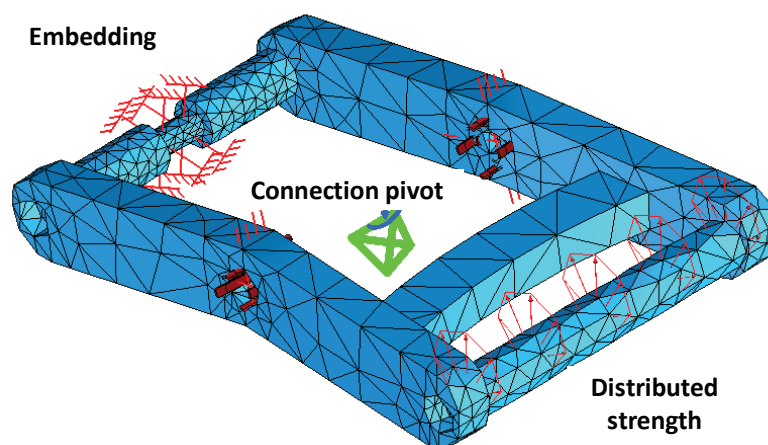

Figure 92. Mesh of the connecting rod with constraints for simulation

The model to simulate is obtained and the simulation can start. Results of the simulation (Figure 93) are analysed to define if the simulation is validated or not.

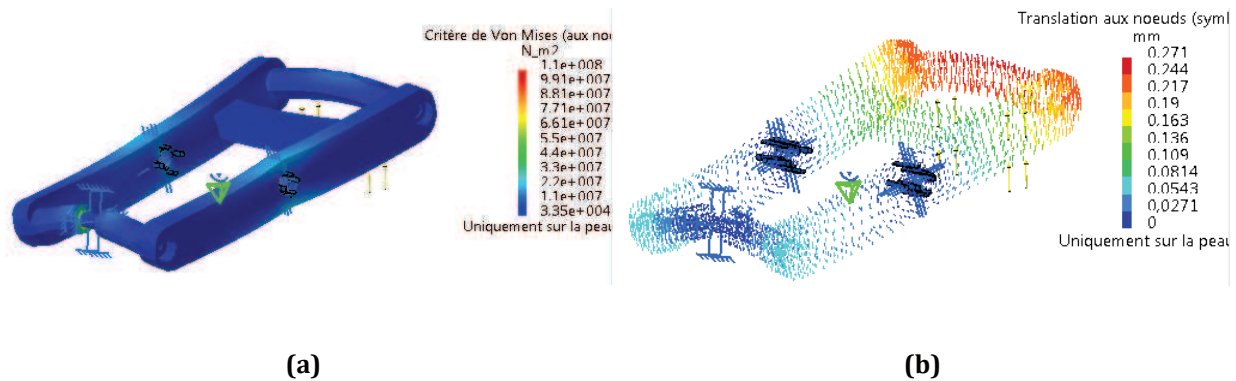

Figure 93. Results of the simulation: Von Mises criteria on the mesh (a) and displacement of mesh nodes (b)

These results do not meet FP defined. Certain areas are dangerously close to the yield strength of aluminium that is 200MPa. These results are not validated and a new simulation must start on a new geometry of the connecting rod. This new simulation enters in the loop of simulation proposed in the FARD methodology.

The optimisation of the connecting rod focuses on some dimensions that refer to these GP:

- GP1: thickness of the arms of the connecting rod
- GP2: width of the arms of the connecting rod
- GP3: diameter of the fixing tube
- GP4: angle of the connecting rod

These parameters allow the geometry of the concept to be controlled. Through these GP, it is possible to modify the strength of the connecting rod. These GP can therefore have an impact on FP: FP1 (forces transmitted to the connections on the ground below 6000N), PF2 (constraints exercised within the connecting rod: $0N < \sigma < 5000N$) and PF3 (weight less than 17 kg). By varying these parameters, the connecting rod can be optimized during the simulation loop with parametric mesh in order to best meet the identified FP.

In a traditional simulation process, and at this step, the designer must change the parameters of the CAD model (in a design software), create again the mesh and reapply the boundary conditions with the force on the model in order to run a new simulation. In this process, the optimisation of the simulation needs the modification of the initial CAD model.

In the proposed FARD methodology, the goal is to apply parameters directly on the mesh in order to modify the CAD model for a new simulation. The use of the Paramesh macro is proposed. Currently, the VBA macro allows the application of homothetic coefficients along the three axis x, y and z (axis of the reference frame used to design the product or component), as shown in Figure 94. It multiplies each coordinate node by the corresponding coefficient that is applied along each axis. A node possesses three coordinates, each along an axis. For instance, if a coefficient of 2 is applied on the axe x, the coordinate on x of the node is multiplied by 2.

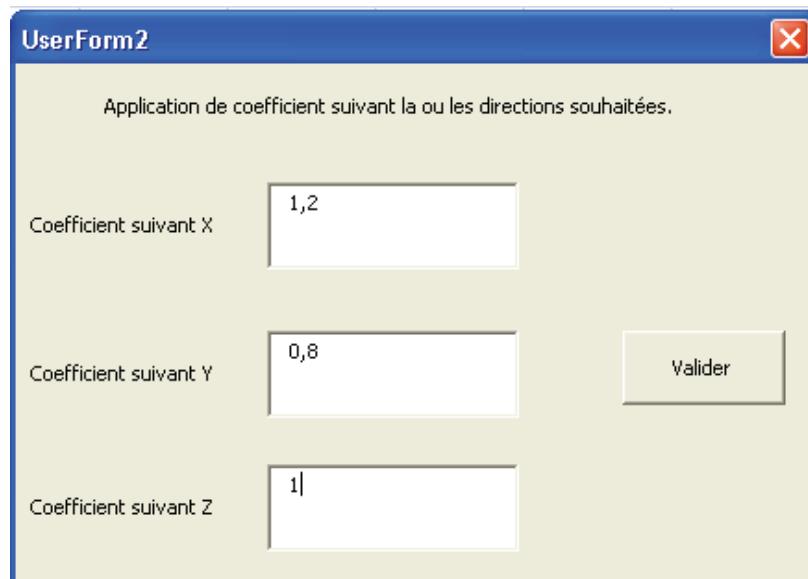

Figure 94. Window of the Paramesh macro for applying homothetic coefficient

The simulation expert must export the initial mesh. He/she obtains a data file containing all the information of the mesh (node with their coordinates, mesh information, etc.). According to the use of the software CATIA, the resulting file is a file “dat”. This file is imported in the Paramesh macro when it is started. The expert simulation informs the homothetic coefficients in the window of the Paramesh macro (Figure 94). The macro applies the coefficient to each coordinate of every node of the mesh (Figure 95). This step is very fast. Finally, the simulation expert can save the end file with the new mesh of the connecting rod. The geometry of the mesh is modified without changes to the CAD model.

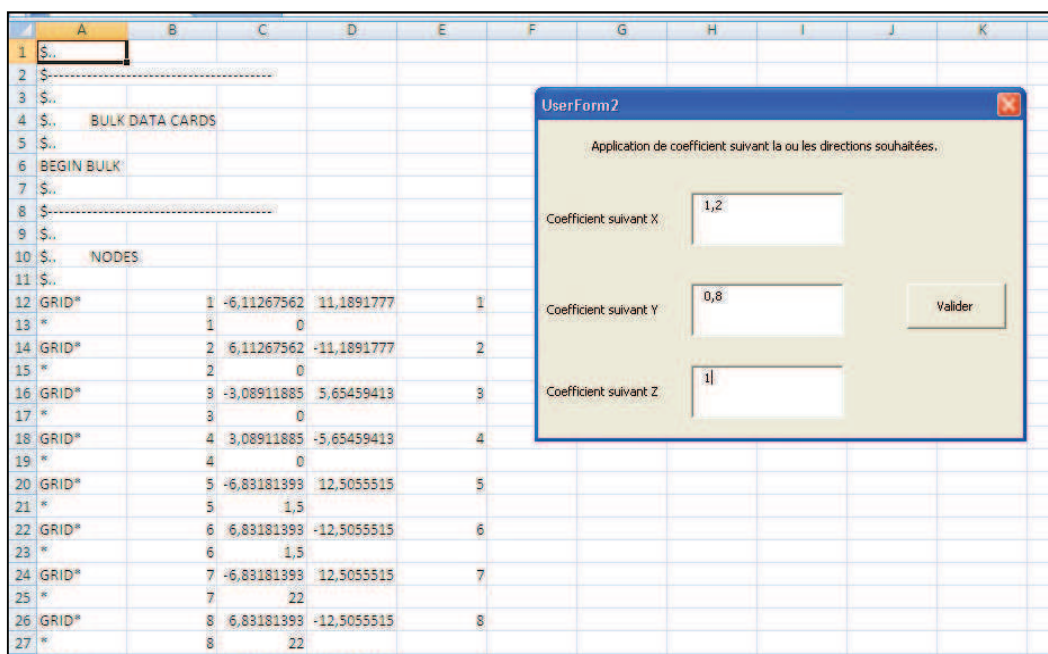

Figure 95. Application of homothetic coefficient by the Paramesh macro on nodes of the mesh

The new file of the mesh is then imported into the simulation software to update the initial mesh without changes to the boundary conditions or force. The mesh is independent.

As the first results of the simulation of the connecting rod are not satisfactory (connecting rod with a mechanical strength too low), the simulation expert decides to increase the thickness. The corresponding homothety is the application of the same homothetic coefficient along the axis x and y that are equivalent to the modification of GP1 and GP2. The coefficient chosen is 1,2, and it is like applying a new set of geometric parameters to the CAD model. After modification of the mesh, a new simulation starts.

This loop of simulation with modification of the mesh is repeated as many times as is necessary until the results are validated. It means that the dangerous areas detected in the initial simulation move away from the yield strength of aluminium. Example of sets of GP corresponding to the application of various homothetic coefficients:

Geometric parameters	Values of GP with their corresponding homothetic coefficient		
	Initial set of GP	Set number 2 of GP	Set number 3 of GP
GP1	30mm	30mm (coeff.: 1)	30mm (coeff.: 1)
GP2	12mm	14,5mm (coeff.: 1,2)	16,7mm (coeff.: 1,15)
GP3	10mm	12mm (coeff.: 1,2)	13,8mm (coeff.: 1,15)
GP4	170°	170° (coeff.: 1)	170° (coeff.: 1)

Table 9. Example of sets of GP applied to the connecting rod thanks to homothetic coefficients

As explained, the same homothetic coefficient is applied on x and y in order to increase the global thickness of the connecting rod. This modification impacts GP2 and GP3. Moreover, the tube needs the same coefficient in the radial axis. Otherwise its circle will become an oval.

After several loops of simulation, the final results are:

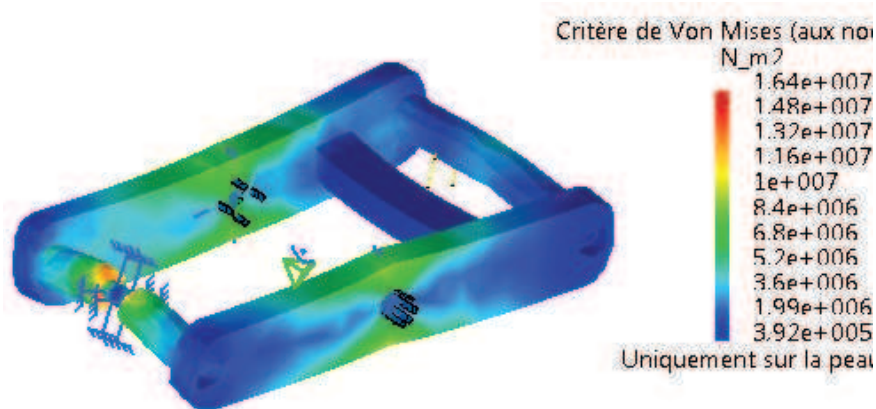

Figure 96. Von Mises results after various loops of simulation using the Paramesh macro

These results are consistent because the old dangerous areas moved away from the yield strength of the chosen material (aluminum). As results are validated, the CAD model can then be updated. The update consists of the application of the global homothetic coefficients resulting from every homothetic coefficient applied during the loop of simulation, like a cumulative change. For instance, if an expert simulation applies an homothetic coefficient of 1,2 and another of 1,2 during a second loop, on the same axe, the global homothetic coefficient applied on the CAD model is 1,44. Finally, the parametric and skeletal CAD model of the connecting rod updated thanks to the modification of a few parameters is:

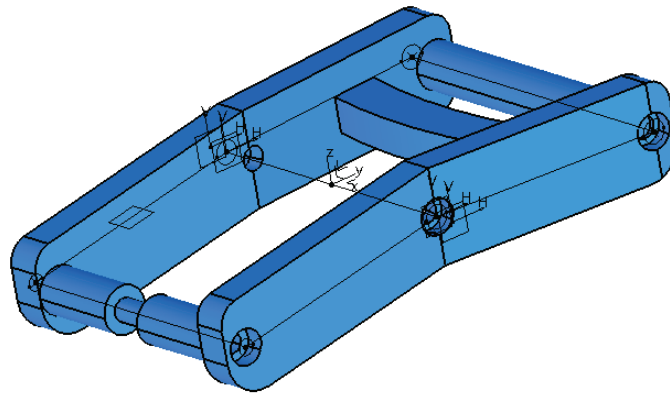

Figure 97. Final CAD model of the connecting rod after simulation validated

If many homothetic coefficients were applied on the mesh, a last traditional simulation can be realized to validate the final CAD model. It consists of the meshing of the CAD model, the application of simulation constraints and the simulation. It allows the simulation expert to be sure of his/her modifications of the CAD model. However, this last control step is not mandatory.

4.4 Conclusion

The approach of simulation allows good simulation results to be gained quickly with a simplified CAD model in order to optimise a solution or to find various solutions according to some simulation parameter sets. Indeed, the approach can be used to optimise a concept with various geometric parameter sets. But it can also be used to define products of a family with various GP sets combined with simulation parameter sets (constraints that represent physical phenomena applied to the product).

To check the HP design aspect of the simulation approach in the FARD methodology, a comparison of the time needed to modify the mesh in traditional simulation process with the approach is proposed. This comparison takes into account only the mesh phase because the design of the CAD model, the application of simulation constraints and the simulation phases are identical in the two methodologies.

For this, it is proposed to study the evolution of meshing time according to the two methodologies described. The comparison is performed on the example of the connecting rod to a series of 10 simulations made by a novice designer. This designer was observed and timed during the execution of these tasks. Comparing the two methods allows the highly productive aspect of the method of parametric mesh proposed in the FARD methodology to be highlighted. With a small component, an improvement in design time by more than 8 minutes in 10 cycles is obtained. In this case study, an average decrease design time of 40% per cycle using the parametric mesh is calculated. In this experimentation, the “High Productive” aspect is demonstrated. However, the CAD model must be updated using the various homothetic coefficients applied with the macro. But this part is quickly done thanks to the parameterization with skeleton of the CAD model. It does not require the time saved to be realized thanks to the Paramesh macro. In traditional methodology, the design is updated for each simulation (10 updates of the design for 9 cycles and only 1 update with the Paramesh macro).

5 CONCLUSION

To sum up, these three experimentations allow the whole aspects of the FARD methodology (functional design, modular design based on DFA and multi-physics simulation) to be tested in the two typologies of possible projects (redesign and first design). The “High Productive” aspect of the FARD methodology is not easy to prove. Indeed, creation of a parametric CAD model takes longer to achieve than a traditional design, but a new product from a parametric and skeletal CAD model is generated in a few minutes. But the “High Productive” aspect is not the only contribution of the FARD methodology. The main contribution is the combination of functional design with modularity and DFA with the first validated behaviour simulation.

For the pneumatic scraper, the old product family took months to be performed at the time (first design, no use of CAD software, etc.). With the FARD methodology, new products of the family that fulfil the customer needs, faster generated. Moreover, the modular aspects in accordance with the assembly phase of products are taken into account. This a plus compared with the old family. With the same number of components, new functions are added to the products family.

For the biomimetic spy system, the main interest of the application of the FARD methodology applied on a first design project is highlighted. Indeed, taking into account the modularity to answer the customer needs from the beginning of the product development allows a good fit of the product to the evolution of the needs to be had. For instance, the initial BioZard designed is dedicated to spying with a small camera. But it is easy to adapt the BioZard to spy on other information like sounds with a new tail including the corresponding sound sensor. This adaptation does not impact strongly the design or the assembly phase of the product and allows rapid answers to new customer needs.

The third experimentation on a connecting rod of a mountain bike tests the definition of the parametric and skeletal CAD model linked with functional parameters used to simulate various designs for a product or products of the same family. The “High Productive” contribution of the Paramesh macro used for parameterisation of the mesh was demonstrated by a time comparison.

The last point highlighted by these three experimentations is the need for a good level of expertise to use the FARD methodology as this methodology is quite complex. Then, the use of a software dedicated to the application of the FARD methodology to guide the users into the various steps is needed.

Chapter 4

Our application tool: ORASSE

Chapter contents:

1	Introduction to Orasse tool.....	142
2	Introduction to Orasse Product tool.....	142
3	Link of Orasse Product with the PLM tool: ACSP.....	144
4	Tool development.....	146
4.1	Use case diagram.....	146
4.2	Activity diagram.....	148
4.3	Sequence diagram.....	149
4.4	Class diagram.....	151
5	Orasse Product Man – Machine interface illustrated with the Scrap'Air experimentation.....	153
6	Efficiency of Orasse Product.....	161
7	Conclusion and perspectives.....	163

1 INTRODUCTION TO ORASSE TOOL

As highlighted in the previous chapters, users need a tool that can guide them for the application of the various algorithms proposed in the FARD methodology. Indeed, the generation of the assembly sequence and the definition of the product architecture are based on specific algorithms. However, these algorithms constitute a reasoning procedure that can be applied on various design domains. In this chapter, a generic approach namely “ORASSE” (ORdered ActivitieS Sequence) is proposed. It is only focused in this current research work and in accordance with the industrial context of this thesis, as explained previously, on the “Product design” domain. ORASSE is developed as a “meta-model” for bringing reasoning mechanisms on data and information concerning the Product domain. But it has been defined in order to be adapted and generalized to other design domains such as Process domain, Project domain, Knowledge domain, etc. ORASSE makes the MD-MV design model operational and dynamic thanks to the proposed specific reasoning procedure. This procedure adds dynamic interactions between the various data and information well structured in ORASSE and/or in the ACSP collaborative platform linked with ORASSE.

In the Product design context, the ORASSE meta-model applied to the Product design domain is declined in “Orasse Product” software which is a variant of ORASSE generic software. Orasse Product is based on the customer requirements and the product concept in order to establish the eligible assembly sequence of the modular product and the product structure itself. Its objective is to define a family of modular products respecting the best assembly sequence for the product’s family while checking the correspondence with the functions of the product and the proper assembly relationships of this family.

2 INTRODUCTION TO ORASSE PRODUCT TOOL

Orasse Product tool comes from a need to guide and support the users of the FARD methodology when using it with a large number of products components. Indeed, the methodology is complex and requires a good expertise from the users. The Orasse Product tool aims to guide the users during the definition of the assembly sequence of the generic product of a family. It goes from the concept with its list of components and the modular product architecture (from the adaptation of the FAST diagram) to the assembly sequence defined by the assembly planner thanks to Orasse Product features. Indeed, Orasse Product implements the algorithm for the decision support system for generating the best assembly sequence (ordered and eligible) according to the context and the assembly planner knowledge. To sum up Orasse Product (i.e. ORdered and eligible ActivitieS Sequence applied to the Product design domain) integrates mainly the step number 2 of the FARD methodology (Figure 12 in the section 1 of the Chapter 2) and detailed in Figure 19 (section 3 of the Chapter 2).

We have decided to develop a tool limited to the part of the FARD methodology that represents our largest contribution to already well known methodologies. This contribution consists of the combination of functional design, modularity and DFA principles, with the application of some specific matrix-based and graph-based reasoning algorithms. Moreover, this part needs the most expertise from the users. As no existing tool realizes this part of the FARD methodology, we have decided to develop our own software.

The development of a tool for the application of a part of the FARD methodology allows automating some aspects and then allows going faster in the application. Some links

are automated by the tool such as the generation of the contact graph from the coloured PP matrix. In the previous chapter, all the experimentations were realized manually and this was very fastidious and represented a risk of human errors.

A lot of functionalities are needed in this tool such as:

- Visualizing some general information about the project,
- Integrating the list of components of the product,
- Visualizing the position of each component on the concept and with each other,
- Assigning a single number to each component and different from the others,
- Integrating the product architecture,
- Assigning components to modules and sub-modules,
- Creating colour links between components and corresponding modules or sub-modules,
- Creating and fulfilling the PP matrix,
- Applying the various algorithms to the PP matrix (as for defining clusters),
- Generating automatically the contact graph from the PP matrix with coloured components,
- Representing assembly constraints on the contact graph in order to create the direct and coloured graph,
- Applying the algorithm for the simplification of the direct and coloured graph,
- Implementing the decision support system for generating the best assembly sequence in accordance with constraints like functions, modularity and assembly,
- Linking the tool Orasse Product with our collaborative project platform ACSP (in order to import and export some information).

Orasse Product aims to guide the users, in each step of the concerned FARD method and is based on various tabs. The users go tab on tab, which corresponds to the various steps matching to the chosen part of the developed FARD methodology. If the users follow the sequence of the tabs, every step will be done. Otherwise the tool will block some actions and users will be stopped. They will not have access to all functions of Orasse Product and the definition of the assembly sequence will not be possible. Then, users must fulfil all information needed and imposed by the FARD methodology to generate the assembly sequence of the product.

In Orasse Product, six main tabs were defined in order to fulfil the needed functionalities that are:

- Global project information;
- Concept of the generic product with its list of components;
- Functional architecture of the product;
- Coloured PP matrix with clusters;
- Direct and coloured graph;
- Decision support system for generating the best assembly sequence.

To link each tab with the corresponding step(s) of the FARD methodology, Figure 98 shows details of the steps implemented in Orasse Product tool for the definition of the assembly sequence (Figure 19 of the chapter 2, section 3) with the delimitation of each tab.

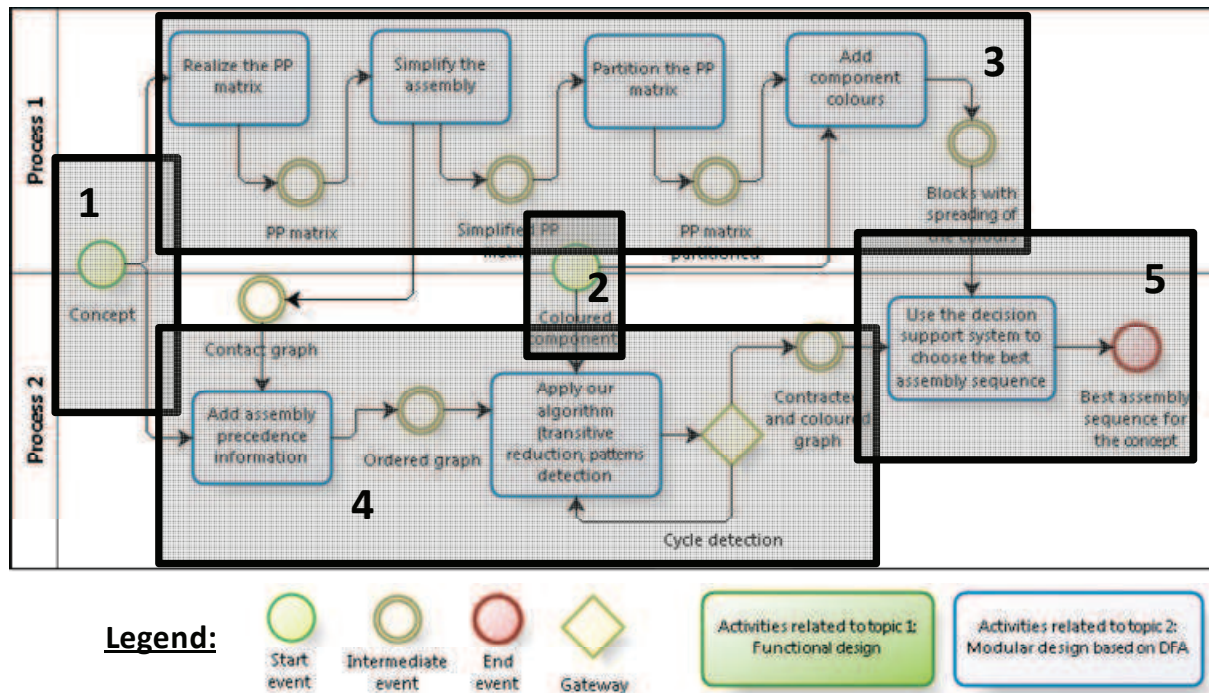

- Legend:**
- Start event
 - Intermediate event
 - End event
 - Gateway
- 1: Concept with its list of components
 - 2: Architecture of the product
 - 3: Coloured PP matrix with clusters
 - 4: Direct and coloured graph
 - 5: Decision support system for generating the best assembly sequence

Figure 98. Steps of the definition of the best assembly sequence of the FARD methodology with the delimitation of each tab of Orasse Product (except the tab of the global project information)

As you can see on the above figure, tabs interact together. Links between steps of the FARD methodology are kept. This is a contribution of the tool compared to a manual approach and it allows the application of the FARD methodology to be accelerated.

In this tool, like in the FARD methodology, there are three main experts: the designer, the product architect and the assembly planner. The tool is at the crossroads of these specialists.

3 LINK OF ORASSE PRODUCT WITH THE PLM TOOL: ACSP

The Orasse Product software is usable independently to any other software. But a Web Services approach was developed to link Orasse Product with other software's. A Web Service is a method of communication between electronic devices over the web. It is like a service that interfaces software together. This application integration becomes much more flexible because its communication form is not tied to any specific platform or programming language and it is applicable to any type of Web environment [Tichkiewitch et al. 2007].

Then, Orasse Product is also linked with ACSP as shown in Figure 99. It allows collecting information already made in the global project in ACSP. Orasse Product is just a part of the FARD methodology and corresponds to a part of the development process of a product. But it is also possible to export information at the end of Orasse Product and import them into ACSP.

Information exchange between Orasse Product and ACSP are put in “xml” files (Extensible Markup Language). Xml is a textual data format both human-readable and machine-readable. Many applications use xml data.

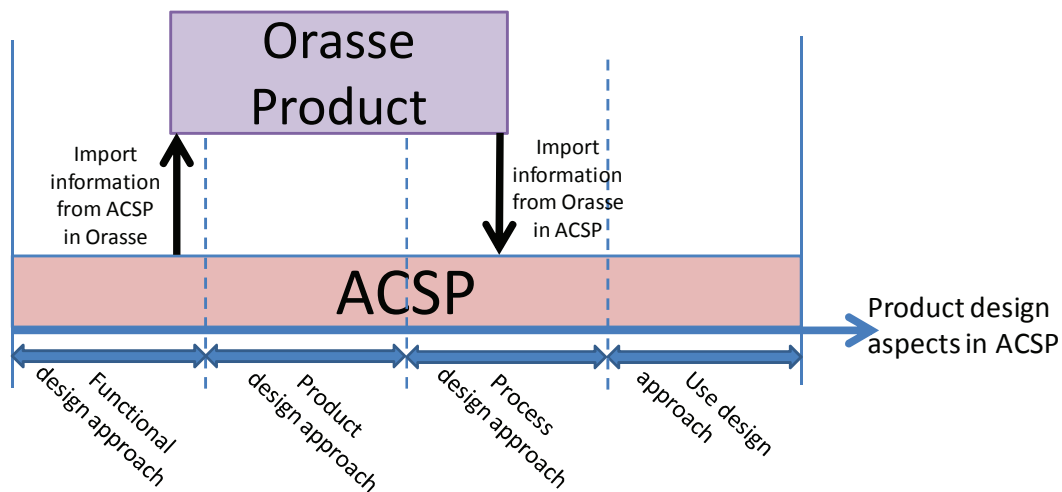

Figure 99. Interaction between Orasse and ACSP

ACSP (Atelier Coopératif de Suivi de Projets) is a web PLM (Product Lifecycle Management) platform developed by our research team [Gomes 1999]. ACSP aims to help various design actors working in a concurrent engineering context according to four design domains:

- The design of the “Project” (tasks, resources...),
- The design of the “Product” (structure, functions...),
- The design of the “Process” (resources, ranges...),
- The design of the “Use” (populations, activities...).

The goals are: facilitate and secure the data and information shared, improve the communication between actors of a same project, help to coordinate the activities management and promote a collaborative project organisation.

As you can see, there are some common aspects with Orasse Product. If a team works on ACSP, a lot of information needed by the Orasse Product is able to be previously defined in ACSP and/or then exported. A link between ACSP and Orasse Product was created to import and export information existing in one of them and used in the second one. The Table 10 shows the current information shared between ACSP and Orasse Product. But, nowadays, the only possibility is to export information in order to import them in Orasse Product. The reverse is not yet possible but will be developed in future works.

ACSP design domains containing the information shared	Information shared	Orasse tabs using the information shared
The design of the "Project"	General information	Global project information
The design of the "Product"	List of components	Concept of the generic product with its list of components
	FAST diagram(base for the product architecture)	Functional architecture of the product
	Link between some components and functions	
	FBD of the internal functional analysis (contact between components)	Coloured PP matrix with clusters

Table 10. Current information shared between ACSP and Orasse and its location in each software

As it is possible to do a functional analysis (external and internal) in ACSP, a lot of information used in Orasse Product is able to be put into ACSP as functions, links between some components and functions, etc.

The link between the two software reduces the time used to fulfil Orasse Product or ACSP and avoids repeating the same things twice. This link is possible thanks to the start window of Orasse Product. Two types of beginning are possible:

- Starting directly in Orasse Product with a new project or an old saved Orasse Product project,
- Starting with information imported from ACSP. In this case, the user selects its project and the information needed. This information is automatically imported by Orasse Product in the right position in the tabs concerned.

4 TOOL DEVELOPMENT

In order to develop our tool, we have worked with a computer science team. Then, a standard informatics language, the UML (Unified Modeling Language), was adopted. In this section, some extracts of the UML of Orasse Product are presented. The whole informatics specifications are not explained because of the large number of specifications.

UML allows a system to be modelled in order to have a better understanding of the knowledge of a system, its functioning and the system itself. UML is used in the field of object-oriented software engineering. UML includes some graphic notation techniques that allow visual models of object oriented software to be created. The definition of the tool focuses on four types of graphics: the use case diagram, the activity diagram, the sequence diagram and the class diagram.

To illustrate the UML schemes developed, we focus on the direct and coloured graph tab of Orasse Product. The various UML graphics of this tab are presented to illustrate the informatics developments.

4.1 Use case diagram

Use case diagram is a behaviour diagram that describes the functionalities of the system (in our case: Orasse Product) in terms of actors (designer, assembly planner and product architect). Each oval corresponds to a function of the system and actors are represented by a little man.

For describing the Orasse Product functionalities, eight use case diagrams have been created. Here is the list of use case diagrams for Orasse Product:

- The global use case of Orasse Product,
- The list of components,
- The contact between components,
- The functions,
- The precedence between components (from the contacts),
- The assembly sequence,
- The product architecture.

To illustrate the global functionalities of Orasse Product, the Figure 100 presents the use case of Orasse Product.

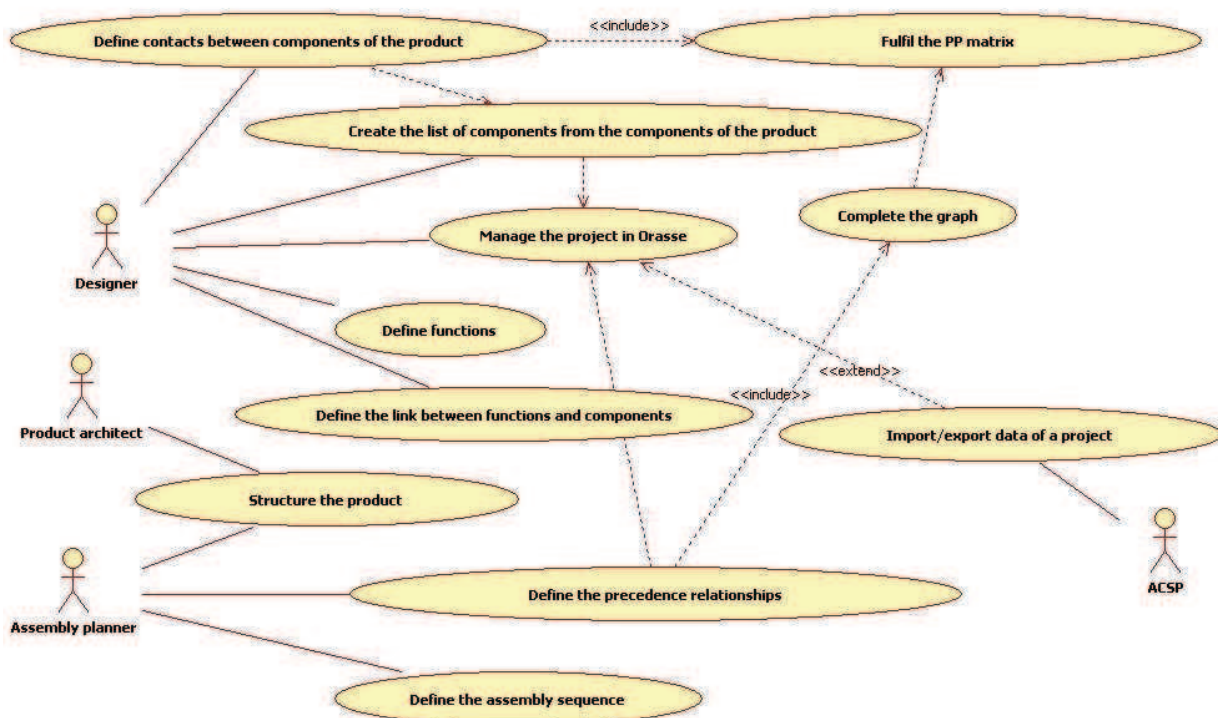

Figure 100. Use case of Orasse Product

In this use case, all the general functions implemented into Orasse Product are represented with their links from each other and with the three experts. This use case also highlights the actions of each expert (the designer, the product architect and the assembly planner).

As explained, the graph part of Orasse Product is focused on illustrating the UML. The next use case (Figure 101) shows functionalities corresponding to the graph tab and details the functions “Define the precedence relationships” and “Complete the graph” of the global use case (Figure 100).

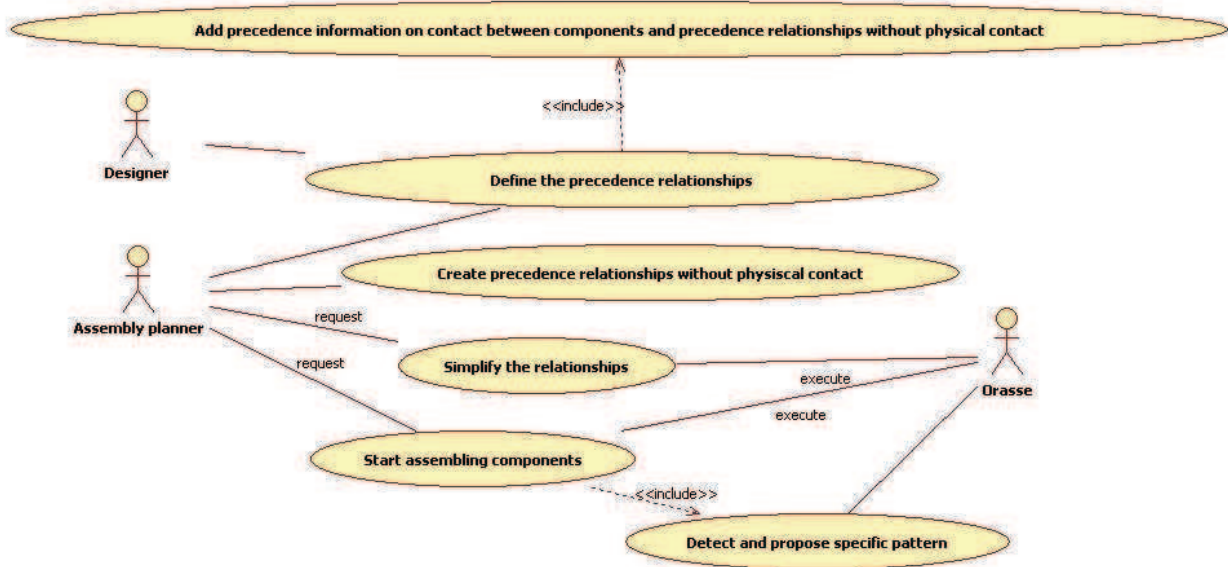

Figure 101. Use case of the definition of precedence relationships on the contact graph

As shown in the previous use case, the assembly planner is the main actor in this tab. However, the designer can also intervene for the definition of precedence relationships with contact that are equivalent to the contacts between components with a precedence information.

But the use case shows only functionalities and their interaction together. This is not enough to develop a software. Other information like processes to define their order of concatenation are needed.

4.2 Activity diagram

An activity diagram is a behaviour diagram that describes the business and operational step by step workflows of the system in terms of components. It represents the overall flow of control. Each oval corresponds to a function of a system that can be followed by a diamond. A diamond represents a decision. The ovals are linked in a specific sense described by arrows.

For describing the process of Orasse Product, three activity diagrams have been defined. Here is the list of activity diagrams for Orasse Product:

- The global activity diagram of Orasse Product,
- The definition of contacts between components in the PP matrix,
- The definition of precedence relationships between components.

For an overview of the whole Orasse Product process, the activity diagram of Orasse Product is presented in Figure 102.

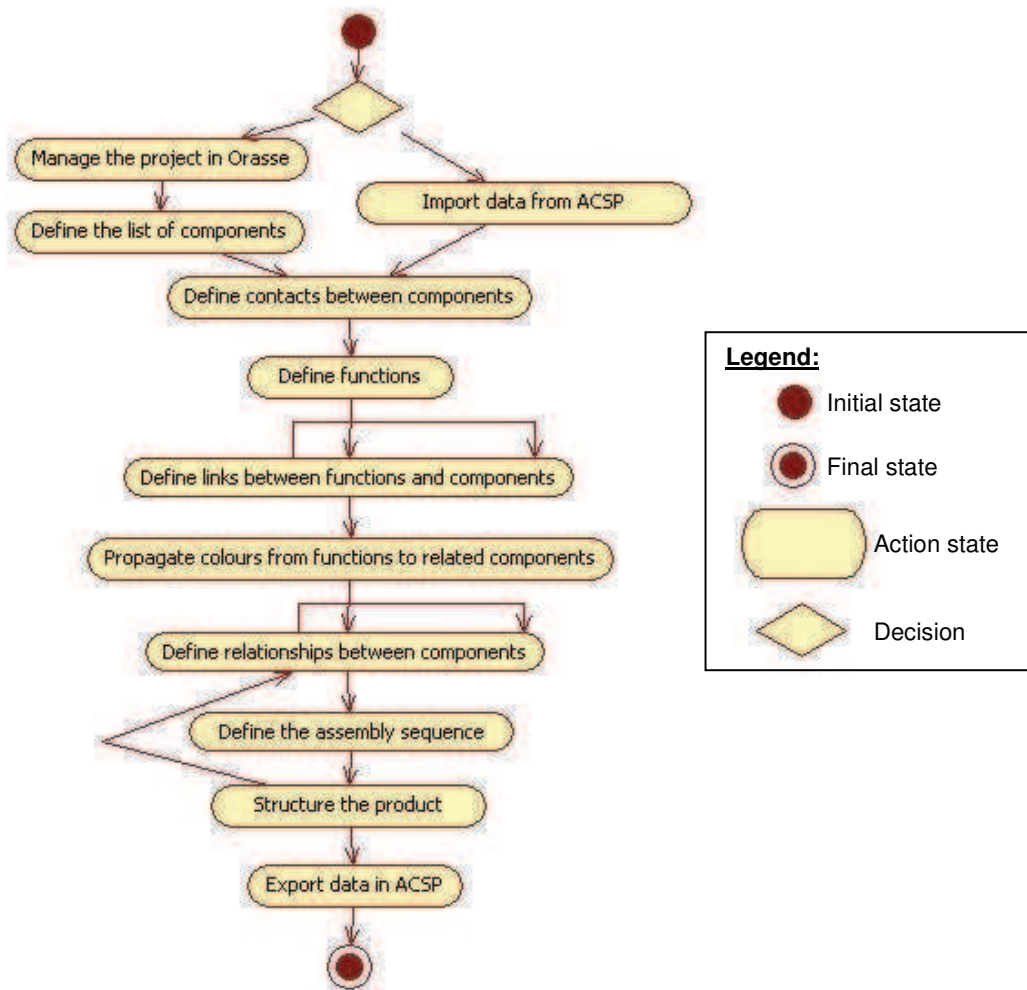

Figure 102. Activity diagram of Orasse Product

This activity diagram shows the concatenation of the general functions of Orasse Product. At the beginning of a project, two possibilities are given. The project can be done directly in Orasse Product (with a new or a saved project) or it can be the result of a project started in ACSP. In the second possibility, a lot of information is imported into the Orasse Product. Then, the process is like a sequential process with loops to optimize some aspects of the project. For instance, the loop from the product structure to the definition of relationships between components aims to adjust the precedence relationships in order to optimize the product structure. Sometimes a sense inversion can help to improve the structure. However, the assembly sequence must be updated before the new generation of the product structure.

4.3 Sequence diagram

A sequence diagram is an interaction diagram (a subset of behaviour diagram) that describes how objects of the system communicate with each other. It is a representation of the details of the activity diagram. It also represents the message exchanges between actors (designer, assembly planner and product architect) with the system (in our case: Orasse Product).

To describe the interaction into Orasse Product, ten sequence diagrams have been defined. Here is the list of sequence diagrams for Orasse Product:

- The import general data from ACSP,
- The import product data from ACSP,
- The specific actions of the designer,
- The specific actions of the assembly planner,
- The specific actions of the product architect,
- The list of components,
- The product architecture with functions that represent modules and sub-modules,
- The contacts in the PP matrix,
- The assembly simplifications in the PP matrix,
- The direct graph.

These sequence diagrams are divided into three groups that depend on the actions of each actor (designer, assembly planner and product architect) according to the various tabs. For instance, the assembly planner is the one that works the most in the graph tab as shown in Figure 101. In his/her sequence diagram (Figure 103), the tabs in which he/she operates are present.

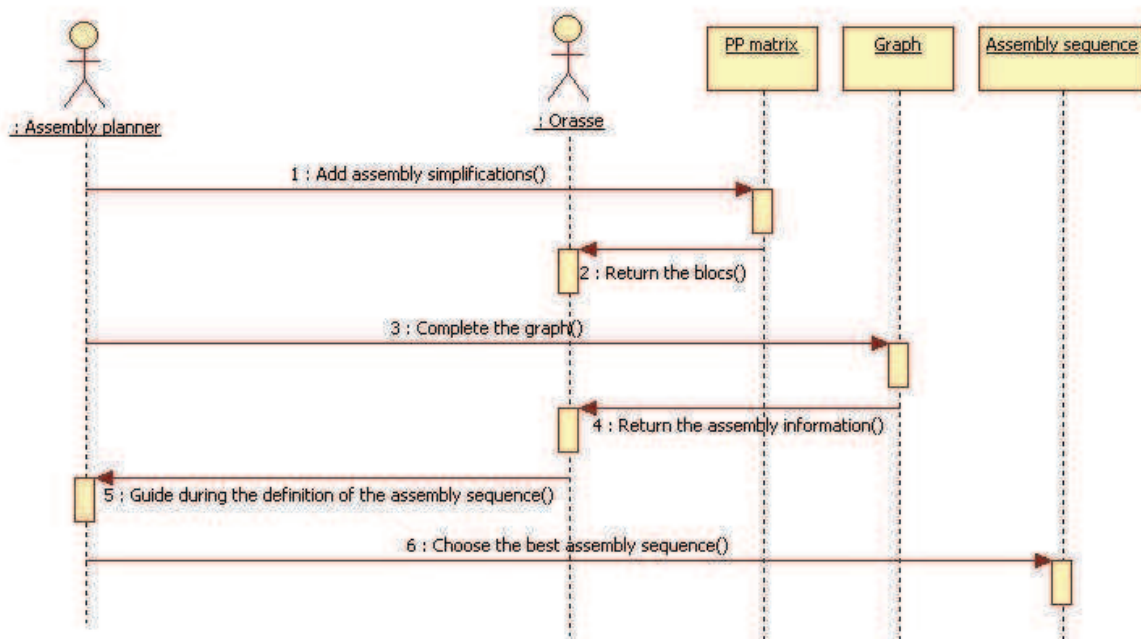

Figure 103. Sequence diagram of the assembly planner

As shown in Figure 103, the assembly planner intervenes in the PP matrix, graph and assembly sequence tabs. Moreover, the order to complete tabs is highlighted. The assembly planner completes the graph when the PP matrix tab is fulfilled. From the graph, Orasse Product guides the assembly planner during the definition of the best assembly sequence.

The next sequence diagram (Figure 104) presents details of the graph tabs and the process to complete it.

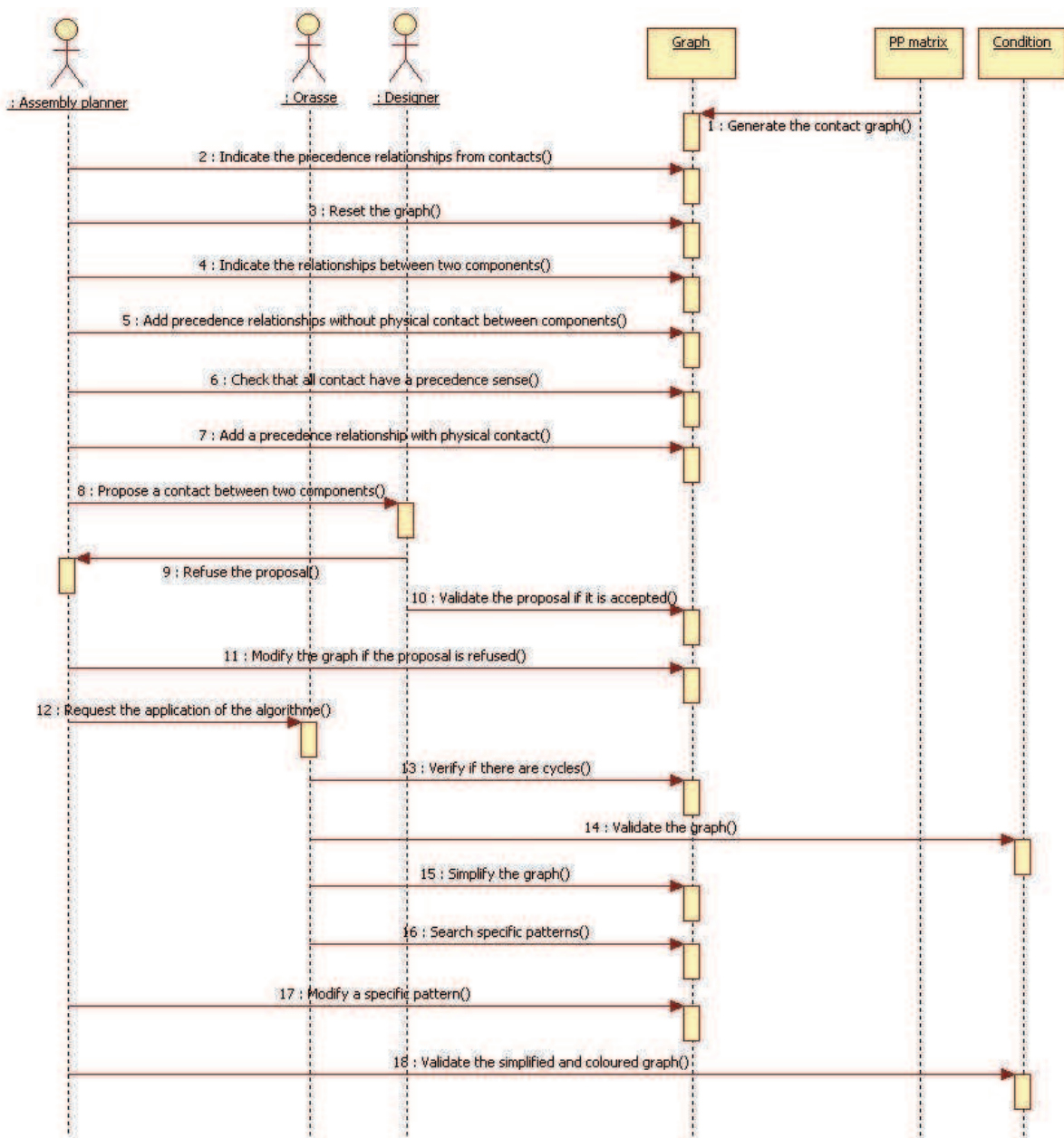

Figure 104. Sequence diagram of the graph tab

As shown in Figure 104, the assembly planner interacts with Orasse Product on the graph. Moreover, this Figure 104 highlights the importance of completing the PP matrix before the graph tab. The coloured contact graph is automatically generated by Orasse Product from the PP matrix. The assembly planner is the most important actor in this graph but he/she can also exchange information with the designer.

This Figure 104 emphasizes that the graph must be validated before the generation of the simplified graph by Orasse Product. The validation consists of the verification of the absence of cycles in the graph.

4.4 Class diagram

A class diagram is a structure diagram that describes the structure of a system (in our case: Orasse Product) from the system classes with their attributes. It represents the relationships between the classes of the system.

For the development of Orasse Product, three class diagrams of two main types were defined. The first one illustrates the classes of the system and their interactions. The second one represents the assignment of each class of the system, used in the first types of class diagrams, to the various tabs.

The Figure 105 focuses on the part of the class diagram that illustrates the graph in Orasse Product. The first class diagram (Figure 105) represents all the classes of the system and their interactions together. For instance, Figure 105 shows that a component is modelled by a node and nodes are in the graph. If the graph is deleted, nodes are also deleted thanks to the specific link between node and graph.

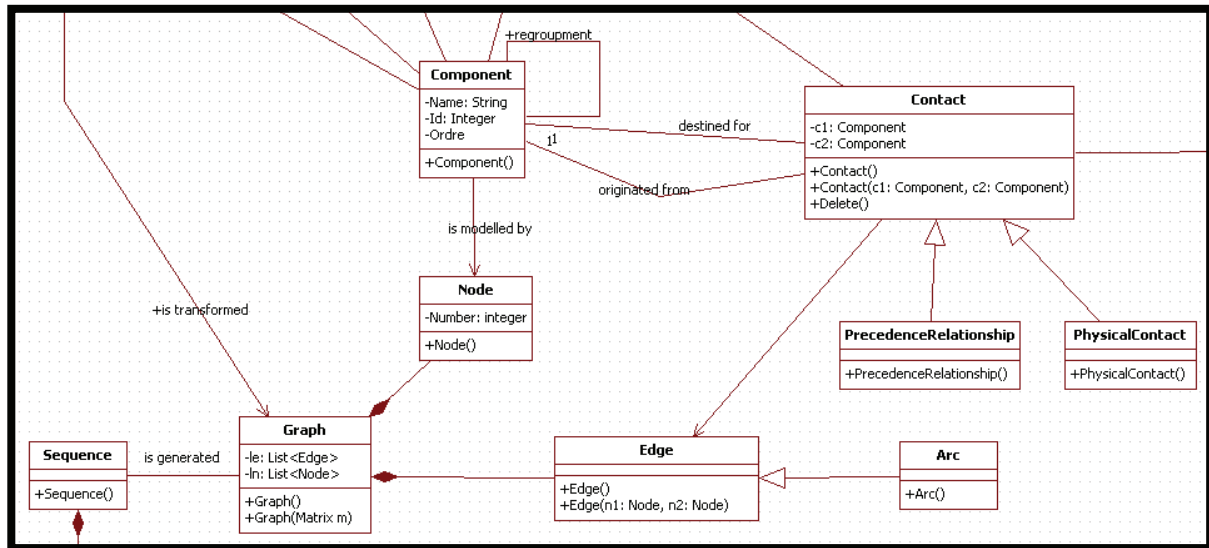

Figure 105. Part of the class diagram of Orasse Product dedicated to the graph tab

As shown in the Figure 105, each class is represented in a box divided into three parts (from the top to the bottom of the box): the name of the class, its attributes and actions that define its behaviour. For instance, a graph is composed of nodes and edges. There are two main actions: the creation of a graph and its creation from the PP matrix. The graph cannot be deleted, it is only possible to initialize it (initial graph in the tab: contact graph, before the precedence information). So the required elements to create a graph are known and the class diagram shows that the graph is used to generate the sequence.

To sum up the class diagram allows all links between elements used in the whole Orasse Product to be defined. Then, a second type of class diagram was created, the package. This diagram allows the position of each class in the various tabs to be represented in order to prepare the tool architecture. Figure 106 shows a part of all Orasse Product tabs focused on the graph tab.

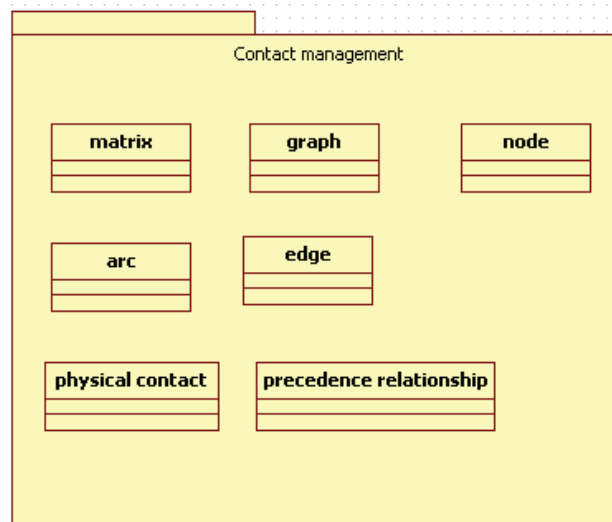

Figure 106. Part of the class diagram of Orasse Product dedicated to the contact management linked with the graph tab

This tab summarizes the classes that intervene in the graph tab. Then, the combination of the various class diagrams allows links between the tabs through their internal classes to be defined.

5 ORASSE PRODUCT MAN – MACHINE INTERFACE ILLUSTRATED WITH THE SCRAP’AIR EXPERIMENTATION

In this section, Orasse Product software developed by our research team is illustrated with the experimentation of the pneumatic scraper presented in the previous chapter 3.

When the user starts Orasse Product, a first window opens (Figure 107). This window proposes various options to begin: create a new project, open a saved project, open a project from information of ACSP and quit.

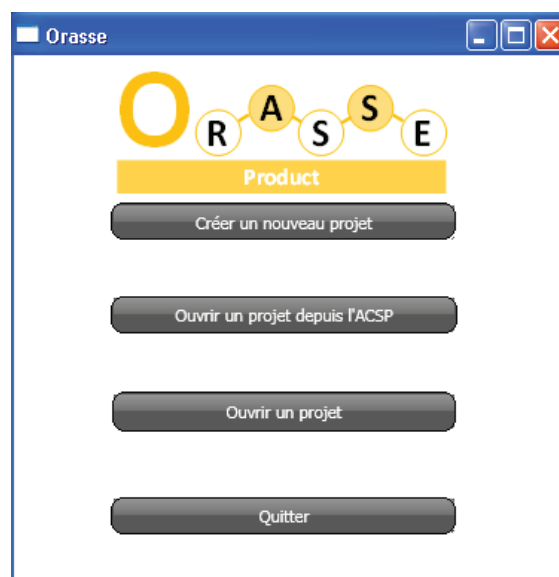

Figure 107. Start up window of Orasse Product

As soon as the user chooses his/her project type, Orasse Product starts and the user accesses the various tabs. The first tab automatically proposed is the global project information (Figure 108). This tab contains general information about the project like the name of the project, the number of components of the product... For instance the number of components allows the right number of components to be automatically created in the list of components in the next tab.

The screenshot shows a software window titled 'Orasse' with a sub-header 'Application'. Below this is a tabbed interface with the following tabs: 'Général', 'Nomenclature', 'Schéma', 'Fonctions', 'Matrice', and 'Graphe'. The 'Général' tab is active and contains the following fields:

Nom du projet:	Scrap'Air
Chef de projet:	AR
Date de début de projet:	25/08/2012 15
Date de fin de projet:	30/09/2012 15
Auteur:	AR
Description:	Development of a pneumatic scraper family used
Importer une image:	D:\Aurelie\Recherche\ <input type="button" value="Ouvrir"/>
Nombre de pièces:	39

Figure 108. Global project information tab

The next tab after general information concerns the concept of generic product studies. This tab is divided into two different tabs: the list of components with their number (Figure 109) and the sketch(s) of the concept (Figure 110). The sketch(s) of the concept is separate from the list in order to put it in a new window. Indeed, in design office, it is increasingly common to work with two computer screens. Then, we would like offer to the users the possibility to place the concept in a second screen. However, this is not yet possible.

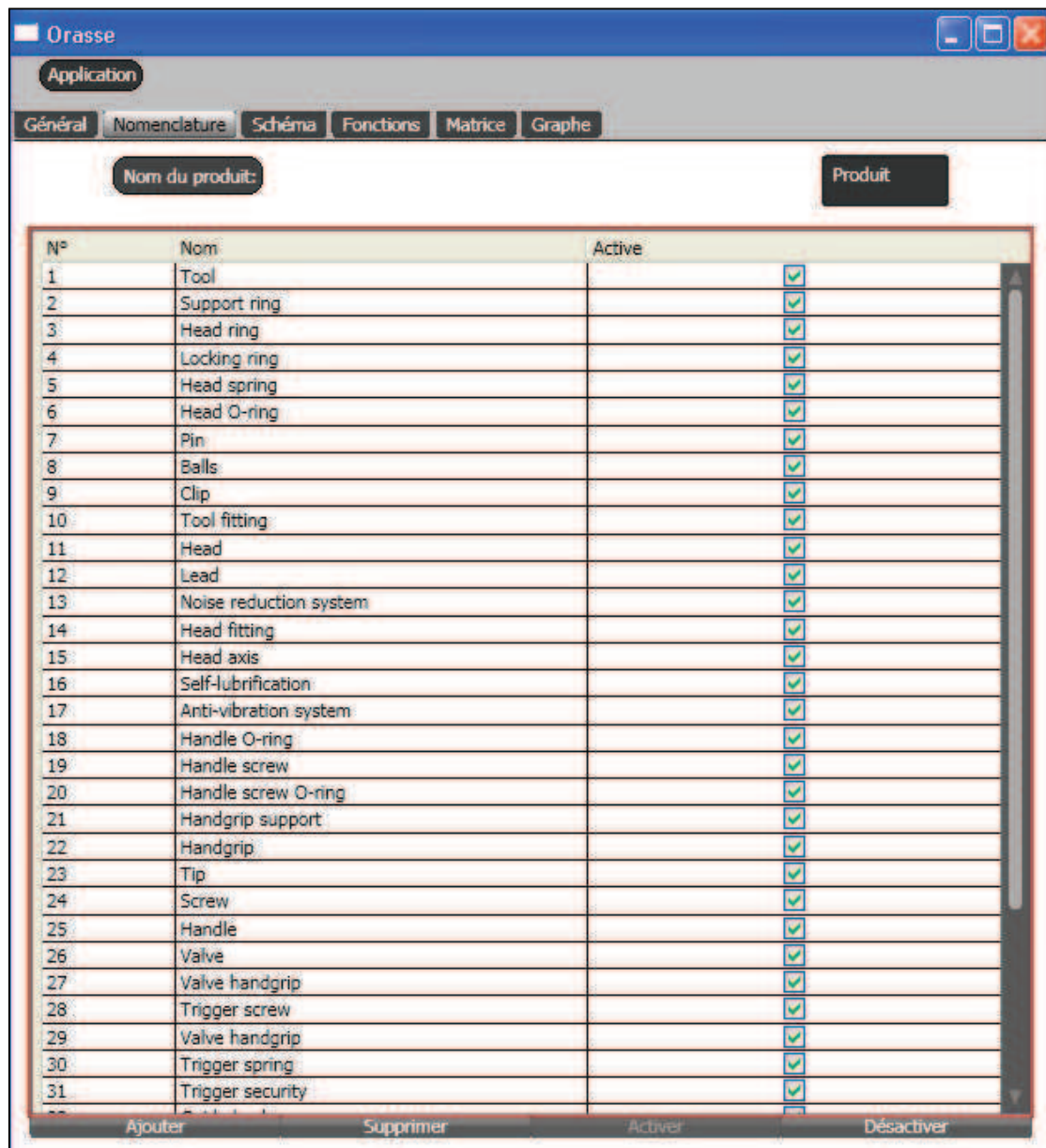

Figure 109. List of components of the concept

The list of components is automatically generated by information from the previous tab (number of parts is requested in the previous tab). But it is also possible to insert or delete a component in this tab. The designer can change/indicate the name of each component and deactivate or activate some of them. For instance, it is possible to work with just a part of all components of a product or just remove certain components for any reason.

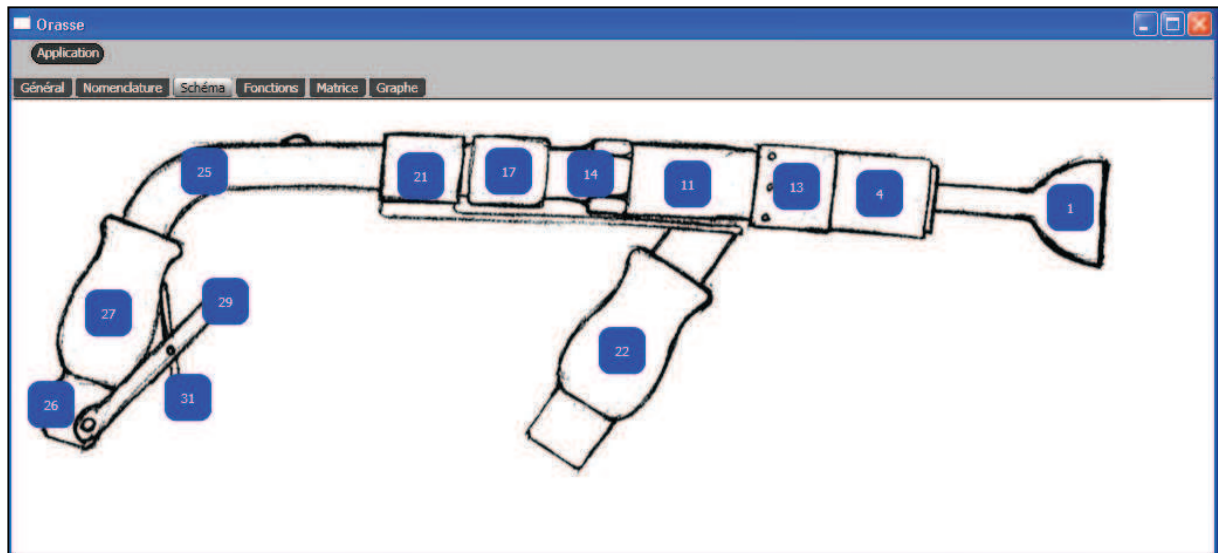

Figure 110. Sketch of the pneumatic scraper concept with some marks with number corresponding to components of the product

The sketch(s) of the concept allow the number or name of component to be linked with physical components on the concept. It is like a product plan with nomenclature, usually used in the field of mechanic to detail product and components against each other.

Then, the functional architecture can be created and some components can be linked with the technical functions corresponding to sub-modules of the product. The tab of the functional architecture (Figure 111) is divided into two parts: the functional architecture on the left and the list of components on the right. The first step consists of the definition of the functional architecture. The designer can create functions and sub-functions thanks to the various buttons.

To assign components to sub-functions, the user selects a function and on the right of the tab, he/she selects the components to add and clicks on the button to assign the component to the selected functions. The button is under the list of component. It is the only action possible on components in this tab. Then, components take the same colour from their function. A first colour is automatically assigned to each function but the user can change it. Components added to a function are placed below the corresponding function. If two components have the same name, the user can check the number (that is specific to each component compared to the name) by passing his/her mouse over the name of the component. The number corresponding to the components appears temporarily.

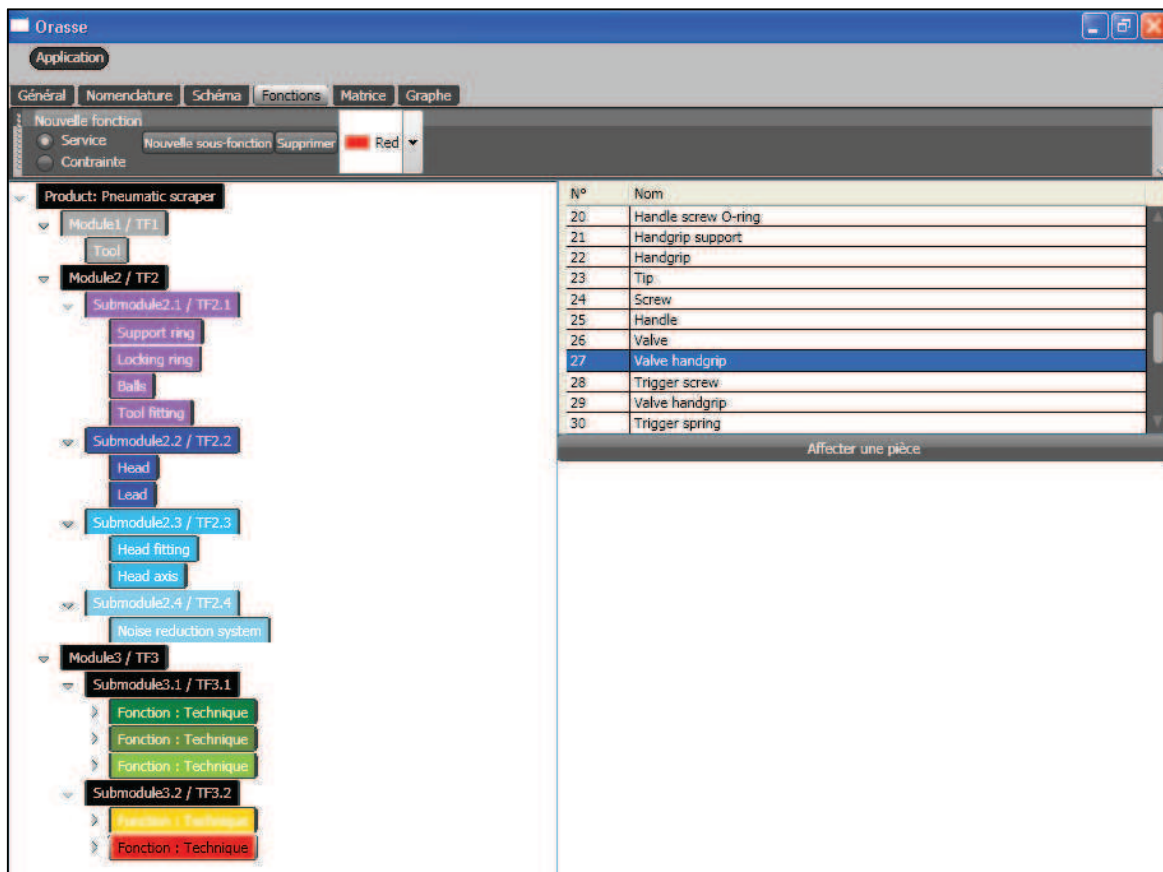

Figure 111. Functional architecture tab of the product

The next tab concerns the PP matrix (Figure 112). In this tab there are several steps to follow. The first step is the filling of the PP matrix. The PP matrix is automatically generated by Orasse Product from the list of active components. At the beginning, all the boxes of the matrix have a "0". The design put a "1" in each box of the matrix that crosses two components in physical contact. The designer fulfils only the half of the PP matrix. Orasse Product generates automatically progressively the symmetric of the matrix during the filling.

Then, the assembly planner can add assembly simplifications by regrouping some specific components like O-ring with their axis component. The grouping of components takes into account the physical contacts of each component that are combined.

The next step is the research of clusters. Thanks to a clustering algorithm, Orasse Product proposes various blocks of components. If the designer finds them not consistent with the concept, he/she can reject some of them. This step is important because blocks are used to guide the assembly planner during the definition of the best assembly sequence.

As shown in the Figure 112 there are very few possible functions in this tab. The users can only find clusters, group some components or divide them and reset the PP matrix.

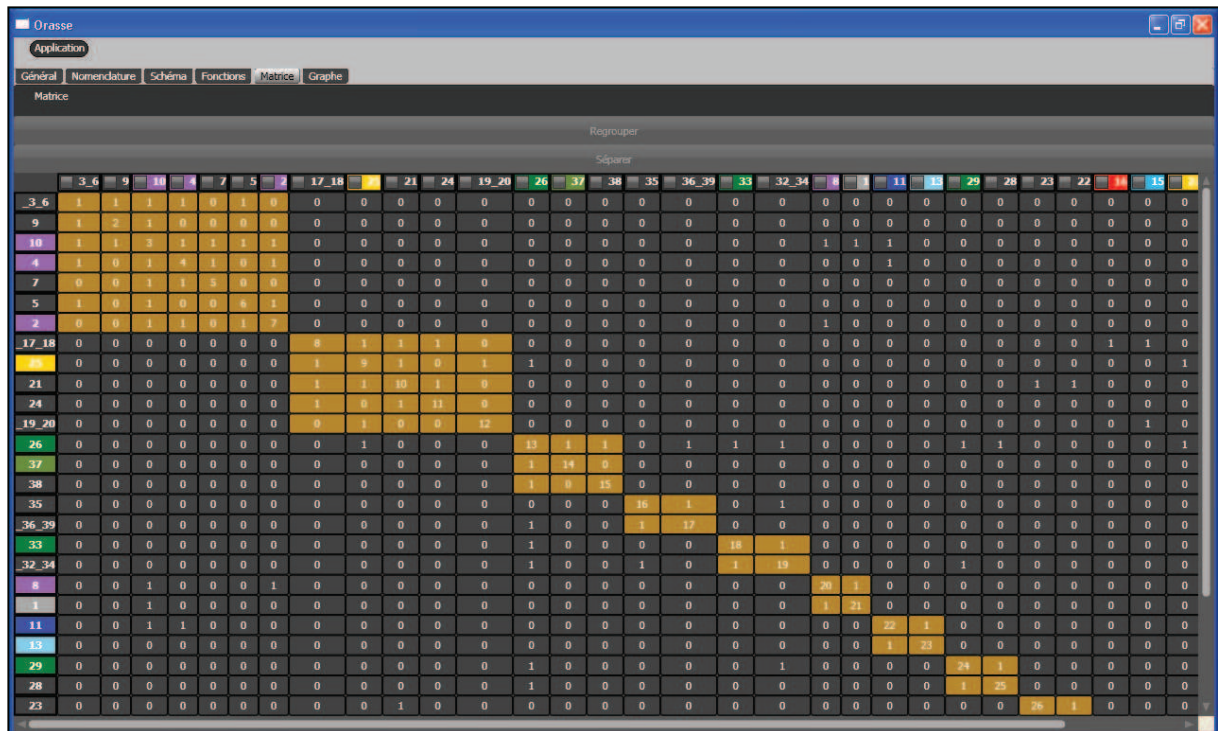

Figure 112. Coloured PP matrix with its clusters, tab proposed by Orasse Product thanks to an algorithm

The blocks generated by Orasse Product may not be the same as in the manual experimentation because an heuristic is developed to find clusters. An heuristic approach does not find the best and only one solution but an eligible solution that approximates the best solution in a reasonable execution time. So solutions can differ from each other. However, both solutions are consistent and similar.

The next step is the definition of the direct graph. There are two steps: the definition of the coloured and direct graph with all precedence relationships with or without physical contact between components and the simplified coloured and direct graph used for the definition of the best assembly sequence (Figure 113). This tab is divided itself into two “sub-tabs”: one for the full coloured and direct graph and the second for the simplified coloured and direct graph.

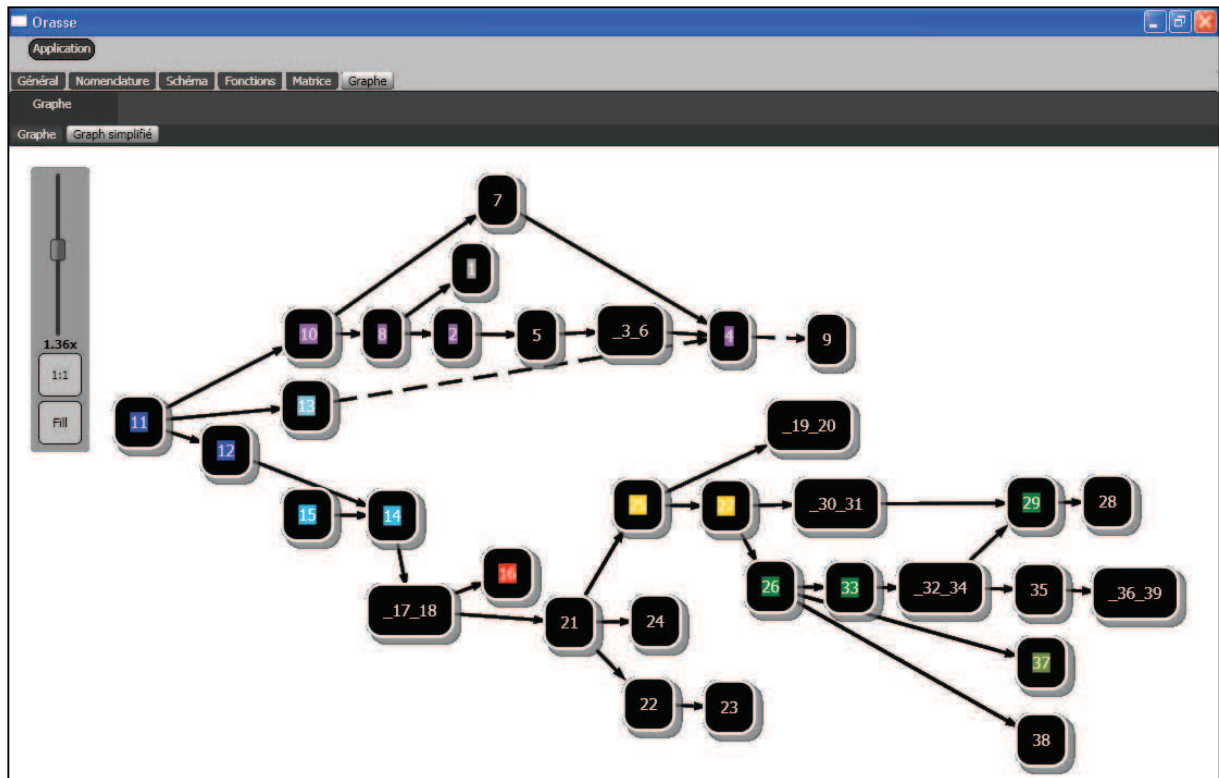

Figure 113. Simplified coloured and direct graph tab

When the assembly planner opens this tab, the coloured contact graph is automatically generated from the PP matrix. He/she must add order information on every contact existing between two components. For this, he/she must click on the existing line between two components. A first sense is proposed, if the other sense is the right, the user clicks again on the same line to invert the sense. When the line is transformed into an arrow, its initial grey colour becomes black. It allows the user to see quickly which line remains to be transformed. After he/she can add precedence relationships without physical contact between components thanks to a function in the graph tab menu (in the top left of the tab). The coloured and direct graph is obtained.

Before generating the simplified graph, the user must check the graph with a searching cycle. The user initiates the function by the graph tab menu. If a cycle is detected by Orasse Product, the numbers of components in the cycle are posted into a new window. Otherwise, the user is informed that no cycle was detected.

Then, it is possible to generate the simplified coloured and direct graph. As you can see, a similar graph to the one in the manual experimentation is obtained (Figure 113). The only difference with the manual experimentation comes from the detection of specific patterns that is not yet implemented in Orasse Product.

The current last tab of Orasse Product is the definition of the assembly sequence tab. It gathers information from all the previous tabs. This is currently like the focal point of Orasse Product (gathering point). In order to minimize disruption to the user, this tab aims to conserve some standard of representation adopted in Orasse Product, in the previous tabs:

- The direct graph representation (in the graph tab),
- The coloured node representation (in the graph tab),
- The block representation for clusters (in the PP matrix),
- The reading from the left to the right of the assembly sequence and the direct and coloured graph, that corresponds to the reading direction.

In order to guide the user, the graph evolves during the selection of components for generating the assembly sequence. As to the selection of a node, the graph is reduced and selected components or nodes are removed. Then, only nodes without precedence can be selected in a list, according to the evolution of the graph. To highlighting the possible selected nodes, the size of these nodes evolves. Moreover, the algorithm aims to propose the best next component or node choice to the assemble planner (the user of this tab) thanks to a classified list of selectable components (in the left bottom left part of the tab). The top node represents the first choice proposed by the algorithm to the user. The second node represents the second proposed choice and so on until the last node of the list (the bottom of the list) that is the worst choice according to the algorithm.

The last thing to improve the reading of the graph is the evolution of details of the graph. For instance all the blocks for which it is not possible to select a node or component (they have no direct link with the previous selected node), are not visible. This is valid until a node of a simplified block becomes selectable. Then, this block and its components are detailed and it is possible to see all the components of this block.

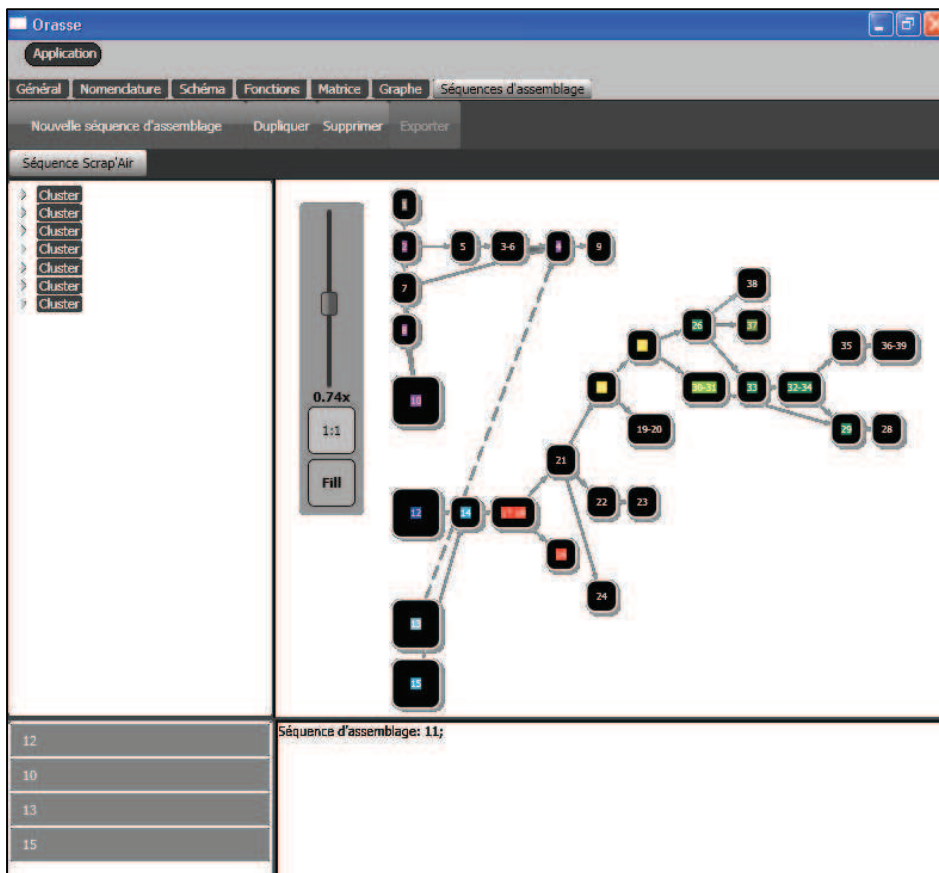

Figure 114. Decision support system tab for generating the best assembly sequence

As shown in Figure 114, the tab is divided into four main parts. The top left part of the tab presents the blocks with their components. The bottom left part of the tab contains the selected components for the assembly sequence. The top of this list proposes the most suitable components for selection. In opposition, the bottom of this list proposes the less suitable components for selection in order to complete the assembly sequence. The top right part of the tab shows the direct and coloured graph with all the components not yet added in the assembly sequence. In the bottom right part of the tab, the assembly sequence is under construction and selected components are added after their selection or automatically by the algorithm. If a component is alone for the selection, it is automatically added in the assembly sequence by the algorithm. The assembly planner has no choice to do this because it is the only possible selection.

6 EFFICIENCY OF ORASSE PRODUCT

In order to prove the efficiency for using Orasse Product some experiments were done.

The first experiment is the Scrap'Air presented in the previous section to explain Orasse Product tabs. The manually application needs between 2 and 3 full days compare to the Orasse Product application that needs around 4 hours. There is a minimum gain of 75% of the time needed for doing this use case with Orasse Product.

Another small use case was done by three non experimented testers. The tested use case is an electric towel radiator (shown in Figure 115) which is a very well known and easy to understand by the testers.



Figure 115. An electric towel radiator

This use case is composed by 34 components. The total number of functions and sub-functions that represent the modules and sub-modules of the product, is 13.

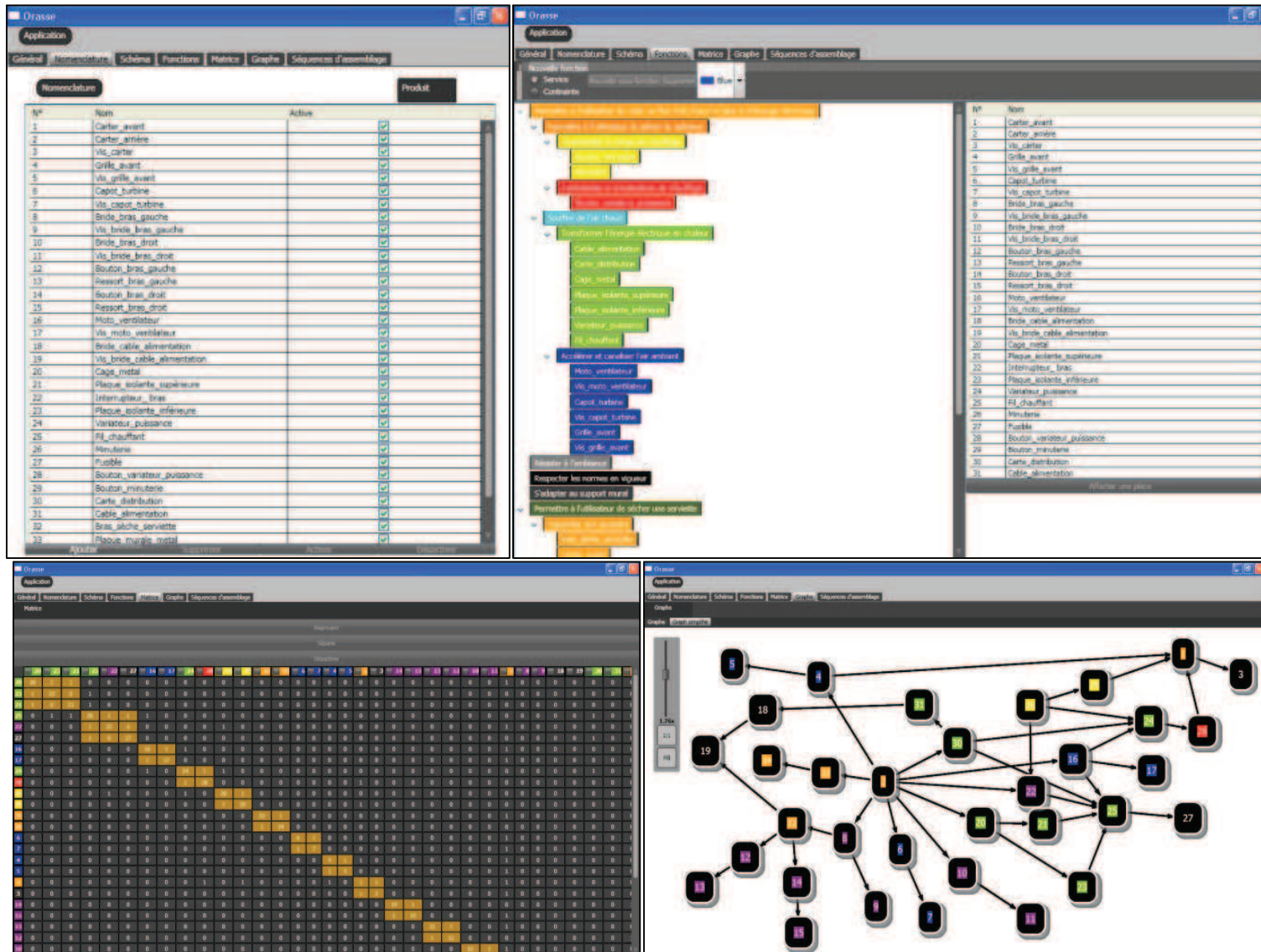

Figure 116. Some illustrations of the use of Orasse Product with the electric towel radiator use case

The manual application of the FARD methodology to this product takes around 5 hours. Thanks to Orasse Product software, this application time is reduced to around 1h20 (Figure 116). Moreover, the creation of clusters is not possible manually, it needs too much time. Then, the manual application is limited compared to the use of Orasse Products. The obtained time and quality gain through this use case is around 75%.

Moreover this electric towel radiator use case confirms the impact of the FARD methodology on the modularity of a product. The Csapm indicator (capacity of the assembly sequence to generate a modular product according to the FARD methodology) of this product is 0,75 (6 functions in the lower level of the modular product structure / 8 colour change according the assembly order of the product added 1 =0,75). The Imp of the initial product use for this application is 0,18. This initial Imp illustrates that this product has not been developed with the objective of modularity (24% of the Csapm). Thanks to the application of the FARD methodology for developing a new modular product, the Imp increases from 0,18 to 0,6 (6 functions in the lower level of the modular product structure / 10 modules and sub-modules in the lower levels of the product structure = 0,6). Finally, a manual improvement of the final product structure allows us to obtain an Imp of 0,67 (6/9=0,67). To sum up, from a none modular product it is possible to develop a new product with a greater modular indicator that corresponds to 89% of the best theoretical modular product possible according to the chosen assembly sequence.

According to these two experiments, using Orasse Product allows more time to be freed up compared to a manual application of the methodology. A time saving of about 75% is possible thanks to Orasse Product software. Moreover, the use of this tool allows a better control of human errors, such as the specific features developed in order to validate the direct graph. For instance, the realization of the Scrap'Air use case with Orasse Product tool highlighted a precedence error in the manual application that an expert user did not find before.

7 CONCLUSION AND PERSPECTIVES

Thanks to the Scrap'Air use case from MABI Company, the manual application process and the tool application process can be compared. Orasse Product software allows the experimentation of a part of the FARD methodology. The same results concerning the assembly sequences are obtained in the comparison. Moreover, Orasse Product software is much more efficient in terms of time saving and complexity avoiding compared to a manual application and allows the computation of some specific algorithms that the user is not possible to operate manually. Moreover, some human errors are detected by the software tool and can then be manually corrected by the user.

The efficiency of Orasse Product is possible thanks a deliberate ergonomic work on the Man – Machine Interface of the tool. The proposed part of the FARD methodology developed in Orasse Product software is decomposed into various tabs which integrate very few possible functions in each tab. This choice was made in order to simplify the software interface to have an ease of use and an intuitive tool that facilitates the end-user work. Every tab corresponds to a specific part of the FARD methodology and they are linked together thanks to the tool's architecture which follows the various steps of the proposed methodology. If the users follow the sequence of tabs, all requested information will be

fulfilled. It is then possible to generate the best assembly sequence from information of the previous tabs. Otherwise, it is not possible, the assembly planner is stopped.

Some improvements of Orasse Product remain to be done in order to improve the ergonomic aspect and to add new functions. For instance, the importation of the list of components from a text file would be easier and faster to operate. If the designer creates a CAD model of the product concept, he/she can export easily the list of components which could be directly imported in Orasse Product. For instance, it would be more convenient to import multiple figures or sketches of the product concept for the definition of the components position.

Another perspective to improve Orasse Product is the creation of a new tab: the product structure that corresponds to the step number 3 of the FARD methodology in chapter 2, section 1. The FARD methodology proposed an algorithm for the product re-structuration in accordance with the assembly sequence, the functional product architecture and the contact between components. This tab will complete Orasse Product especially when all the necessary information for this future tab are already available in Orasse Product software.

This tool is a part of a whole project of tool development, which is envisaged and initiated by the FARD methodology research work. Two axes of development are initiated: the communication with the ACSP platform and a variation of Orasse Product for other design domains.

As explained in the section 3 of this chapter, Orasse Product will be linked with ACSP platform, our own PLM platform developed at UTBM since 1998. Many data are already available in ACSP platform and can be exported in order to insert them in Orasse Product software. But it is also possible to export some information from Orasse Product in order to be imported in ACSP platform. These import/export features and connectors must be developed. Today, data can be imported from ACSP PLM platform to Orasse Product software, but the export features are not available yet. The import features of the product structure with modules and components from Orasse Product can allow the user to quickly create new structural variants of products in the same family in the ACSP platform. This feature needs to be developed in order to help the designer to make a product that meets new customer needs in terms of functions or options which require some local modifications on the product.

The second project planned in terms of tool development is the creation of various variations of Orasse Product software, which is more specifically dedicated to the Product Design Domain. The matrix-based and graph-based reasoning features implemented into this tool can be easily applied on various other design domains such as the Project Design Domain, the Process Design Domain, the Knowledge design domain, etc. The Table 11 below shows the equivalences between some design domains.





Elements in Orasse	Design domains				
	Product design domain 	Process design domain 	Project design domain 	Knowledge design domain 	Human activity design domain 
Entity	Product components	Process unit	Project design task	Design parameter	Human working task
Tree	Functional product structure (from product functions)	Process functions required for the product line	Project skills needed for the development of a product	Knowledge classification based on functions and/or knowledge focus (knowledge configurations)	Human activity typology
Contact matrix	Contacts between components of the product	Contacts between the process units (according to the path of the manufactured product)	Contacts between the various project design tasks in order to create blocks	Contacts between design parameters, representing rules that link parameters together	Contacts between human working tasks
Direct graph	Assembly precedence between components	Manufacture precedence between the process units	Representation of precedence between task of a project	Precedence between design parameters and/or rules (groups of parameters manually done in the contact matrix)	Precedence between human working tasks
Ordered sequence of entities	Assembly sequence of the product	Manufacturing sequence planning for a product	Project task sequence	Knowledge based design sequence in order to guide the user in the definition of a product	Human activity operative sequence
Structure of entities	Product structure from functions, with the repartition of all the components	Formation of islands or blocks of process units in order to create areas in the factory and improve the product flow	Formation of functional groups of tasks for a better organization of the teams and a better data communication	Groups of knowledge according to a knowledge classification based on functions and/or knowledge focus (ex: calculation gear of a product, thermal formula, global size calculation, etc.)	Creation of human activity work packages in order to improve the efficiency by working task groups (working task typology by typology and not everything at the same time and not passing from one group to another without stopping)

Table 11: Illustration of the links between Project, Product, Process, Human activity and Knowledge design domains and their main entities

The algorithms developed for the product design domains can be easily reused in the other proposed design domains, showing some promising generic character for our proposed

methodology, but only applied in details for the Product Design Domain. But some design domain tool may require some small adaptations due to the specificity of the product domain or the constraints brought by the modularity assumptions. For instance, in the process design domain, a process unit can be used for several manufacturing operations and then a process unit can be in various functions in the functional tree. For instance, some design domains require the representation of parallelized entity in the ordered sequence of entities as with the Project design process (in order to not be in sequential project model). For instance, the knowledge design domain may require the addition of weight in the contact matrix for representing the membership of certain parameters of some rules. The addition of a weight in the contact matrix is proposed in the FARD mythology but has not yet been developed in the Orasse Product tool.

Finally, another interesting aspect consists of the link established between ACSP PLM platform and all the variation of the Orasse Product tool, as presented previously, in the scope of a more generic ORASSE tool, developed as software pattern. Indeed, ACSP platform links various design domains such as Project, Product, Process, use, etc. Design Domains. It is like a crossroads between these design domains, which create relationships and dynamic behaviours among themselves. This tool network can be the crossroads of various tools derivated from an ORASSE tool but applied to the various design domains listed previously, as "Orasse Product software" is the variation of the Product Design Domain.

The next steps will also consist of specifying and developing the other application thanks to the design pattern defined for the generic ORASSE tool: Orasse Project, Orasse Process, Orasse Activity and Orasse Knowledge.

Chapter 5

General conclusion and perspectives

Chapter contents:

1	Conclusion.....	168
1.1	Contribution of our results to the research domain.....	168
1.2	Impact of our research activities in MABI Innovation process	171
2	Research perspectives	173

1 CONCLUSION

In the scope of our industrial context, the purpose of this research work is to decline a generic methodology to the Product design domain in order to generate, in a fast and efficient way, all the products of a complete family. Moreover, these products must respect the customer needs and the assembly constraints of the Company. The final goal consists in assembling a product in the assembly workshop of the company, as late as possible, only when an order is edited. For these reasons, the proposed methodology is based on a modular approach that is used to fulfil all these constraints. Today, only a part of the FARD (Functional And Robust Design) methodology have been implemented in the MABI Company. Nevertheless, it is possible to observe some causes-effects links between the academic research work performed and the several projects, dedicated to product innovation, developed in the company with our personal contribution. The implementation of the whole FARD methodology was too difficult to operate according to the structure of the MABI Company (Small and Medium Enterprise). However, the architecture of the new research and development office that we have contributed to build in the company is based on a simplified and reorganized design process, including some parts of our proposed FARD methodology. This re-adapted design process rebuilt for the company, includes various “good practices” including design development procedures and standard files, defined as templates, specific to the MABI Company context for each step of the design process, have allowed us to work in parallel on various design projects for innovative products definition. This result seems to confirm our initial assumptions that “High productive” design methods and tools, applied for streamlining the design activities, can allow to save time and efforts which can be spent in innovative design activities.

To sum up the global methodology described in this thesis, our research approach is structured into three levels:

- First, our approach globally aims to develop dynamics links and interactions inside and between the various domains of the MD-MV design model thanks to reasoning mechanisms based on graphs and matrices in order to drive a decision support system integrated in the ORASSE software.
- Then, the dynamic links and interactions are more specifically detailed and developed between the Product and Process Domain, allowing us to develop the ORASSE Product software.
- At the third and more detailed level, our approach focuses on modular products design.

The first part of this section synthesizes the results obtained with our FARD methodology and verifies that the initial objectives of our research work, established in the first chapter, have been fulfilled. The second part of this chapter illustrates some other results of our research and development activity focused on the innovation design process in the MABI Company, in the scope of developing innovative products.

1.1 Contribution of our results to the research domain

As a conclusion to our research work, presented in this manuscript, all the questions, defined in the scientific problematic, at the end of the chapter 1, are formulated in order to summarize the contributions of our proposals, through the FARD (Functional And Robust Design) methodology, to the research domain.

“Is it possible to create in a very fast way new products in the same family in a routine design context and ensure that the new developed products respect the customer needs?”

As explained in the beginning of the chapter 2, the proposed FARD methodology can be applied to two types of projects: a re-design project and a first design project. But both projects allow the creation of new products in a same family, but starting from a well defined generic product. Even if the first design project integrates innovative aspects, all the other products will be designed from this generic product base. Then, the FARD methodology is applied to a routine design project. This methodology significantly accelerates the design phase of new products within a same family, thanks to a parameterization approach of the product CAD model. Thereafter, from a new set of parameters, a new product of the same product family can easily be created. Moreover, these parameters (mainly geometrical) are linked with the functional parameters that come from the customer requirements. Thus, the application of the new set of parameters ensures the respect of the customer needs.

“How can the organization of the assembly phase of the products be simplified in order to decrease the stocks while assembling the products as fast as possible?”

The FARD methodology proposes a modular approach based on functional design to ensure the respect of the customer’s needs and to combine it with a design for assembly approach. From the creation of the modular architecture of a design concept, the assembly phase is taken into account. The composition of modules (groups of components that each fulfils a function) is coupled with assembly constraints thanks to a coloured and direct graph and the assembly sequence of the generic product. The assembly sequence has a great influence on the composition of the modules and the distribution of the components inside, as presented in the two first experimentations of the chapter 3. The end goal of this approach is to have modules that fulfil a function and that are assembled independently. It is then possible to finally assemble all the modules of a product family in order to create a product upon receipt of an order. Then, the assembly workshop can anticipate an order by preparing assembled modules.

“Is it possible to reuse the numerical simulation for the validation of the behaviour of the generic product of the family in order to accelerate the physical phenomena simulations of all the other variants of products and finally to save time?”

In the FARD methodology, a macro is proposed to directly modify a mesh without regenerating a complete mesh from the modified and updated CAD model. In a classical loop of modelling and simulation process, the meshing step can be fastidious and time consuming. Our Visual Basic macro “Paramesh” allows the traditional meshing phase to be shunted and then reduces the time needed to simulate physical phenomena of various configurations of a same product. The Paramesh macro can have two applications:

- modify or adapt the mesh of a product in accordance with the CAD model modifications or
- adapt the mesh to the new product generated from the generic product that has the same features and is almost the same according to some modified geometric parameters.

The efficiency of the use of the Paramesh macro is presented in the third experimentation of the chapter 3, despite some needed improvements of the proposed macro.

“Is it possible to create a new software for guiding the users during the application of the proposed methodology taking into account multiple objectives and doing it faster?”

The part of the FARD methodology handle by ORASSE software application is the most complex part for a manual application because of the necessity to use several algorithms. For this reason the “Orasse Product” software focuses on this part. This tool accelerates the application of the proposed methodology but it also guides the users step by step and integrates some decision support systems features. The current last tab of Orasse Product guides the assembly planner during the definition of the product assembly sequence, in accordance with modular architecture constraints, functional and assembly constraints. An experimentation shows the use of Orasse Product software and the quality of the obtained results are similar to the manual application. But the use of this software reduces significantly time spent on the problem and reduces the possibilities of making more human errors. The methodology applied with Orasse Product needs a certain expertise level from the users. The software helps the users and simplifies the proposed methodology. Moreover, some check points are provided by Orasse Product in order to limit the errors such as the validation of the coloured and direct graph (for instance, a specific algorithm identifies if there are any cycling loops in the graph) which is required before the simplification process of the graph.

“Is it possible to link this software with the design domain structured in the collaborative platform ACSP?”

As explained in the previous chapter, the links between Orasse Product software and the collaborative and PLM platform ACSP are still in progress. For instance, it is now possible to export some information from ACSP and to import them into Orasse Product software. But the reverse operation is not possible yet. However, the realization of exchange information in both directions will ensure a total integration of Orasse Product to the ACSP PLM platform. Then, Orasse Product will add some reasoning process on data and information within the Product design domain and the Process design domain structured in the ACSP collaborative and PLM platform.

“Is it possible to make the interactions between data and information within the MD-MV model operational and dynamic with a generic methodology based on reasoning processes that could be applied to various design domains?”

Orasse Product allows some reasoning on data and information of the Product design domain and of the Process design domain, and creates dynamic interactions between them. It is also an operational software application for the Product design domain, as a part of the MD-MV model. Moreover, the methodology implemented in Orasse Product is a generic methodology in so far as it can be applied to others domains such as the Project design domain, the Knowledge design domain, etc (as presented in the conclusion of the chapter 4). To sum up, ORASSE proposes a reasoning process on the data and information of various design domains and is then an operational and dynamic methodology of the MD-MV model. When the variants of Orasse software applied to different design domains are coupled with the collaborative PLM platform ACSP (imports and export in both directions between the

various Orasse and the ACSP database), there will be operational and dynamic interactions between well structured data and information of various design domains of the MD-MV model.

1.2 Impact of our research activities in MABI Innovation process

As explained previously, this thesis is an industrial thesis realized in the MABI Company. The goal of MABI during this thesis was to establish a real strategy of own product development and innovation. Innovation constitutes the origin and the base of the development and the evolution of the company. But when we integrate our position into the MABI Company, in December 2009, there was no design office and no CAD software. Our first activity in the company was to create the cornerstone of the design office in order to restart their own product development process thanks to the definition of a simplified design process, adapted to the SME context, and the purchase of a CAD software. Moreover, a knowledge capitalisation project was launched in order to save the MABI Company knowledge; this is linked with the INGÉPROD project objectives in which the MABI Company is involved. These structured bases will allow restarting the development of various innovative products of the MABI Company. Several projects of product development were made as the new Scrap'Air product family, the new Blow'Box and other new products still under development (pump, injector, termite systems, etc.). The most representative of the development and innovative efforts is the development of the new Scrap'Air family.

The products of the Scrap'Air family were created in 1985 and optimized during these 27 years. But this family of products needs to be renewed in order to mark a break with other more competitive products. Moreover, the evolution of certain European Directives requires improvements of the Scrap'Air products more specifically on the level of mechanical vibrations which is too important for using 8 hours per day a Scrap'Air. Then, Olivier BIDAUX, the chief executive of MABI Company, decided to develop a new Scrap'Air family, which should improve the functions in terms of ergonomics, mechanical vibrations, common components, modularity, etc.

The new Scrap'Air family products obtained during our research and development studies decrease significantly the level of mechanical vibration for the user and are more ergonomic. These improvements reduce the risk of causing musculoskeletal disorders for the users. Moreover, the modularity work on the new products allows new functions to be added to the products like the anti-vibration system, the adaptation of the handgrips, the creation of new tools, a new design, etc. while maintaining the total number of components for all the products of the Scrap'Air family. More components are common and shared among several products. This reduces the manufacturing costs of these common components in order to maintain the total manufacturing costs of all the products of the family while adding new components and considering the new functions of the products. But the most significant result of the improvement of this product family is the obtained patent which is focused on the anti-vibration system (Figure 117). This patent certifies the innovative aspect of this new product family.



Figure 117. New patented logo of the MABI Company created for highlighting the innovative character of the new products of the company

Thanks to the development of the new Scrap'Air family of pneumatic stripper, the MABI Company participated to the first French national innovative competition of the CAPEB: the "Lumières et Innovation" (extra-ordinary inventions) for the season 2010-2011 (Figure 118). The new Scrap'Air family won the first prize of the competition in the category: "Produits et Services pour les Entreprises" (products and services for enterprises). This competition is dedicated to the building craft companies. This is a great sign of recognition from the users because the CAPEB (Confédération de l'Artisanat et des Petites Entreprises du Bâtiment – committee of development for workshops and smaller building contractors) is a professional organization that represents the French building craft companies. Then, this award is a recognition of the benefits of product from the the Scrap'Air products users.



(a)



(b)

Figure 118. New logo representing the first prize of the MABI Company in the French national "Lumières et Innovation" 2011 competition (a) and a picture of the ceremony (b)

Another award that highlights the efforts of the MABI Company in terms of innovation is the Stars & Métiers 2012 competition. MABI competed in the "Stratégie Globale d'Innovation" category that aims to reward the permanent innovation capacity of a company applied to all domains as organizational, product development, human, commercial, etc. This competition is organized by the Banque Populaire and the Chambre des Métiers et de l'Artisanat. The MABI Company won the first departmental prize and the first French national prize in this category. Moreover, the first national prize is supplemented by a special mention.



(a)



(b)

Figure 119. New logo representing the first prize of the MABI Company in the French national Stars & Métiers 2012 competition (a) and a picture of the departmental ceremony (b)

The national ceremony of this last prize has not yet taken place. The ceremony is planned for the 3th of December in the “Théâtre de Paris”, in Paris.

The last award won by the MABI Company is the regional “Trophées INPI de l’Innovation” 2012 in the category for the companies. The goal of this competition is to reward enterprises for their ability to grow through their innovation strategy and the use of industrial property as a lever for growth. This competition is organized by the INPI (Institut National de la Propriété Industrielle) that delivers the French patents. The regional ceremony is planned for the end of the year 2012.

The new strategy of the MABI Company was recognized thanks to all these awards obtained in various innovation competitions. Moreover, other hopeful competitions in which the MABI Company competes are still in progress. These first results encourage the MABI Company to continue its efforts in this direction for future works.

2 RESEARCH PERSPECTIVES

From this thesis, multiple perspectives for future research work related to the FARD (Functional And Robust Design) methodology are emerging. A list of some of them is presented below.

If the design project is a redesign project, it would be interesting, during the definition of the assembly sequence, to display the prior assembly sequence(s) of previously designed product(s) used for creating the new family. This kind of information could help the assembly planner to adjust the new assembly sequence thanks to his/her knowledge of old product(s). In perspective, it could be interesting to propose a comparison step by step of the old assembly sequence during the definition of the new assembly sequence. Then, the old assembly sequence could be adapted to new modularity constraints for all the products of a family. The optimization and the best practices of the old assembly sequence can be taken into account. The experience and the knowledge of the assembly planner could be more integrated in the methodology.

In order to continue to develop the decision support system for generating the assembly sequence, some coefficients can be added. Currently the algorithm is parametric

and it is easy to add a weight in the edges of the coloured and ordered graph. For instance, a specific weight representing the stability of the assembly of two components can be used. This information corresponds to the level of binding between two components. This information is interesting for the assembly planner because it is preferable to have stable components during the assembly process. Other criteria can be considered in same context such as ergonomics standards, when considering for instance the maximal mass that can be handled by workers without any mechanical assistance (sum of mass of components) in order to prevent musculo-skeletal disorders.

Concerning the criteria used to sort components suggested to the assembly planner, some other approaches may be considered. Instead of sorting nodes in a lexicographic manner, a weighted sum of criteria can be defined and elements could be sorted in decreasing order of this weighted sum. One of these criteria may take into account that two components belong to the same colour range (related to the same technical function). Difficulty lies in assigning the different weightings.

Another research perspective consists in formalizing the explicit knowledge of the assembly planner, using an ontology, in order to offer another decision support system during the simplifications steps by grouping parts during the partitioning process of the DSM matrix. Mostly, some simplifications are made with the same specific components (for example: O-ring, spring, etc). A system of identification of these specific parts can be developed in order to guide the user during the simplification process by recognition of already simplified parts operated in the past.

Concerning the modelling and simulation aspect included in our FARD methodology, our Visual Basic macro "Paramesh" can be more developed in order to allow the modification of the mesh on limited section of the geometrical model (for instance apply locally a dilatation coefficient between 1cm and 2cm on the axe x). This modification of the Paramesh macro seems not to be too difficult. But the behaviour of a mesh in a limited section must be checked. Another improvement is the application of coefficient along a specific direction, which can be different from the traditional axes x, y and z. The modification of some angles could be interesting for this application. It could allow the modification of the geometry form without modification of the CAD model or the skeleton. Another improvement is the automatic adjustment of the coefficients in the case of a symmetrical geometry. For instance, the Paramesh macro can ask to the user if the geometry has a symmetrical plane and then the user indicates in which plane is located this symmetry. When the user enters the value of a coefficient in the symmetry plane, the other coefficient in this plane will be automatically fulfilled by the Visual Basic macro "Paramesh". Another improvement consists of its link with commercial optimisation softwares such as ModeFrontier. This link would allow autonomous loops of optimisation on sets of parameters to be added.

In order to manage the products' configurations, our methodology can be coupled with a Knowledge Management System and a Knowledge Based Engineering (KBE) system. It will be possible to save the knowledge created during the application of FARD methodology and the generation of new products. The configuration management can be included in this knowledge management process and then allow managing modules and possible incompatibilities between various instances of modules. We are currently involved in the INGéPROD collaborative research program, funded in February 2010 by the Automotive cluster "Vehicle of the Future". This program is dedicated to the consideration of Product-

Process knowledge for routine design context for developing Highly Productive Design methods and tools applied to mechanical systems. INGéPROD program involves several manufacturers including Faurecia Exhaust System (project manager), General Electric, MABI, Zurfluh-Feller, Faurecia Exterior Trim, Exine3D and 3DSemantix. Associated academic research laboratories are IRTES-M3M and IRTES-SeT laboratory at UTBM and LGECO laboratory at INSA Strasbourg. In this program a tool for knowledge capitalization and reuse is under development. This tool could be linked with our FARD methodology in order to manage configurations of parameters, rules and knowledge configurations instead of parts, functions and modules.

The process aspect of the FARD methodology can also be developed in more details. A first idea consists in the transformations of the product structure into groups for the assembly phase and then in creating the planning for the assembly process. Initial contact was made with the Dr Rei HINO [Hino et al. 2002] [Hino and Moriwaki 2002] [Hino and Moriwaki 2003], in Nagoya University in Japan. This Japanese researcher is specialized in the modelling models of manufacturing systems and scheduling process. His approach of optimisation resource allocation, based on a planned schedule, can be adapted to our assembly plan schedule. Another idea consists in adding information on the links between two components in the direct and coloured graph for instance. Each link represents an assembly operation and this is an important information for the assembly process. For instance, from these information, it is possible to apply other methods based on “time of the assembly” criterion in order to determine the time needed to assemble a product. Then, a MTM (Method Time Measurement) can be used to calculate an estimation of the assembly time. This method is based on movement, difficulty for assembling components, etc. This kind of information can be obtained as soon as the parametric CAD model is created.

Some improvements of Orasse Product remain to be done in order to improve the ergonomic aspect and to add new functions such as: the import of the list of components from a text file, the import of multiple figures or sketches of the product concept, etc. In this way, a new tab for structuring the product using an algorithm could be added (the step number 3 of the FARD methodology in chapter 2, section 1).

Another perspective for the Orasse Product software is its link with the ACSP collaborative and PLM platform. A lot of information are created in the ACSP platform and then could be imported into the Orasse Product. At the end of the use of the Orasse Product, some information could be exported in order to be imported in the ACSP platform and to update its information. These links are still in development. They will create a better integration of Orasse Product to other software like ACSP. For instance, with the last future tab of Orasse Product for the product structure, the product architecture could be updated in the ACSP platform in order to generate the CAD files respecting this architecture.

The last and more promising research perspective is to continue to further develop the generic nature of the proposed methodology by applying it to other design domains, except the already developed Product domain, as the design domains of the Project or the Process, and also the knowledge design domain (as described in the conclusion of the chapter 4). Then, certain points must be developed in the Orasse generic tool and its different future declination "ORASSE Project", "ORASSE Process", "Orasse Human activity" or "ORASSE Knowledge", in addition to the first version of "ORASSE Product" already developed (Figure 120). These variations of the generic tool allow further possibilities offered

to be explored by the proposed generic methodology and its variations in various already identified design domains.

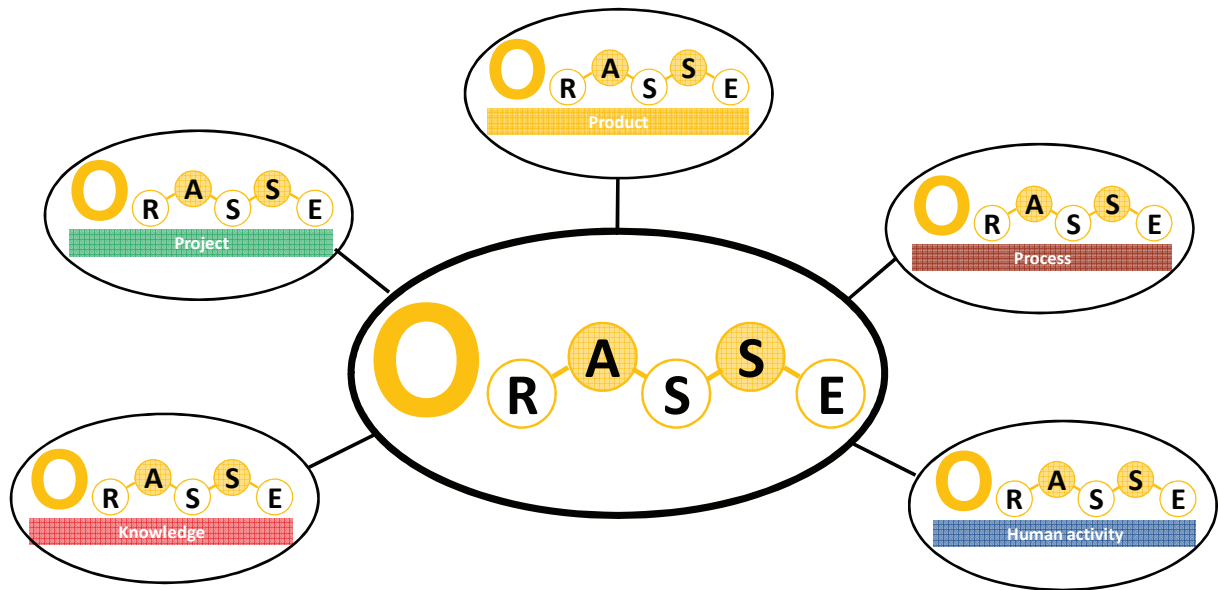

Figure 120. Declination of the Orasse software's

These softwares are based on the generic “Ordered Activities Sequence” (Orasse) part of the FARD methodology. The Figure 121 and Figure 122 show the two generic approach schemes corresponding to this generic part (section 3 of the chapter 2).

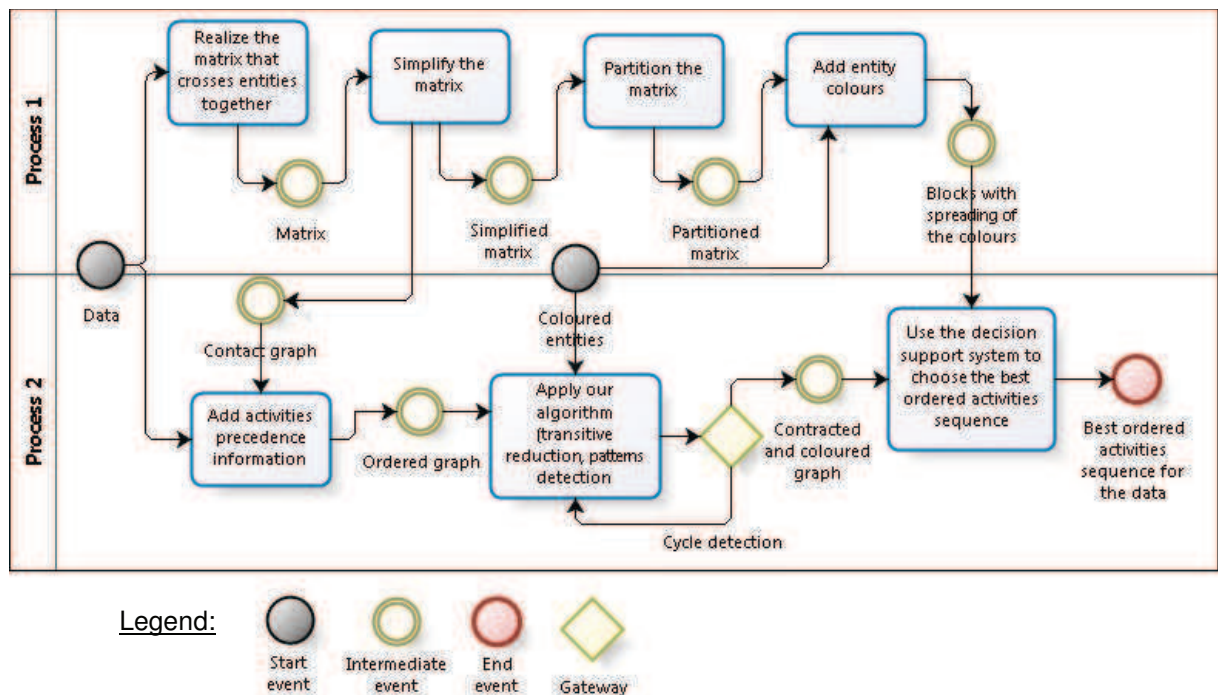

Figure 121. Definition of the best ordered activities sequence of each design domain according to a generic approach

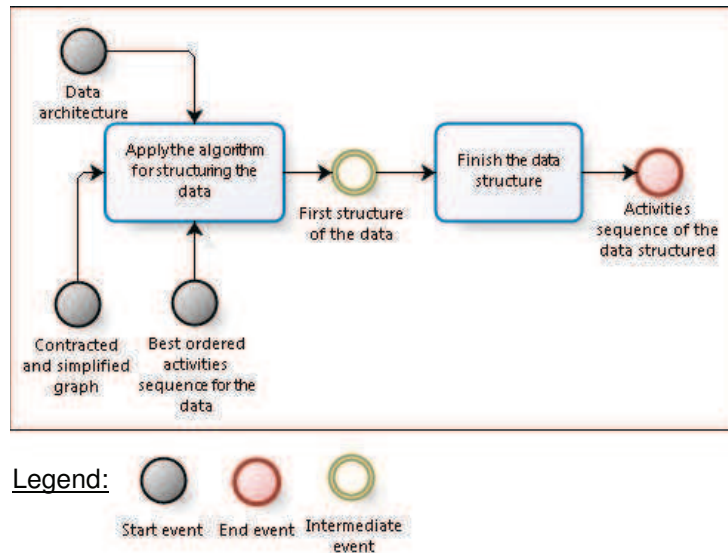

Figure 122. Structure the data of each design domain according to a generic approach

The Orasse Knowledge software dedicated to the management of the parameters of a product constitutes a future contribution to the INGÉPROD project that aims to manage knowledge. The approach of Orasse Knowledge adds a reasoning process on the parameters not yet included in the project. This reasoning process can help the designer to define its Knowledge Based Engineering application. The blocks of parameters, considered as a Knowledge Configuration, proposed by Orasse Knowledge tool thanks to the various algorithms defined, can be used to create the various steps of the Knowledge Based Engineering application. Moreover, the ordered activities sequence can guide the designer during the definition of the different parameters in the application. This can add a great added value to the starting INGÉPROD project.

Bibliography

1 VALORISATION OF RESEARCH WORK

1.1 Papers in international journals with peer review

Robert A., Roth S., Chamoret D., Yan X.T., Peyraut F., and Gomes S., "Functional design method for improving safety and ergonomics of mechanical products", *Journal Biomedical Science and Engineering*, 5(8), pp. 457–468.

1.2 International conferences with peer review

Robert A., Deschinkel K., Roth S., Yan X. T. and Gomes S., 2011, "Approche DFA et conception fonctionnelle de produits modulaires : le modèle FARD," 9e Congrès International de Génie Industriel (CIGI2011), Québec, CANADA, 12–14 octobre.

Robert A., Yan X.T., Roth S., Deschinkel K. and Gomes S., 2011, "A new approach to modularity in product development – utilising assembly sequence knowledge," 18th International Conference on Engineering Design (ICED11), Copenhagen, Denmark, August 15-18.

Vernier C., Robert A., Lebaal N., Yan X. T. and Gomes S., 2011, "A "high productive design methodology" integrated in a PLM context using Knowledge Configuration Management," International Conference in Product Lifecycle Management (PLM11), Eindhoven, Pays-Bas, July 11-13.

Robert A., Vernier C., Boudouh T., Roth S. and Gomes S., 2011, "Towards a "high productive design methodology" dedicated to modular products design using a Knowledge Configuration approach," International conference on Innovative Methods in Product Design IMProVe2011, Venice, Italie, June 15–17.

1.3 National conferences with peer review

Blancke O., Recalt S., Robert A., and Gomes S., 2012, "Vers une nouvelle démarche de maillage paramétrique appliquée à une conception hautement productive de produits modulaires," 19ème Colloque des Sciences de la Conception et de l'Innovation CONFERE, 5-6 Juillet San Servolo, Venise Italie.

Contassot T., Fournier S., Robert A., and Gomes S., 2012, "Conception hautement productive de produits modulaires," 19ème Colloque des Sciences de la Conception et de l'Innovation CONFERE, 5-6 Juillet San Servolo, Venise Italie.

Robert A., Roth S., Deschinkel K., Yan X.T., and Gomes S., 2011, "Vers une nouvelle approche de conception « hautement productive » intégrant la démarche DFA," 12ème colloque sur la Conception Mécanique Intégrée Aip Primeca 2011, Le Mont Dore, France, 29 mars – 1er avril.

Robert A., Demoly F., Roth S., and Gomes S., 2010, "Conception et simulation multiphysique des produits modulaires," 17ème séminaire CONFERE (Collège d'Etudes et de Recherches en Design et Conception de Produits) sur l'Innovation et la Conception, Sousse, Tunisie, 1-2 juillet.

1.4 Communications without papers

Robert A., Deschinkel K., Yan X. T., Roth S., and Gomes S., 2012 "Smart Generation of Assembly Sequences Applied to Modular Product Ranges," 2nd International Workshop to Foster Publications in Engineering Design, 2-3 february, Grenoble, France.

Robert A., 2011, "FARD Model, a new approach to "high productive" routine design process of modular product using DFA constraints," 4th Doctoral Spring Workshop "Product and Asset Lifecycle Management", May 9-11, Ardèche, France.

Robert A., Roth S., Demoly F., Yan X. T., and Gomes S., 2010, "Vers une nouvelle approche de conception "hautement productive" de produits modulaires appliquant la démarche DFA," GDR MACS 2010, 18-19 novembre, Paris, France.

1.5 Patent

Brevet concernant le manche anti-vibrations MABI «Dispositif d'outil à percussion», Numéro de dépôt 10 51594, 5 mars 2010, dépôt réalisé par le Cabinet Bleger-Rhein. Les inventeurs sont Olivier BIDAUX, Aurélie ROBERT et Samuel GOMES, brevet français.

2 EXTERNAL REFERENCES

A

- [Abdalla 1999] Abdalla H. S., 1999, "Concurrent engineering for global manufacturing," *International Journal of Production Economics*, 60–61, pp. 251–260.
- [Abdennadher and Frühwirth 2003] Abdennadher S., and Frühwirth T., 2003, *Essentials of Constraint Programming*, Springer.
- [Abdullah et al. 2003] Abdullah T. A., Popplewell K., and Page C. J., 2003, "A review of the support tools for the process of assembly method selection and assembly planning," *International Journal of Production Research*, 41(11), pp. 2391–2410.
- [AFNOR 1990a] AFNOR, 1990, « Vocabulaire de l'analyse de la valeur et de l'analyse fonctionnelle, » Norme NF-X-50-150.
- [AFNOR 1990b] AFNOR, 1990, « Analyse de la valeur, caractéristiques fondamentales, » Norme NF-X-50-152.
- [AFNOR 1991] AFNOR, 1991, « Analyse de la valeur, analyse fonctionnelle, expression fonctionnelle du besoin et cahier des charges fonctionnel, caractéristiques fondamentales, » Norme NF-X-50-151.
- [AFNOR 1996a] AFNOR, 1996, "Analyse Fonctionnelle – Caractéristiques fondamentales", Standard NF X 50-100.
- [AFNOR 1996b] AFNOR, 1996, "Vocabulaire du Management de la Valeur, de l'Analyse de la Valeur et de l'Analyse Fonctionnelle – Partie 1 : Analyse de la Valeur et Analyse Fonctionnelle", Standard NF EN 1325-1.
- [AFNOR 1997] AFNOR, 1997, « Association Française pour l'Analyse de la Valeur AFAV - Qualité en conception : la Rencontre Besoin-Produit-Ressources. »
- [AFNOR 2007] AFNOR, 2007, "Management par la valeur – Expression Fonctionnelle du Besoin et cahier des charges fonctionnel", Standard NF X 50-151.
- [AFNOR 2009] AFNOR, 2009, "Analyse de la valeur – Recommandations pour sa mise en oeuvre," FD X 50-153.
- [Akao 1990] Akao Y., 1990, *QFD-Integrating Customer Requirements into Product Design*, Productivity Press.
- [Andreasen, et al. 1983] Andreasen M.M., Kähler S., and Lund T., 1983. *Design for assembly*. IFS Publications.
- [Andreasen and Hein 1985] Andreasen M. and Hein L., 1985, *Integrated Product Development*, IFS Springer-Verlag.
- [Andreasen and Hein 1987] Andreasen M. M., and Hein L., 1987, *Integrated Product Development*, IFS.
- [Assouroko et al. 2009] Assouroko I., Ducellier G., Eynard B., and Boutinaud P., 2009, « Processus d'ingénierie numérique et intégration Conception-Calcul, » 19ème Congrès Français de Mécanique.

B

- [Badin 2011] Badin J., 2011, *Ingénierie hautement productive et collaborative à base de connaissances métier : vers une méthodologie et un méta-modèle de gestion des connaissances en configurations*, Thèse de Doctorat, Université de Technologie de Belfort-Montbéliard.
- [Badin et al. 2012] Badin J., Chamoret D., Roth S., Imbert J.R. and Gomes S, 2012. "Knowledge Based Simulation Driven Design for Crash Applications." *International Journal of Mechanics and Applications*, 4(2).
- [Bahrami and Dagli 1993] Bahrami A., and Dagli C. H., 1993, "From fuzzy input requirements to crisp design," *The International Journal of Advanced Manufacturing Technology*, 8(1), pp. 52–60.

- [Baldwin and Clark 1997] Baldwin C. Y., and Clark K. B., 1997, "Managing in an age of modularity," *Harv Bus Rev*, 75(5), pp. 84-93.
- [Barnes 1999] Barnes C.J., 1999, *A methodology for the concurrent design of products and their assembly sequence*, Ph.D Thesis, Cranfield University.
- [Barnes et al. 1997] Barnes C. J., Dalglish G. F., Jared G. E. M., Swift K. G., and Tate S. J., 1997, "Assembly sequence structures in design for assembly," 1997 IEEE International Symposium on Assembly and Task Planning (ISATP 97), pp. 164 –169.
- [Barnes et al. 2004] Barnes C., Jared G., and Swift K., 2004, "Decision support for sequence generation in an assembly oriented design environment," *Robotics and Computer-Integrated Manufacturing*, 20(4), pp. 289–300.
- [Bathe 1996] Bathe K., 1996, *Finite element procedure*, Prentice-Hall.
- [Belytschko et al. 2000] Belytschko T., Liu W. K., and Moran B., 2000, *Nonlinear Finite Elements for Continua and Structures*, John Wiley & Sons Ltd.
- [Ben Sta 2006] Ben Sta H., 2006, "Contribution de la modélisation conceptuelle à l'ingénierie du knowledge management : application dans le cadre de la mémoire de projet," Thèse de doctorat, École centrale de Lille.
- [Bissay 2009] Bissay A., 2009, *Du déploiement d'un système PLM, vers une intégration des connaissances*. Thesis (PhD). Université de Lyon 2.
- [Blakenfelt 2001] Blakenfelt M., 2001, *Managing complexity by product modularization*, Ph.D. Thesis, Royal Institute of Technology, Stockholm.
- [Bonneville et al. 1995] Bonneville F., Perrard C., and Henrioud J. M., 1995, "A genetic algorithm to generate and evaluate assembly plans," *INRIA/IEEE Symposium on Emerging Technologies and Factory Automation (ETFA '95)*, 2, pp. 231 –239.
- [Boothroyd 1974] Boothroyd G., 1974, "Automatic Handling of Small Parts," *Proc. International Production Engineering Conference*, Tokyo.
- [Boothroyd and Dewhurst 1983] Boothroyd G., and Dewhurst P., 1983, *Design for assembly*, University of Massachusetts, Dept. of Mechanical Engineering.
- [Boothroyd et al. 2001] Boothroyd G., Dewhurst P., and Knight W. A., 2001, *Product Design for Manufacture and Assembly*, Second Edition, Revised and Expanded, CRC Press.
- [Börjesson 2012] Börjesson F., 2012, "Approaches to Modularity in Product Architecture," dissertation, KTH, Royal Institute of Technology in Stockholm.
- [Bourjault 1984] Bourjault A., 1984, *Contribution à une approche méthodologique de l'assemblage automatisé : élaboration automatique des séquences opératoires*, Thèse de Doctorat. Université de Franche Comté.
- [Brissaud and Garro 1996] Brissaud D., and Garro O., 1996, "An Approach to Concurrent Engineering Using Distributed Design Methodology," *Concurrent Engineering*, 4(3), pp. 303–311.
- [Brissaud and Tichkiewitch 2001] Brissaud D., and Tichkiewitch S., 2001, "PRODUCT MODELS for LIFE-CYCLE," *CIRP Annals - Manufacturing Technology*, 50(1), pp. 105–108.
- [Brown and Chandrasekaran 1985] Brown D.C., and Chandrasekaran B., 1985, « Expert Systems for a Class of Mechanical Design Activity, » *Knowledge Engineering in Computer-Aided Design*, pp. 259-282.
- [Browning 2001] Browning T. R., 2001, "Applying the design structure matrix to system decomposition and integration problems: a review and new directions," *IEEE Transactions on Engineering Management*, 48(3), pp. 292 –306.
- [Burkard 1998] Burkard R. E., Çela E., Pardalos P. M., and Pitsoulis L. S., 1998, The Quadratic Assignment Problem. In P.P. Pardalos and M.G.C. Resende, editors, *Handbook of Combinatorial Optimization*, 1998. Kluwer Academic Publishers, Dordrecht, pp. 241-238.
- [Bytheway 2007] Bytheway C. W., 2007, *Fast Creativity & Innovation: Rapidly Improving Processes, Product Development and Solving Complex Problems*, J Ross Publishing.

C

- [Castellani 1993] Castellani X., 1993, *Méthodologie générale d'analyse et de conception des systèmes d'objets Tome 1: L'ingénierie des besoins*, Masson.
- [Chang 1990] Chang T.C., 1990, *Expert process planning for manufacturing*, Addison-Wesley.
- [Chen and Li 2005] Chen L., and Li S., 2005, "Analysis of Decomposability and Complexity for Design Problems in the Context of Decomposition," *ASME J. Mech. Des.*, 127, pp. 545–557.
- [Chen et al. 2006] Chen G., Zhou J., Cai W., Lai X., Lin Z., and Menassa R., 2006, "A framework for an automotive body assembly process design system," *Computer-Aided Design*, 38(5), pp. 531–539.
- [Cormen 2009] Cormen T. H., Leiserson C. E., Rivest R. L., and Stein C., 2009, *Introduction to Algorithms*, The MIT Press.
- [Cross 2000] Cross N., 2000. *Engineering Design Methods: Strategies for Product Design*, 3rd Edition, Wiley.

D

- [Da Silveira et al. 2001] Da Silveira G., Borenstein D., and Fogliatto F. S., 2001, "Mass customization: Literature review and research directions," *International Journal of Production Economics*, 72(1), pp. 1–13.
- [Daahub and Abdalla 1999] Daahub A.M. and Abdalla H.S., 1999, "A Computer-based Intelligent System for Design for Assembly," *Computer & Industrial Engineering*, 37, pp. 111-115.
- [Dahmus et al. 2001] Dahmus J. B., Gonzalez-Zugasti J. P., Otto K. N., 2001, "Modular product architecture," *Design Studies*, 22(5), pp. 409-424.
- [Daniilidis et al. 2011] Daniilidis C., Ensslin V., Eben K., Lindemann U., 2011. « A classification framework for product modularization methods, » *International Conference on Engineering Design, ICED11, Denmark*.
- [De Fazio 1999] De Fazio T. L., Rhee S. J., and Whitney D. E., 1999, "Design-specific approach to design for assembly (DFA) for complex mechanical assemblies," *IEEE Transactions on Robotics and Automation*, 15(5), pp. 869–881.
- [De Fazio and Whitney 1987] De Fazio T., and Whitney D., 1987, "Simplified generation of all mechanical assembly sequences," *IEEE Journal of Robotics and Automation*, 3 (6), pp. 640–658.
- [De La Bretesche 2000] De La Bretesche B., 2000, *La Méthode APTE : analyse de la valeur, analyse fonctionnelle*, Pétrele.
- [De Lit 2001] De Lit P., 2001, *A comprehensive and integrated approach for the design of a product family and its assembly system*, Ph.D. Thesis, Université Libre de Bruxelles.
- [De Lit et al. 2001] De Lit P., Latinne P., Rekiek B., and Delchambre A., 2001, "Assembly planning with an ordering genetic algorithm," *International Journal of Production Research*, 39(16), pp. 3623–3640.
- [Defaux 1989] Defaux M., 1989, "Conception des produits : simplifier l'assemblage," *TECHNOLOGIES*, 61.
- [Delafollie 1996] Delafollie G., 1991, *Analyse de la valeur*, Hachette.
- [Delchambre 1996] Delchambre A., 1996, *CAD Method for Industrial Assembly: Concurrent Design of Products, Equipment and Control Systems*, John Wiley & Sons Ltd.
- [Demoly 2010] Demoly F., 2010, *Conception intégrée et gestion d'informations techniques : application à l'ingénierie du produit et de sa séquence d'assemblage*. Thèse de doctorat. Université de Technologie de Belfort-Montbéliard.
- [Demoly et al. 2011] Demoly F., Yan X.-T., Eynard B., Rivest L., and Gomes S., 2011. An

- 2011] assembly oriented design framework for product structure engineering and assembly sequence planning. *Robot. Comput.-Integr. Manuf.*, 27 (1), 33–46.
- [Deneux 2002] Deneux D., 2002, *Méthodes et modèles pour la conception concurrente*, Habilitation à Diriger des Recherches, Université de Valenciennes et du Hainaut Cambrésis.
- [Deng and Yu 2006] Deng Q. and Yu D., 2006, "An Approach To Integrating Knowledge Management Into The Product Development Process," *Journal of Knowledge Management Practice*, 7(2).
- [Drezner et al. 2005] Drezner Z., Hahn P. M., and Taillard E. D., 2005, "Recent Advances for the Quadratic Assignment Problem with Special Emphasis on Instances that are Difficult for Meta-Heuristic Methods," *Annals of Operations Research*, 139(1), pp. 65–94.

E

- [Eppinger et al. 1994] Eppinger S. D., Whitney D. E., Smith R. P., and Gebala D. A., 1994, "A model-based method for organizing tasks in product development," *Research in Engineering Design*, 6(1), pp. 1–13.
- [Ericsson and Erixon 1999] Ericsson A., and Erixon G., 1999, *Controlling Design Variants: Modular Product Platforms*, Society of Manufacturing Engineers.
- [Eskilander 2001] Eskilander S., 2001, *Design for Automatic Assembly – A method for Product Design DFA2*, Ph.D. Thesis, Royal Institute of Technology, Stockholm.
- [European Directive 94/9/EC 1994] European Directive 94/9/EC of the European Parliament and of the Council of 23 March 1994 on the approximation of the laws of the Member States concerning equipment and protective systems intended for use in potentially explosive atmospheres. *Official Journal of the European Community L 100*, 19.4.1994.
- [European Directive 1999/92/EC 2000] European Directive 1999/92/EC of the European Parliament and of the Council of 16 December 1999 on minimum requirements for improving the safety and health protection of workers potentially at risk from explosive atmospheres (15th individual Directive within the meaning of Article 16(1) of Directive 89/391/EEC). *Official Journal of the European Community L 23*, 28.1.2000.
- [Evbuomwan et al. 1996] Evbuomwan N. F. O., Silvaloganathan S. and Jebb A., 1996, "A survey of design philosophies, models, methods and systems," *Proceedings of the Institution of Mechanical Engineers. Part B. Journal of engineering manufacture*, 210(4), pp. 301–320.

F

- [Fernandez 1998] Fernandez C., 1998, *Integration Analysis of Product Architecture to Support Effective Team Co-location*, Thesis, Massachusetts Institute of Technology.
- [French 1985] French M. J., 1985, *Conceptual Design for Engineers*, Springer-Verlag.
- [Frey 2010] Frey E., 2010, *Contribution à une méthode de chaînage numérique de données pour la gestion des modifications lors de la conception de produit multi-métiers*. Thèse de doctorat. Université de Technologie de Belfort-Montbéliard.
- [Frey et al. 2010] Frey E., Ostrosi E., Gomes S., Roucoules L., 2010, "Tool based supporting collaborative design from specification development to CAD modelling," *TMCE 2010*, Italy.
- [Fixson 2007] Fixson S., 2007, "Modularity and Commonality research: Past developments and Future Opportunities," *Concurrent Engineering*, 15(2), pp. 85-111.

- [Galsworth 1994] Galsworth G. D., 1994, *Smart, Simple Design: Using Variety Effectiveness to Reduce Total Costs and Maximise Customer Selection*, John Wiley & Sons.
- [Gardan and Gardan 2003] Gardan N., and Gardan Y., 2003, "An application of knowledge based modelling using scripts," *Expert Systems with Applications*, 25(4), pp. 555–568.
- [Gero 2000] Gero J. S., 2000, "Computational Models of Innovative and Creative Design Processes," *Technological Forecasting and Social Change*, 64(2–3), pp. 183–196.
- [Gershenson et al 2003] Gershenson J. K., Prasad G. J., and Zhang Y., 2003, "Product modularity: Definitions and benefits," *J. Eng. Design*, 14(3), pp. 295-313.
- [Gershenson et al. 2004] Gershenson J.K., Prasad G.J., Zhang Y, 2004, "Product modularity: measures and design methods," *J. Eng. Design*, 15(1), pp. 33-51.
- [Gomes 1999] Gomes S., 1999, *Contribution de l'analyse de l'activité au processus de conception de produits innovants. Application à la conception de systèmes de contrôle-commande automobiles*, Thèse de doctorat, Institut national polytechnique de Lorraine.
- [Gomes 2008] Gomes S., 2008, *Ingénierie à base de connaissances pour une conception, productive, optimisée, collaborative et innovante du système Projet-Produit-Process-Usage*, Habilitation à Diriger des Recherches, Université de Technologie de Belfort-Montbéliard.
- [Gomes, et al. 1999] Gomes S., Sagot J.C., Koukam A., Leroy N., 1999, "ACSP, an Intranet forum supporting a concurrent engineering design life cycle," 6th European Concurrent Engineering Conference, ECEC'99, Erlangen-Nuremberg, 21-23 April, p 249-251.
- [Gomes et al. 2002] Gomes S. and Sagot J-C., 2002, A concurrent engineering experience based on a cooperative and object oriented design methodology. In *Best papers book, 3rd International Conference on Integrated Design and Manufacturing in Mechanical Engineering*, Kluwer Academic Publishers, Dordrecht.
- [Gomes et al. 2009] Gomes S., Varret A., Bluntzer J. B., and Sagot J. C., 2009, "Functional design and optimisation of parametric CAD models in a knowledge-based PLM environment," *International Journal of Product Development*, 9(1-3), pp. 60–77.
- [Gondran 1995] Gondran M., and Minoux M., 1995, *Graphes et algorithmes*, Eyrolles.
- [Gottipolu and Ghosh 1997] Gottipolu R. B., and Ghosh K., 1997, "Representation and selection of assembly sequences in computer-aided assembly process planning," *International Journal of Production Research*, 35(12), pp. 3447–3466.
- [Gottipolu and Ghosh 2003] Gottipolu R. B., and Ghosh K., 2003, "A simplified and efficient representation for evaluation and selection of assembly sequences," *Computers in Industry*, 50(3), pp. 251–264.
- [Gries et al. 1989] Gries D., Martin A.J., Van De Snepscheut J.L., and Udding J.T., 1989, "An algorithm for transitive reduction of an acyclic graph," *Sci. Comput. Program.*, 12 (2), pp. 151–155.
- [Gu et al. 2008] Gu T., Xu Z., and Yang Z., 2008, "Symbolic OBDD representations for mechanical assembly sequences," *Computer-Aided Design*, 40(4), pp. 411–421.
- [Gupta and Okudan 2007] Gupta S., and Okudan G. E., 2007, "Modular Design: A Review of Research and Industrial Applications," *IIE Annual Conference. Proceedings*.
- [Gupta and Okudan 2008] Gupta S., and Okudan G. E., 2008, "Computer-aided generation of modularised conceptual designs with assembly and variety considerations," *Journal of Engineering Design*, 19(6), pp. 533–551.

H

- [Harmel 2007] Harmel G., 2007, *Vers une conception conjointe des architectures du produit et de l'organisation du projet dans le cadre de l'Ingénierie Système*, Thèse de Doctorat, Université de Franche-Comté.
- [Haugan 2002] Haugan G. T., 2002, *Effective Work Breakdown Structures*, Kogan Page.
- [Hino and Moriwaki 2002] Hino R., and Moriwaki T., 2002, "Decentralized job shop scheduling by recursive propagation method," *JSME international journal. Series C, Mechanical systems, machine elements and manufacturing*, 45(2), pp. 551–557.
- [Hino et al. 2002] Hino R., Fujimoto Y., Moriwaki T., 2002, "Resource Reallocation Based on Evaluation of Production Scheduling", *Japan-USA Symposium on Flexible Automation, Vol.1*, pp97–102.
- [Hino and Moriwaki 2003] Rei H., and Toshimichi M., 2003, "Resource Reallocation Based on Production Scheduling (1st report)-Adoption of Schedule as Index for Resource Allocation-," *Journal of the Japan Society for Precision Engineering*, 69(5), pp. 655–659.
- [Holt and Barnes 2009] Holt R. and Barnes C., 2009, "Towards and integrated approach to "Design for X": an agenda for decision-based DFX research," *Research in Engineering Design*, 21(2), pp. 123-136.
- [Höltkä-Otto 2005] Höltkä-Otto K., 2005, "Modular product platform design," Ph.D. thesis, University of Technology of Helsinki.
- [Homem de Mello and Sanderson 1988] Homem de Mello L. S., and Sanderson A. C., 1988, *Automatic Generation of Mechanical Assembly Sequences*, Technical report: Carnegie Mellon University.
- [Homem de Mello and Sanderson 1991] Homem de Mello L. S., and Sanderson A. C., 1991, "Representations of mechanical assembly sequences," *IEEE Transactions on Robotics and Automation*, 7(2), pp. 211–227.
- [Hsu et al. 1998] Hsu W., Jerry Fuh Y., and Zhang Y., 1998, "Synthesis of design concepts from a design for assembly perspective," *Computer Integrated Manufacturing Systems*, 11(1–2), pp. 1–13.
- [Huang 2000] Huang C.C., 2000, « Overview of Modular Product Development, » *Proc. Natl. Sci. Counc. ROC(A)*, 24(3), pp. 149-165.
- [Huang and Kusiak 1998] Huang, C-C. and Kusiak, A., 1998, "Modularity in design of product and systems," *IEEE transactions on systems. Man and Cybernetics*, 28 (1), pp. 66–78.

I

- [Idicula 1995] Idicula J., 1995, *Planning for Concurrent Engineering*, Thesis, Nanyang Technology University.

J

- [Jose Flores 2005] Jose Flores A., 2005, *Contribution aux méthodes de conception modulaire de produits et processus industriels*, Institut national polytechnique Grenoble.
- [Jose Flores and Tollenaere 2005] Jose Flores A., and Tollenaere M., 2005, "Modular and platform methods for product family design: literature analysis," *J. Intelligent manufacturing*, 16(3), pp. 371-390.

K

- [Kuo et al. 2001] Kuo T.-C., Huang S. H. and Zhang H.-C., 2001, "Design for manufacture and design for X: concepts, applications, and perspectives," *Computers & Industrial Engineering*, 41(3), pp. 241-260.
- [Kurowski 1995] Kurowski P.M., 1995, "When good engineers deliver bad FEA," *Machine Design*, 67(20).
- [Kusiak 1999] Kusiak A., 1999, *Engineering Design: Products, Processes, and Systems*, Academic Press.
- [Kusiak et al. 1994] Kusiak A., Larson T. N., and Wang J. R., 1994, "Reengineering of design and manufacturing processes," *Comput. Ind. Eng.*, 26(3), pp. 521–536.

L

- [Lafon 2007] Lafon P., 2007, *Dimensionnement et optimisation en mécanique : application à la conception intégrée des systèmes mécaniques, aux procédés et aux structures*, Habilitation à Diriger des Recherches, Université de Technologie de Troyes.
- [Langlois and Robertson 1992] Langlois R. N., and Robertson P. L., 1992, "Networks and innovation in a modular system: Lessons from the microcomputer and stereo component industries," *Research Policy*, 21(4), pp. 297–313.
- [Laperrière and ElMaraghy 1996] Laperrière L., and ElMaraghy H. A., 1996, "GAPP: A generative assembly process planner," *Journal of Manufacturing Systems*, 15(4), pp. 282–293.
- [Lee and Tang 1998] Lee H., Tang C. S., 1998. Variability reduction through reversal. *Management Science*, vol. 44(2), pp. 162-172.
- [Lim et al. 1995] Lim S.S., Lee I.B.H., Lim L.E.N., and Ngoi, B.K.A., 1995, "Computer-Aided Concurrent Design of Product and Assembly Processes: a Literature Review," *Journal of Design and Manufacturing*, 5, pp. 67-88.
- [Lin et al. 2008] Lin M.-C., Tai Y.-Y., Chen M.-S., and Chang C. A., 2007, "A Rule Based Assembly Sequence Generation Method for Product Design," *Concurrent Engineering*, 15(3), pp. 291–308.
- [Luke 2009] Luke S., 2011, *Essentials of Metaheuristics*, lulu.com.

M

- [Mantripragada 1998] Mantripragada R., 1998, *Assembly oriented design: concepts, algorithms and computational tools*, Ph.D. Thesis, Massachusetts Institute of Technology.
- [Mantripragada and Whitney 1999] Mantripragada R., and Whitney D. E., 1999, "Modeling and controlling variation propagation in mechanical assemblies using state transition models," *IEEE Transactions on Robotics and Automation*, 15(1), pp. 124 –140.
- [Marguet 2001] Marguet B., 2001, *Contribution à l'analyse des variations géométriques dans les ensembles structuraux en aéronautique : Démarche et Outils*, Thèse de Doctorat, Ecole de Normale Supérieure de Cachan.
- [Marian et al. 2006] Marian R. M., Luong L. H. S., and Abhary K., 2006, "A genetic algorithm for the optimisation of assembly sequences," *Comput. Ind. Eng.*, 50(4), pp. 503–527.
- [Mathieu and Marguet 2001] Mathieu L. and Marguet B., 2001, "Integrated Design Method to Improve Productibility based on Product Key Characteristics and Assembly Sequences," *CIRP Annals – Manufacturing Technology*, 50(1), pp. 85-88.
- [Meyer and Lehnerd 1997] Meyer M. H., and Lehnerd A. P., 1997, *The Power of Product Platforms*, Free Press.

- [Miguel 2005] Miguel P.A.C., 2005. Modularity in product development: a literature review towards a research agenda. *Product: Management and Development*, 3(2).
- [Miles 1961] Miles L. D., 1961, *Techniques of value analysis and engineering*, McGraw-Hill.
- [Miyakawa and Ohashi 1986] Miyakawa S. and Ohashi T., 1986, "The Hitachi Assemblability Evaluation Method," *Proceedings international Conference on Product Design for Assembly*.
- [Monticolo 2008] Monticolo D., 2008, "Une approche organisationnelle pour la conception d'un système de gestion des connaissances fondé sur le paradigme agent.," Thèse de Doctorat, Université de Technologie de Belfort-Montbéliard.

N

- [Nadler 1995] Nadler G., 1995, "Systems methodology and design," In A. Collen & W.W. Gasparski (Eds.), *Design and systems: General applications of methodology* (Vol. 3, pp. 130-132).
- [Newcomb et al. 1998] Newcomb P. J., Bras B., and Rosen D. W., 1998, "Implications of Modularity on Product Design for the Life Cycle," *ASME J. Mech. Des.*, 120, pp. 483–490.

O

- [O'Grady et al. 1992] O'Grady P., Ramers D., and Bowen J., 1988, "Artificial intelligence constraint nets applied to design for economic manufacture and assembly," *Computer Integrated Manufacturing Systems*, 1(4), pp. 204–210.
- [Otto and Wood 2000] Otto K., and Wood K., 2000, *Product Design: Techniques in Reverse Engineering and New Product Development*, Prentice Hall.

P

- [Pahl et al. 2007] Pahl G., Beitz W., Feldhusen J., Grote K.H., 2007. *Engineering Design: A Systematic Approach*, third edition. New York: Springer-Verlag
- [Pandremenos et al. 2009] Pandremenos J., Paralikas J., Salonitis K., and Chryssolouris G., 2009, "Modularity concepts for the automotive industry: A critical review," *CIRP Journal of Manufacturing Science and Technology*, 1(3), pp. 148–152.
- [Peck 1973] Peck H., 1973, *Designing For Manufacture (Topics In Engineering Design)*, London, Pitman.
- [Perrin 2001] Perrin J., 2001, *Concevoir l'innovation industrielle : Méthodologie de conception de l'innovation*, CNRS Editions.
- [Prasad 1996] Prasad B., 1996, *Concurrent Engineering Fundamentals, Volume II: Integrated Product Development*, Prentice Hall.
- [Pugh 1990] Pugh S., 1990, *Total Design: Integrated Methods for Successful Product Engineering*, Prentice Hall.

R

- [Rai and Allada 2003] Rai R. and Allada V., 2003. Modular product family design: agent-based Pareto-optimization and quality loss functionbased post-optimal analysis. *International Journal of Production*, 41 (17), pp. 4075-4098.
- [Rampersad 1994] Rampersad H. K., 1995, *Integrated and Simultaneous Design for Robotic Assembly (Wiley Series in Product Development)*, John Wiley & Sons.
- [Rampersad 1995] Rampersad H. K., 1995, "The house of DFA," *IEEE International Symposium*

on Assembly and Task Planning, Proceedings, pp. 312 -318.

- [Redford and Chal 1994] Redford A. and Chal J., 1994, Design for Assembly – Principles and Practice, McGraw- Hill Inc, England.
- [Rodriguez-Toro et al. 2004] Rodriguez-Toro C.A., Jared G.E.M., and Swift, K.G., 2004, "Product-Development Complexity Metrics: A Framework for Proactive-DFA Implementation," Proceedings of the 8th International Design Conference DESIGN 2004, Dubrovnik, Croatia, pp. 483-490.
- [Ross 1985] Ross D. T., 1985, "Applications and Extensions of SADT," Computer, 18(4), pp. 25 –34.

S

- [Sako and Murray 2000] Sako M., and Murray F. 2000, "Modules in Design, Production and Use: Implications for the Global Automotive Industry," 8th Gerpisa International Conference, pp. 38.
- [Salvador 2007] Salvador F., 2007, "Toward a Product System Modularity Construct: Literature Review and Reconceptualization," IEEE Transactions on Engineering Management, 54(2), pp. 219-240.
- [Santochi and Dini 1992] Santochi M., and Dini G., 1992, "Computer-aided planning of assembly operations: the selection of assembly sequences," Robotics and computer-integrated manufacturing, 9(6), pp. 439–446.
- [Schepacz 1989] Schepacz C., 1989, "Des methods pour un assemblage montage rationnel," CETIM-Information, 23.
- [Serrafero et al. 2006] Serrafero P., Gomes S., Bonnivard D. and Jézéquel L., 2006, "De la mémoire projet à la compétence métier : vers la synthèse de connaissances métier en ingénierie robuste des produits/process," 6th International conference on Integrated Design and Manufacturing in Mechanical Engineering (IDMME'06), Grenoble.
- [Simon 1995] Simon H.A., 1995, « Problem Forming, Problem Finding, and Problem Solving in Design, » In A. Collen & W.W. Gasparski (Eds.), Design and systems: General applications of methodology (Vol. 3, pp. 245-257).
- [Simpson et al. 2011] Simpson T. W., Bobuk A., Slingerland L. A., Brennan S., Logan D., and Reichard K., 2011, "From user requirements to commonality specifications: an integrated approach to product family design," Research in Engineering Design, 23(2), pp. 141–153.
- [Smith and Smith 2002] Smith G. C., and Smith S. S.-F., 2002, "An enhanced genetic algorithm for automated assembly planning," Robotics and Computer-Integrated Manufacturing, 18(5–6), pp. 355–364.
- [Sobiech, 1995] Sobiech R., 1995, "Design as an Object of Sociological Reflection and Study," In A. Collen & W.W. Gasparski (Eds.), Design and systems: General applications of methodology (Vol. 3, pp. 389-402).
- [Solehnus 1992] Solehnus G., 1992, "Concurrent engineering," Annals of the CIRP, Vol 41(2) pp 645-655.
- [Sosa et al. 2003] Sosa M. E., Eppinger S. D., and Rowles C. M., 2003, "Identifying Modular and Integrative Systems and Their Impact on Design Team Interactions," ASME J. Mech. Des., 125(2), p. 240.
- [Sriram et al. 1989] Sriram D., Stephanopoulous G., Logcher R., Gossard D., Groleau N., Serrano D., and Navinchandra D., 1989, "Knowledge-based system applications in engineering design: research at MIT," AI Mag., 10(3), pp. 79–95.
- [Stake 2000] Stake R.B., 2000, *On conceptual development of modular products*. Ph.D. Thesis, Royal Institute of Technology, Stockholm.
- [Stark 2004] Stark J., 2004, Product Lifecycle Management: 21st century Paradigm for Product Realisation, Springer London Ltd.
- [Steward 1981] Steward D., 1981, "The design structure system: a method for modelling the

- design of complex systems,” IEEE Trans Eng Manage, 28, pp 71–74.
- [Stone et al. 2000] Stone R. B., Wood K. L., and Crawford R. H., 2000, “A heuristic method for identifying modules for product architectures,” Design studies, 21(1), pp. 5–31.
- [Stone et al. 2004] Stone R.B., McAdams D.A., and Kayyalethekkel V.J., 2004, “A product architecture-based conceptual DFA technique,” Design Studies, 25 (3), pp. 301–325.
- [Su 2009] Su Q., 2009, “A hierarchical approach on assembly sequence planning and optimal sequences analyzing,” Robotics and Computer-Integrated Manufacturing, 25(1), pp. 224–234.
- [Suh 1990] Suh N. P., 1990, The Principles of Design, Oxford University Press, USA.
- [Suh 2001] Suh N. P., 2001, Axiomatic Design: Advances and Applications, Oxford University Press, USA.
- [Sun 2012] Sun H., 2012, *L'amélioration de la performance du produit par l'intégration des tâches d'utilisation dès la phase de conception : une approche de conception comportementale*, Thèse, Université de Strasbourg.
- [Swift 1989] Swift K., 1989, “Expert System aids design for assembly,” Assembly Automation, 9 (3), pp. 132-136.

T

- [Tate et al. 2000] Tate S.J., Jared G.E.M., Brown J.N., and Swift K.G., 2000, “An introduction to the Designer’s Sandpit,” Proceedings of DFM 2000 Design for manufacturing, Baltimore, USA.
- [Thebeau 2001] Thebeau R. E., 2001, “Knowledge management of system interfaces and interactions from product development processes,” Thesis, Massachusetts Institute of Technology.
- [Tichkiewitch et al. 2007] Tichkiewitch S., Tollenaere M., and Ray P., 2007, Advances in Integrated Design and Manufacturing in Mechanical Engineering II, Springer-Verlag New York Inc.
- [Tollenaere 1998] Tollenaere M., 1998, Conception de produits mécaniques: Méthodes, modèles et outils, Ed.Hermes, Paris.
- [Toussaint 2010] Toussaint L., 2010, Modèles et méthodes pour une conception hautement productive orientée vers la fabrication : application à l'ingénierie routinière de pièces plastiques, Thèse de doctorat, Université de Technologie de Belfort-Montbéliard.
- [Toussaint et al. 2010] Toussaint, L., Demoly, F., Lebaal, N., and Gomes, S., 2010, “PLM-based Approach for Design Verification and Validation using Manufacturing Process Knowledge,” J. of Systemics, Cybernetics and Informatics, 8(1), pp. 1-7.
- [Troussier et al. 1999] Troussier N., Pourroy F., Tollenaere M. and Trebucq B., 1999, “Information structuring for use and reuse of mechanical analysis models in engineering design,” Journal of Intelligent Manufacturing, 10(1), pp. 61–71.
- [Tsang 1993] Tsang E., 1993, Foundations of Constraint Satisfaction, Academic Press.
- [Tseng and Liou 2000] Tseng Y.-J., and Liou L.-C., 2000, “Integrating assembly and machining planning using graph-based representation models,” International Journal of Production Research, 38(12), pp. 2619–2641.
- [Tseng et al. 2004] Tseng H.-E., Li J.-D., and Chang Y.-H., 2004, “Connector-based approach to assembly planning using a genetic algorithm,” International Journal of Production Research, 42(11), pp. 2243–2261.

U

- [Ullman 2002] Ullman D. G., 2002, The Mechanical Design Process, McGraw-Hill

Science/Engineering/Math.

- [Ulrich 1995] Ulrich K., 1995, "The role of product architecture in the manufacturing firm," *Research policy*, 24(3), pp. 419–440.
- [Ulrich and Eppinger 2007] Ulrich K., and Eppinger S., 2007, *Product Design and Development*, McGraw-Hill/Irwin. Pandremenos, Paralikas J., Salonitis K., and Chryssolouris G., 2009, "Modularity concepts for the automotive industry: A critical review," *CIRP Journal of Manufacturing Science and Technology*, 1(3), pp. 148–152.

V

- [Vareilles et al. 2012] Vareilles É., Aldanondo M., Codet de Boisse A., Coudert T., Gaborit P., and Geneste L., 2012, "How to take into account general and contextual knowledge for interactive aiding design: Towards the coupling of CSP and CBR approaches," *Engineering Applications of Artificial Intelligence*, 25(1), pp. 31–47.
- [Varret 2012] Varret A., 2012, "De la conception collaborative à l'ingénierie performante de produits optimisés à base de connaissances métier," Thèse de doctorat, Université de Technologie de Belfort-Montbéliard.
- [VDI 2221 1987] DTU, 2010, "VDI 2221 - Systematic approach to the design of Technical Systems and products," DTU.
- [Vernadat 1996] Vernadat F., 1996, *Enterprise Modeling and Integration: Principles and Applications*, Springer.
- [Visser 1996] Visser W., 1996, "Two functions of analogical reasoning in design: a cognitive-psychology approach," *Design Studies*, 17(4), pp. 417–434.
- [Von Stamm 2003] Von Stamm B., 2008, *Managing Innovation, Design and Creativity*, John Wiley & Sons.

W

- [Wang and Li 1991] Wang H.-P., and Li J., 1991, *Computer-aided process planning*, Elsevier.
- [Wang et al. 2005] Wang W., Chen G., Lin Z., and Lai X., 2005, "Automated Hierarchical Assembly System Construction in Automobile Body Assembly Planning," *Journal of Mechanical Design*, 127(2), pp. 347-351.
- [Wang et al. 2009] Wang L., Keshavarzmanesh S., Feng H.-Y., and Buchal R., 2009, "Assembly process planning and its future in collaborative manufacturing: a review," *The International Journal of Advanced Manufacturing Technology*, 41(1), pp. 132–144.
- [Ward et al. 1995] Ward A., Liker J. K., Cristiano J. J., and Sobek II D. K., 1995, "The Second Toyota Paradox: How Delaying Decisions Can Make Better Cars Faster.," *Sloan Management Review*, 36(3), pp. 43–61.
- [Whitney 2004] Whitney D. E., 2004, *Mechanical Assemblies: Their Design, Manufacture, and Role in Product Development*, Oxford University Press, USA.
- [Whitney et al. 1988] Whitney D.E., Nevins J.L., and De Fazio T.L., 1988, "The strategic approach to product design," *Design and Analysis of Integrated Manufacturing Systems*, pp. 200-224.
- [Wilhelm 1997] Wilhelm, B., 1997, "Platform and modular concepts at Volkswagen - their effects on the assembly process," *Transforming Automobile Assembly: Experience in Automation and Work Organization*, K. Shimokawa, et al., eds., Springer, New-York, p. 146-156.

Y

- [Yamagawa 1988] Yamagawa S., 1988, "An Assembly Ease Evaluation Method for Product Engineers: DAC," *Techno Japan*, 21 (12).
- [Yang 2010] Yang X.-S., 2010, *Engineering Optimization: An Introduction with Metaheuristic Applications*, Wiley.
- [Yannou 2006] Yannou B., and Harmel G., 2006, "Use of Constraint Programming for Design," *Advances in Design*, H.A. ElMaraghy, and W.H. ElMaraghy, eds., Springer London, pp. 145–157.
- [Yvars 2008] Yvars P.-A., 2008, "Using constraint satisfaction for designing mechanical systems," *International Journal on Interactive Design and Manufacturing*, 2(3), pp. 161–167.

Z

- [Zha et al. 1998] Zha X. F., Lim S. Y. E., and Fok S. C., 1998, "Integrated intelligent design and assembly planning: A survey," *The International Journal of Advanced Manufacturing Technology*, 14(9), pp. 664–685.
- [Zha et al. 1999] Zha X. F., Lim S. Y. E., and Fok S. C., 1999, "Development of Expert System for Concurrent Product Design and Planning for Assembly," *The International Journal of Advanced Manufacturing Technology*, 15(3), pp. 153–162.
- [Zha et al. 2001] Zha X., Du H., and Qiu J., 2001, "Knowledge-based approach and system for assembly oriented design, Part I: the approach," *Engineering Applications of Artificial Intelligence*, 14(1), pp. 61–75.
- [Zhang et al. 2002] Zhang Y., Ni J., Lin Z., and Lai X., 2002, "Automated sequencing and sub-assembly detection in automobile body assembly planning," *Journal of Materials Processing Technology*, 129(1–3), pp. 490–494.

Table of figures

Figure 1. Schema of the chapter organization of our manuscript	12
Figure 2. Block diagram of French's design process	18
Figure 3. Systematic Design model (Pahl and Beitz, 1992)	19
Figure 4. VDI 2221 model of the design process	20
Figure 5. Concurrent engineering model of Solehnius	21
Figure 6. Multi-domain and Multi-viewpoints design model [Gomes et al. 2002]: functional, structural and dynamic aspects considered in each design domain.....	22
Figure 7. "High Productive" routine design methodology [Gomes et al. 2009].....	24
Figure 8. Illustration of a diagram for the use phase of a product	33
Figure 9. Scheme for illustrating a FAST diagram structure.....	33
Figure 10. Illustration of a Functional Block Diagram extract from [Frey et al. 2010].....	34
Figure 11. Example of direct graph and its corresponding connection matrix according to the PASODE approach and based on the concept of a suspension triangle for automobile	43
Figure 12. Whole FARD (Functional And Robust Design) methodology built with a BPMN format (Business Process Modelling Notation [Bissay 2009])	53
Figure 13. Repartition of the various steps of the FARD methodology in association with the next sections of this chapter	56
Figure 14. Functional design approach of the FARD methodology	57
Figure 15. Equivalence between FAST diagram and modular architecture of the products ..	58
Figure 16. Representation of the modular architecture as a FBD. Black lines represent contacts between modules and the red lines illustrates how the Service Function (SF) crosses the product's architecture	60
Figure 17. Combination of our graph representing the modular architecture in a FBD format with the FBD of a product.	60
Figure 18. Distributions of parts of the SF into the lower-level TF in the FAST diagram.....	61
Figure 19. Definition of the best assembly sequence of modular products of the family, as a part of the FARD modular design approach based on DFA principles	62
Figure 20. Correspondence between a PP matrix and a contact graph	64
Figure 21. Example of a direct graph with 5 components	65
Figure 22. Example of a direct cycle in a direct graph of 4 components	65
Figure 23. Assignment from one colour to an uncoloured part.....	66
Figure 24. Assignment from one colour to an uncoloured part.....	66
Figure 25. Detection and substitution of a specific pattern between components 3, 4 and 5 in a direct graph of 7 components	68
Figure 26. Flowchart of the clustering algorithm [Fernandez 1998].....	70
Figure 27. A direct graph with 9 components.....	76
Figure 28. Example with 6 parts of the use of the decision support system for defining the best assembly sequence according to our three constraints.....	77
Figure 29. Illustration of our notation for assembly sequences	78
Figure 30. Definition of the structure of the products from the modular family, part of the modular design approach based on DFA principles of the FARD methodology	79
Figure 31. Example of product structure with six components and two mains modules with sub-modules.....	80

Figure 32. Example of product structure with six components and two mains modules with sub-modules.....	81
Figure 33. Allocation of the Component A to the yellow module with the Component B by our algorithm	82
Figure 34. No allocation of the Component B by our algorithm in this first example.....	82
Figure 35. No allocation of the Component B by our algorithm in this second example	83
Figure 36. Component B is allocated to a module without any function	83
Figure 37. Configuration management of the products of the same family and creation of the parametric and skeletal CAD model for the product's modular family, parts of the modular design approach based on DFA methodology	84
Figure 38. Simplification of the product structure according to configuration information	86
Figure 39. Illustrative example of product with three components: the product and its components, the direct graph of the product and its product structure.....	88
Figure 40. Multi-physics simulation approach applied to products variants in the product's family, as the product's dimensioning aspect of the FARD methodology. The colour of start events depends on the origin of the previous activities.	89
Figure 41. Simplified representation of a classical loop of a modelling and simulation process	90
Figure 42. Loop of simulation with the Paramesh macro and a parametric mesh proposed in the FARD methodology	91
Figure 43. Circular geometry with a circle in the axes x and y	92
Figure 44. Parallelepiped geometry with a square in the axes x and y.....	92
Figure 45. Scheme of our systematic approach for defining the product structure from a concept with a list of components.....	95
Figure 46. Positioning of the various experimentations.....	99
Figure 47. Old versions of products.....	100
Figure 48. Positioning of the Scrap'Air experimentation according to the FARD methodology steps	100
Figure 49. Graph for positioning the product in its environment.....	101
Figure 50. FAST diagram of the main function of a pneumatic scraper.....	101
Figure 51. Modular architecture for new products of the modular range of pneumatic scrapers	102
Figure 52. Representation of the modular architecture of a product like its FBD.....	102
Figure 53. Sketch of a product concept of a pneumatic scraper	103
Figure 54. Details of the components of the valve part of the concept.....	103
Figure 55. IFA of the concept of pneumatic scraper according to the SF defined in the EFA	104
Figure 56. Some coloured components linked by a TF using an IFA of the product.....	105
Figure 57. PP matrix of all components of the pneumatic scraper used for this case study	106
Figure 58. Partitioned PP matrix with assembly planner simplifications and blocks with spreading of the colour	107
Figure 59. Contact graph from the PP matrix with assembly planner simplifications.....	108
Figure 60. Direct graph with coloured components and assembly planner simplifications, of the concept of pneumatic scraper.....	108
Figure 61. Direct graph with simplifications of the graph generated by the algorithm.....	109
Figure 62. Graph with blocks to start the decision support system for the definition of the best assembly sequence.....	109
Figure 63. First step of the algorithm for structuring the product.....	111

Figure 64. Beginning of the product structure with components allocated to modules (first level of the modular architecture)	111
Figure 65. Example of components not assignable to a sub-module and without colour.....	112
Figure 66. Product structure proposal of the algorithm for the product architect	112
Figure 67. Final product architecture of a pneumatic scraper	113
Figure 68. An abacus for calculating a dimension of the lead	116
Figure 69. A table for calculating dimensions of the lead and the head	117
Figure 70. Lead parameterization	117
Figure 71. Parametric and skeletal CAD model of a generic pneumatic scraper.....	118
Figure 72. Example of product design generated from the parametric and skeletal CAD model	118
Figure 73. Visualization of the modules on the product design	118
Figure 74 : Power part of the head of a pneumatic scraper	119
Figure 75 : Multi-physics calculations: mechanical static created with CATIA© (a) and impact resistance achieved with the software RADIOSS© (b)	119
Figure 76. Evolution of the indicators (Imp and Csapm) of the old and the new product family of Scrap'Air.....	121
Figure 77. Positioning of the Biomimetic spy system experimentation according to the FARD methodology steps	122
Figure 78. EFA of the product.....	123
Figure 79. Concept of the BioZard (b) based on the FAST diagram (a) defined from the SF of the EFA	123
Figure 80. IFA of the BioZard represented by a FBD	124
Figure 81. Diagram of the BioZard with the repartition of components among TFs.....	125
Figure 82. Coloured PP matrix with blocks of components (clusters).....	125
Figure 83. Direct graph with coloured components of the generic product.....	126
Figure 84. Coloured and direct graph with the representation of the path of the assembly sequence (a) and diagram of the link between some components and lower level of TF of the FAST diagram (b).....	127
Figure 85. Product structure initially generated by the algorithm for structuring the product (a) and final product structure adapted by the product architect (b)	127
Figure 86. BioZard developed thanks the FARD methodology	129
Figure 87. Evolution of the indicators (Imp and Csapm) of the BioZard	130
Figure 88. Positioning of the Mountain bike experimentation according to the FARD methodology steps	131
Figure 89. Sketch of the frame of the mountain bike developed in this use case	132
Figure 90. Skeleton (a) with geometry (b) of the connecting rod.....	133
Figure 91. Mesh of the connecting rod	134
Figure 92. Mesh of the connecting rod with constraints for simulation	134
Figure 93. Results of the simulation: Von Mises criteria on the mesh (a) and displacement of mesh nodes (b)	135
Figure 94. Window of the Paramesh macro for applying homothetic coefficient	136
Figure 95. Application of homothetic coefficient by the Paramesh macro on nodes of the mesh	136
Figure 96. Von Mises results after various loops of simulation using the Paramesh macro	137
Figure 97. Final CAD model of the connecting rod after simulation validated	138

Figure 98. Steps of the definition of the best assembly sequence of the FARD methodology with the delimitation of each tab of Orasse Product (except the tab of the global project information)	144
Figure 99. Interaction between Orasse and ACSP	145
Figure 100. Use case of Orasse Product	147
Figure 101. Use case of the definition of precedence relationships on the contact graph ...	148
Figure 102. Activity diagram of Orasse Product.....	149
Figure 103. Sequence diagram of the assembly planner	150
Figure 104. Sequence diagram of the graph tab.....	151
Figure 105. Part of the class diagram of Orasse Product dedicated to the graph tab.....	152
Figure 106. Part of the class diagram of Orasse Product dedicated to the contact management linked with the graph tab	153
Figure 107. Start up window of Orasse Product.....	153
Figure 108. Global project information tab.....	154
Figure 109. List of components of the concept	155
Figure 110. Sketch of the pneumatic scraper concept with some marks with number corresponding to components of the product.....	156
Figure 111. Functional architecture tab of the product.....	157
Figure 112. Coloured PP matrix with its clusters, tab proposed by Orasse Product thanks to an algorithm	158
Figure 113. Simplified coloured and direct graph tab.....	159
Figure 114. Decision support system tab for generating the best assembly sequence	160
Figure 115. An electric towel radiator	161
Figure 116. Some illustrations of the use of Orasse Product with the electric towel radiator use case.....	162
Figure 117. New patented logo of the MABI Company created for highlighting the innovative character of the new products of the company	172
Figure 118. New logo representing the first prize of the MABI Company in the French national “Lumières et Innovation” 2011 competition (a) and a picture of the ceremony (b) .	172
Figure 119. New logo representing the first prize of the MABI Company in the French national Stars & Métiers 2012 competition (a) and a picture of the departmental ceremony (b)	173
Figure 120. Declination of the Orasse software’s.....	176
Figure 121. Definition of the best ordered activities sequence of each design domain according to a generic approach	176
Figure 122. Structure the data of each design domain according to a generic approach	177

Table of tables

Table 1. List of variants of a module for defining a power	85
Table 2. Example of the definition of the three first product of a modular family including four specific modules for the creation of variants. Module 4 is a standard module and is necessarily used in all the products of the family	85
Table 3. List of all components of the pneumatic scraper concept considered in this case study	104
Table 4. Definition of standard and specific elements of the family to create variants of products	115
Table 5. Variants of the Sub-Module2.2	115
Table 6. Configuration management of the products of the modular family with definition of each variant of specific elements for every product	116
Table 7. List of components of the concept and their number assigned.....	124
Table 8. Definition of standard and common parts of the family used to create variants of product.....	128
Table 9. Example of sets of GP applied to the connecting rod thanks to homothetic coefficients	137
Table 10. Current information shared between ACSP and Orasse and its location in each software	146
Table 11: Illustration of the links between Project, Product, Process, Human activity and Knowledge design domains and their main entities	165