



HAL
open science

Agent-Based Architectures and Algorithms for Energy Management in Smart Grids: Application to Smart Power Generation and Residential Demand Response

Robin Roche

► **To cite this version:**

Robin Roche. Agent-Based Architectures and Algorithms for Energy Management in Smart Grids: Application to Smart Power Generation and Residential Demand Response. Other. Université de Technologie de Belfort-Montbéliard, 2012. English. NNT : 2012BELF0191 . tel-00864268

HAL Id: tel-00864268

<https://theses.hal.science/tel-00864268>

Submitted on 20 Sep 2013

HAL is a multi-disciplinary open access archive for the deposit and dissemination of scientific research documents, whether they are published or not. The documents may come from teaching and research institutions in France or abroad, or from public or private research centers.

L'archive ouverte pluridisciplinaire **HAL**, est destinée au dépôt et à la diffusion de documents scientifiques de niveau recherche, publiés ou non, émanant des établissements d'enseignement et de recherche français ou étrangers, des laboratoires publics ou privés.

——— UNIVERSITÉ DE TECHNOLOGIE DE BELFORT–MONTBÉLIARD ———

Institut de Recherche sur les Transports, l'Énergie et la Société
Laboratoire Systèmes et Transports
École Doctorale Sciences pour l'Ingénieur et Microtechniques

Algorithmes et Architectures Multi-Agents pour la Gestion de l'Énergie dans les Réseaux Électriques Intelligents

Application aux Centrales à Turbines à Gaz et à l'Effacement Diffus Résidentiel

Thèse n°191 présentée et soutenue publiquement en vue de l'obtention du titre de
Docteur en Génie Électrique

par

Robin Roche

le 7 décembre 2012

Membres du jury :

M. Mohamed Benbouzid	IUT de Brest, LBMS	Président
M. Nouredine Hadjsaid	INP Grenoble, G2Elab	Rapporteur
M. Lhassane Idoumghar	Université de Haute Alsace, LMIA	Co-encadrant
M. Emmanuel Kerrand	GE Power & Water	Membre invité
M. Abderrafiâa Koukam	UTBM, IRTES-SET	Examineur
M. Abdellatif Miraoui	UTBM, IRTES-SET	Directeur de thèse
M. Stéphane Ploix	INP Grenoble, GSCOP	Rapporteur
M. Marcelo G. Simões	Colorado School of Mines	Examineur
M. Siddharth Suryanarayanan	Colorado State University	Co-encadrant

**Agent-Based Architectures and Algorithms
for Energy Management in Smart Grids**

Application to Smart Power Generation and Residential Demand Response

Dissertation submitted in fulfilment of the requirements for the degree of
Doctor of Philosophy (Ph.D.) in Electrical Engineering

of the

University of Technology of Belfort–Montbéliard

by

Robin Roche

December 7, 2012

In the memory of Dr. Benjamin Blunier

On rencontre sa destinée
Souvent par des chemins qu'on prend pour l'éviter.

Jean de La Fontaine,
Livre VIII (1678–1679), L'horoscope

Please refer to this work as follows:

Robin Roche, *Agent-Based Architectures and Algorithms for Energy Management in Smart Grids: Application to Smart Power Generation and Residential Demand Response*. Ph.D. dissertation, Université de Technologie de Belfort-Montbéliard, Belfort, France, December 2012.

The author and the advisors give the authorization to consult and to copy parts of this work for personal use only. Permission to reproduce any material contained in this work should be obtained from the author.

Abstract

Due to the convergence of several profound trends in the energy sector, smart grids are emerging as the main paradigm for the modernization of the electric grid. Smart grids hold many promises, including the ability to integrate large shares of distributed and intermittent renewable energy sources, energy storage and electric vehicles, as well as the promise to give consumers more control on their energy consumption. Such goals are expected to be achieved through the use of multiple technologies, and especially of information and communication technologies, supported by intelligent algorithms.

These changes are transforming power grids into even more complex systems, that require suitable tools to model, simulate and control their behaviors. In this dissertation, properties of multi-agent systems are used to enable a new systemic approach to energy management, and allow for agent-based architectures and algorithms to be defined. This new approach helps tackle the complexity of a cyber-physical system such as the smart grid by enabling the simultaneous consideration of multiple aspects such as power systems, the communication infrastructure, energy markets, and consumer behaviors. The approach is tested in two applications: a “smart” energy management system for a gas turbine power plant, and a residential demand response system.

An energy management system for gas turbine power plants is designed with the objective to minimize operational costs and emissions, in the smart power generation paradigm. A gas turbine model based on actual data is proposed, and used to run simulations with a simulator specifically developed for this problem. A metaheuristic achieves dynamic dispatch among gas turbines according to their individual characteristics. Results show that the system is capable of operating the system properly while reducing costs and emissions. The computing and communication requirements of the system, resulting from the selected architecture, are also evaluated.

With other demand-side management techniques, demand response enables reducing load during a given duration, for example in case of a congestion on the transmission system. A demand response system is proposed and relies on the use of the assets of residential customers to curtail and shift local loads (hybrid electric vehicles, air conditioning, and water heaters) so that the total system load remains under a given threshold. Aggregators act as interfaces between grid operators and a demand response market. A simulator is also developed to evaluate the performance of the proposed system. Results show that the system manages to maintain the total load under a threshold by using available resources, without compromising the steady-state stability of the distribution system.

Résumé

Avec la convergence de plusieurs tendances profondes du secteur énergétique, les réseaux électriques intelligents (smart grids) émergent comme le paradigme principal pour la modernisation des réseaux électriques. Les smart grids doivent notamment permettre d'intégrer de larges proportions d'énergie renouvelable intermittente, de stockage et de véhicules électriques, ainsi que donner aux consommateurs plus de contrôle sur leur consommation énergétique. L'atteinte de ces objectifs repose sur l'adoption de nombreuses technologies, et en particulier des technologies de l'information et de la communication.

Ces changements transforment les réseaux en des systèmes de plus en plus complexes, nécessitant des outils adaptés pour modéliser, contrôler et simuler leur comportement. Dans cette thèse, l'utilisation des systèmes multi-agents (SMA) permet une approche systémique de la gestion de l'énergie, ainsi que la définition d'architectures et d'algorithmes bénéficiant des propriétés des SMA. Cette approche permet de prendre en compte la complexité d'un tel système cyber-physique, en intégrant de multiples aspects comme le réseau en lui-même, les infrastructures de communication, les marchés ou encore le comportement des utilisateurs. L'approche est mise en valeur à travers deux applications.

Dans une première application, un système de gestion de l'énergie pour centrales à turbines à gaz est conçu avec l'objectif de minimiser les coûts de fonctionnement et les émissions de gaz à effet de serre pour des profils de charge variables. Un modèle de turbine à gaz basé sur des données réelles est proposé et utilisé dans un simulateur spécifiquement développé. Une métaheuristique optimise dynamiquement le dispatching entre les turbines en fonction de leurs caractéristiques propres. Les résultats montrent que le système est capable d'atteindre ses objectifs initiaux. Les besoins en puissance de calcul et en communication sont également évalués.

Avec d'autres mesures de gestion de la demande, l'effacement diffus permet de réduire temporairement la charge électrique, par exemple dans la cas d'une congestion du réseau de transport. Dans cette seconde application, un système d'effacement diffus est proposé et utilise les ressources disponibles chez les particuliers (véhicules électriques, climatisation, chauffe-eau) pour maintenir la demande sous une valeur limite. Des agrégateurs de capacité de réduction de charge servent d'interface entre les opérateurs du réseau et un marché de l'effacement. Un simulateur est également développé pour évaluer la performance du système. Les résultats de simulations montrent que le système réussit à atteindre ses objectifs sans compromettre la stabilité du réseau de distribution en régime continu.

Acknowledgments

It is my pleasure to thank all who have helped and inspired me during the last three years, from the day I became a Ph.D. student to the day of my defense.

At first, I would like to thank Dr. Nouredine Hadjsaid and Dr. Stéphane Ploix for accepting to review this dissertation, despite their very busy schedules, and for their helpful comments. I would also like to thank Dr. Mohamed Benbouzid for serving as chair of the defense committee, and Dr. Emmanuel Kerrand, Dr. Abderrafiâa Koukam and Dr. Marcelo G. Simões for accepting to participate in this committee.

I am very grateful to Dr. Abdellatif Miraoui for giving me the opportunity to work under his supervision in the flourishing field of smart grids. His leadership has been a great motivation and taught me to dare take risks and be ambitious.

I would then like to thank my co-advisors, and especially Dr. Benjamin Blunier, who passed away in February 2012. His communicative enthusiasm for research and education greatly inspired me. The numerous passionate and open discussions we had about a wide variety of topics taught me a lot, and had enabled us to work very well together. He is, and will be missed. As a co-advisor, as a colleague, and as a friend. I am thankful to Dr. Lhassane Idoumghar for his continuous support and guidance, and for introducing me to optimization. His precious help contributed a lot to the realization of large parts of the work presented in this dissertation. Dr. Siddharth Suryanarayanan has been a great motivating professor and a wonderful co-advisor. In just a few months, his extensive knowledge in power systems, his insights, his efficient work methods, and his demand for quality and excellence have influenced me and my work more than I could say. I am also very thankful to him and his students for their support when I needed it most.

I would also like to thank UTBM, and especially the UTBM Foundation for funding me throughout these years, and the Colorado State University Energy Supercluster for funding my stay in Colorado.

Many people in Belfort have made my everyday life more productive, interesting, and fun. My fellow doctoral students and colleagues at UTBM, with their friendship, good temper, and amazing ability to come up with funny/weird ideas and stories, gave me the strength to keep working toward my goal: Dr. Mohammad Kabalo, Mr. Hugues Ostermann, Dr. Alexandre Ravey, Mr. Nicolas Watrin, and Mr. Dongdong Zhao. Without them, these years would have been a lot more difficult, and I think our mutual support has been an essential element in our successes. My thanks also go to, in no particular order, Dr. El-Hassane Aglzim, M. Gillian Basso, Ms. Florence Berthold, Dr. David Bouquain, Dr. Béatrice Bouriot, Dr. Daniela Chrenko, Mr. Sébastien Faivre, Dr. Fei Gao, Dr. Arnaud Gaillard, Ms. Ariane Glatiny, Dr. Jérémie, Dr. Fabrice Lauri, M'Boua, Dr. Damien Paire, and Dr. Dimitri Torregrossa, for their helpfulness and friendliness. My thanks also go to

the numerous other people I cannot list, especially people from the EE department, from IRTES-SET, and from GE Energy (now GE Power & Water).

I also want to thank Mr. Ayan Bhattacharyya, Mr. Manish Mohanpurkar, Mr. Sudarshan Natarajan, Mr. David Palchak, Mr. Mayank Panwar, Dr. Siddharth Suryanarayanan, Prof. Daniel Zimmerle, and Mr. Adam Zipperer at Colorado State University, as well as Dr. Marcelo G. Simões from Colorado School of Mines, for their very warm welcome. I had a wonderful time in Colorado due to them.

Finally, I am extremely grateful to my family for their love, encouragement and confidence in me. Specifically, I would like to thank my parents and my sister for their continuous trust and support throughout the years. And last but not least, I want to thank Aurélie for her support, especially over the last few months.

Contents

Abstract	i
Résumé	iii
Acknowledgments	v
Contents	vii
1 Energy Management in Smart Power Systems	1
1.1 Toward Smarter Power Grids	2
1.1.1 Drivers	2
1.1.2 Definition	4
1.1.3 Characteristics	6
1.1.4 Technologies	8
1.1.5 Challenges	12
1.2 Modernization of Control Systems	13
1.2.1 Power System Restructuring	13
1.2.2 Control Systems Typology	14
1.3 Problem Statement	16
1.4 Outline	17
2 Agent-Based Modeling, Control and Simulation	21
2.1 Multi-Agent Systems	22
2.1.1 Smart Grids as Complex Adaptive Systems	22
2.1.2 Concept	23
2.1.3 Relevance for Power Systems Applications	24
2.1.4 Communication, Languages and Ontologies	29
2.1.5 Agent Management	31
2.1.6 Topologies	33
2.1.7 Inter-Agent Interaction	35
2.2 Multi-Agent Development Framework	38
2.2.1 Development Platforms	38
2.2.2 The JADE Platform	38
2.3 Co-Simulation Framework	41
2.3.1 Need for Co-Simulation Tools	41
2.3.2 Specifications	43
2.3.3 Structure	44

2.3.4	Operation	45
3	Gas Turbine Power Plants for Smart Power Generation	47
3.1	Smart Power Generation	49
3.1.1	Drivers	49
3.1.2	Concept	49
3.1.3	State-of-the-Art	50
3.1.4	Application to Gas Turbine Power Plants	50
3.1.5	Energy Management Systems for Smart Generating Plants	51
3.2	Gas Turbine Characteristics	51
3.2.1	Fuel Consumption	52
3.2.2	Combustion Gas Emissions	53
3.2.3	Starting and Stopping Cycles	55
3.3	Energy Management System Architecture	56
3.3.1	Agent Structure	56
3.3.2	Selected MAS Architecture	57
3.3.3	Agent Interactions	61
3.4	Energy Management Strategy	64
3.4.1	Start and Stop Algorithm	64
3.4.2	Turbine Operation Ranges	65
3.5	Economic and Environmental Dispatch	66
3.5.1	Single and Multi-Objective Optimization	66
3.5.2	Problem Definition	68
3.5.3	Aggregation-Based Power Dispatching	69
3.6	Simulation Results	70
3.6.1	MAS Implementation	70
3.6.2	Parameters	70
3.6.3	Dispatching Algorithms Comparison	73
3.6.4	Performance Coefficients Effectiveness	77
3.6.5	Start and Stop Algorithm Effectiveness	77
3.6.6	Energy Costs Comparison	79
3.6.7	Flexibility and Resilience Test	79
3.6.8	Communication and Computation Requirements	82
3.7	Conclusion	83
4	Aggregator-Based Residential Demand Response	85
4.1	Demand Response	86
4.1.1	Drivers and Components	86
4.1.2	State-of-the-Art	88
4.1.3	Proposed Approach	89
4.2	System Architecture	89
4.2.1	T&D Infrastructure	90
4.2.2	Demand Response Aggregators	91
4.2.3	Demand Response Market	91
4.2.4	Residential Customers	92
4.3	Residential Load Model	93

4.3.1	Enabling Technologies and Assumptions	93
4.3.2	Electric Water Heater Model	93
4.3.3	Air Conditioning Model	95
4.3.4	Appliances Model	95
4.3.5	PHEV Fleet Model	98
4.3.6	PV Model	101
4.4	System Operation	101
4.4.1	Objective and Constraints	101
4.4.2	Metering Mode	102
4.4.3	Demand Response Event Mode	102
4.4.4	Rescheduling Algorithm	104
4.5	Simulation Results	107
4.5.1	Simulator	107
4.5.2	Test Case	108
4.5.3	Simulation Parameters	108
4.5.4	System-wide Net Load Results	110
4.5.5	Results for Residential Customers	113
4.5.6	Impact on the Distribution System	113
4.6	Conclusion	116
5	Conclusions	117
5.1	Concluding Remarks	117
5.1.1	Conclusions on the Proposed Approach	117
5.1.2	Conclusions on the Presented Applications	118
5.2	Future Work	119
5.3	Scientific Production Overview	121
	Appendices	123
A	Metaheuristics for Optimal Dispatching	125
A.1	Definition	125
A.2	Common Metaheuristics	125
A.2.1	Particle Swarm Optimization (PSO)	125
A.2.2	Differential Evolution (DE)	126
A.2.3	Genetic Algorithm (GA)	128
A.2.4	Imperialist Competitive Algorithm (ICA)	129
A.3	Hybrid Algorithms	132
A.3.1	Metropolis PSO with Mutation Operation (MPSOM)	132
A.3.2	ICA-PSO Algorithm	133
A.4	Performance Comparison and Analysis	135
A.4.1	Benchmark Functions	135
A.4.2	Algorithms Implementation	135
A.4.3	Test Results and Analysis	138
B	Publications	141

Bibliography	145
List of Acronyms	163
List of Figures	166
List of Tables	168

1

Energy Management in Smart Power Systems

Contents

1.1	Toward Smarter Power Grids	2
1.1.1	Drivers	2
1.1.2	Definition	4
1.1.3	Characteristics	6
1.1.4	Technologies	8
1.1.5	Challenges	12
1.2	Modernization of Control Systems	13
1.2.1	Power System Restructuring	13
1.2.2	Control Systems Typology	14
1.3	Problem Statement	16
1.4	Outline	17

1.1 Toward Smarter Power Grids

The last few years have seen the popularization of the *smart grid* concept, a new paradigm for power systems. This relatively new concept, through the need for smarter energy management systems in the electricity grid, is at the core of this dissertation.

1.1.1 Drivers

The electric power grid is over a century old in most Western countries, and has seen relatively few breakthrough innovations since its creation. Some even argue that Thomas Edison would recognize most of the equipment in use in today's power grids, contrary to Graham Bell in the telecommunication infrastructure [1]. However, due to the combination of several profound trends, power grids will have to evolve and become much smarter than they are today. Drivers for such changes include [2]:

- *Increasing energy demand.* Worldwide energy demand is expected to rise by over 150 % by 2050 [3], due to population and economic growths, and the use of new technologies such as electric vehicles (EVs). As installing new traditional and centralized generation capacity and transmission lines is extremely expensive, alternative solutions are being considered [4].
- *Environmental concerns.* Evidences of global warming throughout the world are pushing legislators to foster the use of new technologies and non-pollutant energy sources to reduce greenhouse gases emissions. The European Union has set the goal of achieving 20 % reduction in carbon dioxide emissions, 20 % improvement in energy efficiency and a 20 % share of renewable energy sources (RESs) in the energy mix, by 2020 from 1990 levels. Similarly, in the United States (US), renewable portfolio standards (RPSs) were introduced with the aim of increasing energy production from RESs [5].
- *Increasing share of intermittent renewable generation.* RESs are an answer to these environmental concerns, due to their low emission levels. However, their intermittency is a source of instability for power systems, as the balance between supply and demand is harder to maintain with such sources present in the energy mix [4,6]. Fig. 1.1 shows the solar radiation and wind speed measured in Belfort on June 6, 2011, at a height of 15 m¹, and the total French demand observed by the transmission system operator (TSO) RTE [7]. This data shows that due to sudden variations in solar radiation (due to clouds, for example) or wind speed, the output of RESs can change very rapidly. Short-term generation peaks and long periods without generation can be observed within the same day, whereas demand tends to change rather slowly throughout the day.
- *Increasing share of distributed generation.* Contrary to bulk power generation, where a few large power plants supply large areas, distributed generation (DG) relies on small units, capable of powering from a single customer to an appropriate portion of the grid. Such a transition requires newer control systems to operate on such scales.

1. This data is acquired using a weather station owned by UTBM.

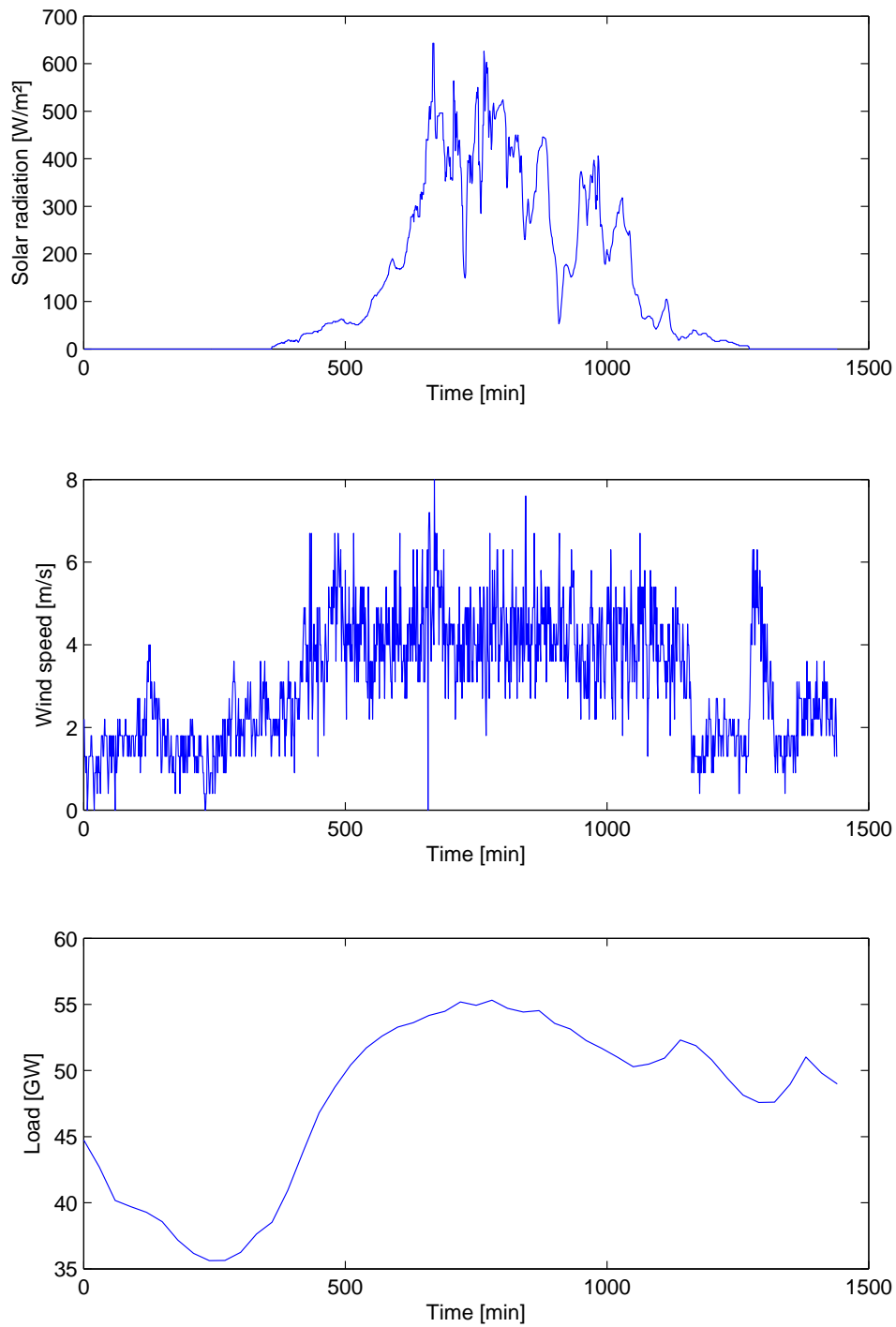

Figure 1.1: Solar radiation (top) and wind speed (middle) measured in Belfort on June 6, 2011, at a height of 15 m, with a time resolution of 1 min, and total French demand observed by RTE (bottom), with a resolution of 30 min.

- *Energy costs.* As most fossil fuel resources are expected to be depleted in the coming decades or centuries, at best, energy prices can be expected to increase, especially because of energy demand growth in developing countries [8]. For example, India’s electricity consumption is expected to grow by 500 % by 2050, with only a share of 10 % for RESs [3].
- *Security of energy supply.* As a consequence to rising energy costs, especially with respect to oil and gas, some countries may be at risk of supply shortage in case of a major socio-economic or political conflict. This situation also leads to negative balances of trade which penalize the economies of these countries. RESs and energy efficiency may provide some locally available solutions to reduce the dependency on foreign imports.
- *Aging infrastructure.* Most of the infrastructures built in the second half of the 20th century are reaching their end of life, and due to a general trend of under-investment, their failure rates tend to increase over the years [9].
- *Information technology (IT) systems security concerns.* Recent threats such as Stuxnet [10] and Flame [11] have shown that most power systems are not as secure as expected and can be targeted by malicious entities, whether they are part of common malicious or benign hacking activities or of larger cyber-warfare plans [12].

The combination of these concerns indicates that the stability and efficiency of power grids will be more and more at risk in the coming years, and may be compromised. The smart grid is expected to help tackle these issues.

1.1.2 Definition

Although the term *smart grid* tends to be used rather as a marketing term than in a purely technical context, its concept refers to the modernization of the electric grid². By adding an extensive communication and control infrastructure to the electric infrastructure, a smart power grid becomes a *cyber-physical system* (CPS). As defined by the US National Science Foundation (NSF), “cyber-physical systems are engineered systems that are built from and depend upon the synergy of computational and physical components” [13]. For the smart grid, these components are the electrical and communication and control infrastructures.

In 2007, the Energy Independence and Security Act [14] of the 110th US congress defined the smart grid as follows:

It is the policy of the United States to support the modernization of the Nation’s electricity transmission and distribution system to maintain a reliable and secure electricity infrastructure that can meet future demand growth and to achieve each of the following, which together characterize a Smart Grid:

2. The same term, with a similar meaning, is sometimes used for other types of networks, such as smart water and smart gas networks.

- Increased use of digital information and controls technology to improve reliability, security, and efficiency of the electric grid.
- Dynamic optimization of grid operations and resources, with full cyber-security.
- Deployment and integration of distributed resources and generation, including renewable resources.
- Development and incorporation of demand response, demand-side resources, and energy-efficiency resources.
- Deployment of “smart” technologies (real-time, automated, interactive technologies that optimize the physical operation of appliances and consumer devices) for metering, communications concerning grid operations and status, and distribution automation.
- Integration of “smart” appliances and consumer devices.
- Deployment and integration of advanced electricity storage and peak-shaving technologies, including plug-in electric and hybrid electric vehicles, and thermal-storage air conditioning.
- Provision to consumers of timely information and control options.
- Development of standards for communication and interoperability of appliances and equipment connected to the electric grid, including the infrastructure serving the grid.
- Identification and lowering of unreasonable or unnecessary barriers to adoption of smart grid technologies, practices, and services

Source: Energy Independence and Security Act of 2007 [14].

This very detailed definition focuses on the technologies and characteristics of the smart grid from a US perspective. The European Technology Platform (ETP) for the Electricity Networks of the Future provides another definition that focuses on the objectives of the smart grid, and that shows that the smart grid impacts the entire energy industry, from the largest nuclear power plants to the smallest consumers [15]:

A smart grid is an electricity network that can intelligently integrate the actions of all users connected to it — generators, consumers and those that do both — in order to efficiently deliver sustainable, economic and secure electricity supplies. A smart grid employs innovative products and services together with intelligent monitoring, control, communication, and self-healing technologies in order to:

- Better facilitate the connection and operation of generators of all sizes and technologies,

- Allow consumers to play a part in optimizing the operation of the system,
- Provide consumers with more information and better options choosing their energy supplier,
- Significantly reduce the environmental impact of the whole electricity supply system,
- Maintain and improve the existing high levels of system reliability, quality, and security of supply,
- Maintain and improve the existing services efficiently,
- Foster the development of an integrated European market.

Source: European Technology Platform for the Electricity Networks of the Future [15].

1.1.3 Characteristics

The complete characteristics of a smart grid heavily depend on the point-of-view of the player: consumer, distribution and transmission system operator, generator, regulator, equipment supplier, etc. A general consensus is that the smart grid relies on the addition of a communication and control network to an updated electric grid.

Several levels of smart grids can be identified, and compared with legacy power grids that were used up to a few years or decades ago, and with the current state of power grids. Legacy power grids were only very partially automated, mostly at the transmission level, and relied on large power plants to power customers, as pictured in Fig. 1.2.

In current power systems (Fig. 1.3), the development of information technologies and the restructuring of the electricity sector has led to several changes, such as the separation between generation, distribution and transmission entities via unbundling, the introduction of control systems based on advanced supervisory control and data acquisition (SCADA) systems, and the integration of relatively low shares of RESs. The operation of transmission infrastructures is also equipped with efficient communication and automatic control capacities, while distribution infrastructures are not.

For the development of future smart grids, several steps or versions can be distinguished, as described by Carvallo and Cooper [16], each with an increasing degree of complexity and automation. The first generation smart grid, called *Smart grid v1*, requires the implementation of an advanced metering infrastructure (AMI) using smart meters, that in turn enable basic demand response (DR) [17], of distribution automation and of advanced energy management systems (EMSs) and distribution management systems (DMSs). Several of these technological changes are already ongoing in most parts of the world, especially for smart meters deployment.

The advanced smart grid, or *Smart grid v2*, builds on the success of Smart grid v1 and includes the integration of new technologies such as EVs, large shares of DG and RESs, and energy storage, as shown in Fig. 1.4. The communication infrastructure spans the entire electrical infrastructure, so that each asset such as a DG source, storage unit,

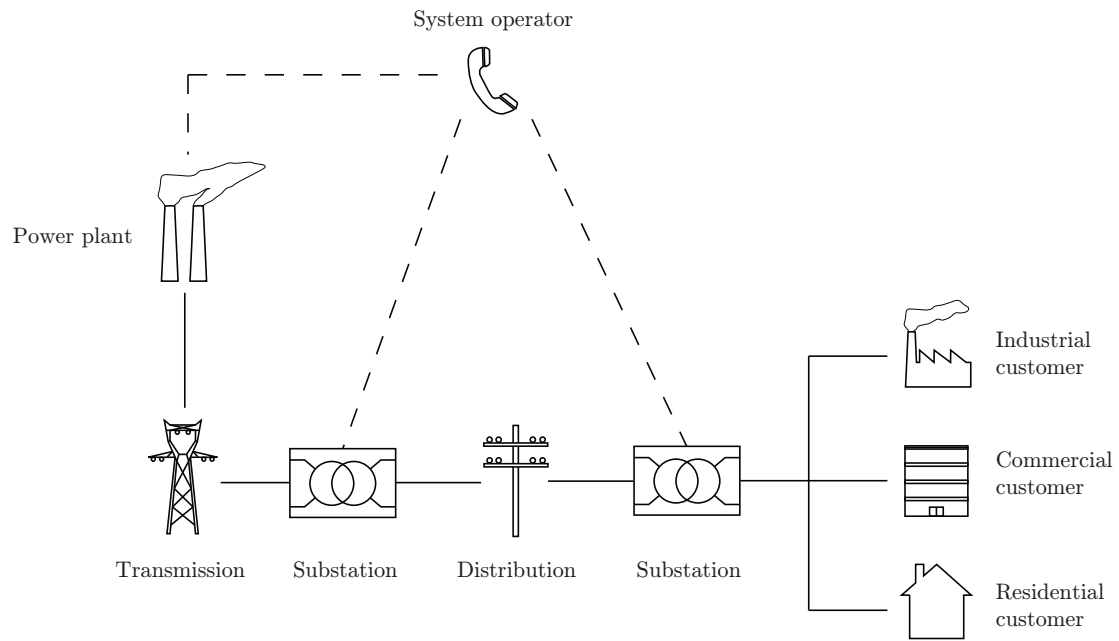

Figure 1.2: Architecture of legacy power systems, based on [3]. Plain lines indicate electrical infrastructures and dashed line communication channels.

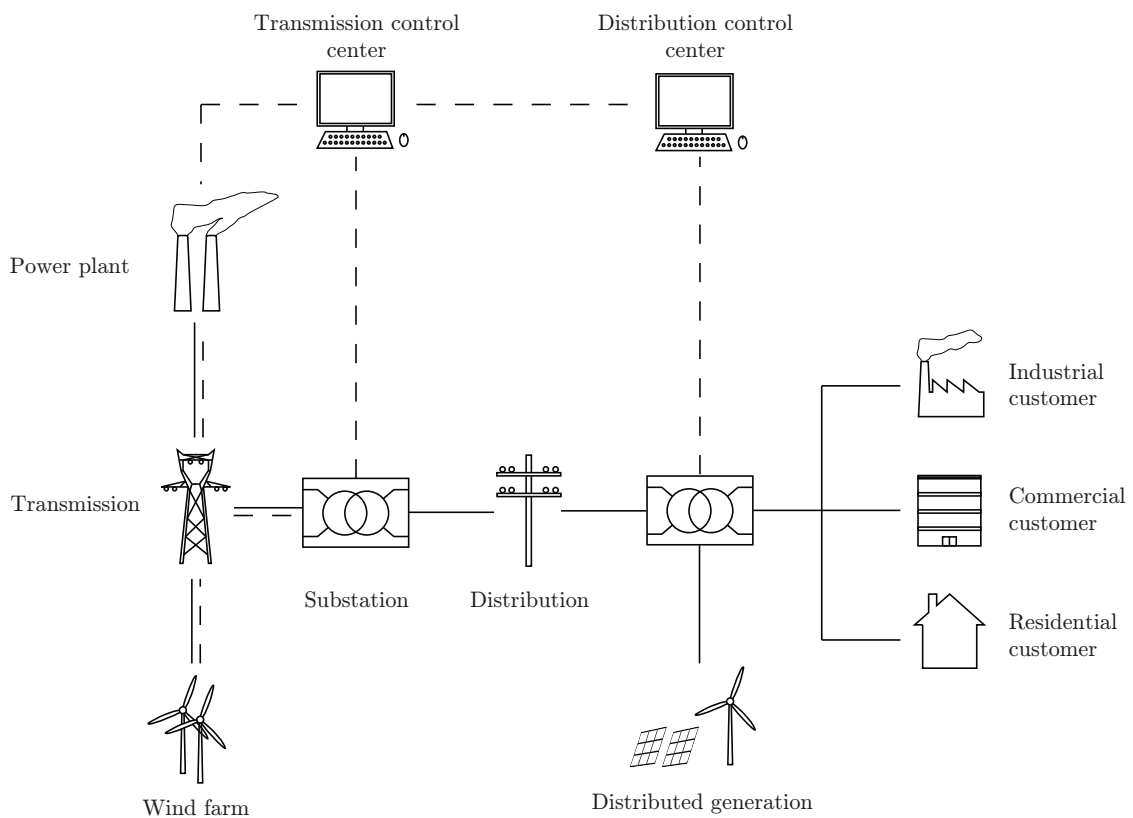

Figure 1.3: Architecture of current power systems, based on [3]. Plain lines indicate electrical infrastructures and dashed line communication channels.

customer and operator, is capable of communicating with others if required. To accommodate these changes, control systems are more dispersed and automated, with self-healing capabilities [18]. Energy service providers, such as aggregators, provide services to customers that enable them to participate in programs, such as advanced DR with the ability to automatically control smart appliances. A *Web of Things* is expected to emerge from the popularization of smart appliances and communicating electronic devices [19]. Such changes can be expected to occur within the next couple of decades in the most advanced Western countries. It is within this scope that this dissertation provides some original fundamental contributions of the application of multi-agent systems, a CPS enabler, to the energy management of smart grid elements.

Smart grid v3 is currently considered as the ultimate step of the proposed vision and includes peer-to-peer energy trading and energy roaming, sometimes called *enernet* [20]. This term refers to Internet, in that as information is easily shared over the Internet, energy could tomorrow become as easy to trade among individuals. The IT and electricity infrastructures would then be fully integrated. The enernet concept could become a reality by 2030 to 2050, but would require tremendous changes in the way electric energy is managed.

Similar visions and frameworks were proposed by entities such as the French Energy Agency (ADEME), which lists several visions for 2020 and 2050 [21], and the US National Institute of Standards and Technology (NIST) [22].

1.1.4 Technologies

The realization of the smart grid relies on the development and maturation of numerous technologies. According to [3], these technologies include:

- *Wide-area monitoring and control technologies*, such as phasor measurement units (PMUs), are required to monitor the performance of power system components and control their operation over large geographic areas. Wide-area monitoring systems (WAMSs) and other technologies are required to avoid blackouts and facilitate the integration of large RESs, such as offshore wind farms, by generating data useful to control systems and grid operators [23].
- *Information and communications technologies* are required to enable the communication and IT infrastructures to adapt to the features of the smart grid. Whether they use private utility networks or public ones, such as the Internet, data needs to be transmitted in a reliable and efficient manner throughout the entire system. Such transmission has to occur in real-time for some applications, such as monitoring and control, or can be deferred in time for others, such as for billing and event logging. Similarly, computing capabilities, both on the hardware and software sides, need to be upgraded, especially as a lot more data is going to transit along communication infrastructures and need to be processed.
- *Renewable and distributed generation technologies*, from the residential level to the transmission level, are difficult to integrate due their intermittent output, which does not match demand patterns. Energy storage technologies are thus required to help mitigate these problems by providing energy buffers. For example, storage can discharge and provide peaking power in the evening, when demand is high and

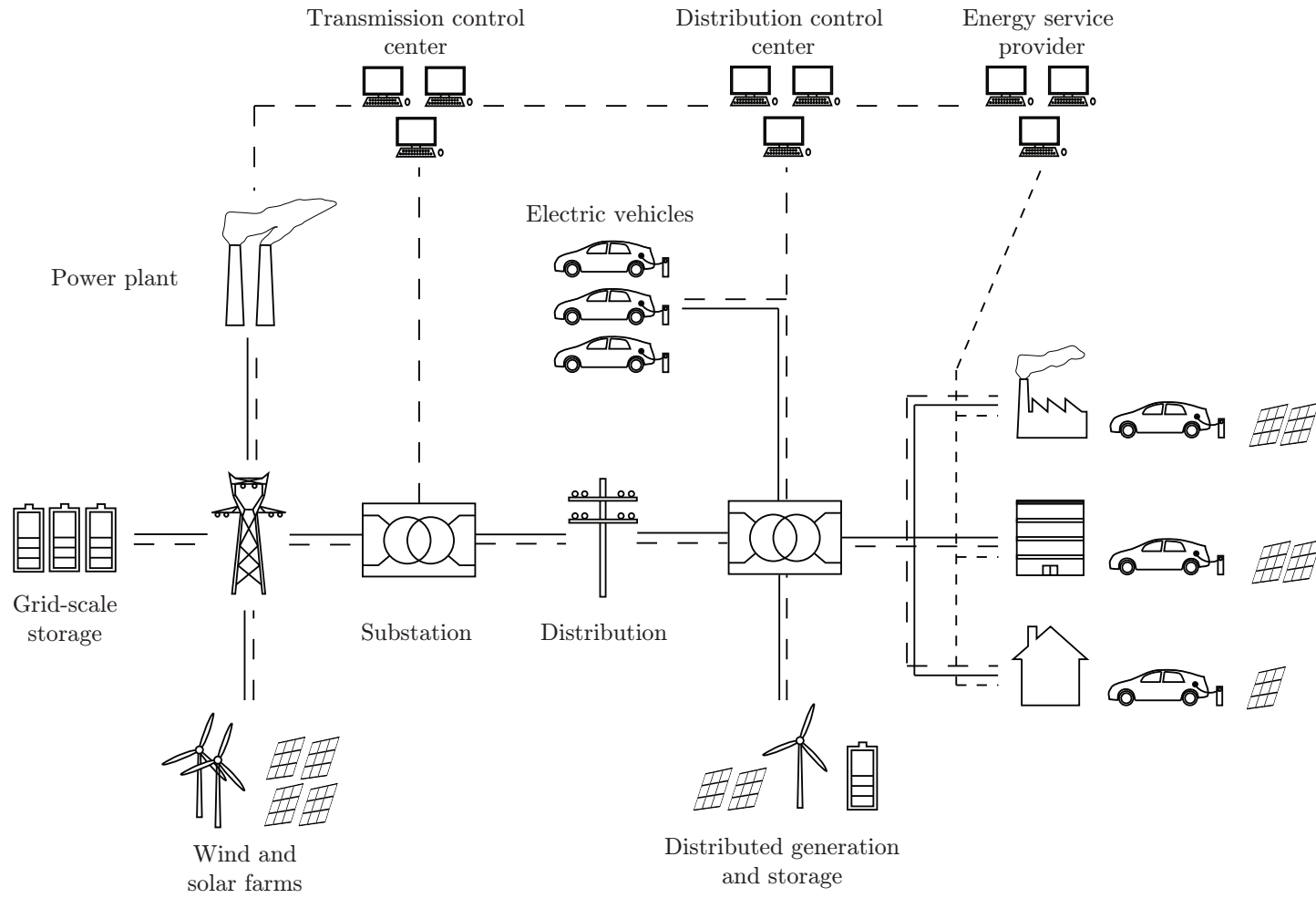

Figure 1.4: Architecture of future power systems, based on [3]. Plain lines indicate electrical infrastructures and dashed line communication channels.

solar power decreases, and recharge at night when the wind might blow faster. DR technologies are another response to this challenge. Tools such as EMSs, DMSs, and geographical information systems (GISs) facilitate such integration.

- *Transmission enhancement technologies*, such as flexible AC transmission systems (FACTSs), high voltage DC (HVDC), dynamic line rating (DLR) and high temperature superconductors (HTSs), are useful tools for enabling a more flexible and efficient transmission of electric power. FACTSs improve the ability to control and transfer power flows [24], while HVDC lines enable the transmission of large amounts of power (e.g., originating from large RESs farms) at the continental scale with low losses [25]. DLR provides information on the carrying capability of network sections in real-time through sensors, and enable optimizing the use of transmission assets. HTSs use the properties of superconducting materials to reduce transmission losses, and hereby the economic efficiency of the system.
- *Distribution grid management technologies* are used to improve the reliability of distribution systems and reduce outage and repair time through advanced sensing and automation. Distribution automation (DA) aims at processing real-time data for applications such as fault location, automatic feeder reconfiguration, reactive power and voltage control and DG control. The condition of distribution assets can also be monitored through such means, for example to monitor the performance of an aging transformer.
- *The advanced metering infrastructure* enables two-way information flow through smart meters, notably between customers and utilities for consumption and pricing data. The corresponding technologies are typically the ones that are currently being deployed by utilities with smart meters. Such services include time-of-use pricing, consumption profiling and diagnosis, theft detection, remote connection and disconnection, etc. Meter data management systems (MDMSs) are required to handle the large amounts of data resulting from the adoption of such new devices and services.
- *The electric vehicle charging infrastructure* is essential in enabling the development of plug-in hybrid electric and battery electric vehicles. It handles the billing, scheduling and smart charging of vehicles, while taking into account the demand and market context in real-time. More advanced services can also be developed, such as the participation of vehicles in ancillary services using the vehicle-to-grid (V2G) technology.
- *Customer-side systems* are supposed to help users manage energy consumption, for example by enabling them to monitor their consumption, to automate their loads such as smart appliances, and to participate in electricity markets through the intermediary of aggregators. Such features can be achieved via in-home energy dashboards and dedicated online and smartphone applications, capable of communicating with smart devices and controlling them adequately with an home energy management system (HEMS).

These technologies will be used at different complementary levels given below, each corresponding to a different power system scale.

Buildings, whether they are for residential, commercial, office or industrial use, are expected to become smarter in their consumption of energy. Through advanced home

automation, smart metering and HEMSs, the use of most loads (smart appliances, air conditioning, water heaters, etc.) can be improved and lead to energy and electricity bill savings, especially if systems have a learning capability. They can also integrate DG sources such as photovoltaic (PV) panels, EV charging stations, possibly with V2G capability, and other energy storage assets.

Microgrids are defined by the US Department of Energy (DOE) as “a group of interconnected loads and distributed energy resources within clearly defined electrical boundaries that acts as a single controllable entity with respect to the grid [and can] connect and disconnect from the grid to enable it to operate in both grid-connected or island-mode” [26]. The islanding capability of microgrids enables them to operate separately from the main grid when necessary, e.g., during a blackout. Although this feature could improve the quality of service to customers, its realization requires important advances in control technologies, especially if large amounts of RESs and storage are to be integrated. As large centralized power plants may become less common in the future, large networks of interconnected microgrids could partially replace today’s large transmission systems.

The largest scale corresponds to *Super grids*, which are large continental or inter-continental-scale power grids. The pan-European grid could for example be connected to North African power grids to form a large electricity grid, where large amounts of PV and wind energy could transit through HVDC lines, as in the Desertec project [27].

Another element of smart grids is *smart power generation*, or smart power plants. This concept aims at matching electricity production with demand using multiple identical generators which can start, stop and operate efficiently at a given load, independently from each other, making them suitable for base load and peaking power generation [28]. Smart power generation promises to be one of the tools to help integrate intermittent RESs, due to their ability to adapt rapidly to changing conditions.

1.1.5 Challenges

For this vision to become a reality, several challenges have to be solved. A first challenge is related to the *funding and financing* of smart grid projects. Most early smart grid projects were supported by government stimulus funds initiated after several recent blackouts, such as the 2003 blackouts in Italy [29] and in Northern America [30]. In France, the ADEME and the National Research Agency (ANR) launched several demonstration projects from 2009 to 2012, as did the US DOE and other institutions [31]. In France, frequent changes in feed-in tariffs for RESs have slowed down the adoption of these technologies, due to the uncertainty it triggers for investors. A similar behavior could be observed for smart grids projects in the future, unless private investors can clearly quantify the benefits they could gain from the smart grid.

On the other hand, regulators have an essential role to play in *defining policies* for the smart grid, while taking into account the constraints of all market players. Current legislation in most countries will have to change to enable some smart grid functionalities, especially regarding power markets and rate structures, e.g., for demand response. As business models heavily depend on such policies, such as for energy service providers, clear policy decisions are expected from regulating entities.

Due to the multiplicity of manufacturers and operators, standards have to be created to enable *interoperability* between hardware and software from different providers, and reduce

development costs. NIST recently published a roadmap for smart grid interoperability standards [22]. The Institute of Electrical and Electronics Engineers (IEEE) has also been working on numerous smart grid-related standards; some of them are named in NIST's roadmap.

Consumer acceptance is another concern. As consumers (or *prosumers*) are expected to play an increasingly important role in the smart grid, utilities have to make sure that their customers actually feel implicated in the transition to the smart grid. Consumer backlash in several US states has shown that rational (privacy concerns) and irrational (radiations leading to cancers) fears can arise, simply from smart meter installation [32]. The use of intelligent HEMSs is also questionable for people who might not be comfortable with technology. Large scale experiments must be conducted to analyze the impact of such behaviors on operations and on the validity of business models.

And lastly, *technical challenges* are some of the biggest to be tackled. The largest concerns are about the integration of RESs, storage and EVs, which introduce a lot of stochasticity in grid operation, as opposed to today's grid where only the load has to be forecast. But many other challenges can be derived from these larger ones. In this work, two technical challenges are of interest. The first one is a consequence of the development of the metering infrastructure, which will lead to gigantic amounts of data to process in almost real-time by utilities. The second corresponds to energy management algorithms capable of leveraging the possibilities offered by the smart grid, namely, here, smart power plants and demand response.

1.2 Modernization of Control Systems

1.2.1 Power System Restructuring

In addition to the change drivers listed earlier, the restructuring of power systems that has been going on for a couple of decades in Europe and in other parts of the world is also affecting the way control systems operate [33].

In the paradigm of *vertically integrated utilities* (Table 1.1), the utility owns at the same time generation, transmission and distribution assets, and also acts as an electricity retailer for the end-users. Such architecture enables an efficient management of costs and benefits, as well as appropriate investment decisions for the benefit of the grid as a whole. On the other hand, it leaves almost no space for competitors due the monopoly the utility has. In most US states, utilities operate at the city or state scale under a structure close to the vertically integrated utility, where generation can also be liberalized.

In *unbundled electricity markets* (Table 1.1), the only monopolies are for the transmission and distribution infrastructures, while several generators and retailers are free to compete on markets to sell energy to their respective customers. While this paradigm enables multiple competitors enter the market and theoretically puts more pressure on prices, it sometimes leads to slower technology deployments, increased complexity and lack of investment strategies that can benefit to all activities. From the late 1990s and until 2007, France has progressively liberalized its electricity market by switching from an (almost) single vertically integrated utility (Électricité de France, EDF) to an unbundled electricity market, where multiple entities (EDF, GDF-SUEZ, POWEO, etc.) compete at

the wholesale and retail levels. RTE and ERDF have kept the monopoly for the transmission and distribution (T&D) infrastructures [34].

Activities	Integrated utility	Unbundled market
Generation	Regulated	Market
Transmission	Regulated	
Distribution	Regulated	
Retail	Regulated	Market

Table 1.1: Comparison of vertically integrated utilities and unbundled electricity markets.

1.2.2 Control Systems Typology

Multiple control systems are at the core of electric grids, and allow these grids to operate efficiently and safely. Four complementary objectives have to be fulfilled by control systems:

1. *Safety*: The overall safety of the system and of the surrounding populations has to be ensured, for example to avoid catastrophes such as the ones of Chernobyl or Fukushima Dai-ichi [35], or large blackouts [29].
2. *Protection*: A control system must protect equipment from self-inflicted and external damages, for example by isolating equipment from the rest of the system.
3. *Stability and reliability*: The system must operate correctly as long as possible while providing its customers with electric power of satisfactory quality. Stability often relies on maintaining electricity quantities as close as possible to their reference values, e.g., regulating frequency, voltage and reactive power, while reliability involves the uninterrupted supply of acceptable quality of electricity supply. It also requires operating equipment in a way that does not degrade it too rapidly, e.g., managing storage within its proper state-of-charge limits, or not overloading transformers for long durations.
4. *Economics*: All other system priorities must be fulfilled while minimizing costs for all market players. Traditional energy management control primarily focuses on economics, but a broader paradigm should be considered in taking into account all technical specifications, economics and environmental concerns as well.

The work presented in this dissertation mostly focuses on the last two objectives, i.e., stability and economics. In order to meet these requirements, several complementary, and sometimes overlapping, control systems are employed over several time scales, and rely on different mechanisms depending on the market structure (Fig. 1.5).

- *Capacity and operations planning* aims at taking techno-economical decisions regarding investments for increasing and expanding generation or transmission capacity, as well as planning the operation of these assets over long periods, e.g., for long maintenance duties. In vertically integrated structures, investment and planning departments are in charge of such operations, while in liberalized market environments, capacity and forward energy contracts are used to reach agreements between sellers and buyers.

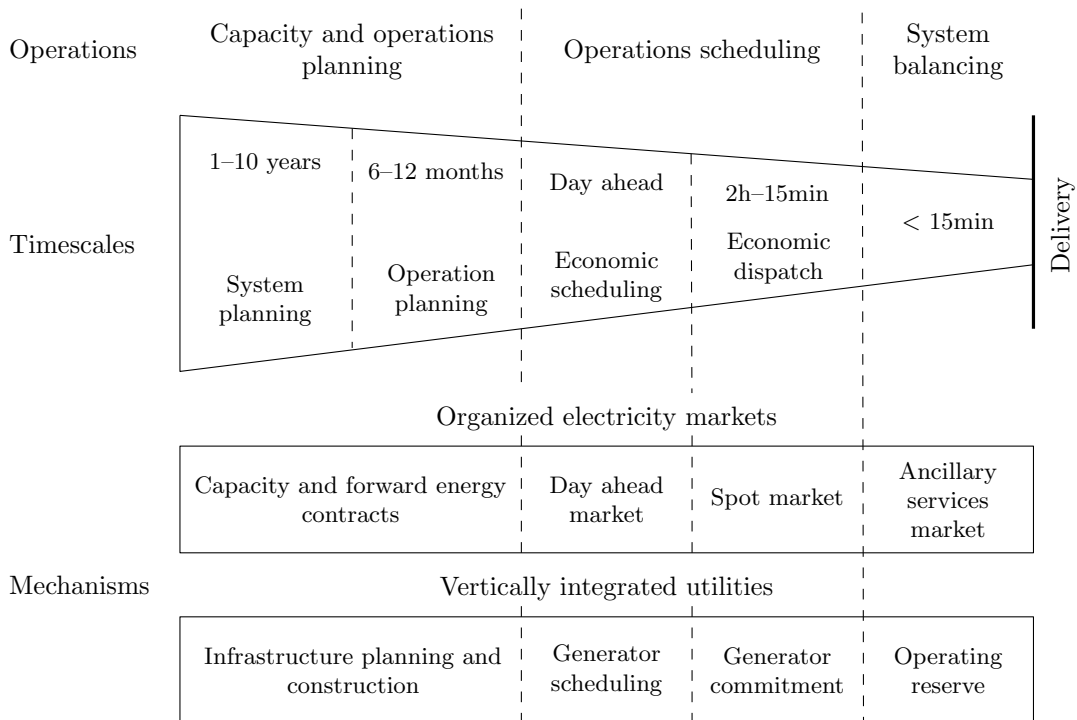

Figure 1.5: Timescales and decision mechanisms for electric system operation, based on [36].

- *Operations scheduling* includes two complementary processes. Day-ahead scheduling takes place up to 24 hours before delivery, and typically aims at deciding which generators should be used for each hour of the day, using demand forecasts. Economic dispatch uses the results of the scheduling process to derive the optimal output of each turned-on generator to meet demand. Vertically integrated utilities and generation companies (GENCOs) use unit commitment and economic dispatch algorithms to run such processes, while liberalized markets rely on day-ahead and real-time markets to reach settlements.
- *System balancing* occurs just before delivery, and relies either on ancillary markets, or on operational reserve. Operating reserve is used by integrated utilities for this, while ancillary services markets are used in market environments.

Modern control systems used by utilities are based on SCADA systems. SCADAs are information systems used for monitoring and supervising power systems or industrial processes, but without control functionalities. However, with the recent popularization of the term, SCADAs are now associated with extensive systems, some-times performing control actions. With the development of communication interfaces, power systems restructuring and distributed generation, distributed control systems (DCSs) have emerged. They have many similarities with SCADAs, but instead of relying on a centralized intelligence, their intelligence is rather distributed in several subsystems called intelligent electronic devices (IEDs) [37]. They have extended capabilities such as the ability to autonomously issue control commands, e.g., commanding a circuit breaker by detecting an abnormal voltage,

current or frequency.

Although SCADAs only provide communication interfaces between a control system and physical end-points, further control capabilities can be integrated: DMSs for substation automation, condition monitoring, fault location, voltage control, load flow calculations, etc.; outage management systems (OMSs) for assisting operators in system restoration after a failure; GISs with geographically-referenced data, for visualizing events in a distribution grid; additional systems for network analysis, demand response management, business management, billing, customer information, etc.

EMSs, on which this dissertation focuses, are another category of control systems. They include computer-aided tools that enable controlling and scheduling the operation of a power system under given constraints (e.g., at a minimal cost), without affecting the capability to meet their technical requirements and quality standards. EMSs are used for multiple applications, from smart buildings to generation commitment and dispatching.

1.3 Problem Statement

The smart grid is enabling numerous new possibilities, and, at the same time, new difficulties to tackle, such as a much higher level of complexity. Overcoming these problems is crucial to exploit as well as possible these promises.

Energy management is considered as a major research topic for smart grids, mainly due to the high stochasticity introduced by new generation, storage and load assets (DG, distributed storage, DR, EVs, etc.): how can these assets be utilized as optimally as possible and at the same time to meet their design objectives, while maintaining grid stability, ensuring economic efficiency and customer satisfaction? The need to create efficient and flexible EMSs arises, as well as the need to take into account the system architecture to quantify their impact on the communication infrastructure. EMSs have to profoundly evolve, become smarter, and make of the smart grid an evolving intelligent system. Two requirements can be distinguished for this to happen:

- EMS architectures need to adapt to the increasing complexity of electric grids. More decentralized architectures are favored to integrate large numbers of market players and pro-active consumers, and solutions to evaluate the need for communication infrastructures are required to avoid a data “deluge”. As these two objectives are in most cases contradictory, especially if optimal or near optimal results are expected, a compromise has to be found.
- EMSs also have to gain intelligence to become more efficient and enable new features, such as smart power generation and advanced demand response.

This dissertation focuses on the design and development of intelligent energy management systems, and especially on their architecture and the algorithms employed, while trying to meet these requirements. The underlying questions are:

- How should energy management systems in a smart grid environment be designed?
- How should they be structured to operate as efficiently as possible?
- How can algorithms leverage these architectures, improve the operation of power systems, and enable new features?

- How do the chosen architecture and algorithms impact the need for computation and communication?

These concerns are studied through two applications, which, while providing test cases for answering the previous issues, also aim at providing answers to the following questions:

- How can energy management systems for gas turbine power plants be improved with respect to costs and greenhouse gases emissions?
- How can a residential demand response system be designed in order to reliably reduce demand during peaks?

1.4 Outline

This dissertation is divided into four chapters. The current chapter has presented the context of this research work, and especially the ongoing transition toward the smart grid which is emerging as the main paradigm for the modernization of the electric grid. The promises of smart grids have been listed, such as the ability to integrate large shares of distributed and intermittent renewable energy sources, energy storage and electric vehicles, as well as the promise to give consumers more control on their energy consumption. Multiple technologies, and especially information and communication technologies supported by intelligent algorithms, have been listed, and are expected to enable this transition to smarter power grids. Then, by identifying architectures and algorithms for energy management systems as one of the barriers for smart grid implementation, this chapter has given an overview of control systems and has shown that their modernization required the ability to tackle the complexity of smart grids. The main problems this dissertation tries to solve have been listed, both at the fundamental and at the application level.

The applications presented in chapters 3 and 4 use two specific simulators that were designed and developed for the purpose of investigating the performance of the proposed EMSs. Both these simulators rely on several artificial intelligence and simulation tools that are presented in chapter 2. This chapter identifies the multi-agent systems (MAS) concept as a facilitator for solving the problems at hand, and as a tool for designing advanced EMSs for smart power systems. In the proposed approach, MASs enable a new systemic and multi-disciplinary approach to energy management, and allow for agent-based architectures and algorithms to be defined. This new approach helps tackle the complexity smart grids by enabling the simultaneous consideration of multiple aspects such as power systems, communication infrastructures, energy markets, and consumer behavior. The chapter presents the multi-agent tools used to design, model, control and simulate the EMSs. The multi-agent concept is explained, as well as its relevance for smart grids, considered as a complex adaptive systems. Several aspects of MAS design, based on standards and specifications, are also described. Then the multi-agent development framework used to develop the simulators for both applications is described. The co-simulation framework that builds on this middleware to enable evaluating the impact of EMS decisions on steady-state grid stability is also presented. Parts of the explanations related to this framework, which was developed in collaboration with Colorado State University, are based on a conference publication [38].

Chapter 3 presents a first application in which an EMS for gas turbine power plants is proposed. The EMS is designed with the objective to try to minimize operational costs and emissions in the smart power generation paradigm. A gas turbine model based on actual data from GE's 9E turbines is proposed, and enables estimating the power plants operational costs and NO_x and CO₂ emission levels. This model is then used to run simulations with a MAS-based simulator specifically developed for this problem. The architecture of the simulator is presented, as well as the roles and main specifications of the constituting agents, and their interactions. Several metaheuristics are then compared on mathematical benchmark problems. From the results of this comparison, a metaheuristic is selected and used to achieve dynamic dispatch among gas turbines, according to their individual characteristics. An algorithm is also designed to start and stop turbines adequately according to load forecasts. Simulation results show that the system is capable of operating the system properly while reducing costs and emissions, as expected. The computing and communication requirements of the system, resulting from the selected architecture, are also evaluated. Parts of this chapter are based on a publication in *Applied Energy*, an Elsevier journal [39]. This work was done in collaboration with GE and with the Université de Haute Alsace.

With other demand-side management techniques, DR enables reducing load during a given duration, for example in case of a congestion on the transmission system. In chapter 4, a second application is presented and proposes a DR system targeted at residential customers. The system relies on the use of the assets of residential customers to curtail and shift local loads (PHEVs, air conditioning, and water heaters), so that the total system load remains under a given threshold. The system is integrated with the distribution and transmission systems, as well as a DR market and aggregators serving as energy service providers. As customers cannot directly participate in markets, aggregators act as interfaces between grid operators and the DR market. A MAS-based simulator is developed to evaluate the performance of the proposed system. The architecture of this simulator is described by presenting the roles and interactions of the agents constituting it. The algorithms used to implement the load reductions are also presented. Results show that the system manages to maintain the total load under a threshold by adequately controlling available resources, without compromising the steady-state stability of the distribution system. The impact for individual customers is also evaluated. This work was done in collaboration with Colorado State University.

A general conclusion ends this dissertation, and summarizes this research work. The advantages and drawbacks of the proposed approach are analyzed using the results obtained from the two applications, and some lessons learned on the use of MASs for energy management in smart grids are listed. Some perspectives on future work directions are also given, especially about the further developments of the DR application.

2

Agent-Based Modeling, Control and Simulation

Contents

2.1	Multi-Agent Systems	22
2.1.1	Smart Grids as Complex Adaptive Systems	22
2.1.2	Concept	23
2.1.3	Relevance for Power Systems Applications	24
2.1.4	Communication, Languages and Ontologies	29
2.1.5	Agent Management	31
2.1.6	Topologies	33
2.1.7	Inter-Agent Interaction	35
2.2	Multi-Agent Development Framework	38
2.2.1	Development Platforms	38
2.2.2	The JADE Platform	38
2.3	Co-Simulation Framework	41
2.3.1	Need for Co-Simulation Tools	41
2.3.2	Specifications	43
2.3.3	Structure	44
2.3.4	Operation	45

2.1 Multi-Agent Systems

2.1.1 Smart Grids as Complex Adaptive Systems

The electric power grid is sometimes considered as “one of the largest and most complex of man-made objects” [40]. Similarly, smart grids can be considered as complex adaptive systems (CAS) [41,42], i.e., complex collections of interacting entities called agents. CASs, as well as smart grids, are complex by their size and heterogeneity, and adaptive by their evolving nature [43]. According to Cilliers [44], complex systems have the following main characteristics:

- *They consist of a large number of elements.* Numerous types of loads, generators and other types of components and entities impact the behavior of the grid, have their own objectives and have specific interaction patterns. Therefore, it is impossible to model the behavior of the grid through conventional descriptions such as differential-algebraic equation systems alone.
- *Elements have to interact with each other.* In order to maintain a balance between supply and demand, elements have to interact directly (by communicating) or indirectly (by consuming or converting energy). However, not all elements are required for the whole system to operate properly: for example, disconnecting a load may temporarily make the grid unstable, but the system should be able to keep operating.
- *Interactions are non-linear*, i.e., small causes can have large results. And *although interactions have primarily a short range, their influence may extend much further.* For example, large blackouts often rely on a simple failure, such as a power line down due to tree falling. The 2003 North American blackout is an example [30].
- *Interactions can have positive or negative feedback associated.* Most control systems include such types of feedback loops, from simple proportional-integral-derivative (PID) controllers to most elaborate systems, e.g., to maintain frequency and voltage.
- *They are open systems*, i.e., they interact with the environment. The size and structure of the power grid can evolve, and its constituents impact other infrastructures such as the water and transportation infrastructures. It is also hard to draw borders.
- *They need to be maintained in a state of equilibrium that is not “natural”:* advanced control systems are required to maintain the grid in operation, e.g., to maintain an equilibrium between supply and demand. If these control systems were disabled, an immense blackout would almost immediately occur.
- *They have a history.* Power grids evolve in time, not only in the way their various constituents are used, but also in their architecture, for example when new generation or transmission capacity is added. Their past is at least partially responsible for their present state.
- *Each element is ignorant of the behavior of the whole system.* Except grid operators that have an aggregated view of the macroscopic behavior of the grid, simple components only have a local view of the grid, with access to little information on other elements.

These characteristics tend to confirm that smart grids are complex systems and also CASs due to their advanced control systems, which justifies the choice of modeling them using a concept called multi-agent systems. Although the first uses of this concept for the same type of applications date back to 1997 [45], this idea has not been fully exploited by researchers thus far.

2.1.2 Concept

Multi-agent systems (MASs) support a framework for the modeling and control of multiple structures that can be decomposed into several interacting entities. Formal definitions for MASs have been proposed by Wooldridge and Weiss [46] and Ferber [47]. The following definition provides a simple overview of the MAS concept: *a MAS is a system composed of a collection of interacting entities called agents, evolving in an environment where they can autonomously perceive and act to satisfy their needs and objectives.* As shown in Fig. 2.1, agents receive data from their environment, called *percepts*, take decisions on the basis of current and possibly past percepts, and effect actions through the actuators they may be equipped with. The *environment* of an agent can be defined as the external entities and resources the MAS can interact with.

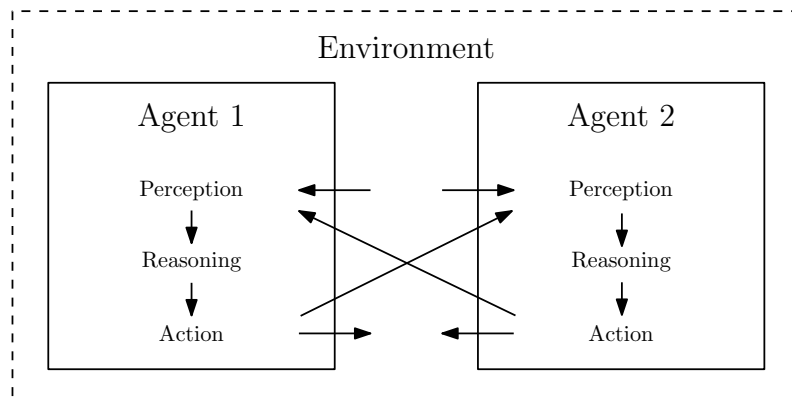

Figure 2.1: Diagram of a generic agent, from [48]. An agent perceives its environment through sensors and acts on it with its actuators.

Agents can exhibit different behaviors and properties which give them a certain degree of autonomy with various degrees of intelligence. Three main types of agents can be distinguished from these characteristics [49]:

- *Reactive agents* only show some simple reactions to any excitation (stimuli), and their representation of the environment is minimal. But by interacting with each other, such agents can together lead to emerging behaviors, difficult to achieve if the system had been modeled as a single agent [50]. They are useful when fast response times are needed.
- *Cognitive or intelligent agents* have extended intellectual capabilities and can use their resources and skills to reach their local goals. Such agents are useful to carry out tasks that require complex decision-making.

- *Learning agents* can gain knowledge by analyzing the results of their actions, and usually have a much better knowledge of the environment, which is required to take complex decisions.

Based on such definition, many existing systems from various domains can be classified as MASs. Examples include a society or a group, in which agents are people, and can communicate with each other, cooperate, compete, and so on; a network of computers, where agents are software algorithms, interacting by exchanging messages and data, for example to solve a problem faster than a single computer; robots of a production line, where they need to cooperate and coordinate themselves to perform a given task.

Finally, a power system, where the constituting elements of the grid (generators, loads, distribution infrastructure, operators, etc.) are agents and interact with each other to serve consumers while respecting given constraints can be considered as a MAS.

2.1.3 Relevance for Power Systems Applications

As shown earlier, smart power grids may be considered as complex adaptive systems, and agent-based solutions could be a practical way to achieve efficient and reliable modeling, control and simulation of such large and heterogeneous systems. Advantages of MASs for tackling these conditions include the following properties: they are inherently distributed, they are pro-active and they have social abilities.

2.1.3.1 Distributed Architecture

Much like power grids, MASs may be geographically dispersed, interconnected and heterogeneous. They are distributed by design with three main attributes: (i) local knowledge, (ii) flexible interactions, and (iii) bottom-up approach.

Local knowledge means that the agents view of the environment is local, and as a consequence, their knowledge is limited to only what they can or need to know. The perception of agents can be limited to immediate neighbors, enabling reduction in data communications. For example, in a large power grid, an agent controlling a distributed generator does not need to receive information about a small load, which can be several kilometers away. Therefore, a distributed MAS architecture contributes to a scalable distribution grid, and also enables evaluating distributed control schemes. These schemes include market-based systems, where agents are market participants, and have a limited knowledge of the market they can use to determine bidding or buying strategies.

A flexibly designed MAS incorporates *plug-and-play, robust and fault-tolerant* procedures when required by changes in the environment. Control systems should be robust enough to operate sub-optimally if needed, a property enabled by the distributed nature of MASs. For example, if a generator or load agent is disconnected, i.e., turned-on or off (regardless of whether it has been scheduled or not) or loses communication, the MAS, if properly designed, should acknowledge this modification and take it into account when taking decisions towards reaching its objectives (e.g., maintaining the system stable) [51]. Compared to most conventional analytical control methods where all possible events, changes and faulty conditions, usually have to be predicted when designing the control system so that proper corrective action can be taken, this possibility is a clear progress. In addition, a flexible MAS can add or remove new agents and functionalities

without requiring to completely redesign the system, which could help lower development and maintenance costs. This characteristic is similar to how computer systems use plug-and-play devices, and usually relies on the use of a yellow and white-pages system described in section 2.1.5. The operation of electric vehicles with the distribution grid for charging could for example benefit from this property, as EVs may or may not be present at charging stations depending on the time of the day.

The previous two features, viz., local knowledge and flexible interactions, enable the third one, i.e., a *bottom-up approach*. This feature is particularly well-suited for complex and distributed problems, such as the ones related to smart grids. As a global model of the grid does not exist, or at least does not reliably represent the real system, the adoption of a bottom-up approach is needed. This approach relies on modeling components of the grid separately, with their own roles, knowledge, actuators, etc., and making them interact with other. Agents can operate autonomously (at least partially), and cooperate or compete with each other if needed. The complexity of a control system can therefore be reduced by distributing tasks among interacting agents. If properly modeled, a realistic behavior, similar to the actual grid behavior, could be obtained. This property could for example play an important role in a MAS designed for a smart grid with a high penetration rate of distributed energy sources. The grid could be divided into several interconnected microgrids (see section 1.1.4) containing local generators, loads and storage devices. Intermediate layers, consisting of groups of microgrids, could also be added.

2.1.3.2 Pro-Activity

Proactive agents have goals which can be *local and/or global*. A single agent usually has local goals while a group of agents may have global goals (goals the entire MAS tries to achieve). For example, maintaining a steady voltage at a specific bus is mainly a local goal for a power source, but maintaining balance between generation and supply is a global goal and cannot be reached by a single agent, thus requiring cooperation. Such pro-activity might be enabled by local intelligence with information based on knowledge about the environment and with further information by communicating with other agents. Agents can then take decisions based on such on-line knowledge and their goals, plan actions to perform, and finally execute them for achieving the required actions.

The scheduling of the use of storage in a distribution system could be an example: if the system knows (based on forecasting) that demand is going to peak and conventional generation sources will not be sufficient to match it, a battery agent may take pre-emptive actions by charging the battery to its maximum state-of-charge before the peak and making it available for use during the said peak time for supplying the extra load. This strategy would enable the system to meet demand during such peak. Other examples could be procedures to start, synchronize and reconnect a turbine to the grid, and the planning of required reactive power for such connection.

2.1.3.3 Social Behavior

Agents need to have a social behavior compatible with other fellow agents, expressed under various forms. Their social organization can vary from one system to another and with time, as well as the way they interact with each other and take decisions. Agents can

notably *coordinate* themselves and *cooperate* for reaching goals that may not be reachable by a single agent. Agents can influence the actions of others or act as interfaces through negotiations, requests and contracts, or other protocols. Indirectly, this property enables testing and comparing several interaction configurations, such as the ones listed in section 2.1.6.

Continuing the previous example with the demand peak and storage, before the MAS decides that the battery should absorb the peak, a “discussion” with other agents (such as power system brokers) may occur about whether the load can be supplied by another source, and maybe a better solution would arise from economic and/or technical points-of-view.

2.1.3.4 Practical Implications

In addition to these aspects, the use of MASs with smart grids has several practical advantages, that are mainly related to the ability to take into account interactions between agents, hereby enabling proper systemic approaches.

- Communication aspects, and indirectly interaction aspects between various components and entities, are an important feature of smart grids. MASs enable to specify such aspects, that are rarely considered in power systems studies. For example, this property enables specifying what information is transmitted from one agent to another, under which form, how it is processed, when it is sent, etc.
- Due to these specifications, switching from a MAS-based simulation system to a working real-scale prototype is easier, as communication and interaction aspects are already taken into account. Therefore, such systems tend to be closer to implementation, as they are already distributed, and are easily deployable. Moreover, agents can also be tested separately, as with unit tests.
- Due to the distributed nature of MASs, distributed and parallel implementations are also facilitated. As each agent is at least partially autonomous, it can be assigned to a particular computing system (computer, core, etc.), and exchange data with others.
- Agent-based modeling forces modelers to respect specific constraints. Procedures must be encapsulated in the agent, and can only be implemented using the resources of that agent. Based on a close monitoring of the activity of each agent and on the requirements of the user (speed, reactivity, etc.), the corresponding hardware (and software, in some cases) specifications can be derived.
- Finally, the ability to define how and where data is structured, located and exchanged facilitates taking into account information security aspects, for example by precisely defining which agent has access to which information.

Due to these reasons, the MAS concept is the primary paradigm choice for this dissertation, and is used for designing the EMSs proposed in the following chapters.

2.1.3.5 Application to Smart Power Systems and Energy Management

The use of MASs in smart grids, and more generally in power systems, is therefore relevant for the multiple reasons that were just listed. Fig. 2.2 shows an example of how MASs could be utilized for communication and intelligent decision-making in power systems. Depending on the application, an agent may be associated to each sensor and actuator of the grid and its control systems. Agents may then communicate and interact, either directly by communicating with each other through a communication network, or indirectly through measurements on the grid.

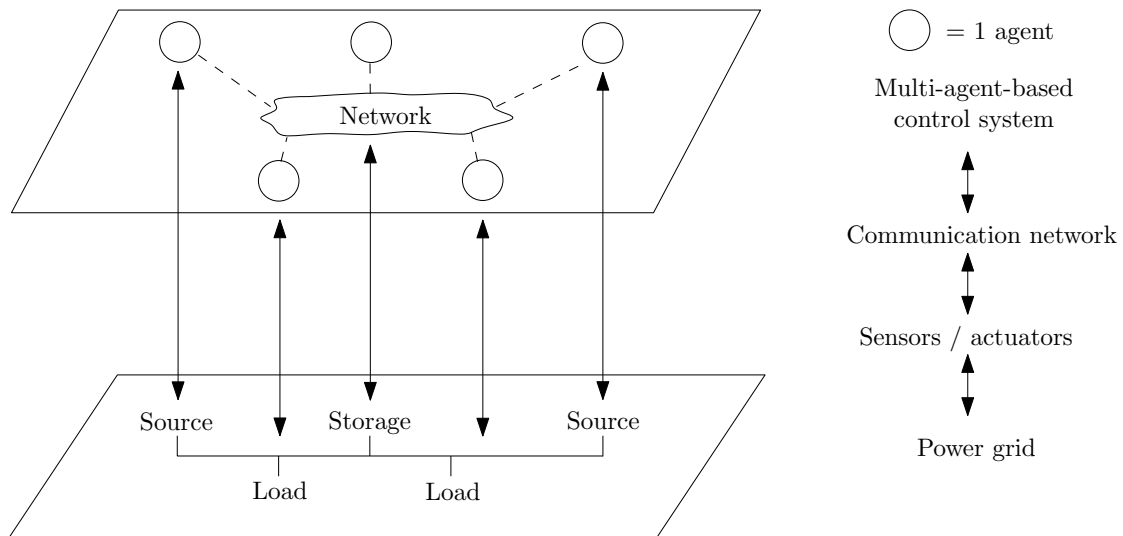

Figure 2.2: Conceptual diagram of an example application of MASs for smart grids.

MASs have been applied to solve a variety of problems in power systems. Applications include voltage/VAR control [52, 53], restoration [54, 55], monitoring and fault analysis [56], and energy management. State-of-the-art reviews of applications of MASs in power systems can be found in McArthur et al. [57, 58]. Energy management solutions using MASs have been used by several researchers over the past 10 years, including the following applications:

- A fully decentralized MAS-based EMS for microgrids was proposed by Lagorse et al. in [59, 60]. Each component of the microgrid (load, storage, sources and grid) is controlled by an agent through a power electronics converter connected to a DC bus. The agents coordinate themselves using a token mechanism, so that the DC bus voltage is maintained to a constant value. For example, a battery may have the token to begin with, and controls the bus voltage until it is empty. It can then give the token to another source, storage unit or the grid, so that it takes over the bus voltage regulation.
- Dimeas and Hatziargyriou used a partially decentralized approach to microgrid control, and proposed two energy management methodologies. In the first one, loads, storage units and sources are modeled as agents and are grouped to form microgrids, each with a central controller [61]. Several microgrids are interconnected and coordinated by a distribution network operator. Agents then engage in market-based

negotiations to achieve dispatching [62, 63]. In the second methodology, reinforcement learning is substituted to market negotiations for dispatching [64].

- Logenthiran et al. use a similar approach for multi-agent coordination of generation and supply in microgrids [65–67], for short-term generation scheduling [68], for managing PHEVs [69], and for demand-side management [70].
- The IDAPS (Intelligent Distributed Autonomous Power Systems) concept introduced by Rahman, Pipattanasomporn et al. in [71] and used in [72] also relies on a comparable multi-agent architecture for microgrid operation.
- The PowerMatcher is another MAS and market-based approach that is tested in field test experiments in the Netherlands. The corresponding test bed is called PowerMatching City, and is part of several large European projects [73, 74]. The project aims at balancing supply and demand in an economically efficient way, using agents with the ability to competitively trade energy on a common market. Test results showed that PowerMatcher is able to perform the technical and commercial coordination of end-users power consumption and generation, even on a large system, and to optimize the operation of virtual power plants (VPPs) [75–77].
- The energy market simulator MASCEM also uses a multi-agent architecture and game theory, machine learning and optimization techniques to model power markets and VPPs [78, 79].
- Finally, the GridAgents platform from Infotility is a commercial MAS for intelligent load control, that provides a centralized decision-support solution for demand response using a variety of agents [80].

2.1.3.6 Proposed Approach and Design Methodology

These examples show that MASs are used for multiple applications, using a wide variety of approaches. Some of these approaches rely on distributed decision-making mechanisms with autonomous agents, while others do not and focus on other aspects. *The approach used in this dissertation belongs to the latter category, and therefore does not focus on distributed decision-making with autonomous agents, but rather on the other advantages of the use of MASs.*

Although this approach may seem surprising to readers used to traditional applications of MASs, this work does only consider the properties of MASs that are relevant to the selected context. The proposed approach aims at using MASs for solving emerging engineering problems in a critical infrastructure, the power grid. MASs are chosen as the main paradigm for EMS design in smart power systems, and enable specifying architectures and interactions between subsystems. This in turn enables systemic and multi-disciplinary studies.

The proposed EMSs are designed according to the following methodology:

1. Identification of the objectives and constraints of the system.
2. Definition of the architecture of the EMS/MAS.
3. Definition of the interactions between agents.
4. Modeling of the subsystems as agents.

5. Implementation in a simulator.
6. Testing and validation.

2.1.4 Communication, Languages and Ontologies

Designing a MAS requires formalizing how the agents coordinate themselves, cooperate, take decisions, etc., which implies that agents and MASs need to share at least common languages. To this end, the Foundation for Intelligent Physical Agents (FIPA) has defined some specifications and standards for the use of MASs [81].

Languages such as ACL (Agent Communication Language) and KQML (Knowledge Query and Manipulation Language) were created for use in MAS development, so that agent can use a common language and vocabulary to communicate. ACL is a FIPA specification [82] and is usually preferred. Each message is given several attributes, including the content of the message, and information about the participants and the ownership of the conversation. The structure of an ACL message should contain the following parameters:

- A parameter defining the type of communication, called *performative*; this field indicates whether the message is a request, a reply, an information, etc.;
- The list of the participants in the conversation, with information on the sender and the receiver(s), and reply-to fields, including the names of the corresponding agents;
- The content of the message;
- A description of the content, with the used language, encoding and vocabulary, called *ontology*;
- And conversation control parameters, such as a conversation identifier and protocol.

Fig. 2.3 shows the structure of an example ACL message, sent by *agent1* to *agent2*. The performative is the only mandatory parameter in the specification, but others should also be included when necessary to facilitate message sorting. The FIPA semantic language (FIPA-SL) is a content language specification with a specific syntax and semantic for use with ACL, that is implemented in several MAS development tools [83].

```
(REQUEST
:sender ( agent-identifier :name agent1@platform:1099/JADE )
:receiver (set ( agent-identifier :name agent2@platform:1099/JADE ) )
:content "Hello! How are you?"
:language FIPA-SL0
)
```

Figure 2.3: Sample ACL message, using the default ontology.

For complex conversations between heterogeneous agents, ontologies may be needed to define the vocabulary agents use in their conversations. As for humans, using a common language may not be sufficient. An ontology is a formal representation of knowledge, under the form of a set of concepts and of relationships between these concepts. As described in McArthur et al. [58], standards specifying data models, such as CIM (Common Information Model), can be used as a basis to build such ontologies. A CIM-based ontology

was for example made available by the IEEE Power & Energy Society (PES) Multi-Agent Systems Working Group [84].

2.1.5 Agent Management

FIPA specification SC00023 [85] defines two levels in how agents should be managed, exist and operate. The first level, called *agent level*, corresponds to each agent itself, while the second relates to groups of agents and how they interact with each other, called the *MAS level*. At the agent level, it defines the life cycle of the agent, and at the MAS level, it proposes agent management services and a message transport system. These services are essential in enabling the MAS to operate in a distributed and flexible manner.

The first level defines how agents have their life cycles, from their creation to their end. During its lifetime, an agent can be in five possible states (Fig. 2.4):

- *Initiated*, just after its creation. In this state, the agent executes a series of instructions defined by the user, and run once as an initialization procedure.
- *Active* is the normal state in which the agent operates.
- *Waiting*, when the agent is pooling for an external event and has not been woken up. This state can for example be used when the agent is waiting for a message from another agent.
- *Suspended*, when the agent has been halted from the active state. For example, an agent controlling a power source may be suspended during certain maintenance operations.
- *In transit*, when the agent is physically moving from one agent platform to another (e.g., from a computer to another).

At the MAS level, each agent platform (AP) contains several entities listed below and at least one agent. A single platform can consist of agents located in different physical locations, such as on remote computers. The platform should implement the agent management reference model (Fig. 2.5), which defines service entities including:

- A *directory facilitator* (DF) that provides a yellow-pages service to agents, i.e., a list of agents with their respective capabilities. Each agent can register its services in the DF and then query it for knowing if other agents have a certain service registered. Implementing a DF is optional, and multiple DFs can exist in a single AP.
- A unique *agent management system* (AMS), which supervises the AP and maintains a list of all agents and their addresses in the AP. This functionality is similar to a white-pages service, i.e., a list of agents and their name and address, to which each agent must register.
- A *message transport system* (MTS), which enables messages to be transported from one agent to the other. A *message transport protocol* (MTP) is used for physically transferring messages between agents on possibly different platforms; all messages exchanged between platforms go through the MTP.
- The *agent* itself, which communicates with other agents using the ACL language and may have access to external software.

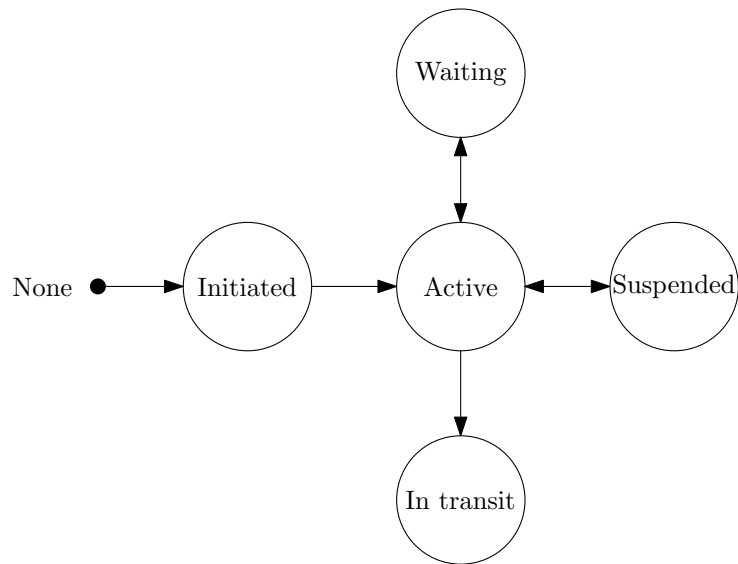

Figure 2.4: Life cycle of an agent, based on [85]. The cycle starts with the creation, the transition to the initiated state and thne to the active state. The agent can then switch to three other states, or be destroyed.

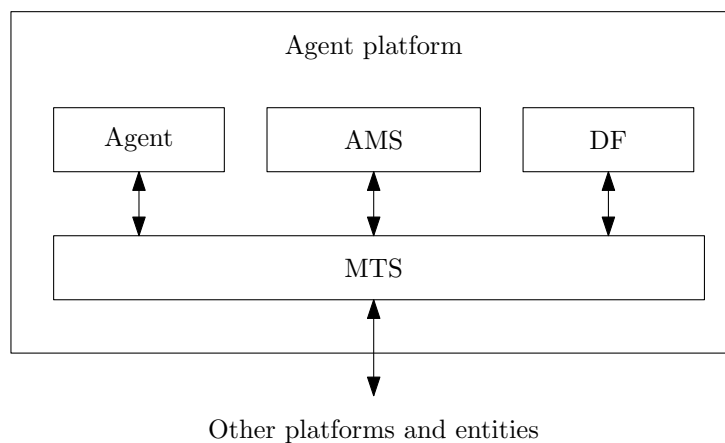

Figure 2.5: The FIPA agent management reference model, based on [85].

For enabling the previous services to operate properly, each agent is assigned a unique Agent Identifier (AID). Each AID is composed of three parameters: a unique *name*, usually consisting of a local name and the address of the AP; an *address list*, to which the messages should be delivered; and a *resolver*, used by the AMS for resolving the transport address of the agent.

2.1.6 Topologies

The collection of roles, authority relationships, data flow, resource allocation and co-ordination patterns that guide the behaviors of agents is defined as an organizational topology. The major topologies used in MASs include hierarchies, holarchies, coalitions, teams, congregations, societies, federations, markets and matrix organizations [86]. Each has its own strengths and weaknesses, and some topologies are more appropriate than others, depending on the selected application (Fig. 2.6):

- A *hierarchy* is the earliest and the most widely used topology, in which agents are arranged in a tree-like structure. Agents higher in the tree have a more global view than agents below them. Lower-level agents transmit the information perceived locally to higher-level agents, which provide directions to those below them, on the basis of a more complete amount of information. This topology is typically used in most current control systems.
- *Holarchies* consist of agents (called holons) that are constituted by several entities and are at same time part of a larger entity. Biological species, individuals, cells and atoms can each be viewed as holons sharing this dual characteristic.
- *Coalitions* are dynamic and short-lived, and emerge as soon as a goal has to be fulfilled by a subset of an agent population. The coalition is destroyed when the constituent agents have managed to perform the task. The structure of a coalition is typically flat, although there can exist a leading agent that represents the coalition as a whole. In a coalition, agents are selfish, i.e., they try to maximize their own profit. Such topology may be suited for the restoration of supply after a blackout.
- *Teams* are an altruist type of organization, as opposed to coalitions; they attempt to maximize the utility of the whole team, and coordinate their actions in order to efficiently fulfil a common task. Team agents have an explicit representation of the shared tasks and they know the means by which cooperation should progress.
- *Congregations* are generally long-lived and formed from heterogeneous agents that have great interest to get together. Some simple examples of congregations are clubs or academic departments. Congregating agents are expected to be rational, by maximizing their own long-term utility. Congregations are formed if agents want to increase information gain or decrease commitment failure.
- *Societies* are inherently long-lived and open. Agents living in a society may have different goals, levels of rationality and heterogeneous capabilities. They meet and interact according to social laws (or norms), which dictate how they should coexist. Vehicular traffic laws are an example of social laws that minimize conflicts and encourage efficient solutions.

- *Federations* are arranged such that some agents delegate a part of their autonomy to a single agent that represents the group. Group members interact only with this delegate (also called facilitator, mediator or broker), which acts as an interface between the group and the outside world. The delegate typically receives undirected messages from its group members and sends information to the delegates of other federations. Messages from group members include skill descriptions, task requirements or status information, whereas messages from or to other delegates include task requests or capability notifications. This structure could for example be used to interface several microgrids, where the central controller of each microgrid would be the delegate.
- *Marketplaces*, or market-based organizations, enable buyers and sellers to send and receive bids for a common set of items, such as shared resources or tasks. Like for federations, an individual or a group of individuals in a marketplace is responsible for coordinating the actions of other agents. Unlike for a federation though, agents within a marketplace are competitive. This topology is already used in bulk electric power markets, where independent power providers and utilities (among other players) bid to sell and buy power.
- *Matrix organizations* mimic how humans influence one another, i.e., the behavior of an agent or of an agent group may be influenced by multiple centers of authority. How the agent perceives these influences can influence other agents as well. Simple examples of such influences include someone receiving guidance from interacting entities or agents.

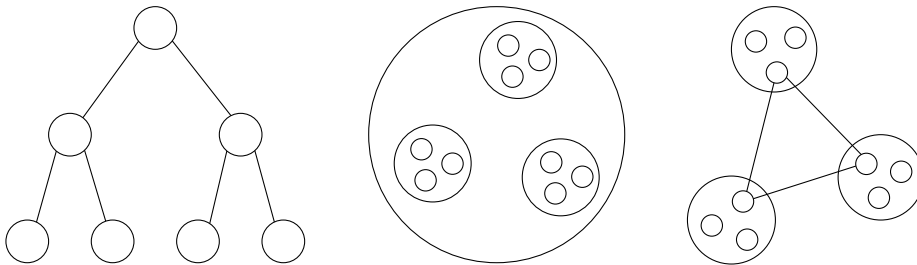

Figure 2.6: A hierarchy (left), an holarchy (center) and a federation (right) example.

For power systems, no preferred topology is considered better than others, and actual topologies usually consists of hybrid combinations of the previous types, as the selected topologies often derive from the physical architecture of the systems. The MASs proposed in the next chapters illustrate this remark. Several parameters may influence the choice of a topology:

- *The structure of the real world organization of the system* or the power grid. Intuitively, a MAS-based grid control system would be designed to mimic the architecture of the real grid, or of a part of it. Elaborate functionalities may however require different configurations.
- *Whether decisions require negotiations.* For example, market-based mechanisms require to take into account the structure of the market, the possible coalitions that

may arise, the role of regulators, etc.

- *Needs for reliability.* Possible failures in the communication infrastructure may for example require redundancy.
- *The scale of the system and possible evolutions.* For example, a control system spanning a very large distribution system may need to be divided into several interconnected subsystems.
- *The necessity of changes of topology to reach goals.* In case of a localized failure on the distribution system, the architecture of the grid and the corresponding control system may need to be reconfigured to keep the lights on for a maximum of customers, e.g., through a self-healing mechanism.
- *Constraints imposed by legislations and standards.* Regulations and best practices may also require adopting certain specific architectures, e.g., to ensure interoperability.

Such choices are a trade-off between several parameters including computation, coordination simplicity and organizational rules, plus the simplicity of the architecture. An analysis according to these criteria defines the topology of the system and the way agents interact. It should also be noted that the architecture of a MAS may change over time, depending on what it is trying to achieve and how the environment evolves.

2.1.7 Inter-Agent Interaction

The described topologies define how agents are organized, but it is still needed to define how they interact. Interactions are paramount notions for defining MASs [47]. An interaction between agents can take place if they can act or communicate and if there are situations where they can get together, such as the need to fulfil a common objective. They are conducted under the form of discussions between at least two agents and can occur in numerous situations: the rescue of an agent by others, a conversation between two agents, the implicit agreement when two agents have to decide which one goes first, the cooperation of several agents to fulfil a common task, and so on.

Interactions are usually required when agents have to satisfy a common objective while taking into account their limited resources and individual skills. Getting together to fulfil a common objective involves that some agents are part of a possibly emerging organization, as described in the previous section. Therefore, every agent organization is the result of these interactions and of the place where they take place. The dynamic characteristics of interactions implies that new agent organizations are likely to be formed as new objectives have to be satisfied. For example, agents can form coalitions if it helps them reach their goals [87].

Defining interactions between agents depends on answers to the following questions: What is the nature of their goals? What are their resources? Which skills do they possess to fulfil these goals? Several criteria can be used to classify interactions, including the nature of the goals pursued by the agents, their relationship to external resources and their individual skills regarding the task at hand:

- Typically, agents are engaged in competitive tasks when their goals are contradictory, whereas they cooperate or co-evolve when their individual goals are compatible

(that is when the satisfaction of a goal by an agent does not interfere with the possibility of satisfying another goal by another agent). Maintaining the balance between electricity supply and generation is an example of problem where cooperation is essential.

- External resources include all environment elements that agents need to satisfy a goal, such as raw materials, energy, available amounts of space and time, etc. For example, every energy source or power line has a limited capacity. Limited resources can lead agents to conflicts as they will likely need the same resources at the same time and at the same place than other agents. Such conflict situations can generally be resolved by the coordination of agent actions.
- The last criterion relates to whether the task can be pursued by a single agent rather than by a group of agents, and if each one of them has the appropriate skills to perform its subtask.

To enable interoperability (i.e., the ability of several systems to exchange information and use it), not only between agents but also between MASs, interactions are structured and follow common rules called protocols. Basic and common types of interactions are requests, queries, subscriptions and propositions. An example is the FIPA-Request protocol [88]: an agent can formulate a request, that other agents can accept or refuse (Fig. 2.7).

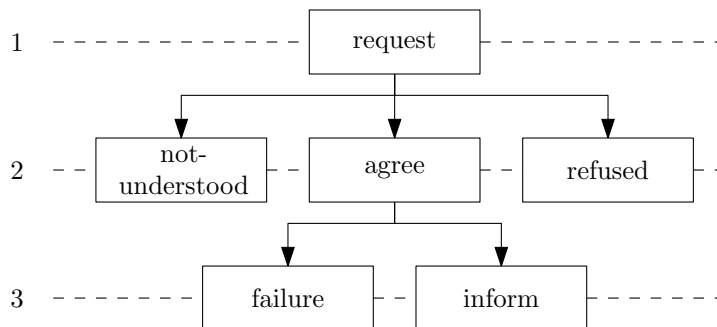

Figure 2.7: Diagram of the FIPA-Request protocol, based on [88]. The protocol enables an agent to formulate a request that other agents may accept or refuse. The corresponding conversation is divided into three consecutive steps.

Those interactions are often limited, and combinations of them are used instead. There are several types of such complex interaction protocols. Contracting, auctions, bargaining, voting and brokering are the most common ones.

- The *contract-net protocol* is an example of contracting, defined in FIPA specification SC00029 [89]. This task-sharing protocol consists of a collection of agents forming a contract network. Two categories of agents are distinguished: the manager, and contractor agents. A typical round starts with a call for proposals sent by the initiator. A deadline can be set to limit the duration spent waiting for answers. Contractors (participants) can then submit proposals (prices, time to execute an action, etc.) or refuse. The initiator evaluates the proposals and selects zero, one or several agents to perform the task to be done. The selected participants are free to accept or refuse this offer.

- Agents can interact and distribute tasks through auctions. Four main types of auctions are commonly used: English, Dutch, sealed first-price or Vickrey, and Walrasian auctions [90].
 - *English auctions* are the most common ones. Participants bid openly against each other, with each subsequent bid higher than the previous one. A reservation price (the minimum price) may be set by the auctioneer. The auction ends when no participant is willing to bid further. FIPA defines a specification for English auctions in XC00031 [91].
 - In *Dutch auctions*, the auctioneer starts with a high price which is lowered until some participant accepts the announced price. This type of auction is also defined by FIPA in its XC00032 specification [92].
 - With *sealed first-price auctions*, all bidders simultaneously submit their bids, and the winner is the one with the highest bid. Bidders can only submit a single bid. *Vickrey auctions* are identical except that the winner pays the second highest submitted price [93].
 - *Walrasian auctions* are more complex and enable matching supply and demand in a market of perfect competition. A market clearing price is set so that the total demand equals the amount of sold goods, and leads to a general equilibrium [75]. This type of auction was proposed for use in electricity markets using locational margin pricing [94].
- *Bargaining* is an alternative to auctions for pricing goods, i.e., when prices are not fixed and can be negotiated. The goods can for example be split into several parts and be themselves subject to bargaining. As humans, agents can employ various strategies to reach their goals.
- Interactions can also happen under the form of *votes*. Voting protocols, such as Robert’s rules of order [95], define procedures for conducting votes between agents. Voting can be used to take decisions when votes are very simple (e.g., yes or no). Similarly to votes during elections, various rules can be adopted for selecting the winner(s).
- Another interaction type specified by FIPA is *brokering* [96]. For example, an agent can request a broker to find other agents who can answer a query; the broker would then relay the answer back to the initiator.

As for topologies, no preferred interaction means is considered better than others for power systems. The choice of an interaction protocol is mainly influenced by requirements for security, by regulations, or by existing market structures. In this dissertation, a simplified version of the control net protocol and other basic protocols are used for the presented applications.

2.2 Multi-Agent Development Framework

Although it is possible to develop a MAS from scratch, using a dedicated development platform (*middleware*) is, in most cases, a better solution. Many different toolkits

were created over the years [97], and include tools and functionalities that facilitate the development of MASs.

2.2.1 Development Platforms

Among the numerous existing platforms, common general-purpose examples include JADE (Java Agent DEvelopment Framework), AgentBuilder, MadKit and ZEUS. Other platforms may be of interest for specific uses: NetLogo enables beginners to get started with MAS programming, JANUS simplifies holonic agents building, Cougaar enables very large scale simulations, JADEX proposes a framework for developing intelligent agents, JACK for autonomous agents, etc. Some of them also comply with FIPA standards, especially for messaging and agent management. A list of such platforms is available in [98]. Most of these platforms are written in Java, but other languages can be used.

2.2.2 The JADE Platform

For power systems applications, JADE is the most popular framework used in the literature. JADE is an open source platform for peer-to-peer agent-based applications. It provides a runtime environment for agents and a library of classes that provide ready-made pieces of functionality and interfaces for custom and application-dependent tasks. Its main advantage is that it has an extensive documentation, with tutorials, books [99] and an active community. It also includes built-in graphical tools that support the debugging and deployment phases of MAS development. It is fully compatible with FIPA standards and specifications, enables agent platforms to be distributed across different machines, and supports agent mobility. As it is fully implemented in the Java language, it is also cross-platform, and works on multiple operating systems. Many third-party plug-ins and extensions (e.g., for mobile devices, for intelligent agents, etc.) are available for specific uses. Due to these properties, the JADE platform is selected as a basis for building the MAS-based simulators described in this dissertation.

Agents running in JADE are organized as follows. A *platform* is created, in which at least one *container* containing agents is created. The first container, called the *Main Container*, holds two specialized agents: the AMS and DF agents. The *AMS agent* is the one that creates and destroys other agents, containers and platforms. The *DF agent* implements a yellow-pages service the other agents can query to retrieve information about services offered by other agents.

Agents created in JADE can be in any of the states shown in Fig. 2.4. Additionally, their execution follows a model that relies on behaviors. The notion of *behavior* describes how an agent reacts to an event, and enables agents to operate independently and to be executed in parallel with other agents. This feature is made possible by assigning a Java thread to each behavior instead of a single thread per agent, as each agent may be involved in several tasks in parallel. Fig. 2.8 summarizes the agent execution model. In the *setup()* method, agents are initialized and initial behaviors are launched. Then, as long as the agent is alive, each active behavior *b* is executed until it is done. The *done()* method is run at the end of each execution of the behavior and determines whether the behavior will be run again or not. If it will not, then it is removed, otherwise, the next

active behavior is called. If the agent is taken down, the *takeDown()* method is run to enable the programmer to run some clean-up operations.

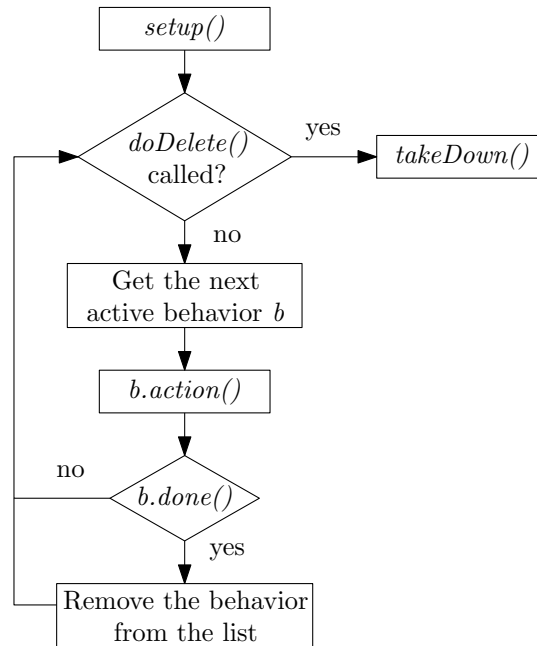

Figure 2.8: Agent execution model of agents in JADE.

Three graphical tools enable faster and easier debugging and monitoring:

- The *Introspector agent* (Fig. 2.9) helps monitoring and controlling agents by providing information on their life cycle and behaviors, and on ACL messages exchanges.
- The *Dummy agent* can be used to create and send ACL messages to other agents and viewing the list of messages sent and received by an agent.
- The *Sniffer agent* (Fig. 2.10) intercepts ACL messages and displays them similarly to UML (Unified Modeling Language) sequence diagrams, which is useful for monitoring how agents interact through message exchanges.

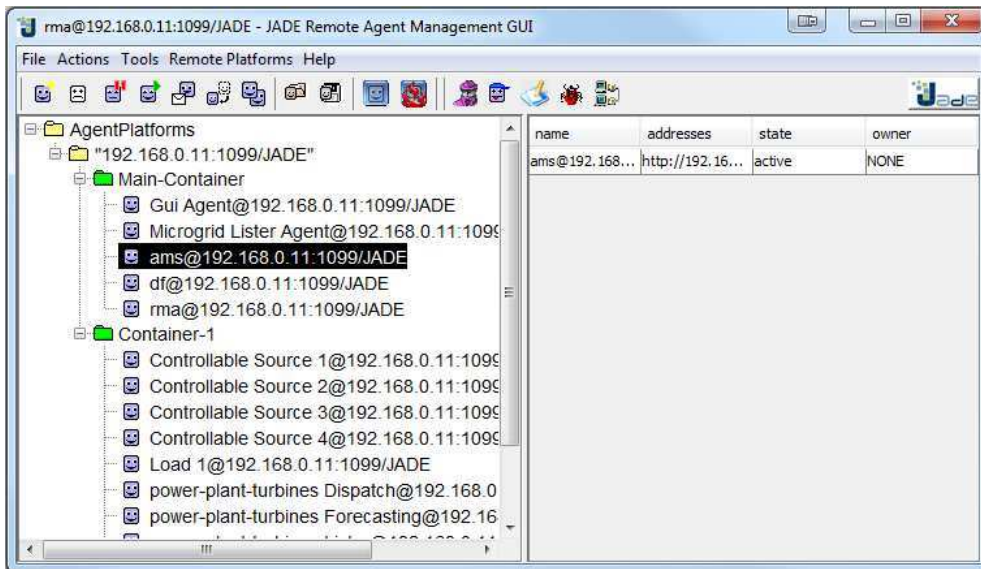

Figure 2.9: Screenshot of the Introspector agent interface in JADE.

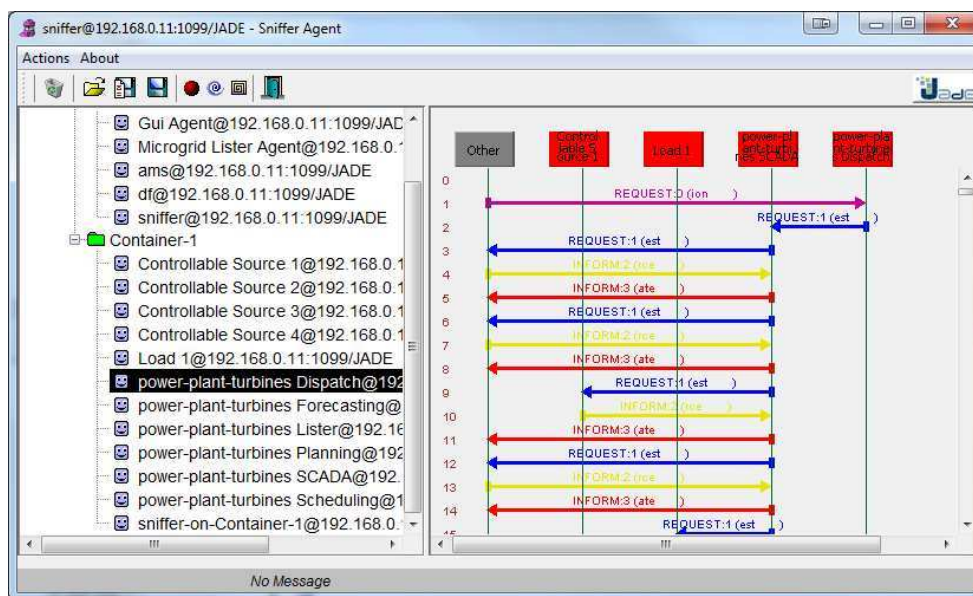

Figure 2.10: Screenshot of the Sniffer agent interface in JADE.

2.3 Co-Simulation Framework

With JADE used for modeling, controlling and simulating the studied power systems, a dedicated co-simulation framework is developed to enable the analysis of simulation results with a power systems analysis software, PowerWorld Simulator.

2.3.1 Need for Co-Simulation Tools

Modern technological product development requires phases of specification, development, simulation and prototyping, before reaching the first test phases. However, as prototyping and testing costs are often high, simulations have taken an ever increasing importance over the last few decades, especially as computing capabilities have dramatically increased and enabled new possibilities.

For the smart grid to become a reality, numerous new technological products have to be developed, from advanced energy management systems to distributed storage, and will have to go through extensive tests in simulation before they are actually implemented on the grid. The risks of compromising the stability of the grid are too high to integrate new products without ensuring they will not create problems.

In the advent of the smart grid, intelligent and distributed control systems are major research topics, in that they are envisioned as essential elements required for making such smart grids a reality. These smart control systems often rely on AI algorithms, such as learning algorithms, optimization algorithms, expert systems, etc. [100]. The main objectives justifying the use of these algorithms is their capacity to solve complex problems efficiently. Problems to solve can range from optimal economic and environmental dispatch and unit commitment to load forecasting and fault diagnosis and analysis. The capacity of AI algorithms to learn from experience and explore search spaces efficiently makes them particularly suitable for smart grid applications, although their industrial use is still rather low.

By enabling the modeling and simulation of a large number of elements (sources, loads, substations, market players, etc.) as well as their interaction, the MAS concept is a useful tool for conducting smart grid-related research, as shown earlier. However, in order to evaluate the practical validity of a developed control system, tests need to be carried out with advanced power systems analysis tools [101]. As a decision-making algorithm in a power system takes decisions that are physically translated by electrical components, such as switches, generators, etc., the impact of these decisions on the power grid has to be evaluated. An example is the effect of opening a switch on a power line, as a function of a decision-making algorithm. This action may overload a transformer or exceed the voltage rating of a power line. Without an analysis tool capable of running power flows (in this case), such results could not be found. Unfortunately, AI tools do not include advanced power systems analysis algorithms yet, and these analysis tools do not enable developing AI-based decision-making algorithms either. Therefore, these two different kinds of tools need to be interfaced.

Researchers have tried to resolve this issue by interfacing AI algorithms with external physical simulation-oriented software. A brief listing of most of these co-simulation possibilities can be found in [102]. Two main approaches have been used:

- The first one is designed for communication analysis purposes, and software such as OpenDSS and NS2 [103], PSLF and NS2 [104], and Modelica and NS2 [105] were interfaced successfully.
- The second approach is designed for combined multi-agent and power systems analysis purposes. Past work has focused on interfacing Matlab/Simulink with JADE through a TCP server [106], and JADE and Matlab’s PSAT toolbox [107]. JADE and PowerWorld Simulator were also interfaced through a COM interface, but this implementation is not documented [66]. Software such as GridLAB-D [108] have recently attempted to integrate both simulation sides and rely on multi-agent systems, but lack a user interface and a detailed documentation.

As current simulation tools do not enable the interaction between these two interdependent fields, creating a co-simulation framework is therefore required. A framework for interfacing a power systems analysis software like PowerWorld Simulator simultaneously with Matlab and JADE is proposed in the following section. The objective is to enable reliable communication and coordinated interaction between both simulations for validating the integration feasibility of the developed AI algorithms and systems.

2.3.2 Specifications

2.3.2.1 Requirements

Co-simulation is a simulation methodology in which several individual components are simulated simultaneously by different tools and exchange information with each other. In the present case, the objective of co-simulation is to run a coordinated simulation with an AI-based (or multi-agent-based) decision-making tool, and a power systems analysis tool. The output of the first one is the input of the second, and vice-versa. The validity of the decision-making algorithm can then be tested, by evaluating its impact on the behavior of the electric system.

For using the co-simulation tool in the applications presented in this dissertation, several constraints have to be met:

- One of the simulation tools must enable easy AI-based decision-making algorithms development, ideally multi-agent systems and advanced computational intelligence algorithms.
- The other tool must enable easy and advanced modeling and power systems analysis, in coordination with the first tool.
- Both simulations must be synchronized.
- Both simulators must be able to exchange information as fast as possible; one should not dramatically slow down the other.
- Both simulations should be able to run on different computers, especially if one or both of them are demanding in terms of computation power.

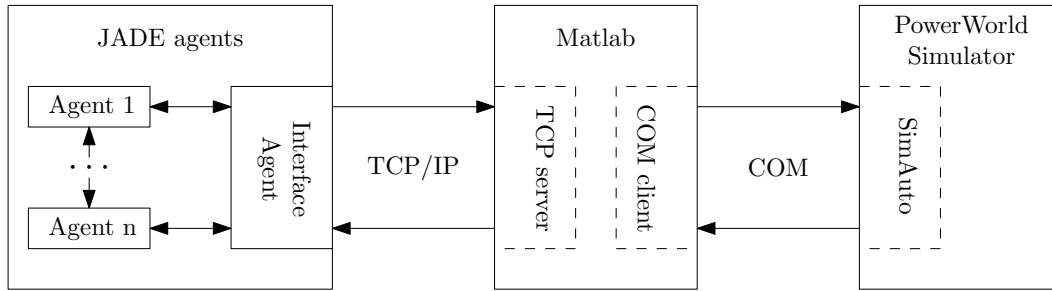

Figure 2.11: Interface between JADE, Matlab and PowerWorld, from [38].

2.3.2.2 Software and Tools

A first step toward the definition of this framework, is the selection of the software tools used for running the coordinated simulations. Three tools are used:

- *PowerWorld Simulator* [109] is a popular simulation software used to simulate high voltage power systems. Using this tool, it is possible to perform power flow analysis on a system with up to 100,000 buses. Multiple add-ons enable performing additional analysis such as transient stability, optimal power flow, voltage stability, reserves, transfer capacity, etc. SimAuto is an add-on used to control the simulator from external applications. SimAuto acts as a COM object, with which other software can communicate, by sending requests and receiving data. Any programming tool, such as Visual Basic, Matlab or Borland Delphi, capable of accessing COM objects can thus be interfaced with it. These add-ons, combined with the ease of use of PowerWorld enabling fast modeling and simulation, make PowerWorld a tool well adapted for the needs of this framework.
- *MathWorks Matlab* [110] is a powerful software that provides a programming environment to perform complex numerical computations and data analysis. Numerous toolboxes are available for many applications ranging from multi-physical systems modeling to signal processing. Matlab can also be interfaced with various programming languages such as C, C++ and Java. Matlab is commonly used for rapidly prototyping complex numerical algorithms, especially as its toolboxes facilitate the use of AI-based solutions. However, although the modeling and analysis of power systems is possible through several toolboxes, their use is more complex than with PowerWorld and requires more development time.
- The multi-agent development framework *JADE*, presented earlier, is also used.

2.3.3 Structure

2.3.3.1 Matlab–PowerWorld Interface

The second step in the development of this framework is the creation of an interface between Matlab and PowerWorld. This interface is established using the COM server offered by SimAuto, which is documented in PowerWorld’s user manual [111]. Through this interface, PowerWorld can be requested to run instructions such as the following:

- Open, save and close a case (network);
- List the devices of each type (buses, branches, generators, loads, etc.) present in the opened case;
- Get the parameters (status, MW and MVAR rating, nominal voltage, etc.) of a precise element or of all elements of a given type;
- Change the parameters of a precise element or of all elements of a given type;
- Run a power flow using a given algorithm (Newton-Raphson, Gauss-Seidel, etc.);
- Add elements to the network.

Once a connection between both software is established, functions running the above-mentioned instructions can be used in Matlab to interact with PowerWorld and return results.

2.3.3.2 JADE–PowerWorld Interface

In order to enable the use of MASs for power systems control while maintaining the capability to use power systems analysis tools, the interface between Matlab and PowerWorld is extended. As multi-agent frameworks such as JADE are commonly written in Java, they cannot be directly interfaced with external power systems analysis software. As no off-the-shelf solution exists, a custom interface must be created.

Building on the first interface between Matlab and PowerWorld, an interface between JADE and Matlab is created. Matlab then serves as a data gateway between both softwares, as in Fig. 2.11. A direct connection between JADE and PowerWorld is theoretically possible through the SimAuto COM interface; however, contrary to Matlab, no Java documentation is readily available from PowerWorld. Moreover, the chosen structure allows simultaneously running specific instructions in Matlab, such as for solving complex equations. Matlab embeds toolboxes and functions that enable fast prototyping, which often take longer to develop in Java alone.

The interface between Matlab and PowerWorld/SimAuto described earlier is modified so that it can act as a gateway for requests issued by JADE agents. A TCP connection is established to enable communication between JADE and Matlab. The TCP/IP connection enables running all softwares on a single computer, or using a remote computer for running Matlab and PowerWorld. The Instrument Control Toolbox is required for Matlab to support TCP communication (however, any other toolbox enabling TCP connection could also be used). The connection between Matlab and PowerWorld is achieved with a COM object through SimAuto, as mentioned earlier. On JADE's side, a single agent handles all communication with Matlab, and is referred to as InterfaceAgent from now on.

2.3.4 Operation

On initialization, a TCP connection is established between InterfaceAgent and Matlab, and is maintained open throughout the entire simulation duration. Then, the following process is used to handle each request issued by any agent (see Fig. 2.12, where messages are numbered according to the following list):

1. The JADE agent originating the request sends a message to InterfaceAgent using the standard MTP, with information on what the intended action is, and, if that is the case, the data to pass to PowerWorld.
2. InterfaceAgent processes the content of the message, formats it to be sent and understood by Matlab, and sends it through TCP.
3. Matlab receives the message, processes it, and requests PowerWorld to run the appropriate instruction based on the content of the message it received. The instructions are the same as the ones listed earlier for the Matlab–PowerWorld interface. In some cases, Matlab can also run some instructions itself using the data provided by the agent.
4. After PowerWorld (and Matlab, if that is the case) has run the selected instructions, it returns the result to Matlab through the COM interface of SimAuto.
5. Matlab then reprocesses the answer and sends it through TCP back to InterfaceAgent.
6. Finally, InterfaceAgent processes the answer it received and sends the final answer to the agent that issues the initial request.

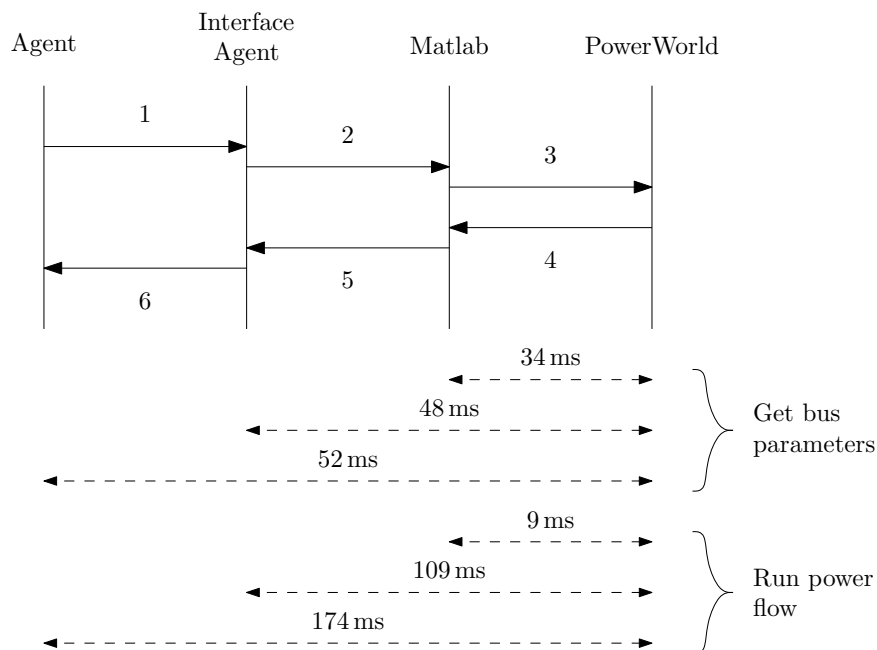

Figure 2.12: Communication flowchart of a request issued by a JADE agent, from [38]. Run times are given for each part of the framework, for two example requests with a 14-bus system.

Run times indicated in Fig. 2.12 show that these interfaces perform well for both test cases (getting the parameters of the buses, and running a power flow). However, these run times are given briefly as an example based on a 14-bus system, and are not to be treated as standard. Run times may vary for other systems and other runs.

The source code for both interfaces (JADE–Matlab and Matlab–PowerWorld) are available online at Colorado State University, with a working example [112].

3

Gas Turbine Power Plants for Smart Power Generation

Contents

3.1	Smart Power Generation	49
3.1.1	Drivers	49
3.1.2	Concept	49
3.1.3	State-of-the-Art	50
3.1.4	Application to Gas Turbine Power Plants	50
3.1.5	Energy Management Systems for Smart Generating Plants	51
3.2	Gas Turbine Characteristics	51
3.2.1	Fuel Consumption	52
3.2.2	Combustion Gas Emissions	53
3.2.3	Starting and Stopping Cycles	55
3.3	Energy Management System Architecture	56
3.3.1	Agent Structure	56
3.3.2	Selected MAS Architecture	57
3.3.3	Agent Interactions	61
3.4	Energy Management Strategy	64
3.4.1	Start and Stop Algorithm	64
3.4.2	Turbine Operation Ranges	65
3.5	Economic and Environmental Dispatch	66
3.5.1	Single and Multi-Objective Optimization	66
3.5.2	Problem Definition	68
3.5.3	Aggregation-Based Power Dispatching	69
3.6	Simulation Results	70
3.6.1	MAS Implementation	70
3.6.2	Parameters	70
3.6.3	Dispatching Algorithms Comparison	73
3.6.4	Performance Coefficients Effectiveness	77
3.6.5	Start and Stop Algorithm Effectiveness	77
3.6.6	Energy Costs Comparison	79
3.6.7	Flexibility and Resilience Test	79
3.6.8	Communication and Computation Requirements	82
3.7	Conclusion	83

3.1 Smart Power Generation

3.1.1 Drivers

With the growing share of renewable energy sources in modern power grids and the increasing electricity consumption, intermittency and fast power ramps are increasingly important concerns. Short-term peaks and long periods without generation can be observed within the same day (Fig. 1.1). Grid operators need to maintain a balance between generation and supply to ensure the stability of the system, and generation patterns of RESs do generally not match demand profiles [6].

The smart grid is expected to help tackle these problems, but the generation-side also needs to adapt. As a consequence, the paradigm of simply increasing generation capacity with larger generators to satisfy an increasing demand is not sufficient any more. Large generators with long start times, slow ramp rates, and long maintenance durations are also not well-suited for load balancing applications. A new approach relying on flexible and fast-response generation sources is required for fast power ramps resulting from such external factors [113]: *smart power generation*.

3.1.2 Concept

Smart power generation is a concept proposed by Klimstra and Hotakainen in [28], which aims at providing maximum reliability and flexibility by matching electricity generation with demand using multiple identical generators. These generators can start, stop and operate efficiently independently. These characteristics make these smart generating plants (SGPs) flexible enough so that they are suitable for both base load and peaking power generation.

This concept is useful for load balancing applications, an essential task to ensure a stable and reliable supply of electric energy. This statement is particularly relevant when the share of intermittent energy sources in the energy mix is high, and producers need to adapt their output more frequently than earlier. In order to adapt to sudden variations in intermittent generation, SGPs may need to react quickly and to operate either at base load, at intermediate load, as peaking sources, or may even be stopped if renewable generation is higher than demand.

Klimstra and Hotakainen identify a series of properties for SGPs [28]. The ability to start rapidly is required to enable adapting the output of the plant to varying demand and intermittent generation. By starting and stopping small units appropriately (a process called cascading) instead of simply changing the output of a single larger unit, higher efficiency and reliability levels can be achieved [28]. For the same reasons, these small units must be able to ramp up and down rapidly, while maintaining a high efficiency over a wide load range. As SGPs rely on multiple identical units, such plants are inherently modular and their capacity can be adapted according to medium and long term requirements, at a minimal cost. This specificity facilitates maintenance operations. Non-necessary generators can also participate in ancillary services (e.g., spinning reserve). Generation units should additionally be able to be controlled remotely, and independently from each others. For example, the failure of a unit should not affect the operation of another one. Fuel flexibility, low maintenance, black start capability, short building time, low spatial

impact, low costs, low water use, and low sensitivity to ambient conditions are other concerns.

3.1.3 State-of-the-Art

Due to its relative novelty, this concept has been little studied in the literature. Most works tend to focus on precise topics such as economic and/or environmental dispatching algorithms [114–116], unit commitment algorithms [117, 118], or turbine modeling [119, 120], but lack a systemic approach required for designing a complete EMS that takes into account additional aspects required for practical implementation, such as interactions between subsystems and communication [121]. Only a few studies, such as in [122, 123], focused on optimizing gas turbine operation without altering thermodynamics. Moreover, most papers deal with economic dispatch between power plants, each with their own characteristics, rather than between power sources inside a single one. Tests are conducted on well-known benchmarks but for a single data set only [114–116], which does not give any information on how the algorithms behave in such a dynamic process. They also do not consider the varying efficiency of each source over time, assuming it remains constant.

3.1.4 Application to Gas Turbine Power Plants

Among sources capable of meeting the requirements for SGPs, gas turbine power plants are, with coal-fired power plants, some of the most common solutions used for meeting such high ramps. Power plants made of simple cycle gas turbines comply with most of the characteristics of SGPs listed earlier. Gas turbines enable a great operational flexibility: ramp-up and ramp-down rates can exceed several tens of MWs per minute; the turbines constituting the plant can be started and stopped frequently and independently, depending on demand; turbines can be operated with a variety of fuels; time from planning to completion is less than a year; capital costs are relatively low; and maintenance outage times are short [124, 125].

However, these sources are more expensive to operate (considering the cost per generated MWh) than sources with slower dynamics such as nuclear power plants, and have non-negligible emission levels that are only surpassed by traditional coal power plants [126].

Due to these characteristics, gas turbine power plants are often used for providing power during demand peaks or to compensate ramps originating from intermittent sources. Other applications include powering remote loads, where transmission capacities do not exist or are insufficient, and powering large industrial facilities, where production processes require large amounts of electric and thermal energy (e.g., paper mills or other chemical processes).

3.1.5 Energy Management Systems for Smart Generating Plants

As the power grid is subject to a deep ongoing modernization, power plants also need to become smarter, that is, in this case, more flexible and efficient, following the principles of smart power generation. Satisfying these two requirements at the same time is however a non-trivial objective, as designing an efficient EMS usually implies modeling very precisely the target power system, resulting in a loss of flexibility.

On the one hand, although initial investment costs for building gas turbine power plants are relatively low, their high operation costs require efficient algorithms for managing energy flows so as to minimize costs as well as emission levels [126]. With legislations on greenhouse gases becoming stricter in most parts of the world through cap and trade, allowances or taxing mechanisms, limiting emissions is a growing concern to be added to operational costs. On the other hand, an EMS with a flexible architecture enables not only to adapt to a variety of new or existing plants, but also to make the structure of the plant evolve over time, while requiring very little modifications. This characteristic helps reduce commissioning costs, in addition to operation costs, and can also increase the resilience of the system, e.g., after the failure of a component.

This chapter proposes an EMS for gas turbine power plants operated in the SGP paradigm, addressing these concerns without altering turbine thermodynamics.

3.2 Gas Turbine Characteristics

Gas turbines are a mature technology with decades of use history, not only in the field of power generation, but also for transportation, such as for aircraft engines. Associated with a generator, their power output can range from a few MWs to several hundreds of MWs, and are sometimes used as combined heat and power (CHP) or combined-cycle sources.

Gas turbines operate upon the Brayton thermodynamic cycle. Fig. 3.1 shows the interactions of the main parts of a simple cycle, single shaft gas turbine. Air enters the compressor at ambient conditions, and is compressed to some higher pressure. This compression process heats the air, which enters the combustor. In the combustor, the compressed air is used for fuel combustion. The thermal energy generated by the combustion is then converted into mechanical work, which is used to drive an alternator that transforms mechanical energy into electricity.

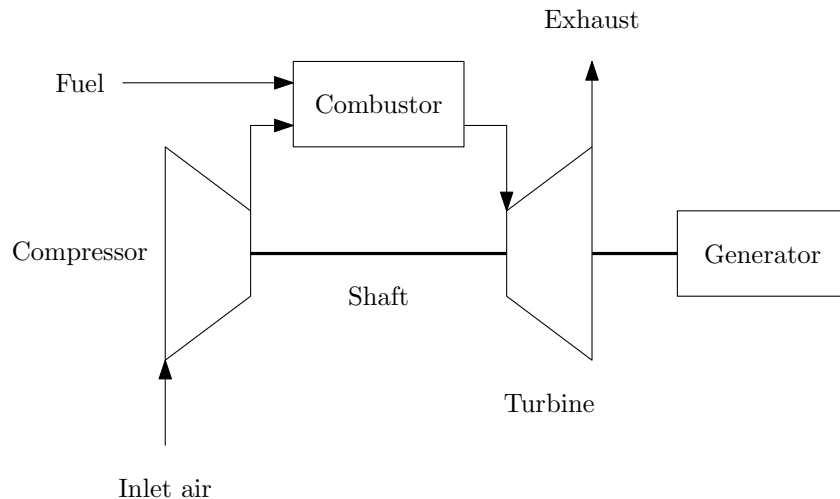

Figure 3.1: Diagram of a simple cycle, single shaft gas turbine, based on [124].

General Electric (GE)'s 9E gas turbine series is an example of such a turbine, and is used as a basis for simulation. These turbines are suitable for simple cycle peaking service,

base load generation, load following and combined cycles. These gas turbines are able to start, shut-down and handle load changes quickly, and are therefore preferred for these applications.

Their main characteristics are summarized in Table 3.1. Gas turbine data shown in the following sections are derived from documentation provided by GE¹.

Characteristics	Values
Output	128.1 MW
Efficiency	34.1 %
Design frequency	50 Hz
Fast start duration	16 min
Normal start duration	28 min
Ramp-up rate	12.6 MW/min
Ramp-down rate	9.5 MW/min
Emission compliant turn-down	50 % base load

Table 3.1: Typical characteristics of a simple cycle 9E gas turbine.

3.2.1 Fuel Consumption

The *fuel cost* of a turbine is given by the quadratic function (3.1), where f is the total fuel cost, c_{fuel} is the unitary fuel cost in € /kg, and $p \in [0, 1]$ is the set point expressed as a per unit of the maximum power output [127]. Fig. 3.2 shows the quadratic nature of the fuel flow of the turbine. No valve-point effect is observable, and there is also no prohibited operating zone.

$$f_i(p_i) = c_{\text{fuel}} \cdot (a_i p_i^2 + b_i p_i + c_i) \quad (3.1)$$

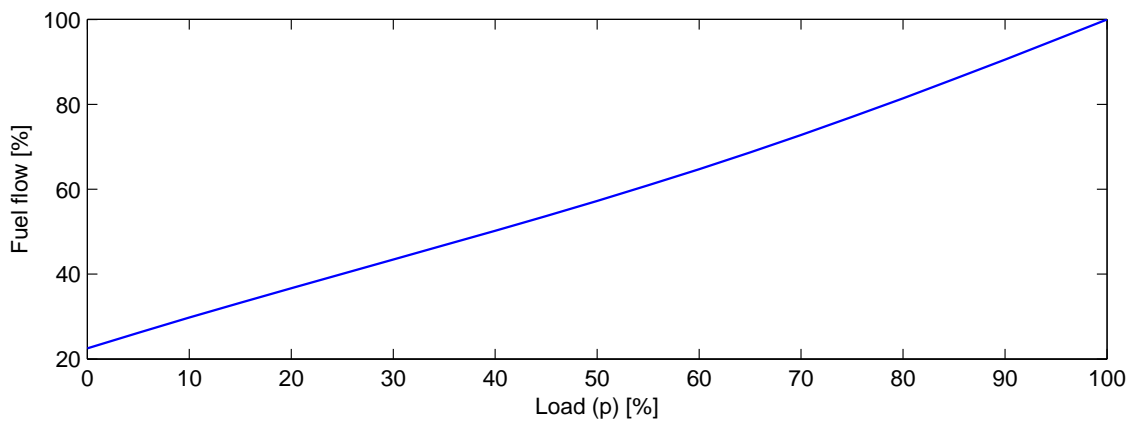

Figure 3.2: Fuel flow of the turbine.

1. As some data is confidential and is covered by a non-disclosure agreement between GE and UTBM, only their relative or p.u. value is given.

Due to the wearing and maintenance history of the turbine, the performance of the turbine can vary over time, which impacts its cost function [128]. To account for this, a performance coefficient α_i is introduced and corresponds to the ratio of the reference value of efficiency for a new turbine, η_{ref} , with the actual measured efficiency of the turbine, η_{meas} (3.2). It is assumed that this coefficient can be derived from performance monitoring systems, such as the ones presented in [128]. This ratio α_i is assumed constant, with values typically included in the $[1, 1.03]$ range, meaning that the measured efficiency of a turbine decreases over time; although it can be temporarily re-increased with maintenance. The final fuel cost function is then obtained with (3.3).

$$\alpha_i(p_i) = \frac{\eta_{\text{ref}}(p_i)}{\eta_{\text{meas}}(p_i)} \quad (3.2)$$

$$c_{\text{tu},i}(p_i) = \alpha_i(p_i) \cdot f_i(p_i) \quad (3.3)$$

3.2.2 Combustion Gas Emissions

As shown in Fig. 3.3, which displays the *emission curves* for NOx, CO and CO₂ gases, combustion gas emissions are highly dependent on load [129]. NOx gases result from the combustion of gases at high temperature and are therefore usually higher at base load. In most places, air quality regulations require low NOx emissions, especially in urban areas, due to their highly local toxic effects [130]. On the contrary, CO emissions are higher for partial loads and result from incomplete combustion. CO₂ emissions are also monitored, as they are sometimes subject to regulations such as carbon trading.

Although technologies such as dry low NOx (DLN) help reduce NOx emissions to low levels, it should be noted that they are trade-offs between several turbine parameters (emissions, reliability, load range, etc.): Fig. 3.3 shows that the trends in CO and NOx emissions tend to take opposite directions, i.e., decreasing one increases the other [129]. CO₂ emissions are assumed to depend only on the amount of burned fuel, as in (3.4), where e_{CO_2} is the total CO₂ emissions level, and d is a coefficient giving the emissions level from the fuel flow. Consequently, reducing fuel consumption is equivalent to reducing CO₂ emissions, as reducing NOx emissions necessarily results in increasing CO emissions. Emissions are also directly impacted by values of α_i .

$$e_{\text{CO}_2,i}(p_i) = d_i \cdot f_i(p_i) \quad (3.4)$$

Although most papers in the literature assume emissions vary according to quadratic functions [131, 132], Fig. 3.3 shows that this assumption is clearly not verified for 9E turbines. On the contrary, the NOx and CO curves show that 9E turbines use four different combustion modes (Fig. 3.4):

- For $0 \leq p < 0.225$ (Mode 1): At partial loading, both NOx and CO emissions are moderately high. This mode is typically only used for starting turbines, leading to high levels of unburned hydrocarbons.
- For $0.225 < p < 0.50$ (Mode 2): This mode exhibits a peak in CO emissions at the beginning and a peak in NOx when nearing 50% load.
- If the turbine stays in Mode 2 longer than 5 minutes, it then enters in an extended version of Mode 2, called Mode 2 Extended, even if the load increases above 50%, and exits this extended mode only after going back to Mode 1.

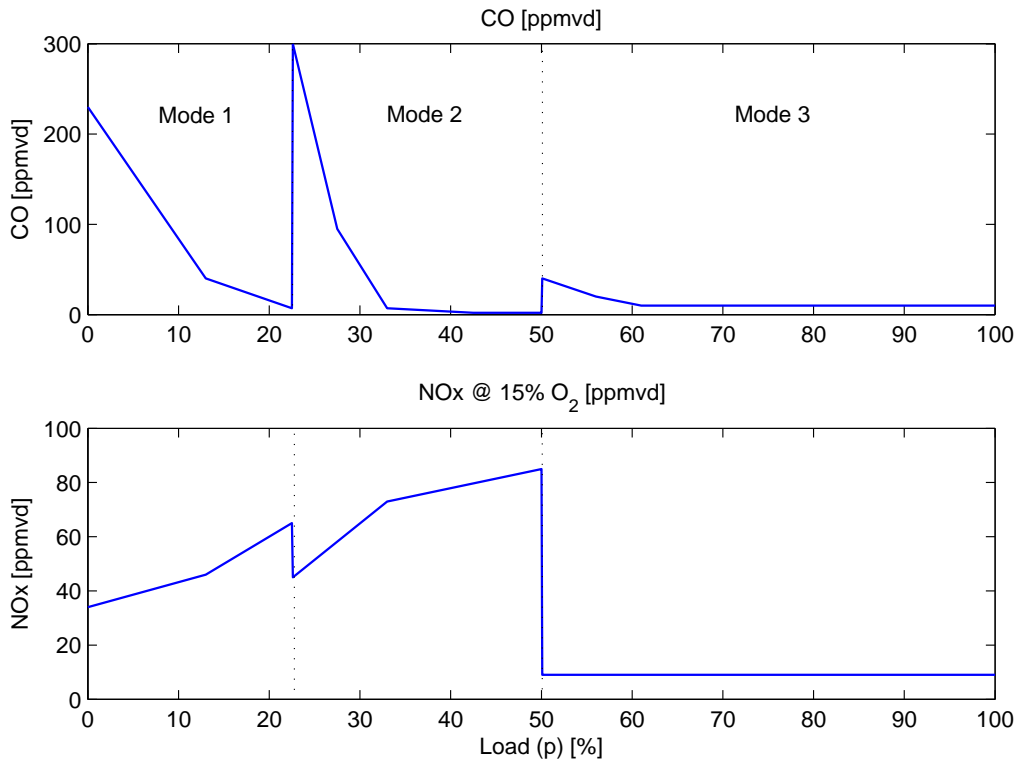

Figure 3.3: NOx and CO emission curves of 9E gas turbines, based on [129]. Emissions are heavily dependent on the load and combustion mode of the turbine.

- For $p \geq 0.50$ (Mode 3): This last mode enables reaching the lowest emissions (except for CO₂), by maintaining them to stable levels around 9 ppmvd for NOx and 25 ppmvd for CO, due to DLN combustion, even for high load values.

3.2.3 Starting and Stopping Cycles

In order to be able to account for the costs of starting a turbine, the fuel consumption during the starting cycle is measured and is shown in Fig. 3.5. The corresponding emissions are obtained using a similar procedure. The cycle lasts 16 minutes [133], after which the loading cycle can begin and the load increases. Regarding the stopping cycle, the turbine simply decreases its output to zero and disconnects, without any special procedure that would have an impact on fuel consumption or emissions.

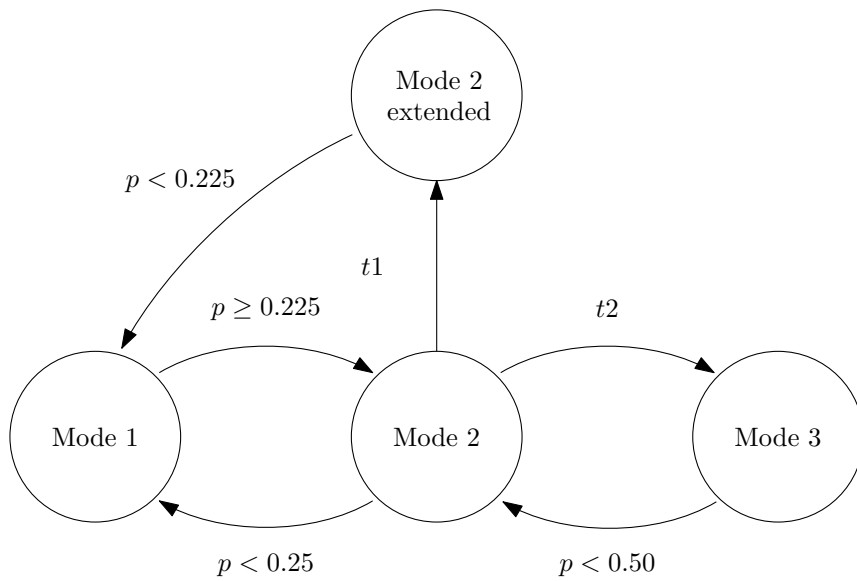

Figure 3.4: Finite state machine describing the turbines, from [39]. Condition $t1$ is verified if the turbine stays in Mode 2 more than 5 minutes, and $t2$ if $p \geq 0.5$ without staying more than 5 minutes in Mode 2.

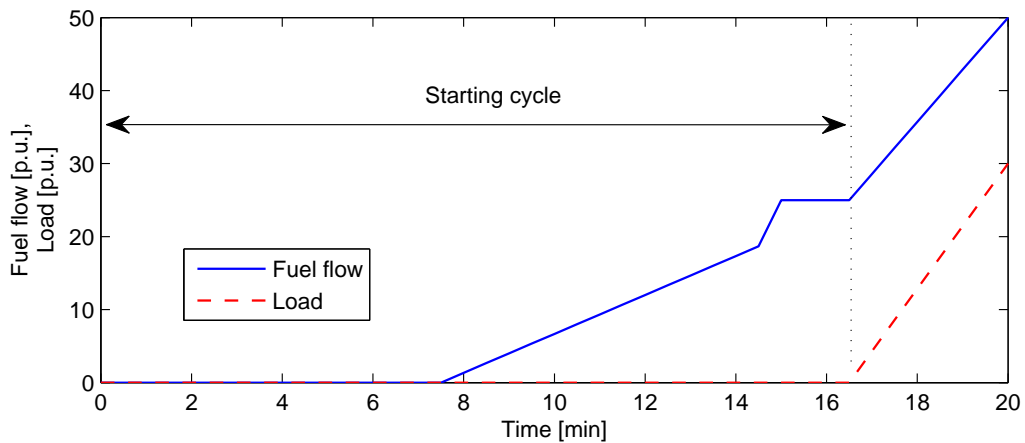

Figure 3.5: Fuel consumption of a turbine during its starting cycle, from [39]. During this cycle, the turbine is gradually brought to its operational state, which consumes fuel.

3.3 Energy Management System Architecture

One of the main objectives of this EMS is to reach a high level of flexibility, not only during its operation, but also during partial outages, and over the entire life-cycle: the system is designed to adapt to most changes in the structure of the power plant, whether they are intentional (e.g., increasing the generation capacity by adding a turbine, or stopping one for maintenance) or not (e.g., after an outage). MASs enable this flexibility due to their inherent characteristics.

3.3.1 Agent Structure

All agents in this application are based on a similar structure (Fig. 3.6). As the agent is created, it runs a set of initialization instructions. These instructions enable it to gather information on the component it is connected to (e.g., the turbine), and to register with the other agents interacting with it. The agent then reaches a state in which it waits for a message from another agent. This message can be a request or can contain an information the agent needs. Depending on the content of the message, the agent runs a given sequence of instructions, that can include running measurements or interacting with other agents. At the end of this sequence, the agent goes back to waiting for a message, and can run background tasks until a new message is received. If the message is a request for the agent to delete itself, the agent runs some clean-up instructions and deletes itself after unregistering from other agents. In case of a communication problem, the agent also has the capability to switch a degraded mode, in which the agent can choose to progressively stop to ensure the safety of the system, if it does not manage to re-establish communication on its own [51].

3.3.2 Selected MAS Architecture

The selected MAS architecture consists of seven agent types, divided into three categories. A first category corresponds to agents controlling or representing physical components in the power plant: turbine and load agents.

- A *turbine agent* is a reactive agent created for each turbine in the power plant, and that resides in the turbine control system. Through its integration with the turbine control system, the agent is capable of retrieving information about the current status of the turbine, for example through measurements, and to impact its operation, by changing the set point and the state of the turbine. Low level control actions (fuel flow regulation, air compression, temperature monitoring, etc.) are not controlled by the agent but by the control system itself; however, the agent has access to all available data on the turbine. Depending on interactions with other agents, the turbine agent executes different processes (Fig. 3.7). For example, it can communicate with the SCADA agent by sending data about the actual turbine state, and receive new set points in return. Similarly, if requested to change of state (e.g., start or stop), or to be deleted (e.g., when the turbine is un-installed or shut-down for long maintenance), the agent takes appropriate measures to ensure the correct operation of the system.

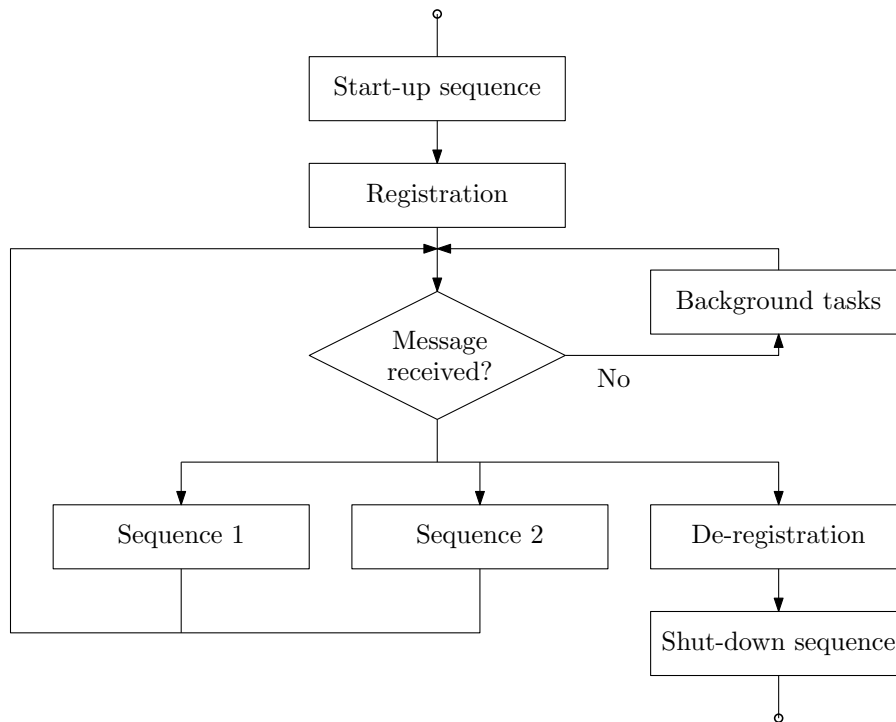

Figure 3.6: Generic flowchart of an agent life cycle, from creation to deletion, from [39]. Instruction sequences are selected according to interactions with other agents.

- The *load agent* is a reactive agent in charge of communicating with the other agents to provide them information on the total load. It converses with the SCADA agent and provides it with the current load value.

The second category contains agents fulfilling energy management-related roles: SCADA, dispatching, forecasting and yellow/white pages agents.

- The *SCADA agent* plays a role similar to commercial SCADA systems, and acts as a communication interface between the different agent types of the system, as well as the power plant operator through the control interface. It gathers data from the turbine and load agents, and forwards them the set points issued by the dispatching agent. It also provides other agents with information they require to operate, whenever they request it, and if they are allowed to do so, and stores logs of events occurring in the plant. This agent makes the system ready for future evolutions including additional functionalities, such as advanced scheduling.
- The *dispatch agent* (Fig. 3.8) is an intelligent agent in charge of controlling the operation of the turbines with respect to the forecast and actual load, while minimizing costs and emission levels. At first, based on load forecasts, it decides whether each turbine needs to be switched on or off. It then computes the optimal set points for the switched-on turbines, based on data provided by these turbines and the load agent and forwarded by the SCADA agent. It also maintains a database containing information on the turbines, dispatch results and events.

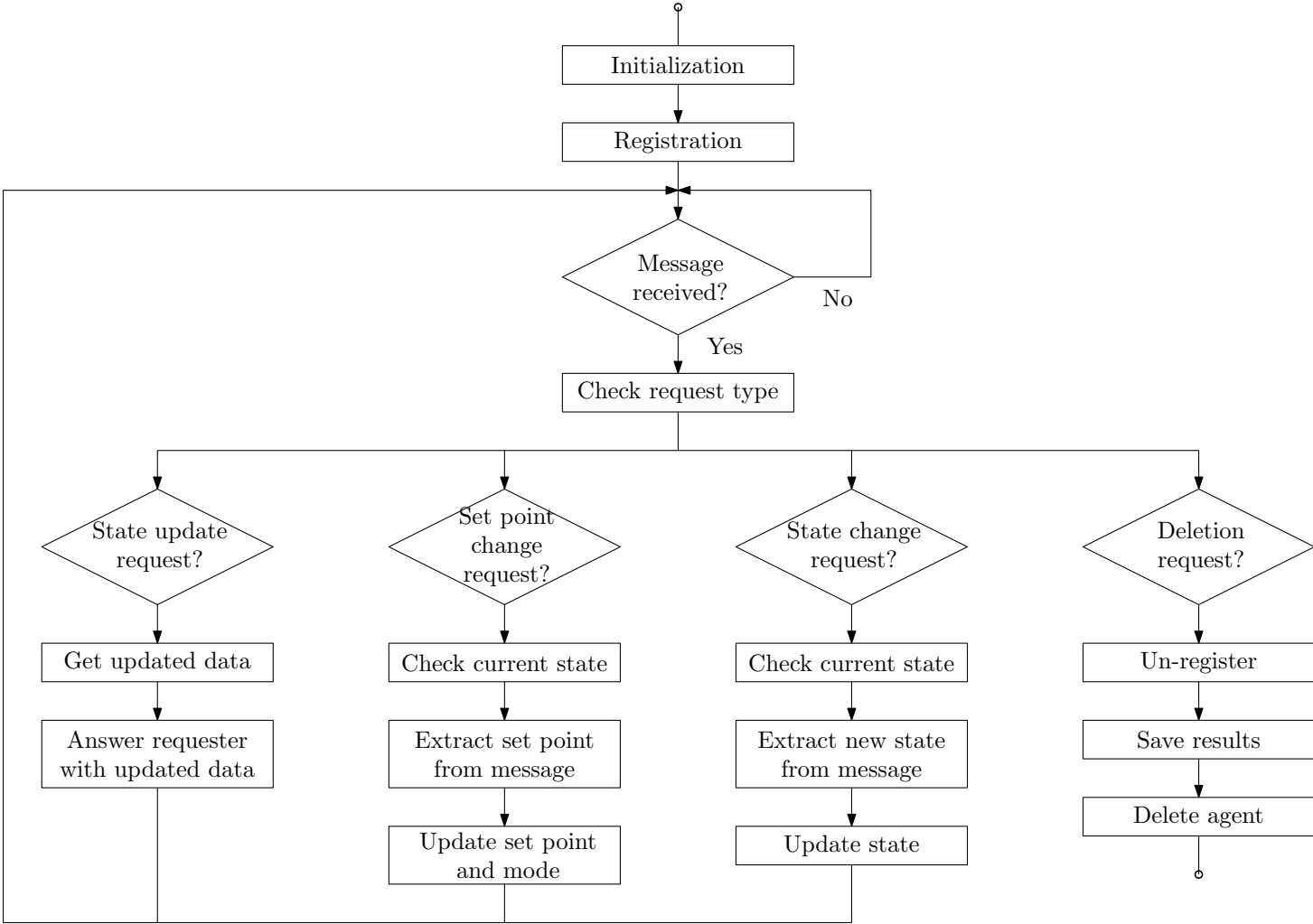

Figure 3.7: Simplified turbine agent flowchart.

- The *forecasting agent* is an intelligent agent capable of forecasting the load several hours ahead. It is in charge of computing forecasts of the expected peak load at a given frequency for the dispatch agent. Forecasts can be obtained either through a learning algorithm, or through the results of power market bids. This behavior is not implemented in this application, and the agent simply provides the future load.
- The *yellow/white pages agent* serves as a name and service server, providing requesting agents with the names and addresses of the agents corresponding to their needs. All agents can communicate with this particular agent. Upon being created and deleted, each agent in the power plant registers with the pages agent so that it can be found by the other agents who might need its services. This agent is essential in enabling the system to evolve when its structure changes, by facilitating the discovery of new services.

The third and last category corresponds to the *human-machine interface agent*. The GUI agent receives updates on the current status of the system provided by the SCADA agent. This information enables human operators to monitor it, and to take appropriate decisions when required. In a real implementation, the operators would have the ability to override the decisions taken automatically by the system, and to operate in a manual mode. The commands issued by the operators are also sent to the SCADA agent.

Fig. 3.9 provides an overview of the EMS and of the basic interactions between these agents. This figure indicates that the selected MAS topology has some similarities with the federations described in section 2.1.6, as the SCADA agent acts as a delegate to other agents.

3.3.3 Agent Interactions

The way the agents of the MAS interact depends on the situation at hand. Two situations are described here: architecture change and normal system operation. In the following figures and simulations, measures taken to ensure data is properly transferred and received are not considered. However, in a real test case, these should be implemented to guarantee the proper operation of the system.

3.3.3.1 MAS Architecture Change

When the architecture of the power plant changes, e.g., when it is started for the first time, or when a turbine is added, the MAS structure needs to adapt. In the first case, the GUI and the energy management-related agents are started, initialized and parameterized by the operator. The system then waits for power plant agents to register. The operation of the system can then begin. For a turbine agent, the following process is followed (Fig. 3.11, where numbers given at the beginning of each line correspond to the numbers given in the following enumeration):

1. The agent of the turbine is created as its control system starts.
2. As it initializes, it loads or measures the characteristics of the turbine (model, maximum output, type of fuel, etc.).
3. It registers with the yellow/white pages agent, so that other agents can find it when they look for turbines.

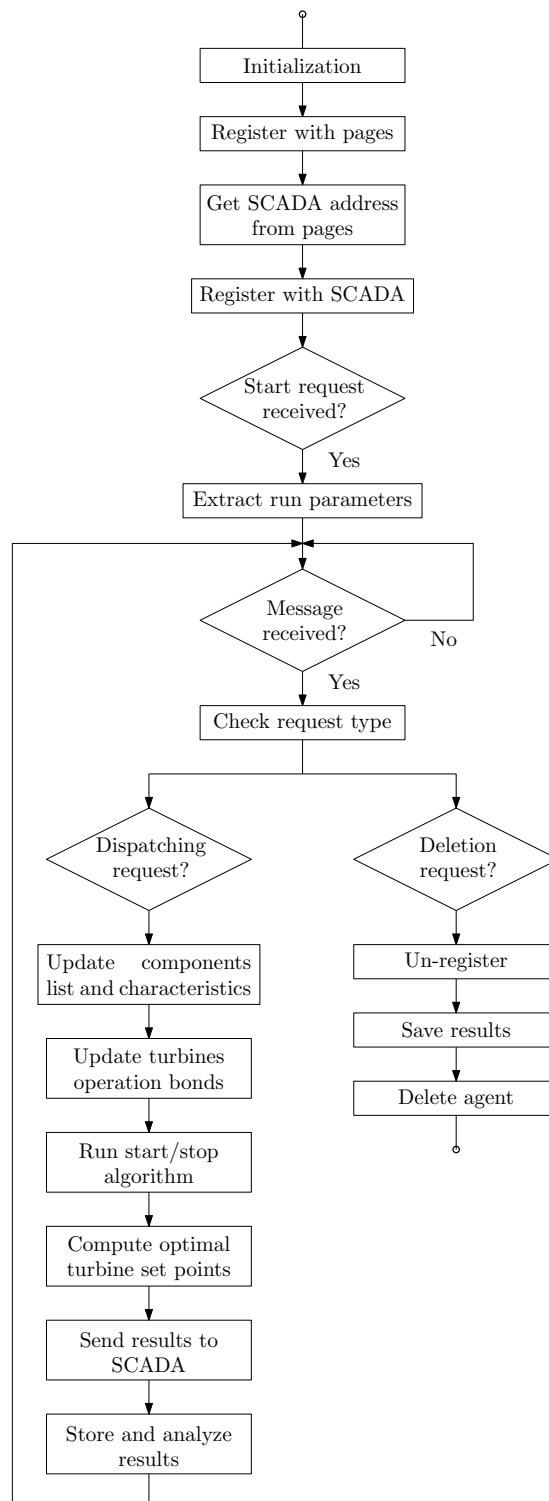

Figure 3.8: Simplified dispatch agent flowchart.

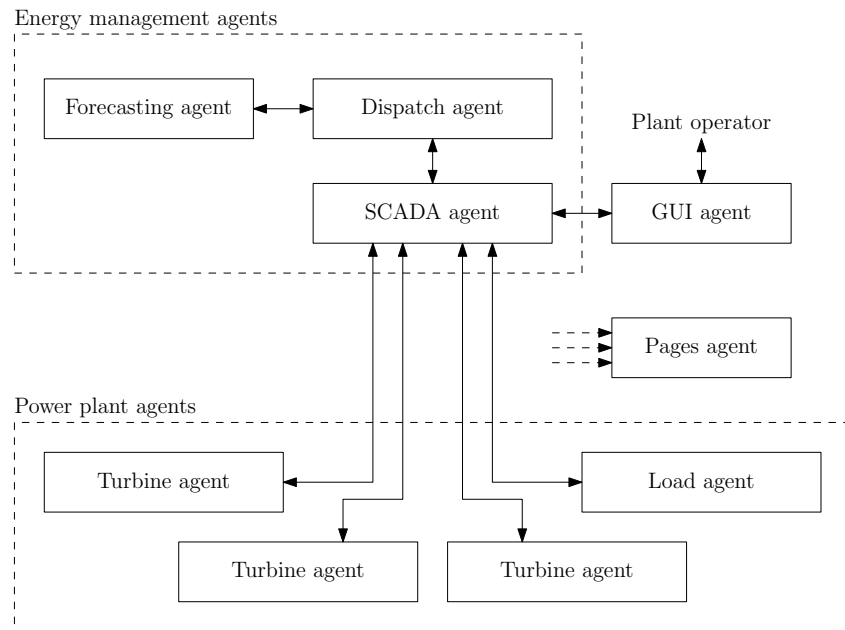

Figure 3.9: Overview of the power plant EMS architecture, from [39]. Each arrow corresponds to a usual communication channel between agents in normal operation mode.

4. It then registers with the SCADA agent, and waits for a request to transmit information about the current state. The agent has then reached the normal operational state.
5. The SCADA agent finally registers the new agent with the dispatch agent. The turbine is then fully operational.

Similarly, when a component is required to disconnect, either by the operator or by the system, the corresponding agent starts by un-registering from the pages and from the other databases the agents have, so that they do not try to communicate with it any more. A series of instructions related to the deletion of the agent, e.g., saving measured data, are then run before the actual deletion from the system. In cases where the agent only needs to be temporarily disconnected, the agent can also be suspended, by switching to a standby mode. When requested, the agent can then switch back to normal mode.

This ability of the system to accommodate structural changes enables it to adapt to a wide variety of power plants, with variable numbers and types of turbines and loads.

3.3.3.2 Normal System Operation

During normal system operation, i.e., when the structure of the system does not change, the system runs the same instructions continuously at a given frequency chosen by the operator or imposed by regulators (Fig. 3.11):

1. The dispatch agent asks the SCADA agent to send measurements on the current state of the whole system.
2. The SCADA agent requests each registered agent to send the latest information it has, e.g., by running measurements.

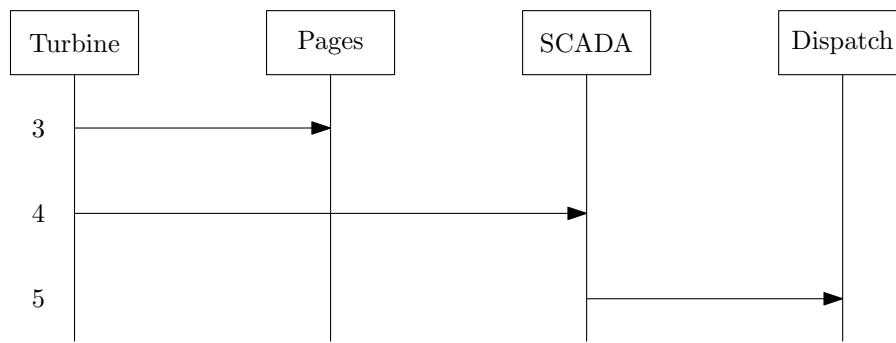

Figure 3.10: Operation and interactions of agents when a new turbine is connected.

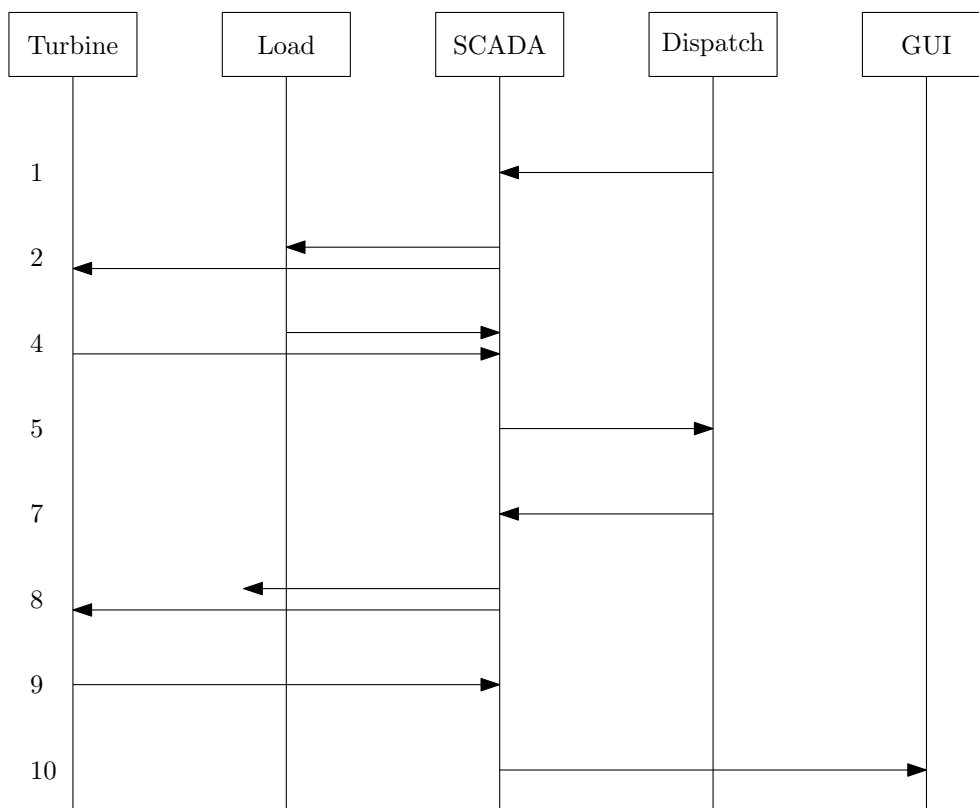

Figure 3.11: Interactions between agents during normal operation of the EMS. Each arrow describes the direction of a message exchange between two agents. This example is limited to two components, one load and one turbine, for ease of understanding.

3. Each agent, based on these measurements, updates its characteristics, such as the operation zone.
4. The updated data is then sent to the SCADA agent, which centralizes the measurements and updates the database.
5. The SCADA agent sends only the required data to the dispatch agent.
6. The dispatch agent computes the optimal set points.

7. These set points are then sent to the SCADA agent.
8. The results are forwarded to the respective recipients.
9. The turbines update their status, after they have either accepted or rejected the requested set point changes.
10. The results are sent to the GUI agent for display.

3.4 Energy Management Strategy

In order to properly manage power flows so as to meet demand in the most efficient and flexible way, an energy management strategy is defined and is implemented in three complementary steps:

1. The first step, called *start and stop algorithm* (SSA), defines whether and when each turbine should be turned-on or off.
2. The second step is the definition of the operation range of each turbine according to a set of criteria.
3. The last step is the *dispatching algorithm* presented in details in section 3.5.

3.4.1 Start and Stop Algorithm

The SSA handles decisions regarding whether and when each turbine should be started or stopped. Although such decisions are traditionally taken by advanced unit commitment algorithms using day-ahead load forecasting, such algorithms are not required or applicable here. The first reason is that as all generators are identical except for the value of their performance coefficient, there is no reason to privilege using a specific turbine over the others. The second reason is that due to the uncertainties related to intermittent energy sources, the load forecasting error increases with the forecasting horizon [134, 135]. Consequently, very short term (one hour-ahead or less) forecasts are more reliable than day-ahead predictions and can be used to take the required decisions, even if they sometimes simply consist in persistence models [136].

The decisions taken by the SSA are therefore based on one hour-ahead forecasts of peak load provided by the forecasting agent, and are used to maintain a minimum spinning reserve required to meet demand. Reserve is defined here as the amount of generation capacity that is not used by the generators, i.e., the difference between the rated power output and the actual output. As reserve is computed when the algorithm takes the decision and not when the turbine actually starts (in the case of a turbine starting), the actual reserve value may be lower than its reference value until the turbine is operational.

The algorithm derives the number of turbines to start (n_{start}) or stop (n_{stop}) from the total forecast peak load (P_1^{peak}), the minimum amount of reserve R_{start} or R_{stop} given as a percentage of the total load, the maximum output of a turbine $P^{\text{tu,max}}$ and the number of turbines currently running n_{run} . The turbines with the best performance coefficients are started first, similarly to a priority list-based algorithm, and using the fast start procedure shown in Fig. 3.5.

If the spinning reserve is too low, i.e., if condition (3.5) is verified, n_{start} is derived from (3.6):

$$P_1^{\text{peak}} \cdot (1 + R_{\text{start}}) > P^{\text{tu,max}} \cdot n_{\text{run}} \quad (3.5)$$

$$n_{\text{start}} = \max \left(\text{ceil} \left[\frac{P_1^{\text{peak}}}{(1 - R_{\text{start}}) \cdot P^{\text{tu,max}}} - n_{\text{run}} \right], 0 \right) \quad (3.6)$$

On the contrary, if the spinning reserve is too high, the turbine with the highest (worst) performance coefficient is requested to stop, and the same process is repeated as long as condition (3.7) is verified:

$$P_1^{\text{peak}} \cdot (1 + R_{\text{stop}}) < P^{\text{tu,max}} \cdot (n_{\text{run}} - 1) \quad (3.7)$$

3.4.2 Turbine Operation Ranges

The second step is distributed in each turbine agent. As each turbine agent has access to all information available on the turbine it controls, it can autonomously define its operation range. The rest of the system has no influence on such decisions. The agents define the operation ranges of the turbines through these criteria:

- The turbines cannot be started or stopped as long as the minimum up and down time constraints, (3.8) and (3.9), respectively, are not verified. These constraints avoid the turbines to be switched-on or off for just a few minutes, which would degrade them faster than expected:

$$T_i^{\text{up}}(t) \geq T_{i,\text{min}}^{\text{up}} \quad (3.8)$$

$$T_i^{\text{down}}(t) \geq T_{i,\text{min}}^{\text{down}} \quad (3.9)$$

where $T_{i,\text{min}}^{\text{up}}$ is the minimum up-time of turbine i and $T_{i,\text{min}}^{\text{down}}$ the minimum down-time.

- The physically possible operation ranges of the turbine are bounded with their minimum and maximum limits:

$$P_i^{\text{tu,min}} \leq P_i^{\text{tu}}(t) \leq P_i^{\text{tu,max}} \quad (3.10)$$

where P_i^{tu} is the power output of turbine i , and $P_i^{\text{tu,min}}$ and $P_i^{\text{tu,max}}$ are the minimum and maximum values, respectively.

- While its starting cycle is not over, or if it is in standby mode, the turbine cannot produce any output. Its operation range is thus restricted to a nil output.
- In normal operation mode, the positive and negative ramp rates ($R_u, R_d > 0$) are also enforced:

$$P_i^{\text{tu}}(t_k) - R_d \cdot (t_{k+1} - t_k) \leq P_i^{\text{tu}}(t_{k+1}) \leq P_i^{\text{tu}}(t_k) + R_u \cdot (t_{k+1} - t_k) \quad (3.11)$$

- Finally, if the turbine is being stopped, its output is forced to decrease according to (3.12):

$$P_i^{\text{tu}}(t_{k+1}) = P_i^{\text{tu}}(t_k) - R_d \cdot (t_{k+1} - t_k) \quad (3.12)$$

Based on these criteria, each turbine is capable of providing the dispatching system with its operation range for the next period. In a real implementation of the EMS, the turbine agent could also take decisions regarding the safety of the turbine, for example by turning it off if a problem is detected. As a consequence, the turbine agent has the highest priority among agents and can override requests by other agents if required, for example to ensure the safety of the equipment. A degraded mode, used if communication channels fail, would also be implemented at this level, and would base its decisions on direct measurements.

3.5 Economic and Environmental Dispatch

After the energy management strategy has defined which component should be used and how, the *economic and environmental dispatch algorithm* performs optimal control for the power plant. From this strategy, an optimization problem is dynamically defined and solved through a metaheuristic technique (see Appendix A) with one or more objectives.

As gas turbines use carbon-based products as fuels, their emissions contribute to a large share of greenhouse gases resulting from power generation. Minimizing these emissions is therefore one of the objectives of power plant operators, especially in a context of growing environmental legislation. The DLN combustion system is an example of a technology helping such minimization, while another leverage is to optimize the load dispatch while taking into account emissions in addition to fuel costs.

However, these two objectives are sometimes conflicting: reducing fuel costs by resorting to uncleaner options can increase emissions, and vice-versa, for the same total amount of energy generated [137, 138]. For example, only optimizing costs would enable a turbine to operate in Mode 2 during long periods (see Fig. 3.3), whereas also taking emissions into account would favor exiting this zone to Mode 3 to reduce NOx emissions. The operator is required to take a decision resulting from a trade-off between emissions and costs, as no solution is entirely better than all others. This problem can therefore be seen as a multi-objective optimization problem, where the first objective is to minimize operation costs, resulting from fuel consumption, and the other is to minimize gas emissions.

3.5.1 Single and Multi-Objective Optimization

An optimization problem aims at minimizing a real function, called *objective*, *cost*, *utility or fitness function*, by systematically choosing input values from a specific set and evaluating the corresponding fitness. Mathematically, for a minimization problem, this proposition is equivalent to searching for an element x_0 in a search space A such that $f(x_0) \leq f(x)$ for all $x \in A$.

Another formulation is used for most numerical optimization problems. An optimization problem with m objectives can be formulated as follows:

$$\min_x [f_1(x), f_2(x), \dots, f_m(x)]^T \quad (3.13)$$

$$\text{s.t.} \quad g_i(x) \leq 0 \quad i = 1, \dots, n_{\text{ineq}} \quad (3.14)$$

$$h_i(x) = 0 \quad i = 1, \dots, n_{\text{eq}} \quad (3.15)$$

$$x_i^l \leq x_i \leq x_i^u \quad i = 1, \dots, n \quad (3.16)$$

where x is the vector of n decision variables, f_i is the i -th objective function, g_i is the i -th of n_{ineq} inequality constraints, h_i is the i -th of n_{eq} equality constraints, and x_i^l and x_i^u are the lower and upper bounds for the i -th decision variable of x . If $m = 1$, then the problem has a single objective, and if $m > 1$, then this is a multi-objective problem.

Solving single-objective problems returns a single solution, that is the best solution found by the algorithm. However, for multi-objective problems, two main approaches can be used, depending on the objectives and constraints of the problem: aggregating the objective functions to create a composite objective function to minimize, or looking for a set of equivalent solutions, called the *Pareto front*, from which the most appropriate can be chosen.

3.5.1.1 Aggregation-Based Multi-Objective Optimization

Aggregation relies on combining the m objective functions f_i to create a single composite objective function Φ , as in (3.17). This function can then be minimized by a single-objective optimization algorithm, and return a single solution. The main advantage of the aggregation technique is its simplicity; however, tuning the weight α_i to give to each objective may be problematic, especially if the objectives correspond to different quantities. For example, combining costs and emissions requires to give emissions a cost, so that the total cost of the solution can be evaluated.

$$\Phi(x) = \sum_{i=1}^m (\alpha_i \cdot f_i(x)) \quad (3.17)$$

3.5.1.2 Pareto Multi-Objective Optimization

The second approach is based on the search for a set of non-dominated (equivalent) Pareto-efficient solutions, forming a m -dimensional surface called *Pareto front* obtained by a multi-objective optimization algorithm. These solutions are not dominated by any other solution for all objectives at the same time, and require an additional algorithm to select the most appropriate solution that will be used.

Formally, a vector x^* is Pareto-optimal (efficient) if, for all vectors x from the feasible solutions set Ω , and all m objective functions f , both the following conditions are verified for $I = \{1, \dots, m\}$ [139]:

$$\forall i \in I : f_i(x^*) \leq f_i(x) \quad (3.18)$$

$$\exists j \in I : f_j(x^*) < f_j(x) \quad (3.19)$$

The set of Pareto-optimal solutions P^* includes all found x^* vectors belonging to Ω . Consequently, the Pareto front F (Fig. 3.12) is defined as:

$$F = \{f(x) \in R^m \mid x \in P^*\} \quad (3.20)$$

This Pareto dominance approach has the advantage of not requiring any experimental tuning of parameters for running the optimization, as in the previous one, but as it provides a set of solutions, another algorithm has to be used to select the most appropriate solution.

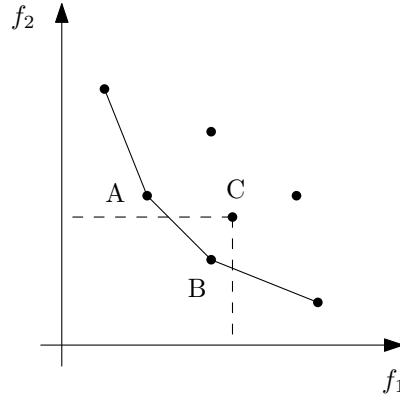

Figure 3.12: A Pareto front example. Here, C is dominated by A on f_1 and B on f_2 . Contrary to A, B is better than A on f_2 but not on f_1 . A and B are not Pareto-dominated by any other solution and thus belong to P^* .

3.5.1.3 Method Selection

For the EMS application, the aggregation method is selected for several reasons:

- It is simpler to implement;
- The simple-objective algorithms it requires are simpler to implement than multi-objective ones;
- Aggregation does not require selecting a particular solution from a set of equivalent solution, as such selection criteria are difficult to define. Such selection requirement is also not well-suited for a dynamic problem.

As a consequence, only single-objective metaheuristics are considered in the following sections.

3.5.2 Problem Definition

Equations (3.13) to (3.16) describe the general formulation of a multi-objective optimization problem. In the present case, vector x , i.e., the vector of decision variables, includes a list of set points and powers corresponding to the turbines:

$$x = [P_0^{\text{tu}}(t), \dots, P_{n_{\text{tu}}}^{\text{tu}}(t)]^T \quad (3.21)$$

where n_{tu} is the number of turbines. Their respective power outputs P_i^{tu} use the same indexes.

The first objective is the total fuel cost (3.22), which is obtained by computing the sum of the operation costs of all connected components.

$$\min \left[c_{\text{tot}}(t) = \sum_{i=0}^{n_{\text{tu}}} \left[c_{\text{tu},i}(P_i^{\text{tu}}(t)) + \Delta P_i^{\text{tu}}(t) \right] \right] \quad (3.22)$$

where $c_{\text{tot}}(t)$ is the total generation cost, and c_i are the cost functions using the same indexes as in (3.21). c_{tu} is defined by (3.3).

The term ΔP represents the power output change for turbine i from the last set point, where β_0 is a real positive constant, and helps the algorithm avoid fluctuating around optimal solutions over time:

$$\Delta P_i^{\text{tu}}(t) = \beta_0 |P_i^{\text{tu}}(t) - P_i^{\text{tu}}(t-1)| \quad (3.23)$$

The second and third objectives correspond to the emissions of gas g (NOx and CO₂) from the gas turbines as expressed in (3.24).

$$\min \left[e_{g,\text{tot}}(t) = \sum_{i=0}^{n_{\text{tu}}} e_{g,\text{tu},i}(P_i^{\text{tu}}(t)) \right] \quad (3.24)$$

where $e_{g,\text{tot}}$ is the total emissions amount, and $e_{\text{tu},g}$ is the emission function of the turbines for this specific gas.

The only equality constraint is the required balance between the total generation from the turbines and the total load P_L (3.25).

$$P_{\text{imb}}(t) = \sum_{i=0}^{n_{\text{tu}}} P_i^{\text{tu}}(t) - P_L(t) = 0 \quad (3.25)$$

The inequalities for this problem are defined in section 3.4.2 and are summarized in the optimization boundaries provided by the turbine agents.

3.5.3 Aggregation-Based Power Dispatching

As described earlier in section 3.5.1, the aggregation technique is selected for this application, and the objective functions are therefore combined to create a single composite objective function Φ . This function is then minimized by the single-objective optimization algorithm MPSOM (see Appendix A for the description and comparison of MPSOM and other metaheuristics). However, combining costs and emissions is not straightforward, and tuning the weight to give to each objective may be problematic. A solution is to give emissions an equivalent cost to add to fuel costs: the total cost is then to be minimized. For example, CO₂ emissions can be subject to a carbon tax [140], as well as NOx emissions. This penalty method is also used to handle the power balance constraint: a high penalty is added to prevent any imbalance. The composite function becomes:

$$\Phi(t) = \beta_1 \cdot [\gamma_c \cdot c_{\text{tot}}(t) + \gamma_{\text{NO}_x} \cdot e_{\text{NO}_x,\text{tot}}(t) + \gamma_{\text{CO}_2} \cdot e_{\text{CO}_2,\text{tot}}(t)] + \beta_2 \cdot |P_{\text{imb}}(t)| \quad (3.26)$$

where γ_c is a binary variable that controls whether costs are included in the optimization or not, γ_{NO_x} and γ_{CO_2} are respectively the costs of NOx and CO₂ emissions, and β_1 and β_2 are positive real values.

3.6 Simulation Results

The performance of the proposed system is evaluated through several tests. Three main aspects of the EMS are tested in simulations: its efficiency with respect to costs and emissions, its flexibility, and its requirements in communication and computational power.

3.6.1 MAS Implementation

In order for the system to be tested, a simulator called MAEMS (Multi-Agent EMS) is implemented in JADE. A graphical user interface (Fig. 3.13) is also developed, and enables the user to define test cases and to monitor simulation results.

3.6.2 Parameters

Efficiency tests are run using a custom load profile shown in Fig. 3.14. A first load curve, spanning the four first days of year 2012, is extracted from data available on the website of the French transmission system operator RTE [7]. This profile corresponds to the total load for France during four days, starting with two weekend days. Data is scaled-down so that the maximum load is slightly lower than the maximum output of four 9E turbines (i.e., approximately 480 MW).

As one of the objectives of the EMS is to enable the operation of a SGP with a medium to high penetration of renewable energy sources, a wind power profile is added. This profile is based on a wind speed profile measured by UTBM's weather station, also during the first days of 2012. This profile is then scaled-up, so that the output of a large wind farm with a peak output of about 150 MW is obtained, i.e., a 33% penetration in terms of rated power. It is assumed that the output of the wind farm can be smoothed, e.g., with storage [141, 142], so that sudden variations do not have to be absorbed by the power plant.

This wind farm output profile is then subtracted to the previous load profile in order to obtain the final net load profile. A ramp is added at the beginning of the profile to enable the turbines to start, as each simulation starts with all turbines turned off.

Table 3.2 lists the parameters used in the simulations. The following tests are run for a power plant with four 9E series turbines, each with a different performance coefficient ranging from 1.0 to 1.03, i.e., a 3% change at maximum. Data related to taxes on emissions were extracted from Norway's legislation, one of the only countries in the world to have such a system, and where taxes on NO_x (16.34 NOK/kg – 2,149 €/tonne) and CO₂ (342 NOK/tonne – 44.46 €/tonne) emissions have been in use for years [143, 144]. This price for NO_x can be considered as high compared to the 300\$/ton price currently set for NO_x emission allowances by the US FERC [145]. Set points are computed every 60s throughout the test profile. Values of β_0 , β_1 and β_2 are obtained empirically by the authors.

3.6.3 Dispatching Algorithms Comparison

In this first series of tests, several dispatching algorithms are used and compared, while the turbines are not enabled to start and stop. Results are summarized in Table 3.3. The objective here is to analyze the behavior of the algorithms and the decisions they take, by comparing the resulting costs and emissions. The tested algorithms are:

- *Algorithm A – Sequential dispatch*: This rule-base algorithm states that if the total load is lower than the maximum output of one turbine, only one (selected randomly) is used, otherwise this turbine is kept at its maximum output, and the others share the rest of the load. This algorithm is currently used in some power plants, and

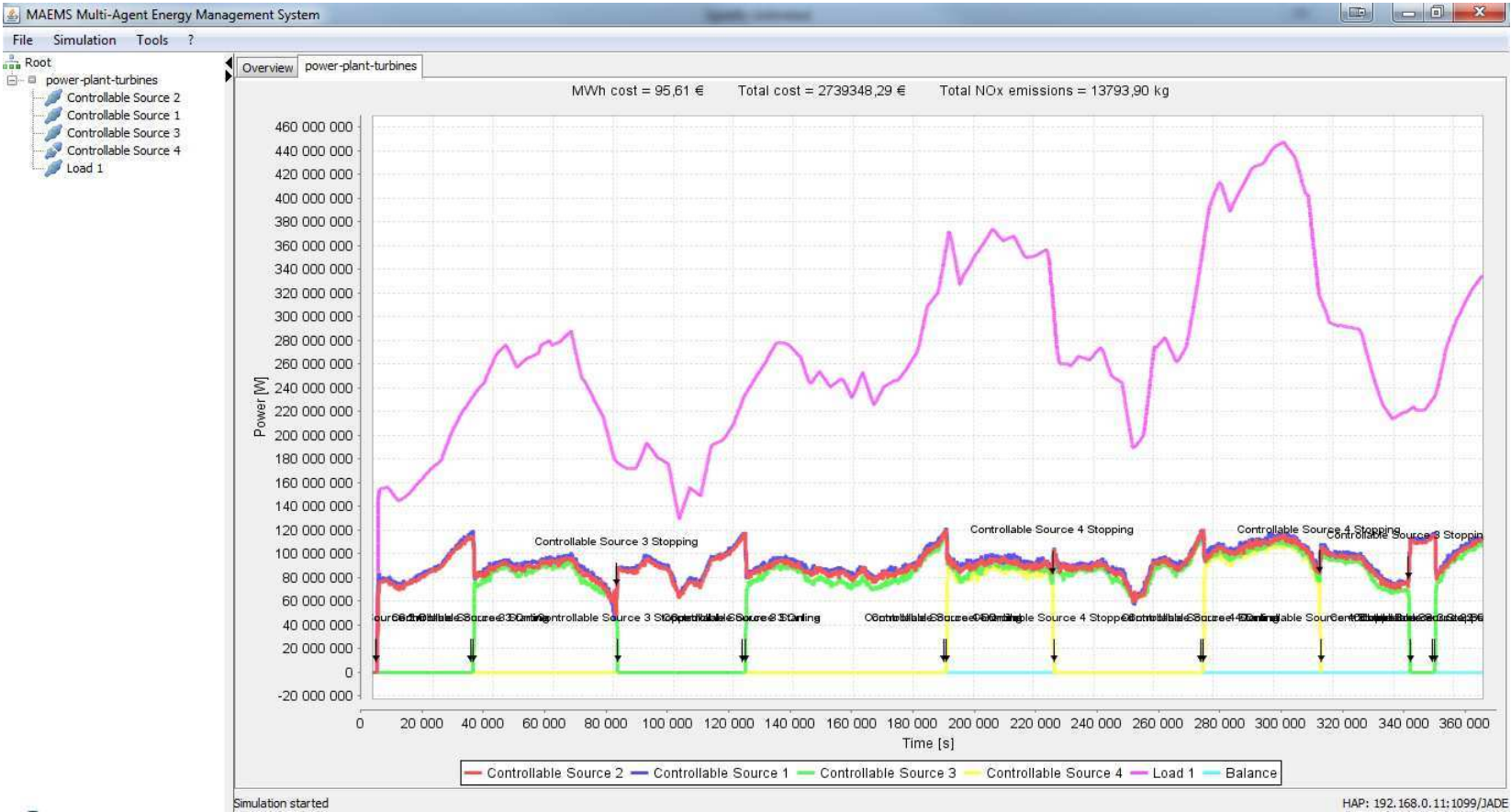

Figure 3.13: Screenshot of the developed GUI.

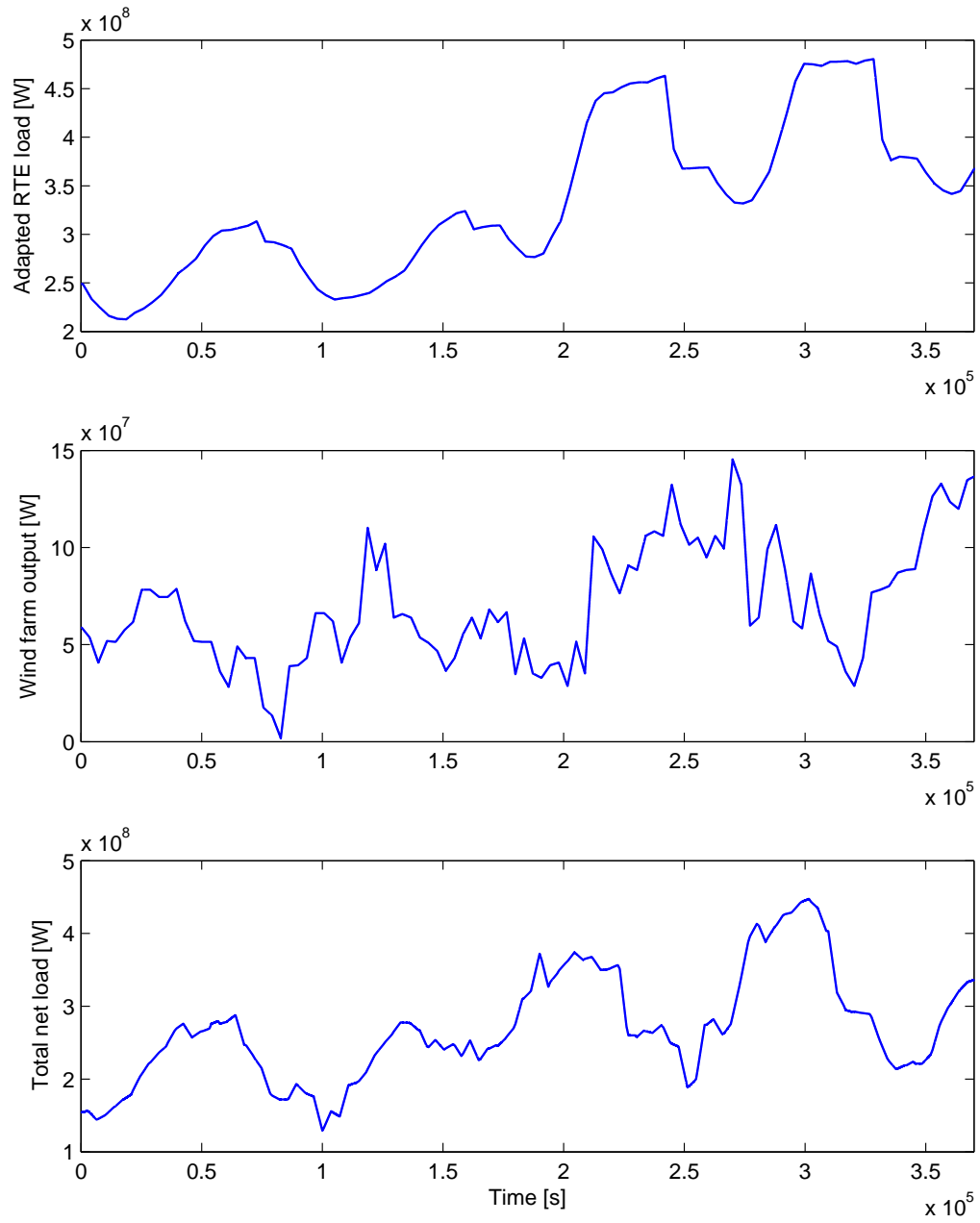

Figure 3.14: Total French load from RTE (top), synthetic wind farms output (middle), and load profile used in the simulations (bottom).

Parameter	Value
α_i	{1.0, 1.01, 1.02, 1.03}
c_{fuel}	0.3748 €/kg
γ_c	1
γ_{NO_x}	2,149 €/tonne
γ_{CO_2}	44.46 €/tonne
Δt	60 s
β_0	0.5
β_1	10^5
β_2	1
n_{iter}	3,000

Table 3.2: Selected simulation parameters.

does not consider the individual performance of each turbine. Results show that the performance of this algorithm is average for fuel costs; however, the lowest NO_x emissions are achieved. Fig. 3.15 shows that the turbines are in Modes 2 and 2 Extended during most of the simulation, except for turbine T3 that rapidly switches to Mode 3, which enables drastically reducing NO_x emissions.

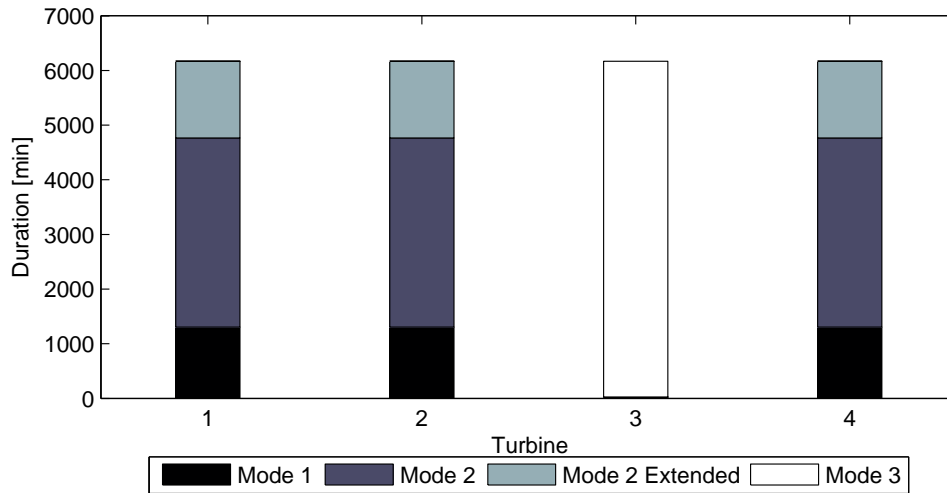

Figure 3.15: Duration spent by each turbine in each mode during the simulation for Algorithm A.

- *Algorithm B – Equal dispatch*: In this algorithm, the total load is dispatched equally between the turbines, regardless of their respective performance. This algorithm returns relatively low fuel costs, but also the highest NO_x emissions because, as shown in Fig. 3.16, all turbines switch to Mode 2 Extended where NO_x emissions are the highest.
- *Algorithm C – Fuel costs optimization* (DE with $\gamma_{\text{NO}_x} = \gamma_{\text{CO}_2} = 0$): Fuel consumption is the only objective, and as expected, the total fuel cost is reduced by 2.3%

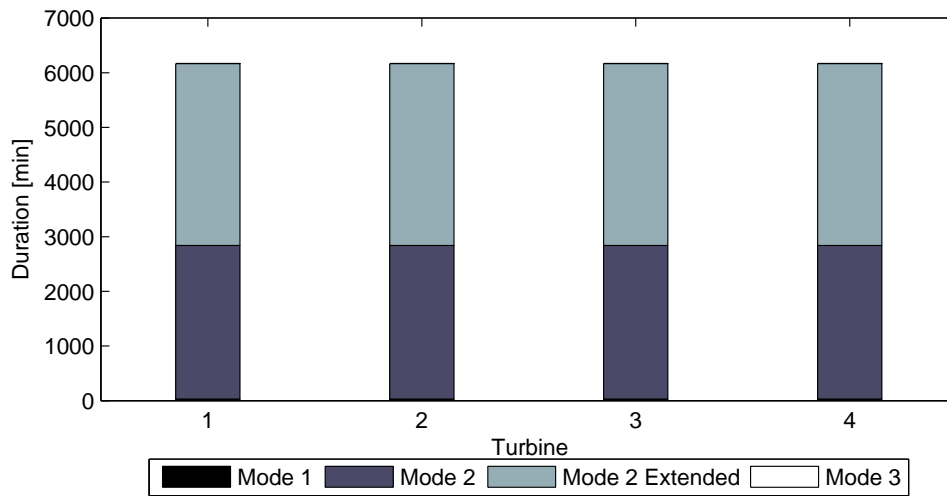

Figure 3.16: Duration spent by each turbine in each mode during the simulation for Algorithm B.

compared to Algorithm A, and is close to the cost returned by Algorithm B. If the same profile was run continuously, savings of about 5.1 million € could be achieved compared to Algorithm A over a year. In terms of operating modes (Fig. 3.17), results for this algorithm are similar to the ones observed for Algorithm B, except that the influence of the performance coefficients is observable: the higher the performance of a turbine, the more it is used.

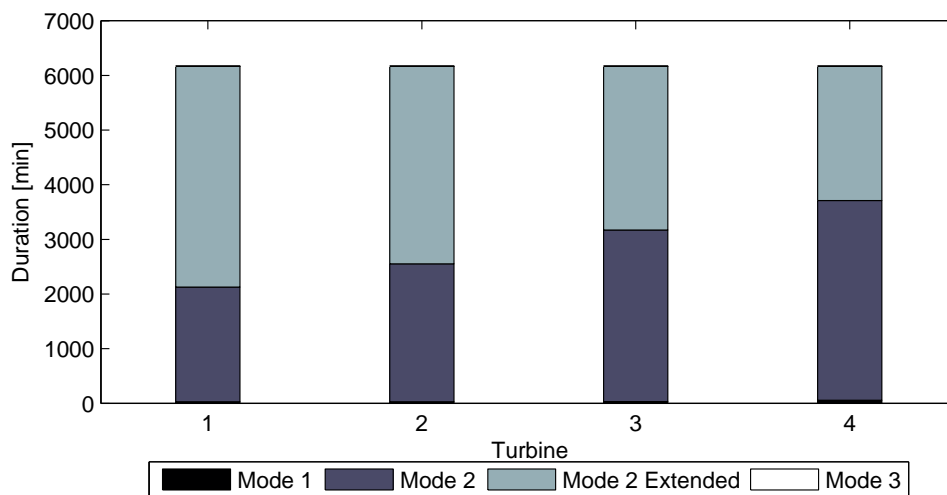

Figure 3.17: Duration spent by each turbine in each mode during the simulation for Algorithm C.

– Algorithm D – NOx optimization (DE with $\gamma_c = \gamma_{CO_2} = 0$): NOx emissions are

reduced by 34.8% compared to Algorithm B, but fuel costs increase by 3.4%. This algorithm achieves lower NOx emissions by minimizing the use of turbine T3, which spends more time in Modes 1 and 2 than the others (Fig. 3.18). However, contrary to what could be expected, this algorithm does not return the lowest NOx emissions and is outperformed by algorithm A. Additionally, this algorithm has the highest costs.

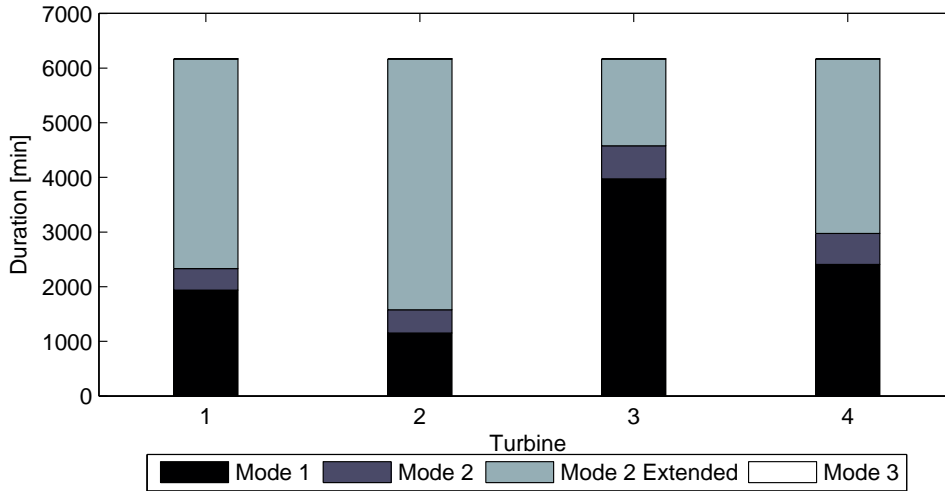

Figure 3.18: Duration spent by each turbine in each mode during the simulation for Algorithm D.

- *Algorithm E – Fuel and emissions optimization (DE)*: The costs of fuel and of emissions are combined to create a composite objective function, as in (3.26). Results show that the obtained fuel costs are close to the ones obtained for Algorithms B and C, while average NOx emission levels are obtained. Fig. 3.19 shows results similar to the ones obtained for Algorithm C.

For all algorithms, the maximum total imbalance remains low, with less than 0.05%, which means that the balance constraint is verified. As expected, the lowest costs are obtained for Algorithm C, but fuel costs for Algorithms B and E are also very close.

However, the counter-performance of Algorithm D on NOx emissions is more surprising, although the total emission levels are close to the ones obtained by Algorithm A, which has the best performance on this criterion. This result can be partially explained by the fact that the algorithm, without the SSA, has only limited means to lower NOx emissions, especially as it is not capable of taking into account load forecasts. The SSA should however help improve these results.

Finally, Algorithm E manages to obtain rather low costs and average NOx emissions at the same time; the impact of the high price for NOx emissions is clearly observable. This last algorithm thus proposes an interesting compromise solution, taking both fuel costs and emissions into account.

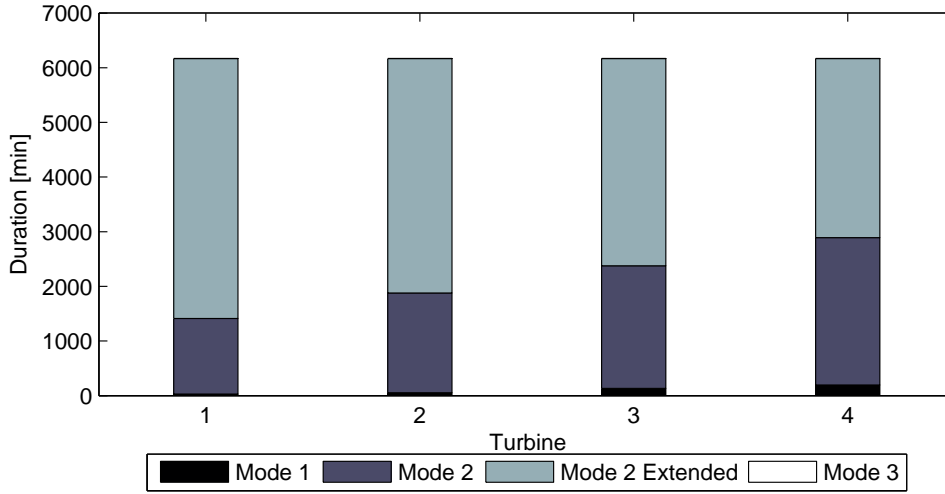

Figure 3.19: Duration spent by each turbine in each mode during the simulation for Algorithm E.

Algorithm	Fuel costs (k€)	NOx (kg)	CO ₂ (ktonne)
(A) Sequential dispatch	3,069.7	14,452	20,379
(B) Equal dispatch	2,999.1	22,682	19,910
(C) Fuel costs optimization	2,998.8	22,240	19,908
(D) NOx optimization	3,099.8	14,799	20,579
(E) Cost and emissions optimization	3,000.4	19,150	19,919

Table 3.3: Results for each dispatching algorithm without the SSA.

3.6.4 Performance Coefficients Effectiveness

As the efficiency of turbines varies over time and with maintenance, performance coefficients were introduced in (3.2). Three elements are used to measure the impact of these coefficients, using results for Algorithms B and C: (1) by comparing the total fuel costs and emissions; (2) by comparing the total energy generated by each turbine to meet the same demand; and (3) by comparing the time spent by each turbine in the first two modes.

As shown earlier in Table 3.3, the coefficients enable reducing costs and emissions. In addition to these results, Table 3.4 and Figs. 3.16 and 3.17 show how coefficients impact the behavior of each turbine. For example, turbine T1, which has the best performance, produces more energy (i.e., is more used) than the other ones, and the higher the coefficient, the less the turbine is used. As a consequence, the best performing turbines spend less time in Modes 1 and 2.

3.6.5 Start and Stop Algorithm Effectiveness

In addition to the optimal dispatch algorithm, the SSA is another way to further cut costs and emissions. Moreover, as shown earlier with NOx emissions, the system needs to

Metric	Unit	Algorithm	T1	T2	T3	T4
Coefficient	–	–	1.0	1.01	1.02	1.03
Energy	GWh	B	6.8759	6.8759	6.8759	6.8759
		C	7.3153	7.0248	6.7207	6.4418
Mode 1	min	B	30	30	30	30
		C	28	30	32	56
Mode 2	min	B	2,810	2,810	2,810	2,810
		C	2,100	2,523	3,140	3,656

Table 3.4: Impact of the performance coefficients on dispatching results.

be guided because it does not have a knowledge of the full emissions curve of the turbines, but only of a portion of it due to ramp rates. Consequently, the decisions of the algorithm at time t depend on the decisions it took earlier. Additionally, the algorithm has no memory, learning capability, or forecasting ability for periods longer than an hour. The SSA is therefore expected to increase the time spent by each turbine in Mode 3, where NOx emissions are the lowest.

In order to tune the parameters of the SSA so that it operates properly and efficiently, several simulations were run for fuel costs optimization with various values of R_{start} and R_{stop} . The system is allowed to choose which turbines to turn off or on and when to do it. Reserve values ranging from 0 to 30% (with increments of 10%) were selected and tested. Results showed that any combination including 0 leads to unserved energy, as the turbines do not have enough time to start. Also, choosing values of R_{start} and R_{stop} such that $R_{\text{start}} > R_{\text{stop}}$ leads to a chaotic behavior where turbines are started and stopped for short periods of time. Results with the lowest costs are obtained for reserve values equal to 10%. This value is therefore selected for running the tests. Higher values result in higher costs and emissions, as the algorithm is more conservative in the decisions it takes.

Simulations with Algorithms C, D and E are re-run with the SSA enabled and the selected reserve values, and turbines T1 and T2 are turned-on by default. Results in Table 3.5 show that the SSA can reduce fuel costs by 8.7% for fuel costs optimization. NOx emissions are dramatically cut by all algorithms, especially for Algorithm D (-21.9% compared to without the SSA), which now achieves the lowest NOx emissions, and for Algorithm C (-28.6%). Similarly to without the SSA, Algorithm E returns a fuel cost close to the one obtained by Algorithm C, with moderately low NOx emissions. Compared to Algorithm A, the SSA and the dispatching algorithms enable reducing fuel costs and CO₂ emissions by 10.8% (Algorithm C), and NOx emissions by 20.0% (Algorithm D).

Algorithm	Fuel costs (k€)	NOx (kg)	CO ₂ (ktonne)
(C) Fuel costs optimization	2,739.1	15,885	18,184
(D) NOx optimization	2,780.7	11,557	18,461
(E) Cost and emissions optimization	2,739.9	13,794	18,186

Table 3.5: Results for each dispatching algorithm with the SSA.

Figs. 3.20 to 3.22 provide additional details on the behavior of the algorithms with respect to turbine operation modes. The duration spent by each turbine in each mode

show that the SSA enables one to two turbines to operate in Mode 3, which was never used earlier except for Algorithm A, and strongly impacts the amount of NO_x emitted. At the same time, turbines T3 and T4 are temporarily stopped when they are not required, which enables achieving lower fuel costs and emissions.

These results also show that in a best case scenario (i.e., switching from the worst case to the best), fuel costs can be reduced by as much as 360 k€, and NO_x emissions by as much as 10.6 metric tonnes, simply by using the SSA and the optimization algorithms, and for the selected load profile.

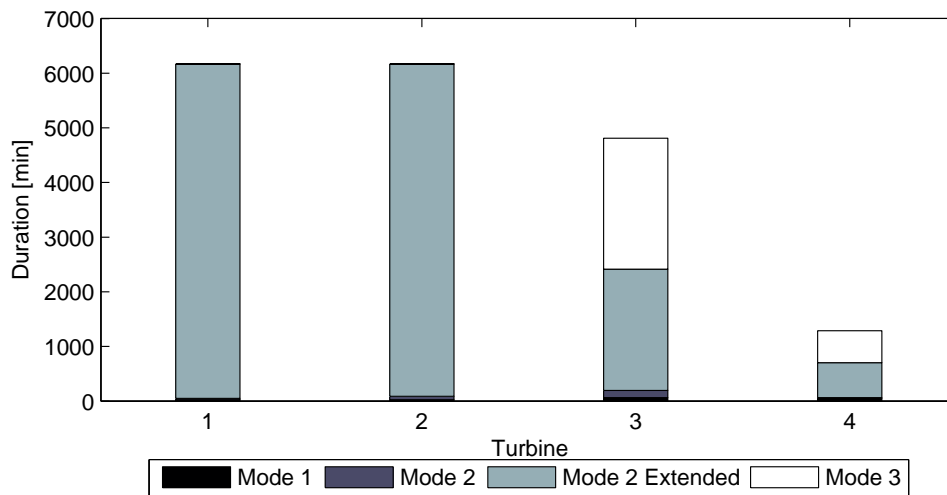

Figure 3.20: Duration spent by each turbine in each mode during the simulation for Algorithm C with the SSA enabled.

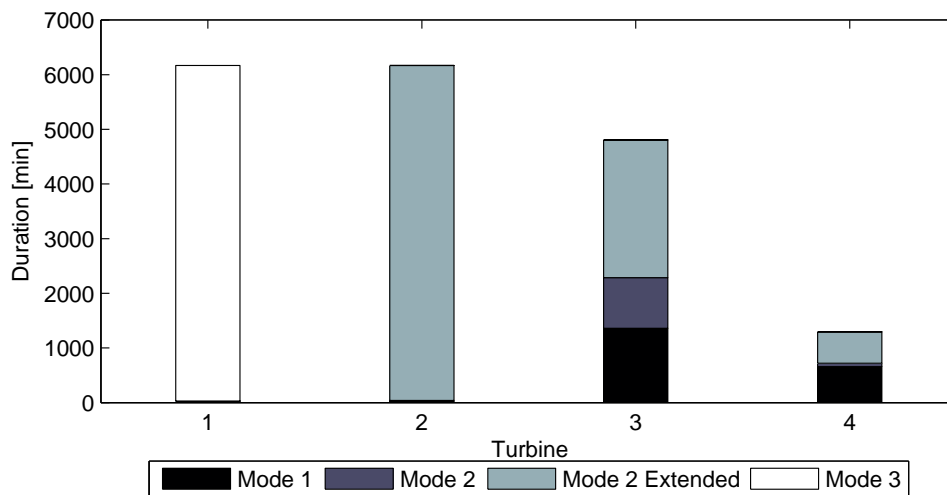

Figure 3.21: Duration spent by each turbine in each mode during the simulation for Algorithm D with the SSA enabled.

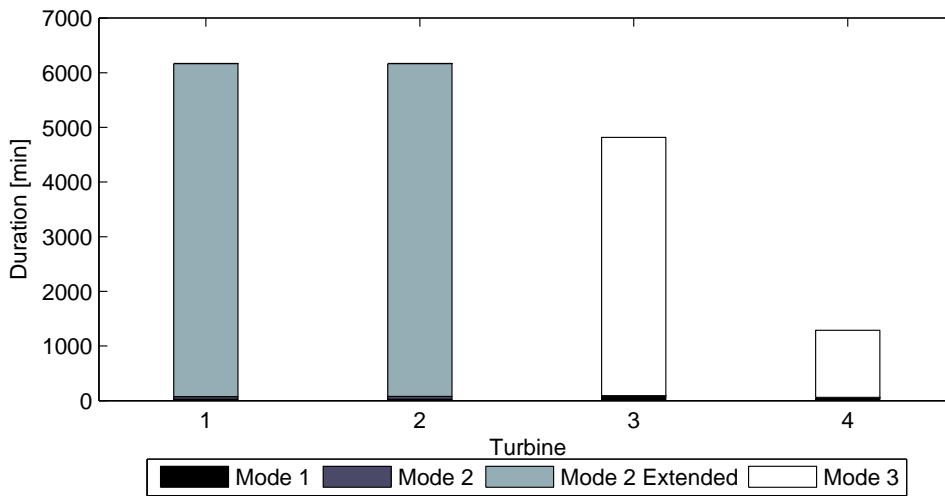

Figure 3.22: Duration spent by each turbine in each mode during the simulation for Algorithm E with the SSA enabled.

3.6.6 Energy Costs Comparison

In order to compare the cost efficiency of the algorithms, the instantaneous cost per MWh generated is plotted in Fig. 3.23. Results show that, as observed earlier with total costs results, the optimization algorithms and the SSA enable significantly improving the efficiency of the system. The peaks present in Fig. 3.23 for Algorithm C with SSA are the result of turbines stopping, which mathematically increases the cost per MWh generated.

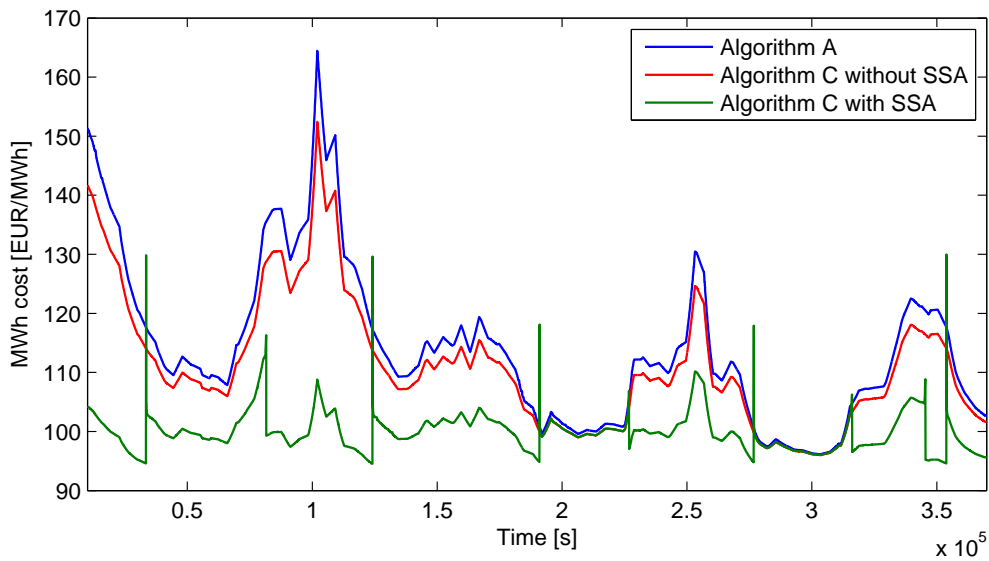

Figure 3.23: Comparison of the MWh costs obtained by the algorithms.

3.6.7 Flexibility and Resilience Test

The claimed flexibility and resilience of the system relies on its architecture, but needs to be tested on an example. The outage of a turbine is simulated to analyze the behavior of the algorithms. Fig. 3.24 shows that the EMS is capable of responding to the situation quickly and to minimize its impact, by reducing as much as possible the unserved energy. At mark 1, turbine T1 fails and is immediately disconnected. Turbine T2 increases its output to its maximum value. At mark 2, right after the failure has been detected, turbine T3 starts and increases its output as fast as possible to replace the power lost from T1. The simulation then goes on as it would have without the failure, at mark 3. The system has thus managed to keep operating despite the unexpected loss of a turbine.

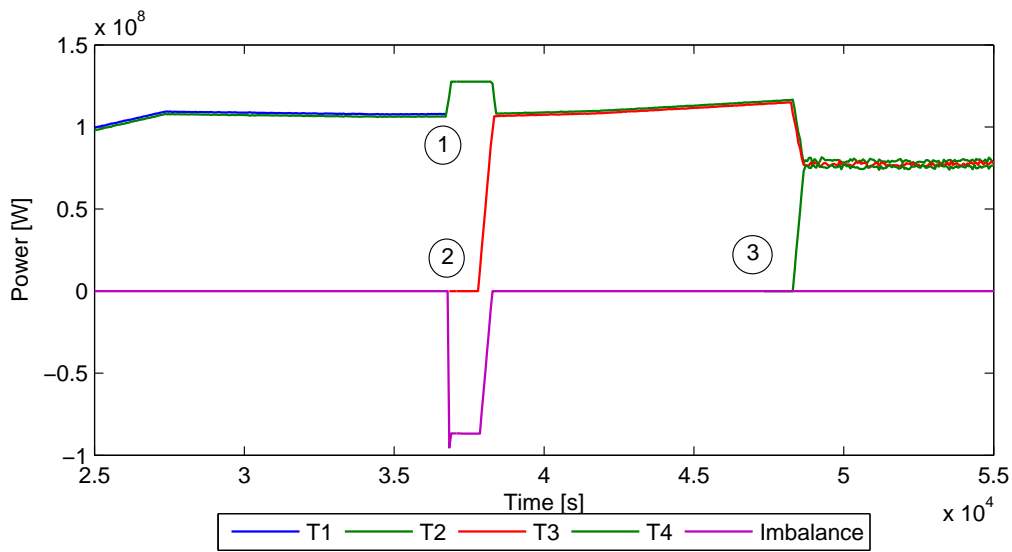

Figure 3.24: Results of the flexibility test, based on [39].

In addition to this test, the ones run in the following section with various numbers of turbines also show that the system can be adapted to different power plant sizes, and could also include various types of turbines as long as their characteristics, costs and emission curves are inputted in the system.

3.6.8 Communication and Computation Requirements

The last series of tests concerns the communication and computational power requirements of the system. Intuitively, the more agents there are, the higher their needs, but the increase rate has to be empirically quantified. Simulations are run on a dedicated Sony S12V9E laptop with a 2.40 GHz CPU.

From the results in Table 3.6 and Fig. 3.25, empirical expression giving the number of messages exchanged and the optimization duration as a function of the number of turbines are obtained. The mean number of messages n_{mess} exchanged between the agents for one round increases linearly with the number of turbines in the system n_{turb} (3.27). The mean

optimization duration t_{opt} increases at least polynomially with n_{turb} (3.28).

$$n_{\text{mess}} = 5.0 n_{\text{turb}} + 18 \quad (3.27)$$

$$t_{\text{opt}} = 0.44 n_{\text{turb}}^2 + 9.5 n_{\text{turb}} + 39 \quad (3.28)$$

These empirical results indicate that the requirements in communication and computation power are limited, and that managing up to a few dozens of turbines is possible. However, controlling a large number of sources would increase these needs rapidly (especially as the number of iterations in the optimization would have to be increased). A more decentralized control system would become more appropriate, although the algorithms would perform less well than in the proposed centralized architecture.

n_{turb}	n_{mess}	t_{opt} (ms)
1	23.0	43.7
5	42.7	95.1
10	67.4	197.2
20	117.8	389.2
30	166.9	726.6

Table 3.6: Number of messages exchanged and optimization duration as a function of the number of turbines to control.

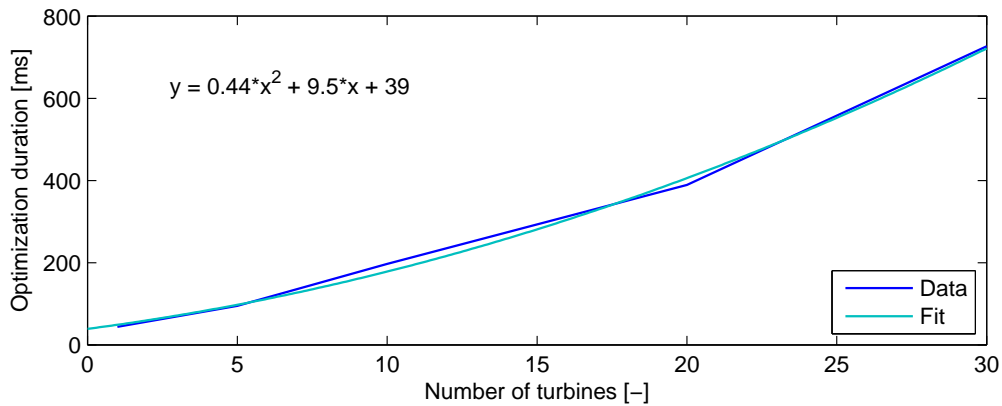

Figure 3.25: Plot of the mean optimization duration as a function of the number of turbines to control.

3.7 Conclusion

This chapter has presented a flexible, resilient and efficient gas power plant EMS based on a multi-agent architecture, which enables the EMS to adapt to a large variety of power plant structures, as well as to their temporary or definitive evolutions, and facilitates its transfer to the real system mostly by taking into account communication aspects by defining how agents interact. Another advantage of the EMS is its ability to run with several dispatching algorithms according to the objectives and constraints of the operator.

Simulations based on actual data of GE 9E turbines have shown that the algorithms are capable of reducing costs and NOx emission levels, and that further reductions can be achieved using the SSA.

4

Aggregator-Based Residential Demand Response

Contents

4.1	Demand Response	86
4.1.1	Drivers and Components	86
4.1.2	State-of-the-Art	88
4.1.3	Proposed Approach	89
4.2	System Architecture	89
4.2.1	T&D Infrastructure	90
4.2.2	Demand Response Aggregators	91
4.2.3	Demand Response Market	91
4.2.4	Residential Customers	92
4.3	Residential Load Model	93
4.3.1	Enabling Technologies and Assumptions	93
4.3.2	Electric Water Heater Model	93
4.3.3	Air Conditioning Model	95
4.3.4	Appliances Model	95
4.3.5	PHEV Fleet Model	98
4.3.6	PV Model	101
4.4	System Operation	101
4.4.1	Objective and Constraints	101
4.4.2	Metering Mode	102
4.4.3	Demand Response Event Mode	102
4.4.4	Rescheduling Algorithm	104
4.5	Simulation Results	107
4.5.1	Simulator	107
4.5.2	Test Case	108
4.5.3	Simulation Parameters	108
4.5.4	System-wide Net Load Results	110
4.5.5	Results for Residential Customers	113
4.5.6	Impact on the Distribution System	113
4.6	Conclusion	116

4.1 Demand Response

4.1.1 Drivers and Components

Electricity demand for the residential sector in the US is expected to grow by 18% from 2010 to 2035, not only due to population growth but also due to changes in consumption patterns and habits [146]. The deployment of EVs transfers a part of the total energy consumption from the transportation infrastructure to the electricity infrastructure, and may cause increases in peak load on distribution systems [147]. In order to meet these demand peaks, utilities usually resort to increasing generation capacity and distribution assets, e.g., by building new power plants, and installing larger transformers, transmission lines, and distribution cables. Such changes require expensive investments, and the operational costs of peaking power plants (gas or coal-based) are also generally more expensive than their base load counterparts [148]. Instead of trying to increase generation, transmission, and distribution capacity, other approaches, labelled as *demand-side management* (DSM) programs, try to mitigate demand in various ways (Fig. 4.1).

A first solution is to try to permanently reduce the energy consumption by resorting to *energy efficiency* solutions. The main objective of energy efficiency is to reduce the energy consumption for a same or better level of service for the consumer. This can be achieved through various means. An example is the improvement of housing insulation to reduce the energy consumed for space heating or cooling, through the use of better materials. Another common example is the use of compact fluorescent lights instead of traditional incandescent light bulbs — the latter consume more energy for a similar level of illumination than the former [149]. Although such approaches can result in potentially significant energy savings [150], the required capital investments are often prohibitive and tend to slow down the adoption of such technologies.

Another category of solutions is known as *demand response* (DR). The programs using this concept aim at reducing demand peaks by shifting or shedding loads directly or indirectly, in response to supply conditions. This concept has been in use in Europe and in the US under various forms since the 1980s [151], and has been gaining momentum again over the last few years. A study by the US FERC has shown that, in a best case scenario, a reduction of up to 20% in peak demand could be achieved by 2019 using DR programs [152]. As supply costs can exceed 1000\$/MWh during extreme demand peaks (while costs typically remain under 50\$/MWh most the time), DR could provide a solution to drastically reduce electricity costs during such peaks. Studies have shown that a 5% reduction in peak demand during the California energy crisis of 2000–2001 could have reduced highest prices by 50% [153]. In addition to 40% lower capital investment costs compared to building new power plants, DR can also be deployed as fast as in a few minutes [36, 153], which enables DR to participate in day-ahead dispatch and ancillary services. Examples of existing programs and benefits can be found in [154] and [155].

Two main categories of DR programs can be distinguished [157] (Fig. 4.1). A first category of solutions corresponds to non-dispatchable (non-event-based) programs based on custom pricing schemes, that rely on the assumption that customers tend to reduce their consumption when prices increase. Examples include:

- *Time-of-use* (TOU) schedules, in which the price paid for a kWh of electricity depends on the time window when it is consumed, and tends to be higher when demand

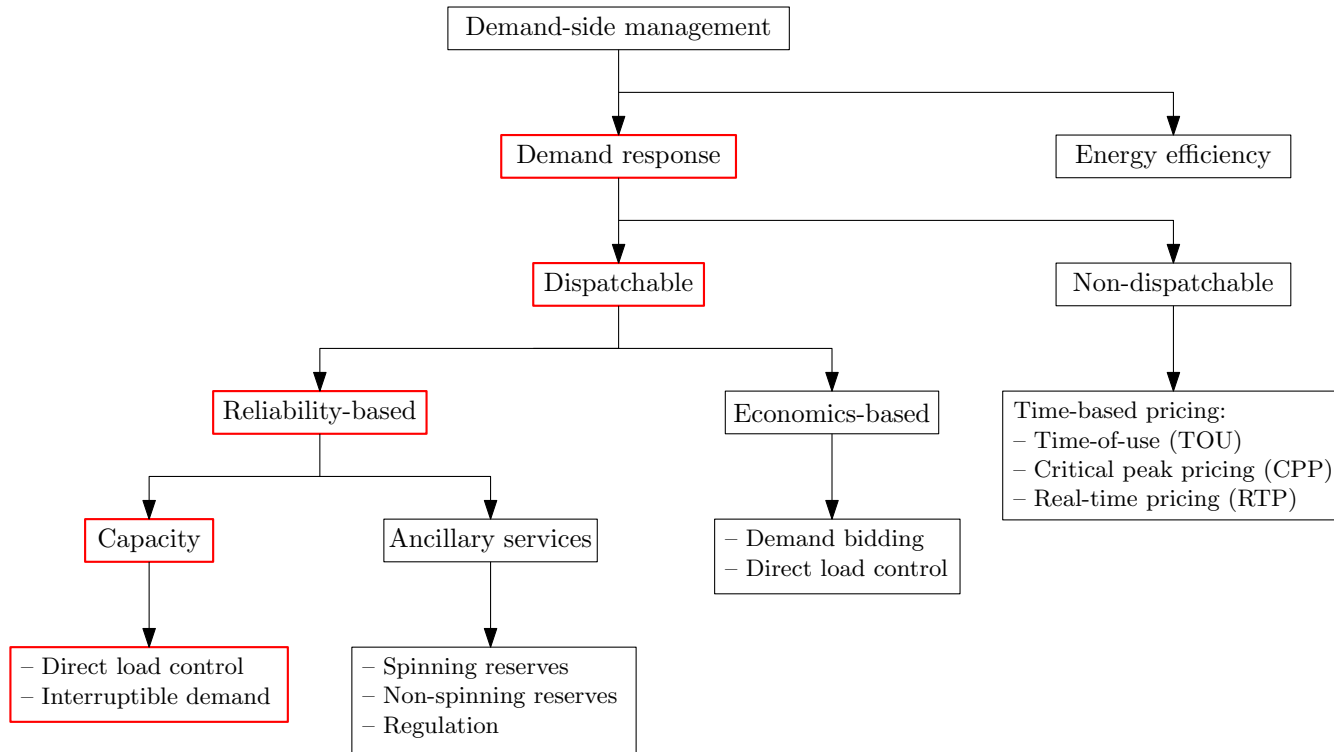

Figure 4.1: Main components of demand-side management, based on [156].

increases. On and off-peak periods are typically defined within each day, while the on-peak period may be different in winter and summer.

- *Real-time pricing* (RTP) schedules, in which prices vary in real-time with supply and demand, in order to better reflect generation costs.
- *Critical peak pricing* schedules, in which prices are higher during peaks, and especially when the peak load is much higher than the average load. This scheme may be combined with TOU schedules.

Another category of DR programs corresponds to dispatchable (event-based) DR systems, which use dedicated control systems to control loads in response to a signal sent by the utility to improve or maintain the reliability of the system, or to market price conditions. Two main types of dispatchable DR are used:

- *Interruptible demand* corresponds to loads that can be reduced or stopped, usually manually, with little or no notice. These programs are mostly suited for entities that may need low energy prices to be profitable, i.e., mainly industrial and commercial customers.
- *Direct load control* (DLC) programs are able to directly control specific loads, such as air conditioning and electric water heaters. These programs are best suited for residential and commercial customers, and are therefore favored for these applications.

Dispatchable programs are considered to allow a high degree of certainty compared to non-dispatchable programs, as they are capable of predicting the amount of load reduction with a higher reliability, and are also capable of reaching their goal faster than their price-based counterparts [156]. However, as such programs are event-based, they cannot be used more than a few times, perhaps a dozen times a year, which makes them only suitable to mitigate the largest peaks for short periods of time.

4.1.2 State-of-the-Art

Additionally, although such DR systems have been used for industrial and commercial customers for years, most DR programs offered by utilities for residential customers rely either on pricing schemes or on basic DLC, using only one type of load (typically air conditioning or water heaters), without taking into account the potential of newer technologies that are penetrating the distribution grid such as electric vehicles.

Existing research work has focused on the participation in DR of: PHEVs [158, 159]; thermal loads such as air conditioning (AC) and electric water heaters (EWHs) [160–162]; and other appliances [163]. Others have looked at incentives for DR participation [164] and at control architectures [165]. Thomas et. al [166] studied the impact of price-responsive residential demand on power market operations, but do not consider the need to achieve a given load reduction with a reasonable degree of confidence. Also, the focus is set on the impact of DR on markets, but not on how residential loads are used for DR.

As 38% of the US total demand is from residential customers [167], this essentially untapped potential provides opportunities for new residential DR systems [168]. Experiments have shown that load reductions of up to 1.5 kW per residential customer can be reached [154], which does not enable them to participate in power markets. *Aggregators*

are thus required, and are able to bid on markets using the aggregated capacity from their customers [169]. Depending on the local market structure, utilities themselves can serve as aggregators, which can also be independent commercial entities.

To the knowledge of the authors, no work in the literature examines how residential customers with diverse assets could participate in large-scale DR through aggregators, and with the ability to achieve a given load reduction with a reasonable degree of confidence. Communication aspects are also rarely considered.

4.1.3 Proposed Approach

This chapter addresses this concern and proposes an architecture for a DR system targeted at residential customers. Independent aggregators serve as interfaces between end-users and a DR market, where buyers and sellers of DR services can meet. Participating customers can have their PHEV, AC unit and EWH use controlled by the aggregator through a DLC program. This strategy is preferred to other solutions to enable the system operator to have a high level of confidence on the load reduction that is achieved by the DR system. It is also assumed that higher participation levels could be reached using such method, and may be better accepted by consumers than price-based programs.

Section 4.2 describes the architecture of the system and the roles of each element. In section 4.3, the models used for residential customers are presented. Section 4.4 details how the system operates using these architecture and models, by specifying how the various elements interact with each other to reach the DR goal. Finally, section 4.5 presents an analysis of the simulation results at both the system and customer level. Commercial and financial aspects for aggregators and customers are not discussed.

4.2 System Architecture

The architecture of the proposed system, as shown in Fig. 4.2, contains several elements: a T&D infrastructure with physical assets as well as market entities, such as aggregators, a DR marketplace, and residential customers. Commercial and industrial customers are not considered in this study.

4.2.1 T&D Infrastructure

The T&D infrastructure used in the proposed system reproduces a simplified version of the infrastructure found in North American power systems. This infrastructure contains physical and market assets. Physical assets include residential customers, load points, feeders, and substations, ordered by increasing voltage level. Customers are connected to the distribution system through load points and feeders, which are in turn connected to substations, themselves connected to the transmission system. In this study, substations are “transparent”, in that their role is not modeled or considered. Feeders and load points are only considered in the power system simulation described in section 4.5, and are not equipped any autonomous intelligence.

Two other entities are also included: DSOs and ISOs. DSOs are in charge of operating and maintaining the distribution infrastructure, while ISOs are non-profit entities in charge of maintaining the balance between supply and demand in the grid in the selected area,

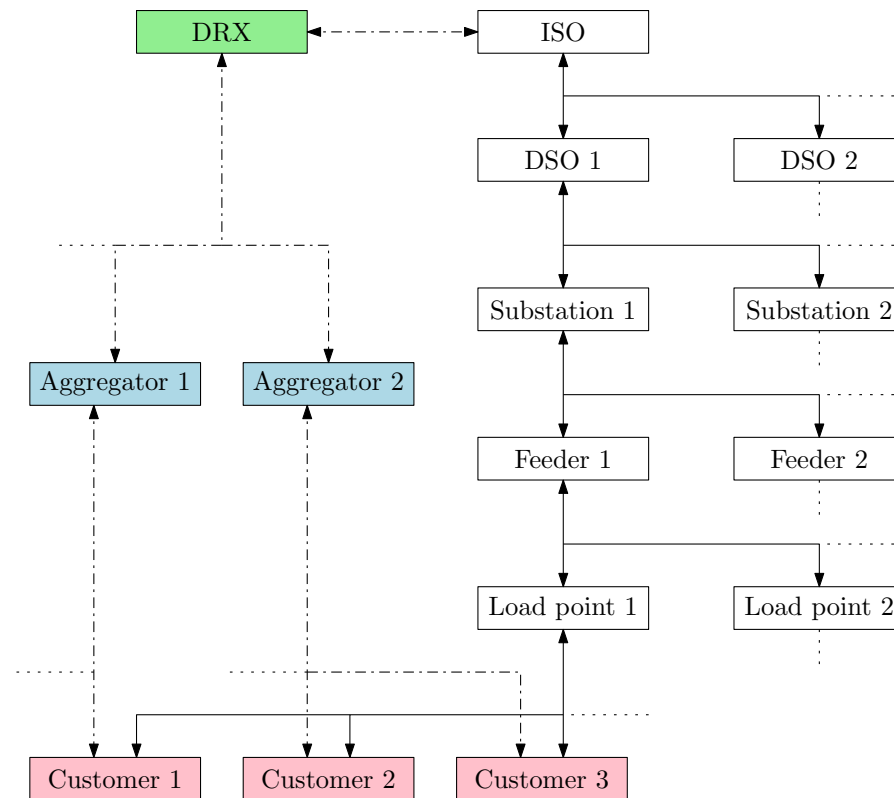

Figure 4.2: Architecture of the DR system. Short-dashed lines indicate that multiple avatars of entities are not represented, e.g., only three customers are shown while there are many. Dashed-dotted lines indicate communication channels, while plain lines indicate power and communication flows.

sometimes encompassing multiple US states, by providing non-discriminatory access to the transmission infrastructure and by facilitating competition among wholesale suppliers. Most ISO operations are regulated by the FERC. Based on load forecasts and on the knowledge of the available generation capacity, ISOs are capable of determining whether the stability of the regional grid is at risk, and are in charge of finding proper solutions, e.g., through the intermediary of markets. In case a transmission congestion or a temporary insufficient generation capacity or available transmission capacity is detected, the ISO may need to leverage available DR capacity to avoid making the grid unstable.

4.2.2 Demand Response Aggregators

Although large customers can sign up for DR programs directly with utilities, it is often simpler for them to outsource this activity to another entity, due to the regulatory, administrative and technical difficulties. Utilities may also resort to such entities for the same reasons. Aggregators are energy service providers that are capable of providing DR services. Companies such as EnerNOC and Comverge in the US [170] operate on this business model, and provide DR capacity to utilities, either directly or through markets. Contrary to large customers, smaller customers (e.g., residential customers) do generally

not qualify for direct DR programs with utilities, which are primarily targeted at customers with loads of at least a few MWs. For the same reason, smaller customers are also not able to participate in markets. A residential DR aggregator is therefore proposed to enable residential customers to participate in DR programs and markets through the intermediary of aggregators.

Each customer can have a specific contract with an aggregator, and make some of its loads available for curtailment or DLC under given conditions. By aggregating the capacity of thousands of small customers, aggregators are capable to participate in power markets where minimum capacities are usually of several MWs, something only large industrial customers could achieve on their own. For end users, the main benefit is the possibility to save on electricity bills, estimated to about \$40 per year per residential customers for a few DR events a year [153]. Several business model for aggregators are possible, and are not developed in this dissertation. However, it is assumed that several aggregators use different business models so that they are able to compete for residential DR capacity.

4.2.3 Demand Response Market

A DR market, or *DR exchange* (DRX), is implemented in the system and serves as a marketplace where DR is treated as a public good, and sellers and buyers of DR capacity meet. The DRX presented here is inspired by Nguyen et al.'s work [171], in which a pool-based DRX is proposed. Such market enables multiple players to benefit from DR, including ISOs, DSOs, retailers and aggregators. ISOs, and DSOs may for example need to buy DR capacity to improve the reliability of their system, while aggregators have some capacity to offer. Several applications of DR, such as transmission and distribution congestion management or peak shaving, may be achieved using the aggregator and DRX model.

A DRX operator collects the bids and offers from market players (buyers and sellers of DR capacity). The market is then cleared a day ahead according to specific objectives and constraints. In the present case, the players place bids for capacity, and aggregators submit offers based on the capacity they have at their disposal, the bid price, and the profit margin they intend to achieve. This enables multiple aggregators with different business models to compete for DR markets and customers. As market aspects are not developed in this work, it is also assumed that only a single ISO is capable of buying DR capacity.

4.2.4 Residential Customers

As the proposed system focuses on residential DR, other types of customers such as industrial, commercial and offices, are not considered. Residential customers are assumed to have typical loads (Fig. 4.3), such as air conditioning, electric water heating and other appliances listed in section 4.3.4. Some of the customers may also have DGs such as PV panels, and/or a PHEV. The V2G capability of PHEVs is not considered. The models used for these loads and sources are presented in the following section. The residential building is assumed to be equipped with a smart meter and an autonomous HEMS.

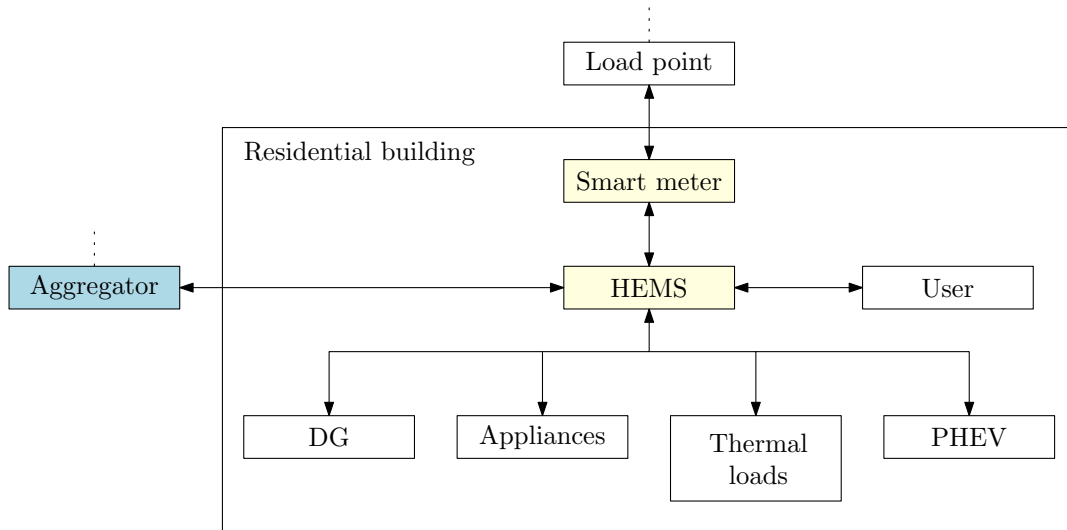

Figure 4.3: Diagram representing the interactions between residential loads, assets, smart meter, HEMS and the rest of the system.

4.3 Residential Load Model

Probabilistic residential load models rely on several methodologies based on statistical usage data and are used to generate synthetic load curves, corresponding to thermal loads such as air conditioning and electric water heaters, typical appliances, PHEVs and PVs. This bottom-up approach enables achieving DR operation with high granularity, where a specific load or asset from a given customer can be controlled separately from the rest.

4.3.1 Enabling Technologies and Assumptions

For the proposed system to operate properly, this paper assumes that several technologies are available and adopted by all considered residential customers, and are used according to the following principles:

- Each residence is assumed to be equipped with a smart meter owned by the utility. It is also assumed that the smart meter is only used for metering purposes.
- An intelligent HEMS capable of forecasting the load of the customer using weather and historical data (especially for thermal loads) [172], as well as schedule the recharge of a PHEV (if present) using user-supplied information [173], is also assumed to be present at each residence. In addition, the HEMS could also serve as an advanced home automation device, and would communicate with the smart meter.
- The customers who have a PHEV are assumed to have a charger with a rating of 1.8 kW (120 V / 15 A) or 7.2 kW (240 V / 30 A) [174,175]. The former does not require any special modification in the power installation of the user, while the second one does and would therefore be more expensive, although it would reduce the charging duration.

- The customers who have a PV installation on their roof are assumed to sell all the energy they produce to the grid, without storing it.
- Selected loads such as air conditioning (AC) units and electric water heaters (EWH) are assumed to be directly controllable by the HEMS, using signals sent by aggregators. These loads are all assumed to be electric.

4.3.2 Electric Water Heater Model

The selected EWH model is based on the model proposed in [176]. The water temperature is given by (4.1), where T_w is the water temperature, T_i is the indoor temperature, C_w is the tank thermal capacity, R_w is the thermal resistance of tank walls, K_w is the status of the EWH (1 for on and 0 for off), P_w is the maximum power output, c_p is the specific heat constant for water, q is the hot water flow, $T_{\text{ref},w}$ is the desired temperature set by the user, and T_{cold} is the temperature of the inlet water. Parameter values are given in Table 4.1, and are distributed according to a normal distribution with standard deviations arbitrarily chosen as 10% of the mean value.

$$C_w \frac{dT_w(t)}{dt} = -\frac{1}{R_w} (T_w(t) - T_i(t)) + K_w \cdot P_w - c_p \cdot q \cdot (T_{\text{ref},w} - T_{\text{cold}}) \quad (4.1)$$

The hot water flow is obtained assuming a daily consumption of 266l with 17 events of 15 minutes a day [176], each with the same amount of hot water consumed, and following a linear event distribution from 6am to 12am. Solving (4.1) for T_w yields the current temperature, which is then used as an input for the on-off controller of the EWH. This thermostat from [176] is given by (4.2), where ΔT_w is the deadband value (Fig. 4.4).

$$K_w(t) = \begin{cases} 0 \rightarrow 1, & \text{if } T_w(t-1) \leq T_{\text{ref},w} \\ 1 \rightarrow 0, & \text{if } T_w(t-1) \geq T_{\text{ref},w} + \Delta T_w \end{cases} \quad (4.2)$$

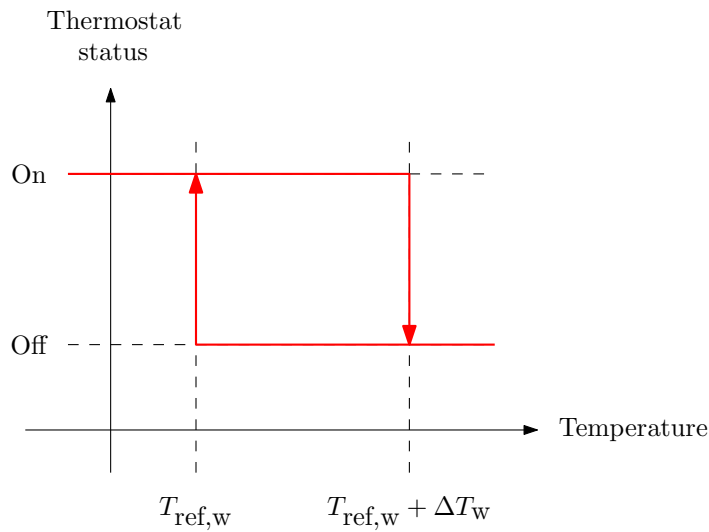

Figure 4.4: Operation principle of the EWH thermostat.

Variable	Mean value
C_w	0.351 kWh/°C
R_w	370 °C/kW
P_w	4.50 kW
c_p	0.00117 kWh/(°C·l)
$T_{\text{ref},w}$	60.0 °C
T_{cold}	15.0 °C
ΔT_w	5.00 °C

Table 4.1: EWH model parameters, with data from [176].

4.3.3 Air Conditioning Model

The AC model is based on a household temperature model given in (4.3) and proposed in [177], where T_i is the inside temperature, T_o is the outside temperature, ϵ is the system inertia, η is the coefficient of performance (COP) of the AC system, K_{ac} is its status (1 for cooling, -1 for heating, and 0 for off), P_{ac} is its maximum power output, and A is the thermal conductivity of the building. Parameter values from [177] are given in Table 4.2, and are distributed according to a normal distribution with standard deviations arbitrarily chosen equal to 10% of the mean value. As parameters are given in °F, the temperature is converted to °C at the end of the simulation.

$$T_i(t) = \epsilon \cdot T_i(t-1) + (1 - \epsilon) \left(T_o(t) - \eta \cdot K_{\text{ac}}(t) \cdot \frac{P_{\text{ac}}}{A} \right) \quad (4.3)$$

An hysteresis controller is adapted from (4.2), and uses the temperature model in (4.3) and user settings to decide when to turn-on or off the AC, as in (4.4), where $T_{\text{ref},i}$ is the optimal comfort temperature set by the user and ΔT_i is the deadband temperature (Fig. 4.5). The AC is assumed to operate for cooling or heating, depending on the outdoor temperature.

$$K_{\text{ac}}(t) = \begin{cases} 0 \rightarrow -1, & \text{if } T_i(t-1) < T_{\text{ref},i} - \Delta T_i \quad \text{[Heating]} \\ -1 \rightarrow 0, & \text{if } T_i(t-1) \geq T_{\text{ref},i} \\ 0 \rightarrow 1, & \text{if } T_i(t-1) > T_{\text{ref},i} + \Delta T_i \quad \text{[Cooling]} \\ 1 \rightarrow 0, & \text{if } T_i(t-1) \leq T_{\text{ref},i} \end{cases} \quad (4.4)$$

Variable	Mean value
ϵ	0.93
η	2.5
P_{ac}	3.5 kW
A	0.14 kW/°F
$T_{\text{ref},i}$	70.0 °F
ΔT_i	2.00 °F

Table 4.2: AC model parameters, with data from [177].

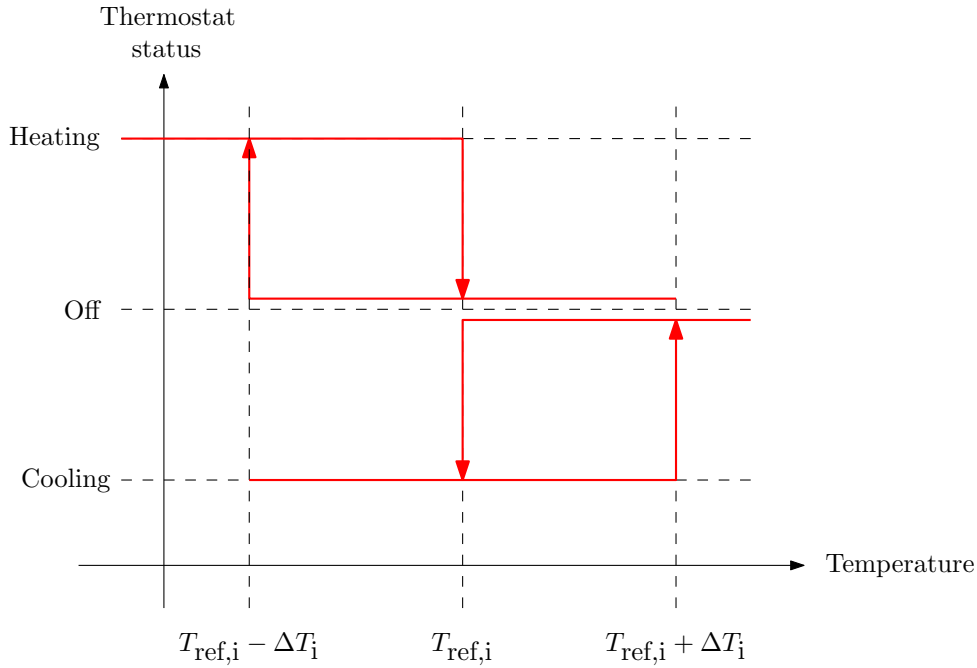

Figure 4.5: Operation principle of the AC thermostat.

4.3.4 Appliances Model

The probabilistic load curve model proposed by Dickert and Schegner in [178] is used to generate synthetic load profiles for appliances. Appliances include kitchen, laundry and household appliances, consumer goods (TV, computer, etc.) and lighting. A four step methodology adapted from [178] is used to generate the load profile of each appliance:

1. At first, the statistical penetration level for the appliance is used to generate whether or not the appliance is present in the household.
2. If it is present, the frequency of use, turn-on time and operation duration are generated according to random distributions (linear or normal) that depend on the appliance.
3. Similarly, the power consumption of the appliance is generated randomly according to a normal distribution.
4. Using the parameters obtained in the two previous steps, the load profile of the appliance is generated.

Parameters for appliances use are partially derived from [178] and are given in Table 4.3. Parameters not given in [178] were arbitrarily selected by the authors from their own use habits. For each daily occurrence of each appliance, a start time is obtained from one of the distributions listed in the start time column of Table 4.3. After the appliance has started, its power consumption is considered constant for a duration given in 15 min blocks.

Figure 4.6 shows the load curve obtained for a single customer over a day. The load curve includes not only appliances but also the load for the AC and the EWH (PHEVs

and PVs are not included). Figure 4.7, on the other hand, shows the aggregated (i.e., summed) load for 1000 customers, and is obtained using the same methodology as for a single customer. This aggregation of load assumes the same usage characteristics for all customers. The aggregated load curve is much smoother than the load curve of a single customer, and is similar to load curves generally observed on most distribution systems: a peak is observed in the late afternoon, between 4pm and 8pm; the load is lower at night; and increases again in the morning till late afternoon.

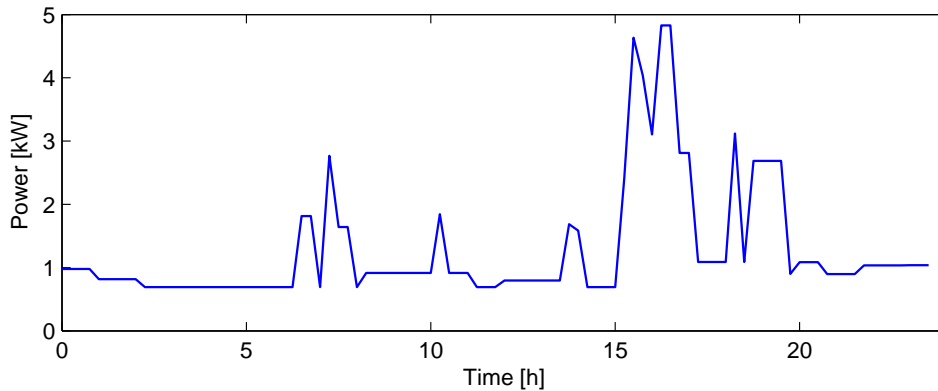

Figure 4.6: Load profile example for one customer.

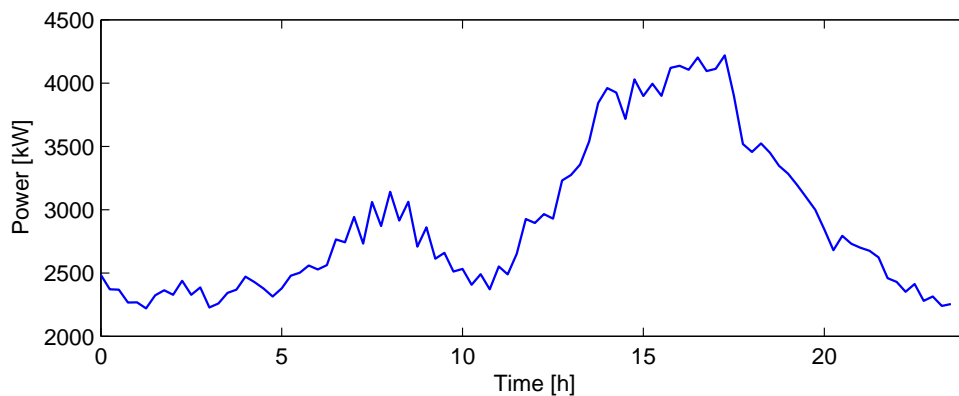

Figure 4.7: Aggregated load profile example for 1000 customers.

4.3.5 PHEV Fleet Model

The PHEV fleet generation methodology is based on the one presented in [179], and adapted and used in [174] and [175], that gives a realistic model of a PHEV fleet characteristics and usage data. PHEVs are identified as one of the means for deploying and integrating advanced electricity storage and peak-shaving technologies. Additionally, contrary to battery electric vehicles (BEVs), PHEVs have high driving ranges and can be used even when the battery is discharged. Due to this property and to range anxiety [180], PHEVs

Appliance	Penetr. [%]	Rating [kW]	Occur.	Start time [h]	Duration [15 min blocks]
Electric cooker	100	N(3.00,1.00)	2	N(12,1), N(18,1)	3
Water kettle	95	N(2.00,0.20)	2	N(8,1), L(14-18)	1
Dishwasher	95	N(1.60,0.10)	1	N(10,2), N(14,2), N(20,2)	4
Coffee maker	80	N(1.00,0.20)	2	N(7,1), L((14-18)	2
Microwave	85	N(1.00,0.10)	3	N(8,1), N(12,2), N(18,2)	1
Toaster	92	N(1.00,0.10)	1	N(9,1)	2
Fridge-freezer	100	N(0.13,0.03)	–	–	Continuous
Freezer	45	N(0.10,0.03)	–	–	Continuous
Other kitchen appl.	95	N(0.50,0.10)	3	N(8,1), N(13,2), N(19,2)	1
Washing machine	99	N(1.60,0.20)	1	L(8-20)	4
Laundry dryer	80	N(2.50,0.25)	1	L(10-22))	5
Vacuum cleaner	97	N(1.50,0.50)	1	L(10-20))	2
Hair dryer	80	N(2.00,0.10)	2	N(8,1), N(18,2)	1
Circulation pump	100	N(0.05,0.01)	–	–	Continuous
TV 1 and 2	99 and 80	N(0.15,0.03)	2	N(13,5), N(19,2)) and N(13,5), N(21,2)	16 and 8
PC 1 and 2	84 and 40	N(0.15,0.03)	1	N(14,7)	16 and 8
Hi-fi system	81	N(0.03,0.01)	1	N(19,3)	4
Other goods	100	N(0.05,0.03)	–	–	Continuous
Lighting	100	N(0.20,0.05)	2	N(7,1), N(19,3)	12

Table 4.3: Appliances model parameters, partially based on [178]. N(A,B) indicates that the value is obtained from a normal distribution with mean A and standard deviation B, and L(A-B), that the value is obtained from a linear distribution between hours A and B.

are expected to penetrate the market faster than BEVs, and are therefore considered in this study.

The selected methodology is separated in four main parts. In the first part, the penetration rate of PHEVs p_{phev} is used to determine whether the PHEV is present at the considered household. A random number r is generated from the uniform distribution, such that $r \sim U(0,1)$. If $r \geq p_{\text{phev}}$, then it is assumed that one PHEV is present in the household. Otherwise, the household is assumed to possess no PHEV, and only conventional internal combustion engine (ICE) vehicles.

If a PHEV is present in a household, the characteristics of the vehicle are generated according to the following procedure:

1. At first, the class of each PHEV is selected randomly from four vehicle classes, which are arbitrarily defined to provide a diverse representation of a future US vehicle fleet [174, 179]. The following vehicles are used as inspiration for each class: Honda Civic and Ford Taurus for class 1 (compacts), Honda Accord and Ford Taurus for class 2 (sedans), Ford Explorer and Ford F-150 for class 3 (medium sport utility vehicles (SUVs)), and Chevrolet Suburban and Chevrolet Silverado for class 4 (large SUVs).
2. Two PHEV control strategies are distinguished. In charge-depleting mode, the PHEV only uses power drawn from the battery for driving. When the charge depleting distance D_{dep} is reached, i.e., when the state-of-charge (SOC) of the battery reaches its lower limit, the ICE is switched on. In charge-sustaining mode, the ICE is used to maintain the SOC of the battery around a given average value. The variable $k \in [0, 1]$ represents the share of electric driving power for each vehicle, and is equal to 0 for an ICE vehicle and to 1 for a full electric one.
3. For each PHEV class, the used battery capacity B_{cap} and a value for k are selected according to a specific method that uses the ranges given in Table 4.4 for each PHEV class.

Class	Share [%]	B_{cap} range [kWh]	k range [-]	a_e [kWh/mi]	b_e [-]
Class 1	20	[8,12]	[0.2447,0.5976]	0.3790	0.4541
Class 2	30	[10,14]	[0.2750,0.6151]	0.4288	0.4179
Class 3	30	[17,21]	[0.3217,0.5428]	0.6720	0.4040
Class 4	20	[19,23]	[0.3224,0.4800]	0.8180	0.4802

Table 4.4: Main characteristics of the four PHEV classes, based on data from [179].

B_{cap} and k are assumed to be distributed according to a bivariate normal distribution, with a correlation parameter ρ of 0.8 as suggested in [179]. This type of distribution enables the possibility to have a correlation between B_{cap} and k , which should intuitively vary similarly. The parameters of the distribution are defined as follows, for each class. At first, the mean vector $\boldsymbol{\mu}$ is obtained using (4.5).

$$\boldsymbol{\mu} = \begin{bmatrix} \frac{k_{\min} + k_{\max}}{2} \\ \frac{B_{\text{cap},\min} + B_{\text{cap},\max}}{2} \end{bmatrix} \quad (4.5)$$

Then, the covariance matrix Σ is obtained using (4.6) to (4.8).

$$\sigma_k = \frac{k_{\max} - k_{\min}}{4} \quad (4.6)$$

$$\sigma_B = \frac{B_{\text{cap,max}} - B_{\text{cap,min}}}{4} \quad (4.7)$$

$$\Sigma = \begin{bmatrix} \sigma_k^2 & \rho \cdot \sigma_k \cdot \sigma_B \\ \rho \cdot \sigma_k \cdot \sigma_B & \sigma_B^2 \end{bmatrix} \quad (4.8)$$

Using the Cholesky decomposition, the covariance matrix is decomposed into a lower triangular matrix \mathbf{S} , such that $\Sigma = \mathbf{S} \cdot \mathbf{S}^T$. Then, a vector of two standard normal values \mathbf{N} is generated using the Box-Müller method, where N_{bm} is a standard normal value, and r_1 and r_2 are distributed from a uniform distribution $U(0, 1)$:

$$N_{bm} = \sqrt{-2 \cdot \ln(r_1)} \cdot \cos(2\pi \cdot r_2) \quad (4.9)$$

This vector \mathbf{N} is then used to obtain the desired multivariate normal distribution:

$$\begin{bmatrix} k \\ B_{\text{cap}} \end{bmatrix} = \boldsymbol{\mu} + \mathbf{S} \cdot \mathbf{N} \quad (4.10)$$

4. The required energy per mile driven E_{mil} is a performance metric of the vehicle, and is generated using (4.11) where a_e and b_e are given in Table 4.4 for each class.

$$E_{\text{mil}} = a_e \cdot k^{b_e} \quad (4.11)$$

5. The charge-depleting distance D_{dep} is then obtained with (4.12).

$$D_{\text{dep}} = \frac{B_{\text{cap}}}{E_{\text{mil}}} \quad (4.12)$$

In the third part of the methodology, the daily usage characteristics of the PHEVs are obtained. These characteristics include the daily driven distance D_{dri} , the energy required to fully recharge the battery of the PHEV E_{rec} , and the departure and arrival time from and to the residence.

1. D_{dri} is derived from a log normal distribution, with mean μ_m and standard deviation σ_m , as in (4.13) where r is a standard normal random number. In this case, μ_m and σ_m are assumed to be equal to 3.37 and 0.5, respectively, as in [179].

$$D_{\text{dri}} = \exp(\mu_m + \sigma_m \cdot r) \quad (4.13)$$

2. The daily energy to recharge the PHEV required from the grid E_{rec} is equal to the battery capacity if the driven distance is equal to or larger than the depleting distance, or to the consumed driving energy if not, as in (4.14).

$$E_{\text{rec}} = \begin{cases} B_{\text{cap}} & \text{if } D_{\text{dri}} \geq D_{\text{dep}} \\ D_{\text{dri}} \cdot E_{\text{mil}} & \text{otherwise.} \end{cases} \quad (4.14)$$

3. The departure and arrival times t_{dep} and t_{arr} , respectively, are obtained using (4.15) and (4.16), where N_1 and N_2 are standard normal random numbers obtained with (4.9), μ_{dep} and μ_{arr} are the departure and arrival mean times, and σ_{dep} and σ_{arr} are the corresponding standard deviations. Values for these parameters from [179] are given in Table 4.5 for a typical weekday.

$$t_{\text{dep}} = \mu_{\text{dep}} + \sigma_{\text{dep}} \cdot N_1 \quad (4.15)$$

$$t_{\text{arr}} = \mu_{\text{arr}} + \sigma_{\text{arr}} \cdot N_2 \quad (4.16)$$

Parameter	Departure	Arrival
Mean	7.0	18.0
Standard deviation	1.732	1.732

Table 4.5: Departure and arrival time distribution parameters of PHEVs for a typical weekday, based on data from [179].

In the last part of the methodology, the battery charger present in the household is selected and determines the charging rate. As in [179], the rating of the charger is obtained from a random distribution, where each rating (1.8 or 7.2 kW) has a 50% probability to be picked.

From these results, the initial charging schedule of the PHEV, i.e., its load curve, can be established, as in Fig. 4.19. The initial charging schedule is based on a simple strategy in which the vehicle starts charging as fast as possible as soon as it arrives at the residence, and until the battery is fully charged. In the following, the charging efficiency is assumed to be equal to 0.88, as in [181].

4.3.6 PV Model

The output of the photovoltaic panels is obtained using a methodology similar to the ones employed for the appliances and the PHEVs: if a PV is present at the considered household, its rating P_r is obtained from a normal distribution with mean 5.9 kW and a standard deviation of 3 kW [182]. The output of the system is simply obtained using an irradiation profile E given in W/m^2 as input, as in (4.17), which is then normalized with respect to the “one sun” ($1000 \text{ W}/\text{m}^2$) method [183].

$$P_{PV}(t) = \frac{E(t)}{1000} \cdot P_r \quad (4.17)$$

4.4 System Operation

4.4.1 Objective and Constraints

The objective of the proposed system is to shape the load so that it remains under a given threshold for a given duration, typically a few hours, using curtailable and shiftable capacity made available by residential customers through aggregators. In the following, the term *event* is used to refer to the time during which the proposed DR system operates

to maintain the load under the threshold. The selected constraints set for system operation require that, after the DR system has been run:

- Thermal loads (AC and EWH) can be controlled by the aggregator as long as critical temperatures are not reached.
- PHEVs should be fully charged by the time the user has specified.
- Users can manually override settings until one hour before the event begins. This duration is arbitrarily selected so that aggregators have enough time to adapt their strategy to meet the total bid capacity, based on the number of customer overrides.

The proposed system can operate in two modes: for metering, and for solving a DR event.

4.4.2 Metering Mode

The first mode is used for basic metering purposes, i.e., for obtaining the forecast and actual load in each location of the system. In this mode, the T&D infrastructure described earlier is used to obtain the load at each node of the system. A request is issued by the ISO and is transmitted in the hierarchy down to the end customers. Each customer then measures its net load and sends it to the element that originally sent the request, i.e., the feeder. The feeders aggregate the answers of the customers that are connected to it, and send the results to the substation they are connected. The same process is repeated along the infrastructure hierarchy. At the end of this process, the net load in each node of the system is known. This mode is used primarily to obtain the actual net load in the system after the DR action has been taken. It is also used to obtain a baseline load curve before the event; in reality, this would be achieved using load forecasting algorithms.

4.4.3 Demand Response Event Mode

The second mode is more elaborate and uses the elements listed earlier to implement a DR action. In this mode, the elements of the system interact and cooperate to solve a DR scenario such as a congestion [166]. Fig. 4.8 shows the main chronological steps of a DR event, seen from the point-of-view of a residential customer: the customer is noticed in advance that a DR event is going to happen, and receives information about its characteristics, e.g., start time, duration, etc.; then the DR is deployed, until the end of the planned event when the loads affected by DR are released. The recovery period may last a few hours, depending on the strategy used by the aggregators, and after this period is over, the system is back to normal operation.

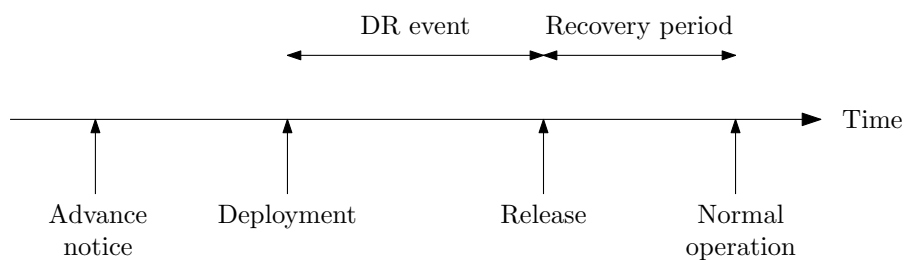

Figure 4.8: Main chronological steps of a DR event, from the point-of-view of a customer.

However, many more steps have to be followed before the DR capacity is actually deployed (Fig. 4.9). These steps follow a process that starts a day before the DR event:

1. The area ISO detects a potential transmission congestion issue for the next day using load and generation forecasting. It computes the required DR event duration and capacity, i.e., the load to curtail and shift. The ISO then submits a request for this capacity to the DRX containing the event start time, duration, the required capacity, and the MWh price. According to FERC order 745, this price is equal to the price offered to generators [184].
2. The DRX informs all registered aggregators that a request has been received, and provides them with its characteristics.
3. Aggregators request the customers that have a contract with them to submit the capacity they are willing to curtail during the event, using the provided event characteristics.
4. The HEMS of each customer computes the average capacity that is predicted for curtailment or shifting during the event, and reschedules the recharge of the PHEV accordingly, if required. The bid is then submitted to the aggregator. Bids contain the average value of the predicted load reduction over the event duration. In this study, three categories of loads are used, in the order of decreasing curtailment priority: PHEVs, thermal loads (AC, EWH), and others loads (which are not considered for DR). These loads are selected because they have a limited impact on customers if their use is scheduled properly, and because the corresponding load reduction during the DR event can be quantified.
5. Aggregators centralize the bids from the customers, and decide on a bid for the DRX according to their respective internal criteria and business model.
6. Using the bids of the aggregators and the offer of the ISO, the DRX dispatches the capacity among aggregators and informs the ISO of whether the request can be fully met or not. As the ISO is neutral and non-partisan, it is assumed in this study that each aggregator is allocated a portion of the total required DR capacity proportional to its bid.
7. Aggregators randomly select customers to commit to their bid capacity, until 200% of the bid capacity aggregators are expected to achieve is reached. The value of this adjustment coefficient α is obtained empirically in this study, and accounts for several phenomenon: 1) customers bid their average load reduction, but the goal is to mitigate the peak, which requires to curtail more than the average amount; 2) new loads may be switched-on during the event; 3) other loads may increase their consumptions; and 4) customers may later override the committed capacity, which needs to be compensated. Lower values would result in the total net load exceeding the threshold value during the event.

After the commitment has occurred, and until one hour before the event begins:

9. Each customer that has been requested to curtail or shift load by an aggregator has the ability to manually override this automated commitment, using the HEMS interface. This could also be achieved through a dedicated smartphone application [185]. Choosing to override a DR event would reduce the financial benefit for the customer.

Right before, during, and after the event:

10. Aggregators send a signal to the customers that have committed to curtail or shift their loads to implement the plan they committed to. From this moment on, the customer is assumed not to be able to override the curtailment request.
11. Customer HEMSs implement the committed measures, until the end of the scheduled event: the controls of the AC and EWH units are changed, and the charge of the PHEV, if present, is rescheduled.
12. At the end of the event, each customer HEMS returns to its normal (i.e., non-DR) operation mode. The end of the event is scheduled at different times for customers in order to avoid rebound effects, as explained in sections 4.4.4 and 4.5.4.

The steps required to check that customers have actually implemented the load reduction they committed to are not considered in this study. However, in a real system, this would be an essential feature, especially for fair compensation.

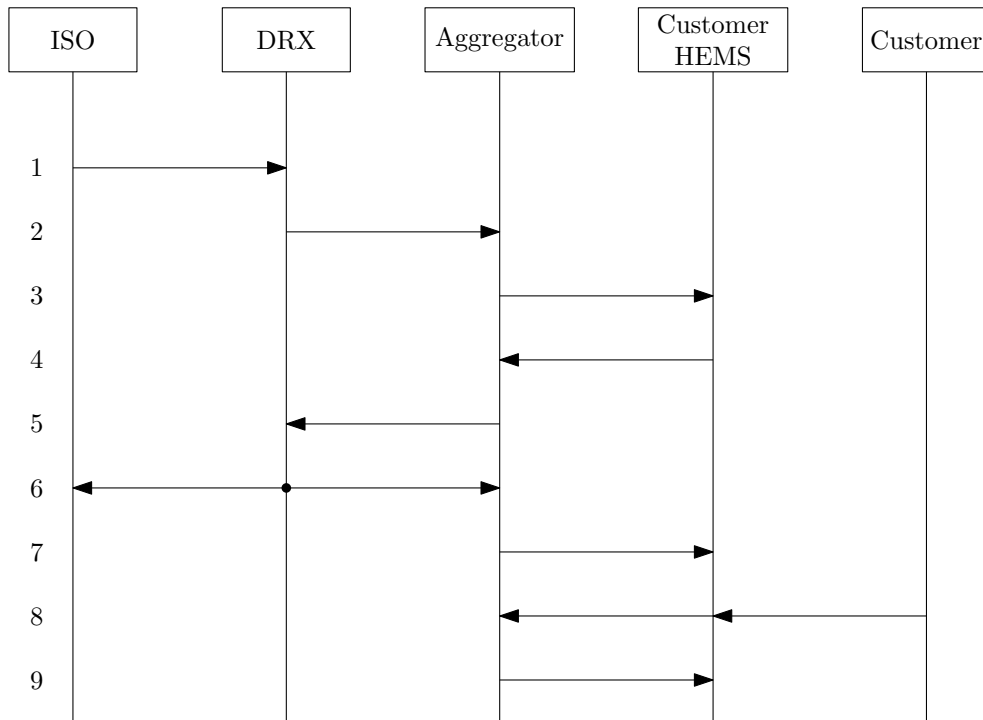

Figure 4.9: Interactions between agents during a DR event. Interactions are numbered according to the list given in section 4.4.3.

4.4.4 Rescheduling Algorithm

In order to decrease the local residential load, several strategies may be used by the customer. These strategies rely on temporary load reduction or load shifting achieved by rescheduling PHEV charging and changing the control parameters of thermal loads.

4.4.4.1 PHEV Rescheduling Strategy

The PHEV charging schedule is modified to decrease the load as much as possible during the event. As shown in Figs. 4.10 and 4.11, several cases are distinguished.

- If the PHEV cannot be fully recharged during the time it is plugged-in, then the initial schedule is not altered, and the PHEV does not participate in the event.
- If the battery can be fully recharged without charging at all during the event, then a first strategy is used: the maximum charging rate is used before the event; charging stops during the event; and restarts as late as possible so that the battery is full when required by the user (Strategy 1). This strategy helps avoiding all PHEVs to start charging at the same time right after the event.
- If there is not enough time to recharge the vehicle without charging during the event, and the vehicle arrives before or after the event, then the maximum charging rate is used before and after the event, and the charging rate during the event is chosen so that the remaining energy to recharge is equally split at each time (Strategy 2).
- If the vehicle is plugged-in during the event and there is not enough time to recharge the vehicle without charging during the event, the same process as in Strategy 2 is used, except that the charging starts when the vehicle is plugged-in (Strategy 3).

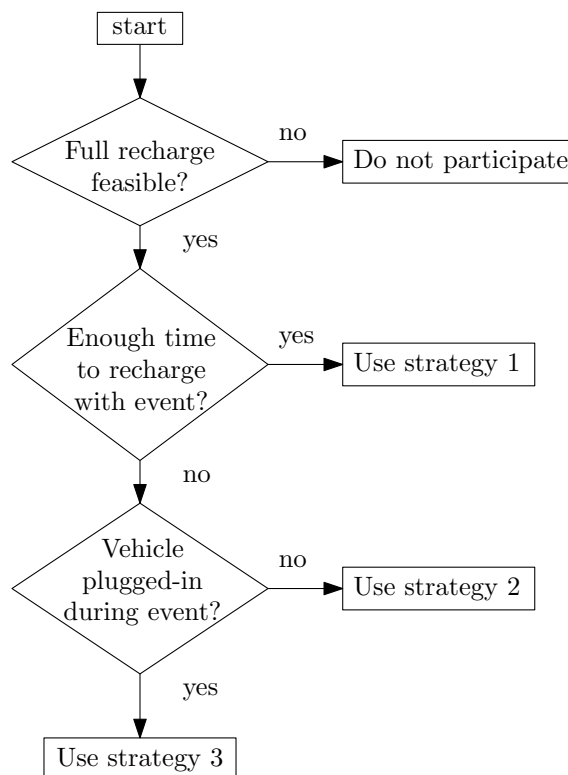

Figure 4.10: Flowchart of the PHEV charging rescheduling algorithm.

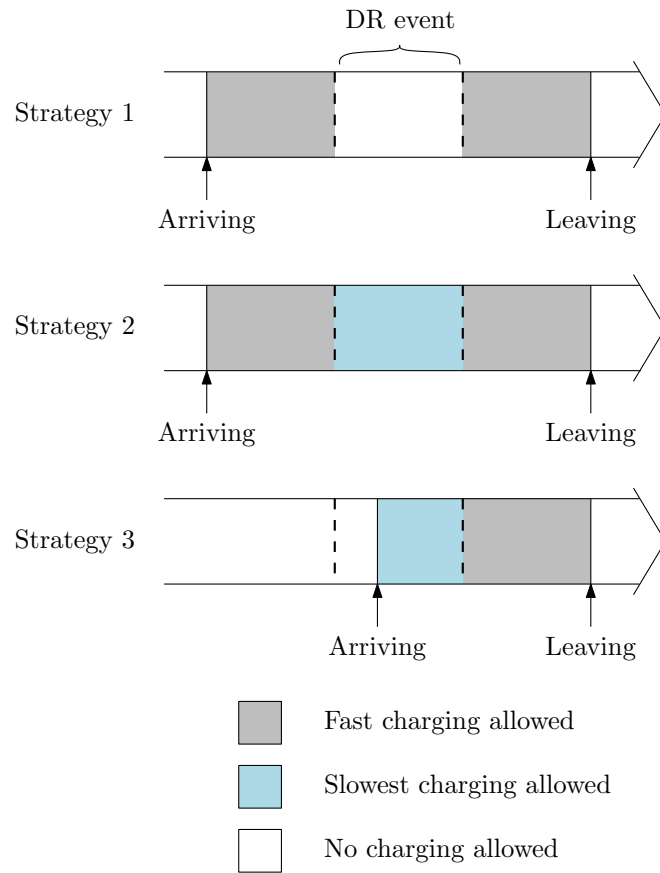

Figure 4.11: Diagram of the available PHEV rescheduling strategies.

4.4.4.2 Thermal Loads Rescheduling Strategy

For thermal loads, the rescheduling strategy simply overrides the temperature settings of the user and temporarily modifies them. The settings are changed so that the indoor temperature may become warmer and cooler than it would with the original settings, but without altering the user comfort significantly, i.e., the room temperature should be bearable. The same principle is used for the EWH. The following settings are selected:

- For AC units, $T_{\text{ref},i}$ is set to 80°F (i.e., $+10^{\circ}\text{F}$ compared to the initial set point) for cooling, and to 65°F (-5°F) for heating. These values are chosen arbitrarily by the authors, according to their own habits and opinion. However, these settings could be easily changed to more conservative values.
- Similarly, for EWHs, $T_{\text{ref},w}$ is set to 45°C (-5°C) [176].
- In order to avoid all thermal loads restarting at the same time and resulting in a rebound effect, the end of the event is locally postponed by a random duration shorter than 2 hours.

4.5 Simulation Results

4.5.1 Simulator

In order to evaluate the performance of the proposed system, a simulator was developed. The architecture of the system is implemented using JADE. The models described earlier are implemented in Java, are embedded in the corresponding agents, and are set up so that they can communicate with each other. The physical agents (feeder and substation) are also interfaced with PowerWorld using the co-simulation framework described in section 2.3.

Three consecutive steps are used to obtain the results shown in the following pages:

1. The system is first run in metering mode, so as to obtain the initial load profiles, where no DR action is taken.
2. The DR system is then run, and acts on load profiles through the process described earlier in section 4.4.4.
3. A second metering pass is run in order to obtain the load curves after the loads and PHEVs have been rescheduled, i.e., to verify the effectiveness of the system.

4.5.2 Test Case

The proposed methodology is tested with a portion of the RBTS, a large test system with transmission and distribution subsystems, a peak load of 85 MW, and about 15,000 customers [186]. Bus 5 of the RBTS is modeled in PowerWorld Simulator (Fig. 4.12) and is interfaced with the simulator using the co-simulation. The peak load for this bus is 20 MW, with an average load of 11.29 MW, and a total of 2,858 customers of all types (residential, commercial, industrial, and offices).

As shown in Table 4.6 and according to data given in [186], each load point contains 1 to 250 customers, which can be of residential, industrial, commercial or office type. For this study, all non-residential customers are converted to residential customers, by assuming a 4 kW average peak load. For example, an industrial customer with a 400 kW peak load is replaced by 100 residential customers of 4 kW rating each. A total of 5,555 residential customers is thus simulated.

Load points	Customer type	Peak load [MW]	Avg. load [MW]	No. of cust.
1-2,20,21	Residential	0.7625	0.4269	210
4,6,15,25	Residential	0.7450	0.4171	240
26,9-11,13	Residential	0.5740	0.3213	195
3,5,8,17,23	Gov. and inst.	1.1100	0.6247	1
7,14,18,22,24	Commercial	0.7400	0.4089	15
12,16,19	Office buildings	0.6167	0.3786	1

Table 4.6: Customer data for load points at bus 5 of the RBTS, based on data from [186].

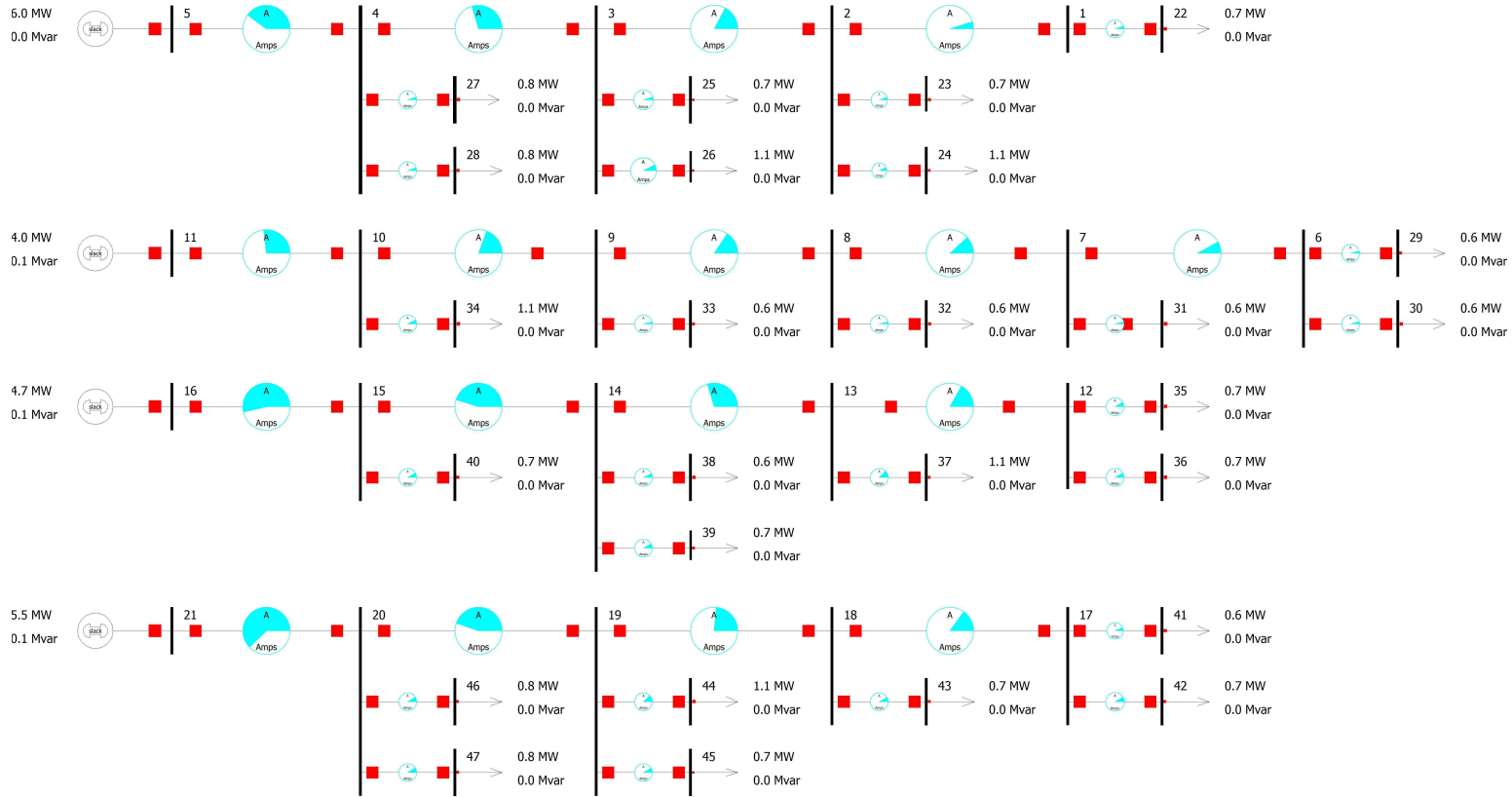

Figure 4.12: Oneline diagram of bus 5 of the RBTS in PowerWorld Simulator. Bus numbers are different from the ones given in Table 4.6.

4.5.3 Simulation Parameters

The time resolution of operation is set to 15 minutes, to coincide with that of bulk power markets [187]. The penetration rates for PV and PHEVs are chosen as 15 % and 30 % of the customers, respectively. Regarding aggregators, 70 % of the customers are assumed to have a contract with one (and only one) of the aggregators, while 10 % of these contracted customers override either the rescheduling of their loads (thermal loads) or the charging of their PHEV. The number of aggregators is arbitrarily chosen to be three in this study, with market shares of 40 %, 40 % and 20 % of the customers having a DR contract. However, the number of aggregators and their respective market shares can be changed. Customers are required to set the time by which they expect the PHEV to be charged the next day. The objective of the DR system is to maintain the system load under a threshold, assumed to be constant during the DR event, and arbitrarily equal to 90 % of the maximum forecast load (i.e., demand during the peak should be decreased by 10 %).

4.5.4 System-wide Net Load Results

A first run in metering mode acquires the forecast load profile, and detects the maximum capacity threshold shown as an horizontal line in Fig. 4.13. The corresponding event, where the system load exceeds 90 % of the maximum forecast value, starts at 4:30pm and ends at 8:00pm.

Figure 4.13 shows the net load curve obtained for the system with the first pass of the system with metering, i.e., the baseline or forecast load curves, and the net load curve obtained after the DR system is used, i.e., the actual load. This load curve shows that the DR system decreases the load so that it remains below the threshold during the event, by curtailing and shifting load for use later in the day or night.

Figure 4.14 shows the load reduction, which corresponds to the difference between the baseline and the actual load curve. It shows that the load is reduced on average by about 1.96 MW during the event, and fluctuates for a few hours after the event has ended. This fluctuation is due to the shifted loads restarting. The average of this curve is 0.0642 MW, which indicates that the total energy is almost exactly maintained by shifting the use of the loads, except a small part that corresponds to the energy not used by the ACs and EWHs during the event. The total energy consumed is reduced by 0.43 %, which is considered negligible in the following.

Tables 4.7 and 4.8 indicate that the average load reduction during the event is of 1.96 MW (10.0 %), with a maximum of 2.36 MW, or 12.3 % of the total baseline load, and a minimum of 0.0 (i.e., the actual load does not exceed the threshold). Considering the target load reduction of 10 %, these results indicate that the objective is met. Consequent to the DR event, the load is increased by as much as 1.03 MW (+6.81 %, peak value) after the event to compensate for the energy shifted during the peak. Additionally, 6.86 MWh, or 0.92 %, of the on-peak energy consumption is shifted to off-peak hours. An average of 0.73 kW is curtailed or shifted by each participating customer during the event.

The rebound effect is a phenomenon where the load increases above its expected value after it was temporarily reduced [188]. The rebound effect indicates that the load is essentially shifted later in time: PHEVs still need to be charged, and the indoor and

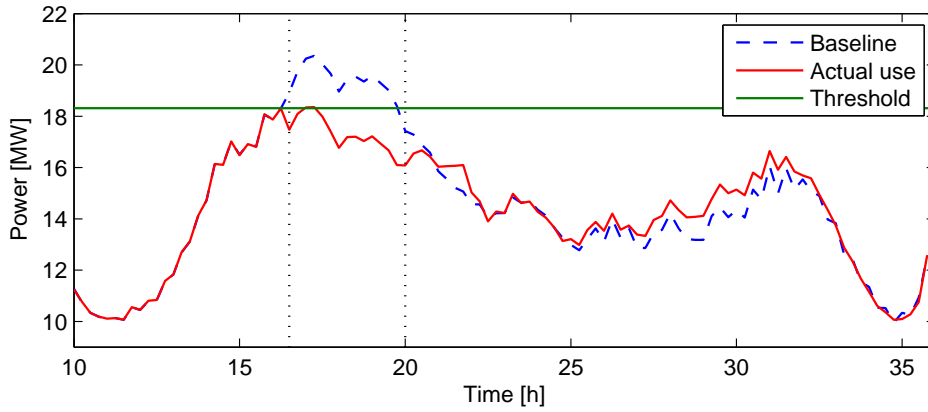

Figure 4.13: Baseline and actual net load curves.

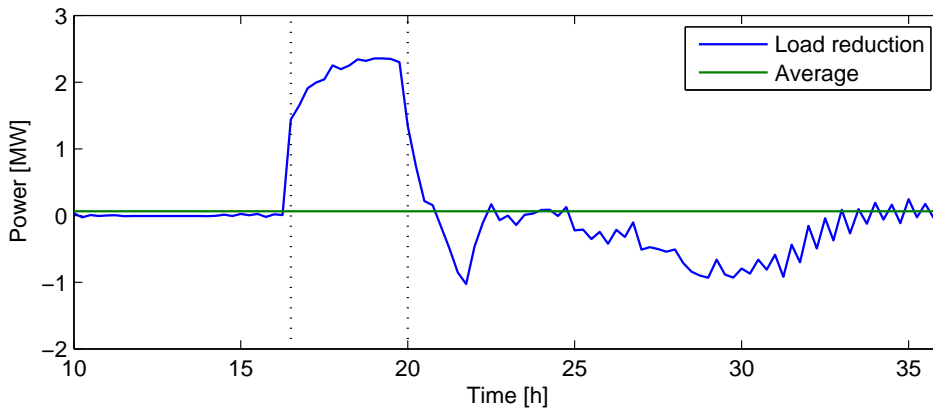

Figure 4.14: Total load reduction achieved with the DR system.

Metric	Value [MW]	Value [% of total load]
Average load reduction	-1.96	-10.0
Max. load reduction	-2.26	-12.3
Max. load increase	+1.03	+6.81

Table 4.7: Metrics for the DR event (Part 1).

Metric	Baseline value	Actual value
On peak energy	68.1 MWh	61.2 MWh
On peak energy share	9.52 %	8.60 %

Table 4.8: Metrics for the DR event (Part 2).

water temperatures need to be brought back to their reference value after the event. The rescheduling algorithm described earlier contains two measures to mitigate this effect: postponing PHEV charging as late as possible, and restarting the use of thermal loads randomly a few hours after the event. Fig. 4.15 shows the load curve that would be obtained without these measures: as soon as the event is over (here, at 7pm), the loads and PHEVs that were curtailed all restart at the same time, which leads to a large peak that largely exceeds the threshold capacity by about 3 MW. The rebound mitigation measures are thus needed to properly maintain the net load below the capacity threshold. As a load profile is generated randomly at each run, the load curve show in Fig. 4.15 corresponds to a different run than the previous one; however, a similar profile would be obtained if the same run could have been used.

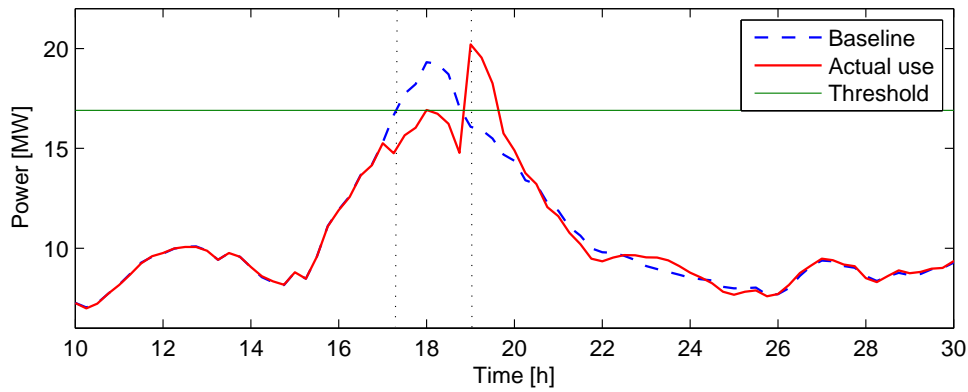

Figure 4.15: Rebound effect example, observed after the DR event if no measure is taken to mitigate it.

Taking a closer look at how each category of loads is affected, Fig. 4.16 shows that the load of PHEVs is decreased during the event, and increases after it, so that the total energy remains unchanged (18.8 MWh). A small proportion of the PHEVs (2.8% of them) cannot be *fully* charged when leaving (the DR event has no impact on it), which is not problematic as, in a worst case scenario, PHEVs can operate using fuel instead of the battery. The curves also show that PHEVs account for about a third of the total load reduction, with a maximum of almost 1 MW load reduction during the event.

Similarly, for thermal loads (ACs and EWHs), the load is reduced during the event and consequently increases after it, leading to a difference between the baseline and the actual load curve for several hours. The rebound mitigation strategy manages to limit the load increase after the event to a reasonable value. The use of these loads enables reducing the total net load by more than 1 MW during the event, which means that these loads account for about half of the total load reduction.

4.5.5 Results for Residential Customers

Figure 4.18 shows the impact on indoor and water temperature of rescheduling for a single typical residential customer. During the event, the indoor temperature clearly increases (as the outdoor temperature is warmer than the setting temperature) and the

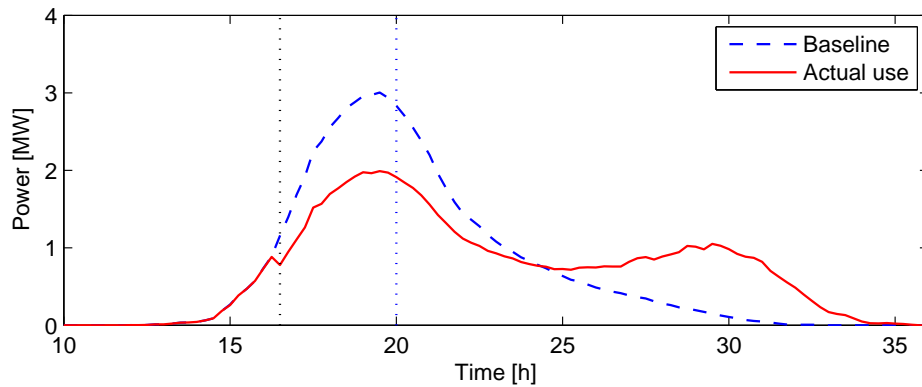

Figure 4.16: Baseline and actual load curves for PHEV charging.

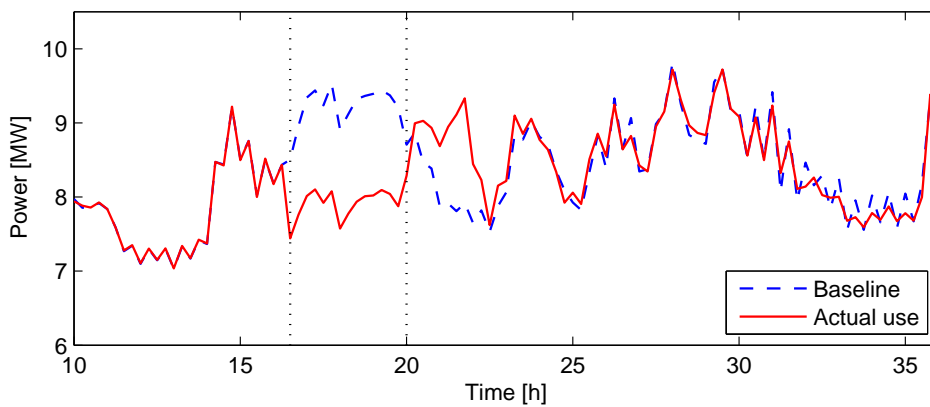

Figure 4.17: Baseline and actual load curves for thermal loads.

water temperature decreases. These two temperatures are brought back to their set values after the event.

Regarding the charging schedule of the PHEV, Fig. 4.19 shows that the PHEV uses recharging strategy 1 after having its charging scheduled modified: charging starts before the event, and stops during its entire duration. Charging restarts only a few hours after the event has ended, so that the vehicle is fully charged when leaving. Fig. 4.20 shows a PHEV using recharging strategy 2, where the charging rate is decreased but not stopped during the DR event, and Fig. 4.21 shows the result of strategy 3, where the event starts before the PHEV is plugged-in.

4.5.6 Impact on the Distribution System

The impact of the DR system on the distribution is evaluated using the interface with PowerWorld. For each time period, a power flow algorithm is run and checks whether the voltage on every bus of the system V_i meets condition (4.18). The power flow solved by the PowerWorld setup is a balanced three-phase power flow; its use is enabled by the selected approach of load aggregation. Results show that before and after the DR event,

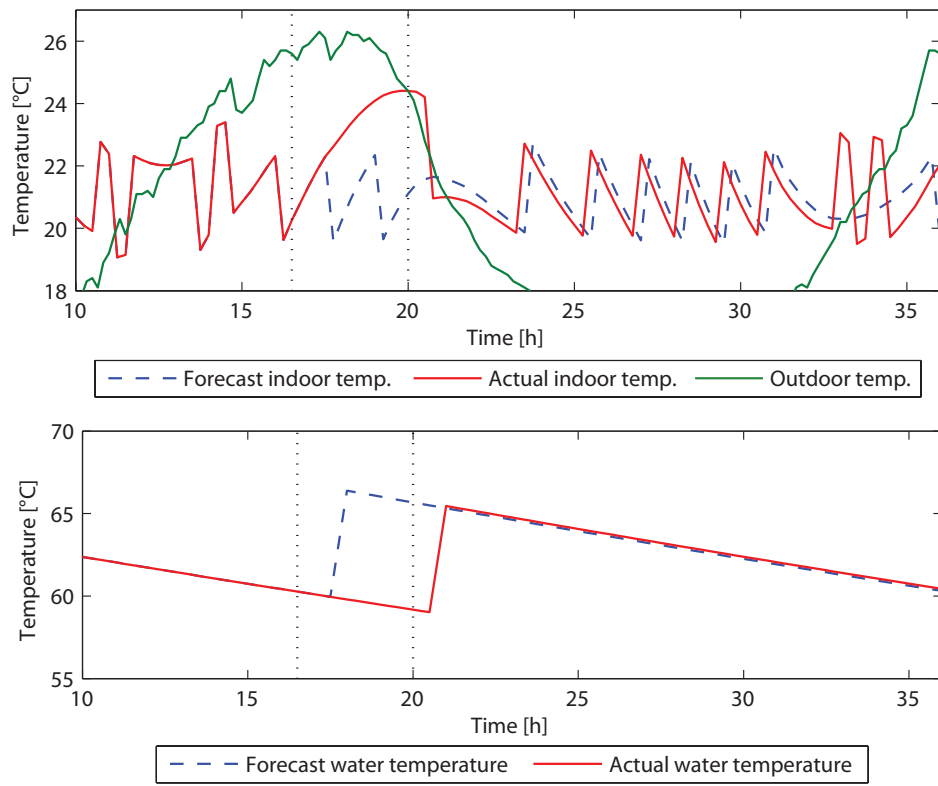

Figure 4.18: Impact of the DR system on indoor and water temperature for a typical residential customer.

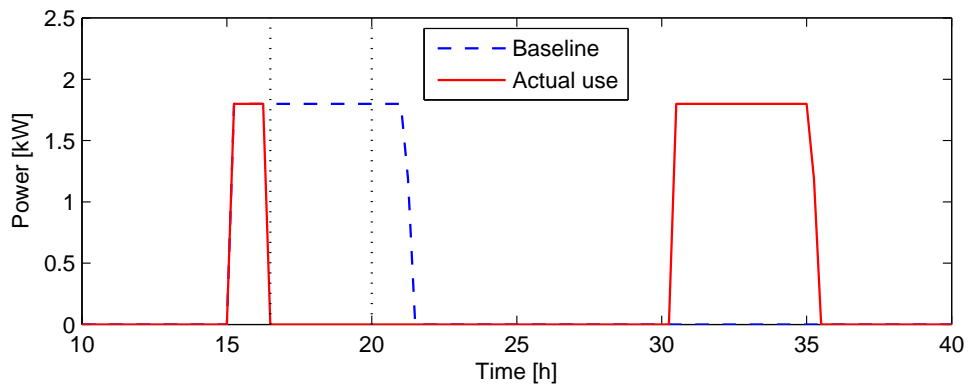

Figure 4.19: Rescheduling of the charge of a PHEV using strategy 1.

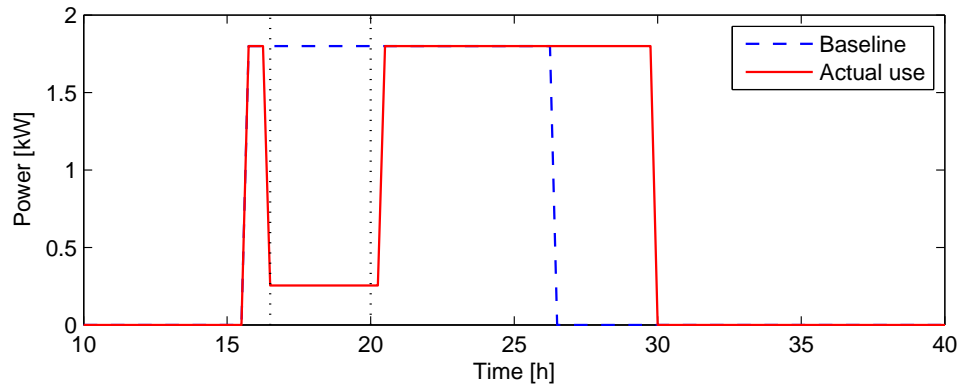

Figure 4.20: Rescheduling of the charge of a PHEV using strategy 2.

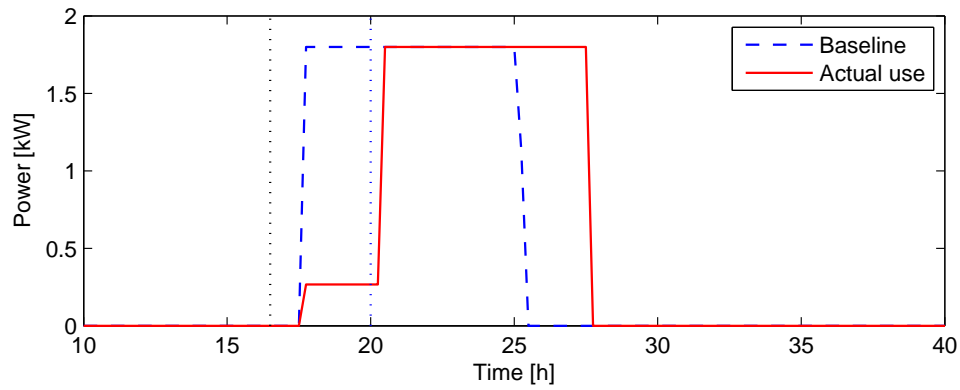

Figure 4.21: Rescheduling of the charge of a PHEV using strategy 3.

this condition is verified, which means that the system does not lead to steady-state instabilities. The minimum and maximum voltage deviations for all buses are 0.9963 and 0.9995 p.u., respectively. Fig. 4.22 shows the voltage profile at Feeder 4, and indicates that the DR system enables slightly improving the voltage profile. As the same customer model is used at each load point, similar results are obtained for other feeders.

$$0.95 \leq V_i \leq 1.05 \quad \text{p.u.} \quad (4.18)$$

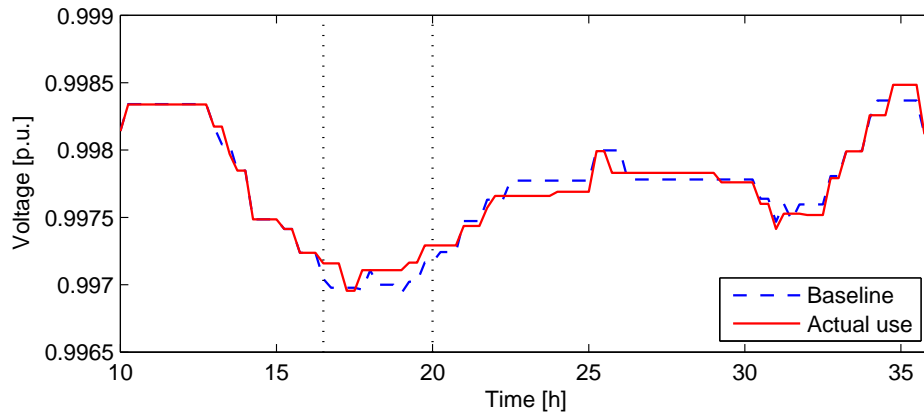

Figure 4.22: Voltage profile at Feeder 4 of bus 5 in RBTS.

4.6 Conclusion

This chapter has shown that an agent-based DR architecture and system can use small residential assets such as AC units, EWHs and PHEVs to temporarily reduce load under a given threshold for participation in a DR event. By rescheduling the use of these assets at a limited cost and impact on comfort for the end user, aggregators can coordinate their actions through a DRX and meet a request for capacity issued by the ISO. The resulting rebound effect can also be mitigated by carefully planning the end of the DR event in time, while limiting the impact on customer comfort. The system does not cause any steady-state instability when tested on a 5000+ customers test system.

5

Conclusions

5.1 Concluding Remarks

5.1.1 Conclusions on the Proposed Approach

In the advent of the smart grid, the need for energy management solutions capable of handling the increasing complexity of electric power systems has become even more important. This dissertation has proposed a new and unique approach for the design and development of EMSs for smart power systems, based on the use of MASs and other artificial intelligence techniques to model, control and simulate such systems.

This approach relies on the combination of several disciplines: it tackles issues in the field of electrical engineering, using computer engineering and applied mathematics tools, while also taking into account economic and sociological parameters. It therefore facilitates multi-disciplinary studies of CPSs including physical power systems, the communication and control infrastructure, energy markets, and their users. It also enables truly systemic studies of smart grids, which is a requirement to handle the inherent complexity of these complex adaptive systems.

This work has also shown that MASs do have a potential application of high impact in power systems, even for problems where decision-making cannot be fully distributed. Traditional approaches generally tend to focus on decision-making algorithms, but do not discuss how system entities interact with each other. The selected approach helps simultaneously taking into account communication and interaction aspects, that are at the core of smart grid technologies, and facilitates the specification of EMS architectures and of the corresponding hardware and communication infrastructure, ultimately enabling a faster transition from simulation to real-scale prototypes.

The approach has been applied to two applications of energy management in smart grids. Due to the specificity of each application, the approach has been adapted to define the most appropriate architecture and interactions to meet design objectives. However, it should be re-stated that the definition for an agent adopted in this work is generally broader than the one used in “traditional” MAS works, especially for non-power systems applications, in that not all agents are fully autonomous and may depend on each other. The dispatching agent in the power plant application is an example. However, for such an application, a distributed dispatching algorithm would return sub-optimal results [189], and would therefore not make sense compared to centralized ones considering economical

design constraints. Nevertheless, the other advantages of the agent concept are utilized, for the reasons and advantages described in chapter 2. The operational constraints and objectives are thus the main drivers in deciding on the centralized or decentralized nature of decision-making in an EMS.

In a broader perspective, it is expected that the adoption of the proposed approach could facilitate the design and development of EMSs with a truly systemic point-of-view. It holds promises for a variety of applications, also outside the fields that were presented in this work. Examples include the comparison of centralized and distributed architectures and algorithms, the study of various market structures and regulations, the analysis of various planning studies, e.g., for the integration of storage and DG, etc.

5.1.2 Conclusions on the Presented Applications

The proposed applications have shown that the two presented systems could provide practical solutions for energy management in smart grids, and especially for the integration of intermittent RESs, through two main means: by making generation capable of handling high demand ramps with a high economic and environmental performance, and by controlling residential assets through market mechanisms.

In the first application, the proposed unique gas turbine power plant system has shown that agent-based modeling and simulation enables to design and test a flexible, resilient and efficient power plant EMS, capable of handling a large penetration of intermittent generation. GE's 9E gas turbines were modeled using real fuel consumption and NO_x and CO₂ emissions data. A specific MAS architecture was designed to enable a flexible and resilient power plant operation, and was combined with advanced decision-making algorithms to reduce operational costs and emissions. The agent-based approach has enabled specifying how each element in the system interacts with the others, as well as evaluating the computational and communication requirements, which may facilitate a faster transfer to real-world applications. Simulation results on a dynamic load profile with high intermittent RESs penetration also showed that significant cost savings and emissions reductions could be achieved without altering turbine thermodynamics. Dynamic dispatching optimization was done by a metaheuristic selected from a comparison of several, and a rule-based automatic start and stop algorithm in charge of controlling the operation of the gas turbines further improved results.

In the second application, the proposed unique and scalable DR system has shown that agent-based approaches enable to model, simulate and control large power systems. An agent-based architecture was developed to model a distribution grid based on the RBTS with numerous residential customers, each with their own characteristics (housing insulation, PHEV, DG, etc.). Probabilistic models of residential customers with several load categories were implemented and used with an advanced load control algorithm that includes PHEV charging rescheduling and DLC for AC and EWH units, i.e., small residential loads. The role of each entity in the system, from end-users to a regional market operator, was specified, as well as their respective interactions in part through a DR market and aggregators. Simulation results showed that the system is capable of reducing residential load under a given threshold, with a limited impact on customer comfort. A steady-state stability analysis was performed using a specific co-simulation framework that was made

available to the research community, and showed that the operation of the system did not compromise stability.

5.2 Future Work

Future research work will focus on several aspects of the proposed approach and applications. As the studied field is an almost virgin territory, future avenues are very fertile.

At first, the MAS design methodology proposed in this dissertation could be enhanced with more detailed steps, in order to obtain a full design methodology suited for power systems applications. Another aspect would be to focus on distributed decision-making algorithms, that were not considered in this work, and are particularly relevant given the selected MAS framework.

Then, solutions to overcome the soft spots of the applications could be developed. Additional topics related to the proposed approach and framework could be explored.

A solution to take into account forecasting inaccuracies could be included in both applications. For the power plant EMS, this could simply consist in including the forecasting error estimation in the computations for the SSA, which could result in a more conservative but also more reliable behavior. For the DR system, a simple solution could be to increase the value of the adjustment coefficient α , so that more capacity is committed. However, in both cases, a detailed study would be required to find a compromise between costs and reliability.

Enhanced forecasting capabilities could also enable reducing the probability of non-optimal choices being made by the power plant EMS. Equipping the EMS with the capability to establish strategies in advance, e.g., through a unit commitment algorithm, while taking into account the entire emissions curve could also result in even lower costs and emissions, especially for NOx. The difficulty for metaheuristics-based dispatching algorithms to return results that do not exhibit unnecessary variations (which mostly depend on the optimization objective) could be tackled by combining these stochastic algorithms with a deterministic algorithm.

The integration of the power plant EMS with markets would also enable new studies, e.g., related to the participation of power plants in ancillary services, or in day-ahead markets. Another example would be the possibility for the power plant to sell the surplus energy it does not need to power a local load (such as a paper mill), depending on electricity prices.

In addition to these aspects, many other topics related to the residential DR system may also be investigated in the future. A first objective would be to evaluate the financial impact of the DR system on customer billing and on aggregator business models. This aspect is currently not accounted for, and is expected to give an insight on how residential customers could benefit from such DR measures, but also on which business models would benefit the most to aggregators. A better integration with power markets, e.g., by interfacing it with test beds such as the AMES wholesale power market test bed [190] from Iowa State University, USA, would enable detailed studies on the impact of DR on markets, and of markets on the behavior of customers with respect to DR.

Enhancing customers behavior models, e.g., with respect to overrides, could also provide interesting results, and could improve the reliability of the results (i.e., more realistic

results may be obtained after such a study). Through a collaboration with researchers from Colorado State University (CSU), and with the RECITS laboratory at UTBM, which has specialists in consumer acceptance toward technological changes, the modeling of the behaviors of customers could be greatly improved by taking into account the various categories of customers and their different reactions toward new technologies. For example, a teenager and an elderly person could have different comfort zones with respect to room temperatures, as well as have completely different uses of energy management interfaces.

Improving residential load models could also increase the accuracy of the results. In the future, more accurate load models, separating different dwellings sizes and types could be introduced to reflect the diversity of housing in a distribution system. GridLAB-D, developed by the US Pacific Northwest National Laboratory, may be an alternative to the models that are currently used [108]. Additionally, a sensitivity analysis on the penetration level of the loads and DGs (PHEVs, PV, etc.) could provide interesting perspectives on the impact and potential of such resources on the grid.

Using such detailed load models, a learning HEMS, such as the one assumed to be present in the DR application, could be developed. Using learning techniques such as reinforcement learning or artificial neural networks, the behavior of customers could be learned automatically, which would enable the HEMS to take decisions based on information extracted from users habits. This capability could enable estimating the amount of capacity that could be shed or shifted, and to take action automatically so as to maximize the benefit for the user. For example, savings could probably be achieved if the system was able to control heating and cooling based on users schedules and price forecasts.

Implementing dynamic, real-time or time-of-use pricing, and elastic load models is another aspect. As customers would react differently if prices vary according to the balance between supply and demand, various pricing schemes may be used. This alternative DR method could be compared with the proposed one, with the main disadvantage that the DR capacity can only be roughly estimated using historical empirical data, as it depends on the behavior of each customer, which is by nature hard to predict. Although the use of smart appliances was not considered in the proposed study, it could be included with such price-based DR methods. Another approach based on heuristic optimization proposed in [191] could also be tested and compared with current results.

Integrating additional elements in the grid is another aspect that could provide interesting results. On the one hand, integrating distributed energy storage at the distribution level would provide additional flexibility, and could contribute to temporarily reduce the net load during demand peaks, by serving as a buffer and a complement — or competitor — to DR. On the other hand, the integration of larger shares of DG resources could enable microgrid islanding. Although distribution PV resources are currently considered, larger DG sources could be added, and their impact on the operation of the system evaluated. This would ultimately enable parts of the distribution system to be islanded and to operate autonomously, using local generation, storage and DR resources.

Finally, two last aspects of the DR simulator could be modified and improved. Firstly, the system could be implemented (fully or partially) on a real-time simulator. The IRTESSET laboratory recently acquired two real-time OPAL-RT simulators that could be used to simulate the DR system. Secondly, replacing PowerWorld Simulator with DIgSILENT PowerFactory would give more accurate results regarding the impact of the DR system

on the distribution grid. PowerWorld assumes three-phase balanced systems only, which does not fully represent real distribution system conditions. PowerFactory has the ability to model and simulate unbalanced power flows, and would fill this gap [192].

5.3 Scientific Production Overview

The work presented in this dissertation was also an opportunity for collaborations with the industry and with local and international academic partners. It led to multiple publications, as shown in Appendix B:

- The development of the gas turbine power plant EMS was realized in collaboration with the company GE established in Belfort, France, which provided data on the gas turbines, and with the Université de Haute Alsace (UHA) from Mulhouse, France, for the study of metaheuristics. It resulted in an international journal publication in *Applied Energy* [39], and a French and international patent [193]. Additionally, this work was ranked second of the international GE Energy Innovation Awards of 2011.
- The design and development of the residential DR system was done in collaboration with CSU, Fort Collins, USA, and was initiated during a visiting period of four months in 2012. Its results were submitted to an international journal, in collaboration with a researcher from the Lawrence Berkeley National Laboratory (LBNL), Berkeley, USA.
- Several other publications were derived from these works, including a co-simulation framework [38], other applications of metaheuristics for energy management [194, 195], a state-of-the-art of MASs [48], a book chapter on MAS design for power systems [196], a comparison of smart grid developments in Europe and in the US [2, 197], and a hybrid metaheuristic algorithm [198].

In addition to these works, several other topics, mostly related to PHEVs, were investigated in collaboration with other researchers and are not presented in this dissertation. The impact of PHEVs with V2G capability on distribution systems was investigated in [175], in collaboration with researchers from CSU and the US National Renewable Energy Laboratory (NREL). A study of the combined optimal energy management and sizing of hybrid electric vehicles was conducted at UTBM [199], as well as an experimental analysis of the performance of a lithium-ion battery multi-physical model and its application to Kalman filter-based SOC estimation [200]. Finally, a short-term distribution load forecasting methodology was recently developed in collaboration with GE Power & Water [201].

Additionally, some of the source code of the developed algorithms were made available to the research community [112, 202], with the hope to facilitate the re-use of elements of the proposed approach by other researchers.

Appendices

A

Metaheuristics for Optimal Dispatching

The dispatching algorithm, which is at the heart of the EMS proposed in chapter 3, relies on optimization algorithms called *metaheuristics*. This appendix describes and compares several metaheuristics in order to select one for the EMS.

A.1 Definition

Metaheuristics are computational methods that optimize a problem by iteratively trying to improve candidate solutions with regards to a given measure of quality called fitness. These stochastic optimization algorithms require very few or no assumption about the problem and can explore almost any kind of search space, but do not guarantee that the best solution found is optimal.

For real-valued search spaces, classical optimization algorithms generally derive the gradient (i.e., compute the Hessian matrix) of the fitness function to be optimized and then employ gradient descent or a quasi-Newton methods to find local maxima or minima. Metaheuristics do not use this process and can therefore be employed with problems where the fitness function may not be continuous or differentiable. In the following sections, it is assumed that the goal of the optimization process is to find the global minimum.

A.2 Common Metaheuristics

Since the invention of genetic algorithms in the early 1970's that made metaheuristics popular for solving complex optimization problems, dozens of new algorithms have been invented [203]. In the following, *particle swarm optimization* (PSO), *genetic algorithms* (GAs), *differential evolution* (DE) and *imperialist competitive algorithms* (ICAs) are presented.

A.2.1 Particle Swarm Optimization (PSO)

The original PSO algorithm (Algorithm 1) is inspired from the behavior and movement of bird and fish swarms [204] and enables exploring a multi-dimensional search space based on this principle. In this population-based stochastic optimization technique, each individual, called particle, tries to improve itself by observing other group members and imitating the best ones. To do that, each particle keeps track of its coordinates in the

solution space using two values: the best solution it has achieved so far, called personal best p_{best} , and the best value obtained so far by any particle in the n_{neighb} particles constituting the neighborhood of that particle, called group best g_{best} .

The movement of each particle depends on its velocity v , computed according to (A.1). The new velocity depends not only on the particle's previous velocity and position, but also on p_{best} and g_{best} . The relative importance of each term of the equation can be tuned by modifying the cognitive and social coefficients c_1 and c_2 , respectively, as well as the inertia weight w_t which determines the influence of the previous velocity. To enable the algorithm to search the solution space and to avoid particles getting stuck in local minima, two random real values $r_1, r_2 \in [0, 1]$ are also generated.

$$v_{t+1} = w_t \cdot v_t + \underbrace{c_1 \cdot r_1 \cdot (p_{\text{best}} - x_t)}_{\text{cognitive component}} + \underbrace{c_2 \cdot r_2 \cdot (g_{\text{best}} - x_t)}_{\text{social component}} \quad (\text{A.1})$$

The particle's position x is then obtained from its previous position and its current velocity:

$$x_{t+1} = x_t + v_{t+1} \quad (\text{A.2})$$

Each particle moves in the search space based on the previous movements, until a stopping condition is met, e.g., a maximum number of function evaluations or generations.

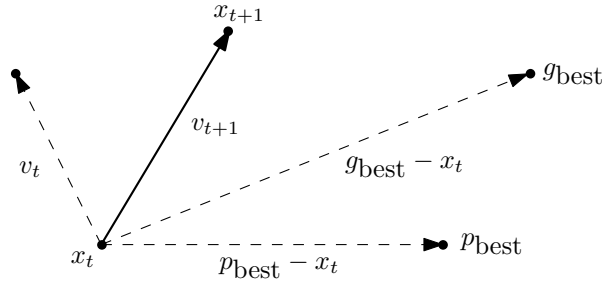

Figure A.1: Diagram of the movement of a particle with the PSO algorithm, from [195].

Algorithm 1 Pseudo-code of the PSO algorithm.

```

Initialize the population of  $n_{\text{pop}}$  particles
while the stopping condition is not satisfied do
  for each particle  $x_i$  do
    Update the particle's velocity  $v_i$ 
    Update the particle's position  $x_i$ 
    Evaluate the fitness  $f(x_i(t))$  of the particle
    Update the values of  $p_{\text{best}}$  and  $g_{\text{best}}$ 
  end for
end while
Return the best found solution.

```

The parameter settings used for PSO are given in Table A.1.

Parameter	Value
c_1	2.0
c_2	2.0
ω	0.5
v_{\max}	1.0
n_{pop}	50
n_{neighb}	10

Table A.1: Parameter settings for the PSO algorithm.

A.2.2 Differential Evolution (DE)

DE is a stochastic population-based metaheuristic developed by Storn and Price [205], that is particularly well-suited for continuous problems. Similarly to other evolutionary algorithms like genetic algorithms, it uses mutation, crossover and selection operators to make its solutions population explore the search space while looking for the best fitness value. Algorithm 2 describes its operation principle. The main advantages of this algorithm are its fast operation, and its low number of parameters.

The mutation operator generates a trial vector $u_i(t)$ for each individual $x_i(t)$ by combining an individual $x_{i1}(t)$ of the population with the weighted difference between two other individuals, as in (A.3) where β is a positive real value and $i \neq i1 \neq i2 \neq i3$.

$$u_i(t) = x_{i1}(t) + \beta \cdot (x_{i2}(t) - x_{i3}(t)) \quad (\text{A.3})$$

The crossover operator uses this trial vector to produce an offspring $x'_i(t)$ with (A.4), where $x_{i,j}(t)$ refers to the j -th element of individual i , r is a random number between 0 and 1, and γ is a real positive value.

$$x'_{i,j}(t) = \begin{cases} u_{i,j}(t) & \text{if } r < \gamma \\ x_{i,j}(t) & \text{otherwise.} \end{cases} \quad (\text{A.4})$$

Finally, the selection operator is used to decide which solution to keep in the population between $x_i(t)$ and its offspring $x'_i(t)$. The offspring replaces its parent only if its fitness $f(x'_i(t))$ is better than the one of its parent $f(x_i(t))$.

Algorithm 2 Pseudo-code of the DE algorithm.

```

Initialize the population of  $n_{\text{pop}}$  individuals
while the stopping condition is not satisfied do
  for each individual  $x_i(t)$  do
    Evaluate the fitness  $f(x_i(t))$  of the individual
    Create a trial vector  $u_i(t)$  (mutation)
    Create an offspring  $x'_i(t)$  (crossover)
    Keep only the best between  $x_i(t)$  and  $x'_i(t)$  (selection)
  end for
end while
Return the best found solution.

```

The parameter settings used for DE are given in Table A.2.

Parameter	Value
β	0.8
γ	0.8
n_{pop}	50

Table A.2: Parameter settings for the DE algorithm.

A.2.3 Genetic Algorithm (GA)

GAs model genetic evolution, where the characteristics of individuals are expressed using genotypes [206]. Individuals called chromosomes consist of several genes, one for each dimension. The algorithm (Algorithm 3) uses the selection, recombination and mutation operators. Numerous variations of each operator are possible, and the following explains the operation principle of the ones that were selected.

- The selection operator models the survival of the fittest. Tournament selection involves running tournaments among chromosomes randomly chosen from a genotype. The winner of each tournament is selected for crossover. Parameter n_{tourn} control the number of chromosomes in the tournament.
- The crossover operator models reproduction. New individuals can be obtained either by generating an offspring from a parent, by using two parents to generate one or two offspring, or by using multiple parents to generate one or more offspring. The uniform crossover operator belongs to the second category, uses a fixed mixing ratio, and enables parent chromosomes to contribute at the gene level rather than at the segment level. For example, if a mixing ratio of 0.5 is chosen, each gene has a 50% probability to be part of the first offspring, and 50% to be part of the second. These probabilities are exclusive, i.e., each gene can only be part of a single offspring. As a consequence, the offspring statistically has half the genes from its first parent and the second half from its other parent. The probability of a crossover happening is set by $p_{\text{cross}} < 1$.
- The mutation operator aims at introducing new genetic material to maintain genetic diversity in the genotype. This is achieved by attributing random values to some genes. Parameters p_{mut} and σ control the mutation probability.
- The use of elitism can help improve convergence speed by enabling the selection of the best chromosomes to form the new population.

The parameter settings used for GA are given in Table A.3.

Parameter	Value
p_{cross}	0.85
p_{mut}	0.05
n_{tourn}	2
σ	0.01
n_{pop}	50

Table A.3: Parameter settings for the GA algorithm.

Algorithm 3 Pseudo-code of the GA algorithm.

```

Initialize the population of  $n_{\text{pop}}$  chromosomes
while the stopping condition is not satisfied do
  for each chromosome  $x_i$  do
    Evaluate the fitness  $f(x_i(t))$  of the chromosome
    Select the next generation
    Perform reproduction using crossover
    Perform mutation
  end for
end while
Return the best found solution.

```

A.2.4 Imperialist Competitive Algorithm (ICA)

The ICA is a recent evolutionary optimization approach introduced in 2007 by E. Atashpaz-Gargari [207]. It is inspired by the imperialistic competition processes of human societies. The algorithm can be seen as a social counterpart of genetic algorithms. Several of its steps are indeed similar: countries can undergo revolutions as chromosomes can mutate, for example. Historical events such as the competition between France and Britain during the 18th century for taking control of India are used by the author of [207] to illustrate the concept of the algorithm.

This algorithm uses a precise terminology, in which a solution is called a country. There are two types of countries: imperialist countries, and colonies which depend on these imperialists. An imperialist and its colonies form a group of countries called empire.

Algorithm 4 Pseudo-code of the ICA algorithm.

```

1: Initialize the countries and form the empires
2: while the stopping condition is not satisfied do
3:   for all empires do
4:     Move the colonies toward the imperialist (assimilation)
5:     Make some colonies undergo a revolution
6:     if a colony is more powerful than the imperialist then
7:       The colony becomes the imperialist and vice versa (overthrow)
8:     end if
9:   end for
10:  if two empires are too close then
11:    Merge them (unification)
12:  end if
13:  Make imperialistic competition occur
14:  if there is an empire with no colony then
15:    Eliminate this empire
16:  end if
17: end while
18: Return the best found solution.

```

ICA works as illustrated in Algorithm 4, where the following processes are used:

- *Initialization and empire formation:* Like other evolutionary algorithms, ICA starts

with an initial population of solutions called countries, of size N_{pop} . Among them, the N_{imp} best countries (the most powerful) are selected to be imperialists. The remaining N_{col} countries form the colonies of these imperialists. The n initial empires are formed by dividing the colonies among imperialists according to their normalized power P derived from their cost (fitness) c (A.5).

$$P_n = \left| \frac{c_n - \max_i c_i}{\sum_{i=1}^{N_{\text{imp}}} (c_n - \max_i c_i)} \right| \quad (\text{A.5})$$

The number of colonies $N_{\text{col},n}$ attached to empire n is computed according to (A.6):

$$N_{\text{col},n} = \text{round}(P_n \cdot N_{\text{col}}) \quad (\text{A.6})$$

- *Assimilation*: Imperialist countries attract colonies using the assimilation policy illustrated in Fig. A.2. To update its position x , each colony moves toward its imperialist by updating its position using (A.7).

$$x_{t+1} = x_t + \beta \cdot \gamma \cdot r \cdot d \quad (\text{A.7})$$

where $\beta > 1$ causes the colonies to get closer to the imperialist, $\gamma < 1$ corresponds to an assimilation coefficient, r is a random number chosen from the uniform distribution $\mathcal{U}(-\theta, \theta)$, θ adjusts the deviation from the original direction and enables searching around the imperialist, and d is the distance between the colony and the imperialist.

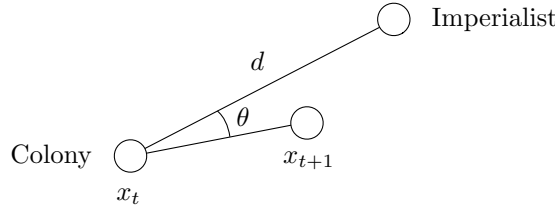

Figure A.2: Movement of a colony toward its imperialist, from [194].

- *Revolution*: The revolution process introduces sudden random changes in the position of some countries. It plays the same role as the mutation operator in GAs. Parameter R_r can be tuned for change the revolution probability.
- *Overthrow*: After assimilation and revolution, a colony might reach a better position than the imperialist of the empire. In this case, the colony can become the imperialist and vice versa.
- *Unification*: If two empires are too close to each other, they can unite and become a single empire, with the sum of the colonies of the two initial empires. Parameter U_t can be tuned for change the minimal unification distance.
- *Imperialistic competition*: Each empire tries to take possession of colonies of other empires and to control them. This imperialistic competition is modeled by selecting

the weakest colonies of the weakest empire, and giving them to the empire that has the highest likelihood to possess them.

The total power $P_{\text{tot},n}$ of each empire n is defined by the power of its imperialist plus its average colonies power, as defined in (A.8) where $\zeta \ll 1$, I refers to the empire's imperialist, and C to its colonies.

$$P_{\text{tot},n} = P(I_n) + \zeta \cdot \text{mean}(P(C_n)) \quad (\text{A.8})$$

The likelihood p_n , called possession probability, is then derived from each empire's power (A.9).

$$p_n = \left| \frac{c_{\text{tot},\text{norm},n}}{\sum_{i=1}^{N_{\text{imp}}} c_{\text{tot},\text{norm},i}} \right| \quad (\text{A.9})$$

where $c_{\text{tot},\text{norm},n} = c_{\text{tot},n} - \max_i c_{\text{tot},i}$ is the total normalized cost of empire n and $c_{\text{tot},n}$ its total cost.

In order to divide the colonies among empires based on their possession probability, a vector A is built (A.10), where P_n is the power of empire n , and r_n is a random value between 0 and 1. The selected colonies are then assigned to the empire whose relevant index in A is the highest.

$$A = [P_1 - r_1, P_2 - r_2, \dots, P_{N_{\text{imp}}} - r_{N_{\text{imp}}}] \quad (\text{A.10})$$

The parameters for ICA are empirically determined by running iterative trials using the mathematical functions described in Table A.7, and starting with the parameters given by the authors of the algorithm in [207]. The tuned parameters are listed in Table A.4.

Parameter	Value
N_{pop}	50
N_{imp}	6
R_r	0.1
β	2
θ	$\frac{\pi}{6}$
ζ	0.02
U_t	0.02

Table A.4: Parameter settings for the ICA approach.

A.3 Hybrid Algorithms

In order to improve the performance of standard metaheuristics, *hybrid metaheuristics* were introduced. These algorithms are skilled combinations of two optimization methods, that can enable the resulting algorithm to benefit from the strengths of each constituting algorithm [208].

A.3.1 Metropolis PSO with Mutation Operation (MPSOM)

The PSO algorithm has been hybridized multiple times, and the MPSOM variant was introduced in [209] to avoid a premature convergence of PSO. This hybrid algorithm uses a combination of PSO and simulated annealing with the Metropolis rule [210]. When a local optimal solution is reached with a PSO algorithm, all particles gather around it, and escaping from this local optimum may become difficult. MPSOM introduces the following changes:

- The social component of each particle in (A.1) is computed as a weighted average of all solutions which are better than its own. This allows the particles to prefer following a group of particles rather than a single one. In (A.11), N_t is a set of solutions which are better than the particle, and v_{\max} is the maximum velocity.

$$v_{t+1} = w_t \cdot v_t + c_1 \cdot r_1 \cdot (p_{\text{best}} - x_t) + \min \left(v_{\max}, \sum_{i=1}^{|N_t|} \frac{p_{\text{best}} - x_t}{i} \right) \quad (\text{A.11})$$

- The value of p_{best} is updated according to the Metropolis rule which gives the probability of accepting the position x of a particle according to its fitness f . Rule (A.12) uses a random variable r_3 and a variable T representing a temperature, similarly to temperature in the physical annealing process [210]. This modification improves the convergence capability of the algorithm.

$$p = \begin{cases} 1 & \text{if } f(x) \leq f(p_{\text{best}}) \quad \text{or} \quad r_3 \cdot \exp \left(\frac{f(x) - f(p_{\text{best}})}{T} \right) < 1 \\ 0 & \text{otherwise.} \end{cases} \quad (\text{A.12})$$

- If g_{best} has not been improved after a given number of iterations (here 60), a mutation operator gives the particles the maximum allowed velocity to help them escape a local optimum.

The parameter settings used for MPSOM are given in Table A.5.

Parameter	Value
c_1	1.7
c_2	1.3
w_t	0.9
v_{\max}	1.0
n_{pop}	50
n_{neighb}	10
T	2.5

Table A.5: Parameter settings for the MPSOM algorithm.

A.3.2 ICA-PSO Algorithm

The ICA-PSO algorithm combines the ICA and PSO approaches in order to improve the exploration capacity of ICA for single and multi-objective problems. The ICA-PSO

approach (Algorithm 5) proposed by the authors introduces the following main changes to the original ICA algorithm [198]:

- Two archives are used to keep a memory of the best solutions found by the individuals. A global archive stores the non-dominated solutions found by the algorithm, and local archives store the best solutions found by each individual. A crowding distance operator is used to determine which solutions should be kept in the archive. The crowding distance value of a solution provides an evaluation of the density of solutions surrounding that solution [211].
- Equation (A.7), which defines the movement of the colonies toward the imperialists, is replaced by an adapted version of the equation defining the movement of particles in the PSO algorithm. The colonies now have a memory of the best solutions they could find (similarly to p_{best}), and adapt their position according to the position of the imperialist and their best solution in memory. The speed of each colony is updated according to (A.13):

$$v_{k+1} = w_t \cdot v_k + c_1 \cdot r_1 \cdot (p_k - x_k) + c_2 \cdot r_2 \cdot (e_k - x_k) \quad (\text{A.13})$$

Similarly, the speed of the imperialists is updated according to (A.14):

$$v_{k+1} = w_t \cdot v_k + c_1 \cdot r_1 \cdot (p_k - x_k) + c_2 \cdot r_2 \cdot (g_k - x_k) \quad (\text{A.14})$$

The respective positions of the colonies and of the imperialists are then updated using (A.2). In these equations, p_k is the best position of the colony, e_k is the best position of its imperialist, and g_k is the best position in the global archive.

- A crossover operator is also introduced to improve the solutions contained in the local archive. The crossover mixes a solution of the archive of a colony with a solution of the local archive of an imperialist.

Although this algorithm was primarily designed for multi-objective problems, it can also be used for single-objective problems, and, in this case, returns a single solution. The parameters for ICA-PSO are given in Table A.6.

Parameter	Value
N_{pop}	50
N_{imp}	5
ω	0.65
c_1	1.0
c_2	1.5
v_{max}	18
ζ	0.01
U_t	0.02

Table A.6: Parameter settings for the ICA-PSO approach.

Algorithm 5 Pseudo-code of the ICA-PSO algorithm.

```

1: Initialize and evaluate the empires
2: Initialize the archive
3: Initialize the particles memory
4: while the stopping condition is not satisfied do
5:   for each empire do
6:     Compute imperialist and colonies speed
7:     Move each particle according to its speed
8:     Evaluate each particle
9:     if a colony dominates its imperialist then
10:      This colony becomes the new imperialist of its empire
11:    end if
12:  end for
13:  Crossover operations
14:  Update the memory of the particles
15:  Update the archive
16:  Compute the total cost of the empires
17:  Imperialistic competition
18:  if there is an empire with no colony then
19:    Eliminate the empire
20:  end if
21: end while
22: return the external archive.

```

A.4 Performance Comparison and Analysis

In order to compare the algorithms and to select the most appropriate one, a series of tests is run. The performance of each algorithm is tested with mathematical functions, so that their proper operation can be verified and their respective performance compared.

A.4.1 Benchmark Functions

Several *benchmark functions*, described in Table A.7 where n is the dimension of the problem, are used to test the performance of the algorithms [212]. As the focus is primarily on the dispatching problem, the number of functions is limited to four, although very rigorous tests in the optimization field generally rely on much more advanced tests, which are not relevant in this study. These functions provide a good start for testing the credibility of an optimization algorithm.

Each of these functions (except the Sphere function) has many local optima in its solution space. The amount of local optima increases with their dimension, which is set to 20, as in [213]. For each algorithm, the maximum number of evaluations is set to 200,000. The optimal minimal value of these functions is 0, as show in Figs. A.3 to A.6 where the dimension is set to 2 to enable display. For each algorithm, a total of 20 runs are conducted and the average fitnesses and standard deviations of the best solutions are recorded.

Function	Problem	Range
Sphere	$\sum_{i=1}^n x_i^2$	[-5.12;5.12]
Rastrigin	$\sum_{i=1}^n (x_i^2 - 10 \cos(2\pi x_i) + 10)$	[-5.12;5.12]
Rosenbrock	$\sum_{i=1}^{n-1} (100(x_{i+1} - x_i^2)^2 + (x_i - 1)^2)$	[-2.048;2.048]
Ackley	$20 + e - 20 e^{-0.2 (\frac{1}{n} \sum_{i=1}^n x_i^2)^{\frac{1}{2}}} - e^{\frac{1}{n} \sum_{i=1}^n \cos(2\pi x_i)}$	[-32.0; 32.0]

Table A.7: Standard mathematical benchmark functions definition.

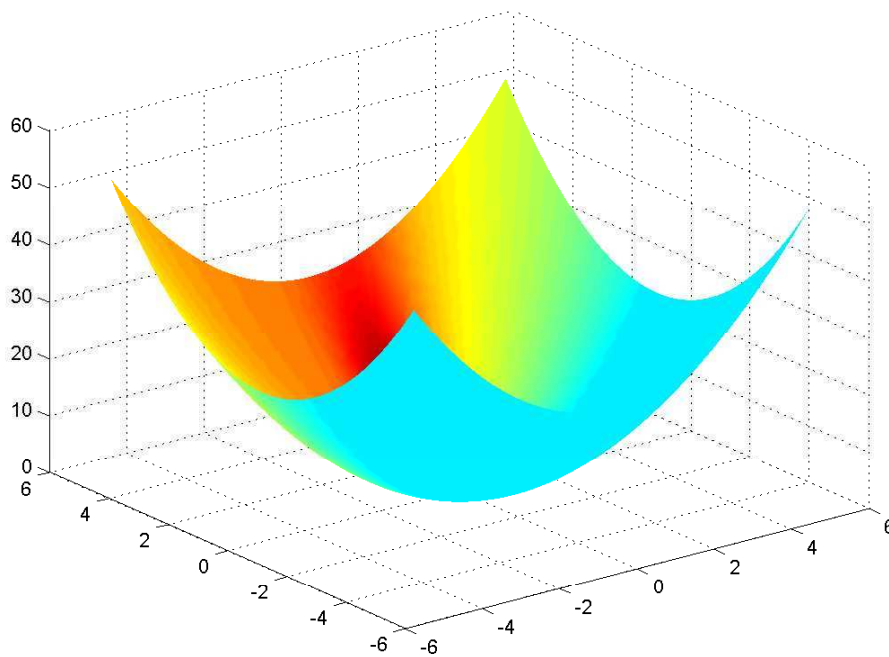
Figure A.3: Plot of the Sphere function for $n = 2$.

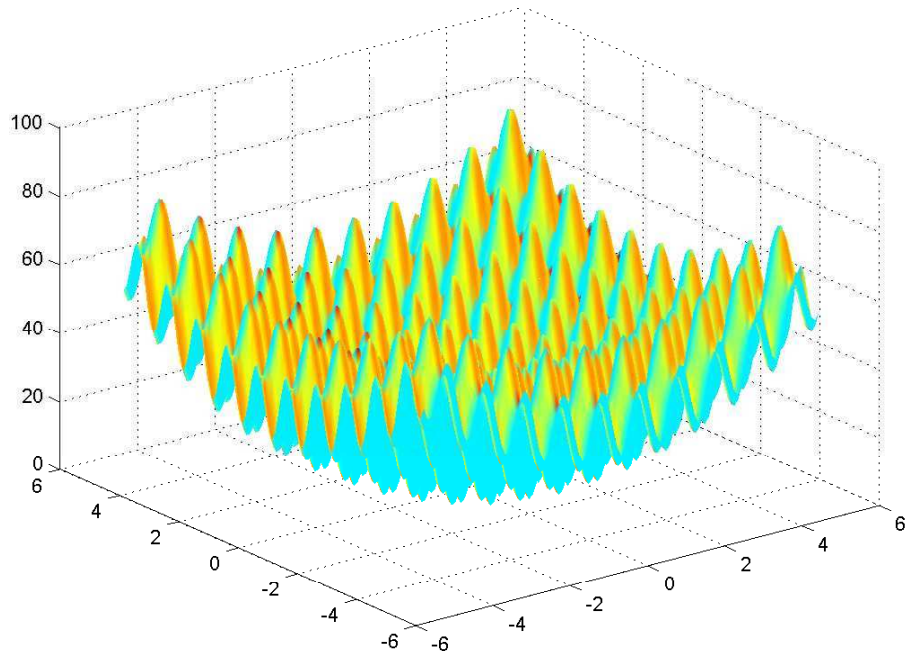

Figure A.4: Plot of the Rastrigin function for $n = 2$.

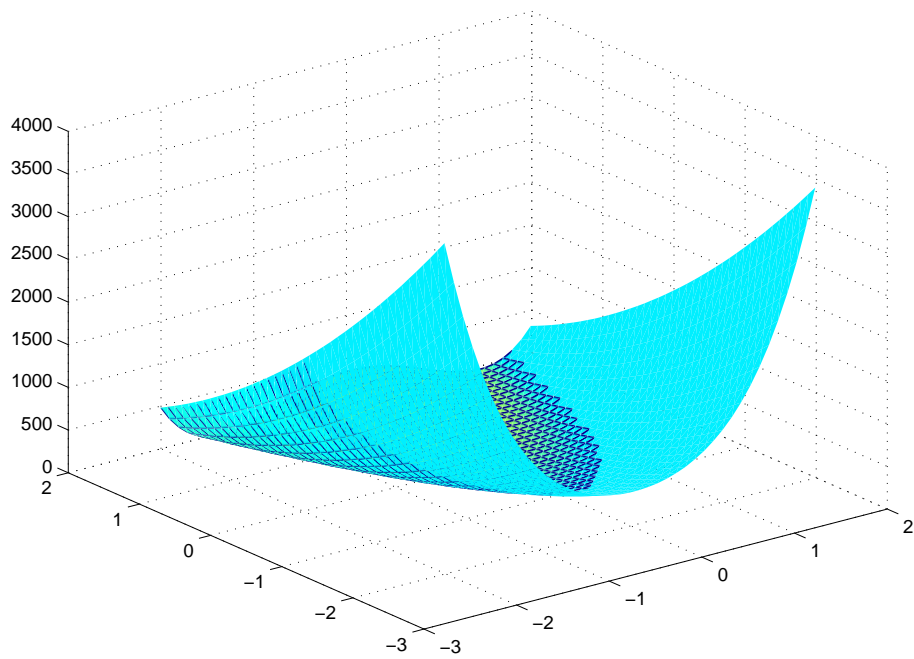
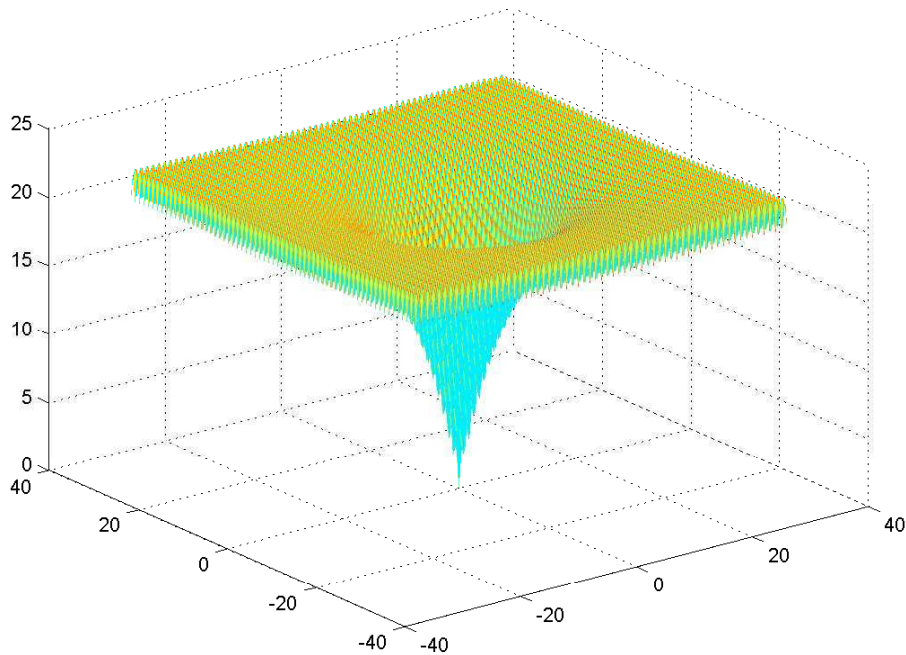

Figure A.5: Plot of the Rosenbrock function for $n = 2$.

Figure A.6: Plot of the Ackley function for $n = 2$.

A.4.2 Algorithms Implementation

The algorithms described earlier are implemented in the Java language as follows. The PSO, DE and GA algorithms are directly used from their implementation in MetaHeuristicDemo, a framework for single objective metaheuristic optimization [214]. The ICA algorithm is implemented in Java by the author, based on a Matlab implementation proposed by E. Atashpaz-Gargari in 2008 [215]. This implementation is available under the LGPL licence at Github [202]. The MPSOM algorithm was implemented in MetaHeuristicDemo by L. Idoumghar [209]. The ICA-PSO algorithm was implemented by N. Chérin and L. Idoumghar in jMetal, a framework for multi-objective optimization [216].

A.4.3 Test Results and Analysis

The mean solutions and the corresponding standard deviations obtained for the algorithms are listed in Table A.8. MPSOM obtains the best results for the Sphere, Rastrigin and Ackley functions, while DE obtains the best solutions the Rosenbrock function. From these results, MPSOM clearly stands out as the best metaheuristic for these kinds of mathematical problems, followed by DE. On the other hand, PSO, GA and ICA return average to low performance results, comparatively. More surprisingly, ICA-PSO has an average performance, even on a simple problem such as the Sphere. As a consequence of these results, the MPSOM algorithm is selected for running the EMS simulations.

Function	PSO	DE	GA	ICA	MPSOM	ICA-PSO
Sphere	22.31	7.744×10^{-12}	6.000×10^{-06}	1.311×10^{-20}	0	4.754×10^{-01}
	± 8.583	$\pm 5.395 \times 10^{-12}$	$\pm 3.513 \times 10^{-06}$	$\pm 3.631 \times 10^{-20}$	± 0	$\pm 1.729 \times 10^{-01}$
Rastrigin	138.5	89.61	40.69	67.13	0	76.84
	± 30.61	± 12.66	± 11.12	± 4.513	± 0	± 37.99
Rosenbrock	437.3	1.606	13.01	17.29	18.79	114.6
	± 201.0	± 0.4734	± 4.367	± 22.79	± 0.1129	± 51.20
Ackley	16.00	2.056×10^{-05}	1.037×10^{-02}	1.718	4.441×10^{-16}	1.718
	± 1.327	$\pm 6.623 \times 10^{-06}$	$\pm 2.896 \times 10^{-03}$	$\pm 4.556 \times 10^{-16}$	$\pm 5.059 \times 10^{-32}$	$\pm 4.556 \times 10^{-16}$

Table A.8: Comparison of the solutions obtained by the selected metaheuristics.

B

Publications

Publications list updated on December 7, 2012.

International Journals

1. **[Submitted]** Roche R., Suryanarayanan S., Kiliccote S. and Miraoui A., *An Aggregator-Based Residential Demand Response System*.
2. Roche R., Idoumghar L., Suryanarayanan S., Daggag M., Solacolu C.-A. and Miraoui A., *A Flexible and Efficient Gas Power Plant Operation System With Economic and Environmental Constraints*. Applied Energy, vol. 101, pp. 644–654, January 2013.
3. Watrin N., Roche R., Ostermann H., Blunier B. and Miraoui A., *Multi-physical lithium-based battery model for use in state-of-charge determination*. IEEE Transactions on Vehicular Technology, vol. 61, no. 8, pp. 3420–3429, October 2012.
4. Simões M.G., Roche R., Kyriakides E., Suryanarayanan S., Blunier B., McBee K., Nguyen P., Ribeiro P. and Miraoui A., *A Comparison of Smart Grid Technologies and Progresses in Europe and the U.S.* IEEE Transactions on Industry Applications, vol. 48, no. 4, pp.1154–1162, July-August 2012.

Book Chapter

1. **[In press]** Roche R., Lauri F., Blunier B., Miraoui A. and Koukam A., *Multi-Agent Technology in Power Systems*, in Chakraborty S., Simões M.G., Kramer W.E. (eds.), *Power Electronics for Renewable and Distributed Energy Systems*, Springer.

Patent

1. Daggag M., Roche R., Idoumghar L., Blunier B., Miraoui A. and Koukam A., *System and method for controlling an electrical energy production installation*. Patent no. WO/2012/143424 (international) / FR1153369 (France).

International Conferences and Workshops

1. **[Submitted]** Lauri F., Roche R., Basso G., Zhu J., and Hilaire V., *Distributed Microgrid Control Using Multi-Agent Reinforcement Learning*.
2. **[Submitted]** Couraud B., Roche R., and Traill B., *A Distribution Load Forecasting Methodology Based on Primary Substations SCADA Data*.
3. **[Submitted]** Giráldez J., Roche R., Suryanarayanan S., and Zimmerle D., *A Linear Programming Methodology to Quantify the Impact of PHEVs with V2G Capabilities on Distribution Systems*.
4. Roche R., Idoumghar L., Blunier B., and Miraoui A., *Imperialist Competitive Algorithm for Dynamic Optimization of Economic Dispatch in Power Systems*, in Hao J.-K. et al. (Eds.): *Artificial Evolution, Lecture Notes in Computer Science (LNCS)*, vol. 7401, pp. 217–228. Springer, Heidelberg. 2012.
5. Hansen T., Roche R., Suryanarayanan S., Siegel H.J., Zimmerle D., Young P.M., and Maciejewski A.A., *A Proposed Framework for Heuristic Approaches to Resource Allocation in the Emerging Smart Grid*. IEEE PES International Conference on Power Systems Technology (POWERCON 2012). pp. 1–6. October 2012.
6. Roche R., Natarajan S., Bhattacharyya A., and Suryanarayanan S., *A Framework for Co-simulation of AI Tools with a Power Systems Analysis Software*. 1st International Workshop on Intelligent Agent Technology, Power Systems and Energy Markets (IATEM 2012). pp. 350–354. September 2012.
7. Ravey A., Roche R., Blunier B. and Miraoui A., *Combined Optimal Sizing and Energy Management of Hybrid Electric Vehicles*. IEEE Transportation Electrification Conference and Expo (ITEC 2012). pp. 1–6. June 2012.
8. Basso G., Hilaire V., Lauri F., Roche R., Cossentino M., *A MAS-based simulator for the prototyping of Smart Grids*. 9th European Workshop on Multi-Agent Systems (EUMAS 2011). November 2011.
9. Roche R., Idoumghar L., Blunier B. and Miraoui A., *Imperialist Competitive Algorithm for Dynamic Optimization of Economic Dispatch in Power Systems*. International Conference on Artificial Evolution (EA 2011). pp. 375–386. October 2011.
10. Roche R., Idoumghar L., Blunier B. and Miraoui A., *Optimized Fuel Cell Array Energy Management Using Multi-Agent Systems*. 46th IEEE Industry Applications Annual Meeting (IAS 2011). pp. 1–8. October 2011.
11. Simões M.G., Roche R., Kyriakides E., Miraoui A., Blunier B., McBee K., Suryanarayanan S., Nguyen P. and Ribeiro P., *Smart-Grid Technologies and Progress in Europe and the USA*. IEEE Energy Conversion Congress & Exposition (ECCE 2011). pp. 383–390. September 2011.
12. Roche R., Blunier B. and Miraoui A., *Multi-Agent Systems For Grid Energy Management: A Short Review*. 36th Annual Conference of the IEEE Industrial Electronics Society (IECON 2010). pp. 3341–3346. November 2010.

National Conferences and Symposia

1. Roche R., Idoumghar L., Blunier B. and Miraoui A., *Algorithmes hybrides pour la gestion intelligente de l'énergie dans les smart grids*. 7èmes Journées Francophones Planification, Décision, et Apprentissage pour la conduite de systèmes (JFPDA 2012). May 2012.
2. Chérin N., Idoumghar L., Siarry P., Roche R. and Blunier B., *Métaheuristique hybride pour les problèmes d'optimisation continue*. 13e congrès annuel de la Société Française de Recherche Opérationnelle et d'Aide à la Décision (ROADEF 2012). April 2012.
3. Roche R., *Application de métaheuristiques pour la gestion optimale de l'énergie dans les réseaux électriques intelligents*. Conférence des Jeunes Chercheurs en Génie Electrique (JCGE 2011). December 2011.
4. Roche R., Blunier B., Miraoui A., *Gestion intelligente de l'énergie dans les smart grids : combiner flexibilité et efficacité*. IngéDoc seminar for young researchers, UTBM, Belfort, France. December 2011.

Oral Communications

1. Roche R., *An aggregator-based architecture and simulator for residential demand response*. UTBM, Belfort, France. July 2012.
2. Roche R., *A Framework for a Multi-Agent Distribution Management System*, Clean Energy Supercluster & Cenergy Expo 2012. Colorado State University, Fort Collins, USA. April 2012.
3. Roche R., *Design and Development of an Intelligent, Flexible and Integrated Energy Management System for Smart Microgrids*. Colorado State University, Fort Collins, USA. February 2012.
4. Roche R., Blunier B., Miraoui A., *Smart grids et smart meters : Vers des réseaux électriques décentralisés et intelligents*. Vers une ville post-carbone symposium, with the French Academy of Technology, UTBM, Belfort, France. April 2010.

Bibliography

- [1] J. Miller, “A modest proposal for kickstarting smartgrid with smarter devices: Lessons from wireless spectrum regulatory and policy models for protocols and devices necessary for realizing the smarter grid,” 2012, available at SSRN: <http://ssrn.com/abstract=2032378>.
- [2] M. Simões, R. Roche, E. Kyriakides, S. Suryanarayanan, B. Blunier, K. McBee, P. Nguyen, P. Ribeiro, and A. Miraoui, “A comparison of smart grid technologies and progresses in europe and the U.S.” *IEEE Transactions on Industry Applications*, vol. 48, no. 4, pp. 1154–1162, 2012.
- [3] International Energy Agency, “Technology roadmap smart grids,” 2011, accessed September 30, 2012. [Online]. Available: http://www.iea.org/publications/freepublications/publication/smartgrids_roadmap.pdf
- [4] S. Suryanarayanan, F. Mancilla-David, J. Mitra, and Y. Li, “Achieving the smart grid through customer-driven microgrids supported by energy storage,” in *IEEE International Conference on Industrial Technology (ICIT)*, 2010, pp. 884–890.
- [5] K. Cory and B. Swezey, “Renewable portfolio standards in the states: Balancing goals and implementation strategies,” 2007, NREL/TP-670-41409. [Online]. Available: <http://www.nrel.gov/docs/fy08osti/41409.pdf>
- [6] European Renewable Energy Council, Greenpeace International, “Renewables 24/7: Infrastructure needed to save the climate,” November 2009, accessed October 6, 2012. [Online]. Available: http://www.erec.org/fileadmin/erec_docs/Documents/Publications/global%20energy%20grid%20scenario.pdf
- [7] RTE France - Réseau de Transport d'Électricité. (2012) Customers portal. Accessed June 25, 2012. [Online]. Available: <http://clients.rte-france.com/477lang/an/visiteurs/vie/telecharge.jsp>
- [8] U.S. Energy Information Administration, “International energy outlook 2011,” 2011, DOE/EIA-0484(2011). [Online]. Available: [http://www.eia.gov/forecasts/ieo/pdf/0484\(2011\).pdf](http://www.eia.gov/forecasts/ieo/pdf/0484(2011).pdf)
- [9] D. Coll-Mayor, M. Paget, and E. Lightner, “Future intelligent power grids: Analysis of the vision in the European Union and the United States,” *Energy Policy*, vol. 35, no. 4, pp. 2453–2465, 2007.
- [10] T. Chen, “Stuxnet, the real start of cyber warfare? [editor’s note],” *IEEE Network*, vol. 24, no. 6, pp. 2–3, 2010.

- [11] W. Boothby, W. von Heinegg, J. Michael, M. Schmitt, and T. Wingfield, “When is a cyberattack a use of force or an armed attack?” *Computer*, pp. 82–84, 2012.
- [12] A. Stefanov and C.-C. Liu, “Cyber-power system security in a smart grid environment,” in *IEEE PES Innovative Smart Grid Technologies (ISGT)*, jan. 2012, pp. 1–3.
- [13] National Science Foundation. (2012) Cyber-physical systems (CPS). Accessed September 10, 2012. [Online]. Available: http://www.nsf.gov/funding/pgm_summ.jsp?pims_id=503286
- [14] 110th U.S. Congress, “Energy independence and security act of 2007,” 2007, publication 110-140. [Online]. Available: <http://www.gpo.gov/fdsys/pkg/BILLS-110hr6enr/pdf/BILLS-110hr6enr.pdf>
- [15] SmartGrids European Technology Platform. (2012) The SmartGrids European Technology Platform. Accessed August 15, 2012. [Online]. Available: <http://www.smartgrids.eu/web/node/81>
- [16] A. Carvallo and J. Cooper, *The Advanced Smart Grid: Edge Power Driving Sustainability*. Artech House, 2010.
- [17] F. Rahimi and A. Ipakchi, “Demand response as a market resource under the smart grid paradigm,” *IEEE Transactions on Smart Grid*, vol. 1, no. 1, pp. 82–88, 2010.
- [18] M. Amin, “Challenges in reliability, security, efficiency, and resilience of energy infrastructure: Toward smart self-healing electric power grid,” in *IEEE Power and Energy Society General Meeting - Conversion and Delivery of Electrical Energy in the 21st Century*, 2008, pp. 1–5.
- [19] S. Duquennoy, G. Grimaud, and J. Vandewalle, “The web of things: interconnecting devices with high usability and performance,” in *IEEE International Conference on Embedded Software and Systems (ICCESS)*, 2009, pp. 323–330.
- [20] E. Palm. (2009, March) Enernet - A smart-grid vision from a net tycoon. CNET News. Accessed September 10, 2012. [Online]. Available: http://news.cnet.com/8301-11128_3-10203683-54.html
- [21] Agence de l’Environnement et de la Maitrise de l’Energie (ADEME), “Roadmap for smart grids and electricity systems integrating renewable energy sources,” 2009, accessed September 10, 2012. [Online]. Available: http://www.google.fr/url?sa=t&rct=j&q=&esrc=s&source=web&cd=1&ved=0CGsQFjAA&url=http%3A%2F%2Fwww2.ademe.fr%2Fservlet%2FgetBin%3Fname%3DEA7316C69FBD6C4A1AF9FD685A474A941260278372367.pdf&ei=d_wrUKvvKMn8igL2tIG4Dw&usq=AFQjCNHx5_0-gSeDufpzZuj71Ry-ahHUpg
- [22] NIST, “Framework and roadmap for smart grid interoperability standards, release 2.0,” NIST, 2012, Special Publication 1108R2.
- [23] V. Terzija, G. Valverde, D. Cai, P. Regulski, V. Madani, J. Fitch, S. Skok, M. Begovic, and A. Phadke, “Wide-area monitoring, protection, and control of future electric power networks,” *Proceedings of the IEEE*, vol. 99, no. 1, pp. 80–93, 2011.

- [24] N. Hingorani, L. Gyugyi, and M. El-Hawary, *Understanding FACTS: concepts and technology of flexible AC transmission systems*. IEEE Press New York, 2000.
- [25] N. Kirby, X. Lie, M. Lockett, and W. Siepman, “HVDC transmission for large offshore wind farms,” *Power Engineering Journal*, vol. 16, no. 3, pp. 135–141, 2002.
- [26] U.S. Department of Energy – Office of Electricity Deliver and Energy Reliability – Smart Grid R&D Program, “Microgrid workshop report,” 2011. [Online]. Available: <http://energy.gov/sites/prod/files/Microgrid%20Workshop%20Report%20August%202011.pdf>
- [27] F. Trieb and H. Müller-Steinhagen, “The DESERTEC Concept-Sustainable Electricity and Water for Europe, Middle East and North Africa,” *Whitebook of TREC and Club of Rome—Clean Power from Deserts*, pp. 23–43, 2007.
- [28] J. Klimstra and M. Hotakainen, *Smart power generation: the future of electricity production*. Avain, 2012.
- [29] A. Berizzi, “The Italian 2003 blackout,” in *IEEE Power Engineering Society General Meeting*, 2004, pp. 1673–1679.
- [30] D. White, A. Roschelle, P. Peterson, D. Schlissel, B. Biewald, and W. Steinhurst, “The 2003 blackout: solutions that won’t cost a fortune,” *The Electricity Journal*, vol. 16, no. 9, pp. 43–53, 2003.
- [31] SmartGrid.gov. (2012) Project information and locations. Accessed September 10, 2012. [Online]. Available: http://www.smartgrid.gov/recovery_act/project_information
- [32] G. Zachary, “Saving smart meters from a backlash,” *IEEE Spectrum*, vol. 48, no. 8, p. 8, august 2011.
- [33] N. Hadjsaïd and J. Sabonnadière, *Power Systems and Restructuring*. ISTE, 2009.
- [34] N. Hadjsaid, *La distribution d’énergie électrique en présence de production décentralisée (série Génie électrique)*. Hermès – Lavoisier, 2010.
- [35] M. Aoki and G. Rothwell, “A comparative institutional analysis of the Fukushima nuclear disaster: Lessons and policy implications,” 2012, accessed September 10, 2012. [Online]. Available: <http://ssrn.com/abstract=1940207>
- [36] U.S. Department of Energy, “Benefits of demand response in electricity markets and recommendations for achieving them,” 2006, Report to the U.S. Congress pursuant to Section 1252 of the Energy Policy Act of 2005. [Online]. Available: <http://eetd.lbl.gov/ea/ems/reports/congress-1252d.pdf>
- [37] T. Sezi and B. Duncan, “New intelligent electronic devices change the structure of power distribution systems,” in *IEEE IAS Annual Meeting*, vol. 2, 1999, pp. 944–952.
- [38] R. Roche, S. Natarajan, A. Bhattacharyya, and S. Suryanarayanan, “A framework for co-simulation of AI tools with a power systems analysis software,” in *1st International Workshop on Intelligent Agent Technology, Power Systems and Energy Markets (IATEM 2012)*, 2012, pp. 350–354.

- [39] R. Roche, L. Idoumghar, S. Suryanarayanan, M. Daggag, C. Solacolu, and A. Miraoui, "A flexible and efficient multi-agent gas turbine power plant energy management system with economic and environmental constraints," *Applied Energy*, vol. 101, pp. 644–654, 2013.
- [40] T. Overbye and J. Weber, "Visualizing the electric grid," *IEEE Spectrum*, vol. 38, no. 2, pp. 52–58, 2001.
- [41] M. Shahidehpour and Y. Wang, *Communication and control in electric power systems: applications of parallel and distributed processing*. Wiley-IEEE Press, 2003.
- [42] C. Petermann, S. Ben Amor, and A. Bui, "A pretopological multi-agents based model for an efficient and reliable smart grid simulation," in *International Conference on Artificial Intelligence (ICAI)*, 2012.
- [43] J. Miller and S. Page, *Complex adaptive systems: An introduction to computational models of social life*. Princeton Univ Press, 2007.
- [44] P. Cilliers, *Complexity and Postmodernism: Understanding Complex Systems*. Routledge, 1998.
- [45] A. Wildberger, "Autonomous adaptive agents for distributed control of the electric power grid in a competitive electric power industry," in *IEEE International Conference on Knowledge-Based Intelligent Electronic Systems (KES)*, vol. 1, 1997, pp. 2–11.
- [46] M. Wooldridge and G. Weiss, *Multi-Agent Systems*. The MIT Press, 1999.
- [47] J. Ferber, *Multi-Agent Systems: An Introduction to Artificial Intelligence*. Addison-Wesley, 1999.
- [48] R. Roche, B. Blunier, A. Miraoui, V. Hilaire, and A. Koukam, "Multi-agent systems for grid energy management: A short review," in *36th Annual Conference on IEEE Industrial Electronics Society (IECON)*, 2010, pp. 3341–3346.
- [49] S. Russell and P. Norvig, *Artificial Intelligence, A modern approach*. Prentice-Hall, 1995.
- [50] G. Serugendo, "Self-organisation and emergence in multi-agent systems," *The Knowledge Engineering Review*, vol. 20, no. 2, pp. 165–189, 2005.
- [51] S. Srivastava, S. Suryanarayanan, P. Ribeiro, D. Cartes, and M. Stcurer, "A conceptual power quality monitoring technique based on multi-agent systems," in *Proceedings of the 37th Annual North American Power Symposium (NAPS)*, 2005, pp. 358–363.
- [52] M. Baran and I. El-Markabi, "A multiagent-based dispatching scheme for distributed generators for voltage support on distribution feeders," *IEEE Transactions on Power Systems*, vol. 22, no. 1, pp. 52–59, 2007.
- [53] H. F. Wang, H. Li, and H. Chen, "Coordinated secondary voltage control to eliminate voltage violations in power system contingencies," *IEEE Transactions on Power Systems*, vol. 18, no. 2, pp. 588–595, 2003.

- [54] T. Nagata and H. Sasaki, "A multi-agent approach to power system restoration," *IEEE Transactions on Power Systems*, vol. 17, no. 2, pp. 457–462, 2002.
- [55] J. Solanki, S. Khushalani, and N. Schulz, "A multi-agent solution to distribution systems restoration," *IEEE Transactions on Power Systems*, vol. 22, no. 3, pp. 1026–1034, 2007.
- [56] E. Davidson, S. McArthur, J. McDonald, T. Cumming, and I. Watt, "Applying multi-agent system technology in practice: automated management and analysis of SCADA and digital fault recorder data," *IEEE Transactions on Power Systems*, vol. 21, no. 2, pp. 559–567, 2006.
- [57] S. McArthur, E. Davidson, V. Catterson, A. Dimeas, N. Hatziargyriou, F. Ponci, and T. Funabashi, "Multi-Agent Systems for Power Engineering Applications - Part I: Concepts, Approaches, and Technical Challenges," *IEEE Transactions on Power Systems*, vol. 22, no. 4, pp. 1743–1752, 2007.
- [58] —, "Multi-Agent Systems for Power Engineering Applications - Part II: Technologies, Standards, and Tools for Building Multi-agent Systems," *IEEE Transactions on Power Systems*, vol. 22, no. 4, pp. 1753–1759, nov. 2007.
- [59] J. Lagorse, D. Paire, and A. Miraoui, "A multi-agent system for energy management of distributed power sources," *Renewable Energy*, vol. 35, no. 1, pp. 174–182, 2010.
- [60] J. Lagorse, M. Simoes, and A. Miraoui, "A multiagent fuzzy-logic-based energy management of hybrid systems," *IEEE Transactions on Industry Applications*, vol. 45, no. 6, pp. 2123–2129, 2009.
- [61] A. Dimeas and N. Hatziargyriou, "Operation of a multiagent system for microgrid control," *IEEE Transactions on Power Systems*, vol. 20, no. 3, pp. 1447–1455, 2005.
- [62] —, "A multiagent system for microgrids," in *IEEE Power Engineering Society General Meeting*, vol. 1, 2004, pp. 55–58.
- [63] N. Hatziargyriou, A. Dimeas, A. Tsikalakis, J. Lopes, G. Karniotakis, and J. Oyarzabal, "Management of microgrids in market environment," in *International Conference on Future Power Systems*, 2005, p. 7.
- [64] A. Dimeas and N. Hatziargyriou, "Multi-agent reinforcement learning for microgrids," in *IEEE Power and Energy Society General Meeting*, 2010, pp. 1–8.
- [65] T. Logenthiran, D. Srinivasan, A. Khambadkone, and H. N. Aung, "Multiagent system for real-time operation of a microgrid in real-time digital simulator," *IEEE Transactions on Smart Grid*, vol. 3, no. 2, pp. 925–933, 2012.
- [66] T. Logenthiran, D. Srinivasan, and D. Wong, "Multi-agent coordination for DER in microgrid," in *IEEE International Conference on Sustainable Energy Technologies (ICSET 2008)*, 2008, pp. 77–82.
- [67] T. Logenthiran, D. Srinivasan, A. Khambadkone, and H. Aung, "Scalable multi-agent system (MAS) for operation of a microgrid in islanded mode," in *Joint International Conference on Power Electronics, Drives and Energy Systems (PEDES)*, 2010, pp. 1–6.

- [68] ———, “Multi-agent system (MAS) for short-term generation scheduling of a micro-grid,” in *IEEE International Conference on Sustainable Energy Technologies (ICSET)*, 2010, pp. 1–6.
- [69] T. Logenthiran and D. Srinivasan, “Multi-agent system for managing a power distribution system with plug-in hybrid electrical vehicles in smart grid,” in *IEEE PES Innovative Smart Grid Technologies - India (ISGT India)*, 2011, pp. 346–351.
- [70] T. Logenthiran, D. Srinivasan, and T. Z. Shun, “Multi-agent system for demand side management in smart grid,” in *IEEE International Conference on Power Electronics and Drive Systems (PEDS)*, 2011, pp. 424–429.
- [71] S. Rahman, M. Pipattanasomporn, and Y. Teklu, “Intelligent distributed autonomous power systems (IDAPS),” in *IEEE Power Engineering Society General Meeting*, 2007, pp. 1–8.
- [72] M. Pipattanasomporn, H. Feroze, and S. Rahman, “Multi-agent systems in a distributed smart grid: Design and implementation,” in *IEEE/PES Power Systems Conference and Exposition (PSC)*, 2009, pp. 1–8.
- [73] J. Kok, B. Roossien, P. MacDougall, O. Pruisen, G. Venekamp, I. Kamphuis, J. Laarakkers, and C. Warmer, “Dynamic pricing by scalable energy management systems - Field experiences and simulation results using PowerMatcher,” in *IEEE Power and Energy Society General Meeting*, 2012.
- [74] F. Bliet, A. van den Noort, B. Roossien, R. Kamphuis, J. de Wit, J. van der Velde, and M. Eijgelaar, “PowerMatching City, a living lab smart grid demonstration,” in *IEEE PES Innovative Smart Grid Technologies Conference - Europe (ISGT Europe)*, 2010, pp. 1–8.
- [75] J. Kok, M. Scheepers, and I. Kamphuis, “Intelligence in electricity networks for embedding renewables and distributed generation,” *Intelligent Infrastructures*, pp. 179–209, 2010.
- [76] J. K. Kok, C. J. Warmer, and I. G. Kamphuis, “PowerMatcher: multiagent control in the electricity infrastructure,” in *Proceedings of the international joint conference on autonomous agents and multiagent systems (AAMAS)*, 2005, pp. 75–82.
- [77] M. Hommelberg, C. Warmer, I. Kamphuis, J. Kok, and G. Schaeffer, “Distributed control concepts using multi-agent technology and automatic markets: An indispensable feature of smart power grids,” in *IEEE Power Engineering Society General Meeting*, 2007, pp. 1–7.
- [78] I. Praca, C. Ramos, Z. Vale, and M. Cordeiro, “MASCEM: a multiagent system that simulates competitive electricity markets,” *IEEE Intelligent Systems*, vol. 18, no. 6, pp. 54–60, nov-dec 2003.
- [79] Z. Vale, T. Pinto, H. Morais, I. Praca, and P. Faria, “VPP’s multi-level negotiation in smart grids and competitive electricity markets,” in *IEEE Power and Energy Society General Meeting*, 2011, pp. 1–8.
- [80] Infotility. (2012) Infotility products. Accessed October 4, 2012. [Online]. Available: <http://www.infotility.com/>

- [81] Foundation for Intelligent Physical Agents (FIPA). (2012) Accessed September 10, 2012. [Online]. Available: <http://www.fipa.org>
- [82] *FIPA ACL Message Structure Specification*, Foundation For Intelligent Physical Agents Std. SC00061G, 2002.
- [83] *FIPA SL Content Language Specification*, Foundation For Intelligent Physical Agents Std. SC00008I, 2002.
- [84] V. Catterson, P. Baker, E. Davidson, and S. McArthur. (2010) An upper ontology for power engineering applications. Accessed July 1, 2011. [Online]. Available: <http://ewh.ieee.org/mu/pes-mas/>
- [85] *FIPA Agent Management Specification*, Foundation For Intelligent Physical Agents Std. SC00023K, 2004.
- [86] B. Horling and V. Lesser, “A survey of multi-agent organizational paradigms,” *The Knowledge Engineering Review*, vol. 19, no. 4, pp. 281–316, 2004.
- [87] J. Yen, Y. Yan, B. Wang, P. Sin, and F. Wu, “Multi-agent coalition formation in power transmission planning,” in *Proceedings of the Thirty-First Hawaii International Conference on System Sciences*, vol. 4, 1998, pp. 433–443.
- [88] *FIPA Request Interaction Protocol Specification*, Foundation For Intelligent Physical Agents Std. XC00026F, 2001.
- [89] *FIPA Contract Net Interaction Protocol Specification*, Foundation For Intelligent Physical Agents Std. SC00029H, 2002.
- [90] G. Sheble, *Computational auction mechanisms for restructured power industry operation*. Springer, 1999.
- [91] *FIPA English Auction Interaction Protocol Specification*, Foundation For Intelligent Physical Agents Std. XC00031F, 2001.
- [92] *FIPA Dutch Auction Interaction Protocol Specification*, Foundation For Intelligent Physical Agents Std. XC00032F, 2001.
- [93] L. Ausubel and P. Milgrom, “The lovely but lonely Vickrey auction,” *Combinatorial Auctions*, pp. 17–40, 2006.
- [94] A. Motto, F. Galiana, A. Conejo, and M. Huneault, “On walrasian equilibrium for pool-based electricity markets,” *IEEE Transactions on Power Systems*, vol. 17, no. 3, pp. 774–781, 2002.
- [95] J. Pitt, L. Kamara, M. Sergot, and A. Artikis, “Voting in multi-agent systems,” *The Computer Journal*, vol. 49, no. 2, pp. 156–170, 2006.
- [96] *FIPA Brokering Interaction Protocol Specification*, Foundation For Intelligent Physical Agents Std. SC00033H, 2002.
- [97] Wikipedia, “Comparison of agent-based modeling software — Wikipedia, The Free Encyclopedia,” 2012, accessed August 7, 2012. [Online]. Available: http://en.wikipedia.org/w/index.php?title=Comparison_of_agent-based_modeling_software&oldid=505030846

- [98] Foundation for Intelligent Physical Agents. (2003) Publicly available agent platform implementations. Accessed August 7, 2012. [Online]. Available: <http://www.fipa.org/resources/livesystems.html>
- [99] F. Belfemine, G. Caire, and D. Greenwood, *Developing multi-agent systems with JADE*. Wiley, 2007.
- [100] K. Warwick, A. Ekwue, and R. Aggarwal, *Artificial intelligence techniques in power systems*. IET, 1997.
- [101] G. Venayagamoorthy, “Potentials and promises of computational intelligence for smart grids,” in *IEEE Power & Energy Society General Meeting (PES’09)*, 2009, pp. 1–6.
- [102] J. de Haan, P. Nguyen, W. Kling, and P. Ribeiro, “Social interaction interface for performance analysis of smart grids,” in *IEEE First International Workshop on Grid Modeling and Simulation (SGMS)*, 2011, pp. 79–83.
- [103] T. Godfrey, S. Mullen, R. Dugan, C. Rodine, D. Griffith, and N. Golmie, “Modeling smart grid applications with co-simulation,” in *First IEEE International Conference on Smart Grid Communications (SmartGridComm)*, 2010, pp. 291–296.
- [104] H. Lin, S. Sambamoorthy, S. Shukla, J. Thorp, and L. Mili, “Power system and communication network co-simulation for smart grid applications,” in *IEEE PES Innovative Smart Grid Technologies (ISGT)*, 2011, pp. 1–6.
- [105] V. Liberatore and A. Al-Hammouri, “Smart grid communication and co-simulation,” in *IEEE Energytech*, 2011, pp. 1–5.
- [106] J. Gomez-Gualdron and M. Velez-Reyes, “Simulating a multi-agent based self-reconfigurable electric power distribution system,” in *IEEE Workshops on Computers in Power Electronics (COMPEL’06.)*, 2006, pp. 1–7.
- [107] C. J. Bankier, “GridIQ - A Test Bed for Smart Grid Agents,” Master’s thesis, University of Queensland, 2010. [Online]. Available: <http://gridiq.sourceforge.net/>
- [108] D. Chassin, K. Schneider, and C. Gerkensmeyer, “GridLAB-D: An open-source power systems modeling and simulation environment,” in *IEEE/PES Transmission and Distribution Conference and Exposition (T&D 2008)*, 2008, pp. 1–5.
- [109] PowerWorld Corporation. (2012) PowerWorld, the visual approach to electric power systems. Accessed September 21, 2012. [Online]. Available: <http://www.powerworld.com/>
- [110] MathWorks. (2012) MATLAB and Simulink for technical computing. Accessed September 21, 2012. [Online]. Available: <http://www.mathworks.com/>
- [111] PowerWorld Corporation, “User’s Guide - Simulator Version 16,” 2011. [Online]. Available: <http://www.powerworld.com/>
- [112] R. Roche. (2012) Co-simulation framework for JADE-Matlab-PowerWorld Simulator. [Online]. Available: <http://www.engr.colostate.edu/madims>

- [113] C. De Jonghe, E. Delarue, R. Belmans, and W. D'haeseleer, "Determining optimal electricity technology mix with high level of wind power penetration," *Applied Energy*, vol. 88, no. 6, pp. 2231–2238, 2011.
- [114] N. Sinha, R. Chakrabarti, and P. Chattopadhyay, "Evolutionary programming techniques for economic load dispatch," *IEEE Transactions on Evolutionary Computation*, vol. 7, no. 1, pp. 83–94, 2003.
- [115] M. Abido, "Environmental/economic power dispatch using multiobjective evolutionary algorithms," *IEEE Transactions on Power Systems*, vol. 18, no. 4, pp. 1529–1537, 2003.
- [116] —, "Multiobjective evolutionary algorithms for electric power dispatch problem," *IEEE Transactions on Evolutionary Computation*, vol. 10, no. 3, pp. 315–329, 2006.
- [117] S. Kazarlis, A. Bakirtzis, and V. Petridis, "A genetic algorithm solution to the unit commitment problem," *IEEE Transactions on Power Systems*, vol. 11, no. 1, pp. 83–92, 1996.
- [118] N. Padhy, "Unit commitment - A bibliographical survey," *IEEE Transactions on Power Systems*, vol. 19, no. 2, pp. 1196–1205, 2004.
- [119] S. K. Yee, J. Milanovic, and F. Hughes, "Overview and comparative analysis of gas turbine models for system stability studies," *IEEE Transactions on Power Systems*, vol. 23, no. 1, pp. 108–118, 2008.
- [120] S. Simani, "Identification and fault diagnosis of a simulated model of an industrial gas turbine," *IEEE Transactions on Industrial Informatics*, vol. 1, no. 3, pp. 202–216, 2005.
- [121] E.-H. T. El-Shirbeeney and M. K. Kadum, "Communication schemes for electric energy management," *Applied Energy*, vol. 24, no. 4, pp. 277–286, 1986.
- [122] V. V. Silva, W. Khatib, and P. J. Fleming, "Performance optimization of gas turbine engine," *Engineering Applications of Artificial Intelligence*, vol. 18, no. 5, pp. 575–583, 2005.
- [123] A. K. Kralj and P. Glavic, "Optimization of a gas turbine in the methanol process, using the NLP model," *Applied Thermal Engineering*, vol. 27, no. 11-12, pp. 1799–1805, 2007.
- [124] F. Brooks, "GE gas turbine performance characteristics," GE Power Systems, Schenectady, NY, Tech. Rep. GER3567h, 2000. [Online]. Available: http://site.ge-energy.com/prod_serv/products/tech_docs/en/downloads/ger3567h.pdf
- [125] M. Boyce, *Gas turbine engineering handbook*. Butterworth-Heinemann, 2011.
- [126] L. Freris and D. Infield, *Renewable energy in power systems*. Wiley, 2008.
- [127] A. Wood and B. Wollenberg, *Power generation, operation, and control*. Wiley, 1996.
- [128] J. Petek and P. Hamilton, "Performance monitoring for gas turbines," *ORBIT*, vol. 25, no. 1, pp. 64–74, 2005.

- [129] L. Davis and S. Black, "Dry Low NO_x Combustion Systems for GE Heavy-Duty Gas Turbines," GE Power Systems, Tech. Rep. GER-3568G, 2000.
- [130] U.S. Environmental Protection Agency, "Alternative Control Techniques Document – NO_x Emissions from Stationary Gas Turbines," 1993, EPA-453/R-93-007. [Online]. Available: <http://www.epa.gov/ttn/catc1/dir1/gasturb.pdf>
- [131] R. Hooshmand, M. Parastegari, and M. Morshed, "Emission, reserve and economic load dispatch problem with non-smooth and non-convex cost functions using the hybrid bacterial foraging-Nelder–Mead algorithm," *Applied Energy*, vol. 89, no. 1, pp. 443–453, 2012.
- [132] V. Vahidinasab and S. Jadid, "Multiobjective environmental/techno-economic approach for strategic bidding in energy markets," *Applied Energy*, vol. 86, no. 4, pp. 496–504, 2009.
- [133] GE Energy. (2012) 9E Heavy Duty Gas Turbine. Accessed March 7, 2012. [Online]. Available: http://www.ge-energy.com/products_and_services/products/gas_turbines_heavy_duty/9e_heavy_duty_gas_turbine.jsp
- [134] M. Albadi and E. El-Saadany, "Overview of wind power intermittency impacts on power systems," *Electric Power Systems Research*, vol. 80, no. 6, pp. 627–632, 2010.
- [135] A. Botterud, J. Wang, V. Miranda, and R. J. Bessa, "Wind Power Forecasting in U.S. Electricity Markets," *The Electricity Journal*, vol. 23, no. 3, pp. 71–82, 2010.
- [136] M. Lei, L. Shiyan, J. Chuanwen, L. Hongling, and Z. Yan, "A review on the forecasting of wind speed and generated power," *Renewable and Sustainable Energy Reviews*, vol. 13, no. 4, pp. 915–920, 2009.
- [137] J. Talaq, F. El-Hawary, and M. El-Hawary, "A summary of environmental/economic dispatch algorithms," *IEEE Transactions on Power Systems*, vol. 9, no. 3, pp. 1508–1516, 1994.
- [138] C.-M. Huang and Y.-C. Huang, "A novel approach to real-time economic emission power dispatch," *IEEE Transactions on Power Systems*, vol. 18, no. 1, pp. 288–294, 2003.
- [139] C. Coello, "A comprehensive survey of evolutionary-based multiobjective optimization techniques," *Knowledge and Information systems*, vol. 1, no. 3, pp. 129–156, 1999.
- [140] M. Shao and W. Jewell, "CO₂ emission-incorporated ac optimal power flow and its primary impacts on power system dispatch and operations," in *IEEE Power and Energy Society General Meeting*, 2010, pp. 1–8.
- [141] M. Khalid and A. Savkin, "A model predictive control approach to the problem of wind power smoothing with controlled battery storage," *Renewable Energy*, vol. 35, no. 7, pp. 1520–1526, 2010.
- [142] S. Teleke, M. Baran, A. Huang, S. Bhattacharya, and L. Anderson, "Control strategies for battery energy storage for wind farm dispatching," *IEEE Transactions on Energy Conversion*, vol. 24, no. 3, pp. 725–732, 2009.

- [143] OECD, "OECD Environmental Performance Reviews: Norway 2011," Tech. Rep., 2011, accessed September 10, 2012. [Online]. Available: <http://www.oecd.org/norway/oecdenvironmentalperformancereviewsnorway2011.htm>
- [144] J. Sumner, L. Bird, and H. Smith, "Carbon taxes: A review of experience and policy design considerations," NREL, Tech. Rep. NREL/TP-6A2-47312, 2009.
- [145] Federal Energy Regulatory Commission. (2012) Emissions Allowances - GHG, SO_x & NO_x. Accessed June 25, 2012. [Online]. Available: <http://www.ferc.gov/market-oversight/othr-mkts/emiss-allow.asp>
- [146] U.S. Energy Information Administration, "Annual energy outlook 2012," 2012. [Online]. Available: [http://www.eia.gov/forecasts/aeo/pdf/0383\(2012\).pdf](http://www.eia.gov/forecasts/aeo/pdf/0383(2012).pdf)
- [147] R. Green II, L. Wang, and M. Alam, "The impact of plug-in hybrid electric vehicles on distribution networks: A review and outlook," *Renewable and Sustainable Energy Reviews*, vol. 15, no. 1, pp. 544–553, 2011.
- [148] S. Kaplan, "Power plants: Characteristics and costs," 2008, Congressional Research Service RL34746. [Online]. Available: <http://www.fas.org/sgp/crs/misc/RL34746.pdf>
- [149] A. Kumar, S. Jain, and N. Bansal, "Disseminating energy-efficient technologies: a case study of compact fluorescent lamps (CFLs) in India," *Energy Policy*, vol. 31, no. 3, pp. 259–272, 2003.
- [150] R. Brown, "U.S. building-sector energy efficiency potential," Lawrence Berkeley National Laboratory, Tech. Rep. LBNL-1096E, 2008. [Online]. Available: <http://enduse.lbl.gov/info/LBNL-1096E.pdf>
- [151] A. Rosenfeld, D. Bulleit, and R. Peddie, "Smart meters and spot pricing: experiments and potential," *IEEE Technology and Society Magazine*, vol. 5, no. 1, pp. 23–28, 1986.
- [152] Federal Energy Regulatory Commission, "A national assessment of demand response potential," 2009. [Online]. Available: <http://www.ferc.gov/legal/staff-reports/06-09-demand-response.pdf>
- [153] J. Osborne and D. Warrier, "A Primer On Demand Response – The Power Grid: Evolving from a Dumb Network to a Smart Grid," Thomas Weisel Partners, Tech. Rep., 2007. [Online]. Available: http://downloads.lightreading.com/internetevolution/Thomas_Weisel_Demand_Response.pdf
- [154] Federal Energy Regulatory Commission, "Assessment of demand response and advanced metering," 2006, AD06-2-000. [Online]. Available: <http://www.ferc.gov/legal/staff-reports/2010-dr-report.pdf>
- [155] E. McKenna, K. Ghosh, and M. Thomson, "Demand response in low-carbon power systems: a review of residential electrical demand response projects," in *2nd International Conference on Microgeneration and Related Technologies*, 2011. [Online]. Available: <http://hdl.handle.net/2134/8709>

- [156] AEIC Research Load Committee, “Demand response measurement & verification,” 2009. [Online]. Available: http://www.aeic.org/load_research/AEIC-MV-Whitepaper-030409.pdf
- [157] M. Albadi and E. El-Saadany, “A summary of demand response in electricity markets,” *Electric Power Systems Research*, vol. 78, no. 11, pp. 1989–1996, 2008.
- [158] S. Shao, M. Pipattanasomporn, and S. Rahman, “Demand response as a load shaping tool in an intelligent grid with electric vehicles,” *IEEE Transactions on Smart Grid*, 2012, to appear.
- [159] —, “Grid integration of electric vehicles and demand response with customer choice,” *IEEE Transactions on Smart Grid*, vol. 3, no. 1, pp. 543–550, 2012.
- [160] K. Schneider, J. Fuller, and D. Chassin, “Analysis of distribution level residential demand response,” in *IEEE/PES Power Systems Conference and Exposition (PSCE)*, 2011, pp. 1–6.
- [161] H. Sæle and O. Grande, “Demand response from household customers: Experiences from a pilot study in Norway,” *IEEE Transactions on Smart Grid*, vol. 2, no. 1, pp. 102–109, 2011.
- [162] A. Thomas, P. Jahangiri, D. Wu, C. Cai, H. Zhao, D. Aliprantis, and T. L., “Intelligent residential air-conditioning system with smart-grid functionality,” *IEEE Transactions on Smart Grid*, 2012, to appear.
- [163] M. Pipattanasomporn, M. Kuzlu, and S. Rahman, “An algorithm for intelligent home energy management and demand response analysis,” *IEEE Transactions on Smart Grid*, to appear.
- [164] M. Mallette and G. Venkataramanan, “Financial incentives to encourage demand response participation by plug-in hybrid electric vehicle owners,” in *IEEE Energy Conversion Congress and Exposition (ECCE)*, 2010, pp. 4278–4284.
- [165] S. Lu, N. Samaan, R. Diao, M. Elizondo, C. Jin, E. Mayhorn, Y. Zhang, and H. Kirkham, “Centralized and decentralized control for demand response,” in *IEEE PES Innovative Smart Grid Technologies (ISGT)*, 2011, pp. 1–8.
- [166] A. Thomas, C. Cai, D. Aliprantis, and T. L., “Effects of price-responsive residential demand on retail and wholesale power market operations,” in *IEEE Power and Energy Society General Meeting*, 2012, to appear.
- [167] T. Lui, W. Stirling, and H. Marcy, “Get smart,” *IEEE Power and Energy Magazine*, vol. 8, no. 3, pp. 66–78, 2010.
- [168] C. O’Dwyer, R. Duignan, and M. O’Malley, “Modeling demand response in the residential sector for the provision of reserves,” in *IEEE Power and Energy Society General Meeting*, 2012, to appear.
- [169] C. Quinn, D. Zimmerle, and T. Bradley, “The effect of communication architecture on the availability, reliability, and economics of plug-in hybrid electric vehicle-to-grid ancillary services,” *Journal of Power Sources*, vol. 195, no. 5, pp. 1500–1509, 2010.

- [170] N. Hopper, C. Goldman, R. Bharvirkar, and D. Engel, "The summer of 2006: A milestone in the ongoing maturation of demand response," *The Electricity Journal*, vol. 20, no. 5, pp. 62–75, 2007.
- [171] D. Nguyen, M. Negnevitsky, and M. de Groot, "Pool-based demand response exchange – concept and modeling," *IEEE Transactions on Power Systems*, no. 99, pp. 1677–1685, 2011.
- [172] F. Lai, F. Magoulès, and F. Lherminier, "Vapnik's learning theory applied to energy consumption forecasts in residential buildings," *International Journal of Computer Mathematics*, vol. 85, no. 10, pp. 1563–1588, 2008.
- [173] M. Pedrasa, T. Spooner, and I. MacGill, "Coordinated scheduling of residential distributed energy resources to optimize smart home energy services," *IEEE Transactions on Smart Grid*, vol. 1, no. 2, pp. 134–143, 2010.
- [174] J. Giráldez, A. Jaientilal, J. Walz, S. Suryanarayanan, S. Sankaranarayanan, H. Brown, and E. Chang, "An evolutionary algorithm and acceleration approach for topological design of distributed resource islands," in *IEEE PowerTech*, 2011, pp. 1–8.
- [175] J. Giráldez, R. Roche, S. Suryanarayanan, and D. Zimmerle, "A Linear Programming Methodology to Quantify the Impact of PHEVs with V2G Capabilities on Distribution Systems," submitted, in review.
- [176] J. Laurent, G. Desaulniers, R. Malhame, and F. Soumis, "A column generation method for optimal load management via control of electric water heaters," *IEEE Transactions on Power Systems*, vol. 10, no. 3, pp. 1389–1400, 1995.
- [177] M. Ilic, J. Black, and J. Watz, "Potential benefits of implementing load control," in *IEEE Power Engineering Society Winter Meeting*, 2002, pp. 177–182.
- [178] J. Dickert and P. Schegner, "A time series probabilistic synthetic load curve model for residential customers," in *IEEE PowerTech*, 2011, pp. 1–6.
- [179] S. Meliopoulos, J. Meisel, G. Cokkinides, and T. Overbye, "Power system level impacts of plug-in hybrid vehicles," Power Systems Engineering Research Center (PSERC), Tech. Rep. 09-12, 2009. [Online]. Available: http://www.pserc.wisc.edu/documents/publications/reports/2009_reports/meliopoulos_phev_pserc_report_t-34_2009.pdf
- [180] E. Graham-Rowe, B. Gardner, C. Abraham, S. Skippon, H. Dittmar, R. Hutchins, and J. Stannard, "Mainstream consumers driving plug-in battery-electric and plug-in hybrid electric cars: A qualitative analysis of responses and evaluations," *Transportation Research Part A: Policy and Practice*, vol. 46, no. 1, pp. 140–153, 2012.
- [181] C.-S. N. Shiau, C. Samaras, R. Haufler, and J. J. Michalek, "Impact of battery weight and charging patterns on the economic and environmental benefits of plug-in hybrid vehicles," *Energy Policy*, vol. 37, no. 7, pp. 2653–2663, 2009.
- [182] G. Barbose, N. Dargouth, R. Wiser, and J. Seel, "Tracking the sun IV: An historical summary of the installed cost of photovoltaics in the U.S. from 1998

- to 2010,” Lawrence Berkeley National Laboratory, Tech. Rep. LBNL-5047E, 2011. [Online]. Available: <http://eetd.lbl.gov/ea/emp/reports/lbnl-5047e.pdf>
- [183] G. Masters, *Renewable and efficient electric power systems*. Wiley - IEEE Press, 2004.
- [184] P. Davis, “Energy Efficiency & Demand Response – Smart Grid, Evolution of DR and the Impact of FERC 745,” *Electric Light and Power*, vol. 89, no. 3, p. 46, 2011, accessed October 4, 2012. [Online]. Available: <http://www.elp.com/index/display/article-display/8190235016/articles/electric-light-power/volume-89/issue-3/sections/smart-grid-evolution-of-dr-and-the-impact-of-ferc-745.html>
- [185] L. Huang, J. Walrand, and K. Ramchandran, “Optimal smart grid tariffs,” in *Information Theory and Applications Workshop (ITA)*, 2012, pp. 212–220.
- [186] R. Billinton and S. Jonnavithula, “A test system for teaching overall power system reliability assessment,” *IEEE Transactions on Power Systems*, vol. 11, no. 4, pp. 1670–1676, 1996.
- [187] X. Ma, D. Sun, and K. Cheung, “Evolution toward standardized market design,” *IEEE Transactions on Power Systems*, vol. 18, no. 2, pp. 460–469, 2003.
- [188] L. Greening, D. Greene, and C. Difiglio, “Energy efficiency and consumption – The rebound effect – A survey,” *Energy policy*, vol. 28, no. 6, pp. 389–401, 2000.
- [189] P. Werbos, “Computational intelligence for the smart grid – history, challenges, and opportunities,” *IEEE Computational Intelligence Magazine*, vol. 6, no. 3, pp. 14–21, 2011.
- [190] L. Tesfatsion. (2012) The AMES Wholesale Power Market Test Bed. [Online]. Available: <http://www2.econ.iastate.edu/tesfatsi/AMESMarketHome.htm>
- [191] T. Hansen, R. Roche, S. Suryanarayanan, H. Siegel, D. Zimmerle, P. Young, and A. Maciejewski, “A proposed framework for heuristic approaches to resource allocation in the emerging smart grid,” in *IEEE PES International Conference on Power Systems Technology (POWERCON 2012)*, 2012, pp. 1–6.
- [192] DIgSILENT GmbH. (2012) PowerFactory – DIgSILENT Germany. Accessed October 4, 2012. [Online]. Available: <http://www.digsilent.de/index.php/products-powerfactory.html>
- [193] M. Daggag, R. Roche, L. Idoumghar, B. Blunier, A. Miraoui, and A. Koukam, “System and method for controlling an electrical energy production installation,” 2012, patent no. WO/2012/143424 (international) / FR1153369 (France).
- [194] R. Roche, L. Idoumghar, B. Blunier, and A. Miraoui, “Imperialist competitive algorithm for dynamic optimization of economic dispatch in power systems,” in *International Conference on Artificial Evolution (EA 2011)*, 2011, pp. 375–390.
- [195] —, “Optimized fuel cell array energy management using multi-agent systems,” in *IEEE Industry Applications Society Annual Meeting (IAS)*, 2011, pp. 1–8.

- [196] R. Roche, F. Lauri, B. Blunier, A. Miraoui, and A. Koukam, *Power Electronics for Renewable and Distributed Energy Systems*. Springer, 2012, ch. Multi-Agent Technology in Power Systems, in press.
- [197] M. Simões, R. Roche, E. Kyriakides, A. Miraoui, B. Blunier, K. McBee, S. Suryanarayanan, P. Nguyen, and P. Ribeiro, “Smart-grid technologies and progress in Europe and the USA,” in *IEEE Energy Conversion Congress and Exposition (ECCE)*, 2011, pp. 383–390.
- [198] N. Chérin, L. Idoumghar, P. Siarry, R. Roche, and B. Blunier, “Métaheuristique hybride pour les problèmes d’optimisation continue,” in *13e congrès annuel de la Société française de Recherche Opérationnelle et d’Aide à la Décision (ROADEF 2012)*, 2012.
- [199] A. Ravey, R. Roche, B. Blunier, and A. Miraoui, “Combined optimal sizing and energy management of hybrid electric vehicles,” in *IEEE Transportation Electrification Conference and Expo (ITEC)*, 2012, pp. 1–6.
- [200] N. Watrin, R. Roche, H. Ostermann, B. Blunier, and A. Miraoui, “Multi-physical lithium-based battery model for use in state-of-charge determination,” *IEEE Transactions on Vehicular Technology*, vol. 61, no. 8, pp. 3420–3429, 2012.
- [201] B. Couraud, R. Roche, and B. Traill, “A Distribution Load Forecasting Methodology Based on Primary Substations SCADA Data,” 2013, submitted, in review.
- [202] R. Roche. (2011) JICA: A Java Implementation of the Imperialist Competitive Algorithm for real variables. Accessed September 8, 2012. [Online]. Available: <https://github.com/robinroche/jica>
- [203] G. Kochenberger, *Handbook of metaheuristics*. Springer, 2003.
- [204] J. Kennedy and R. C. Eberhart, *Swarm Intelligence*. Morgan Kaufmann Academic Press, 2001.
- [205] R. Storn and K. Price, “Differential evolution – A simple and efficient heuristic for global optimization over continuous spaces,” *Journal of global optimization*, vol. 11, no. 4, pp. 341–359, 1997.
- [206] J. Holland, “Genetic algorithms,” *Scientific american*, vol. 267, no. 1, pp. 66–72, 1992.
- [207] E. Atashpaz-Gargari and C. Lucas, “Imperialist competitive algorithm: An algorithm for optimization inspired by imperialistic competition,” in *IEEE Congress on Evolutionary Computation*, 2007, pp. 4661–4667.
- [208] C. Blum and A. Roli, “Hybrid metaheuristics: An introduction,” *Hybrid Metaheuristics*, pp. 1–30, 2008.
- [209] L. Idoumghar, M. Idrissi-Aouad, M. Melkemi, and R. Schott, “Metropolis particle swarm optimization algorithm with mutation operator for global optimization problems,” in *22nd IEEE International Conference on Tools with Artificial Intelligence (ICTAI)*, 2010, pp. 35–42.

- [210] M. Locatelli, *Handbook Of Global Optimization*. Kluwer Academic Pub, 2002, ch. Simulated annealing algorithms for continuous global optimization, pp. 179–229.
- [211] C. Raquel and P. Naval Jr, “An effective use of crowding distance in multiobjective particle swarm optimization,” in *Proceedings of the 2005 ACM conference on Genetic and evolutionary computation*, 2005, pp. 257–264.
- [212] P. N. Suganthan, N. Hansen, J. J. Liang, K. Deb, Y.-P. Chen, A. Auger, and S. Tiwari, “Problem definitions and evaluation criteria for the CEC 2005 special session on real-parameter optimization,” Nanyang Technological University, Singapore and IIT Kanpur, India, Tech. Rep. 2005005, 2005.
- [213] M. Pant, R. Thangaraj, and A. Abraham, “Particle swarm based meta-heuristics for function optimization and engineering applications,” in *Conference on Computer Information Systems and Industrial Management Applications*, vol. 7, 2008, pp. 84–90.
- [214] L. Idoumghar. (2012) MetaHeuristicDemo. Accessed September 9, 2012. [Online]. Available: <http://www.lmia.uha.fr/~mage/idoumghar/MetaheuristicDemo.jar>
- [215] E. Atashpaz Gargari. (2008) Imperialist competitive algorithm (ica). Accessed September 8, 2012. [Online]. Available: <http://www.mathworks.com/matlabcentral/fileexchange/22046-imperialist-competitive-algorithm-ica>
- [216] J. J. Durillo and A. J. Nebro, “jMetal: A Java framework for multi-objective optimization,” *Advances in Engineering Software*, vol. 42, pp. 760–771, 2011.

List of Acronyms

AC	Air conditioning
ACL	Agent communication language
AI	Artificial intelligence
AID	Agent identifier
AMS	Agent management system
AP	Agent platform
AMI	Advanced metering infrastructure
BEV	Battery electric vehicle
CAS	Complex adaptive system
CHP	Combined heat and power
CIM	Common information model
COM	Component object model
COP	Coefficient of performance
CPP	Critical peak pricing
CPS	Cyber-physical system
DA	Distribution automation
DCS	Distributed control system
DE	Differential evolution
DF	Directory facilitator
DG	Distributed generation
DLC	Direct load control
DLN	Dry low NO _x
DLR	Dynamic line rating
DMS	Distribution management system
DR	Demand response
DRX	Demand response exchange
DSM	Demand-side management
DSO	Distribution system operator
ED	Economic dispatch
EMS	Energy management system
EV	Electric vehicle
EWH	Electric water heater
FACTS	Flexible AC transmission system

FIPA	Foundation for intelligent physical agents
GA	Genetic algorithm
GENCO	Generation company
GIS	Geographical information system
GUI	Graphical user interface
HEMS	Home energy management system
HTS	High temperature superconductor
HVDC	High voltage DC
ICA	Imperialist competitive algorithm
ICE	Internal combustion engine
IED	Intelligent electronic device
ISO	Independent system operator
IT	Information technology
JADE	Java agent development framework
KQML	Knowledge query and manipulation language
MAS	Multi-agent system
MDMS	Meter data management system
MPSOM	Metropolis particle swarm optimization with mutation operation
MTP	Message transport protocol
MTS	Message transport system
OMS	Outage management system
PHEV	Plug-in hybrid electric vehicle
PID	Proportional-integral-derivative
PMU	Phasor measurement unit
PSO	Particle swarm optimization
PV	Photovoltaic
RBTS	Roy Billinton test system
RES	Renewable energy source
RTP	Real-time pricing
SCADA	Supervisory control and data acquisition
SGP	Smart generating plant
SOC	State-of-charge
SSA	Start and stop algorithm
T&D	Transmission and distribution
TCP	Transmission control protocol
TOU	Time-of-use
TSO	Transmission system operator
UML	Unified modeling language
US	United States
V2G	Vehicle-to-grid
VPP	Virtual power plant

WAMS Wide area measurement system

List of Figures

1.1	Solar radiation and wind speed measured in Belfort, and total French load on June 6, 2011	3
1.2	Architecture of legacy power systems	7
1.3	Architecture of current power systems	8
1.4	Architecture of future power systems	9
1.5	Timescales and decision mechanisms for electric system operation	15
2.1	Diagram of a generic agent	23
2.2	Conceptual diagram of an example application of MASs for smart grids	28
2.3	Sample ACL message	30
2.4	Life cycle of an agent	32
2.5	The FIPA agent management reference model	32
2.6	Diagrams of hierarchy, holarchy and federation topologies	34
2.7	Diagram of the FIPA-Request protocol	37
2.8	Agent execution model of agents in JADE	40
2.9	Screenshot of the Introspector agent interface in JADE	40
2.10	Screenshot of the Sniffer agent interface in JADE	41
2.11	Interface between JADE, Matlab and PowerWorld	43
2.12	Communication flowchart of a request issued by a JADE agent	46
3.1	Diagram of a simple cycle, single shaft gas turbine	52
3.2	Fuel flow of the turbine.	53
3.3	NOx and CO emission curves of 9E gas turbines	54
3.4	Finite state machine describing the turbines combustion modes	55
3.5	Fuel consumption of a turbine during its starting cycle	56
3.6	Generic flowchart of an agent life cycle	57
3.7	Simplified turbine agent flowchart	59
3.8	Simplified dispatch agent flowchart	60
3.9	Overview of the power plant EMS architecture	61
3.10	Operation and interactions of agents when a new turbine is connected	62
3.11	Interactions between agents during normal operation of the EMS	63
3.12	Pareto front example	68
3.13	Screenshot of the developed GUI for the power plant EMS	71
3.14	Load profile used in the simulations	72
3.15	Duration spent by each turbine in each mode for Algorithm A	74
3.16	Duration spent by each turbine in each mode for Algorithm B	74

3.17	Duration spent by each turbine in each mode for Algorithm C	75
3.18	Duration spent by each turbine in each mode for Algorithm D	76
3.19	Duration spent by each turbine in each mode for Algorithm E	76
3.20	Duration spent by each turbine in each mode for Algorithm C with the SSA	79
3.21	Duration spent by each turbine in each mode for Algorithm D with the SSA	80
3.22	Duration spent by each turbine in each mode for Algorithm E with the SSA	80
3.23	Comparison of the MWh costs obtained by the algorithms	81
3.24	Results of the EMS flexibility test	81
3.25	Plot of the mean optimization duration as a function of the number of turbines to control	83
4.1	Main components of demand-side management	87
4.2	Architecture of the DR system	90
4.3	Diagram representing the interactions between residential loads, assets, smart meter, HEMS and the rest of the system	92
4.4	Operation principle of the EWH thermostat	94
4.5	Operation principle of the AC thermostat	96
4.6	Load profile example for one customer	98
4.7	Aggregated load profile example for 1000 customers	98
4.8	Main chronological steps of a DR event	103
4.9	Interactions between agents during a DR event	105
4.10	Flowchart of the PHEV charging rescheduling algorithm	106
4.11	Diagram of the available PHEV rescheduling strategies	107
4.12	Online diagram of bus 5 of the RBTS in PowerWorld Simulator	109
4.13	Baseline and actual net load curves	110
4.14	Total load reduction achieved with the DR system	111
4.15	Rebound effect example	112
4.16	Baseline and actual load curves for PHEV charging	112
4.17	Baseline and actual load curves for thermal loads	113
4.18	Impact of the DR system on indoor and water temperature	114
4.19	Rescheduling of the charge of a PHEV using strategy 1	114
4.20	Rescheduling of the charge of a PHEV using strategy 2	115
4.21	Rescheduling of the charge of a PHEV using strategy 3	115
4.22	Voltage profile at Feeder 4 of bus 5 in RBTS	116
A.1	Diagram of the movement of a particle with the PSO algorithm	126
A.2	Movement of a colony toward its imperialist in the ICA algorithm	130
A.3	Plot of the Sphere function for $n = 2$	136
A.4	Plot of the Rastrigin function for $n = 2$	136
A.5	Plot of the Rosenbrock function for $n = 2$	137
A.6	Plot of the Ackley function for $n = 2$	137

List of Tables

1.1	Comparison of vertically integrated utilities and unbundled electricity markets	14
3.1	Typical characteristics of a simple cycle 9E gas turbine	52
3.2	Selected parameters for the power plant EMS simulation	73
3.3	Results for each dispatching algorithm without the SSA	77
3.4	Impact of the performance coefficients on dispatching results	78
3.5	Results for each dispatching algorithm with the SSA	78
3.6	Number of messages exchanged and average optimization duration as a function of the number of turbines to control	82
4.1	Electric water heater model parameters	94
4.2	Air conditioning model parameters	95
4.3	Appliances model parameters	97
4.4	Characteristics of the four PHEV classes	99
4.5	Departure and arrival time distribution parameters of PHEVs for a typical weekday	101
4.6	Customer data for load points at bus 5 of the RBTS	108
4.7	Metrics for the DR event (Part 1)	111
4.8	Metrics for the DR event (Part 2)	111
A.1	Parameter settings for the PSO algorithm	127
A.2	Parameter settings for the DE algorithm	127
A.3	Parameter settings for the GA algorithm	129
A.4	Parameter settings for the ICA approach	132
A.5	Parameter settings for the MPSOM algorithm	133
A.6	Parameter settings for the ICA-PSO approach	134
A.7	Standard mathematical benchmark functions definition	135
A.8	Comparison of the solutions to the benchmark functions obtained by the selected metaheuristics	139

List of Algorithms

1	Pseudo-code of the PSO algorithm.	127
2	Pseudo-code of the DE algorithm.	128
3	Pseudo-code of the GA algorithm.	129
4	Pseudo-code of the ICA algorithm.	130
5	Pseudo-code of the ICA-PSO algorithm.	134