



HAL
open science

Reliability Assessment for Intelligent Vehicles System

Tian Zheng

► **To cite this version:**

Tian Zheng. Reliability Assessment for Intelligent Vehicles System. Other. Ecole Centrale de Lille, 2013. English. NNT : 2013ECLI0014 . tel-00866223

HAL Id: tel-00866223

<https://theses.hal.science/tel-00866223>

Submitted on 26 Sep 2013

HAL is a multi-disciplinary open access archive for the deposit and dissemination of scientific research documents, whether they are published or not. The documents may come from teaching and research institutions in France or abroad, or from public or private research centers.

L'archive ouverte pluridisciplinaire **HAL**, est destinée au dépôt et à la diffusion de documents scientifiques de niveau recherche, publiés ou non, émanant des établissements d'enseignement et de recherche français ou étrangers, des laboratoires publics ou privés.

N° d'ordre :

2	2	6
---	---	---

ÉCOLE CENTRALE DE LILLE

THÈSE

présentée en vue
d'obtenir le grade de

DOCTEUR

Spécialité : Automatique, génie informatique, traitement du signal et des images

par

ZHENG Tian

Master of Engineering of Beijing University of Aeronautics and Astronautics (BUAA)

Doctorat délivré par l'École Centrale de Lille

**Analyse de Fiabilité et de Performance d'un
Système de Véhicules Intelligents**

Soutenue le 09 septembre 2013 devant le jury :

Monsieur Pierre BORNE	Ecole Centrale de Lille	Président
Monsieur Ahmed EL HAJJAJI	Université de Picardie Jules Verne	Rapporteur
Monsieur Noureddine ELLOUZE	Ecole Nationale d'Ingénieurs de Tunis	Rapporteur
Monsieur Abdelkader EL KAMEL	Ecole Centrale de Lille	Directeur de Thèse
Monsieur Khaled MELLOULI	IHEC de Carthage , Tunisie	Examineur
Monsieur Sehl MELLOULI	Université Laval, Canada	Examineur
Monsieur Dumitru POPESCU	Université Politehnique de Bucarest	Examineur
Madame Shaoping WANG	Beihang University, China	Examineur

Thèse préparée au Laboratoire d'Automatique, Génie Informatique et Signal
L.A.G.I.S. - UMR 8219 - École Centrale de Lille
École Doctorale Sciences pour l'ingénieur - 072
PRES Université Lille Nord-de-France

Serial N° :

2	2	6
---	---	---

ECOLE CENTRALE DE LILLE

THESIS

Presented to obtain
the degree of

DOCTOR

Topic : Automatic control, computer engineering, signal and image processing
by

ZHENG Tian

Master of Engineering of Beijing University of Aeronautics and Astronautics (BUAA)

Ph.D. awarded by Ecole Centrale de Lille

Reliability Assessment for Intelligent Vehicles System

Defended on September 09, 2013 in presence of the committee :

Mr Pierre BORNE	Ecole Centrale de Lille	President
Mr Ahmed EL HAJJAJI	Université de Picardie Jules Verne	Reporter
Mr Noureddine ELLOUZE	Ecole Nationale d'Ingénieurs de Tunis	Reporter
Mr Abdelkader EL KAMEL	Ecole Centrale de Lille	Supervisor
Mr Khaled MELLOULI	IHEC de Carthage, Tunisie	Examiner
Mr Sehl MELLOULI	Université Laval, Canada	Examiner
Mr Dumitru POPESCU	Université Politehnique de Bucarest	Examiner
Mrs Shaoping WANG	Beihang University, China	Examiner

Thèse préparée au Laboratoire d'Automatique, Génie Informatique et Signal
L.A.G.I.S. - UMR 8219 - École Centrale de Lille
École Doctorale Sciences pour l'ingénieur - 072
PRES Université Lille Nord-de-France

Acknowledgments

The PhD work presented in this thesis has been done at "Laboratoire d'Automatique, G Informatique et Signal" (LAGIS) in Ecole Centrale de Lille, from September 2010 to September 2013. This work is partly supported by the China Scholarship Council (CSC).

This thesis would not have been possible without the help and support of so many people in so many ways. I would like to take the opportunity to express my gratitude to all those who contributed to this work.

First of all, my sincere thanks go to my supervisor, Prof. Abdelkader EL KAMEL, for his valuable guidance, continuous encouragement and the share of his research experience.

I would like to thank Prof. Pierre BORNE for his generous cooperation and helpful discussions and the share of his outstanding research experience. A special acknowledgment should be shown to Prof. Shaoping WANG, I benefited a lot from her helpful suggestions and discussions.

I would like to express my sincere gratitude to Prof. Ahmed EL HAJJAJI and Prof. Noureddine ELLOUZE, who have kindly accepted the invitation to be the reviewers of my PhD thesis. My heartfelt thanks go to Prof. Khaled MELLOULI, Prof. Dumitru POPESCU and Prof. Sehl MELLOULI, for their kind acceptance to be the members of my PhD Committee.

I am also very grateful to the staff in EC Lille. Virginie LECLERCQ, Marie-Fr TRICOT, Christine YVOZ, and Brigitte FONCEZ have helped me in the administrative works. Many thanks go also to Bernard SZUKALA, Hilaire ROSSI, Gilles MARGUERITE, Jacques LASUE, Patrick GALLAIS and Rne DUPLOUICH, for their kind help and hospitality.

I wish to express my special appreciation to Prof. H CATSIAPIS, my French teacher. In her courses, I learned not only the language but also the culture, history, especially the many trips, which enrich my life in France.

I would like also to thank my colleagues and friends, Yahong, Minzhi, Lian, Yang, Dapeng, Jinlin, Jian, Huarong, Hui, Guoguang, Bo, Wenhua, Yue, Yongliang, Xiaojian, Jiangfeng, Daji, Chen, Baisi, ... for their friendship and supports.

Finally, my parents have provided me with their supports throughout, as always, for which my mere expression of gratitude does not suffice. Thanks to my girlfriend, Nina, for her love, understanding and great patience during the past 3 years, even if that meant sacrificing the time we spent together.

Contents

List of Figures	7
List of Tables	9
Acronyms	11
Notations	13
General Introduction	15
Chapter 1 Intelligent Vehicles System and Reliability Assessment	21
1.1 Background	22
1.1.1 Driverless vehicles	22
1.1.2 Dedicated short range communications	24
1.1.3 Current systems for short range communication application	27
1.2 Reliability estimation of the ITS	30
1.2.1 Reliability engineering	30
1.2.2 Reliability of vehicles	31
1.3 QoS of the network	31
1.3.1 Routing protocols of ad hoc	34
1.4 Performance of control system under the considering of QoS	37
1.4.1 Lyapunov method	37
1.4.2 Describing function	38
1.4.3 Limit circle & stability margin	39
1.5 Conclusion	41
Chapter 2 Reliability/QoS Assessment of Typical Short Range Wireless Communication	43
2.1 Related work	43

2.2	Packet reliability on broadcast repetition scheme	46
2.2.1	Introduction	46
2.2.2	Simulation results	47
2.3	Packet reliability on point-to-point unicast scheme	48
2.4	Packet delivering delay estimation of single hop	54
2.5	Conclusion	56

Chapter 3 Node Performance Model 59

3.1	Related work	60
3.2	Model descriptions	60
3.2.1	Packet-oriented Markov model	61
3.2.2	Node-oriented Markov model	62
3.3	Model solving	64
3.3.1	Serving time is exponentially distributed	64
3.3.2	Serving time is PH distributed	67
3.3.3	Service time is randomly distributed (semi-Markov process)	70
3.3.3.1	Explications for some formulas used	71
3.3.3.2	Semi-Markov model	73
3.4	Numerical examples for the model	74
3.4.1	Exponential distribution	74
3.4.2	PH distribution	77
3.4.3	Semi-Markov process	79
3.5	Performance related characters	83
3.5.1	Influence of the characters of the network	84
3.5.2	Influence of the characters of the node	85
3.6	Conclusion	86

Chapter 4 A QoS-aware Ad hoc Protocol Based on Node Performance Model 91

4.1	Related work	91
4.2	Reliability based routing protocol	94
4.2.1	NPMSR protocol	94
4.2.2	Route discover process	95
4.2.3	Route update process	97
4.2.4	Route maintenance process	98

4.3	Numerical example	99
4.4	Conclusion	103
Chapter 5 Effect of Communication QoS on Performance of PID Control Systems		105
5.1	Related work	105
5.2	Model constructions	107
5.3	Performance Degradation with Transmission Delay	108
5.3.1	Performance degradation with fixed delay	110
5.3.2	Performance degradation with variable delay	113
5.3.3	Conclusion	115
5.4	Performance degradation with data loss	115
5.4.1	Loss at different period	118
5.4.2	Regarding the system with big sampling time	119
5.4.3	Conclusion	120
5.5	Conclusion	120
Chapter 6 Effect of Communication QoS on Stability of Fuzzy Control Systems		123
6.1	Related work	123
6.2	Fuzzy controller descriptions	125
6.2.1	Limit circle & stability margin	126
6.2.2	Describing function for Mamdani fuzzy controller	127
6.2.3	Calculation example	128
6.2.4	Describing function for Takagi-Sugeno (T-S) fuzzy controller	130
6.3	Stability & performance analysis	131
6.4	Example in the research of intelligent vehicle control	132
6.5	Conclusion	135
Conclusions and Perspective		137
Résumé étendu en français		145
Bibliography		151

List of Figures

1.1	Driverless vehicles in the world	23
1.2	Vision generated by driverless vehicle	24
1.3	ITS developing steps	25
1.4	DSRC demonstrate	28
1.5	Vehicle longitudinal system	31
1.6	Fault tree of the diesel engine downtime [Li 2010]	32
1.7	Queuing theory	33
1.8	Frequency responds transfer diagram of a control system	39
1.9	GM & PM on the Nyquist plot	40
2.1	Scatternet and piconet structure of Bluetooth	44
2.2	Scatternet vehicles with bluetooth	44
2.3	Bluetooth broadcast scheme	46
2.4	Packet reliability under different conditions	48
2.5	Packet reliability with the same effective message length	49
2.6	ARQ scheme	50
2.7	ARQ working process	51
2.8	Structure of the payload of Bluetooth packet	52
2.9	Simulation of CRC working process	52
2.10	Delivering delay for three types of packet to transmit the effective message with the same length	57
2.11	Calculations with limited retransmission attempt	58
3.1	State transform of the packet	62
3.2	State transform of the node	63
3.3	Absorbing process of PH distribution	68
3.4	Possibility simulation of the states in node-oriented Markov chain	75
3.5	Possibility simulation of the states in packet-oriented Markov chain (expo- nential distribution)	77
3.6	Possibility simulation of the states in packet-oriented Markov chain (PH distribution)	79
3.7	State possibility of "success" and "failure" in the packet-oriented Markov process	83
3.8	Node performance with different network status	87
3.9	Node performance with different node status	88

4.1	Route Request & Route Reply	97
4.2	Route Update	98
4.3	Route Maintenance	99
4.4	A simple path example	100
4.5	Node performance	101
4.6	Whole path performance	102
5.1	Discrete control system	107
5.2	Wireless discrete control system	108
5.3	Comparison between the normal signal and the signal with delay	109
5.4	Discrete control system used in this paper	110
5.5	Root locus corresponding the time delay $\tau(T_s = 0.01s)$	111
5.6	Root locus corresponding the time delay $\tau(T_s = 0.1s)$	112
5.7	Comparison between the normal signal and signal with delay	114
5.8	Corresponding relation between the overshoot and the accommodation time	115
5.9	Corresponding relations between the overshoot and the IAE	116
5.10	Comparison between the normal signal and the signal with loss	117
5.11	Corresponding relations between the control input and the overshoot	119
5.12	Influence of data loss on the control input with different sampling time	121
5.13	Performance degradation with the sampling time	122
6.1	Membership functions of fuzzy controller	129
6.2	Structure for experimental verification of the describing function	130
6.3	Extended Nyquist plot of $H(A, \omega)G(\omega)$ with delay increasing	130
6.4	Extended Nyquist plot of $H(A, \omega)G(\omega)$ with different $A(1 - 10)$	131
6.5	Extended Nyquist plot of $H(A, \omega)G(\omega)$ with delay increasing	132
6.6	Multi-model fuzzy controller of intelligent vehicle in [Zhao 2010b]	133
6.7	Extended Nyquist plot of the open loop respond function of the lateral control system	135
6.8	System with delay becomes unstable	136

List of Tables

1.1	Work groups involved in cooperation of DSRC system standardisation of CEN/TC278 and ISO/TC204	27
1.2	Comparison of the short range communication systems	29
2.1	Undetected error rate result (number of samples:10 ⁶)	53
3.1	Stable possibility of each state in node-oriented Markov chain(service time exponential distributed)	76
3.2	Stable possibility of each state in node-oriented Markov chain(service time PH distributed)	78
3.3	Stable possibility of each state in node-oriented Markov chain($\lambda = 0.5, \lambda_1 = 0.8, \lambda_2 = 0.5, p_1 = 0.455, p_2 = 0.545, \rho = 0.9$)	82
3.4	Node performance in different network characters (exponential model) . . .	84
3.5	Node performance in different network characters(semi-Markov model) . .	85
3.6	Node performance in different node characters (exponential model)	86
3.7	Node performance in different node characters (semi-Markov model)	86
4.1	RREQ packet	95
4.2	RRER packet	96
4.3	RUPD packet	97
5.1	Possibility Calculation of The Performance Crossing the Threshold	114
6.1	Fuzzy controller rules	128

Acronyms

ITS - Intelligent Vehicle System

DSRC - Dedicated Short Range Communication

AODV - Ad hoc On-Demand Distance Vector Routing

DSR - Dynamic Source Routing

RREQ - Route Request

RREP - Route Reply

NPDSR - Node Performance-based Dynamic Source Routing

QoS - Quality of Service

FTA - Fault Tree Analysis

ARQ - Automatic Repeat-Request

MANET - Mobile Ad hoc Network

V2V - Vehicle-to-Vehicle

V2I - Vehicle-to-Infrastructure

Notations

$F(t) * A(t) = \int_0^t A(t - \tau) dF(\tau)$: Mutant convolution defined

$\mathcal{L}[F(t)] = F(s) = \int_0^\infty e^{-st} F(t) dt$: Normal Laplace transfer

$\hat{\mathcal{L}}[F(t)] = \hat{F}(s) = \int_0^\infty e^{-st} dF(t)$: Mutant Laplace transfer defined

General Introduction

The research presented in this thesis focuses on the reliability assessment of intelligent vehicles systems. With the rapid development of the world automobile industry and the massive growth of the population of vehicles and drivers, our society nowadays tends to suffer from the traffic congestions, pollution, man-made accidents... Scientists and engineering conceived the idea of Intelligent Transportation Systems (ITS) dealing with these problems. In the past decades, progress has been made on the intelligent vehicles or we can say driverless vehicle for now. Many famous manufactures all over world even have tested their driverless vehicles in the real traffic. Some have made the velocity up to 130km/h in the highways. But, these vehicles just use a series of sensor system installed on board to gather the environment information in order to make pilot decisions, which is not quite the same with the concept of the ITS.

An important part of the ITS is that the interaction between the vehicles and the environment, which is carried out with a Dedicated Short Range Communications (DSRC) technology. DSRC includes V2V (vehicle-to-vehicle) and V2I (vehicle-to-infrastructure) communication. It is a modified version of short range communication specifically designed for high speed automotive use. Standard organizations all over the world is now working on the integration of the DSRC standards so that ITS can be world spread. Researches have been done using the short range communication system existent such as Bluetooth, Zigbee and Wi-fi. Vehicles are the main transportation method in our modern life and it concerns the safety of human lives. Before the ITS becomes practical in the reality, the assurance of reliability of the system would be cautious and a job must-be-done. The communications act important roles as "eyes" and "ears" of the ITS, so the reliability of the communication is crucial to the reliability of the whole system. Data reliability in wireless communication system may not just be whether the data is able to reach the destination as the traditional definition. We borrow the concept of Quality of Service of the network and use data delay and loss as the main criterion of the communication. One hop between two nodes and the QoS of the multi-hop in the network will be analyzed. A

reliability based routing protocol is also necessary. Finally with the imperfect communication quality, the control performance of the vehicles should be predictable so that the accidents can be avoided.

- **Data reliability**

Two main criterions are considered in the data reliability: transmission delay and data loss. The researches in this subject will emphasis on the data reliability of short range communication but not mess up with the deep mechanism of the special protocols. Although the protocols of the short range communication (Bluetooth, Zigbee and Wi-fi) are different, they share something in common in the scheme of data protection. The three common protocols all applied Forward Error Correcting (FEC) and Cyclic Redundancy Check (CRC) scheme to ensure that the data packet can arrive correctly. Moreover automatic repeat request (ARQ) scheme in the traffic control protocol of all these protocols. All these schemes can be regarded as a reliability control method and be analyzed in the domain of reliability. Vehicles forms a network of communication and two vehicles may not be connected by a single hop directly because the range limitation of the transmission. So other vehicles may act like the routers to relay the data information. The reliability of data may be varied based on the conditions of network traffic.

- **Effects on the performance of control**

ITS controls the vehicle with the information gathered from the communication system. Any incorrect information of the environment may directly leads to a wrong decision. Delayed information can cause a slow response which makes the system unsafe. But the imperfect information may not always jeopardize the piloting. The QoS of communication can be controlled and the performance degradation can be predicted based on the variation of QoS of communication.

The thesis is basically addressed on the two main concerns above. Redundancy theory is used in data protection analysis. Queuing theory with Markov process are introduce in the modeling of node performance as a intermediate node. Semi-Markov process is applied for the modeling with a more general condition. Then a new routing protocol is proposed based on the node performance model for the reliability requirement of communication. Next, the thesis analyzed the effects of the communication error on the classic PID control system with the consideration of the sampling period. For the nonlinear system like fuzzy control system, we use describing function to analyze the stability with the communication

delay and the describing function method for multi-fuzzy control system is provided at last.

Outline of the thesis

Chapter 1 reviews the background of intelligent vehicle system and the reliability assessment of ITS. At first, current development of driverless vehicle was introduced. Second, we briefly introduced the Dedicated Short Range Communications especially for ITS, although the final standard for the DSRC is under debating, research of application have been done with the current developed short range communication systems. The reaches for the system reliability is introduced too. Next, the QoS models for the network communication were surveyed in detail. Finally, some methods related to the contents in this thesis for analyzing the effects of imperfect communication on the control systems have been mentioned.

In **Chapter 2**, we take Bluetooth communication protocol on behalf of the short range communication systems extant. Three data protection methods are defined in Bluetooth transmission (1/3FEC (Forward Error Correcting), 2/3FEC and ARQ scheme). This chapter analyzed the effect of these three schemes in the two typical working method of Bluetooth, and the reliability of the data transmission is calculated. Also, the method to calculate transmission delay is introduced.

Chapter 3 analyzes the working mode of the wireless network working in the ARQ mode. A packet-oriented model and node-oriented model has been built to estimate the performance. As to the problem of the nodes' service time distribution, we gave three typical types of assumption to cover different network communications (exponential distribution, PH distribution and random distribution with semi-Markov process). The examples for each type have been provided, too. The result of the model provides the criteria of the network quality. With the help of the node performance model, the conditions of the network can be easily monitored by the node itself, thus the performance of the node can be predicted according to the status of the nodes, with this information we monitor the QoS (Quality of Service) of the whole network and made adjustment when it is necessary. For example, if we have detected that a crucial node is suffering a rush hour of packet and we need to assure the quality of an important node-to-node path, we can enhance the signal power of the node, or change the queue length and attempting number, or even we

can bypass this node accordingly. The energy and efficiency of the network will be saved.

Based on the **Chapter 3**, an QoS-aware ad hoc protocol called NPDSR is proposed in **Chapter 4**. Our protocol can guarantee the quality requirement of the transmission. Routing, update and maintenance process are discussed. A numerical example has been brought to demonstrate how the protocol works and how it can do to improve and guarantee the quality of service of the network. Our protocol is derived from DSR protocol but it has inherited the advantages of the DSR and optimized several disadvantages:

1. In the routing discovery process, it compares the path characters with the previous cached path, RREQ packets are selectively dropped. So the re-broadcast of the RREQ packet is limited and overhead problems of DSR can be avoided.

2. The cached path information is updated by the intermediate nodes without costing bandwidth which make the network more efficient and the staled cached path can be cleared out in time.

In **Chapter 5** we analyzed the data transmission problems of the wireless control system. The problem has been separated to two circumstances: delay and data loss. Time-fixed delay and the time-varying delay are both discussed using mathematical and statistical simulation method respectively. For the data loss, the performance degradation has been determined by the sampling points during the rising process. The results are useful for the system designer to control the performance of the response to a tolerable extent and also, it is helpful for counteracting the influence of the communication problems during the use. For example, if the extension of the data delay can be determined, we can know that whether the system would be stable in the best or worst condition. The first several sampling points are so important shown in this chapter, so we can try to thinks ways to make them successful like the retransmission scheme or appliance of compensation. Markov chain can be used to describe the degradation progress with the data loss, so the health condition of the system can be monitored. Threshold can be set to measure the possibility of failure which can be providing for the reliability engineers to evaluate the dependability of the system.

In **Chapter 6** the describing function of general Mamdani and Takagi-Sugeno (T-S) type fuzzy controller is provided. The describing function for Mamdani type is various because of different reasoning methods and different membership functions can be used in this type of fuzzy controller. Since the T-S type fuzzy controller uses a linear function

for the reasoning of every rule, the formation of the describing function of T-S type fuzzy controller is more stable. The result of the describing function is compared with the result coming from the experimental simulation, which performs well. The usage of the describing function is to analyze the frequency characteristics of the fuzzy controller, and the stability and performance of the whole system as well. Examples have been given on the multi-fuzzy controller of the previous work on the longitudinal control of intelligent vehicle to demonstrate how to apply in the real systems.

Final conclusion and future work is presented in **Conclusions and Perspective**. A network simulator NS2 is introduced. NS2 is an open source simulator that is used all over the world. The users can modify the source code and change the characteristics of the models. New protocols can be added according to the wish of the users such as Blue-hoc package developed by India Research Lab enables the simulation to build a model of Bluetooth communication. A example to compare the routing overhead of the AODV and DSR routing protocol is provided. The C-coded NS2 gives the users possibility of second development, for example, the PiccSIM developed by Aalto University is a co-simulator for network and control system simulation in a networked control system by integrating NS2 and Matlab.

Chapter 1

Intelligent Vehicles System and Reliability Assessment

Contents

1.1	Background	22
1.1.1	Driverless vehicles	22
1.1.2	Dedicated short range communications	24
1.1.3	Current systems for short range communication application	27
1.2	Reliability estimation of the ITS	30
1.2.1	Reliability engineering	30
1.2.2	Reliability of vehicles	31
1.3	QoS of the network	31
1.3.1	Routing protocols of ad hoc	34
1.4	Performance of control system under the considering of QoS	37
1.4.1	Lyapunov method	37
1.4.2	Describing function	38
1.4.3	Limit circle & stability margin	39
1.5	Conclusion	41

1.1 Background

Intelligent transportation system (ITS) is recently regarded as the solution for many problem on quotidian transport, city congestion, pollution, noise, car accident. . . . According to the Car Accident Statistics, Around 40000 people died in car accidents in the United States every year. The majority of car accidents could be avoided if only the drivers would drive more responsibly. About 40% of car accident fatalities occur because of a drunken driver. About 30% of the car accident fatalities can be attributed to driving above the speed limits and 33% and above because of reckless driving that causes the car to go off the road and result in an accident.

The ITS technology could double the capacity of roads by allowing cars to drive more safely and closer together. Because the intelligent cars would eventually be less likely to crash, they could be built lighter, reducing fuel consumption. There remain the safety issues and other technology problems in practical applications, so yet, the conception of ITS remains to be theoretical, but the intelligent vehicles have been developed greatly all over the world.

1.1.1 Driverless vehicles

Defense Advanced Research Projects Agency (DARPA) of USA has found a prize competition called "DARPA Grand Challenge" for American driverless vehicles since 2004. Driverless vehicles have been put in the desert [Russell 2006] and urban environment [Markoff 2007]. This competition has attracted many research institutes and universities and gathered a variety of different software and hardware combinations for interpreting sensor data, planning, and execution on the intelligent vehicles.

Google company issued the project of driverless cars charged by the winner of 2005 DARPA Grand Challenge tournament. The US government has passed a law for the Google self driving car to be tested on public roads in 2012. [Guizzo 2011]

European Research Council has sponsored a project to built 4 driverless vans to accomplish a huge feat. The 4 vans made their way from Italy to China in 2010. The vehicles run 13,000km over three months without maps and drivers along every type of road imaginable, from the high-rise urban jungle to the broad expanses of Siberia. [Bardsley 2010]

Famous large car enterprise like BMW, Audi, Volkswagen, Ford and Toyota paid also interests in this field. Among which, BMW , Audi and Volkswagen have succeeded in having their driverless vehicles running at a high speed tests have been made in the

highways, mountains. . . [Carfrae 2011, Audi 2012, Leohold 2011]. The intelligent vehicles of Ford and Toyota paid more attention on the applying of the multi-sensor for drivers' aiding. [Fitchard 2012, BBC 2013]



Figure 1.1: Driverless vehicles in the world

Of all the vehicles above, speed controlling, lane keeping, lane shifting, environment detecting are the basic functions of the autonomous vehicles. Despite the different equipment utilized by different facilities, the applications of detection/sensing systems are indispensable. Video cameras, radar sensors, a laser range finder advanced GPS system or maps make the vehicles able to aware the existence of obstacles, pedestrian or other vehicles. All the tests of the vehicles are carried out under the surveillance of a human driver behind the steering wheel with the authority of taking control of the car at any moment by stepping on the brake or turning the wheel, similar to "cruise control" systems already found in many cars today. Even though, accidents happened on Google self-driving cars. Because transportation vehicles relate to human lives, before the vehicles are reliable e-

nough intelligent vehicles will remain in testing and improving. A prediction has been made that by the year of 2020, we are going to expecting a truly available intelligent vehicle. [Stephen 2013, Drew 2013]

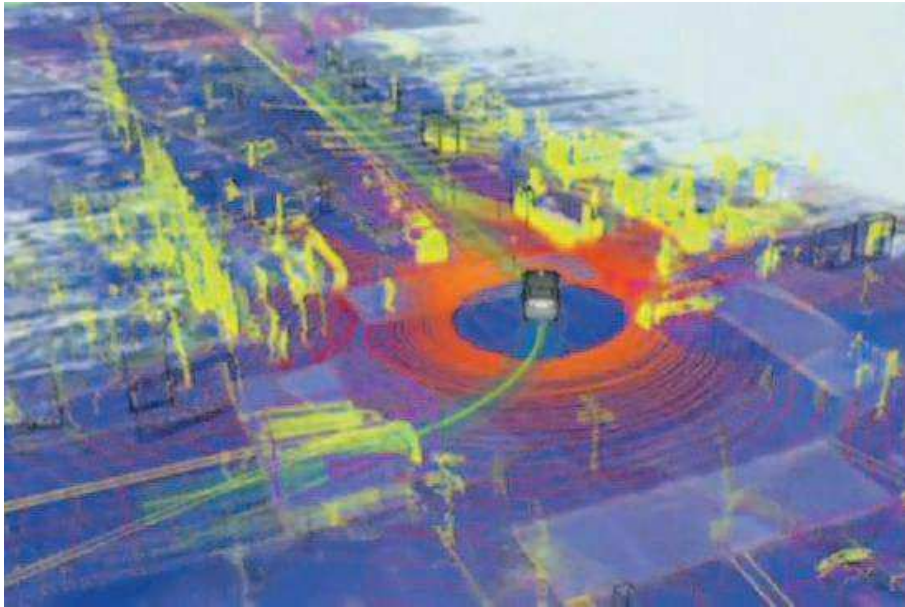


Figure 1.2: Vision generated by driverless vehicle

1.1.2 Dedicated short range communications

Individual driverless vehicles can not represent the intelligent vehicle system. The ITS emphasis on the interaction with other vehicles and also the environments such as pedestrian, obstacles, traffic lights; in order to exchange these information in ITS all over the world, the standards of Dedicated Short Range Communications (DSRC) technology have been formulated for use in the vehicle-to-vehicle and vehicle-to-infrastructure communication. DSRC is a kind of one-way or two-way short-range multi-media wireless communication. Based on common communication protocols like IEEE802.11/3G/LTE, DSRC tends to be a modified version specifically designed for high speed automotive use. The mainstream of DSRC standards systems are TC278 formulated by CEN (European Committee for Standardization) and TC204 formulated by ISO (International Organization for Standards). Other standardization organizations such as European Telecommunications Standards Institute (ETSI) and Japanese Association of Radio Industries and Businesses (ARIB) have also been involved in the process of formulating DSRC standards. Cooperation and harmonization efforts among government and standards organizations have been made for

global utilization. [Kenny 2011] As intelligence vehicle is becoming an important method to decrease the rate of traffic accidents and relive the urban traffic rush, this work becomes important for the interpretability of systems and globalization of ITS. We can easily foresee the development track of the ITS.

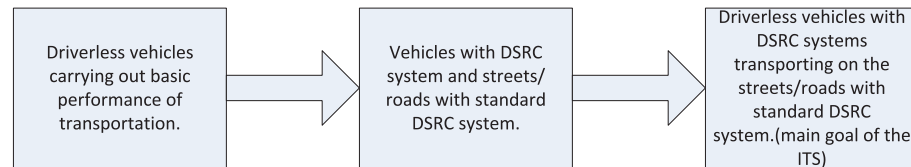


Figure 1.3: ITS developing steps

DSRC deals with two main tasks: vehicle-to-vehicle (V2V) communication and vehicle-to-infrastructure (V2I) communication. V2V communications carry out through a MANET (mobile ad hoc network), in which the word "ad hoc" comes from Latin and it means "for this purpose" and MANET is a self-configuring infrastructureless network of mobile devices connected by wireless. But the V2V network is still a little different from ad hoc and cellular systems in resource availability and mobility characteristics. Therefore, adopting existing wireless networking solutions to this environment may result in low performance in delay, throughput, and fairness. The vehicle-to-infrastructure communication transfers information between vehicles and the immobile infrastructures. The protocols may be also different from V2V networks because a rush traffic may cause a concentration of the information. The V2I network will support high throughput, low delay, and fair access to available resources.

Originally designed for ETC (Electronic toll collection) system, DSRC technology has been developed and applied in many other typical fields:

- Cooperative Adaptive Cruise Control. An improved version of ACC (Adaptive Cruise Control) with vehicle-to-vehicle communication. The current speed and acceleration of a vehicle can be transmitted to the following vehicles by inter-vehicle communication. [Desjardins 2011] [Fehrenbacher 2010] The CACC system provides a developed controller for the secure longitudinal following of a front vehicle.
- Cooperative Forward Collision Warning. University of California Partners for Advanced Transit and Highways (PATH) program and General Motors Research and Development which examined and demonstrated wireless-enabled vehicle-to-vehicle cooperative safety systems for collision warning. [Misener 2005] The system use V2V

communication to enable each vehicle with the system maintain the awareness of the motions and status of the neighbors. GPS information is also fused with onboard sensors to predict the movement of the vehicle itself. Warnings can be given when collision is about to happen.

- Emergency warning system for vehicles. This system is an application of combination of V2V and V2I communication. The system warns varieties of potential dangerous condition of the environments such as the traffic lights or a pedestrian trying to cross the road Early warning alerts are generated by the system to assist the driver in more safely and intelligently conducting the vehicle. [Hazen 2001]
- Advanced Driver Assistance Systems (ADAS). ADAS system is an on-board system providing real time information dedicated to safe and comfortable highway driving. Through the V2I communication, the system provides the driver with traffic conditions, road information, weather conditions, incidents signaling or even personalized traffic information with tourist information, petrol stations and service areas.. [Malone 2004]
- Emergency vehicle warning system. Instead of using sirens alone, emergency vehicle warning system helps driver making the right reaction when encountered the emergency vehicles such as fire trucks and ambulance. Such an application of V2V communications can reduce accident risks during emergency response trips and also help save valuable time. [Buchenscheit 2009, Perez 2004]
- Vehicle safety inspection. In which vehicle is inspected to ensure that it conforms to regulations governing safety, emissions... and so on, Automatically done by vehicle-to-infrastructure communications which can save time, man power, ...
- Electronic parking payments. Electronic parking fee payment systems can provide benefits to parking facility operators, simplify payment for customers, and reduce congestion at entrances and exits to parking facilities. These payment systems can be enabled by any of a variety of technologies including magnetic stripe cards, smart cards, in-vehicle transponders, or vehicle-mounted bar-codes.
- Rollover warning. A warning system able to prevent rollover of the heavy trucks by detecting the speed of the vehicle and the radian of the curve of the turn, vehicle-to-infrastructure communication is used

Table 1.1: Work groups involved in cooperation of DSRC system standardisation of CEN/TC278 and ISO/TC204

Involved CEN/TC278 WGs	Involved ISO/TC204 WGs
WG13 (Architecture)	WG1 (Architecture)
WG8(Road traffic data)	WG3(Database technology)
WG12 (Automatic vehicle & equipment Identification)	WG4 (Automatic vehicle & equipment Identification)
WG1 (Electronic fee collection)	WG5 (Fee and toll collection)
	WG7 (General fleet management and comercial/freight operations)
WG3 (Public transport)	WG8 (Public transport)
	WG9 (Integrated transport inform management and control)
WG4 (Traffic and traveller inform)	WG10 (Traveller inform system)
	WG14 (Vehicle/roadway warning and control systems)
	WG16 (CALM)
	WG17 (Nomadic device)
WG14 (After theft systems for the recovery of stolen vehicles)	
WG15 (e safety,e call)	
WG16 (Cooperative systems)	WG18 (Cooperative systems)

1.1.3 Current systems for short range communication application

Though the DSRC standardization is in process, a number of institutes and companies did some early researches on the DSRC applications with well developed short range communication systems such as Bluetooth [Held 2007, Hedd 2000, Hedd 2001, Goonewardene 2011], Zigbee [Dorle 2010, Eamsomboon 2008] and WiFi [Misener 2005, Fehrenbacher 2010, Hartenstein 2001, Kim 2005], because they are off-the-shelf commercially ready solutions.

- Bluetooth. Bluetooth network forms a Piconet with one master and a collection of slaves is called. There can only be one master and up to seven active slaves in a single Piconet. The slaves only have a direct link to the master, and not with each other. Multiple Piconets can be joined together to form a Scatternet. A frequency-hopping channel based on the address of the master defines each piconet. The master's transmissions may be either point-to-point or point-to-multipoint. Also,

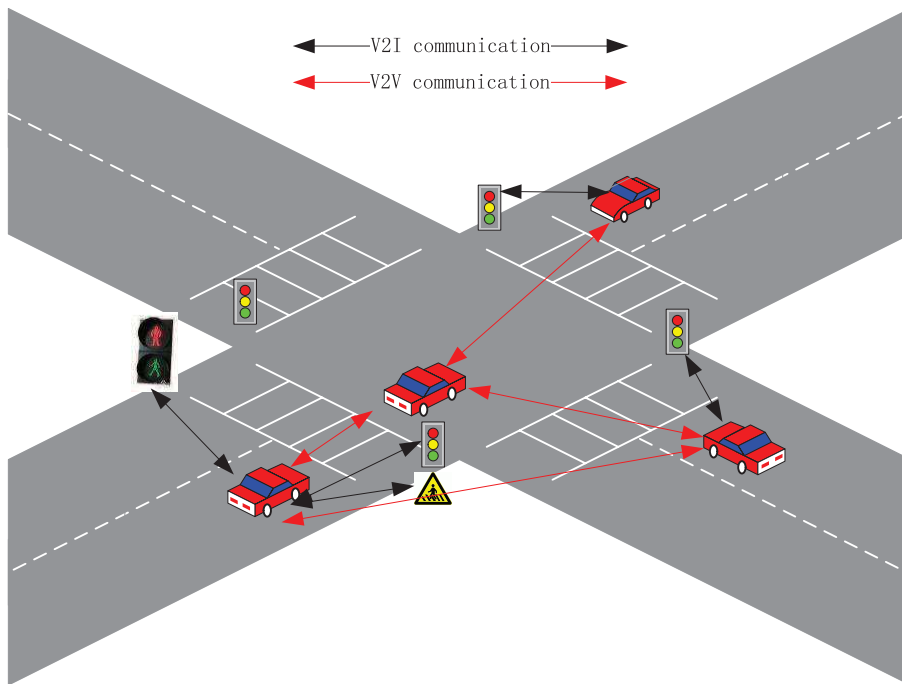


Figure 1.4: DSRC demonstrate

besides in an active mode, a slave device can be in the parked or standby modes so as to reduce power consumptions. The effective range of the original version of Bluetooth is less than 10 meters. But the later version promoted the function of Bluetooth and allows the device to transmit data at the distance up to 100 meters, the data rate is also been promoted.

- ZigBee. ZigBee is another short range wireless communication protocol designed specifically for individual remote controls. ZigBee was designed costless and "sleeping" strategy leads to low power consumption so that a Zigbee device would work for over years without changing the battery. But the transmission has a lower data rate comparing to Bluetooth. Zigbee system is widely used in the industrial environments which have lower requirement on the data rate.
- Wireless fidelity (Wi-Fi). A series of standards for wireless local area networks (WLAN). Wi-Fi is a wireless version of a common wired Ethernet network, and requires configuration to set up shared resources, transmit data. Wi-Fi uses the same radio frequencies as Bluetooth, but with higher power, resulting in higher data rates. As Wi-Fi is connected to the World Wide Web, it is easy to exchange information with the database long distance away. It is more complicate in installing

the infrastructures and configuration, so using in V2V communication maybe less advantaged compare to the former two systems. But in the V2I communication which has the requirement of data rate and node tolerance, the Wi-Fi would be more suitable.

In [Eamsomboon 2008] author presented a simulation of the performance of V2V communication with the uses of AODV routing protocol. Two different wireless protocols of IEEE802.11 (WLAN) and IEEE802.15.1(Zigbee) were compared under the same condition. The result showed that when the number of vehicle nodes increases, the transmission in WLAN yields the higher successful rate and shorter delay than that in Zigbee. In addition, when the number of vehicle nodes increases, WLAN yields less number of hops and tends to be constant while the average number of hops in Zigbee network keeps increasing as the network density increases. From the comparison of these short range communication systems, we can see they all have advantages and disadvantages in applying in ITS. [Goonewardene 2011] focused on issues relating to ad-hoc network formation in a mobile environment using Bluetooth technology, the author found Bluetooth is a good choice for inter-vehicle communication because the nodes (vehicles) are constantly moving in and out of range of the master node and local piconets. Though Bluetooth provides a strong foundation in forming ad-hoc networks for mobile vehicles, problems like large connection time and topological changing for the mobile nodes have been showed too. While for IEEE802.11 connection, the result of [Kim 2005] showed the Wi-Fi protocol have also the problems in routing overheads in the environment of long distance and high velocities. Besides, IEEE802.11 (Wi-Fi) standard were designed to provide a replacement for wired infrastructure networks, so it is highly infrastructure-depended. However, the short-range communication system dedicated for ITS should have high flexibility with respect to asymmetric data flows, allows the communication over large distances and supports high velocities.

Table 1.2: Comparison of the short range communication systems

Standard	Bluetooth	Zigbee	Wi-Fi
IEEE specification	802.15.1	802.15.4	802.11a/b/g
Maximum data rate	24Mb/s(version 3.0)	250kb/s	54Mb/s
Transmission range	100m(class1)	100m	300m
Maximum number of nodes	7(single piconet)	65536+	2007

1.2 Reliability estimation of the ITS

1.2.1 Reliability engineering

Reliability is theoretically defined as the probability of failure, the frequency of failures, or in terms of availability—the ability of a "system" or component to perform its required functions under stated conditions for a specified period of time. [Society 1991] For the main task of reliability engineering, several departments have been derived from reliability:

- **Maintainability.** No system can be 100% reliable. The maintainability is related to reliability since failure data is collected and statistical data is analyzed. Maintainability focuses on the reaction when the failure happens and how to restore products or systems to their original reliability level.
- **Prognostic and Health Management (PHM).** An engineering discipline focused on predicting the time at which a system or a component will no longer perform its intended function [Vachtsevanos 2006]. The PHM system uses advanced multi-sensors system, involved with multiple algorithms (Gabor FFT...) and intelligent models (expert system, NN, fuzzy logic...) to predict and monitor the status of a complex system.
- **Dependability.** A collection of terms used to evaluate the reliability, maintainability and maintenance of the system.
- **Quality.** Quality control is effective in preventing failures. The products or systems with good quality of course are more reliable. On the other way, quality can present the performance of the product. Traditional reliability is about a "yes" or "no" question about the product which means whether the system "can" or "can not" perform its functions. But some systems nowadays like network system which is always able to accomplish the tasks with different performance with the criteria of delay, error, throughput and so on. Quality of Service (QoS) refers to several related aspects of telephony and computer networks that allow the transport of traffic with special requirements.

In this thesis we have an extended concept on reliability. Similar to the concept of QoS, we evaluate the performance of the communication system in ITS and how this performance will influence on the performance of the behavior of the vehicles.

1.2.2 Reliability of vehicles

The main subject of ITS is still the vehicles. Vehicle itself is a very huge system with parts of hardware including mechanical part, electrical part, transmission system... Reliability researches on vehicles have been developed maturely. For example, Fault tree analysis (FTA) is a top down, Deductive reasoning failure analysis in which an undesired state of a system is analyzed using Boolean logic to combine a series of lower-level events. This analysis method is mainly used in the field of safety engineering and Reliability engineering to determine the probability of a safety accident or a particular system level (functional) failure.

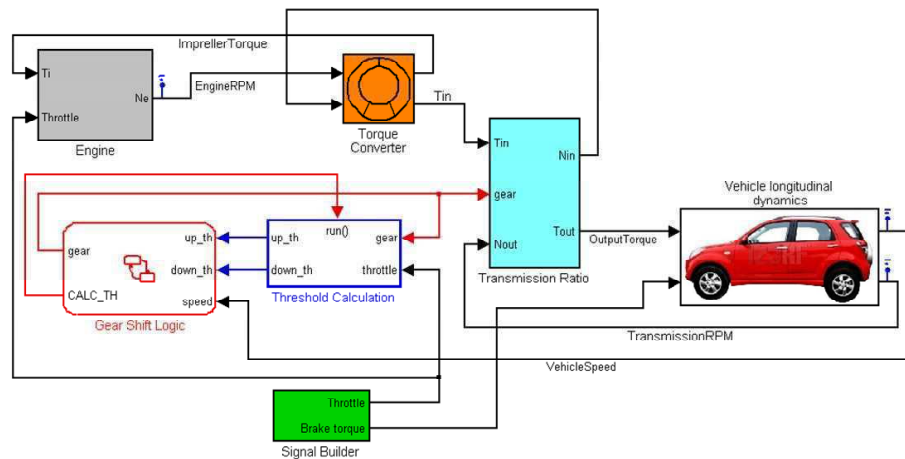


Figure 1.5: Vehicle longitudinal system

Figure is the diagram of vehicle longitudinal system in ref [Zhao 2002]. The basic elements are engine, torque converter, gear box and throttle/brake system. Break down in any of the parts will cause the longitudinal mission fail. Of which, the FTA of the engine is shown in the figure 1.6.

1.3 QoS of the network

QoS of the network refers to the level of quality of service, which is determined by varies of factors for example the channel condition, the efficiency of the routing protocols, the ability of transmission of the nodes in the network et etc. QoS control of the network provides high quality of communication over the network by over-provisioning the capacity so that it is sufficient for the expected peak traffic load. The quality of service of the

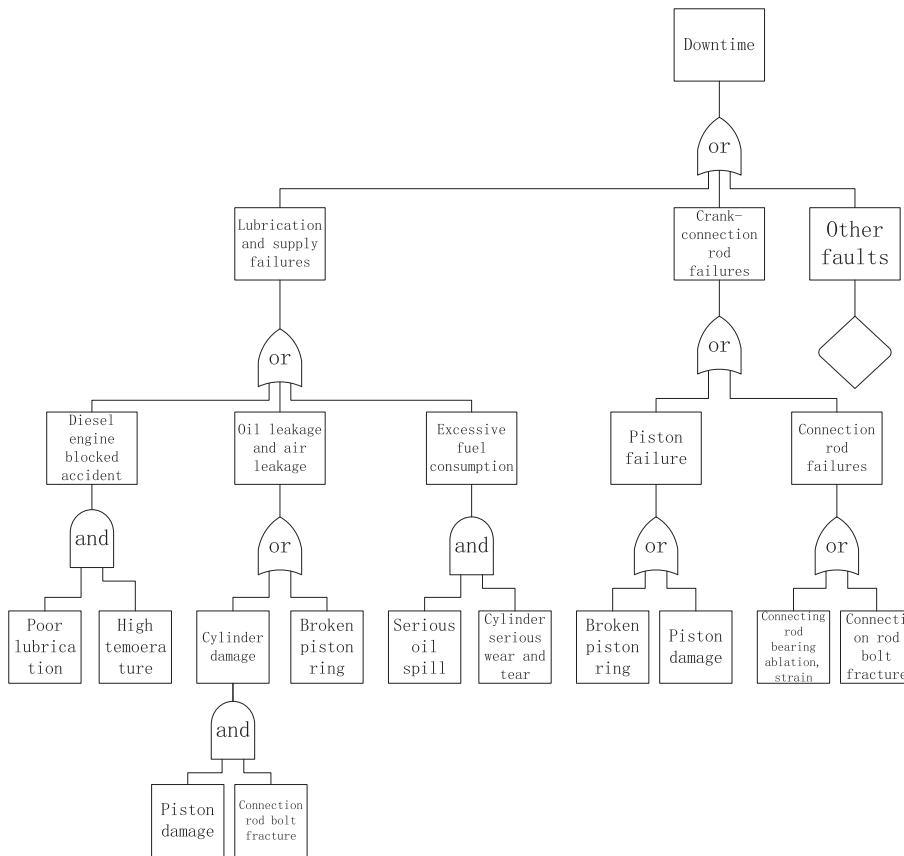


Figure 1.6: Fault tree of the diesel engine downtime [Li 2010]

network always combined with the criteria of the performance of communication such as: error rate, latency time, throughput...

Queuing theory is widely used for modeling the process of service of the network. It is a mathematical study of waiting lines, or queues. The model simulates the behavior of the queue in order to predict the queue lengths and waiting times. Queuing theory is originally considered a branch of operations research and the results are often used for making business decisions.

Networks are systems that a number of nodes are connected by customer routing. When a data packet of information or we can regard it as a customer has arrived at one node it joins the queue waiting for service by the node, until it leaves the node after being served. The expression of the queuing model is presented by A/S/c/K/N/D which is proposed by David Kendall in 1953 [Kendall 2008]. The letters A,S,c,K,N,D represent *the arrival process, the service time distribution, the number of servers, the number of places in the system, the calling population and the queue's discipline*, respectively.

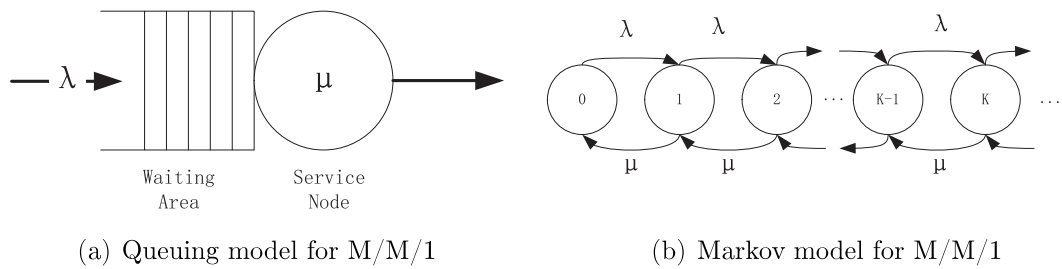


Figure 1.7: Queuing theory

Take the M/M/1 queue for example which means the arriving rate of customer and serving rate are exponentially distributed and only one serving channel for the queue. K, N, D are assumed as ∞ (infinite on queue capacity), ∞ (infinite on customer source) and FIFO (First In First Out), the queuing figure and Markov states transfer figure are shown in figure 1.7.

Little's formula has given the direct method of calculating the properties of the M/M/1 queuing model: (in which λ and μ refers to the arriving rate of the customers and serving rate of the node)

- utilization of the node: $\rho = \frac{\lambda}{\mu}$
- average number of customers in the node: $L_s = \frac{\lambda}{\mu - \lambda}$
- average time time a customer stayed in the mode: $W_s = \frac{1}{\mu - \lambda}$
- average time time a customer stayed in the queue: $W_g = \frac{\lambda}{\lambda(\mu - \lambda)}$

The assumptions of classical queuing theory may be too restrictive to be able to model real-world situations exactly. The complexity of network systems with network-specific characteristics cannot be handled with those models. Therefore specialized tools have been developed to simulate, analyze, visualize and optimize time dynamic queuing line behavior. For example, in the real network communication systems, the arriving rate or the serving rate of data packet may not be ideally exponentially distributed. With the development of wireless communication, exponential distribute became less accurate in approximating the behavior of the nodes. Works have been done on the various distribution of the network. [Xu 2006] investigated the waiting time distribution of M/Pareto/1 queuing model. The author used Pareto distribution approximate the heavy-tailed service distribution. [Shortle 2002] used a modified TAM (Transform Approximation Method) to calculate

the serving time generally distributed M/G/1 queue. P-K (Pollaczek–Khintchine) formula is widely used in solving M/G/1 queuing model [Azaron1 2005], but [Brandwajn 2009] proposed that P-K formula may not be accurate in the situation that the distribution of serving time is a stochastic process and queue capacity is limited. The queue capacity varies with different service time distribution.

The short range wireless communications we talked about in the last section have a sort of transmission protection scheme. For example, in order to avoid transmit interfering of the neighbor nodes, a back-off scheme is applied in the wireless transmission protocols such as IEEE802.11 MAC protocol. Back-off timer is exponential distributed but the timer of the node freezes each time an interfering neighbor starts transmitting a packet. When the back-off timer of a node expires, it starts transmitting the packet and the back-off timers of all its interfering neighbors are immediately frozen. The timers of the interfering neighbors are resumed as soon as the transmission of the packet is complete. [Bisnik 2006] and [Tickoo 2008] have modeled the back-off mechanism of the IEEE802.11 communication. Also, other analytical models are also used for the QoS measure of the wireless communication. [Wang 2012] proposed a cross-layer model to analyze the end-to-end delay of the wireless sensor network, based on TinyOS CAMA/CA protocol which is similar to IEEE502.15.4 (Zigbee). A back-off scheme is also applied in this protocol.

In the unicast working mode of the wireless communication, another important scheme is applied — the automatic repeat request (ARQ) scheme. Packets shall be retransmitted until acknowledgement of a successful reception is returned by the destination (or until a certain time runs out for the transmission). A retransmission shall be carried out either because the packet transmission itself failed, or because the acknowledgment transmitted in the return packet failed. This special process can not be presented by the simple queuing model, other method should be developed. [Sakurai 2007] developed a unified analytical model and unlimited retransmission times have been considered while in [Zhai 2004] treated it as infinite.

1.3.1 Routing protocols of ad hoc

According to the characteristics of the intelligent vehicle system, an ad hoc network is more practical to be established to transmit the data between the vehicles. Ad hoc network can be deployed instantly without any base station or infrastructure support. A mobile ad hoc network (MANET) allows the nodes to enter or leave the network dynamically and change the relative positions between each other, which fits the real usage of the

intelligent vehicle system. Wireless communication networks transmit the data from one client to another. Usually the transmission range of the nodes is limited. So the mission would be accomplished by multi-hop if the source node and the destination node are not within each other's range. The topology and the routing protocols become a crucial part to ensure the reliability of network.

An ideal ad hoc routing protocol for intelligent vehicle system should satisfy the following properties:

- Distributed operation mode. The V2V and V2I network is dynamic mobile ad hoc network. Vehicles keep changing their positions and relative distance with each other or the infrastructures. A centralized routing may cause a large network overhead. So, distributed operation is necessary for ITS.
- Rapid convergence. Routing protocols for ITS must respond rapidly to the change of the topology of the network. The available route should be acquired soon to avoid congestion.
- Loop-free routing protocol. This is a basic demand for the ad hoc routing protocol. The loop route in the dynamic topology network would cause a waste of bandwidth.
- On-demand routing. This is also for the consideration for avoidance of network overhead, which is often caused by the periodic update of the routing information. This type of routing protocol may be the main direction for ITS.
- Security scheme. Route request is sent by broadcasting, attacks may happen during the process of routing by the black hole nodes or malicious nodes. The routing protocol should be invulnerable to the attacks from the inside or outside.
- Scalability. Topology of the ITS communication network is changing all the time as the vehicles join and leave the MANET randomly. Scalability enables the network to expand to a larger scale.

Numerous routing protocols have been developed since the 1980s [Jubin 1987]. Protocols deal with different conditions and requirements of network which can be generally categorized as:

- Table-driven (Pro-active) routing. This type of protocols maintains up-to-date lists of routing information from each node to all the destinations by periodically distributing routing tables throughout the network. The nodes respond to the changes

in network topology by propagating updates throughout the network in order to maintain a consistent network view [Royer 1999]. Also, this kind of protocol periodically exchanges the routing information with their neighbors. Thus, the networks using this kind of protocol have the advantage that routes are immediately available when requested. Apparently, it is unsuitable for ITS communication networks because the topology changes so frequently and the periodically table maintaining request throughout the network may cause a massive network overhead.

- On demand (Reactive) routing. This kind of routing protocol initiate the routing discovery process only when desired by the source node, either because a new path is needed or the current route is broken. The source node keeps the entire available route until they are all blocked. Route maintenance process can ensure the connectivity of the end-to-end communication and initiate a new discovery process until either the destination becomes inaccessible along every routes or the route is no longer desired.
- Hybrid (both pro-active and reactive) routing. Hybrid routing protocols aim at balancing the pro-active and reactive protocols in order to reduce the network overheads. The advantages of the other two types of protocols are combined. Network with this kind of protocols acquires at least one-hop neighborhood information and initially established with some proactively prospected routes and then serves the demand from additionally activated nodes through reactive flooding.

Based on the advantages of the on demand routing protocol, researches have been done to improve the efficiency of route discovery, overhead controlling, maintenance strategy and QoS controlling [Khazaei 2009, Sengul 2006, Lee 2001, Leung 2001, Liu 2010, Sinha 1999]... The most typical routing protocols are AODV(Ad hoc On-Demand Distance Vector Routing) and DSR(Dynamic Source Routing).

The basic concepts of AODV and DSR protocol are the same. When a route from the source to the destination. Source node will broadcast RREQ(Route Request) Packets to its neighbors, the neighbors rebroadcast the RREQ to their neighbors... until the RREQ reaches the destination node. RREP (Route) packets are sent backwards to the source node, and then the path can be built. But there are some differences between the two protocols. In AODV protocol, the intermediate nodes only keep the information for the nodes of next hop and it used a sequence number marking in the RREQ packets which prevents the loop of routing and saves the control overhead. Also it has a quick

response for the link failure. But the disadvantage is that the route discovery process may cause more time and bidirectional links are needed between the nodes to construct an unidirectional path. While in the scheme of DSR protocol, all of the intermediate nodes cache the route information so they are able to use this information in the process of route discovering which can efficiently reduce the control overhead. Unidirectional link is supported for DSR protocol. But on the other hand, the cached route information may have gone stale if the topology of the network is always changing. Moreover, the scalability of the DSR protocol may be weaker than that of AODV. The DSR routing protocol may only support the network with less than 200 nodes.

1.4 Performance of control system under the considering of QoS

Wireless communication systems have been applied in the control systems to substitute the cables, simplify the hardware system. But unlike the system with the cables, the data transmission (state parameters or control signals) is not that reliable or predictable, which is called assessment of the quality of service. Transmission through the air often gets interfered by the noise, obstacle which randomly causes the transmission delay and data fault or loss. All these kinds of error will somehow influence the performance of the control system. In some of the system which has the long settling time would be hardly influenced by little of the transmission fault. But nowadays more and more control systems are required for faster, more accurate and stable. The fault discussed above can slow the process, make it inaccurate and unstable. Performance will be degraded such as bigger settling time and overshoot, or sometimes the whole system will be harmed for example the system become unstable. There are several mythologies for the research of the control systems with imperfect communication.

1.4.1 Lyapunov method

Lyapunov stability is used to describe the stability of a dynamical system. If all solutions of the dynamical system that start out near an equilibrium point x_0 stay near x_0 forever, then x_0 is Lyapunov stable. More strongly, if x_0 is Lyapunov stable and all solutions that start out near x_0 converge to x_0 , then x_0 is asymptotically stable. Exponential stability guarantees a minimal rate of decay.

- Lyapunov method for continuous-time systems. Consider an autonomous nonlinear dynamical system $\dot{x} = f(x(t)), x(0) = x_0$, Where $x(t) \in D \subseteq \mathbb{R}^n$ denotes the system state vector, D is an open set containing the origin, and $f : \mathbb{R}^n \rightarrow \mathbb{R}^n$ continuous on D . Suppose f has an equilibrium x_0 .
 1. The equilibrium of the above system is said to be Lyapunov stable, if, for every $\varepsilon > 0$, there exists a $\delta = \delta(\varepsilon) > 0$ such that, if $\|x(0) - x_0\| < \delta$, then $\|x(t) - x_0\| < \varepsilon$ for every $t \geq 0$
 2. The equilibrium of the above system is said to be asymptotically stable if it is Lyapunov stable and if there exists $\delta > 0$ such that, if $\|x(0) - x_0\| < \delta$, then $\lim_{t \rightarrow \infty} \|x(t) - x_0\| = 0$
 3. The equilibrium of the above system is said to be exponentially stable if it is asymptotically stable and if there exist $\alpha, \beta, \delta > 0$ such that, if $\|x(0) - x_0\| < \delta$, then $\|x(t) - x_0\| \leq \alpha \|x(0) - x_0\| e^{-\beta t}$, for $t \geq 0$
- Lyapunov's second method for stability. Consider a function $V(x) : \mathbb{R}^n \rightarrow \mathbb{R}$ such that:
 1. $V(x) \geq 0$ with equality if and only if $x = 0$ (positive definite)
 2. $\dot{V}(x) \leq -\frac{d}{dt}V(x) \leq 0$ with equality if and if $x = 0$ (negative definite)

Then $V(x)$ is called a Lyapunov function candidate and the system is asymptotically stable in the sense of Lyapunov.

Lyapunov method for system stability method can be used in both linear and non-linear systems. Since there are many other typical method for linear systems, Lyapunov method is more often used for the analysis of non-linear systems such as the rule-based fuzzy control systems [Langari 1991, Tanaka 1993, Tomescu 2007, Precup 2009, Boukas 2006, El-Hajjaji 2006].

1.4.2 Describing function

The describing function (DF) is another method for analyzing nonlinear control systems using an approximate procedure. It is used to analyze a system in the aspect of frequency. Consider again the autonomous feedback system with nonlinearity. If a limit cycle exists in the autonomous system with the output approximately sinusoidal, then the input to the nonlinearity might also be expected to be sinusoidal. A low-pass assumption has been made that the higher harmonics generated at the nonlinearity can be neglected. Then

the system response can be described by one of a family of sinusoidal waveforms. In this case the system would be characterized by a sine input describing function (SIDF) $H(A, j\omega)$ giving the system response to an input consisting of a sine wave of amplitude A and frequency ω . Thus description function method allows one to apply frequency domain procedures in analysis and design of nonlinearity of the system. Linear part and non-linear part can be de coupled for the system that low-pass assumption is satisfied.

The fuzzy controllers are usually realized as computer algorithms and the describing function method is simple and practical for fuzzy control system. It can be determined by both analytical evaluation [Kim 2000, Sijak 2005] or experimental simulation [Sijak 2001, Aracil 2004].

1.4.3 Limit circle & stability margin

For a control system with the frequency transfer function shown in 1.8 Then the charac-

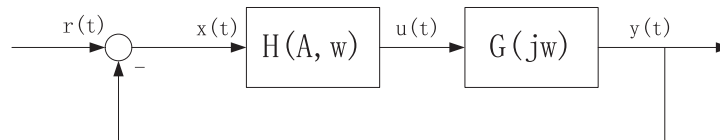


Figure 1.8: Frequency responds transfer diagram of a control system

teristic equation of the system is

$$1 + H(A, \omega) G(j\omega) = 0 \quad (1.1)$$

The limit circle can be predicted by the plot of $\frac{1}{H(A, \omega)}$ and $G(j\omega)$ on the complex plane [Kim 2000, Aracil 2004, Xing 1996]. In this thesis, if A and identical \emptyset at the intersection of the two plots can be found means there exist the limit circle and the system with limit circle may be undesirable or dangerous. [Xing 1996] has provided two graphical method to analyze the limit circle. Both of the method requires to draw a cluster of $\frac{1}{H(A, \omega)}$ and $G(j\omega)$ in order to find the corresponding ω and A . Also, the stability of the system can be told from the plot by the positional relation of the plot of $\frac{1}{H(A, \omega)}$ and $G(j\omega)$ on the complex plane [Leephakpreeda 1997].

If $H(A, \omega)$ can be calculated, the Bode of $H(A, \omega)$ can tell us some characteristics of the transfer function of the fuzzy controller. The stability of the system can be estimated using Niquist criterion. Details will be described in the following. In the system that is

minimum-phase system, stability margin is able to show how far the system is away of the stability boundary quantitatively. It is also a criterion of the performance of the system. Delay in the system may change the parameters of the system but, the stability margin expresses how large parameter changes can be tolerated before the stability of the system changes. Stability margin contains gain margin (GM) and phase margin (PM) which should be both considered at the same time. Both GM and PM can be easily shown in the plot of Nyquist(figure 1.9:

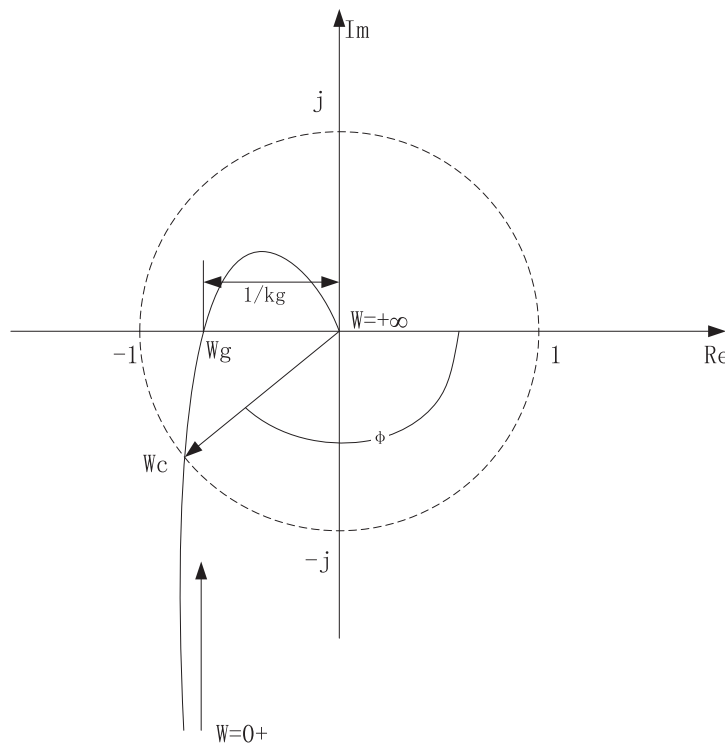


Figure 1.9: GM & PM on the Nyquist plot

$$\text{Gain margin: } \gamma = 180^\circ + \varphi(\omega_c)$$

$$\text{Phase margin: } k_g \text{ (dB)} = 20 \lg k_g = -20 \lg |G(j\omega_g)H(j\omega_g)|$$

When both gain margin and phase margin are positive, the system is stable. On the other hand, phase margin is able to express the dynamic performance of the system. The system with less phase margin has better response latency.

1.5 Conclusion

This chapter reviewed the background of intelligent vehicle system and the reliability assessment of ITS. At first, current development of driverless vehicle was introduced. Second, we briefly introduced the Dedicated Short Range Communications especially for ITS, although the final standard for the DSRC is under debating, research of application have been done with the current developed short range communication systems. The reaches for the system reliability is introduced too. Next, the QoS models for the network communication were surveyed in detail. Finally, some methods related to the contents in this thesis for analyzing the effects of imperfect communication on the control systems have been mentioned.

An important part of ITS is the short range communication system, which make the vehicles aware of the situation of the environment. Decisions for the vehicles are automatically made by intelligence controller based on the information of the environment. Traditional vehicles use human being to get the information and making decision. Compare to the natural flaw of human being, controller with reliable source of information has many advantages in traffic security. So, besides the mechanical reliability of the vehicle itself, the error during the receiving process of this information is crucial in the reliability analysis of ITS reliability.

In the following chapters, we will firstly consider the transmit reliability of the one-hop communication of the short range wireless communication. Then the other aspects relating to the reliability of ITS platoon will be developed.

Chapter 2

Reliability/QoS Assessment of Typical Short Range Wireless Communication

Contents

2.1	Related work	43
2.2	Packet reliability on broadcast repetition scheme	46
2.2.1	Introduction	46
2.2.2	Simulation results	47
2.3	Packet reliability on point-to-point unicast scheme	48
2.4	Packet delivering delay estimation of single hop	54
2.5	Conclusion	56

2.1 Related work

Bluetooth, Zigbee, Wi-Fi are the three short range wireless communication technology widely used all over the world. These three kinds of protocols share certain characteristics in common for example the frequency band and the data protection schemes. In this chapter, we are going to take the Bluetooth communication as an example to analyze the data protection scheme on the data reliability control of the short range communication.

Since the Bluetooth technology was developed by SIG (Special Interest Group) in 1998 [Group 2010] , the Bluetooth technology has become the most wildly used short-ranged wireless communication technology. It realized the easy communication between the multimedia devices. Bluetooth devices are connected by piconet shown in Fig. 2.1., it

is constructed by one master unit and several slave units, and all the units share a physical channel. The master unit controls the slave units and synchronizes them. A slave unit in one piconet can be the master unit in the other piconet, so more than one piconet can make up a scatternet. Data protection scheme are determined in the baseband protocol.

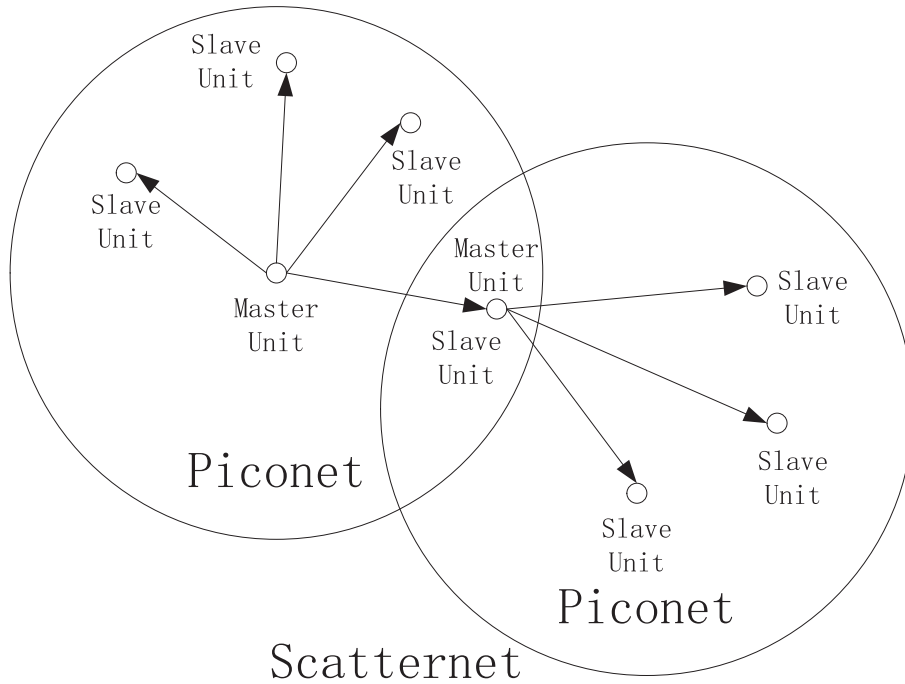


Figure 2.1: Scatternet and piconet structure of Bluetooth

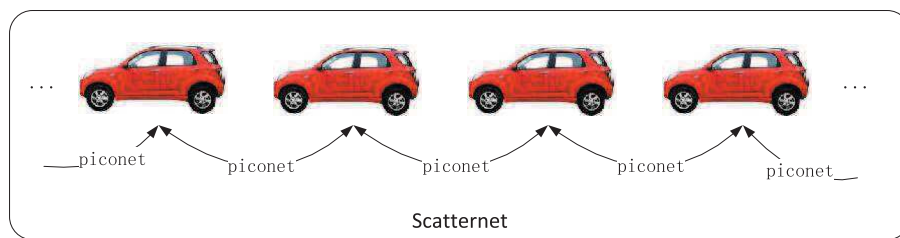


Figure 2.2: Scatternet vehicles with bluetooth

The baseband defines also the hop selection scheme, and it manages the physical channel, transmission of the data, code correction, synchrony/asynchrony link, page and inquiry. In fact, Bluetooth uses frequency-hopping technology and data whitening to reduce the interference of the same frequency signals and noise that improves the reliability of the transmission but they are not discussed here. The Bluetooth channel is divided into

timeslots at the length of $625\mu s$. The baseband protocol provides a series of packet types. All the different packet types are different in payload length, error protection scheme it uses and the number of timeslot one packet takes during the transmission.

Two kinds of links can be established between master/slave devices in the network: the synchronous connection-oriented (SCO) link and the asynchronous connectionless (ACL) link. These two types of connection have their specialized packet type. The SCO link can be established between one master device and one slave or at most three different slave devices. It allows duplex synchronous symmetric transmission by receiving a returning packet in the following time slot. The eSCO (enhanced SCO) implies a CRC to verify that weather the packet is transmitted correctly, if not, the master can receive a message to retransmission.

The ACL link allows asynchronous transmissions and Piconet-wide broadcasts between the master and its slaves. ACL uses the slot or multi-slot that is not being used for SCO packets.

At the beginning, the SCO connection is designed to transmit voice while the ACL connection is designed to transmit data, each one uses a different modulation scheme. But nowadays, the ACL link can be used to transmit high quality sounds signal [Dogan 2004]and according to reference [Jang 2001], SCO link can be used for data acquisition in the time constraint system as it synchronous identity and performs better than ACL link.

There are two working method of Bluetooth communication, broadcast and point to point unicast. This paper starts with the analysis of the two working method, the performance of the three types of error protection scheme will be analyzed and the data transmit reliability under different packet characteristics (payload length, error protection scheme used) and channel conditions(bit error rate) will be studied in detail.

Previous work have also analyzed the relationship between the packet size and QoS of single hop transmission in wireless communication [Korhonen 2005, Modiano 1999]. [Chien 1999] a method to adapt the packet size with the network conditions. [Korhonen 2005] suggested that the bit error rate is not constant during the communication. A two-state Markov process is probably more accurate for the modeling of bit error rate. The Markov process has the state "good" and "bad" and the bite error rate is different in the states. However, if the state transition rate is determined, there will be the steady possibility for both two states and the steady possibility can be regarded as the weights on the bit error rate of each state, which makes the bit error rate constant for every bit.

2.2 Packet reliability on broadcast repetition scheme

2.2.1 Introduction

In broadcast scheme, packets are transmitted by the master to all the slaves simultaneously. Each broadcast packet is transmitted at a fixed number of times. The CRC code is used only for check the correctness but cannot be acknowledged shown, see figure 2.3:.

Previous work on the reliability transmission basically focused on the broadcast scheme. As the different packet has the different property; the difference of the packets has been studied thoroughly. Reference [Jang 2001] analyzed the different baseband ACL packet scheme based on the Bluetooth specification version 1.0. This reference calculated the reliability and effective throughput of the different packet types with the different error protection scheme using the SNR (Signal Noise Rate) to describe the channel. In [Liang 2006], the author analyzed the different baseband ACL packet scheme based on the Bluetooth specification version 2.0+EDR. This paper then compared different performances of data transmission under different BER (Bit Error Rate), and summarized the optimal packet type in different circumstance.

Reference [Chen 2004] suggested an "adaptive packet type". The broadcast scheme can change the packet type according to the channel condition. Because one type of packet cannot be suitable for all the channel conditions, it can achieve a good reliability when the condition changes.

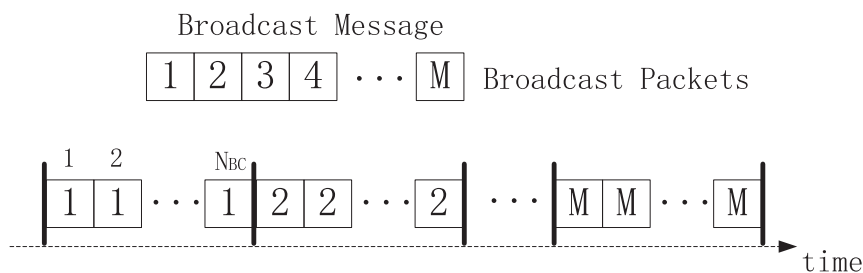


Figure 2.3: Bluetooth broadcast scheme

Since in the broadcast working mode, the packets cannot be acknowledged, only the FEC scheme which is applied to the payload can improve the reliability of transmission. Not all the packets apply the FEC scheme, and a FEC-applied packet can be either 1/3 rate FEC or 2/3 rate FEC. When using 1/3 FEC coding scheme, each bit is simply sent

three times, over three consecutive bits. The one time error in the three consecutive bits is tolerated just like the 2 in 3 vote system. While when using 2/3FEC scheme, each sequence of 10 bits is followed by 5 parity bits calculated using a (15,10) shortened Hamming code. Any single bit error in the whole 15 bit code word can be corrected, and any double bit error can be detected.

For the packets that do not have any FEC protection, the packet error rate can be defined as followed: (the rest part of the packet such as the header is highly protected so the payload is the only consideration here)

$$p = 1 - (1 - BER)^S \quad (2.1)$$

The packet error rate p is defined as the possibility that the whole payload of the packet cannot be received by the receiver. S is the size of the payload counted in bits. For the packet applied 2/3 FEC scheme (the ACL packets only apply 2/3 FEC).

$$p = 1 - [(1 - BER)^{15} + 15 \times BER \times (1 - BER)^{14}]^{\frac{S}{15}} \quad (2.2)$$

For the packet, 1/3 FEC scheme is applied in the SCO packet HV1.

$$p = 1 - [1 - BER^3 - 3BER^2 \times (1 - BER)]^S \quad (2.3)$$

We assume that every packet is broadcasted NBC times, the possibility that the packet will be transferred is as followed:

$$r = 1 - p^{NBC} \quad (2.4)$$

2.2.2 Simulation results

Simulations are carried out under different conditions (different packet lengths, BERs). The result for the packets with the same length is shown in Fig. 2.4. The results show that the packets that applied 1/3FEC scheme have always the most transfer reliability.

The results show that the packets that applied with 1/3FEC scheme have always the most transfer reliability. But as a tradeoff, the efficiency of the transmission is sacrificed by using 1/3FEC scheme. That is to say the packet who has the same length with these three conditions, the effective message length is not the same. If a s bit-length message is to sent, the packet with 1/3FEC will be $3s$ bit-long and the packet with 2/3FEC will be $1.5s$ bit-long. The packet reliability is recalculated with the same length of effective message, the results are shown Fig. 2.5.

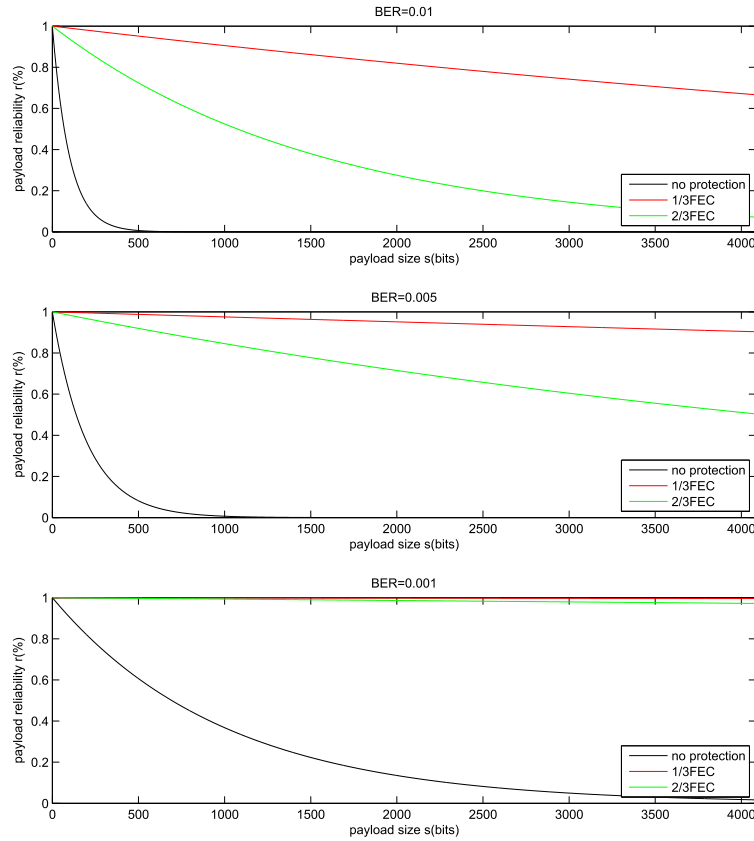


Figure 2.4: Packet reliability under different conditions

We can see that either of the protection scheme has apparently advantages in increasing the packet reliability than the no-protection channel. But between the two schemes, 1/3FEC seems more competent than 2/3FEC, the disadvantage of the 1/3FEC is the large redundancy of overheads which will cause a long transmission delay and will discussed later.

2.3 Packet reliability on point-to-point unicast scheme

With an automatic repeat request (ARQ) scheme, DM, DH the data field of DV packets, and EV packets shall be transmitted until acknowledgement of a successful reception is returned by the destination (or timeout is exceeded). The acknowledgement information shall be included in the header of the return packet. The ARQ scheme is only used on

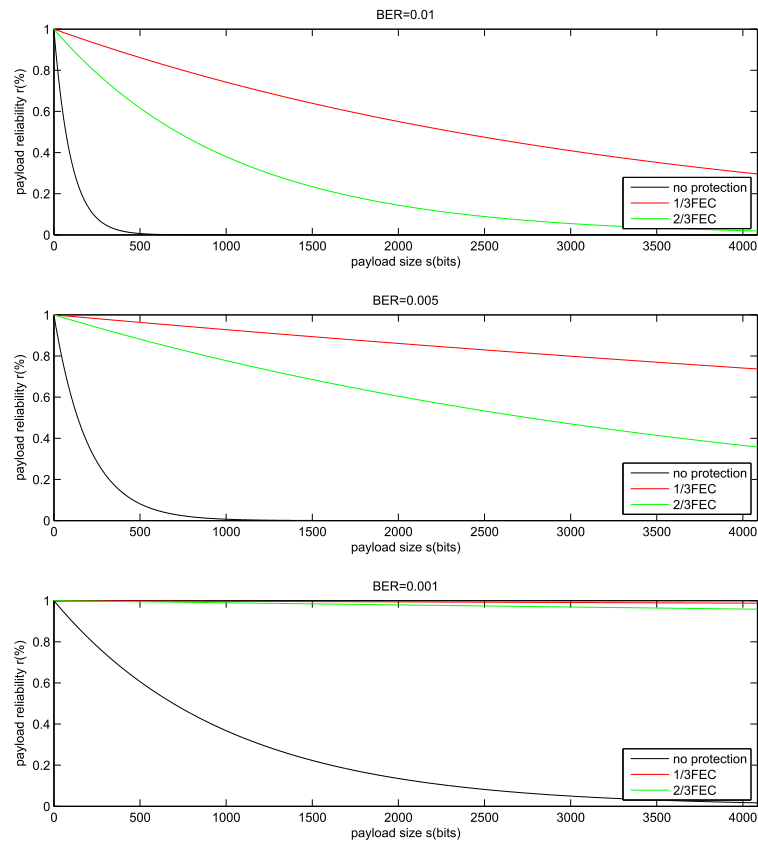


Figure 2.5: Packet reliability with the same effective message length

the payload in the packet and only on packets that have a CRC. Broadcast packets shall be checked on errors using the CRC, but no ARQ scheme shall be applied.

The data payload shall be transmitted until a positive acknowledgment is received or a timeout is exceeded. A retransmission shall be carried out either because the packet transmission itself failed, or because the acknowledgment transmitted in the return packet failed. Fig. 2.6 shows the scheme of ARQ.

The working process of ARQ scheme is showed in Fig. 2.7. Whether the packet should be retransmitted is mostly determined by the CRC code in the payload, as described above, two conditions will cause the packet error in the point-to-point transmission using ARQ scheme:

- (1) CRC code failed to detect the error of the payload so the receiver didn't send the retransmission request.

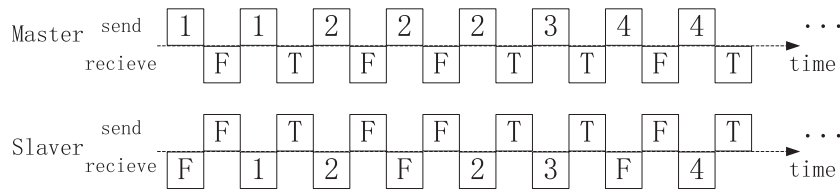


Figure 2.6: ARQ scheme

(2) The retransmission time have exceeded a certain threshold value so the sender cannot send it anymore but the packet still hasn't been received correctly. Error occurred can be detected or the CRC code mistook the right transmission for error. CRC error detection computes the remainder of a polynomial division of a generator polynomial into a message. Then the remainder is appended to the message that forms the whole message. When the message has been received by the receiver, the message will be divided by the same polynomial again and the remainder is computed, a nonzero value indicates an error happened during the transmission [CRC]. For the first error scheme, the checking process fails in several ways according to the generator polynomial's size or the bit error rate of the channel. So, it is very difficult to determine how effective a given CRC will be at detecting errors. At first people determined the bounds to describe the undetected probability of the error check code [Leung-Yan-Cheong 1976, Wolf 2006], according to the bounds, when the bit error rate of the channel (BER) is 0.5, the probability of undetected error which is denoted by for an (n, k) linear block code in a binary symmetric channel is described as

$$p_{ud} = (2^k - 1)2^{-n} = 2^{-r} - 2^{-n} < 2^{-r} \quad (2.5)$$

In which r is the length of the error checking code. Later, people found that the bound is too inaccurate because the 0.5 is the worst BER condition of a channel and it doesn't reflects the different effects of the different code polynomials. An exact evaluation of the probability of undetected error has been developed using the weight enumerator of the code [Baicheva 2000, Wolf 1988, Fujiwara 1985, Lin 2005], the performance of different polynomial under different BER conditions have been considered. The Bluetooth transmission uses the CRC-CCITT 16 to check whether the payload of the packets has been transmitted correctly, and nearly every type of packet has been applied CRC code (except HV packets). It follows the payload as shown in the Fig 2.8. CRC-CCITT-16 is a standard 16-bits CRC code recommended by CCITT (International Telephone and Telegraph Consultative Committee). For its error check capability it is said that it can

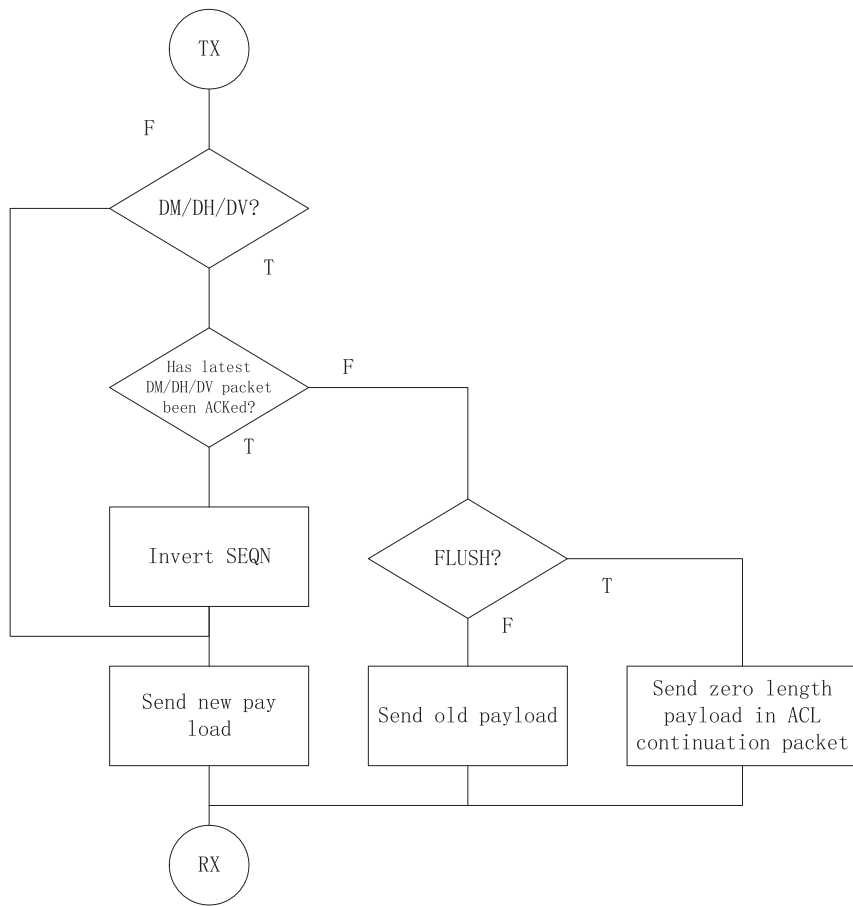


Figure 2.7: ARQ working process

100% detect the one bit error and two bits error or any odd number of bits error in the payload, it can also detect an error burst as wide as the checksum itself [Wolf 1988], that is to say detect a 16-bits long burst error. According the bound that has referred above,

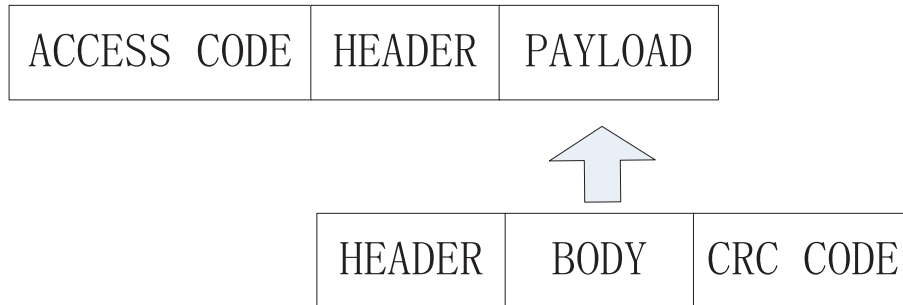


Figure 2.8: Structure of the payload of Bluetooth packet

the undetected error probability is:

$$p_e = 1 - (1 - BER)^S \quad (2.6)$$

When the bit error rate of the channel is 0.5, which is unlikely to happen because it's too big. Considering the theory of the CRC working process, the undetected error happens because the message changed to another message that has the zero remainder when divided by the polynomial. As the CRC-CCITT code has a good ability to resist little error of the message, the error message need to have a great number of changes to escape the checking of it. So the channel with bigger BER has the more opportunities to create the undetectable error packets, and the longer the message is the more difficult to detect.

In this chapter, the coding, transmission through the binary symmetric channel and checking process have been described in Matlab shown in Fig.2.9 and Monte Carlo method is used to simulate the probability of undetected error. The module and the results are shown in table 6.1.

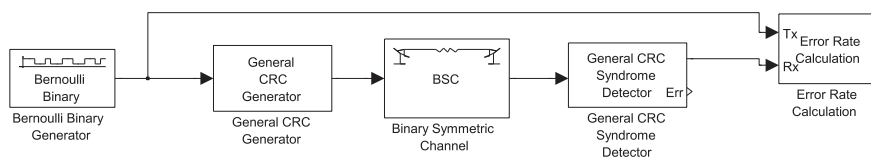


Figure 2.9: Simulation of CRC working process

Table 2.1: Undetected error rate result (number of samples:10⁶)

Payload length (bit)	BER	errors present	errors checked out	packet error rate(%)	undetected error rate(%)
32	0.00001	471	471	0.0471	0
	0.0001	4834	4834	0.4834	0
	0.001	47127	47127	4.7127	0
	0.01	383026	383026	38.3026	0
	0.1	993574	993529	99.3574	0.004529104
	0.5	1000000	999977	100	0.0023
64	0.00001	820	820	0.082	0
	0.0001	7852	7852	0.7852	0
	0.001	76581	76581	7.6581	0
	0.01	552977	552977	55.2977	0
	0.1	993574	993529	99.3574	0.004529104
	0.5	1000000	999990	100	0.001
128	0.00001	1482	1482	0.1482	0
	0.0001	14497	14497	1.4497	0
	0.001	133743	133743	13.3743	0
	0.01	765080	765078	76.508	0.000261411
	0.1	1000000	999989	100	0.0011
	0.5	1000000	999978	100	0.0022
256	0.00001	2730	2730	0.273	0
	0.0001	27045	27045	2.7045	0
	0.001	238923	238923	23.8923	0
	0.01	934725	934722	93.4725	0.00032095
	0.1	1000000	999978	100	0.0022
	0.5	1000000	999980	100	0.002
512	0.00001	5263	5263	0.5263	0
	0.0001	51411	51411	5.1411	0
	0.001	410102	410102	41.0102	0
	0.01	995221	995208	99.5221	0.001306243
	0.1	1000000	999984	100	0.0016
	0.5	1000000	999986	100	0.0014
1024	0.00001	10403	10403	1.0403	0
	0.0001	647065	647064	64.7065	0.000154544
	0.001	999978	999978	99.9978	0
	0.01	999978	999963	99.9978	0.001500033
	0.1	1000000	999983	100	0.0017
	0.5	1000000	999985	100	0.0015

In the results, the 0s in the last line of undetected error rate doesn't mean that CRC can detect out 100% the error, it just indicates the undetected error rate is under a certain order of magnitude. On the other hand the result shows a phenomenon that when the BER descend from 0.5, the undetected error rate goes up at a range and then goes down, the shorter the packet is, the more obvious this phenomenon is. This phenomenon is corresponded with the previews research.

For the second error scheme, the sender cannot afford to repeat the transmission endlessly, so we can assume a number N_r as the time limit that it can retransmit. So if we used the BER described in the last section, the possibility that the packet been transmitted incorrectly can be described as followed:

Possibility of the packet error:

$$p_e = 1 - (1 - BER)^S \quad (2.7)$$

Packet error rate:

$$p = p_e^{N_r} \times p_c^{N_r-1} + p_e^{N_r-1} \times p_c^{N_r-2} \times (1 - p_c) + p_e^{N_r-2} \times p_c^{N_r-3} \times (1 - p_c) + \dots + p_c \times (1 - p_c) \quad (2.8)$$

Where p_c denotes to the error detection rate of the CRC code.

2.4 Packet delivering delay estimation of single hop

The packet delivering delay is the amount of time from the source node begins preparing the packet until the destination node successfully receives the packet. In the case of a digital message, it is the time from the first bit is prepared until the last bit of a message has reached the destination node. The delivering delay we are talking about consist three parts as shown in formula 2.9

$$t_{delay} = t_p + t_t + t_{pro} \quad (2.9)$$

In which, t_p refers to the time that the source node used for packing the message. This process is mainly carried out in the media access control layer of the node, which depends on the protocol type of MAC. It is also determined by the processing speed of the node and it is neglected here. t_t is the transmission time spend between the first bit of message leaves the source node and the last bit leaves the node which is equal to the time between the first

bit reaches the destination node and the last bit reaches. t_{pro} is the prorogation time that the message travels between the nodes, which depends on the physical medium of the link. Usually in the wireless communication, the medium is the air and the propagation speed of the message $3 \times 10^8 m/s$. In the short range communication, t_{pro} is often negligible.

The transmission time t_t can be obtained from the packet size L_p in bit and the bit rate R in bit/s as:

$$t_t = \frac{L_p}{R} \quad (2.10)$$

In the broadcasting scheme and consider the protection methods, the 1/3 FEC scheme will take three times in transmission delay than the no-protection scheme, while the 2/3 FEC scheme will take two times in transmission delay than the no-protection scheme. In the ARQ transmission scheme, the CRC code is used by the destination node to check if the packet is as the same as when it is sent. The source node will continue to transmit until an ACK packet sent by the destination node was received. So, though the ARQ scheme is effective in ensuring the packet reliability, it causes network overhead and increases the delay time. We can assume that the ACK packets are small compare to the data packet, the time acknowledgement of successful reception is neglected, the total time of delivering delay in the ARQ scheme is:

$$T_{delay} = (n_{rt} + 1) \times t_{delay} \quad (2.11)$$

In which, n_{rt} is the number of retransmission times. Packets are retransmitted when the packet has error and the CRC code have detected the error. The possibility that a packet will be retransmitted is:

$$p_{rt} = p \times r_{crc} \quad (2.12)$$

In which, p is the packet error rate and r_{crc} is the error detected rate as shown in table2.1. Accordingly, if the number of possible retransmission attempts is infinite, the mathematical expectation of the retransmission number is in equation 2.13

$$n_{rta} = p_{rt} + p_{rt}^2 + p_{rt}^3 + \dots + p_{rt}^n + \dots = \frac{p_{rt}}{1 - p_{rt}} \quad (2.13)$$

If the number of retransmission is limited to N , then the possibility that the packet is transmitted by $n(n \leq N + 1)$ times is as equation 2.14, the possibility that the packet is able to be delivered successfully in N or less time is shown in equation 2.15 and the possibility that the packet is dropped because of the retransmission time exceeds is as equation 2.16:

$$P_{rt=n} = (1 - p_{rt})p_{rt}^{n-1} \quad (2.14)$$

$$P_{rt \leq N+1} = (1 - p_{rt}) + p_{rt}(1 - p_{rt}) + (1 - p_{rt})p_{rt}^2 + \dots + p_{rt}^N(1 - p_{rt}) = 1 - p_{rt}^{N+1} \quad (2.15)$$

$$P_{drop} = p_{rt}^{N+1} \quad (2.16)$$

Now the problems of delivering delay and packet error rate have been connected and both of the two attributes of QoS have a relation with the packet size. An error-protection-scheme-used may have less error rate but will cause more delivering time. Assuming that the channel that the three kinds of packets used has a bit rate $1Mb/s$ and the ARQ scheme is applied. The comparisons of delivering delay and packet error rate for transmitting a certain length of message are calculated and shown in the figure 2.10

Though 1/3FEC packets have a little more reliability than 2/3FEC packets, but according to the calculation of delivering time, 2/3FEC has lot advantages in controlling the overhead. At last, in a more reality situation that the number of retransmission is limited to N , the delivering delay and delivering successful rate can be calculated with different setting of N and BER. See figure 2.11

2.5 Conclusion

This Chapter analyzes the three error protection schemes applied in the Bluetooth communication. The effects to improve the data reliability of the two FEC schemes in the broadcasting scheme are calculated. Result shows that the packets with FEC error protection schemes have a better reliability performance than the ones that doesn't apply the schemes. While in the point to point working scheme, the sender can retransmit the failed packet but can't be endlessly. The performance of the CRC code used in Bluetooth protocol has been analyzed and the performance has been evaluated by simulation. Then, the method to calculate the single hop-delay is introduced, it is proved that the packet size can both effect on the delivering delay and the packet reliability. Calculations have been made to analyze the trade-off.

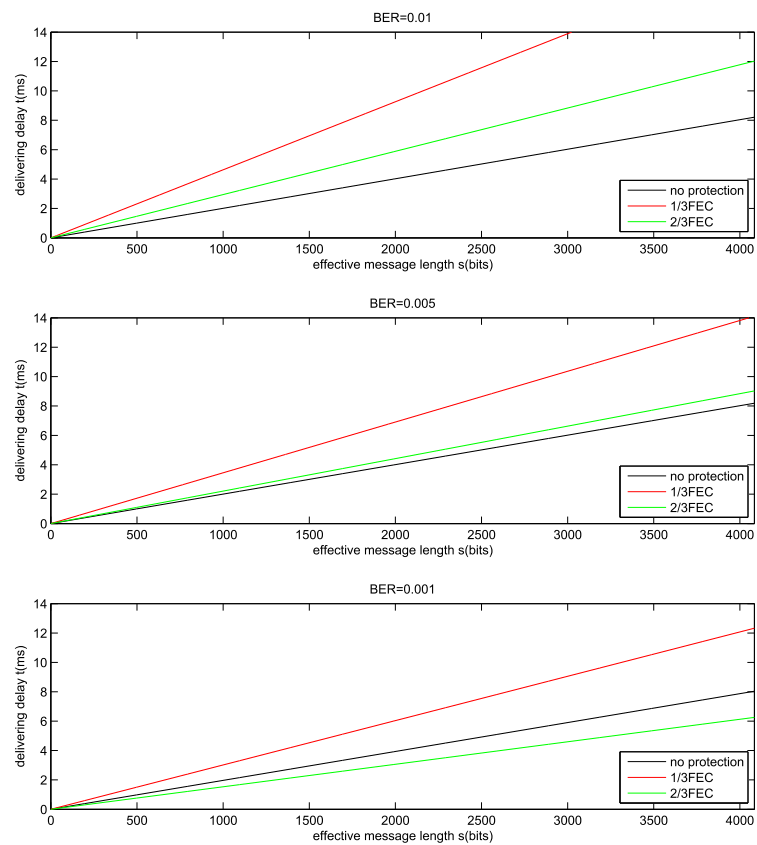
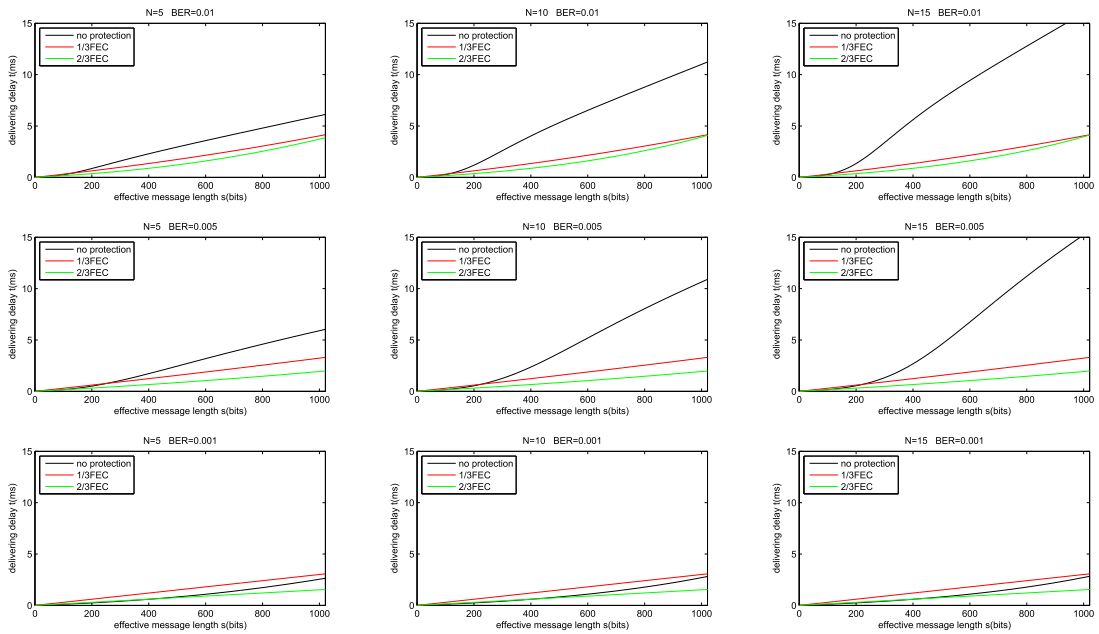
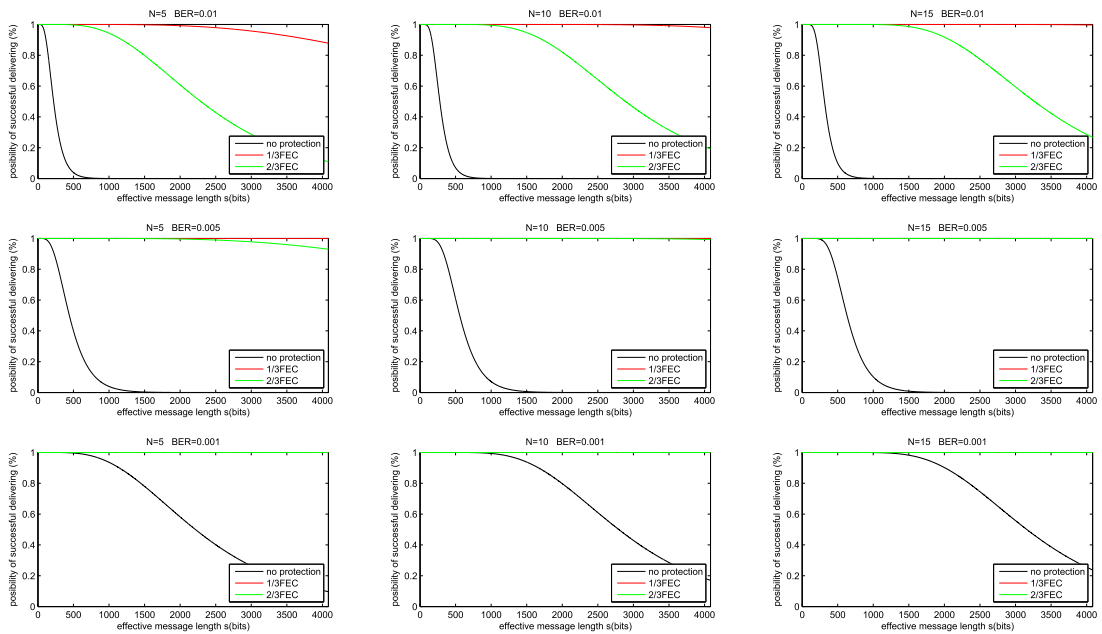


Figure 2.10: Delivering delay for three types of packet to transmit the effective message with the same length



(a) Delivering time



(b) Delivering successful rate

Figure 2.11: Calculations with limited retransmission attempt

Chapter 3

Node Performance Model

Contents

3.1	Related work	60
3.2	Model descriptions	60
3.2.1	Packet-oriented Markov model	61
3.2.2	Node-oriented Markov model	62
3.3	Model solving	64
3.3.1	Serving time is exponentially distributed	64
3.3.2	Serving time is PH distributed	67
3.3.3	Service time is randomly distributed (semi-Markov process) . .	70
3.4	Numerical examples for the model	74
3.4.1	Exponential distribution	74
3.4.2	PH distribution	77
3.4.3	Semi-Markov process	79
3.5	Performance related characters	83
3.5.1	Influence of the characters of the network	84
3.5.2	Influence of the characters of the node	85
3.6	Conclusion	86

3.1 Related work

An ad hoc network is practical to be established to transmit the data between the clients, like in the wireless sensors network or intelligent vehicle platform. Ad hoc network can be deployed instantly without any base station or infrastructure support. A mobile ad hoc network (MANET) allows the nodes to enter or leave the network dynamically and change the relative positions between each other, which fits the real usage of the intelligent vehicle platform.

QoS of the ad hoc network and other networks has been analyzed on the multi-hop (end-to-end) delay with the method of queuing theory. Statistics analysis of the latency of network has been provided which is not enough for the variable stochastic situations that mathematical model is required [Bisnik 2006]. Moreover, network QoS is estimated on the worst channel conditions [Burchard 2006] however, the conservative result cannot provide the real situation of the network. The QoS of networks under heavy traffic were analyzed which is similar but not the same conditions with the networks based on the wireless communications. Recently, the model of network has been more specific which the characters of different MAC (Medium Access Control) protocols and different cast types (broadcast, anycast, unicast...) [Tickoo 2008]. The previous work prefer to take the network as it's consisted by a bunch of identical clients, however the difference between the nodes have been neglected. In fact, according to the self attributes of the nodes or the position in the network, the ability of each node may not be identical. It is obvious that a node with a low battery has less power in transmission, not to mention the difference of the hardware structures, queuing protocols. The different positions in the network can cause different traffic which leads to performance variance. Our model is based on the node. Queuing protocol and node characteristic are considered to solve this problem.

3.2 Model descriptions

During the working process of wireless communication network, there are two aspects of QoS we concern mostly: data loss and delay. The QoS of single-hop communication has been analyzed in the previous work. In the model of this chapter, we consider a wireless network of several nodes. Each of the nodes is available of receiving and transmits data. The mission of the network is to transmit data packet from any of these nodes to another, directly with a single-hop or indirectly with a multi-hop. Nodes in the network can generate transmission request or retransmit relay packets as a outer. Failure of the

nodes will cause the breakdown of the current path. The real working scheme of the nodes is complicated when the details of the network such as the protocols of the layers are involved. Different types of these protocols can cause influence on the models of the network [Sakurai 2007, Bianchi 2000, Wang 2012]. The accuracy of the result may be decided under the real using conditions such as noise, transmit power and channel condition. That is why statistics method is used to provide probabilistic estimations of the network [Abdelzher 2004, Gupta 2009, Oliver 2009]. The empirical measurements are easy to carry out but lack of analytical models. So we try to balance the detail of the model and combine it with crucial parameters of the network.

The Markov models for both the nodes and the packets will be built. We consider the unicast work mode under certain characteristics of the transition protocols, such as retransmission times, maximums queuing length, ACK patterns etc. The distribution of delay can be derived from the models. Also the model is going to reflect the packet loss rate under the certain circumstance.

3.2.1 Packet-oriented Markov model

For the model packet-oriented we have to assume the condition as followed and make other assumptions: The packets are generated (either relay or self generation) in the rate of λ (λ packets-to-send are generated in one second). We assume the packets generation (either self-generate or arriving relay packet from other node) process is governed by a Poisson process, the interval time is exponentially distributed. The packet-oriented model focused on the process of a single packet from the arrival at a node until it leaves it. The packet-to-send is going to be sent to the nearest node in the mode unicast which means ARQ scheme is applied. The nodes serve the packets in the rate of μ (μ packets leave the node in one second) and successfully transferred possibility is ρ . The interval time between the services is considered in three types of distributions we are going to discuss. Assume that the capability of the queue of each node is M , which means only M packets maximum can be waiting for transmit in each node. The new arrival packets will be dropped. In the unicast scheme, each packet is going to be sent K times maximally until it is successfully sent or dropped.

So the process of a packet in each node is shown Markov process as Fig. 3.1.

In the Fig. 3.1, the blocks shadowed by crossed lines represent the packets considered. Any of the $M \times K + 2$ states can be the state when the packet arrives. The state in the m th row means there are $M - m$ other packets—represented by the blank blocks—are

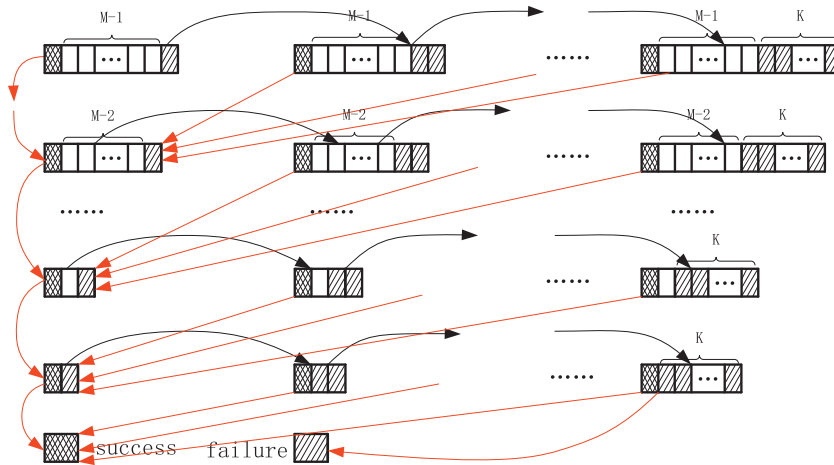


Figure 3.1: State transform of the packet

already in the queue waiting for service. Maximally there are $M - 1$ packets before the object packet because the capability of the queue of each node is M . The blocks with slash on the right side of the blank blocks represent for the first packet in the queue is now being serving for the k th time. Each row is identified by the number of packets in the queue. The transfer will end up in either the state "success" or the state "failure" which means the two possibility results for the considered packet.

During the transfer of the states, the transfer possibility of each state is related to the success possibility of the transmission in a single attempt. The state-transfer between the states in the same row which is designated with the black arrow means that no packet has left the node. While the state-transfer between the states in different rows which is designated with the black arrow means one packet has left the node. Notice that when the state is at the end of each row, which means the packet comes to the last transmission attempt, the packet is either been transmitted or dropped at the next transmission of the state.

3.2.2 Node-oriented Markov model

The solution of the packet-oriented Markov model with the initial conditions of the process can show the probability of the states at any time. The initial condition means the node status when the considered packet arrives at the node. In order to solve this problem, another Markov chain for the nodes should be built. Under the same assumptions above, a queuing model can be suitable for this process. Assume that packet arrives at node

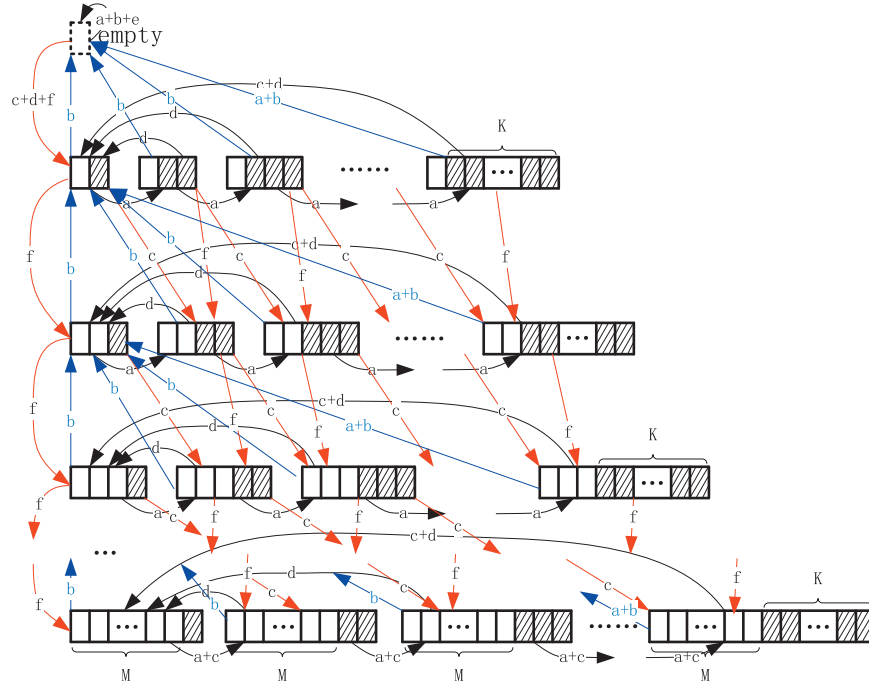


Figure 3.2: State transform of the node

separately (including the self-generate or arriving relay packet from other node). The following event combinations can trigger the state transmission:

- a. No packet arrives; No packet leaves the node (with transmission attempt).
- b. No packet arrives; One packet leaves the node.
- c. One packet arrives; No packet leaves the node (with transmission attempt).
- d. One packet arrives; One packet leaves the node.
- e. No packet arrives; No packet leaves the node (no transmission attempt).
- f. One packet arrives; No packet leaves the node (no transmission attempt).

So the Markov state transition chain of the nodes is shown in Fig. 3.2

In the Fig. 3.2, the blank blocks refer to the packets waiting in the queue for transmission. The number of blocks shadowed with right slash in each state represents the ordinal of the transmission attempt. There are totally $M \times K + 1$ states including the state "empty", which present the status of the nodes. S_{ij} denotes the state in the position of i th row and j th column except for the S_{empty} which represents for the state that no packet is in the node and use the $P_{ij}(t)$ indicates the probability that the system will be at state S_{ij} at the time t like the former Markov process. Notice that the condition e with refers to the state stays at the same state is not shown in the figure.

3.3 Model solving

In order to make our model more widely suited, we provide three different distributions of service time. The exponential distribution is widely used as the most ideal condition to simplify the models. PH distribution is recently more widely used because its fitting ability. Random distribution with semi-Markov process can be used under the circumstance that the service time can be described by another function.

3.3.1 Serving time is exponentially distributed

For the packet-oriented model, if we indicate the states with the numbers according to the position of the states in the Markov chain, such as S_{ij} refers to the state located at the m th row n th column of the figure. $P_{ij}(t)$ indicates the probability that the system will be at state S_{ij} at the time t . We can obtain the total probability formula of the process:

$$P_{ij}(t + \Delta t) = \begin{cases} P_{11}(t)(1 - \mu\Delta t) \\ P_{ij}(t)(1 - \mu\Delta t) + P_{i(j-1)}(t)\mu(1 - \rho)\Delta t, \\ i \in (1, M), j \in (2, K) \\ P_{ij}(t)(1 - \mu\Delta t) + \sum_{a=1}^{a=K-1} P_{(i-1)a}(t)\mu\rho\Delta t \\ + P_{(i-1)K}(t)\mu\Delta t, \quad i \in (2, M), j = 1 \end{cases} \quad (3.1)$$

The total probability formula for the last two states "success" and "failure" will be:

$$P_{success}(t + \Delta t) = P_{success}(t) + \sum_{a=1}^{a=K} P_{Ma}(t)\mu\rho\Delta t \quad (3.2)$$

$$P_{failure}(t + \Delta t) = P_{failure}(t) + P_{MK}(t)\mu(1 - \rho)\Delta t \quad (3.3)$$

Differential equations derived from the formula above:

$$P'_{ij}(t) = \begin{cases} -\mu P_{11}(t) \\ -\mu P_{ij}(t) + P_{i(j-1)}(t)\mu(1 - \rho), \quad i \in (1, M), j \in (2, K) \\ -\mu P_{ij}(t) + \sum_{a=1}^{a=K-1} P_{(i-1)a}(t)\mu\rho + P_{(i-1)K}(t)\mu, \quad i \in (2, M), j = 1 \end{cases} \quad (3.4)$$

$$P'_{success}(t) = \sum_{a=1}^{a=K} P_{Ma}(t) \mu \rho \quad (3.5)$$

$$P'_{failure}(t) = P_{MK}(t) \mu(1 - \rho) \quad (3.6)$$

The initial possibilities of the total possibility functions above are correspondent with the stable possibilities of the node-oriented Markov process. For example, the initial possibility for state P_{ij} in the packet-oriented Markov process is the stable possibility of the state $P_{(M-i)j}$ of the node-oriented Markov process. It is noticed that the initial possibility for state $P_{success}$ is 0 and the initial possibility for state $P_{failure}$ is the sum of the stable possibilities of the states which are in the last row of node-oriented Markov process.

Then for the node-oriented model, using the same method we can have the total probability formula for the states are (except "empty"):

$$P_{ij}(t + \Delta t) = \left\{ \begin{array}{l} P_{emp}(t)(c + d + f)\Delta t + \sum_{a=2}^{a=K-1} P_{1a}(t)d\Delta t + P_{1K}(t)(c + d)\Delta t + \\ \sum_{a=1}^{a=K-1} P_{2a}(t)b\Delta t + P_{2K}(t)(a + b)\Delta t + P_{11}(t)(1 - (1 - e - d)\Delta t) \\ i = 1, j = 1 \\ P_{i(j-1)}(t)a\Delta t + P_{ij}(t)(1 - (1 - e)\Delta t) \quad i = 1, j \in (2, K) \\ P_{(i-1)1}(t)f\Delta t + \sum_{a=2}^{a=K-1} P_{ia}(t)d\Delta t + P_{iK}(t)(c + d)\Delta t + \\ \sum_{a=1}^{a=K-1} P_{(i+1)a}(t)b\Delta t + P_{(i+1)K}(t)(a + b)\Delta t + P_{i1}(t)(1 - (1 - e - d)\Delta t) \\ i \in (2, M - 1), j = 1 \\ P_{(i-1)(j-1)}(t)c\Delta t + P_{(i-1)j}(t)f\Delta t + P_{i(j-1)}(t)a\Delta t \\ + P_{ij}(t)(1 - (1 - e)\Delta t) \quad i \in (2, M - 1), j \in (2, K) \\ P_{(M-1)1}(t)f\Delta t + \sum_{a=2}^{a=K-1} P_{Ma}(t)d\Delta t + P_{MK}(t)(c + d)\Delta t \\ + P_{M1}(t)(1 - (1 - f - e - d)\Delta t) \quad i = M, j = 1 \\ P_{(M-1)(j-1)}(t)c\Delta t + P_{(M-1)j}(t)f\Delta t + P_{M(j-1)}(t)(a + c)\Delta t \\ + P_{Mj}(t)(1 - (1 - e - f)\Delta t) \quad i = M, j \in (2, K) \end{array} \right. \quad (3.7)$$

For the state "empty" :

$$P_{emp}(t + \Delta t) = \sum_{a=1}^{a=K-1} P_{1a}(t)b\Delta t + P_{emp}(t)(1 - (1 - a - b - e)\Delta t) \quad (3.8)$$

In the formula above a,b,c,d,e,f refer to the transfer possibility, which:

$$\begin{aligned}
 a &= (1 - \lambda) \mu (1 - \rho) \\
 b &= (1 - \lambda) \mu \rho \\
 c &= \lambda \mu (1 - \rho) \\
 d &= \lambda \mu \rho \\
 e &= (1 - \lambda) (1 - \mu) \\
 f &= \lambda (1 - \mu)
 \end{aligned} \tag{3.9}$$

Differential equations derived from the formula above:

$$P'_{ij}(t) = \begin{cases}
 P_{emp}(t)(c + d + f) + \sum_{a=2}^{a=K-1} P_{1a}(t) d \Delta t + P_{1K}(t)(c + d) \\
 \quad + \sum_{a=1}^{a=K-1} P_{2a}(t) b + P_{2K}(t)(a + b) - P_{11}(t)(1 - e - d) \quad i = 1, j = 1 \\
 P_{i(j-1)}(t) a - P_{ij}(t)(1 - e) \quad i = 1, j \in (2, K) \\
 P_{(i-1)1}(t) f \Delta t + \sum_{a=2}^{a=K-1} P_{ia}(t) d + P_{iK}(t)(c + d) + \sum_{a=1}^{a=K-1} P_{(i+1)a}(t) b \\
 \quad + P_{(i+1)K}(t)(a + b) - P_{i1}(t)(1 - e - d) \quad i \in (2, M), j = 1 \\
 P_{(i-1)(j-1)}(t) c + P_{(i-1)j}(t) f + P_{i(j-1)}(t) a \\
 \quad - P_{ij}(t)(1 - e) \quad i \in (2, M - 1), j \in (2, K) \\
 P_{(M-1)1}(t) f + \sum_{a=2}^{a=K-1} P_{Ma}(t) d + P_{MK}(t)(c + d) \\
 \quad - P_{M1}(t)(1 - e - d - f) \quad i = M, j = 1 \\
 P_{(M-1)(j-1)}(t) c + P_{(M-1)j}(t) f + P_{M(j-1)}(t)(a + c) \\
 \quad + P_{Mj}(t)(1 - e - f) \quad i = M, j \in (2, K)
 \end{cases} \tag{3.10}$$

$$P'_{emp}(t) = \sum_{a=1}^{a=K-1} P_{1a}(t) b + P_{1K}(a + b) - P_{emp}(t)(1 - a - b - e) \tag{3.11}$$

Solve the equations under the initial conditions of $[P_{emp}(0), P_{11}, P_{12}, \dots, P_{MK}] = [1, 0, 0, \dots, 0]$ can obtain the initial possibility for the states of the packet-oriented Markov process.

3.3.2 Serving time is PH distributed

Recently, PH (Phase Type) distribution have been usually applied to describe the interval time of the serve time of a network node, for it has a suitability of the real working mode of the nodes. For the node using different MAC protocols has more complicate characteristics in the serving process rather than the exponential distribution [Gosar 2004]. In fact exponential distribution is a special form of the PH distribution. Also, PH distribution has been defined for the absorption Markov process like the first process describe above. Phase-type distributions have the additional appealing feature of forming a dense class of distributions within the class of distribution on the positive real axis, that is, for any distribution μ on the positive real axis there exists a sequence of phase-type distributions which converges weakly to μ . [Mogens 2005]. For the fitting methods we can see ref [Riska 2002] [Ishay 2002, Asnussen 1996].

If we assume that the service time of the node for a packet is phase-type distributed of order m presented in the form of (α, T) . Then the distribution of the service time for each node is given by

$$P(t) = 1 - \alpha \exp(Tt)e \quad (3.12)$$

In which $\alpha e = 1$ and e is a column vector of all 1s with the dimension contextualized. α is a $1 \times m$ dimensioned initial possibility vector of the transient states. T is a mm dimensioned stable matrix with negative diagonal entries, nonnegative off-diagonal entries and non-positive row sums. $T^0 = -Te$ is pre-defined here for later use.

In the second Markov process, assume that the service time for each transmission attempt for the packet is PH distributed of order x with representation (α, T) . Thus it has x phases in each transmission attempt and the initial possibility for each phase is indicated by the vector.

The PH distribution essentially imports a series of transient states between the two states that have physical meanings. The object state is seen as the absorbing state of the transient states, which is shown in the Fig. 3.3.

The transitions between the transient states are controlled by the matrix T , which is decided by the distributions of the transition time between the original state and the object states. The PH distribution has a good ability of fitting other distributions by matrix T . Macro-states can be introduced to simplify the expression of the process. Macro-states here are defined as the states that the nodes have the same number of packets in the transmission queue. The macro-states are indicated by the $E_0, E_1, E_2, E_3, E_i, \dots, E_M$, in which the subscript i refers to the number of packet thus, E_0 is the empty state. This

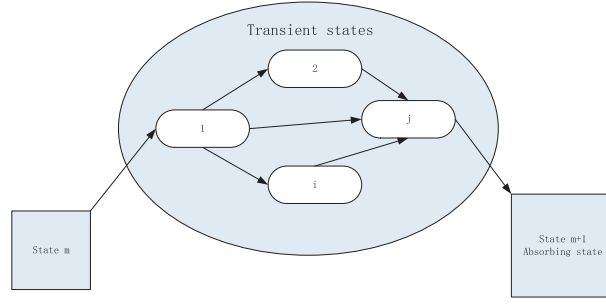


Figure 3.3: Absorbing process of PH distribution

Markov process has the infinitesimal generator Q given by a series of sub-matrix:

$$Q = \begin{bmatrix} Q_{00} & Q_{01} & 0 & & & \\ Q_{10} & Q_{11} & Q_{12} & \cdots & & 0 \\ 0 & Q_{21} & Q_{22} & & & \\ \vdots & \vdots & & \ddots & & \vdots \\ 0 & & & & Q_{(M-1)(M-1)} & Q_{(M-1)M} \\ & & & & Q_{M(M-1)} & Q_{MM} \end{bmatrix} \quad (3.13)$$

Considering the same transmit conditions of the same Markov process, each of the sub-matrixes is built as followed:

$$Q_{00} = -\lambda \quad (3.14)$$

$$Q_{01} = \lambda\alpha \quad (3.15)$$

$$Q_{i(i-1)} = \begin{bmatrix} a \\ a \\ a \\ \dots \\ a \\ a+b \end{bmatrix} \quad i \in (1, M) \quad (3.16)$$

$$Q_{ii} = \begin{bmatrix} c & b & 0 & & & \\ 0 & c & b & \cdots & 0 & 0 \\ 0 & 0 & c & & & \\ \vdots & \vdots & & \ddots & \vdots & \\ 0 & 0 & 0 & \cdots & c & b \\ 0 & 0 & 0 & & 0 & c \end{bmatrix} \quad i \in (1, M-1) \quad (3.17)$$

$$Q_{i(i+1)} = \begin{bmatrix} \lambda I & 0 & 0 & & & \\ 0 & \lambda I & 0 & \cdots & 0 & 0 \\ 0 & 0 & \lambda I & & & \\ & \vdots & & \ddots & & \vdots \\ 0 & 0 & 0 & \cdots & \lambda I & 0 \\ 0 & 0 & 0 & & 0 & \lambda I \end{bmatrix} \quad i \in (1, M-1) \quad (3.18)$$

In which,

$$\begin{aligned} a &= pT^0 \\ b &= (1-p)T^0 \\ c &= -a - b - \lambda I \end{aligned} \quad (3.19)$$

With the acquaintance of Q , if we assume the stable possibility vector of the states is $\pi = [\pi_0, \pi_1, \pi_2, \pi_3, \dots, \pi_{MK}]$, we have:

$$\begin{aligned} \pi Q &= 0 \\ \pi e &= 1 \end{aligned} \quad (3.20)$$

Accordingly, the vector π can be solved.

Same for the other Markov process— packet state transform chain. We have the infinitesimal generator Q as below:

$$Q = \begin{bmatrix} Q_{MM} & Q_{M(M-1)} & 0 & & & \\ 0 & Q_{(M-1)(M-1)} & Q_{(M-1)(M-2)} & \cdots & & 0 \\ 0 & 0 & Q_{(M-2)(M-2)} & & & \\ & \vdots & & \ddots & & \vdots \\ & & 0 & \cdots & Q_{00} & Q_{0s} & Q_{0f} \\ & & & & 0 & 0 & 0 \\ & & & & 0 & 0 & 0 \end{bmatrix} \quad (3.21)$$

In which:

$$\begin{aligned}
 Q_{0f} &= \begin{bmatrix} 0 \\ 0 \\ 0 \\ \dots \\ 0 \\ x \end{bmatrix} \\
 Q_{0s} &= \begin{bmatrix} y \\ y \\ y \\ \dots \\ y \\ y \end{bmatrix} \\
 Q_{ii} &= \begin{bmatrix} z & y & 0 & & & \\ 0 & z & y & \dots & 0 & 0 \\ 0 & 0 & z & & & \\ \vdots & & \ddots & & \vdots & \\ 0 & 0 & 0 & \dots & z & y \\ 0 & 0 & 0 & & 0 & z \end{bmatrix} \quad i \in (0, M) \\
 Q_{i(i-1)} &= \begin{bmatrix} x & 0 & 0 & & & \\ x & 0 & 0 & \dots & 0 & 0 \\ x & 0 & 0 & & & \\ \vdots & & \ddots & & \vdots & \\ x & 0 & 0 & \dots & 0 & 0 \\ x+y & 0 & 0 & & 0 & 0 \end{bmatrix} \quad i \in (1, M)
 \end{aligned} \tag{3.22}$$

In which,

$$\begin{aligned}
 x &= \rho T^0 \alpha \\
 y &= (1 - \rho) T^0 \alpha \\
 z &= T
 \end{aligned} \tag{3.23}$$

3.3.3 Service time is randomly distributed (semi-Markov process)

More generously, the time stayed at each state is randomly distributed by a certain function, which depends on the current state and the object state. Because the process is

not accord with the characteristic of Markov process at all the time points, this kind of process is called semi-Markov process.

Let $X(t), t \geq 0$ be a stochastic process and assuming it's time homogenous. Let $\theta_n, n = 0, 1, \dots$ be the transition epochs on the non-negative half of the real line. At the time interval (θ_n, θ_{n+1}) , has:

$$\begin{aligned} P\{X_{n+1} = j, \theta_{n+1} - \theta_n \leq \tau | X_0 = k, \dots, X_n = i; \theta_0 = t_0, \dots, \theta_n = t_n\} = \\ P\{X_{n+1} = j, \theta_{n+1} - \theta_n \leq \tau | X_n = i\} = H_{ij}(\tau) \end{aligned} \quad (3.24)$$

If we define:

$$H_{ij}(t) = P\{X_{n+1} = j, \theta_{n+1} - \theta_n \leq t | X_n = i\} \quad (3.25)$$

Let $p_{ij} = \lim_{t \rightarrow \infty} H_{ij}(t)$ and $F_{ij}(t) = \frac{H_{ij}(t)}{p_{ij}}$

Then p_{ij} is the transition probability of the embedded Markov chain $X(t), t \geq 0$ and $F_{ij}(t)$ is a cumulative distribution function of the sojourn time of the process in state i defined as:

$$F_{ij}(t) = P\{\theta_{n+1} - \theta_n \leq t | X_n = i, X_{n+1} = j\} \quad (3.26)$$

3.3.3.1 Explications for some formulas used

A. In probability theory, the probability distribution of the sum of two independent random variables is the convolution of their individual distributions. Which means the PDF (Probability Density Function) of the sum two independent random variables X and Y is the convolution of the PDF of X and Y :

$$Q(t) = P\{X_i + Y_i \leq t\} = \int_0^\infty f(t) * g(t) dt = \int_0^\infty \int_0^t f(\tau) g(t - \tau) d\tau dt \quad (3.27)$$

Assume that $f(t), g(t)$ are the PDF and $F(t), G(t)$ are the CDF (Cumulative Distribution Function) of the two independent random variables. We can get

$$F(t) = \int_0^t f(t) dt, G(t) = \int_0^t g(t) dt \quad (3.28)$$

So we have:

$$\begin{aligned} P\{X_i + Y_i \leq t\} &= \int_0^\infty \int_0^t f(\tau) g(t - \tau) d\tau dt = \\ &= \int_0^t \left[\int_0^{t-\tau} g(t - \tau) dt \right] f(\tau) d\tau = \int_0^t G(t - \tau) dF(\tau) \end{aligned} \quad (3.29)$$

B. If we define the convolution as $F(t) * A(t) = \int_0^t A(t - \tau)dF(\tau)$, then the Laplace transform of the convolution is:

$$\mathcal{L} [F(t) * A(t)] = \hat{F}(s)A(s) \quad (3.30)$$

In which, $\hat{F}(s) = \int_0^\infty e^{-st}dF(t), A(s) = \int_0^\infty e^{-st}A(t)dt$.

Prove:

$$\begin{aligned} \mathcal{L} [F(t) * A(t)] &= \int_0^\infty \left[\int_0^t A(t - \tau)dF(\tau) \right] e^{-st}dt \\ &= \int_0^\infty \left[\int_\tau^\infty A(t - \tau)e^{-st}dt \right] dF(\tau) \end{aligned} \quad (3.31)$$

Let $t - \tau = u$, we have $\int_\tau^\infty A(t - \tau)e^{-st}dt = \int_0^\infty A(u)e^{-s(u+\tau)}du = e^{-s\tau}A(s)$ so:

$$\begin{aligned} \mathcal{L} [F(t) * A(t)] &= \int_0^\infty \left[\int_0^t A(t - \tau)dF(\tau) \right] e^{-st}dt \\ &= \int_0^\infty A(s)e^{-s\tau}dF(\tau) = \hat{F}(s)A(s) \end{aligned} \quad (3.32)$$

C. If $Q(t)$ is bounded and $Q(t) = 0$ when $t = 0$ then.

$$\hat{Q}(s) = sQ(s) \quad (3.33)$$

In which

$$\begin{aligned} \hat{Q}(s) &= \int_0^\infty e^{-st}dQ(t) \\ Q(s) &= \int_0^\infty e^{-st}Q(t)dt \end{aligned}$$

Prove:

$$\hat{Q}(s) = \int_0^\infty e^{-st}dQ(t) = e^{-st}Q(t)|_0^\infty - \int_0^\infty Q(t)d(e^{-st}) = s \int_0^\infty Q(t)e^{-st}dt = sQ(s) \quad (3.34)$$

D. Assuming two independent random events A and B are distributed by the CDF $F(t)$ and $G(t)$, then the possibility that the two events both happen during a certain time period $0 t$, and event A happened before event B is $F(t) - \int_0^t f(\tau)G(\tau)d\tau$.

Prove: Divide the time axis into different small pieces Δt . In the Δt , we can assume that the probability of event A and B is constant during each Δt . So during each Δt , the possibility that A and B happen is $f(t)\Delta t$ and $g(t)\Delta t$ respectively. And, the probability

that event A happens before B means that when A happens, no B happened before, so the possibility that event A happened before event B is

$$\begin{aligned}
 & f(0)\Delta t(1 - G(\Delta t)) + f(\Delta t)\Delta t(1 - G(2\Delta t)) + f(2\Delta t)\Delta t(1 - G(3\Delta t)) + \dots \\
 & + f(n\Delta t)\Delta t(1 - G((n + 1)\Delta t)) = \sum_{n=0}^{\infty} f(n\Delta t)\Delta t(1 - G((n + 1)\Delta t)) = \quad (3.35) \\
 & F(t) - \int_0^t f(\tau)G(\tau)d\tau
 \end{aligned}$$

For the same reason the possibility that event B happened before event A is $F(t) - \int_0^t f(\tau)G(\tau)d\tau$.

Noticed that the possibility that A and B happen at the same time is $\int_0^t \int_0^t f(\tau)g(\tau)d\tau d\tau$. But this part is usually too small and negligible so we assume that only one thing can happen at each time moment.

3.3.3.2 Semi-Markov model

In our models, we continuously assume that the packet arrives at the node in a Poisson process which means the distribution of the interval time of two packets is exponential distributed. The CDF of arrival distribution time is $F(t) = 1 - e^{-\lambda t}$. The serving process of the nodes is normally distributed and the cumulative distribution function is assumed as $G(t)$. According to the definition above, this process can be regarded as a semi-Markov process. Still consider the process of the node first. Assume:

$$\begin{aligned}
 P_{ij}(t) = P\{system\ is\ in\ state\ j\ at\ time\ t\ | \\
 system\ enters\ state\ i\ at\ the\ time\ 0\} \quad i, j \in E \quad (3.36)
 \end{aligned}$$

And, consider the transfer of the state of the node as a Semi-Markov process and according to the definition of the core of semi-Markov:

$$Q_{ij}(t) = P\{Z_{n+1} = j, T_{n+1} - T_n \leq t | Z_n = i\} \quad i, j \in E \quad (3.37)$$

For the model node-oriented we have:

$$\left\{ \begin{array}{l} Q_{01}(t) = F(t) \\ Q_{(iK+k)(iK+k+K)}(t) = F(t) - \int_0^t f(\tau)G(\tau)d(\tau), i \in (1, M-1), k \in (1, K) \\ Q_{(iK+k)(iK+k+1)}(t) = (1 - \overline{F}(t)\overline{G}(t) - Q_{(iK+k)(iK+k+K)}(t)) (1 - \rho), i \in (0, M-2) \\ Q_{(iK+k)(iK-K+1)}(t) = (1 - \overline{F}(t)\overline{G}(t) - Q_{(iK+k)(iK+k+K)}(t)) \rho, i \in (1, M-2) \\ Q_{(MK-K+k)(MK-K+k+1)}(t) = G(t) (1 - \rho) \\ Q_{(MK-K+k)(MK-2K+1)}(t) = G(t)\rho, k \in (1, K-1) \\ Q_{K0}(t) = Q_{(iK)(iK-2K+1)}(t) = 1 - \overline{F}(t)\overline{G}(t) - Q_{(iK+k)(iK+k+K)}(t), i \in (2, M-1) \\ Q_{MK(MK-2K+1)}(t) = G(t) \\ Q(t) = 0 \text{ for the rest} \end{array} \right. \quad (3.38)$$

In which, M is the queue tolerance of the node and K is the maximum transmission attempt for each packet and k always satisfy $k \in (1, K-1)$. $\overline{G}(t), \overline{G}(t)$ are the complementary cumulative distribution function(CCDF) of $F(t)$ and $G(t)$ which $\overline{F}(t) = 1 - F(t)$.

For the model packet-oriented we have:

$$\left\{ \begin{array}{l} Q_{(iK+k)(iK+k+1)}(t) = G(t) (1 - \rho), i \in (0, M-1), k \in (1, K-1) \\ Q_{(iK+k)(iK+K)}(t) = G(t)\rho, i \in (0, M-1), k \in (1, K-1) \\ Q_{(iK)(iK+1)}(t) = G(t), i \in (0, M-1), k \in (1, K-1) \\ Q_{(MK-K+k)s}(t) = G(t)\rho, i \in (0, M-1), k \in (1, K-1) \\ Q_{MKf}(t) = G(t) (1 - \rho) \\ Q(t) = 0 \text{ for the rest} \end{array} \right. \quad (3.39)$$

3.4 Numerical examples for the model

3.4.1 Exponential distribution

First we give an example for that the service time of each node is exponentially distributed. Consider a wireless network, in which every node has a queue tolerance of 3 and 3 transmission attempts for each packet, so there are 10 states in the node-oriented Markov transfer chain. Assume that packet arriving rate is λ , the serving rate is μ , and the success possibility of transmission is ρ as previous.

Calculations are run in Matlab(λ, μ, ρ are set to 0.1,0.3,0.9, respectively), the result shows the stable possibility for each of the states, which will be the initial condition for the packet-oriented Markov chain. The differential equations for the node-oriented Markov

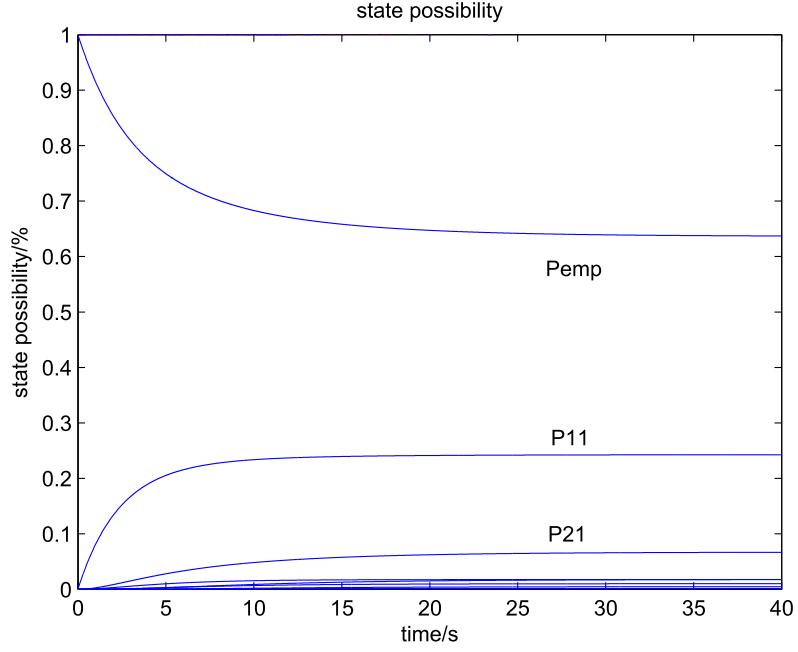


Figure 3.4: Possibility simulation of the states in node-oriented Markov chain

states transferring are:

$$\left\{ \begin{array}{l}
 P'_{emp}(t) = P_{11}(t)b + P_{12}(t)b + P_{13}(t)(a+b) - P_{emp}(t)(1-a-b-e) \\
 P'_{11}(t) = P_{emp}(t)(c+d+f) + P_{12}(t)d + P_{13}(t)(c+d) + P_{21}(t)b \\
 \quad + P_{22}(t)b + P_{23}(t)(a+b) - P_{11}(t)(1-d-e) \\
 P'_{12}(t) = P_{11}(t)a - P_{12}(t)(1-e) \\
 P'_{13}(t) = P_{12}(t)a - P_{13}(t)(1-e) \\
 P'_{21}(t) = P_{11}(t)f + P_{22}(t)d + P_{23}(t)(c+d) + P_{31}(t)b + P_{32}(t)b \\
 \quad + P_{33}(t)(a+b) - P_{21}(t)(1-e-d) \\
 P'_{22}(t) = P_{11}(t)c + P_{12}(t)f + P_{21}(t)a - P_{22}(t)(1-e) \\
 P'_{23}(t) = P_{12}(t)c + P_{13}(t)f + P_{22}(t)a - P_{23}(t)(1-e) \\
 P'_{31}(t) = P_{21}(t)f + P_{32}(t)d + P_{33}(t)(c+d) - P_{31}(t)(1-e-d-f) \\
 P'_{32}(t) = P_{21}(t)c + P_{22}(t)f + P_{31}(t)(a+c) - P_{32}(t)(1-e-f) \\
 P'_{33}(t) = P_{22}(t)c + P_{23}(t)f + P_{32}(t)(a+c) - P_{33}(t)(1-e-f)
 \end{array} \right. \quad (3.40)$$

Table 3.1: Stable possibility of each state in node-oriented Markov chain(service time exponential distributed)

States	P_{emp}	P_{11}	P_{12}	P_{13}	P_{21}
Stable possibility	0.6363	0.2427	0.0177	0.0013	0.0671
States	P_{22}	P_{23}	P_{31}	P_{32}	P_{33}
Stable possibility	0.0102	0.0011	0.0178	0.0048	0.0009

It is noticed that the states $P_{31}(t), P_{32}(t), P_{33}(t)$ will directly lead to packet drop if the packet arrives when the node is in one of the three states. So, for the packet-oriented Markov chain, there will be 11 states in the process including to absorbing states "success" and "failure". The differential equations for the states transferring are:

$$\left\{ \begin{array}{l} P'_{11}(t) = -P_{11}(t) \mu \\ P'_{12}(t) = \mu P_{11}(t) (1 - \rho) - \mu P_{12}(t) \\ P'_{13}(t) = \mu P_{12}(t) (1 - \rho) - \mu P_{13}(t) \\ P'_{21}(t) = \mu \rho P_{11}(t) + \mu \rho P_{12}(t) d + \mu P_{13}(t) - \mu \rho P_{21}(t) \\ P'_{22}(t) = \mu (1 - \rho) P_{21}(t) - \mu P_{22}(t) \\ P'_{23}(t) = \mu (1 - \rho) P_{22}(t) - \mu P_{23}(t) \\ P'_{31}(t) = \mu \rho P_{21}(t) + \mu \rho P_{22}(t) d + \mu P_{23}(t) - \mu P_{31}(t) \\ P'_{32}(t) = \mu (1 - \rho) P_{31}(t) - \mu P_{32}(t) \\ P'_{33}(t) = \mu (1 - \rho) P_{32}(t) - \mu P_{33}(t) \\ P'_{success}(t) = \mu \rho P_{31}(t) + \mu \rho P_{32}(t) d + \mu \rho P_{33}(t) \\ P'_{failure}(t) = \mu (1 - \rho) P_{33}(t) \end{array} \right. \quad (3.41)$$

Notice that $P_{success}(t), P_{failure}(t)$ refer to the states "success" and "failure" respectively. The result shows us the possibility that a packet can be delivered successfully by the node and the math expectation for the service time for a packet of the node (queuing time included.)

From the figure we can tell the possibility that a packet is successfully transferred is 97.56% and the failure rate for a packet is 2.44%. The mathematical expectation of the average transmission time for each packet can be calculated by the formula:

$$E(t) = \int_0^{\infty} [1 - P_{service}(t)] dt \quad (3.42)$$

In which $P_{service}(t) = P_{success}(t) + P_{failure}(t)$ because a packet is either transmitted or

dropped. So in this example we have the result for average successfully transmission time 5.16s

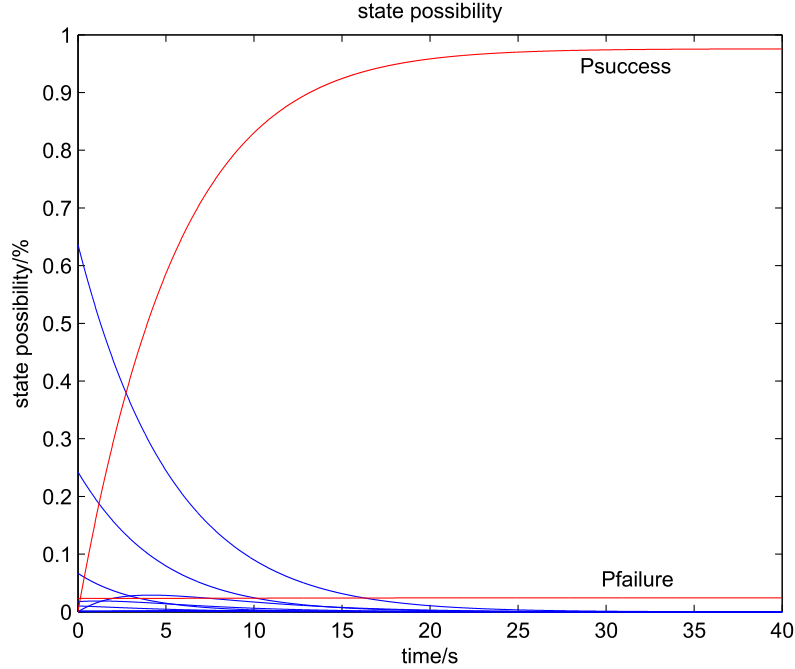


Figure 3.5: Possibility simulation of the states in packet-oriented Markov chain (exponential distribution)

3.4.2 PH distribution

Then we can have an example with the service time PH-distributed. Also consider the nodes who has the queue length of 3 and maximally 3 transmission attempts for each packet. Assume packet is arriving at a exponential rate $\lambda = 0.1$, every transmit attempt has a successful rate $\rho = 0.9$ and the service time for each node is PH-distributed and the cumulative distribution function is:

$$G(t) = 1 - \alpha e^{Tt} e(t \geq 0) \quad (3.43)$$

In which

$$T = \begin{bmatrix} -0.6 & 0.6 & 0 \\ 0 & -0.4 & 0.4 \\ 0 & 0 & -0.8 \end{bmatrix}, e = [1 \ 1 \ 1]', \alpha = [1 \ 0 \ 0], T_0 = -Te. \text{ So for the node-oriented}$$

Markov model, we have transition probability matrix Q as followed:

$$Q = \begin{bmatrix} -\lambda & \lambda\alpha & 0 & 0 \\ A & B\alpha & C & 0 \\ 0 & A\alpha & B & C \\ 0 & 0 & A\alpha & D \end{bmatrix}$$

In which

$$A = \begin{bmatrix} T_0(1-\rho) \\ T_0(1-\rho) \\ T_0 \end{bmatrix}, B = \begin{bmatrix} T - \lambda I & T_0\rho\alpha & 0 \\ 0 & T - \lambda I & T_0\rho\alpha \\ 0 & 0 & T - \lambda I \end{bmatrix}$$

$$C = \begin{bmatrix} \lambda I & 0 & 0 \\ 0 & \lambda I & 0 \\ 0 & 0 & \lambda I \end{bmatrix}, D = \begin{bmatrix} T & T_0\rho\alpha & 0 \\ 0 & T & T_0\rho\alpha \\ 0 & 0 & T \end{bmatrix}$$

Assuming that $p = [p_0, p_1, p_2, \dots, p_9]$ refers to the states vector. According to the principle:

$$\begin{cases} pQ = 0 \\ pe = 1 \end{cases}$$

The stable probability of the states can be solved as followed:

Table 3.2: Stable possibility of each state in node-oriented Markov chain(service time PH distributed)

States	P_{emp}	P_{11}	P_{12}	P_{13}	P_{21}
Stable possibility	0.4417	0.2952	0.0180	0.0011	0.1533
States	P_{22}	P_{23}	P_{31}	P_{32}	P_{33}
Stable possibility	0.0175	0.0016	0.0544	0.0148	0.0024

The same as the previous example, we have the initial conditions for the packet-oriented Markov model and the result is as Fig. 3.6: From the figure we can tell the possibility that a packet is successfully transferred is 92.09% and the failure rate for the packet is 7.91%. The mathematical expectation of the average transmission time for each successful transmission is 8.73s.

Notice that the model parameters may be not appropriate for the real conditions but it just shows an example of the solving methods. The characteristic parameters of the

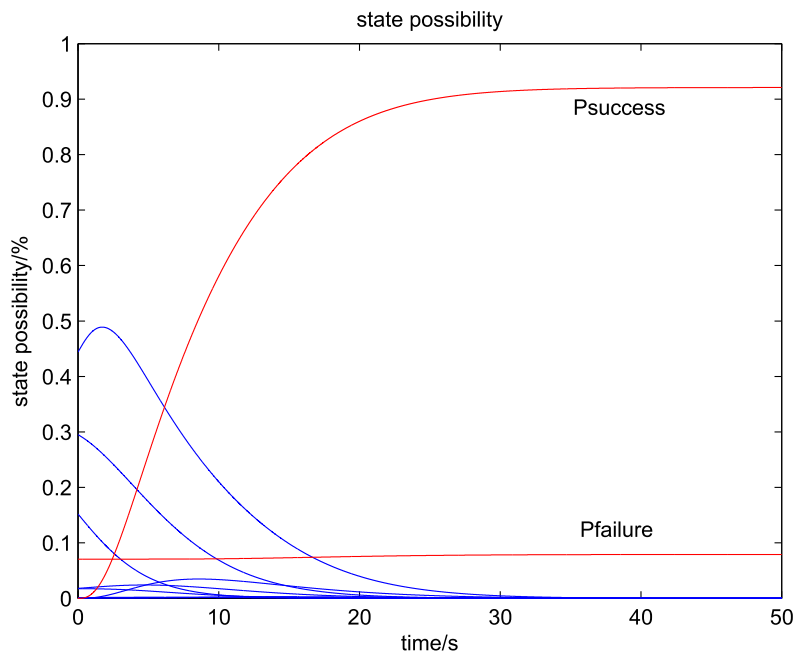


Figure 3.6: Possibility simulation of the states in packet-oriented Markov chain (PH distribution)

network can be obtained from experiments.

3.4.3 Semi-Markov process

The former research on the service time of network node showed that the distribution of service time appears to be a heavy tailed. Pareto distribution is a typical heavy tailed distribution and is used for description of the service time of the wireless network nodes. [Xu 2006] pointed out that the Pareto distribution has a limit in usage because of the difficulty in Laplace transfer. So [Xu 2006] proposed to use hyperexponential distribution to fit the Pareto distribution. So in our example we take the hyperexponential distribution to describe the service time for the packet of each node. Take hyperexponential distribution $g(t) = \sum_{i=1}^2 p_i \lambda_i e^{-\lambda_i t}$, $\sum_{i=1}^2 p_i = 1$ as the PDF of the service time distribution in our model. Assume the packet arrives is exponential distributed by PDF $f(t) = \lambda e^{-\lambda t}$ and success rate of every transition attempt (service) is ρ .

Notice that when considering the state that has to different directions to transfer in the Markov process, and the the two different directions are two events are isolated random events with different distributions of possibility, the result in 3.3.3.1(D) will be

used. In our case, in the process of node-oriented Markov chain, each state has two isolated random events which can cause the transition of the state: a new packet comes and a sending attempt carries out.

Still consider a network with the same nodes, the maximum transmission attempt is 3 ($M = 3, K = 3$). For each state j we have a series of $\{P_{ij}(t)\}, i = 0, 1, \dots, n$. Take state 1 in the node-oriented Markov process for example — the state 1 refers to the state that the node has only one packet waiting for transmission and at the first attempt of transmit. We can get the total probability formula:

$$\left\{ \begin{array}{l} P_{01}(t) = Q_{01}(t) * P_{11}(t) \\ P_{11}(t) = 1 - [Q_{10}(t) + Q_{12}(t) + Q_{14}(t)] + Q_{10}(t) * P_{01}(t) + \\ \quad Q_{12}(t) * P_{21}(t) + Q_{14}(t) * P_{41}(t) \\ P_{21}(t) = Q_{20}(t) * P_{01}(t) + Q_{23}(t) * P_{31}(t) + Q_{25}(t) * P_{51}(t) \\ P_{31}(t) = Q_{30}(t) * P_{01}(t) + Q_{36}(t) * P_{61}(t) \\ P_{41}(t) = Q_{41}(t) * P_{11}(t) + Q_{45}(t) * P_{51}(t) + Q_{47}(t) * P_{71}(t) \\ P_{51}(t) = Q_{51}(t) * P_{11}(t) + Q_{56}(t) * P_{61}(t) + Q_{58}(t) * P_{81}(t) \\ P_{61}(t) = Q_{61}(t) * P_{11}(t) + Q_{69}(t) * P_{91}(t) \\ P_{71}(t) = Q_{74}(t) * P_{41}(t) + Q_{78}(t) * P_{81}(t) \\ P_{81}(t) = Q_{84}(t) * P_{41}(t) + Q_{89}(t) * P_{91}(t) \\ P_{91}(t) = Q_{94}(t) * P_{41}(t) \end{array} \right. \quad (3.44)$$

Notice that the " *" in the formula above represents the convolution in the chapter 3.3.3.1 (B).

In fact, for the second formula above,

$$\begin{aligned} P_{11}(t) &= P\{Z_t = 1 | Z_0 = 1\} = \\ &P\{Z_t = 1, T > t | Z_0 = 1\} + P\{Z_t = 1, T \leq t | Z_0 = 1\} \end{aligned} \quad (3.45)$$

$Z_t = 1$ means the system is in state 1 when the time is t . In the first part of the right side of the equation above, the system begins at the state 1 when time $t = 0$. $T > t$ means system have not any state transfer, so the system is still in state 1, so:

$$P\{Z_t = 1, T > t | Z_0 = 1\} = 1 - [Q_{10}(t) + Q_{12}(t) + Q_{14}(t)] \quad (3.46)$$

For the second part, $T \leq t$ means the system have transferred the states, so:

$$\begin{aligned}
 & P \{Z_t = 1, T \leq t | Z_0 = 1\} \\
 &= \sum_{j \in E} \int_0^t P \{Z_t = 1, T > t | Z_0 = 1, Z_u = j\} dQ_{ij}(u) \\
 &= \int_0^t P_{10}(t) dQ_{01}(t) + \int_0^t P_{12}(t) dQ_{21}(t) + \int_0^t P_{14}(t) dQ_{41}(t) \\
 &= Q_{10}(t) * P_{01}(t) + Q_{12}(t) * P_{21}(t) + Q_{14}(t) * P_{41}(t)
 \end{aligned} \tag{3.47}$$

After the Laplace transfer for the formulas above we can solve the result of P_{01} for the probability that the system is at state 1 when it begins at state 0 at the time $t = 0$.

And in the formula (3.44), according to the assumptions, we have:

$$\left\{ \begin{array}{l}
 Q_{01}(t) = 1 - e^{-\lambda t} \\
 Q_{14}(t) = Q_{25}(t) = Q_{36}(t) = Q_{47}(t) = Q_{58}(t) = Q_{69}(t) = \\
 1 - e^{-\lambda t} - \int_0^t \lambda e^{-\lambda \tau} \left[1 - \sum_{i=1}^2 p_i e^{-\lambda_i \tau} \right] d\tau \\
 Q_{12}(t) = Q_{23}(t) = Q_{45}(t) = Q_{56}(t) = \left[1 - e^{-\lambda t} \sum_{i=1}^2 p_i e^{-\lambda_i t} - Q_{14}(t) \right] (1 - \rho) \\
 Q_{10}(t) = Q_{20}(t) = Q_{41}(t) = Q_{51}(t) = \left[1 - e^{-\lambda t} \sum_{i=1}^2 p_i e^{-\lambda_i t} - Q_{14}(t) \right] \rho \\
 Q_{78}(t) = Q_{89}(t) = \left(1 - \sum_{i=1}^2 p_i e^{-\lambda_i t} \right) (1 - \rho) \\
 Q_{74}(t) = Q_{84}(t) = \left(1 - \sum_{i=1}^2 p_i e^{-\lambda_i t} \right) \rho \\
 Q_{30}(t) = Q_{61}(t) = \left[1 - e^{-\lambda t} \sum_{i=1}^2 p_i e^{-\lambda_i t} - Q_{14}(t) \right] \\
 Q_{94}(t) = \left(1 - \sum_{i=1}^2 p_i e^{-\lambda_i t} \right)
 \end{array} \right. \tag{3.48}$$

We can construct the formulas for all the states as the form of (3.44), using Laplace transform and certain mathematical software, we can get the stable probability for all the states in the node-oriented Markov process shown in the table (4.3):

Table 3.3: Stable possibility of each state in node-oriented Markov chain($\lambda = 0.5, \lambda_1 = 0.8, \lambda_2 = 0.5, p_1 = 0.455, p_2 = 0.545, \rho = 0.9$)

States	P_0	P_1	P_2	P_3	P_4
Stable possibility	0.2896	0.2462	0.0136	0.0008	0.2150
States	P_5	P_6	P_7	P_8	P_9
Stable possibility	0.0180	0.0013	0.1784	0.0327	0.0044

Then it comes to the packet-oriented Markov process again. The only difference is that the event of packet arriving is not considered in this process. So the total possibility formula for the state "success" and "failure" is as followed separately.

$$\left\{ \begin{array}{l}
 P_{ss}(t) = 1 \\
 P_{1s}(t) = Q_{12}(t) * P_{2s}(t) + Q_{14}(t) * P_{4s}(t) \\
 P_{2s}(t) = Q_{23}(t) * P_{3s}(t) + Q_{24}(t) * P_{4s}(t) \\
 P_{3s}(t) = Q_{34}(t) * P_{4s}(t) \\
 P_{4s}(t) = Q_{45}(t) * P_{5s}(t) + Q_{47}(t) * P_{7s}(t) \\
 P_{5s}(t) = Q_{56}(t) * P_{6s}(t) + Q_{57}(t) * P_{7s}(t) \\
 P_{6s}(t) = Q_{67}(t) * P_{7s}(t) \\
 P_{7s}(t) = Q_{78}(t) * P_{8s}(t) + Q_{7s}(t) * P_{ss}(t) \\
 P_{8s}(t) = Q_{89}(t) * P_{9s}(t) + Q_{8s}(t) * P_{ss}(t) \\
 P_{9s}(t) = Q_{9s}(t) * P_{ss}(t)
 \end{array} \right. \quad (3.49)$$

$$\left\{ \begin{array}{l}
 P_{ff}(t) = 1 \\
 P_{1f}(t) = Q_{12}(t) * P_{2f}(t) + Q_{14}(t) * P_{4f}(t) \\
 P_{2f}(t) = Q_{23}(t) * P_{3f}(t) + Q_{24}(t) * P_{4f}(t) \\
 P_{3f}(t) = Q_{34}(t) * P_{4f}(t) \\
 P_{4f}(t) = Q_{45}(t) * P_{5f}(t) + Q_{47}(t) * P_{7f}(t) \\
 P_{5f}(t) = Q_{56}(t) * P_{6f}(t) + Q_{57}(t) * P_{7f}(t) \\
 P_{6f}(t) = Q_{67}(t) * P_{7f}(t) \\
 P_{7f}(t) = Q_{78}(t) * P_{8f}(t) \\
 P_{8f}(t) = Q_{89}(t) * P_{9f}(t) \\
 P_{9f}(t) = Q_{9f}(t) * P_{ff}(t)
 \end{array} \right. \quad (3.50)$$

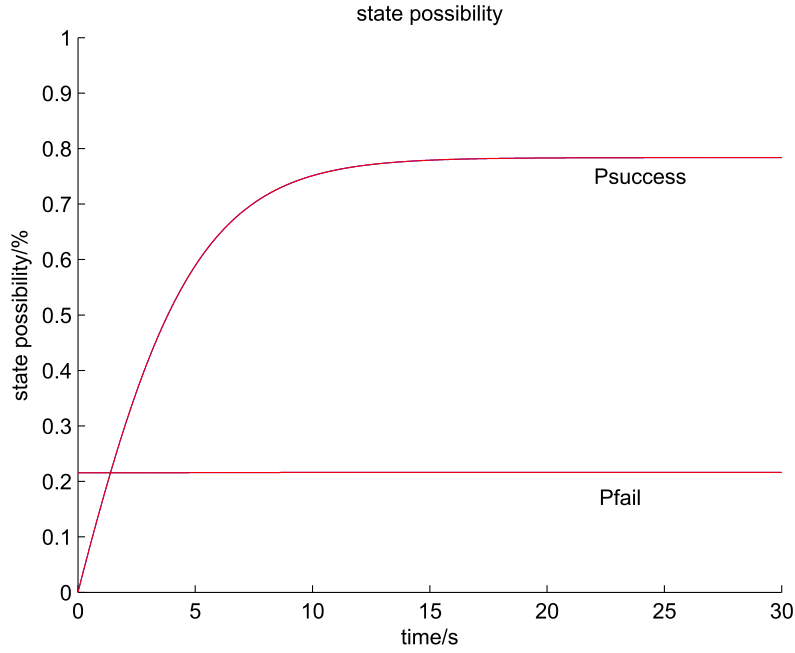


Figure 3.7: State possibility of "success" and "failure" in the packet-oriented Markov process

In which:

$$\left\{ \begin{array}{l} Q_{12}(t) = Q_{23}(t) = Q_{45}(t) = Q_{56}(t) = Q_{78}(t) = Q_{9f}(t) = \left(1 - \sum_{i=1}^2 p_i e^{-\lambda_i t}\right) (1 - \rho) \\ Q_{14}(t) = Q_{24}(t) = Q_{47}(t) = Q_{57}(t) = Q_{7s}(t) = Q_{8s}(t) = Q_{9s}(t) = \left(1 - \sum_{i=1}^2 p_i e^{-\lambda_i t}\right) \rho \\ Q_{34}(t) = Q_{67}(t) = \left(1 - \sum_{i=1}^2 p_i e^{-\lambda_i t}\right) \end{array} \right. \quad (3.51)$$

With the initial state possibilities of the result of node-oriented Markov process, we can calculate for the states of the packet. Accordingly we can get the mathematical expectations of the time that a packet from it arrives at the node to its departure (successfully transmitted or dropped) is 2.78s which can be regard it as the delay time.

3.5 Performance related characters

In this section, we are going to compare the nodes' performance (transmission delay and successful rate) under different characters of the network or node. By the characters of network, we mean the packet arriving rate λ and the quality of channel which is

represented by the successful rate of a single attempt ρ . While for the characters of node, we mean the service rate, the maximum waiting length and the maximum attempting number.

We choose the typical exponential distributed service time model and the model with Semi-Markov distributed service time, so that the results can be compared between different type of service-time models. The characters vary on the base of the numerical examples we have shown in the last chapter. We change the characters and re-run the simulation in order to display the difference of the performance.

3.5.1 Influence of the characters of the network

In the numerical examples of exponential-service-time distributed model, we set the packet arriving rate $\lambda = 0.1, 0.2, 0.3$ and the successful rate of attempt $\rho = 0.85, 0.9, 0.95$. While for the semi-Markov model λ is set to $0.1, 0.5, 0.8$, ρ is also set to $0.85, 0.9, 0.95$. The figure (3.8) compares the performance when λ and ρ are changed separately.

In the figure (3.8) the red lines represents the simulation results with fixed $\rho = 0.9$, from the top to the bottom are the possibility of states "success" and "failure" with λ changes from small to big separately. While the blue lines represents the simulation results with fixed λ , from the top to the bottom are the possibility of states "success" and "failure" with $\rho = 0.95, 0.9$ and 0.85 separately. Table (3.4),(3.5) displays the details of the node performance.

Table 3.4: Node performance in different network characters (exponential model)

λ	ρ	success possibility	failure possibility	delay(s)
0.1	0.9	0.9756	0.0244	5.1654
0.2	0.9	0.8574	0.1426	5.8867
0.3	0.9	0.6749	0.3251	5.4746
0.1	0.85	0.9690	0.0310	5.5249
0.1	0.95	0.9801	0.0199	4.8369

Table 3.5: Node performance in different network characters(semi-Markov model)

λ	ρ	success possibility	failure possibility	delay(s)
0.1	0.9	0.9940	0.0060	2.21
0.5	0.9	0.7837	0.2163	2.78
0.8	0.9	0.5972	0.4028	2.45
0.5	0.85	0.7623	0.2377	2.90
0.5	0.95	0.8025	0.1975	2.65

Apparently, a heavy traffic will cause a bigger possibility that the node in the statue of "full queue", so when the new packet arrives, it will be dropped directly which will cause a bigger possibility to fail in transmission that is also why the delay time of $\lambda = 0.8$ is less than $\lambda = 0.5$. So the less ρ will cause the same result. As for the delay, a light traffic or bigger successful rate would abbreviate the length of waiting queue, so when the new packet arrives, it will get the service sooner and the delay will be decreased.

3.5.2 Influence of the characters of the node

In this subsection, the characters of the node will be studied, which concerns the service ability and the maximum queue or attempting number. The figure (3.9) compares the performance when these characters are changed separately.

In the figure (3.9) the red lines represents the simulation results with fixed service time distribution(for exponential model $\mu = 0.3$, for semi-Markov model $\lambda_1 = 0.8, \lambda_2 = 0.5$), from the top to the bottom are the possibility of states "success" and "failure" with $queue_length = 3, attempt_number = 3$, $queue_length = 3, attemp_number = 2$, $queue_length = 2, attemp_number = 3$ and $queue_length = 2, attemp_number = 2$ separately. While the blue lines represents the simulation results with fixed $queue_length = 3, attemp_number = 3$, from the top to the bottom are the possibility of states "success" and "failure" with service time from big to small separately. Table (3.6)(3.7) displays the details of the node performance.

Table 3.6: Node performance in different node characters (exponential model)

λ	μ	queue length	attempt number	success possibility	failure possibility	delay(s)
0.1	0.3	3	3	0.9756	0.0244	5.1654
0.1	0.3	3	2	0.9677	0.0323	5.1025
0.1	0.3	2	3	0.9188	0.0812	4.3981
0.1	0.3	2	2	0.9122	0.0878	4.3570
0.1	0.4	3	3	0.9904	0.0096	3.6188
0.1	0.2	3	3	0.9236	0.0764	8.4339

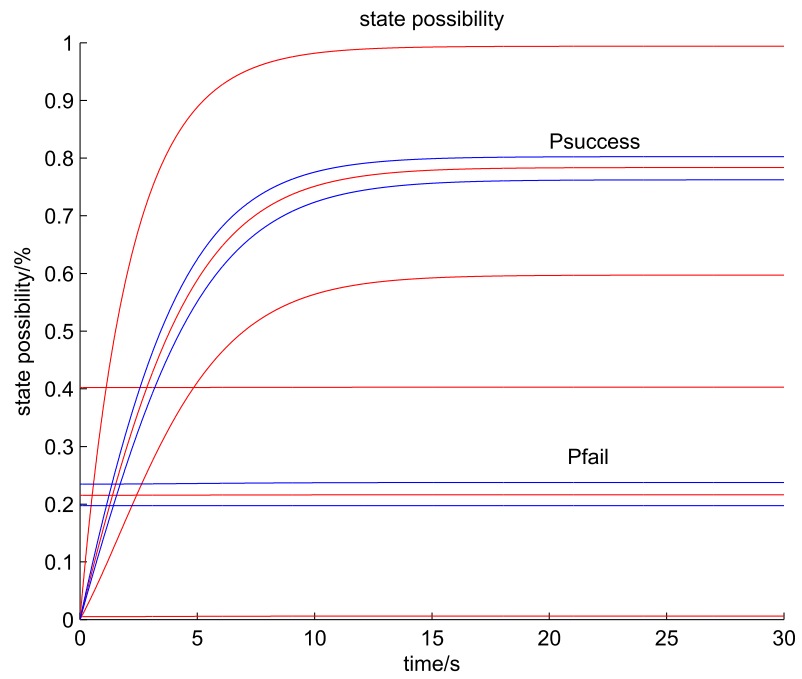
Table 3.7: Node performance in different node characters (semi-Markov model)

λ_1	λ_2	queue length	attempt number	success possibility	failure possibility	delay(s)
0.8	0.5	3	3	0.7838	0.2163	2.78
0.8	0.5	3	2	0.7804	0.2196	2.76
0.8	0.5	2	3	0.6958	0.3042	1.89
0.8	0.5	2	2	0.6929	0.3071	1.88
0.9	0.7	3	3	0.8599	0.1401	2.16
0.5	0.3	3	3	0.5868	0.4132	3.98

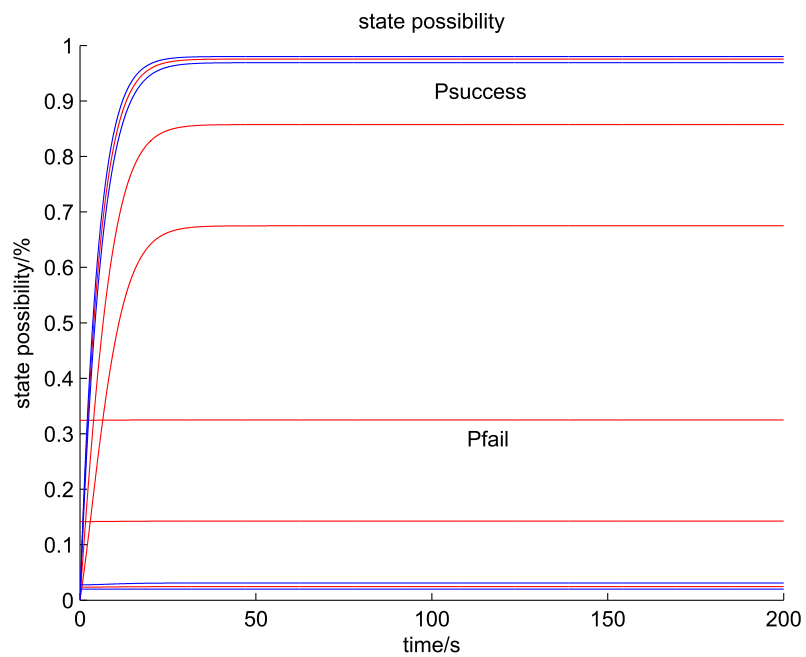
We can see from the results, when the other conditions remain the same, one more attempt of the node can make tiny influence on the transmission rate and the delay time. Better service ability of the node can make certainly better transmission rate and less delay. Bigger queue tolerance of the node will make the transmission rate higher but more delay.

3.6 Conclusion

In this chapter, we have analyzed the working mode of the wireless network working in the ARQ mode. A packet-oriented model and node-oriented model has been built to estimate the performance. As to the problem of the nodes' service time distribution, we gave three typical types of assumption to cover different network communications. The examples

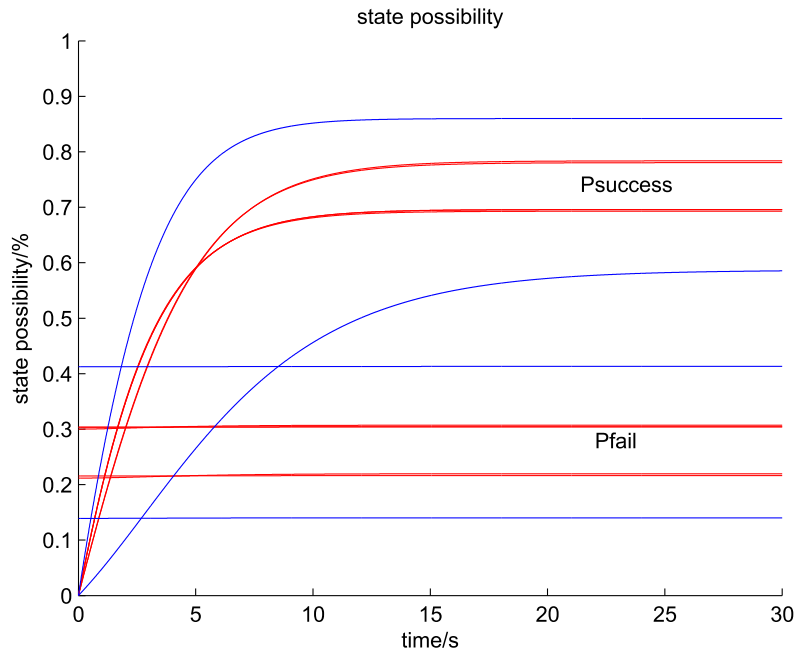


(a) exponential model

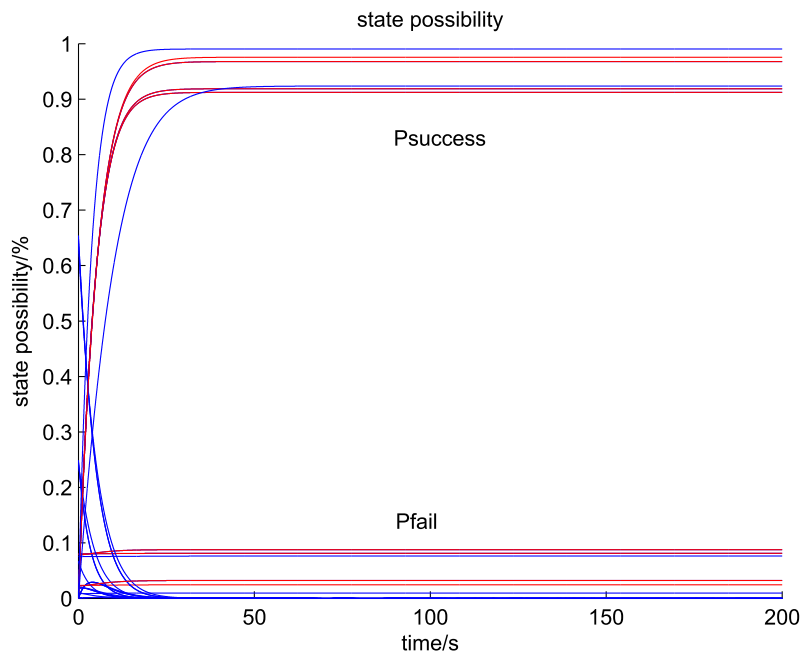


(b) semi-Markov model

Figure 3.8: Node performance with different network status



(a) exponential model



(b) semi-Markov model

Figure 3.9: Node performance with different node status

for each type have been provided, too. The result of the model provides the criteria of the network quality. With the help of the node performance model, the conditions of the network can be easily monitored by the node itself, thus the performance of the node can be predicted according to the status of the nodes, with this information we monitor the QoS (Quality of Service) of the whole network and made adjustment when it is necessary. For example, if we have monitor that a crucial node is suffering a rush hour of packet and we need to assure the quality of an important node-to-node path, we can enhance the signal power of the node, or change the queue length and attempting number, or even we can bypass this node accordingly. the energy and efficiency of the network will be saved.

Chapter 4

A QoS-aware Ad hoc Protocol Based on Node Performance Model

Contents

4.1	Related work	91
4.2	Reliability based routing protocol	94
4.2.1	NPMSR protocol	94
4.2.2	Route discover process	95
4.2.3	Route update process	97
4.2.4	Route maintenance process	98
4.3	Numerical example	99
4.4	Conclusion	103

4.1 Related work

Wireless communication networks transmit data from one client to another. Usually the transmission range of the nodes is limited. So the mission would be accomplished by multi-hop if the source node and the destination node are not within each other's range. The topology and the routing protocols become a crucial part to ensure the reliability of network.

According to the characteristics of the intelligent vehicle platform, an ad hoc network is more practical to be established to transmit the data between the vehicles. Ad hoc network can be deployed instantly without any base station or infrastructure support.

A mobile ad hoc network (MANET) allows the nodes to enter or leave the network dynamically and change the relative positions between each other, which fits the real usage of the intelligent vehicle platform.

Reference [Sengul 2006] categorized the routing protocol into proactive, reactive (on-demand) and hybrid based on when routes are discovered. The proactive protocols require every node to maintain a table with the information of the neighbors. A periodically update is often necessary in these kind of protocols, such as DSDV, CGSR [Royer 1999]. Basically, since the on-demand protocol has more advantages such as more efficiency and fewer burdens on the bandwidth, the on-demand protocol has been improved these years. AODV (ad hoc on-demand distance vector) and DSR(Dynamic Source Routing) [Perkins 1999, Johnson 2003] are two popular on-demand routing protocols and are widely studied. AODV protocol uses Route Request Packet (RREQ) to initiate a routing process. RREQs rebroadcasted by the intermediate nodes are needed, who also save the ID of the last-hop node. When the RREQ is received by the destination node, Route Reply packet (RREP) will be sent back to the source in the mode of unicast according to the information of the last-hop nodes that are save by the intermediate nodes. A destination sequence number (DestSeqNum) is used to mark the newest path. Multiple reply for the Rout Request Packet (RREQ) and the periodic update of the routing table lead to heavy control overhead. While DSR protocol uses route cache information to reduce the overhead but lack of ability in repairing a broken link, also, not well performed in the mobile networks. The improvements on the protocols basically lay on two aspects: reduce the overhead and enhance the durability of the network.

[Li 2004] extended AODV protocol to decrease broadcast overhead. The intermediate nodes count the hop number and restore the shortest number as the reverse route, other received RREQ will be dropped.

Durability requires the network to be reliable or it can find another path to transmit the packet when there comes a break down on the current path, which is called route recovery mechanism. There are basically three ways to repair the failure link:

1. the broken link will trigger a RRER(Route Error) packet reversed to the source, then the source initiate a new process of route discovery. This is a basic recover mechanism which takes more time in re-establishing transmission path.

2. Multiple paths protocol in [Khazaei 2009, Wu 2001, Lee 2001] can build multiple paths on demand, one path is primarily used and others stored for back up. [Lee 2001] proposed a SMR (split multipath routing) protocol which can establish and utilize multiple routs of maximally disjoint paths. The source can discover two paths to the destina-

tion and use a certain allocation scheme to split the traffic. However, this protocol has limitations with some of the network. If the protocol can provide a rapid method for the network to remain connected when a single broken link appears, it would also makes the network durable. Multiple-path protocols provide a fault tolerance scheme for the network. These protocols permit the source to choose the backup paths to continue the mission immediately. However, as the nodes are always moving in the mobile network, these backup paths can easily be stale. If all the paths are failed to connect, the source will also initiate a new process of route discovery.

3. A local error recovery scheme [Duggirala 2003, Sengul 2006, Spohn 2001, Lee 2001]. The basic idea of this scheme is enable the relay nodes to recover from the broken link locally. Small range of re-route can limit the request overhead and extend the lifetime of the current route. By-pass routing protocol in [Sengul 2006] keeps the updated information of the neighbor nodes. When failure happens a novel path can be built to bypass the broken link. A local error recovery scheme is very useful to save the reconstruction time in large scaled networks. [Aron 2000]

There are also some protocols based on the reliability/QoS control. Based on the conception of DSR protocol, [Leung 2001] proposed a MP-DSR protocol (distributed multi-path dynamic source routing protocol), which emphasized on the end-to-end reliability. The author allocates the whole reliability request onto every hop link, the routing discovery process estimate the reliability of every hop can keeps the ones that fits the requirement. [Sun 2010] focused on the delay of the communication and [Liu 2010] proposed a DMSR (delay-aware multipath source routing) protocol. The demand of the delay is broadcast with the RREQ, intermediate nodes decide whether or not relay the RREQ according to the accumulated delay. Then the prediction-based protocols have been brought out [Jiang 2005, Gong 2008]. These protocols try to predict a time period (T_p) that the link will be reliable from the time t_0 . These protocols use the relative position of the node to predict the availability $L(T_p)$ of the link from time t_0 to $t_0 + T_p$, either by the measurement of the node itself or a global position system [Su 1999]. The network is consisted by the nodes. In a mobile ad hoc network, nodes come in and out, position is changing all the time. The performance of the nodes decides the performance of the network. So the protocol we propose here is a reliability protocol based on the performance of the nodes. Our protocol provides the method to avoid congestion and assure the reliability of the end-to-end paths.

The former chapter has provided a performance model to estimate the behavior of the nodes during the working process in a wireless communication system. Model was

built on the consideration of queue length, channel condition and transition protocol for certain type of wireless networks. Solutions of three different distributions of service time were provided. Transmit reliability and data delay become predictable according to this model. Then in this chapter, based on the performance model, we propose a NPMSR (Node Performance based Multi-path Source Routing) protocol, which is a type of on demand ad hoc routing protocol. This protocol focuses on the QoS of the end-to-end transmission and assures the arriving rate and delay is controlled as required

4.2 Reliability based routing protocol

4.2.1 NPMSR protocol

We now going to present our node-performance based routing algorithm (NPMSR). Our protocol improves the DSR protocol which inherits the advantages of DSR routing protocol. This algorithm regards the service delay of the packet and transmission successful rate as the main metric of choosing the path. Of which the end-to-end delay of a path is basically accumulated by the service delay of the nodes along the path because the transmission delay can be neglected. The transmission successful rate means the possibility that a packet can arrive correctly at the destination. Knowing that the two metrics are to some extent contradictory, which means if we require the delay of the transmission to be less, the transmission reliability has to be sacrificed. But this protocol can automatically find a balance between the two metrics.

The maximum delay demand and the minimum transmission successful rate of the path are set by the user. The mission of the protocol is to find the path that fulfills the requirements and monitors the service quality of the path. When the path tends to unfulfill the requirements, an alternative path will be used. In the route discovery process, local information of the nodes along the path has been collected, which includes the average delay D_s and the transmission successful rate of the next hop ρ_s . The destination node values all the available routes and chooses the most suitable path among them according to the requirement and sends back the route reply (RREP) packets through the chosen path. The maintain process is carried out all the time. Monitoring by the node itself when the node status are changing for example, the node is suffering a heavy traffic and the delay is going to increase significantly, the node will send a signal to the upstream node notifying it to choose another less congested node. This process will be specified later.

4.2.2 Route discover process

NPMSR is an on-demand routing protocol using request/reply cycles. If the source node S has to deliver data to a destination node D but no path information in the cache of S (see table 4.1), it initiates the process of route discovery by broadcasting the route request packet to its neighbors. Apart from the normal information contained in the RREQ, our protocol requests the RREQ to include the maximum end-to-end delay D_r and the minimum transmission successful rate ρ_r requirement of the whole path. Also, the delay time and transmission successful rate accumulated D_{acc} and ρ_{acc} are contained. D_{acc} denotes to the summation of the service delay of the intermediate nodes in the path sequence while ρ_{acc} is the multiply of the successful rate. In the RREQ packet sent by the source node, $D_{acc} = 0$ and $\rho_{acc} = 1$.

Table 4.1: RREQ packet

Source ID
Request ID
Destination ID
D_r
D_{acc}
ρ_r
ρ_{acc}
Path sequence

Then node B receives the RREQ packet. Since it is not the destination node of the request, it looks into its cache to see if there is a cached route to the destination node D. If there is, and the QoS fulfills the request, the route is immediately used. If not, it appends its ID to the path sequence, adds the service delay D_s to the D_{acc} , multiply ρ_{acc} with ρ_s and re-broadcast the packet. Notice that node B may continuously receive the RREQ packet forwarded by other intermediate node i.e. node C, if it discovered that the later-received RREQ has the same information in source and destination, it discards the request. In order to avoid the overhead problem, the intermediate nodes only re-broadcast the RREQ with less D_{acc} or more ρ_{acc} than the first RREQ.

When the first RREQ finally reaches the destination node D, the destination node will start a timer t . After this time t , the node stops caching all the RREQ. Then the nodes filter the paths that can't fulfill the requirement on the end-to-end delay D_r and

successful rate ρ_r . The best path that has the largest W will be chosen as the primary path and the rest of the paths will be cached. The definition and method to calculate of W is as (4.1).

$$W = \frac{D_r \rho_{acc}}{D_{acc} \rho_r} \quad (4.1)$$

The destination will send back a route reply packet via the primary path and all the caches paths. The RREP will contain the information as in table 4.2.

Table 4.2: RREP packet

Source ID
Request ID
Destination ID
D_r
D_p
ρ_r
ρ_p
Path sequence

In which D_p denotes to the summation of the service delay of the intermediate nodes in the path sequence while ρ_p is the multiplication of the successful rate.

As we use the source routing approach, the information of the nodes that consist the path is included in the RREP packet. The intermediate that receive these RREP will cache the node sequence of the entire path. D_{ts} and ρ_{ts} are cached along with the information of the path. D_{ts} and ρ_{ts} denote the maximum tolerable service delay and the minimum tolerable successful rate of the transmission. They are allocated by the formulas below:

$$\begin{aligned} D_{ts} &= D_s + \frac{D_r - D_p}{N} \\ \rho_{ts} &= \rho_s \sqrt[N]{\frac{\rho_r}{\rho_p}} \end{aligned} \quad (4.2)$$

In which N denotes to the number of the intermediate node in the path. When the source node receives the RREP, it starts transmitting the data with the primary path and caches the other paths.

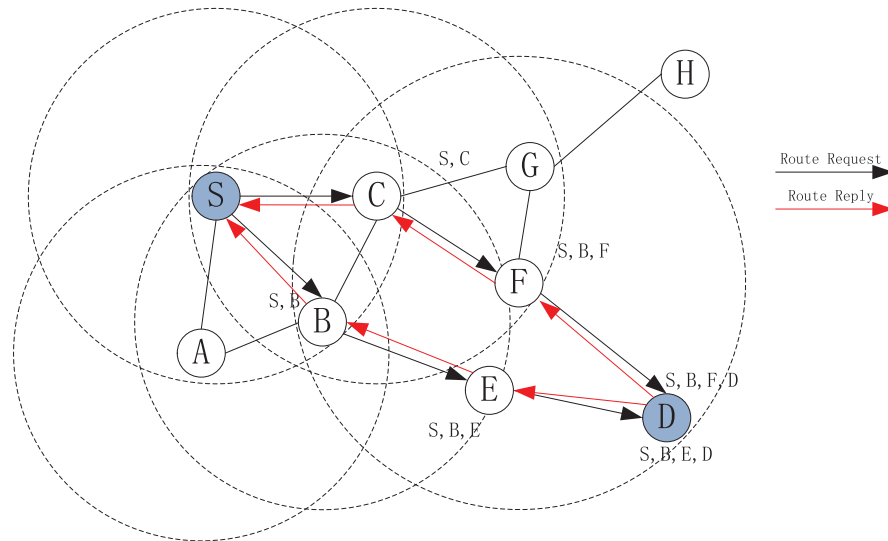


Figure 4.1: Route Request & Route Reply

4.2.3 Route update process

Obviously, an intermediate node may be (or may exist) in several available paths at the same time. In the different paths the D_{ts} and ρ_{ts} may not be the same. So when the intermediate node caches the redundant paths, the D_{ts} and ρ_{ts} correspond with each of the available paths. The nodes monitor the up-to-date status of the two metrics. If either of the metrics goes out of the reliable range, the node will delete the path correspondent and send a route update packet (RUPD) to all of the intermediate nodes in the path. The route update packet contains the information as table 4.3 shows.

Table 4.3: RUPD packet

Source ID
Request ID
Destination ID
Path sequence

The route update process takes place in the local node and cause no bandwidth of the network. Route update packet is send only when the node fails out of the performance threshold. This process keeps the paths in the cache always reliable.

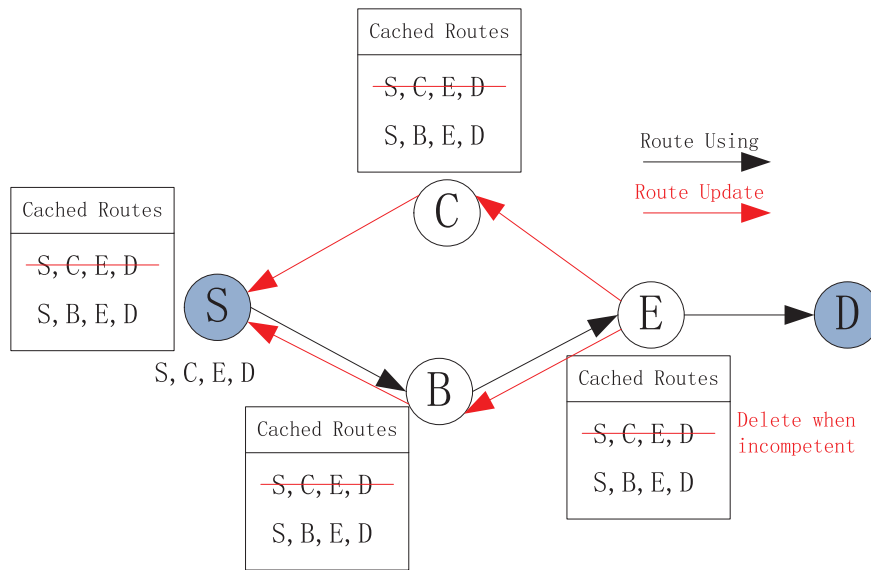


Figure 4.2: Route Update

4.2.4 Route maintenance process

Because the dynamic nature of the ad hoc networks, the network works in an unstable condition. The malfunction and the mobility of the nodes, congestion of the traffic will cause the disconnection or performance degradation. The maintenance process of the protocol is able to recover the broken path immediately and improve the performance of the end-to-end transmission by finding an alternative path when the performance of current path is degraded. We categorize the causes of network failure to two different aspects.

a. Sudden breakdown of the node without any presage. This kind of failure usually happens because of the hardware failure of the nodes. If such the failure occurs in the currently used end-to-end path, the upstream node of the broken node will not receive the ACK confirming packet of the node. After several retransmission attempts, the packet will be dropped. This node will delete this path in its cache and find another path from the cache until there is no path available left for the destination. Then a route error packet (RERR) will be sent to the upstream node of this node and repeat the path reconstruction process until the RERR is sent back to the source node. Then a new route discovery process will be initiated.

b. A gradual process of performance degradation of the network. This kind of failure doesn't actually makes the network disconnected. The consumption of the battery or a

growing traffic will lead to this kind of situation. As always monitored by the node itself, the node will be fully aware of this tendency. When one of these metrics degraded to the threshold calculated during the process of route discovery, node will send a RERR to its upstream node to delete the current path and find an alternative path in its cache until there is no path available left for the transmission. This process will continue until an available path is discovered or the RERR arrives at the source node. If the process ends up the latter, a new route discovery process will be initiated. The route maintenance process in our protocol is efficient because it uses the local recover policy which is suitable in large scale networks. As the paths' availability is always up-to-date because the existences of the route update process, staled paths will be eliminated before trying to use it. All the redundant paths left will be available.

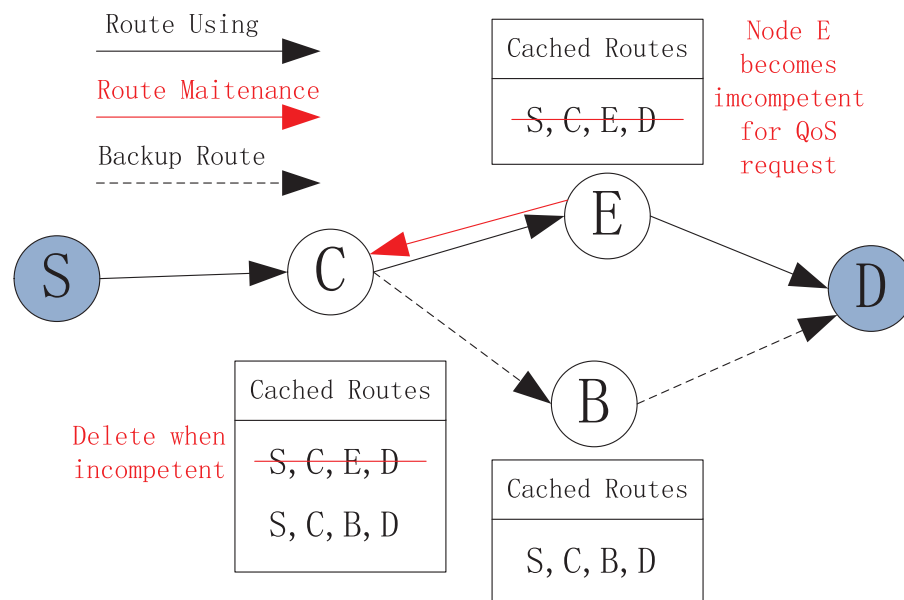


Figure 4.3: Route Maintenance

4.3 Numerical example

In this subsection, we are going to display how our protocol will control the QoS of end-to-end transmission. The structure of the example network is shown in the Fig.4.4.

Apparently, there are two paths from our source S to the destination D. S-1-3-D and S-2-3-D. Assuming that all the node is working under the assumptions and characters as

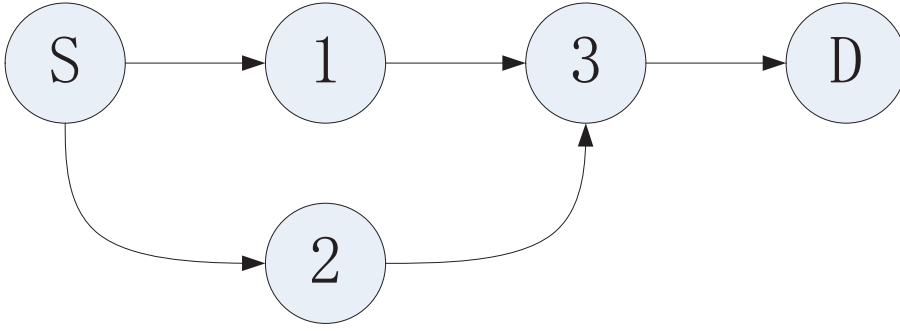


Figure 4.4: A simple path example

showed in section 3.1: maximum queuing packet is 3, maximum retransmission attempt is 3, packet arriving rate is $\lambda = 0.1$, the serving rate is $\mu = 0.3$, and the success possibility of transmission is $\rho = 0.9$. Except node 2, its serving rate is $\mu = 0.25$. According to section 3.1, intermediate node 1,3 has the stable transmit possibility of 97.65% and the average delay 5.16s.

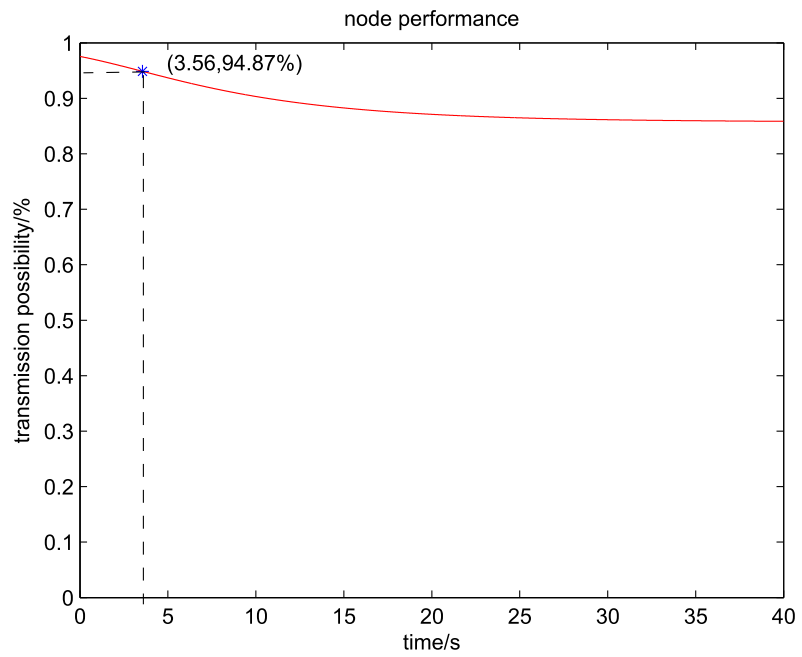
While node 2 has the stable transmit possibility of 95.8% and the average delay of 6.46s. Assuming that the QoS requirement is $\rho_r = 90\%$ and $D_r = 12s$ according to the formula (4.1)

$$\begin{cases} W_{S-1-3-D} = \frac{D_r \rho_{acc}}{D_{acc} \rho_r} = 1.2297 \\ W_{S-2-3-D} = \frac{D_r \rho_{acc}}{D_{acc} \rho_r} = 1.0724 \end{cases}$$

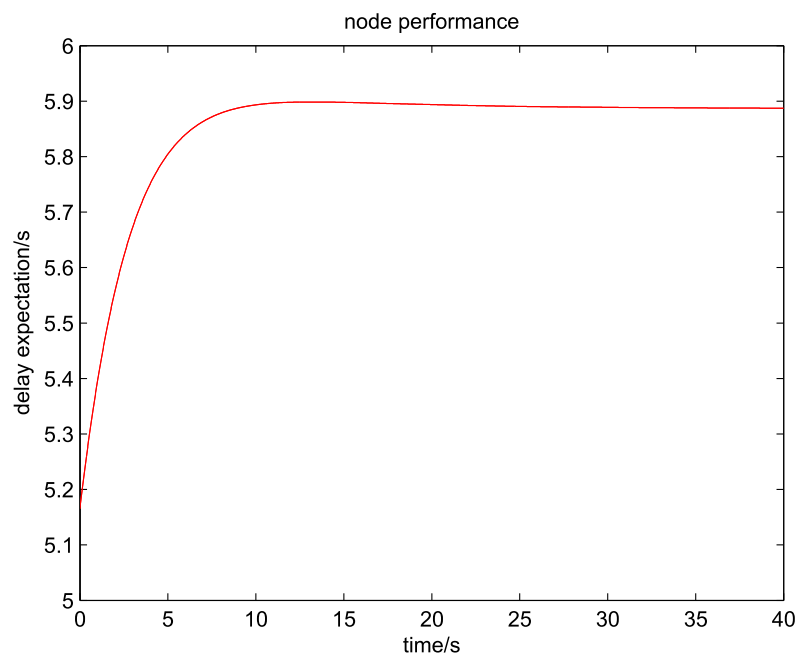
So, that makes the most optimistic path from S to D is S-1-3-D, and S-2-3-D is cached for backup. According to formula (4.2), for path S-1-3-D,

$$\begin{cases} D_{ts} = D_s + \frac{D_r - D_p}{N} = 6s \\ \rho_{ts} = \rho_s \sqrt[N]{\frac{\rho_r}{\rho_p}} = 94.87\% \end{cases}$$

Suppose that at t_0 , the arriving rate of node 1 is somehow increased to $\lambda' = 0.2$ the states possibility of the node will change. The initial state possibility will be changed, too. The performance of the node will be changed eventually. Start from the time t_0 , the performance tendency is shown in the figure (4.5). From the figure above, we can see from the time $t' = 3.56s$. Path S-1-3-D starts to unfulfill the requirement of the QoS demand even the delay is still in range. According to the protocol we provided, the path will be changed to S-2-3-D to keep fulfilling the demand. The QoS performance curve from time t_0 will be figure (4.6). Although the network still be connected using the old protocols,

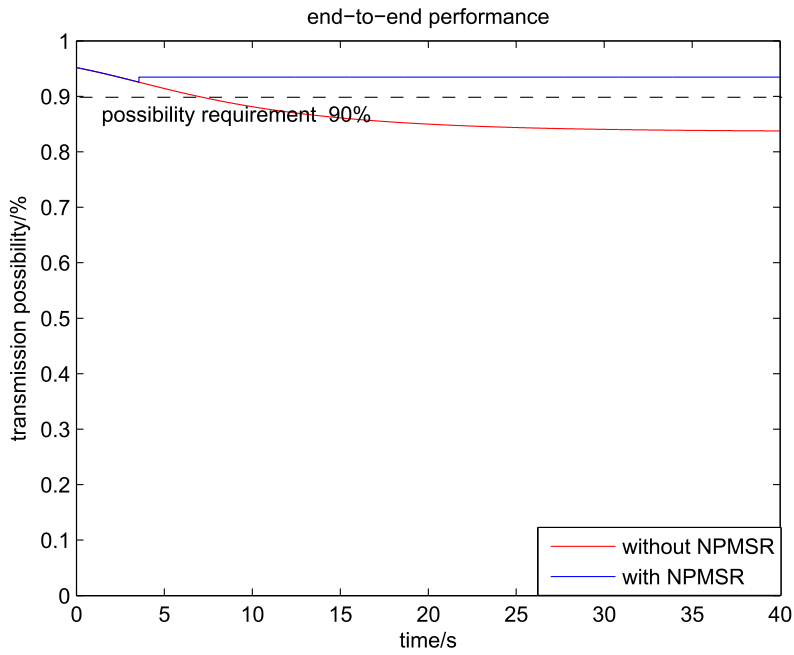


(a) transmission possibility

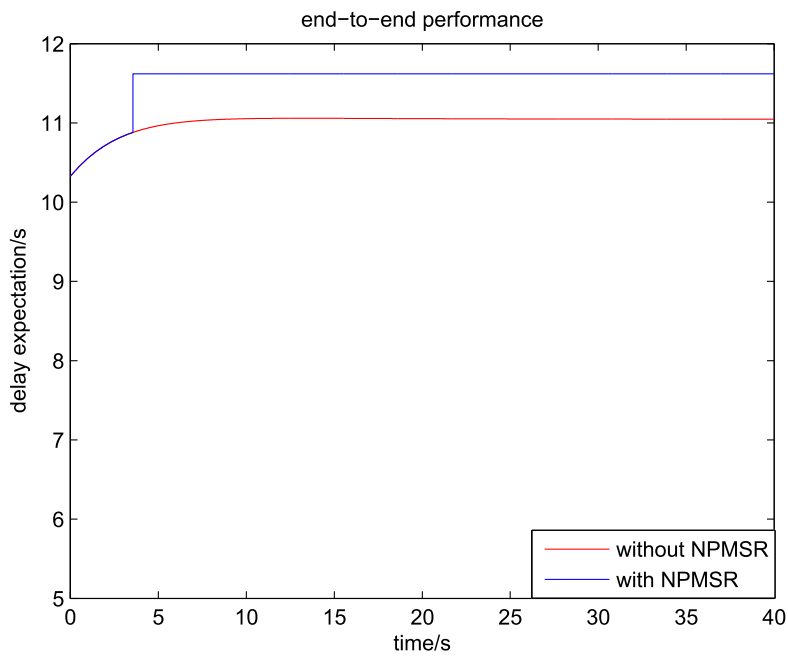


(b) delay expectation

Figure 4.5: Node performance



(a) transmission possibility



(b) delay expectation

Figure 4.6: Whole path performance

the QoS can't be guaranteed. The example we provided just showed the basic function of the protocol applied in the immobile network, but the performance of MANET will be also enhanced by this protocol. The discussion of the MANET would be carried out in the future.

4.4 Conclusion

Based on the performance model of the nodes, we provided a QoS aware ad hoc routing protocol which can guarantee the quality requirement of the transmission. Routing, update and maintenance process are discussed in this chapter. A numerical example has been brought to demonstrate how the protocol works and how it can do to improve and guarantee the quality of service of the network. Our protocol is derived from DSR protocol but it has inherited the advantages of the DSR and optimized several disadvantages:

1. In the routing discovery process, it compares the path characters of with the previous cached path, RREQ packets are selectively drop. So the re-broadcast of the RREQ packet is limited and overhead problems of DSR can be avoided.
2. The cached path information is updated by the intermediate nodes without costing bandwidth which make the network more efficient and the staled cached path can be cleared out in time.

But there are also some the problems with the protocol for example, in order to monitor the status of the nodes. The node should acquire a computing unit powerful enough to obtain the latest characters of the nodes.

Chapter 5

Effect of Communication QoS on Performance of PID Control Systems

Contents

5.1	Related work	105
5.2	Model constructions	107
5.3	Performance Degradation with Transmission Delay	108
5.3.1	Performance degradation with fixed delay	110
5.3.2	Performance degradation with variable delay	113
5.3.3	Conclusion	115
5.4	Performance degradation with data loss	115
5.4.1	Loss at different period	118
5.4.2	Regarding the system with big sampling time	119
5.4.3	Conclusion	120
5.5	Conclusion	120

5.1 Related work

Wireless communication systems are applied in the control systems to substitute the cables, simplify the hardware system. But unlike the system with the cables, the data transmission (state parameters or control signals) is not that reliable or predictable. Transmission through the air often get interfered by the noise, obstacle etc. and randomly

cause the transmission delay and data fault or loss. All these kinds of error will somehow influence the performance of the control system. The extent depends on the extent of the error and the system itself. In some of the systems which have the long settling time would be hardly influenced by little of the transmission fault. But nowadays more and more control systems are required for faster, more accurate and stable. The fault discussed above can slow the process, make it inaccurate and unstable. Performance will be degraded such as bigger settling time and overshoot, or sometimes the whole system will be harmed for example the system become unstable.

Previous work has more focused on the stability problems that the transmission error would cause to the control system by finding the control methods of counteract the effect of delay and loss. For the time delay system, reference [Richard 2003] has given a thorough analysis and summarized some of the optimal control methods to deal with the delay. In the system with data delay, the stability of the new system becomes the most important for the system. [Bozorg 2006, Alit 1998] have applied the linkage of time-delay $e^{-\tau s}$ to the close-loop transfer function of the system and used different ways to deal with the quasi-polynomials according to the rules of stability. As to the control system with packet loss, the stability of the system doesn't change no matter if there is or no loss because the structure of the system never changes [Okano 2008]. So the research on the system with the data-loss system is more emphasized on the performance degradation of the system [Okano 2008]. [Sadjadi 2003, Yu 2004] used state space representation to describe the control system with the data loss. Methods are proposed to deal with data loss. [Okano 2008] proposed a compensation method to counteract the effect to the performance of the loss of control signal. [Imera 2006] has proposed the optimal control method under both the conditions that the communication network is acknowledgement-support (TCP) and no acknowledgement-support (UDP). But when come across the systems without all these kinds of control strategy, the degradation becomes important to be aware. [Ghostine 2011] has applied the concept of dependability to the close-loop control system with variable delays and message losses. He used Mobius tools to simulate the control system with the benchmark $G(s) = \frac{1}{s(s+1)}$. The influence of the delay and data loss has been simulated using the Monte Carlo method. Some evaluations of criteria of reliability were proposed (failure by overshoot, failure by stability).

Intelligent vehicles use wireless communications to make important driving decisions, pass, speed control ... [Zhao 2002]. This chapter focuses on the degradation of control performance of the discrete sampling control system. By analyzing the process of the system, the method of estimation of the degradation will be proposed according to the

system characters, data delay and data loss. The second section of this chapter deals with the discrete sampling control system analyzing and the model construction. The third section discusses the degradation of performance that caused by the data delay. The fourth section is about the degradation of performance that caused by data loss.

5.2 Model constructions

Among the real control systems, the existence of discontinuous signal is common. The system in which the signals have to presence on the isolated time point series is called discrete control system. The structure of discrete control system is shown in Fig. 5.1.

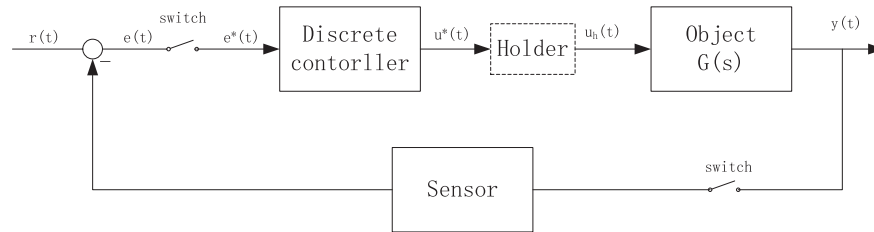


Figure 5.1: Discrete control system

As the PID (proportional Integral Derivative) controller is very classic and widely used, this paper uses the discrete PID controller in the model. The other control strategy like fuzzy (PID), nerve net will be researched in the future for the reason that the degradation may be different for different controllers. The HOLDER is not an indispensable part for the impulse control system. But in this chapter, we use it to make the control signal continues. The sampling frequency is a key point of a discrete control system. It determines the performance of the system basically. In this paper, the sampling frequency of the discrete controller is corresponded with the sampling frequency of the sensor. The object is a continuous linkage. The whole system works like this: the sensor measures the status of the object at every sample time, then compare with the required status. The controller makes control decisions according to the error between the status and the required. Discrete control signal was set and the holder makes it to a continuous signal. We assume that the controller is separated from the object and they transmit the data using the wireless communication, which is shown in the Fig. 5.2:

In this chapter we assume that the delay time is smaller than the sample time. Because if the delay time is larger than the sample time, the delay can be regarded as one or several continuous data loss combined with a delay that is smaller than the sample time which

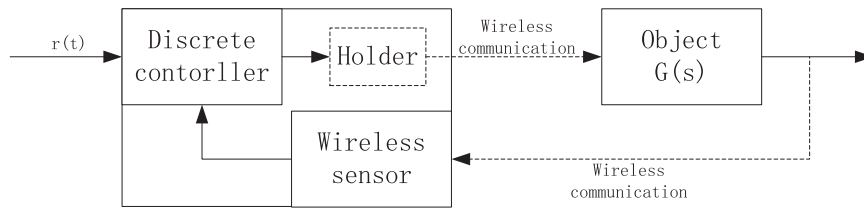


Figure 5.2: Wireless discrete control system

will be discussed later. And we have made another assumption that the output of the discrete PID control is invariable until a new signal is input, which means if delay or data loss happens, the PID control signal will not change until the delayed data arrives and the loss data will be ignored.

If delay/loss happens during the process of getting the object status, things will be different. The controller has its own sample time too, and the control signal will be generated only when the data arrives at the controller, after the data arrives, it will wait until the next sample time of the controller. So the sample time of controller must be smaller than the sample time of the sensor. If the controller has a very small sample time than the sensor, we can assume that the influence on the control signal is the same in both of the conditions.

The signal of discrete PID control is generated by:

$$u_n = K_p e_n + K_i \sum_{i=0}^n e_i + \frac{K_d(e_n - e_{n-1})}{T_s} \quad (5.1)$$

5.3 Performance Degradation with Transmission Delay

Communication delay may happen at the process of getting object's status and sending the control signals. The signals will be influenced as shown in the Fig.5.3: Previous work [Ghostine 2011] has applied that if the delay is greater or equal to $48\%T_s$, the system will become unstable. [Ghostine 2011] has used a benchmark $G(s) = \frac{1}{s(s+1)}$ as the researching object. So in this paper we follow this benchmark in order to have some comparisons with the previous results.

If we substitute the object and the controller in the previous talked structure of the control system, we can easily obtain the transfer function as Fig. 5.4:

In this function, τ refers to the fixed delay time of the system. T_s refers to the sample period of the system.

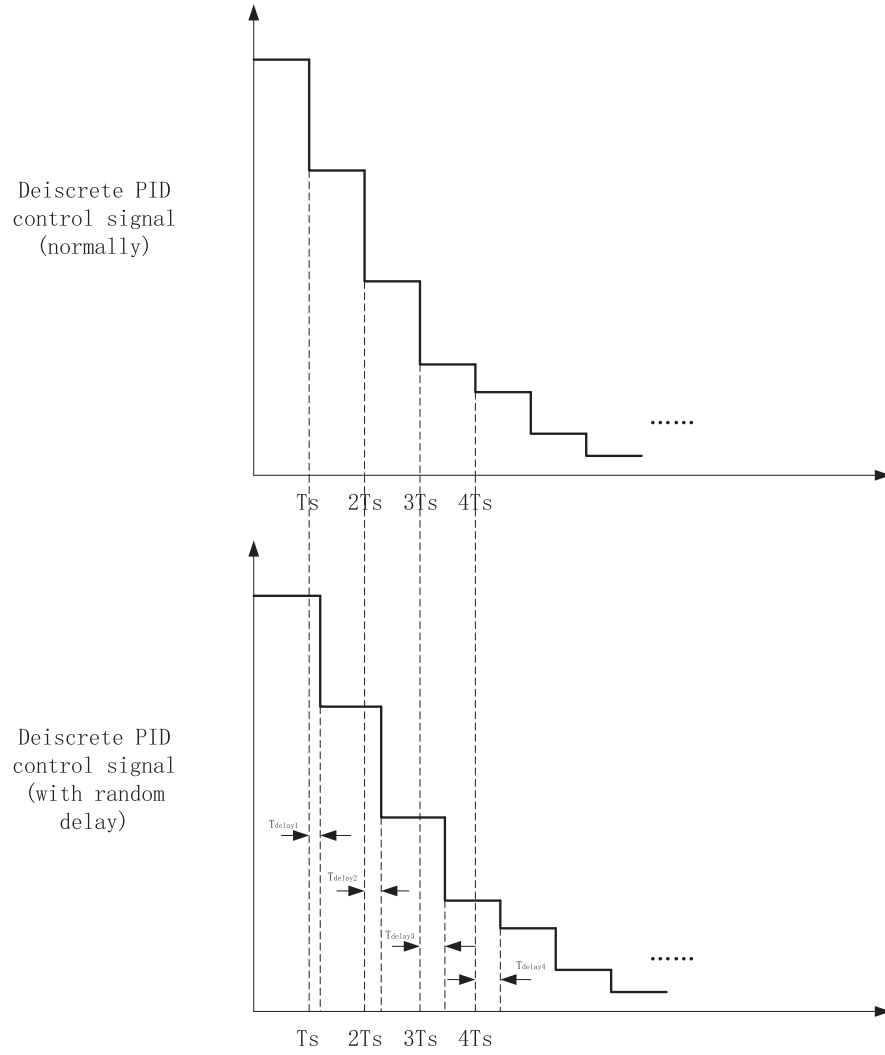


Figure 5.3: Comparison between the normal signal and the signal with delay

In our assumptions, the time delay is not the integral mutilation of the sampling time. The discrete transfer function helps us analyze the system theoretically. We can get the open-loop transfer function of the system as followed:

$$G(z) = \frac{(K_p T_s + K_i T_s^2 + K_d) z^2 - (K_p T_s + 2K_d) z + K_d}{T_s z^2 - T_s z} \times \frac{(T_s + e^{-T_s} - 1) z + (-T_s e^{-T_s} - e^{-T_s} + 1)}{z^2 - (1 + e^{-T_s}) z + e^{-T_s}} \quad (5.2)$$

If the transmission delay occurs in the system, the transfer function will be applied with

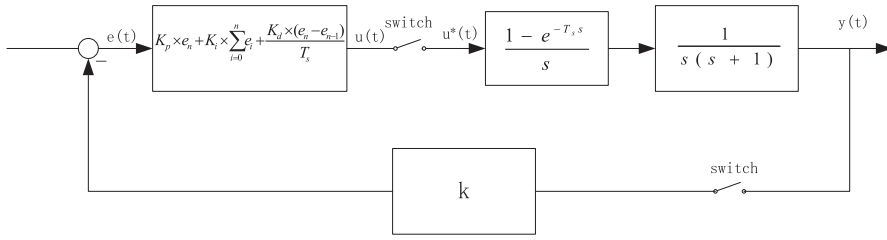


Figure 5.4: Discrete control system used in this paper

the $e^{-\tau s}$ on the input of the object. So the open-loop transfer function will be:

$$G(z) = \frac{(K_p T_s + K_i T_s^2 + K_d) z^2 - (K_p T_s + 2K_d) z + K_d}{T_s z^2 - T_s z} \times \frac{(T_s + e^{\tau - T_s} - \tau - 1) z^2 + ((\tau + 1)(e^{-T_s} + 1) - 2e^{\tau - T_s} - T_s e^{-T_s}) z + e^{\tau - T_s} - (\tau + 1)e^{-T_s}}{z^3 - (1 + e^{-T_s}) z^2 + e^{-T_s} z} \quad (5.3)$$

We can easily get the characteristic equation of the system and from the characteristic equation, and then we can get all the performance data of the system, such as stability, response time and so on.

Some result comes different with the reference [Ghostine 2011], as in the reference, the control strategy of the PID controller has been point out specifically, the characteristic of the system is not determined precisely, so the 48% rule may not be applicable to all the system. In fact, for example, if we set the PID controller as $K_p = 20$, $K_i = 0.1$, $K_d = 5$ and the $T_s = 0.01$, then even the delay is $80\%T_s$, the all the poles of the closed-loop transfer function of the system stay in the unit circle of the z-plane. So how the communication delay influence the performance of the response is basically decided by the characters of the system itself.

5.3.1 Performance degradation with fixed delay

The response of the sampling control system is made up by steady state component and transient component, in which the transient has decided the control performance. The transient component is related with the distribution of the pole points of the closed-loop transfer function (assume that there is no pole point same as the zero point). It is known that for the poles that are real numbers, if the modulus of the pole is larger than 1, then the transient component correspondent with this pole is diverged which will cause the system unstable. If the modulus of the pole is smaller than 1, the transient

component is converged and when the pole is less than 0, the transient component will be positive-negative alternation. When there is a pair of conjugate complex number, the transient component is a vibration with the cosine law. So if we want the system has a better dynamic performance, we have to keep the pole points of the transfer function be distributed not in the left part of the z-plane especially not near the negative real axis, it's better to keep them in the right part and the closer to the origin of the coordinate.

Consider the transfer function of the system we discussed in the last chapter, we can get the distribution of the pole points according to the change of the sampling time T_s , delay time τ or any other characters of the system such as PID controller or the object itself.

When the parameters of the PID controller is decided as above, the tendency of the pole points with the change of fixed delay under different sampling time situation can be showed in the Fig.5.5. This result comes from the system of which the sampling time

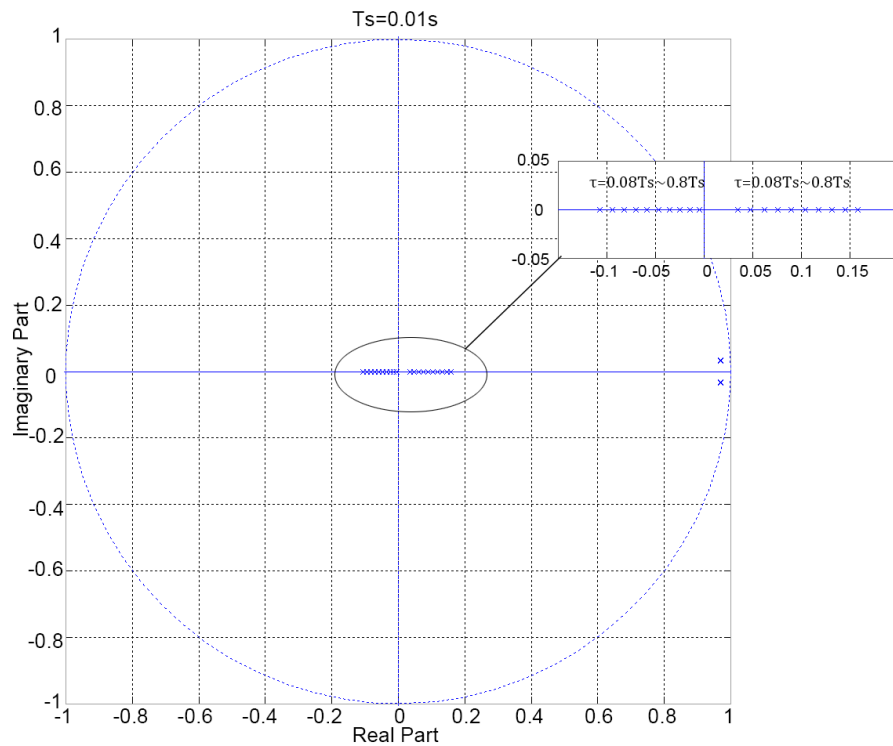


Figure 5.5: Root locus corresponding the time delay $\tau(T_s = 0.01s)$

$T_s = 0.01$. As we can see in the root locus plot, the system has 4 pole points including a pair of conjugate complex root and two real roots, in which, the positive real roots is the dominant pole of the system because there is a zero point close to the other real root and

the pair of conjugate complex roots has a way bigger real part than the real ones. Along with the growth of the fixed-delay time, the two real roots has a trend to move away from the original point, but the pair of conjugate complex roots only has a tiny movement.

As analyzed before that the only dominant pole of the system has moved a little away from the original on the positive real axis, the performance only changes on the overshoot from about 30% to 70%, but the response time and the stability doesn't change.

Accordingly we can get the root locus plots and the response performance change corresponded with the delay-time growth under different sampling time. As the sampling

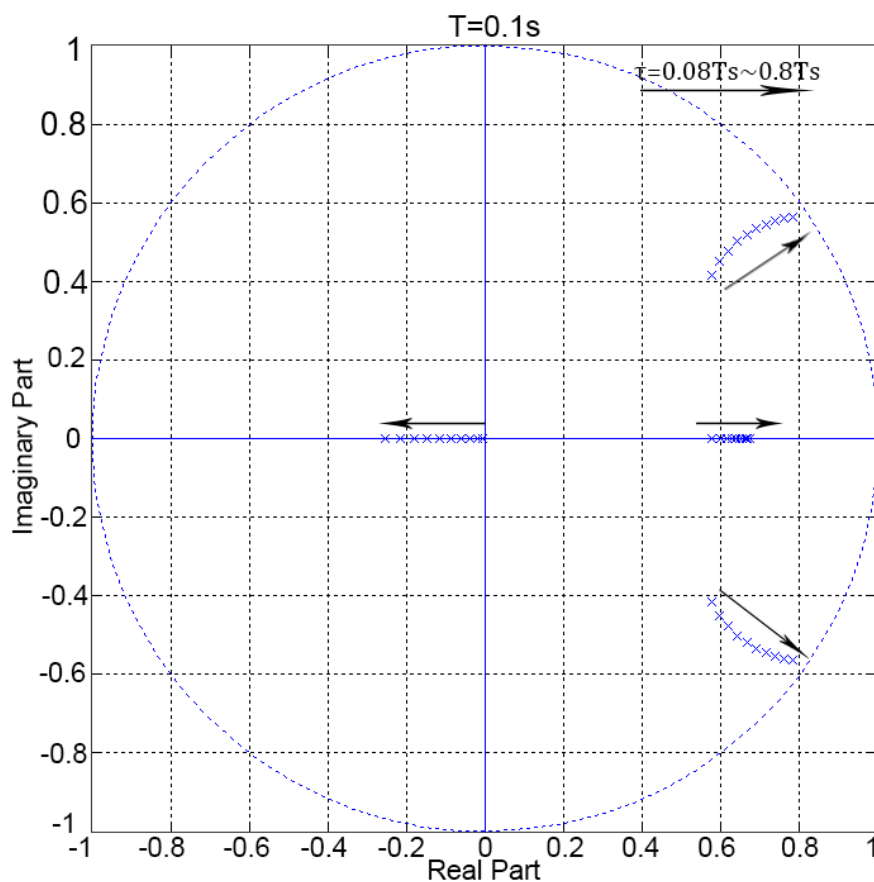


Figure 5.6: Root locus corresponding the time delay $\tau(T_s = 0.1s)$

time changed, the root locus has changed, the dominant pole is no longer only the positive real one, and the pair of the conjugate complex root also becomes the fact to determine the performance of the system. So a vibration part has become obvious. As the time-delay becomes larger, the pole is more close to a zero point, meanwhile, the conjugate complex roots have moved towards the unit circle. Thus, the performance behaves much

the vibration.

5.3.2 Performance degradation with variable delay

The real system works in an environment which changes all the time, so the transmission delay cannot be consistent. If the time-delay τ of the system is variable during the work (assumed to be random and uniform distributed), the whole system is changing, the pole points of the system are changed so the transient component of the response is changing. Last chapter, we have simulated the best and worst situation of the system (assume that time-delay is in the range of $0.08T_s$ $0.08T_s$).

Since the worst and best situation has been decided, the performance curve with random delay is basically limited in the area which is enclosed by the two extreme situations.

If we consider the overshoot and the accommodation time (time between the system begins reacting to the control signal to the system reaches a tolerable extent of control goal, here is 5%) as the two main criteria of the performance, then these two criteria are bounded between the two extreme situations. From the degradation curves above, we can prognosticate the basic criteria of the performance at the beginning of rising process.

The rising process is crucial for the performance, it can determine some basic characteristics of the performance such as overshoot and responding time, so if big delays happened during the process of rising, the degradation would be more severe. Figure 5.7 shows that a short period of big delay during the rising process can do more harm to the performance of control and the performance often appear incongruous. The delay character during the process has too many random factors. Both the delay extent and the numbers of delay can be random. So in order to find the relation between the delay and the performance we use the Mont Carlo method.

Simulation shows that there are corresponding relations between the overshoot and the accommodation time, see figure 5.8: We can see from the figure 5.7 that when overshoot cross the threshold 33.1%, the accommodation time will increase to longer than 1.43s on this criterion, performance has appeared an obvious degradation. We can take this threshold as the criterion to judge a system whether is failed or not. And the overshoot can represent the other criteria e.g. accommodation time. If the number of simulation is big enough, we can calculate the possibility that the system "fails" by the threshold. Equally, the threshold can be adjusted to the different systems or the customers' needs.

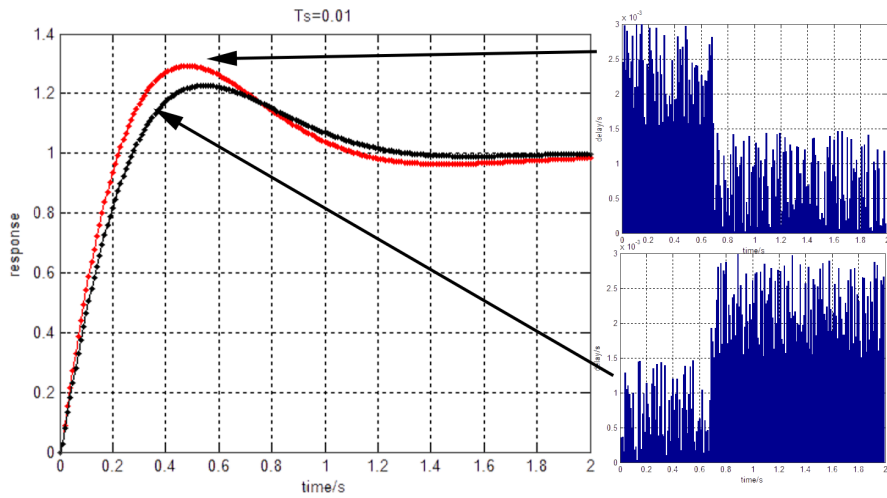


Figure 5.7: Comparison between the normal signal and signal with delay

Table 5.1: Possibility Calculation of The Performance Crossing the Threshold

Number of Simulation	Over the Threshold	Possibility
5000	3974	79.48%
3000	2369	78.97%
2000	1575	78.75%
1000	800	80.00%
500	395	79,00%

On the other hand, the classical control theory told us if we want a better control performance for the system, we have to keep the IAE (integral absolute error, $IAE = \int_0^{\infty} |e(t)| dt$) at a minimum value during the process. So the IAE is related to the other criteria such as the overshoot, see Fig.5.9(a). The simulation shows this kind of relation have nothing to do with the time point of the control progress we can call it "self-similarity", see Fig.5.9(b). That is to say, we can predict the performance degradation of the system at the beginning of the process so that decisions according to the degradation can be made.

But, this kind of characteristic can only be found in the performance of second-order system or the higher-order system which can be approximated as a second-order system.

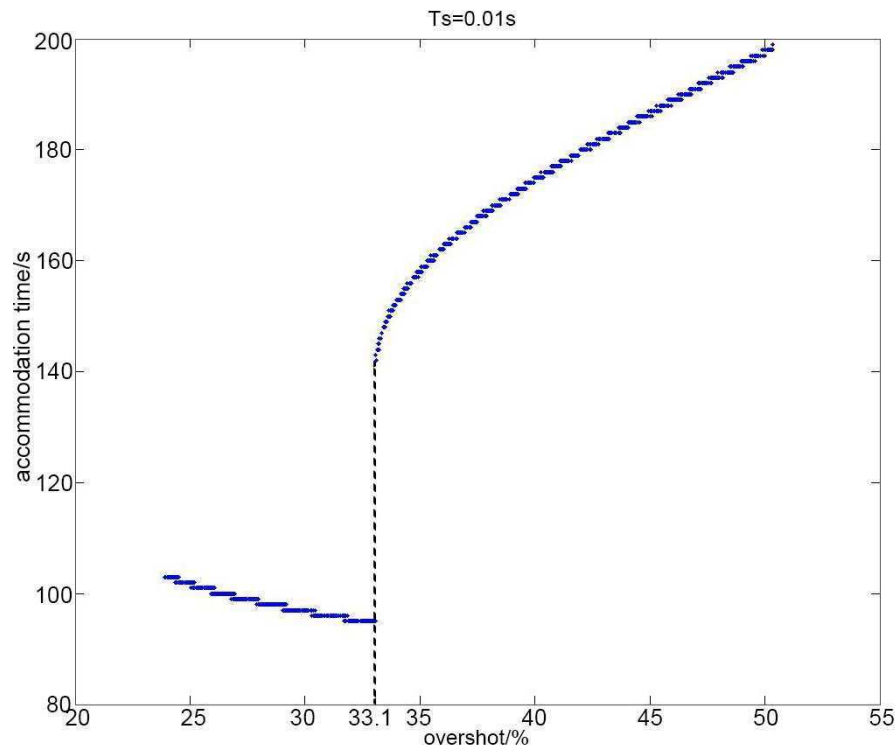


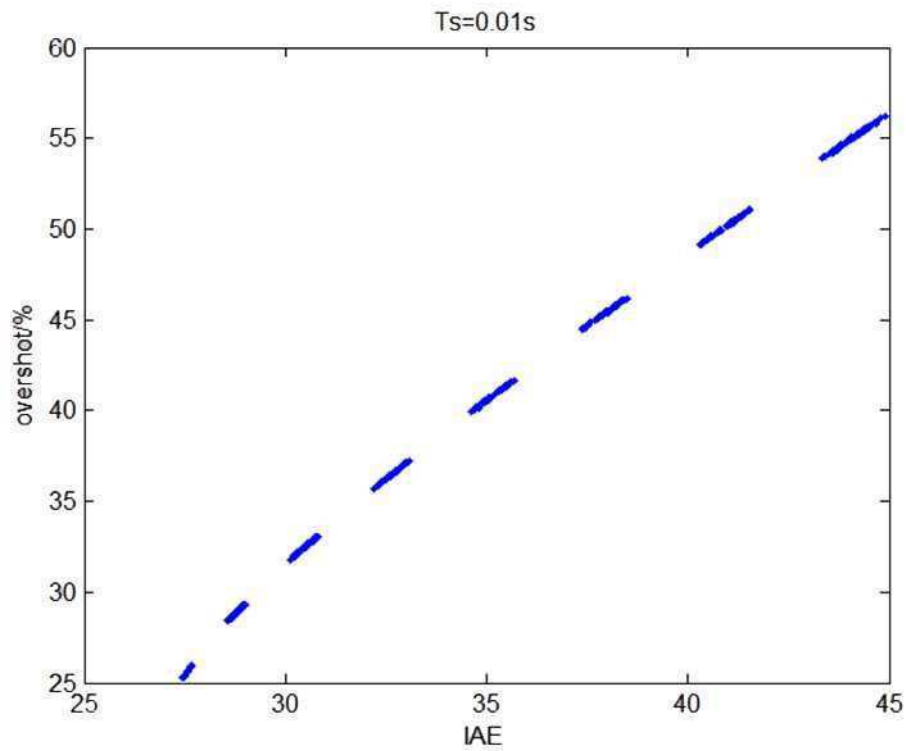
Figure 5.8: Corresponding relation between the overshoot and the accommodation time

5.3.3 Conclusion

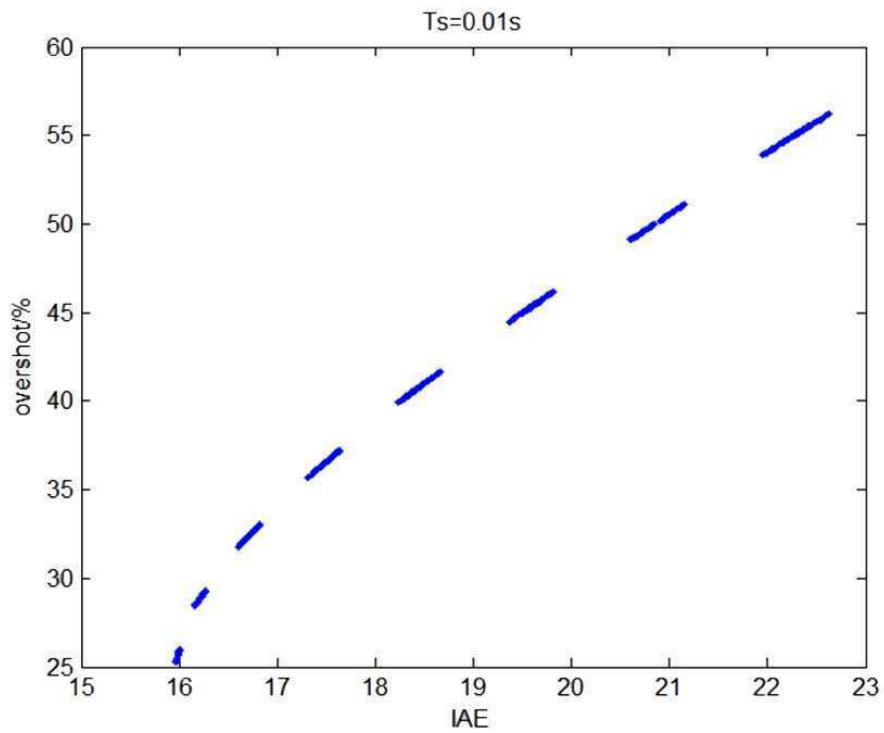
In this section, we have analyzed the scheme of the system which has time delay in the close loop. The delay effect cause the change of the structure of the system, especially it moves the poles points of the transfer function. Performance degradation can be simulated under fixed delay time and variable delay time. The results can be instructional to control the degradation into a tolerable extension. Also, the simulation shows that if the delay is control by some method at a lower extent during the rising process of response, the degradation of performance can be at a minimum level.

5.4 Performance degradation with data loss

Based on the assumptions in this paper, the signal of control changes only the signal reaches the object, if not, the control on the object remains the same. When data loss happens during the communication, which comes to two situations: first, the new object status cannot reach the controller so the new control signals cannot be provided; second, the communication failed to transmit the control signal to the object. These two situations



(a) X-label is IAE on the whole time of control



(b) X-label is IAE on a short part at the beginning of control

Figure 5.9: Corresponding relations between the overshoot and the IAE

can be summed up in one that the updated control signal cannot reach the object in time and according to our assumption that the control signal remains the same as it is in the last control period until the new signal is generated. This is shown in the Fig. 5.10: The

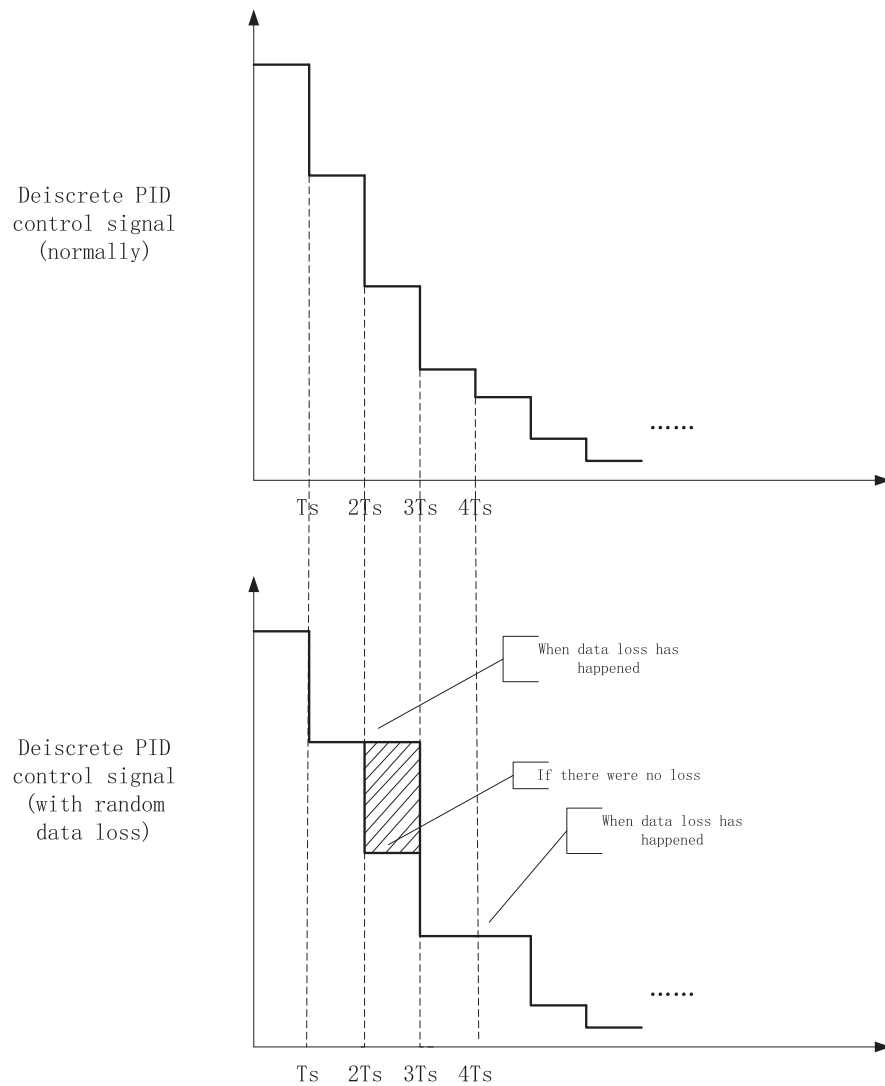


Figure 5.10: Comparison between the normal signal and the signal with loss

difference between a data loss and delay is that the data loss happens more randomly and it doesn't change the stability of the system theoretically, but if the loss happens too often, the accommodation time will be longer.

The control signal is just like the force applied on the objects, the area encircled by the curve of controller output represents the "force" on the object. According to the figure 5.10 above, the area with shadow is the extra "work" on the object. So the

performance of the response to the may be degraded which means more overshoot and longer accommodation time.

5.4.1 Loss at different period

The PID controller deals with the error between the control goal and the actual value. Every time generating the control signal, all the errors in the past are calculated. Consequently, the integral term becomes too large and will result in an inevitable overshoot [Okano 2008]. So as the same as dealing with system with time delays, the rising process is very important in considering the system with data loss.

In fact, the second control signal is the most important one because, in the step response of the PID control system, the first control signal is the largest, if the second control is lost, the control signal will remain in a high level according to the assumption which will cause a large scale of performance degradation.

We continuously follow the example above, when the sample time is 0.01s, we can see from the figure of the controller output signal that after the first 2 ~ 3 sampling period of control, the control signal became more smooth, there are little difference between the adjacent point. So if one single loss occurs during this period, little harm can be done to the system. If the sampling time is 0.1s, during the whole accommodation time, the sampling point will be less and the difference of control signal between the adjacent points will be larger and if loss happens, degradation of performance will be obvious.

Consider a situation that the loss rate of transmission is 30% which rarely seen in the real application. The first several sampling points still to be the most crucial points to decide the performance (the first sampling point cannot be lost because the system starts at the first response of the control).

Just as the time integral of force is the impulse, the time integral of the control value can be seen as the effect on the object, in the figure 5.11, we can see the corresponding relation between the time integral of the control value and the overshoot of the system. The performance degradation is apparent in this figure.

Different conditions of control input can cause different levels of overshoot, thus consequently different accommodation time. The experiments show that the performance level is decided by the several beginning sampling points.

Once the second sampling point is not lost, the performance will be at the first level with the overshoot 17% ~ 18%.

If the second sampling point is lost while the third one is not, the performance will be

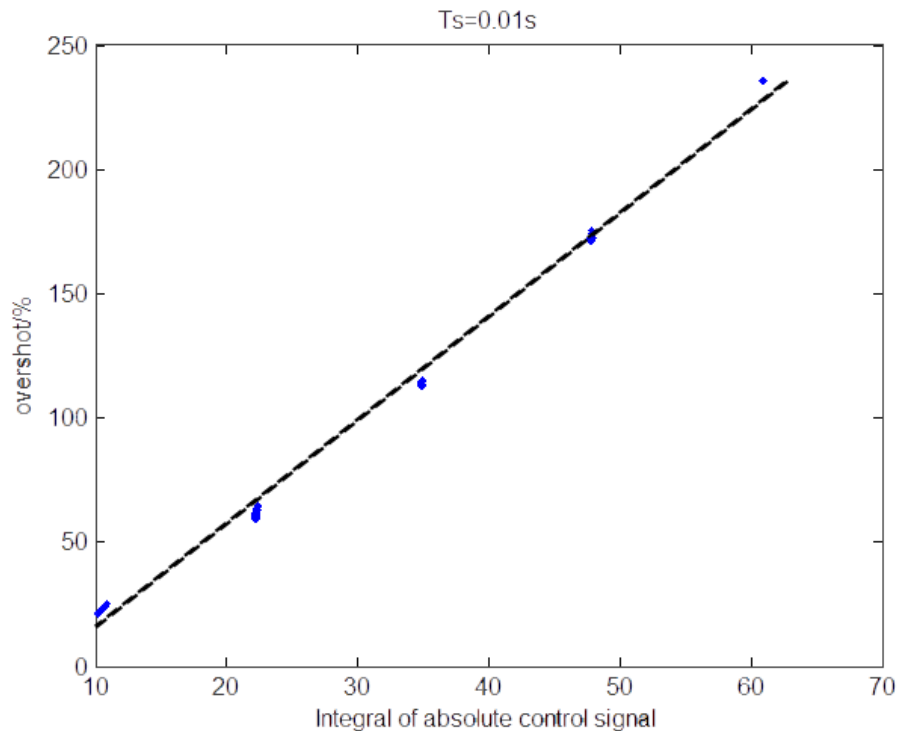


Figure 5.11: Corresponding relations between the control input and the overshoot

at the second level with the overshoot 54% ~ 60%.

If the second and the third sampling point are lost while the fourth one is not, the performance will be at the third level with the overshoot 104% ~ 110%.

If the second, the third and the fourth sampling point are lost while the fifth one is not, the performance will be at the fourth level with the overshoot 160% ~ 170%.

...

Assume that the loss rate of communication is $x\%$, the performance level one happens in the possibility $1-x\%$, and the performance level two happens in the possibility $x\%(1-x\%)$, the performance level three happens in the possibility $(x\%)^2(1-x\%) \dots$

5.4.2 Regarding the system with big sampling time

The system in this paper we have discussed has an accommodation time normally 1.1s, in the last chapter we have set the sampling time at 0.01 which samples nearly 110 points during the accommodation process. But when come across the situation that the sampling time is big for example 0.1s, there would be less the sampling point before the system stabilized.

We can see from the figure 5.12, when the sampling time is smaller, the controller output curve is more subtle and smooth. So when a single loss happens, the effect to the "work" on the object is smaller. The performance degradation no longer depends on one loss of the sampling point. The situation becomes more complicate than the systems with shorter sampling time.

When the sampling time is set to 0.01s for example, the crucial sampling point becomes the second and the third one. Once these two points are not lost, the performance will not be apparently degraded. The figure below shows the performance curve that the system samples every 0.01s with a 30% data transmission lost possibility. The performance with the crucial point successfully transmitted is way better than the performance that hasn't.

5.4.3 Conclusion

In this section, we have analyzed the scheme of the system with communication loss. The sampling period makes the performance degradation presents a trend of ladder form. The determine factors for the performance appear to be the loss situation of the several sampling points in the beginning. But the extent of influence of the loss is corresponded with the sampling time of the system. The result shows that the systems with less sampling time has more tolerance on the data loss and has more clear corresponding relation between the time integral of the control value and the overshoot of the system.

5.5 Conclusion

In this chapter, we analyzed the data transmission problems of the wireless control system. The problem has been separated to two circumstances: delay and data loss. Time-fixed delay and the time-varying delay are both discussed using mathematical and statistical simulation method respectively. For the data loss, the performance degradation has been determined by the sampling points during the rising process.

The result of this work is useful for the system designer to optimize the performance of the response to a tolerable extent and also, it is helpful for counteracting the influence of the communication problems during the use. For example, if the extension of the data delay can be determined, we can know that whether the system would be stable in the best or worst condition. The first several sampling points is so important shown in this paper, so we can try to thinks ways to make them successful like the retransmission scheme

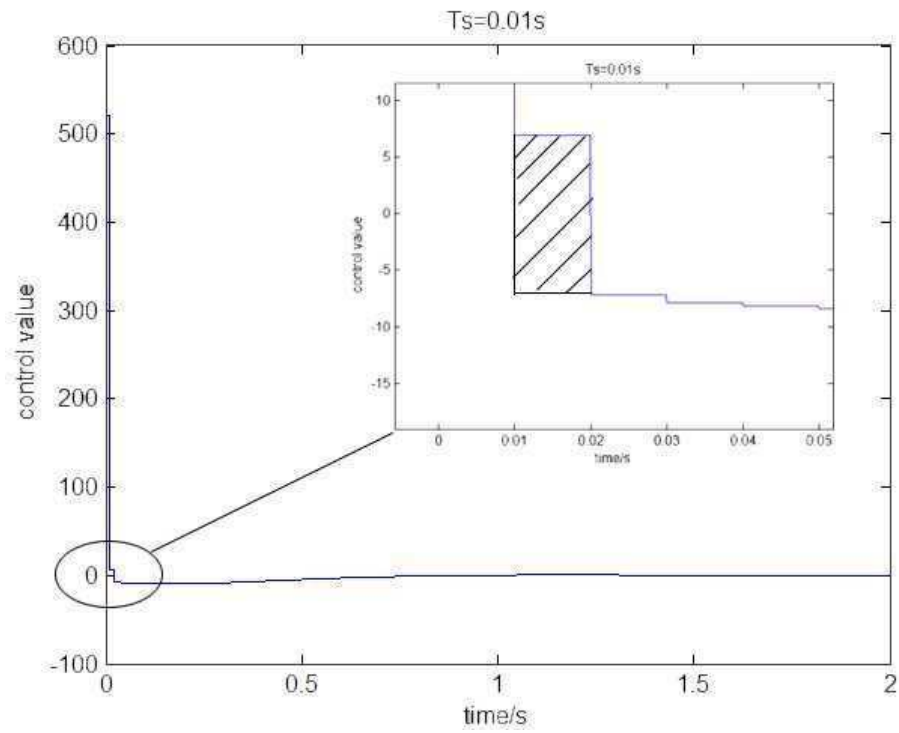
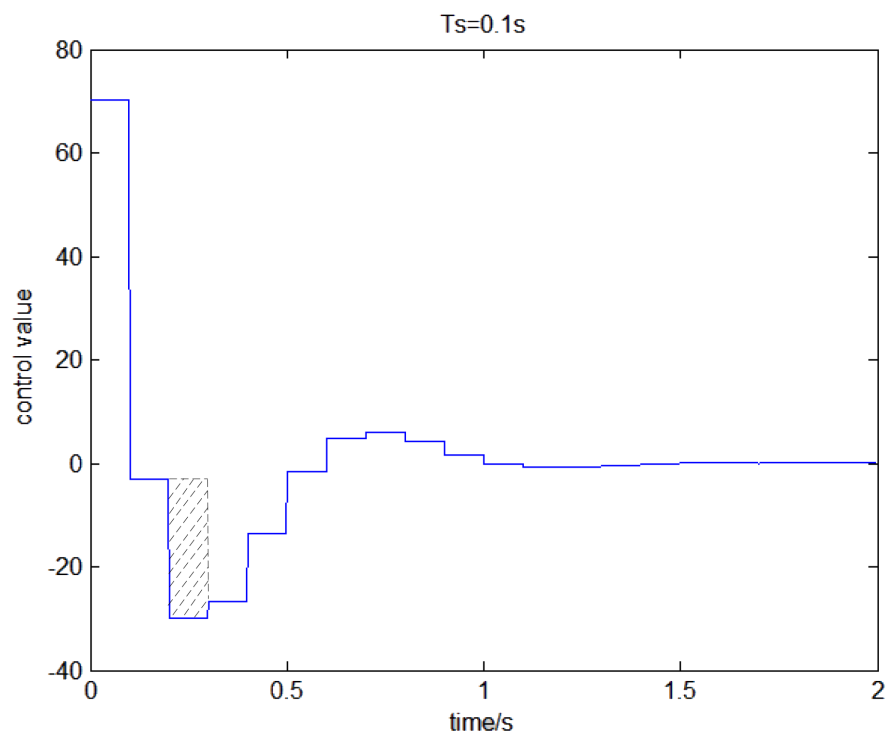
(a) $T_s = 0.01s$ (b) $T_s = 0.1s$

Figure 5.12: Influence of data loss on the control input with different sampling time

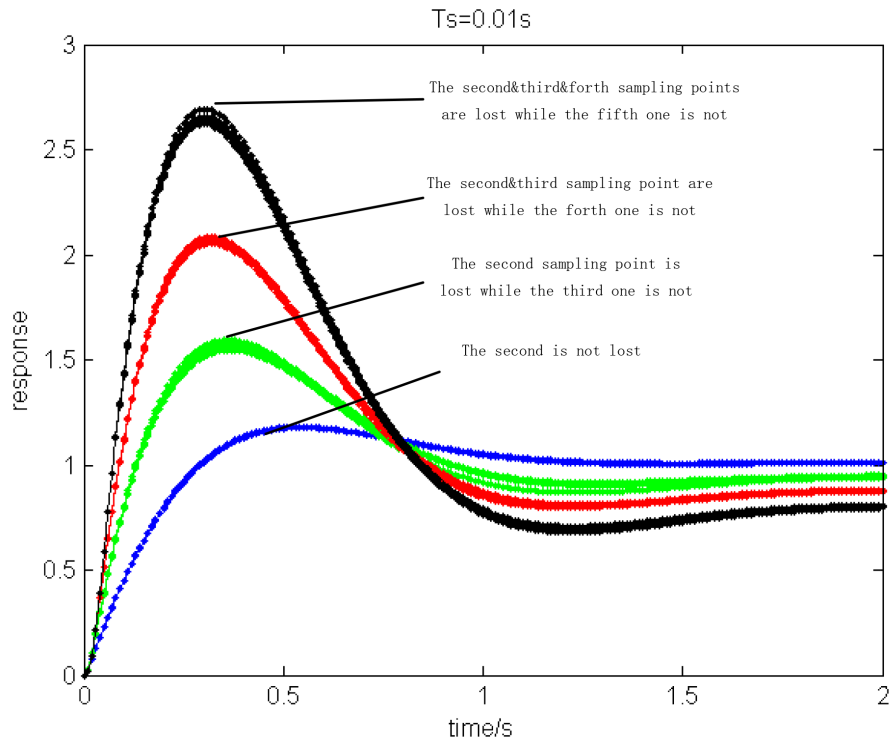


Figure 5.13: Performance degradation with the sampling time

or appliance of compensation. Markov chain can be used to describe the degradation progress with the data loss, so the health condition of the system can be monitored. Threshold can be set to measure the possibility of failure which can be providing for the reliability engineers to evaluate the dependability of the system.

Chapter 6

Effect of Communication QoS on Stability of Fuzzy Control Systems

Contents

6.1	Related work	123
6.2	Fuzzy controller descriptions	125
6.2.1	Limit circle & stability margin	126
6.2.2	Describing function for Mamdani fuzzy controller	127
6.2.3	Calculation example	128
6.2.4	Describing function for Takagi-Sugeno (T-S) fuzzy controller . .	130
6.3	Stability & performance analysis	131
6.4	Example in the research of intelligent vehicle control	132
6.5	Conclusion	135

6.1 Related work

Works are done for the performance of fuzzy control systems. They are basically emphasized on the question of yes-or-no of the stability of the systems. The definition of Takagi-Sugeno (T-S) fuzzy model [Takagi 1985] has provided a mathematical method of describing the input-output relation of the fuzzy controller. Since then, the stability analysis has been promoted. [Sio 1998] has divided the approaches in analyzing the system stability into two groups: the Lyapunov approach and the variable structure or

the phase-plan approach. In which, the core problem of Lyapunov approach is to find a common Lyapunov function and use the Lyapunov theorem to test the stability of the system [Tomescu 2007, Precup 2009, Xiu 2004]. In order to find a suitable Lyapunov function, every rule of the fuzzy controller often needs to be analyzed one by one, which can cause a large computational demand with the increase of rules. Also, the Lyapunov method gives a criterion that estimates the stability. The stable region given by this method is larger than the real region according to the chosen Lyapunov function.

Differ from the Lyapunov asymptotic stability in a neighborhood of an equilibrium point, the BIBO (Bounded-Input Bounded-Output) stability is global and is particularly suitable for nonlinear systems described by input-output maps [Chen 2000]. BIBO system is based upon the response of the control system to a bounded input and uses the small gain theorem to ensure the output is also bounded. [Malki 1994, Chen 1993, Misir 1996] analyzes the regions of the fuzzy controller input-combination values and has proposed that in order to ensure the BIBO stability of the system, the parameters of fuzzy controller has to satisfy a certain conditions. They also indicated that the resulting fuzzy PID controller system has the same stability as its conventional counterpart. [Leephakpreeda 1997] used passivity theorem as a guide to design the fuzzy logic of fuzzy PID controller based on the passivity condition of the giving plant. [Fuh 1997] has corresponded the relation of the input and output of the fuzzy controller, and provides an equivalent system with the original system. Then use the criterion of Lur's system on the fuzzy control system with disturbance.

Describing function method is a way to approximately describe the fuzzy controller with the frequency respond function, which derived from single system input. The output can be obtained by both experimental method [Gordillo 1997, Kuljaca 1999, Sijak 2001, Aracil 2004] or mathematical method [Kim 2000, Sijak 2005, Xing 1996]. Then the stability condition is evaluated by the Nyquist plot using the limit cycle theory. The experimental method is more practical than the mathematical method for it can directly plot the frequency respond on the complex plane. But for different fuzzy controllers, the experimental should be carried out specifically. The mathematical method considers the fundamental harmonic of the Fourier expansion of the system output. The results turn out to be complex. [Kim 2000] has given the describing function of the both static FLC (Fuzzy Logic Controller with one input) and the dynamic FLC (those with two inputs) applying two overlapped-rules fuzzy partition and Mamdani method. Previous works have investigated the problem of the stability of a certain fuzzy control system with time-delay based on the Lyapunov criterion. The works above planted the time delay into the fuzzy

plant. The stability design of fuzzy control rules [Lam 2008] and the feedback for each rule [Wang 2004] are developed based on Lyapunov inequity function method. [Gu 2001] analyzed the system with both control and feedback delay while [Cao 2000] extended the stability analysis and control design to both continuous and discrete-time system.

This chapter studies the control performance degradation when the time-delay happens in the fuzzy control systems. The stability is of course a crucial criterion to analyze when the degradation happened, also, the other performance criteria is going to be studied. The system performance is not treated as just stable or unstable. The degradation during the process along with the time delay is valuable for the safety analysis of the system. The next section will discuss the problem and the fuzzy control model we are going to use. Then method we use is described. An example will be given at last.

6.2 Fuzzy controller descriptions

The fuzzy logic controller (FLC) is a kind of nonlinear controller based on the expert experience. It is formed by a series of IF-THEN rules. In this chapter, the FLC has two inputs (x, \dot{x}) and one output u .

$R_{i,j}$: If x is m_i and \dot{x} is n_j , then u is $u_{i,j}$

The number of rules depends on the number of combination possibility of the two implication premise. Normally, the number of the rules is $i \times j$. For the definition of $u_{i,j}$, which is defined as a fuzzy set in a Mamdani type FLC, while if $u_{i,j}$ is a linear function, it becomes a Takagi-Sugeno (T-S) type FLC.

In the rules, M_i and N_j refers to the implication premise. Every input of x and \dot{x} is correspond with a membership degree on the mapping of membership function $M_i(x)$ and $N_j(\dot{x})$. Then the membership degree of every rule is evaluated by the function $f_m(M_i(x), N_j(\dot{x}))$. After another series of process of implication and defuzzification, we can get the output of the fuzzy controller $\hat{U}_{i,j}(x, \dot{x})$.

Frequency respond function is the Fourier transfer of the ratio of output and input. It reflects the amplitude-frequency and the phase-frequency characteristics of the system. So it is useful to the analysis of stability and performance.

If the system is simple harmonic motivated (for example $A \sin(\omega t)$), the output can be expressed by a periodic function $f(x)$. According to the Fourier series, $f(x)$ is integral on $[-\pi, \pi]$:

$$f(x) = \frac{a_0}{2} + \sum_{n=1}^N [a_n \cos(n\omega x) + b_n \sin(n\omega x)], N \geq 1 \quad (6.1)$$

In which,

$$\begin{aligned} a_n &= \frac{\omega}{\pi} \int_{-\frac{\pi}{\omega}}^{\frac{\pi}{\omega}} f(x) \cos(n\omega x) dx, n \geq 0 \\ b_n &= \frac{\omega}{\pi} \int_{-\frac{\pi}{\omega}}^{\frac{\pi}{\omega}} f(x) \sin(n\omega x) dx, n \geq 1 \end{aligned} \quad (6.2)$$

If the higher harmonics is small compare to the fundamental harmonic or the object plant of fuzzy controller has the low-pass property and filters out the higher frequency control signals, the output of fuzzy controller can be expressed approximately as followed (with the input $X = A \sin(\omega t)$)

$$Y(X) = \frac{a_0}{2} + a_1 \cos(\omega t) + b_1 \sin(\omega t) \quad (6.3)$$

In which,

$$\begin{cases} a_0 = \frac{\omega}{\pi} \int_{-\frac{\pi}{\omega}}^{\frac{\pi}{\omega}} \hat{U}(x, \dot{x}) dt, n \geq 0 \\ a_1 = \frac{\omega}{\pi} \int_{-\frac{\pi}{\omega}}^{\frac{\pi}{\omega}} \hat{U}(x, \dot{x}) \cos(\omega t) dt \\ b_1 = \frac{\omega}{\pi} \int_{-\frac{\pi}{\omega}}^{\frac{\pi}{\omega}} \hat{U}(x, \dot{x}) \sin(\omega t) dt \end{cases} \quad (6.4)$$

So, the frequency respond function of the fuzzy controller is as followed ($\omega \neq 0$):

$$\begin{aligned} H(A, \omega) &= \frac{a_0 \pi \delta(\omega) + a_1 \pi [\delta(2\omega) + \delta(0)]}{A \pi j [\delta(2\omega) - \delta(0)]} + \\ &= \frac{b_1 \pi j [\delta(2\omega) - \delta(0)]}{A \pi j [\delta(2\omega) - \delta(0)]} = \frac{b_1 + a_1 j}{A} \end{aligned} \quad (6.5)$$

6.2.1 Limit circle & stability margin

For a system who has the characteristic equation

$$1 + H(A, \omega) G(j\omega) = 0 \quad (6.6)$$

$H(A, \omega), G(j\omega)$ are the frequency respond functions of the controller and the plant, respectively. The limit circle can be predicted by the plot of $1/H(A, \omega)$ and $G(j\omega)$ on the complex plane [Aracil 2004, Xing 1996]. In these paper, if A and identical ω at the intersection of the two plots can be found means there exist the limit circle and the system with limit circle may be undesirable or dangerous.

Here, since $H(A, \omega)$ can be calculated, the Bode of $H(A, \omega)$ can tell us some characteristics of the transfer function of the fuzzy controller. The stability of the system can

be estimated by using Niquist criterion. Details will be described in the following.

In the system that is minimum-phase system, stability margin is able to show how far the system is away of the stability boundary quantitatively. It is also a criterion of the performance of the system. Delay in the system may change the parameters of the system but, the stability margin expresses how large the parameter changes can be tolerated before the stability of the system changes.

Stability margin contains gain margin (GM) and phase margin (PM) which should be both considered at the same time.

Gain margin: $\gamma = 180^\circ + \varphi(\omega_c)$

Phase margin: $k_g = 20 \lg k_g = -20 \lg |G(j\omega_g)H(j\omega_g)|$

6.2.2 Describing function for Mamdani fuzzy controller

In this chapter we are going to show how the describing function works. Assume that the fuzzy controller employ two-overlapped fuzzy partition (TFP) inputs and output which means each of the input is corresponded with at most two values in the fuzzy description of the input. Assume the rules are constructed as followed:

$R_{i,j}$: If x is m_i and \dot{x} is n_j , then u is $u_{i,j}$

The number of rules depends on the number of combination possibility of the two implication premise. Normally, the number of the rules is $i \times j$. For the definition of $u_{i,j}$, which is defined as a fuzzy set in a Mamdani type FLC, while if $u_{i,j}$ is a linear function, it becomes a Takagi-Sugeno (T-S) type FLC.

m_i, n_j are the linguistic values of the two inputs respectively. $u_{i,j}$ is corresponding with the linguistic value $u_k M_i(x), N_j(\dot{x}), U_k(u)$ are the membership functions correspond with the linguistic values.

Then assume the fuzzy controller uses method $f_m(M_i(x), N_j(\dot{x}))$ for implication, method $f_{ag}(f_m)$ for aggregation and $f_{de}(f_{ag})$ for defuzzification. The output of fuzzy controller will be generated as:

$$\hat{U}(x, \dot{x}) = f_{de}(f_{ag}(f_m(M_i(x), N_j(\dot{x})))) \quad (6.7)$$

Thus, the describing function is

$$H(A, \omega) = \frac{b_1 + a_1 j}{A} \quad (6.8)$$

In which,

$$\begin{aligned}
 a_1 &= \frac{\omega}{\pi} \int_{-\frac{\pi}{\omega}}^{\frac{\pi}{\omega}} \hat{U}(x, \dot{x}) \cos(\omega t) dt \\
 b_1 &= \frac{\omega}{\pi} \int_{-\frac{\pi}{\omega}}^{\frac{\pi}{\omega}} \hat{U}(x, \dot{x}) \sin(\omega t) dt
 \end{aligned}
 \tag{6.9}$$

6.2.3 Calculation example

Assume that the two input of a Mamdani fuzzy controller x, \dot{x} has a range of $[-1, 1]$ and the range of output is $[-1, 1]$, too. $m_{-2} = n_{-2} = u_{-2} = -1, m_{-1} = n_{-1} = u_{-1} = -0.5, m_0 = n_0 = u_0 = 0, m_1 = n_1 = u_1 = 0.5, m_2 = n_2 = u_2 = 1$. The rules are shown in the following table.

Table 6.1: Fuzzy controller rules

		\dot{x}				
		m_{-2}	m_{-1}	m_0	m_1	m_2
x	n_{-2}	u_{-2}	u_{-2}	u_{-1}	u_0	u_0
	n_{-1}	u_{-2}	u_{-1}	u_{-1}	u_0	u_1
	n_0	u_{-1}	u_{-1}	u_0	u_1	u_1
	n_1	u_{-1}	u_0	u_1	u_1	u_2
	n_2	u_0	u_0	u_1	u_2	u_2

The membership functions correspond with the linguistic values are shown below: Assume the fuzzy controller uses min method for implication, max method for aggregation and centroid for defuzzification, which is a common configuration of a Mamdani fuzzy controller. Then we have:

$$f_m = \min [M_i(x), N_j(\dot{x})] \text{ and } f_{ag} = \max [f_m]$$

According to the describing function in the chapter above, the frequency response function of the fuzzy controller in the form of (6.7-6.9).

In order to verify the result of the mathematical method, the experimental method is also employed with the structure as Fig.6.2.:

We can draw the both Nyquist plot with different A on the complex plane

In the Fig. 6.3. we can see that the result of mathematical method has perfectly matched the result of the experimental method.

In the previous work [Leephakpreeda 1997, Kim 2000, Xing 1996], an extended Nyquist plot of $H(A, \omega) \& \frac{1}{G(\omega j)}$ or $G(\omega j) \& \frac{1}{H(A, \omega)}$ will be then generated to predict the existence

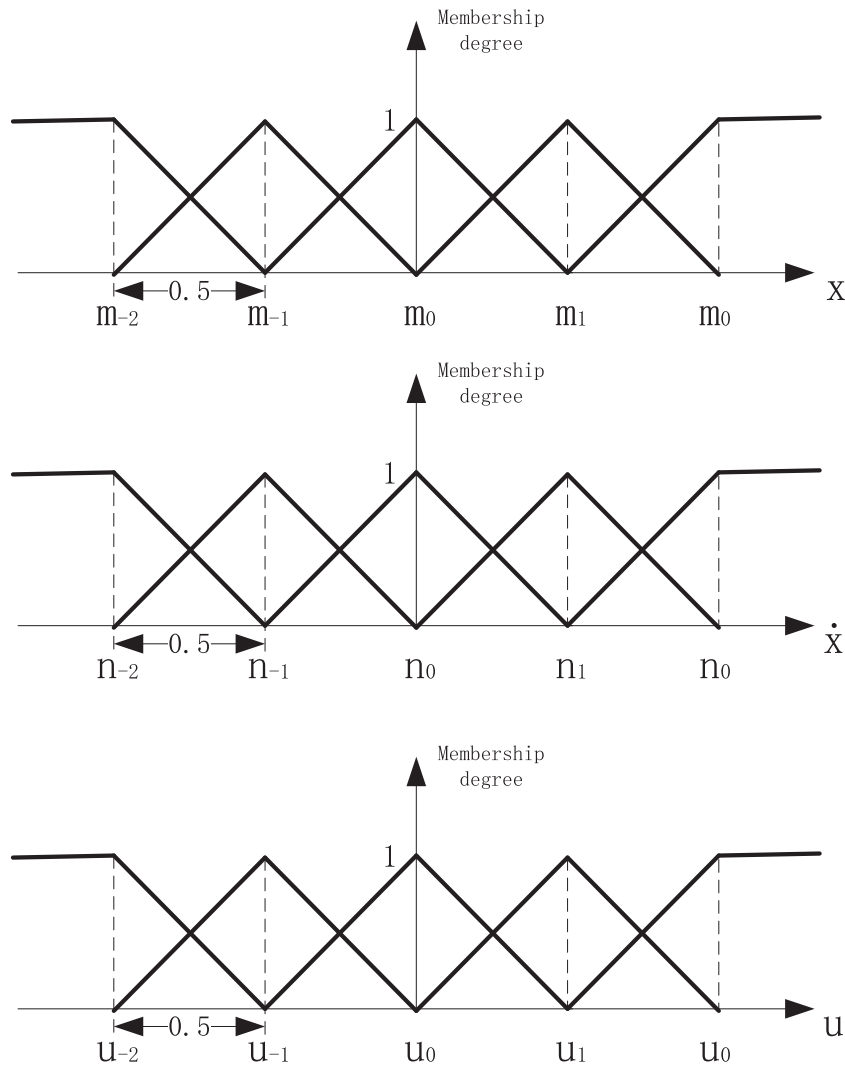


Figure 6.1: Membership functions of fuzzy controller

of the limit circle.

From the figure above we can easily tell that the describing function has no pole not to mention the pole on the right part of the complex plane.

Proof: Assume that there exist a pole K , so $(s - K)$ is one of the factors of the denominator of the transfer function. And $(\omega j - K)$ is one of the factors of the denominator of the frequency respond function. When $(\omega j - K) \rightarrow 0$, the amplitude of the output is $\rightarrow 0$ But according to the output function, a_1 and b_1 are two integrals on the limited interval, so the output is limited, so there doesn't exist a pole.

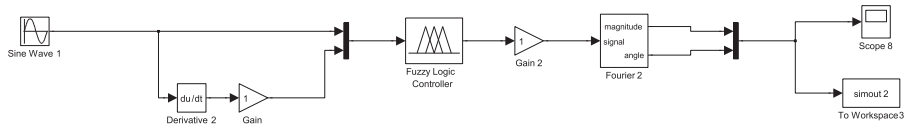


Figure 6.2: Structure for experimental verification of the describing function

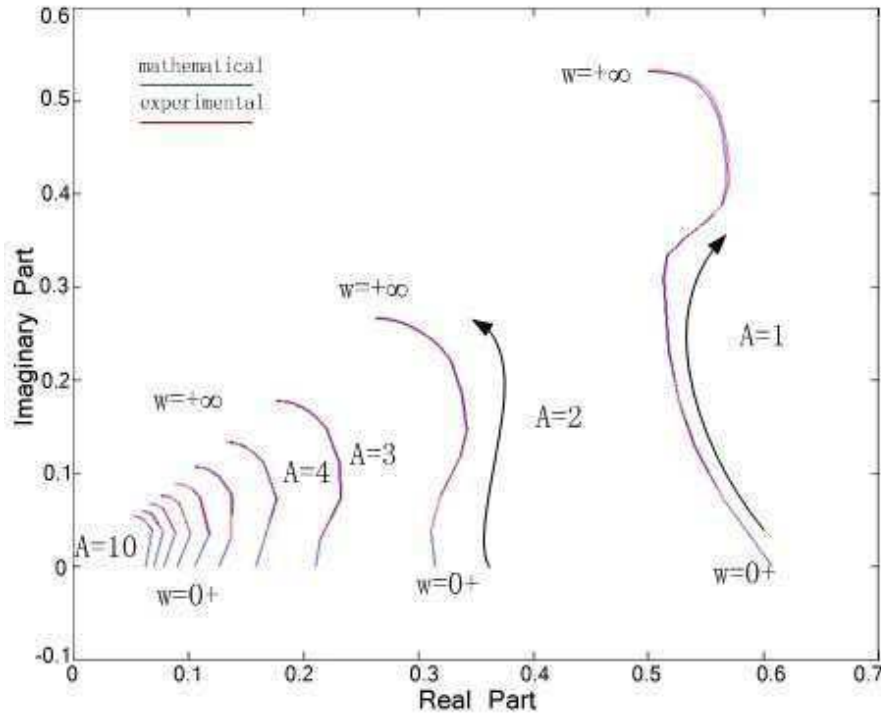


Figure 6.3: Extended Nyquist plot of $H(A, \omega)G(\omega)$ with delay increasing

6.2.4 Describing function for Takagi-Sugeno (T-S) fuzzy controller

The difference between a Mamdani FLC and a T-S FLC is that in the T-S FLC, the reasoning results of the rules is represented by linear functions:

$$R_{i,j}: \text{ If } x \text{ is } m_i \text{ and } \dot{x} \text{ is } n_j, \text{ then } u \text{ is } u_{i,j} = a_{i,j} \times x + b_{i,j} \dot{x} + c_{i,j}$$

In the T-S FLC, the process of implication and aggregation are overlapped. The output function of the T-S type fuzzy controller is:

$$\hat{U}(x, \dot{x}) = \frac{\sum_i \sum_j [f_m(M_i(x), N_j(\dot{x}))u_{i,j}(x, \dot{x})]}{\sum_i \sum_j f_m(M_i(x), N_j(\dot{x}))} \quad (6.10)$$

In which $f_m(M_i(x), N_j(\dot{x})) = \min[M_i(x), N_j(\dot{x})]$ if min operation is employed.

For the same reason, we can have the transfer function of the T-S fuzzy controller.

6.3 Stability & performance analysis

Since whether there exists a limit circle of the system is a little complicate to decide, we can draw the Nyquist plot of the open loop transfer function and use the Nyquist stability criterion to analyze the system.

We take the fuzzy controller in the last section as an example and assume the object system is $f(s) = \frac{1}{s(s+1)}$, According to the discussion above, if the winding-number of the Nyquist plot of $H(A, \omega)G(\omega)$ around the point $(-1, j)$ is 0, the system is stable.

On the other hand, the stability margin can be read from the Nyquist plot. From the stability margin, we can also balance the stability and the respond speed of the system by modifying the parameters of the system, or even the fuzzy controller. For a servo system, the phase margin is better to be more than 40 degree while the gain margin be more than 10-20dB. Either little or too wide the margin will cause the performance degradation to the system.

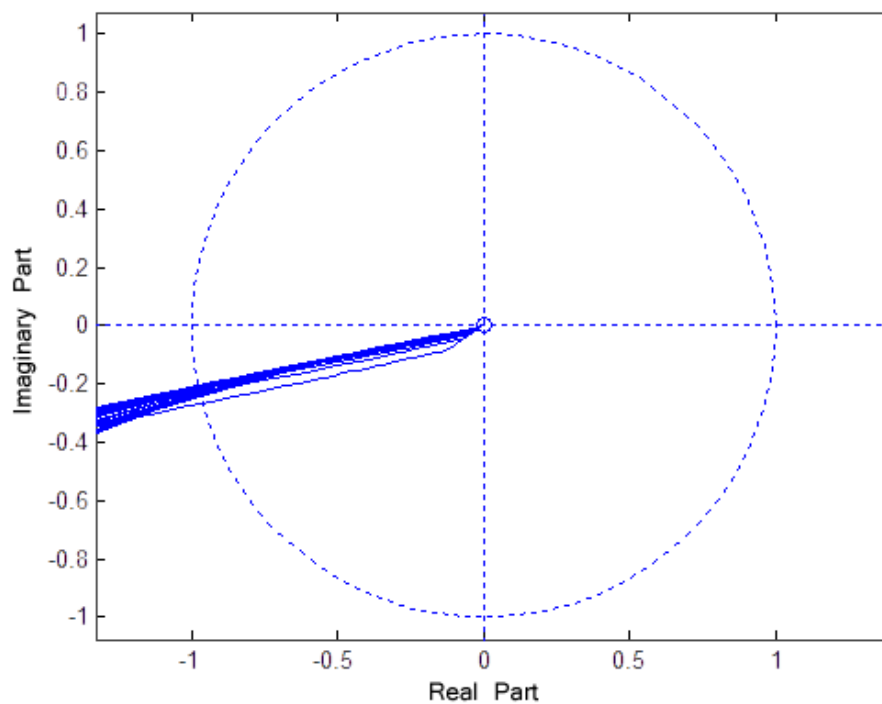


Figure 6.4: Extended Nyquist plot of $H(A, \omega)G(\omega)$ with different $A(1-10)$

Next, we are going to consider the fuzzy control system with transmission delay. The influence of the delay to the frequency respond function is expressed on the phase angle. Assume that the frequency respond function is $H(\omega) = A(\omega)e^{j\varphi(\omega)}$, then the frequency

response function with delay is shown as followed:

$$H(\omega) = A(\omega) e^{j[\varphi(\omega) - \tau\omega]} \quad (6.11)$$

In which τ refers to the system delay.

The delay of the system generally causes a counter clockwise rotation around the original point on the Nyquist plot. The effect of the delay is obvious on the plot Nyquist.

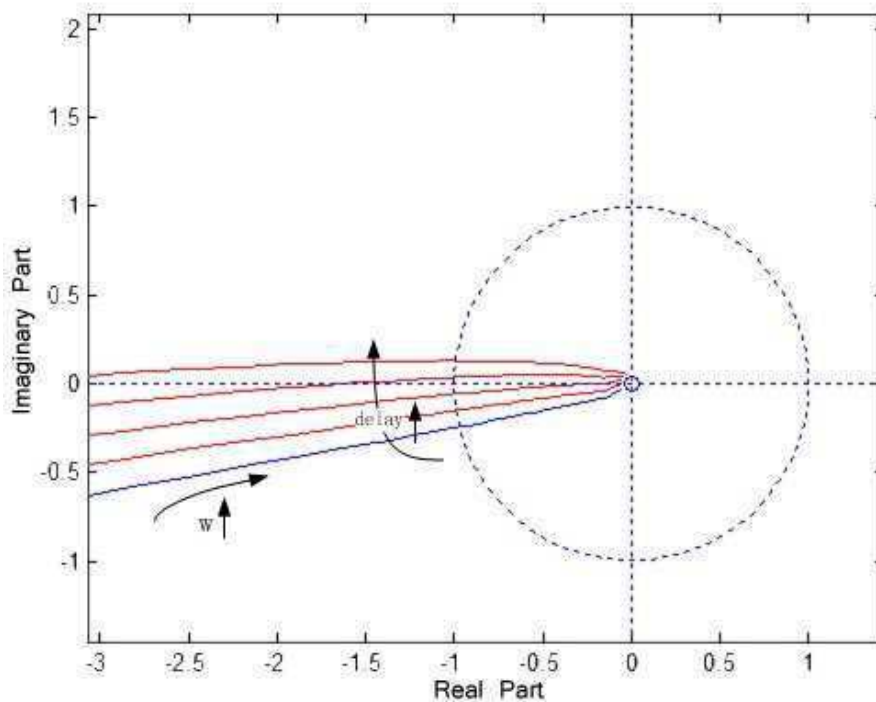


Figure 6.5: Extended Nyquist plot of $H(A, \omega)G(\omega)$ with delay increasing

As the delay increases, the Nyquist plot makes a counter clockwise rotation, then the plot goes around the point $(-1, j)$, which makes the system unstable. Even if the delay doesn't make the plot go around $(-1, j)$, the gain margin and the phase margin is reduced, so the performance of the system degrades. See figure 6.5

6.4 Example in the research of intelligent vehicle control

[Zhao 2010a] has provided a multi-model fuzzy control system for the lateral control of intelligent vehicle. In order to fulfill the lateral control under different speed of the

vehicle on the highway, the author provided a mixed-4-fuzzy controller for different speed regimes, and then merges them with a series of weighting functions. The multi-model fuzzy controller is shown in the followed: Remarks: if the frequency respond function of

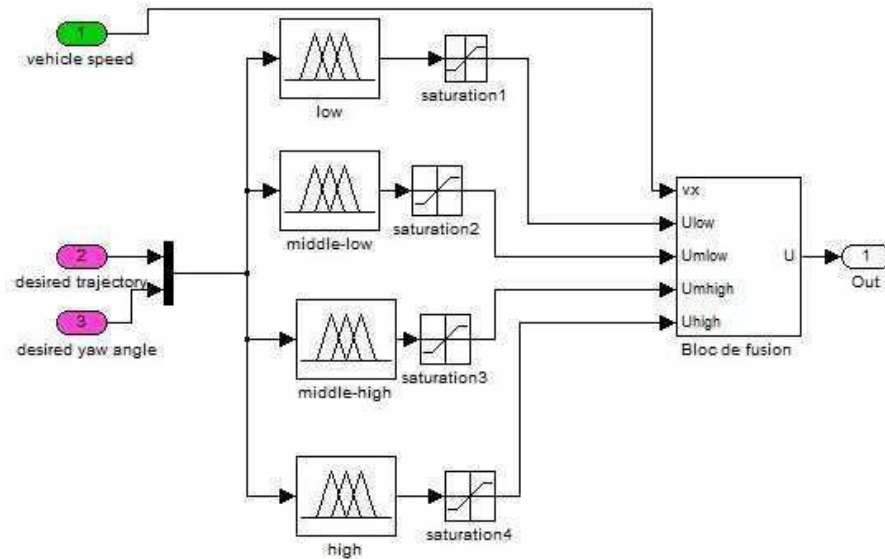
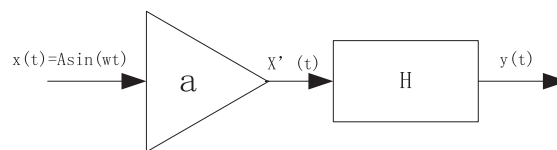


Figure 6.6: Multi-model fuzzy controller of intelligent vehicle in [Zhao 2010b]

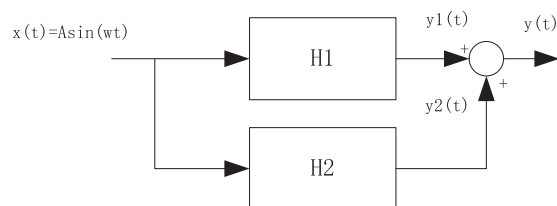
the plant is $H(A, \omega)$, then the following frequency respond function will be tenable:

1. The frequency respond function for



is $a \times H(A, \omega)$

2. The frequency respond function for



is $H_1(A, \omega) + H_2(A, \omega)$

Proof: 1. According to the block diagram of the plant, we have:

$$x'(t) = ax(t)$$

So the frequency respond function $H'(A, \omega) = \frac{F(y(t))}{F(x(t))} = \frac{F(ax(t))}{F(x(t))} = a \times H(A, \omega)$

2. According to the block diagram of the plant, the frequency respond function

$$\begin{aligned} H'(A, \omega) &= \frac{F(y(t))}{F(x(t))} = \frac{F(y_1(t) + y_2(t))}{F(x(t))} \\ &= H_1(A, \omega) + H_2(A, \omega) \end{aligned} \quad (6.12)$$

So, assume that the describing function for the four fuzzy controllers are $H_{low}(A, \omega)$, $H_{mlow}(A, \omega)$, $H_{mhigh}(A, \omega)$ and $H_{high}(A, \omega)$. According to the reference, the describing function of the controller is:

$$\begin{aligned} H(A, \omega) &= H_{low}(A, \omega) \times \text{sat}\left(\frac{v - v_2}{v_1 - v_2}\right) + \\ &H_{mlow}(A, \omega) \times \min\left(\text{sat}\left(\frac{v - v_1}{v_2 - v_1}\right), \text{sat}\left(\frac{v - v_4}{v_3 - v_4}\right)\right) \\ &+ H_{mhigh}(A, \omega) \times \min\left(\text{sat}\left(\frac{v - v_3}{v_4 - v_3}\right), \text{sat}\left(\frac{v - v_6}{v_5 - v_6}\right)\right) \\ &+ H_{high}(A, \omega) \times \text{sat}\left(\frac{v - v_5}{v_6 - v_5}\right) \end{aligned} \quad (6.13)$$

In which, function

$$\text{sat}(x) = \begin{cases} 0 & \text{if } x \leq 0 \\ 1 & \text{if } x \geq 1 \\ x & \text{else} \end{cases} \quad (6.14)$$

And v refers to the speed of vehicle, v_1 - v_6 are the boundaries of the operating speed regimes:

$$\begin{aligned} v_1 &= \frac{25}{3.6} \text{m/s}, v_2 = \frac{35}{3.6} \text{m/s}, v_3 = \frac{55}{3.6} \text{m/s}, v_4 = \frac{65}{3.6} \text{m/s}, \\ v_5 &= \frac{85}{3.6} \text{m/s}, v_6 = \frac{95}{3.6} \text{m/s}, \end{aligned}$$

Get the frequency respond function of each fuzzy controller as former told, the Nyquist plot for the open loop transfer function of the lateral control system is shown in the

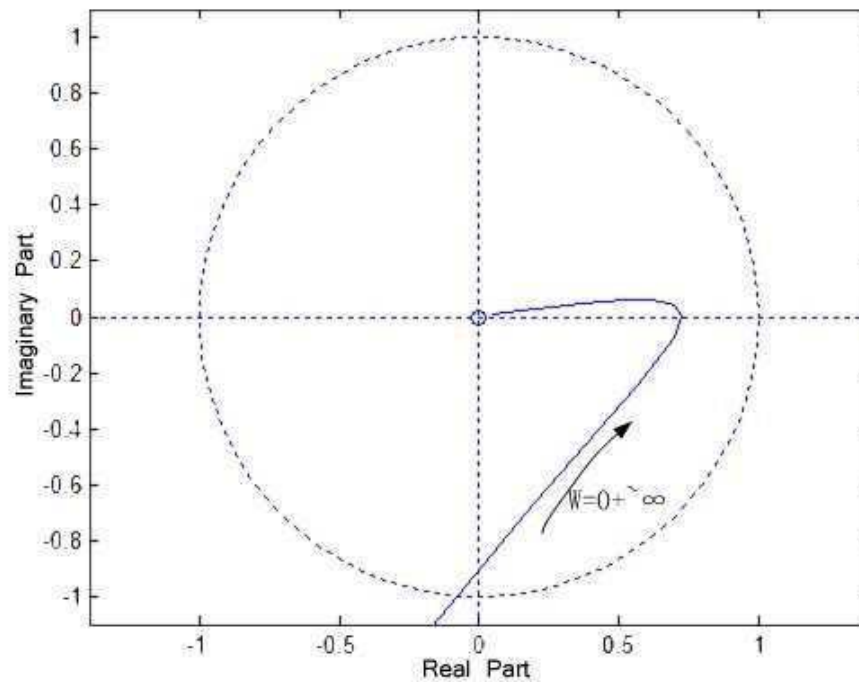
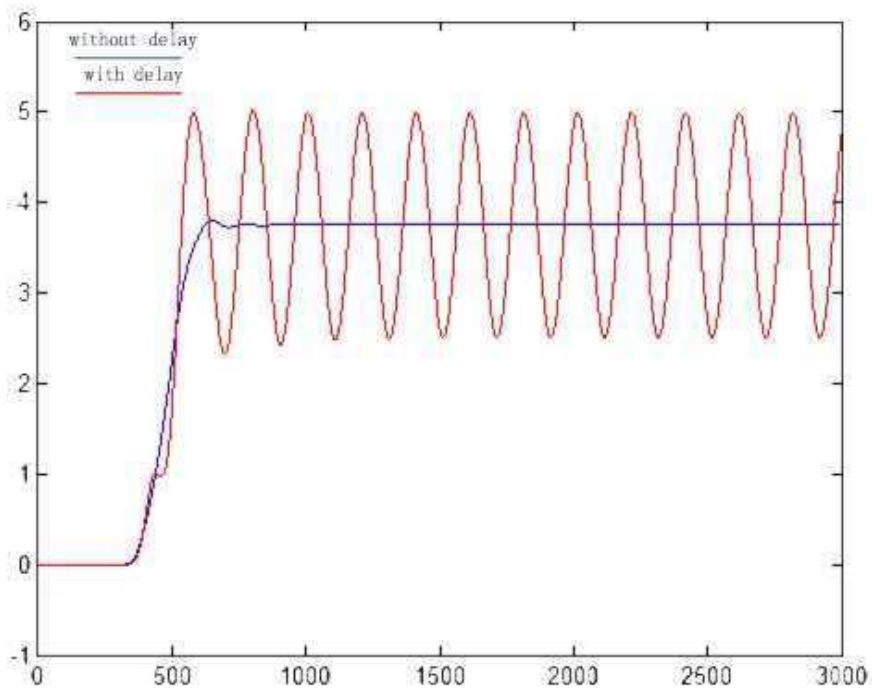


Figure 6.7: Extended Nyquist plot of the open loop response function of the lateral control system

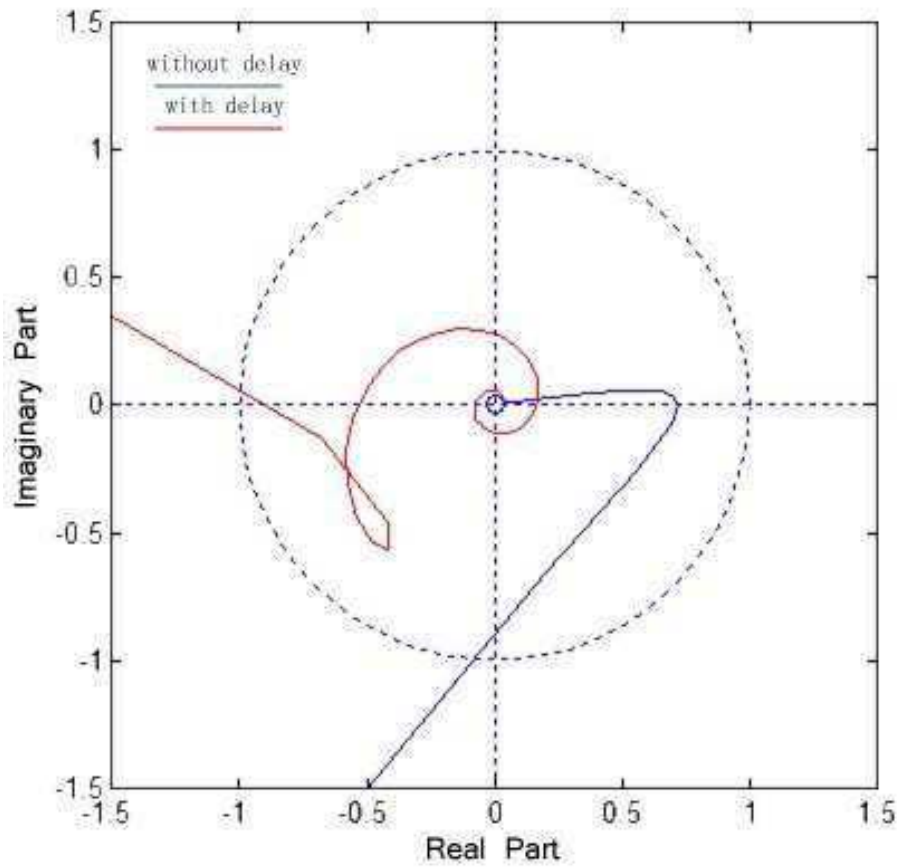
Fig.6.7: ($A = 1, v = 60$) If there exists a transmission delay between the controller and the vehicle, the Nyquist plot and the performance will be changed. The system becomes unstable and this will be reflected on the Nyquist plot.

6.5 Conclusion

In this chapter, the describing function of general Mamdani and Takagi-Sugeno (T-S) type fuzzy controller has been provided. The describing function for Mamdani type is various because of different reasoning methods and membership functions can be used in this type of fuzzy controller. Since the T-S type fuzzy controller uses a linear function for the reasoning results of every rule, the formation of the describing function of T-S type fuzzy controller is more stable. The result of the describing function is compared with the result coming from the experimental simulation, which performs well. The usage of the describing function is to analyze the frequency characteristics of the fuzzy controller, and the stability and performance of the whole system as well. Examples on the mixed-fuzzy controller of longitudinal control system of intelligent vehicles have been given to demonstrate how to apply in the real systems.



(a) step response



(b) root locus

Figure 6.8: System with delay becomes unstable

Conclusions and Perspective

Conclusions

This thesis is devoted to the reliability assessment of intelligent vehicles systems, with the main aim of resolving the traffic congestion and traffic safety problems. The whole document is structured around five themes:

1. Data reliability analysis of single-hop transmission of short range communication.
2. Node performance model for the nodes in the communication network is built to evaluate the QoS
3. An QoS-aware ad hoc protocol called NPDSR is proposed
4. Control performance degradation with the effects of transmission QoS on PID sampling control system
5. Describing function method for stability evaluation of fuzzy control system (Mamdani, T-S & multi-fuzzy control)

The main contributions of this thesis include the following:

- We take Bluetooth communication protocol on behalf of the short range communication systems extant. Three data protection methods are defined in Bluetooth transmission (1/3FEC (Forward Error Correcting), 2/3FEC and ARQ scheme). This chapter analyzed the effect of these three schemes in the two typical working method of Bluetooth, and the reliability of the data transmission is calculated. Also, the method to calculate transmission delay is introduced. [Zheng 2011]
- We analyzed the working mode of the wireless network working in the ARQ mode. A packet-oriented model and node-oriented model has been built to estimate the performance. As to the problem of the nodes' service time distribution, we gave three

typical types of assumptions to cover different network communications (exponential distribution, PH distribution and random distribution with semi-Markov process). The examples for each type have been provided, too. The result of the model provides the criteria of the network quality. With the help of the node performance model, the conditions of the network can be easily monitored by the node itself, thus the performance of the node can be predicted according to the status of the nodes, with this information we monitor the QoS (Quality of Service) of the whole network and made adjustment when it is necessary. For example, if we have monitor that a crucial node is suffering a rush hour of packet and we need to assure the quality of an important node-to-node path, we can enhance the signal power of the node, or change the queue length and attempting number, or even we can bypass this node accordingly. The energy and efficiency of the network will be saved. [Zheng 2013a, Zheng 2013c]

- An QoS-aware ad hoc protocol called NPDSR is proposed. Our protocol can guarantee the quality requirement of the transmission. Routing, update and maintenance process are discussed. A numerical example has been brought to demonstrate how the protocol works and how it can do to improve and guarantee the quality of service of the network. Our protocol is derived from DSR protocol but it has inherited the advantages of the DSR and optimized several disadvantages. [Zheng 2013c]
- We analyzed the data transmission problems of the wireless control system. The problem has been separated to two circumstances: delay and data loss. Time-fixed delay and the time-varying delay are both discussed using mathematical and statistical simulation method respectively. For the data loss, the performance degradation has been determined by the sampling points during the rising process. The result of this analysis is useful for the system designer to control the performance of the response to a tolerable extent and also, it is helpful for counteracting the influence of the communication problems during the use. For example, if the extension of the data delay can be determined, we can know that whether the system would be stable in the best or worst condition. The first several sampling points are so important, so we can try to think ways to make them successful like the retransmission scheme or appliance of compensation. Markov chain can be used to describe the degradation progress with the data loss, so the health condition of the system can be monitored. Threshold can be set to measure the possibility of failure which can be provided for the reliability engineers to evaluate the dependability of the system. [Zheng 2012]

-
- Describing function of general Mamdani and Takagi-Sugeno (T-S) type fuzzy controller is provided. The describing function for Mamdani type is various because of different reasoning methods and membership functions can be used in this type of fuzzy controller. Since the T-S type fuzzy controller uses a linear function for the reasoning results of every rule, the formation of the describing function of T-S type fuzzy controller is more stable. The result of the describing function is compared with the result coming from the experimental simulation, which performs well. The usage of the describing function is to analyze the frequency characteristics of the fuzzy controller, and the stability and performance of the whole system as well. Examples have been given on the multi-fuzzy controller of the previous work on the longitudinal control of intelligent vehicle to demonstrate how to apply in the real systems. [Zheng 2013b]

Perspective

Based on the results given by this thesis, several perspectives should be considered:

- For the single hop QoS analysis of short range communication, we have considered the data protection scheme which aim at making data arrives at destination correctly. But the other aspect of QoS was less paid attention that is the transmission time. Because there are different package preparing scheme and transmission schemes according to different protocols, such as the back-off scheme as we have discussed in the thesis, different Mac protocols causing the different size of packages would also influence the transmission delay. This kind of analysis requests very familiarity with different protocols and deep researching in the future.

Another problem with the initial connecting time is important in real application. The vehicles keep joining and leaving the network, there left only a short period time of window for them to exchange information, which is the same with the V2I communication. [Goonewardene 2011] have analyzed the connection states of Bluetooth communication and calculated the establishment time for Bluetooth connection. With the consideration of limited connection widow in the certain application scenario, the control strategy might have some change accordingly.

As the short range communication shares the frequency band, there is interference between them. Although DSRC protocol will using a higher frequency band 5.9Ghz, there still may have other interference from the noise and so on. The DSR

have schemes trying to minimize this kind of interference such as Bluetooth uses frequency-hopping spread spectrum. The transmitted data is divided into packets and each packet is transmitted on one of the 79 designated Bluetooth channels. This kind of scheme is difficult to model mathematically.

- The node performance model have been built theoretically with the numerical examples for different assumptions. However, there should be experimental prove to support the model. If the hardware conditions allows, the proof can be carried out in two aspects.
 1. Setup the transmission module with the assumptions of the model described in this thesis, the loss rate and transmission delay can be measured by the reception module can the source module. As to the service time distribution, is can be tested by repeating the send-receive experiment with the Monte-Carlo method.
 2. Using the network simulator software to model the network performance. There are several outstanding tools developed by different organization which are powerful in simulating network behavior, such as OPNET and NS2. The parameters and simulation result can be easily gathered by the program. Some details are going to be discussed lately.
- The network QoS with certain routing protocol is not only the delivering delay and packet arriving rate. There are also some other criterion to evaluate the efficiency and property of the routing protocol such as routing overhead, average routing time. Our protocol shows good ability in maintaining the performance of end-to-end transmission, but the other aspects were not deeply analyzed. Comparisons with other protocols and also by simulated using the network simulator by defining our own routing protocols.
- Dealing with the time-delay and data loss problems is an attractive topic in the field of automation science. Much works have been done for this. A complicated control strategy may be counterfeit the effects of imperfect transmission to a certain extent, but the complexity added to the system can be a burden to the system design. ITS control may also have its specialties in strategy. However, it is important and necessary to have future work on this topic and make sure the intelligent vehicle system is reliable enough to bring benefit to us human being.

Network Simulator

Network simulator can imitate the working of a network, predicts the behavior of the network either by calculating the interaction between the different network entities using mathematical formulas, or actually capturing and playing back observations from a production network. Without involving actual network hardware, researchers are able to modify various attributes of the network environment. Also, users can model the network devices, protocols, applications design and analyze the performance of the network.

There are several powerful network simulator software that have complicated modeling schemes, more complete model library and improved external interfaces. World widely used commercial network simulators such as OPNET [opnet] of Riverbed Technology and Netsim [net] from Tetcos company, they are capable of simulate various aspects of the network. They are GUI-based, integrated with debugging and analysis. They have complete model library with hundreds of protocols and vendor device model. However, getting these commercial software cost a big amount of money which is unnecessary for normal modeling.

NS is a kind of open-source network simulator software that requires input or commands. It uses object-oriented modeling method as the other software does. The first version of NS is developed was developed at Lawrence Berkeley National Laboratory on the base of REAL network simulator. The most popular and developed version which is the second version NS-2 is by UC Berkeley in 1996. Recently a third version has been developed to replace NS-2. The core of NS is always written in C++ but TCL, Object TCL and Python are used as scripting language for the simulation of scenarios in the three versions of NS respectively.

Since NS is open-source, it is free for user to change the code as wished. During the 15 years of developing of NS-2, there is a huge amount of contributed code that is not integrated directly into the main release. There are some tools may be worth noticing in the future work.

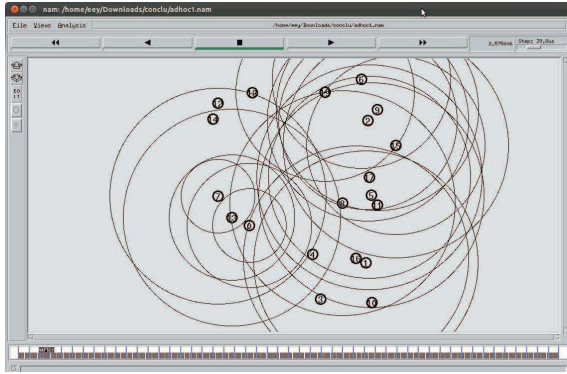
- BlueHoc [blu] simulator is a Bluetooth extension provided by IBM. It implements basic features of Bluetooth baseband, Logical Link Control and Adaptation Protocol (L2CAP) and Link Manager Protocol (LMP) specifications. Then a more recent Bluetooth simulator, UCBT [ucb] simulate Bluetooth property more accurately and completely. It adopts the Enhanced Data Rate (EDR) specification to simulate new devices with 2 or 3 Mbps data rate. Scatternet is consisted by piconet is supported also.

- PiccSim [Kohtamaki 2009], a graphical user interface with design tools for the network and control co-simulation platform. With this tool, NS-2 network model can synchronize with the control model in Simulink/Matlab by using interfaces for network and controller design during the simulation. A more accurate model for network control systems can be built too. It also provides an automatic network configuration script generation for the NS-2 network simulator [Pohjola 2009].

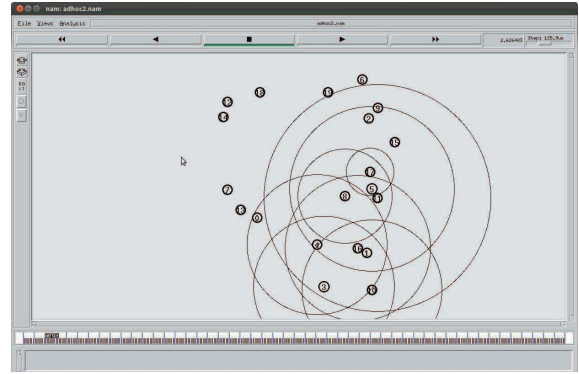
Previously talked subject of thorough evaluation for the routing protocols can also be done by the help of NS-2. At last an example — the comparison of routing overhead between AODV and DSR protocol using NS-2 will be provided.

The example is given by the general process of creating a simulation:

- Topology definition: NS-2 provides the generator for simulation scenes which includes motion scene generator "setdest" and traffic generator "cbrgen". Using the generator, we can easily get the scene file which contains the information of nodes' movement and network traffic during the simulation randomly. In this example, we create a scene $500m \times 500m$ filled with 20 randomly moved nodes. Random network traffic was generated too.
- Model usage: IEEE802.11 (Wi-Fi) communication model is used and the node capacity for maximum queue length is set to 100, transmission range is set to 50m. Propagation type was set to Two-ray ground reflection model which considers both the direct path and a ground reflection path and gives more accurate prediction at a long distance than the free space model [Fall 2011]. Different routing protocols are used for comparison (AODV,DSR).
- Execution: Simulations are done by executing the script file. NS-2 has a companion animation object called the Network Animator (NAM) used for visualization of the simulation output. NAM can present the simulation result of the scene by animation. The simulation compares the average end-to-end delay and the normalized routing overhead (number of routing packet transmitted per data packet) between AODV protocol and DSR protocol.
- Performance analysis: After the simulation is finished, every event during the simulation will be save in a trace file. The file is accessible with analyze tools. Usually an AWK script is used to extract the information for analysis. Moreover, a shell script can be compiled to perform a batch processing, and the result can be drawn with the graphical visualization tools such as Gnuplot or XGRAPH.

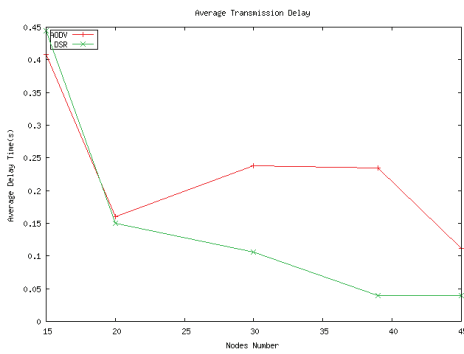


(a) AODV protocol routing process

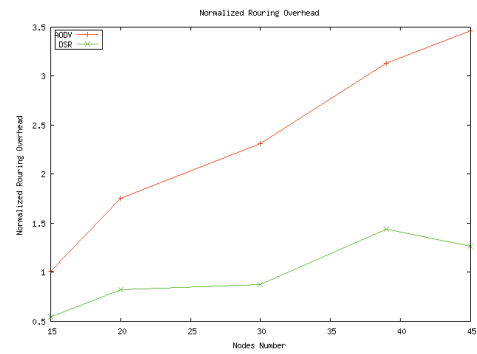


(b) DSR protocol routing process

Figure 1: NAM display for NS-2 simulation



(a) Average delay



(b) Normalized routing overhead

Figure 2: Graphical results

Résumé étendu en français

La recherche présentée dans cette thèse est axée sur l'évaluation de la fiabilité d'un système de véhicules intelligents. Avec le développement rapide de l'industrie automobile mondiale et de la population de véhicules et de conducteurs, notre société tend aujourd'hui à subir les embouteillages, la pollution, les accidents... Les scientifiques et les ingénieurs ont eu l'idée des systèmes de transport intelligents (ITS) traitant ces problèmes. Pendant la décennie dernière, des progrès ont été réalisés sur les véhicules intelligents communément appelés «véhicule sans conducteur». Plusieurs entreprises célèbres ont d'ores et déjà testé leurs véhicules sans conducteur sur route pouvant monter, pour certains, jusqu'à une vitesse de 130 kilomètres par heure sur autoroute. Ces véhicules utilisent une série de systèmes de capteurs installés à bord pour recueillir les informations de l'environnement afin de prendre des décisions de pilotage.

Une partie importante de l'ITS est l'interaction entre les véhicules et l'environnement souvent réalisée par une technologie de communication courte portée dédiée (DSRC). DSRC inclut les communications de V2V (véhicule à véhicule) et V2I (véhicule à infrastructure). Il s'agit d'une version de communication courte portée modifiée particulièrement adaptée pour l'automobile à grande vitesse. Des organismes de normalisation travaillent actuellement sur l'intégration des normes DSRC. Les recherches ont été effectuées en utilisant les systèmes de communication existants comme Bluetooth, Zigbee et Wi-Fi. Les véhicules sont le moyen de transport principal dans notre vie moderne et concernent la sécurité de vies humaines. Avant l'ITS devient réellement opérationnelle, l'assurance de la fiabilité du système est indispensable. Les communications jouent un rôle important et agissent comme que les «yeux» et les «oreilles» de l'ITS, donc la fiabilité de la communication est essentielle à la fiabilité du système entier. Nous étudierons la notion de qualité de service (QoS) du réseau et l'utilisation de retards et perte de données comme critères principaux de cette communication. La QoS entre deux nœuds et dans le réseau sera analysée. Un protocole de routage basé sur la fiabilité est également nécessaire. Enfin, avec une qualité de communication imparfaite, la performance de contrôle des véhicules

doit être prévisible ainsi les accidents peuvent être évités

- **La fiabilité des données**

Deux principaux critères sont pris en compte dans la fiabilité des données : délai de transmission et perte de données. La recherche dans ce sujet est souvent limitée à la fiabilité des données de communication à courte portée, mais s'attaque pas au mécanisme des protocoles spéciaux. Bien que les protocoles de communication à courte portée (Bluetooth, Zigbee et Wi-Fi) soient différents, ils ont quelques similitudes dans le régime de protection des données. Les trois protocoles appliquent toutes le FEC (Forward Error Correction) et le schéma CRC (Cyclic Redundancy Check) pour assurer que le paquet de données puisse arriver correctement. Il existe un autre schéma appelé ARQ (Automatic Repeat Request) utilisé dans les protocoles de contrôle de trafic. Tous ces schémas peuvent être considérés comme une méthode de contrôle de la fiabilité et être analysés dans le domaine de la fiabilité. Les véhicules construisent un réseau de communication et deux véhicules ne peuvent pas être reliés par un seul bond directement à cause de la limitation de la portée de transmission. Ainsi, les autres véhicules peuvent agir comme des routeurs pour relayer les informations et données. La fiabilité des données peut varier avec les conditions de trafic du réseau.

- **Effets sur les performances de contrôle**

L'ITS pilote le véhicule avec les informations recueillies du système de communication. Toute information incorrecte de l'environnement peut conduire directement à une mauvaise décision. Le délai de l'information peut causer une réponse lente qui rend le système dangereux. Mais l'information imparfaite ne met pas forcément en péril le pilotage. La qualité de service de communication peut être limitée et la dégradation des performances peut être prédite sur la base de la variation de la qualité de service de communication.

La thèse est essentiellement consacrée aux deux principaux critères précédents. La théorie de la redondance est utilisée dans l'analyse de la protection des données. La théorie des files d'attente avec le processus de Markov sont introduites pour la modélisation des performances du nœud de communication. Le processus semi-Markov est utilisé pour la modélisation d'un état plus général. Ensuite, un nouveau protocole de routage est proposé sur la base du modèle de performance nœud pour l'exigence de fiabilité de la communication. De plus, la thèse analyse les effets d'erreurs de communication sur un système

de régulation par PID en se focalisant, en particulier, sur la période d'échantillonnage. Pour le système de contrôle basé sur l'expertise et l'utilisation de contrôleurs flous, nous utilisons les fonctions descriptives pour analyser la stabilité du système avec délai. Une méthode adaptée aux contrôleurs multi-flous est fournie à la fin.

Organisation de la thèse

Chapitre 1 présente les systèmes de véhicules intelligents et l'évaluation de la fiabilité de l'ITS. D'abord, le développement actuel des véhicules sans conducteurs est introduit. Deuxièmement, nous présentons brièvement la communication à courte portée dédiée spécialement à l'ITS. La recherche de la fiabilité du système est aussi introduite. Ensuite, les modèles de qualité de service pour la communication en réseau sont proposés en détail. Enfin, certaines méthodes liées au contenu de cette thèse pour analyser les effets de la communication imparfaite sur les systèmes de contrôle sont mentionnées.

Dans le **Chapitre 2**, nous considérons le protocole Bluetooth comme un des systèmes de communication courte portée. Il y a trois méthodes de protection des données définies dans la transmission Bluetooth (1/3FEC (Forward Error Correction), 2/3FEC et schéma ARQ). Ce chapitre analyse l'effet de ces trois schémas dans les deux modes typiques de fonctionnement du Bluetooth. La fiabilité de la transmission des données est calculée. En outre, la méthode de calcul de délai de transmission est présentée.

Chapitre 3 analyse le mode du réseau sans fil utilisé dans le schéma ARQ. Un modèle paquet-orienté et un modèle nœud-orienté sont construits pour évaluer la performance. Pour le problème du temps de service du nœud, nous avons trois types de distributions typiques pour couvrir les différentes communications de réseau (la distribution exponentielle, la distribution de PH et la distribution aléatoire des processus semi-Markov). Des exemples de chaque type sont fournis. Les résultats des modèles fournissent les critères de qualité du réseau. Avec l'aide du modèle de performance nœud, les conditions du réseau peuvent être facilement contrôlées par le nœud, donc la performance du nœud peut être prédit basé sur l'état des nœuds. Avec ces informations nous surveillons la QoS du réseau entier et faisons l'ajustement lorsque il est nécessaire. Par exemple, si nous avons détecté qu'un nœud important souffre de congestion du paquet et nous avons besoin d'assurer la qualité d'un important chemin de nœud à nœud, nous pouvons améliorer la puissance du signal du nœud, ou changer la longueur de la file d'attente et le numéro, ou même,

proposer de contourner ce nœud en conséquence. L'énergie et l'efficacité du réseau seront économisées.

Basé sur le **Chapitre 3**, un protocole ad hoc QoS appelé NPDSR est proposé dans le **Chapitre 4**. Notre protocole peut garantir l'exigence de qualité de la transmission. Les problèmes de routage, de mise à jour et de maintenance sont discutés. Un exemple numérique est proposé pour démontrer comment le protocole fonctionne et ce qu'il peut apporter pour améliorer et garantir la qualité de service du réseau. Notre protocole est dérivé du protocole DSR mais hérite des avantages du DSR et optimise plusieurs aspects:

1. Dans le processus de découverte de routage, il compare les caractères de chemin avec le chemin caché précédent, les paquets RREQ sont abandonnés sélectivement. Ainsi, la retransmission du paquet RREQ est limitée et plus économe.

2. Les informations de chemin en cache est mise à jour par les nœuds intermédiaires sans coût de bande passante qui rendent le réseau plus efficace et le chemin cache vicié peut être effacé à temps.

Dans le **Chapter 5**, nous analysons les problèmes de transmission de données du système de commande sans fil. Le problème a été séparé en deux circonstances: retard et la perte de données. Le retard fixé et variant sont tous analysés en utilisant la méthode de simulation mathématique et statistique. Pour la perte de données, la dégradation des performances est déterminé par les points d'échantillonnage pendant le processus hausse. Les résultats sont utiles pour le concepteur du système pour contrôler les performances de la réponse, aussi, ils sont utiles pour contrecarrer l'influence des problèmes de communication.

Dans le **Chapter 6**, les fonctions descriptives de contrôleurs flou Mamdani et Takagi-Sugeno (T-S) sont fournies. La fonction descriptive de type Mamdani est différent en raison des différentes méthodes de raisonnement. En effet, le floue de type T-S utilise une fonction linéaire pour le raisonnement de chaque règle, la formation de la fonction descriptive du contrôleur T-S est plus stable. Le résultat de la fonction descriptive est comparé avec les résultats expérimentaux. L'objet de la fonction descriptive est d'analyser les caractéristiques de fréquence du contrôleur floue, ainsi que la stabilité et les performances du système. Des exemples sont donnés sur le contrôleur multi-flou des travaux antérieurs. Ce contrôleur est introduit pour le contrôle longitudinal du véhicule intelligent.

La Conclusion finale et les perspectives de travaux futurs sont présentées à la fin. Un simulateur réseau NS2 est introduit. NS2 est un simulateur open source utilisé partout dans le monde entier. Les utilisateurs peuvent modifier le code source et modifier les caractéristiques de ses modèles. Des nouveaux protocoles peuvent être ajoutés selon le souhait des utilisateurs tels que le Bluehoc développé par l'Inde Research Lab qui permet la simulation du modèle de communication Bluetooth. Un exemple pour comparer le routage du protocole AODV et DSR est fourni. Le NS2 est C-codé donnent la possibilité aux utilisateurs de développements secondaires, par exemple, le PiccSIM développé par l'Université Aalto est un co-simulateur composé par NS2 et Matlab. Avec PiccSIM on peut simuler les systèmes contrôlés en réseau d'une façon plus pratique.

Bibliography

- [Abdelzher 2004] T. Abdelzher, S. Prabh and R. Kiran. *On real-time capacity limits of multihop wireless sensor networks*. Proceedings 25th IEEE Real-Time Systems Symposium, pages 359–370, 2004.
- [Alit 1998] M. Alit, Z. Hou and M. Noori. *Stability and performance of feedback control systems with time delays*. Computer & Structures, vol. 66, no. 2-3, pages 241–248, 1998.
- [Aracil 2004] J. Aracil and F. Gordillo. *Describing function method for stability analysis of PD and PI fuzzy controllers*. Fuzzy Sets and Systems, vol. 143, pages 233–249, 2004.
- [Aron 2000] I. D. Aron and S. K. S. Gupta. *Analytical comparison of local and end-to-end error recovery for reactive protocols for mobile ad hoc networks*. 3rd ACM International Workshop on Modeling, Naalysis and Simulation of Wireless and Mobile Systems, pages 69–76, 2000.
- [Asnussen 1996] S. Asnussen, O. Nerman and M. Olsson. *Fitting phase-type distributions via the EM algorithm*. Scandinavian Journal of Statistics, vol. 23, no. 4, pages 419–441, 1996.
- [Audi 2012] Audi. *Reaffirmed Mission for Autonomous Audi TTS Pikes*. Audiusa.com, 2012.
- [Azaron1 2005] A. Azaron1 and M. Modarres. *Distribution function of the shortest path in networks of queues*. OR Spectrum, vol. 27, pages 123–144, 2005.
- [Baicheva 2000] T. Baicheva, S. Dodunekov and P. Kazakov. *Undetected error probability performance of cyclic redundancy-check codes of 16-bit redundancy*. IEEE Proceedings Communications, vol. 147, no. 5, pages 253–256, 2000.
- [Bardsley 2010] D. Bardsley. *From Europe to China with no driver*. The National, 2010.
- [BBC 2013] BBC. *Toyota sneak previews self-drive car ahead of tech show*. BBC News, 2013.
- [Bianchi 2000] G. Bianchi. *Performance analysis of the IEEE 802.11 distributed coordination function*. IEEE Transactions on Selected Areas in Communications, vol. 18, no. 3, pages 535–547, 2000.

- [Bisnik 2006] N. Bisnik and A. Abouzeid. *Queuing network models for delay analysis of multihop wireless ad hoc networks*. Proceedings of the 2006 international conference on Wireless communication and mobile computing, pages 773–778, 2006.
- [blu] <http://bluehoc.sourceforge.net/tutorial/docpage3.html#Ref1>.
- [Boukas 2006] E. K. Boukas and A. El-Hajjaji. *On stabilizability of stochastic fuzzy systems*. Proceedings of the 2006 American Control Conference, pages 4362–4366, 2006.
- [Bozorg 2006] M. Bozorg and E. Davison. *Control of time delay processes with uncertain delays: Time delay stability margins*. Journal of Process Control, vol. 16, pages 403–408, 2006.
- [Brandwajn 2009] A. Brandwajn and T. Begin. *A Note on the Effects of Service Time Distribution in the M/G/1 Queue*. Computer Performance Evaluation and Benchmarking, vol. 5419, pages 138–144, 2009.
- [Buchenscheit 2009] A. Buchenscheit, F. Schaub, F. Kargl and M. Weber. *Cooperative Adaptive Cruise Control: A Reinforcement Learning Approach*. IEEE Vehicular Networking Conference, pages 1–8, 2009.
- [Burchard 2006] A. Burchard, J. Liebeherr and S. Patek. *A min-plus calculus for end-to-end statistical service guarantees*. IEEE Transactions on Information Theory, vol. 52, no. 9, pages 4105–4114, 2006.
- [Cao 2000] Y. Cao and P. M. Frank. *Analysis and synthesis of nonlinear time-delay systems via fuzzy control approach*. IEEE Transactions on Fuzzy Systems, vol. 8, no. 2, pages 200–211, 2000.
- [Carfrae 2011] J. Carfrae. *An automated adventure at the wheel of a driverless BMW*. The National, 2011.
- [Chen 1993] G. Chen and H. Ying. *Stability analysis of nonlinear fuzzy PI control systems*. Industrial Fuzzy Control and Intelligent Systems, pages 128–133, 1993.
- [Chen 2000] G. Chen and T. T. Pham. Introduction to fuzzy sets, fuzzy logic, and fuzzy control systems. Numeéro illustrated edition. CRC Press Inc., 2000.
- [Chen 2004] L. Chen, R. Kapoor, M. Sanadidi and Mario Gerla. *Enhancing Bluetooth TCP Throughput via Link Layer Packet Adaptation*. Proc. IEEE International Conference on Communications, vol. 7, pages 4012–4016, 2004.
- [Chien 1999] C. Chien, M. B. Srivastava, R. Jain, P. Lettieri, V. Aggarwal and R. Sternowski. *Adaptive radio for multimedia wireless links*. Journal on Selected Areas in Communications, vol. 17, no. 5, pages 793–813, 1999.
- [CRC] *Cyclic redundancy check*.

-
- [Desjardins 2011] C. Desjardins and B. Chaib-draa. *Cooperative Adaptive Cruise Control: A Reinforcement Learning Approach*. IEEE Transactions on Intelligent Transportation Systems, vol. 12, no. 4, pages 1248–1260, 2011.
- [Dogan 2004] K. Dogan, G. Gurel, A. Kamci and I. Korpeoglu. *A Performance Analysis of Bluetooth Broadcasting scheme*. 2004.
- [Dorle 2010] S. S. Dorle, D. M. Deshpande, A. G. Keskar and M. Chakole. *Vehicle Classification and Communication Using Zigbee Protocol*. 3rd International Conference on Emerging Trends in Engineering and Technology (ICETET), pages 106–109, 2010.
- [Drew 2013] J. Drew. *Audi predicts self-driving cars by 2020*. leftlane.com, 2013.
- [Duggirala 2003] R. Duggirala, R. Gupsta, Q. Zeng and D.P. Agrawal. *Performance enhancements of ad hoc networks with localized route repair*. IEEE Transactions on Computers, vol. 52, no. 7, pages 854–861, 2003.
- [Eamsomboon 2008] P. Eamsomboon, K. Phongsak, A. G. Keskar and C. Mitrpant. *The Performance of Wi-Fi and Zigbee Networks for Inter-Vehicle Communication in Bangkok Metropolitan Area*. 8th International Conference on ITS Telecommunications, pages 408–411, 2008.
- [El-Hajjaji 2006] A. El-Hajjaji, M. Chadli, M. Oudghiri and O. Pages. *Observer-based robust fuzzy control for vehicle lateral dynamics*. Proceedings of the 2006 American Control Conference, pages 4664–4669, 2006.
- [Fall 2011] K. Fall. *The NS Manual*. http://www.isi.edu/nsnam/ns/doc/ns_doc.pdf, 2011.
- [Fehrenbacher 2010] K. Fehrenbacher. *Ford's "Talking Cars" Could Reduce Crashes, Fuel Use*. gigaom.com, 2010.
- [Fitchard 2012] K. Fitchard. *Ford is ready for the autonomous car. Are drivers?* gigaom.com, 2012.
- [Fuh 1997] C. Fuh and P. Tung. *Robust stability analysis of fuzzy control systems*. Fuzzy Sets and Systems, vol. 88, no. 3, pages 289–298, 1997.
- [Fujiwara 1985] T. Fujiwara, T. Kasami, A. Kitai and S. Lin. *On the Undetected Error Probability for Shortened Hamming Codes*. IEEE Transactions on Communications, vol. 33, no. 6, pages 287–292, 1985.
- [Ghostine 2011] R. Ghostine, J. Thiriet and J. Aubry. *Variable delays and message losses: Influence on the reliability of a control loop*. Reliability Engineering & System Safety, vol. 96, no. 1, pages 160–171, 2011.
- [Gong 2008] L. Gong, Y. Bai, M. Chen and D. Qian. *Link availability prediction in ad hoc networks*. 14th IEEE International Conference on Parallel and Distributed Systems, pages 423–428, 2008.

- [Goonewardene 2011] R. Goonewardene, A. Baburam, F.H. Ali and E. Stipidis. *Wireless Ad-hoc Networking for Intelligent Vehicles*. available on line:<http://www.ee.ucl.ac.uk/lcs/previous/LCS2002/LCS069.pdf>, 2011.
- [Gordillo 1997] F. Gordillo, J. Aracil and T. Alamo. *Determining limit cycles in fuzzy control systems*. FUZZ-IEEE'97, pages 193–198, 1997.
- [Gosar 2004] J. Gosar, W. Lee and R.K. Mehra. *On the statistical distribution of processing times in network intrusion detection*. 43rd IEEE Conference on Decision and Control, vol. 1, pages 297–314, 2004.
- [Group 2010] Bluetooth Special Interest Group. *Specification of the Bluetooth system: core package version: 4.0*, 2010.
- [Gu 2001] Y. Gu, H. Wang and K. Tanaka. *Fuzzy control of nonlinear time-delay systems: stability and design issues*. American Control Conference, vol. 6, pages 4771–4776, 2001.
- [Guizzo 2011] E. Guizzo. *How Google's Self-Driving Car Works*. IEEE Spectrum, 2011.
- [Gupta 2009] G.R. Gupta and N.B. Shroff. *Delay analysis for multi-hop wireless networks*. Proceedings INFOCOM, pages 2356–2364, 2009.
- [Hartenstein 2001] H. Hartenstein, B. Bochow, A. Ebner, M. Lott, M. Radimirsch and D. Vollmer. *Position-Aware Ad Hoc Wireless Networks for Inter-Vehicle Communications: the Fleetnet Project*. Proceeding on MobiHoc '01 Proceedings of the 2nd ACM international symposium on Mobile ad hoc networking & computing, pages 259–262, 2001.
- [Hazen 2001] G. Hazen. *Emergency warning system for vehicles*. United States Patent, Patent No. US6222461B1, 2001.
- [Hedd 2000] H. Hedd, J. Rioult, M. Cuvelier, S. Ambellouis, M. S. Venant and A. Rivenq. *Technical Evaluation of an Electronic Millimeter Wave Pre-View Mirror*. IEEE Vehicular Technology Conference, vol. 5, pages 2025–2032, 2000.
- [Hedd 2001] H. Hedd, J. Rioult, M. Klinger, A. Menhaj, and C. Gransart. *Microwave radio coverage for vehicle-to-vehicle and in-vehicle communication*. 8th World Congress on Intelligent Transport Systems, 2001.
- [Held 2007] G. Held. *Inter- and intra- vehicle communications*. Auerbach Publishers Inc., 2007.
- [Imera 2006] O. Imera, S. Yüksel and T. Basar. *Optimal control of LTI systems over unreliable communication links*. Automatica, vol. 42, pages 1429–1439, 2006.
- [Ishay 2002] E. Ishay. *Performance analysis of the IEEE 802.11 distributed coordination function*. PhD thesis, Technion Israel Institute of Technology, Israel, 2002.

-
- [Jang 2001] K. Jang, J. Park, T. Lee and Y. Kim. *Reliable Delivery of Broadcast Packet in Bluetooth*. IEEE Vehicular Technology Conference, pages 1119–1123, 2001.
- [Jiang 2005] S. Jiang, D. He and J. Rao. *A prediction-based link availability estimation for routing metrics in manets*. IEEE/ACM Transactions on Networking, vol. 13, no. 6, pages 1302–1312, 2005.
- [Johnson 2003] D. B. Johnson, D. A. Maltz and Y. Hu. *The Dynamic Source Routing Protocol for Mobile Ad Hoc Networks (DSR)*. IETF MANET Working Group INTERNET-DRAFT, 2003.
- [Jubin 1987] J. Jubin and J. Tornow. *The DARPA packet radio network protocols*. Proceedings of the IEEE, vol. 75, no. 1, pages 21–32, 1987.
- [Kendall 2008] D. G. Kendall. *Stochastic Processes Occurring in the Theory of Queues and their Analysis by the Method of the Imbedded Markov Chain*. The Annals of Mathematical Statistics, vol. 24, no. 3, 2008.
- [Kenny 2011] J. Kenny. *Dedicated Short-Range Communications (DSRC) Standards in the United States*. Proceedings of IEEE, vol. 99, no. 7, pages 1162–1182, 2011.
- [Khazaei 2009] M. Khazaei and R. Berangi. *A multi-path routing protocol with fault tolerance in mobile ad hoc networks*. 14th International CSI Computer Conference, pages 77–82, 2009.
- [Kim 2000] E. Kim, H. Lee and M. Park. *Limit-cycle prediction of a fuzzy control system based on describing function method*. IEEE Transactions on Fuzzy Systems, vol. 8, no. 1, pages 11–22, 2000.
- [Kim 2005] J. Kim, W. Han, W. Choi, Y. Hwang, T. Kim, J. Jang, J. Um and J. Lim. *Performance Analysis on Mobility of Ad-hoc Network for Inter-vehicle Communication*. Proceedings of the Fourth Annual ACIS International Conference on Computer and Information Science, pages 528–533, 2005.
- [Kohtamaki 2009] T. Kohtamaki, M. Pohjola, J. Brand and L.M. Eriksson. *PiccSIM Toolchain — Design, Simulation and Automatic Implementation of Wireless Networked Control Systems*. IEEE International Conference on Networking, Sensing and Control, pages 49–54, 2009.
- [Korhonen 2005] J. Korhonen and Y. Wang. *Effect of packet size on loss rate and delay in wireless links*. IEEE Wireless Communications and Networking Conference, vol. 3, pages 1608–1613, 2005.
- [Kuljaca 1999] K. Kuljaca, S. Tesnjak and Z. Vukie. *Describing function of Mamdani type fuzzy controller with input signals derived from single system input and singleton output membership functions*. Proceedings of the 1999 IEEE Hong Kong Symposium on Robotics and Control, vol. 1, pages 327–331, 1999.

- [Lam 2008] H.K. Lam and F. Leung. *Stability analysis of discrete-time fuzzy-model-based control systems with time delay: Time delay-independent approach*. Fuzzy Sets and Systems, vol. 159, pages 990–1000, 2008.
- [Langari 1991] R. Langari and M. Tomizuka. *An analysis of stability of a class of fuzzy linguistic controllers with internal dynamics*. Proceedings of American Society of Mechanical Engineers(ASME), 1991.
- [Lee 2001] S. Lee and M. Gerla. *Split multipath routing with maximally disjoint paths in ad hoc networks*. IEEE International Conference on Communication, vol. 10, pages 3201–3205, 2001.
- [Leephakpreeda 1997] T. Leephakpreeda and C. Batur. *Stability analysis of a fuzzy control system*. Thammasa International Journal of Science and Technology, vol. 2, no. 1, pages 1–5, 1997.
- [Leohold 2011] J. Leohold. *Driving without a driver - Volkswagen presents the "Temporary auto pilot"*. media.vw.com, 2011.
- [Leung-Yan-Cheong 1976] S. Leung-Yan-Cheong and M. Hellman. *Concerning a bound on undetected error probability*. IEEE Transactions on Information Theory, vol. 22, no. 2, pages 235–237, 1976.
- [Leung 2001] R. Leung, J. Liu, A.C. Chan and B. Li. *MP-DSR: A QoS-aware multipath dynamic source routing protocol for wireless ad-hoc networks*. 26th Annual IEEE International Conference on Local Computer Networks (LCN2001), pages 132–141, 2001.
- [Li 2004] X. Li and L. Cuthbert. *On-demand node-disjoint multipath routing in wireless ad hoc networks*. Proceedings of the 29th Annual IEEE International Conference on Local Computer Networks (LCN'04), pages 419–420, 2004.
- [Li 2010] Y. Li, W. Shao and J. Zhang. *Fuzzy grey fault tree analysis on diesel engine*. 7th International Conference on Fuzzy Systems and Knowledge Discovery, vol. 3, pages 1263–1267, 2010.
- [Liang 2006] J. Liang, Y. Li and Bin Yu. *Performance Analysis and Reliability Improvement of Bluetooth Broadcast Scheme*. 1st International Symposium on Pervasive Computing and Applications, pages 775–780, 2006.
- [Lin 2005] R. Lin and W. Chen. *Fast Calculation Algorithm of the Undetected Errors Probability of CRC Codes*. Proceedings of the 19th International Conference on Advanced Information Networking and Applications, vol. 2, pages 480–483, 2005.
- [Liu 2010] S. Liu and J. Liu. *Delay-aware Multipath source routing protocol to providing QoS support for wireless ad hoc networks*. 12th IEEE International Conference on Communication Technology, pages 1340–1343, 2010.

-
- [Malki 1994] H. A. Malki, H. Li and G. Chen. *New design and stability analysis of fuzzy proportional-derivative control systems*. IEEE Transactions on Fuzzy Systems, vol. 2, no. 4, pages 245–254, 1994.
- [Malone 2004] K. Malone and P. Eijkelenbergh. *A quick scan of quantified effects of advanced driver support systems: ADASE II Extension*. TNO Inro, 2004.
- [Markoff 2007] J. Markoff. *Crashes and Traffic Jams in Military Test of Robotic Vehicles*. New York Times, 2007.
- [Misener 2005] J. Misener, R. Sengupta and H. Krishnan. *Cooperative Collision Warning: Enabling Crash Avoidance with Wireless Technology*. 12th World Congress on ITS, vol. 3, pages 1–11, 2005.
- [Misir 1996] D. Misir, H. A. Malki and G. Chen. *Design and analysis of a fuzzy proportional-integral-derivative controller*. Fuzzy Sets and Systems, vol. 79, pages 297–314, 1996.
- [Modiano 1999] E. Modiano. *An adaptive algorithm for optimizing the packet size used in wireless ARQ protocols*. Wireless Networks, vol. 5, no. 4, pages 279–286, 1999.
- [Mogens 2005] B. Mogens. *A review on Phase-Type distributions and their use in risk theory*. Astin Bulletin, vol. 35, no. 1, pages 145–161, 2005.
- [net] http://tetcos.com/netsim_gen.html.
- [Okano 2008] R. Okano, T. Ohtani and A. Nagashima. *Networked Control Systems by PID Controller Improvement of Performance Degradation Caused by Packet loss*. 6th IEEE International Conference on Industrial Informatics, pages 1126–1132, 2008.
- [Oliver 2009] R. Oliver and G. Fohler. *Probabilistic estimation of end-to-end path latency in wireless sensor networks*. IEEE 6th International Conference on Mobile Adhoc and Sensor Systems, pages 423–431, 2009.
- [opnet] opnet. http://www.opnet.com/solutions/network_rd/modeler.html.
- [Perez 2004] L Perez and B. Corzilius. *Emergency warning system for vehicles*. United States Patent, Patent No. US6714127B2, 2004.
- [Perkins 1999] C. E. Perkins and E. M. Royer. *Ad-hoc on-demand distance vector routing*. Proceedings of Second IEEE Workshop on Mobile Computing Systems and Applications(WMCSA'99), pages 90–100, 1999.
- [Pohjola 2009] M. Pohjola and S. Nethi. *PiccSIM Manual*. <http://autsys.aalto.fi/en/attach/Control/PiccSIM%20Manual.pdf>, 2009.
- [Precup 2009] R. Precup, M.L.Tomescu and St. Preitl. *Fuzzy logic control system stability analysis based on Lyapunov's direct method*. International Journal of Computers, Communications and Control, vol. 4, no. 4, pages 415–426, 2009.

- [Richard 2003] J-P. Richard. *Time-delay systems:an overview of some recent advances and open problems*. Automatica, vol. 39, pages 1667–1694, 2003.
- [Riska 2002] A. Riska, V. Diev and E. Smirni. *Efficient fitting of long-tailed data sets into phase-type distributions*. ACM SIGMETRICS Performance Evaluation Review, vol. 30, no. 3, pages 6–8, 2002.
- [Royer 1999] E. M. Royer and C. K. Toh. *A review of current routing protocols for ad hoc mobile wireless networks*. IEEE Personal Communications, vol. 6, no. 2, pages 46–55, 1999.
- [Russell 2006] S. Russell. *DARPA Grand Challenge Winner: Stanley the Robot!* Popular Mechanics, 2006.
- [Sadjadi 2003] B. Sadjadi. *Stability of Networked Control Systems in the Presence of Packet Losses*. 42nd IEEE Conference on Decision and Control, vol. 1, pages 676–681, 2003.
- [Sakurai 2007] T. Sakurai and H. Vu. *MAC access delay of IEEE 802.11 DCF*. IEEE Transactions on Wireless Communication, vol. 6, no. 5, pages 1702–1710, 2007.
- [Sengul 2006] C. Sengul and R. Kravets. *Bypass routing: an on-demand local recovery protocol for ad hoc networks*. Ad Hoc Networks, vol. 4, pages 380–397, 2006.
- [Shortle 2002] J. F. Shortle, J. F. Fischer and M. J. Masi. *An algorithm to compute the waiting time distribution for M/G/1 queue*. INFORMS Journal on Computing, vol. 16, no. 2, pages 152–161, 2002.
- [Sijak 2001] T. Sijak, S. Tesnjak and O. Kuljaca. *Stability analysis of fuzzy control system using describing function method*. 9th Mediterranean Conferene on Control and Automation (MED’01), 2001.
- [Sijak 2005] T. Sijak, O. Kuljaca, R. Antonic and L. Kuljaca. *Analytical determination of describing function of nonlinear element with fuzzy logic*. IEEE International Symposium on Industrial Electronics, vol. 1, pages 75–80, 2005.
- [Sinha 1999] P. Sinha, R. Sivakumar and V. Bharghavan. *CEDAR, a core extraction distributed as hoc routing algorithm*. IEEE Journal on Selected Areas in Communication, vol. 17, no. 8, pages 1454–1465, 1999.
- [Sio 1998] K. C. Sio and C. K. Lee. *On the statistical distribution of processing times in network intrusion detection*. 43rd IEEE Conference on Decision and Control, vol. 28, no. 4, pages 490–495, 1998.
- [Society 1991] IEEE Computer Society. *IEEE Standard Computer Dictionary. A Compilation of IEEE Standard Computer Glossaries*. E-ISBN:0-7381-4768-0, <http://ieeexplore.ieee.org/servlet/opac?punumber=2267>, page 170, 1991.

-
- [Spohn 2001] M. Spohn, J. J. Kuljaca, R. Antonic and L. Kuljaca. *Neighborhood aware source routing*. Proceedings of the 2nd ACM International Symposium on Mobile Ad Hoc Networking and Computing (MobiHoc), pages 11–21, 2001.
- [Stephen 2013] E. Stephen. *BMW Targets 2020 for Self-Driving Cars*. autoguide.com, 2013.
- [Su 1999] W. Su and M. Gerla. *IPv6 flow handoff in ad hoc wireless networks using mobility prediction*. Proceedings of IEEE GLOBECOM, pages 271–275, 1999.
- [Sun 2010] Y.H. Sun, H. Wang and K. Tanaka. *Practical realization of ad hoc network based on DSR protocol considering QoS for multimedia service*. Second International conference on Multimedia and Information Technology, vol. 2, pages 6–9, 2010.
- [Takagi 1985] T. Takagi and M. Sugeno. *Fuzzy identification of systems and its applications to modeling and control*. IEEE Transactions on Systems, Man, and Cybernetics, vol. SMC-15, no. 1, pages 116–132, 1985.
- [Tanaka 1993] K. Tanaka and M. Sano. *Concept of stability margin for fuzzy systems and design of robust fuzzy controllers*. Proceedings of 2nd International Conference on Fuzzy Systems, pages 29–34, 1993.
- [Tickoo 2008] O. Tickoo and B. Sikdar. *Modeling queueing and channel access delay in unsaturated IEEE 802.11 random access MAC based wireless networks*. IEEE/ACM Transactions on Networking, vol. 16, no. 4, pages 878–891, 2008.
- [Tomescu 2007] M. L. Tomescu, S. Preitl, R. Precup and J.K. Tar. *Stability analysis method for fuzzy control systems dedicated controlling nonlinear processes*. Acta Polytechnica Hungarica, vol. 4, no. 3, pages 127–141, 2007.
- [ucb] <http://www.cs.uc.edu/~cdmc/ucbt/>.
- [Vachtsevanos 2006] G. Vachtsevanos, F. L. Lewis, M. Roemer, A Hess and B. Wu. *Intelligent fault diagnosis and prognosis for engineering systems*. John Wiley & Sons Inc, 2006.
- [Wang 2004] R. J. Wang, W. W. Lin and W.J Wang. *Stabilizability of linear quadratic state feedback for uncertain fuzzy time-delay systems*. Transactions on Systems, Man, and Cybernetics-Part B: Cybernetics, vol. 34, no. 2, pages 1288–1292, 2004.
- [Wang 2012] Y. Wang, M.C. Vuran and S. Goddard. *Cross-Layer Analysis of the End-to-End Delay Distribution in Wireless Sensor Networks*. IEEE/ACM Transactions on Networking, vol. 20, no. 1, pages 305–318, 2012.
- [Wolf 1988] J. Wolf and R. Blakenry. *An Exact Evaluation of the Probability of Undetected Error for Certain Shortened Binary CRC Codes*. Military Communications Conference, vol. 1, pages 287–292, 1988.

- [Wolf 2006] J. Wolf, A. Michelson and A. Levesque. *On the probability of Undetected Error for Undetected Error for Linear Block Codes*. IEEE International Conference on Communications, vol. 30, no. 2, pages 317–325, 2006.
- [Wu 2001] K. Wu and J. Harms. *On demand multipath routing for mobile ad hoc networks*. 4th European Personal Mobile Communications Conference(EPMCC'001), pages 1–7, 2001.
- [Xing 1996] J. Xing, Z. Shi and G. Dai. *Using describing function to analyze wriggling phenomenon of fuzzy control systems*. Proceedings of the Fifth IEEE International Conference on Fuzzy Systems, vol. 2, pages 8–11, 1996.
- [Xiu 2004] Z. Xiu and G. Ren. *Stability Analysis and Systematic Design of T-S Fuzzy Control Systems*. Fuzzy Sets and Systems, vol. 151, no. 1, pages 119–138, 2004.
- [Xu 2006] S. Xu, B. Xu and D. Peng. *The waiting time distribution of a Pereto service self-similar queuing model for wireless network nodes*. International Conference on Wireless Communications Networking and Mobile Computing, no. 1, pages 1–3, 2006.
- [Yu 2004] M. Yu, L. Wang, T. Chu and G. Xie. *Stabilization of Networked Control Systems with Data PacketDropout and Network Delays via Switching System pproach*. 43rd IEEE Conference on Decision and Control, 2004.
- [Zhai 2004] H. Zhai, Y. Kwpm and Y. Fang. *Performance analysis of IEEE 802.11 MAC protocols in wireless LANs*. Wireless Communication & Mobile Computing, vol. 4, pages 917–931, 2004.
- [Zhao 2002] J. Zhao. *Contribution to Intelligent Vehicle Platoon Control*. PhD thesis, Ecole Central de Lille, Lille France, 2002.
- [Zhao 2010a] J. Zhao. *Contribution to Intelligent Vehicle Platoon Control*. PhD thesis, Ecole Central de Lille, Lille France, 2010.
- [Zhao 2010b] J. Zhao and A. EL Kamel. *Coordinated throttle and brake fuzzy controller design for vehicle following*. 13th International IEEE Conference on Intelligent Transportation Systems (ITSC), pages 659–664, 2010.
- [Zheng 2011] T. Zheng, S. Wang and A. El Kamel. *Bluetooth communication reliability of mobile vehicles*. International Conference on Fluid Power and Mechatronics, page 873, 2011.
- [Zheng 2012] T. Zheng, A. El Kamel and S. Wang. *Control performance degradation in the sampling control system considering data delay and loss*. Proceeding of IEEE International Conference on Computational Engineering and Scientific Applications, pages 215–221, 2012.
- [Zheng 2013a] T. Zheng, A. El Kamel and S. Wang. *Data Loss and Delay Distribution of Wireless Sensor Networks*. IEEE Asia Control Conference, 2013.

-
- [Zheng 2013b] T. Zheng, A. El Kamel and S. Wang. *Performance Analysis of Fuzzy Controller with Delay*. The 8th IEEE Conference on Industrial Electronics and Applications, pages 794–799, 2013.
- [Zheng 2013c] T. Zheng, A. El Kamel and S. Wang. *An QoS-aware ad hoc protocol based on node performance model*. Reliability Engineering & System Safty (submitted), 2013.

Analyse de Fiabilité et de performance d'un Système de Véhicules Intelligents

Résumé: Cette thèse est consacrée à l'évaluation de la fiabilité d'une caravane de véhicules intelligents avec les principaux objectifs de fournir une méthode pour évaluer et améliorer la sécurité des ITS. Après examen de l'évolution des ITS et DSRC, la fiabilité/qualité de service (QoS) de transmission de bout-en-bout des communications courtes est analysée. Ensuite, les effets de la transmission et QoS sur le système de commande PID et flou sont étudiés respectivement.

D'abord, nous considérons le protocole Bluetooth comme un des systèmes de communication avec courte portée. Les méthodes de protection des données utilisées dans les communications de courte portée sont analysées en termes de fiabilité. D'un point de vue réseau, un modèle de performance du nœud est construit pour les différentes distributions de temps de service du nœud. Ainsi, chaque nœud dans le réseau peut surveiller directement la qualité de service du nœud à tout moment. Basé sur ce modèle, un protocole de routage ad hoc (NPDSR) est proposé. Les problèmes de routage, de mise à jour et de maintenance sont discutés. Ce protocole présente les avantages de maintenir la qualité de service requise de la communication, et des économies de routage.

Deuxièmement, les effets sur les systèmes de contrôle, en termes de retards de temps fixe, et temps variable et de pertes, sont analysés en utilisant la méthode de simulation mathématique et statistique. Des fonctions descriptives pour les contrôleurs flous de types Mamdani et T-S sont fournies, et la stabilité du contrôleur multi-flou avec un retard de communication est analysée à l'aide des lieux de Nyquist.

Enfin, en perspective, l'utilisation possible de NS-2 sur le modèle de simulation et de vérification est discutée, ce qui s'avère intéressant pour simuler des protocoles différents. En outre, il peut être connecté avec Simulink permettant une meilleure analyse de performances des systèmes de contrôle en réseau.

Mots-clés: Véhicule intelligent, Fiabilité, Qualité de Service, Performance de nœud, Modèle de Markov, Contrôleur flou.

Reliability Assessment for Intelligent Vehicles System

Abstract: This PhD thesis is dedicated to the reliability assessment for intelligent vehicles platoon with the main aim of providing an approach to evaluate and enhance the safety of ITS. After a review of developments of ITS and DSRC, the reliability/QoS of end-to-end transmission of short range communication is analyzed. Then, the effects of transmission QoS on PID sampling control system and fuzzy control system are studied respectively.

At first, we consider Bluetooth communication protocol on behalf of the short range communication systems extant. The data protection methods used in short range communication are analyzed for the data reliability. From the point view of network, a node performance model is built, suitable for different distributions of service time of the node. Hence, a node in the network can monitor the QoS of the node by itself at any time. Based on this model, a QoS-aware ad hoc routing protocol (NPDSR) is proposed. Routing, updating and maintenance processes are discussed. This protocol has the advantages in maintaining requested QoS of communication, and it has less routing overhead.

Secondly, for the effects on the control systems and fuzzy control, time-fixed delay, time-varying delay and loss are both discussed using mathematical and statistical simulation methods. Describing functions for both Mamdani and T-S type fuzzy controllers are provided, the stability of multi-fuzzy controller with communication delay is analyzed using Nyquist stability plots.

Finally, in the perspective, the possible use of NS-2 on the model simulation and verification has been discussed, which is powerful in simulating different behavior of protocols, routing protocol comparisons. Also, it can be connected with Simulink to enhance performance the simulation of network control systems.

Keywords: Intelligent vehicle, Reliability, Quality of Service, Node performance, Markov model, Fuzzy controller.