



HAL
open science

Interacting partially directed self-avoiding walk

Gia Bao Nguyen

► **To cite this version:**

Gia Bao Nguyen. Interacting partially directed self-avoiding walk. Probability [math.PR]. Université de Nantes, 2013. English. NNT: . tel-00876122

HAL Id: tel-00876122

<https://theses.hal.science/tel-00876122>

Submitted on 24 Oct 2013

HAL is a multi-disciplinary open access archive for the deposit and dissemination of scientific research documents, whether they are published or not. The documents may come from teaching and research institutions in France or abroad, or from public or private research centers.

L'archive ouverte pluridisciplinaire **HAL**, est destinée au dépôt et à la diffusion de documents scientifiques de niveau recherche, publiés ou non, émanant des établissements d'enseignement et de recherche français ou étrangers, des laboratoires publics ou privés.

Thèse de Doctorat

Gia Bao NGUYEN

*Mémoire présenté en vue de l'obtention du
grade de Docteur de l'Université de Nantes
sous le label de l'Université de Nantes Angers Le Mans*

École doctorale : Sciences et technologies de l'information, et mathématiques

Discipline : Mathématiques et applications, section CNU 26

Unité de recherche : Laboratoire de Mathématiques Jean Leray (LMJL)

Soutenue le 17 octobre 2013

Thèse n° : ...

Marche aléatoire auto-évitante en auto-interaction

JURY

- Président : **M. Giambattista GIACOMIN**, Professeur, Université Paris Diderot
- Rapporteurs : **M. Vincent BEFFARA**, Chargé de Recherche, ENS Lyon
M. Matthias BIRKNER, Professeur, Universität Mainz
- Examineur : **M. Jean-Christophe BRETON**, Professeur, Université de Rennes 1
- Directeur de thèse : **M. Philippe CARMONA**, Professeur, Université de Nantes
- Co-directeur de thèse : **M. Nicolas PÉTRÉLIS**, Maître de conférences, Université de Nantes

Remerciements

Je tiens d'abord à remercier sincèrement mon directeur Philippe Carmona de m'avoir donné l'occasion de venir faire ma thèse en France. Ses qualités humaines et sa gentillesse m'ont beaucoup touché. Mes remerciements vont aussi à Nicolas Pétrélis pour nos nombreuses discussions et ses chers conseils. Je n'aurais jamais pu finir cette thèse sans avoir toutes ces aides précieuses.

Je remercie Vincent Beffara et Matthias Birkner, rapporteurs de ma thèse, pour la tâche qu'ils ont bien voulu accomplir et l'intérêt qu'ils ont porté à mes travaux. Je remercie également les autres membres du jury, Jean-Christophe Breton et Giambattista Giacomin, son président, pour l'honneur qu'ils me font en acceptant ce rôle.

Incrit en thèse à l'université de Nantes, j'ai passé trois ans au sein du laboratoire de mathématiques Jean Leray. Je remercie chaque membre du laboratoire et du département pour leur soutien et leur amitié.

Pour finir, je remercie ma famille et mon amie Nga, et tous ceux qui m'ont encouragé lors de la préparation de cette thèse.

Table des matières

1	Introduction	9
1.1	Motivation physique et modèle mathématique	10
1.1.1	Motivation physique	10
1.1.2	Le modèle mathématique	10
1.2	Le modèle	12
1.2.1	Les configurations de polymères	12
1.2.2	Le Hamiltonien	13
1.2.3	L'énergie Libre	14
1.3	Un bilan rapide des articles de physique	16
1.4	Les principaux résultats	17
1.4.1	La formule variationnelle	18
1.4.2	Asymptotique fine de l'énergie libre au voisinage du point critique	20
1.4.3	Propriétés trajectorielles du polymère dans sa phase effondrée	21
1.5	Dépliement d'un polymère sous l'effet d'une force extérieure	22
1.6	Les principaux outils	24
1.6.1	Une représentation probabiliste de la fonction de partition	24
1.6.2	Construction et étude asymptotique de g_β	26
1.6.3	Construction et étude asymptotique de h_β	30
1.6.4	Estimations de grande déviation	38
2	English Introduction	41
2.1	Physical motivations and the model setting	42
2.1.1	Physical motivations	42
2.1.2	The model setting	42
2.2	The model	44
2.2.1	Polymer configurations	44
2.2.2	The Hamiltonian	45
2.2.3	The free energy	46
2.3	Physical background	48
2.4	The main results	49
2.4.1	Variational formula	50
2.4.2	A sharper asymptotic of the free energy close to criticality	52
2.4.3	Path properties inside the collapsed phase	52
2.5	Collapsed polymer unfolded by a force	54
2.6	The main tools	56
2.6.1	Probabilistic representation of the partition function	56

2.6.2	Construction and asymptotics of g_β	58
2.6.3	Construction and asymptotics of h_β	61
2.6.4	Large deviation estimates	69
3	Variational formula for the free energy	71
3.1	Introduction	72
3.1.1	The model	72
3.1.2	Background	73
3.1.3	A new approach	74
3.1.4	Main results	75
3.2	A new representation of the partition function	78
3.3	Construction and asymptotics of g_β	80
3.3.1	Construction and regularity of g_β	80
3.3.2	Asymptotics of g_β	83
3.4	Proof of the main results	84
3.4.1	Proof of Theorem 3.1.2	84
3.4.2	Proof of Theorem 3.1.3	85
3.4.3	Proof of Theorem 3.1.4	85
3.4.4	Proof of Lemma 3.3.4	87
3.4.5	Proof of Lemma 3.3.5	88
4	Geometry of the collapsed phase	93
4.1	Introduction	94
4.1.1	Model and physical insight	94
4.1.2	Free energy and collapse transition	96
4.1.3	Relationship to earlier work	97
4.1.4	Main results	99
4.2	Preparation	101
4.2.1	Probabilistic representation of the partition function	101
4.2.2	Construction and regularity of h_β	103
4.2.3	Large deviation estimates	105
4.3	The order of the phase transition	107
4.3.1	Proof of Theorem 4.1.3 (Free energy equation)	107
4.3.2	Proof of Theorem 4.1.4 (Phase transition asymptotics)	108
4.3.3	Asymptotics of h_β	109
4.4	Geometry of the collapsed phase	114
4.4.1	Proof of Theorem 4.1.6 (One bead Theorem)	114
4.4.2	Proof of Proposition 4.4.2	117
4.4.3	Proof of Theorem 4.1.7 (Horizontal expansion)	119
4.4.4	Proof of Lemmas 4.4.1 and 4.4.4	120
4.5	Decay rate of large area probability	121
4.5.1	Proof of Proposition 4.2.3	121
4.5.2	Proof of Lemmas 4.5.3, 4.5.5 and 4.5.6	123
4.6	Limit theorems for the joint distribution	126
4.6.1	Proof of Proposition 4.2.2	126
4.6.2	Proof of Proposition 4.2.5 (Unique excursion for large area)	129
4.7	Appendix	134

4.7.1	The distribution of Brownian area	134
4.7.2	Proof of Lemma 4.3.2	135
5	Collapsed polymer unfolded by a force	137
5.1	Introduction	137
5.1.1	The model	137
5.1.2	Background	139
5.1.3	The free energy	139
5.2	Pulling in the horizontal direction ($F_y = 0$)	140
5.2.1	The critical value	140
5.2.2	The order of the phase transition	141
5.3	Pulling in the vertical direction ($F_x = 0$)	141
5.4	The re-entrant phase transition	143
	Bibliography	148

Introduction

Sommaire

1.1	Motivation physique et modèle mathématique	10
1.1.1	Motivation physique	10
1.1.2	Le modèle mathématique	10
1.2	Le modèle	12
1.2.1	Les configurations de polymères	12
1.2.2	Le Hamiltonien	13
1.2.3	L'énergie Libre	14
1.3	Un bilan rapide des articles de physique	16
1.4	Les principaux résultats	17
1.4.1	La formule variationnelle	18
1.4.2	Asymptotique fine de l'énergie libre au voisinage du point critique	20
1.4.3	Propriétés trajectorielles du polymère dans sa phase effondrée	21
1.5	Déplieement d'un polymère sous l'effet d'une force extérieure	22
1.6	Les principaux outils	24
1.6.1	Une représentation probabiliste de la fonction de partition	24
1.6.2	Construction et étude asymptotique de g_β	26
1.6.3	Construction et étude asymptotique de h_β	30
1.6.4	Estimations de grande déviation	38

1.1 Motivation physique et modèle mathématique

1.1.1 Motivation physique

Le but de cette thèse est d'étudier les phénomènes d'effondrement pour différents modèles d'homopolymères en solution. La structure géométrique d'un homopolymère en solution dépend de la température et/ou des propriétés du solvant. Dans un bon solvant (ou à haute température) les monomères se repoussent entre eux, préférant être environnés de solvant (on parle de répulsion entropique). En revanche, quand la qualité du solvant se détériore, ou quand la température diminue, alors les monomères essaient d'exclure le solvant, et donc s'attirent, et le polymère se replie sur lui-même pour former une masse dense qui ressemble à une boule compacte, et minimiser ainsi le nombre de contacts entre les monomères et le solvant (Fig. 1.1). Pour un couple donné polymère-solvant, l'effondrement se produit à une température appelée point θ . La dynamique de la transition d'effondrement est bien connue pour les polymères flexibles, y compris la partie théorique étudiée depuis de nombreuses années. Comprendre la transition pour des polymères rigides est un prérequis pour la compréhension et l'étude de l'effondrement de macromolécules biologiques telles que les protéines ou l'ADN.

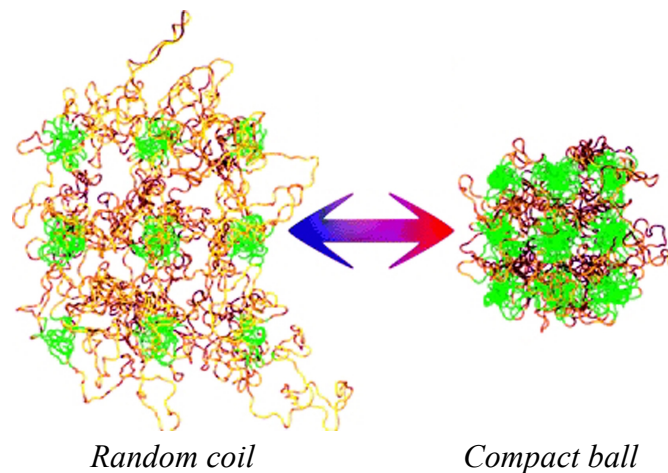

FIGURE 1.1 – Hydrogel behavior (*Macromolecules*, 2007, 40, 5827).

1.1.2 Le modèle mathématique

En mathématiques, les polymères vivent sur un réseau d dimensionnel \mathbb{Z}^d , $d \geq 1$. Ils sont en réalité des trajectoires de marches aléatoires sur ce réseau : les monomères sont les sites de la trajectoire, et les liens chimiques entre les monomères sont les arrêtes de la marche.

Étant donné $L \in \mathbb{N}$, on considère \mathcal{W}_L l'ensemble des chemins autorisés de longueur L , sous la loi de probabilité \mathbf{P} . A chaque trajectoire $w = (w_n)_{n \in [0, L]}$ on associe une énergie donnée par le Hamiltonien $H_L(w)$. Pour tout $L \in \mathbb{N}$, la loi du polymère de longueur L est la mesure de probabilité $\mathbf{P}_L(w)$ sur \mathcal{W}_L donnée par

$$\mathbf{P}_L(w) = \frac{\exp(H_L(w))}{Z_L} \mathbf{P}(w), \quad w \in \mathcal{W}_L, \quad (1.1.1)$$

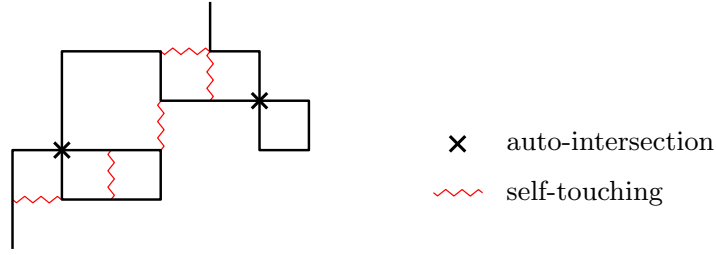

FIGURE 1.2 – Une SRW avec auto-intersections et self-touchings.

où Z_L est la constante de normalisation appelée fonction de partition du système :

$$Z_L = \mathbf{E}[\exp(H_L(w))]. \quad (1.1.2)$$

On dit que P_L est la *mesure de Gibbs* associée au couple (\mathcal{W}_L, H_L) : elle décrit le polymère de longueur fixe L en équilibre avec lui même et avec son environnement. Sous cette mesure de Gibbs, les trajectoire de faible énergie ont une probabilité plus grande, alors que les trajectoires de haute énergie ont une probabilité plus faible.

Examinons brièvement deux modèles de base pour une chaîne de polymère : la marche aléatoire simple et la marche aléatoire auto-évitante.

(1) La marche aléatoire simple (SRW) L'ensemble des chemins autorisés est

$$\mathcal{W}_L = \{w = (w_i)_{i=0}^L \in (\mathbb{Z}^d)^{L+1} : w_0 = 0, \|w_{i+1} - w_i\| = 1, \forall 0 \leq i < L\}, \quad (1.1.3)$$

et \mathbf{P} est la loi uniforme sur \mathcal{W}_L . Étant donné $\beta, \gamma \in (0, \infty)$, on considère un polymère qui reçoit une pénalité γ pour chaque auto-intersection et une récompense de β chaque fois qu'un monomère est voisin d'un autre monomère (un *self-touching*) (Fig. 1.2). En d'autres termes, nous associons à tout chemin de marche aléatoire le Hamiltonien :

$$H_L^{\beta, \gamma}(w) := \frac{\beta}{2d} \sum_{\substack{i, j=0 \\ i < j-1}}^L \mathbf{1}_{\{\|w_i - w_j\|=1\}} - \gamma \sum_{\substack{i, j=0 \\ i < j-1}}^L \mathbf{1}_{\{\|w_i - w_j\|=0\}}. \quad (1.1.4)$$

Le facteur $\frac{1}{2d}$ est introduit pour tenir compte du fait que chaque site a $2d$ voisins possibles pour lesquels le polymère peut réaliser un self-touching.

Sous la mesure polymère, les auto-intersections sont pénalisées alors que les self-touchings sont récompensés.

(2) La marche aléatoire auto-évitante (SAW) On ne considère que les trajectoires de marche aléatoire qui ne visitent pas deux fois le même site :

$$\mathcal{W}_L = \{w = (w_i)_{i=0}^L \in (\mathbb{Z}^d)^{L+1} : w_0 = 0, \|w_{i+1} - w_i\| = 1, \forall 0 \leq i < L, \\ w_i \neq w_j \forall 0 \leq i < j \leq L\}.$$

C'est un modèle très populaire car il satisfait la condition d'exclusion de volume, et est donc adapté pour décrire un phénomène d'effondrement. Les interactions entre les monomères

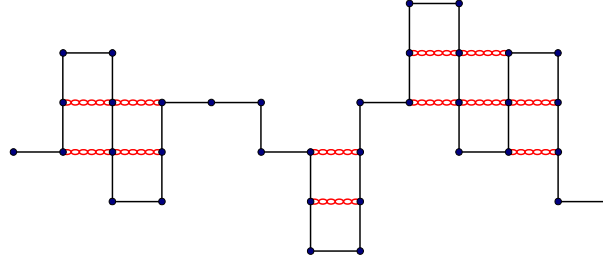

FIGURE 1.4 – Une marche aléatoire partiellement dirigée avec 12 self-touchings représentés par des arrêtes grisées.

(1) Le modèle uniforme : tous les chemins de longueur L ont le même poids, i.e.,

$$\mathbf{P}_L^u(w) = \frac{1}{|\mathcal{W}_L|}, \quad w \in \mathcal{W}_L. \quad (1.2.2)$$

(2) Le modèle non uniforme (cinétique) : le prochain pas est choisi uniformément parmi les pas autorisés :

- A l'origine, ou après un pas horizontal : le marcheur peut aller au nord, au sud ou à l'est avec la probabilité $\frac{1}{3}$.
- Après un pas vers le nord (resp. sud) , le marcheur se déplace vers le nord (resp. le sud) ou l'est avec la probabilité $\frac{1}{2}$.

Plus précisément, sous \mathbf{P}_L^{nu} , la suite de variables aléatoires $(x_i := w_i - w_{i-1})_{i \in [1, L]}$ est une chaîne de Markov de probabilités de transition

$$\begin{aligned} \mathbf{P}_L^{\text{nu}}(x_{i+1} = y \mid x_i = \vec{e}_1) &= 1/3, \quad y \in \{\vec{e}_1, \vec{e}_2, -\vec{e}_2\}, \\ \mathbf{P}_L^{\text{nu}}(x_{i+1} = y \mid x_i = \vec{e}_2) &= 1/2, \quad y \in \{\vec{e}_1, \vec{e}_2\}, \\ \mathbf{P}_L^{\text{nu}}(x_{i+1} = y \mid x_i = -\vec{e}_2) &= 1/2, \quad y \in \{\vec{e}_1, -\vec{e}_2\}. \end{aligned}$$

La loi de probabilité choisie sur \mathcal{W}_L est notée \mathbf{P}_L^m , avec $m \in \{u, \text{nu}\}$.

1.2.2 Le Hamiltonien

Grâce au caractère dirigé des trajectoires, nous pouvons décrire les chemins de \mathcal{W}_L par une suite de segments verticaux séparés par un pas horizontal. Ainsi, nous posons $\Omega_L := \bigcup_{N=1}^L \mathcal{L}_{N,L}$, où $\mathcal{L}_{N,L}$ est l'ensemble des configurations constituées de N segments verticaux, et d'une longueur totale L , c'est à dire

$$\mathcal{L}_{N,L} = \left\{ l \in \mathbb{Z}^N : \sum_{n=1}^N |l_n| + N = L \right\}. \quad (1.2.3)$$

Il y a donc une bijection entre \mathcal{W}_L et Ω_L (Fig. 1.5). Rappelons la définition de \mathbf{P}_L^m dans (1.2.2) et notons que pour un N donné, $N \in \{1, \dots, L\}$, la fonction $l \mapsto \mathbf{P}_L^m(l)$ est constante sur $\mathcal{L}_{N,L}$ et vaut $1/|\mathcal{W}_L|$ si $m = u$ et $(1/3)^N (1/2)^{L-N}$ si $m = \text{nu}$.

Le Hamiltonien associé à une trajectoire de \mathcal{W}_L peut être réécrit en utilisant la suite $l \in \mathcal{L}_{N,L} \subset \Omega_L$ de segments verticaux :

$$H_{L,\beta}(l_1, \dots, l_N) = \beta \sum_{n=1}^{N-1} (l_n \tilde{\wedge} l_{n+1}) \quad (1.2.4)$$

avec

$$x \tilde{\wedge} y = \begin{cases} |x| \wedge |y| & \text{si } xy < 0, \\ 0 & \text{sinon.} \end{cases} \quad (1.2.5)$$

En conséquence, la fonction de partition peut être réécrite sous la forme

$$Z_{L,\beta}^m = \sum_{N=1}^L \sum_{l \in \mathcal{L}_{N,L}} e^{\beta \sum_{i=1}^{N-1} (l_i \tilde{\wedge} l_{i+1})} \mathbf{P}_L^m(l). \quad (1.2.6)$$

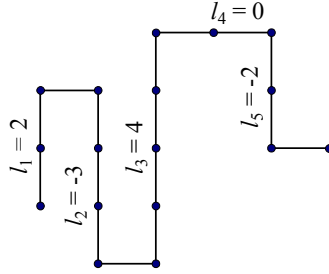

FIGURE 1.5 – Une trajectoire avec $N = 5$ segments verticaux et de longueur $L = 16$.

1.2.3 L'énergie Libre

Une technique classique pour différencier les phases effondrée et étendue de notre modèle consiste à étudier le taux de croissance exponentiel de la fonction de partition $Z_{L,\beta}^m$ quand $L \rightarrow +\infty$. Plus précisément, on définit l'énergie libre du modèle par

$$f^m(\beta) := \lim_{L \rightarrow \infty} f_L^m(\beta), \quad \text{avec} \quad f_L^m(\beta) := \frac{1}{L} \log Z_{L,\beta}^m. \quad (1.2.7)$$

Pour comprendre la nécessité de l'étude de f nous introduisons la variable aléatoire

$$S_L(w) := \sum_{\substack{i,j=0 \\ i < j-1}}^L \mathbf{1}_{\{\|w_i - w_j\|=1\}} \quad (1.2.8)$$

et nous observons après un rapide calcul, que les dérivées successives de $f_L^m(\beta)$ donnent la moyenne et la variance, sous la mesure du polymère, du paramètre d'ordre $\frac{S_L}{L}$ de notre système :

$$\frac{\partial}{\partial \beta} f_L^m(\beta) = \mathbf{E}_{L,\beta}^m \left(\frac{S_L}{L} \right), \quad (1.2.9)$$

$$\frac{\partial^2}{\partial \beta^2} f_L^m(\beta) = L \text{Var}_{\mathbf{P}_{L,\beta}^m} \left(\frac{S_L}{L} \right). \quad (1.2.10)$$

Par l'inégalité de Hölder, $\beta \mapsto f_L^m(\beta)$ est convexe pour tout $L \in \mathbb{N}$ et donc il en est de même pour $f^m(\beta)$. La convexité entraîne que dès que $f^m(\beta)$ est dérivable en β , alors

$$\frac{\partial}{\partial \beta} f^m(\beta) = \lim_{L \rightarrow \infty} E_{L,\beta}^m \left(\frac{S_L}{L} \right). \quad (1.2.11)$$

Ainsi, la dérivée de $f^m(\beta)$ donne la proportion limite de self-touching par monomère, ce qui justifie l'étude de $f^m(\beta)$. En fait, un problème important est de déterminer l'ensemble des valeurs de β pour lesquelles l'énergie libre n'est pas analytique. Ces valeurs correspondent physiquement à une transition de phase du système.

Observons que la suite $\{\log Z_{L,\beta}^m\}_L$ est sur-additive, et comme le nombre de self-touching est plus petit que le nombre de monomère, on a $H_{L,\beta}(w) \leq \beta L$, d'où l'on déduit immédiatement la borne supérieure $Z_{L,\beta}^m \leq e^{\beta L}$ pour $\beta \in (0, \infty)$ et $m \in \{u, nu\}$. Par conséquent, la limite dans l'équation (1.2.7) existe et est finie

$$f^m(\beta) = \lim_{L \rightarrow \infty} \frac{1}{L} \log Z_{L,\beta}^m = \sup_{L \in \mathbb{N}} \frac{1}{L} \log Z_{L,\beta}^m \leq \beta. \quad (1.2.12)$$

Si nous annulons l'auto-interaction du polymère, c'est à dire si nous prenons $\beta = 0$, alors la proportion de self-touching d'une trajectoire typique de marche aléatoire de longueur L est dans $(0, 1)$, l'extension horizontale de cette trajectoire est d'ordre L et le déplacement vertical d'ordre \sqrt{L} . Quand β devient strictement positif, la configuration géométrique adoptée par la marche aléatoire est le résultat d'une compétition *énergie-entropie* qui peut être comprise ainsi. Pour accroître sa densité de self-touching, ce polymère doit à la fois réduire le nombre de pas horizontaux et contraindre les suites consécutives de segments verticaux à être de directions opposées. Cependant ces deux contraintes géométriques ont un coût entropique tel que l'énergie libre est le résultat d'une optimisation entre le gain énergétique et le coût entropique d'une croissance de la proportion de self-touching. Quand β devient grand, le système entre dans une phase repliée qui correspond à une saturation du nombre de self-touching. En d'autres termes, les configurations repliées ont une densité de self-touching égale à 1, ce qui impose que le nombre de pas horizontaux d'ordre $o(L)$, et que la plupart des segments verticaux consécutifs soient de directions opposées. Ces contraintes géométriques sont associées à une entropie d'effondrement κ_m , pour $m \in \{u, nu\}$, telle que l'énergie libre prend la forme $\beta + \kappa_m$. Dans le Lemme 1.2.1 ci-dessous, nous explicitons la valeur de cette entropie d'effondrement.

Lemme 1.2.1. *Pour $\beta > 0$, $m \in \{u, nu\}$*

$$f^m(\beta) \geq \varphi_\beta^m, \quad (1.2.13)$$

avec $\varphi_\beta^u = \beta - \log(1 + \sqrt{2})$ et $\varphi_\beta^{nu} = \beta - \log 2$.

Démonstration. Soit L tel que $\sqrt{L} \in \mathbb{N}$. Nous ne gardons dans la somme qui définit $Z_{L,\beta}^m$ que la contribution d'une unique trajectoire \tilde{w} , de longueur L , qui commence par $\sqrt{L} - 1$ pas vers le nord puis fait un pas vers l'est, puis $\sqrt{L} - 1$ pas vers le sud puis un pas à l'est ... (Fig. 1.6). Cette trajectoire fait \sqrt{L} pas horizontaux qui séparent \sqrt{L} segments verticaux de longueur $\sqrt{L} - 1$. Comme les segments verticaux consécutifs sont de directions opposées,

le Hamiltonien de \tilde{w} est donné par $\beta(\sqrt{L}-1)^2 \geq \beta L - 2\beta\sqrt{L}$. En outre, $\mathbf{P}_L^u(\tilde{w}) = 1/|\mathcal{W}_L|$ et $\mathbf{P}_L^{\text{nu}}(\tilde{w}) = (2/3)^{\sqrt{L}}(1/2)^L$, et donc

$$Z_{L,\beta}^u \geq \frac{e^{\beta(L-2\sqrt{L})}}{|\mathcal{W}_L|} \quad \text{et} \quad Z_{L,\beta}^{\text{nu}} \geq \left(\frac{e^\beta}{2}\right)^L \left(\frac{2}{3e^{2\beta}}\right)^{\sqrt{L}}. \quad (1.2.14)$$

Comme $\lim_{L \rightarrow \infty} L^{-1} \log |\mathcal{W}_L| = \log(1 + \sqrt{2})$ (voir [4, p. 5]), il suffit de composer les inégalités de (1.2.14) par $\frac{1}{L} \log$ puis de laisser $L \rightarrow \infty$ pour terminer la preuve du Lemme. \square

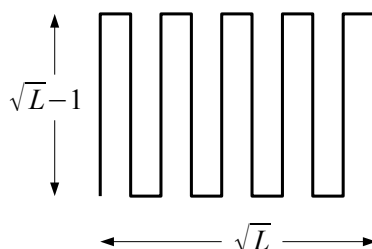

FIGURE 1.6 – Restriction de la fonction de partition à une trajectoire de longueur L dont le nombre de self-touching est maximum.

En d'autres termes, Le Lemme 1.2.1 dit que les entropies effondrées vérifient $\kappa_u \geq -\log(1 + \sqrt{2})$ et $\kappa_{\text{nu}} \geq -\log 2$. Toutefois, nous allons voir que ces inégalités sont en fait des égalités.

On définit l'énergie libre en excès par $\tilde{f}^m(\beta) := f^m(\beta) - \varphi_\beta^m$, une quantité positive en vertu du Lemme 1.2.1. Cette borne inférieure nous permet de partitionner $[0, \infty)$ en une phase effondrée notée \mathcal{C} et une phase dépliée notée \mathcal{E} , i.e,

$$\mathcal{C} := \{\beta : \tilde{f}^m(\beta) = 0\} \quad (1.2.15)$$

et

$$\mathcal{E} := \{\beta : \tilde{f}^m(\beta) > 0\}. \quad (1.2.16)$$

Comme $\tilde{f}^m(\beta)$ est convexe positive et majorée, dès que nous aurons établi l'existence de $\beta_0^m \in [0, \infty)$ tel que $\tilde{f}^m(\beta_0^m) = 0$, nous aurons automatiquement $\tilde{f}^m(\beta) = 0$ pour $\beta \geq \beta_0^m$. Ainsi, le point critique est défini par

$$\beta_c^m := \inf\{\beta \geq 0 : \tilde{f}^m(\beta) = 0\}, \quad (1.2.17)$$

et les ensembles \mathcal{C} et \mathcal{E} s'écrivent $\mathcal{C} = \{\beta : \beta \geq \beta_c^m\}$, $\mathcal{E} = \{\beta : \beta < \beta_c^m\}$.

1.3 Un bilan rapide des articles de physique

La marche aléatoire autoévitante en auto-interaction (IPDSAW) et ses analogues continus ont été l'objet de nombreuses études par les physiciens, dont certaines sont très récentes (voir par exemple [5] or [22]). Les méthodes employées sont principalement basées sur des techniques combinatoires (voir [6], [18] ou plus récemment [17]). Plus précisément, cette méthode consiste à établir une expression analytique de la fonction génératrice $G(z) = \sum_{L=1}^{\infty} Z_{L,\beta}^m z^L$

dont le rayon de convergence R vérifie $f^m = -\log R$. Ce calcul est obtenu en écrivant $G(z)$ sous la forme d'une série $\sum_{r=0}^{\infty} g_r(z)$ avec $g_r(z)$ la contribution des trajectoires qui ont exactement r pas verticaux consécutifs à l'origine, et sans tenir compte de la longueur de la trajectoire. Grâce à une astucieuse technique de concaténation des trajectoires, est établie une relation de récurrence entre g_{r-1} , g_r et g_{r+1} . Enfin, en utilisant un ansatz qui suppose que g_r peut être exprimée elle-même comme une série particulière, la relation de récurrence précédente permet le calcul exact de tous les termes de l'expression en série de $G(z)$.

En particulier le lieu exact de la transition de phase d'effondrement a été déterminé par Binder et al [3], et la forme exacte de la fonction génératrice de la fonction de partition, en termes de fonctions q-Bessel, déterminée par Brak et al [6]. Le fait que cette transition corresponde à l'existence de deux phases a été mis en évidence par Owczarek et al [18], et l'asymptotique précise de la fonction génératrice peut être déduite du travail de Prellberg et al. [19]. La même méthode a ensuite été appliquée par la suite à des généralisations de la IPDSAW, par exemple en [5], où une force est appliquée à l'extrémité droite du polymère, ou encore en [18] où une version continue du polymère est étudiée.

Le calcul de la fonction génératrice G permet de déterminer la valeur exacte de β_c et de prédire le comportement de l'énergie libre au voisinage de ce point critique. Cependant, l'expression analytique utilisée pour G est très complexe et ne donne qu'un accès détourné à l'énergie libre. En outre, cette méthode combinatoire ne permet pas l'étude d'une observable non ballistique. Par exemple, en phase effondrée, l'expansion horizontale est de l'ordre de \sqrt{L} et ce résultat semble hors de portée des méthodes combinatoires.

1.4 Les principaux résultats

Une nouvelle approche a été développée dans [16] permettant de travailler directement sur la fonction de partition. Notre méthode est basée sur une représentation probabiliste de la fonction de partition à l'aide d'une marche aléatoire auxiliaire et plus particulièrement de l'aire géométrique sous cette marche. Il existe une abondante littérature concernant l'intégrale de la marche aléatoire (l'aire algébrique sous la marche). Une des questions les plus importantes est de calculer la probabilité que l'aire algébrique sous la courbe de la marche de longueur N reste positive (voir [8] et les références qu'il contient) ou encore d'estimer le comportement asymptotique de la fonction de survie pour une classe de processus stochastiques intimement reliés aux marches aléatoires et aux processus de Lévy (voir [2]). Dans le travail que nous présentons, la quantité intégrée que nous étudions est légèrement différente, c'est l'aire géométrique comprise entre la trajectoire de la marche et l'axe des abscisses, ce qui signifie que cette aire est également comptée positivement quand la marche aléatoire est négative.

Prenons le temps de fixer les notations pour les objets apparaissant dans cette section. Soit $V := (V_n)_{n \in \mathbb{N}}$ une marche aléatoire symétrique sur \mathbb{Z} , dont les accroissements sont indépendants de même loi géométrique, i.e., $V_0 = 0$, $V_n = \sum_{i=1}^n v_i$ pour $n \in \mathbb{N}$ et $v := (v_i)_{i \in \mathbb{N}}$ est une suite i.i.d. sous la probabilité \mathbf{P}_β , de loi

$$\mathbf{P}_\beta(v_1 = k) = \frac{e^{-\frac{\beta}{2}|k|}}{c_\beta}, \quad \forall k \in \mathbb{Z} \quad \text{avec} \quad c_\beta := \frac{1+e^{-\beta/2}}{1-e^{-\beta/2}}. \quad (1.4.1)$$

Pour $n, k \in \mathbb{N}$, soit $\mathcal{V}_{n,k}$ l'ensemble des trajectoires de longueur n de la marche aléatoire V

satisfaisant $V_n = 0$ et dont l'aire géométrique $A_n := \sum_{i=1}^n |V_i|$ vaut k , i.e.,

$$\mathcal{V}_{n,k} := \{(V_i)_{i=0}^n : A_n = k, V_n = 0\}. \quad (1.4.2)$$

Grâce à une manipulation algébrique du Hamiltonien, manipulation qui sera décrite en détail dans section 1.6, il est possible de réécrire la fonction de partition de (1.2.6) sous la forme

$$Z_{L,\beta}^m = c_\beta \Phi_{L,\beta}^m \sum_{N=1}^L (\Gamma^m(\beta))^N \mathbf{P}_\beta(\mathcal{V}_{N+1,L-N}), \quad (1.4.3)$$

où $\beta \mapsto \Gamma^m(\beta)$ est une bijection continue décroissante de $(0, \infty)$ sur $(0, \infty)$, et où $\Phi_{L,\beta}^m$ croît exponentiellement à la vitesse φ_β^m , de sorte que l'énergie libre en excès $\tilde{f}^m(\beta)$ soit le taux de croissance exponentiel de la somme apparaissant dans (1.4.3).

La formule (1.4.3) sera établie rigoureusement dans section 1.6, mais nous pouvons déjà lire le diagramme de phase sur cette formule. Suivant la valeur prise par $\Gamma^m(\beta)$, on peut déterminer les trois phases du modèle :

- $\Gamma^m(\beta) > 1$: *la phase étendue*. Pour $c \in (0, 1)$, les probabilités $\mathbf{P}_\beta(\mathcal{V}_{cL,L(1-c)})$ décroissent exponentiellement vite quand $L \rightarrow \infty$, avec une vitesse qui croît avec c . En conséquence, les termes dont la contribution est la plus importante dans (1.4.3) sont ceux indexés par $N \sim \tilde{c}L$, avec $\tilde{c} \in (0, 1)$ le résultat d'une optimisation. Cette phase est dite étendue car les trajectoires qui contribuent à la fonction de partition ont une extension horizontale N et une longueur totale L du même ordre (Fig. 1.7).
- $\Gamma^m(\beta) = 1$: *la phase critique*. Ici les termes de (1.4.3) dont la contribution est la plus forte sont ceux indexés par N d'ordre $L^{2/3}$, car la probabilité $\mathbf{P}_\beta(\mathcal{V}_{N+1,L-N})$ atteint son maximum pour ces valeurs de N .
- $\Gamma^m(\beta) < 1$: *la phase effondrée*. Pour $c \in (0, \infty)$, les probabilités $\mathbf{P}_\beta(\mathcal{V}_{c\sqrt{L},L})$ décroissent comme $e^{-t_c\sqrt{L}}$ où $t_c > 0$ décroît avec c . Par conséquent, les contributions principales de (1.4.3) sont indexées par $N \sim \hat{c}\sqrt{L}$, avec $\hat{c} \in (0, \infty)$ à nouveau le résultat d'une optimisation. Cette phase est dite effondrée car les trajectoires qui contribuent à la fonction de partition sont celles dont l'expansion horizontale N est beaucoup plus petite que la longueur totale L (Fig. 1.7).

1.4.1 La formule variationnelle

Nous établissons dans le Théorème 1.4.1 ci-dessous une formule variationnelle pour l'énergie libre en excès. Pour tout $\alpha \in [0, \infty)$, on pose

$$g_\beta(\alpha) := \lim_{N \rightarrow \infty} \frac{1}{N} \log \mathbf{P}_\beta \left(\sum_{n=1}^N |V_n| \leq \alpha N, V_N = 0 \right). \quad (1.4.4)$$

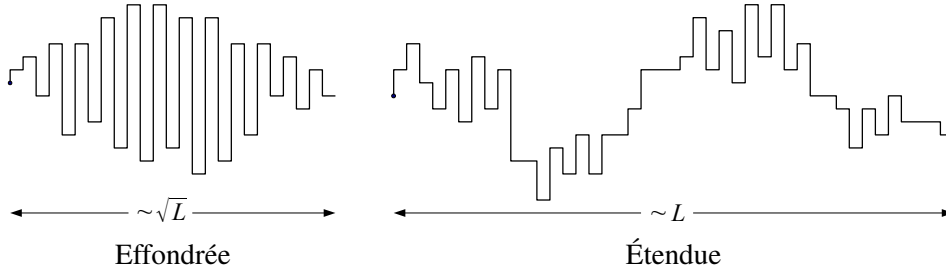

FIGURE 1.7 – Une trajectoire typique de chacune des deux phases.

On définit également la fonction $\Gamma^m : (0, \infty) \rightarrow (0, \infty)$, pour $m \in \{u, nu\}$, par

$$\begin{cases} \Gamma^u(\beta) = \frac{c_\beta}{e^\beta}, \\ \Gamma^{nu}(\beta) = \frac{2c_\beta}{3e^\beta}. \end{cases} \quad (1.4.5)$$

Théorème 1.4.1 ([16], Theorem 1.2). *Pour $m \in \{u, nu\}$, l'énergie libre en excès $\tilde{f}^m(\beta)$ est donnée par*

$$\tilde{f}^m(\beta) = \sup_{\alpha \in [0,1]} [\alpha \log(\Gamma^m(\beta)) + \alpha g_\beta\left(\frac{1-\alpha}{\alpha}\right)]. \quad (1.4.6)$$

Une conséquence du Théorème 1.4.1 est que la connaissance de propriétés analytiques de $\alpha \mapsto g_\beta(\alpha)$ suffit pour obtenir non seulement une expression exacte du point critique β_c^m , mais aussi pour établir l'ordre de la transition de phase. On montre dans section 1.6 que $\alpha \mapsto g_\beta(\alpha)$ est croissante sur $(0, \infty)$ et que $\lim_{\alpha \rightarrow \infty} g_\beta(\alpha) = 0$, ce qui, combiné avec (1.4.6), entraîne que β_c^m existe et est l'unique solution de $\Gamma^m(\beta) = 1$ (Fig. 1.8).

Théorème 1.4.2 ([16], Theorem 1.3). *Pour $m \in \{u, nu\}$, il existe $\beta_c^m \in (0, \infty)$ tel que*

$$\tilde{f}^m(\beta) \begin{cases} = 0, & \text{si } \beta \geq \beta_c^m, \\ > 0, & \text{si } \beta < \beta_c^m, \end{cases} \quad (1.4.7)$$

et β_c^m est l'unique solution positive de l'équation $\Gamma^m(\beta) = 1$.

Rappelons (1.4.1) et (1.4.5), et observons que l'équation $\Gamma^{nu}(\beta) = 1$ est équivalente à l'équation $3x^3 - 3x^2 - 2x - 2 = 0$ où $x = e^{\beta/2}$. En outre, le polynôme $3x^3 - 3x^2 - 2x - 2$ a une unique racine positive x_c , ce qui entraîne $\beta_c^{nu} = 2 \log x_c$. De même, le point critique β_c^u du modèle uniforme est l'unique racine de l'équation $\Gamma^u(\beta) = 1$. Cette valeur β_c^u correspond à la valeur trouvée dans [6].

En outre, une étude asymptotique de $\alpha \mapsto g_\beta(\alpha)$ à l'infini permet d'établir que l'ordre de la transition de phase est $\frac{3}{2}$.

Théorème 1.4.3 ([16], Theorem 1.4). *La transition de phase est d'ordre 3/2. Cela signifie qu'il existe deux constantes $c_1, c_2 > 0$ telles que pour ε suffisamment petit*

$$c_1 \varepsilon^{3/2} \leq \tilde{f}^m(\beta_c^m - \varepsilon) \leq c_2 \varepsilon^{3/2}. \quad (1.4.8)$$

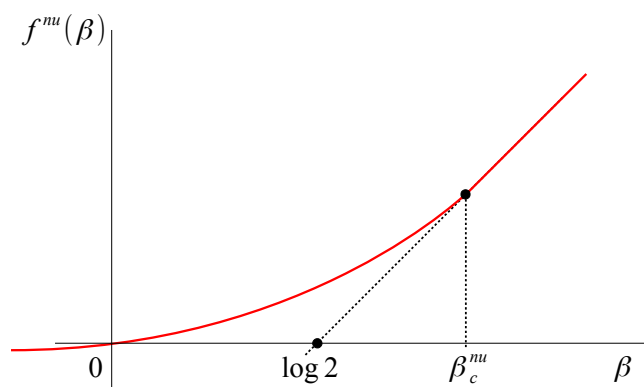

FIGURE 1.8 – Diagramme de phase du modèle non uniforme ($\beta_c^{\text{nu}} \sim 1$).

1.4.2 Asymptotique fine de l'énergie libre au voisinage du point critique

Le premier Théorème que nous énonçons ci-dessous donne une nouvelle expression de l'énergie libre en excès. Rappelons nous les définitions de (1.4.1) et de l'aire géométrique A_N (1.4.2). Pour $\delta \geq 0$, on pose

$$h_\beta(\delta) := \lim_{N \rightarrow \infty} \frac{1}{N} \log \mathbf{E}_\beta(e^{-\delta A_N}). \quad (1.4.9)$$

On montre dans section 1.6 que la limite de (1.4.9) existe et que $\delta \mapsto h_\beta(\delta)$ est négative, décroissante et continue sur $[0, \infty)$.

Théorème 1.4.4 ([7], Theorem 1.3). *Pour $m \in \{u, \text{nu}\}$, l'énergie libre en excès $\tilde{f}^m(\beta)$ est l'unique solution de l'équation $\log(\Gamma^m(\beta)) - \delta + h_\beta(\delta) = 0$, lorsqu'il y a une solution, et $\tilde{f}^m(\beta) = 0$ le cas échéant.*

Observons tout d'abord que le Théorème 1.4.4 combiné avec l'identité $h_\beta(0) = 0$ est suffisant pour montrer que β_c^m est l'unique solution de $\Gamma^m(\beta) = 1$.

Le principal intérêt du Théorème 1.4.4 est qu'il permet d'utiliser les propriétés analytiques de $\delta \mapsto h_\beta(\delta)$ en 0^+ pour étudier la régularité de $\beta \mapsto \tilde{f}^m(\beta)$ en β_c^m . Cela permet, entre autres, d'aller une étape plus loin que le Théorème 1.4.3 dans l'étude de la transition de phase.

Théorème 1.4.5 ([7], Theorem 1.4). *Pour $m \in \{u, \text{nu}\}$, la transition de phase est d'ordre $3/2$ et le développement de Taylor d'ordre 1 de l'énergie libre en excès au voisinage de $(\beta_c^m)^-$ est donné par*

$$\lim_{\varepsilon \rightarrow 0^+} \frac{\tilde{f}^m(\beta_c^m - \varepsilon)}{\varepsilon^{3/2}} = \left(\frac{c_m}{d_m}\right)^{3/2}, \quad (1.4.10)$$

avec

$$c_m = 1 + \frac{e^{-\beta_c^m/2}}{1 - e^{-\beta_c^m}}, \quad (1.4.11)$$

et

$$d_m = - \lim_{T \rightarrow \infty} \frac{1}{T} \log \mathbf{E}(e^{-\sigma_{\beta_c^m} \int_0^T |B(t)| dt}) = 2^{-1/3} |a'_1| \sigma_{\beta_c^m}^{2/3}, \quad (1.4.12)$$

où $\sigma_\beta^2 = \mathbf{E}_\beta(v_1^2)$ et a'_1 est le premier zéro de $Ai'(x) = \partial Ai(x)/\partial x$ la dérivée de la fonction d'Airy $Ai(x)$.

1.4.3 Propriétés trajectorielles du polymère dans sa phase effondrée

Nous abordons maintenant un autre type de résultats établis dans cette thèse en étudiant la structure géométrique adoptée par le polymère dans sa phase effondrée.

Des physiciens ont entrepris cette étude dans plusieurs articles, comme par exemple [20]. Il y est argumenté que les monomères se disposent en une série de longs segments verticaux de directions opposées qui constituent de grandes *perles* (Fig. 1.7). Des simulations numériques permettent de penser que l'expansion horizontale N_L du polymère de longueur L croît comme \sqrt{L} et que le déplacement de l'extrémité libre croît comme $L^{1/4}$ (voir [20], table II page 2394).

Nous montrons dans le Théorème 1.4.4 que le polymère ne forme qu'une seule perle macroscopique et que le nombre de monomères, qui ne font pas partie de cette perle (situés en début et en fin de chaîne), croît au plus comme $(\log L)^4$. We also make rigorous the conjecture concerning the horizontal expansion of the polymer, since we identify the limit in probability of N_L/\sqrt{L} , which turns out to be the constant extracted from an optimization.

On décompose chaque trajectoire en une succession de *perles*. Chaque perle est formée de segments verticaux de longueur non nulle, tels que deux segments consécutifs ont des directions opposées (nord et sud) et sont séparés par un seul pas horizontal (voir Fig. 1.9). Une perle se termine quand le polymère a deux segments verticaux consécutifs dans la même direction, ou que un segment de longueur zéro apparaît, i.e. quand il y a deux pas horizontaux consécutifs. Nous allons démontrer que le polymère se replie pour ne former qu'une seule *perle macroscopique*, et nous identifierons l'asymptotique de son expansion horizontale.

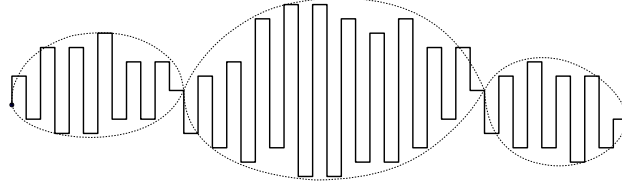

FIGURE 1.9 – Exemple d'une trajectoire avec 3 perles.

Expansion horizontale et nombre de perles

Étant donné $l \in \Omega_L$, on note $N_L(l)$ son expansion horizontale, i.e., $N_L(l)$ est l'entier N tel que $l \in \mathcal{L}_{N,L}$. Soit $l \in \mathcal{L}_{N,L}$ et soit $(u_j)_{j=1}^N$ la suite des longueurs cumulées du polymère après chaque segment vertical, i.e., $u_j = |l_1| + \dots + |l_j| + j$ pour $j \in \{1, \dots, N\}$. Pour simplifier les écritures on pose $l_{N+1} = 0$. Posons également $x_0 = 0$ et pour $j \in \mathbb{N}$ tel que $x_{j-1} < N$, posons $x_j = \inf\{i \geq x_{j-1} + 1 : l_i \wedge l_{i+1} = 0\}$.

Enfin, soit $n_L(l)$ l'index du dernier x_j bien défini, i.e., $x_{n_L(l)} = N$. Toute trajectoire $l \in \Omega_L$ se décompose en une suite de $n_L(l)$ perles (Fig. 1.10), chacune d'elle étant associée à un sous intervalle de $\{1, \dots, L\}$ que l'on note

$$I_j = \{u_{x_{j-1}} + 1, \dots, u_{x_j}\}, \quad \text{pour } j \in \{1, \dots, n_L(l)\}. \quad (1.4.13)$$

Ainsi $\cup_{j=1}^{n_L(l)} I_j$ est une partition de $\{1, \dots, L\}$. Nous pouvons maintenant définir la plus grande perle de la trajectoire $l \in \Omega_L$ comme la trajectoire décrite sur l'intervalle $I_{j_{\max}}$ avec

$$j_{\max} = \arg \max \{|I_j|, j \in \{1, \dots, n_L(l)\}\}. \quad (1.4.14)$$

Le Théorème suivant établit qu'en phase repliée il y a une et une seule perle macroscopique.

Théorème 1.4.6 ([7], Theorem 1.6). *Pour tous $m \in \{u, nu\}$ et $\beta > \beta_c^m$, il existe $c > 0$ tel que*

$$\lim_{L \rightarrow \infty} P_{L,\beta}^m(|I_{j_{max}}| \geq L - c(\log L)^4) = 1. \quad (1.4.15)$$

La proposition suivant montre elle que l'expansion horizontale est alors d'ordre \sqrt{L} .

Proposition 1.4.7 ([7], Proposition 1.7). *Pour tous $m \in \{u, nu\}$ et $\beta > \beta_c^m$, il existe $a_m > 0$ tel que, pour tout $\varepsilon > 0$*

$$\lim_{L \rightarrow \infty} P_{L,\beta}^m\left(\left|\frac{N_L}{\sqrt{L}} - a_m\right| > \varepsilon\right) = 0. \quad (1.4.16)$$

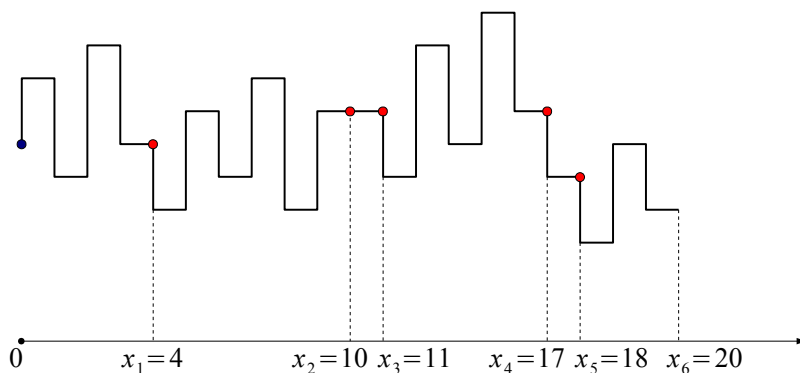

FIGURE 1.10 – Une trajectoire avec 20 barres verticales décomposée en $n_L(l) = 6$ perles.

1.5 Déplie ment d'un polymère sous l'effet d'une force extérieure

On peut induire une transition de phase en appliquant une *force* à l'extrémité du polymère, tout en gardant constante la force d'auto-interaction. Cette force peut être appliquée par une *pince optique*.

Un phénomène intéressant que l'on peut observer est la transition de *ré-entrance*. Cela signifie que pour une force fixée f , le polymère est étendu à basse température et à haute température, mais il est effondré pour les températures intermédiaires, comme si la force n'était pas présente.

Pour modéliser l'effet de la force on remplace l'Hamiltonien de (1.2.4) par

$$H_{L,\beta}^{f_x, f_y}(l) := \beta \sum_{n=1}^N (l_n \tilde{\wedge} l_{n-1}) + \beta f_x N + \beta f_y \sum_{n=1}^N l_n, \quad l \in \mathcal{L}_{N,L}. \quad (1.5.1)$$

où $f_x, f_y \geq 0$ sont les forces dans les directions horizontale et verticale qui agissent sur l'extrémité du polymère (Fig. 1.11). Observons que N est la distance horizontale et $\sum_{n=1}^N l_n$

1.5. DÉPLIEMENT D'UN POLYMÈRE SOUS L'EFFET D'UNE FORCE EXTÉRIEURE 23

est la distance verticale entre les deux extrémités du polymère. On note $Z_{L,\beta}^{f_x, f_y}$ la fonction de partition et

$$f(\beta, f_x, f_y) = \lim_{L \rightarrow \infty} \frac{1}{L} \log Z_{L,\beta}^{f_x, f_y} \quad (1.5.2)$$

l'énergie libre.

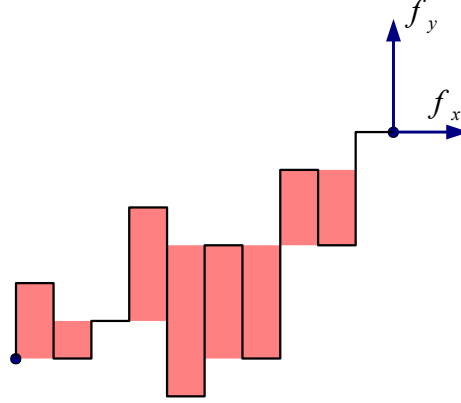

FIGURE 1.11 – Une force horizontale f_x et une force verticale f_y sont appliquées à l'extrémité du polymère.

Nous allons montrer que le phénomène de ré-entrance dépend fortement du modèle choisi. Voilà pourquoi nous définissons tout d'abord une marche aléatoire partiellement dirigée de probabilités de transition plus générales. On considère la marche aléatoire partiellement dirigée sur \mathbb{Z}^2 de loi \mathbf{P} définie par :

- A l'origine ou après un pas horizontal, le marcheur fait un pas vers le nord (resp le sud et l'est) avec la probabilité p (resp. p' , $1 - p - p'$).
- Après un pas vertical vers le nord, le marcheur fait un pas vers le nord avec la probabilité q et vers l'est avec la probabilité $1 - q$.
- Après un pas vertical vers le sud, le marcheur fait un pas vers le sud avec la probabilité q' et vers l'est avec la probabilité $1 - q'$.

Pour simplifier les calculs, nous nous restreignons au cas $p = \frac{q(1-q')}{1-qq'}$ and $p' = \frac{q'(1-q)}{1-qq'}$ avec $q, q' \in (0, 1)$. Ainsi, les variables aléatoires $(l_n)_{n=1}^N$ sont i.i.d. de loi géométrique

$$\mathbf{P}(l_1 = 0) = \frac{(1-q)(1-q')}{1-qq'}, \quad (1.5.3)$$

$$\mathbf{P}(l_1 = k) = \frac{(1-q)(1-q')}{1-qq'} q^k, \quad (1.5.4)$$

$$\mathbf{P}(l_1 = -k) = \frac{(1-q)(1-q')}{1-qq'} q'^k, \quad \text{pour } k \in \mathbb{N}. \quad (1.5.5)$$

Soit $q_0 = \mathbf{P}(l_1 = 0)$, $q_1 = \frac{\log q + \log q'}{2} \leq 0$ et $q_2 = \frac{\log q - \log q'}{2}$. On a

$$\mathbf{P}(l_1 = k) = q_0 e^{q_1 |k| + q_2 k} \quad \text{pour tout } k \in \mathbb{Z}. \quad (1.5.6)$$

Pour simplifier l'exposé ci-dessous, nous nous restreignons au cas où les segments verticaux $(l_n)_{n=1}^N$ de la marche aléatoire partiellement dirigée suivent une loi symétrique, i.e.

$q = q' \in (0, 1)$. Il est évident que $q_0 = \frac{(1-q)^2}{1-q^2}$, $q_1 = \log q$ et $q_2 = 0$. Traitons d'abord le cas $f_y = 0$, c'est à dire que seule une force horizontale est exercée. On définit l'énergie libre en excès par $\tilde{f}(\beta, f_x, 0) = f(\beta, f_x, 0) - (\beta + \log q)$. Observons que pour tout $\beta > 0$, il existe une force critique $f_c(\beta)$ telle que

$$\tilde{f}(\beta, f_x, 0) \begin{cases} = 0, & \text{si } f_x \leq f_c(\beta), \\ > 0, & \text{si } f_x > f_c(\beta). \end{cases} \quad (1.5.7)$$

Le cas le plus intéressant à étudier est $\beta \geq \beta_c$, car sinon le système est déjà étendu quand $f_x = 0$. La force critique peut être calculée explicitement

$$f_c(\beta) = \frac{1}{\beta} \log \left(\frac{e^{\beta/2} - 1}{e^{-\beta/2} + e^{-\beta}} \right) + \frac{1}{\beta} \log \left(\frac{q(1+q)}{1-q} \right). \quad (1.5.8)$$

Proposition 1.5.1. *Il existe $\beta_c > 0$ tel que $f_c(\beta) = 0$ pour $\beta \leq \beta_c$. En outre, pour β grand*

$$f_c(\beta) = 1 + \frac{1}{\beta} \log \left(\frac{q(1+q)}{1-q} \right) + o\left(\frac{1}{\beta}\right) \text{ quand } \beta \rightarrow \infty. \quad (1.5.9)$$

Enfin, il y a ré-entrance pour $q > \sqrt{2} - 1$.

1.6 Les principaux outils

Dans cette section nous introduisons les principaux outils de cette thèse. Dans la section 1.6.1 nous montrons comment la fonction de partition peut être réécrite en termes d'une marche aléatoire géométrique V de loi \mathbf{P}_β (cf (1.4.1)), et nous verrons comment l'étude de cette marche aléatoire, sous un conditionnement judicieux, permet de déduire des propriétés trajectorielles de la mesure polymère. La construction de la fonction entropique g_β et l'étude de son comportement asymptotique sont détaillées en section 1.6.2. Dans la section 1.6.3, nous définissons la fonction $\delta \mapsto h_\beta(\delta)$ qui apparaît dans l'équation satisfaite par l'énergie libre donnée dans le Théorème 1.4.4, puis nous étudions sa régularité et son asymptotique. Enfin, la section 1.6.4 est dédiée à l'étude des probabilités de certains événements de grandes déviations sous \mathbf{P}_β , et nous introduisons un changement de probabilité pour laquelle ces événements deviennent typiques.

1.6.1 Une représentation probabiliste de la fonction de partition

Dans la première partie de cette section, nous établissons la formule (1.4.3) et nous montrons comment la mesure polymère peut être vue comme la mesure image, par une transformation géométrique, de la loi de la marche aléatoire V introduite en (1.4.1). Dans la seconde partie de cette section, nous concentrerons notre attention sur les trajectoires qui ne forment qu'une perle, et montrerons qu'en termes de la marche aléatoire auxiliaire V , ces trajectoires deviennent des excursions hors de l'origine.

La marche aléatoire auxiliaire

Nos donnons ici les détails de la preuve de la formule (1.4.3) en ne traitant que le cas non-uniforme. Le cas uniforme est encore plus facile à traiter. Rappelons (1.2.3–1.2.6) et observons que l'opérateur $\tilde{\Lambda}$ peut s'exprimer

$$x \tilde{\Lambda} y = (|x| + |y| - |x + y|) / 2, \quad \forall x, y \in \mathbb{Z}. \quad (1.6.1)$$

Ainsi, pour $\beta > 0$ et $L \in \mathbb{N}$, la fonction de partition de (1.2.6) devient

$$\begin{aligned} Z_{L,\beta}^{\text{nu}} &= \sum_{N=1}^L \left(\frac{1}{3}\right)^N \left(\frac{1}{2}\right)^{L-N} \sum_{\substack{l \in \mathcal{L}_{N,L} \\ l_0=l_{N+1}=0}} \exp\left(\beta \sum_{n=1}^N |l_n| - \frac{\beta}{2} \sum_{n=0}^N |l_n + l_{n+1}|\right) \\ &= c_\beta \left(\frac{e^\beta}{2}\right)^L \sum_{N=1}^L \left(\frac{2c_\beta}{3e^\beta}\right)^N \sum_{\substack{l \in \mathcal{L}_{N,L} \\ l_0=l_{N+1}=0}} \prod_{n=0}^N \frac{\exp\left(-\frac{\beta}{2}|l_n + l_{n+1}|\right)}{c_\beta}, \end{aligned} \quad (1.6.2)$$

où c_β a été définie en (1.4.1).

L'idée cruciale est de définir, pour $N \in \{1, \dots, L\}$ fixé, la bijection $T_N : \mathcal{V}_{N+1, L-N} \mapsto \mathcal{L}_{N,L}$ par $T_N(V)_i = (-1)^{i-1} V_i$ pour tout $i \in \{1, \dots, N\}$.

Étant donné $l \in \mathcal{L}_{N,L}$, on considère $V = (T_N)^{-1}(l)$ (voir Fig. 1.12) et on observe que les accroissements $(v_i)_{i=1}^{N+1}$ de V vérifient nécessairement la relation $v_i := (-1)^{i-1}(l_{i-1} + l_i)$. Ainsi, la fonction de partition de (1.6.2) s'écrit

$$Z_{L,\beta}^{\text{nu}} = c_\beta \left(\frac{e^\beta}{2}\right)^L \sum_{N=1}^L \left(\frac{2c_\beta}{3e^\beta}\right)^N \sum_{V \in \mathcal{V}_{N+1, L-N}} \mathbf{P}_\beta(V), \quad (1.6.3)$$

ce qui entraîne immédiatement (1.4.3).

Une conséquence pratique de la formule (1.6.3) est que, conditionnée à faire exactement N pas horizontaux, la mesure polymère est exactement l'image par la transformation T_N de la marche aléatoire géométrique V conditionnée à retourner à l'origine en $N+1$ pas, et à balayer l'aire géométrique $L-N$, c'est à dire

$$P_{L,\beta}^{\text{m}}(l \in \cdot \mid N_L(l) = N) = \mathbf{P}_\beta(T_N(V) \in \cdot \mid V_N = 0, A_N = L - N). \quad (1.6.4)$$

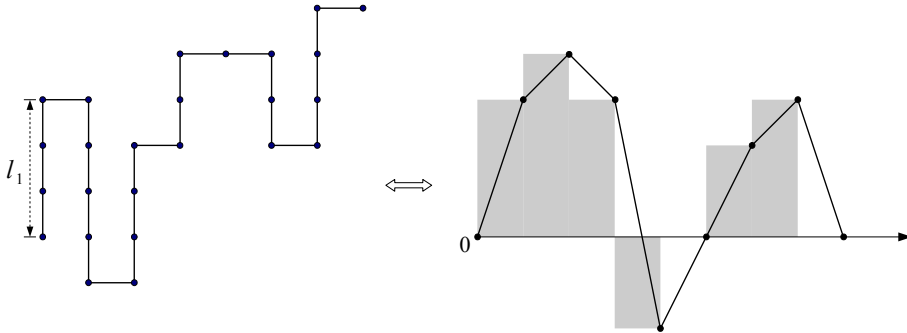

FIGURE 1.12 – Un exemple de transformation de $w \in \mathcal{W}_{24}$ en $(V_n)_{n=0}^8 \in \mathcal{V}_{8,17}$. La trajectoire w de longueur 24 sur la gauche a 7 segments : $l_1 = 3, l_2 = -4, l_3 = 3, l_4 = 2, l_5 = 0, l_6 = -2$ et $l_7 = 3$. Les accroissements correspondants de $(V_n)_{n=0}^8$ sont : $v_1 = 3, v_2 = 1, v_3 = -1, v_4 = -5, v_5 = 2, v_6 = 2$ and $v_7 = 1$.

Perles et excursions

On définit Ω_L° comme le sous ensemble de Ω_L constitué des trajectoires $l \in \Omega_L$ qui n'ont qu'une perle, c'est à dire $n_L(l) = 1$. En conséquence, nous pouvons écrire $\Omega_L^\circ := \bigcup_{N=1}^L \mathcal{L}_{N,L}^\circ$, où $\mathcal{L}_{N,L}^\circ$ est la partie de $\mathcal{L}_{N,L}$ définie par

$$\mathcal{L}_{N,L}^\circ = \{l \in \mathcal{L}_{N,L} : l_i \tilde{\wedge} l_{i+1} \neq 0 \forall j \in \{1, \dots, N-1\}\}, \quad (1.6.5)$$

et nous notons $Z_{L,\beta}^{m,\circ}$ la contribution à la fonction de partition des trajectoire de Ω_L° , i.e.,

$$Z_{L,\beta}^{m,\circ} = \sum_{l \in \Omega_L^\circ} e^{H_{L,\beta}(l)} \mathbf{P}_L^m(l), \quad m \in \{u, nu\}. \quad (1.6.6)$$

Nous noterons également $\mathcal{V}_{n,k}^+$ les trajectoires de la marche auxiliaire qui retournent à l'origine après n étapes, satisfont $A_n = k$ et sont strictement positives sur $\{1, \dots, n\}$, i.e.,

$$\mathcal{V}_{n,k}^+ := \{V : V_n = 0, A_n = k, V_i > 0 \forall i \in \{1, \dots, n-1\}\}. \quad (1.6.7)$$

En reprenant mutatis mutandis (1.6.2), et en notant que l'image de $\mathcal{L}_{N,L}^\circ$ par T_N est $\mathcal{V}_{N+1,L-N}^+$, nous obtenons la représentation

$$Z_{L,\beta}^{m,\circ} = 2c_\beta \Phi_{L,\beta}^m \sum_{N=1}^L (\Gamma^m(\beta))^N \mathbf{P}_\beta(\mathcal{V}_{N+1,L-N}^+). \quad (1.6.8)$$

1.6.2 Construction et étude asymptotique de g_β

Nous allons donner une définition légèrement différente de la définition (1.4.4), mais nous verrons en fin de la section 1.6.2 que les deux définitions coïncident. Rappelons nous la définition de $\mathcal{V}_{n,k}$ dans (1.4.2) et considérons, pour $\alpha \in \mathbb{Q}^+ := \mathbb{Q} \cap [0, \infty)$,

$$N_\alpha := \{n \in \mathbb{N} \cap [2, \infty) : \alpha n \in \mathbb{N}\}. \quad (1.6.9)$$

Observons que $\mathbf{P}_\beta(\mathcal{V}_{N,\alpha K}) > 0$ pour tout $N \in \mathbb{N} \cap [2, \infty)$ et $K \in N_\alpha$. Soit $g_\beta : \mathbb{Q}^+ \rightarrow \mathbb{R}$ définie par

$$g_\beta(\alpha) := \lim_{\substack{N \in N_\alpha \\ N \rightarrow \infty}} g_{N,\beta}(\alpha), \quad \text{where} \quad g_{N,\beta}(\alpha) := \frac{1}{N} \log \mathbf{P}_\beta(\mathcal{V}_{N,\alpha N}). \quad (1.6.10)$$

Pour étudier les propriétés de g_β , nous utiliserons

$$\mathbf{P}_\beta(\mathcal{V}_{N_1+N_2, K_1+K_2}) \geq \mathbf{P}_\beta(\mathcal{V}_{N_1, K_1}) \mathbf{P}_\beta(\mathcal{V}_{N_2, K_2}), \quad \text{for } N_1, N_2, K_1, K_2 \in \mathbb{N}. \quad (1.6.11)$$

Pour établir (1.6.11), il suffit de se restreindre aux trajectoires que retournent à l'origine à l'instant N_1 et vérifient $A_{N_1} = K_1$. Puis, on utilise la propriété de Markov du couple $\{V_n, A_n\}_{n \in \mathbb{N}}$ pour conclure.

Lemma 1.6.1. (i) $g_\beta(\alpha)$ existe, est finie, négative pour tout $\alpha \in \mathbb{Q}^+$. En particulier, $g_\beta(0) = -\log c_\beta$.

(ii) $\alpha \mapsto g_\beta(\alpha)$ est continue, concave, croissante sur \mathbb{Q}^+ et converge vers 0 quand $\alpha \rightarrow \infty$.

Remark 1.6.2. La continuité et la concavité de g_β garantissent l'existence d'un prolongement continu à \mathbb{R}^+ .

Démonstration. (i) En vertu de (1.6.11), pour $N_1, N_2 \in N_\alpha$, on a

$$\mathbf{P}_\beta(\mathcal{V}_{N_1+N_2, \alpha(N_1+N_2)}) \geq \mathbf{P}_\beta(\mathcal{V}_{N_1, \alpha N_1}) \mathbf{P}_\beta(\mathcal{V}_{N_2, \alpha N_2}). \quad (1.6.12)$$

Ainsi, $\{\log \mathbf{P}_\beta(\mathcal{V}_{N, \alpha N})\}_{N \in N_\alpha}$ est une suite sur-additive et comme $0 < \mathbf{P}_\beta(\mathcal{V}_{N, \alpha N}) \leq 1$ pour $N \in N_\alpha$, la limite (1.6.10) existe, est finie et satisfait

$$g_\beta(\alpha) = \sup_{N \in N_\alpha} \frac{1}{N} \log \mathbf{P}_\beta(\mathcal{V}_{N, \alpha N}) \leq 0. \quad (1.6.13)$$

Rappelons que $\mathcal{V}_{n,0} = \{V : V_n = 0, A_n = 0\}$, et donc que

$$\mathbf{P}_\beta(\mathcal{V}_{N,0}) = \mathbf{P}_\beta(V_i = 0 \text{ for } i = 0, \dots, N) = (1/c_\beta)^N. \quad (1.6.14)$$

En conséquence, $g_\beta(0) = -\log c_\beta$.

(ii) Appliquons de nouveau (1.6.11), pour obtenir que pour tous $p, q \in \mathbb{N}, q > 0, 0 \leq p \leq q$ et $\alpha_1, \alpha_2 \in \mathbb{Q}^+, N \in N_{\alpha_1} \cap N_{\alpha_2}$

$$\mathbf{P}_\beta(\mathcal{V}_{qN, p\alpha_1 N + (q-p)\alpha_2 N}) \geq \mathbf{P}_\beta(\mathcal{V}_{N, \alpha_1 N})^p \mathbf{P}_\beta(\mathcal{V}_{N, \alpha_2 N})^{q-p}. \quad (1.6.15)$$

Ainsi

$$\frac{1}{qN} \log \mathbf{P}_\beta \left(\mathcal{V}_{qN, \left(\frac{p}{q} \alpha_1 + \left(1 - \frac{p}{q}\right) \alpha_2 \right) qN} \right) \geq \frac{p}{qN} \log \mathbf{P}_\beta(\mathcal{V}_{N, \alpha_1 N}) + \frac{q-p}{qN} \log \mathbf{P}_\beta(\mathcal{V}_{N, \alpha_2 N}), \quad (1.6.16)$$

ce qui entraîne que

$$g_\beta \left(\frac{p}{q} \alpha_1 + \left(1 - \frac{p}{q}\right) \alpha_2 \right) \geq \frac{p}{q} g_\beta(\alpha_1) + \left(1 - \frac{p}{q}\right) g_\beta(\alpha_2), \quad (1.6.17)$$

qui est la propriété de concavité.

Nous allons maintenant montrer que $g_\beta(\alpha) \rightarrow 0$ quand $\alpha \rightarrow \infty$. Comme g_β est concave sur \mathbb{Q}^+ , cela suffira pour en conclure que g_β est croissante.

Raisonnons par l'absurde et supposons que $g_\beta(\alpha)$ ne converge pas vers 0 quand $\alpha \rightarrow \infty$. Alors, par concavité de g_β ,

- soit g_β est croissante sur \mathbb{Q}^+ et il existe $M > 0$ tel que $g_\beta(\alpha) \leq -M$ pour tout $\alpha \in \mathbb{Q}^+$;
- soit g_β est décroissante pour α suffisamment grand et converge vers $-\infty$ quand $\alpha \rightarrow \infty$.

Dans les deux cas, il existe $M > 0$ et $\alpha_M > 0$ tels que $g_\beta(\alpha) \leq -M$ pour tout $\alpha \geq \alpha_M$. Ainsi, on peut utiliser (1.6.13) pour obtenir

$$\mathbf{P}_\beta(\mathcal{V}_{N, \alpha N}) \leq e^{-NM} \text{ for all } N \in \mathbb{N}, \alpha \geq \alpha_M. \quad (1.6.18)$$

Pour $\alpha \in [\alpha_M, \infty) \cap 2\mathbb{N}$, on considère l'ensemble

$$\mathcal{N}_\alpha = \{V : V_1 = 3\alpha/2 + 1, \alpha + 1 < V_i < 2\alpha + 1 \text{ for } i = 2, \dots, N, V_{N+1} = 0\}. \quad (1.6.19)$$

Pour $N > \alpha$, observons que

$$\mathcal{N}_\alpha \subseteq \left\{ V : V_{N+1} = 0, \alpha(N+1) \leq \sum_{i=0}^{N+1} |V_i| \leq (2\alpha+1)(N+1) \right\}, \quad (1.6.20)$$

et donc, au vu de (1.6.18), nous pouvons écrire

$$\mathbf{P}_\beta(\mathcal{N}_\alpha) \leq \sum_{k=\alpha(N+1)}^{(2\alpha+1)(N+1)} \mathbf{P}_\beta(\mathcal{V}_{N+1,k}) \leq (\alpha+1)(N+1)e^{-(N+1)M}. \quad (1.6.21)$$

Notre but est d'exhiber une borne inférieure pour $\mathbf{P}_\beta(\mathcal{N}_\alpha)$. Par la propriété de Markov, nous avons, en notant $V_N^* := \max_{1 \leq n \leq N} |V_n|$,

$$\begin{aligned} \mathbf{P}_\beta(\mathcal{N}_\alpha) &= \mathbf{P}_\beta\left(v_1 = \frac{3\alpha}{2} + 1\right) \sum_{k=-\alpha/2-1}^{\alpha/2-1} \mathbf{P}_\beta\left(V_{N-1}^* < \frac{\alpha}{2}; V_N = k\right) \\ &\quad \cdot \mathbf{P}_\beta\left(v_1 = -\frac{3\alpha}{2} - 1 - k\right). \end{aligned} \quad (1.6.22)$$

Comme $\mathbf{P}_\beta(v_1 = -\frac{3\alpha}{2} - 1 - k) \geq \mathbf{P}_\beta(v_1 = -2\alpha - 1)$ for $k \in \{-\alpha/2, \dots, \alpha/2\}$, l'équation (1.6.22) implique

$$\mathbf{P}_\beta(\mathcal{N}_\alpha) \geq \frac{e^{-\frac{\beta}{2}(\frac{7\alpha}{2}+2)}}{c_\beta^2} \sum_{k=-\alpha/2-1}^{\alpha/2-1} \mathbf{P}_\beta\left(V_{N-1}^* < \alpha/2; V_N = k\right). \quad (1.6.23)$$

On choisit $\alpha > 4$ pour obtenir

$$\mathbf{P}_\beta(\mathcal{N}_\alpha) \geq \frac{e^{-2\beta\alpha}}{c_\beta^2} \mathbf{P}_\beta\left(V_N^* < \alpha/2\right), \quad (1.6.24)$$

et on peut appliquer l'inégalité de Kolmogorov (voir [11, p. 61]), pour obtenir

$$\mathbf{P}_\beta\left(V_N^* < \frac{\alpha}{2}\right) \geq 1 - \frac{4}{\alpha^2} \mathbf{Var}_\beta(V_N). \quad (1.6.25)$$

En combinant (1.6.21), (1.6.24) et (1.6.25), nous avons

$$\frac{e^{-2\alpha\beta}}{c_\beta^2} \left(1 - \frac{4}{\alpha^2} \mathbf{Var}_\beta(V_N)\right) \leq (\alpha+1)(N+1)e^{-(N+1)M}. \quad (1.6.26)$$

Comme l'inégalité ci dessus est vraie pour $\alpha > \alpha_M$ et $N > \alpha$, on peut choisir $\alpha = 2\sqrt{\lambda N \mathbf{Var}_\beta(v_1)}$ avec $\lambda > 1$ tel que pour N assez grand, (1.6.26) devient

$$\frac{1}{c_\beta^2} \left(1 - \frac{1}{\lambda}\right) e^{-4\beta\sqrt{\lambda N \mathbf{Var}_\beta(v_1)}} \leq (2\sqrt{\lambda N \mathbf{Var}_\beta(v_1)} + 1)(N+1)e^{-(N+1)M}. \quad (1.6.27)$$

Pour N grand, (1.6.27) est clairement impossible à satisfaire, et donc $g_\beta(\alpha)$ converge vers 0 quand $\alpha \rightarrow \infty$ et g_β est croissante. □

Il nous reste à montrer que les deux définitions de g_β de (1.4.4) et (1.6.10) coïncident. Pour cela, nous notons tout d'abord que par sur-additivité, la limite de (1.4.4) existe pour tout $\alpha \in [0, \infty)$. Rappelons de nouveau (1.4.2) et notons que pour $\alpha \in \mathbb{Q}^+$ et $N \in N_\alpha$, nous avons $\mathcal{V}_{N,\alpha N} \subset \{A_N \leq \alpha N, V_N = 0\}$. Ainsi,

$$\lim_{\substack{N \in N_\alpha \\ N \rightarrow \infty}} \frac{1}{N} \log \mathbf{P}_\beta(\mathcal{V}_{N,\alpha N}) \leq \lim_{N \rightarrow \infty} \frac{1}{N} \log \mathbf{P}_\beta(A_N \leq \alpha N, V_N = 0). \quad (1.6.28)$$

Observons également que $\{A_N \leq \alpha N, V_N = 0\} = \cup_{i=0}^{\alpha N} \mathcal{V}_{N,i}$ et utilisons (1.6.13) et la croissance de g_β pour établir que

$$\frac{1}{N} \log \mathbf{P}_\beta(A_N = i, V_N = 0) \leq g_\beta\left(\frac{i}{N}\right) \leq g_\beta(\alpha), \quad \text{for } i \leq \alpha N, \quad (1.6.29)$$

où g_β dans (1.6.29) doit être vue comme sa définition dans (1.6.10). Ainsi,

$$\mathbf{P}_\beta(A_N \leq \alpha N, V_N = 0) \leq (\alpha N + 1)e^{Ng_\beta(\alpha)} \quad (1.6.30)$$

et il suffit de prendre $\frac{1}{N} \log$ des deux côtés de l'équation (1.6.30), puis de faire tendre N vers $+\infty$ pour conclure que les deux définitions coïncident.

Étude asymptotique de g_β

Proposition 1.6.3. *Pour tout $\beta > 0$, il existe $c_1 > 0$ (dépendant de β) telle que*

$$g_\beta(\alpha) \geq -\frac{c_1}{\alpha^2}, \quad \text{pour } \alpha \text{ suffisamment grand.} \quad (1.6.31)$$

Pour tout compact $K \subset (0, +\infty)$, il existe $c_2, \alpha_2 > 0$ (dépendants de K) such that

$$g_\beta(\alpha) \leq -\frac{c_2}{\alpha^2}, \quad \text{for } \beta \in K, \alpha \geq \alpha_2. \quad (1.6.32)$$

Démonstration. Nous établirons d'abord la Proposition 1.6.3 à partir des lemmes 1.6.4 et 1.6.5 ci-dessous. Les preuves de ces lemmes sont reportées aux chapitre 3, sections 3.4.4 et 3.4.5. Rappelons (1.4.2) et la notation $V_N^* = \max_{1 \leq n \leq N} |V_n|$.

Lemma 1.6.4. *Pour $\beta > 0$, il existe $c_1 > 0$ (dépendant de β) telle que pour α suffisamment grand*

$$\mathbf{P}_\beta(V_N^* \leq \alpha) \geq e^{-\frac{c_1 N}{\alpha^2}}, \quad \text{pour } N \text{ assez grand.} \quad (1.6.33)$$

Lemma 1.6.5. *Soit K un compact de $(0, +\infty)$. Il existe $c_2, \alpha_2 > 0$ (dépendant de K) tels que pour $\beta \in K$, $\alpha \geq \alpha_2$*

$$\mathbf{P}_\beta(A_N \leq \alpha N) \leq e^{-\frac{c_2 N}{\alpha^2}}, \quad \text{pour } N \text{ assez grand.} \quad (1.6.34)$$

Rappelons (1.4.2), (1.6.10) et notons que l'ensemble $\mathcal{V}_{N,\alpha N}$ est inclus dans $\{V : A_N \leq \alpha N\}$ quand $\alpha \in \mathbb{Q}^+$ et $N \in N_\alpha$. En conséquence, la borne supérieure de (1.6.32) est une conséquence directe du Lemme 1.6.5 et de la continuité de g_β .

Pour la borne inférieure de (1.6.31), observons que la propriété de Markov entraîne que

$$\begin{aligned} \mathbf{P}_\beta(V_N^* \leq \alpha, V_N = 0) &= \sum_{x \in [-\alpha, \alpha]} \mathbf{P}_\beta(V_{N-1}^* \leq \alpha, V_{N-1} = x) \mathbf{P}_\beta(v_1 = -x) \\ &\geq \mathbf{P}_\beta(V_{N-1}^* \leq \alpha) \mathbf{P}_\beta(v_1 = \alpha). \end{aligned} \quad (1.6.35)$$

Comme $V_N^* \leq \alpha$ entraîne $A_N = \sum_{n=1}^N |V_n| \leq \alpha N$, on peut déduire de (1.6.35)

$$\mathbf{P}_\beta(A_N \leq \alpha N, V_N = 0) \geq \mathbf{P}_\beta(V_{N-1}^* \leq \alpha) \mathbf{P}_\beta(v_1 = \alpha). \quad (1.6.36)$$

Rappelons la définition de g_β dans (1.4.4) et appliquons le Lemme 1.6.4, pour obtenir $g_\beta(\alpha) \geq -\frac{c_1}{\alpha^2}$ pour α suffisamment grand, et la preuve de la Proposition 1.6.3 est terminée. \square

1.6.3 Construction et étude asymptotique de h_β

Nous donnerons tout d'abord une définition de la fonction h_β légèrement différente de (1.4.9), mais nous verrons en fin de section que les deux définitions coïncident.

Etant donnés $N \in \mathbb{N}$, $\delta \geq 0$, on pose

$$h_{N,\beta}(\delta) := \frac{1}{N} \log \mathbf{E}_\beta(e^{-\delta A_N} \mathbf{1}_{\{V_N=0\}}) \quad \text{and let} \quad h_\beta(\delta) = \lim_{N \rightarrow \infty} h_{N,\beta}(\delta). \quad (1.6.37)$$

Lemma 1.6.6. (i) $h_\beta(\delta)$ existe, est finie et négative pour tous $\beta > 0$, $\delta \geq 0$.
(ii) $\delta \mapsto h_\beta(\delta)$ est continue convexe et décroissante sur $[0, \infty)$.

Démonstration. (i) Pour $N, M \in \mathbb{N}$, nous restreignons les marches aléatoires de taille $M+N$ à celles qui retournent en zéro aux instants N et $N+M$ pour obtenir

$$\mathbf{E}_\beta(e^{-\delta A_{N+M}} \mathbf{1}_{\{V_{N+M}=0\}}) \geq \mathbf{E}_\beta(e^{-\delta A_N} \mathbf{1}_{\{V_N=0\}}) \mathbf{E}_\beta(e^{-\delta A_M} \mathbf{1}_{\{V_M=0\}}). \quad (1.6.38)$$

Ainsi, $\{\log \mathbf{E}_\beta(e^{-\delta A_N} \mathbf{1}_{\{V_N=0\}})\}_{N \in \mathbb{N}}$ est une suite sur-additive qui est majorée par 0 donc la limite de (1.6.37) existe, est finie et satisfait

$$h_\beta(\delta) = \sup_{N \in \mathbb{N}} \frac{1}{N} \log \mathbf{E}_\beta(e^{-\delta A_N} \mathbf{1}_{\{V_N=0\}}) \leq 0. \quad (1.6.39)$$

(ii) Le fait que $A_N \geq 0$ pour tout $N \in \mathbb{N}$ entraîne immédiatement que $\delta \mapsto h_\beta(\delta)$ décroît sur $[0, \infty)$. Par l'inégalité de Hölder, la fonction $\delta \mapsto h_{N,\beta}(\delta)$ est convexe pour tout $N \in \mathbb{N}$ et donc il en est de même de la limite $\delta \mapsto h_\beta(\delta)$. La fonction h_β est convexe et finie : elle est donc continue sur $(0, \infty)$. Pour établir la continuité en 0, observons d'abord que $\lim_{\delta \rightarrow 0} h_\beta(\delta) = \sup_{\delta \geq 0} h_\beta(\delta)$. En conséquence, grâce à la formule 1.6.39 et à un échange de supremum nous obtenons

$$\begin{aligned} \lim_{\delta \rightarrow 0} h_\beta(\delta) &= \sup_{\delta \geq 0} \sup_{N \in \mathbb{N}} \frac{1}{N} \log \mathbf{E}_\beta(e^{-\delta A_N} \mathbf{1}_{\{V_N=0\}}) \\ &= \sup_{N \in \mathbb{N}} \frac{1}{N} \log \mathbf{P}_\beta(V_N = 0) = 0. \end{aligned} \quad (1.6.40)$$

\square

Il reste à montrer que les deux définitions de h_β de (1.4.9) et (1.6.37) coïncident. Pour cela, il suffit de montrer que

$$\limsup_{N \rightarrow \infty} \frac{1}{N} \log \mathbf{E}_\beta(e^{-\delta A_N}) \leq \lim_{N \rightarrow \infty} \frac{1}{N} \log \mathbf{E}_\beta(e^{-\delta A_N} \mathbf{1}_{\{V_N=0\}}). \quad (1.6.41)$$

On pose $\mathcal{I}_{N^2} := [-N^2, N^2] \cap \mathbb{Z}$ et on décompose $\mathbf{E}_\beta(e^{-\delta A_N})$ en la somme de deux fonctions de partition $C_{N,\beta}$ et $B_{N,\beta}$ définies par

$$C_{N,\beta} = \mathbf{E}_\beta(e^{-\delta A_N} \mathbf{1}_{\{V_N \in \mathcal{I}_{N^2}\}}) \quad \text{and} \quad B_{N,\beta} = \mathbf{E}_\beta(e^{-\delta A_N} \mathbf{1}_{\{V_N \notin \mathcal{I}_{N^2}\}}). \quad (1.6.42)$$

Comme $A_N \geq 0$ et $\mathbf{E}_\beta(\exp(\beta|v_1|/4)) < \infty$, l'inégalité de Markov implique

$$B_{N,\beta} \leq \mathbf{E}_\beta(\mathbf{1}_{\{V_N \notin \mathcal{I}_{N^2}\}}) \leq \mathbf{P}_\beta\left(\sum_{i=1}^N |v_i| \geq N^2\right) \leq \frac{\mathbf{E}_\beta(e^{(\beta/4)|v_1|})^N}{e^{(\beta/4)N^2}}, \quad (1.6.43)$$

ce qui entraîne immédiatement que $\limsup_{N \rightarrow \infty} \frac{1}{N} \log B_{N,\beta} = -\infty$. En conséquence,

$$\limsup_{N \rightarrow \infty} \frac{1}{N} \log \mathbf{E}_\beta(e^{-\delta A_N}) = \limsup_{N \rightarrow \infty} \frac{1}{N} \log C_{N,\beta}, \quad (1.6.44)$$

et comme le cardinal de \mathcal{I}_{N^2} croît polynomialement, pour terminer la preuve de (1.6.41) il nous suffit de montrer que

$$\limsup_{N \rightarrow \infty} \frac{1}{N} \log \sup_{x \in \mathcal{I}_{N^2}} \mathbf{E}_\beta(e^{-\delta A_N} \mathbf{1}_{\{V_N=x\}}) \leq \lim_{N \rightarrow \infty} \frac{1}{N} \log \mathbf{E}_\beta(e^{-\delta A_N} \mathbf{1}_{\{V_N=0\}}). \quad (1.6.45)$$

On considère la fonction de partition sur les chemins de longueur $2N$ et on utilise la propriété de Markov à l'instant N pour obtenir

$$\mathbf{E}_\beta(e^{-\delta A_{2N}} \mathbf{1}_{\{V_{2N}=0\}}) \geq \mathbf{E}_\beta(e^{-\delta A_N} \mathbf{1}_{\{V_N=x\}}) \mathbf{E}_{\beta,x}(e^{-\delta A_N} \mathbf{1}_{\{V_N=0\}}), \quad x \in \mathbb{Z}. \quad (1.6.46)$$

Grâce à la stabilité de la loi de la marche aléatoire V par retournement du temps, nous avons l'identité en loi $(V_N - V_{N-n}, 0 \leq n \leq N) \stackrel{d}{=} (V_n - V_0, 0 \leq n \leq N)$ et en conséquence, pour tout $x \in \mathbb{Z}$,

$$\begin{aligned} \mathbf{E}_{\beta,x}(e^{-\delta \sum_{n=1}^N |V_n|} \mathbf{1}_{\{V_N=0\}}) &= \mathbf{E}_\beta(e^{-\delta \sum_{n=1}^N |V_n+x|} \mathbf{1}_{\{V_N=-x\}}) \\ &= \mathbf{E}_\beta(e^{-\delta \sum_{n=1}^N |V_N - V_{N-n} + x|} \mathbf{1}_{\{V_N=-x\}}) \\ &= \mathbf{E}_\beta(e^{-\delta \sum_{n=1}^{N-1} |V_n|} \mathbf{1}_{\{V_N=-x\}}). \end{aligned} \quad (1.6.47)$$

Il reste à combiner la symétrie de la loi de V , la majoration $\sum_{n=1}^{N-1} |V_n| \leq A_N$, et les inégalités (1.6.46) et (1.6.47) pour obtenir

$$\mathbf{E}_\beta(e^{-\delta A_{2N}} \mathbf{1}_{\{V_{2N}=0\}}) \geq \left[\sup_{x \in \mathcal{I}_{N^2}} \mathbf{E}_\beta(e^{-\delta A_N} \mathbf{1}_{\{V_N=x\}}) \right]^2. \quad (1.6.48)$$

On applique maintenant $\frac{1}{2N} \log$ aux deux côtés de l'inégalité, puis on fait $N \rightarrow +\infty$ pour conclure à (1.6.45), ce qui termine la preuve.

Étude asymptotique de h_β

Lemma 1.6.7. *Pour $m \in \{u, nu\}$,*

$$\lim_{\beta \rightarrow \beta_c^m} \frac{h_\beta(\tilde{f}^m(\beta))}{\tilde{f}^m(\beta)^{2/3}} = -d_m. \quad (1.6.49)$$

avec d_m définie en (1.4.12).

Heuristique Essayons de donner une explication heuristique à l'asymptotique $h_\beta(\delta) \sim -c\delta^{2/3}$, pour une constante $c > 0$. L'idée principale est de décomposer la trajectoire de V en blocs indépendants de longueur $T\delta^{-2/3}$ avec $T \in \mathbb{N}$ et δ suffisamment petit : il y a approximativement $N/(T\delta^{-2/3})$ blocs. En conséquence, quand $\delta \searrow 0$, on peut estimer

$$\lim_{N \rightarrow \infty} \frac{1}{N} \log \mathbf{E}_\beta(e^{-\delta A_N}) \sim \lim_{T \rightarrow \infty} \frac{\delta^{2/3}}{T} \log \mathbf{E}_\beta(e^{-\delta A_{T\delta^{-2/3}}}). \quad (1.6.50)$$

Il est notoire que pour une marche aléatoire dans L^2 (supposons pour simplifier les notations que $\mathbf{E}_\beta(v_1^2) = 1$) (voir par exemple [11, p. 405]), on a la convergence en loi

$$k^{-3/2} \sum_{i=1}^{Tk} |V_i| \xrightarrow{\mathcal{L}} \int_0^T |B(t)| dt \quad \text{as } k \rightarrow \infty, \quad (1.6.51)$$

avec B un mouvement Brownien standard. On pose $k = \delta^{-2/3}$. Comme $|e^{-\delta A_{T\delta^{-2/3}}}| \leq 1$, on conclut que

$$\mathbf{E}_\beta(e^{-\delta A_{T\delta^{-2/3}}}) \rightarrow \mathbf{E}(e^{-\int_0^T |B(t)| dt}) \quad \text{quand } \delta \rightarrow 0. \quad (1.6.52)$$

Cette convergence combinée avec l'estimation (1.6.50) impliquent immédiatement que $h_\beta(\delta) \sim -c\delta^{2/3}$ où c peut être calculée à partir de la loi de l'aire Brownienne

$$c = - \lim_{T \rightarrow \infty} \frac{1}{T} \log \mathbf{E}(e^{-\int_0^T |B(t)| dt}) > 0. \quad (1.6.53)$$

Preuve du Lemme 1.6.7.

Borne supérieure Soit $T \in \mathbb{N}$, $\delta > 0$ tels que $\delta^{-2/3} \in \mathbb{N}$ et soit $\Delta := \delta^{-2/3}$. On se limite à N qui satisfait $N/(T\Delta) \in \mathbb{N}$ et partitionnons $\{1, \dots, N\}$ en $k = N/(T\Delta)$ intervalles de longueur $T\Delta$.

Nous allons décomposer $\mathbf{E}_\beta(e^{-\delta A_N})$ par rapport aux positions occupées par la marche aléatoire V aux instants $T\Delta, 2T\Delta, \dots, (k-1)T\Delta$. Par la propriété de Markov, nous obtenons

$$\mathbf{E}_\beta(e^{-\delta A_N}) = \sum_{\substack{x_0=0, x_i \in \mathbb{Z} \\ i=1, \dots, k}} \prod_{i=0}^{k-1} \mathbf{E}_{\beta, x_i} \left(e^{-\delta A_{T\Delta}} \mathbf{1}_{\{V_{T\Delta} = x_{i+1}\}} \right) \leq \left[\sup_{x \in \mathbb{Z}} \mathbf{E}_{\beta, x} \left(e^{-\delta A_{T\Delta}} \right) \right]^k. \quad (1.6.54)$$

Le Lemme 1.6.8 ci-dessous nous autorise à remplacer le supremum du membre de droite par le terme obtenu pour $x = 0$. Nous prouverons le Lemme 1.6.8 en section 1.6.3.

Lemma 1.6.8. *Pour tous $\delta > 0, n \in \mathbb{N}$ et $x, x' \in \mathbb{Z}$ tels que $|x'| \geq |x|$, on a l'inégalité*

$$\mathbf{E}_{\beta, x'}(e^{-\delta A_n}) \leq \mathbf{E}_{\beta, x}(e^{-\delta A_n}). \quad (1.6.55)$$

Par conséquence (1.6.54) devient

$$\mathbf{E}_{\beta}(e^{-\delta A_N}) \leq \left[\mathbf{E}_{\beta}(e^{-\delta A_{T\Delta}}) \right]^{N/(T\Delta)}. \quad (1.6.56)$$

Rappelons que $\Delta := \delta^{-2/3}$, appliquons $\frac{1}{N} \log$ aux deux membres de (1.6.56) et passons à la limite $N \rightarrow \infty$ pour obtenir, pour $\beta > 0$ et $\delta > 0$,

$$\frac{h_{\beta}(\delta)}{\delta^{2/3}} \leq \frac{1}{T} \log \mathbf{E}_{\beta}(e^{-\delta A_{T\Delta}}). \quad (1.6.57)$$

Dans ce qui suit nous aurons besoin d'une version uniforme (en β) de la convergence de $\mathbf{E}_{\beta}(e^{-\delta A_{T\Delta}})$ vers $\mathbf{E}(e^{-\int_0^T |B(t)| dt})$ as $\delta \rightarrow 0$. Pour cela, nous introduisons un théorème d'approximation forte (Sakhanenko [21]) pour approcher les sommes partielles de variables aléatoires indépendantes v_i de (1.6.57) par des sommes partielles de variables aléatoires gaussiennes.

Theorem 1.6.9 (Q. M. Shao [24], Theorem B). *Soit σ_{β}^2 la variance de la variable aléatoire v_1 sous \mathbf{P}_{β} . Il existe un espace probabilisé sur lequel nous pouvons définir une suite $(v_i^{\beta})_{i \geq 1}$ de variables aléatoires indépendantes qui a même loi que $(v_i)_{i \geq 1}$ sous \mathbf{P}_{β} , et une suite $(y_i)_{i \geq 1}$ de variables indépendantes normales centrées réduites, telles que pour tout $p > 2, x > 0$,*

$$\mathbf{P}\left(\max_{i \leq n} \left| \sum_{j=1}^i v_j^{\beta} - \sigma_{\beta} \sum_{j=1}^i y_j \right| \geq x\right) \leq (Ap)^p x^{-p} \sum_{i=1}^n \mathbf{E}|v_i^{\beta}|^p, \quad (1.6.58)$$

où $A > 0$ désigne une constante universelle.

On pose, pour $n \in \mathbb{N}$, $Y_n = \sum_{i=1}^n y_i$, $A_n(Y) = \sum_{i=1}^n |Y_i|$ et $V_n^{\beta} = \sum_{i=1}^n v_i^{\beta}$, $A_n(V^{\beta}) = \sum_{i=1}^n |V_i^{\beta}|$. Soit $T > 0, p > 2, \theta > 0$ et K un compact de $(0, \infty)$. En combinant le thorem 1.6.9 et le fait que (d'après (1.4.1)) $\mathbf{E}[|v_1^{\beta}|^p]$ est majorée uniformément en $\beta \in K$, pour affirmer l'existence d'une constante $c_{p,K} > 0$ telle que pour tous $\Delta > 0$ et $\beta \in K$

$$\mathbf{P}\left(\max_{i \leq T\Delta} |V_i^{\beta} - \sigma_{\beta} Y_i| \geq \Delta^{\theta}\right) \leq c_{p,K} T \Delta^{1-\theta p}. \quad (1.6.59)$$

Observons que sur l'évènement $\{\max_{i \leq T\Delta} |V_i^{\beta} - \sigma_{\beta} Y_i| < \Delta^{\theta}\}$, on a évidemment $|A_{T\Delta}(V^{\beta}) - \sigma_{\beta} A_{T\Delta}(Y)| \leq T \Delta^{\theta+1}$. En conséquence, comme $x \mapsto \exp(-x)$ est 1-Lipschitzienne sur $[0, \infty)$ et qu'en outre $\Delta = \delta^{-2/3}$, on a pour $\beta \in K$ et $\delta > 0$

$$\begin{aligned} |\mathbf{E}(e^{-\delta A_{T\Delta}(V^{\beta})} - e^{-\delta \sigma_{\beta} A_{T\Delta}(Y)})| &\leq \mathbf{P}\left(\max_{i \leq T\Delta} |V_i^{\beta} - \sigma_{\beta} Y_i| \geq \Delta^{\theta}\right) + \delta T \Delta^{\theta+1} \\ &\leq c_{p,K} T \delta^{\frac{2}{3}(\theta p - 1)} + T \delta^{\frac{1}{3}(1 - 2\theta)}. \end{aligned} \quad (1.6.60)$$

On choisit $p = 3$ et $\theta \in (1/3, 1/2)$. Les inégalités (1.6.57) et (1.6.60) entraînent que pour $\beta \in K$ et $\delta > 0$,

$$\frac{h_{\beta}(\delta)}{\delta^{2/3}} \leq \frac{1}{T} \log \left[\mathbf{E}(e^{-\delta \sigma_{\beta} A_{T\Delta}(Y)}) + c_{3,K} T \delta^{\frac{2(3\theta-1)}{3}} + T \delta^{\frac{1-2\theta}{3}} \right]. \quad (1.6.61)$$

Lemma 1.6.10. *Soit K un compact de $(0, +\infty)$. Pour tout $T > 0$ et $\varepsilon > 0$ il existe $\delta_0 > 0$ tel que $\delta \leq \delta_0$ (avec $\Delta = \delta^{2/3}$),*

$$\sup_{\beta \in K} \left| \mathbf{E} \left(e^{-\delta \sigma_\beta A_{T\Delta}(Y)} \right) - \mathbf{E} \left(e^{-\sigma_\beta \int_0^T |B(t)| dt} \right) \right| < \varepsilon, \quad (1.6.62)$$

où B est un mouvement Brownien standard.

Preuve du lemme 1.6.10. On considère $\{B(t), t \geq 0\}$ et $\{y_i, i \geq 1\}$ définis sur un même espace de probabilité en posant $y_i = B(i) - B(i-1)$ et donc $Y_i = B(i)$ for $i \in \mathbb{N}$. Puisque la fonction exponentielle 1-Lipschitzienne sur $(-\infty, 0]$, on a

$$\sup_{\beta \in K} \left| \mathbf{E} \left(e^{-\delta \sigma_\beta A_{T\Delta}(Y)} \right) - \mathbf{E} \left(e^{-\sigma_\beta \int_0^T |B(t)| dt} \right) \right| \leq \max\{\sigma_\beta, \beta \in K\} \mathbf{E} \left[\left| \delta A_{T\Delta}(Y) - \int_0^T |B(t)| dt \right| \right]. \quad (1.6.63)$$

Puisque $\max\{\sigma_\beta, \beta \in K\} < \infty$, la preuve sera terminée dès qu'on aura prouvé que l'espérance dans le terme de droite tend vers 0 quand $\Delta \rightarrow +\infty$. On rappelle que $\delta = \Delta^{-3/2}$ et que $A_{T\Delta}(Y) = \sum_{i=1}^{T\Delta} |B(i)|$. En utilisant les propriétés de scaling du mouvement Brownien et les sommes de Riemann, on peut montrer que

$$\Delta^{-3/2} A_{T\Delta}(Y) \stackrel{d}{=} \Delta^{-1} \sum_{i=1}^{T\Delta} |B(i/\Delta)| \xrightarrow[\Delta \rightarrow \infty]{a.s.} \int_0^T |B(t)| dt, \quad (1.6.64)$$

et comme on a l'uniforme intégrabilité (car $\sup_{\Delta > 0} \mathbf{E}(|\Delta^{-3/2} A_{T\Delta}(Y)|^2) < \infty$) on peut affirmer que

$$\lim_{\Delta \rightarrow \infty} \mathbf{E} \left(\left| \Delta^{-3/2} A_{T\Delta}(Y) - \int_0^T |B(t)| dt \right| \right) = 0. \quad (1.6.65)$$

□

Nous reprenons la preuve de la borne supérieure. Puisque $\theta \in (1/3, 1/2)$, le terme de droite dans (1.6.60) tend vers 0 quand $\delta \rightarrow 0$ uniformément en $\beta \in K$. Ainsi, on peut remplacer δ par $\tilde{f}^m(\beta_c^m)$ dans (1.6.61) et utiliser le Lemme 1.6.10 et le fait que $\lim_{\varepsilon \rightarrow 0^+} \tilde{f}^m(\beta_c^m - \varepsilon) = 0$ pour conclure que, pour tout $T > 0$,

$$\limsup_{\varepsilon \rightarrow 0^+} \frac{h_\beta(\tilde{f}^m(\beta_c^m - \varepsilon))}{\tilde{f}^m(\beta_c^m - \varepsilon)^{2/3}} \leq \frac{1}{T} \log \mathbf{E} \left(e^{-\sigma_{\beta^m} \int_0^T |B(t)| dt} \right). \quad (1.6.66)$$

Il suffit à présent de laisser T tendre vers l'infini et de rappeler (1.4.12) pour obtenir

$$\limsup_{\varepsilon \rightarrow 0^+} \frac{h_\beta(\tilde{f}^m(\beta_c^m - \varepsilon))}{\tilde{f}^m(\beta_c^m - \varepsilon)^{2/3}} \leq -d_m. \quad (1.6.67)$$

Lower bound On rappelle que $T \in \mathbb{N}$, $\delta > 0$ et que $\Delta = \delta^{-2/3} \in \mathbb{N}$. On choisit aussi $N \in \mathbb{N}$ tel que $N/(T\Delta) \in \mathbb{N}$. Soit $\eta > 0$, on utilise la décomposition introduite dans (1.6.54) pour obtenir

$$\mathbf{E}_\beta \left(e^{-\delta A_N} \right) \geq \sum_{\substack{x_0=0, x_i \in [-\eta\sqrt{\Delta}, \eta\sqrt{\Delta}] \\ i=1, \dots, k}} \prod_{i=0}^{k-1} \mathbf{E}_{\beta, x_i} \left(e^{-\delta A_{T\Delta}} \mathbf{1}_{\{V_{T\Delta} = x_{i+1}\}} \right) \quad (1.6.68)$$

$$\geq \left[\inf_{x \in [-\eta\sqrt{\Delta}, \eta\sqrt{\Delta}]} \mathbf{E}_{\beta, x} \left(e^{-\delta A_{T\Delta}} \mathbf{1}_{\{V_{T\Delta} \in [-\eta\sqrt{\Delta}, \eta\sqrt{\Delta}]\}} \right) \right]^{N/(T\Delta)}. \quad (1.6.69)$$

Pour tout entier $x \in [-\eta\sqrt{\Delta}, \eta\sqrt{\Delta}]$, on considère les deux sous-ensembles de trajectoires

$$\Pi_1^x = \{(V_i)_{i=0}^{T\Delta} : V_0 = x, V_{T\Delta} \in [-\eta\sqrt{\Delta}, \eta\sqrt{\Delta}]\}, \quad (1.6.70)$$

et

$$\Pi_2 = \{(V_i)_{i=0}^{T\Delta} : V_0 = 0, V_{T\Delta} \in [-\eta\sqrt{\Delta}, 0]\}. \quad (1.6.71)$$

Il est clair que, si $V = (V_i)_{i=0}^{T\Delta} \in \Pi_2$, alors la trajectoire $V + x$ est un élément de Π_1^x . De la même façon, pour $x \in [-\eta\sqrt{\Delta}, 0]$, $\Pi_2' + x \subseteq \Pi_1^x$ où

$$\Pi_2' = \{(V_i)_{i=0}^{T\Delta} : V_0 = 0, V_{T\Delta} \in [0, \eta\sqrt{\Delta}]\}. \quad (1.6.72)$$

Puisque $\mathbf{P}_\beta(V \in \Pi_2) = \mathbf{P}_\beta(V \in \Pi_2')$, on en conclut que

$$\mathbf{P}_{\beta,x}(V \in \Pi_1^x) \geq \mathbf{P}_\beta(V \in \Pi_2') \quad \text{pour tout } x \in [-\eta\sqrt{\Delta}, \eta\sqrt{\Delta}]. \quad (1.6.73)$$

de plus pour chaque $V^* \in \Pi_1^x$,

$$\delta \sum_{i=1}^{T\Delta} |V_i^*| = \delta \sum_{i=1}^{T\Delta} |x + V_i| \leq \delta \sum_{i=1}^{T\Delta} |V_i| + \delta T\Delta |x| \leq \delta \sum_{i=1}^{T\Delta} |V_i| + \eta T, \quad (1.6.74)$$

où la trajectoire V vérifie $V_0 = 0$. En combinant (1.6.73) et (1.6.74), nous obtenons alors que, pour $x \in [-\eta\sqrt{\Delta}, \eta\sqrt{\Delta}]$,

$$\mathbf{E}_{\beta,x} \left(e^{-\delta A_{T\Delta}} \mathbf{1}_{\{V_{T\Delta} \in [-\eta\sqrt{\Delta}, \eta\sqrt{\Delta}]\}} \right) \geq e^{-\eta T} \mathbf{E}_\beta \left(e^{-\delta A_{T\Delta}} \mathbf{1}_{\{V_{T\Delta} \in [0, \eta\sqrt{\Delta}]\}} \right). \quad (1.6.75)$$

En utilisant la borne inférieure ci-dessus dans (1.6.68) et en utilisant les propriétés de symétrie de V , on obtient immédiatement que

$$\mathbf{E}_\beta(e^{-\delta A_N}) \geq \left[e^{-\eta T} \mathbf{E}_\beta \left(e^{-\delta A_{T\Delta}} \mathbf{1}_{\{V_{T\Delta} \in [0, \eta\sqrt{\Delta}]\}} \right) \right]^{N/T\Delta}, \quad (1.6.76)$$

ce qui, en appliquant $\frac{1}{N} \log$ dans les termes de gauche et de droite de (1.6.76) et en laissant $N \rightarrow \infty$, donne, pour tout $\beta > 0$,

$$\frac{h_\beta(\delta)}{\delta^{2/3}} \geq \frac{1}{T} \log \mathbf{E}_\beta \left(e^{-\delta A_{T\Delta}} \mathbf{1}_{\{V_{T\Delta} \in [0, \eta\sqrt{\Delta}]\}} \right) - \eta, \quad \delta, \eta > 0. \quad (1.6.77)$$

A ce stade, on utilise la même méthode que pour la borne supérieure (de (1.6.57)) pour obtenir, pour tout $T \in \mathbb{N}, \eta > 0$,

$$\liminf_{\beta \rightarrow \beta_c^m} \frac{h_\beta(\tilde{f}^m(\beta))}{\tilde{f}^m(\beta)^{2/3}} \geq \frac{1}{T} \log \mathbf{E} \left(e^{-\sigma_{\beta_c^m} \int_0^T |B(t)| dt} \mathbf{1}_{\{B(T) \in [0, \eta]\}} \right) - \eta. \quad (1.6.78)$$

Donc, la preuve de la borne inférieure sera terminée dès que nous aurons prouvé que, pour tout $\eta > 0$

$$\lim_{T \rightarrow \infty} \frac{1}{T} \log \mathbf{E} \left(e^{-\sigma_{\beta_c^m} \int_0^T |B(t)| dt} \mathbf{1}_{\{B(T) \in [0, \eta]\}} \right) = \lim_{T \rightarrow \infty} \frac{1}{T} \log \mathbf{E} \left(e^{-\sigma_{\beta_c^m} \int_0^T |B(t)| dt} \right). \quad (1.6.79)$$

A l'aide de (1.4.12), on obtient, pour tout $\eta < 0$, la borne inférieure

$$\liminf_{\beta \rightarrow \beta_c^m} \frac{h_\beta(\tilde{f}^m(\beta))}{\tilde{f}^m(\beta)^{2/3}} \geq -d_m - \eta, \quad (1.6.80)$$

On fait tendre η vers 0 et ceci termine la preuve.

La preuve de (1.6.79) est très similaire à la preuve présentée en section 1.6.3 qui montre que les deux définitions de h_β coïncident. Soit $T > 0$, nous partitionons l'intervalle $[-T^2, T^2]$ en $2T^2/\eta$ sous-intervalles de taille η , i.e.,

$$[-T^2, T^2] = \cup_{i=-(T^2/\eta)+1}^{T^2/\eta} J_i, \quad \text{où } J_i = [(i-1)\eta, i\eta]. \quad (1.6.81)$$

Puisque $\lim_{T \rightarrow \infty} \frac{1}{T} \log \mathbf{P}(|B(T)| \geq T^2) = -\infty$, on peut affirmer que

$$\lim_{T \rightarrow \infty} \frac{1}{T} \log \mathbf{E}(e^{-\sigma_\beta \int_0^T |B(t)| dt}) = \liminf_{T \rightarrow \infty} \frac{1}{T} \log \mathbf{E}(e^{-\sigma_\beta \int_0^T |B(t)| dt} \mathbf{1}_{\{B(T) \in [-T^2, T^2]\}}). \quad (1.6.82)$$

L'espérance dans le membre de droite de (1.6.82) peut être borné supérieurement par

$$\mathbf{E}(e^{-\sigma_\beta \int_0^T |B(t)| dt} \mathbf{1}_{\{B(T) \in [-T^2, T^2]\}}) \leq \frac{2T^2}{\eta} \sup_{i \in \mathcal{T}_\eta} \mathbf{E}(e^{-\sigma_\beta \int_0^T |B(t)| dt} \mathbf{1}_{\{B(T) \in J_i\}}), \quad (1.6.83)$$

avec $\mathcal{T}_\eta := \{-T^2/\eta + 1, \dots, T^2/\eta\}$. En appliquant $\frac{1}{T} \log$ à chaque'un des deux membres de (1.6.83) et en prenant $T \rightarrow \infty$, on obtient que

$$\lim_{T \rightarrow \infty} \frac{1}{T} \log \mathbf{E}(e^{-\sigma_\beta \int_0^T |B(t)| dt}) \leq \liminf_{T \rightarrow \infty} \frac{1}{T} \log \sup_{i \in \mathcal{T}_\eta} \mathbf{E}(e^{-\sigma_\beta \int_0^T |B(t)| dt} \mathbf{1}_{\{B(T) \in J_i\}}). \quad (1.6.84)$$

L'étape suivante consiste à borner par en dessous la fonction de partition de taille $2T$, de façon à ce que pour tout $i \in \mathcal{T}_\eta$ on ait

$$\begin{aligned} & \mathbf{E}(e^{-\sigma_\beta \int_0^{2T} |B(t)| dt} \mathbf{1}_{\{B(2T) \in [-\eta, \eta]\}}) \\ & \geq \mathbf{E} \left[e^{-\sigma_\beta \int_0^T |B(t)| dt} \mathbf{1}_{\{B(T) \in J_i\}} \mathbf{E}(e^{-\sigma_\beta \int_T^{2T} |B(t)| dt} \mathbf{1}_{\{B(2T) \in [-\eta, \eta]\}} \mid B(T)) \right] \\ & \geq \mathbf{E} \left(e^{-\sigma_\beta \int_0^T |B(t)| dt} \mathbf{1}_{\{B(T) \in J_i\}} \right) \inf_{x \in J_i} \mathbf{E}_x \left(e^{-\sigma_\beta \int_0^T |B(t)| dt} \mathbf{1}_{\{B(T) \in [-\eta, \eta]\}} \right). \end{aligned} \quad (1.6.85)$$

On utilise maintenant un renversement du temps et la symétrie de $\{B(t), t \geq 0\}$ pour conclure que, pour tout $x \in J_i, i \in \mathcal{T}_\eta$,

$$\begin{aligned} \mathbf{E}_x(e^{-\sigma_\beta \int_0^T |B(t)| dt} \mathbf{1}_{\{B(T) \in [-\eta, \eta]\}}) &= \mathbf{E}(e^{-\sigma_\beta \int_0^T |B(t)+x| dt} \mathbf{1}_{\{B(T)+x \in [-\eta, \eta]\}}) \\ &= \mathbf{E}(e^{-\sigma_\beta \int_0^T |B(T)-B(T-t)+x| dt} \mathbf{1}_{\{B(T)+x \in [-\eta, \eta]\}}) \\ &\geq e^{-\sigma_\beta \eta T} \mathbf{E}(e^{-\sigma_\beta \int_0^T |B(t)| dt} \mathbf{1}_{\{B(T) \in [x-\eta, x+\eta]\}}) \\ &\geq e^{-\sigma_\beta \eta T} \mathbf{E}(e^{-\sigma_\beta \int_0^T |B(t)| dt} \mathbf{1}_{\{B(T) \in J_i\}}). \end{aligned} \quad (1.6.86)$$

A ce stade, on remarque que les deux inégalités (1.6.86) et (1.6.85) sont valides pour tout $i \in \mathcal{T}_\eta$, et donc

$$\mathbf{E}(e^{-\sigma_\beta \int_0^{2T} |B(t)| dt} \mathbf{1}_{\{B(2T) \in [-\eta, \eta]\}}) \geq e^{-\sigma_\beta \eta T} \sup_{i \in \mathcal{T}_\eta} \mathbf{E}(e^{-\sigma_\beta \int_0^T |B(t)| dt} \mathbf{1}_{\{B(T) \in J_i\}})^2. \quad (1.6.87)$$

On applique $\frac{1}{2T} \log$ à chaque'un des deux membres de (1.6.87) et on laisse $T \rightarrow \infty$ pour obtenir

$$\begin{aligned} \liminf_{T \rightarrow \infty} \frac{1}{2T} \log \mathbf{E} \left(e^{-\sigma_\beta \int_0^{2T} |B(t)| dt} \mathbf{1}_{\{B(2T) \in [-\eta, \eta]\}} \right) \\ \geq \frac{-\sigma_\beta \eta}{2} + \liminf_{T \rightarrow \infty} \frac{1}{T} \sup_{i \in \mathcal{T}_\eta} \log \mathbf{E} \left(e^{-\sigma_\beta \int_0^T |B(t)| dt} \mathbf{1}_{\{B(T) \in J_i\}} \right), \end{aligned} \quad (1.6.88)$$

ce qui, une fois combiné avec (1.6.84) et puisque $\{B(t), t \geq 0\}$ est symétrique, donne

$$\lim_{T \rightarrow \infty} \frac{1}{T} \log \mathbf{E} \left(e^{-\sigma_\beta \int_0^T |B(t)| dt} \right) \leq \liminf_{T \rightarrow \infty} \frac{1}{T} \log \mathbf{E} \left(e^{-\sigma_\beta \int_0^T |B(t)| dt} \mathbf{1}_{\{B(T) \in [0, \eta]\}} \right) + \frac{\sigma_\beta \eta}{2}. \quad (1.6.89)$$

Pour tout $\eta > 0$, on pose

$$d(\eta) := \lim_{T \rightarrow \infty} \frac{1}{T} \log \mathbf{E} \left(e^{-\sigma_\beta \int_0^T |B(t)| dt} \right) - \liminf_{T \rightarrow \infty} \frac{1}{T} \log \mathbf{E} \left(e^{-\sigma_\beta \int_0^T |B(t)| dt} \mathbf{1}_{\{B(T) \in [-\eta, \eta]\}} \right). \quad (1.6.90)$$

La fonction $\eta \mapsto d(\eta)$ est décroissante et positive sur $(0, \infty)$, et une conséquence directe de (1.6.89) est que $0 \leq d(\eta) \leq \frac{\sigma_\beta \eta}{2}$, ce qui implique que $d(\eta) = 0$ pour tout $\eta \in (0, \infty)$. Ceci termine la preuve. \square

Preuve du Lemme 1.6.8

Démonstration. Puisque V et A_n sont symétriques, on peut supposer que $x, x' \in \mathbb{N}_0 := \mathbb{N} \cup \{0\}$ et donc, il suffit de montrer que le résultat est vrai en $x' = x + 1$. On va raisonner par récurrence. Puisque $A_0 = 1$, le cas $m = 0$ est trivial. A présent, on suppose que l'inégalité est vérifiée en $m \in \mathbb{N}$. on considère la fonction de partition de taille $m + 1$, et on peut la réécrire en fonction de la position de V_1 , i.e.,

$$\begin{aligned} \mathbf{E}_{\beta, x} \left(e^{-\delta A_{m+1}} \right) &= \sum_{y \in \mathbb{Z}} \mathbf{E}_{\beta, x} \left(e^{-\delta(|y| + |V_2| + \dots + |V_{m+1}|)} \mathbf{1}_{\{V_1 = y\}} \right) \\ &= \sum_{y \in \mathbb{Z}} \mathbf{P}_\beta(v_1 = y - x) e^{-\delta|y|} \mathbf{E}_{\beta, y} \left(e^{-\delta A_m} \right) \\ &= \sum_{y \in \mathbb{N}} R_x(y) e^{-\delta y} \mathbf{E}_{\beta, y} \left(e^{-\delta A_m} \right) + \mathbf{P}_\beta(v_1 = x) \mathbf{E}_\beta \left(e^{-\delta A_m} \right), \end{aligned} \quad (1.6.91)$$

où $R_x(y) = \mathbf{P}_\beta(v_1 = y - x) + \mathbf{P}_\beta(v_1 = -y - x)$. Ainsi, on pose $\bar{R}_x(y) = \sum_{y' \geq y} R_x(y')$ pour $y \in \mathbb{N}$. Puisque $\bar{R}_x(1) + \mathbf{P}_\beta(v_1 = x) = 1$, on peut réécrire le membre de droite de (1.6.91) sous la forme

$$\mathbf{E}_{\beta, x} \left(e^{-\delta A_{m+1}} \right) = \sum_{y \in \mathbb{N}} \bar{R}_x(y) \left[e^{-\delta y} \mathbf{E}_{\beta, y} \left(e^{-\delta A_m} \right) - e^{-\delta(y-1)} \mathbf{E}_{\beta, (y-1)} \left(e^{-\delta A_m} \right) \right] + \mathbf{E}_\beta \left(e^{-\delta A_m} \right). \quad (1.6.92)$$

On va montrer que, pour tout $y \in \mathbb{N}$, la fonction $x \mapsto \bar{R}_x(y)$ est croissante sur \mathbb{N}_0 . D'abord, si $y \geq x + 1$, on a évidemment

$$\bar{R}_x(y) = \sum_{y' \geq y} R_x(y') \leq \sum_{y' \geq y} R_{x+1}(y') = \bar{R}_{x+1}(y). \quad (1.6.93)$$

Ensuite, si $1 \leq y \leq x$, puisque

$$\bar{R}_x(y) + \sum_{y'=1}^{y-1} R_x(y') + \mathbf{P}_\beta(v_1 = x) = \bar{R}_{x+1}(y) + \sum_{y'=1}^{y-1} R_{x+1}(y') + \mathbf{P}_\beta(v_1 = x + 1) = 1, \quad (1.6.94)$$

et

$$\mathbf{P}_\beta(v_1 = x) + \sum_{y'=1}^{y-1} R_x(y') \geq \mathbf{P}_\beta(v_1 = x + 1) + \sum_{y'=1}^{y-1} R_{x+1}(y'), \quad (1.6.95)$$

on obtient immédiatement l'égalité $\bar{R}_x(y) \leq \bar{R}_{x+1}(y)$. En revenant à (1.6.92), on utilise l'hypothèse de récurrence pour affirmer que

$$e^{-\delta y} \mathbf{E}_{\beta,y}(e^{-\delta A_m}) - e^{-\delta(y-1)} \mathbf{E}_{\beta,(y-1)}(e^{-\delta A_m}) \leq 0, \quad y \in \mathbb{N}, \quad (1.6.96)$$

ce qui, grâce à la monotonie de $x \mapsto \bar{R}_x(y)$, implique que

$$\begin{aligned} \mathbf{E}_{\beta,x}(e^{-\delta A_{m+1}}) &\geq \sum_{y \in \mathbb{N}} \bar{R}_{x+1}(y) \left[e^{-\delta y} \mathbf{E}_{\beta,y}(e^{-\delta A_m}) - e^{-\delta(y-1)} \mathbf{E}_{\beta,(y-1)}(e^{-\delta A_m}) \right] + \mathbf{E}_\beta(e^{-\delta A_m}) \\ &= \mathbf{E}_{\beta,x+1}(e^{-\delta A_{m+1}}). \end{aligned}$$

□

1.6.4 Estimations de grande déviation

Dans cette section, on introduit les techniques nécessaires pour estimer la probabilité de certains événements de grandes déviations associés à des trajectoires qui décrivent de grandes aires géométriques. Ces estimées seront utiles dans la section 1.4.3 pour approximer la probabilité que, sous la mesure du polymère, les trajectoires décrivent une seule perle macroscopique.

On conserve les notations introduites par Dobrushin et Hryniv dans [10], pour $n \in \mathbb{N}$, on définit

$$Y_n := \frac{1}{n}(V_0 + V_1 + \cdots + V_{n-1}), \quad (1.6.97)$$

et pour $q \in (0, \infty) \cap \frac{\mathbb{N}}{n}$ fixé, on se concentre sur les deux quantités $\mathbf{P}_\beta(Y_n = nq, V_n = 0)$ et $\mathbf{P}_\beta(Y_n = nq, V_n = 0, V_i > 0 \forall i \in \{1, \dots, n-1\})$. Notre objectif est d'identifier les taux de décroissance exponentiel et les corrections polynômiales respectifs de ces deux types de probabilité. Dans ce but, on utilise un *tilting exponentiel* de la mesure de probabilité \mathbf{P}_β (grâce à la transformation de Cramer) combinée avec un théorème centrale limite. Sous la mesure de probabilité tiltée, l'évènement de grande déviation $\{Y_n = nq, V_n = 0\}$ devient typique, comme nous le verrons dans le chapitre 4 de la section 4.6.

D'abord, on note $L(h)$, $h \in \mathbb{R}$ le logarithme de la fonction génératrice des moments de la marche aléatoire V , i.e.,

$$L(h) := \log \mathbf{E}_\beta[e^{hV_1}]. \quad (1.6.98)$$

Par définition de la loi de \mathbf{P}_β dans (1.4.1), on a clairement que $L(h) < \infty$ pour tout $h \in (-\beta/2, \beta/2)$. Pour simplifier les notations, on pose $\Lambda_n := (Y_n, V_n)$ et on appelle $L_{\Lambda_n}(H)$ pour $H := (h_0, h_1) \in \mathbb{R}^2$, le logarithme de sa fonction génératrice des moments, i.e.,

$$L_{\Lambda_n}(H) := \log \mathbf{E}_\beta[e^{h_0 Y_n + h_1 V_n}] = \sum_{i=1}^n L\left(\left(1 - \frac{i}{n}\right)h_0 + h_1\right). \quad (1.6.99)$$

Clairement, $L_{\Lambda_n}(H)$ est fini pour tout $H \in \mathcal{D}_n$ avec

$$\mathcal{D}_n := \left\{ (h_0, h_1) \in \mathbb{R}^2 : h_1 \in \left(-\frac{\beta}{2}, \frac{\beta}{2}\right), (1 - \frac{1}{n})h_0 + h_1 \in \left(-\frac{\beta}{2}, \frac{\beta}{2}\right) \right\}. \quad (1.6.100)$$

On introduit aussi L_Λ l'homologue continu de L_{Λ_n} , i.e.,

$$L_\Lambda(H) := \int_0^1 L(xh_0 + h_1)dx, \quad (1.6.101)$$

qui est défini sur

$$\mathcal{D} := \left\{ (h_0, h_1) \in \mathbb{R}^2 : h_1 \in \left(-\frac{\beta}{2}, \frac{\beta}{2}\right), h_0 + h_1 \in \left(-\frac{\beta}{2}, \frac{\beta}{2}\right) \right\}. \quad (1.6.102)$$

A l'aide de (1.6.99) et pour $H = (h_0, h_1) \in \mathcal{D}_n$, on définit la distribution H -tiltée par

$$\frac{d\mathbf{P}_{n,H}}{d\mathbf{P}_\beta}(V) = e^{h_0 Y_n + h_1 V_n - L_{\Lambda_n}(H)}. \quad (1.6.103)$$

Pour $n \in \mathbb{N}$ et $q \in \frac{\mathbb{N}}{n}$ fixés, le tilt exponentiel est donné par $H_n^q := (h_{n,0}^q, h_{n,1}^q)$, qui est l'unique solution de

$$\mathbf{E}_{n,H}(\frac{\Lambda_n}{n}) = \nabla[\frac{1}{n}L_{\Lambda_n}](H) = (q, 0), \quad (1.6.104)$$

et donc, on a l'égalité

$$\mathbf{P}_\beta(\Lambda_n = (nq, 0)) = \mathbf{P}_{n,H_n^q}(\Lambda_n = (nq, 0))e^{n(-h_{n,0}^q q + \frac{1}{n}L_{\Lambda_n}(H_n^q))}. \quad (1.6.105)$$

Il est facile de déduire de (1.6.105) que le taux de décroissance exponentiel de $\mathbf{P}_\beta(\Lambda_n = (nq, 0))$ est donné par la quantité $-h_{n,0}^q q + \frac{1}{n}L_{\Lambda_n}(H_n^q)$ tandis que la correction polynômiale est associée à la quantité $\mathbf{P}_{n,H_n^q}(\Lambda_n = (nq, 0))$. Pour être plus précis, on énonce d'abord une proposition qui donne un théorème centrale limite local pour la loi tiltée \mathbf{P}_{n,H_n^q} .

Proposition 1.6.11. *Pour tout $[q_1, q_2] \subset (0, \infty)$, il existe $C > 0, n_0 > 0$ tels que pour tout $q \in [q_1, q_2]$ et $n \geq n_0$ on a*

$$\frac{1}{Cn^2} \leq \mathbf{P}_{n,H_n^q}(Y_n = nq, V_n = 0) \leq \frac{C}{n^2}. \quad (1.6.106)$$

Ensuite, on définit l'homologue continu de H_n^q par $\tilde{H}(q, 0) := (\tilde{h}_0(q, 0), \tilde{h}_1(q, 0))$, qui est l'unique solution de l'équation

$$\nabla L_\Lambda(H) = (q, 0), \quad (1.6.107)$$

et on énonce une proposition qui nous permet de supprimer la dépendance en n du taux de décroissance exponentielle.

Proposition 1.6.12 (Decay rate of large area probability). *Pour $[q_1, q_2] \subset (0, +\infty)$, il existe $c_1, c_2 > 0$ et $n_0 \in \mathbb{N}$ tels que*

$$\left| \left[\frac{1}{n}L_{\Lambda_n}(H_n^q) - h_{n,0}^q q \right] - \left[L_\Lambda(\tilde{H}(q, 0)) - \tilde{h}_0(q, 0) q \right] \right| \leq \frac{c_1}{n}, \quad \text{pour } n \geq n_0, q \in [q_1, q_2]. \quad (1.6.108)$$

et

$$\left\| H_n^q - \tilde{H}(q, 0) \right\| \leq \frac{c_2}{n}, \quad \text{pour } n \geq n_0, q \in [q_1, q_2]. \quad (1.6.109)$$

Les Propositions 1.6.11 et 1.6.12 seront prouvées dans les sections 4.5.1 du chapitre 4 et 4.6. A l'aide de (1.6.105) et en appliquant les propositions 1.6.11 et 1.6.12 on peut finalement donner des bornes supérieure et inférieure précises pour la quantité $\mathbf{P}_\beta(Y_n = nq, V_n = 0)$.

Proposition 1.6.13. *Pour $[q_1, q_2] \subset (0, \infty)$, il existe $C_1 > C_2 > 0$ et $n_0 \in \mathbb{N}$ tels que pour tout $q \in [q_1, q_2]$ et $n \geq n_0$ on a*

$$\frac{C_2}{n^2} e^{n[-\tilde{h}_0^q q + L_\Lambda(\tilde{H}(q,0))]} \leq \mathbf{P}_\beta(Y_n = nq, V_n = 0) \leq \frac{C_1}{n^2} e^{n[-\tilde{h}_0^q q + L_\Lambda(\tilde{H}(q,0))]} \quad (1.6.110)$$

Nous aurons également besoin dans cet article, d'une borne inférieure précise sur la probabilité que, sous la mesure \mathbf{P}_β , la marche aléatoire V fasse une seule excursion en dehors de l'origine, conditionnellement à ce qu'elle décrive une grande aire géométrique fixée au préalable. A notre connaissance, une telle estimation n'était pas disponible dans la littérature existante. On rappelle la définition de Y_n dans (1.6.97).

Proposition 1.6.14 (Unicité de l'excursion pour de grandes aires). *Pour $[q_1, q_2] \subset (0, \infty)$, il existe $C > 0, \mu > 0$ et $n_0 \in \mathbb{N}$ tels que pour tout $q \in [q_1, q_2]$ et tout $n \geq n_0$*

$$\mathbf{P}_\beta(V_i > 0, 0 < i < n \mid Y_n = nq, V_n = 0) \geq \frac{C}{n^\mu}. \quad (1.6.111)$$

English Introduction

Sommaire

2.1	Physical motivations and the model setting	42
2.1.1	Physical motivations	42
2.1.2	The model setting	42
2.2	The model	44
2.2.1	Polymer configurations	44
2.2.2	The Hamiltonian	45
2.2.3	The free energy	46
2.3	Physical background	48
2.4	The main results	49
2.4.1	Variational formula	50
2.4.2	A sharper asymptotic of the free energy close to criticality	52
2.4.3	Path properties inside the collapsed phase	52
2.5	Collapsed polymer unfolded by a force	54
2.6	The main tools	56
2.6.1	Probabilistic representation of the partition function	56
2.6.2	Construction and asymptotics of g_β	58
2.6.3	Construction and asymptotics of h_β	61
2.6.4	Large deviation estimates	69

2.1 Physical motivations and the model setting

2.1.1 Physical motivations

This thesis is devoted to the study of the phenomena expansion and collapse for different polymer models. The conformation of individual polymer chains depends on the temperature or the solvent properties. In good solvent (or at high temperature) the monomers effectively repel each other, preferring to be surrounded by solvent. This effect leads to a *extended* conformation for polymers in good solvent. When the solvent quality deteriorates (or the temperature is lowered), conversely, the monomers try to exclude the solvent and effectively attract one another, and the polymer condenses into a dense, globule, that looks like a *compact ball*, to minimize the contacts between monomers and solvent (see Fig. 2.1). For a given polymer-solvent pair, the collapsed state is satisfied at a certain temperature, called the θ -point. The dynamics of the extended/collapsed transition in flexible polymers are well known and has been studied theoretically for many years. Understanding the collapse transition is foremost a precursor to understanding biological macromolecules folding such as proteins and DNA.

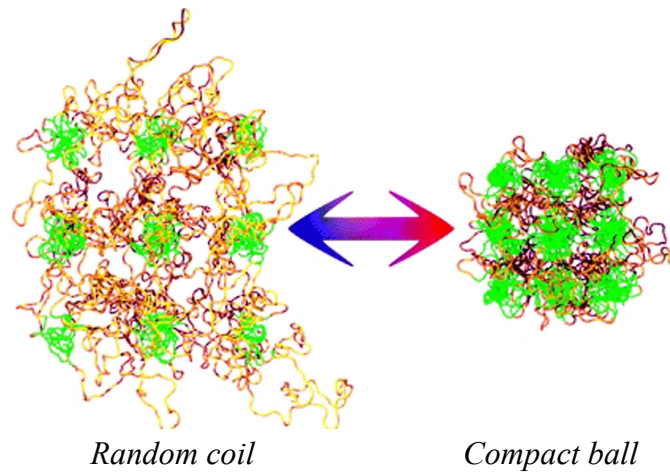

FIGURE 2.1 – Hydrogel behavior (*Macromolecules*, 2007, 40, 5827).

2.1.2 The model setting

In mathematics, polymer models often live on the d -dimensional Euclidean lattice \mathbb{Z}^d , $d \geq 1$. They consist of random walk trajectories on this lattice, the monomers being the vertices of the walk, and the chemical bonds connecting the monomers being the edges of the walk.

For $L \in \mathbb{N}$, let \mathcal{W}_L be the set of allowed L -step paths with law denoted by \mathbf{P} . Each trajectory $w = (w_n)_{n \in [0, L]}$ we associate a energy given by the Hamiltonian $H_L(w)$. The choice of H_L captures the interaction of the polymer with itself or its environment. Typically, H_L depends on one or two parameters, including the temperature. For each $L \in \mathbb{N}$, the law of the polymer of length L is given by the probability measure $\mathbf{P}_L(w)$ on \mathcal{W}_L

$$\mathbf{P}_L(w) = \frac{\exp(H_L(w))}{Z_L} \mathbf{P}(w), \quad w \in \mathcal{W}_L, \quad (2.1.1)$$

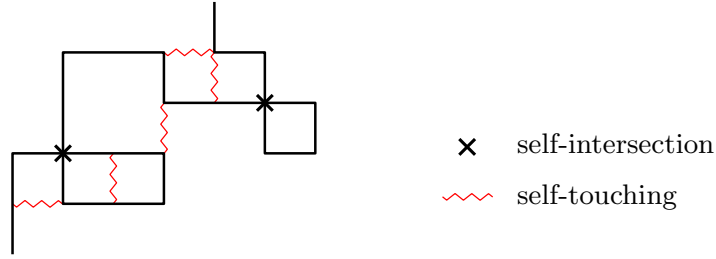

FIGURE 2.2 – A SRW with self-intersections and self-touchings.

where Z_L is the normalizing constant known as the partition function of the system

$$Z_L = \mathbf{E}[\exp(H_L(w))]. \quad (2.1.2)$$

This is called the Gibbs measure associated with the pair (\mathcal{W}_L, H_L) , and it describes the polymer in equilibrium with itself or its environment, at a fixed length L . Under this Gibbs measure, paths with a low energy have a high probability, while paths with a high energy have a low probability.

Let us have a brief look at two basic models for a polymer chain : the simple random walk and the self-avoiding walk.

(1) The simple random walk (SRW) Our choice for the set of allowed paths is

$$\mathcal{W}_L = \{w = (w_i)_{i=0}^L \in (\mathbb{Z}^d)^{L+1} : w_0 = 0, \|w_{i+1} - w_i\| = 1, \forall 0 \leq i < L\}, \quad (2.1.3)$$

with law \mathbf{P} is a uniform distribution on \mathcal{W}_L . For $\beta, \gamma \in (0, \infty)$, we consider a polymer that receives a reward β for each self-touching and a penalty γ for each self-intersection (Fig. 2.2). Thus, we associate with every random walk w the Halmiltonian

$$H_L^{\beta, \gamma}(w) := \frac{\beta}{2d} \sum_{\substack{i, j=0 \\ i < j-1}}^L \mathbf{1}_{\{\|w_i - w_j\|=1\}} - \gamma \sum_{\substack{i, j=0 \\ i < j-1}}^L \mathbf{1}_{\{\|w_i - w_j\|=0\}}. \quad (2.1.4)$$

The factor $\frac{1}{2d}$ is added to account for the fact that each site has $2d$ neighboring sites where the polymer can achieve a self-touching.

Under the polymer measure, self-intersections are penalized while self-touchings are rewarded. van der Hofstad and Klenke [13] showed that for $\beta > \gamma$ the polymer localizes, i.e., with high probability the polymer is contained in a finite box whose size is independent of the length of the polymer. For $\beta < \gamma$ the behaviour is different : the polymer extends in space, i.e., the probability for the polymer consisting of n monomers to be contained in a cube of side length $\varepsilon n^{1/d}$ tends to 0 as n tends to infinity.

(2) The self-avoiding random walk (SAW) We consider only the subset of random walks which never visit the same site again :

$$\mathcal{W}_L = \{w = (w_i)_{i=0}^L \in (\mathbb{Z}^d)^{L+1} : w_0 = 0, \|w_{i+1} - w_i\| = 1, \forall 0 \leq i < L, \\ w_i \neq w_j \forall 0 \leq i < j \leq L\}.$$

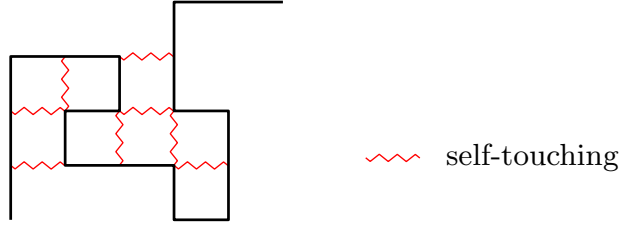

FIGURE 2.3 – A SAW with self-touchings.

This is a popular model to describe the collapsed effect since the self-avoiding walks satisfy the so-called excluded volume condition, i.e., no site can be occupied by more than one monomer. The interactions between monomers are taken into account by assigning an energetic reward $\beta \geq 0$ to the polymer for each self-touching (Fig. 2.3). Thus, we associate with every random walk trajectory $w = (w_i)_{i=0}^L \in \mathcal{W}_L$ the Hamiltonian

$$H_{L,\beta}(w) := \beta \sum_{\substack{i,j=0 \\ i < j-1}}^L \mathbf{1}_{\{\|w_i - w_j\|=1\}}. \quad (2.1.5)$$

This model has exhibited many important conjectured properties of the physical problem even though it is not exactly solved in the sense that the generating function of partition functions has not been explicitly calculated, in two or three dimensions.

2.2 The model

In order to deal with the collapse transition mathematically, it is necessary to turn to a directed version of the model. The interacting partially directed self avoiding walk (IPDSA) was introduced in [26] as a partially directed model of an homopolymer in a poor solvent. This model, and a closely related semi-continuous variant, on the square lattice were studied extensively in the early 1990's [3, 6, 18, 20].

2.2.1 Polymer configurations

The spatial configurations of the polymer of length L (L monomers) are modelled by the trajectories of a partially directed random walk on \mathbb{Z}^2 . This random walk is *self-avoiding* and only takes unitary steps *upwards, downwards and to the right* (Fig. 2.4). More precisely, we let $\vec{e}_1 = (1, 0)$, $\vec{e}_2 = (0, 1)$ denote the canonical basis of \mathbb{Z}^2 and we choose the set of allowed L -step paths as :

$$\begin{aligned} \mathcal{W}_L = \{ w = (w_i)_{i=0}^L \in (\mathbb{N}_0 \times \mathbb{Z})^{L+1} : w_0 = 0, \\ w_{i+1} - w_i \in \{ \vec{e}_1, \vec{e}_2, -\vec{e}_2 \} \forall 0 \leq i < L-1, \\ w_i \neq w_j \forall 0 \leq i < j \leq L, \\ w_L - w_{L-1} = \vec{e}_1 \}. \end{aligned} \quad (2.2.1)$$

Note that the choice of w ending with an horizontal step is made for convenience only. Let us introduce two different laws on \mathcal{W}_L , uniform and non-uniform, denoted by \mathbf{P}_L^u and \mathbf{P}_L^{nu} ,

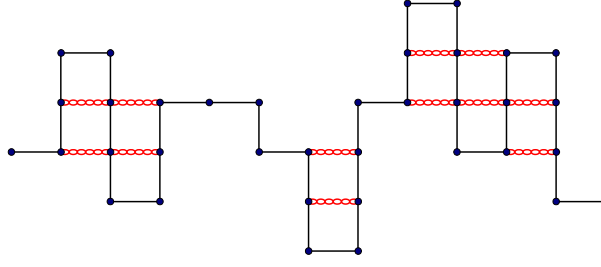

FIGURE 2.4 – A partially directed walk with 12 self-touchings represented by red bonds.

respectively.

(1) The uniform model : all L -step paths have the same probability, i.e.,

$$\mathbf{P}_L^u(w) = \frac{1}{|\mathcal{W}_L|}, \quad w \in \mathcal{W}_L. \quad (2.2.2)$$

(2) The non-uniform (kinetic) model : the walker is chosen uniformly among the allowed directions, i.e.,

- At the origin or after an horizontal step : the walker must step north, south or east with equal probability $1/3$.
- After a vertical step north (respectively south) : the walker must step north (respectively south) or east with probability $1/2$.

More formally, under \mathbf{P}_L^{nu} the sequence of random variables $(x_i := w_i - w_{i-1})_{i \in [1, L]}$ satisfies the Markov property with transition probabilities

$$\begin{aligned} \mathbf{P}_L^{\text{nu}}(x_{i+1} = y \mid x_i = \vec{e}_1) &= 1/3, \quad y \in \{\vec{e}_1, \vec{e}_2, -\vec{e}_2\}, \\ \mathbf{P}_L^{\text{nu}}(x_{i+1} = y \mid x_i = \vec{e}_2) &= 1/2, \quad y \in \{\vec{e}_1, \vec{e}_2\}, \\ \mathbf{P}_L^{\text{nu}}(x_{i+1} = y \mid x_i = -\vec{e}_2) &= 1/2, \quad y \in \{\vec{e}_1, -\vec{e}_2\} \end{aligned}$$

For later convenience, the law on \mathcal{W}_L is denoted by \mathbf{P}_L^m , where $m \in \{u, \text{nu}\}$.

2.2.2 The Hamiltonian

Due to the directed nature of this problem, we can describe these configurations in \mathcal{W}_L through a collection of vertical stretches separated by one horizontal step. Thus, we set $\Omega_L := \bigcup_{N=1}^L \mathcal{L}_{N,L}$, where $\mathcal{L}_{N,L}$ is the set of all possible configurations consisting of N vertical stretches that have a total length L , that is

$$\mathcal{L}_{N,L} = \left\{ l \in \mathbb{Z}^N : \sum_{n=1}^N |l_n| + N = L \right\}. \quad (2.2.3)$$

At this state, we have a one-to-one correspondance between \mathcal{W}_L and Ω_L (Fig. 2.5). By recalling the definition of \mathbf{P}_L^m in (2.2.2), we note that for a given $N \in \{1, \dots, L\}$ the function $l \mapsto \mathbf{P}_L^m(l)$ is constant on $\mathcal{L}_{N,L}$ and equals $1/|\mathcal{W}_L|$ if $m = u$ and $(1/3)^N (1/2)^{L-N}$ if $m = \text{nu}$.

The Hamiltonian associated with a given path of \mathcal{W}_L can be rewritten in terms of its associated collection of vertical stretches $l \in \Omega_L$ as

$$H_{L,\beta}(l_1, \dots, l_N) = \beta \sum_{n=1}^{N-1} (l_n \tilde{\wedge} l_{n+1}) \quad (2.2.4)$$

where

$$x \tilde{\wedge} y = \begin{cases} |x| \wedge |y| & \text{if } xy < 0, \\ 0 & \text{otherwise.} \end{cases} \quad (2.2.5)$$

Therefore, the partition function can be rewritten under the form

$$Z_{L,\beta}^m = \sum_{N=1}^L \sum_{l \in \mathcal{L}_{N,L}} e^{\beta \sum_{i=1}^{N-1} (l_i \tilde{\wedge} l_{i+1})} \mathbf{P}_L^m(l). \quad (2.2.6)$$

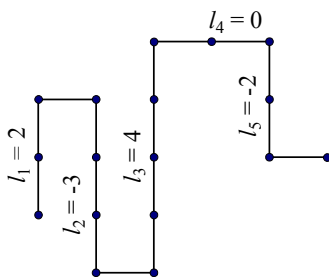

FIGURE 2.5 – An example trajectory with $N = 5$ vertical stretches and length $L = 16$.

2.2.3 The free energy

The standard way of determining the collapsed state for our model is by looking at the asymptotic behavior of the partition function $Z_{L,\beta}^m$ for large L . More precisely, we define the *free energy* of the model

$$f^m(\beta) := \lim_{L \rightarrow \infty} f_L^m(\beta), \quad \text{where} \quad f_L^m(\beta) := \frac{1}{L} \log Z_{L,\beta}^m. \quad (2.2.7)$$

To understand why one should look at f , we introduce the random variable

$$S_L(w) := \sum_{\substack{i,j=0 \\ i < j-1}}^L \mathbf{1}_{\{\|w_i - w_j\|=1\}} \quad (2.2.8)$$

and observe that an easy computation yields

$$\frac{\partial}{\partial \beta} f_L^m(\beta) = \mathbf{E}_{L,\beta}^m \left(\frac{S_L}{L} \right), \quad (2.2.9)$$

$$\frac{\partial^2}{\partial \beta^2} f_L^m(\beta) = L \text{Var}_{\mathbf{P}_{L,\beta}^m} \left(\frac{S_L}{L} \right). \quad (2.2.10)$$

By the Hölder inequality, $\beta \mapsto f_L^m(\beta)$ is convex for all $L \in \mathbb{N}$ and hence so $f^m(\beta)$. Convexity implies that provide $f^m(\beta)$ is differentiable at β , then

$$\frac{\partial}{\partial \beta} f^m(\beta) = \lim_{L \rightarrow \infty} \mathbb{E}_{L,\beta}^m \left(\frac{S_L}{L} \right). \quad (2.2.11)$$

Thus, the first derivative of $f^m(\beta)$ gives the limiting number of self-touchings per monomer, which explains the reason for looking at $f^m(\beta)$. In fact, a basic problem is the determination of the set of values of β where the free energy fails to be analytic. They correspond physically to the occurrence of a phase transition of the system.

Note that $\{\log Z_{L,\beta}^m\}_L$ is a super-additive sequence and since the number of self-touchings is smaller than the number of monomers, i.e. $H_{L,\beta}(w) \leq \beta L$, we immediately obtain the upper bound $Z_{L,\beta}^m \leq e^{\beta L}$ for $\beta \in (0, \infty)$ and $m \in \{u, nu\}$. Thus the limit in (2.2.7) exists and is finite

$$f^m(\beta) = \lim_{L \rightarrow \infty} \frac{1}{L} \log Z_{L,\beta}^m = \sup_{L \in \mathbb{N}} \frac{1}{L} \log Z_{L,\beta}^m \leq \beta. \quad (2.2.12)$$

If we shut down the self-interaction of the polymer, that is if we take $\beta = 0$, then the density of self-touching performed by a typical L -step random walk trajectory belongs to $(0, 1)$, the horizontal extension of this trajectory is of order L and its vertical displacement of order \sqrt{L} . When β becomes strictly positive, in turn, the geometric conformation adopted by the random walk is the result of an "energy-entropy" competition which can be understood as follows. To increase its self-touching density, the polymer must both, reduce its number of horizontal steps and constrain its consecutive sequences of vertical steps to take opposite directions. However, these two geometric constraints have an entropic cost such that the free energy is the result of an optimization between the energetic gain and the entropic cost induced by a raise of the self-touching density. When β becomes large, the system enters its collapsed phase which corresponds to a saturation of the self-touchings made by the polymer. In other words, the collapsed configurations have a self-touching density equal to 1, which necessarily entails that the number of horizontal steps made by such configurations is of order $o(L)$ and that most pairs of consecutive vertical stretches are of opposite directions. These geometric restrictions are associated with a collapsed entropy κ_m for $m \in \{u, nu\}$ such that the free energy takes the form $\beta + \kappa_m$. In Lemma 2.2.1 below, we display the value of this collapsed entropy.

Lemma 2.2.1. For $\beta > 0$, $m \in \{u, nu\}$

$$f^m(\beta) \geq \varphi_\beta^m, \quad (2.2.13)$$

where $\varphi_\beta^u = \beta - \log(1 + \sqrt{2})$ and $\varphi_\beta^{nu} = \beta - \log 2$.

Démonstration. We pick L such that $\sqrt{L} \in \mathbb{N}$ and restrict the sum giving $Z_{L,\beta}^m$ to a single L -step trajectory \tilde{w} which starts with $\sqrt{L} - 1$ steps north then makes one step east, then $\sqrt{L} - 1$ steps south, then one step east, then $\sqrt{L} - 1$ steps north and so on... (Fig. 2.6). This trajectory makes \sqrt{L} horizontal steps, separating \sqrt{L} vertical stretches of length $\sqrt{L} - 1$ each. Since any two consecutive vertical stretches of \tilde{w} have opposite direction, its Hamiltonian is given by $\beta(\sqrt{L} - 1)^2 \geq \beta L - 2\beta\sqrt{L}$. Moreover, $\mathbf{P}_L^u(\tilde{w}) = 1/|\mathcal{W}_L|$ and $\mathbf{P}_L^{nu}(\tilde{w}) = (2/3)^{\sqrt{L}}(1/2)^L$, therefore

$$Z_{L,\beta}^u \geq \frac{e^{\beta(L-2\sqrt{L})}}{|\mathcal{W}_L|} \quad \text{and} \quad Z_{L,\beta}^{nu} \geq \left(\frac{e^\beta}{2}\right)^L \left(\frac{2}{3e^{2\beta}}\right)^{\sqrt{L}}. \quad (2.2.14)$$

Since $\lim_{L \rightarrow \infty} L^{-1} \log |\mathcal{W}_L| = \log(1 + \sqrt{2})$ (see [4, p. 5]), it remains to take $\frac{1}{L} \log$ in each term of the two inequalities in (2.2.14) and to let $L \rightarrow \infty$ to complete the proof of the Lemma. \square

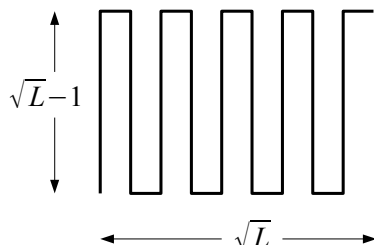

FIGURE 2.6 – Restrict the partition function to a single L -step trajectory whose the number of self-touchings is maximum.

Clearly, all what Lemma 2.2.1 is saying is that the collapsed entropies satisfy $\kappa_u \geq -\log(1 + \sqrt{2})$ and $\kappa_{nu} \geq -\log 2$. However, we will see below that these two inequalities are in fact equalities.

Let us define the *excess free energy* $\tilde{f}^m(\beta) := f^m(\beta) - \varphi_\beta^m$, which by Lemma 2.2.1 above is always non negative. The lower bound in Lemma 2.2.1 allows us to partition $[0, \infty)$ into a collapsed phase denoted by \mathcal{C} and an extended phase denoted by \mathcal{E} , i.e,

$$\mathcal{C} := \{\beta : \tilde{f}^m(\beta) = 0\} \quad (2.2.15)$$

and

$$\mathcal{E} := \{\beta : \tilde{f}^m(\beta) > 0\}. \quad (2.2.16)$$

Since $\tilde{f}^m(\beta)$ is convex, non negative and bounded above, proving that there exists $\beta_0^m \in [0, \infty)$ such that $\tilde{f}^m(\beta_0^m) = 0$ will be sufficient to claim that $\tilde{f}^m(\beta) = 0$ for $\beta \geq \beta_0^m$. Then, the critical point will be defined as

$$\beta_c^m := \inf\{\beta \geq 0 : \tilde{f}^m(\beta) = 0\}, \quad (2.2.17)$$

and the sets \mathcal{C} and \mathcal{E} will become $\mathcal{C} = \{\beta : \beta \geq \beta_c^m\}$ and $\mathcal{E} = \{\beta : \beta < \beta_c^m\}$.

2.3 Physical background

The IPDSAW and its continuous versions have attracted a lot of attention from physicists until very recently (see for instance [5] or [22]). The main method that has been employed to investigate the IPDSAW involves combinatoric techniques (see [6], [18] or more recently [17]). To be more specific, this method consists in providing an analytic expression of the generating function $G(z) = \sum_{L=1}^{\infty} Z_{L,\beta}^m z^L$ whose radius of convergence R satisfies $f^m = -\log R$. This computation is achieved by rewriting $G(z)$ under the form $\sum_{r=0}^{\infty} g_r(z)$ where $g_r(z)$ is the contribution to $G(z)$ of those trajectories making exactly r consecutive vertical steps at the beginning, regardless of the total length of the trajectory. With the help of some smart path concatenation, a recurrence relation is obtained between g_{r-1} , g_r and g_{r+1} and,

after making the ansatz that g_r can be expressed as an infinite sum, the recurrence relation allows for an exact computation of the terms in the infinite sum that provides g_r .

In particular, the location of the collapse transition was found by Binder et al [3], while the exact generating function was found by Brak et al [6] in terms of q-Bessel functions. The tricritical nature of the collapse transition was elucidated by Owczarek et al [18], and the full asymptotics of the generating function can be deduced from the work of Prellberg [19]. The same method has subsequently been applied to some variations of the IPDSAW, for instance in [5] where a force is applied at the right extremity of the polymer or in [18] where a continuous version of the model is studied.

The computation of the generating function G allows to determine the exact value of β_c and to predict the behavior of the free energy close to criticality. However, the analytic expression of G is very complicated and only gives an undirect access to the free energy. Furthermore, this combinatoric method does not allow to study a non ballistic observable, for instance, inside the collapsed phase, the horizontal expansion is of order \sqrt{L} and this can not be proven by such method.

2.4 The main results

A new approach has been developed in [16] to work with the partition function directly. Our method is based on a probabilistic representation of the partition function in terms of an auxiliary random walk. It involves analyzing the integral of a suitable walk. There is an important literature about integrated random walk. One of the main issues is to compute the probability that the *algebraic area* below a random walk remain positive after N steps (see [23], [8] and references therein) or to estimate the asymptotic behavior of a survival function for a class of stochastic processes related to random walks and Lévy processes (see [2]). In our work, the integrated quantity that we are considering is slightly different because we consider the *geometric area* below the random walk, meaning that this area is counted positively also when the random walk is negative.

We need to settle some of the ingredients appearing in this section. We let $V := (V_n)_{n \in \mathbb{N}}$ be a symmetric random walk on \mathbb{Z} , whose increments are independent and follow a geometric distribution, i.e. $V_0 = 0$, $V_n = \sum_{i=1}^n v_i$ for $n \in \mathbb{N}$ and $v := (v_i)_{i \in \mathbb{N}}$ is an i.i.d sequence under the law \mathbf{P}_β , with distribution

$$\mathbf{P}_\beta(v_1 = k) = \frac{e^{-\frac{\beta}{2}|k|}}{c_\beta} \quad \forall k \in \mathbb{Z} \quad \text{with} \quad c_\beta := \frac{1+e^{-\beta/2}}{1-e^{-\beta/2}}. \quad (2.4.1)$$

For $n, k \in \mathbb{N}$, let $\mathcal{V}_{n,k}$ be the set of those n -step trajectories of the V random walk whose geometric area $A_n := \sum_{i=1}^n |V_i|$ equals k , i.e.,

$$\mathcal{V}_{n,k} := \{(V_i)_{i=0}^n : A_n = k, V_n = 0\}. \quad (2.4.2)$$

Via an algebraic manipulation of the Hamiltonian, that will be described in [16, Proposition 2.1], it is indeed possible to rewrite the partition function in (2.2.6) under the form

$$Z_{L,\beta}^m = c_\beta \Phi_{L,\beta}^m \sum_{N=1}^L (\Gamma^m(\beta))^N \mathbf{P}_\beta(\mathcal{V}_{N+1,L-N}), \quad (2.4.3)$$

where $\beta \mapsto \Gamma^m(\beta)$ is a continuous and decreasing bijection from $(0, \infty)$ to $(0, \infty)$ and where $\Phi_{L,\beta}^m$ has an exponential growth rate that equals φ_β^m , such that the excess free energy $\tilde{f}^m(\beta)$ is the exponential growth rate of the summation in (2.4.3).

The formula in (2.4.3) will be made rigorous in section 2.6, but the phase diagram of the model can already be read on this formula. According to the value taken by $\Gamma^m(\beta)$, we can indeed distinguish between the 3 regimes displayed by the model :

- $\Gamma^m(\beta) > 1$: *the extended regime*. For $c \in (0, 1)$, the quantities $\mathbf{P}_\beta(\mathcal{V}_{cL, L(1-c)})$ are decaying exponentially fast when $L \rightarrow \infty$, at a rate which grows with c . Thus, the leading terms in (2.4.3) are those indexed by $N \sim \tilde{c}L$, where $\tilde{c} \in (0, 1)$ is the result of an optimization. This phase is extended because those trajectories that are mainly contributing to the partition function have an horizontal length N and a total length L of the same order (Fig. 2.7).
- $\Gamma^m(\beta) = 1$: *the critical regime*. The leading terms in (2.4.3) are those indexed by N of order $L^{2/3}$, because the quantity $\mathbf{P}_\beta(\mathcal{V}_{N+1, L-N})$ reaches its maximum for such values of N .
- $\Gamma^m(\beta) < 1$: *the collapsed regime*. For $c \in (0, \infty)$, the quantities $\mathbf{P}_\beta(\mathcal{V}_{c\sqrt{L}, L})$ are decaying like $e^{-t_c\sqrt{L}}$ where $t_c > 0$ is decreasing in c . Thus, the leading terms in (2.4.3) are those indexed by $N \sim \hat{c}\sqrt{L}$, where $\hat{c} \in (0, \infty)$ is again the result of an optimization. This phase is collapsed because the trajectories that are mainly contributing to the partition function have an horizontal length N much smaller than their total length L (Fig. 2.7).

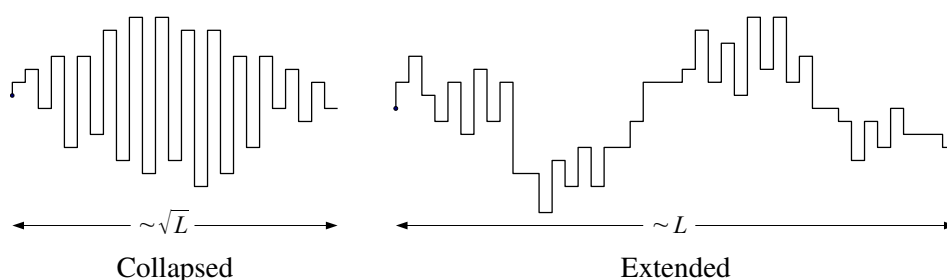

FIGURE 2.7 – A typical path of both phases.

2.4.1 Variational formula

In Theorem 2.4.1 below we provide a variational formula for the excess free energy of the model. For each $\alpha \in [0, \infty)$, we set

$$g_\beta(\alpha) := \lim_{N \rightarrow \infty} \frac{1}{N} \log \mathbf{P}_\beta \left(\sum_{n=1}^N |V_n| \leq \alpha N, V_N = 0 \right). \quad (2.4.4)$$

We also define the function $\Gamma^m : (0, \infty) \rightarrow (0, \infty)$, for $m \in \{u, nu\}$, as

$$\begin{cases} \Gamma^u(\beta) = \frac{c_\beta}{e^\beta}, \\ \Gamma^{nu}(\beta) = \frac{2c_\beta}{3e^\beta}. \end{cases} \quad (2.4.5)$$

Theorem 2.4.1 ([16], Theorem 1.2). *For $m \in \{u, nu\}$, the excess free energy $\tilde{f}^m(\beta)$ is given by*

$$\tilde{f}^m(\beta) = \sup_{\alpha \in [0,1]} [\alpha \log(\Gamma^m(\beta)) + \alpha g_\beta(\frac{1-\alpha}{\alpha})]. \quad (2.4.6)$$

A consequence of Theorem 2.4.1 is that the knowledge of some analytic properties of $\alpha \mapsto g_\beta(\alpha)$ are sufficient to extract both an exact expression of the critical point β_c^m and the precise order of the phase transition. It is shown in section 2.6 that $\alpha \mapsto g_\beta(\alpha)$ is nondecreasing on $(0, \infty)$ and that $\lim_{\alpha \rightarrow \infty} g_\beta(\alpha) = 0$, which, combined with (2.4.6), entails that β_c^m exists and is the unique solution of $\Gamma^m(\beta) = 1$ (Fig. 2.8).

Theorem 2.4.2 ([16], Theorem 1.3). *For $m \in \{u, nu\}$, there exists a $\beta_c^m \in (0, \infty)$ such that*

$$\tilde{f}^m(\beta) \begin{cases} = 0, & \text{if } \beta \geq \beta_c^m, \\ > 0, & \text{if } \beta < \beta_c^m, \end{cases} \quad (2.4.7)$$

and β_c^m is the unique positive solution of the equation $\Gamma^m(\beta) = 1$.

By recalling (2.4.1) and (2.4.5), we observe that the equation $\Gamma^{nu}(\beta) = 1$ is equivalent to the equation $3x^3 - 3x^2 - 2x - 2 = 0$ where $x = e^{\beta/2}$. Moreover, the cubic polynomial $3x^3 - 3x^2 - 2x - 2$ has a unique positive zero x_c , so that $\beta_c^{nu} = 2 \log x_c$. Similarly, the critical point β_c^u of the uniform model is the unique root of the equation $\Gamma^u(\beta) = 1$. This value of β_c^u corresponds to the value provided in [6].

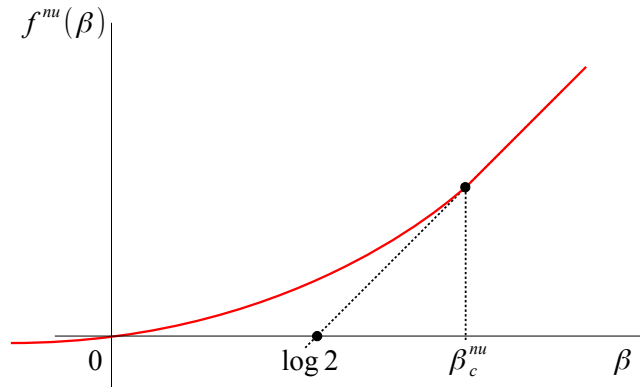

FIGURE 2.8 – Phase diagram in the non-uniform case ($\beta_c^{nu} \sim 1$).

Moreover, a fine asymptotic of $\alpha \mapsto g_\beta(\alpha)$ at infinity allows us to prove that the collapsed transition is second order with critical exponent $3/2$.

Theorem 2.4.3 ([16], Theorem 1.4). *The phase transition is of order $3/2$. That is, there exist two constants $c_1, c_2 > 0$ such that for ε small enough*

$$c_1 \varepsilon^{3/2} \leq \tilde{f}^m(\beta_c^m - \varepsilon) \leq c_2 \varepsilon^{3/2}. \quad (2.4.8)$$

2.4.2 A sharper asymptotic of the free energy close to criticality

The first Theorem that we state below gives a new expression of the excess free energy. To that aim, we recall (2.4.1) and the definition of A_N above (2.4.2). For $\delta \geq 0$, we set

$$h_\beta(\delta) := \lim_{N \rightarrow \infty} \frac{1}{N} \log \mathbf{E}_\beta(e^{-\delta A_N}). \quad (2.4.9)$$

We prove in section 2.6 that the limit in (2.4.9) exists and that $\delta \mapsto h_\beta(\delta)$ is non-positive, non-increasing and continuous on $[0, \infty)$.

Theorem 2.4.4 ([7], Theorem 1.3). *For $m \in \{u, nu\}$, the excess free energy $\tilde{f}^m(\beta)$ is the unique solution of the equation $\log(\Gamma^m(\beta)) - \delta + h_\beta(\delta) = 0$ if such a solution exists and $\tilde{f}^m(\beta) = 0$ otherwise.*

Note first that Theorem 2.4.4 and the obvious equality $h_\beta(0) = 0$ are sufficient to check that β_c^m is the unique solution of $\Gamma^m(\beta) = 1$. One of the main interest of Theorem 2.4.4 is that it allows us to use the analytic properties of $\delta \mapsto h_\beta(\delta)$ at 0^+ to investigate the regularity of $\beta \mapsto \tilde{f}^m(\beta)$ at β_c^m . This is useful, in particular, to go further than Theorem 2.4.3 in the analysis of the collapse transition.

Theorem 2.4.5 ([7], Theorem 1.4). *For $m \in \{u, nu\}$, the phase transition is second order with critical exponent $3/2$ and the first order of the Taylor expansion of the excess free energy at $(\beta_c^m)^-$ is given by*

$$\lim_{\varepsilon \rightarrow 0^+} \frac{\tilde{f}^m(\beta_c^m - \varepsilon)}{\varepsilon^{3/2}} = \left(\frac{c_m}{d_m}\right)^{3/2}, \quad (2.4.10)$$

where

$$c_m = 1 + \frac{e^{-\beta_c^m/2}}{1 - e^{-\beta_c^m}}, \quad (2.4.11)$$

and where

$$d_m = - \lim_{T \rightarrow \infty} \frac{1}{T} \log \mathbf{E}(e^{-\sigma_{\beta_c^m} \int_0^T |B(t)| dt}) = 2^{-1/3} |a'_1| \sigma_{\beta_c^m}^{2/3}, \quad (2.4.12)$$

with $\sigma_\beta^2 = \mathbf{E}_\beta(v_1^2)$ and a'_1 is the first zero of $Ai'(x) = \partial Ai(x)/\partial x$ where $Ai(x)$ is the Airy function.

2.4.3 Path properties inside the collapsed phase

The second class of results that we prove in this thesis is concerned with the path behavior of the polymer in its collapsed phase ($\beta > \beta_c$). The question of the geometric conformation adopted by the polymer inside the collapsed phase has been raised and discussed by physicists in several papers, as for instance [20]. It was believed that the monomers arrange themselves in a succession of long vertical stretches of opposite directions that constitute large beads (Fig. 2.7). There are numerical evidences that the horizontal expansion (N_L) of the polymer in size L grows as \sqrt{L} and that the vertical displacement of the endpoint grows as $L^{1/4}$ (see [20], table II page 2394). In this paper, we prove with Theorem 2.4.4, that the polymer makes only one macroscopic bead and that the number of monomers (located at the beginning and at the end of the polymer) which do not belong to this bead grow slower than a power of the logarithm. We also make rigorous the conjecture concerning the horizontal

expansion of the polymer, since we identify the limit in probability of N_L/\sqrt{L} , which turns out to be the constant extracted from an optimization.

We divide each trajectory into a succession of beads. Each bead is made of vertical stretches of strictly positive length and arranged in such a way that two consecutive stretches have opposite directions (north and south) and are separated by one horizontal step (see Fig. 2.9). A bead ends when the polymer gives the same direction to two consecutive vertical stretches or when a zero length stretch appears, which corresponds to two consecutive horizontal steps. We will prove that the polymer folds itself up into a *unique macroscopic bead* and we will identify its horizontal expansion. To quantify these results we need the following notations.

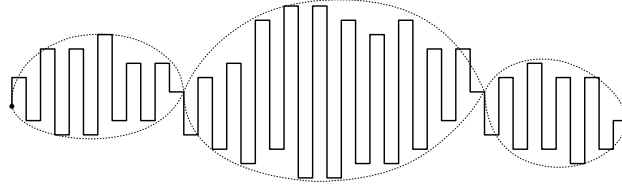

FIGURE 2.9 – Example of a trajectory with 3 beads.

Horizontal extension and number of beads

Let $l \in \Omega_L$ and denote by $N_L(l)$ its horizontal extension, i.e., $N_L(l)$ is the integer N such that $l \in \mathcal{L}_{N,L}$. Pick $l \in \mathcal{L}_{N,L}$ and let $(u_j)_{j=1}^N$ be the sequence of cumulated lengths of the polymer after each vertical stretch, i.e., $u_j = |l_1| + \dots + |l_j| + j$ for $j \in \{1, \dots, N\}$. For convenience only, set $l_{N+1} = 0$. Set also $x_0 = 0$ and for $j \in \mathbb{N}$ such that $x_{j-1} < N$, set $x_j = \inf\{i \geq x_{j-1} + 1 : l_i \tilde{\wedge} l_{i+1} = 0\}$. Finally, let $n_L(l)$ be the index of the last x_j that is well defined, i.e., $x_{n_L(l)} = N$. Thus we can decompose any trajectory $l \in \Omega_L$ into a succession of $n_L(l)$ beads (Fig. 2.10), each of them being associated with a subinterval of $\{1, \dots, L\}$ written as

$$I_j = \{u_{x_{j-1}} + 1, \dots, u_{x_j}\}, \quad \text{for } j \in \{1, \dots, n_L(l)\}, \quad (2.4.13)$$

and therefore, we can partition $\{1, \dots, L\}$ into $\cup_{j=1}^{n_L(l)} I_j$. At this stage can define the largest bead of a trajectory $l \in \Omega_L$ as $I_{j_{\max}}$ with

$$j_{\max} = \arg \max \{|I_j|, j \in \{1, \dots, n_L(l)\}\}. \quad (2.4.14)$$

With Theorem 2.4.6 below, we claim that, in the collapsed phase, there is only one macroscopic bead.

Theorem 2.4.6 ([7], Theorem 1.6). *For $m \in \{u, nu\}$ and $\beta > \beta_c^m$, there exists $c > 0$ such that*

$$\lim_{L \rightarrow \infty} P_{L,\beta}^m(|I_{j_{\max}}| \geq L - c(\log L)^4) = 1. \quad (2.4.15)$$

In Theorem 2.4.7 below, we identify the limit in probability of $\frac{N_L}{\sqrt{L}}$ as $L \rightarrow \infty$.

Proposition 2.4.7 ([7], Proposition 1.7). *For $m \in \{u, nu\}$ and $\beta > \beta_c^m$, there exists $a_m > 0$ such that, for all $\varepsilon > 0$*

$$\lim_{L \rightarrow \infty} P_{L,\beta}^m\left(\left|\frac{N_L}{\sqrt{L}} - a_m\right| > \varepsilon\right) = 0. \quad (2.4.16)$$

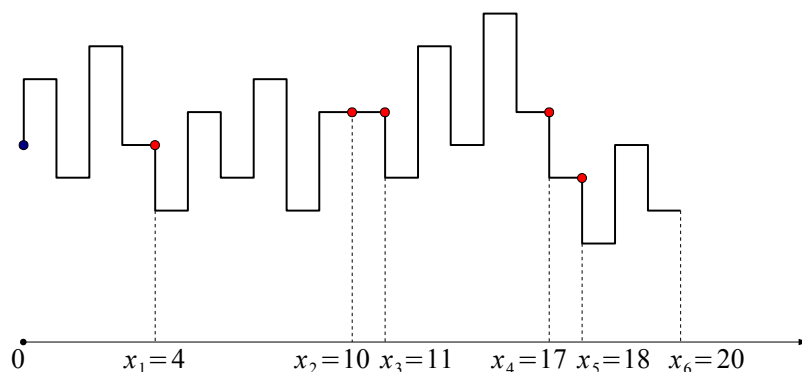

FIGURE 2.10 – An example of a 20-stretches trajectory is decomposed into $n_L(l) = 6$ beads.

2.5 Collapsed polymer unfolded by a force

It is possible to induce a collapse transition by applying a *force* to the endpoint of a polymer rather than changing its interaction strength. The force can be applied, for instance, with the help of optical tweezers. One of the interesting phenomena that has been pointed out is the presence of a *re-entrant* transition. This means for a fixed force f , the polymer is extended at low temperature and at high temperature, but for intermediate temperatures it is collapsed, very much like if the force was not present. To model the effect of the force on a collapsed directed polymer we replace the Hamiltonian (recall (2.2.4)) by

$$H_{L,\beta}^{f_x, f_y}(l) := \beta \sum_{n=1}^N (l_n \tilde{\wedge} l_{n-1}) + \beta f_x N + \beta f_y \sum_{n=1}^N l_n, \quad l \in \mathcal{L}_{N,L}. \quad (2.5.1)$$

where $f_x, f_y \geq 0$ are two forces in the x-direction and y-direction respectively acting on the right endpoint of the polymer (Fig. 2.11). Note that N is the horizontal distance and $\sum_{n=1}^N l_n$ is the vertical distance between two endpoints of the polymer. We write $Z_{L,\beta}^{f_x, f_y}$ to denote the partition function and

$$f(\beta, f_x, f_y) = \lim_{L \rightarrow \infty} \frac{1}{L} \log Z_{L,\beta}^{f_x, f_y} \quad (2.5.2)$$

to denote the free energy.

We will show that the re-entrance phenomenon is strongly model dependent. For this reason, we first introduce the partially directed random walk with general distributed steps. We consider the partially directed random walk on \mathbb{Z}^2 with law \mathbf{P} is defined as follows :

- At the origin or after an horizontal step : the walker must step north, south or east with probabilities correspond p, p' and $1 - p - p'$.
- After a vertical step north : the walker must step north with probability q or east with probability $1 - q$.
- After a vertical step south : the walker must step south with probability q' or east with probability $1 - q'$.

For convenience of exposition, we restrict to the case where $p = \frac{q(1-q')}{1-qq'}$ and $p' = \frac{q'(1-q)}{1-qq'}$ with $q, q' \in (0, 1)$. Recall that with each L -steps trajectory $w \in \mathcal{W}_L$, we associate the sequence

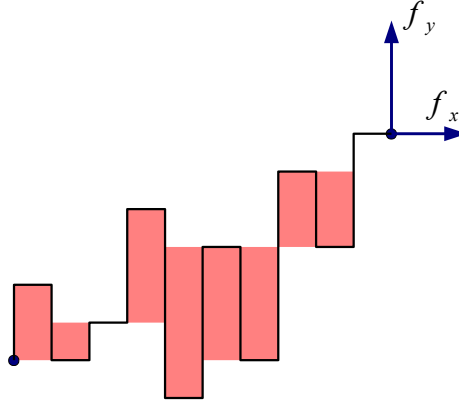

FIGURE 2.11 – A horizontal force f_x and a vertical force f_y are applied to one end of the polymer. The self-touchings shown as light red areas.

$l := (l_1, \dots, l_N) \in \mathbb{Z}^N$ such that N is the number of vertical stretches and l_n corresponds to the vertical length of the n^{th} stretch. At this stage, the random variables $(l_n)_{n=1}^N$ are i.i.d with geometric distribution

$$\mathbf{P}(l_1 = 0) = \frac{(1-q)(1-q')}{1-qq'}, \quad (2.5.3)$$

$$\mathbf{P}(l_1 = k) = \frac{(1-q)(1-q')}{1-qq'} q^k, \quad (2.5.4)$$

$$\mathbf{P}(l_1 = -k) = \frac{(1-q)(1-q')}{1-qq'} q'^k, \text{ for } k \in \mathbb{N}. \quad (2.5.5)$$

Let $q_0 = \mathbf{P}(l_1 = 0)$, $q_1 = \frac{\log q + \log q'}{2} \leq 0$ and $q_2 = \frac{\log q - \log q'}{2}$, we can write

$$\mathbf{P}(l_1 = k) = q_0 e^{q_1 |k| + q_2 k} \quad \text{for all } k \in \mathbb{Z}. \quad (2.5.6)$$

For convenience of exposition, we restrict to the case where the stretch of the partially directed random walk has a symmetric distribution, i.e., $q = q' \in (0, 1)$. Obviously in this case, $q_0 = \frac{(1-q)^2}{1-q^2}$, $q_1 = \log q$ and $q_2 = 0$. We first consider the case $f_y = 0$, namely, there is only one horizontal force is applied. Let us define the excess free energy $\tilde{f}(\beta, f_x, 0) = f(\beta, f_x, 0) - (\beta + \log q)$. We observe that, for all $\beta > 0$, there exists a critical force $f_c(\beta)$ such that

$$\tilde{f}(\beta, f_x, 0) \begin{cases} = 0, & \text{if } f_x \leq f_c(\beta), \\ > 0, & \text{if } f_x > f_c(\beta). \end{cases} \quad (2.5.7)$$

The most interesting case is when $\beta \geq \beta_c$, otherwise the system is already extended at $f_x = 0$. This critical force can be computed explicitly

$$f_c(\beta) = \frac{1}{\beta} \log \left(\frac{e^{\beta/2} - 1}{e^{-\beta/2} + e^{-\beta}} \right) + \frac{1}{\beta} \log \left(\frac{q(1+q)}{1-q} \right). \quad (2.5.8)$$

Proposition 2.5.1. *There exists $\beta_c > 0$ such that $f_c(\beta) = 0$ for $\beta < \beta_c$. Moreover, for large β*

$$f_c(\beta) = 1 + \frac{1}{\beta} \log \left(\frac{q(1+q)}{1-q} \right) + o\left(\frac{1}{\beta}\right) \text{ as } \beta \rightarrow \infty. \quad (2.5.9)$$

Re-entrance takes place for $q > \sqrt{2} - 1$.

2.6 The main tools

In this section, we introduce the main tools that are used in this thesis. In section 2.6.1 we show how the partition function can be rewritten in terms of the random walk V of law \mathbf{P}_β (recall (2.4.1)) and how studying this random walk under an appropriate conditioning can be used to derive some path properties under the polymer measure. The construction of entropic function g_β and its asymptotic behavior are given in section 2.6.2. In section 2.6.3, we define function $\delta \mapsto h_\beta(\delta)$ that appears in the expression of the excess free energy in Theorem 2.4.4 and we study its regularity and asymptotics. In section 2.6.4, we consider the probability of some large deviations events under \mathbf{P}_β , and we introduce an appropriate tilting under which these events become typical.

2.6.1 Probabilistic representation of the partition function

In the first part of this section we prove formula (2.4.3) and we show how the polymer measure can be expressed as the image measure by an appropriate transformation of the geometric random walk V introduced in (2.4.1). In the second part of the section, we focus on those trajectories that make only one bead and we show that, in terms of the auxiliary random walk V , these beads become excursions away from the origin.

Auxiliary random walk

We display here the details of the proof of formula (2.4.3) in the non-uniform case only. The uniform case is indeed easier to handle. Recall (2.2.3–2.2.6) and note that the $\tilde{\wedge}$ operator can be written as

$$x \tilde{\wedge} y = (|x| + |y| - |x + y|) / 2, \quad \forall x, y \in \mathbb{Z}. \quad (2.6.1)$$

Hence, for $\beta > 0$ and $L \in \mathbb{N}$, the partition function in (2.2.6) becomes

$$\begin{aligned} Z_{L,\beta}^{\text{nu}} &= \sum_{N=1}^L \left(\frac{1}{3}\right)^N \left(\frac{1}{2}\right)^{L-N} \sum_{\substack{l \in \mathcal{L}_{N,L} \\ l_0=l_{N+1}=0}} \exp\left(\beta \sum_{n=1}^N |l_n| - \frac{\beta}{2} \sum_{n=0}^N |l_n + l_{n+1}|\right) \\ &= c_\beta \left(\frac{e^\beta}{2}\right)^L \sum_{N=1}^L \left(\frac{2c_\beta}{3e^\beta}\right)^N \sum_{\substack{l \in \mathcal{L}_{N,L} \\ l_0=l_{N+1}=0}} \prod_{n=0}^N \frac{\exp\left(-\frac{\beta}{2}|l_n + l_{n+1}|\right)}{c_\beta}, \end{aligned} \quad (2.6.2)$$

where c_β was defined in (2.4.1). At this stage, we pick $N \in \{1, \dots, L\}$ and we introduce the one-to-one correspondence $T_N : \mathcal{V}_{N+1,L-N} \mapsto \mathcal{L}_{N,L}$ defined as $T_N(V)_i = (-1)^{i-1} V_i$ for all $i \in \{1, \dots, N\}$. We pick $l \in \mathcal{L}_{N,L}$, we consider $V = (T_N)^{-1}(l)$ (see Fig. 2.12) and we note that the increments $(v_i)_{i=1}^{N+1}$ of V necessarily satisfy $v_i := (-1)^{i-1}(l_{i-1} + l_i)$. Thus, the partition function in (2.6.2) becomes

$$Z_{L,\beta}^{\text{nu}} = c_\beta \left(\frac{e^\beta}{2}\right)^L \sum_{N=1}^L \left(\frac{2c_\beta}{3e^\beta}\right)^N \sum_{V \in \mathcal{V}_{N+1,L-N}} \mathbf{P}_\beta(V), \quad (2.6.3)$$

which immediately implies (2.4.3). A useful consequence of formula (2.6.3) is that, once conditioned on taking a given number of horizontal steps N , the polymer measure is exactly

the image measure by the T_N -transformation of the geometric random walk V conditioned to return to the origin after $N+1$ steps and to make a geometric area $L - N$, i.e.,

$$P_{L,\beta}^m(l \in \cdot \mid N_L(l) = N) = \mathbf{P}_\beta(T_N(V) \in \cdot \mid V_N = 0, A_N = L - N). \quad (2.6.4)$$

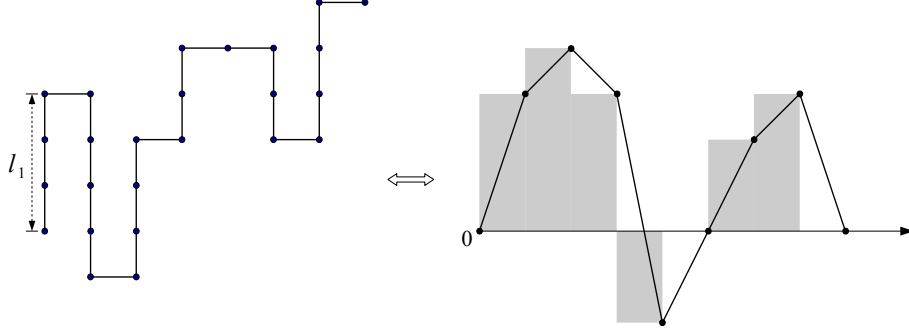

FIGURE 2.12 – An example of transformation of $w \in \mathcal{W}_{24}$ into $(V_n)_{n=0}^8 \in \mathcal{V}_{8,17}$. The 24-step trajectory w on the left has 7 stretches : $l_1 = 3, l_2 = -4, l_3 = 3, l_4 = 2, l_5 = 0, l_6 = -2$ and $l_7 = 3$. The correspondent increments of $(V_n)_{n=0}^8$ are : $v_1 = 3, v_2 = 1, v_3 = -1, v_4 = -5, v_5 = 2, v_6 = 2$ and $v_7 = 1$.

From beads to excursions

We define Ω_L° as the subset of Ω_L containing those trajectories $l \in \Omega_L$ that have only one bead, i.e. $n_L(l) = 1$. Thus, we can rewrite $\Omega_L^\circ := \bigcup_{N=1}^L \mathcal{L}_{N,L}^\circ$, where $\mathcal{L}_{N,L}^\circ$ is the subset of $\mathcal{L}_{N,L}$ defined as

$$\mathcal{L}_{N,L}^\circ = \{l \in \mathcal{L}_{N,L} : l_i \tilde{\wedge} l_{i+1} \neq 0 \forall j \in \{1, \dots, N-1\}\}, \quad (2.6.5)$$

and we denote by $Z_{L,\beta}^{m,\circ}$ the contribution to the partition function of those trajectories in Ω_L° , i.e.,

$$Z_{L,\beta}^{m,\circ} = \sum_{l \in \Omega_L^\circ} e^{H_{L,\beta}(l)} \mathbf{P}_L^m(l), \quad m \in \{u, nu\}. \quad (2.6.6)$$

We let also $\mathcal{V}_{n,k}^+$ be the subset containing those trajectories that return to the origin after n steps, satisfy $A_n = k$ and are strictly positive on $\{1, \dots, n\}$, i.e.,

$$\mathcal{V}_{n,k}^+ := \{V : V_n = 0, A_n = k, V_i > 0 \forall i \in \{1, \dots, n-1\}\}. \quad (2.6.7)$$

By mimicking (2.6.2) and by noticing that by the T_N -transformation, the subset $\mathcal{L}_{N,L}^\circ$ becomes $\mathcal{V}_{N+1,L-N}^+$ we obtain

$$Z_{L,\beta}^{m,\circ} = 2 c_\beta \Phi_{L,\beta}^m \sum_{N=1}^L (\Gamma^m(\beta))^N \mathbf{P}_\beta(\mathcal{V}_{N+1,L-N}^+). \quad (2.6.8)$$

2.6.2 Construction and asymptotics of g_β

We now define the function g_β in a slightly different way from (2.4.4), but we will see at the end of section 2.6.2 that the two definitions are equivalent. Recall (2.4.2) and for each $\alpha \in \mathbb{Q}^+ := \mathbb{Q} \cap [0, \infty)$, let

$$N_\alpha := \{n \in \mathbb{N} \cap [2, \infty) : \alpha n \in \mathbb{N}\}. \quad (2.6.9)$$

Note that $\mathbf{P}_\beta(\mathcal{V}_{N,\alpha K}) > 0$ for all $N \in \mathbb{N} \cap [2, \infty)$ and $K \in N_\alpha$. Let $g_\beta : \mathbb{Q}^+ \rightarrow \mathbb{R}$ be defined as

$$g_\beta(\alpha) := \lim_{\substack{N \in N_\alpha \\ N \rightarrow \infty}} g_{N,\beta}(\alpha), \quad \text{where} \quad g_{N,\beta}(\alpha) := \frac{1}{N} \log \mathbf{P}_\beta(\mathcal{V}_{N,\alpha N}). \quad (2.6.10)$$

To study the properties of g_β , we will use that

$$\mathbf{P}_\beta(\mathcal{V}_{N_1+N_2, K_1+K_2}) \geq \mathbf{P}_\beta(\mathcal{V}_{N_1, K_1}) \mathbf{P}_\beta(\mathcal{V}_{N_2, K_2}), \quad \text{for } N_1, N_2, K_1, K_2 \in \mathbb{N}. \quad (2.6.11)$$

To prove (2.6.11), we simply restrict the set $\mathcal{V}_{N_1+N_2, K_1+K_2}$ to those trajectories that return to origin at time N_1 and satisfy $A_{N_1} = K_1$. Then, by using the Markov property of the pair process $\{V_n, A_n\}_{n \in \mathbb{N}}$, we obtain the result.

Lemma 2.6.1. (i) $g_\beta(\alpha)$ exists and is finite, non-positive for all $\alpha \in \mathbb{Q}^+$. In particular, $g_\beta(0) = -\log c_\beta$.

(ii) $\alpha \mapsto g_\beta(\alpha)$ is continuous, concave, nondecreasing on \mathbb{Q}^+ and tends to 0 as $\alpha \rightarrow \infty$.

Remark 2.6.2. The continuity and the concavity of g_β guarantee that it can be extended to a continuous function on \mathbb{R}^+ .

Démonstration. (i) Because of (2.6.11), for $N_1, N_2 \in N_\alpha$, we have

$$\mathbf{P}_\beta(\mathcal{V}_{N_1+N_2, \alpha(N_1+N_2)}) \geq \mathbf{P}_\beta(\mathcal{V}_{N_1, \alpha N_1}) \mathbf{P}_\beta(\mathcal{V}_{N_2, \alpha N_2}). \quad (2.6.12)$$

Thus, $\{\log \mathbf{P}_\beta(\mathcal{V}_{N, \alpha N})\}_{N \in N_\alpha}$ is a super-additive sequence and since $0 < \mathbf{P}_\beta(\mathcal{V}_{N, \alpha N}) \leq 1$ for $N \in N_\alpha$, the limit in (2.6.10) exists, is finite and satisfies

$$g_\beta(\alpha) = \sup_{N \in N_\alpha} \frac{1}{N} \log \mathbf{P}_\beta(\mathcal{V}_{N, \alpha N}) \leq 0. \quad (2.6.13)$$

We recall that $\mathcal{V}_{n,0} = \{V : V_n = 0, A_n = 0\}$, so that

$$\mathbf{P}_\beta(\mathcal{V}_{N,0}) = \mathbf{P}_\beta(V_i = 0 \text{ for } i = 0, \dots, N) = (1/c_\beta)^N. \quad (2.6.14)$$

Hence $g_\beta(0) = -\log c_\beta$.

(ii) Applying again (2.6.11), we observe that for all $p, q \in \mathbb{N}, q > 0, 0 \leq p \leq q$ and $\alpha_1, \alpha_2 \in \mathbb{Q}^+, N \in N_{\alpha_1} \cap N_{\alpha_2}$

$$\mathbf{P}_\beta(\mathcal{V}_{qN, p\alpha_1 N + (q-p)\alpha_2 N}) \geq \mathbf{P}_\beta(\mathcal{V}_{N, \alpha_1 N})^p \mathbf{P}_\beta(\mathcal{V}_{N, \alpha_2 N})^{q-p}. \quad (2.6.15)$$

Therefore

$$\frac{1}{qN} \log \mathbf{P}_\beta \left(\mathcal{V}_{qN, \left(\frac{p}{q} \alpha_1 + \left(1 - \frac{p}{q}\right) \alpha_2 \right) qN} \right) \geq \frac{p}{qN} \log \mathbf{P}_\beta(\mathcal{V}_{N, \alpha_1 N}) + \frac{q-p}{qN} \log \mathbf{P}_\beta(\mathcal{V}_{N, \alpha_2 N}), \quad (2.6.16)$$

which proves that

$$g_\beta\left(\frac{p}{q}\alpha_1 + \left(1 - \frac{p}{q}\right)\alpha_2\right) \geq \frac{p}{q}g_\beta(\alpha_1) + \left(1 - \frac{p}{q}\right)g_\beta(\alpha_2), \quad (2.6.17)$$

which is the desired concavity.

Now we will show that $g_\beta(\alpha) \rightarrow 0$ as $\alpha \rightarrow \infty$ and since g_β is concave on \mathbb{Q}^+ , it will be sufficient to conclude that g_β is nondecreasing.

Assume that $g_\beta(\alpha)$ does not converge to 0 as $\alpha \rightarrow \infty$, then the concavity of g_β insures that either g_β is nondecreasing on \mathbb{Q}^+ and there exists $M > 0$ such that $g_\beta(\alpha) \leq -M$ for all $\alpha \in \mathbb{Q}^+$ or g_β is decreasing for α large enough and converges to $-\infty$ as $\alpha \rightarrow \infty$. In both cases we can claim that there exists $M > 0$ and $\alpha_M > 0$ such that $g_\beta(\alpha) \leq -M$ for all $\alpha \geq \alpha_M$. Thus, we can use (2.6.13) to obtain

$$\mathbf{P}_\beta(\mathcal{V}_{N,\alpha N}) \leq e^{-NM} \text{ for all } N \in \mathbb{N}, \alpha \geq \alpha_M. \quad (2.6.18)$$

For $\alpha \in [\alpha_M, \infty) \cap 2\mathbb{N}$, we consider the set

$$\mathcal{N}_\alpha = \{V : V_1 = 3\alpha/2 + 1, \alpha + 1 < V_i < 2\alpha + 1 \text{ for } i = 2, \dots, N, V_{N+1} = 0\}. \quad (2.6.19)$$

For $N > \alpha$, we observe that

$$\mathcal{N}_\alpha \subseteq \left\{V : V_{N+1} = 0, \alpha(N+1) \leq \sum_{i=0}^{N+1} |V_i| \leq (2\alpha+1)(N+1)\right\}, \quad (2.6.20)$$

and hence, (2.6.18) allows us to write

$$\mathbf{P}_\beta(\mathcal{N}_\alpha) \leq \sum_{k=\alpha(N+1)}^{(2\alpha+1)(N+1)} \mathbf{P}_\beta(\mathcal{V}_{N+1,k}) \leq (\alpha+1)(N+1)e^{-(N+1)M}. \quad (2.6.21)$$

Now, we want to exhibit a lower bound on $\mathbf{P}_\beta(\mathcal{N}_\alpha)$. By using the Markov property, we have, with $V_N^* := \max_{1 \leq n \leq N} |V_n|$,

$$\begin{aligned} \mathbf{P}_\beta(\mathcal{N}_\alpha) &= \mathbf{P}_\beta\left(v_1 = \frac{3\alpha}{2} + 1\right) \sum_{k=-\alpha/2-1}^{\alpha/2-1} \mathbf{P}_\beta\left(V_{N-1}^* < \frac{\alpha}{2}; V_N = k\right) \\ &\quad \cdot \mathbf{P}_\beta\left(v_1 = -\frac{3\alpha}{2} - 1 - k\right). \end{aligned} \quad (2.6.22)$$

Since $\mathbf{P}_\beta(v_1 = -\frac{3\alpha}{2} - 1 - k) \geq \mathbf{P}_\beta(v_1 = -2\alpha - 1)$ for $k \in \{-\alpha/2, \dots, \alpha/2\}$, equation (2.6.22) implies

$$\mathbf{P}_\beta(\mathcal{N}_\alpha) \geq \frac{e^{-\frac{\beta}{2}\left(\frac{7\alpha}{2}+2\right)}}{c_\beta^2} \sum_{k=-\alpha/2-1}^{\alpha/2-1} \mathbf{P}_\beta\left(V_{N-1}^* < \alpha/2; V_N = k\right). \quad (2.6.23)$$

We choose $\alpha > 4$ to get

$$\mathbf{P}_\beta(\mathcal{N}_\alpha) \geq \frac{e^{-2\beta\alpha}}{c_\beta^2} \mathbf{P}_\beta\left(V_N^* < \alpha/2\right), \quad (2.6.24)$$

and we can apply the Kolmogorov's inequality (see [11, p. 61]), which gives

$$\mathbf{P}_\beta\left(V_N^* < \frac{\alpha}{2}\right) \geq 1 - \frac{4}{\alpha^2} \mathbf{Var}_\beta(V_N). \quad (2.6.25)$$

Therefore, (2.6.21), (2.6.24) and (2.6.25) allow us to write

$$\frac{e^{-2\alpha\beta}}{c_\beta^2} \left(1 - \frac{4}{\alpha^2} \mathbf{Var}_\beta(V_N)\right) \leq (\alpha + 1)(N + 1)e^{-(N+1)M}. \quad (2.6.26)$$

Since the above inequality is true for all $\alpha > \alpha_M$ and $N > \alpha$, we can choose $\alpha = 2\sqrt{\lambda N \mathbf{Var}_\beta(v_1)}$ with $\lambda > 1$ such that for N large enough (2.6.26) becomes

$$\frac{1}{c_\beta^2} \left(1 - \frac{1}{\lambda}\right) e^{-4\beta\sqrt{\lambda N \mathbf{Var}_\beta(v_1)}} \leq (2\sqrt{\lambda N \mathbf{Var}_\beta(v_1)} + 1)(N + 1)e^{-(N+1)M}. \quad (2.6.27)$$

For N large, (2.6.27) is clearly impossible and therefore $g_\beta(\alpha)$ converges to 0 as $\alpha \rightarrow \infty$ and g_β is nondecreasing. \square

It remains to show that the two definitions of g_β in (2.4.4) and (2.6.10) are equivalent. To this end, we first remark that by super-additivity, the limit in (2.4.4) exists for all $\alpha \in [0, \infty)$. We recall (2.4.2) and we note that, for $\alpha \in \mathbb{Q}^+$ and $N \in N_\alpha$, we have $\mathcal{V}_{N, \alpha N} \subset \{A_N \leq \alpha N, V_N = 0\}$. Therefore

$$\lim_{\substack{N \in N_\alpha \\ N \rightarrow \infty}} \frac{1}{N} \log \mathbf{P}_\beta(\mathcal{V}_{N, \alpha N}) \leq \lim_{N \rightarrow \infty} \frac{1}{N} \log \mathbf{P}_\beta(A_N \leq \alpha N, V_N = 0). \quad (2.6.28)$$

We note also that $\{A_N \leq \alpha N, V_N = 0\} = \cup_{i=0}^{\alpha N} \mathcal{V}_{N, i}$ and we use (2.6.13) and the fact that g_β is nondecreasing to state

$$\frac{1}{N} \log \mathbf{P}_\beta(A_N = i, V_N = 0) \leq g_\beta\left(\frac{i}{N}\right) \leq g_\beta(\alpha), \quad \text{for } i \leq \alpha N, \quad (2.6.29)$$

where g_β in (2.6.29) must be taken in the sense of its definition in (2.6.10). Thus,

$$\mathbf{P}_\beta(A_N \leq \alpha N, V_N = 0) \leq (\alpha N + 1)e^{Ng_\beta(\alpha)} \quad (2.6.30)$$

and it suffices to take $\frac{1}{N} \log$ of both sides in (2.6.30) and to let $N \rightarrow \infty$ to conclude that the two definitions are indeed equivalent.

Asymptotics of g_β

Proposition 2.6.3. *For all $\beta > 0$, there exists $c_1 > 0$ (depending on β) such that*

$$g_\beta(\alpha) \geq -\frac{c_1}{\alpha^2}, \quad \text{for } \alpha \text{ large enough.} \quad (2.6.31)$$

For all compact $K \subset (0, +\infty)$, there exist $c_2, \alpha_2 > 0$ (depending on K) such that

$$g_\beta(\alpha) \leq -\frac{c_2}{\alpha^2}, \quad \text{for } \beta \in K, \alpha \geq \alpha_2. \quad (2.6.32)$$

Démonstration. We will first prove Proposition 2.6.3 subject to Lemmas 2.6.4 and 2.6.5 below. The proofs of these two Lemmas will be postponed to chapter 3, sections 3.4.4 and 3.4.5. We recall (2.4.2) and the notation $V_N^* = \max_{1 \leq n \leq N} |V_n|$.

Lemma 2.6.4. *For $\beta > 0$, there exists $c_1 > 0$ (depending on β) such that for α large enough*

$$\mathbf{P}_\beta(V_N^* \leq \alpha) \geq e^{-\frac{c_1 N}{\alpha^2}}, \quad \text{for } N \text{ large enough.} \quad (2.6.33)$$

Lemma 2.6.5. *Let K be a compact subset of $(0, +\infty)$. There exist $c_2, \alpha_2 > 0$ (depending on K) such that for $\beta \in K$, $\alpha \geq \alpha_2$*

$$\mathbf{P}_\beta(A_N \leq \alpha N) \leq e^{-\frac{c_2 N}{\alpha^2}}, \quad \text{for } N \text{ large enough.} \quad (2.6.34)$$

Recall (2.4.2), (2.6.10) and note that the set $\mathcal{V}_{N, \alpha N}$ is included in $\{V : A_N \leq \alpha N\}$ when $\alpha \in \mathbb{Q}^+$ and $N \in N_\alpha$. Therefore, the upper bound in (2.6.32) is a direct consequence of Lemma 2.6.5 and of the continuity of $\alpha \rightarrow g_\beta(\alpha)$.

For the lower bound in (2.6.31), by Markov property, we obtain

$$\begin{aligned} \mathbf{P}_\beta(V_N^* \leq \alpha, V_N = 0) &= \sum_{x \in [-\alpha, \alpha]} \mathbf{P}_\beta(V_{N-1}^* \leq \alpha, V_{N-1} = x) \mathbf{P}_\beta(v_1 = -x) \\ &\geq \mathbf{P}_\beta(V_{N-1}^* \leq \alpha) \mathbf{P}_\beta(v_1 = \alpha). \end{aligned} \quad (2.6.35)$$

Since $V_N^* \leq \alpha$ implies $A_N = \sum_{n=1}^N |V_n| \leq \alpha N$, we can use (2.6.35) to write

$$\mathbf{P}_\beta(A_N \leq \alpha N, V_N = 0) \geq \mathbf{P}_\beta(V_{N-1}^* \leq \alpha) \mathbf{P}_\beta(v_1 = \alpha). \quad (2.6.36)$$

Recall the definition of g_β in (2.4.4) and apply Lemma 2.6.4, we obtain $g_\beta(\alpha) \geq -\frac{c_1}{\alpha^2}$ for α large enough, and the proof of Proposition 2.6.3 is complete. \square

2.6.3 Construction and asymptotics of h_β

We define the function h_β in a slightly different way from (2.4.9), but we will see at the end of this section that the two definitions are equivalent. For $N \in \mathbb{N}$, $\delta \geq 0$, define

$$h_{N, \beta}(\delta) := \frac{1}{N} \log \mathbf{E}_\beta(e^{-\delta A_N} \mathbf{1}_{\{V_N=0\}}) \quad \text{and let} \quad h_\beta(\delta) = \lim_{N \rightarrow \infty} h_{N, \beta}(\delta). \quad (2.6.37)$$

Lemma 2.6.6. (i) $h_\beta(\delta)$ exists and is finite, non-positive for all $\beta > 0, \delta \geq 0$.
(ii) $\delta \mapsto h_\beta(\delta)$ is continuous, convex and non-increasing on $[0, \infty)$.

Démonstration. (i) For $N, M \in \mathbb{N}$, we restrict the partition of size $N + M$ to those trajectories that return to the origin at time N and use the Markov property to obtain

$$\mathbf{E}_\beta(e^{-\delta A_{N+M}} \mathbf{1}_{\{V_{N+M}=0\}}) \geq \mathbf{E}_\beta(e^{-\delta A_N} \mathbf{1}_{\{V_N=0\}}) \mathbf{E}_\beta(e^{-\delta A_M} \mathbf{1}_{\{V_M=0\}}). \quad (2.6.38)$$

Thus, $\{\log \mathbf{E}_\beta(e^{-\delta A_N} \mathbf{1}_{\{V_N=0\}})\}_{N \in \mathbb{N}}$ is a super-additive sequence that is bounded above by 0 and therefore the limit in (2.6.37) exists, is finite and satisfies

$$h_\beta(\delta) = \sup_{N \in \mathbb{N}} \frac{1}{N} \log \mathbf{E}_\beta(e^{-\delta A_N} \mathbf{1}_{\{V_N=0\}}) \leq 0. \quad (2.6.39)$$

(ii) The fact that $A_N \geq 0$ for all $N \in \mathbb{N}$ immediately entails that $\delta \mapsto h_\beta(\delta)$ is non-increasing on $[0, \infty)$. By Hölder's inequality, the function $\delta \mapsto h_{N, \beta}(\delta)$ is convex for all $N \in \mathbb{N}$ and hence so is $\delta \mapsto h_\beta(\delta)$. Convexity and finiteness imply continuity on $(0, \infty)$. In order to prove the continuity at 0, we first note that $\lim_{\delta \rightarrow 0} h_\beta(\delta) = \sup_{\delta \geq 0} h_\beta(\delta)$. Then, with the help of formula 2.6.39 and via an exchange of suprema we obtain

$$\begin{aligned} \lim_{\delta \rightarrow 0} h_\beta(\delta) &= \sup_{\delta \geq 0} \sup_{N \in \mathbb{N}} \frac{1}{N} \log \mathbf{E}_\beta(e^{-\delta A_N} \mathbf{1}_{\{V_N=0\}}) \\ &= \sup_{N \in \mathbb{N}} \frac{1}{N} \log \mathbf{P}_\beta(V_N = 0) = 0. \end{aligned} \quad (2.6.40)$$

\square

It remains to show that the two definitions of h_β in (2.4.9) and (2.6.37) coincide. To that aim it suffices to show that

$$\limsup_{N \rightarrow \infty} \frac{1}{N} \log \mathbf{E}_\beta(e^{-\delta A_N}) \leq \lim_{N \rightarrow \infty} \frac{1}{N} \log \mathbf{E}_\beta(e^{-\delta A_N} \mathbf{1}_{\{V_N=0\}}). \quad (2.6.41)$$

We set $\mathcal{I}_{N^2} := [-N^2, N^2] \cap \mathbb{Z}$ and we decompose $\mathbf{E}_\beta(e^{-\delta A_N})$ into the two partition functions $C_{N,\beta}$ and $B_{N,\beta}$ defined as

$$C_{N,\beta} = \mathbf{E}_\beta(e^{-\delta A_N} \mathbf{1}_{\{V_N \in \mathcal{I}_{N^2}\}}) \quad \text{and} \quad B_{N,\beta} = \mathbf{E}_\beta(e^{-\delta A_N} \mathbf{1}_{\{V_N \notin \mathcal{I}_{N^2}\}}). \quad (2.6.42)$$

Since $A_N \geq 0$ and since $\mathbf{E}_\beta(\exp(\beta|v_1|/4)) < \infty$, the Markov inequality gives

$$B_{N,\beta} \leq \mathbf{E}_\beta(\mathbf{1}_{\{V_N \notin \mathcal{I}_{N^2}\}}) \leq \mathbf{P}_\beta\left(\sum_{i=1}^N |v_i| \geq N^2\right) \leq \frac{\mathbf{E}_\beta(e^{(\beta/4)|v_1|})^N}{e^{(\beta/4)N^2}}, \quad (2.6.43)$$

which immediately implies that $\limsup_{N \rightarrow \infty} \frac{1}{N} \log B_{N,\beta} = -\infty$. Consequently

$$\limsup_{N \rightarrow \infty} \frac{1}{N} \log \mathbf{E}_\beta(e^{-\delta A_N}) = \limsup_{N \rightarrow \infty} \frac{1}{N} \log C_{N,\beta}, \quad (2.6.44)$$

and since the cardinality of \mathcal{I}_{N^2} grows polynomially, the proof of (2.6.41) will be complete once we show that

$$\limsup_{N \rightarrow \infty} \frac{1}{N} \log \sup_{x \in \mathcal{I}_{N^2}} \mathbf{E}_\beta(e^{-\delta A_N} \mathbf{1}_{\{V_N=x\}}) \leq \lim_{N \rightarrow \infty} \frac{1}{N} \log \mathbf{E}_\beta(e^{-\delta A_N} \mathbf{1}_{\{V_N=0\}}). \quad (2.6.45)$$

We consider the partition function of size $2N$ and use Markov property at time N to obtain

$$\mathbf{E}_\beta(e^{-\delta A_{2N}} \mathbf{1}_{\{V_{2N}=0\}}) \geq \mathbf{E}_\beta(e^{-\delta A_N} \mathbf{1}_{\{V_N=x\}}) \mathbf{E}_{\beta,x}(e^{-\delta A_N} \mathbf{1}_{\{V_N=0\}}), \quad x \in \mathbb{Z}. \quad (2.6.46)$$

By using the time reversal property of the random walk V , we can assert that $(V_N - V_{N-n}, 0 \leq n \leq N) \stackrel{d}{=} (V_n - V_0, 0 \leq n \leq N)$ and consequently, for all $x \in \mathbb{Z}$, it comes that

$$\begin{aligned} \mathbf{E}_{\beta,x}(e^{-\delta \sum_{n=1}^N |V_n|} \mathbf{1}_{\{V_N=0\}}) &= \mathbf{E}_\beta(e^{-\delta \sum_{n=1}^N |V_n+x|} \mathbf{1}_{\{V_N=-x\}}) \\ &= \mathbf{E}_\beta(e^{-\delta \sum_{n=1}^N |V_N - V_{N-n} + x|} \mathbf{1}_{\{V_N=-x\}}) \\ &= \mathbf{E}_\beta(e^{-\delta \sum_{n=1}^{N-1} |V_n|} \mathbf{1}_{\{V_N=-x\}}). \end{aligned} \quad (2.6.47)$$

Thanks to the symmetry of V and since $\sum_{n=1}^{N-1} |V_n| \leq A_N$, the inequalities (2.6.46) and (2.6.47) allow us to write

$$\mathbf{E}_\beta(e^{-\delta A_{2N}} \mathbf{1}_{\{V_{2N}=0\}}) \geq \left[\sup_{x \in \mathcal{I}_{N^2}} \mathbf{E}_\beta(e^{-\delta A_N} \mathbf{1}_{\{V_N=x\}}) \right]^2. \quad (2.6.48)$$

It remains to apply $\frac{1}{2N} \log$ in both sides of (2.6.48) and to let $N \rightarrow \infty$ to obtain (2.6.45), which completes the proof.

Asymptotics of h_β

Lemma 2.6.7. For $m \in \{u, nu\}$,

$$\lim_{\beta \rightarrow \beta_m^c} \frac{h_\beta(\tilde{f}^m(\beta))}{\tilde{f}^m(\beta)^{2/3}} = -d_m. \quad (2.6.49)$$

where we recall that d_m was defined in (2.4.12).

Heuristics Let us give the heuristic explanation of why $h_\beta(\delta) \sim -c\delta^{2/3}$ for some constant $c > 0$. The main idea is to decompose the trajectory of the random walk V into independent blocks of length $T\delta^{-2/3}$ for $T \in \mathbb{N}$ and δ small enough : we have approximately $N/(T\delta^{-2/3})$ such blocks. Hence, as $\delta \searrow 0$, we can estimate

$$\lim_{N \rightarrow \infty} \frac{1}{N} \log \mathbf{E}_\beta(e^{-\delta A_N}) \sim \lim_{T \rightarrow \infty} \frac{\delta^{2/3}}{T} \log \mathbf{E}_\beta(e^{-\delta A_{T\delta^{-2/3}}}). \quad (2.6.50)$$

It is well known that for such random walks (assume that $\mathbf{E}_\beta(v_1^2) = 1$) (see [11, p. 405])

$$k^{-3/2} \sum_{i=1}^{Tk} |V_i| \xrightarrow{\mathcal{L}} \int_0^T |B(t)| dt \quad \text{as } k \rightarrow \infty, \quad (2.6.51)$$

where B is a standard Brownian motion. Now, let $k = \delta^{-2/3}$ and since $|e^{-\delta A_{T\delta^{-2/3}}}| \leq 1$, we conclude that

$$\mathbf{E}_\beta(e^{-\delta A_{T\delta^{-2/3}}}) \rightarrow \mathbf{E}(e^{-\int_0^T |B(t)| dt}) \quad \text{as } \delta \rightarrow 0. \quad (2.6.52)$$

This convergence and (2.6.50) would immediately imply $h_\beta(\delta) \sim -c\delta^{2/3}$ where c can be estimated via the distribution of the *Brownian area*, that is

$$c = - \lim_{T \rightarrow \infty} \frac{1}{T} \log \mathbf{E}(e^{-\int_0^T |B(t)| dt}) > 0. \quad (2.6.53)$$

Proof of Lemma 2.6.7.

Upper bound Pick $T \in \mathbb{N}$, $\delta > 0$ such that $\delta^{-2/3} \in \mathbb{N}$ and let $\Delta := \delta^{-2/3}$. We take N that satisfies $N/(T\Delta) \in \mathbb{N}$ and partition $\{1, \dots, N\}$ into $k = N/(T\Delta)$ intervals of length $T\Delta$. By the Markov property of V , we desintegrate $\mathbf{E}_\beta(e^{-\delta A_N})$ with respect to the position occupied by the random walk V at times $T\Delta, 2T\Delta, \dots, (k-1)T\Delta$,

$$\mathbf{E}_\beta(e^{-\delta A_N}) = \sum_{\substack{x_0=0, x_i \in \mathbb{Z} \\ i=1, \dots, k}} \prod_{i=0}^{k-1} \mathbf{E}_{\beta, x_i} \left(e^{-\delta A_{T\Delta}} \mathbf{1}_{\{V_{T\Delta} = x_{i+1}\}} \right) \leq \left[\sup_{x \in \mathbb{Z}} \mathbf{E}_{\beta, x} (e^{-\delta A_{T\Delta}}) \right]^k. \quad (2.6.54)$$

With the help of Lemma 2.6.8 below, we can replace the supremum in the right hand side of (2.6.54) by the term indexed by $x = 0$ only. The proof of Lemma 2.6.8 is postponed to section 2.6.3.

Lemma 2.6.8. For all $\delta > 0, n \in \mathbb{N}$ and $x, x' \in \mathbb{Z}$ such that $|x'| \geq |x|$, the following inequality holds true

$$\mathbf{E}_{\beta, x'}(e^{-\delta A_n}) \leq \mathbf{E}_{\beta, x}(e^{-\delta A_n}). \quad (2.6.55)$$

Therefore (2.6.54) becomes

$$\mathbf{E}_\beta(e^{-\delta A_N}) \leq \left[\mathbf{E}_\beta(e^{-\delta A_{T\Delta}}) \right]^{N/(T\Delta)}. \quad (2.6.56)$$

Recall that $\Delta := \delta^{-2/3}$, apply $\frac{1}{N} \log$ to both sides of (2.6.56) and let $N \rightarrow \infty$ to obtain, for $\beta > 0$ and $\delta > 0$, that

$$\frac{h_\beta(\delta)}{\delta^{2/3}} \leq \frac{1}{T} \log \mathbf{E}_\beta(e^{-\delta A_{T\Delta}}). \quad (2.6.57)$$

In what follows we need a uniform version (in β) of the convergence of $\mathbf{E}_\beta(e^{-\delta A_{T\Delta}})$ towards $\mathbf{E}(e^{-\int_0^T |B(t)| dt})$ as $\delta \rightarrow 0$. For this reason, we introduce the strong approximation theorem (Sakhanenko [21]) to approximate the partial sums of independent random variables v in the right hand side in (2.6.57) by independent normal random variables.

Theorem 2.6.9 (Q. M. Shao [24], Theorem B). *Denote by σ_β^2 the variance of the random variable v_1 under \mathbf{P}_β . We can redefine $\{v_i, i \geq 1\}$ (denoted by v^β) on a richer probability space together with a sequence of independent standard normal random variables $\{y_i, i \geq 1\}$ such that for every $p > 2$, $x > 0$,*

$$\mathbf{P}\left(\max_{i \leq n} \left| \sum_{j=1}^i v_j^\beta - \sigma_\beta \sum_{j=1}^i y_j \right| \geq x\right) \leq (Ap)^p x^{-p} \sum_{i=1}^n \mathbf{E}|v_i^\beta|^p, \quad (2.6.58)$$

where A is an absolute positive constant.

We let also, for $n \in \mathbb{N}$, $Y_n = \sum_{i=1}^n y_i$, $A_n(Y) = \sum_{i=1}^n |Y_i|$ and redefine $V_n^\beta = \sum_{i=1}^n v_i^\beta$, $A_n(V^\beta) = \sum_{i=1}^n |V_i^\beta|$. We pick $T > 0$, $p > 2$, $\theta > 0$ and K a compact subset of $(0, \infty)$. We use Theorem 2.6.9 and the fact that (recall (2.4.1)) $\mathbf{E}[|v_1^\beta|^p]$ is bounded from above uniformly in $\beta \in K$, to assert that there exists a constant $c_{p,K} > 0$ such that for all $\Delta > 0$ and $\beta \in K$

$$\mathbf{P}\left(\max_{i \leq T\Delta} |V_i^\beta - \sigma_\beta Y_i| \geq \Delta^\theta\right) \leq c_{p,K} T \Delta^{1-\theta p}. \quad (2.6.59)$$

Note that on the event $\{\max_{i \leq T\Delta} |V_i^\beta - \sigma_\beta Y_i| < \Delta^\theta\}$, we obviously have $|A_{T\Delta}(V^\beta) - \sigma_\beta A_{T\Delta}(Y)| \leq T\Delta^{\theta+1}$. Therefore, since $x \mapsto \exp(-x)$ is 1-Lipshitz on $[0, \infty)$ and since $\Delta = \delta^{-2/3}$, we can write that for $\beta \in K$ and $\delta > 0$

$$\begin{aligned} |\mathbf{E}(e^{-\delta A_{T\Delta}(V^\beta)} - e^{-\delta \sigma_\beta A_{T\Delta}(Y)})| &\leq \mathbf{P}\left(\max_{i \leq T\Delta} |V_i^\beta - \sigma_\beta Y_i| \geq \Delta^\theta\right) + \delta T \Delta^{\theta+1} \\ &\leq c_{p,K} T \delta^{\frac{2}{3}(\theta p - 1)} + T \delta^{\frac{1}{3}(1-2\theta)}. \end{aligned} \quad (2.6.60)$$

We chose $p = 3$ and $\theta \in (1/3, 1/2)$ and plug it in the right hand side of (2.6.57) to obtain that for $\beta \in K$ and $\delta > 0$,

$$\frac{h_\beta(\delta)}{\delta^{2/3}} \leq \frac{1}{T} \log \left[\mathbf{E}(e^{-\delta \sigma_\beta A_{T\Delta}(Y)}) + c_{3,K} T \delta^{\frac{2(3\theta-1)}{3}} + T \delta^{\frac{1-2\theta}{3}} \right]. \quad (2.6.61)$$

Lemma 2.6.10. *Let K be a compact subset of $(0, +\infty)$. For $T > 0$ and $\varepsilon > 0$ there exists a $\delta_0 > 0$ such that for $\delta \leq \delta_0$ (with $\Delta = \delta^{2/3}$),*

$$\sup_{\beta \in K} \left| \mathbf{E}(e^{-\delta \sigma_\beta A_{T\Delta}(Y)}) - \mathbf{E}(e^{-\sigma_\beta \int_0^T |B(t)| dt}) \right| < \varepsilon, \quad (2.6.62)$$

where B is a standard Brownian motion.

Proof of Lemma 2.6.10. We can consider $\{B(t), t \geq 0\}$ and $\{y_i, i \geq 1\}$ on the same probability space by letting $y_i = B(i) - B(i-1)$ and thus $Y_i = B(i)$ for $i \in \mathbb{N}$. Since the exponential function is 1-Lipschitz on $(-\infty, 0]$, we have

$$\sup_{\beta \in K} \left| \mathbf{E} \left(e^{-\delta \sigma_\beta A_{T\Delta}(Y)} \right) - \mathbf{E} \left(e^{-\sigma_\beta \int_0^T |B(t)| dt} \right) \right| \leq \max\{\sigma_\beta, \beta \in K\} \mathbf{E} \left[\left| \delta A_{T\Delta}(Y) - \int_0^T |B(t)| dt \right| \right]. \quad (2.6.63)$$

Since $\max\{\sigma_\beta, \beta \in K\} < \infty$, the proof is complete once we show that the expectation in the right hand side vanishes as $\Delta \rightarrow +\infty$. Recall that $\delta = \Delta^{-3/2}$ and $A_{T\Delta}(Y) = \sum_{i=1}^{T\Delta} |B(i)|$. By Brownian scaling and Riemann sum approximation, we know that

$$\Delta^{-3/2} A_{T\Delta}(Y) \stackrel{d}{=} \Delta^{-1} \sum_{i=1}^{T\Delta} |B(i/\Delta)| \xrightarrow[\Delta \rightarrow \infty]{a.s.} \int_0^T |B(t)| dt, \quad (2.6.64)$$

and since we have uniform integrability (because $\sup_{\Delta > 0} \mathbf{E}(|\Delta^{-3/2} A_{T\Delta}(Y)|^2) < \infty$) we can conclude that

$$\lim_{\Delta \rightarrow \infty} \mathbf{E} \left(\left| \Delta^{-3/2} A_{T\Delta}(Y) - \int_0^T |B(t)| dt \right| \right) = 0. \quad (2.6.65)$$

□

We resume the proof of the upper bound. Since $\theta \in (1/3, 1/2)$, the right hand side of (2.6.60) vanishes as $\delta \rightarrow 0$ uniformly in $\beta \in K$. Thus, we can replace δ by $\tilde{f}^m(\beta_c^m)$ in (2.6.61) and use Lemma 2.6.10 and the fact that $\lim_{\varepsilon \rightarrow 0^+} \tilde{f}^m(\beta_c^m - \varepsilon) = 0$ to conclude that, for all $T > 0$,

$$\limsup_{\varepsilon \rightarrow 0^+} \frac{h_\beta(\tilde{f}^m(\beta_c^m - \varepsilon))}{\tilde{f}^m(\beta_c^m - \varepsilon)^{2/3}} \leq \frac{1}{T} \log \mathbf{E} \left(e^{-\sigma_{\beta_c^m} \int_0^T |B(t)| dt} \right). \quad (2.6.66)$$

It remains to let T tend to infinity and to recall (2.4.12) to obtain

$$\limsup_{\varepsilon \rightarrow 0^+} \frac{h_\beta(\tilde{f}^m(\beta_c^m - \varepsilon))}{\tilde{f}^m(\beta_c^m - \varepsilon)^{2/3}} \leq -d_m. \quad (2.6.67)$$

Lower bound Recall that $T \in \mathbb{N}$, $\delta > 0$ and $\Delta = \delta^{-2/3} \in \mathbb{N}$. We also take $N \in \mathbb{N}$ such that $N/(T\Delta) \in \mathbb{N}$. Pick $\eta > 0$ and use the decomposition in (2.6.54) to obtain

$$\mathbf{E}_\beta \left(e^{-\delta A_N} \right) \geq \sum_{\substack{x_0=0, x_i \in [-\eta\sqrt{\Delta}, \eta\sqrt{\Delta}] \\ i=1, \dots, k}} \prod_{i=0}^{k-1} \mathbf{E}_{\beta, x_i} \left(e^{-\delta A_{T\Delta}} \mathbf{1}_{\{V_{T\Delta} = x_{i+1}\}} \right) \quad (2.6.68)$$

$$\geq \left[\inf_{x \in [-\eta\sqrt{\Delta}, \eta\sqrt{\Delta}]} \mathbf{E}_{\beta, x} \left(e^{-\delta A_{T\Delta}} \mathbf{1}_{\{V_{T\Delta} \in [-\eta\sqrt{\Delta}, \eta\sqrt{\Delta}]\}} \right) \right]^{N/(T\Delta)}. \quad (2.6.69)$$

For any integer $x \in [-\eta\sqrt{\Delta}, \eta\sqrt{\Delta}]$, we consider the two sets of paths

$$\Pi_1^x = \left\{ (V_i)_{i=0}^{T\Delta} : V_0 = x, V_{T\Delta} \in [-\eta\sqrt{\Delta}, \eta\sqrt{\Delta}] \right\}, \quad (2.6.70)$$

and

$$\Pi_2 = \left\{ (V_i)_{i=0}^{T\Delta} : V_0 = 0, V_{T\Delta} \in [-\eta\sqrt{\Delta}, 0] \right\}. \quad (2.6.71)$$

Clearly, if $V = (V_i)_{i=0}^{T\Delta} \in \Pi_2$, then the trajectory $V + x$ starts at $x \in [0, \eta\sqrt{\Delta}]$ and is an element of Π_1^x . Similarly, for $x \in [-\eta\sqrt{\Delta}, 0]$, $\Pi_2' + x \subseteq \Pi_1^x$ where

$$\Pi_2' = \{(V_i)_{i=0}^{T\Delta} : V_0 = 0, V_{T\Delta} \in [0, \eta\sqrt{\Delta}]\}. \quad (2.6.72)$$

Since $\mathbf{P}_\beta(V \in \Pi_2) = \mathbf{P}_\beta(V \in \Pi_2')$, we conclude that

$$\mathbf{P}_{\beta,x}(V \in \Pi_1^x) \geq \mathbf{P}_\beta(V \in \Pi_2') \quad \text{for all } x \in [-\eta\sqrt{\Delta}, \eta\sqrt{\Delta}]. \quad (2.6.73)$$

Moreover, for any $V^* \in \Pi_1^x$,

$$\delta \sum_{i=1}^{T\Delta} |V_i^*| = \delta \sum_{i=1}^{T\Delta} |x + V_i| \leq \delta \sum_{i=1}^{T\Delta} |V_i| + \delta T \Delta |x| \leq \delta \sum_{i=1}^{T\Delta} |V_i| + \eta T, \quad (2.6.74)$$

where the trajectory V satisfies $V_0 = 0$. Combining (2.6.73) and (2.6.74), we then have, for $x \in [-\eta\sqrt{\Delta}, \eta\sqrt{\Delta}]$,

$$\mathbf{E}_{\beta,x} \left(e^{-\delta A_{T\Delta}} \mathbf{1}_{\{V_{T\Delta} \in [-\eta\sqrt{\Delta}, \eta\sqrt{\Delta}]\}} \right) \geq e^{-\eta T} \mathbf{E}_\beta \left(e^{-\delta A_{T\Delta}} \mathbf{1}_{\{V_{T\Delta} \in [0, \eta\sqrt{\Delta}]\}} \right). \quad (2.6.75)$$

By plugging the lower bound above into (2.6.68) and by using the symmetry of V we immediately get

$$\mathbf{E}_\beta \left(e^{-\delta A_N} \right) \geq \left[e^{-\eta T} \mathbf{E}_\beta \left(e^{-\delta A_{T\Delta}} \mathbf{1}_{\{V_{T\Delta} \in [0, \eta\sqrt{\Delta}]\}} \right) \right]^{N/T\Delta}, \quad (2.6.76)$$

which, by applying $\frac{1}{N} \log$ to both sides in (2.6.76) and by letting $N \rightarrow \infty$, gives, for all $\beta > 0$,

$$\frac{h_\beta(\delta)}{\delta^{2/3}} \geq \frac{1}{T} \log \mathbf{E}_\beta \left(e^{-\delta A_{T\Delta}} \mathbf{1}_{\{V_{T\Delta} \in [0, \eta\sqrt{\Delta}]\}} \right) - \eta, \quad \delta, \eta > 0. \quad (2.6.77)$$

At this stage, we proceed as in the upper bound (from (2.6.57)) to obtain, for all $T \in \mathbb{N}$, $\eta > 0$,

$$\liminf_{\beta \rightarrow \beta_m^*} \frac{h_\beta(\tilde{f}^m(\beta))}{\tilde{f}^m(\beta)^{2/3}} \geq \frac{1}{T} \log \mathbf{E} \left(e^{-\sigma_{\beta_m^*} \int_0^T |B(t)| dt} \mathbf{1}_{\{B(T) \in [0, \eta]\}} \right) - \eta. \quad (2.6.78)$$

Therefore the proof of the lower bound will be complete once we show that for all $\eta > 0$

$$\lim_{T \rightarrow \infty} \frac{1}{T} \log \mathbf{E} \left(e^{-\sigma_{\beta_m^*} \int_0^T |B(t)| dt} \mathbf{1}_{\{B(T) \in [0, \eta]\}} \right) = \lim_{T \rightarrow \infty} \frac{1}{T} \log \mathbf{E} \left(e^{-\sigma_{\beta_m^*} \int_0^T |B(t)| dt} \right). \quad (2.6.79)$$

Then, by recalling (2.4.12), we achieve the bound

$$\liminf_{\beta \rightarrow \beta_m^*} \frac{h_\beta(\tilde{f}^m(\beta))}{\tilde{f}^m(\beta)^{2/3}} \geq -d_m - \eta, \quad (2.6.80)$$

for all $\eta > 0$. It remains to let $\eta \rightarrow 0$ to complete the proof.

The proof of (2.6.79) is very similar to the one displayed in section 2.6.3 that shows that the two definitions of h_β coincide. Pick $T > 0$, and partition the interval $[-T^2, T^2]$ into $2T^2/\eta$ sub-intervals of length η , i.e.,

$$[-T^2, T^2] = \bigcup_{i=-(T^2/\eta)+1}^{T^2/\eta} J_i, \quad \text{where } J_i = [(i-1)\eta, i\eta]. \quad (2.6.81)$$

Since $\lim_{T \rightarrow \infty} \frac{1}{T} \log \mathbf{P}(|B(T)| \geq T^2) = -\infty$, we can claim that

$$\lim_{T \rightarrow \infty} \frac{1}{T} \log \mathbf{E} \left(e^{-\sigma_\beta \int_0^T |B(t)| dt} \right) = \liminf_{T \rightarrow \infty} \frac{1}{T} \log \mathbf{E} \left(e^{-\sigma_\beta \int_0^T |B(t)| dt} \mathbf{1}_{\{B(T) \in [-T^2, T^2]\}} \right). \quad (2.6.82)$$

The expectation in right hand side of (2.6.82) can be bounded from above as

$$\mathbf{E} \left(e^{-\sigma_\beta \int_0^T |B(t)| dt} \mathbf{1}_{\{B(T) \in [-T^2, T^2]\}} \right) \leq \frac{2T^2}{\eta} \sup_{i \in \mathcal{T}_\eta} \mathbf{E} \left(e^{-\sigma_\beta \int_0^T |B(t)| dt} \mathbf{1}_{\{B(T) \in J_i\}} \right), \quad (2.6.83)$$

where $\mathcal{T}_\eta := \{-T^2/\eta + 1, \dots, T^2/\eta\}$. By applying $\frac{1}{T} \log$ to both sides of (2.6.83) and by letting $T \rightarrow \infty$, it comes that

$$\lim_{T \rightarrow \infty} \frac{1}{T} \log \mathbf{E} \left(e^{-\sigma_\beta \int_0^T |B(t)| dt} \right) \leq \liminf_{T \rightarrow \infty} \frac{1}{T} \log \sup_{i \in \mathcal{T}_\eta} \mathbf{E} \left(e^{-\sigma_\beta \int_0^T |B(t)| dt} \mathbf{1}_{\{B(T) \in J_i\}} \right). \quad (2.6.84)$$

The next step consists in bounding from below the partition function of size $2T$, so that for all $i \in \mathcal{T}_\eta$ we have

$$\begin{aligned} & \mathbf{E} \left(e^{-\sigma_\beta \int_0^{2T} |B(t)| dt} \mathbf{1}_{\{B(2T) \in [-\eta, \eta]\}} \right) \\ & \geq \mathbf{E} \left[e^{-\sigma_\beta \int_0^T |B(t)| dt} \mathbf{1}_{\{B(T) \in J_i\}} \mathbf{E} \left(e^{-\sigma_\beta \int_T^{2T} |B(t)| dt} \mathbf{1}_{\{B(2T) \in [-\eta, \eta]\}} \mid B(T) \right) \right] \\ & \geq \mathbf{E} \left(e^{-\sigma_\beta \int_0^T |B(t)| dt} \mathbf{1}_{\{B(T) \in J_i\}} \right) \inf_{x \in J_i} \mathbf{E}_x \left(e^{-\sigma_\beta \int_0^T |B(t)| dt} \mathbf{1}_{\{B(T) \in [-\eta, \eta]\}} \right). \end{aligned} \quad (2.6.85)$$

We now use the time reversal and the symmetry of $\{B(t), t \geq 0\}$ to conclude, for all $x \in J_i$, $i \in \mathcal{T}_\eta$,

$$\begin{aligned} \mathbf{E}_x \left(e^{-\sigma_\beta \int_0^T |B(t)| dt} \mathbf{1}_{\{B(T) \in [-\eta, \eta]\}} \right) &= \mathbf{E} \left(e^{-\sigma_\beta \int_0^T |B(t)+x| dt} \mathbf{1}_{\{B(T)+x \in [-\eta, \eta]\}} \right) \\ &= \mathbf{E} \left(e^{-\sigma_\beta \int_0^T |B(T)-B(T-t)+x| dt} \mathbf{1}_{\{B(T)+x \in [-\eta, \eta]\}} \right) \\ &\geq e^{-\sigma_\beta \eta T} \mathbf{E} \left(e^{-\sigma_\beta \int_0^T |B(t)| dt} \mathbf{1}_{\{B(T) \in [x-\eta, x+\eta]\}} \right) \\ &\geq e^{-\sigma_\beta \eta T} \mathbf{E} \left(e^{-\sigma_\beta \int_0^T |B(t)| dt} \mathbf{1}_{\{B(T) \in J_i\}} \right). \end{aligned} \quad (2.6.86)$$

At this stage, we plug (2.6.86) into (2.6.85) and we note that both inequalities hold for all $i \in \mathcal{T}_\eta$, so that

$$\mathbf{E} \left(e^{-\sigma_\beta \int_0^{2T} |B(t)| dt} \mathbf{1}_{\{B(2T) \in [-\eta, \eta]\}} \right) \geq e^{-\sigma_\beta \eta T} \sup_{i \in \mathcal{T}_\eta} \mathbf{E} \left(e^{-\sigma_\beta \int_0^T |B(t)| dt} \mathbf{1}_{\{B(T) \in J_i\}} \right)^2. \quad (2.6.87)$$

We apply $\frac{1}{2T} \log$ to both sides of (2.6.87) and we let $T \rightarrow \infty$ to obtain

$$\begin{aligned} & \liminf_{T \rightarrow \infty} \frac{1}{2T} \log \mathbf{E} \left(e^{-\sigma_\beta \int_0^{2T} |B(t)| dt} \mathbf{1}_{\{B(2T) \in [-\eta, \eta]\}} \right) \\ & \geq \frac{-\sigma_\beta \eta}{2} + \liminf_{T \rightarrow \infty} \frac{1}{T} \sup_{i \in \mathcal{T}_\eta} \log \mathbf{E} \left(e^{-\sigma_\beta \int_0^T |B(t)| dt} \mathbf{1}_{\{B(T) \in J_i\}} \right), \end{aligned} \quad (2.6.88)$$

which, once combined with (2.6.84) and since $\{B(t), t \geq 0\}$ is symmetric, gives

$$\lim_{T \rightarrow \infty} \frac{1}{T} \log \mathbf{E} \left(e^{-\sigma_\beta \int_0^T |B(t)| dt} \right) \leq \liminf_{T \rightarrow \infty} \frac{1}{T} \log \mathbf{E} \left(e^{-\sigma_\beta \int_0^T |B(t)| dt} \mathbf{1}_{\{B(T) \in [0, \eta]\}} \right) + \frac{\sigma_\beta \eta}{2}. \quad (2.6.89)$$

For all $\eta > 0$, we let

$$d(\eta) := \lim_{T \rightarrow \infty} \frac{1}{T} \log \mathbf{E} \left(e^{-\sigma_\beta \int_0^T |B(t)| dt} \right) - \liminf_{T \rightarrow \infty} \frac{1}{T} \log \mathbf{E} \left(e^{-\sigma_\beta \int_0^T |B(t)| dt} \mathbf{1}_{\{B(T) \in [-\eta, \eta]\}} \right). \quad (2.6.90)$$

The function $\eta \mapsto d(\eta)$ is non-increasing and non-negative on $(0, \infty)$, and it follows from (2.6.89) that $0 \leq d(\eta) \leq \frac{\sigma_\beta \eta}{2}$, which implies that $d(\eta) = 0$ for all $\eta \in (0, \infty)$. The proof is therefore complete. \square

Proof of Lemma 2.6.8

Démonstration. Since V and A_n are symmetric, we can assume that $x, x' \in \mathbb{N}_0 := \mathbb{N} \cup \{0\}$ and thus it is sufficient to show that the result holds for $x' = x + 1$. We will argue by induction. Since $A_0 = 1$, the $m = 0$ case is trivial. Now, we assume that the inequality holds true for $m \in \mathbb{N}$. We consider the partition function of size $m + 1$, and we can disintegrate it in dependence of the position of V_1 , i.e.,

$$\begin{aligned} \mathbf{E}_{\beta, x} \left(e^{-\delta A_{m+1}} \right) &= \sum_{y \in \mathbb{Z}} \mathbf{E}_{\beta, x} \left(e^{-\delta(|y| + |V_2| + \dots + |V_{m+1}|)} \mathbf{1}_{\{V_1 = y\}} \right) \\ &= \sum_{y \in \mathbb{Z}} \mathbf{P}_\beta(v_1 = y - x) e^{-\delta|y|} \mathbf{E}_{\beta, y} \left(e^{-\delta A_m} \right) \\ &= \sum_{y \in \mathbb{N}} R_x(y) e^{-\delta y} \mathbf{E}_{\beta, y} \left(e^{-\delta A_m} \right) + \mathbf{P}_\beta(v_1 = x) \mathbf{E}_\beta \left(e^{-\delta A_m} \right), \end{aligned} \quad (2.6.91)$$

where $R_x(y) = \mathbf{P}_\beta(v_1 = y - x) + \mathbf{P}_\beta(v_1 = -y - x)$. Then, we set $\bar{R}_x(y) = \sum_{y' \geq y} R_x(y')$ for $y \in \mathbb{N}$. Since $\bar{R}_x(1) + \mathbf{P}_\beta(v_1 = x) = 1$, we can rewrite the right hand side in (2.6.91) as

$$\mathbf{E}_{\beta, x} \left(e^{-\delta A_{m+1}} \right) = \sum_{y \in \mathbb{N}} \bar{R}_x(y) \left[e^{-\delta y} \mathbf{E}_{\beta, y} \left(e^{-\delta A_m} \right) - e^{-\delta(y-1)} \mathbf{E}_{\beta, (y-1)} \left(e^{-\delta A_m} \right) \right] + \mathbf{E}_\beta \left(e^{-\delta A_m} \right). \quad (2.6.92)$$

We will show that, for all $y \in \mathbb{N}$, the function $x \mapsto \bar{R}_x(y)$ is non-decreasing on \mathbb{N}_0 . First, if $y \geq x + 1$, we obviously have

$$\bar{R}_x(y) = \sum_{y' \geq y} R_x(y') \leq \sum_{y' \geq y} R_{x+1}(y') = \bar{R}_{x+1}(y). \quad (2.6.93)$$

Then, if $1 \leq y \leq x$, since

$$\bar{R}_x(y) + \sum_{y'=1}^{y-1} R_x(y') + \mathbf{P}_\beta(v_1 = x) = \bar{R}_{x+1}(y) + \sum_{y'=1}^{y-1} R_{x+1}(y') + \mathbf{P}_\beta(v_1 = x + 1) = 1, \quad (2.6.94)$$

and

$$\mathbf{P}_\beta(v_1 = x) + \sum_{y'=1}^{y-1} R_x(y') \geq \mathbf{P}_\beta(v_1 = x + 1) + \sum_{y'=1}^{y-1} R_{x+1}(y'), \quad (2.6.95)$$

we immediately obtain $\bar{R}_x(y) \leq \bar{R}_{x+1}(y)$. Coming back to (2.6.92), we use the induction hypothesis to claim that

$$e^{-\delta y} \mathbf{E}_{\beta, y} \left(e^{-\delta A_m} \right) - e^{-\delta(y-1)} \mathbf{E}_{\beta, (y-1)} \left(e^{-\delta A_m} \right) \leq 0, \quad y \in \mathbb{N}, \quad (2.6.96)$$

which, together with the monotonicity of $x \mapsto \bar{R}_x(y)$ yields that

$$\begin{aligned} \mathbf{E}_{\beta,x}(e^{-\delta A_{m+1}}) &\geq \sum_{y \in \mathbb{N}} \bar{R}_{x+1}(y) \left[e^{-\delta y} \mathbf{E}_{\beta,y}(e^{-\delta A_m}) - e^{-\delta(y-1)} \mathbf{E}_{\beta,(y-1)}(e^{-\delta A_m}) \right] + \mathbf{E}_{\beta}(e^{-\delta A_m}) \\ &= \mathbf{E}_{\beta,x+1}(e^{-\delta A_{m+1}}). \end{aligned}$$

□

2.6.4 Large deviation estimates

In this section, we introduce the techniques that will be required to estimate the probability of some large deviation events associated with trajectories making a large arithmetic area. Such estimates will be needed in section 2.4.3 to approximate the probability that, under the polymer measure, the trajectories make only one bead.

Following Dobrushin and Hryniv in [10], for $n \in \mathbb{N}$, we define

$$Y_n := \frac{1}{n}(V_0 + V_1 + \cdots + V_{n-1}), \quad (2.6.97)$$

and for a given $q \in (0, \infty) \cap \frac{\mathbb{N}}{n}$, we focus on both probabilities $\mathbf{P}_{\beta}(Y_n = nq, V_n = 0)$ and $\mathbf{P}_{\beta}(Y_n = nq, V_n = 0, V_i > 0 \forall i \in \{1, \dots, n-1\})$. Our aim is to identify the exponential rate at which such probabilities are decreasing and their asymptotic polynomial correction. To that aim, we will use an *exponential tilting* of the probability measure \mathbf{P}_{β} (through the Cramer transform) in combination with a local limit theorem. Under the tilted probability measure the large deviation event $\{Y_n = nq, V_n = 0\}$ becomes typical, as will be seen in chapter 4, section 4.6.

First, we denote by $L(h), h \in \mathbb{R}$ the logarithmic moment generating function of the random walk V , i.e.,

$$L(h) := \log \mathbf{E}_{\beta}[e^{hV_1}]. \quad (2.6.98)$$

From the definition of the law \mathbf{P}_{β} in (2.4.1), we obviously have $L(h) < \infty$ for all $h \in (-\beta/2, \beta/2)$. For the ease of notations, we set $\Lambda_n := (Y_n, V_n)$ and we denote its logarithmic moment generating function by $L_{\Lambda_n}(H)$ for $H := (h_0, h_1) \in \mathbb{R}^2$, i.e.,

$$L_{\Lambda_n}(H) := \log \mathbf{E}_{\beta}[e^{h_0 Y_n + h_1 V_n}] = \sum_{i=1}^n L\left(\left(1 - \frac{i}{n}\right)h_0 + h_1\right). \quad (2.6.99)$$

Clearly, $L_{\Lambda_n}(H)$ is finite for all $H \in \mathcal{D}_n$ with

$$\mathcal{D}_n := \left\{ (h_0, h_1) \in \mathbb{R}^2 : h_1 \in \left(-\frac{\beta}{2}, \frac{\beta}{2}\right), \left(1 - \frac{1}{n}\right)h_0 + h_1 \in \left(-\frac{\beta}{2}, \frac{\beta}{2}\right) \right\}. \quad (2.6.100)$$

We also introduce L_{Λ} the continuous counterpart of L_{Λ_n} as

$$L_{\Lambda}(H) := \int_0^1 L(xh_0 + h_1) dx, \quad (2.6.101)$$

which is defined on

$$\mathcal{D} := \left\{ (h_0, h_1) \in \mathbb{R}^2 : h_1 \in \left(-\frac{\beta}{2}, \frac{\beta}{2}\right), h_0 + h_1 \in \left(-\frac{\beta}{2}, \frac{\beta}{2}\right) \right\}. \quad (2.6.102)$$

With the help of (2.6.99) and for $H = (h_0, h_1) \in \mathcal{D}_n$, we define the H -tilted distribution by

$$\frac{d\mathbf{P}_{n,H}}{d\mathbf{P}_{\beta}}(V) = e^{h_0 Y_n + h_1 V_n - L_{\Lambda_n}(H)}. \quad (2.6.103)$$

For a given $n \in \mathbb{N}$ and $q \in \frac{\mathbb{N}}{n}$, the exponential tilt is given by $H_n^q := (h_{n,0}^q, h_{n,1}^q)$ which is the unique solution of

$$\mathbf{E}_{n,H}(\frac{\Lambda_n}{n}) = \nabla[\frac{1}{n}L_{\Lambda_n}](H) = (q, 0), \quad (2.6.104)$$

and therefore, we have the equality

$$\mathbf{P}_\beta(\Lambda_n = (nq, 0)) = \mathbf{P}_{n,H_n^q}(\Lambda_n = (nq, 0))e^{n(-h_{n,0}^q q + \frac{1}{n}L_{\Lambda_n}(H_n^q))}. \quad (2.6.105)$$

From (2.6.105) it is easy to deduce that the exponential decay rate of $\mathbf{P}_\beta(\Lambda_n = (nq, 0))$ is given by the quantity $-h_{n,0}^q q + \frac{1}{n}L_{\Lambda_n}(H_n^q)$ and that the polynomial correction is associated with $\mathbf{P}_{n,H_n^q}(\Lambda_n = (nq, 0))$. To be more specific, we first state a Proposition which gives a local central limit theorem for the tilted law \mathbf{P}_{n,H_n^q} .

Proposition 2.6.11. *For $[q_1, q_2] \subset (0, \infty)$, there exist $C > 0, n_0 > 0$ such that for all $q \in [q_1, q_2]$ and $n \geq n_0$ we have*

$$\frac{1}{Cn^2} \leq \mathbf{P}_{n,H_n^q}(Y_n = nq, V_n = 0) \leq \frac{C}{n^2}. \quad (2.6.106)$$

Then, we define the continuous counterpart of H_n^q by $\tilde{H}(q, 0) := (\tilde{h}_0(q, 0), \tilde{h}_1(q, 0))$ which is the unique solution of the equation

$$\nabla L_\Lambda(H) = (q, 0), \quad (2.6.107)$$

and we state a Proposition that allows us to remove the n dependence of the exponential decay rate.

Proposition 2.6.12 (Decay rate of large area probability). *For $[q_1, q_2] \subset (0, +\infty)$, there exist $c_1, c_2 > 0$ and $n_0 \in \mathbb{N}$ such that*

$$\left| \left[\frac{1}{n}L_{\Lambda_n}(H_n^q) - h_{n,0}^q q \right] - \left[L_\Lambda(\tilde{H}(q, 0)) - \tilde{h}_0(q, 0) q \right] \right| \leq \frac{c_1}{n}, \quad \text{for } n \geq n_0, q \in [q_1, q_2]. \quad (2.6.108)$$

and

$$\left| \left| H_n^q - \tilde{H}(q, 0) \right| \right| \leq \frac{c_2}{n}, \quad \text{for } n \geq n_0, q \in [q_1, q_2]. \quad (2.6.109)$$

Proposition 2.6.12 and 2.6.11 will be proven in chapter 4, sections 4.5.1 and 4.6, respectively. With the help of (2.6.105) and by applying Proposition 2.6.11 and Proposition 2.6.12 we can finally give some sharp upper and lower bounds of $\mathbf{P}_\beta(Y_n = nq, V_n = 0)$.

Proposition 2.6.13. *For $[q_1, q_2] \subset (0, \infty)$, there exist $C_1 > C_2 > 0$ and $n_0 \in \mathbb{N}$ such that for all $q \in [q_1, q_2]$ and $n \geq n_0$ we have*

$$\frac{C_2}{n^2} e^{n[-\tilde{h}_0^q q + L_\Lambda(\tilde{H}(q,0))]} \leq \mathbf{P}_\beta(Y_n = nq, V_n = 0) \leq \frac{C_1}{n^2} e^{n[-\tilde{h}_0^q q + L_\Lambda(\tilde{H}(q,0))]}]. \quad (2.6.110)$$

In addition, we shall need in this paper a precise lower bound on the probability that, under \mathbf{P}_β , the random walk V makes only one excursion away from the origin, conditionally on having a large prescribed area. To our knowledge, such an estimate is not available in the existing literature. Recall the definition of Y_n in (2.6.97).

Proposition 2.6.14 (Unique excursion for large area). *For $[q_1, q_2] \subset (0, \infty)$, there exist $C > 0, \mu > 0$ and $n_0 \in \mathbb{N}$ such that for all $q \in [q_1, q_2]$ and every $n \geq n_0$*

$$\mathbf{P}_\beta(V_i > 0, 0 < i < n \mid Y_n = nq, V_n = 0) \geq \frac{C}{n^\mu}. \quad (2.6.111)$$

A variational formula for the free energy of the partially directed polymer collapse

Les résultats exposés dans ce chapitre sont le fruit d'une collaboration avec Nicolas Pétrélis, ils sont parus dans Journal of Statistical Physics (cf. [16]).

Sommaire

3.1	Introduction	72
3.1.1	The model	72
3.1.2	Background	73
3.1.3	A new approach	74
3.1.4	Main results	75
3.2	A new representation of the partition function	78
3.3	Construction and asymptotics of g_β	80
3.3.1	Construction and regularity of g_β	80
3.3.2	Asymptotics of g_β	83
3.4	Proof of the main results	84
3.4.1	Proof of Theorem 3.1.2	84
3.4.2	Proof of Theorem 3.1.3	85
3.4.3	Proof of Theorem 3.1.4	85
3.4.4	Proof of Lemma 3.3.4	87
3.4.5	Proof of Lemma 3.3.5	88

3.1 Introduction

3.1.1 The model

The spatial configurations of the polymer of length L (L monomers) are modelled by the trajectories of a partially directed random walk on \mathbb{Z}^2 . This random walk is self-avoiding and does not take any step in the negative x-direction. More precisely, we let $\vec{e}_1 = (1, 0)$, $\vec{e}_2 = (0, 1)$ denote the canonical basis of \mathbb{Z}^2 and we choose the set of allowed L -step paths as :

$$\begin{aligned} \mathcal{W}_L = \{w = (w_i)_{i=0}^L \in (\mathbb{N}_0 \times \mathbb{Z})^{L+1} : w_0 = 0, \\ w_{i+1} - w_i \in \{\vec{e}_1, \vec{e}_2, -\vec{e}_2\} \forall 0 \leq i < L - 1, \\ w_i \neq w_j \forall 0 \leq i < j \leq L, \\ w_L - w_{L-1} = \vec{e}_1\}. \end{aligned} \quad (3.1.1)$$

Note that the choice of w ending with an horizontal step is made for convenience only. Let us introduce two different laws on \mathcal{W}_L , uniform and non-uniform, denoted by \mathbf{P}_L^u and \mathbf{P}_L^{nu} , respectively.

(1) The uniform model : all L -step paths have the same probability, i.e.,

$$\mathbf{P}_L^u(w) = \frac{1}{|\mathcal{W}_L|}, \quad w \in \mathcal{W}_L. \quad (3.1.2)$$

(2) The non-uniform model : the L -step paths have the following law

- At the origin or after an horizontal step : the walker must step north, south or east with equal probability $1/3$.
- After a vertical step north (respectively south) : the walker must step north (respectively south) or east with probability $1/2$.

For later convenience, the law on \mathcal{W}_L is denoted by \mathbf{P}_L^m , where $m \in \{u, nu\}$.

Any non-consecutive vertices of the walk though adjacent on the lattice are called *self-touching* (Fig. 3.1). To take into account the interactions between monomers, we assign an energetic reward $\beta \geq 0$ to the polymer for each of its self-touchings. Thus, we associate with every random walk trajectory $w = (w_i)_{i=0}^L \in \mathcal{W}_L$ the Hamiltonian

$$H_{L,\beta}(w) := \beta \sum_{\substack{i,j=0 \\ i < j-1}}^L \mathbf{1}_{\{\|w_i - w_j\|=1\}}, \quad (3.1.3)$$

such that the partition function of the model can be written as

$$Z_{L,\beta}^m = \sum_{w \in \mathcal{W}_L} e^{H_{L,\beta}(w)} \mathbf{P}_L^m(w), \quad m \in \{u, nu\}. \quad (3.1.4)$$

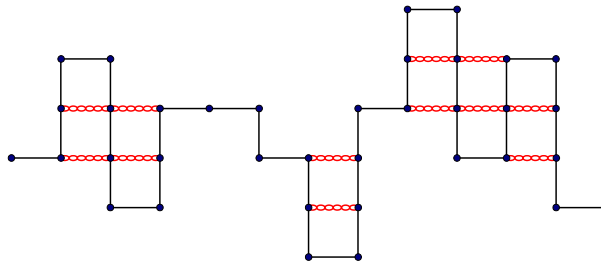

FIGURE 3.1 – A partially directed walk with 12 self-touchings represented by red bonds.

3.1.2 Background

The model presented in section 3.1.1 is often referred to in the physics literature as the Interacting partially directed self-avoiding walk (IPDSAW). The IPDSAW was first introduced in [26], and later in [3], as a directed version of the Interacting self-avoiding walk (ISAW) for which the set \mathcal{W}_L is similar to what we defined in (3.1.1) except that steps to the west ($-\vec{e}_1$) are allowed as well.

The ISAW allows for a better understanding of the geometric configuration adopted by an homopolymer dipped in a poor solvent. The monomers constituting the polymer try to exclude the solvent and therefore attract one another. Consequently, at low temperature, the polymer will fold on itself to form a *compact ball*. The transition from an extended configuration to a compact ball is called *collapse transition*. Both ISAW and IPDSAW are known to undergo a collapse transition at some critical temperature $T_c = 1/\beta_c$. Detecting the phase transition requires to spot the temperature at which the free energy f of the model loses its analyticity. In [6], [18] or more recently in [17], the method employed consists in providing an analytic expression of the generating function $G(z) = \sum_{L=1}^{\infty} Z_{L,\beta}^m z^L$ whose radius of convergence R satisfies $f = -\log R$. The idea behind the computation of the generating function is to rewrite $G(z)$ under the form $\sum_{r=0}^{\infty} g_r(z)$ where $g_r(z)$ is the contribution to $G(z)$ of those trajectories making exactly r consecutive vertical steps at the beginning, regardless of the total length of the trajectory. By applying some smart paths concatenation, a recurrence relation is obtained between g_{r-1} , g_r and g_{r+1} and then, after making the ansatz that g_r can be expressed as an infinite sum, the recurrence relation allows for an exact computation of the terms in the infinite sum that provides g_r . For a detailed version of the computation, we can refer to [9, p. 371–375].

The same method has subsequently been applied to some variations of the IPDSAW, for instance in [5] where a force is applied at the right extremity of the polymer or in [18] where a continuous version of the model is studied.

One of the main difficulty arising from the computation of the generating function G is that its analytic expression is very complicated and only gives an indirect access to the free energy. Our aim in this paper is to present a new method, that allows to work directly with the partition function of finite size. We will provide a variational formula for the free energy, from which the critical temperature can be computed easily. With the help of this variational formula, we will also give a rigorous proof of the fact that the collapse transition is of second order with exponent $3/2$.

Our method is based on a probabilistic representation of the partition function in terms of an auxiliary random walk. It involves analyzing the integral of a suitable walk. There

is an important literature about integrated random walk. Some of the main issue consist in computing the probability that the *algebraic area* below a random walk remain positive after N steps (see [23], [8] and references therein) or estimating the asymptotic behavior of a survival function for a class of stochastic processes related to random walks and Lévy processes (see [2]). In this paper, the integrated quantity that we are considering is slightly different because we consider the *geometric area* below the random walk, meaning that this area is counted positively also when the random walk is negative. We need in particular to compute the probability that the *geometric area* below the random walk is of order N after N steps.

3.1.3 A new approach

We partition the set \mathcal{W}_L into L subsets, each of them containing those trajectories that have the same number of horizontal steps. Via an algebraic manipulation of the Hamiltonian, it turns out that the contribution to the partition function $Z_{L,\beta}^m$ in (3.1.4) of those trajectories making exactly N horizontal steps can be expressed in a convenient manner. To be more specific, this contribution is proportional to a constant term (depending on β only) at power N times the probability that a symmetric random walk, whose law \mathbf{P}_β will be defined in (3.1.13), satisfies some geometric constraints. Thus, we have

$$Z_{L,\beta}^m \sim \sum_{N=1}^L (\Gamma^m(\beta))^N \mathbf{P}_\beta(\mathcal{V}_{N+1,L-N}), \quad (3.1.5)$$

where

$$\mathcal{V}_{n,k} := \{V : \sum_{i=1}^n |V_i| = k, V_n = 0\},$$

where $\beta \mapsto \Gamma^m(\beta)$ is a continuous and decreasing bijection from $(0, \infty)$ to $(0, \infty)$ and where $V := (V_i)_{i \in \mathbb{N}}$ is a random walk with geometric increments. The formula in (3.1.5) will be made rigorous in section 3.2, but the phase diagram of the model can already be read on this formula. In dependence of the value taken by $\Gamma^m(\beta)$, we can indeed distinguish between the 3 regimes displayed by the model :

- $\Gamma^m(\beta) > 1$: *the extended regime*. For $c \in (0, 1)$, the quantities $\mathbf{P}_\beta(\mathcal{V}_{cL,L(1-c)})$ are decaying exponentially fast when $L \rightarrow \infty$, at a rate which grows with c . Thus, the leading terms in (3.1.5) are those indexed by $N \sim \tilde{c}L$, where $\tilde{c} \in (0, 1)$ is the result of an optimization. This phase is extended because those trajectories that are mainly contributing to the partition function have an horizontal length N and a total length L of the same order (Fig. 3.2).
- $\Gamma^m(\beta) = 1$: *the critical regime*. The leading terms in (3.1.5) are those indexed by N of order $L^{2/3}$, because the quantity $\mathbf{P}_\beta(\mathcal{V}_{N+1,L-N})$ reaches its maximum for such values of N .
- $\Gamma^m(\beta) < 1$: *the collapsed regime*. For $c \in (0, \infty)$, the quantities $\mathbf{P}_\beta(\mathcal{V}_{c\sqrt{L},L})$ are decaying like $e^{-t_c\sqrt{L}}$ where $t_c > 0$ is decreasing in c . Thus, the leading terms in (3.1.5)

are those indexed by $N \sim \hat{c} \sqrt{L}$, where $\hat{c} \in (0, \infty)$ is again the result of an optimization. This phase is collapsed because the trajectories that are mainly contributing to the partition function have an horizontal length N much smaller than their total length L (Fig. 3.2).

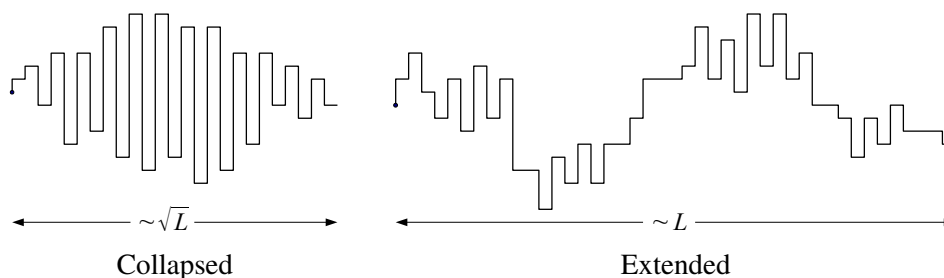

FIGURE 3.2 – A typical path of both phases.

3.1.4 Main results

For both models, i.e., $m \in \{u, nu\}$, the free energy per step $f^m : (0, \infty) \rightarrow \mathbb{R}$ is defined as the limit

$$f^m(\beta) := \lim_{L \rightarrow \infty} f_L^m(\beta), \quad \text{where} \quad f_L^m(\beta) := \frac{1}{L} \log Z_{L,\beta}^m. \quad (3.1.6)$$

Note that $\{\log Z_{L,\beta}^m\}_L$ is a super-additive sequence and since the number of self-touchings is smaller than the number of monomers, i.e. $H_{L,\beta}(w) \leq \beta L$, we immediately obtain the upper bound $Z_{L,\beta}^m \leq e^{\beta L}$ for $\beta \in (0, \infty)$ and $m \in \{u, nu\}$. Then the limit in (3.1.6) exists and is finite

$$f^m(\beta) = \lim_{L \rightarrow \infty} \frac{1}{L} \log Z_{L,\beta}^m = \sup_{L \in \mathbb{N}} \frac{1}{L} \log Z_{L,\beta}^m \leq \beta. \quad (3.1.7)$$

If we shut down the self-interaction of the polymer, that is if we take $\beta = 0$, then the density of self-touching performed by a typical L -step random walk trajectory belongs to $(0, 1)$, the horizontal extension of this trajectory is of order L and its vertical displacement of order \sqrt{L} . When β becomes strictly positive, in turn, the geometric conformation adopted by the random walk is the result of an "energy-entropy" competition which can be understood as follows. To increase its self-touching density, the polymer must both, reduce its number of horizontal steps and constrain its consecutive sequences of vertical steps to take opposite directions. However, these two geometric constraints have an entropic cost such that the free energy is the result of an optimization between the energetic gain and the entropic cost induced by a raise of the self-touching density. When β becomes large, the system enters its collapsed phase which corresponds to a saturation of the self-touchings made by the polymer. In other words, the collapsed configurations have a self-touching density equal to 1, which necessarily entails that the number of horizontal steps made by such configurations is of order $o(L)$ and that most pairs of consecutive vertical stretches are of opposite directions. These geometric restrictions are associated with a collapsed entropy κ_m for $m \in \{u, nu\}$ such that the free energy takes the form $\beta + \kappa_m$. In Lemma 3.1.1 below, we display the value of this collapsed entropy.

Lemma 3.1.1. For $\beta > 0$, $m \in \{u, nu\}$

$$f^m(\beta) \geq \varphi_\beta^m, \quad (3.1.8)$$

where $\varphi_\beta^u = \beta - \log(1 + \sqrt{2})$ and $\varphi_\beta^{nu} = \beta - \log 2$.

Démonstration. We pick L such that $\sqrt{L} \in \mathbb{N}$ and restrict the sum giving $Z_{L,\beta}^m$ to a single L -step trajectory \tilde{w} which starts with $\sqrt{L} - 1$ steps north then makes one step east, then $\sqrt{L} - 1$ steps south, then one step east, then $\sqrt{L} - 1$ steps north and so on... This trajectory makes \sqrt{L} horizontal steps, separating \sqrt{L} vertical stretches of length $\sqrt{L} - 1$ each. Since any two consecutive vertical stretches of \tilde{w} have opposite direction, its Hamiltonian is given by $\beta(\sqrt{L} - 1)^2 \geq \beta L - 2\beta\sqrt{L}$. Moreover, $\mathbf{P}_L^u(\tilde{w}) = 1/|\mathcal{W}_L|$ and $\mathbf{P}_L^{nu}(\tilde{w}) = (2/3)^{\sqrt{L}}(1/2)^L$, therefore

$$Z_{L,\beta}^u \geq \frac{e^{\beta(L-2\sqrt{L})}}{|\mathcal{W}_L|} \quad \text{and} \quad Z_{L,\beta}^{nu} \geq \left(\frac{e^\beta}{2}\right)^L \left(\frac{2}{3e^{2\beta}}\right)^{\sqrt{L}}. \quad (3.1.9)$$

Since $\lim_{L \rightarrow \infty} L^{-1} \log |\mathcal{W}_L| = \log(1 + \sqrt{2})$ (see [4, p. 5]), it remains to take $\frac{1}{L} \log$ in each term of the two inequalities in (3.1.9) and to let $L \rightarrow \infty$ to complete the proof of the Lemma. \square

Clearly, all what Lemma 3.1.1 is saying is that the collapsed entropies satisfy $\kappa_u \geq -\log(1 + \sqrt{2})$ and $\kappa_{nu} \geq -\log 2$. However, we will see below that these two inequalities are in fact equalities.

Let us define the *excess free energy* $\tilde{f}^m(\beta) := f^m(\beta) - \varphi_\beta^m$, which by Lemma 3.1.1 above is always non-negative. The lower bound in Lemma 3.1.1 allows us to partition $[0, \infty)$ into a collapsed phase denoted by \mathcal{C} and an extended phase denoted by \mathcal{E} , i.e.,

$$\mathcal{C} := \{\beta : \tilde{f}^m(\beta) = 0\} \quad (3.1.10)$$

and

$$\mathcal{E} := \{\beta : \tilde{f}^m(\beta) > 0\}. \quad (3.1.11)$$

Since $\tilde{f}^m(\beta)$ is convex, non-negative and bounded above, proving that there exists $\beta_0^m \in [0, \infty)$ such that $\tilde{f}^m(\beta_0^m) = 0$ will be sufficient to claim that $\tilde{f}^m(\beta) = 0$ for $\beta \geq \beta_0^m$. Then, the critical point will be defined as

$$\beta_c^m := \inf\{\beta \geq 0 : \tilde{f}^m(\beta) = 0\}, \quad (3.1.12)$$

and the sets \mathcal{C} and \mathcal{E} will become $\mathcal{C} = \{\beta : \beta \geq \beta_c^m\}$ and $\mathcal{E} = \{\beta : \beta < \beta_c^m\}$.

Variational formula

In Theorem 3.1.2 below we provide a variational formula for the excess free energy of the model. We need to settle some of the ingredients appearing in the formula. We let $V := (V_n)_{n \in \mathbb{N}}$ be a symmetric random walk on \mathbb{Z} , whose increments are independent and follow a geometric distribution, i.e. $V_0 = 0$, $V_n = \sum_{i=1}^n v_i$ for $n \in \mathbb{N}$ and $v := (v_i)_{i \in \mathbb{N}}$ is an i.i.d sequence under the law \mathbf{P}_β , with distribution

$$\mathbf{P}_\beta(v_1 = k) = \frac{e^{-\frac{\beta}{2}|k|}}{c_\beta} \quad \forall k \in \mathbb{Z} \quad \text{with} \quad c_\beta := \frac{1+e^{-\beta/2}}{1-e^{-\beta/2}}. \quad (3.1.13)$$

For each $\alpha \in [0, \infty)$, we set

$$g_\beta(\alpha) := \lim_{N \rightarrow \infty} \frac{1}{N} \log \mathbf{P}_\beta \left(\sum_{n=1}^N |V_n| \leq \alpha N, V_N = 0 \right). \quad (3.1.14)$$

We will prove in section 3.3 below that the limit in (3.1.14) exists and that $\alpha \mapsto g_\beta(\alpha)$ is negative, concave, increasing on $[0, \infty)$ and converges to 0 as $\alpha \rightarrow \infty$. Finally, we define the function $\Gamma^m : (0, \infty) \rightarrow (0, \infty)$, for $m \in \{u, nu\}$, as

$$\begin{cases} \Gamma^u(\beta) = \frac{c_\beta}{e^\beta}, \\ \Gamma^{nu}(\beta) = \frac{2c_\beta}{3e^\beta}. \end{cases} \quad (3.1.15)$$

Theorem 3.1.2 (Variational formula). *For $m \in \{u, nu\}$, the excess free energy $\tilde{f}^m(\beta)$ is given by*

$$\tilde{f}^m(\beta) = \sup_{\alpha \in [0,1]} \left[\alpha \log(\Gamma^m(\beta)) + \alpha g_\beta \left(\frac{1-\alpha}{\alpha} \right) \right]. \quad (3.1.16)$$

A consequence of Theorem 3.1.2 is that there exists a critical point $\beta_c^m > 0$ at which the polymer undergoes the collapse transition (Fig. 3.3) and that β_c^m can be computed explicitly.

Theorem 3.1.3 (Critical point). *For $m \in \{u, nu\}$, there exists a $\beta_c^m \in (0, \infty)$ such that*

$$\tilde{f}^m(\beta) \begin{cases} = 0, & \text{if } \beta \geq \beta_c^m, \\ > 0, & \text{if } \beta < \beta_c^m, \end{cases} \quad (3.1.17)$$

and β_c^m is the unique positive solution of the equation $\Gamma^m(\beta) = 1$.

By recalling (3.1.13) and (3.1.15), we observe that the equation $\Gamma^{nu}(\beta) = 1$ is equivalent to the equation $3x^3 - 3x^2 - 2x - 2 = 0$ where $x = e^{\beta/2}$. Moreover, the cubic polynomial $3x^3 - 3x^2 - 2x - 2$ has a unique positive zero x_c , so that $\beta_c^{nu} = 2 \log x_c$. Similarly, the critical point β_c^u of the uniform model is the unique root of the equation $\Gamma^u(\beta) = 1$. This value of β_c^u corresponds to the value provided in [6].

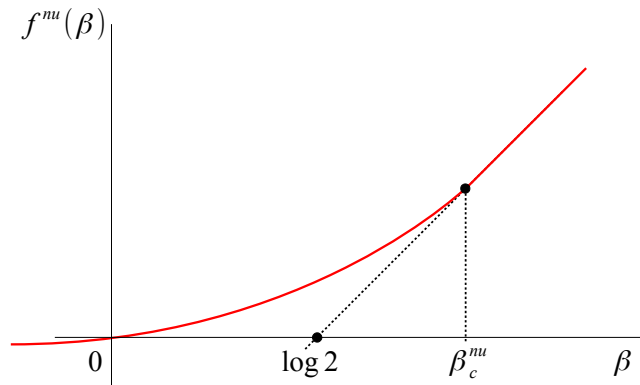

FIGURE 3.3 – Phase diagram in the non-uniform case ($\beta_c^{nu} \sim 1$).

Theorem 3.1.4 (Order of the phase transition). *The phase transition is of order $3/2$. That is, for $m \in \{u, nu\}$, there exist two constants $c_1, c_2 > 0$ such that for ε small enough*

$$c_1 \varepsilon^{3/2} \leq \tilde{f}^m(\beta_c^m - \varepsilon) \leq c_2 \varepsilon^{3/2}. \quad (3.1.18)$$

Let us give a heuristic explanation for these asymptotics. Notice first that $\Gamma^m(\beta)$ tends to 1 from above as β tends to β_c^m from below. As a consequence, for $\beta < \beta_c^m$ the function inside square brackets in (3.1.16) reaches its maximum at some $\alpha^*(\beta) > 0$ satisfying $\lim_{\beta \rightarrow \beta_c^m} \alpha^*(\beta) = 0$. Therefore, analysing the excess free energy near criticality requires the asymptotic behavior of $g_\beta(\alpha)$ when $\alpha \rightarrow \infty$. In other words we need, for α large, a good estimate of the rate of exponential decay of $\mathbf{P}_\beta(\sum_{n=1}^N |V_n| \leq \alpha N, V_N = 0)$ as $N \rightarrow \infty$. The latter probability can be approximated by the probability that a random walk $(V_n)_{n \in \mathbb{N}}$ remains in the interval $[-\alpha, \alpha]$ up to time N , which decays exponentially fast in N with a rate that decreases as $1/\alpha^2$ when $\alpha \rightarrow \infty$. Thus $g_\beta(\alpha) \sim -1/\alpha^2$ as $\alpha \rightarrow \infty$ and since $\log \Gamma^m(\beta) \sim \beta_c^m - \beta$ as $\beta \rightarrow (\beta_c^m)^-$ we can use (3.1.16) to conclude that $\alpha^*(\beta) \sim \sqrt{\beta_c^m - \beta}$ and $\tilde{f}^m(\beta) \sim (\beta_c^m - \beta)^{3/2}$ when $\beta \rightarrow (\beta_c^m)^-$.

3.2 A new representation of the partition function

With Proposition 3.2.1 below, we give a rigorous statement of the formula (3.1.5) which is the corner stone of our paper.

We need to settle a few notations before stating Proposition 3.2.1. For that, we recall (3.1.13) and we let $V = (V_i)_{i \in \mathbb{N}}$ be a random walk of law \mathbf{P}_β . We let

$$A_n := \sum_{i=1}^n |V_i| \quad (3.2.1)$$

represent the area enclosed between the random walk V and the horizontal line $y = 0$. We let also $\mathcal{V}_{n,k}$ be the subset containing those trajectories that return to the origin after n steps and satisfy $A_n = k$, that is

$$\mathcal{V}_{n,k} := \{V : V_n = 0, A_n = k\}. \quad (3.2.2)$$

Finally, we recall the definition of $\Gamma^m(\beta)$ in (3.1.15) and we set

$$\begin{cases} \Phi_{L,\beta}^u = e^{\beta L} / |\mathcal{W}_L|, \\ \Phi_{L,\beta}^{nu} = (e^\beta / 2)^L. \end{cases} \quad (3.2.3)$$

Proposition 3.2.1. *For $\beta > 0$, $L \in \mathbb{N}$, $m \in \{u, nu\}$, we have*

$$Z_{L,\beta}^m = c_\beta \Phi_{L,\beta}^m \sum_{N=1}^L (\Gamma^m(\beta))^N \mathbf{P}_\beta(\mathcal{V}_{N+1,L-N}). \quad (3.2.4)$$

Démonstration. We will display the details of the proof in the non-uniform case only. The uniform case is indeed easier to handle because the probability associated with each trajectory in \mathcal{W}_L is constant. The walk can be decomposed into N stretches $\gamma_1, \dots, \gamma_N$, each of them consisting of a vertical part of length $l_n \in \mathbb{Z}$ for $n \in \{1, \dots, N\}$ and of one horizontal step. Thus, with each configuration $w \in \mathcal{W}_L$, we associate the sequence $l := (l_1, \dots, l_N) \in$

\mathbb{Z}^N such that N is the number of vertical stretches made by w and l_n corresponds to the vertical length of the n^{th} stretch for $n \in \{1, \dots, N\}$ (Fig. 3.4). At this stage, we have a one-to-one correspondence between \mathcal{W}_L and $\Omega_L := \bigcup_{N=1}^L \mathcal{L}_{N,L}$, where $\mathcal{L}_{N,L}$ is the set of all possible configurations consisting of N vertical stretches that have a total length L , that is

$$\mathcal{L}_{N,L} = \left\{ l \in \mathbb{Z}^N : \sum_{n=1}^N |l_n| + N = L \right\}. \quad (3.2.5)$$

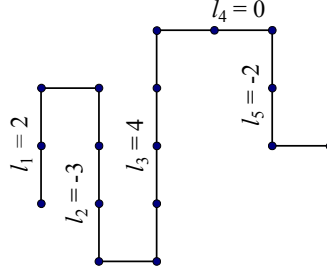

FIGURE 3.4 – An example of decomposition of $w \in \mathcal{W}_{16}$ into 5 stretches.

By recalling the definition of \mathbf{P}_L^{nu} in section 3.1.1, we note that the function $l \mapsto \mathbf{P}_L^{\text{nu}}(l)$ is constant equal to $(2/3)^N (1/2)^L$ on each subset $\mathcal{L}_{N,L}$. Moreover, the Hamiltonian associated with a stretch configuration $l = (l_1, \dots, l_N)$ is given by

$$H_{L,\beta}(l_1, \dots, l_N) = \beta \sum_{n=1}^{N-1} (l_n \tilde{\wedge} l_{n+1}) \quad (3.2.6)$$

where

$$x \tilde{\wedge} y = \begin{cases} |x| \wedge |y| & \text{if } xy < 0, \\ 0 & \text{otherwise.} \end{cases} \quad (3.2.7)$$

The one-to-one correspondance between Ω_L and \mathcal{W}_L allows us to rewrite the partition function in terms of the stretches, i.e.,

$$Z_{L,\beta}^{\text{nu}} = \sum_{N=1}^L \sum_{l \in \mathcal{L}_{N,L}} \left(\frac{1}{3}\right)^N \left(\frac{1}{2}\right)^{L-N} e^{\beta \sum_{n=1}^{N-1} (l_n \tilde{\wedge} l_{n+1})}. \quad (3.2.8)$$

At this stage, it is useful to remark that the $\tilde{\wedge}$ operator can be written as

$$x \tilde{\wedge} y = (|x| + |y| - |x + y|) / 2, \quad \forall x, y \in \mathbb{Z}. \quad (3.2.9)$$

Hence, for $\beta > 0$ and $L \in \mathbb{N}$, the partition function in (3.2.8) becomes

$$\begin{aligned} Z_{L,\beta}^{\text{nu}} &= \sum_{N=1}^L \left(\frac{1}{3}\right)^N \left(\frac{1}{2}\right)^{L-N} \sum_{\substack{l \in \mathcal{L}_{N,L} \\ l_0 = l_{N+1} = 0}} \exp\left(\beta \sum_{n=1}^N |l_n| - \frac{\beta}{2} \sum_{n=0}^N |l_n + l_{n+1}|\right) \\ &= \left(\frac{e^\beta}{2}\right)^L \sum_{N=1}^L c_\beta \left(\frac{2c_\beta}{3e^\beta}\right)^N \sum_{\substack{l \in \mathcal{L}_{N,L} \\ l_0 = l_{N+1} = 0}} \prod_{n=0}^N \frac{\exp\left(-\frac{\beta}{2}|l_n + l_{n+1}|\right)}{c_\beta}, \end{aligned} \quad (3.2.10)$$

where c_β was defined in (3.1.13). By rewriting the last sum in (3.2.10) in terms of $v_n := (-1)^{n-1}(l_{n-1} + l_n)$, $n = 1, \dots, N + 1$, we see that this sum is equal to the probability that the random walk $(V_n)_{n \in \mathbb{N}}$ belongs to $\mathcal{V}_{N+1, L-N}$ (Fig. 3.5). Therefore

$$Z_{L,\beta}^{\text{nu}} = c_\beta \left(\frac{e^\beta}{2}\right)^L \sum_{N=1}^L \left(\frac{2c_\beta}{3e^\beta}\right)^N \mathbf{P}_\beta(\mathcal{V}_{N+1, L-N}). \quad (3.2.11)$$

□

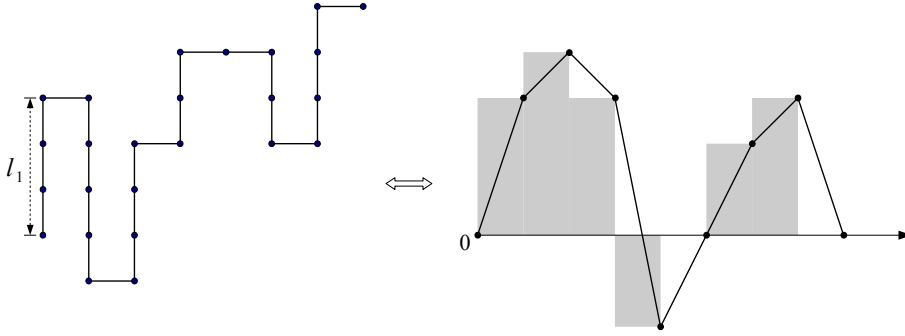

FIGURE 3.5 – An example of transformation of $w \in \mathcal{W}_{24}$ into $(V_n)_{n=0}^8 \in \mathcal{V}_{8,17}$. The 24-step trajectory w on the left has 7 stretches : $l_1 = 3, l_2 = -4, l_3 = 3, l_4 = 2, l_5 = 0, l_6 = -2$ and $l_7 = 3$. The correspondent increments of $(V_n)_{n=0}^8$ are : $v_1 = 3, v_2 = 1, v_3 = -1, v_4 = -5, v_5 = 2, v_6 = 2$ and $v_7 = 1$.

3.3 Construction and asymptotics of g_β

In section 3.3.1, we construct rigorously the entropic function g_β and we study its regularity and monotonicity. In section 3.3.2, we focus on the asymptotic behavior of $g_\beta(\alpha)$ when $\alpha \rightarrow \infty$.

3.3.1 Construction and regularity of g_β

We now define the function g_β in a slightly different way from (3.1.14), but we will see at the end of section 3.3.1 that the two definitions are equivalent. Recall (3.2.2) and for each $\alpha \in \mathbb{Q}^+ := \mathbb{Q} \cap [0, \infty)$, let

$$N_\alpha := \{n \in \mathbb{N} \cap [2, \infty) : \alpha n \in \mathbb{N}\}. \quad (3.3.1)$$

Note that $\mathbf{P}_\beta(\mathcal{V}_{N,\alpha K}) > 0$ for all $N \in \mathbb{N} \cap [2, \infty)$ and $K \in N_\alpha$. Let $g_\beta : \mathbb{Q}^+ \rightarrow \mathbb{R}$ be defined as

$$g_\beta(\alpha) := \lim_{\substack{N \in N_\alpha \\ N \rightarrow \infty}} g_{N,\beta}(\alpha), \quad \text{where} \quad g_{N,\beta}(\alpha) := \frac{1}{N} \log \mathbf{P}_\beta(\mathcal{V}_{N,\alpha N}). \quad (3.3.2)$$

To study the properties of g_β , we will use that

$$\mathbf{P}_\beta(\mathcal{V}_{N_1+N_2, K_1+K_2}) \geq \mathbf{P}_\beta(\mathcal{V}_{N_1, K_1}) \mathbf{P}_\beta(\mathcal{V}_{N_2, K_2}), \quad \text{for } N_1, N_2, K_1, K_2 \in \mathbb{N}. \quad (3.3.3)$$

To prove (3.3.3), we simply restrict the set $\mathcal{V}_{N_1+N_2, K_1+K_2}$ to those trajectories that return to origin at time N_1 and satisfy $A_{N_1} = K_1$. Then, by using the Markov property of the pair process $\{V_n, A_n\}_{n \in \mathbb{N}}$, we obtain the result.

Lemma 3.3.1. (i) $g_\beta(\alpha)$ exists and is finite, non-positive for all $\alpha \in \mathbb{Q}^+$. In particular, $g_\beta(0) = -\log c_\beta$.
(ii) $\alpha \mapsto g_\beta(\alpha)$ is continuous, concave, nondecreasing on \mathbb{Q}^+ and tends to 0 as $\alpha \rightarrow \infty$.

Remark 3.3.2. The continuity and the concavity of g_β guarantee that it can be extended to a continuous function on \mathbb{R}^+ .

Démonstration. (i) Because of (3.3.3), for $N_1, N_2 \in N_\alpha$, we have

$$\mathbf{P}_\beta(\mathcal{V}_{N_1+N_2, \alpha(N_1+N_2)}) \geq \mathbf{P}_\beta(\mathcal{V}_{N_1, \alpha N_1}) \mathbf{P}_\beta(\mathcal{V}_{N_2, \alpha N_2}). \quad (3.3.4)$$

Thus, $\{\log \mathbf{P}_\beta(\mathcal{V}_{N, \alpha N})\}_{N \in N_\alpha}$ is a super-additive sequence and since $0 < \mathbf{P}_\beta(\mathcal{V}_{N, \alpha N}) \leq 1$ for $N \in N_\alpha$, the limit in (3.3.2) exists, is finite and satisfies

$$g_\beta(\alpha) = \sup_{N \in N_\alpha} \frac{1}{N} \log \mathbf{P}_\beta(\mathcal{V}_{N, \alpha N}) \leq 0. \quad (3.3.5)$$

We recall that $\mathcal{V}_{n,0} = \{V : V_n = 0, A_n = 0\}$, so that

$$\mathbf{P}_\beta(\mathcal{V}_{N,0}) = \mathbf{P}_\beta(V_i = 0 \text{ for } i = 0, \dots, N) = (1/c_\beta)^N. \quad (3.3.6)$$

Hence $g_\beta(0) = -\log c_\beta$.

(ii) Applying again (3.3.3), we observe that for all $p, q \in \mathbb{N}, q > 0, 0 \leq p \leq q$ and $\alpha_1, \alpha_2 \in \mathbb{Q}^+, N \in N_{\alpha_1} \cap N_{\alpha_2}$

$$\mathbf{P}_\beta(\mathcal{V}_{qN, p\alpha_1 N + (q-p)\alpha_2 N}) \geq \mathbf{P}_\beta(\mathcal{V}_{N, \alpha_1 N})^p \mathbf{P}_\beta(\mathcal{V}_{N, \alpha_2 N})^{q-p}. \quad (3.3.7)$$

Therefore

$$\frac{1}{qN} \log \mathbf{P}_\beta \left(\mathcal{V}_{qN, \left(\frac{p}{q} \alpha_1 + \left(1 - \frac{p}{q}\right) \alpha_2 \right) qN} \right) \geq \frac{p}{qN} \log \mathbf{P}_\beta(\mathcal{V}_{N, \alpha_1 N}) + \frac{q-p}{qN} \log \mathbf{P}_\beta(\mathcal{V}_{N, \alpha_2 N}), \quad (3.3.8)$$

which proves that

$$g_\beta \left(\frac{p}{q} \alpha_1 + \left(1 - \frac{p}{q}\right) \alpha_2 \right) \geq \frac{p}{q} g_\beta(\alpha_1) + \left(1 - \frac{p}{q}\right) g_\beta(\alpha_2), \quad (3.3.9)$$

which is the desired concavity.

Now we will show that $g_\beta(\alpha) \rightarrow 0$ as $\alpha \rightarrow \infty$ and since g_β is concave on \mathbb{Q}^+ , it will be sufficient to conclude that g_β is nondecreasing.

Assume that $g_\beta(\alpha)$ does not converge to 0 as $\alpha \rightarrow \infty$, then the concavity of g_β insures that either g_β is nondecreasing on \mathbb{Q}^+ and there exists $M > 0$ such that $g_\beta(\alpha) \leq -M$ for all $\alpha \in \mathbb{Q}^+$ or g_β is decreasing for α large enough and converges to $-\infty$ as $\alpha \rightarrow \infty$. In both cases we can claim that there exists $M > 0$ and $\alpha_M > 0$ such that $g_\beta(\alpha) \leq -M$ for all $\alpha \geq \alpha_M$. Thus, we can use (3.3.5) to obtain

$$\mathbf{P}_\beta(\mathcal{V}_{N, \alpha N}) \leq e^{-NM} \text{ for all } N \in \mathbb{N}, \alpha \geq \alpha_M. \quad (3.3.10)$$

For $\alpha \in [\alpha_M, \infty) \cap 2\mathbb{N}$, we consider the set

$$\mathcal{N}_\alpha = \{V: V_1 = 3\alpha/2 + 1, \alpha + 1 < V_i < 2\alpha + 1 \text{ for } i = 2, \dots, N, V_{N+1} = 0\}. \quad (3.3.11)$$

For $N > \alpha$, we observe that

$$\mathcal{N}_\alpha \subseteq \left\{V: V_{N+1} = 0, \alpha(N+1) \leq \sum_{i=0}^{N+1} |V_i| \leq (2\alpha+1)(N+1)\right\}, \quad (3.3.12)$$

and hence, (3.3.10) allows us to write

$$\mathbf{P}_\beta(\mathcal{N}_\alpha) \leq \sum_{k=\alpha(N+1)}^{(2\alpha+1)(N+1)} \mathbf{P}_\beta(\mathcal{V}_{N+1,k}) \leq (\alpha+1)(N+1)e^{-(N+1)M}. \quad (3.3.13)$$

Now, we want to exhibit a lower bound on $\mathbf{P}_\beta(\mathcal{N}_\alpha)$. By using the Markov property, we have, with $V_N^* := \max_{1 \leq n \leq N} |V_n|$,

$$\mathbf{P}_\beta(\mathcal{N}_\alpha) = \mathbf{P}_\beta(v_1 = \frac{3\alpha}{2} + 1) \sum_{k=-\alpha/2-1}^{\alpha/2-1} \mathbf{P}_\beta\left(V_{N-1}^* < \frac{\alpha}{2}; V_N = k\right) \mathbf{P}_\beta(v_1 = -\frac{3\alpha}{2} - 1 - k). \quad (3.3.14)$$

Since $\mathbf{P}_\beta(v_1 = -\frac{3\alpha}{2} - 1 - k) \geq \mathbf{P}_\beta(v_1 = -2\alpha - 1)$ for $k \in \{-\alpha/2, \dots, \alpha/2\}$, equation (3.3.14) implies

$$\mathbf{P}_\beta(\mathcal{N}_\alpha) \geq \frac{e^{-\frac{\beta}{2}(\frac{7\alpha}{2}+2)}}{c_\beta^2} \sum_{k=-\alpha/2-1}^{\alpha/2-1} \mathbf{P}_\beta\left(V_{N-1}^* < \alpha/2; V_N = k\right). \quad (3.3.15)$$

We choose $\alpha > 4$ to get

$$\mathbf{P}_\beta(\mathcal{N}_\alpha) \geq \frac{e^{-2\beta\alpha}}{c_\beta^2} \mathbf{P}_\beta\left(V_N^* < \alpha/2\right), \quad (3.3.16)$$

and we can apply the Kolmogorov's inequality (see [11, p. 61]), which gives

$$\mathbf{P}_\beta\left(V_N^* < \frac{\alpha}{2}\right) \geq 1 - \frac{4}{\alpha^2} \mathbf{Var}_\beta(V_N). \quad (3.3.17)$$

Therefore, (3.3.13), (3.3.16) and (3.3.17) allow us to write

$$\frac{e^{-2\alpha\beta}}{c_\beta^2} \left(1 - \frac{4}{\alpha^2} \mathbf{Var}_\beta(V_N)\right) \leq (\alpha+1)(N+1)e^{-(N+1)M}. \quad (3.3.18)$$

Since the above inequality is true for all $\alpha > \alpha_M$ and $N > \alpha$, we can choose $\alpha = 2\sqrt{\lambda N \mathbf{Var}_\beta(v_1)}$ with $\lambda > 1$ such that for N large enough (3.3.18) becomes

$$\frac{1}{c_\beta^2} \left(1 - \frac{1}{\lambda}\right) e^{-4\beta\sqrt{\lambda N \mathbf{Var}_\beta(v_1)}} \leq (2\sqrt{\lambda N \mathbf{Var}_\beta(v_1)} + 1)(N+1)e^{-(N+1)M}. \quad (3.3.19)$$

For N large, (3.3.19) is clearly impossible and therefore $g_\beta(\alpha)$ converges to 0 as $\alpha \rightarrow \infty$ and g_β is nondecreasing. \square

It remains to show that the two definitions of g_β in (3.1.14) and (3.3.2) are equivalent. To this end, we first remark that by super-additivity, the limit in (3.1.14) exists for all $\alpha \in [0, \infty)$. We recall (3.2.1) and we note that, for $\alpha \in \mathbb{Q}^+$ and $N \in N_\alpha$, we have $\mathcal{V}_{N,\alpha N} \subset \{A_N \leq \alpha N, V_N = 0\}$. Therefore

$$\lim_{\substack{N \in N_\alpha \\ N \rightarrow \infty}} \frac{1}{N} \log \mathbf{P}_\beta(\mathcal{V}_{N,\alpha N}) \leq \lim_{N \rightarrow \infty} \frac{1}{N} \log \mathbf{P}_\beta(A_N \leq \alpha N, V_N = 0). \quad (3.3.20)$$

We note also that $\{A_N \leq \alpha N, V_N = 0\} = \cup_{i=0}^{\alpha N} \mathcal{V}_{N,i}$ and we use (3.3.5) and the fact that g_β is nondecreasing to state

$$\frac{1}{N} \log \mathbf{P}_\beta(A_N = i, V_N = 0) \leq g_\beta\left(\frac{i}{N}\right) \leq g_\beta(\alpha), \quad \text{for } i \leq \alpha N, \quad (3.3.21)$$

where g_β in (3.3.21) must be taken in the sense of its definition in (3.3.2). Thus,

$$\mathbf{P}_\beta(A_N \leq \alpha N, V_N = 0) \leq (\alpha N + 1)e^{Ng_\beta(\alpha)} \quad (3.3.22)$$

and it suffices to take $\frac{1}{N} \log$ of both sides in (3.3.22) and to let $N \rightarrow \infty$ to conclude that the two definitions are indeed equivalent.

3.3.2 Asymptotics of g_β

Proposition 3.3.3. *For all $\beta > 0$, there exists $c_1 > 0$ (depending on β) such that*

$$g_\beta(\alpha) \geq -\frac{c_1}{\alpha^2}, \quad \text{for } \alpha \text{ large enough.} \quad (3.3.23)$$

For all compact $K \subset (0, +\infty)$, there exist $c_2, \alpha_2 > 0$ (depending on K) such that

$$g_\beta(\alpha) \leq -\frac{c_2}{\alpha^2}, \quad \text{for } \beta \in K, \alpha \geq \alpha_2. \quad (3.3.24)$$

Démonstration. We will first prove Proposition 3.3.3 subject to Lemmas 3.3.4 and 3.3.5 below. The proofs of these two Lemmas will be postponed to sections 3.4.4 and 3.4.5. We recall (3.2.1) and the notation $V_N^* = \max_{1 \leq n \leq N} |V_n|$.

Lemma 3.3.4. *For $\beta > 0$, there exists $c_1 > 0$ (depending on β) such that for α large enough*

$$\mathbf{P}_\beta(V_N^* \leq \alpha) \geq e^{-\frac{c_1 N}{\alpha^2}}, \quad \text{for } N \text{ large enough.} \quad (3.3.25)$$

Lemma 3.3.5. *Let K be a compact subset of $(0, +\infty)$. There exist $c_2, \alpha_2 > 0$ (depending on K) such that for $\beta \in K, \alpha \geq \alpha_2$*

$$\mathbf{P}_\beta(A_N \leq \alpha N) \leq e^{-\frac{c_2 N}{\alpha^2}}, \quad \text{for } N \text{ large enough.} \quad (3.3.26)$$

Recall (3.2.1), (3.2.2) and (3.3.2) and note that the set $\mathcal{V}_{N,\alpha N}$ is included in $\{V : A_N \leq \alpha N\}$ when $\alpha \in \mathbb{Q}^+$ and $N \in N_\alpha$. Therefore, the upper bound in (3.3.24) is a direct consequence of Lemma 3.3.5 and of the continuity of $\alpha \rightarrow g_\beta(\alpha)$.

For the lower bound in (3.3.23), by Markov property, we obtain

$$\begin{aligned} \mathbf{P}_\beta(V_N^* \leq \alpha, V_N = 0) &= \sum_{x \in [-\alpha, \alpha]} \mathbf{P}_\beta(V_{N-1}^* \leq \alpha, V_{N-1} = x) \mathbf{P}_\beta(v_1 = -x) \\ &\geq \mathbf{P}_\beta(V_{N-1}^* \leq \alpha) \mathbf{P}_\beta(v_1 = \alpha). \end{aligned} \quad (3.3.27)$$

Since $V_N^* \leq \alpha$ implies $A_N = \sum_{n=1}^N |V_n| \leq \alpha N$, we can use (3.3.27) to write

$$\mathbf{P}_\beta(A_N \leq \alpha N, V_N = 0) \geq \mathbf{P}_\beta(V_{N-1}^* \leq \alpha) \mathbf{P}_\beta(v_1 = \alpha). \quad (3.3.28)$$

Recall the definition of g_β in (3.1.14) and apply Lemma 3.3.4, we obtain $g_\beta(\alpha) \geq -\frac{c_1}{\alpha^2}$ for α large enough, and the proof of Proposition 3.3.3 is complete. \square

3.4 Proof of the main results

In section 3.4.1, we prove the variational formula stated in Theorem 3.1.2. In section 3.4.2, we deduce from the variational formula that the collapse transition exists and we compute the critical point (Theorem 3.1.3). In section 3.4.3, we prove that the collapse transition is of order $3/2$ (Theorem 3.1.4), although this proof is subject to Lemmas 3.3.4 and 3.3.5, that provide the asymptotic of $g_\beta(\alpha)$ as $\alpha \rightarrow \infty$. These two lemmas are established in sections 3.4.4 and 3.4.5, respectively.

3.4.1 Proof of Theorem 3.1.2

Démonstration. Recall Proposition 3.2.1 and note that $f^m(\beta) = \lim_{L \rightarrow \infty} \frac{1}{L} \log Z_{L-1, \beta}^m$. For convenience, let $N' = N + 1$ and consider the partition function of size $L - 1$

$$\begin{aligned} Z_{L-1, \beta}^m &= c_\beta \Phi_{L-1, \beta}^m \sum_{N'=2}^L (\Gamma^m(\beta))^{N'-1} \mathbf{P}_\beta(\mathcal{V}_{N', L-N'}) \\ &= \frac{c_\beta}{\Gamma^m(\beta)} \Phi_{L-1, \beta}^m \sum_{N'=2}^L (\Gamma^m(\beta))^{N'} \mathbf{P}_\beta(\mathcal{V}_{N', L-N'}). \end{aligned} \quad (3.4.1)$$

(a) The lower bound :

Pick $\alpha \in (0, 1] \cap \mathbb{Q}$, $L \in N_\alpha$ and restrict the summation in (3.4.1) to $N' = \alpha L$

$$Z_{L-1, \beta}^m \geq \frac{c_\beta}{\Gamma^m(\beta)} \Phi_{L-1, \beta}^m (\Gamma^m(\beta))^{\alpha L} \mathbf{P}_\beta(\mathcal{V}_{\alpha L, L-\alpha L}). \quad (3.4.2)$$

Take $\frac{1}{L} \log$ of both sides in (3.4.2) and let $L \rightarrow \infty$ to get

$$\tilde{f}^m(\beta) \geq \alpha \log(\Gamma^m(\beta)) + \alpha g_\beta\left(\frac{1-\alpha}{\alpha}\right). \quad (3.4.3)$$

By continuity of $\alpha \rightarrow g_\beta(\alpha)$ on $[0, \infty)$, we can conclude that

$$\tilde{f}^m(\beta) \geq \sup_{\alpha \in [0, 1]} \left[\alpha \log(\Gamma^m(\beta)) + \alpha g_\beta\left(\frac{1-\alpha}{\alpha}\right) \right]. \quad (3.4.4)$$

(b) The upper bound :

For $L \in \mathbb{N}$, let

$$M(L) = \sup_{\alpha \in \{2/L, \dots, 1\}} [(\Gamma^m(\beta))^{\alpha L} \mathbf{P}_\beta(\mathcal{V}_{\alpha L, L-\alpha L})], \quad (3.4.5)$$

and use (3.4.1) to observe that

$$\frac{1}{L} \log Z_{L-1, \beta}^m - \frac{1}{L} \log \Phi_{L-1, \beta}^m \leq \frac{1}{L} \log \left(\frac{c_\beta}{\Gamma^m(\beta)} \right) + \frac{1}{L} \log L + \frac{1}{L} \log M(L). \quad (3.4.6)$$

With the help of (3.3.5), we can claim that

$$\frac{1}{L} \log M(L) \leq \sup_{\alpha \in [0, 1]} [\alpha \log(\Gamma^m(\beta)) + \alpha g_\beta \left(\frac{1-\alpha}{\alpha} \right)],$$

which, together with (3.4.6), is sufficient to obtain the upper bound. \square

3.4.2 Proof of Theorem 3.1.3

Démonstration. To begin with, we will show that $\tilde{f}^m(\beta) > 0$ if and only if $\Gamma^m(\beta) > 1$. From Theorem 3.1.2 and since g_β is negative (see Lemma 3.3.1), it follows that if $\Gamma^m(\beta) \leq 1$

$$\tilde{f}^m(\beta) = \sup_{\alpha \in [0, 1]} [\alpha \log(\Gamma^m(\beta)) + \alpha g_\beta \left(\frac{1-\alpha}{\alpha} \right)] \leq 0. \quad (3.4.7)$$

Recall that, by Lemma 3.1.1, $\tilde{f}^m(\beta) \geq 0$ for all $\beta > 0$. Thus $\tilde{f}^m(\beta) = 0$ when $\Gamma^m(\beta) \leq 1$.

When $\Gamma^m(\beta) > 1$ in turn, Lemma 3.3.1 gives that $g_\beta \left(\frac{1-\alpha}{\alpha} \right)$ is nondecreasing and tends to 0 when $\alpha \rightarrow 0$. Consequently,

$$\tilde{f}^m(\beta) = \sup_{\alpha \in [0, 1]} [\alpha \log(\Gamma^m(\beta)) + \alpha g_\beta \left(\frac{1-\alpha}{\alpha} \right)] > 0. \quad (3.4.8)$$

By recalling the definition of $\Gamma^m(\beta)$ and c_β in (3.1.15) and (3.1.13), we note that $\beta \mapsto \Gamma^m(\beta)$ is decreasing on $[0, \infty)$ and therefore, the collapse transition occurs at β_c^m , the unique positive solution of the equation $\Gamma^m(\beta) = 1$. \square

3.4.3 Proof of Theorem 3.1.4

Démonstration. In this proof, we will focus on the non-uniform case. Again, adapting the proof to the uniform case is straightforward. For $\beta < \beta_c^m$, let $\varepsilon = \beta_c^m - \beta$. A first order Taylor expansion of $\Gamma^m(\beta)$ near β_c^m gives

$$\Gamma^m(\beta) = 1 + c_{\text{nu}} \varepsilon + o(\varepsilon) \quad \text{as } \varepsilon \downarrow 0 \quad \text{and where } c_{\text{nu}} = 1 + \frac{e^{-\beta_c^m/2}}{1 - e^{-\beta_c^m}}. \quad (3.4.9)$$

Thus, we can choose $\varepsilon_0 \in (0, \beta_c^m)$ such that for all $\beta \in I_0 := (\beta_c^m - \varepsilon_0, \beta_c^m)$, we have $\log(\Gamma^m(\beta)) \leq 2c_{\text{nu}}\varepsilon$. By Proposition 3.3.3, there exist two constants $c_2 := c_2(\beta_c^m, \varepsilon_0) > 0$ and $\alpha_2 := \alpha_2(\beta_c^m, \varepsilon_0) \in (0, 1)$, such that for all $\beta \in I_0$

$$g_\beta \left(\frac{1-\alpha}{\alpha} \right) \leq -\frac{c_2 \alpha^2}{(1-\alpha)^2} \leq -c_2 \alpha^2, \quad \alpha \in [0, \alpha_2]. \quad (3.4.10)$$

For $\beta \in I_0$, we can write $\tilde{f}^{\text{nu}}(\beta) = \max\{A_{\alpha_2, \beta}^{\text{nu}}, B_{\alpha_2, \beta}^{\text{nu}}\}$ with

$$\begin{aligned} A_{\alpha_2, \beta}^{\text{nu}} &= \sup_{\alpha \in [0, \alpha_2)} \left[\alpha \log(\Gamma^{\text{nu}}(\beta)) + \alpha g_\beta\left(\frac{1-\alpha}{\alpha}\right) \right] \\ B_{\alpha_2, \beta}^{\text{nu}} &= \sup_{\alpha \in [\alpha_2, 1]} \left[\alpha \log(\Gamma^{\text{nu}}(\beta)) + \alpha g_\beta\left(\frac{1-\alpha}{\alpha}\right) \right]. \end{aligned} \quad (3.4.11)$$

By (3.4.10), we can claim that for $\alpha \in [0, \alpha_2)$, we have

$$\alpha \log(\Gamma^{\text{nu}}(\beta)) + \alpha g_\beta\left(\frac{1-\alpha}{\alpha}\right) \leq 2c_{\text{nu}}\alpha\varepsilon - c_2\alpha^3, \quad (3.4.12)$$

and we recall that (by Proposition 3.3.3) $\log(\Gamma^{\text{nu}}(\beta)) + g_\beta\left(\frac{1-\alpha}{\alpha}\right) > 0$ when α is chosen small enough. Therefore

$$0 < A_{\alpha_2, \beta}^{\text{nu}} \leq \sup_{\alpha \in [0, \alpha_2)} [2c_{\text{nu}}\alpha\varepsilon - c_2\alpha^3]. \quad (3.4.13)$$

Since g_β is increasing, it suffices to apply (3.4.10) at α_2 to obtain

$$g_\beta\left(\frac{1-\alpha}{\alpha}\right) \leq g_\beta\left(\frac{1-\alpha_2}{\alpha_2}\right) \leq -\frac{c_2\alpha_2^2}{(1-\alpha_2)^2}, \quad \text{for } \alpha \in [\alpha_2, 1] \quad (3.4.14)$$

and therefore

$$B_{\alpha_2, \beta}^{\text{nu}} \leq \sup_{\alpha \in [\alpha_2, 1]} \left[\alpha \left(2c_{\text{nu}}\varepsilon - \frac{c_2\alpha_2^2}{(1-\alpha_2)^2} \right) \right]. \quad (3.4.15)$$

At this stage, we can choose $\varepsilon_1 < \varepsilon_0$ such that for all $\varepsilon \in (0, \varepsilon_1)$, the right hand side in (3.4.15) is negative. Hence, for $\varepsilon \in (0, \varepsilon_1)$, we have

$$\tilde{f}^{\text{nu}}(\beta_c^{\text{nu}} - \varepsilon) = A_{\alpha_2, \beta_c^{\text{nu}} - \varepsilon}^{\text{nu}} \leq \sup_{\alpha \in [0, \alpha_2)} [2c_{\text{nu}}\alpha\varepsilon - c_2\alpha^3]. \quad (3.4.16)$$

In order to obtain the lower bound, we let $\varepsilon \in (0, \beta_c^{\text{nu}})$ and we can rewrite the partition function $Z_{L, \beta_c^{\text{nu}} - \varepsilon}^{\text{nu}}$ as

$$Z_{L, \beta_c^{\text{nu}} - \varepsilon}^{\text{nu}} = \left(\frac{e^{\beta_c^{\text{nu}} - \varepsilon}}{2} \right)^L \sum_{N=1}^L c_{\beta_c^{\text{nu}}} \left(\frac{2c_{\beta_c^{\text{nu}}}}{3e^{\beta_c^{\text{nu}} - \varepsilon}} \right)^N \sum_{\substack{l \in \mathcal{L}_{N, L} \\ l_0 = l_{N+1} = 0}} \prod_{i=0}^N \frac{e^{-\frac{\beta_c^{\text{nu}} - \varepsilon}{2} |l_i + l_{i+1}|}}{c_{\beta_c^{\text{nu}}}}. \quad (3.4.17)$$

Since $\varepsilon > 0$ and $\frac{2c_{\beta_c^{\text{nu}}}}{3e^{\beta_c^{\text{nu}} - \varepsilon}} = 1$, we have

$$\begin{aligned} Z_{L, \beta_c^{\text{nu}} - \varepsilon}^{\text{nu}} &\geq c_{\beta_c^{\text{nu}}} \left(\frac{e^{\beta_c^{\text{nu}} - \varepsilon}}{2} \right)^L \sum_{N=1}^L e^{\varepsilon N} \sum_{\substack{l \in \mathcal{L}_{N, L} \\ l_0 = l_{N+1} = 0}} \prod_{i=0}^N \frac{e^{-\frac{\beta_c^{\text{nu}}}{2} |l_i + l_{i+1}|}}{c_{\beta_c^{\text{nu}}}} \\ &= c_{\beta_c^{\text{nu}}} \left(\frac{e^{\beta_c^{\text{nu}} - \varepsilon}}{2} \right)^L \sum_{N=1}^L e^{\varepsilon N} \mathbf{P}_{\beta_c^{\text{nu}}}(\mathcal{V}_{N+1, L-N}). \end{aligned} \quad (3.4.18)$$

Proceeding as in (3.4.1)-(3.4.4), we get, for all $\varepsilon \in (0, \beta_c^{\text{nu}})$,

$$\tilde{f}^{\text{nu}}(\beta_c^{\text{nu}} - \varepsilon) \geq \sup_{\alpha \in [0, 1]} \left[\alpha\varepsilon + \alpha g_{\beta_c^{\text{nu}}}\left(\frac{1-\alpha}{\alpha}\right) \right]. \quad (3.4.19)$$

By applying again Proposition 3.3.3, we conclude that there exist two constants $c_1 := c_1(\beta_c^{\text{nu}}) > 0$ and $\alpha_1 := \alpha_1(\beta_c^{\text{nu}}) \in (0, 1)$ such that for all $\alpha \in [0, \alpha_1]$

$$g_{\beta_c^{\text{nu}}} \left(\frac{1-\alpha}{\alpha} \right) \geq -\frac{c_1 \alpha^2}{(1-\alpha)^2} \geq -\frac{c_1 \alpha^2}{(1-\alpha_1)^2}. \quad (3.4.20)$$

Therefore,

$$\sup_{\alpha \in [0,1]} \left[\alpha \varepsilon + \alpha g_{\beta_c^{\text{nu}}} \left(\frac{1-\alpha}{\alpha} \right) \right] \geq \sup_{\alpha \in [0, \alpha_1]} \left[\alpha \varepsilon - \frac{c_1 \alpha^3}{(1-\alpha_1)^2} \right], \quad (3.4.21)$$

and for $\varepsilon \in (0, \beta_c^{\text{nu}})$, we have

$$\tilde{f}^{\text{nu}}(\beta_c^{\text{nu}} - \varepsilon) \geq \sup_{\alpha \in [0, \alpha_1]} \left[\alpha \varepsilon - c'_1 \alpha^3 \right], \quad (3.4.22)$$

where $c'_1 = \frac{c_1}{(1-\alpha_1)^2}$. Since any function of type $\alpha \mapsto c_3 \varepsilon \alpha - c_4 \alpha^3$ (with $c_3, c_4 > 0$) reaches its maximum at $\alpha = \sqrt{\frac{c_3 \varepsilon}{3c_4}}$, we can combine (3.4.16) and (3.4.22) and conclude that there exist $\varepsilon_2 > 0$ and $c_5, c_6 > 0$ such that

$$c_5 \varepsilon^{3/2} \leq \tilde{f}^{\text{nu}}(\beta_c^{\text{nu}} - \varepsilon) \leq c_6 \varepsilon^{3/2} \text{ for } \varepsilon \in (0, \varepsilon_2). \quad (3.4.23)$$

The last estimate yields that $\tilde{f}^{\text{nu}}(\cdot)$ is C^1 but is not C^2 at the critical point β_c^{nu} . This means that the non-uniform system undergoes a second order phase transition. \square

3.4.4 Proof of Lemma 3.3.4

We recall the notation $V_N^* = \max_{1 \leq n \leq N} |V_n|$ and let $\mathbf{P}_{\beta, x}$ be the law of the random walk V starting from $x \in \mathbb{Z}$. We also let $a = \lfloor \alpha \rfloor$ where $\lfloor \alpha \rfloor$ denotes the integer part of a real number α . Since V takes integer values only, we have

$$\mathbf{P}_{\beta}(V_N^* \leq \alpha) = \mathbf{P}_{\beta}(V_N^* \leq a). \quad (3.4.24)$$

For α large, pick an integer N such that $N/a^2 \in \mathbb{N}$ and let $k = N/a^2$. With the help of the Markov property of V , we desintegrate $\mathbf{P}_{\beta}(V_N^* \leq a)$ with respect to the position occupied by the random walk V at times $a^2, 2a^2, \dots, (k-1)a^2$,

$$\begin{aligned} \mathbf{P}_{\beta}(V_N^* \leq a) &= \sum_{\substack{x_0=0, x_i \in [-a, a] \\ i=1, \dots, k}} \prod_{i=0}^{k-1} \mathbf{P}_{\beta, x_i} \left(V_{a^2}^* \leq a; V_{a^2} = x_{i+1} \right) \\ &\geq \sum_{\substack{x_0=0, x_i \in [-a/4, a/4] \\ i=1, \dots, k}} \prod_{i=0}^{k-1} \mathbf{P}_{\beta, x_i} \left(V_{a^2}^* \leq a; V_{a^2} = x_{i+1} \right). \end{aligned} \quad (3.4.25)$$

For any integer $x \in [0, a/4]$, we consider the two sets of paths

$$\Pi_1^x = \{(V_i)_{i=0}^{a^2} : V_0 = x; V_{a^2}^* \leq a; V_{a^2} \in [-a/4, a/4]\}, \quad (3.4.26)$$

and

$$\Pi_2 = \{(V_i)_{i=0}^{a^2} : V_0 = 0; V_{a^2}^* \leq 3a/4; V_{a^2} \in [-a/4, 0]\}. \quad (3.4.27)$$

Clearly, if $V = (V_i)_{i=0}^{a^2} \in \Pi_2$, then the trajectory $V + x$ starts at x and is an element of Π_1^x . Similarly, for $x \in [-a/4, 0]$, $\Pi_2' + x \subseteq \Pi_1^x$ where

$$\Pi_2' = \{(V_i)_{i=0}^{a^2} : V_0 = 0; V_{a^2}^* \leq 3a/4; V_{a^2} \in [0, a/4]\}. \quad (3.4.28)$$

Since V is symmetric, the quantities $\mathbf{P}_{\beta,0}(\Pi_2)$ and $\mathbf{P}_{\beta,0}(\Pi_2')$ are equal and therefore, for $x \in [-a/4, a/4]$,

$$\mathbf{P}_{\beta,x}(V_{a^2}^* \leq a; V_{a^2} \in [-a/4, a/4]) \geq \mathbf{P}_{\beta}(V_{a^2}^* \leq 3a/4; V_{a^2} \in [-a/4, 0]). \quad (3.4.29)$$

Recall (3.4.25), we conclude that

$$\mathbf{P}_{\beta}(V_N^* \leq a) \geq [\mathbf{P}_{\beta}(V_{a^2}^* \leq 3a/4; V_{a^2} \in [-a/4, 0])]^k. \quad (3.4.30)$$

It remains to bound from below the right hand side of (3.4.30). Let $\theta_{a^2}(t)$, $t \in [0, 1]$ be the continuously interpolated process associated with the random walk trajectory $(V_i)_{i=0}^{a^2}$, i.e.,

$$\theta_{a^2}(t) = V_{\lfloor a^2 t \rfloor} + \{a^2 t\}v_{\lfloor a^2 t \rfloor + 1}, \quad t \in [0, 1]. \quad (3.4.31)$$

Let $\sigma_{\beta}^2 = \mathbf{E}_{\beta}(v_1^2)$. By Donsker's theorem, $\theta_{a^2}(\cdot)/(\sigma_{\beta}a) \Rightarrow B(\cdot)$ as $a \rightarrow \infty$ on $C[0, 1]$, where B is a standard Brownian motion (see [11, p. 399]). Therefore

$$\begin{aligned} \lim_{a \rightarrow \infty} \mathbf{P}_{\beta}(V_{a^2}^* \leq 3a/4; V_{a^2} \in [-a/4, 0]) \\ = \mathbf{P}\left(\max_{0 \leq t \leq 1} |B(t)| \leq \frac{3}{4\sigma_{\beta}}; B(1) \in \left[-\frac{1}{4\sigma_{\beta}}, 0\right]\right) \in (0, 1). \end{aligned} \quad (3.4.32)$$

Consequently, there exist $u_1 \in (0, 1)$ and $\alpha_0 > 0$ such that for all $\alpha > \alpha_0$,

$$\mathbf{P}_{\beta}(V_{a^2}^* \leq 3a/4; V_{a^2} \in [-a/4, 0]) \geq u_1, \quad (3.4.33)$$

and (3.4.30) becomes $\mathbf{P}_{\beta}(V_N^* \leq a) \geq u_1^{N/a^2}$. To overcome the limitation $N/a^2 \in \mathbb{N}$, we write

$$\mathbf{P}_{\beta}(V_N^* \leq a) \geq \mathbf{P}_{\beta}(V_{a^2 \lfloor N/a^2 \rfloor}^* \leq a) \geq u_1^{\lfloor N/a^2 \rfloor}. \quad (3.4.34)$$

It remains to choose $c_1 > 0$ satisfying $u_1 > e^{-c_1}$, so that for N large enough $u_1^{\lfloor N/a^2 \rfloor} \geq e^{-\frac{c_1 N}{a^2}}$, which completes the proof.

3.4.5 Proof of Lemma 3.3.5

The proof is a coarse graining argument divided into 3 steps. In step 1, we pick $M \in \mathbb{N}$, we set $a = \lfloor \alpha \rfloor$ and we partition $\{1, \dots, N\}$ into N/Ma^2 intervals of length Ma^2 . We show that a random walk trajectory satisfying $A_N \leq \alpha N$ must, in a positive fraction of these N/Ma^2 intervals, spend more than a third of the time at distance less than 2α from 0. This gives the upper bound

$$\mathbf{P}_{\beta}(A_N \leq \alpha N) \leq \left[4e \sup_{x \in \mathbb{Z}} \varphi_{\beta,x}(2\alpha, Ma^2, Ma^2/3)\right]^{\frac{N}{4Ma^2}} \quad (3.4.35)$$

with

$$\varphi_{\beta,x}(t, n, m) := \mathbf{P}_{\beta,x}\left(\sum_{i=1}^n \mathbf{1}_{\{|V_i| < t\}} \geq m\right), \quad t, m \in [0, \infty), x \in \mathbb{Z}, n \in \mathbb{N}. \quad (3.4.36)$$

In step 2, we prove that we can remove the supremum over the starting position of V in (3.4.35) by simply enlarging α to 2α . To be more specific we will show that

$$\sup_{x \in \mathbb{Z}} \varphi_{\beta,x}(\alpha, N, N/3) \leq \varphi_{\beta,0}(2\alpha, N, N/4), \quad \text{for } \alpha > 0 \text{ and } N \in \mathbb{N}. \quad (3.4.37)$$

Finally, we will see in step 3 that, by choosing M large enough, there exists $\alpha_M > 0$ such that for all $\alpha > \alpha_M$

$$\sup_{\beta \in K} \varphi_{\beta,0}(4\alpha, Ma^2, Ma^2/4) < 1/4e. \quad (3.4.38)$$

By putting together (3.4.36), (3.4.37) and (3.4.38), we complete the proof of Lemma 3.3.5.

Step 1.

For $\alpha > 0$, recall that $a = \lfloor \alpha \rfloor$, $M \in \mathbb{N}$ and pick $N \in Ma^2\mathbb{N} := \{Ma^2n, n \in \mathbb{N}\}$. Then, partition the time interval $\{1, \dots, N\}$ into the N/Ma^2 subintervals $\{I_{j,M}\}_{j \in \{1, \dots, N/Ma^2\}}$ of length Ma^2 each, i.e.,

$$I_{j,M} = \{(j-1)Ma^2 + 1, \dots, jMa^2\} \quad \text{for } j = 1, \dots, \frac{N}{Ma^2}. \quad (3.4.39)$$

Pick $V = (V_i)_{i=0}^N \in \{0\} \times \mathbb{Z}^N$ and consider, for each $j \leq N/Ma^2$, the number of steps made by V on the time interval $I_{j,M}$ that satisfy $|V_i| \leq 2\alpha$. Then, set

$$A_{N,\alpha} = \left\{ (V_i)_{i=0}^N : \sum_{i=0}^N |V_i| \leq \alpha N \right\}, \quad (3.4.40)$$

$$B_{N,M,\alpha} = \left\{ (V_i)_{i=0}^N : \#\left\{ 1 \leq j \leq \frac{N}{Ma^2} : \sum_{i \in I_{j,M}} \mathbf{1}_{\{|V_i| < 2\alpha\}} \geq \frac{Ma^2}{3} \right\} \geq \frac{N}{4Ma^2} \right\}.$$

Lemma 3.4.1. *For all $\alpha > 0$ and $M, N \in \mathbb{N}$ such that $N \in Ma^2\mathbb{N}$, the following relation holds true*

$$A_{N,\alpha} \subseteq B_{N,M,\alpha}. \quad (3.4.41)$$

Démonstration. Note that $V \in A_{N,\alpha}$ necessarily satisfies $\sum_{i=0}^N \mathbf{1}_{\{|V_i| \leq 2\alpha\}} \geq N/2$ and this latter conditions is clearly not verified if $V \notin B_{N,M,\alpha}$. \square

We recall (3.4.40), we pick $N \in 4Ma^2\mathbb{N}$ and we set $k := \frac{N}{4Ma^2} \in \mathbb{N}$. By taking into account the indices of those intervals $I_{j,M}$ on which $\sum_{i \in I_{j,M}} \mathbf{1}_{\{|V_i| < 2\alpha\}} \geq \frac{Ma^2}{3}$, we obtain the upper bound

$$\mathbf{P}_\beta(B_{N,M,\alpha}) \leq \sum_{j_1 < \dots < j_k} \mathbf{E}_\beta \left(\prod_{s=1}^k \mathbf{1}_{\left\{ \sum_{i \in I_{j_s,M}} \mathbf{1}_{\{|V_i| < 2\alpha\}} \geq \frac{Ma^2}{3} \right\}} \right) \quad (3.4.42)$$

where the sum is taken all over possible k -uples in $\{1, \dots, \frac{N}{Ma^2}\}$. We recall (3.4.36) and we apply the Markov property k times at $(j_1 - 1)Ma^2, \dots, (j_k - 1)Ma^2$ to obtain

$$\mathbf{E}_\beta \left(\prod_{s=1}^k \mathbf{1}_{\left\{ \sum_{i \in I_{j_s,M}} \mathbf{1}_{\{|V_i| < 2\alpha\}} \geq \frac{Ma^2}{3} \right\}} \right) \leq \left[\sup_{x \in \mathbb{Z}} \varphi_{\beta,x}(2\alpha, Ma^2, Ma^2/3) \right]^k. \quad (3.4.43)$$

At this stage, Lemma 3.4.1, (3.4.42), (3.4.43) and the inequalities $\binom{n}{m} \leq n^m/m!$ and $m! \geq (m/e)^m$ allow us to write

$$\begin{aligned} \mathbf{P}_\beta(A_N \leq \alpha N) &\leq \left(\frac{eN}{Ma^2k}\right)^k \left[\sup_{x \in \mathbb{Z}} \varphi_{\beta,x}(2\alpha, Ma^2, Ma^2/3)\right]^k \\ &= \left[4e \sup_{x \in \mathbb{Z}} \varphi_{\beta,x}(2\alpha, Ma^2, Ma^2/3)\right]^{\frac{N}{4Ma^2}}. \end{aligned} \quad (3.4.44)$$

Step 2.

We want to prove (3.4.37). First, we prove that

$$\sup_{x \notin (-\alpha, \alpha)} \varphi_{\beta,x}(\alpha, N, N/3) \leq \sup_{y \in (-\alpha, \alpha)} \varphi_{\beta,y}(\alpha, N, N/4). \quad (3.4.45)$$

Let $\tau_1 = \inf\{n \in \mathbb{N} : V_n \in (-\alpha, \alpha)\}$. Pick $x \notin (-\alpha, \alpha)$ and apply the Markov property at time τ_1 to obtain

$$\begin{aligned} \varphi_{\beta,x}(\alpha, N, N/3) &= \mathbf{P}_{\beta,x}\left(\sum_{i=1}^N \mathbf{1}_{\{|V_i| < \alpha\}} \geq \frac{N}{3}\right) \\ &= \sum_{n=1}^N \sum_{y=-a}^a \mathbf{P}_{\beta,x}(\tau_1 = n, V_n = y) \mathbf{P}_{\beta,y}\left(\sum_{i=1}^{N-n} \mathbf{1}_{\{|V_i| < \alpha\}} \geq \frac{N}{3} - 1\right). \end{aligned} \quad (3.4.46)$$

We have, for $N \geq 12$,

$$\begin{aligned} \mathbf{P}_{\beta,y}\left(\sum_{i=1}^{N-n} \mathbf{1}_{\{|V_i| < \alpha\}} \geq \frac{N}{3} - 1\right) &\leq \mathbf{P}_{\beta,y}\left(\sum_{i=1}^N \mathbf{1}_{\{|V_i| < \alpha\}} \geq \frac{N}{4}\right) \\ &\leq \sup_{y \in (-\alpha, \alpha)} \varphi_{\beta,y}(\alpha, N, N/4), \end{aligned} \quad (3.4.47)$$

and by plugging (3.4.47) into (3.4.46), we can write that $\varphi_{\beta,x}(\alpha, N, N/3)$ is smaller than $\sup_{y \in (-\alpha, \alpha)} \varphi_{\beta,y}(\alpha, N, N/4)$. The latter is valid for all $x \notin (-\alpha, \alpha)$, therefore

$$\sup_{x \notin (-\alpha, \alpha)} \varphi_{\beta,x}(\alpha, N, N/3) \leq \sup_{y \in (-\alpha, \alpha)} \varphi_{\beta,y}(\alpha, N, N/4). \quad (3.4.48)$$

Because of (3.4.48), the step will be complete once we show that

$\varphi_{\beta,x}(\alpha, N, N/4) \leq \varphi_{\beta,0}(2\alpha, N, N/4)$ for $x \in (-\alpha, \alpha)$. We recall that $P_{\beta,x}$ is the law of the random walk $(V_i)_{i \geq 0}$ defined in (3.1.13) with $V_0 = x$. Thus, if $(V_i)_{i \geq 0}$ follows the law $\mathbf{P}_\beta = \mathbf{P}_{\beta,0}$ then $(V_i + x)_{i \geq 0}$ follows the law $\mathbf{P}_{\beta,x}$. Moreover, for $|x| < \alpha$ the inequality $|V_i + x| < \alpha$ immediately entails $|V_i| < 2\alpha$. Thus,

$$\mathbf{P}_{\beta,x}\left(\sum_{i=1}^N \mathbf{1}_{\{|V_i| < \alpha\}} \geq \frac{N}{4}\right) \leq \mathbf{P}_{\beta,0}\left(\sum_{i=1}^N \mathbf{1}_{\{|V_i| < 2\alpha\}} \geq \frac{N}{4}\right), \quad (3.4.49)$$

which is exactly $\varphi_{\beta,x}(\alpha, N, N/4) \leq \varphi_{\beta,0}(2\alpha, N, N/4)$ and completes the step.

Step 3.

In this step, we show (3.4.38). First observe that

$$\mathbf{P}_\beta\left(\sum_{i=1}^{Ma^2} \mathbf{1}_{\{|V_i| < 4\alpha\}} \geq \frac{Ma^2}{4}\right) \leq \mathbf{P}_\beta\left(\sum_{i=Ma^2/5}^{Ma^2} \mathbf{1}_{\{|V_i| < 4\alpha\}} \geq \frac{Ma^2}{20}\right). \quad (3.4.50)$$

Let $\sigma_\beta^2 = \mathbf{E}_\beta(v_1^2)$ and $\rho_\beta = \mathbf{E}_\beta(|v_1|^3)$. For all $x \in \mathbb{R}$ and $n \in \mathbb{N}$, by Berry-Esseen Theorem (see [11, p. 124]), we obtain

$$\left| \mathbf{P}_\beta \left(\frac{|v_1 + \dots + v_n|}{\sigma_\beta \sqrt{n}} \leq x \right) - \mathbf{P} \left(|\mathcal{N}(0, 1)| \leq x \right) \right| \leq \frac{6\rho_\beta}{\sigma_\beta^3 \sqrt{n}}. \quad (3.4.51)$$

From (3.4.50), we can apply the Markov's inequality, which gives

$$\mathbf{P}_\beta \left(\sum_{i=Ma^2/5}^{Ma^2} \mathbf{1}_{\{|V_i| < 4\alpha\}} \geq \frac{Ma^2}{20} \right) \leq \frac{20}{Ma^2} \sum_{i=Ma^2/5}^{Ma^2} \mathbf{P}_\beta(|V_i| < 4\alpha). \quad (3.4.52)$$

For all $i \geq Ma^2/5$, we have

$$\mathbf{P}_\beta(|V_i| < 4\alpha) = \mathbf{P}_\beta \left(\frac{|V_i|}{\sigma_\beta \sqrt{i}} < \frac{4\alpha}{\sigma_\beta \sqrt{i}} \right) \leq \mathbf{P}_\beta \left(\frac{|V_i|}{\sigma_\beta \sqrt{i}} \leq \frac{4\sqrt{5}}{\sigma_\beta \sqrt{M}} \right). \quad (3.4.53)$$

By using the upper bound in (3.4.51), we can rewrite (3.4.53) as

$$\mathbf{P}_\beta(|V_i| < 4\alpha) \leq \mathbf{P} \left(|\mathcal{N}(0, 1)| \leq \frac{4\sqrt{5}}{\sigma_\beta \sqrt{M}} \right) + \frac{6\rho_\beta}{\sigma_\beta^3 \sqrt{i}}. \quad (3.4.54)$$

Thus, we can use (3.4.54) in (3.4.52) to obtain

$$\mathbf{P}_\beta \left(\sum_{i=Ma^2/5}^{Ma^2} \mathbf{1}_{\{|V_i| < 4\alpha\}} \geq \frac{Ma^2}{20} \right) \leq 20 \mathbf{P} \left(|\mathcal{N}(0, 1)| \leq \frac{4\sqrt{5}}{\sigma_\beta \sqrt{M}} \right) + \frac{20}{Ma^2} \sum_{i=Ma^2/5}^{Ma^2} \frac{6\rho_\beta}{\sigma_\beta^3 \sqrt{i}}. \quad (3.4.55)$$

At this stage, we replace σ_β and ρ_β by $\sigma = \inf_{\beta \in K} \sigma_\beta$ and $\rho = \sup_{\beta \in K} \rho_\beta$ in (3.4.55) so that the inequality in (3.4.55) becomes uniform in $\beta \in K$. We can choose M such that $20 \mathbf{P}(|\mathcal{N}(0, 1)| \leq \frac{4\sqrt{5}}{\sigma \sqrt{M}}) < 1/4e$. Since

$$\frac{120\rho}{Ma^2\sigma^3} \sum_{i=Ma^2/5}^{Ma^2} \frac{1}{\sqrt{i}} \rightarrow 0 \text{ as } \alpha \rightarrow \infty, \quad (3.4.56)$$

there exists $\alpha_M > 0$ such that for all $\alpha \geq \alpha_M$

$$20 \mathbf{P} \left(|\mathcal{N}(0, 1)| \leq \frac{4\sqrt{5}}{\sigma \sqrt{M}} \right) + \frac{120\rho}{Ma^2\sigma^3} \sum_{i=Ma^2/5}^{Ma^2} \frac{1}{\sqrt{i}} < 1/4e. \quad (3.4.57)$$

It remains to recall (3.4.36), and then (3.4.50), (3.4.55) and (3.4.57) are sufficient to complete the step.



4

Interacting partially directed self avoiding walk : from phase transition to the geometry of the collapsed phase

Les résultats exposés dans ce chapitre sont le fruit d'une collaboration avec Philippe Carmona et Nicolas Pétrélis, ils sont soumis (cf. [7]).

Sommaire

4.1	Introduction	94
4.1.1	Model and physical insight	94
4.1.2	Free energy and collapse transition	96
4.1.3	Relationship to earlier work	97
4.1.4	Main results	99
4.2	Preparation	101
4.2.1	Probabilistic representation of the partition function	101
4.2.2	Construction and regularity of h_β	103
4.2.3	Large deviation estimates	105
4.3	The order of the phase transition	107
4.3.1	Proof of Theorem 4.1.3 (Free energy equation)	107
4.3.2	Proof of Theorem 4.1.4 (Phase transition asymptotics)	108
4.3.3	Asymptotics of h_β	109
4.4	Geometry of the collapsed phase	114
4.4.1	Proof of Theorem 4.1.6 (One bead Theorem)	114
4.4.2	Proof of Proposition 4.4.2	117
4.4.3	Proof of Theorem 4.1.7 (Horizontal expansion)	119

4.4.4	Proof of Lemmas 4.4.1 and 4.4.4	120
4.5	Decay rate of large area probability	121
4.5.1	Proof of Proposition 4.2.3	121
4.5.2	Proof of Lemmas 4.5.3, 4.5.5 and 4.5.6	123
4.6	Limit theorems for the joint distribution	126
4.6.1	Proof of Proposition 4.2.2	126
4.6.2	Proof of Proposition 4.2.5 (Unique excursion for large area)	129
4.7	Appendix	134
4.7.1	The distribution of Brownian area	134
4.7.2	Proof of Lemma 4.3.2	135

4.1 Introduction

4.1.1 Model and physical insight

A solvent is said to be "poor" for a given homopolymer if the chemical affinity between the solvent and the monomers constituting the homopolymer is low. When dipped in such a solvent, the homopolymer folds itself up to exclude the solvent and therefore adopts a collapsed conformation, that looks like a compact ball. If the quality of the solvent improves, the chemical affinity raises until it reaches a threshold above which the polymer extends itself in such a way that a positive fraction of its monomers are in contact with the solvent.

The interacting partially directed self avoiding walk (IPDSAW) was introduced in [26] as a partially directed model of an homopolymer in a poor solvent. The spatial configurations of the polymer of length L (L monomers) are modelled by the trajectories of a *self-avoiding* random walk on \mathbb{Z}^2 that only takes unitary steps *upwards, downwards and to the right*. Thus, the set of allowed L -step paths is

$$\mathcal{W}_L = \{w = (w_i)_{i=0}^L \in (\mathbb{N}_0 \times \mathbb{Z})^{L+1} : w_0 = 0, w_L - w_{L-1} = \rightarrow, \\ w_{i+1} - w_i \in \{\uparrow, \downarrow, \rightarrow\} \forall 0 \leq i < L - 1, \\ w_i \neq w_j \forall i < j\}.$$

Note that the choice of w ending with an horizontal step is made for convenience only. Henceforth, we will consider two different laws on \mathcal{W}_L , uniform and non-uniform, denoted by \mathbf{P}_L^m with $m \in \{u, nu\}$.

(1) The uniform model : all L -step paths have the same probability, i.e.,

$$\mathbf{P}_L^u(w) = \frac{1}{|\mathcal{W}_L|}, \quad w \in \mathcal{W}_L. \quad (4.1.1)$$

(2) The non-uniform model : the L -step paths have the following law

- At the origin or after an horizontal step : the walker must step north, south or east with equal probability $1/3$.

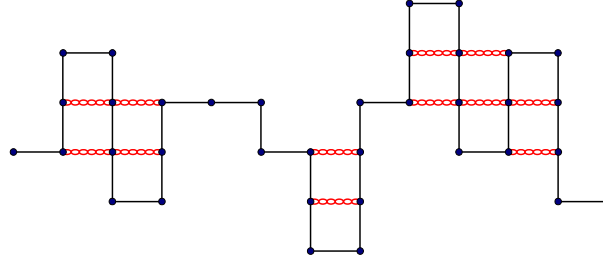

FIGURE 4.1 – Example of a trajectory with 12 self-touchings in light red.

- After a vertical step north (respectively south) : the walker must step north (respectively south) or east with probability $1/2$.

The monomer-solvent interactions are not taken into account directly in the IPDSAW. We rather consider that, when dipped in a poor solvent, the monomers try to exclude the solvent and therefore attract one another. For this reason, any non-consecutive vertices of the walk though adjacent on the lattice are called *self-touchings* (see Fig. 4.1) and the interactions between monomers are taken into account by assigning an energetic reward $\beta \geq 0$ to the polymer for each self-touching (consequently, a lower chemical affinity corresponds to a larger β). Thus, we associate with every random walk trajectory $w = (w_i)_{i=0}^L \in \mathcal{W}_L$ the Hamiltonian

$$H_{L,\beta}(w) := \beta \sum_{\substack{i,j=0 \\ i < j-1}}^L \mathbf{1}_{\{\|w_i - w_j\|=1\}}, \quad (4.1.2)$$

which allows to define the law $P_{L,\beta}^m$ of the polymer in size L as,

$$P_{L,\beta}^m(w) = \frac{e^{H_{L,\beta}(w)}}{Z_{L,\beta}^m} \mathbf{P}_L^m(w), \quad m \in \{\mathbf{u}, \mathbf{nu}\}. \quad (4.1.3)$$

where $Z_{L,\beta}^m$ is the normalizing constant known as the partition function of the system. Henceforth, in the uniform model $m = \mathbf{u}$, we remove the term $1/|\mathcal{W}_L|$ from the definition of \mathbf{P}_L^m (recall (4.1.1)) and from the computation of the partition function $Z_{L,\beta}^m$. Although \mathbf{P}_L^m is not a probability law anymore, the latter simplification is harmless, because it does not change the polymer law $P_{L,\beta}^m$ and because it only induces a constant shift of the free energy $f^m(\beta)$ introduced in section 4.1.2 below.

From random walk paths to vertical stretches

It is easy to see that any path in \mathcal{W}_L can be decomposed into a collection of vertical stretches separated by one horizontal step. Thus, we set $\Omega_L := \bigcup_{N=1}^L \mathcal{L}_{N,L}$, where $\mathcal{L}_{N,L}$ is the set of all possible configurations consisting of N vertical stretches that have a total length L , that is

$$\mathcal{L}_{N,L} = \left\{ l \in \mathbb{Z}^N : \sum_{n=1}^N |l_n| + N = L \right\}. \quad (4.1.4)$$

We build the natural one to one correspondence between Ω_L and \mathcal{W}_L by associating to a given $l \in \Omega_L$ the path of \mathcal{W}_L that starts at 0, takes $|l_1|$ vertical steps north if $l_1 > 0$ and south

if $l_1 < 0$, then take one horizontal step, then take $|l_2|$ vertical steps north if $l_2 > 0$ and south if $l_2 < 0$ then take one horizontal step and so on... (see Fig. 4.2). Recall (4.1.1) and note that for a given $N \in \{1, \dots, L\}$ the function $l \mapsto \mathbf{P}_L^m(l)$ is constant on $\mathcal{L}_{N,L}$ and equals 1 if $m = u$ and $(1/3)^N(1/2)^{L-N}$ if $m = nu$. The Hamiltonian associated with a given path of \mathcal{W}_L can be rewritten in terms of its associated collection of vertical stretches $l \in \Omega_L$ as

$$H_{L,\beta}(l_1, \dots, l_N) = \beta \sum_{n=1}^{N-1} (l_n \tilde{\wedge} l_{n+1}) \quad (4.1.5)$$

where

$$x \tilde{\wedge} y = \begin{cases} |x| \wedge |y| & \text{if } xy < 0, \\ 0 & \text{otherwise.} \end{cases} \quad (4.1.6)$$

Therefore, the partition function can be rewritten under the form

$$Z_{L,\beta}^m = \sum_{N=1}^L \sum_{l \in \mathcal{L}_{N,L}} \mathbf{P}_L^m(l) e^{\beta \sum_{i=1}^{N-1} (l_i \tilde{\wedge} l_{i+1})}. \quad (4.1.7)$$

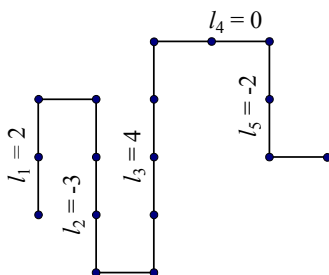

FIGURE 4.2 – Example of a trajectory with $N = 5$ vertical stretches and length $L = 16$.

4.1.2 Free energy and collapse transition

For both models, i.e., $m \in \{u, nu\}$, the sequence $\{\log Z_{L,\beta}^m\}_L$ is super-additive and the Hamiltonian in (4.1.2) is obviously bounded from above by βL . As a consequence, we can define the free energy per step $f^m : (0, \infty) \rightarrow \mathbb{R}$ as

$$f^m(\beta) = \lim_{L \rightarrow \infty} \frac{1}{L} \log Z_{L,\beta}^m = \sup_{L \in \mathbb{N}} \frac{1}{L} \log Z_{L,\beta}^m \leq \beta. \quad (4.1.8)$$

The collapse transition corresponds to a loss of analyticity of $\beta \mapsto f^m(\beta)$ at some critical parameter $\beta_c^m \in (0, \infty)$ above which the density of self-touchings performed by the polymer equals 1. In this collapsed phase, the expression of the free energy per step is rather simple, i.e., $\beta + \kappa_m$, where κ_m is the entropic constant associated to those trajectories in \mathcal{W}_L whose self-touching density is equal to $1 + o(1)$. To achieve such a saturation of its self-touching, the polymer must choose its configuration among those satisfying two major geometric restrictions, i.e.,

- the number of horizontal steps is $o(L)$

- most pairs of consecutive vertical stretches are of opposite directions.

It turns out that an appropriate choice of a trajectory satisfying both restrictions above is sufficient to exhibit the collapsed free energy. To that aim, we pick $L \in \mathbb{N}$: $\sqrt{L} \in \mathbb{N}$ and consider the trajectory $l^* \in \mathcal{L}_{\sqrt{L}, L}$ defined as $l_i^* = (-1)^{i-1}(\sqrt{L} - 1)$ for $i \in \{1, \dots, \sqrt{L}\}$. By computing the contribution of l^* to $Z_{L, \beta}^m$ one immediately obtain that, for $\beta > 0$ and $m \in \{u, nu\}$,

$$f^m(\beta) \geq \varphi_\beta^m, \quad (4.1.9)$$

where $\varphi_\beta^u = \beta$ and $\varphi_\beta^{nu} = \beta - \log 2$. At this stage, we can define the *excess free energy* $\tilde{f}^m(\beta) := f^m(\beta) - \varphi_\beta^m$, which is always non negative by (4.1.9). We define the critical parameter

$$\beta_c^m := \inf\{\beta \geq 0 : \tilde{f}^m(\beta) = 0\}, \quad (4.1.10)$$

and the convexity of $\beta \mapsto \tilde{f}^m(\beta)$ allows us to partition $[0, \infty)$ into a collapsed phase denoted by \mathcal{C} and an extended phase denoted by \mathcal{E} , i.e.,

$$\mathcal{C} := \{\beta : \tilde{f}^m(\beta) = 0\} = \{\beta : \beta \geq \beta_c^m\} \quad (4.1.11)$$

and

$$\mathcal{E} := \{\beta : \tilde{f}^m(\beta) > 0\} = \{\beta : \beta < \beta_c^m\}. \quad (4.1.12)$$

4.1.3 Relationship to earlier work

The IPDSAW and its continuous versions have attracted a lot of attention from physicists until very recently (see for instance [5] or [22]). The main method that has been employed to investigate the IPDSAW involves combinatoric techniques (see [6], [18] or more recently [17]). To be more specific, this method consists in providing an analytic expression of the generating function $G(z) = \sum_{L=1}^{\infty} Z_{L, \beta}^m z^L$ whose radius of convergence R satisfies $f^m = -\log R$. This computation is achieved by rewriting $G(z)$ under the form $\sum_{r=0}^{\infty} g_r(z)$ where $g_r(z)$ is the contribution to $G(z)$ of those trajectories making exactly r consecutive vertical steps at the beginning, regardless of the total length of the trajectory. With the help of some smart path concatenation, a recurrence relation is obtained between g_{r-1} , g_r and g_{r+1} and, after making the ansatz that g_r can be expressed as an infinite sum, the recurrence relation allows for an exact computation of the terms in the infinite sum that provides g_r . For a detailed version of the computations, we refer to [9, p. 371–375].

The computation of the generating function G allows to determine the exact value of β_c and to predict the behavior of the free energy close to criticality. However, the analytic expression of G is very complicated and only gives an undirect access to the free energy. Furthermore, this combinatoric method does not allow to study a non ballistic observable, for instance, inside the collapsed phase, the horizontal expansion is of order \sqrt{L} and this can not be proven by such method.

A new approach has been developed in [16] to work with the partition function directly. With the help of an algebraic manipulation of the Hamiltonian, that will be described in section 4.2.1, it is indeed possible to rewrite the partition function in (4.1.7) under the form

$$Z_{L, \beta}^m = c_\beta \Phi_{L, \beta}^m \sum_{N=1}^L (\Gamma^m(\beta))^N \mathbf{P}_\beta(\mathcal{V}_{N+1, L-N}), \quad (4.1.13)$$

where \mathbf{P}_β is the law of an auxiliary symmetric random walk $V := (V_n)_{n \in \mathbb{N}}$ with geometric increments, i.e., $V_0 = 0$, $V_n = \sum_{i=1}^n v_i$ for $n \in \mathbb{N}$ and $v := (v_i)_{i \in \mathbb{N}}$ is an i.i.d sequence under the law \mathbf{P}_β , with distribution

$$\mathbf{P}_\beta(v_1 = k) = \frac{e^{-\frac{\beta}{2}|k|}}{c_\beta} \quad \forall k \in \mathbb{Z} \quad \text{with} \quad c_\beta := \frac{1 + e^{-\beta/2}}{1 - e^{-\beta/2}}, \quad (4.1.14)$$

where $\Gamma^m(\beta)$ is an energetic term, which penalizes the horizontal steps when it is smaller than 1 and favors them when it is larger than 1,

$$\begin{cases} \Gamma^u(\beta) = \frac{c_\beta}{e^\beta}, \\ \Gamma^{\text{nu}}(\beta) = \frac{2c_\beta}{3e^\beta}, \end{cases} \quad (4.1.15)$$

where $\mathcal{V}_{n,k}$ is the set of those n -step trajectories of the V random walk whose geometric area $A_n := \sum_{i=1}^n |V_i|$ equals k , i.e.,

$$\mathcal{V}_{n,k} := \{(V_i)_{i=0}^n : A_n = k, V_n = 0\}, \quad (4.1.16)$$

and where the term $\Phi_{L,\beta}^m$ is given by

$$\begin{cases} \Phi_{L,\beta}^u = e^{\beta L}, \\ \Phi_{L,\beta}^{\text{nu}} = (e^\beta/2)^L \end{cases} \quad (4.1.17)$$

and has an exponential growth rate that equals φ_β^m , such that the excess free energy $\tilde{f}^m(\beta)$ is the exponential growth rate of the summation in (4.1.13).

In this new expression of the partition function, the term indexed by $N \in \{1, \dots, L\}$ in the summation corresponds to the contribution to the partition function of those trajectories $l \in \mathcal{L}_{N,L}$ making N horizontal steps. By writing the number of horizontal steps under the form $N = \alpha L$ with $\alpha \in [0, 1]$, formula (4.1.13) can be used to derive a variational expression of the excess free energy.

Theorem 4.1.1 ([16], Theorem 1.2). *For $m \in \{u, \text{nu}\}$, the excess free energy $\tilde{f}^m(\beta)$ is given by*

$$\tilde{f}^m(\beta) = \sup_{\alpha \in [0,1]} \left[\alpha \log(\Gamma^m(\beta)) + \alpha g_\beta \left(\frac{1-\alpha}{\alpha} \right) \right], \quad (4.1.18)$$

where

$$g_\beta(\alpha) := \lim_{N \rightarrow \infty} \frac{1}{N} \log \mathbf{P}_\beta(A_N \leq \alpha N, V_N = 0), \quad \alpha \in [0, \infty). \quad (4.1.19)$$

A consequence of Theorem 4.1.1 is that the knowledge of some analytic properties of $\alpha \mapsto g_\beta(\alpha)$ are sufficient to extract both an exact expression of the critical point β_c^m and the precise order of the phase transition. It is shown in [16] that $\alpha \mapsto g_\beta(\alpha)$ is nondecreasing on $[0, \infty)$ and that $\lim_{\alpha \rightarrow \infty} g_\beta(\alpha) = 0$, which, combined with (4.1.18), entails that β_c^m is the unique solution of $\Gamma^m(\beta) = 1$. Moreover, a fine asymptotic of $\alpha \mapsto g_\beta(\alpha)$ at infinity allows us to prove that the collapsed transition is second order with critical exponent $3/2$.

Theorem 4.1.2 ([16], Theorem 1.4). *The phase transition is of order $3/2$. That is, there exist two constants $c_1, c_2 > 0$ such that for ε small enough*

$$c_1 \varepsilon^{3/2} \leq \tilde{f}^m(\beta_c^m - \varepsilon) \leq c_2 \varepsilon^{3/2}. \quad (4.1.20)$$

In this paper, we take the analysis of the phase transition two steps further (see Theorem 4.1.4). In the first step, we establish the precise asymptotics : $\tilde{f}(\beta_c - \varepsilon) \sim \gamma \varepsilon^{3/2}$ as $\varepsilon \searrow 0$ with γ an explicit constant. In the second step, we give an expression of γ in terms of the free energy of a auxiliary continuous model, that is $F_c = \lim_{T \rightarrow \infty} \frac{1}{T} \log \mathbf{E}[\exp(-\int_0^T |B(t)| dt)]$. Moreover, the Laplace transform of $\int_0^T |B(t)| dt$ was computed by Kac in [15] and this allows us to express F_c with the smallest zero (in modulus) of the derivative of the Airy function.

The question of the geometric conformation adopted by the polymer inside the collapsed phase has been raised and discussed by physicists in several papers, as for instance [20]. It was believed that the monomers arrange themselves in a succession of long vertical stretches of opposite directions that constitute large beads. There are numerical evidences that the horizontal expansion N_L of the polymer in size L grows as \sqrt{L} and that the vertical displacement of the endpoint grows as $L^{1/4}$ (see [20], table II page 2394) . In this paper, we prove with Theorem 4.1.6, that the polymer makes *only one macroscopic bead* and that the number of monomers (located at the beginning and at the end of the polymer) which do not belong to this bead grows at most like $(\log L)^4$. We also make rigorous the conjecture concerning the horizontal expansion of the polymer, since we identify the limit in probability of N_L/\sqrt{L} , which turns out to be the constant extracted from an optimization procedure.

4.1.4 Main results

A sharper asymptotic of the free energy close to criticality

The first Theorem that we state below gives a new expression of the excess free energy. To that aim, we recall (4.1.14) and the definition of A_N above (4.1.16). For $\delta \geq 0$, we set

$$h_\beta(\delta) := \lim_{N \rightarrow \infty} \frac{1}{N} \log \mathbf{E}_\beta(e^{-\delta A_N}). \quad (4.1.21)$$

We will prove in section 4.2.2 below that the limit in (4.1.21) exists and that $\delta \mapsto h_\beta(\delta)$ is non-positive, non-increasing and continuous on $[0, \infty)$.

Theorem 4.1.3 (Free energy equation). *For $m \in \{u, nu\}$, the excess free energy $\tilde{f}^m(\beta)$ is the unique solution of the equation $\log(\Gamma^m(\beta)) - \delta + h_\beta(\delta) = 0$ if such a solution exists and $\tilde{f}^m(\beta) = 0$ otherwise.*

It is tedious, but straightforward, to prove that g_β is the Legendre-Fenchel transform of h_β , that is

$$g_\beta(\alpha) = \inf_{\delta > 0} (\delta \alpha + h_\beta(\delta)). \quad (4.1.22)$$

Note first that Theorem 4.1.3 and the obvious equality $h_\beta(0) = 0$ are sufficient to check that β_c^m is the unique solution of $\Gamma^m(\beta) = 1$. One of the main interest of Theorem 4.1.3 is that it allows us to use the analytic properties of $\delta \mapsto h_\beta(\delta)$ at 0^+ to investigate the regularity of $\beta \mapsto \tilde{f}^m(\beta)$ at β_c^m .

Theorem 4.1.4 (Phase transition asymptotics). *For $m \in \{u, nu\}$, the phase transition is second order with critical exponent $3/2$ and the first order of the Taylor expansion of the excess free energy at $(\beta_c^m)^-$ is given by*

$$\lim_{\varepsilon \rightarrow 0^+} \frac{\tilde{f}^m(\beta_c^m - \varepsilon)}{\varepsilon^{3/2}} = \left(\frac{c_m}{d_m} \right)^{3/2}, \quad (4.1.23)$$

where

$$c_m = 1 + \frac{e^{-\beta c^m/2}}{1 - e^{-\beta c^m}}, \quad (4.1.24)$$

and where

$$d_m = - \lim_{T \rightarrow \infty} \frac{1}{T} \log \mathbf{E} \left(e^{-\sigma_{\beta c^m} \int_0^T |B(t)| dt} \right) = 2^{-1/3} |a'_1| \sigma_{\beta c^m}^{2/3}, \quad (4.1.25)$$

with $\sigma_{\beta}^2 = \mathbf{E}_{\beta}(v_1^2)$ and a'_1 is the smallest zero (in absolute value) of the first derivative of the Airy function.

Remark 4.1.5. The Laplace transform $\mathbf{E}(e^{-s \int_0^1 |B_s| ds})$ for $s > 0$ was first computed analytically by Kac in [15]. The proof of the limit (4.1.25) is given in Appendix 4.7.1.

Path properties inside the collapsed phase

The main result of this paper is concerned with the path behavior of the polymer inside its collapsed phase ($\beta > \beta_c$). We divide each trajectory into a succession of beads. Each bead is made of vertical stretches of strictly positive length and arranged in such a way that two consecutive stretches have opposite directions (north and south) and are separated by one horizontal step (see Fig. 4.3). A bead ends when the polymer gives the same direction to two consecutive vertical stretches or when a zero length stretch appears, which corresponds to two consecutive horizontal steps. We will prove that the polymer folds itself up into a *unique macroscopic bead* and we will identify its horizontal expansion. To quantify these results we need the following notations.

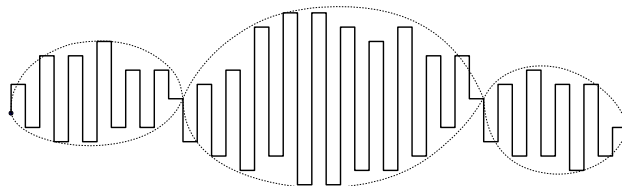

FIGURE 4.3 – Example of a trajectory with 3 beads.

Horizontal extension and number of beads

Let $l \in \Omega_L$ and denote by $N_L(l)$ its horizontal extension, i.e., $N_L(l)$ is the integer N such that $l \in \mathcal{L}_{N,L}$. Pick $l \in \mathcal{L}_{N,L}$ and let $(u_j)_{j=1}^N$ be the sequence of cumulated lengths of the polymer after each vertical stretch, i.e., $u_j = |l_1| + \dots + |l_j| + j$ for $j \in \{1, \dots, N\}$. For convenience only, set $l_{N+1} = 0$. Set also $x_0 = 0$ and for $j \in \mathbb{N}$ such that $x_{j-1} < N$, set $x_j = \inf\{i \geq x_{j-1} + 1 : l_i \tilde{\wedge} l_{i+1} = 0\}$ (see Fig. 4.4). Finally, let $n_L(l)$ be the index of the last x_j that is well defined, i.e., $x_{n_L(l)} = N$. Thus we can decompose any trajectory $l \in \Omega_L$ into a succession of $n_L(l)$ beads, each of them being associated with a subinterval of $\{1, \dots, L\}$ written as

$$I_j = \{u_{x_{j-1}} + 1, \dots, u_{x_j}\}, \quad \text{for } j \in \{1, \dots, n_L(l)\}, \quad (4.1.26)$$

and therefore, we can partition $\{1, \dots, L\}$ into $\cup_{j=1}^{n_L(l)} I_j$. At this stage can define the largest bead of a trajectory $l \in \Omega_L$ as $I_{j_{\max}}$ with

$$j_{\max} = \arg \max \{|I_j|, j \in \{1, \dots, n_L(l)\}\}. \quad (4.1.27)$$

With Theorem 4.1.6 below, we claim that, in the collapsed phase, there is only one macroscopic bead.

Theorem 4.1.6 (One bead Theorem). *For $m \in \{u, nu\}$ and $\beta > \beta_c^m$, there exists $c > 0$ such that*

$$\lim_{L \rightarrow \infty} P_{L,\beta}^m(|I_{j_{\max}}| \geq L - c(\log L)^4) = 1. \quad (4.1.28)$$

In Theorem 4.1.7 below, we identify the limit in probability of $\frac{N_L}{\sqrt{L}}$ as $L \rightarrow \infty$.

Theorem 4.1.7 (Horizontal expansion). *For $m \in \{u, nu\}$ and $\beta > \beta_c^m$, there exists a $a_m(\beta) > 0$ such that, for all $\varepsilon > 0$*

$$\lim_{L \rightarrow \infty} P_{L,\beta}^m\left(\left|\frac{N_L}{\sqrt{L}} - a_m(\beta)\right| > \varepsilon\right) = 0. \quad (4.1.29)$$

Remark 4.1.8. *The quantity $a_m(\beta)$ can be expressed as the unique maximizer of $a \mapsto \tilde{G}_m(a)$ on $(0, \infty)$ with*

$$\tilde{G}_m(a) := a \log \Gamma^m(\beta) - \frac{1}{a} \tilde{h}_0\left(\frac{1}{a^2}, 0\right) + a L_\Lambda(\tilde{H}\left(\frac{1}{a^2}, 0\right)), \quad (4.1.30)$$

where we recall (4.1.15) and where L_Λ and \tilde{H} are defined in (4.2.25) and (4.2.31), and will be further investigated in section 4.6. Note that, for $\beta > \beta_c^m$, the function $a \mapsto \tilde{G}_m(a)$ is \mathcal{C}^∞ , strictly concave, strictly negative and $a_m(\beta)$ is the unique zero of its derivative on $(0, \infty)$. These latter properties will be proven at the beginning of section 4.4.3.

4.2 Preparation

In this section, we introduce the three main tools that are used in this paper. In section 4.2.1 we show how the partition function can be rewritten in terms of the random walk V of law \mathbf{P}_β (recall (4.1.14)) and how studying this random walk under an appropriate conditioning can be used to derive some path properties under the polymer measure. In section 4.2.2, we define the function $\delta \mapsto h_\beta(\delta)$ that appears in the expression of the excess free energy in Theorem 4.1.3 and we study its regularity. In section 4.2.3, we consider the probability of some large deviations events under \mathbf{P}_β , and we introduce an appropriate tilting under which these events become typical.

4.2.1 Probabilistic representation of the partition function

In the first part of this section we prove formula (4.1.13) and we show how the polymer measure can be expressed as the image measure by an appropriate transformation of the geometric random walk V introduced in (4.1.14). In the second part of the section, we focus on those trajectories that make only one bead and we show that, in terms of the auxiliary random walk V , these beads become excursions away from the origin.

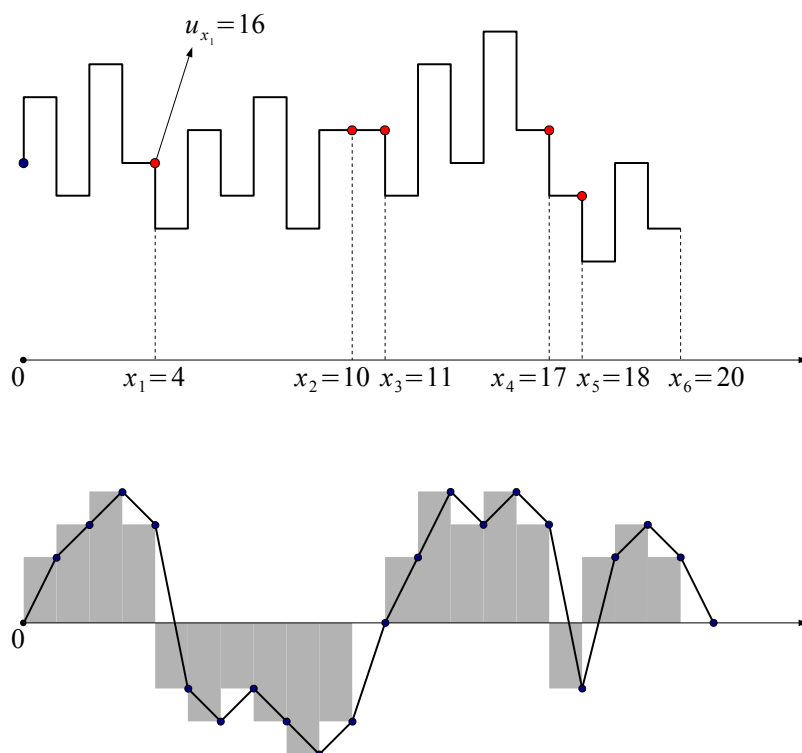

FIGURE 4.4 – An example of a trajectory $l = (l_i)_{i=1}^{20}$ with 6 beads is drawn on the upper picture. The auxiliary random walk V associated with l , i.e., $(V_i)_{i=0}^{21} = (T_{20})^{-1}(l)$ is drawn on the lower picture.

Auxiliary random walk

We display here the details of the proof of formula (4.1.13) in the non-uniform case only. The uniform case is indeed easier to handle. Recall (4.1.4–4.1.7) and note that the $\tilde{\wedge}$ operator can be written as

$$x \tilde{\wedge} y = (|x| + |y| - |x + y|) / 2, \quad \forall x, y \in \mathbb{Z}. \quad (4.2.1)$$

Hence, for $\beta > 0$ and $L \in \mathbb{N}$, the partition function in (4.1.7) becomes

$$\begin{aligned} Z_{L,\beta}^{\text{nu}} &= \sum_{N=1}^L \left(\frac{1}{3}\right)^N \left(\frac{1}{2}\right)^{L-N} \sum_{\substack{l \in \mathcal{L}_{N,L} \\ l_0=l_{N+1}=0}} \exp\left(\beta \sum_{n=1}^N |l_n| - \frac{\beta}{2} \sum_{n=0}^N |l_n + l_{n+1}|\right) \\ &= c_\beta \left(\frac{e^\beta}{2}\right)^L \sum_{N=1}^L \left(\frac{2c_\beta}{3e^\beta}\right)^N \sum_{\substack{l \in \mathcal{L}_{N,L} \\ l_0=l_{N+1}=0}} \prod_{n=0}^N \frac{\exp\left(-\frac{\beta}{2}|l_n + l_{n+1}|\right)}{c_\beta}, \end{aligned} \quad (4.2.2)$$

where c_β was defined in (4.1.14). At this stage, we pick $N \in \{1, \dots, L\}$ and we introduce the one-to-one correspondence $T_N : \mathcal{V}_{N+1,L-N} \mapsto \mathcal{L}_{N,L}$ defined as $T_N(V)_i = (-1)^{i-1} V_i$ for all $i \in \{1, \dots, N\}$. We pick $l \in \mathcal{L}_{N,L}$, we consider $V = (T_N)^{-1}(l)$ (see Fig. 4.4) and we note that the increments $(v_i)_{i=1}^{N+1}$ of V necessarily satisfy $v_i := (-1)^{i-1}(l_{i-1} + l_i)$. Thus, the

partition function in (4.2.2) becomes

$$Z_{L,\beta}^{\text{nu}} = c_\beta \left(\frac{e^\beta}{2}\right)^L \sum_{N=1}^L \left(\frac{2c_\beta}{3e^\beta}\right)^N \sum_{V \in \mathcal{V}_{N+1,L-N}} \mathbf{P}_\beta(V), \quad (4.2.3)$$

which immediately implies (4.1.13). A useful consequence of formula (4.2.3) is that, once conditioned on taking a given number of horizontal steps N , the polymer measure is exactly the image measure by the T_N -transformation of the geometric random walk V conditioned to return to the origin after $N+1$ steps and to make a geometric area $L - N$, i.e.,

$$P_{L,\beta}^{\text{m}}(l \in \cdot \mid N_L(l) = N) = \mathbf{P}_\beta(T_N(V) \in \cdot \mid V_N = 0, A_N = L - N). \quad (4.2.4)$$

From beads to excursions

We define Ω_L° as the subset of Ω_L containing those trajectories $l \in \Omega_L$ that have only one bead, i.e. $n_L(l) = 1$. Thus, we can rewrite $\Omega_L^{\circ} := \bigcup_{N=1}^L \mathcal{L}_{N,L}^{\circ}$, where $\mathcal{L}_{N,L}^{\circ}$ is the subset of $\mathcal{L}_{N,L}$ defined as

$$\mathcal{L}_{N,L}^{\circ} = \{l \in \mathcal{L}_{N,L} : l_i \tilde{\wedge} l_{i+1} \neq 0 \forall j \in \{1, \dots, N-1\}\}, \quad (4.2.5)$$

and we denote by $Z_{L,\beta}^{\text{m},\circ}$ the contribution to the partition function of those trajectories in Ω_L° , i.e.,

$$Z_{L,\beta}^{\text{m},\circ} = \sum_{l \in \Omega_L^{\circ}} e^{H_{L,\beta}(l)} \mathbf{P}_L^{\text{m}}(l), \quad \text{m} \in \{\text{u}, \text{nu}\}. \quad (4.2.6)$$

We let also $\mathcal{V}_{n,k}^+$ be the subset containing those trajectories that return to the origin after n steps, satisfy $A_n = k$ and are strictly positive on $\{1, \dots, n\}$, i.e.,

$$\mathcal{V}_{n,k}^+ := \{V : V_n = 0, A_n = k, V_i > 0 \forall i \in \{1, \dots, n-1\}\}. \quad (4.2.7)$$

By mimicking (4.2.2) and by noticing that by the T_N -transformation, the subset $\mathcal{L}_{N,L}^{\circ}$ becomes $\mathcal{V}_{N+1,L-N}^+$ we obtain

$$Z_{L,\beta}^{\text{m},\circ} = 2 c_\beta \Phi_{L,\beta}^{\text{m}} \sum_{N=1}^L (\Gamma^{\text{m}}(\beta))^N \mathbf{P}_\beta(\mathcal{V}_{N+1,L-N}^+). \quad (4.2.8)$$

4.2.2 Construction and regularity of h_β

We define the function h_β in a slightly different way from (4.1.21), but we will see at the end of this section that the two definitions are equivalent. For $N \in \mathbb{N}, \delta \geq 0$, define

$$h_{N,\beta}(\delta) := \frac{1}{N} \log \mathbf{E}_\beta(e^{-\delta A_N} \mathbf{1}_{\{V_N=0\}}) \quad \text{and let} \quad h_\beta(\delta) = \lim_{N \rightarrow \infty} h_{N,\beta}(\delta). \quad (4.2.9)$$

Lemma 4.2.1. (i) $h_\beta(\delta)$ exists and is finite, non-positive for all $\beta > 0, \delta \geq 0$.
(ii) $\delta \mapsto h_\beta(\delta)$ is continuous, convex and non-increasing on $[0, \infty)$.

Démonstration. (i) For $N, M \in \mathbb{N}$, we restrict the partition of size $N + M$ to those trajectories that return to the origin at time N and use the Markov property to obtain

$$\mathbf{E}_\beta(e^{-\delta A_{N+M}} \mathbf{1}_{\{V_{N+M}=0\}}) \geq \mathbf{E}_\beta(e^{-\delta A_N} \mathbf{1}_{\{V_N=0\}}) \mathbf{E}_\beta(e^{-\delta A_M} \mathbf{1}_{\{V_M=0\}}). \quad (4.2.10)$$

Thus, $\{\log \mathbf{E}_\beta(e^{-\delta A_N} \mathbf{1}_{\{V_N=0\}})\}_{N \in \mathbb{N}}$ is a super-additive sequence that is bounded above by 0 and therefore the limit in (4.2.9) exists, is finite and satisfies

$$h_\beta(\delta) = \sup_{N \in \mathbb{N}} \frac{1}{N} \log \mathbf{E}_\beta(e^{-\delta A_N} \mathbf{1}_{\{V_N=0\}}) \leq 0. \quad (4.2.11)$$

(ii) The fact that $A_N \geq 0$ for all $N \in \mathbb{N}$ immediately entails that $\delta \mapsto h_\beta(\delta)$ is non-increasing on $[0, \infty)$. By Hölder's inequality, the function $\delta \mapsto h_{N,\beta}(\delta)$ is convex for all $N \in \mathbb{N}$ and hence so is $\delta \mapsto h_\beta(\delta)$. Convexity and finiteness imply continuity on $(0, \infty)$. In order to prove the continuity at 0, we first note that $\lim_{\delta \rightarrow 0} h_\beta(\delta) = \sup_{\delta \geq 0} h_\beta(\delta)$. Then, with the help of formula 4.2.11 and via an exchange of suprema we obtain

$$\begin{aligned} \lim_{\delta \rightarrow 0} h_\beta(\delta) &= \sup_{\delta \geq 0} \sup_{N \in \mathbb{N}} \frac{1}{N} \log \mathbf{E}_\beta(e^{-\delta A_N} \mathbf{1}_{\{V_N=0\}}) \\ &= \sup_{N \in \mathbb{N}} \frac{1}{N} \log \mathbf{P}_\beta(V_N = 0) = 0. \end{aligned} \quad (4.2.12)$$

□

It remains to show that the two definitions of h_β in (4.1.21) and (4.2.9) coincide. To that aim it suffices to show that

$$\limsup_{N \rightarrow \infty} \frac{1}{N} \log \mathbf{E}_\beta(e^{-\delta A_N}) \leq \lim_{N \rightarrow \infty} \frac{1}{N} \log \mathbf{E}_\beta(e^{-\delta A_N} \mathbf{1}_{\{V_N=0\}}). \quad (4.2.13)$$

We set $\mathcal{I}_{N^2} := [-N^2, N^2] \cap \mathbb{Z}$ and we decompose $\mathbf{E}_\beta(e^{-\delta A_N})$ into the two partition functions $C_{N,\beta}$ and $B_{N,\beta}$ defined as

$$C_{N,\beta} = \mathbf{E}_\beta(e^{-\delta A_N} \mathbf{1}_{\{V_N \in \mathcal{I}_{N^2}\}}) \quad \text{and} \quad B_{N,\beta} = \mathbf{E}_\beta(e^{-\delta A_N} \mathbf{1}_{\{V_N \notin \mathcal{I}_{N^2}\}}). \quad (4.2.14)$$

Since $A_N \geq 0$ and since $\mathbf{E}_\beta(\exp(\beta|v_1|/4)) < \infty$, the Markov inequality gives

$$B_{N,\beta} \leq \mathbf{E}_\beta(\mathbf{1}_{\{V_N \notin \mathcal{I}_{N^2}\}}) \leq \mathbf{P}_\beta\left(\sum_{i=1}^N |v_i| \geq N^2\right) \leq \frac{\mathbf{E}_\beta(e^{(\beta/4)|v_1|})^N}{e^{(\beta/4)N^2}}, \quad (4.2.15)$$

which immediately implies that $\limsup_{N \rightarrow \infty} \frac{1}{N} \log B_{N,\beta} = -\infty$. Consequently

$$\limsup_{N \rightarrow \infty} \frac{1}{N} \log \mathbf{E}_\beta(e^{-\delta A_N}) = \limsup_{N \rightarrow \infty} \frac{1}{N} \log C_{N,\beta}, \quad (4.2.16)$$

and since the cardinality of \mathcal{I}_{N^2} grows polynomially, the proof of (4.2.13) will be complete once we show that

$$\limsup_{N \rightarrow \infty} \frac{1}{N} \log \sup_{x \in \mathcal{I}_{N^2}} \mathbf{E}_\beta(e^{-\delta A_N} \mathbf{1}_{\{V_N=x\}}) \leq \lim_{N \rightarrow \infty} \frac{1}{N} \log \mathbf{E}_\beta(e^{-\delta A_N} \mathbf{1}_{\{V_N=0\}}). \quad (4.2.17)$$

We consider the partition function of size $2N$ and use Markov property at time N to obtain

$$\mathbf{E}_\beta(e^{-\delta A_{2N}} \mathbf{1}_{\{V_{2N}=0\}}) \geq \mathbf{E}_\beta(e^{-\delta A_N} \mathbf{1}_{\{V_N=x\}}) \mathbf{E}_{\beta,x}(e^{-\delta A_N} \mathbf{1}_{\{V_N=0\}}), \quad x \in \mathbb{Z}. \quad (4.2.18)$$

By using the time reversal property of the V random walk, we can assert that $(V_N - V_{N-n}, 0 \leq n \leq N) \stackrel{d}{=} (V_n - V_0, 0 \leq n \leq N)$ and consequently, for all $x \in \mathbb{Z}$, it comes that

$$\begin{aligned} \mathbf{E}_{\beta,x}(e^{-\delta \sum_{n=1}^N |V_n|} \mathbf{1}_{\{V_N=0\}}) &= \mathbf{E}_\beta(e^{-\delta \sum_{n=1}^N |V_n+x|} \mathbf{1}_{\{V_N=-x\}}) \\ &= \mathbf{E}_\beta(e^{-\delta \sum_{n=1}^N |V_N - V_{N-n} + x|} \mathbf{1}_{\{V_N=-x\}}) \\ &= \mathbf{E}_\beta(e^{-\delta \sum_{n=1}^{N-1} |V_n|} \mathbf{1}_{\{V_N=-x\}}). \end{aligned} \quad (4.2.19)$$

Thanks to the symmetry of V and since $\sum_{n=1}^{N-1} |V_n| \leq A_N$, the inequalities (4.2.18) and (4.2.19) allow us to write

$$\mathbf{E}_\beta(e^{-\delta A_{2N}} \mathbf{1}_{\{V_{2N}=0\}}) \geq \left[\sup_{x \in \mathcal{I}_{N^2}} \mathbf{E}_\beta(e^{-\delta A_N} \mathbf{1}_{\{V_N=x\}}) \right]^2. \quad (4.2.20)$$

It remains to apply $\frac{1}{2N} \log$ in both sides of (4.2.20) and to let $N \rightarrow \infty$ to obtain (4.2.17), which completes the proof.

4.2.3 Large deviation estimates

In this section, we introduce the techniques that will be required to estimate the probability of some large deviation events associated with trajectories making a large arithmetic area. Such estimates will be needed in section 4.4 to approximate the probability that, under the polymer measure, the trajectories make only one bead.

Following Dobrushin and Hryniv in [10], for $n \in \mathbb{N}$, we define

$$Y_n := \frac{V_0 + V_1 + \cdots + V_{n-1}}{n}, \quad (4.2.21)$$

and for a given $q \in (0, \infty) \cap \frac{\mathbb{N}}{n}$, we focus on both probabilities $\mathbf{P}_\beta(Y_n = nq, V_n = 0)$ and $\mathbf{P}_\beta(Y_n = nq, V_n = 0, V_i > 0 \forall i \in \{1, \dots, n-1\})$. Our aim is to identify the exponential rate at which such probabilities are decreasing and their asymptotic polynomial correction. To that aim, we will use an *exponential tilting* of the probability measure \mathbf{P}_β (through the Cramer transform) in combination with a local limit theorem. Under the tilted probability measure the large deviation event $\{Y_n = nq, V_n = 0\}$ becomes typical, as will be seen in section 4.6.

First, we denote by $L(h), h \in \mathbb{R}$ the logarithmic moment generating function of the random walk V , i.e.,

$$L(h) := \log \mathbf{E}_\beta[e^{hV_1}]. \quad (4.2.22)$$

From the definition of the law \mathbf{P}_β in (4.1.14), we obviously have $L(h) < \infty$ for all $h \in (-\beta/2, \beta/2)$. For the ease of notations, we set $\Lambda_n := (Y_n, V_n)$ and we denote its logarithmic moment generating function by $L_{\Lambda_n}(H)$ for $H := (h_0, h_1) \in \mathbb{R}^2$, i.e.,

$$L_{\Lambda_n}(H) := \log \mathbf{E}_\beta[e^{h_0 Y_n + h_1 V_n}] = \sum_{i=1}^n L\left(\left(1 - \frac{i}{n}\right)h_0 + h_1\right). \quad (4.2.23)$$

Clearly, $L_{\Lambda_n}(H)$ is finite for all $H \in \mathcal{D}_n$ with

$$\mathcal{D}_n := \left\{ (h_0, h_1) \in \mathbb{R}^2 : h_1 \in \left(-\frac{\beta}{2}, \frac{\beta}{2}\right), (1 - \frac{1}{n})h_0 + h_1 \in \left(-\frac{\beta}{2}, \frac{\beta}{2}\right) \right\}. \quad (4.2.24)$$

We also introduce L_Λ the continuous counterpart of L_{Λ_n} as

$$L_\Lambda(H) := \int_0^1 L(xh_0 + h_1)dx, \quad (4.2.25)$$

which is defined on

$$\mathcal{D} := \left\{ (h_0, h_1) \in \mathbb{R}^2 : h_1 \in \left(-\frac{\beta}{2}, \frac{\beta}{2}\right), h_0 + h_1 \in \left(-\frac{\beta}{2}, \frac{\beta}{2}\right) \right\}. \quad (4.2.26)$$

With the help of (4.2.23) and for $H = (h_0, h_1) \in \mathcal{D}_n$, we define the H -tilted distribution by

$$\frac{d\mathbf{P}_{n,H}}{d\mathbf{P}_\beta}(V) = e^{h_0 Y_n + h_1 V_n - L_{\Lambda_n}(H)}. \quad (4.2.27)$$

For a given $n \in \mathbb{N}$ and $q \in \frac{\mathbb{N}}{n}$, the exponential tilt is given by $H_n^q := (h_{n,0}^q, h_{n,1}^q)$ which, by Lemma 4.5.5 in section 4.5.1, is the unique solution of

$$\mathbf{E}_{n,H}(\frac{\Lambda_n}{n}) = \nabla \left[\frac{1}{n} L_{\Lambda_n} \right](H) = (q, 0), \quad (4.2.28)$$

and therefore, we have the equality

$$\mathbf{P}_\beta(\Lambda_n = (nq, 0)) = \mathbf{P}_{n,H_n^q}(\Lambda_n = (nq, 0)) e^{n(-h_{n,0}^q q + \frac{1}{n} L_{\Lambda_n}(H_n^q))}. \quad (4.2.29)$$

From (4.2.29) it is easy to deduce that the exponential decay rate of $\mathbf{P}_\beta(\Lambda_n = (nq, 0))$ is given by the quantity $-h_{n,0}^q q + \frac{1}{n} L_{\Lambda_n}(H_n^q)$ and that the polynomial correction is associated with $\mathbf{P}_{n,H_n^q}(\Lambda_n = (nq, 0))$. To be more specific, we first state a Proposition which gives a local central limit theorem for the tilted law \mathbf{P}_{n,H_n^q} .

Proposition 4.2.2. *For $[q_1, q_2] \subset (0, \infty)$, there exist $C > 0, n_0 > 0$ such that for all $q \in [q_1, q_2]$ and $n \geq n_0$ we have*

$$\frac{1}{Cn^2} \leq \mathbf{P}_{n,H_n^q}(Y_n = nq, V_n = 0) \leq \frac{C}{n^2}. \quad (4.2.30)$$

Then, we define the continuous counterpart of H_n^q by $\tilde{H}(q, 0) := (\tilde{h}_0(q, 0), \tilde{h}_1(q, 0))$ which, by Lemma 4.5.3 in section 4.5.1, is the unique solution of the equation

$$\nabla L_\Lambda(H) = (q, 0), \quad (4.2.31)$$

and we state a Proposition that allows us to remove the n dependence of the exponential decay rate.

Proposition 4.2.3 (Decay rate of large area probability). *For $[q_1, q_2] \subset (0, +\infty)$, there exist $c_1, c_2 > 0$ and $n_0 \in \mathbb{N}$ such that*

$$\left| \left[\frac{1}{n} L_{\Lambda_n}(H_n^q) - h_{n,0}^q q \right] - \left[L_\Lambda(\tilde{H}(q, 0)) - \tilde{h}_0(q, 0) q \right] \right| \leq \frac{c_1}{n}, \quad \text{for } n \geq n_0, q \in [q_1, q_2]. \quad (4.2.32)$$

and

$$\left\| H_n^q - \tilde{H}(q, 0) \right\| \leq \frac{c_2}{n}, \quad \text{for } n \geq n_0, q \in [q_1, q_2]. \quad (4.2.33)$$

Proposition 4.2.3 and 4.2.2 will be proven in sections 4.5.1 and 4.6, respectively. With the help of (4.2.29) and by applying Proposition 4.2.2 and Proposition 4.2.3 we can finally give some sharp upper and lower bounds of $\mathbf{P}_\beta(Y_n = nq, V_n = 0)$.

Proposition 4.2.4. *For $[q_1, q_2] \subset (0, \infty)$, there exist $C_1 > C_2 > 0$ and $n_0 \in \mathbb{N}$ such that for all $q \in [q_1, q_2]$ and $n \geq n_0$ we have*

$$\frac{C_2}{n^2} e^{n[-\tilde{h}_0^q q + L_\Lambda(\tilde{H}(q,0))]} \leq \mathbf{P}_\beta(Y_n = nq, V_n = 0) \leq \frac{C_1}{n^2} e^{n[-\tilde{h}_0^q q + L_\Lambda(\tilde{H}(q,0))]} \quad (4.2.34)$$

In addition, we shall need in this paper a precise lower bound on the probability that, under \mathbf{P}_β , the V random walk makes only one excursion away from the origin, conditionally on having a large prescribed area. To our knowledge, such an estimate is not available in the existing literature. Recall the definition of Y_n in (4.2.21).

Proposition 4.2.5 (Unique excursion for large area). *For $[q_1, q_2] \subset (0, \infty)$, there exist $C > 0, \mu > 0$ and $n_0 \in \mathbb{N}$ such that for all $q \in [q_1, q_2]$ and every $n \geq n_0$*

$$\mathbf{P}_\beta(V_i > 0, 0 < i < n \mid Y_n = nq, V_n = 0) \geq \frac{C}{n^\mu}. \quad (4.2.35)$$

4.3 The order of the phase transition

In section 4.3.1 below, we prove Theorem 4.1.3 that expresses the excess free energy as the solution of an equation involving the function h_β introduced in section 4.2.2. In section 4.3.2, we first state Lemma 4.3.1 which provides the behavior of $h_\beta(\tilde{f}_c^m(\beta))$ close to β_c^m and then we combine this Lemma with Theorem 4.1.3 to complete the proof of Theorem 4.1.4. Finally, in section 4.3.3 we give a proof of Lemma 4.3.1.

4.3.1 Proof of Theorem 4.1.3 (Free energy equation)

By the representation formula (4.1.13) and the definition of \tilde{f}^m , we have

$$\tilde{f}^m(\beta) = \lim_{L \rightarrow \infty} \frac{1}{L} \log \tilde{Z}_{L,\beta}^m, \quad (4.3.1)$$

where

$$\tilde{Z}_{L,\beta}^m := \sum_{N=1}^L (\Gamma^m(\beta))^N \mathbf{P}_\beta(\mathcal{V}_{N+1, L-N}). \quad (4.3.2)$$

As a consequence, the excess free energy satisfies $\tilde{f}^m(\beta) = -\log R$ where R is the radius of convergence of the generating function $G(z) = \sum_{L=1}^{\infty} \tilde{Z}_{L,\beta}^m z^L$, that is

$$\tilde{f}^m(\beta) = \sup \left\{ \delta \geq 0 : \sum_{L=1}^{\infty} \tilde{Z}_{L,\beta}^m e^{-\delta L} = +\infty \right\}, \quad (4.3.3)$$

if the set is non-empty and $\tilde{f}^m(\beta) = 0$ otherwise. We recall (4.1.16) and we use (4.3.2) to rewrite the sum in (4.3.3) as

$$\begin{aligned} \sum_{L=1}^{\infty} \tilde{Z}_{L,\beta}^m e^{-\delta L} &= \sum_{L=1}^{\infty} \sum_{N=1}^L (\Gamma^m(\beta) e^{-\delta})^N \sum_{\substack{V_0=V_{N+1}=0 \\ A_N=L-N}} \mathbf{P}_\beta(V) e^{-\delta(L-N)} \\ &= \sum_{L=1}^{\infty} \sum_{N=1}^L (\Gamma^m(\beta) e^{-\delta})^N \mathbf{E}_\beta \left(e^{-\delta A_N} \mathbf{1}_{\{A_N=L-N, V_{N+1}=0\}} \right) \\ &= \sum_{N=1}^{\infty} (\Gamma^m(\beta) e^{-\delta})^N \mathbf{E}_\beta \left(e^{-\delta A_N} \mathbf{1}_{\{V_{N+1}=0\}} \right). \end{aligned} \quad (4.3.4)$$

Since $A_N = A_{N+1}$ on the set $\{V_{N+1} = 0\}$ and by using the definition of $h_{N,\beta}(\delta)$ in (4.2.9), the equality (4.3.4) becomes

$$\sum_{L=1}^{\infty} \tilde{Z}_{L,\beta}^m e^{-\delta L} = \sum_{N=1}^{\infty} \exp \left(N \left[\log \Gamma^m(\beta) - \delta + \frac{N+1}{N} h_{N+1,\beta}(\delta) \right] \right), \quad (4.3.5)$$

which together with (4.3.3) gives $\tilde{f}^m(\beta) = \sup \{ \delta \geq 0 : \log \Gamma^m(\beta) - \delta + h_\beta(\delta) > 0 \}$. Since $h_\beta(\delta) \leq 0$, it follows that $\tilde{f}^m(\beta) = 0$ if $\Gamma^m(\beta) \leq 1$. When $\Gamma^m(\beta) > 1$, Lemma 4.2.1 gives that $\delta \mapsto -\delta + h_\beta(\delta)$ is continuous, strictly decreasing, non-positive on $[0, \infty)$, equals 0 at $\delta = 0$ and tends to $-\infty$ when $\delta \rightarrow \infty$. Therefore, $\tilde{f}^m(\beta) > 0$ and is the unique solution of the equation $\log \Gamma^m(\beta) - \delta + h_\beta(\delta) = 0$. In addition, by recalling the definition of the collapsed phase (4.1.11) and the extended phase (4.1.12), we can observe that

$$\mathcal{C} = \{ \beta : \Gamma^m(\beta) \leq 1 \} \quad \text{and} \quad \mathcal{E} = \{ \beta : \Gamma^m(\beta) > 1 \}. \quad (4.3.6)$$

We note that $\beta \mapsto \Gamma^m(\beta)$ is decreasing on $[0, \infty)$ (recall (4.1.15) and (4.1.14)) and therefore, the collapse transition occurs at β_c^m , the unique positive solution of the equation $\Gamma^m(\beta) = 1$.

4.3.2 Proof of Theorem 4.1.4 (Phase transition asymptotics)

We display here the proof of Theorem 4.1.4 subject to Lemma 4.3.1 below, that will be proven in section 4.3.3 afterwards.

Lemma 4.3.1. *For $m \in \{u, nu\}$,*

$$\lim_{\beta \rightarrow \beta_c^m} \frac{h_\beta(\tilde{f}^m(\beta))}{\tilde{f}^m(\beta)^{2/3}} = -d_m. \quad (4.3.7)$$

where we recall that d_m was defined in (4.1.25).

Our aim is to study the asymptotic behavior of the equation in Theorem 4.1.3 near the critical point. We recall (4.1.15) and we perform a first order Taylor expansion of $\Gamma^m(\beta)$ near β_c^m which gives $\log \Gamma^m(\beta_c^m - \varepsilon) = c_m \varepsilon (1 + o(1))$ as $\varepsilon \searrow 0$. Next, we consider the function h_β near β_c^m and it follows from Lemma 4.3.1 that when $\varepsilon \searrow 0$

$$h_{\beta_c^m - \varepsilon}(\tilde{f}^m(\beta_c^m - \varepsilon)) = -d_m \tilde{f}^m(\beta_c^m - \varepsilon)^{2/3} (1 + o(1)). \quad (4.3.8)$$

Therefore, by plugging (4.3.8) and the expansion of $\log \Gamma^m(\beta_c^m - \varepsilon)$ in the equation in Theorem 4.1.3 that is verified by the excess free energy, we obtain that

$$c_m \varepsilon (1 + o(1)) - \tilde{f}^m(\beta_c^m - \varepsilon) - d_m \tilde{f}^m(\beta_c^m - \varepsilon)^{2/3} (1 + o(1)) = 0, \quad (4.3.9)$$

which allows to conclude that

$$\tilde{f}^m(\beta_c^m - \varepsilon) \sim \left(\frac{c_m}{d_m} \right)^{3/2} \varepsilon^{3/2} \quad \text{as } \varepsilon \searrow 0, \quad (4.3.10)$$

and the proof is complete.

4.3.3 Asymptotics of h_β

Heuristics

Let us give the heuristic explanation of why $h_\beta(\delta) \sim -c \delta^{2/3}$ for some constant $c > 0$. The main idea is to decompose the trajectory of the random walk V into independent blocks of length $T\delta^{-2/3}$ for $T \in \mathbb{N}$ and δ small enough : we have approximately $N/(T\delta^{-2/3})$ such blocks. Hence, as $\delta \searrow 0$, we can estimate

$$\lim_{N \rightarrow \infty} \frac{1}{N} \log \mathbf{E}_\beta(e^{-\delta A_N}) \sim \lim_{T \rightarrow \infty} \frac{\delta^{2/3}}{T} \log \mathbf{E}_\beta(e^{-\delta A_{T\delta^{-2/3}}}). \quad (4.3.11)$$

It is well known that for such random walks (assume that $\mathbf{E}_\beta(v_1^2) = 1$) (see [11, p. 405])

$$k^{-3/2} \sum_{i=1}^{Tk} |V_i| \xrightarrow{\mathcal{L}} \int_0^T |B(t)| dt \quad \text{as } k \rightarrow \infty, \quad (4.3.12)$$

where B is a standard Brownian motion. Now, let $k = \delta^{-2/3}$ and since $|e^{-\delta A_{T\delta^{-2/3}}}| \leq 1$, we conclude that

$$\mathbf{E}_\beta(e^{-\delta A_{T\delta^{-2/3}}}) \rightarrow \mathbf{E}(e^{-\int_0^T |B(t)| dt}) \quad \text{as } \delta \rightarrow 0. \quad (4.3.13)$$

This convergence and (4.3.11) would immediately imply $h_\beta(\delta) \sim -c \delta^{2/3}$ where c can be estimated via the distribution of the *Brownian area*, that is

$$c = - \lim_{T \rightarrow \infty} \frac{1}{T} \log \mathbf{E}(e^{-\int_0^T |B(t)| dt}) > 0. \quad (4.3.14)$$

Proof of Lemma 4.3.1.

Upper bound

Pick $T \in \mathbb{N}$, $\delta > 0$ such that $\delta^{-2/3} \in \mathbb{N}$ and let $\Delta := \delta^{-2/3}$. We take N that satisfies $N/(T\Delta) \in \mathbb{N}$ and partition $\{1, \dots, N\}$ into $k = N/(T\Delta)$ intervals of length $T\Delta$. By the Markov property of V , we desintegrate $\mathbf{E}_\beta(e^{-\delta A_N})$ with respect to the position occupied by the random walk V at times $T\Delta, 2T\Delta, \dots, (k-1)T\Delta$,

$$\mathbf{E}_\beta(e^{-\delta A_N}) = \sum_{\substack{x_0=0, x_i \in \mathbb{Z} \\ i=1, \dots, k}} \prod_{i=0}^{k-1} \mathbf{E}_{\beta, x_i} \left(e^{-\delta A_{T\Delta}} \mathbf{1}_{\{V_{T\Delta} = x_{i+1}\}} \right) \leq \left[\sup_{x \in \mathbb{Z}} \mathbf{E}_{\beta, x} (e^{-\delta A_{T\Delta}}) \right]^k. \quad (4.3.15)$$

With the help of Lemma 4.3.2 below, we can replace the supremum in the right hand side of (4.3.15) by the term indexed by $x = 0$ only. The proof of Lemma 4.3.2 is postponed to Appendix 4.7.2.

Lemma 4.3.2. *For all $\delta > 0, n \in \mathbb{N}$ and $x, x' \in \mathbb{Z}$ such that $|x'| \geq |x|$, the following inequality holds true*

$$\mathbf{E}_{\beta, x'}(e^{-\delta A_n}) \leq \mathbf{E}_{\beta, x}(e^{-\delta A_n}). \quad (4.3.16)$$

Therefore (4.3.15) becomes

$$\mathbf{E}_{\beta}(e^{-\delta A_N}) \leq \left[\mathbf{E}_{\beta}(e^{-\delta A_{T\Delta}}) \right]^{N/(T\Delta)}. \quad (4.3.17)$$

Recall that $\Delta := \delta^{-2/3}$, apply $\frac{1}{N} \log$ to both sides of (4.3.17) and let $N \rightarrow \infty$ to obtain, for $\beta > 0$ and $\delta > 0$, that

$$\frac{h_{\beta}(\delta)}{\delta^{2/3}} \leq \frac{1}{T} \log \mathbf{E}_{\beta}(e^{-\delta A_{T\Delta}}). \quad (4.3.18)$$

In what follows we need a uniform version (in β) of the convergence of $\mathbf{E}_{\beta}(e^{-\delta A_{T\Delta}})$ towards $\mathbf{E}(e^{-\int_0^T |B(t)| dt})$ as $\delta \rightarrow 0$. For this reason, we introduce the strong approximation theorem (Sakhanenko [21]) to approximate the partial sums of independent random variables v in the right hand side in (4.3.18) by independent normal random variables.

Theorem 4.3.3 (Q. M. Shao [24], Theorem B). *Denote by σ_{β}^2 the variance of the random variable v_1 under \mathbf{P}_{β} . We can redefine $\{v_i, i \geq 1\}$ (denoted by v^{β}) on a richer probability space together with a sequence of independent standard normal random variables $\{y_i, i \geq 1\}$ such that for every $p > 2, x > 0$,*

$$\mathbf{P}\left(\max_{i \leq n} \left| \sum_{j=1}^i v_j^{\beta} - \sigma_{\beta} \sum_{j=1}^i y_j \right| \geq x\right) \leq (Ap)^p x^{-p} \sum_{i=1}^n \mathbf{E}|v_i^{\beta}|^p, \quad (4.3.19)$$

where A is an absolute positive constant.

We let also, for $n \in \mathbb{N}$, $Y_n = \sum_{i=1}^n y_i$, $A_n(Y) = \sum_{i=1}^n |Y_i|$ and redefine $V_n^{\beta} = \sum_{i=1}^n v_i^{\beta}$, $A_n(V^{\beta}) = \sum_{i=1}^n |V_i^{\beta}|$. We pick $T > 0, p > 2, \theta > 0$ and K a compact subset of $(0, \infty)$. We use Theorem 4.3.3 and the fact that (recall (4.1.14)) $\mathbf{E}[|v_1^{\beta}|^p]$ is bounded from above uniformly in $\beta \in K$, to assert that there exists a constant $c_{p,K} > 0$ such that for all $\Delta > 0$ and $\beta \in K$

$$\mathbf{P}\left(\max_{i \leq T\Delta} |V_i^{\beta} - \sigma_{\beta} Y_i| \geq \Delta^{\theta}\right) \leq c_{p,K} T \Delta^{1-\theta p}. \quad (4.3.20)$$

Note that on the event $\{\max_{i \leq T\Delta} |V_i^{\beta} - \sigma_{\beta} Y_i| < \Delta^{\theta}\}$, we obviously have $|A_{T\Delta}(V^{\beta}) - \sigma_{\beta} A_{T\Delta}(Y)| \leq T \Delta^{\theta+1}$. Therefore, since $x \mapsto \exp(-x)$ is 1-Lipshitz on $[0, \infty)$ and since $\Delta = \delta^{-2/3}$, we can write that for $\beta \in K$ and $\delta > 0$

$$\begin{aligned} |\mathbf{E}(e^{-\delta A_{T\Delta}(V^{\beta})}) - e^{-\delta \sigma_{\beta} A_{T\Delta}(Y)}| &\leq \mathbf{P}\left(\max_{i \leq T\Delta} |V_i^{\beta} - \sigma_{\beta} Y_i| \geq \Delta^{\theta}\right) + \delta T \Delta^{\theta+1} \\ &\leq c_{p,K} T \delta^{\frac{2}{3}(\theta p - 1)} + T \delta^{\frac{1}{3}(1 - 2\theta)}. \end{aligned} \quad (4.3.21)$$

We chose $p = 3$ and $\theta \in (1/3, 1/2)$ and plug it in the right hand side of (4.3.18) to obtain that for $\beta \in K$ and $\delta > 0$,

$$\frac{h_{\beta}(\delta)}{\delta^{2/3}} \leq \frac{1}{T} \log \left[\mathbf{E}(e^{-\delta \sigma_{\beta} A_{T\Delta}(Y)}) + c_{3,K} T \delta^{\frac{2(3\theta-1)}{3}} + T \delta^{\frac{1-2\theta}{3}} \right]. \quad (4.3.22)$$

Lemma 4.3.4. *Let K be a compact subset of $(0, +\infty)$. For $T > 0$ and $\varepsilon > 0$ there exists a $\delta_0 > 0$ such that for $\delta \leq \delta_0$ (with $\Delta = \delta^{2/3}$),*

$$\sup_{\beta \in K} \left| \mathbf{E} \left(e^{-\delta \sigma_\beta A_{T\Delta}(Y)} \right) - \mathbf{E} \left(e^{-\sigma_\beta \int_0^T |B(t)| dt} \right) \right| < \varepsilon, \quad (4.3.23)$$

where B is a standard Brownian motion.

Proof of Lemma 4.3.4. We can consider $\{B(t), t \geq 0\}$ and $\{y_i, i \geq 1\}$ on the same probability space by letting $y_i = B(i) - B(i-1)$ and thus $Y_i = B(i)$ for $i \in \mathbb{N}$. Since the exponential function is 1-Lipschitz on $(-\infty, 0]$, we have

$$\sup_{\beta \in K} \left| \mathbf{E} \left(e^{-\delta \sigma_\beta A_{T\Delta}(Y)} \right) - \mathbf{E} \left(e^{-\sigma_\beta \int_0^T |B(t)| dt} \right) \right| \leq \max\{\sigma_\beta, \beta \in K\} \mathbf{E} \left[\left| \delta A_{T\Delta}(Y) - \int_0^T |B(t)| dt \right| \right]. \quad (4.3.24)$$

Since $\max\{\sigma_\beta, \beta \in K\} < \infty$, the proof is complete once we show that the expectation in the right hand side vanishes as $\Delta \rightarrow +\infty$. Recall that $\delta = \Delta^{-3/2}$ and $A_{T\Delta}(Y) = \sum_{i=1}^{T\Delta} |B(i)|$. By Brownian scaling and Riemann sum approximation, we know that

$$\Delta^{-3/2} A_{T\Delta}(Y) \stackrel{d}{=} \Delta^{-1} \sum_{i=1}^{T\Delta} |B(i/\Delta)| \xrightarrow[\Delta \rightarrow \infty]{a.s.} \int_0^T |B(t)| dt, \quad (4.3.25)$$

and since we have uniform integrability (because $\sup_{\Delta > 0} \mathbf{E}(|\Delta^{-3/2} A_{T\Delta}(Y)|^2) < \infty$) we can conclude that

$$\lim_{\Delta \rightarrow \infty} \mathbf{E} \left(\left| \Delta^{-3/2} A_{T\Delta}(Y) - \int_0^T |B(t)| dt \right| \right) = 0. \quad (4.3.26)$$

□

We resume the proof of the upper bound. Since $\theta \in (1/3, 1/2)$, the right hand side of (4.3.21) vanishes as $\delta \rightarrow 0$ uniformly in $\beta \in K$. Thus, we can replace δ by $\tilde{f}^m(\beta_c^m)$ in (4.3.22) and use Lemma 4.3.4 and the fact that $\lim_{\varepsilon \rightarrow 0^+} \tilde{f}^m(\beta_c^m - \varepsilon) = 0$ to conclude that, for all $T > 0$,

$$\limsup_{\varepsilon \rightarrow 0^+} \frac{h_\beta(\tilde{f}^m(\beta_c^m - \varepsilon))}{\tilde{f}^m(\beta_c^m - \varepsilon)^{2/3}} \leq \frac{1}{T} \log \mathbf{E} \left(e^{-\sigma_{\beta_c^m} \int_0^T |B(t)| dt} \right). \quad (4.3.27)$$

It remains to let T tend to infinity and to recall (4.1.25) to obtain

$$\limsup_{\varepsilon \rightarrow 0^+} \frac{h_\beta(\tilde{f}^m(\beta_c^m - \varepsilon))}{\tilde{f}^m(\beta_c^m - \varepsilon)^{2/3}} \leq -d_m. \quad (4.3.28)$$

Lower bound

Recall that $T \in \mathbb{N}$, $\delta > 0$ and $\Delta = \delta^{-2/3} \in \mathbb{N}$. We also take $N \in \mathbb{N}$ such that $N/(T\Delta) \in \mathbb{N}$. Pick $\eta > 0$ and use the decomposition in (4.3.15) to obtain

$$\mathbf{E}_\beta \left(e^{-\delta A_N} \right) \geq \sum_{\substack{x_0=0, x_i \in [-\eta\sqrt{\Delta}, \eta\sqrt{\Delta}] \\ i=1, \dots, k}} \prod_{i=0}^{k-1} \mathbf{E}_{\beta, x_i} \left(e^{-\delta A_{T\Delta}} \mathbf{1}_{\{V_{T\Delta} = x_{i+1}\}} \right) \quad (4.3.29)$$

$$\geq \left[\inf_{x \in [-\eta\sqrt{\Delta}, \eta\sqrt{\Delta}]} \mathbf{E}_{\beta, x} \left(e^{-\delta A_{T\Delta}} \mathbf{1}_{\{V_{T\Delta} \in [-\eta\sqrt{\Delta}, \eta\sqrt{\Delta}]\}} \right) \right]^{N/(T\Delta)}. \quad (4.3.30)$$

For any integer $x \in [-\eta\sqrt{\Delta}, \eta\sqrt{\Delta}]$, we consider the two sets of paths

$$\Pi_1^x = \{(V_i)_{i=0}^{T\Delta} : V_0 = x, V_{T\Delta} \in [-\eta\sqrt{\Delta}, \eta\sqrt{\Delta}]\}, \quad (4.3.31)$$

and

$$\Pi_2 = \{(V_i)_{i=0}^{T\Delta} : V_0 = 0, V_{T\Delta} \in [-\eta\sqrt{\Delta}, 0]\}. \quad (4.3.32)$$

Clearly, if $V = (V_i)_{i=0}^{T\Delta} \in \Pi_2$, then the trajectory $V + x$ starts at $x \in [0, \eta\sqrt{\Delta}]$ and is an element of Π_1^x . Similarly, for $x \in [-\eta\sqrt{\Delta}, 0]$, $\Pi_2' + x \subseteq \Pi_1^x$ where

$$\Pi_2' = \{(V_i)_{i=0}^{T\Delta} : V_0 = 0, V_{T\Delta} \in [0, \eta\sqrt{\Delta}]\}. \quad (4.3.33)$$

Since $\mathbf{P}_\beta(V \in \Pi_2) = \mathbf{P}_\beta(V \in \Pi_2')$, we conclude that

$$\mathbf{P}_{\beta,x}(V \in \Pi_1^x) \geq \mathbf{P}_\beta(V \in \Pi_2') \quad \text{for all } x \in [-\eta\sqrt{\Delta}, \eta\sqrt{\Delta}]. \quad (4.3.34)$$

Moreover, for any $V^* \in \Pi_1^x$,

$$\delta \sum_{i=1}^{T\Delta} |V_i^*| = \delta \sum_{i=1}^{T\Delta} |x + V_i| \leq \delta \sum_{i=1}^{T\Delta} |V_i| + \delta T\Delta |x| \leq \delta \sum_{i=1}^{T\Delta} |V_i| + \eta T, \quad (4.3.35)$$

where the trajectory V satisfies $V_0 = 0$. Combining (4.3.34) and (4.3.35), we then have, for $x \in [-\eta\sqrt{\Delta}, \eta\sqrt{\Delta}]$,

$$\mathbf{E}_{\beta,x} \left(e^{-\delta A_{T\Delta}} \mathbf{1}_{\{V_{T\Delta} \in [-\eta\sqrt{\Delta}, \eta\sqrt{\Delta}]\}} \right) \geq e^{-\eta T} \mathbf{E}_\beta \left(e^{-\delta A_{T\Delta}} \mathbf{1}_{\{V_{T\Delta} \in [0, \eta\sqrt{\Delta}]\}} \right). \quad (4.3.36)$$

By plugging the lower bound above into (4.3.29) and by using the symmetry of V we immediately get

$$\mathbf{E}_\beta \left(e^{-\delta A_N} \right) \geq \left[e^{-\eta T} \mathbf{E}_\beta \left(e^{-\delta A_{T\Delta}} \mathbf{1}_{\{V_{T\Delta} \in [0, \eta\sqrt{\Delta}]\}} \right) \right]^{N/T\Delta}, \quad (4.3.37)$$

which, by applying $\frac{1}{N} \log$ to both sides in (4.3.37) and by letting $N \rightarrow \infty$, gives, for all $\beta > 0$,

$$\frac{h_\beta(\delta)}{\delta^{2/3}} \geq \frac{1}{T} \log \mathbf{E}_\beta \left(e^{-\delta A_{T\Delta}} \mathbf{1}_{\{V_{T\Delta} \in [0, \eta\sqrt{\Delta}]\}} \right) - \eta, \quad \delta, \eta > 0. \quad (4.3.38)$$

At this stage, we proceed as in the upper bound (from (4.3.18)) to obtain, for all $T \in \mathbb{N}$, $\eta > 0$,

$$\liminf_{\beta \rightarrow \beta_c^m} \frac{h_\beta(\tilde{f}^m(\beta))}{\tilde{f}^m(\beta)^{2/3}} \geq \frac{1}{T} \log \mathbf{E} \left(e^{-\sigma_{\beta_c^m} \int_0^T |B(t)| dt} \mathbf{1}_{\{B(T) \in [0, \eta]\}} \right) - \eta. \quad (4.3.39)$$

Therefore the proof of the lower bound will be complete once we show that for all $\eta > 0$

$$\lim_{T \rightarrow \infty} \frac{1}{T} \log \mathbf{E} \left(e^{-\sigma_{\beta_c^m} \int_0^T |B(t)| dt} \mathbf{1}_{\{B(T) \in [0, \eta]\}} \right) = \lim_{T \rightarrow \infty} \frac{1}{T} \log \mathbf{E} \left(e^{-\sigma_{\beta_c^m} \int_0^T |B(t)| dt} \right). \quad (4.3.40)$$

Then, by recalling (4.1.25), we achieve the bound

$$\liminf_{\beta \rightarrow \beta_c^m} \frac{h_\beta(\tilde{f}^m(\beta))}{\tilde{f}^m(\beta)^{2/3}} \geq -d_m - \eta, \quad (4.3.41)$$

for all $\eta > 0$. It remains to let $\eta \rightarrow 0$ to complete the proof.

The proof of (4.3.40) is very similar to the one displayed in section 4.2.2 that shows that the two definitions of h_β coincide. Pick $T > 0$, and partition the interval $[-T^2, T^2]$ into $2T^2/\eta$ sub-intervals of length η , i.e.,

$$[-T^2, T^2] = \cup_{i=-T^2/\eta+1}^{T^2/\eta} J_i, \quad \text{where } J_i = [(i-1)\eta, i\eta]. \quad (4.3.42)$$

Since $\lim_{T \rightarrow \infty} \frac{1}{T} \log \mathbf{P}(|B(T)| \geq T^2) = -\infty$, we can claim that

$$\lim_{T \rightarrow \infty} \frac{1}{T} \log \mathbf{E}(e^{-\sigma_\beta \int_0^T |B(t)| dt}) = \liminf_{T \rightarrow \infty} \frac{1}{T} \log \mathbf{E}(e^{-\sigma_\beta \int_0^T |B(t)| dt} \mathbf{1}_{\{B(T) \in [-T^2, T^2]\}}). \quad (4.3.43)$$

The expectation in right hand side of (4.3.43) can be bounded from above as

$$\mathbf{E}(e^{-\sigma_\beta \int_0^T |B(t)| dt} \mathbf{1}_{\{B(T) \in [-T^2, T^2]\}}) \leq \frac{2T^2}{\eta} \sup_{i \in \mathcal{T}_\eta} \mathbf{E}(e^{-\sigma_\beta \int_0^T |B(t)| dt} \mathbf{1}_{\{B(T) \in J_i\}}), \quad (4.3.44)$$

where $\mathcal{T}_\eta := \{-T^2/\eta + 1, \dots, T^2/\eta\}$. By applying $\frac{1}{T} \log$ to both sides of (4.3.44) and by letting $T \rightarrow \infty$, it comes that

$$\lim_{T \rightarrow \infty} \frac{1}{T} \log \mathbf{E}(e^{-\sigma_\beta \int_0^T |B(t)| dt}) \leq \liminf_{T \rightarrow \infty} \frac{1}{T} \log \sup_{i \in \mathcal{T}_\eta} \mathbf{E}(e^{-\sigma_\beta \int_0^T |B(t)| dt} \mathbf{1}_{\{B(T) \in J_i\}}). \quad (4.3.45)$$

The next step consists in bounding from below the partition function of size $2T$, so that for all $i \in \mathcal{T}_\eta$ we have

$$\begin{aligned} & \mathbf{E}(e^{-\sigma_\beta \int_0^{2T} |B(t)| dt} \mathbf{1}_{\{B(2T) \in [-\eta, \eta]\}}) \\ & \geq \mathbf{E}\left[e^{-\sigma_\beta \int_0^T |B(t)| dt} \mathbf{1}_{\{B(T) \in J_i\}} \mathbf{E}(e^{-\sigma_\beta \int_T^{2T} |B(t)| dt} \mathbf{1}_{\{B(2T) \in [-\eta, \eta]\}} \mid B(T))\right] \\ & \geq \mathbf{E}\left(e^{-\sigma_\beta \int_0^T |B(t)| dt} \mathbf{1}_{\{B(T) \in J_i\}}\right) \inf_{x \in J_i} \mathbf{E}_x\left(e^{-\sigma_\beta \int_0^T |B(t)| dt} \mathbf{1}_{\{B(T) \in [-\eta, \eta]\}}\right). \end{aligned} \quad (4.3.46)$$

We now use the time reversal and the symmetry of $\{B(t), t \geq 0\}$ to conclude, for all $x \in J_i$, $i \in \mathcal{T}_\eta$,

$$\begin{aligned} \mathbf{E}_x\left(e^{-\sigma_\beta \int_0^T |B(t)| dt} \mathbf{1}_{\{B(T) \in [-\eta, \eta]\}}\right) &= \mathbf{E}\left(e^{-\sigma_\beta \int_0^T |B(t)+x| dt} \mathbf{1}_{\{B(T)+x \in [-\eta, \eta]\}}\right) \\ &= \mathbf{E}\left(e^{-\sigma_\beta \int_0^T |B(T)-B(T-t)+x| dt} \mathbf{1}_{\{B(T)+x \in [-\eta, \eta]\}}\right) \\ &\geq e^{-\sigma_\beta \eta T} \mathbf{E}\left(e^{-\sigma_\beta \int_0^T |B(t)| dt} \mathbf{1}_{\{B(T) \in [x-\eta, x+\eta]\}}\right) \\ &\geq e^{-\sigma_\beta \eta T} \mathbf{E}\left(e^{-\sigma_\beta \int_0^T |B(t)| dt} \mathbf{1}_{\{B(T) \in J_i\}}\right). \end{aligned} \quad (4.3.47)$$

At this stage, we plug (4.3.47) into (4.3.46) and we note that both inequalities hold for all $i \in \mathcal{T}_\eta$, so that

$$\mathbf{E}(e^{-\sigma_\beta \int_0^{2T} |B(t)| dt} \mathbf{1}_{\{B(2T) \in [-\eta, \eta]\}}) \geq e^{-\sigma_\beta \eta T} \sup_{i \in \mathcal{T}_\eta} \mathbf{E}(e^{-\sigma_\beta \int_0^T |B(t)| dt} \mathbf{1}_{\{B(T) \in J_i\}})^2. \quad (4.3.48)$$

We apply $\frac{1}{2T} \log$ to both sides of (4.3.48) and we let $T \rightarrow \infty$ to obtain

$$\begin{aligned} \liminf_{T \rightarrow \infty} \frac{1}{2T} \log \mathbf{E}(e^{-\sigma_\beta \int_0^{2T} |B(t)| dt} \mathbf{1}_{\{B(2T) \in [-\eta, \eta]\}}) \\ \geq \frac{-\sigma_\beta \eta}{2} + \liminf_{T \rightarrow \infty} \frac{1}{T} \sup_{i \in \mathcal{T}_\eta} \log \mathbf{E}(e^{-\sigma_\beta \int_0^T |B(t)| dt} \mathbf{1}_{\{B(T) \in J_i\}}), \end{aligned} \quad (4.3.49)$$

which, once combined with (4.3.45) and since $\{B(t), t \geq 0\}$ is symmetric, gives

$$\lim_{T \rightarrow \infty} \frac{1}{T} \log \mathbf{E} \left(e^{-\sigma_\beta \int_0^T |B(t)| dt} \right) \leq \liminf_{T \rightarrow \infty} \frac{1}{T} \log \mathbf{E} \left(e^{-\sigma_\beta \int_0^T |B(t)| dt} \mathbf{1}_{\{B(T) \in [0, \eta]\}} \right) + \frac{\sigma_\beta \eta}{2}. \quad (4.3.50)$$

For all $\eta > 0$, we let

$$d(\eta) := \lim_{T \rightarrow \infty} \frac{1}{T} \log \mathbf{E} \left(e^{-\sigma_\beta \int_0^T |B(t)| dt} \right) - \liminf_{T \rightarrow \infty} \frac{1}{T} \log \mathbf{E} \left(e^{-\sigma_\beta \int_0^T |B(t)| dt} \mathbf{1}_{\{B(T) \in [-\eta, \eta]\}} \right). \quad (4.3.51)$$

The function $\eta \mapsto d(\eta)$ is non-increasing and non-negative on $(0, \infty)$, and it follows from (4.3.50) that $0 \leq d(\eta) \leq \frac{\sigma_\beta \eta}{2}$, which implies that $d(\eta) = 0$ for all $\eta \in (0, \infty)$. The proof is therefore complete. \square

4.4 Geometry of the collapsed phase

In section 4.4.1 below, a proof of Theorem 4.1.6 is displayed subject to Lemma 4.4.1, which ensures that the horizontal extension of the polymer inside the collapsed phase is of order \sqrt{L} , and to Proposition 4.4.2, which provides a sharp estimate of the partition function restricted to those trajectories making only one bead. Proposition 4.4.2 is proven in section 4.4.2 subject to Lemma 4.4.4, which is the counterpart of Lemma 4.4.1 for the one bead trajectory and to Proposition 4.2.5, which gives a lower bound on the probability that the V random walk makes an n -step excursion away from the origin conditioned on the large deviation event $\{Y_n = qn, V_n = 0\}$. Lemmas 4.4.1 and 4.4.4 are proven in section 4.4.4 whereas the proof of Proposition 4.2.5 is postponed to section 4.6.2 because it requires more preparation.

4.4.1 Proof of Theorem 4.1.6 (One bead Theorem)

The proof of Theorem 4.1.6 will be displayed subject to

Lemma 4.4.1. *For $m \in \{u, nu\}$ and $\beta > \beta_c^m$, there exist $a, a_1, a_2 > 0$ such that*

$$P_{L,\beta}^m(N_L \geq a_1 \sqrt{L}) \leq a_2 e^{-aL}, \quad L \in \mathbb{N}. \quad (4.4.1)$$

Recall (4.2.6–4.2.8)

Proposition 4.4.2. *For $m \in \{u, nu\}$ and $\beta > \beta_c^m$, there exist $c, c_1, c_2 > 0$ and $\kappa > 1/2$ such that*

$$\frac{c_1}{L^\kappa} \Phi_{L,\beta}^m e^{-c\sqrt{L}} \leq Z_{L,\beta}^{m,o} \leq \frac{c_2}{\sqrt{L}} \Phi_{L,\beta}^m e^{-c\sqrt{L}}, \quad L \in \mathbb{N}. \quad (4.4.2)$$

Proof of Theorem 4.1.6

We will first show that, for $\beta > \beta_c$ and under the polymer measure, the probability that there is exactly one macroscopic bead in the polymer tends to 1 as $L \rightarrow \infty$. Then, we will show that, with a probability converging to 1 as $L \rightarrow \infty$, the first step and the last step of this macroscopic bead are at distance less than $(\log L)^4$ from 0 and L , respectively.

We will use the following notation to compute the partition function restricted to a given subset A of Ω_L , i.e.,

$$Z_{L,\beta}^m(A) = \sum_{l \in A} e^{H_{L,\beta}(l)} \mathbf{P}_L^m(l), \quad m \in \{\mathbf{u}, \mathbf{nu}\}. \quad (4.4.3)$$

In particular, for $r \in \mathbb{N}$, we set $Z_{L,\beta}[r] = Z_{L,\beta}^m(|I_{j_{\max}}| \leq r)$ that is the partition function restricted to those trajectories that do not have any bead larger than r . For simplicity, we will omit the m dependence of most quantities along this proof. At this stage, we pick $s > 0$ and we let $A_{L,s}$ be the subset consisting of those trajectories having at most one bead larger than $s(\log L)^2$, i.e.,

$$A_{L,s} = \left\{ l \in \Omega_L : \left| \{j \in \{1, \dots, n_L(l)\} : |I_j| \geq s(\log L)^2\} \right| \leq 1 \right\}. \quad (4.4.4)$$

Partition $A_{L,s}^c$ in dependence of the locations of the two subintervals $\{i_1+1, \dots, i_2\}$ and $\{i_3+1, \dots, i_4\}$ associated with the first two beads that are larger than $s(\log L)^2$. For notational convenience we let $L_1 := i_2 - i_1$ and $L_2 := i_4 - i_3$ be the length of these two first large beads. We do not have Markov property but, with the help of Lemma 4.4.3 below, we can estimate the partition function restricted to those trajectory that make a bead between two given steps.

Lemma 4.4.3. *Let x_1 be the first bead, so that u_{x_1} is the size of the first bead. For $m \in \{\mathbf{u}, \mathbf{nu}\}$,*

$$\frac{1}{2} Z_{L',\beta}^{m,\circ} Z_{L-L',\beta}^m \leq Z_{L,\beta}^m(u_{x_1} = L') \leq Z_{L',\beta}^{m,\circ} Z_{L-L',\beta}^m \quad \text{for } L' \in \{1, \dots, L\}. \quad (4.4.5)$$

Proof of Lemma 4.4.3. In the case $u_{x_1} = 1$, the first bead contains only one horizontal step, hence the sign of the stretch after x_1 is arbitrary, we obviously have $Z_{L,\beta}^m(u_{x_1} = 1) = Z_{1,\beta}^{m,\circ} Z_{L-1,\beta}^m$. In case $u_{x_1} = L' > 1$, note that the stretch l_{x_1} is non-zero, therefore the next stretch has the same sign as l_{x_1} . By concatenating the trajectories

$$Z_{L,\beta}^m(u_{x_1} = L') = Z_{L',\beta}^{m,\circ}(l_{N_{L'}} > 0) Z_{L-L',\beta}^m(l_1 \geq 0) + Z_{L',\beta}^{m,\circ}(l_{N_{L'}} < 0) Z_{L-L',\beta}^m(l_1 \leq 0) \quad (4.4.6)$$

$$= Z_{L',\beta}^{m,\circ} Z_{L-L',\beta}^m(l_1 \geq 0). \quad (4.4.7)$$

In both cases, thanks to the symmetry of the stretches, we have

$$\frac{1}{2} Z_{L',\beta}^{m,\circ} Z_{L-L',\beta}^m \leq Z_{L,\beta}^m(u_{x_1} = L') \leq Z_{L',\beta}^{m,\circ} Z_{L-L',\beta}^m \quad \text{for } L' \in \{1, \dots, L\}. \quad (4.4.8)$$

□

We resume the proof of Theorem 4.1.6 and, we use Lemma 4.4.3 to obtain

$$P_{L,\beta}(A_{L,s}^c) \leq \sum_{\substack{1 \leq i_1 < i_2 < i_3 < i_4 \leq L \\ L_1, L_2 \geq s(\log L)^2}} \frac{Z_{i_1,\beta} [s(\log L)^2] Z_{L_1,\beta}^\circ Z_{i_3-i_2,\beta} [s(\log L)^2] Z_{L_2,\beta}^\circ Z_{L-i_4,\beta}}{Z_{L,\beta}}, \quad (4.4.9)$$

and we write the lower bound

$$Z_{L,\beta} \geq \left(\frac{1}{2}\right)^3 Z_{i_1,\beta} [s(\log L)^2] Z_{L_1+L_2,\beta}^\circ Z_{i_3-i_2,\beta} [s(\log L)^2] Z_{L-i_4,\beta} \quad (4.4.10)$$

such that

$$P_{L,\beta}(A_{L,s}^c) \leq 8 \sum_{\substack{1 \leq i_1 < i_2 < i_3 < i_4 \leq L \\ L_1, L_2 \geq s(\log L)^2}} \frac{Z_{L_1,\beta}^\circ Z_{L_2,\beta}^\circ}{Z_{L_1+L_2,\beta}^\circ}. \quad (4.4.11)$$

By using Proposition 4.4.2 and the convex inequality

$$\sqrt{L_1} + \sqrt{L_2} - \sqrt{L_1 + L_2} \geq \frac{1}{2} \sqrt{\min\{L_1, L_2\}}, \quad (4.4.12)$$

we can bound from above the quantity in the sum in (4.4.11) by

$$\frac{Z_{L_1,\beta}^\circ Z_{L_2,\beta}^\circ}{Z_{L_1+L_2,\beta}^\circ} \leq \frac{c_1^2 (L_1 + L_2)^\kappa}{c_2 \sqrt{L_1 L_2}} e^{-c[\sqrt{L_1} + \sqrt{L_2} - \sqrt{L_1 + L_2}]} \quad (4.4.13)$$

$$\leq \frac{c_1^2 (L_1 + L_2)^\kappa}{c_2 \sqrt{L_1 L_2}} e^{-\frac{c}{2} \sqrt{s} \log L} \quad (4.4.14)$$

and since $\frac{(L_1+L_2)^\kappa}{\sqrt{L_1 L_2}} \leq L^\kappa$ we can state that, for L large enough, (4.4.11) becomes

$$P_{L,\beta}(A_{L,s}^c) \leq \frac{8c_1^2}{c_2} L^{\kappa+4} e^{-\frac{c}{2} \sqrt{s} \log L}. \quad (4.4.15)$$

Therefore, it suffices to choose $\sqrt{s} = \frac{4(\kappa+4)}{c}$ to conclude that $\lim_{L \rightarrow \infty} P_{L,\beta}(A_{L,s}^c) = 0$.

At this stage we set $B_{L,s} = A_{L,s} \cap \{N_L(l) \leq a_1 \sqrt{L}\}$ and we can use Lemma 4.4.1 and the fact that $P_{L,\beta}(A_{L,s}^c)$ vanishes as $L \rightarrow \infty$ to conclude that $\lim_{L \rightarrow \infty} P_{L,\beta}(B_{L,s}) = 1$. Moreover, it comes easily that under the event $B_{L,s}$ there is exactly one bead larger than $s(\log L)^2$ because if there were no bead larger than $s(\log L)^2$, then the total number of beads $n_L(l)$ would be larger than $\frac{L}{s(\log L)^2}$ which contradicts the fact that $N_L(l) \leq a_1 \sqrt{L}$ because each bead contains at least one horizontal step and consequently $N_L(l) \geq n_L(l)$. Under the event $B_{L,s}$ we denote by i_1 and i_2 the end-steps of the maximal bead, i.e., $I_{j_{\max}} = \{i_1 + 1, \dots, i_2\}$. Then, the proof of Theorem 4.1.6 will be complete once we show that there exists a $v > 0$ such that

$$\lim_{L \rightarrow \infty} P_{L,\beta}(B_{L,s} \cap \{i_1 \geq v(\log L)^4\}) = 0 \quad (4.4.16)$$

$$\lim_{L \rightarrow \infty} P_{L,\beta}(B_{L,s} \cap \{i_2 \leq L - v(\log L)^4\}) = 0. \quad (4.4.17)$$

We can bound from above

$$\begin{aligned} P_{L,\beta}(B_{L,s} \cap \{i_1 \geq v(\log L)^4\}) &= \sum_{t=v(\log L)^4}^L P_{L,\beta}(B_{L,s} \cap \{i_1 = t\}) \\ &\leq \sum_{t=v(\log L)^4}^L P_{L,\beta} \left(\exists j \in \{1, \dots, n_L(l)\} : u_{x_j} = t, \right. \\ &\quad \left. |I_d| \leq s(\log L)^2 \quad \forall d \in \{1, \dots, j\} \right) \\ &\leq \frac{1}{2} \sum_{t=v(\log L)^4}^L \frac{Z_{t,\beta}[s(\log L)^2] Z_{L-t,\beta}}{Z_{t,\beta} Z_{L-t,\beta}}, \end{aligned} \quad (4.4.18)$$

which finally gives

$$P_{L,\beta}(B_{L,s} \cap \{i_1 \geq v(\log L)^4\}) \leq \frac{1}{2} \sum_{t=v(\log L)^4}^L P_{t,\beta}(|I_{j_{\max}}| \leq s(\log L)^2). \quad (4.4.19)$$

We note that, under $P_{t,\beta}$ and on the event $\{|I_{j_{\max}}| \leq s(\log L)^2\}$, the number of beads is larger than $\frac{t}{s(\log L)^2}$, therefore $N_t(l) \geq \frac{t}{s(\log L)^2}$ and since $\sqrt{t} \geq \sqrt{v}(\log L)^2$ we obtain that $N_t(l) \geq \sqrt{t}(\sqrt{v}/s)$. By choosing $v = (a_1 s)^2$, we can apply Lemma 4.4.1 to get

$$\begin{aligned} P_{L,\beta}(B_{L,s} \cap \{i_1 \geq v(\log L)^4\}) &\leq \frac{1}{2} \sum_{t=v(\log L)^4}^L P_{t,\beta}(N_t(l) \geq a_1 \sqrt{t}) \\ &\leq \frac{1}{2} a_2 \sum_{t=v(\log L)^4}^L e^{-a \sqrt{t}}. \end{aligned} \quad (4.4.20)$$

Since the sum in (4.4.20) vanishes as $L \rightarrow \infty$, the proof is complete.

4.4.2 Proof of Proposition 4.4.2

We recall the definition of the one bead partition function introduced in section 4.2.1, equations (4.2.5–4.2.8). Henceforth, we will use the notation $\tilde{Z}_{L,\beta}^{m,o} = Z_{L,\beta}^{m,o}/(c_\beta \Phi_{L,\beta}^m)$, so that Proposition 4.4.2 will be proven once we show that there exist $c, c_1, c_2 > 0$ and $\kappa > 1/2$ such that

$$\frac{c_1}{L^\kappa} e^{-c\sqrt{L}} \leq \tilde{Z}_{L,\beta}^{m,o} \leq \frac{c_2}{\sqrt{L}} e^{-c\sqrt{L}}, \quad \text{for } L \in \mathbb{N}. \quad (4.4.21)$$

We will prove (4.4.21) subject to Lemma 4.4.4 below and Proposition 4.2.5. The proof of Lemma 4.4.4 is given in section 4.4.4 whereas the proof of Proposition 4.2.5 is postponed to section 4.6.2.

Lemma 4.4.4. *For $m \in \{u, nu\}$ and $\beta > \beta_c^m$, there exists $a_2 > a_1 > 0$ such that for $L \in \mathbb{N}$,*

$$\lim_{L \rightarrow \infty} \frac{\tilde{Z}_{L,\beta}^{m,o}(a_1 \sqrt{L} \leq N \leq a_2 \sqrt{L})}{\tilde{Z}_{L,\beta}^{m,o}} = 1. \quad (4.4.22)$$

We resume the proof of Proposition 4.4.2. With (4.2.8) and by definition of $\tilde{Z}_{L,\beta}^{m,o}$ we can easily deduce that, for $\beta > 0$, $L \in \mathbb{N}$, $m \in \{u, nu\}$,

$$\tilde{Z}_{L,\beta}^{m,o} = 2 \sum_{N=1}^L (\Gamma^m(\beta))^N \mathbf{P}_\beta(\mathcal{V}_{N+1,L-N}^+). \quad (4.4.23)$$

For $K \subset \{1, \dots, L\}$, we set

$$\tilde{Z}_{L,\beta}^{m,o}(N \in K) = 2 \sum_{N \in K} (\Gamma^m(\beta))^N \mathbf{P}_\beta(\mathcal{V}_{N+1,L-N}^+). \quad (4.4.24)$$

By using Lemma 4.4.4, we note that it suffices to prove (4.4.21) with $\tilde{Z}_{L,\beta}^{m,o}(N \in \sqrt{L}[a_1, a_2])$ instead of $\tilde{Z}_{L,\beta}^{m,o}$. To that aim, we write

$$\tilde{Z}_{L,\beta}^{m,o}(N \in \sqrt{L}[a_1, a_2]) = 2 \sum_{N=a_1 \sqrt{L}}^{a_2 \sqrt{L}} (\Gamma^m(\beta))^{N-1} \mathbf{P}_\beta(\mathcal{V}_{N,L-N+1}^+). \quad (4.4.25)$$

For $n \in \mathbb{N}$, we recall (4.1.16) and (4.2.21) and we note that $nY_n = A_n$ on the set $\{V_n = 0, V_i > 0 \forall i \in [1, N-1] \cap \mathbb{N}\}$. Therefore, we set $q_{N,L} := \frac{L-N+1}{N^2}$ for $N \in \sqrt{L}[a_1, a_2] \cap \mathbb{N}$ and we can write

$$\mathcal{V}_{N,L-N+1}^+ = \{V : Y_N = Nq_{N,L}, V_N = 0, V_i > 0 \forall i \in [1, N-1] \cap \mathbb{N}\}. \quad (4.4.26)$$

At this stage, our aim is to bound from above and below the quantities $\mathbf{P}_\beta(\mathcal{V}_{N,L-N+1}^+)$ for $N \in \sqrt{L}[a_1, a_2] \cap \mathbb{N}$. The upper bound is obvious, i.e.,

$$\mathbf{P}_\beta(\mathcal{V}_{N,L-N+1}^+) \leq \mathbf{P}_\beta(Y_N = Nq_{N,L}, V_N = 0), \quad (4.4.27)$$

while the lower bound is obtained as follows. Since $q_{N,L} \in [\frac{1}{2a_2^2}, \frac{1}{a_1^2}]$ when $N \in \sqrt{L}[a_1, a_2]$, we can apply Proposition 4.2.5 to claim that, there exists $C, \mu > 0$ such that for L large enough,

$$\mathbf{P}_\beta(\mathcal{V}_{N,L-N+1}^+) \geq \frac{C}{N^\mu} \mathbf{P}_\beta(Y_N = Nq_{N,L}, V_N = 0), \quad N \in \sqrt{L}[a_1, a_2] \cap \mathbb{N}. \quad (4.4.28)$$

By using again the fact that $q_{N,L} \in [\frac{1}{2a_2^2}, \frac{1}{a_1^2}]$ when $N \in \sqrt{L}[a_1, a_2]$, we can apply Proposition 4.2.4, which provides a lower and an upper bound on $\mathbf{P}_\beta(Y_N = Nq_{N,L}, V_N = 0)$. By combining these last two bounds with (4.4.27–4.4.28) and by setting $\kappa = 1 + \mu/2$ we can assert that there exists $R_1 > R_2 > 0$ such that for L large enough and all $N \in \sqrt{L}[a_1, a_2]$ we have that

$$\begin{aligned} \frac{R_2}{L^\kappa} e^N \left[-\tilde{h}_0(q_{N,L}, 0) q_{N,L} + L_\Lambda(\tilde{H}(q_{N,L}, 0)) \right] \\ \leq \mathbf{P}_\beta(\mathcal{V}_{N,L-N+1}^+) \leq \frac{R_1}{L} e^N \left[-\tilde{h}_0(q_{N,L}, 0) q_{N,L} + L_\Lambda(\tilde{H}(q_{N,L}, 0)) \right]. \end{aligned} \quad (4.4.29)$$

At this stage, we recall the definition of \tilde{G}_m in (4.1.30) and we set

$$Q_{L,\beta}^m := \sum_{N=a_1\sqrt{L}}^{a_2\sqrt{L}} e^{\sqrt{L}G_{L,N}} \quad (4.4.30)$$

with

$$G_{L,N} = \frac{N}{\sqrt{L}} (q_{N,L})^{1/2} \tilde{G}_m \left(\frac{1}{(q_{N,L})^{1/2}} \right) \quad (4.4.31)$$

and we use (4.4.24) and (4.4.29) to claim that there exists $R_3 > R_4 > 0$ (depending on β only) such that for L large enough,

$$\frac{R_4}{L^\kappa} Q_{L,\beta}^m \leq \tilde{Z}_{L,\beta}^{m,\circ}(N \in \sqrt{L}[a_1, a_2]) \leq \frac{R_3}{L} Q_{L,\beta}^m. \quad (4.4.32)$$

We recall that $a \mapsto \tilde{G}_m(a)$ is a strictly negative and strictly concave function on $(0, \infty)$ and reaches its unique maximum at $a_m(\beta)$, which obviously belongs to $[a_1, a_2]$. Since, by Lemma 4.5.3, $a \mapsto \tilde{G}_m(a)$ is \mathcal{C}^1 on $(0, \infty)$, we can assert that it is Lipschitz on each compact subset of $(0, \infty)$. Moreover, there exists a $C > 0$ such that $|q_{N+1,L} - q_{N,L}| \leq C/\sqrt{L}$ for $N \in \sqrt{L}[a_1, a_2]$ and we have that

$$\left(1 - \frac{a_2}{\sqrt{L}}\right)^{\frac{1}{2}} \leq \frac{N}{\sqrt{L}} (q_{N,L})^{\frac{1}{2}} \leq \left(1 - \frac{a_1}{\sqrt{L}}\right)^{\frac{1}{2}}, \quad N \in \sqrt{L}[a_1, a_2], \quad (4.4.33)$$

therefore, we can take the supremum of $G_{L,N}$ on $N \in [a_1\sqrt{L}, a_2\sqrt{L}] \cap \mathbb{N}$ and it comes that

$$\sup \{G_{L,N}; N \in \sqrt{L} [a_1, a_2] \cap \mathbb{N}\} = \tilde{G}_m(a_m(\beta)) + O(\frac{1}{\sqrt{L}}). \quad (4.4.34)$$

By putting together (4.4.30) and (4.4.34) we obtain that there exists $R_5 > R_6 > 0$ such that for L large enough,

$$R_6 e^{\tilde{G}_m(a_m(\beta))\sqrt{L}} \leq Q_{L,\beta}^m \leq R_5 \sqrt{L} e^{\tilde{G}_m(a_m(\beta))\sqrt{L}}. \quad (4.4.35)$$

At this stage it suffices to combine (4.4.32) with (4.4.35) to complete the proof of (4.4.21) with $\kappa = \mu/2 + 1$ and $c = -\tilde{G}_m(a_m(\beta))$.

4.4.3 Proof of Theorem 4.1.7 (Horizontal expansion)

To begin this section, we prove that \tilde{G}_m is strictly concave and reaches its maximum at a unique point $a_m(\beta) \in (0, \infty)$. Recall (4.1.30) and compute its first two derivative (by using that $\nabla L_\Lambda(\tilde{H}(q, 0)) = (q, 0)$), i.e.,

$$\partial_a \tilde{G}_m(a) = \log \Gamma^m(\beta) + \frac{1}{a^2} \tilde{h}_0(\frac{1}{a^2}, 0) + L_\Lambda(\tilde{H}(\frac{1}{a^2}, 0)), \quad (4.4.36)$$

$$\partial_a^2 \tilde{G}_m(a) = -\frac{2}{a^3} \tilde{h}_0(\frac{1}{a^2}, 0) - \frac{4}{a^5} \partial_1 \tilde{h}_0(\frac{1}{a^2}, 0). \quad (4.4.37)$$

It suffices to show that $\partial_a^2 \tilde{G}_m(a) < 0$ on $(0, \infty)$ and that $\partial_a \tilde{G}_m(a)$ has a zero on $(0, \infty)$. Since $\tilde{h}_0(x, 0) = -2\tilde{h}_1(x, 0)$ (recall Remark 4.5.4), we consider $R : u \mapsto \int_0^1 xL'((x - \frac{1}{2})u)dx$ so that $\partial_1(L_\Lambda)(\tilde{H}(x, 0)) = R(\tilde{h}_0(x, 0))$. Clearly $R(0) = 0$ and $R'(u) = 2 \int_0^1 x^2 L''(xu)dx$ because L is even (recall (4.2.22)). Therefore $R'(u) > 0$ when $u \neq 0$ and $R < 0$ on $(-\infty, 0)$ and $R > 0$ on $(0, \infty)$. Since $R(\tilde{h}_0(x, 0)) = x$ for $x \in \mathbb{R}$, we can claim that $\tilde{h}_0(x, 0) > 0$ for $x \in (0, \infty)$ and by differentiating this latter equality we obtain that $\partial_1 \tilde{h}_0(x, 0) = 1/R'(\tilde{h}_0(x, 0))$ which is strictly positive on $(0, \infty)$. This completes the proof.

Let us start the proof of Theorem 4.1.7. Recall that i_1 and i_2 are the end-steps of the largest bead $I_{j_{\max}}$, i.e., $I_{j_{\max}} = \{i_1 + 1, \dots, i_2\}$. For $v > 0$, we let

$$A_{L,v} := \{l \in \Omega_L : i_1 \leq v(\log L)^4, i_2 \geq L - v(\log L)^4, I_{j_{\max}} = \{i_1 + 1, \dots, i_2\}\}. \quad (4.4.38)$$

By Theorem 4.1.6, there exists a $v > 0$ such that $\lim_{L \rightarrow \infty} P_{L,\beta}^m(A_{L,v}) = 1$. Therefore, the proof will be complete once we show that

$$\lim_{L \rightarrow \infty} P_{L,\beta}^m \left(\left\{ \left| \frac{N_L}{\sqrt{L}} - a_m \right| > \varepsilon \right\} \cap A_{L,v} \right) = 0. \quad (4.4.39)$$

Let $N_{I_{j_{\max}}}$ denote the number of horizontal steps made by the random walk in its largest bead. Pick $\varepsilon' < \varepsilon$ and since the first step and the last step of the largest bead are at distance less

than $v(\log L)^4$ from 0 and L , respectively, we can write that for L large enough

$$\begin{aligned}
P_{L,\beta}^m \left(\left\{ \left| \frac{N_L}{\sqrt{L}} - a_m \right| > \varepsilon \right\} \cap A_{L,v} \right) \\
\leq \sum_{\substack{1 \leq i_1 \leq v(\log L)^4 \\ L - v(\log L)^4 \leq i_2 \leq L}} P_{L,\beta}^m \left(\left| \frac{N_{I_{j_{\max}}}}{\sqrt{i_2 - i_1}} - a_m \right| > \varepsilon', I_{j_{\max}} = \{i_1 + 1, \dots, i_2\} \right) \\
\leq 4 \sum_{\substack{1 \leq i_1 \leq v(\log L)^4 \\ L - v(\log L)^4 \leq i_2 \leq L}} \frac{Z_{i_2 - i_1, \beta}^{m, \circ} \left(\left| \frac{N}{\sqrt{i_2 - i_1}} - a_m \right| > \varepsilon' \right)}{Z_{i_2 - i_1, \beta}^{m, \circ}},
\end{aligned} \tag{4.4.40}$$

where the coefficient 4 in front of the r.h.s. in (4.4.40) comes from a direct application of Lemma 4.4.3. Now, we focus on the numerator of the r.h.s. in (4.4.40) and since \tilde{G}_m is strictly concave and reaches its maximum at $a_m(\beta)$ we can claim that the maximum of \tilde{G}_m on $(0, a_m(\beta) - \varepsilon'] \cup [a_m(\beta) + \varepsilon', \infty)$ is given by $T_m(\varepsilon') = \max\{\tilde{G}_m(a_m(\beta) - \varepsilon'), \tilde{G}_m(a_m(\beta) + \varepsilon')\}$. We proceed as in (4.4.25)-(4.4.34) and we get that there exists a $C_1 > 0$ such that

$$Z_{i_2 - i_1, \beta}^{m, \circ} \left(\left| \frac{N}{\sqrt{i_2 - i_1}} - a_m \right| > \varepsilon' \right) \leq \frac{C_1}{\sqrt{i_2 - i_1}} \Phi_{i_2 - i_1, \beta}^m e^{T_m(\varepsilon') \sqrt{i_2 - i_1}}. \tag{4.4.41}$$

We apply Proposition 4.4.2 and the denominator can be bounded from below as

$$Z_{i_2 - i_1, \beta}^{m, \circ} \geq \frac{C_2}{(i_2 - i_1)^\kappa} \Phi_{i_2 - i_1, \beta}^m e^{\tilde{G}_m(a_m(\beta)) \sqrt{i_2 - i_1}}, \tag{4.4.42}$$

for some constants $\kappa > 1/2$ and $C_2 > 0$. Since $L - 2v(\log L)^4 \leq i_2 - i_1 \leq L$, we can state that, for L large enough, (4.4.40) becomes

$$P_{L,\beta}^m \left(\left\{ \left| \frac{N_L}{\sqrt{L}} - a_m \right| > \varepsilon \right\} \cap A_{L,v} \right) \leq C_3 L^{\kappa - \frac{1}{2}} (\log L)^8 e^{-(\tilde{G}_m(a_m(\beta)) - T_m(\varepsilon')) \sqrt{L - 2v(\log L)^4}}. \tag{4.4.43}$$

Since $\tilde{G}_m(a_m(\beta)) > T_m(\varepsilon')$, the right hand side vanishes as $L \rightarrow \infty$ and this completes the proof.

4.4.4 Proof of Lemmas 4.4.1 and 4.4.4

We will only display the proof of Lemma 4.4.4 because the proof of Lemma 4.4.1 is obtained in a very similar manner. We recall (4.4.23) and (4.4.24) and we will first show that there exists $\gamma > 0$ and $c > 0$ such that

$$\tilde{Z}_{L,\beta}^{m, \circ} \geq c e^{-\gamma \sqrt{L}}, \quad L \in \mathbb{N}. \tag{4.4.44}$$

Then, we will show that there exist $a_2 > a_1 > 0$ and $c_1, c_2 > 0$ such that

$$\begin{aligned}
\tilde{Z}_{L,\beta}^{m, \circ}(N \geq a_2 \sqrt{L}) &\leq c_2 e^{-2\gamma \sqrt{L}}, \quad L \in \mathbb{N}, \\
\tilde{Z}_{L,\beta}^{m, \circ}(N \leq a_1 \sqrt{L}) &\leq c_1 e^{-2\gamma \sqrt{L}}, \quad L \in \mathbb{N}.
\end{aligned} \tag{4.4.45}$$

Putting together (4.4.44) and (4.4.45), we will immediately obtain (4.4.22). To begin with, set $r := \lfloor \frac{L}{1+\sqrt{L}} \rfloor$, $u := L - r - (r-1)\lfloor \sqrt{L} \rfloor$ and note that $u \in \{\lfloor \sqrt{L} \rfloor, \dots, 2\lfloor \sqrt{L} \rfloor\}$. Then, consider the trajectory $V^* \in \mathcal{V}_{r+1, L-r}^+$ defined as $V_0 = V_{r+1} = 0$, $V_1 = \dots = V_{r-1} = \lfloor \sqrt{L} \rfloor$ and $V_r = u$. One can therefore compute

$$\mathbf{P}_\beta(V^*) = \left(\frac{1}{c_\beta}\right)^{r+1} e^{-\frac{\beta}{2}(2u)} \geq \left(\frac{1}{c_\beta}\right)^{r+1} e^{-2\beta\lfloor \sqrt{L} \rfloor}, \quad (4.4.46)$$

and consequently by restricting the sum in (4.4.24) to $N = r$, by using (4.4.46) and the inequality $\lfloor \sqrt{L} \rfloor \leq L$, we obtain

$$\tilde{Z}_{L,\beta}^{\text{m.o}} \geq \frac{2}{c_\beta} \left(\frac{\Gamma^{\text{m}}(\beta)}{c_\beta}\right)^r e^{-2\beta\sqrt{L}}. \quad (4.4.47)$$

It remains to note that $r \leq \sqrt{L}$ and to recall that $c_\beta > 1$ and that $\Gamma^{\text{m}}(\beta) < 1$ because $\beta > \beta_c^{\text{m}}$. This is sufficient to obtain (4.4.44).

Proving the first inequality in (4.4.45) is easy because $\Gamma^{\text{m}}(\beta) < 1$ and thus, we can use (4.4.24) to claim that there exists a $C > 0$ such that

$$\tilde{Z}_{L,\beta}^{\text{m.o}}(N \geq a_2\sqrt{L}) \leq 2 \sum_{N=a_2\sqrt{L}}^{\infty} (\Gamma^{\text{m}}(\beta))^N \leq C e^{a_2 \log(\Gamma^{\text{m}}(\beta))\sqrt{L}}. \quad (4.4.48)$$

Since $\log(\Gamma^{\text{m}}(\beta)) < 0$, it suffices to choose a_2 large enough to obtain the first inequality in (4.4.45).

To prove the last inequality in (4.4.45), we note that, for $N \leq a_1\sqrt{L}$ and for all $(V_i)_{i=0}^{N+1} \in \mathcal{V}_{N+1, L-N}^+$ we have $\max\{V_j, j \in \{1, \dots, N\}\} \geq \frac{L-N}{N} \geq \frac{\sqrt{L}}{a_1} - 1$ and therefore, for L large enough we have

$$\mathbf{P}_\beta(\mathcal{V}_{N+1, L-N}^+) \leq \mathbf{P}_\beta\left(\max\{V_j, j \leq a_1\sqrt{L}\} \geq \frac{\sqrt{L}}{2a_1}\right) \quad (4.4.49)$$

$$\leq \mathbf{P}_\beta\left(\sum_{i=1}^{a_1\sqrt{L}} |v_i| > \frac{\sqrt{L}}{2a_1}\right), \quad (4.4.50)$$

and since v_1 has some finite exponential moments, we can apply a standard Cramer's Theorem to obtain that for L large enough, there exists $g(a_1) > 0$ such that $\lim_{a_1 \rightarrow 0^+} g(a_1) = \infty$ and that $\mathbf{P}_\beta(\mathcal{V}_{N+1, L-N}^+) \leq e^{-g(a_1)\sqrt{L}}$ for $N \leq a_1\sqrt{L}$. Therefore, by taking a_1 small enough we obtain the second inequality in (4.4.45), which completes the proof of Lemma 4.4.4.

4.5 Decay rate of large area probability

4.5.1 Proof of Proposition 4.2.3

We will display here the proof of Proposition 4.2.3 subject to Lemma 4.5.1, Corollary 4.5.2 and Lemmas 4.5.3, 4.5.5, 4.5.6 that are stated below. The proofs of Lemmas 4.5.3, 4.5.5 and 4.5.6 are postponed to section 4.5.2.

In what follows we use the notation $\|(x, y)\| = \max\{|x|, |y|\}$.

Lemma 4.5.1. *For all $(j_1, j_2) \in (\mathbb{N} \cup \{0\})^2$ and all compact and convex subsets K in \mathcal{D} , there exist $c > 0$ such that*

$$\sup_{H \in K} \left\| \partial^{(j_1, j_2)} \left[\frac{1}{n} L_{\Lambda_n} \right] (H) - \partial^{(j_1, j_2)} L_\Lambda(H) \right\| \leq \frac{c}{n}, \quad n \in \mathbb{N}. \quad (4.5.1)$$

Démonstration. For all $(j_1, j_2) \in \mathbb{N}^2$, we first differentiate inside the integral

$$\partial^{(j_1, j_2)} L_\Lambda(H) = \int_0^1 \partial_{h_0, h_1}^{(j_1, j_2)} L(xh_0 + h_1) dx. \quad (4.5.2)$$

Then, by using the error estimate for the Riemann sum of $x \mapsto \partial_{h_0, h_1}^{(j_1, j_2)} L(xh_0 + h_1)$, we obtain the result. \square

By applying Lemma 4.5.1 for $(j_1, j_2) = (0, 1)$ and $(j_1, j_2) = (1, 0)$, we immediately obtain

Corollary 4.5.2. *For all compact and convex subsets K in \mathcal{D} , there exist a $c > 0$ such that*

$$\sup_{H \in K} \left\| \nabla \left[\frac{1}{n} L_{\Lambda_n} \right] (H) - \nabla L_\Lambda(H) \right\| \leq \frac{c}{n}, \quad n \in \mathbb{N}. \quad (4.5.3)$$

For $\eta > 0$, we let K_η be the compact and convex subset of \mathcal{D} defined as

$$K_\eta := \left\{ (h_0, h_1) \in \mathbb{R}^2 : h_1 \in \left[-\frac{\beta}{2} + \eta, \frac{\beta}{2} - \eta \right], h_0 + h_1 \in \left[-\frac{\beta}{2} + \eta, \frac{\beta}{2} - \eta \right] \right\}. \quad (4.5.4)$$

Lemma 4.5.3. *The function $\nabla L_\Lambda : \mathcal{D} \mapsto \mathbb{R}^2$ defined as*

$$\nabla L_\Lambda(H) = (\partial_{h_0} L_\Lambda, \partial_{h_1} L_\Lambda)(H) \quad (4.5.5)$$

$$= \left(\int_0^1 x L'(xh_0 + h_1) dx, \int_0^1 L'(xh_0 + h_1) dx \right). \quad (4.5.6)$$

is a \mathcal{C}^1 diffeomorphism. Moreover, for all $M > 0$ there exists a $\eta > 0$ such that $\|\nabla L_\Lambda(H)\| > M$ for $H \in \mathcal{D} \setminus K_\eta$.

Remark 4.5.4. *In what follows we will denote by $\tilde{H} := (\tilde{h}_0, \tilde{h}_1)$ the inverse function of $\nabla L_\Lambda(H)$. Since L is an even function, we easily obtain that $\tilde{h}_0(q, 0) = -2\tilde{h}_1(q, 0) > 0$ for all $q > 0$.*

Lemma 4.5.5. *For $[q_1, q_2] \subset (0, \infty)$, there exists a $n_0 \in \mathbb{N}$ such that for all $n \geq n_0$ and all $q \in [q_1, q_2]$, there exists a unique $H_n^q = (h_{n,0}^q, h_{n,1}^q) \in \mathcal{D}_n$ such that*

$$\nabla \left[\frac{1}{n} L_{\Lambda_n} \right] (H_n^q) = (\partial_{h_0} \left[\frac{1}{n} L_{\Lambda_n} \right], \partial_{h_1} \left[\frac{1}{n} L_{\Lambda_n} \right]) (H_n^q) = (q, 0). \quad (4.5.7)$$

Lemma 4.5.6. *For $[q_1, q_2] \subset (0, +\infty)$, there exist a $n_0 \in \mathbb{N}$ and a $\eta > 0$ such that $H_n^q \in K_\eta$ for all $q \in [q_1, q_2]$ and all $n \geq n_0$.*

At this stage, we have enough tools to prove Proposition 4.2.3.

Proof of Proposition 4.2.3. Pick $q \in [q_1, q_2]$, $n \in \mathbb{N}$ and note that

$$\left| \left[\frac{1}{n} L_{\Lambda_n}(H_n^q) - h_{n,0}^q q \right] - \left[L_\Lambda(\tilde{H}(q, 0)) - \tilde{h}_0(q, 0) q \right] \right| \leq U + V + W \quad (4.5.8)$$

with

$$U = \left| \frac{1}{n} L_{\Lambda_n}(H_n^q) - L_\Lambda(H_n^q) \right|, \quad V = \left| L_\Lambda(H_n^q) - L_\Lambda(\tilde{H}(q, 0)) \right|, \quad W = q \left| h_{n,0}^q - \tilde{h}_0(q, 0) \right|. \quad (4.5.9)$$

From Lemma 4.5.6, we know that there exists an $\eta > 0$ and a $n_0 \in \mathbb{N}$ such that $H_n^q \in K_\eta$ for all $q \in [q_1, q_2]$ and $n \geq n_0$. By using Lemma 4.5.1 with $(j_1, j_2) = (0, 0)$ and $K = K_\eta$ we can claim that there exists a $C_1 > 0$ satisfying $U \leq \frac{C_1}{n}$ for $n \geq n_0$ and $q \in [q_1, q_2]$. The V quantity is dealt with by applying Corollary 4.5.2 with $K = K_\eta$, that is there exists a $C_2 > 0$ such that

$$\sup_{x \in K_\eta} \left\| \nabla \left[\frac{1}{n} L_{\Lambda_n} \right] (x) - \nabla L_\Lambda(x) \right\| \leq \frac{C_2}{n}, \quad n \geq n_0. \quad (4.5.10)$$

Therefore, for $q \in [q_1, q_2]$ and $n \geq n_0$ we can write

$$\begin{aligned} \nabla \left[\frac{1}{n} L_{\Lambda_n} \right] (H_n^q) &= \nabla L_\Lambda(H_n^q) + \varepsilon_{n,q}, \\ (q, 0) &= \nabla L_\Lambda(H_n^q) + \varepsilon_{n,q} \end{aligned} \quad (4.5.11)$$

with $\|\varepsilon_{n,q}\| \leq \frac{C_2}{n}$. Therefore, by Lemma 4.5.3, we can claim that $H_n^q = \tilde{H}((q, 0) - \varepsilon_{n,q})$. We set

$$K_n = \left\{ (x, y) \in \mathbb{R}^2 : d((x, y), [q_1, q_2] \times \{0\}) \leq \frac{C_2}{n} \right\},$$

so that there exists a $n_1 \geq n_0$ such that K_{n_1} is a convex subset of \mathcal{D} and since $c \mapsto \tilde{H}(c)$ is \mathcal{C}^1 on \mathcal{D} we can claim that \tilde{H} is Lipschitz on K_{n_1} . Thus, there exists a $C_3 > 0$ such that

$$\|H_n^q - \tilde{H}((q, 0))\| \leq C_3 \|\varepsilon_{n,q}\| \leq \frac{C_2 C_3}{n}, \quad q \in [q_1, q_2], n \geq n_1, \quad (4.5.12)$$

and this proves (4.2.33). Moreover

$$W \leq q_2 \|H_n^q - \tilde{H}((q, 0))\| \leq \frac{q_2 C_2 C_3}{n}, \quad q \in [q_1, q_2], n \geq n_1. \quad (4.5.13)$$

Finally, since L_Λ is \mathcal{C}^1 on \mathcal{D} , there exists a $C_4 > 0$ such that L_Λ is Lipschitz with constant C_4 on K_{n_1} . Thus,

$$V \leq C_4 \|H_n^q - \tilde{H}((q, 0))\| \leq \frac{C_2 C_3 C_4}{n}, \quad q \in [q_1, q_2], n \geq n_1. \quad (4.5.14)$$

This completes the proof of Proposition 4.2.3. \square

4.5.2 Proof of Lemmas 4.5.3, 4.5.5 and 4.5.6

Proof of Lemma 4.5.3

The fact that $h \mapsto L'(h)$ is \mathcal{C}^1 and that $L''(h)$ is strictly positive on $(-\frac{\beta}{2}, \frac{\beta}{2})$ ensures that ∇L_Λ is \mathcal{C}^1 and that its Jacobian determinant that takes value

$$J_{(h_0, h_1)} \nabla L_\Lambda = \int_0^1 x^2 L''(xh_0 + h_1) dx \int_0^1 L''(xh_0 + h_1) dx - \left[\int_0^1 x L''(xh_0 + h_1) dx \right]^2 \quad (4.5.15)$$

is, by Cauchy Schwartz inequality, strictly positive. Thus, the proof that ∇L_Λ is a \mathcal{C}^1 diffeomorphism from \mathcal{D} to \mathbb{R}^2 will be complete once we show that ∇L_Λ is a bijection from \mathcal{D} to \mathbb{R}^2 .

For the ease of notations, we will use, during this proof only, the notation $(F_1, F_2) := \nabla L_\Lambda$. Thus, for $(q, b) \in \mathbb{R}^2$ the equation $\nabla L_\Lambda = (q, b) \in \mathbb{R}^2$, can be rewritten as

$$\begin{cases} F_1(h_0, h_1) = \int_0^1 x L'(xh_0 + h_1) dx = q, & (i) \\ F_2(h_0, h_1) = \int_0^1 L'(xh_0 + h_1) dx = b, & (ii) \end{cases} \quad (4.5.16)$$

Pick $b \in \mathbb{R}$. By using that $h \mapsto L'(h)$ is a strictly increasing bijection from $(-\frac{\beta}{2}, \frac{\beta}{2})$ to \mathbb{R} , we can show that for all $h_1 \in (-\frac{\beta}{2}, \frac{\beta}{2})$, there exists a unique $\tilde{h}_0(h_1, b) \in \mathbb{R}$ such that $(\tilde{h}_0(h_1, b), h_1) \in \mathcal{D}$ and satisfies equation (ii). Moreover, the fact that $L''(h) > 0$ on $(-\frac{\beta}{2}, \frac{\beta}{2})$ immediately tells us that $\partial_{h_0} F_2$ and $\partial_{h_1} F_2$ are strictly positive on \mathcal{D} and therefore, we can apply the implicit function theorem and claim that $h_1 \mapsto \tilde{h}_0(h_1, b)$ is \mathcal{C}^1 on $(-\frac{\beta}{2}, \frac{\beta}{2})$ and strictly decreasing because $\partial_{h_1} \tilde{h}_0(h_1, b) = -[\partial_{h_1} F_2 / \partial_{h_0} F_2](\tilde{h}_0(h_1, b), h_1) < 0$ for all $h_1 \in (-\frac{\beta}{2}, \frac{\beta}{2})$.

At this stage, proving that, for all $b \in \mathbb{R}$, $\psi_b : h_1 \mapsto F_1(\tilde{h}_0(h_1, b), h_1)$ is a strictly decreasing bijection from $(-\frac{\beta}{2}, \frac{\beta}{2}) \mapsto \mathbb{R}$ will be sufficient to complete the proof of the \mathcal{C}^1 diffeomorphism. To that aim, we compute the derivative of ψ_b and we use the expression of $\partial_{h_1} \tilde{h}_0(h_1, b)$ above to show that

$$\psi'_b(h_1) = -\frac{\int_0^1 L''(x\tilde{h}_0 + h_1) dx}{\int_0^1 xL''(x\tilde{h}_0 + h_1) dx} \int_0^1 x^2 L''(x\tilde{h}_0 + h_1) dx + \int_0^1 xL''(x\tilde{h}_0 + h_1) dx.$$

A straightforward application of Cauchy Schwartz inequality, together with the fact that $L'' > 0$ implies that ψ_b is strictly decreasing. Thus it suffices to prove that ψ_b diverges in both $(-\frac{\beta}{2})^+$ and $(\frac{\beta}{2})^-$ to complete the proof. The latter divergences are direct consequences of the last property stated in Lemma 4.5.3 and that we are going to prove now, i.e., for all $M > 0$ there exists a $\eta > 0$ such that $\|\nabla L_\Lambda(H)\| > M$ for $H \in \mathcal{D} \setminus K_\eta$.

Proving that $\|\nabla L_\Lambda(H)\|$ is arbitrarily large provided we choose H outside K_η (for a small enough η) can be achieved without facing any major technical difficulty. It requires mainly to use that $h \mapsto L(h)$ is strictly convex and that $L(h)$ and $L'(h)$ both diverge when $|h| \rightarrow (\beta/2)^-$. However, the proof is long and tedious and for this reason we will only give a heuristic of the proof based on Fig. 4.5. First, we note that the two coordinates of $\nabla L_\Lambda(h_0, h_1)$ can be reexpressed as

$$\begin{cases} F_1(h_0, h_1) = \int_0^1 xL'(xh_0 + h_1)dx = \frac{1}{2}F_2(h_0, h_1) + \frac{1}{h_0^2}\mathcal{A}(h_0, h_1), & (i) \\ F_2(h_0, h_1) = \int_0^1 L'(xh_0 + h_1)dx = \frac{1}{h_0}(L(h_1 + h_0) - L(h_1)), & (ii) \end{cases} \quad (4.5.17)$$

where $\mathcal{A}(h_0, h_1) = \frac{h_0(L(h_1+h_0)+L(h_1))}{2} - \int_0^{h_0} L(x+h_1)dx$. Then, we denote by A and B the points of coordinates $(h_1, L(h_1))$ and $(h_1 + h_0, L(h_1 + h_0))$, respectively. Thus, $|\mathcal{A}(h_0, h_1)|$ can be seen as the area of the domain in between AB and the arc of the graph of $L(\cdot)$ (See Fig. 4.5), while equation (ii) tells us that $F_2(h_0, h_1)$ is the slope coefficient of the segment AB . As we can easily check on the picture, for a given $M > 0$, there exists an $\eta_0 > 0$ such that if $h_1 \notin [-\frac{\beta}{2} + \eta_0, \frac{\beta}{2} - \eta_0]$, and if $\text{sign}(h_1) = \text{sign}(h_1 + h_0)$ then the absolute value of the AB -slope ($|F_2(h_0, h_1)|$) is larger than M (see the left picture of Fig. 4.5). By symmetry the same happens if we switch h_1 and $h_0 + h_1$. Thus it remains to check what happens if $h_1 \notin [-\frac{\beta}{2} + \eta_0, \frac{\beta}{2} - \eta_0]$ and $\text{sign}(h_1) \neq \text{sign}(h_1 + h_0)$. In this latter case, for the AB -slope to be small, we must have that $|h_1| \sim |h_0 + h_1|$. But then, obviously, $|\mathcal{A}(h_0, h_1)|/h_0^2$ becomes very large (see the right picture of Fig. 4.5), which ensure that $|F_1(h_0, h_1)| > M$ and completes the proof.

Proof of Lemma 4.5.5

For the ease of notations, we settle the discrete version of those notations introduced in the proof of Lemma 4.5.3, that is $(F_{1,n}, F_{2,n}) := \nabla(\frac{1}{n}L_{\Lambda_n})$. Thus, for $q \in \mathbb{R}$ the equation

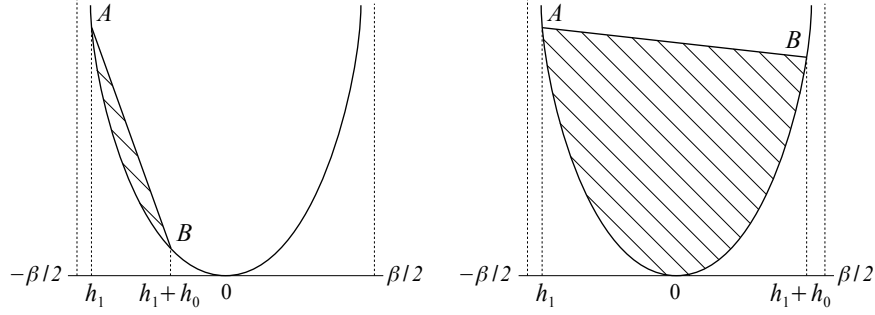
FIGURE 4.5 – The hatched domain corresponds to $|\mathcal{A}(h_0, h_1)|$.

$\nabla(\frac{1}{n}L_{\Lambda_n}) = (q, 0)$, can be rewritten as

$$\begin{cases} F_{1,n}(h_0, h_1) := \frac{1}{n} \sum_{i=0}^{n-1} \frac{i}{n} L'(\frac{i}{n}h_0 + h_1) = q, & \text{(i)} \\ F_{2,n}(h_0, h_1) := \frac{1}{n} \sum_{i=0}^{n-1} L'(\frac{i}{n}h_0 + h_1) = 0. & \text{(ii)} \end{cases} \quad (4.5.18)$$

By simply mimicking the first part of the proof of Lemma 4.5.3, we obtain with no further difficulty that for all $h_1 \in (-\frac{\beta}{2}, \frac{\beta}{2})$, there exists a unique $h_{0,n}(h_1) \in \mathbb{R}$ such that $(h_{0,n}(h_1), h_1) \in \mathcal{D}_n$ and satisfies equation (ii). Moreover, $h_1 \mapsto h_{0,n}(h_1)$ is \mathcal{C}^1 and strictly decreasing and $\psi_n := h_1 \mapsto F_{1,n}(h_{0,n}(h_1), h_1)$ is also \mathcal{C}^1 and strictly decreasing.

Given $0 < q_1 < q_2$, it remains to show that there exists a $n_0 \in \mathbb{N}$ such that for all $n \geq n_0$, $[q_1, q_2] \subset \psi_n((-\frac{\beta}{2}, \frac{\beta}{2}))$. The fact that L is even implies that, for all $n \in \mathbb{N}$, $h_{0,n}(0) = 0$ and therefore $\psi_n(0) = 0$. Thus it suffices to find $n_0 \in \mathbb{N}$ and $x \in (-\frac{\beta}{2}, 0)$ such that $|\psi_n(x)| > q_2$ for all $n \geq n_0$. By Lemma 4.5.3, we can take $\eta > 0$ such that $\|\nabla L_{\Lambda}(H)\| > 2q_2$ for $H \in \mathcal{D} \setminus K_{\eta}$. We pick $\eta' < \eta$, we let $K = K_{\eta'} \setminus K_{\eta}$ and we apply Corollary 4.5.2 to get that there exists a $c > 0$ such that

$$\sup_{H \in K} \|\nabla[\frac{1}{n}L_{\Lambda_n}](H) - \nabla L_{\Lambda}(H)\| \leq \frac{c}{n}, \quad n \in \mathbb{N}. \quad (4.5.19)$$

Thus, (4.5.19) implies that $\|\nabla[\frac{1}{n}L_{\Lambda_n}](H)\| > q_2$ for all $H \in K$ and n large enough. We choose $x = -\beta/2 + \eta'$ and we obtain that for n large enough $\|\nabla[\frac{1}{n}L_{\Lambda_n}](h_{0,n}(x), x)\| = |F_{1,n}(h_{0,n}(x), x)| = |\psi_n(x)| > q_2$, which completes the proof.

Proof of Lemma 4.5.6

We keep using the notations introduced in the proof of Lemma 4.5.5 so that $H_n^q = (h_{n,0}^q, h_{n,1}^q) = (h_{0,n}(h_{n,1}^q), h_{n,1}^q)$ and satisfies $F_{1,n}(H_n^q) = q$ and $F_{2,n}(H_n^q) = 0$. The proof will be complete once we show that there exist $\eta > 0$ and $n_0 \in \mathbb{N}$ such that $|F_{1,n}(h_{0,n}(h_1), h_1)| > q_2$ for all $n \geq n_0$ and all $h_1 \in (-\frac{\beta}{2}, \frac{\beta}{2})$: $(h_{0,n}(h_1), h_1) \in \mathcal{D}_n \setminus K_{\eta}$.

In the proof of Lemma 4.5.3, we showed that there exist $n_0 \in \mathbb{N}$ and $\eta > \eta' > 0$ such that $|F_{1,n}(h_{0,n}(h_1), h_1)| > q_2$ for all $n \geq n_0$ and all $(h_{0,n}(h_1), h_1) \in K := K_{\eta'} \setminus K_{\eta}$. Now, assume that there exist a $n \geq n_0$ and a $h_1 \in (-\frac{\beta}{2}, 0)$: $(h_{0,n}(h_1), h_1) \in \mathcal{D}_n \setminus K_{\eta}$ such that $F_{2,n}(h_{0,n}(h_1), h_1) \leq q_2$ (the case $h_1 > 0$ is treated similarly). The latter inequality implies that $(h_{0,n}(h_1), h_1) \in \mathcal{D}_n \setminus K_{\eta'}$. Since $x \mapsto (h_{0,n}(x), x)$ is continuous, and since $(h_{0,n}(0), 0) = (0, 0) \in K_{\eta}$, there exists necessarily a $h'_1 \in (h_1, 0)$ such that $(h_{n,0}(h'_1), h'_1) \in K_{\eta'} \setminus K_{\eta}$ which

leads to a contradiction because in this case

$$F_{2,n}(h_{0,n}(h_1), h_1) > F_{2,n}(h_{0,n}(h'_1), h'_1) > q_2. \quad (4.5.20)$$

This completes the proof.

4.6 Limit theorems for the joint distribution

In section 4.6.1 below, we give a proof of Proposition 4.2.2 which estimates, uniformly in $q \in [q_1, q_2] \subset (0, \infty)$, the probability of the event $\{\Lambda_n = (Y_n, V_n) = (nq, 0)\}$ under the tilted law \mathbf{P}_{n, H_n^q} (recall (4.2.29)). To that aim, we state and prove Proposition 4.6.1, which gives a local central limit Theorem for (Y_n, V_n) under \mathbf{P}_{n, H_n^q} . In section 4.6.2, we prove Proposition 4.2.5 which allows us to bound from below the probability that, under \mathbf{P}_β and conditioned on both $V_n = 0$ and $Y_n = nq$ the random walk V remains strictly positive.

4.6.1 Proof of Proposition 4.2.2

We display the proof of Proposition 4.2.2 which turns out to be a straightforward consequence of Proposition 4.6.1 below. The latter Proposition will be proven at the end of the section.

Démonstration. Recall (4.2.21–4.2.29) and for any $H \in \mathcal{D}$, define the matrix

$$\mathbf{B}(H) := \text{Hess } L_\Lambda(H) \quad (4.6.1)$$

and let Θ be the Gaussian random vector with zero mean and covariance matrix $\mathbf{B}(H)$. We denote the density of Θ by

$$f_H(X) = \frac{1}{2\pi\sqrt{\det \mathbf{B}(H)}} \exp\left(-\frac{1}{2}\langle \mathbf{B}(H)^{-1}X, X \rangle\right), \quad X \in \mathbb{R}^2, \quad (4.6.2)$$

and its characteristic function by

$$\bar{\Phi}_H(T) = \exp\left(-\frac{1}{2}\langle \mathbf{B}(H)T, T \rangle\right), \quad T \in \mathbb{R}^2. \quad (4.6.3)$$

Consider now the case $(Y_N, V_N) = (Nq_{N,L}, 0)$ as in section 4.4.2 and recall that $q_{N,L} \in [\frac{1}{2a_2^2}, \frac{1}{a_1^2}]$. We will show that the local central limit theorem below is valid uniformly in q in some compact subsets.

Proposition 4.6.1. *For $[q_1, q_2] \subset \mathbb{R}$ we have*

$$\tau_N := \sup_{q \in [q_1, q_2]} \sup_{x, y \in \mathbb{Z}} \left| N^2 \mathbf{P}_{N, H_N^q}(NY_N = N^2q + x, V_N = y) - f_{\tilde{H}(q,0)}\left(\frac{x}{N^{3/2}}, \frac{y}{\sqrt{N}}\right) \right| \rightarrow 0, \quad (4.6.4)$$

as $N \rightarrow \infty$.

By applying Proposition 4.6.1 with $x = y = 0$, we obtain that

$$\sup_{q \in [q_1, q_2]} \left| N^2 \mathbf{P}_{N, H_N^q}(NY_N = N^2q, V_N = 0) - f_{\tilde{H}(q,0)}(0, 0) \right| \leq \tau_N \rightarrow 0, \quad (4.6.5)$$

and since the Hessian matrix $B(\tilde{H}(q, 0))$ is uniformly bounded in $q \in [q_1, q_2]$, we observe that there exists $C > 0$ such that

$$\frac{1}{CN^2} \leq \mathbf{P}_{N, H_N^q}(NY_N = N^2q, V_N = 0) \leq \frac{C}{N^2} \quad \text{for } N \text{ large enough} \quad (4.6.6)$$

which completes the proof of Proposition 4.2.2. \square

Proof of Proposition 4.6.1

We follow closely the proof of Dobrushin and Hryniv in [10], making sure that the result holds uniformly in $q \in [q_1, q_2]$. From Lemma 4.5.3 and Lemma 4.5.6, there exists $\eta > 0$ such that both $\tilde{H}(q, 0)$ and H_N^q are in K_η for all $q \in [q_1, q_2]$ and for N large enough. For any $h \in \mathcal{K} := [-\beta/2 + \eta, \beta/2 - \eta]$ we denote by $\varphi_h(t)$ the characteristic function of the random variable v_1 under the tilted probability distribution

$$\varphi_h(t) = \mathbf{E}_h[e^{itv_1}] = e^{L(h+it) - L(h)}. \quad (4.6.7)$$

Let us recall some properties of the function $\varphi_h(t)$ in [10] which will be used in what follows. First of all, for any $h \in \mathcal{K}$ and $t \in \mathbb{R}$

$$|\varphi_h(t)| \leq \varphi_h(0) = 1. \quad (4.6.8)$$

Secondly, for any $\delta \in (0, \pi)$, there exists a constant $C = C(\mathcal{K}, \delta) > 0$ such that for every $h \in \mathcal{K}$ and any $t \in [\delta, 2\pi - \delta]$, we have

$$|\varphi_h(t)| \leq e^{-C}. \quad (4.6.9)$$

And finally, there exists a constant $\alpha = \alpha(\mathcal{K}) > 0$ such that for all $h \in \mathcal{K}$ and any $t, |t| \leq \pi$, the following inequality holds

$$|\varphi_h(t)| \leq \exp(-\alpha^2 t^2 L''(h)). \quad (4.6.10)$$

For any $T = (t_0, t_1) \in \mathbb{R}^2$, let $\Phi_{N, H_N^q}(T)$ be the characteristic function of the random vector $\Lambda_N = (Y_N, V_N)$. Let us rewrite it with the functions $\varphi_h(t)$,

$$\Phi_{N, H_N^q}(T) = \mathbf{E}_{N, H_N^q}[e^{i\langle T, \Lambda_N \rangle}] = \prod_{j=1}^N \varphi_{h_{j,N}}(t_{j,N}), \quad (4.6.11)$$

where

$$h_{j,N} = (1 - \frac{j}{N})h_{N,0}^q + h_{N,1}^q \quad \text{and} \quad t_{j,N} = (1 - \frac{j}{N})t_0 + t_1. \quad (4.6.12)$$

Note that

$$\hat{\Phi}_{N, H_N^q}(T) = \Phi_{N, H_N^q}(N^{-1/2}T) \exp\left(-\frac{i}{\sqrt{N}}\langle T, \mathbf{E}_{N, H_N^q}(\Lambda_N) \rangle\right) \quad (4.6.13)$$

is the characteristic function of the centered random vector $\Lambda_N^* := \Lambda_N - \mathbf{E}_{N, H_N^q}(\Lambda_N)$.

Let $X_N = (\frac{x}{N^{3/2}}, \frac{y}{\sqrt{N}})$ and using the well known inversion formula for the Fourier transform, we rewrite the left hand side of (4.6.4), i.e.,

$$R_N = N^2 \mathbf{P}_{N, H_N^q}(NY_N = N^2q + x, V_N = y) - f_{\tilde{H}(q,0)}(X_N) \quad (4.6.14)$$

in the form

$$R_N = \frac{1}{(2\pi)^2} \int_{\mathcal{A}} \hat{\Phi}_{N, H_N^q}(T) e^{-i\langle T, X_N \rangle} dT - \frac{1}{(2\pi)^2} \int_{\mathbb{R}^2} \bar{\Phi}_{\tilde{H}(q,0)}(T) e^{-i\langle T, X_N \rangle} dT, \quad (4.6.15)$$

where

$$\mathcal{A} = \{T = (t_0, t_1) \in \mathbb{R}^2 : |t_0| \leq \pi N^{3/2}, |t_1| \leq \pi \sqrt{N}\}. \quad (4.6.16)$$

Following the proof in [10] we bound the left hand side of (4.6.15) by the sum of four terms,

$$|R_N| \leq (2\pi)^{-2} (J_1^{(q)} + J_2^{(q)} + J_3^{(q)} + J_4^{(q)}) \quad (4.6.17)$$

where, for some positive constants A and Δ ,

$$J_1^{(q)} = \int_{\mathcal{A}_1} |\hat{\Phi}_{N, H_N^q}(T) - \bar{\Phi}_{\tilde{H}(q,0)}(T)| dT, \quad \mathcal{A}_1 = [-A, A]^2, \quad (4.6.18)$$

$$J_2^{(q)} = \int_{\mathcal{A}_2} \bar{\Phi}_{\tilde{H}(q,0)}(T) dT, \quad \mathcal{A}_2 = \mathbb{R}^2 \setminus \mathcal{A}_1, \quad (4.6.19)$$

$$J_3^{(q)} = \int_{\mathcal{A}_3} |\hat{\Phi}_{N, H_N^q}(T)| dT, \quad \mathcal{A}_3 = \{T \in \mathbb{R}^2 : |t_l| \leq \Delta \sqrt{N}, l = 0, 1\} \setminus \mathcal{A}_1, \quad (4.6.20)$$

$$J_4^{(q)} = \int_{\mathcal{A}_4} |\hat{\Phi}_{N, H_N^q}(T)| dT, \quad \mathcal{A}_4 = \mathcal{A} \setminus (\mathcal{A}_1 \cup \mathcal{A}_3). \quad (4.6.21)$$

For an arbitrary $\varepsilon > 0$, Dobrushin and Hryniv proved that for a convenient choice of the constants $A = A(\varepsilon)$ and Δ , we have the bounds $J_i^{(q)} < \varepsilon/4$ for $i = 1, 2, 3, 4$ for sufficiently large N . Therefore, the proof will be complete once we show that this assertion is also valid uniformly in $q \in [q_1, q_2]$. It remains to evaluate all $J_i^{(q)}$.

First, we bound $J_1^{(q)}$. For $H \in \mathcal{D}_n$, define the matrix

$$\mathbf{B}_n(H) := \frac{1}{n} \text{Hess } L_{\Lambda_n}(H), \quad n \in \mathbb{N}. \quad (4.6.22)$$

By Lemma 4.5.1 and Proposition 4.2.3, we obtain the relation

$$\mathbf{B}_N(H_N^q) = \mathbf{B}(\tilde{H}(q, 0)) + O(N^{-1}), \quad (4.6.23)$$

where the term $O(N^{-1})$ is uniform in $q \in [q_1, q_2]$. Fix $T \in \mathbb{R}^2$, using the Taylor expansion for the logarithm of the characteristic function $\hat{\Phi}_{N, H_N^q}(T)$ of the vector Λ_N^* , we get

$$\log \hat{\Phi}_{N, H_N^q}(T) = L_{\Lambda_N}(H_N^q + iN^{-1/2}T) - L_{\Lambda_N}(H_N^q) - \frac{i}{\sqrt{N}} \langle T, \mathbf{E}_{N, H_N^q(\Lambda_N)} \rangle \quad (4.6.24)$$

$$= -\frac{1}{2} \langle \mathbf{B}_N(H_N^q) T, T \rangle + R_N, \quad (4.6.25)$$

where the remainder term R_N equals

$$R_N = -\frac{i}{6N^{3/2}} \sum_{l, m, p=0}^2 t_l t_m t_p \frac{\partial^3}{\partial h_l \partial h_m \partial h_p} L_{\Lambda_N}(H_N^q + iwN^{-1/2}T) \quad (4.6.26)$$

with some $w = w(H_N^q, T)$, $0 \leq w \leq 1$. Since $R_N = O(N^{-1/2})$ as $N \rightarrow \infty$ uniformly in $q \in [q_1, q_2]$ and in T from any fixed compact set in \mathbb{R}^2 , it follows from (4.6.23) that

$$\sup_{q \in [q_1, q_2]} |\hat{\Phi}_{N, H_N^q}(T) - \bar{\Phi}_{\tilde{H}(q,0)}(T)| \rightarrow 0 \quad \text{as } N \rightarrow \infty. \quad (4.6.27)$$

Therefore, for every finite $A > 0$, we obtain the convergence $J_1^{(q)} \rightarrow 0$ as $N \rightarrow \infty$ uniformly in $q \in [q_1, q_2]$.

Let \underline{B} be such that $0 < \underline{B} \leq B(\tilde{H}(q, 0))$ for all $q \in [q_1, q_2]$. Hence, we can bound $J_2^{(q)}$ as follows

$$\sup_{q \in [q_1, q_2]} J_2^{(q)} \leq \int_{\mathcal{A}_2} e^{-\frac{1}{2}\langle \underline{B}T, T \rangle} dT \rightarrow 0 \quad \text{as } A \rightarrow \infty. \quad (4.6.28)$$

To estimate $J_3^{(q)}$ we fix any $T \in \mathcal{A}_3$ and put $\Delta = \pi/2$. Then all the numbers $t_{j,N}$ in (4.6.12) satisfy the condition $|t_{j,N}| \leq \pi\sqrt{N}$, evaluating each factor in (4.6.11) with the help of (4.6.10) and (4.6.23) we obtain the bound

$$|\hat{\Phi}_{N, H_N^q}(T)| \leq \exp(-\alpha \langle B_N(H_N^q)T, T \rangle) \leq C \exp(-\alpha \langle B(\tilde{H}(q, 0))T, T \rangle), \quad (4.6.29)$$

for some constant $C > 0$. As a result,

$$\sup_{q \in [q_1, q_2]} J_3^{(q)} = \sup_{q \in [q_1, q_2]} \int_{\mathcal{A}_3} |\hat{\Phi}_{N, H_N^q}(T)| dT \leq C \int_{\mathcal{A}_2} \exp(-\alpha \langle \underline{B}T, T \rangle) dT \rightarrow 0 \quad \text{as } A \rightarrow \infty. \quad (4.6.30)$$

To evaluate $J_4^{(q)}$ put $\delta = \frac{1}{17(2)^2}$ and for any $T \in \mathcal{A}_4$ denote by $\mathbf{N}_N(T)$ the number of indexes $j = 1, 2, \dots, N$ such that $\tau_{j,N} \notin \mathcal{O}_\delta := \cup_{m \in \mathbb{Z}} [m - \delta, m + \delta]$, where

$$\tau_{j,N} := \frac{1}{2\pi\sqrt{N}} t_{j,N}. \quad (4.6.31)$$

Use (4.6.8) and (4.6.9) to estimate those factors in (4.6.11) and we have

$$|\hat{\Phi}_{N, H_N^q}(T)| = \prod_{j=1}^N \left| \varphi_{h_{j,N}} \left(\frac{1}{\sqrt{N}} t_{j,N} \right) \right| \leq \exp(-C \mathbf{N}_N(T)). \quad (4.6.32)$$

A lower bound of $\mathbf{N}_N(T)$ is given in [10, p. 443] : for all $T \in \mathcal{A}_4$ and N large enough, there exists a constant $\beta > 0$ such that $\mathbf{N}_N(T) \geq \beta N$. Then, uniformly in $q \in [q_1, q_2]$,

$$J_4^{(q)} = \int_{\mathcal{A}_4} |\hat{\Phi}_{N, H_N^q}(T)| dT \leq (2\pi)^2 N^2 \exp(-C\beta N) \rightarrow 0 \quad \text{as } N \rightarrow \infty. \quad (4.6.33)$$

4.6.2 Proof of Proposition 4.2.5 (Unique excursion for large area)

From now on, the letters C, C', C_1, \dots shall denote constants that do not depend on N and on $q \in [q_1, q_2] \subset (0, \infty)$. In other words, all the bounds we are going to establish are uniform in $N \geq N_0$ and $q \in [q_1, q_2]$.

To begin with, we prove Lemma 4.6.4 subject to Lemmas 4.6.2 and 4.6.3 below. Lemma 4.6.4 is crucial in the proof of Proposition 4.2.5. It allows us indeed to bound from below, for any $j \in \mathbb{N}$, the probability that the V random walk, conditioned on making a large area, is below 0 at time j . Such a lower bound was available in [10] but only for j of order N . Here, we deal with any $j \leq N$. The first step of the proof is an upper bound on the moment generating function of the tilted V random walk.

Lemma 4.6.2. *There exist three positive constants C', C_1, λ such that for every integer $j \leq N/2$, the following bound holds*

$$\mathbf{E}_{N, H_N^q} [e^{-\lambda V_j}] \leq C' e^{-C_1 j}, \quad N \in \mathbb{N}. \quad (4.6.34)$$

Démonstration. For any positive λ we have

$$\log \mathbf{E}_{N, H_N^q} [e^{-\lambda V_j}] = \sum_{1 \leq i \leq j} (L(-\lambda + h_N^i) - L(h_N^i)) \quad (4.6.35)$$

with $h_N^i := (1 - \frac{i}{N})h_{N,0}^q + h_{N,1}^q$. Recall that (see Lemma 4.5.6) we picked $\eta > 0$ such that for all $N \geq N_0$ and every $q \in [q_1, q_2]$, $H_N^q \in K_\eta$. We shall impose $\lambda \in [0, \eta/2]$ so that with $I_\eta := (-\beta/2 + \eta/2, \beta/2 - \eta/2)$ we have

$$h_N^i \in I_\eta \text{ and } h_N^i - \lambda \in I_\eta \text{ for all } i \leq N, N \geq N_0, q \in [q_1, q_2]. \quad (4.6.36)$$

Observe that by convexity of $L(\cdot)$,

$$\sum_{1 \leq i \leq j} (L(-\lambda + h_N^i) - L(h_N^i)) \leq -\lambda \sum_{1 \leq i \leq j} L'(-\lambda + h_N^i). \quad (4.6.37)$$

We established in Proposition 4.2.3 the existence of a constant $C > 0$ such that for all $N \geq N_0$, and every $q \in [q_1, q_2]$, we have

$$\|H_N^q - \tilde{H}(q, 0)\| \leq \frac{C}{N}. \quad (4.6.38)$$

Hence we have, thanks to Remark 4.5.4,

$$h_N^i \geq (1 - \frac{i}{N})\tilde{h}_0(q, 0) + \tilde{h}_1(q, 0) - 2\frac{C}{N} \geq (\frac{1}{2} - \frac{i}{N})\tilde{h}_0(q, 0) - 2\frac{C}{N} =: \tilde{h}_{N,i}^q. \quad (4.6.39)$$

We now introduce the set of indices

$$\Gamma = \Gamma(j, \lambda, N) := \{i : 1 \leq i \leq j, -\lambda + \tilde{h}_{N,i}^q < 0\}. \quad (4.6.40)$$

With these notations, we have, since L' increases, and $L(s) \geq 0$ for $s \geq 0$,

$$\begin{aligned} \sum_{1 \leq i \leq j} L'(-\lambda + h_N^i) &\geq \sum_{1 \leq i \leq j} L'(-\lambda + \tilde{h}_{N,i}^q) \\ &\geq \sum_{i \leq j, i \in \Gamma^c} L'(-\lambda + \tilde{h}_{N,i}^q) + \sum_{i \leq j, i \in \Gamma} L'(-\lambda + \tilde{h}_{N,i}^q) \\ &\geq \sum_{i \leq j, i \in \Gamma^c} L'(-\lambda + \tilde{h}_{N,i}^q) - C_\eta |\Gamma|, \end{aligned}$$

with $C_\eta := \sup_{x \in I_\eta} |L'(x)|$. □

Case 1 : Assume that $j \leq N/4$. Thanks to Lemma 4.5.3 there exists a constant $R > 0$ such that

$$\tilde{h}_0(q, 0) \geq R > 0 \quad \forall q \in [q_1, q_2]. \quad (4.6.41)$$

We shall impose the constraint $\lambda \leq \frac{R}{16}$. By letting N_0 be a little larger, we can assume that $\frac{2C}{N} \leq \frac{R}{8}$ and therefore, for any $i \in [1, j]$,

$$-\lambda + \tilde{h}_{N,i}^q \geq \frac{1}{4}\tilde{h}_0(q, 0) - \lambda - \frac{2C}{N} \geq \frac{R}{16} > 0, \quad (4.6.42)$$

and thus the index set Γ is empty. Hence, since $s \rightarrow L(s)$ is increasing positive on $[0, \beta/2)$,

$$\sum_{1 \leq i \leq j} L'(-\lambda + h_N^i) \geq jL'(R/16). \quad (4.6.43)$$

Case 2 : Assume now that $N/4 \leq j \leq N/2$. With the same constant R as before,

$$\sum_{1 \leq i \leq j} L'(-\lambda + h_N^i) \geq \sum_{1 \leq i \leq \frac{N}{4}} L'(-\lambda + h_N^i) + \sum_{\frac{N}{4} \leq i \leq j: i \in \Gamma^c} L'(-\lambda + h_N^i) - C_\eta |\Gamma|, \quad (4.6.44)$$

$$\geq \frac{N}{4} L'(R/16) - C_\eta |\Gamma|, \quad (4.6.45)$$

$$(4.6.46)$$

Since $\tilde{h}_0(q, 0) \geq R$ and $i \leq j \leq \frac{N}{2}$, we have

$$|\Gamma| \leq \left| \left\{ i: i \leq \frac{N}{2}, -\lambda + \left(\frac{1}{2} - \frac{i}{N}\right)R - \frac{2C}{N} < 0 \right\} \right| \leq \frac{\lambda N}{R} + \frac{2C}{R}. \quad (4.6.47)$$

We shall now impose the bound

$$\lambda \leq \frac{L'(R/16)R}{8C_\eta}. \quad (4.6.48)$$

We obtain

$$\sum_{1 \leq i \leq j} L'(-\lambda + h_N^i) \geq \frac{N}{8} L'(R/16) - \frac{2CC_\eta}{R} \geq \frac{j}{4} L'(R/16) - \frac{2CC_\eta}{R}. \quad (4.6.49)$$

The next lemma ensures that we can restrict ourselves to $j \leq N/2$.

Lemma 4.6.3. *For $a \in \mathbb{R}$ and $j \in \{1, \dots, N\}$*

$$\mathbf{P}_\beta(V_j \leq a, Y_N = Nq, V_N = 0) = \mathbf{P}_\beta(V_{N-j} \leq a, Y_N = Nq, V_N = 0). \quad (4.6.50)$$

Démonstration. We just need to use time reversal, i.e.,

$$(V_N - V_{N-j}, 0 \leq j \leq N) \stackrel{d}{=} (V_j, 0 \leq j \leq N), \quad (4.6.51)$$

to obtain that

$$\mathbf{P}_\beta(V_j \leq a, Y_N = Nq, V_N = 0) = \mathbf{P}_\beta(-V_{N-j} \leq -a, -Y_N = Nq, V_N = 0). \quad (4.6.52)$$

By using the symmetry of V , we complete the proof :

$$(-V_j, 0 \leq j \leq N) \stackrel{d}{=} (V_j, 0 \leq j \leq N). \quad (4.6.53)$$

□

At this stage, we need to use precise results for the local central limit theorem. We recall (4.2.29) and for convenience we use the notations $\alpha_N^q := \mathbf{P}_{N, H_N^q}(NY_N = N^2q, V_N = 0)$ and $\beta_N^q = \exp(L_{\Lambda_N}(H_N^q) - Nh_{N,0}^q q)$ such that

$$\mathbf{P}_\beta(Y_N = Nq, V_N = 0) = \beta_N^q \alpha_N^q. \quad (4.6.54)$$

We can handle α_N^q with the help of Proposition 4.2.2 : there exists a $C_2 > 0$ such that

$$\frac{1}{C_2} \frac{1}{N^2} \leq \alpha_N^q \leq \frac{C_2}{N^2}. \quad (4.6.55)$$

Proposition 4.2.3 allows us to write that there exists a positive constant C_3 so that

$$e^{-C_3} e^{N(L_\Lambda(\tilde{H}(q,0)) - \tilde{h}_0(q,0)q)} \leq \beta_N^q \leq e^{C_3} e^{N(L_\Lambda(\tilde{H}(q,0)) - \tilde{h}_0(q,0)q)}. \quad (4.6.56)$$

We can state that

Lemma 4.6.4. *There exists a constant $\lambda > 0$ such that for all $a > 0, q \in [q_1, q_2], N \geq N_0$ and $0 \leq j \leq N$*

$$\mathbf{P}_\beta(V_j \leq -a, Y_N = Nq, V_N = 0) \leq \beta_N^q C' e^{-C_1(j \wedge (N-j)) - \lambda a}. \quad (4.6.57)$$

Démonstration. By the symmetry in Lemma 4.6.3, we can without loss of generality assume $j \leq N/2$. By using Lemma 4.6.2, we can write

$$\begin{aligned} \mathbf{P}_\beta(V_j \leq -a, Y_N = Nq, V_N = 0) &\leq \mathbf{E}_\beta[e^{-\lambda V_j}, Y_N = Nq, V_N = 0] e^{-\lambda a} \\ &= \beta_N^q e^{-\lambda a} \mathbf{E}_{N, H_N^q}[e^{-\lambda V_j}, Y_N = Nq, V_N = 0] \\ &\leq \beta_N^q e^{-\lambda a} \mathbf{E}_{N, H_N^q}[e^{-\lambda V_j}] \leq \beta_N^q C' e^{-C_1 j - \lambda a}. \end{aligned}$$

□

Proof of Proposition 4.2.5. Let $u_N = \lfloor \nu \log N \rfloor$ where $\nu > 0$ will be chosen afterwards. The first step is to write

$$\begin{aligned} &\mathbf{P}_\beta(V_i > 0, 0 < i < N; NY_N = N^2q, V_N = 0) \\ &\geq \mathbf{P}_\beta(V_1 = V_{N-1} = u_N, V_i > 0, 2 < i < N-2; NY_N = N^2q, V_N = 0). \end{aligned} \quad (4.6.58)$$

By using the Markov property at time 1 and $N-1$, we obtain

$$\begin{aligned} &\mathbf{P}_\beta(V_1 = V_{N-1} = u_N, V_i > 0, 2 < i < N-2; NY_N = N^2q, V_N = 0) \\ &= \mathbf{P}_\beta(v_1 = u_N)^2 \mathbf{P}_\beta(V_i > -u_N, 1 < i < N-3; (N-2)Y_{N-2} = N^2q - (N-1)u_N, V_{N-2} = 0). \end{aligned} \quad (4.6.59)$$

Then we can easily get the lower bound

$$\begin{aligned} &\mathbf{P}_\beta(V_i > -u_N, 1 < i < N-3; (N-2)Y_{N-2} = N^2q - (N-1)u_N, V_{N-2} = 0) \quad (4.6.60) \\ &\geq \mathbf{P}_\beta((N-2)Y_{N-2} = N^2q - (N-1)u_N, V_{N-2} = 0) \\ &\quad - \sum_{i=1}^{N-3} \mathbf{P}_\beta(V_i \leq -u_N, (N-2)Y_{N-2} = N^2q - (N-1)u_N, V_{N-2} = 0). \end{aligned}$$

We take care of the second term with the help of Lemma 4.6.4, i.e.,

$$\begin{aligned} &\sum_{i=1}^{N-3} \mathbf{P}_\beta(V_i \leq -u_N, (N-2)Y_{N-2} = N^2q - (N-1)u_N, V_{N-2} = 0) \\ &\leq \beta_{N-2}^q \sum_{i=1}^{N-3} C' e^{-C_1(i \wedge (N-2-i)) - \lambda u_N} \leq C_4 \beta_{N-2}^q e^{-\lambda u_N}. \end{aligned} \quad (4.6.61)$$

Observe that we can write the first term in the r.h.s. of (4.6.60) as

$$\mathbf{P}_\beta((N-2)Y_{N-2} = N^2q - (N-1)u_N, V_{N-2} = 0) = \hat{\beta}_{N-2}^q \hat{\alpha}_{N-2}^q, \quad (4.6.62)$$

where

$$\hat{\alpha}_{N-2}^q = \mathbf{P}_{N-2, H_{N-2}^b}((N-2)Y_{N-2} = N^2q - (N-1)u_N, V_{N-2} = 0), \quad (4.6.63)$$

$$\hat{\beta}_{N-2}^q = \exp\left(L_{\Lambda_{N-2}}(H_{N-2}^q) - \frac{N^2q - (N-1)u_N}{N-2} h_{N-2,0}^q\right). \quad (4.6.64)$$

We can write $N^2q - (N-1)u_N = (N-2)^2q + x$ where $x = 4qN - 4q - (N-1)u_N$. Recall that $u_N = \lfloor \nu \log N \rfloor$, therefore the Gaussian density $f_{\tilde{H}(q,0)}\left(\frac{x}{(N-2)^{3/2}}, 0\right)$ is bounded uniformly in $q \in [q_1, q_2], N \geq N_0$. Thanks to Proposition 4.6.1, there exists a constant C_5 such that

$$\hat{\alpha}_{N-2}^q \geq \frac{C_5}{(N-2)^2}. \quad (4.6.65)$$

By Proposition 4.2.3, we get a lower bound for $\hat{\beta}_{N-2}^q$ as

$$\begin{aligned} \hat{\beta}_{N-2}^q &\geq C_6 \exp\left((N-2)(L_\Lambda(\tilde{H}(q,0)) - \tilde{h}_0(q,0)q) + h_{N-2,0}^q \left[(N-2)q - \frac{N^2q - (N-1)u_N}{N-2}\right]\right) \\ &\geq C_7 \exp\left((N-2)(L_\Lambda(\tilde{H}(q,0)) - \tilde{h}_0(q,0)q) + \tilde{h}_0(q,0)u_N\right). \end{aligned} \quad (4.6.66)$$

We put (4.6.58–4.6.62) and (4.6.65–4.6.66) together and we get

$$\begin{aligned} &\mathbf{P}_\beta(V_i > 0, 0 < i < N; NY_N = N^2q, V_N = 0) \\ &\geq \mathbf{P}_\beta(v_1 = u_N)^2 \left[C_5 C_7 \frac{e^{(N-2)(L_\Lambda(\tilde{H}(q,0)) - \tilde{h}_0(q,0)q)}}{(N-2)^2} e^{\tilde{h}_0(q,0)u_N} - C_4 \beta_{N-2}^q e^{-\lambda u_N} \right] \\ &\geq \mathbf{P}_\beta(v_1 = u_N)^2 \left[C_8 \beta_N^q \alpha_N^q e^{\tilde{h}_0(q,0)u_N} - C_9 \beta_N^q e^{-\lambda u_N} \right], \end{aligned} \quad (4.6.67)$$

where the last inequality is obtained by using the bounds of α_N^q and β_N^q (see (4.6.55), (4.6.56)). Now compute

$$\mathbf{P}_\beta(v_1 = u_N)^2 = \frac{1}{c_\beta^2} N^{-\beta\nu} \quad (4.6.68)$$

and recall that $\mathbf{P}_\beta(NY_N = N^2q, V_N = 0) = \beta_N^q \alpha_N^q$ and $\alpha_N^q \geq \frac{1}{C_2 N^2}$, then we obtain

$$\mathbf{P}_\beta(V_i > 0, 0 < i < N \mid NY_N = N^2q, V_N = 0) \geq \frac{N^{-\beta\nu}}{c_\beta^2} [C_8 e^{\tilde{h}_0(q,0)u_N} - C_{10} N^2 e^{-\lambda u_N}]. \quad (4.6.69)$$

Since $\tilde{h}_0(q,0) \geq R > 0$ for all $q \in [q_1, q_2]$, the term inside brackets in the r.h.s. of (4.6.69) becomes strictly positive if we take $u_N > 2 \log N/R$, that is $\nu > 2/R$ and N large enough. Consequently, by choosing $\mu > 0$ large enough, we get,

$$\mathbf{P}_\beta(V_i > 0, 0 < i < N \mid NY_N = N^2q, V_N = 0) \geq C_{11} N^{(R-\beta)\nu} \geq C_{12} N^{-\mu}. \quad (4.6.70)$$

□

4.7 Appendix

4.7.1 The distribution of Brownian area

We are going to recall some basic facts about the distribution of Brownian area, especially in connection with the *Airy function*. A good reference on the subject is [14].

The Airy function

For real values of x , the Airy function $Ai(x)$ is defined by the conditionally convergent integral

$$Ai(x) = \frac{1}{\pi} \int_0^\infty \cos(t^3/3 + xt) dt := \frac{1}{\pi} \lim_{y \rightarrow \infty} \int_0^y \cos(t^3/3 + xt) dt. \quad (4.7.1)$$

The entire function $Ai'(x) = \partial Ai(x)/\partial x$ has all its zeros on the negative real axis and we denote them by $a'_i = -|a'_i|$, $i = 1, 2, \dots$, with $0 < |a'_1| < |a'_2| < \dots$, thus

$$Ai'(a'_i) = Ai'(-|a'_i|) = 0, \quad i = 1, 2, \dots \quad (4.7.2)$$

See also Abramowitz and Stegun [1, p. 450] for the asymptotic series of the zeros

$$|a'_i| \sim \left(\frac{3\pi(4i-3)}{8} \right)^{2/3} \quad \text{as } i \rightarrow \infty. \quad (4.7.3)$$

Brownian area

We let $\{B(t), t \geq 0\}$ be a standard Brownian motion with $B(0) = 0$ and $\mathfrak{B}(T) := \int_0^T |B(t)| dt$ be the geometric area under the Brownian motion over the interval $[0, T]$ (usually we consider only the unit interval $[0, 1]$). The Laplace transform $\psi(s) := \mathbf{E}(e^{-s\mathfrak{B}(1)})$ was first computed analytically by Kac [15] (see for instance [25])

$$\psi(s) = \sum_{i=1}^{\infty} \kappa_i e^{-2^{-1/3}|a'_i|s^{2/3}}, \quad s > 0 \quad (4.7.4)$$

where

$$\kappa_i := \frac{1 + 3 \int_{a'_i}^0 Ai(x) dx}{3|a'_i| Ai(a'_i)} \sim (-1)^{i-1} (2/(3i))^{1/2} \quad \text{as } i \rightarrow \infty. \quad (4.7.5)$$

By Brownian scaling $B(t) \stackrel{d}{=} \sqrt{T} B(t/T)$, $t \in [0, T]$. Hence, the area $\mathfrak{B}(T) \stackrel{d}{=} T^{3/2} \mathfrak{B}(1)$ scales as $T^{3/2}$. Thanks to formula (4.7.4)

$$\mathbf{E}(e^{-s\mathfrak{B}(T)}) = \mathbf{E}(e^{-sT^{3/2}\mathfrak{B}(1)}) = \sum_{i=1}^{\infty} \kappa_i e^{-2^{-1/3}|a'_i|s^{2/3}T}, \quad s > 0. \quad (4.7.6)$$

Since $0 < |a'_1| < |a'_2| < \dots$ and (4.7.3), we immediately obtain

$$\lim_{T \rightarrow \infty} \frac{1}{T} \log \mathbf{E}(e^{-s\mathfrak{B}(T)}) = -2^{-1/3}|a'_1|s^{2/3}, \quad s > 0. \quad (4.7.7)$$

4.7.2 Proof of Lemma 4.3.2

Démonstration. Since V and A_n are symmetric, we can assume that $x, x' \in \mathbb{N}_0 := \mathbb{N} \cup \{0\}$ and thus it is sufficient to show that the result holds for $x' = x + 1$. We will argue by induction. Since $A_0 = 1$, the $m = 0$ case is trivial. Now, we assume that the inequality holds true for $m \in \mathbb{N}$. We consider the partition function of size $m + 1$, and we can disintegrate it in dependence of the position of V_1 , i.e.,

$$\begin{aligned} \mathbf{E}_{\beta,x}(e^{-\delta A_{m+1}}) &= \sum_{y \in \mathbb{Z}} \mathbf{E}_{\beta,x}(e^{-\delta(|y|+|V_2|+\dots+|V_{m+1}|)} \mathbf{1}_{\{V_1=y\}}) \\ &= \sum_{y \in \mathbb{Z}} \mathbf{P}_{\beta}(v_1 = y - x) e^{-\delta|y|} \mathbf{E}_{\beta,y}(e^{-\delta A_m}) \\ &= \sum_{y \in \mathbb{N}} R_x(y) e^{-\delta y} \mathbf{E}_{\beta,y}(e^{-\delta A_m}) + \mathbf{P}_{\beta}(v_1 = x) \mathbf{E}_{\beta}(e^{-\delta A_m}), \end{aligned} \quad (4.7.8)$$

where $R_x(y) = \mathbf{P}_{\beta}(v_1 = y - x) + \mathbf{P}_{\beta}(v_1 = -y - x)$. Then, we set $\bar{R}_x(y) = \sum_{y' \geq y} R_x(y')$ for $y \in \mathbb{N}$. Since $\bar{R}_x(1) + \mathbf{P}_{\beta}(v_1 = x) = 1$, we can rewrite the right hand side in (4.7.8) as

$$\mathbf{E}_{\beta,x}(e^{-\delta A_{m+1}}) = \sum_{y \in \mathbb{N}} \bar{R}_x(y) \left[e^{-\delta y} \mathbf{E}_{\beta,y}(e^{-\delta A_m}) - e^{-\delta(y-1)} \mathbf{E}_{\beta,(y-1)}(e^{-\delta A_m}) \right] + \mathbf{E}_{\beta}(e^{-\delta A_m}). \quad (4.7.9)$$

We will show that, for all $y \in \mathbb{N}$, the function $x \mapsto \bar{R}_x(y)$ is non-decreasing on \mathbb{N}_0 . First, if $y \geq x + 1$, we obviously have

$$\bar{R}_x(y) = \sum_{y' \geq y} R_x(y') \leq \sum_{y' \geq y} R_{x+1}(y') = \bar{R}_{x+1}(y). \quad (4.7.10)$$

Then, if $1 \leq y \leq x$, since

$$\bar{R}_x(y) + \sum_{y'=1}^{y-1} R_x(y') + \mathbf{P}_{\beta}(v_1 = x) = \bar{R}_{x+1}(y) + \sum_{y'=1}^{y-1} R_{x+1}(y') + \mathbf{P}_{\beta}(v_1 = x + 1) = 1, \quad (4.7.11)$$

and

$$\mathbf{P}_{\beta}(v_1 = x) + \sum_{y'=1}^{y-1} R_x(y') \geq \mathbf{P}_{\beta}(v_1 = x + 1) + \sum_{y'=1}^{y-1} R_{x+1}(y'), \quad (4.7.12)$$

we immediately obtain $\bar{R}_x(y) \leq \bar{R}_{x+1}(y)$. Coming back to (4.7.9), we use the induction hypothesis to claim that

$$e^{-\delta y} \mathbf{E}_{\beta,y}(e^{-\delta A_m}) - e^{-\delta(y-1)} \mathbf{E}_{\beta,(y-1)}(e^{-\delta A_m}) \leq 0, \quad y \in \mathbb{N}, \quad (4.7.13)$$

which, together with the monotonicity of $x \mapsto \bar{R}_x(y)$ yields that

$$\begin{aligned} \mathbf{E}_{\beta,x}(e^{-\delta A_{m+1}}) &\geq \sum_{y \in \mathbb{N}} \bar{R}_{x+1}(y) \left[e^{-\delta y} \mathbf{E}_{\beta,y}(e^{-\delta A_m}) - e^{-\delta(y-1)} \mathbf{E}_{\beta,(y-1)}(e^{-\delta A_m}) \right] + \mathbf{E}_{\beta}(e^{-\delta A_m}) \\ &= \mathbf{E}_{\beta,x+1}(e^{-\delta A_{m+1}}). \end{aligned}$$

□

Collapsed polymer unfolded by a force

Sommaire

5.1 Introduction	137
5.1.1 The model	137
5.1.2 Background	139
5.1.3 The free energy	139
5.2 Pulling in the horizontal direction ($F_y = 0$)	140
5.2.1 The critical value	140
5.2.2 The order of the phase transition	141
5.3 Pulling in the vertical direction ($F_x = 0$)	141
5.4 The re-entrant phase transition	143

5.1 Introduction

5.1.1 The model

In this chapter, as in the former one, we consider an interacting partially directed self-avoiding walk (IPDSAW). This time, we apply a horizontal force $F_x \in [0, \infty)$ and a vertical force $F_y \in [0, \infty)$ at the right extremity of the random walk. It is a way to unfold the polymer in the collapsed state (in a poor solvent). Recall that the allowed configurations of the polymer of length L (L monomers) are given by the L -step trajectories of a partially directed random walk on \mathbb{Z}^2 . As in the previous chapter, we let \mathcal{W}_L be the set of allowed L -step paths and \mathbf{P} be the law on this set. For each configuration $w = (w_n)_{n=0}^L \in \mathcal{W}_L$, we denote by $N_L(w)$ the vertical distance and $S_L(w)$ the horizontal distance between two end-points of

the random walk (see Fig. 5.1). Now we define the following Hamiltonian

$$H_{L,\beta}^{F_x,F_y}(w) := \beta \sum_{\substack{i,j=0 \\ i < j-1}}^L \mathbf{1}_{\{\|w_i - w_j\|=1\}} + F_x N_L(w) + F_y S_L(w). \quad (5.1.1)$$

With this Hamiltonian we perturb the law of the polymer as follow

$$P_{L,\beta}^{F_x,F_y}(w) = \frac{\exp(H_{L,\beta}^{F_x,F_y}(w))}{Z_{L,\beta}^{F_x,F_y}} \mathbf{P}(w), \quad w \in \mathcal{W}_L. \quad (5.1.2)$$

This new measure $P_{L,\beta}^{F_x,F_y}$ is called polymer measure of size L and $Z_{L,\beta}^{F_x,F_y}$ is called the partition function. In this model, the two parts of the Hamiltonian have opposite effects on the polymer. The force extends the horizontal and vertical extensions, whereas, similarly to what happens in the former model, the interactions between the monomers constrain the chain to the collapsed form. Thus, a competition between these possible behaviors arises. In this chapter, we consider the non-uniform law on \mathcal{W}_L , that is, $\mathbf{P} := \mathbf{P}^{\text{nu}}$ (see the first chapter).

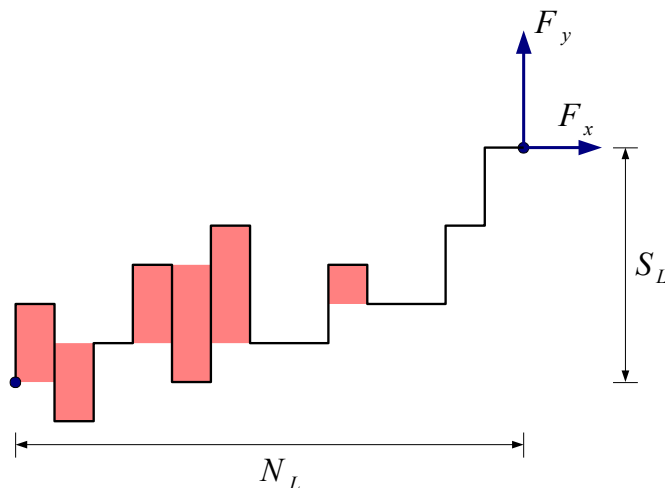

FIGURE 5.1 – Example of an IPDSAW with one end point is fixed at the origin, while forces are applied to the other end. The self-touchings shown as light red areas.

As we did in the first chapter we can describe these configurations in a natural way through the collection of vertical stretches separated by one horizontal step. Thus we associate to each configuration the sequence $l := (l_1, \dots, l_N) \in \mathbb{Z}^N$ such that N is the number of vertical stretches and l_n corresponds to the vertical length of the n^{th} stretch. We have a one-to-one correspondence between \mathcal{W}_L and $\Omega_L := \bigcup_{N=1}^L \mathcal{L}_{N,L}$, where $\mathcal{L}_{N,L}$ is the set of all possible configurations consisting of N vertical stretches that have a total length L , that is,

$$\mathcal{L}_{N,L} = \left\{ l \in \mathbb{Z}^N : \sum_{n=1}^N |l_n| + N = L \right\}. \quad (5.1.3)$$

At this stage, since $N_L(w) = N$ and $S_L(w) = \sum_{n=1}^N l_n$, the Hamiltonian can be rewritten in terms of vertical stretches $l \in \Omega_L$ as

$$H_{L,\beta}^{F_x,F_y}(l_1, \dots, l_N) = \beta \sum_{n=1}^{N-1} (l_n \tilde{\wedge} l_{n+1}) + F_x N + F_y \sum_{n=1}^N l_n, \quad (5.1.4)$$

where, we recall,

$$x \tilde{\wedge} y = \begin{cases} |x| \wedge |y| & \text{if } xy < 0, \\ 0 & \text{otherwise.} \end{cases} \quad (5.1.5)$$

We note that the function $l \mapsto \mathbf{P}(l)$ is constant equal to $(2/3)^N (1/2)^L$ on each subset $\mathcal{L}_{N,L}$. Therefore, we can write the partition function as follows

$$Z_{L,\beta}^{F_x, F_y} = \sum_{N=1}^L \sum_{l \in \mathcal{L}_{N,L}} \left(\frac{1}{3}\right)^N \left(\frac{1}{2}\right)^{L-N} e^{\beta \sum_{n=1}^{N-1} (l_n \tilde{\wedge} l_{n+1}) + F_x N + F_y \sum_{n=1}^N l_n}. \quad (5.1.6)$$

5.1.2 Background

The development of atomic force microscopy and optical tweezers has allowed the micro-manipulation of polymer molecules. In particular, by exerting a small range of forces at a certain point of the polymer (proteins, RNA, ...), it is possible to unfold/refold its molecules one at a time. The IPDSAW provided here shows collapsed-extended transition in the presence of physical force f . This model has been studied in the physical literature (see [5] and references therein) and, more recently, in the chemical literature [22]. In particular, it is known that a second order phase transition between a collapsed state and an extended one also occurs at a critical force f^c at a fixed temperature T . One of the interesting phenomena that has been pointed out is the presence of a re-entrant transition. That means for a range of f values, the extended state is stable at both low and high temperatures.

Our purpose is to point out that the same approach as in the previous chapters can be applied to deal with the partition function in presence of a force. We still derive a variational formula of the free energy, which allow us to identify the critical force-temperature curve and the order of the phase transition. In addition, the condition for the re-entrant transition is easily related to the asymptotic behavior of a function appearing in this formula.

5.1.3 The free energy

For this model, the free energy is defined as in the previous chapter, that is,

$$f(\beta, F_x, F_y) = \lim_{L \rightarrow \infty} \frac{1}{L} \log Z_{L,\beta}^{F_x, F_y} \quad (5.1.7)$$

where the existence of the limit can be established by concatenation arguments. We pick $L \in \mathbb{N}$: $\sqrt{L} \in \mathbb{N}$ and consider a single trajectory $l^* \in \mathcal{L}_{\sqrt{L}, L}$ such that $l_i^* = (-1)^{i-1} (\sqrt{L} - 1)$ for $i \in \{1, \dots, \sqrt{L}\}$. Its horizontal and vertical expansions satisfy $N_L(l) = \sqrt{L}$ and $S_L(l) \in \{0, \sqrt{L} - 1\}$. By computing the contribution of l^* to $Z_{L,\beta}^{F_x, F_y}$ one immediately obtains that,

$$f(\beta, F_x, F_y) \geq \beta - \log 2. \quad (5.1.8)$$

At this stage, we can define the *excess free energy* $\tilde{f}(\beta, F_x, F_y) := f(\beta, F_x, F_y) - (\beta - \log 2)$, which is always non negative by (5.1.8). This excess free energy will still be a good tool to decide, for fixed parameters (β, F_x, F_y) , if the polymer is collapsed or not. More precisely, the region of parameters

$$\mathcal{C} := \{(\beta, F_x, F_y) : \tilde{f}(\beta, F_x, F_y) = 0\} \quad (5.1.9)$$

and

$$\mathcal{E} := \{(\beta, F_x, F_y) : \tilde{f}(\beta, F_x, F_y) > 0\}, \quad (5.1.10)$$

as referred to as collapsed and extended phase, respectively.

In what follows we look at the effect of two forces on the polymer separately, namely $(F_x > 0, F_y = 0)$ and $(F_x = 0, F_y > 0)$.

5.2 Pulling in the horizontal direction ($F_y = 0$)

In this section, we will discuss the case of horizontal pulling force where $F_y = 0$. For fixed β , since $F_x \mapsto \tilde{f}(\beta, F_x) := \tilde{f}(\beta, F_x, 0)$ is convex, non-decreasing and non-negative, proving that there exists $F_0 \in [0, \infty)$ such that $\tilde{f}(\beta, F_0) = 0$ will be sufficient to claim that $\tilde{f}(\beta, F_x) = 0$ for $F_x \leq F_0$. Then, the critical force will be defined as

$$F_x^c(\beta) := \sup\{F_x \geq 0 : \tilde{f}(\beta, F_x) = 0\}, \quad (5.2.1)$$

and the set \mathcal{C} and \mathcal{E} will become $\mathcal{C} = \{(\beta, F_x) : F_x \leq F_x^c(\beta)\}$ and $\mathcal{E} = \{(\beta, F_x) : F_x > F_x^c(\beta)\}$.

In section 5.2.1, we establish the existence of the critical force F_x^c for fixed β . The precise asymptotic of the free energy near the transition is studied in section 5.2.2. For simplicity, we will omit the F_y dependence of most quantities along this section.

5.2.1 The critical value

First, we recall that the partition function in the no-force case, i.e., $Z_{L,\beta} := Z_{L,\beta}^{0,0}$ can be rewritten in term of an auxiliary symmetric random walk V with geometric increments

$$Z_{L,\beta} = c_\beta \Phi_{L,\beta} \sum_{N=1}^L (\Gamma(\beta))^N \mathbf{P}_\beta(\mathcal{V}_{N+1,L-N}), \quad (5.2.2)$$

where we recall the energetic term $\Gamma(\beta) = \frac{2c_\beta}{3e^\beta}$ and the function $\Phi_{L,\beta} = (e^\beta/2)^L$.

Since the force F_x is only having an effect on the horizontal steps of each path, we can easily conclude that the partition function $Z_{L,\beta}^{F_x}$ can be rewritten exactly as in (5.2.2) except the energetic term $\Gamma(\beta)$:

$$Z_{L,\beta}^{F_x} = c_\beta \Phi_{L,\beta} \sum_{N=1}^L (\Gamma(\beta, F_x))^N \mathbf{P}_\beta(\mathcal{V}_{N+1,L-N}), \quad (5.2.3)$$

where the function $\Gamma : (0, \infty) \times [0, \infty) \mapsto (0, \infty)$ is defined as follows

$$\Gamma(\beta, F_x) = \frac{2c_\beta e^{F_x}}{3e^\beta}. \quad (5.2.4)$$

In analogy with the non-force case, the energetic term $\Gamma(\beta, F_x)$ penalizes the horizontal steps when it is smaller than 1 and favors them when it is larger than 1. Consequencetly, the force either leaves most of the polymer collapsed or pulls most of the polymer. By writing the number of horizontal steps under the form $N = \alpha L$ with $\alpha \in [0, 1]$, formula (5.2.3) can be used to derive a variational expression of the excess free energy.

Theorem 5.2.1. For $\beta > 0, F_x \geq 0$, the excess free energy $\tilde{f}(\beta, F_x) := \tilde{f}(\beta, F_x, 0)$ is given by

$$\tilde{f}(\beta, F_x) = \sup_{\alpha \in [0,1]} \left[\alpha \log(\Gamma(\beta, F_x)) + \alpha g_\beta\left(\frac{1-\alpha}{\alpha}\right) \right], \quad (5.2.5)$$

where

$$g_\beta(\alpha) := \lim_{N \rightarrow \infty} \frac{1}{N} \log \mathbf{P}_\beta(A_N \leq \alpha N, V_N = 0), \quad \alpha \in [0, \infty). \quad (5.2.6)$$

Theorem 5.2.1 tells us that a phase transition occurs at those values of β and F_x where $\Gamma(\beta, F_x) = 1$, that is, the critical value of the force is given by

$$F_x^c(\beta) = \log\left(\frac{3(e^{\beta/2}-1)}{2(e^{-\beta/2}+e^{-\beta})}\right) \vee 0, \quad (5.2.7)$$

which is the result of [5]. Note that $F_x^c(\beta) = 0$ for $\beta \leq \beta_c$ and $F_x^c(\beta) > 0$ for $\beta > \beta_c$ where β_c is the critical value of the system in the no-force case.

5.2.2 The order of the phase transition

By replacing the function $\Gamma(\beta)$ by $\Gamma(\beta, F_x)$ in the Theorem 4.1.3 in chapter 4, we can easily obtain the following results

Theorem 5.2.2. For $\beta > 0$ and $F_x \geq 0$, the excess free energy $\tilde{f}(\beta, F_x)$ is the unique positive solution of the equation $\log(\Gamma(\beta, F_x)) - \delta + h_\beta(\delta) = 0$ if such a solution exists and $\tilde{f}(\beta, F_x) = 0$ otherwise.

As we know, with the help of the Theorem 5.2.2 and the analytic properties of $\delta \mapsto h_\beta(\delta)$ at 0^+ , we can investigate the regularity of $F_x \mapsto \tilde{f}(\beta, F_x)$ at $F_x^c(\beta)$ (for fixed $\beta > \beta_c$).

Theorem 5.2.3. For $\beta > \beta_c$, the phase transition is second order in F_x with critical exponent $3/2$. That is, there exists an explicit constant $c > 0$ (depends on β) such that

$$\tilde{f}(\beta, F_x^c(\beta) + \varepsilon) \sim c\varepsilon^{3/2} \quad \text{as } \varepsilon \rightarrow 0^+. \quad (5.2.8)$$

5.3 Pulling in the vertical direction ($F_x = 0$)

Note that when $F_y > 0$, we have one more sum in the exponential function of (5.1.6). However, with Proposition 5.3.1 below, we also give a representation of the partition function in terms of an auxiliary asymmetric random walk. We need to settle some of the ingredients appearing in the formula. We let $V := (V_n)_{n \in \mathbb{N}}$ be a asymmetric random walk on \mathbb{Z} whose increments are independent and follow a geometric distribution, that is $V_0 = 0, V_n = \sum_{i=1}^n v_i$ for $n \in \mathbb{N}$ and $v := (v_i)_{i \in \mathbb{N}}$ is an independent sequence (not identically distributed) under the law \mathbf{P}_{β, F_y} , with distribution

$$\mathbf{P}_{\beta, F_y}(v_{2i-1} = k) = \frac{e^{-\frac{\beta}{2}|k| + \frac{F_y}{2}k}}{c_{\beta, F_y}} \quad \text{and} \quad (5.3.1)$$

$$\mathbf{P}_{\beta, F_y}(v_{2i} = k) = \frac{e^{-\frac{\beta}{2}|k| - \frac{F_y}{2}k}}{c_{\beta, F_y}} \quad \forall k \in \mathbb{Z}, i \in \mathbb{N} \quad (5.3.2)$$

with

$$c_{\beta, F_y} = \sum_{k \in \mathbb{Z}} e^{-\frac{\beta}{2}|k| + \frac{F_y}{2}k} = 1 + \frac{e^{\frac{F_y}{2}}}{e^{\frac{\beta}{2}} - e^{\frac{F_y}{2}}} + \frac{1}{e^{\frac{\beta+F_y}{2}} - 1}. \quad (5.3.3)$$

We define the function $\Gamma(\beta, F_y): (0, \infty) \times [0, \infty) \mapsto (0, \infty)$ as

$$\Gamma(\beta, F_y) = \frac{2c_{\beta, F_y}}{3e^{\beta}}. \quad (5.3.4)$$

Finally, we recall that $\mathcal{V}_{n,k}$ is the set of those n -step trajectories of the random walk V whose geometric area $A_n := \sum_{i=1}^n |V_i|$ equals k , i.e.,

$$\mathcal{V}_{n,k} := \{(V)_{i=0}^n : A_n = k, V_n = 0\}, \quad (5.3.5)$$

and the term $\Phi_{L,\beta} = (e^{\beta}/2)^L$.

Proposition 5.3.1. *For $\beta > 0$, $F_y \in [0, \beta)$ and $L \in \mathbb{N}$, we have*

$$Z_{L,\beta}^{F_y} = c_{\beta, F_y} \Phi_{L,\beta} \sum_{N=1}^L (\Gamma(\beta, F_y))^N \mathbf{P}_{\beta, F_y}(\mathcal{V}_{N+1, L-N}). \quad (5.3.6)$$

Démonstration. Recall that the $\tilde{\wedge}$ operator can be written as

$$x \tilde{\wedge} y = (|x| + |y| - |x + y|)/2, \quad \forall x, y \in \mathbb{Z}. \quad (5.3.7)$$

Hence, for $\beta > 0$, $F_y \in [0, \beta)$ and $L \in \mathbb{N}$, the partition function in (5.1.6) becomes

$$\begin{aligned} Z_{L,\beta}^{F_y} &= \sum_{N=1}^L \left(\frac{1}{3}\right)^N \left(\frac{1}{2}\right)^{L-N} \sum_{\substack{l \in \mathcal{L}_{N,L} \\ l_0 = l_{N+1} = 0}} \exp\left(\beta \sum_{n=1}^N |l_n| - \frac{\beta}{2} \sum_{n=0}^N |l_n + l_{n+1}| + \frac{F_y}{2} \sum_{n=0}^N (l_n + l_{n+1})\right) \\ &= c_{\beta, F_y} \left(\frac{e^{\beta}}{2}\right)^L \sum_{N=1}^L \left(\frac{2c_{\beta, F_y}}{3e^{\beta}}\right)^N \sum_{\substack{l \in \mathcal{L}_{N,L} \\ l_0 = l_{N+1} = 0}} \prod_{n=0}^N \frac{\exp\left(-\frac{\beta}{2}|l_n + l_{n+1}| + \frac{F_y}{2}(l_n + l_{n+1})\right)}{c_{\beta, F_y}}, \end{aligned} \quad (5.3.8)$$

where c_{β, F_y} was defined in (5.3.3). By rewriting the last sum in (5.3.8) in terms of $v_n := (-1)^{n-1}(l_{n-1} + l_n)$, $n = 1, \dots, N+1$, we see that this sum is equal to the probability that the random walk $(V_n)_{n \in \mathbb{N}}$ belongs to $\mathcal{V}_{N+1, L-N}$. Therefore

$$Z_{L,\beta}^{F_y} = c_{\beta, F_y} \left(\frac{e^{\beta}}{2}\right)^L \sum_{N=1}^L \left(\frac{2c_{\beta, F_y}}{3e^{\beta}}\right)^N \sum_{V \in \mathcal{V}_{N+1, L-N}} \mathbf{P}_{\beta, F_y}(V), \quad (5.3.9)$$

which immediately implies the result. \square

As in chapter 4, we state below an expression for the excess free energy.

Theorem 5.3.2. *For $\beta > 0$ and $F_y \in [0, \beta)$, the excess free energy $\tilde{f}(\beta, F_y)$ is the unique positive solution of the equation $\log(\Gamma(\beta, F_y)) - \delta + h_{\beta, F_y}(\delta) = 0$ (if such a solution exists, otherwise $\tilde{f}(\beta, F_y) = 0$), where h_{β, F_y} is the free energy of an auxiliary discrete model*

$$h_{\beta, F_y}(\delta) := \lim_{N \rightarrow \infty} \frac{1}{N} \log \mathbf{E}_{\beta, F_y}(e^{-\delta A_N}), \quad \delta \in [0, \infty). \quad (5.3.10)$$

Although the random walk V is asymmetric, we still have the same properties of the function h_{β, F_y} as in chapter 4. More precisely, the limit in (5.3.10) exists and $\delta \mapsto h_{\beta, F_y}(\delta)$ is non-positive, non-increasing and continuous on $[0, \infty)$ for all $\beta > 0$, $F_y \in [0, \beta)$, which, combined with Theorem 5.3.2 and the obviously equality $h_{\beta, F_y}(0) = 0$ are sufficient to check that a phase transition occurs at those values of β and F_y where $\Gamma(\beta, F_y) = 1$, that is, the critical value of the force is given by

$$F_y^c(\beta) = 2 \cosh^{-1} \left(\frac{3e^{2\beta} + e^\beta + 2}{6e^{3\beta/2}} \right). \quad (5.3.11)$$

Moreover, a fine asymptotic of $\delta \mapsto h_{\beta, F_y}(\delta)$ at 0^+ allows us to prove that the phase transition is second order with critical exponent $3/2$.

Theorem 5.3.3. *For $\beta > \beta_c$, the phase transition is second order in F_y with critical exponent $3/2$. That is, there exists a constant $c > 0$ (depends on β) such that*

$$\lim_{\varepsilon \rightarrow 0^+} \frac{\tilde{f}(\beta, F_y^c(\beta) + \varepsilon)}{\varepsilon^{3/2}} = c. \quad (5.3.12)$$

5.4 The re-entrant phase transition

One of the interesting phenomena that has been pointed out is the presence of a re-entrant transition. This means, for a fixed physical force f , the polymer is unfolded at low temperature and at high temperature, but for intermediate temperatures it is collapsed, very much like if the force was not present. We will show that the re-entrance phenomenon is strongly model dependent. For this reason, we first introduce the partially directed random walk with general distributed steps.

We consider the partially directed random walk on \mathbb{Z}^2 with law \mathbf{P} is defined as follows :

- At the origin or after an horizontal step : the walker must step north, south or east with probabilities correspond p, p' and $1 - p - p'$.
- After a vertical step north : the walker must step north with probability q or east with probability $1 - q$.
- After a vertical step south : the walker must step south with probability q' or east with probability $1 - q'$.

For convenience of exposition, we restrict to the case where $p = \frac{q(1-q')}{1-qq'}$ and $p' = \frac{q'(1-q)}{1-qq'}$ with $q, q' \in (0, 1)$. Recall that with each L -steps trajectory $w \in \mathcal{W}_L$, we associate the sequence $l := (l_1, \dots, l_N) \in \mathbb{Z}^N$ such that N is the number of vertical stretches and l_n corresponds to the vertical length of the n^{th} stretch. At this stage, the random variables $(l_n)_{n=1}^N$ are i.i.d with geometric distribution

$$\mathbf{P}(l_1 = 0) = \frac{(1-q)(1-q')}{1-qq'}, \quad (5.4.1)$$

$$\mathbf{P}(l_1 = k) = \frac{(1-q)(1-q')}{1-qq'} q^k, \quad (5.4.2)$$

$$\mathbf{P}(l_1 = -k) = \frac{(1-q)(1-q')}{1-qq'} q'^k, \text{ for } k \in \mathbb{N}. \quad (5.4.3)$$

Let $q_0 = \mathbf{P}(l_1 = 0)$, $q_1 = \frac{\log q + \log q'}{2} \leq 0$ and $q_2 = \frac{\log q - \log q'}{2}$, we can write

$$\mathbf{P}(l_1 = k) = q_0 e^{q_1 |k| + q_2 k} \quad \text{for all } k \in \mathbb{Z}. \quad (5.4.4)$$

Recall that $\mathcal{L}_{N,L}$ is the set of all possible configurations consisting of N vertical stretches that have a total length L . We can write the partition function in terms of the stretches, that is,

$$\begin{aligned} Z_{L,\beta}^{F_x, F_y} &= \sum_{N=1}^L \sum_{l \in \mathcal{L}_{N,L}} \exp \left(\beta \sum_{n=1}^N (l_n \tilde{\wedge} l_{n-1}) + F_x N + F_y \sum_{n=1}^N l_n \right) \mathbf{P}(l) \\ &= \sum_{N=1}^L (q_0 e^{F_x})^N \sum_{l \in \mathcal{L}_{N,L}} \exp \left(\beta \sum_{n=1}^N (l_n \tilde{\wedge} l_{n-1}) + q_1 \sum_{n=1}^N |l_n| + (q_2 + F_y) \sum_{n=1}^N l_n \right) \\ &= e^{q_1 L} \sum_{N=1}^L \left(\frac{q_0 e^{F_x}}{e^{q_1}} \right)^N \sum_{l \in \mathcal{L}_{N,L}} \exp \left(\beta \sum_{n=1}^N (l_n \tilde{\wedge} l_{n-1}) + (q_2 + F_y) \sum_{n=1}^N l_n \right). \end{aligned} \quad (5.4.5)$$

For convenience of exposition, we restrict to the case where $F_y = 0$ and the stretches of the partially directed random walk have a symmetric distribution, namely, $q = q' \in (0, 1)$. At this stage $q_0 = \frac{(1-q)^2}{1-q^2}$, $q_1 = \log q$ and $q_2 = 0$. Therefore

$$Z_{L,\beta}^{F_x, 0} = q^L \sum_{N=1}^L \left(\frac{(1-q)^2 e^{F_x}}{q(1-q^2)} \right)^N \sum_{l \in \mathcal{L}_{N,L}} \exp \left(\beta \sum_{n=1}^N (l_n \tilde{\wedge} l_{n-1}) \right). \quad (5.4.6)$$

As usual, we use the notations $\Phi_{L,\beta} = e^{\beta L} q^L$ and $\Gamma(\beta, F_x) = \frac{(1-q)^2 c_\beta e^{F_x}}{q(1-q^2) e^{\beta}}$

$$Z_{L,\beta}^{F_x, 0} = c_\beta \Phi_{L,\beta} \sum_{N=1}^L (\Gamma(\beta, F_x))^N \mathbf{P}_\beta(\mathcal{V}_{N+1, L-N}). \quad (5.4.7)$$

The most interesting case is when $\beta \geq \beta_c$, otherwise the system is already extended at $F_x = 0$. This critical force can be computed explicitly

$$F_x^c(\beta) = \log \left(\frac{e^{\beta/2} - 1}{e^{-\beta/2} + e^{-\beta}} \right) + \log \left(\frac{q(1+q)}{1-q} \right). \quad (5.4.8)$$

We put

$$\beta = 1/T, \quad F_x = f_x/T, \quad f_x^c(T) = F_x^c(1/T)T \quad (5.4.9)$$

with $T > 0$ is the physical temperature and f_x the physical force.

Proposition 5.4.1. *There exists $T_c > 0$ such that $f_x^c(T) = 0$ for $T > T_c$. Moreover, for small T*

$$f_x^c(T) = 1 + T \log \left(\frac{q(1+q)}{1-q} \right) + o(T) \quad \text{as } T \rightarrow 0. \quad (5.4.10)$$

Re-entrance takes place for $q > \sqrt{2} - 1$ (see Fig. 5.2).

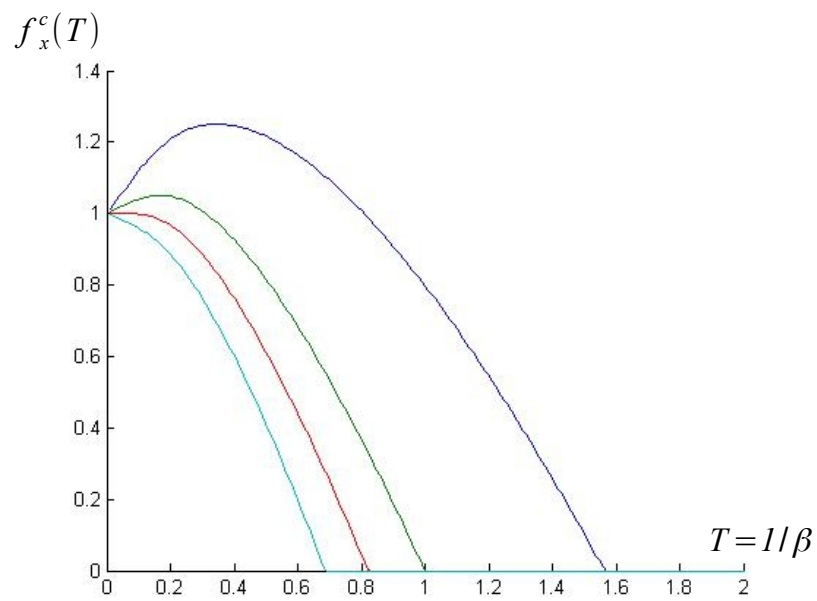

FIGURE 5.2 – Critical force f_x^c as function of $1/\beta$. The curves correspond $q = 2/3, 1/2, \sqrt{2} - 1$ and $1/3$, from top to bottom.

Table des figures

1.1	Hydrogel behavior (<i>Macromolecules</i> , 2007, 40, 5827).	10
1.2	Une SRW avec auto-intersections et self-touchings.	11
1.3	Une SAW avec self-touchings.	12
1.4	Une marche aléatoire partiellement dirigée avec 12 self-touchings représentés par des arrêtes grisées.	13
1.5	Une trajectoire avec $N = 5$ segments verticaux et de longueur $L = 16$.	14
1.6	Restriction de la fonction de partition à une trajectoire de longueur L dont le nombre de self-touching est maximum.	16
1.7	Une trajectoire typique de chacune des deux phases.	19
1.8	Diagramme de phase du modèle non uniforme ($\beta_c^{\text{nu}} \sim 1$).	20
1.9	Exemple d'une trajectoire avec 3 perles.	21
1.10	Une trajectoire avec 20 barres verticales décomposée en $n_L(l) = 6$ perles.	22
1.11	Une force horizontale f_x et une force verticale f_y sont appliquées à l'extrémité du polymère.	23
1.12	Un exemple de transformation de $w \in \mathcal{W}_{24}$ en $(V_n)_{n=0}^8 \in \mathcal{V}_{8,17}$. La trajectoire w de longueur 24 sur la gauche a 7 segments : $l_1 = 3, l_2 = -4, l_3 = 3, l_4 = 2, l_5 = 0, l_6 = -2$ et $l_7 = 3$. Les accroissements correspondants de $(V_n)_{n=0}^8$ sont : $v_1 = 3, v_2 = 1, v_3 = -1, v_4 = -5, v_5 = 2, v_6 = 2$ and $v_7 = 1$.	25
2.1	Hydrogel behavior (<i>Macromolecules</i> , 2007, 40, 5827).	42
2.2	A SRW with self-intersections and self-touchings.	43
2.3	A SAW with self-touchings.	44
2.4	A partially directed walk with 12 self-touchings represented by red bonds.	45
2.5	An example trajectory with $N = 5$ vertical stretches and length $L = 16$.	46
2.6	Restrict the partition function to a single L-step trajectory whose the number of self-touchings is maximum.	48
2.7	A typical path of both phases.	50
2.8	Phase diagram in the non-uniform case ($\beta_c^{\text{nu}} \sim 1$).	51
2.9	Example of a trajectory with 3 beads.	53
2.10	An example of a 20-stretches trajectory is decomposed into $n_L(l) = 6$ beads.	54
2.11	A horizontal force f_x and a vertical force f_y are applied to one end of the polymer. The self-touchings shown as light red areas.	55
2.12	An example of transformation of $w \in \mathcal{W}_{24}$ into $(V_n)_{n=0}^8 \in \mathcal{V}_{8,17}$. The 24-step trajectory w on the left has 7 stretches : $l_1 = 3, l_2 = -4, l_3 = 3, l_4 = 2, l_5 = 0, l_6 = -2$ and $l_7 = 3$. The correspondent increments of $(V_n)_{n=0}^8$ are : $v_1 = 3, v_2 = 1, v_3 = -1, v_4 = -5, v_5 = 2, v_6 = 2$ and $v_7 = 1$.	57

3.1	A partially directed walk with 12 self-touchings represented by red bonds.	73
3.2	A typical path of both phases.	75
3.3	Phase diagram in the non-uniform case ($\beta_c^{\text{nu}} \sim 1$).	77
3.4	An example of decomposition of $w \in \mathcal{W}_{16}$ into 5 stretches.	79
3.5	An example of transformation of $w \in \mathcal{W}_{24}$ into $(V_n)_{n=0}^8 \in \mathcal{V}_{8,17}$. The 24-step trajectory w on the left has 7 stretches : $l_1 = 3, l_2 = -4, l_3 = 3, l_4 = 2, l_5 = 0, l_6 = -2$ and $l_7 = 3$. The correspondent increments of $(V_n)_{n=0}^8$ are : $v_1 = 3, v_2 = 1, v_3 = -1, v_4 = -5, v_5 = 2, v_6 = 2$ and $v_7 = 1$	80
4.1	Example of a trajectory with 12 self-touchings in light red.	95
4.2	Example of a trajectory with $N = 5$ vertical stretches and length $L = 16$	96
4.3	Example of a trajectory with 3 beads.	100
4.4	An example of a trajectory $l = (l_i)_{i=1}^{20}$ with 6 beads is drawn on the upper picture. The auxiliary random walk V associated with l , i.e., $(V_i)_{i=0}^{21} = (T_{20})^{-1}(l)$ is drawn on the lower picture.	102
4.5	The hatched domain corresponds to $ \mathcal{A}(h_0, h_1) $	125
5.1	Example of an IPDSAW with one end point is fixed at the origin, while forces are applied to the other end. The self-touchings shown as light red areas.	138
5.2	Critical force f_x^c as function of $1/\beta$. The curves correspond $q = 2/3, 1/2, \sqrt{2}-1$ and $1/3$, from top to bottom.	145

Bibliographie

- [1] M. Abramowitz, I. A. Stegun, *Handbook of Mathematical Functions*, Dover, New York (1965). [134](#)
- [2] F. Aurzada, T. Simon, Persistence probabilities & exponents (2012, submitted). arXiv :1203.6554v1 [math.PR]. [17](#), [49](#), [74](#)
- [3] P. M. Binder, A. L. Owczarek, A. R. Veal and J. M. Yeomans, Collapse transition in a simple polymer model : exact results. *J. Phys. A*, 23, (1990) 975–979. [12](#), [17](#), [44](#), [49](#), [73](#)
- [4] M. Bousquet-Mélou, Families of prudent self-avoiding walks. *J. Combin. Theory Ser. A* 177 (No. 3) (2010) 313–344. [16](#), [48](#), [76](#)
- [5] R. Brak, P. Dyke, J. Lee, A. L. Owczarek, T. Prellberg, A. Rechnitzer and S. G. Whittington, A self-interacting partially directed walk subject to a force. *J. Phys. A : Math. Theor.* 42, 085001 (2009). [16](#), [17](#), [48](#), [49](#), [73](#), [97](#), [139](#), [141](#)
- [6] R. Brak, A. J. Guttmann and S. G. Whittington, A collapse transition in a directed walk model. *J. Phys. A : Math. Gen.* 25 (1992) 2437–2446. [12](#), [16](#), [17](#), [19](#), [44](#), [48](#), [49](#), [51](#), [73](#), [77](#), [97](#)
- [7] P. Carmona, G. B. Nguyen, N. Pétrélis, Interacting partially directed self avoiding walk : from phase transition to the geometry of the collapsed phase (2013, submitted). arXiv :1306.4887v1 [math.PR]. [20](#), [22](#), [52](#), [53](#), [93](#)
- [8] F. Caravenna and J.-D. Deuschel, Pinning and wetting transition for (1+1)-dimensional fields with Laplacian interaction. *Ann. Probab.* 36 (6) (2008) 2388–2433. [17](#), [49](#), [74](#)
- [9] F. Caravenna, F. den Hollander and N. Pétrélis, Lectures on Random Polymers in : *Probability and Statistical Physics in Two and more Dimensions*. Clay Mathematics Proceedings 15 (2012) 319–393. [73](#), [97](#)
- [10] R. Dobrushin, O. Hryniv, Fluctuations of shapes of large areas under paths of random walks. *Probability Theory and Related Fields.* 102 (No. 3) (1995) 313–330. [38](#), [69](#), [105](#), [127](#), [128](#), [129](#)
- [11] R. Durrett, *Probability theory and examples* (3rd ed.), Duxbury Press (2005). [28](#), [32](#), [59](#), [63](#), [82](#), [88](#), [91](#), [109](#)
- [12] G. Giacomin, *Random Polymer Models*, Imperial College Press, London, (2007).

- [13] R. van der Hofstad and A. Klenke, Self-attractive random polymers. *Ann. Appl. Probab.* 11 (2001) 1079–1115. [43](#)
- [14] S. Janson, Brownian excursion area, Wright’s constants in graph enumeration, and other Brownian areas. *Probability Surveys* 3 (2007) 80–145. [134](#)
- [15] M. Kac, On the average of a certain Wiener functional and a related limit theorem in calculus of probability. *Trans. Amer. Math. Soc.* 59 (1946), 401–414. [99](#), [100](#), [134](#)
- [16] G. B. Nguyen, N. Pétrélis, A variational formula for the free energy of the partially directed polymer collapse. *J. Stat. Phys.* DOI : 10.1007/s10955-013-0748-2 (2013). [17](#), [19](#), [49](#), [51](#), [71](#), [97](#), [98](#)
- [17] A. L. Owczarek and T. Prellberg, Exact solution of semi-flexible and super-flexible interacting partially directed walks. *J. Stat. Mech. : Theor. Exp.* P11010 (2007) 1–14. [16](#), [48](#), [73](#), [97](#)
- [18] A. L. Owczarek, T. Prellberg and R. Brak, The tricritical behavior of self-interacting partially directed walks. *J. Stat. Phys.* 72 (1993) 737–772. [12](#), [16](#), [17](#), [44](#), [48](#), [49](#), [73](#), [97](#)
- [19] T. Prellberg, Uniform q-series asymptotics for staircase polygons. *J. Phys. A : Math. Gen.* 28 1289 (1995). [17](#), [49](#)
- [20] T. Prellberg, A. L. Owczarek, R. Brak and A. J. Guttmann, Finite-length scaling of collapsing directed walks. *Phys. Rev. E* 48 (No. 4) (1993) 2386–2396. [12](#), [21](#), [44](#), [52](#), [99](#)
- [21] A. I. Sakhanenko, On unimprovable estimates of the rate of convergence in invariance principle. *Colloq. Math. Soc. János Bolyai* 32 Nonparametric Statistical Inference, Budapest, Hungary (1980) 779–783. [33](#), [64](#), [110](#)
- [22] H. S. Samanta and D. Thirumalai, Exact solution of the Zwanzig-Lauritzen model of polymer crystallization under tension. *J. Chem. Phys.* 138, 104901 (2013). [16](#), [48](#), [97](#), [139](#)
- [23] Y. G. Sinai, Distribution of some functionals of the integral of a random walk. *Theor. Math. Phys.* 90 (1992) 219–241. [49](#), [74](#)
- [24] Q. M. Shao, Strong approximation theorems for independent random variables and their applications. *J. Multivariate Analysis* 52 (1995) 107–130. [33](#), [64](#), [110](#)
- [25] L. Takács, On the distribution of the integral of the absolute value of the Brownian motion. *Ann. Appl. Probab.* 3 (No. 1) (1993) 186–197. [134](#)
- [26] R. Zwanzig and J. I. Lauritzen, Exact calculation of the partition function for a model of two dimensional polymer crystallization by chain folding. *J. Chem. Phys.* 48 (1968) 3351–3360. [12](#), [44](#), [73](#), [94](#)

Thèse de Doctorat

Gia Bao NGUYEN

Marche aléatoire auto-évitante en auto-interaction

Interacting partially directed self avoiding walk

Résumé

Dans cette thèse nous étudions le phénomène d'effondrement de différents modèles d'homopolymères. Nous étudions une marche aléatoire partiellement dirigée en dimension $1+1$, auto-évitante et en auto-interaction, connue sous l'acronyme anglais IPDSAW. Il est établi que le modèle IPDSAW a une transition de phase d'effondrement en un paramètre critique β_c . Pour étudier la fonction de partition de ce modèle, nous développons une nouvelle méthode qui nous permet d'en déduire une formule variationnelle pour son énergie libre. Cette formule variationnelle peut être utilisée pour prouver l'existence de la transition d'effondrement et pour identifier simplement le point critique. Nous donnons une asymptotique précise de l'énergie libre au voisinage du point critique. Ensuite, nous établissons plusieurs propriétés trajectorielles de notre marche aléatoire à l'intérieur de la phase effondrée ($\beta > \beta_c$). Finalement, nous étudions le modèle IPDSAW soumis à une force extérieure. Nous montrons comment détecter la présence d'un phénomène de ré-entrance sans toutefois résoudre intégralement le modèle.

Mots clés

Polymère effondré, marche aléatoire auto-évitante, transition de phase, formulation variationnelle, grandes déviations, aire de marche aléatoire, aire de mouvement brownien, déroulement du polymère par force.

Abstract

This work is devoted to the study of the phenomena expansion and collapse for difference polymer models. We investigate the $1 + 1$ dimensional self-interacting and partially directed self-avoiding walk, usually referred to by the acronym IPDSAW. The IPDSAW is known to undergo a extended-collapsed transition at a critical point β_c . We develop a new method to study the partition function of this model, from which we derive a variational formula for the free energy. This variational formula allows us to prove the existence of the collapse transition and to identify the critical point in a simple way. We provide the precise asymptotic of the free energy close to criticality. We then establish some path properties of the random walk inside the collapsed phase ($\beta > \beta_c$). Finally, we study the IPDSAW subject to a force. We show how to detect the presence of a re-entrant phenomenon without fully solving the model.

Key Words

Polymer collapse, partially self-avoiding walk, phase transition, variational formula, large deviations, area of random walk, area under Brownian motion, force-induced unfolding.