



HAL
open science

**Deployment & scheduling in Wimax with relays :
IEEE802.16j**

Hai Dang Nguyen

► **To cite this version:**

Hai Dang Nguyen. Deployment & scheduling in Wimax with relays : IEEE802.16j. Networking and Internet Architecture [cs.NI]. Université d'Evry-Val d'Essonne, 2011. English. NNT : . tel-00878774

HAL Id: tel-00878774

<https://theses.hal.science/tel-00878774v1>

Submitted on 30 Oct 2013

HAL is a multi-disciplinary open access archive for the deposit and dissemination of scientific research documents, whether they are published or not. The documents may come from teaching and research institutions in France or abroad, or from public or private research centers.

L'archive ouverte pluridisciplinaire **HAL**, est destinée au dépôt et à la diffusion de documents scientifiques de niveau recherche, publiés ou non, émanant des établissements d'enseignement et de recherche français ou étrangers, des laboratoires publics ou privés.

UNIVERSITE D'EVRY VAL-D'ESSONNE

Laboratoire IBICS

THÈSE

pour obtenir le grade

DOCTEUR de l'Université d'Evry Val-d'Essonne

Spécialité : Informatique

présentée et soutenue publiquement

par

Hai Dang NGUYEN

Le 01 Juillet 2011

**Deployment & Scheduling in
Wimax with Relays -
IEEE802.16j**

JURY

<i>Directeur :</i>	Prof. Nazim AGOULMINE	Université d'Evry Val-d'Essonne
<i>Rapporteur :</i>	Prof. Monique BECKER	Telecom Paris Sud
	Prof. Roch GLITHO	Université de Concordia
<i>Examineur :</i>	Prof. Miche MAROT	Telecom Paris Sud
	Prof. José Neuman DE SOUZA	Federal University of Ceara
	Prof. Youssef IRAQI	Kurtar University
	Dr. Quoc-Thinh NGUYEN VUONG	France Telecom

Abstract

Wimax mobile cellular systems are envisioned to provide high data rate multimedia services to users at anytime, anywhere at an affordable cost. The combination of orthogonal division multiple accesses (OFDMA) and relaying in Wimax provide rich opportunities for cost-effective and high performance networks. Wimax standard 802.16j extends not only the coverage of the cell but also increases the average throughput of the users. Much research of this standard has been published in order to optimize the performance of this network. However, when we reviewed the existing architectures of Wimax standard 802.16j and assessed their performance, we realized that the throughput of the system could still be enhanced by using a more efficient frequency reuse and scheduling algorithm.

In the first part of the thesis, we review the existing standard 802.16j architectures in which the total throughput of system is slightly higher than that in the standard without relay one. To enhance even more the system performance of this standard, we propose a new architecture built on frequency reuse and sectoring technique. The total throughput increased strongly in our approach compared with to the existing studies.

In the second part of the thesis, we study the impact of interference in our relay model. The simulation results showed that the SINR of mobile stations in our approach increase very slightly comparing to the one in Wimax with relay without frequency reuse and sectoring. Therefore the impact of interference is small and can be considered as negligible. We concluded that our proposition still provide a better performance.

In the third part of the thesis, we proposed a new radio resource management approach in downlink in order to guarantee the user's fairness but still maintain a high total throughput. The simulation results showed that there was a trade-off between the fairness-aware and the total throughput of the system.

Index Terms : OFDM, OFDMA, AMC, MIMO, Relay Stations, 3G, WiMax, 802.16e, 802.16j, 602.16m, LTE, Frame Structure, Path Selection, User Fairness, Cooperative Relay, Relay Placement, Cooperative Relay Sectoring, Performance Measurement, Frequency Reuse, Clustering, Dimensioning, Scheduling, Allocation Resource

Résumé

WiMAX mobile cellulaire systèmes ont pour objective de fournir des services multimédias à haut débit à n'importe quel moment, n'importe quel endroit avec un prix abordable. La combinaison d'orthogonale accès multiples (OFDMA) et le relais en Wimax donnent plusieurs opportunités pour des réseaux moins coûteux et plus performances. La norme Wimax 802.16j élargit non seulement la couverture de la cellule, mais aussi augmente le débit moyen des utilisateurs. Plusieurs recherches de cette norme ont été publiées afin d'optimiser la performance du réseau. Cependant, lorsque nous étudions les architectures existantes du Wimax 802.16j standard et leur rendement, nous nous sommes aperçus que le débit du système pourrait être encore amélioré à l'aide de la réutilisation de fréquence.

Dans la première partie de ce travail de recherche, nous avons examiné l'architecture existante de la norme 802.16j. Le débit total du système est légèrement plus élevé dans ces architectures que dans la norme sans relais. Afin d'améliorer le rendement du système de cette norme, nous avons proposé une nouvelle architecture de cette norme avec réutilisation de fréquence et de la technique de sectorisation. Le débit total augmente fortement dans notre approche comparant aux études existantes.

Dans la deuxième partie, nous avons étudié l'impact de l'interférence dans notre modèle de relais. Les résultats de simulation montrent que les SINR de station mobile augmentent très légèrement. Cet impact d'interférence est assez faible et pourrait être négligeable. Nous concluons que notre proposition fournit toujours une meilleure performance.

Dans la troisième partie, nous avons proposé une nouvelle approche d'allocation de ressources en liaison descendante afin de garantir les mêmes qualités de service pour les utilisateurs en maintenant un haut débit total. Les résultats de simulation montrent qu'il existe un compromis entre l'équité de la qualité de service et le débit total du système.

Mots Clés : OFDM, OFDMA, AMC, MIMO, Relay Stations, 3G, WiMax, 802.16e, 802.16j, 602.16m, LTE, Frame Structure, Path Selection, User Fairness, Cooperative Relay, Relay Placement, Cooperative Relay Sectoring, Performance Measurement, Frequency Reuse, Clustering, Dimensioning, Scheduling, Allocation Resource

To my parents, my little brother and my fiancé

Acknowledgements

In the first place I would like to express my gratitude to my Ph.D. supervisor, Prof. Nazim Agoulmine for his supervision, advice, and guidance from the very early stage of this research as well as giving me extraordinary experiences through out the work.

I am thankful to Prof. Monique BECKER, Prof. Roch GLITHO who did accept to be the reporters of my thesis and to Prof. Miche MAROT, Prof. José Neuman DE SOUZA, Prof. Youssef IRAQUI and Dr. Quoc-Thinh NGUYEN-VUONG for the time and effort that they invested in judging my work.

I am indebted to all my colleagues at IBISC for their support, especially to my LRSM team members : Elyes LEHTIHET, Mehdi NAFA, Hui WANG, Halim ZAIDI, Ismael NENNOUCHE, Khanh Toan TRAN, Vamsi Krishna GONDI, José BRINGEL FILHO.

Many thanks go in particular to my best friends in high school NAME, NAME, NAME, my friends at Ecole Polytechnique Minh Anh TRAN, Ha DAO, Thanh Ha LE, Trung Tu NGUYEN, Ngoc Minh VO, Ngoc Anh VU, Thanh Tung VU, Thuong Van Du TRAN, Dac Trung NGUYEN, Thi Kim Thanh VUONG, Minh Bao LE, Lu Tuan Le, Si Hai MAI, Trung Lap NGUYEN, Thu Hien TO, Minh Quan TRAN, Dinh Ha NGUYEN, Minh Hoang TO, Quang Tien NGO, Hong Loc NGUYEN and Anh Quan NGUYEN for helping me through the difficult times, and for all the emotional support, entertainment and caring they provided. I wish you all good luck in your way.

I am grateful to my beloved family for their love and support throughout my life. My father, my mother and my little brother were particularly supportive.

Lastly, and most importantly, I wish to thank Mai Hong for her patience, love and encouragement. For her I dedicate this thesis . . .

Table des matières

Table des figures	vii
Liste des tableaux	ix
Glossary	xi
Introduction	1
1 Evolution of Wireless Broadband	7
1.1 Introduction	7
1.2 Evolution of cellular networks to LTE and LTE advanced	8
1.2.1 First Generation of cellular network	9
1.2.2 Second Generation of cellular network	9
1.2.3 2.5G	9
1.2.4 3G	10
1.2.5 LTE, LTE advanced & 4G requirements	10
1.2.5.1 LTE	10
1.2.5.2 LTE advanced & 4G requirements	11
1.3 Background of Wifi IEEE 802.11	13
1.4 Background of Wimax IEEE 802.16	14
1.5 Wimax vs LTE and Wifi	15
1.5.1 Wimax vs Wifi	15
1.5.2 LTE vs Wimax	16
1.6 Wimax Physical Layer	18
1.6.1 Orthogonal Frequency Division Multiplexing	18
1.6.2 OFDM in Wimax	19
1.6.3 Subchannelization OFDMA	20
1.6.4 Wimax Frame Structure	21
1.6.5 Adaptive Modulation and Coding Rate in Wimax	22
1.7 Summary	23
2 Wimax Network Quality of Service measurement and Rational of Evolution towards Wimax with Relay	25

TABLE DES MATIÈRES

2.1	Introduction	25
2.2	Wimax Quality of Service measurement	25
2.2.1	Related Work	25
2.2.2	Measurement results	26
2.2.2.1	Measurement results in LOS	27
2.2.2.2	Measurement results in NLOS	27
2.3	Principle and Architecture of Wimax Relay	30
2.3.1	Introduction	30
2.3.2	The goals of IEEE 802.16j	30
2.3.2.1	Fixed Infrastructure	31
2.3.2.2	In Building Coverage	31
2.3.2.3	Temporary Coverage	31
2.3.2.4	Coverage On Mobile Vehicles	32
2.3.3	Technical overview	33
2.3.3.1	Relay Modes	33
2.3.3.2	PHY frame structure modifications	34
2.3.3.3	MAC modifications	34
2.4	Summary	36
3	A new deployment architecture for Wimax relay using sectoring technique	37
3.1	Introduction	37
3.2	Advanced in IEEE 802.16j research and motivations	37
3.3	Relay system Models	39
3.3.1	Assumptions	39
3.3.2	Existing Relay Models	39
3.3.3	Existing cooperative relay models	41
3.4	Proposition of new sectoring relay model	42
3.4.1	Clustering and sectoring	42
3.4.2	Applying sectoring technique to relay model	43
3.4.2.1	Principle of the approach	44
3.4.2.2	An example of Wimax relay with sectoring	44
3.4.3	Frame structure of our new sectoring relay model	45
3.5	Simulation scenario and result discussion	45
3.5.1	Simulation scenario	47
3.5.2	Results and Discussions	49
3.6	Summary	51
4	Impact of interference on the system performance of Wimax Relay 802.16j with Sectoring	53
4.1	Introduction	53
4.2	Related works and research motivations	53
4.3	Assumptions and System Models	54
4.3.1	Assumptions	54

4.3.2	System Model	55
4.4	Impact of interference to the route decision	56
4.4.1	Signal propagation model	57
4.4.2	SINR evaluation	57
4.4.3	Route selection	58
4.4.4	Spectrum efficiency	59
4.5	Simulation scenario and result discussions	59
4.5.1	Simulation scenario	59
4.5.2	Performance evaluation	60
4.5.2.1	SINR evaluation	60
4.5.2.2	Spectrum efficiency evaluation	61
4.6	Summary	64
5	Radio Resource Management : Algorithm and Optimization	65
5.1	Introduction	65
5.2	Overview of Radio Resource Management in Wimax	65
5.2.1	Definitions	65
5.2.2	Design Factors	66
5.2.3	Radio Resource Management in Wimax without relay	67
5.2.4	Radio Resource Management in Wimax with relays	68
5.3	System description and Assumptions	69
5.4	RRM formulations and heuristic algorithms	70
5.4.1	Maximum total throughput formulation and algorithm	70
5.4.2	Proportional Fairness Scheduling formulation and algorithm	72
5.4.3	Queuing Fairness formulation	74
5.5	Simulated Network Performance	75
5.5.1	Simulation Model and Parameters	75
5.5.2	Simulation Result and Discussion	76
5.5.2.1	Throughput comparison	77
5.5.2.2	Fairness Discussion	78
5.6	Summary	80
	Conclusion and Perspective	81
	References	85

TABLE DES MATIÈRES

Table des figures

1	Organization of the thesis' chapters	4
1.1	All Ip 4G convergence	7
1.2	Evolution of cellular networks	8
1.3	LTE to LTE advanced	12
1.4	3GPP and Wimax Timeline	17
1.5	Orthogonal Frequency Diviosion Multiplexing System (from [44])	19
1.6	Frame structure in Wimax (from source[24])	21
2.1	Relief profile allowing WiMax transmission	28
2.2	Relief profile not allowing WiMax transmissions	29
2.3	Fixed Infrastructure Usage Model	31
2.4	In Building Relay Usage Model	32
2.5	Example of Temporary Coverage	32
2.6	Example of Coverage on Mobile Vehicle	33
2.7	An example of configuration for a transparent relay frame structure in IEEE 802.16j- 2009 [75]	35
2.8	An example of configuration for a transparent relay frame structure in IEEE 802.16j- 2009 [75]	36
3.1	Frame structure in a non cooperative relay system (from [14])	40
3.2	Frame structure in a non-cooperative relay system at base station	41
3.3	Frame structure in a cooperative relay system (from [14])	42
3.4	Clustering and sectoring in Wimax network	43
3.5	Two phases in a cell with 3 sectors in the Wimax with relays system	44
3.6	Frame structure of BS and RS in a Wimax relay system with three sectors	46
3.7	SNR as a function of the distance	48
3.8	SNR as a function of the distance	48
3.9	Throughput of BS as a function of the number of MSs	49
3.10	Spectrum efficiency Bit/Hz/s in different relay model	50
4.1	Two phases in a Sectoring Wimax relay model with frequency reuse	55
4.2	Interference between peripheral cells and cell center that use the same frequency band	58

TABLE DES FIGURES

4.3	SINR of mobile station at all the positions in the cell	61
4.4	Spectrum efficiency of base station at all the point in the cell (three difference cases)	62
4.5	Spectrum efficiency Bit/Hz/s in different relay model	63
5.1	Total cell throughput in different resource allocation scenarios : $N = 25$; $\lambda = 2.10^6 bit/s$	77
5.2	Spectrum efficiency (Bit/Hz/s) in different resource allocation scenarios : $N = 25$; $\lambda = 2.10^6 bit/s$	77
5.3	Scatter of average throughput distribution at different position in the cell with different RRM schemes $N = 25$; $\lambda = 2.10^6 bit/s$	79
5.4	Jain's fairness index CDF function of different RRM schemes $N = 25$; $\lambda = 2.10^6 bit/s$	80

Liste des tableaux

1.1	802.11 Network Standards	13
1.2	Basic data on IEEE 802.16 standard	15
1.3	Comparison between Wimax and Wifi	16
1.4	OFDM parameters in Fixed Wimax and Mobile Wimax	20
1.5	PHY-layer Data Rate with various modulation and coding	22
3.1	Simulation parameters	47
4.1	Simulation parameters	60
5.1	Simulation parameters	76

GLOSSARY

Glossary

3G	Third generation of cellular wireless standards	CSMA	Carrier Sense Multiple Access
4G	Fourth generation of cellular wireless standards	CTC	Convolutional Turbo Code
AC	Admission Control	DAC	Digital-to-Analog Converter
AES	Advanced Encryption Standard	DCD	Downlink Channel Descriptor
AF	Amplify and Forward	DF	Decode and Forward
AMC	Adaptive Modulation and Coding	DFT	Discrete Fourier Transform
ARQ	Automatic Retransmission Requests	DHCP	Dynamic Host Control Protocol
BE	Best Effort	DL	Downlink
BEP	Bit Error Probability	DNS	Domain Name System
BER	Bit Error Ratio	DS	Delay Spread
BICM	Bit interleaved Coded Modulation	DSA	Dynamic Service Allocation
BLER	Block Error Rate	FBSS	Fast Base Station Switching
BPSK	Binary Phase Shift Keying	FCC	Federal Communications Commission
BRS	Broadband Radio Services	FCH	Frame control header
BS	Base Station	FDD	Frequency Division Duplex
BSC	Base Station Controller	FDMA	Frequency Division Multiple Access
BTS	Base Station Transceivers	FEC	Forward Error Correction
CBR	Constant Bit Rate	FER	Frame Error Rate
CC	Convolutional Coding	FFT	Fast Fourier Transform
CDMA	Code Division Multiple Access	FM	Frequency Modulation
CP	Cyclic Prefix	GPRS	GSM Packet Radio Services
CQI	Channel Quality Indicator	GSM	Global system for mobile communications
CS	Convergence Sub-layer	GW	Gateway
CSI	Channel State Information	HA	Home agent
		HARQ	Hybrid-ARQ
		HDTV	High definition TV
		HHO	Hard Handover
		HO	Handover
		HSDPA	High-Speed Downlink Packet Access
		HSPA	High-Speed Packet Access
		ICI	Inter-Carrier Interference
		ICMP	Internet Control Message Protocol
		IDFT	Inverse Discrete Fourier Transform

GLOSSARY

IEEE	Institute of Electrical and Electronics Engineers	PER	Packet Error Rate
IETF	Internet Engineering Task Force	PHY	Physical layer
IFFT	Inverse Fast Fourier Transform	PMP	Point to Multipoint
IFFT	Inverse fast Fourier transform	PUSC	Partial Usage of Subcarriers
IP	Internet Protocol	QAM	Quadrature Amplitude Modulation
ISI	Inter Symbol Interference	QoS	Quality of Service
LOS	Line of Sight	QPSK	Quadrature Phase Shift Keying
LTE	Long-Term Evolution	RF	Radio Frequency
MAC	Media Access Control	RFC	Request For Comments
MAC	Message-Authentication Code	RR	Radio Resource
MAN	Metropolitan Area Network	RRM	Radio Resource Management
MBS	Multicast Broadcast Service	RS	Relay Station
MC-CDMA	Multicarrier CDMA	RSS	Received Signal Strength
MCS	Modulation and Coding Scheme	RSSI	Received Signal Strength Indicator
MIMO	Multiple Input Multiple Output	RTT	Roundtrip Time
MIP	Mobile IP	SIMO	Single Input/Multiple Output
MIP-HA	Mobile IP Home Agent	SINR	Signal-to-Interference-plus-Noise Ratio
MISO	Multiple Input/Single Output	SIP	Session Initiation Protocol
MN	Mobile Node	SIR	Signal-to-Interference ratio
MRC	Maximal Ratio Combining	SISO	Single Input/Single Output
MRT	Maximum Ratio Transmission	SNR	Signal-to-Noise Ratio
MS	Mobile Station	SOFDMA	Sealable OFDMA
NAP	Network Access Provider	SS	Subscriber Station
NAS	Network Access Server	SSL	Secure Sockets Layer
NAT	Network Address Translation	STBC	Space/Time Block Code
NLOS	Non-Line-of-Sight	TCP	Transport Control Protocol
NSP	Network Services Provider	TD-SCDMA	Time Division/Synchronous CDMA
OFDM	Orthogonal Frequency Division Multiplexing	TDD	Time Division Duplexing
OFMDA	Orthogonal Frequency Division Multiple access	TDM	Time Division Multiplexing
PAPR	Peak-to-Average-Power Ratio	TDMA	Time Division Multiple Access
PAR	Peak-to-Average Ratio	UL	UpLink
PC	Paging Controller	UMTS	Universal Mobile Telephone System
PDF	Probability Density Function	VoD	Video on Demand
		VoIP	Voice over Internet Protocol
		WCDMA	Wideband Code Division Multiple Access

GLOSSARY

Wi-Fi Wireless Fidelity

WiBro Wireless Broadband

WiMAX Worldwide Interoperability
for Microwave Access

WISP Wireless Internet Service Pro-
vider

WLAN Wireless Local Area Network

GLOSSARY

Introduction

During the last two decades, the explosion of Internet has changed the way people communicate with each others, the way they share and exchange information, the way they conduct business and the way they seek entertainment. Digital Subscriber Line (DSL) and Cable Modem are the two predominant technologies in the broadband access market today. These technologies provide up to several megabits of data per second to each user and continue to increase the data rate to several megabits per second. As a result, we are not only able to surf Web faster and to download file more quickly but also to access easily million of multimedia applications such as real time audio, video streaming, multimedia conferencing and interactive gaming. The advanced broadband access systems such as fiber to the home (FTTH) and very high data rate digital subscriber loop (VDSL) have paved the way to the delivery of high definition TV (HDTV), video on demand (VoD) and many other high quality video applications.

Wireless broadband aims to bring the same services with high quality of service (QoS) in wireless context. There are two fundamental different types of wireless broadband services. The first one provides services similar to that of the traditional fixed line broadband while using wireless as a medium of transmission. This type, so-called fixed wireless broadband, is low-cost and could be an alternative solution when there is no traditional fixed line infrastructure installed. The second type of wireless broadband is called mobile broadband. This type offers its users additional functionalities of portability and mobility. Users are still able to connect to the network via base station (BS) from different locations and the connections are still maintained while the user are moving at vehicular speed. Wimax (Worldwide Interoperability for Microwave Access) is designed for both fixed wireless broadband and mobile broadband. The original Wimax standard 802.16, published in 2001, described an orthogonal frequency division multiplexing (OFDM) based point to multipoint (PMP). This standard has been completed by Wimax 802.16d standard with lower frequency operation, published in 2004. Wimax 802.16e standard with mobility support has been published in 2005.

The standard Wimax is supposed to provide broadband connectivity services “*any where*” with a large coverage. However, many Wimax 802.16d/Wimax Mobile 802.16e performance measurement researches have shown many loss of connections when there is

INTRODUCTION

no line of sight between the mobile station and its base station. The spectrum efficiency is also very low when the user is located at the edge of the cell. One straightforward solution is to add more base stations. However this reduces the coverage of the cell and increases the deployment cost. To overcome this problem, the low-cost relay station with less functionalities than the base station has been proposed to be deployed in the cell in order to improve the total system throughput and to augment the coverage of the cell with lower cost.

In this thesis, we aim to contribute to the improvement of some open issues in Wi-max standard 802.16j to increase the overall performance. This thesis describes the main contributions of the author's research studies during the last three years.

Motivation and Objective

In March 2006, a new task group 802.16j was officially established, which aims to improve the IEEE 802.16e standard in order to support multi-hop relay (MMR) operation in the wireless broadband network. Many researchers participated in the development of this IEEE 802.16j which was approved in IEEE-SA Standards Board on May 2009 as an amendment to IEEE Std 802.16-2009 and which was published by IEEE on June 2009. The 802.16j standard introduces many basic changes in the MAC layer, in the frame structure, in the relay modes, etc. to support multi-hop relay. However, there are still a lot of unanswered issues and many aspects of this standard which could be improved. The researcher community is continuously addressing these issues to improve the standard.

There are a number of contributions on different aspects of multi-hop relay such as frame structure, routing, optimal relay placement, radio resource management, etc. One particular aspect that has attracted our interest at the beginning of this research, is the performance of multihop relay systems. In several performance analysis, the authors have shown that the total throughput of the cell increases about 10% to 15% when the relay station is deployed. How could we explain this improvement? In fact, if the user connects to the base station via the relay station, the frame duration must be divided into two zones. In the first zone, the base station transmits the data to the relay station, and the second zone is the data transmission from the relay station to the mobile station. In the second phase, the base station is almost silent because the frequency band is occupied by the relay station. The time to reach the mobile stations from the base station and vice versa is twice. Hence the spectrum efficiency is reduced by a factor of two. According to the studies, the most helpful case of relay station deployment is when the link between base station and user is really bad and the link between relay station and mobile station is really good. The end-to-end throughput from the base station to the mobile station can increase more than 100%. This increase

is impressive but is only possible for a fraction of users in the cell. So the conclusion of most articles is that the end-to-end throughput could strongly increase in Wimax with relay systems but the total throughput of the cell could only increase slightly. More advanced research proposes a cooperative relay scheme in which the base station cooperates to the relay station to transmit the data in the second phase. The diversity gain from two transmissions could enhance the Signal to Interference-plus-Noise Ratio (SINR) to the user, so a better modulation and coding scheme would be applied to the mobile station. Even in the cooperative relay model, the base station needs two durations of times to reach the mobile station in the indirect path. The total throughput improvement of the cell is not remarkable.

This gives us a motivation to study and to ameliorate the IEEE 802.16j performance. Our objective is to highlight the considerable enhancement of the total throughput in multi-hop relay Wimax compared with the single hop Wimax (without relay station). We aim to propose a model where base stations can transmit data to the other mobile station in the second phase. To avoid the interference between relay station and base station, the idea is to use different narrow frequency band to transmit in the second phase. The combination of frequency reuse technique and sectoring technique allow us to investigate a new architecture where base station is efficiently used in the second phase. Using frequency reuse technique may cause a severe interference. Therefore, we need to study the impact of interferences on the proposition model.

The resource allocation in 802.16j is more complex when the relay station is deployed because it is not a simple scheduling problem as in Wimax but also a joint routing. The user's fairness is very important issue in 802.16j. The last aspect to consider is the resource allocation. A lot of contributions in radio resource management and user's fairness aware has been published. In this study, we aimed to address this problem in our architecture taking into account not only the total throughput but also the fairness.

Outline

Figure.1 highlights the structure of this thesis, which is organized as follows :

Introduction : This chapter outlines the motivation and the scope of the work.

Chapter 1 : Evolution of broadband wireless

In this chapter, we present an overview of wireless broadband network. Then we review the Wimax concept, one of the most important wireless broadband technologies. Finally we present a comparison between WIMAX and others current wireless

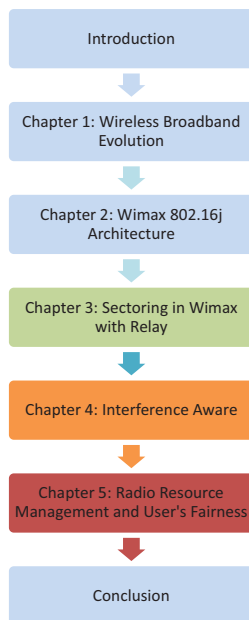

Figure 1: Organization of the thesis' chapters

broadband technologies. This chapter gives the reader a development trend in wireless broadband.

Chapter 2 : Principle and architecture of Wimax with Relay

In chapter 2, we review several important studies on system performance measurement of Wimax 802.16d and 802.16e networks. These researches highlight the limitation of the level of QoS (Quality of Service) obtained by a user at the edge of the cell. In addition, if there is no line of sight (cause of obstacle) between the mobile station and Wimax base station, the QoS can be completely jeopardized. Then, we present the Wimax 802.16j concept aiming to extend the network coverage with new low-cost relay stations in the cell to improve the system performance. This chapter also highlights the open issues in Wimax deployment

Chapter 3 : Proposition a new architecture of Wimax relay using Sectoring

In this chapter, we first review the existing works on Wimax 802.16j system performance. We show that there is still a window of enhancement of the total throughput with a better frequency re-utilisation technique. A new architecture of Wimax using Sectoring and frequency reuse technique is then presented. The corresponding frame

structure as well as communication principles for this new architecture are described. To validate the architecture, we conducted a number of simulations which are presented.

Chapter 4 : Impact of interference on the system performance of Wimax 802.16j with Sectoring

In the previous chapter, we evaluate the system performance in an isolated cell and we assume that there is no interference from the other transmitters in the neighbour cell and inside the cell. In this chapter, we improve the performance evaluation of the architecture by introducing the impact of interference. In addition, the equal amount of frequency band is allocated to each user in the previous study. This may strongly reduces the total throughput in some particular deployment of mobile station in the cell. In this chapter, we also ameliorate the way that total frequency band is shared among the sectors.

Chapter 5 : Radio Resource management : Algorithm and optimization

In this chapter, we study the RRM in Wimax 802.16j with sectoring and users' fairness aware. We propose some heuristic resource allocation algorithms in order to maintain high total throughput and a good users' fairness index. Finally, we conclude that there is a trade-off between the user fairness and the total throughput in Wimax 802.16j.

Conclusion : This final chapter provides a summary of the thesis, discusses open issues and further research directions.

INTRODUCTION

Chapter 1

Evolution of Wireless Broadband

1.1 Introduction

Wireless broadband allows users to get access to the high data services/internet without any cables, wires or telephone connections. It brings to the user almost the same data services as those of broadband wire such as web surfing, file downloading, multimedia application video streaming, multimedia conferencing and interactive gaming. Wireless broadband also intends to support very high data rate services including high-definition TV (HDTV) and video on demand (VoD). Nowadays, wireless broadband access are build around Wifi, Wimax and LTE (Long Term Evolution) technologies.

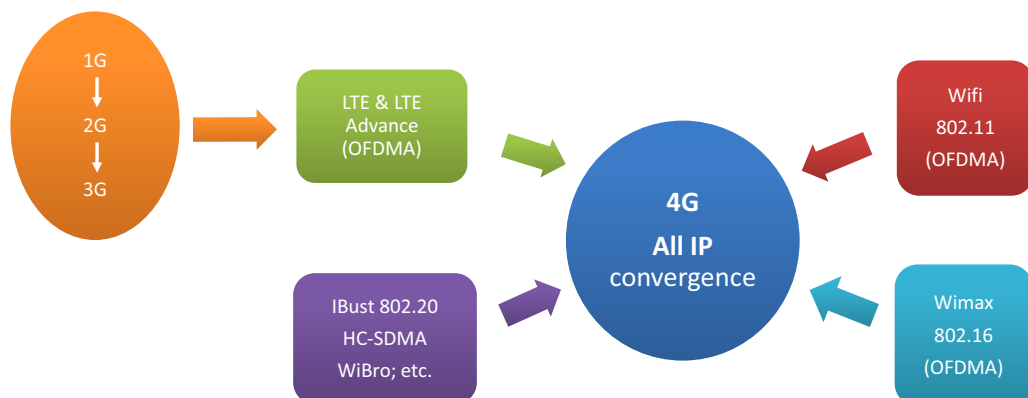

Figure 1.1: All Ip 4G convergence

1. EVOLUTION OF WIRELESS BROADBAND

Wifi is based on IEEE 802.11 standards and is one of the most deployed local area network (LAN) technologies designed to provide in-building coverage broadband coverage. Wifi standard 802.11n-2009 supports a high peak data rate of 600Mbps. While wifi employs for fixed and low mobility users with small coverage, Wimax standard is supposed to cover a large area with both fixed users and users at vehicular speed. Otherwise, Long Term Evolution is the current development standard of cellular network. The first purpose of cellular network is to provide voice services for mobile users but from 2.5G, the service providers start to deploy the advanced technologies to provide data services (multimedia messaging, video calling ...). Actually, LTE supports up to 300Mbps download speed and is expected to have a peak download speed at 1Gbps with LTE advanced in a near future. The objective of 4G convergence (Figure.1.1) is to build a network in which high data rate services are available anytime, anywhere. Depending on the user context, 4G convergence can adapt to the demand, the link condition to provide the best service at the best price. In the following of this chapter, we will first present an overview of the three major standards (Wifi, Wimax and LTE) and a comparison study. We will then present in details the concept of Wimax technology in which we will make our further research.

1.2 Evolution of cellular networks to LTE and LTE advanced

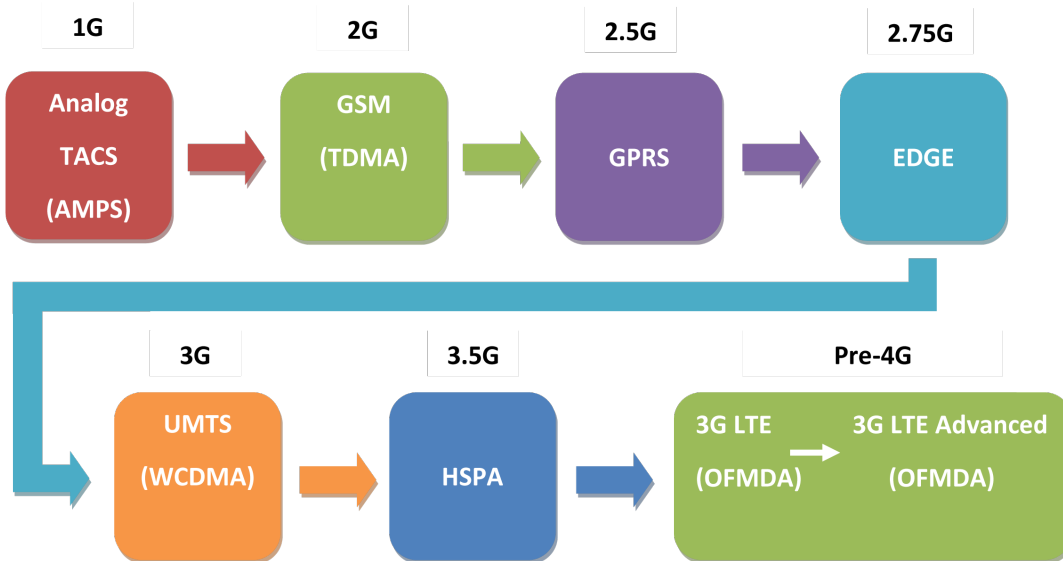

Figure 1.2: Evolution of cellular networks

1.2.1 First Generation of cellular network

1G refers to the first generation of wireless telephone technology. This first generation of cellular network was initially deployed in the metropolitan area of Tokyo in Japan by NTT in 1979. After the big success of this deployment, many other countries launched their proper 1G using different standards including NMT (Nordic Mobile Telephone), AMPS (Advanced Mobile Phone System), TACS (Total Access Communication System) and JTACS (Japanese Total Access Communication system). 1G is an important innovation in telecommunication history. Nevertheless, 1G used analogue radio signals that caused many problem of quality of transmission, security and really low spectrum efficiency.

1.2.2 Second Generation of cellular network

2G is the short term of second generation wireless telephony technologies. This generation of cellular network was commercially launched in Europe in 1991. In 2G networks, there are three more advantages over the first generation networks. First, the phone conversations are digitally encrypted. This strongly reduced the fraud in 1G using the analogue systems in which it was possible to have two or more handsets with the same number. Second, the spectrum efficiency increases significantly in 2G system. Third, 2G start to introduce text messaging services for mobiles.

The main standard of this generation is GSM (Global System for Mobile Communications) using TDMA-based (Time Division Multiple Access). GSM has become the world's fastest-growing communication technology with more than 80% of all subscribers around the world today. The second major standard using CDMA-based is IS-95 (or cdmaOne) covers about 17% of all subscribes globally. CdmaOne is deployed in Americans and many parts of Asia. The other standards are locally used, such as PDC (Personal Digital Cellular) only in Japan; iDEN (Integrated Digital Enhanced Network) provided by Nextel in United States and Telus Mobility in Canada.

1.2.3 2.5G

General packet radio service (GPRS) is a packet oriented mobile data service on the 2G cellular communication systems. GPRS is expected to profoundly change the mobile data services that GSM network providers can offer. GPRS combines mobile access with Internet protocol-based services, using packet data transmission that makes highly efficient use of radio spectrum and enables high data speeds. The data speeds of this technology vary from 14.4 kbps to 115 kbps and offer continuous connection for mobile phone and computer users. GPRS extends the GSM Packet circuit switched data capabilities and makes the following services possible :

1. EVOLUTION OF WIRELESS BROADBAND

- “Always on” internet access
- Multimedia messaging service (MMS)
- Push to talk over cellular (PoC)
- Instant messaging
- Internet applications for smart devices through wireless application protocol (WAP)
- Point to point (P2P) service : inter-networking with the internet
- Point to Multipoint (P2M) service : point to multipoint multicast and point to multipoint group calls

This is the first important step on the path to 3G. The next step to 3G from GSM is EDGE (Enhanced Data rates for GSM Evolution). This technology requires no hardware and software changes in GSM core networks. EDGE is considered as 2.75G or pre 3G and can carry a bandwidth up to 236.8 kbps.

1.2.4 3G

3G refers to third generation mobile telecommunication, a generation of standards for mobile phones and mobile telecommunication services fulfilling the International Mobile Telecommunications – 2000 (IMT – 2000) specifications by the International Telecommunication Union. This generation of mobile telecommunication proposes a higher peak data rates up to several Mbps, a greater system capacity and spectrum efficiency improvement. 3G provides wide area wireless voice telephone, mobile Internet access, video calls and mobile TV, all in a mobile environment. CDMA, UMTS (Universal Mobile Telecommunications System) with both FDD and TDD variants, CDMA2000 and TD-SCDMA (Time Division – Synchronous Code Division Multiple Access) are the technologies for 3G.

1.2.5 LTE, LTE advanced & 4G requirements

1.2.5.1 LTE

A new cellular standard called 3GPP LTE (Long Term Evolution)[78], which is also considered as E-UTRA (Evolved UMTS Terrestrial Radio Access), is officially defined to replace the UMTS third-generation system. LTE has been designed as a future technology to cope with higher user requirements in data rates. This standard represents the next step in the evolution of 2G and 3G systems and also in the provisioning of quality similar to those of the current wire network.

OFDMA (Orthogonal Frequency Division Multiple Access) and SC-FDMA (Single Carrier Frequency Division Multiple Access) are the two technologies in downlink and uplink respectively in the standard. The system is required to support peak data rates

1.2 Evolution of cellular networks to LTE and LTE advanced

of 100Mbps in downlink and 50Mbps in uplink within a 20MHz bandwidth. This is equivalent to a spectral efficiency 5 bps/Hz in downlink or 2.5bps/Hz in uplink. Beyond the high data rates, LTE supports a low latency, plug and play and FDD & TDD in the same platform to improve the end-user experience. The LTE architecture is simpler than the previous U-TMS architecture and that results in a low operating cost. LTE also supports the seamless passing to the cell tower with older network technology such as GSM, CdmaOne, UMTS and CDMA200.

LTE important dates

- In 2004 : The dominant operator NTT of Japan proposed LTE as the international standard.
- In early 2008, at the Mobile World Congress 2008 in Barcelona, some companies demonstrated the world's first LTE test equipments.
- In January 2009, the LTE standard completed the 3GPP Release 8 so that the hardware designers could start to design chipsets, test equipments and base station.
- On December 14, 2009, the world's first publicly available LTE service was opened by TeliaSonera in the two capitals of Stockholm and Oslo.
- On December 1, 2010, Vodafone Germany launched the LTE services for the residence in the countryside.
- On December 5, 2010, Verizon Wireless started the commercial sale of LTE services in United States, which supported 5-12Mbps download data rates and 2-5Mbps upload data rates.

LTE current characteristics

- In a 20MHz of spectrum, the peak data download rates is 326.4Mbps with MIMO 4x4 antennas ; 172.8 Mbps with MIMO 2x2 antennas and 86.4 Mbps with systems using single antenna.
- The system can support at least 200 active data clients in every 5MHz cell.
- This standard can support frequency band as small as 1.4MHz and as large as 20MHz.
- In the city or urban areas, the high frequency bands (about 2.GHz) are employed to support high speed mobile clients. The cell coverage is about 1km or even smaller in this case. However, in rural areas, the 900MHz frequency band could be used to support a larger size cell up to 5km and 30km with reasonable performance and up to 100km with acceptable performance.
- High performance mobile data are possible up to 350 km/h, or even up to 500km/h, depending on the frequency band used.

1.2.5.2 LTE advanced & 4G requirements

4G requirements

1. EVOLUTION OF WIRELESS BROADBAND

In mid 1990s, the ITU-R (International Telecommunication Union – Radio-communication Sector) organization defined the IMT-2000 (International Mobile Telecommunication) specifications for what standard that should be considered as 3G systems. However, this definition is locally in cellular networks. Many other standards also satisfy the IMT-2000 requirements but they are typically not branded as 3G. That is why ITU-R specified the IMT-Advanced (International Mobile Telecommunication Advanced) requirements for 4G systems. 4G is not only a definition of fourth generation of cellular network but also a mobile broadband which provides all IP data services (including voice service) laptop computers, smartphones and other mobile devices. An ITM-Advanced must fulfil the following requirements :

- Based on an all IP packet switched network
- Peak data rates up to 1Gbps for low mobility such as nomadic/local wireless access and up to approximately 100 Mbps for high mobility such as mobile access.
- Peak link spectral efficiency of 15bit/s/Hz in the downlink and 6.75 bit/s/Hz in the uplink.
- Scalable channel bandwidth between 5 and 20MHz, optionally up to 40MHz.
- Dynamical share and utilize the network resources to support more simultaneous users per cell.
- Smooth handovers across heterogeneous networks.
- Ability to offer high quality of service for next generation multimedia support.

LTE advanced

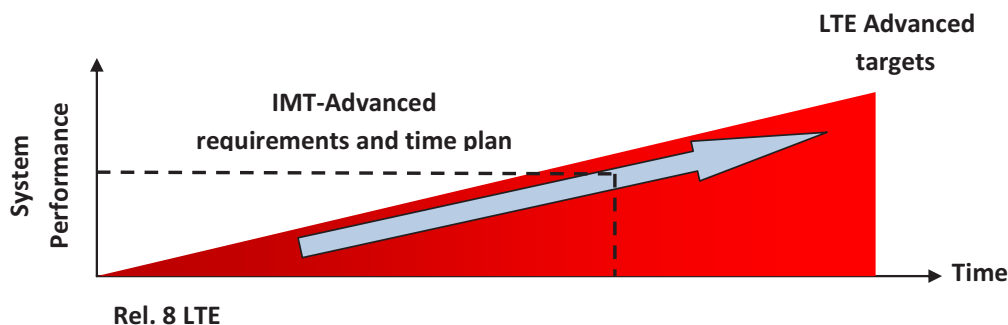

Figure 1.3: LTE to LTE advanced

Taking into account the IMT-Advanced standardization process in ITU-R, the project for LTE advanced was started in 3GPP from March 2008 built upon to the LTE release 8. The LTE advanced is the evolution of LTE and that satisfy all the requirements from IMT-Advanced as described above. The achievement of LTE Advanced is based on the following techniques (from 3GPP) :

- Supporting wider bandwidth (Increase the peak data rates and spectrum flexibility)
 - Carrier aggregation to achieve wider bandwidth
 - Support spectrum aggregation

- Advanced MIMO techniques (Increase the peak data rates, capacity, cell-edge user throughput)
 - Extension to up to 8-layer transmission in downlink
 - Introduction of single-user MIMO up to 4 layer transmission in uplink
- Coordinated multipoint transmission and reception in downlink and uplink (Increase the cell-edge user throughput, coverage and deployment flexibility)
- Further reduction of Delay
 - AS/NAS parallel processing for reduction of C-Plane Delay

1.3 Background of Wifi IEEE 802.11

In addition to LTE & LTE advance, Wi-Fi based-systems are also used to provide wireless broadband services. Wi-fi is not a technical term, even the Wi-Fi Alliance has often used the phrase Wireless Fidelity in its press release. Wi-Fi belongs to the IEEE 802.11 standards which permit devices, such as laptop computers, smartphones, video game consoles and digital audio players to access Internet in WLAN (Wireless Local Area Networking). This technology is designed to provide high data rate service in-building broadband coverage. The current Wi-Fi systems based on IEEE 802.11a/g support a peak physical-layer data rate of 54Mbps and typically provide indoor coverage over a distance of 38 meters (Table.1.1).

802.11	Release	Band.	Freq. (Ghz)	Data rates Mbps	Modulation	Indoor range(m)	Outdoor range(m)
-	Jun 1997	2.4	20	2	DSSS/FHSS	20	100
a	Sep 1999	5	20	54	OFDM	35	120
b	Sep 1999	2.4	20	11	OFDM/DSSS	38	140
g	Jun 2003	2.4	20	54	OFDM	38	140
n	Oct 2009	2.4/5	40	600	OFDM	70	250

Table 1.1: 802.11 Network Standards

In the last few years, Wi-Fi has developed very rapidly. Wi-Fi is used by more than 700 million people and there are more than 750 000 hotspots (places with Wi-Fi Internet Connectivity) around the world. Each year, more than 800 million new devices integrated with Wi-Fi technology are produced. These numbers show the very big success of 802.11 standards. Wi-Fi has become the standard for “last feet” broadband connectivity in homes, offices, and public hotspot locations. Due to the remarkably high data rates of Wi-Fi, its propose to cover the metropolitan area with Wi-Fi so that Internet and high data services are provided anywhere. However, even the high power transmitters, Wi-Fi systems can typically provide a coverage range of only about 300 meter from the access point. Consequently, a lot of access points must be deployed, which makes it impractical for large-scale. In addition, Wi-Fi systems are not designed

1. EVOLUTION OF WIRELESS BROADBAND

to support high speed mobility. Nevertheless, WiFi could be deployed to provide broadband access to hotzones within a city or community.

802.11n is the last amendment which improves the previous 802.11 standard by adding MIMO antennas. 802.11n, operated on both 2.4GHz and 5GHz bands, provides a very high peak data rate up to 600Mbps with system of 4x4 MIMO. A new standard 802.11ac is currently under development in order to satisfy the ITM-Advanced requirement. This is accomplished by extending the air interface concepts embraced in 802.16n with wider RF bandwidths (up to 160MHz), high density modulations (up to 256 QAM) and 8x8 MIMO systems. This standard finalization is anticipated in late 2012.

1.4 Background of Wimax IEEE 802.16

Wimax (Worldwide Interoperability for Microwave Access) is based on WLAN (Wireless Metropolitan Area Networking) standard developed by the IEEE 802.16. In 1998, the 802.16 group was formed and started to develop an air-interface standard for wireless broadband for a metropolitan coverage. Their first purpose is the development of a LOS (Line of Sight) based point-to-multipoint wireless broadband at high frequency bands from 10GHz to 66GHz. In December 2001, the group accomplished the original 802.16 standard which was based on a TDM (Time Division Multiplexing) technology on MAC layer with a single carrier on physical layer.

After the first result, the IEEE 802.16 groups continued to develop a new standard that supported NLOS (Non Line of Sight) services in the smaller frequency band from 2GHz to 11GHz. In 2003, 802.16a, an amendment to the standard, was completed. The key technique of this amendment is the using of both OFDM and OFDMA to support NLOS applications. Further revisions resulted in a new standard in 2004, called IEEE 802.16-2004, which replaced the previous versions and formed the basis for the first Wimax solution. The IEEE 802.16 2004 focused only on the fixed location users and is usually referred to the fixed Wimax.

In December 2005, the IEEE 802.16e-2005, an amendment to the standard 802.16-2004 with mobility support, was completed and approved by IEEE. This standard forms the basis for the Wimax solution for nomadic and mobile applications and is considered to be mobile Wimax. IEEE 802.16j-2009 is the current amendment of Wimax that adds the relay station support and an improvement in data rates. The peak data rates of Wimax Release 1.0 (802.16e) are about 45Mbps in the downlink and 13Mbps in the uplink. In Wimax Release 1.5 (802.16j-2009), the peak data rate is up to 289Mbps in downlink and up to 69Mbps in downlink. The next amendment 802.16m[3][46], a

1.5 Wimax vs LTE and Wifi

potential candidate for 4G networks, is expected to be completed in 2012. This standard is supposed to satisfy all the requirement of ITM-Advanced. A summary of Wimax IEEE 802.16 standard is presented in the Table.1.2 below :

	802.16	802.16-2004	802.16e-2005	802.16j-2009	802.16m
Status	Completed 2001	Completed 2004	Completed 2005	Completed 2009	In Progress
Frequency band	10Ghz-66GHz	2Ghz-11Ghz	2-11Ghz for fixed; 2-6Ghz for mobile application	2-11Ghz for fixed; 2-6Ghz for mobile application	2-11Ghz for fixed; 2-6Ghz for mobile application
Applications	Fixed LOS	Fixed NLOS	Fixe and Mobile NLOS	Fixe and Mobile NLOS	Fixe and Mobile NLOS
MAC architecture	Point-to-Multipoint	Point-to-Multipoint	Point-to-Multipoint, Mesh	Point-to-Multipoint, Mesh, Relay	Point-to-Multipoint, Mesh, Relay
Transmission Scheme	Single carrier	Single carrier, 256 OFDM or 2048 OFDM	Single carrier, 256 OFDM or scalable OFDM with 128, 512, 1024 or 2048 subcarriers	Single carrier, 256 OFDM or scalable OFDM with 128, 512, 1024 or 2048 subcarriers	Single carrier, 256 OFDM or scalable OFDM with 128, 512, 1024 or 2048 subcarriers
Modulation	QPSK up to 64QAM	QPSK up to 64QAM	QPSK up to 64QAM	QPSK up to 64QAM	QPSK up to 128QAM or 256QAM
Peak down-link data rate	46Mbps with 10MHz, DL :UL ratio 3 :1	46Mbps with 10MHz, DL :UL ratio 3 :1	46Mbps with 10MHz, DL :UL ratio 3 :1	289Mbps with 20MHz, DL :UL ratio 3 :1, 4x4 MIMO	More than 1Gpbs
Multiplexing	Burst TDM TDMA	Bust TDM TDMA OFDMA	Bust TDM TDMA OFDMA	Bust TDM TDMA OFDMA	Bust TDM TDMA OFDMA

Table 1.2: Basic data on IEEE 802.16 standard

1.5 Wimax vs LTE and Wifi

1.5.1 Wimax vs Wifi

Due to their different purposes, Wimax and Wi-Fi have different coverages. Wimax is a long range system that covers many kilometers and uses licensed or unlicensed spectrum to deliver connection to a network, in most case the internet, while Wi – Fi uses unlicensed spectrum to provide access to a local network. Wi-Fi is an older wireless broadband technology which has had a great success. That is why Wi-Fi is very popular in end user devices and people used to propose to cover the whole metropolitan with hotspots Wi-Fi. However, due to the small coverage and the lack of mobility support,

1. EVOLUTION OF WIRELESS BROADBAND

this idea could not be real. Wimax has been recently deployed and has much fewer end user devices.

From a technical point, Wimax and Wifi have different quality of service (QoS) mechanisms. In Wimax, the QoS is based on the connections between the base station and the user device. The QoS of each connection is decided by a specific scheduling algorithm. Wi-fi uses contention access in which all data subscribers that demand data service through a wireless access point (AP) are competing for the AP's attention on a random interrupting basis. This can cause subscriber stations distant from the AP to be repeatedly interrupted by closer stations, greatly reducing their throughput. Both Wi-Fi and Wimax define Peer to Peer and ad hoc networks, where an end-user could communicate to other users using an access point or a base station. However, Wi-Fi also supports direct ad hoc or peer to peer networking between end user devices without any access point while Wimax end user devices must be in the range of the base station. Table 1.3 presents a summary comparison between Wimax IEEE 802.16j-2009 and Wifi IEEE 802.11n-2009 :

	IEEE 802.16j-2009	Wifi IEEE 802.11n-2009
Peak DL data rate	Up to 289Mbps MIMO 4x4 20MHz 3 :1	Up to 600Mbps
Peak UP data rate	Up to 69Mbps SIMO 1x2 20MHz 3 :1	Up to 600Mbps
Bandwidth	3.5MHz to 20MHz	20/40MHz
Duplexing	TDD	TDD
Multiplexing	TDMA/OFDMA	CSMA-CA
Coverage	Up to 3.5km	Up to 300m
Mobility	High	Low

Table 1.3: Comparison between Wimax and Wifi

Although Wi-Fi and Wimax are designed for different situations, they are complementary. The idea of a hybrid system which combines Wimax and Wi-Fi to provide a seamless and a high data rate anywhere is proposed in several research studies. An end user device can connect to Wimax in outdoor metropolitans with high data rate. When this user device enters the indoor location, due to the weak link to Wimax, the user device can smoothly switch to Wi-Fi to have a better connection to the network. The convergence of these two standards is part of the next generation network of ITU-R

1.5.2 LTE vs Wimax

LTE and Wimax are both accepted as candidates to meet ITM advanced performance goals (Figure.1.4). From the summary of the evolution to LTE, LTE advanced in cellular network and the background of Wimax (in the sections above). We may conclude that Wimax (Release 1.5) and LTE have a comparable performance. They

both use OFMDA in downlink with higher modulation and coding. The peak data rates are similar for the same modulation and code rate in these two standards. They both support FDD and TDD with channel bandwidth up to 20MHz. A high order MIMO solution is employed for LTE and Wimax (Release 1.5). Finally, they both offer a reduced latency. In the very near future, LTE advanced and Wimax Release 2 will also provide the same performance.

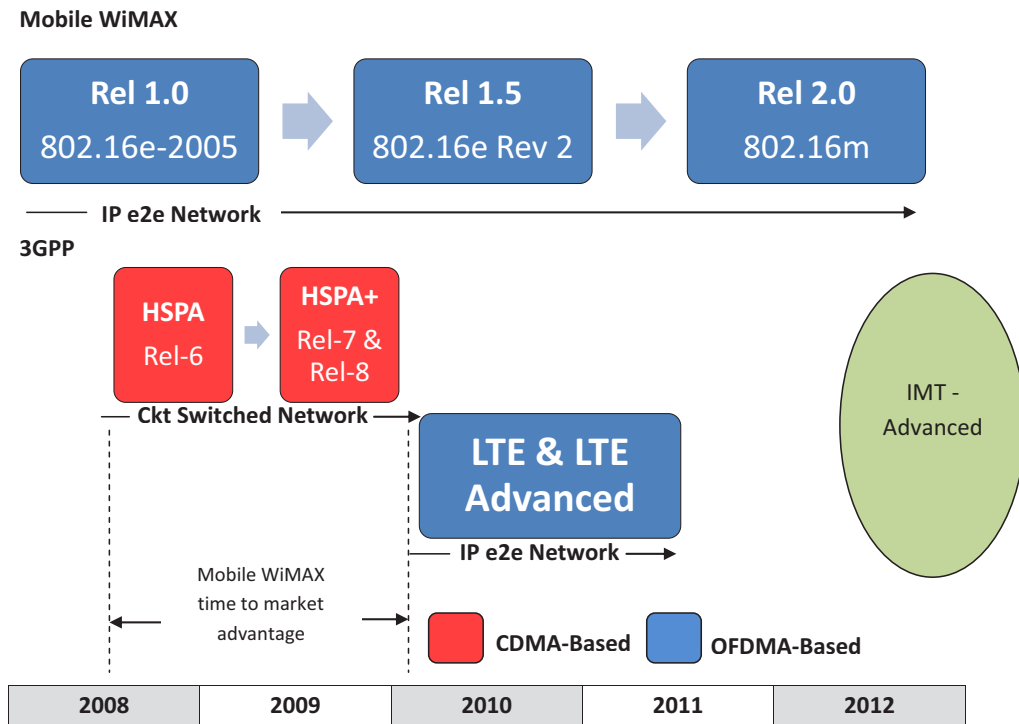

Figure 1.4: 3GPP and Wimax Timeline

The differences between these two standards comes from the cellular network providers and the hierarchy of cellular networks. Despite the earlier development of Wimax 802.16 technology, mobile operators are less likely to adopt Wimax and more likely to continue along the path of 3G evolution for higher data rate capabilities. This is because of the significant cost of deploying the new Wimax systems. Thanks to the support of the cellular network providers, LTE seems to be faster developed than Wimax in the last few years. Nevertheless, the most important advantage of Wimax may be the potential for lower cost owing to its lightweight IP architecture. Using an IP architecture which simplifies high hierarchy and complex in core cellular networks, reduces the operating expenses. The mobile operators benefit more in the short term but less in the long term if they employ LTE rather than Wimax.

1. EVOLUTION OF WIRELESS BROADBAND

However, in 4G convergence concept – IMT Advanced requirement, the handover between different technologies needs to be seamless. Clients can choose the best service provider depending on their demands. These two standards will parallelly exist and develop to provide the best services to the user.

1.6 Wimax Physical Layer

Wimax physical layer is based on orthogonal frequency division multiplexing (OFDM) which is the transmission scheme to enable high-speed data, video and multimedia communications. Nowadays, OFDM is used by a variety of commercial broadband systems, including DSL, Wi-Fi and LTE besides WiMAX. This transmission scheme is very efficient for high data rate applications in NLOS or multipath radio environment. In this section, we present the basics of OFDM and provide an overview of the WiMax physical layer.

1.6.1 Orthogonal Frequency Division Multiplexing

OFDM is a combination of modulation and multiplexing where modulation is a mapping of information on changes in the carrier phase, frequency or amplitude and multiplexing is a method of sharing a bandwidth with other independent data channels. The idea of OFDM is to divide a given high bit rate data stream into several parallel lower bit rate stream (Figure.1.5) and modulating each stream on separate carriers (usually called subcarriers). OFDM is a special case of Frequency Multiplexing. If we consider FDM as the water flow from a faucet, so OFDM is the water flow from a shower. If we now put a thumb on the faucet hole, we can stop the water flow but we cannot do the same for the shower. This concept is the same as OFDM. When the high bit rate data stream is divided to several lower bit rate streams, the interference affects only some of the lower bit-rate streams but not all of the streams. That is why OFDM limits the risk of data lost due to interference.

OFDM belongs to modulation schemes in which the inter-symbol interference is minimized or eliminated by making the symbol time large enough to avoid the delay spread of signal. The symbol duration is inversely proportional to the data rate, therefore splitting the data stream to many smaller data stream augments the symbol duration of each stream, and thereby the delay spread is only a fraction of the symbol duration. In addition the subcarriers are all orthogonal to one another in OFDM, so that the inter-carrier interference is eliminated. Thanks to Fourier Transformation, it is very easy to divide the channel signal into orthogonal subcarriers by using IFFT (inverse Fast Fourier Transformation) and FFT in the transmitter and the receiver respectively.

The guard time intervals are also used between the OFDM symbols to completely eliminate ISI (Inter Symbol Interference). Nevertheless, adding the guard intervals de-

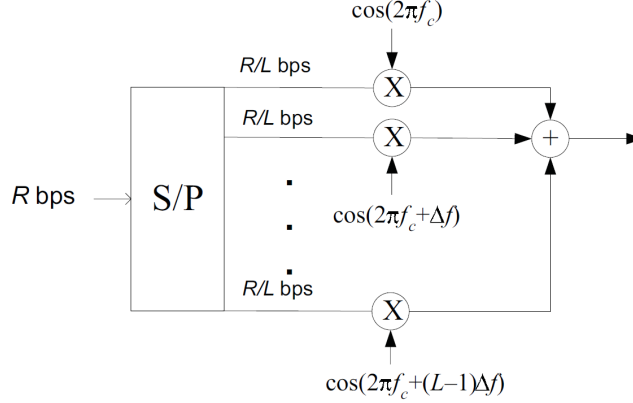

Figure 1.5: Orthogonal Frequency Division Multiplexing System (from [44])

increases the spectrum efficiency and increase the power wastage. A large FFT size would increase the symbol time and reduce the guard intervals. However, that makes the system more vulnerable to inter carrier interference caused by Doppler spread in mobile applications. The size of the FFT in OFDM design should be chosen to balance the protection against Doppler effect and system efficiency.

1.6.2 OFDM in Wimax

The implementations of OFDM in Wimax are slightly different for fixed Wimax and mobile Wimax. While Fixed Wimax employs only 256 FFT-based OFDM physical layer, mobile Wimax uses a scalable OFDMA-based physical layer in which the FFT sizes vary from 128 to 2048. Some OFDM parameters in Wimax are presented in table 1.4

In Fixed Wimax OFDM-PHY, FFT size is fixed at 256 in which 192 subcarriers are used for carrying data. For the channel estimation and synchronization, 8 pilot subcarriers are used. The other subcarriers are used as guard band subcarriers. Since the FFT is fixed, the subcarrier spacing varies with the channel bandwidth. Thereby, if larger bandwidths are used, the subcarrier spacing augments and the symbol time is reduced. The guard time must increase to overcome delay spread causing of symbol time decreasing. In Wimax, a wide range of guard times allows system designers to make appropriate trade-offs between spectrum efficiency and delay spread robustness. A 25% guard time can be used for a high delay spread. This guard time allows delay spreads up to $16\mu\text{s}$ when operating in a 3.5MHz channel and up to $8\mu\text{s}$ when operating in a 7MHz channel.

In Mobile Wimax OFDMA-PHY, the FFT size varies from 128 to 2048. In this case, the subcarrier spacing is always 10.94 kHz because when the available bandwidth

1. EVOLUTION OF WIRELESS BROADBAND

Parameters	Fixed Wimax	Mobile Wimax			
FFT sizes	256	128	512	1024	2048
Number of used data subcarriers	192	72	360	720	1440
Number of pilot subcarriers	8	12	60	120	240
Number of null/guardband subcarriers	56	44	92	184	368
Cyclic prefix or guard time(T_g/T_b)	1/32, 1/16, 1/8 , 1/4				
Channel Bandwidth (MHz)	3.5	1.25	5	10	20
Subcarrier frequency spacing (kHz)	15.625		10.94		
Useful symbol time (μs)	64		91.4		
Guard time assuming 12.5% (μs)	8		11.4		
OFDM symbol duration (μs)	72		102.94		
Number of OFDM symbols in 5 ms frame	69		48		

Table 1.4: OFDM parameters in Fixed Wimax and Mobile Wimax

augmentations, the FFT size is also increased. This keeps the OFDM symbol duration, which is the basic resource unit, fixed and therefore makes scaling have minimal impact on higher layers. The design cost is also low in a scalable system. The subcarrier spacing of 10.94 kHz is chosen as a good balance between Doppler effect and system efficiency in both fixed and mobile environments. This subcarrier spacing can support delay-spread values up to 20 μs and vehicular mobility up to 125 kmph when operating in 3.5GHz.

1.6.3 Subchannelization OFDMA

The available subcarriers may be divided into several groups of subcarriers called subchannels. In Fixed Wimax, the subchannelization is allowed only in the uplink. The standard defines 16 subchannels, where 1, 2, 4, 8 or all sets can be allocated to a subscriber station (SS) in uplink. In Mobile Wimax, OFDMA allows subchannelization in both the uplink and the downlink and here, subchannels form the minimum frequency resource-unit allocated by the base station. Therefore, different subchannels may be allocated to different users. This type of multi-access scheme is called orthogonal frequency division multiple access (OFDMA).

In Wimax, contiguous subcarriers and subcarriers pseudo-randomly distributed are two ways to form subchannels. The distributed subcarriers provide more frequency diversity, which is very useful for mobile applications. The subchannelization scheme based on contiguous subcarriers is called band adaptive modulation and coding (AMC). Band AMC permits system designers to exploit multiuser diversity and subchannels are assigned to users according to their frequency response. In general, contiguous subchannels are more suitable for fixed and low mobility applications.

1.6.4 Wimax Frame Structure

The minimum time frequency resource that can be allocated to a given link in Wimax system is called slot. Depending on the particular subchannelization scheme, each slot is constituted by one or more OFDM symbols. A contiguous series of slots allocated to a given user creates the user's data region. Scheduling algorithms could allocate data regions to different users, according to their demand, QoS requirement and channel conditions.

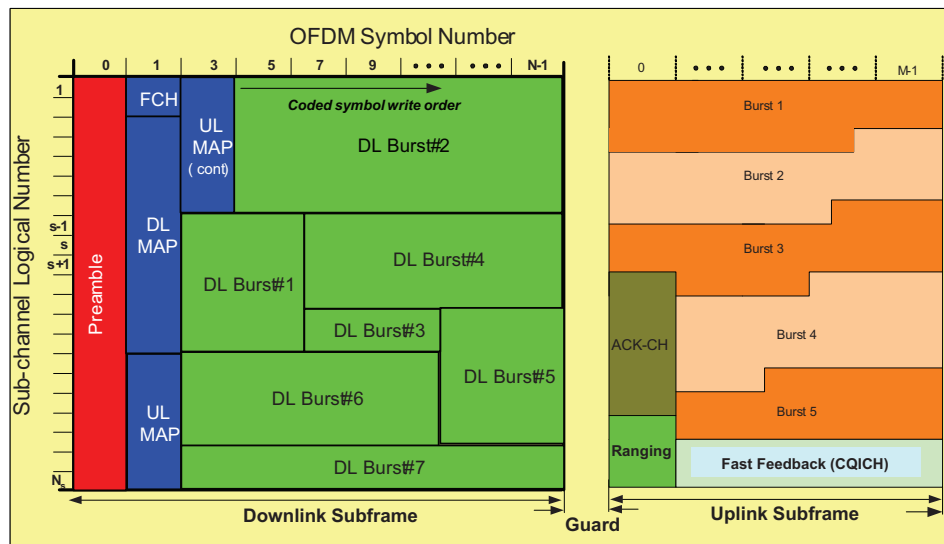

Figure 1.6: Frame structure in Wimax (from source[24])

The OFDMA and OFDM frame operating in TDD mode is illustrated in Figure.1.6. The frame is divided into a downlink subframe and an uplink subframe which are separated by a small guard interval. The downlink-to-uplink subframe ration can vary from 3 :1 to 1 :1 to support different traffic profiles. Some of the fixed Wimax still use FDD. Nevertheless, most Wimax deployments use TDD mode because it is more flexible in sharing bandwidth between uplink and downlink and it has a simpler transceiver design.

Wimax is also quite flexible in terms of how multiple users and packets are multiplexed on a single frame. Many bursts of different sizes and type carrying data for several users can be allocated in the same downlink frame. The frame size is also variable on a frame by frame basis from 2 ms to 20 ms but the current Wimax equipments only support 5 ms frames.

1. EVOLUTION OF WIRELESS BROADBAND

1.6.5 Adaptive Modulation and Coding Rate in Wimax

In Wimax, different modulation and coding schemes can be allocated to each burst in a frame and can be changed frame by frame depending on the channel conditions. The base station can estimate the uplink channel quality according to the received signal quality. For the downlink quality, the mobile station can send a quality feedback indicator to the base station. Taking into account the channel quality of each user's uplink and downlink, the base station scheduler can decide a modulation and coding scheme on each link to maximize the throughput. Adaptive modulation and coding can significantly enhance the total capacity of the system.

Channel bandwidth	3.5MHz		1.25MHz		5MHz		10MHz	
PHY mode	256OFDM		128OFDMA		512OFDMA		1024OFDMA	
Oversampling	8/7		28/25		28/25		28/25	
Modulation and Coding Rate	PHY-Layer Data Rate (kbps)							
	DL	UL	DL	UL	DL	UL	DL	UL
BPSK 1/2	946	326	Not applicable					
QPSK 1/2	1882	653	504	154	2520	653	5040	1344
QPSK 3/4	2822	979	756	230	3780	979	7560	2016
16QAM 1/2	3763	1306	1008	307	5040	1306	10080	2688
16QAM 3/4	5645	1958	1512	461	7560	1958	15120	4032
64QAM 1/2	5645	1958	1512	461	7560	1958	15120	4032
64QAM 2/3	7526	2611	2016	614	10080	2611	20160	5376
64QAM 3/4	8467	2938	2267	691	11340	2938	22680	6048
64QAM 5/6	9408	3264	2520	768	12600	3264	25200	6720

Table 1.5: PHY-layer Data Rate with various modulation and coding

The current modulation and coding scheme employed by both fixed Wimax and mobile Wimax are BPSK, QPSK, 16QAM and 64QAM. In the next amendment IEEE 802.16m, Wimax may support higher modulation and coding schemes such as 128QAM and 256QAM to provide better spectrum efficiency. In fact, if the channel quality between a mobile station and base station is good, the base station will employ the modulation and coding schemes with high data rates such as 64QAM, 16QAM to transmit data to this user and vice versa. The standard optionally supports turbo codes and low-density parity check (LDPC) codes that closely approach the theoretical limits imposed by Shannon's theorem. In Table 1.5, we present different achieved PHY-layer data rates with various modulation and coding rates.

1.7 Summary

In the first part of this chapter, we presented the evolution of wireless broadband via an overview of three remarkable current standards including Wimax, Wi-Fi and LTE. Despite their different purposes and their different advantages, they are complementary to provide high data rate services to both fixed and mobile devices. However they are now not compatible with each other and in addition, they have not yet met the high data rate requirements of ITM advanced. In the near future, we expect to see the convergence of these standards and also the other standards in 4G where all standards are compatible and provide a very high data rate services in wireless context. In the second part of this chapter, we gave an overview of Wimax physical layer where many salient features have been presented.

In the next chapter, we will present the measurement analysis of Wimax performance. The analysis shows the rational behind the new amendment IEEE 802.16j where the low cost relays deployment in the cell is specified in order to improve the QoS and the system performance. Afterwards, the we introduce the architecture of Wimax with relays and the essential modifications in this standard.

1. EVOLUTION OF WIRELESS BROADBAND

Chapter 2

Wimax Network Quality of Service measurement and Rational of Evolution towards Wimax with Relay

2.1 Introduction

In the previous chapter, we presented the evolution of wireless broadband technologies in which the ITU-R specified the IMT-Advanced requirements for 4G system. It's a mobile broadband that provides all IP high data rate services to mobile devices. We also gave an overview of Wimax which is an important candidate of 4G systems. In this chapter, we will first present QoS measurement studies in Wimax without relay. Particularly, the measurement results on an operational Wimax network is given in LOS and NLOS cases. Then, we introduce the amendment IEEE 802.16j Wimax with relay which aims to improve the performance of Wimax. The principles and the usage scenarios of this standard are also presented. Finally, the we specify the technical modifications in Wimax with relay system.

2.2 Wimax Quality of Service measurement

2.2.1 Related Work

As the majority of wireless communication systems, the exact coverage of these networks and the corresponding QoS are very difficult to predict, especially in none free space. Thanks to OFDMA, WiMax can adapt the transmission over each bandwidth sub-channel in order to compensate transmission perturbations such as anisotropic attenuation and sometimes multipath transmission. However, this adaptation requires a

2. WIMAX NETWORK QUALITY OF SERVICE MEASUREMENT AND RATIONAL OF EVOLUTION TOWARDS WIMAX WITH RELAY

small but non negligible delay in order to reconfigure and, if the path characteristics changes during this delay, the system cannot reach a stationary state. Moreover, it is impossible to adjust the power of the channels in some situations due to the dynamic property of the obstacles between the transmitter and the receiver (e.g. trees). In order to evaluate and understand the real performance of WiMax, we will present the results of several campaign of measurements of an operational network conducted by different researchers.

Although there is few performance studies dealing with measurements obtained from real Wimax networks, some interesting information and publication can be found in the literature. In [68], the paper describes a real Wimax testbed settled up to transmit videos. In [21], the authors show that it is possible to achieve up to 1.8Mbps data rate with Wimax up to several kilometers between the base station and the mobile station. Authors in [79] succeed in achieving seamless hand over of VoIP sessions within a hybrid Wi-Fi and Wimax network. In [48], the authors discover that the round trip delay can be very large when using TCP over Wimax. However, they can setup seamless communications with a moving car in a city. In [23], large throughput variations are noticed in NLOS channel conditions in an urban street-level environment due to the existence of moving vehicles in the radio path. The authors in [18] noticed that there are few correlations between the distance and the performance, but in contrary, there are many correlations between the performance and the carrier to interference noise ratio (CINR). They have shown that an elevation of the base station increases the performance but not the coverage until a certain height above which the coverage is also improved. The measurement in [100] shows that it is possible to have satisfactory throughput up to about 10 kilometers, but the SINR is very sensitive to small vertical or horizontal changes (even as small as 1cm). In [94], the authors have observed a street level range up from 300 to 2100 meters in urban environment, depending on the emission power. They also compared their measurements with simulation and noticed a good correlation between the computational results and the empirical results.

It appears from these results that the diversity of parameters that influence communication and make it difficult to obtain general results and much more experimental work is necessary. The following section will present the result of measurements performed on an operational Wimax network provided by a French operator. Several tests have been conducted in different operating conditions (weather, distance, LOS or NLOS, influence of metal, speed, etc.) to better understand the performance of Wimax system[19].

2.2.2 Measurement results

This section will present the results of the measurement campaign performed by our colleague and published in “Computer Communications” journal in November 2010. This work has been conducted by Doctor Pierre Delannoy in collaboration with Hai

Dang Nguyen, Michel Marot, Nazim Agoulmine and Monique Becker. After OFDMA correction, the attenuation caused by the obstacles and their impact on QoS is estimated. For this purpose, a free path loss model is used and serves to calibrate the system at different places. The obtained results are then compared to a non-free path loss model using the prediction for the same distance.

2.2.2.1 Measurement results in LOS

In line of sight (LOS) cases (no obstacles between the transmitter and the receiver), all of our measurements show that the transmission is very good at distances up to 3.2km. The average transmission rate is about 100kbytes/s for FTP file transfer or during IMAP mail fetching (both applications use TCP). The SMTP mail emission rate is about half due to the asymmetric resource allocation between uplink and downlink channels. Video streaming is possible up to 800kb/s. Therefore, it is possible to preview in real time via the network any videos encoded with an H.264 codec. The perception of the video is as good as with a wire xDSL line. In this network the resource allocation is not managed for the throughputs exceeding 2 Mb/s. That is why it is not possible to conclude on the average throughput of the entire network. However, from the measurement results, we could see that less bandwidth is used when the user is close to the BS because the system uses a stronger modulation and coding scheme.

Indeed, the measurements show that if the user is close to the BS (up to 1,2km), the best modulation and coding scheme (64QAM1/2) is used. When the user is far away from BS, the stronger modulation and coding scheme (QPSK1/2) is used. The BS operates on two modulation and coding 64QAM1/2 and QPSK1/2. Therefore the theoretical coverage radius is 3.1 km. The measurement coverage radius is about 3.2 km. Moreover, the modulation and coding scheme for the user depend only on the distance because there is no adding SNR from obstacles. The measurement result is almost the same in the theoretical case of free-space pathloss model as in the field campaign.

2.2.2.2 Measurement results in NLOS

In this section, the result of measurement in the case of NLOS are presented. First of all, the following highlights the different type of materials that can be a source of attenuation.

- *In city*

Three different tests were made in a city to evaluate the impact of an urban environment on WiMax transmissions. As the obstacles are fixed (such as building, walls, etc), OFDMA can better correct with multipath than with variable attenuations. However, it was noticed an extra attenuation of 9 to 12 dB as compared

2. WIMAX NETWORK QUALITY OF SERVICE MEASUREMENT AND RATIONAL OF EVOLUTION TOWARDS WIMAX WITH RELAY

to free-space path loss.

- *Indoor*

Indoor, the extra attenuation is between 12 to 15 dB. It is possible to compensate this attenuation using a +15 dB gain antenna. Indeed, in some situations, without a high-gain antenna, the transmission is still possible when the base station configures to use a stronger modulation and coding scheme.

- *Metal*

Metal can cause an extra attenuation of more than 30 dB. For example, it is almost impossible to communicate through iron or through an iron grid with spaces between the edges of the same order of magnitude as the wavelength. Three different performed tests highlighted that.

- *Glance*

A 2.5 centimeter width glass causes an extra attenuation of about 7.5 dB, as compared to free path loss. With a standard half-centimeter thick glass, the attenuation is between 1.5 and 2 dB.

Relief and nature obstacle

- *Relief*

Relief attenuation can sometimes be compensated with OFDM and multipath. Thus, a transmission is possible between two points that are separated by a topographical profile such as the one experimented and shown in Figure.2.1. Despite the fact that the transmitter cannot be seen from the receiver, communication is still possible.

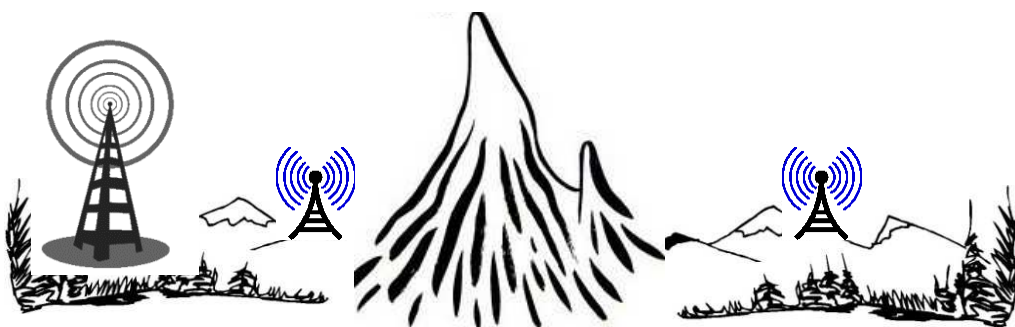

Figure 2.1: Relief profile allowing WiMax transmission

As the transmission path has constant properties, the impact on QoS is limited and the extra attenuation is less than 3dB. At less than 2 km from the transmitter, the receiver can correctly receive a video stream encoded with an H.264 codec. However, at more than 4 km from the BS, there are sometimes disconnections

exponentially distributed with an average of about 20 minutes. For elastic applications such as FTP, IMAP and SMTP, the average transmission rate is reduced by less than 15%.

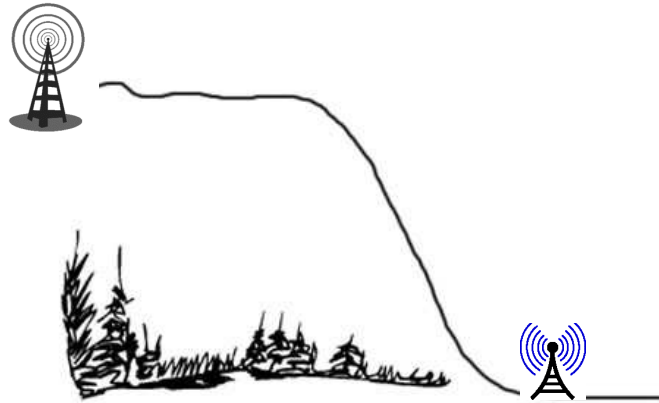

Figure 2.2: Relief profile not allowing WiMax transmissions

In the steep-sided valley whose profile is represented in Figure.2.2, it was verified that it is not possible for a receptor in the valley to connect to a BS with an omni directional antenna installed on the top of the hill (see Figure.2.2).

- *Vegetation*
Vegetation generally generates fast and random attenuations which are very difficult to predict. The path becomes anisotropic. Several performed tests have shown that the signal strength can vary by ± 9 dB, depending on the season. In spring time, it is sometimes not possible to connect at all to a BS located only at 300 m distance, especially when the weather is windy and thus even if there is no other obstacles than vegetation. This is mainly due to the multi-path and frequency-dependent attenuation which quickly change with the movement of the leaves. The OFDMA is not fast enough to compensate the random and frequency-dependent changes of the path loss.
- *Impact of weather conditions*
As many wireless transmission systems, WiMax is sensitive to weather conditions because moisture has an impact on the propagation of the waves. Since these perturbations are not constant and predictable, OFDMA cannot always compensate them.

Two tests were made at the same place, under different weather conditions. During raining conditions, an extra attenuation of about 6 dB was observed at 1800 meters from the BS. At 3000 meters of the BS, the attenuation was about 10 dB

2. WIMAX NETWORK QUALITY OF SERVICE MEASUREMENT AND RATIONAL OF EVOLUTION TOWARDS WIMAX WITH RELAY

which sometimes makes the transmission impossible or very difficult : frequent disconnections, no possibility of receiving a video streaming or of video-conferencing and a very low bit rate transfer. In very dry and cold weather, the reduced thermal noise and water attenuation can offer an extra signal quality of 2 dB comparing to the reference model.

2.3 Principle and Architecture of Wimax Relay

2.3.1 Introduction

The measurement studies on Wimax performance in the previous section and also in the literature have shown the high level of attenuation in many situations. This extra attenuation can varies from 3 up to 15dB. Consequently, a strong modulation and coding (such as BPSK, QPSK1/2) must be employed, this significantly reduces the capacity and the spectrum efficiency of the Wimax system. In addition, connection to the BS cannot be always established due to geographical factors, users' locations, obstacles, etc between users and BS. Therefore the services cannot be provided "anywhere", "anytime" as defined in the objectives of Wimax standard.

The most pragmatic and also the most widely used strategy is to increase the number of BSs. However, this solution enhances the users' QoS, it will also increase interferences and thus decrease the cell coverage. Moreover, the deployment cost of BSs is also high. The IEEE 802.16j amendment proposes to insert low-cost relay stations into the cell to aid the communications between BS to mobile station (MS) and vice versa. Such networks are also called multihop systems and are the focus of recent researches. In March 2006, the IEEE 802.16j task group was formed and the first technical contribution was presented in November of the same year. After two years, the group completed the draft 9 and this draft was ratified by the sponsor members to be submitted to IEEE Standards Association (SA) in late 2008. The amendment was approved by IEEE SA in March 2009.

2.3.2 The goals of IEEE 802.16j

IEEE 802.16j does not aim to provide a new standard that includes multihop capability but to expand previous single-hop 802.16 standards with multihop capability support. This new amendment is fully compatible with IEEE 802.16e devices and also satisfies the requirements for several levels of relay functionality. In this amendment, the relays do not have the same functionality to cope with different users scenario. Service providers may deploy a new relay into the cell to extend the coverage area or one client may buy a relay equipment and install it in his house to receive a better signal. We present here four main relay usage scenarios for IEEE 802.16j deployment[22].

2.3.2.1 Fixed Infrastructure

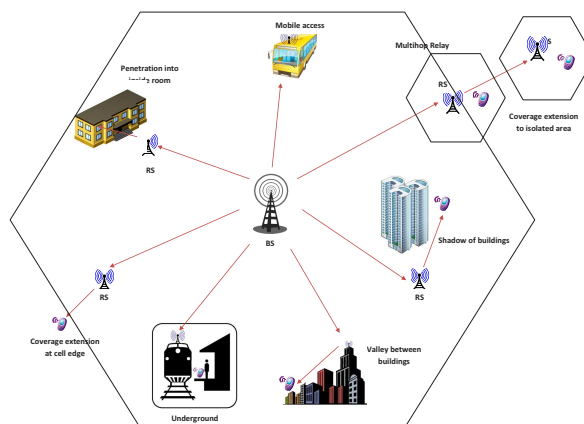

Figure 2.3: Fixed Infrastructure Usage Model

Fixed relay infrastructure scenario is illustrated in Figure 2.3. In this usage scenario, fixed relay stations (RSs) are deployed within a cell by a service provider. The first purpose of this deployment is to extend the network coverage to areas that are beyond the boundaries of the cell coverage. In case there is NLOS of the link BS - MS or no connection between the BS and the MS, the service provider can deploy the RS antennas to obtain the LOS channels in both BS - RS link and RS - MS link. The MS will connect to the BS via the RS and by this way, the user's throughput and also total cell throughput are increased. Topologies can include communication paths that range from 2 hops to multiple hops.

2.3.2.2 In Building Coverage

The measurement study presented in the first part of this chapter have shown the existence of a high extra attenuation (about 10dB) when the MS is located inside the building. Consequently, without the RS, the BS often performs poor services to the MS. Relay stations can be deployed in the building by both the end user or the service provider in order to provide better coverage and higher throughput in a building, tunnel and underground. Both fixed and nomadic relay stations can be deployed outside or inside the building. In addition, the RSs may operate on battery power due to their low complexity. Figure 2.4 shows an example of both fixed and nomadic relay usage.

2.3.2.3 Temporary Coverage

In some situations such as concert or sport event in which a large group of people is located in a small area, the BS and the fixed RSs can not provide enough capacity or coverage. The network provider can temporarily deploy nomadic RSs to increase

2. WIMAX NETWORK QUALITY OF SERVICE MEASUREMENT AND RATIONAL OF EVOLUTION TOWARDS WIMAX WITH RELAY

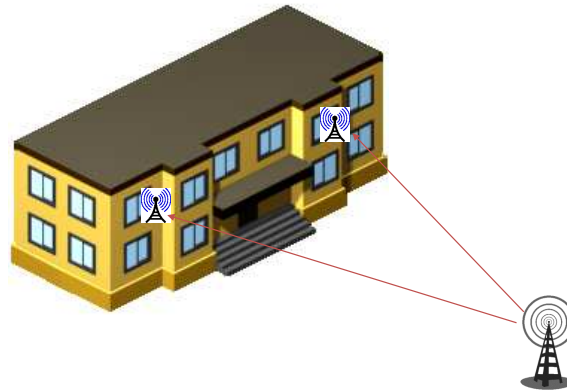

Figure 2.4: In Building Relay Usage Model

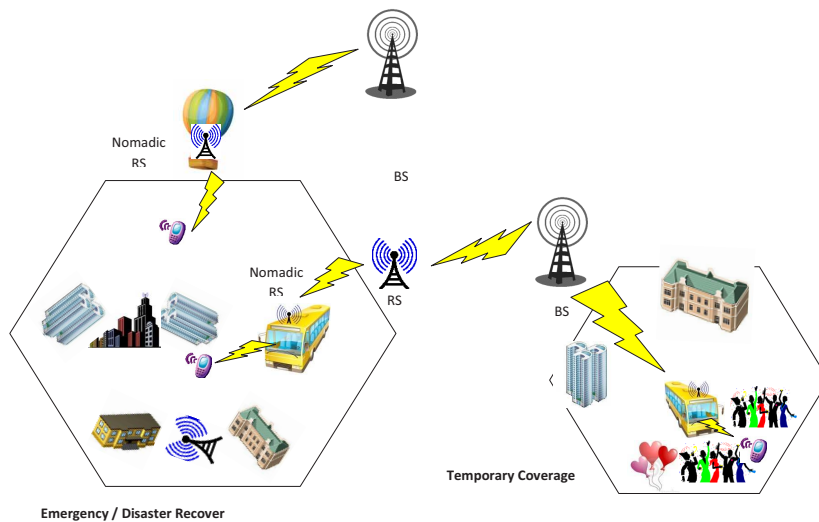

Figure 2.5: Example of Temporary Coverage

capacity or coverage in these locations. In these situations, the nomadic RSs will be part of the network during the event and the nomadic RSs could be removed when the event has ended. The temporary RSs can be also deployed in emergency cases or disaster recovery cases where the fixed infrastructure may have been destroyed. Figure2.5 presents some examples of temporary RSs deployment.

2.3.2.4 Coverage On Mobile Vehicles

Service providers may want to provide good communication services to mobile who travelling together in a vehicle such as a bus or a train. In this case a mobile RS



Figure 2.6: Example of Coverage on Mobile Vehicle

is mounted on the vehicle to provide a fixed access link to mobile devices inside the vehicle. The RSs must be enough powerful to be able to allocate resources to all of the users in the vehicle and also to have a good connection with the BS even during high mobility. These RSs will enter the network during the vehicle mobility as illustrated in figure2.6.

2.3.3 Technical overview

In the first chapter, we have presented Wimax standard without relay stations, here we will highlight the improvements introduced by the amendment 802.16j vs the previous standards. The specific aspects of these improvement are described in this section, i.e relay modes, the modification on frame structure of PHY layer and the tunneling & the scheduling at medium access control (MAC) layer.

2.3.3.1 Relay Modes

IEEE 802.16j introduces two different relay modes of operation. In the amendment of the standard [75], the definitions are the followings :

- **Transparent RS** “ A relay station that does not transmit DL frame-start preamble, FCH, MAP message(s) or channel descriptor (DCD/UCD) messages.”
- **Non-transparent RS** “ A relay station that transmits DL frame-start preamble, FCH, MAP message(s) and channel descriptor (DCD/UCD) messages.”

2. WIMAX NETWORK QUALITY OF SERVICE MEASUREMENT AND RATIONAL OF EVOLUTION TOWARDS WIMAX WITH RELAY

More precisely in the transparent mode operation, RS receives messages from BS and then sends these messages to MS without any change and no buffering. On the contrary, in non transparent mode operation, RS receives messages from BS then may decode these messages, create its proper mapping and then send these messages to MS. Transparent RSs, are a low cost communication, can be used to increase the system capacity and may be deployed for two hops system only. Non transparent RSs are more complex and higher cost. Its can be deployed to enhance the system capacity, the cell coverage and may be able to support more than two hops systems. In addition, transparent RSs can only be used in centralized systems however non transparent RSs can be used in both centralized or distributed systems.

2.3.3.2 PHY frame structure modifications

The frame structure of IEEE 802.16 is designed for single hop in PHY layer, therefore modifications of the frame structure were mandatory to support relay network architectures. In single hop frame structure, the frame is divided into downlink subframe and uplink subframe. In the amendment 802.16j, these subframes are further divided into “access zone” and “relay zone” to support BS-RS communication and RS-MS communication. In addition, the RS frame structure has been defined to be compatible with BS frame structure. Figure.2.7 and Figure2.8 illustrate the frame structure of BS and RS in transparent and non transparent relay modes.

In transparent relay mode illustrated in Figure.2.7, the BS frame structure begins with Preamble, Frame Control Header (FCH) and DL-MAP and is followed by downlink “access zone”, downlink “Relay zone” and uplink “access zone”. In *downlink access zone*, BS transmits data to MSs which is directly served and to subordinate RSs. Then in *downlink relay zone*, BS is silent or cooperative to transmit to MSs in the subchannels that are used by RSs. The procedure is inverse in BS uplink frame structure. In RS frame structure, RS receives data from BS in the *downlink access zone* and then forwards data to MSs without any change in the *downlink relay zone*.

In non transparent relay mode illustrated in Figure.2.8, the frame structure relay is more complex with its proper preamble, FCH and DL MAP. In addition, the relay zones of both BS frame structure and RS frame structure may be divided into several subzones to support more than two hops relay.

2.3.3.3 MAC modifications

Tunneling : In the point to multi point communication in IEEE 802.16e, each MS connects separately and directly to the BS. If the same scheme is applied to IEEE 802.16j, each connection via RSs or not via RSs to the MS is separated and the message header will contain all the RSs MAC address of the connection in the header.

2.3 Principle and Architecture of Wimax Relay

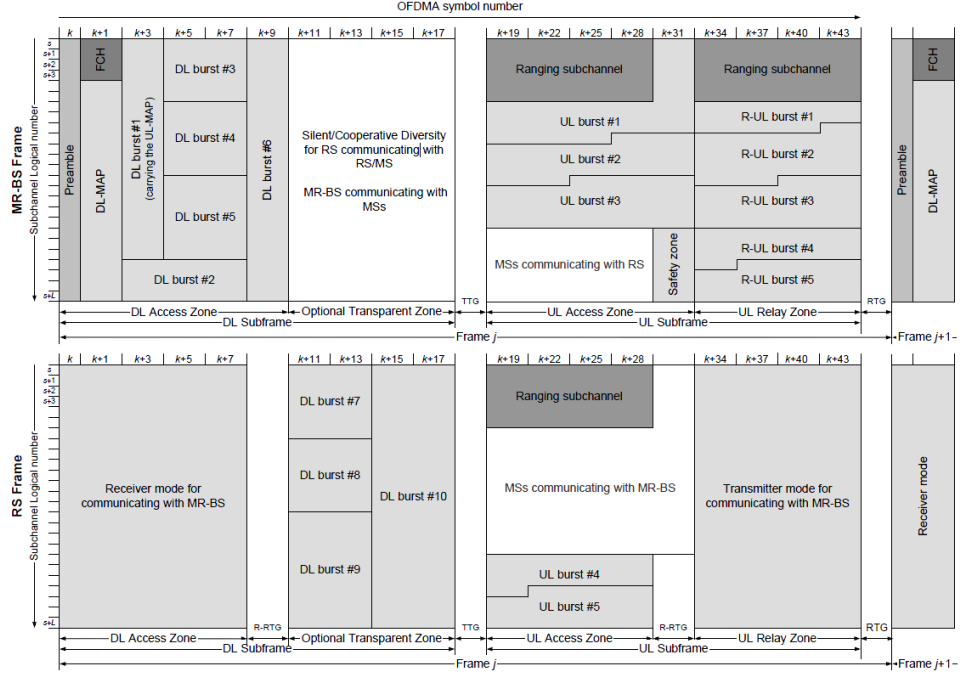

Figure 2.7: An example of configuration for a transparent relay frame structure in IEEE 802.16j- 2009 [75]

Therefore, the risk of overhead signaling is considered due to RS deployment. Consequently, the efficiency spectrum and the capacity of the system may be reduced. In [92], the author proposes modifications in medium access control of relay station to aggregate traffics where possible called tunneling. Instead of separating all of the connections to MSs, IEEE 802.16j groups the MSs and the RSs that have the same antecedent RS, in the same tunnel with the unique MAC of this antecedent RS in the message header. This approach also simplifies the connection management.

Scheduling : MAC layer design must deal with decisions which transceivers can transmit and how the decisions are communicated to the network. In a centralized single-hop IEEE 802.16e, the BS makes these decisions based on the demand of MSs and the channel information of each link between BS and MS in the cell. The situation is more complex when several RSs are deployed in the cell. A centralized system or distributed system may be proposed to provide the best system performance. In addition, the BS-MS connection is not only direct but also via relay. The scheduler in MAC layer must deal with routing and load balancing problems. This situation requires new scheduler in IEEE 802.16j MAC layer.

2. WIMAX NETWORK QUALITY OF SERVICE MEASUREMENT AND RATIONAL OF EVOLUTION TOWARDS WIMAX WITH RELAY

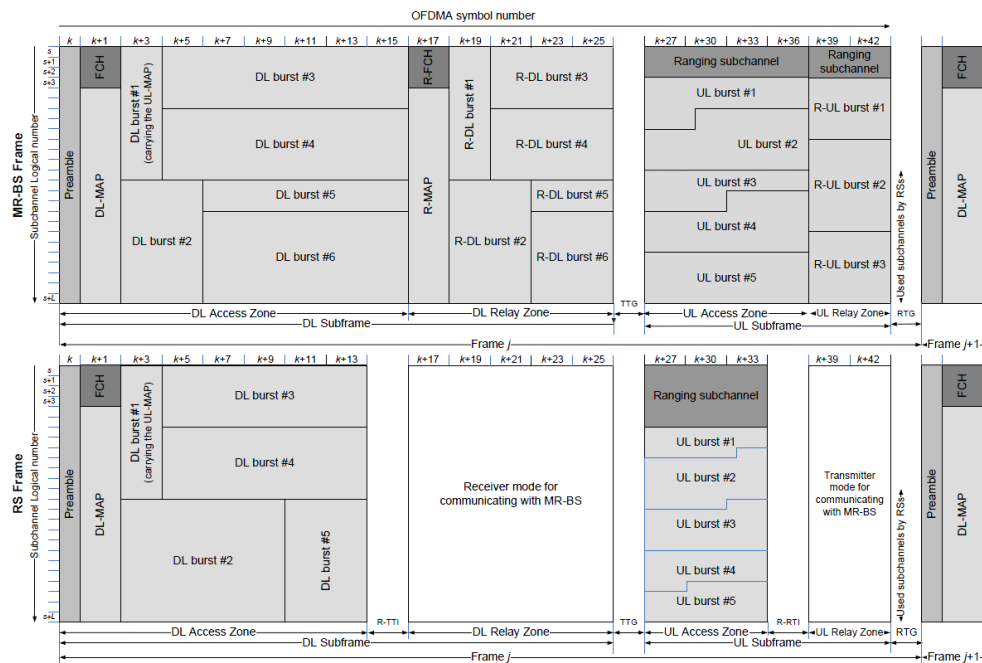

Figure 2.8: An example of configuration for a transparent relay frame structure in IEEE 802.16j- 2009 [75]

2.4 Summary

In the first part of this chapter we presented measurement studies on fixed and mobile Wimax (IEEE 802.16-2004 & IEEE 802.16-2005) performance. The experiments have shown that the transmitted signal is subject to important additional attenuations in the case of NLOS links between BS-MS. This has a bad impact on the users' QoS as well as on the spectrum efficiency of the system. The amendment IEEE 802.16j-2009 proposes the deployment of low cost relay stations in Wimax cells in order to enhance the QoS, the system capacity and also to enhance the cell coverage. The second part of this chapter presents an overview the architecture of Wimax with relays and the essential modifications in PHY layer and MAC layer to support RS deployment.

Despite the important work of the IEEE 802.16j group on the architecture and PHY/MAC layers, many technical issues such as resource allocation, relay placement, path management, frequency reuse, etc. still open and the topics of many researchers which aim to ameliorate the performance of this standard system.

Chapter 3

A new deployment architecture for Wimax relay using sectoring technique

3.1 Introduction

In this chapter, we would like to first introduce the studies on different aspects of Multihop Wimax and our motivation on cell capacity improvement. We then highlight the assumptions of our research and review the existing relay models of IEEE 802.16j standard in section III. In section IV, we propose a new architecture using sectoring and frequency reuse technique. Based on these principles, we present the adaptive frame structure at both BS and RS. The simulation scenarios and our first results are presented and discussed in section V. Section VI gives the summary of our studies in the chapter.

3.2 Advanced in IEEE 802.16j research and motivations

Before and after the approval of amendment IEEE 802.16j-2009, many articles have been published to improve different aspects of Wimax with relays. In [29, 80], the authors introduced the basis concepts and principles of Wimax with relays. The most fundamental modifications in IEEE 802.16j are presented. The specifications of amendment IEEE 802.16-2009 are given in details in [75].

The frame structure for multihop relays was studied in [91], where authors proposed a flexible multi-zone framework to support multihop relay while maintaining the backward compatibility with the legacy 802.16e mobile stations. The performance evaluations presented in this paper highlight the benefit of deploying relay station in a cell

3. A NEW DEPLOYMENT ARCHITECTURE FOR WIMAX RELAY USING SECTORING TECHNIQUE

to enhance the capacity and the coverage area of the single cell.

In [37, 38, 95], the authors introduced the analytical dimensioning approaches to both cellular Wimax and cellular Wimax with relays. The results showed the coverage extension in cellular Wimax networks with multihop deployments. Ubiquitous broadband services over large geographic regions can be offered with an appropriate deployment of low cost relays. However, some inefficient utilizations of available bandwidths have been also demonstrated.

Some other studies on relay placement were presented in [61, 62, 64, 73]. These researches focused on the decision of relay placement to find the best location for the relay station in order to extend the service area as well as to improve the performance of Wimax system. In [73], the authors showed that the placement of relay stations can be optimized based on the relay bandwidth reservation. They also proposed an optimization framework where relay placement and relay bandwidth reservation are combined.

The routing in Wimax with relay network was presented in [8]. In this paper, the authors proposed a path selection method that minimizes the latency and maximizes the network throughput. In this approach, link available bandwidth, Signal to Noise Ratio (SNR) and a number of hops are taken into account to find the best routing.

In all these previous works, the authors proposed different approaches to improve the users' QoS, the coverage area and the cell capacity, however, in [30], the authors have shown that the maximum throughput could only increase about 10% on the downlink. Only a half of coverage from the BS can benefit from throughput enhancement. In the article, the authors analysed the system performance on transparent relay mode, i.e the BS is silent when RS transmit data to MS. This explains the low throughput enhancement.

The cooperative relay was investigated in [14] [15]. In these articles, the authors analysed the performance of various cooperative diversity schemes in order to choose the best scheme, i.e. the one with the highest end-to-end throughput. They proposed a frame structure for two-hops cooperative relay, in which there are two phases in a frame structure. In the first phase, the BS sends data to the RSs, in the second phase, the BS and the RSs create a SIMO system to send data to the terminals. One can notice that the link condition between the BS and the MS is not reliable when the RSs are transmitting, which explains why the BS does not help much in the cooperative scheme. Our study shows that we could use the resource of the BS in the second phase for the other MS to optimize the BS resource.

3.3 Relay system Models

3.3.1 Assumptions

Our study is based on a set of assumptions about the target system. (1) We only study systems with single antenna terminals and two-hops relay. (2) We consider downlink transmissions in a TDD-OFDM based cellular wireless relay network. (3) Our system is centralized at the base station (i.e., all the decisions are made there). (4) We used the RS in decoding and forwarding mode to guarantee the best performance. In this mode, the RS receives the message from the BS, then the RS decodes and encodes the message one more time. The RS sends the encoded message to the MS.

(5) We suppose that mobile users move at a relatively low speed. For such users, the channel remains unchanged for the duration of a frame which consists of a certain number of OFDM [44] symbols. Therefore, the link adaptations according to the obtained channel state information are feasible and effective. (6) Hence, we consider transmissions with band Adaptive Modulation and Coding (AMC) [44] mode of operation which requires channel state information at the BS. Since users move at a relatively low speed, we use instantaneous SINR as channel state information. This defines the AMC mode and the best transmission method per sub-channel. The throughput is defined as the number of payload bits per second that are received correctly at the corresponding receiver. (7) The modulation schemes used in this study are : Binary phase shift keying (BPSK), quadrature phase shift keying (QPSK), 16-quadrature amplitude modulation (QAM) and 64-QAM. (8) The power control at the transmitters does not contribute significantly to the throughput enhancement. Consequently, throughout this study, power control at the transmitters is not taken into account, the power at the base station and relay stations are fixed but their power can be different at each relay stations.

OFDM adds a cyclic prefix to each symbol to mitigate inter-symbol interference caused by multi-path propagation. If the cyclic prefix is longer than the delay spread of the wireless channel, the frequency selective fading caused by multi-path propagation can be converted into frequency flat fading at each sub-carrier. Adding a cyclic prefix to achieve this causes a small reduction in total transmission rate. We do not take it into account in the throughput.

3.3.2 Existing Relay Models

In the relay model, one MS can connect to the BS directly or via an RS depending on the condition of the links between MS, RS and BS. The frame structure for this model is presented in Figure.3.1. The users requesting service access at the BS report their channel state information (CSI) to the BS using the flat feedback channel. Based on this CSI, the BS allocates the radio resources and schedules the users. It transmits in

3. A NEW DEPLOYMENT ARCHITECTURE FOR WIMAX RELAY USING SECTORING TECHNIQUE

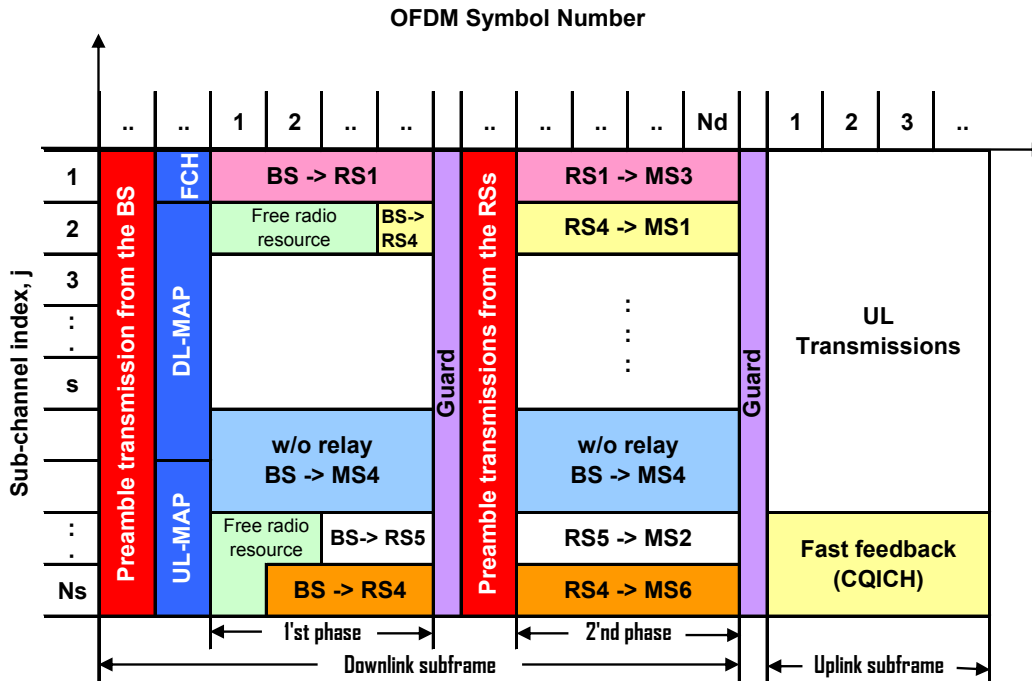

Figure 3.1: Frame structure in a non cooperative relay system (from [14])

DL-MAP[1] the information on the sub-channels on which the users are scheduled and for each scheduled user whether relaying should be used or not. All of the relays and the users listen to this information. According to the decision at the BS, one user can connect directly to the BS or connect to the BS via an RS. For the users who connect to the BS via an RS, the frame structure is divided into two phases. During the first phase, the BS sends data to the RS or directly to the MS. Since the links between the BS and the RS have good channel conditions, the duration of the first phase at each sub-channel can be shorter than or equal to that of the second phase.

The frame structure seems to be filled and the resource allocation seems to be optimized. However, if we redesign the frame structure only at the base station as shown in Figure.3.2, we will see that there are a lot of resources in the frame that can not be used in the second phase of all connections via relay. In fact, the base station can not use these resources because these sub-channels are occupied by the relay station in the same time. Hence, the resource allocation at the base station is not optimized. We will present in the next sub section the study of cooperative relay in which the authors try to use the empty blocks at the BS frame to serve the MSs in order to improve the throughput at the BS.

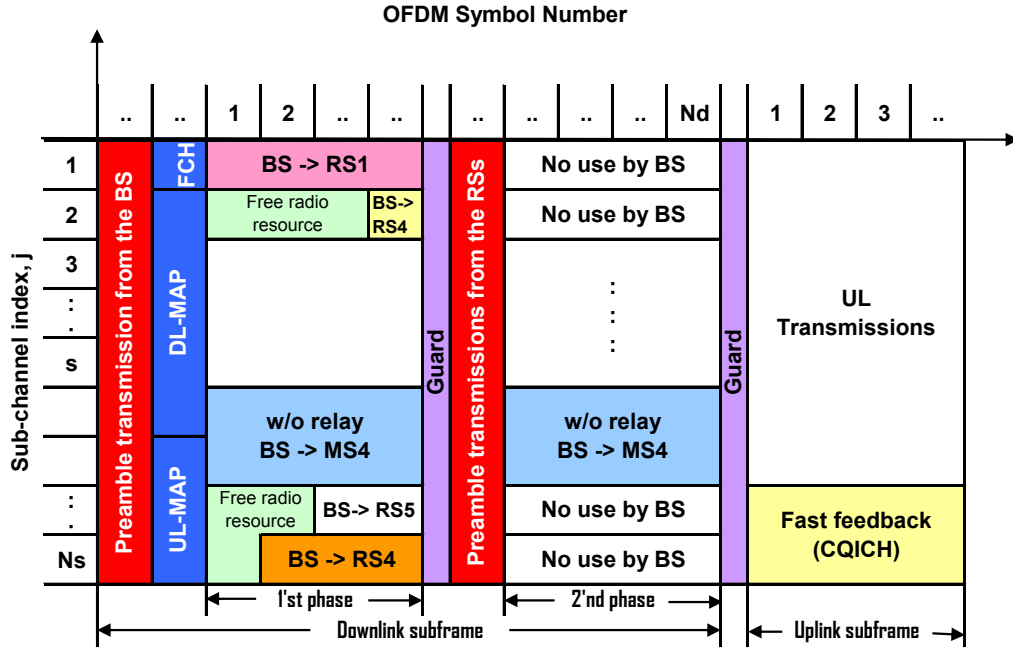

Figure 3.2: Frame structure in a non-cooperative relay system at base station

3.3.3 Existing cooperative relay models

In cooperative relay systems, MSs are also connected to their BS directly (without relay) or via relay depending on the link condition between BS, RS and MS. The concept is almost the same in the non-cooperative relay model except for the connection via the RS. In these connections, during the first phase, the BS sends the data to the RSs. In the second phase, the BS and the RSs create a SIMO system and send the data to MS. Due to diversity gains from the RSs and BS to MS, the throughput could be increased. In this case, the frame structure at the BS is fulfilled in the two phases (Figure.3.3). However, we usually use a relay station in case the link condition between the BS and the MS is not reliable or there is no link connection between the BS and the RS. That is why the BS will not really help much the MS in the cooperative scheme. Instead of using the cooperative scheme, we propose a model where the BS can serve the other MSs that have better link conditions in the second phase. We will show that the throughput at the BS strongly increases in this case. We will present our proposition in the next section.

3. A NEW DEPLOYMENT ARCHITECTURE FOR WIMAX RELAY USING SECTORING TECHNIQUE

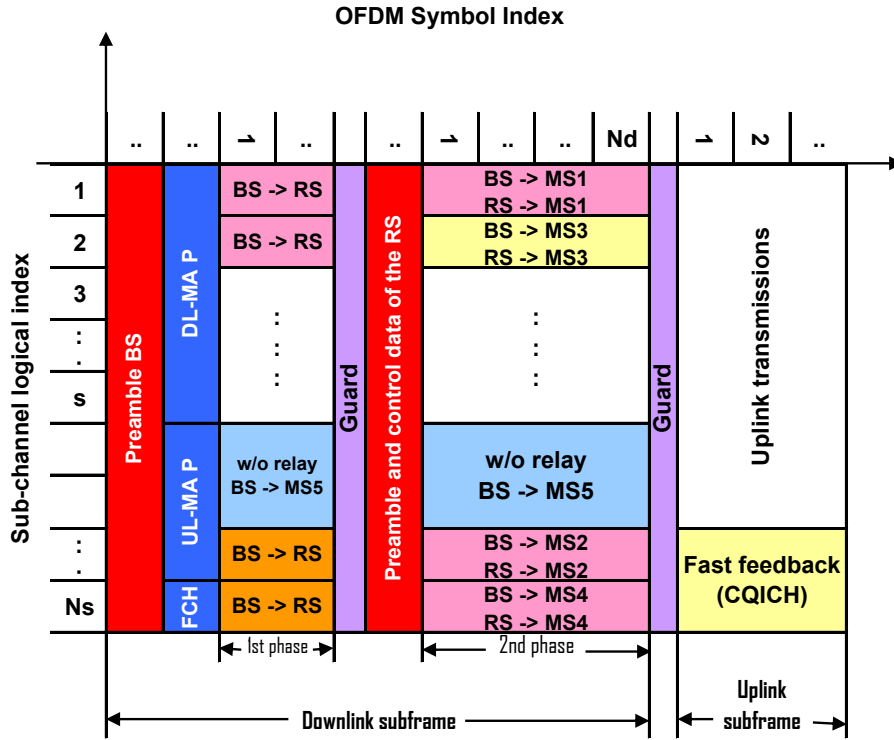

Figure 3.3: Frame structure in a cooperative relay system (from [14])

3.4 Proposition of new sectoring relay model

In the non-cooperative relay model, many resources at the base station will not be used in the second phase if the MS is connected to the BS via the RS. In the cooperative relay model, the resources are fully used although they are not efficient. Based on these identified limitations, we propose a new relay model which aims intended to increase the system performance. Firstly, we present the advantages of clustering and sectoring in WiMax systems. Secondly, we propose the design principle of our relay model using sectoring technique. Finally, we investigate the frame structure of the sectoring relay model and show that the resource at the BS is used efficiently.

3.4.1 Clustering and sectoring

In order to avoid interference in Wimax cellular networks, frequency channels used within one cell can only be reused within a sufficient reuse distance. Hence, cells are combined into clusters, where frequency channels are uniquely assigned to cells. The

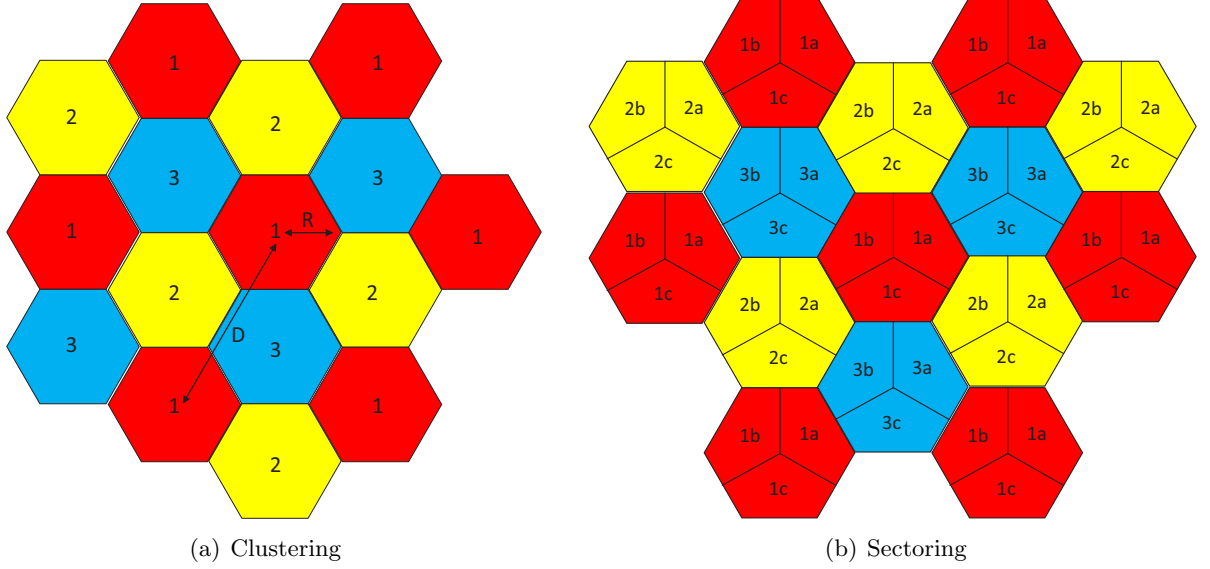

Figure 3.4: Clustering and sectoring in Wimax network

frequency usage pattern of the entire cluster is regularly repeated throughout the network. This way, the distance to co-channel cells can be increased. Figure.3.4a shows a cellular network with clustering order three. We can also divide the cells into several sectors to further reduce the interference level in cellular wireless networks. The cell is subdivided into several sectors. Each sector is covered by a sector antenna. An individual frequency channel is assigned to each sector. The sectoring of cells and the frequency assignment are periodically repeated all over the network. Figure.3.4b shows a cellular network with 3 sectored cells. In [53], the author investigates the impact of clustering and sectoring onto Carrier to Interference Ratio (CIR), and shows that the CIR increases in multiple sector numbers and in exponential cluster order. In the example illustrated in Figure.3.4b, the cell is divided into three sectors therefore CIR increases by a factor of three. We conclude in this part that the sectoring technique increases the system performance of Wimax.

3.4.2 Applying sectoring technique to relay model

As mentioned above, the system performance of Wimax increases when the sectoring technique is used. In this part, we aim to use this technique in the Wimax system with relay to create a new sectoring relay model in which the resource allocation is optimized. We will present in the following section the principle of our proposition, and highlight its application in a cell divided in three sectors.

3. A NEW DEPLOYMENT ARCHITECTURE FOR WIMAX RELAY USING SECTORING TECHNIQUE

3.4.2.1 Principle of the approach

We propose a new sectoring relay model where we will divide the zone of a cell in many sectors. We also divide the frequency band of a cell to several sub frequency bands and allocate them to each sector of the cell. The relays deployed in each sector receive the data from the BS using the sector's band frequency in the first phase then they send data to the MS by using the band frequencies allocated to other sectors. This way, the BS resource could be used efficiently because the BS can transmit data in two phases without interference between the BS and the RS in each sector.

3.4.2.2 An example of Wimax relay with sectoring

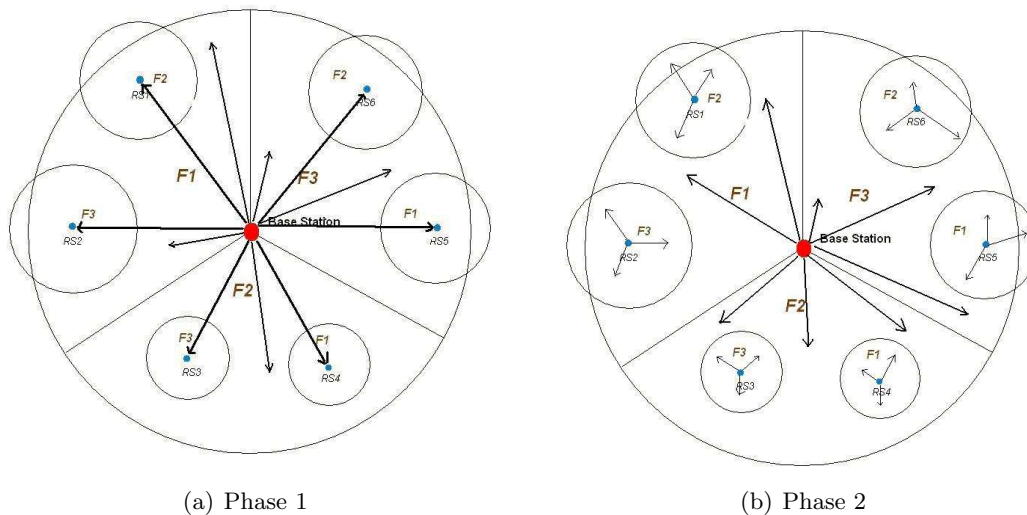

Figure 3.5: Two phases in a cell with 3 sectors in the Wimax with relays system

An example of the implementation of our model is illustrated in Figure.3.5. In this example, the cell is divided into three sectors and we allocate the band frequencies F_1 , F_2 , F_3 to each sector. The band frequency F of a cell is the sum of the three band frequencies F_1 , F_2 and F_3 . Six relay stations are deployed in three sectors of the cell. In the first phase, the BS sends data to the MSs that a the direct link to the BS and the RS using band frequency in each sector. In the second phase, the BS continues to send data to the MSs that are connected directly to the BS using the frequency of the sector, while the RSs receive data from the BS and simultaneously send data to the MSs that connect to the BS via the RS using the frequency of these other sectors. For example : In the second phase, the BS continues to send data to the MSs using F_1 in the sector 1 and the RS1 sends data to the MSs using F_2 ; and the RS2 sends data to the MSs using F_3 . The same concept is used in sector 2 and 3. Therefore, there will be no interference between the transmissions from the BS and the RS in each sector in the

3.5 Simulation scenario and result discussion

second phase even if they send the data at the same time because they use different band frequencies. Moreover, power transmission of the RS is much smaller than that of the BS thus the RS coverage is also much smaller than that of the BS. That is why we assume that there is no interference between the RSs in two different sectors. In this example, the BS transmits data in two phases to the stations that have a good link condition to the BS. This way, the resource allocation is fully optimized.

3.4.3 Frame structure of our new sectoring relay model

To better understand how the resource is fully used, we present the frame structure of the BS and the RS in a Wimax relay system with three sectors in this section. The frame structure of Wimax sectoring relay model is illustrated in Figure.3.6. In the DL frame structure, the frequency axis is divided into three band frequencies F1, F2, F3; the time axis is divided into two phases. In the first phase of the frame structure at the BS (3.6a), the BS transmits to the RS for the connection via the RS and also transmits to the MSs without relay station (w/o). In this phase, the transmission is almost the same, compared to the existing models. In the second phase of the frame structure at the BS (3.6a), the BS continues to transmit to the MSs which have a direct link to the BS in our new sectoring relay model. There is no interference in each sector between the BS and the RS because in the second phase of the frame structure at the RS, the RS sends data to the MSs using other band frequencies. Looking at the second phase of the frame structure at the BS and the RS (3.6a, 3.6b), if the BS and the RS transmit data at the same time, they will use different band frequency to transmit data to the MSs. For example, in the first sector, the BS transmits data in phase 1 and phase 2 using frequency F1. The relay stations (R1 and R2) of this sector receive data in phase 1 via frequency band F1, and then transmit data to the MSs using frequency band F2 and F3 in phase 2. The BS, the RS1 and the RS3 transmit data to the MSs using three different frequencies. Compared to the other existing models, the resource will be better used in our model because in the second phase, the BS always transmits data to the MSs which have the good link to the BS while the BS does not transmit data to other MSs if the RS transmit data to the MSs in the same frequency (c.f Figure.3.1) in the simple relay model or the BS still transmits data to the MSs but the link condition to the BS are not good in the cooperative relay model (c.f Figure.3.3).

3.5 Simulation scenario and result discussion

In the following, we will compare our new sectoring model against the other existing models. We will analyse the system performance in terms of throughput at the BS and in terms of efficiency Bits/Hz/s.

3. A NEW DEPLOYMENT ARCHITECTURE FOR WIMAX RELAY USING SECTORING TECHNIQUE

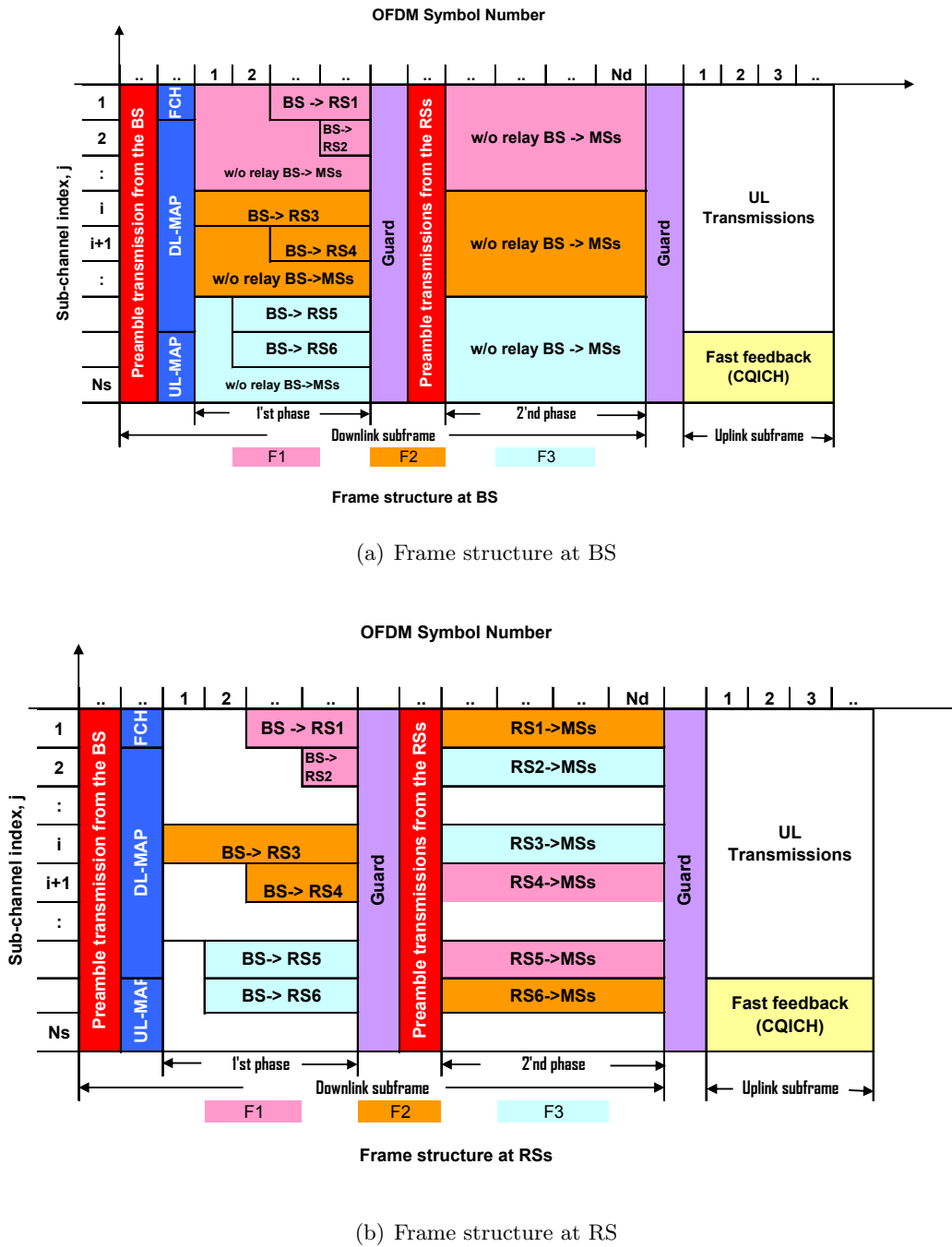

Figure 3.6: Frame structure of BS and RS in a Wimax relay system with three sectors

3.5 Simulation scenario and result discussion

Table 3.1: Simulation parameters

Parameter	Value
Number of sector in cell	3
Bandwidth	10Mhz
BS transmit power	43dBm
BS antenna height	30m
BS antenna gain	18dB
RS transmit power	30dBm
RS antenna height	20m
RS antenna gain	6,3dB
MS antenna height	1,5m
MS antenna gain	0dB
Other loss L_0	Random
Signal model	Free space path loss

3.5.1 Simulation scenario

In order to evaluate the system performance of the new sectoring relay model, we used Matlab version 7.0 to develop a simulation programme to experience our system and to compare the system capacity of our solution against other systems.

In the simulation scenario, a Wimax cell infrastructure of BS and RSs is deployed. The cell is divided into 3 equal sectors and each sector occupies 1/3 total band frequency (the total frequency band of the cell is 10MHz). In each sector, two RSs are deployed and they use the band frequency that is different to the sector's band frequency. A number of MSs are randomly deployed in the cell and request different services to the BS. We reminded that our system is centralized at the BS and the RS is in the decode and forward mode.

Firstly, we evaluate the link condition (SNR) between the BS, the RS and the MS in function of distance. We will use the free space signal propagation model for each link between BS \leftrightarrow RS, BS \leftrightarrow MS and RS \leftrightarrow MS. The simulation parameters are given in Table.3.1. From the propagation model and the values from the table, we evaluate the SNR as a function of the distance between two nodes in Figure.3.7. We notice that, with the same distance between two nodes the BS-RS link condition is always better than the BS \leftrightarrow MS and RS \leftrightarrow MS link conditions.

From the SNR between two nodes, we fix the modulation and coding scheme between them. The modulation and coding schemes considered in this paper are QPSK $\frac{1}{2}$; QPSK $\frac{3}{4}$; 16QAM $\frac{1}{2}$; 16 QAM $\frac{3}{4}$; 64QAM $\frac{1}{2}$; 64QAM $\frac{2}{3}$ and 64 QAM $\frac{3}{4}$. Fig.3.8 present the coding rate as the function of the distance [44]. We can see that a higher SNR results in a higher coding rate. If the SNR between two nodes is higher than 16dB, we can use the scheme 64QAM $\frac{3}{4}$ with the best coding rate 4.5 Bits/Hz/s.

3. A NEW DEPLOYMENT ARCHITECTURE FOR WIMAX RELAY USING SECTORING TECHNIQUE

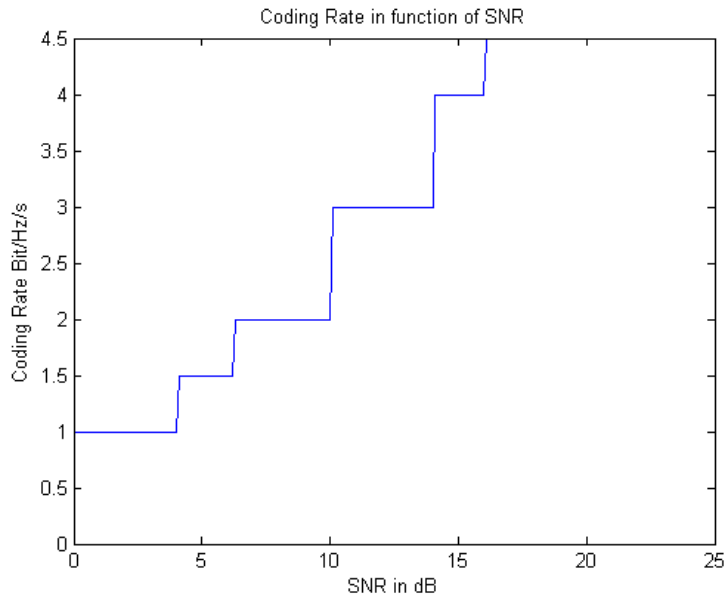

Figure 3.7: SNR as a function of the distance

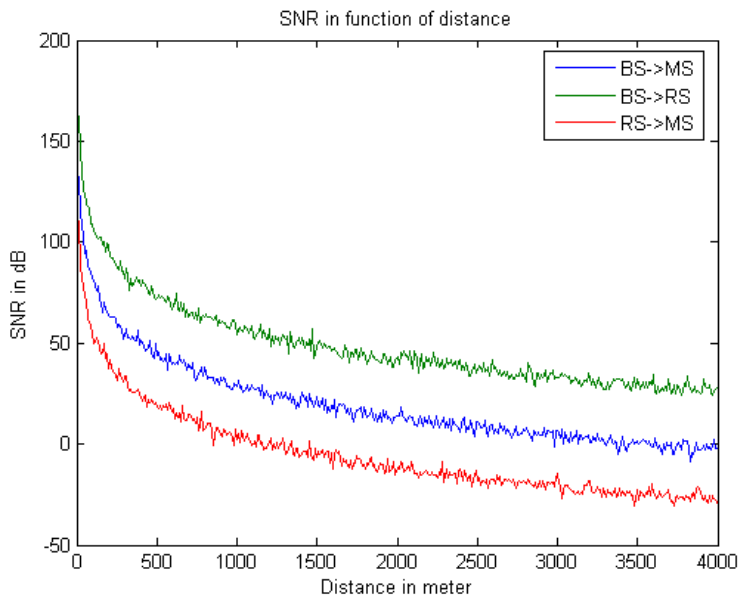

Figure 3.8: SNR as a function of the distance

When the modulation and coding schemes of all links $BS \leftrightarrow RS$; $BS \leftrightarrow MS$ and $RS \leftrightarrow MS$ are decided, we can choose the route from MSs to BS. For each MS that wants to connect to BS, we will evaluate the SNR of three different links $BS \leftrightarrow RS$; $RS \leftrightarrow$

3.5 Simulation scenario and result discussion

MS and BS \leftrightarrow MS then we decide the coding rate for each link. We consider γ is the SNR from the BS to the MS; γ_1 is the SINR from the RS to the MS and γ_2 is the SNR for the direct link BS \leftrightarrow MS. We defined 4 scenarios of simulation “Without relay”; “Non cooperative relay”; “Cooperative relay” and “Sectoring relay”. The decision of the route from the BS to the MS is different in each scenario :

- In the “Without relay” scenario, we only have the direct link from the BS to the MS, so the coding rate is selected based on the SNR from the BS to the MS.
- In the “Non cooperative relay” scenario, R_1 , R_2 and R are the coding rates corresponding to SNR γ_1 , γ_2 and γ . In the route via relay, the data rate from the BS to the MS is $\frac{R_1 R_2}{R_1 + R_2}$. If $R \geq \frac{R_1 R_2}{R_1 + R_2}$, we will choose the direct link.
- In the “Cooperative relay” scenario, in the second phase, the BS and the RS create a MIMO system to transmit data to the MS so the coding rate R_2 is correspond to the SNR $(\gamma_1 + \gamma_2)$. And then we applied the same concept to decide the route in “Non cooperative relay”.
- In the “Sectoring relay” scenario, the BS is free to transmit data to the others MSs in the second phase even if we decide to use the route via the RS. That is why if $R_1 \geq R$ we decide to use the route via relay and if not, we use the direct route from the BS to the MS.

3.5.2 Results and Discussions

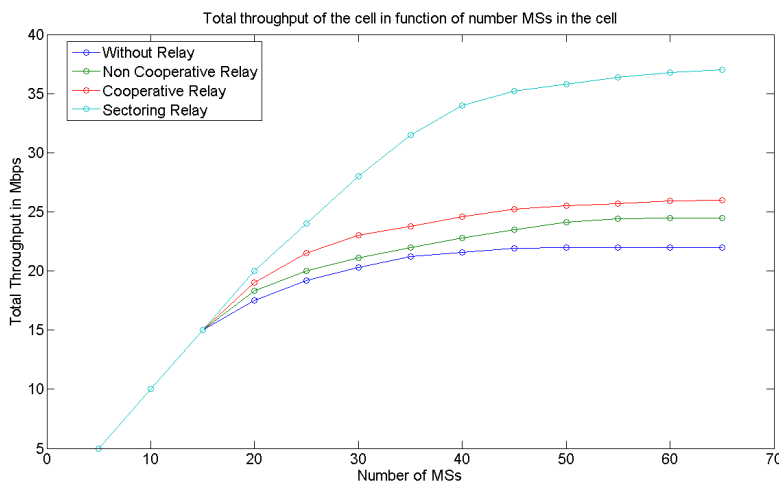

Figure 3.9: Throughput of BS as a function of the number of MSs

In order to compare the performance of the system defined in four cases “Without relay”, “Non cooperative relay”, “Cooperative relay” and “Sectoring relay”, we first compare the throughput of the BS as a function of the number of the MSs in the cell. We calculate the throughput of each case where the number of the MSs varies

3. A NEW DEPLOYMENT ARCHITECTURE FOR WIMAX RELAY USING SECTORING TECHNIQUE

from 5 to 65. The result is presented in Fig.3.9. When the number of the MSs is small (from 5 to 20), the throughput is almost the same in the 4 cases, because the BS can use all the resources to provide the communication service even if the BS can use a strong modulation and coding rate. However, when the number of the MSs increases, the BS can not provide more service if the resource are fully previously used because of the used strong modulation and coding rate. We see that the maximum throughput at the BS in the case “Non cooperative relay” and “Cooperative relay” are slightly better than the throughput in case “Without relay” when the number of the MSs increase. The maximum throughput at the BS varies 22 to 26 Mbs for the three cases. In cases “Sectoring relay”, the maximum throughput at the BS can achieve up to 37Mbs. Therefore, we can conclude that this new sectoring relay model achieves a better maximum throughput and provider service to more MSs.

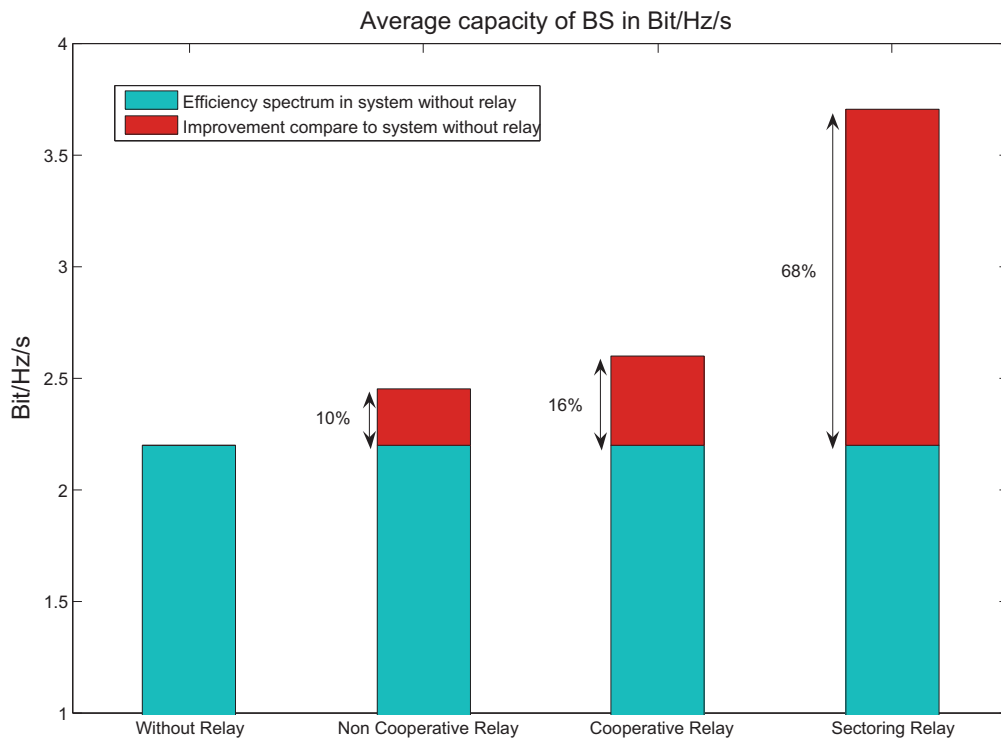

Figure 3.10: Spectrum efficiency Bit/Hz/s in different relay model

Other important criteria to evaluate the system performance is the spectrum efficiency Bit/Hz/s. Therefore, we estimated the spectrum efficiency Bit/Hz/s in the four use-cases. In the simulation, we repeat the experience where one MS is deployed randomly each time and calculate the coding rate of the link from the BS to the MS (with relay or without relay) and then we calculate the average of all of the experiences. The results of the simulations running over 10 000 experiences is illustrated in Figure.3.10. We obtain the average spectrum efficiency with 2% variation. Comparing to the sys-

tem without relay in term of spectrum efficiency Bit/Hz/s the “Non cooperative relay” increases by 10%; the “Cooperative relay” increases by 16% and the “Sectoring relay” increases by 68%. This shows that, we achieved a strong increase in terms of spectrum efficiency when we use the sectoring technique in the relay model.

3.6 Summary

In this chapter, we studied the resource optimization in Wimax relay standard 802.16j system. We reviewed the existing works on non-cooperative relay and cooperative relay. We found that the resource of the frame structure is not used efficiently. Therefore we propose a new architecture of Wimax relay system that uses sectoring technique to enhance the system performance. In this system, the RS can receive data from the BS using one frequency and transmit data over another frequency and we also propose a new frame structure in order to use the whole resource. We defined several simulation scenarios to compare our new model to the existing models. The results show that our solution introduces a significant increase in terms of spectrum efficiency and throughput at the base station. The most significant cost of our approach is the deployment of sector antennas at the BS.

The obtained results, despite their goodness, they do not take into account the impact of interference. In addition, we performed the simulation in only one cell and the users are distribute uniformly in the cell. To improve this work, we enhanced this contribution by taking into account the impact of interference on our proposed model in the next chapter. The simulation will be performed in several cells. There will be some modifications in frequency band sharing when the users are not uniformly distributed in the cell.

3. A NEW DEPLOYMENT ARCHITECTURE FOR WIMAX RELAY USING SECTORING TECHNIQUE

Chapter 4

Impact of interference on the system performance of Wimax Relay 802.16j with Sectoring

4.1 Introduction

In the previous chapter, we proposed a new deployment architecture which aims to enhance the overall cell throughput. The results showed that the efficiency spectrum and the total throughput significantly increase in this new architecture. However, we assumed the non existence of the impact of interference in the previous study. In this chapter, we improve our contribution by taking into account the “Interference aware”. In section II, the interference studies in the literature are reviewed. The assumptions of our research is redefined in section III. In section IV, we study the signal propagation model to evaluate the SINR of MSs. The routing decisions are based on these SINR. The simulation scenarios and result discussion are presented in section V. The summary of the chapter is presented in section VI.

4.2 Related works and research motivations

There are several contribution in the area of interference. In [34], novel decentralized and interference aware medium access control (MAC) protocol combined with a dynamic subchannel selection algorithm for OFDM (orthogonal frequency division multiplexing) is presented. The interference awareness allows the system to avoid significant co-channel interference (CCI) and to operate with full frequency reuse. In another study [97], the authors studied 802.16 mesh network systems. Their objective was to propose an efficient approach to improve spectral utilization. As multiple access interference is a major limiting factor for wireless communication system, the authors

4. IMPACT OF INTERFERENCE ON THE SYSTEM PERFORMANCE OF WIMAX RELAY 802.16J WITH SECTORING

propose an interference aware solution to validate their approach.

In multi-hop Wimax networks such as Wimax Mesh or mobile multi-hop relay networks, providing QoS is challenging as multiple links can interfere with each other if they are scheduled at the same time. In [31], the authors proposed efficient heuristic algorithms for scheduling flows in a centrally scheduled multi-hop Wimax network. The proposed algorithms guarantee bandwidth and relay constraints of flows and allow multiple non interfering links to be scheduled at the same time.

In [26], the authors proposed an interference-aware analytical model of IEEE 802.16j systems in transparent mode. The authors studied the level of the CINR (Carrier Interference to Noise Ratio) all over the cell in both Wimax and multihop Wimax in [37, 38]. From the level of CINR, the authors evaluated the enhancement of cell coverage and the enhancement of system capacity in multihop Wimax.

In the previous chapter, we analysed the capacity enhancement in WiMAX networks with relays. The analysis showed that the resource is not efficiently allocated in the existing models. Therefore we proposed a new mechanism using sectoring technique in order to improve the total throughput of Wimax cell. The simulation showed that our model can achieve better performance than other related models. The throughput of the cell and the spectrum efficiency increase significantly. However, in that study, we assumed that there is no interference and we studied the system performance in only one isolated cell. For a model to be more realistic, the impact of interference can not be ignored. By evaluating the SINR for the user at all position of the MSs in the cell, we can see if the interference is important and decide how the system should route from the BS to the MSs. In this study, the frequency band in each sector can be more or less important depending on the total data demand in the sectors. The simulation results show that the system still performs better in our model for all users' deployment in the cell even the interference from the BSs and the RSs in other cells is taken into account.

4.3 Assumptions and System Models

4.3.1 Assumptions

In this chapter, our research is based on the following assumptions. We consider a Wimax system with only two hops. Each terminal is deployed with single antenna which cannot transmit and receive at the same time (half duplex). All scheduling decisions made at the base station (centralized system). We study only the downlink transmission in a TDD-OFDM base cellular wireless relay network. The relay station is in non transparent mode in which the relay station can decode the received data from the BS

and transmits the data to the MS using its proper mapping.

We suppose that mobile users move at a relatively low speed. Therefore the channel remains unchanged for the duration of frame. Hence, we use Adaptive Modulation and Coding to allow the system to attribute the modulation and coding scheme to each link between the BS and the MS (via or not via the RS). The modulation and coding scheme used in this chapter are : BPSK, QPSK, 16 QAM and 64 QAM. We do not take into account the cyclic prefix for each symbol in our model.

Throughout this study, the power control at transmitters is not considered. The transmission powers are differently predefined for the BS, the RS and the MS. The transmission power on the RS is much smaller than that on the BS (about 10 times in simulation scenario) to avoid the interference due to frequency reused. The assumptions are essentially similar to the one in previous chapter. However, in the study of this chapter, we consider the interference in the cell (between the BS & the RS and between the RS & the RS).

4.3.2 System Model

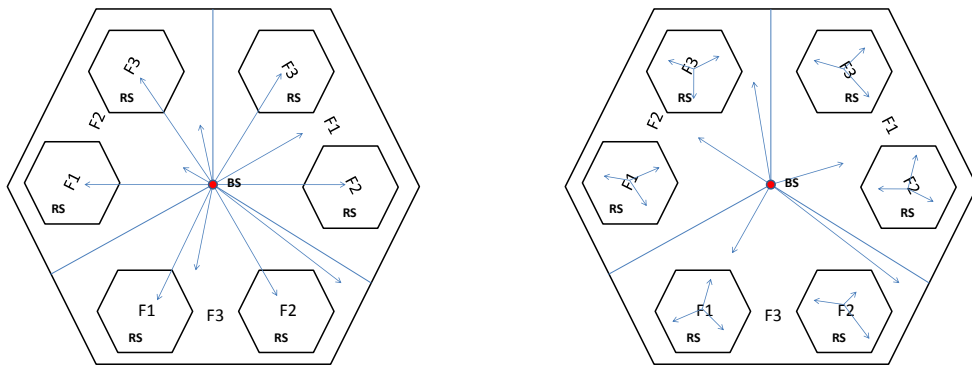

(a) Phase 1 in downlink frame structure

(b) Phase 2 in downlink frame structure

Figure 4.1: Two phases in a Sectoring Wimax relay model with frequency reuse

In the previous chapter, we proposed a new sectoring relay model where the cell is divided into several equal area sectors. The total bandwidth is divided into equal smaller frequency bands and these smaller frequency bands are allocated to each sector. The relay stations deployed in each sector receive data from the BS using the sector's band frequency in the first phase, then they send data to the MS on frequency bands used in other sectors.

4. IMPACT OF INTERFERENCE ON THE SYSTEM PERFORMANCE OF WIMAX RELAY 802.16J WITH SECTORING

In the first phase, the BS sends data to the MSs that have a direct link to the BS and the RS on frequency band of each sector. In the second phase, the BS continues to send data to the MSs that are connected directly to the BS using the frequency of the sector. The MSs which connect indirectly to BS via a RS, in this case, receive the data from the RS through frequency bands from other sectors. Therefore, there will be no interference between the transmissions from the BS and the RS in each sector in the second phase even if they send the data at the same time because they use different band frequencies. Moreover, the power transmission of RS is much smaller than that of the BS thus the RS' coverage is also much smaller than that of BS. However, the signals that the MSs receive from the correspondent RSs can be interfered by signals from the other sectors due to common used frequencies. Fortunately, this impact is negligible as we will see it in the next section. In our model, the BS transmits data in two phases to the stations that have a good link condition, thus optimizes the resource allocation.

Figure.4.1 illustrates the principle of our approach in which a cell is divided into three sectors with frequency bands F1, F2, F3. In each sector, for example sector 1, the BS sends data on frequency band F1 in the first and second phases while the two corresponding RSs send on frequency F2 and F3. Hence, there is no interference within the sectors. However, the interference can be found between the two RS using the same frequency band F3 in sector 1 and 2. In addition, the mobile receiving data in sector 1 from BS on frequency band F1 can be interfered by the two RSs which also perform on frequency band F1. We proposed to study the impact of inference in this model in the next section.

Another limitation of the architecture previously proposes is that when the MSs are not uniformly distributed all over the system, if all the MSs are deployed in one sector while the total frequency bands is divided into equal smaller frequency bands, the BS uses only a portion of the total frequency bands to serve the MSs. Therefore, the total frequency band, attributed to the BS, is inefficiently used. In this chapter, we present our proposal to dynamically divide the total frequency band into smaller frequency bands proportional to the number of MSs that are located in each sector. We will also present the system performance evaluation in the next section.

4.4 Impact of interference to the route decision

In this section, we will first present the used signal propagation model in order to evaluate the level power of signal that reaches the receiver. Then, we will present the estimation of the Signal to Interference plus Noise Ratio (SINR) of the MSs. From this, we define the process to set the decision-making of modulation and coding scheme and the route between the BS and the MS are decided. Finally, the spectrum efficiency of the Wimax cell is evaluated.

4.4.1 Signal propagation model

When a transmitter sends a radio signal to a receiver, the power received at destination decreases during propagation. Radio propagation in urban areas is quite complex to model because it often consists of reflection and diffraction due to multipath propagation. Radio propagation in open areas free of obstacles is too simple to treat, but, in general, propagation over land and water still invokes at least one reflected way. The general formulation of radio propagation path loss model [44] is expressed as follows :

$$P_r = \frac{P_t \cdot g_t \cdot g_r}{L_p}$$

Where P_r and P_t are the power received and the power transmitted. g_t and g_r are the antenna gain at the transmitter and the receiver. L_p is the path loss between the transmitter and the receiver. In reality, the path loss depends on the distance between the transmitter and the receiver, the transmitter height, the receiver height and also the environment between the transmitter and the receiver. COST 231 Hata model takes into account these aspects and is recommended for systems simulations and network planning [44] in both urban and suburban areas. The median path loss for the COST 231 Hata model is given by :

$$L_p = 46.3 + 33.9 \log_{10} f - 13.82 \log_{10} h_b + (44.9 - 6.55 \log_{10} h_b) \log_{10} d - a(h_m) + C_F$$

The MS antenna-correction factor, $a(h_m)$, is given by

$$a(h_m) = (1.11 \log_{10} f - 0.7) h_m - (1.56 \log_{10} f - 0.8)$$

Where h_m and h_b are the transmitter height and receiver height in meter ; d is the distance between the transmitter and the receiver in km and f is the used frequency in MHz. This is the model we are using in our simulations.

4.4.2 SINR evaluation

The performance of wireless cellular systems is significantly limited by cochannel interference (CCI), which comes from the other users in the same cell or from the other cells. The SINR is defined by :

$$S = \frac{S}{I + N}$$

where S is the received power of the desired signal ; N is the background-noise power ; I is the interference power from the other base stations and relay stations that use the same band frequency. In Wimax relay models, we define :

$$I = \sum_{i=1}^{N_I} Pr_{BS_i} + \sum_{j=1}^{M_J} Pr_{RS_j}$$

4. IMPACT OF INTERFERENCE ON THE SYSTEM PERFORMANCE OF WIMAX RELAY 802.16J WITH SECTORING

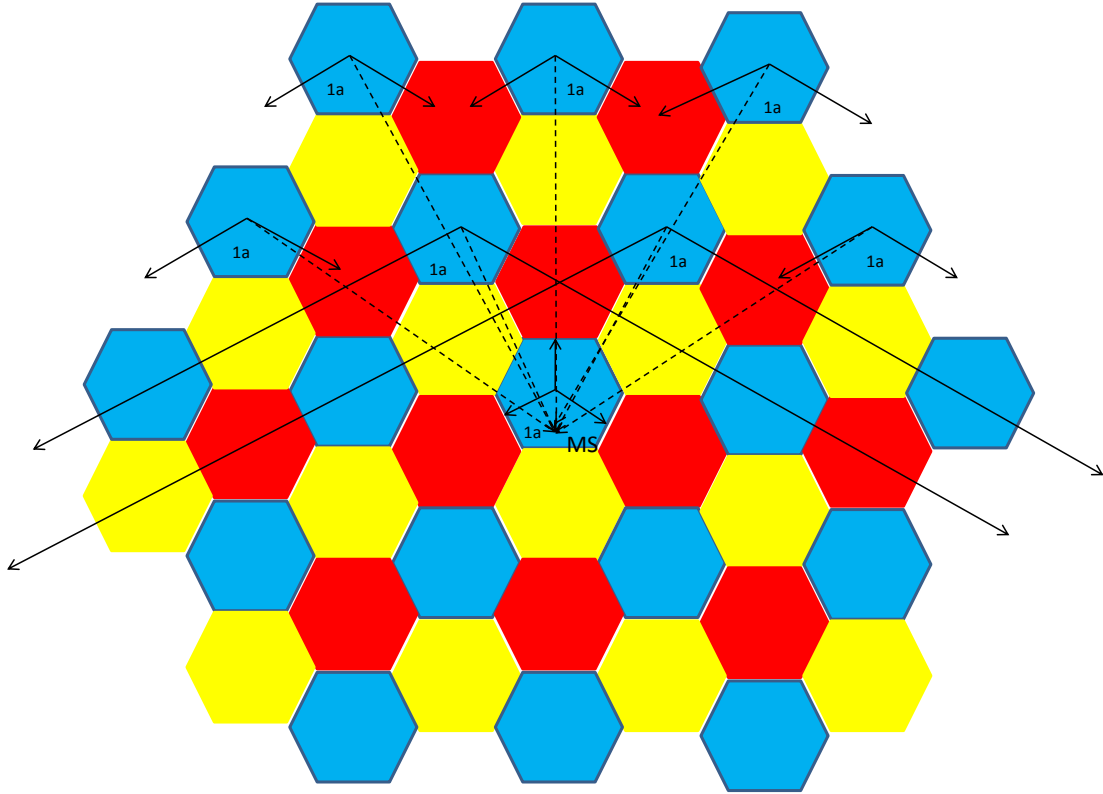

Figure 4.2: Interference between peripheral cells and cell center that use the same frequency band

N_I and M_j are the number of base stations and relay stations that use the same frequency band as the transmitter does. Pr_{BS_i} and Pr_{RS_j} are the received power at destination from BS_i and RS_j . Figure.4.2 illustrates that the interference between the central cell and peripheral cells that use the same band frequency. The MS located in the central cell is also interfered by the other RSs that use the same frequency (the interference from the RSs in the other cells is negligible).

4.4.3 Route selection

Based on the SINR between the transmitter and the receiver, the appropriate modulation and coding scheme is chosen. The modulation and coding schemes considered in this paper are QPSK $_{\frac{1}{2}}$; QPSK $_{\frac{3}{4}}$; 16QAM $_{\frac{1}{2}}$; 16 QAM $_{\frac{3}{4}}$; 64QAM $_{\frac{1}{2}}$; 64QAM $_{\frac{2}{3}}$ and 64 QAM $_{\frac{3}{4}}$. If the SINR between two nodes is more than 16dB, the 64QAM $_{\frac{3}{4}}$ is selected and it gives the best coding rate of 4.5 Bits/Hz/s.

Once the modulation and coding schemes of all the links BS \leftrightarrow RS; BS \leftrightarrow MS and

RS \leftrightarrow MS are determined, the route from the MSs to the BS can be determined. For each MS that wants to connect to the BS, the SINR of the three links BS \leftrightarrow RS ; RS \leftrightarrow MS and BS \leftrightarrow MS are evaluated then the coding rate for each link is decided. Let γ be the SINR from the BS to the RS ; γ_1 is the SINR from the RS to the MS and γ_2 is the SINR for the direct link BS \leftrightarrow MS. Comparing three scenarios “Non cooperative relay” ; “Cooperative relay” and “Sectoring relay”, the decision of the route from the BS to the MS is different in each scenario :

- In the “Non cooperative relay” scenario, R_1 , R_2 and R are the coding rates corresponding to SINR γ_1 , γ_2 and γ . In the route via relay, the data rate from the BS to the MS is equal to $\frac{R_1 R}{R_1 + R}$. If $R_2 \geq \frac{R_1 R}{R_1 + R}$, the direct link is chosen.
- In the “Cooperative relay” scenario, in the second phase, BS and RS create a MIMO system to transmit data to MS so the coding rate R_1 correspond to the SINR ($\gamma_1 + \gamma$). And then similarly to the “Non cooperative relay” case, the route from the BS to the MS is decided.
- In the proposed “Sectoring relay” scenario, the BS is free to transmit data to the other MSs in the second phase even if the route is via RS. Hence the route via relay is used if $R_1 \geq R$, otherwise the direct link from the BS to the MS is used.

4.4.4 Spectrum efficiency

Spectrum efficiency is defined by the number of bits that a base station can transmit over 1Hz in 1s (Bit/Hz/s). If the MS connects directly to th BS, the spectrum efficiency is the coding rate (R) that corresponds to the SINR between the BS and the MS. If the MS connects to the BS via relay station, the spectrum efficiency is equal to $\frac{R_1 R}{R_1 + R}$ in the case of non cooperative relay and $\frac{(R_1 + R)R}{(R_1 + R) + R}$ in the case cooperative relay. In ”Sectoring relay”, the spectrum efficiency is the coding rate R_1 that corresponds to the SINR between the BS and the RS because the BS is free to transmit data to the other MSs in the second phase after transmitting data to the RS in the first phase. We consider the spectrum efficiency of the BS in the cell as the average spectrum efficiency of all of the positions of the MS in the cell.

4.5 Simulation scenario and result discussions

4.5.1 Simulation scenario

In order to evaluate our proposal of a new sectoring relay model, a Wimax infrastructure of 19 cells is designed with reuse factor 3. The frequency band of the cell is 10MHz. Each cell is divided into 3 sectors, each sector allocates one smaller frequency band which is proportional to the MSs that are located in the sector. In each sector, two RSs are deployed at a distance of 1,3 km to the BS and use the frequency band that is different to the sector’s frequency band. The transmit power of the BS is 43dBm

4. IMPACT OF INTERFERENCE ON THE SYSTEM PERFORMANCE OF WIMAX RELAY 802.16J WITH SECTORING

Parameter	Value
Number of cells	19
Number of sector in cell	3
Frequency reuse	1,3,3
Bandwidth	10Mhz
Carrier frequency	3500MHz
BS transmit power	43dBm
BS antenna height	30m
BS antenna gain	18dB
RS transmit power	35dBm
RS antenna height	10m
MS noise figure	8dB
RS antenna gain	6dB
MS antenna height	2m
MS antenna gain	0dB
Other loss L_0	Random
Path loss model	Suburban COST 231 Hata model
Coverage range	1,5km

Table 4.1: Simulation parameters

and the BS height is 30m. The coverage range of the BS (1,5km) is much bigger than the coverage of RS (0,3km) due to the limited transmission power at the RS. The link condition between the BS and the RS is reliable (using 64-QAM) because of the important antenna gain at the RS and the height of the RS. COST 231 Hata path loss model is used in our simulation with path loss exponent of 3.5. A number of the MSs are randomly deployed in the cell and request different services from the BS. We remind that our system is centralized at the BS and the RS is in a decode and forward mode. The simulation parameters are given in Table.5.1.

4.5.2 Performance evaluation

4.5.2.1 SINR evaluation

We have calculated the SINR for various position of the MS in the cell. Figure.4.3 shows the SINR of all of the positions of the MS in the sectoring relay model. The SINR is very high when the MS is near the RSs or the BS and decreases with exponent factor 3.5 (COST231 Hata path loss model) when the distance between the MS and the BS/RS increases. This result is almost the same when we evaluate the SINR in non cooperative an cooperative relay model. In the coverage zone of the RS or the BS, the numerical result shows that the received power from other stations is always much smaller than that from the main station. In the worst case (edge of coverage zone), SINR decreases to most 2dB when we take into account the interferences from other

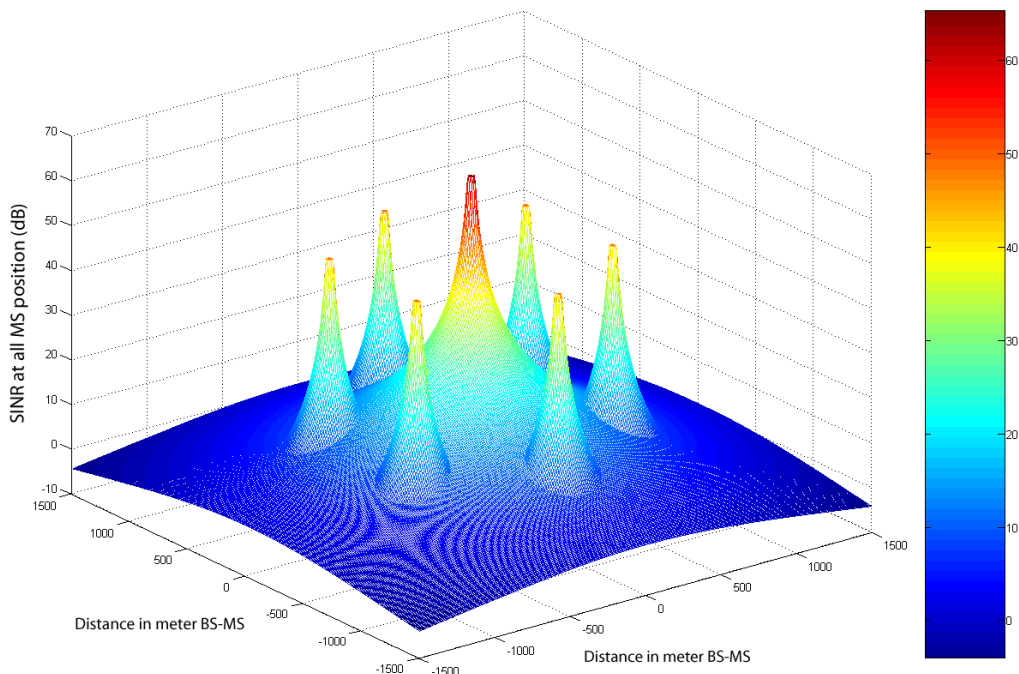

Figure 4.3: SINR of mobile station at all the positions in the cell

stations. We can conclude that the impact of interferences in our model is the same as in the other relay models.

4.5.2.2 Spectrum efficiency evaluation

In this section we discuss about the spectrum efficiency at the base station for all of the possible positions of MSs in the cell. We remind that BS is not used in the second phase in the cooperative relay station and the BS only helps the RS to transmit data to the MS in the second phase. The resource at the BS is not used efficiently in these two cases. If the link between the BS and the RS is reliable (using the best coding scheme 64-QAM), the BS spends at least twice time to transmit the same amount of data to the MS than it spends on the direct connection. This correlates with the result obtained in the simulation (c.f Figure.4.4). Even if the MS is near to RS, the spectrum efficiency of BS is always smaller than 2.5 bits/Hz/s. In the sectoring relay model, the RS uses a different frequency band to transmit data in the second phase so that the BS is free to transmit data to the other MSs without being interfered by the RS in the same sector. To transmit an amount of data to the MS via the RS, the BS spends only a fraction of its communication resources (time and frequency channel) to transmit this data to

4. IMPACT OF INTERFERENCE ON THE SYSTEM PERFORMANCE OF WIMAX RELAY 802.16J WITH SECTORING

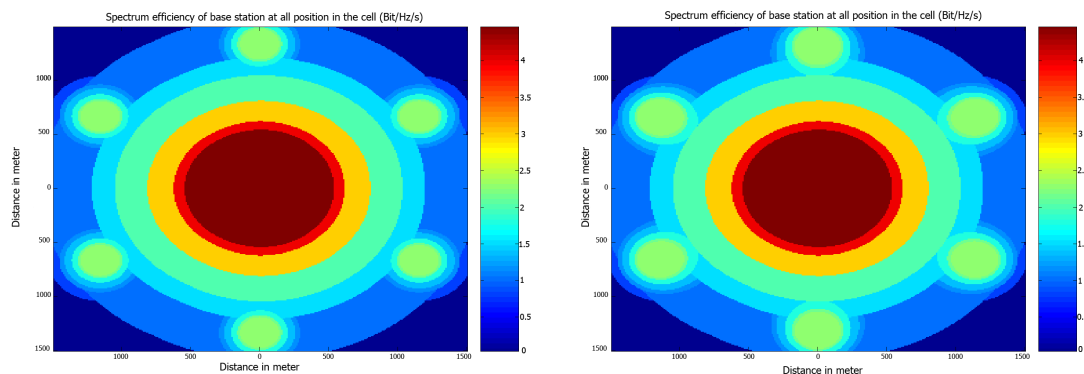

(a) Non cooperative relay

(b) Cooperative relay

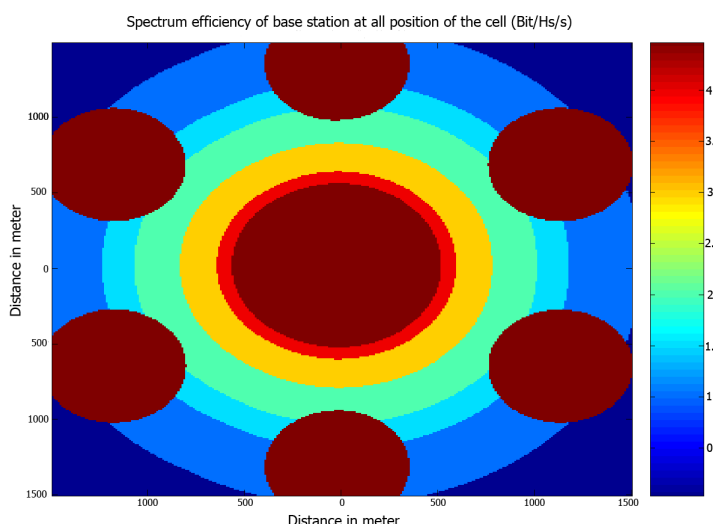

(c) Sectoring relay

Figure 4.4: Spectrum efficiency of base station at all the point in the cell (three difference cases)

the RS. That is why even if the coding scheme from the RS to the MS is weak, the spectrum efficiency at the BS is still the best because the link between BS and RS is always reliable. Figure.4.4(b) shows that the BS achieves the best spectrum efficiency at the coverage range of the RS. This result proves the superiority of our proposed sectoring relay model in term of spectrum efficiency vs other models.

The average spectrum efficiency is also evaluated in different models and in different deployments of the MS in the cell. The “Static sectoring” model was proposed in our previous work [71] where the entire frequency band is equally divided among the different sectors of the cell. In the worst case, all the MSs are allocated in only one

4.5 Simulation scenario and result discussions

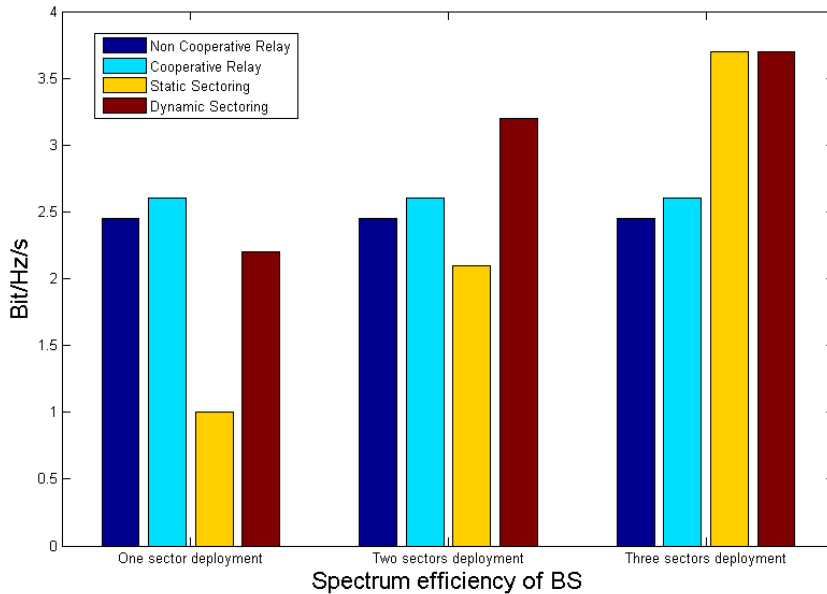

Figure 4.5: Spectrum efficiency Bit/Hz/s in different relay model

sector, and therefore the resource at BS is wasted in the two other sectors. To solve this problem, we propose a scheme called “Dynamic sectoring” where the frequency band in each sector is adjusted based on the data demand in each sector. The result of the simulation running over 10 000 experiences is illustrated in Figure.4.5. The average spectrum efficiency with 2% variation is presented. The result shows that the average capacity of the BS decreases significantly in “Static sectoring” model when all fo the MSs are located in only one sector. In this case, the “Dynamic sectoring” model becomes the “non cooperative relay”. Hence, the average spectrum efficiency in “Non cooperative relay” model is the same as the one in “Dynamic sectoring” model. It is slightly smaller than the average spectrum in “Cooperative relay” model. When the MSs are deployed in two sector, the “Dynamic sectoring” model performs much better than “Cooperative relay” and “Non cooperative relay” model while average capacity of the BS in the “Static sectoring” model is slightly smaller than the one in the other models. When the MSs are distributed uniformly in all the three sectors of the cell, the “Static sectoring” model becomes the “Dynamic sectoring” model, the simulation shows that the average spectrum efficiency is equivalent in the two models. Comparing to the system non cooperative relay and cooperative relay in terms of spectrum efficiency Bit/Hz/s, the sectoring relay model increases by 50%. We conclude that the proposed sectoring technique significantly improve spectrum efficiency.

4. IMPACT OF INTERFERENCE ON THE SYSTEM PERFORMANCE OF WIMAX RELAY 802.16J WITH SECTORING

4.6 Summary

In this chapter, we studied the impact of interference in the sectoring relay 802.16j model. We reviewed the non cooperative relay model, the cooperative relay model and also the proposed sectoring relay model. We used the COST231 Hata path loss model to evaluate the impact of interference in all of these three relay models. We also proposed a new dynamic frequency band allocation among the sectors. The results show that the average spectrum efficiency in our model is almost the same as the average spectrum efficiency in the other models in the worst case where the MSs are located in one sector. In the other deployment of the MSs, our solution introduces a significant increase in terms of spectrum efficiency at the base station when the interference is taken into account.

Chapter 5

Radio Resource Management : Algorithm and Optimization

5.1 Introduction

In the previous chapter, we described a new architecture of Wimax with Relays standard and its frame structure in order to enhance the spectrum efficiency. We also studied the impact of interference in this model. We showed an improvement of the system throughput due to the capability of the architecture to mitigate interferences. In this chapter we will study the radio resource management in our system. In section II, III, the radio resource management(RRM) studies are presented in both Wimax and Wimax with Relays. We then formulate the RRM optimization problem in section IV. We also propose a heuristic algorithms with low complexity to solve the optimization problem are given in this section. The simulation results are discussed in section V. Finally, the conclusion of our study in this chapter is given in section VI.

5.2 Overview of Radio Resource Management in Wimax

5.2.1 Definitions

Radio Resource Management or scheduling is the essential component of Wimax MAC layer that guarantees the Qos to various service classes. This scheduler allocates the resources of the cell among MSs. In Wimax OFDMA, the smallest logical unit for bandwidth is a slot which contains a number of subcarriers in one to three durations of OFDM symbol. Therefore, the allocation resource must decide what power transmission to use (for MSs, RSs and BS) and how many slots (bits information) should be assigned to each user. The goal of this decision is to maximize or minimize some desire performances indicators such as system capacity ; total power consumption ; user's fairness ; ... in the network. There are three distinct scheduling processes to specify : two

5. RADIO RESOURCE MANAGEMENT : ALGORITHM AND OPTIMIZATION

at the BS in both downlink and uplink and on at the MS for uplink. In our study, we focus on the resource allocation in downlink at the BS, but the results can be extended to other process.

Depending on the output objectives or the processing requirements, RRM algorithms are classified in different groups. In term of the output objectives, the RRM algorithms can be “*network-centric*” which provides high system throughput from the perspective of the service provider, or “*user-centric*” which provides reliable services and fair resource sharing to the MSs. If we consider the processing viewpoint, RRM algorithms can be “*centralized*” or “*distributed*”. In centralized system, the resource allocation is based on the global knowledge of interference and channel state information (CSI) for all of the nodes (MSs and RSs) in the network. On the contrary, each node is able to allocate resource based on local channel condition in distributed system. Although the distributed scheme provides a lower signaling overhead and a lower complexity, it may cause service delays to the MSs. We focus therefore the centralized scheme in this thesis.

5.2.2 Design Factors

In this section, we describe the main factors that a scheduler needs to consider in order to provide the best resource assignment to MSs. These factors are the followings :

- *Throughput Optimization* : One of the most important aspects to consider is how to maximize the total system throughput while the resources in wireless networks are limited. In some profound discussion, a better term called goodput is used instead of throughput. Goodput represents the transmitted data not including the overhead and lost packets.
- *Fairness* : The scheduler also needs to share the resources fairly among the MSs. The time to converge to fairness can be defined as short term or long term.
- *QoS Parameters* : The objective here is to assure the QoS requirement for various service classes. The minimum reserved traffic and the maximum allowable delay are essential QoS parameters. Hence, the systems must allocate the resources in order to meet the delay and to provide the minimum throughput requirement. Earliest Deadline First (EDF) [5] and Largest Weighted Delay First (LWDF) [90] are the techniques to guarantee the delay requirement and minimum throughput respectively.
- *Energy Consumption and Power Control* : In each cell, the total power is also limited thereby the scheduler must consider the maximum allowable power. The scheduler may evaluate the suitable power allocated to each node depending upon the Chanel State Information (CSI). For example, if one MS is close to BS and the SINR of the link BS-MS is really high, BS can send data to MS in a good modulation and coding scheme even with small transmission power.

- *Implementation Complexity* : In the Wimax context, BS must handle many simultaneous connections and make a lot of decision within 5ms time frame. Hence, the scheduling algorithms have to be simple at both BS and MS.
- *Scalability* : The algorithm should efficiently operate when the number of connections increase significantly.

5.2.3 Radio Resource Management in Wimax without relay

In Wimax without Relay, the resource allocation algorithms are classified into the category “centralized” and “network centric”. Most of the recent scheduler proposals for Wimax focus on the downlink BS scheduler. Channel unaware schedulers and channel aware schedulers are the two main categories of scheduling techniques. In channel unaware scheduler, the resource allocation is decided without the feedback of the channel state information. In the other words, the channel condition is supposed to be perfect without loss and they assume an unlimited power source, thereby the QoS is perfectly guaranteed. Round Robin (RR), Weighted Fair Queuing (WFQ), Delay-based and Priority based [16] are some examples of channel unaware algorithms. Nevertheless, these hypotheses are too strong due to the nature of wireless medium and the user mobility. In wireless environment, the radio link such as fading, interference, noise and signal attenuation may vary strongly, the channel aware scheduler must be considered. The scheduler should take into account the channel condition in order to optimally and efficiently take the appropriate allocation decision.

In [103], the author proposed a resource allocation algorithm that maximizes the total throughput system. In this study, Wimax scheduler is used to opportunistically assign resource to the MS with the highest SINR (or CINR). Some modifications in this approach is possible to allocate the minimum number of slots to the connection with low modulation and coding scheme. However, the MS with better channel conditions receive always a higher bandwidth.

The Proportional Fairness Scheme (PFS) is studied in [49]. The objective of PFS scheme is the long term user fairness. In this scheme, the scheduler is designed to take advantage of multiuser diversity while maintaining comparable long term throughput for all MSs. The system allocates the resource to the MS with the highest instantaneous rate to mean rate ratio. If we denote $R_k(t)$ the instantaneous data rate that user k can achieve at time t and $W_k(t)$ the average throughput for user k up to time slot t . The PFS will allocate the bandwidth for the user with the highest $\frac{R_k(t)}{W_k(t)}$.

For QoS guarantee purpose, a Modified Largest Weighted Delay First (M-LWDF) algorithm was proposed in [7]. This algorithm ensures a minimum throughput guarantee and also maintains delays smaller than a predefined threshold value with a given

5. RADIO RESOURCE MANAGEMENT : ALGORITHM AND OPTIMIZATION

probability of each user.

In general, the total transmission power over an area is predefined and limited. In addition, the MS operates using its battery which is also limited in power. Least amount of transmission power is preferred for MSs due to their limited battery to reduce the radio interference. As a result, the maximum power allowable is the constraint in wireless communication. In [104], the authors proposed Link Adaptive Largest Weighted Throughput for OFDM systems. The purpose of this algorithm is not only to optimize the throughput but also to satisfy the power constraint.

5.2.4 Radio Resource Management in Wimax with relays

Although the RRM algorithms were well investigated in Wimax without relay, these algorithms can not apply directly to Wimax system in which low cost relays are deployed. In Wimax with relay, the path selection from BS to MS must be considered in RRM algorithms. The RRM scheme can be “*centralized*” or “*distributed*”. We will present here some recent researches on centralized and distributed system.

In [47], centralized RRM was studied in downlink single-cell network with a single fixed RS. The authors proposed two algorithms (fixed time division and adaptive time division) to improve the cell throughput and coverage while minimizing complexity and overhead requirements. In both algorithms, the path selection is decoupled from resource allocation to reduce the overhead. The frame is divided into two subframes reserved for BS-RS transmission and for RS-MS transmission. The duration of two subframes are equal in the first algorithm and are flexible in the second algorithm in order to provide more throughput gain. The throughput within the frame defined as the average of the BS-RS throughput and RS-MS throughput. In [67], the authors investigated the RRM in downlink single cell with multiple fixed RSs. Two low complexity algorithms were proposed to improve the overall cell throughput. The power allocation of each subcarrier is equal and predetermined in the first algorithm. The second algorithm presented an adaptive power scheme in which power is allocated to each subcarrier depend on its SINR. The simulation results show that the second algorithm performs better and provides better total throughput than the first algorithm as the number of RSs increases.

The RRM in multihop downlink system was studied in an isolated cell [10, 11]. The authors proposed a fairness aware resource allocation scheme which performs adaptive subchannel, path and power allocation. The scheme first allocated a minimum bandwidth to each MSs to satisfy the fairness condition then allocated the rest bandwidth to the MSs with higher modulation and coding scheme in order to maximize the total throughput. In [55], a centralized downlink OFDMA scenario in a multicellular topology was studied with six relays per cell. The RSs are located at the edge of BS coverage in order to extend the cell coverage. The RSs may also reuse the frequency band of BS

5.3 System description and Assumptions

to serve the MSs in extension area. The objective of this scheme is to provide the QoS guarantee. However, the frequency reuse may cause the high level of interference in BS coverage zone.

Beside the studies on centralized RRM scheme which better guarantees the QoS, few articles also focus on the distributed RRM scheme in order to reduce the signal overhead and computational complexity. In [50], the author proposed two radio resource control (RRC) schemes where both BS and RSs perform dynamic resource allocation. These schemes showed a comparable performance to the centralized RRM schemes. However, these schemes fail to exploit the interference avoidance and traffic diversity gains.

The studies, presented above, showed the important of the RRM research in Wimax with relay. Nevertheless, there is no RRM research on our approach where sectoring technique and frequency reuse technique are presented. In the rest of the chapter, we will investigate the RRM problem in our model.

5.3 System description and Assumptions

This section describes the radio resource management problem in the downlink of multicellular Wimax with relay network that is considered in this research. In each cell, one BS and a number of low cost RSs are deployed to provide the services to the MSs. The system is considered in half duplex mode. Hence, each terminal (BS, RS or MS) with single antenna can not transmit and receive simultaneously. Each cell is divided into some equal area sectors and each sector is allocated a portion of the total cell frequency band. The RSs in each sector reuse the frequency band of the other sectors in the transmission to MSs as we concretely describe in the chapter 3. Since the RSs power is predefined, much smaller than the BS, to serve a determined area, thereby the impact of interference due to frequency reuse can be negligible as we highlighted in chapter 4. The objectives of RRM in our research are total throughput, fairness and QoS guarantee. Transmission power of each subcarrier is supposed to be equal and the total transmission power of all subcarrier is predetermined at each BS and each RS. The RRM with total power constraint will be further investigated.

The RRM problem is studied in only two hop relay system. The RSs are in mode decode and forward to guarantee the best QoS. For the connection via RS, the RS receives and decodes the information from the BS then forwards the information to MSs in a different frequency band. The downlink subframe period is divided into two equal zones. In the first zone, the BS can transmit data to either the MS directly or to the RSs. In the second zone, the BS and the RSs transmit data to the MSs. We assume that the channel condition does not change within the frame duration. In addition, the BS has the knowledge of all channel state information (CSI) in the network to perform

5. RADIO RESOURCE MANAGEMENT : ALGORITHM AND OPTIMIZATION

the centralized RRM algorithms. From overall system CSI, the SINR of all the links is also estimated to provide a suitable modulation and coding scheme on each link. The modulation and coding schemes can vary from BPSK, QPSK to 64QAM in the Wimax system.

5.4 RRM formulations and heuristic algorithms

In the previous section, the RRM studies in Wimax and Wimax with relays were introduced but there is still no RRM investigation on sectoring based Wimax with relays. In this section, our analytical RRM formulations in sectoring based Wimax with relays will be presented. The first objective of RRM formulation is to maximize the cell throughput while ensuring a minimum bandwidth amount for each user. If the minimum bandwidth for each user is equal to zero, the objective of RRM formulation is to maximum the total throughput. The second formulation is given for Proportional Fairness Scheduling (PFS). Here, the resource is allocated for the user with high instantaneous data rate but low average throughput in the past. Finally, the data queue is introduced in the MSs and the RRM mathematical formulation is given in order to empty the queue data and maximize the cell capacity.

Let N and k represent the number of users within the cell and number of sectors respectively. N_i denotes the number of users in sector i . F is the total frequency band and F_i is the frequency band of BS in sector i , so $F = \sum_{i=1}^k F_i$. L is the total number of sub-channels of frequency band F and L_i is the number of sub-channels of frequency band F_i so $L = \sum_{i=1}^k L_i$. R_{ij} denotes the relay in sector i and using the frequency band F_i ($i \neq j$). U_{il} denotes the user l in sector i . $X_{BS,R_{ij},h}$ ($h \in F_i$); $X_{BS,U_{il},h}$ ($h \in F_i$); $X_{RS_{ij},U_{il},h}$ ($h \in F_j$) represent the link between the BS, the RS and the MS on the sub-channel h . Let $\beta_{BS,R_{ij},h}$, $\beta_{BS,U_{il},h}$ and $\beta_{RS_{ij},U_{il},h}$ denote the signal-to-interference-plus-noise ratio (SINR) in the corresponding links.

5.4.1 Maximum total throughput formulation and algorithm

$$\max(A + B) \tag{5.1}$$

$$\text{where : } A = \sum_{i=1}^k \sum_{j=1(j \neq i)}^k \sum_{\forall h \in F_i} X_{BS,R_{ij},h} \cdot \log(1 + \beta_{BS,R_{ij},h} P_{BS})$$

$$B = \sum_{i=1}^n \sum_{l=1}^{N_i} \sum_{\forall h \in F_i} X_{BS,U_{il},h} \cdot \log(1 + \beta_{BS,U_{il},h} P_{BS})$$

5.4 RRM formulations and heuristic algorithms

$$\sum_{i=1}^k \sum_{j=1, j \neq i}^k X_{BS, R_{ij}, h} + \sum_{i=1}^k \sum_{l=1}^{N_i} X_{BS, U_{il}, h} \leq 1, \forall h \in F \quad (5.2)$$

where : $X_{BS, R_{ij}, h}$ and $X_{BS, U_{il}, h} \in \{0, 1\} \forall i, j, l, h$

$$\sum_{l=1}^{N_i} X_{RS_{ij}, U_{il}, h} \leq 1 \forall h \in F_j \quad (5.3)$$

where : $X_{RS_{ij}, U_{il}, h} (h \in F_j) \in \{0, 1\} \forall i, j, l, h$

$$F = \sum_{i=1}^k F_i \quad (5.4)$$

$$\sum_{h \in F_j} \sum_{l=1}^{N_i} X_{RS_{ij}, U_{il}, h} \cdot \log(1 + \beta_{RS_{ij}, U_{il}, h} \cdot P_{RS}) = \sum_{h \in F_i} X_{BS, R_{ij}, h} \cdot \log(1 + \beta_{BS, R_{ij}, h} \cdot P_{BS}) \quad (5.5)$$

$$\sum_{h \in F_i} X_{BS, U_{il}, h} + \sum_{j=1, j \neq i}^k \sum_{h \in F_{ij}} X_{RS_{ij}, U_{il}, h} \geq \alpha \quad (5.6)$$

In equation 5.1, B represents the total throughput of the users that connects directly to BS and A represents the throughput of the users that connects to BS via RS. The constraints in (5.2) & (5.3) assure that each sub-channel of BS or RS serves only one destination. In (5.4), the frequency band of the cell is the sum of frequency band of each sector. The data flow from the MSs to the BS via relay is described in (5.5), the data transmission from the BS to the RS is equal to the data transmission from the RS to MSs. The last constraint guarantees a minimum number of sub-channels α for all users. α is an integer between 0 and L/N . As α approaches L/N , the optimization problem guarantees the strictly user fairness, and as α approaches zero, the optimisation problem becomes one of capacity maximization.

It is difficult to determine the optimal solution for the RRM formulation that we have just presented, because there is no general algorithm for solving a mixed nonlinear integer programming problem efficiently. To reduce the high complexity, we propose to predefine the frequency band in each sector proportional to the number of each sector. Each sector will be considered as a "cell" with frequency band F_i available for BS and frequency band $F - F_i$ available for RSs. An heuristic algorithms with low complexity is given in order to solve the RRM optimization problems.

5. RADIO RESOURCE MANAGEMENT : ALGORITHM AND OPTIMIZATION

Algorithm 5.4.1 Maximum throughput while ensuring a minimum bandwidth for each user

Input Multicellular Wimax system with one base station, M relay station and N mobile stations in each cell. The cell is divided into k sectors.

Output Maximum overall cell throughput while each user is allocated at least α subchannel.

Initial the parameters for BS, RSs and MSs

for Each duration Frame **do**

 Predefine frequency band for BS in each sector $F_i = \frac{N_i}{N} \cdot B$.

 Frequency band for RSs in sector i is $F - F_i$

 Initial all subchannel from BS and RSs equal to zeros.

for Each sector i **do**

while (Remained bandwidth of RSs in sector $i > 0$) and ($\exists U_{il}$ may be connected via RSs) **do**

$R_{U_{il},h}(t) = \log(1 + \beta_{BS,R_{ij},h} \cdot P_{BS})$ for U_{il} may be connected via RSs

$R_{U_{il},h}(t) = \log(1 + \beta_{BS,U_{il},h} P_{BS})$ for U_{il} has only direct connection to BS.

$l^*, h^* = \operatorname{argmax}_{l,h} R_{U_{il},h}(t) \forall U_{il}$ that does not have enough α subchannel.

 Assign subchannel h^* of BS to user l^* in sector i .

end while

$R_{U_{il},h}(t) = \log(1 + \beta_{BS,U_{il},h} P_{BS})$ for U_{il}

 Sort $R_{U_{il},h}(t)$ of each user on each subchannel in descending order.

 Assign subchannels to each user according to the sorted order. If an user receives α subchannel, stop allocating subchannel to that user.

 The remained subchannels are assigned to the user who has the best instantaneous data rate.

end for

end for

5.4.2 Proportional Fairness Scheduling formulation and algorithm

$$\max(A + B) \quad (5.7)$$

$$\text{where : } A = \sum_{i=1}^k \sum_{j=1(j \neq i)}^k \sum_{h \in F_j} \sum_{l=1}^{N_i} X_{RS_{ij}, U_{il}, h} \cdot \frac{\log(1 + \beta_{BS, R_{ij}, h} P_{BS})}{W_{U_{il}}(t)}$$

$$B = \sum_{i=1}^n \sum_{l=1}^{N_i} \sum_{h \in F_i} X_{BS, U_{il}, h} \cdot \frac{\log(1 + \beta_{BS, U_{il}, h} P_{BS})}{W_{U_{il}}(t)}$$

$$\sum_{i=1}^k \sum_{j=1, j \neq i}^k X_{BS, R_{ij}, h} + \sum_{i=1}^k \sum_{l=1}^{N_i} X_{BS, U_{il}, h} \leq 1, \forall h \in F \quad (5.8)$$

5.4 RRM formulations and heuristic algorithms

where : $X_{BS,R_{ij},h}$ and $X_{BS,U_{il},h} \in \{0, 1\} \forall i, j, l, h$

$$\sum_{l=1}^{N_i} X_{RS_{ij},U_{il},h} \leq 1 \forall h \in F_j \quad (5.9)$$

where : $X_{RS_{ij},U_{il},h}(h \in F_j) \in \{0, 1\} \forall i, j, l, h$

$$F = \sum_{i=1}^k F_i \quad (5.10)$$

$$\sum_{h \in F_j} \sum_{l=1}^{N_i} X_{RS_{ij},U_{il},h} \cdot \log(1 + \beta_{RS_{ij},U_{il},h} \cdot P_{RS}) = \sum_{h \in F_i} X_{BS,R_{ij},h} \cdot \log(1 + \beta_{BS,R_{ij},h} \cdot P_{BS}) \quad (5.11)$$

The PFS scheme which is formulated above, has the same principle as the PFS scheme in the literature. We define $W_{U_{il}}(t)$ as the average throughput until instant t of the user l in sector i . We remind that $B \cdot \log(1 + \beta * P)$ (in bit/s) represents the capacity of the subchannel with frequency band B ; SINR = β and power transmission P . As frequency band of the subchannels is fixed and equal we can reduce the factor B in the optimization formulation. $\log(1 + \beta * P)$ is the limit data rate in bit/Hz/s following the Shanon theory but it can be replaced by Adaptive Modulation and Coding (AMC) such as BPSK, QPSK, QAM in real Wimax system. If we define $R_{U_{il}}(t)$ as the instantaneous AMC for the transmission to user l in sector i , $R_{U_{il}}(t)$ is equal to $\log(1 + \beta_{BS,U_{il},h} P_{BS})$ for direct transmission or to $\log(1 + \beta_{BS,R_{ij},h} P_{BS})$ for via relay transmission. In each sector i and each subchannel h in the sector, PFS scheme will select an index l^* such as $\frac{R_{U_{il}^*}(t)}{W_{U_{il}^*}(t)} = \max \frac{R_{U_{il}}(t)}{W_{U_{il}}(t)}$ and the subchannel h is allocated to user l . The objectives of PFS scheme in long term are maximum total throughput : “priority for the user with high instantaneous data rate R ” while maintaining the fairness among users : “priority for the user with low average data rate in the past”. The heuristic algorithm is given as follows :

Algorithm 5.4.2 Proportional Fair Scheduling

Input Multicellular Wimax system with one base station, M relay station and N mobile stations in each cell. The cell is divided into k sectors.

Output Fairness resource distribution among users depending on instantaneous data rate R and average data rate W .

Initial the parameters for BS, RSs and MSs

for Each duration Frame **do**

Predefine frequency band for BS in each sector $F_i = \frac{N_i}{N} \cdot B$.

5. RADIO RESOURCE MANAGEMENT : ALGORITHM AND OPTIMIZATION

Frequency band for RSs in sector i is $F - F_i$
Initial all subchannel from BS and RSs equal to zeros.
for Each sector i **do**
 for Each subchannel $h \in F_i$ **do**
 while (Remained bandwidth of RSs in sector $i > 0$) and ($\exists U_{il}$ may be connected via RSs) **do**
 $R_{U_{il,h}}(t) = \log(1 + \beta_{BS,R_{ij},h} P_{BS})$ for U_{il} may be connected via RSs
 $R_{U_{il,h}}(t) = \log(1 + \beta_{BS,U_{il},h} P_{BS})$ for U_{il} has only direct connection to BS.
 $l^* = \underset{l}{\operatorname{argmax}} \frac{R_{U_{il,h}}(t)}{W_{U_{il}}}$
 Assign subchannel h of BS to user l^* in sector i .
 end while
 $R_{U_{il,h}}(t) = \log(1 + \beta_{BS,U_{il},h} P_{BS})$ for U_{il}
 $l^* = \underset{l}{\operatorname{argmax}} \frac{R_{U_{il,h}}(t)}{W_{U_{il}}}$
 Assign subchannel h of BS to user l^* in sector i .
 end for
end for
end for

5.4.3 Queuing Fairness formulation

The PFS scheme takes benefit from the diversity gain of the transmission to maximize the total throughput. In fact, if the Wimax system can provide high instantaneous data rates to an user, this user has high priority. However, in the fairness aspect, PFS scheme does not take into account the user's demand. Hence, a user with low data rate demand may be given too much data while a user with high data rate demand does not receive enough data. We propose to introduce the notion queue demand Q to all MSs in the cell. In a real network, each active user will send continuously the requests with different data rate demand to the BS where the RRM is located. We note $Q_{U_{il}}(t)$ as the remained data demand that needs to be treated at the instant t of user l in sector i . We propose a Queuing Fairness scheme which gives the advantage for the user with high instantaneous data rate and high queue demand. Each subchannel of each sector will be assigned to the user with highest combination of Q and R . This combination may be $R.Q$ or $R^\alpha.Q$. If the maximum total throughput is more important, the network provider may choose an important value α or a combination $R.\log(Q)$. In the contrary, a small α close to 0 or a combination $Q.\log(R)$ is chosen to get a better fairness system. The constraints in this formulation are the same as the constraints in PFS scheme. The queuing optimization formulation is given as following :

$$\max(A + B) \tag{5.12}$$

$$\text{where : } A = \sum_{i=1}^k \sum_{j=1(j \neq i)}^k \sum_{h \in F_j} \sum_{l=1}^{N_i} X_{RS_{ij}, U_{il}, h} \cdot \log(1 + \beta_{BS, RS_{ij}, h} P_{BS}) \cdot Q_{U_{il}}(t)$$

$$B = \sum_{i=1}^n \sum_{l=1}^{N_i} \sum_{\forall h \in F_i} X_{BS, U_{il}, h} \cdot \log(1 + \beta_{BS, U_{il}, h} P_{BS}) \cdot Q_{U_{il}}(t)$$

The corresponding heuristic algorithm is presented as following :

Algorithm 5.4.3 Queuing Fairness Scheduling

Input Multicellular Wimax system with one base station, M relay station and N mobile stations in each cell. The cell is divided into k sectors.

Output Fairness resource distribution among users depending on instantaneous data rate R and the queue demand Q .

Initial the parameters for BS, RSs and MSs

for Each duration Frame **do**

Predefine frequency band for BS in each sector $F_i = \frac{N_i}{N} \cdot B$.

Frequency band for RSs in sector i is $F - F_i$

Initial all subchannel from BS and RSs equal to zeros.

for Each sector i **do**

for Each subchannel $h \in F_i$ **do**

while (Remained bandwidth of RSs in sector $i > 0$) and $(\exists U_{il}$ may be connected via RSs) **do**

$R_{U_{il}, h}(t) = \log(1 + \beta_{BS, RS_{ij}, h} \cdot P_{BS})$ for U_{il} may be connected via RSs

$R_{U_{il}, h}(t) = \log(1 + \beta_{BS, U_{il}, h} P_{BS})$ for U_{il} has only direct connection to

BS.

$l^* = \text{argmax}_l (R_{U_{il}, h}(t) \cdot Q_{U_{il}}(t))$

Assign subchannel h of BS to user l^* in sector i .

end while

$R_{U_{il}, h}(t) = \log(1 + \beta_{BS, U_{il}, h} P_{BS})$ for U_{il}

$l^* = \text{argmax}_l (R_{U_{il}, h}(t) \cdot Q_{U_{il}}(t))$

Assign subchannel h of BS to user l^* in sector i .

end for

end for

end for

5.5 Simulated Network Performance

5.5.1 Simulation Model and Parameters

In order to evaluate and compare the performance of different RRM schemes and its heuristic algorithms, a Wimax infrastructure of 19 cells is deployed with reuse factor

5. RADIO RESOURCE MANAGEMENT : ALGORITHM AND OPTIMIZATION

3. The total frequency band of the cell is 10MHz which is shared among three sectors, proportional to the number of user in each sector. In each sector, two RSs are deployed to provide better services to users. As RS in each sector reuse the frequency band of the other sectors, we consider the interference aware problem. A fixed number of MS are deployed in each cell and request different services and the data rate of the services follows Poisson law with a predefined parameter λ . Q represents the remained demand data of the users. The signal propagation model used in our simulation is COST 231 Hata path loss model with path loss exponent of 3.5. The same simulation parameters as the previous chapter are given in Table.5.1

Parameter	Value
Number of cells	19
Number of sector in cell	3
Frequency reuse	1,3,3
Bandwidth	10Mhz
Carrier frequency	3500MHz
BS transmit power	43dBm
BS antenna height	30m
BS antenna gain	18dB
RS transmit power	35dBm
RS antenna height	10m
MS noise figure	8dB
RS antenna gain	6dB
MS antenna height	2m
MS antenna gain	0dB
Other loss L_0	Random
Path loss model	Suburban COST 231 Hata model
Coverage range	1,5km

Table 5.1: Simulation parameters

5.5.2 Simulation Result and Discussion

In this section, we propose to compare the system performance of different RRM schemes. In the throughput optimization while ensuring a minimum bandwidth for each user scheduling, we apply the heuristic algorithm to “maximize the total throughput” or “distribute equal bandwidth among the users”. In the queuing fairness scheduling, three combination of R and Q are considered : $R.Q$; $R.log(Q)$ and Q . We also investigate the performance of Proportional Fair Scheduling. Two mains factors which will be compared are “Total throughput” and “Fairness”.

5.5 Simulated Network Performance

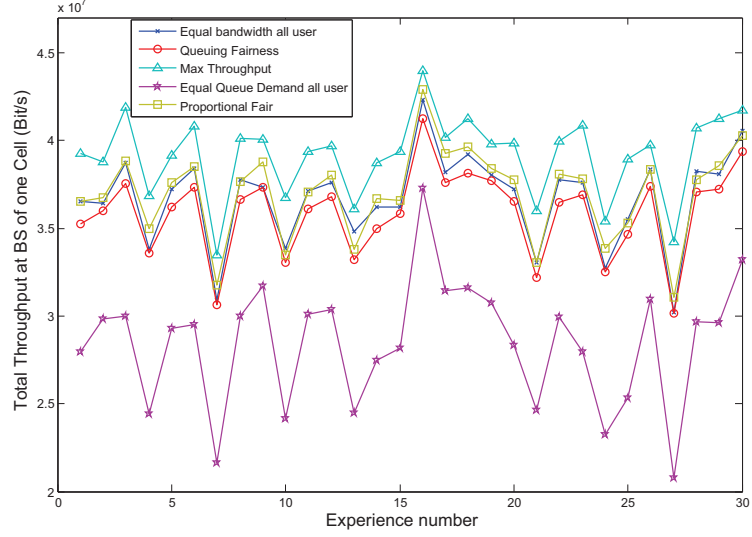

Figure 5.1: Total cell throughput in different resource allocation scenarios : $N = 25$; $\lambda = 2.10^6 \text{ bit/s}$

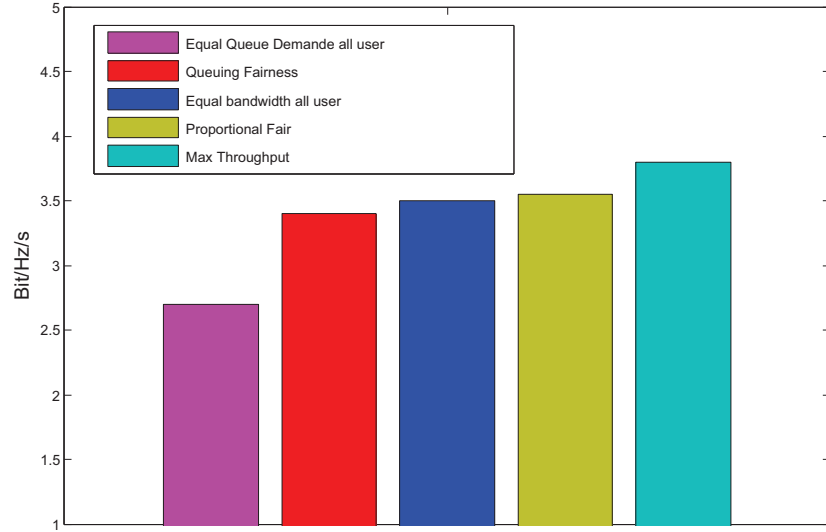

Figure 5.2: Spectrum efficiency (Bit/Hz/s) in different resource allocation scenarios : $N = 25$; $\lambda = 2.10^6 \text{ bit/s}$

5.5.2.1 Throughput comparison

We performed several experiences to evaluate the total cell throughput in different scenarios. The number of users and the Poisson parameters λ are varied in these experiences. The results showed that the total throughput depends on the total demand data rate from all users which can be represented by factor of number of users and λ .

5. RADIO RESOURCE MANAGEMENT : ALGORITHM AND OPTIMIZATION

If the total demand data rate is small enough, all the scheduling schemes can satisfy the requests from the users, hence the total throughput are the same in these cases. For example, if 25 active users are deployed in the cell and parameter λ is 10^6bit/s , the average arrival rate to the cell is about $25 \cdot 10^6 \text{bit/s}$. This demand is quite small and can be satisfy by all RRM algorithm proposed. To better compare the total cell throughput, an extra average arrival rate must be considered. Figure.5.2 illustrated the spectrum efficiency of different RRM schemes with 25 active user and $\lambda = 2 \cdot 10^6 \text{bit/s}$ over 10 000 experiences. The results shows that “Equal queue demand all user” scheme and “Max Throughput” scheme provide the lowest and the highest spectrum efficiency respectively. The three others schemes : “Equal bandwidth for all user”, “Queuing Fairness” and “Proportional Fair” have comparable spectrum efficiency levels. This observation is confirmed in the other experiences with different extra data rate demand. Figure.5.1 illustrated the total cell throughput of different RRM schemes in 30 different experiences. In each experience, the total cell throughput of “Equal queue demand all user” scheme and “Max Throughput” scheme provide the lowest and the highest total cell throughput levels and the other schemes have comparable total cell throughput levels. This result is observed not only in 30 experiences that we have shown but in all simulation experiences.

5.5.2.2 Fairness Discussion

Figure.5.3 shows the average throughput of the users depends on its position in the cell while applying different RRM schemes. We notice that, MS could receive a high data rate/ high spectrum efficiency in all schemes even if it position is close to edge of the cell. Thank to the RSs deployment with frequency reuse, this better performance is performed. However, in “max throughput” scheme or “max $R \log(Q)$ ” scheme, we remark that there are many MSs receive the total data rate demand while some other MSs get no service. Even these schemes perform high total cell throughput, the fairness aware is ignored. On the contrary, the “equal queue demand” scheme seems to provide almost the same average data rate to all of the MSs but the total throughput is too low (Figure.5.1). The three other RRM schemes : “Queuing Fairness”, “Proportional fair” and “equal bandwidth to all user” seem to take into account the “fairness aware” among the user. All users have at least some amount of data rates even its have the bad link condition to BS. In addition, the total cell throughput of these schemes is quite high.

To better compare the fairness among different RRM scheme, Jain’s fairness index was proposed to measure the “fairness” in the literature, the formulation is the following :

$$J(x_1, x_2, \dots, x_n) = \frac{(\sum_1^n x_i)^2}{n \cdot \sum_1^n x_i^2}$$

Jain’s fairness index is varied from 0 to 1, the higher of the index the better fairness of the RRM scheme. In our system, x_i takes the value of the remained queue data

5.5 Simulated Network Performance

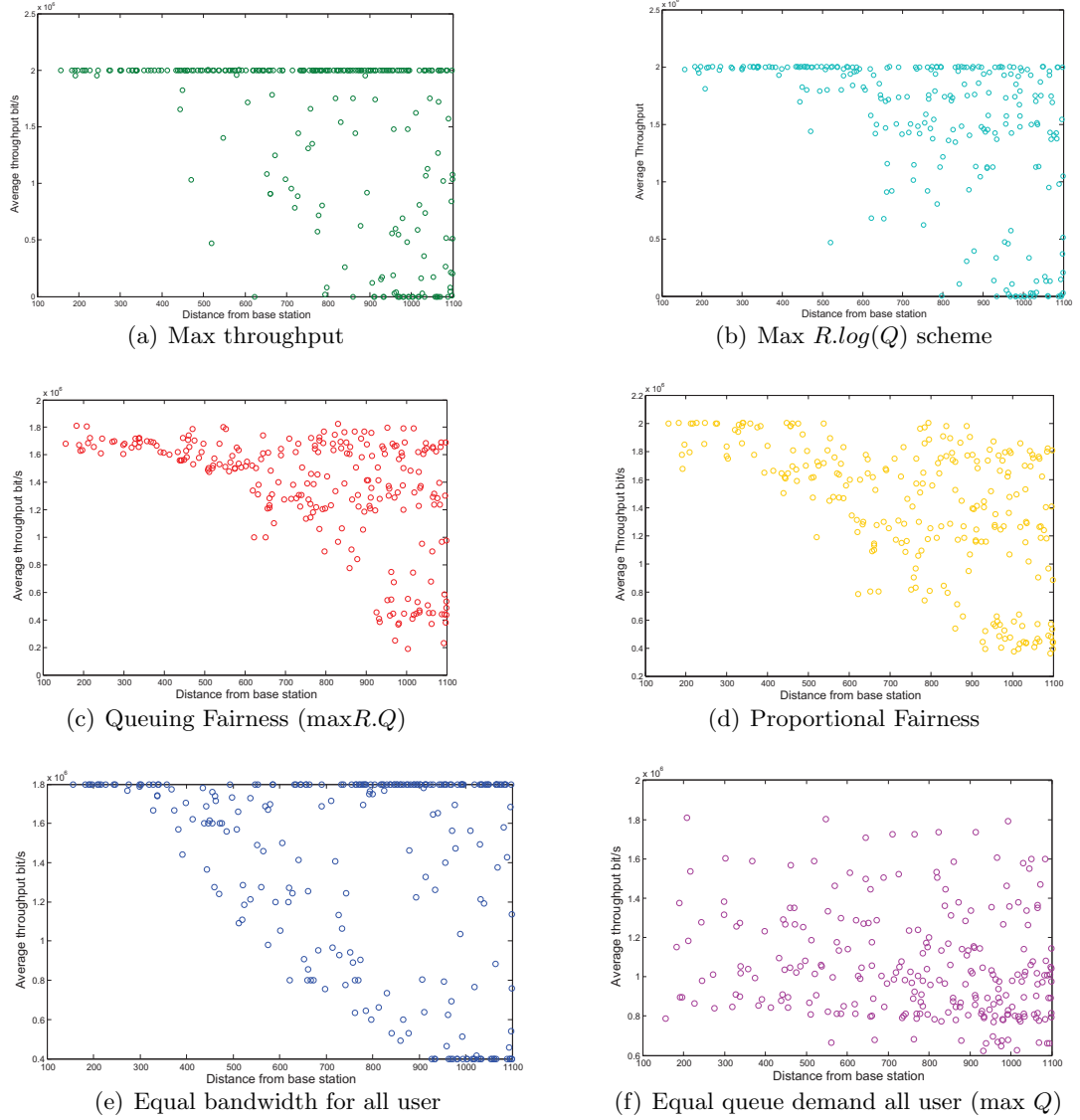

Figure 5.3: Scatter of average throughput distribution at different position in the cell with different RRM schemes $N = 25$; $\lambda = 2.10^6 \text{ bit/s}$

demand of each MSs. We will establish the “Cumulative Distribution Function” (CDF) of Jain’s index in different schemes. Figure.5.4 illustrates the CDF of Jain’s index over 400 experiences and the system performs over 10s in each experience. The simulation result show that, the “max throughput” scheduling has the worst fairness index which is smaller than 0.8 in about 50% experience. Although, the total throughput is really low, the “equal queue demand” scheduling has the best fairness index which is higher than 0.95 in more than 80% experience. In the three schemes “Equal bandwidth to all

5. RADIO RESOURCE MANAGEMENT : ALGORITHM AND OPTIMIZATION

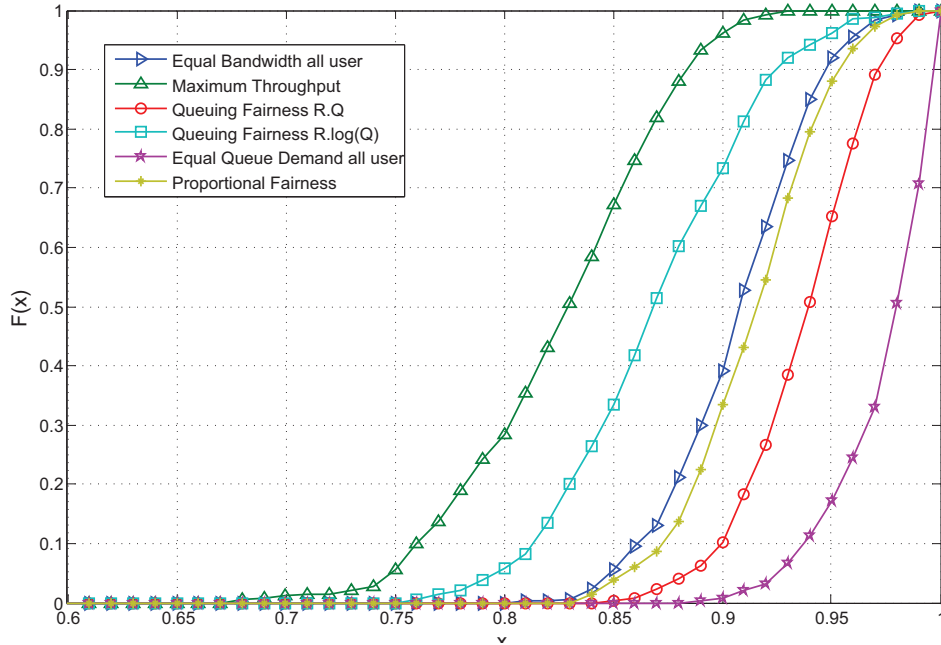

Figure 5.4: Jain's fairness index CDF function of different RRM schemes $N = 25$; $\lambda = 2.10^6 \text{ bit/s}$

user”, “Proportional fair “ and “Queuing Fairness” which have the comparative high total throughput, “Queuing Fairness” provide the better fairness index which is higher than 0.9 in more than 90% experience. We recommend the “Queuing Fairness” scheme to allocate the resource in sectoring based Wimax with relay. This scheme provides a high total cell throughput while maintaining a high fairness index.

5.6 Summary

In this chapter, the radio resource management has been investigated in Wimax and Wimax with relay. In the recent works, the authors show that the RRM scheduling is more complicated in Wimax with relay. We studied RRM optimization in sectoring based wimax with relay system. Three RRM optimization scheme were formulated. The first scheme is to maximize total throughput while guaranteeing a minimum amount bandwidth to each user. The second scheme is “Proportional Fairness Scheduling”. These two first schemes uses the same approach as the literature RRM in Wimax. We proposed our approach by introducing the queue data demand of each user, the resource is allocated to the user with highest $R.Q$, where R is the instantaneous data rate and Q is the queue data demand of the users. We also created the heuristic algorithm to reduce the complexity of these three RRM scheme. The simulation results showed that our scheme proposed the better performance in term of total throughput and

fairness.

5. RADIO RESOURCE MANAGEMENT : ALGORITHM AND OPTIMIZATION

Conclusion

Conclusion

Nowadays, many wireless broadband technologies allow us to get access to high data services such as video streaming, multimedia conferencing and interactive gaming without any cables, wires or telephone connection. Built on different wireless standards, the technologies have been developed to support better services to users. However, these wireless standards provide their services independently and are not compatible with one another. That is why ITU-R defined the IMT-Advanced requirements for 4G systems, in which the wireless broadband standard must be compatible with and able to support a very high data rate up to 1Gbps in downstream. Wimax is one of the most important candidates for 4G system. The advantage of Wimax comparing to the other candidates is the lightweight IP architecture which reduces the operating expenses. Wimax has been the subject of our thesis and more particularly the deployment and scheduling optimization in Wimax with relays networks.

In the first part of this work, we have assessed the performance in Wimax networks. For this, measurement study on fixed and mobile Wimax performance was presented in chapter 2. These experiments showed that the users do not experience an appropriate QoS “everywhere” in the Wimax cell. Due to the obstacles and channel conditions between the mobile station and the base station, high attenuations are adjusted in the link BS-MS and that makes the connections impossible with good QoS. Therefore, Wimax system performs with low efficiency spectrum. This measurement study indicates the necessity of an improvement in fixed and mobile wimax performance. One solution is to deploy low cost relay stations in Wimax cell in addition to the BS in order to enhance the cell capacity and the cell coverage. The amendment IEEE 802.16j Wimax with relay proposing this approach was finalized in 2009.

Recent researches on Wimax with relay have indicated that the cell throughput improvement is not as high as the expectation of the amendment IEEE802.16j. The reason is the silent state of the base station when the frequency band is occupied by the relay stations in multihop connection. In some cooperative relay works, the base stations are supposed to cooperate with the relay station to transmit data to the mobile sta-

CONCLUSION

tions. A higher QoS have been shown for some users in the cell, nevertheless the overall throughput enhancement is still relatively low. This problem has been the focus of this thesis. We first proposed a new deployment architecture in which the BS and the RSs can transmit simultaneously data to different users in the cell. This new architecture of Wimax relay uses sectoring technique and frequency reused technique to eventually improve the overall cell throughput. In this architecture, the cell is divided into several sectors and a portion of the cell frequency band is allocated to each user. The RSs in each sector reuse the frequency band of the other sectors to transmit data to the users. In each sector, the BS and the RSs employ different frequency band which allow them to transmit simultaneously. The adaptive frame structure was also created for the BS and the RS. Finally, simulations were conducted in order to evaluate the total throughput in our new approach. The result showed an important throughput increase in the new architecture. This contribution is describe in chapter 3 and was published in International Workshop on Broadband Convergence Networks (BCN) 2010[71].

In chapter 3, we have made strong assumptions regarding the non existence of interference among the BSs and the RSs. In addition, the total frequency band was proposed to divide equally among the sectors. In some particular deployment of user in the cell, this may significantly decrease the throughput of the cell. We want to relax these strong assumptions and study the impact of interference in Wimax with relay using sectoring. In the study presented in chapter 4, we evaluated the interference level in multicellular network and we took into account the interference from all the terminals using the same frequency band. Moreover the frequency band is proportionally allocated to each sector depending on the number of users in each sector. The results indicated that the impact of interference in the system is low and it can be negligible. A high throughput augmentation was provided with all deployment scenarios of the users in the cell. This study was published in International Conference on Communication (ICC) 2011[70].

Our last contribution focused on the radio resource management problem. Recent research showed that the RRM problem in Wimax with relay is complex because it's not only a scheduling problem but also a routing problem from BS to MSs. To the best of our knowledge, there is still no work on RRM optimization on Wimax with relay network using relay. In chapter 5, we reformulated resource allocation optimization scheme similarly to Wimax study. Two main schemes were presented : "Maximum throughput while ensuring a minimum bandwidth to each user" and "Proportional Fair Scheduling". We proposed a new scheme that takes into account the parameter Q , which represents the remained data demand of the users, in RRM problem. In this scheme, the resource is allocated to the user with the highest $R.Q$, where R is the instantaneous data rate. The heuristic algorithms with low complexity are given for each scheme. The result shows that our approach performed a comparable throughput to the other schemes while the fairness index is better.

Perspective

Wimax with relay networks has a quite complex architecture comprising of a large number of challenging issues. Regarding the aspects addressed in this thesis, there are still many possible research areas that the future works may take.

The transmission power of relay stations is supposed to be fixed and much smaller than that of base stations. Due to this assumption, the coverage area of relay station is small and the impact of interference can be negligible. In fact, the higher transmission power of RS results in the larger RS coverage. This may increase the total throughput of the cell. However, the impact of interference will also be stronger. We would like to find out the optimal transmission power of RSs in order to maximize the throughput improvement with interference aware.

In this thesis, we proposed a new deployment architecture Wimax with relays with sectoring and frequency reuse technique. Nevertheless, we assumed that BS can reach MS in maximum two hops. This architecture cannot apply directly to Wimax multihop relay networks. In addition, we studied only on the downlink transmission. We aim to extend our research on Wimax multihop relay networks in both the uplink and the downlink transmission.

In our RRM study, we did not take into account the limited transmission power over an area which is important for the community health. Moreover, the power transmission is equally divided among the subcarriers. Therefore the system cannot fully benefit the diversity gain. If the power control is considered, the system can provide less power to the subcarrier with good link condition while guaranteeing the spectrum efficiency and more power to the subcarrier with bad link condition to enhance the spectrum efficiency. A RRM investigation with transmission power constraint and flexible power control is a very interesting issue.

The centralized RRM in downlink transmission was studied in the proposed sectoring Wimax with relays. The centralized algorithms provide the benchmark performance. However, the high complexity of scheduling algorithms may make the centralized RRM scheme less attractive than the distributed RRM scheme. Distributed RRM or a hybrid centralized and distributed RRM study in both downlink and uplink transmission is a challenging problem in our proposed architecture.

CONCLUSION

References

- [1] IEEE. STANDARD 802.16-2004. **Part16 : “Air interface for fixed broadband wireless access systems”**. October 2004. 40
- [2] IEEE. STANDARD 802.16E 2005. **Part16 : “Air interface for fixed and mobile broadband wireless access systems—Amendment for physical and medium access control layers for combined fixed and mobile operation in licensed band”**. December 2005.
- [3] IEE 802.16M/D7. **Part 16 : ”Air Interface for Broadband Wireless Access Systems”**. July 2010. 14
- [4] S.IBRAHIM AHMED, IEEE STUDENT MEMBER, K. SADEK AHMED, IEEE MEMBER, WEIFENG SU, IEEE MEMBER, AND K. J. RAYLIU FELLOW IEEE. **“Cooperative Communications with Relay-Selection : When to Cooperate and Whom to Cooperate With ?”**. *IEEE Transactions on wireless communications*, Vol.7(No.7) :pp 2814–2827, July 2008.
- [5] M. ANDREWS. **“Probabilistic end-to-end delay bounds for earliest deadline first scheduling”**. *IEEE Computer Communication Conference*, Vol. 2 :pp. 603–612, 2000. 66
- [6] M. ANDREWS. **“Instability of the proportional fair scheduling algorithm for HDR”**. *IEEE Trans. Wireless Commun.*, pages pp. 1422–1426, September 2004.
- [7] M. ANDREWS, K. KUMARAN, K. RAMANAN, A. STOLYAR, P. WHITING, AND R. VIJAYAKUMAR. **“Providing quality of service over a shared wireless link”**. *IEEE Communication Magazine*, Vol.39 :pp. 150–154, February 2001. 67
- [8] SOJEONG ANN, KYUNG GEUN LEE, AND HYUNG SEOK KIM. **“A Path Selection Method in IEEE 802.16j Mobile Multi-hop Relay Networks”**. *2008 International Symposium on a World of Wireless, Mobile and Multimedia Networks*, 2008. 38
- [9] MOHAMADE KHATTAR AWAD AND XUEMIN SHEN. **“OFDMA Based Two-Hop Cooperative Relay Network Resources Allocation”**. *IEEE International Conference on Communications (ICC)*, 2008.

REFERENCES

- [10] C. BAE AND D.-H. CHO. “**Adaptive resource allocation based on channel information in multi-hop OFDM systems**”. *IEEE Vehicular Technology Conference*, September 2006. 68
- [11] C. BAE AND D.-H. CHO. “**Fairness-aware adaptive resource allocation scheme in multi-hop OFDMA systems**”. *IEEE Commun. Lett.*, Vol.11(No.2) :pp. 134–136, February 2007. 68
- [12] YAN Q. BIAN, YONG SUN, ANDREW R. NIX, AND JOSEPH P. MCGEEHAN. “**High Efficient Mobile WiMAX with MIMO and Multihop Relay**”. *Journal of Communications*, Vol.2(No.5) :pp 7–16, August 2007.
- [13] YAN Q. BIAN, YONG SUN, ANDREW R. NIX, AND P. STRAUCH. “**Performance Evaluation of Mobile WiMAX with MIMO and Relay Extensions**”. *Wireless Communications and Networking Conference(WCNC)*, pages 1814–1819, juin 2007.
- [14] BASAK CAN, HALIM YANIKOMEROGLU, FURUZAN ATAY ONAT, ELISABETH DE CARVALHO, AND HIROYUKI YOMO. “**Efficient Cooperative Diversity Schemes and Radio Resource Allocation for IEEE 802.16j**”. *Wireless Communication and Networking Conference(WCNC)*, 2008. vii, 38, 40, 42
- [15] BASAK CAN, HIROYUKI YOMO, AND ELISABETH DE CARVALHO. **Link Adaptation and Selection Method for OFDM Based Wireless Relay Networks**. *Journal of Communications and Networks*, Vol.9(No.2) :pp 118–127, June 2007. 38
- [16] SO-IN CHAKCHAI, R. JAIN, AND A. K. TAMIMI. “**Scheduling in IEEE 802.16e mobile WiMAX networks : key issues and a survey**”. *IEEE Selected Areas in Communications*, Vol.27 :pp. 156 – 171, February 2009. 67
- [17] WOONG CHO, IEEE STUDENT MEMBER, AND LIUQING YANG IEEE SENIOR MEMBER. **Optimum Resource Allocation for Relay networks with Differential Modulation**. *Transactions on communication*, Vol.56(No.4) :pp 531–535, April 2008.
- [18] J. DE BRUYNE, W. JOSEPH, L. VERLOOK, AND L. MARTENS. “**Measurements and evaluation of the network performance of a fixed WiMAX system in a suburban environment**”. *IEEE International Symposium on Wireless Communication Systems(ISWCS)*, 2008. 26
- [19] PIERRE DELANNOY, HAI DANG NGUYEN, MICHEL MAROT, NAZIM AGOULMINE, AND MONIQUE BECKER. “**WiMax Quality-of-Service estimations and measurement**”. *Computer Communications*, Vol.33, Novembre 2010. 26
- [20] OLIVIER DOUSSE, IEEE MEMBER, MASSIMO FRANCESCHETTI, IEEE MEMBER, AND PARTRICK THIRANIEEE MEMBER. “**On the Throughput Scaling**

- of **Wireless Relay Networks**". *IEEE Transactions on Information Theory*, Vol.52(No.6) :pp 2756–2761, June 2006.
- [21] A. DURANTINI AND M. PETRACCA. “**Test of 2.5 GHz WiMAX performances for business and SOHO in a multi-service environment**”. *IEEE 19th International Symposium on Personal, Indoor and Mobile Radio Communications (PIMRC)*, 2008. 26
- [22] J. SYDIR ET AL. “**Harmonized Contribution on 802.16j Usage Models**”. *IEEE C802.16j-06/015*, 2006. 30
- [23] K. FILIS, E. THEODOROPOULOU, AND G. LYBEROPOULOS. “**The effect of a rapidly changing urban environment on nomadic WiMAX performance**”. *16th IST Mobile and Wireless Communications Summit*, 2007. 26
- [24] WiMAX FORUM. **Mobile WiMAX—Part I : “A technical overview and performance evaluation. White Paper**”. March 2006. vii, 21
- [25] WiMAX FORUM. **Mobile WiMAX—Part II : “A comparative analysis. White Paper**”. May 2006.
- [26] V. GEN, S. MURPHY, AND J. MURPHY. “**An Interference-Aware Analytical Model for Performance Analysis of Transparent Mode 802.16j Systems**”. *IEEE GLOBECOM Workshops*, November 2008. 54
- [27] V. GEN, S. MURPHY, AND J. MURPHY. “**Analysis of Transparent Mode IEEE 802.16j System Performance with varying Numbers of Relays and Associated Transmit Power**”. *IEEE Wireless Communications and Networking Conference (WCNC)*, 2009.
- [28] V. GEN, S. MURPHY, AND J. MURPHY. “**System-Level Performance Evaluation of Multi-cell Transparent Mode Relay 802.16j Systems**”. *IEEE Globecom*, 2009.
- [29] V. GEN, S. MURPHY, YANG YU, AND J. MURPHY. “**IEEE 802.16J relay-based wireless access networks : an overview**”. *Wireless Communications, IEEE*, Vol.15, 2008. 37
- [30] VASKEN GEN, SEN MURPHY, AND JOHN MURPHY. “**Performance Analysis of Transparent Relays in 802.16j MMR Networks**”. *Modeling and Optimization in Mobile, Ad Hoc, and Wireless Networks and Workshops. WiOPT 6th International Symposium on*, August 2008. 38
- [31] DEBALINA GHOSH, ASHIMA GUPTA, AND PRASANT MOHAPATRA. “**Admission Control and Interference-Aware Scheduling in Multi-hop WiMAX Networks**”. *IEEE International Conference on Mobile Adhoc and Sensor Systems*, 2007. 54

REFERENCES

- [32] XIAOWEN GONG, WEI YUAN, WEI LIU, WENQING CHENG, AND SHU WANG. “**A Cooperative Relay Scheme for Secondary Communication in Cognitive Radio Networks**”. *Global Telecommunication Conference, IEE GLOBE-COM*, December 2008.
- [33] O. GRONDALEN, P. GRONSUND, T. BREIVIK, AND P. ENGELSTAD. “**Fixed WiMAX Field Trial Measurements and Analyses**”. *16th IST Mobile and Wireless Communications Summit*, 2007.
- [34] H. HAAS, V.D. NGUYEN, P. OMIYI, N. NEDEV, AND G. AUER. “**Interference Aware Medium Access in Cellular OFDMA/TDD Networks**”. *IEEE International Conference on Communications(ICC)*, June 2006. 53
- [35] Z. HAN AND K. J. R. LIU. “*Resource Allocation for Wireless Networks : Basics, Techniques, and Applications*”. Cambridge, 2008.
- [36] G. R. HIERTZ, S. MAX, R. ZHAO, D. DENTENEER, AND L. BERLEMANN. “**Principles of IEEE 802.11s**”. *International Conference on Computer Communications and Networks*, pages pp. 1002–1007, August 2007.
- [37] C. HOYMAN, M. DITTRICH, AND S. BOEBBELS. “**Dimensioning Cellular Wimax Part I : Singlehop Networks**”. *European Wireless, Paris, France*, April 2007. 38, 54
- [38] C. HOYMAN, M. DITTRICH, AND S. BOEBBELS. “**Dimensioning Cellular Wimax Part II : Multihop Networks**”. *European Wireless, Paris, France*, April 2007. 38, 54
- [39] HUINING HU, H. YANIKOMEROGLU, D.D. FALCONER, AND S. PERIYALWAR. “**Range extension without capacity penalty in cellular networks with digital fixed relays**. *Global Telecommunications Conference(GLOBECOM)*, pages pp. 3053–3057, Decembre 2004.
- [40] C. Y. HUANG, H.-H JUAN, M.-S LIN, AND C.-J. CHANG. “**Radio resource management of heterogeneous services in mobile WIMAX systems**”. *IEEE Wireless Commun.*, pages pp. 20–26, February 2007.
- [41] IEEE BASELINE DOCUMENT V4 FOR DRAFT STANDARD IEEE. **Part 16 : “Air Interface for Fixed and Mobile Broadband Wireless Access Systems, Multihop Relay Specification**”. May 2007.
- [42] M. ISLAM, M. CHOWDHURY, YOUNG MIN SEO, YOUNG KI LEE, SANG BUM KANG, SUN WOONG CHOI, AND YEONG MIN JANG. “**Measurement and Statistical Analysis of QoS Parameters for Mobile WiMAX Network**”. *10th International Conference on Advanced Communication Technology(ICAICT)*, 2008.

-
- [43] J. JANG AND K. B. LEE. “**Transmit power adaptation for multiuser OFDM systems**”. *IEEE Journal on Selected Areas in Communication*, Vol.21(No.2) :pp. 171–178, February 2003.
- [44] G.ANDREWS JEFFREY, GHOSH ARUNABHA, AND MUHAMED RIAS. “*Fundamentals of WiMAX Understanding Broadband Wireless Networking*”. Prentice Hall, 2007. vii, 19, 39, 47, 57
- [45] JUNCHENG JIA, JIN ZHANG, AND QIAN ZHANG. “**Cooperative Relay for Cognitive Radio Networks**”. *IEEE INFOCOM*, 2009.
- [46] SUNGGEUN JINA, XI CHEN, DAJI QIAO, AND SUNGHYUN CHOI. “**Adaptive sleep mode management in IEEE 802.16m wireless metropolitan area networks**”. *Computer Networks*, March 2011. 14
- [47] M. KANEKO AND P. POPOVSKI. “**Radio resource allocation algorithm for relay-aided cellular OFDMA system**”. *IEEE International Conference on Communications(ICC)*, pages pp. 4831–4836, June 2007. 68
- [48] DONGMYOUNG KIM, HUA CAI, MINSOO NA, AND SUNGHYUN CHOI. “**Performance measurement over mobile WiMAX/IEEE 802.16e network**”. *International Symposium on a World of Wireless, Mobile and Multimedia Networks (WoWMoM)*, 2008. 26
- [49] H. KIM AND Y. HAN. “**A proportional fair scheduling for multicarrier transmission systems**”. *IEEE Communication Letter*, Vol.9 :pp. 210–212, March 2005. 67
- [50] M. KIM AND H. LEE. “**Radio resource management for a two-hop OFDMA relay system in downlink**”. *IEEE Symposium on Computers and Communications*, pages pp. 25–31, July 2007. 69
- [51] S. KIM, X. WANG, AND M. MADIHAN. “**Optimal resource allocation in multi-hop OFDMA wireless networks with cooperative relay**”. *IEEE Transactions on Wireless Communication*, Vol.7(No.5) :pp. 1833–1838, May 2008.
- [52] R. KWAK AND J. M. CIOFFI. “**Resource-allocation for OFDMA multihop relaying downlink systems**”. *IEEE Global Telecommunications Conference*, pages 3225–3229, November 2007.
- [53] J. ROBERTO B. DE MARCA KWANG-CHENG CHEN. “*MOBILE WiMAX*”. WILEY, April 2008. 43
- [54] LONG LE AND E. HOSSAIN. “**Multihop Cellular Networks : Potential Gains, Research Challenges, and a Resource Allocation Framework**”. *Communications Magazine, IEEE*, pages pp. 66–73, Septembre 2007.

REFERENCES

- [55] J. LEE, S. PARK, H. WANG, AND D. HONG. “**QoS-guarantee transmission scheme selection for OFDMA multi-hop cellular networks**”. *IEEE International Conference on Communications(ICC)*, pages pp. 4587–4591, June 2007. 68
- [56] G. LI AND H. LIU. “*OFDM-based Broadband Wireless Networks : Design and Optimization*”. Wiley, October 2005.
- [57] G. LI AND H. LIU. “**Downlink dynamic resource allocation for multi-cell OFDMA systems**”. *IEEE Transactions on Wireless Communications*, Vol.5(No.12) :pp. 3451–3459, Decembre 2006.
- [58] G. LI AND H. LIU. “**Resource allocation for OFDMA relay networks with fairness constraints**”. *IEEE J. Sel. Areas Commun.*, Vol.24(No.11) :pp. 2061–2069, November 2006.
- [59] P. LI, M. RONG, T. LIU, AND D. YU. “**Interference modeling and analysis in two-hop cellular network with fixed relays in FDD mode**”. *International Conference on Wireless Communications, Networking and Mobile Computing*, pages pp. 427–451, September 2005.
- [60] XUE JUN LIA, BOON-CHONG SEETB, AND PETER HAN JOO CHONGC. “**Multi-hop cellular networks : Technology and economics**”. *Computer Networks*, Vol.52(No.9) :pp. 1825–1837, June 2008.
- [61] BIN LIN, PIN HAN HO, XIE, LIANG LIANG, AND XUEMIN (SHERMAN) SHEN. “**Optimal relay station placement in IEEE 802.16j networks**”. *IEEE International Conference on Wireless Communications and Mobile Computing(IWCMC)*, 2007. 38
- [62] BIN LIN, PIN HAN HO, XIE, LIANG LIANG, AND XUEMIN (SHERMAN) SHEN. “**Relay Station Placement in IEEE 802.16j Dual-Relay MMR Networks**”. *IEEE International Conference on Communications (ICC)*, May 2008. 38
- [63] JIN ZI LONG, CHOONGYONG SHIN, DAE-YOUNG KIM, AND JINSUNG CHO. “**On the optimal number of relay stations in two-hop relay cooperative cellular networks**”.
- [64] HSIAO-CHEN LU, WANJIUN LIAO, AND F.Y. LIN. “**Relay Station Placement Strategy in IEEE 802.16j WiMAX Networks**”. *IEEE Transaction on Communications*, Vol.59 :151–158, January 2011. 38
- [65] Y. MA. “**Proportional fair scheduling for downlink OFDMA**”. *IEEE International Conference on Communications (ICC)*, pages pp. 4843–4848, June 2007.

-
- [66] J. MILANOVIC, S. RIMAC-DRLJE, AND K. BEJUK. “**Comparison of Propagation Models Accuracy for WiMAX on 3.5 GHz**”. *14th IEEE International Conference on Electronics, Circuits and Systems(ICECS)*, 2007.
- [67] W. NAM, W. CHANG, S.-Y CHUNG, AND Y. LEE. “**Transmit optimization for relay-based cellular OFDMA systems**”. *IEEE International Conference on Communications(ICC)*, pages pp. 5714–5719, June 2007. 68
- [68] P. NEVES, P. SIMOES, A. GOMES, L. MARIO, F. FRONTES, E. MONTEIRO, AND T. BOHNERT. “**WiMAX for emergency services : an empirical evaluation**”. *International Conference on Next Generation Mobile Applications and Technologies (NGMAST)*, 2007. 26
- [69] T. C. NG AND W. YU. “**Joint optimization of relay strategies and resource allocations in cooperative cellular networks**”. *IEEE J. Sel. Areas Commun.*, Vol.25(No.2) :pp. 328–339, February 2007.
- [70] HAI DANG NGUYEN, KHANH TOAN TRAN, AND NAZIM AGOULMINE. “**Impact of interference on the system performance of Wimax Relay 802.16j with Sectoring**”. *IEEE International Conference on Communications(ICC)*, June 2011. 82
- [71] HAI DANG NGUYEN, HUI WANG, AND NAZIM AGOULMINE. “**Sectoring in WIMAX relay to enhance the system throughput**”. *5th IFIP/IEEE International Workshop on Broadband Convergence Networks(BCN)*, 2010. 62, 82
- [72] D. NIYATO AND E. HOSSAIN. “**Adaptive fair subcarrier/rate allocation in multirate OFDMA networks : Radio link level queuing performance analysis**”. *IEEE Trans. Veh. Technol.*, Vol.55(No.6), November 2006.
- [73] D. NIYATO, E. HOSSAIN, DONG IN KIM, AND ZHU HAN. “**Joint Optimization of Placement and Bandwidth Reservation for Relays in IEEE 802.16j Mobile Multihop Networks**”. *IEEE International Conference on Communications(ICC)*, June 2009. 38
- [74] O. OYMAN, N.J. LANEMAN, AND S. SANDHU. “**Multihop Relaying for Broadband Wireless Mesh Networks : From Theory to Practice**”. *IEEE Communications Magazine*, Vol.45(No.11), November 2007.
- [75] IEEE P802.16J/D9. “**Draft IEEE standard for local and metropolitan area networks Part 16 : Air interface for fixed and mobile broadband wireless access systems : multihop relay specification**”. February 2009. vii, 33, 35, 36, 37
- [76] R. PABST, B. WALKE, D. SCHULTZA, P. HERHOLD, H. YANIKOMEROGLU, S. MUKHERJEE, H. VISWANATHAN, M. LOTT, W. ZIRWAS, M. DOHLER, H. AGHVAMI, D. FALCONER, AND G. FETTWEIS. “**Relay-based deployment**

REFERENCES

- concepts for wireless and mobile broadband cellular radio**". *IEEE Communications Magazine*, Vol.42(No.9) :pp. 80–89, Septembre 2004.
- [77] Y. PARK AND E.-S. JUNG. "**Resource-aware routing algorithms for multihop cellular networks**". *International Conference on Multimedia and Ubiquitous Engineering*, pages 1164–1167, April 2007.
- [78] S. PARKVALL, A. FURUSKAR, AND E. DAHLMAN. "**Evolution of LTE toward IMT-advanced**", February 2011. 10
- [79] E. PEH, W. SEAH, Y. CHEW, AND Y. GE. "**Experimental study of voice over IP Services over broadband wireless networks**". *22nd International Conference on Advanced Information Networking and Applications (AINA)*, 2008. 26
- [80] STEVEN W. PETERS AND ROBERT W. HEATH. "**The future of WiMAX : Multihop relaying with IEEE 802.16j**". *Communications Magazine, IEEE*, January 2009. 37
- [81] S. PIETRZYK AND G. J. M. JANSSEN. "**Radio resource allocation for cellular networks based on OFDMA with QoS guarantees**". *IEEE Global Telecommunications Conference*, Novembre 2004.
- [82] T. ROUSE, I. BAND, AND S. MCLAUGHLIN. "**Capacity and power investigation of opportunity driven multiple access (ODMA) networks in TDD-CDMA based systems**". *IEEE International Conference on Communications(ICC)*, Vol.5 :pp. 3202–3206, May 2002.
- [83] S. SADR, A. ANPALAGAN, AND K. RAAHEMIFAR. "**Radio resource allocation algorithms for the downlink of multiuser OFDM communication systems**". *IEEE Commun. Surveys Tutorials*, Vol.11(No.3) :pp. 92–106, August 2009.
- [84] M. SALEM, A. ADINOYI, M. RAHMAN, H. YANIKOMEROGLU, D. FALCONER, AND Y.-D. KIM. "**Fairness-aware radio resource management in downlink OFDMA cellular relay networks**". *IEEE Transaction on Wireless Communications*, Vol.9(No.5) :pp. 1628–1639, May 2010.
- [85] M. SALEM, A. ADINOYI, M. RAHMAN, H. YANIKOMEROGLU, D. FALCONER, Y.-D. KIM, AND E. KIM. "**Fairness-aware joint routing and scheduling in OFDMA-based multi-cellular fixed relay networks**". *IEEE International Communications Conference(ICC)*, June 2009.
- [86] M. SALEM, A. ADINOYI, M. RAHMAN, H. YANIKOMEROGLU, D. FALCONER, YOUNG-DOO KIM, EUNGSUN KIM, AND YOON-CHAE CHEONG. "**An Overview of Radio Resource Management in Relay-Enhanced OFDMA-Based Networks**". *Communications Surveys & Tutorials, IEEE*, Vol.12(No.3) :422–438, April 2010.

-
- [87] M. SALEM, A. ADINOYI, H. YANIKOMEROGLU, AND D. FALCONER. “**Opportunities and challenges in OFDMA-based cellular relay networks : A radio resource management perspective**”. *IEEE Trans. Veh. Technol.*, Vol.59(No.5) :pp. 2496 – 2510, January 2010.
- [88] Z. SHEN, J. G. ANDEWS, AND B. L. EVANS. “**Adaptive resource allocation in multiuser OFDM systems with proportional rate constraints**”. *IEEE Trans. Wireless Commun.*, pages pp. 2726–2737, November 2005.
- [89] V. SRENG, H. YANIKOMEROGLU, AND D. FALCONER. “**Coverage enhancement through two-hop relaying in cellular radio systems**”. *IEEE Wireless Communications and Networking Conference(WCNC)*, pages pp. 881–885, March 2002.
- [90] A. L. STOLYAR AND K. RAMANAN. “**Largest Weighted Delay First Scheduling : Large Deviations and Optimality**”. *Annals of Applied Probability*, Vol.11 :pp. 1–48, 2001. 66
- [91] ZHIFENG TAO, ANFEI LI, KOON HOO TEO, AND JINYUN ZHANG. “**Frame Structure Design for IEEE 802.16j Mobile Multihop Relay (MMR) Networks**”. *Global Telecommunications Conference, IEEE GLOBECOM*, December 2007. 37
- [92] ZHIFENG TAO, KOON HOO TEO, AND JINYUN ZHANG. “**Aggregation and Concatenation in IEEE 802.16j Mobile Multihop Relay (MMR) Networks**”. *Mobile WiMAX Symposium IEEE*, pages pp. 85–90, 2007. 35
- [93] E. TRAGOS, A. MIHOVS, E. MINO, J. LOU, R. FRACCHIA, G. VIVIER, AND X. XUE. “**Hybrid RRM architecture for future wireless networks**”. *IEEE International Symposium on Personal, Indoor and Mobile Radio Communications*, September 2007.
- [94] M. TRAN, G. ZAGGOULOS, A. NIX, AND A. DOUFEXI. “**Mobile WiMAX : Performance Analysis and Comparison with Experimental Results**”. *IEEE 68th Vehicular Technology Conference(VTC) - Fall*, 2008. 26
- [95] B. UPASE AND M. HUNUKUMBURE. “**Dimensioning and Cost Analysis of Multihop Relay-Enabled WiMAX Networks**”. *Futjisu Scientific and Technical Journal*, July 2008. 38
- [96] H. VISWANATHAN AND S. MUKHERJEE. “**Performance of cellular networks with relays and centralized scheduling**”. *IEEE Trans. Wireless Commun.*, Vol.4(No.5) :2318–2328, September 2005.
- [97] HUNG YU WEI, S. GANGULY, R. IZMAILOV, AND Z.J. HAAS. “**Interference-aware IEEE 802.16 WiMax mesh networks**”. *IEEE Vehicular Technology Conference, VTC Spring*, May 2006. 53

REFERENCES

- [98] LIAM MURPHY YANG YU, SEAN MURPHY. “**A Clustering Approach to Planning Base Station and Relay Station Locations in IEEE 802.16j Multi-Hop Relay Networks**”. *IEEE International Conference on Communications (ICC)*, May 2008.
- [99] H. YANIKOMEROGLU. “**Fixed and mobile relaying technologies for cellular networks**”. *Second Workshop on Applications and Services in Wireless Networks(ASWN)*, pages pp. 75–81, July 2008.
- [100] F. YOUSAF, K. DANIEL, AND C. WIETFELD. “**Performance Evaluation of IEEE 802.16 WiMAX Link With Respect to Higher Layer Protocols**”. *4th International Symposium on Wireless Communication Systems(ISWCS)*, 2007. 26
- [101] H. ZENG AND C. ZHU. “**System-Level Modeling and Performance Evaluation of Multi-hop 802.16j Systems**”. *Wireless Communications and Mobile Computing Conference(IWCMC)*, August 2008.
- [102] HUI ZENG AND CHENXI ZHU. **Resource Allocation in 802.16j Multi-Hop Relay Systems with the User Resource Fairness Constraint**. *Wireless Communications and Networking Conference(WCNC)*, May 2009.
- [103] Y. J. ZHANG AND K. B. LETAIEF. “**Multiuser adaptive subcarrier-and-bit allocation with adaptive cell selection for OFDM systems**”. *IEEE Transactions on Wireless Communications*, Vol.3 :pp. 1566 – 1575, September 2004. 67
- [104] Y. J. ZHANG AND S. S. LIEW. “**Link-adaptive largest-weighted-throughput packet scheduling for real-time traffics in wireless OFDM networks**”. *IEEE Global Telecommunication Conference*, Vol.5 :pp. 5–9, 2005. 68