



**HAL**  
open science

# Optimisation of repetitive transcranial magnetic stimulation using electroencephalographic measurements in patients suffering from mood disorders

Agata Wozniak-Kwasniewska Wozniak-Kwasniewska

► **To cite this version:**

Agata Wozniak-Kwasniewska Wozniak-Kwasniewska. Optimisation of repetitive transcranial magnetic stimulation using electroencephalographic measurements in patients suffering from mood disorders. Human health and pathology. Université de Grenoble, 2013. English. NNT : 2013GRENS015 . tel-00905316

**HAL Id: tel-00905316**

**<https://theses.hal.science/tel-00905316>**

Submitted on 18 Nov 2013

**HAL** is a multi-disciplinary open access archive for the deposit and dissemination of scientific research documents, whether they are published or not. The documents may come from teaching and research institutions in France or abroad, or from public or private research centers.

L'archive ouverte pluridisciplinaire **HAL**, est destinée au dépôt et à la diffusion de documents scientifiques de niveau recherche, publiés ou non, émanant des établissements d'enseignement et de recherche français ou étrangers, des laboratoires publics ou privés.

## THÈSE

Pour obtenir le grade de

## DOCTEUR DE L'UNIVERSITÉ DE GRENOBLE

Spécialité : **Biotechnologie, instrumentation, signal et imagerie pour la biologie, la médecine et l'environnement**

Arrêté ministériel : 7 août 2006

Présentée par

**Agata WOŹNIAK-KWAŚNIEWSKA**

Thèse dirigée par **Olivier DAVID**

préparée au sein du **Grenoble Institut des Neurosciences**  
dans l'**École Doctorale Ingénierie pour la Santé, la Cognition et l'Environnement**

### **Evaluation de l'excitabilité corticale par électroencéphalographie pour l'optimisation de la stimulation magnétique transcrânienne répétée chez les patients souffrant de troubles de l'humeur**

Thèse soutenue publiquement le **7 Octobre 2013**,  
devant le jury composé de :

**Mme, Mireille BONNARD**

Directeur de recherches, Institut de Neurosciences des Systèmes INS-INSERM UMR 1106, Aix-Marseille Université Faculté de Médecine, Marseille (Rapporteur)

**M., Jean DAUNIZEAU**

Chargé de recherches, Institut du Cerveau et de la Moelle épinière, Paris (Rapporteur)

**M., Olivier DAVID**

Chargé de recherches, Grenoble Institut des Neurosciences (Directeur de thèse)

**M., Emmanuel POULET**

Service de Psychiatrie des Urgences et Addictologie, Lyon (Examineur)

**M., Thierry BOUGEROL**

Professeur, Faculté de Médecine, Université Joseph Fourier, Grenoble (Examineur)

**M., David SZEKELY**

Chef service adjoint, Service de psychiatrie, Centre Hospitalier Princesse Grace, Principauté de Monaco (Invité)





PhD thesis of the Joseph Fourier University, Grenoble

Defended by

Agata Woźniak-Kwaśniewska

**Evaluation of cortical excitability with electroencephalography recordings for optimizing the repetitive transcranial magnetic stimulation in patients with mood disorders.**

Thesis supervisor: Olivier David

prepared in Grenoble Institute of Neuroscience

defended on 7<sup>th</sup> of October 2013

**Jury:**

**Mireille BONNARD**

Institut de Neurosciences des Systèmes INS- INSERM UMR 1106, Aix-Marseille Université  
Faculté de Médecine, Marseille (Reviewer)

**Jean DAUNIZEAU**

Institut du Cerveau et de la Moelle épinière, Paris (Reviewer)

**Olivier DAVID**

Grenoble Institut des Neurosciences (Supervisor)

**Emmanuel POULET**

Service de Psychiatrie des Urgences et Addictologie, Lyon (Examinator)

**Thierry BOUGEROL**

Faculté de Médecine, Université Joseph Fourier, Grenoble (Examinator)

**David SZEKELY**

Service de psychiatrie, Centre Hospitalier Princesse Grace, Principauté de Monaco (Invited)



# Contents

<b>Acknowledgments</b>	<b>ix</b>
<b>Abstract</b>	<b>x</b>
<b>Introduction</b>	<b>xiv</b>
<b>1 Depression</b>	<b>2</b>
1.1 Introduction . . . . .	2
1.2 Neurobiology of depression . . . . .	3
1.2.1 Dopaminergic pathways . . . . .	4
1.2.2 Norepinephrine pathways . . . . .	6
1.2.3 Serotonin pathways . . . . .	7
1.2.4 Glutamate pathways . . . . .	9
1.2.5 Gamma-aminobutyric acid pathways . . . . .	10
1.3 Neurocognitive models of depression . . . . .	11
1.3.1 Neural mechanisms of biased attention for emotional stimuli .	11
1.3.2 Neural mechanisms of biased processing of emotional stimuli	12
1.3.3 Integrated neurocognitive model . . . . .	14
<b>2 Electroencephalography</b>	<b>16</b>
2.1 Introduction . . . . .	16
2.2 Neural activity . . . . .	17
2.2.1 Cortical cytoarchitecture . . . . .	18
2.3 EEG Generation . . . . .	19
2.3.1 EEG . . . . .	19
2.3.2 Brain waves . . . . .	22
2.4 Source localisation . . . . .	24
2.4.1 Forward problem . . . . .	25
2.4.2 Inverse problem . . . . .	27

---

<b>3</b>	<b>Transcranial Magnetic Stimulation</b>	<b>31</b>
3.1	Introduction . . . . .	31
3.2	Principles of magnetic stimulation . . . . .	32
3.3	Targeting rTMS and neuronavigation . . . . .	36
3.4	Physiology of TMS-induced changes . . . . .	37
3.4.1	Synaptic plasticity . . . . .	38
3.4.2	LTD and LTP . . . . .	39
3.5	rTMS protocols . . . . .	40
3.5.1	1 Hz rTMS . . . . .	42
3.5.2	10 Hz rTMS . . . . .	44
3.5.3	Theta burst stimulation . . . . .	45
3.6	Functional connectivity and cortical excitability . . . . .	47
3.7	TMS in the treatment . . . . .	48
3.7.1	TMS in the treatment of MDD . . . . .	48
3.7.2	TMS in the treatment of BP depression . . . . .	53
3.8	Conclusions . . . . .	54
<b>4</b>	<b>rTMS, EEG and depression</b>	<b>57</b>
4.1	Introduction . . . . .	57
4.2	Challenges of EEG-rTMS co-registration . . . . .	58
4.3	EEG changes correlated with mood disorders . . . . .	59
4.3.1	Quantitative electroencephalography . . . . .	59
4.3.2	Depressed vs. healthy brain . . . . .	61
4.3.3	EEG as the predictor of depression treatment . . . . .	63
4.4	Conclusions . . . . .	65
<b>5</b>	<b>General methods</b>	<b>67</b>
5.1	Participants, instrumentation and methodology . . . . .	67
5.1.1	Participants . . . . .	67
5.1.2	rTMS methodology . . . . .	70
5.1.3	Self-evaluation of mood changes . . . . .	72
5.1.4	EEG acquisition and pre-processing . . . . .	72

---

5.1.5	EEG spectral analysis at the scalp and cortex levels . . . . .	74
5.1.6	Statistical analyses . . . . .	76
<b>6</b>	<b>Results</b>	<b>80</b>
6.1	Introduction . . . . .	80
6.2	Paper I . . . . .	80
6.3	Paper II . . . . .	92
<b>7</b>	<b>Conclusions and future works</b>	<b>103</b>
7.1	Conclusions . . . . .	103
7.2	Future works . . . . .	107
	<b>Bibliography</b>	<b>109</b>



# List of Figures

1.1	Dopaminergic pathways . . . . .	6
1.2	Noradrenergic pathways . . . . .	7
1.3	Serotonergic pathways . . . . .	8
1.4	Cognitive neurobiological model of biased processing . . . . .	13
1.5	Summary of an integrated cognitive neurobiological model of depression	14
2.1	Diagram of a typical myelinated neuron . . . . .	17
2.2	Neocortex . . . . .	20
2.3	Micro current sources . . . . .	21
2.4	EEG 10-20 system . . . . .	22
2.5	Head models . . . . .	27
2.6	Forward and inverse problem . . . . .	27
3.1	Current flows in TMS coil . . . . .	33
3.2	Types of coils . . . . .	33
3.3	H-coil . . . . .	34
3.4	Iron core coil . . . . .	34
3.5	TMS-induced electric fields . . . . .	35
3.6	Neuronavigation . . . . .	37
3.7	TMS protocols . . . . .	42
3.8	Increase of rCBF after 20 Hz TMS . . . . .	50
3.9	Decrease of rCBF after 1-Hz TMS . . . . .	51
3.10	rTMS effects on brain function . . . . .	53
5.1	Description of rTMS protocols . . . . .	71
5.2	Visual analogue scale . . . . .	73

# Acronyms

5-HT serotonin

ACC dorsal anterior cingulate cortex

AMPA  $\alpha$ -amino-3-hydroxy-5-methylisoxazole-4-propionic acid

AMT active motor threshold

AP action potential

APB abductor pollicis brevis

BA Brodman area

BEM boundary element method

BOLD blood oxygen level-dependent

BP bipolar

CNS central nervous system

CSF cerebrospinal fluid

cTBS continuous theta burst stimulation

DA dopamine

DC direct current

DCM dynamic causal modeling

DIS distributed inverse solutions

DLPFC dorsolateral prefrontal cortex

ECT electroconvulsive therapy

EEG electroencephalography

EPSP	excitatory postsynaptic potential
ERPs	event-related potentials
FDM	finite difference method
FEM	finite-element method
fMRI	functional magnetic resonance imaging
GABA	gamma-aminobutyric acid
HDRS	Hamilton depression rating scale
HFS	high frequency stimulation
ICA	independent component analysis
ICF	intracortical facilitation
IPSP	inhibitory postsynaptic potential
ISIs	inter-stimulus intervals
iTBS	intermittent theta burst stimulation
LAURA	local autoregressive average
LC	locus coeruleus
LORETA	low resolution electrical tomography
LTD	long-term depression
LTP	long-term potentiation
MDD	major depressive disorder
MEG	magnetoencephalography
MEP	motor evoked potential
MNE	minimum norm estimator

---

MRI	magnetizing resonanse imaging
MSP	multiple sparse priors
MT	motor threshold
NAc	nucleus accumbens
NE	norepinephrine
NMDA	N-methyl-D-aspartate
NREM	non-REM
PET	positron emission tomography
PFC	prefrontal cortex
PSP	postsynaptic potential
qEEG	quantitative electroencephalography
rACC	rostral anterior cingulate cortex
rCBF	regional cerebral blood flow
REM	rapid eye movement
RMT	resting motor threshold
rTMS	repetitive transcranial magnetic stimulation
SICI	short intracortical inhibition
sLORETA	standardized low resolution brain electromagnetic tomography
SPC	superior parietal cortex
SSRI	serotonin reuptake inhibitor
STDP	spike timing-dependent plasticity
TBS	theta burst stimulation

TCAs	tricyclic antidepressants
TMS	transcranial magnetic stimulation
VAS	visual analogue scale
VLPFC	ventrolateral prefrontal cortex
VSDI	voltage-sensitive dye imaging

# Acknowledgments

---

I would not be able to write this thesis without the help and support of many people during these three years.

First of all, I would like to thank Oliver David – my supervisor, who gave me the opportunity to take up this PhD project. He dedicated a significant amount of his time to guide me sharing his impressive knowledge and experience.

I sincerely thank David Szekely, for guiding me through TMS and neuronavigation techniques. And for all necessary lessons and explanations about depression.

I would also like to thank the staff of Psychiatry Department of CHU for their friendly and useful help during EEG-TMS recordings with patients.

This work could not have been done without TMS hardware provided by Pr. Christian Marendaz. Thank you Christian for charing with us all the equipment.

I would also like to thank Sylvain Harquel, the engineer who helped me a lot during EEG sessions with patients. Sylvain, without you it would last twice longer. Additionally, many thanks to participants, especially healthy once. Without you it would not be possible at all. And thank you for your time!

I am deeply thankful to my dear friend, C line Tisseyre, for translating abstracts from English to French. C line, you were very helpful.

I would like to thank my family who helped and supported me from the very beginning of this project. Without them it would be much more difficult. I am deeply grateful to my mother, who always supported me and believed in me, making me the person I am now.

Finally, I would like to express my gratitude to my beloved husband, Pawel, for his understanding, courage and support. Especially for his help with programming and our fruitful discussions about my project. And of course, my daughter Zuzanna, whose bright smile overcomes all fatigue. And for her intriguing questions about the brain anatomy.

# Abstract

---

Transcranial magnetic stimulation (TMS) is a non-invasive technique for stimulating the brain. A brief electric current passing through a magnetic coil produces a brief, high-intensity magnetic field which stimulates the brain. Repetitive TMS, application of many magnetic pulses, is able to induce relatively long-lasting excitability changes and nowadays is being developed for various therapeutic and scientific purposes. The after-effects of rTMS over motor cortex are well documented in healthy individuals, however less is known about the stimulation of dorso-lateral prefrontal cortex (DLPFC).

The aim of this PhD thesis was to compare different rTMS protocols in healthy subjects and to find neurophysiological EEG biomarkers characteristic for response or not to rTMS therapy in major and bipolar depression. The main originality of presented method is within-subject comparison of between-protocols effects. Additionally, source localisation was performed in both analyses.

Here, we studied in 20 healthy subjects how cortical oscillations are modulated by four different active rTMS protocols (1 Hz, 10 Hz, cTBS and iTBS) of the left DLPFC, and by a sham-1Hz protocol used as a control condition, by comparing the spectral power of pre- and post-rTMS electroencephalographic (EEG) recordings of 15 minutes duration. EEG spectrum was estimated with the Fast Fourier transform (FFT) and partitioned using the common physiological frequency.

We found for every active protocol a significant decrease of delta and theta power on left prefrontal electrodes, mainly localised in the left DLPFC. In higher frequency bands (beta and gamma), the decrease of power in the DLPFC was also observed additionally in the contralateral DLPFC and depended on the stimulation protocol. Because large delta and theta activity is usually associated with cortical inhibition, these results suggest that rTMS of DLPFC transiently decreases local cortical inhibition. Furthermore, fast EEG oscillations are associated to cortical

excitability and it can be concluded that observed decreases in fast activity, unspecific to protocol, localised in the DLPFC also suggest reduced cortical excitability, which accompanies a decrease in cortical inhibition.

In the second experiment we worked on two subgroups of patients, with major depressive disorder (MDD) and bipolar disorder (BP). In this open study we aimed to examine whether there are EEG differences in resting brain activity between BP and MDD patients, and between responders and non-responders to 10 Hz repetitive transcranial magnetic stimulation (rTMS) by studying EEG biomarkers. Eight MDD (6 females) and 10 BP patients (6 females) were included. The 10 Hz rTMS protocol was the same for MDD and BP. The different patterns of EEG activity in both depressive disorders were studied, by comparing spectral power of pre- and post-rTMS EEG recordings throughout the therapeutic sessions in responders and non-responders.

The most important finding is that it is possible to distinguish responders from non-responders to the rTMS treatment. Responders showed significantly higher power of low frequencies. Therefore, an increase of alpha power was observed in ventral cingulate cortex in both groups. The comparison of MDD and BP disorders revealed significantly higher activity in theta and beta bands power in BP patients, mainly localised in prefrontal cortex.

The results of multiple regression analysis revealed that alpha band power on the left fronto-temporal regions was significantly and negatively correlated with  $\Delta$ MADRS. Additionally, we found positive correlation of  $\Delta$ MADRS and theta band power in the posterior midline areas. We can suggest that both EEG features could be used as biomarkers to predict rTMS outcome.

**Keywords:**

rTMS, EEG, prefrontal cortex, depression



# Résumé

La stimulation magnétique transcrânienne (SMT) est une technique non invasive qui permet de stimuler le cerveau. Les SMT répétitives (SMTr), c'est-à-dire l'application de nombreuses impulsions magnétiques, sont capables d'induire des modifications de longue durée de l'excitabilité neuronale. La SMT s'est développée dans un but thérapeutique et scientifique. Les effets après la SMTr sur le cortex moteur sont bien documentés chez les individus sains, mais on en sait moins sur la stimulation du cortex préfrontal dorso-latéral (DLPFC).

L'objectif de cette thèse était de comparer différents protocoles SMTr sur des sujets sains et de trouver des marqueurs électroencéphalographiques (EEG) de la réponse ou pas à la thérapie SMTr dans la dépression majeure et bipolaire. La principale originalité de la méthode présentée est la comparaison intra-sujet d'effets entre-protocoles et le développement de techniques de localisation de sources.

Nous avons étudié chez 20 sujets sains comment les oscillations corticales sont modulées suite à quatre protocoles SMTr actifs différents, et à un protocole sham utilisé comme contrôle, du DLPFC gauche et en comparant la puissance spectrale d'EEG avant et après SMTr de durée de 15 minutes. Le spectre EEG a été estimé grâce à la transformée de Fourier rapide (FFT) et partitionné en bandes de fréquence selon la classification commune.

Nous avons trouvé pour chaque protocole actif une diminution significative de puissance delta et theta sur les électrodes préfrontales gauches, principalement localisées dans le DLPFC gauche. Dans des bandes de fréquences plus hautes, la diminution de puissance dans le DLPFC a été de plus observée dans le DLPFC controlatéral et dépend du protocole de stimulation. Parce que les activités delta et theta sont généralement associées à l'inhibition corticale, ces résultats suggèrent que la SMTr du DLPFC diminue transitoirement l'inhibition corticale locale. Aussi, les oscillations d'EEG rapides sont associées à l'excitabilité corticale et on peut conclure que des diminutions observées non spécifiques dans l'activité rapide localisée dans le DLPFC suggèrent également une réduction de l'excitabilité corticale.

Dans la deuxième expérience, nous avons travaillé sur groupe de patients, souffrant de trouble dépressif majeur (MDD) et de trouble bipolaire (BP). Dans cette étude ouverte, nous avons cherché à déterminer s'il existe des différences d'EEG de repos dans l'activité cérébrale entre patients BP et MDD, et entre les répondeurs et non-répondeurs à la SMTr à 10 Hz en étudiant des biomarqueurs d'EEG. Le protocole SMTr à 10 Hz étaient le même entre patients MDD et BP. Les propriétés EEG dans les deux troubles dépressifs ont été étudiées, en comparant la puissance spectrale des enregistrements pré- et post-SMTr EEG au cours des sessions thérapeutiques chez les patients répondeurs et non-répondeurs.

La conclusion est qu'il est possible de distinguer les répondeurs des non-répondeurs au traitement SMTr. Les répondeurs avaient une puissance en basse fréquence plus importante. Une augmentation de puissance alpha a aussi été observée au niveau du cortex cingulaire ventral dans les deux groupes. La comparaison des MDD et BP a révélé une activité significativement plus élevée dans la puissance des bandes thêta et bêta chez les patients BP, principalement localisée dans le cortex préfrontal.

Les résultats de l'analyse de régression ont révélé que la puissance de la bande alpha sur les régions fronto-temporales gauches était significativement et négativement corrélée avec le score clinique de dépression (MADRS). En outre, nous avons trouvé une corrélation positive du score MADRS et de la puissance de la bande thêta dans les zones médianes postérieures. Nous pouvons suggérer que les deux caractéristiques EEG pourraient être utilisés comme marqueurs pour prédire les résultats SMTr.

**Les mots clés:**

EEG, rTMS, cortex préfrontal dorso-latéral (DLPFC), la depression

# Introduction

---

Nowadays, transcranial magnetic stimulation (TMS) is a very popular tool widely used to stimulate the brain non-invasively. The application of many pulses (repetitive TMS, rTMS) can modulate brain's activity during periods that outlast the stimulation time and additionally has a therapeutic potential in treating neurological and psychiatric disorders such as depression [Dell'Osso 2009, George 2010, Richieri 2011], schizophrenia with auditory hallucinations [Hasan 2013, Homan 2012], migraines [Brigo 2012, Magis 2012] or stroke [Hummel 2008, Jung 2012, Hummel 2012]. Depending on the stimulation parameters, it has different influence on the brain. The main stimulation parameters are the frequency of stimulation and the temporal structure of the pulses, i.e. whether the series of pulses are applied continuously or not [Classen 2008]. The easiest way to estimate the influence of the TMS on the neuronal activity is to stimulate over the motor cortex. Then, it is possible to record the response as motor evoked potentials (MEPs) on peripheral muscles. Numerous studies of electromyographic (EMG) recordings showed that in most cases low-frequency stimulation ( $\leq 1$  Hz) produces lasting decrease in motor cortex excitability, whereas high-frequency stimulation ( $\geq 5$  Hz) induces facilitatory effects [Romero 2002, Hayashi 2004, Houdayer 2008, Di Lazzaro 2011, Noh 2012]. Regarding theta burst stimulation (TBS, burst of three 50 Hz pulses repeated every 200 ms), it is also possible to obtain two opposite results, where the after-effects depend on bursts application. If stimulation is delivered continuously (cTBS) it has an inhibitory effect, whereas when delivered as an intermittent TBS (iTBS) the effect is excitatory [Huang 2005, Hoogendam 2010].

Although the rTMS-effects over the motor cortex are well documented, less is known about the stimulation over the dorso-lateral prefrontal cortex (DLPFC). In this case, the rTMS pulses do not spread through the cortico-spinal pathways

and must be measured with other technique, electroencephalography (EEG). Using EEG, it is possible to measure directly from the scalp the rTMS after-effects and to investigate how rTMS pulses propagate in the brain network. Additionally, EEG brought important information about depression and various studies have found that typically 20% to 40% of depressed patients have EEG abnormalities, with several characteristics and controversial patterns [Coburn 2006]. Moreover, up to 80% of psychiatric patients present various quantitative EEG (qEEG) abnormalities on contrary to only 10% of healthy subjects [Begic 2011, Coburn 2006].

Generally, there are two main types of depression, major depressive disorder (MDD) and bipolar disorder (BP). Although a physiopathology of these two types of depression is due to distinct neuropathologies, the clinical symptoms are sometimes difficult to distinguish between depressive symptoms. In this perspective, the possibility to predict treatment response in mental health disorders with biomarkers became very important clinical issue. Different pre-treatment EEG parameters were tested as possible biomarkers, and alpha and theta bands were reported as the most valuable indices to differentiate responders from non-responders.

There are two main aspects of this work. First, concurrent EEG-rTMS were recorded on healthy subjects maintained at rest and awake, and the aim was to investigate how cortical oscillations are modulated by four different active rTMS protocols (1 Hz, 10 Hz, cTBS and iTBS) of the left DLPFC, and by a sham protocol used as a control condition. Spectral power of pre- and post-rTMS EEG recordings was compared on the scalp and cortical sources levels.

The second part is devoted to research on patients. Here, the aim was to examine whether it is possible to distinguish BP from MDD patients, and responders from non-responders to 10 Hz repetitive transcranial magnetic stimulation by studying EEG biomarkers of resting state brain activity. This was also done at both scalp and cortical sources levels.

The thesis is organized as follows:

- The first chapter introduces the general informations about depression. Classification of depression and its neurobiological basis with neurotransmitters' pathways are described.

- Second chapter gives a detailed description of EEG technique. The neural activity and cortical cytoarchitecture are briefly discussed. Next, EEG brain waves and source localisation method which are used in this thesis are addressed.
- The main technique used in this study, repetitive transcranial magnetic stimulation, is described in the third chapter. There is a description of physical principles of magnetic stimulation and of physiology of elicited brain activity changes, followed by long-term depression and potentiation definitions. Next, rTMS protocols which has been used in this work are discussed. Functional connectivity and cortical excitability with neuronavigation technique are additionally described. Also, an overview of current use of rTMS in the clinical applications is presented.
- The fourth chapter brings together the EEG-rTMS co-registration. The challenges of EEG-rTMS co-registration and the overview of EEG changes correlated with mood disorders are presented. There is also a comparison of differences in brain oscillations between healthy and depressed individuals. Finally, EEG is presented as a plausible predictor of depression treatment.
- Chapter five describes the experimental design and the data processing used in this thesis.
- The results are presented in chapter six. There are short introductions and manuscripts of two articles submitted to NeuroImage. The first paper is in revision and the second one is about to be submitted. Presented papers describe results for EEG-rTMS co-registration on healthy and depressed patients, separately.
- The last chapter, the seventh one, includes a discussion of presented results and gives an introduction to the next steps of this project.

# Résumé du Chapitre 1

Dans le chapitre suivant, je présenterai la classification de la dépression ainsi que l'un de ses modèles. Je décrirai également la neurobiologie de la dépression ainsi que le rôle de certains neurotransmetteurs tels que la dopamine, la norépinéphrine, la sérotonine, le glutamate et l'acide gamma-aminobutyrique. Je terminerai en présentant le lien entre l'absence ou le dysfonctionnement de certains neurotransmetteurs et les symptômes caractéristiques de la dépression.

# Depression

---

## Contents

---

<b>1.1</b>	<b>Introduction</b>	<b>2</b>
<b>1.2</b>	<b>Neurobiology of depression</b>	<b>3</b>
1.2.1	Dopaminergic pathways	4
1.2.2	Norepinephrine pathways	6
1.2.3	Serotonin pathways	7
1.2.4	Glutamate pathways	9
1.2.5	Gamma-aminobutyric acid pathways	10
<b>1.3</b>	<b>Neurocognitive models of depression</b>	<b>11</b>
1.3.1	Neural mechanisms of biased attention for emotional stimuli	11
1.3.2	Neural mechanisms of biased processing of emotional stimuli	12
1.3.3	Integrated neurocognitive model	14

---

## 1.1 Introduction

Brain disorders, including depression and bipolar disorder, are among the leading causes of disability worldwide. Underlying pathophysiological mechanisms are still largely unknown and they are among the most mysterious of brain diseases.

One of these affective disorders is depression. Depression is defined as a state of sadness, low mood accompanied by low self-esteem, loss of interest in activities that once were pleasurable and reduced capabilities to concentrate or decide. It is also characterised by altered emotional and cognitive functioning [APA 2000]. Depressed mood is not necessarily a psychiatric disorder. It is related to a normal reaction to certain life events, a symptom of some medical conditions, and a side effect of some

medical treatments. But, depressed mood is also a primary or associated feature of certain psychiatric syndromes such as clinical depression. Classic severe states of depression, however, often have no dramatic external causes.

Depression classification includes:

- **major depressive disorder (MDD)**, also referred to as major depression, unipolar depression or clinical depression. In this case a person has one or more major depressive episodes.
- **bipolar (BP) depression**, also known as “manic depression”, is described by alternating periods of depression and mania. Depending on how rapidly the mood changes occur, the episodes of bipolar disorder can also be classified as rapid cycling, mixed or with psychotic symptoms. This type of disorder has been subdivided into:
  - *Bipolar I* requires the presence or history of at least one manic episode with or without major depressive episodes.
  - *Bipolar II* consists alternating episodes of major depression and hypomania. In this type of disorder, the “manic” moods never reach full mania. The less-intense elevated moods in bipolar II disorder are called hypomanic episodes, or hypomania.
  - *Cyclothymia* is a mild-form of bipolar disorder, consisting of less severe mood swings. Episodes alternate between hypomania and mild depression, but no full manic episodes or full major depressive episodes.
  - *Mixed episode* is the simultaneous presence of elements of the manic line and clinical elements of depressive line during a single episode.

## 1.2 Neurobiology of depression

The pathophysiology of depression has not been clearly understood, but social, psychological, and biological factors all play an important role in depression [Goldman 1999]. Previous studies point out evidences that there is an association of specific symptoms and features of depression and dysfunction or deficit of certain neurotransmitters [Nutt 2008]. One of the oldest hypothesis, the monoamine



hypothesis, suggests disturbances in serotonin (5-HT), norepinephrine (NE), and dopamine (DA) neurotransmission in the central nervous system [Belmaker 2008, Krishnan 2008]. Hence, reduced NE neurotransmission is associated with low energy, decreased alertness, problems with concentration and cognitive ability. Lack-off 5-HT is related to anxiety, obsessions and compulsions, while increased 5-HT activity can be associated with certain symptoms such as fatigue [Marin 2005]. Dysfunctional DA activity is linked with problems of motivation, reward, psychomotor speed, concentration and the ability to experience pleasure and interest in life [Cowen 2008]. The role of NE [Delgado 2000, Nutt 2008] and DA [Dunlop 2007, Montgomery 2008] has been less extensively studied, than 5-HT role.

This suggests that specific antidepressant drugs can target symptom-specific neurotransmitters, because specific symptoms of depression could be assigned to specific neurochemical mechanisms. Nowadays, all available antidepressants act on one or more of the following mechanisms: antagonism of inhibitory presynaptic 5-HT or NE receptors, or inhibition of monoamine oxidase, or inhibition of reuptake of DA and 5-HT or NE. All of these mechanisms result in an enhanced neurotransmission of 5-HT and/or NE. However, most antidepressant treatments do not directly enhance DA neurotransmission.

Abnormal metabolism in limbic and paralimbic structures of the prefrontal cortex is associated with major depression. Patients with MDD have different symptoms of depression, which implies that they may all have different malfunctioning circuits. According to Stahl [Stahl 2003b, Stahl 2003a, Stahl 2003c, Stahl 2004], it is interesting to look at the brain neuroanatomy in terms of specific functional centers. The “emotional” and “somatic” networks receive input from both, NE and 5-HT, as well as DA systems. On the other hand, the “cognitive” centers receive information only from NE, DA and histaminergic pathways, but not 5-HT projections (Table 1.1).

### 1.2.1 Dopaminergic pathways

In the brain, dopamine plays an important role in the regulation of reward and movement. Dopaminergic neurons are organized into four major DA pathways

Table 1.1: Neurological projections of DA, NE and 5-HT to different brain regions [Drevets 2002].

---

<b>Emotional systems</b>
NE projections from the locus coeruleus to the hypothalamus
NE projections from the locus coeruleus to the amygdala and prefrontal cortex
5-HT projections from the midbrain raphe to the hypothalamus
5-HT projections from the midbrain raphe to the amygdala and prefrontal cortex
DA projections from the ventral tegmentum to the nucleus accumbens

---

<b>Somatic systems</b>
NE projections from the locus coeruleus to the hypothalamus
NE projections from the locus coeruleus to the cerebellum
NE projections from the locus coeruleus to the spinal cord
5-HT projections from the midbrain raphe to the hypothalamus
5-HT projections from the midbrain raphe to the striatum
5-HT projections from the midbrain raphe to the spinal cord
DA projections from the substantia nigra to the striatum

---

<b>Cognitive systems</b>
NE projections from the locus coeruleus to the dorsolateral prefrontal cortex
DA projections from the ventral tegmentum to the dorsolateral prefrontal cortex
Histamine projections from the hypothalamus to the dorsolateral prefrontal cortex

---

depicted in Figure 1.1 [Dunlop 2007, Schatzberg 2004]:

1. *The nigrostriatal system*, which is linked with regulation of movement, originates in substantia nigra pars compacta and projects to the dorsal striatum (putamen and caudate).
2. *The mesocortical system* is important for concentration and executive functions such as working memory. This DA pathway originates in the VTA and its fibers arise to the frontal and temporal cortices, particularly the entorhinal, prefrontal and anterior cingulate cortices.
3. *The mesolimbic system* is particularly important for motivation, the experi-

ence of pleasure and reward. It also arises in VTA, but release dopamine into the ventral striatum, nucleus accumbens, bed nucleus of the stria terminalis, hippocampus, amygdala and septum.

4. *The tuberoinfundibular system* regulates the secretion of prolactin from the anterior pituitary. It originates in the arcuate nucleus of the mediobasal hypothalamus that projects to the median eminence.

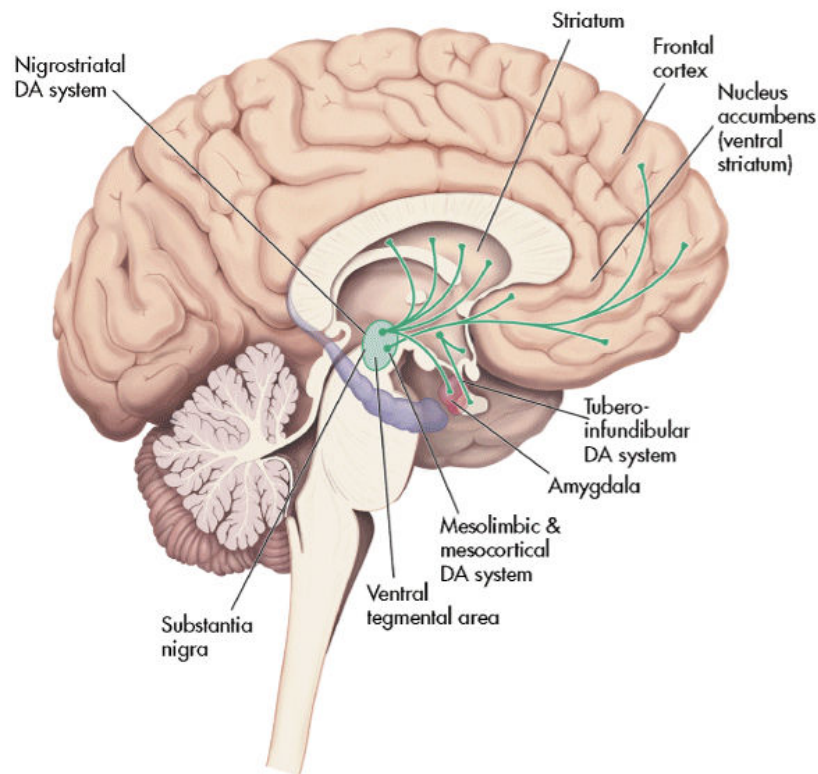

Figure 1.1: Major dopaminergic pathways in the human brain [Dunlop 2007, Schatzberg 2004]

### 1.2.2 Norepinephrine pathways

The recent studies [Cowen 2008, Moret 2011] on depression and neuronal pathways indicated the specific role of the norepinephrine in the depressive disorders. Norepinephrine (NE) implicates the regularization of emotions and regulates such executive function as cognition, motivation, and intellect, which are fundamental in social relationships. Norepinephrine is produced in the cell bodies of the

locus coeruleus (LC) and reaches to a variety of different structures, such as cerebral cortex, thalamus, cerebellar cortex, hippocampus, hypothalamus and amygdala [Moret 2011]. Components of the limbic system (hippocampus, hypothalamus and amygdala) are affected in a number of functions which are modified in depression such as emotion and cognition, response to pain, level of pleasure, appetite, sexual satisfaction and aggressive behaviour [Drevets 2002]. Figure 1.2 illustrates the noradrenergic projections throughout the brain.

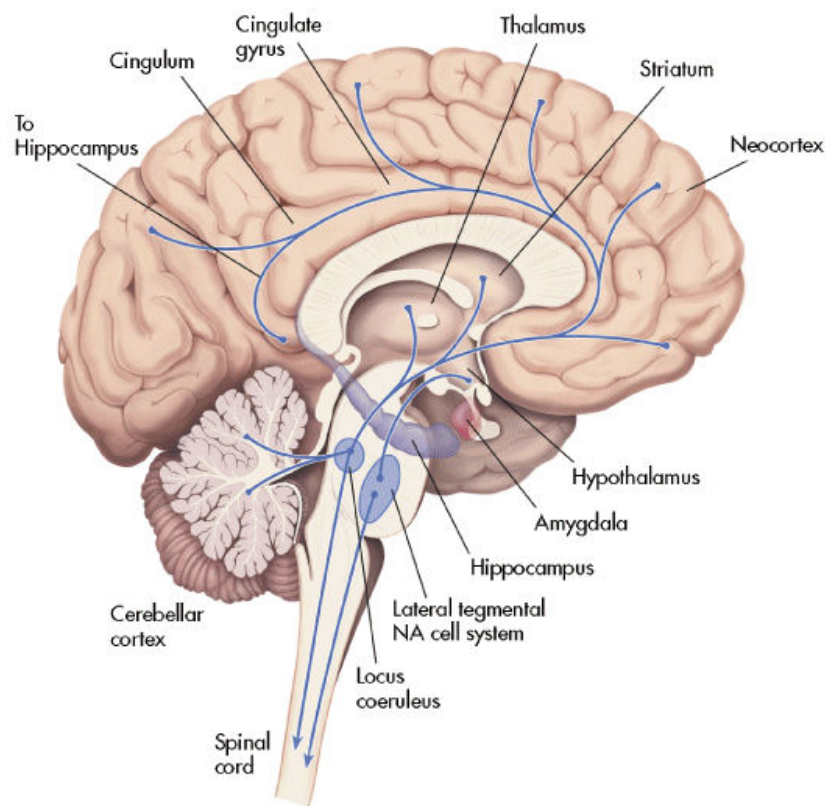

Figure 1.2: The noradrenergic pathways in the human brain [Moret 2011, Schatzberg 2004]

### 1.2.3 Serotonin pathways

Serotonin (5-HT) is a neurotransmitter derived enzymatically from tryptophan and produced in neurons of the rostral and caudal raphe nuclei. Projections arising from the raphe nuclei are widespread and stimulate many of forebrain structures including the hypothalamus, amygdala, basal ganglia, thalamus, hippocam-

pus, cingulate cortex and prefrontal cortex. The serotonergic system controls numerous physiological and behavioural functions. It also modulates mood, emotions, sleep, appetite, memory and learning, temperature regulation and some social behaviors. The 5-HT hypothesis of depression proposes that decreased serotonergic neurotransmission plays a key role in the pathophysiology of depression. The concentration of synaptic serotonin is controlled directly by its reuptake into the pre-synaptic terminal and, thus, drugs blocking serotonin transport have been successfully used for the treatment of depression [Coppen 1967, Cowen 2008, Schatzberg 2004, Schloss 1998]. Figure 1.3 illustrates the major serotonin-producing structures.

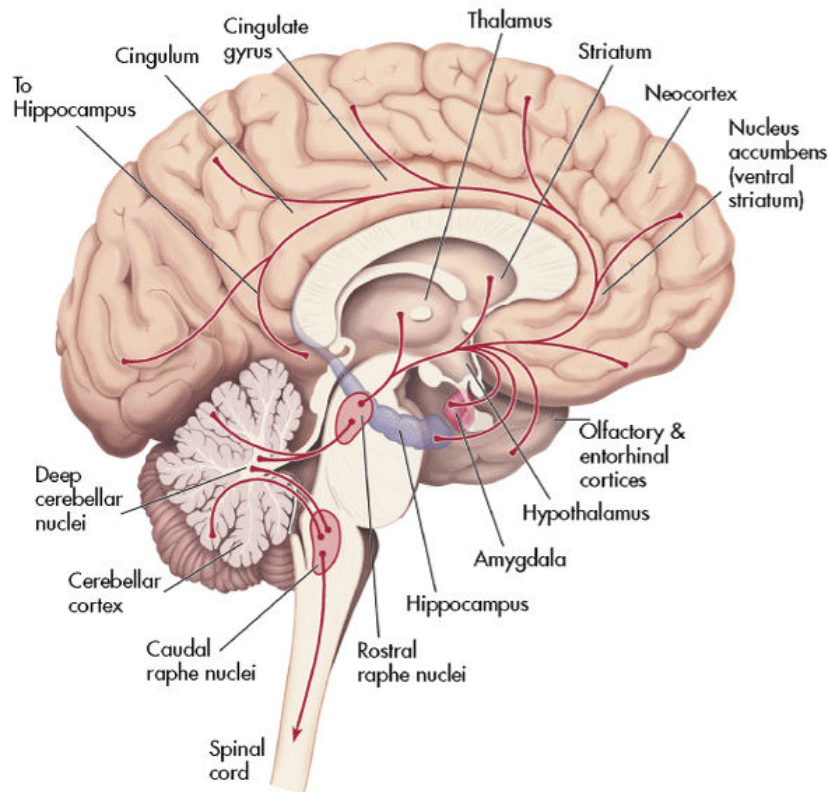

Figure 1.3: The serotonergic pathways in the human brain [Schatzberg 2004]

### 1.2.4 Glutamate pathways

The most popular monoamine theory of the pathophysiology of major depression and bipolar illness has involved abnormalities in NE and 5-HT and contributed greatly to our understanding of mood disorders and their treatment. Nevertheless, this theory does not fully explain the fact that >40% patients fail to achieve full remission following treatment with conventional antidepressants, raising the possibility that other neurotransmitter systems may also contribute to the pathophysiology of mood disorders and the mechanism of antidepressant action. Recent studies have provided strong evidence that glutamate and other amino acid neurotransmitters are involved in the pathophysiology and treatment of mood disorders [Kugaya 2005].

The end of this section reviews studies suggesting that the glutamatergic and gamma-aminobutyric acid (GABA)-ergic systems are altered in mood disorders and contribute to the mechanism of antidepressant action for several treatment modalities.

Glutamate is the major excitatory neurotransmitter which plays a key role in synaptic plasticity, learning and memory. Effects of action are mediated by a large variety of glutamate receptor subtypes which include three major groups of excitatory ionotropic receptors: N-methyl-D-aspartate (NMDA) receptor, the  $\alpha$ -amino-3-hydroxy-5-methylisoxazole-4-propionic acid (AMPA) receptor, and the kainate receptor.

Alterations of the glutamatergic system in mood regulation has been investigated for several years. Early studies measuring plasma or serum glutamate levels in depressed patients yielded interesting but inconsistent results. Increased serum glutamate concentrations in medicated patients was first reported in the research of Kim and colleagues [Kim 1982]. Then, Altamura obtained the same results, but this group was later unable to replicate this finding in unmedicated patients [Altamura 1993]. Next, Maes and colleagues [Maes 1998] also showed elevated plasma and platelet glutamate levels in depressed subjects. However, in contrast to the previous studies, they found no baseline abnormality in serum glutamate

levels, but did report that glutamate levels were reduced after antidepressant treatment. Other studies revealed no significant difference in frontal cortex glutamate levels of antemortem glutamate in neurosurgical samples from depressed subjects [Francis 1989].

A recent study by Sanacora and colleagues [Sanacora 2004] showed glutamate levels in the occipital cortex to be significantly elevated, in medication-free patients with MDD, as compared with healthy controls. Another interesting point of this study is that the glutamate levels were significantly increased in patients with melancholic depression subtype than those with no subtype as compared with controls. However, patients with atypical depression did not have significantly different glutamate levels than controls. The glutamate levels were inversely correlated with GABA levels in studied occipital cortex.

### 1.2.5 Gamma-aminobutyric acid pathways

Gamma-aminobutyric acid (GABA) is the major inhibitory neurotransmitter in the central nervous system (CNS). In recent decades alteration of GABAergic neurotransmission in mood disorders has been widely studied.

In 1980 Gold et al. [Gold 1980] revealed that GABA concentrations in lumbar cerebrospinal fluid (CSF) in depressed patients were significantly decreased comparing to nondepressed control group, and since then the results have been replicated in several studies. Petty and coworkers [Petty 1981, Petty 1984] showed that GABA plasma concentrations were reduced in depressed patients as well. Moreover, Honig et al. [Honig 1988] reported that GABA concentrations in brain tissue from patients undergoing cingulotomy for intractable depression were inversely correlated with severity of depression.

More recent studies employing magnetic resonance spectroscopy also suggest that unipolar, but not bipolar, depression is associated with reductions in cortical GABA levels. Sanacora and colleagues [Sanacora 1999, Sanacora 2004], additionally, found reduction in cortical GABA levels in patients with melancholic subtype of depression, with the ratio of glutamate to GABA significantly higher in the patients than the controls. This finding suggests a potential alteration in the common

metabolic pathway that couples the two systems of glutamate and GABA.

## 1.3 Neurocognitive models of depression

In the following sections I will describe recent studies on the functional and structural neurobiological mechanisms associated with depression.

### 1.3.1 Neural mechanisms of biased attention for emotional stimuli

The main point of the cognitive model of depression is the inability to allocate attention to appropriate emotional cues [Disner 2011]. Attention towards positive and negative stimuli is different between healthy and depressed subjects. On contrary to healthy individuals whose attention is generally biased towards positive stimuli, depressed patients show an attentional bias for negative thoughts.

The intraparietal sulcus, precentral sulcus, superior temporal sulcus, prefrontal cortex (PFC) and areas which control shifts in gaze are associated with attention in healthy individuals. These areas help to select competing visual stimuli represented in the visual cortex and healthy subjects are able to switch attention from one to another stimuli. As functional magnetic resonance imaging (fMRI) studies revealed the act of attentional disengagement requires top-down connection from high-order cortical structures such as dorsolateral prefrontal cortex (DLPFC) (related to executive functions), ventrolateral prefrontal cortex (VLPFC) (related to control over stimulus selection) and superior parietal cortex (SPC) (associated with shifts in gaze) [Fales 2008, Passarotti 2009, Beevers 2010]. Increased attention for negative stimuli in people with depression may stem from an impaired ability to inhibit attention for negative stimuli, which is related to decreased activity in right VLPFC, DLPFC and SPC. Functional MRI results indicated that inhibitory processing is associated with activity in the rostral anterior cingulate cortex (rACC) [Bush 2000, Shafritz 2006]. Healthy subjects showed higher rACC activity inhibiting attention to positive stimuli, whereas depressed patients showed greater activation inhibiting negative thoughts [Disner 2011, Elliott 2002, Eugene 2010, Mitterschiffthaler 2008].



### 1.3.2 Neural mechanisms of biased processing of emotional stimuli

*The amygdala* is known to be involved in the processing of emotions and in the interpretation of the emotional aspect of stimuli. According to Davidson and Drevets [Davidson 2000, Drevets 2001] it is controlled partially by indirect inhibitory connection from the left DLPFC (Figure 1.4). In depressed patients hyperactivity of left amygdala and putamen is associated with faster processing of negative stimuli. This reactivity creates a bottom-up connection which distorts stimulus processing in higher cortical areas.

Recent neuroimaging studies identified functional abnormalities also in the DLPFC. Compared with nondepressed human being, patients with depression have decreased left prefrontal gray matter volume [Li 2010, Lopez-Larson 2002, Adler 2005], lower resting-state activity and reduced reactivity for positive and negative stimuli [Gotlib 2008]. Moreover, altered function in the DLPFC is correlated with decreased cognitive control [Disner 2011, Gotlib 2008, Hooley 2005, Schaefer 2006, Siegle 2002]. Abnormalities in negative emotional information processing are caused, in addition, by abnormalities in the *thalamocortical pathway*, which is responsible for processing and organizing external stimuli [LeDoux 1996, Greicius 2007]. This pathway is composed of the thalamus, involved in transmitting the afferent signals [Guillery 1995, Sherman 2002], the dorsal anterior cingulate cortex (ACC), an area that sends top-down cognitive control to the DLPFC [Ochsner 2005], and the subgenual cingulate cortex, a region that integrates emotional feedback from the limbic system and projects to higher-order cognitive structures (Figure 1.4) [Greicius 2007].

Discussed researches indicated that people with depression experience a positive blockage, which means that the capacity to process positive thoughts is decreased, whereas it is increased for negative ones. Moreover, it was shown in previous studies [Arco 2008, Kim 2007, Wager 2008] that in healthy individuals the PFC regulates the activity of the nucleus accumbens (NAc) and amygdala, and in particular the release of dopamine in this area of the brain. In depressed patients, reduced NAc responses to rewards are associated with diminished volume and activity in

the caudate nucleus. This suggests that rewarding properties associated with a stimulus may not be accurately classified [Disner 2011, Epstein 2006, Heller 2009, Pizzagalli 2009]. As a result, positive stimuli may fail to activate reinforcement mechanisms, which could reduce the ability of depressed patients to pursue rewarding behaviours [Disner 2011]. Based on this evidence, Disner and colleagues [Disner 2011] suggested, that the inability of depressed human being to adaptively alter reward-seeking behaviour is associated with reduced reward sensitivity of the NAc due to decreased PFC activity.

To conclude, there are several mechanisms which increase the projection of negative thoughts and decrease the positive or rewarding stimuli (Figure 1.4). They are: amygdala hyperactivity, hypoactivity in the DLPFC and attenuated NAc response.

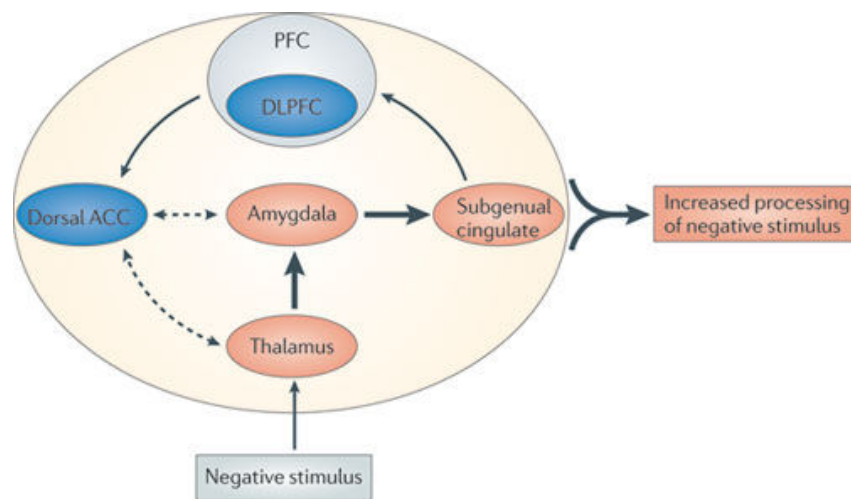

Nature Reviews | Neuroscience

Figure 1.4: Hypothetical cognitive neurobiological model of biased processing of negative stimuli in depressed human beings. Negative input stimulus induce hyperactivity (orange) in the thalamus, from the thalamus to the amygdala and onto the subgenual cingulate cortex, which transmits limbic activity to higher cortical regions such as the PFC. Concurrently, hypoactivity (blue) in the DLPFC is associated with attenuated cognitive control, which impairs the ability of the dACC to adaptively regulate the lower regions. As result, awareness and conscious processing of negative stimuli in the environment is increased. Solid arrows (which show intact associations) and dashed arrows (which show attenuated associations) are intended to represent functional connections, not necessarily direct anatomical connections. Thicker arrows show increased information flow. [Disner 2011]

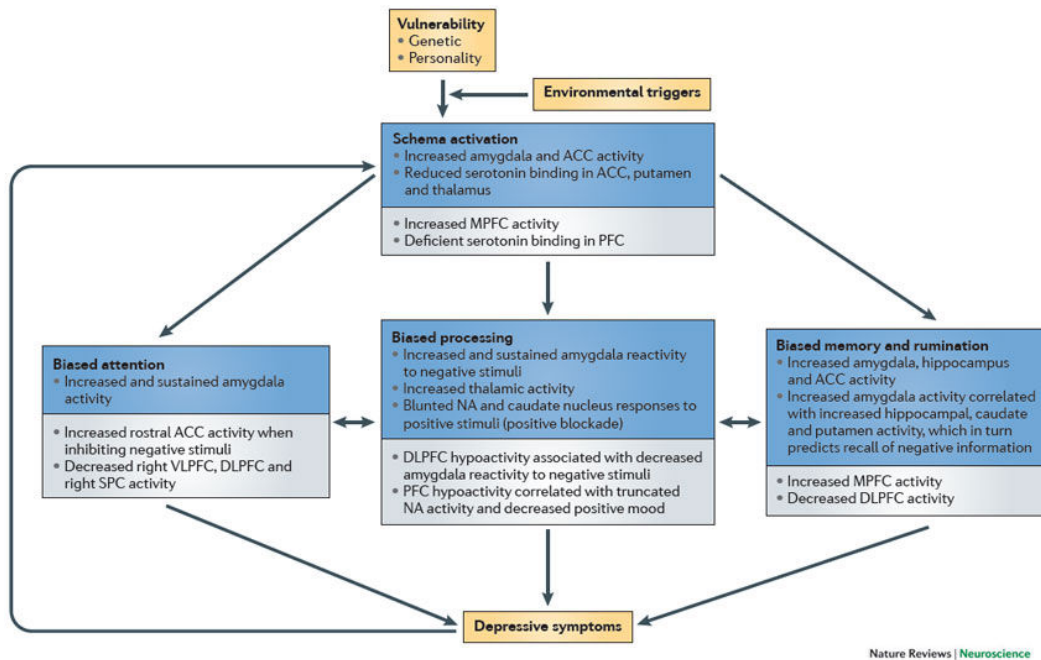

Figure 1.5: Summary of an integrated cognitive neurobiological model of depression. (ACC - anterior cingulate cortex; DLPFC - dorsolateral prefrontal cortex; MPFC - medial prefrontal cortex; NAc - nucleus accumbens; PFC - prefrontal cortex; SPC - superior parietal cortex) [Disner 2011].

### 1.3.3 Integrated neurocognitive model

Neurobiological processes that initiate cognitive bias and attenuated cognitive control, also underly cognitive biases in depression. Figure 1.5 presents the flowchart of the sequence of events that are proposed to be involved in the development of depression, beginning with depression vulnerability factors and environmental stressors, and resulting in depressive symptoms. Figure 1.5 outlines the neurobiological events that are associated with each step of the cognitive model: schema activation, biased attention, biased processing, and biased memory and rumination. The brain regions in this flowchart are divided into two groups: regions associated with bottom-up, limbic system influences (shown by the blue boxes), and regions that maintain bottom-up influences through altered top-down cognitive control (shown by the grey boxes). Note that all elements contribute directly to depressive symptoms, and that depressive symptoms also feed back into the system, thus exacerbating schema activation [Disner 2011].

# Résumé du Chapitre 2

Le chapitre suivant représente une introduction à l'électroencéphalographie, c'est-à-dire à une description générale de l'activité neuronale, de la génération des signaux électriques dans le cerveau ainsi que de la mesure des signaux EEG. Je définirai également les différentes ondes cérébrales, qui sont un concept important de l'analyse EEG. Enfin, des méthodes plus avancées telles que l'EEG quantitative et la localisation de la source ainsi qu'une description générale des problèmes forward et inverse seront présentées.

# Electroencephalography

---

## Contents

---

<b>2.1</b>	<b>Introduction</b>	<b>16</b>
<b>2.2</b>	<b>Neural activity</b>	<b>17</b>
2.2.1	Cortical cytoarchitecture	18
<b>2.3</b>	<b>EEG Generation</b>	<b>19</b>
2.3.1	EEG	19
2.3.2	Brain waves	22
<b>2.4</b>	<b>Source localisation</b>	<b>24</b>
2.4.1	Forward problem	25
2.4.2	Inverse problem	27

---

## 2.1 Introduction

In 1875, Richard Caton discovered brain electrical activity in the animals, but the history of human electroencephalography (EEG) began only in the late 1920s, when the first EEG recordings from the human scalp were obtained by the German psychiatrist Hans Berger [Berger 1929]. Berger recorded mostly from his children, showing that human brain normally produces near-sinusoidal voltage oscillations (alpha rhythms) in awake, relaxed subjects with eyes closed. Strong reduction in alpha amplitude during eyes opening or performing mental calculation has been verified by modern studies. Unfortunately, Berger's research waited more than 10 years to be accepted by the scientific community as validated brain signals. By the 1950s, EEG technology was viewed as a genuine technique, with important applications in neurosurgery, neurology, and cognitive science.

## 2.2 Neural activity

The electrical signals generated by the brain represent a part of its physiological activities. The neural activity of the human brain starts around the 17th and 23rd week of prenatal development [Sanei 2007]. Understanding of neurophysiological properties of the brain with mechanisms underlying the generation of electrical signals and their recording is crucial for signal detection. The CNS contains a network of specialized cells called neurons that coordinate the actions of a subject and transmit signals between different parts of its body. A typical neuron is composed of an axon, dendrites and synapses. Its morphology is presented in Figure 2.1.

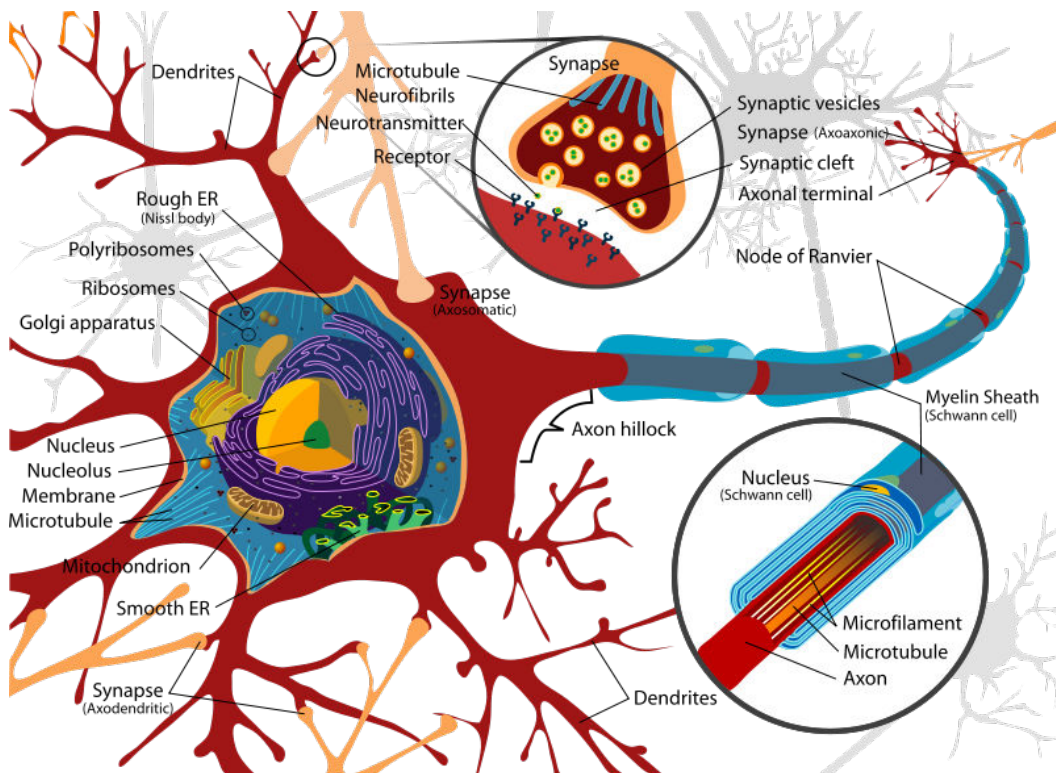

Figure 2.1: Diagram of a typical myelinated neuron [Wikipedia 2012].

To fully understand what EEG measures, I will explain some general definitions:

- A *synapse* is a structure that permits a neuron to pass an electrical or chemical signal to another neuron.
- *Neurotransmitters* are chemical molecules that transmit signals from the presynaptic neuron to a postsynaptic target cell across a synapse.

- *Postsynaptic neuron* is the target neuron of the opposite side of the synapse.
- An *action potential (AP)* is a discharge of the neuron that is associated with fast (around millisecond) opening and closing of  $\text{Na}^+$  and  $\text{K}^+$  ion channels in the neuronal membrane of the axon. The discharge takes place if depolarization of the membrane reaches a firing threshold. The action potential is considered as the simplest event of information processing in neuronal networks associated with transfer of information from one neuron to others.
- *Postsynaptic potential (PSP)* is a change in the membrane potential of the postsynaptic neuron induced by a presynaptic AP. When the opening of ion channel causes a positive charge across the membrane, the membrane is said to be depolarized, as the potential comes closer to zero. This is an excitatory postsynaptic potential (EPSP), as it brings the neuron's potential closer to its firing threshold, about -50 mV. On the other hand, if the opening of the ion channel builds negative charge, this moves the potential further from zero and is referred to as hyperpolarization. This is an inhibitory postsynaptic potential (IPSP), as it changes the charge across the membrane to be further from the firing threshold.

### 2.2.1 Cortical cytoarchitecture

The neocortex is described as a six-layer structure [DeFelipe 2002]. Smooth and spiny neurons (pyramidal cells and spiny stellate cells) are the two major groups of cortical neurons. The pyramidal cells are the majority of cortical neurons that can be found in layers II and VI. Most spiny stellate cells are interneurons that are localized in the middle cortical layers. Smooth neurons are substantially GABAergic interneurons allocated in all layers. In general, it is believed that neocortical neurons are organized into multiple, small repeating microcircuits, based around pyramidal cells and their input-output connections. Despite of the cortical heterogeneity, a common basic microcircuit has evolved. The pyramidal cells form its skeleton. They receive excitatory inputs originate from extrinsic afferent systems and spiny cells. Inhibitory inputs originate mostly from GABAergic interneurons. These micro-anatomical characteristics have been found in all cortical areas and can be

considered as the fundamental aspects of cortical organisation [DeFelipe 2002].

## 2.3 EEG Generation

The EEG signal is a sum of the collective electrical behaviour of vertically oriented pyramidal neurons located mainly in cortical layers III, V, and VI (Figure 2.2). Layers of cortical neurons are the main source of the EEG. Differences of electrical potentials are caused by summed postsynaptic graded potentials from pyramidal cells that create electrical dipoles between the soma (body of a neuron) and apical dendrites, which branch from neurons (Figure 2.3). The dipoles are induced by local currents that are associated with excitatory and inhibitory postsynaptic potentials. Generally, EEG can be modelled as being generated by small current dipoles, located in the grey matter [Friston 2007].

### 2.3.1 EEG

EEG is a very important clinical tool to study brain activity, in normal or pathological conditions like: mental diseases and retardation, epilepsy, brain tumors, strokes, infectious diseases, severe head injury, drug overdose, sleep and metabolic disorders, and ultimately brain death.

EEG measures the electrical activity along the scalp, that is voltage fluctuations resulting from ionic current flows within the neurons of the brain. Scalp electrodes are more sensitive to the activation of cortical sources, close to scalp electrodes, while the activation of deep sources is attenuated by layers including the scalp, skull, brain and many other thin layers in between. Furthermore, the waveforms that are recorded from the scalp represent summed activity from large populations of neurons. This is because the electric field of each active source of the brain spreads in all directions and is registered in every electrode. Thus, EEG has limited anatomical specificity (spatial resolution) when compared with other functional brain imaging techniques such as fMRI. However, EEG is still a very good tool to explore brain activity. First of all, time resolution is much higher than in other methods, such as fMRI or positron emission tomography (PET), and reaches mil-



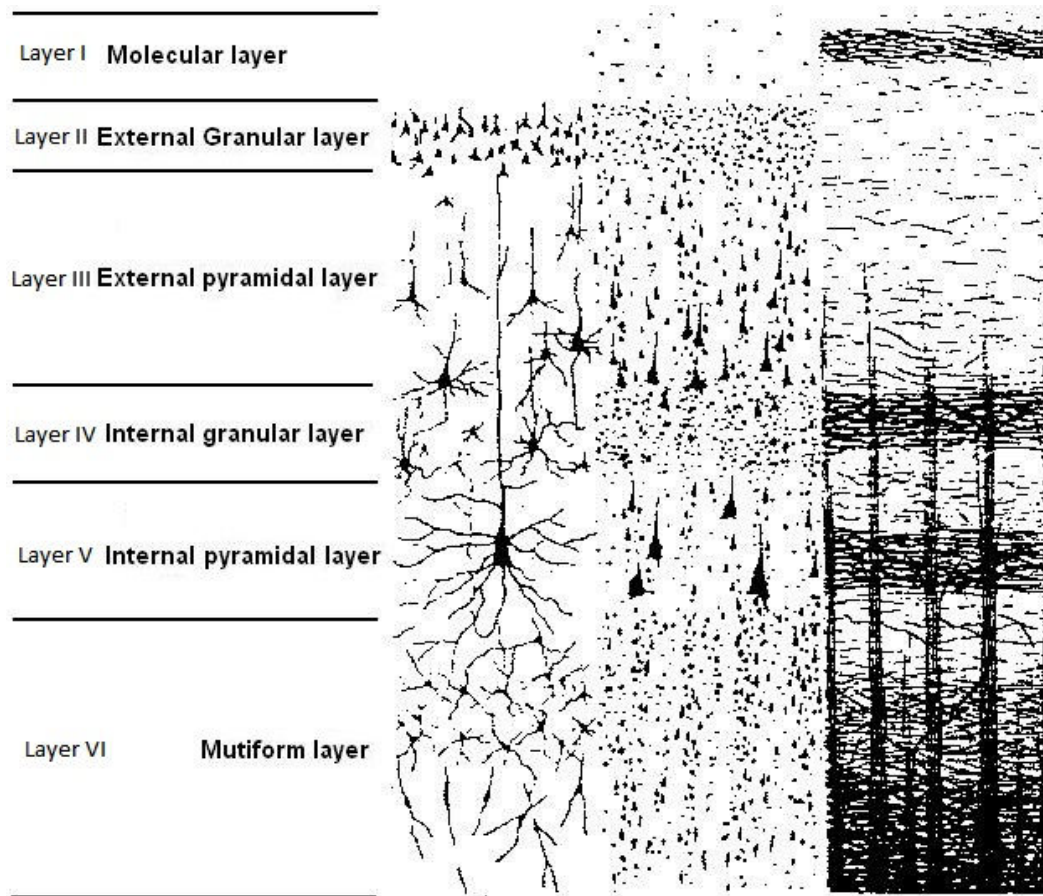

Figure 2.2: Organization of the neocortex in 6 layers [Pernet 2012].

liseconds. Additionally, EEG is one of the few methods (with magnetoencephalography (MEG) or voltage-sensitive dye imaging (VSDI)) able to measure the electric activity of the brain. Other methods for exploring functions in the brain rely on blood flow, blood volume or metabolism which may be decoupled from the brain electric activity. Some researches combine EEG or MEG with fMRI or PET to get high temporal and spatial resolution. Another huge advantage of EEG is its low price.

The recordings can be varied so that the potential difference is measured either between pairs of electrodes (bipolar derivation) or between individual electrodes and a common reference point (referential montage). Because the amplitude of electrical signal of the brain is very weak (up to  $100 \mu V$ ), the signal must be amplified before being displayed. The scheme of electrodes position in the International 10-20 System

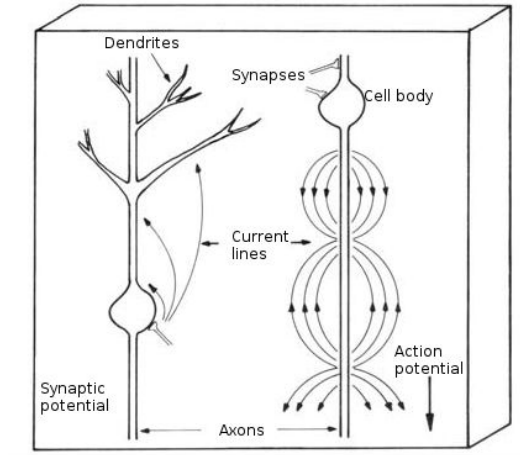
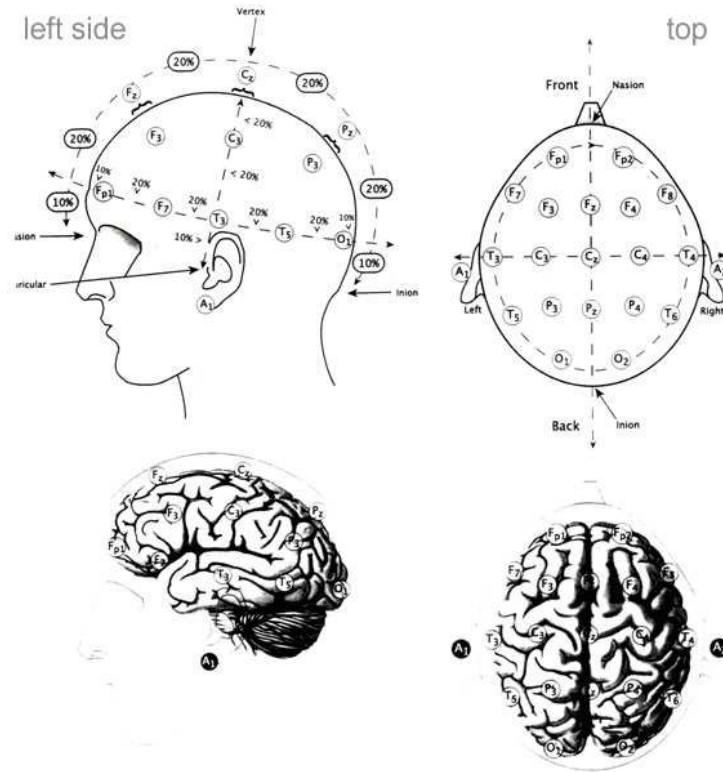

Figure 2.3: Micro current sources due to synaptic and action potentials [Nunez 2006].

is depicted in Figure 2.4. The more detailed technical and practical aspects of EEG techniques are beyond the scope of this work. It can be found in numerous literature [Nunez 2006, Sanei 2007, Tatum 2008].

A lot of brain dysfunctions are diagnosed by visual inspection of EEG signals. In healthy adults, the frequencies and amplitudes of brain waves change from one state to another, such as wakefulness and sleep. Moreover, it can slightly differ between two human beings in the same state of mind. Moreover, the characteristics of brain oscillations also change with the age. Nevertheless, brain oscillations have been divided into five major brain waves distinguished by their different frequency range, as follows: delta ( $\delta$ , 0.5-4 Hz), theta ( $\theta$ , 4-7 Hz), alpha ( $\alpha$ , 8-13 Hz), beta ( $\beta$ , 13-30 Hz) and gamma ( $\gamma$ , above 30 Hz). The alpha and beta waves were introduced by Berger in 1929 [Berger 1929]. In 1938 Jasper and Andrews used for the first time the “gamma” to refer to the waves above 30 Hz [Jasper 1958]. Walter introduced delta range in 1936 to describe all frequencies below alpha rhythm [Walter 1964]. The notion of a theta wave was introduced by Wolter and Dovey in 1944 [Sterman 1974].



lucid dreaming, creative inspiration and deep meditation. Cortical theta is observed frequently in young children. In older children and adults, large contingents of theta waves in awake and during the deepest stages of sleep are caused by several brain pathologies [Sanei 2007].

### Alpha waves

Alpha waves (8-13 Hz) can be detected bilaterally in all posterior lobes. It is usually found over the occipital part of the brain, where the amplitude is higher than in other regions and is normally less than 50  $\mu\text{V}$ . Alpha waves indicate wakeful relaxation with closed eyes, but they are suppressed by eye opening, visual stimuli and visual scanning, drowsiness and sleep. This type of alpha oscillations normally appears at age 4 months, initially with 4 waves per second. With the brain development alpha reaches 10 Hz, and is established around age 3 years [Kolev 1994, Niedermeyer 1997]. There are also other alpha variants, like: fast-alpha or alpha-delta (slow-wave, SWS) state spreading across the brain in an anterior-posterior gradient [Pivik 1995].

Interestingly, according to a recent study, alpha oscillations are enhanced during internal tasks, such as mental calculation and working memory [Palva 2007]. Recent research of alpha-amplitude and phase dynamic suggested a direct and active role for alpha-frequency band rhythmicity in the mechanisms of attention and consciousness [Palva 2007].

### Mu waves

Mu waves (encompassed in the alpha range 8-12 Hz) can be found in primary sensory or motor cortical areas when they are not processing sensory information or producing motor output. It is strongly suppressed during the execution of contralateral motor acts, the thought of a movement, or tactile stimulation [Cochin 1998, Pfurtscheller 2006]. Mu rhythm is thought to be produced by interactions between the thalamus and the cortex. Additionally, mu wave is most often asymmetric and asynchronous between the 2 sides and may be also unilateral [McFarland 2000]. It

has low to medium amplitude and comparable to that of the alpha rhythm. In contrary to alpha wave, it does not react to eye opening and closing.

### Beta waves

Beta waves (13-30 Hz) are detected mostly over the frontal and central regions of the brain in normal adults. It appears during waking state and is associated with active thinking and attention, concentration or solving certain problem. Importantly, a central beta rhythm is related to the rolandic mu wave and can be blocked by motor activity or tactile stimulation. The amplitude of beta rhythm is normally under  $30 \mu\text{V}$ . Interestingly, the beta wave may be enhanced around tumoural regions [Sanei 2007].

### Gamma waves

Theoretical and experimental work suggests that gamma waves (30-100 Hz) are related with sensory processing [Jensen 2007]. They also have an important role in attention and both working and long-term memory. In recent years, intracranial and high-density EEG and MEG recordings allowed to study gamma band synchronization during various cognitive functions in humans [Kaiser 2003, Herrmann 2004] and in relation to psychiatric and neurological dysfunctions [Quyen 2006, Uhlhaas 2006]. The gamma oscillations, which have a crucial role in synaptic plasticity and neuronal communication, allow to develop models of the neuronal processing in local and distributed cortical networks engaged in complex cognitive functions [Jensen 2007].

## 2.4 Source localisation

For many years, researchers have been interested in the source reconstruction of M/EEG recordings. In this section I will focus on forward models which relate electrical measurements  $\mathbf{M}$  to neural activity  $\mathbf{J}$ .

### 2.4.1 Forward problem

The first step of source localisation entails modelling of the brain electrical activity (in case of EEG signal) and head volume conduction. This step is called **Forward Problem** and its output is called the **gain matrix**. Each column of the gain matrix represents a surface potential, linking the scalp recordings with the cortical source corresponding to the column. To be able to do that, it is necessary to model the conductivity and the geometry of the head, which is further explained in section 2.4.1.1. The main assumption of the source model is that the neighbouring pyramidal cells (current sources) which are parallel to each other and perpendicular to the cortical surface, are the EEG generators [David 2002].

Given the three spatial coordinates  $(x, y, z)$ , orientation angles  $(\theta, \phi)$  and strength  $(d)$  of  $N$  sources,  $T$  time samples of EEG data measured with  $S$  electrodes the model for distributed sources is described by the following linear equation:

$$M = GJ + E \quad (2.1)$$

where  $M$  is a  $S \times T$  matrix of measured EEG signal,  $G$  is a  $S \times N$  gain matrix representing a scalp potential,  $J$  is a  $N \times T$  matrix representing an activity of cortical sources, and  $E$  is a  $S \times T$  matrix representing noise [David 2002].

To solve the forward model, first, it is necessary to understand the nature of neuronal activity and cerebral anatomy, and that lead to the head model. The generation of neural activity has already been described in section 2.3, so further I will focus on the head models.

#### 2.4.1.1 Head models

The forward problem is to solve Maxwell's equations describing the electromagnetic field produced by neural activity. The difficulty of forward model computation lies in modelling the volume conductor, a human head, and the sources, the neuronal activity of the brain. The structure of the head and the brain is very complicated. The brain is surrounded by meninges and the CSF. The head comprises various organs and tissues (skull, scalp, eyes, vessels, nerves, CSF, etc.). The brain tis-

sues have highly anisotropic electrical conductivity. For example the conductivity of white matter is 10 times greater along an axon fibre than in the transverse direction [Malmivuo 1995], whereas skull's conductivity is 15 times lower than skin's or cortex' [Oostendorp 2000]. [Haueisen 1995] studied the influence of volume currents on the magnetic field and found that "the computed magnetic field of radial sources varied significantly with the conductivities of the surrounding tissues where the dipole was located". For this reason, the complications are generally ignored and the head model often assumes that the head consists of concentric homogeneous shells: the brain (comprising the white and grey matter), the CSF, the skull and the scalp.

The standard spherical model was the first and simplest model used in forward model computations. The head is modelled as a set of concentric homogeneous and spherical volume conductors: the brain, skull and scalp. Sphere-shaped models are very fast in forward model estimation. They can be expressed in simple analytic form, however it is a crude approximation of real geometry.

Boundary element method (BEM), finite-element method (FEM) and finite difference method (FDM) algorithms allowed for more detailed and accurate forward models. These algorithms reconstruct the realistic geometry of the head and the brain, with all anatomical structures, using individual or standardized MRI scans. The boundary element method BEM estimates the surface potential generated by current sources located in homogeneous tissues [Meijs 1987, Meijs 1989, Hallez 2007]. The shape of the different compartments of a volume conductor is modeled by closed triangle meshes [Fuchs 2007]. In comparison to standard spherical models, the volume currents are more precisely taken into account [Vatta 2010]. Although, it uses only isotropic conductivities and lacks the capacity to accurately represent the cortical structures (such as sulci and gyri) it remains to be widely used because of its low computational needs [Hallez 2007]. Even better accuracy is possible when FDM or five or eleven tissue-type FEM models are used [Ramon 2006]. The summary of different head models is presented on Figure 2.5. However I will not focus on mathematical differences between all models, because it is beyond the scope of this thesis.

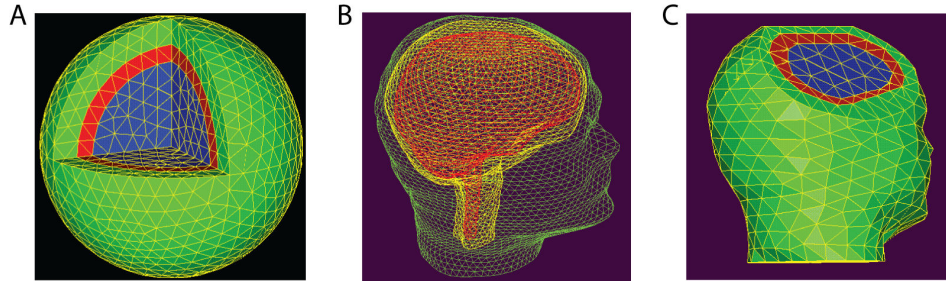

Figure 2.5: Summary of different head models. (A) The standard spherical model. (B) Realistic model with homogeneous layers computed with boundary element method (BEM). (C) Non homogeneous realistic model estimated with finite elements methods (FEM) or finite differences methods (FDM).

Once the forward problem is solved the inverse problem can be estimated from acquired EEG signals. The **Inverse Problem** describes the opposite situation: having the electric field at the scalp and the gain matrix, the aim is to estimate the time course of the sources. Figure 2.6 depicts a schematic representation of forward and inverse problems.

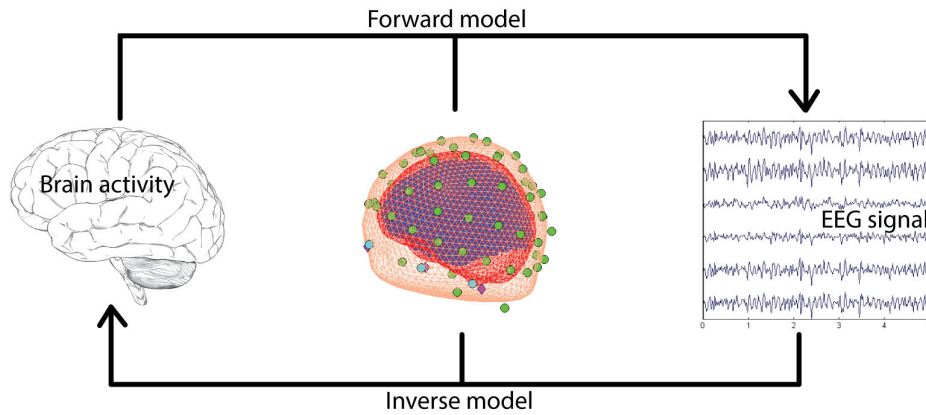

Figure 2.6: Schematic representation of forward and inverse problems.

### 2.4.2 Inverse problem

The inverse problem is an estimation  $\hat{J}$  of sources  $J$  that generate the measured EEG (or MEG) data  $M$ . This model can be described by the following equation:

$$\hat{J} = f(G, M) \quad (2.2)$$



where  $J$  is a matrix of estimated current density obtained from measured data  $M$  and  $G$  is the gain matrix. In other words, the aim is to reconstruct the underlying current distribution in the cortex using potential differences which are measured non-invasively from the head surface [Wolters 2004]. Unfortunately, EEG source localisation is an ill-posed inverse problem, because the number of estimated sources ( $\gg 1000$ ) is higher than the number of electrodes ( $< 300$ ), and in the absence of constraints, the solution is non-unique and unstable. Although the number of parameters can be reduced, if some constraints are placed on the sources [Phillips 2001, Friston 2007, Grech 2008]. Many different sources configurations can still generate the same distribution of potentials (or magnetic fields in MEG) on the scalp [Helmholtz 1853, Fender 1987].

Over the years, a number of various techniques have been developed to solve the inverse model for EEG source localisation. These approaches can be divided into two categories: parametric and non parametric. Non parametric methods are also named as Distributed Source Models, distributed inverse solutions (DIS) or imaging methods.

The *parametric technique* estimates the dipole parameters of an *a priori* determined number of dipoles, whereas in the *non parametric* several dipole sources with fixed locations and possibly fixed orientations are distributed in the brain volume or cortical surface [Grech 2008]. As it must be assumed that cortical pyramidal neurons are normally oriented to the cortical surface, fixed orientation dipoles are set to be perpendicularly aligned. Then, the amplitudes of current sources are estimated. Since the dipole location is not assessed, these methods present a linear problem which can be solved by various methods, including: minimum norm estimator (MNE) [Hämäläinen 1994], low resolution electrical tomography (LORETA) [Pascual-Marqui 1994], standardized low resolution brain electromagnetic tomography (sLORETA) [Pascual-Marqui 2002], multiple sparse priors (MSP) [Friston 2008], local autoregressive average (LAURA) [Menendez 2004] and many others [Grech 2008]. However, the aim of this project was not to describe all possible source localisation methods, so in next paragraphs I will focus only on MNE used in this work.

### Minimum Norm Estimates

According to Hämäläinen and Ilmoniemi [Hämäläinen 1994], minimum norm estimators (MNE) are the best estimates for the currents in the absence of any *a priori* information. MN estimates are generally based on the assumption that the current distribution should have minimum overall power (the smallest L2-norm). The estimate  $\hat{J}^M$  of  $J$  can be then written as [Dale 1993, Hämäläinen 1994, Pascual-Marqui 1999, Michel 2004]:

$$\hat{J}^M = G^T(GG^T + \lambda I)^{-1}M \quad (2.3)$$

where  $I$  is the identity matrix. The relative weight of the prior term are modulated by the positive hyperparameter  $\lambda$ . On the one hand, this method gives unique solution, where only one combination of current sources can exactly fit the data and have the lowest overall intensity. But on the other, it is considered to produce quite poor estimation of the true source locations [Michel 2004, Grech 2008]. However it remains the most used approach.

In the following section 5.1.5 the independent and identically distributed (IID) model (corresponds to the MNE) from SPM8 toolbox was used to solve the inverse problem.

# Résumé du Chapitre 3

Dans ce chapitre, je présenterai la stimulation magnétique transcrânienne. Dans la première partie, je décrirai les principes de la stimulation magnétique, l'instrumentation de la TMS ainsi que la technique de neuronavigation. Ensuite, je décrirai la plasticité synaptique dans le cas de LTD et LTP, et les mécanismes des changements induits par la TMS. Ce chapitre se conclura par la définition et la description de différents protocoles utilisés dans cette thèse. De plus, je présenterai une rapide introduction à d'autres applications de la rTMS, telles que l'étude fonctionnelle de la connectivité et de l'excitabilité corticale, ou le traitement de la dépression.

# Transcranial Magnetic Stimulation

---

## Contents

---

<b>3.1</b>	<b>Introduction</b>	<b>31</b>
<b>3.2</b>	<b>Principles of magnetic stimulation</b>	<b>32</b>
<b>3.3</b>	<b>Targeting rTMS and neuronavigation</b>	<b>36</b>
<b>3.4</b>	<b>Physiology of TMS-induced changes</b>	<b>37</b>
3.4.1	Synaptic plasticity	38
3.4.2	LTD and LTP	39
<b>3.5</b>	<b>rTMS protocols</b>	<b>40</b>
3.5.1	1 Hz rTMS	42
3.5.2	10 Hz rTMS	44
3.5.3	Theta burst stimulation	45
<b>3.6</b>	<b>Functional connectivity and cortical excitability</b>	<b>47</b>
<b>3.7</b>	<b>TMS in the treatment</b>	<b>48</b>
3.7.1	TMS in the treatment of MDD	48
3.7.2	TMS in the treatment of BP depression	53
<b>3.8</b>	<b>Conclusions</b>	<b>54</b>

---

## 3.1 Introduction

Transcranial magnetic stimulation (TMS) is a non-invasive technique for stimulating the brain. A brief electric current passing through a magnetic coil produces

a brief, high-intensity magnetic field which stimulates the brain. The field can excite or inhibit a small brain area below the coil. Although the stimulation can be applied over any part of the brain, most of the studies focused on the motor cortex where a focal muscle twitch can be produced, associated with a motor evoked potential (MEP). The first successful TMS study was performed in 1985 by Anthony Barker and colleagues [Barker 1985]. Its earliest application investigated nervous propagation along the cortico-spinal tract, spinal roots, and peripheral muscles in humans [Rossini 2007]. In addition, TMS can be used to map brain function and explore the excitability of different regions. Repetitive TMS, application of many magnetic pulses, which is able to induce relatively long-lasting excitability changes, is being developed for various therapeutic purposes.

### 3.2 Principles of magnetic stimulation

TMS follows the fundamental physical principles of electromagnetic induction. A brief, high-intensity electrical pulse is produced in a coil and placed tangentially to the scalp (see Figure 3.1). According to Lenz's law, the flow of the induced current is parallel but in opposite direction to the current in the coil, whereas the magnetic field passes perpendicularly to the coil. The magnetic field can reach up to about 2 Tesla and typically lasts for about 100 ms. The electric field can excite neurons, but more important are the induced currents [Hallett 2000, Hallett 2007].

In a homogeneous medium, in this case the brain, changes of the electric field cause the current to flow in loops parallel to the plane of the coil. The loops with the strongest current are near the circumference of the coil. The current loops become weak near the centre until disappearance at the centre of the coil. Neuronal elements are activated by the induced electric field. If the field is parallel to the neuronal element, then the field is most effective where the intensity changes as a function of distance [Hallett 2000, Hallett 2007].

Magnetic coils may have different shapes. A figure-of-eight, or butterfly coil, can stimulate a relatively focal area, producing maximal current at the intersection of the two round components (Figure 3.2 A), whereas the circular coil produces

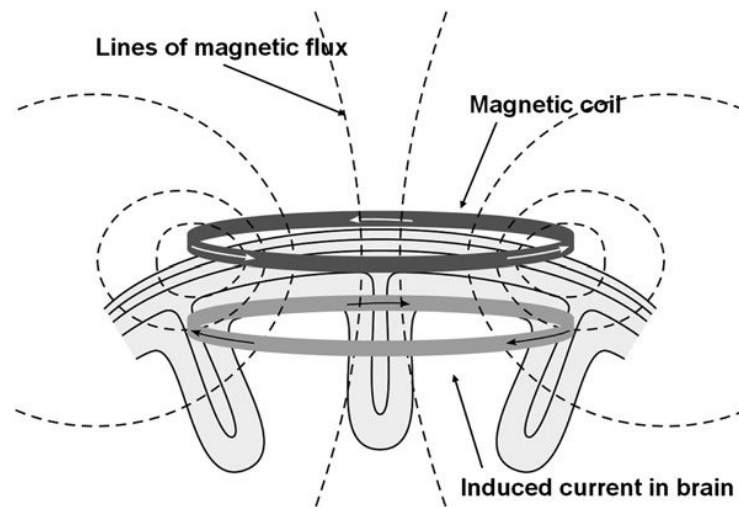

Figure 3.1: Illustration of direction of current flows in a TMS coil and the induced current in the brain [Hallett 2000].

more diffuse magnetic field (like it is shown on Figure 3.2 B).

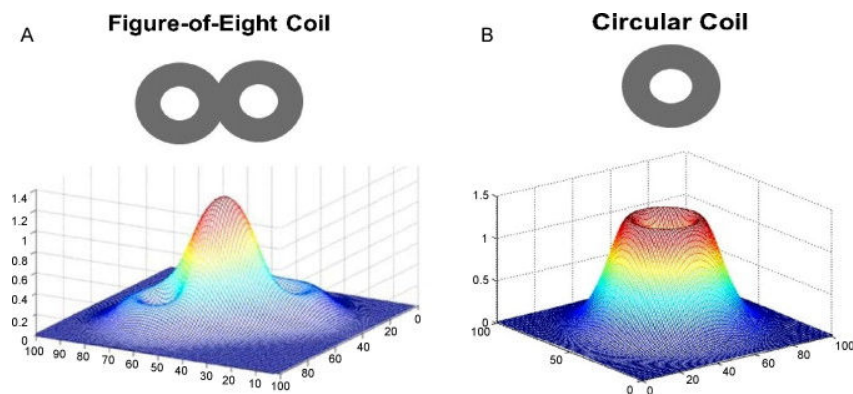

Figure 3.2: Magnetic field generated by the different coils: (a) magnetic field by a figure-of-eight coil and (b) magnetic field by a circular coil [Giordano 2012].

The figure-of-eight coil with the two components at an angle, called the cone-shaped coil, increases the power at the intersection. Another configuration is called the H-coil (Figure 3.3), with complex windings that permit a slower fall-off of the intensity of the magnetic field with depth [Zangen 2005]. In another coil, called iron-coil (Figure 3.4), the windings of the coil are around an iron core rather than around the air. This focuses the field and allows greater strength and depth of penetration [Epstein 2002].

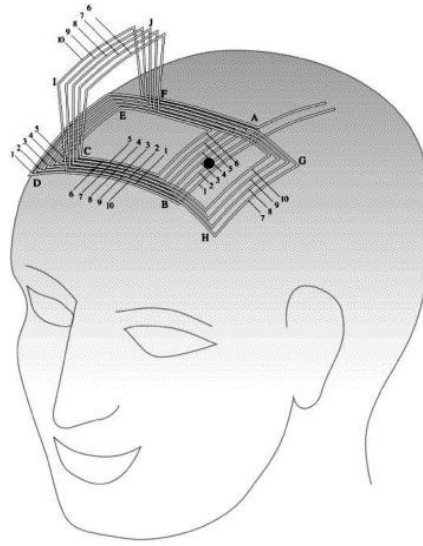

Figure 3.3: Sketch of the H-coil version used in this study of Zangen and coworkers [Zangen 2005] placed on a human head.

Recently Bijsterbosch and coworkers [Bijsterbosch 2012] additionally modeled the TMS-induced electric field for some common cortical and cerebellar targets. Using an anatomically detailed and realistic head model, they were able to construct the first numerical and graphical atlas of TMS-induced electric fields for various coil positions. Figure 3.5 depicts example of the TMS-induced electric field distribution on the gray matter surface in the right DLPFC.

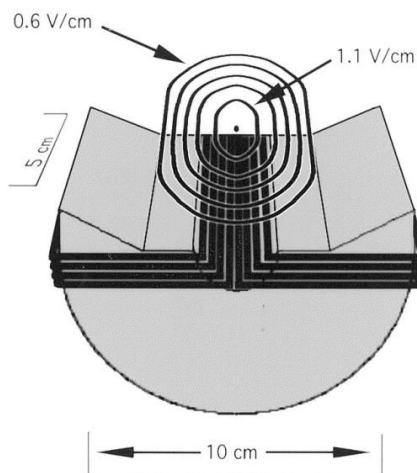

Figure 3.4: Three-dimensional view of the iron core and coil windings. Concentric ovals above the coil represent isopotential contour lines for magnitude of the induced electrical field in the model head at a depth of 2 cm. The peak field above the center point is 1.2 V/cm. From the outside in, contour lines represent 0.6, 0.8, 0.9, 1.0, and 1.1 V/cm. Direction of the induced electrical field is into the page [Epstein 2002].

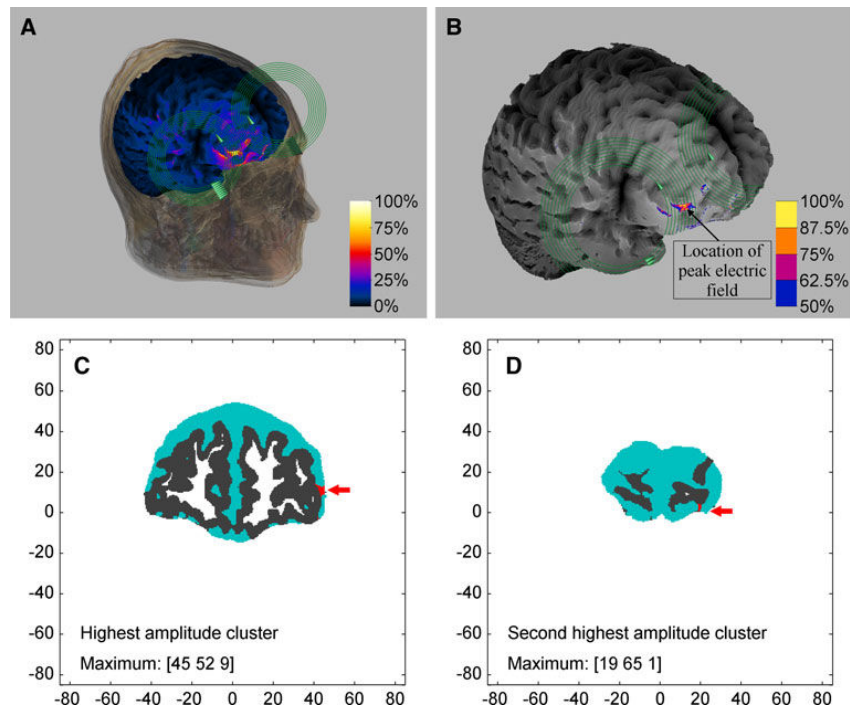

Figure 3.5: TMS-induced electric fields in the right DLPFC. The induced electric field strength is shown on a rendered view of the gray matter surface in the full range (a) 0-100% of 804 V/m, and in the threshold range (b) 50-100% of 804 V/m. The view is presented looking down the central axis of the coil. The green concentric circles represent the geometry of individual coil turns that were modelled. Note that some darkening of the cortical structure occurs at the centre of each coil wing in a and b. This darkening is caused by local minima in the electric field results, which have been used to illuminate and thus reveal the cortical structure. c, d Voxels with supra-threshold electric field intensity induced in grey matter (in red) are shown on coronal slices through the peak electric field (c) and through the local maximum of the cluster with the next highest electric field strength (d). Grey matter is shown in grey and CSF is shown in cyan. The coordinates shown are those of the peak electric field voxels in the relevant cluster (the coordinates and the units on the axes are in Talairach space). We have chosen to show the figures such that they include the whole head in order to facilitate localization and interpretation of the results. However, the high resolution of the figures allows further inspection of finer details [Bijsterbosch 2012].



### 3.3 Targeting rTMS and neuronavigation

Precise and consistent position and orientation of the TMS coil is crucial to obtain reliable and reproducible results of stimulation [Mills 1992]. In 2001, Herwig with coworkers questioned previous method of coil placement [Herwig 2001a]. According to [Herwig 2001a] “to place the coil above Brodman area (BA) 9 and 46 as functionally relevant parts of the DLPFC, George et al. [George 1995] and Pascual-Leone et al. [Pascual-Leone 1996] proposed a *standard procedure*, which was then applied by nearly all investigators in this field. First, the motor cortex was localized by evoking a response of contralateral hand muscles, for instance, the abductor pollicis brevis (APB) muscle. Then the coil was moved 5 cm rostrally, presumably targeting the DLPFC. The measure of 5 cm was derived from the Talairach atlas [Talairach 1988, George 1995]”. Although this method is easy and cheap to perform, it does not take into account any individual variations in the brain size and anatomy, which changes the distance between motor areas and the DLPFC. Based on their results, they introduced a neuronavigation system to ensure consistency of coil placement. To date, most neuronavigation systems work in cooperation with anatomical magnetizing resonance imaging (MRI) to identify target areas and guide positioning of the TMS coil relative to anatomical or functional landmarks [Sparing 2008, Julkunen 2009, Fleming 2012].

In general, the neuronavigation system allows the visualisation of the coil location in relation to the brain in real time on a computer screen. The system is based on frameless stereotaxy, thereby avoiding head fixation [Herwig 2001a, Herwig 2001b]. Coil and subject’s head are tracked by a high-resolution optical tracking system build with CCD cameras and infrared transmitters (Figure 3.6 A). The CCD camera can detect the position and orientation of reference markers in 3D space. Three passive reflecting spheres are mounted on these markers on the subject’s head and on the magnetic coil (Figure 3.6 B and C). The reflections of infrared beams are captured by the CCD camera, and the computer uses them to determine the position of the markers in space. A referencing procedure using anatomic landmarks is performed to coregister the head and the coil in the coordinate system of

the MRI of the brain (Figure 3.6 D).

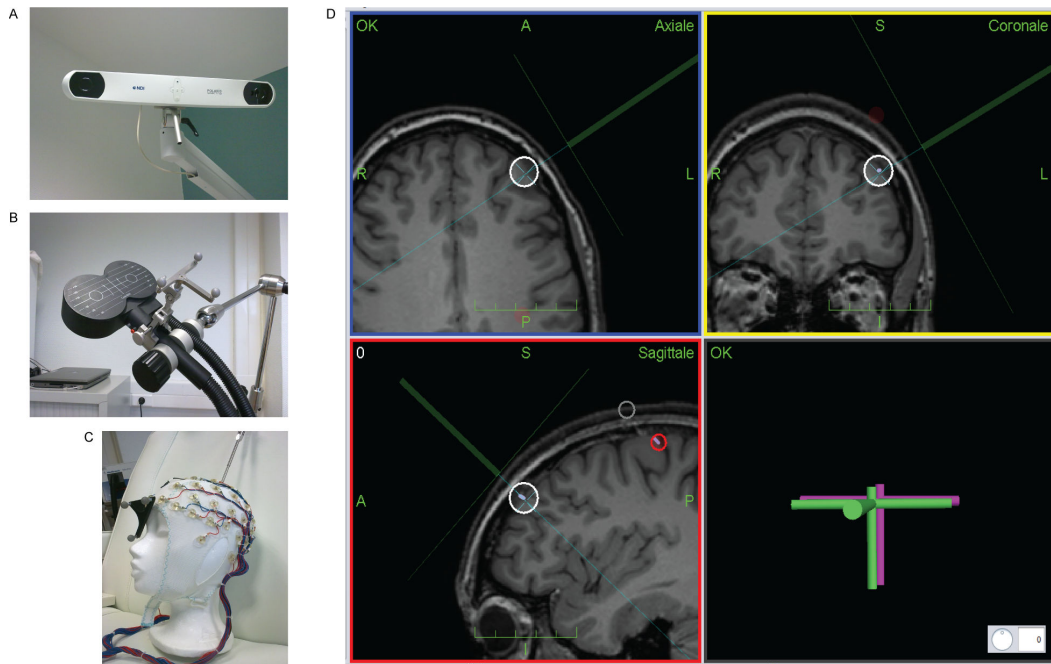

Figure 3.6: Neuronavigation system includes: A) CCD camera; B) Reflecting spheres placed on reference markers which are mounted on the coil C) and the head; D) Scene representation in the Localite Premium software used in this thesis.

### 3.4 Physiology of TMS-induced changes

Depending on the stimulation parameters, TMS is able to excitate or inhibit brain activity. Stimulation can be delivered in single TMS pulse, in pairs of stimuli separated by a variable interval (paired pulse - ppTMS), or in trains (repetitive TMS - rTMS) [Rossi 2009]. Single pulse TMS is mostly used to map motor cortical outputs and to study central motor conduction time with causal chronometry in brain-behavior relations. When a single TMS pulse is applied over the motor cortex at sufficient intensity, a peripheral MEP is elicited. The amplitude and latency of the MEP reflect the excitability of the stimulated area [Hallett 2007]. Paired pulse TMS can be delivered with one coil to a single cortical target or to two different brain regions using two different and synchronised coils. Using ppTMS it is possible to measure the intracortical facilitation and inhibition. rTMS

is able to modulate and change activity beyond the stimulation time. Its therapeutic properties in patients with psychiatric and neurological disorders have been shown [Robertson 2003, Hallett 2007, Ridding 2007]. However, by which mechanisms rTMS influences the brain, causing these long-lasting effects, remains unclear. A common hypothesis of these after-effects implicates changes in synaptic plasticity such as long-term depression (LTD)- or long-term potentiation (LTP)-like [Hoogendam 2010].

### 3.4.1 Synaptic plasticity

According to Butler and Wolf, *plasticity* is the ability of the brain to reorganise itself, enabling short- and long-term remodeling of neural communication that outlasts an experimental manipulation or period of training [Butler 2007]. Plasticity occurs at various levels of brain organisation, from synaptic to structural modifications. At first, I describe the synaptic level, because the long-lasting effects of rTMS seem to arise from synaptic plasticity [Hallett 2000, Hallett 2007].

*Long-term potentiation* (LTP) of chemical synaptic transmission and the converse process of *long-term depression* (LTD) have been the focus of an enormous amount of investigation and are widely studied in a variety of species [Cooke 2006, Hoogendam 2010]. Long-term potentiation is an *increase* in the synaptic strength that could last for hours in vitro and for weeks or months in vivo. LTP can be induced in experimental conditions as a result of brief high-frequency stimulation. In the complementary process of LTD the efficacy of synaptic transmission is reduced [Duffau 2006].

LTP and LTD can be exploited to treat disorder and disease in the human CNS. A variety of neurological conditions arise from lost or excessive synaptic drive due to sensory deprivation during childhood, brain damage or disease. Manipulation of synaptic strength using various stimulations may provide a means of normalising synaptic strength and thereby ameliorating plasticity-related disorders of the CNS [Bliss 2011].

### 3.4.2 LTD and LTP

#### LTP

In 1973, Bliss and Gardner-Medwin observed an occurrence of LTP in vivo in the hippocampus of anaesthetised rabbits [Bliss 1973]. They described that high-frequency stimuli trains (tetani) delivered to the axons of pyramidal cells in the hippocampus led to a long-lasting increase in the amplitude of excitatory post-synaptic potentials (EPSP). Crucial for the induction of LTP are the coincidence between pre- and post-synaptic activity and a specific temporal relationship between these activities [Cooke 2006].

N-methyl-D-aspartate (NMDA) receptor, which is placed post-synaptically, seems to be the cellular basis of synaptic potentiation. This receptor has an intrinsic cation channel, which is blocked by magnesium ions when the cell is at its normal resting membrane potential. The  $Mg^{2+}$  blockade can be released and the channel of the NMDA receptor can be opened only when the post-synaptic neuron is sufficiently depolarized. As the result, LTP is induced by  $Ca^{2+}$  entering into the post-synaptic cell [Cooke 2006, Hoogendam 2010]. This mechanism explains several features of LTP, among which *cooperativity* and *associativity*.

Cooperativity can be observed when a crucial number of pre-synaptic neurons must be simultaneously activated to elicit LTP. This suggests the presence of some threshold for LTP induction, depending on the number of pulses, stimulus intensity and the pattern of stimulation. Another key characteristic of LTP is *associativity* closely related to cooperativity. Associativity ensures that a weak tetanus, which is not by itself capable of initiating LTP, can become potentiated through association with a strong tetanus [McNaughton 1978, Levy 1979, Barrionuevo 1983]. This can be explained by the fact that weak stimulation means that the postsynaptic neuron is not enough depolarized to expel  $Mg^{2+}$  from the NMDA receptor. In contrast, strong activation in another pathway is able to depolarize this postsynaptic neuron nevertheless, to open the NMDA receptor, and to induce LTP in both pathways [Malenka 2003, Hoogendam 2010].

## LTD

The phenomenon opposite to LTP is LTD, in which synaptic strength is reduced for a long period. In vitro, LTD is induced by low-frequency stimulation (1 Hz) with long periods of stimulation (600-900 impulses). LTD can also be activated when the stimulation of post-synaptic neuron is followed by the stimulation of the pre-synaptic neuron within a specific window of tens of milliseconds [Bi 1998].

Like in LTP induction, NMDA receptors are also responsible for LTD induction. The activation of the NMDA receptor leads to a rise of the postsynaptic  $\text{Ca}^{2+}$  concentration. The nature of the  $\text{Ca}^{2+}$  signal is crucial for determining whether LTP or LTD arises. Small and slow rises in the calcium ion concentration induce LTD, whereas large and fast lead to LTP [Hoogendam 2010].

## STDP

In 1983, Levy and Steward activated weak and strong input together, and they observed that the temporal order of the pre- and post-synaptic spiking determined whether LTP or LTD was induced and that timing of pre- and post-synaptic action potentials (spikes) determines the polarity of synaptic change [Levy 1983, Bi 1998]. This was called *spike timing-dependent plasticity (STDP)*. Repeated activation of a pre-synaptic spike followed by post-synaptic spike, within a brief time window of approximately 50 ms, leads to LTP, while the reverse order leads to LTD [Markram 1997, Bi 1998]. Additionally, independent stimulation of two afferent pathways has revealed that neighbouring synapses can be independently potentiated or depressed. This property of *input specificity* is an important characteristic of Hebbian LTP and LTD [Barrionuevo 1983, Markram 1997, Martin 2000].

## 3.5 rTMS protocols

There are several rTMS protocols with different lasting effects and purposes. Parameters influencing the after-effects of stimulation are stimulus intensity and frequency, total number of delivered impulses, the duration of the application period, and the shape of the magnetic pulse [Arai 2005, Taylor 2007a, Classen 2008].

Moreover, 3D position and orientation of the TMS coil, which means the orientation of the induced currents and the anatomy of the underlying gyri, also play a crucial role in the effects of rTMS [Thielscher 2010]. However, the exact mechanisms of rTMS on neural activity remain partly unknown and not fully understood. In fact, TMS in humans is relatively non-focal stimulation and one can suggest that it activates a mixture of interacting neuronal systems which makes the after-effects difficult to predict.

Previous studies have shown that rTMS of human motor cortex can produce long-lasting changes in the excitability of excitatory and inhibitory neuronal networks. Low-frequency stimulation ( $\leq 1$  Hz) produces lasting decrease in motor cortex excitability, whereas high-frequency stimulus ( $\geq 5$  Hz) induces facilitatory effects [Romero 2002, Hayashi 2004, Houdayer 2008, Di Lazzaro 2011, Noh 2012]. Furthermore, it was shown that longer stimulation period produced longer duration of after-effects [Robertson 2003]. Moreover, it appeared that the structure of the pulse train has an important influence on the effects of rTMS protocol [Classen 2008]. In basic protocols, individual stimuli are separated by identical inter-stimulus intervals (ISIs), whereas in patterned protocols, different ISIs are used [Hoogendam 2010]. On the top panel of Figure 3.7, there are two protocols: 1) a low-frequency protocol - 1 Hz stimulation, 2) a high-frequency protocol - 5 Hz stimulation. Patterned protocols are shown on bottom panel and, as it can be found on the figure, they are characterised by different ISIs. In theta burst stimulation (TBS), which is able to induce LTP and LTD, a pattern has three pulses of stimulation given at 50 Hz (ISI 20 ms), repeated every 200 ms (5 Hz). There are two main types of theta burst paradigm. In continuous theta burst stimulation (cTBS), a 40-second train of uninterrupted TBS is delivered. In intermittent theta burst stimulation (iTBS), a 2-second train of TBS is repeated every 10 seconds for a total of 600 pulses (190 seconds) [Hoogendam 2010].

Table 3.1 and Table 3.2 present a summary of the studies using different rTMS protocols. In described studies, the intensity of the stimulation was defined as the percentage of the individual motor threshold (MT), resting motor threshold (RMT) or active motor threshold (AMT). The MT is the lowest intensity of stim-

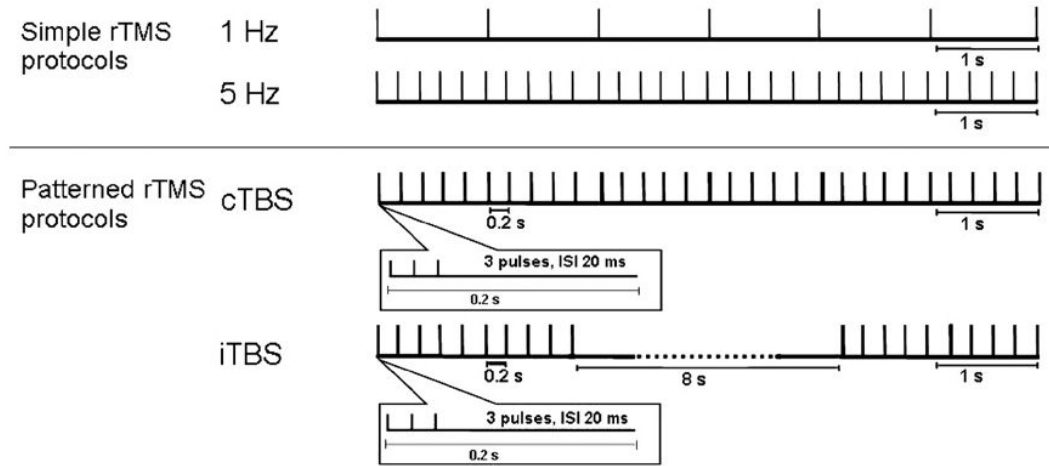

Figure 3.7: Overview of rTMS protocols [Hoogendam 2010].

ulation applied to the primary motor cortex that induces a muscle response in the contralateral hand, at least in 5 of 10 trials. RMT is measured during complete relaxation, whereas the AMT is determined in a voluntary contracted muscle [Hoogendam 2010]. The researches summarised in Tables 3.1 and 3.2 investigated the effects of rTMS by measuring the amplitude of MEPs.

In this section I will focus on recent papers describing 1 Hz, 10 Hz stimulation and thetaborst protocols, cTBS and iTBS. This choice is based on the further section 5.1.2 where these paradigms are used in my experimental protocols.

### 3.5.1 1 Hz rTMS

1 Hz stimulation is the most widely used protocol to stimulate motor cortex, as well as other brain areas. It allows the structure-function relationships in the brain to be investigated. In the literature, there are a lot of studies investigating the effects of 1 Hz rTMS on motor excitability, but they vary in the stimulus intensity and in the number of pulses (see Table 3.1). Variations in the results can be found in the effects of stimulation, inhibitory in most cases, with large interindividual variability, with some subjects even showing facilitatory effects [Daskalakis 2006]. The duration of the after-effects also vary, which can be explained by the technical differences (number of pulses, used waveform [Taylor 2007a]) and interindividual

Table 3.1: Low-frequency rTMS protocol (1 Hz): sign and duration of MEP amplitude modulation [Hoogendam 2010].

Protocol	Study	n	Intensity	Imp.	MEP	Duration	Note
<b>1 Hz</b>	Bagnato	9	90% RMT	900	↔	NA	High interindividual variability
	Chouinard	7	90% RMT	900	↓	10 min	
	Daskalakis	12	90% RMT	900	↔	NA	High interindividual variability
	Heide	11	115% RMT	900	↓	2 min	MEP size of nonstimulated motor cortex increased (up to 30 min)
	Lang	9	90% RMT	1200	↓	4 min	Decrease in MEP more pronounced after pretreatment with D1/D2 receptor agonist
	Modugno	14	90% RMT	900	↔	NA	
	O'Shea	5	90% AMT	900	↓	>15 min	
	Pal	13	115% RMT	900	↔	NA	
	Rizzo	8	90% AMT	1500	↓	NI	
	Suppa	15	90% AMT	1500	↓	30 min	
	Taylor	12	90% RMT	900	↓	5 min	Monophasic waveform: significant effect at 5 min after rTMS. Biphasic at 20 min after rTMS
	Zafar	9	90% RMT	900	↓	NI	

AMT - active motor threshold; RMT - resting motor threshold; NA - not applicable; NI - not investigated; ↓ : decrease; ↑ : increase; ↔ : no significant change.



Table 3.2: High-frequency rTMS protocols (10 Hz): sign and duration of MEP amplitude modulation [Hoogendam 2010].

Protocol	Study	n	Intensity	Imp.	MEP	Duration	Note
<b>10 Hz</b>	Arai	11	90% AMT	1000	↔	NA	Only monophasic waveform induces significant effect
	Arai	11	90% RMT	1000	↑	10 min	
	Daskalakis	12	90% RMT	900	↔	NA	High interindividual variability
	Jung	20	80% RMT	300	↑	up to 120 min	Trains of 1.5 s
	Jung	20	80% RMT	1000	↓	up to 90 min	Trains of 5.0 s

AMT - active motor threshold; RMT - resting motor threshold; NA - not applicable; ↓ : decrease; ↑ : increase; ↔ : no significant change.

variability.

### 3.5.2 10 Hz rTMS

In contrast to 1 Hz, high frequency stimulation (HFS) (*i.e.* 10 Hz) tends to increase cortical excitability (see Table 3.2). As it was reported in papers of Modugno et al., Quartarone et al. and Arai et al. [Modugno 2001, Quartarone 2005, Arai 2007], the after-effects of HFS highly depend on the intensity of stimulation. With low intensities of HFS, they reported a decrease in excitability, whereas an increase was observed after HFS at higher intensities (see Table 3.2). Moreover, Quartarone et al. and Arai et al. [Quartarone 2005, Arai 2007] reported differences in the effects between HFS at 90% of the AMT and RMT. At 90% of AMT they did not find any effect, whereas they found the effect of rTMS at 90% of RMT. The resting threshold is, however, higher than AMT, which may indicate that if one refers to the active threshold, the energy delivered is higher, the current induced deeper and therefore the neurons involved in the response are not the same, the results are therefore not comparable.

### 3.5.3 Theta burst stimulation

In 1978, Hill observed that when an animal explores a new environment, pyramidal cells in the hippocampus fire in short (approximately 30 milliseconds) bursts and at a frequency of approximately 5 to 7 Hz [Hill 1978]. In 2005, Huang with coworkers [Huang 2005] introduced a new type of rTMS, theta burst stimulation where pulses are applied in bursts of three, delivered at a frequency of 50 Hz and an interburst interval of 200 ms (5 Hz). The parameters of TBS paradigm were based on these observations and additionally, on animal studies indicating that theta rhythms are associated with LTP [Hill 1978, Larson 1986, Davies 1991, Hess 1996]. The goal of TBS is thus to maximise the probability to produce LTD/LTP.

Two different modes of TBS have been tested showing opposite effects on motor cortex excitability. If the stimulation is given intermittently (iTBS), say 2 s of stimulation every 8 s, it leads to prolonged LTP-like increase of motor cortex excitability, in the contrary to continuous theta burst (cTBS) which produces a prolonged LTD-like decrease of motor cortex excitability [Huang 2005]. The main difference between TBS paradigm and conventional rTMS protocols is that even brief periods of stimulation (between 20 and 190 s) cause changes in cortical excitability that outlast the time of stimulation for at least 20-30 min (see Table 3.3) [Cardenas-Morales 2010].

Since its first description, TBS has started to be used not only in motor cortex stimulation, but also in other brain regions. However, little is known about the modulatory effects of cTBS and iTBS over non-motor regions. Recent studies combining TBS and EEG or fMRI have observed the after-effects of TBS on PFC and the frontal eye field, showing heterogeneous results [Hubl 2008, Schindler 2008, Grossheinrich 2009]. Additionally, the abilities of TBS to induce long-lasting after-effects led to therapeutic implications for neuropsychiatric disorders. However, the neurobiological mechanisms of TBS are not fully understood at present. As Huang suggested, it may involve LTD- and LTP-like processes [Huang 2005], as well as inhibitory mechanisms modulated by GABA-ergic activity [Cardenas-Morales 2010].

Table 3.3: TBS: effects and effect-durations on MEPs size [Hoogendam 2010].

Protocol	Study	n	Intensity	Imp.	MEP	Duration	Note
cTBS	Cheeran	18	80% AMT	300	↓	>30 min	Influence of genotype: only in individuals with Val/Val group significant change of MEP
	Di Lazzaro	4*	80% AMT	300	↓	8 min	
	Huang	9	80% AMT	600	↓	60 min	
	Huang	6	80% AMT	600	↓	NI	No change in MEP size after pretreatment with NMDA receptor-antagonist
	Huang	9	80% AMT	300	↓	20 min	No change in MEP size if stimulation was given during contraction FDI
	Iezzi	10	80% AMT	300	↓	30 min	Increase in MEP size if finger-movements preceded cTBS
	Martin	8	80% AMT	600	↓	35 min	
	Murakami	6	80% AMT	600	↓	35 min	
	Zafar	9	80% AMT	600	↓	30 min	Effects independent of current direction or pulse configuration
	iTBS	Cheeran	18	80% AMT	600	↑	30 min
Di Lazzaro		3*	80% AMT	600	↑	6 min	In one subject increase not significant; just one measurement after rTMS
Di Lazzaro		18	80% AMT	600	↑	6 min	High interindividual variability; just one measurement after rTMS
Huang		9	80% AMT	600	↑	15 min	
Huang		6	80% AMT	600	↑	NI	No change in MEP size after pretreatment with NMDA receptor antagonist
Huang		7	80% AMT	600	↑	20 min	No change in MEP size if stimulation was given during contraction FDI
Iezzi		10	80% AMT	600	↑	30 min	Decrease in MEP size if finger-movements preceded iTBS
Murakami		6	80% AMT	600	↑	15 min	
Teo		6	80% AMT	600	↑	20 min	
Zafar		9	80% AMT	600	↑	30 min	Effects independent of current direction or pulse configuration

AMT - active motor threshold; cTBS - continuous theta burst stimulation; FDI - first dorsal interosseus muscle; iTBS - intermittent theta burst stimulation; NA - not applicable; NI - not investigated; RMT - resting motor threshold; ↓ : decrease; ↑ : increase; ↔ : no significant change. \* Patient with epidural electrode.

### 3.6 Functional connectivity and cortical excitability

It is well known that TMS changes brain activity as an independent variable. It temporarily elicits “virtual lesions”, stimulate neuronal networks, increase or decrease cortical excitability. But, without any additional neuroimaging measure the localisation of effects remains unknown. As it was already mentioned, single or ppTMS are used to study the excitability of motor circuits. A TMS pulse spreads along the corticospinal pathway and induces electromyographic (EMG) responses. Although EMG is a good technique to measure TMS-evoked responses of the motor cortex, it does not allow to directly measure the cortical reactivity and connectivity of other brain areas. Combining TMS with EEG is a solution to enable direct measurements of these parameters [Ilmoniemi 1997].

In recent study, Ferreri and coworkers combined ppTMS with EEG and EMG recordings. They confirmed that ppTMS modulates early and late ERPs and MEPs [Paus 2001, Ferreri 2011]. Additionally, their findings revealed that “for some TMS-induced EEG peaks, the measures of short intracortical inhibition (SICI) and intracortical facilitation (ICF) are somewhat related to the same mechanisms mediating EMG measures of SICI and ICF”. Most importantly, these results indicate that with EEG it is possible to directly evaluate intracortical inhibition and facilitation induced by ppTMS in each cortical area.

Subsequently, in a very interesting study, Rosanova and coworkers investigated direct perturbation of different regions of the human cortico-thalamic system to measure their “natural frequencies”. This group stimulated three cortical sites (middle or superior occipital gyrus, superior parietal gyrus, and middle or caudal portion of the superior frontal gyrus) with a focal TMS bipulse. They used TMS-compatible 60-channel amplifier to record TMS-evoked potentials. Their findings revealed that stimulating the cortex at different sites results in various responses. TMS evoked dominant alpha oscillations in the occipital cortex, beta oscillations in the parietal cortex, and beta/gamma oscillations (21-50 Hz) in the frontal cortex. Furthermore, they found that “each cortical area tended to preserve its own natural frequency also when indirectly engaged by TMS through brain connections and

when stimulated at different intensities, indicating that the observed oscillations reflect local physiological mechanisms” [Rosanova 2009]. These findings suggest that in healthy subjects each corticothalamic system is tuned to oscillate at its own characteristic frequency.

Next, recent TMS-neuroimaging studies have shown that the neural consequences of rTMS are not restricted to the brain areas directly under the stimulating coil, but they spread to remote and interconnected regions [Sack 2006, Taylor 2007b, Leuchter 2013, Peters 2013]. It was shown that even a short train of high-frequency rTMS is able to modulate activity of distant interconnected sites and in the contralateral regions [Bestmann 2003, Sack 2007]. Moreover, Zandbelt and colleagues [Zandbelt 2009] detected with fMRI that primed 1-Hz rTMS over the prefrontal cortex increased resting-state activity locally for at least 45 minutes.

Knowing that a TMS pulse effectively inserts the energy into the neuronal networks, which then spreads throughout the anatomical and functional connections, these results are not surprising. The question is then not “whether” but “how” rTMS pulses propagate in the brain system.

## 3.7 TMS in the treatment

### 3.7.1 TMS in the treatment of MDD

Major depressive disorder is a chronic disorder that leads the patient to sociological disability and functional impairment [Murray 1996]. Treatment is often difficult and challenging. Moreover, an estimated 20-40% of patients do not respond to the standard trials of medication and psychotherapy, resulting in a need for alternative options of treatment [Greden 2001, Rush 2006, Trivedi 2006]. As a result of incidental observation that a number of subjects reported mood changes after TMS stimulation, studies of TMS as a potential alternative to electroconvulsive therapy (ECT) treatment for depression were initiated [Bickford 1987, Wassermann 2008]. In 1993, repeated daily left prefrontal TMS was first proposed as an alternative treatment for mood disorders [George 2010]. Since then, researchers repeatedly demonstrated that rTMS on the left and right DLPFC has antidepressant effects, and that these

after-effects are clinically significant [George 1995, Pascual-Leone 1996, Klein 1999, O'Reardon 2007, Padberg 2009, Fitzgerald 2009b, George 2010].

The initial clinical trials of rTMS were driven by functional imaging evidence that depressed patients have reduced activity in the left prefrontal cortex [Cummings 1993, Hirono 1998]. The first studies used HFS to excite the affected area and to obtain a long-lasting after-effects by applying rTMS during several daily sessions. Another idea was that an imbalance in the activity of the frontal lobes, with hypo-function in the left frontal lobe was caused by excess inhibition from the right frontal lobe [Ridding 2007]. This led to an alternative suppressive low-frequency stimulation of the right DLPFC [Klein 1999]. The study of Speer et al. [Speer 2000] confirmed that daily high-frequency rTMS applied during a 2-week period over left DLPFC induce increases in regional cerebral blood flow (rCBF) in bilateral frontal, limbic, and paralimbic regions implicated in depression, whereas low-frequency rTMS produced more focal decrease of rCBF (Figure 3.8 and 3.9). It suggested frequency-dependent rTMS-after-effects on local and distant regional brain activity and, additionally, indicated that higher stimulation frequencies lead to more widespread changes in cerebral activity.

In most cases, TMS studies has confirmed that rTMS has antidepressant properties when delivered to the left or right DLPFC, at high- and low-frequency, respectively [George 1995, Pascual-Leone 1996, Klein 1999, George 2000, Fitzgerald 2003, Avery 2006, O'Reardon 2007, Ahn 2013]. Although there is no evidence that rTMS makes depression worse, a number of authors suggested that rTMS has very little advantage over sham stimulation [Martin 2003, Couturier 2005]. In Miniussi et al. study [Miniussi 2005], we can find that “depressed patients benefit from rTMS treatment, but this benefit is not strictly and clearly related to the real effect of TMS itself. In fact, it is not possible to say whether the improvement in the clinical outcome is attributable to real or “placebo” TMS. However, it is worth of mentioning that the power of the effect is modest probably due to methodological limitations of the trials: lack of precision in the location of the target, quality of the placebo procedure or heterogeneity of recruited patients, often resistant to pharmacological treatment. Now it is known, that the more severe depression the worst is the re-

sponse to rTMS treatment. In another paper by Loo et al. [Loo 1999], the results indicate that “the groups receiving real and sham rTMS improved in mood significantly over the 2-week double-blind period, but there was no significant difference between groups”. What is important, in this paper the placebo was performed with a coil placed at  $45^\circ$  to the scalp. In a paper by Lisanby et al. [Lisanby 2000] it was shown that this type of sham procedure produces a biological effect, in this case collection of MEPs, so it is difficult to show different effects.

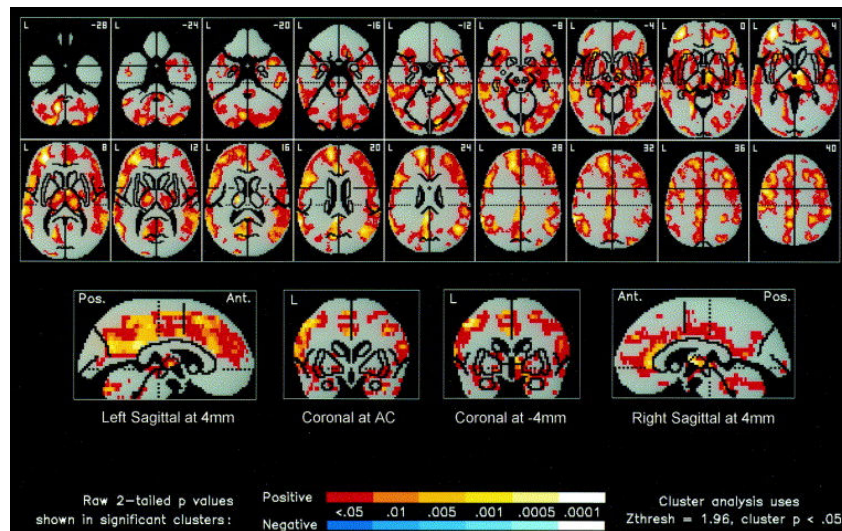

Figure 3.8: Significant increases in absolute rCBF 72 hours after 2 weeks of 20 Hz rTMS over the left prefrontal cortex in the group of 10 depressed patients. A statistical parametric map shows voxels that occur within significant clusters and is color coded according to their raw p value. Increases in rCBF are displayed with a red - orange - yellow color scale, and there were no areas of decreases in rCBF displayed with a darklight blue color scale. Nonsignificant values are displayed as gray on the positron emission tomography template. The number in the top right corner of each horizontal section (top two rows) indicates its position in mm with respect to the anterior commissure / posterior commissure plane. 20 Hz rTMS resulted in widespread increases in rCBF in the following regions: prefrontal cortex ( $L > R$ ), cingulate gyrus ( $L \gg R$ ), bilateral insula, basal ganglia, uncus, hippocampus, parahippocampus, thalamus, cerebellum, and left amygdala. Note the distal effects in bilateral cortical and subcortical structures following stimulation over the left prefrontal cortex. Coronal sections (middle, bottom row) are displayed at the AC and 4 mm behind it to maximize visualization of the amygdala. Increases in the left amygdala but not the right are best viewed in horizontal sections at -20, -16, and -12 mm, however. Sagittal sections are 4 mm to the left and right of midline to illustrate the greater increases in the left cingulate gyrus relative to the right. L, “left” side of image. [Speer 2000].

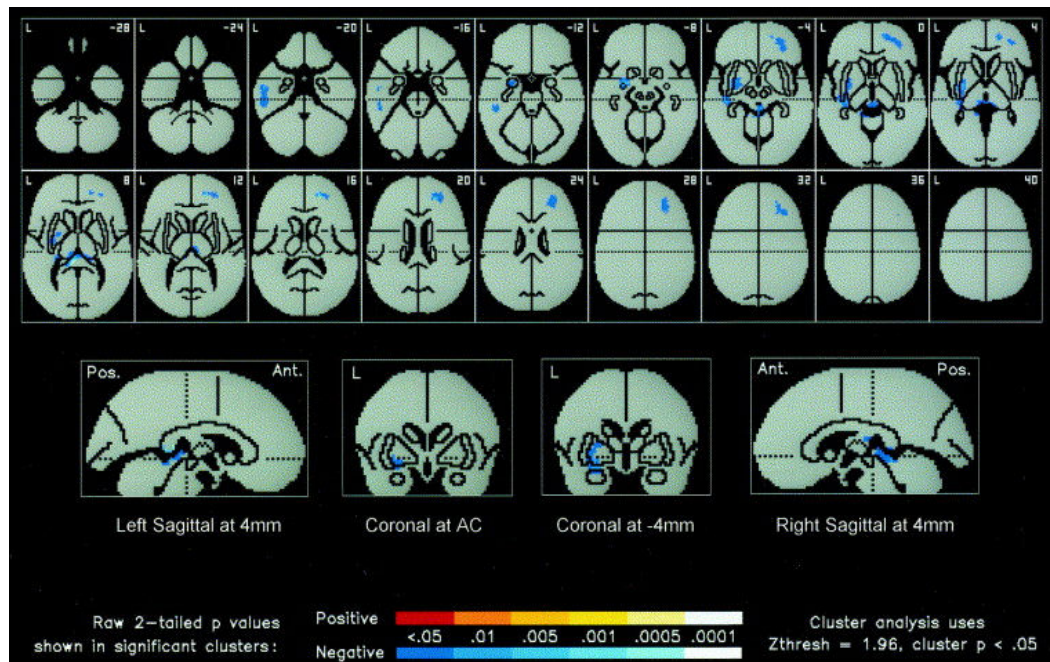

Figure 3.9: Significant decreases in absolute rCBF 72 hours after 2 weeks of 1-Hz rTMS over the left prefrontal cortex in the same group of 10 depressed patients. Horizontal, sagittal, and coronal images are illustrated as in Figure 3.8. Focal decreases in rCBF were present in the right prefrontal cortex (horizontal sections -4 to 32 mm), left medial temporal cortex (-20 to -12 mm), left basal ganglia (14 to 8 mm), and left amygdala (-12 to -8 mm). Note the opposite effect of rTMS frequency on rCBF in the left amygdala (horizontal section = -12 mm) in Figure 3.8 [Speer 2000].

Table 3.4 presents a summary of meta-analysis of rTMS-after-effects studies in the treatment of major depressive depression.

To quote Ridding et al. “rTMS is unlikely to restore function to specific sets of synaptic connections that are affected by disease or injury because TMS is too non-specific in its action on populations of neurons, both at the site of stimulation and at a distance. However, it might interact with some natural process and lead to restoration of normality in malfunctioning neural circuits. In this model, rTMS increases the ability of the brain to undergo compensatory changes that improve behaviours” [Ridding 2007].

However, a very recent study by [Leuchter 2013] suggested how rTMS may act in mood disorders. In most cases, patients with MDD show a high synchronisation of theta and alpha activity over most brain regions (Figure 3.10 A).



Table 3.4: The review of meta-analysis investigating the effects of rTMS on MDD [Ridding 2007].

Meta-analysis	Nr of studies	rTMS approach	Outcome measure	Analysis conclusion
[Couturier 2005]	6	Randomized sham-controlled trials using Left DLPFC rTMS	Change in HDRS	Suggests rTMS no better than sham
[Martin 2003]	14	Most (13 out of 14 studies) used high frequency Left DLPFC and sham control	Change in HDRS	Real rTMS significantly greater effect than sham on HDRS when applied for 2 weeks (but not 1 week). No significant difference for BDI
[Kozel 2002]	12	Randomized sham-controlled trials involving Left DLPFC rTMS	Change in HDRS	Real rTMS led to small but significantly greater effect than sham
[Burt 2002]	16	Randomized controlled (sham or other control) trials predominantly involving Left/Right DLPFC	Change in HDRS	Real rTMS significantly better than sham. Improvement in HAM-D of 20%. Doubtful clinical significance
[Holtzheimer 2001]	12	Most (11/12) used Left DLPFC and sham control	Change in HDRS	Real rTMS significantly better than sham. However, clinical significance considered only modest

BDI - Beck depression inventory; DLPFC - dorsolateral prefrontal cortex; HDRS - Hamilton Rating Scale for Depression.

Leuchter and coworkers proposed the hypothesis that repetitive magnetic pulses entrain oscillation at the frequency of the stimuli, thereby reset cortical and thalamo-cortical oscillators facilitating the resumption of normal brain activity [Paus 2001, Fuggetta 2005, Fuggetta 2008, Leuchter 2013] (Figure 3.10 B). However, as [Leuchter 2013] wrote, to maintain the resetting effect, multiple treatments over time are crucial. As they showed, rTMS seems to work in the entire spectrum of frequency oscillations, consisting in beta and gamma activity in the frontal cortex, beta in parietal cortex, and alpha in the occipital cortex (Figure 3.10 C).

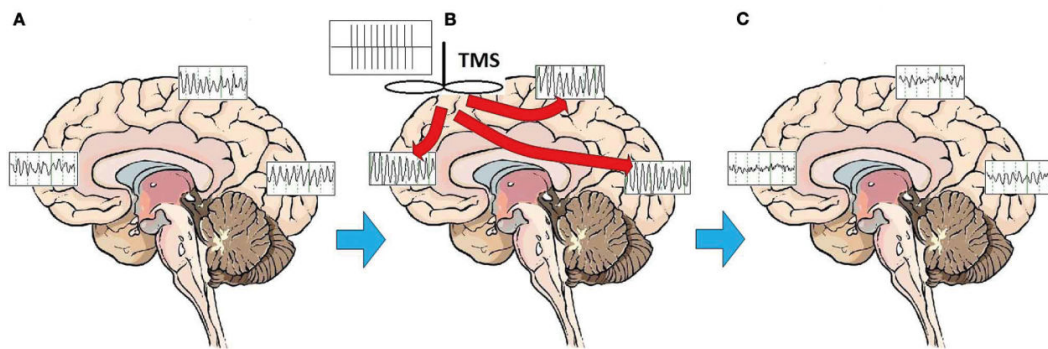

Figure 3.10: Effects of rTMS on the brain activity (description in the text) [Leuchter 2013].

### 3.7.2 TMS in the treatment of BP depression

Bipolar disorder is a chronic, severe and often life-threatening disorder which affects approximately 1-3% of the population causing substantial psychosocial morbidity [Goodwin 1990]. The therapy of BP depression consists mainly of antidepressants during the depressive phase of the illness. Moreover, pharmacological treatment is not efficient for many patients.

Although rTMS has been widely tested as a treatment of MDD, it has been poorly investigated in BP. Two small randomized controlled trials [Dolberg 2002, Nahas 2003] and one open study [Dell’Osso 2009] have tested the efficacy of rTMS in BP depression therapy.

The study on Nahas et al. [Nahas 2003] was a 2-week study on 23 subjects assigned to either sham treatment or rTMS (left prefrontal stimulation at 5 Hz, 110% motor threshold for 8 s, with an off period of 22 s, and a 20-min session

duration). They did not manage to find statistically significant TMS clinical antidepressant effects greater than sham. However, the results of the active TMS indicated a trend towards an improvement in mood-related symptoms. Another sham-controlled research of Dolberg and coworkers [Dolberg 2002] included 20 patients, where 10 patients received 20 sessions of active rTMS (real group) and 10 patients received 10 sessions of sham-rTMS followed by 20 sessions of rTMS (control group). The results showed statistically significant improvement in depression rating scales in the real-group compared with the control group at week 2.

A more recent paper studying rTMS as the depression treatment was published by [Dell’Osso 2009]. They investigated the efficacy of 1-Hz navigation-guided rTMS of right DLPFC as a supplement to mood stabilizers in eleven subjects with bipolar I or bipolar II disorder and major depressive episode who did not respond to previous pharmacological treatment. The results showed that rTMS was effective and well tolerated in this small sample of drug-resistant bipolar depressive patients.

Additionally, Harel and coworkers [Harel 2011] analysed the usefulness of H1-Coil rTMS as an adjuvant treatment to mood stabilizers and antidepressants for BP disorder. A significant mean decrease from baseline in the Hamilton depression rating scale (HDRS) score was observed a week after the last treatment session. They suggested that add-on H1-coil rTMS treatment protocol in BP subjects can help to improve bipolar depression symptoms.

### 3.8 Conclusions

Although some studies have shown that rTMS has very little advantage over sham stimulation, there is convincing statistical evidence for rTMS as the antidepressant treatment with a substantial proportion of patients achieving a treatment response. Numerous researchers have provided several plausible hypotheses for the antidepressant effects of rTMS. Furthermore, clinical trials have proved rTMS to be safe when delivered within recommended parameter guidelines [Groppa 2012]. Interestingly, the most optimal combination of rTMS parameters to maximize the therapeutic effects is still not established and leaves a wide scope of research for

further studies.

It should also be noted that the lack of minor therapeutic effects reported in some of reviewed papers [George 1999, Loo 1999, Padberg 1999, Martin 2003, Miniussi 2005] might be explained by not having stimulated the intended area of the DLPFC. These studies used standard procedure for coil placement and rTMS could be performed at cortical sites that were not involved in the pathologic processes of depression [Herwig 2001a].

# Résumé du Chapitre 4

Dans le dernier chapitre de l'introduction, je présenterai un résumé de la rTMS, de l'EEG et de la dépression. Je décrirai les défis que représente l'enregistrement simultané de l'EEG et de la rTMS, les changements d'EEG liés aux troubles de l'humeur et l'utilité des mesures d'EEG comme potentiel biomarqueur d'efficacité thérapeutique.

# rTMS, EEG and depression

---

## Contents

---

<b>4.1</b>	<b>Introduction</b>	<b>57</b>
<b>4.2</b>	<b>Challenges of EEG-rTMS co-registration</b>	<b>58</b>
<b>4.3</b>	<b>EEG changes correlated with mood disorders</b>	<b>59</b>
4.3.1	Quantitative electroencephalography	59
4.3.2	Depressed vs. healthy brain	61
4.3.3	EEG as the predictor of depression treatment	63
<b>4.4</b>	<b>Conclusions</b>	<b>65</b>

---

## 4.1 Introduction

In 1997, Ilmoniemi with coworkers [Ilmoniemi 1997] first introduced measurements of complete scalp distribution of event-related potentials (ERPs) following TMS with an EEG amplifier specially designed to work in the presence of huge gradients of magnetic field, such as those produced by TMS. Since then, EEG-TMS co-registration is used to assess local and distant response of the brain to the stimulation. Moreover, EEG allows to investigate the pathophysiology of neuropsychiatric disorders and, additionally, short- and long-term rTMS-after-effects can be evaluated from EEG changes following TMS [Komssi 2006, Miniussi 2010]. Additionally, thanks to EEG it is possible to study the TMS-evoked activity not only from motor cortex but also from other brain regions. Theoretically complex brain networks can be functionally and spatially characterised [Taylor 2008, Miniussi 2010]. However, even after the introduction of EEG systems which do not saturate in the presence

of high magnetic fields EEG-TMS co-registration remains technically challenging [Bonato 2006]. The questions about the best technical conditions of recording and, the most important about how long the rTMS-induced after-effects lasts are still unanswered.

## 4.2 Challenges of EEG-rTMS co-registration

In the first studies of TMS-evoked EEG responses conducted by [Cracco 1989] and [Amassian 1992], the induced currents produced large artefacts in the EEG leads [Ilmoniemi 2010]. In addition, using standard EEG systems with TMS, one need to be aware of amplifiers saturation. It takes hundreds of milliseconds for the amplifiers to recover from large induced electric signals, and to go back to the baseline. Furthermore, even after the recovery, recharging the capacitor of the TMS device for the next pulse may cause a significant artifact. In the first type of TMS-compatible EEG devices a delay circuit was inserted. A sample-and-hold circuit is an analog device that grab and hold the voltages of a continuously varying analog signal. A typical sample and hold circuit stores electric charge in a capacitor [Horowitz 2001]. These amplifiers did not eliminate the TMS-artefacts, but they remained operational and recorded clean EEG later, with a 30 to 1000 ms delay after the pulse [Wassermann 2008]. Recently, most commonly available EEG for TMS are modern direct current (DC) amplifiers that allow EEG recording at high sampling frequencies [Bonato 2006, Daskalakis 2008, Fitzgerald 2008, Fitzgerald 2009a]. The main point is that DC amplifiers do not have a high-pass filter, so they do not have to recover after the artefact. They also allow for continuous EEG recording during TMS without long-lasting or permanent amplifier saturation [Taylor 2008].

The next issue for EEG-rTMS co-registration is the use of suitable electrodes. These electrodes should be made from a suitable surface material, such as Ag/AgCl, be small to avoid heating which is proportional to the square of electrode diameter and to the square of TMS intensity. Also, the electrical contact with the scalp is crucial for high-quality EEG-TMS recordings. This step requires cautious preparation of the skin surface, before inserting a conductive electrode paste. It is necessary

to clean the skin with alcohol directly underneath the recording electrodes. Then, the impedance must be checked for all of the electrodes, and kept as low as possible, because the higher impedance the longer TMS-artefacts.

When studying TMS-evoked brain activity, like ERP, one must keep in mind that a loud click sound from TMS and skin sensations produces auditory and somatosensory responses, respectively. These responses may mistakenly be interpreted as TMS-ERP [Wassermann 2008]. However, this is not an issue in the present work, where only pre- and post-stimulus recordings were analysed.

The exact position of TMS coil is also very important. To be sure where exactly the stimulation is delivered, it is worth of using a neuronavigation technique. Targeting rTMS and neuronavigation system were described in section 3.3.

Although recording of TMS-evoked responses remains technically challenging, it is possible to obtain interpretable data. EEG-TMS studies give novel insights into underlying physiological TMS-after-effects and allow to study the fundamental aspects of brain network dynamics in healthy and diseased brain [Ilmoniemi 2010, Thut 2010, Dayan 2013].

## 4.3 EEG changes correlated with mood disorders

### 4.3.1 Quantitative electroencephalography

Quantitative electroencephalography (qEEG) has been defined as a numerical analysis of raw EEG data. This method provides more detailed information about brain activity than visual interpretation of EEG [Leuchter 1994].

The basic values which are calculated in qEEG analysis are total, absolute and relative power of recorded signals. If  $a_{s(f)}$  represents the absolute power at single electrode  $s$  in frequency band  $f$ , then a total power at the electrode  $s$  is defined as a summary of power across the frequency spectrum:

$$T_s = \sum_f a_{s(f)} \quad (4.1)$$

Then, relative power is calculated on the basis of the absolute and total power



values:

$$r_{s(f)} = \frac{a_{s(f)}}{T_s} \quad (4.2)$$

In 1994, Leuchter with coworkers introduced a new measure called *cordance*. It is a qEEG technique which combines absolute and relative power of EEG spectra, characterizing both the magnitude of and the relationship between absolute and relative power at each recording electrode [Leuchter 1994]. The first step to compute the cordance is calculation of relative power in each frequency band. Then, it is necessary to relate power from one electrode to all recording sites. To do that we need to defined the maximum absolute and relative values  $AMAX_f$  and  $RMAX_f$ , respectively, in each frequency band. These maximum values are used to normalise the absolute and relative power at each electrode for each frequency band:

$$a_{NORMs(f)} = \frac{a_{s(f)}}{AMAX_s} \quad (4.3)$$

$$r_{NORMs(f)} = \frac{r_{s(f)}}{RMAX_s} \quad (4.4)$$

The next step is to subtract the half-maximal values on the normalised scale from  $a_{NORM(s,f)}$  and  $r_{NORM(s,f)}$  (this half-maximal value is used to as an arbitrary cutoff). If  $a_{NORM(s,f)} - 0.5 < 0$  and  $r_{NORM(s,f)} - 0.5 > 0$ , then this electrode  $s$  is determined to show *discordance* in that frequency band. On contrary, if both absolute and relative power are greater than the half-maximal value, then the recording site is determined to represent concordance in that frequency. If  $r_{NORM(s,f)} \leq 0.5$ , the electrode is neither concordant nor discordant and has a cordance value of zero. The absolute values of explained above differences are summed to calculate the *cordance magnitude*:

$$CORDANCE_{s,f} = \pm(|a_{NORM(s,f)} - 0.5| + |r_{NORM(s,f)} - 0.5|) \quad (4.5)$$

In this study Leuchter investigated MRI, PET and SPECT scans from groups of subjects with brain diseases which cause cortical deafferentation. On that basis they suggested that areas with high perfusion or metabolism are characterised

by concordance, whereas discordance is found over areas with low perfusion or metabolism [Leuchter 1994, Leuchter 1999]. Application of concordance as a predictor of depression treatment will be mentioned in the following 4.3.3 section.

### 4.3.2 Depressed vs. healthy brain

A lot of brain areas are involved in emotion and mood disorders. The neural pathways responsible for emotion include the dorsolateral and ventromedial prefrontal cortex, temporal and parietal cortex, nucleus accumbens, basal ganglia, amygdala and hippocampus [Begic 2011, Deslandes 2008]. Although it is not typically used to diagnose depression, EEG has been used to study how depression affects brain's function and to follow changes in the brain activity during antidepressant treatment.

The last twenty years of research resulted in many reports about the clinical usefulness of the EEG in the diagnosis of psychiatric disorders. Additionally, nowadays, EEG is used to search for disease-specific biomarkers in MDD and BP disorders. The aim is to find objective biomarkers of treatment response, which could distinguish between responders and non-responders for a treatment, or identify those at greater risk for relapse [Iosifescu 2011]. The ability to predict response to the treatment before, or just after the new treatment is initiated, would significantly improve the therapy selection process and has important increase in the efficacy of the therapy (*i.e.* antidepressant therapy, rTMS or ECT).

EEG brought important information about depression. Different studies have found that typically 20% to 40% of depressed patients have EEG abnormalities, but with several characteristics and controversial patterns [Coburn 2006]. Moreover, up to 80% of psychiatric patients present various qEEG abnormalities on contrary to only 10% of healthy subjects [Begic 2011, Coburn 2006].

Quantitative studies of resting EEG in elderly depressed patients with mild cognitive deficits found that the mean power of delta and theta waves was significantly higher than in the patients without cognitive impairment. Moreover, total delta power was negatively correlated with cognitive performance [Adler 1999]. Pollock and Schneider [Pollock 1990] used measures of the absolute and relative

amplitude of EEG to compare elderly patients with major depression to healthy control subjects. They observed significantly higher absolute alpha amplitude in patients than in controls, but without regional differences. Relative alpha amplitudes, absolute and relative measures of beta, delta, and theta did not definitely distinguish depressed and control subjects. A quantitative spectral analysis of EEG was also performed by [Coutin-Churchman 2003] where different psychiatric disorders were tested. Importantly, this study took into account BP patients, and the results showed decrease in absolute and relative power of slow bands with increase in beta band. Unfortunately, EEG studies on bipolar depression are very limited [Coutin-Churchman 2003, Micoulaud-Franchi 2012].

Sleep abnormalities occur in more than half of depressed patients. These aberrations include polysomnographic features of sleep continuity disturbance, reduced non-REM (NREM) stages 3 and 4 sleep, decreased REM latency, increased phasic REM activity and increased duration of REM sleep early in the night [Pfurtscheller 1999].

Measuring absolute and relative power, inter- and intra-hemispheric power ratios, mean frequency, and both inter and intra-hemispheric coherence indices of resting EEG recordings of unipolar major depressive disorder male outpatients and healthy controls, Knott and colleagues [Knott 2001] observed increased relative and absolute beta power and higher mean frequency at bilateral frontal regions in depressed patients than in controls. The inter-hemispheric alpha power asymmetry was noted in controls, showing relative right anterior hemispheric hypoactivation. Reduction of intra-hemispheric asymmetry of theta power was exhibited bilaterally at all regions and beta power asymmetry was observed only in the right hemisphere in patients. Moreover, in each band, patients exhibited reduced inter-hemispheric coherence values for delta, theta, alpha and beta.

Moreover, recent studies reported asymmetry in EEG activity over frontal regions in depression. Debener and coworkers [Debener 2000] studied resting EEG alpha (8-13 Hz) asymmetry in 15 clinically depressed patients and 22 healthy adults and observed difference between two groups in frontal EEG asymmetry. It was suggested that increased frontal EEG asymmetry may be a characteristic feature for

depression and be the marker for depression. They assumed that left hemisphere activation is linked to positive emotion and right hemisphere activation to negative affect. Although resting frontal EEG alpha asymmetry has been shown to be a stable measure over time in nonclinical populations, its reliability and stability in clinically depressed individuals has not been fully investigated. Decreased left frontal activity, inferred by relatively higher left than right alpha band activity, appeared to characterise individuals with major depression [Allen 2004]. This study tested resting EEG alpha asymmetry in a group of 30 women diagnosed with major depression at 4-week intervals for 8 or 16 weeks. Asymmetry scores displayed good internal consistency and exhibited modest stability over the 8- and 16-week assessment intervals. These findings suggest that resting EEG alpha asymmetry can be reliably assessed in clinically depressed populations. In a study by [Vuga 2006], resting EEG was recorded in 49 adults with a history of unipolar depression and 50 controls with no history of major psychopathology across a 1- to 3-year interval. As in the previous studies, frontal EEG asymmetry in alpha range was observed and moderately stable across time intervals. Likewise to , the magnitude of frontal EEG asymmetry was uncorrelated with depressive symptom severity.

Both studies [Allen 2004, Vuga 2006] indicate that EEG activity in individuals with MDD reveals left-right asymmetry of combined theta and alpha power, and changes in frontal regions. In the following section I review findings regarding the EEG as the predictor of depression treatment outcome.

### 4.3.3 EEG as the predictor of depression treatment

One of possible predictors of treatment outcome in MDD and BP are changes in the alpha and theta bands. Almost 20 years ago, Ulrich with coworkers [Ulrich 1984] observed differences between 20 responders and 20 non-responders after 4 weeks of treatment with tricyclic antidepressants (TCAs). Left lateralization of alpha power at baseline and decreased in absolute alpha power from baseline to week 4 was reported in responders with endogenous depression. The same group, in a follow-up study, found that early changes in alpha oscillations after the first dose of antidepressants were associated with treatment response at three weeks

[Ulrich 1988, Ulrich 1994]. Another group, Knott and colleagues [Knott 1996], studied 29 patients with unipolar depression treated with imipramine (belongs to TCAs group) for six weeks, discovered increased alpha power in responders compared to non-responders, but the differences were not statistically significant. In contrary, baseline theta activity in responders was significantly lower than in non-responders. In another study [Knott 2000] of 70 MDD patients, responders showed increase in baseline alpha power. Moreover responders showed greater theta activity and lower beta activity at frontal recording sites. More recent study of Iosifescu and coworkers [Iosifescu 2009] reported that frontal relative theta power at baseline and at week 1 were significant predictors of treatment response to open-label SSRIs in major depressive disorder. Baseline relative theta power was lower in responders, predicting treatment response.

Alpha asymmetry between brain hemispheres recorded at baseline also differentiated responders from non-responders. Bruder and colleagues [Bruder 2001] noticed that non-responders to fluoxetine showed higher activation of alpha waves over the right hemisphere, but responders did not. Alpha asymmetry was a significant predictor of treatment outcome. Seven years later the same group observed that responders to fluoxetine (antidepressant of the serotonin reuptake inhibitor (SSRI) class) had greater alpha power compared with non-responders and healthy control subjects, with largest differences at occipital sites where alpha was largest [Bruder 2008]. There were also differences in alpha asymmetry between responders and non-responders at occipital sites. Responders showed greater alpha (less activity) over right, versus left, hemisphere, whereas non-responders tended to show the opposite pattern.

Hunter with colleagues [Hunter 2007] used qEEG to predict end-of-trial outcomes within the first week of a treatment. Early changes in prefrontal theta cordance, in particular, have been associated with endpoint response and remission in double blind placebo-controlled trials [Cook 2002, Leuchter 2008] and have been found to predict antidepressant response across independent research institutions [Bares 2007, Bares 2008]. Mentioned researches indicated that MDD subjects treated with various antidepressant medications, decrease in prefrontal theta

cordance one week after the beginning of the treatment. It has consistently predicted response to the treatment with overall accuracy ranging from 72% to 88% [Iosifescu 2011].

As it was shown, there is a lot of studies of EEG as the predictor of pharmacological antidepressant treatment. Unfortunately, little is known on the predictive value of EEG regarding the therapeutic response to rTMS in depression. Recently, [Micoulaud-Franchi 2012] analysed 13 MDD and 8 BP patients to study the responses of depressed patients to the therapeutic rTMS. They investigated Spearman correlations between pretreatment alpha band power in eight regions of analysis and absolute improvement in Beck Depression Inventory Short Form ( $\Delta$ BDI-SF). In agreement with [Price 2008], they found that changes of alpha band power between the baseline and the end of high frequency (10 Hz) rTMS therapy in the left DLPFC negatively correlated in the left and right parieto-temporal regions with changes of mood of MDD and BP patients, as assessed with  $\Delta$ BDI-SF. To conclude, it was suggested that alpha activity could be used as a marker of response to rTMS.

## 4.4 Conclusions

Although the reviewed studies showed the usefulness of EEG as a potential predictor of antidepressant therapy response, there are only few about the correlation between pretreatment brain oscillations and the outcome of rTMS therapy. In the next chapter of this manuscript I will present the results of the EEG-rTMS co-registration on healthy participants and depressed patients in the form of two scientific reports. The aim was to find what kind of perturbation rTMS induces on healthy brain, and whether resting state EEG can be used to predict the response to therapeutic rTMS stimulation. In addition, an analysis to distinguish BP and MDD patients was performed.

The next chapter describes the methods used in these two studies.

# Résumé du Chapitre 5

Dans le dernier chapitre de l'introduction, je présenterai un résumé de la rTMS, de l'EEG et de la dépression. Je décrirai les défis que représente l'enregistrement simultané de l'EEG et de la rTMS, les changements d'EEG liés aux troubles de l'humeur et l'utilité des mesures d'EEG comme potentiel biomarqueur d'efficacité thérapeutique.

# General methods

---

## Contents

---

<b>5.1</b>	<b>Participants, instrumentation and methodology . . . . .</b>	<b>67</b>
5.1.1	Participants . . . . .	67
5.1.2	rTMS methodology . . . . .	70
5.1.3	Self-evaluation of mood changes . . . . .	72
5.1.4	EEG acquisition and pre-processing . . . . .	72
5.1.5	EEG spectral analysis at the scalp and cortex levels . . . . .	74
5.1.6	Statistical analyses . . . . .	76

---

In the following sections I will describe the experimental design used in this study. I will characterize the groups of participant, both healthy and depressed (with BP depression and MDD), who underwent the EEG-rTMS co-registration. Although, I will not focus on detailed description of used rTMS parameters, because it has already been explained in the previous section 3.5.

## 5.1 Participants, instrumentation and methodology

### 5.1.1 Participants

The study was approved by the regional ethical committee of Grenoble University Hospital (CPP Sud-Est I, ID RCB: 2011-A00114-37). All participants (patients and healthy subjects, Table 5.1) were evaluated by a licensed psychiatrist (Dr David Szekely) following an interview process. A written informed consent to participate in the study was obtained from all subjects.



In the first experimental study, twenty *healthy volunteers* (10 males, 10 females), aged 21 to 60 (mean  $31.2 \pm 10.3$  years) were enrolled for five rTMS sessions with concurrent EEG recordings. Two successive experimental sessions in the same subject were separated by at least 1 week and up to 10 days. All sessions for a given subject were performed under identical conditions, at the same time of the day. Three subjects were left-handed as assessed by the Edinburgh handedness inventory [Oldfield 1971]. None had neurological or psychological disorder or any contraindication for TMS. All subjects were familiarized with the TMS and the experimental protocol, but none of them had received rTMS previously.

In the second experimental study, eighteen right-handed [Oldfield 1971] *patients* who met Diagnostic and Statistical Manual of Mental Disorder 4th ed. (DSM-IV) criteria for Major Depressive Episode participated in the study. Eight *MDD* patients (6 females, age range 44-64, mean  $52.1 \pm 7.8$ ) and ten *BP* patients (6 females, age range 32-69, mean  $48.7 \pm 12.6$ ) according to the DSM-IV criteria [APA 2000] were recruited from the Psychiatry Department of Grenoble University Hospital. Inclusion criteria included nonresponse to pharmacological treatment of depression using a minimum of two distinctly different classes of antidepressant medications for actual depressive episode (appropriate doses and duration) occurring at the time of enrolment or earlier. Exclusion criteria included age under 18 years, drug abuse, current comorbid major mental disorders assessed by clinical examination, neurological illness or convulsive disorders, and previous ECT treatments. All patients were on a range of medications. For bipolar patients, mood stabilizer medication has been unmodified for at least two weeks prior to the entry in the study, and remained unchanged throughout the course of the study. No benzodiazepines were administered two weeks before and during rTMS treatment. For MDD patients, pre-treatment with an antidepressant and/or mood stabilizer medication has been unmodified for at least four weeks prior to the entry in the study, and remained unchanged throughout the course of the study. Only cyanemazine and hydroxyzine were tolerated during the study.

Demographics characteristics (gender and age) and clinical characteristics (illness and episode duration, depression severity) using Montgomery Asberg De-

pression Rate Scale (MADRS) [Montgomery 1979], 13-item Beck Depression Inventory (BDI-Short Form) [Collet 1986, Bouvard 1992, Beck 1996] and Clinical Global Impression (CGI) were evaluated for each patient. For bipolar patients, manic or mixed symptoms were evaluated with Young Mania Rating Scale (YMRS) [Young 1978]. All patients were assessed at inclusion, before the first EEG recording and after each 5 rTMS sessions by the same senior psychiatrist. The response to rTMS treatment was defined as at least 50% reduction of the baseline MADRS scores. Patients were qualified as remitters when MADRS score was less than 8. If YMRS was more than 15, at inclusion or during the course of rTMS treatment, patients were excluded from the trial. The absolute changes in MADRS scores ( $\Delta$ MADRS) between baseline and the end of rTMS (4 weeks after the first evaluation) were used to calculate clinical improvement and then, correlated with EEG power in each frequency band.

Seventeen out of twenty healthy volunteers (9 females, 8 males), aged 21 to 60 (mean  $31.2 \pm 10.3$  years), with no history of any neurological or psychological disorder or any contraindication for TMS were chosen to be used as controls. This cohort of healthy controls was taken from the first experimental study of this thesis. EEG signals of control participants were recorded under the same conditions as in patients, but with no TMS pulses actually delivered.

Demographic features of the three subject groups and the corresponding statistical results are presented in Table 5.1

Table 5.1: Demographic features.

	HC	MDD	BP
	n=20	n=8	n=10
Mean age (years)	$31.2 \pm 10.3$	$52.1 \pm 7.8$	$48.7 \pm 12.6$
Gender (male/female)	10/10	2/6	4/6
MADRS at baseline	-	$24.6 \pm 9.3$	$23.6 \pm 3.2$
Duration of illness	-	$10.3 \pm 6.4$	$18.9 \pm 10.9$

### 5.1.2 rTMS methodology

At the first rTMS/EEG session, the resting motor threshold (RMT) of the right thumb abductor was determined by delivering single TMS pulses to the left motor cortex with pre-gelled surface electrodes connected to an electromyographic (EMG) amplifier (MEP Monitor, Tonika Elektronik A/S, Denmark). The motor threshold was defined as the minimum stimulation intensity capable to induce at least 5 motor evoked potentials of at least 50  $\mu V$  peak-to-peak amplitude in 10 single TMS stimulations [Pascual-Leone 1996].

During rTMS treatment, the stimulation was guided by a neuronavigation system (Premium Edition, Localite GmbH, Germany) to precisely define the neuroanatomical target of TMS from a T1-weighted magnetic resonance image (MRI) of patient's brain [Herwig 2001b] (the procedure has been described in the section 3.3). The TMS coil was then positioned in every session over the left DLPFC target point, defined as the intersection between Brodmann areas 9 and 46 along the middle frontal gyrus. Active rTMS was performed using a MagPro X100 TMS stimulator (Tonika Elektronik A/S, Denmark) with butterfly coil MCF-B65 for healthy participants or MCF-B65-cooled coil for patients (Tonika Elektronik A/S, Denmark). The coil was placed tangentially to the scalp to produce the highest level of the stimulation on the cortical region parallel to the coil [Chen 2003]. The handle was placed backward and laterally, approximately at 45° from the midline perpendicular to the central sulcus. In case of head movement during the experiment, the coil was manually repositioned to its initial position.

#### *Healthy controls*

In addition to active stimulation, healthy volunteers underwent sham-1 Hz stimulation. In sham rTMS condition, a MCF-P-B65 Placebo coil (Tonika Elektronik A/S, Denmark) was used to reduce the emitted magnetic field by approximately 80% with identical sound level and mechanical outline as with active MCF-B65 coil.

Repetitive TMS protocols (1 Hz, 10 Hz, iTBS, cTBS, Sham-1 Hz) were constructed following the safety guidelines of the International Society of Transcranial

Stimulation (ISTS) [Rossi 2009]. They all included between 792 and 800 pulses distributed into four periods for a total duration of 15 min. Inter-trains were included in between stimulation periods to homogenise total duration of every protocol (Figure 5.1). Stimulation amplitude was 80% of RMT for cTBS and iTBS protocols, 120% of RMT for 1 Hz and 10 Hz protocols, and 24% (including coil attenuation) for sham-1 Hz protocol. Protocol order was randomly distributed between subjects, and subjects were not told about which protocol was used at the time of recording.

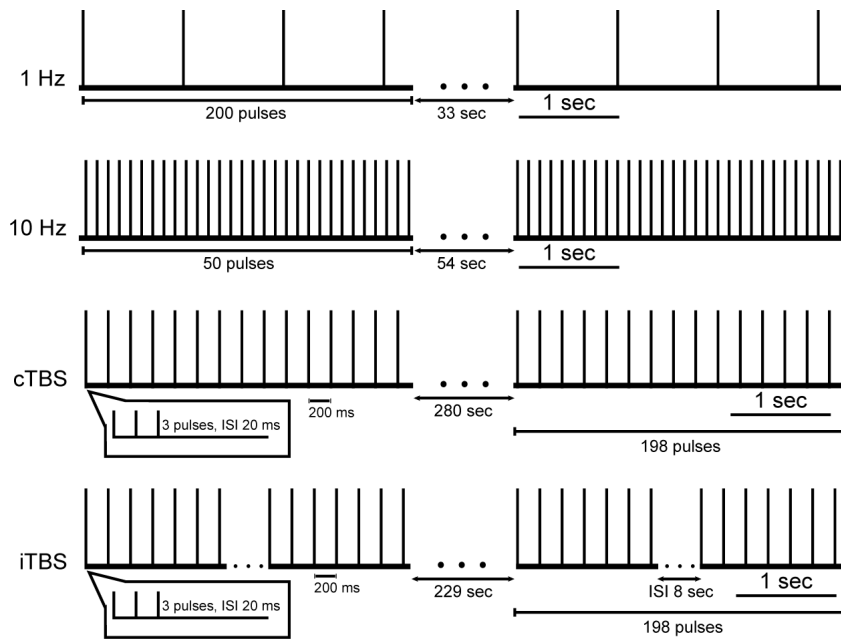

Figure 5.1: Description of rTMS protocols: 1 Hz and 10 Hz stimulations have identical intervals between trains of pulses. In TBS protocols, three pulses of stimulation are given with 20 ms interstimulus interval (ISI), repeated every 200 ms. In cTBS, 4 trains with 198 pulses each one were given with 280 s interval between successive trains. In iTBS, a 2 s train was repeated every 8 s, which was then repeated 6 times for a total number of 198 pulses train with an interval of 229 s between successive long train.

### *Patients*

Repetitive TMS was delivered using the standard procedure of depression treatment at Grenoble University Hospital. Left DLPFC was stimulated at a frequency of 10 Hz in 5-second trains at 120% of the estimated RMT. Forty trains were given in each session (2000 pulses per session) with a 25-second intertrain interval. Twenty

sessions were administrated within a 4-week period.

### 5.1.3 Self-evaluation of mood changes

A visual analogue scale (VAS) was used to proceed to a subjective assessment of mood changes by every participant during the few hours following each rTMS session, both for healthy volunteers and patients. The VAS consisted of 10 cm horizontal lines with anchors at both poles and indicating mood changes from happy / unhappy, joyful / sad, relaxed / tense, calm / excited, vivid / gloomy, smiling / serious. During the evening of the rTMS day, participants were asked to mark those 6 items between -5 and 5. The exact form used in these experiments is presented on Figure 5.2. A positive/negative score reflected a positive/negative valence of mood alteration. The sum over items was used to parsimoniously quantify mood changes (score range from -30 to 30).

### 5.1.4 EEG acquisition and pre-processing

Subjects were seated in a reclining armchair with neck and back supported with a pillow, arms relaxed and eyes closed. EEG was recorded before the first TMS pulse, then during stimulation and after the last pulse. Each of three recordings lasted 15 minutes. Healthy subjects underwent five separated rTMS-EEG sessions, whereas patients underwent three EEG recordings performed at the first TMS session, in the middle TMS session (2 weeks after inclusion) and during the last, 4 weeks after inclusion.

EEG signals were recorded with a 64-channel elastic cap with Ag/AgCl electrodes positioned at the beginning of the experimental session according to the 10-20 system (Fast'n'Easy cap, Brain Products GmbH, Munich, Germany) and connected to TMS-compatible DC amplifiers (BrainAmp, Brain Products GmbH, Munich, Germany). Right eye vertical movements were recorded with one electro-oculogram (EOG) electrode. Electrode impedances were kept below 10  $k\Omega$  using conduction gel. Recordings were made with a referential montage, where the reference electrode was placed just anterior to Fz, and the ground electrode just posterior

Nom et prénom:

Date de naissance:

Date à laquelle le questionnaire est rempli:

### Echelle analogique visuelle (EVA)

Notez le point correspondant à la perception de votre état actuel. Zéro „0” signifie l'état qui n'a pas été modifié par TMS.

Ce formulaire doit être renseigné la journée qui suit la séance de rTMS.

<b>Malheureux</b>		<b>Heureux</b>
	○ ○ ○ ○ ○ ○ ○ ○ ○ ○ ○ -5 -4 -3 -2 -1 0 1 2 3 4 5	
<b>Triste</b>		<b>Joyeux</b>
	○ ○ ○ ○ ○ ○ ○ ○ ○ ○ ○ -5 -4 -3 -2 -1 0 1 2 3 4 5	
<b>Mou</b>		<b>Tonique</b>
	○ ○ ○ ○ ○ ○ ○ ○ ○ ○ ○ -5 -4 -3 -2 -1 0 1 2 3 4 5	
<b>Calme</b>		<b>Agité</b>
	○ ○ ○ ○ ○ ○ ○ ○ ○ ○ ○ -5 -4 -3 -2 -1 0 1 2 3 4 5	
<b>Morne</b>		<b>Vivant</b>
	○ ○ ○ ○ ○ ○ ○ ○ ○ ○ ○ -5 -4 -3 -2 -1 0 1 2 3 4 5	
<b>Sérieux</b>		<b>Souriant</b>
	○ ○ ○ ○ ○ ○ ○ ○ ○ ○ ○ -5 -4 -3 -2 -1 0 1 2 3 4 5	

Figure 5.2: Visual analogue scale.

to Fz. The EEG amplifier was used in DC mode with a high frequency cut off at 1000 Hz and no additional online filtering. EEG data were digitized at 2500 Hz sampling frequency with 16-bit resolution. Positions of the 64 EEG electrodes and of the three fiducials (left and right tragus and nasion) were measured with the TMS neuronavigation system.

Only pre- and post-rTMS EEG recordings, which did not contain any artefact due the TMS pulses, were analysed. EEG data were pre-processed off-line in EEGlab [Delorme 2004] and SPM8 (Wellcome Trust Centre for Neuroimaging, University College London, UK) running in Matlab (The MathWorks, USA). Continuous recordings were first band-pass filtered between 1 and 45 Hz and down sampled at 128 Hz to speed up subsequent analyses. Time periods that contained large muscular and other non-stereotyped artefacts were then carefully pruned from the signals. Up to 5 bad channels per session were visually identified. This data selection was followed by an independent component analysis (ICA) to remove eye blinks and cardiac components from the EEG. After first decomposition and elimination of bad components, a second round of ICA filtering was performed as proposed in [Onton 2006]. The choice of bad components was based on visual inspection of the spatial and temporal patterns of every component. Finally, 10-minute cleaned EEG signals were re-referenced to the common average for scalp and source analyses, in accordance with the assumption made for EEG forward modelling of SPM8.

### 5.1.5 EEG spectral analysis at the scalp and cortex levels

The first 10 minutes of artefact-free signals for each condition were selected for further processing. They were segmented into 20-second successive epochs onto which fast Fourier transform (FFT) was applied to estimate spectral power for each electrode. Power spectrum was then averaged over frequencies in separate bands: delta (1-4 Hz), theta (3.5-7 Hz), alpha (7.5-13 Hz), low beta (14-22 Hz), high beta (22-30 Hz) and gamma (30-45 Hz). To analyse patients data, only one beta band was used (14-30 Hz). For statistical analyses in SPM8, spectral power of each frequency band and each time bin was converted into a scalp map (128x128 pixels) using a two-dimensional (2D) spatial linear interpolation. Those maps were

smoothed with a Gaussian kernel of 5 mm full width half maximum (FWHM) to conform to assumptions of subsequent statistical analysis and to diminish inter-subject variability.

To reconstruct cortical current source densities, the procedure proposed in Litvak and Friston [Litvak 2008] was used. The canonical mesh at standard spatial resolution (8196 sources) was warped to each subject’s anatomy. This step ensured that cortical activity was reconstructed in the same source space over subjects [Mattout 2007]. EEG electrodes were repositioned in subject’s MRI space with rigid co-registration using the coordinates of the three fiducials (left ear, nasion, right ear) and spatial projection of the electrode coordinates to the closest scalp points. Then, a boundary element method (BEM) head model was used to compute the forward operator that encodes the lead field of each cortical source. Finally, an image of cortical power was produced every 20 s of the 10 min selected scalp data using the following steps:

1. Each 20 s time-window was epoched into ten successive time windows of 2 s duration.
2. Induced cortical power was estimated from the 10 small time windows using the inverse procedure of [Litvak 2008], based on a hierarchical model with multiple sparse priors for EEG source reconstruction [Friston 2008] and empirical priors that force uniformity of source reconstruction over epochs. The “independent and identically distributed” (IID) option for spatial priors in SPM8 was used, which corresponds to a minimum norm-like inverse solution described in the section 2.4.2.
3. The image of cortical power for every frequency band of interest was created using a contrast that did a band-pass filtering.
4. Finally, images of cortical power were smoothed with an isotropic Gaussian kernel of 8 mm FWHM.



### 5.1.6 Statistical analyses

Statistical analyses of spectral power images were separated into first level (subject level) and second level (group level) analyses. The statistical design of those analyses was similar between scalp and cortical images for both, healthy controls and patients. Subject level analysis consisted of a one sample t-test for each recording session that allowed to obtain an image of the mean activity for recording session applying the contrast “1” on the parameter estimates, as usual in SPM8. Those images were used as input data to the second level analyses performed separately in two following experimental designs.

#### Healthy controls

A 5x2 analysis of variance (ANOVA) over subject with 2 factors “rTMS protocol” (10Hz, 1Hz, iTBS, cTBS, sham) and “time condition” (pre- and post-rTMS) was used as a second level analysis. To identify significant effects of each active rTMS protocol as compared to sham stimulation, post hoc tests (Tukey HSD) were used. Because the effects of this 5x2 ANOVA were very much weighted by the sham condition, a 4x2 ANOVA using only active protocols was also run, in order to focus on interaction effects that identify regions that responded differently between active rTMS protocols. All ANOVAs were performed with adequate covariates to remove the mean of the data of each experimental session. For scalp analysis, the statistical threshold was set at  $p < 0.05$ , with correction for multiple comparisons by controlling the family wise error (FWE). For cortical sources, a less stringent threshold was applied ( $p < 0.001$ , uncorrected for multiple comparisons).

#### Patients

Firstly, a three-way analysis of variance (ANOVA) on baseline recordings over patients was used to assess significant changes during the treatment. The 3 factors were “Session” (session 1, 10 and 20), “Response” to treatment (responders vs. non-responders) and “Disease” (MDD vs. BP). Then, to be able to verify short-term changes in the brain plasticity, another three-way ANOVA was applied, using

baseline and post-stimulus recordings for MDD and BP patients separately. Here, the factors were: “Session”, “Response” and “Time” (pre-rTMS vs post-rTMS). To study the changes of oscillatory power after rTMS therapy, a three-way ANOVA with three factors: “Response”, “Disease” and “Therapy” (first pre-rTMS vs. last post-rTMS) was used. In case of a significant effects, post hoc tests (Tukey HSD) were performed. For scalp and cortical sources analysis, the statistical threshold was set at  $p < 0.05$ , with correction for multiple comparisons by controlling the family wise error (FWE).

# Résumé du Chapitre 6

Le chapitre suivant présente les résultats.

Dans un groupe de sujets sains, nous avons trouvé pour chaque protocole actif une diminution significative des puissances delta et thêta au niveau des électrodes préfrontales, principalement localisées dans le DLPFC gauche. Dans les bandes à plus haute fréquence (bêta et gamma), la diminution de la puissance dans le DLPFC a également été observée en contralatéral et dépendait du protocole de stimulation. Puisqu'une importante activité delta et thêta est généralement associée à une inhibition corticale, ces résultats suggèrent que la SMTr au niveau du DLPFC diminue de façon transitoire l'inhibition corticale locale. De plus, les oscillations EEG rapides sont associées à une excitabilité corticale et on peut en conclure que les diminutions observées dans l'activité rapide localisée au niveau du DLPFC suggèrent également une excitabilité corticale réduite, qui accompagne une diminution de l'inhibition corticale.

Dans la seconde expérience, conduite sur des patients déprimés, la découverte la plus importante est qu'il est possible de distinguer les sujets répondant au traitement SMTr des non répondants. Les patients répondants montrent une puissance significativement plus haute dans les fréquences basses. Par conséquent, une augmentation de la puissance alpha a été observée au niveau du cortex cingulaire ventral pour les deux groupes.

La comparaison entre les patients et les sujets sains a mis en évidence une plus haute activité des fréquences basses au niveau du lobe occipital pour les sujets sains que pour les patients. Les patients ont également montré une puissance accrue des bandes alpha dans les régions frontales et plus spécialement dans le DLPFC, de façon bilatérale. Une augmentation du rythme alpha peut s'expliquer par une association de la bande alpha avec une dysfonction thalamique et une perturbation de l'activité corticale. La comparaison entre la dépression majeure et les troubles bipolaires a révélé une activité plus importante dans les bandes thêta et bêta dans les patients bipolaires, principalement localisée au niveau du cortex préfrontal.

Les résultats de l'analyse de régression multiple ont révélé que la puissance de la bande alpha au niveau des régions fronto-temporales gauches était significativement et négativement corrélée avec  $\Delta$ MADRS. De plus, nous avons trouvé une corrélation positive entre  $\Delta$ MADRS et la puissance de la bande thêta dans les zones de la ligne médiane postérieure. Ceci suggère que les deux caractéristiques de l'EEG pourraient être utilisées comme marqueurs afin de prévoir le résultat de la SMTr.

# Results

---

## Contents

---

<b>6.1</b>	<b>Introduction</b>	<b>80</b>
<b>6.2</b>	<b>Paper I</b>	<b>80</b>
<b>6.3</b>	<b>Paper II</b>	<b>92</b>

---

## 6.1 Introduction

The aim of the first experimental part of this thesis was to investigate the modulations of healthy brain activity after different rTMS protocols. To do that there were four active rTMS protocols (1 Hz, 10 Hz, cTBS and iTBS) and sham condition applied. The results are presented in the following manuscript of the first submitted paper, under the title *“Changes of oscillatory brain activity induced by repetitive transcranial magnetic stimulation of the left dorsolateral prefrontal cortex in healthy subjects”*.

## 6.2 Paper I

**Changes of oscillatory brain activity induced by repetitive transcranial magnetic stimulation of the left dorsolateral prefrontal cortex in healthy subjects**

## Changes of oscillatory brain activity induced by repetitive transcranial magnetic stimulation of the left dorsolateral prefrontal cortex in healthy subjects

A. Woźniak-Kwaśniewska<sup>a,b</sup>, D. Szekely<sup>a,b,c</sup>, Pierre Aussedat<sup>a</sup>, Thierry Bougerol<sup>c</sup>, O. David<sup>a,b,\*</sup>

<sup>a</sup>Fonctions Cérébrales et Neuromodulation, Université Joseph Fourier, Grenoble, France

<sup>b</sup>Inserm, U836, Grenoble Institut des Neurosciences, Grenoble, France

<sup>c</sup>Clinique Universitaire de Psychiatrie, Pôle Psychiatrie Neurologie, Centre Hospitalier Universitaire, Grenoble, France

### Abstract

Repetitive transcranial magnetic stimulation (rTMS) modulates brain activity in different ways according to the stimulation parameters. Although the after-effects of rTMS over motor cortex are well documented in healthy individuals, less is known about the stimulation of dorso-lateral prefrontal cortex (DLPFC). Here, we studied in 20 healthy subjects how cortical oscillations are modulated by four different active rTMS protocols (1 Hz, 10 Hz, continuous and intermittent theta bursts - cTBS and iTBS) of the left DLPFC, and by a sham protocol used as a control condition, by comparing the spectral power of pre- and post-rTMS electroencephalographic (EEG) recordings of 15 minutes duration. EEG spectrum was estimated with the Fast Fourier transform (FFT) and partitioned using the common physiological frequency bands: delta (1-4 Hz), theta (3.5-7 Hz), alpha (7.5-13 Hz), low beta (14-22 Hz), high beta (22-30 Hz) and gamma (30-45 Hz). Statistical analyses of EEG changes induced by rTMS were computed with Statistical Parametric Mapping (SPM) for EEG, in every frequency band, at the scalp level and at the cortex level. We found for every active protocol a significant decrease of delta and theta power on left prefrontal electrodes, mainly localised in the left DLPFC. In higher frequency bands (beta and gamma), the decrease of power in the DLPFC was also observed in the contralateral DLPFC. Protocol-specific amplitude effects were also observed in the prefrontal cortex bilaterally in all frequency bands, but also in parietal and temporal regions in low EEG frequencies. In high frequencies, EEG power in the prefrontal cortex increased after rTMS for 10 Hz and iTBS protocols, but this effect did not survive the comparison to Sham responses. Because large delta and theta activity is usually associated with cortical inhibition, observed rTMS-induced EEG changes in low frequencies suggest that rTMS of DLPFC transiently decreases local cortical inhibition. Importantly, local responses take place in association with other unknown mechanisms that modulate inter-hemispheric connectivity between homologous regions, resulting in the increase or decrease of fast activity in each prefrontal lobe, depending on the stimulation protocol. Only decreases of fast activity following active rTMS could be detected as significant when compared to Sham stimulation.

**Keywords:** EEG, rTMS, dorsolateral prefrontal cortex, methods

### Introduction

Transcranial magnetic stimulation (TMS) uses a brief electric current passing through a magnetic coil positioned on the scalp to create a transient high-intensity magnetic field that focuses on the cortex and induces neuronal responses (Di Lazzaro et al., 2011; Hallett, 2007). The application of many pulses (repetitive TMS, rTMS) can modulate brain's activity during periods that outlast the stimulation time and is thus of potential interest for therapeutic applications, such as depression (Dell'Osso et al., 2009; George, 2010; Richieri et al., 2011), schizophrenia with auditory hallucinations (Hasan et al., 2013; Homan et al., 2012), migraines (Brigo et al., 2012; Magis et al., 2012) or stroke (Hummel et al., 2008; Jung et al., 2012).

It is supposed that the inhibitory and excitatory properties of rTMS protocols depend on the stimulation parameters, particularly the frequency of stimulation and the temporal structure of the paradigm, i.e. whether the series of pulses are applied continuously or not Classen and Stefan (2008). Those properties can be efficiently estimated when stimulating the motor cortex by recording motor evoked potentials on peripheral muscles. From such electromyographic (EMG) recordings, it has been shown that low-frequency stimulation ( $\leq 1\text{Hz}$ ) produces lasting decrease in motor cortex excitability, whereas high-frequency stimulation ( $\geq 5\text{Hz}$ ) induces facilitatory effects (Romero et al., 2002; Hayashi et al., 2004; Houdayer et al., 2008; Di Lazzaro et al., 2011; Noh et al., 2012). Similarly, theta burst stimulation (TBS, burst of three 50 Hz pulses repeated every 200 ms) is supposed to produce opposite neuronal after-effects depending whether bursts are applied continuously (cTBS, inhibitory) or intermittently (iTBS, excitatory) (Huang et al., 2005; Hoogendam et al., 2010). When stimulating outside the motor cortex, electroencephalographic (EEG) signals during or just following single pulse TMS provide similar valuable information

\*Corresponding author at:  
Grenoble Institut des Neurosciences - Chemin Fortun Ferrini - Bt EJ Safran -  
CHU 38700 La Tronche, France  
Tel: +33 4 56 52 05 86  
Fax: +33 4 56 52 05 98  
Email address: odavid@ujf-grenoble.fr (O. David)

about the changes in cortical activity, either locally or at remote locations from the site of stimulation (Ilmoniemi et al., 1997; Rosanova et al., 2009). Concerning rTMS, a recent review and meta-analysis of EEG/rTMS studies pointed out that it exists a certain degree of inter-study variability in the observed EEG after-effects (Thut and Pascual-Leone, 2010). In addition, the classical dichotomy between low vs. high frequency rTMS and inhibition vs. excitation has been challenged by a series of studies of EEG power changes following rTMS at different frequencies (1 Hz, 5 Hz, 20 Hz) that all showed increases of cortical motor oscillations in alpha and beta bands (Brignani et al., 2008; Fuggetta et al., 2008; Veniero et al., 2011). However, EEG oscillatory activity is only an indirect measure of inhibitory and excitatory properties of underlying neuronal networks. Still, from recordings in anesthetised animals combining extracellular and EEG recordings (Contreras and Steriade, 1995), it has been shown a direct correlation between low frequencies of EEG and hyperpolarisation waves, suggesting that amplitude of low frequency EEG positively correlate with large-scale neuronal inhibition. Importantly, it has also been shown that in the range of beta-gamma bands (20-80 Hz), oscillatory power was positively correlated with inhibitory transmission of fast-spiking cells (Cardin et al., 2009), making this band an indirect marker of local inhibition (see (Buzsaki and Wang, 2012)) for a recent review on the mechanisms of gamma oscillations).

Whereas rTMS of dorsolateral prefrontal cortex (DLPFC) is commonly used for treating depression (Avery et al., 2006; Fitzgerald et al., 2003; George et al., 2000, 1995; Pascual-Leone et al., 1996), only a limited number of studies performed in healthy subjects described brain's responses to this type of stimulation (Graf et al., 2001; Griskova et al., 2007; Grossheinrich et al., 2009; Okamura et al., 2001). While the responses to motor cortex rTMS are relatively consistent across studies in healthy controls, it is not the case for DLPFC rTMS because of the heterogeneity of the population samples and of the experimental design. The main experimental factors that introduced variability in reported rTMS effects are the pulse parameters (Arai et al., 2005; Classen and Stefan, 2008; Taylor and Loo, 2007), the different ways of targeting the DLPFC between experimenters and the different anatomy of the underlying gyri between subjects (Thielscher et al., 2010).

In this study, we overcome these potential confounds by studying the EEG after-effects of five rTMS protocols (sham, 1 Hz, 10 Hz, iTBS, cTBS) of the left DLPFC performed on the same subjects by the same experimenter (A. W.-K.). In contrast to the previous studies where only one or two active protocols were compared to sham, the same subject underwent here all five protocols. From such repeated measures, we wanted to evaluate which rTMS protocol induces the most significant after-effects and whether patterns of cortical responses differ between rTMS protocols. To that end, statistical results on modifications of EEG oscillatory activity by rTMS are presented below at the group level.

## Methods

### Participants

The study was approved by the regional ethical committee of Grenoble University Hospital (CPP Sud-Est I, ID RCB: 2011-A00114-37) and a written informed consent to participate in the study was obtained from all participants. Twenty healthy volunteers (10 males, 10 females), aged 21 to 60 (mean  $31.2 \pm 10.3$  years) were enrolled for five rTMS sessions with concurrent EEG recordings. Two successive experimental sessions in the same subject were separated by at least 1 week and up to 10 days. All sessions for a given subject were performed under identical conditions, at the same time of the day. Three subjects were left-handed as assessed by the Edinburgh handedness inventory (Oldfield, 1971). The group was recruited after a preliminary interview performed by a psychiatrist (D. S.). None had neurological or psychological disorder or any contraindication for TMS. All subjects were familiarized with the TMS and the experimental protocol, but none of them had received rTMS previously.

### rTMS protocols

During the first rTMS/EEG session, the resting motor threshold (RMT) of the right thumb abductor was measured with pre-gelled surface electrodes connected to an EMG amplifier (MEP Monitor, Tonika Elektronik A/S, Denmark) when stimulating the left primary motor cortex (Pascual-Leone et al., 1996). The motor threshold was defined as the lowest stimulation intensity that induced in 10 trials at least 5 motor evoked potentials of at least  $50\mu\text{V}$  peak-to-peak amplitude.

For all rTMS sessions, the stimulation was guided by a neuronavigation system (Premium Edition, Localite GmbH, Germany) to precisely define the neuroanatomical target of TMS from a T1-weighted magnetic resonance image (MRI) of subject's brain (Herwig et al., 2001). The TMS coil was then positioned in every session over the left DLPFC target point, defined as the intersection between Brodmann areas 9 and 46 along the middle frontal gyrus. Active rTMS was performed using a MagPro X100 TMS stimulator (Tonica Elektronik A/S, Denmark) with butterfly coil MCF-B65 (Tonica Elektronik A/S, Denmark). In sham rTMS condition, a MCF-P-B65 Placebo coil (Tonica Elektronik A/S, Denmark) was used to reduce the emitted magnetic field by approximately 80% with identical sound level and mechanical outline as with active MCF-B65 coil. The coil was placed tangentially to the scalp to produce the highest level of the stimulation on the cortical region parallel to the coil (Chen et al., 2003). The handle was placed backward and laterally, approximately at  $45^\circ$  from the midline perpendicular to the central sulcus. In case of head movement during the experiment, the coil was manually repositioned to its initial position.

Repetitive TMS protocols (1 Hz, 10 Hz, iTBS, cTBS, Sham) were constructed following the safety guidelines of the International Society of Transcranial Stimulation (ISTS) (Rossi et al., 2009). They all included between 792 and 800 pulses distributed into four periods for a total duration of 15 min.

Inter-trains were included in between stimulation periods to homogenise total duration of every protocol (Figure 1). Stimulation amplitude was 80% of RMT for cTBS and iTBS protocols, 120% of RMT for 1 Hz and 10 Hz protocols, and 24% (including coil attenuation) for Sham protocol. The pattern of the Sham protocol was identical to the one used for 1 Hz stimulation. Protocol order was randomly distributed between subjects, and subjects were not told about which protocol was used at the time of recording.

#### *Self-evaluation of mood changes*

A visual analogue scale (VAS) was used to proceed to a subjective assessment of mood changes by every participants during the few hours following each rTMS session. The VAS consisted 10 cm horizontal lines with anchors at both poles and indicating mood changes from happy / unhappy, joyful / sad, relaxed / tense, calm / excited, vivid / gloomy, smiling / serious. During the evening of the rTMS day, participants were asked to mark those 6 items between -5 and 5. A positive/negative score reflected a positive/negative valence of mood alteration. The sum over items was used to parsimoniously quantify mood changes (score range from -30 to 30).

#### *EEG acquisition*

Participants were seated in a reclining armchair with neck and back supported with a pillow, arms relaxed and eyes closed. They were asked to inhibit eye movements and blinks during recordings. In case of drowsiness detected online from EEG waves, the experimenter told the subject to open their eyes for a short duration. These periods were noted and corresponding signals removed from further analysis. EEG signals were recorded before (at least during 15 min), during and after (at least during 15 min) rTMS with a 64-channel elastic cap with Ag/AgCl electrodes positioned at the beginning of the experimental session according to the 10-20 system (Fast'n'Easy cap, Brain Products GmbH, Munich, Germany) and connected to TMS-compatible DC amplifiers (BrainAmp, Brain Products GmbH, Munich, Germany). Right eye vertical movements were recorded with one electro-oculogram (EOG) electrode. Electrode impedances were kept below 10k $\Omega$  using conduction gel. Recordings were made with a referential montage, where the reference electrode was placed just anterior to Fz, and the ground electrode just posterior to Fz. The EEG amplifier was used in DC mode with a high frequency cut off at 1000 Hz and no additional online filtering. EEG data were digitized at 2500 Hz sampling frequency with 16-bit resolution. Positions of the 64 EEG electrodes and of the three fiducials (left and right tragus and nasion) were measured with the TMS neuronavigation system.

#### *EEG pre-processing*

Only pre- and post-rTMS EEG recordings, which did not contain any artefact due the TMS pulses, were analysed for the

study of rTMS after-effects. EEG data were pre-processed offline in EEGlab (Delorme and Makeig, 2004) and SPM8 (Wellcome Trust Centre for Neuroimaging, University College London, UK) running in Matlab (The MathWorks, USA). Continuous recordings were first band-pass filtered between 1 and 45 Hz and down sampled at 128 Hz to speed up subsequent analyses. Time periods that contained large muscular and other non-stereotyped artefacts were then carefully pruned from the signals. Up to 6 bad channels per session were visually identified. This data selection was followed by an independent component analysis (ICA) to remove eye blinks and cardiac components from the EEG. After first decomposition and elimination of bad components, a second round of ICA filtering was performed as proposed in Onton et al. (2006). The choice of bad components was based on visual inspection of the spatial and temporal patterns of every component. Finally, cleaned EEG signals were re-referenced to the common average for scalp and source analyses, in accordance with the assumption made for EEG forward modelling.

#### *EEG spectral analysis at the scalp and cortical levels*

The first 10 minutes of artefact-free signals for each condition were selected for further processing. They were segmented into 20-second successive epochs onto which fast Fourier transform (FFT) was applied to estimate spectral power for each electrode. For each channel, peak frequency of the spectrum within the band [4-14] Hz was extracted and power spectrum was averaged over frequencies in separate bands: delta (1-4 Hz), theta (3.5-7 Hz), alpha (7.5-13 Hz), low beta (14-22 Hz), high beta (22-30 Hz) and gamma (30-45 Hz). For statistical analyses in SPM8, peak frequency and spectral power of each frequency band and each time bin was converted into a scalp map (128x128 pixels) using a two-dimensional (2D) spatial linear interpolation. Those maps were smoothed with a Gaussian kernel of 5 mm full width half maximum (FWHM) to conform to assumptions of subsequent statistical analysis and to diminish inter-subject variability.

To reconstruct cortical current source densities, we used the procedure proposed in Litvak and Friston (2008). The canonical mesh at standard spatial resolution (8196 sources) was warped to each subject's anatomy. This step ensured that cortical activity was reconstructed in the same source space over subjects (Mattout et al., 2007). EEG electrodes were repositioned in subject's MRI space with rigid co-registration using the coordinates of the three fiducials (left ear, nasion, right ear) and spatial projection of the electrode coordinates to the closest scalp points. Then, a boundary element method (BEM) head model was used to compute the forward operator that encodes the lead field of each cortical source. Finally, an image of cortical power was produced every 20 s of the 10 min selected scalp data using the following steps: 1) Each 20 s time-window was epoched into ten successive time windows of 2 s duration. 2) Induced cortical power was estimated from the 10 small time windows using the inverse procedure of Litvak and Friston (2008), based on a hierarchical model with multiple sparse priors for EEG source reconstruction (Friston et al., 2008) and empirical priors that force uniformity of source reconstruction over



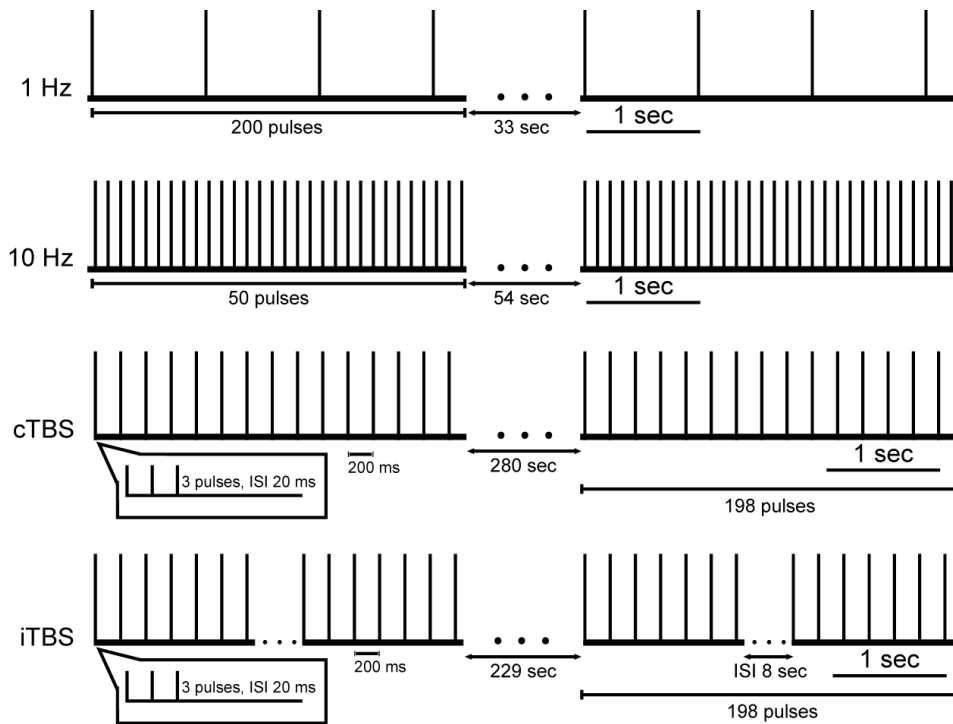

Figure 1: Description of rTMS protocols. 1 Hz and 10 Hz stimulations have identical intervals between trains of pulses. In TBS protocols, three pulses of stimulation are given with 20 ms interstimulus interval (ISI), repeated every 200 ms. In cTBS, 4 trains with 198 pulses each one were given with 280 s interval between successive trains. In iTBS, a 2 s train was repeated every 8 s (so called “small” train) which was then repeated 6 times for a total number of 198 pulses of “long” train with an interval of 229 s between successive long train. All protocols were composed of 4 trains, except 10 Hz protocol that used 16 trains.

epochs. We used the “independent and identically distributed” (IID) option for spatial priors in SPM8, which corresponds to a minimum norm-like inverse solution. 3) The image of cortical power for every frequency band of interest was created using a contrast that did a band-pass filtering. 4) Finally, images of cortical power were smoothed with an isotropic Gaussian kernel of 8 mm FWHM.

#### Statistical analyses

Statistical analyses of spectral power images were separated into first level (subject level) and second level (group level) analyses. The statistical design of those analyses was similar between scalp and cortical images. First level analysis consisted of a one sample t-test for each protocol (1 Hz, 10 Hz, cTBS, iTBS, sham), time condition (pre- and post-rTMS), and subject. It allowed to obtain an image of the mean activity for each condition applying the contrast “1” on the parameter estimates, as usual in SPM8. Those images were used as input data to the second level analyses. Firstly, a 5x2 analysis of variance (ANOVA) over subject was used. The 2 factors were “rTMS protocol” (10Hz, 1Hz, iTBS, cTBS, sham) and “time condition” (pre- and post-rTMS). To identify significant effects of each active rTMS protocol as compared to sham stimulation, post hoc tests (Tukey HSD) were used. Because the effects of this 5x2 ANOVA were very much weighted by the

sham condition, we also run a 4x2 ANOVA using only active protocols, in order to focus on interaction effects that identify regions that responded differently between active rTMS protocols. All ANOVAs were performed with covariates of no interest introduced in the design matrix to remove the temporal mean of the data during the pre- and post-rTMS periods for each recording session. This was done in order to diminish the confounding effects of any variations of electrode impedance and/or of any sources of experimental noise between recording sessions. Because EEG was continuously recorded during pre-, per- and post-rTMS periods, we assumed in the statistical model that confounds had the same amplitude between those pre- and post-rTMS periods and were thus all contained in the EEG power averaged over time, whereas effects of interest were represented in variations around the mean. For scalp analysis, the statistical threshold was set at  $p < 0.05$ , with correction for multiple comparisons by controlling the family wise error (FWE) rate. For cortical sources, a less stringent threshold was applied ( $p < 0.001$ , uncorrected for multiple comparisons).

## Results

#### Experimental events

Three out of 20 subjects had to be excluded from the entire analysis because of very bad quality of EEG signals or because

Table 1: Summed scores of self-evaluated mood changes after rTMS session of subjects showing the score different from zero (no change).

Subject No	1 Hz	10 Hz	cTBS	iTBS	Sham
S3	0	0	5	12	0
S7	0	0	0	2	0
S8	0	0	1	2	0
S11	0	5	0	1	-1
S13	0	0	1	-1	1
S16	0	4	0	0	0
S17	1	5	-1	0	5
S18	-3	1	2	-1	0
S19	5	6	1	-7	0
S20	0	2	0	9	0
Total	3	23	9	17	5

of drowsiness. One additional subject had to also be removed from 10 Hz and 1 Hz analyses because of too short artefact free periods. Additionally, the coil position was slightly adapted in 3 subjects who experienced pain in the left eye or in the trigeminal nerve when stimulated on the target defined a priori. Two subjects reported headache after 10 Hz rTMS and one subject had nausea after cTBS. Those uncomfortable sensations disappeared in all subjects few hours after rTMS sessions.

#### Self-evaluation of mood changes

Half of subjects ( $n = 10$ ) did not notice any mood change on the VAS for any type of rTMS protocol. The summed scores of the 10 other subjects are shown in Table 1, where positive/negative values mean positive/negative mood alterations. Reports varied a lot between subjects. No negative score was reported for 10 Hz rTMS. Positive and negative scores were equally reported for sham, 1 Hz, cTBS and iTBS. Total score after summation over subjects was positive for all protocols, including sham (Total score = 5), and was the largest for 10 Hz stimulation (Total score = 23). Regression analysis of VAS scores and EEG spectral power changes induced by rTMS on every sessions pooled together did not reveal any significant correlation in every frequency band.

#### Modulation of EEG spectral power - Active vs. Sham stimulation

No significant changes in EEG peak frequency were found to be induced by any active rTMS protocol as compared to sham.

All active rTMS protocols induced significant decrease of delta power as compared to sham (Figure 2). On the scalp, the most significant responses were clearly observed on left prefrontal electrodes, i.e. close to the stimulated site as confirmed by source localisation. Continuous TBS showed the least diffuse activation, with only the left DLPFC significantly deactivated, whereas the other conditions showed more diffuse scalp activity which translated in the presence of significant decrease of power mainly in bilateral central and parietal regions while the most significant decrease was always observed in the left DLPFC. Figure 3 shows pre- and post-rTMS absolute power in electrode AF3, which was the closest to the stimulation target,

to illustrate how reproducible was the reduction in scalp delta power across protocols and subjects. Despite one outlier (blue circle, S1), the decrease in power is clearly visible across subjects.

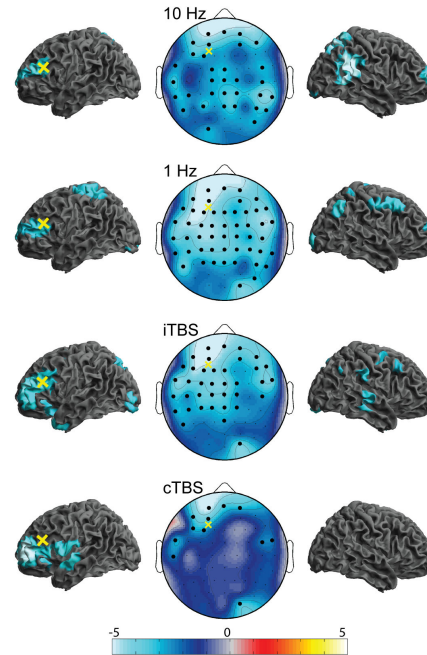

Figure 2: Group analysis of EEG after effects in the delta band. Colours code for post-hoc t-test comparing active rTMS to Sham. Cortical maps are thresholded at  $p < 0.001$ , uncorrected ( $t = 3.09$ ). Significance threshold ( $p < 0.05$  FWE) is at  $t = 2.91$  on scalp maps (light blue). Electrodes showing significant differences are marked with bigger black dots. Yellow cross on the scalp and cortex indicate the cortical target.

In the theta band, EEG after-effects induced by rTMS were found very similar to those observed in the delta band, but slightly less significant (Figure 4). The only decreases of theta power that survived outside the DLPFC were located in parietal regions, at the parietal-occipital and parietal-temporal junctions.

No after-effect was found to be significant in the alpha band.

In higher frequency bands (low beta, high beta, gamma), a decrease of power was also detected on prefrontal electrodes (Figures 5, 6 and 7). The main difference with low frequencies was that this decrease could be left-sided, right sided or bilateral on the scalp electrodes, depending on the stimulation protocol. Source localisation confirmed the deactivation of the DLPFC, but it was never significant on the left hemisphere alone. DLPFC deactivation was bilateral (in low beta for 1 Hz and iTBS; in high beta for 1 Hz, iTBS and cTBS; in gamma for iTBS) or right sided (in low beta for 10 Hz and cTBS; in high beta for 10 Hz; in gamma for 10 Hz, 1 Hz and cTBS).

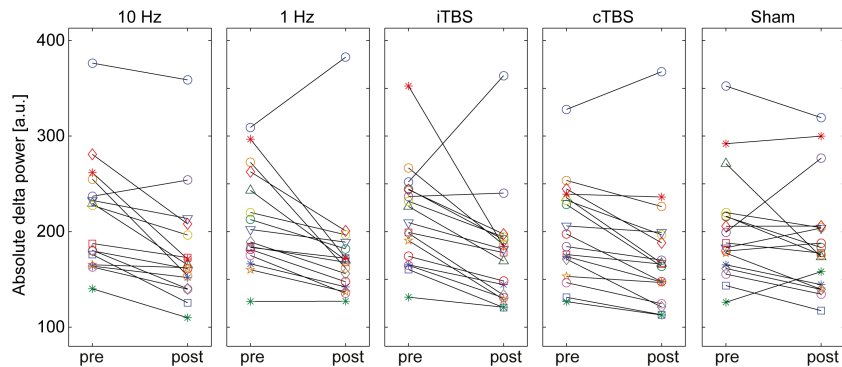

Figure 3: Pre- and post-rTMS absolute delta power on electrode AF3. Each subject is represented using a specific marker.

In addition, an increase of EEG power induced by rTMS was also observed in central and posterior electrodes, particularly for iTBS and cTBS protocols. On the cortex it corresponded to small clusters in occipital and left opercular cortices.

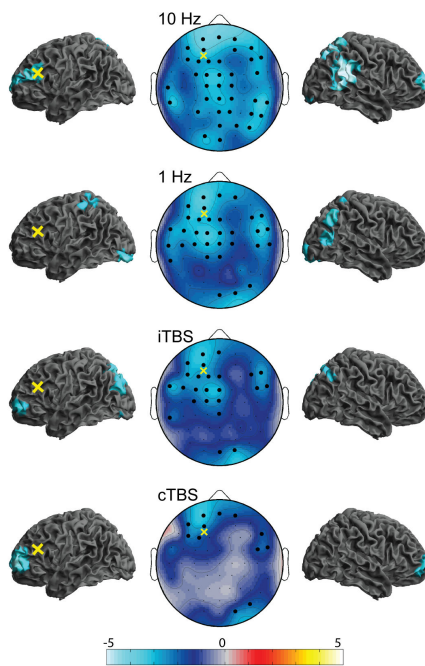

Figure 4: Group analysis of EEG after effects in the theta band. See Figure 2 for details. Significance thresholds:  $t = 3.56$  (cortex) and  $t = 2.82$  (scalp).

#### Modulation of EEG spectral power - Interaction effects between active protocols

Interaction effects between active protocols were found in all frequency bands, except in the alpha band (Figure 8). In

the delta band, significant interactions were distributed in parietal and temporal regions, also including left prefrontal cortex (PFC). The most significant activations were at the right temporo-parieto-occipital junction as a consequence of the strong decrease of power observed only for 10 Hz and 1 Hz stimulation (Figure 2). In the theta band, the interaction effect in the right parietal cortex was still there (specific response to 10 Hz and 1 Hz stimulation, Figure 4), but the DLPFC was also bilaterally activated. In higher frequency, interactions were always significant bilaterally in the DLPFC, suggesting specific lateralisation effect depending on stimulation parameters (see Figures 5, 6 and 7).

To get a full picture of interaction effects in the PFC, we extracted the amplitude of relative changes of power between pre- and post-rTMS. This was done by constructing a symmetrical mask from PFC regions showing significant interactions (Figure 8 middle) that was used to extract values of relative power in every subject from left (Figure 8 left) and right (Figure 8 right) PFC. Pair-wise comparisons of relative changes were then performed to detect significant differences in the modulatory effects of rTMS protocols (Figure 8). We found that in low frequency bands (delta, theta), all protocols induced a decreased of EEG power and that interaction effects thus concerned only amplitude of this effect, with the smallest changes occurring for 10 Hz protocol. However, in high frequency bands (beta and gamma), the sign of the modulatory effect of 10 Hz protocol was inverted bilaterally. This inversion of effect was also detected for iTBS, but only in the right hemisphere and for the highest frequencies (high beta and gamma). It is important to note that the interactions showing an inversion of the sign of the effects were observed more anterior and more inferior in the PFC than the main effects (decrease of power) corrected by Sham (Figures 2, 4, 5, 6 and 7). It indicates that the inversion of effects observed for 10 Hz and iTBS did not actually survive the correction by Sham recordings.

#### Discussion

The aim of this research was to investigate the EEG after-effects of different rTMS protocols of the left DLPFC in

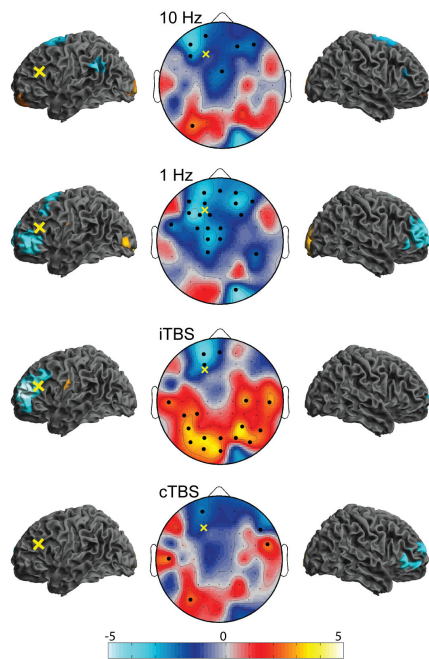

Figure 5: Group analysis of EEG after effects in the low beta band. See Figure 2 for details. Significance thresholds:  $t = 3.47$  (cortex) and  $t = 3.05$  (scalp).

healthy controls maintained at rest and awake. From scalp and source localisation analyses, the largest responses were identified around the anatomical target of rTMS, but also distant responses could be observed, particularly in the homologous region in high frequency bands.

#### Review of the literature

To our knowledge, only five studies of EEG changes after DLPFC rTMS were performed in healthy subjects (Okamura et al., 2001; Schutter et al., 2001; Graf et al., 2001; Griskova et al., 2007; Grossheinrich et al., 2009). Described methods and results are extremely variable. In the study by Okamura et al. (2001) (10 Hz vs. sham, 60 pulses, 100% MT, left DLPFC, 32 healthy subjects), no spectral analysis was performed but it was shown that rTMS increased the maximal absolute power of EEG within 2 minutes after stimulation, which was then decreased after 3 minutes, whereas the mean absolute power increased only after 4 minutes. In contrast, Graf et al. (2001) noticed a decrease of delta and theta power induced by rTMS (20 Hz, 1600 pulses, 90% MT, left DLPFC, 8 healthy subjects). However, they concluded that observed effects were small, and may thus be related to non-specific effects. Schutter et al. (2001) (1 Hz, 1200 pulses, 130% MT, right DLPFC, 12 healthy subjects) found different results as these authors revealed a “stimulation x hemisphere” interaction in theta band

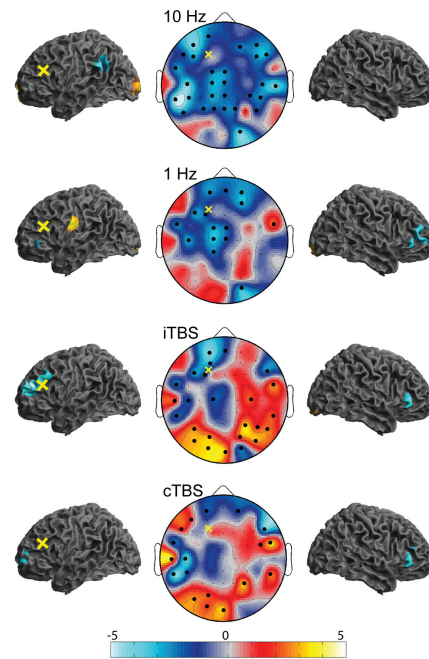

Figure 6: Group analysis of EEG after effects in the high beta band. See Figure 2 for details. Significance thresholds:  $t = 3.46$  (cortex) and  $t = 3.21$  (scalp).

power and a significant increase in left prefrontal theta activity between 25-35 min and 55-65 min after rTMS. More recent studies by Griskova et al. (2007) and Grossheinrich et al. (2009) reported an overall increase in delta power after 10 Hz rTMS and significant effect in the alpha2 band (8.5-10 Hz) after iTBS. In the study by Griskova et al. (2007), the rTMS after-effects in the other frequency bands were highly variable, whereas Grossheinrich et al. (2009) did not find any effects for cTBS and shamTBS comparing each TBS condition with baseline.

Because all the parameters influencing rTMS after-effects - stimulus intensity and frequency, total number of delivered impulses, duration of stimulation period, the shape of the magnetic pulse (Arai et al., 2005, 2007; Taylor and Loo, 2007; Classen and Stefan, 2008) - were different between studies, and because most of experiments were not performed with a neuronavigation system, it is difficult to interpret on solid ground the results of those different studies. This is the main reason why we performed an additional study in which several protocols were tested in the same subjects with up-to-date EEG-TMS methodology based on distributed EEG source localisation and neuronavigated TMS to minimise inter-subject variability.

#### EEG after-effects

The most robust finding of this study, which was observed for every active protocol, was a decrease of delta and theta power

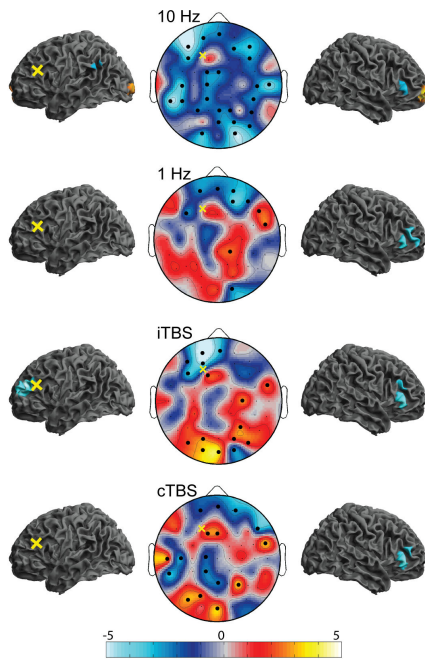

Figure 7: Group analysis of EEG after effects in the gamma band. See Figure 2 for details. Significance thresholds:  $t = 3.31$  (cortex) and  $t = 3.26$  (scalp).

on left prefrontal electrodes, which was localised mainly in the DLPFC (superior, middle and inferior frontal gyri). In healthy adults, delta and theta bands are usually observed during resting state in frontal brain regions and they are correlated with the deepest stages of sleep (delta) and drowsiness or arousal (theta) (Buzsaki, 2006). Under pathological conditions, delta and theta waves are considered as markers of cortical inhibition, which leads to suppression of neural activities, and are associated with frontal hypo-activation (Angrilli et al., 2009; Gasser et al., 1988; Spironelli et al., 2011). According to this assumption, the observed decrease of frontal delta and theta oscillatory power after active rTMS could be interpreted as a decrease of DLPFC inhibition induced by all tested rTMS protocols. Under the same line of thinking, because fast EEG oscillations (20-80 Hz) are positively correlated with local inhibitory transmission of fast spiking cells onto excitatory pyramidal cells (Benali et al., 2011; Cardin et al., 2009), unspecific observed decreases in fast activity localised in the DLPFC also advocate for reduced cortical inhibition. This is apparently in contrast with the effects that would have been observed on motor cortex stimulation where half of the protocols were assumed to be inhibitory and the other half excitatory. However, this comparison falls short because we did not directly measure cortical excitability with an additional paired-pulse paradigm. Interestingly though, it has been demonstrated by others using the

long interval cortical inhibition (LICI) paradigm that cortical excitability of DLPFC and motor cortex are different, which strongly suggests different excitatory/inhibitory local mechanisms induced by rTMS (Farzan et al., 2009).

No significant effects of active rTMS were observed in the alpha band, whereas the beta and gamma bands exhibited significant responses but with distinct patterns from that in low frequencies. Critically, probably because EEG signal to noise ratio decreases with frequency, more variability was observed between responses to the different protocols in the higher frequency bands. Interestingly, significant responses obtained on prefrontal electrodes or cortical regions always corresponded to a decrease of post-rTMS power as compared to pre-rTMS state, similarly to results obtained in low frequencies. In addition, negative effects on DLPFC were extended to the right side in contrast to responses in low frequencies, which were more exclusively left-sided. This very interesting, and quite unexpected, finding appeared to be robust as it was obtained with several protocols. If one assumes that low frequency oscillations are carrier frequencies used to synchronise high frequency oscillations that would support computational processes between remote regions (Fries, 2005), then one could interpret the bilateral desynchronisation of high frequencies by DLPFC rTMS as if locally inhibiting low frequencies decreases synchronisation of fast activity not only locally but also in the homologous region by the means of strong transcallosal connectivity.

Overall, we did not find that a change in rTMS protocol induced fundamentally different EEG after-effects, though some interaction effects were detected (Figure 8). This is in line with the series of studies of EEG responses to rTMS of motor cortex performed at different frequencies (1 Hz, 5 Hz, 20 Hz) (Brignani et al., 2008; Fuggetta et al., 2008; Veniero et al., 2011). These authors showed increases of EEG power over parietal and central regions in the alpha and beta bands, which were the only bands of interest of those studies. Taken together, these results and ours suggest a rather unspecific effect of rTMS frequency on the modulation of cortical oscillations.

Finally, it is important to remind that we chose to keep the duration of rTMS delivery and the number of stimuli constant across protocols, but to reproduce standard clinical protocols, stimulation amplitude varied from 80% of RMT for cTBS and iTBS protocols to 120% of RMT for 1 Hz and 10 Hz protocols. The slightly less diffused effects obtained in low frequencies for cTBS and iTBS, as compared to 1 Hz and 10 Hz protocols (Figures 2 and 4), may thus be due to less powerful stimulation used for theta burst protocols.

#### *Transposition to patient studies*

All participants were asked to fill the self-evaluation psychological test to evaluate the mood and behaviour changes 3 hours after each rTMS session. Though the change of mood was positive for all protocols on average, it is important to note that no significant correlations were found between EEG after-effects and mood changes. Since the goal of DLPFC rTMS is to improve mood in bipolar or unipolar patients (Avery et al., 2006; Fitzgerald et al., 2009), we cannot predict from our data what

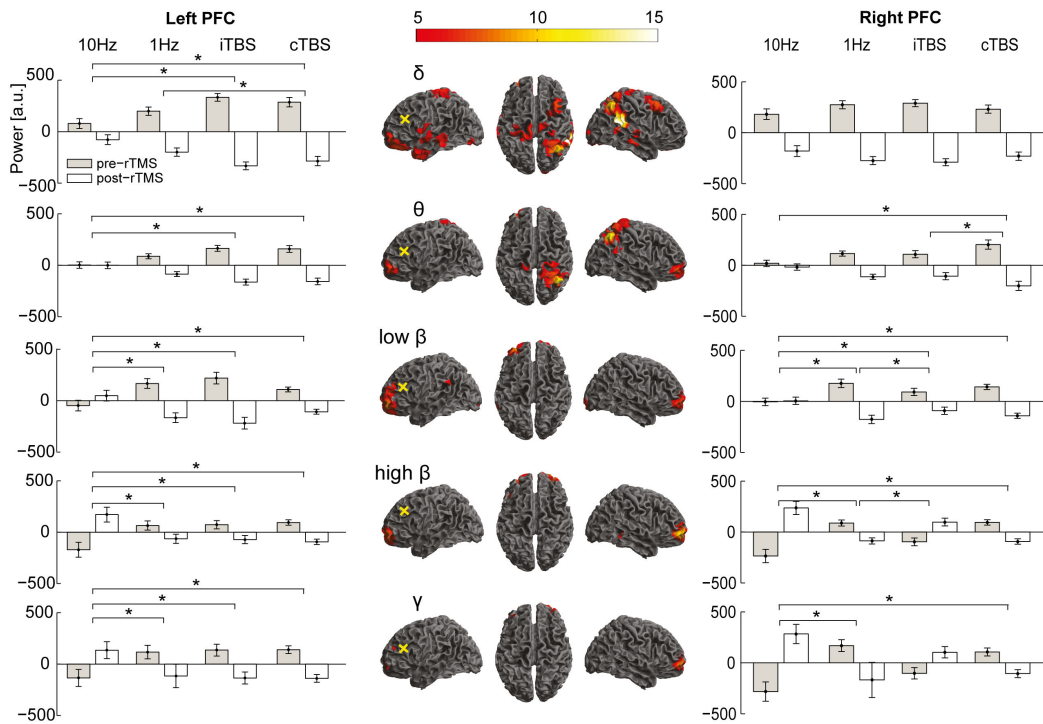

Figure 8: Significant interaction effects in the different EEG bands between the two factors “active rTMS protocol” x “time condition” ( $p < 0.001$  uncorrected). Bar plots show the relative changes of power (arbitrary units) in the prefrontal cortex, averaged over subjects (vertical lines indicate standard errors). Stars indicate significant pairwise comparison between protocols of the change of power between pre- and post-rTMS ( $p < 0.001$  uncorrected).

would be the optimal protocol to test first in patients and what would be the EEG biomarker that would indicate an early therapeutic response to successive rTMS sessions. Only EEG data gathered in patients being treated by rTMS will be likely to provide pieces of information regarding this issue.

#### *Improvements and limitations of the study*

This study significantly consolidates DLPFC rTMS research for several reasons. First, the definition of the anatomical target and the repositioning of the coil between protocols were very much improved using the neuronavigation system (Herwig et al., 2001). Most studies performed so far used a limited empirical approach proposed in the early days of rTMS to place the coil above Brodman area (BA) 9 and 46 (George et al., 1995; Pascual-Leone et al., 1996). We can thus suggest that, additionally to the dissimilarities between stimulation parameters, the discrepancies of the stimulus precision can produce opposite (or negative) results between our work and cited literature. Second, to our knowledge, there is still no available EEG source localisation study of resting state recordings in healthy subjects after rTMS, so that it has not been yet clarified what generators are modulated by rTMS of DLPFC. Last but not at least, this is the first research performing analysis of changes of neural activity as a response to five different rTMS protocols over left

DLPFC applied in the same subjects. In particular, the literature suffers from a lack of direct comparison between 1 Hz and 10 Hz on the one hand, and cTBS and iTBS on the other hand.

However, our study has some limitations. First, changes over time of spectral power were not analysed, as in Okamura et al. (2001). The main reason for that is that many contaminated periods were cut differently between subjects to increase the likelihood of capturing neuronal signatures. As a consequence, it was difficult to reach a sufficient statistical power over every successive time period when concatenating data from the different subjects. Second, the post-EEG recording period was limited to 15 minutes, because of the lengthy experimental procedure duration (preparation and recordings) that made subjects to easily become drowsy or asleep. Ideally, it would have been interesting to record longer but this was already difficult to obtain this kind of data five times in the same subjects. Third, only 64 electrodes were used, which makes spatial precision of source analysis more limited than if the number of electrodes was doubled. Fourth, there was no control of subjects’ mental state and this would have been interesting to compare this passive condition to an active, as proposed in Noh et al. (2012) for rTMS of motor cortex. However, this would have again doubled the duration of the recordings. Finally, as mentioned above, no measure of cortical excitability has been performed and this

would have been relevant to relate the sign of EEG after-effects to direct measures of cortical excitability from brain potentials evoked by paired-pulse TMS for every session. Unfortunately, we did not anticipate this step. To go further in the understanding of our data, it would also be relevant to develop neuronal models of EEG after-effects, as already proposed for motor cortex Bey et al. (2012). This is out of the scope of this report but is an interesting avenue to explore.

### Acknowledgments

This study was funded by a research grant from Région Rhône-Alpes. Agata Woźniak-Kwaśniewska is a PhD student sponsored by Région Rhône-Alpes scholarship Cluster HVN. Olivier David is funded by Inserm. The authors also thank Pr. Christian Marendaz for sharing the TMS research facility, Mr. Sylvain Harquel for technical assistance in EEG recordings and Dr. Marjorie Villien and Dr. Manik Bhattacharjee for MRI acquisitions.

### References

- Angrilli, A., Spironelli, C., Elbert, T., Crow, T.J., Marano, G., Stegagno, L., 2009. Schizophrenia as failure of left hemispheric dominance for the phonological component of language. *PLoS ONE* 4, e4507.
- Arai, N., Okabe, S., Furubayashi, T., Mochizuki, H., Iwata, N.K., Hanajima, R., Terao, Y., Ugawa, Y., 2007. Differences in after-effect between monophasic and biphasic high-frequency rTMS of the human motor cortex. *Clin Neurophysiol* 118, 2227 – 2233.
- Arai, N., Okabe, S., Furubayashi, T., Terao, Y., Yuasa, K., Ugawa, Y., 2005. Comparison between short train, monophasic and biphasic repetitive transcranial magnetic stimulation (rTMS) of the human motor cortex. *Clin Neurophysiol* 116, 605 – 613.
- Avery, D.H., III, P.E.H., Fawaz, W., Russo, J., Neumaier, J., Dunner, D.L., Haynor, D.R., Claypoole, K.H., Wajdik, C., Roy-Byrne, P., 2006. A controlled study of repetitive transcranial magnetic stimulation in medication-resistant major depression. *Biological Psychiatry* 59, 187 – 194. URL: <http://www.sciencedirect.com/science/article/pii/S0006322305008498>, doi:10.1016/j.biopsych.2005.07.003.
- Benali, A., Trippe, J., Weiler, E., Mix, A., Petrasch-Parwez, E., Girzalsky, W., Eysel, U.T., Erdmann, R., Funke, K., 2011. Theta-burst transcranial magnetic stimulation alters cortical inhibition. *J. Neurosci.* 31, 1193 – 1203.
- Bey, A., Leue, S., Wienbruch, C., 2012. A neuronal network model for simulating the effects of repetitive transcranial magnetic stimulation on local field potential power spectra. *PLoS ONE* 7, e49097.
- Brignani, D., Manganotti, P., Rossini, P.M., Miniussi, C., 2008. Modulation of cortical oscillatory activity during transcranial magnetic stimulation. *Hum Brain Mapp* 29, 603 – 612.
- Brigo, F., Storti, M., Nardone, R., Fiaschi, A., Bongiovanni, L.G., Tezzon, F., Manganotti, P., 2012. Transcranial magnetic stimulation of visual cortex in migraine patients: a systematic review with meta-analysis. *J Headache Pain* 13, 339 – 349.
- Buzsáki, G., 2006. *Rhythms of the brain*. Oxford University Press.
- Buzsáki, G., Wang, X.J., 2012. Mechanisms of gamma oscillations. *Annu Rev Neurosci*, In Press.
- Cardin, J.A., Carlen, M., Meletis, K., Knoblich, U., Zhang, F., Deisseroth, K., Tsai, L.H., Moore, C.I., 2009. Driving fast-spiking cells induces gamma rhythm and controls sensory responses. *Nature* 459, 663 – 667.
- Chen, R., Yung, D., Li, J.Y., 2003. Organization of ipsilateral excitatory and inhibitory pathways in the human motor cortex. *J. Neurophysiol.* 89, 1256 – 1264.
- Classen, J., Stefan, K., 2008. Changes in eeg measures induced by repetitive tms. in: E. Wassermann, c.m. Epstein, u. Ziemann editor. *The Oxford handbook of transcranial stimulation*. New York: Oxford University Press.
- Contreras, D., Steriade, M., 1995. Cellular basis of EEG slow rhythms: a study of dynamic corticothalamic relationships. *J. Neurosci.* 15, 604 – 622.
- Dell'Osso, B., Mundo, E., D'Urso, N., Pozzoli, S., Buoli, M., Ciabatti, M., Rosanova, M., Massimini, M., Bellina, V., Mariotti, M., Altamura, A.C., 2009. Augmentative repetitive navigated transcranial magnetic stimulation (rTMS) in drug-resistant bipolar depression. *Bipolar Disord* 11, 76 – 81.
- Delorme, A., Makeig, S., 2004. Eeglab: an open source toolbox for analysis of single-trial eeg dynamics including independent component analysis. *Journal of Neuroscience Methods* 134, 9 – 21. URL: <http://www.sciencedirect.com/science/article/pii/S0165027003003479>, doi:10.1016/j.jneumeth.2003.10.009.
- Di Lazzaro, V., Dileone, M., Pilato, F., Capone, F., Musumeci, G., Ranieri, F., Ricci, V., Bria, P., Di Iorio, R., de Waure, C., Pasqualetti, P., Profice, P., 2011. Modulation of motor cortex neuronal networks by rTMS: comparison of local and remote effects of six different protocols of stimulation. *J. Neurophysiol.* 105, 2150 – 2156. URL: <http://jn.physiology.org/doi:10.1152/jn.00000.2011>.
- Farzan, F., Barr, M.S., Wong, W., Chen, R., Fitzgerald, P.B., Daskalakis, Z.J., 2009. Suppression of gamma-oscillations in the dorsolateral prefrontal cortex following long interval cortical inhibition: a tms-eeg study. *Neuropsychopharmacology* 34, 1543 – 1551.
- Fitzgerald, P.B., Brown, T.L., Marston, N.A., Daskalakis, Z.J., De Castella, A., Kulkarni, J., 2003. Transcranial magnetic stimulation in the treatment of depression: a double-blind, placebo-controlled trial. *Arch. Gen. Psychiatry* 60, 1002 – 1008.
- Fitzgerald, P.B., McQueen, S., Herring, S., Hoy, K., Segrave, R., Kulkarni, J., Daskalakis, Z.J., 2009. A study of the effectiveness of high-frequency left prefrontal cortex transcranial magnetic stimulation in major depression in patients who have not responded to right-sided stimulation. *Psychiatry Research* 169, 12 – 15. URL: <http://www.sciencedirect.com/science/article/pii/S0165178108001856>, doi:10.1016/j.psychres.2008.06.017.
- Fries, P., 2005. A mechanism for cognitive dynamics: neuronal communication through neuronal coherence. *Trends in Cognitive Sciences* 9, 474 – 480. URL: <http://www.sciencedirect.com/science/article/pii/S13646661305002421>, doi:10.1016/j.tics.2005.08.011.
- Friston, K., Harrison, L., Daunizeau, J., Kiebel, S., Phillips, C., Trujillo-Barreto, N., Henson, R., Flandin, G., Mattout, J., 2008. Multiple sparse priors for the M/EEG inverse problem. *NeuroImage* 39, 1104 – 1120. URL: <http://www.sciencedirect.com/science/article/pii/S1053811907008786>, doi:10.1016/j.neuroimage.2007.09.048.
- Fuggetta, G., Pavone, E.F., Fiaschi, A., Manganotti, P., 2008. Acute modulation of cortical oscillatory activities during short trains of high-frequency repetitive transcranial magnetic stimulation of the human motor cortex: A combined eeg and tms study. *Human Brain Mapping* 29, 1–13.
- Gasser, T., Verleger, R., Bacher, P., Sroka, L., 1988. Development of the eeg of school-age children and adolescents. I. analysis of band power. *Electroencephalogr Clin Neurophysiol* 69, 91 – 99.
- George, M.S., 2010. Transcranial magnetic stimulation for the treatment of depression. *Expert Rev Neurother* 10, 1761 – 1772.
- George, M.S., Nahas, Z., Molloy, M., Speer, A.M., Oliver, N.C., Li, X.B., Arana, G.W., Risch, S.C., Ballenger, J.C., 2000. A controlled trial of daily left prefrontal cortex tms for treating depression. *Biological Psychiatry* 48, 962 – 970. URL: <http://www.sciencedirect.com/science/article/pii/S0006322300010489>, doi:10.1016/S0006-3223(00)01048-9.
- George, M.S., Wassermann, E.M., Williams, W.A., Callahan, A., Ketter, T.A., Basser, P., Hallett, M., Post, R.M., 1995. Daily repetitive transcranial magnetic stimulation (rTMS) improves mood in depression. *Neuroreport* 6, 1853 – 1856.
- Graf, T., Engeler, J., Achermann, P., Mosimann, U.P., Noss, R., Fisch, H.U., Schlaepfer, T.E., 2001. High frequency repetitive transcranial magnetic stimulation (rTMS) of the left dorsolateral cortex: EEG topography during waking and subsequent sleep. *Psychiatry Research: Neuroimaging* 107, 1 – 9. URL: <http://www.sciencedirect.com/science/article/pii/S092549270100083X>, doi:10.1016/S0925-4927(01)00083-X.
- Griskova, I., Ruksenas, O., Dapsys, K., Herpertz, S., Hoppner, J., 2007. The effects of 10 hz repetitive transcranial magnetic stimulation on resting eeg power spectrum in healthy subjects. *Neuroscience Letters* 419, 162 – 167. URL: <http://www.sciencedirect.com/science/article/pii/S0304394007004685>, doi:10.1016/j.neulet.2007.04.030.
- Grossheinrich, N., Rau, A., Pogarell, O., Hennig-Fast, K., Reinl, M., Karch, S., Dieler, A., Leicht, G., Mulert, C., Sterr, A., Padberg, F., 2009. Theta

- burst stimulation of the prefrontal cortex: Safety and impact on cognition, mood, and resting electroencephalogram. *Biological Psychiatry* 65, 778 – 784. URL: <http://www.sciencedirect.com/science/article/pii/S0006322308013188>, doi:10.1016/j.biopsych.2008.10.029.
- Hallett, M., 2007. Transcranial magnetic stimulation: a primer. *Neuron* 55, 187 – 199. URL: <http://www.sciencedirect.com/science/article/pii/S0896627307004606>, doi:10.1016/j.neuron.2007.06.026.
- Hasan, A., Falkai, P., Wobrock, T., 2013. Transcranial brain stimulation in schizophrenia: targeting cortical excitability, connectivity and plasticity. *Curr. Med. Chem.* 20, 405 – 413.
- Hayashi, T., Ohnishi, T., Okabe, S., Teramoto, N., Nonaka, Y., Watabe, H., Imabayashi, E., Ohta, Y., Jino, H., Ejima, N., Sawada, T., Iida, H., Matsuda, H., Ugawa, Y., 2004. Long-term effect of motor cortical repetitive transcranial magnetic stimulation [correction]. *Ann. Neurol.* 56, 77 – 85.
- Herwig, U., Padberg, F., Unger, J., Spitzer, M., Schonfeldt-Lecuona, C., 2001. Transcranial magnetic stimulation in therapy studies: examination of the reliability of "standard" coil positioning by neuronavigation. *Biological Psychiatry* 50, 58 – 61. URL: <http://www.sciencedirect.com/science/article/pii/S0006322301011532>, doi:10.1016/S0006-3223(01)01153-2.
- Homan, P., Kindler, J., Hauf, M., Hubl, D., Dierks, T., 2012. Cerebral blood flow identifies responders to transcranial magnetic stimulation in auditory verbal hallucinations. *Transl Psychiatry* 2, e189.
- Hoogendam, J.M., Ramakers, G.M., Di Lazzaro, V., 2010. Physiology of repetitive transcranial magnetic stimulation of the human brain. *Brain Stimul* 3, 95 – 118.
- Houdayer, E., Degardin, A., Cassim, F., Bocquillon, P., Derambure, P., Devanne, H., 2008. The effects of low- and high-frequency repetitive tms on the input/output properties of the human corticospinal pathway. *Exp Brain Res* 187, 207 – 217.
- Huang, Y.Z., Edwards, M.J., Rouinis, E., Bhatia, K.P., Rothwell, J.C., 2005. Theta burst stimulation of the human motor cortex. *Neuron* 45, 201 – 206. URL: <http://www.sciencedirect.com/science/article/pii/S0896627304008463>, doi:10.1016/j.neuron.2004.12.033.
- Hummel, F.C., Celnik, P., Pascual-Leone, A., Fregni, F., Byblow, W.D., Buettner, C.M., Rothwell, J., Cohen, L.G., Gerloff, C., 2008. Controversy: Non-invasive and invasive cortical stimulation show efficacy in treating stroke patients. *Brain Stimul* 1, 370 – 382.
- Ilmoniemi, R.J., Virtanen, J., Ruohonen, J., Karhu, J., Aronen, H.J., Naatanen, R., Katila, T., 1997. Neuronal responses to magnetic stimulation reveal cortical reactivity and connectivity. *Neuroreport* 8, 3537 – 3540.
- Jung, S.H., Kim, Y.K., Kim, S.E., Paik, N.J., 2012. Prediction of motor function recovery after subcortical stroke: Case series of activation pet and tms studies. *Ann Rehabil Med* 36, 501 – 511.
- Litvak, V., Friston, K., 2008. Electromagnetic source reconstruction for group studies. *NeuroImage* 42, 1490 – 1498. URL: <http://www.sciencedirect.com/science/article/pii/S1053811908007532>, doi:10.1016/j.neuroimage.2008.06.022.
- Magis, D., Jensen, R., Schoenen, J., 2012. Neurostimulation therapies for primary headache disorders: present and future. *Curr. Opin. Neurol.* 25, 269 – 276.
- Mattout, J., Henson, R.N., Friston, K.J., 2007. Canonical source reconstruction for MEG. *Comput Intell Neurosci* , 67613.
- Noh, N.A., Fuggetta, G., Manganotti, P., Fiaschi, A., 2012. Long lasting modulation of cortical oscillations after continuous theta burst transcranial magnetic stimulation. *PLoS ONE* 7, e35080.
- Okamura, H., Jing, H., Takigawa, M., 2001. Eeg modification induced by repetitive transcranial magnetic stimulation. *J Clin Neurophysiol* 18, 318 – 325.
- Oldfield, R., 1971. The assessment and analysis of handedness: The Edinburgh inventory. *Neuropsychologia* 9, 97 – 113. URL: <http://www.sciencedirect.com/science/article/pii/0028393271900674>, doi:10.1016/0028-3932(71)90067-4.
- Onton, J., Westerfield, M., Townsend, J., Makeig, S., 2006. Imaging human EEG dynamics using independent component analysis. *Neurosci Biobehav Rev* 30, 808 – 822.
- Pascual-Leone, A., Rubio, B., Pallardo, F., Catala, M.D., 1996. Rapid-rate transcranial magnetic stimulation of left dorsolateral prefrontal cortex in drug-resistant depression. *Lancet* 348, 233 – 237.
- Richieri, R., Boyer, L., Farisse, J., Colavolpe, C., Mundler, O., Lancon, C., Guedj, E., 2011. Predictive value of brain perfusion spect for rTMS response in pharmacoresistant depression. *Eur. J. Nucl. Med. Mol. Imaging* 38, 1715 – 1722.
- Romero, J.R., Ansel, D., Sparing, R., Gangitano, M., Pascual-Leone, A., 2002. Subthreshold low frequency repetitive transcranial magnetic stimulation selectively decreases facilitation in the motor cortex. *Clinical Neurophysiology* 113, 101 – 107. URL: <http://www.sciencedirect.com/science/article/pii/S1388245701006939>, doi:10.1016/S1388-2457(01)00693-9.
- Rosanov, M., Casali, A., Bellina, V., Resta, F., Mariotti, M., Massimini, M., 2009. Natural frequencies of human corticothalamic circuits. *J. Neurosci.* 29, 7679 – 7685.
- Rossi, S., Hallett, M., Rossini, P.M., Pascual-Leone, A., Avanzini, G., Bestmann, S., Berardelli, A., Brewer, C., Canli, T., Cantello, R., Chen, R., Classen, J., Demitrack, M., Di Lazzaro, V., Epstein, C.M., George, M.S., Fregni, F., Risto, I., Jalinous, R., Karp, B., Lefaucheur, J.P., Lisanby, S., Meunier, S., Miniussi, C., Miranda, P., Padberg, F., Paulus, W., Peterchev, A., Porteri, C., Provost, M., Quartarone, A., Rotenberg, A., Rothwell, J., Ruohonen, J., Siebner, H., Thut, G., Valls-Sole, J., Ugawa, Y., Zangen, A., Ziemann, U., 2009. Safety, ethical considerations, and application guidelines for the use of transcranial magnetic stimulation in clinical practice and research. *Clin Neurophysiol* 120, 2008 – 2039.
- Schutter, D.J., van Honk, J., d'Alfonso, A.A., Postma, A., de Haan, E.H., 2001. Effects of slow rTMS at the right dorsolateral prefrontal cortex on eeg asymmetry and mood. *Neuroreport* 12, 445 – 447.
- Spironelli, C., Angrilli, A., Calogero, A., Stegagno, L., 2011. Delta eeg band as a marker of left hypofrontality for language in schizophrenia patients. *Schizophr Bull* 37, 757 – 767.
- Taylor, J.L., Loo, C.K., 2007. Stimulus waveform influences the efficacy of repetitive transcranial magnetic stimulation. *J Affect Disord* 97, 271 – 276.
- Thielscher, A., Reichenbach, A., Uğurbil, K., Uludag, K., 2010. The cortical site of visual suppression by transcranial magnetic stimulation. *Cereb. Cortex* 20, 328 – 338.
- Thut, G., Pascual-Leone, A., 2010. A review of combined TMS-EEG studies to characterize lasting effects of repetitive TMS and assess their usefulness in cognitive and clinical neuroscience. *Brain Topogr* 22, 219–232.
- Veniero, D., Brignani, D., Thut, G., Miniussi, C., 2011. Alpha-generation as basic response-signature to transcranial magnetic stimulation (tms) targeting the human resting motor cortex: a tms/eeg co-registration study .



### 6.3 Paper II

#### **Distinct neural oscillatory activity patterns between responders and non-responders with bipolar and major depressive disorder to repetitive transcranial magnetic stimulation treatment**

In the second part, the results from an open study on depressed patients are presented. The question was whether it is possible to distinguish BP from MDD patients, and responders from non-responders to 10 Hz rTMS by studying EEG biomarkers of resting state brain activity. These findings are presented in the second paper which is going to be submitted, under the title “*Distinct neural oscillatory activity patterns between responders and non-responders with bipolar and major depressive disorder to repetitive transcranial magnetic stimulation treatment*”.

## The influence of 10 Hz repetitive Transcranial Magnetic Stimulation treatment on resting EEG activity in patients with Bipolar Depression and Major Depressive Disorder

Agata Woźniak-Kwaśniewska<sup>a,b</sup>, David Szekely<sup>a,b,c</sup>, Sylvain Harquel<sup>d,e</sup>, Thierry Bougerol<sup>c</sup>, Olivier David<sup>a,b,\*</sup>

<sup>a</sup>Fonctions Cerebrales et Neuromodulation, Université Joseph Fourier, Grenoble, France

<sup>b</sup>Inserm, U836, Grenoble Institut des Neurosciences, Grenoble, France

<sup>c</sup>Clinique Universitaire de Psychiatrie, Pole Psychiatrie Neurologie, Centre Hospitalier Universitaire, Grenoble, France

<sup>d</sup>UMR 5105 UPMF CNRS, Laboratoire Psychologie Neurocognition, Saint Martin d'Hères, France

<sup>e</sup>UMS IRMaGe, Grenoble, France

### Abstract

Major depressive disorder (MDD) and bipolar disorder (BP) are the main cause of disability among adults around the world. On a physiopathological point of view, these two types of depression are due to distinct neuropathologies, though it is sometimes difficult to distinguish between depressive clinical symptoms. In this perspective, the possibility to predict treatment response in mental health disorders with biomarkers is an important clinical issue. This open study aimed to examine whether it is possible to distinguish BP from MDD patients, and responders from non-responders to 10 Hz repetitive transcranial magnetic stimulation (rTMS) by studying EEG features of resting brain activity.

Eight MDD (6 females) and 10 BP patients (6 females) were enrolled to navigated rTMS therapy. Stimulation consisted of from 10 up to 20 sessions of continuous 10 Hz stimulation of the left DLPFC (2000 pulses, 120% motor threshold). We studied the different patterns of EEG activity in both depressive disorders, by comparing spectral power of pre- and post-rTMS EEG recordings throughout the therapeutic sessions in responders and non-responders. As a reference, we used EEG recordings at rest performed in the same conditions in 17 healthy subjects (HS, 9 females).

EEG spectrum was estimated with the Fast Fourier transform (FFT) and partitioned using the common physiological frequency bands: delta (1-4 Hz), theta (3.5-7 Hz), alpha (7.5-13 Hz) and beta (14-30 Hz). Statistical analyses of induced diseases-specific EEG patterns were computed with Statistical Parametric Mapping (SPM) for EEG, in every frequency band at the scalp level, and at the cortex level using a distributed source model with a minimum norm-like inverse solution. Furthermore, multiple regression analysis of all frequency bands and absolute improvement in Montgomery Asberg Depression Rate Scale ( $\Delta$ MADRS) was performed.

The comparison of MDD and BP disorders revealed significantly higher activity in theta and beta bands power in bipolar patients, mainly localised in prefrontal cortex. Next, responders showed increased activity in low frequencies and decreased power of alpha band, when compared to non-responders. The results of multiple regression analysis revealed that alpha band power on the left fronto-temporo-parietal regions was significantly ( $p < 0.05$ ) and negatively correlated with  $\Delta$ MADRS. Additionally, we found positive correlation of  $\Delta$ MADRS and theta band power in the posterior midline areas ( $p < 0.01$ ). We suggest that both EEG features could be used as biomarkers to predict rTMS outcome.

**Keywords:** rTMS, EEG, MDD, BP, resting state

### Introduction

Nowadays depression is a leading cause of disability worldwide among adults. As long as mental health disorders are associated with lost productivity, high risk of mortality and family burden, rapid and effective discrimination of responders and non-responders could potentially help in more targeted and more focused clinical treatment (Disner et al., 2011). The review by Pigott et al. (2010) of recent meta- and re-

analyses of sequenced treatment alternatives to relieve depression (STAR\*D) suggests that the rate of success of antidepressant treatments is below 30%. To date, many different predictors of treatment response such as clinical manifestations, physiological indices or neuroimaging markers have been developed (Kemp et al., 2008). Unfortunately, the sensitivity and specificity of these biomarkers are still not properly determined.

For the last two decades, repetitive transcranial magnetic stimulation (rTMS) has been demonstrated to be an effective therapeutic treatment for major depressive disorder (MDD) (George et al., 1995; Pascual-Leone et al., 1996; Fitzgerald et al., 2006; George et al., 2000; Carpenter et al., 2012). Studies on bipolar depression (BP) (Dolberg et al., 2002; Tamas et al., 2007; Dell'Osso et al., 2009) are, however, very limited. The effects of rTMS outlast the period of the stimulation, and can

\*Corresponding author at:  
Grenoble Institut des Neurosciences - Chemin Fortun Ferrini - Bt EJ Safran -  
CHU 38700 La Tronche, France  
Tel: +33 4 56 52 05 86  
Fax: +33 4 56 52 05 98  
Email address: odavid@ujf-grenoble.fr (Olivier David)

last for minutes after one session, and if repeated, some days or weeks after the end of the treatment. Moreover, the effects depending on intensity of stimulation spread to brain areas remote from the targeted site, altering oscillatory activity, plasticity and connectivity of neural networks. Here, we will focus on the potential EEG biomarkers for predicting the response to rTMS treatment of MDD and BP disorders.

Unfortunately, the actual knowledge about antidepressant mechanisms of rTMS is still unclear. The limbic-cortical network is supposed to have a crucial role in depression and be correlated emotional dysregulation (Drevets et al., 2008; Mayberg, 2003). This neuronal network consists from cortical (dorsolateral, medial and ventral prefrontal cortices) and limbic (hippocampus and amygdala) structures (Li et al., 2010).

EEG brought important information about depression and various studies have found that typically 20% to 40% of depressed patients have EEG abnormalities, with several characteristics and controversial patterns (Coburn et al., 2006). Moreover, up to 80% of psychiatric patients present various quantitative EEG (qEEG) abnormalities on contrary to only 10% of healthy subjects (Begic et al., 2011; Coburn et al., 2006).

In short, the strongest evidence in this field is that when different pre-treatment EEG parameters were tested as possible biomarkers, alpha and theta bands were reported as the most valuable indices to differentiate responders from non-responders.

Increased frontal EEG asymmetry, as measured by relatively higher left than right alpha band activity, appears to characterise depressed individuals (Debener et al., 2000; Allen et al., 2004; Vuga et al., 2006) and to be a state-marker of depression. Interestingly, alpha asymmetry between brains hemispheres recorded at baseline also differentiates responders from non-responders to pharmacological treatment (Ulrich et al., 1984; Knott et al., 1996; Bruder et al., 2001, 2008; Tenke et al., 2011). Responders showed greater alpha power over right, versus left, hemisphere, whereas non-responders tended to show the opposite pattern. Micoulaud-Franchi et al. (2012) studied the absolute alpha power as a predictive value of responses to high frequency (10 Hz) rTMS in the left DLPFC. They observed significant and negative correlation of absolute variations in BDI-Short Form ( $\Delta$ BDI-SF) scores between baseline and the end of rTMS with alpha band power in left and right parieto-temporal regions.

Frontal theta band modulations have been interpreted as reflecting altered activity in the anterior cingulate cortex implicated in emotional regulations (Iosifescu, 2011). Many studies have shown the association of theta alternations with treatment response to antidepressants, although these findings are inconsistent across studies (Knott et al., 1996, 2000; Heikman et al., 2001; Iosifescu et al., 2009). However, recently Schulman et al. (2011) proposed that a perturbation of the thalamo-cortical resonance known as thalamo-cortical dysrhythmia (TCD) might be an underlying process of many psychiatric disorders. Thalamo-cortical dysrhythmia can be described as persistent abnormal internally-generated delta and theta oscillations in thalamic neurons which disrupt the normal, state-dependent, flow of information within the thalamo-cortico-thalamic networks

(Fuggetta and Noh, 2013). Increased low-frequency oscillations registered during awake and at rest can lead to perturbation of cognition and sensory-motor performance observed in many disorders, including major depression.

Regarding possibilities to distinguish MDD from BP patients, a recent study by Ford et al. (2013) showed differences in bipolarity index (BI) of youth patients in this resting-state fMRI scans. This group observed higher activation in putamen, caudatum and insula in BP patients, whereas activation in postcentral and posterior cingulate gyrus was higher in MDD patients Ford et al. (2013).

In this open study, we aimed to distinguish rTMS after-effects between responders and non-responders by analysing resting state EEG with fast Fourier transformation (FFT) using normalised power and source localisation technique. We suggest that it is also possible to differentiate MDD from BP patients using EEG power analysis as a marker.

## Methods

### Participants

This study has been approved by the regional ethical committee of Grenoble University Hospital (ID RCB: 2011-A00114-37). All participants (patients and healthy subjects, Table 1) were evaluated by a licensed psychiatrist (D.S.) following an interview process. A written informed consent to participate in the study was obtained from all participants. All patients were on a range of medications.

Eighteen right-handed (Oldfield, 1971) patients who met Diagnostic and Statistical Manual of Mental Disorder 4th ed. (DSM-IV) criteria for major depressive episode or bipolar depressive episode participated in the study. Eight MDD patients (6 females, age range 44-64, mean  $52.1 \pm 7.8$ ) and ten BP patients (6 females, age range 32-69, mean  $48.7 \pm 12.6$ ) according to the DSM-IV criteria (APA, 2000) were recruited from the Psychiatry Department of Grenoble University Hospital. If bipolar patients met mixed characteristic, they were excluded from the study. Inclusion criteria for MDD included nonresponse to pharmacological treatment of depression level of resistance 3 on Thase and Rush (1997) criteria using a minimum of two distinctly different classes of antidepressant medications for actual depressive episode (appropriate doses and duration) occurring at the time of enrolment or earlier. For MDD patients, pre-treatment with an antidepressant and/or mood stabilizer medication has been unmodified for at least four weeks prior to entry in the study, and remained unchanged throughout the course of the study.

For bipolar patients, mood stabilizer medication has been optimized according to recent recommendation (Frances et al. 1998), then maintained at an unmodified dosage for at least two weeks prior to the entry in the study, and remained unchanged throughout the course of the study.

For all patients, exclusion criteria included age under 18 years, drug abuse, current comorbid major mental disorders assessed by clinical examination in axe II (DSM IV-TR), neurological illness or convulsive disorders, and previous treatment with electro-convulsive therapy (ECT).

No benzodiazepines were administered two weeks before and during rTMS treatment. Only cyanemazine and hydroxyzine were tolerated during the study.

Demographics characteristics (gender and age) and clinical characteristics (illness and episode duration, depression severity) using Montgomery Asberg Depression Rate Scale (MADRS) (Montgomery and Asberg, 1979), 13-item Beck Depression Inventory (BDI-Short Form) (Collet and Cottraux, 1986; Beck et al., 1996; Bouvard et al., 1992) and Clinical Global Impression (CGI) were evaluated for each patient. For bipolar patients, manic or mixed symptoms were evaluated on clinical examination. During the study, manic or mixed symptoms have been evaluated with Young Mania Rating Scale (YMRS) (Young et al., 1978). All patients were assessed at inclusion, before the first EEG recording and after each of the 5 rTMS sessions by the same senior psychiatrist. The response to rTMS treatment was defined as at least 50% reduction of the baseline MADRS scores. Patients were qualified as remitters when MADRS score was less than 10. If YMRS was more than 15, at inclusion or during the course of rTMS treatment, patients were excluded from the trial. The absolute changes in MADRS scores ( $\Delta$ MADRS) between baseline and the end of rTMS (4 weeks after the first evaluation) were used to calculate clinical improvement and then, correlated with power in different EEG frequency bands.

Seventeen healthy volunteers (9 females), aged 21 to 60 (mean  $31.2 \pm 10.3$  years), with no history of any neurological or psychological disorder or any contraindication for TMS were recruited to be used as controls. EEG signals of control participants were recorded under the same conditions as in patients, but with no TMS pulses actually delivered.

Table 1: Demographic features.

	HC	MDD	BP
	n=17	n=8	n=10
Mean age (years)	$31.2 \pm 10.3$	$52.1 \pm 7.8$	$48.7 \pm 12.6$
Gender (male/female)	9/8	2/6	4/6
MADRS at baseline	-	$24.6 \pm 9.3$	$23.6 \pm 3.2$
Duration of illness	-	$10.3 \pm 6.4$	$18.9 \pm 10.9$

#### *Repetitive transcranial magnetic stimulation (rTMS)*

At the first rTMS/EEG session, resting motor threshold (RMT) of the right thumb abductor was determined by delivering single TMS pulses to the left motor cortex with pre-gelled surface electrodes connected to an electromyographic (EMG) amplifier (MEP Monitor, Tonika Elektronik A/S, Denmark). The motor threshold was defined as the minimum stimulation intensity capable to induce at least 5 motor evoked potentials of at least  $50 \mu\text{V}$  peak-to-peak amplitude in 10 single TMS stimulations (Pascual-Leone et al., 1996).

During rTMS treatment, the stimulation was guided by a neuronavigation system (Premium Edition, Localite GmbH, Germany) to precisely define the neuroanatomical target of TMS

from a T1-weighted magnetic resonance image (MRI) of patient's brain (Herwig et al., 2001). The TMS coil was then positioned in every session over the left DLPFC target point, defined as the intersection between Brodmann areas 9 and 46 along the middle frontal gyrus. Active rTMS was performed using a MagPro X100 TMS stimulator (Tonika Elektronik A/S, Denmark) with butterfly MCF-B65-cooled coil (Tonika Elektronik A/S, Denmark). The coil was placed tangentially to the scalp to produce the highest level of the stimulation on the cortical region parallel to the coil (Chen et al., 2003). The handle was placed backward and laterally, approximately at  $45^\circ$  from the midline perpendicular to the central sulcus. In case of head movement during the experiment, stimulation was stopped transiently and the coil was manually repositioned to its initial position.

Repetitive TMS was delivered using standard procedure of depression treatment. Left DLPFC was stimulated at a frequency of 10 Hz in 5-second trains at 120% of the estimated RMT. Forty trains were given in each session (2000 pulses per session) with a 25-second intertrain interval. Twenty sessions were administrated within a 4-week period.

#### *EEG acquisition*

Patients were seated in a reclining armchair with neck and back supported with a pillow, arms relaxed and eyes closed. EEG was recorded before the first rTMS, then during stimulation and after stimuli. The following two recordings were taken in the middle session (2 weeks after inclusion) and during the last one, 4 weeks after inclusion. EEG signals were recorded with a 64-channel elastic cap with Ag/AgCl electrodes positioned at the beginning of the experimental session according to the 10-20 system (Fast'n'Easy cap, Brain Products GmbH, Munich, Germany) and connected to TMS-compatible DC amplifiers (BrainAmp, Brain Products GmbH, Munich, Germany). Right eye vertical movements were recorded with one electrooculogram (EOG) electrode. Electrode impedances were maintained below  $10 \text{ k}\Omega$  using conduction gel. Data were recorded with a referential montage, where the reference electrode was placed just anterior to Fz, and the ground electrode just posterior to Fz. The EEG amplifier was used in DC mode with a high frequency cut off at 1000 Hz and no additional on-line filtering. Recordings were digitized at 2500 Hz sampling frequency with 16-bit resolution. Positions of the 64 EEG electrodes and of the three fiducials (left and right tragus and nasion) were measured with the TMS neuronavigation system.

#### *EEG processing*

Fifteen-minutes resting state pre- and post-rTMS EEG recordings, which did not contain any artefact due the TMS pulses, were analysed for this study. EEG data were pre-processed off-line in EEGLab (Delorme and Makeig, 2004) and SPM8 (Wellcome Trust Centre for Neuroimaging, University College London, UK) running in Matlab (The MathWorks, USA). Continuous recordings were first band-pass filtered between 1 and 45 Hz and down sampled at 128 Hz to speed up subsequent analyses. Time periods that contained large muscular and other non-stereotyped artefacts were then carefully

pruned from the signals. Up to 5 bad channels per session were visually identified. This data selection was followed by an independent component analysis (ICA) to remove eye blinks and cardiac components from the EEG. After first decomposition and elimination of bad components, a second round of ICA filtering was performed as proposed in Onton et al. (2006). The choice of bad components was based on visual inspection of the spatial and temporal patterns of every component. Finally, 10-minute cleaned EEG signals were re-referenced to the common average for scalp and source analyses, in accordance with the assumption made for EEG forward modelling.

#### *EEG spectral analysis at the scalp and cortex levels*

The artefact-free signals were selected for further processing. In order to remove the impedance bias between recordings, EEG signals of each channel and each recording was divided by its square root of variance over all channels during the recording. Normalized EEG recordings were segmented into 20-second successive epochs. A fast Fourier transform (FFT) was applied to estimate spectral power for each electrode and epoch. Then, the normalized spectral power was averaged over frequencies in separate bands: delta (1-4 Hz), theta (3.5-7 Hz), alpha (7.5-13 Hz), beta (14-30 Hz) and gamma (30-45 Hz). For statistical analyses in SPM8, the normalized spectral power of each frequency band and each time bin was converted into a scalp map (128x128 pixels) using a two-dimensional (2D) spatial linear interpolation. Those maps were smoothed with a Gaussian kernel of 5 mm full width half maximum (FWHM) to conform to assumptions of subsequent statistical analysis and to diminish inter-subject variability.

Source reconstruction was performed on normalized EEG recordings using the procedure proposed in Litvak and Friston (2008). The canonical mesh at standard spatial resolution (8196 sources) was warped to each subject's anatomy. This step ensured that cortical activity was reconstructed in the same source space over subjects (Mattout et al., 2007). EEG electrodes were repositioned in subject's MRI space with rigid co-registration using the coordinates of the three fiducials (left ear, nasion, right ear) and spatial projection of the electrode coordinates to the closest scalp points. Then, a boundary element method (BEM) head model was used to compute the forward operator that encodes the lead field of each cortical source. Finally, an image of cortical power was produced every 20 s of the 10 min selected scalp data using the following steps: 1) Every 20 s time-window was epoched into ten successive time windows of 2 s duration. 2) Induced cortical power was estimated from the 10 small time windows using the inverse procedure of (Litvak and Friston, 2008), based on a hierarchical model with multiple sparse priors for EEG source reconstruction (Friston et al., 2008) and empirical priors that force uniformity of source reconstruction over epochs. We used the "independent and identically distributed" (IID) option for spatial priors in SPM8, which corresponds to a minimum norm-like inverse solution. 3) The image of cortical power for every frequency band of interest was created using a contrast that did a band-pass filtering. 4) Finally, images of cortical power were smoothed with an isotropic Gaussian kernel of 8 mm FWHM.

#### *EEG asymmetry analysis*

To analyse the asymmetry in EEG signal we created a new image of EEG Asymmetry according to the following formula:

$$\text{Asymmetry map} = \text{Recorded EEG map} - \text{Left/Right Flipped Image of Recorded EEG}$$

Using this formula we can calculate the differences between original and flipped images.

#### *Statistical analyses*

Statistical analyses of spectral power and asymmetry images were separated into first level (subject level) and second level (group level) analyses. The statistical design of those analyses was similar between scalp and cortical images. Subject level analysis consisted of a one sample t-test for each recording session that allowed to obtain an image of the mean activity for recording session applying the contrast "1" on the parameter estimates, as usual in SPM8. Those images were used as input data to the second level analyses. To assess potential group differences in power of different frequency waves, factorial and regression analysis with age as covariates of no interest was used between-group comparisons. Firstly, a three-way analysis of variance (ANOVA) on baseline recordings over patients was used to assess significant changes during the treatment. The 3 factors were "Session" (session 1, 10 and 20), "Response" to treatment (responders vs. non-responders) and "Disease" (MDD vs. BP). Then, to be able to verify short-term changes in the brain plasticity, we run another three-way ANOVA, using baseline and post-stimulus recordings for MDD and BP patients separately. Here, the factors were: "Session", "Response" and "Time" (pre-rTMS vs post-rTMS). To study the changes of oscillatory power after rTMS therapy, we used next three-way ANOVA with three factors: "Response", "Disease" and "Therapy" (first pre-rTMS vs. last post-rTMS). In case of significant effects, post hoc tests (Tukey HSD) were performed. For scalp and cortical sources analysis, the statistical threshold was set at  $p < 0.05$ , with correction for multiple comparisons by controlling the family wise error (FWE).

## **Results**

#### *Clinical outcome*

Two out of 20 recruited patients had to be excluded after the first session. The first one declined to continue to participate to the study, while the second one was not manageable for EEG recordings because of very severe depression. Four out of 18 remaining patients stopped rTMS treatment after 10 sessions (second EEG-rTMS recording, 2 weeks after inclusion) because of lack of the response to the rTMS therapy. Four out of 8 MDD and 6 out of 10 BP patients were responders to rTMS. Overall, we were able to analysed 18 patients in sessions 1 and 2, and 14 patients in session 3.

#### *Fast modulation of EEG spectral power*

At the group level, we did not find any significant short-term changes between pre-rTMS and post-rTMS EEG recorded during the same session in all frequency bands.

### Comparison of responders and non-responders

The analysis of responders and non-responders (Figure 1) revealed larger delta and theta power in responders, while alpha oscillations were higher in non-responders ( $p < 0.05$  FWE). In responders, higher delta activity was observed bilaterally in a distributed network, with largest effects in the left hemisphere. Theta band showed the same pattern as delta, but more significant and thus more spread. The most significant changes were observed in the temporo-parietal lobes, reaching supramarginal gyri and right temporal lobe, up to bilateral prefrontal cortex, including DLPFC. Interestingly, non-responders to rTMS treatment showed higher alpha activity than responders. Significant difference in alpha was observed in left and right frontal lobes (most significant), ventral cingulate gyrus and lateral visual cortex (Figure 1).

To detect disease specific responses, we plotted MDD and BP groups separately (Figures 2 and 3). This revealed that beta band was significantly higher in posterior and inferior parietal lobes, bilaterally, reaching left DLPFC in responders than non-responders only in a group of MDD patients. Delta activity in BP responders was much more focused comparing to MDD patients. The highest activation was observed in the right and left supramarginal gyri, inferior occipital lobes, and in prefrontal cortex. Theta oscillations demonstrated the same pattern of activity as in MDD patients, however with higher amplitude than in MDD responders. In two groups of patients non-responders showed increased alpha power. In BP non-responders, power of alpha oscillations was significantly increased in frontal and occipital lobes. In MDD nonresponders the most significant differences were observed bilaterally in superior parietal cortex, and to a less extent in the visual cortex.

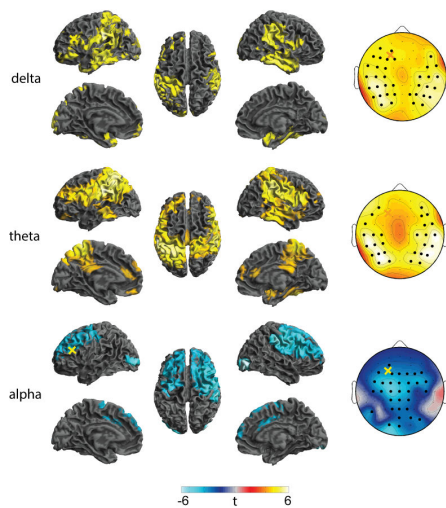

Figure 1: Group analysis of responders and non-responders in a group of patients. Blue colour indicates higher activity in non-responders, red colour higher activity in responders. Scalp and cortical maps are thresholded at  $p < 0.05$  FWE ( $T = 3.2$ ). Yellow cross on the scalp and cortex indicates the target of stimulation.

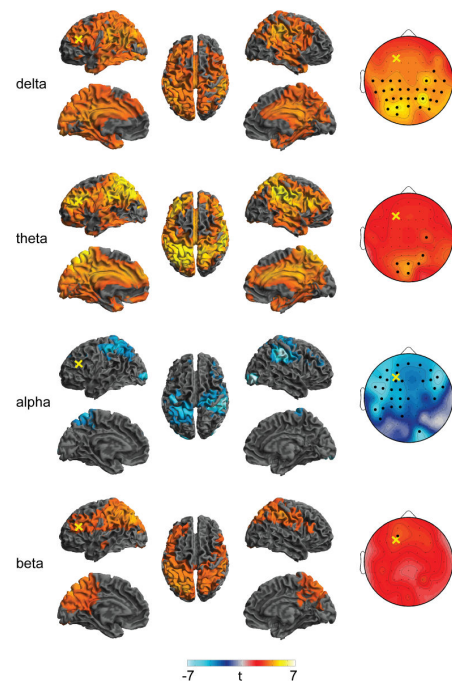

Figure 2: Group analysis of responders and non-responders in a group of MDD patients. Scalp and cortical maps are thresholded at  $p < 0.05$  FWE ( $T = 3.1$ ). See Figure 1 for details.

### Comparison of healthy controls with patients

One way ANOVA of patients (responders and non-responders) and healthy controls baseline recordings showed significantly higher delta and theta power in non-responders, where alpha oscillations were clearly increased ( $p < 0.05$  FWE, 4 Differences in beta band were not significant).

Most significant differences for delta band were found in parieto-occipital lobes with higher power in healthy controls. Regarding theta band, in the left posterior temporal and parieto-occipital lobes we observed higher absolute power in HC group than non-responders to the treatment. In non-responders an increase of alpha power was found in the left middle frontal gyri and right inferior frontal lobe with additional higher activity in ventral and posterior cingulate cortex.

Regarding comparison of HC with responders, we did not observed any significant differences between these two groups.

### MDD and BP

A comparison of all MDD and BP patients revealed that BP patients demonstrate higher theta and beta band oscillations than MDD patients ( $p < 0.05$  FWE, Figure 5). In theta range, BP patients showed higher activity in the left and right anterior dorsolateral frontal gyri and bilaterally in the ventral cingulate cortex. Additionally, we observed more activity in the left than right rostral section of temporal gyrus. However, in beta range higher power in bipolar patients was observed in the

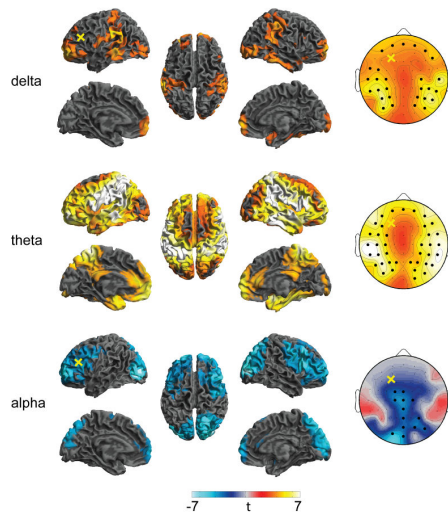

Figure 3: Group analysis of responders and non-responders in a group of BP patients. Significance threshold  $p < 0.05$  FWE ( $T = 3.1$ ). See Figure 1 for details.

right frontal gyri, left and right temporal pole and interestingly, in the right rostral section of temporal gyrus. In addition, patients suffering from bipolar depression showed higher activity in the right primary motor cortex in both frequencies.

#### *First baseline compared with last post-rTMS*

Post-hoc comparison for the significant interaction of “Resp-Non x Pre-Post” on the scalp level showed that there was slightly higher, however not significant, theta activity in responders after the rTMS therapy than in non-responders ( $p < 0.05$  unc.). The highest activity was observed in the right and left parieto-temporal areas. The same analysis on the cortex level did not reveal any significant changes.

#### *Regression analysis*

Ten out of eighteen studied patients responded to the 10 Hz rTMS therapy. They showed more than 50% reduction in the initial MADRS score after 4 weeks of the treatment. The scores are presented in Table 2.

Multiple regression analysis implemented in SPM8 allowed to study the correlation of the EEG power and  $\Delta$ MADRS scores not only on the scalp, but also on the cortex. The results revealed that  $\Delta$ MADRS was significantly and positively correlated with posterior midline theta band power ( $p < 0.01$  unc.), while alpha band power on the fronto-temporal regions, around post central and precentral gyri, was correlated negatively ( $p < 0.05$  unc., Figure 6). Right anterior temporal lobe presented high pre-treatment theta activity in responders, seen on scalp and cortex level. Additionally, using the source analysis, higher baseline activity in theta band power in ventral section of cingulate cortex was observed in responders to rTMS therapy. Correlation, however, was not highly significant, probably because of only 10 patients who were recorded for the third

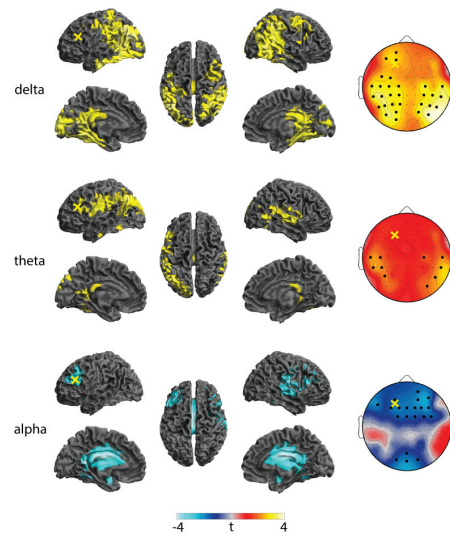

Figure 4: Group analysis of differences between healthy controls and non-responding patients. Red colour indicates higher power in healthy controls, blue colour higher power in non-responders. Scalp maps are thresholded at  $p < 0.05$  FWE ( $t = 3.1$ ) and on cortical level  $p < 0.001$  uncorrected, ( $t = 3.35$ ). See Figure 1 for details.

time and had measured the third MADRS score. The regression analysis between MADRS changes and power in other frequency bands did not show any significant correlation.

#### *Asymmetry of baseline EEG*

No statistically significant differences in EEG asymmetry were reported in the group of examined patients.

## Discussion

The main objectives were to investigate the short and long-lasting changes in cortical activity induced by 10 Hz rTMS treatment and to study the possible EEG biomarkers to distinguish a priori responders and non-responders to rTMS therapy. Additionally, we studied EEG differences between BP and MDD patients. Different patterns of oscillatory activity were analysed and demonstrated significant dissimilarities, despite the small number of participants. The results of the present study also indicate that pre-treatment EEG baseline analysis reveals important information about the treated patients, and the further possible treatment course.

#### *EEG after-effects*

The most robust finding of this study is that it is possible to distinguish non-responders to the treatment from responders and healthy controls. Significantly lower power of low frequency oscillations was observed in non-responding patients. Next, in both groups of patients (responders and non-responders) increase of alpha power was observed in ventral

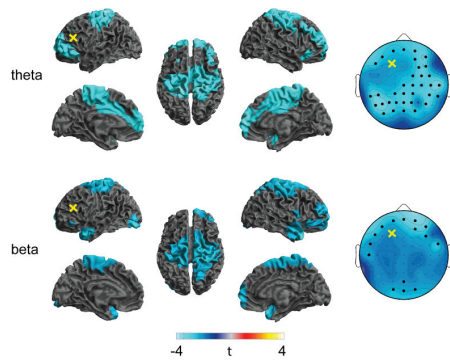

Figure 5: Group analysis of differences between MDD and BP patients, responders and non-responders put together. Blue colour indicates higher activity in BP, red colour higher activity in MDD. Scalp and cortical maps are thresholded at  $p < 0.05$  FWE ( $T = 3.4$ ). See Figure 1 for details.

Table 2: Scores of MADRS scale of depressed patients during the rTMS therapy. (- indicates missing data)

Patient	Baseline	2 weeks	4 weeks
P1	15	-	-
P2	15	11	-
P3	36	33	-
P5	23	-	-
P7	32	18	5
P9	32	23	13
P10	26	15	5
P11	25	28	8
P12	23	26	21
P13	28	28	15
P14	21	23	1
P15	15	22	-
P16	27	17	36
P17	24	10	5
P18	18	4	-
P19	27	24	-

cingulate cortex. In addition, non-responders showed higher alpha activity in prefrontal cortex.

Schulman et al. (2011) and Fuggetta and Noh (2013) demonstrated opposite results to the present analysis of HC and patients group. They observed increased low-frequencies oscillations, caused by constant thalamic delta or theta bands activity, registered during awake and at rest in depressed patients, when compared to healthy controls. However, our findings are in line with a study by Coutin-Churchman et al. (2003), where more activity in low frequencies in occipital lobe in the group of healthy participants than in non-responding patients was registered. Also, patients demonstrated increased power of alpha band in the frontal regions, especially in DLPFC, bilaterally. Increased alpha rhythm can be explained as an association of alpha band with thalamic dysfunction and cortical activity perturbation (Begic et al., 2011). As it was indicated in previous stud-

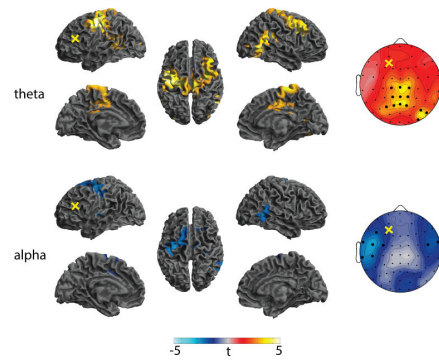

Figure 6: Regression analysis of theta and alpha power and  $\Delta$ MADRS score changes. Theta band is thresholded at  $p < 0.01$ , uncorrected ( $T = 2.9$ ) and alpha band at  $p < 0.05$ , uncorrected ( $T = 1.9$ ). Yellow dots on the scalp indicate electrodes near rTMS coil and yellow cross shows the cortical target. The higher alpha power at baseline in posterior fronto-temporal regions and the lower theta power at baseline in posterior frontal regions, the lower was the rTMS-treatment response. See Figure 1 for details.

ies (Cook et al., 1998; Pollock and Schneider, 1990), reduced left frontal activity is followed by increased activity of alpha oscillations. Researches using functional magnetic resonance imaging (fMRI) of resting-state blood oxygen level-dependent (BOLD) signal in MDD have shown lower relative blood flow in the left DLPFC areas and what come along, decreased cortical excitability. 10 Hz rTMS is then suggested to boost the activity not only in the stimulated region, but also in other areas including anterior cingulate cortex (Paus et al., 2001; Rossini et al., 2010).

Analysis of responders and non-responders in a group of MDD and BP patients also revealed similar results (Figure 1). Non-responders tend to show decreased activity in low frequencies, and increased power in alpha band. Interestingly, when this test was performed separately on two types of depression, higher beta power was observed only in MDD responders than non-responders.

Interestingly, group analysis of different oscillatory patterns in MDD and BP patients demonstrated increased power in theta and beta bands in BP patients (see Figure 5). Higher beta rhythm observed in patients with bipolar disorder can be implicated by high sensitivity of emotional context and may be associated with increased vulnerability in bipolar disease model (Phillips et al., 2003). Furthermore, increased power in theta and beta bands in motor areas in BP patients can suggest that psychomotor activation and thoughts acceleration might be a potential marker for bipolar type of depression. Our findings are in line with a study by Cassano et al. (2012), where the psychomotor activation factor was determined for patients with unipolar and bipolar disorder.

#### Long-lasting rTMS treatment effects

The analysis of long-lasting rTMS-after-effects (comparing baseline with last post-rTMS) revealed that increased theta activity outlasted the rTMS treatment in responders to the stimula-



tion. However, this result did not reach significant level ( $p < 0.05$  unc.). It can be partially explained by small number of patients recorded for the third time. Right and left parieto-temporal and frontal midline areas showed increase of theta power in MDD and BP group of responders, which can suggest that decreased theta band power in non-responders is associated with higher level of anxiety (Gold et al., 2013).

#### Regression analysis

Importantly, we observed a negative correlation between alpha power at baseline and  $\Delta$ MADRS amelioration, amelioration, which is in line with Price et al. (2008) and Micoulaud-Franchi et al. (2012). However, in cited studies depression severity were recorded with 13-item Beck Depression Inventory (BDI-Short Form) whereas here, we used MADRS scores. Furthermore, we also observed significant positive correlation between  $\Delta$ MADRS and theta band power. However, researchers analysing the predictive value of alpha band power at baseline to different antidepressant pharmacological treatment outcome showed an opposite results to ours (Ulrich et al., 1984; Knott et al., 1996; Bruder et al., 2001, 2008; Tenke et al., 2011). These reversed results between rTMS and pharmacological treatment may indicate on two different mechanisms of action underling the antidepressant drugs and magnetic stimulation effects. According to Leuchter et al. (2013), rTMS seems to act trough entraining pathological brain activity to the frequency of delivered stimulation, facilitating the re-emergence of normal, intrinsic oscillatory activity by resetting cortical and thalamo-cortical oscillators (Paus et al., 2001; Fuggetta et al., 2005, 2008; Leuchter et al., 2013).

#### Advances and limitations of the study

To our knowledge, no study compares unipolar and bipolar depression and responders and non-responders in one study, using also source localisation analysis. However, several limitations should be considered in this study. First of all, patients were not drug-naive or drug-free, which could have an influence on the brain oscillatory activity and be different compared to drug-free patients (Itil et al., 1983). Second, here we studied only pharmacoresistant patients whose brain activity can vary from depressed patients in general, especially non-pharmacoresistant. Regarding the signal analysis, changes over time of spectral power were not analysed. The main reason for that is that many contaminated periods were cut differently between subjects to increase the likelihood of capturing neuronal signatures. Second, the post-EEG recording period was limited to 15 minutes, because of the lengthy experimental procedure duration (preparation and recordings) that made patients very tired.

Future studies with similar design, with more homogeneous cohort of patients and with bigger number of participants are required to confirm these results. Nevertheless, the presented results demonstrate that neurophysiological EEG biomarkers can be useful as a tool to distinguish MDD from BP patients, and the most important, responders from non-responders to rTMS treatment. Additionally, we can suggest that lateral parietal

cortex can be a potential rTMS target in future works. Results presented on figures 1-3 shows inhibited activity in the left and right parietal cortex in non-responders to rTMS, suggesting that these patients suffer from stronger inhibition of emotion-regulating regions (Downar and Daskalakis, 2013). However this approach should be based on pre-treatment EEG analysis of each individual patient.

#### Acknowledgments

Agata Woźniak-Kwaśniewska is a PhD student sponsored by Rhône-Alpes scholarship. O.D. is funded by Inserm. We thank Pr. Christian Marendaz for sharing the TMS research facility.

#### References

2000. *Diagnostic and Statistical Manual of Mental Disorders*. American Psychiatric Association, Washington, DC.
- Allen, J. J., Urry, H. L., Hitt, S. K., and Coan, J. A. 2004. The stability of resting frontal electroencephalographic asymmetry in depression. *Psychophysiology*, 41(2):269 – 280.
- Beck, A. T., Steer, R. A., Ball, R., and Ranieri, W. 1996. Comparison of beck depression inventories-IA and -II in psychiatric outpatients. *Journal of Personality Assessment*, 67:588-597.
- Begic, D., Popovic-Knapic, V., Grubisin, J., Kosanovic-Rajacic, B., Filipic, I., Telarovic, I., and Jakovljevic, M. 2011. Quantitative electroencephalography in schizophrenia and depression. *Psychiatr Danub*, 23(4):355 – 362.
- Bouvard, M., Charles, S., Guerin, J., Aimard, G., and Cottraux, J. 1992. Study of beck's hopelessness scale. validation and factor analysis. *Encephale*, 18:237-240.
- Bruder, G. E., Sedoruk, J. P., Stewart, J. W., McGrath, P. J., Quitkin, F. M., and Tenke, C. E. 2008. Electroencephalographic alpha measures predict therapeutic response to a selective serotonin reuptake inhibitor antidepressant: Pre- and post-treatment findings. *Biological Psychiatry*, 63(12):1171 – 1177.
- Bruder, G. E., Stewart, J. W., Tenke, C. E., McGrath, P. J., Leite, P., Bhat-tacharya, N., and Quitkin, F. M. 2001. Electroencephalographic and perceptual asymmetry differences between responders and nonresponders to an ssri antidepressant. *Biological Psychiatry*, 49(5):416 – 425.
- Carpenter, L. L., Janicak, P. G., Aaronson, S. T., Boyadjis, T., Brock, D. G., Cook, I. A., Dunner, D. L., Lanocha, K., Solvason, H. B., and Demitrack, M. A. 2012. Transcranial magnetic stimulation (TMS) for major depression: a multisite, naturalistic, observational study of acute treatment outcomes in clinical practice. *Depress Anxiety*, 29(7):587 – 596.
- Cassano, G. B., Rucci, P., Benvenuti, A., Miniati, M., Calugi, S., Maggi, L., Pini, S., Kupfer, D. J., Maj, M., Fagiolini, A., and Frank, E. 2012. The role of psychomotor activation in discriminating unipolar from bipolar disorders: a classification-tree analysis. *J Clin Psychiatry*, 73(1):22 – 28.
- Chen, R., Yung, D., and Li, J. Y. 2003. Organization of ipsilateral excitatory and inhibitory pathways in the human motor cortex. *J Neurophysiol.*, 89(3):1256 – 1264.
- Coburn, K. L., Lauterbach, E. C., Boutros, N. N., Black, K. J., Arciniegas, D. B., and Coffey, C. E. 2006. The value of quantitative electroencephalography in clinical psychiatry: a report by the committee on research of the american neuropsychiatric association. *The Journal of Neuropsychiatry and Clinical Neurosciences*, 18:460 – 500.
- Collet, L. and Cottraux, J. 1986. The shortened beck depression inventory (13 items). study of the concurrent validity with the hamilton scale and wid-locher's retardation scale. *Encephale*, 12:777-79.
- Cook, I. A., O'Hara, R., Uijtdehaage, S. H., Mandelkern, M., and Leuchter, A. F. 1998. Assessing the accuracy of topographic EEG mapping for determining local brain function. *Electroencephalogr Clin Neurophysiol*, 107(6):408–14.
- Coutin-Churchman, P., Anez, Y., Uzcategui, M., Alvarez, L., Vergara, F., Mendez, L., and Fleitas, R. 2003. Quantitative spectral analysis of EEG in psychiatry revisited: drawing signs out of numbers in a clinical setting. *Clinical Neurophysiology*, 114(12):2294 – 2306.

- Debener, S., Beauducel, A., Nessler, D., Brocke, B., Heilemann, H., and Kayser, J. 2000. Is resting anterior EEG alpha asymmetry a trait marker for depression? Findings for healthy adults and clinically depressed patients. *Neuropsychobiology*, 41(1):31 – 37.
- Dell'Osso, B., Mundo, E., D'Urso, N., Pozzoli, S., Buoli, M., Ciabatti, M., Rosanova, M., Massimini, M., Bellina, V., Mariotti, M., and Altamura, A. C. 2009. Augmentative repetitive navigated transcranial magnetic stimulation (rTMS) in drug-resistant bipolar depression. *Bipolar Disord*, 11(1):76 – 81.
- Delorme, A. and Makeig, S. 2004. Eeglab: an open source toolbox for analysis of single-trial eeg dynamics including independent component analysis. *Journal of Neuroscience Methods*, 134(1):9 – 21.
- Disner, S. G., Beevers, C. G., Haigh, E. A., and Beck, A. T. 2011. Neural mechanisms of the cognitive model of depression. *Nat. Rev. Neurosci.*, 12(8):467 – 477.
- Dolberg, O. T., Dannon, P. N., Schreiber, S., and Grunhaus, L. 2002. Transcranial magnetic stimulation in patients with bipolar depression: a double blind, controlled study. *Bipolar Disord*, 4 Suppl 1:94 – 95.
- Downar, J. and Daskalakis, Z. J. 2013. New targets for rTMS in depression: A review of convergent evidence. *Brain Stimulation*, 6(3):231–240.
- Drevets, W. C., Price, J. L., and Furey, M. L. 2008. Brain structural and functional abnormalities in mood disorders: implications for neurocircuitry models of depression. *Brain Struct Funct*, 213(1-2):93 – 118.
- Fitzgerald, P. B., Huntsman, S., Gunewardene, R., Kulkarni, J., and Daskalakis, Z. J. 2006. A randomized trial of low-frequency right-prefrontal-cortex transcranial magnetic stimulation as augmentation in treatment-resistant major depression. *Int. J. Neuropsychopharmacol.*, 9(6):655 – 666.
- Ford, K. A., Théberge, J., Neufeld, R. J., Williamson, P. C., and Osuch, E. A. 2013. Correlation of brain default mode network activation with bipolarity index in youth with mood disorders. *Journal of Affective Disorders*, 150(3):1174 – 1178.
- Friston, K., Harrison, L., Daunizeau, J., Kiebel, S., Phillips, C., Trujillo-Barreto, N., Henson, R., Flandin, G., and Mattout, J. 2008. Multiple sparse priors for the M/EEG inverse problem. *NeuroImage*, 39(3):1104 – 1120.
- Fuggetta, G., Fiaschi, A., and Manganotti, P. 2005. Modulation of cortical oscillatory activities induced by varying single-pulse transcranial magnetic stimulation intensity over the left primary motor area: A combined EEG and TMS study. *NeuroImage*, 27(4):896 – 908.
- Fuggetta, G. and Noh, N. A. 2013. A neurophysiological insight into the potential link between transcranial magnetic stimulation, thalamocortical dysrhythmia and neuropsychiatric disorders. *Experimental Neurology*, 245:87–95.
- Fuggetta, G., Pavone, E. F., Fiaschi, A., and Manganotti, P. 2008. Acute modulation of cortical oscillatory activities during short trains of high-frequency repetitive transcranial magnetic stimulation of the human motor cortex: A combined eeg and tms study. *Human Brain Mapping*, 29:1–13.
- George, M. S., Nahas, Z., Molloy, M., Speer, A. M., Oliver, N. C., Li, X. B., Arana, G. W., Risch, S. C., and Ballenger, J. C. 2000. A controlled trial of daily left prefrontal cortex tms for treating depression. *Biological Psychiatry*, 48(10):962 – 970.
- George, M. S., Wassermann, E. M., Williams, W. A., Callahan, A., Ketter, T. A., Basser, P., Hallett, M., and Post, R. M. 1995. Daily repetitive transcranial magnetic stimulation (rTMS) improves mood in depression. *Neuroreport*, 6(14):1853 – 1856.
- Gold, C., Fachner, J., and Erkkila, J. 2013. Validity and reliability of electroencephalographic frontal alpha asymmetry and frontal midline theta as biomarkers for depression. *Scand J Psychol*, 54(2):118 – 126.
- Heikman, P., Salmelin, R., Makela, J. P., Hari, R., Katila, H., and Kuoppasalmi, K. 2001. Relation between frontal 3-7 Hz MEG activity and the efficacy of ECT in major depression. *J ECT*, 17(2):136 – 140.
- Herwig, U., Padberg, F., Unger, J., Spitzer, M., and Schonfeldt-Lecuona, C. 2001. Transcranial magnetic stimulation in therapy studies: examination of the reliability of "standard" coil positioning by neuronavigation. *Biological Psychiatry*, 50(1):58 – 61.
- Iosifescu, D. V. 2011. Electroencephalography-derived biomarkers of antidepressant response. *Harvard Review of Psychiatry*, 19(3):144 – 154.
- Iosifescu, D. V., Greenwald, S., Devlin, P., Mischoulon, D., Denninger, J. W., Alpert, J. E., and Fava, M. 2009. Frontal EEG predictors of treatment outcome in major depressive disorder. *European Neuropsychopharmacology*, 19(11):772 – 777.
- Itil, T. M., Shrivastava, R. K., Mukherjee, S., Coleman, B. S., and Michael, S. T. 1983. A double-blind placebo-controlled study of fluvoxamine and imipramine in out-patients with primary depression. *Br J Clin Pharmacol*, 15 Suppl 3:433S–438S.
- Kemp, A. H., Gordon, E., Rush, A. J., and Williams, L. M. 2008. Improving the prediction of treatment response in depression: integration of clinical, cognitive, psychophysiological, neuroimaging, and genetic measures. *CNS Spectr*, 13(12):1066 – 1086.
- Knott, V., Mahoney, C., Kennedy, S., and Evans, K. 2000. Pre-treatment EEG and it's relationship to depression severity and paroxetine treatment outcome. *Pharmacopsychiatry*, 33(6):201 – 205.
- Knott, V., Telner, J. I., Lapierre, Y. D., Browne, M., and Horn, E. R. 1996. Quantitative EEG in the prediction of antidepressant response to imipramine. *Journal of Affective Disorders*, 39(3):175 – 184.
- Leuchter, A. F., Cook, I. A., Jin, Y., and Phillips, B. 2013. The relationship between brain oscillatory activity and therapeutic effectiveness of transcranial magnetic stimulation in the treatment of major depressive disorder. *Frontiers in Human Neuroscience*, 7(37).
- Li, C., Lin, C., Chou, K., Chen, I., Hsieh, J., Wu, C., Lin, W., and Su, T. 2010. Structural and cognitive deficits in remitting and non-remitting recurrent depression: a voxel-based morphometric study. *NeuroImage*, 50:347 – 356.
- Litvak, V. and Friston, K. 2008. Electromagnetic source reconstruction for group studies. *NeuroImage*, 42(4):1490 – 1498.
- Mattout, J., Henson, R. N., and Friston, K. J. 2007. Canonical source reconstruction for MEG. *Comput Intell Neurosci*, page 67613.
- Mayberg, H. S. 2003. Modulating dysfunctional limbic-cortical circuits in depression: towards development of brain-based algorithms for diagnosis and optimised treatment. *Br. Med. Bull.*, 65:193 – 207.
- Micoulaud-Franchi, J.-A., Richieri, R., Cermolacce, M., Loundou, A., Lancon, C., and Vion-Dury, J. 2012. Parieto-temporal alpha EEG band power at baseline as a predictor of antidepressant treatment response with repetitive transcranial magnetic stimulation: A preliminary study. *Journal of Affective Disorders*, 137(13):156 – 160.
- Montgomery, S. A. and Asberg, M. 1979. A new depression scale designed to be sensitive to change. *Br J Psychiatry*, 134:382 – 389.
- Oldfield, R. 1971. The assessment and analysis of handedness: The Edinburgh inventory. *Neuropsychologia*, 9(1):97 – 113.
- Onton, J., Westerfield, M., Townsend, J., and Makeig, S. 2006. Imaging human EEG dynamics using independent component analysis. *Neurosci Biobehav Rev*, 30(6):808 – 822.
- Pascual-Leone, A., Rubio, B., Pallardo, F., and Catala, M. D. 1996. Rapid-rate transcranial magnetic stimulation of left dorsolateral prefrontal cortex in drug-resistant depression. *Lancet*, 348(9022):233 – 237.
- Paus, T., Sipila, P. K., and Strafella, A. P. 2001. Synchronization of neuronal activity in the human primary motor cortex by transcranial magnetic stimulation: an EEG study. *J. Neurophysiol.*, 86(4):1983 – 1990.
- Phillips, M. L., Drevets, W. C., Rauch, S. L., and Lane, R. 2003. Neurobiology of emotion perception II: implications for major psychiatric disorders. *Biological Psychiatry*, 54(5):515 – 528.
- Pigott, H. E., Leventhal, A. M., Alter, G. S., and Boren, J. J. 2010. Efficacy and effectiveness of antidepressants: current status of research. *Psychother Psychosom*, 79(5):267 – 279.
- Pollock, V. E. and Schneider, L. S. 1990. Topographic quantitative eeg in elderly subjects with major depression. *Psychophysiology*, 27(4):438 – 444.
- Price, G., Lee, J., Garvey, C., and Gibson, N. 2008. Appraisal of sessional EEG features as a correlate of clinical changes in an rTMS treatment of depression. *Clin EEG Neurosci*, 39(3):131 – 8.
- Rossini, D., Lucca, A., Magri, L., Malaguti, A., Smeraldi, E., Colombo, C., and Zanardi, R. 2010. A symptom-specific analysis of the effect of high-frequency left or low-frequency right transcranial magnetic stimulation over the dorsolateral prefrontal cortex in major depression. *Neuropsychobiology*, 62(2):91 – 97.
- Schulman, J. J., Cancro, R., Lowe, S., Lu, F., Walton, K. D., and Llinas, R. R. 2011. Imaging of thalamocortical dysrhythmia in neuropsychiatry. *Front Hum Neurosci*, 5:69.
- Tamas, R. L., Menkes, D., and El-Mallakh, R. S. 2007. Stimulating research: a prospective, randomized, double-blind, sham-controlled study of slow transcranial magnetic stimulation in depressed bipolar patients. *J Neuropsychiatry Clin Neurosci*, 19(2):198 – 199.
- Tenke, C. E., Kayser, J., Manna, C. G., Fekri, S., Kropfmann, C. J., Schaller, J. D., Alschuler, D. M., Stewart, J. W., McGrath, P. J., and Bruder, G. E. 2011. Current source density measures of electroencephalographic alpha predict antidepressant treatment response. *Biological Psychiatry*, 70(4):388

- 394.
- Thase, M. E. and Rush, A. J. 1997. When at first you don't succeed: sequential strategies for antidepressant nonresponders. *J Clin Psychiatry*, 58 Suppl 13:23 – 29.
- Ulrich, G., Renfordt, E., Zeller, G., and Frick, K. 1984. Interrelation between changes in the EEG and psychopathology under pharmacotherapy for endogenous depression. a contribution to the predictor question. *Pharmacopsychiatry*, 17(6):178 – 183.
- Vuga, M., Fox, N. A., Cohn, J. F., George, C. J., Levenstein, R. M., and Kovacs, M. 2006. Long-term stability of frontal electroencephalographic asymmetry in adults with a history of depression and controls. *Int J Psychophysiol*, 59(2):107 – 115.
- Young, R. C., Biggs, J. T., Ziegler, V. E., and Meyer, D. A. 1978. A rating scale for mania: reliability, validity and sensitivity. *Br J Psychiatry*, 133:429 – 435.

# Conclusions and future works

---

## Contents

---

<b>7.1</b>	<b>Conclusions</b> . . . . .	<b>103</b>
<b>7.2</b>	<b>Future works</b> . . . . .	<b>107</b>

---

## 7.1 Conclusions

This thesis presents the results from concurrent EEG-rTMS on healthy participants and depressed patients. This project was introduced in context of the development of EEG for rTMS treatment in Psychiatry Department in CHU in Grenoble. This is the first thesis on this subject and the method used here is still being improved. Recently, the rTMS robot was bought, which allows to have precise coil placement during the entire stimulation period.

Using two cohorts of participants we aimed: 1) to find the rTMS after-effects on healthy brain when stimulated over left DLPFC, 2) to verify if resting state EEG can be used as a prediction of the response to therapeutic rTMS stimulation. Also, the analysis to distinguish BP and MDD patients was performed.

### Study I

The first experiment studied the changes in cortical oscillatory activities in response to five different rTMS protocols (1 Hz, 10 Hz, iTBS, cTBS and sham-1 Hz) using 64-channel EEG-rTMS compatible. To be able to compare between-protocols effect, stimulation duration and approximately the same number of pulses

were applied over left DLPFC. Absolute power of six frequency bands (delta, theta, alpha, low and high beta, and gamma) was examined on the scalp and cortex levels.

The most important result is the demonstration that rTMS induced a decrease in low and high frequencies mainly in frontal areas. Although, the significant changes were also observed in distant areas, particularly in the homologous region in high frequency bands. Significant after-effects in delta and theta oscillations were found over the left stimulation sites, whereas beta and gamma oscillations' changes were bilateral or in remote regions, including right DLPFC. Interestingly, there was no significant effect in the alpha band oscillations, even after 10 Hz stimulation. Moreover, regression analysis of visual analogue scale (VAS) scores and EEG spectral power changes induced by rTMS on every sessions pooled together did not reveal any significant correlation in every frequency band. Based on these results, we can suggest that tested active rTMS protocols may generally induce a transient reduction in local cortical inhibition and excitation when applied on the DLPFC.

According to the literature, it is the first study investigating various rTMS protocols within-subject, allowing for comprehensible between-protocols comparison. To our knowledge, this was not done before and all previous EEG-rTMS studies on DLPFC only tested a subset of these protocols [Graf 2001, Okamura 2001, Griskova 2007, Grossheinrich 2009]. Next, by using the neuronavigation system we improved the definition of the anatomical target and the repositioning of the coil between protocols [Herwig 2001a]. Most studies performed so far used a limited empirical approach proposed in the early days of rTMS to place the coil above Brodman area (BA) 9 and 46 [George 1995, Pascual-Leone 1996]. We may suggest that, additionally to the dissimilarities between stimulation parameters, the discrepancies of the stimulus precision can produce opposite (or negative) results between our work and above mentioned literature. Additionally, to our knowledge, there is still no available EEG source localisation study of resting state recordings in healthy subjects after rTMS.

However, this work still has some limitations. First of all, we did not analyse changes over time of spectral power as it was done in [Okamura 2001]. There are two reasons why we did not perform this test. Many contaminated periods were

cut differently between subjects and second, post-EEG recording period was limited only to 15 minutes. The preparation and recordings were already long (minimum 2 hours), which made subjects drowsy or sleepy. Next, used 64-electrodes EEG makes spatial precision of source analysis more limited than if higher number of electrodes was used.

## Study II

In the second part of this project, we performed EEG-rTMS co-registration on depressed patients undergoing 10 Hz rTMS treatment. Although some studies showed usefulness of EEG as a potential predictor of antidepressant therapy outcome [Knott 1996, Knott 2000, Heikman 2001, Iosifescu 2009], there are only few about the correlation between pretreatment brain oscillations and the response to rTMS treatment [Price 2008, Micoulaud-Franchi 2012].

The main goal was to distinguish neural oscillatory activity patterns between responders and non-responders with BP and MDD to standard 10 Hz rTMS treatment. As in previous experiment, we used 64-electrode EEG-rTMS compatible cap, although with a different protocol design (2000 pulses). To study changes in EEG during antidepressant treatment, each patient underwent three EEG-rTMS sessions which took place at the beginning of the treatment (day 1), in the middle (day 10) and at the last (20<sup>th</sup>) day of the treatment. To study different patterns of EEG activity in both depressive disorders, the spectral power of standard frequency bands was examined on the scalp and cortex levels. Furthermore, multiple regression analysis of all frequency bands and absolute improvement in Montgomery Asberg Depression Rate Scale ( $\Delta$ MADRS) was performed.

Here, the most important finding is an observation of negative correlation between alpha power at baseline and  $\Delta$ MADRS amelioration, which is in line with [Price 2008] and [Micoulaud-Franchi 2012]. Furthermore, we also observed significant positive correlation between  $\Delta$ MADRS and theta band power. However, researchers analysing the predictive value of alpha band power at baseline to different antidepressant pharmacological treatment outcome showed an opposite results to ours [Ulrich 1984, Knott 1996, Bruder 2001, Bruder 2008, Tenke 2011]. These

reversed results between rTMS and pharmacological treatment may indicate two different mechanisms of action underlying the effects of antidepressant drugs and of magnetic stimulation. According to [Thut 2011, Leuchter 2013], rTMS seems to act through entraining pathological brain activity to the frequency of delivered stimulation, facilitating the re-emergence of normal, intrinsic oscillatory activity by resetting cortical and thalamo-cortical oscillators [Paus 2001, Fuggetta 2005, Fuggetta 2008, Leuchter 2013].

Next, we showed that it is possible to distinguish non-responders to the treatment from responders and healthy controls. Significantly lower power of low frequency oscillations was observed in non-responding patients, which can be explained by deficit in inhibitory mechanisms. Although studies of [Schulman 2011] and [Fuggetta 2013] demonstrated opposite results, our findings are in line with a study by [Coutin-Churchman 2003], where more activity in low frequencies in occipital lobe in the group of healthy participants than in patients was registered.

Next, in both groups of patients (responders and non-responders) increase of alpha power was observed in ventral cingulate cortex. In addition, non-responders also showed higher alpha activity in prefrontal cortex. Increased alpha rhythm can be explained as an association of alpha band with thalamic dysfunction and cortical activity perturbation [Begic 2011]. As it was indicated in previous studies [Cook 1998, Pollock 1990], reduced left frontal activity is followed by increased activity of alpha oscillations. Researches using fMRI of resting-state blood oxygen level-dependent (BOLD) signal in MDD have shown lower relative blood flow in the left DLPFC areas and what come along, decreased cortical excitability. 10 Hz rTMS is thus suggested to boost the activity not only in the stimulated region, but also in other areas including anterior cingulate cortex [Paus 2001, Rossini 2010]. Importantly, analysis of responders and non-responders in a group of MDD and BP patients also revealed similar results.

Interestingly, group analysis of different oscillatory patterns in MDD and BP patients demonstrated increased power in theta and beta bands in BP patients. Higher beta rhythm observed in patients with bipolar disorder can be implicated by high sensitivity of emotional context and may be associated with increased vul-

nerability in bipolar disease according to the model of [Phillips 2003].

To our knowledge, no study compares unipolar and bipolar depression and responders and non-responders in one study, using also source localisation analysis. However, several limitations should be considered in this study. First of all, patients were not drug-naive or drug-free, which could have an influence on the brain oscillatory activity and be different compared to drug-free patients [Itil 1983]. Second, here we studied only pharmacoresistant patients whose brain activity can vary from depressed patients in general, especially non-pharmacoresistant. Regarding the signal analysis, changes over time of spectral power were not analysed. The main reason for that is that many contaminated periods were cut differently between subjects to increase the likelihood of capturing neuronal signatures. Second, the post-EEG recording period was limited to 15 minutes, because of the lengthy experimental procedure duration (preparation and recordings) that made patients very tired.

Future studies with similar design, with more homogeneous cohort of patients and with bigger number of participants are required to confirm these results. Nevertheless, the presented results demonstrate that neurophysiological EEG biomarkers can be useful as a tool to distinguish MDD from BP patients, and the most important, responders from non-responders to rTMS treatment.

## 7.2 Future works

To go further in the understanding of our data, it would also be relevant to develop neuronal models of EEG after-effects, as already proposed for motor cortex [Bey 2012]. This was out of the scope of this thesis but is an interesting avenue to explore. To do that I will work on rTMS-evoked responses and on the functional connectivity analysis of the same recordings using dynamic causal modeling (DCM) [Friston 2003, David 2006]. These method is based on Bayesian model comparison procedure that rests on comparing models of how data were generated. The basic idea is to construct reasonably realistic models of functionally connected cortical regions and then, to select the best model which can be identified from observed



data based on the model evidences.

# Bibliography

- [Adler 1999] G. Adler, A. Bramesfeld and A. Jajcevic. *Mild cognitive impairment in old-age depression is associated with increased EEG slow-wave power*. Neuropsychobiology, vol. 40, no. 4, pages 218 – 222, Nov 1999. (Cited on page 61.)
- [Adler 2005] C. M. Adler, A. D. Levine, M. P. DelBello and S. M. Strakowski. *Changes in Gray Matter Volume in Patients with Bipolar Disorder*. Biological Psychiatry, vol. 58, no. 2, pages 151 – 157, 2005. (Cited on page 12.)
- [Ahn 2013] H. M. Ahn, S. E. Kim and S. H. Kim. *The effects of high-frequency rTMS over the left dorsolateral prefrontal cortex on reward responsiveness*. Brain Stimulation, vol. 6, no. 3, pages 310 – 314, May 2013. (Cited on page 49.)
- [Allen 2004] J. J. Allen, H. L. Urry, S. K. Hitt and J. A. Coan. *The stability of resting frontal electroencephalographic asymmetry in depression*. Psychophysiology, vol. 41, no. 2, pages 269 – 280, Mar 2004. (Cited on page 63.)
- [Altamura 1993] C. A. Altamura, M. C. Mauri, A. Ferrara, A. R. Moro, G. D'Andrea and F. Zamberlan. *Plasma and platelet excitatory amino acids in psychiatric disorders*. Am J Psychiatry, vol. 150, no. 11, pages 1731 – 1733, Nov 1993. (Cited on page 9.)
- [Amassian 1992] V. E. Amassian, R. Q. Cracco, P. J. Maccabee and J. B. Cracco. *Cerebello-frontal cortical projections in humans studied with the magnetic coil*. Electroencephalogr Clin Neurophysiol, vol. 85, no. 4, pages 265 – 272, Aug 1992. (Cited on page 58.)
- [APA 2000] Diagnostic and statistical manual of mental disorders. American Psychiatric Association, Washington, DC., 2000. (Cited on pages 2 and 68.)
- [Arai 2005] N. Arai, S. Okabe, T. Furubayashi, Y. Terao, K. Yuasa and Y. Ugawa. *Comparison between short train, monophasic and biphasic repetitive tran-*

- scranial magnetic stimulation (rTMS) of the human motor cortex.* Clin Neurophysiol, vol. 116, no. 3, pages 605 – 613, Mar 2005. (Cited on page 40.)
- [Arai 2007] N. Arai, S. Okabe, T. Furubayashi, H. Mochizuki, N. K. Iwata, R. Hanajima, Y. Terao and Y. Ugawa. *Differences in after-effect between monophasic and biphasic high-frequency rTMS of the human motor cortex.* Clin Neurophysiol, vol. 118, no. 10, pages 2227 – 2233, Oct 2007. (Cited on page 44.)
- [Arco 2008] A. Del Arco and F. Mora. *Prefrontal cortex nucleus accumbens interaction: In vivo modulation by dopamine and glutamate in the prefrontal cortex.* Pharmacology Biochemistry and Behavior, vol. 90, no. 2, pages 226 – 235, 2008. (Cited on page 12.)
- [Augustyniak 2001] P. Augustyniak. *Przetwarzanie sygnałów elektrodiagnostycznych.* Uczelniane Wydawnictwo Naukowo-Dydaktyczne, 2001. (Cited on page 22.)
- [Avery 2006] D. H. Avery, P. E. Holtzheimer III, W. Fawaz, J. Russo, J. Neumaier, D. L. Dunner, D. R. Haynor, K. H. Claypoole, C. Wajdik and P. Roy-Byrne. *A Controlled Study of Repetitive Transcranial Magnetic Stimulation in Medication-Resistant Major Depression.* Biological Psychiatry, vol. 59, no. 2, pages 187 – 194, 2006. (Cited on page 49.)
- [Bares 2007] M. Bares, M. Brunovsky, M. Kopecek, P. Stopkova, T. Novak, J. Kozeny and C. Hschi. *Changes in QEEG prefrontal cordance as a predictor of response to antidepressants in patients with treatment resistant depressive disorder: A pilot study.* Journal of Psychiatric Research, vol. 41, no. 34, pages 319 – 325, 2007. (Cited on page 64.)
- [Bares 2008] M. Bares, M. Brunovsky, M. Kopecek, T. Novak, P. Stopkova, J. Kozeny, P. Sos, V. Krajca and C. Hschi. *Early reduction in prefrontal theta QEEG cordance value predicts response to venlafaxine treatment in patients with resistant depressive disorder.* European Psychiatry, vol. 23, no. 5, pages 350 – 355, 2008. (Cited on page 64.)
- [Barker 1985] A.T. Barker, R. Jalinous and I.L. Freeston. *Non-invasive stimulation of the human motor cortex.* The Lancet, vol. 325, no. 8437, pages 1106 –

- 1107, 1985. (Cited on page 32.)
- [Barrionuevo 1983] G. Barrionuevo and T. H. Brown. *Associative long-term potentiation in hippocampal slices*. Proc. Natl. Acad. Sci. U.S.A., vol. 80, no. 23, pages 7347 – 7351, Dec 1983. (Cited on pages 39 and 40.)
- [Beck 1996] A. T. Beck, R. A. Steer, R. Ball and W. Ranieri. *Comparison of Beck Depression Inventories-IA and -II in psychiatric outpatients*. Journal of Personality Assessment, vol. 67, page 588597, 1996. (Cited on page 69.)
- [Beevers 2010] C.G. Beevers, P. Clasen, E. Stice and D. Schnyer. *Depression symptoms and cognitive control of emotion cues: a functional magnetic resonance imaging study*. Neuroscience, vol. 167, no. 1, pages 97 – 103, 2010. (Cited on page 11.)
- [Begic 2011] D. Begic, V. Popovic-Knapic, J. Grubisin, B. Kosanovic-Rajacic, I. Filipcic, I. Telarovic and M. Jakovljevic. *Quantitative electroencephalography in schizophrenia and depression*. Psychiatr Danub, vol. 23, no. 4, pages 355 – 362, Dec 2011. (Cited on pages xv, 61 and 106.)
- [Belmaker 2008] R. H. Belmaker and G. Agam. *Major depressive disorder*. N. Engl. J. Med., vol. 358, no. 1, pages 55 – 68, Jan 2008. (Cited on page 4.)
- [Berger 1929] H. Berger. *Über das Electrenkephalogramm des Menschen*. Arch Psychiatr Nervenkr, vol. 87, pages 527 – 570, 1929. (Cited on pages 16 and 21.)
- [Bestmann 2003] S. Bestmann, J. Baudewig, H. R. Siebner, J. C. Rothwell and J. Frahm. *Subthreshold high-frequency TMS of human primary motor cortex modulates interconnected frontal motor areas as detected by interleaved fMRI-TMS*. NeuroImage, vol. 20, no. 3, pages 1685 – 1696, 2003. (Cited on page 48.)
- [Bey 2012] A. Bey, S. Leue and C. Wienbruch. *A neuronal network model for simulating the effects of repetitive transcranial magnetic stimulation on local field potential power spectra*. PLoS ONE, vol. 7, no. 11, page e49097, 2012. (Cited on page 107.)

- [Bi 1998] G. Q. Bi and M. M. Poo. *Synaptic modifications in cultured hippocampal neurons: dependence on spike timing, synaptic strength, and postsynaptic cell type*. J. Neurosci., vol. 18, no. 24, pages 10464 – 10472, Dec 1998. (Cited on page 40.)
- [Bickford 1987] R. G. Bickford, M. Guidi, P. Fortesque and M. Swenson. *Magnetic stimulation of human peripheral nerve and brain: response enhancement by combined magnetoelectrical technique*. Neurosurgery, vol. 20, no. 1, pages 110 – 116, Jan 1987. (Cited on page 48.)
- [Bijsterbosch 2012] J. D. Bijsterbosch, A. T. Barker, K. H. Lee and P. W. Woodruff. *Where does transcranial magnetic stimulation (TMS) stimulate? Modelling of induced field maps for some common cortical and cerebellar targets*. Med Biol Eng Comput, vol. 50, no. 7, pages 671 – 681, Jul 2012. (Cited on pages 34 and 35.)
- [Bliss 1973] T. V. Bliss and A. R. Gardner-Medwin. *Long-lasting potentiation of synaptic transmission in the dentate area of the unanaesthetized rabbit following stimulation of the perforant path*. J. Physiol. (Lond.), vol. 232, no. 2, pages 357 – 374, Jul 1973. (Cited on page 39.)
- [Bliss 2011] T. V. Bliss and S. F. Cooke. *Long-term potentiation and long-term depression: a clinical perspective*. Clinics (Sao Paulo), vol. 66 Suppl 1, pages 3 – 17, 2011. (Cited on page 38.)
- [Bonato 2006] C. Bonato, C. Miniussi and P.M. Rossini. *Transcranial magnetic stimulation and cortical evoked potentials: A TMS/EEG co-registration study*. Clinical Neurophysiology, vol. 117, no. 8, pages 1699 – 1707, 2006. (Cited on page 58.)
- [Bouvard 1992] M. Bouvard, S. Charles, J. Guerin, G. Aimard and J. Cottraux. *Study of Beck's hopelessness scale. Validation and factor analysis*. Encephale, vol. 18, page 237240, 1992. (Cited on page 69.)
- [Brigo 2012] F. Brigo, M. Storti, R. Nardone, A. Fiaschi, L. G. Bongiovanni, F. Tezzon and P. Manganotti. *Transcranial magnetic stimulation of visual cortex*

- in migraine patients: a systematic review with meta-analysis.* J Headache Pain, vol. 13, no. 5, pages 339 – 349, Jul 2012. (Cited on page xiv.)
- [Bruder 2001] G. E. Bruder, J. W. Stewart, C. E. Tenke, P. J. McGrath, P. Leite, N. Bhattacharya and F. M. Quitkin. *Electroencephalographic and perceptual asymmetry differences between responders and nonresponders to an SSRI antidepressant.* Biological Psychiatry, vol. 49, no. 5, pages 416 – 425, 2001. (Cited on pages 64 and 105.)
- [Bruder 2008] G. E. Bruder, J. P. Sedoruk, J. W. Stewart, P. J. McGrath, F. M. Quitkin and C. E. Tenke. *Electroencephalographic Alpha Measures Predict Therapeutic Response to a Selective Serotonin Reuptake Inhibitor Antidepressant: Pre- and Post-Treatment Findings.* Biological Psychiatry, vol. 63, no. 12, pages 1171 – 1177, 2008. (Cited on pages 64 and 105.)
- [Burt 2002] T. Burt, S. H. Lisanby and H. A. Sackeim. *Neuropsychiatric applications of transcranial magnetic stimulation: a meta analysis.* Int. J. Neuropsychopharmacol., vol. 5, no. 1, pages 73 – 103, Mar 2002. (Cited on page 52.)
- [Bush 2000] G. Bush, P. Luu and M. I. Posner. *Cognitive and emotional influences in anterior cingulate cortex.* Trends in Cognitive Sciences, vol. 4, no. 6, pages 215 – 222, 2000. (Cited on page 11.)
- [Butler 2007] A. J. Butler and S. L. Wolf. *Putting the brain on the map: use of transcranial magnetic stimulation to assess and induce cortical plasticity of upper-extremity movement.* Phys Ther, vol. 87, no. 6, pages 719 – 736, Jun 2007. (Cited on page 38.)
- [Cardenas-Morales 2010] L. Cardenas-Morales, D. A. Nowak, T. Kammer, R. C. Wolf and C. Schonfeldt-Lecuona. *Mechanisms and applications of theta-burst rTMS on the human motor cortex.* Brain Topogr, vol. 22, no. 4, pages 294 – 306, Jan 2010. (Cited on page 45.)
- [Chen 2003] R. Chen, D. Yung and J. Y. Li. *Organization of ipsilateral excitatory and inhibitory pathways in the human motor cortex.* J. Neurophysiol., vol. 89, no. 3, pages 1256 – 1264, Mar 2003. (Cited on page 70.)

- [Classen 2008] J. Classen and K. Stefan. *Changes in EEG measures induced by repetitive TMS*. In: E. Wassermann, C.M. Epstein, U. Ziemann editor. *The Oxford handbook of transcranial stimulation*. New York: Oxford University Press, 2008. (Cited on pages xiv, 40 and 41.)
- [Coburn 2006] K. L. Coburn, E. C. Lauterbach, N. N. Boutros, K. J. Black, D. B. Arciniegas and C. E. Coffey. *The value of quantitative electroencephalography in clinical psychiatry: a report by the Committee on Research of the American Neuropsychiatric Association*. *The Journal of Neuropsychiatry and Clinical Neurosciences*, vol. 18, pages 460 – 500, 2006. (Cited on pages xv and 61.)
- [Cochin 1998] S. Cochin, C. Barthelemy, B. Lejeune, S. Roux and J. Martineau. *Perception of motion and qEEG activity in human adults*. *Electroencephalogr Clin Neurophysiol*, vol. 107, no. 4, pages 287 – 295, Oct 1998. (Cited on page 23.)
- [Collet 1986] L. Collet and J. Cottraux. *The shortened Beck Depression Inventory (13 items). Study of the concurrent validity with the Hamilton scale and Widlocher's retardation scale*. *Encephale*, vol. 12, page 7779, 1986. (Cited on page 69.)
- [Cook 1998] I. A. Cook, R. O'Hara, S. H. Uijtdehaage, M. Mandelkern and A. F. Leuchter. *Assessing the accuracy of topographic EEG mapping for determining local brain function*. *Electroencephalogr Clin Neurophysiol*, vol. 107(6), pages 408–14, December 1998. (Cited on page 106.)
- [Cook 2002] I. A. Cook, A. F. Leuchter, M. Morgan, E. Witte, W. F. Stubbs, M. Abrams, S. Rosenberg and S. H. Uijtdehaage. *Early changes in prefrontal activity characterize clinical responders to antidepressants*. *Neuropsychopharmacology*, vol. 27, no. 1, pages 120 – 131, Jul 2002. (Cited on page 64.)
- [Cooke 2006] S. F. Cooke and T. V. Bliss. *Plasticity in the human central nervous system*. *Brain*, vol. 129, pages 1659 – 1673, Jul 2006. (Cited on pages 38 and 39.)

- [Coppen 1967] A. Coppen. *The biochemistry of affective disorders*. Br J Psychiatry, vol. 113, no. 504, pages 1237 – 1264, Nov 1967. (Cited on page 8.)
- [Coutin-Churchman 2003] P. Coutin-Churchman, Y. Anez, M. Uzcategui, L. Alvarez, F. Vergara, L. Mendez and R. Fleitas. *Quantitative spectral analysis of EEG in psychiatry revisited: drawing signs out of numbers in a clinical setting*. Clinical Neurophysiology, vol. 114, no. 12, pages 2294 – 2306, 2003. (Cited on pages 62 and 106.)
- [Couturier 2005] J. L. Couturier. *Efficacy of rapid-rate repetitive transcranial magnetic stimulation in the treatment of depression: a systematic review and meta-analysis*. J Psychiatry Neurosci, vol. 30, no. 2, pages 83 – 90, Mar 2005. (Cited on pages 49 and 52.)
- [Cowen 2008] P. J. Cowen. *Serotonin and depression: pathophysiological mechanism or marketing myth?* Trends in Pharmacological Sciences, vol. 29, no. 9, pages 433 – 436, 2008. (Cited on pages 4, 6 and 8.)
- [Cracco 1989] R. Q. Cracco, V. E. Amassian, P. J. Maccabee and J. B. Cracco. *Comparison of human transcallosal responses evoked by magnetic coil and electrical stimulation*. Electroencephalogr Clin Neurophysiol, vol. 74, no. 6, pages 417 – 424, 1989. (Cited on page 58.)
- [Cummings 1993] J. L. Cummings. *The neuroanatomy of depression*. J Clin Psychiatry, vol. 54 Suppl, pages 14 – 20, Nov 1993. (Cited on page 49.)
- [Dale 1993] A. M. Dale and M. I. Sereno. *Improved localization of cortical activity by combining EEG and MEG with MRI cortical surface reconstruction: A linear approach*. J. Cogn. Neurosci., vol. 5, no. 2, pages 162 – 176, 1993. (Cited on page 29.)
- [Daskalakis 2006] Z. J. Daskalakis, B. Moller, B. K. Christensen, P. B. Fitzgerald, C. Gunraj and R. Chen. *The effects of repetitive transcranial magnetic stimulation on cortical inhibition in healthy human subjects*. Exp Brain Res, vol. 174, no. 3, pages 403 – 412, Oct 2006. (Cited on page 42.)
- [Daskalakis 2008] Z. J. Daskalakis, F. Farzan, M. S. Barr, J. J. Maller, R. Chen and P. B. Fitzgerald. *Long-interval cortical inhibition from the dorsolateral*



- prefrontal cortex: a TMS-EEG study*. *Neuropsychopharmacology*, vol. 33, no. 12, pages 2860 – 2869, Nov 2008. (Cited on page 58.)
- [David 2002] O. David, L. Garnero, D. Cosmelli and F. J. Varela. *Estimation of neural dynamics from MEG/EEG cortical current density maps: application to the reconstruction of large-scale cortical synchrony*. *IEEE Trans Biomed Eng*, vol. 49, no. 9, pages 975 – 987, Sep 2002. (Cited on page 25.)
- [David 2006] O. David, S. J. Kiebel, L. M. Harrison, J. Mattout, J. M. Kilner and K. J. Friston. *Dynamic causal modeling of evoked responses in EEG and MEG*. *NeuroImage*, vol. 30, no. 4, pages 1255 – 1272, 2006. (Cited on page 107.)
- [Davidson 2000] R. J. Davidson. *Affective style, psychopathology, and resilience: Brain mechanisms and plasticity*. *American Psychologist*, vol. 55(11), pages 1196 – 1214, 2000. (Cited on page 12.)
- [Davies 1991] C. H. Davies, S. J. Starkey, M. F. Pozza and G. L. Collingridge. *GABA autoreceptors regulate the induction of LTP*. *Nature*, vol. 349, no. 6310, pages 609 – 611, Feb 1991. (Cited on page 45.)
- [Dayan 2013] E. Dayan, N. Censor, E. R. Buch, M. Sandrini and L. G. Cohen. *Noninvasive brain stimulation: from physiology to network dynamics and back*. *Nat. Neurosci.*, vol. 16, no. 7, pages 838 – 844, Jun 2013. (Cited on page 59.)
- [Debener 2000] S. Debener, A. Beauducel, D. Nessler, B. Brocke, H. Heilemann and J. Kayser. *Is resting anterior EEG alpha asymmetry a trait marker for depression? Findings for healthy adults and clinically depressed patients*. *Neuropsychobiology*, vol. 41, no. 1, pages 31 – 37, 2000. (Cited on page 62.)
- [DeFelipe 2002] J. DeFelipe, L. Alonso-Nanclares and J. L. Arellano. *Microstructure of the neocortex: comparative aspects*. *J Neurocytol.*, vol. 31, no. (3-5), pages 299 – 316, 2002. (Cited on pages 18 and 19.)
- [Delgado 2000] P. L. Delgado and F. A. Moreno. *Role of norepinephrine in depression*. *J Clin Psychiatry*, vol. 61 Suppl 1, pages 5 – 12, 2000. (Cited on page 4.)

- [Dell’Osso 2009] B. Dell’Osso, E. Mundo, N. D’Urso, S. Pozzoli, M. Buoli, M. Ciabatti, M. Rosanova, M. Massimini, V. Bellina, M. Mariotti and A. C. Altamura. *Augmentative repetitive navigated transcranial magnetic stimulation (rTMS) in drug-resistant bipolar depression*. *Bipolar Disord*, vol. 11, no. 1, pages 76 – 81, Feb 2009. (Cited on pages xiv, 53 and 54.)
- [Delorme 2004] A. Delorme and S. Makeig. *EEGLAB: an open source toolbox for analysis of single-trial EEG dynamics including independent component analysis*. *Journal of Neuroscience Methods*, vol. 134, no. 1, pages 9 – 21, 2004. (Cited on page 74.)
- [Deslandes 2008] A. C. Deslandes, H. de Moraes, F. A. M. S. Pompeu, P. Ribeiro, M. Cagy, C. Capito, H. Alves, R. A. M. Piedade and J. Laks. *Electroencephalographic frontal asymmetry and depressive symptoms in the elderly*. *Biological Psychology*, vol. 79, no. 3, pages 317 – 322, 2008. (Cited on page 61.)
- [Di Lazzaro 2011] V. Di Lazzaro, M. Dileone, F. Pilato, F. Capone, G. Musumeci, F. Ranieri, V. Ricci, P. Bria, R. Di Iorio, C. de Waure, P. Pasqualetti and P. Profice. *Modulation of motor cortex neuronal networks by rTMS: comparison of local and remote effects of six different protocols of stimulation*. *J. Neurophysiol.*, vol. 105, no. 5, pages 2150 – 2156, May 2011. (Cited on pages xiv and 41.)
- [Disner 2011] S. G. Disner, C. G. Beevers, E. A. Haigh and A. T. Beck. *Neural mechanisms of the cognitive model of depression*. *Nat. Rev. Neurosci.*, vol. 12, no. 8, pages 467 – 477, Aug 2011. (Cited on pages 11, 12, 13 and 14.)
- [Dolberg 2002] O. T. Dolberg, P. N. Dannon, S. Schreiber and L. Grunhaus. *Transcranial magnetic stimulation in patients with bipolar depression: a double blind, controlled study*. *Bipolar Disord*, vol. 4 Suppl 1, pages 94 – 95, 2002. (Cited on pages 53 and 54.)
- [Drevets 2001] W.C. Drevets. *Neuroimaging and neuropathological studies of depression: implications for the cognitive-emotional features of mood disorder*.

- ders*. *Current Opinion in Neurobiology*, vol. 11, no. 2, pages 240 – 249, 2001. (Cited on page 12.)
- [Drevets 2002] W. C. Drevets, W. Bogers and M. E. Raichle. *Functional anatomical correlates of antidepressant drug treatment assessed using PET measures of regional glucose metabolism*. *European Neuropsychopharmacology*, vol. 12, no. 6, pages 527 – 544, 2002. (Cited on pages 5 and 7.)
- [Duffau 2006] H. Duffau. *Brain plasticity: From pathophysiological mechanisms to therapeutic applications*. *Journal of Clinical Neuroscience*, vol. 13, no. 9, pages 885 – 897, 2006. (Cited on page 38.)
- [Dunlop 2007] B. W. Dunlop and C. B. Nemeroff. *The role of dopamine in the pathophysiology of depression*. *Arch. Gen. Psychiatry*, vol. 64, no. 3, pages 327 – 337, Mar 2007. (Cited on pages 4, 5 and 6.)
- [Elliott 2002] R. Elliott, J. S. Rubinsztein, B. J. Sahakian and R. J. Dolan. *The Neural Basis of Mood-Congruent Processing Biases in Depression*. *Archives of General Psychiatry*, vol. 59, no. 7, pages 597 – 604, 2002. (Cited on page 11.)
- [Epstein 2002] C. M. Epstein and K. R. Davey. *Iron-Core Coils for Transcranial Magnetic Stimulation*. *Journal of Clinical Neurophysiology*, vol. 19, no. 4, pages 376 – 381, August 2002. (Cited on pages 33 and 34.)
- [Epstein 2006] J. Epstein, H. Pan, J. H. Kocsis, Y. Yang, T. Butler, J. Chusid, H. Hochberg, J. Murrugh, E. Strohmayer, E. Stern and D. A. Silbersweig. *Lack of ventral striatal response to positive stimuli in depressed versus normal subjects*. *Am J Psychiatry*, vol. 163, no. 10, pages 1784 – 1790, Oct 2006. (Cited on page 13.)
- [Eugene 2010] F. Eugene, J. Joormann, R. E. Cooney, L. Y. Atlas and I. H. Gotlib. *Neural correlates of inhibitory deficits in depression*. *Psychiatry Research: Neuroimaging*, vol. 181, no. 1, pages 30 – 35, 2010. (Cited on page 11.)
- [Fales 2008] Christina L. Fales, Deanna M. Barch, Melissa M. Rundle, Mark A. Mintun, Abraham Z. Snyder, Jonathan D. Cohen, Jose Mathews and Yvette I. Sheline. *Altered Emotional Interference Processing in Affective*

- and Cognitive-Control Brain Circuitry in Major Depression*. *Biological Psychiatry*, vol. 63, no. 4, pages 377 – 384, 2008. (Cited on page 11.)
- [Fender 1987] DH Fender. *Source localization of brain electrical activity*, volume 1. Elsevier, 1987. (Cited on page 28.)
- [Ferreri 2011] F. Ferreri, P. Pasqualetti, S. Mtt, D. Ponzo, F. Ferrarelli, G. Tononi, E. Mervaala, C. Miniussi and P. M. Rossini. *Human brain connectivity during single and paired pulse transcranial magnetic stimulation*. *NeuroImage*, vol. 54, no. 1, pages 90 – 102, 2011. (Cited on page 47.)
- [Fitzgerald 2003] P. B. Fitzgerald, T. L. Brown, N. A. Marston, Z. J. Daskalakis, A. De Castella and J. Kulkarni. *Transcranial magnetic stimulation in the treatment of depression: a double-blind, placebo-controlled trial*. *Arch. Gen. Psychiatry*, vol. 60, no. 10, pages 1002 – 1008, Oct 2003. (Cited on page 49.)
- [Fitzgerald 2008] P. B. Fitzgerald, Z. J. Daskalakis, K. Hoy, F. Farzan, D. J. Upton, N. R. Cooper and J. J. Maller. *Cortical inhibition in motor and non-motor regions: a combined TMS-EEG study*. *Clin EEG Neurosci*, vol. 39, no. 3, pages 112 – 117, Jul 2008. (Cited on page 58.)
- [Fitzgerald 2009a] P. B. Fitzgerald, J. J. Maller, K. Hoy, F. Farzan and Z. J. Daskalakis. *GABA and cortical inhibition in motor and non-motor regions using combined TMS-EEG: a time analysis*. *Clin Neurophysiol*, vol. 120, no. 9, pages 1706 – 1710, Sep 2009. (Cited on page 58.)
- [Fitzgerald 2009b] P. B. Fitzgerald, S. McQueen, S. Herring, K. Hoy, R. Segrave, J. Kulkarni and Z. J. Daskalakis. *A study of the effectiveness of high-frequency left prefrontal cortex transcranial magnetic stimulation in major depression in patients who have not responded to right-sided stimulation*. *Psychiatry Research*, vol. 169, no. 1, pages 12 – 15, 2009. (Cited on page 49.)
- [Fleming 2012] M. K. Fleming, I. O. Sorinola, D. J. Newham, S. F. Roberts-Lewis and J. H. Bergmann. *The Effect of Coil Type and Navigation on the Reliability of Transcranial Magnetic Stimulation*. *IEEE Trans Neural Syst Rehabil Eng*, vol. PP, no. 99, page 1, Jun 2012. (Cited on page 36.)

- [Francis 1989] P. T. Francis, A. Poynton, S. L. Lowe, A. Najlerahim, P. K. Bridges, J. R. Bartlett, A. W. Procter, C. J. Bruton and D. M. Bowen. *Brain amino acid concentrations and  $Ca^{2+}$  -dependent release in intractable depression assessed antemortem*. *Brain Res.*, vol. 494, no. 2, pages 315 – 324, Aug 1989. (Cited on page 10.)
- [Friston 2003] K.J. Friston, L. Harrison and W. Penny. *Dynamic causal modelling*. *NeuroImage*, vol. 19, no. 4, pages 1273 – 1302, 2003. (Cited on page 107.)
- [Friston 2007] K. J. Friston, J. T. Ashburner, S. J. Kiebel, T. E. Nichols and W. D. Penny, editeurs. *Statistical parametric mapping: The analysis of functional brain images*. Academic Press, 2007. (Cited on pages 19 and 28.)
- [Friston 2008] K. Friston, L. Harrison, J. Daunizeau, S. Kiebel, Ch. Phillips, N. Trujillo-Barreto, Ri. Henson, G. Flandin and J. Mattout. *Multiple sparse priors for the M/EEG inverse problem*. *NeuroImage*, vol. 39, no. 3, pages 1104 – 1120, 2008. (Cited on pages 28 and 75.)
- [Fuchs 2007] M. Fuchs, M. Wagner and J. Kastner. *Development of volume conductor and source models to localize epileptic foci*. *J Clin Neurophysiol*, vol. 24, no. 2, pages 101 – 119, Apr 2007. (Cited on page 26.)
- [Fuggetta 2005] Giorgio Fuggetta, Antonio Fiaschi and Paolo Manganotti. *Modulation of cortical oscillatory activities induced by varying single-pulse transcranial magnetic stimulation intensity over the left primary motor area: A combined EEG and TMS study*. *NeuroImage*, vol. 27, no. 4, pages 896 – 908, 2005. (Cited on pages 53 and 106.)
- [Fuggetta 2008] G. Fuggetta, E. F. Pavone, A. Fiaschi and P. Manganotti. *Acute modulation of cortical oscillatory activities during short trains of high-frequency repetitive transcranial magnetic stimulation of the human motor cortex: A combined EEG and TMS study*. *Human Brain Mapping*, vol. 29, pages 1–13, 2008. (Cited on pages 53 and 106.)
- [Fuggetta 2013] G. Fuggetta and N. A. Noh. *A neurophysiological insight into the potential link between transcranial magnetic stimulation, thalamocorti-*

- cal dysrhythmia and neuropsychiatric disorders*. *Experimental Neurology*, vol. 245, pages 87–95, July 2013. (Cited on page 106.)
- [George 1995] M. S. George, E. M. Wassermann, W. A. Williams, A. Callahan, T. A. Ketter, P. Basser, M. Hallett and R. M. Post. *Daily repetitive transcranial magnetic stimulation (rTMS) improves mood in depression*. *Neuroreport*, vol. 6, no. 14, pages 1853 – 1856, Oct 1995. (Cited on pages 36, 49 and 104.)
- [George 1999] M. S. George, S. H. Lisanby and H. A. Sackeim. *Transcranial magnetic stimulation: applications in neuropsychiatry*. *Arch. Gen. Psychiatry*, vol. 56, no. 4, pages 300 – 311, Apr 1999. (Cited on page 55.)
- [George 2000] M. S. George, Z. Nahas, M. Molloy, A. M. Speer, N. C. Oliver, X. B. Li, G. W. Arana, S. C. Risch and J. C. Ballenger. *A controlled trial of daily left prefrontal cortex TMS for treating depression*. *Biological Psychiatry*, vol. 48, no. 10, pages 962 – 970, 2000. (Cited on page 49.)
- [George 2010] M. S. George. *Transcranial magnetic stimulation for the treatment of depression*. *Expert Rev Neurother*, vol. 10, no. 11, pages 1761 – 1772, Nov 2010. (Cited on pages xiv, 48 and 49.)
- [Giordano 2012] D. Giordano, I. Kavasidis, C. Spampinato, R. Bella, G. Pennisi and M. Pennisi. *An integrated computer-controlled system for assisting researchers in cortical excitability studies by using transcranial magnetic stimulation*. *Computer Methods and Programs in Biomedicine*, vol. 107, no. 1, pages 4 – 15, 2012. *Advances in Biomedical Engineering and Computing: the MEDICON conference case*. (Cited on page 33.)
- [Gold 1980] B. I. Gold, M. B. Bowers, R. H. Roth and D. W. Sweeney. *GABA levels in CSF of patients with psychiatric disorders*. *Am J Psychiatry*, vol. 137, no. 3, pages 362 – 364, Mar 1980. (Cited on page 10.)
- [Goldman 1999] H. H. Goldman, P. Rye and P. Sirovatka. *The Fundamentals of Mental Health and Mental Illness*. <http://137.187.25.243/library/mentalhealth/chapter2/sec1.html>, 1999. (Cited on page 3.)

- [Goodwin 1990] F.K. Goodwin and K.R. Jamison. *Manic-depressive illness*. Oxford University Press, New York, 1990. (Cited on page 53.)
- [Gotlib 2008] I. H. Gotlib and J. P. Hamilton. *Neuroimaging and depression: current status and unresolved issues*. *Current Directions in Psychological Science*, vol. 17, no. 2, pages 159 – 163, 2008. (Cited on page 12.)
- [Graf 2001] T. Graf, J. Engeler, P. Achermann, U. P. Mosimann, R. Noss, H. U. Fisch and T. E. Schlaepfer. *High frequency repetitive transcranial magnetic stimulation (rTMS) of the left dorsolateral cortex: EEG topography during waking and subsequent sleep*. *Psychiatry Research: Neuroimaging*, vol. 107, no. 1, pages 1 – 9, 2001. (Cited on page 104.)
- [Grech 2008] R. Grech, T. Cassar, J. Muscat, K. P. Camilleri, S. G. Fabri, M. Zervakis, P. Xanthopoulos, V. Sakkalis and B. Vanrumste. *Review on solving the inverse problem in EEG source analysis*. *J Neuroeng Rehabil*, vol. 5, page 25, 2008. (Cited on pages 28 and 29.)
- [Greden 2001] J. F. Greden. *The burden of recurrent depression: causes, consequences, and future prospects*. *J Clin Psychiatry*, vol. 62 Suppl 22, pages 5 – 9, 2001. (Cited on page 48.)
- [Greicius 2007] M. D. Greicius, B. H. Flores, V. Menon, G. H. Glover, H. B. Solvason, H. Kenna, A. L. Reiss and A. F. Schatzberg. *Resting-state functional connectivity in major depression: abnormally increased contributions from subgenual cingulate cortex and thalamus*. *Biol. Psychiatry*, vol. 62, no. 5, pages 429 – 437, Sep 2007. (Cited on page 12.)
- [Griskova 2007] Inga Griskova, Osvaldas Ruksenas, Kastytis Dapsys, Sabine Hoppertz and Jacqueline Hoppner. *The effects of 10 Hz repetitive transcranial magnetic stimulation on resting EEG power spectrum in healthy subjects*. *Neuroscience Letters*, vol. 419, no. 2, pages 162 – 167, 2007. (Cited on page 104.)
- [Groppa 2012] S. Groppa, A. Oliviero, A. Eisen, A. Quartarone, L.G. Cohen, V. Mall, A. Kaelin-Lang, T. Mima, S. Rossi, G.W. Thickbroom, P.M. Rossini, U. Ziemann, J. Valls-Sol and H.R. Siebner. *A practical guide to*

- diagnostic transcranial magnetic stimulation: Report of an IFCN committee.* Clinical Neurophysiology, vol. 123, no. 5, pages 858 – 882, 2012. (Cited on page 54.)
- [Grossheinrich 2009] N. Grossheinrich, A. Rau, O. Pogarell, K. Hennig-Fast, M. Reinl, S. Karch, A. Dieler, G. Leicht, C. Mulert, A. Sterr and F. Padberg. *Theta Burst Stimulation of the Prefrontal Cortex: Safety and Impact on Cognition, Mood, and Resting Electroencephalogram.* Biological Psychiatry, vol. 65, no. 9, pages 778 – 784, 2009. (Cited on pages 45 and 104.)
- [Guillery 1995] R. W. Guillery. *Anatomical evidence concerning the role of the thalamus in corticocortical communication: a brief review.* J. Anat., vol. 187, pages 583 – 592, Dec 1995. (Cited on page 12.)
- [Hallett 2000] M. Hallett. *Transcranial magnetic stimulation and the human brain.* Nature, vol. 406, no. 6792, pages 147 – 150, Jul 2000. (Cited on pages 32, 33 and 38.)
- [Hallett 2007] M. Hallett. *Transcranial magnetic stimulation: a primer.* Neuron, vol. 55, no. 2, pages 187 – 199, Jul 2007. (Cited on pages 32, 37 and 38.)
- [Hallez 2007] H. Hallez, B. Vanrumste, R. Grech, J. Muscat, W. De Clercq, A. Vergult, Y. D’Asseler, K. P. Camilleri, S. G. Fabri, S. Van Huffel and I. Lemahieu. *Review on solving the forward problem in EEG source analysis.* J Neuroeng Rehabil, vol. 4, page 46, 2007. (Cited on page 26.)
- [Hämäläinen 1994] M. S. Hämäläinen and R. J. Ilmoniemi. *Interpreting magnetic fields of the brain: minimum norm estimates.* Med Biol Eng Comput, vol. 32, no. 1, pages 35 – 42, Jan 1994. (Cited on pages 28 and 29.)
- [Harel 2011] E. V. Harel, A. Zangen, Y. Roth, I. Reti, Y. Braw and Y. Levkovitz. *H-coil repetitive transcranial magnetic stimulation for the treatment of bipolar depression: an add-on, safety and feasibility study.* World J. Biol. Psychiatry, vol. 12, no. 2, pages 119 – 126, Mar 2011. (Cited on page 54.)
- [Hasan 2013] A. Hasan, P. Falkai and T. Wobrock. *Transcranial brain stimulation in schizophrenia: targeting cortical excitability, connectivity and plasticity.*



- Curr. Med. Chem., vol. 20, no. 3, pages 405 – 413, Jan 2013. (Cited on page xiv.)
- [Haueisen 1995] J. Haueisen, C. Ramon, P. Czapski and M. Eiselt. *On the influence of volume currents and extended sources on neuromagnetic fields: a simulation study*. Ann Biomed Eng, vol. 23, no. 6, pages 728 – 739, 1995. (Cited on page 26.)
- [Hayashi 2004] T. Hayashi, T. Ohnishi, S. Okabe, N. Teramoto, Y. Nonaka, H. Watabe, E. Imabayashi, Y. Ohta, H. Jino, N. Ejima, T. Sawada, H. Iida, H. Matsuda and Y. Ugawa. *Long-term effect of motor cortical repetitive transcranial magnetic stimulation [correction]*. Ann. Neurol., vol. 56, no. 1, pages 77 – 85, Jul 2004. (Cited on pages xiv and 41.)
- [Heikman 2001] P. Heikman, R. Salmelin, J. P. Makela, R. Hari, H. Katila and K. Kuoppasalmi. *Relation between frontal 3-7 Hz MEG activity and the efficacy of ECT in major depression*. J ECT, vol. 17, no. 2, pages 136 – 140, Jun 2001. (Cited on page 105.)
- [Heller 2009] A. S. Heller, T. Johnstone, A. J. Shackman, S. N. Light, M. J. Peterson, G. G. Kolden, N. H. Kalin and R. J. Davidson. *Reduced capacity to sustain positive emotion in major depression reflects diminished maintenance of fronto-striatal brain activation*. Proc. Natl. Acad. Sci. U.S.A., vol. 106, no. 52, pages 22445 – 22450, Dec 2009. (Cited on page 13.)
- [Helmholtz 1853] H. L. F. Helmholtz. *Ueber einige Gesetze der Vertheilung elektrischer Strome in korperlichen Leitern mit Anwendung auf die thierisch-elektrischen Versuche*. Ann Physik und Chemie, vol. 9, pages 211 – 33, 1853. (Cited on page 28.)
- [Herrmann 2004] C. S. Herrmann, M. H.J. Munk and A. K. Engel. *Cognitive functions of gamma-band activity: memory match and utilization*. Trends in Cognitive Sciences, vol. 8, no. 8, pages 347 – 355, 2004. (Cited on page 24.)
- [Herwig 2001a] U. Herwig, F. Padberg, J. Unger, M. Spitzer and C. Schonfeldt-Lecuona. *Transcranial magnetic stimulation in therapy studies: examination of the reliability of "standard" coil positioning by neuronavigation*. Biological

- Psychiatry, vol. 50, no. 1, pages 58 – 61, 2001. (Cited on pages 36, 55 and 104.)
- [Herwig 2001b] U. Herwig, C. Schnfeldt-Lecuona, A. P. Wunderlich, C. von Tiesenhäusen, A. Thielscher, H. Walter and M. Spitzer. *The navigation of transcranial magnetic stimulation*. Psychiatry Research: Neuroimaging, vol. 108, no. 2, pages 123 – 131, 2001. (Cited on pages 36 and 70.)
- [Hess 1996] G. Hess, C. D. Aizenman and J. P. Donoghue. *Conditions for the induction of long-term potentiation in layer II/III horizontal connections of the rat motor cortex*. J. Neurophysiol., vol. 75, no. 5, pages 1765 – 1778, May 1996. (Cited on page 45.)
- [Hill 1978] A.J. Hill. *First occurrence of hippocampal spatial firing in a new environment*. Exp Neurol., vol. 62, pages 282 – 297, 1978. (Cited on page 45.)
- [Hirono 1998] N. Hirono, E. Mori, K. Ishii, Y. Ikejiri, T. Imamura, T. Shimomura, M. Hashimoto, H. Yamashita and M. Sasaki. *Frontal lobe hypometabolism and depression in Alzheimer's disease*. Neurology, vol. 50, no. 2, pages 380 – 383, Feb 1998. (Cited on page 49.)
- [Holtzheimer 2001] P. E. Holtzheimer, J. Russo and D. H. Avery. *A meta-analysis of repetitive transcranial magnetic stimulation in the treatment of depression*. Psychopharmacol Bull, vol. 35, no. 4, pages 149 – 169, 2001. (Cited on page 52.)
- [Homan 2012] P. Homan, J. Kindler, M. Hauf, D. Hubl and T. Dierks. *Cerebral blood flow identifies responders to transcranial magnetic stimulation in auditory verbal hallucinations*. Transl Psychiatry, vol. 2, page e189, 2012. (Cited on page xiv.)
- [Honig 1988] A. Honig, J. R. Bartlett, N. Bouras and P. K. Bridges. *Amino acid levels in depression: a preliminary investigation*. J Psychiatr Res, vol. 22, no. 3, pages 159 – 164, 1988. (Cited on page 10.)
- [Hoogendam 2010] J. M. Hoogendam, G. M. Ramakers and V. Di Lazzaro. *Physiology of repetitive transcranial magnetic stimulation of the human brain*.

- Brain Stimul, vol. 3, no. 2, pages 95 – 118, Apr 2010. (Cited on pages xiv, 38, 39, 40, 41, 42, 43, 44 and 46.)
- [Hooley 2005] J. M. Hooley, S. A. Gruber, L. A. Scott, J. B. Hiller and D. A. Yurgelun-Todd. *Activation in dorsolateral prefrontal cortex in response to maternal criticism and praise in recovered depressed and healthy control participants*. Biol. Psychiatry, vol. 57, no. 7, pages 809 – 812, Apr 2005. (Cited on page 12.)
- [Horowitz 2001] Paul Horowitz. The art of electronics. Cambridge University Press, 2001. (Cited on page 58.)
- [Houdayer 2008] E. Houdayer, A. Degardin, F. Cassim, P. Bocquillon, P. Derambure and H. Devanne. *The effects of low- and high-frequency repetitive TMS on the input/output properties of the human corticospinal pathway*. Exp Brain Res, vol. 187, no. 2, pages 207 – 217, May 2008. (Cited on pages xiv and 41.)
- [Huang 2005] Y. Z. Huang, M. J. Edwards, E. Rounis, K. P. Bhatia and J. C. Rothwell. *Theta Burst Stimulation of the Human Motor Cortex*. Neuron, vol. 45, no. 2, pages 201 – 206, 2005. (Cited on pages xiv and 45.)
- [Hubl 2008] D. Hubl, T. Nyffeler, P. Wurtz, S. Chaves, T. Pflugshaupt, M. Lthi, R. von Wartburg, R. Wiest, T. Dierks, W.K. Strik, C.W. Hess and R.M. Mri. *Time course of blood oxygenation leveldependent signal response after theta burst transcranial magnetic stimulation of the frontal eye field*. Neuroscience, vol. 151, no. 3, pages 921 – 928, 2008. (Cited on page 45.)
- [Hummel 2008] F. C. Hummel, P. Celnik, A. Pascual-Leone, F. Fregni, W. D. Byblow, C. M. Buetefisch, J. Rothwell, L. G. Cohen and C. Gerloff. *Controversy: Noninvasive and invasive cortical stimulation show efficacy in treating stroke patients*. Brain Stimul, vol. 1, no. 4, pages 370 – 382, Oct 2008. (Cited on page xiv.)
- [Hummel 2012] F. C. Hummel and C. Gerloff. *Transcranial brain stimulation after stroke*. Nervenarzt, vol. 83, no. 8, pages 957 – 965, Aug 2012. (Cited on page xiv.)

- [Hunter 2007] A. M. Hunter, I. A. Cook and A. F. Leuchter. *The Promise of the Quantitative Electroencephalogram as a Predictor of Antidepressant Treatment Outcomes in Major Depressive Disorder*. The Psychiatric clinics of North America, vol. 30, pages 105 – 124, March 2007. (Cited on page 64.)
- [Ilmoniemi 1997] R. J. Ilmoniemi, J. Virtanen, J. Ruohonen, J. Karhu, H. J. Aronen, R. Naatanen and T. Katila. *Neuronal responses to magnetic stimulation reveal cortical reactivity and connectivity*. Neuroreport, vol. 8, no. 16, pages 3537 – 3540, Nov 1997. (Cited on pages 47 and 57.)
- [Ilmoniemi 2010] R. J. Ilmoniemi and D. Kici. *Methodology for combined TMS and EEG*. Brain Topogr, vol. 22, no. 4, pages 233 – 248, Jan 2010. (Cited on pages 58 and 59.)
- [Iosifescu 2009] D. V. Iosifescu, S. Greenwald, P. Devlin, D. Mischoulon, J. W. Denninger, J. E. Alpert and M. Fava. *Frontal EEG predictors of treatment outcome in major depressive disorder*. European Neuropsychopharmacology, vol. 19, no. 11, pages 772 – 777, 2009. (Cited on pages 64 and 105.)
- [Iosifescu 2011] D. V. Iosifescu. *Electroencephalography-Derived Biomarkers of Antidepressant Response*. Harvard Review of Psychiatry, vol. 19, no. 3, pages 144 – 154, 2011. (Cited on pages 61 and 65.)
- [Itil 1983] T. M. Itil, R. K. Shrivastava, S. Mukherjee, B. S. Coleman and S. T. Michael. *A double-blind placebo-controlled study of fluvoxamine and imipramine in out-patients with primary depression*. Br J Clin Pharmacol, vol. 15 Suppl 3, pages 433S–438S, 1983. (Cited on page 107.)
- [Jasper 1958] H. H. Jasper. *Report of the Committee on Methods of Clinical Examination in Electroencephalography*. Electroencephalogr Clin Neurophysiol, vol. 10, pages 370 – 375, 1958. (Cited on page 21.)
- [Jensen 2007] O. Jensen, J. Kaiser and J. P. Lachaux. *Human gamma-frequency oscillations associated with attention and memory*. Trends in Neurosciences, vol. 30, no. 7, pages 317 – 324, 2007. (Cited on page 24.)
- [Julkunen 2009] P. Julkunen, L. Sisnen, N. Danner, E. Niskanen, T. Hukkanen, E. Mervaala and M. Knnen. *Comparison of navigated and non-navigated*

- transcranial magnetic stimulation for motor cortex mapping, motor threshold and motor evoked potentials.* NeuroImage, vol. 44, no. 3, pages 790 – 795, 2009. (Cited on page 36.)
- [Jung 2012] S. H. Jung, Y. K. Kim, S. E. Kim and N. J. Paik. *Prediction of Motor Function Recovery after Subcortical Stroke: Case Series of Activation PET and TMS Studies.* Ann Rehabil Med, vol. 36, no. 4, pages 501 – 511, Aug 2012. (Cited on page xiv.)
- [Kaiser 2003] J. Kaiser and W. Lutzenberger. *Induced gamma-band activity and human brain function.* Neuroscientist, vol. 9, no. 6, pages 475 – 484, Dec 2003. (Cited on page 24.)
- [Kim 1982] J. S. Kim, W. Schmid-Burgk, D. Claus and H. H. Kornhuber. *Increased serum glutamate in depressed patients.* Arch Psychiatr Nervenkr, vol. 232, no. 4, pages 299 – 304, 1982. (Cited on page 9.)
- [Kim 2007] S. H. Kim and S. Hamann. *Neural correlates of positive and negative emotion regulation.* J Cogn Neurosci, vol. 19, no. 5, pages 776 – 798, May 2007. (Cited on page 12.)
- [Klein 1999] E. Klein, I. Kreinin, A. Chistyakov, D. Koren, L. Mecz, S. Marmur, D. Ben-Shachar and M. Feinsod. *Therapeutic efficacy of right prefrontal slow repetitive transcranial magnetic stimulation in major depression: a double-blind controlled study.* Arch. Gen. Psychiatry, vol. 56, no. 4, pages 315 – 320, Apr 1999. (Cited on page 49.)
- [Knott 1996] V. Knott, J. I. Telner, Y. D. Lapierre, M. Browne and E. R. Horn. *Quantitative EEG in the prediction of antidepressant response to imipramine.* Journal of Affective Disorders, vol. 39, no. 3, pages 175 – 184, 1996. (Cited on pages 64 and 105.)
- [Knott 2000] V. Knott, C. Mahoney, S. Kennedy and K. Evans. *Pre-treatment EEG and it's relationship to depression severity and paroxetine treatment outcome.* Pharmacopsychiatry, vol. 33, no. 6, pages 201 – 205, Nov 2000. (Cited on pages 64 and 105.)

- [Knott 2001] V. Knott, C. Mahoney, S. Kennedy and K. Evans. *EEG power, frequency, asymmetry and coherence in male depression*. *Psychiatry Research: Neuroimaging*, vol. 106, no. 2, pages 123 – 140, 2001. (Cited on page 62.)
- [Kolev 1994] V. Kolev, C. Basar-Eroglu, F. Aksu and E. Basar. *EEG rhythmicities evoked by visual stimuli in three-year-old children*. *Int. J. Neurosci.*, vol. 75, no. 3 - 4, pages 257 – 270, Apr 1994. (Cited on page 23.)
- [Komssi 2006] S. Komssi and S. Khknen. *The novelty value of the combined use of electroencephalography and transcranial magnetic stimulation for neuroscience research*. *Brain Research Reviews*, vol. 52, no. 1, pages 183 – 192, 2006. (Cited on page 57.)
- [Kozel 2002] F. A. Kozel and M. S. George. *Meta-analysis of left prefrontal repetitive transcranial magnetic stimulation (rTMS) to treat depression*. *J Psychiatr Pract*, vol. 8, no. 5, pages 270 – 275, Sep 2002. (Cited on page 52.)
- [Krishnan 2008] V. Krishnan and E. J. Nestler. *The molecular neurobiology of depression*. *Nature*, vol. 455, no. 7215, pages 894 – 902, Oct 2008. (Cited on page 4.)
- [Kugaya 2005] A. Kugaya and G. Sanacora. *Beyond monoamines: glutamatergic function in mood disorders*. *CNS Spectr*, vol. 10, no. 10, pages 808 – 819, Oct 2005. (Cited on page 9.)
- [Larson 1986] J. Larson, D. Wong and G. Lynch. *Patterned stimulation at the theta frequency is optimal for the induction of hippocampal long-term potentiation*. *Brain Res.*, vol. 368, no. 2, pages 347 – 350, Mar 1986. (Cited on page 45.)
- [LeDoux 1996] J. LeDoux. *The emotional brain: the mysterious underpinnings of emotional life*. Simon & Schuster, 1996. (Cited on page 12.)
- [Leuchter 1994] A. F. Leuchter, I. A. Cook, R. B. Lufkin, J. Dunkin, T. F. Newton, J. L. Cummings, J. K. Mackey and D. O. Walter. *Cordance: a new method for assessment of cerebral perfusion and metabolism using quantitative electroencephalography*. *Neuroimage*, vol. 1, no. 3, pages 208 – 219, Jun 1994. (Cited on pages 59, 60 and 61.)

- [Leuchter 1999] A. F. Leuchter, S. H. Uijtdehaage, I. A. Cook, R. O'Hara and M. Mandelkern. *Relationship between brain electrical activity and cortical perfusion in normal subjects*. *Psychiatry Res*, vol. 90, no. 2, pages 125 – 140, Apr 1999. (Cited on page 61.)
- [Leuchter 2008] A. F. Leuchter, I. A. Cook, D. J. DeBrotta, A. M. Hunter, W. Z. Potter, C. C. McGrouther, M. L. Morgan, M. Abrams and B. Siegman. *Changes in brain function during administration of venlafaxine or placebo to normal subjects*. *Clin EEG Neurosci*, vol. 39, no. 4, pages 175 – 181, Oct 2008. (Cited on page 64.)
- [Leuchter 2013] A. F. Leuchter, I. A. Cook, Y. Jin and B. Phillips. *The Relationship Between Brain Oscillatory Activity and Therapeutic Effectiveness of Transcranial Magnetic Stimulation in the Treatment of Major Depressive Disorder*. *Frontiers in Human Neuroscience*, vol. 7, no. 37, 2013. (Cited on pages 48, 51, 53 and 106.)
- [Levy 1979] W. B. Levy and O. Steward. *Synapses as associative memory elements in the hippocampal formation*. *Brain Research*, vol. 175, no. 2, pages 233 – 245, 1979. (Cited on page 39.)
- [Levy 1983] W. B. Levy and O. Steward. *Temporal contiguity requirements for long-term associative potentiation/depression in the hippocampus*. *Neuroscience*, vol. 8, no. 4, pages 791 – 797, Apr 1983. (Cited on page 40.)
- [Li 2010] C.T. Li, C.P. Lin, K.H. Chou, I.Y. Chen, J.C. Hsieh, C.L. Wu, W.C. Lin and T.P. Su. *Structural and cognitive deficits in remitting and non-remitting recurrent depression: a voxel-based morphometric study*. *Neuroimage*, vol. 50, pages 347 – 356, 2010. (Cited on page 12.)
- [Lisanby 2000] S. H. Lisanby, B. Luber, T. Perera and H. A. Sackeim. *Transcranial magnetic stimulation: applications in basic neuroscience and neuropsychopharmacology*. *Int. J. Neuropsychopharmacol.*, vol. 3, no. 3, pages 259 – 273, Sep 2000. (Cited on page 50.)
- [Litvak 2008] V. Litvak and K. Friston. *Electromagnetic source reconstruction for group studies*. *NeuroImage*, vol. 42, no. 4, pages 1490 – 1498, 2008. (Cited

on page 75.)

- [Loo 1999] C. Loo, P. Mitchell, P. Sachdev, B. McDarmont, G. Parker and S. Gandevia. *Double-blind controlled investigation of transcranial magnetic stimulation for the treatment of resistant major depression*. Am J Psychiatry, vol. 156, no. 6, pages 946 – 948, Jun 1999. (Cited on pages 50 and 55.)
- [Lopez-Larson 2002] M.P. Lopez-Larson, M.P. DelBello, M.E. Zimmerman, M.L. Schwiers and S.M. Strakowski. *Regional prefrontal gray and white matter abnormalities in bipolar disorder*. Biol Psychiatry, vol. 52, no. 2, pages 93 – 100, 2002. (Cited on page 12.)
- [Maes 1998] M. Maes, R. Verkerk, E. Vandoolaeghe, A. Lin and S. Scharpe. *Serum levels of excitatory amino acids, serine, glycine, histidine, threonine, taurine, alanine and arginine in treatment-resistant depression: modulation by treatment with antidepressants and prediction of clinical responsivity*. Acta Psychiatr Scand, vol. 97, no. 4, pages 302 – 308, Apr 1998. (Cited on page 9.)
- [Magis 2012] D. Magis, R. Jensen and J. Schoenen. *Neurostimulation therapies for primary headache disorders: present and future*. Curr. Opin. Neurol., vol. 25, no. 3, pages 269 – 276, Jun 2012. (Cited on page xiv.)
- [Malenka 2003] R. C. Malenka. *The long-term potential of LTP*. Nat. Rev. Neurosci., vol. 4, no. 11, pages 923 – 926, Nov 2003. (Cited on page 39.)
- [Malmivuo 1995] J. Malmivuo and R. Plonsey. *Bioelectromagnetism: Principles and applications of bioelectrical and biomagnetic fields*. Oxford University Press, 1995. (Cited on page 26.)
- [Marin 2005] H. Marin and M. A. Menza. *The management of fatigue in depressed patients*. Essent Psychopharmacol, vol. 6, no. 4, pages 185 – 192, 2005. (Cited on page 4.)
- [Markram 1997] H. Markram, J. Lubke, M. Frotscher and B. Sakmann. *Regulation of synaptic efficacy by coincidence of postsynaptic APs and EPSPs*. Science, vol. 275, no. 5297, pages 213 – 215, Jan 1997. (Cited on page 40.)



- [Martin 2000] S. J. Martin, P. D. Grimwood and R. G. Morris. *Synaptic plasticity and memory: an evaluation of the hypothesis*. Annu. Rev. Neurosci., vol. 23, pages 649 – 711, 2000. (Cited on page 40.)
- [Martin 2003] J. L. Martin, M. J. Barbanoj, T. E. Schlaepfer, E. Thompson, V. Perez and J. Kulisevsky. *Repetitive transcranial magnetic stimulation for the treatment of depression. Systematic review and meta-analysis*. Br J Psychiatry, vol. 182, pages 480 – 491, Jun 2003. (Cited on pages 49, 52 and 55.)
- [Mattout 2007] J. Mattout, R. N. Henson and K. J. Friston. *Canonical source reconstruction for MEG*. Comput Intell Neurosci, page 67613, 2007. (Cited on page 75.)
- [McFarland 2000] D. J. McFarland, L. A. Miner, T. M. Vaughan and J. R. Wolpaw. *Mu and beta rhythm topographies during motor imagery and actual movements*. Brain Topogr, vol. 12, no. 3, pages 177 – 186, 2000. (Cited on page 23.)
- [McNaughton 1978] B.L. McNaughton, R.M. Douglas and G.V. Goddard. *Synaptic enhancement in fascia dentata: Cooperativity among coactive afferents*. Brain Research, vol. 157, no. 2, pages 277 – 293, 1978. (Cited on page 39.)
- [Meijs 1987] P Meijs and M. J. Peters. *The EEG and MEG using a model of eccentric spheres to describe the human head*. IEEE Transactions on Biomedical Engineering, vol. 34, pages 913–920, 1987. (Cited on page 26.)
- [Meijs 1989] J. W. H. Meijs, O. W. Weier, M. J. Peters and A. van Oosterom. *On the Numerical Accuracy of the Boundary Element Method*. IEEE Transactions on Biomedical Engineering, vol. 36, no. 10, pages 1038–1049, 1989. (Cited on page 26.)
- [Menendez 2004] R. G. De Peralta Menendez, M. M. Murray, C. M. Michel, R. Martuzzi and S. L. Gonzalez-Andino. *Electrical neuroimaging based on biophysical constraints*. NeuroImage, vol. 21, no. 2, pages 527–539, 2004. (Cited on page 28.)

- [Michel 2004] C. M. Michel, M. M. Murray, G. Lantz, S. Gonzalez, . Spinelli and R. Grave de Peralta. *EEG source imaging*. *Clinical Neurophysiology*, vol. 115, no. 10, pages 2195 – 2222, 2004. (Cited on page 29.)
- [Micoulaud-Franchi 2012] Jean-Arthur Micoulaud-Franchi, Raphalle Richieri, Michel Cermolacce, Anderson Loundou, Christophe Lancon and Jean Vion-Dury. *Parieto-temporal alpha EEG band power at baseline as a predictor of antidepressant treatment response with repetitive Transcranial Magnetic Stimulation: A preliminary study*. *Journal of Affective Disorders*, vol. 137, no. 13, pages 156 – 160, 2012. (Cited on pages 62, 65 and 105.)
- [Mills 1992] K. R. Mills, S. J. Boniface and M. Schubert. *Magnetic brain stimulation with a double coil: the importance of coil orientation*. *Electroencephalogr Clin Neurophysiol*, vol. 85, no. 1, pages 17 – 21, Feb 1992. (Cited on page 36.)
- [Miniussi 2005] C. Miniussi, C. Bonato, S. Bignotti, A. Gazzoli, M. Gennarelli, P. Pasqualetti, G.B. Tura, M. Ventriglia and P.M. Rossini. *Repetitive transcranial magnetic stimulation (rTMS) at high and low frequency: an efficacious therapy for major drug-resistant depression?* *Clinical Neurophysiology*, vol. 116, no. 5, pages 1062 – 1071, 2005. (Cited on pages 49 and 55.)
- [Miniussi 2010] C. Miniussi and G. Thut. *Combining TMS and EEG offers new prospects in cognitive neuroscience*. *Brain Topogr*, vol. 22, no. 4, pages 249–256, Jan 2010. (Cited on page 57.)
- [Mitterschiffthaler 2008] M.T. Mitterschiffthaler, S.C.R. Williams, N.D. Walsh, A.J. Cleare, C. Donaldson, J. Scott and C.H.Y. Fu. *Neural basis of the emotional Stroop interference effect in major depression*. *Psychological Medicine*, vol. 38, no. 2, pages 247 – 256, 2008. (Cited on page 11.)
- [Modugno 2001] N. Modugno, Y. Nakamura, C. D. MacKinnon, S. R. Filipovic, S. Bestmann, A. Berardelli and J. C. Rothwell. *Motor cortex excitability following short trains of repetitive magnetic stimuli*. *Exp Brain Res*, vol. 140, no. 4, pages 453 – 459, Oct 2001. (Cited on page 44.)
- [Montgomery 1979] S. A. Montgomery and M. Asberg. *A new depression scale designed to be sensitive to change*. *Br J Psychiatry*, vol. 134, pages 382 –

- 389, Apr 1979. (Cited on page 69.)
- [Montgomery 2008] S. A. Montgomery. *The under-recognized role of dopamine in the treatment of major depressive disorder*. *Int Clin Psychopharmacol*, vol. 23, no. 2, pages 63 – 69, Mar 2008. (Cited on page 4.)
- [Moret 2011] C. Moret and M. Briley. *The importance of norepinephrine in depression*. *Neuropsychiatric Disease and Treatment*, vol. 7, pages 9 – 13, 2011. (Cited on pages 6 and 7.)
- [Murray 1996] C. Murray and A. Lopez. *The global burden of disease: A comprehensive assessment of mortality and disability from diseases, injuries and risk factors in 1990 and projected to 2020*. Harcourt University Press, Cambridge, MA, 1996. (Cited on page 48.)
- [Nahas 2003] Z. Nahas, F. A. Kozel, X. Li, B. Anderson and M. S. George. *Left prefrontal transcranial magnetic stimulation (TMS) treatment of depression in bipolar affective disorder: a pilot study of acute safety and efficacy*. *Bipolar Disord*, vol. 5, no. 1, pages 40 – 47, Feb 2003. (Cited on page 53.)
- [Niedermeyer 1997] E. Niedermeyer. *Alpha rhythms as physiological and abnormal phenomena*. *Int J Psychophysiol*, vol. 26, no. 1-3, pages 31 – 49, Jun 1997. (Cited on page 23.)
- [Noh 2012] N. A. Noh, G. Fuggetta, P. Manganotti and A. Fiaschi. *Long lasting modulation of cortical oscillations after continuous theta burst transcranial magnetic stimulation*. *PLoS ONE*, vol. 7, no. 4, page e35080, 2012. (Cited on pages xiv and 41.)
- [Nunez 2006] P. L. Nunez and R. Srinivasan. *Electric fields of the brain: The neurophysics of eeg*. Oxford University Press, 2006. (Cited on page 21.)
- [Nutt 2008] D. J. Nutt. *The Symptoms of Major Depressive Disorder*. *Psychiatry Interpersonal and Biological Processes*, vol. 69, no. 11, pages 4 – 7, 2008. (Cited on pages 3 and 4.)
- [Ochsner 2005] K. N. Ochsner and J. J. Gross. *The cognitive control of emotion*. *Trends Cogn. Sci. (Regul. Ed.)*, vol. 9, no. 5, pages 242 – 249, May 2005. (Cited on page 12.)

- [Okamura 2001] H. Okamura, H. Jing and M. Takigawa. *EEG modification induced by repetitive transcranial magnetic stimulation*. J Clin Neurophysiol, vol. 18, no. 4, pages 318 – 325, Jul 2001. (Cited on page 104.)
- [Oldfield 1971] R.C. Oldfield. *The assessment and analysis of handedness: The Edinburgh inventory*. Neuropsychologia, vol. 9, no. 1, pages 97 – 113, 1971. (Cited on page 68.)
- [Onton 2006] J. Onton, M. Westerfield, J. Townsend and S. Makeig. *Imaging human EEG dynamics using independent component analysis*. Neurosci Biobehav Rev, vol. 30, no. 6, pages 808 – 822, 2006. (Cited on page 74.)
- [Oostendorp 2000] T. Oostendorp, J. Delbeke and D. Stegeman. *The conductivity of the human skull: results of in vivo and in vitro measurements*. IEEE Transactions on Biomedical Engineering, vol. 47, no. 11, pages 1487 – 1492, 2000. (Cited on page 26.)
- [O’Reardon 2007] J. P. O’Reardon, H. B. Solvason, P. G. Janicak, S. Sampson, K. E. Isenberg, Z. Nahas, W. M. McDonald, D. Avery, P. B. Fitzgerald, C. Loo, M. A. Demitrack, M. S. George and H. A. Sackeim. *Efficacy and Safety of Transcranial Magnetic Stimulation in the Acute Treatment of Major Depression: A Multisite Randomized Controlled Trial*. Biological Psychiatry, vol. 62, no. 11, pages 1208 – 1216, 2007. (Cited on page 49.)
- [Padberg 1999] F. Padberg, P. Zwanzger, H. Thoma, N. Kathmann, C. Haag, B. D. Greenberg, H. Hampel and H. J. Mller. *Repetitive transcranial magnetic stimulation (rTMS) in pharmacotherapy-refractory major depression: comparative study of fast, slow and sham rTMS*. Psychiatry Research, vol. 88, no. 3, pages 163 – 171, 1999. (Cited on page 55.)
- [Padberg 2009] F. Padberg and M. S. George. *Repetitive transcranial magnetic stimulation of the prefrontal cortex in depression*. Exp. Neurol., vol. 219, no. 1, pages 2 – 13, Sep 2009. (Cited on page 49.)
- [Palva 2007] S. Palva and J. M. Palva. *New vistas for alpha-frequency band oscillations*. Trends in Neurosciences, vol. 30, no. 4, pages 150 – 158, 2007. (Cited on page 23.)

- [Pascual-Leone 1996] A. Pascual-Leone, B. Rubio, F. Pallardo and M. D. Catala. *Rapid-rate transcranial magnetic stimulation of left dorsolateral prefrontal cortex in drug-resistant depression*. *Lancet*, vol. 348, no. 9022, pages 233 – 237, Jul 1996. (Cited on pages 36, 49, 70 and 104.)
- [Pascual-Marqui 1994] R. D. Pascual-Marqui, C. M. Michel and D. Lehmann. *Low resolution electromagnetic tomography: a new method for localizing electrical activity in the brain*. *Int. J. Psychophysiol.*, vol. 18, pages 49 – 65, 1994. (Cited on page 28.)
- [Pascual-Marqui 1999] R. D. Pascual-Marqui. *Review of Methods for Solving the EEG Inverse Problem*. *International Journal of Bioelectromagnetism*, vol. 1, pages 75 – 86, 1999. (Cited on page 29.)
- [Pascual-Marqui 2002] R.D. Pascual-Marqui. *Standardized Low-Resolution Brain Electromagnetic Tomography (sLORETA): Technical Details*. *Methods Find Exp Clin Pharmacol.*, vol. 24, pages 5 – 12, 2002. (Cited on page 28.)
- [Passarotti 2009] A. M. Passarotti, J. A. Sweeney and M. N. Pavuluri. *Neural correlates of incidental and directed facial emotion processing in adolescents and adults*. *Soc Cogn Affect Neurosci*, vol. 4, no. 4, pages 387 – 398, Dec 2009. (Cited on page 11.)
- [Paus 2001] T. Paus, P. K. Sipila and A. P. Strafella. *Synchronization of neuronal activity in the human primary motor cortex by transcranial magnetic stimulation: an EEG study*. *J. Neurophysiol.*, vol. 86, no. 4, pages 1983 – 1990, Oct 2001. (Cited on pages 47, 53 and 106.)
- [Pernet 2012] Cyril Pernet. *Neurophysiology pages*. <http://www.sbirc.ed.ac.uk/cyril/cpneurophysio2.html>, 2012. (Cited on page 20.)
- [Peters 2013] J. C. Peters, J. Reithler, T. Schuhmann, T. de Graaf, K. Uludag, R. Goebel and A. T. Sack. *On the feasibility of concurrent human TMS-EEG-fMRI measurements*. *J. Neurophysiol.*, vol. 109, no. 4, pages 1214 – 1227, Feb 2013. (Cited on page 48.)

- [Petty 1981] F. Petty and M. A. Schlessler. *Plasma GABA in affective illness. A preliminary investigation.* J Affect Disord, vol. 3, no. 4, pages 339 – 343, Dec 1981. (Cited on page 10.)
- [Petty 1984] F. Petty and A. D. Sherman. *Plasma GABA levels in psychiatric illness.* J Affect Disord, vol. 6, no. 2, pages 131 – 138, Apr 1984. (Cited on page 10.)
- [Pfurtscheller 2006] G. Pfurtscheller, C. Brunner, A. Schlgl and F.H. Lopes da Silva. *Mu rhythm (de)synchronization and EEG single-trial classification of different motor imagery tasks.* NeuroImage, vol. 31, no. 1, pages 153 – 159, 2006. (Cited on page 23.)
- [Pfurtscheller 1999] G. Pfurtscheller and F.L. da Silva. *Handbook of electroencephalography and clinical neurology.* Elsevier, 1999. (Cited on page 62.)
- [Phillips 2001] C. L. M. Phillips. *Source localisation in EEG. Combining anatomical and functional constraints.* phdthesis, Universite de Liege, Faculte des Science Appliquees, 2001. (Cited on page 28.)
- [Phillips 2003] M. L. Phillips, W. C. Drevets, S. L. Rauch and R. Lane. *Neurobiology of emotion perception II: implications for major psychiatric disorders.* Biological Psychiatry, vol. 54, no. 5, pages 515 – 528, 2003. (Cited on page 107.)
- [Pivik 1995] R. T. Pivik and K. Harman. *A reconceptualization of EEG alpha activity as an index of arousal during sleep: all alpha activity is not equal.* J Sleep Res, vol. 4, no. 3, pages 131 – 137, September 1995. (Cited on page 23.)
- [Pizzagalli 2009] D. A. Pizzagalli, A. J. Holmes, D. G. Dillon, E. L. Goetz, J. L. Birk, R. Bogdan, D. D. Dougherty, D. V. Iosifescu, S. L. Rauch and M. Fava. *Reduced caudate and nucleus accumbens response to rewards in unmedicated individuals with major depressive disorder.* Am J Psychiatry, vol. 166, no. 6, pages 702 – 710, Jun 2009. (Cited on page 13.)

- [Pollock 1990] V. E. Pollock and L. S. Schneider. *Topographic quantitative EEG in elderly subjects with major depression*. *Psychophysiology*, vol. 27, no. 4, pages 438 – 444, Jul 1990. (Cited on pages 61 and 106.)
- [Price 2008] G.W. Price, J.W. Lee, C. Garvey and N. Gibson. *Appraisal of sessional EEG features as a correlate of clinical changes in an rTMS treatment of depression*. *Clin EEG Neurosci*, vol. 39, no. 3, pages 131 – 8, July 2008. (Cited on pages 65 and 105.)
- [Quartarone 2005] A. Quartarone, S. Bagnato, V. Rizzo, F. Morgante, A. Sant'angelo, F. Battaglia, C. Messina, H. R. Siebner and P. Girlanda. *Distinct changes in cortical and spinal excitability following high-frequency repetitive TMS to the human motor cortex*. *Exp Brain Res*, vol. 161, no. 1, pages 114 – 124, Feb 2005. (Cited on page 44.)
- [Quyen 2006] M. Le Van Quyen, I. Khalilov and Y. Ben-Ari. *The dark side of high-frequency oscillations in the developing brain*. *Trends in Neurosciences*, vol. 29, no. 7, pages 419 – 427, 2006. (Cited on page 24.)
- [Ramon 2006] C. Ramon, J. Haueisen and P. H. Schimpf. *Influence of head models on neuromagnetic fields and inverse source localizations*. *Biomed Eng Online*, vol. 5, page 55, 2006. (Cited on page 26.)
- [Richieri 2011] R. Richieri, L. Boyer, J. Farisse, C. Colavolpe, O. Mundler, C. Lanccon and E. Guedj. *Predictive value of brain perfusion SPECT for rTMS response in pharmacoresistant depression*. *Eur. J. Nucl. Med. Mol. Imaging*, vol. 38, no. 9, pages 1715 – 1722, Sep 2011. (Cited on page xiv.)
- [Ridding 2007] M. C. Ridding and J. C. Rothwell. *Is there a future for therapeutic use of transcranial magnetic stimulation?* *Nat Rev Neurosci*, vol. 8, 2007. (Cited on pages 38, 49, 51 and 52.)
- [Robertson 2003] E. M. Robertson, H. Theoret and A. Pascual-Leone. *Studies in cognition: the problems solved and created by transcranial magnetic stimulation*. *J Cogn Neurosci*, vol. 15, no. 7, pages 948 – 960, Oct 2003. (Cited on pages 38 and 41.)

- [Romero 2002] Jose Rafael Romero, David Anshel, Roland Sparing, Massimo Gan-  
gitano and Alvaro Pascual-Leone. *Subthreshold low frequency repetitive tran-  
scranial magnetic stimulation selectively decreases facilitation in the motor  
cortex*. *Clinical Neurophysiology*, vol. 113, no. 1, pages 101 – 107, 2002.  
(Cited on pages xiv and 41.)
- [Rosanova 2009] M. Rosanova, A. Casali, V. Bellina, F. Resta, M. Mariotti and  
M. Massimini. *Natural frequencies of human corticothalamic circuits*. *J.  
Neurosci.*, vol. 29, no. 24, pages 7679 – 7685, Jun 2009. (Cited on page 48.)
- [Rossi 2009] S. Rossi, M. Hallett, P. M. Rossini, A. Pascual-Leone, G. Avanzini,  
S. Bestmann, A. Berardelli, C. Brewer, T. Canli, R. Cantello, R. Chen,  
J. Classen, M. Demitrack, V. Di Lazzaro, C. M. Epstein, M. S. George,  
F. Fregni, I. Risto, R. Jalinous, B. Karp, J. P. Lefaucheur, S. Lisanby,  
S. Meunier, C. Miniussi, P. Miranda, F. Padberg, W. Paulus, A. Peterchev,  
C. Porteri, M. Provost, A. Quartarone, A. Rotenberg, J. Rothwell, J. Ruo-  
honen, H. Siebner, G. Thut, J. Valls-Sole, Y. Ugawa, A. Zangen and U. Zie-  
mann. *Safety, ethical considerations, and application guidelines for the use  
of transcranial magnetic stimulation in clinical practice and research*. *Clin  
Neurophysiol*, vol. 120, no. 12, pages 2008 – 2039, Dec 2009. (Cited on  
pages 37 and 71.)
- [Rossini 2007] P. M. Rossini and S. Rossi. *Transcranial magnetic stimulation: di-  
agnostic, therapeutic, and research potential*. *Neurology*, vol. 68, no. 7, pages  
484 – 488, Feb 2007. (Cited on page 32.)
- [Rossini 2010] D. Rossini, A. Lucca, L. Magri, A. Malaguti, E. Smeraldi,  
C. Colombo and R. Zanardi. *A symptom-specific analysis of the effect of  
high-frequency left or low-frequency right transcranial magnetic stimulation  
over the dorsolateral prefrontal cortex in major depression*. *Neuropsychobi-  
ology*, vol. 62, no. 2, pages 91 – 97, 2010. (Cited on page 106.)
- [Rush 2006] A. J. Rush, M. H. Trivedi, S. R. Wisniewski, J. W. Stewart, A. A.  
Nierenberg, M. E. Thase, L. Ritz, M. M. Biggs, D. Warden, J. F. Luther,  
K. Shores-Wilson, G. Niederehe and M. Fava. *Bupropion-SR, sertraline,*



- or venlafaxine-XR after failure of SSRIs for depression.* N. Engl. J. Med., vol. 354, no. 12, pages 1231 – 1242, Mar 2006. (Cited on page 48.)
- [Sack 2006] A. T. Sack. *Transcranial magnetic stimulation, causal structure-function mapping and networks of functional relevance.* Current Opinion in Neurobiology, vol. 16, no. 5, pages 593 – 599, 2006. (Cited on page 48.)
- [Sack 2007] A. T. Sack, A. Kohler, S. Bestmann, D. E. Linden, P. Dechent, R. Goebel and J. Baudewig. *Imaging the brain activity changes underlying impaired visuospatial judgments: simultaneous FMRI, TMS, and behavioral studies.* Cereb. Cortex, vol. 17, no. 12, pages 2841 – 2852, Dec 2007. (Cited on page 48.)
- [Sanacora 1999] G. Sanacora, G. F. Mason, D. L. Rothman, K. L. Behar, F. Hyder, O. A. Petroff, R. M. Berman, D. S. Charney and J. H. Krystal. *Reduced cortical gamma-aminobutyric acid levels in depressed patients determined by proton magnetic resonance spectroscopy.* Arch. Gen. Psychiatry, vol. 56, no. 11, pages 1043 – 1047, Nov 1999. (Cited on page 10.)
- [Sanacora 2004] G. Sanacora, R. Gueorguieva, C. N. Epperson, Y. T. Wu, M. Appel, D. L. Rothman, J. H. Krystal and G. F. Mason. *Subtype-specific alterations of gamma-aminobutyric acid and glutamate in patients with major depression.* Arch. Gen. Psychiatry, vol. 61, no. 7, pages 705 – 713, Jul 2004. (Cited on page 10.)
- [Sanei 2007] S. Sanei and J. A. Chambers. *Eeg signal processing, volume 1.* Wiley-Interscience, 2007. (Cited on pages 17, 21, 22, 23 and 24.)
- [Schaefer 2006] H. S. Schaefer, K. M. Putnam, R. M. Benca and R. J. Davidson. *Event-related functional magnetic resonance imaging measures of neural activity to positive social stimuli in pre- and post-treatment depression.* Biol. Psychiatry, vol. 60, no. 9, pages 974 – 986, Nov 2006. (Cited on page 12.)
- [Schatzberg 2004] A.F. Schatzberg and C.B. Nemeroff. *The american psychiatric press textbook of psychopharmacology.* The American Psychiatric Press, 2004. (Cited on pages 5, 6, 7 and 8.)

- [Schindler 2008] K. Schindler, T. Nyffeler, R. Wiest, M. Hauf, J. Mathis, Ch.W. Hess and R. Mri. *Theta burst transcranial magnetic stimulation is associated with increased EEG synchronization in the stimulated relative to unstimulated cerebral hemisphere*. *Neuroscience Letters*, vol. 436, no. 1, pages 31 – 34, 2008. (Cited on page 45.)
- [Schloss 1998] P. Schloss and D. C. Williams. *The serotonin transporter: a primary target for antidepressant drugs*. *J. Psychopharmacol. (Oxford)*, vol. 12, no. 2, pages 115 – 121, 1998. (Cited on page 8.)
- [Schulman 2011] J. J. Schulman, R. Cancro, S. Lowe, F. Lu, K. D. Walton and R. R. Llinas. *Imaging of thalamocortical dysrhythmia in neuropsychiatry*. *Front Hum Neurosci*, vol. 5, page 69, 2011. (Cited on page 106.)
- [Shafritz 2006] K. M. Shafritz, S. H. Collins and H. P. Blumberg. *The interaction of emotional and cognitive neural systems in emotionally guided response inhibition*. *NeuroImage*, vol. 31, no. 1, pages 468 – 475, 2006. (Cited on page 11.)
- [Sherman 2002] S. M. Sherman and R. W. Guillery. *The role of the thalamus in the flow of information to the cortex*. *Philos. Trans. R. Soc. Lond., B, Biol. Sci.*, vol. 357, no. 1428, pages 1695 – 1708, Dec 2002. (Cited on page 12.)
- [Siegle 2002] G. J. Siegle, S. R. Steinhauer, M. E. Thase, V. A. Stenger and C. S. Carter. *Can't shake that feeling: event-related fMRI assessment of sustained amygdala activity in response to emotional information in depressed individuals*. *Biol. Psychiatry*, vol. 51, no. 9, pages 693 – 707, May 2002. (Cited on page 12.)
- [Sparing 2008] R. Sparing, D. Buelte, I. G. Meister, T. Paus and G. R. Fink. *Transcranial magnetic stimulation and the challenge of coil placement: a comparison of conventional and stereotaxic neuronavigational strategies*. *Hum Brain Mapp*, vol. 29, no. 1, pages 82 – 96, Jan 2008. (Cited on page 36.)
- [Speer 2000] A. M. Speer, T. A. Kimbrell, E. M. Wassermann, J. D. Repella, M. W. Willis, P. Herscovitch and R. M. Post. *Opposite effects of high and low frequency rTMS on regional brain activity in depressed patients*. *Biological*

- Psychiatry, vol. 48, no. 12, pages 1133 – 1141, 2000. (Cited on pages 49, 50 and 51.)
- [Stahl 2003a] S. M. Stahl. *Brainstorms: symptoms and circuits, part 2: anxiety disorders*. J Clin Psychiatry, vol. 64, no. 12, pages 1408 – 1409, Dec 2003. (Cited on page 4.)
- [Stahl 2003b] S. M. Stahl. *Symptoms and circuits, part 1: major depressive disorder*. J Clin Psychiatry, vol. 64, no. 11, pages 1282 – 1283, Nov 2003. (Cited on page 4.)
- [Stahl 2003c] S. M. Stahl, L. Zhang, C. Damatarca and M. Grady. *Brain circuits determine destiny in depression: a novel approach to the psychopharmacology of wakefulness, fatigue, and executive dysfunction in major depressive disorder*. J Clin Psychiatry, vol. 64 Suppl 14, pages 6 – 17, 2003. (Cited on page 4.)
- [Stahl 2004] S. M. Stahl. *Symptoms and circuits, part 3: schizophrenia*. J Clin Psychiatry, vol. 65, no. 1, pages 8 – 9, Jan 2004. (Cited on page 4.)
- [Sterman 1974] M. B. Sterman, L. R. MacDonald and R. K. Stone. *Biofeedback training of sensorimotor EEG in man and its effect on epilepsy*. Epilepsia, vol. 15, pages 395 – 416, 1974. (Cited on page 21.)
- [Talairach 1988] J. Talairach and P. Tournoux. *Co-planar stereotaxic atlas of the human brain*. New York: Thieme Medical Publishers, 1988. (Cited on page 36.)
- [Tatum 2008] W. O. Tatum. *Handbook of eeg interpretation*. Demos Medical Publishing, LLC, 2008. (Cited on page 21.)
- [Taylor 2007a] J. L. Taylor and C. K. Loo. *Stimulus waveform influences the efficacy of repetitive transcranial magnetic stimulation*. J Affect Disord, vol. 97, no. 1 - 3, pages 271 – 276, Jan 2007. (Cited on pages 40 and 42.)
- [Taylor 2007b] P. C. Taylor, A. C. Nobre and M. F. Rushworth. *Subsecond changes in top down control exerted by human medial frontal cortex during conflict and action selection: a combined transcranial magnetic stimulation elec-*

- troencephalography study*. J. Neurosci., vol. 27, no. 42, pages 11343 – 11353, Oct 2007. (Cited on page 48.)
- [Taylor 2008] P. C. J. Taylor, V. Walsh and M. Eimer. *Combining TMS and EEG to study cognitive function and corticocortico interactions*. Behavioural Brain Research, vol. 191, no. 2, pages 141 – 147, 2008. (Cited on pages 57 and 58.)
- [Tenke 2011] Craig E. Tenke, Jrgen Kayser, Carlye G. Manna, Shiva Fekri, Christopher J. Kropfmann, Jennifer D. Schaller, Daniel M. Alschuler, Jonathan W. Stewart, Patrick J. McGrath and Gerard E. Bruder. *Current Source Density Measures of Electroencephalographic Alpha Predict Antidepressant Treatment Response*. Biological Psychiatry, vol. 70, no. 4, pages 388 – 394, 2011. (Cited on page 105.)
- [Thielscher 2010] A. Thielscher, A. Reichenbach, K. Ugurbil and K. Uludag. *The cortical site of visual suppression by transcranial magnetic stimulation*. Cereb. Cortex, vol. 20, no. 2, pages 328 – 338, Feb 2010. (Cited on page 41.)
- [Thut 2010] G. Thut and A. Pascual-Leone. *Integrating TMS with EEG: How and what for?* Brain Topogr, vol. 22, no. 4, pages 215 – 218, Jan 2010. (Cited on page 59.)
- [Thut 2011] G. Thut, D. Veniero, V. Romei, C. Miniussi, P. Schyns and J. Gross. *Rhythmic TMS Causes Local Entrainment of Natural Oscillatory Signatures*. Current Biology, vol. 21, no. 14, pages 1176 – 1185, 2011. (Cited on page 106.)
- [Trivedi 2006] M. H. Trivedi, A. J. Rush, S. R. Wisniewski, A. A. Nierenberg, D. Warden, L. Ritz, G. Norquist, R. H. Howland, B. Lebowitz, P. J. McGrath, K. Shores-Wilson, M. M. Biggs, G. K. Balasubramani and M. Fava. *Evaluation of outcomes with citalopram for depression using measurement-based care in STAR\*D: implications for clinical practice*. Am J Psychiatry, vol. 163, no. 1, pages 28 – 40, Jan 2006. (Cited on page 48.)
- [Uhlhaas 2006] P. J. Uhlhaas and W. Singer. *Neural Synchrony in Brain Disorders: Relevance for Cognitive Dysfunctions and Pathophysiology*. Neuron, vol. 52, no. 1, pages 155 – 168, 2006. (Cited on page 24.)

- [Ulrich 1984] G. Ulrich, E. Renfordt, G. Zeller and K. Frick. *Interrelation between changes in the EEG and psychopathology under pharmacotherapy for endogenous depression. A contribution to the predictor question.* Pharmacopsychiatry, vol. 17, no. 6, pages 178 – 183, Nov 1984. (Cited on pages 63 and 105.)
- [Ulrich 1988] G. Ulrich, H. J. Haug, R. D. Stieglitz and E. Fahndrich. *EEG characteristics of clinically defined on-drug-responders and non-responders: a comparison clomipramine vs. maprotiline.* Pharmacopsychiatry, vol. 21, no. 6, pages 367 – 368, Nov 1988. (Cited on page 64.)
- [Ulrich 1994] G. Ulrich, H.J. Haug and E. Fahndrich. *Acute vs. chronic EEG effects in maprotiline- and in clomipramine-treated depressive inpatients and the prediction of therapeutic outcome.* J Affect Disord, vol. 32, no. 3, pages 213 – 217, Nov 1994. (Cited on page 64.)
- [Vatta 2010] F. Vatta, F. Meneghini, F. Esposito, S. Mininel and F. Di Salle. *Realistic and spherical head modeling for EEG forward problem solution: a comparative cortex-based analysis.* Comput Intell Neurosci, page 972060, 2010. (Cited on page 26.)
- [Vuga 2006] M. Vuga, N. A. Fox, J. F. Cohn, C. J. George, R. M. Levenstein and M. Kovacs. *Long-term stability of frontal electroencephalographic asymmetry in adults with a history of depression and controls.* Int J Psychophysiol, vol. 59, no. 2, pages 107 – 115, Feb 2006. (Cited on page 63.)
- [Wager 2008] T. D. Wager, M. L. Davidson, B. L. Hughes, M. A. Lindquist and K. N. Ochsner. *Prefrontal-Subcortical Pathways Mediating Successful Emotion Regulation.* Neuron, vol. 59, no. 6, pages 1037 – 1050, 2008. (Cited on page 12.)
- [Walter 1964] W. G. Walter. *Slow potential waves in the human brain associated with expectancy, attention and decision.* Arch. Psychiat. Nervenkr., vol. 206, pages 309 – 322, 1964. (Cited on page 21.)
- [Wassermann 2008] E.M. Wassermann, C. Epstein and U. Ziemann, editors. *The oxford handbook of transcranial stimulation.* Oxford University Press, 2008. (Cited on pages 48, 58 and 59.)

- [Wikipedia 2012] Wikipedia. *Neuron*. <http://en.wikipedia.org/wiki/Neuron>, 2012. (Cited on page 17.)
- [Wolters 2004] C. H. Wolters, L. Grasedyck and W. Hackbusch. *Efficient computation of lead field bases and influence matrix for the FEM-based EEG and MEG inverse problem*. *Inverse Problems*, vol. 20, page 1099, 2004. (Cited on page 28.)
- [Young 1978] R. C. Young, J. T. Biggs, V. E. Ziegler and D. A. Meyer. *A rating scale for mania: reliability, validity and sensitivity*. *Br J Psychiatry*, vol. 133, pages 429 – 435, Nov 1978. (Cited on page 69.)
- [Zandbelt 2009] B.B. Zandbelt, J.M. Hoogendam, M. van Buuren, A.T. Sack, R.S. Kahn and M. Vink. *Repetitive transcranial magnetic stimulation alters resting-state functional connectivity*. In Poster presentation at the 15th Annual meeting of the Organization for Human Brain Mapping, San Francisco, CA, USA, 2009. (Cited on page 48.)
- [Zangen 2005] A. Zangen, Y. Roth, B. Voller and M. Hallett. *Transcranial magnetic stimulation of deep brain regions: evidence for efficacy of the H-Coil*. *Clinical Neurophysiology*, vol. 116, no. 4, pages 775 – 779, 2005. (Cited on pages 33 and 34.)







## Abstract

### **Evaluation of cortical excitability with electroencephalography recordings for optimizing the repetitive transcranial magnetic stimulation in patients with mood disorders.**

Transcranial magnetic stimulation (TMS) is a non-invasive technique for stimulating the brain. Repetitive TMS, application of many magnetic pulses, is able to induce relatively long-lasting excitability changes and nowadays is being developed for various therapeutic and scientific purposes. The aim of this PhD thesis was to compare different rTMS protocols in healthy subjects and to find neurophysiological EEG biomarkers characteristic for response or not to rTMS therapy in major and bipolar depression. The main originality of presented method is within-subject comparison of between-protocols effects. Additionally, source localisation was performed in both analyses. Here, we studied in 20 healthy subjects how cortical oscillations are modulated by four different active rTMS protocols of the left DLPFC, and by a sham-1Hz protocol used as a control condition, by comparing the spectral power of pre- and post-rTMS electroencephalographic (EEG) recordings. We found for every active protocol a significant decrease of delta and theta power on left prefrontal electrodes, mainly localised in the left DLPFC. In higher frequency bands (beta and gamma), the decrease of power in the DLPFC was also observed additionally in the contralateral DLPFC and depended on the stimulation protocol. In the second experiment we worked on two subgroups of patients, with major depressive disorder (MDD) and bipolar disorder (BP). In this open study we aimed to examine whether there are EEG differences in resting brain activity between BP and MDD patients, and between responders and non-responders to 10 Hz repetitive transcranial magnetic stimulation (rTMS) by studying EEG biomarkers. The most important finding is that it is possible to distinguish responders from non-responders to the rTMS treatment.

**Keywords:** EEG, rTMS, dorso-lateral prefrontal cortex, depression.

## Résumé

### **Evaluation de l'excitabilité corticale par électroencéphalographie pour l'optimisation de la stimulation magnétique transcrânienne répétée chez les patients souffrant de troubles de l'humeur**

La stimulation magnétique transcrânienne (SMT) est une technique non invasive qui permet de stimuler le cerveau. Les SMT répétitives (SMTr), c'est-à-dire l'application de nombreuses impulsions magnétiques, sont capable d'induire des modifications de longue durée de l'excitabilité neuronale. La SMT s'est développée dans un but thérapeutique et scientifique. L'objectif de cette thèse était de comparer différents protocoles SMTr sur des sujets sains et de trouver des marqueurs électroencéphalographiques (EEG) de la réponse ou pas à la thérapie SMTr dans la dépression majeure et bipolaire. La principale originalité de la méthode présentée est la comparaison intra-sujet d'effets entre-protocoles et le développement de techniques de localisation de sources. Ceci était la première thèse d'EEG-SMTr dans notre groupe et la méthode a été développée pour la première fois tant pour les deux modèles expérimentaux et d'autres analyses EEG. Cette thèse présente les résultats de deux expériences séparément conduites, sur des sujets sains et des patients déprimés. Dans la deuxième expérience, nous avons travaillé sur deux groupes de patients, souffrant de trouble dépressif majeur (MDD) et de trouble bipolaire (BP). Dans cette étude ouverte, nous avons cherché à déterminer s'il existe des différences d'EEG de repos dans l'activité cérébrale entre patients BP et MDD, et entre les répondeurs et non-répondeurs à la SMTr à 10 Hz en étudiant des biomarqueurs d'EEG. La conclusion la plus importante est qu'il est possible de distinguer les répondeurs des non-répondeurs au traitement SMTr.

**Les mots clés:** EEG, rTMS, cortex préfrontal dorso-latéral (DLPFC), la dépression.

