



HAL
open science

Immune regulations in a *Drosophila* model of Alzheimer's disease

Élie Maksoud

► **To cite this version:**

Élie Maksoud. Immune regulations in a *Drosophila* model of Alzheimer's disease. Immunology. Université de Strasbourg, 2012. English. NNT : 2012STRAJ106 . tel-00911811

HAL Id: tel-00911811

<https://theses.hal.science/tel-00911811>

Submitted on 30 Nov 2013

HAL is a multi-disciplinary open access archive for the deposit and dissemination of scientific research documents, whether they are published or not. The documents may come from teaching and research institutions in France or abroad, or from public or private research centers.

L'archive ouverte pluridisciplinaire **HAL**, est destinée au dépôt et à la diffusion de documents scientifiques de niveau recherche, publiés ou non, émanant des établissements d'enseignement et de recherche français ou étrangers, des laboratoires publics ou privés.

ÉCOLE DOCTORALE DES SCIENCES DE LA VIE ET DE LA SANTE

Réponses immunitaires et développement chez les insectes

UPR9022

THÈSE présentée par :

Elie MAKSOU

soutenue le : **28 novembre 2012**

pour obtenir le grade de : **Docteur de l'université de Strasbourg**

Discipline/ Spécialité : **Aspects moléculaires et cellulaires de la biologie**

**REGULATIONS IMMUNITAIRES DANS UN
MODELE *DROSOPHILE* DE LA MALADIE
D'ALZHEIMER**

THÈSE dirigée par :

M. HOFFMANN Jules

M. HETRU Charles

Professeur, université de Strasbourg

Docteur, université de Strasbourg

RAPPORTEURS :

Mme FAUVARQUE-MARRAS Marie-Odile

M. MENSAH-NYAGAN Ayikoé, Guy

M. PRINZ Marco

Docteur, CEA Grenoble

Professeur, université de Strasbourg

Professeur, university medical centre of Freiburg

Acknowledgments

And I thought that writing the acknowledgments of my thesis would be easy... Too many people come to my mind. A sudden rush prevents me from continuing. I stop for a while, take a moment, breathe and realize that this is the end: the end of three years of hard work with failure sometimes, hard lessons and mostly success. It all went too fast.

Three years have passed; I have changed yet somehow I am still the same. I am the same 21-year-old who arrived in France on a sunny, cold, autumn day with big hopes and a clear goal. The only difference is that, now, I have achieved my goal with the help of my precious friends. The list of people I want to thank seems endless: I truly believe I have been blessed.

I will start by thanking Pr. Jean-Marc Reichhart, our unit leader, for providing us with the best work environment.

I would like to express my deepest gratitude to my two PhD supervisors Pr. Jules Hoffmann and Dr. Charles Hetru. Working at your side has been a great honor and I am proud of every moment I have spent next to you.

The “one and only”, Dr. Hidehiro Fukuyama, my advisor. Hide, as I like to call you, nothing I could do or say will ever be enough to express my gratitude. You have always been there for me, in the highs as in the lows. Your guidance, your support, your advices have made this thesis possible. You have taught me a lot in science and much more in life. Hide, thank you!

Then our team members come to my mind: Xi, Guan, Toshiko, Laurence, Sylvain and Sarah. Working with you has been a huge pleasure. We have laughed, talked and gossiped in the small fly room and most importantly you have taught me how to distinguish male from female flies!

I am very grateful to my officemates: Stan, Sunny a.k.a. "Dr. Lee", Olivier and Francois for their encouragements, their patience and their friendship. I will miss you all. I will miss our "coolest" office and don't forget to close the door when the air conditioning is on.

Estelle, mon "amie du labo", I will truly miss you. Thank you for your moral support, for listening to me, for your advices when I most doubted myself and when everything I was doing felt wrong.

Jelena, you have been a great friend. Thank you for your unconditional love, for the memories and for showing me how to pronounce "Bon Iver" properly.

To all the members of UPR9022, I am very grateful.

Mira, my closest friend, I will always remember the day we first met in Strasbourg. It felt like you needed protection. Little did I know that you were the one who is going to help me and support me through it all. Getting to know you has been the highlight of this journey. You are one of the strongest and most courageous people I have met. You made it all feel easy. Thank you for being my friend, for being my family, for being the one I always turn to when I am feeling down and for sharing this experience with me.

Ahmad, my friend, you have also been a huge support. I have always looked at you as a younger brother. I think about our long discussions over a cup of tea, our trip to Spain, "the picture" and I smile. Thank you Mr.

To Mr Barhoum and Ranine, Joelle and Marianne, thank you for the long coffee breaks during which you had to listen to me complaining about how hard it was to write a thesis.

Amoulé and Aimé, thank you for changing my life and for believing in me. Because of you I can dream of a brighter future. Without you none of this would have happened.

Tarrouza, je t'aime.

To my family: Vivo, Pierrot, Kooky and Fara, I love you. You mean the world to me. It kills me to feel that I wasn't there when you needed me the most. Please forgive me. I hope I have made you proud. I dedicate my thesis to you.

Résumé

Les réponses immunitaires innées affectent le développement de nombreuses maladies neurodégénératives. La maladie d'Alzheimer (MA), la démence la plus fréquente chez l'homme, se caractérise par une accumulation de l'amyloïde β ($A\beta$) dans le cerveau. Plusieurs études suggèrent l'existence d'un lien étroit entre la MA et la neuroinflammation. Cependant, les mécanismes moléculaires des réactions immunitaires innées dirigées contre l' $A\beta$ n'ont pas encore été élucidés. La mouche du vinaigre, *Drosophila melanogaster*, a été utilisée avec succès pour caractériser la réponse immunitaire innée. Cet organisme invertébré, privé d'immunité adaptative, a récemment émergé comme un modèle d'étude pour la MA.

Dans le cadre de cette thèse, nous avons utilisé la drosophile comme organisme modèle pour étudier les relations entre les réactions immunitaires innées et le développement de la MA.

Tout d'abord, en utilisant des drosophiles développant la MA en exprimant l' $A\beta$ dans le cerveau, nous avons observé l'induction de la Metchnikowin, peptide antifongique et antibactérien. L'expression de ce dernier est régulée par les deux voies NF- κ B chez la drosophile, la voie IMD et la voie Toll, qui s'apparentent aux voies de signalisation TNF-R et TLR/IL-1R chez les mammifères respectivement. Nous avons généré par la suite des lignées de drosophiles MA immunodéficientes et nous avons observé que les mutants de la voie IMD, contrairement à ceux de la voie Toll, présentent une réduction de l'aptitude à grimper plus importante que les drosophiles MA sauvages, caractéristique de la pathogenèse rencontrée dans nos lignées MA. Des études histologiques ont révélé une accumulation plus importante de l' $A\beta$ accompagnée d'une neurodégénérescence dans les mouches MA déficientes pour *immune deficiency (imd)*. De plus nous avons observé des cellules gliales Draper-positives qui co-localisent avec les amas d' $A\beta$. Nous avons conclu que la présence d'une voie IMD active exerce un effet protecteur dans le développement de la MA en limitant l'accumulation de l' $A\beta$.

En parallèle, une analyse protéomique a été développée au sein de notre équipe afin d'identifier les protéines qui interagissent avec onze membres canoniques

de la voie IMD en cellules S2 suite à une stimulation par des *Escherichia coli* tuées à la chaleur. Ce crible a permis d'identifier 345 partenaires putatifs dont 90% possèdent des orthologues chez l'Homme. Une analyse bioinformatique des voies KEGG associées à ces gènes a révélé un enrichissement du terme « Alzheimer Disease ». Douze des gènes identifiés exercent un rôle majeur dans le maintien de l'homéostasie du calcium ou des fonctions mitochondriales. Les résultats de ce crible soulignent l'importance des connections existant entre la neuroinflammation et la MA et constituent d'intéressantes pistes à suivre pour la poursuite de cette étude.

Enfin, nous avons initié la réalisation d'un crible génétique par mutagenèse sur des drosophiles MA, en utilisant l'EMS comme agent mutagène. Ce crible permettra *in fine* d'identifier de façon non biaisée de nouveaux modulateurs de la neurotoxicité de l'A β , notamment fonctionnellement reliés à l'immunité innée. Au cours d'un pré-crible, nous avons généré et étudié 250 lignées mutantes en estimant leur aptitude à grimper en tant qu'évaluation de la pathologie liée à la MA. Nous avons retenu deux lignées réduisant les capacités locomotrices.

Mes travaux de thèse ont permis : 1) de démontrer que notre modèle drosophile de la MA est adapté à l'étude des liens existant entre la MA et la neuroinflammation; 2) de proposer une liste de gènes potentiellement impliqués dans le développement de la MA chez la drosophile; 3) d'initier un crible génétique qui nous permettra d'identifier de nouveaux gènes requis dans l'ontogenèse de la MA. L'ensemble de ces résultats pourrait à plus long terme fournir de nouvelles cibles thérapeutiques dans le développement d'un traitement contre la MA.

Summary

Innate immune responses impact the course of numerous neurodegenerative diseases. Alzheimer's disease (AD), the most common form of dementia, is characterized by the accumulation of the amyloid β ($A\beta$) peptide in the brain. Several lines of evidence point towards a strong link between AD and neuroinflammation. However, the exact molecular events of the innate immune reactions against $A\beta$ need to be elucidated.

The fruit fly, *Drosophila melanogaster*, has been successfully used to decipher the mechanisms of innate immunity. This invertebrate organism, deprived of adaptive immunity, has recently emerged as a model for neurodegenerative diseases including AD.

In the course of this PhD, we have used *Drosophila* as a model organism to study the impact of the innate immune reactions on AD following three different approaches.

First, using AD model flies, we have demonstrated that the expression of $A\beta$ in the brain induces the antifungal and antibacterial peptide, *Metchnikowin*; the expression of which is mediated either by the IMD or the TOLL pathway, similar to mammalian TNF-R and TLR signaling cascades respectively. Next, we have established a series of immunocompromised AD flies and found that mutants for the IMD pathway, unlike those for the TOLL pathway, present severe climbing defects. Further histological studies revealed increased $A\beta$ accumulation in *immune deficiency (imd)* deficient AD flies and neurodegeneration. In addition, Drapper-positive glial cells co-localized with accumulated $A\beta$. We concluded that the IMD pathway plays a neuroprotective role by limiting the accumulation of $A\beta$.

Second, our team generated an IMD interactome dataset. We aimed to identify proteins associated with eleven canonical members of the IMD pathway. Upon stimulation with heat-killed *E. coli*, we have identified 345 interacting proteins out of which 90% have human orthologs. Bioinformatic analysis of the corresponding genes demonstrated that the KEGG pathway term 'Alzheimer disease' was significantly enriched in the dataset. Twelve genes were associated

with this term and their described functions included roles in maintaining calcium homeostasis and mitochondrial functions. This work has shown that the *Drosophila* IMD interactome dataset could be potentially used to elucidate the mechanisms linking AD to neuroinflammation.

Third, we have set up a genetic screen using chemical mutagenesis to identify novel immune-related genes affecting the development of AD-like pathology in flies. We used the EMS mutagenesis approach and monitored the climbing ability of the mutants as readout of AD development. In a pilot screen, we have tested 250 mutant lines and retained two showing deficits in climbing activity.

In short, my Ph.D. thesis work provides: 1) a proof-of-concept that our *Drosophila* AD model is suitable for studying the link between AD and neuroinflammation; 2) a generated dataset providing a list of genes potentially relevant to AD; 3) the genetic screen as a research tool that will enable us to identify novel genes linked to AD. These outcomes from our *Drosophila* studies could provide insights into new therapeutic strategies against AD.

Table of contents

Abbreviations	1
Introduction	4
1 <i>Alzheimer's disease</i>	5
1.1 History	5
1.2 Statistics	6
1.3 Neuropathology in Alzheimer's disease	6
1.3.a Neurofibrillary tangles	8
1.3.b Amyloid Plaques	9
1.4 Proteolytic processing of APP	10
1.5 Evolution of the amyloid cascade hypothesis	13
1.6 Neuropsychological stages of Alzheimer's disease	17
1.7 Biomarkers of Alzheimer's disease	17
1.8 Genetic Factors	18
1.8.a Early-onset familial Alzheimer's disease	18
1.8.b Late-onset Alzheimer's disease	19
1.9 Environmental risk factors	20
2 <i>Animal models of Alzheimer's disease</i>	21
2.1 Spontaneous animal models	21
2.2 Transgenic animal models	22
2.2.a Mouse models	22
2.2.b <i>Drosophila</i> models	25
2.2.c Nematode and zebrafish models	30
3 <i>Inflammation and Alzheimer's disease</i>	31
3.1 Activation of microglial cells in Alzheimer's disease	31
3.2 Anti-inflammatory drugs reduce the risk of Alzheimer's disease	32
3.3 Epidemiological studies link immune-related genes to Alzheimer's disease	33
3.4 Mouse genetic studies reveal the importance of immune regulations in Alzheimer's disease	35
3.5 Immunization with A β against Alzheimer's disease	38
4 <i>Drosophila immunity</i>	41
4.1 <i>Drosophila's</i> innate immune system	41
4.1.a The Toll pathway	44
4.1.b The IMD pathway	44
4.2 <i>Drosophila's</i> glial cells	45
4.3 Lessons from <i>Drosophila</i> models of neurodegeneration	46
5 <i>Thesis outline</i>	48
Results	49
1 <i>Drosophila IMD pathway limits the accumulation of amyloid β in Alzheimer's disease fly model</i>	50
2 <i>Drosophila IMD interactome in bacterial challenge</i>	92
3 <i>EMS mutagenesis screen for Alzheimer's modifying genes</i>	136
3.1 Ethyl methane sulphonate (EMS) mutagenesis	137
3.2 Practical approach	137
3.3 Results and mapping strategy	141
3.4 Perspectives	144
Discussion and perspectives	146
1 <i>The IMD pathway prevents the development of AD phenotypes</i>	148

2	<i>Alzheimer's disease-related genes are enriched in the IMD interactome dataset</i>	150
3	<i>Genetic screening for AD modifying genes in Drosophila</i>	157
	Bibliography	159

Abbreviations

a.a.	Amino acids
A β	Amyloid beta
A β 40	Amyloid beta 40
A β 42	Amyloid beta 42
ABAD	A β -binding alcohol dehydrogenase
ABCA7	ATP-binding cassette sub-family A member 7
AD	Alzheimer's disease
ADAM	A disintegrin- and metalloproteinase
ADAPT	Alzheimer's Disease Anti-inflammatory Prevention Trial
AMP	Anti-microbial peptide
AP2	Adaptor complex protein 2
aph-1	Anterior pharynx defective 1
APLP	Amyloid precursor-like protein
APOE	Apolipoprotein E
APP	Amyloid precursor protein
APP Arc	APP Arctic
APP Swe	APP Swedish
APPL	<i>Drosophila</i> β -amyloid protein precursor-like
ATP5A1	ATP synthase, H ⁺ transporting, mitochondrial F1 complex, alpha 1
ATP5B	ATP synthase subunit beta, mitochondrial
ATP5F1	ATP synthase subunit b, mitochondrial
Bace	<i>Drosophila</i> BACE
BACE1	Beta-site APP-cleaving enzyme 1
BBB	Blood-brain barrier
BIN1	Bridging integrator 1
BNP	B-type natriuretic peptide
Bsg	Basigin
Ca ²⁺	Calcium
CAA	Cerebral amyloid angiopathy
CD2AP	CD2-associated protein
CLU	Clusterin
CMS	Cas ligand with multiple SH 3 domains
CNS	Central nervous system
Cortactin	Cortical actin binding protein
COX-1	Cyclooxygenase-1
COX-2	Cyclooxygenase-2
CR1	Complement receptor type 1
CRP	C-reactive protein
CSF	Cerebrospinal fluid
Cx	Complex
CX3CR1	CX3C chemokine receptor 1
CYC	Cytochrome C1

dAPPL	<i>Drosophila</i> APP-like protein
DAVID	Database for Annotation, Visualization and Integrated Discovery
Dif	Disordered facets
dPsn	<i>Drosophila</i> presenellin
DREDD	Death-related ced-3/Nedd2-like protein
EAE	Experimental autoimmune encephalomyelitis
ELISA	Enzyme-linked assays (ELISA)
EM	Electron microscopy
EMS	Ethyl methane sulfonate
ER	Endoplasmic reticulum
FAD	Familial Alzheimer disease
FADD	Fas-associated death domain
GSAP	Gamma-secretase activating protein
HuGENet	Human Genome Epidemiology Network
IFN γ	Interferon gamma
IKK	Inhibitor of κ B kinase
IL	Interleukin
imd	Immune Deficiency
IP ₃	Inositol 1,4,5-trisphosphate
IP ₃ R	Inositol trisphosphate receptor
JNK	c-Jun N-terminal kinase
KEGG	Kyoto Encyclopedia of Genes and Genomes
LTP	Long term potentiation
MA	Maladie d'Alzheimer
MEGF10	Multiple EGF-like-domains 10
MEGF11	Multiple EGF-like-domains 11
MHC II	Major histocompatibility complex type II
MRI	Magnetic resonance imaging
MS4A	Membrane-spanning 4-domains subfamily A
nct	<i>Drosophila</i> Nicastrin
NDUFS2	NADH dehydrogenase [ubiquinone] iron-sulfur protein 2
NF- κ B	Nuclear factor-kappa B
NFTs	Neurofibrillary tangles
NMDAR	N-methyl-d-aspartate receptors
NSAID	Non-steroidal anti-inflammatory drug
OXPHOS	Oxidative phosphorylation system
PET	Positron emission tomography
PGRP-LC	Peptidoglycan recognition protein LC
PGRP-LE	Peptidoglycan recognition protein LE
PICALM	Phosphatidylinositol-binding clathrin assembly protein
PP	Pancreatic peptide
PS	Presenellin
PSEN	Presenellin
PSENEN	Presenilin enhancer 2 homolog
RC	Respiratory chain
ROS	Reactive oxygen species

SERCA	Sarco ER Ca ²⁺ -ATPase
SH	Src homology
t-tau	Total tau
Tak1	TGF-β activated kinase 1
TGF-β	Transforming growth factor beta
Tl	Toll
TLRs	Toll-like Receptors
TNF	Tumor necrosis factor
TNFR I	Tumor necrosis factor receptor I
TNFR II	Tumor necrosis factor receptor II
UAS	Upstream activation sequence
UQCRC2	Ubiquinol cytochrome c reductase core protein 2

Introduction

1 *Alzheimer's disease*

1.1 History

On November 4th 1906, at the 37th Conference of South-West German Psychiatrists, *Alois Alzheimer* first described a form of dementia that was subsequently named after him. The German psychiatrist, considered to be the founding father of neuropathology, (Zilka and Novak, 2006) presented the case of a 51-year-old female patient, *Auguste Deter* (Figure 1), who was suffering from progressive cognitive impairment, focal symptoms, hallucinations, delusions and psychosocial incompetence (Maurer et al., 1997).

After the death of *Auguste Deter*, *Alois Alzheimer* analyzed her brain in *Munich Medical School*. Using the silver staining method, he was able to identify neuritic plaques and neurofibrillary tangles, two hallmarks of an Alzheimer's disease (AD) brain. Although a variety of senile dementias were known at that time, the early age onset of the disease and the presence of tangles made his finding unique (Castellani et al., 2010).

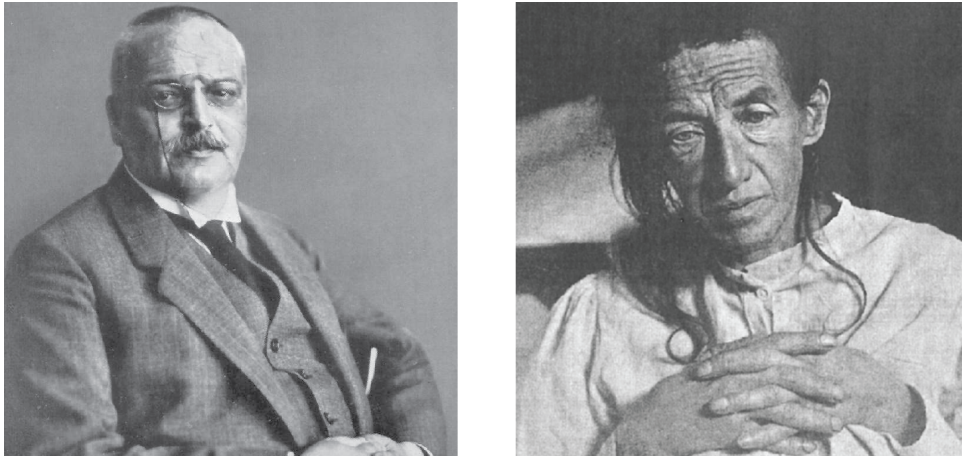

Fig. 1: Photographs of Alois Alzheimer (Left) and Auguste Deter (Right)

1.2 Statistics

Nowadays, AD is the main cause for dementia and the 6th leading cause of death according to the latest *Alzheimer's Disease Facts and Figures report* (Alzheimer's Association). It accounts for an estimated 60 to 80% of cases of dementia and affects more than 26 million people worldwide. The incidence of AD increases rapidly with age: from 0.5% among 65-70 years old, it rises to approximately 6-8% of individuals over the age of 85. In fact, due to medical progress, the proportion of the world population in the older ages is increasing. As a direct result, the number of people suffering from AD is estimated to triple by 2050.

1.3 Neuropathology in Alzheimer's disease

Alzheimer's disease is characterized by a progressive loss of synapses and neurons in the cerebral cortex. On a macroscopic level, this results in a typical

symmetric pattern of cortical atrophy predominantly affecting the medial temporal lobes and the primary motor, sensory and visual cortices. Due to this structure change in the brain, lateral ventricles containing cerebrospinal fluid are frequently found enlarged (Dickerson et al., 2009) (Figure 2).

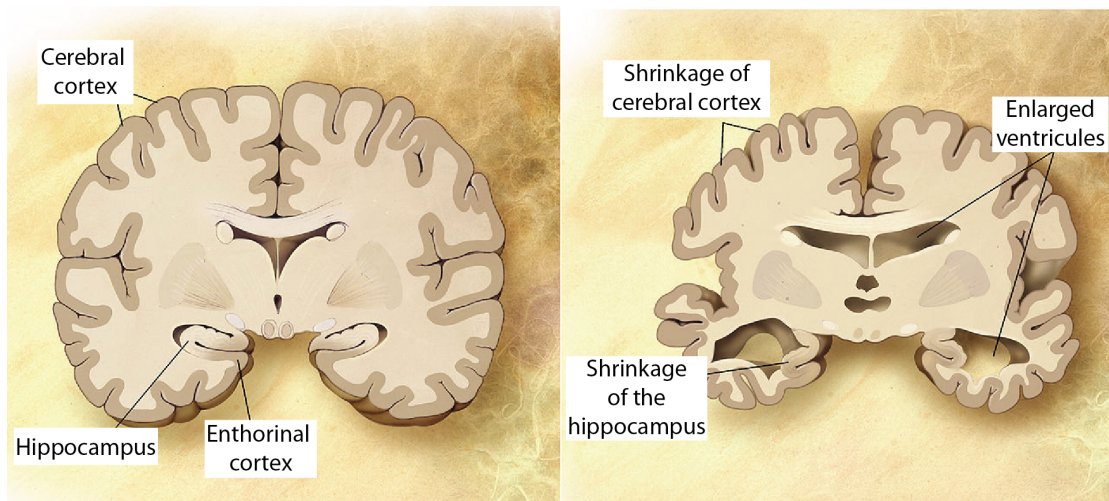

Fig. 2: Schematic representation of brain atrophy in AD

Comparison of a healthy brain (left) and the brain of an AD patient (right). Gross changes are represented. (Image taken from commons.wikimedia.org)

However, these anatomical changes are merely specific to AD. A definitive diagnosis requires a postmortem examination of the brain tissue for the existence of amyloid plaques and NFTs (Figure 3) (Mott and Hulette, 2005).

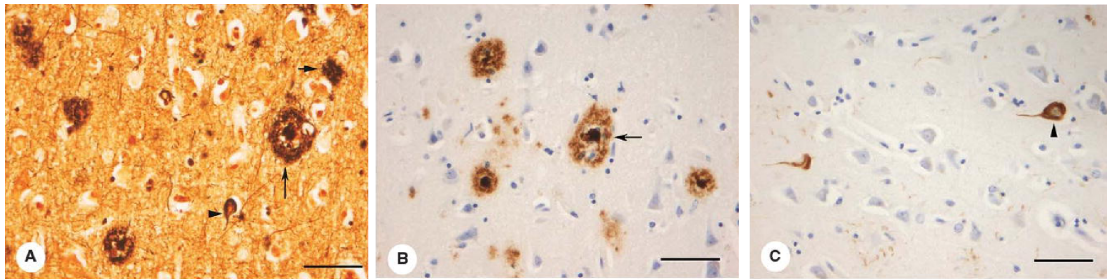

Fig. 3: Neuropathological features of AD

Histological images of AD-related lesions: (A) modified silver staining method showing amyloid plaques (arrows) and NFTs (arrowheads), (B) A β immunohistochemistry revealing amyloid plaques and (C) hyperphosphorylated Tau immunohistochemistry revealing neurofibrillary tangles. (Purohit et al., 2011)

1.3.a Neurofibrillary tangles

Neurofibrillary tangles (NFTs) are intraneuronal filamentous inclusions within the perikaryal region of pyramidal neurons. Electron microscopy (EM) studies of AD brains revealed that NFTs are largely made of paired helical filaments, which are fibrils of approximately 10nm in diameter that gather in a helical tridimensional conformation (Crowther, 1991). The main component of NFTs is the microtubule-associated protein Tau, which is found to be in a misfolded and hyperphosphorylated state (Wegmann et al., 2010). Neurofibrillary threads are always present with NFTs. They most likely result from the breakdown of dendrites and axons of the tangle-bearing neurons (Figure 3).

1.3.b Amyloid Plaques

Amyloid or senile plaques are heterogeneous lesions ranging between 10 and 160 μ m. They result from an abnormal extracellular accumulation and aggregation of A β peptides (38-43 a.a. long). These peptides are produced by proteolytic processing of a larger amyloid precursor protein (APP). There are two different types of amyloid plaques: diffuse versus dense-core plaques.

Dense-core plaques are usually neuritic, surrounded by dystrophic neurites (degenerated axons and dendrites). They are abundantly found in the brain of AD patients (Figure 3). On the contrary, diffuse plaques are commonly found in the brain of the cognitively normal elderly (Itagaki et al., 1989; Knowles et al., 1999; Masliah et al., 1990; Urbanc et al., 2002).

The ultrastructure of dense-core plaques, as revealed by EM, consists of a central star-shaped nucleus. Fibrils extend toward the periphery, where they are combined to astrocytic, microglial and neuronal processes, also known as dystrophic neurites. Dystrophic neurites, of axonal or dendritic origins, usually contain packets of paired helical filaments, as well as abundant abnormal mitochondria and dense bodies of probable mitochondrial and/or lysosomal origins (Hirai et al., 2001; Kidd, 1964).

Diffuse plaques demonstrate light, amorphous A β -immunoreactivity without a clear fibrillar compact core. They were identified in the 1980's following the development of antibodies against A β (Joachim et al., 1989). They

are associated with very little or no neuritic dystrophy. They are usually found in limbic and association cortices, areas that are typical of neuritic plaques, but also in areas that are not implicated in the symptomatology of AD such as the thalamus and cerebellum (Joachim et al., 1989).

1.4 Proteolytic processing of APP

Amyloid peptides are generated by endoproteolytic processing of the parental amyloid precursor protein APP. APP is a ubiquitously expressed type-I transmembrane protein. Its gene is located on chromosome 21. It has a large, extracellular, glycosylated N-terminus, a single trans-membrane domain and a shorter cytoplasmic C-terminus. The A β region is situated at the cell surface with a part of the peptide embedded in the membrane (Kang et al., 1987).

APP is a member of a large family of conserved type I membrane proteins, the amyloid precursor-like proteins (APLPs) including APLP1 and APLP2 in mammals, APPL in *Drosophila* and APL-1 in *C. elegans* (Rosen et al., 1989). All these proteins share conserved motifs and undergo processing similarly to APP. Of particular interest the A β peptide is only conserved among mammals. The biological function of this family is not fully elucidated. However, APP has been implicated in a variety of important roles such as cell adhesion, cell migration and apoptosis, as well as synaptogenesis and insulin and glucose homeostasis (Zheng and Koo, 2006). APP knockout mice exhibit reduced body weight, brain weight, size of forebrain commissures, locomotor activity, forelimb grip strength,

and spatial learning scores. Many mice also exhibit agenesis of the corpus callosum, and extensive reactive gliosis (Zheng et al., 1995).

APP is sequentially cleaved by groups of enzymes or enzyme complexes known as α -, β - and γ -secretases. Three enzymes with an α -secretase activity have been identified, all belonging to the ADAM (a disintegrin- and metalloproteinase) family. They include ADAM9, ADMA10 and tumor necrosis factor converting enzyme ADAM17 (Allinson et al., 2003). The β -secretase or BACE1 (beta-site APP cleaving enzyme 1) has been identified as a type I integral membrane protein belonging to the pepsin family aspartyl proteases (Hussain et al., 1999; Sinha et al., 1999; Vassar et al., 1999). The γ -secretase has been identified as a complex of enzymes constituted of presenilin 1 or 2 (PSEN1 and PSEN2), nicastrin, anterior pharynx defective and presenilin enhancer 2 (Francis et al., 2002; Levitan et al., 2001; Steiner et al., 2002; Wolfe et al., 1999; Yu et al., 2000). Recently He et al. identified the γ -secretase activating protein (GSAP) that enhances the production of amyloid β without affecting Notch cleavage (He et al., 2010).

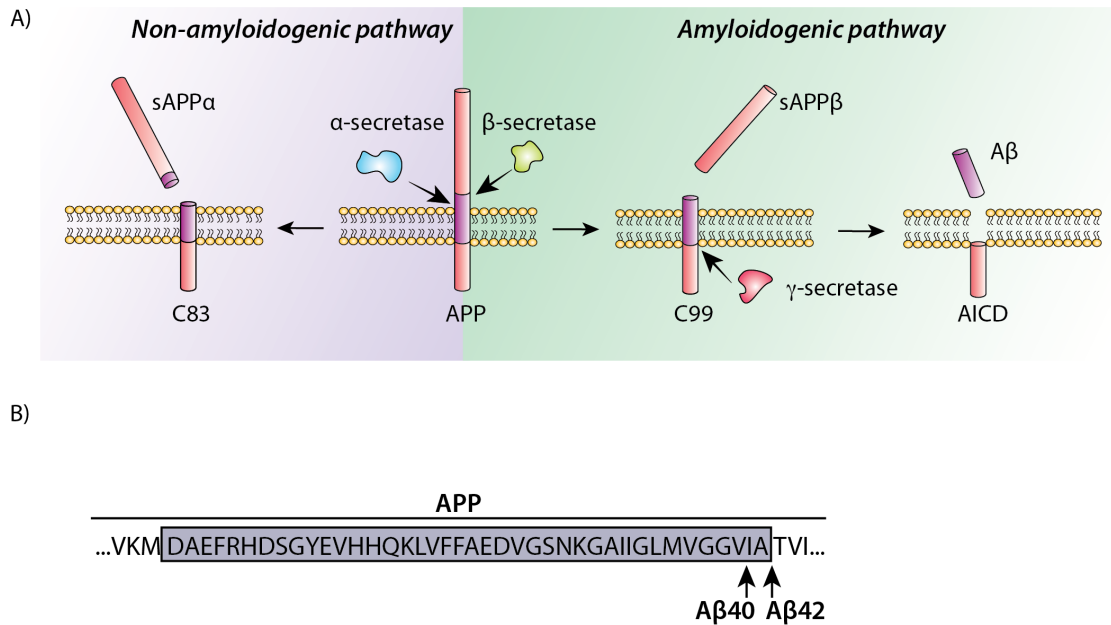

Fig. 4: APP proteolytic processing

- A) Schematic representation of the non-amyloidogenic and amyloidogenic pathways.
B) A β 40 and A β 42 peptides amino acid sequences.

APP can be cleaved and processed through two different pathways: the amyloidogenic pathway and the non-amyloidogenic pathway (Figure 4A). In the prevalent, non-amyloidogenic pathway, which precludes the formation of amyloids, the cleavage of APP is mediated by α -secretase. This cleavage occurs within the A β domain and leads to the release of two fragments. The first is a large ectodomain, sAPP α , secreted in the lumen and is thought to have neuroprotective and neurotrophic effects (Furukawa et al., 1996; Kojro and Fahrenholz, 2005). The second is a smaller carboxy-terminal fragment, C83, which is retained to the membrane. The C83 fragment is subsequently cleaved by α -secretase to produce P3 that is believed to be benign or even neuroprotective (Dulin et al., 2008; Haass et al., 1993).

The amyloidogenic pathway is an alternative cleavage pathway for APP and leads to the generation of A β peptides (Figure 4A). APP molecules that were not processed through the non-amyloidogenic pathway become substrates for the β -secretase, releasing an ectodomain, sAPP β , which appears to have proapoptotic functions. The remaining 99 a.a. of APP or C99 are retained in the membrane. Furthermore, C99 is cleaved 38 to 43 a.a. from the amino terminus by the γ -secretase complex releasing A β peptides (Figure 4B) (Jarrett et al., 1993a). This cleavage abundantly produces A β 40. Nevertheless the production of A β 42 is noteworthy, because of its hydrophobic nature and its tendency to oligomerise and form amyloid fibrils (Burdick et al., 1992; Jarrett et al., 1993b).

1.5 Evolution of the amyloid cascade hypothesis

More than a century following the case description of *Auguste Deter*, the exact etiology of AD remains elusive. However, in 1992, Hardy and Higgins proposed the amyloid cascade hypothesis, which is, thus far, the main basis for most work on the pathogenesis of AD (Hardy and Allsop, 1991; Hardy and Higgins, 1992; Selkoe, 1991; Tanzi and Bertram, 2005).

The amyloid cascade hypothesis first proposed that the deposition of A β peptides in the brain might be the central event in AD pathology, whereas the rest of the disease process including Tau dysfunction and the formation of

tangles results from an imbalance between A β production and A β clearance (Hardy et al., 2002).

Four evidence support this hypothesis: (1) the localization of the *APP* gene to chromosome 21 (Kang et al., 1987). Since 1969, it had been known that middle-aged patients with Down's syndrome invariably develop AD-like pathology and that plaques found in their brain are predominantly composed of A β (Glenner and Wong, 1984a, b; Olson and Shaw, 1969). Thus, the mapping of *APP* to chromosome 21 hinted to an effect of a genetic dose of *APP* on the development of AD-like pathology. In strong support of this observation, a patient with Down's syndrome, carrying only 2 copies of the *APP* gene because of a rare breakpoint in the distal location of chromosome 21q, showed no signs of dementia. Amyloid deposition was absent from his brain upon death at 78 years-old; (2) Genetic studies that have demonstrated that all causing mutations of early onset familial Alzheimer's disease (FAD) cases in *APP*, *PSEN1* and *PSEN2* affect A β levels (Borchelt et al., 1996; Chartier-Harlin et al., 1991; Citron et al., 1997; Duff et al., 1996; Goate et al., 1991; Levy et al., 1990); (3) Transgenic mice expressing mutant human APP show plaque formations and behavioral changes similar to those seen in AD (Games et al., 1995; Hsiao et al., 1996; SturchlerPierrat et al., 1997); (4) Fibrillar A β induces tauopathy. Injection of synthetic A β into the brains of Tau transgenic mice accelerates Tau hyperphosphorylation and leads to tangle formation reminiscent of tauopathy in AD (Gotz et al., 2001) (Santacruz et al. 2005). Co-expression of mutant APP with mutant Tau leads to enhanced tauopathy (Lewis et al., 2001; Oddo et al., 2003b).

Over the years, the amyloid cascade hypothesis has been modified. Increasing evidence from mouse models and human studies suggested a non-linear correlation between dementia and the accumulation of amyloids in the brain in the form of plaques (Games et al., 1995; Price et al., 2009). Reasons for questioning the pathogenicity of amyloid plaques included their presence in cognitively normal individuals (Katzman et al., 1988) and the lack of correlation between the number of amyloid deposits in the brain and the degree of cognitive impairment that a patient experiences in life (Arriagada et al., 1992). This aspect was particularly exemplified in mouse models that display behavioral deficits before the detection of plaque pathology (Billings et al., 2005; Mucke et al., 2000; Oddo et al., 2003b).

Studies that have followed the development of sensitive A β enzyme-linked assays (ELISA) found that the degree of dementia correlates most with the concentration of soluble A β species (Arriagada et al., 1992; Bierer et al., 1995; Giannakopoulos et al., 2003; Hyman et al., 1993). These observations and further studies have led to the proposal of the new amyloid cascade hypothesis, following which small, soluble A β oligomeric species are the ultimate cause of synaptic dysfunction and memory impairment in early AD (Lue et al., 1999; Wang et al., 1999). The concept of A β -derived soluble toxic oligomers, not monomers or insoluble fibrils, has been proposed to account for the neurotoxicity of the A β peptide (Glabe, 2006; Walsh et al., 2002). These oligomers, which composition remains uncertain have been isolated from transgenic mouse brains, the human brain or even reconstituted *in vitro* and their toxicity has been demonstrated (Lesne et al., 2006; Shankar et al., 2008).

The amyloid cascade hypothesis now suggests that the synaptotoxicity and neurotoxicity of A β may be mediated by soluble multimeric A β species through a poorly defined mechanism (Figure 5) (Karran et al., 2011).

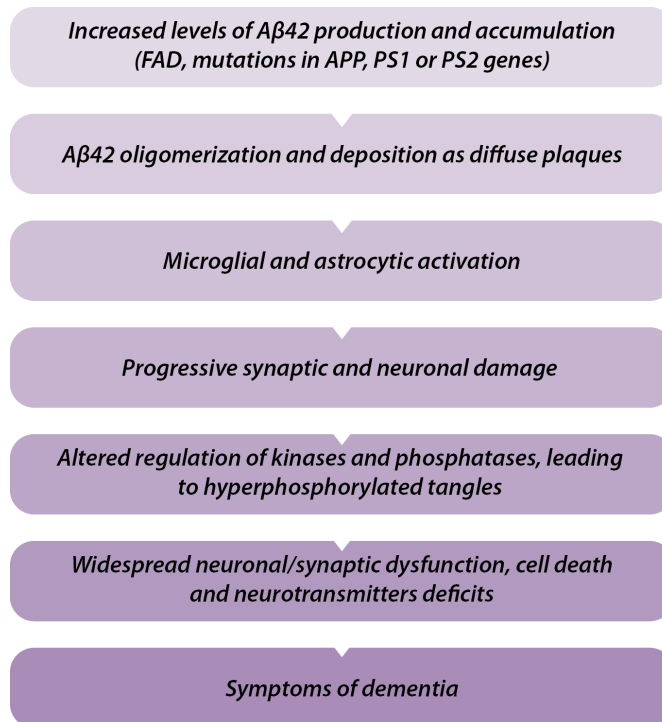

Fig. 5: The amyloid cascade hypothesis

The sequence of pathogenic events leading to AD is presented. Increased levels of A β 42 initiate AD pathogenesis cascade. A β oligomers might directly affect synapses and neuronal degeneration, in addition to activating microglia and astrocytes. Tau pathology, central to AD, is triggered by A β 42.

1.6 Neuropsychological stages of Alzheimer's disease

It is possible to distinguish three neuropsychological clinical stages of AD: (1) the *pre-clinical stage* characterized by impairments in episodic memory while other cognitive functions are intact; (2) the *early clinical stage* during which deficits occur in episodic memory, verbal abilities, visuo-spatial functions, attention, and executive functions; (3) the *advanced stage* characterized by cognitive dysfunction in global primary memory, although sensory-motor performance may be well preserved. At this stage, the brain's association cortices are severely affected (Almkvist, 1996; Braak et al., 1994; Braak and Braak, 1991).

1.7 Biomarkers of Alzheimer's disease

Nowadays, several biomarkers have been identified that can be predictive of an underlying AD pathology. These include amyloid A β 42, total Tau (t-tau), Tau phosphorylated at threonine 181 (p-Tau181) in the CSF (Shaw et al., 2009), substrate specific brain imaging such as ^{11}C and ^{18}F PET imaging (Apostolova et al., 2010; Jack et al., 2009) and structural MRI observations such as hippocampal volume (Gerardin et al., 2009). Recently Hu et al. added four plasma biomarkers ApoE, BNP (B-type natriuretic peptide), CRP (C-reactive protein), PP (pancreatic peptide) (Hu et al., 2012). BNP is elevated in acute strokes (Shibazaki et al., 2009) and vascular dementia (Kondziella et al., 2009) and is known as a biomarker of left ventricular dysfunction. PP is also increased in the CSF of patients with AD

(Hu et al., 2010). CRP is a well-established biomarker for tissue injury and infections.

1.8 Genetic Factors

1.8.a Early-onset familial Alzheimer's disease

Autosomal dominant mutations in three genes- *APP*, *PSEN1* and *PSEN2*- are known to cause most cases of early onset familial AD (St George-Hyslop and Petit, 2005). These rare forms of AD account for less than 1% of all cases and typically involve patients in their 4th or 5th decade. Interestingly, all these mutations affect the metabolism or stability of A β by increasing its propensity to aggregate.

One well-characterized mutation in *APP* is the Swedish mutation (*APP_{Swe}*), in which double K670M/N671L substitution leads to an increased cleavage of APP by the β -secretase (Haass et al., 1995). Other mutations, such as the Arctic mutation (*APP_{Arc}*) increase the aggregation propensity of A β , leading to early-onset manifestation of AD (Lord et al., 2006; Nilsberth et al., 2001). Mutations in the presenilins, such as *PSEN1* M146V mutation, increase levels of A β ₄₂ (Jankowsky et al., 2004). Increased *APP* gene dosage also affects AD (Gyure et al., 2001; Mori et al., 2002; Rovelet-Lecrux et al., 2006).

To date, 182 FAD mutations have been mapped to *PSEN1* and 13 to *PSEN2* (www.molgen.ua.ac.be/ADMutations). These mutations, in the core catalytic elements of the γ -secretase, spread all over the proteins and typically result in an increased A β 42 to A β 40 ratio.

1.8.b Late-onset Alzheimer's disease

Several genes are known to increase the risk for the common form of AD with late-onset. Based on the HuGENet interim criteria for the cumulative assessment of genetic association studies on AD, the ten top-ranked genes are listed in Table 1.

Gene	Polymorphism	P-value
APOE_e2/3/4	APOE_e2/3/4	<1E-50
BIN1	rs744373	1.59E-26
CLU	rs11136000	3.37E-23
ABCA7	rs3764650	8.17E-22
CR1	rs3818361	4.72E-21
PICALM	rs3851179	2.85E-20
MS4A6A	rs610932	1.81E-11
CD33	rs3865444	2.04E-10
MS4A4E	rs670139	9.51E-10
CD2AP	rs9349407	2.75E-09

Table 1: AD susceptibility loci

Results are assessed for their epidemiological credibility using HuGENet interim criteria for the cumulative assessment of genetic associations (Ioannidis et al., 2008; Khoury et al., 2009) and Bayesian analyses (Ioannidis, 2008; Stephens and Balding, 2009). Only meta-analysis results with P-values <0.00001 are shown (ref. AlzGene: www.alzgene.org/TopResults.asp).

1.9 Environmental risk factors

Several risk factors have been linked to AD. They are summarized in table 2 (Mayeux et al., 2012).

Antecedent	Direction	Possible mechanisms
Cardiovascular disease	Increased	Parenchymal destruction, Strategic location
Smoking	Increased	Increased A β deposition Cerebrovascular effects Oxidative stress
Hypertension	Increased and decreased	Microvascular disease
Type II diabetes	Increased	Cerebrovascular effect Insulin and A β compete for clearance
Obesity	Increased	Increased risk of type II diabetes inflammatory
Traumatic head injury	Increased	Increased A β and amyloid precursor protein deposition
Education	Decreased	Provides cognitive reserve
Leisure activity	Decreased	Improves lipid metabolism Mental stimulation
Mediterranean diet	Decreased	Antioxidant, anti-inflammatory
Physical activity	Decreased	Activates brain plasticity, promotes brain vascularization

Table 2: Environmental risk factors of AD

Refer to (Mayeux et al., 2012).

2 Animal models of Alzheimer's disease

Due to methodological and ethical issues, the study of AD in humans is very complicated; hence the necessity to develop and phenotype animal models in AD-related research. Most importantly, reliable animal models enable the identification of biomarkers, drug discovery, and the study of pathological changes, which are often not accessible in patients post mortem tissues (Wentzell and Kretschmar, 2010).

2.1 Spontaneous animal models

Few species, including dogs, cats, bears, goats, sheep, wolverine and several non-human primates spontaneously develop plaque pathology and sometimes exhibit tauopathy. Such histopathological changes might be even associated with cognitive decline (Van Dam and De Deyn, 2011). Among these species, the dog has been pointed out as an appropriate model for the study of human brain diseases in general and AD in particular. In addition to their phylogenetic proximity to humans and the deep knowledge of canine behavior, dogs naturally reproduce several key features of AD including A β cortical pathology, neuronal degeneration, and learning and memory problems. Thus, dogs are frequently used for longitudinal studies like the beneficial effects of an A β immune therapy, or of an anti-oxidant rich diet (Cotman and Head, 2008). In contrast, rodents in general do not naturally develop AD-like histopathological

hallmarks. The formation of plaques and NFTs in their brains has only been reported once in *Octodon degus* (Ardiles et al., 2012; Link, 2005).

2.2 Transgenic animal models

Over the past decades several transgenic species have been generated to create phenocopies of AD. Mammalian models have been pre-eminent; namely mouse models and rats to a lesser extent. Several other models were generated as well in various species like zebrafish (*Danio rerio*), nematodes (*Caenorhabditis elegans*) and the fruit fly (*Drosophila melanogaster*).

2.2.a Mouse models

In the early 90's, several groups generated mouse models that would replicate the pathophysiology of AD based on the amyloid cascade hypothesis. Games et al. introduced the first transgenic AD model mouse (PDAPP) that developed robust amyloid pathology (Games et al., 1995). The Tg2576 (Hsiao et al., 1996) and APP23 (SturchlerPierrat et al., 1997) mouse models, currently the most used in AD-related research, later followed. The PDAPP model expresses human APP carrying the Indiana FAD mutation (V717F) (Murrell et al., 1991) driven by the platelet-derived growth factor-beta promoter, whereas the other two, Tg2576 and APP23, express human APP with the Swedish mutation (K670N/M671L) (Mullan et al., 1992) driven by the hamster prion protein and murine *Thy-1* promoter, respectively. All three models show most AD-like phenotypes from both diffuse and neuritic plaques to cerebral amyloid

angiopathy (CAA), astroglyosis, microgliosis, hippocampal atrophy, synaptic and neurotransmitter alterations, and cognitive and behavioral deficits. Nevertheless they lack the formation of NFTs even when hyperphosphorylated Tau proteins are present (for review, see (Van Dam and De Deyn, 2011; Van Dam et al., 2005). Moreover, they show limited neuronal loss (Duyckaerts et al., 2009).

After the discovery of mutations in the *PSEN* genes in early-onset FAD, transgenic PSEN1 and PSEN2 mice were developed. Plaques or NFTs didn't form in the brain of these mice despite the few cognitive and behavioral abnormalities they presented. Amyloid deposition was dramatically accelerated in the resulting double transgenic APP/PSEN mice due to an increased A β 42 production mediated by the mutations in *PSEN*. In addition, these mice exhibited neuronal loss, amyloid-associated inflammation and cognitive decline (McGowan et al., 2006; Van Dam and De Deyn, 2006).

The major caveat of the previously mentioned models, that is the lack of NFTs, was partially overcome by the development of human mutated Tau mice and their crossing with APP models (Lewis et al., 2001). The mice that were generated featured enhanced amyloid deposition in addition to increased Tau phosphorylation, NFT-like structures and neuronal loss, thereby suggesting that APP or A β mediates Tau pathology. However, NFTs and plaques didn't co-localize in regions of the brain relevant to AD, like the hippocampus and the cortex (Gotz et al., 2004; Ribe et al., 2005), an issue that was later solved with the development of triple transgenic mice (Oddo et al., 2003a; Oddo et al., 2003b).

Triple transgenic mice (3xTg) are perhaps the most complete models of AD. They were generated by microinjection of two transgenic constructs (mutant *APP_{Swe}* and *Tau_{P301L}*) into single-cell embryos from homozygous mutant *PSEN1_{M146V}* knock-in mice (Oddo et al., 2003b). These mice progressively develop A β plaques and NFTs (Gotz et al., 2001b; Lewis et al., 2001). Synaptic dysfunction, including LTP deficits, manifests in an age dependent manner, but before plaque and tangles pathology.

In addition to reproducing APP processing in mice models of AD, a number of models that directly overexpress A β have been developed. LaFerla et al. used a neuron-specific mouse neuronal filament light gene promoter to drive the expression of A β 42 without a secretory signal peptide in the brain of mice (Laferla et al., 1995). A β largely accumulated in neurons intracellularly. The aged mice displayed extensive neuronal degeneration, a strong reactive gliosis and a 50% reduction in lifespan. However, plaques or NFTs were not observed.

McGowan et al. generated another AD mouse model directly expressing A β 42 and A β 40 (McGowan et al., 2005). Both peptides were fused to the C-terminus part of the transmembrane protein BRI. The cleavage of BRI released A β into the lumen or extracellular space, resulting in efficient secretion. Mice expressing high levels of A β 40 didn't develop amyloid pathology. In contrast, mice expressing lower levels of A β 42 accumulated the peptide and developed amyloid plaques, diffuse A β deposits and CAA. When mice expressing A β 42 were crossed with mutant APP (Tg2576) mice, they presented a massive increase in

amyloid deposition. This study clearly demonstrated that A β 42 is essential for amyloid deposition in the parenchyma and also in vessels.

2.2.b *Drosophila* models

The fruit fly *Drosophila melanogaster*, a rather simple organism, has been extensively used to study human diseases, their underlying pathological mechanisms and to identify their modifier genes (Fortini and Bonini, 2000; Reiter et al., 2001). An analysis of the *Drosophila* genome reveals that more than 75% of human disease-related genes have orthologs in *Drosophila* (Reiter et al., 2001).

Fly modeling successfully recapitulates key features of human neurodegenerative diseases, namely, AD, Parkinson's disease, Huntington's disease etc. (Bilen and Bonini, 2005; Iijima-Ando and Iijima, 2010; Soto, 2003). These models present numerous advantages. For instance, the fly brain is composed of more than 300,000 neurons and shows some similarities with mammalian brains in terms of functions and cell-type components. It is organized in separate areas with specialized functions such as learning, memory, olfaction and vision. Flies are inexpensive and easy to rear. They have a short life cycle with a generation time of approximately 10 days when raised at 25 °C (Figure 6). The maximum lifespan of a fly is 50 to 80 days, which makes it one of the most suitable models for studies on neurodegeneration in the ageing brain.

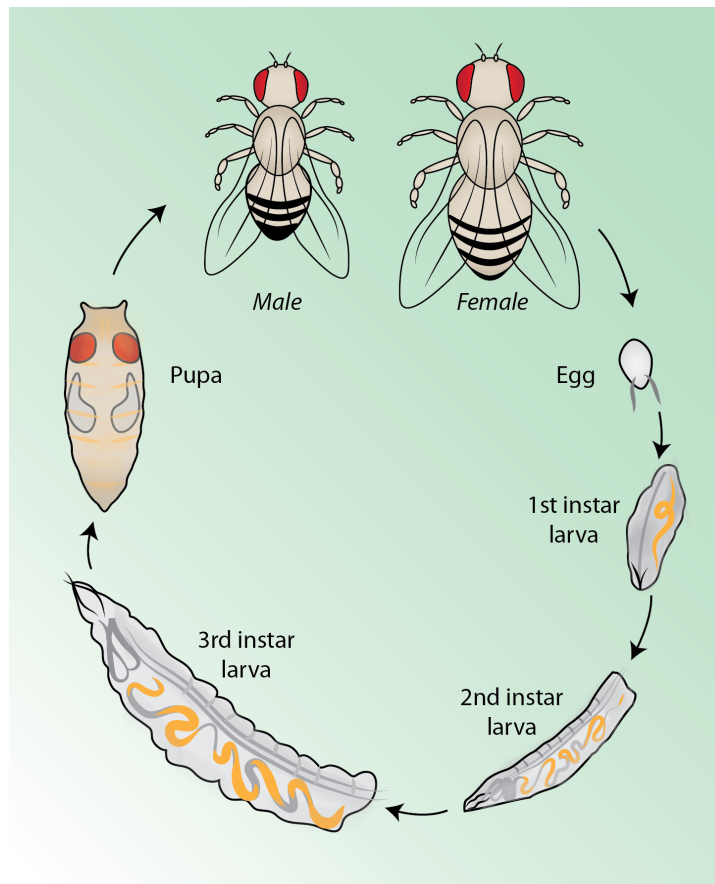

Fig. 6: The *Drosophila* life cycle

Development of a fertile egg to an adult fly over a period of 10 days at 25°C. After hatching, larvae go through three instars before reaching pupation. During pupation, metamorphosis occurs leading to the emergence of an adult fly.

Drosophila models are particularly advantageous due to the wide battery of genetic tools that have been developed for research. The GAL4/UAS system is a good example. It allows for spatio-temporal expression of a targeted gene such as the human $A\beta$ gene in AD model flies (Figure 7) (Duffy, 2002). In this system, the yeast transcription activator GAL4 binds to the enhancer UAS (upstream activating sequence) and initiates transcription. Various public resources provide large collections of tissue- or cell type- specific GAL4 driver lines, libraries of *Drosophila* RNAi lines and mutant lines. Another advantage for using

Drosophila consists in the possibility of realizing forward genetic screens to determine genes functions by chemical mutagenesis (see Results, Section 3), genetic deletion lines, or mobile genetic elements such as P- elements.

Drosophila possesses numerous molecular components related to APP processing: APPL (β amyloid protein precursor-like, human APP), Bace (beta-site APP-cleaving enzyme, human BACE1 know as β -secretase), the γ -secretase complex including Psn (human PEN1), pen-2 (human PSENEN, also known as PEN2), nct (human NCSTN), aph-1 (human APH1A), Bsg (human BSG, also known as CD147, EMMPRIN, or OK), and pigeon (human PION, also known as human gamma-secretase activating protein, GSAP). Yet, *Drosophila* APPL does not contain the sequence generating amyloid β (Rosen et al., 1989) and *Drosophila* A β has not been found under physiological condition. It is noteworthy that the behavioral phenotypes of *Drosophila* APPL deficient flies can be rescued by an expression of human APP. Psn with roles in Notch signaling, is also present in *Drosophila* (Li et al., 2007).

Two major approaches have been undertaken to generate AD model flies. The first one consisted in the reconstitution of the human APP/secretase system in *Drosophila*. Greeve et al. produced transgenic flies for both human BACE1 and human APP. The fruit fly possesses a γ -secretase capable of correctly cleaving human APP. Thus, they were able to replicate APP processing and the production of amyloids (Greeve et al., 2004). In their model when the transgenes were expressed in the eye, retinal deposition of A β plaques was observed. They were associated with degeneration of the retina and the underlying neurons in the

optic pathway. A ubiquitous expression led to a shortened lifespan and defects in wing vein development. This relatively complex APP-based model is very useful for the assessment of modulators of BACE or APP metabolism (Figure 7).

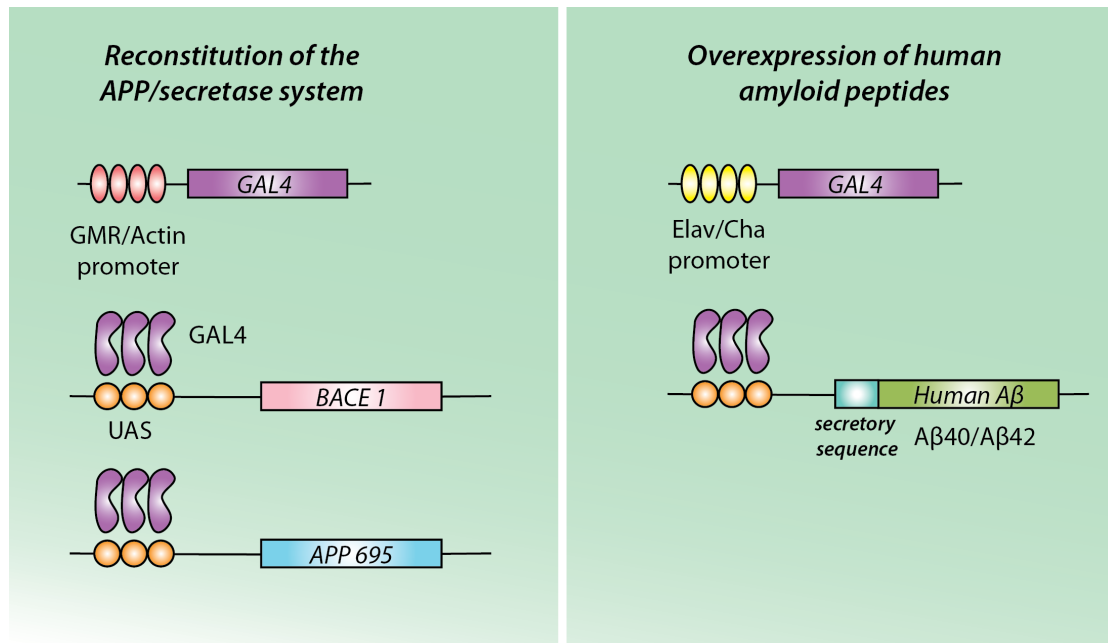

Fig. 7: The two major approaches to generate *Drosophila* models of AD

The second approach is suitable for investigating the downstream consequences of A β production. Both Iijima et al. and Crowther et al. expressed human A β s in the fly brain. The human A β sequence was fused to a secretion signal peptide allowing its expression and secretion in the nervous system (Crowther et al., 2005; Iijima et al., 2004) (Figure 7). Flies expressing A β 42 developed progressive intracellular accumulation of A β , extracellular A β plaques deposition and neurodegeneration. These flies also showed olfactory memory deficits, reduced survival and a reduction of climbing activity (Figure 8). AD-like phenotypes developed in both age- and A β dose-dependent manners. In contrast, flies expressing A β 40 didn't show any phenotypical alteration.

In addition to human A β -expressing models, *Drosophila* tauopathy models have also been generated. Human TauR406W transgenic flies showed adult onset progressive neurodegeneration, early death, enhanced toxicity of mutant Tau, accumulation of abnormal Tau, and relative anatomic selectivity. However, neurodegeneration occurred without NFTs formation that is seen in human disease and some rodent tauopathy models (Wittmann et al., 2001).

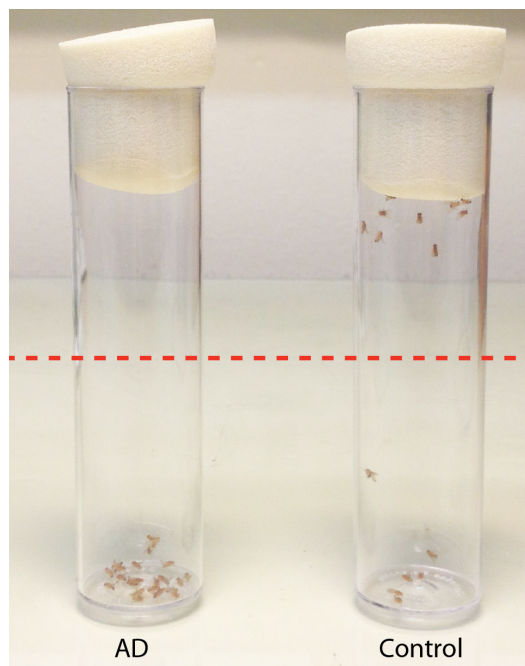

Fig. 8: Climbing Assay

AD model flies show a reduced climbing ability compared to control flies. AD flies are unable to climb to the top half of the tube after being tapped to the bottom.

2.2.c Nematode and Zebrafish models

In nematodes (*Caenorhabditis elegans*) AD models, human A β was expressed in muscles and neurons (Link, 1995; Link et al., 2001). The generated AD worms developed A β deposits. In the case of an expression in muscles, the animals manifested paralysis. In addition, a tauopathy model was developed by Kraemer et al. (Kraemer et al., 2003). Pan-neuronal expression of human TauP301L or TauV337M in *Caenorhabditis elegans* caused progressive uncoordinated locomotion and other characteristic of nervous system defects in worms, accompanied by substantial neurodegeneration.

In zebrafish (*Danio rerio*) AD models, human A β -expressing models are not available. However, a human Tau transgenic model clearly showed tauopathies, including phosphorylation and conformational changes of human Tau protein, tangle formation, neuronal and behavioral disturbances, and cell death (Paquet et al., 2009).

3 Inflammation and Alzheimer's disease

Several lines of evidence point towards a strong link between AD and neuroinflammation: (1) Microglial cells are activated in AD brain; (2) Non-steroidal anti-inflammatory drugs (NSAID) reduce the risk of AD; (3) Mouse genetic studies highlight the importance of immune regulations in AD; (4) Epidemiology studies have link immune-related genes and (5) active and passive vaccination to AD.

3.1 Activation of microglial cells in Alzheimer's disease

Microglia, the brain resident macrophages, are considered to be pivotal players in innate immune and inflammatory responses in several neurologic diseases. They survey the brain every few hours and respond by expressing pro- and anti-inflammatory mediators and receptors (Wyss-Coray and Rogers, 2012).

Since the discovery of activated microglia, in the mid 1980s, in AD cortex, numerous reports have looked into their effect on neurodegeneration. In AD patients and mouse models brains, activated microglia expressing major histocompatibility complex type II (MHCII) cluster at sites of aggregated A β deposition and interlace with neuritic plaques (Lubernarod and Rogers, 1988; McGeer et al., 1988; Rogers et al., 1988). They present an altered morphology and an increased expression of inflammatory factors including reactive oxygen

species (ROS), Th1 cytokines such as IL-1B, IL-6, TNF-alpha and interferon gamma (IFN- γ) receptors (TLRs) (Hanisch and Kettenmann, 2007).

3.2 Anti-inflammatory drugs reduce the risk of Alzheimer's disease

McGeer et al. first suggested that anti-inflammatory drugs might have a protective effect against AD in 1996 (McGeer et al., 1996). To date more than 30 epidemiologic studies, including 9 prospective studies on the effect of anti-inflammatory drugs have been conducted or initiated. Most of these have concluded as to a protective effect of NSAID against the development of AD (Wyss-Coray and Rogers, 2012).

Surprisingly, treatment trials with NSAID such as large-scale trials with ibuprofen, flurbiprofen (Green et al., 2009; Pasqualetti et al., 2009) or cyclooxygenase-2 inhibitors (COX-2) have most turned negative (Aisen et al., 2003). Nevertheless, COX-2 is expressed by neurons in the brain and might have neuroprotective effects (Yasojima et al., 1999). COX-1 that is highly expressed in microglia has been suggested as an alternative target (McGeer et al., 2006). A treatment trial with COX-1 inhibitor produced the only positive study except it only evaluated 44 subjects (Rogers et al., 1993). In contrast, seven of the nine prospective studies have reported decreased risks of AD associated with NSAID use (Cornelius et al., 2004; Lindsay et al., 2002; Stewart et al., 1997; Szekely et al.,

2008; Veld et al., 2001; Vlad et al., 2008; Zandi et al., 2002). Interestingly, Alzheimer's Disease Anti-inflammatory Prevention Trial (ADAPT) research group reported that treatment effects could vary at various stages of AD. Particularly, conventional NSAIDs such as naproxen reduced AD incidence, but only after 2 to 3 years. However, NSAIDs have an adverse effect in later stages of AD pathogenesis (Breitner et al., 2011).

3.3 Epidemiological studies link immune-related genes to Alzheimer's disease

Meta-analysis of multiple GWAS has identified a list of genes as AD susceptibility loci (Table 1)

APOE (apolipoprotein E) is the strongest genetic variant of typical late-onset AD. Among its three alleles of *APOE* $\epsilon 4$ is the strongest risk allele influencing age onset in a dose dependent manner (Corder et al., 1993). Recent studies suggested that the human ApoE4 isoform is less efficient in clearing A β than the ApoE2 or ApoE3 isoforms (Castellano et al., 2011). CLU (clusterin, also known as APOJ) is another major apolipoprotein in the brain (Jenne and Tschopp, 1992). Similar to ApoE, CLU can be a molecular chaperon of A β . CR1 (complement receptor type 1) is the receptor of the complement C3b and C4b proteins (Iida et al., 1982; Klickstein et al., 1988). Particles opsonized by C3b or C4b can be phagocytosed through CR1 (Khera and Das, 2009). ABCA7 (ATP-binding cassette sub-family A member 7, also known as Macrophage ABC

transporter) plays a role in phagocytosis of apoptotic cells by macrophages and may function in apolipoprotein-mediated phospholipids' efflux from cells (Abe-Dohmae et al., 2004; Ikeda et al., 2003; Kielar et al., 2003; Wang et al., 2003). It localizes to cell membrane ruffles and phagocytic cups of macrophages stimulated by C1q or apoptotic cells (Abe-Dohmae et al., 2004; Ikeda et al., 2003; Wang et al., 2003). BIN1 (Bridging integrator 1, also known as Myc-box-dependent-interacting protein 1, and Amphiphysin II) is involved in synaptic vesicle endocytosis (Cousin and Robinson, 2001). CD33 (also known as Sialic acid-binding Ig-like lectin 3) acts as a receptor for endocytosis through a mechanism independent of clathrin (Tateno et al., 2007). CD2AP (also known as Adapter protein CMS (Cas ligand with multiple Src homology (SH) 3 domains)) is a scaffold adaptor protein (Dustin et al., 1998) and associates with Cortactin, which is involved in the regulation of receptor-mediated endocytosis (Lynch et al., 2003). PICALM (Phosphatidylinositol-binding clathrin assembly protein, also known as Clathrin assembly lymphoid myeloid leukemia protein) plays a role in the AP2 (adaptor complex protein 2)-dependent clathrin-mediated endocytosis at the neuromuscular junction (Tebar et al., 1999). MS4A (membrane-spanning 4-domains subfamily A) gene family in human includes CD20 (MS4A1) (Einfeld et al., 1988; Stamenkovic and Seed, 1988; Tedder et al., 1988), FcR β (MS4A2) (Kuster et al., 1992; Maekawa et al., 1992), Htm4 (MSA43, also known as CD20 antigen-like protein) (Adra et al., 1994) and at least 13 other syntenic genes (Zuccolo et al., 2010). Most of these genes have no known specific functions. CLU, CR1, ABCA7, CD2AP, and CD33 have putative functions in the immune system.

3.4 Mouse genetic studies reveal the importance of immune regulations in Alzheimer's disease

Several mouse genetics studies have been conducted. Deletion or overexpression of immune-related genes can modify AD-like phenotypes in AD mouse models with opposing, beneficial or detrimental, effects (Czirr and Wyss-Coray, 2012). A summary of these studies is listed in Table 3 and 4.

Molecule	Genetic manipulation	Outcome	Reference
C1q	Deletion	Decreased neurodegeneration	(Fonseca et al., 2004)
CCL2	Overexpression in astrocytes	Increased plaque load	(Yamamoto et al., 2005)
CD14	Deletion	Decreased plaque load	(Reed-Geaghan et al., 2010)
CD36	Deletion	Decreased neurovascular dysfunction, reduced vascular oxidative stress; no changes in plaque pathology	(Park et al., 2011)
CD40L	Deletion	Decreased plaque load and gliosis	(Tan et al., 2002)
Cry	Overexpression under metallothionein promoter	Increased plaque load and neurodegeneration	(Wyss-Coray et al., 2002)
CX3CR1	Deletion	Prevention of neuron loss	(Fuhrmann et al., 2010)
CX3CR1	Deletion	Reduced plaque load	(Lee et al., 2010)
CXCR2	Deletion	Decreased A β production	(Bakshi et al., 2011)
IFNGR1	Deletion	Decreased plaque load and gliosis	(Yamamoto et al., 2007)
PTGER2	Deletion	Decreased plaque load and oxidative damage	(Liang et al., 2005)
RAGE	Overexpression in neurons	Accelerated abnormalities in learning and memory	(Arancio et al., 2004)
RAGE	Overexpression of dominant-negative form in neurons	Preservation of learning and memory; decreased neurodegeneration	(Arancio et al., 2004)
S100B	Overexpression under human S100B promoter	Increased plaque load and gliosis	(Mori et al., 2010)
TGF- β 1	Overexpression in astrocytes	Increased amyloidosis in the cerebral vasculature	(Wyss-Coray et al., 1997)
TGFBR2	Overexpression of dominant-negative form in cells of the myeloid lineage	Decreased plaque load and vascular A β deposition	(Town et al., 2008)
TNFR1	Deletion	Decreased A β generation and plaque load	(He et al., 2007)

Table 3: Genetic modifications in mouse models of AD: molecules with detrimental effects (adapted from (Czirr and Wyss-Coray, 2012))

Molecule	Genetic manipulation	Outcome	Reference
Beclin 1	Deletion (haplo-insufficiency)	Increased plaque load and neurodegeneration	(Pickford et al., 2008)
C3	Deletion	Increased plaque load and neurodegeneration	(Maier et al., 2008)
CCR2	Deletion	Increased A β levels, decreased survival	(El Khoury et al., 2007)
CCR2	Deletion	Increased plaque load and memory impairment	(Naert and Rivest, 2011)
CCR5	Deletion	Increased levels of endogenous mouse A β 42	(Lee et al., 2009)
CD45	Deletion	Increased plaque load	(Zhu et al., 2011)
IFN- γ	AAV-mediated overexpression in brain	Decreased plaque load, increased microglial activation	(Chakrabarty et al., 2010a)
IL-1R1	Deletion	No changes in plaque load	(Das et al., 2006)
IL-1 β	Overexpression of active form in astrocytes	Decreased plaque load, increased gliosis	(Shaftel et al., 2007)
IL-6	AAV-mediated overexpression in the brain	Decreased plaque load, increased gliosis	(Chakrabarty et al., 2010b)
TGF- β 1	Overexpression in astrocytes	Decreased plaque load and neurodegeneration	(Wyss-Coray et al., 2001)
TGFBR2	Deletion in neurons	Increased plaque load and dendritic loss	(Tesseur et al., 2006)
TLR2	Deletion	Increased A β levels and accelerated memory impairments	(Richard et al., 2008)
TLR4	Deletion	Increased plaque load	(Tahara et al., 2006)

Table 4: Genetic modifications in mouse models of AD: molecules with beneficial effects (adapted from (Czirr and Wyss-Coray, 2012))

3.5 Immunization with A β against Alzheimer's disease

In 1999, Schenk et al. reported that immunization with human A β reduced the amyloid pathology in APP mice (Schenk et al., 1999). A β plaque burden, neuritic dystrophy and gliosis were all significantly improved in vaccinated animals. Consequently to this discovery, a number of strategies for anti-A β immunotherapy have been developed (Morgan, 2011). They included: active immunization with synthetic intact A β 42 or with synthetic fragments of A β 42 conjugated to carrier proteins and passive immunization with antibodies against A β 42. The clinical trial of the active immunization was halted as a result of a fraction of the patients developing meningoencephalopathy by autoreactive CD8+ T cells. Passive immunization clinical trials are under investigation. Three hypothesis have been put forward to explain the mechanisms of action of immunotherapy in AD (Delrieu et al., 2012) (Figure 9): (1) the elimination of the fibrillar amyloid plaques by means of microglial phagocytosis; (2) the sequestration of amyloids and their elimination through the blood (peripheral sink); and (3) the inhibition of aggregation.

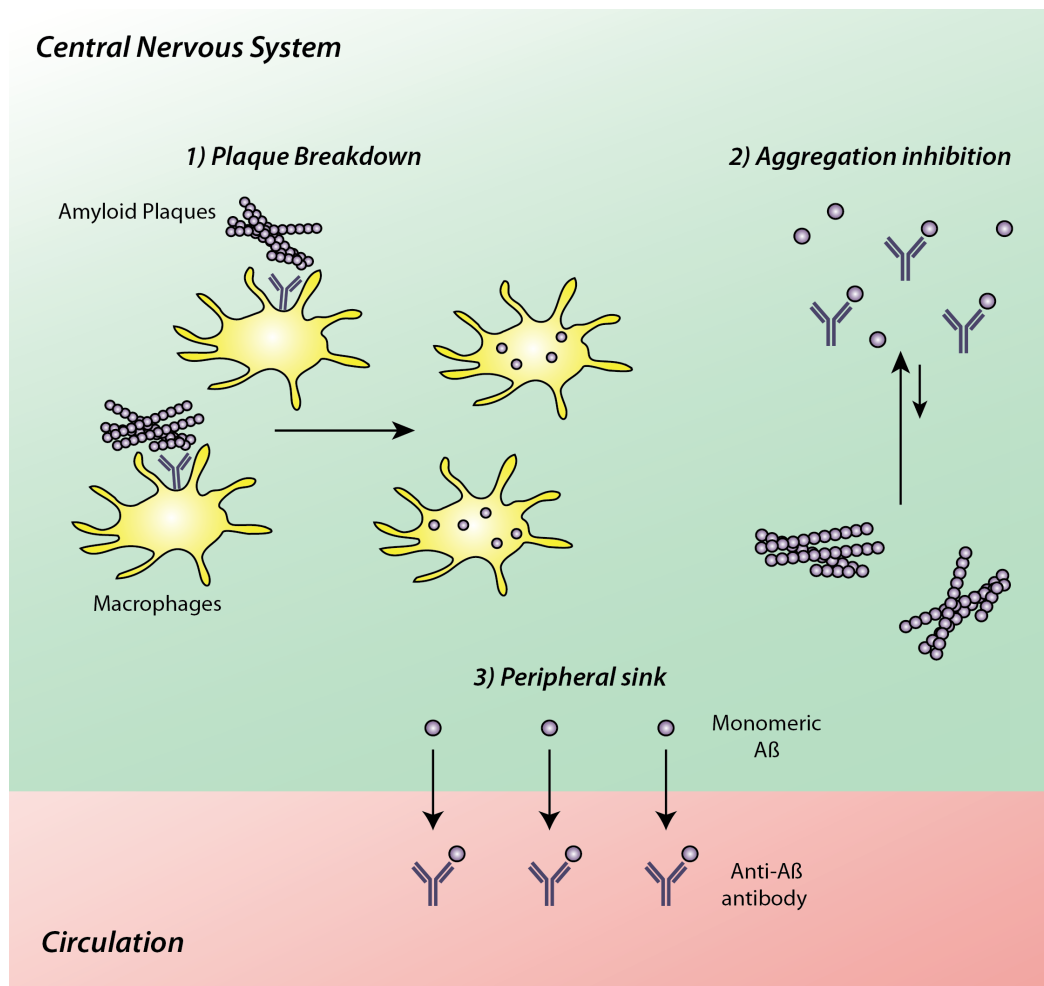

Fig. 9: Models of antibody-mediated clearance

Three different models were proposed to explain the mechanisms of action in immunotherapy. 1) *Plaque breakdown*: amounts of the anti-A β antibodies reach the amyloid plaques and trigger a microglial mediated phagocytosis; 2) *Aggregation inhibition*: anti-A β antibodies reach the amyloid plaques and resolve them through the interaction antibody-A β ; 3) *Peripheral sink*: the anti-A β antibodies act as a peripheral sink for soluble A β species, leading to the resolution of deposits in the brain by mass action.

Frenkel et al. reported that the induction of EAE by vaccination (Experimental autoimmune encephalomyelitis) clears A β in APP transgenic mice. Most interestingly, the vaccinated animals developed activated microglia that co-localized with fibrillar A β . These animals presented increased clearance of A β

that correlated strongly with the extent of microglial activation (Frenkel et al., 2005).

4 *Drosophila* immunity

4.1 *Drosophila*'s innate immune system

Being devoided of an adaptive immune system, *Drosophila* has served as a model of choice for studies on innate immunity and host-pathogen interactions. Studies on *Drosophila* innate immune responses were initiated in the laboratory of Hans Boman who clarified the humoral nature of the response, its inducibility and its lack of specificity (Boman et al., 1972; Hultmark et al., 1983; Steiner et al., 1981). Boman's work was followed by numerous studies on the immune defense mechanisms and some were conducted in our affiliated laboratory (Lemaitre et al., 1996).

Drosophila relies on an array of defense mechanisms to fight pathogen infections that include both cellular and humoral reactions. The cellular response is best characterized by the phagocytic activities of plasmocytes (Braun et al., 1998; Rizki and Rizki, 1984), whereas the hallmark of humeral reactions is the induction of a battery of antimicrobial peptides genes in the fat body (equivalent to the mammalian liver), followed by there subsequent secretion in the hemolymph (blood) (Hoffmann, 2003) (Hoffmann and Reichhart, 2002).

Almost 20 anti-microbial peptides, grouped into seven classes, have been identified in *Drosophila*. These are small molecules with a broad range activity against bacteria and/or fungi (Imler and Bulet, 2005). For example, Attacin is

very effective against Gram-negative bacteria (Fehlbaum et al., 1994), whereas Drosomycin and Metchnikowin are targeted against fungi (Asling et al., 1995; Levashina et al., 1995). After infection, the regulation of the expression of AMPs occurs at the transcriptional level and requires NF- κ B binding sites in the AMP genes promoter regions (Engstrom et al., 1993; Kappler et al., 1993; Meister et al., 1994). Three NF- κ B/Rel-like proteins are encoded in the *Drosophila* genome: Dorsal, Dif and Relish (Dushay et al., 1996; Ip et al., 1993; Reichhart et al., 1993; Steward, 1987). Their production is ruled by two major immune signaling pathways: the Toll pathway and the Immune deficiency (IMD) pathway (Figure 10). Depending on the κ B binding motif present in their promoter, AMP genes are more sensitive either to the Toll or the IMD pathway (Lemaitre and Hoffmann, 2007).

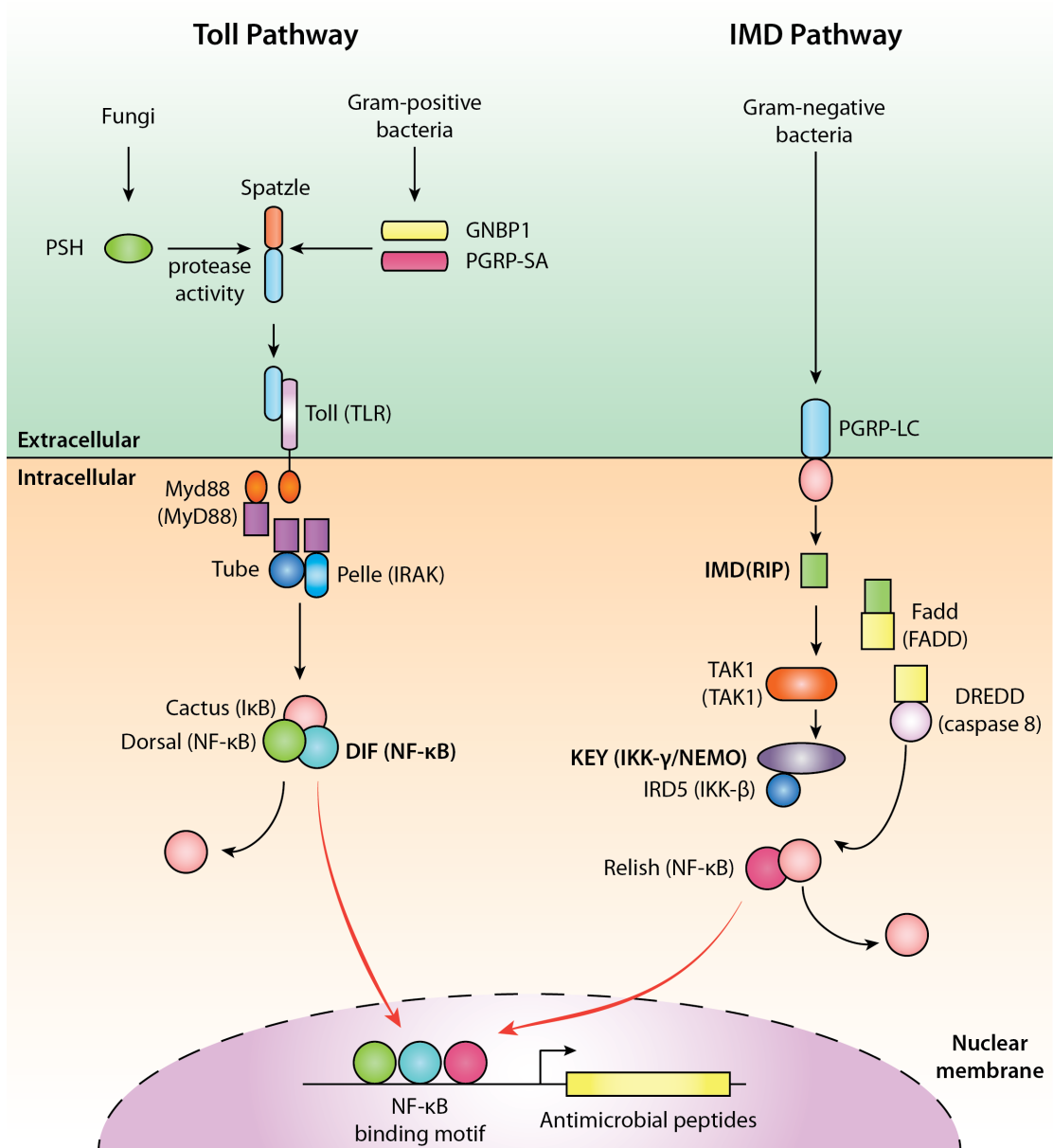

Fig. 10: The Toll and the Imd pathways

The hallmark of *Drosophila*'s immune response is the activation of the Toll and the IMD signaling pathways, which are similar to mammalian IL1R/TLR and TNFR signaling cascades, respectively. Vertebrate orthologs are indicated in between parentheses (Lemaitre, 2004).

4.1.a The Toll pathway

The Toll signaling pathway, similar to the Toll-like Receptors (TLRs) signaling pathway in mammals (Akira et al., 2001), is mainly activated by Gram-positive bacteria and fungi (Lemaitre, 2004). The activation of Toll requires the binding of an active form of Spätzle, cleaved by proteolytic processing cascades that are activated by secreted recognition molecules (DeLotto and DeLotto, 1998; Mizuguchi et al., 1998; Weber et al., 2003). Through interaction with three death domain proteins, namely MyD88, Tube and Pelle (Charatsi et al., 2003; Horng and Medzhitov, 2001; Sun et al., 2002; Tauszig-Delamasure et al., 2002), activated Toll stimulates the degradation of the ankyrin-repeat inhibitory protein Cactus (Fernandez et al., 2001; Nicolas et al., 1998). Following the degradation of Cactus, DIF (at adult stage) or Dorsal (at larval stage) translocate to the nucleus where they activate the transcription of immune-effector genes including different AMPs (Avila et al., 2002; Drier et al., 1999).

4.1.b The IMD pathway

The IMD pathway, similar to mammalian tumor necrosis factor receptor (TNFR) pathway, is largely involved in defense mechanisms against Gram-negative bacteria (Hoffmann, 2003; Lemaitre, 2004). Peptidoglycan from Gram-negative bacteria is sensed by PGRP-LC (Choe et al., 2005; Choe et al., 2002; Gottar et al., 2002; Takehana et al., 2002) and PGRP-LE (Takehana et al., 2002; Takehana et al., 2004). The binding of peptidoglycans and PGRP-LC/LE leads to the recruitment of the IMD adaptor protein (Kaneko et al., 2006). IMD binds to

Fadd, which interacts with the caspase DREDD (Death-related ced-3/Nedd2-like protein) (Georgel et al., 2001; Leulier et al., 2000; Leulier et al., 2002; Naitza et al., 2002). The complex of IMD, Fadd, and DREDD leads to the activation of RELISH through two processes: (1) the cleavage of RELISH by DREDD (caspase-8) and (2) the phosphorylation of RELISH by the *Drosophila* IKK (inhibitor of κ B kinase) complex, Immune response deficient 5 (IRD5) and Kenny (KEY) (Rutschmann et al., 2000; Silverman et al., 2000) via TAK1 (Transforming-growth-factor- β -activated kinase 1) (Vidal et al., 2001). Afterwards, the N-terminal truncated form of RELISH translocates to the nucleus and activates various immune-effector genes such as AMPs (Lemaitre, 2004; Wu and Anderson, 1998).

4.2 *Drosophila's* glial cells

Drosophila studies on the phagocytic activity of glial cells in the CNS have provided insights into the importance of glia in neurodegenerative processes. There are four main classes of CNS glia in *Drosophila*: cortex, neuropil, surface, and peripheral glia (Freeman and Doherty, 2006). These cells exhibit many morphological and functional similarities to mammalian counterparts. However, the fruit fly is deprived of a CNS glia subtype specifically assigned to immune functions like microglia in mammals; rather, all glia seem competent to perform immune-like functions such as engulfment of neuronal corpses during development (Freeman et al., 2003; Freeman and Doherty, 2006; Sonnenfeld and Jacobs, 1995).

MacDonald et al. demonstrated that following neural injury, neurons undergo an injury-induced degeneration eliciting potent recruitment of activated glia cells in the adult fly. Interestingly, recruited glia necessarily showed enhanced expression of the engulfment receptor Draper (MacDonald et al., 2006). Draper is a transmembrane protein that acts as a docking phagocytic receptor. It has homologs in *C. elegans* (*ced-1*) and humans (*MEGF10* and *MEGF11*). This family of genes is implicated in the removal of apoptotic neuronal cell corpses from the CNS (Cabello et al., 2010; Freeman et al., 2003; Wu et al., 2009). In flies, Draper is considered as a “cleaning agent” and is required for clearance mechanisms (Freeman et al., 2003; Fuentes-Medel et al., 2009; MacDonald et al., 2006).

4.3 Lessons from *Drosophila* models of neurodegeneration

Chinchore et al. found that the activation of RELISH from the IMD pathway is required for neurodegeneration in a *Drosophila* model of human retinal disorder. Mutations in *Relish*, *key* and *Dredd* completely blocked neurodegeneration in the eye. However mutations in *imd* or *fadd* didn't reduce the observed rough-eye phenotype, which suggests a non-canonical innate immune response that activates DREDD (Chinchore et al., 2012).

In another study, Petersen et al. induced Ataxia-telangiectasia in a *Drosophila* model by mutating its causative gene *ATM*. They observed neuron

and glial cell death in the adult brain, a reduction in longevity and mobility and most interestingly an increased expression of numerous innate immune genes notably AMPs. Moreover, they demonstrated that *ATM* knockdown in glial cells, but not neurons, was sufficient for triggering the disease, indicating that a non-cell-autonomous mechanism contributes to neurodegeneration.

5 Thesis outline

The aims of this thesis were to investigate the innate immune response against human A β using a *Drosophila* model of Alzheimer's disease, particularly, in terms of the association between neuroinflammation and neurodegeneration. Our specific aims were to: (1) determine whether any of the fruit fly's innate immune pathways could be activated by the accumulation of A β 42 peptides in the brain; (2) reveal whether this activation could affect the development of neurodegeneration; 3) identify genetic factors modifying AD phenotypes in flies by establishing a non-biased forward genetic screen and building the IMD interactome database.

Our aims were achieved by:

- 1) Generating an X-linked AD fly model expressing human A β 42 in the brain and demonstrating the presence of an immune response against human A β 42 (Results, Section 1)
- 2) Defining the immune pathway responsible for the immune responses and its roles in neurodegeneration (Results, Section 1)
- 3) Building the IMD interactome database (Results, Section 2) and its relevance to AD research (Discussion)
- 4) Establishing a chemical mutagenesis-based forward genetics screen (Results, Section 3)

Results

1 Drosophila IMD pathway limits the accumulation of amyloid β in Alzheimer's disease fly model

Elie et al. ver.1

Title:

Drosophila IMD pathway limits accumulation of Amyloid β in fly model for Alzheimer disease

Authors:

Elie Maksoud^{1,2}, Chieko Makino-Okamura^{2,4}, Sarah Merklings^{1,3,5}, Charles Hetru^{2,3}, Jules A. Hoffmann^{2,3}, Hidehiro Fukuyama^{1,6}

Key words:

Innate immune responses, Alzheimer disease, *Drosophila*, IMD,

Affiliations:

¹ INSERM Equipe Avenir, CNRS UPR9022, Institut de Biologie Moléculaire et Cellulaire, 15 rue Rene Descartes, Strasbourg, 67084, France

² CNRS UPR9022, Institut de Biologie Moléculaire et Cellulaire, 15 rue Rene Descartes, Strasbourg, 67084, France

³ University of Strasbourg, Strasbourg, 67084, France

⁴ Current Address: Kobe Skin Research laboratory, Biosignal Research Center, Kobe University, Kobe 657-8501, Japan

⁵ Current Address: Department of Medical Microbiology, Radboud University Nijmegen Medical Centre, Nijmegen Centre for Molecular Life Sciences, Nijmegen Institute for Infection, Inflammation and Immunity, Nijmegen, The Netherlands

⁶ Correspondence to H.F (h.fukuyama@unistra.fr)

Abstract

Innate immune responses largely impact the course of neurodegenerative diseases. In both sporadic and familial Alzheimer disease (AD), amyloid β accumulation is a hallmark of the pathogenesis and is strongly linked to neuroinflammation. However, the precise molecular events of the immune reactions against amyloid β and their resulting effects on AD need to be elucidated. We made use of a *Drosophila* model for AD, secreting human amyloid β in the brain, to investigate the link between the innate immune reactions and the developed phenotypes in the AD model fly. *Drosophila* AD model flies induce the expression of the antifungal and antibacterial peptide gene *Metchnikowin*, which is mediated through the IMD and the TOLL pathway, similar to mammalian TNF-R and TLR signaling cascades, respectively. By generating several immunocompromised fly lines carrying the transgene encoding human amyloid β , we found that mutants for the IMD pathway had severe defects in climbing activity unlike mutants for the TOLL pathway. Further histological studies revealed that amyloid β accumulation and neurodegeneration are enhanced in the *immune deficiency (imd)* gene deficient AD flies. In addition, Drapper-expressing the cell surface of glia cells co-localize with accumulated amyloid β . We concluded that the activation of the *Drosophila* IMD pathway has a neuroprotective role by limiting the accumulation of amyloid β in a *Drosophila* AD model. This model will provide tools to study the link between neuroinflammation and neurodegeneration.

Introduction

Innate immune responses and their effector functions heavily impact the course of various human diseases. Aging with Alzheimer disease (AD), the most common form of dementia, is a growing medical and socio-economical problem, especially with population aging in the coming decades[1]. AD pathology is characterized by the formation of amyloid- β plaques and neurofibrillary tangles in the brain[2]. Several lines of evidence from studies on AD patients and AD model mice suggest a strong link between AD and immune responses, often termed as neuroinflammation: (1) Immunohistochemical studies revealed the induction of pro-inflammatory mediators and the activation of microglia or astrocytes in both human AD patients and in AD model mice [3]; (2) Chronic use of non-steroidal anti-inflammatory drugs (NSAIDs) has been shown to reduce the risk of developing AD [4]. For instance, recent trial studies indicated that asymptomatic individuals treated with conventional NSAIDs such as naproxen experience reduced AD incidence, although NSAIDs use has adverse effects in the later stages of AD pathogenesis [5]. (3) Epidemiologic studies of AD have identified several immune-related genes, namely CD33, CR1, CD2AP, ABCA7, and MS4A [6,7,8], (4) Microglial activation upon vaccination is strongly correlated with decreased levels of A β fibrils in a B-cell independent manner[9]. Inflammation plays opposing, neurotoxic and neuroprotective, roles during AD[10]. However, the nature of the molecular pathways affecting these roles throughout AD progression is still unclear. Understanding how innate immune responses affect the early

Elie et al. ver.1

stage of AD in particular will facilitate the identification of new prognostic markers and the development of preventive treatments reducing the risk of AD.

Drosophila melanogaster has provided significant insights into research on innate immunity[11]. Like mammals, *Drosophila* has humoral and cell-mediated immunity. Small humoral effector molecules called antimicrobial peptides are largely secreted in the fat body (equivalent to the mammalian liver) and attack pathogens. The induction of antimicrobial peptides is a hallmark of the activation of the immune system in flies. Two major immune-signaling pathways IMD and TOLL via NF- κ B are responsible for the gene induction. The antibacterial peptide Attacin A is induced by the activation of the IMD pathway, while the antifungal peptide *Drosomycin* is induced by the activation of the TOLL pathway.

To date various animal models of AD, including *Drosophila* models, have been established based on the amyloid hypothesis. In this hypothesis, amyloid β (38-43 aa long) is generated by the cleavage of APP by β - and γ - secretases[12]. The structure conversion of amyloid β from α -helix to β -sheet facilitates aggregation of this small peptide, which leads to the formation of amyloid plaques. Regardless of the type of AD, sporadic or familial, the plaque formation is a common feature of AD pathology. Two major approaches were undertaken to establish AD model in flies. First, Iijima et al. generated a *Drosophila* model that expresses human amyloid β extracellularly in neurons[13]. Those flies formed plaques of diffused amyloid deposits and showed age-dependent learning defects, climbing disability, and extensive neurodegeneration. Based on this model, a number of other *Drosophila* models have been generated with some modifications [14,15]. Second, Greeve et al. generated a double transgenic AD model fly

Elie et al. ver.1

coexpressing both human APP and BACE1[16]. The generated flies showed plaques formation and age-dependent neurodegeneration as well as semilethality, a shortened lifespan, and defects in wing vein development. The Iijima model directly produces amyloid β without any further processing. It serves as an excellent model for studies on the downstream events after cleavage of APP, such as amyloid neurotoxicity to cells, inflammation in the brain, and clearance of amyloid β . On the other hand, the Greeve model includes the APP processing and offers a comprehensive view of amyloid β metabolism.

Recent studies demonstrated that the inflammatory IMD pathway in *Drosophila* could be activated without infection. After cell death, DNA is digested by DNases. Deficiency in *DNaseII* leads to the accumulation of DNA and the subsequent activation of the IMD pathway, which is characterized by a constitutive expression of antimicrobial peptides [17,18]. These observations, led us to test: (1) whether misfolded and non-degraded proteins can also trigger a strong innate inflammatory response in *Drosophila* and (2) whether *Drosophila* AD models can serve to better understand the link between AD and immune responses. In that case, *Drosophila* AD models would provide the means to determine, in vivo, how innate immune cells recognize amyloid β and transduce the signal for effector functions against amyloid β .

To these aims, we generated an X-linked AD model fly based on the Iijima model. The expression of human A β 42 in the brain reduced the climbing activity of our model fly over time. The antimicrobial peptide gene *Metchnikown* was highly expressed in the flies. Genetic studies revealed that the activation of the IMD pathway, unlike the TOLL pathway, play a preventive role in development of AD-like phenotypes in flies such as

Elie et al. ver.1

the accumulation of amyloid β , neurodegeneration, and climbing deficits. Interestingly, the accumulated amyloid β co-localized with the cell surface Draper on glial cells. We concluded that the IMD pathway is activated by amyloid β and limits accumulation of amyloid β . We propose that this activation induces cell-mediated immune responses to clear amyloid β , possibly by Draper-positive glial cells.

Results

***Metchnikowin* is highly induced in *Drosophila* AD model**

We generated a fly model for Alzheimer's disease carrying the transgene encoding human A β 42 fused to the rat pre-proenkephalin signal peptide to allow its secretion. Using the Φ C31 integrase-mediated transgenesis, we introduced the transgene on the X chromosome; thereby, we were able to cross the newly obtained AD fly with several other mutant lines carrying mutation alleles on the 2nd or 3rd chromosome. The UAS-*GAL4*-UAS system allows the expression of A β 42 in the brain with *elav-GAL4* (pan-neuron-specific) or *cha-GAL4* (cholinergic neuron specific) driver lines (Figure 1A).

Next, we investigated the effect of the expression of human A β 42 on neuronal functions in flies by assessing their locomotor activity. For this purpose, we have performed climbing assay over time. Both human A β 42-expressing flies and wild-type control flies showed an age-related decline in their climbing activity. However, the climbing activity of human A β 42-expressing flies was significantly reduced in comparison to wild type flies (Figure 1B). Our AD model shows relatively weak phenotype as compared to the original model previously reported[13]. The survival of our AD model fly was not affected (Supplementary Figure 1).

To monitor the activation status of the immune system in our AD model flies, we measured the expression of antimicrobial peptide genes (Figure 1C). Among those, *Metchnikowin* was highly induced in our AD flies while expression levels of *Drosomycin* or *Attacin A* remained unchanged. However, we noted that the expression of *Attacin A*

Elie et al. ver.1

was slightly increased repeatedly. *Metchnikowin* can be regulated either through the IMD or the TOLL pathway [19,20] whereas *Attacin A* and *Drosomycin* are mainly regulated by the IMD and the TOLL pathway, respectively. These results indicate that the expression of the human A β 42 in the fly brain activates the immune system and induces the antimicrobial peptide gene *Metchnikowin*.

***imd* deficiency enhanced AD fly phenotypes**

In *imd* and *Toll* double mutants, *Metchnikowin* gene expression can no longer be detected after immune challenge [20]. To determine which immune-signaling pathway, IMD or TOLL, contributes to the AD-like phenotypes in flies, we generated AD flies in *imd*- and *Dif*-deficient backgrounds and first tested their climbing activities. Surprisingly, the climbing activity of *imd*-deficient AD flies was dramatically reduced from the earliest time point of the assay when compared to AD flies and *imd*-deficient flies without the AD transgene (Figure 2A). In good agreement, the survival of *imd*-deficient AD flies was also severely affected, as compared to AD flies (Supplementary Figure 2). In contrast, we didn't observe any difference in the climbing activity of *Dif*-deficient AD flies and control lines: AD flies and *Dif*-deficient flies without the AD transgene (Figure 2B). We noticed that the survival of AD flies was reduced by the deficiency in *Dif* (Supplementary Figure 2). When we compared the survival of *imd*-deficient AD flies to that of *Dif*-deficient AD flies, the former was significantly reduced (Supplementary Figure 2). Furthermore, we observed that the mRNA levels of human A β 42 in the brain of *imd*- and *Dif*-deficient AD flies were comparable; those levels were almost half of the mRNA

Elie et al. ver.1

level of human A β 42 in the brain of AD flies (Supplementary Figure 3). These results indicate that human A β 42 transcript levels cannot explain the deficit of the climbing activity of *imd*-deficient flies. However, we We assume that the reduction of the survival of both *imd*- and *Dif*- deficient AD flies might be due to the loss of the *elav*-expressing neuronal cells during development. Our results demonstrate that the decline of the climbing activity and the survival are enhanced in *imd*-deficient AD flies. This suggests that the activation of the IMD pathway plays a preventive role for development of the AD fly phenotype, but not the TOLL pathway.

Deficiencies in *PGRP-LE* and *Tak1* from the IMD pathway reduce the climbing activity of AD flies

To further confirm the protective effect of an activation of the IMD pathway against the development of AD-like phenotypes in flies, we tested deficiencies in other genes from the IMD pathway, namely: *PGRP-LE* and *Tak1*, using the neuron-specific GAL4 driver (*cha-GAL4*) and the original human A β 42-expressing fly line. The climbing activity of hemizygous AD male flies for each of the deficiencies was assessed. Consistently with our previous results, the climbing activity of each of the mutants was significantly reduced (Figure 3A and B).

Hence, deficiencies in three components of the IMD pathway, namely *imd*, *PGRP-LE* and *Tak1* enhance the deficits in climbing activity in AD flies. We concluded that the activation of the IMD pathway is beneficial for flies to prevent the development of AD-like phenotypes in flies.

Enhanced amyloid β accumulation in the brain of *imd*-deficient AD flies

As characteristically seen in the brain of human AD patients and AD model mice, AD flies develop plaque-like structures due to the accumulation of β -sheet-structured amyloid β . We examined the accumulation of amyloid β in our AD flies in *imd*- and *Dif*-deficiency backgrounds.

We performed immunohistochemistry studies on the whole brain using anti-human amyloid β antibody. Our results revealed that the accumulation of amyloid β in the brain of *imd*-deficient AD flies was increased as compared to AD control flies. Conversely, the accumulation of amyloid β in the brain of *Dif*-deficient AD flies was comparable to that of AD control flies. It is important to note that neither wild-type flies nor *imd* mutants accumulate amyloid β without the AD transgene (Figure 4A and data not shown).

In order to quantify the accumulation of amyloid β , we measured the fluorescence level of Thioflavin T in fly brains. Thioflavin T has high affinity to β -sheet structured proteins and displays an enhanced fluorescence upon binding to amyloid fibrils [21]. At day 10 after eclosion, the Thioflavin signal level of *imd*-deficient AD flies was significantly increased as compared to the signal level of either wild-type flies or AD control flies. In contrast, the signal level of *Dif*-deficient AD flies was similar to wild-type flies (Figure 4B).

Collectively, these data demonstrate that levels of amyloid β are increased in *imd*-deficient flies.

Elie et al. ver.1

***imd* deficient AD flies show enhanced neurodegeneration**

We have next investigated the neuropathology in *imd*-deficient AD flies. Our results showed a loss of cell bodies in *imd*-deficient AD flies that is concomitant with enhanced vacuolization when compared to AD control flies or *imd* mutants (Figure 5). These data suggest that neurodegeneration is enhanced in the *imd*-deficient AD flies.

Draper is associated with amyloid β deposits

Freeman et al. identified *Draper* gene responsible for phagocytosis of apoptotic neurons and axonal debris during axon injury [22]. Draper is a single-spanning transmembrane protein in the glia membrane. It has orthologues in *C.elegans*, CED-1, and mammals, Jedi-1 and MEGF10 [23]. To investigate whether glial cells can associate with the plaques found in AD flies, we performed immunohistochemistry studies using anti-Draper antibody as a marker of glial cells [22]. At day 10 after eclosion, the cell surface expression of Draper is enhanced in *imd*-deficient AD flies' brains (Figure 6A). Dot-shaped and mostly diffused plaque-like aggregates largely colocalized with Draper (Figure 6B and C). We concluded that Draper-positive glial cells are activated and associated with amyloid β deposits.

Discussion

Here we demonstrate that the *Drosophila* IMD pathway plays a protective role by limiting the accumulation of amyloid β in an AD fly model. In *imd*-deficient AD flies, Draper-positive glial cells are activated and associate with Amyloid- β aggregates.

Although the strong link between innate immune and AD has been suggested, the molecular mechanisms of the response are complex and still unclear. We used a *Drosophila* model lacking the adaptive immune system and the vascular system to minimize this complexity. However, as a drawback, our system does not cover the full pathology developed in human. The IMD pathway is similar to mammalian TNF-R signaling pathway. Mammals have two TNF receptors, TNFR1 (also known as p55 and TNFRSF1A) and TNFR2 (also known as p75 and TNFRSF1B) [24]. TNFR1 is expressed on nearly all cell types, whereas the expression of TNFR2 is restricted to certain cell types including microglia, endothelial cells, and CD4/CD8 T cells. TNFR1 recruits an adaptor molecule TRADD and activates both caspase-mediated apoptosis pathway via FADD and NF- κ B-mediated transcriptions through RIP (equivalent to *Drosophila* IMD in this study). On the other hand, TNFR2 recruits TRAF2 and cIAP2 and transduces the signal to NF- κ B-, MAPK-, and JNK-cascades for cell survival.

Drosophila IMD pathway conserves many molecular components from both mammalian TNF-R1 and TNF-R2 pathways[25]. He et al. reported that APP23/ TNF-R1^{-/-} AD model mice show a significant reduction of A β deposits, by lowering BACE activity and A β generation [26]. In contrast, Montgomery et al. generated triple-transgenic AD mice lacking both TNF-R1 and TNF-R2 (3xTg-ADx TNF-R1/RII KO mice) [27]. These mice

Elie et al. ver.1

show enhanced amyloid and tau-related pathological features. Primary microglia from 3xTg-ADx TNF-RI/RII KO mice have reduced level of phagocytic activity. These results indicate that TNF-R signaling is important for microglial-mediated uptake of extracellular A β pools. Although we have no data of phenotypes of AD model mice lacking solely TNF-R2, our results resemble the later case. Interestingly, TNF-R1 and TNF-R2 have opposing roles toward retinal ischemia [28]. The lack of TNF-R1 leads to a strong reduction of neurodegeneration, whereas TNF-R2 deficiency promotes enhanced neurodegeneration after insult. All together, we propose a neuroprotective role of NF- κ B activation during A β -mediated neurodegeneration by the *Drosophila* IMD pathway or by mammalian TNF-R2 signaling pathway.

Tan et al. suggested that the activation of the TOLL pathway mediates the neurotoxic effects of the human A β 42 in *Drosophila* [29]. In their studies, a series of independent loss-of-function mutations in the heterozygous *Tl* suppress the rough eye phenotype induced by ectopic expression of A β 42 in the compound eye. The lifespan of the UAS-A β 42/elav-GAL4 flies was extended by the *Tl*^{r4} mutation in a heterozygous fashion but not other *Tl* mutations or mutations in other genes belonging to the TOLL pathway such as *tub* and *pll*. We first examined the immune response of the heterozygous *Tl*^{r4} flies against Gram-negative bacteria *M.luteus* as a most potent and well-established activator of the TOLL pathway. The heterozygous *Tl*^{r4} flies induced *Drosomycin*, a representative read-out of the activation of the TOLL pathway, by 8-fold. This induction level is similar to other *Tl*-intact lines, Oregon-R (data not shown) and a fly line (BL1783) carrying similar markers (Supplementary Figure 4). In addition, we compared the climbing activity of *Tl*^{r4} heterozygous AD flies to that of the BL1783 heterozygous AD flies. We

Elie et al. ver.1

couldn't detect any difference (Supplementary Figure 5). However, as previously reported[29], we found the survival rate of the UAS-A β 42/elav-GAL4 flies was significantly increased by the *Tl*^{r4} mutation in a heterozygous fashion. Our results demonstrated that *Dif*- and *Tl*-deficient AD flies show no alternation in the climbing activity, on the other hand, the climbing activity of *imd*-deficient AD flies is reduced, negatively correlated with the amount of accumulated A β . At this moment, we favor to conclude that the *Drosophila* TOLL pathway is not involved in the development of AD-like phenotypes in terms of the climbing activity and the accumulation of human A β 42.

Surprisingly, the cell surface expression of *Draper* is increased in *imd*-deficient AD flies' brains. We speculate that the enhanced cell surface expression of *Draper* is a sign of activation of glial cells by A β aggregates. Since this phenomenon is seen in *imd*-deficient AD flies' brains, the activation of glial cells is independent of IMD. We currently hypothesize that IMD can regulate A β phagocytosis activity. In support, Ramet et al. reported that knockdown of *PGRP-LC*, a bacterial sensor activating the IMD pathway, reduces the phagocytosis activity of *E.coli* in *Drosophila* S2 cells[30]. *Draper* has EGF-like motifs at the extracellular region[23] and belongs to the mammalian class F scavenger receptor in the SR family[31]. A recent study has shown that its mammalian orthologue MEGF10 can be a receptor for A β [32]. Both *Draper* and MEGF10 are responsible for clearance of apoptotic cells using similar molecular machineries found in *C.elegans*. Our study also supports that the *Drosophila* orthologue *Draper* can bind to human A β . It is unknown whether MEGF10 or *Draper* play a role in A β clearance in vivo. Our central question is how innate immunity in the brain can recognize human A β and how is it activated. How are its effector functions of phagocytosis regulated? If the IMD

Elie et al. ver.1

pathway plays roles in these processes, how does it engage in these processes? It would be of great interest to explore the molecular mechanism of the immune response against human A β .

Our AD flies provide a study model for the immune response against misfolded protein such as human A β . This model will help us to reveal the molecular mechanisms of how glia cells encounter A β to prevent from AD, leading to the therapeutic intervention.

Material and Methods

Fly maintenance and strains

Flies were cultured in a temperature-, humidity-, and light cycle-controlled environment on a semi-solid medium containing yeast. Flies used especially for AMP expression experiments were raised on a medium mixed with antibiotics (100 µg/ml ampicillin, 50 µg/ml vancomycin, 100 µg/ml neomycin and 100 µg/ml metronidazole)[33] to minimize the risk of bacterial infection that could induce antimicrobial peptide gene expression [18]. The following fly strains were gifted: *elav-Gal4^{c155}*, *UAS-Aβ42^{H29.3}* from Novartis Institutes for BioMedical Research, Inc. [13]; *Dredd^{D55}* (FBal0120963) [34] and *Tak1¹* (FBal0126475) [35] from Bruno Lemaitre; *PGRP-LE¹¹²* (FBal0182386) [36] from Shoichiro Kurata. *Cha-GAL4*(FBst0006798); 2A-PhiC31 fly line (M{vas-int.Dm}ZH-102D, M{3xP3-RFP.attP}ZH-2A) [37] from Konrad Basler. *Tl⁴*(FBal0016839) and FBst0001783 (used as control for *Tl⁴*) were obtained from Bloomington Stock Center. *Dif¹* (*DIF*), *imd^{shadok}* (*IMD*), and *UAS-Aβ42^{2A.1}* (X-linked AD) were generated in the affiliated laboratory.

Generation of Human Aβ42 transgenic flies on 1st chromosome

cDNA encoding rat pre-proenkephalin signal peptide fused with human amyloid-β 42 was amplified with enkab primer (5'-GCGAGATCTGCCACCATGGCGCAGTTCCTGAGACTT-3') and enkab42 primer (5'-GAGGTCGACCTACGCTATGACAACACCGCCCACCAT-3') by PCR using genomic DNA as a template from *UAS-Aβ42^{H29.3}*[38], cloned into pUASTattB vector (gifted

Elie et al. ver.1

from Konrad Basler), and verified by DNA sequencing. This plasmid was designated as pUASTattB-hAbeta42 and was subjected to phiC31-mediated transgenesis using a 2A-PhiC31 fly line. The generated line, UAS- $A\beta 42^{2A.1}$, was designated X-linked AD line.

Climbing and survival assays

Three to five days post-eclosion, 15 to 20 flies were placed in a (ø25 x h95 mm) plastic tube (Genesee Scientific Corporation, USA), and gently tapped 5 times to the bottom. After 18 seconds, the number of flies that have crossed a line situated at 5 cm from the bottom of the tube was counted.

A constant light source illuminated the tubes from the top and the tests were performed under the following conditions: 21.5 ± 1.0 °C, 35 ± 5 % humidity. Three to five independent tubes were tested per genotype. For each tube the test was repeated 5 times at each time point. The percentage of climbing activity was determined by dividing the average number of flies that have climbed during 5 tests by the total number of flies in a tube at the starting day. For survival analysis, death events were counted over time.

RNA analysis

Total RNA was extracted from 10 adult flies using TRI REAGENT[®] RT (Molecular Research Center) and treated with DNase I (Thermo Scientific). To determine the mRNA level of human A β 42, reverse transcription was performed using iScript[™] cDNA Synthesis Kit (BIO-RAD). Fast SYBR[®] Green Master Mix (Applied Biosystems) was used for Quantitative RT-PCR using 7500 Fast Real-Time PCR System (Applied Biosystems). Human A β 42 mRNA level was quantified and normalized to the mRNA

Elie et al. ver.1

level of Rp49 using primer sets: Q-A β 42_F primer (5'-GATGCAGAATTCCGACATGAC -3') and Q-A β 42_R primer (5'-CGCTATGACAACACCGCCCAC -3'); Q-Rp49_F primer (5'-GACGCTTCAAGGGACAGTATCTG-3') and Q-Rp49_R (5'-AAACGCGGTTCTGCATGAG -3'). The AMP mRNA expression levels were determined using TaqMan[®] RNA-to-CT[™] 1-Step Kit (Applied Biosystems) and TaqMan[®] Gene Expression Assays primers and probes (Applied Biosystems) with 7500 Fast Real-Time PCR System (Applied Biosystems). These assays include Attacin A (Dm02362218_s1), Drosomycin (Dm01822006_s1), Metchnikowin (Dm01821460_s1) and Rp49 (also known as RpL32, Dm02151827_g1). The expressions of the antimicrobial peptide genes were normalized to the expression of the Rp49 gene for each sample. Three to five independent experiments were performed.

Thioflavin T binding assay

Ten fly heads were homogenized with a pestle (Kontes[®] Microtube Pellet Pestle[®]) in 110 μ L of TE buffer (10mM Tris-HCl, 1mM EDTA, pH8.0). Ninety microliters of supernatant after centrifugation was divided into two parts. Each part in a volume of 45 μ L was mixed with 5 μ L of 120mM Thioflavin T (Sigma-Aldrich) as a sample or 5 μ L H₂O as a control. Since TE buffer contains substantial levels of autofluorescence, we prepared background control mixtures by replacing the brain homogenates with TE buffer. The mixtures were incubated at RT for 1 hour. The level of fluorescence intensity was measured as an arbitrary unit using a Mithras LB 940 Multimode Microplate Reader (Berthold technologies) with a combination of an excitation filter 450nm and an emission

Elie et al. ver.1

filter 485nm and an average of 5 repeated reads was considered as a value. We determined the net of fluorescence intensity level as Thioflavin T index (ThT index) as follow:

$$\text{ThT index} = \frac{FL_{\text{sample}} [Fluorescence (\text{Sample} + \text{ThT}) - Fluorescence (\text{Sample} + \text{H}_2\text{O})] - FL_{\text{background}} [Fluorescence (\text{TE} + \text{ThT}) - Fluorescence (\text{TE} + \text{H}_2\text{O})]}{}$$

Then, we determined the relative ThT index as follows:

$$\text{Relative ThT Index} = \frac{\text{ThT index}(\text{Mutant})}{\text{ThT index}(\text{WT})}$$

Three independent experiments were performed.

Whole mount brains Immunohistochemistry

Fly whole brains were dissected and fixed with 4% paraformaldehyde in PBST (Phosphate Buffered Saline with 0.5% Triton X-100) at RT for 50 min. Fixed brains were washed and incubated overnight in blocking solution (PBST with 10% normal goat serum (Jackson ImmunoResearch)). They were treated with 10% formic acid for 5 min and washed in PBST. After blocking again, the brains were incubated sequentially with a mouse monoclonal anti-human A β antibody (clone 4G8, 1:500, Sigma-Aldrich) in blocking solution at 4°C overnight, with a biotinylated goat anti-mouse IgG (1:2100) in blocking solution, and with Streptavidine-Alexa Fluor 546 (Invitrogen) (1:2000) in PBS. After washing, the brains were mounted in mounting media containing DAPI (Vector Laboratories) and observed under a LSM700 confocal microscope and an Apotome microscope (Carl Zeiss).

Histology

Elie et al. ver.1

Flies heads without proboscis and antennas were fixed and embedded in paraffin. The blocks were sectioned at a thickness of 5 μ m, subjected to hematoxylin and eosin staining (Sigma-Aldrich), and examined by brightfield microscopy (Zeis Axioskop 2). At least 6 brain hemispheres were analyzed per genotype.

Statistics

Two-tailed Student's t-test, one-way ANOVA with Dunnett's multiple comparison test, and Two-way ANOVA for repeated measures with Bonferroni post-tests were used for statistic analysis using Prism software.

Acknowledgements

We are grateful to S.Ozkan for transgenesis, F.Nakaki for hA β 42 clonings, T.Rhinn-Tanaka for technical assistance, and V.Wolf and S.Risch for administrative supports. We thank the Bloomington Stock Center, Novartis Institutes for BioMedical Research, Drs. K.Basler and S.Kurata for providing fly stocks.

Figure Legends

Figure 1 Induction of the antimicrobial peptide gene *Metchnikowin* by expression of human A β 42 in *Drosophila* neurons

A) AD flies show reduced climbing ability. Climbing abilities of AD flies (dotted line) and WT flies (solid line). Three independent experiments were performed and similar results were obtained. One representative result is shown. Data are presented as the average climbing ability \pm SE from 3-5 tubes per genotype. Each tube contains 15-20 flies. ANOVA followed by Bonferroni post-tests was performed at each time point. Statistical significance: ** $p < 0.01$ and *** $p < 0.001$.

B) Gene expression of various antimicrobial peptide genes in adult whole bodies of AD^{elav} transgenic flies at 5 days after eclosion. mRNA levels of *Metchnikowin*, *Drosomycin*, and *AttacinA* were determined by quantitative RT-PCR and normalized to Rp49 expression (also known as RpL32). AD^{elav} flies were compared to control WT flies. Five independent experiments were performed and each data is plotted. *w¹¹¹⁸* flies were used as the internal control for each experiment. The relative values are indicated against a value obtained from WT data plot as 1. The average \pm SE are presented as bars. Mann-Whitney test was performed. ** indicates statistical significance, $p < 0.05$ as compared to WT.

Genotypes: AD^{elav}, *elav-Gla4^{c155} / UAS-A β 42^{2A.1}*; WT, *elav-Gla4^{c155} / 2A*.

Figure 2 *imd* deficiency reduces the climbing ability in AD transgenic flies

Elie et al. ver.1

A) Climbing ability of AD^{elav} (black solid line), $AD^{elav} imd^{shadok}$ (dashed line), and imd^{shadok} (grey solid line) flies.

B) Climbing ability of AD^{elav} (black solid line), $AD^{elav} Dif^d$ (dashed line) and Dif^d (grey solid line) flies.

Three independent experiments were performed and similar results were obtained. One representative result is shown. Data are presented as the average climbing ability \pm SE. Two-way ANOVA followed by Bonferroni post-tests was performed at each time point. Statistical significance: *** $p < 0.001$.

Genotypes: $AD^{elav}, elav-Gla4^{c155}/UAS-A\beta42^{2A.1};cn bw/cn bw$; $AD^{elav} imd^{shadok}, elav-Gla4^{c155}/UAS-A\beta42^{2A.1};cn imd^{shadok} bw/cn imd^{shadok} bw$; $imd^{shadok}, cn imd^{shadok} bw/cn imd^{shadok} bw$; $AD^{elav} Dif^d, elav-Gla4^{c155}/UAS-A\beta42^{2A.1};cn Dif^d bw/cn Dif^d bw$; $Dif^d, cn Dif^d bw/cn Dif^d bw$

Figure 3 Deficiencies of *PGRP-LE* and *Tak1* in the IMD pathway affect climbing ability in AD transgenic flies

Climbing ability of **A)** *PGRP-LE*- and **B)** *Tak1*- deficient AD^{cha} flies.

Three independent experiments were performed and similar results were obtained. One representative result is shown. Data are presented as the average climbing ability \pm SE. Two-way ANOVA followed by Bonferroni post-tests was performed at each time point. Statistical significance: * $p < 0.05$ and *** $p < 0.001$.

Elie et al. ver.1

Genotypes: $AD^{cha} (w^{1118})$ (black solid line in A and B), $w^{1118}/Y;cha-Gla4, UAS-A\beta42^{H29.3}/+$; $AD^{cha} PGRP-LE^{112}$ (dashed line in A), $y^1w^{67c23}PGRP-LE^{112}/Y;cha-Gla4, UAS-A\beta42^{H29.3}/+$; $AD^{cha} Tak1^1$ (dashed line in B), $y^1w^1Tak1^1/Y;cha-Gla4, UAS-A\beta42^{H29.3}/+$

Figure 4 Amyloid β accumulated in the AD imd^{shadok} fly brain and formed plaque-like structures

A) Clusters of dot-shaped amyloid aggregates appeared in the AD^{elav} imd^{shadok} fly brain. Immunostaining of human amyloid β of 12-day-old whole brains using anti-human A β antibody (clone 4G8). (a) WT, (b and e) AD^{elav}, (c) AD^{elav} Dif^1 and (d and f) AD^{elav} imd^{shadok} flies. (e and f) Anti-human A β antibody (clone 4G8; red) and DAPI (blue).

B) The amount of Thioflavin T-sensitive amyloid fibrils was increased in the AD imd^{shadok} fly brain of 10 day-old flies. Data are presented as the average ThT index \pm SE as compared to WT from 3 independent experiments. Results were analyzed using one-way ANOVA followed by Tukey's multiple comparison test. Statistical significance: * $p < 0.05$ and ** $p < 0.01$.

Genotypes: AD^{elav}, $elav-Gla4^{c155}/UAS-A\beta42^{2A.1};cn bw/cn bw$; AD^{elav} imd^{shadok} , $elav-Gla4^{c155}/UAS-A\beta42^{2A.1};cn imd^{shadok} bw/cn imd^{shadok} bw$; imd^{shadok} , $cn imd^{shadok} bw/cn imd^{shadok} bw$; AD^{elav} Dif^1 , $elav-Gla4^{c155}/UAS-A\beta42^{2A.1};cn Dif^1 bw/cn Dif^1 bw$; Dif^1 , $cn Dif^1 bw/cn Dif^1 bw$

Figure 5 Neurodegeneration in the AD *imd^{shadok}* fly brain

H & E staining of brain sections of 20-day-old AD^{elav} *imd^{shadok}* flies show enhanced vacuolization when compared to AD^{elav} or *imd^{shadok}* flies. At least 3 hemispheres were checked for each genotype. Magnification x200

Genotypes: WT, *cn bw/cn bw*; AD^{elav}, *elav-Gla4^{c155}/UAS-Aβ42^{2A.1};cn bw/cn bw*;
 AD^{elav}*imd^{shadok}*, *elav-Gla4^{c155}/UAS-Aβ42^{2A.1};cn imd^{shadok} bw/ cn imd^{shadok} bw*; *imd^{shadok}*,
cn imd^{shadok} bw/ cn imd^{shadok} bw

Figure 6 Human Aβ aggregants are associated with Draper-positive cells

A) Cell surface expression of Draper. The Draper expression on the cell surface was enhanced in AD^{elav}, *imd^{shadok}*. **B) Draper and human Aβ staining.** Brains from WT, AD^{elav}, and AD^{elav} *imd^{shadok}* flies were stained with anti-Draper antibody and anti-human Aβ antibody. Amounts of human Aβ aggregants were increased in AD^{elav} *imd^{shadok}*. **C) Colocalization of Draper and human Aβ.** Majority of human human Aβ aggregants were co-localized with Draper-staining, which is expressed in glia cells. Pearson's coefficient: $R = 0.596 \pm 0.111$; Overlap coefficient: $R = 0.894 \pm 0.022$. Pearson's coefficient and Overlap coefficient were calculated using the JACoP plugin in ImageJ64 [39]. Averaged and the standard deviation were calculated with coefficients from three different images and shown.

Genotype: WT, *cn bw/cn bw*; AD^{elav}, *elav-Gla4^{c155}/UAS-Aβ42^{2A.1};cn bw/cn bw*;
 AD^{elav}*imd^{shadok}*, *elav-Gla4^{c155}/UAS-Aβ42^{2A.1};cn imd^{shadok} bw/ cn imd^{shadok} bw*

Supplementary Figures

Supplementary Figure 1: Survival assay.

Survival curves of WT (black solid line) and AD^{elav} (dashed line). The long-rank test was performed. No statistic significance was observed. $N=180$ per genotype.

Genotypes: AD^{elav} , $elav-Gla4^{c155}/UAS-A\beta42^{2A.1}$; **WT**, $elav-Gla4^{c155}/2A$.

Supplementary Figure 2: Survival assay.

Survival curves of AD^{elav} (black solid line), $AD^{elav} imd^{shadok}$ (dashed line), and $AD^{elav} Dif^d$ (dotted line) flies. The long-rank test was performed. Statistic significance: $p<0.001$

(AD^{elav} vs. $AD^{elav} imd^{shadok}$ or $AD^{elav} Dif^d$); $p<0.005$ ($AD^{elav} imd^{shadok}$ vs. $AD^{elav} Dif^d$)

$N=180$ per genotype.

Genotypes: AD^{elav} , $elav-Gla4^{c155}/UAS-A\beta42^{2A.1};cn bw/cn bw$; $AD^{elav} imd^{shadok}$, $elav-Gla4^{c155}/UAS-A\beta42^{2A.1};cn imd^{shadok} bw/cn imd^{shadok} bw$; $AD^{elav} Dif^d$, $elav-Gla4^{c155}/UAS-A\beta42^{2A.1};cn Dif^d bw/cn Dif^d bw$.

Supplementary Figure 3: A β 42 transgene expression levels.

Human A β 42 mRNA levels in the head of WT, AD^{elav} , $AD^{elav} Dif^d$, and $AD^{elav} imd^{shadok}$ flies were quantified by real-time quantitative PCR and normalized to rp49 mRNA expression levels. The results are presented as the average \pm SE from three independent experiments. One-way ANOVA followed by Tukey's multiple comparison tests was performed. Statistic significance: * $P<0.05$ and ** $P<0.01$

Elie et al. ver.1

Genotypes: **WT**, *cn bw/cn bw*; **AD^{elav}**, *elav-Gla4^{c155}/UAS-Aβ42^{2A.1};cn bw/cn bw*;
AD^{elav}imd^{shadok}, *elav-Gla4^{c155}/UAS-Aβ42^{2A.1};cn imd^{shadok} bw/cn imd^{shadok} bw*; **AD^{elav} Dif^d**,
elav-Gla4^{c155}/UAS-Aβ42^{2A.1};cn Dif^d bw/cn Dif^d bw.

Supplementary Fig 4: Induction of *Drosomycin* in *Tl^{r4}/+* flies during *M. luteus* infection.

5-day-old flies were pricked either by Gram-positive bacteria *M. luteus* or PBS. The mRNA level of *Drosomycin* was determined by quantitative PCR and normalized to Rp49 expression levels. The values were indicated relatively to non-pricked CONT flies. Data are presented as the average ± SE from three independent experiments. One-way ANOVA followed by Tukey's multiple comparison test was performed. * indicates statistically significance, $p < 0.05$. White, gray, and black columns indicated groups of flies with non-, PBS-, and bacteria-pricked, respectively. No significant difference was observed between CONT-*M. luteus* and *Tl^{r4}-M. luteus*.

Genotypes: **CONT**, *ru¹ h¹ th¹ st¹ kni¹ cu¹ sr¹ e^s ca¹/TM3, Sb¹ Ser¹*; **Tl^{r4}**, *elav-Gla4^{c155}/UAS-Aβ42^{2A.1}; ru¹ h¹ th¹ st¹ kni^{ri-1} rn^{roe-1} p^p e¹ Tl^{r4}/TM3, Ser¹*

Elie et al. ver.1

Supplementary Fig 5 : Climbing ability and life span of AD^{elav} Tl^{r4} flies

(**upper**) Climbing ability of AD^{elav} CONT (black solid line) and AD^{elav} Tl^{r4} (dashed line).

Three independent experiments were performed and similar results were obtained. One representative result is shown. Data are presented as the average climbing ability ± SE.

Two-way ANOVA followed by Bonferroni post-tests was performed. Significant

difference was not observed between the two groups. (**below**) Survival curves of AD^{elav} CONT (black solid line) and AD^{elav} Tl^{r4} (dashed line). The long-rank test was performed.

Statistic significance: p<0.0001. N=100 per genotype.

Genotypes: **AD^{elav} CONT**, *elav-Gla4^{c155}/UAS-Aβ42^{2A.1}*; ; *ru¹ h¹ th¹ st¹ kni¹ cu¹ sr¹ e^s ca¹/+*; **AD^{elav} Tl^{r4}**, *elav-Gla4^{c155}/UAS-Aβ42^{2A.1}*; ; *ru¹ h¹ th¹ st¹ kni^{ri-1} rn^{roe-1} p^p e¹ Tl^{r4}/+*

Reference

1. Ferri CP, Prince M, Brayne C, Brodaty H, Fratiglioni L, et al. (2005) Global prevalence of dementia: a Delphi consensus study. *Lancet* 366: 2112-2117.
2. Selkoe DJ (1991) THE MOLECULAR PATHOLOGY OF ALZHEIMERS-DISEASE. *Neuron* 6.
3. Akiyama H, Barger S, Barnum S, Bradt B, Bauer J, et al. (2000) Inflammation and Alzheimer's disease. *Neurobiology of aging* 21: 383-421.
4. McGeer PL, Schulzer M, McGeer EG (1996) Arthritis and anti-inflammatory agents as possible protective factors for Alzheimer's disease: a review of 17 epidemiologic studies. *Neurology* 47: 425-432.
5. Breitner JC, Baker LD, Montine TJ, Meinert CL, Lyketsos CG, et al. (2011) Extended results of the Alzheimer's disease anti-inflammatory prevention trial. *Alzheimers Dement* 7: 402-411.
6. Hollingworth P, Harold D, Sims R, Gerrish A, Lambert J-C, et al. (2011) Common variants at ABCA7, MS4A6A/MS4A4E, EPHA1, CD33 and CD2AP are associated with Alzheimer's disease. *Nature Genetics* 43.
7. Harold D, Abraham R, Hollingworth P, Sims R, Gerrish A, et al. (2009) Genome-wide association study identifies variants at CLU and PICALM associated with Alzheimer's disease. *Nat Genet* 41: 1088-1093.
8. Lambert JC, Grenier-Boley B, Chouraki V, Heath S, Zelenika D, et al. (2010) Implication of the immune system in Alzheimer's disease: evidence from genome-wide pathway analysis. *J Alzheimers Dis* 20: 1107-1118.
9. Frenkel D, Maron R, Burt DS, Weiner HL (2005) Nasal vaccination with a proteosome-based adjuvant and glatiramer acetate clears beta-amyloid in a mouse model of Alzheimer disease. *J Clin Invest* 115: 2423-2433.
10. Saijo K, Collier JG, Li AC, Katzenellenbogen JA, Glass CK (2011) An ADIOL-ERbeta-CtBP transrepression pathway negatively regulates microglia-mediated inflammation. *Cell* 145: 584-595.
11. Lemaitre B, Hoffmann J (2007) The host defense of *Drosophila melanogaster*. *Annual review of immunology* 25: 697-743.
12. Selkoe DJ (2001) Alzheimer's disease: genes, proteins, and therapy. *Physiol Rev* 81: 741-766.
13. Iijima K, Liu HP, Chiang AS, Hearn SA, Konsolaki M, et al. (2004) Dissecting the pathological effects of human Abeta40 and Abeta42 in *Drosophila*: a potential model for Alzheimer's disease. *Proceedings of the National Academy of Sciences of the United States of America* 101: 6623-6628.
14. Rival T, Page RM, Chandraratna DS, Sendall TJ, Ryder E, et al. (2009) Fenton chemistry and oxidative stress mediate the toxicity of the beta-amyloid peptide in a *Drosophila* model of Alzheimer's disease. *Eur J Neurosci* 29: 1335-1347.
15. Sofola O, Kerr F, Rogers I, Killick R, Augustin H, et al. (2010) Inhibition of GSK-3 ameliorates Abeta pathology in an adult-onset *Drosophila* model of Alzheimer's disease. *PLoS Genet* 6.

16. Greeve I, Kretzschmar D, Tschape JA, Beyn A, Brellinger C, et al. (2004) Age-dependent neurodegeneration and Alzheimer-amyloid plaque formation in transgenic *Drosophila*. *J Neurosci* 24: 3899-3906.
17. Mukae N, Yokoyama H, Yokokura T, Sakoyama Y, Nagata S (2002) Activation of the innate immunity in *Drosophila* by endogenous chromosomal DNA that escaped apoptotic degradation. *Genes & development* 16: 2662-2671.
18. Liu X, Sano T, Guan Y, Nagata S, Hoffmann JA, et al. (2012) *Drosophila* EYA Regulates the Immune Response against DNA through an Evolutionarily Conserved Threonine Phosphatase Motif. *PLoS ONE* 7: e42725.
19. Levashina EA, Ohresser S, Bulet P, Reichhart JM, Hetru C, et al. (1995) Metchnikowin, a novel immune-inducible proline-rich peptide from *Drosophila* with antibacterial and antifungal properties. *European journal of biochemistry / FEBS* 233: 694-700.
20. Levashina EA, Ohresser S, Lemaitre B, Imler JL (1998) Two distinct pathways can control expression of the gene encoding the *Drosophila* antimicrobial peptide metchnikowin. *J Mol Biol* 278: 515-527.
21. Khurana R, Coleman C, Ionescu-Zanetti C, Carter Sa, Krishna V, et al. (2005) Mechanism of thioflavin T binding to amyloid fibrils. *Journal of structural biology* 151: 229-238.
22. Freeman MR, Delrow J, Kim J, Johnson E, Doe CQ (2003) Unwrapping glial biology: Gcm target genes regulating glial development, diversification, and function. *Neuron* 38: 567-580.
23. Ziegenfuss JS, Doherty J, Freeman MR (2012) Distinct molecular pathways mediate glial activation and engulfment of axonal debris after axotomy. *Nature neuroscience* 15: 979-987.
24. Faustman D, Davis M (2010) TNF receptor 2 pathway: drug target for autoimmune diseases. *Nat Rev Drug Discov* 9: 482-493.
25. Hoffmann JA (2003) The immune response of *Drosophila*. *Nature* 426: 33-38.
26. He P, Zhong Z, Lindholm K, Berning L, Lee W, et al. (2007) Deletion of tumor necrosis factor death receptor inhibits amyloid beta generation and prevents learning and memory deficits in Alzheimer's mice. *J Cell Biol* 178: 829-841.
27. Montgomery SL, Mastrangelo MA, Habib D, Narrow WC, Knowlden SA, et al. (2011) Ablation of TNF-RI/RII expression in Alzheimer's disease mice leads to an unexpected enhancement of pathology: implications for chronic pan-TNF-alpha suppressive therapeutic strategies in the brain. *Am J Pathol* 179: 2053-2070.
28. Fontaine V, Mohand-Said S, Hanoteau N, Fuchs C, Pfizenmaier K, et al. (2002) Neurodegenerative and neuroprotective effects of tumor Necrosis factor (TNF) in retinal ischemia: opposite roles of TNF receptor 1 and TNF receptor 2. *J Neurosci* 22: RC216.
29. Tan L, Schedl P, Song HJ, Garza D, Konsolaki M (2008) The Toll->NFkappaB signaling pathway mediates the neuropathological effects of the human Alzheimer's Abeta42 polypeptide in *Drosophila*. *PLoS ONE* 3: e3966.
30. Ramet M, Manfruelli P, Pearson A, Mathey-Prevot B, Ezekowitz RA (2002) Functional genomic analysis of phagocytosis and identification of a *Drosophila* receptor for *E. coli*. *Nature* 416: 644-648.

Elie et al. ver.1

31. Wilkinson K, El Khoury J (2012) Microglial scavenger receptors and their roles in the pathogenesis of Alzheimer's disease. *Int J Alzheimers Dis* 2012: 489456.
32. Singh TD, Park SY, Bae JS, Yun Y, Bae YC, et al. (2010) MEGF10 functions as a receptor for the uptake of amyloid-beta. *FEBS Lett* 584: 3936-3942.
33. Ryu JH, Kim SH, Lee HY, Bai JY, Nam YD, et al. (2008) Innate immune homeostasis by the homeobox gene *caudal* and commensal-gut mutualism in *Drosophila*. *Science (New York, NY)* 319: 777-782.
34. Leulier F, Rodriguez A, Khush RS, Abrams JM, Lemaitre B (2000) The *Drosophila* caspase *Dredd* is required to resist gram-negative bacterial infection. *EMBO Rep* 1: 353-358.
35. Vidal S, Khush RS, Leulier F, Tzou P, Nakamura M, et al. (2001) Mutations in the *Drosophila* *dTAK1* gene reveal a conserved function for MAPKKKs in the control of rel/NF-kappaB-dependent innate immune responses. *Genes Dev* 15: 1900-1912.
36. Takehana A, Yano T, Mita S, Kotani A, Oshima Y, et al. (2004) Peptidoglycan recognition protein (PGRP)-LE and PGRP-LC act synergistically in *Drosophila* immunity. *EMBO J* 23: 4690-4700.
37. Bischof J, Maeda RK, Hediger M, Karch F, Basler K (2007) An optimized transgenesis system for *Drosophila* using germ-line-specific ϕ C31 integrases. *Proceedings of the National Academy of Sciences of the United States of America* 104: 3312-3317.
38. Finelli A, Kelkar A, Song HJ, Yang H, Konsolaki M (2004) A model for studying Alzheimer's A β 42-induced toxicity in *Drosophila melanogaster*. *Molecular and cellular neurosciences* 26: 365-375.
39. Bolte S, Cordelieres FP (2006) A guided tour into subcellular colocalization analysis in light microscopy. *J Microsc* 224: 213-232.

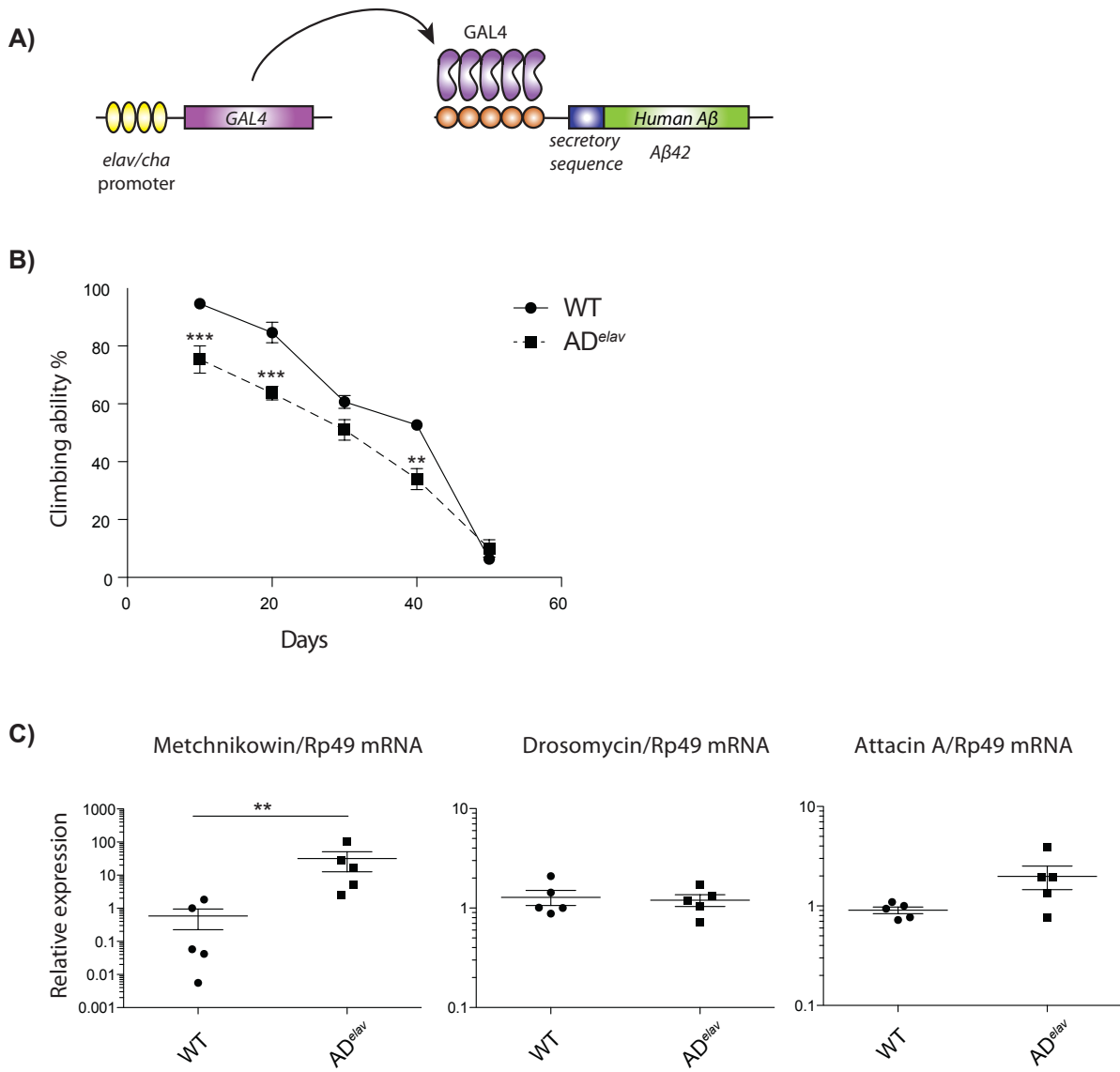

Figure 1

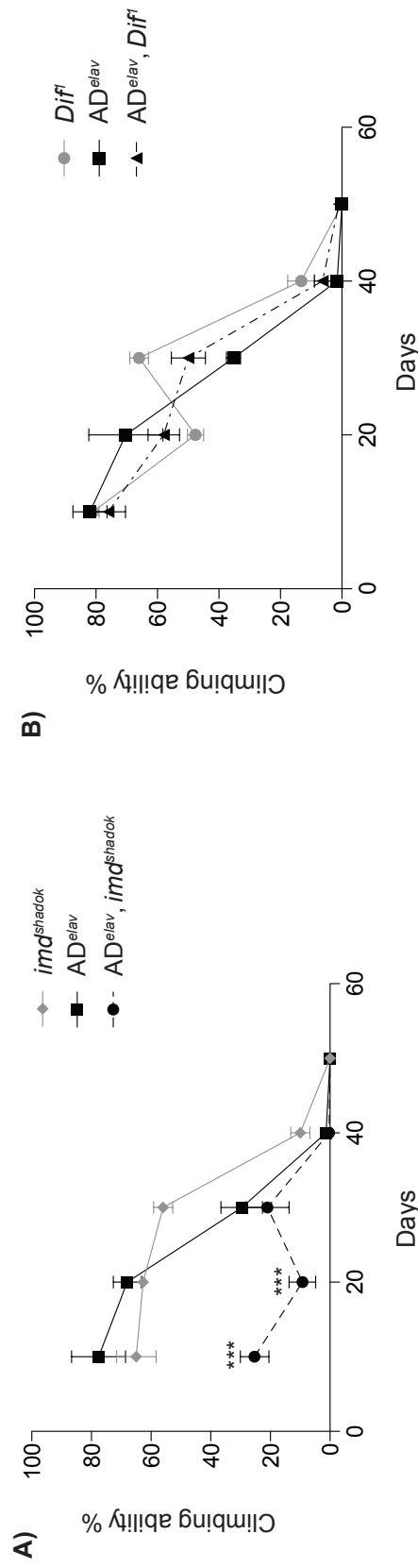

Figure 2

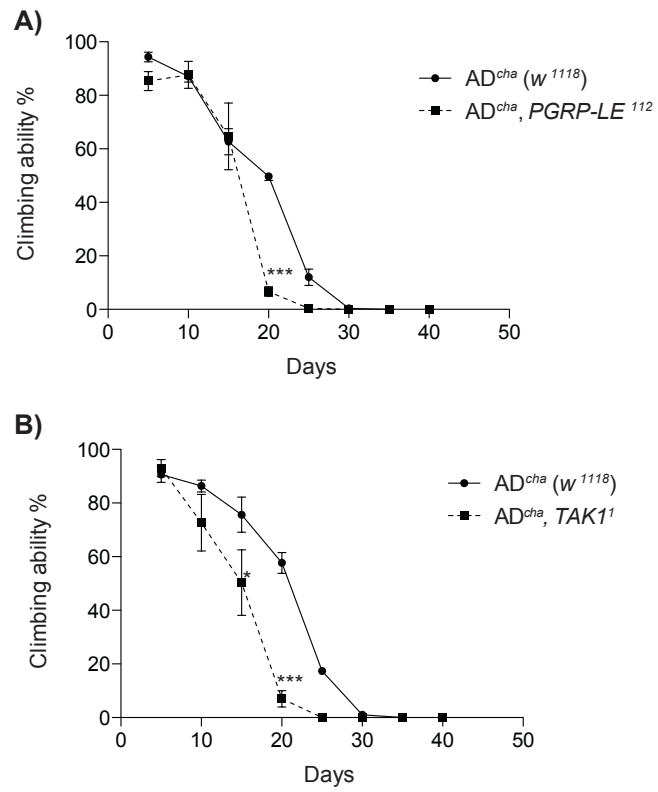
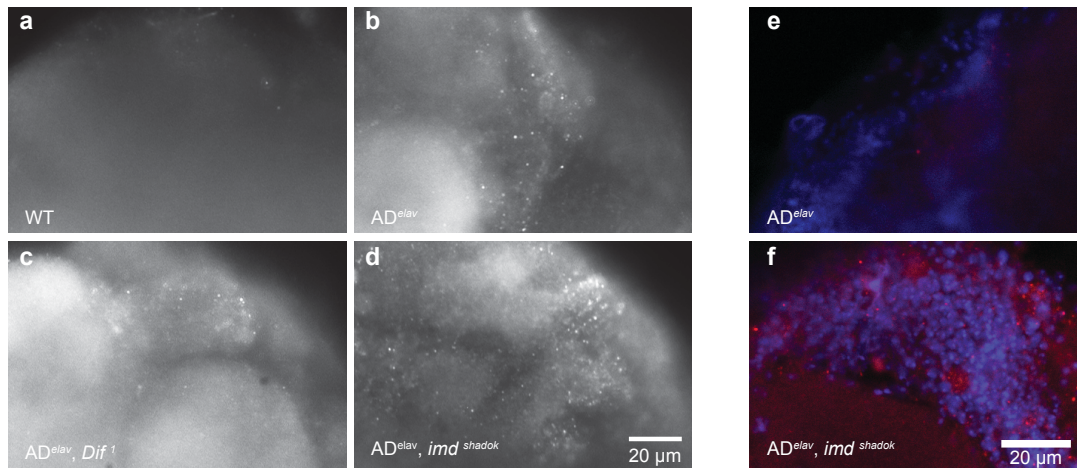

Figure 3

A)



B)

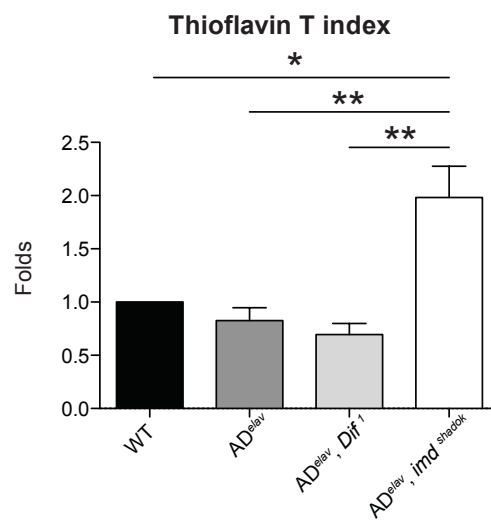

Figure 4

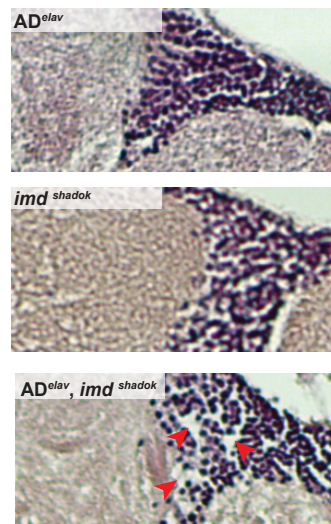

Figure 5

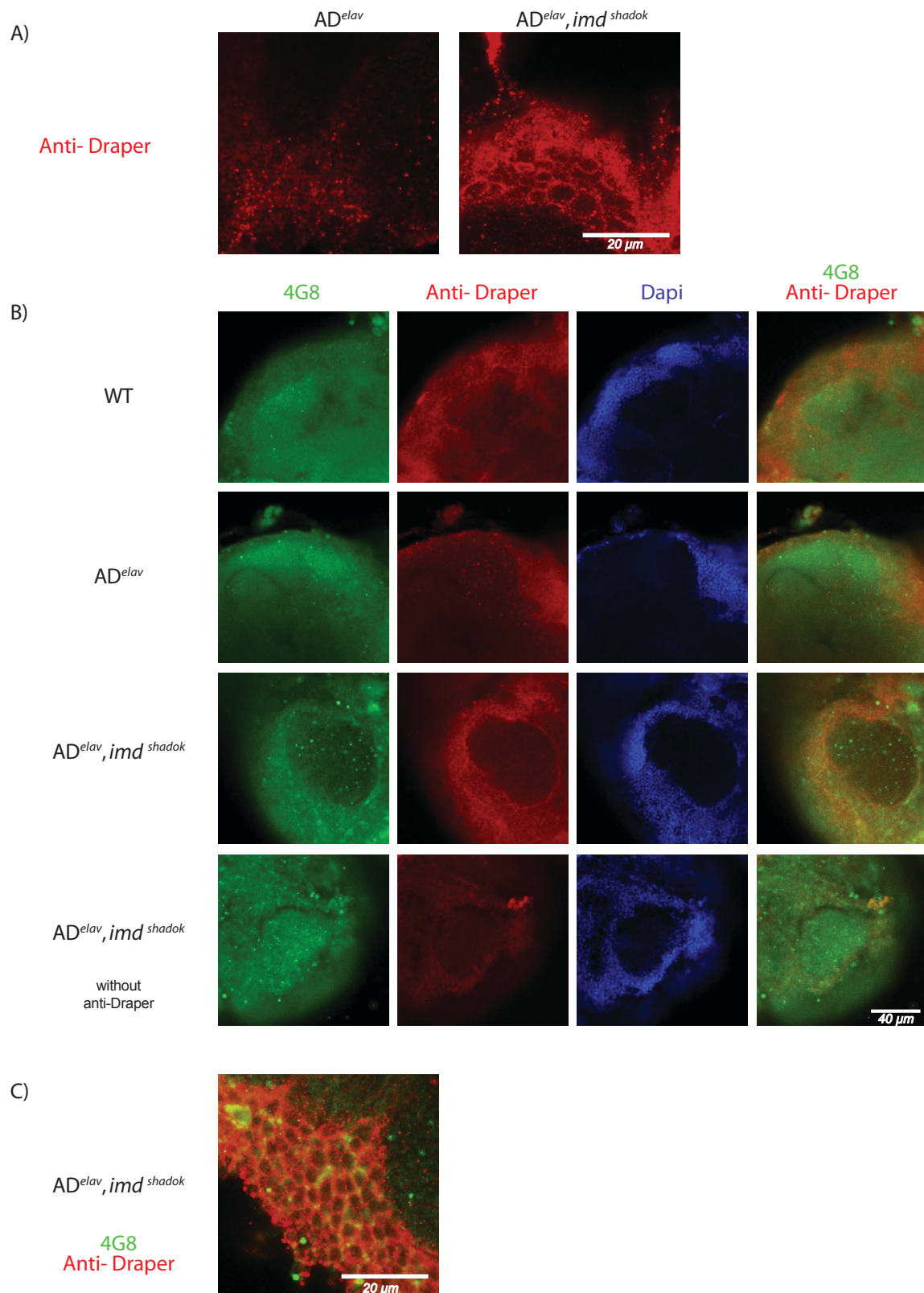
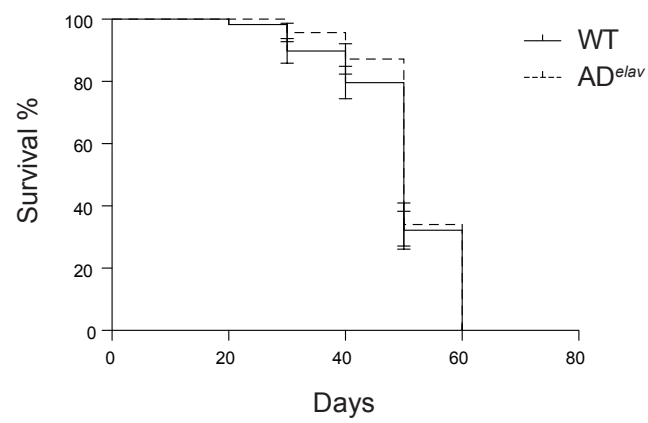
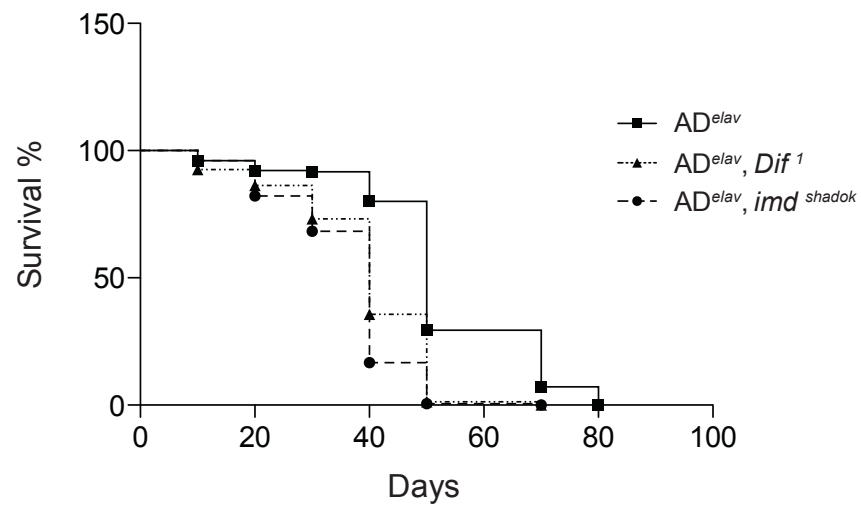

Figure 6



Supplementary Figure 1



Supplementary Figure 2

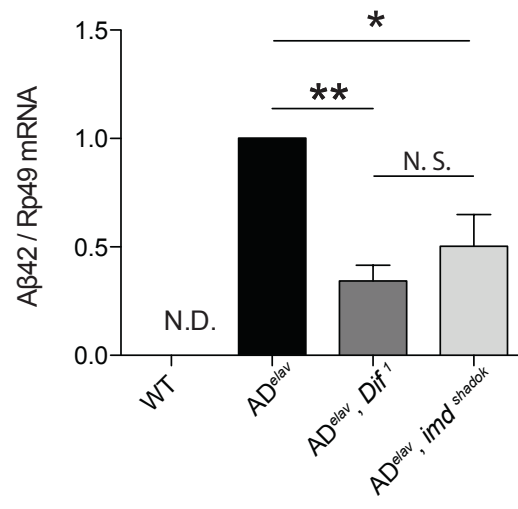

Supplementary Figure 3

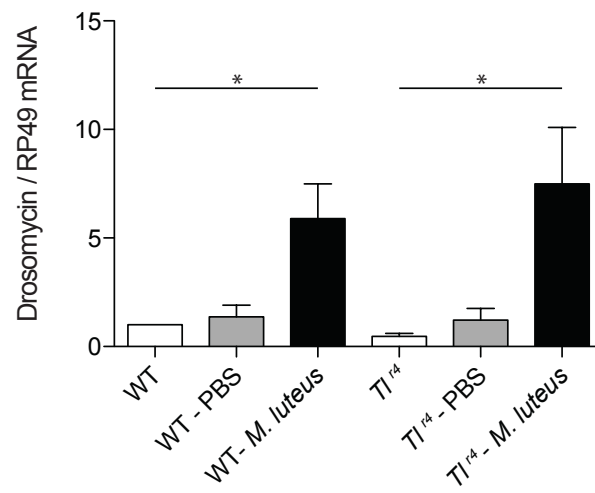

Supplementary Figure 4

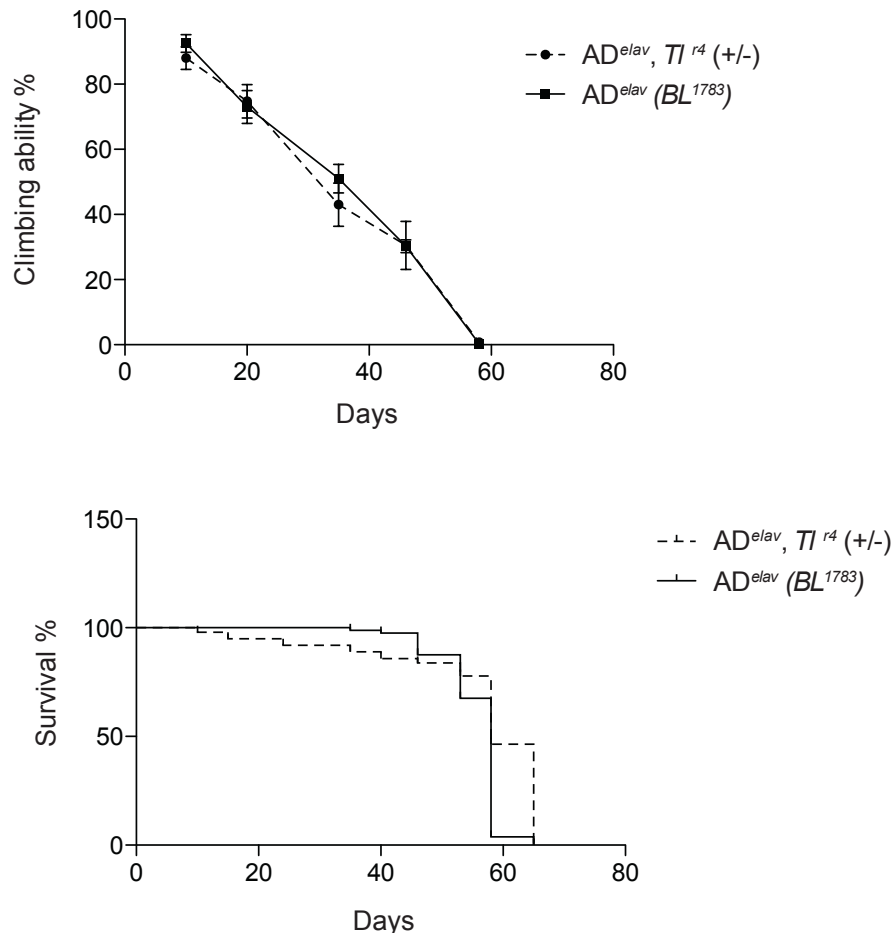

Supplementary Figure 5

2 Drosophila IMD interactome in bacterial challenge

Titles:

Drosophila IMD interactome in Bacterial challenge

Authors (tentative):

Hidehiro Fukuyama^{*,1,8}, Yann Verdier^{*,2}, Yongsheng Guan¹, Chieko Makino³,
Victoria Shilova³, Xi LIU^{1,4}, Elie Maksoud^{1,4}, Charles Hetru^{3,4}, Jean Rossier², Joëlle
Vinh², and Jules A. Hoffmann^{3,4,8}

Affiliations (tentative):

¹ INSERM Equip Avenir, Institut de Biologie Moléculaire et Cellulaire, 15 rue Rene
Descartes, Strasbourg, 67084, France

² Spectrométrie de Masse Biologique et Protéomique, USR 3149, Centre National de
La Recherche Scientifique ESPCI ParisTech,, 10 rue Vauquelin, 75231 Paris, France

³ Institut de Biologie Moléculaire et Cellulaire, 15 rue Rene Descartes, Strasbourg,
67084, France

⁴ University of Strasbourg, 67000, Strasbourg, France

* These authors are equally contributed to this work

⁸ Correspondence should be addressed to H.F. (h.fukuyama@unistra.fr) or
J.H. (J.Hoffmann@unistra.fr)

Summary

The *Drosophila* defense against pathogens largely relies on the activation of two major pathways, IMD and TOLL¹. The IMD pathway is activated mainly by Gram-negative bacteria², whereas the TOLL pathway responds predominantly to Gram-positive bacteria and fungi³. The activation of these pathways leads to the rapid induction via NF- κ B of numerous immune genes, which include various antimicrobial peptide genes. Recent evidence indicates that the IMD pathway is also involved in responses to various other reactions in the absence of infection (“inflammatory-like” reactions)^{4,5}. To gain a better understanding of the molecular machineries underlying the pleiotropic functions of this pathway, we have developed a proteomics analysis. Our first aim was to identify the proteins interacting with the 11 canonical members of the pathway initially identified by genetic studies¹. We have identified 345 interactant proteins in heat-killed *E.coli* stimulated *Drosophila* S2 cells, 90% of which have human orthologues. Comparative analysis of Gene Ontology (GO) annotation datasets from Human and Flies point to three significant common categories: (1) NuA4 Histone acetyltransferase complex, (2) SWI/SNF-type Chromatin remodeling complex, and (3) Transcription cofactor binding. Our *Drosophila* data point in particular to sumoylation of the I κ B-kinase homologue Ird5 in *Drosophila*, a layer of regulation not described to date. Among numerous directions opened by our proteomics analysis, we have decided to first investigate this facet of the IMD pathway. Here we show that a highly conserved sumoylation consensus site binds *Drosophila* SUMO (SMT3)

in a challenge-dependent manner and that this process confers an increased level of activation of the antimicrobial peptide genes during bacterial challenge both in vitro and in flies. Our results demonstrate that sumoylation in IKK β plays an important role for the induction of antimicrobial peptide genes.

Text

We chose as baits the following 11 proteins previously shown to be involved in the activation of the IMD pathway: PGRP-LC, PGRP-LE, IMD, BG4 (dFADD), DREDD, TAK1, TAB2, IAP2, IRD5 (DmIKK β), KEY (DmIKK γ), and RELISH¹. Each protein was fused N-terminally or C-terminally with a biotin tag and was stably expressed in S2 cells previously subjected to stable integration of the bacterial enzyme BirA to allow for biotinylation of the tags. In total, we established 22 stable transformant cell lines (11 genes x 2 tag locations), which were individually stimulated by heat-killed *E.coli* before harvest at 4 different time points (t=0 min, 10 min, 2 hour, and 8 hour) (Fig. 1a). This procedure was followed by streptavidin-mediated affinity purification of 95 bait-protein complexes (22 transformants x 4 time points, plus 7 unstimulated controls without baits), on-bead trypsin digestions of the protein complexes and LC-MS/MS analysis⁶. To define a cut-off method, we performed a small-scale RNAi-mediated functional test on selected 519 genes (see Supplemental materials and methods). We identified 345 proteins and visualized the IMD pathway interactome in an open-source Cytoscape platform⁷(Fig. 1b). Each bait-protein complex, merged from both N- and C-terminal tags, contained an average of 86 proteins with values ranging from 36 for DREDD to 146 for IRD5 (Fig. 1c). Interestingly, 313 out of the 345 proteins identified in this interactome have human orthologues (Supplementary Data, Cytoscape Annotation file). The number of identified proteins also changed over time depending on the bait protein (Figure 1d). As shown in

supplementary Fig.S1, our results on some interactants and protein-protein interactions are in good agreement with those found in the comprehensive *Drosophila* Interaction Database (DroID) which contains all known protein-protein and genetic interactions⁸. For instance, both sets show that IMD, FADD, and DREDD form a complex and that IRD5 and KEY are also associated. In addition, several proteins identified as interactants in previous genome-wide RNAi functional screens of the IMD pathway genes were also identified in this study: KAY, PVR, MASK, α TUB84B CG6509, IntS1, RPL22, OST48, EIF-2 α , α TUB84D, MESR4, AGO2, SCAR, RpS27, hyx, and MED11⁹⁻¹¹. However, some interacting proteins present in insoluble fractions would be absent from our analysis due to the extraction method which we used¹².

We next submitted our interactome dataset to a gene ontology (GO) analysis, using DAVID Bioinformatics Resources¹³. Comparison of GO terms from Fly or Human gene annotation databases point to 3 major shared GO terms: (1) Histone acetyltransferase complex [GO:0000123], (2) Chromatin remodeling complex[GO:0016585], and (3)Transcription cofactor binding[GO:0008134](Figure 2a). Of the 345 genes identified, 43 genes are listed in the 3 major GO terms. We grouped the individual genes under each GO term as presented in the Venn diagram, Fig.2b, Of particular interest, pont (human RUVB1, RuvB-like 1), rept (human RUVB2, RuvB-like 2) and dom (human SRCAP, Snf2-related CREBBP activator protein) are located in an overlapping area of the three GO term groups defined above. Knockdown by

RNA interference of the *pont*, *rept*, or *dom* genes showed a marked reduction of the NF- κ B reporter activity in S2 cells after heat-killed *E.coli* stimulation (Supplementary Data, RNAi screen file). Pont and Rept belong to the AAA+ (ATPase associated with diverse cellular activities) family of ATPases and are part of chromatin-remodeling complexes. Recent studies implicate these molecules in various cellular processes including transcription, DNA damage response, snoRNA assembly, and cancer metastasis¹⁴. Our data indicate that PONT and REPT are constitutively present in the IKK complex. It is an interesting possibility that the *Drosophila* IKK β kinase might directly phosphorylate one or both of these molecules — Dom is an SWR1-class chromatin-remodeling ATPase and has a role in the exchange of the phosphorylated form of the H2Av histone variant with unmodified H2Av in nucleosomal arrays during DNA damage¹⁵. Before H2A exchange by DOM, mammalian H2AX, an equivalent of *Drosophila* H2Av, can be acetylated by TIP60 (catalytic subunit of NuA4-type HAT complex), followed by polyubiquitinylation by the E2 ubiquitin-conjugating enzyme UBC13¹⁶. Interestingly, in our dataset, DOM is associated only at 2hr, with IAP2, which carries ubiquitin E3 ligase activity. We also noted that H2Av is associated with IAP2 only at 2 hr in our primary dataset (before cut-off). The precise mechanism of the NusA4 (TIP60) HAT complex in the activation of NF- κ B during bacterial challenge remains to be elucidated.

Pending an in-depth analysis of the precise functions of the various interactants found in this study, we chose to focus here on the relevance of the GO term “I κ B kinase activity”, which ranks first in Fig.3a, and the GO term “SUMO

binding". Indeed, we observed the presence of SUMO proteins in the *Drosophila* IKK complex which associates IRD5 (IKK β) and KEY(IKK γ). *Drosophila* expresses a gene encoding a SUMO protein (smt3) and we addressed the well-characterized *lwr*⁵ mutant flies, which carry a G-to-A missense mutation, replacing an Arg by a His at amino acid position 104 of the E2 SUMO-conjugation enzyme DmUBC9. As the homozygous mutants are lethal¹⁷, we infected heterozygote *lwr* flies with live *E.coli* and noted that these flies rapidly succumbed to this infection (Fig.3b). Consistently, bacterial growth in heterozygote *lwr* flies was drastically increased at day 10 postinfection, as compared to wild-type (Fig. 3c). Furthermore, the expression of the anti-bacterial peptide gene *Attacin A*, one of the representative target genes of NF- κ B in the IMD pathway, was significantly reduced in heterozygote *lwr* flies (Fig. 3d). These results reveal that sumoylation plays an important role in IMD-dependent immune responses against bacteria.

Sumoylation is a post-translational protein modification that contributes to many facets of functional regulations of proteins such as kinase activity, subcellular localization, protein-DNA binding etc. We next stably expressed HA-tagged IRD5 and KEY, together with polyhistidine-tagged SMT3, and performed affinity-purification of sumoylated proteins in denatured conditions followed by immunoblot using anti-HA antibodies. We found that IRD5 is sumoylated, but not KEY (Fig. 3e). In our experimental conditions, we observed that the majority of IRD5 is mono-sumoylated (Supplementary Fig.S2). Amino acid sequence alignment of the IRD5 homologues among 12

Drosophila species and several mammalian species, and the prediction of sumoylation sites using web-based bioinformatics software SUMOsp 2.0 (<http://sumosp.biocuckoo.org/>), led us to identify a potential sumoylation motif Y-K-x-D/E around K152. This sequence motif is conserved among all *Drosophila* species and in many vertebrate species; it is shared with another IKK family member, *i.e.* IKK α in mammals (Fig. 4a). Note that *Drosophila* IK2, and its mammalian orthologues TBK1 and IKK ϵ , do not have this Lysine residue although the sequence in this region is well conserved (Supplementary Fig.S3). As shown by 3D-structure analysis by Xu G et al¹⁸, the residue K152 is located in the loop between two β strands, β 6 and β 7 (Fig.4b). We next investigated whether the sumoylation consensus sequence in IRD5 is indeed sumoylated and, if so, which functional relevance it would assert in NF-kB activation. For this, we used *Drosophila* cell lines stably expressing polyhistidine-tagged SMT3 and either wild-type (WT) or mutated (K152A) IRD5 tagged with HA. Cells were stimulated with heat-killed *E.coli* and proteins were extracted followed by immunoprecipitation and immunoblotting. Figure 4c and d show that WT IRD5 is increasingly sumoylated over time; in contrast the mutated form (K152A) remains at the level of unstimulated cells. Note that IRD5 has three other potential sumoylation sites, which are not conserved among the different *Drosophila* species. We next analyzed the relevance of K152-sumoylation of IRD5 for NF-kB activation. For this, we knocked down *idr5* by RNA interference and observed that the level of induction of the reporter gene activity was lowered by 50% as compared to

controls. We then transfected these *ird5* knockdown cells by either (1) wild-type (WT), (2) SUMO mutant-form (K152A), or (3) kinase dead-form (K50A)¹⁹ of IRD5. Significantly only wild-type IRD5 could restore the effect observed in *ird5* knockdown cells (Fig 4e). The expression of different forms of *ird5* did not affect the level of induction (Supplementary Fig.S4). Furthermore we established *ird5* transgenic fly lines expressing either WT or K152A in an *ird5* deficient background. At 6 hours after injecting Gram-negative bacteria into these flies, we observed that only the WT construct could induce endogenous *Attacin A*, in contrast to K152A (Fig.4f). These data indicate that K152 sumoylation of IRD5 plays a pivotal role in NF- κ B activation *in vivo* and *in vitro*.

The data provided above may serve as a basis for further in depth analysis in the highly conserved regulatory network of the IMD pathway. The roles of many of the interactant proteins presented in the figures have remained elusive to date and their functions will have to be established both in the antimicrobial defense and in the “inflammation-like” reactions such as those noted in *DNaseII* deficient flies. In the latter case the receptors of the endogenous insults have not been characterized and we hope that studies like the one presented here will also be helpful to that effect.

Finally, as the vast majority of the 345 proteins isolated here have human orthologues, it is reasonable to expect that understanding their functions in *Drosophila* and in mammals will provide new targets for fighting diseases in the complex area of immune and these defenses.

Methods summary

Identification of interactants. Each of 11 canonical members of the IMD pathway was fused with biotin tag at N- or C- terminal and individual proteins were stably expressed in S2 cell line expressing bacterial biotinylation enzyme BirA. Individual stable transformants were stimulated by heat-killed E.coli and harvested at 4 different time points. The *in vivo* biotinylated bait protein complex at each time point was purified and subjected to LC-MS/MS analysis. After defining a cut-off, 345 genes were identified, visualized by Cytoscape⁷, and subjected to the GO analysis using DAVID¹³. Small scale-RNAi screens were performed as previously described^{10,20}.

Flies. Flies were infected with E.coli by injection and monitored for the survival and the bacteria growth. Transgenic flies were generated by ϕ C31 integrase-mediated transgenesis²¹.

Molecular biology and Biochemistry. S2 cells were transformed by Ca-Phosphate transfection. The Gateway® system was used for clonings (Life Technologies). The activation of the IMD pathway was measured by the promoter activities of the antimicrobial peptide *Metchnikowin* and *Attacin A* genes using Dual-Luciferase Reporter Assay System (Promega), or by quantitative RT-PCR (Applied Biosystems). Sumoylated proteins were purified under denatured condition using His-tagged SUMO.

Statistics. Prism software was used.

Figure Legends

Figure 1 Overview of the functional proteomics analysis of the IMD pathway. a, Work flow of the experiment. **b,** Overview of the IMD interactome. Diamonds, bait proteins; Circles, interactants. The size of nodes is in relation to the numbers of interactants. Gene symbols are listed. **c,** Number of identified proteins per bait. **d,** Fold change of number of identified proteins over time in each bait. Number of identified proteins at 0min is considered as a base.

Figure 2 Functional clusters common between Humans and Flies and their associated genes. a, GO terms of cellular component, biological process, and molecular function shared between Human and Fly annotation databases are shown. Black and Grey bars indicate fold enrichment values for Humans and Flies, respectively. Blue, green, or red color refers to the family or relative of the GO term described in the text. **b,** Clusters of genes in GO terms: Chromatin remodeling(SWI/SNF-type complex), Histone acetyltransferase complex (NuA4 histone acetylase complex), and Transcription cofactor binding. Colors correspond to those in section a.

Figure 3 Sumoylation cascade and its role in the defense against bacteria. **a**, Ontology term enrichment in Molecular function in the IMD interactome using *Drosophila* database. **b**, The survival of *dUbc9* mutants during bacterial challenge (WT, n=43; MUT, n=50). Statistical significance: * p<0.0001 by Log-rank test. **c**, Bacterial growth over time postinfection (n=3-4 per dot). Statistical significance: * p<0.0001 by two-tailed Student-t test (WT vs. MUT at day 10). Individual experiments are shown in dots and bars indicate the average and standard deviation. **d**, *Attacin A* induction at 6 hrs postinfection. The average and standard deviation of three independent experiments are shown. *Attacin A* expression is normalized to that of ribosomal protein RpL32. Statistical significance: * p=0.0143 by Student's t-test (WT vs. MUT during infection). **e**, SMT3 is covalently linked to IRD5 but not to KEY. HIS-tagged SMT3 was immunoprecipitated and HA-tagged IRD5 and KEY were detected by anti-HA antibody. 5% of input is shown as Total.

Figure 4 K152-sumoylation of IRD5 is induced and critical in AMP expression. **a**, Amino acid sequence alignment of the IRD5 homologues among 12 *Drosophila* species and of several mammalian species. Sumoylation consensus motif, Ψ-K-x-D/E: Ψ, hydrophobic amino acids; x, any amino acid. **b**, 3D-view of *Xenopus* IKKβ. Yellow region indicates Lysine in the consensus motif^{d18}. **c**, K152 of IRD5 is sumoylated in a stimulation-dependent manner. HIS-tagged SMT3 was immunoprecipitated and HA-tagged IRD5 WT and IRD5 K152A were detected by anti-HA antibody. 5% of input is shown as Total. **d**, A time dependent analysis of the levels of sumoylation in cells transfected with WT versus K152A

IRD5 constructs; cells were in addition challenged by administration of heat-killed *E.coli* at 0 min (control), 10 min, 2 hour and 8 hour. The value observed at 0 min for WT constructs was set as 1 in the scale. The average and standard deviation from three experiments are shown. One-way ANOVA was performed ($p=0.0009$) and followed by Dunnett's multiple comparison test. * indicates statistically significance ($p<0.05$) as compared to WT at 0 min. **e**, IRD5 WT constructs restore *Attacin A* induction but not the SUMO-mutant and Kinase-dead forms. S2 cells were knocked down by *GFP* dsRNA as negative control or 3'UTR *Ird5* dsRNA and various forms (WT, wild-type; K152A, SUMO-mutant; K50A, kinase-dead) of *Ird5* were individually expressed. Firefly luciferase activities of the reporter *AttacinA*-Firefly Luciferase were measured and normalized to Renilla luciferase activities of *Act5C*-Renilla Luciferase. The relative value against non-stimulated cells is shown. The value represents the average and standard deviation from three independent experiments. One-way ANOVA was performed ($p=0.0003$) and followed by Dunnett's multiple comparison test. * indicates statistically significance ($p<0.05$) as compared to Vec/GFP:GFP dsRNA knockdown; empty vector transfection. **f**, *In vivo* rescue experiment. *Ird5* WT or K152A transgenic flies in *Ird5*-deficient background were established using Φ C31 transgenesis. Flies were challenged by live *E.coli*. *Attacin A* mRNA level was measured by quantitative RT-PCR and normalized to RpL32. The relative values are indicated against non-transgenic *Ird5* mutants. Each value represents the average with standard deviation, from three independent experiments. A pool of 5-7 adult flies per genotype was collected in each experiment. One-way ANOVA was performed ($p<0.0001$) and followed by Dunnett's multiple comparison test. * indicates statistical significance ($p<0.05$) by comparing to non-transgenic *Ird5* mutants.

Materials and Methods:

Fly lines and transgenesis

All flies were raised on standard cornmeal–agar medium at 25°C at a light cycle- and humidity controlled-room. *cn[1] bw[1]* and *y[1] w[1]* flies were used for wild-type controls. *y[1] w[*]; lwr[5] b[1] cn[1] bw[1]/CyO*, *y[+](FBst0009317)* and *P{ry[+t7.2]=Dipt2.2-lacZ}3, ird5[1] ca[1]/TM6B, Tb[1](FBst0030916)* were obtained from the Bloomington stock center. For Φ C31-mediated transgenesis previously described²¹, we utilized 2nd chromosome-linked attB landing fly line *y[1] M{vas-int.Dm}ZH-2A w[*]; M{3xP3-RFP.attP}ZH-51D (FBst0024483)* from the Bloomington stock center. By crossings, we generated and analyzed on *y[1] w[*]/Y; M{3xP3-RFP.hsp-IRD5-WT or K152A}ZH-51D/+; P{ry[+t7.2]=Dipt2.2-lacZ}3, ird5[1] ca[1]*.

Antibodies and other reagents

The following antibodies and a reagent were used in this study: mouse monoclonal antibodies against human CD4 (clone RPA-T4; GE Healthcare) for flow cytometry; streptavidin-HRP (Roche), rabbit polyclonal antibodies against HA (Sigma), and mouse monoclonal antibodies against 6X His (clone HIS.H8, Millipore) for immunoblotting.

Cloning and plasmid construct

Each cDNA from 11 genes in the *Drosophila* IMD pathway was amplified by PCR and inserted into a pDONR221 or a pDONR201 vector (Invitrogen) using Gateway[®]

cloning system according to the manufacture's protocol. These genes are: PGRP-LCx (FBgn0035976), PGRP-LE (FBgn0030695), imd (FBgn0013983), FADD (FBgn0038928), Dredd (FBgn0020381), Iap2 (FBgn0015247), Tab2 (FBgn0086358), Tak1 (FBgn0026323), Key (FBgn0041205), Ird5 (FBgn0024222) and Rel (FBgn0014018). Briefly, for N-terminal tagging, forward primers consist of 31-nucleotide sequence containing *attB1* sequence and gene specific sequence depleting Methionine codon(s) in the beginning of CDS. Reverse primers contain gene specific sequence followed by triple STOP codons and *attB2* sequence. For C-terminal tagging, forward primers contain *attB1* sequence, KOZAK sequence, and gene specific sequence. Reverse primers have *attB2* sequence and gene specific sequence excluding STOP codon. For TAB2 cloning, we used pCR[®]8/GW/TOPO[®] vector (Invitrogen). pIZ/V5-His(Invitrogen)-backbone pDEST-BIO-N or -C contains biotin-tag sequence (encoding a peptide of GLNDIFEAQKIEWHE), the chloramphenicol resistance gene and the *ccdB* gene flanked by *attR1* and *attR2* sites, and *Drosophila* C virus inter ribosomal entry site (between *gp1* and *gp2*) fused with cDNA of cytoplasmic region-truncated form of human CD4 C-terminal tagged with V5 epitope and 6XHis for clone selections by flow cytometry (Supplementary Fig.S5). After confirming sequence of each pENTRY construct, LR reaction was performed using pDEST-BIO-N or -C for N-terminal or C-terminal tagging, respectively. A total of 22 plasmids (11 genes x 2 different location tagging) were prepared for establishing stable transformants. BirA cDNA was gift from F.G. Glosveld and cloned into pPAC *Drosophila* expression vector under the control of *Actin5C* promoter (pPAC-HA-BirA). pJL169 is a NF- κ B activation reporter plasmid containing *Firefly luciferase* gene fused with *Attacin A* promoter. pJL346 contains Renilla Luciferase gene driven by *Actin5C* promoter. pJL1 plasmid contains *pac* (Puromycin N-acetyl-transferase)

gene fused with *Act5C* promoter. Plasmid for IRD5 kinase-dead form K50A or SUMO-mutant form K152A was generated from pENTRY-N-IRD5 WT by mutagenesis. Series of expression plasmid pHHW-IRD5 (WT, K152A, and K50A) were generated by gateway cloning and then by conventional subcloning method we generated pMT-HA-N-IRD5 series for immunoprecipitation experiment. For functional analysis by transient expression of IRD5 (also known as DLAK) using S2 cells, pPAC-His-DLAK series were used. pPAC-His-DLAK WT and K50A were provided by Dr. WJ Lee. Further pPAC-His-DLAK K152A was generated using DNA fragment from pENTRY-N-IRD5 K152A.

All primers used in this study are listed in Supplementary Data, List of primers.

dsRNA synthesis

Forward and reverse primers contain T7 promoter sequences and gene-specific sequences were synthesized. PCR fragments were amplified with pairs of primers targeting at GFP and IRD5 3' UTR listed in Supplementary Table 2. dsRNA were synthesized using the PCR fragments as templates by MEGAscript T7 transcription kit (Ambion) and purified by RNeasy Mini kit (Qiagen) or NucleoSpin® RNAII kit (Macherey-Nagel).

Cell lines

Drosophila S2 cells were purchased from Invitrogen and transfected with plasmid DNAs by Ca-phosphate precipitation method. A stable cell line 1F3 was established by transfecting pPAC-HA-BirA, pJL169 (*AttacinA*-Firefly Luciferase), and pJL1

(Puromycin selection) plasmids, and selected in the media containing 2 µg/ml puromycin. After testing the BirA protein expression by immunoblotting and immune response against Heat-killed *E.coli* by the luciferase reporter assay described below, the clone was chosen. Each plasmid of 22 pDEST-BIO constructs was transfected into 1F3 cell line and stable clones were selected in the media containing both Zeocine (125 µg/ml) and puromycin (1 µg/ml) and further by the expression level of human CD4 by flow cytometry using antibodies against human CD4. After three rounds of flow cytometry screens, clones giving high expression profiles were chosen and verified by immunoblotting with streptavidin-HRP for their protein expressions and molecular sizes. All selected clones were tested for immune responses against Heat-killed *E.coli* by the luciferase reporter assay. One of clones for each construct was subjected to protein complex purifications. For purification of SMT3-linked IRD5 WT, IRD5 K152A, or KEY, stable cell lines were established by co-transfected with pPAC-6xHis-smt3 and pMT-HA-IRD5 WT or K152A and selected in the media containing 2 µg/ml puromycin.

Luciferase assay

Cells transfected with the reporter gene were stimulated by heat-killed *E.coli* for 8 hours. After harvesting them and lysed with 1x Reporter lysis buffer (Promega), lysates were mixed with luciferase assay reagent (Promega) and measured by Mithras LB 940 (Berthold Technologies). The fold induction was calculated as follows:

$$\text{Fold Induction} = (\text{FLuc/RLuc})_{\text{HK stimulation}} / (\text{FLuc/RLuc})_{\text{No stimulation}}$$

Fly infection study

Flies at age of 3-5 days were infected by intrathoracic injection (Nanoject II apparatus; Drummond Scientific) of 13.8 nl of a tandem dimmer Tomato expressing-DH5a suspension (OD=1), incubated at 25°C, and monitored for their survivals for 2 weeks. For bacterial growth, 3-4 infected flies were homogenized in PBS. Diluted homogenates were spread on LB agar plate containing ampicillin and numbers of colonies were counted.

Q-PCR

Flies were collected at 6 hours after bacterial infections and total RNA was extracted using NucleoSpin® RNAII kit (Macherey-Nagel). TaqMan® RNA-to-CT™ 1-Step Kit (Applied Biosystems) with Attacin A (Dm02362218_s1) and RpL32 (Dm02151827_g1) of TaqMan® Gene Expression Assays primers and probes (Applied Biosystems) was used for quantitative RT-PCR via 7500 Fast Real-Time PCR System (Applied Biosystems). A pool of 5-10 flies was used for each experiment. The expression of the antimicrobial peptide gene was normalized to the expression of the RpL32 gene for each sample. Each assay was performed in duplicates and the average of the duplicates was used for a single experiment data set. Three independent experiments were performed.

IRD5 rescue experiment on S2 cells

1F3 cell line (1.0×10^6 cells) was transfected with 1.5µg of dsRNA against either GFP or IRD5 3' UTR, 1µg of plasmid (pPAC-DLAK-WT, -K50A, or -K152A), and 20ng of the pJL346 (*Act5C*-Renilla Luciferase) by Ca-phosphate precipitation method. At

48 hours after transfections, cells were stimulated with heat-killed *E.coli* at m.o.i 40. Cells were harvested at 8 hours after stimulations for luciferase assays. For each experiment, transfections were performed in triplicates in 24 well plates. The firefly and renilla luciferase activities in each well were measured in duplicates and averaged for a single data set. The experiment was repeated for three times.

Immunoprecipitations and immunoblotting

IRD5 and KEY proteins were expressed in the stable S2 cell lines that were treated with copper sulfate for 24 hours at the final concentration of 500 μ M and then stimulated with heat-killed *E.coli* at m.o.i 40 over time. 6×10^6 cells per a 6cm-dish were divided into two parts: 15% of the portion was used for quantifying the inputs of total proteins and the rest was used for purification of 6xHis-tagged SMT3-protein conjugates. The protocol of Rodriguez, M.S. et al²² was followed. Approximately 5.1×10^6 cells (85%) of cells were lysed in 2.4 ml of Guanidium lysis buffer (6M Guanidium-HCl, 0.1 M Na₂HPO₄/NaH₂PO₄, 0.01 M Tris-HCl pH 8.0 plus 5 mM imidazole and 10 mM β -mercaptoethanol. The lysates were mixed with 50 μ l of Ni²⁺-NTA-agarose beads pre-washed with the lysis buffer and incubated for overnight at room temperature with agitation. The beads were sequentially washed with the following buffers: Buffer A (6M guanidinium-HCl, 0.1M Na₂HPO₄/NaH₂PO₄, 0.01M Tris-HCl pH 8.0 plus 10 mM β -mercaptoethanol); Buffer B (8 M urea, 0.1 M Na₂HPO₄/NaH₂PO₄, 0.01 M Tris-HCl pH 8.0, 10 mM β -mercaptoethanol); Buffer C (8 M urea, 0.1 M Na₂HPO₄/NaH₂PO₄, 0.01 M Tris-HCl pH 6.3, 10 mM β -mercaptoethanol plus 0.2% Triton X-100); Buffer D (8 M urea, 0.1 M Na₂HPO₄/NaH₂PO₄, 0.01 M Tris-HCl pH 6.3, 10 mM β -mercaptoethanol plus 0.1%

Triton X-100). After the last wash with buffer D the beads were eluted with 200 mM imidazole in 5% SDS, 0.15 M Tris-HCl pH 6.7, 30% glycerol, 0.72 M β -mercaptoethanol. The elutes were subjected to SDS-PAGE (10% or 18%) and the proteins transferred to PVDF membrane. Immunoblotting was performed with polyclonal antibodies against HA. Signal intensity per band was quantified by Fusion Fx (Vilber Lourmat). Ratio of the band signal intensity of SMT-IRD5 to that of IRD5 was calculated. The value observed at 0 min for IRD5 WT was set as 1 in the scale. The fold signal intensity was presented.

Protein complex purification

Cells ($\sim 10^8$) of each clone were harvested at four different time points (t=0 min, 10 min, 2 hours, and 8 hours) in 1ml TNT buffer (50mM Tris-HCl, pH7.5, 150mM NaCl, 10% Glycerol, 1% Triton X-100, 100mM NaF, 5 μ M ZnCl₂, 1mM Na₃VO₄, 10mM EGTA, pH8.0, proteinase inhibitor complete containing EDTA). Lysate was kept on ice for 30 min. Centrifuge 13000rpm for 30 min at 4°C. Supernatant was mixed with 150 μ l of pre-washed streptavidin-sepharose beads and rotated for 30 min at 4°C. The beads were washed as follows: three times with WASH buffer I (50mM Tris-HCl, pH7.5, 150mM NaCl, 10% Glycerol, 1% Triton X-100, 100mM NaF, 5 μ M ZnCl₂, 1mM Na₃VO₄, 10mM EGTA, pH8.0), one time with WASH buffer II (50mM Tris-HCl, pH7.5, 150mM NaCl, 10% Glycerol, 100mM NaF, 5 μ M ZnCl₂, 1mM Na₃VO₄, 10mM EGTA, pH8.0), and suspended in WASH buffer III (50mM Tris-HCl, pH7.5, 150mM NaCl, 10% Glycerol, 100mM NaF, 5 μ M ZnCl₂, 1mM Na₃VO₄, 10mM EGTA, pH8.0, proteinase inhibitor complete containing EDTA).

Mass spectrometry and data analysis

The beads in WASH buffer III were further washed by WASH buffer IV (50mM Tris-HCl, pH7.5, 150mM NaCl) for three times. Beads were directly incubated with a reducing solution (5mM DTT, 25mM NH₄HCO₃) for 30min at 56°C and subsequently with alkylating solution (25mM iodoacetamide, 25mM NH₄HCO₃) for 20min to overnight. Then samples were incubated for ?? at ?? at ??°C with 10ng of trypsin and peptides were recovered by filtering through C18 Proxeon Tips. Five times-diluted peptide samples were separated by a reverse-phase column (PepmapC18, 75mm diameter, 15cm long, Dionex) at a flow rate of 220nL/min using a gradient of 90 min from ????. FTICR-type spectrometer (LTQ-FT, ThermoFisher) with resolution 6000 at the range between 500 and 2000Da was used. Total of 6 scans of spectra with the most intense peaks were collected. Searches against 17D_melanogaster (16535 entries) were performed for each sample using MASCOT software (<http://www.matrixscience.com/>). Protein showing two peptides with a score higher than 30 or one peptide with that higher than 50 were validated. Protein modifications of Carbamidomethylation(C), oxydation (M, H, W), Phosphorylation (Y) were incorporated to this analysis. In addition, the fragment spectra should have, at least, a succession of y- and/or b- ions. Peptides failing to meet these criteria were rejected. (See detailed in the section “Selection of the identification method” in Supplementary information)

Interactome visualization and gene ontology studies

Protein-protein interactions were visualized by CYTOSCAPE Ver.2.8 open-source software⁷. Human orthologues corresponding to our interactant genes were listed by

referring to Ensembl BioMart, FlyMine, or FlyBase. Some interactant genes were further analyzed by alignments using BlastP. When multiple human orthologues were found, the highest identity in percentage with respect to *Drosophila* gene was taken as a representative gene. Since we ranked the gene ontology terms in enrichment fold, we submitted the same number of genes for Human or *Drosophila* database. The Database for Annotation, Visualization and Integrated Discovery (DAVID) v6.7 was used for our gene ontology studies¹³.

Statistics

Two-tailed Student's t-test and one-way ANOVA were used for statistic analysis using Prism software.

References

- 1 Ferrandon, D., Imler, J. L., Hetru, C. & Hoffmann, J. A. The *Drosophila* systemic immune response: sensing and signalling during bacterial and fungal infections. *Nature reviews* 7, 862-874 (2007).
- 2 Georgel, P. *et al.* *Drosophila* immune deficiency (IMD) is a death domain protein that activates antibacterial defense and can promote apoptosis. *Developmental cell* 1, 503-514 (2001).
- 3 Lemaitre, B., Nicolas, E., Michaut, L., Reichhart, J. M. & Hoffmann, J. A. The dorsoventral regulatory gene cassette *spatzle/Toll/cactus* controls the potent antifungal response in *Drosophila* adults. *Cell* 86, 973-983 (1996).
- 4 Mukae, N., Yokoyama, H., Yokokura, T., Sakoyama, Y. & Nagata, S. Activation of the innate immunity in *Drosophila* by endogenous chromosomal DNA that escaped apoptotic degradation. *Genes & development* 16, 2662-2671 (2002).
- 5 Liu, X. *et al.* *Drosophila* EYA regulates the immune response against DNA through an evolutionarily conserved threonine phosphatase motif. *PLoS ONE*, in press (2012).
- 6 Fukuyama, H. *et al.* On-bead tryptic proteolysis: An attractive procedure for LC-MS/MS analysis of the *Drosophila* caspase 8 protein complex during immune response against bacteria. *J Proteomics*, doi:S1874-3919(12)00136-4 [pii] 10.1016/j.jprot.2012.03.003 (2012).
- 7 Cline, M. S. *et al.* Integration of biological networks and gene expression data using Cytoscape. *Nat Protoc* 2, 2366-2382, doi:nprot.2007.324 [pii] 10.1038/nprot.2007.324 (2007).
- 8 Murali, T. *et al.* DroID 2011: a comprehensive, integrated resource for protein, transcription factor, RNA and gene interactions for *Drosophila*. *Nucleic Acids Res* 39, D736-743, doi:gkq1092 [pii] 10.1093/nar/gkq1092 (2011).
- 9 Foley, E. & O'Farrell, P. H. Functional dissection of an innate immune response by a genome-wide RNAi screen. *PLoS Biol* 2, E203, doi:10.1371/journal.pbio.0020203 (2004).
- 10 Kleino, A. *et al.* Inhibitor of apoptosis 2 and TAK1-binding protein are components of the *Drosophila* Imd pathway. *EMBO J* 24, 3423-3434, doi:7600807 [pii] 10.1038/sj.emboj.7600807 (2005).
- 11 Gesellchen, V., Kuttenukeuler, D., Steckel, M., Pelte, N. & Boutros, M. An RNA interference screen identifies Inhibitor of Apoptosis Protein 2 as a regulator of innate immune signalling in *Drosophila*. *EMBO reports* 6, 979-984 (2005).
- 12 Lhocine, N. *et al.* PIMS modulates immune tolerance by negatively regulating *Drosophila* innate immune signaling. *Cell Host Microbe* 4, 147-158, doi:S1931-3128(08)00222-9 [pii] 10.1016/j.chom.2008.07.004 (2008).
- 13 Huang da, W., Sherman, B. T. & Lempicki, R. A. Systematic and integrative analysis of large gene lists using DAVID bioinformatics resources. *Nat*

- Protoc* 4, 44-57, doi:nprot.2008.211 [pii] 10.1038/nprot.2008.211 (2009).
- 14 Jha, S. & Dutta, A. RVB1/RVB2: running rings around molecular biology. *Mol Cell* 34, 521-533, doi:S1097-2765(09)00349-9 [pii] 10.1016/j.molcel.2009.05.016 (2009).
- 15 Gevry, N., Chan, H. M., Laflamme, L., Livingston, D. M. & Gaudreau, L. p21 transcription is regulated by differential localization of histone H2A.Z. *Genes Dev* 21, 1869-1881, doi:21/15/1869 [pii] 10.1101/gad.1545707 (2007).
- 16 Ikura, T. *et al.* DNA damage-dependent acetylation and ubiquitination of H2AX enhances chromatin dynamics. *Mol Cell Biol* 27, 7028-7040, doi:MCB.00579-07 [pii] 10.1128/MCB.00579-07 (2007).
- 17 Apionishev, S., Malhotra, D., Raghavachari, S., Tanda, S. & Rasooly, R. S. The Drosophila UBC9 homologue lesswright mediates the disjunction of homologues in meiosis I. *Genes Cells* 6, 215-224, doi:gtc413 [pii] (2001).
- 18 Xu, G. *et al.* Crystal structure of inhibitor of kappaB kinase beta. *Nature* 472, 325-330, doi:nature09853 [pii] 10.1038/nature09853 (2011).
- 19 Kim, Y. S. *et al.* Lipopolysaccharide-activated kinase, an essential component for the induction of the antimicrobial peptide genes in Drosophila melanogaster cells. *J Biol Chem* 275, 2071-2079 (2000).
- 20 Ramadan, N., Flockhart, I., Booker, M., Perrimon, N. & Mathey-Prevot, B. Design and implementation of high-throughput RNAi screens in cultured Drosophila cells. *Nat Protoc* 2, 2245-2264, doi:nprot.2007.250 [pii] 10.1038/nprot.2007.250 (2007).
- 21 Bischof, J., Maeda, R. K., Hediger, M., Karch, F. & Basler, K. An optimized transgenesis system for Drosophila using germ-line-specific phiC31 integrases. *Proc Natl Acad Sci U S A* 104, 3312-3317 (2007).
- 22 Rodriguez, M. S. *et al.* SUMO-1 modification activates the transcriptional response of p53. *EMBO J* 18, 6455-6461, doi:10.1093/emboj/18.22.6455 (1999).

a

11 genes in the IMD pathway for bait proteins

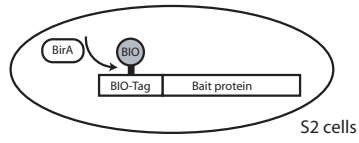

22 stable transformants (N- or C- Tagging)

Stimulation by Heat-killed Bacteria

Harvest at 0 min, 10min, 2hrs, 8hrs

88 samples Affinity purifications
(+ control samples)

88 samples LC-MS/MS mass spectrometry
(+ control samples)

345 proteins identified

b

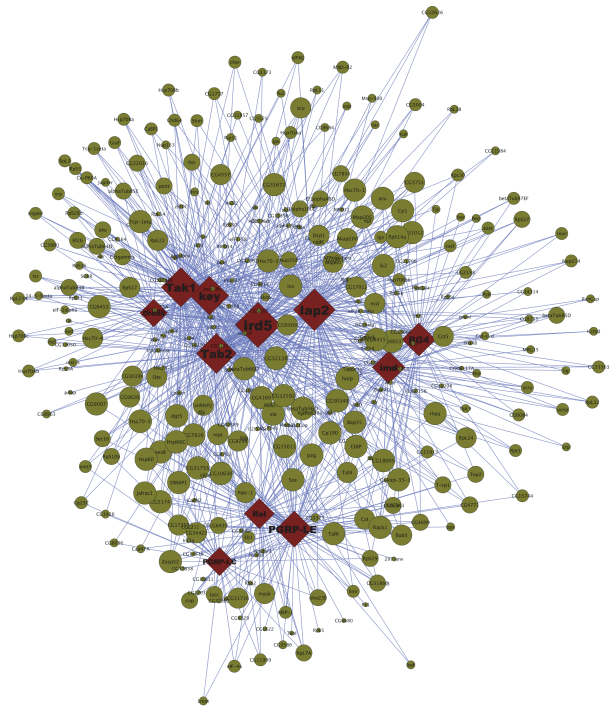

c

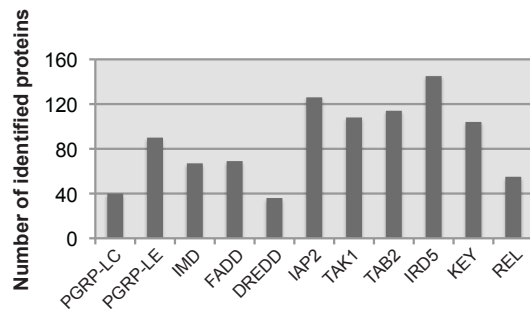

d

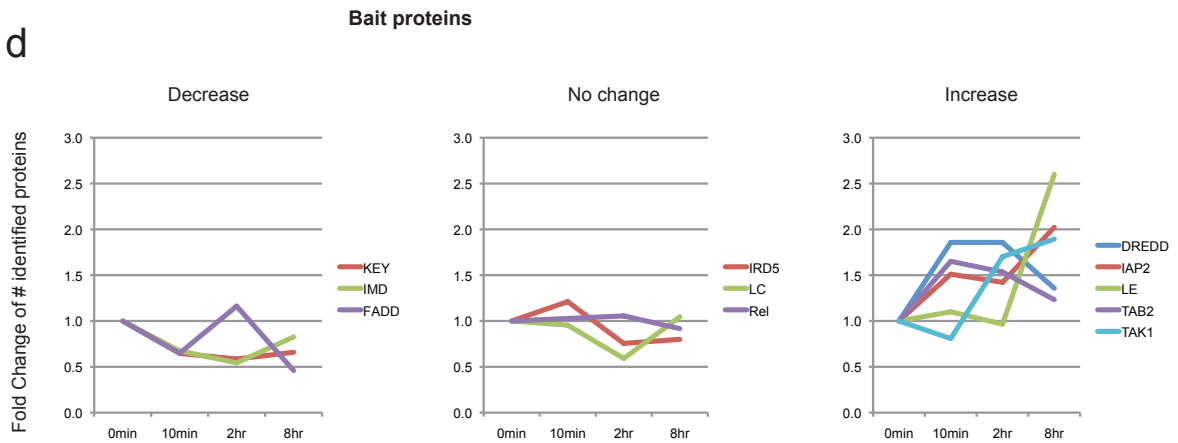

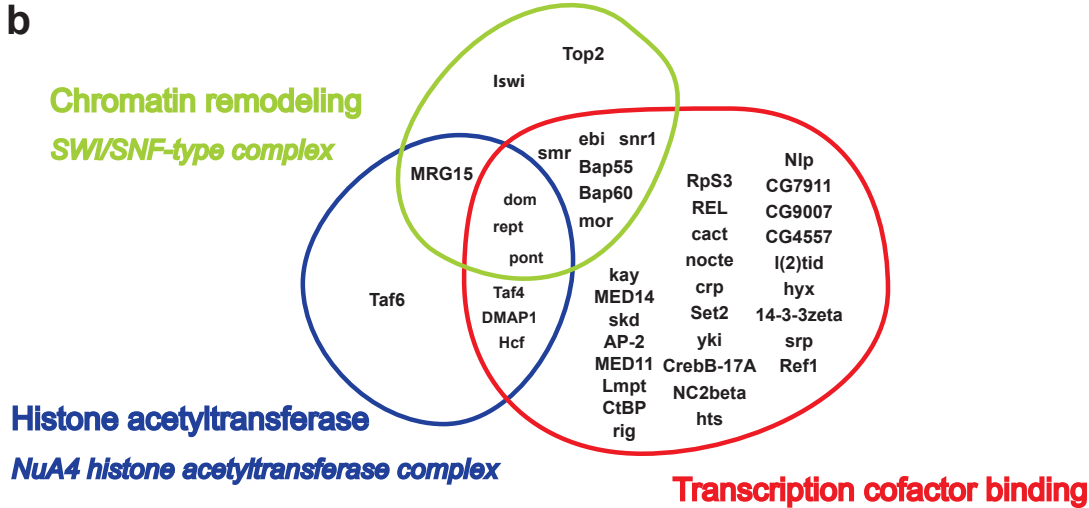
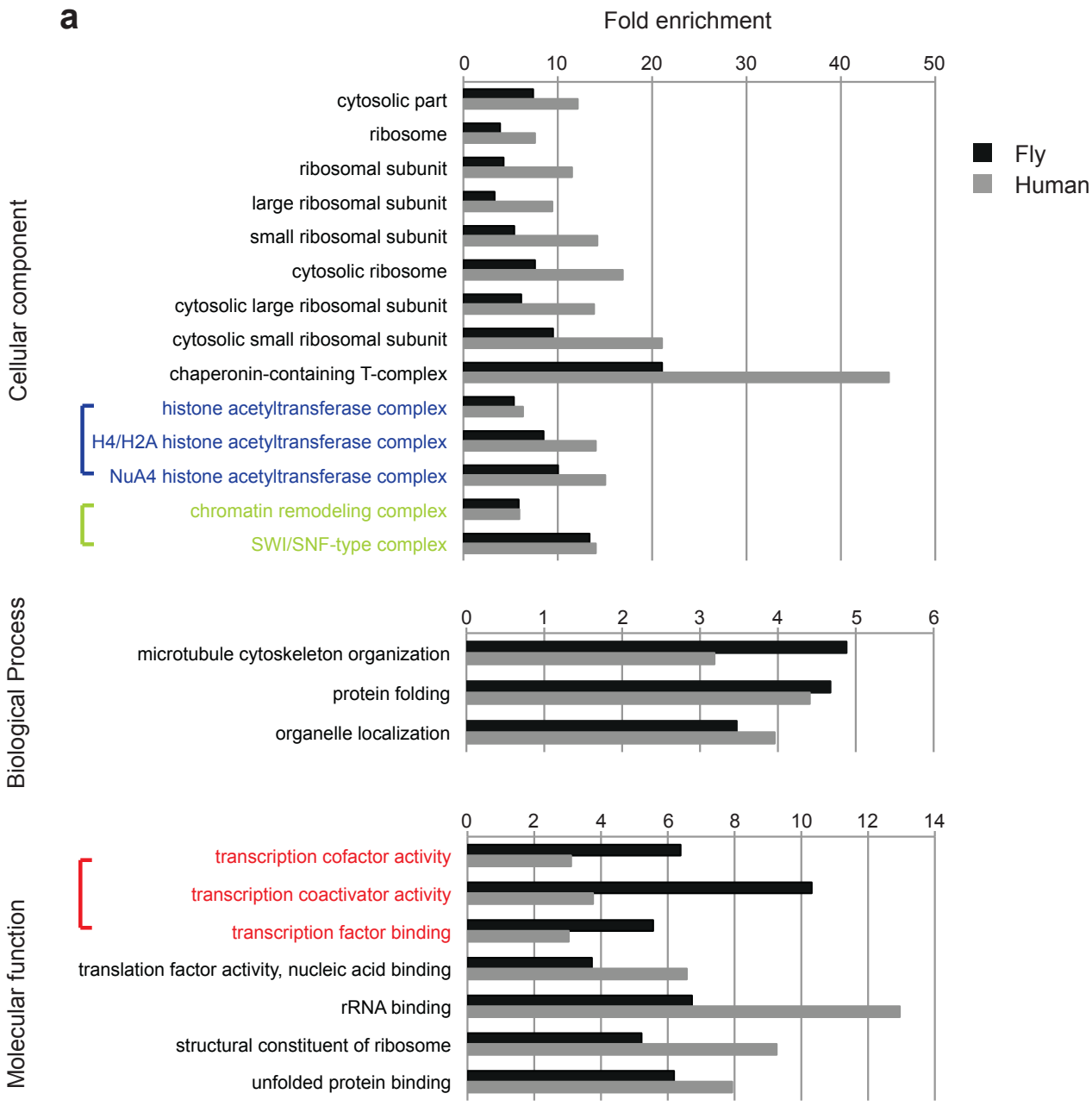

a

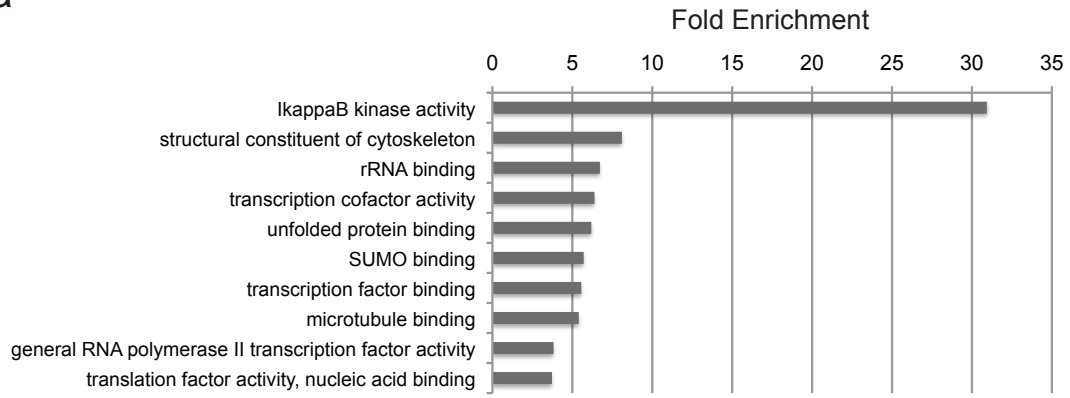

b

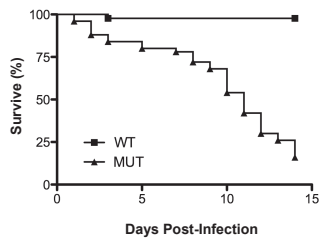

c

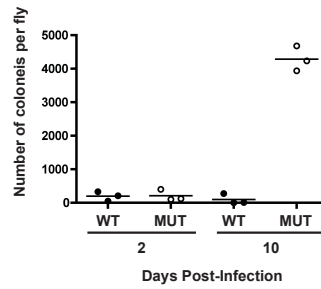

d

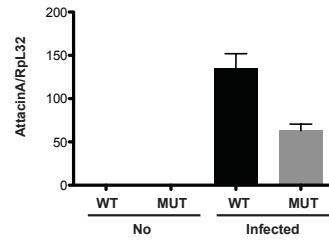

e

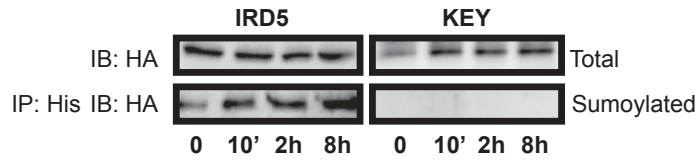

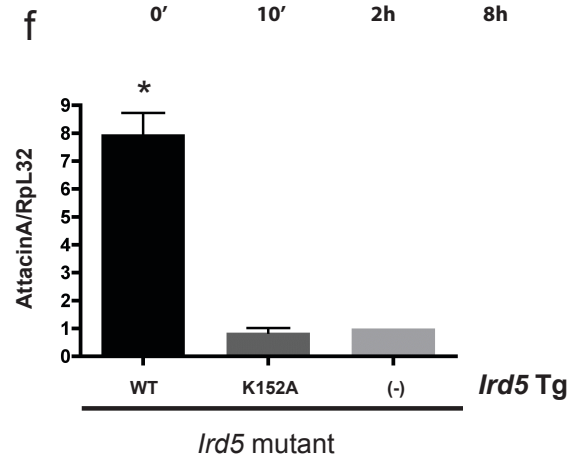
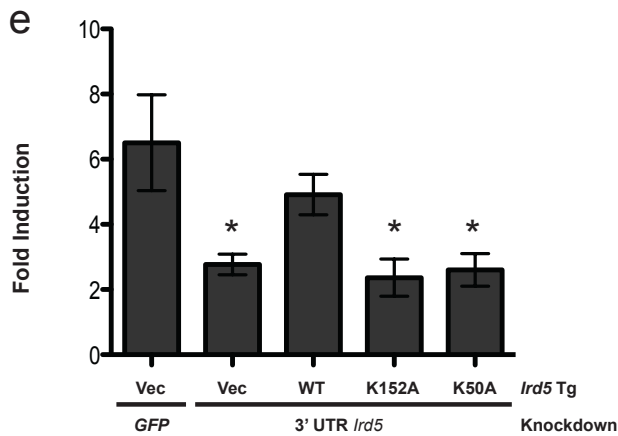
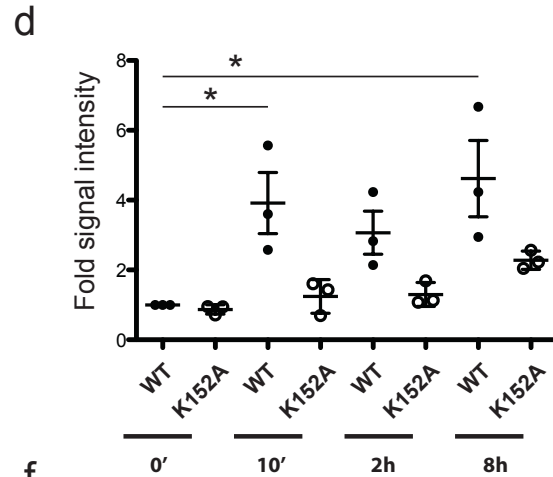
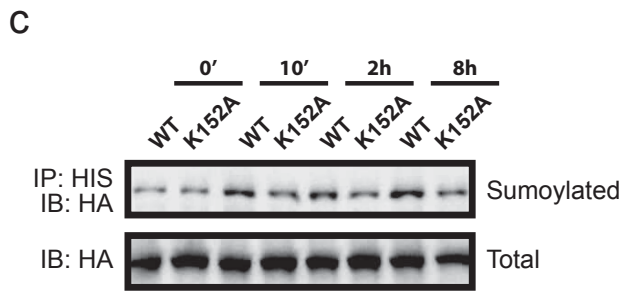
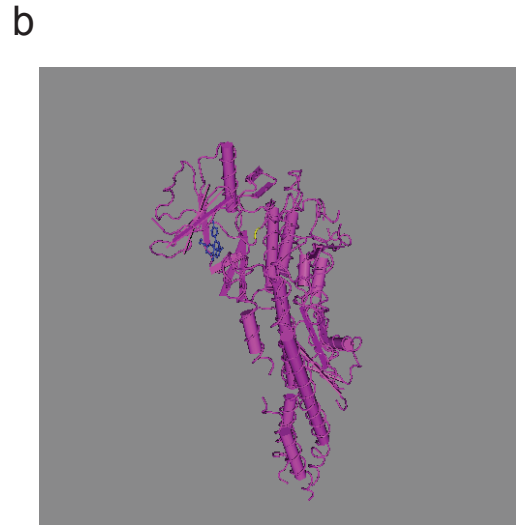
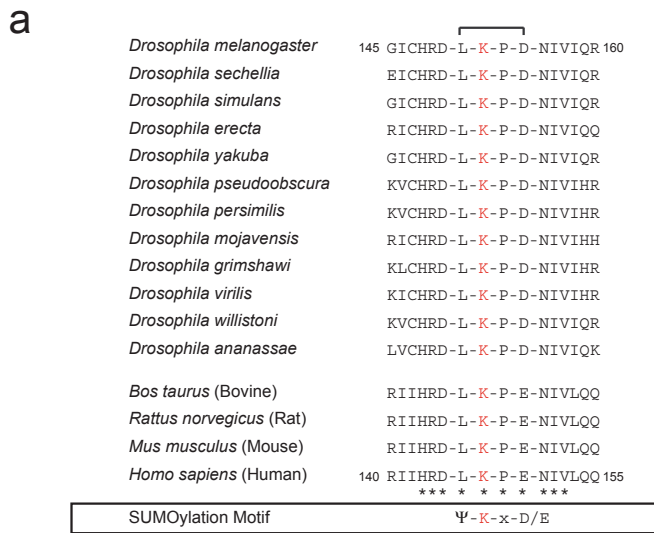

Supplementary Information

Supplementary Methods

Selection of the identification method

Cells and RNAi screens

Supplementary Figures

S1 Interactants and protein-protein interactions shared with DroID

S2 Mono-sumoylation on IRD5

S3 Alignment of IKK family members at the conserved sumoylation site

S4 Expression of IRD5 transgenes

S5 Expression vector construct and the experimental flow

S6 The flow of defining a cut-off method

Supplementary Tables

S1 Different cut-off settings and their parameters

S2 Generating a short list for RNAi-mediated functional screen

S3 Cut-off methods and sizes of population to be handled after cut-off by individual methods

Supplementary Equation

Biological cut-off

Supplementary Data

List of interactants in IMD interactome

Protein-Protein interaction SIF file

Summary of RNAi screens

List of primers

Supplementary Methods

Selection of the identification method

An overview of the procedure of the identification method is shown in Supplementary Figure S5. We took two sequential steps of cut-off and termed them: (1) Mechanical and (2) Biological cut-offs. The mechanical cut-off was performed in the process of MS/MS Ion search. The biological cut-off was made by comparing series of samples to the parental cell line (1F3) that does not express bait protein and was not stimulated in individual experimental runs of MS/MS. The detailed cut-off methods were described as below:

Mechanical data cut-off

We used two different software search engines, MASCOT (Matrix Science) with a cut-off setting (MASCOT 2 in Supplementary Table S1) and Bioworks (ThermoFisher) with a cut-off setting (Bioworks 3 in Supplementary Table S1), and identified 3170 proteins corresponding to 2635 genes in total. To define an identification method with higher stringency that provides us a list of proteins with high confidence, we decided to perform a small-scale RNAi-mediated gene knockdown experiment on a short list of selected 519 genes. We selected these genes as follows. As shown in Supplementary Table S1, several cut-off settings (Mascot 1,2, and 3; Bioworks 1,2, and 3) were established with these options: (1) search engines, (2) number of peptides and threshold values, (3) presence or absence of distinct peptides, (4) the m/z values either of the b- and y- ions or of all ions.

We generated a criss-cross table of different cut-off settings of MASCOT and Bioworks and grouped by different stringencies into 5 (Supplementary Table S2, Upper table). We chose numbers of genes from each group as shown in Supplementary Table S2, Lower table and performed the RNAi experiment. We included 10 genes not related to this experiment and set them as Group 6. *Drosophila* S2 cells were knocked down with dsRNA for each gene, stimulated with heat-killed *E.coli*, and activities of the reporter gene Metchnikowin as a read-out of NF- κ B activation were monitored (Supplemental Data, RNAi screens). We termed genes that give either positive or negative impacts on Metchnikowin reporter activities as “RNAi positive” genes (see the details in RNAi screen section). As we expected, group 1 and 2, which have high stringency cut-off settings, provided us high percentages of “RNAi positive” genes, as compared to other groups. Using this RNAi screen result on selected 519 genes, we next compared 6 different cut-off methods by the proportion of “RNAi positive” genes in the population selected by each method (Supplementary Table S4). From 3170 proteins, Method 2 and 4 reduce to 246 and 132 proteins by cut-off, respectively. In contrast, Method 3 and 5 only reduce to 2157 and 1514 proteins. We decided to take intermediate stringent Method 1 or 6. Method 6 has slightly higher proportion of “RNAi positive” genes, as compared to Method 1. We chose Method 6 for further analysis.

Biological data cut-off

We eliminate interactant candidates with the condition that the average number of peptides of 4 (4 time points in one terminal tag) or 8 (4 time points in both terminal tags)

protein complexes per bait protein is less than or equal to two times larger number of peptides from negative control parental cell line (Supplementary Equation).

As shown in Supplementary Figure S6, the mechanical data cut-off reduces to 495 proteins and the biological data cut-off further eliminates 30 proteins. Proportion of “RNAi positive “ is increased from 16.4% in short list before cut-offs to 26.4% after the biological cut-off. This result indicates that our cut-off method enriches functional population of genes. The size of IMD interactome dataset is 465 proteins corresponding to 345 genes. Two hundred and thirty one genes out of 345 were tested for their function in the activation of IMD pathway using the same cell line 1F3. Thirty three percent of genes affect the activation of the IMD pathway (Supplementary Data files, RNAi screen and Summary of interactants in IMD interactome).

RNAi screens

Cell culture, dsRNA synthesis, RNAi treatment and luciferase experiments were performed essentially as previously described¹¹. Primer and amplicon sequence information is referred to <http://rna.dkfz.de>. For the IMD pathway, briefly, 15,000 S2 cells/well were transfected with mtk-luc firefly luciferase reporter plasmid and pRp128-RL. After 72 hours of incubations, heat-killed *E.coli* was added to final concentration of 200ug/ml. Sixteen hours after stimulation, mtk-luc activity was measured with a Mithras LB940 plate reader (Berthold Technologies). Five hundred nineteen genes listed in

Supplemental Data, RNAi screen were tested. We considered genes with Z-score >1.8 (for positive regulators) or <-1.8 (for negative regulators) as relevant regulators on the IMD pathway activation and termed them as “RNAi positive”. Using the same preparation of dsRNA library, we performed RNAi screen on the parental cell line 1F3 that carry *AttacinA*-luciferase (pJL169) and was used for proteomics analysis. For this RNAi screen, we followed a protocol by Ramadan N et al²⁰. The screen was performed in duplicate. The value was calculated as follows:

$$(\text{FLuc}_{\text{stim.}}/\text{FLuc}_{\text{no stim.}})_{\text{dsRNA treated cells}} / (\text{FLuc}_{\text{stim.}}/\text{FLuc}_{\text{no stim.}})_{\text{no treated cells}}$$

We considered genes with value >1.25 (for negative regulators) or <0.75 (for positive regulators) as “RNAi positive” genes.

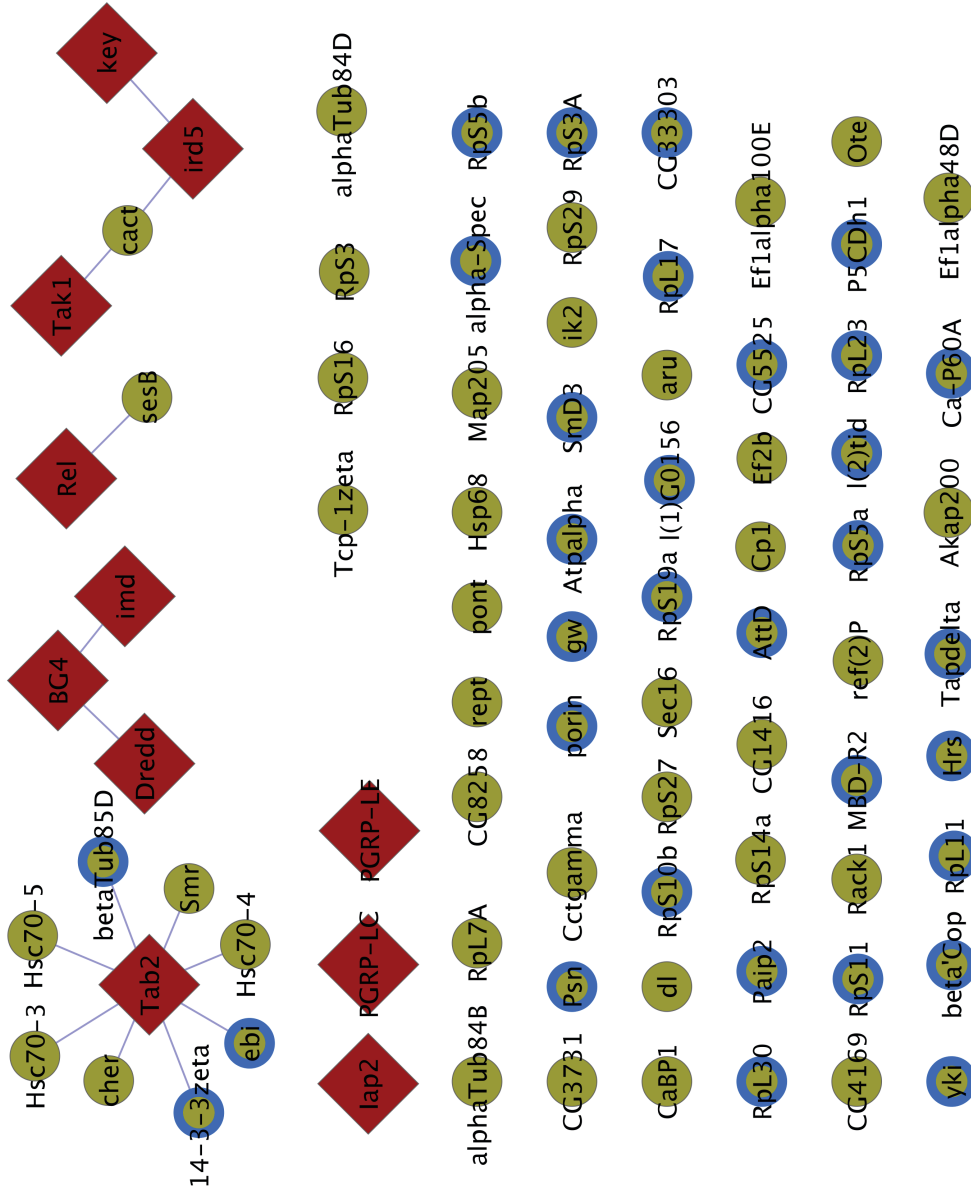

Supplementary Figure S1. Interactors and protein-protein interactions shared with *in scilico* IMD network from Droid
 Eleven bait proteins were subjected to Droid with the selection of all protein-protein interactions (PPI) and Genetic interactions. Using Cytoscape plug-in “Advanced Network Merge”, an intersection network between our experimental IMD interactome and *in scilico* IMD network from Droid was generated and shown here. Red diamonds, bait proteins; Circles, interactants; lines, protein-protein interactions in common; Blue edges, interactants found only in specific time points.

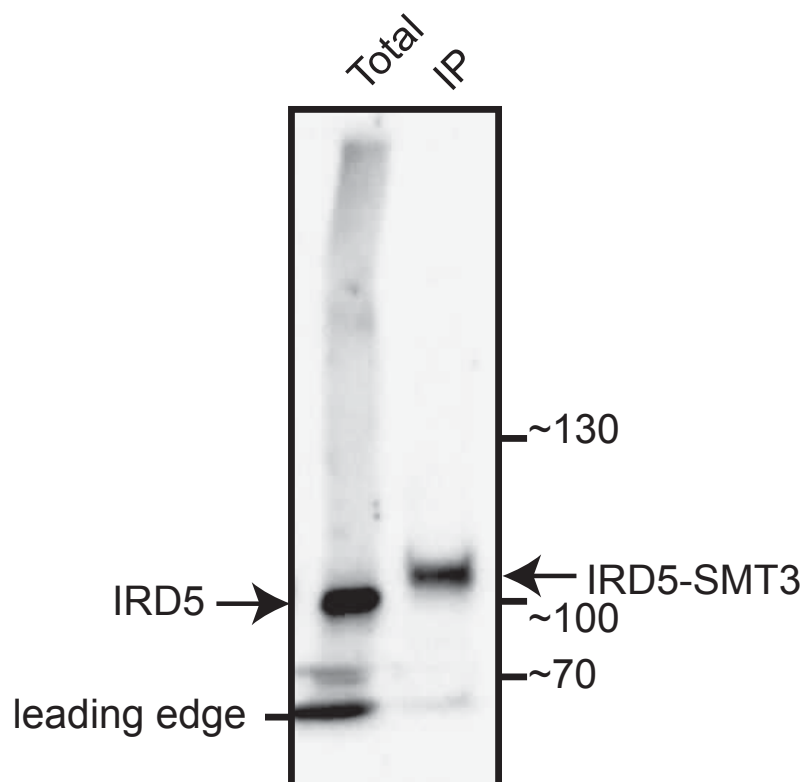
**Supplementary Figure S2. Mono-sumoylation on IRD5**

Total lysate and immunoprecipitate with Ni⁺-beads were loaded side by side on SDS-PAGE gel. The estimated molecular weight of IRD5 with additional HA tag and fragment from Gateway cloning AttB1 is ~93kDa. The estimated molecular weight of His-SMT3 is ~11kDa. The mono-sumoylated IRD4 was predominantly detected at least in this condition.

IRD5	<i>Drosophila melanogaster</i>	145 GICHRD-L-K-P-D-NIVIQR 160
IKK β	<i>Mus musculus</i> (Mouse)	RIIHRD-L-K-P-E-NIVLQQ
	<i>Homo sapiens</i> (Human)	140 RIIHRD-L-K-P-E-NIVLQQ 155
IKK α	<i>Mus musculus</i> (Mouse)	KIIHRD-L-K-P-E-NIVLQD
	<i>Homo sapiens</i> (Human)	KIIHRD-L-K-P-E-NIVLQD *** * * * * ***

SUMOylation Motif		Ψ -K-x-D/E
IK2	<i>Drosophila melanogaster</i>	KLVHRD-L-K-P-G-NIMKFI
	<i>Drosophila sechellia</i>	KLVHRD-L-K-P-G-NIMKFI
	<i>Drosophila simulans</i>	KLVHRD-L-K-P-G-NIMKFI
	<i>Drosophila erecta</i>	KLVHRD-L-K-P-G-NIMKFI
	<i>Drosophila yakuba</i>	KLVHRD-L-K-P-G-NIMKFI
	<i>Drosophila pseudoobscura</i>	KLVHRD-L-K-P-G-NIMKFI
	<i>Drosophila persimilis</i>	KLVHRD-L-K-P-G-NIMKFI
	<i>Drosophila mojavensis</i>	KLVHRD-L-K-P-G-NIMKFI
	<i>Drosophila grimshawi</i>	KLVHRD-L-K-P-G-NIMKFI
	<i>Drosophila virilis</i>	KLVHRD-L-K-P-G-NIMKFI
	<i>Drosophila willistoni</i>	KLVHRD-L-K-P-G-NIMKFI
	<i>Drosophila ananassae</i>	KLVHRD-L-K-P-G-NIMKFI
TBK1	<i>Mus musculus</i> (Mouse)	GIVHRD-L-K-P-G-NIMRVI
	<i>Homo sapiens</i> (Human)	GIVHRD-L-K-P-G-NIMRVI
IKK ϵ	<i>Mus musculus</i> (Mouse)	GIVHRD-L-K-P-G-NIMRLV
	<i>Homo sapiens</i> (Human)	GIVHRD-L-K-P-G-NIMRLV

Supplementary Figure S3.

Alignment of IKK family members at the conserved SUMOylation site

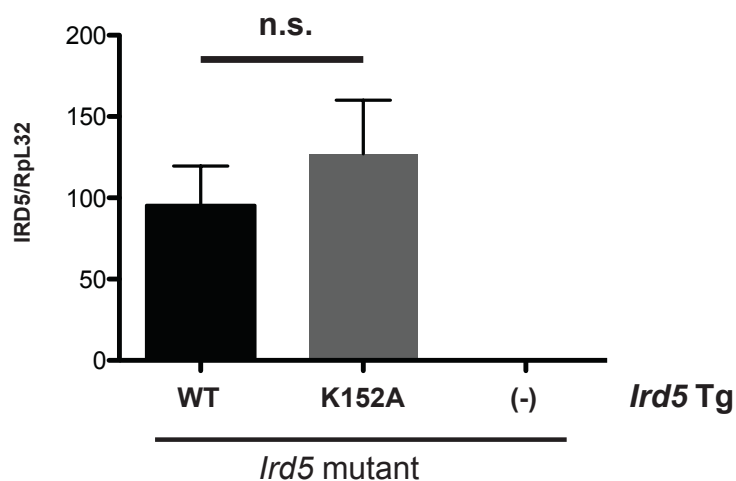

Supplementary Figure S4. Expression of IRD5 transgenes

The same total RNA samples prepared in Figure 4f were used in this study.

Ird5 mRNA level was measured by quantitative RT-PCR and normalized to RpL32. The relative values are indicated against non-transgenic *Ird5* mutants.

Each value represents the average with standard deviation, from three independent experiments. Student-t test was performed. n.s. indicates not statistical significance.

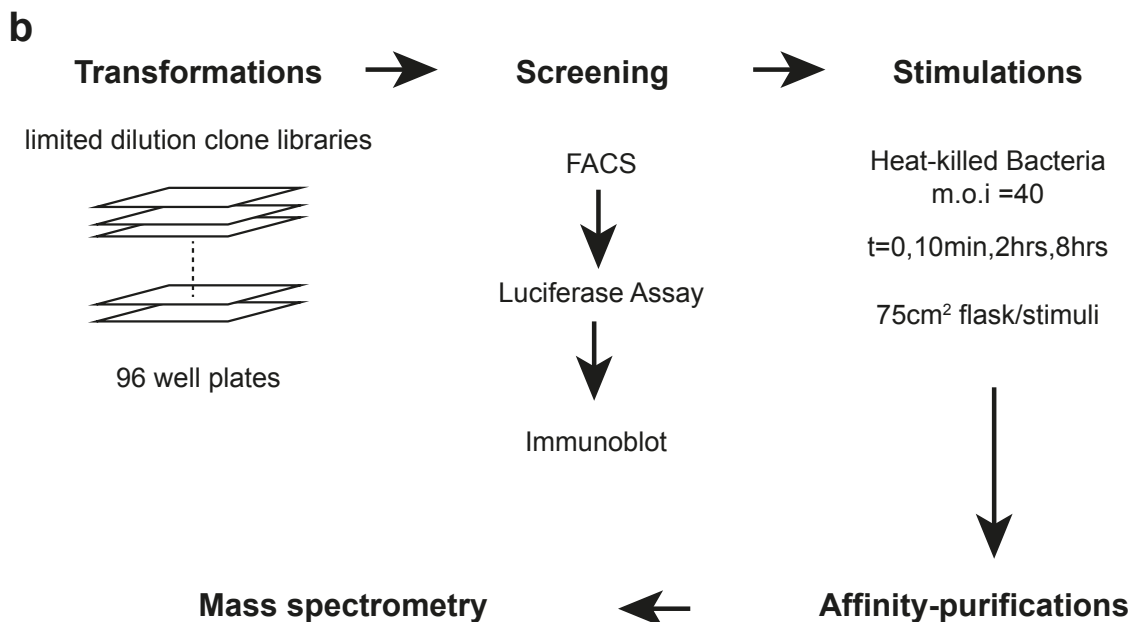
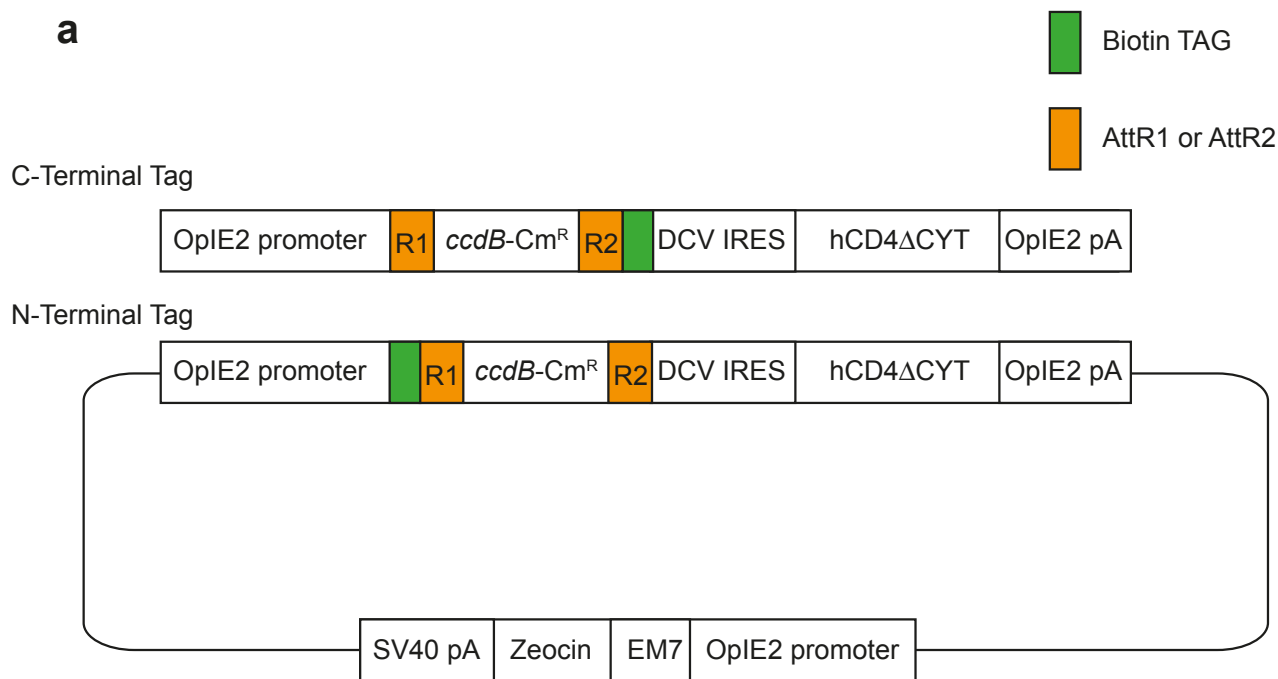

Supplementary Figure S5. Expression vector construct and the experimental flow

a.Expression vector construct. The vector backbone is pIZ/His-V5 from Invitrogen. OpIE2, the constitutive promoter from the baculovirus *Orgyia pseudotsugata* multicapsid nuclear polyhedrosis virus (*OpMNPV*); DCV IRES, *Drosophila C* vitus IRES sequence between gp1 and gp2; hCD4ΔCYT, human CD4 cytoplasmic region truncated form.

b.Experimental flow. By limited dilutions after transfections of bait constructs to 1F3 cell line that carry both *BirA* gene and *AttacinA-luciferase* gene, clones were selected. Each clones were tested for expression of hCD4 by anti-CD4 antibody as primary selections. For positive clones, their expressions of the bait protein and their immune responses against *E.coli* were confirmed by immunoblotting and by luciferase assay, respectively.

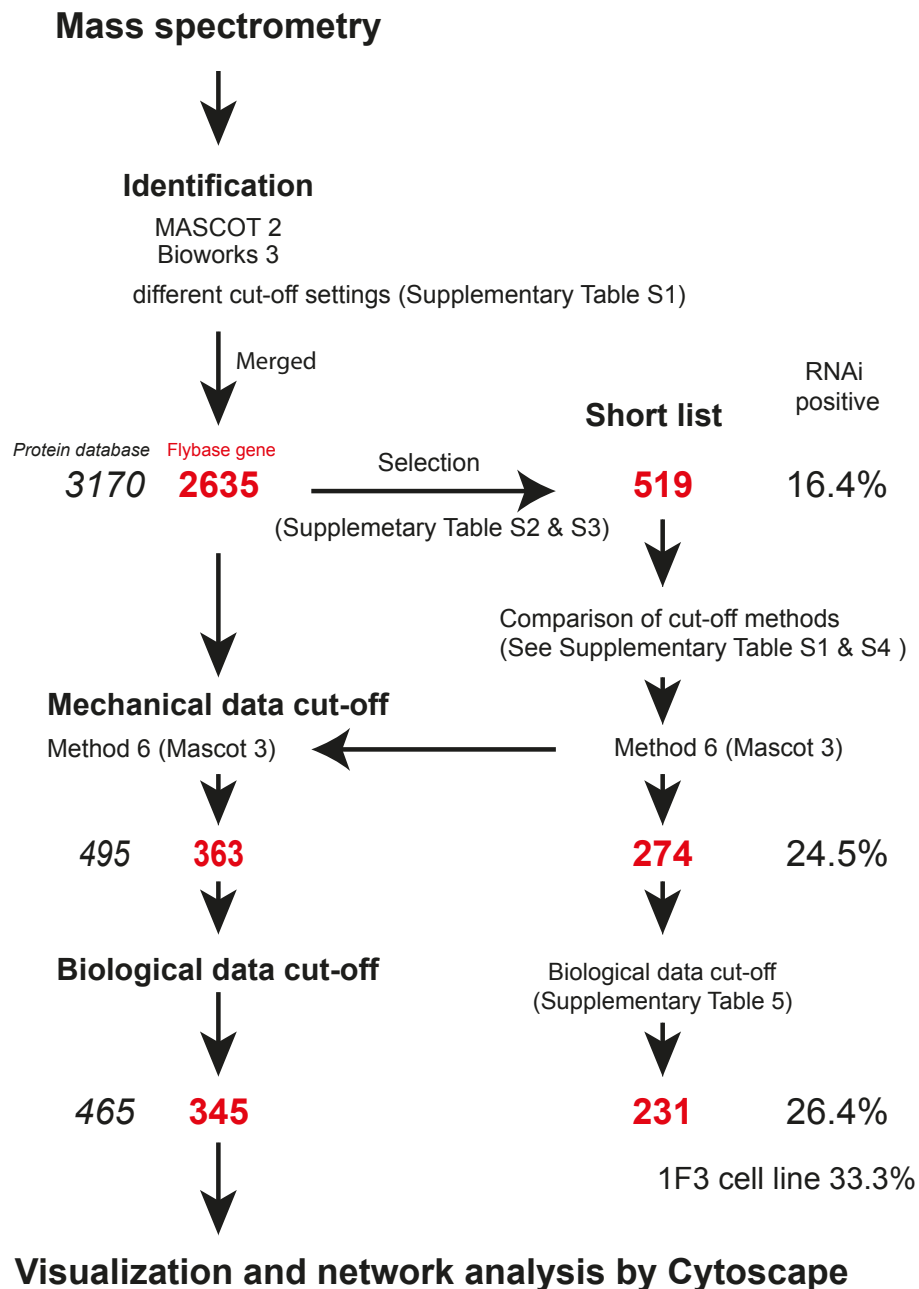

Supplementary Figure S6. The flow of defining a cut-off method.

Numbers of identified proteins and their corresponding genes are shown in black *Italic* and in red, respectively. “RNAi positive” shown in percentage indicates the proportion of genes that give impacts negatively or positively on the promoter activities of *Metchnikowin* gene by RNAi-mediated functional screen on populations of genes in short list. Numbers of tested genes were shown on the left of the percentages of RNAi positive. 1F3 cell line is the same cell line that we used for proteomics. The percentage number is proportion of “RNAi positive” of tested 231 genes using the promoter activities of *Attacin A* gene.

Cut-off setting	Mascot			Bioworks		
	1	2	3	1	2	3
Score 50			X			
1 peptide			X			
Score 30	X	X	X			
2 peptides	X	X	X			
2 distinct peptides peptides	X		X	X	X	X
Xc vs Charge 1-2-3-3						X
Xc vs Charge 1.5-2.5-3-3				X	X	
# top matches =2				X	X	X
Fragments y and b	X	X	X	X		
All fragments					X	X

Supplementary Table S1. Different cut-off settings and their parameters

	MASCOT 1	MASCOT 2	No MASCOT
Bioworks 1			
Bioworks 2			
Bioworks 3			
No Bioworks			

Group	Color code	Descriptions	Dataset Protein #	short list Protein #	RNAi tested Gene #	RNAi Positive Gene #	RNAi Positive (%)
1		MASCOT 1	132	131	92	27	29.3%
2		MASCOT 2 and Bioworks 1-3	240	240	186	40	21.5%
3		Bioworks 1 and no MASCOT1	29	29	21	1	4.8%
4		MASCOT 2	1133	152	139	14	10.1%
5		No MASCOT & Bioworks 2-3	1636	85	76	3	3.9%
6		Irelevant genes		10	5	0	0.0%
Total			3170	647	519	85	16.4%

Supplementary Table S2 Generating a short list for RNAi-mediated functional screen

Upper Table, Criss-cross table of two search engines with different settings. Total number of proteins are divided into 6 groups with color codes.

Lower Table, Sizes of population in each group. The number of proteins, their corresponding genes, tested genes for RNAi, positives in RNAi screen and proportion of “RNAi positive” genes in each group are shown.

Method	Short list total Gene #	Short list Gene #	Short list RNAi positive (%)	Dataset protein # to be handled	Descriptions
1	519	278	24.1	371	Group 1 & 2
2		182	29.1	246	Bioworks 1
3		425	17.6	2157	Bioworks 1 & 2
4		92	29.3	132	Mascot 1
5		423	19.1	1514	Mascot 1 & 2
6		274	24.5	495	Mascot 3

Supplementary Table S3. Cut-off methods and sizes of population to be handled after cut-off by individual methods

		Experiment set 1										...	Experiment set I		
		Bait protein 1										...	Bait protein s		
		N-terminal Tag					N-terminal Tag					...	C-terminal Tag		
No Bait		0 min	10 min	2 hrs	8 hrs	8 hrs	0 min	10 min	2 hrs	8 hrs	8 hrs	...	2 hrs	8 hrs	
Interactant 1	$X_{0,1}^1$	$X_{1,1}^1$	$X_{2,1}^1$	$X_{3,1}^1$	$X_{4,1}^1$	$X_{5,1}^1$	$X_{6,1}^1$	$X_{7,1}^1$	$X_{8,1}^1$	$X_{8,1}^1$	$X_{8,1}^1$...	$X_{i-1,1}^1$	$X_{i,1}^1$	
Interactant 2	$X_{0,2}^1$	$X_{1,2}^1$	$X_{2,2}^1$	$X_{3,2}^1$	$X_{4,2}^1$	$X_{5,2}^1$	$X_{6,2}^1$	$X_{7,2}^1$	$X_{8,2}^1$	$X_{8,2}^1$	$X_{8,2}^1$...	$X_{i-1,2}^1$	$X_{i,2}^1$	
...	
Interactant m	$X_{0,m}^1$	$X_{1,m}^1$	$X_{2,m}^1$	$X_{3,m}^1$	$X_{4,m}^1$	$X_{5,m}^1$	$X_{6,m}^1$	$X_{7,m}^1$	$X_{8,m}^1$	$X_{8,m}^1$	$X_{8,m}^1$...	$X_{i-1,m}^1$	$X_{i,m}^1$	

If $\frac{1}{n} \sum_{i=1}^n X_{i,m}^1 \leq 2 X_{0,m}^1$ eliminate Interactant m of experiment set I

3 EMS mutagenesis screen for Alzheimer's modifying genes

Forward genetic screens in *Drosophila* have been very useful for biomedical research (St Johnston, 2002). We decided to perform a genetic screen for AD modifying genes using a non-biased chemical mutagenesis approach. Our main interest from this screen has been the identification of genes capable of affecting AD phenotypes through an interaction with the innate immune system.

3.1 Ethyl methane sulphonate (EMS) mutagenesis

EMS mutagenesis is the most commonly used method for inducing only point mutations in flies. This chemical mutagenesis screen is advantageous in terms of producing an unbiased library of mutants as opposed to transposable elements generated library (St Johnston, 2002). The ethyl group of EMS reacts with guanine (G) and generates O-6-methylguanine. During DNA replication, polymerases misplace thymine (T) instead of cytosine (C). After subsequent rounds of replication, the original G:C pair is replaced by an A:T pair. Using the standard mutagenesis protocol, the mutation rate for the average gene is about 1 in 1000.

3.2 Practical approach

The duration of a saturated screening is generally long. To ensure that our screening method works, we have decided to first screen genes located on the X chromosome. A time-consuming step for performing genetic screens in flies is producing large numbers of virgin females for crossings. In general, 1 male is

crossed to 3 to 5 females. This means that more than 300 to 500 virgin female flies are needed per screen of a 100 mutants. Moreover, collecting virgin females just after eclosion is a time-sensitive procedure. To avoid this hindered step, we established a “male terminator” line carrying an AD phenotype-inducing allele. This line carries a transgene (X_{hs}) encoding apoptosis-inducing protein Hid under a heat-shock promoter on the X chromosome. To maintain this line, we used attached-X (XX) chromosomes in females.

In *Drosophila*, sex determination is achieved by a balance of female determinants on the X chromosome and male determinants on the autosomes. If there is one X chromosome in a diploid cell the fly is male. If there are two X chromosomes in a diploid cell the fly is female. Flies with three X chromosomes are not viable and the Y chromosome is not involved in determining sex (Gilbert, 2000).

The AD phenotype-inducing allele (termed AD^{cha} in our scheme) on 2nd chromosome contains *cha-GAL4* (cholinergic neurons GAL4 driver) and *UAS-hA β 42* (Figure 11). *CyO* is a balancer chromosome that prevents recombination between homologous chromosomes. We obtained an AD^{cha} fly line in which larvae could be heat-treated at 37°C in order to kill all males and only keep virgin females.

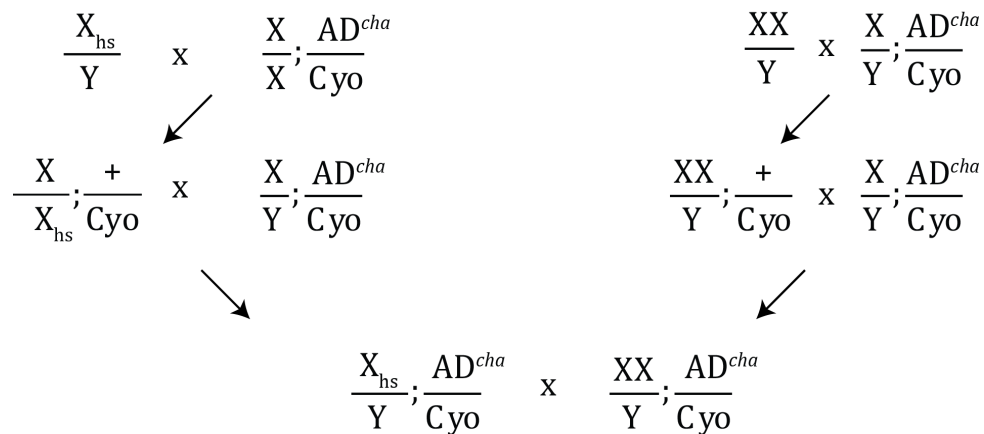

Fig. 11: Crossing scheme for the generation of “male terminator” AD flies

The usage of attached-X (XX) chromosomes has another major advantage. Crossing to regular females carrying two X chromosomes doesn't allow distinguishing a mutated X chromosome coming from EMS-fed males from a non-mutated X chromosome from a female fly; whereas when crossing to attached-X females, all males in the progeny will necessarily carry the mutated paternal X chromosome.

We fed starved wild type male flies on various doses of EMS ranging from 20mM to 50 mM in 5% sucrose for 18 hours. Mutagenized males were later crossed “en masse” to the attached-X AD^{cha} virgin females (Figure 12). As the mutations are induced in mature spermatids, each F1 male inherits a mutagenized X chromosome carrying a different spectrum of mutations. We selected males carrying AD^{cha} allele. Each one of these male was then crossed with virgin females for two reasons. The first is to maintain a stock of flies carrying the mutation for further analysis. The second reason is to obtain the 15 to 20 males required to perform climbing assays (Test 1). Following the

assessment of the climbing activity of the flies, we performed a second larger scaled-test for possible enhancer or repressor mutations that were detected after Test 1 (Test 2).

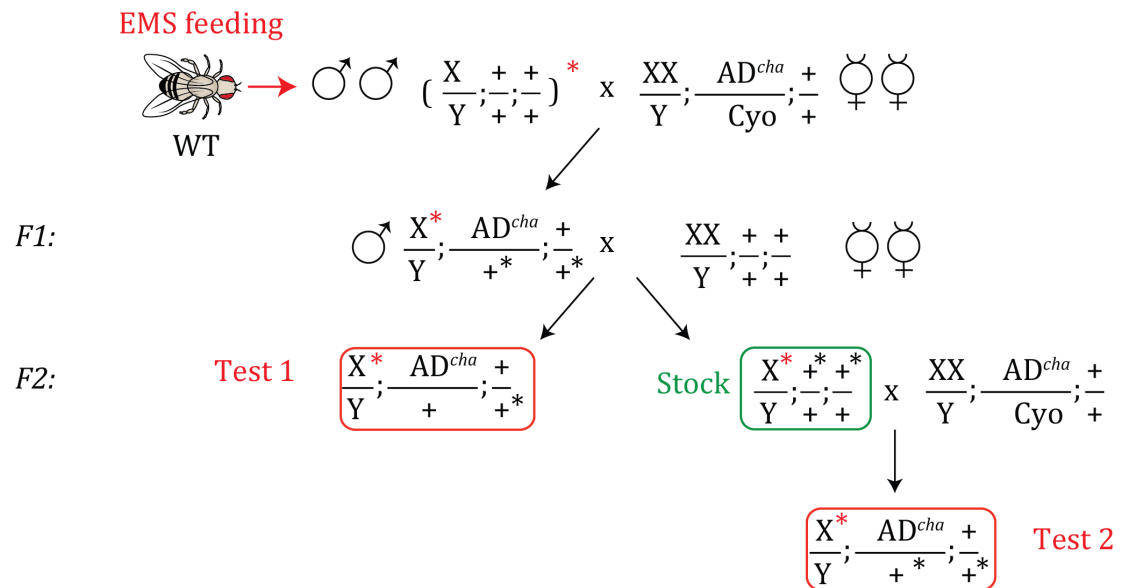

Fig. 12: EMS mutagenesis strategy

Red asterisks correspond to mutations on the X chromosome. Black asterisks correspond to possible EMS-induced mutations on the 2nd or 3rd chromosome.

3.3 Results and mapping strategy

For the first test (Test 1), we assessed the climbing activity of 15 to 20 male flies at 10, 15, 20 and 25 days post-eclosion. We retained the mutants which climbing activity was significantly different from the average climbing activity of AD^{cha} control flies at least at two consecutive time points (Figure 14A). Possible positives were amplified and we performed climbing assays on 3 groups of 20 flies for each positive mutant (Test 2). To date, we have pre-screened 250 flies in total. Out of these, 24 mutations affected the climbing activity mostly by enhancing its reduction. After second testing, we retained only 2 mutants named EM34 and EM52 (Figure 13).

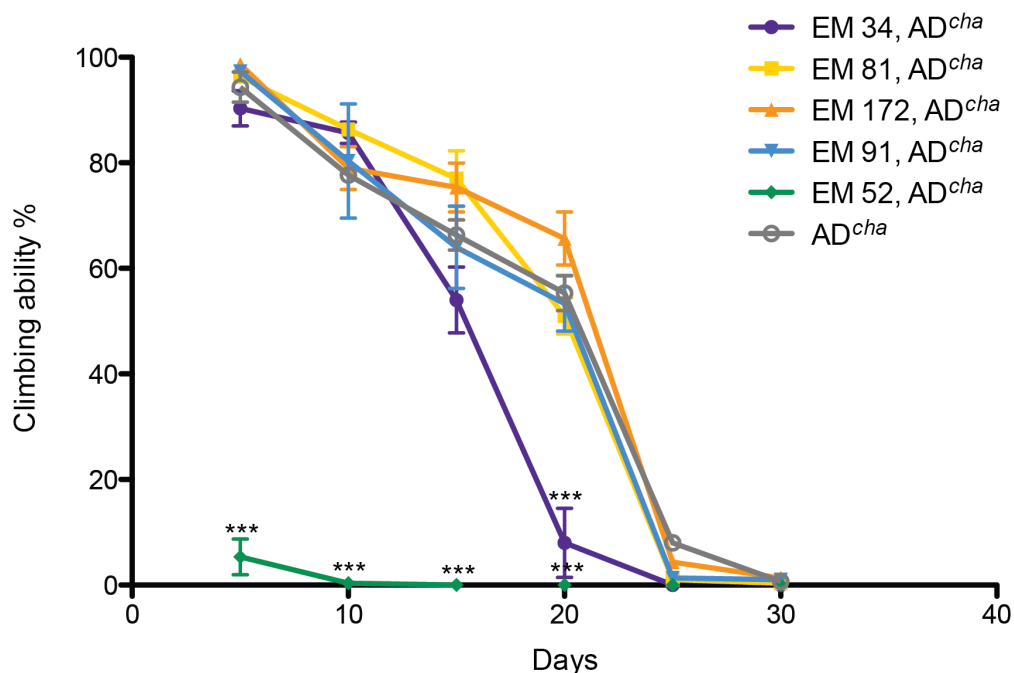

Fig. 13: Representative climbing activity results after Test 2

The climbing activity of the mutants is compared to that of non-mutated AD flies. EM34, AD^{cha} and EM52, AD^{cha} show a significant reduction of their climbing activity at time points indicated by asterisks (***) ($p < 0.001$)

Next, we assessed the mutant flies' climbing ability without expressing A β 42. To our surprise, the EM34 mutant line showed a reduced climbing activity as compared to the A β 42-expressing EM34 line. This result indicated that the expression of A β 42 rescues the reduction in climbing activity of EM34. From our results (Results, Section 1) demonstrating that A β 42 activates the IMD pathway and thus contributes to the protection against the development of AD-like phenotypes in flies, we hypothesize that, in EM34, A β activates the innate immune system which allows the fly to overcome the defects in neuronal activity caused by the mutation. In fact, at later stages, the climbing activity of the A β 42-expressing EM34 line is significantly reduced as compared to control AD flies (Figure 14B). The EM34 allele could possibly have a function in phagocytosis independently of the IMD pathway.

On the other hand, the climbing activity of both EM52 and A β 42-expressing EM52 flies was very low from the beginning of the assay and we couldn't conclude whether the mutation in EM52 allele affects AD-like pathology in flies (Figure 14C). The allele in EM52 could be important for locomotion activity itself.

Further characterizations of these mutants will need to be performed, particularly concerning the activation state of the immune system, the clearance of A β , and neurodegeneration.

A)

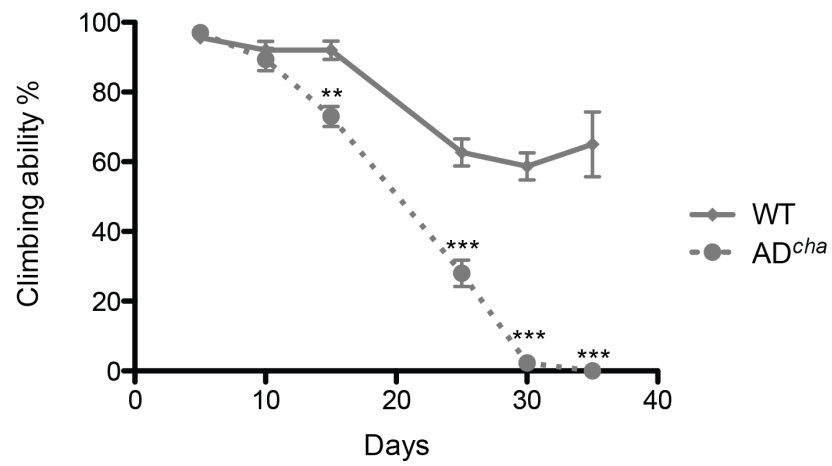

B)

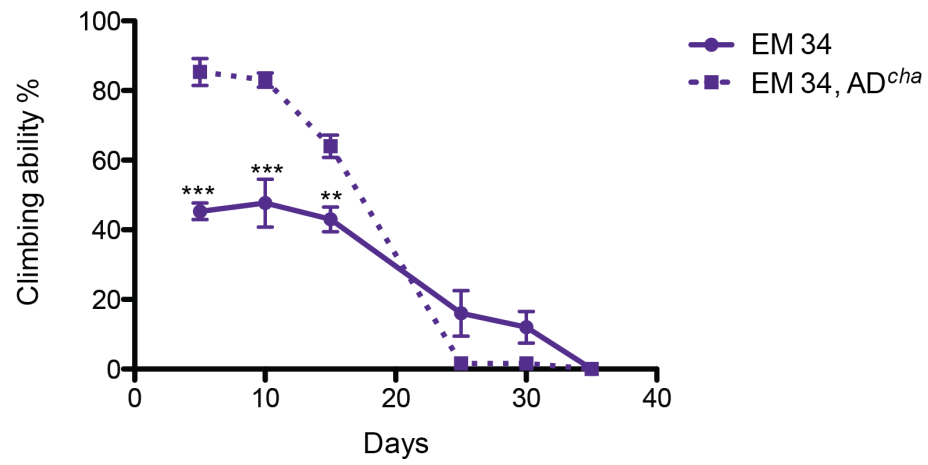

C)

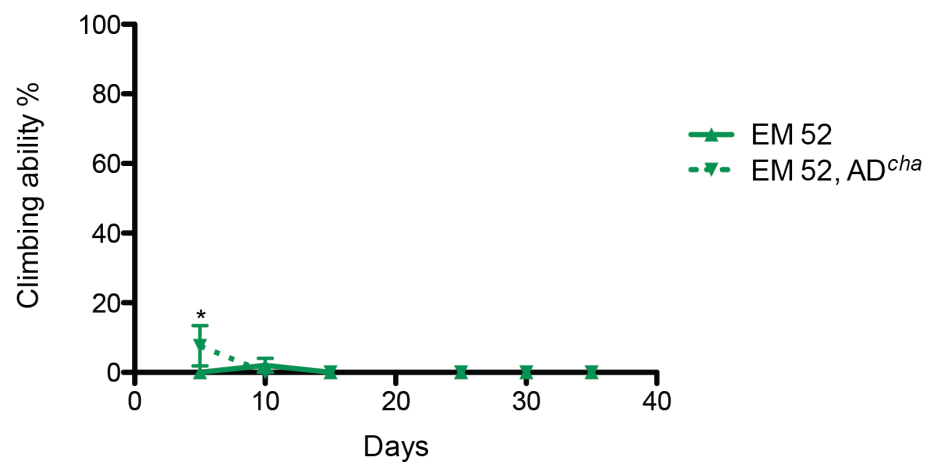

Fig.14: Climbing activity assays

A) The average climbing ability of AD^{cha} flies is significantly reduced as compared to WT flies following the expression of hA β 42; B) The climbing activity of EM34, AD^{cha} flies is significantly higher than the climbing activity of EM34 mutant. C) The climbing activities of EM52, AD^{cha} flies and EM52 are both very low since the beginning of the assay (*: p<0.05 and ***: p<0,001).

3.4 Perspectives

Here, we have generated the material required for a genetic screen and optimized its condition with the aim of identifying novel genes affecting the development of AD-like phenotypes in flies.

We have used the EMS mutagenesis method in order to generate unbiased mutations that span the entire genome of the fly at the same frequency in coding and non-coding sequences. In the past, EMS used to suffer from a major drawback that is the difficulty to map mutations to specific genes. However this problem has been solved with the recent advances in sequencing technologies in addition to the availability of other genetic tools in flies facilitating the mapping processes such as libraries of deletion mutants. It is important however to note that EMS introduces more than 200 mutations on a chromosome. Our strategy to map mutations affecting AD-like pathology consists in crossing male mutant flies with deletion line mutants and looking for a reduction in the climbing activity of female AD flies. In that way, it will be possible to guide the search for modifying mutations to smaller chromosomal regions. Sequencing the X chromosome, in the particular case of our pre-screen, will lead to the identification of one or

several mutations in the region of interest. Further rescue experiments will allow determining which mutation is responsible for modifying AD-like phenotypes in the fly (Figure 15).

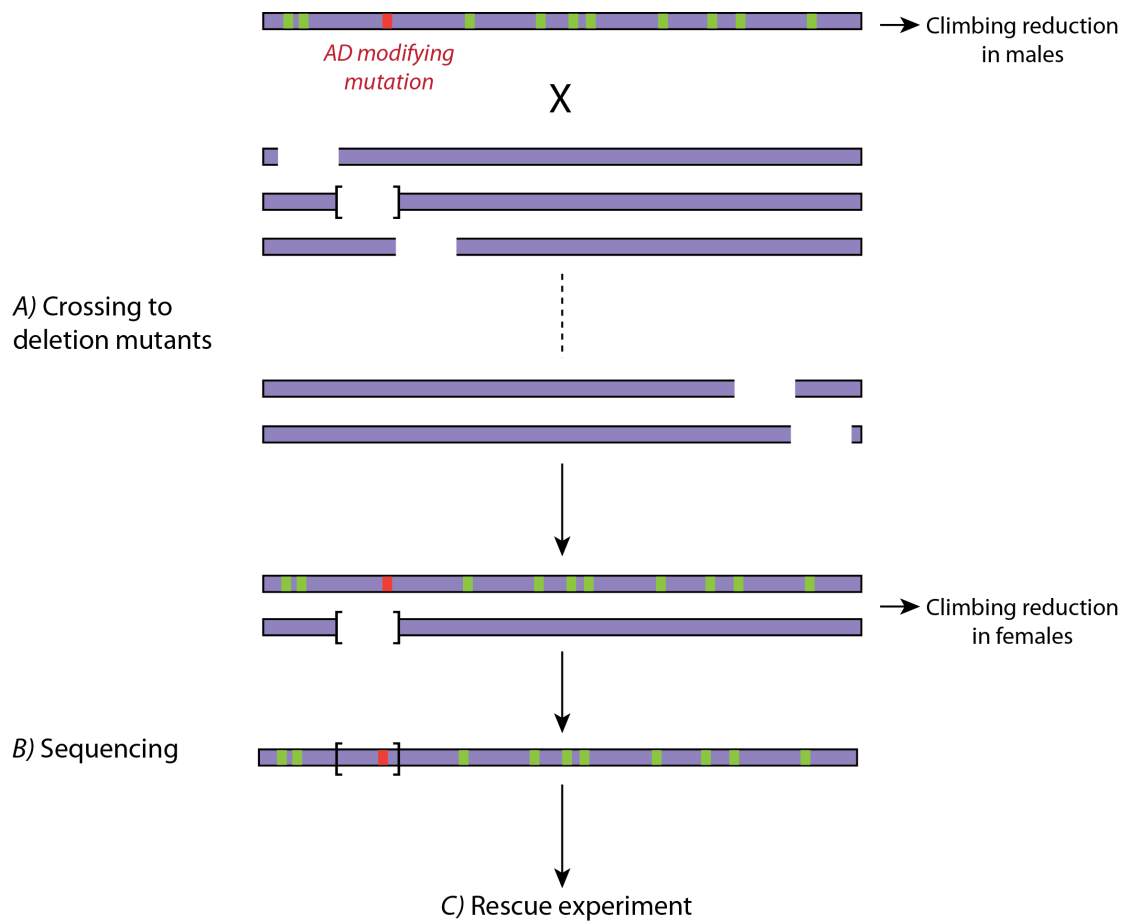

Fig. 15: Mapping strategy of AD modifying mutations

Discussion and perspectives

The impact of inflammatory responses on the pathological processes occurring during the development of AD has become widely accepted. Evidence for a strong link between neuroinflammation and AD has been reported by numerous studies. However, it is still unknown how the activation of the innate immune system, in particular, affects the development of AD pathology. During my PhD, we have aimed at deciphering the molecular mechanisms of the innate immune responses in AD using *Drosophila*.

Drosophila, as a model organism, has been successfully used to study host-pathogen interactions (Lemaitre et al., 1996). More recently, this rather simple invertebrate organism, deprived of an adaptive immune system, has emerged as a model for studying the mechanisms of numerous neurodegenerative diseases including tauopathy, Parkinson's disease, Huntington disease, AD etc. Thus, *Drosophila* has been very helpful in elucidating various aspects of these pathologies providing new insights into research on neurodegeneration (Bilen and Bonini, 2005).

In the last three years, I have been able to: (1) establish a *Drosophila* model to study the inflammatory responses in AD, (2) demonstrate that the IMD pathway, one of *Drosophila*'s inflammatory signaling cascade, plays a protective role against the development of AD, (3) generate the IMD interactome dataset relevant to the study of AD, and (4) introduce a forward genetic screening method for the identification of AD modifying genes.

1 *The IMD pathway prevents the development of AD phenotypes*

The *Drosophila* AD model we have established constitutively expresses antibacterial and antifungal peptide gene *Metchnikowin* following the activation of the IMD pathway. This activation plays a protective role against the development of AD-like phenotypes that include the formation of amyloid plaques, neurodegeneration and neuronal dysfunction. However, an important question needs to be answered: what are the effector cells? We currently hypothesize that Draper-positive glial cells initiate the immune response against human A β 42 based on our immunohistochemistry observations indicating that human A β 42 and Draper co-localize in the brain. In order to test this hypothesis, we are generating a new fly line expressing human A β 42 using a gene expression system independent of the *GAL4-UAS* system, called the Q system (Potter et al., 2010). We decided to use the Q system for human A β 42 expression in an inducible manner whereas we will use the *UAS-GAL4* system to inactivate or express targeted genes in a tissue-specific manner. We anticipate that rescuing IMD in glial or neuronal cells, in an AD background, will provide the answer to our question.

Another question concerns the nature of the molecule, in *Drosophila*, that recognizes aggregated proteins such as human A β upstream of IMD adaptor molecules. We believe that Draper plays this role based on the fact that MEGF10, its mammalian ortholog, can be a receptor for A β . The cell surface expression of Draper is up-regulated in *imd*-deficient background; hence we assume that the

activation of glial cells doesn't require the IMD pathway. However, since the accumulation of A β is enhanced in *imd*-deficient background, we propose that the IMD pathway might rather affect glial cells' clearance ability of A β . The molecular mechanisms of the *imd*-independent activation of glial cells and the *imd*-dependent A β clearance need to be further elucidated.

Another interesting observation from our study is that the deficiency in *PGRP-LE* reduces the climbing activity of AD model flies. Yano et al. demonstrated that PGRP-LE induces autophagy independently of the IMD or the TOLL pathways during infection of intracellular bacteria, such as *Salmonera*, *Listeria*, and *Mycobacterium* (Yano et al., 2008). Mechanisms of autophagy induction by PGRP-LE are still unknown. Nevertheless, loss of autophagy has been shown to induce neurodegeneration in mice (Hara et al., 2006; Komatsu et al., 2006). It will be very interesting to investigate the role of PGRP-LE-mediated autophagy in AD model flies.

2 *Alzheimer's disease-related genes are enriched in the IMD interactome dataset*

The activation of the IMD pathway in *Drosophila* can be activated without pathogen infection. For instance, our team and others have demonstrated that it could be activated by undigested DNA (Liu et al., 2012; Mukae et al., 2002). In order to better understand the process of activation of the IMD pathway, we aimed at identifying proteins interacting with eleven of its canonical members following a functional proteomics approach. Using the *Drosophila* immune-responsible S2 cell line, we were able to identify 345 proteins associated to the eleven chosen members. We found that 90% of the genes encoding these proteins have human orthologs. With our recent finding about the activation of the IMD pathway in AD model flies, we first investigated the applicability of our dataset for studies on AD. Using the Database for Annotation, Visualization and Integrated Discovery (DAVID), we analyzed the human orthologs of the 345 *Drosophila* genes. We were able to identify a statistically significant association with several KEGG pathway terms such as ribosome, NOD-like receptor signaling pathway, apoptosis, RNA degradation etc... Most interestingly, this analysis pointed that genes related to the term “cytosolic DNA-sensing pathway” or to the term “Alzheimer disease” are enriched in this dataset (Table 5). Twelve genes from our analysis are linked to AD: *PSEN*, *FADD*, *NMDAR*, *IP₃R*, *SERCA*, *CYC* (*CytC*), *ABAD*, in addition to *NDUFS2* from the mitochondrial respiratory chain (RC) complex (Cx) I (CxI), *UQCR2* (CxIII) and *ATP5A1*, *AT5F1* and *ATP5B* (CxV) (Figure 16).

Term	Count	Percentage	P Value
Ribosome	28	9.6	0.00000
Huntington's disease	13	4.5	0.00116
Alzheimer's disease	12	4.1	0.00169
NOD-like receptor signaling pathway	7	2.4	0.00346
Apoptosis	8	2.7	0.00460
RIG-I-like receptor signaling pathway	7	2.4	0.00677
Cytosolic DNA-sensing pathway	6	2.1	0.00978
Toll-like receptor signaling pathway	8	2.7	0.01028
RNA degradation	6	2.1	0.01133
Spliceosome	8	2.7	0.03097
Parkinson's disease	8	2.7	0.03336
Antigen processing and presentation	6	2.1	0.04824
Endocytosis	9	3.1	0.07353

Table 5: DAVID bioinformatics analysis on human orthologs of *Drosophila* genes identified from the IMD interactome.

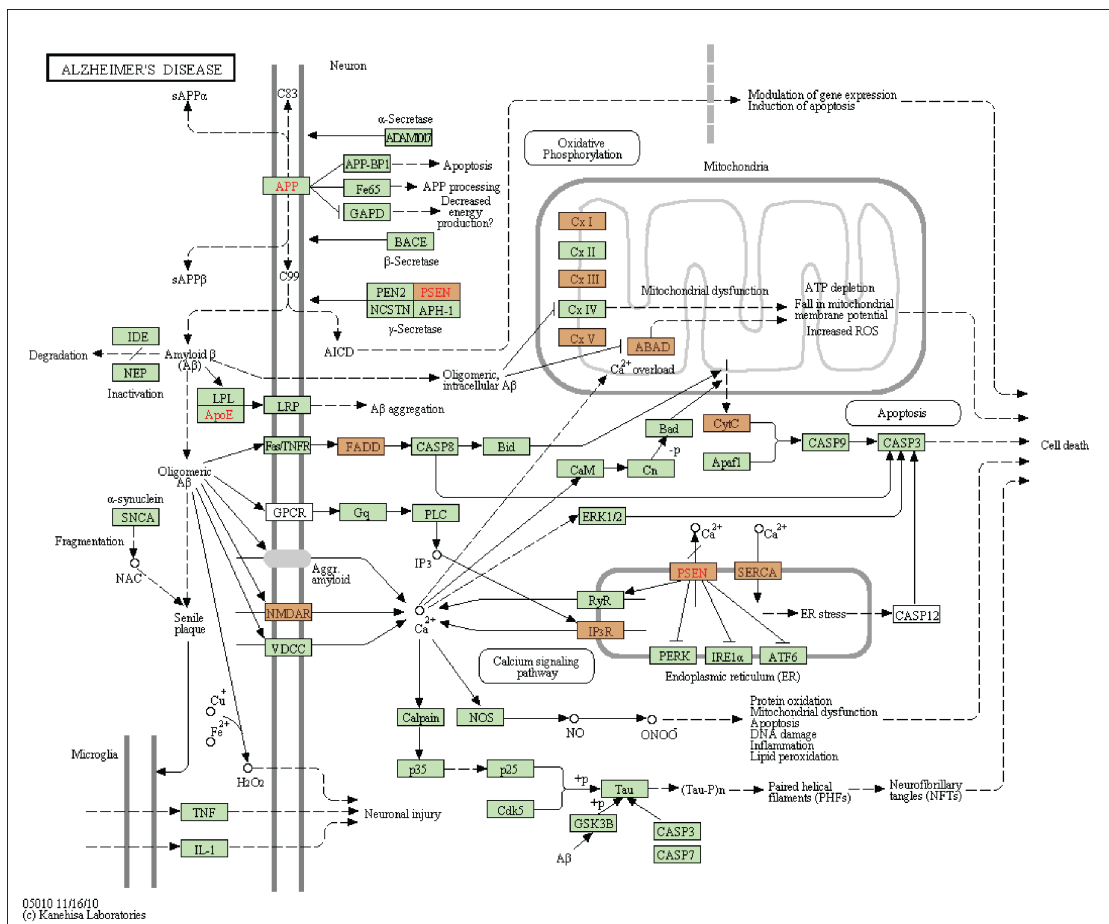

Fig. 16: KEGG pathway relative to Alzheimer's disease.

Proteins or complexes that were identified from the IMD interactome are highlighted in orange.

Presenilin (PSEN) is one of the most interesting proteins that were identified from the IMD interactome. In addition to being part of the γ -secretase complex and its catalytic role in APP processing in neurons, Farfara et al. demonstrated that primary glial cells deficient in *PSEN 1* and *2* show impairment in phagocytosis of soluble A β (Farfara et al., 2011). Interestingly, the plant *Physcomitrella patens* has an ortholog of *PSEN* gene, although it lacks *Notch* or *APP*. Khandelwal et al. showed that PSEN has an evolutionary conserved role in development, independent of its γ -secretase activity. They were able to rescue the growth of *PSEN*-deficient mouse embryonic fibroblasts with the plant PSEN (Khandelwal et al., 2007).

Many familial Alzheimer's disease mutations in *PSEN* cause aberrant Ca²⁺ signaling (Smith et al., 2005). Exaggerated endoplasmic reticulum (ER) Ca²⁺ release has been ascribed to the enhanced loading of the ER lumen due either to enhanced sarco ER Ca²⁺-ATPase (SERCA) Ca²⁺ pump activity (Green et al., 2008) or to dysregulation of a putative Ca²⁺ channel function of wild-type PSEN (Nelson et al., 2007; Tu et al., 2006). Alternately, exaggerated Ca²⁺ release has been accounted for enhanced Ca²⁺ liberation from normal stores through inositol triphosphate receptors (IP₃R) and other Ca²⁺ channels either as a consequence of enhanced channel expression or in the case of the IP₃R of enhanced activity in response to its ligand inositol trisphosphate (IP₃) (Stutzmann, 2005).

Inositol trisphosphate receptors are a family of three genes that modulate the concentration of cytoplasmic Ca^{2+} from internal cellular stores. They are ubiquitously expressed in all cell types (Foskett, 2010). A biochemical interaction of WT and FAD mutant PSEN1 and 2 with IP_3R was identified. Functionally, FAD PSEN specifically had gain-of-function consequences on the activity of the channel, which in turn was associated with exaggerated Ca^{2+} signaling in intact cells (Cheung et al., 2010; Cheung et al., 2008).

SERCA pumps were also identified from the IMD interactome. At rest, these pumps maintain cytosolic Ca^{2+} at low levels by pumping it into stores in the ER (Berridge et al., 2000). SERCA pumps have the highest affinity for Ca^{2+} removal from the cytosol and together with plasma membrane Ca^{2+} -ATPases and transporters, determine the resting cytosolic Ca^{2+} concentration (Aubier and Viires, 1998). SERCA2b, in particular, is ubiquitously expressed in smooth muscle tissues and non-muscle tissues including neurons (Baba-Aissa et al., 1998). Green et al. demonstrated that SERCA2b pump activity is physiologically regulated by PSEN and regulates $\text{A}\beta$ production. They have shown that SERCA activity is diminished in fibroblasts lacking both *PSEN* genes and that PSEN and SERCA interact physically (Green et al., 2008).

When we take into consideration the functions of SERCA, IP_3R , and PSEN identified from the IMD interactome and their close interactions, we speculate that the inactivation of the IMD pathway in AD flies might deregulate Ca^{2+} signaling through the *Drosophila* PSEN affecting glial cells phagocytosis activity, which leads to increased $\text{A}\beta$ levels.

N-methyl-d-aspartate receptors (NMDAR) are one of the families of ionotropic glutamate receptors abundant in the brain that are as well implicated in calcium homeostasis. Glutamatergic modulation plays an important role in the pathogenesis of neuronal death in neurodegenerative diseases notably AD (Xu et al., 2012). A number of studies have shown that NMDAR mediate neuronal loss in AD (Xu et al., 2012). For instance, De Felice et al. have demonstrated that amyloid plaques are capable of over-activating of NMDAR, which leads to an overflow of Ca^{2+} into neurons and the activation of key enzymes linked to AD. They have shown that $\text{A}\beta$ oligomers induce neuronal oxidative stress through an NMDAR-dependent mechanism (De Felice et al., 2007). In another study, it was shown that *NMDAR* knockdown in mature hippocampal neurons abolishes oligomer binding to dendrites, indicating that NMDARs are required for synaptic targeting of oligomers (Decker et al., 2010). Moreover, NMDAR have been reported to be functionally present in glial cells (Verkhatsky and Kirchhoff, 2007). Interestingly, Memantine is one of two FDA-approved drugs. It acts as an agonist of NMDAR.

Another hypothesis proposed to explain the origins of AD implicates mitochondrial dysfunction and oxidative stress as early events in AD development (Blass and Gibson, 1999; Castellani et al., 2002).

AD-related oxidative damage has been associated with an altered function of the mitochondrial respiratory chain (RC) through a decreased complex IV enzyme activity, a common finding in various human and rodent AD cellular models. In this regard, APP and $\text{A}\beta$ have been shown to induce RC activity defects

and oxidative stress by mechanisms that are being investigated. For instance, it was shown that A β treatment alters the assembly and enzyme activities of the RC complexes I and IV in rat choroid plexus epithelial cells and also in human choroid plexus cells from patients suffering from AD (Carro et al., 2010). Moreover, proteomic and functional analysis in transgenic mice overexpressing the P301L mutant human Tau protein identified mainly metabolism-related proteins including mitochondrial respiratory chain complex components mostly from the complex I and V. Functional analysis demonstrated a mitochondrial dysfunction in P301L Tau mice, which was associated with higher levels of reactive oxygen species in aged transgenic mice (David et al., 2005).

A β -binding alcohol dehydrogenase (ABAD) is a member of the short-chain dehydrogenase-reductase family concentrated in the mitochondria of neurons. Following binding of A β to ABAD, the structure of the enzyme is distorted rendering it inactive with respect to its metabolic properties, and promotes mitochondrial generation of free radicals (Yan and Stern, 2005). Lustbader et al. demonstrated that A β interacts with ABAD in the mitochondria of both patients and transgenic mice. By specifically inhibiting ABAD-A β interaction, they have observed a suppression of A β -induced apoptosis and free-radical generation in neurons. Furthermore, they have demonstrated that double transgenic mice in which increased levels of ABAD are expressed in an A β -rich environment, present exaggerated neuronal oxidative stress and impaired memory. Thus mitochondrial ABAD could become a pathogenic factor in an A β -rich environment (Lustbader et al., 2004).

Ubiquinol cytochrome c reductase core protein 2 (UQCRC2) and cytochrome C1 (CYC) identified by our IMD interactome are components of the mitochondrial RC CxIII. They have been shown to bind a cleaved form of ApoE4, ApoE4 (1-272), found in the brains of AD patients and transgenic mice expressing human ApoE. ApoE4 (1-272) associates with NFTs-like structures and causes mitochondrial dysfunction in cultured neuronal cells (Brecht et al., 2004; Huang et al., 2001) (Nakamura et al., 2009). Overexpression of ApoE4 (1-272) fragment in Neuro2a cells impairs activities of complex III and IV. These studies suggest that the C-terminal-truncated fragment of ApoE4 binds to mitochondrial complexes and affects their activities, thereby leading to neurodegeneration (Nakamura et al., 2009).

All previous genes are essential either for calcium homeostasis or mitochondrial functions, two molecular functions known be related to AD pathology (Green and LaFerla, 2008) (Querfurth and Selkoe, 1994).

FADD is a component of the IMD pathway (Leulier et al., 2002). FADD, IMD (similar to RIPK1), and Dredd (equivalent to caspase 8/10) form a complex to transduce the signal to activate NF- κ B and to induce apoptosis. In mammal, Ivins et al. reported that A β -induced neuronal apoptosis could be inhibited by a caspase 8 inhibitor and by expressing a dominant negative form of FADD (Ivins et al., 1999). Hong et al. recently reported that the inhibition of JNK/dFOXO pathway and caspases rescues neurological impairments in a *Drosophila* AD model (Hong et al., 2012).

3 Genetic screening for AD modifying genes in Drosophila

To date, two published genetic screens were performed in AD flies expressing A β 42 fused downstream of a secretion signal peptide. Cao et al. looked for modifiers of the rough eye phenotype generated by over-expression of A β 42 in the compound eye of the fly. They screened for dominant modifiers of the phenotype in a library of 1963 unique insertions of mobile transposon (EP elements) constructs that enhance the expression of neighboring genes (Cao et al., 2008).

In another screen, Rival et al. used a different approach. They expressed A β 42 in neurons and measured differences in lifespan as a read-out for disease modifiers. For their screen, Rival et al. used EP-like elements to up-regulate a set of random genes and were able to identify a number of dominant modifier genes (Rival et al., 2009).

Both screens identified an important role for the transition metals copper and iron amongst genes implicated in vesicle transport, stress response, protein degradation and chromatin structure. The most powerful modifying genes from Rival et al. screen were however those encoding iron binding proteins notably the light and heavy chains of ferritin. Furthermore, the co-expression of ferritin heavy/light chains and A β 42 in the brain prolonged the longevity and improved locomotion. Although the oxidative damage was reduced, A β levels were

increased. The authors suggested a role of the Fenton reaction generating free radicals in A β toxicity.

The screen by Cao et al. focused only on cell-autonomous toxic effects of human A β . Our results from *Toll*-deficient flies and findings from Rival et al. suggest that the lifespan and A β accumulation are not always correlated. This implies the complexity of AD pathogenesis even in a relatively simple animal model such as *Drosophila*. The read-out of a genetic screen is the most important factor for its success.

In summary, we have identified a protective role of the *Drosophila* IMD pathway against the development of AD-like pathology. We have also demonstrated that several AD-related genes are enriched in the IMD interactome. Most of these genes are involved in calcium homeostasis and mitochondrial functions. On the long term, it will be very interesting to continue the genetic screen for modifier genes of AD-like pathology in the fly. Results from this screen would be of great help in defining new pathways of AD pathogenesis.

This work will be pursued to determine how the innate immune system encounters A β and mediates its toxicity and what modulates its impact on the pathophysiology of AD. By answering these questions we believe that we will shed the light over unclear aspects of AD paving the way towards a better understanding of this pathology.

Bibliography

Abe-Dohmae, S., Ikeda, Y., Matsuo, M., Hayashi, M., Okuhira, K., Ueda, K., and Yokoyama, S. (2004). Human ABCA7 supports apolipoprotein-mediated release of cellular cholesterol and phospholipid to generate high density lipoprotein. *J Biol Chem* 279, 604-611.

Adra, C.N., Lelias, J.M., Kobayashi, H., Kaghad, M., Morrison, P., Rowley, J.D., and Lim, B. (1994). Cloning of the cDNA for a hematopoietic cell-specific protein related to CD20 and the beta subunit of the high-affinity IgE receptor: evidence for a family of proteins with four membrane-spanning regions. *Proc Natl Acad Sci U S A* 91, 10178-10182.

Aisen, P.S., Schafer, K.A., Grundman, M., Pfeiffer, E., Sano, M., Davis, K.L., Farlow, M.R., Jin, S., Thomas, R.G., Thal, L.J., *et al.* (2003). Effects of rofecoxib or naproxen vs placebo on Alzheimer disease progression - A randomized controlled trial. *Jama-Journal of the American Medical Association* 289, 2819-2826.

Akira, S., Takeda, K., and Kaisho, T. (2001). Toll-like receptors: critical proteins linking innate and acquired immunity. *Nature Immunology* 2, 675-680.

Allinson, T.M.J., Parkin, E.T., Turner, A.J., and Hooper, N.M. (2003). ADAMs family members as amyloid precursor protein alpha-secretases. *Journal of Neuroscience Research* 74.

Almkvist, O. (1996). Neuropsychological features of early Alzheimer's disease: preclinical and clinical stages. *Acta neurologica Scandinavica Supplementum* 165, 63-71.

Apostolova, L.G., Hwang, K.S., Andrawis, J.P., Green, A.E., Babakchanian, S., Morra, J.H., Cummings, J.L., Toga, A.W., Trojanowski, J.Q., Shaw, L.M., *et al.* (2010). 3D PIB and CSF biomarker associations with hippocampal atrophy in ADNI subjects. *Neurobiol Aging* 31, 1284-1303.

Arancio, O., Zhang, H.P., Chen, X., Lin, C., Trinchese, F., Puzzo, D., Liu, S.M., Hegde, A., Yan, S.F., Stern, A., *et al.* (2004). RAGE potentiates A beta-induced perturbation of neuronal function in transgenic mice. *Embo Journal* 23, 4096-4105.

Ardiles, A.O., Tapia-Rojas, C.C., Mandal, M., Alexandre, F., Kirkwood, A., Inestrosa, N.C., and Palacios, A.G. (2012). Postsynaptic dysfunction is associated with spatial and object recognition memory loss in a natural model of Alzheimer's disease. *Proc Natl Acad Sci U S A* 109, 13835-13840.

Arriagada, P.V., Growdon, J.H., Hedley-Whyte, E.T., and Hyman, B.T. (1992). Neurofibrillary tangles but not senile plaques parallel duration and severity of Alzheimer's disease. *Neurology* 42, 631-631.

Asling, B., Dushay, M.S., and Hultmark, D. (1995). IDENTIFICATION OF EARLY GENES IN THE DROSOPHILA IMMUNE-RESPONSE BY PCR-BASED DIFFERENTIAL DISPLAY - THE ATTACIN-A GENE AND THE EVOLUTION OF ATTACIN-LIKE PROTEINS. *Insect Biochemistry and Molecular Biology* 25, 511-518.

Aubier, M., and Viires, N. (1998). Calcium ATPase and respiratory muscle function. *European Respiratory Journal* 11, 758-766.

Avila, A., Silverman, N., Diaz-Meco, M.T., and Moscat, J. (2002). The Drosophila atypical protein kinase C-Ref(2)P complex constitutes a conserved module for signaling in the toll pathway. *Molecular and Cellular Biology* 22, 8787-8795.

- Baba-Aissa, F., Raeymaekers, L., Wuytack, F., Dode, L., and Casteels, R. (1998). Distribution and isoform diversity of the organellar Ca²⁺ pumps in the brain. *Molecular and Chemical Neuropathology* 33, 199-208.
- Bakshi, P., Margenthaler, E., Reed, J., Crawford, F., and Mullan, M. (2011). Depletion of CXCR2 inhibits gamma-secretase activity and amyloid-beta production in a murine model of Alzheimer's disease. *Cytokine* 53, 163-169.
- Berridge, M.J., Lipp, P., and Bootman, M.D. (2000). The versatility and universality of calcium signalling. *Nature Reviews Molecular Cell Biology* 1, 11-21.
- Bierer, L.M., Hof, P.R., Purohit, D.P., Carlin, L., Schmeidler, J., Davis, K.L., and Perl, D.P. (1995). Neocortical Neurofibrillary Tangles Correlate With Dementia Severity in Alzheimer's Disease. *Archives of Neurology* 52, 81-88.
- Bilen, J., and Bonini, N.M. (2005). Drosophila as a model for human neurodegenerative disease. In *Annual Review of Genetics* (Palo Alto, Annual Reviews), pp. 153-171.
- Billings, L.M., Oddo, S., Green, K.N., McGaugh, J.L., and LaFerla, F.M. (2005). Intraneuronal A beta causes the onset of early Alzheimer's disease-related cognitive deficits in transgenic mice. *Neuron* 45.
- Blass, J.P., and Gibson, G.E. (1999). Cerebrometabolic aspects of delirium in relationship to dementia. *Dementia and Geriatric Cognitive Disorders* 10, 335-338.
- Boman, H.G., Nilsson, I., and Rasmuson, B. (1972). Inducible antibacterial defence system in Drosophila. *Nature* 237, 232-235.
- Borchelt, D.R., Thinakaran, G., Eckman, C.B., Lee, M.K., Davenport, F., Ratovitsky, T., Prada, C.M., Kim, G., Seekins, S., Yager, D., *et al.* (1996). Familial Alzheimer's disease-linked presenilin 1 variants elevate A beta 1-42/1-40 ratio in vitro and in vivo. *Neuron* 17.
- Braak, E., Braak, H., and Mandelkow, E.M. (1994). A sequence of cytoskeleton changes related to the formation of neurofibrillary tangles and neuropil threads. *Acta neuropathologica* 87, 554-567.
- Braak, H., and Braak, E. (1991). Neuropathological staging of Alzheimer-related changes. *Acta Neuropathologica* 82, 239-259.
- Braun, A., Hoffmann, J.A., and Meister, M. (1998). Analysis of the Drosophila host defense in domino mutant larvae, which are devoid of hemocytes. *Proceedings of the National Academy of Sciences of the United States of America* 95, 14337-14342.
- Brecht, W.J., Harris, F.M., Chang, S.J., Tesseur, I., Yu, G.Q., Xu, Q., Fish, J.D., Wyss-Coray, T., Buttini, M., Mucke, L., *et al.* (2004). Neuron-specific apolipoprotein E4 proteolysis is associated with increased tau phosphorylation in brains of transgenic mice. *Journal of Neuroscience* 24, 2527-2534.
- Breitner, J.C., Baker, L.D., Montine, T.J., Meinert, C.L., Lyketsos, C.G., Ashe, K.H., Brandt, J., Craft, S., Evans, D.E., Green, R.C., *et al.* (2011). Extended results of the Alzheimer's disease anti-inflammatory prevention trial. *Alzheimers Dement* 7, 402-411.
- Burdick, D., Soreghan, B., Kwon, M., Kosmoski, J., Knauer, M., Henschen, A., Yates, J., Cotman, C., and Glabe, C. (1992). Assembly and aggregation properties of synthetic Alzheimer's A4/beta amyloid peptide analogs. *J Biol Chem* 267, 546-554.

- Cabello, J., Neukomm, L.J., Guenesdogan, U., Burkart, K., Charette, S.J., Lochnit, G., Hengartner, M.O., and Schnabel, R. (2010). The Wnt Pathway Controls Cell Death Engulfment, Spindle Orientation, and Migration through CED-10/Rac. *Plos Biology* 8.
- Cao, W., Song, H.J., Gangi, T., Kelkar, A., Antani, I., Garza, D., and Konsolaki, M. (2008). Identification of novel genes that modify phenotypes induced by Alzheimer's beta-amyloid overexpression in *Drosophila*. *Genetics* 178, 1457-1471.
- Carro, T.V., Cristina, U., Carlos, S., Desiree, A., Mar√ ≠ a, J.M.n., Miguel, A.M.n., Isidro, F., Felix, B.-P., and Eva (2010). A β accumulation in choroid plexus is associated with mitochondrial-induced apoptosis. 31, 1569, Åì1581.
- Castellani, R., Institute of Pathology, C.W.R.U.C.O., Institute of Pathology, C.W.R.U.A.R.C.O., Hirai, K., Pharmaceutical Research Laboratories I, P.R.D.T.C.I.L.O.J., Aliev, G., Department of Anatomy, C.W.R.U.C.O., Drew, K.L., Institute of Arctic Biology, U.o.A.F., Nunomura, A., *et al.* (2002). Role of mitochondrial dysfunction in Alzheimer's disease. *Journal of Neuroscience Research* 70, 357-360.
- Castellani, R.J., Rolston, R.K., and Smith, M.a. (2010). Alzheimer disease. *Disease-a-month* : DM 56, 484-546.
- Castellano, J.M., Kim, J., Stewart, F.R., Jiang, H., DeMattos, R.B., Patterson, B.W., Fagan, A.M., Morris, J.C., Mawuenyega, K.G., Cruchaga, C., *et al.* (2011). Human apoE isoforms differentially regulate brain amyloid-beta peptide clearance. *Sci Transl Med* 3, 89ra57.
- Chakrabarty, P., Ceballos-Diaz, C., Beccard, A., Janus, C., Dickson, D., Golde, T.E., and Das, P. (2010a). IFN-gamma Promotes Complement Expression and Attenuates Amyloid Plaque Deposition in Amyloid beta Precursor Protein Transgenic Mice. *Journal of Immunology* 184, 5333-5343.
- Chakrabarty, P., Jansen-West, K., Beccard, A., Ceballos-Diaz, C., Levites, Y., Verbeeck, C., Zubair, A.C., Dickson, D., Golde, T.E., and Das, P. (2010b). Massive gliosis induced by interleukin-6 suppresses Abeta deposition in vivo: evidence against inflammation as a driving force for amyloid deposition. *FASEB journal* : official publication of the Federation of American Societies for Experimental Biology 24, 548-559.
- Charatsi, I., Luschnig, S., Bartoszewski, S., Nusslein-Volhard, C., and Moussian, B. (2003). Krapfen/dMyd88 is required for the establishment of dorsoventral pattern in the *Drosophila* embryo. *Mechanisms of Development* 120, 219-226.
- Chartier-Harlin, M.C., Crawford, F., Houlden, H., Warren, A., Hughes, D., Fidani, L., Goate, A., Rossor, M., Roques, P., Hardy, J., *et al.* (1991). Early-onset Alzheimer's disease caused by mutations at codon 717 of the beta-amyloid precursor protein gene. *Nature* 353, 844-846.
- Cheung, K.H., Mei, L., Mak, D.O., Hayashi, I., Iwatsubo, T., Kang, D.E., and Foscett, J.K. (2010). Gain-of-function enhancement of IP3 receptor modal gating by familial Alzheimer's disease-linked presenilin mutants in human cells and mouse neurons. *Sci Signal* 3, ra22.
- Cheung, K.H., Shineman, D., Muller, M., Cardenas, C., Mei, L., Yang, J., Tomita, T., Iwatsubo, T., Lee, V.M., and Foscett, J.K. (2008). Mechanism of Ca²⁺ disruption in Alzheimer's disease by presenilin regulation of InsP3 receptor channel gating. *Neuron* 58, 871-883.

- Chinchore, Y., Gerber, G.F., and Dolph, P.J. (2012). Alternative pathway of cell death in *Drosophila* mediated by NF-kappa B transcription factor Relish. *Proceedings of the National Academy of Sciences of the United States of America* *109*, E605-E612.
- Choe, K.M., Lee, H., and Anderson, K.V. (2005). *Drosophila* peptidoglycan recognition protein LC (PGRP-LC) acts as a signal-transducing innate immune receptor. *Proceedings of the National Academy of Sciences of the United States of America* *102*, 1122-1126.
- Choe, K.M., Werner, T., Stoven, S., Hultmark, D., and Anderson, K.V. (2002). Requirement for a peptidoglycan recognition protein (PGRP) in relish activation and antibacterial immune responses in *Drosophila*. *Science* *296*, 359-362.
- Citron, M., Westaway, D., Xia, W.M., Carlson, G., Diehl, T., Levesque, G., JohnsonWood, K., Lee, M., Seubert, P., Davis, A., *et al.* (1997). Mutant presenilins of Alzheimer's disease increase production of 42-residue amyloid beta-protein in both transfected cells and transgenic mice. *Nature Medicine* *3*.
- Corder, E.H., Saunders, A.M., Strittmatter, W.J., Schmechel, D.E., Gaskell, P.C., Small, G.W., Roses, A.D., Haines, J.L., and Pericakvance, M.A. (1993). GENE DOSE OF APOLIPOPROTEIN-E TYPE-4 ALLELE AND THE RISK OF ALZHEIMERS-DISEASE IN LATE-ONSET FAMILIES. *Science* *261*.
- Cornelius, C., Fastbom, J., Winblad, B., and Viitanen, M. (2004). Aspirin, NSAIDs, risk of dementia, and influence of the apolipoprotein E epsilon 4 allele in an elderly population. *Neuroepidemiology* *23*, 135-143.
- Cotman, C.W., and Head, E. (2008). The canine (dog) model of human aging and disease: dietary, environmental and immunotherapy approaches. *Journal of Alzheimer's disease : JAD* *15*, 685-707.
- Cousin, M.A., and Robinson, P.J. (2001). The dephosphins: dephosphorylation by calcineurin triggers synaptic vesicle endocytosis. *Trends Neurosci* *24*, 659-665.
- Crowther, D.C., Kinghorn, K.J., Miranda, E., Page, R., Curry, J.A., Duthie, F.A., Gubb, D.C., and Lomas, D.A. (2005). Intraneuronal A β , non-amyloid aggregates and neurodegeneration in a *Drosophila* model of Alzheimer's disease. In *Neuroscience (United States)*, pp. 123-135.
- Crowther, R.A. (1991). Straight and paired helical filaments in Alzheimer disease have a common structural unit. *Proceedings of the National Academy of Sciences* *88*, 2288-2292.
- Czirr, E., and Wyss-Coray, T. (2012). The immunology of neurodegeneration. *J Clin Invest* *122*, 1156-1163.
- Das, P., Smithson, L.A., Price, R.W., Holloway, V.M., Levites, Y., Chakrabarty, P., and Golde, T.E. (2006). Interleukin-1 receptor 1 knockout has no effect on amyloid deposition in Tg2576 mice and does not alter efficacy following A β immunotherapy. *Journal of Neuroinflammation* *3*.
- David, D.C., Hauptmann, S., Scherping, I., Schuessel, K., Keil, U., Rizzu, P., Ravid, R., Drose, S., Brandt, U., Muller, W.E., *et al.* (2005). Proteomic and functional analyses reveal a mitochondrial dysfunction in P301L tau transgenic mice. *J Biol Chem* *280*, 23802-23814.
- De Felice, F.G., Velasco, P.T., Lambert, M.P., Viola, K., Fernandez, S.J., Ferreira, S.T., and Klein, W.L. (2007). A β oligomers induce neuronal oxidative stress through an N-methyl-D-aspartate receptor-dependent mechanism that is blocked by the Alzheimer drug memantine. In *J Biol Chem (United States)*, pp. 11590-11601.

- Decker, H., Jurgensen, S., Adrover, M.F., Brito-Moreira, J., Bomfim, T.R., Klein, W.L., Epstein, A.L., De Felice, F.G., Jerusalinsky, D., and Ferreira, S.T. (2010). N-methyl-D-aspartate receptors are required for synaptic targeting of Alzheimer's toxic amyloid-beta peptide oligomers. *J Neurochem* 115, 1520-1529.
- DeLotto, Y., and DeLotto, R. (1998). Proteolytic processing of the *Drosophila* Spatzle protein by Easter generates a dimeric NGF-like molecule with ventralising activity. *Mechanisms of Development* 72, 141-148.
- Delrieu, J., Ousset, P.J., Caillaud, C., and Vellas, B. (2012). Clinical trials in Alzheimer's disease': immunotherapy approaches. *Journal of Neurochemistry* 120, 186-193.
- Dickerson, B.C., Bakkour, A., Salat, D.H., Feczko, E., Pacheco, J., Greve, D.N., Grodstein, F., Wright, C.I., Blacker, D., Rosas, H.D., *et al.* (2009). The cortical signature of Alzheimer's disease: regionally specific cortical thinning relates to symptom severity in very mild to mild AD dementia and is detectable in asymptomatic amyloid-positive individuals. *Cerebral cortex (New York, NY : 1991)* 19, 497-510.
- Drier, E.A., Huang, L.H., and Steward, R. (1999). Nuclear import of the *Drosophila* Rel protein Dorsal is regulated by phosphorylation. *Genes & Development* 13, 556-568.
- Duff, K., Eckman, C., Zehr, C., Yu, X., Prada, C.M., Pereztur, J., Hutton, M., Buee, L., Harigaya, Y., Yager, D., *et al.* (1996). Increased amyloid-beta 42(43) in brains of mice expressing mutant presenilin 1. *Nature* 383.
- Duffy, J.B. (2002). GAL4 system in *Drosophila*: a fly geneticist's Swiss army knife. *Genesis* 34, 1-15.
- Dulin, F., Leveille, F., Ortega, J.B., Mornon, J.P., Buisson, A., Callebaut, I., and Colloc'h, N. (2008). p3 peptide, a truncated form of A beta devoid of synaptotoxic effect, does not assemble into soluble oligomers. *Febs Letters* 582, 1865-1870.
- Dushay, M.S., Asling, B., and Hultmark, D. (1996). Origins of immunity: Relish, a compound Rel-like gene in the antibacterial defense of *Drosophila*. *Proceedings of the National Academy of Sciences of the United States of America* 93, 10343-10347.
- Dustin, M.L., Olszowy, M.W., Holdorf, A.D., Li, J., Bromley, S., Desai, N., Widder, P., Rosenberger, F., van der Merwe, P.A., Allen, P.M., *et al.* (1998). A novel adaptor protein orchestrates receptor patterning and cytoskeletal polarity in T-cell contacts. *Cell* 94, 667-677.
- Duyckaerts, C., Delatour, B.Æ., and Potier, M.-C. (2009). Classification and basic pathology of Alzheimer disease. *Acta neuropathologica* 118, 5-36.
- Einfeld, D.A., Brown, J.P., Valentine, M.A., Clark, E.A., and Ledbetter, J.A. (1988). Molecular cloning of the human B cell CD20 receptor predicts a hydrophobic protein with multiple transmembrane domains. *EMBO J* 7, 711-717.
- El Khoury, J., Toft, M., Hickman, S.E., Means, T.K., Terada, K., Geula, C., and Luster, A.D. (2007). Ccr2 deficiency impairs microglial accumulation and accelerates progression of Alzheimer-like disease. *Nature Medicine* 13, 432-438.
- Engstrom, Y., Kadalayil, L., Sun, S.C., Samakovlis, C., Hultmark, D., and Faye, I. (1993). KAPPA-B-LIKE MOTIFS REGULATE THE INDUCTION OF IMMUNE GENES IN *DROSOPHILA*. *Journal of Molecular Biology* 232, 327-333.
- Farfara, D., Trudler, D., Segev-Amzaleg, N., Galron, R., Stein, R., and Frenkel, D. (2011). gamma-Secretase component presenilin is important for microglia beta-amyloid clearance. *Ann Neurol* 69, 170-180.

- Fehlbaum, P., Bulet, P., Michaut, L., Lagueux, M., Broekaert, W.F., Hetru, C., and Hoffmann, J.A. (1994). INSECT IMMUNITY - SEPTIC INJURY OF DROSOPHILA INDUCES THE SYNTHESIS OF A POTENT ANTIFUNGAL PEPTIDE WITH SEQUENCE HOMOLOGY TO PLANT ANTIFUNGAL PEPTIDES. *Journal of Biological Chemistry* 269, 33159-33163.
- Fernandez, N.Q., Grosshans, J., Goltz, J.S., and Stein, D. (2001). Separable and redundant regulatory determinants in Cactus mediate its dorsal group dependent degradation. *Development* 128, 2963-2974.
- Fonseca, M.I., Zhou, J., Botto, M., and Tenner, A.J. (2004). Absence of C1q leads to less neuropathology in transgenic mouse models of Alzheimer's disease. *The Journal of neuroscience : the official journal of the Society for Neuroscience* 24, 6457-6465.
- Fortini, M.E., and Bonini, N.M. (2000). Modeling human neurodegenerative diseases in Drosophila: on a wing and a prayer. *Trends in genetics : TIG* 16, 161-167.
- Foskett, J.K. (2010). Inositol trisphosphate receptor Ca²⁺ release channels in neurological diseases. *Pflugers Archiv-European Journal of Physiology* 460, 481-494.
- Francis, R., McGrath, G., Zhang, J.H., Ruddy, D.A., Sym, M., Apfeld, J., Nicoll, M., Maxwell, M., Hai, B., Ellis, M.C., *et al.* (2002). aph-1 and pen-2 are required for notch pathway signaling, gamma-secretase cleavage of beta APP, and presenilin protein accumulation. *Developmental Cell* 3.
- Freeman, M.R., Delrow, J., Kim, J., Johnson, E., and Doe, C.Q. (2003). Unwrapping glial biology: Gcm target genes regulating glial development, diversification, and function. In *Neuron (United States)*, pp. 567-580.
- Freeman, M.R., and Doherty, J. (2006). Glial cell biology in Drosophila and vertebrates. *Trends in neurosciences* 29, 82-90.
- Frenkel, D., Maron, R., Burt, D.S., and Weiner, H.L. (2005). Nasal vaccination with a proteosome-based adjuvant and glatiramer acetate clears beta-amyloid in a mouse model of Alzheimer disease. *J Clin Invest* 115, 2423-2433.
- Fuentes-Medel, Y., Logan, M.A., Ashley, J., Ataman, B., Budnik, V., and Freeman, M.R. (2009). Glia and Muscle Sculpt Neuromuscular Arbors by Engulfing Destabilized Synaptic Boutons and Shed Presynaptic Debris. *Plos Biology* 7.
- Fuhrmann, M., Bittner, T., Jung, C.K.E., Burgold, S., Page, R.M., Mitteregger, G., Haass, C., LaFerla, F.M., Kretschmar, H., and Herms, J. (2010). Microglial Cx3cr1 knockout prevents neuron loss in a mouse model of Alzheimer's disease. *Nature Neuroscience* 13, 411-413.
- Furukawa, K., Sopher, B.L., Rydel, R.E., Begley, J.G., Pham, D.G., Martin, G.M., Fox, M., and Mattson, M.P. (1996). Increased activity-regulating and neuroprotective efficacy of alpha-secretase-derived secreted amyloid precursor protein conferred by a C-terminal heparin-binding domain. *Journal of Neurochemistry* 67, 1882-1896.
- Games, D., Adams, D., Alessandrini, R., Barbour, R., Berthelette, P., Blackwell, C., Carr, T., Clemens, J., Donaldson, T., Gillespie, F., *et al.* (1995). ALZHEIMER-TYPE NEUROPATHOLOGY IN TRANSGENIC MICE OVEREXPRESSING V717F BETA-AMYLOID PRECURSOR PROTEIN. *Nature* 373.
- Georgel, P., Naitza, S., Kappler, C., Ferrandon, D., Zachary, D., Swimmer, C., Kopczynski, C., Duyk, G., Reichart, J.M., and Hoffmann, J.A. (2001). Drosophila

- immune deficiency (IMD) is a death domain protein that activates antibacterial defense and can promote apoptosis. *Developmental Cell* 1, 503-514.
- Gerardin, E., Chetelat, G., Chupin, M., Cuingnet, R., Desgranges, B., Kim, H.S., Niethammer, M., Dubois, B., Lehericy, S., Garnero, L., *et al.* (2009). Multidimensional classification of hippocampal shape features discriminates Alzheimer's disease and mild cognitive impairment from normal aging. *Neuroimage* 47, 1476-1486.
- Giannakopoulos, P., Herrmann, F.R., Bussiere, T., Bouras, C., Kovari, E., Perl, D.P., Morrison, J.H., Gold, G., and Hof, P.R. (2003). Tangle and neuron numbers, but not amyloid load, predict cognitive status in Alzheimer's disease. *Neurology* 60, 1495-1500.
- Gilbert, S.F. (2000). Chromosomal Sex Determination in *Drosophila*. In *Developmental Biology* (Sunderland (MA), Sinauer Associates).
- Glabe, C.G. (2006). Common mechanisms of amyloid oligomer pathogenesis in degenerative disease. *Neurobiology of Aging* 27.
- Glenner, G.G., and Wong, C.W. (1984a). Alzheimer's disease and Down's syndrome: sharing of a unique cerebrovascular amyloid fibril protein. In *Biochem Biophys Res Commun* (United States), pp. 1131-1135.
- Glenner, G.G., and Wong, C.W. (1984b). ALZHEIMERS-DISEASE - INITIAL REPORT OF THE PURIFICATION AND CHARACTERIZATION OF A NOVEL CEREBROVASCULAR AMYLOID PROTEIN. *Biochemical and Biophysical Research Communications* 120.
- Goate, A., Chartier-Harlin, M.C., Mullan, M., Brown, J., Crawford, F., Fidani, L., Giuffra, L., Haynes, A., Irving, N., James, L., *et al.* (1991). Segregation of a missense mutation in the amyloid precursor protein gene with familial Alzheimer's disease. *Nature* 349, 704-706.
- Gottar, M., Gobert, V., Michel, T., Belvin, M., Duyk, G., Hoffmann, J.A., Ferrandon, D., and Royet, J. (2002). The *Drosophila* immune response against Gram-negative bacteria is mediated by a peptidoglycan recognition protein. *Nature* 416, 640-644.
- Gotz, J., Chen, F., van Dorpe, J., and Nitsch, R.M. (2001). Formation of neurofibrillary tangles in P301L tau transgenic mice induced by A beta 42 fibrils. *Science* 293, 1491-1495.
- Gotz, J., Schild, A., Hoerndli, F., and Pennanen, L. (2004). Amyloid-induced neurofibrillary tangle formation in Alzheimer's disease: insight from transgenic mouse and tissue-culture models. *International Journal of Developmental Neuroscience* 22, 453-465.
- Green, K.N., Demuro, A., Akbari, Y., Hitt, B.D., Smith, I.F., Parker, I., and LaFerla, F.M. (2008). SERCA pump activity is physiologically regulated by presenilin and regulates amyloid beta production. *J Cell Biol* 181, 1107-1116.
- Green, K.N., and LaFerla, F.M. (2008). Linking calcium to A beta and Alzheimer's disease. *Neuron* 59, 190-194.
- Green, R.C., Schneider, L.S., Amato, D.A., Beelen, A.P., Wilcock, G., Swabb, E.A., Zavitz, K.H., and Tarenflurbil Phase 3 Study, G. (2009). Effect of Tarenflurbil on Cognitive Decline and Activities of Daily Living in Patients With Mild Alzheimer Disease A Randomized Controlled Trial. *Jama-Journal of the American Medical Association* 302, 2557-2564.
- Greeve, I., Kretschmar, D., Tschöp, J.-A., Beyn, A., Brellinger, C., Schweizer, M., Nitsch, R.M., and Reifegerste, R. (2004). Age-dependent neurodegeneration

and Alzheimer-amyloid plaque formation in transgenic *Drosophila*. *The Journal of neuroscience : the official journal of the Society for Neuroscience* 24, 3899-3906.

Gyure, K.A., Durham, R., Stewart, W.F., Smialek, J.E., and Troncoso, J.C. (2001). Intraneuronal A beta-amyloid precedes development of amyloid plaques in Down syndrome. *Archives of Pathology & Laboratory Medicine* 125.

Haass, C., Hung, A.Y., Schlossmacher, M.G., Teplow, D.B., and Selkoe, D.J. (1993). BETA-AMYLOID PEPTIDE AND A 3-KDA FRAGMENT ARE DERIVED BY DISTINCT CELLULAR MECHANISMS. *Journal of Biological Chemistry* 268.

Haass, C., Lemere, C.A., Capell, A., Citron, M., Seubert, P., Schenk, D., Lannfelt, L., and Selkoe, D.J. (1995). THE SWEDISH MUTATION CAUSES EARLY-ONSET ALZHEIMERS-DISEASE BY BETA-SECRETASE CLEAVAGE WITHIN THE SECRETORY PATHWAY. *Nature Medicine* 1.

Hanisch, U.K., and Kettenmann, H. (2007). Microglia: active sensor and versatile effector cells in the normal and pathologic brain. *Nature Neuroscience* 10, 1387-1394.

Hara, T., Nakamura, K., Matsui, M., Yamamoto, A., Nakahara, Y., Suzuki-Migishima, R., Yokoyama, M., Mishima, K., Saito, I., Okano, H., *et al.* (2006). Suppression of basal autophagy in neural cells causes neurodegenerative disease in mice. *Nature* 441, 885-889.

Hardy, J., and Allsop, D. (1991). AMYLOID DEPOSITION AS THE CENTRAL EVENT IN THE ETIOLOGY OF ALZHEIMERS-DISEASE. *Trends in Pharmacological Sciences* 12.

Hardy, J., Selkoe, D.J., Hardy, J., and Selkoe, D.J. (2002). The Amyloid Hypothesis of Alzheimer's Disease: Progress and Problems on the Road to Therapeutics. *Science* 297, 353-356.

Hardy, J.A., and Higgins, G.A. (1992). ALZHEIMERS-DISEASE - THE AMYLOID CASCADE HYPOTHESIS. *Science* 256.

He, G., Luo, W., Li, P., Remmers, C., Netzer, W.J., Hendrick, J., Bettayeb, K., Flajolet, M., Gorelick, F., Wennogle, L.P., *et al.* (2010). Gamma-secretase activating protein is a therapeutic target for Alzheimer's disease. *Nature* 467, 95-98.

He, P., Zhong, Z., Lindholm, K., Berning, L., Lee, W., Lemere, C., Staufenbiel, M., Li, R., and Shen, Y. (2007). Deletion of tumor necrosis factor death receptor inhibits amyloid beta generation and prevents learning and memory deficits in Alzheimer's mice. *Journal of Cell Biology* 178, 829-841.

Hirai, K., Aliev, G., Nunomura, A., Fujioka, H., Russell, R.L., Atwood, C.S., Johnson, A.B., Kress, Y., Vinters, H.V., Tabaton, M., *et al.* (2001). Mitochondrial Abnormalities in Alzheimer's Disease. *J Neurosci* 21, 3017-3023.

Hoffmann, J.A. (2003). The immune response of *Drosophila*. *Nature* 426, 33-38.

Hoffmann, J.A., and Reichhart, J.M. (2002). *Drosophila* innate immunity: an evolutionary perspective. *Nature Immunology* 3, 121-126.

Hong, Y.K., Lee, S., Park, S.H., Lee, J.H., Han, S.Y., Kim, S.T., Kim, Y.K., Jeon, S., Koo, B.S., and Cho, K.S. (2012). Inhibition of JNK/dFOXO pathway and caspases rescues neurological impairments in *Drosophila* Alzheimer's disease model. *Biochem Biophys Res Commun* 419, 49-53.

Hornig, T., and Medzhitov, R. (2001). *Drosophila* MyD88 is an adapter in the Toll signaling pathway. *Proceedings of the National Academy of Sciences of the United States of America* 98, 12654-12658.

- Hsiao, K., Chapman, P., Nilsen, S., Eckman, C., Harigaya, Y., Younkin, S., Yang, F.S., and Cole, G. (1996). Correlative memory deficits, A beta elevation, and amyloid plaques in transgenic mice. *Science* 274.
- Hu, W.T., Chen-Plotkin, A., Arnold, S.E., Grossman, M., Clark, C.M., Shaw, L.M., Pickering, E., Kuhn, M., Chen, Y., McCluskey, L., *et al.* (2010). Novel CSF biomarkers for Alzheimer's disease and mild cognitive impairment. *Acta Neuropathol* 119, 669-678.
- Hu, W.T., Holtzman, D.M., Fagan, A.M., Shaw, L.M., Perrin, R., Arnold, S.E., Grossman, M., Xiong, C., Craig-Schapiro, R., Clark, C.M., *et al.* (2012). Plasma multianalyte profiling in mild cognitive impairment and Alzheimer disease. *Neurology* 79, 897-905.
- Huang, Y.D., Liu, X.Q., Wyss-Coray, T., Brecht, W.J., Sanan, D.A., and Mahley, R.W. (2001). Apolipoprotein E fragments present in Alzheimer's disease brains induce neurofibrillary tangle-like intracellular inclusions in neurons. *Proceedings of the National Academy of Sciences of the United States of America* 98, 8838-8843.
- Hultmark, D., Engstrom, A., Andersson, K., Steiner, H., Bennich, H., and Boman, H.G. (1983). INSECT IMMUNITY - ATTACINS, A FAMILY OF ANTI-BACTERIAL PROTEINS FROM HYALOPHORA-CECROPIA. *Embo Journal* 2, 571-576.
- Hussain, I., Powell, D., Howlett, D.R., Tew, D.G., Week, T.D., Chapman, C., Gloger, I.S., Murphy, K.E., Southan, C.D., Ryan, D.M., *et al.* (1999). Identification of a novel aspartic protease (Asp 2) as beta-secretase. *Molecular and Cellular Neuroscience* 14.
- Hyman, B.T., Marzloff, K., and Arriagada, P.V. (1993). The lack of accumulation of senile plaques or amyloid burden in Alzheimer's disease suggests a dynamic balance between amyloid deposition and resolution. *Journal of neuropathology and experimental neurology* 52, 594-600.
- Iida, K., Mornaghi, R., and Nussenzweig, V. (1982). Complement receptor (CR1) deficiency in erythrocytes from patients with systemic lupus erythematosus. *J Exp Med* 155, 1427-1438.
- Iijima, K., Liu, H.P., Chiang, A.S., Hearn, S.A., Konsolaki, M., and Zhong, Y. (2004). Dissecting the pathological effects of human Abeta40 and Abeta42 in *Drosophila*: a potential model for Alzheimer's disease. In *Proc Natl Acad Sci U S A (United States)*, pp. 6623-6628.
- Iijima-Ando, K., and Iijima, K. (2010). Transgenic *Drosophila* models of Alzheimer's disease and tauopathies. *Brain structure & function* 214, 245-262.
- Ikeda, Y., Abe-Dohmae, S., Munehira, Y., Aoki, R., Kawamoto, S., Furuya, A., Shitara, K., Amachi, T., Kioka, N., Matsuo, M., *et al.* (2003). Posttranscriptional regulation of human ABCA7 and its function for the apoA-I-dependent lipid release. *Biochem Biophys Res Commun* 311, 313-318.
- Imler, J.L., and Bulet, P. (2005). Antimicrobial peptides in *Drosophila*: structures, activities and gene regulation. In *Chem Immunol Allergy (Switzerland)*, pp. 1-21.
- Ioannidis, J.P. (2008). Effect of formal statistical significance on the credibility of observational associations. *Am J Epidemiol* 168, 374-383; discussion 384-390.
- Ioannidis, J.P., Boffetta, P., Little, J., O'Brien, T.R., Uitterlinden, A.G., Vineis, P., Balding, D.J., Chokkalingam, A., Dolan, S.M., Flanders, W.D., *et al.* (2008). Assessment of cumulative evidence on genetic associations: interim guidelines. *Int J Epidemiol* 37, 120-132.

- Ip, Y.T., Reach, M., Engstrom, Y., Kadalayil, L., Cai, H., Gonzalezcrespo, S., Tatei, K., and Levine, M. (1993). DIF, A DORSAL-RELATED GENE THAT MEDIATES AN IMMUNE-RESPONSE IN DROSOPHILA. *Cell* 75, 753-763.
- Itagaki, S., McGeer, P., Akiyama, H., Zhu, S., and Selkoe, D. (1989). Relationship of microglia and astrocytes to amyloid deposits of Alzheimer disease. *Journal of Neuroimmunology* 24, 173-182.
- Ivins, K.J., Thornton, P.L., Rohn, T.T., and Cotman, C.W. (1999). Neuronal apoptosis induced by beta-amyloid is mediated by caspase-8. *Neurobiol Dis* 6, 440-449.
- Jack, C.R., Jr., Lowe, V.J., Weigand, S.D., Wiste, H.J., Senjem, M.L., Knopman, D.S., Shiung, M.M., Gunter, J.L., Boeve, B.F., Kemp, B.J., *et al.* (2009). Serial PIB and MRI in normal, mild cognitive impairment and Alzheimer's disease: implications for sequence of pathological events in Alzheimer's disease. *Brain* 132, 1355-1365.
- Jankowsky, J.L., Fadale, D.J., Anderson, J., Xu, G.M., Gonzales, V., Jenkins, N.A., Copeland, N.G., Lee, M.K., Younkin, L.H., Wagner, S.L., *et al.* (2004). Mutant presenilins specifically elevate the levels of the 42 residue beta-amyloid peptide in vivo: evidence for augmentation of a 42-specific gamma secretase. *Human Molecular Genetics* 13.
- Jarrett, J.T., Berger, E.P., and Lansbury, P.T. (1993a). THE CARBOXY TERMINUS OF THE BETA-AMYLOID PROTEIN IS CRITICAL FOR THE SEEDING OF AMYLOID FORMATION - IMPLICATIONS FOR THE PATHOGENESIS OF ALZHEIMERS-DISEASE. *Biochemistry* 32.
- Jarrett, J.T., Berger, E.P., and Lansbury, P.T., Jr. (1993b). The carboxy terminus of the beta amyloid protein is critical for the seeding of amyloid formation: implications for the pathogenesis of Alzheimer's disease. *Biochemistry* 32, 4693-4697.
- Jenne, D.E., and Tschopp, J. (1992). Clusterin: the intriguing guises of a widely expressed glycoprotein. *Trends Biochem Sci* 17, 154-159.
- Joachim, C.L., Morris, J.H., and Selkoe, D.J. (1989). Diffuse senile plaques occur commonly in the cerebellum in Alzheimer's disease. *The American journal of pathology* 135, 309-319.
- Kaneko, T., Yano, T., Aggarwal, K., Lim, J.H., Ueda, K., Oshima, Y., Peach, C., Erturk-Hasdemir, D., Goldman, W.E., Oh, B.H., *et al.* (2006). PGRP-LC and PGRP-LE have essential yet distinct functions in the drosophila immune response to monomeric DAP-type peptidoglycan. *Nature Immunology* 7, 715-723.
- Kang, J., Lemaire, H.G., Unterbeck, A., Salbaum, J.M., Masters, C.L., Grzeschik, K.H., Multhaup, G., Beyreuther, K., and Muller-Hill, B. (1987). The precursor of Alzheimer's disease amyloid A4 protein resembles a cell-surface receptor. *Nature* 325, 733-736.
- Kappler, C., Meister, M., Lagueux, M., Gateff, E., Hoffmann, J.A., and Reichhart, J.M. (1993). INSECT IMMUNITY - 2 17 BP REPEATS NESTING A KAPPA-B-RELATED SEQUENCE CONFER INDUCIBILITY TO THE DIPTERICIN GENE AND BIND A POLYPEPTIDE IN BACTERIA-CHALLENGED DROSOPHILA. *Embo Journal* 12, 1561-1568.
- Karran, E., Mercken, M., and De Strooper, B. (2011). The amyloid cascade hypothesis for Alzheimer's disease: an appraisal for the development of therapeutics. *Nature Reviews Drug Discovery* 10, 698-U1600.
- Katzman, R., Terry, R., Deteresa, R., Brown, T., Davies, P., Fuld, P., Xiong, R.B., and Peck, A. (1988). CLINICAL, PATHOLOGICAL, AND NEUROCHEMICAL CHANGES

- IN DEMENTIA - A SUBGROUP WITH PRESERVED MENTAL STATUS AND NUMEROUS NEOCORTICAL PLAQUES. *Annals of Neurology* 23, 138-144.
- Khandelwal, A., Chandu, D., Roe, C.M., Kopan, R., and Quatrano, R.S. (2007). Moonlighting activity of presenilin in plants is independent of gamma-secretase and evolutionarily conserved. In *Proc Natl Acad Sci U S A (United States)*, pp. 13337-13342.
- Khera, R., and Das, N. (2009). Complement Receptor 1: disease associations and therapeutic implications. *Mol Immunol* 46, 761-772.
- Khoury, M.J., Bertram, L., Boffetta, P., Butterworth, A.S., Chanock, S.J., Dolan, S.M., Fortier, I., Garcia-Closas, M., Gwinn, M., Higgins, J.P., *et al.* (2009). Genome-wide association studies, field synopses, and the development of the knowledge base on genetic variation and human diseases. *Am J Epidemiol* 170, 269-279.
- Kidd, M. (1964). Alzheimer's disease, Åñan electron microscopical study. *Brain* 87, 307-320.
- Kielar, D., Kaminski, W.E., Liebisch, G., Piehler, A., Wenzel, J.J., Mohle, C., Heimerl, S., Langmann, T., Friedrich, S.O., Bottcher, A., *et al.* (2003). Adenosine triphosphate binding cassette (ABC) transporters are expressed and regulated during terminal keratinocyte differentiation: a potential role for ABCA7 in epidermal lipid reorganization. *J Invest Dermatol* 121, 465-474.
- Klickstein, L.B., Bartow, T.J., Miletic, V., Rabson, L.D., Smith, J.A., and Fearon, D.T. (1988). Identification of distinct C3b and C4b recognition sites in the human C3b/C4b receptor (CR1, CD35) by deletion mutagenesis. *J Exp Med* 168, 1699-1717.
- Knowles, R.B., Wyart, C., Buldyrev, S.V., Cruz, L., Urbanc, B., Hasselmo, M.E., Stanley, H.E., and Hyman, B.T. (1999). Plaque-induced neurite abnormalities: Implications for disruption of neural networks in Alzheimer's disease. *Proceedings of the National Academy of Sciences* 96, 5274-5279.
- Kojro, E., and Fahrenholz, F. (2005). The non-amyloidogenic pathway: Structure and function of alpha-secretases. *Alzheimer's Disease: Cellular and Molecular Aspects of Amyloid* 38.
- Komatsu, M., Waguri, S., Chiba, T., Murata, S., Iwata, J., Tanida, I., Ueno, T., Koike, M., Uchiyama, Y., Kominami, E., *et al.* (2006). Loss of autophagy in the central nervous system causes neurodegeneration in mice. *Nature* 441, 880-884.
- Kondziella, D., Gothlin, M., Fu, M., Zetterberg, H., and Wallin, A. (2009). B-type natriuretic peptide plasma levels are elevated in subcortical vascular dementia. *Neuroreport* 20, 825-827.
- Kraemer, B.C., Zhang, B., Leverenz, J.B., Thomas, J.H., Trojanowski, J.Q., and Schellenberg, G.D. (2003). Neurodegeneration and defective neurotransmission in a *Caenorhabditis elegans* model of tauopathy. *Proceedings of the National Academy of Sciences of the United States of America* 100, 9980-9985.
- Kuster, H., Zhang, L., Brini, A.T., MacGlashan, D.W., and Kinet, J.P. (1992). The gene and cDNA for the human high affinity immunoglobulin E receptor beta chain and expression of the complete human receptor. *J Biol Chem* 267, 12782-12787.
- Laferla, F.M., Tinkle, B.T., Bieberich, C.J., Haudenschild, C.C., and Jay, G. (1995). THE ALZHEIMERS A-BETA PEPTIDE INDUCES NEURODEGENERATION AND APOPTOTIC CELL-DEATH IN TRANSGENIC MICE. *Nature Genetics* 9, 21-30.
- Lee, S., Varvel, N.H., Konerth, M.E., Xu, G., Cardona, A.E., Ransohoff, R.M., and Lamb, B.T. (2010). CX3CR1 Deficiency Alters Microglial Activation and Reduces

- Beta-Amyloid Deposition in Two Alzheimer's Disease Mouse Models. *American Journal of Pathology* 177, 2549-2562.
- Lee, Y.K., Kwak, D.H., Oh, K.W., Nam, S.-Y., Lee, B.J., Yun, Y.W., Kim, Y.-B., Han, S.B., and Hong, J.T. (2009). CCR5 deficiency induces astrocyte activation, A beta deposit and impaired memory function. *Neurobiology of Learning and Memory* 92, 356-363.
- Lemaitre, B. (2004). Landmark - The road to Toll. *Nature Reviews Immunology* 4, 521-527.
- Lemaitre, B., and Hoffmann, J. (2007). The host defense of *Drosophila melanogaster*. In *Annual Review of Immunology* (Palo Alto, Annual Reviews), pp. 697-743.
- Lemaitre, B., Nicolas, E., Michaut, L., Reichhart, J.M., and Hoffmann, J.A. (1996). The dorsoventral regulatory gene cassette *spatzle/Toll/cactus* controls the potent antifungal response in *Drosophila* adults. In *Cell* (United States), pp. 973-983.
- Lesne, S., Koh, M.T., Kotilinek, L., Kaye, R., Glabe, C.G., Yang, A., Gallagher, M., and Ashe, K.H. (2006). A specific amyloid-beta protein assembly in the brain impairs memory. *Nature* 440.
- Leulier, F., Rodriguez, A., Khush, R.S., Abrams, J.M., and Lemaitre, B. (2000). The *Drosophila* caspase Dredd is required to resist Gram-negative bacterial infection. *Embo Reports* 1, 353-358.
- Leulier, F., Vidal, S., Saigo, K., Ueda, R., and Lemaitre, B. (2002). Inducible expression of double-stranded RNA reveals a role for dFADD in the regulation of the antibacterial response in *Drosophila* adults. *Current Biology* 12, 996-1000.
- Levashina, E.A., Ohresser, S., Bulet, P., Reichhart, J.M., Hetru, C., and Hoffmann, J.A. (1995). METCHNIKOWIN, A NOVEL IMMUNE-INDUCIBLE PROLINE-RICH PEPTIDE FROM *DROSOPHILA* WITH ANTIBACTERIAL AND ANTIFUNGAL PROPERTIES. *European Journal of Biochemistry* 233, 694-700.
- Levitan, D., Lee, J., Song, L.X., Manning, R., Wong, G., Parker, E., and Zhang, L.L. (2001). PS1N-and C-terminal fragments form a complex that functions in APP processing and Notch signaling. *Proceedings of the National Academy of Sciences of the United States of America* 98.
- Levy, E., Carman, M.D., Fernandezmadrid, I.J., Power, M.D., Lieberburg, I., Vanduin, S.G., Bots, G., Luyendijk, W., and Frangione, B. (1990). MUTATION OF THE ALZHEIMERS-DISEASE AMYLOID GENE IN HEREDITARY CEREBRAL-HEMORRHAGE, DUTCH TYPE. *Science* 248.
- Lewis, J., Dickson, D.W., Lin, W.L., Chisholm, L., Corral, A., Jones, G., Yen, S.H., Sahara, N., Skipper, L., Yager, D., *et al.* (2001). Enhanced neurofibrillary degeneration in transgenic mice expressing mutant tau and APP. *Science* 293.
- Li, A., Xie, Z., Dong, Y., McKay, K.M., McKee, M.L., and Tanzi, R.E. (2007). Isolation and characterization of the *Drosophila* ubiquilin ortholog dUbqln: in vivo interaction with early-onset Alzheimer disease genes. *Human molecular genetics* 16, 2626-2639.
- Liang, X.B., Wang, Q., Hand, T., Wu, L.J., Breyer, R.M., Montine, T.J., and Andreasson, K. (2005). Deletion of the prostaglandin E-2 EP2 receptor reduces oxidative damage and amyloid burden in a model of Alzheimer's disease. *Journal of Neuroscience* 25, 10180-10187.
- Lindsay, J., Laurin, D., Verreault, R., Hebert, R., Helliwell, B., Hill, G.B., and McDowell, I. (2002). Risk factors for Alzheimer's disease: A prospective analysis

- from the Canadian Study of Health and Aging. *American Journal of Epidemiology* 156, 445-453.
- Link, C.D. (1995). EXPRESSION OF HUMAN BETA-AMYLOID PEPTIDE IN TRANSGENIC CAENORHABDITIS-ELEGANS. *Proceedings of the National Academy of Sciences of the United States of America* 92, 9368-9372.
- Link, C.D. (2005). Invertebrate models of Alzheimer's disease. *Genes, brain, and behavior* 4, 147-156.
- Link, C.D., Johnson, C.J., Fonte, V., Paupard, M., Hall, D.H., Styren, S., Mathis, C.A., and Klunk, W.E. (2001). Visualization of fibrillar amyloid deposits in living, transgenic *Caenorhabditis elegans* animals using the sensitive amyloid dye, X-34. *Neurobiol Aging* 22, 217-226.
- Liu, X., Sano, T., Guan, Y., Nagata, S., Hoffmann, J.A., and Fukuyama, H. (2012). *Drosophila* EYA Regulates the Immune Response against DNA through an Evolutionarily Conserved Threonine Phosphatase Motif. *PLoS ONE* 7, e42725.
- Lord, A., Kalimo, H., Eckman, C., Zhang, X.Q., Lannfelt, L., and Nilsson, L.N.G. (2006). The Arctic Alzheimer mutation facilitates early intraneuronal A beta aggregation and senile plaque formation in transgenic mice. *Neurobiology of Aging* 27.
- Lubernarod, J., and Rogers, J. (1988). IMMUNE-SYSTEM ASSOCIATED ANTIGENS EXPRESSED BY CELLS OF THE HUMAN CENTRAL NERVOUS-SYSTEM. *Neuroscience Letters* 94, 17-22.
- Lue, L.F., Kuo, Y.M., Roher, A.E., Brachova, L., Shen, Y., Sue, L., Beach, T., Kurth, J.H., Rydel, R.E., and Rogers, J. (1999). Soluble amyloid beta peptide concentration as a predictor of synaptic change in Alzheimer's disease. *The American journal of pathology* 155, 853-862.
- Lustbader, J.W., Cirilli, M., Lin, C., Xu, H.W., Takuma, K., Wang, N., Caspersen, C., Chen, X., Pollak, S., Chaney, M., *et al.* (2004). Aβ directly links A beta to mitochondrial toxicity in Alzheimer's disease. *Science* 304, 448-452.
- Lynch, D.K., Winata, S.C., Lyons, R.J., Hughes, W.E., Lehrbach, G.M., Wasinger, V., Corthals, G., Cordwell, S., and Daly, R.J. (2003). A cortactin-CD2-associated protein (CD2AP) complex provides a novel link between epidermal growth factor receptor endocytosis and the actin cytoskeleton. *Journal of Biological Chemistry* 278, 21805-21813.
- MacDonald, J.M., Beach, M.G., Porpiglia, E., Sheehan, A.E., Watts, R.J., and Freeman, M.R. (2006). The *Drosophila* cell corpse engulfment receptor draper mediates glial clearance of severed axons. *Neuron* 50, 869-881.
- Maekawa, K., Imagawa, N., Tanaka, Y., and Harada, S. (1992). Determination of the sequence coding for the beta subunit of the human high-affinity IgE receptor. *FEBS Lett* 302, 161-165.
- Maier, M., Peng, Y., Jiang, L., Seabrook, T.J., Carroll, M.C., and Lemere, C.a. (2008). Complement C3 deficiency leads to accelerated amyloid beta plaque deposition and neurodegeneration and modulation of the microglia/macrophage phenotype in amyloid precursor protein transgenic mice. *The Journal of neuroscience : the official journal of the Society for Neuroscience* 28, 6333-6341.
- Masliah, E., Terry, R.D., Mallory, M., Alford, M., and Hansen, L.A. (1990). Diffuse plaques do not accentuate synapse loss in Alzheimer's disease. *The American journal of pathology* 137, 1293-1297.
- Maurer, K., Volk, S., and Gerbaldo, H. (1997). Auguste D and Alzheimer's disease. In *Lancet (England)*, pp. 1546-1549.

- Mayeux, R., Stern, Y., Johnson, K.A., Fox, N.C., Sperling, R.A., Aisen, P.S., Cummings, J., Lon, S., Nixon, R., Wyss-coray, T., *et al.* (2012). Epidemiology of Alzheimer Disease. Cold Spring Harbor perspectives in medicine.
- McGeer, P.L., Itagaki, S., and McGeer, E.G. (1988). Expression of the histocompatibility glycoprotein HLA-DR in neurological disease. *Acta Neuropathol* 76, 550-557.
- McGeer, P.L., Rogers, J., and McGeer, E.G. (2006). Inflammation, anti-inflammatory agents and Alzheimer disease: the last 12 years. *Journal of Alzheimer's disease : JAD* 9.
- McGeer, P.L., Schulzer, M., and McGeer, E.G. (1996). Arthritis and anti-inflammatory agents as possible protective factors for Alzheimer's disease: A review of 17 epidemiologic studies. *Neurology* 47, 425-432.
- McGowan, E., Eriksen, J., and Hutton, M. (2006). A decade of modeling Alzheimer's disease in transgenic mice. *Trends in genetics : TIG* 22, 281-289.
- McGowan, E., Pickford, F., Kim, J., Onstead, L., Eriksen, J., Yu, C., Skipper, L., Murphy, M.P., Beard, J., Das, P., *et al.* (2005). A beta 42 is essential for parenchymal and vascular amyloid deposition in mice. *Neuron* 47, 191-199.
- Meister, M., Braun, A., Kappler, C., Reichhart, J.M., and Hoffmann, J.A. (1994). INSECT IMMUNITY - A TRANSGENIC ANALYSIS IN DROSOPHILA DEFINES SEVERAL FUNCTIONAL DOMAINS IN THE DIPTERICIN PROMOTER. *Embo Journal* 13, 5958-5966.
- Mizuguchi, K., Parker, J.S., Blundell, T.L., and Gay, N.J. (1998). Getting knotted: a model for the structure and activation of Spatzle. *Trends in Biochemical Sciences* 23, 239-242.
- Morgan, D. (2011). Immunotherapy for Alzheimer's disease. *Journal of Internal Medicine* 269, 54-63.
- Mori, C., Spooner, E.T., Wisniewski, K.E., Wisniewski, T.M., Yamaguchi, H., Saido, T.C., Tolani, D.R., Selkoe, D.J., and Lemere, C.A. (2002). Intraneuronal A beta 42 accumulation in Down syndrome brain. *Amyloid-Journal of Protein Folding Disorders* 9.
- Mori, T., Koyama, N., Arendash, G.W., Horikoshi-Sakuraba, Y., Tan, J., and Town, T. (2010). Overexpression of Human S100B Exacerbates Cerebral Amyloidosis and Gliosis in the Tg2576 Mouse Model of Alzheimer's Disease. *Glia* 58, 300-314.
- Mott, R.T., and Hulette, C.M. (2005). Neuropathology of Alzheimer's disease. *Neuroimaging clinics of North America* 15, 755-765, ix.
- Mucke, L., Masliah, E., Yu, G.Q., Mallory, M., Rockenstein, E.M., Tatsuno, G., Hu, K., Kholodenko, D., Johnson-Wood, K., and McConlogue, L. (2000). High-level neuronal expression of A beta(1-42) in wild-type human amyloid protein precursor transgenic mice: Synaptotoxicity without plaque formation. *Journal of Neuroscience* 20.
- Mukae, N., Yokoyama, H., Yokokura, T., Sakoyama, Y., and Nagata, S. (2002). Activation of the innate immunity in Drosophila by endogenous chromosomal DNA that escaped apoptotic degradation. *Genes & Development* 16, 2662-2671.
- Mullan, M., Crawford, F., Axelman, K., Houlden, H., Lilius, L., Winblad, B., and Lannfelt, L. (1992). A PATHOGENIC MUTATION FOR PROBABLE ALZHEIMERS-DISEASE IN THE APP GENE AT THE N-TERMINUS OF BETA-AMYLOID. *Nature Genetics* 1.

- Murrell, J., Farlow, M., Ghetti, B., and Benson, M.D. (1991). A mutation in the amyloid precursor protein associated with hereditary Alzheimer's disease. *Science* 254, 97-99.
- Naert, G., and Rivest, S. (2011). CC Chemokine Receptor 2 Deficiency Aggravates Cognitive Impairments and Amyloid Pathology in a Transgenic Mouse Model of Alzheimer's Disease. *Journal of Neuroscience* 31, 6208-6220.
- Naitza, S., Rosse, C., Kappler, C., Georgel, P., Belvin, M., Gubb, D., Camonis, J., Hoffmann, J.A., and Reichhart, J.M. (2002). The *Drosophila* immune defense against gram-negative infection requires the death protein dFADD. *Immunity* 17, 575-581.
- Nakamura, T., Watanabe, A., Fujino, T., Hosono, T., and Michikawa, M. (2009). Apolipoprotein E4 (1-272) fragment is associated with mitochondrial proteins and affects mitochondrial function in neuronal cells. *Molecular Neurodegeneration* 4, 11.
- Nelson, O., Tu, H., Lei, T., Bentahir, M., de Strooper, B., and Bezprozvanny, I. (2007). Familial Alzheimer disease-linked mutations specifically disrupt Ca²⁺ leak function of presenilin 1. *J Clin Invest* 117, 1230-1239.
- Nicolas, E., Reichhart, J.M., Hoffmann, J.A., and Lemaitre, B. (1998). In vivo regulation of the I kappa B homologue cactus during the immune response of *Drosophila*. *Journal of Biological Chemistry* 273, 10463-10469.
- Nilsberth, C., Westlind-Danielsson, A., Eckman, C.B., Condron, M.M., Axelman, K., Forsell, C., Sten, C., Luthman, J., Teplow, D.B., Younkin, S.G., *et al.* (2001). The 'Arctic' APP mutation (E693G) causes Alzheimer's disease by enhanced A beta protofibril formation. *Nature Neuroscience* 4.
- Oddo, S., Caccamo, A., Kitazawa, M., Tseng, B.P., and LaFerla, F.M. (2003a). Amyloid deposition precedes tangle formation in a triple transgenic model of Alzheimer's disease. *Neurobiology of Aging* 24, 1063-1070.
- Oddo, S., Caccamo, A., Shepherd, J.D., Murphy, M.P., Golde, T.E., Kaye, R., Metherate, R., Mattson, M.P., Akbari, Y., and LaFerla, F.M. (2003b). Triple-transgenic model of Alzheimer's disease with plaques and tangles: Intracellular A beta and synaptic dysfunction. *Neuron* 39.
- Olson, M.I., and Shaw, C.M. (1969). Presenile dementia and Alzheimer's disease in mongolism. *Brain* 92, 147-156.
- Paquet, D., Bhat, R., Sydow, A., Mandelkow, E.-M., Berg, S., Hellberg, S., Falting, J., Distel, M., Koester, R.W., Schmid, B., *et al.* (2009). A zebrafish model of tauopathy allows in vivo imaging of neuronal cell death and drug evaluation. *Journal of Clinical Investigation* 119, 1382-1395.
- Park, L., Wang, G., Zhou, P., Zhou, J., Pitstick, R., Previti, M.L., Younkin, L., Younkin, S.G., Van Nostrand, W.E., Cho, S., *et al.* (2011). Scavenger receptor CD36 is essential for the cerebrovascular oxidative stress and neurovascular dysfunction induced by amyloid-beta. *Proceedings of the National Academy of Sciences of the United States of America* 108, 5063-5068.
- Pasqualetti, P., Bonomini, C., Dal Forno, G., Paulon, L., Sinforiani, E., Marra, C., Zanetti, O., and Rossini, P.M. (2009). A randomized controlled study on effects of ibuprofen on cognitive progression of Alzheimer's disease. *Aging Clinical and Experimental Research* 21, 102-110.
- Pickford, F., Masliah, E., Britschgi, M., Lucin, K., Narasimhan, R., Jaeger, P.A., Small, S., Spencer, B., Rockenstein, E., Levine, B., *et al.* (2008). The autophagy-related protein beclin 1 shows reduced expression in early Alzheimer disease and

regulates amyloid beta accumulation in mice. *Journal of Clinical Investigation* 118, 2190-2199.

Potter, C.J., Tasic, B., Russler, E.V., Liang, L., and Luo, L. (2010). The Q system: a repressible binary system for transgene expression, lineage tracing, and mosaic analysis. *Cell* 141, 536-548.

Price, J.L., McKeel, D.W., Jr., Buckles, V.D., Roe, C.M., Xiong, C., Grundman, M., Hansen, L.A., Petersen, R.C., Parisi, J.E., Dickson, D.W., *et al.* (2009). Neuropathology of nondemented aging: Presumptive evidence for preclinical Alzheimer disease. *Neurobiology of Aging* 30.

Purohit, D.P., Batheja, N.O., Sano, M., Jashnani, K.D., Kalaria, R.N., Karunamurthy, A., Kaur, S., Shenoy, A.S., Van Dyk, K., Schmeidler, J., *et al.* (2011). Profiles of Alzheimer's Disease-Related Pathology in an Aging Urban Population Sample. *J Alzheimers Dis* 24, 187-196.

Querfurth, H.W., and Selkoe, D.J. (1994). Calcium ionophore increases amyloid beta peptide production by cultured cells. *Biochemistry* 33, 4550-4561.

Reed-Geaghan, E.G., Reed, Q.W., Cramer, P.E., and Landreth, G.E. (2010). Deletion of CD14 Attenuates Alzheimer's Disease Pathology by Influencing the Brain's Inflammatory Milieu. *Journal of Neuroscience* 30, 15369-15373.

Reichhart, J.M., Georgel, P., Meister, M., Lemaitre, B., Kappler, C., and Hoffmann, J.A. (1993). EXPRESSION AND NUCLEAR TRANSLOCATION OF THE REL/NF-KAPPA-B-RELATED MORPHOGEN DORSAL DURING THE IMMUNE-RESPONSE OF DROSOPHILA. *Comptes Rendus De L Academie Des Sciences Serie Iii-Sciences De La Vie-Life Sciences* 316, 1218-1224.

Reiter, L.T., Potocki, L., Chien, S., Gribskov, M., and Bier, E. (2001). A Systematic Analysis of Human Disease-Associated Gene Sequences In *Drosophila melanogaster* A Systematic Analysis of Human Disease-Associated Gene Sequences In *Drosophila melanogaster*. 1114-1125.

Ribe, E.M., Perez, M., Puig, B., Gich, I., Lim, F., Cuadrado, M., Sesma, T., Catena, S., Sanchez, B., Nieto, M., *et al.* (2005). Accelerated amyloid deposition, neurofibrillary degeneration and neuronal loss in double mutant APP/tau transgenic mice. *Neurobiology of Disease* 20, 814-822.

Richard, K.L., Filali, M., Prefontaine, P., and Rivest, S. (2008). Toll-like receptor 2 acts as a natural innate immune receptor to clear amyloid beta 1-42 and delay the cognitive decline in a mouse model of Alzheimer's disease. *J Neurosci* 28, 5784-5793.

Rival, T., Page, R.M., Chandraratna, D.S., Sendall, T.J., Ryder, E., Liu, B., Lewis, H., Rosahl, T., Hider, R., Camargo, L.M., *et al.* (2009). Fenton chemistry and oxidative stress mediate the toxicity of the beta-amyloid peptide in a *Drosophila* model of Alzheimer's disease. *European Journal of Neuroscience* 29, 1335-1347.

Rizki, R.M., and Rizki, T.M. (1984). SELECTIVE DESTRUCTION OF A HOST BLOOD-CELL TYPE BY A PARASITOID WASP. *Proceedings of the National Academy of Sciences of the United States of America-Biological Sciences* 81, 6154-6158.

Rogers, J., Kirby, L.C., Hempelman, S.R., Berry, D.L., McGeer, P.L., Kaszniak, A.W., Zalinski, J., Cofield, M., Mansukhani, L., Willson, P., *et al.* (1993). CLINICAL-TRIAL OF INDOMETHACIN IN ALZHEIMERS-DISEASE. *Neurology* 43, 1609-1611.

Rogers, J., Lubernard, J., Styren, S.D., and Civin, W.H. (1988). EXPRESSION OF IMMUNE SYSTEM-ASSOCIATED ANTIGENS BY CELLS OF THE HUMAN CENTRAL

NERVOUS-SYSTEM - RELATIONSHIP TO THE PATHOLOGY OF ALZHEIMERS-DISEASE. *Neurobiology of Aging* 9, 339-349.

Rosen, D.R., Martin-Morris, L., Luo, L.Q., and White, K. (1989). A *Drosophila* gene encoding a protein resembling the human beta-amyloid protein precursor. *Proceedings of the National Academy of Sciences of the United States of America* 86, 2478-2482.

Rovelet-Lecrux, A., Hannequin, D., Raux, G., Le Meur, N., Laquerriere, A., Vital, A., Dumanchin, C., Feuillet, S., Brice, A., Vercelletto, M., *et al.* (2006). APP locus duplication causes autosomal dominant early-onset Alzheimer disease with cerebral amyloid angiopathy. *Nature Genetics* 38.

Rutschmann, S., Jung, A.C., Zhou, R., Silverman, N., Hoffmann, J.A., and Ferrandon, D. (2000). Role of *Drosophila* IKK gamma in a Toll-independent antibacterial immune response. *Nature Immunology* 1, 342-347.

Schenk, D., Barbour, R., Dunn, W., Gordon, G., Grajeda, H., Guido, T., Hu, K., Huang, J.P., Johnson-Wood, K., Khan, K., *et al.* (1999). Immunization with amyloid-beta attenuates Alzheimer disease-like pathology in the PDAPP mouse. *Nature* 400.

Selkoe, D.J. (1991). THE MOLECULAR PATHOLOGY OF ALZHEIMERS-DISEASE. *Neuron* 6.

Shaftel, S.S., Kyrkanides, S., Olschowka, J.A., Miller, J.-n.H., Johnson, R.E., and O'Banion, M.K. (2007). Sustained hippocampal IL-1 beta overexpression mediates chronic neuroinflammation and ameliorates Alzheimer plaque pathology. *Journal of Clinical Investigation* 117, 1595-1604.

Shankar, G.M., Li, S., Mehta, T.H., Garcia-Munoz, A., Shepardson, N.E., Smith, I., Brett, F.M., Farrell, M.A., Rowan, M.J., Lemere, C.A., *et al.* (2008). Amyloid-beta protein dimers isolated directly from Alzheimer's brains impair synaptic plasticity and memory. *Nature Medicine* 14.

Shaw, L.M., Vanderstichele, H., Knapik-Czajka, M., Clark, C.M., Aisen, P.S., Petersen, R.C., Blennow, K., Soares, H., Simon, A., Lewczuk, P., *et al.* (2009). Cerebrospinal Fluid Biomarker Signature in Alzheimer's Disease Neuroimaging Initiative Subjects. *Annals of Neurology* 65.

Shibazaki, K., Kimura, K., Iguchi, Y., Okada, Y., and Inoue, T. (2009). Plasma brain natriuretic peptide can be a biological marker to distinguish cardioembolic stroke from other stroke types in acute ischemic stroke. *Intern Med* 48, 259-264.

Silverman, N., Zhou, R., Stoven, S., Pandey, N., Hultmark, D., and Maniatis, T. (2000). A *Drosophila* I kappa B kinase complex required for Relish cleavage and antibacterial immunity. *Genes & Development* 14, 2461-2471.

Sinha, S., Anderson, J.P., Barbour, R., Basi, G.S., Caccavello, R., Davis, D., Doan, M., Dovey, H.F., Frigon, N., Hong, J., *et al.* (1999). Purification and cloning of amyloid precursor protein beta-secretase from human brain. *Nature* 402.

Smith, I.F., Green, K.N., and LaFerla, F.M. (2005). Calcium dysregulation in Alzheimer's disease: recent advances gained from genetically modified animals. *Cell Calcium* 38, 427-437.

Sonnenfeld, M.J., and Jacobs, J.R. (1995). MACROPHAGES AND GLIA PARTICIPATE IN THE REMOVAL OF APOPTOTIC NEURONS FROM THE DROSOPHILA EMBRYONIC NERVOUS-SYSTEM. *Journal of Comparative Neurology* 359, 644-652.

Soto, C. (2003). Unfolding the role of protein misfolding in neurodegenerative diseases. *Nature reviews Neuroscience* 4, 49-60.

- St George-Hyslop, P.H., and Petit, A. (2005). Molecular biology and genetics of Alzheimer's disease. *Comptes Rendus Biologies* 328.
- St Johnston, D. (2002). The art and design of genetic screens: *Drosophila melanogaster*. In *Nat Rev Genet* (England), pp. 176-188.
- Stamenkovic, I., and Seed, B. (1988). Analysis of two cDNA clones encoding the B lymphocyte antigen CD20 (B1, Bp35), a type III integral membrane protein. *J Exp Med* 167, 1975-1980.
- Steiner, H., Hultmark, D., Engstrom, A., Bennich, H., and Boman, H.G. (1981). SEQUENCE AND SPECIFICITY OF 2 ANTI-BACTERIAL PROTEINS INVOLVED IN INSECT IMMUNITY. *Nature* 292, 246-248.
- Steiner, H., Winkler, E., Edbauer, D., Prokop, S., Basset, G., Yamasaki, A., Kostka, M., and Haass, C. (2002). PEN-2 is an integral component of the gamma-secretase complex required for coordinated expression of presenilin and nicastrin. *Journal of Biological Chemistry* 277.
- Stephens, M., and Balding, D.J. (2009). Bayesian statistical methods for genetic association studies. *Nat Rev Genet* 10, 681-690.
- Steward, R. (1987). DORSAL, AN EMBRYONIC POLARITY GENE IN DROSOPHILA, IS HOMOLOGOUS TO THE VERTEBRATE PROTOONCOGENE, C-REL. *Science* 238, 692-694.
- Stewart, W.F., Kawas, C., Corrada, M., and Metter, E.J. (1997). Risk of Alzheimer's disease and duration of NSAID use. *Neurology* 48, 626-632.
- SturchlerPierrat, C., Abramowski, D., Duke, M., Wiederhold, K.H., Mistl, C., Rothacher, S., Ledermann, B., Burki, K., Frey, P., Paganetti, P.A., *et al.* (1997). Two amyloid precursor protein transgenic mouse models with Alzheimer disease-like pathology. *Proceedings of the National Academy of Sciences of the United States of America* 94, 13287-13292.
- Stutzmann, G.E. (2005). Calcium dysregulation, IP3 signaling, and Alzheimer's disease. *Neuroscientist* 11, 110-115.
- Sun, H.Y., Bristow, B.N., Qu, G.W., and Wasserman, S.A. (2002). A heterotrimeric death domain complex in Toll signaling. *Proceedings of the National Academy of Sciences of the United States of America* 99, 12871-12876.
- Szekely, C.A., Breitner, J.C.S., Fitzpatrick, A.L., Rea, T.D., Psaty, B.M., Kuller, L.H., and Zandi, P.P. (2008). NSAID use and dementia risk in the Cardiovascular Health Study: role of APOE and NSAID type. *Neurology* 70, 17-24.
- Tahara, K., Kim, H.-D., Jin, J.-J., Maxwell, J.A., Li, L., and Fukuchi, K.-i. (2006). Role of toll-like receptor signalling in A beta uptake and clearance. *Brain* 129, 3006-3019.
- Takehana, A., Katsuyama, T., Yano, T., Oshima, Y., Takada, H., Aigaki, T., and Kurata, S. (2002). Overexpression of a pattern-recognition receptor, peptidoglycan-recognition protein-LE, activates imd/relish-mediated antibacterial defense and the prophenoloxidase cascade in *Drosophila* larvae. *Proceedings of the National Academy of Sciences of the United States of America* 99, 13705-13710.
- Takehana, A., Yano, T., Mita, S., Kotani, A., Oshima, Y., and Kurata, S. (2004). Peptidoglycan recognition protein (PGRP)-LE and PGRP-LC act synergistically in *Drosophila* immunity. *Embo Journal* 23, 4690-4700.
- Tan, J., Town, T., Crawford, F., Mori, T., DelleDonne, A., Crescentini, R., Obregon, D., Flavell, R.A., and Mullan, M.J. (2002). Role of CD40 ligand in amyloidosis in transgenic Alzheimer's mice. *Nature Neuroscience* 5, 1288-1293.

- Tanzi, R.E., and Bertram, L. (2005). Twenty years of the Alzheimer's disease amyloid hypothesis: a genetic perspective. In *Cell* (United States), pp. 545-555.
- Tateno, H., Li, H., Schur, M.J., Bovin, N., Crocker, P.R., Wakarchuk, W.W., and Paulson, J.C. (2007). Distinct endocytic mechanisms of CD22 (Siglec-2) and Siglec-F reflect roles in cell signaling and innate immunity. *Mol Cell Biol* 27, 5699-5710.
- Tauszig-Delamasure, S., Bilak, H., Capovilla, M., Hoffmann, J.A., and Imler, J.L. (2002). *Drosophila* MyD88 is required for the response to fungal and Gram-positive bacterial infections. *Nature Immunology* 3, 91-97.
- Tebar, F., Bohlander, S.K., and Sorkin, A. (1999). Clathrin assembly lymphoid myeloid leukemia (CALM) protein: localization in endocytic-coated pits, interactions with clathrin, and the impact of overexpression on clathrin-mediated traffic. *Mol Biol Cell* 10, 2687-2702.
- Tedder, T.F., Streuli, M., Schlossman, S.F., and Saito, H. (1988). Isolation and structure of a cDNA encoding the B1 (CD20) cell-surface antigen of human B lymphocytes. *Proc Natl Acad Sci U S A* 85, 208-212.
- Tesseur, I., Zou, K., Esposito, L., Bard, F., Berber, E., Van Can, J., Lin, A.H., Crews, L., Tremblay, P., Mathews, P., *et al.* (2006). Deficiency in neuronal TGF-beta signaling promotes neurodegeneration and Alzheimer's pathology. *Journal of Clinical Investigation* 116, 3060-3069.
- Town, T., Laouar, Y., Pittenger, C., Mori, T., Szekeley, C.A., Tan, J., Duman, R.S., and Flavell, R.A. (2008). Blocking TGF-beta-Smad2/3 innate immune signaling mitigates Alzheimer-like pathology. *Nature Medicine* 14, 681-687.
- Tu, H., Nelson, O., Bezprozvanny, A., Wang, Z., Lee, S.F., Hao, Y.H., Serneels, L., De Strooper, B., Yu, G., and Bezprozvanny, I. (2006). Presenilins form ER Ca²⁺ leak channels, a function disrupted by familial Alzheimer's disease-linked mutations. *Cell* 126, 981-993.
- Urbanc, B., Cruz, L., Le, R., Sanders, J., Ashe, K.H., Duff, K., Stanley, H.E., Irizarry, M.C., and Hyman, B.T. (2002). Neurotoxic effects of thioflavin S-positive amyloid deposits in transgenic mice and Alzheimer's disease. *Proceedings of the National Academy of Sciences of the United States of America* 99, 13990-13995.
- Van Dam, D., and De Deyn, P.P. (2006). Model organisms - Drug discovery in dementia: the role of rodent models. *Nature Reviews Drug Discovery* 5, 956-970.
- Van Dam, D., and De Deyn, P.P. (2011). Animal models in the drug discovery pipeline for Alzheimer's disease. *British journal of pharmacology* 164, 1285-1300.
- Van Dam, D., Vloeberghs, E., Abramowski, D., Staufenbiel, M., and De Deyn, P.P. (2005). APP23 mice as a model of Alzheimer's disease: An example of a transgenic approach to modeling a CNS disorder. *Cns Spectrums* 10, 207-222.
- Vassar, R., Bennett, B.D., Babu-Khan, S., Kahn, S., Mendiaz, E.A., Denis, P., Teplow, D.B., Ross, S., Amarante, P., Loeloff, R., *et al.* (1999). beta-secretase cleavage of Alzheimer's amyloid precursor protein by the transmembrane aspartic protease BACE. *Science* 286.
- Veld, B.A.I., Ruitenbergh, A., Hofman, A., Stricker, B.H.C., and Breteler, M.M.B. (2001). Antihypertensive drugs and incidence of dementia: the Rotterdam Study. *Neurobiology of Aging* 22.
- Verkhatsky, A., and Kirchhoff, F. (2007). NMDA Receptors in glia. *Neuroscientist* 13, 28-37.

- Vidal, S., Khush, R.S., Leulier, F., Tzou, P., Nakamura, M., and Lemaitre, B. (2001). Mutations in the *Drosophila* dTAK1 gene reveal a conserved function or MAPKKs in the control of rel/NF-kappa B-dependent innate immune responses. *Genes & Development* 15, 1900-1912.
- Vlad, S.C., Miller, D.R., Kowall, N.W., and Felson, D.T. (2008). Protective effects of NSAIDs on the development of Alzheimer disease. *Neurology* 70, 1672-1677.
- Walsh, D.M., Klyubin, I., Fadeeva, J.V., Cullen, W.K., Anwyl, R., Wolfe, M.S., Rowan, M.J., and Selkoe, D.J. (2002). Naturally secreted oligomers of amyloid beta protein potently inhibit hippocampal long-term potentiation in vivo. *Nature* 416.
- Wang, J., Dickson, D.W., Trojanowski, J.Q., and Lee, V.M. (1999). The levels of soluble versus insoluble brain Abeta distinguish Alzheimer's disease from normal and pathologic aging. *Experimental neurology* 158, 328-337.
- Wang, N., Lan, D., Gerbod-Giannone, M., Linsel-Nitschke, P., Jehle, A.W., Chen, W., Martinez, L.O., and Tall, A.R. (2003). ATP-binding cassette transporter A7 (ABCA7) binds apolipoprotein A-I and mediates cellular phospholipid but not cholesterol efflux. *J Biol Chem* 278, 42906-42912.
- Weber, A.N.R., Tauszig-Delamasure, S., Hoffmann, J.A., Lelievre, E., Gascan, H., Ray, K.P., Morse, M.A., Imler, J.L., and Gay, N.J. (2003). Binding of the *Drosophila* cytokine Spatzle to Toll is direct and establishes signaling. *Nature Immunology* 4, 794-800.
- Wegmann, S., Jung, Y.J., Chinnathambi, S., Mandelkow, E.-M., Mandelkow, E., and Muller, D.J. (2010). Human Tau isoforms assemble into ribbon-like fibrils that display polymorphic structure and stability. *The Journal of biological chemistry* 285, 27302-27313.
- Wentzell, J., and Kretschmar, D. (2010). Alzheimer's disease and tauopathy studies in flies and worms. *Neurobiology of disease* 40, 21-28.
- Wittmann, C.W., Wszolek, M.F., Shulman, J.M., Salvaterra, P.M., Lewis, J., Hutton, M., and Feany, M.B. (2001). Tauopathy in *Drosophila*: Neurodegeneration without neurofibrillary tangles. *Science* 293, 711-714.
- Wolfe, M.S., Xia, W.M., Ostaszewski, B.L., Diehl, T.S., Kimberly, W.T., and Selkoe, D.J. (1999). Two transmembrane aspartates in presenilin-1 required for presenilin endoproteolysis and gamma-secretase activity. *Nature* 398.
- Wu, H.-H., Bellmunt, E., Scheib, J.L., Venegas, V., Burkert, C., Reichardt, L.F., Zhou, Z., Farinas, I., and Carter, B.D. (2009). Glial precursors clear sensory neuron corpses during development via Jedi-1, an engulfment receptor. *Nature Neuroscience* 12, 1534-U1579.
- Wu, L.P., and Anderson, K.V. (1998). Regulated nuclear import of Rel proteins in the *Drosophila* immune response. *Nature* 392, 93-97.
- Wyss-Coray, T., Lin, C., Yan, F.R., Yu, G.Q., Rohde, M., McConlogue, L., Masliah, E., and Mucke, L. (2001). TGF-beta 1 promotes microglial amyloid-beta clearance and reduces plaque burden in transgenic mice. *Nature Medicine* 7, 612-618.
- Wyss-Coray, T., Masliah, E., Mallory, M., McConlogue, L., JohnsonWood, K., Lin, C., and Mucke, L. (1997). Amyloidogenic role of cytokine TGF-beta 1 in transgenic mice and in Alzheimer's disease. *Nature* 389, 603-606.
- Wyss-Coray, T., and Rogers, J. (2012). Inflammation in Alzheimer disease-a brief review of the basic science and clinical literature. *Cold Spring Harbor perspectives in medicine* 2, a006346-a006346.
- Wyss-Coray, T., Yan, F.R., Lin, A.H.T., Lambris, J.D., Alexander, J.J., Quigg, R.J., and Masliah, E. (2002). Prominent neurodegeneration and increased plaque

- formation in complement-inhibited Alzheimer's mice. *Proceedings of the National Academy of Sciences of the United States of America* 99, 10837-10842.
- Xu, Y., Yan, J., Zhou, P., Li, J., Gao, H., Xia, Y., and Wang, Q. (2012). Neurotransmitter receptors and cognitive dysfunction in Alzheimer's disease and Parkinson's disease. *Prog Neurobiol* 97, 1-13.
- Yamamoto, M., Horiba, M., Buescher, J.L., Huang, D.R., Gendelman, H.E., Ransohoff, R.M., and Ikezu, T. (2005). Overexpression of monocyte chemotactic protein-1/CCL2 in beta-amyloid precursor protein transgenic mice show accelerated diffuse beta-amyloid deposition. *American Journal of Pathology* 166, 1475-1485.
- Yamamoto, M., Kiyota, T., Horiba, M., Buescher, J.L., Walsh, S.M., Gendelman, H.E., and Ikezu, T. (2007). Interferon-gamma and tumor necrosis factor- α regulate amyloid- α plaque deposition and beta-secretase expression in Swedish mutant APP transgenic mice. *American Journal of Pathology* 170, 680-692.
- Yan, S.D., and Stern, D.M. (2005). Mitochondrial dysfunction and Alzheimer's disease: role of amyloid-beta peptide alcohol dehydrogenase (ABAD). *International Journal of Experimental Pathology* 86, 161-171.
- Yano, T., Mita, S., Ohmori, H., Oshima, Y., Fujimoto, Y., Ueda, R., Takada, H., Goldman, W.E., Fukase, K., Silverman, N., *et al.* (2008). Autophagic control of listeria through intracellular innate immune recognition in drosophila. *Nature Immunology* 9, 908-916.
- Yasojima, K., Schwab, C., McGeer, E.G., and McGeer, P.L. (1999). Distribution of cyclooxygenase-1 and cyclooxygenase-2 mRNAs and proteins in human brain and peripheral organs. *Brain Research* 830, 226-236.
- Yu, G., Nishimura, M., Arawaka, S., Levitan, D., Zhang, L.L., Tandon, A., Song, Y.Q., Rogaeva, E., Chen, F.S., Kawaral, T., *et al.* (2000). Nicastrin modulates presenilin-mediated notch/glp-1 signal transduction and beta APP processing. *Nature* 407.
- Zandi, P.P., Anthony, J.C., Hayden, K.M., Mehta, K., Mayer, L., Breitner, J.C.S., and Cache County Study, I. (2002). Reduced incidence of AD with NSAID but not H-2 receptor antagonists - The Cache County Study. *Neurology* 59, 880-886.
- Zheng, H., Jiang, M., Trumbauer, M.E., Sirinathsinghji, D.J., Hopkins, R., Smith, D.W., Heavens, R.P., Dawson, G.R., Boyce, S., Conner, M.W., *et al.* (1995). beta-Amyloid precursor protein-deficient mice show reactive gliosis and decreased locomotor activity. *Cell* 81, 525-531.
- Zheng, H., and Koo, E.H. (2006). The amyloid precursor protein: beyond amyloid. *Molecular Neurodegeneration* 1, 12.
- Zhu, Y., Hou, H., Rezai-Zadeh, K., Giunta, B., Ruscin, A., Gemma, C., Jin, J., Dragicevic, N., Bradshaw, P., Rasool, S., *et al.* (2011). CD45 Deficiency Drives Amyloid-beta Peptide Oligomers and Neuronal Loss in Alzheimer's Disease Mice. *Journal of Neuroscience* 31, 1355-1365.
- Zilka, N., and Novak, M. (2006). The tangled story of Alois Alzheimer. *107*, 343-345.
- Zuccolo, J., Bau, J., Childs, S.J., Goss, G.G., Sensen, C.W., and Deans, J.P. (2010). Phylogenetic analysis of the MS4A and TMEM176 gene families. *PLoS One* 5, e9369.

REGULATIONS IMMUNITAIRES DANS UN MODELE *DROSOPHILE* DE LA MALADIE D'ALZHEIMER

Résumé

La maladie d'Alzheimer (MA) se caractérise par l'accumulation de l'amyloïde β ($A\beta$) dans le cerveau. Des indications suggèrent un lien étroit entre la MA et la neuroinflammation. Cependant, l'aspect moléculaire des réactions immunitaires innées contre l' $A\beta$ n'a pas été élucidé. Nous avons utilisé la drosophile pour étudier l'impact des réactions immunitaires innées sur la MA. Au cours de ma thèse, j'ai: (1) mis en place un modèle drosophile de la MA pour l'étude du rôle des réactions inflammatoires, (2) montré que la voie inflammatoire IMD exerce un rôle neuroprotecteur empêchant le développement de phénotypes associés à la MA (3) généré l'interactome de la voie IMD utile lors de l'étude des mécanismes liant la MA à la neuroinflammation, et (4) introduit un crible génétique visant à identifier des gènes modificateurs de la MA. Nous estimons que nos résultats pourraient servir de base à de nouvelles interventions thérapeutiques contre la MA.

Alzheimer, immunité innée, IMD, Drosophile

Résumé en anglais

Alzheimer's disease (AD) is characterized by the accumulation of amyloid β ($A\beta$) in the brain. Several lines of evidences point towards a strong link between AD and neuroinflammation. However, the exact molecular events of the innate immune reactions against $A\beta$ need to be elucidated. We used *Drosophila* as a model organism to study the impact of innate immune reactions on AD. During my PhD I have been able to: (1) establish a *Drosophila* model to study the inflammatory responses in AD, (2) demonstrate that the *Drosophila* inflammatory IMD pathway plays a neuroprotective role in the development of AD-like phenotypes, (3) generate the IMD interactome dataset that could help elucidate the mechanisms linking AD to neuroinflammation, and (4) introduce a forward genetic screen for the identification of modifier genes of AD. We believe that the outcomes from our *Drosophila* studies could provide the basis for new therapeutic interventions against AD.

Alzheimer, innate immunity, IMD, Drosophila