



**HAL**  
open science

# Induction of proteasome-mediated degradation of CTIP2 by HIV-1 Vpr in microglial cells

Sultan Ali

► **To cite this version:**

Sultan Ali. Induction of proteasome-mediated degradation of CTIP2 by HIV-1 Vpr in microglial cells. Agricultural sciences. Université de Strasbourg, 2013. English. NNT: 2013STRAJ016 . tel-00923199

**HAL Id: tel-00923199**

**<https://theses.hal.science/tel-00923199v1>**

Submitted on 2 Jan 2014

**HAL** is a multi-disciplinary open access archive for the deposit and dissemination of scientific research documents, whether they are published or not. The documents may come from teaching and research institutions in France or abroad, or from public or private research centers.

L'archive ouverte pluridisciplinaire **HAL**, est destinée au dépôt et à la diffusion de documents scientifiques de niveau recherche, publiés ou non, émanant des établissements d'enseignement et de recherche français ou étrangers, des laboratoires publics ou privés.

# UNIVERSITÉ DE STRASBOURG

*École Doctorale des Sciences de la vie et de la Santé*

Department of Host-Pathogen Interaction - DHPI

**THÈSE** présentée par :

**Sultan ALI**

soutenue le : **02 Avril en 2013**

pour obtenir le grade de : **Docteur de l'université de Strasbourg**

Discipline / Spécialité : **Science du Vivant / Aspects cellulaire et moléculaires de la Biologie**

**Induction par Vpr de la dégradation de la protéine CTIP2 via la voie du protéasome dans les cellules microgliales.**

**THÈSE dirigée par :**

**ROHR Olivier**

Professeur, université de strasbourg

**SCHWARTZ Christian (Co-directeur)**

MCU HDR, université de Strasbourg

**RAPPORTEURS :**

**MARGOTTIN-GOGUET Florence**

Dir. de recherches, Institut Cochin, Paris

**EKSTRÖM Tomas J**

Pr. Karolinska Institut, Stockholm, Sweden.

**VITALE Nicolas**

Directeur de recherches, UDS.

**EXAMINATEUR :**

**BAUSERO Pedro**

Pr, Univ. Pierre et Marie Curie Paris.

# Acknowledgments

I humbly bow my head before God, the most beneficent and merciful, whose blessing flourished my thoughts and thrived my ambitions. I would like to express my deep and sincere gratitude to my co-Director of the research unit, Professor Ermanno Candolfi, for making it possible for me to work in such a prestigious scientific environment.

I feel immense pleasure to gratefully acknowledge and to express deep sense of gratitude to my supervisor, Pr. Olivier ROHR, for guiding me throughout my course of study. Olivier has been very supportive, encouraging and kind. I owe a great deal of appreciation for his valuable advice, constructive criticism and valuable discussions around my work. It has been a great honor to have him as a supervisor. Apart from his scientific knowledge and devotion to research, I found him an adorable, pure and kind-hearted human being.

I would like to express my deep and sincere gratitude to my co-supervisor, Dr. Christian Schwartz, for his enthusiasm, constructive discussions and motivation throughout the course of my stay under his supervision.

I wish to express my cordial appreciation to my examiners, Dr. Florence Margottin-Goguet, Pr. Tomas J Ekström, Dr. Nicolas Vitale and Pr. Pedro Bausero for the acceptance to be a referee. I feel immense pleasure to gratefully acknowledge and to express deep sense of gratitude to Dr. Valentin le Douce for his enthusiasm, creative suggestions, motivation and exemplary guidance throughout the course of my doctoral research and also during thesis writing. Moreover, I offer my profound gratitude to Thomas Cherrier for his scientific and moral support during my earlier period of stay. Words are lacking to express my gratitude for Higher Education Commission of Pakistan, for providing me with scholarship

during my study in France. The opportunity of studying in France has really broadened my horizon and widened my perspectives in life.

I sincerely acknowledge my colleagues especially Raphael Riclet, Andrea Janossy, Emeline Pelletier, Marion Pouget, Julie Brunet and my other colleagues from the parasitology team for their support during my projects and would like to extend my thanks to Esterina Hoffmann for facilitating all administrative issues.

I own my sincere thanks to Rizwan Aslam, Ghulam Hussain, Asghar Shabbir, M Nauman Zahid and Azeem Sultan for their support, guidance and affection. I would also like to extend huge, warm thanks to my other Pakistani fellows Sarfraz, Adnan, Niaz, Azhar, Rafiq and Ikram for their love and sincerity. I am eternally grateful to my parents, Basharat Ali & Sakina Bibi, my brother M Usman, my sisters, my beloved Rimsha Hassan and other family members for their unconditional love, fidelity, endurance and encouragement. There are so many others whom I may have inadvertently left out and I sincerely thank all of them for their help.

# Table of Contents

<b>Introduction.....</b>	<b>1</b>
<b>1. Acquired immunodeficiency syndrome and HIV .....</b>	<b>2</b>
1.1. Discovery of AIDS and HIV .....	2
1.2. Epidemiology .....	3
1.3. Types of HIV .....	5
1.4. Pathogenesis of AIDS .....	6
<b>2. Description of HIV-1 and its life cycle .....</b>	<b>8</b>
2.1. Structure of infectious viral particle .....	8
2.2. Viral genome .....	10
2.3. Replication of HIV-1 .....	12
2.4. HIV-1 Infection cure .....	22
<b>3. HIV accessory proteins .....</b>	<b>23</b>
3.1. Negative regulatory factor (Nef).....	23
3.2. Viral protein unique (Vpu) .....	24
3.3. Viral infectivity factor (Vif) .....	25
3.4. Viral protein Regulatory (Vpr) .....	25
<b>4. Ubiquitination .....</b>	<b>31</b>
4.1. Process of ubiquitination .....	32
4.2. Types of Ubiquitination .....	33
4.3. Components of ubiquitin ligase .....	35
4.4. Effects of ubiquitination .....	36
<b>5. Viruses using host ubiquitin system .....</b>	<b>38</b>
5.1. Adenoviruses.....	39
5.2. Herpes viruses.....	41
5.3. Papillomaviruses .....	42
5.4. Poxviruses.....	43
5.5. Parvoviruses.....	44
5.6. Reoviruses .....	44
5.7. Orthomyxoviruses .....	45
5.9. Retroviruses .....	45

<b>6. Restriction factor .....</b>	<b>52</b>
6.1. Hallmarks of restriction factors .....	52
6.2. TRIM5.....	54
6.3. Tetherin .....	55
6.4. APOBEC3 .....	57
6.5. SAMHD1 .....	61
<b>7. Reservoir and latency .....</b>	<b>65</b>
7.1. Anatomical reservoirs .....	65
7.2. Cellular reservoirs .....	65
7.3. Molecular latency .....	68
7.4. CTIP2 .....	73
7.5. Vpr and Cul4A-DDB1 <sup>DCAF1</sup> E3 ubiquitin ligase.....	78
<b>Aim of study.....</b>	<b>83</b>
<b>Results.....</b>	<b>86</b>
<b>Supplementary results .....</b>	<b>107</b>
<b>Discussion.....</b>	<b>122</b>
<b>Materials and methods.....</b>	<b>130</b>
<b>Bibliography.....</b>	<b>133</b>
<b>Annexes .....</b>	<b>166</b>

# List of Figures

Figure 1: Estimated adults and children living with HIV in 2011. ....	3
Figure 2: Global HIV trends, 2001-11 .....	4
Figure 3: Financial plan for 2015to eradicate HIV.....	4
Figure 4: Time course of HIV-1 infection. ....	7
Figure 5A: Schematic overview of infectious virion of HIV-1 .....	9
Figure 6: Schematic representation of HIV-1 and HIV-2 integrated genomes...	11
Figure 7: Schematic representation of life cycle of HIV .....	12
Figure 8: Schematic overview of HIV entry from attachment to fusion of the membranes .....	14
Figure 9: Intracellular transport of HIV-1 and DNA Flap-dependent nuclear import of PIC.....	16
Figure 10: HIV-1 genome transcription and splicing of mRNAs.....	21
Figure 11: Schematic overview of HIV-1 assembly, release and maturation....	21
Figure 12A/B: Vpr structure and its functions .....	26
Figure 13: Ubiquitination and its types.....	34
Figure 14: Proteasomal degradation of poly-ubiquitinated protein by the 26S proteasome.....	37
Figure 15: A schematic overview of examples of viral effects on host ubiquitin system .....	51
Figure 17: Overview of Vpu-mediated tetherin regulation.....	57
Figure 22: Degradation of APOBEC3G by Vif by host ubiquitin proteasome system .....	60
Figure 23: Effect of SAMHD1 on dNTP and Vpx can block this process.....	62
Figure 24: Replication of reteroviruses in dendritic cell with Vpx and without Vpx .....	64
Figure 16: Establishment of a latent reservoir in resting T-cell .....	66
Figure 17: Cells of monocyte/macrophage lineage.....	67
Figure 18: Molecular structure of HIV-1 LTR .....	70
Figure 19: Epigenetic modifications and control of transcription .....	72
Figure 25: CTIP2 represses the HIV-1 transcription by favoring heterochromatin structure .....	76
Figure 26: CTIP2 can repress P-TEF-b target genes .....	76

Figure 27: Direct & indirect effects of CTIP2 on HIV-1 transcription .....	77
Figure 28: Summary of restriction factors and their counteraction in myeloid cells .....	81



# List of Tables

Table 1: List of viruses using UPS and function modifications.....	48
Table 2: Proteasome-associated proteins .....	115
Table 3: Upregulated proteins after CTIP2 overexpression in microglial cells.....	116

## ABBREVIATIONS

AIDS:	Acquired ImmunoDeficiency Syndrome
APOBEC:	APOlipoprotein B mRNA-editing, Enzyme-Catalytic, polypeptide-like
ATR:	Ataxia Telangiectasia and Rad3-related protein
CDK9:	Cyclin-dependent kinase 9
CT1:	Cyclin T1
CTIP2:	COUP-TF Interacting Protein 2
DCAF1:	DDB1-Cul4A Adaptor Factor 1
DDB1:	DNA Damage-Binding protein 1
dNTP:	Deoxyribonucleotide triphosphate
GALT:	Gut-Associated Lymphoid Tissue
Gp160/120/41:	GlycoProtein 160/120/41
H3K4me3:	Tri-methylation of lysine 4 of Histone H3
H3K9me3:	Tri-methylation of lysine 9 of Histone H3
HA:	Hemagglutinin
HAART:	Highly Active AntiRetroviral Therapy
HDAC:	Histone DeACetylase
HEXIM:	Hexamethylene bis-acetamide inducible 1
HIV:	Human Immunodeficiency Virus
HMBA:	Hexamethylene bis-acetamide
HMT:	Histone MethylTransferase
HP1:	Heterochromatin Protein 1
HPBP:	Human Phosphate Binding Protein
LSD1:	Lysine Specific Demethylase 1
LTNP:	Long-Term Non-Progressor
LTR:	Long Terminal Repeat
miRNA:	micro RNA
NES:	Nuclear Export Signal
NF-κB:	Nuclear Factor κB
NLS:	Nuclear Localization Signal

NUC-1:	Nucleosome 1
PIC:	Pre-Integration Complex
P-TEFb:	Positive Transcription Elongation Factor-b
RTC:	Reverse Transcription Complex
siRNA:	Small Interfering RNA
SIV:	Simian Immunodeficiency Virus
Sp1:	Specificity protein 1
SUV39H1:	SUppressor of Variegation 3-9 Homolog 1
TAR:	Transactivator Response Element
TAT:	TransActivator of Transcription
TRIM:	Tripartite Motif Protein
TSA:	TrichoStatine A
UNG2:	Uracil DNA Glycosylase 2
UPS:	Ubiquitin Proteasome System
Vpr:	Viral Protein Regulatory
VSV:	Vesicular Stomatitis Virus

## **Induction par Vpr de la dégradation de la protéine CTIP2 via la voie du protéasome dans les cellules microgliales.**

L'infection par le virus de l'immunodéficience humaine (VIH) est toujours un problème majeur de santé public avec 34 millions de personnes infectées dans le monde (ONUSIDA). L'identification d'une nouvelle pathologie sévissant aux USA au début des années 1980, suivie rapidement de la caractérisation de son agent causal, le virus de l'immunodéficience humaine (VIH), avaient suscité l'espoir d'une rapide prise en charge thérapeutique. Cependant, la multithérapie active n'a été introduite qu'en 1996. Le principe était simple et visait à utiliser au moins 3 molécules ciblant, soit la même étape du cycle cellulaire avec des molécules aux mécanismes d'actions différents (NRTI et NNRTI et transcription inverse), soit en ciblant d'autres étapes du cycle. A ce jour, il existe près d'une trentaine de molécules différentes ciblant les étapes du cycle viral que sont l'entrée, la transcription inverse, l'intégration et la maturation des protéines virales.

Ces traitements anti-retroviraux ne sont malheureusement pas en mesure d'éradiquer totalement le virus du VIH-1 de l'organisme, mais permettent de diminuer et de contenir la charge virale. Ceci est dû, en partie, par la possibilité qu'a le virus d'entrer dans une phase de latence transcriptionnelle, au cours de laquelle le génome viral n'est plus actif et devient de fait inaccessible aux molécules antirétrovirales. L'établissement de la latence virale résulte d'une restructuration de la chromatine en une forme compacte inactive ou hétérochromatine.

La latence peut être définie comme la capacité d'un virus pathogène pour sommeiller à l'intérieur de la cellule avec peu ou pas de réplication virale (Geeraert et al. 2008). VIH-1 a été observée pour la première latence chez les patients traités avec succès par HAART, en raison de la réapparition de la virémie après l'arrêt du traitement (Peterlin et Trono 2003). Les virus de la réplication résiduelle ne montrent pas de signes significatifs de l'évolution de leur génome (Hermankova et al. 2001). Ces observations appuient la ré-émergence de souches de type sauvage lors du levage traitement (Finzi et al. 1997; Wong et al. 1997). La réapparition de ces virus infectieux, mais

insuffisantes pour l'environnement thérapeutique, s'explique par la présence de réservoirs viraux (McNamara et Collins 2011).

Réservoirs anatomiques ou sanctuaires viraux sont définies comme des zones immunologiquement privilégiés où la cinétique de réplication de virus sera plus stable que la réplication des virus actifs dans le reste du corps. Dans ces réservoirs, le virus peut persister pendant de longues périodes, en raison de leur accès limité (Blankson et al. 2002). Les obstacles anatomiques séparent sanctuaires viraux du sang et les organes lymphoïdes, la réduction de la diffusion des ARV dans ces sites (Solas et al. 2003). Cette fonction permet au virus de continuer sa réplication résiduelle et aider à maintenir un état d'inflammation permanente des tissus dans les sanctuaires. Il ya trois principaux réservoirs:

Tractus génital et le système nerveux central (SNC), isolé respectivement par la barrière hémato-testiculaire et la barrière hémato-encéphalique et les organes lymphoïdes (principalement dans le tube digestif), lieu de repos de lymphocytes T mémoires (Saez-Cirion et al. 2011, Eisele et Siliciano 2012, Bierhoff et al. 2013).

L'hypothèse de l'existence d'latente cellule de réservoirs viraux a été rapidement validée. Bien que le temps de latence est très rare en repos CD4 + lymphocytes T après l'infection, une cellule par million de cellules infectées entre en latence, mais il se produit très tôt au cours de l'infection du VIH-1 (Chun et al. 1997, Finzi et al. 1997). Ces réservoirs cellulaires viennent d'être soit de l'infection directe des cellules T mémoire ou une infection des cellules CD4 + activés T-cellules. Les + lymphocytes T CD sont très sensibles à l'infection et le plus souvent cette infection semble être productive, causant ainsi la mort de la cellule infectée en quelques jours après l'infection. Les cellules T qui sont dans un processus de retour à un état de repos sont aussi infectés par le VIH-1. L'infection de ces cellules peut conduire à des cellules où les cellules porteuses du VIH-1 ADN intégré dans le génome mais non la production du VIH-1. Persistance et ralenti le métabolisme des cellules CD4 + cellules T mémoire contribue à la mise en place de réservoir du virus à long terme non-productive (Chomont et al. 2011).

En outre, après une virémie rebond suivant l'interruption du traitement ARV, l'analyse génétique indique que les cellules CD4 + T-cellules ne sont pas la seule zone de réservoir de virus latent (Bailey et al. 2011, Chomont et al. 2006). Sur la base de ces observations, les cellules de la macrophages monocytes / ont été proposés comme une source de latence virale à son tour. En effet, la réplication est possible dans ces cellules et, plus important, ces cellules peuvent persister pendant de longues périodes dans le corps (Herbein et al. 2010, Le Douce et al. 2010, Eisele et Siliciano 2012).

Cellules microgliales ou microglies sont les macrophages résidents du SNC. Ils ont d'abord été décrits comme troisième élément de Cajal (1913), car ils sont morphologiquement différents de neurones (premier élément) et les astrocytes (deuxième élément). Les cellules microgliales sont capables de proliférer in-situ et persistent pendant toute la vie de l'individu (Suh et coll. 2005). En raison de la présence de récepteurs CD4, CCR3 et CCR5 co-récepteurs, les microglies sont les principales cibles du VIH-1 dans le SNC et sont infectés très tôt au cours de la phase aiguë de la maladie (Jordan et al. 1991, He et al. 1997). La réplication virale est ensuite rapidement arrêté, provoquant le virus en latence et de rendre le réservoir principal de la microglie dans CNS (Davis et al. 2006, Barber et al. 1992, Le Douce et al. 2012a).

Dans les derniers stades de la maladie, l'inflammation causée par la virémie rebond réactive le réservoir et le nombre de microglies productive infectées augmente considérablement (Cosenza et al. 2002). Le nombre de macrophages du cerveau activées est également étroitement liée à la démence associée au VIH au cours du SIDA (Glass et al. 1995).

Latence moléculaire existe deux formes de latence, la latence pré-et post-intégration.

### **Latence pré-intégration**

En temps de latence avant l'intégration, le temps de latence est établi avant l'intégration du provirus dans le génome de la cellule infectée (Zack et al. 1990). Ce temps de latence peut se produire en raison d'un défaut d'importation du provirus dans le noyau ou en raison d'une perturbation à l'étape de transcription inverse. L'activité de la transcriptase inverse peut être perturbé par

un pool de dNTP insuffisantes ou par hypermutation du génome viral pendant la transcription inverse par APOBEC3 (Bukrinsky et al. 1992, Zack et al. 1992).

Cette forme de latence est régulièrement observée dans les lymphocytes T CD4 +, mais n'explique pas l'existence de réservoirs à long terme. En effet, la demi-vie de l'ADN viral non intégré est une seule journée. Ce n'est pas le cas dans les macrophages, où l'ADN viral non intégré peut persister jusqu'à deux mois et peut être transcrit (. Gillim-Ross et al. 2005, Kelly et al 2008).

### **Latence post-intégration**

Dans ce temps de latence, la réplication virale est bloqué après l'intégration du provirus dans l'ADN de l'hôte. Un bloc post-transcriptionnelle peut être la cause de la latence post-intégration. En effet, les ARNm viraux peuvent être retenus dans le noyau ou ciblés par les microARN, empêchant ainsi la production de protéines virales, qui entravent cycle de réplication complet (Lassen et al. 2006, Huang et al. 2007). Bien que les mécanismes de blocages post-transcriptionnelle des gènes ont un rôle important dans le maintien de la latence, notre accent sera mis plus particulièrement sur les événements qui se produisent au niveau de la transcription du provirus.

Le promoteur viral ou LTR contient de nombreux sites activateurs et répresseurs de la transcription cellulaires. Le promoteur viral est structuré en trois régions, comprenant quatre zones, respectivement, de 5 'vers 3':

La région de modulation, de -454 à -104, contient des sites de liaison pour le cis-répresseurs et le cis-activateurs de l'activité transcriptionnelle. Cette zone est, quel que soit le site d'intégration, le siège du nucléosome 0 (Nuc-0), ce qui limitera l'accès des protéines régulatrices.

La région amplificatrice, de -105 à -79 contient des sites de liaison pour le tandem hétérodimère NF-kB, un facteur de transcription essentiel. Entre ces deux sites de sites NF-kB, il ya une protéine AP-2, un autre activateur de la transcription virale.

Le promoteur de coeur, de -78 à -1 est l'unité minimum pour l'initiation de la transcription. Il existe deux TATA box et d'un initiateur de type région, les deux sites de liaison de la RNAPolII. Cette zone contient également trois sites

pour la protéine SP1 qui sert de plateforme d'ancrage d'autres protéines régulatrices (pour revue (Rohr et al. 2003a, Stevens et al. 2006)).

Ces trois zones sont contenues à l'intérieur de la région U3, tandis que l'élément TAR transactivateur est contenu dans la région R de la LTR. Cette zone va donner naissance à la structure tige-boucle pour l'initiation de la transcription. Ce secteur recrute alors le transactivateur viral Tat, qui interagit avec le facteur d'élongation P-TEFb, nécessaire pour améliorer la processivity de RNAPolII. En outre, la région U3, cette région est invariablement le site de nucléosome 1, Nuc-1 provirus qui bloque et empêche le RNAPolII de l'initiation de la transcription (Van Lint 2000). Après Nuc-1 est U5 région, qui contient des sites de liaison supplémentaires pour des facteurs de transcription AP-1, SP1, NF-AT, SP1 et IRF-1 (Rohr et al. 2003a).

La zone entre les nucléosomes Nuc-0 et Nuc-1 contient la région d'amplification et de promoteur du core. Cette séquence est accessible aux modulateurs de la transcription et sera le site de la concurrence entre les activateurs et les facteurs de répresseurs. La concurrence entre ces facteurs de transcription sont responsables de modifications épigénétiques de Nuc-1 et conduit à la fermeture et l'ouverture de la chromatine à la LTR.

L'intégration du provirus dans des domaines d'hétérochromatine n'est pas la seule explication de la latence transcriptionnelle. En effet, il a été établi que le provirus intègre majorité (93%) dans les introns appartenant à des domaines actifs de transcription du génome de l'hôte (Han et al. 2004). L'hypothèse la plus simple d'expliquer la latence transcriptionnelle est de transformer son site promoteur du site actif d'une structure hétérochromatine. L'hétérochromatine est une structure condensée de l'ADN. Compactage des gènes dans une hétérochromatine inactive leur transcription.

L'unité fondamentale de la chromatine, le nucléosome, est un octamère protéique des histones. Ces histones peuvent être modifiés après traduction par acétylation, phosphorylations, méthylation, ubiquitination et SUMOylation. Les modifications du code des histones sont pas irréversibles, ce qui rend le labile de l'Etat chromatine et augmente la complexité de l'activité transcriptionnelle des gènes. Ces changements, qui ont un impact sur le profil



d'expression des gènes sans modifier le génome, sont désignés comme des modifications épigénétiques (Kouzarides 2007).

Acétylation des histones par acétyl-transférase histones (HAT) est associée à la formation de l'euchromatine, l'état transcriptionnellement actif de la chromatine, tandis que la de-acétylation des histones désacétylases par (HDAC), conduit à la formation de l'hétérochromatine. L'état d'acétylation est directement corrélée à l'état d'activation de la transcription. En revanche, les résultats de sumoylation dans la formation de l'hétérochromatine (Wurtele et al. 2009).

## **CTIP2**

Les facteurs de transcription COUP-TF et SP1 sont des facteurs cellulaires impliqués dans la régulation de la transcription du VIH-1 via leur fixation sur son promoteur (le 5' LTR) (Rohr et al. 1997). La protéine CTIP2 (COUP-TF interacting protein 2) est un facteur de transcription impliqué dans les processus de différenciation et développement des systèmes immunitaires et du SNC. Son action passe par l'induction d'une forme compacte de la chromatine (ou hétérochromatine), suite à sa fixation sur les promoteurs des gènes régulés. Par ailleurs, l'absence d'expression de cette protéine est dans les cellules à l'origine des lymphocytes T ou dans les lymphocytes T-reg conduit à l'apparition de pathologies auto-immunes et de maladies inflammatoire du tube digestif. (Vanvalkenburgh et al. 2011). CTIP2 est décrit comme un facteur répresseur de l'activité transcriptionnelle du VIH-1 dans les cellules lymphocytaires dont l'effet est médié via son interaction avec le complexe NuRD (Cismasiu et al. 2008).

Nos travaux ont permis d'élucider le rôle et le mécanisme d'action de divers facteurs de transcription cellulaires ainsi que de substances physiologiques qui régulent l'expression du virus VIH-1 dans les cellules microgliales et dans les cellules du système immunitaire (Sawaya et al. 1996, Rohr et al. 1997, Schwartz et al. 1997, Rohr et al. 1999, Rohr et al. 2000, Schwartz et al. 2000, Marban et al. 2005). Nous avons découvert le potentiel inhibiteur du cofacteur transcriptionnel CTIP2 et caractérisé son mode de recrutement via Sp1 au niveau du LTR viral (Marban et al. 2005). Plus récemment, nous avons montré l'importance de CTIP2 pour l'établissement de la latence post-intégration dans des cellules microgliales. Nous avons notamment

démontré que CTIP2 recrute un complexe multienzymatique contenant HDAC1, HDAC2 et SUV39H1 pour établir une structure hétérochromatinienne au niveau du LTR viral, favorisant ainsi la répression transcriptionnelle des gènes viraux (Marban et al. 2007). A ce jour, CTIP2 est le seul facteur connu capable de recruter une machinerie enzymatique modulant à la fois l'acétylation et la méthylation des histones. Le recrutement de SUV39H1 constitue donc une nouvelle cible thérapeutique potentielle pouvant être inhibée seule ou en combinaison avec les HDACs. Cette étude révèle de nouvelles cibles dans le cadre d'une stratégie épigénétique de "réduction" des réservoirs viraux. Dernièrement, nous avons démontré que le rôle de CTIP2 ne se limite pas à réprimer le promoteur du VIH-1. Par sa capacité à réprimer p21 et Vpr, CTIP2 induit également un contexte cellulaire défavorable à l'expression du virus (Cherrier et al. 2009a). Enfin, avec l'équipe de Carine Van Lint, nous avons contribué à démontré l'importance de la méthylation du promoteur viral dans le contrôle de la latence du BLV (Pierard et al.). **(Fig A)**.

Enfin, nous avons montré que la protéine LSD1 (lysine-specific demethylase 1) réprimait de manière synergique avec CTIP2 la transcription du VIH-1 en servant de plate-forme d'ancrage pour le complexe hCOMPASS complex. Ce recrutement est associé à l'apparition des marques épigénétiques H3K4me3 et H3K9me3. Ces marques épigénétiques sont associées à une répression de la transcription du VIH-1 (Le Douce et al. 2012).

Ainsi, la protéine est à la fois impliquée dans l'établissement et le maintien de la latence du VIH-1. CTIP2 a aussi été décrit comme un facteur anti-apoptotique dans les cellules de la lignée lymphocytaire T. Ainsi, un KO de CTIP2 dans une lignée de thymocytes induit leur mort cellulaire par apoptose (Wakabayashi et al. 2003). De plus, nous avons montré que CTIP2 réprimait l'expression du gène codant pour la protéine p21 qui est un inhibiteur des kinases dépendant de la cycline. L'expression de cette protéine dans les cellules de la lignée monocyte-macrophage est associée à une réplication du VIH-1 dans ces cellules. De manière intéressante, CTIP2 va favoriser indirectement l'établissement de la latence du VIH-1 en réprimant l'expression de ce gène. Le mécanisme moléculaire de cette répression s'exerce via un mécanisme analogue à celui déjà décrit pour le promoteur du VIH-1. Ainsi, l'activation transactivatrice exercée par la protéine VpR qui passe via sa fixation sur le site Sp1 **(Fig C)** est

contrecarrée par la fixation de la protéine CTIP2 sur ces mêmes sites. Une fois fixée, CTIP2 va recruter la même machinerie enzymatique que celle observée sur le promoteur du VIH-1 afin d'induire la formation d'hétérochromatine (**Fig C**). Ainsi, CTIP2 va induire un microenvironnement cellulaire favorable à l'établissement et au maintien de la latence virale (Cherrier et al. 2009b).

Le complexe pTEFb est, quant à lui, un complexe de protéine constitué d'une cycline (cycline T1) et d'une kinase dépendante des cyclines (CDK9). Ce complexe a été découvert dans le cadre de recherches visant à élucider la régulation de la transcription du VIH-1. Il est vite apparu que ce complexe était associé à de nombreuses fonctions cellulaires, telles que la croissance et la différenciation cellulaire (31). De manière plus intéressante, des dérégulations de son expression et/ou de son activité ont été corrélées à de nombreuses pathologies de type néoplasme (1). Enfin, l'activité de la CDK9 était augmentée suite à l'application de nombreux stimuli, incluant l'interleukine 6 et le TNF $\alpha$ , suggérant ainsi sa participation dans la régulation de processus physiologiques tels que la croissance, la différenciation, la survie, mais aussi dans des processus à l'origine de l'inflammation qui, rappelons le, est incriminé dans la genèse des néoplasmes (1).

Récemment, nous avons démontré que CTIP2 contrôle l'activité de P-TEFb dans le cadre de l'hypertrophie cardiaque, une autre pathologie P-TEFb dépendante. CTIP2, inclus dans un complexe PTEFb inactif (CDK9/CyclinT1, HEXIM1, 7SKsnRNA), inhibe l'activité kinase de la CDK9. De plus CTIP2 contribue au recrutement de ce complexe sur les promoteurs des gènes clés de l'hypertrophie cardiaque. Ce recrutement du complexe P-TEFb inactif est un nouveau mode de contrôle de l'expression des gènes sensibles à P-TEFb. Comme CTIP2 semble contrôler l'expression de gènes responsable de la tumorigenèse (p21waf1/cip1 (27), HDM2 (14)...), sa capacité à réprimer P-TEFb paraît cruciale dans ces phénomènes. (**Fig B**).

En conclusion, la protéine CTIP2 exerce un effet direct et un effet indirect sur la répression de l'expression du VIH-1. L'effet direct est à mettre en relation avec la capacité qu'a CTIP2 de recruter des facteurs cellulaires à l'origine de la compaction de la chromatine mais aussi en réprimant l'activité du complexe d'élongation recruté par le facteur transactivateur TAT prévenant ainsi la réactivation du provirus intégré.

Nos travaux ont permis d'élucider le rôle et le mécanisme d'action de divers facteurs de transcription cellulaires ainsi que de substances physiologiques qui régulent l'expression du virus VIH-1 dans les cellules microgliales et dans les cellules du système immunitaire. Nous avons découvert le potentiel inhibiteur du cofacteur transcriptionnel CTIP2 et caractérisé son mode de recrutement via Sp1 au niveau du LTR viral (Marban et al. 2005, Marban et al. 2007). Plus récemment, nous avons montré l'importance de CTIP2 pour l'établissement de la latence post-intégration dans des cellules microgliales. Nous avons notamment démontré que CTIP2 recrute un complexe multienzymatique contenant HDAC1, HDAC2 et SUV39H1 pour établir une structure hétérochromatinienne au niveau du LTR viral, favorisant ainsi la répression transcriptionnelle des gènes viraux. A ce jour, CTIP2 est le seul facteur connu capable de recruter une machinerie enzymatique modulant à la fois l'acétylation et la méthylation des histones. Le recrutement de SUV39H1 constitue donc une nouvelle cible thérapeutique potentielle pouvant être inhibée seule ou en combinaison avec les HDACs. Cette étude révèle de nouvelles cibles dans le cadre d'une stratégie épigénétique de "réduction" des réservoirs viraux. Dernièrement, nous avons démontré que le rôle de CTIP2 ne se limite pas à réprimer le promoteur du VIH-1. Par sa capacité à réprimer p21 et Vpr, CTIP2 induit également un contexte cellulaire défavorable à l'expression du virus. La compréhension des mécanismes et des différents acteurs impliqués dans la mise en place de la latence au niveau du génome du virus, ainsi que de son maintien, apparaissent ainsi nécessaires en vue de développer de nouvelles stratégies basées sur la purge des réservoirs, qui associées à une multithérapie antirétrovirale, permettrait, à défaut d'éliminer le virus des patients infectés, de réduire suffisamment le pool de réservoirs cellulaires infectés de sorte que le système immunitaire puisse contrôler l'infection par le virus.

Une meilleure compréhension des mécanismes à l'œuvre dans l'immunité virale intrinsèque offre la perspective de développer des alternatives aux stratégies thérapeutiques actuellement utilisées. Il a ainsi été décrit à ce jour 4 facteurs de restriction cellulaire capables d'inhiber l'expression de rétrovirus chez l'homme : Trim5 $\alpha$ , APOBEC3, Tetherin et SAMDH1. Ce système de défense est caractérisé par sa mise en jeu directe et spécifique, s'opposant en cela à l'autre versant de l'immunité acquise mettant en jeu les PRRs qui inhibent indirectement l'expression viral en activant notamment la voie de l'interferon. Ce

mode de défense est certainement ancien et témoignerait d'infections anciennes avec des rétrovirus. En faveur de cette hypothèse, le fait qu'environ 8 % de notre génome est constitué de génome de rétrovirus. Le contact récent du VIH-1 et de son nouvel hôte explique que les contremesures qui ont été opérantes par le passé ne le soient pas contre le VIH-1. Ce dernier a en effet élaboré une série de protéines, longtemps considérées comme accessoires, à même d'annihiler l'efficacité des facteurs de restrictions jusqu'alors connus. Ainsi, la protéine Vpu est impliquée dans l'inactivation de la protéine Tetherin qui empêche le bourgeonnement des virions, alors que la protéine Vif contrecarre l'activité de la protéine APOBEC3 en induisant sa dégradation via la voie du protéasome. Sur la base des précédents résultats, il a été prédit que les protéines accessoires Vpr du VIH-1 et Vpx du VIH-2/VIS, capables de former un complexe Cullin4-ubiquitin ligase via leurs interactions avec la protéine DCAF1, pourraient cibler des facteurs de restrictions non identifiés vers la voie du protéasome. Il a ainsi été possible d'identifier la protéine SAMDH1 comme étant le facteur de restriction du VIH-1 dans les cellules dendritiques. Son activité est ainsi inhibée par Vpx mais pas par Vpr qui reste toujours orphelin de son facteur de restriction, même si certains candidats ont été pressentis.

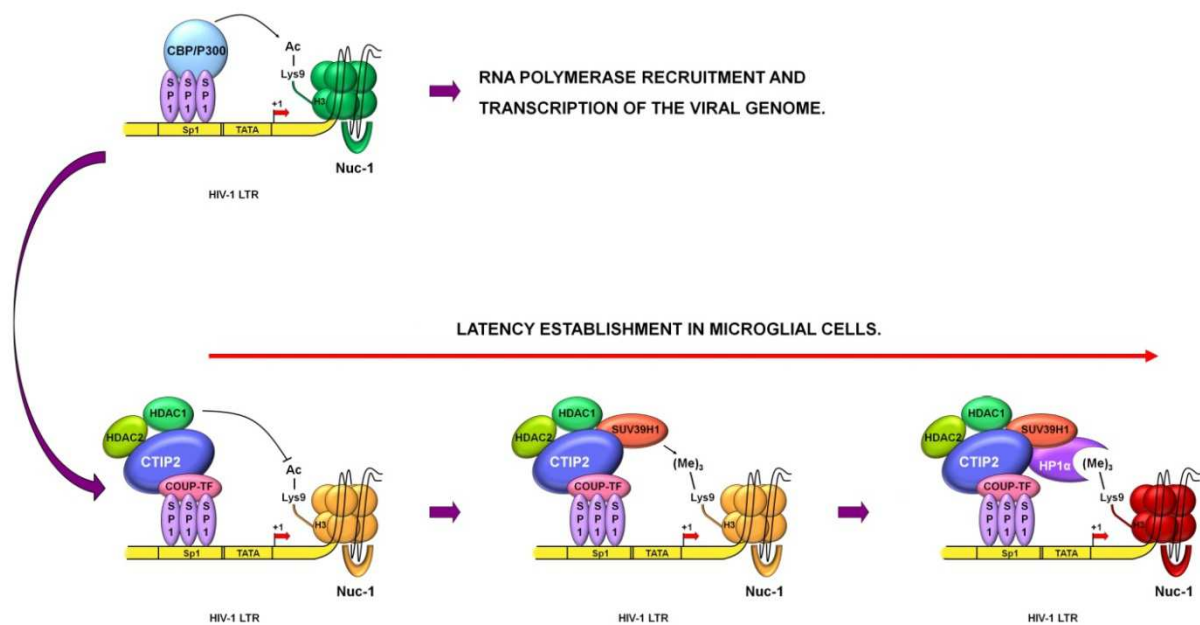

**Fig A: La répression transcriptionnelle des gènes viraux par CTIP2 (Schwartz et al. 2010).**

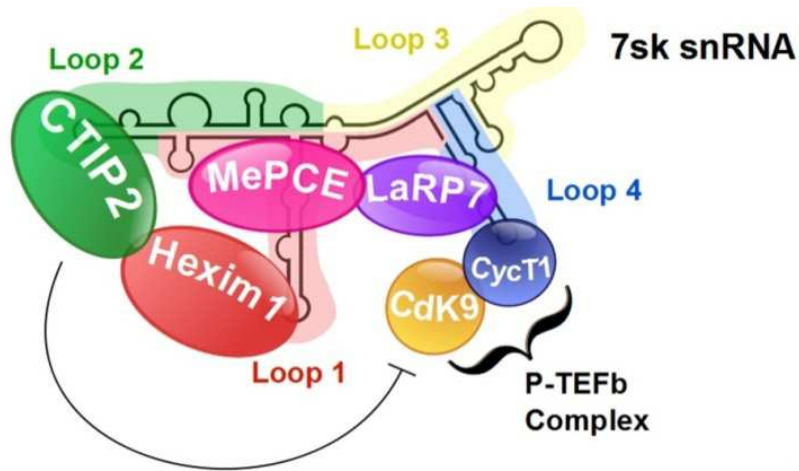

Fig B: P-TEF-b répression par CTIP2 (Cherier et al. PNAS 2013, sous presse).

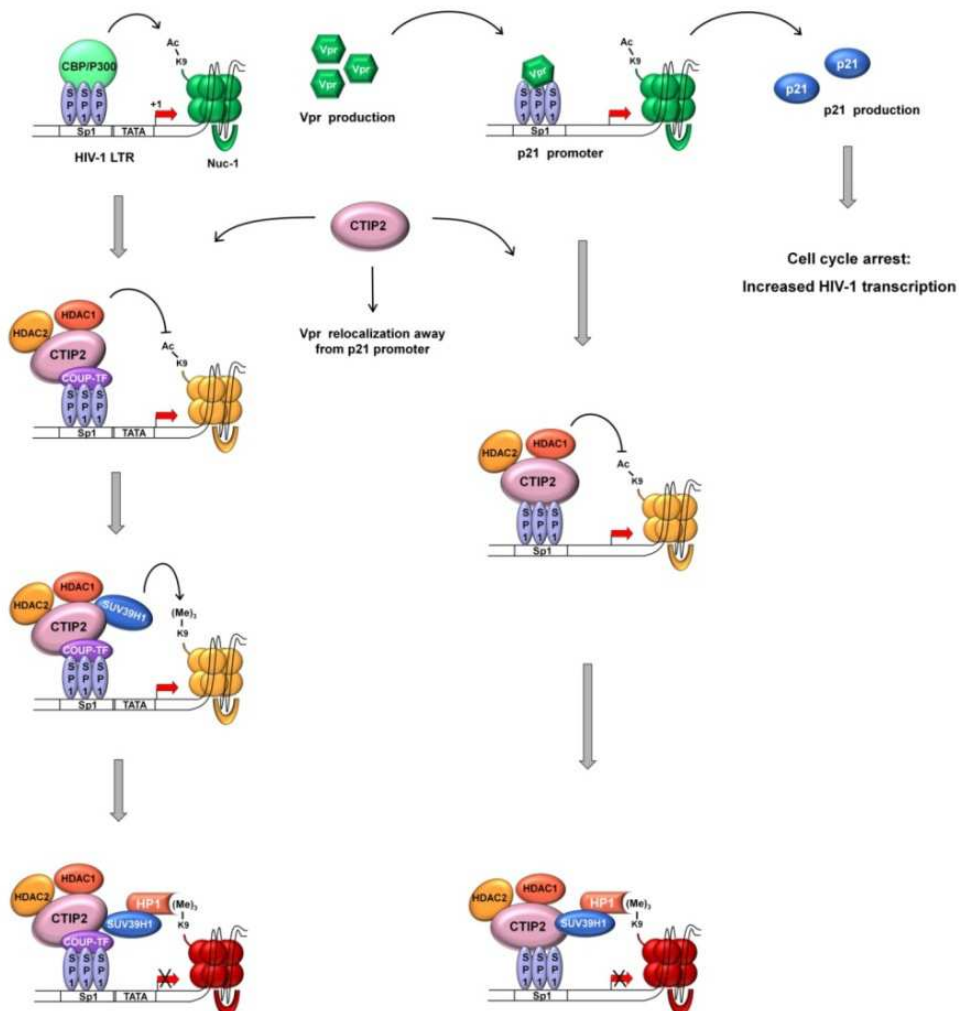

Fig C: Direct et indirect répression transcriptionnelle des gènes viraux par CTIP2 (Le Douce et al. 2010).

## **Vpr et le complexe Cul4A-DDB1<sup>DCAF1</sup> E3 ubiquitin ligase.**

Parmi les nombreuses fonctions attribuées à la protéine accessoire VpR du VIH-1 nous retrouvons l'arrêt du cycle cellulaire au cours de la phase G2 ; Il a été proposé que la protéine vpr régule de manière négative l'activité d'une protéine cellulaire requise pour le bon déroulement du cycle de division cellulaire. L'action de vpr passerait par la dégradation de cette protéine en la recrutant sur le complexe Cul4 E3 ubiquitin ligase. Ce recrutement est à l'origine de son ubiquitynilation suivi de sa dégradation via la voie du protéasome (Belzile et al. 2007, DeHart et al. 2007, Le Rouzic et al. 2007, Tan et al. 2007, Wen et al. 2007). L'importance de l'association de la protéine VpR avec le complexe Cul4 ubiquitin ligase a été montrée dans au moins trois processus biologiques importants :

- 1) Induction de l'arrêt du cycle cellulaire en G2 par la protéine Vpr du HIV-1 ou par la protéine VIH-2/VIS Vpr.
- 2) facilitation de l'infection des macrophages par la protéine VIH2/VIS Vpx.
- 3) La protéine HIV-1 Vpr peut induire la dégradation des protéines UNG2 et SMUG1 via le complexe Cul4 ubiquitin ligase (Schrofelbauer et al. 2005).

La signification biologique d'un arrêt du cycle de division cellulaire en G2 dans des cellules se divisant activement n'est pas encore bien comprise. . Il a été proposé qu'un blocage en G2 génère un environnement favorable à la réplication virale dans la mesure où durant cette phase G2, les phénomènes de transcription et de traduction étaient les plus intenses. Bien que moins importante que prévue, la production du virus en présence de VpR était augmentée d'un facteur 2-3. (Goh et al. 1998). Bien qu'apparemment modeste, ces effets sur la production apparaissent cumulatifs après plusieurs cycles de réplication du virus.

Vpr associé à la protéine DCAF1 est associé à une restructuration de la chromatine dans les cellules infectées. Cette restructuration, associée à un arrêt en G2. serait liée au recrutement du Cul4A-DDB1DCAF1 E3 ubiquitin ligase. Ces complexes visualisés dans des foyers nucléaires sont stables et mobiles ; Ils permettraient de cibler des protéines impliquées dans la structuration de la

chromatine afin de les dégrader via la voie du protéasome. Leurs dégradations s'accompagneraient ainsi d'un arrêt du cycle cellulaire au cours de la phase G2 (Belzile et al. 2010).

Par ailleurs, HIV-1 VpR réprime l'expression de IRF3 (**i**nterferon **r**egulator **f**actor **3**) mais il apparaît que cette dégradation n'est pas à mettre en relation avec un recrutement du complexe Cul4A E3 ubiquitin ligase (Okumura et al. 2008). IRF3 est un facteur essentiel pour la production d'interferon-beta (INF- $\beta$ ) (Doehle et al. 2009, Kogan and Rappaport 2011). De manière intéressante, les ligands des cellules naturel killers est déclenchée par des réponses liées au dommage à l'ADN des cellules infectées (Ward et al. 2009, Richard et al. 2010). De façon importante, Vpr seule ou associée à l'infection virale, favorise l'expression de ces ligands dans les cellules naturel killer afin de leur permettre d'effectuer leurs rôles de cellules tueuses (Pham et al. 2011). L'importance de cette régulation dans la cellule naturel killer n'est pas encore bien comprise.

Les cellules dendritiques et les macrophages jouent un rôle clé dans la lutte contre les agents infectieux. Le virus HIV-1 a la particularité de pouvoir infecter des cellules quiescentes dans lequel la protéine vpr a un rôle central (Connor et al. 1995). En effet, VpR est capable de contourner les défenses du système immunitaire afin de permettre au virus de persister pendant très longtemps dans la cellule de l'hôte infectée. (Harman et al. 2006). De plus, ces cellules infectées de manière persistante contribuent à la dissémination de l'infection vers les lymphocytes T CD4 via des contacts synaptiques. Elles permettent aussi de coloniser des compartiments cellulaires appelés sanctuaire qui sont peu accessible aux cellules du système immunitaire contribuant ainsi à la persistance du virus chez le patient. (McDonald et al. 2003). Ces cellules de part leur très longue demi vie constituent ainsi un des meilleurs réservoirs pour le virus qui peuvent ainsi persister très longtemps chez les patients infectés (Herbein et al. 2010).

Les rôles dédiés à la protéine virale Vpr ne sont toujours pas bien compris. Lors de la réplication des lentivirus, leur génome est transporté vers le noyau et cela sans que l'on observe une rupture de la membrane nucléaire. Vpr est ainsi associé au complexe de pré-intégration qui comprend le génome viral. D'anciens travaux ont clairement établis le rôle facilitant de Vpr dans le transport du complexe pré-intégrationnel dans le noyau des cellules infectées (Bukrinsky et



al. 1992, Popov et al. 1998, Fassati 2006), suggérant ainsi en avant l'importance du signal de nucléo localisation de Vpr pour son transport. Le transport de ce complexe par vpr apparaît ainsi crucial dans les macrophages. Cependant, il a été montré ultérieurement que le signal de localisation nucléaire n'était pas essentiel pour l'infection des cellules quiescentes comme les macrophages .(Yamashita and Emerman 2005, Riviere et al. 2010). De plus, de tels signaux, bien qu'également retrouvés dans d'autres constituants de ce complexe pré-intégrationnel, ne se sont pas non plus avérés essentiels à ce transport. (Riviere et al. 2010). Ainsi, il apparaît que l'importance de Vpr dans la facilitation de l'infection par le HIV des cellules macrophages ne soit pas en relation avec le transport du complexe pré-intégrationnel ni avec son implication dans l'arrêt du cycle. Il apparaît donc que les fonctions dévolues à la protéine vpR soient conditionnées par la nature des cellules infectées même originaire d'un même tissu. Ainsi une déplétion en VpR apparaît délétère dans les cellules macrophagiques retrouvées dans des explants d'organes lymphoïdes alors que tel n'est pas le cas dans les cellules lymphocytes T au repos provenant de ce même tissu (Zennou et al. 2001).

Les virus VIH-2 et VIS infectent de manière encore plus efficace que le VIH-1 les macrophages. Cette propriété serait à mettre au crédit de la protéine VpX qui apparaît plus efficace que VpR dans ces processus (Sharova et al. 2008, Srivastava et al. 2008). Des études récentes montrent clairement que VpX ciblent des facteurs de restriction de l'hôte pour leurs dégradation via la voie du protéasome, facilitant ainsi l'infection des cellules macrophages infectées. Ainsi la protéine SAMHD1 est associée à la protéine Vpx qui va recruter le complexe .Cul4 E3 ubiquitin ligase afin de la polyubiquitinyler et faciliter sa dégradation via le protéasome (Hrecka et al. 2011, Laguette et al. 2011) (for review (Sharifi et al. 2012)). **(Fig 4)**

Plus récemment, il a été propose l'existence d'autres facteurs de restriction de l'infection par le HIV-1 dans les cellules macrophages. Ainsi, des études réalisées dans les cellules de la lignée myéloïde sur les effets de l'interferon-beta (INF- $\beta$ ) et des lipopolysaccharides (LPS) ont suggéré l'existence d'autres facteurs de restriction à même de prévenir l'infection par les rétrovirus. Ce facteur de restriction putatif induit par INF- $\beta$ /LPS semble impliquer dans le transport du complexe pré-intégrationnel. Son action diffère de

celle exercée SAMHD1 qui restreint l'infection rétrovirale via l'inhibition de la transcription inverse (Pertel et al. 2011). Ce facteur de restriction hypothétique verrait son action empêcher par l'intervention des protéines HIV-2/SIV Vpx. De manière intéressante, son action ne semble pas dans ce cas être associée à la protéine DCAF1. Ainsi, les protéines telles que Vpr et Vpx semblent exercer leurs contre-mesures selon différents mécanismes pouvant ou impliquer la protéine DCAF1 (for review (Sharifi et al. 2012)).

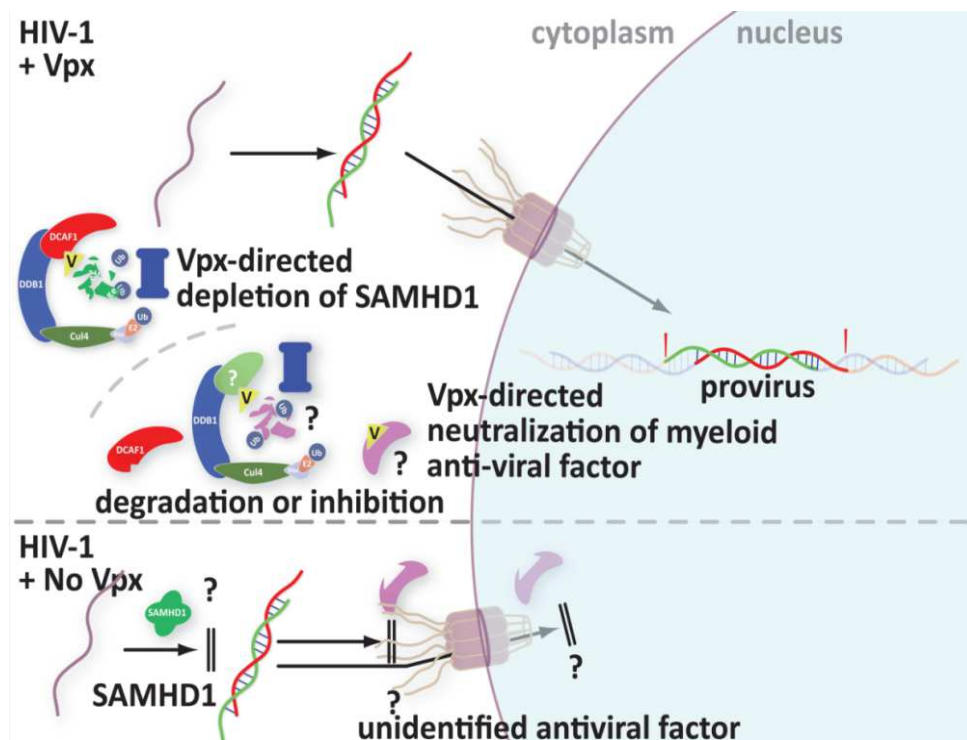

**Fig D : Sommaire des facteurs restriction et contracte dans cellules myeloids (Sharifi et al. 2012).**

Par ailleurs la protéine Vpr a été retrouvée sous forme libre dans le serum ou le liquid céphalorachidien des personnes infectées. L'infection par le VIH-1 peut se disséminer vers le SNC via les cellules lymphocytaires ou monocytaires infectées. Suite à la pénétration de la barrière hémato-méningée, ces cellules infectées vont produire de nouvelles particules virales ainsi que des formes libres de la protéine Vpr. Parmi les cellules résidentes du SNC; les cellules microgliales constituent la cible privilégiée du VIH-1 qui contribuent ainsi à la libération de forme libre de la protéine Vpr (for review (Ferrucci et al. 2011)).

Il a été montré récemment que la protéine Vpr interagissait physiquement avec tout un panel de protéines cellulaires telles que DDB1, DCAF1, Cul4A, UNG, DYHC, HAT1, RbAp46 etc (Jager et al. 2012). De manière intéressante, l'interaction de Vpr avec la protéine HAT1 suggère qu'elle pourrait être impliquée dans la régulation de l'état d'acétylation des protéines histones nouvellement synthétisées (Verreault et al. 1998, Makowski et al. 2001). Son interaction avec DYHC1 (Cytoplasmic dynein 1) indiquerait son implication dans le transport rétrograde de certaines protéines cellulaires (Bharti et al. 2011). Plus intéressant encore, son association avec RbAp46 (Retinoblastoma binding protein p46) suggère un rôle dans le remodelage de la chromatine (Murzina et al. 2008). RbAp46 est une des 7 sous unités du complexe NuRD (Nucleosome remodeling and histone deacetylase).. Les autres sous unités constitutives de ce complexe sont les HDAC (histone deacetylases) 1 & 2, RbAp48 (Retinoblastoma binding protein p48), MTA 1/2/3 (Metastasis-associated proteins), MBD3/2 (methyl-CpG-binding domain proteins) et CHD3/4 (chromodomain helicase DNA binding proteins) (Xue et al. 1998).

Pris ensemble, l'ensemble de ces données suggèrent que la protéine virale Vpx est capable d'induire la dégradation d'un facteur cellulaire encore non identifié vers la voie du protéasome. Afin d'induire un blocage en G2 des cellules se divisant activement. Dans les cellules quiescentes, les protéines HIV-1 Vpr ou HIV-2/SIV Vpx facilitent la réplication virale via plusieurs mécanismes. L'un de ceux-ci repose sur la dégradation d'un facteur de restriction cellulaire dont l'action sera délétère pour la réplication. Les fonctions exercées par la protéine Vpr pourraient être spécifiques du type cellulaire infecté. Ainsi, HIV-1 Vpr peut induire la dégradation de protéines telles que UNG2 and SMUG1 qui partagent un motif commun essentiel à leurs interactions avec Vpr. Enfin, Vpr pourrait

aussi accélérer un processus de dégradation qui existe de manière constitutive comme déjà décrit avec la protéine (Wen et al. 2012).

La protéine CTIP2, initialement caractérisée par notre laboratoire comme étant un acteur majeur dans l'établissement de la latence du VIH-1 dans les macrophages résidants du SNC, les cellules microgliales, pourrait voir son statut s'élargir et être considéré comme un facteur de restriction aux effets pléiotropes.

Mon travail de thèse a consisté à tester l'hypothèse selon laquelle la protéine CTIP2, à même de restreindre l'expression du VIH-1 dans les cellules microgliales, est dégradée via la voie du protéasome en présence de Vpr.

Nous avons ainsi visualiser par WB une diminution de l'expression de la protéine CTIP2 à partir d'extraits protéiques de cellules transfectées avec le génome sauvage du VIH-1 (pNL4.3) comparé aux extraits de protéines provenant de cellules transfectées avec le génome muté pour Vpr (pNL4.3 delta Vpr).

Nous avons alors vérifié par WB que l'expression de la protéine CTIP2 était diminuée en présence de la protéine Vpr surexprimée dans des cellules HEK. Une régulation post traductionnelle par Vpr de l'expression de la protéine CTIP2 est fortement suggérée dans la mesure où nous n'avons pas mis en évidence de régulation transcriptionnelle grâce à l'utilisation de la technique de RT-PCR quantitative. Afin de valider cette hypothèse, nous avons visualisé l'expression de la protéine CTIP2 par WB en absence/présence d'une surexpression de la protéine Vpr et en absence/présence d'un inhibiteur de la voie du protéasome (MG132). En l'absence de la protéine Vpr, l'expression de la protéine CTIP2 est plus importante dans les cellules traitées par le MG132. Ce résultat suggère que la protéine CTIP2 est dégradée de manière constitutive via la voie du protéasome. De manière très intéressante, la dégradation drastique de la protéine CTIP2 observée en présence de la protéine Vpr est complètement prévenue en présence du MG132. Nous avons alors utilisé des approches biochimiques en vue de disséquer finement les différents acteurs et les mécanismes mis en jeu dans ce processus. En effet, Vpr a été décrit comme étant l'intermédiaire, entre la protéine cible qu'il recrute via une interaction physique, et un complexe DDB1/DCAF1/Cullin4 ubiquitine ligase chargé du ciblage pour la dégradation via la voie du protéasome.

Nous avons ainsi montré par immunoprécipitation que les protéines Vpr et CTIP2 interagissaient physiquement. Des approches similaires ont permis de montrer que les protéines Vpr et CTIP2 faisaient partie d'un complexe multiprotéique comprenant les protéines DDB1 et DCAF1. De manière intéressante, la protéine CTIP2 fait partie d'un complexe protéique comprenant DDB1 et DCAF même en l'absence de la protéine Vpr. Ce résultat est en faveur d'une dégradation constitutive de la protéine CTIP2 via le protéasome mise en évidence plus haut. La présence de Vpr accélère de manière drastique ce processus. L'importance de la protéine DCAF1 dans ce processus de dégradation induit par la protéine Vpr a été montrée par l'utilisation de mutant de DCAF n'ayant plus la possibilité d'interagir avec Vpr (Q65R). En surexprimant cette protéine mutée dans des cellules HEK, nous ne visualisons plus par WB de dégradation de la protéine CTIP2 en présence de la protéine Vpr. L'utilisation d'un siRNA dirigé contre la protéine DCAF a permis de réduire drastiquement son expression. En l'absence de la protéine DCAF1, nous n'observons plus de dégradation de la protéine CTIP2 induite par la présence de la protéine virale Vpr. Ces derniers résultats soulignent l'importance du complexe DDB1/DCAF1/Cullin4 ubiquitine ligase dans le processus de dégradation de la protéine CTIP2 qui est favorisée par la présence de la protéine Vpr. Des expériences de microscopie confocale avec les différentes protéines couplées à des fluorophores ont montré que les protéines DCAF et CTIP2 étaient colocalisées dans le noyau des cellules microgliales en l'absence de Vpr confirmant l'existence d'une dégradation constitutive de la protéine CTIP2 via la voie du protéasome. En présence de Vpr, nous visualisons une colocalisation des protéines CTIP2, DCAF et Vpr dans le noyau des cellules microgliales. En présence de l'inhibiteur de la voie du protéasome MG132, nous observons une relocalisation de la protéine DCAF dans le cytoplasme. Cette relocalisation de DCAF1 dans le cytoplasme en présence du MG132 prévient l'interaction de CTIP2 avec le complexe DDB1/DCAF/Cullin4 ubiquitine ligase et contribue à expliquer la prévention de la dégradation de la protéine CTIP2. Enfin, l'utilisation d'anticorps anti ubiquitine a permis de montrer que la protéine CTIP2 était ubiquitinylée et que cette ubiquitinylation augmentait en présence de la protéine CTIP2.

Des résultats obtenus au laboratoire font état de l'existence de plusieurs complexes protéiques différents associés à la protéine CTIP2. Par l'utilisation de la technique de double immunoprécipitation, nous avons montré que le pool de

protéines CTIP2 destiné à être dégradé via la voie du protéasome était celui associé aux protéines HDAC impliquées dans la formation de l'hétérochromatine mais pas à celui associé au complexe pTEFb.

En conclusion, nos résultats suggèrent que la protéine virale Vpr détourne la voie du protéasome dans les cellules microgliales afin d'accélérer le processus de dégradation de la protéine CTIP2 décrit dans le laboratoire comme un facteur à même de restreindre l'expression du VIH-1.

# **Introduction**

# **1. Acquired immunodeficiency syndrome and HIV**

## **1.1. Discovery of AIDS and HIV**

In 1981, there have been appearances of Kaposi's Sarcoma (Durack 1981) and Pneumocystis (Gottlieb et al. 1981) among homosexual men in New York and California, USA. Among the other names this condition was also called "GRID" (gay-related immune deficiency) or GCS (Gay Compromise Syndrome) (Brennan and Durack 1981) stigmatizing the gay community as carrier of this deadly syndrome. However, shortly it was revealed that this syndrome have no boundaries when cases were also reported from other communities including drug addicts (Masur et al. 1981), heterosexuals and people who received blood transfusions. By the incidence of this disease in non-heterosexual groups, the name GRID was antiquated. In 1982, CDC (Centers for disease control) first time used an alternate name for this disease, Acquired Immunodeficiency Syndrome (AIDS) (Quagliarello 1982). In following years, it also became clear that AIDS is not just confined to USA, with several reports of infected patients from European countries (Francioli et al. 1982, Gerstoff et al. 1982, Rozenbaum et al. 1982, Vilaseca et al. 1982).

Shortly, with more than 3,000 identified AIDS cases only in 1983, it became a big threat for public health. A lymphotropic virus, LAV (lymphadenopathy-associated virus) was identified and closely related to AIDS by French researchers in 1983 at the Pasteur Institute (Barre-Sinoussi et al. 1983), but they failed to provide a causal link between these two. In 1984, CDC confirmed to have finally isolated the causative agent of AIDS, HTLV-III (Human T-Lymphotropic retrovirus) (Gallo et al. 1984). It started the struggles for paternity of virus, but later on it was proved that LAV and HTLV-III are in fact one and the same virus, officially renamed HIV (Human Immunodeficiency Virus) in 1986 by the "International Committee on Taxonomy of Viruses", thus putting an end to the identification struggles paternity of the virus between French and American laboratories.



## 1.2. Epidemiology

In 2011, there have been over 34 million individuals living with HIV, with sub-Saharan African region the most affected, where ever each 1 person is infected with HIV in every 20 adults and accounting for 69% of the total number of people living with HIV (**Figure 1**). It is estimated that 0.8% of adults aged 15-49 years worldwide are living with HIV, but burden of epidemic continues to vary considerably among countries and regions. Despite better awareness and knowledge, its pandemics unabatedly continues throughout all areas of the world with more than 2.5 million people got infected with HIV only in 2011. However, these new infections are on a decline, which have decreased from 3.2 to 2.5 million during last decade. There are 24% fewer deaths caused by AIDS in 2011 (1.7 million deaths) as compared to 2005. In other words there are half a million fewer deaths caused by HIV in 2011 than in 2005, but still it demands for a lot of improvement (**Figure 2**).

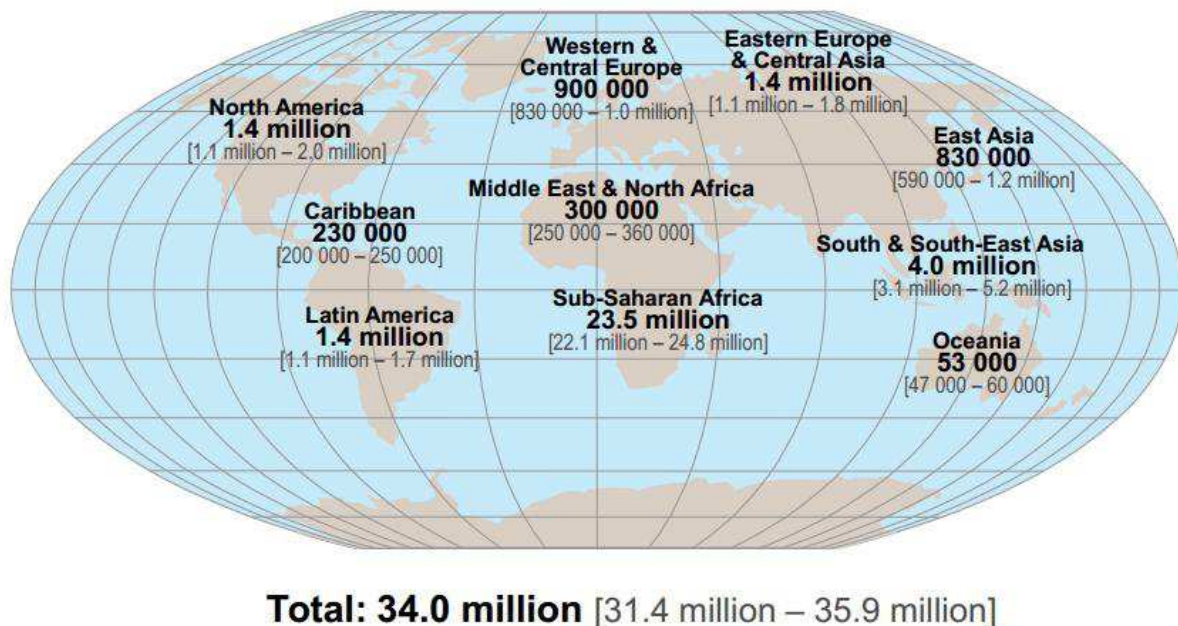

**Figure 1: Estimated individuals living with HIV in 2011.**

World map showing HIV-1 infected individuals. Out of total 34 million, 23.5 million individuals are from sub-Saharan Africa region (**UNAIDS global report 2012**).

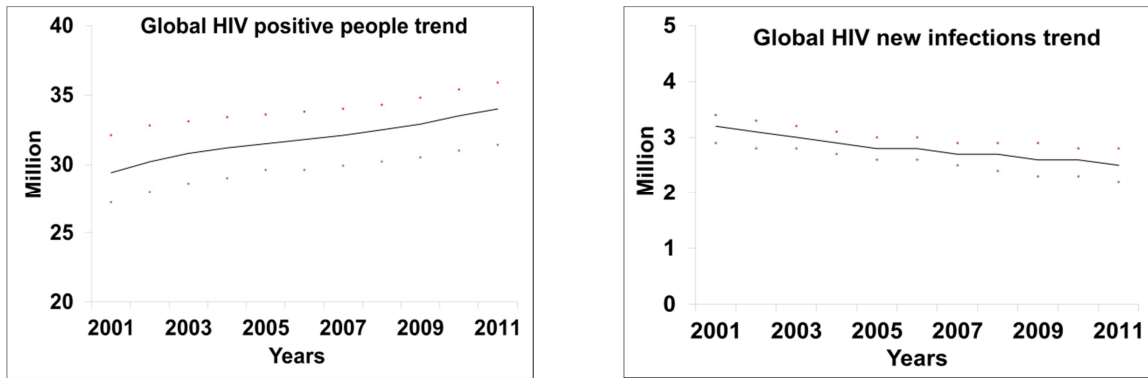

**Figure 2: Global HIV trends, 2001-11.**

Number of infected individuals increased during last decade but it was due to better survival of infected patients, as number of new infections is on a decline during last decade.

The number of people accessing antiretroviral therapy has increased by 63% from 2009 to 2011. In total, more than 8 million people living with HIV had access to antiretroviral therapy, however still there are 7 million people more eligible for HIV treatment but they do not have access (UNAIDS 2012). In 2011, fight against AIDS got allocation of US\$ 16.8 billion, with an estimated annual need between US\$ 22-24 billion by 2015, with main focus to control AIDS in Sub-Saharan Africa (**Figure 3**).

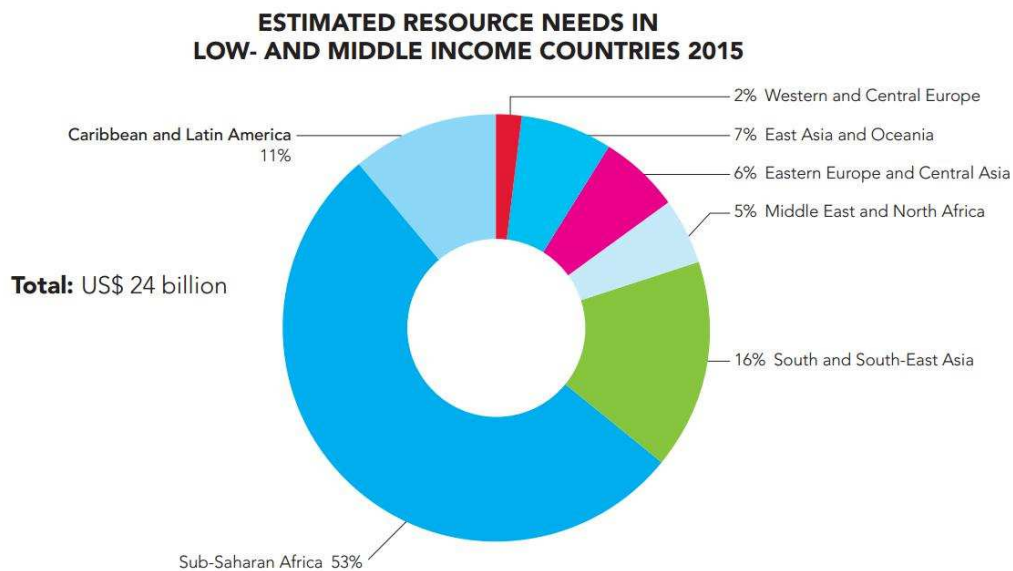

**Figure 3: Financial plan for 2015 to eradicate HIV (UNAIDS Report, 2012).**

### **1.3. Types of HIV**

Human immunodeficiency virus is genetically highly variable, resulting in difficulties for its treatment. It is included in genus lentivirus, family of *Retroviridae* (Hull 2001). There are two major types of HIV; HIV type 1 (HIV-1) and HIV type 2 (HIV-2) (Sharp and Hahn 2011). HIV-2 is less common as compared to HIV-1 and is less spread throughout the world, usually confined to Africa. HIV-2 is divided into 8 groups (A-H) (Santiago et al. 2005). HIV-1 can be divided into a major group and two or three minor groups on the basis of its genetic difference (Sharp and Hahn 2011).

- Group M (Major group) is the most common type of HIV-1 and causes more than 90% of HIV/AIDS cases. This group is further sub-divided in many sub-groups including A, B, C, D, E, F, G, H, I, J, and K (Merson et al. 2008).
- Group O (Outlier) is usually seen in west-central Africa (Peeters et al. 1997).
- Group N (non-M, non-O) was discovered in 1998 and only observed in Cameroon (Yamaguchi et al. 2006).
- Group P is newly described HIV sequence, isolated from a woman residing in France and was diagnosed with HIV-1. It is named under group P "pending identification of further human cases". The sequence of virus is found to closely related to gorilla SIV (*SIVgor.*) (Plantier et al. 2009).

## **1.4. Pathogenesis of AIDS**

Primary HIV-1 infection in human is usually accompanied with acute symptoms that are similar to infectious mononucleosis, for about 3-6 weeks with varying severity and persistence of symptoms. Following HIV-1 infection, level of CD4<sup>+</sup> T lymphocytes (main target of virus in plasma) significantly declines in the peripheral blood in first 2-8 weeks (Gaines et al. 1990, Tindall and Cooper 1991). This decline in CD4<sup>+</sup> T lymphocyte count in peripheral blood is correlated with exponential viral replication that can be observed in peripheral blood within 3 weeks of primary HIV-1 infection, which is followed by a decline of HIV-1 particles count in peripheral blood (Clark et al. 1991, Daar et al. 1991, Espert et al. 2007).

After few weeks, there is a stabilization of CD4<sup>+</sup> T lymphocytes count, which is associated with detection of specific antiviral immune response (Ho et al. 1985, Gaines et al. 1987, Tindall et al. 1988). This response is closely related with the appearance of HIV-specific CD8<sup>+</sup> cytotoxic T cells, without detection of first neutralizing antibodies (Koup and Ho 1994) that appear within 3 months of HIV-1 primary infection (Pauli et al. 1987). At this stage, administration of antiretroviral therapy improves CD4<sup>+</sup> T-cell count and subsequently improves clinical course of the disease, as compared to untreated individuals (Kinloch-de Loes and Perrin 1995).

This little acute phase of infection is followed by clinical latency phase for a period of 6 to 11 years in the absence of treatment (**Figure 4**), where immune system is constantly renewed and maintained plasma viral load at low levels (Chun et al. 1997). It is characterized by few to no clinical manifestations (Lemp et al. 1990). The existence of a residual replication allows production of virus by allowing the system to a state of immune hyperactivation. This persistence of chronic inflammation causes progressive decline in CD4<sup>+</sup> T cells (Breen et al. 1990, Aukrust et al. 1995, Aziz et al. 1999). Time interval from infection to development of AIDS varies greatly from one individual to another (Seage et al. 1993).

With under the threshold of 200 CD4<sup>+</sup> T cells / ml, immune system loses its ability to meet challenges of opportunistic diseases. This ends up in development of a clinical condition in these immune-compromised patients,

which is termed as AIDS (For review (Simon and Ho 2003, Lederman and Margolis 2008)).

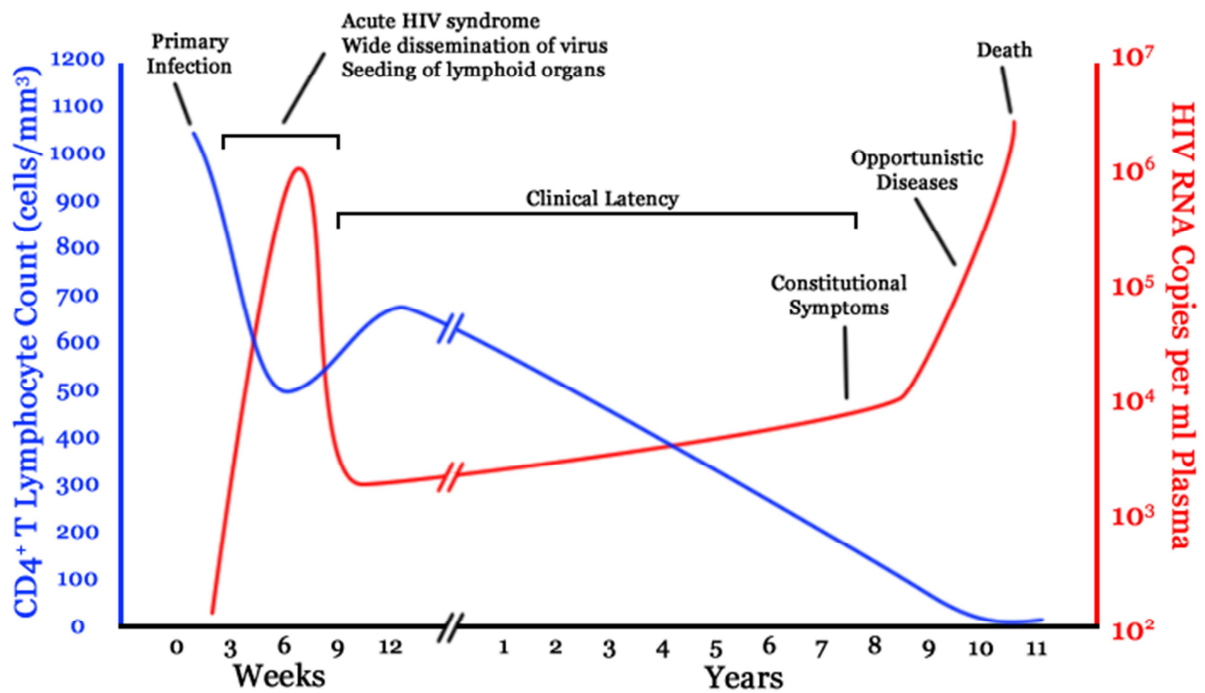

**Figure 4: Time course of HIV-1 infection.**

During the course of HIV-1 infection, we observe variation of T-cell count (**blue**) and level of circulating viruses (**red**) during primary infection, acute HIV syndrome, clinical latency and finally AIDS (**Sanao/Licence Creative Commons**).

## 2. Description of HIV-1 and its life cycle

### 2.1. Structure of infectious viral particle

HIV-1 is a virus included in genus *lentivirus* of family *Reteroviridae*. The viral particle is roughly spherical in shape with a diameter of 80-120 nm. Each viral particle consists of envelope and matrix that enclosed a capsid, which contains several enzymes and two copies of single-stranded RNA genome (**Figure 5A**).

HIV-1 envelope is composed of a lipid bilayer of host-cell origin. This envelope consists of about seventy two little spikes, each consisting of a trimer of **glycoproteins 41** (gp41) connected to a trimer **glycoproteins 120** (gp120). These gp41 form base and gp120 head of the spikes (Zanetti et al. 2006, Roux and Taylor 2007). These spikes play vital role during attachment of virus with target cell during infection. Under HIV-1 envelope is matrix formed by oligomerization of **matrix** protein (MA, p17). Located in the center of virus particle, capsid is formed by assembly of about 1500 mature **capsid** protein (CA, p24). The capsid proteins are combined in a multitude of hexagons forming a cone whose ends are blocked by pentagons (**Figure 5B**).

The capsid contains nucleocapsid and many molecules of cellular origin that help in viral life cycle. The nucleocapsid is composed of nucleocapsid proteins attached to viral genome, which consists of two strands of single-stranded RNA. Single stranded RNA of HIV-1 is closely associated with nucleocapsid proteins (p6 and p7) and enzymes, which will help during its life cycle in host cell. The nucleocapsid protects viral RNA from digestion by nucleases of host cells (Ganser-Pornillos et al. 2012).

Moreover, inside viral core or capsid are some important viral proteins that are involved in replicative cycle of HIV-1 including enzymes such as **protease** (PR), **reverse transcriptase** (RT) and **integrase** (IN) and viral accessory proteins that help HIV-1 during its replication like **viral infectivity factor** (Vif), **negative regulatory factor** (Nef) and **viral protein Regulatory** (Vpr) (for review (Ganser-Pornillos et al. 2008)).

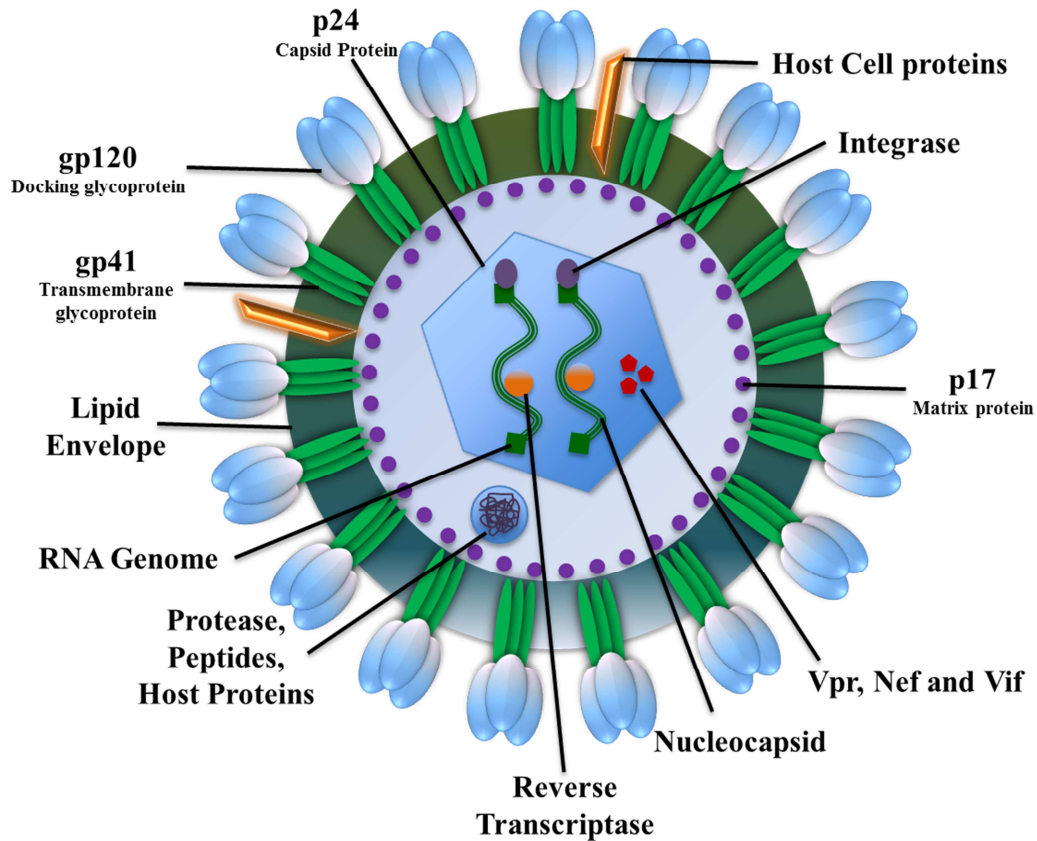

**Figure 5A: Schematic overview of infectious virion of HIV-1.**

HIV-1 virion is an enveloped virus with glycoprotein spikes to facilitate attachment to target cell. Inside matrix, viral genome is enclosed by capsid proteins including essential enzymes and viral accessory proteins (**Personal source**).



**Figure 5B: Model of HIV-1 capsid.**

The hexamers, pentamers and dimers are colored in orange, yellow and blue respectively (**Pornillos et al. 2011**).

## 2.2. Viral genome

HIV genome is composed of 2 copies of single-stranded RNA enclosed in capsid and each strand of viral RNA is approximately 9.7 kb (9193 nucleotides) (Wain-Hobson et al. 1985). HIV genome has several major genes coding for basic structural proteins that are present in all retroviruses, is called coding sequence and it also constitutes of some accessory or nonstructural genes that are unique to HIV, known as non-coding sequence. Retroviruses convert their RNA genome to double-stranded DNA molecule through a process of reverse transcription, with help of viral enzyme reverse transcriptase (Gomez and Hope 2005).

This reverse transcribed DNA is flanked by two identical non-coding 5' and 3' LTR (**l**ong **t**erminal **r**epeat) sequences. These two regions are involved in the process of integration of DNA into host cell DNA and regulate transcription of all viral genes from 5' LTR promoter activity (Paillart et al. 2004). LTR contains three regions, naming U3, R and U5 regions (Tripathy et al. 2011).

- The U3 holds binding sites for cellular transcription factors.
- The R region contains the **t**rans-**a**ctivation **r**esponse element (TAR) implicated in Tat-mediated *trans*-activation.
- The U5 region contains additional binding sites for transcription factors AP-1, SP1, NF-AT, Sp1 and IRF-1 (Rohr et al. 2003a)

The coding sequence of viral genome encodes for 16 viral proteins, including structural proteins (found in all retroviruses) and some non-structural or accessory proteins, which are only present in HIV. The *gag*, *pol* and *env* genes encodes for essential structural proteins (**Figure 6**).

- Group-specific antigen (*gag*) gene encodes for a Gag polyprotein, which later is cleaved by viral protease p11 to form different viral proteins like matrix protein (p17) (Wu et al. 2004), capsid protein (p24), spacer peptide (SP1/p2), spacer peptide (SP2/p1) and nucleocapsid protein (p6 and p7) (Briggs et al. 2003).
- Gene *pol* encodes for different viral enzymes including integrase, reverse transcriptase and HIV protease (Broglia et al. 2008).



- Gene *env* encodes for a polyprotein (gp160), a precursor protein for gp120 and gp41. This polyprotein is cleaved by host cell own protease (furin) to cleave into gp120 and gp41 (Goel et al. 2002).

The HIV genome also encodes for some non-structural proteins that are not encoded by other retroviruses.

- Regulatory proteins: Transactivators help to increase the rate of gene expression via different ways like Tat (**t**rans**a**ctivator of **t**ranscription) and Rev (**r**egulator of **v**irion **e**xpression).
- The HIV genome also encodes for some accessory genes like Vif (**v**iral **i**nfectivity **f**actor), Vpu (**v**iral **p**rotein **u**nique) and Nef (**n**egative regulatory **f**actor) and Vpr (**v**iral **p**rotein **r**egulatory) (Sandefur et al. 2000, Peterlin and Trono 2003, Derdowski et al. 2004).

Additionally, HIV-2 or SIV (**s**imian **i**mmunodeficiency **v**irus) contains a closely related Vpx protein (**v**iral **p**rotein **X**) along with its Vpr. The functions of HIV-1 Vpr are divided between these two proteins (Vpr and Vpx) in HIV-2 or SIV along with some additional functions (Ayinde et al. 2010).

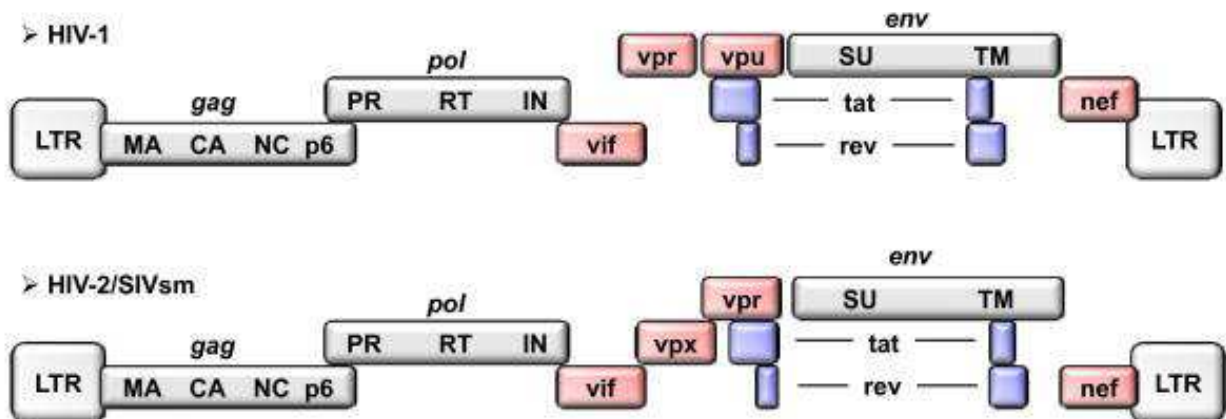

**Figure 6: Schematic representation of HIV-1 and HIV-2 integrated genomes.**

Grey boxes indicate structural proteins; pink boxes represent accessory genes and blue boxes represent regulatory genes (Ayinde et al. 2010).

## 2.3. Replication of HIV-1

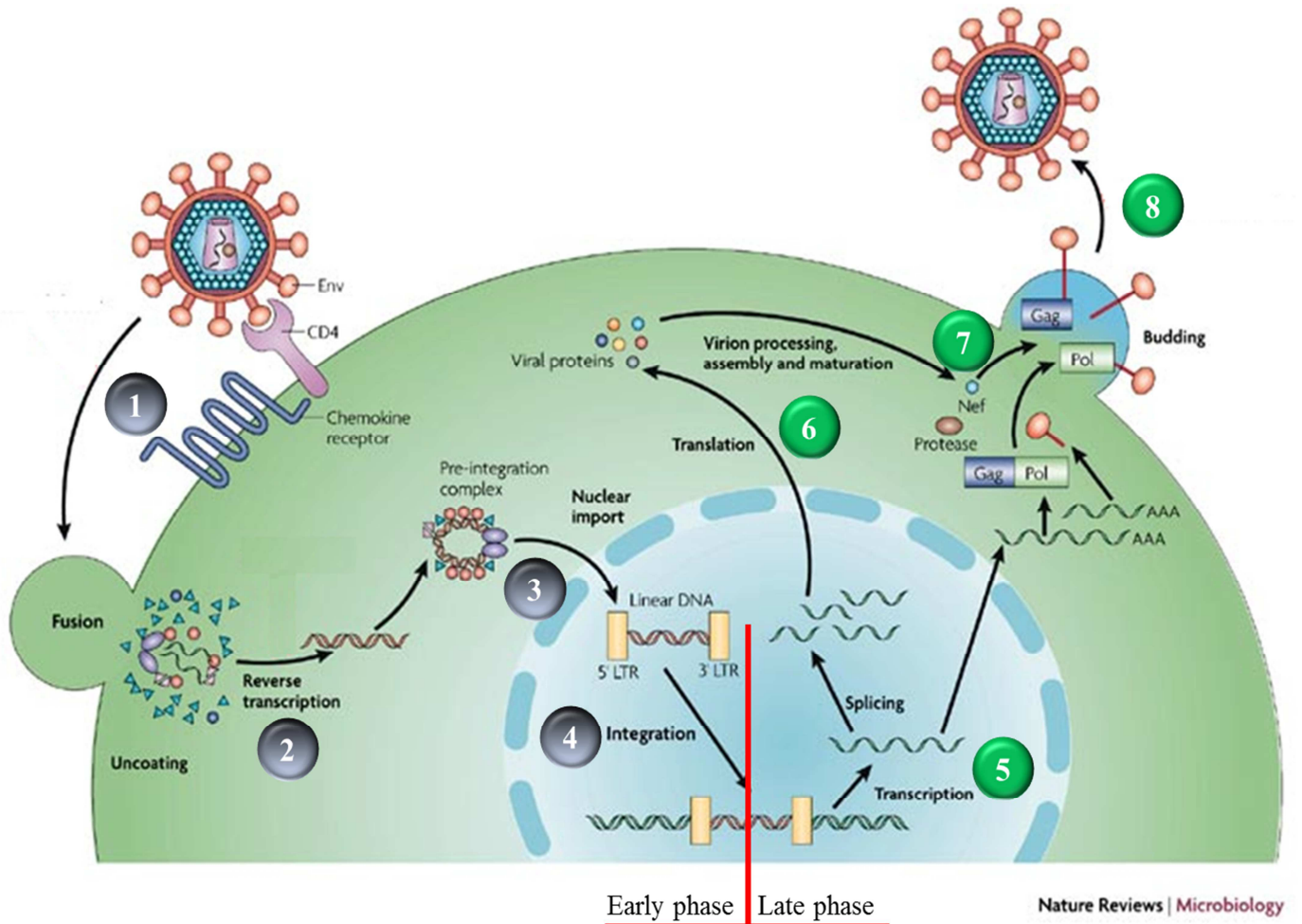

**Figure 7: Schematic representation of life cycle of HIV.**

The life cycle of HIV (attachment to budding) can be divided into two phases; early (in black circles) and late phase (in green circles). The life cycle of HIV is composed of different steps: step from the attachment to integration (1 to 4) are referred as early phase of HIV life cycle and steps from expression of viral genome to budding of the viral particle are referred as late phase ((Han et al. 2007) with modifications).

### **2.3.1. Entry of Virus**

The entry of the virus in the host cell is the first step in the process of infection of the HIV-1. This step of HIV replication is closely controlled; and is accomplished by fusion of viral membrane with the host cell membrane that is followed by the release the capsid of HIV in the host cell cytoplasm (Wyatt and Sodroski 1998).

The virus can enter the host cell by two different means:

- Entry mediated by endocytosis pathways that mostly leads to the degradation of the virus in the host cell. This method of entry was first described in macrophages (Marechal et al. 2001).
- Host cell membrane receptor-mediated entry, and HIV uses this pathway to enter in majority of the cell types.

The attachment of the virus to the host cell is necessary of its entry. The viral glycoprotein gp120 subunit triggers the entry of HIV-1 by binding to CD4 receptors on the surface of lymphocytes and macrophages. This attachment leads to the conformational changes in both the gp120 and CD4 receptor. This connection reveals hypervariable V3 loop of gp120. To successfully entry the cell, HIV gp120 has to bind with co-receptor, such as the chemokine co-receptor CCR5 or CXCR4. The importance of this step was more pronounced when it was observed that the HIV-1 infectivity was compromised in the individuals with non-functioning CCR5 proteins (Tilton and Doms 2010). Simultaneous attachment receptor subunit gp120 and gp41 co-receptor committed in the entry process. The N-terminal portion of gp41, called fusion peptide, is then inserted into the membrane of the host cell. Subsequent folding of gp41 leads to an approximation of viral and cellular membranes and leads to the fusion of the two lipid bilayer membranes (Schols 2004, Wilen et al. 2012a). **(Figure 8)**

Understanding this mechanism helped to understand the mechanism of action of enfuvirtide® or T20. Enfuvirtide bind with the viral gp41 and prevents the refolding step of gp41. Thus, it prevents the viral entry into the host cell. While elegant, this approach is easily compromised by the rapid evolution of the virus. Indeed, some mutations in gp41 were sufficient to leave T20 ineffective (Carmona et al. 2005). Moreover, the T20 should be administered intravenously

to achieve optimal efficiency, which is a heavy protocol for patients. Because of these limitations, the viability of this strategy has been questioned by Roche in 2010 with the abandonment of the development of T1249, second generation fusion inhibitor (Eggink et al. 2009, Berkhout et al. 2012).

Finally, another molecule, maraviroc ® binds to CCR5 co-receptor to prevent gp120/CCR5 interaction (Pugach et al. 2008). This molecule is also known as chemokine receptor antagonist or simply as CCR5 inhibitor. Unfortunately, resistance to this drug may occur due to hypervariability V3 loop (Yuan et al. 2011, Maeda et al. 2012).

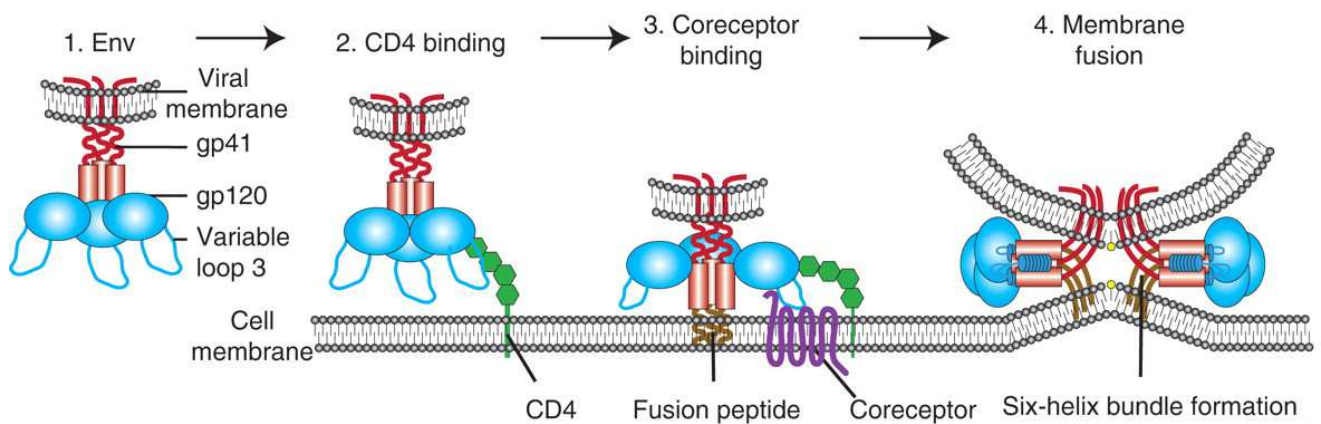

**Figure 8: Schematic overview of HIV entry from attachment to fusion of the membranes.**

Virion gp120 interacts with host CD4 receptor and a co-receptor, which results in fusion of both the membranes (**Wilén et al. 2012b**).

### 2.3.2. Reverse transcription

Once the virus entered in the host cells, it converts its RNA genome into double-stranded DNA by the process of reverse transcription in the cytoplasm of the host cell. It is a vital step in the retroviral replication, as it prepares the genome for its subsequent integration in the host DNA. This conversion of viral RNA genome into the proviral DNA is mediated by reverse transcriptase, a viral enzyme (Basavapathruni and Anderson 2007).

This reverse transcription is carried out in different steps. The tRNA (lys3), previously incorporated into the capsid, serves as a primer for reverse transcriptase. The viral reverse transcriptase attaches itself with the RNA and copies it into a cDNA (complementary DNA) molecule. The viral reverse transcriptase also functions as ribonuclease to degrade reverse transcribed RNA.

This process of reverse transcription is extremely error-prone. The lack of mechanism involving the proofreading after the reverse transcription leads to mutation in the resulting proviral DNA. Indeed, these mutations help the virus to counter the immune system and also a major cause in drug resistance (Hache et al. 2006).

In addition, the reverse transcriptase has the activity of DNA-dependent DNA polymerase, thus facilitating the formation of sense DNA copy from the antisense cDNA. Together, both (cDNA and sense DNA) form a double-stranded proviral DNA with LTR regions at each end, to integrate itself into the host cell DNA (Telesnitsky and Goff 1997, Harrich and Hooker 2002, Nisole and Saib 2004). The synthesis of double-stranded DNA flap serves as a signal for uncoating of matrix protein and leads to the formation of pre-integrations complex (PIC) (Zennou et al. 2000, Arhel et al. 2007, Zhan et al. 2010) **(Figure 9)**. As a key step in the replication cycle, reverse transcription was quickly identified as ARV targets. The reverse transcriptase inhibitors (RTIs) are of two types: nucleoside/nucleotide reverse transcriptase inhibitors (NRTIs/NtRTIs) and non-nucleoside reverse transcriptase inhibitors (NNRTIs). All NRTIs and NtRTIs are also referred as competitive substrate inhibitors, due to their same mode of action and NNRTIs as non-competitive substrate inhibitors (Vivet-Boudou et al. 2006, De Clercq 2010).

NRTIs act as pioneers in the fight against HIV based on ARVs. Indeed, zidovudine (ZDV) or azidothymidine (AZT) was the first anti-retroviral molecule in the market. The mode of action of NRTIs and NtRTIs is based on the early termination reverse transcription step. They are analogues of deoxynucleotides but lack a 3'-OH group. Once incorporated into the chain of nucleotides, they act as terminators and process is known as chain termination. Thus, reverse transcriptase is unable to continue the synthesis of the DNA strand from RNA (for a review (Vivet-Boudou et al. 2006)). NRTIs are important due to their

advantage of better CSF concentration, due to its lowest rate of protein binding and low molecular weight (Strazielle and Gherzi-Egea 2005).

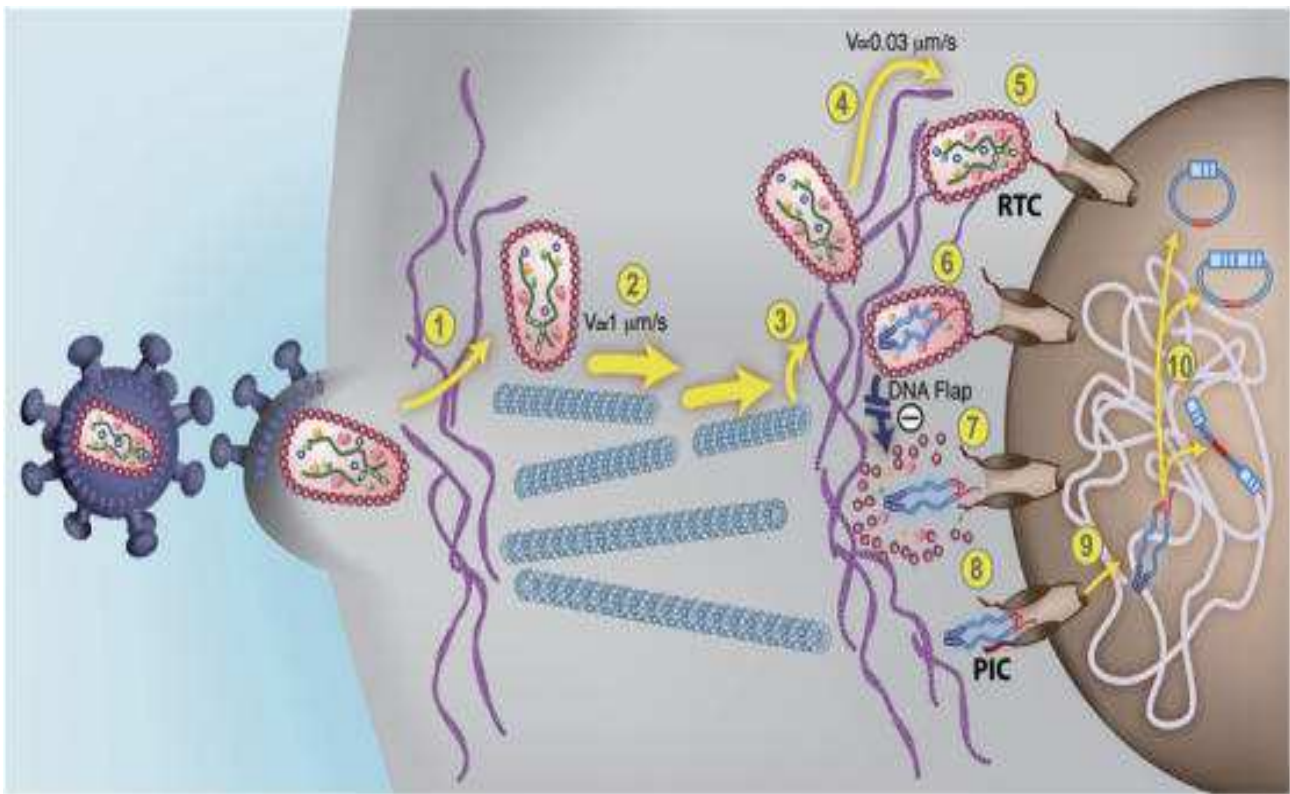

**Figure 9: Intracellular transport of HIV-1 and DNA Flap-dependent nuclear import of PIC.**

After uncoating and reverse transcription, viral genome is transported to the nucleus for its integration in the host genome and it is triggered by DNA Flap (**Arhel et al. 2007**).

NNRTIs are non-competitive reverse transcriptase inhibitors. Conformational changes in the transcriptase induced by the binding of NNRTIs cause a loss of affinity of the enzyme for nucleotides. To mitigate the emergence of resistant variants of the first-generation NNRTIs such as efavirenz® (EFV), second generation molecules, as etravirine® (ETV) were developed. These have greater structural flexibility, which allows them to avoid some of the changes that occur in the reverse transcriptase (Minuto and Haubrich 2008, Sarafianos et al. 2009). Moreover, due to better parameters (molecular weight and protein binding), the new NNRTI, nevirapine (NVP) has best probability of achieving better CSF levels (Ene et al. 2011).

### **2.3.3. PIC and Integration**

The PIC is nucleoprotein complex, containing the newly synthesized DNA flap, viral (integrase, Vpr and matrix) and host (barrier to autointegration factor 1) proteins (Lee and Craigie 1998, Zhao et al. 2011). The PIC is translocated inside the nucleus through nuclear pore complex via signal-facilitating mechanism without disrupting the nuclear envelope. Vpr can import PIC containing viral DNA either by interacting with nucleoporins or destabilizing the nuclear membrane (de Noronha et al. 2001, De Rijck et al. 2007, Morellet et al. 2009). Whereas, the integrase and p17 can facilitate the import of PIC/DNA with the help of their nuclear localization signal (NLS) and binding with cellular protein importin- $\alpha$ 3 (Haffar et al. 2000, Ao et al. 2010) **(Figure 9)**.

Once in the nucleus, the proviral DNA is integrated into the host cell DNA. This process of integration is catalyzed by viral integrase (linked to the ends of the DNA flap) (Fouchier and Malim 1999). This process can be divided into two steps. In the first step (3'-processing), the viral DNA extremities are prepared for its subsequent insertion by second step, named as strand transfer. This step is facilitated by members of PIC cellular proteins (Delelis et al. 2008). Then, overlap in the viral DNA strand is then corrected by the cellular protein, FEN1 (**flap endonuclease-1**) (Rumbaugh et al. 1998). Cellular transcriptional coactivator lens epithelium-derived growth factor (LEDGF)/p75 plays a vital role as cofactor for HIV integration (Llano et al. 2006). Recently, it has been described that a prominent part of DNA-free IN is translocated in the nucleus for the integration (Gerard et al. 2013).

The only integrase inhibitor that can be seen in the market is raltegravir ® (RGV) (Evering and Markowitz 2008). Since its market availability, the long-term effects have not yet been fully assessed, although studies are emerging and pointing side effects reports, including kidney problems or a rare disease Stevens-Johnson (Vassallo et al. 2012). Recently, there is a report of raltegravir resistance in CSF without any evidence of resistance in plasma (Mora-Peris et al. 2013). The only alternative, elvitegravir ® is only available to patients in therapeutic failure. The genetic barrier of these ARV is low; a single mutation is deleterious, making them vulnerable to viral penetration (Markowitz et al. 2007,

Quercia et al. 2009). The future is now turning to the second generation inhibitors, such as dolutegravir ® (Garrido et al. 2011). It is currently in Phase III clinical trials, which is effective against viruses resistant to raltegravir and elvitegravir. Research on the inhibitors for integrase/LEDGF interaction is currently underway (Lee and Carr 2012, Quashie et al. 2013).

### **2.3.4. Viral transcription**

The steps of life cycle of HIV-1 after the integration are referred as late phase of viral replication. After the integration of proviral, cell may either enter to latent phase or lytic phase. In lytic phase, the integrated proviral genome or provirus diverts the cellular machinery for transcription of viral transcripts produced in two distinct phases, the early phase and late phase.

#### **2.3.4.1. Early phase transcription**

Initially, viral gene transcription is dependent on cellular transcription factors. Then activation of the CD4+ T cells triggers NF- $\kappa$ B and NFAT migration into the nucleus and bind to the LTR region of provirus in their respective recognition motifs (Bosque and Planelles 2008). Subsequently, other factors including NF-IL6, CREB etc. are recruited for the complete activation of transcription (Callens et al. 2003).

In microglial cells, the NF- $\kappa$ B binding plays a crucial role to activate HIV-1 gene transcription (Barboric et al. 2001, Rohr et al. 2003a). During this phase, the majority of transcripts produced are short due to the destabilization of the RNA polymerase II (RNAPolII) (Kao et al. 1987, Kessler and Mathews 1992). Few products are then transcribed full multi-spliced migrate into the cytoplasm and lead to the synthesis of viral regulatory proteins Tat and Rev (Frankel 1992, Marzio and Giacca 1999). When the amounts of these two proteins are sufficiently high, the late phase of transcription begins.

#### **2.3.4.2. Late phase transcription**

In the beginning of late phase of transcription, the transactivator (Tat) binds to RNA stem-loop structure, TAR (**T**rans-**a**ctivation **r**esponsive element)



(Berkhout et al., 1989), at 5'end of nascent viral RNA. The recruitment of tat to the TAR region, acts as an intermediate between P-TEFb (**positive transcription elongation factor b**) and RNAPolII (Zhu et al. 1997, Zhou and Rana 2002). Analysis of Tat-associated cofactors has shown that there are two distinct complexes of Tat; Tatcom1 comprising P-TEF-b, MLL-fusion partners and PAF1 complex while the Tatcom2 comprising of CDK9, CycT1 and 7SK snRNA lacking HEXIM1 (Sobhian et al. 2010).

The kinase activity of the Cdk9 subunit of P-TEFb acts on RNAPolII, firstly by increasing the processivity by phosphorylation of residues from the C-terminal domain, and secondly by increasing its stability by phosphorylating negative transcription elongation factors NELF (**negative elongation factor**) and DSIF (5,6-dichloro-1-beta-**d**-ribofuranosylbenzimidazole **sensitivity-inducing factor**) (Price 2000, Ping and Rana 2001, Zhang et al. 2007, Ott et al. 2011). During this elongation favored phase, the full transcripts of the viral genome are produced.

Tat and Rev can bind with high affinity to stem-loop structure in the RNA, RRE site, located in the *Env* gene of provirus (Malim et al. 1989, Watts et al. 2009). Rev has a NES site (**nuclear export signal**) and a NLS site (**nuclear localization signal**), which interact with the export receptor CRM1 (**chromosomal region maintenance 1**) and importin- $\beta$ , respectively (Henderson and Percipalle 1997, Kohler and Hurt 2007). Once attached to the RRE site, Rev will increase the stability of the transcripts and allow them to export out of the nucleus, bypassing the cellular mechanism of retention transcripts that have not completed their splicing. Recently, a study showed that co-operative activity of ribonucleases mediates the RNAPII pausing and premature termination to control transcription elongation (Wagschal et al. 2012). **(Figure 10)**

### **2.3.5. Assembly, budding and maturation**

Mono-and non-spliced transcripts serve as a template for the production of polypeptides proteins like Env, Gag and Gag-Pol. Env polyprotein is cleaved into gp120 and gp41 by furin, a member of the eukaryotic subtilisin family, in the Golgi apparatus (Hallenberger et al. 1997). Meanwhile, precursors of Gag and Gag-Pol oligomerize and migrate to the inner surface of the plasma

membrane to form plasma membrane rafts (Ono and Freed 2001, Chazal and Gerlier 2003, Ono 2010). The increasing concentration of Gag-Pol inside the plasma membrane, about 1500 copies, induces the curvature of the plasma membrane to initiate viral budding (Figure 11) (Provitera et al. 2001). Gag-Pol by p6 domain completes the process by recruiting cellular proteins involved in vacuolar protein sorting (Vps) pathway (Garrus et al. 2001). Envelope glycoproteins are also recruited into the budding virions via the interaction of matrix protein, p17. Meanwhile, ESCRT-I is also recruited via the interactions between viral p6 and host ALIX and TSG101. Finally, this leads to the recruitment of ESCRT-III (membrane scission machinery), which release the neck of the membrane between cell and virion (Martin-Serrano and Neil 2011) **(Figure 11)**.

The new budding viral particle is described as immature. Gag and Gag-Pol oligomerization activate the viral protease, p11 that cleaved protein structure Gag (Figure 11) (Ross et al. 1991, Wieggers et al. 1998). These processed proteins undergo some more structural rearrangements to give rise to a mature virion. Once matured, the viral particle is contagious and can infect other healthy cells (Bieniasz 2009).

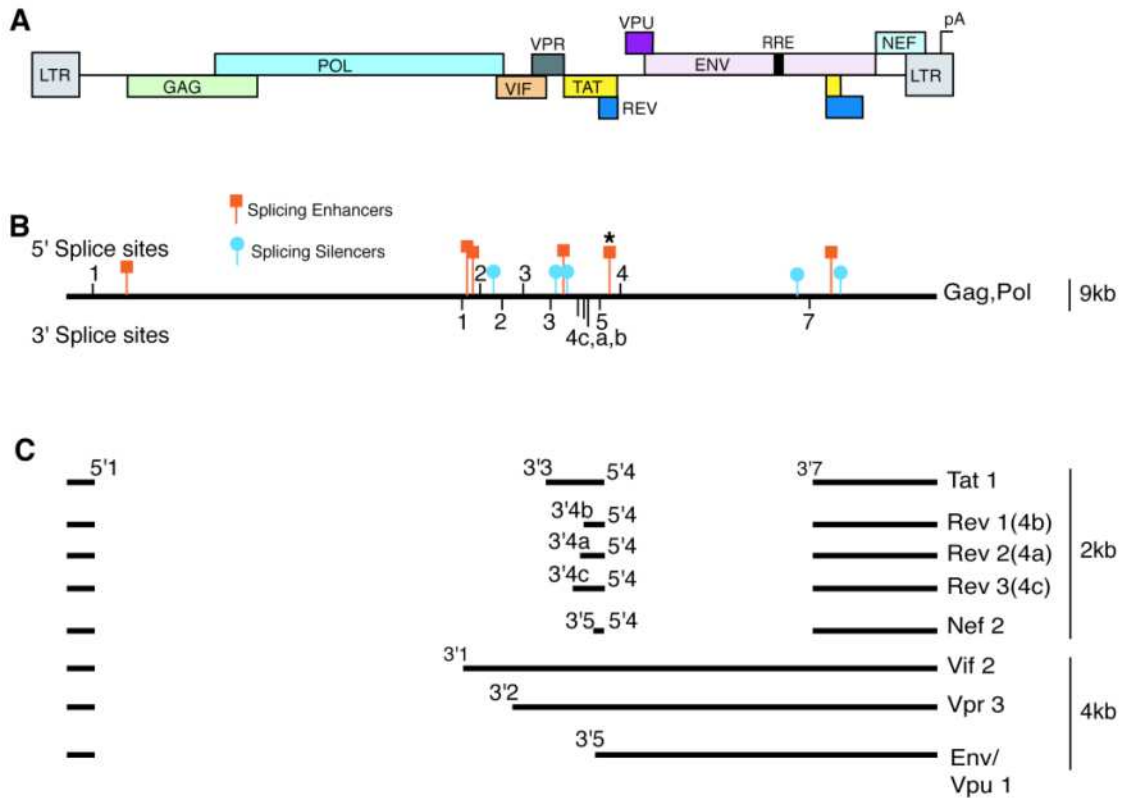

**Figure 10: HIV-1 genome transcription and splicing of mRNAs.**

**A)** HIV-1 proviral genome. **B)** A single pre-mRNA transcribed by the virus with splice sites. **C)** Different spliced viral mRNAs (Caputi 2011).

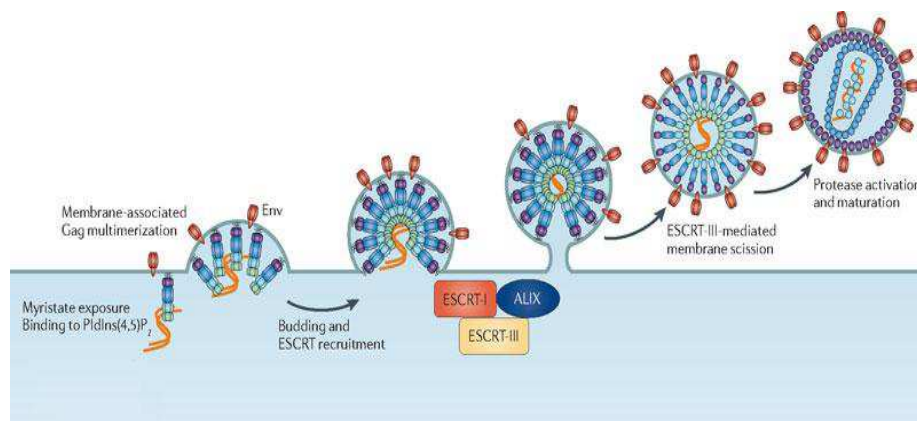

**Figure 11: Schematic overview of HIV-1 assembly, release and maturation**

Translated protein along with viral RNA inside the cell membrane and budding is facilitated by membrane scission machinery and release virus is matured by the action of viral protease (Martin-Serrano and Neil 2011).

The protease (p11) inhibitors were first introduced in 1995. These inhibitors like Saquinavir ® (first available molecule) are designed to prevent the formation and maturation of the viral particle (Noble and Faulds 1996). These inhibitors are commonly used in HAART, even with some major disadvantages like suboptimal bioavailability, particularly in the brain and testes, and many adverse effects (Huisman et al. 2001, Ghosn et al. 2004).

Another molecule, bevirimat® inhibits the maturation of the precursor Gag by interfering with the cleavage site of p24. The development of this inhibitor was easily hurt by mutations in the cleavage site and thus, has been discontinued (Lu et al. 2011).

## **2.4. HIV-1 Infection cure:**

HIV-1 infection has been transformed to a chronic disease from a lethal one after the introduction of HAART (**highly active antiretroviral therapy**) in 1996. The introduction of HAART has decreased dramatically morbidity and mortality in the infected patients. Although, it has improved the life of the patients but still is not capable of curing the HIV infection, main hurdle is the presence of quiescent reservoirs in the infected patients. Several other problems related with the HAART encouraged the research for new ways to cure this infection. Recent advances promised some good results to cure this infection. Beside the new therapeutic means to eliminate the virus, the efforts should be made to improve the already existing HAART. Along with the HAART the strategies must be devised to remove the virus from the reservoirs. Thus, purging reservoirs along with the removal of the virus by aggressive HAART Strategy could improve the chances to cure HIV infection (for complete review see annexes (Le Douce et al., 2012b)).

## 3. HIV accessory proteins

Retroviruses encode for some accessory proteins along with its essential structural proteins and regulatory proteins. These so-called accessory proteins include Nef (**n**egative **r**egulatory **f**actor), Vif (**v**iral **i**nfectivity **f**actor), Vpu (**v**iral **p**rotein **u**nique) and Vpr (**v**iral **p**rotein **r**egulatory) or Vpx (**v**iral **p**rotein **X**). Although the significance of these accessory proteins is often not essential *in vitro* but they play vital roles in the pathogenesis of HIV *in vivo* (Malim and Emerman 2008). These proteins have a range of functions during HIV life cycle ranging from transactivation of transcription to usurping the host ubiquitin system to target the host restriction factors ( for review (Andersen and Planelles 2005, Le Rouzic and Benichou 2005, Ayinde et al. 2010)).

### 3.1. Negative regulatory factor (Nef)

Nef is a 27 kDa viral protein, highly conserved in all primate lentiviruses. It is expressed in abundance during the early stages of viral replication of primate lentiviruses. It was first described to have a negative impact on viral replication, thus named as negative regulatory factor (Ahmad and Venkatesan 1988). Since then it is characterized to have multiple roles in viral replication by altering the host cellular pathways (Cheng-Mayer et al. 1989, Das et al. 2004) including T-cell receptor regulation, expression of critical cell surface proteins and apoptosis.

As Nef is expressed in abundance during early phase of HIV replication along with Tat and Rev, it can affect the production of the viruses. Indeed, the expression of Nef triggers the production of virus not only in cell culture but also *in vivo* (Cullen 1998). Moreover, it is characterized as critical protein for the pathogenesis and development of AIDS-like symptoms in humans and animal models. Nef is able to facilitate the penetration and movement of the viral core within the actin cytoskeleton by remodeling during the initial phase of the infection of the host cell, thereby increasing the viral infectivity (Campbell et al. 2004).

Nef is also involved in the down-regulation of CD4 and MHC class I and II receptors. Nef leads these proteins to endosomes and lysosomes, resulting in

their degradation. These mechanisms are involved in the immune escape of the virus (Schwartz et al. 1996, Schindler et al. 2003, Doria 2011). In addition, Nef is able to induce *in vitro* release of IL-2 by infected T-cells and chemokine secretion by macrophages (Schmidtayerova et al. 1996, Wang et al. 2000). Nef is able to bind newly synthesized cholesterol to the lipid at the sites of budding of HIV-1 virions (Zheng et al. 2003). Moreover, Nef also described as a facilitator for HIV-1 replication in macrophages along with TNF alpha. HIV-1 Nef impairs the protein translation by interacting with 40S ribosomal subunit, RPS10 and 18SrRNA (Herbein et al. 2008, Abbas et al. 2012).

Recently, it has been demonstrated that Nef can down-regulate the cell surface expression of CTLA-4, a negative immune modulator. This down-regulation may have a role in HIV-1 sustain T-cell activation (El-Far et al. 2013). Moreover, decrease in multiple Nef functions is also observed in the HIV-1 elite controllers (Mwimanzi et al. 2013).

### 3.2. Viral protein unique (Vpu)

Vpu is a 9 kDa trans-membrane protein involved in the down-regulation of CD4+ receptors, as well as in the release of viruses by budding. This viral protein promotes the ubiquitination of CD4+ receptors and leads to their degradation by proteasome pathway (Margottin et al. 1998).

Vpu is involved in a mechanism developed to counteract the blocking of budding by the host cell. In fact, under the influence of interferon, some cells can produce the protein BST-2 (**bone marrow stromal antigen 2**) also referred as tetherin. In the absence of Vpu, tetherin inhibits the HIV replication by preventing the budding of virions from the plasma membrane (Hammonds et al. 2012). Infect, Vpu targets tetherin for its ubiquitination and leads to its proteasomal degradation (Neil et al. 2008, Van Damme and Guatelli 2008). Changing the subcellular localization of this protein, Vpu allows virus to increase its replication and dissemination (Arias et al. 2012).

### **3.3. Viral infectivity factor (Vif)**

Viral infectivity factor (Vif) is a 23 kDa viral protein, essential for the replication of retroviruses. Retroviruses have to counter the effects of host restriction factor for its effective replication. Vif was first described to counter the antiviral activity of human APOBEC3G. It was shown that vif-defective viruses lost the ability to counter the antiviral activity of APOBEC3G (Mangeat et al. 2003, Harris and Liddament 2004).

In fact, Vif counter the activity of APOBEC3G and other related genes by targeting them to host ubiquitin proteasome system. Vif loads APOBEC3G/3F to Cul5/ElonginB/C/Rbx1 U3 ubiquitin ligase for its ubiquitination and proteasomal degradation (Marin et al. 2003, Sheehy et al. 2003, Yu et al. 2003). Additionally, Vif can also counter act the APOBEC3G-induced viral inhibition by relocalizing it via the use of same ubiquitin proteasome pathway and by binding APOBEC3G mRNA to inhibit its translation (Mercenne et al. 2010).

### **3.4. Viral protein Regulatory (Vpr)**

Vpr is an accessory protein composed of 96 amino acids (14kDa), highly conserved in SIV, HIV and other lentiviruses (Tristem et al. 1998, Muthumani et al. 2000a). The name viral protein regulatory was given due to its finding that showed the disruption of ORF of Vpr in HIV-1 is closely related with slower kinetics of HIV-1 replication (Hattori et al. 1990). Vpr plays a wide range of roles during the life cycle of HIV-1 by interacting with different cellular partner proteins, summarized in the Figure 12B. It is packaged in the virion via its direct interaction with p6 (Tungaturthi et al. 2003). Moreover, Vpr can also be synthesized de novo by provirus, from single spliced mRNA (Schwartz et al. 1991).

The structure of the Vpr is described as having 3  $\alpha$ -helices (17-33, 38-50, 55-77). The presence of these helices makes Vpr flexible, important for its wide range of functions (Tungaturthi et al. 2004) (**Figure 12A**). The presence of 6 arginine residues at the C-terminal may explain the transduction properties of Vpr like crossing cell membrane (Sherman and Greene 2002, Coeytaux et al.

2003). Moreover, the  $\alpha$ -helices mediate the formation of Vpr oligomers and its ability to induce ubiquitination (Fritz et al. 2008).

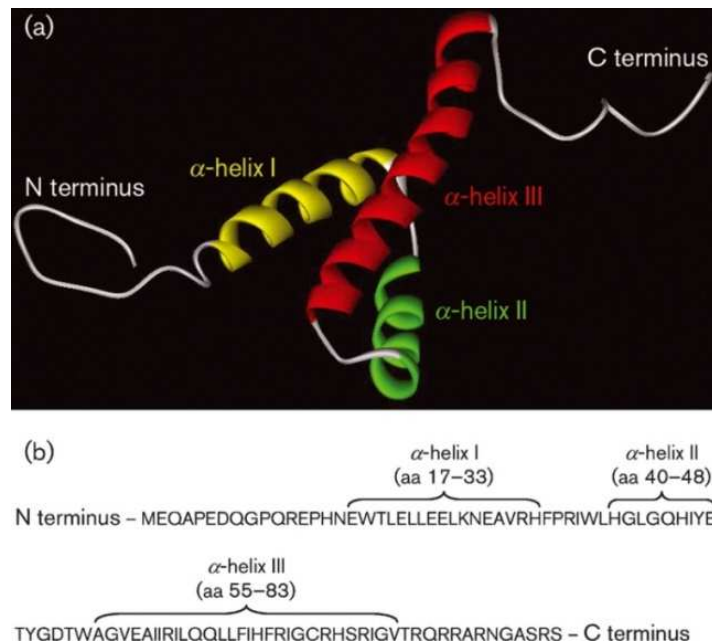

**Figure 12A: Vpr structure.**

(a) 3-dimensional structure of Vpr (b) amino acids sequence of Vpr indicating the  $\alpha$ -helices (Romani and Engelbrecht 2009).

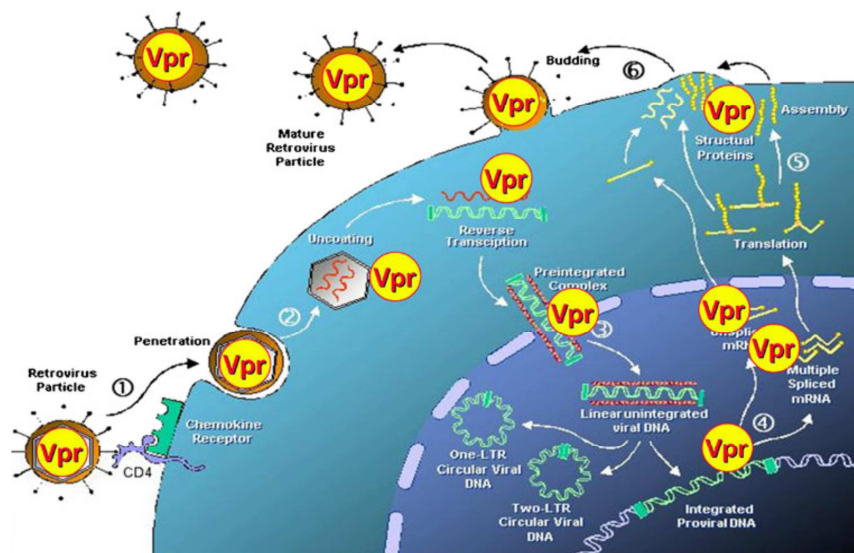

**Figure 12B: Actions of Vpr during HIV-1 life cycle.**

Vpr has different effects on RT, PIC transportation, LTR activation, induction of cell cycle arrest and apoptosis (Zhao et al. 2011).



Vpr plays numerous important functions in the different types of cells. Vpr is well known for its distinct functions including, promotion of reverse transcription, facilitating the nuclear transportation of PIC (Jacquot et al. 2007), activation the HIV-1 LTR transcription (Kino et al. 2002), induction of G2 cell cycle arrest (Li et al. 2007a, Maudet et al. 2011), apoptosis (Stewart et al. 2000) and actions against host immune responses (Muthumani et al. 2000b, Ayinde et al. 2010, Sharifi et al. 2012) (**Figure 12B**).

### **3.4.1. Induction of G2 cell cycle arrest**

HIV-1 Vpr has been described to inhibit host cell proliferation of infected cells in G2/M transition of the cell cycle to favor the viral replication. This process is commonly referred as G2 arrest (He et al. 1995, Jowett et al. 1995, Re et al. 1995). During G2 phase, chromatin is transcribed and active translation of mRNA is carried out. Although, the role of G2 cell cycle arrest is still not clear but it is believed that transcription of virus is increased during this G2 cell cycle arrest, thus providing a replication advantage for the virus (Goh et al. 1998, Elder et al. 2001, Belzile et al. 2007).

Recently, understanding of Vpr-mediated G2 arrest is more elaborated by describing the involvement of host ubiquitin proteasome system. It has been described that Vpr-mediated G2 arrest is specifically associated with host Cullin ubiquitin E3 ligase. This E3 ubiquitin ligase complex, Cul4A-DDB1-DCAF1/VprBP is described to associate with G2 arrest (Belzile et al. 2007, DeHart et al. 2007, Le Rouzic et al. 2007). Indeed, Vpr exploit cellular DCAF1 to hijack the Cul4A-DDB1 E3 ubiquitin ligase. As, this ubiquitin ligase has been described to induce protein polyubiquitination and proteasome-mediated proteolysis, it was suggested that Vpr induces degradation of an unidentified protein that is require for the progression of mitosis. Vpr enhances protein polyubiquitination and activity of E3 ligase activity (Hrecka et al. 2007, Belzile et al. 2010b). This induction of G2 arrest can be inhibited by suppressing proteasome activity such as by MG132 or by inhibiting polyubiquitination such as by ubiquitin mutant (K48R) (DeHart et al. 2007, Le Rouzic et al. 2007, Tan et al. 2007, Belzile et al. 2010a).

Interaction of Cul4A ubiquitin ligase complex with CDT2 leads to ubiquitination of CDT1 and its subsequent proteasome-mediated degradation. Although, CDT1 is a replication factor and its depletion can prevent DNA replication but cell cycle arrest cannot be attributed to degradation of a single protein through Cul4A ubiquitin ligase (Higa and Zhang 2007, Li et al. 2010).

### **3.4.2. Induction of apoptosis**

Vpr also induces cell death, mainly through apoptosis. Like G2 arrest, biological significance of apoptosis during HIV-1 infection is still unclear. Apoptosis is regulated by two cell death-signaling pathways i.e. extrinsic and intrinsic pathways. The initiation of extrinsic pathways is carried out by external stimuli, sensed by cell membrane-associated cell-death receptors. In intrinsic pathway, mitochondria plays vital role by releasing molecules to trigger apoptosis (Holtzman et al. 2000, Zhao et al. 2011). Although, some studies also report the involvement of extrinsic pathway but intrinsic pathway plays a major role in Vpr-induced apoptosis. The release of mitochondrial inter-membrane proteins due to mitochondrial membrane permeabilization (MMP) ultimately induces apoptosis (Green and Kroemer 2004). It has been described that presence of Vpr results in apoptosis via intrinsic pathways (release of Cytochrome C) and caspase 9 (Muthumani et al. 2002).

### **3.4.3. Vpr and reverse transcription**

After entering the host cell, HIV-1 genome must be reverse transcribed for its subsequent integration into host genome. The tRNA<sup>Lys3</sup>-mediated priming is required for initiation of this reverse transcription (Aiyar et al. 1994). Vpr can interact with Lys-tRNA synthetase to inhibit its activity to acetylate tRNA<sup>Lys3</sup>. This may suggest its involvement in promoting the incorporation of deacetylated tRNA<sup>Lys3</sup> into assembling virions (Stark and Hay 1998).

Reverse transcription carried out by HIV is an error-prone process, resulting in the production of diversified viral genomes (Romani and Engelbrecht 2009). These mutations may be lethal, and thus has to be rectified. One of the mechanisms to repair these mutations is carried out by UNG (uracil-N-glycosylase), which removes accidentally incorporated uracils from HIV genome

(Chen et al. 2004). On the other hand, this error-prone reverse transcription also plays an important role to help viruses in adapting adverse host environments like patients receiving HAART. This urges for a balance between production of defective viral genome and diversity of viral genome.

Vpr seems to play an important role in this regard, due to its interaction with UNG2 (uracil-N-glycosylase 2) (Bouhamdan et al. 1996). UNG2 functions as an excision repair enzyme by removing uracils from nuclear DNA (Parikh et al. 2000). Thus, UNG2 is involved in proof reading of reverse transcription in the nucleus. The role of Vpr-UNG2 interaction is still not clear, as Vpr can act as positive inducer for UNG2 and also as an antagonist to counter UNG2 (Chen et al. 2004, Ahn et al. 2010). Vpr may induce the degradation of UNG2 to promote the viral diversity or survival. Recently, it has been described that Vpr actually promotes turnover of UNG2 by inducing its proteasome-mediated degradation (Wen et al. 2012).

### **3.4.4. Vpr and macrophage infection**

Vpr Among many functions attributed to HIV-1 Vpr, G2 cell cycle arrest in dividing cells and enhancing viral infection in non-dividing cells are most widely accepted functions. These two functions are shared with HIV-2/SIV Vpr and Vpx, respectively. It has been well established that macrophages resist HIV-1 infection as compared to CD4+ T cells. Macrophages express several restriction factors in order to inhibit the replication of retroviruses. These restriction factors are counter acted by the expression of retroviral proteins. Recently, identified restriction factor (SAMHD1) is counter acted by HIV-2/SIV Vpx but not by HIV-1 Vpr.

There are contrary reports about involvement of Vpr in PIC transport. Vpr-mediated nuclear transportation of PIC is usually attributed to promote macrophage infection (Connor et al. 1995, Subbramanian et al. 1998). But, recent reports suggested that Vpr is not necessary for transportation of PIC in macrophages, as other viral proteins can also facilitate PIC transport (Yamashita and Emerman 2005, Riviere et al. 2010). Vpr is described as a facilitator for nuclear transportation of PIC, due to its ability to shuttle between cytoplasm and nucleus (de Noronha et al. 2001). Vpr facilitates the transportation of PIC along

with MA and IN. Vpr can induce the PIC transportation by possible 3 different pathways:

- Via importin-independent machinery like, by disrupting the nucleus envelope (de Noronha et al. 2001).
- Via importin-dependent, by promoting NLS-importin  $\alpha$  interaction (Agostini et al. 2000).
- Via alone importin, meaning without the help of  $\beta$ -dependent transporter (Nitahara-Kasahara et al. 2007).

### **3.4.5. Activation of HIV-1 LTR**

Vpr directly enhances HIV-1 LTR-mediated transcription of integrated and un-integrated provirus (Poon and Chen 2003, Poon et al. 2007). Vpr associates with various transcriptional factors or co-factors on the LTR promoter to induce LTR gene transcription. Vpr directly binds with LTR binding sites including NF- $\kappa$ B, p300/CBP and Sp1 binding sites (Hogan et al. 2003). Vpr promotes LTR activity by promoting phosphorylation of I $\kappa$ B, nuclear translocation of NF- $\kappa$ B, and subsequent binding of NF- $\kappa$ B to the LTR response element. This leads to NF- $\kappa$ B and Sp1-mediated increase of gene transcription (Varin et al. 2005). In macrophages, C/EBP binding to LTR is promoted by Vpr either indirectly or jointly to form a complex (Kilareski et al. 2009). Vpr also has been described to increase p21 gene transcription by directly binding to Sp1 sites of its promoter (Cui et al. 2006, Cherrier et al. 2009).

Altogether, Vpr is involved in the induction of G2 arrest, cell death via apoptosis, nuclear import of PIC, transactivation of HIV-1 LTR promoter and modulation of HIV-1 reverse transcription.

## **4. Ubiquitination**

The discovery of lysosomes in the mid-1950s, established the fact that the cellular proteins are indeed constantly under the process of synthesis and degradation (Simpson 1953). This latter revealed the basic function of lysosome for the process of autophagy. But this process failed to explain the degradation of intracellular proteins, resulting from direct contact with the active proteases. Because active proteases cannot be present free in the cytosol, which may lead to destruction of cell.

Degradation of proteins by ubiquitination was initially described while working on lysosomal-independent process for degradation of intracellular proteins (reviewed in (Ciechanover 2010, 2012)). In the late 1970s, ATP-dependent proteasomal degradation of the tyrosine aminotransferase enzyme after the ubiquitination was first discovered (Hershko et al. 1979, Hershko et al. 1980). For the discovery of this ubiquitin-mediated protein degradation, Avram Hershko, Aaron Ciechanover, and Irwin Rose was jointly awarded Noble prize in Chemistry (2004).

After the protein translation, process by which protein is modified by cutting, folding or other processes is called posttranslational modification (PTM) (Boros 2012). Posttranslational modifications include phosphorylation, glycosylation, acetylation and other modifications. A process by which ubiquitin is added to target protein is called ubiquitination. Protein ubiquitination is just like other post-translational modification, which is used to control the protein function (Chen et al. 2012).

Due to diversity and complexity of process involved in ubiquitin conjugation leads to a wide range of modifications in the protein functions. These modifications may vary from enzyme activity modification, conformational changes, cellular re-localization, protein-protein interaction modulation or even reducing it lifespan by targeting it to proteasomal degradation (Peng et al. 2003). This process of protein ubiquitination is reversible and it mediated by a family of enzymes known as de-ubiquitinating enzymes (DUBs) (Nijman et al. 2005, Sowa et al. 2009, Neutzner and Neutzner 2012). Thus, the process of

ubiquitination is closely monitored in the cells and an ubiquitinated protein can be de-ubiquitinated to keep a desired balance in the function of cellular proteins.

## 4.1. Process of ubiquitination

Ubiquitin is a 76-amino acid polypeptide that is highly conserved in the eukaryotes (**Figure 13A**). Ubiquitin is attached to target protein after multistep process via the formation of iso-peptide bond between amino-group of substrate usually a lysine and the glycine of ubiquitin C-terminus (Hershko et al. 1983). This specific protein signalization is essential for the protein degradation by the proteasome. Ubiquitination is catalyzed by the conjugated action of 3 enzymes; the ubiquitin-activating enzyme (E1), the ubiquitin-conjugating enzyme (E2) and the ubiquitin ligase (E3) (Passmore and Barford 2004, Kerscher et al. 2006). In the ubiquitination, usually E3 ligases provide the substrate specificity that has specific binding sites for E2 enzyme and substrate but sometimes it is achieved by the combination of E3 ligases with E2 enzymes (Somesh et al. 2007). Human genome encodes for few E1 enzymes but it encodes for several E2s (11,-30) and even more E3s (>50, >600), in order to achieve high specificity (Li et al. 2008, Bergink and Jentsch 2009). The process of ubiquitination is carried out in 3 steps (rev in (Al-Hakim et al. 2010)) (**Figure 13B**):

- ATP-dependent activation of ubiquitin is carried out by E1 ubiquitin-activating enzyme in a 2-step reaction. E1 employs ATP to form an ubiquitin-adenylate intermediate at its C-terminus. This further leads to transfer of ubiquitin by the formation of thioester bond between the E1 active site cysteine residue and C-terminal carboxyl group of ubiquitin, with the release of AMP (depicted as E1~Ub) (Schulman and Harper 2009).
- This ubiquitin is then transferred to the active site cysteine of E2, ubiquitin-conjugating enzyme (E2~Ub) (Pickart 2001a).
- In the last step, ubiquitin is conjugated to its target protein with the help of E3 ubiquitin ligase, which establish a junction between E2 and substrate (Breitschopf et al. 1998, Pickart 2001b, Cadwell and Coscoy 2005, Wang and Elledge 2007, Williams et al. 2007).

## 4.2. Types of Ubiquitination

The ubiquitination can be divided into different types depending upon the number, site or shape of chain of ubiquitin proteins attached, to carry out different functions (**Fig 13C**).

- **Mono-ubiquitination:** In this process, a single ubiquitin is added to the target protein (Hicke 2001a). It is involved in different functions including DNA repair and replication (Huang and D'Andrea 2006), endocytosis, intracellular trafficking (Haglund et al. 2003a, Haglund and Dikic 2005), virus budding (Hicke 2001b), histone regulation and transcriptional regulation (Pavri et al. 2006, Shilatifard 2006).
- **Multi-ubiquitination:** In this mechanism, several lysine residues of substrate are tagged with a single ubiquitin. This process is often referred as multiple mono-ubiquitination. This type of ubiquitination is usually involved in endocytosis (Haglund et al. 2003b, Mosesson et al. 2003, Mosesson and Yarden 2006).
- **Poly-ubiquitination:** The process of ubiquitination becomes more complex when individual ubiquitin molecules are attached to each other with one or more ubiquitin molecule attaching to substrate (Pickart 2001b, Kirisako et al. 2006). Ubiquitin has itself seven lysine residues (fig A). All of these residues have the ability to participate in chain formation, but K48 and K63 are well characterized residues involved in the process of poly-ubiquitination (Pickart 2000, Haglund and Dikic 2005). The proteins tagged with at least four K-48 or K-11 ubiquitin linked molecules are targeted for proteasomal degradation (Thrower et al. 2000, Wang et al. 2008, Ye and Rape 2009). The proteins tagged with multiple molecules of ubiquitin linked to K-29 or 63, results in the formation of straight chain. This signaling is involved the processes of DNA repair (Huang and D'Andrea 2006, Kolas et al. 2007, Doil et al. 2009, Stewart et al. 2009), regulation of membrane protein transport (Hicke and Dunn 2003), signal transduction (Chan and Hill 2001, Voutsadakis 2012), NF- $\kappa$ B activation and ribosomal protein synthesis (Spence et al. 2000).

- **Branched poly-ubiquitination:** In branched poly-ubiquitination, a single ubiquitin is attached with at least two other ubiquitin molecules. The function of this type of poly-ubiquitination is still unclear (Wickliffe et al. 2011).

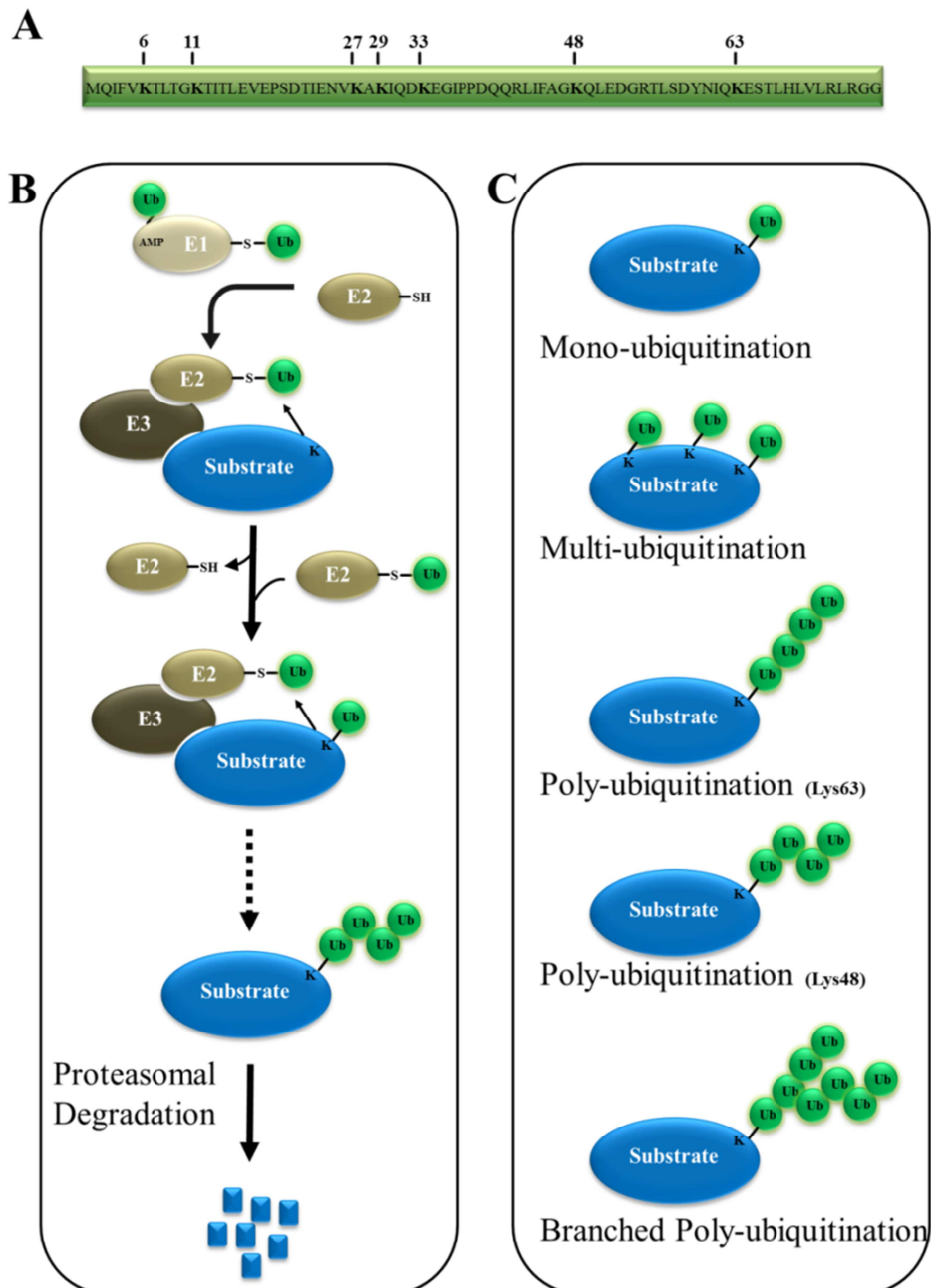

**Figure 13: Ubiquitination and its types.**

**A)** Sequence of human ubiquitin in one letter code, with lysine residues in **bold**. **B)** Schematic representation of process of ubiquitination of a substrate during its proteasomal degradation. **C)** Type of ubiquitination (**Personal source**).



### 4.3. Components of ubiquitin ligase

The human genome encodes few activation enzymes E1, several conjugating enzymes E2 and about more than 600 ubiquitin ligases E3 (Li et al. 2008). There are four main types of enzyme E3 ubiquitin ligases, which are characterized by the presence of RING (really interesting new gene) (Deshaies and Joazeiro 2009, Grutter and Luban 2012), PHD (plant homeodomain) (Bienz 2006), HECT (Homologous to E6-associated protein C-terminus) (Bernassola et al. 2008) or U-box (a modified RING motif without the full complement of Zn<sup>2+</sup>-binding ligands) (Ardley and Robinson 2005).

RING E3 ligases are by foremost common ligases, constituting more than 95% of E3 ligases. RING and U-box E3 ligases act rather as supporter, by facilitating protein ubiquitination by bringing substrate and the E2 close together (Ardley and Robinson 2005). The family of RING ligases catalyzes the direct transfer of ubiquitin E2 enzyme to the substrate without creating covalent intermediate bond. RING ligases can either be monomeric (like MDM2 or MdmX) (Wang et al. 2011a), as a part of multimeric complexes such as the APC (Anaphase-Promoting Complex) (Barford 2011) or CRULs complex (Cullin Ring Ubiquitin Ligases). The CRULs complexes constitute of a catalytic *core*, composed of a Cullin (Cullin1, Cullin2, Cullin3, Cullin4A, Cullin4B, Cullin5, Cullin7 and PARC) (Duda et al. 2011, Sarikas et al. 2011) and ROC1 an adapter subunit, which will recognize the substrate, such as F-box protein for Cul1 and DCAF1 for Cullin4A (for review (Zimmerman et al. 2010, Hua and Vierstra 2011).

The PHD ligases are closely related to RING ligases. PHD domains are present in several chromatin-binding proteins. Due to their similarity with the RING ligase, it absolutely was expected to be acting as E3 ligases however to this point, only two of the proteins are found to act as E3 ligases (Dul and Walworth 2007, Ivanov et al. 2007). Due to their similarity in structure of PHD and U-box ligases to RING ligases, they are sometime studied as RING-like variants (Aravind and Koonin 2000, Ohi et al. 2003, Gustin et al. 2011).

Finally, HECT protein domains are about 28 in numbers. HECT ligases are characterized by extremely conserved cysteine residue that has direct catalytic activity as they form a transitional thioester bond between the catalytic cysteine

residue and ubiquitin (Rotin and Kumar 2009, Metzger et al. 2012). The HECT ligase was first described in the infection of human papillomavirus (HPV), when it was described that viral E6 protein forms a complex with human E3 ubiquitin ligase for inflicting carcinogenesis (Liu and Baleja 2008).

#### **4.4. Effects of ubiquitination**

The addition of a molecule of ubiquitin to the substrate will have totally different consequences: inhibition, activation or modification in cellular localization. The enzyme-catalyzed steps E1, E2 and E3 may also be repeated until the formation of poly-ubiquitin chain using one or mix of seven lysines of ubiquitin to the formation of the peptide bond. As described above, the use of different lysines to form poly-ubiquitination results in the change in function of ubiquitination. Like, the poly-ubiquitin chains linked by lysine K48 primarily result in degradation of ubiquitinated protein by the proteasome (Mallette and Richard 2012), whereas ubiquitin chains linked by lysine K63, in turn, induce changes within the cellular localization of ubiquitinated proteins (Nathan et al. 2013).

The 26S proteasome is a macromolecular protease, present in all eukaryotes and archaea and in certain bacteria, which is operable to degrade proteins. It allows cells to degrade proteins deformed or regulate the intracellular concentration of specific proteins. Proteasomes are found in the cytosol, perinuclear regions or nucleus of the eukaryotic cells (Peters et al. 1994). The 26S proteasome consists of a 28-subunit catalytic core (20S proteasome) and 19S lid component. The subunits of 20S proteasome are assembled to form a hollow cylindrical shape and it contains the catalytic domains having proteases activities (McNaught et al. 2001, Jung and Grune 2012). The 19S component of the proteasome recognizes already poly-ubiquitinated proteins and unfolds them to remove ubiquitin from the proteins and insert them into the 20S component of the proteasome (Marteijn et al. 2006, Kim et al. 2011). Inside the 20S proteasome proteins are degraded into small (7-8) amino acids long inactive peptides, which may be recycled for the biosynthesis of new proteins (Lodish H 2005) (**Figure 14**).

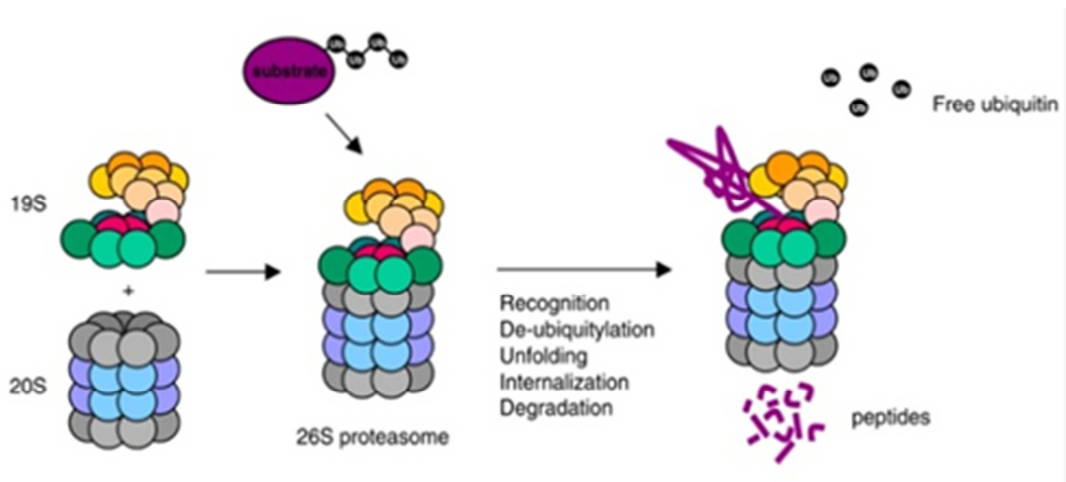

**Figure 14: 26S proteasome-mediated degradation of poly-ubiquitinated protein.**

26S proteasome consists of 20S proteasome and 19S lid (**Marteijn et al. 2006**).

## **5. Viruses using host ubiquitin system**

The cellular processes have been shown to be modified by the well-characterized post-translational modifications like acetylation, methylation, phosphorylation, acylation etc. The process of ubiquitination in which a 76 amino acid ubiquitin protein is attached to the substrate protein is described to govern different cellular process. The ubiquitination may counteract the effects of any intracellular parasite. As expected, the intracellular need to evolve their capabilities in order to counter the detrimental effects of these processes for their replication. The intracellular pathogens use different tools to modify the process by maximize their survival in the hostile environment. They may alter the process ranging from changing the cellular localization of different proteins to the targeted degradation of specific restriction factors of the host cell.

The usurp of host ubiquitinating system by the viruses was first described when it was shown that the Adenoviruses and DNA tumor viruses use host ubiquitin system to deregulate the host cycle to favor their survival (Scheffner et al. 1990, Scheffner et al. 1993). Today, we know a number of viruses usurping the host ubiquitin system like Adenoviruses, Papillomaviruses, Herpesviruses, and Poxviruses etc. These viruses usurp the host ubiquitin system to help the different steps during the life cycle of the viruses starting from viral entry to viral budding.

Although, there are no clear study showing that viruses binding with host cell is regulation by ubiquitin proteasome system (UPS), but some of the viruses are described to use this host UPS in their post-entry steps of life cycle like transport of nucleocapsid. The use of proteasome inhibitors and expressing temperature sensitive mutant of the ubiquitin activating enzyme E1 are the main tools used to show the manipulations of the UPS to enhance the viral transcription and replication. There are several examples showing the involvement of UPS in different aspects for the regulation of lytic replication and latency, especially in herpes viral life cycle. Interestingly, there are a number of examples of viruses that utilize this host UPS in order to destroy host proteins that can be harmful for their survival.

Moreover, the viruses have evolved the modes to evade the host innate immune mechanisms by blocking the function of important mediators of immunity by either down regulating their production or by reducing their anti-viral effects. Today, there are still some other effects resulted from this exploitation of host ubiquitin system by the viruses that are not fully clear. Viruses with different range of effects by host ubiquitin proteasome system are listed in Table 1. A schematic overview is summarized in **(figure 15)** at the end of this chapter.

## **5.1. Adenoviruses**

The importance of host UPS was described in Adenoviruses when it was shown that ubiquitination of capsid protein VI is a vital step in the transport of viral nucleocapsid to the nucleus (Schreiner et al. 2012). The neuronal-precursor-cell-expressed, developmentally-down-regulated (Nedd4) is a member of family E3 ubiquitin ligases. The PPXY motif of capsid protein VI recruits this Nedd4 E3 ubiquitin ligase. This interaction of the proteins plays a vital role in the microtubule-dependent transport of nucleocapsid to nucleus. The mutation of this PPXY motif of capsid protein VI blocks the transport of nucleocapsid to nucleus. Viruses with this mutation are unable to transport to nucleus after their exit from endosomes (Wodrich et al. 2010).

The infection by adenovirus can also bring changes in host cell-cycle regulation. The adenoviral proteins mainly (E4orf6 and E1B55k) exploit the host UPS to degrade the host proteins involved in DNA damage repair and host cell cycle regulation. The adenoviral protein early region 4 ORF 6 (E4orf6) acts as an adaptor to form a complex between E1B55k and Cul E3 ligases. In this complex, E1B55k recognizes different cellular proteins for ubiquitination and subsequent proteasomal degradation. This proteasomal mediated degradation of host proteins results in the accumulation of DNA damage in the infected cells after the prevention of apoptosis (Cheng et al. 2011).

Further, adenoviruses block the ATM (ataxia telangiectasia mutated) and ATR (ATM and Rad3-related) pathways to elude DNA damage responses (Carson et al. 2003). Mostly adenoviruses induce the degradation of MRN (Mre11, Rad50, and Nbs1) DNA damage complex by host UPS, to prevent activation of ATM

pathway. Moreover, some adenovirus types (Ad5 and Ad12) can also prevent the activation of ATR pathway via a different process. Before the proteasomal mediated degradation of MRN, Ad5 immobilize MRN by its delocalization, utilizing viral protein E4orf3. This mislocalization of MRN within the host cell prevents ATR activation (Carson et al. 2009). In Ad12, this prevention of ATR activation is achieved by E4orf6 instead of E4orf3. The adenoviral protein E4orf6 induces UPS-mediated degradation of host ATR activator protein topoisomerase-IL $\beta$ -binding-protein-1 (TOPBP1). Indeed, E4orf6 forms a complex by interacting with a Cul2/Rbx1/ElonginC ligase, without adaptor protein E1B55k (Blackford et al. 2010). Mostly adenovirus uses Cul5 E3 ubiquitin ligase to degrade host proteins but there are some examples, where Cul2 E3 ubiquitin ligase is used (Cheng and Chen 2010). Ad5 is also involved in the inactivation of host cell DNA damage response by inducing the degradation of p53, Mre11 and DNA ligase IV (Forrester et al. 2011).

Furthermore, the adenoviruses also induce cell death by different ways with the help of its protein, E4orf4 (Robert et al. 2002). The expression of this viral protein induces the activity of APC E3 ubiquitin ligase to target APC substrate protein Pds1/securing to proteasomal mediated degradation. This protein is essential to complete the process of mitosis (Mui et al. 2010). In contrast, same effect of cell death is also achieved by reducing the activity of APC E3 ubiquitin ligase (Kornitzer et al. 2001).

As above described, the host UPS plays an important role in the regulation of cell cycle and inhibition of apoptosis in DNA tumor viruses like adenoviruses (Blanchette and Branton 2009). Additionally, in a study focusing on role of adenoviral proteins (E4orf6 and E1B55k) further elaborated the role of host UPS in the transportation of viral mRNA from the nucleus. Adenoviral proteins (E4orf6/E1B55k) form a complex by interacting with the Cul5 E3 ubiquitin ligase. This ubiquitin complex targets a host substrate, yet to be elucidated. This post-translational modification of the targeted protein is necessary for the transport of mRNA from the nucleus (Blanchette et al. 2008).

## 5.2. Herpes viruses

The entry of **herpes simplex virus** (HSV) at a post-penetration step is sensitive to proteasome inhibitor, but this entry of the virus in the cells is host ubiquitin-activating enzyme independent (Delboy et al. 2008). The proteasome activity is necessary for the efficient gene transcription of **human cytomegalovirus** (HCMV) (Tran et al. 2010).

Some of the viral proteins may work as deubiquitinating proteases, thus to favor the viral regulation of lytic and latency. For example, the lytic protein, open reading frame 64 (ORF64) of **kaposi's sarcoma-associated herpesvirus** (KSHV) and (MHV68) are identified as viral deubiquitinating protease, thus they may be involved in viral reactivation from the latency to lytic replication (Gredmark et al. 2007, Gonzalez et al. 2009). The viral protein LMP1 of EBV has a role in the regulation of lytic replication by inducing cellular deubiquitinating protease A20 to inactivate IRF7 (Ning and Pagano 2010). The viral protein BPLF1 of EBV leads the cell to S-phase by stabilizing the licensing factor CDT1. This effect is achieved by the deubiquitinating protease activity of BPLF1 via removing NEDD8 from Cullin-RING ligases (Cul1 and Cul4A) (Gastaldello et al. 2010). The DUB activity of EBNA3C (**Epstein-Barr nuclear antigen 3C**) also promotes G1/S transition by preventing Cyclin D1 degradation (Saha et al. 2011).

The **replication and transcription activator** (RTA) protein of KSHV targets the cellular repressor proteins for their proteasomal degradation. It has been described that RTA uses U3 ubiquitin ligase activity to induce the degradation of K-RBP (Yang et al. 2008) and Hey1 (Gould et al. 2009) and thus may be involved in the mechanism to regulate the lytic reactivation of herpesvirus. The viral protein ORF73 may play an important role in the persistence of **murid herpesvirus-4** (MuHV-4) by usurping the host ubiquitin complex, ElonginC/Cul5/SOCS. This viral protein induces the degradation of NF- $\kappa$ B family member p65/RelA and this degradation of protein inhibits the transcriptional activity of NF- $\kappa$ B, thus may be involved in the persistence of virus (Rodrigues et al. 2009). The EBNA3C is also involved in the proteasomal degradation of retinoblastoma protein (Rb) and p27 (KIP) via SCF (Skp2) E3 ubiquitin ligase

complex (Knight et al. 2005b, Saha et al. 2009). The degradation of **latent membrane protein 2A** (LMP2A) of EBV is promoted by c-Cbl ubiquitin ligase (E3) via UPS. This degradation of LMP2A prevents the virus from entering into lytic replication and thus it promotes viral latency (Ikeda and Longnecker 2009).

Herpes viruses also affect the host immune system to regulate their replication. The viral proteins K3 and K5 of KSHV utilizes E3 ubiquitin ligase complex to induce degradation of CD1d, gamma interferon (INF $\gamma$ ) and **major histocompatibility complex** (MHC) class-1 proteins (Coscoy and Ganem 2000, Ishido et al. 2000, Coscoy et al. 2001, Li et al. 2007b). Moreover, K5 is also involved in the degradation of B7.2, MHC class 1-related chains A and B (MICA/B), ICAM and activation-induced-C-type lectin (AICL) (Coscoy et al. 2001, Thomas et al. 2008). The murine gamma-herpes virus 68 K3 (MK3) can also induce degradation of MHC-1 (Stevenson et al. 2000, Boname and Stevenson 2001). The immediate-early protein ICP0 (**infected cell protein 0**) can act itself as E3 ubiquitin ligase during viral infection (Boutell et al. 2002) and can induce the proteasomal degradation of **promyelocytic leukemia** (PML) and Sp100 (Gu and Roizman 2003, 2009). The viral protein pp71 of HCMV evades immune response by inducing proteasomal degradation of Daxx (Saffert and Kalejta 2006) by SUMOylation (Hwang and Kalejta 2009, 2011).

### **5.3. Papillomaviruses**

The oncogenic **human papillomaviruses** (HPV) were among the earliest examples described to show the host protein degradation by UPS under the effect of viral proteins. The HPV encodes the proteins like E6 and E7 that can target host proteins to proteasomal degradation to extend the lifespan of infected cells. These activities help the viruses to either opt a latent infection or lytic replication.

The high-risk HPV protein E2 can both enhance and inhibits the viral promoter transcription. HPV E2 interacts with the activators of anaphase promoting complex (APC) E3 ubiquitin ligase. This interaction results in the inhibition of normal APC-dependent Cyclin B degradation and thus, favors G2/M arrest (Bellanger et al. 2005).



The HPV16 protein E5 is a small protein having hydrophobic nature that localizes to cell membrane to stabilize the proteins involved in the proliferative cell signaling like EGF-R. The host UPS normally counters the effect of EGF-R by inducing its degradation but binding of E5 to EGF-R renders its binding to cellular E3 c-Cbl ubiquitin ligase (Zhang et al. 2005). The E5 protein of HPV16 can induce the proteasomal degradation of Bax to limit the Bax-dependent apoptosis (Oh et al. 2010). Recently, E5 is also described as a down-regulator of MHC-1 (Ashrafi et al. 2005) and T-cell activation factor CD1d (Miura et al. 2010).

The HPV E6 induces the degradation of several cellular proteins by simply actin as an adaptor to redirect the HECT ligase E6AP (**E6-associated protein**) (Banks et al. 2003). The key target among these cellular proteins is p53. The E6 targets the tumor suppressor Tat-interacting protein 60 (TIP60) for its proteasomal degradation without the involvement of E6AP (Jha et al. 2010). The cellular E3 ubiquitin ligase Siah-1 (seven in absentia homolog) enhances the UPS-dependent degradation of beta-catenin. The activity of Siah-1 is shown to be inhibited by the combination of E6 and E7 proteins (Rampias et al. 2010).

The members of the pocket protein family (pRb) play the role to control the G1/S-phase progression. The chief function of E7 is described as to target the pRb family members to ubiquitination and subsequent proteasomal degradation (Moody and Laimins 2010). Among many detected E3 ubiquitin ligase complexes with E7 but only Cul2/ElonginBC/Rbx1 is known to interact pRb, thus suggesting its involvement in its degradation (Huh et al. 2007). E7 itself is also targeted by the host UPS for its degradation. To counter this effect, E7 interacts with host DUB USP11 to stabilize itself (Lin et al. 2008).

## **5.4. Poxviruses**

The members of this group are not well known for their ability to use the host ubiquitination system. Poxviruses can manipulate the host UPS with the help of three viral proteins:

- The p28 protein that itself acts as E3 ubiquitin ligase by its RING finger domain (Huang et al. 2004).

- BTB-Kelch proteins that associate with Cul3 ubiquitin ligase complexes
- Ankyrin-like proteins that interact with Cul1 ligase complexes (Shchelkunov 2010).

Some poxviruses produce a protein that have a negative effect on the activity of APC E3 ubiquitin ligase. This protein is known as poxvirus APC/cyclosome activator (PARC) and has a RING domain (Mo et al. 2009). PARC has a binding competition with APC11 to APC complex, which suggest that it is a dominant negative inhibitor of APC complex. This inhibition of APC E3 ubiquitin ligase activity may leads to S-phase and enhancement of DNA replication (Mo et al. 2010). Moreover, host-range protein CP77 of cowpox virus has been described to block the nuclear translocation of NF- $\kappa$ B by using host ubiquitination system (Chang et al. 2009).

## **5.5. Parvoviruses**

The host UPS plays a role in the nucleocapsid protein transport in some of the parvoviruses. Although, entry of some parvovirus like adeno-associated virus (AAV) and bovine parvovirus (BPV) is not sensitive to proteasome inhibitors (Yan et al. 2002) but transport of nucleocapsid is sensitive to proteasome inhibitors or its E1 mutant in canine parvovirus (CPV) and minute virus of mice (MMV) (Ros and Kempf 2004).

## **5.6. Reoviruses**

Commonly viruses induce the degradation of IRF3 and IRF7 with the help of host UPS to reduce the production of interferon. It has been described that the rotavirus NSP1 protein may act as E3 ubiquitin ligase in the degradation of IRF3 (Graff et al. 2007). Moreover, NSP1 can limit the INF production by proteasomal degradation of IRF3, IRF5 and IRF7 (Sherry 2009).

## 5.7. Orthomyxoviruses

The entry of influenza virus is influenced by the host UPS. The clathrin-mediated viral transport of influenza virus can be inhibited by either expression of mutant of **Epsin 1** (E1) or by the depletion of Epsin 1 (Chen and Zhuang 2008). The transport of nucleocapsid of influenza virus is also shown to be sensitive to proteasome inhibitor and mutants of E1 (Widjaja et al. 2010).

The influenza virus uses host UPS to target RIG-I (**retinoi-acid-inducible gene-I**) by ubiquitin- dependent mechanisms. For the initiation of anti-viral signaling cascade, RIG-I first has to be ubiquitinated by the cellular E3 ligase TRIM25 (tripartite motif 25). The influenza protein NS1 can block the oligomerization of TRIM25, thus preventing the ubiquitination of RIG-I (Gack et al. 2007). The influenza virus can also inactivate NF- $\kappa$ B function via A20 (Onose et al. 2006).

## 5.8. Hepadenoviruses

The importance of host UPS in hepatitis B virus (HBV) infection is described in transgenic mice. It has been described that treatment with proteasome inhibitor (Bortezomib) resulted in inhibition of viral replication subsequent to viral RNA and protein expression in a dose dependent manner (Bandi et al. 2010).

The **hepatitis B virus x** protein (HBx) promotes the cell cycle progression via different pathways, resulting in **hepatocellular carcinoma** (HCC) (Kew 2011). HBx is known to interact with DDB1 (Martin-Lluesma et al. 2008), which later found to be the part of Cul4a E3 ubiquitin ligase complex. The pituitary tumor-transforming gene 1 (PTTG1) protein interacts and inhibits p53 (Bernal et al. 2002) and is also found to be overexpressed in HCC. The HBx can interact with DDB1 (**DNA-damage binding protein-1**) and Cul4a E3 ubiquitin ligase to induce the stabilization of PTTG1 (Molina-Jimenez et al. 2010).

## 5.9. Retroviruses

The retroviruses usurp the host UPS to help them during different steps of their replication. The HIV-1 accessory protein Vpr and its functional paralog of

HIV-2/SIV (simian immunodeficiency virus) Vpx improve the ability of the related viruses to infect the macrophages (for review (Casey et al. 2010)). HIV-2/SIV Vpx is described to interact with DCAF1/DDB1/Cul4 E3 ubiquitin ligase complex to overcome a specific restriction factor in macrophages and quiescent CD<sup>+</sup> T-cells (Sharova et al. 2008, Descours et al. 2012). The counter actions of retroviruses against the host restriction factors will later be described in detail.

Human T cell leukemia virus type 1 (HTLV-1) encodes a trans-activating protein, Tax. The ubiquitination of Tax is essential for the activation of NF- $\kappa$ B (Harhaj et al. 2007). The HIV-1 Tat protein interacts with the proto-oncoprotein Hdm2. This mediates the ubiquitination of Tat to enhance the LTR (long terminal repeat) activation (Bres et al. 2003). The HIV integrase is shown to interact with cellular protein Ku70 with the help of yeast two-hybrid method. This Ku70 protein is involved in transcription, DNA repair, apoptosis and telomere maintenance (Downs and Jackson 2004). Recently it has been shown that proteasomal degradation of HIV integrase is prevented by Ku70, which is incorporated in HIV virions. Moreover, the viral replication is diminished by knock down of Ku70 with siRNA (Zheng et al. 2011).

HIV-1 accessory protein Vpr can induce the G2 cell cycle arrest. This effect of Vpr is dependent on the interaction with DCAF1 (DDB1-Cul4 associated factor 1). Indeed, it is has been described that Vpr interacts with DCAF1/DDB1/Cul4 Ubiquitin ligase to target a still unknown cellular protein, which results in the G2 arrest (For review (Casey et al. 2010)). The function of this arrest is argued by some as a mere byproduct of different effects of Vpr. The G2 arrest by Vif also supports this notation (DeHart et al. 2008).

HIV-1 has been shown to target IRF3 (interferon regulatory factor 3) for ubiquitination and proteasome-mediated degradation. The degradation of IRF3 is carried under the action of E3 ubiquitin ligase by its adaptor proteins Vpr and Vif (Okumura et al. 2008). Recently, the down-regulation of IRF3 by HIV-1 Vpr has been described by visualizing its ability to attenuate virus-induced INF- $\beta$  promoter expression but Vif failed to produce the same results (Doehle et al. 2009). This suggests that unlike Vpr, Vif may require additional factors to influence IRF-3 expressions.

The host innate immune system counter acts the retroviral replication with the help of a family of cytidine deaminases encoded by APOBEC3 genes (**apolipoprotein B mRNA editing enzyme catalytic polypeptide-like 3**). HIV-1 encoded protein Vif interacts with E3 ubiquitin ligase Cul5/Elongin BC/Rbx1 to prompt the ubiquitination and degradation of APOBEC3G and 3F (Marin et al. 2003, Sheehy et al. 2003, Yu et al. 2003). The effects of retroviruses against the host restriction factors are discussed later in detail under the chapter of restriction factors.

In short, it is a common strategy for viruses to counter act the action of any inhibitory mechanism by using the host UPS. More importantly, HIV-1 can overcome the action of inhibitory proteins, especially by its accessory proteins via host UPS.

**Table 1: List of viruses using UPS and function modifications.**

Virus	Viral protein	Ubiquitin function modification	Reference
<b>Adeno: Ad5</b>	Capsid VI	Nedd4 E3 Ub ligase do ubiquitination of capsid VI for nucleocapsid transport to nucleus	(Wodrich et al. 2010)
	E4orf6 / E1B55k	Involves in viral mRNA transportation from nucleus by making complex with Cul5 Induce degradation of DNA ligase IV, p53 and MRN DNA repair complex proteins, by making complex with E3 Ub ligase Cul5/ElonginB/C/Rbx1	(Blanchette et al. 2008) (Blanchette and Branton 2009, Isaacson and Ploegh 2009, Randow and Lehner 2009)
<b>Adeno: Ad12</b>	E4orf6	Induces degradation by Ub of ATR activator protein TOPBP1, by interacting with E3 Ub ligase Cul2/Rbx1/ElonginC	(Blackford et al. 2010)
<b>Adeno</b>	E1A	Inhibits the E3 Ub ligase Skp1/Cul/Rbx1/Fbw7 that may increase proliferation	(Isobe et al. 2009)
	E4orf4	Promotes degradation of securing/Pds1 by activating E3 Ub ligase APC to induce G2/M cell cycle arrest	(Mui et al. 2010)
<b>Herpes: HSV</b>	Unknown	Nucleocapsid transport is susceptible to proteasomal inhibitors	(Delboy et al. 2008)
<b>Herpes: EBV</b>	EBNA1	Induces ubiquitination of histones by the interaction with cellular de-ubiquitinating USP7 to enhance EBNA1 binding to oriP	(Sarkari et al. 2009)
	LMP1	Induces the cellular de-ubiquitination of A20 to inactivate IRF7	(Ning and Pagano 2010)
	LMP2A	Targeted to ubiquitination and degradation by c-Cbl E3 Ub ligase to promote latency	(Ikeda and Longnecker 2009)
	EBNA3c	Interacts with E3 Ub ligase SCF (Skp2) complex to induce the ubiquitination and degradation of pRb and p27	(Knight et al. 2005a)
		Degradation of Cyclin D1 is prevented by de-ubiquitination activity to promote G1/S transition	(Saha et al. 2009, Saha et al. 2011)
BPLF1	Stabilizes CDT1 via removing Nedd8 from Cul 1 and Cul4a by de-ubiquitinating activity, thus leads to S-phase	(Gastaldello et al. 2010)	
<b>Herpes: MHV68</b>	ORF73	Induces ubiquitination and degradation of RelQ/NF-kB by interacting with ElonginC/Cul5/SOCS-like complex	(Rodrigues et al. 2009)

	ORF64	Acts as viral de-ubiquitinating proteases	(Gredmark et al. 2007)
<b>Herpes: HCMV</b>	Unknown	Early and late transcription is susceptible to proteasomal inhibitors	(Tran et al. 2010)
<b>Herpes: KSHV</b>	ORF64	May have a role in lytic reactivation by acting as viral deubiquitinating proteases	(Gonzalez et al. 2009)
	RTA	Induces degradation of cellular repressors like Hey-1 and K-RBP	(Yang et al. 2008, Gould et al. 2009)
<b>Orthomyxo: influenza</b>	Unknown	Knock down of Epsin 1 or prevention of ubiquitination results in blocking of viral entry	(Chen and Zhuang 2008)
		Proteasome inhibitor reduces nucleocapsid transportation.	(Widjaja et al. 2010)
<b>Papilloma: HPV</b>	E2	Induces G2/M arrest by associating with E3 Ub ligase APC	(Bellanger et al. 2005)
	E5	Induces Bax degradation and inhibits degradation of EGF-R by E3 Ub ligase c-Cbl, thus inhibiting apoptosis	(Zhang et al. 2005, Oh et al. 2010)
	E6	Induces proteasomal degradation of p53, cMyc, Mcm7 (minichromosome maintenance protein 7), Siah-1 (seven in absentia homolog 1), Bak (Bcl-2 homologous antagonist/killer), MMP7 (matrix metalloprotease 7), E6TP1 (E6 targeting protein 1) and NFX1 (nuclear transcription factor, X-box binding 1) by the interaction of HECT ligase E6AP	(Shackelford and Pagano 2004, Mammas et al. 2008, Howie et al. 2009, Rampias et al. 2010)
	E7	Induces proteasomal degradation of pRB by interacting with Cul2/ElonginBC/Rbx1, associates with cellular de-ubiquitinating protease USP11 to avoid its own degradation and target TIEG1 for ubiquitination and degradation.	(Boyer et al. 1996, Huh et al. 2007, Lin et al. 2008, Chang et al. 2010)
<b>Picornia : coxsackie</b>	Unknown	Knock down of ubiquitin or use of proteasomal inhibitor results in viral replication inhibition	(Wong et al. 2007)
<b>Hepadna: HBV</b>	Unknown	Viral replication is sensitive to proteasomal inhibitors.	(Bandi et al. 2010)
	X	Stabilizes PTTG1 by interaction with DDB1 component of E3 Ub ligase Cul4a	(Martin-Lluesma et al. 2008, Molina-Jimenez et al. 2010)
<b>Corna : FIPV, SARS</b>	Unknown	Nucleocapsid transport is susceptible to proteasome inhibitors	(Yu and Lai 2005, Raaben et al. 2010)
<b>Parvo : MMV/CPV</b>	Unknown	Nucleocapsid transport is susceptible to proteasome inhibitors	(Ros and Kempf 2004)

<b>Paramyxo: HRSV</b>	Unknown	Viral replication is susceptible to proteasome inhibitors	(Lupfer and Pастey 2010)
<b>Parapox: Orf virus</b>	PACR	Inhibits APC E3 Ub ligase complex, which may prompt cells into S-phase	(Mo et al. 2009)
<b>Pox: vaccinia</b>	Unknown	Proteasome inhibitor impairs viral replication	(Teale et al. 2009, Barry et al. 2010)
<b>Polyoma : SV40</b>	Large T	Interacts with Fbw7 and thus resulting in inhibition the Skp1/Cul/Rbx1/Fbw7 E3 Ub ligase to augment Cyclin E level	(Welcker and Clurman 2008)
<b>HTLV-1</b>	Tax	ubiquitination of Tax is essential for NF- $\kappa$ B activation	(Nasr et al. 2006, Harhaj et al. 2007)
<b>Retro : SIV/HIV-2</b>	Vpx	Induces ubiquitination and degradation of macrophage-specific restriction factor (SAMHD1) via interaction with DCAF1/DDB1/Cul 4 E3 Ub ligase	(Laguettes et al. , Sharova et al. 2008, Hrecka et al. 2011)
<b>Retro : HIV-1</b>	Tat	LTR activation is enhanced by ubiquitination of Tat by Hdm2	(Bres et al. 2003)
	Vpr	Associates with DCAF1/DDB1/Cul 4 E3 Ub ligase, to induce G2 cell cycle arrest	(Le Rouzic et al. 2007, Andersen et al. 2008); Casey et al. 2010
		Induces degradation of UNG2 via interaction with DCAF1/DDB1/Cul 4 E3 Ub ligase	(Ahn et al. 2010)
	Vpr and Vif	Induce ub-mediated degradation of IRF3	(Okumura et al. 2008)
	Vif	Induce ub-mediated degradation of APOBEC3G and 3F by interacting with E3 Ub ligase Cul5/ElonginBC/Rbx1	(Marin et al. 2003, Sheehy et al. 2003, Yu et al. 2003)





## **6. Restriction factor**

The cells have evolved different mechanism to counter the invading parasites. One of them is the use of host cellular proteins to counter the invading organisms. The host cellular proteins capable of blocking the replication of the invading parasites are termed as "restrictions factors". There are few known restriction factors evolved by the human cells to counter the replication of HIV-1 (Wolf and Goff 2008). The first evidence of presence of host restriction factor against retroviruses was observed, when it was discovered that Friend virus susceptibility factor-1 (Fv1) can inhibit the infection of murine leukemia virus (MLV) (Lilly 1967). Usually the non-permissive cells harbor restriction factors, due to restricted virus replication in these cells (Liu et al. 2011).

### **6.1. Hallmarks of restriction factors**

The defining features of any restriction factors usually include the following hallmarks:

- The first and primary feature is the ability of any restriction factor to induce a considerable decrease in HIV infectivity. The decrease in HIV infectivity is routinely observed by "single-cycle" assay with different levels of expression of the restriction factor (Chiu et al. 2005).
- If the restriction factor is really threat to the virus replication, then predecessors of the virus should have evolved a mechanism to counter the effect of the restriction factor. It means, virus can replicate even in the presence of the restriction factor by counter acting its effects, in at least some cell type. The cells that support virus replication are called "permissive", while the others as "non-permissive". Restriction factors can be expressed constitutively or induced by different factors, and the effects of these restriction factors are neutralized by the countervailing stratagems of the viruses. Mostly, viruses usurps the host UPS to relocate the cellular protein or even lead to their degradation by 26S proteasome pathway (Teale et al. 2009, Hrecka et al. 2011).

- Due to direct protein interactions between restriction factor and its counter acting factor, restriction factor usually displays signs of evolution (Zhang et al. 2012a). Moreover, the restriction factors are frequently closely related to the host innate immune response, such as the expression induced by the interferon. Due to different effects in different species and cell lineage, the type of restriction factor also differs from each other (Mogensen et al. 2010, Vandergeeten et al. 2012).

There are only few restriction factors known against the retroviruses namely TRIM5 $\alpha$ , tetherin, APOBEC3, and SAMHD1. Their functions in producer and target cells are summarized in **(Figure 16)**.

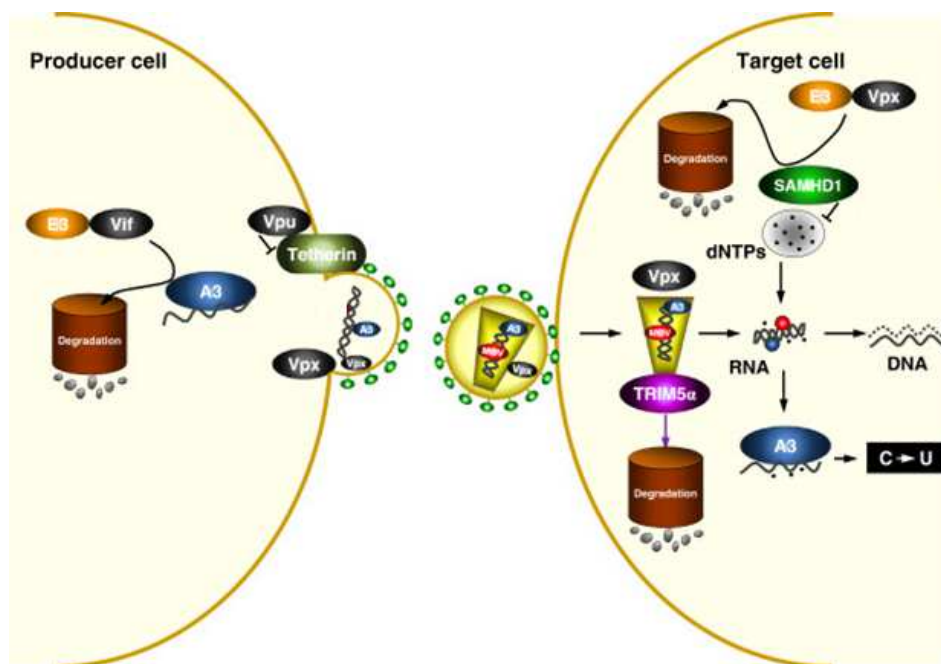

**Figure 16: Schematic overview of the action of host restriction factor against lentiviruses.**

Tetherin can inhibit HIV-1 release but it is counteracted by Vpu or Nef. In the producer cells, A3 is packaged with the virion and inhibits RT in target cells, if not degraded by Vif. TRIM5 $\alpha$  can accelerate uncoating and induces degradation of RT complex and SAMHD1 reduces the dNTPs but counteracted by Vpx **(with modifications (Zheng et al. 2012))**.

## 6.2. TRIM5

**Tripartite motif (TRIM)** - containing protein family is a large family with more than 100 members. TRIM5 is also one of these TRIM proteins with 3 motifs, N-terminal RING finger motif, B-box motif and coiled-coil motif and are collectively referred as RBCC (**R**ING, **B**-box and **c**oiled-**c**oil) domain (Reymond et al. 2001). The C-terminal of TRIM5 has a PRY-SPRY motif. RING finger motif has E3 ubiquitin ligase activity, while B-box and coiled-coil motifs enhance protein oligomerization (Nisole et al. 2005, Towers 2007). The C-terminal motif is important for the capsid interaction. There are 6 isoforms of TRIM5, but TRIM5 $\alpha$  is the most abundant (~50%) (Battivelli et al. 2011).

### 6.2.1. Mode of action of TRIM5 $\alpha$

TRIM5 $\alpha$  was first described for its activity against HIV-1 infection in Old World monkey (Stremlau et al. 2004). TRIM5 $\alpha$  accelerates the uncoating of newly entered virus and interacts with capsid by its C-terminal domain. This interaction inhibits the reverse transcription of viral RNA by targeting reverse transcription complex to proteasomal degradation (**Figure 16**) (Yamauchi et al. 2008, Lienlaf et al. 2011). The exact mechanism of this degradation is not completely clear.

RING finger motif of TRIM5 $\alpha$  has two zinc-binding sites. The presence of these sites helps TRIM5 $\alpha$  to interact simultaneously with ubiquitin enzyme and its substrate. Thus, TRIM5 $\alpha$  can function as E3 ubiquitin ligase, like Rbx1 (RING-box-1) is a vital component of Skp1-Cul1-F box (SCF) complex that regulates cell cycle (Joazeiro and Weissman 2000). TRIM5 $\alpha$  can induce the self-polyubiquitination; the role of this self-polyubiquitination is still unclear (Yamauchi et al. 2008). TRIM5 $\alpha$  is a relatively unstable protein and this turnover is not carried out by proteasomal degradation. Moreover, this rapid turnover does not affect its antiviral activity (Diaz-Griffero et al. 2006). The infection with restriction-sensitive virus enhances this turnover of TRIM5 $\alpha$  and this enhancement of turnover is proteasomal dependent (Rold and Aiken 2008). TRIM5 $\alpha$  is also involved in the activation of NF- $\kappa$ B pathway (de Silva and Wu 2011). Moreover, arsenic trioxide (As<sub>2</sub>O<sub>3</sub>) treatment, blocks the TRIM5 $\alpha$  activity, but the mechanism of this inhibition is not yet fully understood (Wu et al. 2006).

As TRIM5 $\alpha$  is found associated with proteasome machinery and proteasome inhibitor reduces its uncoating, so proteasome and TRIM5 $\alpha$  work together for inhibition of HIV-1 infection (Lukic et al. 2011). Moreover, the presence of proteasome inhibitor does not significantly reduce TRIM5 $\alpha$  antiviral activity. This means there are two independent mechanisms for viral inhibition.

- TRIM5 $\alpha$  induces rapid uncoating of capsid, resulting in proteasomal degradation of reverse transcription complex.
- It blocks the nuclear translocation of pre-integration complex, as exhibited by Fv1 (Wu et al. 2006).

## **6.3. Tetherin**

Tetherin is cell surface protein constitutively expressed in the cells and its expression can be induced by interferon- $\alpha$ . They were originally identified as surface marker for terminally different B-cells and termed as CD317, HM1.24 or BST-2 (Goto et al. 1994). Previously, it was described that the deletion of Vpu gene resulted in 5-10 fold lower levels of release of HIV-1 viruses without having any effect of expression of other viral proteins (Gomez et al. 2005). The importance of tetherin was established with discovery that it can induce late-stage defect in the release of the HIV-1  $\Delta$ Vpu, from non-permissive cells (Neil et al. 2008, Ruiz et al. 2008). Interestingly, electron microscopy showed that this retention of viruses is due to accumulation of viruses on the cell membrane or inside the intracellular compartments (Geraghty et al. 1994). Tetherin has three domains that play important roles for its broad antiviral activity including viruses other than HIV-1. These include N-terminal cytoplasmic domain, a transmembrane domain and C-terminal glycosylphosphatidylinositol (GPI) anchor (Kupzig et al. 2003).

### **6.3.1. Tetherin inhibits virion release**

Restriction of HIV-1 replication by tetherin is detrimental for HIV-1 as the matured virion fail to escape the cells. Being a plasma membrane surface protein, tetherin can interact with both host and viral membranes via its C-terminal domain and membrane-spanning domain (Perez-Caballero et al. 2009). Budding is the last step of HIV-1 replication to escape from the cell. As the

virions are budding from the cells membrane, tetherin integrates with the HIV-1 lipid membrane and does not allow its release from the cell membrane (Neil et al. 2008). These retained viruses are then internalized and degraded by the lysosomes (Miyakawa et al. 2009, Sakuma et al. 2009). **(Figure 17)**

### **6.3.2. Vpu counteracts tetherin via several mechanisms**

HIV-1 has evolved the mechanisms to avoid the restriction by tetherin. This counter action of tetherin is carried out by its accessory protein, Vpu (Van Damme et al. 2008). In the absence of Vpu, tetherin is highly expressed on the cell membrane of the host cell. This expression is regulated by its *de novo* synthesis and recycling after endocytosis (Figure). Indeed, Vpu has the ability to down regulate the expression of tetherin. This down regulation of tetherin is carried out at post transcriptional levels (Mangeat et al. 2009). Tetherin is targeted for its constitutive degradation and Vpu enhances its degradation in the infected cells (Goffinet et al. 2009). Vpu can interact with  $\beta$ -TrCP to polyubiquitinate tetherin and its subsequent proteasomal degradation (Douglas et al. 2009, Mitchell et al. 2009). The ability of Vpu for its anti-viral activity depends partially on  $\beta$ -TrCP interaction (Margottin et al. 1998, Buttica et al. 2007). This means Vpu has developed other mechanism to counter the tetherin effects, which include: **(Figure 17)**

- Blocking the transport of *de novo* tetherin to cell membrane (Dube et al. 2010b).
- Blocking the recycling of tetherin (Mitchell et al. 2009).
- Inducing lysosomal degradation after internalization of tetherin (Janvier et al. 2011).

Only a small portion of anti-tetherin activity of Vpu depends on proteasomal degradation. The degradation of tetherin can be significantly blocked in the presence of lysosomal inhibitors and both the proteins colocalize in the lysosomes (Dube et al. 2011). Moreover, lentiviruses of non-human primates use their Nef protein to counter the effects of tetherin, as they lack Vpu (Jia et al. 2009). This anti-tetherin activity of SIV Nef is species specific, as it cannot degrade the human tetherin. Interestingly, Vpu and Nef of HIV-1 group O

and P are not effective against human tetherin, but their Nef protein can counter primate tetherin (Sauter et al. 2009).

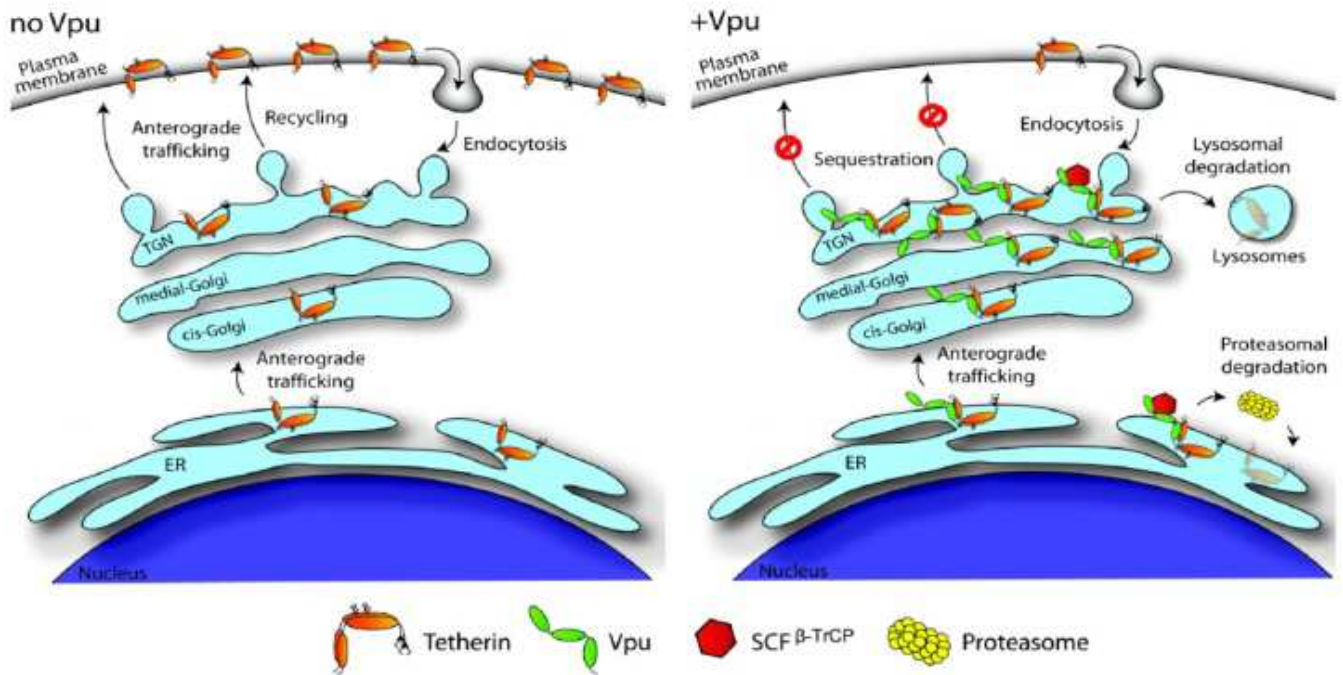

**Figure 17: Overview of Vpu-mediated tetherin regulation.**

In the absence of Vpu, tetherin is constitutively regulated and can block virion release. HIV-1 Vpu can counteract tetherin effects by its down regulation and its degradation (**Dube et al. 2010a**).

## 6.4. APOBEC3

**A**polipoprotein **B** mRNA-editing enzymes catalytic polypeptide-like 3 (APOBEC3) proteins are human enzymes expressed by APOBEC3 (A3) genes and are found in numerous mammals including humans. There are six member of this family namely, A3A, A3B, A3C, A3DE, A3F, A3G and A3H (Jarmuz et al. 2002, Wedekind et al. 2003). Initially, A3D and A3E were thought to be separate but later it was shown that they are produced from a single gene, now known as A3DE. All APOBEC proteins have one or two copies of the Z domain (zinc-

coordinating deaminase domain) (Bransteitter et al. 2009). This Z domain contains the motif required to convert cytosines to uracils by catalyzing cytidine deamination.

Although APOBEC2 and APOBEC4 functions are still unclear, but APOBEC1 is known to regulate the lipid metabolism (Teng et al. 1993) and activation-induced cytidine deaminase (AID) participates to antibody production (Muramatsu et al. 2000). The function of A3 proteins was first described, when A3G found to have a very potent counter action against HIV-1 replication (Sheehy et al. 2002). The most important of APOBEC genes, A3 shows the antiviral activity against retroviruses.

The function of the A3s was first observed from the depiction of the one of the HIV-1 accessory protein, Vif. Vif is a viral accessory protein expressed by all retroviruses, except equine infectious anemia virus (EIAV). Expression of Vif is dispensable in permissive cells but its presence is absolutely required for HIV-1 replication in non-permissive cells (Gabuzda et al. 1992, von Schwedler et al. 1993). In the absence of Vif, HIV-1 replication is severely hampered at the reverse transcription step in the target cells. By genetic complementation assay, the fusion of permissive and non-permissive cells showed that this activity is inheritable (Madani and Kabat 1998, Simon et al. 1998). This elaborated that antiviral activity in the non-permissive cells is due to the presence of a dominant inhibitory factor, which later identified as A3G (Sheehy et al. 2002, Harris and Liddament 2004). This discovery opened the further investigation in the other related proteins. Later on, other proteins related to the same family were shown to have antiviral activity like A3F, A3B, A3DE and A3H (Bishop et al. 2004, Wiegand et al. 2004, OhAinle et al. 2006). A3A and A3C do not have any anti-HIV-1 activity but they have antiviral activity against AAV and SIV replication, respectively (Yu et al. 2004, Chen et al. 2006). Among A3 proteins, A3B is expressed very poorly. Highly polymorphic A3H has seven haplotypes (I-VII), of which only II, V and VII is stably expressed (Harari et al. 2009, Wang et al. 2011b). The expression of A3 proteins is highly inducible by INFs, especially in myeloid cell lineage (Koning et al. 2009).



### 6.4.1. APOBEC3 inhibits RT

A3 proteins are typically packaged with the budding virions, during the replication of HIV in producer cells. When this A3 packaged virion infects the target cell, the viral replication is inhibited due to the presence of A3 already delivered with virion (Harris et al. 2003, Khan et al. 2009). The human A3G has two Z domains. The N-terminal Z domain does not have catalytic activity, but it has high affinity for RNA-binding. This N-terminal Z domain along with YYxW motif plays an important role for packaging of A3G in the virion by interacting with the HIV-1 Gag protein (Schafer et al. 2004). This motif is also essential for A3H packaging. In the target cell, the viral replication is inhibited by the enzymatic activity of the C-terminal Z domain. The viral replication is inhibited at reverse transcription step by either cytosine deamination-dependent or independent processes. In cytosine deamination-dependent mechanism, the C-terminal Z domain directly deaminates cytosines to form uracils during synthesis of cDNA (Lecossier et al. 2003). This enzymatic activity leads to changes in cDNA sequence, due to the presence of uracils. The presence of uracils in the DNA molecules is recognized by the DNA repair mechanism for their degradation. Moreover, A3F and A3G can directly block the reverse transcription, in addition to their induction of hypermutation. They reduce the DNA strand transfer, elongation of RT and also inhibit viral integration in the host DNA. Still, catalytic activity of A3 proteins is always necessary for proper inhibition of viral replication, but sometimes they can also act as deamination-independent (Zhang et al. 2003). In addition, the effects of A3 proteins are dependent on other cellular cofactors (**Figure 20**).

### 6.4.2. Vif counteracts APOBEC3G

As described earlier, the A3G packaging is necessary for its antiviral activity and Vif has the ability to exclude A3 proteins from newly producing virions. This may be done by degradation of A3 proteins or by degradation dependent mechanism. The A3 proteins can be targeted to their proteasomal degradation by the host UPS. This degradation results in the insufficient packaging of A3 protein in virions. Vif interacts with Cul5 E3 ubiquitin ligase complex (Cul5-ElonginB-ElonginC) (Yu et al. 2003). First, Cul5 interacts with A3

proteins via their C-terminal motifs. Secondly, Vif interacts with A3 proteins via widely distributed motifs specific for each A3 protein. These interactions lead to complex formation including A3-Vif-Cul5-ElongB-ElongC, to induce the polyubiquitination and proteasomal degradation (Mehle et al. 2004). The A3G has different lysine sites for polyubiquitination namely Lys-297, 301, 303 and 304 (Iwatani et al. 2009). Interestingly, the polyubiquitination of Vif itself is critical for A3G proteasome-mediated degradation (Dang et al. 2008). The proteins targeted for proteasomal degradation should have at least two signals i.e. polyubiquitination and an unstructured region (USR). The polyubiquitin chain is necessary for proteasome recognition and USR for its entrance in the proteasome. Missing any signal will halt the protein degradation. A protein may have either both signals on it; or one signal on each of two interacting proteins (Prakash et al. 2009). The role of ubiquitination of A3G and Vif are still unclear in the neutralization of A3G (**Figure 18**).

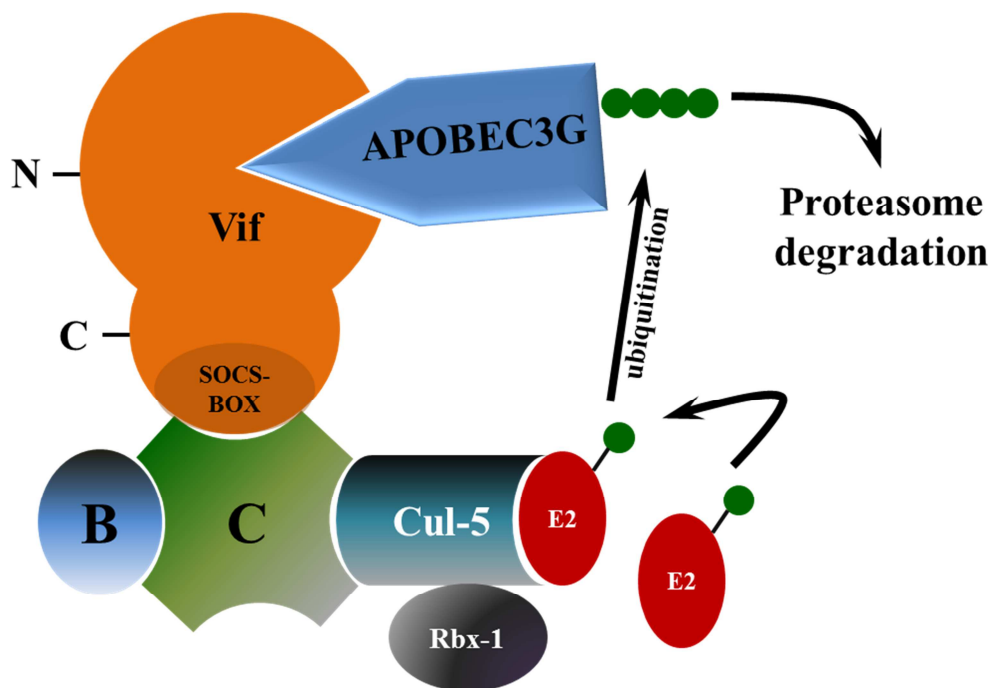

**Figure 18: Degradation of APOBEC3G by Vif by host ubiquitin proteasome system.**

APOBEC3G is recruited by Vif to a Cul-5 E3 ubiquitin ligase for its polyubiquitination and proteasomal degradation (Adapted from (Lv et al. 2007)).

The action of Vif is highly species-specific, thus Vif from one virus may not be active in other species. Recently identified cofactor of Vif, core-binding protein  $\beta$  (CBF- $\beta$ ) increase its binding to target DNA. The ability of Vif to degrade A3G was compromised by knocking down expression of CBF- $\beta$  (Jager et al. 2012a, Zhang et al. 2012b). In Addition, A3G degradation-dependent mechanism is not the only mechanism adopted by Vif to neutralize A3G. Vif can block A3G encapsidation even in the absence of proteasomal degradation (Kao et al. 2004). The neutralization of A3G by Vif is dependent on relative levels of protein expression. As expression of A3G is interferon inducible, the expression of A3G may exceed to a level where Vif is not enough sufficient to neutralize A3G (Iwabu et al. 2010). Secondly, Vif itself can be targeted for hypermutation and may lead to the production of defective Vif. The balance between Vif and A3G can be disturbed to inhibit viral replication by pharmacological interventions (Monajemi et al. 2012).

## **6.5. SAMHD1**

Cells of myeloid lineage like macrophage and dendritic cells are more resistant to HIV-1 infection than CD4+ T-cells (Yu et al. 1991). The major clues to understand the mechanism by which these cells can avoid HIV-1 infection came with the findings of Vpx. This protein is present in HIV-2 or SIV (naturally absent in HIV-1), is shown to increase the HIV-1 susceptibility in the myeloid cell types when infected with Vpx. Without Vpx, HIV-1 infection in these cells is not sufficient. So, the idea arises that these cells have a restriction factor that can only be counter-acted by Vpx. This protein was identified as SAMHD1 by affinity purification and mass spectrometry. Moreover, knock down of SAMHD1 in the myeloid cells made them permissive to HIV-1 infection, which confirms that SAMHD1 plays a vital role to inhibit HIV-1 infection in these cells (Hrecka et al. 2011, Laguette et al. 2011, Planelles 2011). SAMHD1 also inhibits the HIV-1 replication in restring CD4+ T cells (Baldauf et al. 2012).

### **6.5.1. SAMHD1 decreases levels of dNTPs.**

SAMHD1 is a protein composed of two distinct domains. These domains are sterile alpha motif (SAM) and phosphohydrolase (HD) domain, and thus referred as SAMHD1. The two domains of SAMHD1 have different functions in

the cells, SAM domain is a putative protein and RNA interacting part and HD domain is known for its deoxynucleoside triphosphate triphosphohydrolase activity (Goldstone et al. 2011, Lahouassa et al. 2012a). SAMHD1 mutations are present in many Aicardi-Goutieres Syndrome patients showing viral infection symptoms (Powell et al. 2011).

SAMHD1 inhibits the HIV-1 infection in the myeloid cell types by decreasing the pool of cellular deoxynucleotide triphosphates (dNTPs), which is essential for reverse transcription (Lahouassa et al. 2012b). HD domain of SAMHD1 acts as dNTP triphosphohydrolase directly to control the intercellular dNTP pool. SAMHD1 is localized in the nucleus but it still can block reverse transcription that occurs in the cytoplasm (Ayinde et al. 2012, Brandariz-Nunez et al. 2012). As non-dividing cells do not need high levels of dNTPs, unlike dividing cells; so the catalytic activity of SAMHD1 on dNTPs does not harm in these cells. Although, SAMHD1 is expressed endogenously in the CD4+ T cells, but they also maintain high levels of dNTPs. In short, the presence of SAMHD1 decreases dNTPs and reduces HIV-1 infectivity (Fujita et al. 2012, Amie et al. 2013) (**Figure 19**).

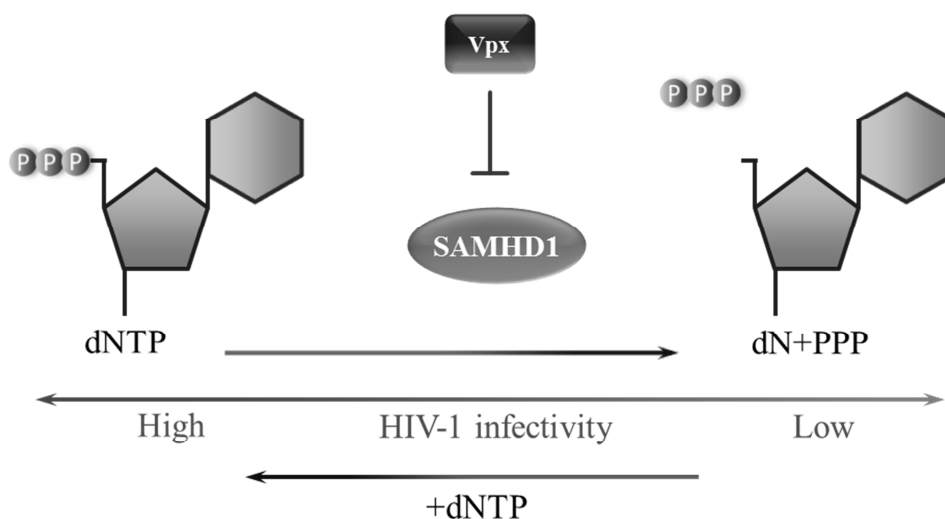

**Figure 19: Effect of SAMHD1 on dNTP and Vpx can block this process.**

SAMHD1 can hydrolyze dNTPs and this process can be inhibited by Vpx. Virus infectivity is directly related with concentration of dNTPs in the cytoplasm (Adapted from (Hofmann et al. 2012)).

### 6.5.2. Vpx induces degradation of SAMHD1

Vpx relieves the inhibition of HIV-1 infection by SAMHD1 in macrophages. Vpx helps the macrophage to maintain sufficient levels of dNTPs required for reverse transcription (Lahouassa et al. 2012b). HIV-1 infection in macrophages is inhibited by a mechanism, which prevents an undesired interferon response.

Vpx can inhibit the activities of SAMHD1 by targeting it to proteasomal degradation. When virion packaged with Vpx enters the dendritic cell, the concentration of SAMHD1 is reduced due to its proteasomal degradation by hijacking the cellular CRL4 (DCAF1) E3 ubiquitin ligase. Vpx only functions as a platform to load SAMHD1 on to the E3 ubiquitin ligase complex containing Cul4, DCAF1 and DDB1 (Zheng et al. 2012). These interactions induce the polyubiquitination of SAMHD1 and eventually its degradation by proteasome (**Figure 20**).

SAMHD1 is recruited to the CRL4 (DCAF1-Vpx) E3 ubiquitin ligase, by interacting with its C-terminal HD domain. There was no stable DCAF1 association alone, meaning Vpx is necessary for this interaction. Thus, Vpx interacts via its N-terminus with DCAF1 and recruits SAMHD1 by C-terminus to CRL4 E3 ubiquitin ligase for its proteasomal degradation (Ahn et al. 2012, Laguette et al. 2012). SAMHD1 is localized in the nucleus of the cells by its nuclear localization signal (NLS), KRPR sequence at amino acid residues 11-14. NLS-mutated or deleted SMHD1s are localized in the cytoplasm of the cells. Its catalytic activity is not hampered by this relocalization and it still can hydrolyze the cellular dNTPs. This relocated SAMHD1 retains its antiviral activity even in the presence of Vpx (Hofmann et al. 2012).

Moreover, the nuclear localization is necessary for its proteasomal-mediated degradation of Vpx. Vpx induces the degradation of the SAMHD1 in the nucleus, and SAMHD1 present in the cytoplasm resists this degradation. Although, Vpx can interact with cytoplasmic SAMHD1 but it is unable to induce its proteasomal degradation. The proteasomal mediated degradation of SAMHD1 is confined to nucleus. Indeed, in the presence of leptomycin B, which retains the complexes in the nucleus, Vpx can induce the degradation of nuclear SAMHD1 and this degradation is still proteasomal mediated (Hofmann et al.

2012). The ability of primate lentiviruses to induce the degradation of SAMHD1 has preceded the emergence of Vpx (Lim et al. 2012, Amie et al. 2013).

Altogether, SAMHD1 is a potent restriction factor in myeloid type cells, which can inhibit HIV-1 replication by reducing cellular dNTPs. The accessory protein of HIV-2/SIV, Vpx can load this SAMHD1 to CRL (DCAF1) E3 ubiquitin ligase for this proteasomal degradation. Finally, this degradation is confined to nucleus, Vpx cannot degrade cytoplasmic SAMHD1 (Romani and Cohen 2012, Schaller et al. 2012).

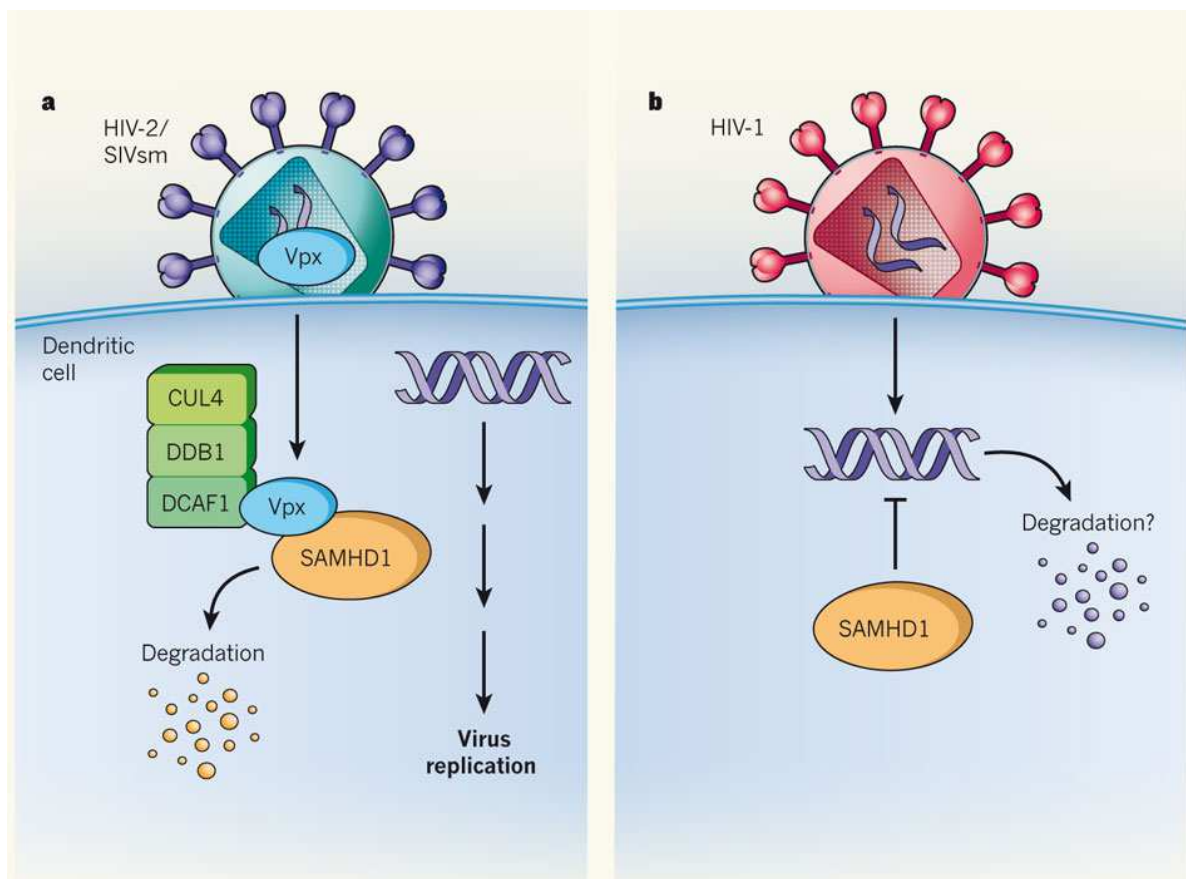

**Figure 20: Replication of reteroviruses in dendritic cell with Vpx and without Vpx.**

**a)** A lentivirus equipped with Vpx can infect a dendritic cell, by inducing SAMHD1 degradation. **b)** When HIV-1 infects a dendritic cell, SAMHD1 inhibits its reverse transcription by decreasing dNTPs level, this leads to degradation of reverse transcription complex (Lim and Emerman 2011).

## **7. Reservoir and latency**

Latency can be defined as the ability of a pathogenic virus to lie dormant inside the cell with little to no viral replication (Geeraert et al. 2008). HIV-1 latency was first observed in the patient successfully treated with HAART, due to re-emergence of viremia after the cessation of therapy (Peterlin and Trono 2003). Viruses from residual replication do not show significant signs of evolution in their genome (Hermankova et al. 2001). These observations support the re-emergence of wild-type strains when lifting treatment (Finzi et al. 1997, Wong et al. 1997). The reappearance of these infectious viruses, however inadequate to the therapeutic environment, is explained by the presence of viral reservoirs (McNamara and Collins 2011).

### **7.1. Anatomical reservoirs**

Anatomical reservoirs or viral sanctuaries are defined as immunologically preferred areas where the virus replication kinetics will be more stable than replicating active viruses in the rest of the body. In these reservoirs, virus can persist for longer periods, due to their limited access (Blankson et al. 2002). Anatomical barriers separate viral sanctuaries of blood and lymphoid organs, reducing the diffusion of ARVs in these sites (Solas et al. 2003). This feature allows the virus to continue its residual replication and help to maintain a state of permanent tissue inflammation in the sanctuaries. There are three main reservoirs:

Genital tract and the central nervous system (CNS), isolated respectively by the blood-testis barrier and the blood-brain barrier and lymphoid organs (mainly in the digestive tract), resting place of memory T lymphocytes (Saez-Cirion et al. 2011, Eisele and Siliciano 2012, Bierhoff et al. 2013).

### **7.2. Cellular reservoirs**

The hypothesis of the existence of latent viral reservoirs cell was quickly validated. Although the latency is very rare in resting CD4+ T-cells after infection, one cell per million infected cells enters into latency but it occurs very

early during infection of HIV-1 (Chun et al. 1997, Finzi et al. 1997). These cellular reservoirs come to being either from direct infection of memory T-cells or infection of activated CD4+ T-cells. The CD4+ T-cells are highly susceptible for infection and usually this infection appears to be productive, thus causing the death of the infected cell within few days of infection. T-cells that are in a process of reverting to a resting state are also infected by HIV-1. The infection in these cells may lead to the cells where cells harbor the HIV-1 DNA integrated in the genome but not producing HIV-1 (**Figure 21**). Persistence and slowed metabolism of CD4+ memory T-Cells helps the establishment of non-productive long term virus reservoir (Chomont et al. 2011).

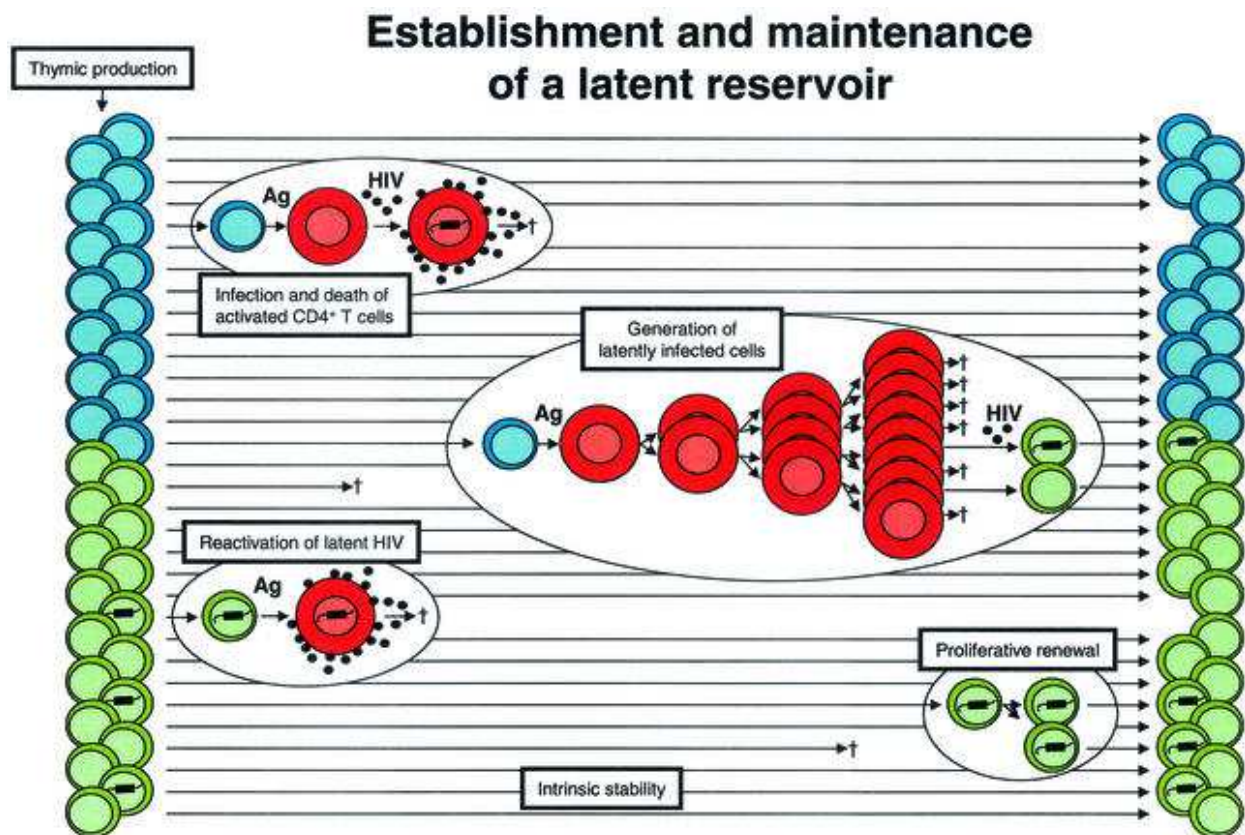
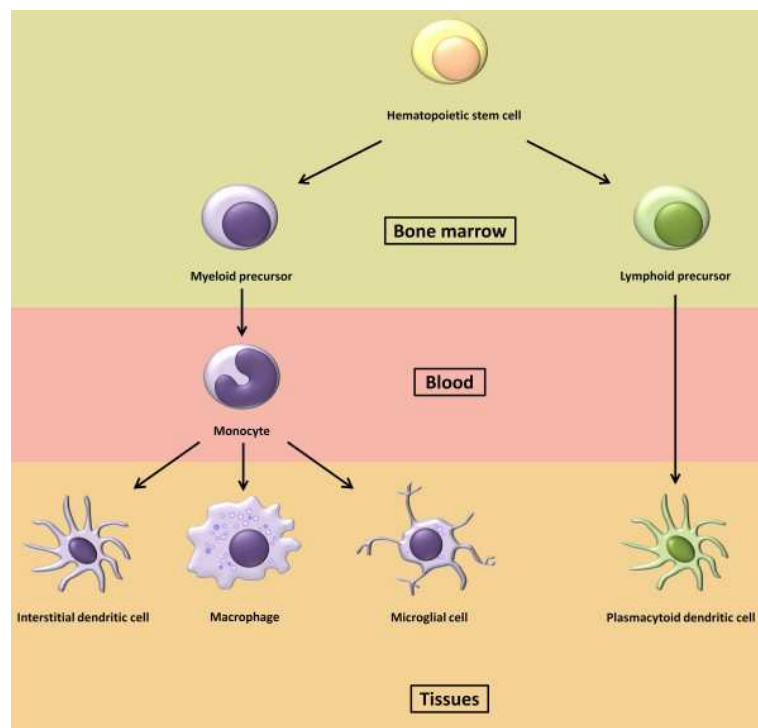

**Figure 21: Establishment of a latent reservoir in resting T-cell.**

The naïve T-cells (blue) can differentiate into active T-cells (red). Latent reservoir can be developed either from infection of resting T-cell or by the conversion of infected T-cell into memory T-cell (green) (**Persaud et al. 2003**).



In addition, after a rebound viremia following interruption of ARV treatment, the genetic analysis indicated that CD4+ T-cells are not the only zone for latent virus reservoir (Bailey et al. 2006, Chomont et al. 2011). Based on these observations, cells of the monocyte / macrophage have been proposed as a source of viral latency in turn (**Figure 22**). Indeed, replication is possible in these cells and more importantly these cells can persist for long periods in the body (Herbein et al. 2010, Le Douce et al. 2010, Eisele and Siliciano 2012).



**Figure 22: Cells of monocyte/macrophage lineage.**

Hematopoietic stem cell appears to be precursor of the entire monocyte/macrophage lineage. It gives rise to different types of macrophages in the tissues (**Le Douce et al. 2010**).

### 7.2.1. Microglial cells

Microglial cells or microglia are the resident macrophages of the CNS. They were first described as third element by Cajal (1913), as they were morphologically different from neurons (first element) and astrocytes (second element). Microglial cells are capable of *in-situ* proliferation and persist for the lifetime of the individual (Suh et al. 2005). Due to the presence of CD4

receptors, CCR3 and CCR5 co-receptors, microglia are the primary targets of HIV-1 in the CNS and are infected very early during the acute phase of the disease (Jordan et al. 1991, He et al. 1997). Viral replication is then quickly stopped, causing the virus into latency and making the main reservoir of microglia in CNS (Davis et al. 1992, Barber et al. 2006, Le Douce et al. 2012a).

In the final stages of the disease, the inflammation caused by the rebound viremia reactivates the reservoir and the number of productively infected microglia increases drastically (Cosenza et al. 2002). The number of activated brain macrophages is also closely linked to HIV-associated dementia during AIDS (Glass et al. 1995).

## **7.3. Molecular latency**

There are two forms of latency, pre-and post-integrative latency.

### **7.3.1. Pre-integrative latency**

In pre-integration latency, the latency is established before the integration of provirus into the genome of the infected cell (Zack et al. 1990). This latency may occur due to a defective import of the provirus into the nucleus or due to a disturbance at the reverse transcription step. The reverse transcriptase activity can be disturbed by a pool of insufficient dNTPs available or by hypermutation of the viral genome during reverse transcription by APOBEC3 (Bukrinsky et al. 1992, Zack et al. 1992).

This form of latency is regularly observed in CD4<sup>+</sup> T cells, but does not explain the existence of long-term reservoirs. Indeed, the half-life of non-integrated viral DNA is only one day. This is not the case in macrophages, where non-integrated viral DNA can persist for up to two months and can be transcribed (Gillim-Ross et al. 2005, Kelly et al. 2008).

### **7.3.2. Post-integrative latency**

In this latency, the viral replication is blocked after the integration of the provirus in the host DNA. A post-transcriptional block may be the cause of post-integrative latency. Indeed, viral mRNAs may be retained in the nucleus or targeted by *miRNAs*, thereby preventing the production of viral proteins, which impede full replication cycle (Lassen et al. 2006, Huang et al. 2007). Although the mechanisms of post-transcriptional blockages have an important role in maintaining latency, our focus will be more specifically on the events occurring at the level of transcription of the provirus.

### 7.3.2.1. Provirus nucleosome structure

The viral promoter or LTR contains many sites for cellular transcriptional activators and repressors. The viral promoter is structured in three regions, comprising four zones, respectively, from 5' to 3' (**Figure 23**):

The **modulatory region**, from -454 to -104, contains binding sites for cis-repressors and cis-activators for transcriptional activity. This area is, whatever the site of integration, the seat of the nucleosome 0 (Nuc-0), which will limit the access of regulatory proteins.

The **enhancer region**, from -105 to -79 contains binding sites for the tandem heterodimer NF- $\kappa$ B, a transcription factor essential. Between these two sites of NF- $\kappa$ B sites, there is an AP-2 protein, another activator of viral transcription.

The **core promoter**, from -78 to -1 is the minimum unit for the initiation of transcription. There are both TATA box and initiator-like region, both binding sites of the RNAPolIII. This area also contains three sites for Sp1 protein that serves as a platform anchoring other regulatory proteins (for review (Rohr et al. 2003a, Stevens et al. 2006)).

These three zones are contained within the U3 region, while the transactivating **TAR element** is contained within the region R of the LTR. This area will give rise to the stem-loop structure for the initiation of transcription. This area then recruits the viral transactivator Tat, which interacts with the elongation factor P-TEFb, necessary to improve the processivity of RNAPolIII. In addition, as the U3 region, this area is invariably the site of nucleosome 1, Nuc-1

provirus that blocks and prevents the RNAPolII from initiation of transcription (Van Lint 2000). After Nuc-1 is U5 region, which contains additional binding sites for transcription factors AP-1, SP1, NF-AT, Sp1 and IRF-1 (Rohr et al. 2003a). **(Figure 23)**

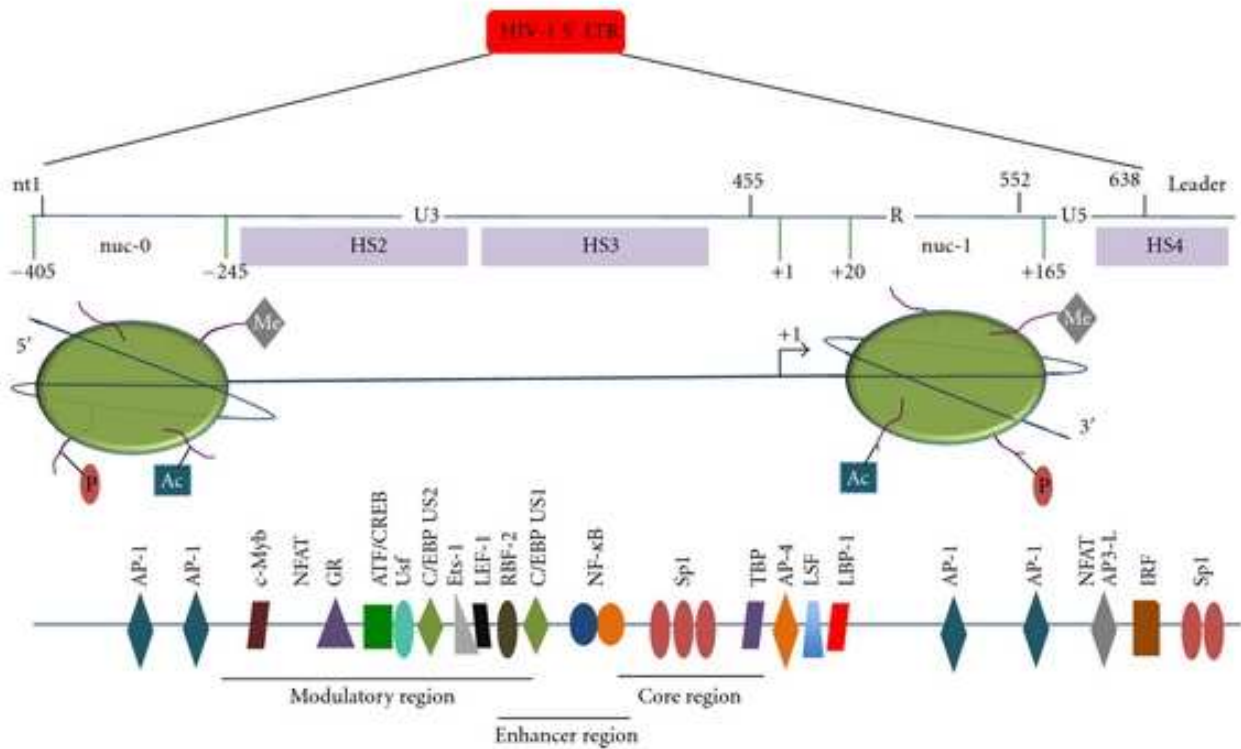

**Figure 23: Molecular structure of HIV-1 LTR.**

HIV promoter LTR has 3 regions (U3, R and U5 regions) containing sites for the different regulatory proteins for HIV-1 transcription (Li et al. 2012).

The area between the nucleosomes Nuc-0 and Nuc-1 contains the amplifying region and core promoter. This sequence is accessible to transcriptional modulators and will be the site of competition between activators and repressors factors. Competition between these transcription factors are responsible for epigenetic modifications of Nuc-1 and lead to the closing and opening of chromatin at the LTR.

### **7.3.2.2. Heterochromatin**

The integration of the provirus in heterochromatin areas is not the only explanation for the transcriptional latency. Indeed, it has been established that the provirus integrates majority (93%) in introns belonging to transcriptionally active regions of the host genome (Han et al., 2004). The simplest hypothesis to explain the transcriptional latency is to turn its promoter site from active site to a heterochromatin structure. The heterochromatin is a condensed structure of the DNA. Compaction of genes in a heterochromatin inactivates their transcription (**Figure 24**).

The fundamental unit of chromatin, the nucleosome, is a protein octamer of histones. These histones can be modified post-translationally by acetylations, phosphorylations, methylations, ubiquitinations and SUMOylations. The histone code modifications are not irreversible, which makes the chromatin state labile and increases the complexity of the transcriptional activity of genes. These changes, which have an impact on the expression profile of genes without altering the genome, are referred as epigenetic modifications (Kouzarides 2007).

Acetylation of histones by histone acetyl-transferases (HAT) is associated with the formation of euchromatin, the transcriptionally active state of chromatin, while the de-acetylation by histone deacetylases (HDACs), leads to the formation of heterochromatin. The acetylation state is directly correlated with transcriptional activation state. Conversely, sumoylation results in the formation of heterochromatin (Wurtele et al. 2009) (**Figure 24**).

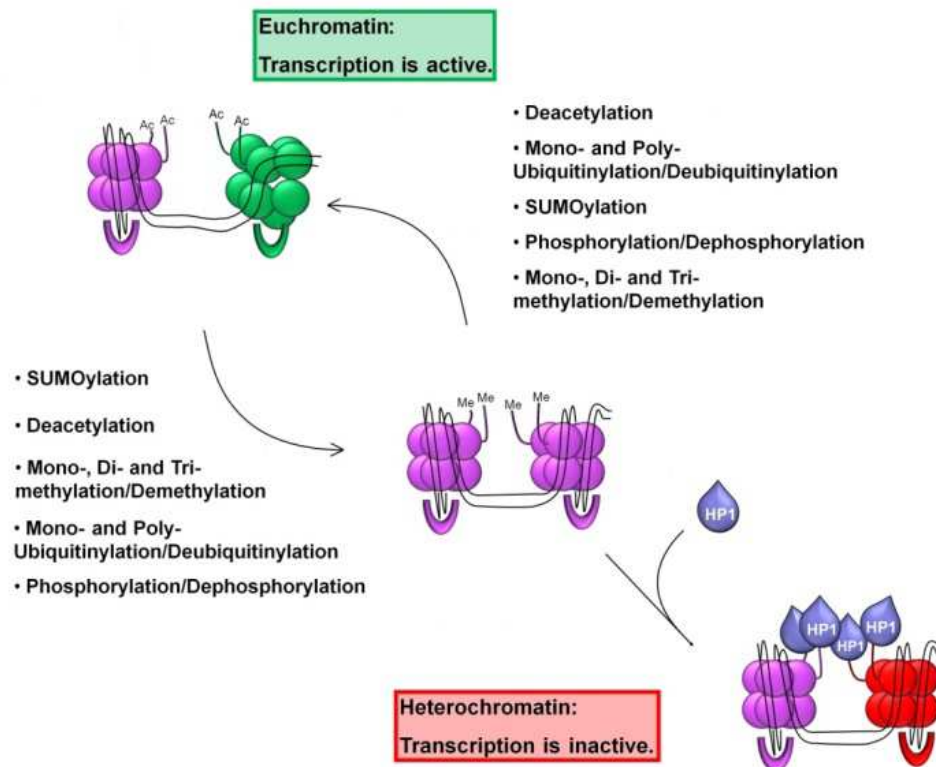

**Figure 24: Epigenetic modifications and control of transcription.**

Transcriptionally active chromatin, euchromatin is shown as **green** and transcriptionally inactive state, heterochromatin as **red** (Schwartz et al. 2010) with modifications).

## 7.4. CTIP2

Chicken ovalbumin upstream promoter transcription factor (COUP-TF) along with Sp1 promotes HIV-1 LTR-mediated transcription (Rohr et al. 1997). CTIP2 (COUP-TF interacting protein 2) is a transcription factor involved in the differentiation and development of the immune system and the central nervous system, inducing the formation of heterochromatin on its target promoters (Enomoto et al. 2011, Kominami 2012). CTIP2 also functions as a key factor to control proliferation of labile epithelium and induces developmental asymmetry of the mouse incisor (Kyrylkova et al. 2012). Moreover, its removal from double positive stage of T cell development or only in T (reg) cells results in the development of autoimmune disease, inflammatory bowel disease (IBD) (Vanvalkenburgh et al. 2011).

CTIP2 works as a general transcriptional repressor of the HIV-1 LTR in the T cells, by interacting with the NuRD complex (Cismasiu et al. 2008). Our laboratory has highlighted the role of CTIP2 in the repression of viral transcription. CTIP2 is indeed capable of inhibiting the late phase transcription by inhibiting Tat-dependent transactivation. Tat is relocated in CTIP2 ball-like sub-nuclear structures containing dense protein HP1 $\alpha$ , heterochromatin indicator areas. The relocalization of Tat in the heterochromatin environment leads to inhibition of HIV-1 transcription (Rohr et al. 2003b). In addition to the disruption of the transactivation pathway, we demonstrated that CTIP2 was able to repress the initial phase of HIV-1 transcription by interacting with Sp1. CTIP2 represses the COUP-TF-Sp1 mediated activation of HIV-1 promoter. CTIP2 colocalizes in complex containing Sp1, COUP-TF and HP1 $\alpha$  to promote heterochromatin formation (Marban et al. 2005). Moreover, CTIP2 promotes the establishment of epigenetic marks inducing the formation of heterochromatin. For that CTIP2 recruits a histone modifying enzyme complex including HDACs (1 and 2) and SUV39H1 methyltransferase. CTIP2 by recruiting HDACs deacetylates H3 histones of the viral LTR and specifically Nuc-1 H3 histones. This is followed by the establishment of the repressive mark on H3K9me3 by SUV39H1. This mark, H3K9me3 allows the recruitment of HP1 $\alpha$  protein, which will stabilize the heterochromatin structure of Nuc-1 and allow compaction cascade following nucleosome along the provirus (Marban et al. 2007) (**Figure 25**).

Moreover, LSD1 (lysine-specific demethylase 1) can repress the HIV-1 transcription and in a synergistic manner with CTIP2. LSD1 is working as an anchorage protein that allows the recruitment of WDR5 and SET1, two proteins belonging to the hCOMPASS complex. This complex induces the trimethylation of H3K4 via H3K4me3 and H3K9me3 epigenetic marks. These epigenetic marks were also previously described for CTIP2. LSD1 is involved in the establishment and persistence of latency in microglial cells (Le Douce et al. 2012b).

Thus, CTIP2 can affect the HIV-1 transcription directly for the establishment and maintenance of latency. CTIP2 has been described to exert anti-apoptotic activities in the T-cells lines, as CTIP2 KO leads to the apoptosis of thymocytes (Wakabayashi et al. 2003). The protein p21 is a cyclin-dependent kinase inhibitor and targets cyclin-CDK complexes. Interestingly, CTIP2 can have an indirect impact on the HIV-1 promoter by silencing the p21 gene. The expression of p21 allows the cell cycle arrest in G1, G2 or S-phase (Niculescu et al. 1998, Warfel and El-Deiry 2013). The activity of p21 is mainly regulated at the transcriptional level (Gartel and Radhakrishnan 2005). Thus, the modification of epigenetic marks in the vicinity of p21 promoter is of primary importance (Suzuki et al. 2000, Gartel and Tyner 2002, Lagger et al. 2003, Warfel and El-Deiry 2013).

In addition, p21 facilitates HIV-1 replication in macrophages by blocking the cell cycle under conditions favorable to its transcription (Thierry et al. 2004, Vazquez et al. 2005). In macrophages, the viral protein Vpr is recruited to the promoter of gene p21 via Sp1, which induces the production of p21 (**Figure 27**) (Amini et al. 2004).

We have also shown that CTIP2 is bound to the p21 promoter via Sp1, instead of Vpr. After the interaction with the promoter, CTIP2 will recruit the same multi-protein chromatin modifying complex previously mentioned (Figure 22). HDACs (HDAC1 and 2) activities and methyltransferase (SUV39H1) will establish marks associated with heterochromatin histones at the promoter p21. Thus, CTIP2 is capable of suppressing the production of p21, allowing to regulate viral transcription indirectly (Cherrier et al. 2009).



Additionally, we have recently been able to demonstrate that CTIP2 is also able to interact with the inactive P-TEFb complex along with HEXIM1 and 7SK snRNA. This interaction of CTIP2 leads to repression of the Cdk9 kinase activity of P-TEFb. (Cherrier et al., under revision PNAS 2013). CTIP2 interacts with HEXIM1 directly and with P-TEFb via loop 2 of 7SK snRNA, thus stabilizing the inactive complex in which P-TEFb is held (**Figure 26**).

Additionally, CTIP2 is also able to suppress the Cdk9 kinase activity of P-TEFb, when CTIP2 is part of the complex CTIP2/P-TEFb/Tat. By inhibiting Cdk9, CTIP2 limits CTD phosphorylation of RNAPolII, thus counteracting the ability of transactivator Tat, although the viral protein was able to extract inactive P-TEFb from 7SK snRNA complex. (Cherrier et al., under revision PNAS 2013). So, CTIP2 can control P-TEFb function in both physiological and pathological conditions.

Altogether, CTIP2 alone is able to repress directly the transcriptional activity of HIV-1 by establishing a compact chromatin environment at the viral promoter and limiting the function of the transactivator Tat. On the other hand, CTIP2 also has indirect negative effect on HIV-1 transcription i.e. via repression of p21 expression, or by sequestering P-TEFb in inactive complex associated with 7SK snRNA.

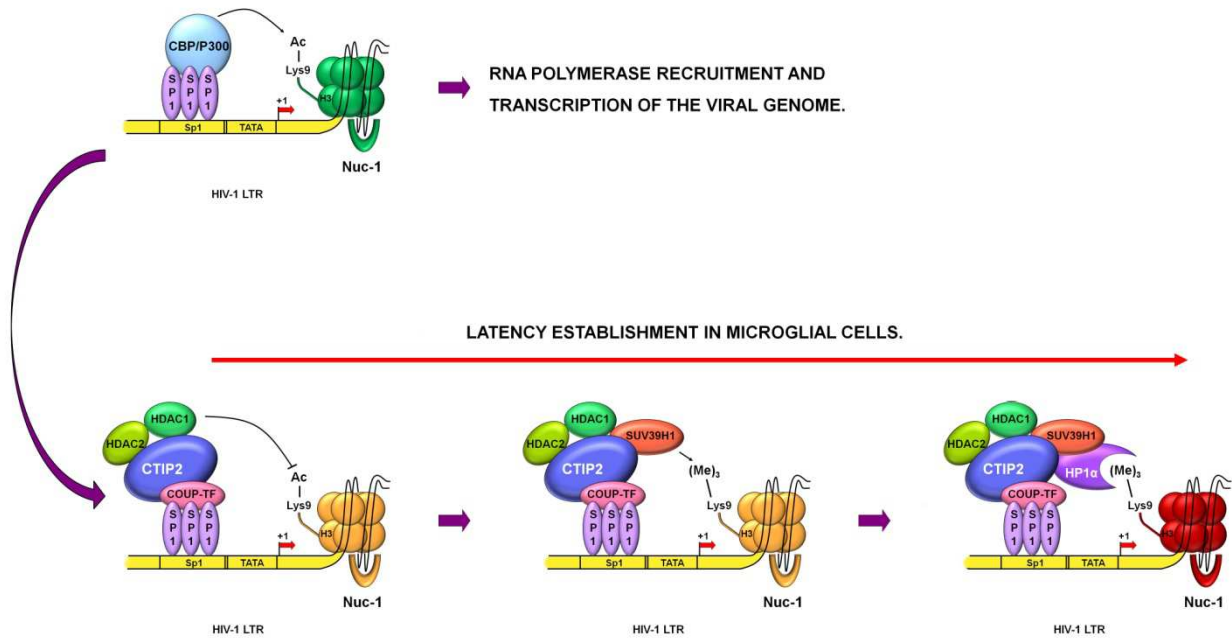

**Figure 25: CTIP2 represses the HIV-1 transcription by favoring heterochromatin structure (Schwartz et al. 2010).**

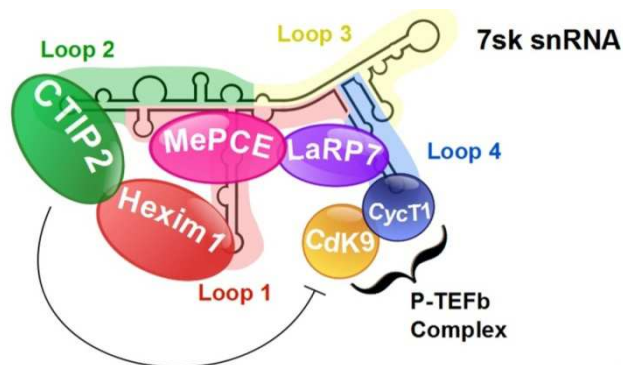

**Figure 26: CTIP2 can repress P-TEF-b target genes (Cherier et al. under revision PNAS 2013).**

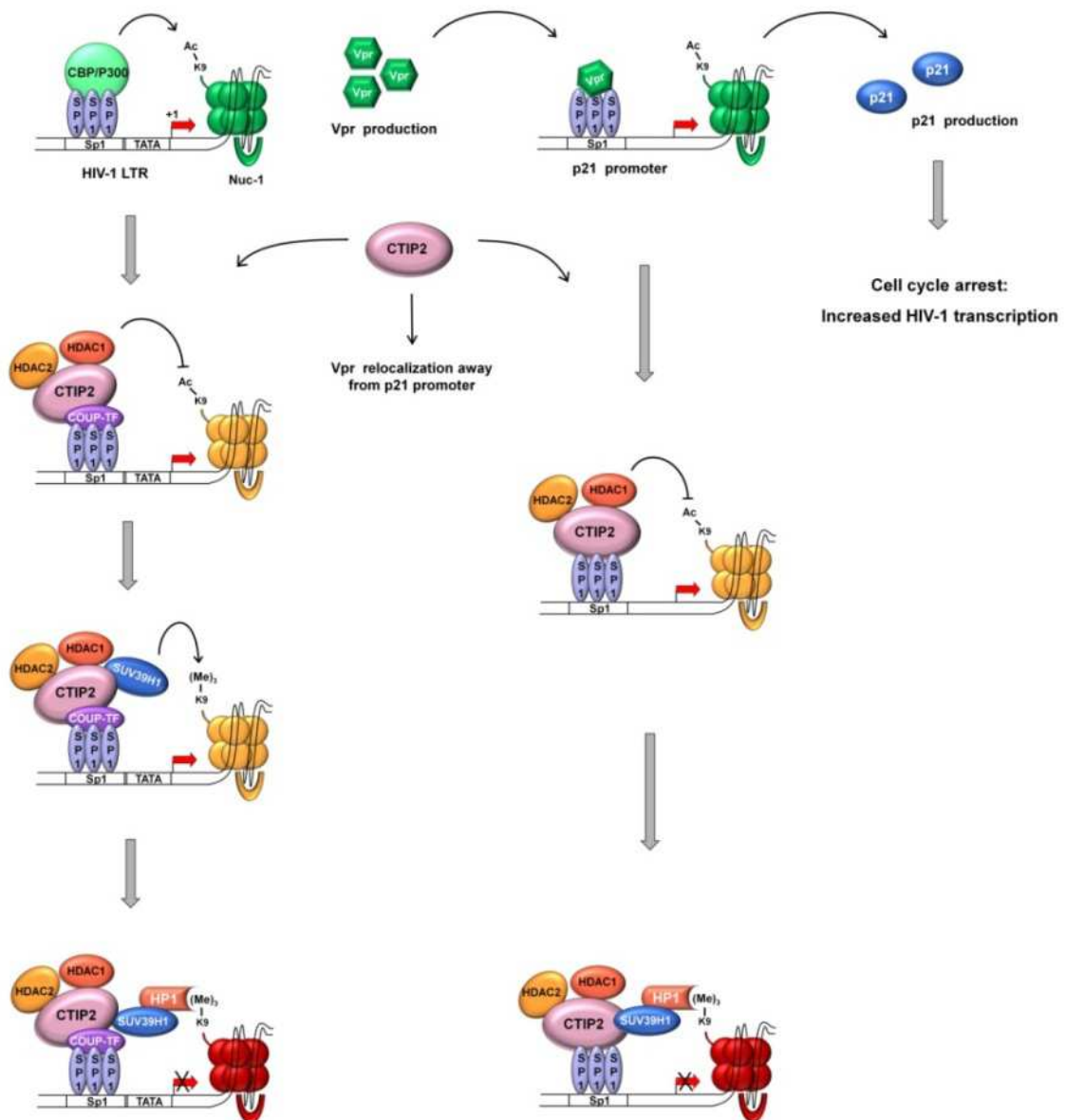

**Figure 27: Direct & indirect effects of CTIP2 on HIV-1 transcription**

CTIP2 associates with HEXIM1 and 7SK snRNA to repress P-TEFb kinase activity. CTIP2 represses HIV-1 transcription by via recruiting chromatin modifying complex to induce heterochromatin structure at Nuc-1. Secondly, CTIP2 can replace Vpr from p21 promoter and repress p21 production, via same mechanism to repress HIV-1 transcription (**Le Douce et al. 2010**).

## 7.5. Vpr and Cul4A-DDB1<sup>DCAF1</sup> E3 ubiquitin ligase.

Among many other functions attributed to HIV-1 Vpr one is the induction of cell cycle arrest at G2 phase. It has been described that the Vpr can induce the G2 arrest by targeting a cellular factor required for propagation of cell cycle. Indeed, Vpr can induce the degradation of a yet-to-be-identified cellular protein by recruiting it to Cul4 E3 ubiquitin ligase. The recruitment of the cellular protein to this E3 ubiquitin ligase, results in the ubiquitin conjugation. This post translational modification alters the function or subcellular localization of the protein. Usually, these polyubiquitin marks may lead to the proteasomal degradation (Belzile et al. 2007, DeHart et al. 2007, Le Rouzic et al. 2007, Tan et al. 2007, Wen et al. 2007). In the absence of Vpr, there are number of targets associated with Cul4-DDB1 E3 ubiquitin ligase, mimicking its involvement in DNA damage response (Shiyanov et al. 1999). The DDB1 protein links the target protein directly or indirectly, including histones, Chk1, p27<sup>kip</sup> etc. (Bondar et al. 2006, Kapetanaki et al. 2006, Leung-Pineda et al. 2009). The association of HIV-1 Vpr with the Cul4 ubiquitin ligase is essential for at least its three functions.

- 4) Induction of G2 cell cycle arrest by HIV-1 Vpr or HIV-2/SIV Vpr.
- 5) Enhancement of macrophage infection by HIV2/SIV Vpx.
- 6) HIV-1 Vpr can also degrade UNG2 and SMUG1 via Cul4 ubiquitin ligase (Schrofelbauer et al. 2005).

The biological significance of Vpr-induced G2 cell cycle arrest in dividing cells is still not clear. It is proposed that this phase of cell cycle provides optimal environment for viral replication, because during this phase we can observe active transcription and translation of mRNA. The production of virions was increased 2-to-3 folds in the presence of Vpr but it was quite less than expected (Goh et al. 1998). Although, this effects looks modest but virus production can be stimulated significantly due to cumulative effect after several replication cycles.

Vpr induces the formation of chromatin associated nuclear foci in the infected cells, which contain DCAF1. This formation of nuclear foci is related to its ability to induce G2 arrest as SIV Vpr can also form these nuclear foci but Vpx cannot. Interestingly, it has been suggested that Vpr recruits the Cul4A-DDB1DCAF1 E3 ubiquitin ligase to these nuclear foci. As, these nuclear foci are stable and mobile, they can target chromatin associated cellular substrates for their ubiquitination and subsequent degradation via 26S proteasome. This degradation of cellular protein ultimately leads to G2 cell cycle arrest in dividing cells (Belzile et al. 2010b).

Moreover, HIV-1 Vpr down regulates IRF3 (**interferon regulator factor 3**) but this degradation is not specific to Cul4A E3 ubiquitin ligase (Okumura et al. 2008). IRF3 is an essential factor for the production of interferon-beta (INF- $\beta$ ) (Doehle et al. 2009, Kogan and Rappaport 2011). Interestingly, expression of natural killer cell ligands is triggered by this DNA-damage response in the infected cells (Ward et al. 2009, Richard et al. 2010). Importantly, Vpr, alone or with virion infection, upregulates this expression of natural killer ligands to increase killing mediated by natural killer cells (Pham et al. 2011). The role of this upregulation of natural killer ligands is still ambiguous.

Macrophages and dendritic cells play a vital role in the host immune system to counter the invading infections. HIV-1 has the ability to infect the non-dividing cells albeit less efficiently and Vpr plays a vital role in this infection (Connor et al. 1995). HIV-1 is capable of counter acting these mechanisms of immune system to persist for longer periods of time. This lack of replication helps the virus to avoid the possible immune counteraction (Harman et al. 2006). Moreover, these cells can disseminate the infection to the CD4+ T cells by direct immunological synapse and to the sanctuaries to reduce the chance of its counteraction by immune system (McDonald et al. 2003). Infection in macrophages can help the viral pathogenesis by triggering the apoptosis in the CD4+ or CD8+ T cells (Oyaizu et al. 1993, Zheng et al. 1995). More importantly, as macrophage half-life is very long as compared to CD4+ T cells, they act as long-term reservoirs of virus (Herbein et al. 2010).

HIV-1 Vpr role in the macrophage infection is still ambiguous. For the replication of lentiviruses, the viral genome is transported in the nucleus and this is achieved without the disruption of nuclear membrane. Being karyophilic in

nature, Vpr can associate with PIC. Initial studies showed the increase of macrophage infection by HIV-1 Vpr by facilitating PIC in non-dividing cells (Bukrinsky et al. 1992, Popov et al. 1998, Fassati 2006), hinting towards the nuclear import signals of Vpr for nuclear transportation of PIC. As a virion packaged protein, Vpr can show its effects from the start of life cycle of virus. The transportation of PIC plays an important role in macrophages; however it was later revealed that none of these nuclear import signals is essential for macrophage infection in non-dividing cells (Yamashita and Emerman 2005, Riviere et al. 2010). Moreover, these signals are found on other components of PICs and nuclear import can be carried out without any known nuclear import signals (Riviere et al. 2010). Thus, Vpr-induced enhancement of HIV-1 infection in macrophages must be related with other mechanisms rather transportation of PIC or non-cycling status of macrophages. The cell type is very important for the function of Vpr, even from the same tissues. Vpr depletion appears to be significant in macrophages of lymphoid tissue explants but not to resting T cells from the same tissue (Zennou et al. 2001).

HIV-2 or SIV also infects the macrophage and even more efficiently than HIV-1 possibly due to better efficiency of Vpx (Sharova et al. 2008, Srivastava et al. 2008). The recent studies showed that Vpx can target host restriction factor present in macrophages to assist the viral replication. This restriction factor is identified as SAMHD1. Indeed, Vpx loads SAMHD1 to Cul4 E3 ubiquitin ligase for its polyubiquitination and proteasome-mediated degradation (Hrecka et al. 2011, Laguette et al. 2011) (for review (Sharifi et al. 2012)). **(Figure 28)**

More recently, another anti-HIV restriction factor has been proposed in macrophages. Indeed, the study focusing on effects of interferon-beta (INF- $\beta$ ) and lipopolysaccharide (LPS) on myeloid-derived lineage cells showed that they initiate mobilization of another new restriction barrier to retroviral infection. The INF- $\beta$ /LPS-induced restriction appears to be at or near PIC transportation but before integration of proviral, contrary to SAMHD1 that restricts retroviral infection during reverse transcription (Pertel et al. 2011). This proposed restriction factor can counteracted by HIV-2/SIV Vpx. Interestingly, HIV-2/SIV itself cannot take benefit of Vpx but HIV-1 can use this Vpx to counter this barrier. Although, Vpx relieves this restriction but this counter action does not require DCAF1. So, Vpx can inhibit this restriction either by direct blocking or

indirectly by depleting other proteins. Thus, proteins like Vpr and Vpx can counteract their targets by either via recruiting DCAF1 adaptor protein or without (for review (Sharifi et al. 2012)).

Moreover, Vpr can be found in free form in the serum or CSF in the infected patients. The HIV-1 infection can be disseminated to CNS by the transport of infected lymphocytes or monocytes. After the entry in CNS, lymphocytes and differentiated monocytes have the ability to produce the viruses and production of free Vpr. Among CNS residing cells, microglia are the primary target of HIV-1 infection and possibly can contribute in releasing the Vpr throughout the CNS. Resting microglia also contribute in this regards after infection albeit less than activated microglia (for review (Ferrucci et al. 2011)).

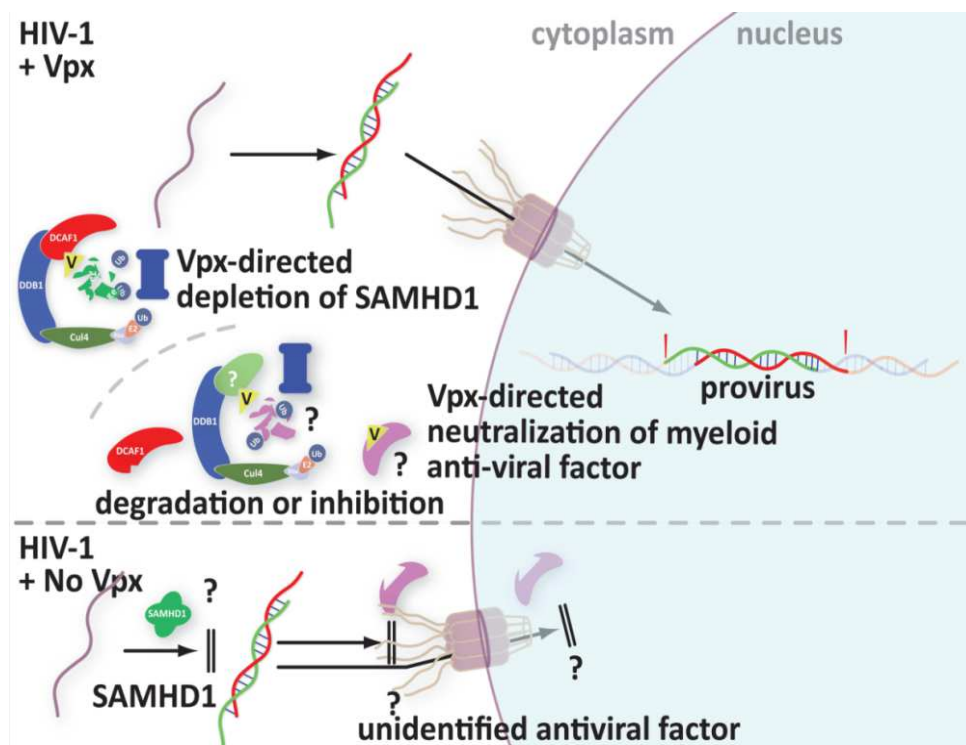

**Figure 28: Summary of restriction factors and their counteraction in myeloid cells (Sharifi et al. 2012).**

Recently, it has been described that Vpr interacts with various cellular proteins including DDB1, DCAF1, Cul4A, UNG, DYHC, HAT1, RbAp46 etc (Jager et al. 2012b). Interestingly, interaction of Vpr with HAT1 may suggest its ability to regulate acetylation of newly synthesized cytoplasmic histones (Verreault et al. 1998, Makowski et al. 2001). Its interaction with DYHC1 (Cytoplasmic dynein 1) may indicate its ability to transport the cellular protein via retrograde motility (Bharti et al. 2011). More interestingly, its association of RbAp46 (Retinoblastoma binding protein p46) indicates its role in histones remodeling (Murzina et al. 2008). RbAp46 is one of the seven subunits of NuRD (Nucleosome remodeling and histone deacetylase) complex. Other subunits include, HDAC (histone deacetylases) 1 & 2, RbAp48 (Retinoblastoma binding protein p48), MTA 1/2/3 (Metastasis-associated proteins), MBD3/2 (methyl-CpG-binding domain proteins) and CHD3/4 (chromodomain helicase DNA binding proteins) (Xue et al. 1998).

Altogether, Vpr is capable of induction of unknown cellular target for proteasome-mediated degradation, to induce G2 cell cycle arrest in dividing cells. In non-dividing cells, HIV-1 Vpr or HIV-2/SIV Vpx promotes viral replication via various mechanisms. One of these mechanisms is the counteraction against a cellular factor, possible detrimental for viral replication. The functions of the Vpr may be cell specific. HIV-1 Vpr may possibly induce the degradation of a protein or a class of protein, as UNG2 and SMUG1 share a common motif essential for Vpr interaction. And lastly not the least, Vpr may possible only acts as an enhancer for the constitutive degradation of a protein, as described by increase turnover of UNG2 in the presence of Vpr (Wen et al. 2012).



# **Aim of study**

HIV-1 accessory proteins use host ubiquitination system to degrade host cellular proteins to avoid their actions that hamper the HIV-1 replication. Indeed, HIV-1 Vpr, Vif and Vpu all are capable of hijacking the host ubiquitination proteasome system (UPS) to induce ubiquitination and therefore resulting in the proteasomal inactivation of their cellular target proteins. HIV-1 Vpr indeed engages with DDB1-cullin4A ubiquitin ligase complex via an adaptor protein, VprBP or DCAF1 that make a link to DDB1 (Belzile et al. 2007, Le Rouzic et al. 2007, Tan et al. 2007, Dehart and Planelles 2008). The HIV-1Vpr recruits a yet-to-be-identified cellular target to this complex for its ubiquitination and subsequent proteasomal degradation.

HIV-1 replication is hampered by the presence of restriction factors like TRIM5 $\alpha$ , tetherin, APOBEC3 and SAMHD1 in the specific cell types. The retroviruses can use their accessory proteins to counter the effects of these restriction factors. Indeed, HIV-1 Vpu counteracts tetherin (Neil et al. 2008, Van Damme et al. 2008, Mitchell et al. 2009) and Vif targets APOBEC3 for its proteasomal degradation (Mangeat et al. 2003, Sheehy et al. 2003). Recently, it has been shown that SAMHD1 is targeted by HIV-2 Vpx for its proteasomal-mediated degradation in myeloid-cell types (Hrecka et al. 2011, Laguette et al. 2011, Lahouassa et al. 2012b). Therefore, retroviruses counteract the host cellular proteins to help for their replication.

We had reported that the transcription factor COUP-TF interacting protein (CTIP2) plays a vital role in promoting viral latency by inhibiting viral replication in human microglial cells (Marban et al. 2007). Our research laboratory has previously shown that CTIP2 inhibits early and late gene transcription of HIV-1 in human microglial cells (Rohr et al. 2003b, Marban et al. 2005), by recruiting chromatin modifying enzyme complex (Marban et al. 2007). Moreover, CTIP2 is able to inhibit HIV-1 gene transcription indirectly by silencing the p21 gene transcription via inducing epigenetic modifications at p21 promoter (Cherrier et al. 2009).

Although, CTIP2 is identified as transcriptional inhibitor in microglial cells but HIV-1 can still avoid this transcriptional inhibition to replicate in the microglial cells. By comparing our previous studies and HIV-1 replication in the microglial cells, the question arises that how can HIV-1 bypass this CTIP-

mediated silencing in the HIV-1 permissive cells. Our previous experiments indicated that Vpr-mediated regulation can be modulated by expressing CTIP2. Moreover, we have observed that Vpr interacts with CTIP2 in microglial cells in its sub-nuclear structures. Moreover, we know that HIV-1 can productively infect microglial cells, this may suggest a counteractive mechanism adapted by HIV-1 to bypass this effect. Thus, we postulated that Can HIV-1 Vpr target undesired cellular proteins by the process of ubiquitination in these cells? The effect of proteasome inhibitor and knockdown of DCAF1 on the degradation of CTIP2 will be investigated. We will also explore the effect of depletion of Vpr from the HIV-1 by using pNL4.3 Vpr. By immunoprecipitation assays, we will identify the physical localization of the proteins and sequential immunoprecipitation assay will be used to decipher the different complexes of CTIP2 interacting with Cul4A-DDB1-DCAF1. Finally by confocal microscopy, we will observe the co-localization of different proteins of this complex in the microglial cells in the absence or presence of MG132.

# **Results**

## 1. Presence of Vpr is important for HIV-1 to down-regulate CTIP2 expression.

HIV-1 accessory proteins induce the degradation of host cellular proteins by hijacking the host ubiquitin proteasome system. HIV-1 accessory proteins induce the ubiquitination of these cellular proteins for their proteasomal degradation. CTIP2 has been described to induce the inhibition of early and late gene transcription of HIV-1 in the microglial cells. HIV-1 is still able to productively infect the microglial cells expressing low levels of CTIP2. This points that HIV-1 has evolved to counter this effect of CTIP2 in microglial cells. We have described that Vpr can interact with CTIP2 to regulate p21 function in microglial cells. Moreover, HIV-1 Vpr can interact with Cul4A-DDB1 E3 ubiquitin ligase complex via adaptor protein DCAF1 to induce the proteasome-mediated degradation of cellular proteins. This helped us to postulate that HIV-1 Vpr may be involved in the counter action of CTIP2 in microglial cells.

To investigate the effect of Vpr expression on CTIP2, we explored the effect of depletion of Vpr from the infectious provirus (pNL4.3- $\square$ ENV-luc *wt*). First, we normalized the amounts of each vectors (pNL4.3 $\square$  $\square$ ENV-luc *wt* and pNL4.3 $\square$  $\square$ ENV- $\Delta$ Vpr -luc) to be transfected in order to obtain the same level of transcription by using the luciferase assay. When we observe the same amount of luciferase production by both plasmids (**Figure 1B**), we used the same ratios of plasmids for the transfection along with stable amount of CTIP2. By western blot probed against CTIP2 antibody we revealed that the expression of CTIP2 was stabilized with depletion of Vpr from the pNL4.3- $\square$ ENV-luc (pNL4.3  $\square$ ENV-luc  $\Delta$ Vpr). We observed that the expression of CTIP2 is inhibited in the presence of pNL4.3- $\square$ ENV-luc *wt*, but the mutant of pNL4.3- $\square$ ENV-luc lacking Vpr failed to induce the inhibition of CTIP2 expression. Loading of the nuclear extracts was controlled by checking the presence of  $\beta$ -actin (**Figure 1A**). This result may suggest that expression of Vpr may down regulate the expression of CTIP2 and Vpr deletion from provirus reduces its down regulation effects of CTIP2.

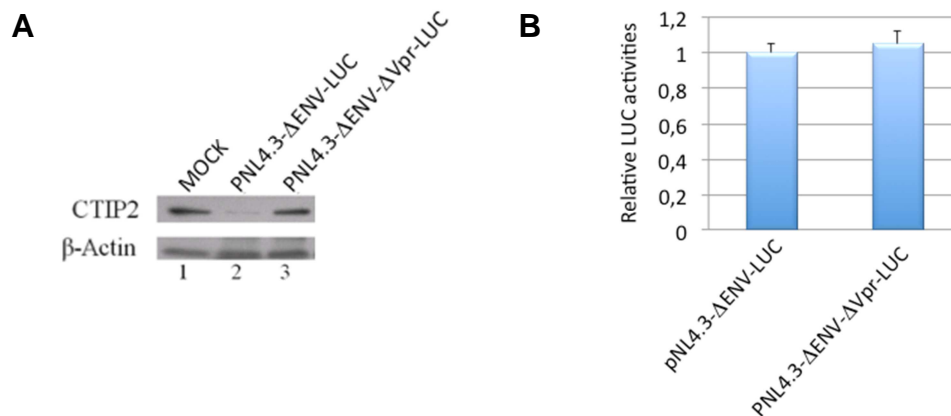

**Figure 1: Depletion of Vpr renders HIV-1 to degrade CTIP2.**

- (A) HEK293T cells transfected with vectors pNL4.3-ΔENV-luc *wt*, or pNL4.3-ΔENV-luc ΔVpr and with vector expressing CTIP2 were lysed. The presence of the indicated proteins was probed with anti-CTIP2 and anti-β-actin.
- (B) Microglial cells transfected with vectors expressing pNL4.3-ΔENV-luc *wt* or pNL4.3-ΔENV-luc ΔVpr were lysed and subjected to luciferase assays 48 hours post-transfection. The values are expressed relative to the value obtained with pNL4.3-ΔENV-luc *wt* (column 1).

## 2. HIV-1 Vpr is capable of CTIP2 degradation with no effect on CTIP2 mRNA.

This effect of HIV-1 Vpr was investigated by measuring the levels of CTIP2 expression in the absence/presence of HIV-1 Vpr *wt*. For this purpose, HEK293T cells were transfected with vectors expressing CTIP2 along with gradual increase of GFP-Vpr *wt*. By western blot probed with CTIP2 antibody, we noticed that the expression of CTIP2 is inversely correlated with the expression of HIV-1 Vpr *wt*, with stable expression of β-actin (**Figure 2A**). This suggested us that CTIP2 might be degraded by HIV-1 Vpr via ubiquitin proteasome system. To investigate the impact of Vpr on CTIP2 mRNA, we measured the levels of CTIP2 mRNA in the presence and absence of Vpr. Cells transfected with vectors expressing CTIP2 or/and Vpr were subjected to a quantitative RT-PCR to assess

the effect of Vpr on the levels of CTIP2 mRNA. We observed that the level of CTIP2 mRNA was not significantly affected in the presence of Vpr (**Figure 2B**), which further suggested that the lower expression of CTIP2 in the presence of Vpr was related to post-translational modification of this protein. Thus, we can say that overexpression of HIV-1 Vpr is correlated with lower levels of CTIP2, without affecting its mRNA levels.

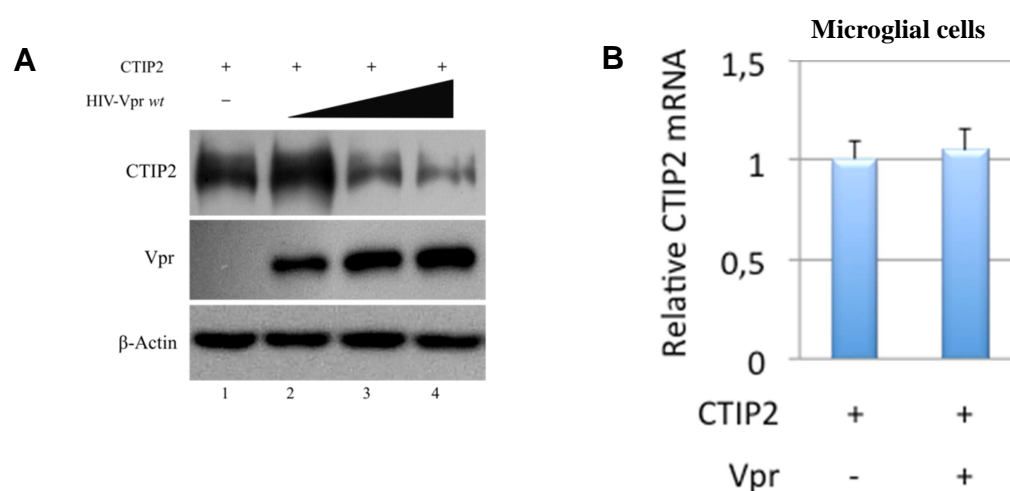

**Figure 2: Effect of HIV-1 Vpr on CTIP2 and CTIP2 mRNA.**

- (A)** HEK293T cells were transfected with vectors expressing CTIP2 and GFP-Vpr *wt* as indicated. Total amounts of transfected DNA were normalized by using mock vector. Expression of the indicated proteins was determined by Western blot analysis probed with anti-CTIP2, anti-GFP (Vpr) and anti- $\beta$ -actin antibodies.
- (B)** HEK293T cells were transfected with vector expressing CTIP2 along with mock vector or vector expressing Vpr. Total amounts of DNA were normalized by using mock. The expression of CTIP2 mRNA were measured by using quantitative RT-PCR and expressed in relative values to control.

### 3. HIV-1 Vpr enhances the proteasome-mediated turnover of CTIP2.

The proteasome-mediated degradation of proteins can be inhibited by the use of proteasome inhibitors such as MG132. These inhibitors block the function of proteasome by binding to its 20S proteasomal core via MB1 proteasomal subunit (Lee and Goldberg 1998). To assess the hypothesis of proteasome mediated degradation of CTIP2, we investigated the effects of Vpr on CTIP2 in the presence of MG132. The cells transfected with vectors expressing CTIP2 and HIV-1 GFP-Vpr *wt* were treated with either DMSO (control) or MG132 (proteasome inhibitor) for 12hr before their lysis. By western blot, we observed that CTIP2 is degraded in the presence of Vpr when the cells were treated with DMSO (**Figure 3, compare lanes 1 and 2**) but this degradation was constrained in the presence of MG132 (**Figure 3, compare lanes 3 and 4**), which confirmed our hypothesis that the degradation of CTIP2 by Vpr is carried out through proteasomal pathway. Interestingly, we noticed that the expression of CTIP2 in the absence of Vpr was also stabilized in the presence of MG132 (**Figure 3, compare lanes 1 and 3**). Indeed, we observed that there was more CTIP2 expressed in the presence of MG132 than DMSO. This may suggest that CTIP2 might be constitutively targeted for its proteasome-mediated degradation even in the absence of Vpr that was inhibited in the presence of MG132. The expression of HIV-1 Vpr uses this endogenous machinery to further abrogate the expression of CTIP2. These results indicated that HIV-1 Vpr may enhance the ongoing constitutive degradation of CTIP2 and this degradation of CTIP2 is achieved by using the cellular ubiquitin proteasome system.



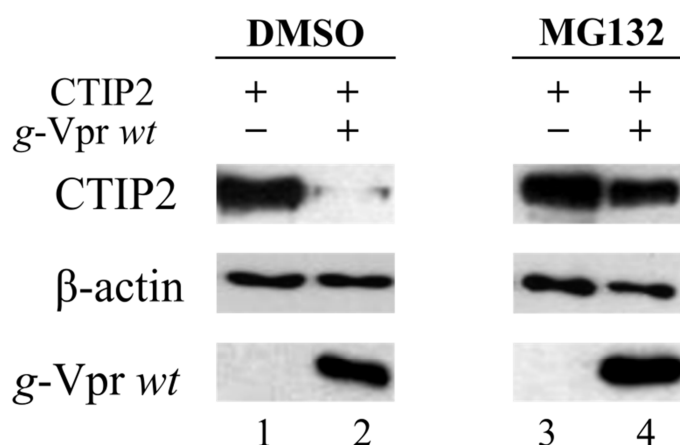

**Figure 3: Proteasome-mediated degradation of CTIP2.**

HEK293T cells were transfected with vectors expressing CTIP2 and GFP-Vpr *wt* as indicated. Cells were treated with either DMSO (Lane 1 and 2) or MG132 (Lane 3 and 4) 12h prior to harvesting the cells. Indicated proteins were probed with anti-CTIP2, anti-GFP (Vpr) and anti- $\beta$ -actin by Western blot.

#### 4. Ubiquitination of CTIP2 is enhanced by HIV-1 Vpr.

DDB1-Cul4A E3 ubiquitin ligase targets the host cellular proteins for their ubiquitination for their subsequent proteasome-mediated degradation. We have shown that CTIP2 is targeted for its degradation by HIV-1 Vpr. CTIP2 must be ubiquitinated before its proteasome-mediated degradation. Moreover, we treated the cells with either DMSO (Mock) or MG132 (proteasome inhibitor) 6hr prior to harvesting, to observe the effect of proteasome inhibitor on the ubiquitination and ubiquitinated CTIP2. The cell lysates were subjected to immunoprecipitation by using antibodies raised against CTIP2. The western blot probed against CTIP2 and ubiquitin showed that CTIP2 is indeed ubiquitinated. Additionally, the levels of the ubiquitinated CTIP2 were higher by 58% in the cells treated with MG132 (**Figure 4, compare lanes 1 and 3**), which further suggested constitutive ubiquitination of CTIP2. These observations indicated that CTIP2 is ubiquitinated

even without HIV-1 Vpr and this ubiquitinated CTIP2 is stabilized in the presence of MG132.

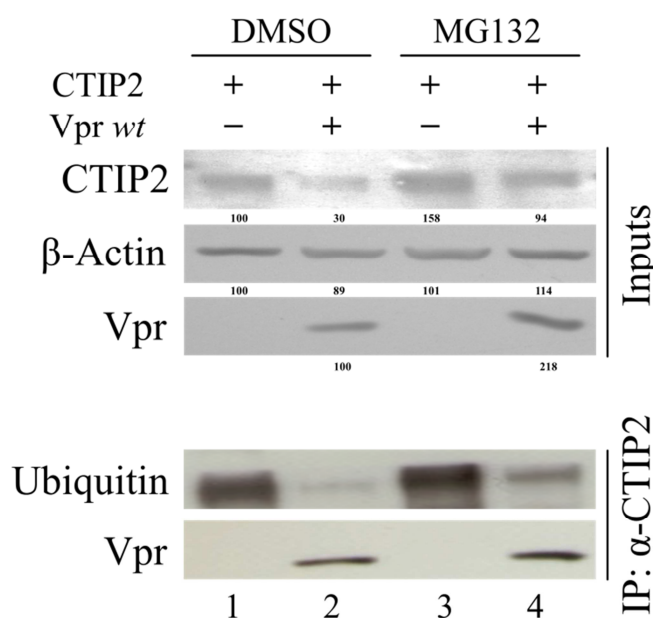

**Figure 4: HIV-1 Vpr enhances ubiquitination of CTIP2.**

HEK293T cells transfected with vectors expressing CTIP2 along with HA-Ub and HIV-1 Vpr *wt* as indicated. Cells were treated with either DMSO (lanes 1 and 2) or MG132 (lanes 3 and 4) 24 h prior to harvest. The nuclear lysates were subjected to immunoprecipitation against CTIP2. The presence of the ubiquitinated CTIP2 and Vpr in immunoprecipitated proteins and in nuclear extracts was probed by western blot using anti-Ubiquitin ( $p$ -CTIP2), anti-GFP (Vpr) and anti- $\beta$ -actin antibodies. The quantification of ubiquitinated proteins was carried out by image J 1.46r and displayed relative to 100 in each row.

Moreover, the presence of Vpr induced the deprivation of ubiquitinated CTIP2 by 70% and this deprivation is re-established in the cells treated with MG132 about 300% as compared to Vpr in DMSO (**Figure 4, compare lanes 2 and 4**). So, this may suggest that the degradation of CTIP2 by HIV-1 Vpr is carried out via proteasome system and can be inhibited by treating cells with proteasome inhibitors. The expression of Vpr in the presence of MG132 is stabilized, which further showed that the Vpr itself is also targeted for

proteasome-mediated degradation as previously described (Le Rouzic et al. 2008) (**Figure 4, compare lanes 2 and 4**). Therefore, CTIP2 is ubiquitinated in the absence of HIV-1 Vpr and this ubiquitination is enhanced by HIV-1 Vpr. Moreover, HIV-1 Vpr targets this ubiquitinated CTIP2 for its proteasome-mediated degradation.

## 5. HIV-1 Vpr needs DCAF1 association to enhance CTIP2 degradation.

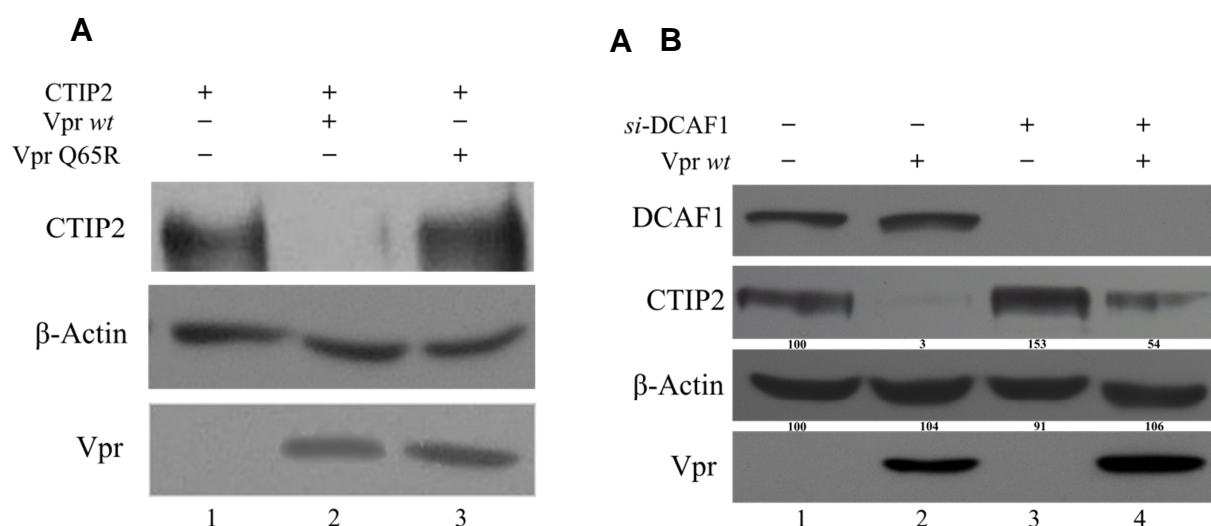

**Figure 5: Association of DCAF1 is essential for Vpr-mediated degradation of CTIP2.**

**(A)** HEK293T cells were transfected with vectors expressing CTIP2, HA-Vpr *wt* (column 2) and HA-Vpr Q65R as indicated. The presence of indicated proteins in the nuclear extracts was determined by Western blot probed with antibodies raised against CTIP2, HA or β-actin.

**(B)** HEK293T cells transfected with vectors expressing CTIP2 and flag-DCAF1 without or with GFP-Vpr *wt* as indicated along with *si*-control (lanes 1 and 2) or *si*-DCAF1 (lanes 3 and 4) were lysed. The presence of the indicated proteins in the nuclear extracts was determined by Western blot probed with antibodies raised against DCAF1, CTIP2, β-actin and GFP. The quantification of the western blot bands was measured by using imageJ 1.46r and is expressed relative to 100 in each row.

DCAF1 serves as an adaptor protein to bridge Vpr to Cul4A-DDB1 E3 ubiquitin ligase. HIV-1 Vpr mutants that are unable to bind with DCAF1 are defective in their functions. Here, we compared the effect of HIV-1 Vpr *wt* and its mutant Q65R, which is unable to interact with DCAF1 and hence is unable to induce G2 cell cycle arrest in dividing cells (Le Rouzic et al. 2007). We observed that the proteasome-mediated degradation of CTIP2 in presence of HIV-1 Vpr *wt* was inhibited in the presence of HIV-1 Vpr mutant Q65R (**Figure 5A**). This data indicated that association of Vpr with DCAF1 is essential to enhance the CTIP2 degradation.

We further investigated the importance of DCAF1 for proteasome-mediated degradation of CTIP2 by using a knock down strategy. The effect of HIV-1 Vpr *wt* was investigated after knocking down DCAF1. The cells were transfected with a siRNA against DCAF1 along with small amounts of vectors expressing DCAF1 and indicated proteins. Again, we observed that CTIP2 is degraded by HIV-1 Vpr in the presence of DCAF1 (97%). We confirmed the DCAF1 knock down efficiency by western blot probed against anti-DCAF1. As expected the degradation of CTIP2 was prevented (**Figure 5B, lane 4**) in cells where DCAF1 is knocked down as compared to cells expressing DCAF1 (**Figure 5B, lane 2**), we observed a very significant recovery of the CTIP2 (from 3% to 54%). Although, knock down of DCAF1, did not restore all CTIP2, but still significant CTIP2 was prevented from degradation. This showed that either there is some DCAF1 still available or there is another mechanism by which CTIP2 is still targeted for degradation. Moreover, here we observed that there was a stabilization of CTIP2 protein expression in the absence of DCAF1 even in the absence of Vpr that further confirmed our previous results about the ongoing constitutive degradation of CTIP2 (about 53%). The loading of all western blots was normalized by visualizing the  $\beta$ -actin expression. From these results, we concluded that DCAF1 association with the Vpr plays an important role in the proteasomal-mediated degradation of CTIP2.

## 6. CTIP2 interacts with DDB1, DCAF1 and HIV-1 Vpr.

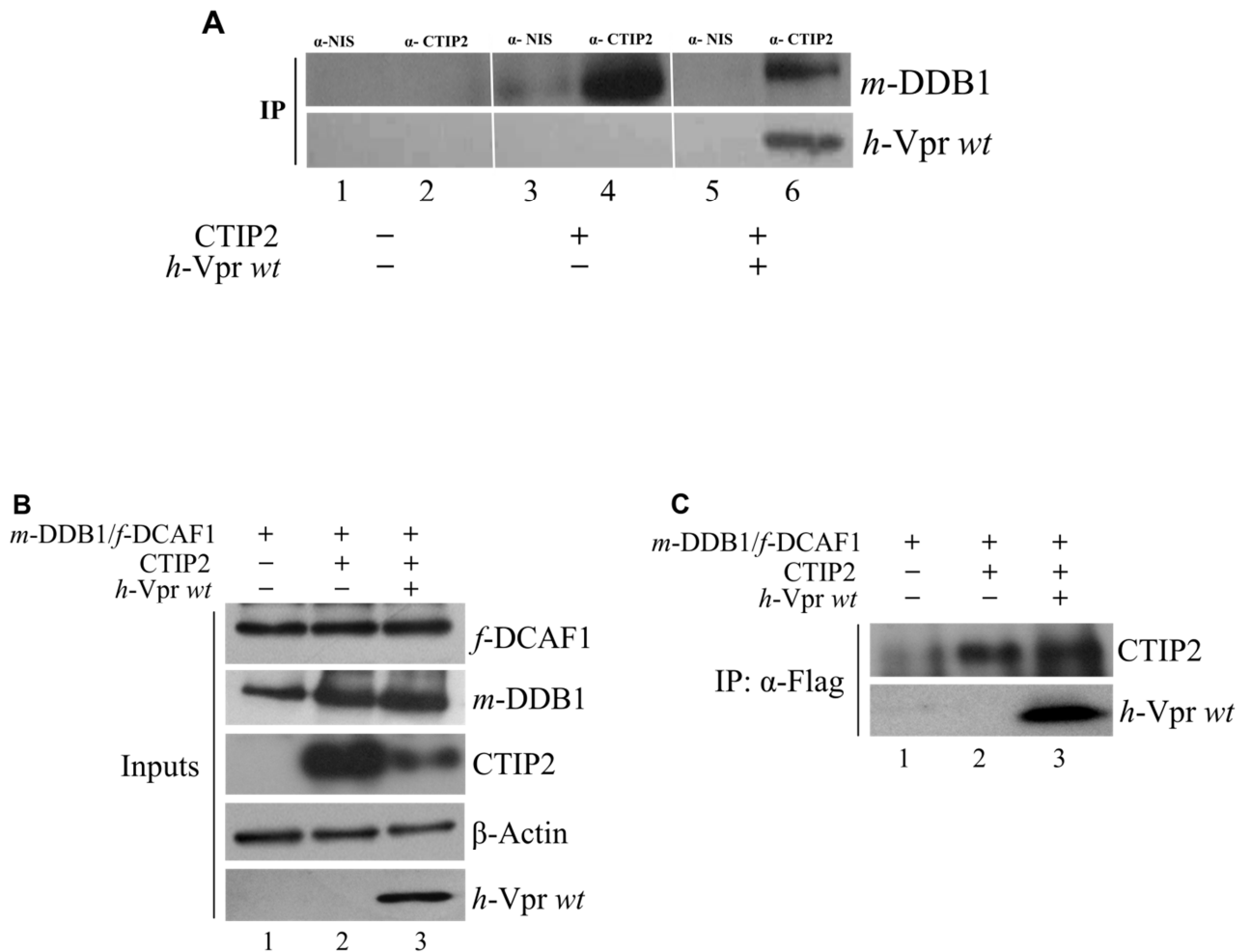

**Figure 6: CTIP2 interacts with DDB1, DCAF1 and HIV-1 Vpr.**

- (A)** HEK293T cells transfected with vectors expressing myc-DDB1, Flag-DCAF1, pNTAP-CTIP2 and HA-Vpr wt as indicated were lysed and immunoprecipitated with non-immune serum IgG (NIS) or anti-CTIP2 antibody. Immunoprecipitated proteins were probed with anti-myc (*m*-DDB1) and anti-HA (*h*-Vpr wt).
- (B)** Input proteins were detected by western blot probed anti-Flag (DCAF1), anti-myc (DDB1), anti-CTIP2, anti- $\beta$ -actin and anti-HA (Vpr) antibodies.
- (C)** HEK293T cells transfected with vectors expressing myc-DDB1, Flag-DCAF1, pNTAP-CTIP2 and HA-Vpr wt as indicated were lysed and immunoprecipitated with anti-FLAG (*f*-DCAF1) antibody. Immunoprecipitated proteins were probed with anti-CTIP2 and HA antibodies.

The current model for HIV-1 Vpr mechanism of action relies on the recruitment of an unknown cellular target protein to a Cul4A-DDB1 ubiquitin ligase complex through DCAF1 binding by Vpr, which leads to the ubiquitination and inactivation of this unknown cellular target. Based on this model, we investigated if CTIP2 belonged to a complex comprising DDB1, DCAF1 and Vpr by using a co-immunoprecipitation strategy. Proteins from cells transiently transfected with DCAF1, DDB1, CTIP2 and Vpr as indicated were subjected to co-immunoprecipitation against either Non-Immune Serum (NIS) as a control or with antibodies raised against CTIP2. The immunoprecipitated complexes were visualized by western blot with antibodies raised against DDB1 and Vpr. We observed that CTIP2 can interact with DDB1 in the absence and in the presence of Vpr (**Figure 6A**). However, the level of DDB1 was lower when Vpr was present (**Figure 6A, compare lanes 4 and 6**). This indicated that lower interaction of CTIP2 with DCAF1-Cul4A-DDB1 ubiquitin ligase complex might be due to degradation of CTIP2. These results further argued that CTIP2 belonged to a DCAF1-DDB1 complex even in the absence of Vpr. The expression of input proteins was detected by the western blot probed with anti-Flag, anti-myc, anti-CTIP2, anti- $\beta$ -actin and anti-HA antibodies (**Figure 6B**). Here, again we observed that the expression of CTIP2 is inhibited in the presence of HIV-1 Vpr.

By using the transfection with the same indicated plasmid as shown in the Figure 6B, we next performed a second co-immunoprecipitation assay with the anti-Flag antibody which targeted Flag-DCAF1 to further elaborate the CTIP2-DCAF1-DDB1 complex. The presence of CTIP2 and Vpr in the immunoprecipitated protein complexes was detected by western blot probed against anti-CTIP2 and anti-HA, respectively. We observed that the DCAF1 and CTIP2 were associated in a same complex either in the absence or presence of Vpr (**Figure 6C**). These results showed that CTIP2 interacts with DCAF1 in the absence and presence of Vpr, in order to induce the degradation of CTIP2 by proteasome. Altogether, we can say CTIP2 is associated in a complex containing DCAF1 and DDB1 without or with Vpr.

## 7. HIV-1 Vpr interacts with CTIP2.

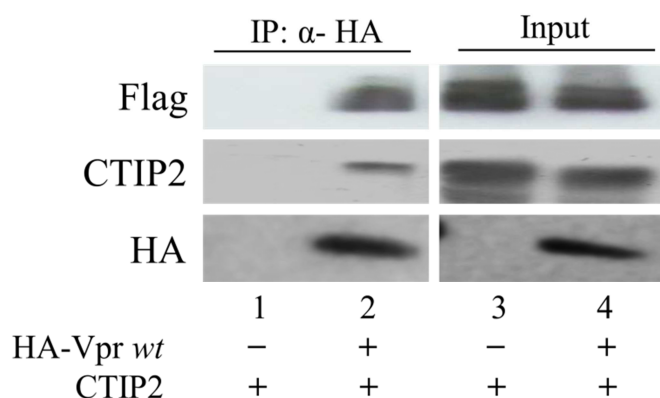
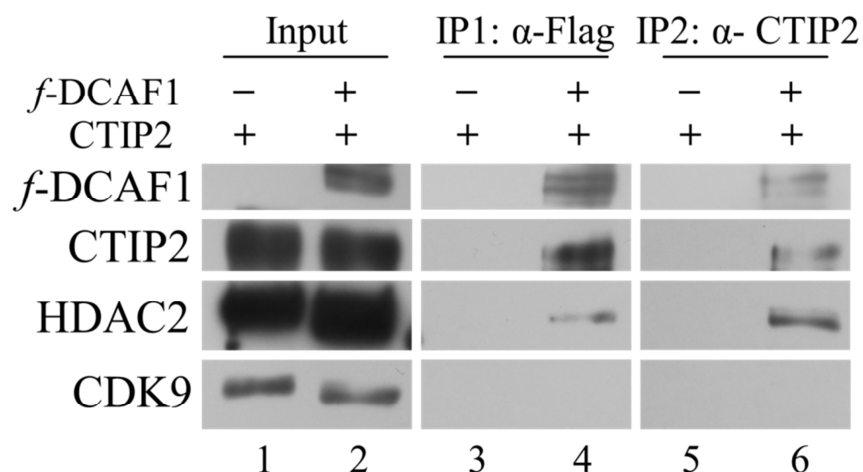

**Figure 7: Interaction of Vpr and CTIP2.**

HEK293T cells transfected with vectors expressing CTIP2, Flag-DCAF1, myc-DDB1 and HA-Vpr *wt* as indicated were lysed and subjected to immunoprecipitation with anti-HA antibody. Input and immunoprecipitated proteins were probed with anti-CTIP2, anti-Flag (DCAF1) and anti-HA (Vpr *wt*) antibodies.

Finally, the association of Vpr and CTIP2 was investigated by the help of co-immunoprecipitation assay. The transfected cells with indicated plasmids were lysed and the nuclear extracts were subjected to co-immunoprecipitation by using anti-HA antibody against HA-Vpr. We observed that CTIP2 can be immunoprecipitated with Vpr along with DCAF1 (**Figure 7, lanes 1 and 2**). Along with previous results, we concluded that CTIP2 is associated in a complex containing DCAF1 and DDB1 either in the absence or presence of HIV-1 Vpr.

## 8. DCAF1 is bound to CTIP2-associated heterochromatin modifying enzymes complex:



**Figure 8: Deciphering the DCAF1 and CTIP2 complex:**

HEK293T cells transfected with vectors expressing CTIP2 and Flag-DCAF1 were lysed and subjected to immunoprecipitation with anti-FLAG antibody. After washing, antibody-bound complexes were eluted with FLAG-peptide and subjected to sequential immunoprecipitation with anti-CTIP2 antibody. The presence of the indicated proteins in input (lanes 1 and 2) and in immunoprecipitated complexes (lanes 3 to 6) was probed against anti-FLAG (DCAF1), anti-CTIP2, anti-HDAC2 and anti-CDK9 antibodies.

CTIP2 interacts with different cellular proteins in order to induce silencing of HIV-1 gene transcription. CTIP2 recruits heterochromatin modifying complex including HDACs (1 and 2) to induce a heterochromatin structure at the HIV-1 promoter. The second identified CTIP2-associated complex comprises of inactive P-TEFb (CyclinT1/CDK9). Here, we tried to decipher the complex of CTIP2, which include DCAF1 and DDB1 to know which complex is hijacked for its degradation. To do so, we observed the association of CTIP2 with HDAC2 (member of heterochromatin modifying complex) and CDK9 (part of P-TEFb) in the complex comprising DCAF1. The cells transfected with vectors expressing CTIP2 and Flag-DCAF1 were subjected to immunoprecipitation against anti-Flag antibody. The eluted complexes were subjected to sequential immunoprecipitation with anti-



CTIP2 antibody and western blot was performed to observe the presence of CTIP2, Flag-DCAF1, HDAC2 and CDK9. By western blot, we observed that Flag-DCAF1 interacts with CTIP2 and this complex also contains HDAC2, which remained associated even after the second IP (**Figure 8**). On the other hand, there was no CDK9 associated with DCAF1-CTIP2 complex. These results showed that DCAF1 associated ubiquitin ligase system targets the CTIP2 complex that includes heterochromatin-modifying complex but not the one with inactive P-TEFb complex.

**9. DCAF1 and Vpr co-localize with CTIP2 in its sub-nuclear structures in the microglial cells.**

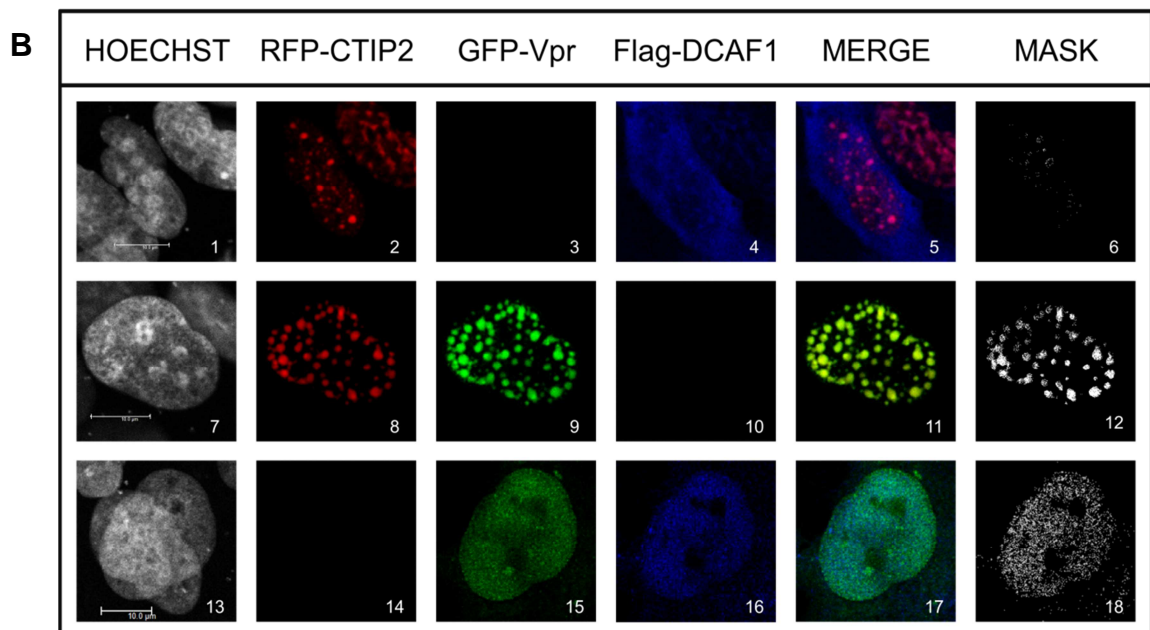
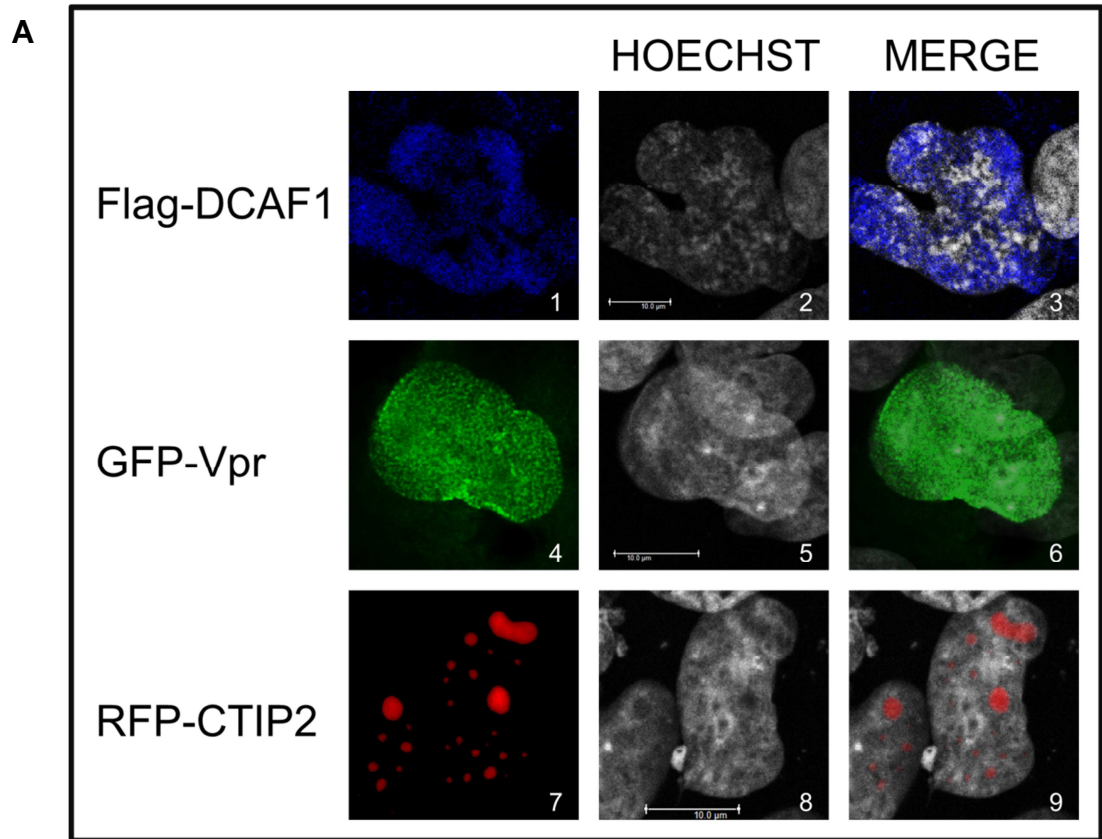

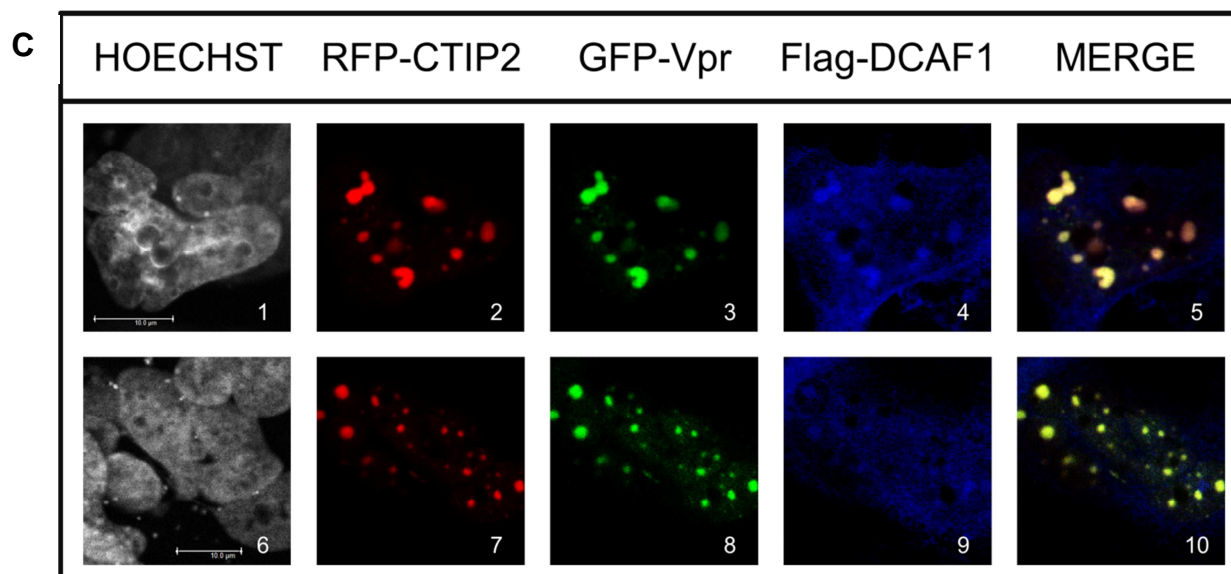

**Figure 9: Colocalization of CTIP2, DCAF1 and Vpr.**

Microglial cells were transfected with vectors expressing RFP-CTIP2, GFP-Vpr and Flag-DCAF1 as indicated. After being treated, overexpressed Flag-DCAF1 was detected with antibodies directed against the Flag epitope. The primary complexes were revealed by CY5-labelled anti-species secondary antibodies (blue staining). The nuclei were stained with Hoechst (grey). Coverslips were subjected to confocal microscopy analysis. The colocalization was measured by ImageJ 1.46r by calculating the Mander's colocalization coefficients m1 and m2. Bar measures 10 $\mu$ m.

(A) Alone protein localization of Flag-DCAF1, GFP-Vpr and RFP-CTIP2 with Hoechst.

(B) Colocalization between Flag-CTIP2, GFP-Vpr and RFP-DCAF1 and mask column (images 6, 12 and 18) shows the localization of the indicated proteins.

(C) Colocalization among all three proteins i.e. Flag-DCAF1, RFP-CTIP2 and GFP-Vpr.

To observe colocalization of RFP-CTIP2 with Flag-DCAF1 and GFP-Vpr inside the nucleus, microglial cells were transfected with these three plasmids as indicated in the **Figure 9 A-C**. These transfected cells were observed by immunofluorescence confocal laser microscopy. The nucleus was stained with Hoechst and shown in grey. As previously described (Rohr et al. 2003b), RFP-CTIP2 is expressed in the ball-like structures in the nuclei of microglial cells. GFP-Vpr is also present predominantly in the nucleus and also along perinuclear

localization (Le Rouzic et al. 2002, Sorgel et al. 2012) and finally Flag-DCAF1 stained with Cy-5 antibodies, also expressed predominantly in the nucleus of the microglial cells (**Figure 9A**).

The overexpression of RFP-CTIP2 and Flag-DCAF1 leads to the re-localization of Flag-DCAF1 inside sub-nuclear structure of RFP-CTIP2. Although, the localization is not very strong, may be due to lesser interaction between CTIP2 and DCAF1 or interaction with Cul4A-DDB1<sup>DCAF1</sup> E3 ubiquitin ligase already resulted in the degradation of CTIP2. Moreover, Flag epitopes within these ball-like structures may be not fully accessible to the anti-Flag antibodies explaining why it stained the periphery of ball like structures. The interaction between RFP-CTIP2 and Flag-DCAF1 was observed in the merge image and the mask image revealed that Flag-DCAF1 is stained around few ball-like structures of the RFP-CTIP2 in the nucleus (**Figure 9B, images 1-6**). Mander's colocalization coefficients revealed that 99% RFP-CTIP2 was co-localized with Flag-DCAF1, while only 38% of Flag-DCAF1 with RFP-CTIP2.

As previously described, we observed the nuclear co-localization of the GFP-Vpr within ball-like structures of RFP-CTIP2 (Cherrier et al. 2009). This co-localization was very strong as compared to the RFP-CTIP2 and Flag-DCAF1 localization, with 97% of each proteins interacting with other (**Figure 9B, images 7-12**). Additionally, we observed that localization of GFP-Vpr with Flag-DCAF1; both are predominantly express in the nucleus (97% of GFP-Vpr and 73% of Flag-DCAF1 co-localizing with the other protein) (**Figure 9B, images 13-18**).

Finally, we observed co-localization of Flag-DCAF1 and RFP-CTIP2 in the presence of GFP-Vpr in the nucleus of microglial cells. Cells expressing all these proteins showed that there is positive co-localization among these proteins. RFP-CTIP2 is expressed as its typical ball-like structures. Flag-DCAF1 and GFP-Vpr colocalize within sub-nuclear ball-like structures of RFP-CTIP2. In the merge, we observed that all these three proteins can co-localize and possibly can interact with each other during their physiological mechanisms (**Figure 9C**). Mander's coefficient showed that the interaction between RFP-CTIP2 and Flag-DCAF1 is significantly increased, with 82-96% of Flag-DCAF1 interacting with the RFP-CTIP2 as compared to only 38% without GFP-Vpr. The other percentages of the

interactions were not significantly changed. Therefore, we can say that Flag-DCAF1 and GFP-Vpr both colocalize in the sub-nuclear ball-like structures of RFP-CTIP2 in microglial cells and GFP-Vpr enhances the colocalization of RFP-CTIP2 and Flag-DCAF1.

**10. DCAF1 and Vpr colocalize with CTIP2 in its sub-nuclear structures in the microglial cells in the presence of MG132.**

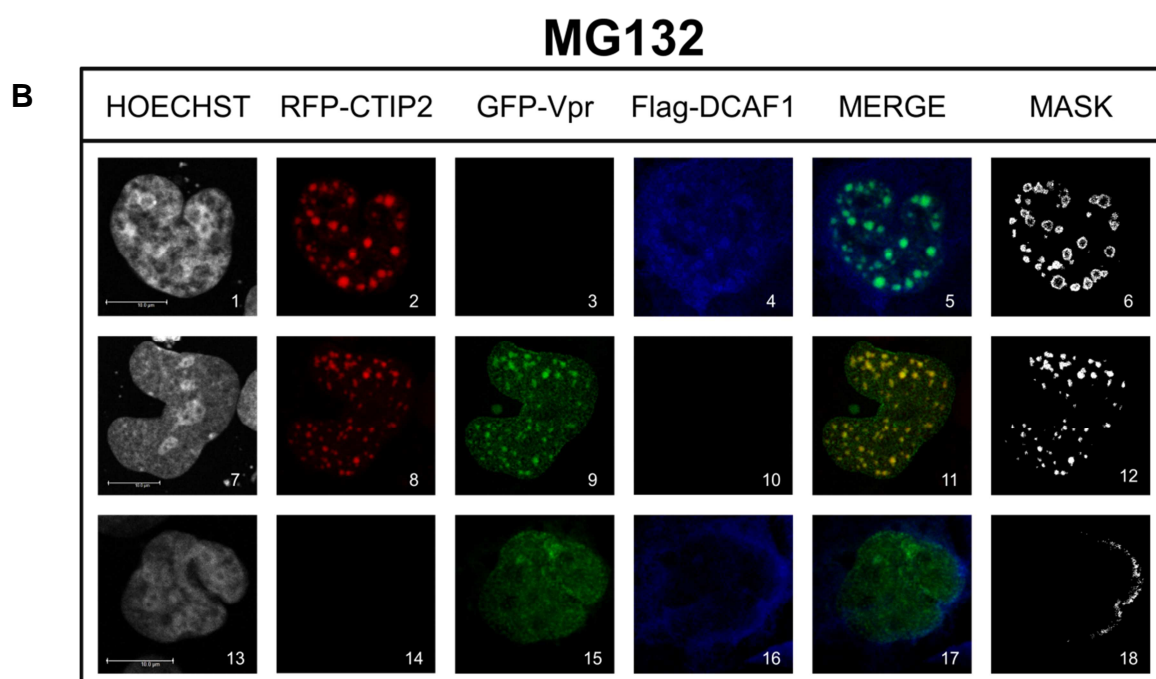
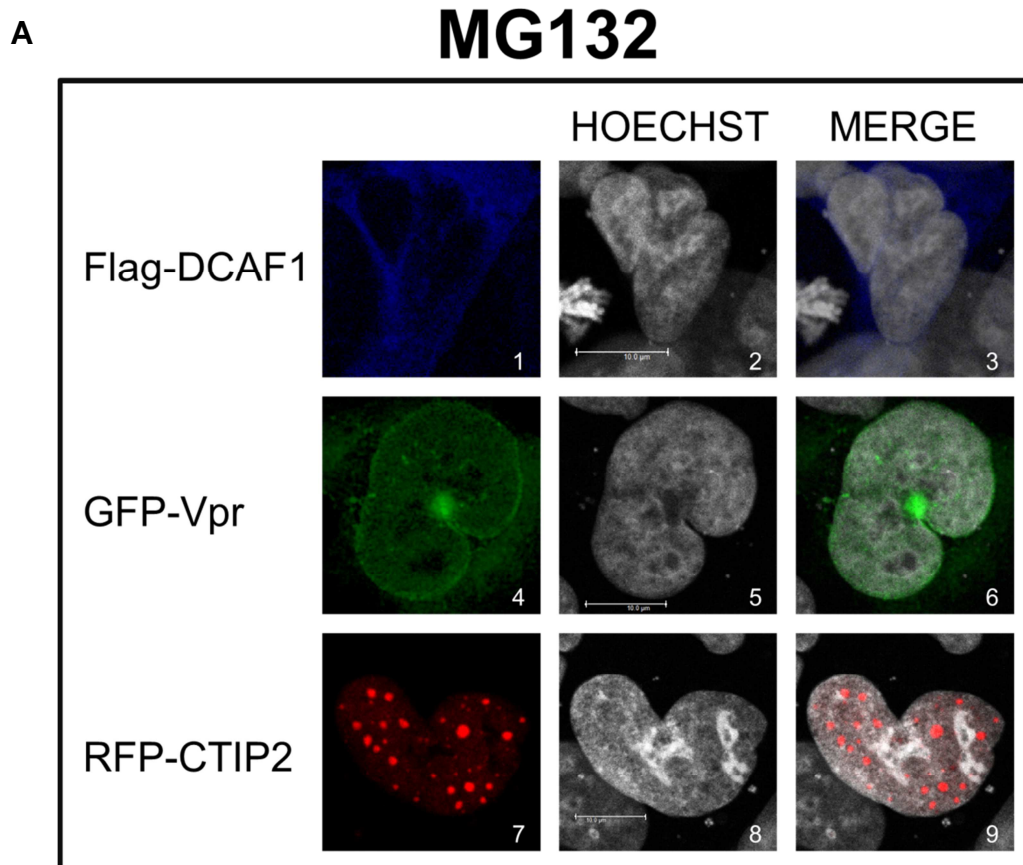

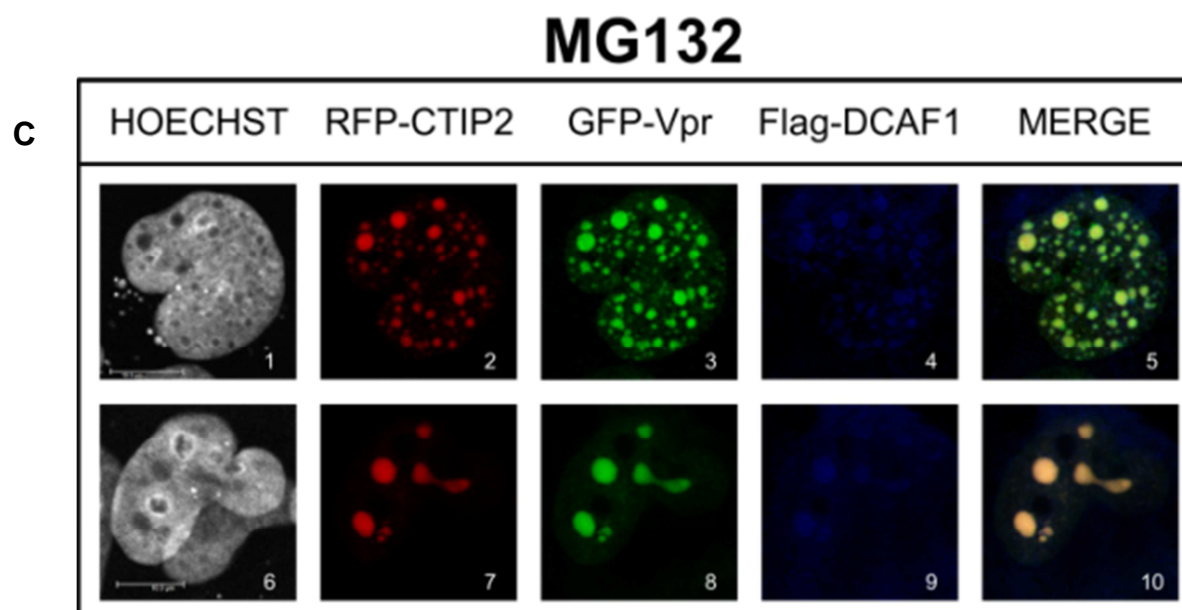

**Figure 10: Co-localization of CTIP2, DCAF1 and Vpr in the presence of MG132.**

Microglial cells were transfected with vectors expressing RFP-CTIP2, GFP-Vpr and Flag-DCAF1 as indicated and are incubated with MG132 for 6hr prior to fixation. After being treated, overexpressed Flag-DCAF1 was detected with antibodies directed against Flag epitope. The primary complexes were revealed by CY5-labelled anti-species secondary antibodies (blue staining). The nuclei were stained with Hoechst (grey). Coverslips were subjected to confocal microscopy analysis. Bar measures 10 $\mu$ m.

(A) Alone protein localization of Flag-DCAF1, GFP-Vpr and RFP-CTIP2 with Hoechst.

(B) Colocalization between RFP-CTIP2, GFP-Vpr and Flag-DCAF1 and mask column (images 6, 12 and 18) shows the localization of the indicated proteins.

(C) Colocalization among all three proteins i.e. RFP-CTIP2, GFP-Vpr and Flag-DCAF1.

Microglial cells transfected with vectors expressing RFP-CTIP2, Flag-DCAF1 and GFP-Vpr as indicated. Cells were treated with MG132 for 6hrs before fixation and were observed under confocal microscopy. The nuclei were stained with Hoechst, shown in grey. As previously observed, RFP-CTIP2 was again observed inside the nucleus as ball-like structures (**Figure 10A, images 7-9**). In the

presence of MG132, GFP-Vpr was also mainly expressed in the nucleus, but here it was more centric in its expression (**Figure 10A, images 4-6**). Finally, as previously shown (Belzile et al. 2010b), Flag-DCAF1 expresses predominantly in the nucleus but in the presence of MG132 it may be relocated and expressed predominantly in the cytoplasm/perinuclear rather than in the nucleus (**Figure 10A, images 1-3**).

When both expressed in the presence of MG132, Flag-DCAF1 colocalized with the ball-like structures of RFP-CTIP2 (**Figure 10B, images 1-6**) and here the localization is much more prominent as compared to the localization in the absence of MG132 treatment. Although, we observed the relocation of Flag-DCAF1 in the cytoplasm but in the presence of RFP-CTIP2, Flag-DCAF1 was colocalized inside ball-like structures of CTIP2 in the nucleus of microglial cell in the presence of MG132. Additionally, this localization was more stronger as compared to cells treated with DMSO, with 55% of Flag-DCAF1 colocalized with RFP-CTIP2 in the presence of MG132 as compared to earlier 38% (**compare Figure 9B, image 6 and Figure 10B, image 6**).

The localization of RFP-CTIP2 and GFP-Vpr was again observed in the presence of MG132 and there was no significant difference as compared to DMSO treated cells, 97% with DMSO and 95% with MG132 (**compare Figure 9B, image 12 and Figure 10B, image 12**). However, Flag-DCAF1 was relocated in cytoplasm in the presence of MG132, and there was less colocalization of GFP-Vpr as compared to DMSO treated cells, 73% with DMSO and 57% with MG132 (**compare Figure 9B, image 18 and Figure 10B, image 18**).

Again in the presence of MG132, Flag-DCAF1 and GFP-Vpr localized in ball-like sub-nuclear structures of RFP-CTIP2 (**Figure 10C**). Mander's coefficient confirmed that there was more percentage of proteins colocalized with each other when expressed altogether. Notably, 80-96% Flag-DCAF1 colocalized with Vpr as compared to earlier 57% without RFP-CTIP2 and 99% of Flag-DCAF1 colocalized with RFP-CTIP2 as compared to earlier 55% without GFP-Vpr. This further confirmed that RFP-CTIP2 colocalizes and possibly can interact with the Flag-DCAF1 in the presence or absence of GFP-Vpr. Moreover, RFP-CTIP2 and Flag-DCAF1 association is more stable in the presence of MG132.



# **Supplementary results**

## SIV Vpx can also induce CTIP2 degradation.

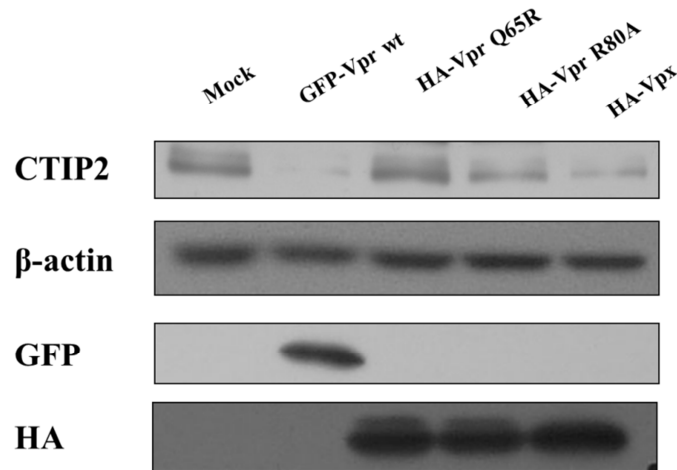

**Figure 11: Interaction of Vpr and CTIP2.**

HEK293T cells transfected with vectors expressing CTIP2 and mock or HIV-1 Vpr *wt* or its mutants as indicated were lysed and subjected to western blot probed with anti-CTIP2, anti- $\beta$ -actin, anti-GFP (Vpr *wt*) and anti-HA (Vpr *mutants*) antibodies.

Expression of CTIP2 was observed in cells transfected with vectors expressing CTIP2, GFP-Vpr *wt*, HA-Vpr Q65R, HA-Vpr R80A and SIV HA-Vpx. Western blot probed with anti-CTIP2 indicated that expression of GFP-Vpr *wt* induces degradation of CTIP2, while its mutant of HA-Vpr (Q65R) failed to induce degradation of CTIP2 due to its inability to interact with DCAF1. Moreover, another mutant HA-Vpr (R80A), which can interact with DCAF1 but unable to induce G2 arrest, presumably due to its inability to interact with unknown substrate of Cul4A-DDB1<sup>DCAF1</sup> E3 ubiquitin ligase, still can induce degradation of CTIP2. This shows that mutant of Vpr unable to induce G2 cell cycle arrest can still induce degradation of CTIP2. So, degradation of CTIP2 by the Vpr may not be correlated with its function to induce G2 cell cycle arrest in the dividing cells. Finally, expression of SIV HA-Vpx leads to inactivation of the CTIP2, which further elaborated that degradation of CTIP2 by Vpr may be correlated with its ability to infect macrophages (**Figure 11**). Therefore, from these results we

observed that HIV-1 Vpr-mediated degradation of CTIP2 is not related to its function to induce G2 cell cycle arrest, however due to degradation of CTIP2 SIV HA-Vpx may indicate that we should further investigate the HIV-1 Vpr-mediated degradation of CTIP2 in microglial cells keeping in mind its function to facilitate replication in the macrophages.

## HIV-1 Vpr can overcome CTIP2-mediated inhibition of gene transcription.

The effect on LTR-luc activity in microglial cells transfected with mock or CTIP2 and with gradual increase in the expression of HIV-1 Vpr was observed by luciferase assay. The results showed that CTIP2 can inhibit LTR-luc of HIV-1 activity in microglial cells. The expression of Vpr in cells overexpressing CTIP2 resulted in the loss in the ability of CTIP2 to induce its effect on the LTR activity of HIV-1 (**Figure 12**). This showed that either CTIP2 is degraded in the presence of HIV-1 Vpr or Vpr overcomes the silencing of the CTIP2 due to its transactivation effect in microglial cells. These results may show that HIV-1 Vpr can overcome CTIP2 mediated silencing of HIV-1 gene transcription in dose dependent manner. This further elaborated that the expression level of Vpr and CTIP2 may be deciding factor for the fate of microglial cells to enter into latency or productive replication after the infection of HIV-1.

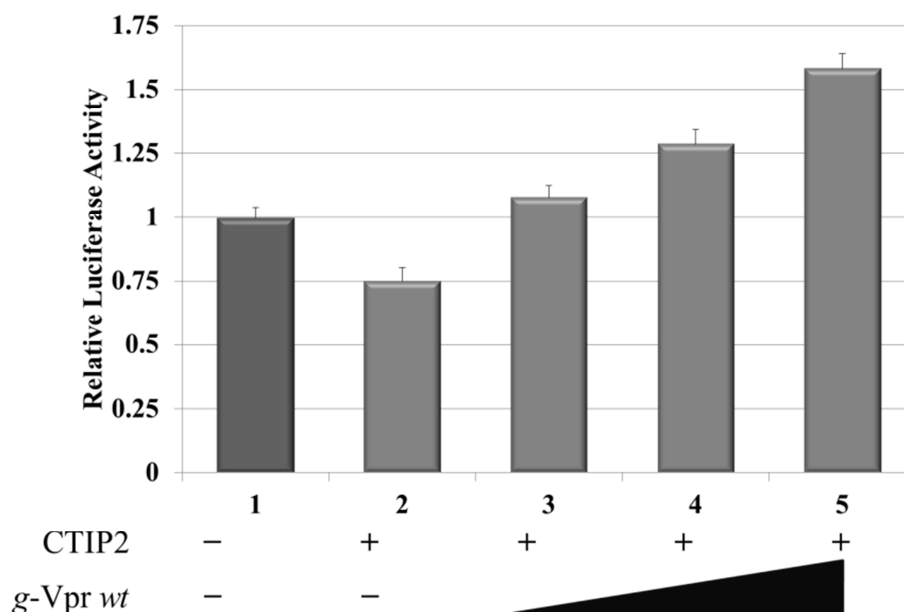

**Figure 12: CTIP2-mediated gene silencing and HIV-1 Vpr**

Microglial cells were transfected with vectors expressing LTR-luc and Renilla in all points and; with vectors expressing CTIP2 and GFP-Vpr *wt* as indicated. Total amounts of transfected DNA were normalized by using mock. Luciferase activity was measured after 2 day post-transfection and

expressed relative to value obtained with LTR-luc alone taken as 1. Luciferase activity was normalized by renilla activity.

## **CTIP2 overexpression and upregulation of proteasome-associated enzyme subunits.**

To observe the expression of different proteins with overexpression of CTIP2 in microglial cells, we lysed microglial cells transfected with mock vector or vector expressing CTIP2. The nuclear protein extracts were subjected to two-dimensional gel electrophoresis and overexpressed and newly expressed bands were subjected to mass spectrometry (**Figure 13**). As expected, we observed an upregulation of many proteins after the expression of CTIP2 in the microglial cells. Specifically, we observed upregulation of some proteins associated with the ubiquitin proteasome pathway. Moreover, we observed an upregulation of the enzymes involved in the deubiquitination of proteins, which showed that ubiquitination of CTIP2 might be a reversible process like some other proteins. The microglial cells can also counteract this ubiquitination of CTIP2 to avoid its enhanced degradation. The proteins found after overexpression of CTIP2 are shown in (**table 3**) and proteins involved in ubiquitination and deubiquitination found after the overexpression of the CTIP2 is shown in (**table 2**).





**Figure 13: Proteins upregulated after CTIP2 overexpression in microglial cells.**

Microglial cells transfected with mock **(A)** or CTIP2 **(B)** were lysed and the same amounts of nuclear extracts were subjected to 2D gel electrophoresis.



**Table 2: Proteasome-associated proteins**

<b>Accession #</b>	<b>Name</b>	<b>AAs#</b>	<b>Function</b>
Q13200	26S proteasome regulatory subunit S2	908	Acts as regulatory subunit of 26S proteasome, involved in ATP-dependent ubiquitination and degradation of proteins.
Q16401	26S proteasome subunit S5B	504	Functions as chaperone protein for 26S proteasome assembly
P43686	26S protease regulatory subunit 6B	418	Functions as ATP-dependent protease to degrade ubiquitinated proteins.
P0CG47	Polyubiquitin-B (ubiquitin)	229	Involved in ubiquitination of proteins by cellular ubiquitinating proteasome system.
P45974	Deubiquitinating enzyme 5	858	Removes linear and branched polyubiquitin polymers.
P51784	Deubiquitinating enzyme 11	963	Acts as protease to remove conjugated ubiquitin and polyubiquitin chains.
P54578	Deubiquitinating enzyme 14	494	Functions as proteasome-associated deubiquitinase.

**Table 2: Proteasome-associated proteins expressed after overexpression of CTIP2 in microglial cells.**

**Table 3: Upregulated proteins after CTIP2 overexpressin in microglial cells.**

Accession #	Protein name	Protein mol wt (kDa)	unique peptides
<b>P49327</b>	Fatty acid synthase OS=Homo sapiens GN=FASN PE=1 SV=3	273	69
<b>P53396</b>	ATP-citrate synthase OS=Homo sapiens GN=ACLY PE=1 SV=3	120	48
<b>P11586</b>	C-1-tetrahydrofolate synthase, cytoplasmic OS=Homo sapiens GN=MTHFD1 PE=1 SV=3	101	46
<b>O60502</b>	Bifunctional protein NCOAT OS=Homo sapiens GN=MGEA5 PE=1 SV=2	102	40
Q13200	<b>26S proteasome non-ATPase regulatory subunit 2 OS=Homo sapiens GN=PSMD2 PE=1 SV=3</b>	<b>100</b>	<b>36</b>
<b>P29401</b>	Transketolase OS=Homo sapiens GN=TKT PE=1 SV=3	67	30
<b>Q9NY33</b>	Dipeptidyl peptidase 3 OS=Homo sapiens GN=DPP3 PE=1 SV=2	82	29
<b>Q92973</b>	Transportin-1 OS=Homo sapiens GN=TNPO1 PE=1 SV=2	102	28
<b>P26038</b>	Moesin OS=Homo sapiens GN=MSN PE=1 SV=3	67	27
<b>P11021</b>	78 kDa glucose-regulated protein OS=Homo sapiens GN=HSPA5 PE=1 SV=2	72	22
<b>P13797</b>	Plastin-3 OS=Homo sapiens GN=PLS3 PE=1 SV=4	71	22
<b>Q9UBT2</b>	SUMO-activating enzyme subunit 2 OS=Homo sapiens GN=UBA2 PE=1 SV=2	71	20
<b>Q99829</b>	Copine-1 OS=Homo sapiens GN=CPNE1 PE=1 SV=1	59	12
<b>P60842</b>	Eukaryotic initiation factor 4A-I OS=Homo sapiens GN=EIF4A1 PE=1 SV=1	46	12
<b>O14787</b>	Transportin-2 OS=Homo sapiens GN=TNPO2 PE=1 SV=3	101	11
<b>Q96G03</b>	Phosphoglucomutase-2 OS=Homo sapiens GN=PGM2 PE=1 SV=4	68	11
<b>P49915</b>	GMP synthase [glutamine-hydrolyzing] OS=Homo sapiens GN=GMPS PE=1 SV=1	77	10
<b>P54136</b>	Arginine--tRNA ligase, cytoplasmic OS=Homo sapiens GN=RARS PE=1 SV=2	75	8
<b>Q08378</b>	Golgin subfamily A member 3 OS=Homo sapiens GN=GOLGA3 PE=1 SV=2	167	7
P51784	<b>Ubiquitin carboxyl-terminal hydrolase 11 OS=Homo sapiens GN=USP11 PE=1 SV=3</b>	<b>110</b>	<b>7</b>
<b>Q13596</b>	Sorting nexin-1 OS=Homo sapiens GN=SNX1 PE=1 SV=3	59	7
<b>O60664</b>	Perilipin-3 OS=Homo sapiens GN=PLIN3 PE=1 SV=3	47	7
<b>Q8N163</b>	Protein KIAA1967 OS=Homo sapiens GN=KIAA1967 PE=1 SV=2	102	6
<b>P13667</b>	Protein disulfide-isomerase A4 OS=Homo sapiens GN=PDIA4 PE=1 SV=2	72	6
<b>Q92900</b>	Regulator of nonsense transcripts 1 OS=Homo sapiens GN=UPF1 PE=1 SV=2	124	6
<b>Q96HE7</b>	ERO1-like protein alpha OS=Homo sapiens GN=ERO1L	54	6

	PE=1 SV=2		
<b>P52292</b>	Importin subunit alpha-2 OS=Homo sapiens GN=KPNA2 PE=1 SV=1	57	6
<b>Q15029</b>	116 kDa U5 small nuclear ribonucleoprotein component OS=Homo sapiens GN=EFTUD2 PE=1 SV=1	109	5
<b>Q6IA86</b>	Elongator complex protein 2 OS=Homo sapiens GN=ELP2 PE=1 SV=2	92	5
<b>O00429</b>	Dynamin-1-like protein OS=Homo sapiens GN=DNM1L PE=1 SV=2	82	5
<b>P61160</b>	Actin-related protein 2 OS=Homo sapiens GN=ACTR2 PE=1 SV=1	45	5
<b>P55010</b>	Eukaryotic translation initiation factor 5 OS=Homo sapiens GN=EIF5 PE=1 SV=2	49	5
<b>P50991</b>	T-complex protein 1 subunit delta OS=Homo sapiens GN=CCT4 PE=1 SV=4	58	5
<b>P18858</b>	DNA ligase 1 OS=Homo sapiens GN=LIG1 PE=1 SV=1	102	4
<b>Q99707</b>	Methionine synthase OS=Homo sapiens GN=MTR PE=1 SV=2	141	4
<b>O95373</b>	Importin-7 OS=Homo sapiens GN=IPO7 PE=1 SV=1	120	4
<b>O60749</b>	Sorting nexin-2 OS=Homo sapiens GN=SNX2 PE=1 SV=2	58	4
<b>P17655</b>	Calpain-2 catalytic subunit OS=Homo sapiens GN=CAPN2 PE=1 SV=6	80	4
<b>Q00610</b>	Clathrin heavy chain 1 OS=Homo sapiens GN=CLTC PE=1 SV=5	192	4
<b>Q8TE77</b>	Protein phosphatase Slingshot homolog 3 OS=Homo sapiens GN=SSH3 PE=1 SV=2	73	4
<b>O60841</b>	Eukaryotic translation initiation factor 5B OS=Homo sapiens GN=EIF5B PE=1 SV=4	139	4
<b>P23526</b>	Adenosylhomocysteinase OS=Homo sapiens GN=AHCY PE=1 SV=4	48	4
<b>Q15020</b>	Squamous cell carcinoma antigen recognized by T-cells 3 OS=Homo sapiens GN=SART3 PE=1 SV=1	110	3
<b>Q9UJC3</b>	Protein Hook homolog 1 OS=Homo sapiens GN=HOOK1 PE=1 SV=2	85	3
<b>Q8N543</b>	2-oxoglutarate and iron-dependent oxygenase domain- containing protein 1 OS=Homo sapiens GN=OGFOD1 PE=1 SV=1	63	3
<b>Q71U36</b>	Tubulin alpha-1A chain OS=Homo sapiens GN=TUBA1A PE=1 SV=1	50	3
<b>Q16576</b>	Histone-binding protein RBBP7 OS=Homo sapiens GN=RBBP7 PE=1 SV=1	48	3
<b>Q5W0V3</b>	Protein FAM160B1 OS=Homo sapiens GN=FAM160B1 PE=2 SV=1	87	2
<b>P17812</b>	CTP synthase 1 OS=Homo sapiens GN=CTPS PE=1 SV=2	67	2
<b>Q9NUQ8</b>	ATP-binding cassette sub-family F member 3 OS=Homo sapiens GN=ABCF3 PE=1 SV=2	80	2
<b>P12956</b>	X-ray repair cross-complementing protein 6 OS=Homo sapiens GN=XRCC6 PE=1 SV=2	70	2
<b>Q01581</b>	Hydroxymethylglutaryl-CoA synthase, cytoplasmic OS=Homo sapiens GN=HMGCS1 PE=1 SV=2	57	2
<b>Q13464</b>	Rho-associated protein kinase 1 OS=Homo sapiens GN=ROCK1 PE=1 SV=1	158	2

<b>Q7Z406</b>	Myosin-14 OS=Homo sapiens GN=MYH14 PE=1 SV=2	228	2
<b>O60610</b>	Protein diaphanous homolog 1 OS=Homo sapiens GN=DIAPH1 PE=1 SV=2	141	2
<b>P49736</b>	DNA replication licensing factor MCM2 OS=Homo sapiens GN=MCM2 PE=1 SV=4	102	2
<b>P52732</b>	Kinesin-like protein KIF11 OS=Homo sapiens GN=KIF11 PE=1 SV=2	119	2
<b>P26374</b>	Rab proteins geranylgeranyltransferase component A 2 OS=Homo sapiens GN=CHML PE=1 SV=2	74	2
<b>Q9H3P7</b>	Golgi resident protein GCP60 OS=Homo sapiens GN=ACBD3 PE=1 SV=4	61	2
<b>O43815</b>	Striatin OS=Homo sapiens GN=STRN PE=1 SV=4	86	2
<b>Q14764</b>	Major vault protein OS=Homo sapiens GN=MVP PE=1 SV=4	99	2
<b>Q9NPQ8</b>	Synembryn-A OS=Homo sapiens GN=RIC8A PE=1 SV=3	60	2
<b>Q96S55</b>	ATPase WRNIP1 OS=Homo sapiens GN=WRNIP1 PE=1 SV=2	72	2
<b>Q99613</b>	Eukaryotic translation initiation factor 3 subunit C OS=Homo sapiens GN=EIF3C PE=1 SV=1	105	2
<b>O94855</b>	Protein transport protein Sec24D OS=Homo sapiens GN=SEC24D PE=1 SV=2	113	2
<b>Q9Y5K6</b>	CD2-associated protein OS=Homo sapiens GN=CD2AP PE=1 SV=1	71	2
<b>P68366</b>	Tubulin alpha-4A chain OS=Homo sapiens GN=TUBA4A PE=1 SV=1	50	2
<b>P55263</b>	Adenosine kinase OS=Homo sapiens GN=ADK PE=1 SV=2	41	2
<b>P13929</b>	Beta-enolase OS=Homo sapiens GN=ENO3 PE=1 SV=4	47	2
<b>P50579</b>	Methionine aminopeptidase 2 OS=Homo sapiens GN=METAP2 PE=1 SV=1	53	2
Q16401	<b>26S proteasome non-ATPase regulatory subunit 5 OS=Homo sapiens GN=PSMD5 PE=1 SV=3</b>	<b>56</b>	<b>2</b>
<b>Q01518</b>	Adenylyl cyclase-associated protein 1 OS=Homo sapiens GN=CAP1 PE=1 SV=5	52	2
<b>Q01082</b>	Spectrin beta chain, brain 1 OS=Homo sapiens GN=SPTBN1 PE=1 SV=2	275	1
<b>Q96R06</b>	Sperm-associated antigen 5 OS=Homo sapiens GN=SPAG5 PE=1 SV=2	134	1
<b>P42285</b>	Superkiller viralicidic activity 2-like 2 OS=Homo sapiens GN=SKIV2L2 PE=1 SV=3	118	1
<b>P50570</b>	Dynamin-2 OS=Homo sapiens GN=DNM2 PE=1 SV=2	98	1
<b>O00148,Q 13838</b>	ATP-dependent RNA helicase DDX39A OS=Homo sapiens GN=DDX39A PE=1 SV=2	49	1
<b>P57081</b>	tRNA (guanine-N(7)-)-methyltransferase subunit WDR4 OS=Homo sapiens GN=WDR4 PE=1 SV=2	45	1
<b>Q5T0F9</b>	Coiled-coil and C2 domain-containing protein 1B OS=Homo sapiens GN=CC2D1B PE=1 SV=1	94	1
<b>Q96CV9</b>	Optineurin OS=Homo sapiens GN=OPTN PE=1 SV=2	66	1
<b>Q6PJG6</b>	BRCA1-associated ATM activator 1 OS=Homo sapiens GN=BRAT1 PE=1 SV=2	88	1
<b>P98174</b>	FYVE, RhoGEF and PH domain-containing protein 1 OS=Homo sapiens GN=FGD1 PE=1 SV=2	107	1
<b>Q86YR5</b>	G-protein-signaling modulator 1 OS=Homo sapiens	75	1

	GN=GPSM1 PE=1 SV=2		
<b>P52209</b>	6-phosphogluconate dehydrogenase, decarboxylating OS=Homo sapiens GN=PGD PE=1 SV=3	53	1
<b>P22234</b>	Multifunctional protein ADE2 OS=Homo sapiens GN=PAICS PE=1 SV=3	47	1
<b>Q8NEZ4</b>	Histone-lysine N-methyltransferase MLL3 OS=Homo sapiens GN=MLL3 PE=1 SV=3	541	1
<b>Q96IJ6</b>	Mannose-1-phosphate guanyltransferase alpha OS=Homo sapiens GN=GMPPA PE=1 SV=1	46	1
<b>P31943,P52597</b>	Heterogeneous nuclear ribonucleoprotein H OS=Homo sapiens GN=HNRNPH1 PE=1 SV=4	49	1
<b>Q6PD62</b>	RNA polymerase-associated protein CTR9 homolog OS=Homo sapiens GN=CTR9 PE=1 SV=1	133	1
<b>Q6ZSC3</b>	RNA-binding protein 43 OS=Homo sapiens GN=RBM43 PE=2 SV=1	41	1
<b>Q8IVF2</b>	Protein AHNAK2 OS=Homo sapiens GN=AHNAK2 PE=1 SV=2	617	1
<b>Q8IW35</b>	Centrosomal protein of 97 kDa OS=Homo sapiens GN=CEP97 PE=1 SV=1	97	1
<b>Q8TEX9</b>	Importin-4 OS=Homo sapiens GN=IPO4 PE=1 SV=2	119	1
<b>Q96PK2,Q9UPN3</b>	Microtubule-actin cross-linking factor 1, isoform 4 OS=Homo sapiens GN=MACF1 PE=1 SV=2	838	1
<b>Q9BV73</b>	Centrosome-associated protein CEP250 OS=Homo sapiens GN=CEP250 PE=1 SV=2	281	1
<b>O14514</b>	Brain-specific angiogenesis inhibitor 1 OS=Homo sapiens GN=BAI1 PE=1 SV=1	174	1
<b>P52888</b>	Thimet oligopeptidase OS=Homo sapiens GN=THOP1 PE=1 SV=2	79	1
<b>Q9H6T3</b>	RNA polymerase II-associated protein 3 OS=Homo sapiens GN=RPAP3 PE=1 SV=2	76	1
<b>A8MVM7</b>	Putative uncharacterized protein ENSP00000382790 OS=Homo sapiens PE=5 SV=3	73	1
<b>P19338</b>	Nucleolin OS=Homo sapiens GN=NCL PE=1 SV=3	77	1
<b>P41214</b>	Eukaryotic translation initiation factor 2D OS=Homo sapiens GN=EIF2D PE=1 SV=3	65	1
<b>Q14653</b>	Interferon regulatory factor 3 OS=Homo sapiens GN=IRF3 PE=1 SV=1	47	1
<b>Q8N3I7</b>	Bardet-Biedl syndrome 5 protein OS=Homo sapiens GN=BBS5 PE=1 SV=1	39	1
<b>P40925</b>	Malate dehydrogenase, cytoplasmic OS=Homo sapiens GN=MDH1 PE=1 SV=4	36	1
<b>P35580</b>	Myosin-10 OS=Homo sapiens GN=MYH10 PE=1 SV=3	229	1
P43686	<b>26S protease regulatory subunit 6B OS=Homo sapiens GN=PSMC4 PE=1 SV=2</b>	<b>47</b>	<b>1</b>
<b>Q86WN1</b>	FCH and double SH3 domains protein 1 OS=Homo sapiens GN=FCHSD1 PE=1 SV=1	77	1
<b>Q8IYE0</b>	Coiled-coil domain-containing protein 146 OS=Homo sapiens GN=CCDC146 PE=2 SV=2	113	1
<b>Q9NQX3</b>	Gephyrin OS=Homo sapiens GN=GPHN PE=1 SV=1	80	1
<b>P20591</b>	Interferon-induced GTP-binding protein Mx1 OS=Homo sapiens GN=MX1 PE=1 SV=4	76	1
<b>Q06265</b>	Exosome complex component RRP45 OS=Homo sapiens GN=EXOSC9 PE=1 SV=3	49	1

<b>Q99873</b>	Protein arginine N-methyltransferase 1 OS=Homo sapiens GN=PRMT1 PE=1 SV=2	42	1
<b>Q9Y5P4</b>	Collagen type IV alpha-3-binding protein OS=Homo sapiens GN=COL4A3BP PE=1 SV=1	71	1
<b>Q05397</b>	Focal adhesion kinase 1 OS=Homo sapiens GN=PTK2 PE=1 SV=2	119	1
<b>Q92974</b>	Rho guanine nucleotide exchange factor 2 OS=Homo sapiens GN=ARHGEF2 PE=1 SV=4	112	1
<b>Q02750</b>	Dual specificity mitogen-activated protein kinase kinase 1 OS=Homo sapiens GN=MAP2K1 PE=1 SV=2	43	1
<b>O15165</b>	Uncharacterized protein C18orf1 OS=Homo sapiens GN=C18orf1 PE=2 SV=1	34	1
P0CG47, P0CG48	<b>Polyubiquitin-B OS=Homo sapiens GN=UBB PE=1 SV=1</b>	<b>15</b>	<b>1</b>
<b>Q86WT1,Q8N4P2</b>	Tetratricopeptide repeat protein 30A OS=Homo sapiens GN=TTC30A PE=2 SV=3	76	1
<b>P35749</b>	Myosin-11 OS=Homo sapiens GN=MYH11 PE=1 SV=3	227	1
<b>O95447</b>	Lebercilin-like protein OS=Homo sapiens GN=LCA5L PE=2 SV=1	76	1
<b>Q09666</b>	Neuroblast differentiation-associated protein AHNAK OS=Homo sapiens GN=AHNAK PE=1 SV=2	629	1
<b>O75116</b>	Rho-associated protein kinase 2 OS=Homo sapiens GN=ROCK2 PE=1 SV=4	161	1
<b>O95163</b>	Elongator complex protein 1 OS=Homo sapiens GN=IKBKAP PE=1 SV=3	150	1
<b>Q8IX30</b>	Signal peptide, CUB and EGF-like domain-containing protein 3 OS=Homo sapiens GN=SCUBE3 PE=1 SV=1	109	1
<b>P58107</b>	Epiplakin OS=Homo sapiens GN=EPPK1 PE=1 SV=2	556	1
<b>Q8N4X5</b>	Actin filament-associated protein 1-like 2 OS=Homo sapiens GN=AFAP1L2 PE=1 SV=1	91	1
<b>Q9BWU0</b>	Kanadaplin OS=Homo sapiens GN=SLC4A1AP PE=1 SV=1	89	1
<b>O60763</b>	General vesicular transport factor p115 OS=Homo sapiens GN=USO1 PE=1 SV=2	108	1
<b>P07996</b>	Thrombospondin-1 OS=Homo sapiens GN=THBS1 PE=1 SV=2	129	1
P45974	<b>Ubiquitin carboxyl-terminal hydrolase 5 OS=Homo sapiens GN=USP5 PE=1 SV=2</b>	<b>96</b>	<b>1</b>
<b>Q4KWH8</b>	1-phosphatidylinositol-4,5-bisphosphate phosphodiesterase eta-1 OS=Homo sapiens GN=PLCH1 PE=1 SV=1	189	1
<b>Q9C0C2</b>	182 kDa tankyrase-1-binding protein OS=Homo sapiens GN=TNKS1BP1 PE=1 SV=4	182	1
<b>Q08380</b>	Galectin-3-binding protein OS=Homo sapiens GN=LGALS3BP PE=1 SV=1	65	1
<b>Q27J81</b>	Inverted formin-2 OS=Homo sapiens GN=INF2 PE=1 SV=2	136	1
<b>Q9UHY1</b>	Nuclear receptor-binding protein OS=Homo sapiens GN=NRBP1 PE=1 SV=1	60	1
<b>P48147</b>	Prolyl endopeptidase OS=Homo sapiens GN=PREP PE=1 SV=2	81	1
<b>Q4L180</b>	Filamin A-interacting protein 1-like OS=Homo sapiens GN=FILIP1L PE=1 SV=2	130	1
<b>Q12840</b>	Kinesin heavy chain isoform 5A OS=Homo sapiens	117	1

	GN=KIF5A PE=1 SV=2		
<b>Q86UU1</b>	Pleckstrin homology-like domain family B member 1 OS=Homo sapiens GN=PHLDB1 PE=1 SV=1	151	1
<b>Q7Z736</b>	Pleckstrin homology domain-containing family H member 3 OS=Homo sapiens GN=PLEKHH3 PE=1 SV=2	85	1
<b>Q14204</b>	Cytoplasmic dynein 1 heavy chain 1 OS=Homo sapiens GN=DYNC1H1 PE=1 SV=5	532	1
<b>Q01813</b>	6-phosphofructokinase type C OS=Homo sapiens GN=PFKP PE=1 SV=2	86	1
<b>P07814</b>	Bifunctional glutamate/proline--tRNA ligase OS=Homo sapiens GN=EPRS PE=1 SV=5	170	1
<b>Q5T9S5,Q 8IYS1</b>	Coiled-coil domain-containing protein 18 OS=Homo sapiens GN=CCDC18 PE=1 SV=1	169	1
<b>O75083</b>	WD repeat-containing protein 1 OS=Homo sapiens GN=WDR1 PE=1 SV=4	66	1
<b>P04350</b>	Tubulin beta-4A chain OS=Homo sapiens GN=TUBB4A PE=1 SV=2	49	1
<b>Q13885</b>	Tubulin beta-2A chain OS=Homo sapiens GN=TUBB2A PE=1 SV=1	50	1
<b>P46821</b>	Microtubule-associated protein 1B OS=Homo sapiens GN=MAP1B PE=1 SV=2	271	1
<b>P31749</b>	RAC-alpha serine/threonine-protein kinase OS=Homo sapiens GN=AKT1 PE=1 SV=2	56	1
P54578	<b>Ubiquitin carboxyl-terminal hydrolase 14</b> <b>OS=Homo sapiens GN=USP14 PE=1 SV=3</b>	<b>56</b>	<b>1</b>
<b>Q9H501</b>	ESF1 homolog OS=Homo sapiens GN=ESF1 PE=1 SV=1	99	1
<b>P30101</b>	Protein disulfide-isomerase A3 OS=Homo sapiens GN=PDIA3 PE=1 SV=4	57	1
<b>Q6NZI2</b>	Polymerase I and transcript release factor OS=Homo sapiens GN=PTRF PE=1 SV=1	43	1

**Table 3: Proteins upregulated by CTIP2 overexpression.**

Bands from the 2D gel were subjected to mass spectrometry and proteins only found after the overexpression of CTIP2 are shown in the table, with highlighted proteins involved in the cellular ubiquitin proteasome system.

# **Discussion**



## **CTIP2 is ubiquitinated and degraded by proteasome pathway.**

Here we have shown that CTIP2 is constitutively ubiquitinated and this ubiquitinated CTIP2 can be targeted for proteasomal degradation, which can be inhibited by proteasome inhibitor MG132. These results are in accordance with the results obtained by (Ahn et al. 2010), where they showed that the expression of both UNG2 and SMUG1 is stabilized in the presence of MG132. This proteasome-mediated degradation of CTIP2 was further elaborated by the knock down of DCAF1, which results in stabilization of CTIP2. These results showed that DCAF1 is an important protein to induce degradation of CTIP2. Several other laboratories have published results showing that the proteasome-mediated degradation of a protein via Cul4-DDB1-DCAF1 E3 ubiquitin ligase complex is impaired with the knock down of DCAF1. For example, expression of UNG2 and SMUG1 is stabilized by knock down of DCAF1 or DDB1 by *shRNA* even in absence of Vpr expression (Wen et al. 2012). More specifically, the HIV-2 replication in the macrophages is hampered by the knock down of DCAF1 (Bergamaschi et al. 2009), in which they showed that HIV-2 Vpx usurps the Cul4A-DDB1 (DCAF1) ligase to inactivate a restriction factor (SAMHD1) in macrophages. So, DCAF1 plays an important role in counteracting restriction induced by host cell proteins in non-dividing cells.

## **Vpr induces this degradation that can be inhibited by blocking proteasomal pathway.**

Our results have shown that CTIP2 turnover is increased in the presence of HIV-1 Vpr, which induces ubiquitination and proteasome-mediated degradation of CTIP2. Moreover, depletion of Vpr from proviral resulted in loss of its ability to reduce expression of CTIP2. This is a typical way by which a restriction factor is targeted for its proteasomal degradation. SAMHD1 is targeted for its proteasomal degradation by Vpx but not with Vpr in the macrophages, which results in increase of intracellular dNTPs pool to facilitate

reverse transcription (Hrecka et al. 2011, Laguette et al. 2011, Lahouassa et al. 2012b). Similarly, depletion of Vif from the proviral makes it unable to inactivate APOBEC3G (Sheehy et al. 2002, Marin et al. 2003, Mehle et al. 2004) and down regulation of tetherin is also hampered with depletion of Vpu from HIV-1 provirus (Neil et al. 2008, Mitchell et al. 2009). Here, we postulated that HIV-1 Vpr uses the same mechanism described for other proteins to target CTIP2 for its proteasomal degradation, usurping host Cul4A-DDB1<sup>DCAF1</sup> E3 ubiquitin ligase.

Moreover, we observed that in presence of MG132 expression of the HIV-1 Vpr is also stabilized, showing that Vpr itself is targeted for proteasomal degradation and it is protected by Cul4A-DDB1<sup>DCAF1</sup> E3 ubiquitin ligase from proteasomal degradation. These results are in accordance with the results already published, showing that the Vpr stability can be increased by MG132 and conversely reduced by knockdown of DCAF1 or by a mutation of Vpr to hinder DCAF1 binding (Le Rouzic et al. 2008).

## **CTIP2 interacts with DCAF1 and DDB1 without or with Vpr.**

We have shown that CTIP2 can interact with DCAF1 and DDB1 in the absence of Vpr and HIV-1 Vpr might increase this interaction of CTIP2 with Cul4A-DDB1<sup>DCAF1</sup> E3 ubiquitin ligase complex. HIV-1 Vpr and HIV-2 Vpx both use this same E3 ubiquitin ligase complex to target host proteins. HIV-1 Vpr is described as to increase association of UNG2 and SMUG1 with this E3 ubiquitin ligase complex for their subsequent proteasomal degradation (Ahn et al. 2010, Wen et al. 2012). In this model, DCAF1 functions as an adaptor protein to make a bridge between DDB1 and Vpr (Belzile et al. 2007, Le Rouzic et al. 2007). Our results show that CTIP2 can associate with Cul4A-DDB1<sup>DCAF1</sup> E3 ubiquitin ligase complex even in the absence of HIV-1 Vpr. It could be another example of virus increasing degradation of cellular protein to favor its replication using host ubiquitin proteasome system, as used by Vpu to down-regulate expression of tetherin via different mechanisms (Neil et al. 2008, Perez-Caballero et al. 2009). Moreover, DDB1 interaction with HIV-1 Vpr also facilitates its functions including

Vpr-induced apoptosis, G2 arrest and UNG2/SMUG1 degradation (Schrofelbauer et al. 2007).

As, Vpr is already packaged into the HIV-1 virions, it helps to facilitate HIV-1 replication from the start of the viral replication and by facilitating in its transportation of PIC in macrophages. The proteasomal mediated degradation of CTIP2 becomes more important as, more recently, it has been shown that there is a barrier for the replication of HIV-1 after reverse transcription and before integration in macrophages that can be inactivated by the HIV-1 (Pertel et al. 2011).

### **DCAF1 is important for proteasome-mediated degradation of CTIP2.**

DCAF1 association with HIV-1 Vpr is essential for the function of HIV-1 Vpr to degrade a cellular protein. Here, we have shown that a mutant Vpr Q65R, which cannot bind DCAF1 loses its ability to induce CTIP2 degradation. This result is in accordance with the results shown earlier depicting that Vpr mutant Q65R lost its ability to interact with the DCAF1 and also lost its ability to induce G2 arrest, presumably due to its inability to induce degradation of host cell protein (Le Rouzic et al. 2007). Moreover, the results with siDCAF1 showed that proteasome-mediated degradation of CTIP2 is counteracted by the knockdown of DCAF1. Indeed, knockdown of DCAF1 resulted in higher expression of CTIP2 in the absence and presence of HIV-1 Vpr. It means that knock down of DCAF1 may also hampered degradation of CTIP2 in the absence of Vpr. We could not achieve same levels of CTIP2 as in the absence of Vpr, this may be due to improper knock down or CTIP2 may also be targeted for its degradation by proteasome independent pathway as has been described for UNG2 (Langevin et al. 2009) and tetherin (Andrew et al. 2011). This similar mechanism of reversion of CTIP2 degradation was tested for different restriction factors, with tetherin showing only partial dependency on the proteasome activity for its down regulation. This partial dependency later was later elaborated that tetherin is down regulated also by pathways other than its proteasomal degradation (Mitchell et al. 2009, Andrew et al. 2011, Lau et al. 2011). Keeping this in mind,

we may say that there could be other mechanisms to down regulate expression of CTIP2 bypassing this E3 ubiquitin ligase.

## **DCAF1 is bound to heterochromatin modifying enzymes complex.**

CTIP2 is found in the nucleus of the microglial cells causing silencing of early and late HIV-1 gene transcription (Rohr et al. 2003b, Marban et al. 2005); and found at least in two distinct well-described complexes. One being associated with Hexim1 and inactive form of P-TEFb via the 7SK snRNA (Cherrier et al., under revision PNAS 2013) and other comprises enzymes including histone deacetylases (HDAC1 and 2) (Marban et al. 2007). Here, we showed that DCAF1 binds with CTIP2 complex consisting of HDAC2 and not with the P-TEFb complex. This interaction showed that the CTIP2 complex involved in the establishment of latency in the microglial cells and may be targeted by HIV-1 Vpr for its proteasomal degradation to counter its silencing of HIV-1 gene transcription.

Moreover, CTIP2 also recruits this enzymes complex to silence the gene transcription of p21 by inducing a heterochromatin structure near the p21 promoter (Cherrier et al. 2009). The present results gave a link that how HIV-1 Vpr can counter this impact of CTIP2 in the p21 promoter. As, the CTIP2 associated with HDACs is bound to the DCAF1, it reduces the levels of this CTIP2 complex and thus favoring again the production of p21. It shows that there could be interplay between the Vpr and CTIP2 to interact with the Sp1 site of the p21 gene promoter. In macrophages, this interplay between the CTIP2 and Vpr can decide the fate of the cell i.e. either establishment of post-integrative latency (if CTIP2 overcomes Vpr) or productive viral replication (if Vpr overcomes CTIP2) as described in **figure D1**.

## **DCAF1 colocalizes with Vpr and CTIP2 without or with Vpr.**

As previously described, we observed that Vpr co-localized with CTIP2 within its ball-like structures (Cherrier et al. 2009) and Vpr was also co-localized with DCAF1 in the nucleus (Belzile et al. 2010b). Importantly, we observed that there was some CTIP2 co-localized with DCAF1 showing that they can interact with each other even without Vpr. Additionally, all three proteins can co-localize with each other simultaneously and here we observed that DCAF1 colocalization with CTIP2 was enhanced in the presence of HIV-1Vpr. This further elaborated that CTIP2 colocalization with DCAF1 is enhanced by HIV-1 Vpr. The same colocalization is observed in the degradation of SAMHD1, where Vpx colocalizes with SAMHD1 for its proteasome-mediated ubiquitination and degradation in the nucleus (Hofmann et al. 2012). Conversely, HIV-1 Vpu causes inactivation of tetherin by inducing its sequestration in a perinuclear compartment from the nucleus in addition to its degradation by the proteasome (Hauser et al. 2010).

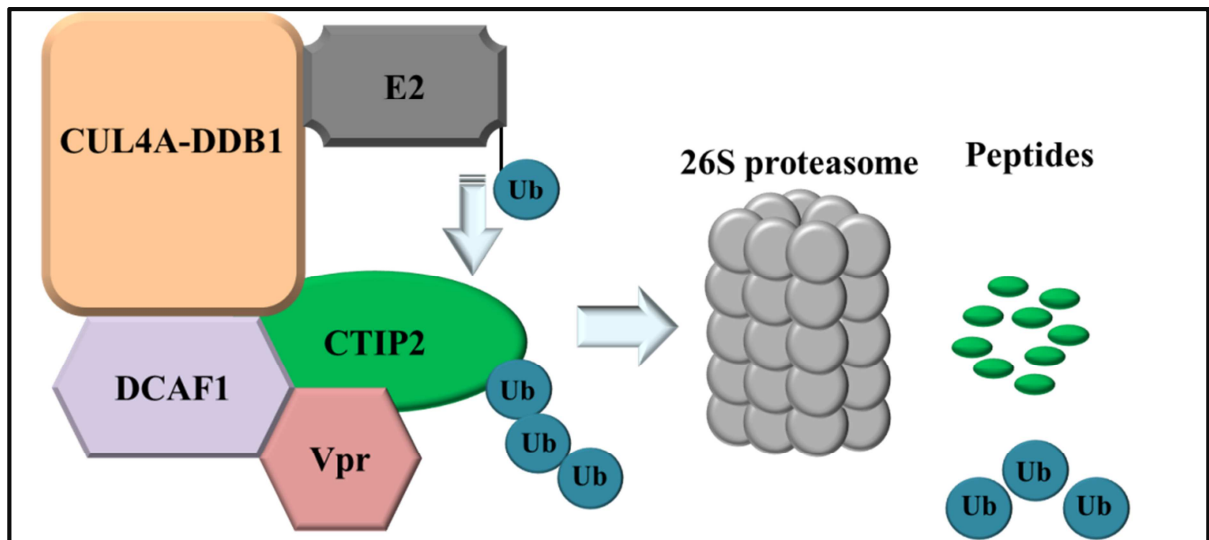
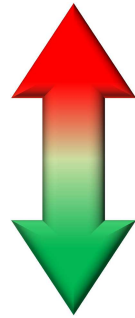
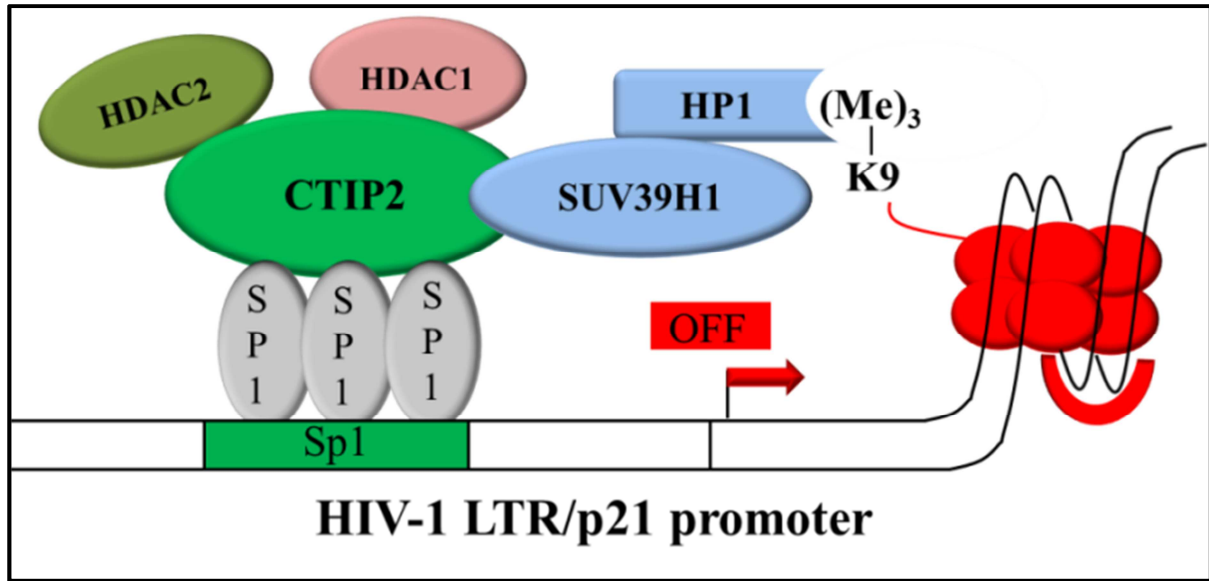

**Figure D1: Interplay between CTIP2 and HIV-1 Vpr in microglial cells.**

Surprisingly, in the cells treated with MG132, we observed that DCAF1 was relocated more as cytoplasmic as compare to its previous predominant nuclear expression. The expression of HIV-1 Vpr alone failed to retrieve this cytoplasmic DCAF1 from the nucleus. But expression of CTIP2 retained DCAF1 in the nucleus and results in much more stronger colocalization between them in the nucleus as compared to the cells treated with DMSO. Moreover, we observed the same colocalization of CTIP2 and DCAF1 with HIV-1 Vpr in the nucleus of the microglial cells. These results showed that CTIP2 might be targeted for its proteasome-mediated degradation inside the nucleus as observed in case of SAMHD1 degradation by Vpx (Hofmann et al. 2012). As CRL4 substrate proteins are nuclear in nature, they play a role in the nuclear functions like transcription, DNA replication, histone methylation and DNA damage response. Additionally, CTIP2 being a nuclear protein known to be involved in the silencing of the transcription in nucleus of microglial cells and it could be a possible target for its proteasomal degradation by HIV-1 in the nucleus.

# **Materials and methods**



## **MATERIAL AND METHODS**

### **Plasmids**

Most of the constructs used in our assays have been described previously: pcDNA3, pNTAP, pFLAG-CTIP2, pRFP-CTIP2, pNTAP-CTIP2, pGFP-Vpr *wt*, pNL-4.3  $\Delta$ Env-luc *wt*, pNL-4.3  $\Delta$ Env-luc  $\Delta$ Vpr and pMyc-DDB1, pFLAG-DCAF1, pHA-Vpr *wt*, pHA-Vpr Q65R were kindly provided by F. Margottin-Goguet. The siRNA-DCAF1 was procured from Dharmacon.

### **Cell culture**

The human microglial (provided by M. Tardieu, Paris, France) and HEK 293 T cell lines were maintained in Dulbecco's modified Eagles's medium (DMEM) containing 10% fetal calf serum and 100U/ml penicillion-streptomycin. When indicated, the cells were treated with DMSO or MG132 (5 $\mu$ g/ $\mu$ l) for 6hr before harvesting the cells.

### **Co-immunoprecipitation assays**

HEK 293 T cells cultured in 150-mm diameter dishes were transfected using calcium phosphate co-precipitation method with the indicated plasmids pNTAP-CTIP2 (15 $\mu$ g), pFLAG-DCAF1 (15 $\mu$ g), pMyc-DDB1 (15 $\mu$ g), HA-Vpr *wt* (15 $\mu$ g) and control empty vector (15 $\mu$ g). Two days post-transfection; immunoprecipitations were performed using the standard technique with M2 anti-FLAG (sigma) or anti-CTIP2 (Bethyl) overnight at 4°C. Finally, the immunoprecipitated complexes were processed for SDS-PAGE and western blot analysis.

### **SDS-PAGE and Western blot analysis**

SDS-PAGE experiments were performed using standard techniques. Proteins were detected using antibodies directed against the FLAG epitope (M2 mouse monoclonal from Sigma), HDAC2 (Merk-Millipore), CTIP2 (Bethyl), HA (Eurogentec), GFP (Merk-Millipore), DCAF1 (abcam), DDB1 (abcam), Ubiquitin (Santa Cruz), CDK9 (Santa Cruz), Myc epitope (Santa Cruz) and  $\beta$ -actin (Sigma). Proteins were visualized by chemiluminescence using the Super Signal Chemiluminescence Detection System (Pierce, Rockford, IL, USA).

### **Luciferase assays**

Microglial cells cultured in 48-well plates were transfected with the indicated vectors and the Renilla control vector using the calcium phosphate co-precipitation method. Two days later, cells were collected and firefly luciferase activity was determined using the Dual-Glo Luciferase Assay System (Promega, Madison, WI, USA) and normalized to the *Renilla* luciferase activity. Values correspond to an average of at least three independent experiments performed in triplicates.

### **Indirect immunofluorescence staining and confocal microscopy**

Microglial cells cultured in 24-well plates were transfected using Lipofectamine 2000 reagent with pRFP-CTIP2, pFLAG-DCAF1, and pGFP-Vpr expression vectors. Cells were treated with either DMSO or MG132 for 6hr prior to be fixed and permeabilized after 2-days post-transfection as previously described ([Rohr et al., 2003](#)). The coverslips were then incubated for 1hr at room temperature with blocking solution (3% BSA) and then for 1hr at room temperature with primary antibodies directed against Flag epitope (M2 mouse monoclonal; Sigma). The primary immunocomplexes were revealed by CY5-labeled secondary anti-species antibodies. The coverslips were then incubated for 15 min at room temperature with HOECHST (Sigma). The stained cells were analysed by confocal microscopy using a Zeiss laser scanning microscope (Zeiss, Jena, Germany; model 510 inverted) equipped with a Planapo oil ( $\times 63$ ) immersion lens (numerical aperture = 1.4). The colocalization coefficients were calculated by ImageJ 1.46r.

### **mRNA Quantification**

The RNAs from Transfected cells were extracted with RNeasy Plus Mini Kit (Qiagen, Germantown, MD, USA) and retrotranscription was performed with Superscript III (Invitrogen). cDNA were quantified and normalized to the  $\beta$ -actin mRNA level.

# **Bibliography**

- Abbas, W., I. Dichamp, and G. Herbein. 2012.** The HIV-1 Nef protein interacts with two components of the 40S small ribosomal subunit, the RPS10 protein and the 18S rRNA. *Virol J* 9: 103.
- Agostini, I., S. Popov, J. Li, L. Dubrovsky, T. Hao, and M. Bukrinsky. 2000.** Heat-shock protein 70 can replace viral protein R of HIV-1 during nuclear import of the viral preintegration complex. *Exp Cell Res* 259: 398-403.
- Ahmad, N., and S. Venkatesan. 1988.** Nef protein of HIV-1 is a transcriptional repressor of HIV-1 LTR. *Science (New York, N.Y.)* 241: 1481-1485.
- Ahn, J., T. Vu, Z. Novince, J. Guerrero-Santoro, V. Rapic-Otrin, and A. M. Gronenborn. 2010.** HIV-1 Vpr loads uracil DNA glycosylase-2 onto DCAF1, a substrate recognition subunit of a cullin 4A-ring E3 ubiquitin ligase for proteasome-dependent degradation. *J Biol Chem* 285: 37333-37341.
- Ahn, J., C. Hao, J. Yan, M. DeLucia, J. Mehrens, C. Wang, A. M. Gronenborn, and J. Skowronski. 2012.** HIV/simian immunodeficiency virus (SIV) accessory virulence factor Vpx loads the host cell restriction factor SAMHD1 onto the E3 ubiquitin ligase complex CRL4DCAF1. *J Biol Chem* 287: 12550-12558.
- Aiyar, A., Z. Ge, and J. Leis. 1994.** A specific orientation of RNA secondary structures is required for initiation of reverse transcription. *J Virol* 68: 611-618.
- Al-Hakim, A., C. Escribano-Diaz, M. C. Landry, L. O'Donnell, S. Panier, R. K. Szilard, and D. Durocher. 2010.** The ubiquitous role of ubiquitin in the DNA damage response. *DNA repair* 9: 1229-1240.
- Amie, S. M., E. Noble, and B. Kim. 2013.** Intracellular nucleotide levels and the control of retroviral infections. *Virology* 436: 247-254.
- Amini, S., M. Saunders, K. Kelley, K. Khalili, and B. E. Sawaya. 2004.** Interplay between HIV-1 Vpr and Sp1 modulates p21(WAF1) gene expression in human astrocytes. *J Biol Chem* 279: 46046-46056.
- Andersen, J. L., and V. Planelles. 2005.** The role of Vpr in HIV-1 pathogenesis. *Curr HIV Res* 3: 43-51.
- Andersen, J. L., E. Le Rouzic, and V. Planelles. 2008.** HIV-1 Vpr: mechanisms of G2 arrest and apoptosis. *Exp Mol Pathol* 85: 2-10.
- Andrew, A. J., E. Miyagi, and K. Strebel. 2011.** Differential effects of human immunodeficiency virus type 1 Vpu on the stability of BST-2/tetherin. *J Virol* 85: 2611-2619.
- Ao, Z., K. Danappa Jayappa, B. Wang, Y. Zheng, S. Kung, E. Rassart, R. Depping, M. Kohler, E. A. Cohen, and X. Yao. 2010.** Importin alpha3 interacts with HIV-1 integrase and contributes to HIV-1 nuclear import and replication. *J Virol* 84: 8650-8663.
- Aravind, L., and E. V. Koonin. 2000.** The U box is a modified RING finger - a common domain in ubiquitination. *Curr Biol* 10: R132-134.
- Ardley, H. C., and P. A. Robinson. 2005.** E3 ubiquitin ligases. *Essays in biochemistry* 41: 15-30.
- Arhel, N. J., S. Souquere-Besse, S. Munier, P. Souque, S. Guadagnini, S. Rutherford, M. C. Prevost, T. D. Allen, and P. Charneau. 2007.** HIV-1 DNA Flap formation promotes uncoating of the pre-integration complex at the nuclear pore. *EMBO J* 26: 3025-3037.
- Arias, J. F., Y. Iwabu, and K. Tokunaga. 2012.** Sites of action of HIV-1 Vpu in BST-2/tetherin downregulation. *Curr HIV Res* 10: 283-291.
- Ashrafi, G. H., M. R. Haghshenas, B. Marchetti, P. M. O'Brien, and M. S. Campo. 2005.** E5 protein of human papillomavirus type 16 selectively downregulates surface HLA class I. *International journal of cancer. Journal international du cancer* 113: 276-283.
- Aukrust, P., A. M. Svardal, F. Muller, B. Lunden, R. K. Berge, and S. S. Froland. 1995.** Decreased levels of total and reduced glutathione in CD4+ lymphocytes in common variable immunodeficiency are associated with activation of the tumor necrosis factor system: possible immunopathogenic role of oxidative stress. *Blood* 86: 1383-1391.
- Ayinde, D., N. Casartelli, and O. Schwartz. 2012.** Restricting HIV the SAMHD1 way: through nucleotide starvation. *Nat Rev Microbiol* 10: 675-680.

- Ayinde, D., C. Maudet, C. Transy, and F. Margottin-Goguet. 2010.** Limelight on two HIV/SIV accessory proteins in macrophage infection: is Vpx overshadowing Vpr? *Retrovirology* 7: 35.
- Aziz, N., P. Nishanian, J. M. Taylor, R. T. Mitsuyasu, J. M. Jacobson, B. J. Dezube, M. M. Lederman, R. Detels, and J. L. Fahey. 1999.** Stability of plasma levels of cytokines and soluble activation markers in patients with human immunodeficiency virus infection. *The Journal of infectious diseases* 179: 843-848.
- Bailey, J. R., A. R. Sedaghat, T. Kieffer, T. Brennan, P. K. Lee, M. Wind-Rotolo, C. M. Haggerty, A. R. Kamireddi, Y. Liu, J. Lee, D. Persaud, J. E. Gallant, J. Cofrancesco, Jr., T. C. Quinn, C. O. Wilke, S. C. Ray, J. D. Siliciano, R. E. Nettles, and R. F. Siliciano. 2006.** Residual human immunodeficiency virus type 1 viremia in some patients on antiretroviral therapy is dominated by a small number of invariant clones rarely found in circulating CD4+ T cells. *J Virol* 80: 6441-6457.
- Baldauf, H. M., X. Pan, E. Erikson, S. Schmidt, W. Daddacha, M. Burggraf, K. Schenkova, I. Ambiel, G. Wabnitz, T. Gramberg, S. Panitz, E. Flory, N. R. Landau, S. Sertel, F. Rutsch, F. Lasitschka, B. Kim, R. Konig, O. T. Fackler, and O. T. Keppler. 2012.** SAMHD1 restricts HIV-1 infection in resting CD4(+) T cells. *Nat Med* 18: 1682-1687.
- Bandi, P., M. L. Garcia, C. J. Booth, F. V. Chisari, and M. D. Robek. 2010.** Bortezomib inhibits hepatitis B virus replication in transgenic mice. *Antimicrobial agents and chemotherapy* 54: 749-756.
- Banks, L., D. Pim, and M. Thomas. 2003.** Viruses and the 26S proteasome: hacking into destruction. *Trends in biochemical sciences* 28: 452-459.
- Barber, S. A., L. Gama, J. M. Dudaronek, T. Voelker, P. M. Tarwater, and J. E. Clements. 2006.** Mechanism for the establishment of transcriptional HIV latency in the brain in a simian immunodeficiency virus-macaque model. *The Journal of infectious diseases* 193: 963-970.
- Barboric, M., R. M. Nissen, S. Kanazawa, N. Jabrane-Ferrat, and B. M. Peterlin. 2001.** NF-kappaB binds P-TEFb to stimulate transcriptional elongation by RNA polymerase II. *Molecular cell* 8: 327-337.
- Barford, D. 2011.** Structural insights into anaphase-promoting complex function and mechanism. *Philosophical transactions of the Royal Society of London. Series B, Biological sciences* 366: 3605-3624.
- Barre-Sinoussi, F., J. C. Chermann, F. Rey, M. T. Nugeyre, S. Chamaret, J. Gruest, C. Dauguet, C. Axler-Blin, F. Vezinet-Brun, C. Rouzioux, W. Rozenbaum, and L. Montagnier. 1983.** Isolation of a T-lymphotropic retrovirus from a patient at risk for acquired immune deficiency syndrome (AIDS). *Science (New York, N.Y.)* 220: 868-871.
- Barry, M., N. van Buuren, K. Burles, K. Mottet, Q. Wang, and A. Teale. 2010.** Poxvirus exploitation of the ubiquitin-proteasome system. *Viruses* 2: 2356-2380.
- Basavapathruni, A., and K. S. Anderson. 2007.** Reverse transcription of the HIV-1 pandemic. *FASEB J* 21: 3795-3808.
- Battivelli, E., J. Migraine, D. Lecossier, S. Matsuoka, D. Perez-Bercoff, S. Saragosti, F. Clavel, and A. J. Hance. 2011.** Modulation of TRIM5alpha activity in human cells by alternatively spliced TRIM5 isoforms. *J Virol* 85: 7828-7835.
- Bellanger, S., S. Blachon, F. Mechali, C. Bonne-Andrea, and F. Thierry. 2005.** High-risk but not low-risk HPV E2 proteins bind to the APC activators Cdh1 and Cdc20 and cause genomic instability. *Cell Cycle* 4: 1608-1615.
- Belzile, J. P., J. Richard, N. Rougeau, Y. Xiao, and E. A. Cohen. 2010a.** HIV-1 Vpr induces the K48-linked polyubiquitination and proteasomal degradation of target cellular proteins to activate ATR and promote G2 arrest. *J Virol* 84: 3320-3330.
- Belzile, J. P., L. G. Abrahamyan, F. C. Gerard, N. Rougeau, and E. A. Cohen. 2010b.** Formation of mobile chromatin-associated nuclear foci containing HIV-1 Vpr and VPRBP is critical for the induction of G2 cell cycle arrest. *PLoS Pathog* 6: e1001080.
- Belzile, J. P., G. Duisit, N. Rougeau, J. Mercier, A. Finzi, and E. A. Cohen. 2007.** HIV-1 Vpr-mediated G2 arrest involves the DDB1-CUL4AVPRBP E3 ubiquitin ligase. *PLoS Pathog* 3: e85.

- Bergamaschi, A., D. Ayinde, A. David, E. Le Rouzic, M. Morel, G. Collin, D. Descamps, F. Damond, F. Brun-Vezinet, S. Nisole, F. Margottin-Goguet, G. Pancino, and C. Transy. 2009.** The human immunodeficiency virus type 2 Vpx protein usurps the CUL4A-DDB1 DCAF1 ubiquitin ligase to overcome a postentry block in macrophage infection. *J Virol* 83: 4854-4860.
- Bergink, S., and S. Jentsch. 2009.** Principles of ubiquitin and SUMO modifications in DNA repair. *Nature* 458: 461-467.
- Berkhout, B., D. Eggink, and R. W. Sanders. 2012.** Is there a future for antiviral fusion inhibitors? *Curr Opin Virol* 2: 50-59.
- Bernal, J. A., R. Luna, A. Espina, I. Lazaro, F. Ramos-Morales, F. Romero, C. Arias, A. Silva, M. Tortolero, and J. A. Pintor-Toro. 2002.** Human securin interacts with p53 and modulates p53-mediated transcriptional activity and apoptosis. *Nature genetics* 32: 306-311.
- Bernassola, F., M. Karin, A. Ciechanover, and G. Melino. 2008.** The HECT family of E3 ubiquitin ligases: multiple players in cancer development. *Cancer cell* 14: 10-21.
- Bharti, P., W. Schliebs, T. Schievelbusch, A. Neuhaus, C. David, K. Kock, C. Herrmann, H. E. Meyer, S. Wiese, B. Warscheid, C. Theiss, and R. Erdmann. 2011.** PEX14 is required for microtubule-based peroxisome motility in human cells. *Journal of cell science* 124: 1759-1768.
- Bieniasz, P. D. 2009.** The cell biology of HIV-1 virion genesis. *Cell Host Microbe* 5: 550-558.
- Bienz, M. 2006.** The PHD finger, a nuclear protein-interaction domain. *Trends in biochemical sciences* 31: 35-40.
- Bierhoff, M., C. A. Boucher, A. Fibrini, and R. W. Ten Kate. 2013.** Ongoing HIV replication in cerebrospinal fluid under successful monotherapy. *Antiviral therapy*.
- Bishop, K. N., R. K. Holmes, A. M. Sheehy, N. O. Davidson, S. J. Cho, and M. H. Malim. 2004.** Cytidine deamination of retroviral DNA by diverse APOBEC proteins. *Curr Biol* 14: 1392-1396.
- Blackford, A. N., R. N. Patel, N. A. Forrester, K. Theil, P. Groitl, G. S. Stewart, A. M. Taylor, I. M. Morgan, T. Dobner, R. J. Grand, and A. S. Turnell. 2010.** Adenovirus 12 E4orf6 inhibits ATR activation by promoting TOPBP1 degradation. *Proceedings of the National Academy of Sciences of the United States of America* 107: 12251-12256.
- Blanchette, P., and P. E. Branton. 2009.** Manipulation of the ubiquitin-proteasome pathway by small DNA tumor viruses. *Virology* 384: 317-323.
- Blanchette, P., K. Kindsmuller, P. Groitl, F. Dallaire, T. Speiseder, P. E. Branton, and T. Dobner. 2008.** Control of mRNA export by adenovirus E4orf6 and E1B55K proteins during productive infection requires E4orf6 ubiquitin ligase activity. *J Virol* 82: 2642-2651.
- Blankson, J. N., D. Persaud, and R. F. Siliciano. 2002.** The challenge of viral reservoirs in HIV-1 infection. *Annu Rev Med* 53: 557-593.
- Boname, J. M., and P. G. Stevenson. 2001.** MHC class I ubiquitination by a viral PHD/LAP finger protein. *Immunity* 15: 627-636.
- Bondar, T., A. Kalinina, L. Khair, D. Kopanja, A. Nag, S. Bagchi, and P. Raychaudhuri. 2006.** Cul4A and DDB1 associate with Skp2 to target p27Kip1 for proteolysis involving the COP9 signalosome. *Mol Cell Biol* 26: 2531-2539.
- Boros, I. M. 2012.** Histone modification in *Drosophila*. *Briefings in functional genomics* 11: 319-331.
- Bosque, A., and V. Planelles. 2008.** Induction of HIV-1 latency and reactivation in primary memory CD4+ T cells. *Blood*.
- Bouhamdan, M., S. Benichou, F. Rey, J. M. Navarro, I. Agostini, B. Spire, J. Camonis, G. Slupphaug, R. Vigne, R. Benarous, and J. Sire. 1996.** Human immunodeficiency virus type 1 Vpr protein binds to the uracil DNA glycosylase DNA repair enzyme. *J Virol* 70: 697-704.

- Boutell, C., S. Sadis, and R. D. Everett. 2002.** Herpes simplex virus type 1 immediate-early protein ICP0 and its isolated RING finger domain act as ubiquitin E3 ligases in vitro. *J Virol* 76: 841-850.
- Boyer, S. N., D. E. Wazer, and V. Band. 1996.** E7 protein of human papilloma virus-16 induces degradation of retinoblastoma protein through the ubiquitin-proteasome pathway. *Cancer Res* 56: 4620-4624.
- Brandariz-Nunez, A., J. C. Valle-Casuso, T. E. White, N. Laguette, M. Benkirane, J. Brojatsch, and F. Diaz-Griffero. 2012.** Role of SAMHD1 nuclear localization in restriction of HIV-1 and SIVmac. *Retrovirology* 9: 49.
- Bransteitter, R., C. Prochnow, and X. S. Chen. 2009.** The current structural and functional understanding of APOBEC deaminases. *Cell Mol Life Sci* 66: 3137-3147.
- Breen, E. C., A. R. Rezai, K. Nakajima, G. N. Beall, R. T. Mitsuyasu, T. Hirano, T. Kishimoto, and O. Martinez-Maza. 1990.** Infection with HIV is associated with elevated IL-6 levels and production. *Journal of immunology (Baltimore, Md. : 1950)* 144: 480-484.
- Breitschopf, K., E. Bengal, T. Ziv, A. Admon, and A. Ciechanover. 1998.** A novel site for ubiquitination: the N-terminal residue, and not internal lysines of MyoD, is essential for conjugation and degradation of the protein. *EMBO J* 17: 5964-5973.
- Brennan, R. O., and D. T. Durack. 1981.** Gay compromise syndrome. *Lancet* 2: 1338-1339.
- Bres, V., R. E. Kiernan, L. K. Linares, C. Chable-Bessia, O. Plechakova, C. Treand, S. Emiliani, J. M. Peloponese, K. T. Jeang, O. Coux, M. Scheffner, and M. Benkirane. 2003.** A non-proteolytic role for ubiquitin in Tat-mediated transactivation of the HIV-1 promoter. *Nature cell biology* 5: 754-761.
- Briggs, J. A., T. Wilk, R. Welker, H. G. Krausslich, and S. D. Fuller. 2003.** Structural organization of authentic, mature HIV-1 virions and cores. *EMBO J* 22: 1707-1715.
- Brogli, R., Y. Levy, and G. Tiana. 2008.** HIV-1 protease folding and the design of drugs which do not create resistance. *Current opinion in structural biology* 18: 60-66.
- Bukrinsky, M. I., N. Sharova, M. P. Dempsey, T. L. Stanwick, A. G. Bukrinskaya, S. Haggerty, and M. Stevenson. 1992.** Active nuclear import of human immunodeficiency virus type 1 preintegration complexes. *Proceedings of the National Academy of Sciences of the United States of America* 89: 6580-6584.
- Butticaz, C., O. Michielin, J. Wyniger, A. Telenti, and S. Rothenberger. 2007.** Silencing of both beta-TrCP1 and HOS (beta-TrCP2) is required to suppress human immunodeficiency virus type 1 Vpu-mediated CD4 down-modulation. *J Virol* 81: 1502-1505.
- Cadwell, K., and L. Coscoy. 2005.** Ubiquitination on nonlysine residues by a viral E3 ubiquitin ligase. *Science (New York, N.Y.)* 309: 127-130.
- Callens, N., J. L. Baert, D. Monte, M. Sunesen, C. Van Lint, and Y. de Launoit. 2003.** Transcriptional regulation of the murine brca2 gene by CREB/ATF transcription factors. *Biochem Biophys Res Commun* 312: 702-707.
- Campbell, E. M., R. Nunez, and T. J. Hope. 2004.** Disruption of the actin cytoskeleton can complement the ability of Nef to enhance human immunodeficiency virus type 1 infectivity. *J Virol* 78: 5745-5755.
- Caputi, M. 2011.** The Regulation of HIV-1 mRNA Biogenesis.
- Carmona, R., L. Perez-Alvarez, M. Munoz, G. Casado, E. Delgado, M. Sierra, M. Thomson, Y. Vega, E. Vazquez de Parga, G. Contreras, L. Medrano, and R. Najera. 2005.** Natural resistance-associated mutations to Enfuvirtide (T20) and polymorphisms in the gp41 region of different HIV-1 genetic forms from T20 naive patients. *J Clin Virol* 32: 248-253.
- Carson, C. T., R. A. Schwartz, T. H. Stracker, C. E. Lilley, D. V. Lee, and M. D. Weitzman. 2003.** The Mre11 complex is required for ATM activation and the G2/M checkpoint. *EMBO J* 22: 6610-6620.
- Carson, C. T., N. I. Orazio, D. V. Lee, J. Suh, S. Bekker-Jensen, F. D. Araujo, S. S. Lakdawala, C. E. Lilley, J. Bartek, J. Lukas, and M. D. Weitzman. 2009.**

- Mislocalization of the MRN complex prevents ATR signaling during adenovirus infection. *EMBO J* 28: 652-662.
- Casey, L., X. Wen, and C. M. de Noronha. 2010.** The functions of the HIV1 protein Vpr and its action through the DCAF1.DDB1.Cullin4 ubiquitin ligase. *Cytokine* 51: 1-9.
- Chan, N. L., and C. P. Hill. 2001.** Defining polyubiquitin chain topology. *Nature structural biology* 8: 650-652.
- Chang, J. T., T. F. Kuo, Y. J. Chen, C. C. Chiu, Y. C. Lu, H. F. Li, C. R. Shen, and A. J. Cheng. 2010.** Highly potent and specific siRNAs against E6 or E7 genes of HPV16- or HPV18-infected cervical cancers. *Cancer gene therapy* 17: 827-836.
- Chang, S. J., J. C. Hsiao, S. Sonnberg, C. T. Chiang, M. H. Yang, D. L. Tzou, A. A. Mercer, and W. Chang. 2009.** Poxvirus host range protein CP77 contains an F-box-like domain that is necessary to suppress NF-kappaB activation by tumor necrosis factor alpha but is independent of its host range function. *J Virol* 83: 4140-4152.
- Chazal, N., and D. Gerlier. 2003.** Virus entry, assembly, budding, and membrane rafts. *Microbiol Mol Biol Rev* 67: 226-237, table of contents.
- Chen, C., and X. Zhuang. 2008.** Epsin 1 is a cargo-specific adaptor for the clathrin-mediated endocytosis of the influenza virus. *Proceedings of the National Academy of Sciences of the United States of America* 105: 11790-11795.
- Chen, H., C. E. Lilley, Q. Yu, D. V. Lee, J. Chou, I. Narvaiza, N. R. Landau, and M. D. Weitzman. 2006.** APOBEC3A is a potent inhibitor of adeno-associated virus and retrotransposons. *Curr Biol* 16: 480-485.
- Chen, R., E. Le Rouzic, J. A. Kearney, L. M. Mansky, and S. Benichou. 2004.** Vpr-mediated incorporation of UNG2 into HIV-1 particles is required to modulate the virus mutation rate and for replication in macrophages. *J Biol Chem* 279: 28419-28425.
- Chen, R. H., Y. R. Lee, and W. C. Yuan. 2012.** The role of PML ubiquitination in human malignancies. *Journal of biomedical science* 19: 81.
- Cheng-Mayer, C., P. Iannello, K. Shaw, P. A. Luciw, and J. A. Levy. 1989.** Differential effects of nef on HIV replication: implications for viral pathogenesis in the host. *Science (New York, N.Y.)* 246: 1629-1632.
- Cheng, C. Y., T. Gilson, F. Dallaire, G. Ketner, P. E. Branton, and P. Blanchette. 2011.** The E4orf6/E1B55K E3 ubiquitin ligase complexes of human adenoviruses exhibit heterogeneity in composition and substrate specificity. *J Virol* 85: 765-775.
- Cheng, Q., and J. Chen. 2010.** Mechanism of p53 stabilization by ATM after DNA damage. *Cell Cycle* 9: 472-478.
- Cherrier, T., S. Suzanne, L. Redel, M. Calao, C. Marban, B. Samah, R. Mukerjee, C. Schwartz, G. Gras, B. E. Sawaya, S. L. Zeichner, D. Aunis, C. Van Lint, and O. Rohr. 2009.** p21(WAF1) gene promoter is epigenetically silenced by CTIP2 and SUV39H1. *Oncogene* 28: 3380-3389.
- Chiu, Y. L., V. B. Soros, J. F. Kreisberg, K. Stopak, W. Yonemoto, and W. C. Greene. 2005.** Cellular APOBEC3G restricts HIV-1 infection in resting CD4+ T cells. *Nature* 435: 108-114.
- Chomont, N., S. DaFonseca, C. Vandergaeten, P. Ancuta, and R. P. Sekaly. 2011.** Maintenance of CD4+ T-cell memory and HIV persistence: keeping memory, keeping HIV. *Curr Opin HIV AIDS* 6: 30-36.
- Chun, T. W., L. Carruth, D. Finzi, X. Shen, J. A. DiGiuseppe, H. Taylor, M. Hermankova, K. Chadwick, J. Margolick, T. C. Quinn, Y. H. Kuo, R. Brookmeyer, M. A. Zeiger, P. Barditch-Crovo, and R. F. Siliciano. 1997.** Quantification of latent tissue reservoirs and total body viral load in HIV-1 infection. *Nature* 387: 183-188.
- Ciechanover, A. 2010.** Intracellular protein degradation: from a vague idea through the lysosome and the ubiquitin-proteasome system and onto human diseases and drug targeting. *Medicina* 70: 105-119.
- Ciechanover, A. 2012.** Intracellular protein degradation: from a vague idea through the lysosome and the ubiquitin-proteasome system and onto human diseases and drug targeting. *Neuro-degenerative diseases* 10: 7-22.



- Cismasiu, V. B., E. Paskaleva, S. Suman Daya, M. Canki, K. Duus, and D. Avram. 2008.** BCL11B is a general transcriptional repressor of the HIV-1 long terminal repeat in T lymphocytes through recruitment of the NuRD complex. *Virology* 380: 173-181.
- Clark, S. J., M. S. Saag, W. D. Decker, S. Campbell-Hill, J. L. Roberson, P. J. Veldkamp, J. C. Kappes, B. H. Hahn, and G. M. Shaw. 1991.** High titers of cytopathic virus in plasma of patients with symptomatic primary HIV-1 infection. *The New England journal of medicine* 324: 954-960.
- Coeytaux, E., D. Coulaud, E. Le Cam, O. Danos, and A. Kichler. 2003.** The cationic amphipathic alpha-helix of HIV-1 viral protein R (Vpr) binds to nucleic acids, permeabilizes membranes, and efficiently transfects cells. *J Biol Chem* 278: 18110-18116.
- Connor, R. I., B. K. Chen, S. Choe, and N. R. Landau. 1995.** Vpr is required for efficient replication of human immunodeficiency virus type-1 in mononuclear phagocytes. *Virology* 206: 935-944.
- Coscoy, L., and D. Ganem. 2000.** Kaposi's sarcoma-associated herpesvirus encodes two proteins that block cell surface display of MHC class I chains by enhancing their endocytosis. *Proceedings of the National Academy of Sciences of the United States of America* 97: 8051-8056.
- Coscoy, L., D. J. Sanchez, and D. Ganem. 2001.** A novel class of herpesvirus-encoded membrane-bound E3 ubiquitin ligases regulates endocytosis of proteins involved in immune recognition. *The Journal of cell biology* 155: 1265-1273.
- Cosenza, M. A., M. L. Zhao, Q. Si, and S. C. Lee. 2002.** Human brain parenchymal microglia express CD14 and CD45 and are productively infected by HIV-1 in HIV-1 encephalitis. *Brain Pathol* 12: 442-455.
- Cui, J., P. K. Tungaturthi, V. Ayyavoo, M. Ghafouri, H. Ariga, K. Khalili, A. Srinivasan, S. Amini, and B. E. Sawaya. 2006.** The role of Vpr in the regulation of HIV-1 gene expression. *Cell Cycle* 5: 2626-2638.
- Cullen, B. R. 1998.** HIV-1 auxiliary proteins: making connections in a dying cell. *Cell* 93: 685-692.
- Daar, E. S., T. Moudgil, R. D. Meyer, and D. D. Ho. 1991.** Transient high levels of viremia in patients with primary human immunodeficiency virus type 1 infection. *The New England journal of medicine* 324: 961-964.
- Dang, Y., L. M. Siew, and Y. H. Zheng. 2008.** APOBEC3G is degraded by the proteasomal pathway in a Vif-dependent manner without being polyubiquitylated. *J Biol Chem* 283: 13124-13131.
- Das, A. T., T. R. Brummelkamp, E. M. Westerhout, M. Vink, M. Madiredjo, R. Bernards, and B. Berkhout. 2004.** Human immunodeficiency virus type 1 escapes from RNA interference-mediated inhibition. *J Virol* 78: 2601-2605.
- Davis, L. E., B. L. Hjelle, V. E. Miller, D. L. Palmer, A. L. Llewellyn, T. L. Merlin, S. A. Young, R. G. Mills, W. Wachsman, and C. A. Wiley. 1992.** Early viral brain invasion in iatrogenic human immunodeficiency virus infection. *Neurology* 42: 1736-1739.
- De Clercq, E. 2010.** Antiretroviral drugs. *Curr Opin Pharmacol* 10: 507-515.
- de Noronha, C. M., M. P. Sherman, H. W. Lin, M. V. Cavrois, R. D. Moir, R. D. Goldman, and W. C. Greene. 2001.** Dynamic disruptions in nuclear envelope architecture and integrity induced by HIV-1 Vpr. *Science (New York, N.Y.)* 294: 1105-1108.
- De Rijck, J., L. Vandekerckhove, F. Christ, and Z. Debyser. 2007.** Lentiviral nuclear import: a complex interplay between virus and host. *Bioessays* 29: 441-451.
- de Silva, S., and L. Wu. 2011.** TRIM5 acts as more than a retroviral restriction factor. *Viruses* 3: 1204-1209.
- Dehart, J. L., and V. Planelles. 2008.** Human immunodeficiency virus type 1 Vpr links proteasomal degradation and checkpoint activation. *J Virol* 82: 1066-1072.
- DeHart, J. L., A. Bosque, R. S. Harris, and V. Planelles. 2008.** Human immunodeficiency virus type 1 Vif induces cell cycle delay via recruitment of the same E3 ubiquitin ligase complex that targets APOBEC3 proteins for degradation. *J Virol* 82: 9265-9272.

- DeHart, J. L., E. S. Zimmerman, O. Ardon, C. M. Monteiro-Filho, E. R. Arganaraz, and V. Planelles. 2007.** HIV-1 Vpr activates the G2 checkpoint through manipulation of the ubiquitin proteasome system. *Virology* 4: 57.
- Delboy, M. G., D. G. Roller, and A. V. Nicola. 2008.** Cellular proteasome activity facilitates herpes simplex virus entry at a postpenetration step. *J Virol* 82: 3381-3390.
- Delelis, O., K. Carayon, A. Saib, E. Deprez, and J. F. Mouscadet. 2008.** Integrase and integration: biochemical activities of HIV-1 integrase. *Retrovirology* 5: 114.
- Derdowski, A., L. Ding, and P. Spearman. 2004.** A novel fluorescence resonance energy transfer assay demonstrates that the human immunodeficiency virus type 1 Pr55Gag I domain mediates Gag-Gag interactions. *J Virol* 78: 1230-1242.
- Descours, B., A. Cribier, C. Chable-Bessia, D. Ayinde, G. Rice, Y. Crow, A. Yatim, O. Schwartz, N. Laguette, and M. Benkirane. 2012.** SAMHD1 restricts HIV-1 reverse transcription in quiescent CD4(+) T-cells. *Retrovirology* 9: 87.
- Deshaies, R. J., and C. A. Joazeiro. 2009.** RING domain E3 ubiquitin ligases. *Annu Rev Biochem* 78: 399-434.
- Diaz-Griffero, F., X. Li, H. Javanbakht, B. Song, S. Welikala, M. Stremlau, and J. Sodroski. 2006.** Rapid turnover and polyubiquitylation of the retroviral restriction factor TRIM5. *Virology* 349: 300-315.
- Doehle, B. P., F. Hladik, J. P. McNevin, M. J. McElrath, and M. Gale, Jr. 2009.** Human immunodeficiency virus type 1 mediates global disruption of innate antiviral signaling and immune defenses within infected cells. *J Virol* 83: 10395-10405.
- Doil, C., N. Mailand, S. Bekker-Jensen, P. Menard, D. H. Larsen, R. Pepperkok, J. Ellenberg, S. Panier, D. Durocher, J. Bartek, J. Lukas, and C. Lukas. 2009.** RNF168 binds and amplifies ubiquitin conjugates on damaged chromosomes to allow accumulation of repair proteins. *Cell* 136: 435-446.
- Doria, M. 2011.** Role of the CD4 down-modulation activity of Nef in HIV-1 infectivity. *Curr HIV Res* 9: 490-495.
- Douglas, J. L., K. Viswanathan, M. N. McCarroll, J. K. Gustin, K. Fruh, and A. V. Moses. 2009.** Vpu directs the degradation of the human immunodeficiency virus restriction factor BST-2/Tetherin via a  $\beta$ -TrCP-dependent mechanism. *J Virol* 83: 7931-7947.
- Downs, J. A., and S. P. Jackson. 2004.** A means to a DNA end: the many roles of Ku. *Nature reviews. Molecular cell biology* 5: 367-378.
- Dube, M., M. G. Bego, C. Paquay, and E. A. Cohen. 2010a.** Modulation of HIV-1-host interaction: role of the Vpu accessory protein. *Retrovirology* 7: 114.
- Dube, M., C. Paquay, B. B. Roy, M. G. Bego, J. Mercier, and E. A. Cohen. 2011.** HIV-1 Vpu antagonizes BST-2 by interfering mainly with the trafficking of newly synthesized BST-2 to the cell surface. *Traffic (Copenhagen, Denmark)* 12: 1714-1729.
- Dube, M., B. B. Roy, P. Guiot-Guillain, J. Binette, J. Mercier, A. Chiasson, and E. A. Cohen. 2010b.** Antagonism of tetherin restriction of HIV-1 release by Vpu involves binding and sequestration of the restriction factor in a perinuclear compartment. *PLoS Pathog* 6: e1000856.
- Duda, D. M., D. C. Scott, M. F. Calabrese, E. S. Zimmerman, N. Zheng, and B. A. Schulman. 2011.** Structural regulation of cullin-RING ubiquitin ligase complexes. *Current opinion in structural biology* 21: 257-264.
- Dul, B. E., and N. C. Walworth. 2007.** The plant homeodomain fingers of fission yeast Msc1 exhibit E3 ubiquitin ligase activity. *J Biol Chem* 282: 18397-18406.
- Durack, D. T. 1981.** Opportunistic infections and Kaposi's sarcoma in homosexual men. *The New England journal of medicine* 305: 1465-1467.
- Eggink, D., J. P. Langedijk, A. M. Bonvin, Y. Deng, M. Lu, B. Berkhout, and R. W. Sanders. 2009.** Detailed mechanistic insights into HIV-1 sensitivity to three generations of fusion inhibitors. *J Biol Chem* 284: 26941-26950.
- Eisele, E., and R. F. Siliciano. 2012.** Redefining the viral reservoirs that prevent HIV-1 eradication. *Immunity* 37: 377-388.

- El-Far, M., C. Isabelle, N. Chomont, M. Bourbonniere, S. Fonseca, P. Ancuta, Y. Peretz, Y. Chouikh, R. Halwani, O. Schwartz, J. Madrenas, G. J. Freeman, J. P. Routy, E. K. Haddad, and R. P. Sekaly. 2013.** Down-Regulation of CTLA-4 by HIV-1 Nef Protein. *PLoS One* 8: e54295.
- Elder, R. T., M. Yu, M. Chen, X. Zhu, M. Yanagida, and Y. Zhao. 2001.** HIV-1 Vpr induces cell cycle G2 arrest in fission yeast (*Schizosaccharomyces pombe*) through a pathway involving regulatory and catalytic subunits of PP2A and acting on both Wee1 and Cdc25. *Virology* 287: 359-370.
- Ene, L., D. Duiculescu, and S. M. Ruta. 2011.** How much do antiretroviral drugs penetrate into the central nervous system? *Journal of medicine and life* 4: 432-439.
- Enomoto, T., M. Ohmoto, T. Iwata, A. Uno, M. Saitou, T. Yamaguchi, R. Kominami, I. Matsumoto, and J. Hirota. 2011.** Bcl11b/Ctip2 controls the differentiation of vomeronasal sensory neurons in mice. *J Neurosci* 31: 10159-10173.
- Espert, L., M. Denizot, M. Grimaldi, V. Robert-Hebmann, B. Gay, M. Varbanov, P. Codogno, and M. Biard-Piechaczyk. 2007.** Autophagy and CD4+ T lymphocyte destruction by HIV-1. *Autophagy* 3: 32-34.
- Evering, T. H., and M. Markowitz. 2008.** Raltegravir: an integrase inhibitor for HIV-1. *Expert opinion on investigational drugs* 17: 413-422.
- Fassati, A. 2006.** HIV infection of non-dividing cells: a divisive problem. *Retrovirology* 3: 74.
- Ferrucci, A., M. R. Nonnemacher, and B. Wigdahl. 2011.** Human immunodeficiency virus viral protein R as an extracellular protein in neuropathogenesis. *Adv Virus Res* 81: 165-199.
- Finzi, D., M. Hermankova, T. Pierson, L. M. Carruth, C. Buck, R. E. Chaisson, T. C. Quinn, K. Chadwick, J. Margolick, R. Brookmeyer, J. Gallant, M. Markowitz, D. D. Ho, D. D. Richman, and R. F. Siliciano. 1997.** Identification of a reservoir for HIV-1 in patients on highly active antiretroviral therapy. *Science (New York, N.Y.)* 278: 1295-1300.
- Forrester, N. A., G. G. Sedgwick, A. Thomas, A. N. Blackford, T. Speiseder, T. Dobner, P. J. Byrd, G. S. Stewart, A. S. Turnell, and R. J. Grand. 2011.** Serotype-specific inactivation of the cellular DNA damage response during adenovirus infection. *J Virol* 85: 2201-2211.
- Fouchier, R. A., and M. H. Malim. 1999.** Nuclear import of human immunodeficiency virus type-1 preintegration complexes. *Adv Virus Res* 52: 275-299.
- Francioli, P., M. Vogt, J. Schadelin, F. Clement, E. Russi, F. Delacretaz, C. Perret, and M. P. Glauser. 1982.** [Acquired immunologic deficiency syndrome, opportunistic infections and homosexuality. Presentation of 3 cases studied in Switzerland]. *Schweizerische medizinische Wochenschrift* 112: 1682-1687.
- Frankel, A. D. 1992.** Activation of HIV transcription by Tat. *Curr Opin Genet Dev* 2: 293-298.
- Fritz, J. V., P. Didier, J. P. Clamme, E. Schaub, D. Muriaux, C. Cabanne, N. Morellet, S. Bouaziz, J. L. Darlix, Y. Mely, and H. de Rocquigny. 2008.** Direct Vpr-Vpr interaction in cells monitored by two photon fluorescence correlation spectroscopy and fluorescence lifetime imaging. *Retrovirology* 5: 87.
- Fujita, M., M. Nomaguchi, A. Adachi, and M. Otsuka. 2012.** SAMHD1-Dependent and -Independent Functions of HIV-2/SIV Vpx Protein. *Frontiers in microbiology* 3: 297.
- Gabuzda, D. H., K. Lawrence, E. Langhoff, E. Terwilliger, T. Dorfman, W. A. Haseltine, and J. Sodroski. 1992.** Role of vif in replication of human immunodeficiency virus type 1 in CD4+ T lymphocytes. *J Virol* 66: 6489-6495.
- Gack, M. U., Y. C. Shin, C. H. Joo, T. Urano, C. Liang, L. Sun, O. Takeuchi, S. Akira, Z. Chen, S. Inoue, and J. U. Jung. 2007.** TRIM25 RING-finger E3 ubiquitin ligase is essential for RIG-I-mediated antiviral activity. *Nature* 446: 916-920.
- Gaines, H., M. A. von Sydow, L. V. von Stedingk, G. Biberfeld, B. Bottiger, L. O. Hansson, P. Lundbergh, A. B. Sonnerborg, J. Wasserman, and O. O. Strannegaard. 1990.** Immunological changes in primary HIV-1 infection. *Aids* 4: 995-999.

- Gaines, H., M. von Sydow, A. Sonnerborg, J. Albert, J. Czajkowski, P. O. Pehrson, F. Chiodi, L. Moberg, E. M. Fenyo, B. Asjo, and et al. 1987.** Antibody response in primary human immunodeficiency virus infection. *Lancet* 1: 1249-1253.
- Gallo, R. C., S. Z. Salahuddin, M. Popovic, G. M. Shearer, M. Kaplan, B. F. Haynes, T. J. Palker, R. Redfield, J. Oleske, B. Safai, and et al. 1984.** Frequent detection and isolation of cytopathic retroviruses (HTLV-III) from patients with AIDS and at risk for AIDS. *Science (New York, N.Y.)* 224: 500-503.
- Ganser-Pornillos, B. K., M. Yeager, and W. I. Sundquist. 2008.** The structural biology of HIV assembly. *Current opinion in structural biology* 18: 203-217.
- Ganser-Pornillos, B. K., M. Yeager, and O. Pornillos. 2012.** Assembly and architecture of HIV. *Advances in experimental medicine and biology* 726: 441-465.
- Garrido, C., V. Soriano, A. M. Geretti, N. Zahonero, S. Garcia, C. Booth, F. Gutierrez, I. Viciano, and C. de Mendoza. 2011.** Resistance associated mutations to dolutegravir (S/GSK1349572) in HIV-infected patients--impact of HIV subtypes and prior raltegravir experience. *Antiviral research* 90: 164-167.
- Garrus, J. E., U. K. von Schwedler, O. W. Pornillos, S. G. Morham, K. H. Zavitz, H. E. Wang, D. A. Wettstein, K. M. Stray, M. Cote, R. L. Rich, D. G. Myszka, and W. I. Sundquist. 2001.** Tsg101 and the vacuolar protein sorting pathway are essential for HIV-1 budding. *Cell* 107: 55-65.
- Gartel, A. L., and A. L. Tyner. 2002.** The role of the cyclin-dependent kinase inhibitor p21 in apoptosis. *Mol Cancer Ther* 1: 639-649.
- Gartel, A. L., and S. K. Radhakrishnan. 2005.** Lost in transcription: p21 repression, mechanisms, and consequences. *Cancer Res* 65: 3980-3985.
- Gastaldello, S., S. Hildebrand, O. Faridani, S. Callegari, M. Palmkvist, C. Di Guglielmo, and M. G. Masucci. 2010.** A deneddylase encoded by Epstein-Barr virus promotes viral DNA replication by regulating the activity of cullin-RING ligases. *Nature cell biology* 12: 351-361.
- Geeraert, L., G. Kraus, and R. J. Pomerantz. 2008.** Hide-and-seek: the challenge of viral persistence in HIV-1 infection. *Annu Rev Med* 59: 487-501.
- Geraghty, R. J., K. J. Talbot, M. Callahan, W. Harper, and A. T. Panganiban. 1994.** Cell type-dependence for Vpu function. *J Med Primatol* 23: 146-150.
- Gerard, A., N. Soler, E. Segeal, M. Belshan, and S. Emiliani. 2013.** Identification of low molecular weight nuclear complexes containing integrase during the early stages of HIV-1 infection. *Retrovirology* 10: 13.
- Gerstoft, J., A. Malchow-Moller, I. Bygbjerg, E. Dickmeiss, C. Enk, P. Halberg, S. Haahr, M. Jacobsen, K. Jensen, J. Mejer, J. O. Nielsen, H. K. Thomsen, J. Sondergaard, and I. Lorenzen. 1982.** Severe acquired immunodeficiency in European homosexual men. *British medical journal (Clinical research ed.)* 285: 17-19.
- Ghosn, J., J. P. Viard, C. Katlama, M. de Almeida, R. Tubiana, F. Letourneur, L. Aaron, C. Goujard, D. Salmon, M. Leruez-Ville, C. Rouzioux, and M. L. Chaix. 2004.** Evidence of genotypic resistance diversity of archived and circulating viral strains in blood and semen of pre-treated HIV-infected men. *Aids* 18: 447-457.
- Gillim-Ross, L., A. Cara, and M. E. Klotman. 2005.** HIV-1 extrachromosomal 2-LTR circular DNA is long-lived in human macrophages. *Viral Immunol* 18: 190-196.
- Glass, J. D., H. Fedor, S. L. Wesselingh, and J. C. McArthur. 1995.** Immunocytochemical quantitation of human immunodeficiency virus in the brain: correlations with dementia. *Ann Neurol* 38: 755-762.
- Goel, A., S. J. Mazur, R. J. Fattah, T. L. Hartman, J. A. Turpin, M. Huang, W. G. Rice, E. Appella, and J. K. Inman. 2002.** Benzamide-based thiolcarbamates: a new class of HIV-1 NCp7 inhibitors. *Bioorg Med Chem Lett* 12: 767-770.
- Goffinet, C., I. Allespach, S. Homann, H. M. Tervo, A. Habermann, D. Rupp, L. Oberbremer, C. Kern, N. Tibroni, S. Welsch, J. Krijnse-Locker, G. Banting, H. G. Krausslich, O. T. Fackler, and O. T. Keppler. 2009.** HIV-1 antagonism of CD317 is

- species specific and involves Vpu-mediated proteasomal degradation of the restriction factor. *Cell Host Microbe* 5: 285-297.
- Goh, W. C., M. E. Rogel, C. M. Kinsey, S. F. Michael, P. N. Fultz, M. A. Nowak, B. H. Hahn, and M. Emerman. 1998.** HIV-1 Vpr increases viral expression by manipulation of the cell cycle: a mechanism for selection of Vpr in vivo. *Nat Med* 4: 65-71.
- Goldstone, D. C., V. Ennis-Adeniran, J. J. Hedden, H. C. Groom, G. I. Rice, E. Christodoulou, P. A. Walker, G. Kelly, L. F. Haire, M. W. Yap, L. P. de Carvalho, J. P. Stoye, Y. J. Crow, I. A. Taylor, and M. Webb. 2011.** HIV-1 restriction factor SAMHD1 is a deoxynucleoside triphosphate triphosphohydrolase. *Nature* 480: 379-382.
- Gomez, C., and T. J. Hope. 2005.** The ins and outs of HIV replication. *Cell Microbiol* 7: 621-626.
- Gomez, L. M., E. Pacyniak, M. Flick, D. R. Hout, M. L. Gomez, E. Nerrienet, A. Ayouba, M. L. Santiago, B. H. Hahn, and E. B. Stephens. 2005.** Vpu-mediated CD4 down-regulation and degradation is conserved among highly divergent SIV(cpz) strains. *Virology* 335: 46-60.
- Gonzalez, C. M., L. Wang, and B. Damania. 2009.** Kaposi's sarcoma-associated herpesvirus encodes a viral deubiquitinase. *J Virol* 83: 10224-10233.
- Goto, T., S. J. Kennel, M. Abe, M. Takishita, M. Kosaka, A. Solomon, and S. Saito. 1994.** A novel membrane antigen selectively expressed on terminally differentiated human B cells. *Blood* 84: 1922-1930.
- Gottlieb, M. S., R. Schroff, H. M. Schanker, J. D. Weisman, P. T. Fan, R. A. Wolf, and A. Saxon. 1981.** Pneumocystis carinii pneumonia and mucosal candidiasis in previously healthy homosexual men: evidence of a new acquired cellular immunodeficiency. *The New England journal of medicine* 305: 1425-1431.
- Gould, F., S. M. Harrison, E. W. Hewitt, and A. Whitehouse. 2009.** Kaposi's sarcoma-associated herpesvirus RTA promotes degradation of the Hey1 repressor protein through the ubiquitin proteasome pathway. *J Virol* 83: 6727-6738.
- Graff, J. W., J. Ewen, K. Ettayebi, and M. E. Hardy. 2007.** Zinc-binding domain of rotavirus NSP1 is required for proteasome-dependent degradation of IRF3 and autoregulatory NSP1 stability. *J Gen Virol* 88: 613-620.
- Gredmark, S., C. Schlieker, V. Quesada, E. Spooner, and H. L. Ploegh. 2007.** A functional ubiquitin-specific protease embedded in the large tegument protein (ORF64) of murine gammaherpesvirus 68 is active during the course of infection. *J Virol* 81: 10300-10309.
- Green, D. R., and G. Kroemer. 2004.** The pathophysiology of mitochondrial cell death. *Science (New York, N.Y.)* 305: 626-629.
- Grutter, M. G., and J. Luban. 2012.** TRIM5 structure, HIV-1 capsid recognition, and innate immune signaling. *Curr Opin Virol* 2: 142-150.
- Gu, H., and B. Roizman. 2003.** The degradation of promyelocytic leukemia and Sp100 proteins by herpes simplex virus 1 is mediated by the ubiquitin-conjugating enzyme UbcH5a. *Proceedings of the National Academy of Sciences of the United States of America* 100: 8963-8968.
- Gu, H., and B. Roizman. 2009.** The two functions of herpes simplex virus 1 ICP0, inhibition of silencing by the CoREST/REST/HDAC complex and degradation of PML, are executed in tandem. *J Virol* 83: 181-187.
- Gustin, J. K., A. V. Moses, K. Fruh, and J. L. Douglas. 2011.** Viral takeover of the host ubiquitin system. *Frontiers in microbiology* 2: 161.
- Hache, G., L. M. Mansky, and R. S. Harris. 2006.** Human APOBEC3 proteins, retrovirus restriction, and HIV drug resistance. *AIDS Rev* 8: 148-157.
- Haffar, O. K., S. Popov, L. Dubrovsky, I. Agostini, H. Tang, T. Pushkarsky, S. G. Nadler, and M. Bukrinsky. 2000.** Two nuclear localization signals in the HIV-1 matrix protein regulate nuclear import of the HIV-1 pre-integration complex. *J Mol Biol* 299: 359-368.
- Haglund, K., and I. Dikic. 2005.** Ubiquitylation and cell signaling. *EMBO J* 24: 3353-3359.
- Haglund, K., P. P. Di Fiore, and I. Dikic. 2003a.** Distinct monoubiquitin signals in receptor endocytosis. *Trends in biochemical sciences* 28: 598-603.

- Haglund, K., S. Sigismund, S. Polo, I. Szymkiewicz, P. P. Di Fiore, and I. Dikic. 2003b.** Multiple monoubiquitination of RTKs is sufficient for their endocytosis and degradation. *Nature cell biology* 5: 461-466.
- Hallenberger, S., M. Moulard, M. Sordel, H. D. Klenk, and W. Garten. 1997.** The role of eukaryotic subtilisin-like endoproteases for the activation of human immunodeficiency virus glycoproteins in natural host cells. *J Virol* 71: 1036-1045.
- Hammonds, J., J. J. Wang, and P. Spearman. 2012.** Restriction of Retroviral Replication by Tetherin/BST-2. *Molecular biology international* 2012: 424768.
- Han, Y., M. Wind-Rotolo, H. C. Yang, J. D. Siliciano, and R. F. Siliciano. 2007.** Experimental approaches to the study of HIV-1 latency. *Nat Rev Microbiol* 5: 95-106.
- Harari, A., M. Ooms, L. C. Mulder, and V. Simon. 2009.** Polymorphisms and splice variants influence the antiretroviral activity of human APOBEC3H. *J Virol* 83: 295-303.
- Harhaj, N. S., S. C. Sun, and E. W. Harhaj. 2007.** Activation of NF-kappa B by the human T cell leukemia virus type I Tax oncoprotein is associated with ubiquitin-dependent relocalization of I kappa B kinase. *J Biol Chem* 282: 4185-4192.
- Harman, A. N., J. Wilkinson, C. R. Bye, L. Bosnjak, J. L. Stern, M. Nicholle, J. Lai, and A. L. Cunningham. 2006.** HIV induces maturation of monocyte-derived dendritic cells and Langerhans cells. *Journal of immunology (Baltimore, Md. : 1950)* 177: 7103-7113.
- Harrich, D., and B. Hooker. 2002.** Mechanistic aspects of HIV-1 reverse transcription initiation. *Rev Med Virol* 12: 31-45.
- Harris, R. S., and M. T. Liddament. 2004.** Retroviral restriction by APOBEC proteins. *Nat Rev Immunol* 4: 868-877.
- Harris, R. S., K. N. Bishop, A. M. Sheehy, H. M. Craig, S. K. Petersen-Mahrt, I. N. Watt, M. S. Neuberger, and M. H. Malim. 2003.** DNA deamination mediates innate immunity to retroviral infection. *Cell* 113: 803-809.
- Hattori, N., F. Michaels, K. Fargnoli, L. Marcon, R. C. Gallo, and G. Franchini. 1990.** The human immunodeficiency virus type 2 vpr gene is essential for productive infection of human macrophages. *Proceedings of the National Academy of Sciences of the United States of America* 87: 8080-8084.
- Hauser, H., L. A. Lopez, S. J. Yang, J. E. Oldenburg, C. M. Exline, J. C. Guatelli, and P. M. Cannon. 2010.** HIV-1 Vpu and HIV-2 Env counteract BST-2/tetherin by sequestration in a perinuclear compartment. *Retrovirology* 7: 51.
- He, J., S. Choe, R. Walker, P. Di Marzio, D. O. Morgan, and N. R. Landau. 1995.** Human immunodeficiency virus type 1 viral protein R (Vpr) arrests cells in the G2 phase of the cell cycle by inhibiting p34cdc2 activity. *J Virol* 69: 6705-6711.
- He, J., Y. Chen, M. Farzan, H. Choe, A. Ohagen, S. Gartner, J. Busciglio, X. Yang, W. Hofmann, W. Newman, C. R. Mackay, J. Sodroski, and D. Gabuzda. 1997.** CCR3 and CCR5 are co-receptors for HIV-1 infection of microglia. *Nature* 385: 645-649.
- Henderson, B. R., and P. Percipalle. 1997.** Interactions between HIV Rev and nuclear import and export factors: the Rev nuclear localisation signal mediates specific binding to human importin-beta. *J Mol Biol* 274: 693-707.
- Herbein, G., G. Gras, K. A. Khan, and W. Abbas. 2010.** Macrophage signaling in HIV-1 infection. *Retrovirology* 7: 34.
- Herbein, G., A. Varin, A. Larbi, C. Fortin, U. Mahlknecht, T. Fulop, and B. B. Aggarwal. 2008.** Nef and TNFalpha are coplayers that favor HIV-1 replication in monocytic cells and primary macrophages. *Curr HIV Res* 6: 117-129.
- Hermankova, M., S. C. Ray, C. Ruff, M. Powell-Davis, R. Ingersoll, R. T. D'Aquila, T. C. Quinn, J. D. Siliciano, R. F. Siliciano, and D. Persaud. 2001.** HIV-1 drug resistance profiles in children and adults with viral load of <50 copies/ml receiving combination therapy. *JAMA : the journal of the American Medical Association* 286: 196-207.
- Hershko, A., A. Ciechanover, and I. A. Rose. 1979.** Resolution of the ATP-dependent proteolytic system from reticulocytes: a component that interacts with ATP. *Proceedings of the National Academy of Sciences of the United States of America* 76: 3107-3110.

- Hershko, A., H. Heller, S. Elias, and A. Ciechanover. 1983.** Components of ubiquitin-protein ligase system. Resolution, affinity purification, and role in protein breakdown. *J Biol Chem* 258: 8206-8214.
- Hershko, A., A. Ciechanover, H. Heller, A. L. Haas, and I. A. Rose. 1980.** Proposed role of ATP in protein breakdown: conjugation of protein with multiple chains of the polypeptide of ATP-dependent proteolysis. *Proceedings of the National Academy of Sciences of the United States of America* 77: 1783-1786.
- Hicke, L. 2001a.** Protein regulation by monoubiquitin. *Nature reviews. Molecular cell biology* 2: 195-201.
- Hicke, L. 2001b.** A new ticket for entry into budding vesicles-ubiquitin. *Cell* 106: 527-530.
- Hicke, L., and R. Dunn. 2003.** Regulation of membrane protein transport by ubiquitin and ubiquitin-binding proteins. *Annual review of cell and developmental biology* 19: 141-172.
- Higa, L. A., and H. Zhang. 2007.** Stealing the spotlight: CUL4-DDB1 ubiquitin ligase docks WD40-repeat proteins to destroy. *Cell division* 2: 5.
- Ho, D. D., T. R. Rota, and M. S. Hirsch. 1985.** Antibody to lymphadenopathy-associated virus in AIDS. *The New England journal of medicine* 312: 649-650.
- Hofmann, H., E. C. Logue, N. Bloch, W. Daddacha, S. B. Polsky, M. L. Schultz, B. Kim, and N. R. Landau. 2012.** The Vpx lentiviral accessory protein targets SAMHD1 for degradation in the nucleus. *J Virol* 86: 12552-12560.
- Hogan, T. H., M. R. Nonnemacher, F. C. Krebs, A. Henderson, and B. Wigdahl. 2003.** HIV-1 Vpr binding to HIV-1 LTR C/EBP cis-acting elements and adjacent regions is sequence-specific. *Biomed Pharmacother* 57: 41-48.
- Holtzman, M. J., J. M. Green, S. Jayaraman, and R. H. Arch. 2000.** Regulation of T cell apoptosis. *Apoptosis* 5: 459-471.
- Howie, H. L., R. A. Katzenellenbogen, and D. A. Galloway. 2009.** Papillomavirus E6 proteins. *Virology* 384: 324-334.
- Hrecka, K., M. Gierszewska, S. Srivastava, L. Kozackiewicz, S. K. Swanson, L. Florens, M. P. Washburn, and J. Skowronski. 2007.** Lentiviral Vpr usurps Cul4-DDB1[VprBP] E3 ubiquitin ligase to modulate cell cycle. *Proceedings of the National Academy of Sciences of the United States of America* 104: 11778-11783.
- Hrecka, K., C. Hao, M. Gierszewska, S. K. Swanson, M. Kesik-Brodacka, S. Srivastava, L. Florens, M. P. Washburn, and J. Skowronski. 2011.** Vpx relieves inhibition of HIV-1 infection of macrophages mediated by the SAMHD1 protein. *Nature* 474: 658-661.
- Hua, Z., and R. D. Vierstra. 2011.** The cullin-RING ubiquitin-protein ligases. *Annual review of plant biology* 62: 299-334.
- Huang, J., F. Wang, E. Argyris, K. Chen, Z. Liang, H. Tian, W. Huang, K. Squires, G. Verlinghieri, and H. Zhang. 2007.** Cellular microRNAs contribute to HIV-1 latency in resting primary CD4+ T lymphocytes. *Nat Med* 13: 1241-1247.
- Huang, J., Q. Huang, X. Zhou, M. M. Shen, A. Yen, S. X. Yu, G. Dong, K. Qu, P. Huang, E. M. Anderson, S. Daniel-Issakani, R. M. Buller, D. G. Payan, and H. H. Lu. 2004.** The poxvirus p28 virulence factor is an E3 ubiquitin ligase. *J Biol Chem* 279: 54110-54116.
- Huang, T. T., and A. D. D'Andrea. 2006.** Regulation of DNA repair by ubiquitylation. *Nature reviews. Molecular cell biology* 7: 323-334.
- Huh, K., X. Zhou, H. Hayakawa, J. Y. Cho, T. A. Libermann, J. Jin, J. W. Harper, and K. Munger. 2007.** Human papillomavirus type 16 E7 oncoprotein associates with the cullin 2 ubiquitin ligase complex, which contributes to degradation of the retinoblastoma tumor suppressor. *J Virol* 81: 9737-9747.
- Huisman, M. T., J. W. Smit, H. R. Wiltshire, R. M. Hoetelmans, J. H. Beijnen, and A. H. Schinkel. 2001.** P-glycoprotein limits oral availability, brain, and fetal penetration of saquinavir even with high doses of ritonavir. *Mol Pharmacol* 59: 806-813.
- Hull, R. 2001.** Classifying reverse transcribing elements: a proposal and a challenge to the ICTV. *International Committee on Taxonomy of Viruses. Arch Virol* 146: 2255-2261.

- Hwang, J., and R. F. Kalejta. 2009.** Human cytomegalovirus protein pp71 induces Daxx SUMOylation. *J Virol* 83: 6591-6598.
- Hwang, J., and R. F. Kalejta. 2011.** In vivo analysis of protein sumoylation induced by a viral protein: Detection of HCMV pp71-induced Daxx sumoylation. *Methods (San Diego, Calif.)* 55: 160-165.
- Ikeda, M., and R. Longnecker. 2009.** The c-Cbl proto-oncoprotein downregulates EBV LMP2A signaling. *Virology* 385: 183-191.
- Isaacson, M. K., and H. L. Ploegh. 2009.** Ubiquitination, ubiquitin-like modifiers, and deubiquitination in viral infection. *Cell Host Microbe* 5: 559-570.
- Ishido, S., C. Wang, B. S. Lee, G. B. Cohen, and J. U. Jung. 2000.** Downregulation of major histocompatibility complex class I molecules by Kaposi's sarcoma-associated herpesvirus K3 and K5 proteins. *J Virol* 74: 5300-5309.
- Isobe, T., T. Hattori, K. Kitagawa, C. Uchida, Y. Kotake, I. Kosugi, T. Oda, and M. Kitagawa. 2009.** Adenovirus E1A inhibits SCF(Fbw7) ubiquitin ligase. *J Biol Chem* 284: 27766-27779.
- Ivanov, A. V., H. Peng, V. Yurchenko, K. L. Yap, D. G. Negorev, D. C. Schultz, E. Psulkowski, W. J. Fredericks, D. E. White, G. G. Maul, M. J. Sadofsky, M. M. Zhou, and F. J. Rauscher, 3rd. 2007.** PHD domain-mediated E3 ligase activity directs intramolecular sumoylation of an adjacent bromodomain required for gene silencing. *Molecular cell* 28: 823-837.
- Iwabu, Y., M. Kinomoto, M. Tatsumi, H. Fujita, M. Shimura, Y. Tanaka, Y. Ishizaka, D. Nolan, S. Mallal, T. Sata, and K. Tokunaga. 2010.** Differential anti-APOBEC3G activity of HIV-1 Vif proteins derived from different subtypes. *J Biol Chem* 285: 35350-35358.
- Iwatani, Y., D. S. Chan, L. Liu, H. Yoshii, J. Shibata, N. Yamamoto, J. G. Levin, A. M. Gronenborn, and W. Sugiura. 2009.** HIV-1 Vif-mediated ubiquitination/degradation of APOBEC3G involves four critical lysine residues in its C-terminal domain. *Proceedings of the National Academy of Sciences of the United States of America* 106: 19539-19544.
- Jacquot, G., E. Le Rouzic, A. David, J. Mazzolini, J. Bouchet, S. Bouaziz, F. Niedergang, G. Pancino, and S. Benichou. 2007.** Localization of HIV-1 Vpr to the nuclear envelope: impact on Vpr functions and virus replication in macrophages. *Retrovirology* 4: 84.
- Jager, S., D. Y. Kim, J. F. Hultquist, K. Shindo, R. S. LaRue, E. Kwon, M. Li, B. D. Anderson, L. Yen, D. Stanley, C. Mahon, J. Kane, K. Franks-Skiba, P. Cimermancic, A. Burlingame, A. Sali, C. S. Craik, R. S. Harris, J. D. Gross, and N. J. Krogan. 2012a.** Vif hijacks CBF-beta to degrade APOBEC3G and promote HIV-1 infection. *Nature* 481: 371-375.
- Jager, S., P. Cimermancic, N. Gulbahce, J. R. Johnson, K. E. McGovern, S. C. Clarke, M. Shales, G. Mercenne, L. Pache, K. Li, H. Hernandez, G. M. Jang, S. L. Roth, E. Akiva, J. Marlett, M. Stephens, I. D'Orso, J. Fernandes, M. Fahey, C. Mahon, A. J. O'Donoghue, A. Todorovic, J. H. Morris, D. A. Maltby, T. Alber, G. Cagney, F. D. Bushman, J. A. Young, S. K. Chanda, W. I. Sundquist, T. Kortemme, R. D. Hernandez, C. S. Craik, A. Burlingame, A. Sali, A. D. Frankel, and N. J. Krogan. 2012b.** Global landscape of HIV-human protein complexes. *Nature* 481: 365-370.
- Janvier, K., A. Pelchen-Matthews, J. B. Renaud, M. Caillet, M. Marsh, and C. Berlioz-Torrent. 2011.** The ESCRT-0 component HRS is required for HIV-1 Vpu-mediated BST-2/tetherin down-regulation. *PLoS Pathog* 7: e1001265.
- Jarmuz, A., A. Chester, J. Bayliss, J. Gisbourne, I. Dunham, J. Scott, and N. Navaratnam. 2002.** An anthropoid-specific locus of orphan C to U RNA-editing enzymes on chromosome 22. *Genomics* 79: 285-296.
- Jha, S., S. Vande Pol, N. S. Banerjee, A. B. Dutta, L. T. Chow, and A. Dutta. 2010.** Destabilization of TIP60 by human papillomavirus E6 results in attenuation of TIP60-dependent transcriptional regulation and apoptotic pathway. *Molecular cell* 38: 700-711.
- Jia, B., R. Serra-Moreno, W. Neidermyer, A. Rahmberg, J. Mackey, I. B. Fofana, W. E. Johnson, S. Westmoreland, and D. T. Evans. 2009.** Species-specific activity of SIV Nef and HIV-1 Vpu in overcoming restriction by tetherin/BST2. *PLoS Pathog* 5: e1000429.



- Joazeiro, C. A., and A. M. Weissman. 2000.** RING finger proteins: mediators of ubiquitin ligase activity. *Cell* 102: 549-552.
- Jordan, C. A., B. A. Watkins, C. Kufra, and M. Dubois-Dalcq. 1991.** Infection of brain microglial cells by human immunodeficiency virus type 1 is CD4 dependent. *J Virol* 65: 736-742.
- Jowett, J. B., V. Planelles, B. Poon, N. P. Shah, M. L. Chen, and I. S. Chen. 1995.** The human immunodeficiency virus type 1 vpr gene arrests infected T cells in the G2 + M phase of the cell cycle. *J Virol* 69: 6304-6313.
- Jung, T., and T. Grune. 2012.** Structure of the proteasome. *Progress in molecular biology and translational science* 109: 1-39.
- Kao, S., E. Miyagi, M. A. Khan, H. Takeuchi, S. Opi, R. Goila-Gaur, and K. Strebel. 2004.** Production of infectious human immunodeficiency virus type 1 does not require depletion of APOBEC3G from virus-producing cells. *Retrovirology* 1: 27.
- Kao, S. Y., A. F. Calman, P. A. Luciw, and B. M. Peterlin. 1987.** Anti-termination of transcription within the long terminal repeat of HIV-1 by tat gene product. *Nature* 330: 489-493.
- Kapetanaki, M. G., J. Guerrero-Santoro, D. C. Bisi, C. L. Hsieh, V. Rapic-Otrin, and A. S. Levine. 2006.** The DDB1-CUL4A/DDB2 ubiquitin ligase is deficient in xeroderma pigmentosum group E and targets histone H2A at UV-damaged DNA sites. *Proceedings of the National Academy of Sciences of the United States of America* 103: 2588-2593.
- Kelly, J., M. H. Beddall, D. Yu, S. R. Iyer, J. W. Marsh, and Y. Wu. 2008.** Human macrophages support persistent transcription from unintegrated HIV-1 DNA. *Virology* 372: 300-312.
- Kerscher, O., R. Felberbaum, and M. Hochstrasser. 2006.** Modification of proteins by ubiquitin and ubiquitin-like proteins. *Annual review of cell and developmental biology* 22: 159-180.
- Kessler, M., and M. B. Mathews. 1992.** Premature termination and processing of human immunodeficiency virus type 1-promoted transcripts. *J Virol* 66: 4488-4496.
- Kew, M. C. 2011.** Hepatitis B virus x protein in the pathogenesis of hepatitis B virus-induced hepatocellular carcinoma. *Journal of gastroenterology and hepatology* 26 Suppl 1: 144-152.
- Khan, M. A., R. Goila-Gaur, S. Kao, E. Miyagi, R. C. Walker, Jr., and K. Strebel. 2009.** Encapsulation of APOBEC3G into HIV-1 virions involves lipid raft association and does not correlate with APOBEC3G oligomerization. *Retrovirology* 6: 99.
- Kilareski, E. M., S. Shah, M. R. Nonnemacher, and B. Wigdahl. 2009.** Regulation of HIV-1 transcription in cells of the monocyte-macrophage lineage. *Retrovirology* 6: 118.
- Kim, H. M., Y. Yu, and Y. Cheng. 2011.** Structure characterization of the 26S proteasome. *Biochim Biophys Acta* 1809: 67-79.
- Kinloch-de Loes, S., and L. Perrin. 1995.** Therapeutic interventions in primary HIV infection. *Journal of acquired immune deficiency syndromes and human retrovirology : official publication of the International Retrovirology Association* 10 Suppl 1: S69-76.
- Kino, T., A. Gragerov, O. Slobodskaya, M. Tsopanomalou, G. P. Chrousos, and G. N. Pavlakis. 2002.** Human immunodeficiency virus type 1 (HIV-1) accessory protein Vpr induces transcription of the HIV-1 and glucocorticoid-responsive promoters by binding directly to p300/CBP coactivators. *J Virol* 76: 9724-9734.
- Kirisako, T., K. Kamei, S. Murata, M. Kato, H. Fukumoto, M. Kanie, S. Sano, F. Tokunaga, K. Tanaka, and K. Iwai. 2006.** A ubiquitin ligase complex assembles linear polyubiquitin chains. *EMBO J* 25: 4877-4887.
- Knight, J. S., N. Sharma, and E. S. Robertson. 2005a.** SCFSkp2 complex targeted by Epstein-Barr virus essential nuclear antigen. *Mol Cell Biol* 25: 1749-1763.
- Knight, J. S., N. Sharma, and E. S. Robertson. 2005b.** Epstein-Barr virus latent antigen 3C can mediate the degradation of the retinoblastoma protein through an SCF cellular ubiquitin

- ligase. Proceedings of the National Academy of Sciences of the United States of America 102: 18562-18566.
- Kogan, M., and J. Rappaport. 2011.** HIV-1 accessory protein Vpr: relevance in the pathogenesis of HIV and potential for therapeutic intervention. *Retrovirology* 8: 25.
- Kohler, A., and E. Hurt. 2007.** Exporting RNA from the nucleus to the cytoplasm. *Nature reviews. Molecular cell biology* 8: 761-773.
- Kolas, N. K., J. R. Chapman, S. Nakada, J. Ylanko, R. Chahwan, F. D. Sweeney, S. Panier, M. Mendez, J. Wildenhain, T. M. Thomson, L. Pelletier, S. P. Jackson, and D. Durocher. 2007.** Orchestration of the DNA-damage response by the RNF8 ubiquitin ligase. *Science (New York, N.Y.)* 318: 1637-1640.
- Kominami, R. 2012.** Role of the transcription factor Bcl11b in development and lymphomagenesis. *Proceedings of the Japan Academy. Series B, Physical and biological sciences* 88: 72-87.
- Koning, F. A., E. N. Newman, E. Y. Kim, K. J. Kunstman, S. M. Wolinsky, and M. H. Malim. 2009.** Defining APOBEC3 expression patterns in human tissues and hematopoietic cell subsets. *J Virol* 83: 9474-9485.
- Kornitzer, D., R. Sharf, and T. Kleinberger. 2001.** Adenovirus E4orf4 protein induces PP2A-dependent growth arrest in *Saccharomyces cerevisiae* and interacts with the anaphase-promoting complex/cyclosome. *The Journal of cell biology* 154: 331-344.
- Koup, R. A., and D. D. Ho. 1994.** Shutting down HIV. *Nature* 370: 416.
- Kouzarides, T. 2007.** Chromatin modifications and their function. *Cell* 128: 693-705.
- Kupzig, S., V. Korolchuk, R. Rollason, A. Sugden, A. Wilde, and G. Banting. 2003.** Bst-2/HM1.24 is a raft-associated apical membrane protein with an unusual topology. *Traffic (Copenhagen, Denmark)* 4: 694-709.
- Kyrylkova, K., S. Kyryachenko, B. Biehs, O. Klein, C. Kioussi, and M. Leid. 2012.** BCL11B regulates epithelial proliferation and asymmetric development of the mouse mandibular incisor. *PLoS One* 7: e37670.
- Lagger, G., A. Doetzelhofer, B. Schuettengruber, E. Haidweger, E. Simboeck, J. Tischler, S. Chiocca, G. Suske, H. Rotheneder, E. Wintersberger, and C. Seiser. 2003.** The tumor suppressor p53 and histone deacetylase 1 are antagonistic regulators of the cyclin-dependent kinase inhibitor p21/WAF1/CIP1 gene. *Mol Cell Biol* 23: 2669-2679.
- Laguette, N., B. Sobhian, N. Casartelli, M. Ringeard, C. Chable-Bessia, E. Segeral, A. Yatim, S. Emiliani, O. Schwartz, and M. Benkirane. 2011.** SAMHD1 is the dendritic- and myeloid-cell-specific HIV-1 restriction factor counteracted by Vpx. *Nature*.
- Laguette, N., B. Sobhian, N. Casartelli, M. Ringeard, C. Chable-Bessia, E. Segeral, A. Yatim, S. Emiliani, O. Schwartz, and M. Benkirane. 2011.** SAMHD1 is the dendritic- and myeloid-cell-specific HIV-1 restriction factor counteracted by Vpx. *Nature* 474: 654-657.
- Laguette, N., N. Rahm, B. Sobhian, C. Chable-Bessia, J. Munch, J. Snoeck, D. Sauter, W. M. Switzer, W. Heneine, F. Kirchhoff, F. Delsuc, A. Telenti, and M. Benkirane. 2012.** Evolutionary and functional analyses of the interaction between the myeloid restriction factor SAMHD1 and the lentiviral Vpx protein. *Cell Host Microbe* 11: 205-217.
- Lahouassa, H., L. Dragin, C. Transy, and F. Margottin-Goguet. 2012a.** [SAMHD1 deprives HIV of nucleotides, essential for viral DNA synthesis]. *Med Sci (Paris)* 28: 909-910.
- Lahouassa, H., W. Daddacha, H. Hofmann, D. Ayinde, E. C. Logue, L. Dragin, N. Bloch, C. Maudet, M. Bertrand, T. Gramberg, G. Pancino, S. Priet, B. Canard, N. Laguette, M. Benkirane, C. Transy, N. R. Landau, B. Kim, and F. Margottin-Goguet. 2012b.** SAMHD1 restricts the replication of human immunodeficiency virus type 1 by depleting the intracellular pool of deoxynucleoside triphosphates. *Nat Immunol* 13: 223-228.
- Langevin, C., P. Maidou-Peindara, P. A. Aas, G. Jacquot, M. Otterlei, G. Slupphaug, and S. Benichou. 2009.** Human immunodeficiency virus type 1 Vpr modulates cellular expression of UNG2 via a negative transcriptional effect. *J Virol* 83: 10256-10263.

- Lassen, K. G., K. X. Ramyar, J. R. Bailey, Y. Zhou, and R. F. Siliciano. 2006.** Nuclear retention of multiply spliced HIV-1 RNA in resting CD4+ T cells. *PLoS Pathog* 2: e68.
- Lau, D., W. Kwan, and J. Guatelli. 2011.** Role of the endocytic pathway in the counteraction of BST-2 by human lentiviral pathogens. *J Virol* 85: 9834-9846.
- Le Douce, V., G. Herbein, O. Rohr, and C. Schwartz. 2010.** Molecular mechanisms of HIV-1 persistence in the monocyte-macrophage lineage. *Retrovirology* 7: 32.
- Le Douce, V., A. Janossy, H. Hallay, S. Ali, R. Riclet, O. Rohr, and C. Schwartz. 2012a.** Achieving a cure for HIV infection: do we have reasons to be optimistic? *J Antimicrob Chemother* 67: 1063-1074.
- Le Douce, V., L. Colin, L. Redel, T. Cherrier, G. Herbein, D. Aunis, O. Rohr, C. Van Lint, and C. Schwartz. 2012b.** LSD1 cooperates with CTIP2 to promote HIV-1 transcriptional silencing. *Nucleic Acids Res* 40: 1904-1915.
- Le Rouzic, E., and S. Benichou. 2005.** The Vpr protein from HIV-1: distinct roles along the viral life cycle. *Retrovirology* 2: 11.
- Le Rouzic, E., A. Mousnier, C. Rustum, F. Stutz, E. Hallberg, C. Dargemont, and S. Benichou. 2002.** Docking of HIV-1 Vpr to the nuclear envelope is mediated by the interaction with the nucleoporin hCG1. *J Biol Chem* 277: 45091-45098.
- Le Rouzic, E., N. Belaidouni, E. Estrabaud, M. Morel, J. C. Rain, C. Transy, and F. Margottin-Goguet. 2007.** HIV1 Vpr arrests the cell cycle by recruiting DCAF1/VprBP, a receptor of the Cul4-DDB1 ubiquitin ligase. *Cell Cycle* 6: 182-188.
- Le Rouzic, E., M. Morel, D. Ayinde, N. Belaidouni, J. Letienne, C. Transy, and F. Margottin-Goguet. 2008.** Assembly with the Cul4A-DDB1DCAF1 ubiquitin ligase protects HIV-1 Vpr from proteasomal degradation. *J Biol Chem* 283: 21686-21692.
- Lecossier, D., F. Bouchonnet, F. Clavel, and A. J. Hance. 2003.** Hypermutation of HIV-1 DNA in the absence of the Vif protein. *Science (New York, N.Y.)* 300: 1112.
- Lederman, M. M., and L. Margolis. 2008.** The lymph node in HIV pathogenesis. *Seminars in immunology* 20: 187-195.
- Lee, D. H., and A. L. Goldberg. 1998.** Proteasome inhibitors: valuable new tools for cell biologists. *Trends in cell biology* 8: 397-403.
- Lee, F. J., and A. Carr. 2012.** Tolerability of HIV integrase inhibitors. *Curr Opin HIV AIDS* 7: 422-428.
- Lee, M. S., and R. Craigie. 1998.** A previously unidentified host protein protects retroviral DNA from autointegration. *Proceedings of the National Academy of Sciences of the United States of America* 95: 1528-1533.
- Lemp, G. F., S. F. Payne, D. Neal, T. Temelso, and G. W. Rutherford. 1990.** Survival trends for patients with AIDS. *JAMA : the journal of the American Medical Association* 263: 402-406.
- Leung-Pineda, V., J. Huh, and H. Piwnica-Worms. 2009.** DDB1 targets Chk1 to the Cul4 E3 ligase complex in normal cycling cells and in cells experiencing replication stress. *Cancer Res* 69: 2630-2637.
- Li, G., H. U. Park, D. Liang, and R. Y. Zhao. 2010.** Cell cycle G2/M arrest through an S phase-dependent mechanism by HIV-1 viral protein R. *Retrovirology* 7: 59.
- Li, G., R. T. Elder, K. Qin, H. U. Park, D. Liang, and R. Y. Zhao. 2007a.** Phosphatase type 2A-dependent and -independent pathways for ATR phosphorylation of Chk1. *J Biol Chem* 282: 7287-7298.
- Li, L., S. Dahiya, S. Kortagere, B. Aiamkitsumrit, D. Cunningham, V. Pirrone, M. R. Nonnemacher, and B. Wigdahl. 2012.** Impact of Tat Genetic Variation on HIV-1 Disease. *Advances in virology 2012*: 123605.
- Li, Q., R. Means, S. Lang, and J. U. Jung. 2007b.** Downregulation of gamma interferon receptor 1 by Kaposi's sarcoma-associated herpesvirus K3 and K5. *J Virol* 81: 2117-2127.
- Li, W., M. H. Bengtson, A. Ulbrich, A. Matsuda, V. A. Reddy, A. Orth, S. K. Chanda, S. Batalov, and C. A. Joazeiro. 2008.** Genome-wide and functional annotation of human E3

- ubiquitin ligases identifies MULAN, a mitochondrial E3 that regulates the organelle's dynamics and signaling. *PLoS One* 3: e1487.
- Lienlaf, M., F. Hayashi, F. Di Nunzio, N. Tochio, T. Kigawa, S. Yokoyama, and F. Diaz-Griffero. 2011.** Contribution of E3-ubiquitin ligase activity to HIV-1 restriction by TRIM5alpha(rh): structure of the RING domain of TRIM5alpha. *J Virol* 85: 8725-8737.
- Lilly, F. 1967.** Susceptibility to two strains of Friend leukemia virus in mice. *Science (New York, N.Y.)* 155: 461-462.
- Lim, E. S., and M. Emerman. 2011.** HIV: Going for the watchman. *Nature* 474: 587-588.
- Lim, E. S., O. I. Fregoso, C. O. McCoy, F. A. Matsen, H. S. Malik, and M. Emerman. 2012.** The ability of primate lentiviruses to degrade the monocyte restriction factor SAMHD1 preceded the birth of the viral accessory protein Vpx. *Cell Host Microbe* 11: 194-204.
- Lin, C. H., H. S. Chang, and W. C. Yu. 2008.** USP11 stabilizes HPV-16E7 and further modulates the E7 biological activity. *J Biol Chem* 283: 15681-15688.
- Liu, L., N. M. Oliveira, K. M. Cheney, C. Pade, H. Dreja, A. M. Bergin, V. Borgdorff, D. H. Beach, C. L. Bishop, M. T. Dittmar, and A. McKnight. 2011.** A whole genome screen for HIV restriction factors. *Retrovirology* 8: 94.
- Liu, Y., and J. D. Baleja. 2008.** Structure and function of the papillomavirus E6 protein and its interacting proteins. *Front Biosci* 13: 121-134.
- Llano, M., D. T. Saenz, A. Meehan, P. Wongthida, M. Peretz, W. H. Walker, W. Teo, and E. M. Poeschla. 2006.** An essential role for LEDGF/p75 in HIV integration. *Science (New York, N.Y.)* 314: 461-464.
- Lodish H, B. A., Matsudaira P, Kaiser CA, Krieger M, Scott MP, Zipursky SL, Darnell J. 2005.** *Molecular cell biology*, 5th ed. ed. W.H. Freeman and CO. , New York.
- Lu, W., K. Salzwedel, D. Wang, S. Chakravarty, E. O. Freed, C. T. Wild, and F. Li. 2011.** A single polymorphism in HIV-1 subtype C SP1 is sufficient to confer natural resistance to the maturation inhibitor bevirimat. *Antimicrobial agents and chemotherapy* 55: 3324-3329.
- Lukic, Z., S. Hausmann, S. Sebastian, J. Rucci, J. Sastri, S. L. Robia, J. Luban, and E. M. Campbell. 2011.** TRIM5alpha associates with proteasomal subunits in cells while in complex with HIV-1 virions. *Retrovirology* 8: 93.
- Lupfer, C., and M. K. Pastey. 2010.** Decreased replication of human respiratory syncytial virus treated with the proteasome inhibitor MG-132. *Virus Res* 149: 36-41.
- Lv, W., Z. Liu, H. Jin, X. Yu, and L. Zhang. 2007.** Three-dimensional structure of HIV-1 VIF constructed by comparative modeling and the function characterization analyzed by molecular dynamics simulation. *Organic & biomolecular chemistry* 5: 617-626.
- Madani, N., and D. Kabat. 1998.** An endogenous inhibitor of human immunodeficiency virus in human lymphocytes is overcome by the viral Vif protein. *J Virol* 72: 10251-10255.
- Maeda, K., D. Das, H. Nakata, and H. Mitsuya. 2012.** CCR5 inhibitors: emergence, success, and challenges. *Expert opinion on emerging drugs* 17: 135-145.
- Makowski, A. M., R. N. Dutnall, and A. T. Annunziato. 2001.** Effects of acetylation of histone H4 at lysines 8 and 16 on activity of the Hat1 histone acetyltransferase. *J Biol Chem* 276: 43499-43502.
- Malim, M. H., and M. Emerman. 2008.** HIV-1 accessory proteins--ensuring viral survival in a hostile environment. *Cell Host Microbe* 3: 388-398.
- Malim, M. H., R. Fenrick, D. W. Ballard, J. Hauber, E. Bohnlein, and B. R. Cullen. 1989.** Functional characterization of a complex protein-DNA-binding domain located within the human immunodeficiency virus type 1 long terminal repeat leader region. *J Virol* 63: 3213-3219.
- Mallette, F. A., and S. Richard. 2012.** K48-linked ubiquitination and protein degradation regulate 53BP1 recruitment at DNA damage sites. *Cell Res* 22: 1221-1223.
- Mammas, I. N., G. Sourvinos, A. Giannoudis, and D. A. Spandidos. 2008.** Human papilloma virus (HPV) and host cellular interactions. *Pathology oncology research : POR* 14: 345-354.

- Mangeat, B., P. Turelli, G. Caron, M. Friedli, L. Perrin, and D. Trono. 2003.** Broad antiretroviral defence by human APOBEC3G through lethal editing of nascent reverse transcripts. *Nature* 424: 99-103.
- Mangeat, B., G. Gers-Huber, M. Lehmann, M. Zufferey, J. Luban, and V. Piguet. 2009.** HIV-1 Vpu neutralizes the antiviral factor Tetherin/BST-2 by binding it and directing its beta-TrCP2-dependent degradation. *PLoS Pathog* 5: e1000574.
- Marban, C., S. Suzanne, F. Dequiedt, S. de Walque, L. Redel, C. Van Lint, D. Aunis, and O. Rohr. 2007.** Recruitment of chromatin-modifying enzymes by CTIP2 promotes HIV-1 transcriptional silencing. *EMBO J* 26: 412-423.
- Marban, C., L. Redel, S. Suzanne, C. Van Lint, D. Lecestre, S. Chasserot-Golaz, M. Leid, D. Aunis, E. Schaeffer, and O. Rohr. 2005.** COUP-TF interacting protein 2 represses the initial phase of HIV-1 gene transcription in human microglial cells. *Nucleic Acids Res* 33: 2318-2331.
- Marechal, V., M. C. Prevost, C. Petit, E. Perret, J. M. Heard, and O. Schwartz. 2001.** Human immunodeficiency virus type 1 entry into macrophages mediated by macropinocytosis. *J Virol* 75: 11166-11177.
- Margottin, F., S. P. Bour, H. Durand, L. Selig, S. Benichou, V. Richard, D. Thomas, K. Strebler, and R. Benarous. 1998.** A novel human WD protein, h-beta TrCp, that interacts with HIV-1 Vpu connects CD4 to the ER degradation pathway through an F-box motif. *Molecular cell* 1: 565-574.
- Marin, M., K. M. Rose, S. L. Kozak, and D. Kabat. 2003.** HIV-1 Vif protein binds the editing enzyme APOBEC3G and induces its degradation. *Nat Med* 9: 1398-1403.
- Markowitz, M., B. Y. Nguyen, E. Gotuzzo, F. Mendo, W. Ratanasuwana, C. Kovacs, G. Prada, J. O. Morales-Ramirez, C. S. Crumpacker, R. D. Isaacs, L. R. Gilde, H. Wan, M. D. Miller, L. A. Wenning, and H. Tepller. 2007.** Rapid and durable antiretroviral effect of the HIV-1 Integrase inhibitor raltegravir as part of combination therapy in treatment-naive patients with HIV-1 infection: results of a 48-week controlled study. *J Acquir Immune Defic Syndr* 46: 125-133.
- Marteijn, J. A., J. H. Jansen, and B. A. van der Reijden. 2006.** Ubiquitylation in normal and malignant hematopoiesis: novel therapeutic targets. *Leukemia : official journal of the Leukemia Society of America, Leukemia Research Fund, U.K* 20: 1511-1518.
- Martin-Lluesma, S., C. Schaeffer, E. I. Robert, P. C. van Breugel, O. Leupin, O. Hantz, and M. Strubin. 2008.** Hepatitis B virus X protein affects S phase progression leading to chromosome segregation defects by binding to damaged DNA binding protein 1. *Hepatology (Baltimore, Md.)* 48: 1467-1476.
- Martin-Serrano, J., and S. J. Neil. 2011.** Host factors involved in retroviral budding and release. *Nat Rev Microbiol* 9: 519-531.
- Marzio, G., and M. Giacca. 1999.** Chromatin control of HIV-1 gene expression. *Genetica* 106: 125-130.
- Masur, H., M. A. Michelis, J. B. Greene, I. Onorato, R. A. Stouwe, R. S. Holzman, G. Wormser, L. Brettman, M. Lange, H. W. Murray, and S. Cunningham-Rundles. 1981.** An outbreak of community-acquired *Pneumocystis carinii* pneumonia: initial manifestation of cellular immune dysfunction. *The New England journal of medicine* 305: 1431-1438.
- Maudet, C., M. Bertrand, E. Le Rouzic, H. Lahouassa, D. Ayinde, S. Nisole, C. Goujon, A. Cimorelli, F. Margottin-Goguet, and C. Transy. 2011.** Molecular insight into how HIV-1 Vpr protein impairs cell growth through two genetically distinct pathways. *J Biol Chem* 286: 23742-23752.
- McDonald, D., L. Wu, S. M. Bohks, V. N. KewalRamani, D. Unutmaz, and T. J. Hope. 2003.** Recruitment of HIV and its receptors to dendritic cell-T cell junctions. *Science (New York, N.Y.)* 300: 1295-1297.
- McNamara, L. A., and K. L. Collins. 2011.** Hematopoietic stem/precursor cells as HIV reservoirs. *Curr Opin HIV AIDS* 6: 43-48.

- McNaught, K. S., C. W. Olanow, B. Halliwell, O. Isacson, and P. Jenner. 2001.** Failure of the ubiquitin-proteasome system in Parkinson's disease. *Nature reviews. Neuroscience* 2: 589-594.
- Mehle, A., B. Strack, P. Ancuta, C. Zhang, M. McPike, and D. Gabuzda. 2004.** Vif overcomes the innate antiviral activity of APOBEC3G by promoting its degradation in the ubiquitin-proteasome pathway. *J Biol Chem* 279: 7792-7798.
- Mercenne, G., S. Bernacchi, D. Richer, G. Bec, S. Henriët, J. C. Paillart, and R. Marquet. 2010.** HIV-1 Vif binds to APOBEC3G mRNA and inhibits its translation. *Nucleic Acids Res* 38: 633-646.
- Merson, M. H., J. O'Malley, D. Serwadda, and C. Apisuk. 2008.** The history and challenge of HIV prevention. *Lancet* 372: 475-488.
- Metzger, M. B., V. A. Hristova, and A. M. Weissman. 2012.** HECT and RING finger families of E3 ubiquitin ligases at a glance. *Journal of cell science* 125: 531-537.
- Minuto, J. J., and R. Haubrich. 2008.** Etravirine: a second-generation NNRTI for treatment-experienced adults with resistant HIV-1 infection. *Future HIV therapy* 2: 525-537.
- Mitchell, R. S., C. Katsura, M. A. Skasko, K. Fitzpatrick, D. Lau, A. Ruiz, E. B. Stephens, F. Margottin-Goguet, R. Benarous, and J. C. Guatelli. 2009.** Vpu antagonizes BST-2-mediated restriction of HIV-1 release via beta-TrCP and endo-lysosomal trafficking. *PLoS Pathog* 5: e1000450.
- Miura, S., K. Kawana, D. J. Schust, T. Fujii, T. Yokoyama, Y. Iwasawa, T. Nagamatsu, K. Adachi, A. Tomio, K. Tomio, S. Kojima, T. Yasugi, S. Kozuma, and Y. Taketani. 2010.** CD1d, a sentinel molecule bridging innate and adaptive immunity, is downregulated by the human papillomavirus (HPV) E5 protein: a possible mechanism for immune evasion by HPV. *J Virol* 84: 11614-11623.
- Miyakawa, K., A. Ryo, T. Murakami, K. Ohba, S. Yamaoka, M. Fukuda, J. Guatelli, and N. Yamamoto. 2009.** BCA2/Rabring7 promotes tetherin-dependent HIV-1 restriction. *PLoS Pathog* 5: e1000700.
- Mo, M., S. B. Fleming, and A. A. Mercer. 2009.** Cell cycle deregulation by a poxvirus partial mimic of anaphase-promoting complex subunit 11. *Proceedings of the National Academy of Sciences of the United States of America* 106: 19527-19532.
- Mo, M., S. B. Fleming, and A. A. Mercer. 2010.** Orf virus cell cycle regulator, PACR, competes with subunit 11 of the anaphase promoting complex for incorporation into the complex. *J Gen Virol* 91: 3010-3015.
- Mogensen, T. H., J. Melchjorsen, C. S. Larsen, and S. R. Paludan. 2010.** Innate immune recognition and activation during HIV infection. *Retrovirology* 7: 54.
- Molina-Jimenez, F., I. Benedicto, M. Murata, S. Martin-Vilchez, T. Seki, J. Antonio Pintor-Toro, M. Tortolero, R. Moreno-Otero, K. Okazaki, K. Koike, J. L. Barbero, K. Matsuzaki, P. L. Majano, and M. Lopez-Cabrera. 2010.** Expression of pituitary tumor-transforming gene 1 (PTTG1)/securin in hepatitis B virus (HBV)-associated liver diseases: evidence for an HBV X protein-mediated inhibition of PTTG1 ubiquitination and degradation. *Hepatology (Baltimore, Md.)* 51: 777-787.
- Monajemi, M., C. F. Woodworth, J. Benkaroun, M. Grant, and M. Larijani. 2012.** Emerging complexities of APOBEC3G action on immunity and viral fitness during HIV infection and treatment. *Retrovirology* 9: 35.
- Moody, C. A., and L. A. Laimins. 2010.** Human papillomavirus oncoproteins: pathways to transformation. *Nature reviews. Cancer* 10: 550-560.
- Mora-Peris, B., N. E. Mackie, D. Suan, D. A. Cooper, B. J. Brew, and A. Winston. 2013.** Raltegravir resistance in the cerebrospinal fluid. *Infection*.
- Morellet, N., B. P. Roques, and S. Bouaziz. 2009.** Structure-function relationship of Vpr: biological implications. *Curr HIV Res* 7: 184-210.
- Mosesson, Y., and Y. Yarden. 2006.** Monoubiquitylation: a recurrent theme in membrane protein transport. *The Israel Medical Association journal : IMAJ* 8: 233-237.

- Mosesson, Y., K. Shtiegman, M. Katz, Y. Zwang, G. Vereb, J. Szollosi, and Y. Yarden. 2003.** Endocytosis of receptor tyrosine kinases is driven by monoubiquitylation, not polyubiquitylation. *J Biol Chem* 278: 21323-21326.
- Mui, M. Z., D. E. Roopchand, M. S. Gentry, R. L. Hallberg, J. Vogel, and P. E. Branton. 2010.** Adenovirus protein E4orf4 induces premature APC<sup>Cdc20</sup> activation in *Saccharomyces cerevisiae* by a protein phosphatase 2A-dependent mechanism. *J Virol* 84: 4798-4809.
- Muramatsu, M., K. Kinoshita, S. Fagarasan, S. Yamada, Y. Shinkai, and T. Honjo. 2000.** Class switch recombination and hypermutation require activation-induced cytidine deaminase (AID), a potential RNA editing enzyme. *Cell* 102: 553-563.
- Murzina, N. V., X. Y. Pei, W. Zhang, M. Sparkes, J. Vicente-Garcia, J. V. Pratap, S. H. McLaughlin, T. R. Ben-Shahar, A. Verreault, B. F. Luisi, and E. D. Laue. 2008.** Structural basis for the recognition of histone H4 by the histone-chaperone RbAp46. *Structure* 16: 1077-1085.
- Muthumani, K., L. J. Montaner, V. Ayyavoo, and D. B. Weiner. 2000a.** Vpr-GFP virion particle identifies HIV-infected targets and preserves HIV-1Vpr function in macrophages and T-cells. *DNA Cell Biol* 19: 179-188.
- Muthumani, K., S. Kudchodkar, E. Pappasavvas, L. J. Montaner, D. B. Weiner, and V. Ayyavoo. 2000b.** HIV-1 Vpr regulates expression of beta chemokines in human primary lymphocytes and macrophages. *J Leukoc Biol* 68: 366-372.
- Muthumani, K., D. Zhang, D. S. Hwang, S. Kudchodkar, N. S. Dayes, B. M. Desai, A. S. Malik, J. S. Yang, M. A. Chattergoon, H. C. Maguire, Jr., and D. B. Weiner. 2002.** Adenovirus encoding HIV-1 Vpr activates caspase 9 and induces apoptotic cell death in both p53 positive and negative human tumor cell lines. *Oncogene* 21: 4613-4625.
- Mwimanzi, P., T. J. Markle, E. Martin, Y. Ogata, X. T. Kuang, M. Tokunaga, M. Mahiti, F. Pereyra, T. Miura, B. D. Walker, Z. L. Brumme, M. A. Brockman, and T. Ueno. 2013.** Attenuation of multiple Nef functions in HIV-1 elite controllers. *Retrovirology* 10: 1.
- Nasr, R., E. Chiari, M. El-Sabban, R. Mahieux, Y. Kfoury, M. Abdulhay, V. Yazbeck, O. Hermine, H. de The, C. Pique, and A. Bazarbachi. 2006.** Tax ubiquitylation and sumoylation control critical cytoplasmic and nuclear steps of NF-kappaB activation. *Blood* 107: 4021-4029.
- Nathan, J. A., H. Tae Kim, L. Ting, S. P. Gygi, and A. L. Goldberg. 2013.** Why do cellular proteins linked to K63-polyubiquitin chains not associate with proteasomes? *EMBO J*.
- Neil, S. J., T. Zang, and P. D. Bieniasz. 2008.** Tetherin inhibits retrovirus release and is antagonized by HIV-1 Vpu. *Nature* 451: 425-430.
- Neutzner, M., and A. Neutzner. 2012.** Enzymes of ubiquitination and deubiquitination. *Essays in biochemistry* 52: 37-50.
- Niculescu, A. B., 3rd, X. Chen, M. Smeets, L. Hengst, C. Prives, and S. I. Reed. 1998.** Effects of p21(Cip1/Waf1) at both the G1/S and the G2/M cell cycle transitions: pRb is a critical determinant in blocking DNA replication and in preventing endoreduplication. *Mol Cell Biol* 18: 629-643.
- Nijman, S. M., M. P. Luna-Vargas, A. Velds, T. R. Brummelkamp, A. M. Dirac, T. K. Sixma, and R. Bernards. 2005.** A genomic and functional inventory of deubiquitinating enzymes. *Cell* 123: 773-786.
- Ning, S., and J. S. Pagano. 2010.** The A20 deubiquitinase activity negatively regulates LMP1 activation of IRF7. *J Virol* 84: 6130-6138.
- Nisole, S., and A. Saib. 2004.** Early steps of retrovirus replicative cycle. *Retrovirology* 1: 9.
- Nisole, S., J. P. Stoye, and A. Saib. 2005.** TRIM family proteins: retroviral restriction and antiviral defence. *Nat Rev Microbiol* 3: 799-808.
- Nitahara-Kasahara, Y., M. Kamata, T. Yamamoto, X. Zhang, Y. Miyamoto, K. Muneta, S. Iijima, Y. Yoneda, Y. Tsunetsugu-Yokota, and Y. Aida. 2007.** Novel nuclear import of Vpr promoted by importin alpha is crucial for human immunodeficiency virus type 1 replication in macrophages. *J Virol* 81: 5284-5293.

- Noble, S., and D. Faulds. 1996.** Saquinavir. A review of its pharmacology and clinical potential in the management of HIV infection. *Drugs* 52: 93-112.
- Oh, J. M., S. H. Kim, E. A. Cho, Y. S. Song, W. H. Kim, and Y. S. Juhn. 2010.** Human papillomavirus type 16 E5 protein inhibits hydrogen-peroxide-induced apoptosis by stimulating ubiquitin-proteasome-mediated degradation of Bax in human cervical cancer cells. *Carcinogenesis* 31: 402-410.
- OhAinle, M., J. A. Kerns, H. S. Malik, and M. Emerman. 2006.** Adaptive evolution and antiviral activity of the conserved mammalian cytidine deaminase APOBEC3H. *J Virol* 80: 3853-3862.
- Ohi, M. D., C. W. Vander Kooi, J. A. Rosenberg, W. J. Chazin, and K. L. Gould. 2003.** Structural insights into the U-box, a domain associated with multi-ubiquitination. *Nature structural biology* 10: 250-255.
- Okumura, A., T. Alce, B. Lubyova, H. Ezelle, K. Strebel, and P. M. Pitha. 2008.** HIV-1 accessory proteins VPR and Vif modulate antiviral response by targeting IRF-3 for degradation. *Virology* 373: 85-97.
- Ono, A. 2010.** Relationships between plasma membrane microdomains and HIV-1 assembly. *Biol Cell* 102: 335-350.
- Ono, A., and E. O. Freed. 2001.** Plasma membrane rafts play a critical role in HIV-1 assembly and release. *Proceedings of the National Academy of Sciences of the United States of America* 98: 13925-13930.
- Onose, A., S. Hashimoto, S. Hayashi, S. Maruoka, F. Kumasawa, K. Mizumura, I. Jibiki, K. Matsumoto, Y. Gon, T. Kobayashi, N. Takahashi, Y. Shibata, Y. Abiko, T. Shibata, K. Shimizu, and T. Horie. 2006.** An inhibitory effect of A20 on NF-kappaB activation in airway epithelium upon influenza virus infection. *European journal of pharmacology* 541: 198-204.
- Ott, M., M. Geyer, and Q. Zhou. 2011.** The Control of HIV Transcription: Keeping RNA Polymerase II on Track. *Cell Host Microbe* 10: 426-435.
- Oyaizu, N., T. W. McCloskey, M. Coronese, N. Chirmule, V. S. Kalyanaraman, and S. Pahwa. 1993.** Accelerated apoptosis in peripheral blood mononuclear cells (PBMCs) from human immunodeficiency virus type-1 infected patients and in CD4 cross-linked PBMCs from normal individuals. *Blood* 82: 3392-3400.
- Paillart, J. C., M. Shehu-Xhilaga, R. Marquet, and J. Mak. 2004.** Dimerization of retroviral RNA genomes: an inseparable pair. *Nat Rev Microbiol* 2: 461-472.
- Parikh, S. S., G. Walcher, G. D. Jones, G. Slupphaug, H. E. Krokan, G. M. Blackburn, and J. A. Tainer. 2000.** Uracil-DNA glycosylase-DNA substrate and product structures: conformational strain promotes catalytic efficiency by coupled stereoelectronic effects. *Proceedings of the National Academy of Sciences of the United States of America* 97: 5083-5088.
- Passmore, L. A., and D. Barford. 2004.** Getting into position: the catalytic mechanisms of protein ubiquitylation. *The Biochemical journal* 379: 513-525.
- Pauli, G., E. Hausmann, R. Weiss, P. Clapham, J. Schneider, G. Hunsmann, R. C. Gallo, M. D. Daniel, M. A. Koch, and H. Gelderblom. 1987.** LAV/HTLV-III: fine-structure analysis, localization of structural proteins, and detection of envelope antigens by patient sera. *Haematology and blood transfusion* 31: 407-409.
- Pavri, R., B. Zhu, G. Li, P. Trojer, S. Mandal, A. Shilatifard, and D. Reinberg. 2006.** Histone H2B monoubiquitination functions cooperatively with FACT to regulate elongation by RNA polymerase II. *Cell* 125: 703-717.
- Peeters, M., A. Gueye, S. Mboup, F. Bibollet-Ruche, E. Ekaza, C. Mulanga, R. Ouedrago, R. Gandji, P. Mpele, G. Dibanga, B. Koumare, M. Saidou, E. Esu-Williams, J. P. Lombart, W. Badombena, N. Luo, M. Vanden Haesevelde, and E. Delaporte. 1997.** Geographical distribution of HIV-1 group O viruses in Africa. *Aids* 11: 493-498.
- Peng, J., D. Schwartz, J. E. Elias, C. C. Thoreen, D. Cheng, G. Marsischky, J. Roelofs, D. Finley, and S. P. Gygi. 2003.** A proteomics approach to understanding protein ubiquitination. *Nature biotechnology* 21: 921-926.



- Perez-Caballero, D., T. Zang, A. Ebrahimi, M. W. McNatt, D. A. Gregory, M. C. Johnson, and P. D. Bieniasz. 2009.** Tetherin inhibits HIV-1 release by directly tethering virions to cells. *Cell* 139: 499-511.
- Persaud, D., Y. Zhou, J. M. Siliciano, and R. F. Siliciano. 2003.** Latency in human immunodeficiency virus type 1 infection: no easy answers. *J Virol* 77: 1659-1665.
- Pertel, T., C. Reinhard, and J. Luban. 2011.** Vpx rescues HIV-1 transduction of dendritic cells from the antiviral state established by type 1 interferon. *Retrovirology* 8: 49.
- Peterlin, B. M., and D. Trono. 2003.** Hide, shield and strike back: how HIV-infected cells avoid immune eradication. *Nat Rev Immunol* 3: 97-107.
- Peters, J. M., W. W. Franke, and J. A. Kleinschmidt. 1994.** Distinct 19 S and 20 S subcomplexes of the 26 S proteasome and their distribution in the nucleus and the cytoplasm. *J Biol Chem* 269: 7709-7718.
- Pham, T. N., J. Richard, F. C. Gerard, C. Power, and E. A. Cohen. 2011.** Modulation of NKG2D-mediated cytotoxic functions of natural killer cells by viral protein R from HIV-1 primary isolates. *J Virol* 85: 12254-12261.
- Pickart, C. M. 2000.** Ubiquitin in chains. *Trends in biochemical sciences* 25: 544-548.
- Pickart, C. M. 2001a.** Mechanisms underlying ubiquitination. *Annu Rev Biochem* 70: 503-533.
- Pickart, C. M. 2001b.** Ubiquitin enters the new millennium. *Molecular cell* 8: 499-504.
- Ping, Y. H., and T. M. Rana. 2001.** DSIF and NELF interact with RNA polymerase II elongation complex and HIV-1 Tat stimulates P-TEFb-mediated phosphorylation of RNA polymerase II and DSIF during transcription elongation. *J Biol Chem* 276: 12951-12958.
- Planelles, V. 2011.** Restricted access to myeloid cells explained. *Viruses* 3: 1624-1633.
- Plantier, J. C., M. Leoz, J. E. Dickerson, F. De Oliveira, F. Cordonnier, V. Leme, F. Damond, D. L. Robertson, and F. Simon. 2009.** A new human immunodeficiency virus derived from gorillas. *Nat Med* 15: 871-872.
- Poon, B., and I. S. Chen. 2003.** Human immunodeficiency virus type 1 (HIV-1) Vpr enhances expression from unintegrated HIV-1 DNA. *J Virol* 77: 3962-3972.
- Poon, B., M. A. Chang, and I. S. Chen. 2007.** Vpr is required for efficient Nef expression from unintegrated human immunodeficiency virus type 1 DNA. *J Virol* 81: 10515-10523.
- Popov, S., M. Rexach, G. Zybarth, N. Reiling, M. A. Lee, L. Ratner, C. M. Lane, M. S. Moore, G. Blobel, and M. Bukrinsky. 1998.** Viral protein R regulates nuclear import of the HIV-1 pre-integration complex. *EMBO J* 17: 909-917.
- Pornillos, O., B. K. Ganser-Pornillos, and M. Yeager. 2011.** Atomic-level modelling of the HIV capsid. *Nature* 469: 424-427.
- Powell, R. D., P. J. Holland, T. Hollis, and F. W. Perrino. 2011.** Aicardi-Goutieres syndrome gene and HIV-1 restriction factor SAMHD1 is a dGTP-regulated deoxynucleotide triphosphohydrolase. *J Biol Chem* 286: 43596-43600.
- Prakash, S., T. Inobe, A. J. Hatch, and A. Matouschek. 2009.** Substrate selection by the proteasome during degradation of protein complexes. *Nat Chem Biol* 5: 29-36.
- Price, D. H. 2000.** P-TEFb, a cyclin-dependent kinase controlling elongation by RNA polymerase II. *Mol Cell Biol* 20: 2629-2634.
- Provitera, P., A. Goff, A. Harenberg, F. Bouamr, C. Carter, and S. Scarlata. 2001.** Role of the major homology region in assembly of HIV-1 Gag. *Biochemistry* 40: 5565-5572.
- Pugach, P., T. J. Ketas, E. Michael, and J. P. Moore. 2008.** Neutralizing antibody and anti-retroviral drug sensitivities of HIV-1 isolates resistant to small molecule CCR5 inhibitors. *Virology* 377: 401-407.
- Quagliarello, V. 1982.** The Acquired Immunodeficiency Syndrome: current status. *The Yale journal of biology and medicine* 55: 443-452.
- Quashie, P. K., T. Mesplede, and M. A. Wainberg. 2013.** Evolution of HIV integrase resistance mutations. *Curr Opin Infect Dis* 26: 43-49.

- Quercia, R., E. Dam, D. Perez-Bercoff, and F. Clavel. 2009.** Selective-advantage profile of human immunodeficiency virus type 1 integrase mutants explains in vivo evolution of raltegravir resistance genotypes. *J Virol* 83: 10245-10249.
- Raaben, M., C. C. Posthuma, M. H. Verheije, E. G. te Lintelo, M. Kikkert, J. W. Drijfhout, E. J. Snijder, P. J. Rottier, and C. A. de Haan. 2010.** The ubiquitin-proteasome system plays an important role during various stages of the coronavirus infection cycle. *J Virol* 84: 7869-7879.
- Rampias, T., E. Boutati, E. Pectasides, C. Sasaki, P. Kountourakis, P. Weinberger, and A. Psyrri. 2010.** Activation of Wnt signaling pathway by human papillomavirus E6 and E7 oncogenes in HPV16-positive oropharyngeal squamous carcinoma cells. *Molecular cancer research : MCR* 8: 433-443.
- Randow, F., and P. J. Lehner. 2009.** Viral avoidance and exploitation of the ubiquitin system. *Nature cell biology* 11: 527-534.
- Re, F., D. Braaten, E. K. Franke, and J. Luban. 1995.** Human immunodeficiency virus type 1 Vpr arrests the cell cycle in G2 by inhibiting the activation of p34cdc2-cyclin B. *J Virol* 69: 6859-6864.
- Reymond, A., G. Meroni, A. Fantozzi, G. Merla, S. Cairo, L. Luzi, D. Riganelli, E. Zanaria, S. Messali, S. Cainarca, A. Guffanti, S. Minucci, P. G. Pelicci, and A. Ballabio. 2001.** The tripartite motif family identifies cell compartments. *EMBO J* 20: 2140-2151.
- Richard, J., S. Sindhu, T. N. Pham, J. P. Belzile, and E. A. Cohen. 2010.** HIV-1 Vpr up-regulates expression of ligands for the activating NKG2D receptor and promotes NK cell-mediated killing. *Blood* 115: 1354-1363.
- Riviere, L., J. L. Darlix, and A. Cimarelli. 2010.** Analysis of the viral elements required in the nuclear import of HIV-1 DNA. *J Virol* 84: 729-739.
- Robert, A., M. J. Miron, C. Champagne, M. C. Gingras, P. E. Branton, and J. N. Lavoie. 2002.** Distinct cell death pathways triggered by the adenovirus early region 4 ORF 4 protein. *The Journal of cell biology* 158: 519-528.
- Rodrigues, L., J. Filipe, M. P. Seldon, L. Fonseca, J. Anrather, M. P. Soares, and J. P. Simas. 2009.** Termination of NF-kappaB activity through a gammaherpesvirus protein that assembles an EC5S ubiquitin-ligase. *EMBO J* 28: 1283-1295.
- Rohr, O., D. Aunis, and E. Schaeffer. 1997.** COUP-TF and Sp1 interact and cooperate in the transcriptional activation of the human immunodeficiency virus type 1 long terminal repeat in human microglial cells. *J Biol Chem* 272: 31149-31155.
- Rohr, O., C. Marban, D. Aunis, and E. Schaeffer. 2003a.** Regulation of HIV-1 gene transcription: from lymphocytes to microglial cells. *J Leukoc Biol* 74: 736-749.
- Rohr, O., D. Lecestre, S. Chasserot-Golaz, C. Marban, D. Avram, D. Aunis, M. Leid, and E. Schaeffer. 2003b.** Recruitment of Tat to heterochromatin protein HP1 via interaction with CTIP2 inhibits human immunodeficiency virus type 1 replication in microglial cells. *J Virol* 77: 5415-5427.
- Rold, C. J., and C. Aiken. 2008.** Proteasomal degradation of TRIM5alpha during retrovirus restriction. *PLoS Pathog* 4: e1000074.
- Romani, B., and S. Engelbrecht. 2009.** Human immunodeficiency virus type 1 Vpr: functions and molecular interactions. *J Gen Virol* 90: 1795-1805.
- Romani, B., and E. A. Cohen. 2012.** Lentivirus Vpr and Vpx accessory proteins usurp the cullin4-DDB1 (DCAF1) E3 ubiquitin ligase. *Curr Opin Virol* 2: 755-763.
- Ros, C., and C. Kempf. 2004.** The ubiquitin-proteasome machinery is essential for nuclear translocation of incoming minute virus of mice. *Virology* 324: 350-360.
- Ross, E. K., T. R. Fuerst, J. M. Orenstein, T. O'Neill, M. A. Martin, and S. Venkatesan. 1991.** Maturation of human immunodeficiency virus particles assembled from the gag precursor protein requires in situ processing by gag-pol protease. *AIDS Res Hum Retroviruses* 7: 475-483.
- Rotin, D., and S. Kumar. 2009.** Physiological functions of the HECT family of ubiquitin ligases. *Nature reviews. Molecular cell biology* 10: 398-409.

- Roux, K. H., and K. A. Taylor. 2007.** AIDS virus envelope spike structure. *Current opinion in structural biology* 17: 244-252.
- Rozenbaum, W., J. P. Coulaud, A. G. Saimot, D. Klatzmann, C. Mayaud, and M. F. Carette. 1982.** Multiple opportunistic infection in a male homosexual in France. *Lancet* 1: 572-573.
- Ruiz, A., M. S. Hill, K. Schmitt, J. Guatelli, and E. B. Stephens. 2008.** Requirements of the membrane proximal tyrosine and dileucine-based sorting signals for efficient transport of the subtype C Vpu protein to the plasma membrane and in virus release. *Virology* 378: 58-68.
- Rumbaugh, J. A., G. M. Fuentes, and R. A. Bambara. 1998.** Processing of an HIV replication intermediate by the human DNA replication enzyme FEN1. *J Biol Chem* 273: 28740-28745.
- Saez-Cirion, A., C. Hamimi, A. Bergamaschi, A. David, P. Versmisse, A. Melard, F. Boufassa, F. Barre-Sinoussi, O. Lambotte, C. Rouzioux, and G. Pancino. 2011.** Restriction of HIV-1 replication in macrophages and CD4+ T cells from HIV controllers. *Blood* 118: 955-964.
- Saffert, R. T., and R. F. Kalejta. 2006.** Inactivating a cellular intrinsic immune defense mediated by Daxx is the mechanism through which the human cytomegalovirus pp71 protein stimulates viral immediate-early gene expression. *J Virol* 80: 3863-3871.
- Saha, A., M. Murakami, P. Kumar, B. Bajaj, K. Sims, and E. S. Robertson. 2009.** Epstein-Barr virus nuclear antigen 3C augments Mdm2-mediated p53 ubiquitination and degradation by deubiquitinating Mdm2. *J Virol* 83: 4652-4669.
- Saha, A., S. Halder, S. K. Upadhyay, J. Lu, P. Kumar, M. Murakami, Q. Cai, and E. S. Robertson. 2011.** Epstein-Barr virus nuclear antigen 3C facilitates G1-S transition by stabilizing and enhancing the function of cyclin D1. *PLoS Pathog* 7: e1001275.
- Sakuma, T., T. Noda, S. Urata, Y. Kawaoka, and J. Yasuda. 2009.** Inhibition of Lassa and Marburg virus production by tetherin. *J Virol* 83: 2382-2385.
- Sandefur, S., R. M. Smith, V. Varthakavi, and P. Spearman. 2000.** Mapping and characterization of the N-terminal I domain of human immunodeficiency virus type 1 Pr55(Gag). *J Virol* 74: 7238-7249.
- Santiago, M. L., F. Range, B. F. Keele, Y. Li, E. Bailes, F. Bibollet-Ruche, C. Fruteau, R. Noe, M. Peeters, J. F. Brookfield, G. M. Shaw, P. M. Sharp, and B. H. Hahn. 2005.** Simian immunodeficiency virus infection in free-ranging sooty mangabeys (*Cercocebus atys atys*) from the Tai Forest, Cote d'Ivoire: implications for the origin of epidemic human immunodeficiency virus type 2. *J Virol* 79: 12515-12527.
- Sarafianos, S. G., B. Marchand, K. Das, D. M. Himmel, M. A. Parniak, S. H. Hughes, and E. Arnold. 2009.** Structure and function of HIV-1 reverse transcriptase: molecular mechanisms of polymerization and inhibition. *J Mol Biol* 385: 693-713.
- Sarikas, A., T. Hartmann, and Z. Q. Pan. 2011.** The cullin protein family. *Genome biology* 12: 220.
- Sarkari, F., T. Sanchez-Alcaraz, S. Wang, M. N. Holowaty, Y. Sheng, and L. Frappier. 2009.** EBNA1-mediated recruitment of a histone H2B deubiquitylating complex to the Epstein-Barr virus latent origin of DNA replication. *PLoS Pathog* 5: e1000624.
- Sauter, D., M. Schindler, A. Specht, W. N. Landford, J. Munch, K. A. Kim, J. Votteler, U. Schubert, F. Bibollet-Ruche, B. F. Keele, J. Takehisa, Y. Ogando, C. Ochsenbauer, J. C. Kappes, A. Ayouba, M. Peeters, G. H. Learn, G. Shaw, P. M. Sharp, P. Bieniasz, B. H. Hahn, T. Hatziioannou, and F. Kirchhoff. 2009.** Tetherin-driven adaptation of Vpu and Nef function and the evolution of pandemic and nonpandemic HIV-1 strains. *Cell Host Microbe* 6: 409-421.
- Schafer, A., H. P. Bogerd, and B. R. Cullen. 2004.** Specific packaging of APOBEC3G into HIV-1 virions is mediated by the nucleocapsid domain of the gag polyprotein precursor. *Virology* 328: 163-168.
- Schaller, T., C. Goujon, and M. H. Malim. 2012.** AIDS/HIV. HIV interplay with SAMHD1. *Science (New York, N.Y.)* 335: 1313-1314.

- Scheffner, M., J. M. Huibregtse, R. D. Vierstra, and P. M. Howley. 1993.** The HPV-16 E6 and E6-AP complex functions as a ubiquitin-protein ligase in the ubiquitination of p53. *Cell* 75: 495-505.
- Scheffner, M., B. A. Werness, J. M. Huibregtse, A. J. Levine, and P. M. Howley. 1990.** The E6 oncoprotein encoded by human papillomavirus types 16 and 18 promotes the degradation of p53. *Cell* 63: 1129-1136.
- Schindler, M., S. Wurfl, P. Benaroch, T. C. Greenough, R. Daniels, P. Easterbrook, M. Brenner, J. Munch, and F. Kirchhoff. 2003.** Down-modulation of mature major histocompatibility complex class II and up-regulation of invariant chain cell surface expression are well-conserved functions of human and simian immunodeficiency virus nef alleles. *J Virol* 77: 10548-10556.
- Schmidtmayerova, H., B. Sherry, and M. Bukrinsky. 1996.** Chemokines and HIV replication. *Nature* 382: 767.
- Schols, D. 2004.** HIV co-receptors as targets for antiviral therapy. *Curr Top Med Chem* 4: 883-893.
- Schreiner, S., R. Martinez, P. Groitl, F. Rayne, R. Vaillant, P. Wimmer, G. Bossis, T. Sternsdorf, L. Marcinowski, Z. Ruzsics, T. Dobner, and H. Wodrich. 2012.** Transcriptional activation of the adenoviral genome is mediated by capsid protein VI. *PLoS Pathog* 8: e1002549.
- Schrofelbauer, B., Y. Hakata, and N. R. Landau. 2007.** HIV-1 Vpr function is mediated by interaction with the damage-specific DNA-binding protein DDB1. *Proceedings of the National Academy of Sciences of the United States of America* 104: 4130-4135.
- Schrofelbauer, B., Q. Yu, S. G. Zeitlin, and N. R. Landau. 2005.** Human immunodeficiency virus type 1 Vpr induces the degradation of the UNG and SMUG uracil-DNA glycosylases. *J Virol* 79: 10978-10987.
- Schulman, B. A., and J. W. Harper. 2009.** Ubiquitin-like protein activation by E1 enzymes: the apex for downstream signalling pathways. *Nature reviews. Molecular cell biology* 10: 319-331.
- Schwartz, C., V. Le Douce, T. Cherrier, L. Redel, C. Marban, D. Aunis, and O. Rohr. 2010.** [Molecular basis of HIV-1 latency - part I: physiology of HIV-1 latency]. *Med Sci (Paris)* 26: 159-163.
- Schwartz, O., V. Marechal, S. Le Gall, F. Lemonnier, and J. M. Heard. 1996.** Endocytosis of major histocompatibility complex class I molecules is induced by the HIV-1 Nef protein. *Nat Med* 2: 338-342.
- Schwartz, S., B. K. Felber, and G. N. Pavlakis. 1991.** Expression of human immunodeficiency virus type 1 vif and vpr mRNAs is Rev-dependent and regulated by splicing. *Virology* 183: 677-686.
- Seage, G. R., 3rd, K. H. Mayer, and C. R. Horsburgh, Jr. 1993.** Risk of human immunodeficiency virus infection from unprotected receptive anal intercourse increases with decline in immunologic status of infected partners. *American journal of epidemiology* 137: 899-908.
- Shackelford, J., and J. S. Pagano. 2004.** Tumor viruses and cell signaling pathways: deubiquitination versus ubiquitination. *Mol Cell Biol* 24: 5089-5093.
- Sharifi, H. J., A. M. Furuya, and C. M. de Noronha. 2012.** The role of HIV-1 Vpr in promoting the infection of nondividing cells and in cell cycle arrest. *Curr Opin HIV AIDS* 7: 187-194.
- Sharova, N., Y. Wu, X. Zhu, R. Stranska, R. Kaushik, M. Sharkey, and M. Stevenson. 2008.** Primate lentiviral Vpx commandeers DDB1 to counteract a macrophage restriction. *PLoS Pathog* 4: e1000057.
- Sharp, P. M., and B. H. Hahn. 2011.** Origins of HIV and the AIDS Pandemic. *Cold Spring Harbor perspectives in medicine* 1: a006841.
- Shchelkunov, S. N. 2010.** Interaction of orthopoxviruses with the cellular ubiquitin-ligase system. *Virus Genes* 41: 309-318.

- Sheehy, A. M., N. C. Gaddis, and M. H. Malim. 2003.** The antiretroviral enzyme APOBEC3G is degraded by the proteasome in response to HIV-1 Vif. *Nat Med* 9: 1404-1407.
- Sheehy, A. M., N. C. Gaddis, J. D. Choi, and M. H. Malim. 2002.** Isolation of a human gene that inhibits HIV-1 infection and is suppressed by the viral Vif protein. *Nature* 418: 646-650.
- Sherman, M. P., and W. C. Greene. 2002.** Slipping through the door: HIV entry into the nucleus. *Microbes Infect* 4: 67-73.
- Sherry, B. 2009.** Rotavirus and reovirus modulation of the interferon response. *Journal of interferon & cytokine research : the official journal of the International Society for Interferon and Cytokine Research* 29: 559-567.
- Shilatifard, A. 2006.** Chromatin modifications by methylation and ubiquitination: implications in the regulation of gene expression. *Annu Rev Biochem* 75: 243-269.
- Shiyanov, P., A. Nag, and P. Raychaudhuri. 1999.** Cullin 4A associates with the UV-damaged DNA-binding protein DDB. *J Biol Chem* 274: 35309-35312.
- Simon, J. H., N. C. Gaddis, R. A. Fouchier, and M. H. Malim. 1998.** Evidence for a newly discovered cellular anti-HIV-1 phenotype. *Nat Med* 4: 1397-1400.
- Simon, V., and D. D. Ho. 2003.** HIV-1 dynamics in vivo: implications for therapy. *Nat Rev Microbiol* 1: 181-190.
- Simpson, M. V. 1953.** The release of labeled amino acids from the proteins of rat liver slices. *J Biol Chem* 201: 143-154.
- Sobhian, B., N. Laguette, A. Yatim, M. Nakamura, Y. Levy, R. Kiernan, and M. Benkirane. 2010.** HIV-1 Tat assembles a multifunctional transcription elongation complex and stably associates with the 7SK snRNP. *Molecular cell* 38: 439-451.
- Solas, C., A. Lafeuillade, P. Halfon, S. Chadapaud, G. Hittinger, and B. Lacarelle. 2003.** Discrepancies between protease inhibitor concentrations and viral load in reservoirs and sanctuary sites in human immunodeficiency virus-infected patients. *Antimicrobial agents and chemotherapy* 47: 238-243.
- Somesh, B. P., S. Sigurdsson, H. Saeki, H. Erdjument-Bromage, P. Tempst, and J. Q. Svejstrup. 2007.** Communication between distant sites in RNA polymerase II through ubiquitylation factors and the polymerase CTD. *Cell* 129: 57-68.
- Sorgel, S., K. Fraedrich, J. Votteler, M. Thomas, T. Stamminger, and U. Schubert. 2012.** Perinuclear localization of the HIV-1 regulatory protein Vpr is important for induction of G2-arrest. *Virology* 432: 444-451.
- Sowa, M. E., E. J. Bennett, S. P. Gygi, and J. W. Harper. 2009.** Defining the human deubiquitinating enzyme interaction landscape. *Cell* 138: 389-403.
- Spence, J., R. R. Gali, G. Dittmar, F. Sherman, M. Karin, and D. Finley. 2000.** Cell cycle-regulated modification of the ribosome by a variant multiubiquitin chain. *Cell* 102: 67-76.
- Srivastava, S., S. K. Swanson, N. Manel, L. Florens, M. P. Washburn, and J. Skowronski. 2008.** Lentiviral Vpx accessory factor targets VprBP/DCAF1 substrate adaptor for cullin 4 E3 ubiquitin ligase to enable macrophage infection. *PLoS Pathog* 4: e1000059.
- Stark, L. A., and R. T. Hay. 1998.** Human immunodeficiency virus type 1 (HIV-1) viral protein R (Vpr) interacts with Lys-tRNA synthetase: implications for priming of HIV-1 reverse transcription. *J Virol* 72: 3037-3044.
- Stevens, M., E. De Clercq, and J. Balzarini. 2006.** The regulation of HIV-1 transcription: molecular targets for chemotherapeutic intervention. *Med Res Rev* 26: 595-625.
- Stevenson, P. G., S. Efstathiou, P. C. Doherty, and P. J. Lehner. 2000.** Inhibition of MHC class I-restricted antigen presentation by gamma 2-herpesviruses. *Proceedings of the National Academy of Sciences of the United States of America* 97: 8455-8460.
- Stewart, G. S., S. Panier, K. Townsend, A. K. Al-Hakim, N. K. Kolas, E. S. Miller, S. Nakada, J. Ylanko, S. Olivarius, M. Mendez, C. Oldreive, J. Wildenhain, A. Tagliaferro, L. Pelletier, N. Taubenheim, A. Durandy, P. J. Byrd, T. Stankovic, A. M. Taylor, and D. Durocher. 2009.** The RIDDLE syndrome protein mediates a ubiquitin-dependent signaling cascade at sites of DNA damage. *Cell* 136: 420-434.

- Stewart, S. A., B. Poon, J. Y. Song, and I. S. Chen. 2000.** Human immunodeficiency virus type 1 vpr induces apoptosis through caspase activation. *J Virol* 74: 3105-3111.
- Strazielle, N., and J. F. Gherzi-Egea. 2005.** Factors affecting delivery of antiviral drugs to the brain. *Rev Med Virol* 15: 105-133.
- Stremlau, M., C. M. Owens, M. J. Perron, M. Kiessling, P. Autissier, and J. Sodroski. 2004.** The cytoplasmic body component TRIM5alpha restricts HIV-1 infection in Old World monkeys. *Nature* 427: 848-853.
- Subbramanian, R. A., A. Kessous-Elbaz, R. Lodge, J. Forget, X. J. Yao, D. Bergeron, and E. A. Cohen. 1998.** Human immunodeficiency virus type 1 Vpr is a positive regulator of viral transcription and infectivity in primary human macrophages. *J Exp Med* 187: 1103-1111.
- Suh, H. S., M. O. Kim, and S. C. Lee. 2005.** Inhibition of granulocyte-macrophage colony-stimulating factor signaling and microglial proliferation by anti-CD45RO: role of Hck tyrosine kinase and phosphatidylinositol 3-kinase/Akt. *Journal of immunology (Baltimore, Md. : 1950)* 174: 2712-2719.
- Suzuki, T., H. Yokozaki, H. Kuniyasu, K. Hayashi, K. Naka, S. Ono, T. Ishikawa, E. Tahara, and W. Yasui. 2000.** Effect of trichostatin A on cell growth and expression of cell cycle- and apoptosis-related molecules in human gastric and oral carcinoma cell lines. *International journal of cancer. Journal international du cancer* 88: 992-997.
- Tan, L., E. Ehrlich, and X. F. Yu. 2007.** DDB1 and Cul4A are required for human immunodeficiency virus type 1 Vpr-induced G2 arrest. *J Virol* 81: 10822-10830.
- Teale, A., S. Campbell, N. Van Buuren, W. C. Magee, K. Watmough, B. Couturier, R. Shipclark, and M. Barry. 2009.** Orthopoxviruses require a functional ubiquitin-proteasome system for productive replication. *J Virol* 83: 2099-2108.
- Telesnitsky, A., and S. P. Goff. 1997.** Reverse Transcriptase and the Generation of Retroviral DNA. In J. M. Coffin, S. H. Hughes and H. E. Varmus (eds.), *Retroviruses*. Cold Spring Harbor Laboratory Press, Cold Spring Harbor NY.
- Teng, B., C. F. Burant, and N. O. Davidson. 1993.** Molecular cloning of an apolipoprotein B messenger RNA editing protein. *Science (New York, N.Y.)* 260: 1816-1819.
- Thierry, S., V. Marechal, M. Rosenzweig, M. Sabbah, G. Redeuilh, J. C. Nicolas, and J. Gozlan. 2004.** Cell cycle arrest in G2 induces human immunodeficiency virus type 1 transcriptional activation through histone acetylation and recruitment of CBP, NF-kappaB, and c-Jun to the long terminal repeat promoter. *J Virol* 78: 12198-12206.
- Thomas, M., M. Wills, and P. J. Lehner. 2008.** Natural killer cell evasion by an E3 ubiquitin ligase from Kaposi's sarcoma-associated herpesvirus. *Biochemical Society transactions* 36: 459-463.
- Thrower, J. S., L. Hoffman, M. Rechsteiner, and C. M. Pickart. 2000.** Recognition of the polyubiquitin proteolytic signal. *EMBO J* 19: 94-102.
- Tilton, J. C., and R. W. Doms. 2010.** Entry inhibitors in the treatment of HIV-1 infection. *Antiviral research* 85: 91-100.
- Tindall, B., and D. A. Cooper. 1991.** Primary HIV infection: host responses and intervention strategies. *Aids* 5: 1-14.
- Tindall, B., D. A. Cooper, B. Donovan, and R. Penny. 1988.** Primary human immunodeficiency virus infection. Clinical and serologic aspects. *Infectious disease clinics of North America* 2: 329-341.
- Towers, G. J. 2007.** The control of viral infection by tripartite motif proteins and cyclophilin A. *Retrovirology* 4: 40.
- Tran, K., J. A. Mahr, and D. H. Spector. 2010.** Proteasome subunits relocalize during human cytomegalovirus infection, and proteasome activity is necessary for efficient viral gene transcription. *J Virol* 84: 3079-3093.
- Tripathy, M. K., W. Abbas, and G. Herbein. 2011.** Epigenetic regulation of HIV-1 transcription. *Epigenomics* 3: 487-502.
- Tristem, M., A. Purvis, and D. L. Quicke. 1998.** Complex evolutionary history of primate lentiviral vpr genes. *Virology* 240: 232-237.

- Tungaturthi, P. K., B. E. Sawaya, V. Ayyavoo, R. Murali, and A. Srinivasan. 2004.** HIV-1 Vpr: genetic diversity and functional features from the perspective of structure. *DNA Cell Biol* 23: 207-222.
- Tungaturthi, P. K., B. E. Sawaya, S. P. Singh, B. Tomkowicz, V. Ayyavoo, K. Khalili, R. G. Collman, S. Amini, and A. Srinivasan. 2003.** Role of HIV-1 Vpr in AIDS pathogenesis: relevance and implications of intravirion, intracellular and free Vpr. *Biomed Pharmacother* 57: 20-24.
- Van Damme, N., and J. Guatelli. 2008.** HIV-1 Vpu inhibits accumulation of the envelope glycoprotein within clathrin-coated, Gag-containing endosomes. *Cell Microbiol* 10: 1040-1057.
- Van Damme, N., D. Goff, C. Katsura, R. L. Jorgenson, R. Mitchell, M. C. Johnson, E. B. Stephens, and J. Guatelli. 2008.** The interferon-induced protein BST-2 restricts HIV-1 release and is downregulated from the cell surface by the viral Vpu protein. *Cell Host Microbe* 3: 245-252.
- Van Lint, C. 2000.** Role of chromatin in HIV-1 transcriptional regulation. *Adv Pharmacol* 48: 121-160.
- Vandergeeten, C., R. Fromentin, and N. Chomont. 2012.** The role of cytokines in the establishment, persistence and eradication of the HIV reservoir. *Cytokine & growth factor reviews* 23: 143-149.
- Vanvalkenburgh, J., D. I. Albu, C. Bapanpally, S. Casanova, D. Califano, D. M. Jones, L. Ignatowicz, S. Kawamoto, S. Fagarasan, N. A. Jenkins, N. G. Copeland, P. Liu, and D. Avram. 2011.** Critical role of Bcl11b in suppressor function of T regulatory cells and prevention of inflammatory bowel disease. *J Exp Med* 208: 2069-2081.
- Varin, A., A. Z. Decrion, E. Sabbah, V. Quivy, J. Sire, C. Van Lint, B. P. Roques, B. B. Aggarwal, and G. Herbein. 2005.** Synthetic Vpr protein activates activator protein-1, c-Jun N-terminal kinase, and NF-kappaB and stimulates HIV-1 transcription in promonocytic cells and primary macrophages. *J Biol Chem* 280: 42557-42567.
- Vassallo, M., B. Dunais, A. Naqvi, R. Garaffo, and J. Durant. 2012.** Raltegravir-induced nephrolithiasis: a case report. *Aids* 26: 1323-1324.
- Vazquez, N., T. Greenwell-Wild, N. J. Marinos, W. D. Swaim, S. Nares, D. E. Ott, U. Schubert, P. Henklein, J. M. Orenstein, M. B. Sporn, and S. M. Wahl. 2005.** Human immunodeficiency virus type 1-induced macrophage gene expression includes the p21 gene, a target for viral regulation. *J Virol* 79: 4479-4491.
- Verreault, A., P. D. Kaufman, R. Kobayashi, and B. Stillman. 1998.** Nucleosomal DNA regulates the core-histone-binding subunit of the human Hat1 acetyltransferase. *Curr Biol* 8: 96-108.
- Vilaseca, J., J. M. Arnau, R. Bacardi, C. Mieras, A. Serrano, and C. Navarro. 1982.** Kaposi's sarcoma and toxoplasma gondii brain abscess in a Spanish homosexual. *Lancet* 1: 572.
- Vivet-Boudou, V., J. Didierjean, C. Isel, and R. Marquet. 2006.** Nucleoside and nucleotide inhibitors of HIV-1 replication. *Cell Mol Life Sci* 63: 163-186.
- von Schwedler, U., J. Song, C. Aiken, and D. Trono. 1993.** Vif is crucial for human immunodeficiency virus type 1 proviral DNA synthesis in infected cells. *J Virol* 67: 4945-4955.
- Voutsadakis, I. A. 2012.** The ubiquitin-proteasome system and signal transduction pathways regulating Epithelial Mesenchymal transition of cancer. *Journal of biomedical science* 19: 67.
- Wagschal, A., E. Rousset, P. Basavarajaiah, X. Contreras, A. Harwig, S. Laurent-Chabalier, M. Nakamura, X. Chen, K. Zhang, O. Meziane, F. Boyer, H. Parrinello, B. Berkhout, C. Terzian, M. Benkirane, and R. Kiernan. 2012.** Microprocessor, Setx, Xrn2, and Rrp6 co-operate to induce premature termination of transcription by RNAPII. *Cell* 150: 1147-1157.
- Wain-Hobson, S., P. Sonigo, O. Danos, S. Cole, and M. Alizon. 1985.** Nucleotide sequence of the AIDS virus, LAV. *Cell* 40: 9-17.

- Wakabayashi, Y., H. Watanabe, J. Inoue, N. Takeda, J. Sakata, Y. Mishima, J. Hitomi, T. Yamamoto, M. Utsuyama, O. Niwa, S. Aizawa, and R. Kominami. 2003.** Bcl11b is required for differentiation and survival of alphabeta T lymphocytes. *Nat Immunol* 4: 533-539.
- Wang, B., and S. J. Elledge. 2007.** Ubc13/Rnf8 ubiquitin ligases control foci formation of the Rap80/Abraxas/Brca1/Brcc36 complex in response to DNA damage. *Proceedings of the National Academy of Sciences of the United States of America* 104: 20759-20763.
- Wang, J., E. L. Reuschel, J. M. Shackelford, L. Jeang, D. K. Shivers, J. A. Diehl, X. F. Yu, and T. H. Finkel. 2011a.** HIV-1 Vif promotes the G(1)- to S-phase cell-cycle transition. *Blood* 117: 1260-1269.
- Wang, J. K., E. Kiyokawa, E. Verdin, and D. Trono. 2000.** The Nef protein of HIV-1 associates with rafts and primes T cells for activation. *Proceedings of the National Academy of Sciences of the United States of America* 97: 394-399.
- Wang, T., C. M. Simbulan-Rosenthal, M. E. Smulson, P. B. Chock, and D. C. Yang. 2008.** Polyubiquitylation of PARP-1 through ubiquitin K48 is modulated by activated DNA, NAD+, and dipeptides. *J Cell Biochem* 104: 318-328.
- Wang, X., A. Abudu, S. Son, Y. Dang, P. J. Venta, and Y. H. Zheng. 2011b.** Analysis of human APOBEC3H haplotypes and anti-human immunodeficiency virus type 1 activity. *J Virol* 85: 3142-3152.
- Ward, J., Z. Davis, J. DeHart, E. Zimmerman, A. Bosque, E. Brunetta, D. Mavilio, V. Planelles, and E. Barker. 2009.** HIV-1 Vpr triggers natural killer cell-mediated lysis of infected cells through activation of the ATR-mediated DNA damage response. *PLoS Pathog* 5: e1000613.
- Warfel, N. A., and W. S. El-Deiry. 2013.** p21WAF1 and tumourigenesis: 20 years after. *Current opinion in oncology* 25: 52-58.
- Watts, J. M., K. K. Dang, R. J. Gorelick, C. W. Leonard, J. W. Bess, Jr., R. Swanstrom, C. L. Burch, and K. M. Weeks. 2009.** Architecture and secondary structure of an entire HIV-1 RNA genome. *Nature* 460: 711-716.
- Wedekind, J. E., G. S. Dance, M. P. Sowden, and H. C. Smith. 2003.** Messenger RNA editing in mammals: new members of the APOBEC family seeking roles in the family business. *Trends Genet* 19: 207-216.
- Welcker, M., and B. E. Clurman. 2008.** FBW7 ubiquitin ligase: a tumour suppressor at the crossroads of cell division, growth and differentiation. *Nature reviews. Cancer* 8: 83-93.
- Wen, X., K. M. Duus, T. D. Friedrich, and C. M. de Noronha. 2007.** The HIV1 protein Vpr acts to promote G2 cell cycle arrest by engaging a DDB1 and Cullin4A-containing ubiquitin ligase complex using VprBP/DCAF1 as an adaptor. *J Biol Chem* 282: 27046-27057.
- Wen, X., L. Casey Klockow, M. Nekorchuk, H. J. Sharifi, and C. M. de Noronha. 2012.** The HIV1 protein Vpr acts to enhance constitutive DCAF1-dependent UNG2 turnover. *PLoS One* 7: e30939.
- Wickliffe, K. E., A. Williamson, H. J. Meyer, A. Kelly, and M. Rape. 2011.** K11-linked ubiquitin chains as novel regulators of cell division. *Trends in cell biology* 21: 656-663.
- Widjaja, I., E. de Vries, D. M. Tscherne, A. Garcia-Sastre, P. J. Rottier, and C. A. de Haan. 2010.** Inhibition of the ubiquitin-proteasome system affects influenza A virus infection at a postfusion step. *J Virol* 84: 9625-9631.
- Wiegand, H. L., B. P. Doehle, H. P. Bogerd, and B. R. Cullen. 2004.** A second human antiretroviral factor, APOBEC3F, is suppressed by the HIV-1 and HIV-2 Vif proteins. *EMBO J* 23: 2451-2458.
- Wieggers, K., G. Rutter, H. Kottler, U. Tessmer, H. Hohenberg, and H. G. Krausslich. 1998.** Sequential steps in human immunodeficiency virus particle maturation revealed by alterations of individual Gag polyprotein cleavage sites. *J Virol* 72: 2846-2854.
- Wilens, C. B., J. C. Tilton, and R. W. Doms. 2012a.** Molecular mechanisms of HIV entry. *Advances in experimental medicine and biology* 726: 223-242.



- Wilens, C. B., J. C. Tilton, and R. W. Doms. 2012b.** HIV: cell binding and entry. Cold Spring Harbor perspectives in medicine 2.
- Williams, C., M. van den Berg, R. R. Sprenger, and B. Distel. 2007.** A conserved cysteine is essential for Pex4p-dependent ubiquitination of the peroxisomal import receptor Pex5p. *J Biol Chem* 282: 22534-22543.
- Wodrich, H., D. Henaff, B. Jammart, C. Segura-Morales, S. Seelmeir, O. Coux, Z. Ruzsics, C. M. Wiethoff, and E. J. Kremer. 2010.** A capsid-encoded PPxY-motif facilitates adenovirus entry. *PLoS Pathog* 6: e1000808.
- Wolf, D., and S. P. Goff. 2008.** Host restriction factors blocking retroviral replication. *Annu Rev Genet* 42: 143-163.
- Wong, J., J. Zhang, X. Si, G. Gao, and H. Luo. 2007.** Inhibition of the extracellular signal-regulated kinase signaling pathway is correlated with proteasome inhibitor suppression of coxsackievirus replication. *Biochem Biophys Res Commun* 358: 903-907.
- Wong, J. K., M. Hezareh, H. F. Gunthard, D. V. Havlir, C. C. Ignacio, C. A. Spina, and D. D. Richman. 1997.** Recovery of replication-competent HIV despite prolonged suppression of plasma viremia. *Science (New York, N.Y.)* 278: 1291-1295.
- Wu, X., J. L. Anderson, E. M. Campbell, A. M. Joseph, and T. J. Hope. 2006.** Proteasome inhibitors uncouple rhesus TRIM5alpha restriction of HIV-1 reverse transcription and infection. *Proceedings of the National Academy of Sciences of the United States of America* 103: 7465-7470.
- Wu, Z., J. Alexandratos, B. Ericksen, J. Lubkowski, R. C. Gallo, and W. Lu. 2004.** Total chemical synthesis of N-myristoylated HIV-1 matrix protein p17: structural and mechanistic implications of p17 myristoylation. *Proceedings of the National Academy of Sciences of the United States of America* 101: 11587-11592.
- Wurtele, H., Q. Li, H. Zhou, Z. Zhang, and A. Verreault. 2009.** [Histone acetylation and chromatin assembly]. *Med Sci (Paris)* 25: 121-122.
- Wyatt, R., and J. Sodroski. 1998.** The HIV-1 envelope glycoproteins: fusogens, antigens, and immunogens. *Science (New York, N.Y.)* 280: 1884-1888.
- Xue, Y., J. Wong, G. T. Moreno, M. K. Young, J. Cote, and W. Wang. 1998.** NURD, a novel complex with both ATP-dependent chromatin-remodeling and histone deacetylase activities. *Molecular cell* 2: 851-861.
- Yamaguchi, J., R. Coffey, A. Vallari, C. Ngansop, D. Mbanya, N. Ndembi, L. Kaptue, L. G. Gurtler, P. Bodelle, G. Schochetman, S. G. Devare, and C. A. Brennan. 2006.** Identification of HIV type 1 group N infections in a husband and wife in Cameroon: viral genome sequences provide evidence for horizontal transmission. *AIDS Res Hum Retroviruses* 22: 83-92.
- Yamashita, M., and M. Emerman. 2005.** The cell cycle independence of HIV infections is not determined by known karyophilic viral elements. *PLoS Pathog* 1: e18.
- Yamauchi, K., K. Wada, K. Tanji, M. Tanaka, and T. Kamitani. 2008.** Ubiquitination of E3 ubiquitin ligase TRIM5 alpha and its potential role. *Febs J* 275: 1540-1555.
- Yan, Z., R. Zak, G. W. Luxton, T. C. Ritchie, U. Bantel-Schaal, and J. F. Engelhardt. 2002.** Ubiquitination of both adeno-associated virus type 2 and 5 capsid proteins affects the transduction efficiency of recombinant vectors. *J Virol* 76: 2043-2053.
- Yang, Z., Z. Yan, and C. Wood. 2008.** Kaposi's sarcoma-associated herpesvirus transactivator RTA promotes degradation of the repressors to regulate viral lytic replication. *J Virol* 82: 3590-3603.
- Ye, Y., and M. Rape. 2009.** Building ubiquitin chains: E2 enzymes at work. *Nature reviews. Molecular cell biology* 10: 755-764.
- Yu, G. Y., and M. M. Lai. 2005.** The ubiquitin-proteasome system facilitates the transfer of murine coronavirus from endosome to cytoplasm during virus entry. *J Virol* 79: 644-648.
- Yu, Q., D. Chen, R. Konig, R. Mariani, D. Unutmaz, and N. R. Landau. 2004.** APOBEC3B and APOBEC3C are potent inhibitors of simian immunodeficiency virus replication. *J Biol Chem* 279: 53379-53386.

- Yu, X., Y. Yu, B. Liu, K. Luo, W. Kong, P. Mao, and X. F. Yu. 2003.** Induction of APOBEC3G ubiquitination and degradation by an HIV-1 Vif-Cul5-SCF complex. *Science (New York, N.Y.)* 302: 1056-1060.
- Yu, X. F., Q. C. Yu, M. Essex, and T. H. Lee. 1991.** The vpx gene of simian immunodeficiency virus facilitates efficient viral replication in fresh lymphocytes and macrophage. *J Virol* 65: 5088-5091.
- Yuan, Y., Y. Maeda, H. Terasawa, K. Monde, S. Harada, and K. Yusa. 2011.** A combination of polymorphic mutations in V3 loop of HIV-1 gp120 can confer noncompetitive resistance to maraviroc. *Virology* 413: 293-299.
- Zack, J. A., A. M. Haislip, P. Krogstad, and I. S. Chen. 1992.** Incompletely reverse-transcribed human immunodeficiency virus type 1 genomes in quiescent cells can function as intermediates in the retroviral life cycle. *J Virol* 66: 1717-1725.
- Zack, J. A., S. J. Arrigo, S. R. Weitsman, A. S. Go, A. Haislip, and I. S. Chen. 1990.** HIV-1 entry into quiescent primary lymphocytes: molecular analysis reveals a labile, latent viral structure. *Cell* 61: 213-222.
- Zanetti, G., J. A. Briggs, K. Grunewald, Q. J. Sattentau, and S. D. Fuller. 2006.** Cryo-electron tomographic structure of an immunodeficiency virus envelope complex in situ. *PLoS Pathog* 2: e83.
- Zennou, V., C. Petit, D. Guetard, U. Nerhbass, L. Montagnier, and P. Charneau. 2000.** HIV-1 genome nuclear import is mediated by a central DNA flap. *Cell* 101: 173-185.
- Zennou, V., C. Serguera, C. Sarkis, P. Colin, E. Perret, J. Mallet, and P. Charneau. 2001.** The HIV-1 DNA flap stimulates HIV vector-mediated cell transduction in the brain. *Nature biotechnology* 19: 446-450.
- Zhan, P., X. Liu, and E. De Clercq. 2010.** Blocking nuclear import of pre-integration complex: an emerging anti-HIV-1 drug discovery paradigm. *Curr Med Chem* 17: 495-503.
- Zhang, B., A. Srirangam, D. A. Potter, and A. Roman. 2005.** HPV16 E5 protein disrupts the c-Cbl-EGFR interaction and EGFR ubiquitination in human foreskin keratinocytes. *Oncogene* 24: 2585-2588.
- Zhang, C., S. de Silva, J. H. Wang, and L. Wu. 2012a.** Co-evolution of primate SAMHD1 and lentivirus Vpx leads to the loss of the vpx gene in HIV-1 ancestor. *PLoS One* 7: e37477.
- Zhang, H., B. Yang, R. J. Pomerantz, C. Zhang, S. C. Arunachalam, and L. Gao. 2003.** The cytidine deaminase CEM15 induces hypermutation in newly synthesized HIV-1 DNA. *Nature* 424: 94-98.
- Zhang, W., J. Du, S. L. Evans, Y. Yu, and X. F. Yu. 2012b.** T-cell differentiation factor CBF-beta regulates HIV-1 Vif-mediated evasion of host restriction. *Nature* 481: 376-379.
- Zhang, Z., A. Klatt, D. S. Gilmour, and A. J. Henderson. 2007.** Negative elongation factor NELF represses human immunodeficiency virus transcription by pausing the RNA polymerase II complex. *J Biol Chem* 282: 16981-16988.
- Zhao, R. Y., G. Li, and M. I. Bukrinsky. 2011.** Vpr-host interactions during HIV-1 viral life cycle. *J Neuroimmune Pharmacol* 6: 216-229.
- Zheng, L., G. Fisher, R. E. Miller, J. Peschon, D. H. Lynch, and M. J. Lenardo. 1995.** Induction of apoptosis in mature T cells by tumour necrosis factor. *Nature* 377: 348-351.
- Zheng, Y., Z. Ao, B. Wang, K. D. Jayappa, and X. Yao. 2011.** Host protein Ku70 binds and protects HIV-1 integrase from proteasomal degradation and is required for HIV replication. *J Biol Chem* 286: 17722-17735.
- Zheng, Y. H., K. T. Jeang, and K. Tokunaga. 2012.** Host restriction factors in retroviral infection: promises in virus-host interaction. *Retrovirology* 9: 112.
- Zheng, Y. H., A. Plemenitas, C. J. Fielding, and B. M. Peterlin. 2003.** Nef increases the synthesis of and transports cholesterol to lipid rafts and HIV-1 progeny virions. *Proceedings of the National Academy of Sciences of the United States of America* 100: 8460-8465.
- Zhou, C., and T. M. Rana. 2002.** A bimolecular mechanism of HIV-1 Tat protein interaction with RNA polymerase II transcription elongation complexes. *J Mol Biol* 320: 925-942.

**Zhu, Y., T. Pe'ery, J. Peng, Y. Ramanathan, N. Marshall, T. Marshall, B. Amendt, M. B. Mathews, and D. H. Price. 1997.** Transcription elongation factor P-TEFb is required for HIV-1 tat transactivation in vitro. *Genes Dev* 11: 2622-2632.

**Zimmerman, E. S., B. A. Schulman, and N. Zheng. 2010.** Structural assembly of cullin-RING ubiquitin ligase complexes. *Current opinion in structural biology* 20: 714-721.

# **Annexes**

## Achieving a cure for HIV infection: do we have reasons to be optimistic?

Valentin Le Douce<sup>1</sup>, Andrea Janossy<sup>1</sup>, Houda Hallay<sup>1</sup>, Sultan Ali<sup>1</sup>, Raphael Riclet<sup>1</sup>, Olivier Rohr<sup>1,3†</sup> and Christian Schwartz<sup>1,2\*†</sup>

<sup>1</sup>University of Strasbourg, EA4438, Institute of Parasitology, Strasbourg, France; <sup>2</sup>IUT de Schiltigheim, 1 Allée d'Athènes, 67300 Schiltigheim, France; <sup>3</sup>Institut Universitaire de France, 103 Bd Saint Michel, Paris, France

\*Corresponding author. Tel: +33-368853673; E-mail: schwartz.christian@unistra.fr

†These authors contributed equally.

The introduction of highly active antiretroviral therapy (HAART) in 1996 has transformed a lethal disease to a chronic pathology with a dramatic decrease in mortality and morbidity of AIDS-related symptoms in infected patients. However, HAART has not allowed the cure of HIV infection, the main obstacle to HIV eradication being the existence of quiescent reservoirs. Several other problems have been encountered with HAART (such as side effects, adherence to medication, emergence of resistance and cost of treatment), and these motivate the search for new ways to treat these patients. Recent advances hold promise for the ultimate cure of HIV infection, which is the topic of this review. Besides these new strategies aiming to eliminate the virus, efforts must be made to improve current HAART. We believe that the cure of HIV infection will not be attained in the short term and that a strategy based on purging the reservoirs has to be associated with an aggressive HAART strategy.

**Keywords:** CCR5, reservoirs, latency, purge, HAART

### Introduction

Human immunodeficiency virus 1 (HIV-1), identified 28 years ago,<sup>1</sup> remains a global health threat responsible for a worldwide pandemic with an estimated 33 million people infected.<sup>2</sup> More than 7000 new HIV infections occur each day, and the number of newly diagnosed infections remains far greater than the number of people (around 50%) who have access to highly active antiretroviral therapy (HAART). Advances have been made in treating AIDS since the introduction of HAART in 1996. This has transformed a lethal disease into a chronic pathology, with a dramatic decrease of mortality and morbidity of AIDS-related symptoms in infected patients.<sup>3,4</sup>

### Why is achieving a cure important?

To date, the only way to treat patients infected with HIV relies on a combination of drugs that acts at different stages of the viral life cycle, preventing the virus from replicating. These molecules target four stages of the cycle: viral entry, reverse transcription of the viral genome, integration into the genome of the host cell and maturation of viral proteins. This therapy can reduce plasma virus levels below detection limits ( $\leq 50$  copies/mL). However, with very sensitive but expensive and technically challenging methods, a residual viraemia is still detected in patients on HAART.<sup>5–8</sup> Moreover, HIV RNA typically returns to a measurable

plasma level in less than 2 weeks when HAART is interrupted, suggesting that even long-term suppression of HIV-1 replication by HAART fails to totally eliminate HIV-1. These two latter phenomena are mainly due to the existence of HIV reservoirs.<sup>6,9–13</sup> The existence of integrated latent viruses or virus replicating at a very low level in different cellular reservoirs is an obstacle to the eradication of the virus, and thus the total recovery of patients, and requires strict adherence to lifelong treatment.<sup>14–21</sup> In addition, these cellular reservoirs are often found in tissue sanctuaries, such as the brain, where drug penetration may be several orders of magnitude lower than in other tissues.<sup>16,18</sup> Viral clearance from other reservoirs, such as from chronically infected macrophages, is also difficult since reverse transcriptase inhibitors are usually ineffective and protease inhibitors have significantly lower activities in these cells than in lymphocytes.<sup>22,23</sup> Moreover, emergence of many side effects may require the cessation of treatment.<sup>24</sup> Furthermore, the development of many types of resistance, related to the extreme mutability of the virus and in part to treatment interruptions, has been described in the literature.<sup>25–28</sup> Another major concern is related to non-AIDS events and non-AIDS mortality in patients having a residual viraemia and a normal CD4+ count, a situation also described in some HIV non-progressors. Owing to the residual viraemia, patients develop chronic inflammation that leads to several complications, for instance, cardiovascular disease, nephropathy, faster evolution of viral hepatitis and cancer.<sup>29–33</sup>

© The Author 2012. Published by Oxford University Press on behalf of the British Society for Antimicrobial Chemotherapy. This is an Open Access article distributed under the terms of the Creative Commons Attribution Non-Commercial License (<http://creativecommons.org/licenses/by-nc/2.5>), which permits unrestricted non-commercial use, distribution, and reproduction in any medium, provided the original work is properly cited.

Last but not least, a major problem related to HAART is the cost of the treatment. Even the cost associated with the cheaper generic forms of the drugs far exceeds the abilities of many resource-limited countries in providing treatment. The cost of this treatment will be increasingly important in the future, with an overall global budget requirement to address this problem from today to 2031 being estimated at US\$397–727 billion.<sup>34</sup> Since, to date, no effective HIV-1 vaccine is available,<sup>35–38</sup> it appears crucial to improve HAART and to develop new strategies to cure HIV.<sup>39,40</sup>

#### **Which cure is needed: a functional or a sterilizing cure?**

A sterilizing cure requires the total eradication of all HIV-infected cells, including quiescent reservoirs. On the other hand, a functional cure aims to mimic a situation encountered in some special patients called 'elite controllers' who are able to control viral replication and have less than 50 copies/mL of the virus without any treatment. Although a sterilizing cure would be the most appropriate and desirable, it may be difficult or impossible to really achieve. Only one reported case, the German case, is known in the literature that suggests a possible eradication of the virus.<sup>41</sup> A functional cure appears more feasible since it seems impossible to get rid of HIV from latent cells and from sanctuaries. We have to keep in mind however that the chronic inflammation described in patients under HAART has also been described in some elite controllers who have presented with residual viraemia and higher immune activation compared with healthy patients.<sup>42–44</sup> It is very likely that these patients will develop more non-AIDS events compared with those who are uninfected or actually cured.

#### **How might we achieve a cure?**

The best scenario would be to eradicate the virus from all infected cells. Even though this appears very difficult, we should be able to drastically decrease the HIV reservoirs by identifying and then eliminating them. Residual on-going viral replication, whatever its origin, also has to be reduced to preclude non-AIDS events.

In this article we will discuss new strategies under investigation that aim to eradicate HIV from infected patients. First we will discuss a recently described case that showed a possible eradication of HIV following transplantation of CCR5-deficient haematopoietic stem cells. This strategy may open new avenues to cure HIV-infected patients. We will also discuss novel strategies based on purging reservoirs followed by aggressive HAART. This approach has already been used in several clinical trials. Finally, we believe that HAART has to be improved and/or intensified; however, we have to keep in mind that HAART alone will not allow for a cure.

### **The critical role of CCR5 in maintaining HIV-1 infection**

#### **A proof of concept**

A report of a German patient being transplanted with stem cells from a donor who carried the  $\Delta 32$  CCR5 mutation and then controlled his HIV infection has highlighted the critical role of CCR5 in

maintaining HIV infection.<sup>45</sup> It is well known that HIV-1 enters cells by using CD4 receptors and CCR5 or CXCR4 coreceptors and persons homozygotic for a 32 bp deletion in the gene coding for CCR5 are resistant to HIV-1 infection.<sup>46,47</sup> It is noteworthy that the origin of the CCR5- $\Delta 32$ -containing ancestral haplotype is recent (estimated range of 275–1875 years) and might be related to a historic strong selective event such as an epidemic of a pathogen that, like HIV-1, utilizes CCR5. This hypothetical epidemic has increased the frequency of this mutation in ancestral Caucasian populations.<sup>48</sup> Hutter understood the significance of the CCR5 mutation and suggested that transplantation of stem cells originating from a donor homozygotic for the mutation could effectively eradicate the virus. After the relapse of leukaemia in the German patient with HIV there was no other choice but to transplant allogeneic stem cells to this person. The patient, as suggested by Hutter, received  $\Delta 32$  CCR5 mutant stem cells. Following the medical intervention, the patient has stopped HAART and HIV RNA has remained below 1 copy/mL for now over 4 years. In a recent paper this group showed evidence even for a possible cure of HIV-1 infection in this patient. Indeed, they demonstrated reconstitution of both circulating and mucosal CD4+ T cells that do not express CCR5 while the patient remained free of the virus. Moreover, they also found evidence that long-lived cells such as macrophages became  $\Delta 32$  CCR5. Since these cells are reservoirs for the virus along with CD4+ T memory cells, it appears that the size of the viral reservoir has decreased. This result was unexpected since the patient's CD4+ memory cells are still susceptible to productive infection by lymphotropic (CXCR4-tropic) HIV. The combination of radiotherapy and chemotherapy has allowed the eradication of long-lived reservoirs, which has prevented HIV rebound during the process of immune reconstitution following stem cell transplantation. Although this specific case is a real success, stem cell transplantation as a general strategy to cure infected patients is not yet feasible due to the high mortality of this treatment (20%–30%). This report constitutes a proof of concept and opens the development of new strategies targeting the CCR5 coreceptor.

#### **CCR5 gene therapy**

Among new treatments, CCR5 gene therapy could be a potential treatment to cure HIV (Figure 1). In preclinical trials, HIV-1-infected mice engrafted with zinc finger nuclease (ZFN)-modified CD4+ T cells had lower viral loads and higher CD4+ T cell counts than mice engrafted with wild-type CD4+ T cells, consistent with the potential to reconstitute immune function in individuals with HIV/AIDS by the maintenance of an HIV-resistant CD4+ T cell population.<sup>49,50</sup> Preliminary results of two Phase 1 clinical trials using this attractive approach were presented at the 2011 Conference on Retroviruses and Opportunistic Infections (CROI).<sup>51,52</sup> Lalezari presented data on transformed CD4+ T cells. The wild-type CD4+ T cells were obtained from six patients who had been living with HIV infection for >20 years. Participants chosen had continued low CD4+ T cell counts (ranging from 200 to 500 cells/mm<sup>3</sup>), despite receiving antiretroviral therapy, which reduced HIV viral load to an undetectable level. Both studies showed a successful and tolerated engraftment of the transformed CD4+ T cells. At the Interscience Conference on Antimicrobial Agents and Chemotherapy (ICAAC),

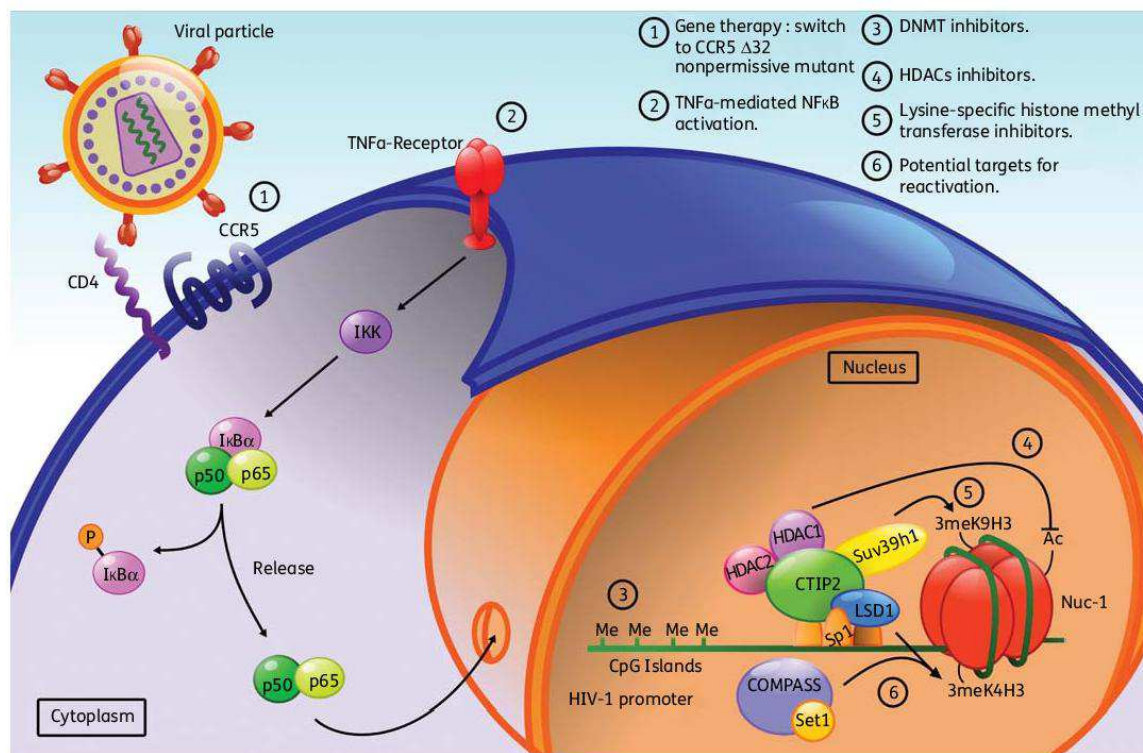

**Figure 1.** Promising new approaches to cure patients of HIV-1: molecular mechanisms at the macrophage level. Beside increasing the pool of new molecules and improving the currently used ones in HAART, new approaches are required to reach a full recovery from HIV-1 infection. To date, HAART can only control and prevent viral replication, but fails to achieve total viral clearance. New potential strategies include virus eradication through gene therapy and clearance of the viral reservoirs. The first strategy derived from the observation of the  $\Delta 32$  CCR5 bone marrow transplanted German patient, who seems to be free of HIV-1 infection. Owing to the high risk associated with surgery and the impossibility of using this method in a large number of patients, gene therapy could be a way to disrupt the CCR5-mediated infection in order to mimic the previous results of the German patient (1). The second strategy relies on associating the current HAART with molecules activating the viral transcription and/or targeting host proteins favouring HIV-1 latency. On the one hand, the early stage of viral replication requires the transcription activator NF- $\kappa$ B, thus cytokines such as TNF- $\alpha$  may allow the recovery of full viral transcription in latent reservoirs (2). On the other hand, chromatin-modifying enzymes have been associated with HIV-1 transcription extinction through fine modifications of the epigenetic code on the viral promoter. Limiting DNA methylation of the CpG islands (3), increasing activation marks, such as acetylation of histones from Nuc-1 (4), and/or avoiding marks associated with heterochromatin, such as simultaneous trimethylation of lysine 4 and lysine 9 (5,6) of histone H3 in Nuc-1 may revert the latently infected state back to productively infected macrophages. This figure appears in colour in the online version of *JAC* and in black and white in the print version of *JAC*.

data from another clinical trial was also presented in which six subjects having initially  $>450$  CD4+ T cells/mm<sup>3</sup> under HAART<sup>53</sup> were followed for 12 weeks after infusion of *ex vivo* transformed CD4+ T cells. Only one patient in this clinical trial became undetectable for the virus. However, this patient entered the clinical study with one  $\Delta 32$  CCR5 mutation. Therefore a functional cure with this gene therapy was not attained. As explained during this conference, only 5% of the total CD4+ T cells were transformed, in contrast to the 100% in the German patient who benefited from stem cell transplantation. There is hope however that this small fraction of cells will rise in the body, since it is expected that the CCR5+ cells infected by HIV-1 will die over time. It is possible that CCR5- mutants

will be selected and will replace the normal CCR5+ cells, since the release of virus from these CCR5+ cells will not be able to infect the transfused population of CCR5- mutants. A much longer follow-up is needed to confirm these expectations.

The long-term control of HIV by the German patient who received a transplant of CCR5-deficient haematopoietic stem cells holds promise for a real cure,<sup>54</sup> but due to its toxicity, it is not a realistic one as claimed by Lewin and Rouzioux.<sup>55</sup> Further investigations in order to understand the mechanism by which HIV was eradicated have to be performed. It would also be interesting to repeat this approach in other patients, which will help us to make further conclusions.<sup>56</sup> It even raises questions such as why there is no HIV rebound from long-lived viral reservoirs

producing CXCR4-tropic viruses or what the role is of the transplantation procedure itself<sup>45,55</sup> in the eradication of the virus. The debate, regarding whether the treatment of the German patient represents a sterilizing cure or not, is far from over.<sup>57</sup> Gene therapy (including CCR5 gene therapy) is indeed a very attractive approach to cure HIV-1 infection, but it is not for immediate use, even though considerable progress in gene delivery has been made.<sup>58,59</sup> Moreover, the debate as to whether or not this gene therapy will lead to a sterilizing cure is still open.<sup>60</sup>

### Purging viral reservoirs

The main drawback of HAART is that it is unable to purge the virus from quiescent reservoirs, i.e. truly latent cells,<sup>61-63</sup> and/or from cells with cryptic on-going HIV replication,<sup>7,64,65</sup> or from sanctuaries such as the brain.<sup>66-68</sup> Resting memory CD4+ T cells are the major cellular and the best characterized reservoirs in the natural host.<sup>6,7,69-71</sup> The presence of latent proviral HIV-1 DNA in this cell population has definitely been proven.<sup>69</sup>

Other reservoirs than resting CD4+ T cells have also been proposed.<sup>16,18-20</sup> Genetic studies showed that during rebound viraemia (due to HAART interruption) the virus could be detected from reservoirs other than CD4+ T cells.<sup>62,72,73</sup> It has been proposed that peripheral blood monocytes, dendritic cells and macrophages in the lymph nodes and haematopoietic stem cells in the bone marrow can be infected latently and therefore contribute to viral persistence.<sup>14-17,19,61,74</sup> It is still debated whether or not viral persistence in these latter reservoirs is due to true latency or to a low-level on-going replication.<sup>75,76</sup>

Deciphering the molecular mechanisms underlying HIV persistence is a prerequisite to devise novel treatments aiming to purge these reservoirs. Several recent reviews describe in more detail the mechanisms of HIV persistence with implications for the development of new therapeutic strategies.<sup>18,20,40,77-79</sup> Before using strategies that aim at purging the reservoir in combination with an intensified HAART, we need: (i) to identify and characterize the molecular actors involved in the persistence of latency, which relies on the chromatin environment; and (ii) to understand the mechanisms of reactivation in order to prevent it.

### Persistence of latency

Once HIV-1 DNA has integrated into the host genome, and latency has been established, maintenance of HIV-1 latency depends on the chromatin environment. The chromatin organization of the HIV-1 promoter with precisely positioned nucleosomes<sup>80,81</sup> has been well described. Nuc-1, a nucleosome located immediately downstream of the transcription initiation site, impedes long terminal repeat (LTR) activity. Epigenetic modifications and disruption of Nuc-1 are a prerequisite of activation of LTR-driven transcription and viral expression.<sup>82</sup> It was recently found that recruitment of deacetylases and methylases on the LTR was associated with epigenetic modifications (deacetylation of H3K9 followed by H3K9 trimethylation and recruitment of HP1 proteins) in CD4+ T cells. In these experiments, the methylase Suv39H1 and the HP1 $\gamma$  proteins were knocked down by small interfering RNA (siRNA). The depletion of these factors increased the level of HIV-1 expression.<sup>83</sup>

Epigenetic modifications of the LTR have also been described in microglial cells, the CNS-resident macrophages. These cells are major targets for HIV-1 and constitute latently infected cellular reservoirs in the brain.<sup>84</sup> Previous work from our laboratory has shown that a COUP-TF interacting protein 2 (CTIP2), a recently cloned transcriptional repressor that can associate with members of the COUP-TF family,<sup>85</sup> inhibits HIV-1 replication in human microglial cells.<sup>86,87</sup> Subsequently we showed that CTIP2 inhibited HIV-1 gene transcription in these cells by recruiting a chromatin-modifying complex.<sup>88</sup> As demonstrated in T lymphocytes, our work suggests a concomitant recruitment of histone deacetylases HDAC1, HDAC2 and methylase SUV39H1 to the viral promoter by CTIP2. Ordered histone modifications would allow HP1 binding, heterochromatin formation and, as a consequence, HIV silencing. The heterochromatin formation at the HIV-1 promoter has been linked to post-integration latency, and this suggests that transcriptional repressors such as CTIP2 are involved in the establishment and maintenance of viral persistence and post-integration latency in the brain.

The corepressor CTIP2 has an even more pleiotropic action by regulating the expression of genes of infected cells. Recruited to the cellular cyclin-dependent kinase inhibitor CDKN1A/p21<sup>waf</sup> (p21) promoter, CTIP2 silences p21 gene transcription by inducing epigenetic modifications, as described above, for the HIV-1 promoter. This effect indirectly favours HIV-1 latency since activation of the p21 gene stimulates viral expression in macrophages.<sup>89</sup> Moreover, CTIP2 counteracts HIV-1 Vpr, which is required for p21 expression. We suggest that all these factors contribute together to HIV-1 transcriptional latency in microglial cells.<sup>90</sup> The picture regarding the importance of p21 in the replicative cycle of HIV-1 is far more complicated since p21 has been described as a restriction factor in macrophages and in resting CD4 T cells.<sup>91,92</sup> The protein p21 might have different effects on HIV-1 infection of macrophages depending on the targeted viral life cycle step, and therefore on the time since infection.<sup>93</sup>

We have also identified a new actor involved in the maintenance of HIV-1 latency in microglial cells, the lysine-specific demethylase (LSD1).<sup>94</sup> We notably showed that LSD1 repressed HIV-1 transcription and viral expression in a synergistic manner with CTIP2 and reported that recruitment of LSD1 at the HIV-1 proximal promoter is associated with both H3K4me3 and H3K9me3 epigenetic marks. Association of both H3K4me3 and H3K9me3 epigenetic marks with LSD1 recruitment may thus constitute a new level of eukaryotic gene regulation. These observations are consistent with the discovery that H3K4 methylation at certain chromatin loci may prevent gene expression.<sup>95</sup> Interestingly, such a gene repression linked to H3K4me3 has been proposed to prevent the expression of cryptic promoters.<sup>95,96</sup> This is strengthened by the finding that HIV-1 preferentially integrates into active genes and therefore could be considered as a cryptic gene.

Surprisingly, LSD1 has been associated with activation of HIV transcription in CD4+ T cells through demethylation of K51 Tat.<sup>97</sup> However, in microglial cells the mechanisms underlying LSD1-mediated increase of H3K4 trimethylation is different and might rely on the ability of LSD1 to anchor other factors at the promoter rather than its own enzymatic activity. Indeed, H3K4 trimethylation was associated with the recruitment of LSD1, HSET1 and WDR5 at the Sp1 binding sites of the HIV-1 LTR. Moreover, reactivation of HIV-1 proviruses correlated with the release



of LSD1, hSET1 and WDR5 from the viral promoter and with a reduced H3K4 trimethylation. In contrast to CD4+ T cells, LSD1 is involved in the maintenance of HIV-1 latency in microglial cells by favouring a local heterochromatin structure. These two studies reporting a dual role of LSD1 through different mechanisms in two main HIV-1 targets point to the complexity of HIV latency and raise the question of how effective the use of inhibitors of LSD1 would be for full HIV-1 reactivation. Indeed, targeting LSD1 for full reactivation in microglial cells might not work in lymphocytes. Instead, in the latter cells an induction of HIV latency is expected.<sup>98</sup> Further investigation of the epigenetic regulation of HIV latency is therefore needed in order to design efficient drugs targeting viral reservoirs.

Another field of interest is DNA methylation, which has been involved in DNA silencing and latency.<sup>99</sup> It is now well established that DNA CpG methylation plays an important role in maintaining HIV-1 latency,<sup>100,101</sup> despite previous controversies.<sup>102</sup> Therefore DNA methylase inhibitors, such as 5-azacytidine, could be useful in strategies aiming to reactivate reservoirs. It is noteworthy that only a few percent of the latent viruses are methylated on their DNA, but these reservoirs of latent viruses are highly resistant to reactivation. Achieving a cure would probably require the treatment of many different types of latency simultaneously by a combination therapy approach.

### Preventing reactivation

Several mechanisms acting at the transcriptional and post-transcriptional level are at work in order to preclude HIV reactivation in latent reservoirs. Affecting these mechanisms may open new ways to purge reservoirs. Sequestration of nuclear factor  $\kappa$ B (NF- $\kappa$ B) in the cytoplasm of latent cells is one of these mechanisms.<sup>103</sup> T cell activation with tumour necrosis factor  $\alpha$  (TNF- $\alpha$ ) allows translocation to the nucleus of NF- $\kappa$ B, which then binds to the LTR and activates the early phase (Tat independent) virus transcription (Figure 1). Besides TNF- $\alpha$ , many other factors have been involved in HIV reactivation, including interleukins (IL) IL-1 $\beta$ , IL-2, IL-6, IL-7, interferon  $\gamma$  (IFN- $\gamma$ ) and CD154,<sup>104–109</sup> and could be used to purge the reservoirs. Among mechanisms acting at the post-transcriptional level, regulation of the exportation of viral RNAs by the poly track binding protein (PTB) seems to be important in memory CD4+ T cells.<sup>110</sup> Another important mechanism that acts at the post-transcriptional level involves microRNAs (miRNAs). These are single-stranded RNAs of 19–25 nucleotides involved in various biological processes in eukaryotic cells.<sup>111,112</sup> miRNAs interact with a complementary sequence in the 3'-untranslated region (UTR) of target mRNAs by partial sequence matching, which leads either to mRNA degradation or, more often, to translational inhibition.<sup>112</sup> miRNAs are involved in the regulation of virus expression as well.<sup>113</sup> Recently it was shown that miRNAs regulate the expression of the histone acetyltransferase Tat cofactor PCAF and HIV replication.<sup>114</sup> In a recent paper, Huang *et al.* reported an enrichment of miRNAs in clusters, which has been observed only in resting CD4+ T cells and not in active CD4+ T cells.<sup>115</sup> They found that several of the miRNA clusters inhibited HIV replication, and suggested that miRNAs contribute to HIV latency in resting primary CD4+ T cells. They proposed to use specific antagomirs (anti-miRNA antisense) raised against these miRNA in order to reactivate latent CD4+ T cells.<sup>116</sup> However, as

discussed by Sun and Rossi, the use of antagomirs to reactivate latently infected cells could be toxic for uninfected cells.<sup>117</sup> The feasibility of using miRNAs for HIV treatment is premature and will need far more investigation.

### Implications for therapies based on purging reservoirs

Original strategies based on the combination of a purge of the reservoirs and intensifying HAART aim to eradicate the virus from infected patients. Understanding the molecular mechanisms involved in latency will allow us to devise new strategies that will facilitate the reactivation of all the reservoirs.

One strategy, known as 'Immune Activation Therapy', aims to activate T cells<sup>118–121</sup> (Figure 1). Many physiological stimuli that effectively activated T cells passed preclinical studies, but all failed in clinical studies.<sup>122</sup> IL-7 held promise since this cytokine is known to be essential for the maintenance of T cell homeostasis. Indeed, there are two subsets of memory T cells:<sup>10</sup> central memory T cells (Tcm), which are maintained through T cell survival and low-level driven proliferation and can persist for decades, and transitional memory T cells (Ttm), which persist, in contrast, by homeostatic proliferation of infected cells and could be reduced by using drugs preventing memory T cells from dividing. Interestingly, an IL-7-driven proliferation of Ttm cells can induce HIV expression from quiescent resting cells without the death of the infected cells. This cytokine might therefore be tested for its ability to reactivate expression of latent HIV in order to purge this quiescent HIV reservoir.<sup>123–125</sup> A clinical trial using IL-7 in order to reduce the size of the latent reservoir is currently running (ERAMUNE led by C. Katlama; <http://www.clinicaltrials.gov>). Another profound therapeutic implication, put forward by Chomont *et al.*,<sup>10</sup> is that the size of the pool of CD4+ Tcm cells infected by HIV-1 should decrease with early treatment interventions.<sup>126</sup> Indeed, these memory Tcm cells (and the CD8+ T cells) are thought to be very important in the control of HIV infection, as shown in elite controllers.<sup>127,128</sup> Since IL-7 is also involved in CD8+ T cell function and T cell survival,<sup>129–131</sup> an early treatment that combines HAART and IL-7 will certainly help patients to control their HIV-1 infection (i.e. to get a functional cure), but might not allow the eradication of the virus (i.e. to get a sterilizing cure).

A second strategy aiming to develop rational therapeutics to flush out HIV from latency relies on the knowledge of its epigenetic regulation<sup>132</sup> (Figure 1). Several potential interesting candidates have emerged, such as the histone deacetylase (HDAC),<sup>88</sup> the histone methyltransferase,<sup>83,88,133</sup> DNA methyltransferases (DNMTs)<sup>100,101</sup> and proteins from the SWI/SNF chromatin complexes.<sup>134,135</sup> A switch from latent to active transcription has been described following treatment with several HDAC inhibitors such as trichostatin, trapoxin, valproic acid and sodium butyrate.<sup>136–141</sup> Valproic acid has been described to effectively reactivate latent HIV reservoirs in a first clinical trial,<sup>142,143</sup> but two other clinical trials did not confirm this.<sup>144,145</sup> Failure of this first clinical trial might be due to the ineffectiveness of valproic acid in inhibiting HDAC3 activity in CD4 T cells.<sup>146</sup> Indeed, several other HDACs, including HDAC3, contribute to the repression of HIV-1 LTR expression.<sup>147–149</sup> Further investigations are needed using inhibitors against newly identified epigenetic regulators of HIV latency such as chaetocine (a histone methyl transferase inhibitor) or the DNA

methyltransferase inhibitors, including well-characterized nucleotide analogue methylation inhibitors (5-azacytidine, 5-aza-2'-deoxycytidine, 5-fluoro-2'-deoxycytidine and zebularidine) and non-nucleoside DNA methylation inhibitors (procaine, procainamide, hydralazine and RG108).<sup>78,150</sup> Purging of latent reservoirs could also be achieved by inhibiting regulatory processes that prevent reactivation.<sup>151</sup> The p-TEFb activator HMBA is a promising molecule currently under study. In pilot studies it was able to reactivate latently infected cells and prevent re-infection by down-regulating CD4 receptor expression.<sup>152</sup>

There are several encouraging new directions in the purge of reservoirs that are based on a combination therapy approach,<sup>153</sup> as already used in clinical trials to treat cancer.<sup>154-156</sup> Such an approach has been found to be promising since the association of an HDAC inhibitor or a DNA methylation inhibitor with prostratin has a synergistic effect on the activation of HIV-1 expression.<sup>101,157</sup> The main benefit of this synergistic effect is that we might use drugs at suboptimal concentrations that would be sufficient to reactivate the virus but would have fewer side effects. We believe that the most promising strategy to purge the reservoirs relies on combinations of such drugs, which would be able to force viral gene expression at both the transcriptional and post-transcriptional levels.

Finally, an alternative option has been proposed, which is not based on virus reactivation, but on rendering the virus unable to replicate in latent cells without inducing cell death.<sup>158</sup> This original 'genome editing therapy' is based on the recognition of essential sequences within HIV-1, such as the *pol* gene by zinc finger endonuclease. Such a therapy has already been proposed to disrupt the CCR5 gene, as described previously.<sup>159</sup>

## Improving HAART

### Why is it important to improve HAART?

There are several reasons why HAART should be improved. One is the existence of a residual viraemia in patients undergoing HAART. The origin of this viraemia is still debated. There are two theories explaining this residual viraemia: (i) long-lived cells containing latent HIV provirus that can produce HIV at low levels following reactivation; and (ii) low-level cryptic on-going replication despite therapy. Latency is best described as a lack of proviral gene expression. In contrast, on-going replication requires continuous viral gene expression without cytopathic effects. Ineffective treatment in cells supporting on-going replication could result from poor drug penetration into sanctuaries such as the brain, where infected microglial cells are located,<sup>160</sup> or from cell-to-cell transfer of the virus.<sup>161</sup> It is important to distinguish between these two theories, since the therapeutic approaches they suggest are essentially different. The theory of on-going replication suggests that drug resistance to treatments might develop. In this case treatment intensification and the design of new anti HIV-1 molecules are needed in the long term. On the other hand, if viruses are released in bursts from stable reservoirs, multidrug resistance does not develop, however, HAART alone is ineffective as well. Several studies have looked at the efficiency of such intensification of HAART on residual viraemia and only one failed to reduce it.<sup>55,162</sup> The second reason to improve HAART is related to the 'shock and kill' strategy discussed above. HAART by itself is not

able to achieve a cure, but is still needed (to kill) in association with HIV reactivation from quiescent cells (to shock). Finally, emergence of drug resistances, toxicity and compliance with treatment are all obstacles to the current management of HIV-1 infection and therefore need improvement of HAART.<sup>163</sup>

### How can we improve HAART?

Current management of HIV-1 treatment is based on seven classes of antiretrovirals: nucleoside/nucleotide reverse transcriptase inhibitors (NRTIs), nucleotide reverse transcriptase inhibitors (NtRTIs), non-nucleoside reverse transcriptase inhibitors (NNRTIs), protease inhibitors (PIs), entry/fusion inhibitors (EIs), coreceptor inhibitors (CRIs) and integrase inhibitors (INIs).<sup>164</sup> The therapy of HIV-1-infected patients is based on a combination of three or more drugs from two or more classes.<sup>165</sup>

We believe that new drugs should target other steps of the HIV-1 cycle such as transcription, since there is no drug currently available targeting this step. An increasing number of studies suggest that inhibitors of cellular LTR-binding factors, such as NF- $\kappa$ B and Sp1, repress LTR-driven transcription.<sup>166-170</sup> Recently it has been shown that proteins of the DING family are good candidates to repress HIV-1 gene transcription.<sup>171-173</sup> Indeed, the inhibitory effect of the human DING protein named HPBP (human phosphate binding protein) on HIV-1 replication is very strong,<sup>173</sup> even compared with other canonical drugs currently used in HAART.<sup>174</sup> HPBP is also a potent anti-HIV-1 drug in peripheral blood lymphocytes and in primary macrophages, which is not true for several other anti-HIV-1 drugs. Very interestingly, HPBP, which targets transcription, is as effective against drug-resistant HIV strains as wild-type strains, highlighting the potential therapeutic advantage of HPBP. Moreover, such drugs could also be used to cope with chronic inflammation, which leads to non-AIDS events.<sup>175</sup> We believe that this protein or its derivatives are potentially interesting molecules and deserve further study. As suggested for X-DING-CD4,<sup>172</sup> proteins belonging to the DING protein family might have a role in the innate response to infections, including HIV-1.

Finally, the use of nanotechnology involving structures 1-100 nm in size is an exciting approach since it will make it possible to reduce toxicity and facilitate treatment adherence.<sup>176</sup> Indeed, these nano-delivery systems will permit: (i) modulation of drug release; (ii) protection of drugs from metabolism; and (iii) specific targeting of infected cells, even those located in sanctuaries. In corollary, this approach will allow improved bioavailability and therefore reduce toxicity.<sup>177-179</sup> Among new nanotechnology-based drug delivery systems are liposomes, polymeric micelles, dendrimers and nanosuspensions. Potential uses of these molecules have been reviewed.<sup>176</sup> This elegant approach will surely improve gene therapy, immunotherapy, vaccinology and microbicides.<sup>180</sup>

### When to start antiretroviral therapy?

Today there is no real consensus on when HAART should be started. Until now, generally HAART was started when the CD4+ T cell count was below 350 cells/mm<sup>3</sup>, however, several observations have pointed to a substantial benefit in reduced mortality if treatment is started at an earlier stage with no consideration of CD4+ T cell count.<sup>181,182</sup> This is in agreement with

the finding that starting treatment earlier reduced the size of the latently infected reservoirs, as discussed above. Another major concern with starting treatment earlier is that it should reduce the outcome of non-AIDS events and non-AIDS mortality.<sup>183</sup> The cost of the treatment, drug toxicities and non-adherence to the treatment by healthy patients has led some regulatory organizations in Europe not to recommend initiation of HAART in asymptomatic patients or patients having more than 350 CD4+ T cells/mm<sup>3</sup>.

## Conclusions

Are there reasons to be optimistic that a cure for HIV infection may be achieved? From our point of view the answer is 'yes', but this will not be achieved in the short term. Advances in some fields are very exciting and offer new opportunities to achieve a cure. For example, using gene therapy to confer HIV resistance (including the CCR5 gene therapy) is a valuable approach compared with chemotherapy, which has several drawbacks, including toxicities, development of resistance and cost. Several gene therapy trials are currently under way,<sup>58</sup> but it is premature to make definitive conclusions regarding the feasibility of these therapies. The 'holy grail' for clinicians will be to achieve a sterilizing cure with total eradication of the virus from the body, but we might only get a functional cure, with few patients who control HIV-1 infection (the elite controllers). The major concern with a functional cure will be to drastically reduce the viraemia in order to prevent non-AIDS events. The 'shock and kill' strategy has also emerged as an exciting potential way to eliminate the virus. Here, too, we might be able to achieve only a functional cure. The German case is the only case where a possible sterilizing cure has occurred, incidentally indicating a weakness of HIV. Today, however, we are limited by a lack of technology to clearly demonstrate that this patient is definitively cured. The war against this virus is far from over and will need much more work. This review has focused on current therapeutic strategies that could lead in the long term to a cure. From a military point of view, this latter strategy constitutes the first front line. However, to win a war you usually need to open a second front line, and this one is research leading to the development of an HIV vaccine. Even if in practice this approach is not yet working, efforts in this direction must be made, but might require new avenues in HIV immunology research.<sup>36,184–186</sup> Undoubtedly research aiming at a therapeutic cure will benefit from research aiming to develop a vaccine, and vice versa. Reasons to be optimistic come mainly from the intensive efforts made in different fields of research, i.e. a multidisciplinary approach, including immunologists, virologists, molecular biologists, clinicians, pharmacologists, chemists, physicists and mathematicians, who have already opened new ways and elaborated new concepts for therapies that are currently being tested in clinical trials.

## Funding

This work was supported by grants from the Agence Nationale de Recherches sur le SIDA (ANRS) (to O. R., C. S. and R. R.), Sidaction Ligue contre le cancer (to O. R. and C. S.) and Institut Universitaire de France (to O. R.). A. J. is a fellow supported by the "Région Alsace". V. L. D. is

supported by a doctoral grant from the French Ministry of Research. S. A. is supported by a doctoral grant from the Pakistan Ministry of Research.

## Transparency declarations

None to declare.

## References

- 1 Barre-Sinoussi F, Chermann JC, Rey F *et al.* Isolation of a T-lymphotropic retrovirus from a patient at risk for acquired immune deficiency syndrome (AIDS). *Science* 1983; **220**: 868–71.
- 2 UN/WHO. AIDS epidemic update 2010. <http://www.unaids.org/en/> (01 December 2011, date last accessed).
- 3 Gulick RM, Mellors JW, Havlir D *et al.* Treatment with indinavir, zidovudine, and lamivudine in adults with human immunodeficiency virus infection and prior antiretroviral therapy. *N Engl J Med* 1997; **337**: 734–9.
- 4 Hammer SM, Squires KE, Hughes MD *et al.* A controlled trial of two nucleoside analogues plus indinavir in persons with human immunodeficiency virus infection and CD4 cell counts of 200 per cubic millimeter or less. AIDS Clinical Trials Group 320 Study Team. *N Engl J Med* 1997; **337**: 725–33.
- 5 Chun TW, Stuyver L, Mizell SB *et al.* Presence of an inducible HIV-1 latent reservoir during highly active antiretroviral therapy. *Proc Natl Acad Sci USA* 1997; **94**: 13193–7.
- 6 Finzi D, Hermankova M, Pierson T *et al.* Identification of a reservoir for HIV-1 in patients on highly active antiretroviral therapy. *Science* 1997; **278**: 1295–300.
- 7 Wong JK, Hezareh M, Gunthard HF *et al.* Recovery of replication-competent HIV despite prolonged suppression of plasma viremia. *Science* 1997; **278**: 1291–5.
- 8 Palmer S, Maldarelli F, Wiegand A *et al.* Low-level viremia persists for at least 7 years in patients on suppressive antiretroviral therapy. *Proc Natl Acad Sci USA* 2008; **105**: 3879–84.
- 9 Carter CC, Onafuwa-Nuga A, McNamara LA *et al.* HIV-1 infects multipotent progenitor cells causing cell death and establishing latent cellular reservoirs. *Nat Med* 2010; **16**: 446–51.
- 10 Chomont N, El-Far M, Ancuta P *et al.* HIV reservoir size and persistence are driven by T cell survival and homeostatic proliferation. *Nat Med* 2009; **15**: 893–900.
- 11 Dai J, Agosto LM, Baytop C *et al.* Human immunodeficiency virus integrates directly into naive resting CD4+ T cells but enters naive cells less efficiently than memory cells. *J Virol* 2009; **83**: 4528–37.
- 12 Ellery PJ, Tippett E, Chiu YL *et al.* The CD16+ monocyte subset is more permissive to infection and preferentially harbors HIV-1 in vivo. *J Immunol* 2007; **178**: 6581–9.
- 13 Wightman F, Solomon A, Khoury G *et al.* Both CD31(+) and CD31 naive CD4(+) T cells are persistent HIV type 1-infected reservoirs in individuals receiving antiretroviral therapy. *J Infect Dis* 2010; **202**: 1738–48.
- 14 Alexaki A, Liu Y, Wigdahl B. Cellular reservoirs of HIV-1 and their role in viral persistence. *Curr HIV Res* 2008; **6**: 388–400.
- 15 Alexaki A, Wigdahl B. HIV-1 infection of bone marrow hematopoietic progenitor cells and their role in trafficking and viral dissemination. *PLoS Pathog* 2008; **4**: e1000215.
- 16 Coleman CM, Wu L. HIV interactions with monocytes and dendritic cells: viral latency and reservoirs. *Retrovirology* 2009; **6**: 51.
- 17 Keele BF, Tazi L, Gartner S *et al.* Characterization of the follicular dendritic cell reservoir of human immunodeficiency virus type 1. *J Virol* 2008; **82**: 5548–61.

## Review

- 18 Redel L, Le Douce V, Cherrier T et al. HIV-1 regulation of latency in the monocyte-macrophage lineage and in CD4+ T lymphocytes. *J Leukoc Biol* 2009.
- 19 Zhu T, Muthui D, Holte S et al. Evidence for human immunodeficiency virus type 1 replication in vivo in CD14(+) monocytes and its potential role as a source of virus in patients on highly active antiretroviral therapy. *J Virol* 2002; **76**: 707–16.
- 20 Le Douce V, Herbein G, Rohr O et al. Molecular mechanisms of HIV-1 persistence in the monocyte-macrophage lineage. *Retrovirology* 2010; **7**: 32.
- 21 Trono D, Marzetta F. Profaning the ultimate sanctuary: HIV latency in hematopoietic stem cells. *Cell Host Microbe* 2011; **9**: 170–2.
- 22 Aquaro S, Bagnarelli P, Guenci T et al. Long-term survival and virus production in human primary macrophages infected by human immunodeficiency virus. *J Med Virol* 2002; **68**: 479–88.
- 23 Perno CF, Newcomb FM, Davis DA et al. Relative potency of protease inhibitors in monocytes/macrophages acutely and chronically infected with human immunodeficiency virus. *J Infect Dis* 1998; **178**: 413–22.
- 24 Nolan D, Reiss P, Mallal S. Adverse effects of antiretroviral therapy for HIV infection: a review of selected topics. *Expert Opin Drug Saf* 2005; **4**: 201–18.
- 25 Vella S, Palmisano L. The global status of resistance to antiretroviral drugs. *Clin Infect Dis* 2005; **41** Suppl 4: S239–46.
- 26 Kozal MJ. Drug-resistant human immunodeficiency virus. *Clin Microbiol Infect* 2009; **15** Suppl 1: 69–73.
- 27 Griffiths PD. A perspective on antiviral resistance. *J Clin Virol* 2009; **46**: 3–8.
- 28 Nijhuis M, van Maarseveen NM, Boucher CA. Antiviral resistance and impact on viral replication capacity: evolution of viruses under antiviral pressure occurs in three phases. *Handb Exp Pharmacol* 2009; **189**: 299–320.
- 29 Achhra AC, Amin J, Law MG et al. Immunodeficiency and the risk of serious clinical endpoints in a well studied cohort of treated HIV-infected patients. *AIDS* 2010; **24**: 1877–86.
- 30 El-Sadr WM, Lundgren JD, Neaton JD et al. CD4+ count-guided interruption of antiretroviral treatment. *N Engl J Med* 2006; **355**: 2283–96.
- 31 Ferry T, Raffi F, Collin-Filleul F et al. Uncontrolled viral replication as a risk factor for non-AIDS severe clinical events in HIV-infected patients on long-term antiretroviral therapy: APROCO/COPILOTE (ANRS C08) cohort study. *J Acquir Immune Defic Syndr* 2009; **51**: 407–15.
- 32 Deeks SG, Phillips AN. HIV infection, antiretroviral treatment, ageing, and non-AIDS related morbidity. *BMJ* 2009; **338**: a3172.
- 33 Neuhaus J, Jacobs DR Jr, Baker JV et al. Markers of inflammation, coagulation, and renal function are elevated in adults with HIV infection. *J Infect Dis* 2010; **201**: 1788–95.
- 34 Hecht R, Stover J, Bollinger L et al. Financing of HIV/AIDS programme scale-up in low-income and middle-income countries, 2009–31. *Lancet* 2010; **376**: 1254–60.
- 35 Barouch DH. Challenges in the development of an HIV-1 vaccine. *Nature* 2008; **455**: 613–9.
- 36 Medzhitov R, Littman D. HIV immunology needs a new direction. *Nature* 2008; **455**: 591.
- 37 Barouch DH, Korber B. HIV-1 vaccine development after STEP. *Annu Rev Med* 2010; **61**: 153–67.
- 38 McMichael AJ, Borrow P, Tomaras GD et al. The immune response during acute HIV-1 infection: clues for vaccine development. *Nat Rev Immunol* 2010; **10**: 11–23.
- 39 Richman DD, Margolis DM, Delaney M et al. The challenge of finding a cure for HIV infection. *Science* 2009; **323**: 1304–7.
- 40 Trono D, Van Lint C, Rouzioux C et al. HIV persistence and the prospect of long-term drug-free remissions for HIV-infected individuals. *Science* 2010; **329**: 174–80.
- 41 Hutter G, Nowak D, Mossner M et al. Long-term control of HIV by CCR5 Delta32/Delta32 stem-cell transplantation. *N Engl J Med* 2009; **360**: 692–8.
- 42 Hatano H, Delwart EL, Norris PJ et al. Evidence for persistent low-level viremia in individuals who control human immunodeficiency virus in the absence of antiretroviral therapy. *J Virol* 2009; **83**: 329–35.
- 43 Hunt PW, Brechley J, Sinclair E et al. Relationship between T cell activation and CD4+ T cell count in HIV-seropositive individuals with undetectable plasma HIV RNA levels in the absence of therapy. *J Infect Dis* 2008; **197**: 126–33.
- 44 Pereyra F, Palmer S, Miura T et al. Persistent low-level viremia in HIV-1 elite controllers and relationship to immunologic parameters. *J Infect Dis* 2009; **200**: 984–90.
- 45 Hutter G, Ganepola S. Eradication of HIV by transplantation of CCR5-deficient hematopoietic stem cells. *Sci World J* 2009; **11**: 1068–76.
- 46 Liu R, Paxton WA, Choe S et al. Homozygous defect in HIV-1 coreceptor accounts for resistance of some multiply-exposed individuals to HIV-1 infection. *Cell* 1996; **86**: 367–77.
- 47 Samson M, Libert F, Doranz BJ et al. Resistance to HIV-1 infection in Caucasian individuals bearing mutant alleles of the CCR-5 chemokine receptor gene. *Nature* 1996; **382**: 722–5.
- 48 Stephens JC, Reich DE, Goldstein DB et al. Dating the origin of the CCR5-Delta32 AIDS-resistance allele by the coalescence of haplotypes. *Am J Hum Genet* 1998; **62**: 1507–15.
- 49 Perez EE, Wang J, Miller JC et al. Establishment of HIV-1 resistance in CD4+ T cells by genome editing using zinc-finger nucleases. *Nat Biotechnol* 2008; **26**: 808–16.
- 50 Holt N, Wang J, Kim K et al. Human hematopoietic stem/progenitor cells modified by zinc-finger nucleases targeted to CCR5 control HIV-1 in vivo. *Nat Biotechnol* 2010; **28**: 839–47.
- 51 Lalezari J, Mitsuyasu R, Deeks S et al. Successful and persistent engraftment of ZFN-M-R5-D autologous CD4 T cells (SB-728-T) in aviremic HIV-infected subjects on HAART. In: *Program and Abstracts of the 18th Conference on Retroviruses and Opportunistic Infections, Boston, MA, 2011*. Abstract 46.
- 52 Tebas P, Levine B, Binder G et al. Disruption of CCR5 in zinc finger nuclease-treated CD4 T cells: Phase I trials. In: *Program and Abstracts from the 18th Conference on Retroviruses and Opportunistic Infections, Boston, MA, 2011*. Abstract 165.
- 53 Ando D, Tang WW, Stein D et al. HAART treatment interruption following adoptive transfer of zinc finger nuclease (ZFN) modified autologous CD4 T-cells (SB-728-T) to HIV-infected subjects demonstrates durable engraftment and suppression of viral load. In: *Abstracts of the Fifty-first Interscience Conference on Antimicrobial Agents and Chemotherapy, Chicago IL, 2011*. Abstract H2-794a. American Society for Microbiology, Washington, DC, USA.
- 54 Cohen J. The emerging race to cure HIV infections. *Science* 2011; **332**: 784–5, 7–9.
- 55 Lewin SR, Rouzioux C. HIV cure and eradication: how will we get from the laboratory to effective clinical trials? *AIDS* 2011; **25**: 885–97.
- 56 Hutter G, Thiel E. Allogeneic transplantation of CCR5-deficient progenitor cells in a patient with HIV infection: an update after 3 years and the search for patient no. 2. *AIDS* 2011; **25**: 273–4.
- 57 Levy JA. Not an HIV cure, but encouraging new directions. *N Engl J Med* 2009; **360**: 724–5.

- 58 Cohen J. Building an HIV-proof immune system. *Science* 2007; **317**: 612–4.
- 59 Kitchen SG, Zack JA. Stem cell-based approaches to treating HIV infection. *Curr Opin HIV AIDS* 2011; **6**: 68–73.
- 60 Deeks SG, McCune JM. Can HIV be cured with stem cell therapy? *Nat Biotechnol* 2010; **28**: 807–10.
- 61 Bailey JR, Sedaghat AR, Kieffer T et al. Residual human immunodeficiency virus type 1 viremia in some patients on antiretroviral therapy is dominated by a small number of invariant clones rarely found in circulating CD4+ T cells. *J Virol* 2006; **80**: 6441–57.
- 62 Chun TW, Davey RT Jr, Ostrowski M et al. Relationship between pre-existing viral reservoirs and the re-emergence of plasma viremia after discontinuation of highly active anti-retroviral therapy. *Nat Med* 2000; **6**: 757–61.
- 63 Nickle DC, Jensen MA, Shriner D et al. Evolutionary indicators of human immunodeficiency virus type 1 reservoirs and compartments. *J Virol* 2003; **77**: 5540–6.
- 64 Dornadula G, Zhang H, VanUitert B et al. Residual HIV-1 RNA in blood plasma of patients taking suppressive highly active antiretroviral therapy. *JAMA* 1999; **282**: 1627–32.
- 65 Palmer S, Wiegand AP, Maldarelli F et al. New real-time reverse transcriptase-initiated PCR assay with single-copy sensitivity for human immunodeficiency virus type 1 RNA in plasma. *J Clin Microbiol* 2003; **41**: 4531–6.
- 66 McGee B, Smith N, Aweeka F. HIV pharmacology: barriers to the eradication of HIV from the CNS. *HIV Clin Trials* 2006; **7**: 142–53.
- 67 Sawchuk RJ, Yang Z. Investigation of distribution, transport and uptake of anti-HIV drugs to the central nervous system. *Adv Drug Deliv Rev* 1999; **39**: 5–31.
- 68 Solas C, Lafeuillade A, Halfon P et al. Discrepancies between protease inhibitor concentrations and viral load in reservoirs and sanctuary sites in human immunodeficiency virus-infected patients. *Antimicrob Agents Chemother* 2003; **47**: 238–43.
- 69 Chun TW, Carruth L, Finzi D et al. Quantification of latent tissue reservoirs and total body viral load in HIV-1 infection. *Nature* 1997; **387**: 183–8.
- 70 Chun TW, Finzi D, Margolick J et al. In vivo fate of HIV-1-infected T cells: quantitative analysis of the transition to stable latency. *Nat Med* 1995; **1**: 1284–90.
- 71 Perelson AS, Essunger P, Cao Y et al. Decay characteristics of HIV-1-infected compartments during combination therapy. *Nature* 1997; **387**: 188–91.
- 72 Ho DD, Zhang L. HIV-1 rebound after anti-retroviral therapy. *Nat Med* 2000; **6**: 736–7.
- 73 Dybul M, Daucher M, Jensen MA et al. Genetic characterization of rebounding human immunodeficiency virus type 1 in plasma during multiple interruptions of highly active antiretroviral therapy. *J Virol* 2003; **77**: 3229–37.
- 74 McNamara LA, Collins KL. Hematopoietic stem/precursor cells as HIV reservoirs. *Curr Opin HIV AIDS* 2011; **6**: 43–8.
- 75 Crowe S, Zhu T, Muller WA. The contribution of monocyte infection and trafficking to viral persistence, and maintenance of the viral reservoir in HIV infection. *J Leukoc Biol* 2003; **74**: 635–41.
- 76 Shen L, Siliciano RF. Viral reservoirs, residual viremia, and the potential of highly active antiretroviral therapy to eradicate HIV infection. *J Allergy Clin Immunol* 2008; **122**: 22–8.
- 77 Coiras M, Lopez-Huertas MR, Perez-Olmeda M et al. Understanding HIV-1 latency provides clues for the eradication of long-term reservoirs. *Nat Rev Microbiol* 2009; **7**: 798–812.
- 78 Colin L, Van Lint C. Molecular control of HIV-1 postintegration latency: implications for the development of new therapeutic strategies. *Retrovirology* 2009; **6**: 111.
- 79 Margolis DM. Mechanisms of HIV latency: an emerging picture of complexity. *Curr HIV/AIDS Rep* 2010; **7**: 37–43.
- 80 Van Lint C, Emiliani S, Ott M et al. Transcriptional activation and chromatin remodeling of the HIV-1 promoter in response to histone acetylation. *EMBO J* 1996; **15**: 1112–20.
- 81 Verdin E, Paras P Jr, Van Lint C. Chromatin disruption in the promoter of human immunodeficiency virus type 1 during transcriptional activation. *EMBO J* 1993; **12**: 3249–59.
- 82 Van Lint C. Role of chromatin in HIV-1 transcriptional regulation. *Adv Pharmacol* 2000; **48**: 121–60.
- 83 du Chene I, Basyuk E, Lin YL et al. Suv39H1 and HP1gamma are responsible for chromatin-mediated HIV-1 transcriptional silencing and post-integration latency. *EMBO J* 2007; **26**: 424–35.
- 84 Barber SA, Gama L, Dudaronek JM et al. Mechanism for the establishment of transcriptional HIV latency in the brain in a simian immunodeficiency virus-macaque model. *J Infect Dis* 2006; **193**: 963–70.
- 85 Avram D, Fields A, Pretty On Top K et al. Isolation of a novel family of C2H2 zinc finger proteins implicated in transcriptional repression mediated by chicken ovalbumin upstream promoter transcription factor (COUP-TF) orphan nuclear receptors. *J Biol Chem* 2000; **275**: 10315–22.
- 86 Marban C, Redel L, Suzanne S et al. COUP-TF interacting protein 2 represses the initial phase of HIV-1 gene transcription in human microglial cells. *Nucleic Acids Res* 2005; **33**: 2318–31.
- 87 Rohr O, Lecestre D, Chasserot-Golaz S et al. Recruitment of Tat to heterochromatin protein HP1 via interaction with CTIP2 inhibits human immunodeficiency virus type 1 replication in microglial cells. *J Virol* 2003; **77**: 5415–27.
- 88 Marban C, Suzanne S, Dequiedt F et al. Recruitment of chromatin-modifying enzymes by CTIP2 promotes HIV-1 transcriptional silencing. *EMBO J* 2007; **26**: 412–23.
- 89 Vazquez N, Greenwell-Wild T, Marinos NJ et al. Human immunodeficiency virus type 1-induced macrophage gene expression includes the p21 gene, a target for viral regulation. *J Virol* 2005; **79**: 4479–91.
- 90 Cherrier T, Suzanne S, Redel L et al. p21(WAF1) gene promoter is epigenetically silenced by CTIP2 and SUV39H1. *Oncogene* 2009; **28**: 3380–9.
- 91 Bergamaschi A, David A, Le Rouzic E et al. The CDK inhibitor p21Cip1/WAF1 is induced by Fc(gamma)R activation and restricts the replication of HIV-1 and related primate lentiviruses in human macrophages. *J Virol* 2009; **83**: 12253–65.
- 92 Chen H, Li C, Huang J et al. CD4+ T cells from elite controllers resist HIV-1 infection by selective upregulation of p21. *J Clin Invest* 2011; **121**: 1549–60.
- 93 Bergamaschi A, Pancino G. Host hindrance to HIV-1 replication in monocytes and macrophages. *Retrovirology* 2010; **7**: 31.
- 94 Le Douce V, Colin L, Redel L et al. LSD1 cooperates with CTIP2 to promote HIV-1 transcriptional silencing. *Nucleic Acids Res* 2011.
- 95 Pinskaya M, Gourvenec S, Morillon A. H3 lysine 4 di- and tri-methylation deposited by cryptic transcription attenuates promoter activation. *EMBO J* 2009; **28**: 1697–707.
- 96 Pinskaya M, Morillon A. Histone H3 lysine 4 di-methylation: a novel mark for transcriptional fidelity? *Epigenetics* 2009; **4**: 302–6.
- 97 Sakane N, Kwon HS, Pagans S et al. Activation of HIV transcription by the viral Tat protein requires a demethylation step mediated by

## Review

- lysine-specific demethylase 1 (LSD1/KDM1). *PLoS Pathog* 2011; **7**: e1002184.
- 98** Ott M, Geyer M, Zhou Q. The control of HIV transcription: keeping RNA polymerase II on track. *Cell Host Microbe* 2011; **10**: 426–35.
- 99** Pierard V, Guiguen A, Colin L et al. DNA cytosine methylation in the bovine leukemia virus promoter is associated with latency in a lymphoma-derived B-cell line: potential involvement of direct inhibition of cAMP-responsive element (CRE)-binding protein/CRE modulator/activation transcription factor binding. *J Biol Chem* 2010; **285**: 19434–49.
- 100** Blazkova J, Trejbalova K, Gondois-Rey F et al. CpG methylation controls reactivation of HIV from latency. *PLoS Pathog* 2009; **5**: e1000554.
- 101** Kauder SE, Bosque A, Lindqvist A et al. Epigenetic regulation of HIV-1 latency by cytosine methylation. *PLoS Pathog* 2009; **5**: e1000495.
- 102** Pion M, Jordan A, Biancotto A et al. Transcriptional suppression of in vitro-integrated human immunodeficiency virus type 1 does not correlate with proviral DNA methylation. *J Virol* 2003; **77**: 4025–32.
- 103** Ganesh L, Burstein E, Guha-Niyogi A et al. The gene product Murr1 restricts HIV-1 replication in resting CD4+ lymphocytes. *Nature* 2003; **426**: 853–7.
- 104** Biswas P, Poli G, Kinter AL et al. Interferon gamma induces the expression of human immunodeficiency virus in persistently infected promonocytic cells (U1) and redirects the production of virions to intracytoplasmic vacuoles in phorbol myristate acetate-differentiated U1 cells. *J Exp Med* 1992; **176**: 739–50.
- 105** Butera ST, Perez VL, Wu BY et al. Oscillation of the human immunodeficiency virus surface receptor is regulated by the state of viral activation in a CD4+ cell model of chronic infection. *J Virol* 1991; **65**: 4645–53.
- 106** Duh EJ, Maury WJ, Folks TM et al. Tumor necrosis factor alpha activates human immunodeficiency virus type 1 through induction of nuclear factor binding to the NF-kappa B sites in the long terminal repeat. *Proc Natl Acad Sci USA* 1989; **86**: 5974–8.
- 107** Folks TM, Justement J, Kinter A et al. Cytokine-induced expression of HIV-1 in a chronically infected promonocyte cell line. *Science* 1987; **238**: 800–2.
- 108** Folks TM, Justement J, Kinter A et al. Characterization of a promonocyte clone chronically infected with HIV and inducible by 13-phorbol-12-myristate acetate. *J Immunol* 1988; **140**: 1117–22.
- 109** Poli G, Kinter AL, Fauci AS. Interleukin 1 induces expression of the human immunodeficiency virus alone and in synergy with interleukin 6 in chronically infected U1 cells: inhibition of inductive effects by the interleukin 1 receptor antagonist. *Proc Natl Acad Sci USA* 1994; **91**: 108–12.
- 110** Lassen KG, Ramyar KX, Bailey JR et al. Nuclear retention of multiply spliced HIV-1 RNA in resting CD4+ T cells. *PLoS Pathog* 2006; **2**: e68.
- 111** Ambros V, Chen X. The regulation of genes and genomes by small RNAs. *Development* 2007; **134**: 1635–41.
- 112** Bartel DP. MicroRNAs: genomics, biogenesis, mechanism, and function. *Cell* 2004; **116**: 281–97.
- 113** Yeung ML, Benkirane M, Jeang KT. Small non-coding RNAs, mammalian cells, and viruses: regulatory interactions? *Retrovirology* 2007; **4**: 74.
- 114** Triboulet R, Mari B, Lin YL et al. Suppression of microRNA-silencing pathway by HIV-1 during virus replication. *Science* 2007; **315**: 1579–82.
- 115** Huang J, Wang F, Argyris E et al. Cellular microRNAs contribute to HIV-1 latency in resting primary CD4+ T lymphocytes. *Nat Med* 2007; **13**: 1241–7.
- 116** Zhang H. Reversal of HIV-1 latency with anti-microRNA inhibitors. *Int J Biochem Cell Biol* 2009; **41**: 451–4.
- 117** Sun G, Rossi JJ. MicroRNAs and their potential involvement in HIV infection. *Trends Pharmacol Sci* 2011; **32**: 675–81.
- 118** Brooks DG, Arlen PA, Gao L et al. Identification of T cell-signaling pathways that stimulate latent HIV in primary cells. *Proc Natl Acad Sci USA* 2003; **100**: 12955–60.
- 119** Brooks DG, Hamer DH, Arlen PA et al. Molecular characterization, reactivation, and depletion of latent HIV. *Immunity* 2003; **19**: 413–23.
- 120** Arlen PA, Brooks DG, Gao LY et al. Rapid expression of human immunodeficiency virus following activation of latently infected cells. *J Virol* 2006; **80**: 1599–603.
- 121** Kulkosky J, Nunnari G, Otero M et al. Intensification and stimulation therapy for human immunodeficiency virus type 1 reservoirs in infected persons receiving virally suppressive highly active antiretroviral therapy. *J Infect Dis* 2002; **186**: 1403–11.
- 122** Geeraert L, Kraus G, Pomerantz RJ. Hide-and-seek: the challenge of viral persistence in HIV-1 infection. *Annu Rev Med* 2008; **59**: 487–501.
- 123** Lehrman G, Ylisastigui L, Bosch RJ et al. Interleukin-7 induces HIV type 1 outgrowth from peripheral resting CD4+ T cells. *J Acquir Immune Defic Syndr* 2004; **36**: 1103–4.
- 124** Sereti I, Dunham RM, Spritzler J et al. IL-7 administration drives T cell-cycle entry and expansion in HIV-1 infection. *Blood* 2009; **113**: 6304–14.
- 125** Wang FX, Xu Y, Sullivan J et al. IL-7 is a potent and proviral strain-specific inducer of latent HIV-1 cellular reservoirs of infected individuals on virally suppressive HAART. *J Clin Invest* 2005; **115**: 128–37.
- 126** Chomont N, DaFonseca S, Vandergeeten C et al. Maintenance of CD4+ T-cell memory and HIV persistence: keeping memory, keeping HIV. *Curr Opin HIV AIDS* 2011; **6**: 30–6.
- 127** Pereyra F, Addo MM, Kaufmann DE et al. Genetic and immunologic heterogeneity among persons who control HIV infection in the absence of therapy. *J Infect Dis* 2008; **197**: 563–71.
- 128** van Grevenynghe J, Procopio FA, He Z et al. Transcription factor FOXO3a controls the persistence of memory CD4(+) T cells during HIV infection. *Nat Med* 2008; **14**: 266–74.
- 129** Fry TJ, Connick E, Falloon J et al. A potential role for interleukin-7 in T-cell homeostasis. *Blood* 2001; **97**: 2983–90.
- 130** Beq S, Delfraissy JF, Theze J. Interleukin-7 (IL-7): immune function, involvement in the pathogenesis of HIV infection and therapeutic potential. *Eur Cytokine Netw* 2004; **15**: 279–89.
- 131** Schluns KS, Kieper WC, Jameson SC et al. Interleukin-7 mediates the homeostasis of naive and memory CD8 T cells in vivo. *Nat Immunol* 2000; **1**: 426–32.
- 132** Hakre S, Chavez L, Shirakawa K et al. Epigenetic regulation of HIV latency. *Curr Opin HIV AIDS* 2011; **6**: 19–24.
- 133** Imai K, Togami H, Okamoto T. Involvement of histone H3 lysine 9 (H3K9) methyltransferase G9a in the maintenance of HIV-1 latency and its reactivation by BIX01294. *J Biol Chem* 2010; **285**: 16538–45.
- 134** Lusic M, Marcello A, Cereseto A et al. Regulation of HIV-1 gene expression by histone acetylation and factor recruitment at the LTR promoter. *EMBO J* 2003; **22**: 6550–61.
- 135** Williams SA, Greene WC. Regulation of HIV-1 latency by T-cell activation. *Cytokine* 2007; **39**: 63–74.
- 136** El Kharroubi A, Piras G, Zensen R et al. Transcriptional activation of the integrated chromatin-associated human immunodeficiency virus type 1 promoter. *Mol Cell Biol* 1998; **18**: 2535–44.

- 137** Jordan A, Bisgrove D, Verdin E. HIV reproducibly establishes a latent infection after acute infection of T cells in vitro. *EMBO J* 2003; **22**: 1868–77.
- 138** Kiernan RE, Vanhulle C, Schiltz L et al. HIV-1 tat transcriptional activity is regulated by acetylation. *EMBO J* 1999; **18**: 6106–18.
- 139** Quivy V, Adam E, Collette Y et al. Synergistic activation of human immunodeficiency virus type 1 promoter activity by NF-kappaB and inhibitors of deacetylases: potential perspectives for the development of therapeutic strategies. *J Virol* 2002; **76**: 11091–103.
- 140** Sheridan PL, Mayall TP, Verdin E et al. Histone acetyltransferases regulate HIV-1 enhancer activity in vitro. *Genes Dev* 1997; **11**: 3327–40.
- 141** Steger DJ, Eberharter A, John S et al. Purified histone acetyltransferase complexes stimulate HIV-1 transcription from preassembled nucleosomal arrays. *Proc Natl Acad Sci USA* 1998; **95**: 12924–9.
- 142** Lehrman G, Hogue IB, Palmer S et al. Depletion of latent HIV-1 infection in vivo: a proof-of-concept study. *Lancet* 2005; **366**: 549–55.
- 143** Mai A. The therapeutic uses of chromatin-modifying agents. *Expert Opin Ther Targets* 2007; **11**: 835–51.
- 144** Sagot-Lerolle N, Lamine A, Choix ML et al. Prolonged valproic acid treatment does not reduce the size of latent HIV reservoir. *AIDS* 2008; **22**: 1125–9.
- 145** Siliciano JD, Lai J, Callender M et al. Stability of the latent reservoir for HIV-1 in patients receiving valproic acid. *J Infect Dis* 2007; **195**: 833–6.
- 146** Huber K, Doyon G, Plaks J et al. Inhibitors of histone deacetylases: correlation between isoform specificity and reactivation of HIV type 1 (HIV-1) from latently infected cells. *J Biol Chem* 2011; **286**: 22211–8.
- 147** Keedy KS, Archin NM, Gates AT et al. A limited group of class I histone deacetylases acts to repress human immunodeficiency virus type 1 expression. *J Virol* 2009; **83**: 4749–56.
- 148** Malcolm T, Chen J, Chang C et al. Induction of chromosomally integrated HIV-1 LTR requires RBF-2 (USF/TFII-I) and Ras/MAPK signaling. *Virus Genes* 2007; **35**: 215–23.
- 149** Margolis DM. Histone deacetylase inhibitors and HIV latency. *Curr Opin HIV AIDS* 2011; **6**: 25–9.
- 150** Yu N, Wang M. Anticancer drug discovery targeting DNA hypermethylation. *Curr Med Chem* 2008; **15**: 1350–75.
- 151** Kam J. The molecular biology of HIV latency: breaking and restoring the Tat-dependent transcriptional circuit. *Curr Opin HIV AIDS* 2011; **6**: 4–11.
- 152** Contreras X, Barboric M, Lenasi T et al. HMBA releases P-TEFb from HEXIM1 and 7SK snRNA via PI3K/Akt and activates HIV transcription. *PLoS Pathog* 2007; **3**: 1459–69.
- 153** Savarino A, Mai A, Norelli S et al. “Shock and kill” effects of class I-selective histone deacetylase inhibitors in combination with the glutathione synthesis inhibitor buthionine sulfoximine in cell line models for HIV-1 quiescence. *Retrovirology* 2009; **6**: 52.
- 154** Cameron EE, Bachman KE, Myohanen S et al. Synergy of demethylation and histone deacetylase inhibition in the re-expression of genes silenced in cancer. *Nat Genet* 1999; **21**: 103–7.
- 155** Chen M, Voeller D, Marquez VE et al. Enhanced growth inhibition by combined DNA methylation/HDAC inhibitors in lung tumor cells with silenced CDKN2A. *Int J Oncol* 2010; **37**: 963–71.
- 156** Kawano T, Akiyama M, Agawa-Ohta M et al. Histone deacetylase inhibitors valproic acid and depsipeptide sensitize retinoblastoma cells to radiotherapy by increasing H2AX phosphorylation and p53 acetylation-phosphorylation. *Int J Oncol* 2010; **37**: 787–95.
- 157** Reuse S, Calao M, Kabeya K et al. Synergistic activation of HIV-1 expression by deacetylase inhibitors and prostratin: implications for treatment of latent infection. *PLoS One* 2009; **4**: e6093.
- 158** Wayengera M. Proviral HIV-genome-wide and pol-gene specific zinc finger nucleases: usability for targeted HIV gene therapy. *Theor Biol Med Model* 2011; **8**: 26.
- 159** Urnov FD, Rebar EJ, Holmes MC et al. Genome editing with engineered zinc finger nucleases. *Nat Rev Genet* 2010; **11**: 636–46.
- 160** Varatharajan L, Thomas SA. The transport of anti-HIV drugs across blood-CNS interfaces: summary of current knowledge and recommendations for further research. *Antiviral Res* 2009; **82**: A99–109.
- 161** Sigal A, Kim JT, Balazs AB et al. Cell-to-cell spread of HIV permits ongoing replication despite antiretroviral therapy. *Nature* 2011; **477**: 95–8.
- 162** Maldarelli F. Targeting viral reservoirs: ability of antiretroviral therapy to stop viral replication. *Curr Opin HIV AIDS* 2010; **6**: 49–56.
- 163** Moreno S, Lopez Aldeguer J, Arribas JR et al. The future of antiretroviral therapy: challenges and needs. *J Antimicrob Chemother* 2010; **65**: 827–35.
- 164** De Clercq E. Antiretroviral drugs. *Curr Opin Pharmacol* 2010; **10**: 507–15.
- 165** Taiwo B, Murphy RL, Katlama C. Novel antiretroviral combinations in treatment-experienced patients with HIV infection: rationale and results. *Drugs* 2010; **70**: 1629–42.
- 166** Baba M. Cellular factors as alternative targets for inhibition of HIV-1. *Antiviral Res* 1997; **33**: 141–52.
- 167** De Clercq E. New anti-HIV agents and targets. *Med Res Rev* 2002; **22**: 531–65.
- 168** Baba M. Recent status of HIV-1 gene expression inhibitors. *Antiviral Res* 2006; **71**: 301–6.
- 169** Daelemans D, Vandamme AM, De Clercq E. Human immunodeficiency virus gene regulation as a target for antiviral chemotherapy. *Antivir Chem Chemother* 1999; **10**: 1–14.
- 170** Stevens M, De Clercq E, Balzarini J. The regulation of HIV-1 transcription: molecular targets for chemotherapeutic intervention. *Med Res Rev* 2006; **26**: 595–625.
- 171** Darbinian-Sarkissian N, Darbinyan A, Otte J et al. p27(SJ), a novel protein in St John's wort, that suppresses expression of HIV-1 genome. *Gene Ther* 2006; **13**: 288–95.
- 172** Lesner A, Shilpi R, Ivanova A et al. Identification of X-DING-CD4, a new member of human DING protein family that is secreted by HIV-1 resistant CD4(+) T cells and has anti-viral activity. *Biochem Biophys Res Commun* 2009; **389**: 284–9.
- 173** Cherrier T, Elias M, Jeudy A et al. Human-phosphate-binding-protein inhibits HIV-1 gene transcription and replication. *Viral J* 2011; **8**: 352.
- 174** Cihlar T, Birkus G, Greenwalt DE et al. Tenofovir exhibits low cytotoxicity in various human cell types: comparison with other nucleoside reverse transcriptase inhibitors. *Antiviral Res* 2002; **54**: 37–45.
- 175** Ivanova A, Shilpi RY, Sachdeva R et al. Native X-DING-CD4 protein secreted by HIV-1 resistant CD4+ T cells blocks activity of IL-8 promoter in human endothelial cells infected with enteric bacteria. *Innate Immun* 2011.
- 176** Kim PS, Read SW. Nanotechnology and HIV: potential applications for treatment and prevention. *Wiley Interdiscip Rev Nanomed Nanobiotechnol* 2010; **2**: 693–702.
- 177** Vyas TK, Shah L, Amiji MM. Nanoparticulate drug carriers for delivery of HIV/AIDS therapy to viral reservoir sites. *Expert Opin Drug Deliv* 2006; **3**: 613–28.

## Review

- 178** das Neves J, Amiji MM, Bahia MF et al. Nanotechnology-based systems for the treatment and prevention of HIV/AIDS. *Adv Drug Deliv Rev* 2010; **62**: 458–77.
- 179** Sharma P, Garg S. Pure drug and polymer based nanotechnologies for the improved solubility, stability, bioavailability and targeting of anti-HIV drugs. *Adv Drug Deliv Rev* 2010; **62**: 491–502.
- 180** Mamo T, Moseman EA, Kolishetti N et al. Emerging nanotechnology approaches for HIV/AIDS treatment and prevention. *Nanomedicine (Lond)* 2010; **5**: 269–85.
- 181** Kitahata MM, Gange SJ, Abraham AG et al. Effect of early versus deferred antiretroviral therapy for HIV on survival. *N Engl J Med* 2009; **360**: 1815–26.
- 182** Egger M, May M, Chene G et al. Prognosis of HIV-1-infected patients starting highly active antiretroviral therapy: a collaborative analysis of prospective studies. *Lancet* 2002; **360**: 119–29.
- 183** Kitahata MM. When to start antiretroviral therapy. *Top HIV Med* 2010; **18**: 121–6.
- 184** Armitage AE, McMichael AJ, Drakesmith H. Reflecting on a quarter century of HIV research. *Nat Immunol* 2008; **9**: 823–6.
- 185** Johnston MI, Fauci AS. An HIV vaccine—evolving concepts. *N Engl J Med* 2007; **356**: 2073–81.
- 186** Fauci AS, Johnston MI, Dieffenbach CW et al. HIV vaccine research: the way forward. *Science* 2008; **321**: 530–2.



## **Induction of proteasome-mediated degradation of CTIP2 by HIV-1 Vpr in microglial cells.**

Usurping the host ubiquitination proteasome system (UPS) to inactivate the undesirable host protein is a common viral strategy. HIV-1 proteins inactivate the detrimental host proteins by this system. In Microglial cells, CTIP2 represses both initial phase and late phase of HIV-1 gene transcription. As HIV-1 can still replicate in the presence of CTIP2, we postulated that it might inactivate CTIP2 by using Cul4 E3 ubiquitin ligase complex to resume its replication.

We observed higher CTIP2 expressions in the absence of Vpr, with no effect on CTIP2 mRNA and proteasome inhibitor can block this degradation. Co-immunoprecipitation assays showed that CTIP2 is associated with DCAF1 and DDB1 in the absence and presence of Vpr. We showed that this degradation is prevented by the using Vpr mutant (Q65R) and by knock down of DCAF1. Finally, we observed the co-localization of CTIP2 with Cul4A-DCAF1-DDB1 complex even in the absence of Vpr, in microglial cells. Additionally, DCAF1 interacts with CTIP2-associated heterochromatin enzymes complex.

Our results suggest that Vpr expression increases the turnover of CTIP2 in HIV-1 productively infected cells. By degrading CTIP2, HIV-1 counteracts CTIP2-mediated silencing of its expression and favors its replication.

**Key words: HIV-1, Vpr, CTIP2, DCAF1 and Ubiquitination.**

## **Induction par Vpr de la dégradation de la protéine CTIP2 via la voie du protéasome dans les cellules microgliales.**

Le détournement de la machinerie cellulaire basé sur la dégradation par la voie du protéasome est une stratégie fréquemment retrouvée chez les virus afin d'optimiser leur réplication. Ainsi, le VIH-1 a développé toute une série de contremesures via ses protéines accessoires, vif et vpr notamment, afin de cibler les facteurs de restriction vers la voie du protéasome. La protéine accessoire Vpr est également associée à un complexe Cul4 E3 ubiquitin ligase mais est toujours orphelin de sa cible.

Nos travaux ont montré que la protéine CTIP2 est un acteur majeur impliqué dans la restriction de la réplication du VIH-1. Nous proposons de défendre la thèse selon laquelle la protéine CTIP2 est dégradée par la voie du protéasome en présence de la protéine vpr. Nous avons ainsi montré que l'expression de la protéine CTIP2 est plus forte en absence qu'en présence de la protéine vpr. Des expériences utilisant des inhibiteurs de la voie du protéasome sont en faveur d'une régulation de type post traductionnel. Par immunoprécipitation, nous avons montré que CTIP2 fait partie d'un complexe comprenant DDB1 et DCAF1 en présence et en absence de Vpr. Sa dégradation est prévenue en présence du mutant vpr (Q65R) qui n'interagit plus avec DCAF, et en présence d'un Knock Down de DCAF1 par ailleurs, DCAF1 est associé avec CTIP2 inclus dans le complexe impliqué dans l'établissement de la latence du VIH-1 comprenant notamment HDAC1. Enfin, les protéines CTIP2, Vpr et DCAF colocalisent dans les noyaux des cellules microgliales.

Nos résultats suggèrent fortement que la protéine Vpr favorise la dégradation du facteur CTIP2, qui est décrit comme un facteur restreignant l'infection par le VIH-1 dans les cellules microgliales, et ainsi favorise sa réplication.

**Mots clés: VIH-1, Vpr, CTIP2, DCAF1 et Ubiquitination.**