

Thesis Defense
Christopher Baker

On-chip nano-optomechanical
whispering gallery mode resonators

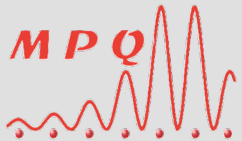

Under the direction of Ivan Favero and Giuseppe Leo



Outline

1. Introduction
2. Whispering gallery mode resonators
3. Nanofabrication
4. Experimental guided optics
5. Mechanics of nanoresonators
6. Optomechanical coupling
7. Experimental optomechanics
8. Conclusions/perspectives

Outline

1. Introduction
2. Whispering gallery mode resonators
3. Nanofabrication
4. Experimental guided optics
5. Mechanics of nanoresonators
6. Optomechanical coupling
7. Experimental optomechanics
8. Conclusions/perspectives

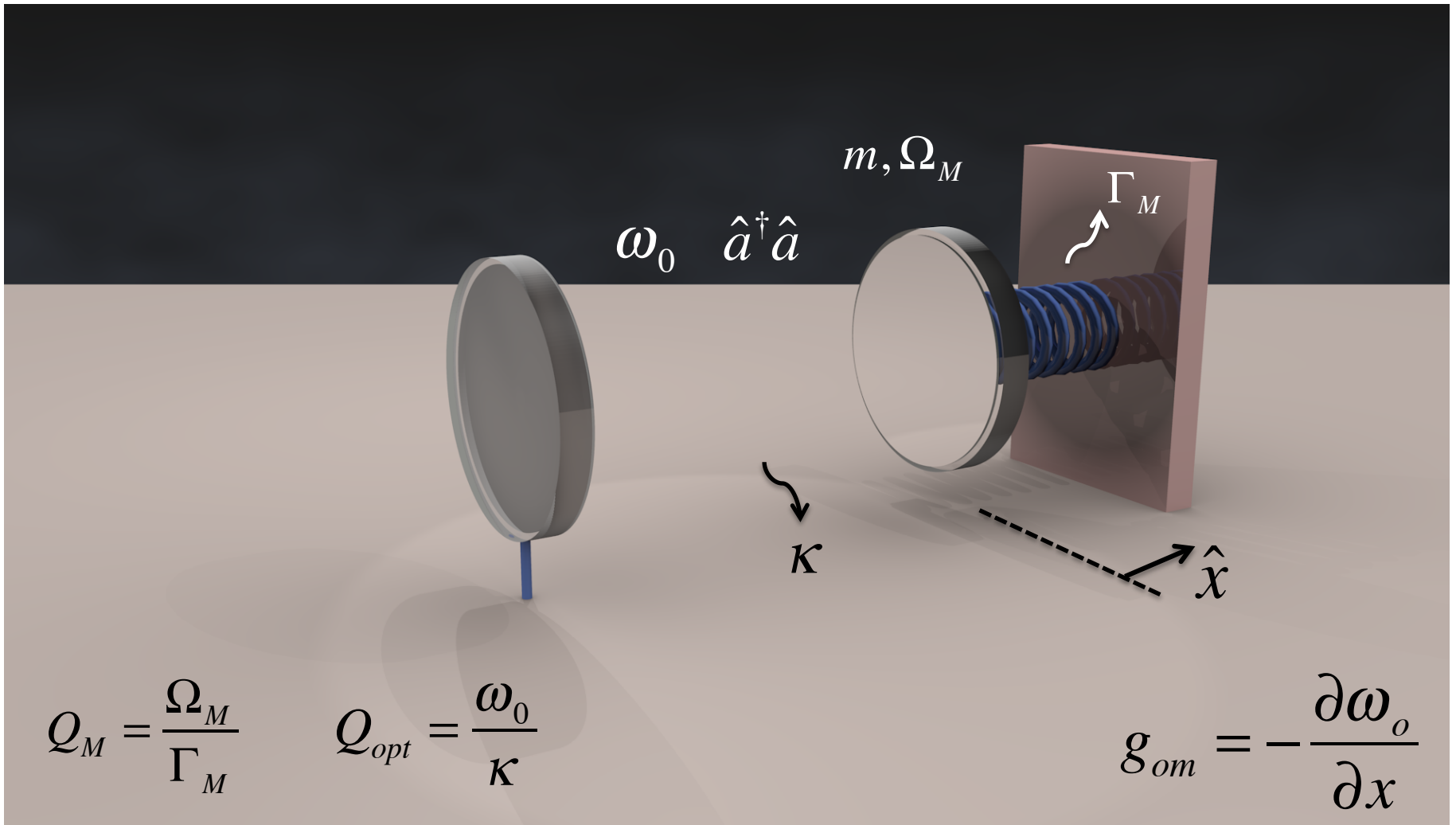

Hamiltonian optomechanics

$$\hat{H} = \underbrace{\hbar\omega_0(\hat{x})\hat{a}^\dagger\hat{a}}_{\text{Optical energy}} + \underbrace{\hbar\Omega_M\hat{b}^\dagger\hat{b}}_{\text{Mechanical energy}}$$

$$\omega_0(\hat{x}) \approx \omega_0 - g_{om}\hat{x}$$

$$\hat{x} = x_{\text{ZPF}}(\hat{b} + \hat{b}^\dagger)$$

$$\hat{H} = \hbar\omega_0\hat{a}^\dagger\hat{a} + \hbar\Omega_M\hat{b}^\dagger\hat{b} - \underbrace{\hbar g_{om}x_{\text{ZPF}}}_{g_0}\hat{a}^\dagger\hat{a}(\hat{b}^\dagger + \hat{b}) \quad x_{\text{ZPF}} = \sqrt{\frac{\hbar}{2m_{\text{eff}}\Omega_M}}$$

$$\hat{H} = \hbar\omega_0\hat{a}^\dagger\hat{a} + \hbar\Omega_M\hat{b}^\dagger\hat{b} - \hbar g_0\hat{a}^\dagger\hat{a}(\hat{b}^\dagger + \hat{b})$$

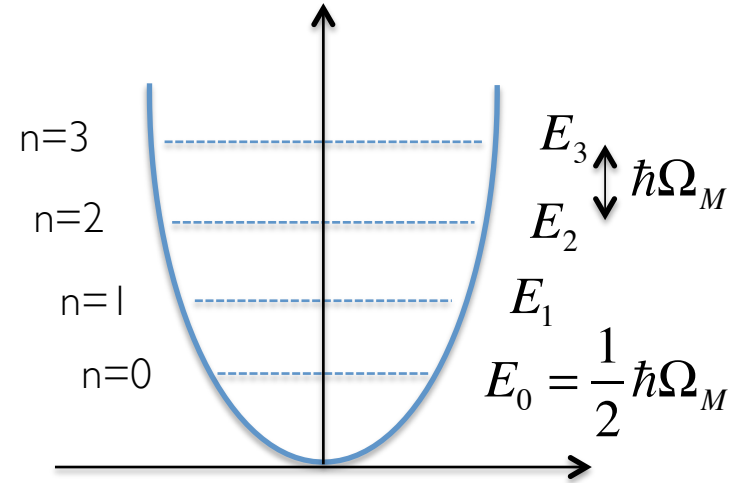

High sensitivity displacement readout

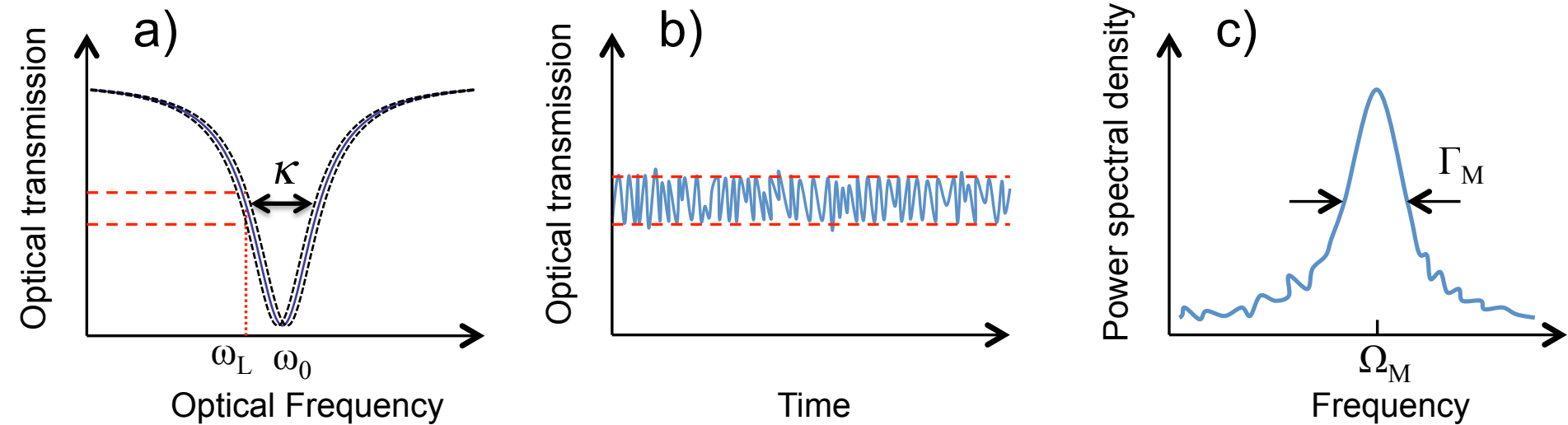

Ultra-high sensitivity optical readout of the mechanical displacement

Optical cooling and amplification of mechanical motion

Towards quantum effects of light and mechanics

Optomechanical setups

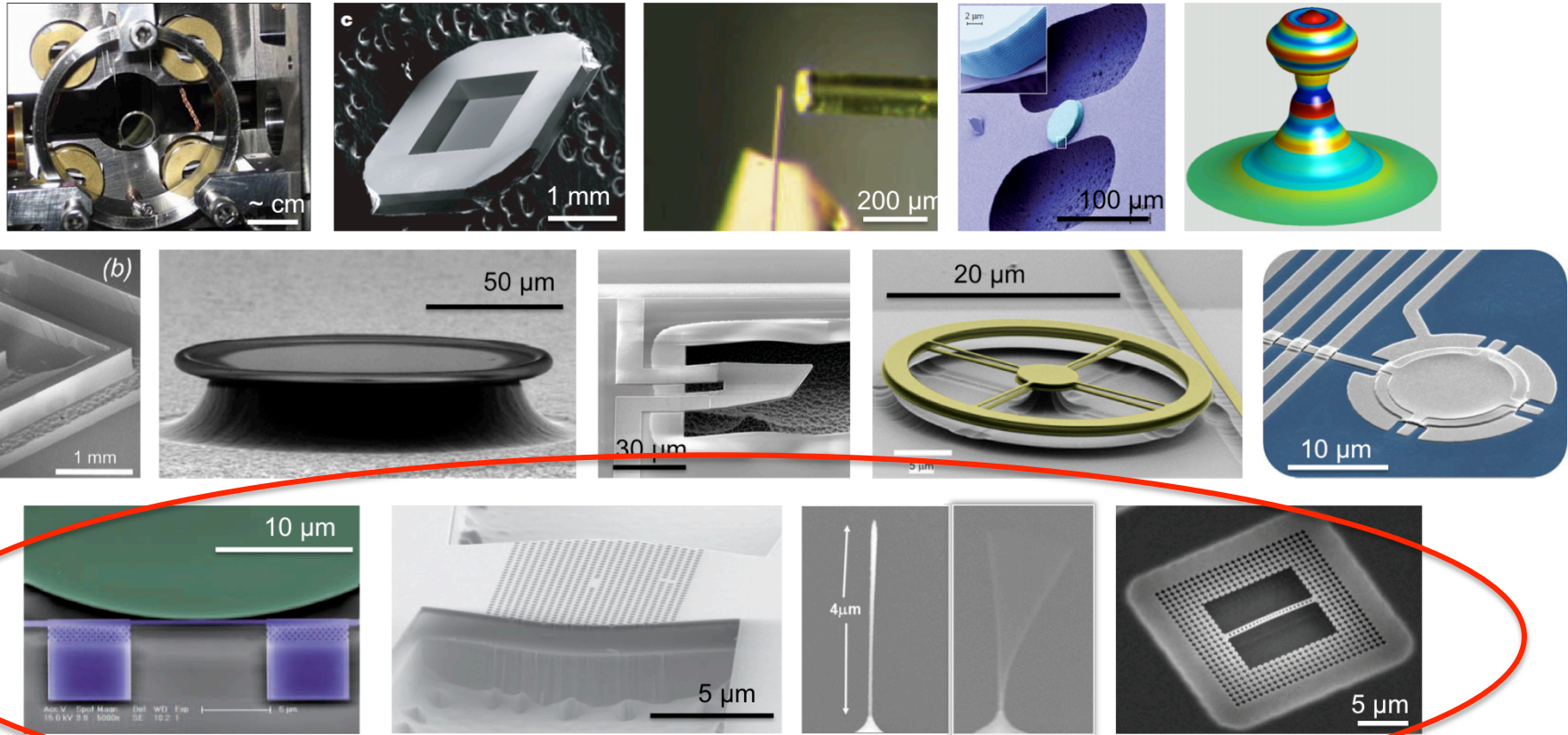

Our systems

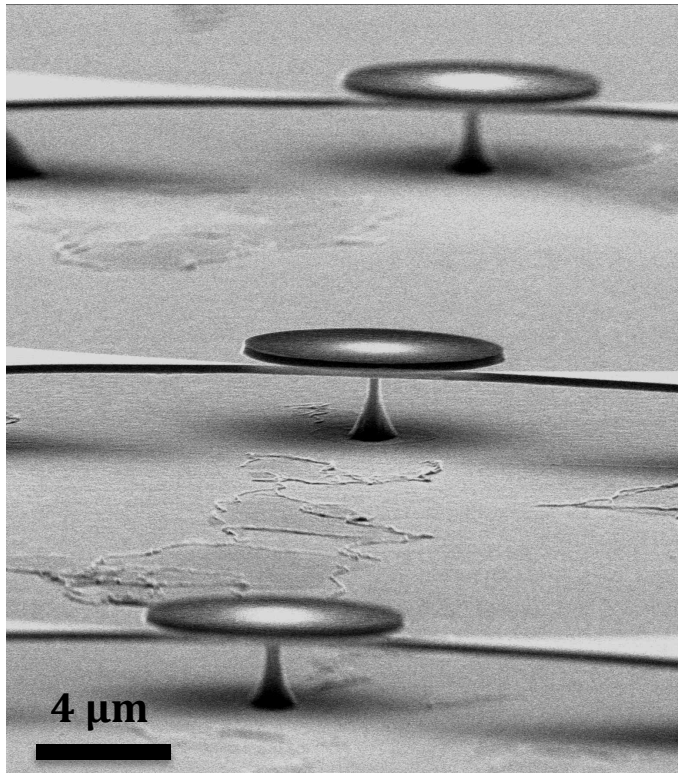

Gallium Arsenide (GaAs) disk
optomechanical resonators

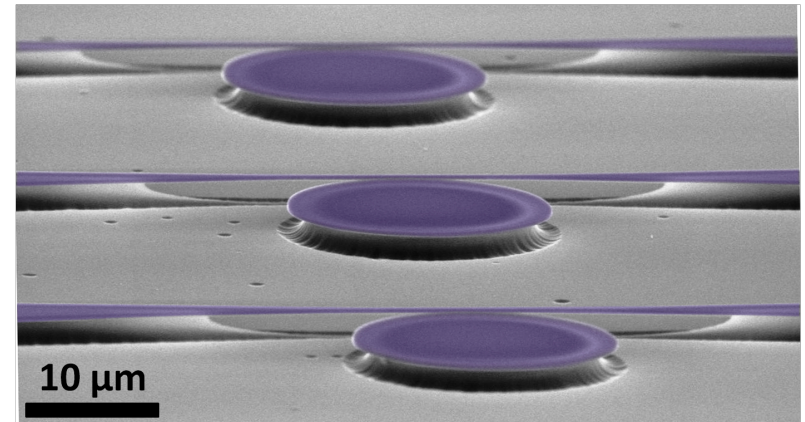

Silicon nitride (SiN)
optomechanical resonators

Outline

1. Introduction
2. Whispering gallery mode resonators
3. Nanofabrication
4. Experimental guided optics
5. Mechanics of nanoresonators
6. Optomechanical coupling
7. Experimental optomechanics
8. Conclusions/perspectives

Optical WGM resonator

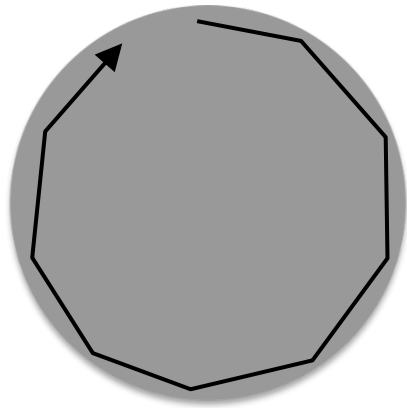

Resonance condition

$$2\pi nR \approx m\lambda_0$$

$$Q_{\text{opt}} = \frac{\omega_0}{\kappa}$$

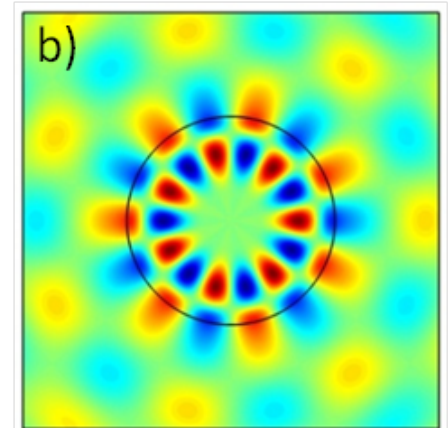
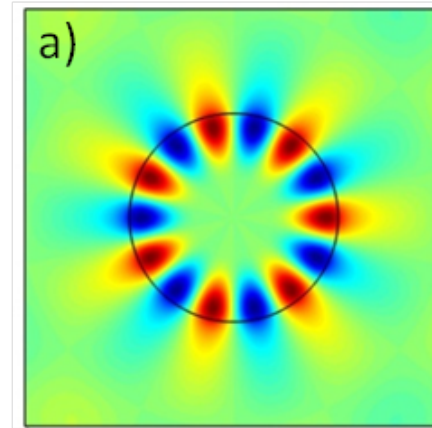

- High optical Q ($> 10^5$) \rightarrow Large field enhancement
- High refractive index, Small mode volume (sub- μm^3)
- Evanescent coupling via bus waveguide

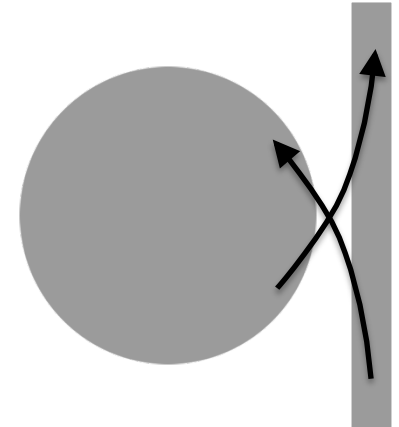
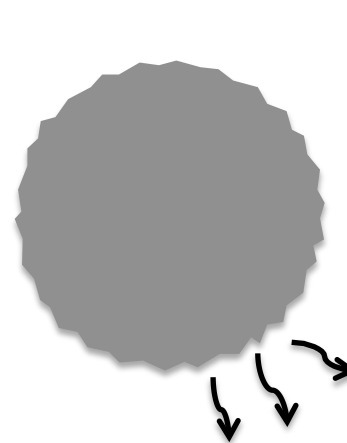

Evanescent coupling

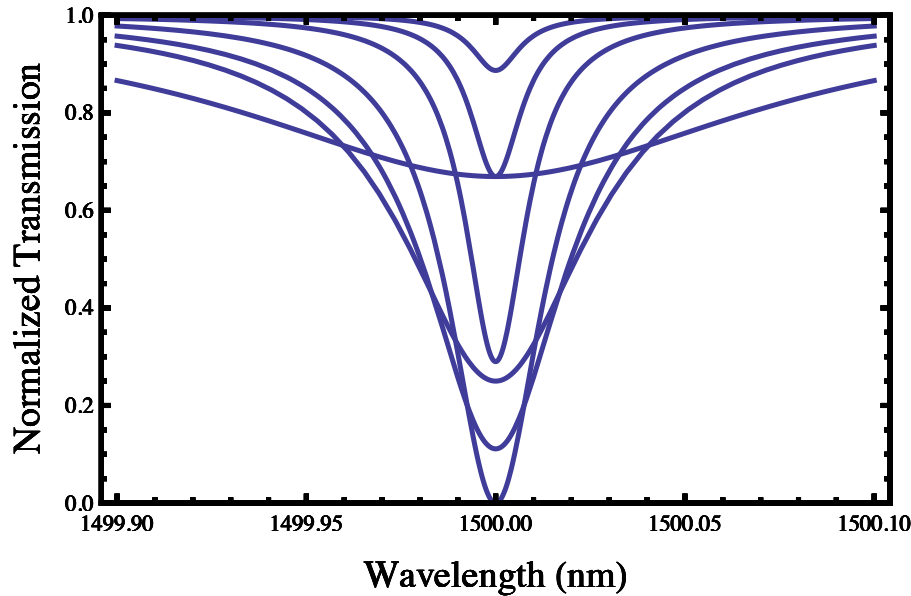

Critical coupling regime
 $T_{\text{on}}=0$, maximum field in the cavity.

➔ Need to precisely tune the coupling strength

Adjust the coupling strength

- Gap distance
- Waveguide width

Described by Coupled Mode Theory (CMT) formalism.

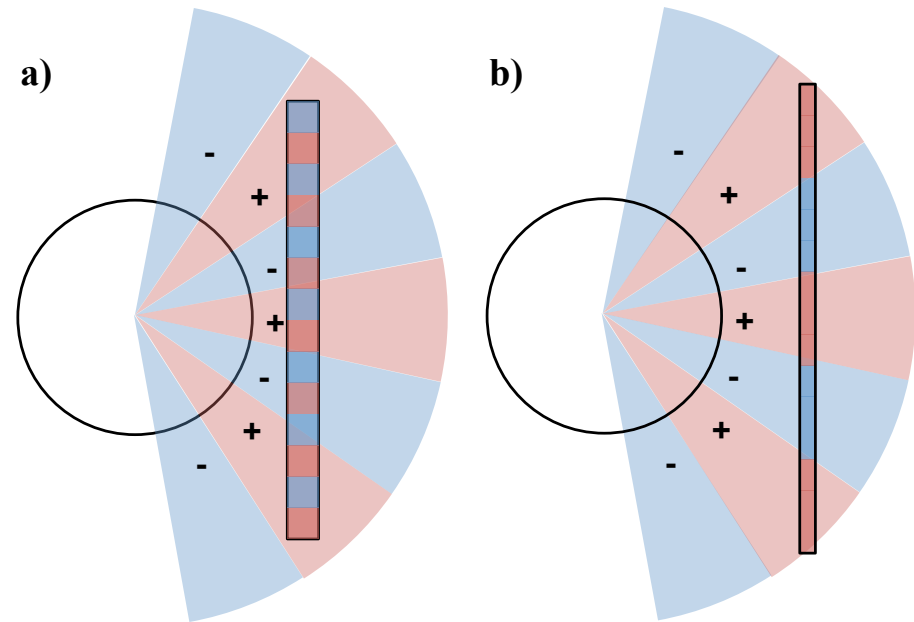

Optical coupling scheme

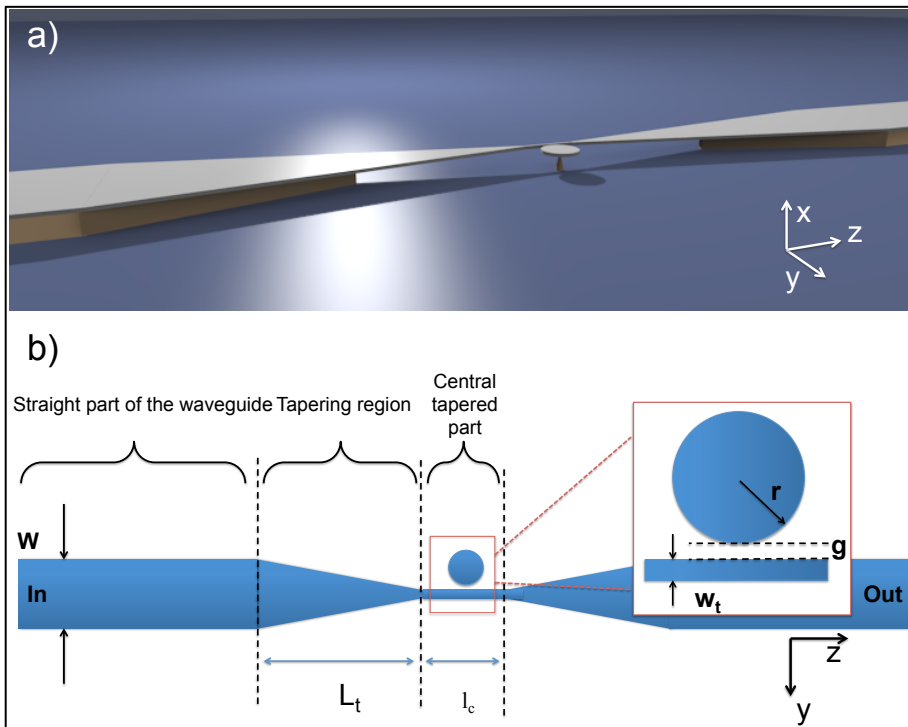
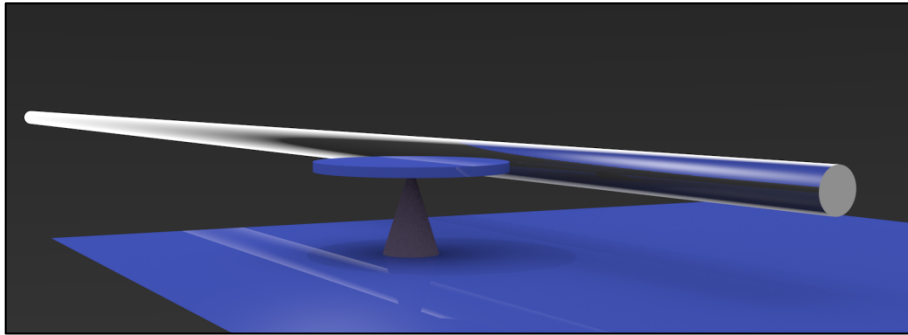

Two different coupling schemes:

- Fiber taper
 - + adjustable coupling strength
 - + high power
 - fragile
 - mechanical stability
 - bulky
- Integrated waveguide
 - + compact
 - + stable
 - non adjustable

Lu Ding, et al. Applied Optics, 49(13):2441-2445, 2010.
C. Baker et al. Applied Physics Letters, 99:151117, 2011.

Outline

1. Introduction
2. Whispering gallery mode resonators
3. Nanofabrication
4. Experimental guided optics
5. Mechanics of nanoresonators
6. Optomechanical coupling
7. Experimental optomechanics
8. Conclusions/perspectives

GaAs nano-fabrication steps

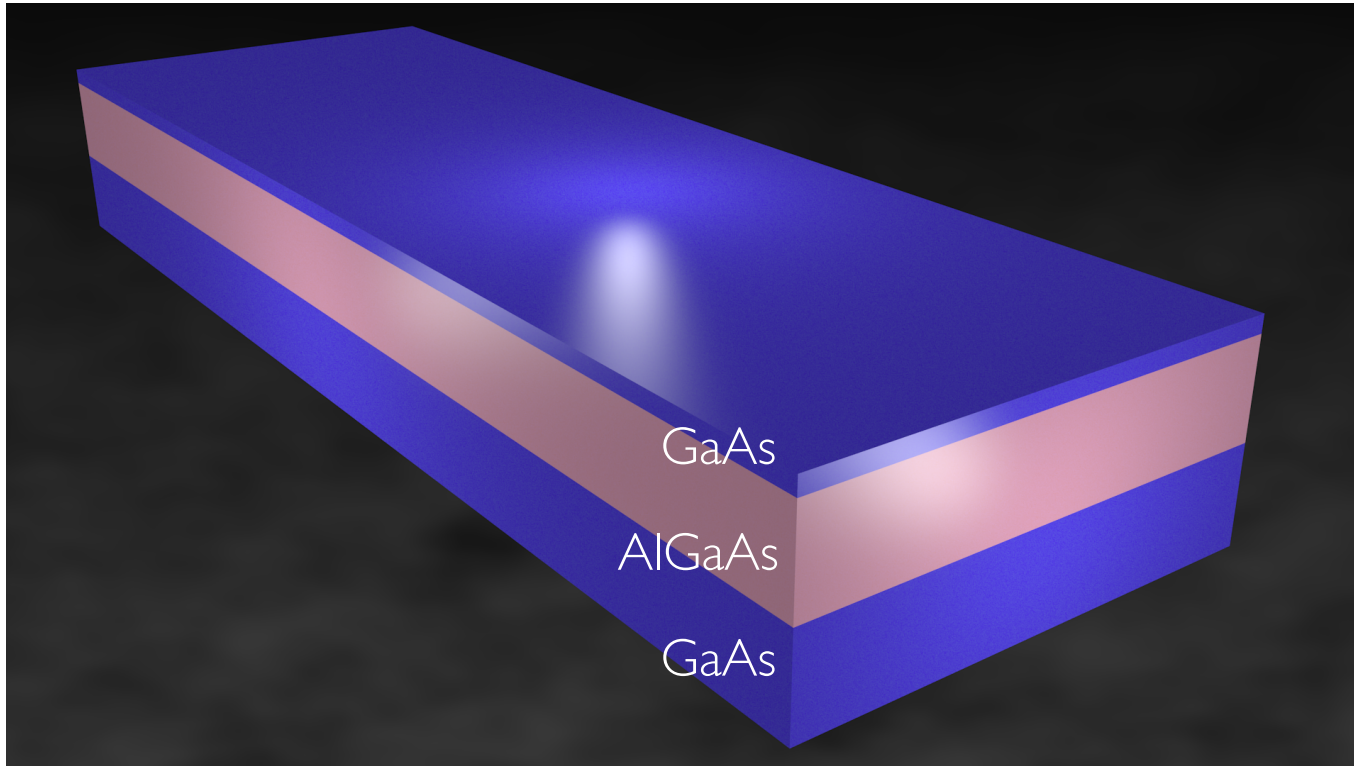

- 1) Clean wafer
- 2) E-beam resist and exposure
- 3) Development
- 4) Non selective ICP etch or wet etch
- 5) Selective HF under-etch
- 6) Cleaning – finished sample

GaAs non selective wet etch

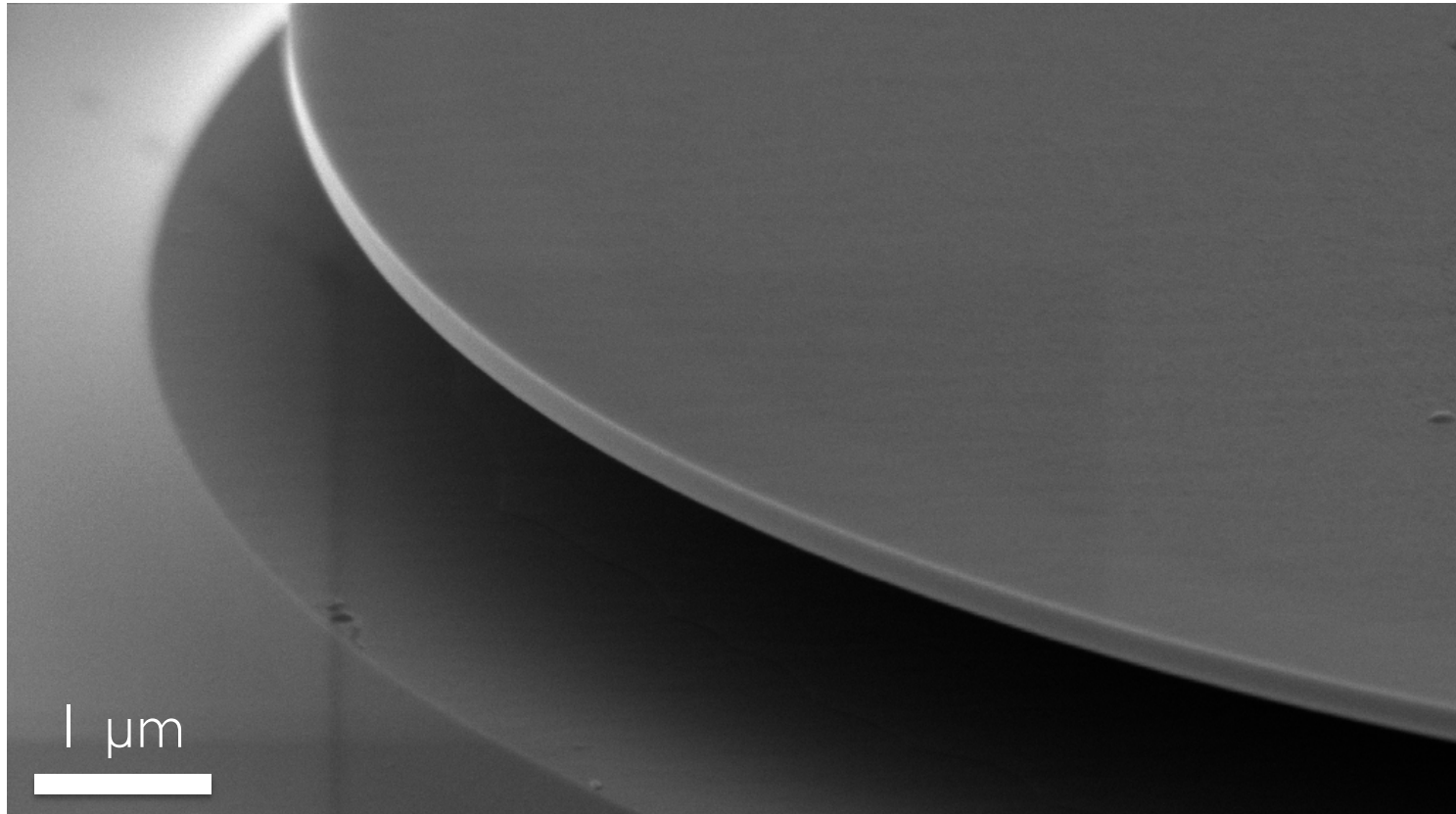

- + Smooth etch
- Poor verticality and gap distance control not adapted for small on-chip resonators

Optimized ICP etch

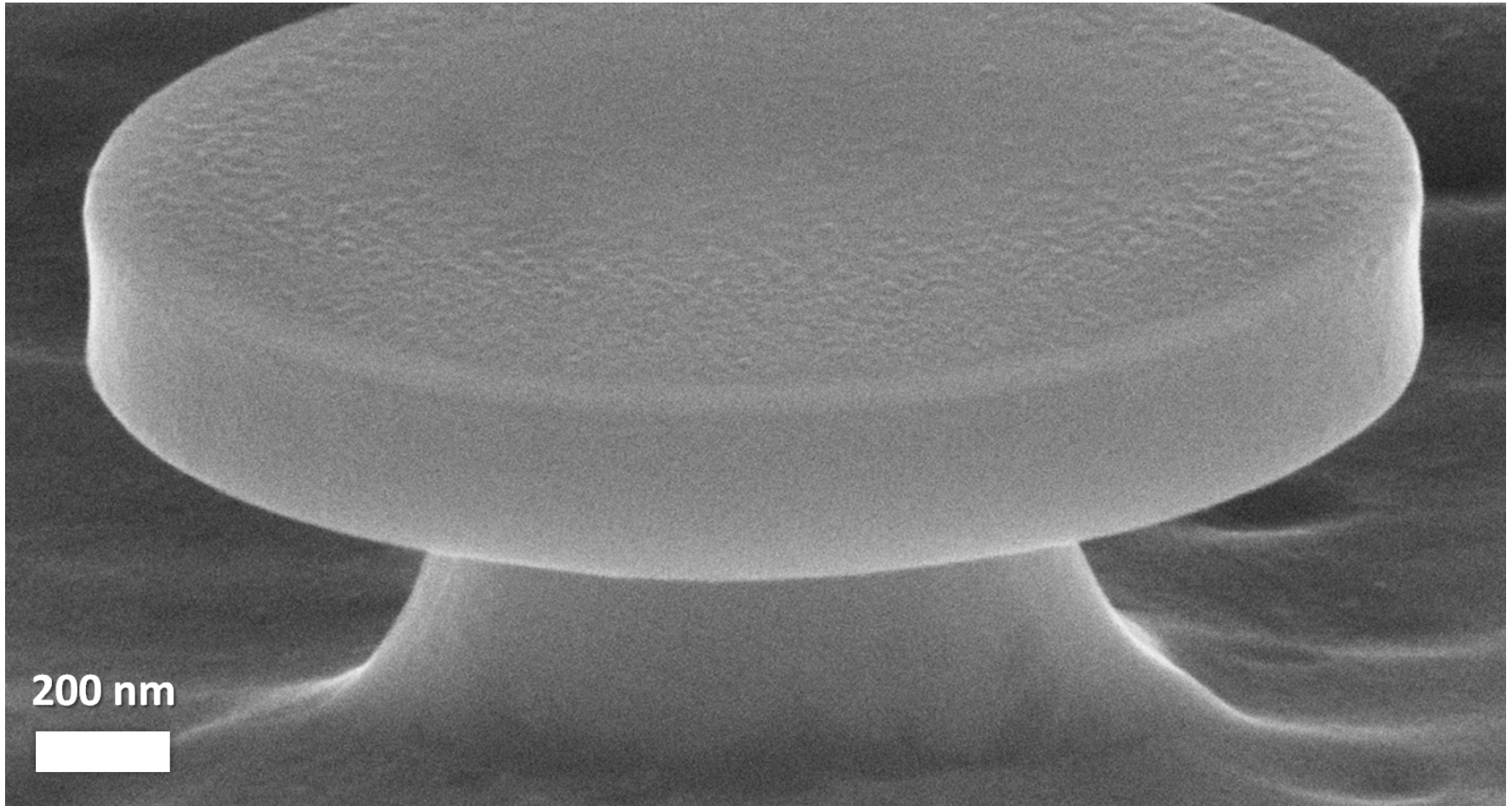

- Ar and SiCl_4 plasma chemistry
- Small sidewall roughness

GaAs nanofabrication potential problems

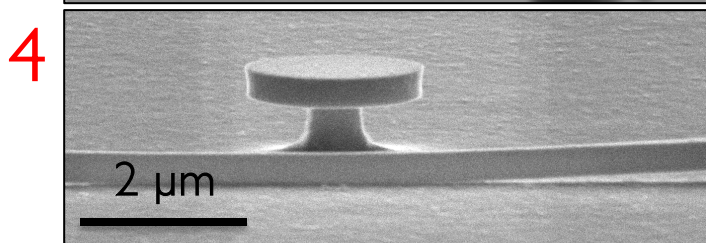
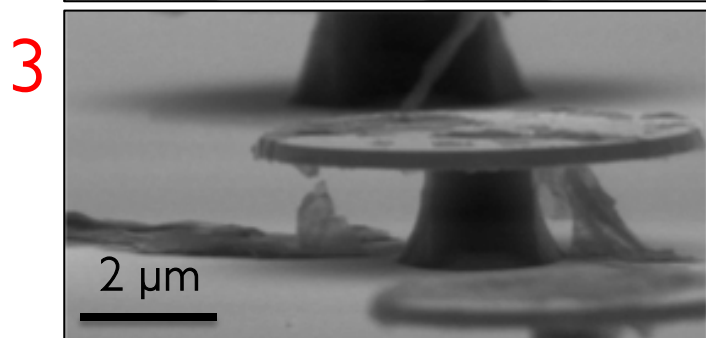
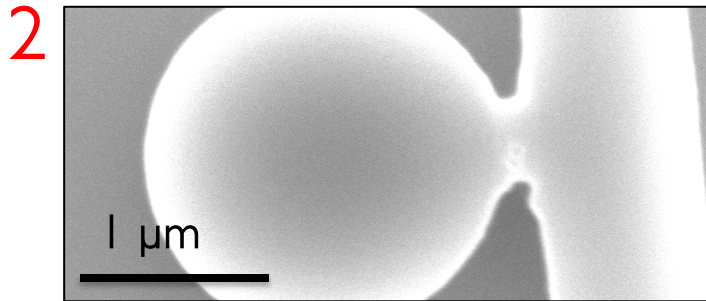
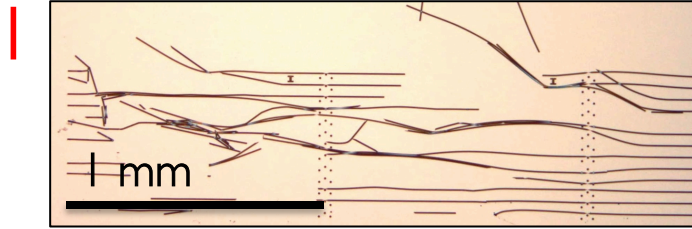

1. Resist delamination
2. Proximity effect
3. Problematic oxidation
4. Collapsing waveguide
5. Pedestal dimension control

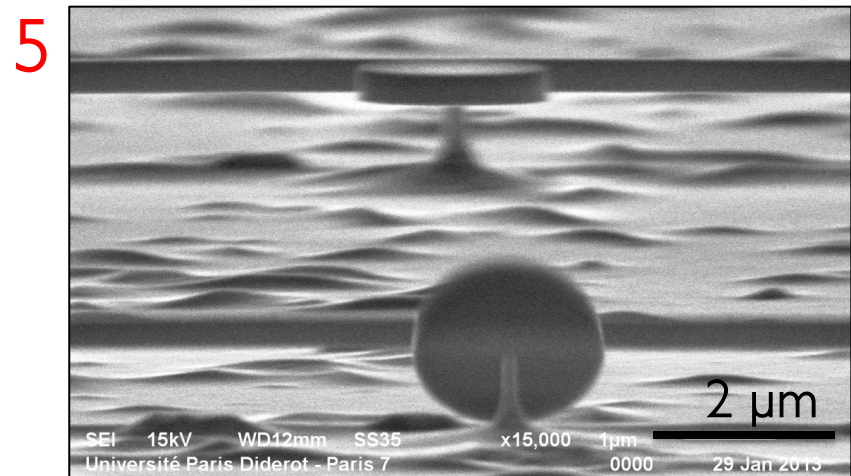

GaAs nano-fabrication results

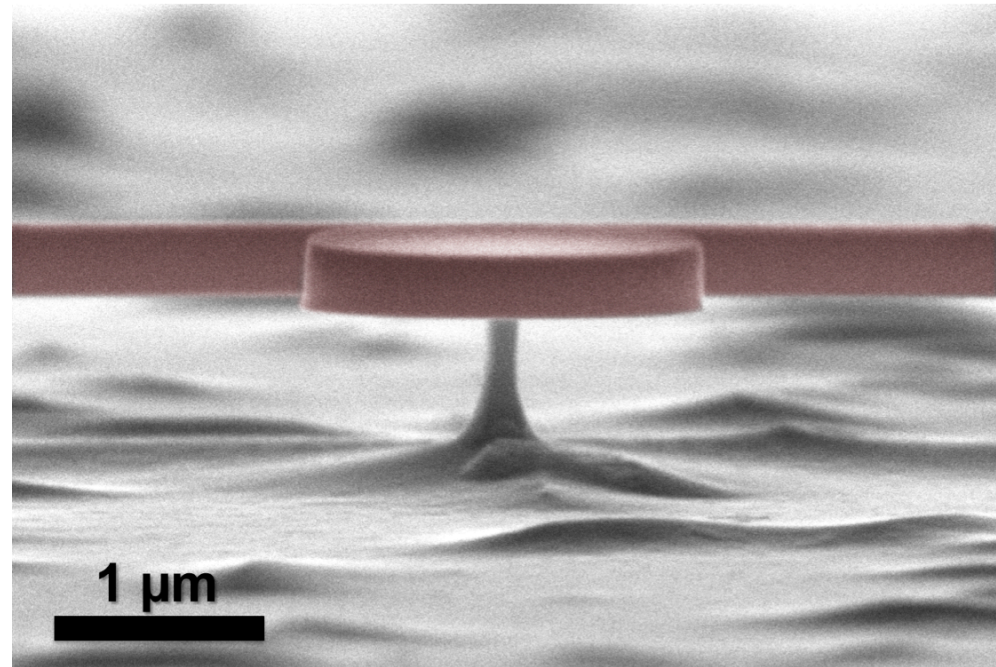
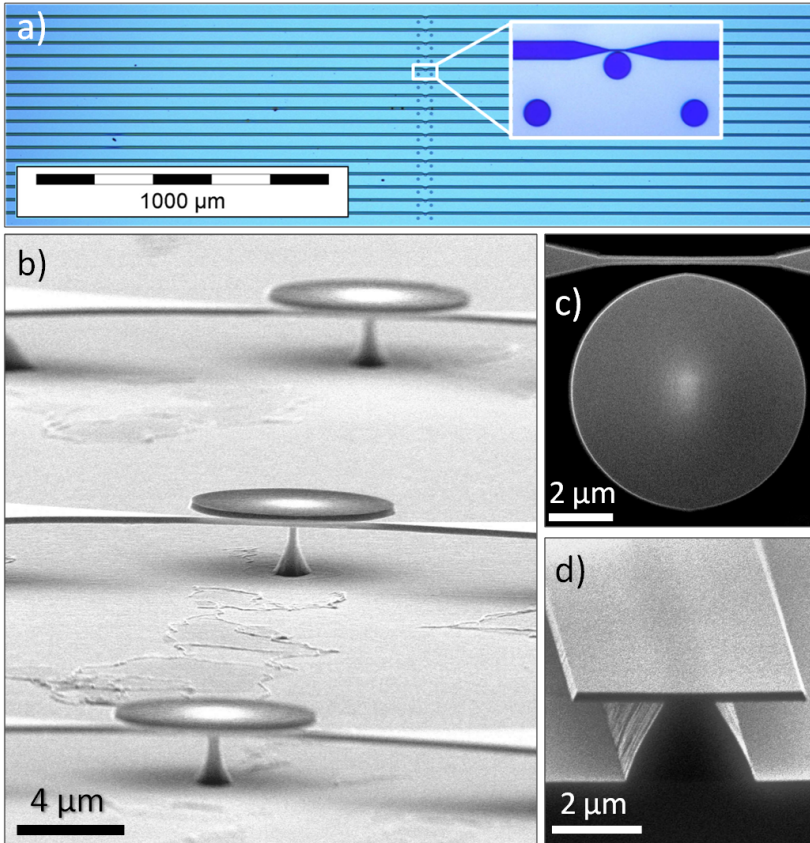

	DISK	PEDESTAL	WAVEGUIDE
1 st Gen	3.5 μm radius 200 nm thickness	>100 nm radius 1.8 μm height	300 nm width 300 nm gap
2 nd Gen	1 μm radius 320 nm thickness	80 nm radius 1 μm height	200 nm width 400 nm gap

SiN resonators fabrication steps

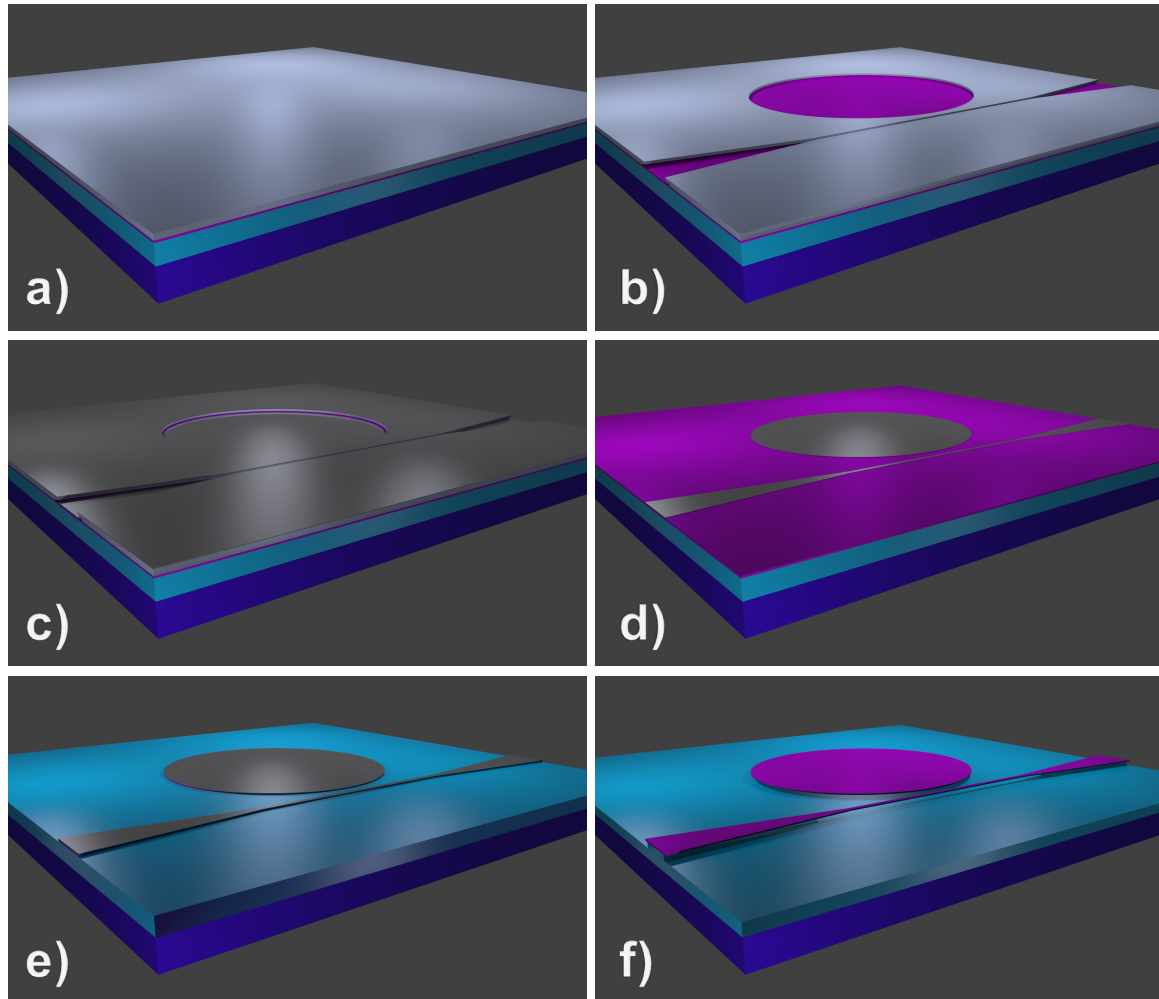

On-chip silicon nitride resonators

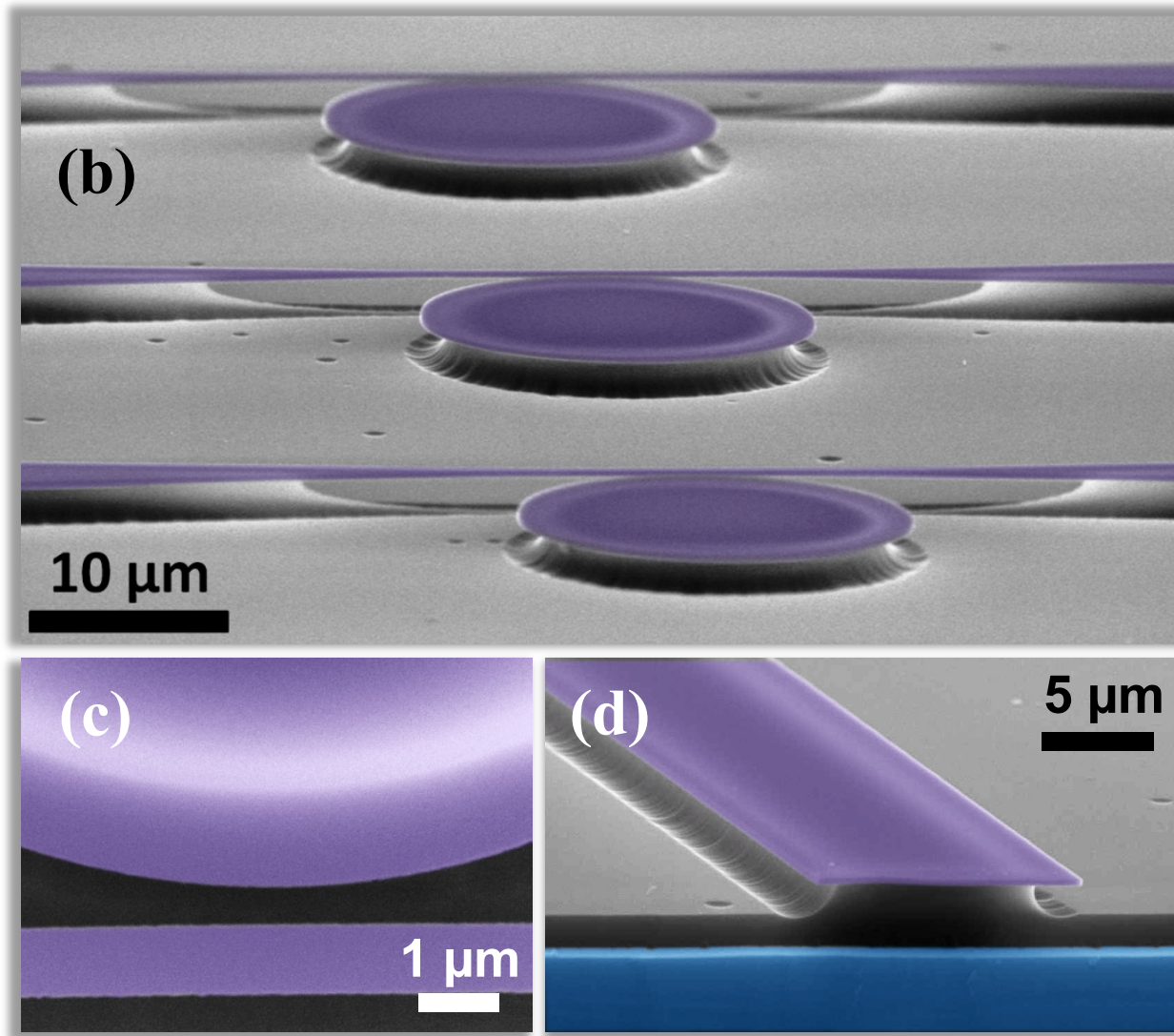

Outline

1. Introduction
2. Whispering gallery mode resonators
3. Nanofabrication
4. Experimental guided optics
5. Mechanics of nanoresonators
6. Optomechanical coupling
 - a. Optical forces
 - b. Geometric and photoelastic optomechanical coupling
7. Experimental optomechanics
8. Conclusions/perspectives

GaAs on-chip photonics

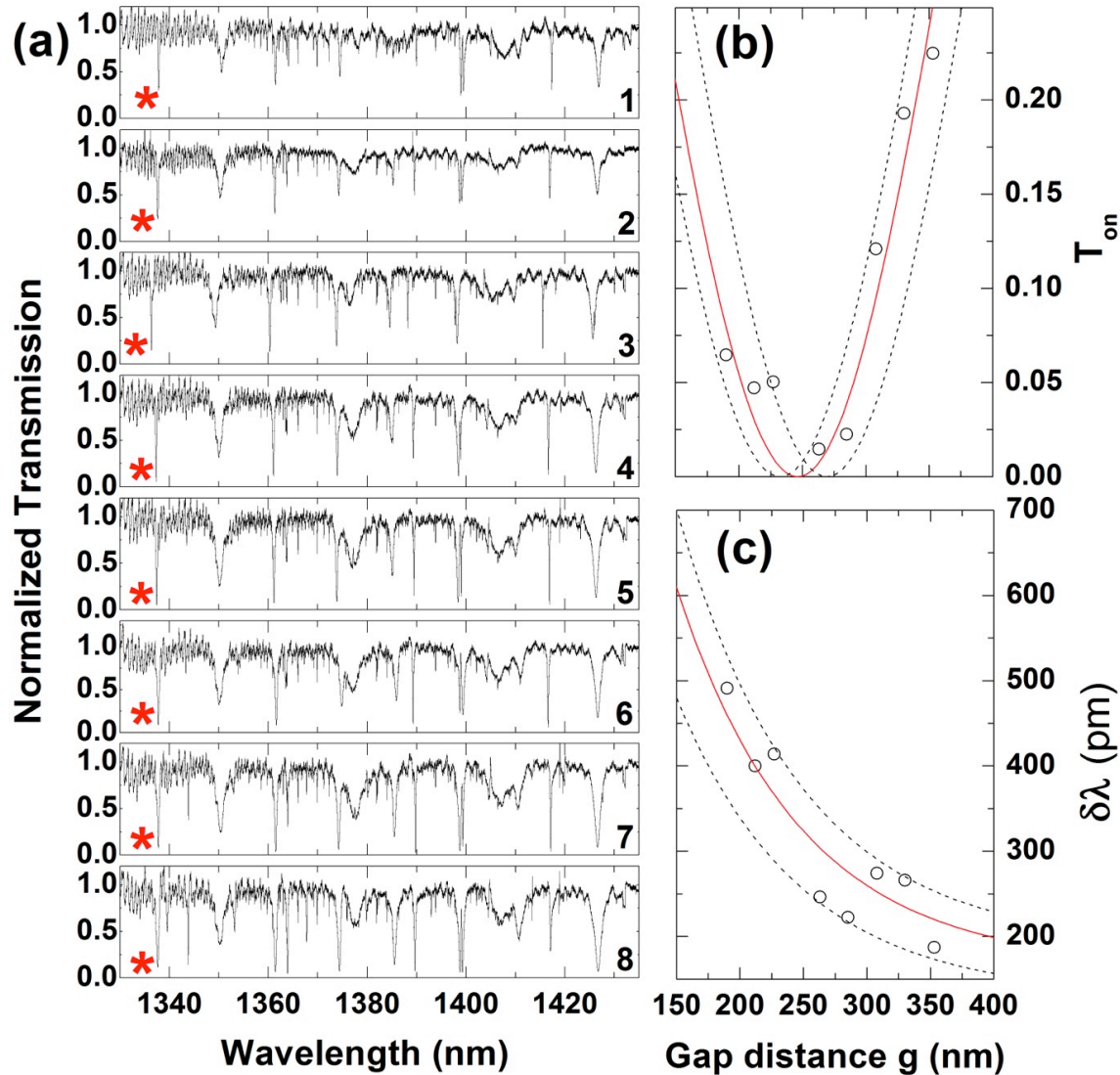

Observation of critical coupling, $Q_{opt} = \text{few } 10^4$

Since 2011 enhancements:
×100 optical transmission
×10 optical Q
(Q_{opt} now limited by optical absorption)

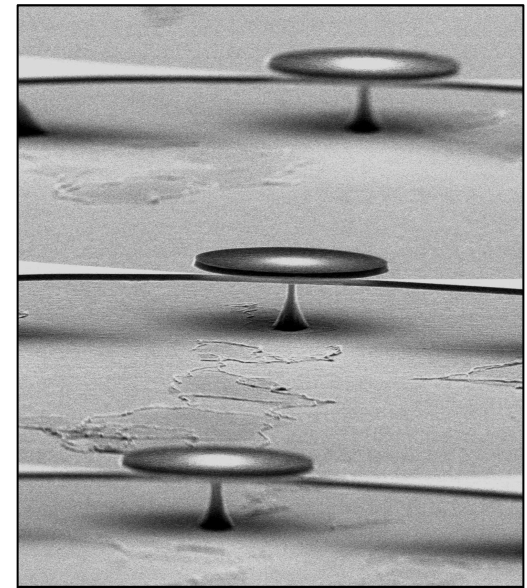

C. Baker et al., *Applied Physics Letters*, 99:151117, 2011.

Silicon nitride on-chip WGM resonators

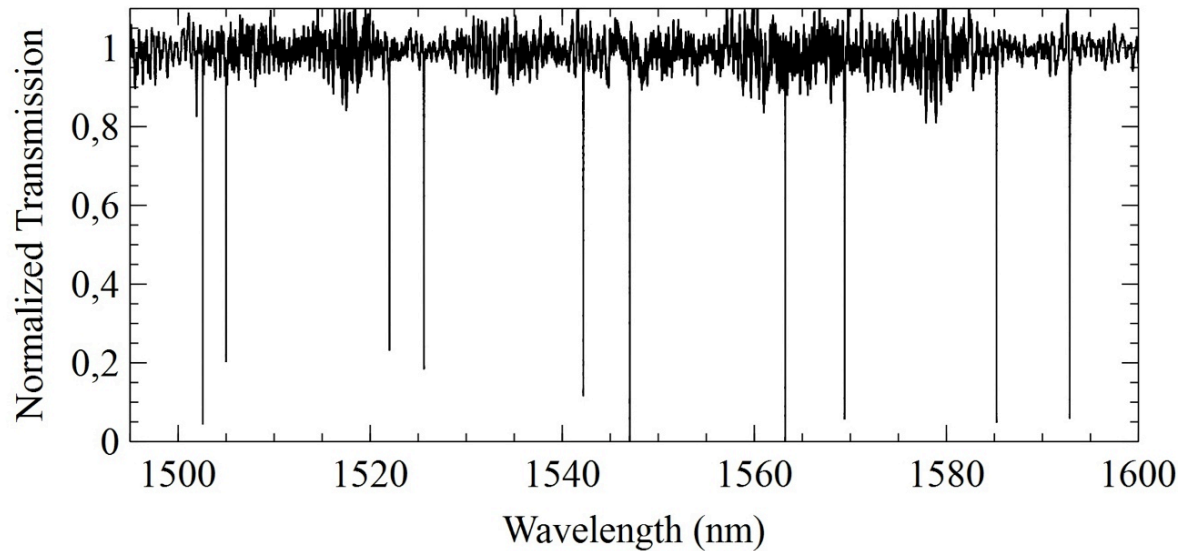

Several high Q high contrast optical resonances

Highest optical $Q \sim 400\,000$

$$(dn/dT)_{\text{SiN}} \sim 2 \times 10^{-5} \text{ K}^{-1}$$

Thermo-optic distortion

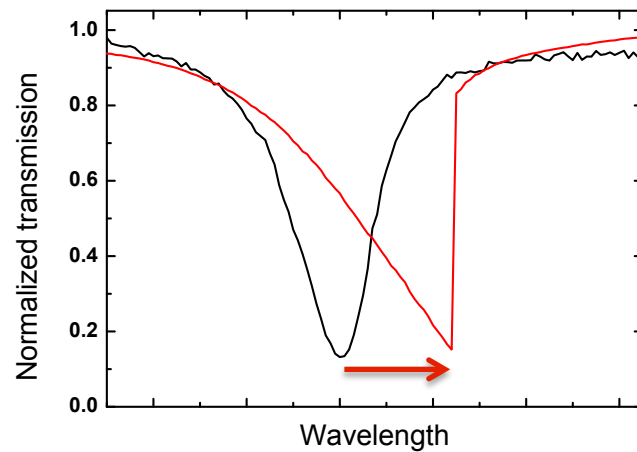

Optical instability and self-pulsing in SiN

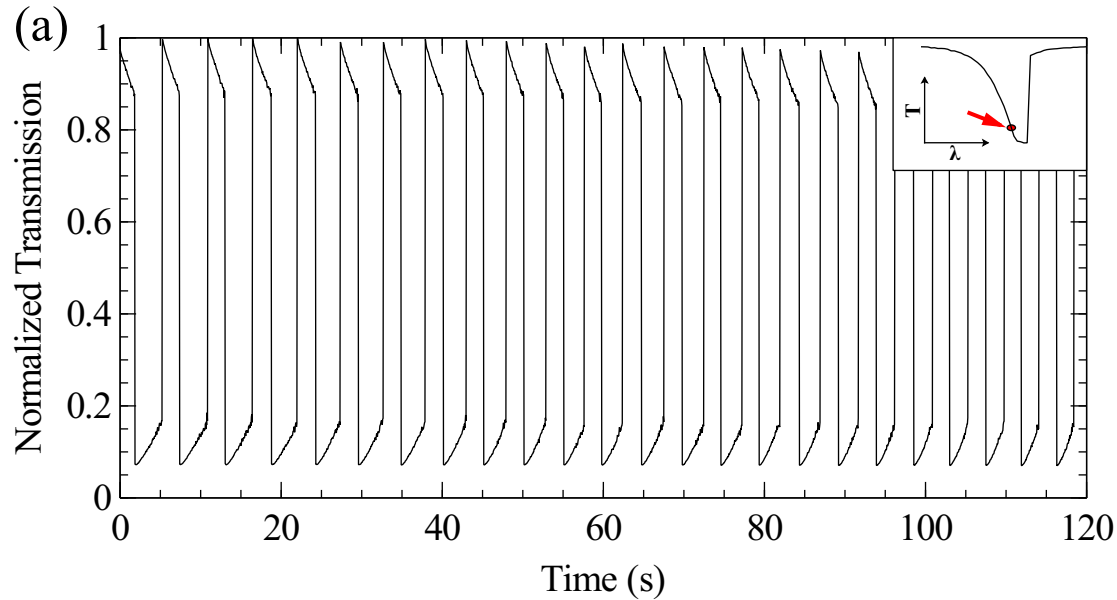

For constant laser power and wavelength light injection chaotic or periodic optical output.

Behavior depends upon:

- laser power
- laser detuning

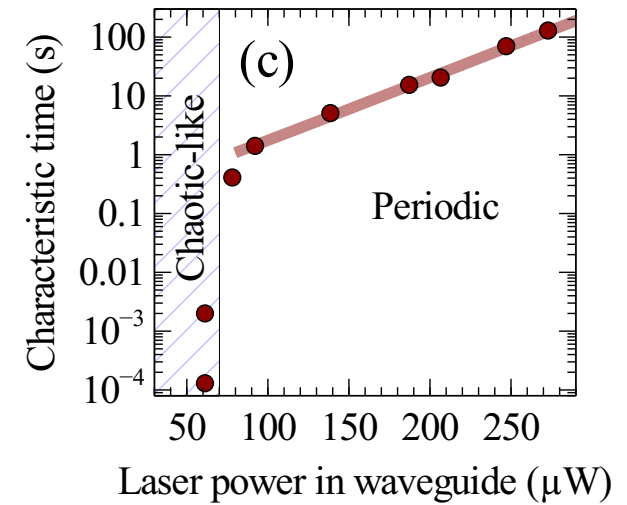
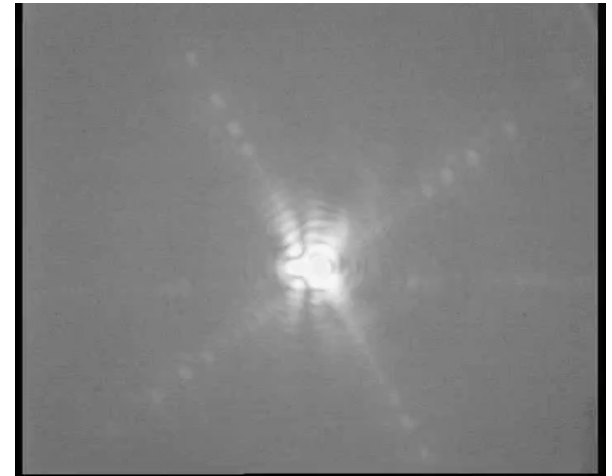

Optical instability and self-pulsing in SiN

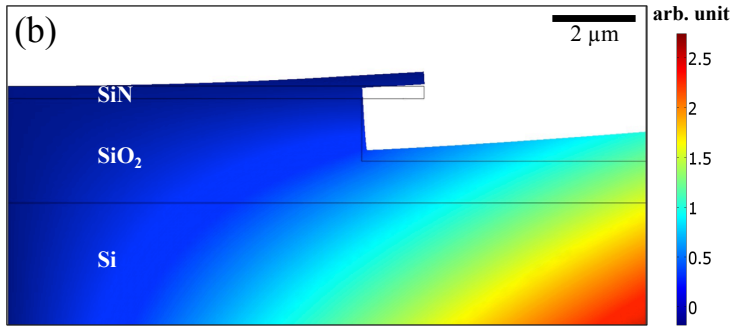

Interaction between fast thermo-optic and slow thermo-mechanical nonlinearity

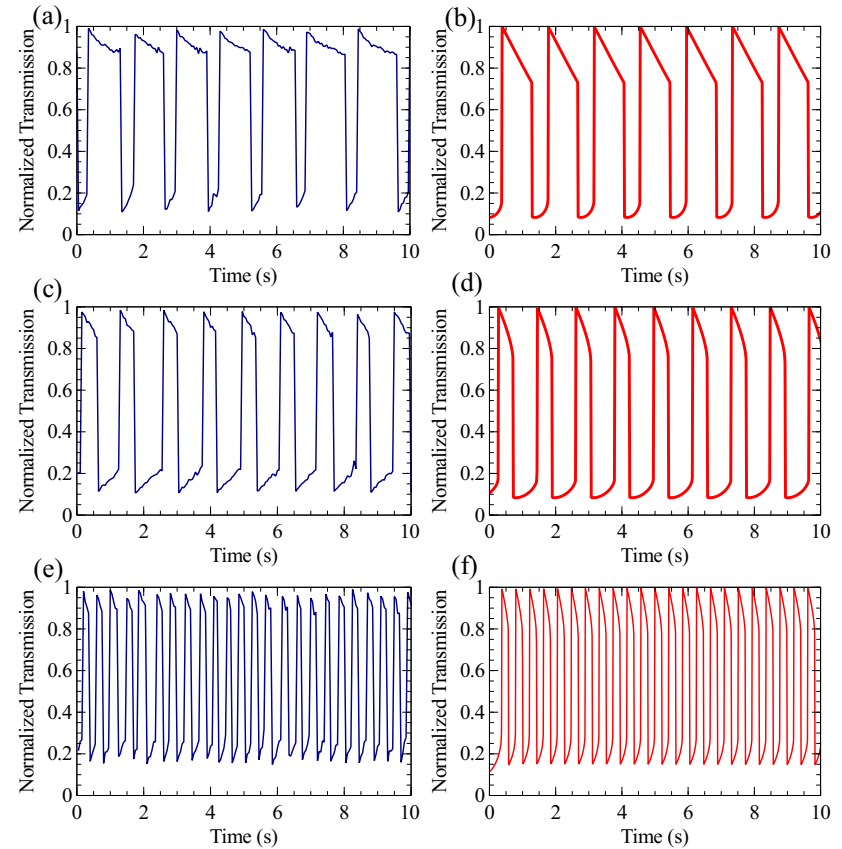
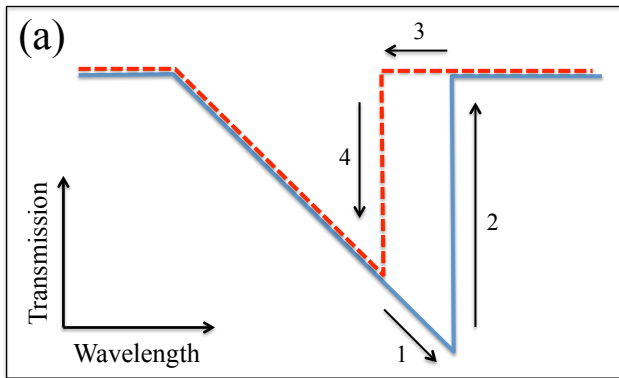

Blue: experimental data
Red: numerical model

C. Baker et al. *Optics Express*, 20(27):29076–29089, 2012.

Outline

1. Introduction
2. Whispering gallery mode resonators
3. Nanofabrication
4. Experimental guided optics
5. Mechanics of nanoresonators
6. Optomechanical coupling
7. Experimental optomechanics
8. Conclusions/perspectives

GaAs disk mechanics

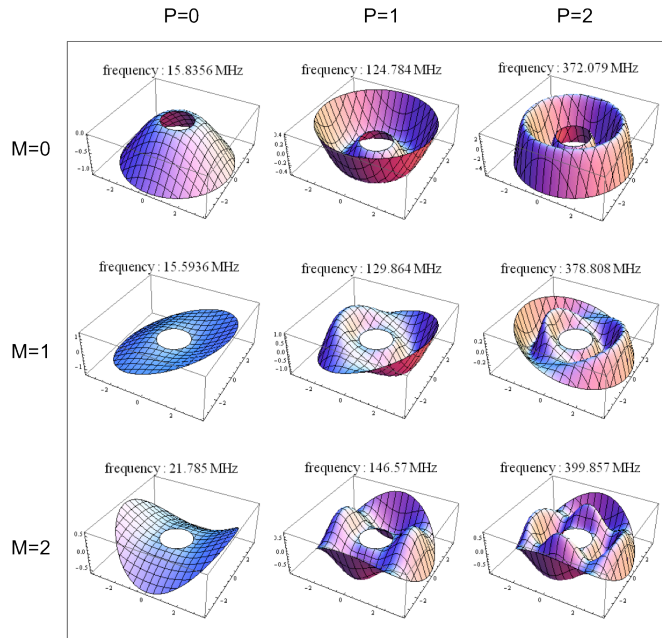

Out-of-plane mechanical modes

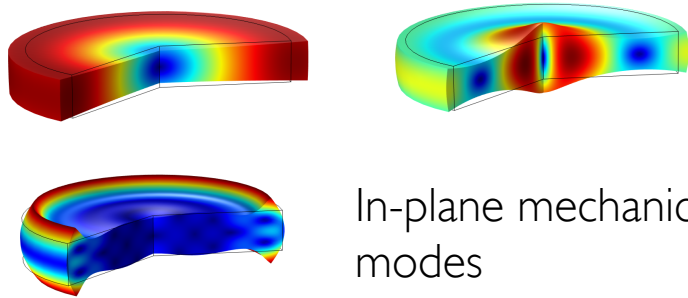

In-plane mechanical modes

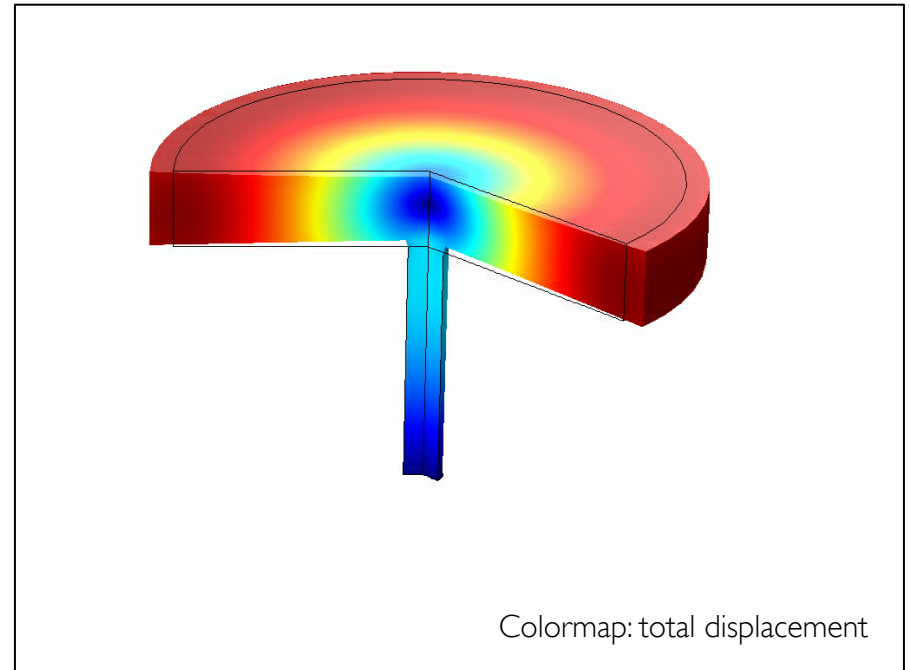

- + Small mass: picogram range
- + High frequency: > 1 GHz range

In plane/out-of-plane coupling → losses via pedestal

Mechanical dissipation through clamping losses in GaAs disks

▲ -31.4906443298

Colormap: log(total displacement)

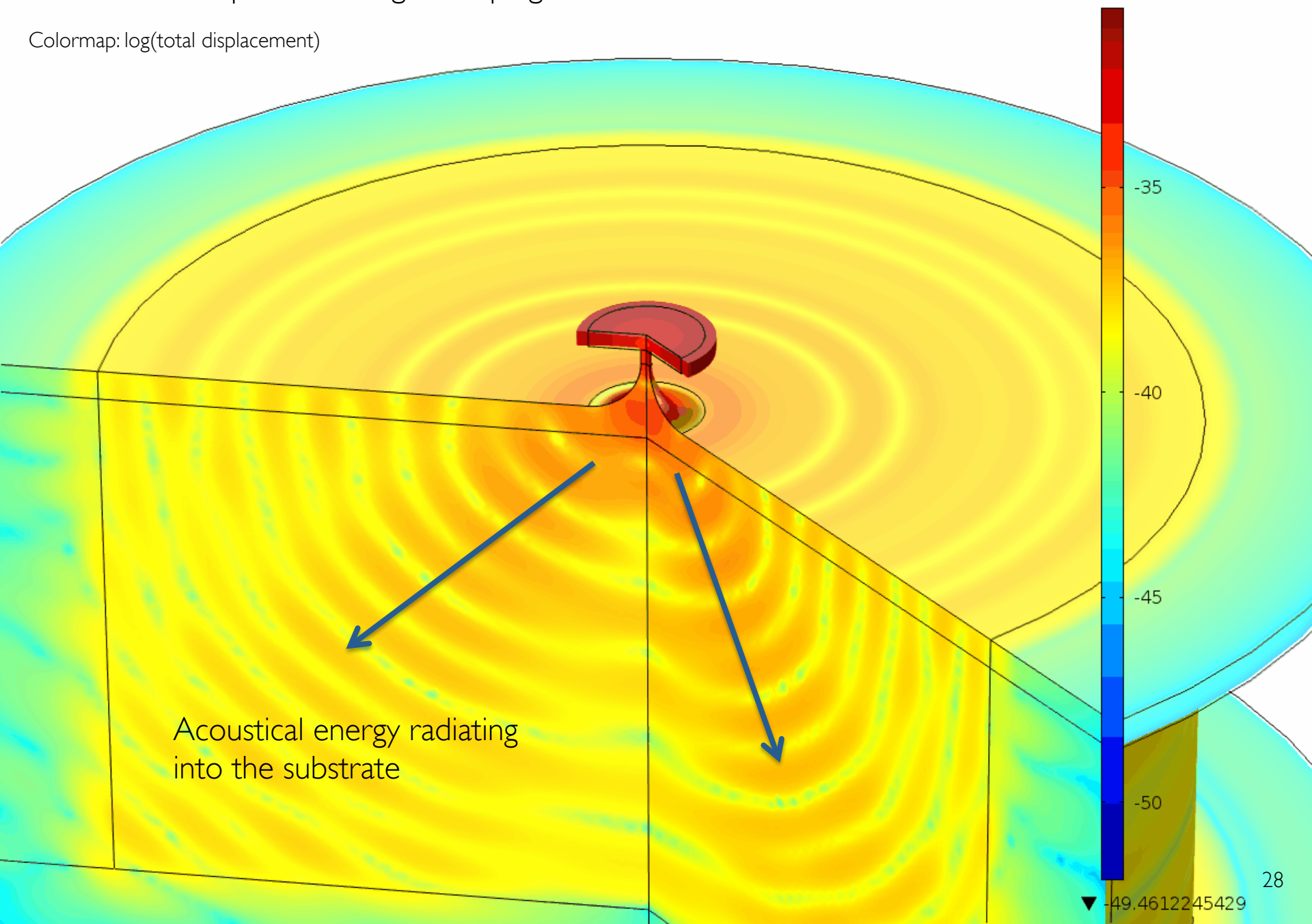

Mechanical clamping losses in GaAs disks

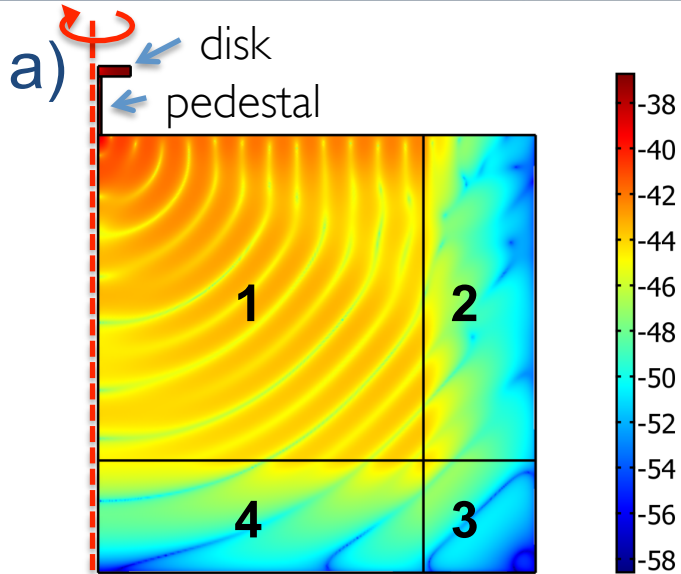

2,3,4 Perfectly matched layers

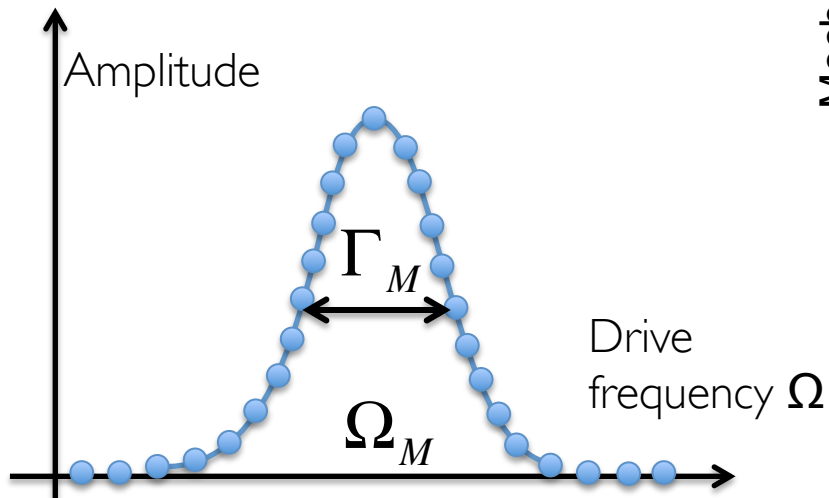

b)

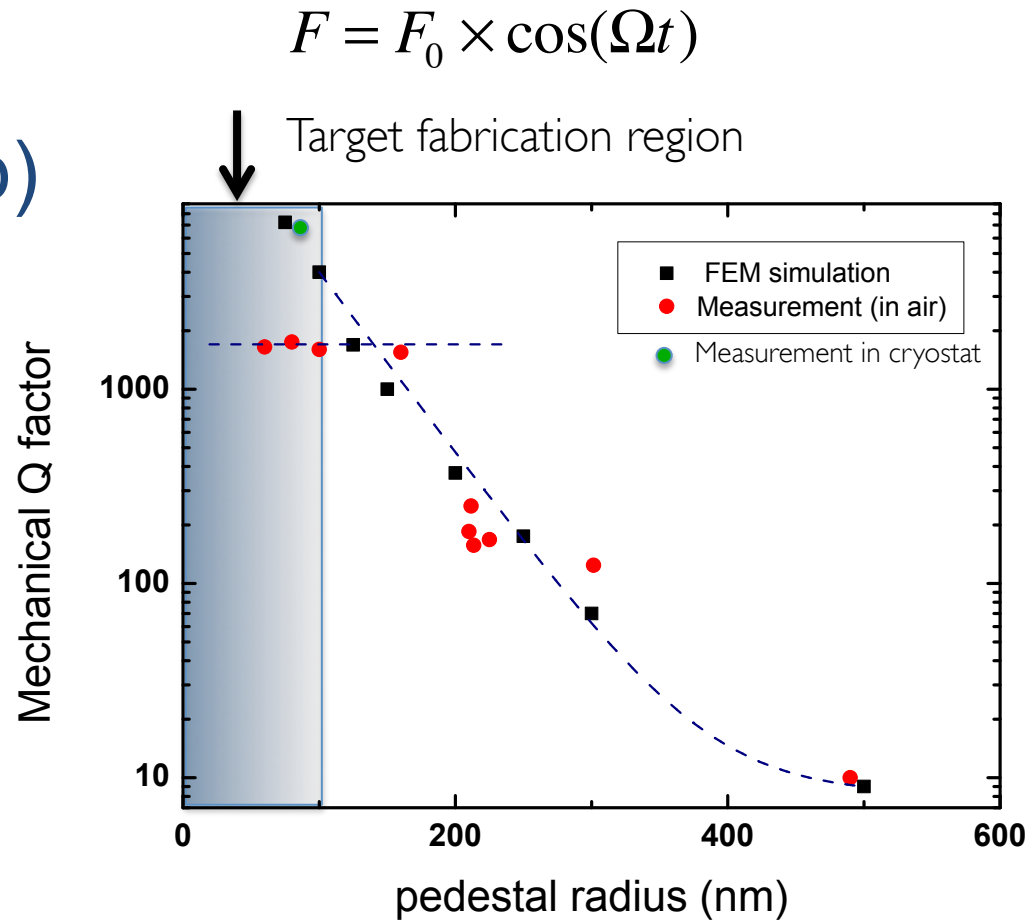

$$Q \times f_M$$

DT.NGuyen, C. Baker et al. arXiv:1309.4971, 2013.

Outline

1. Introduction
2. Whispering gallery mode resonators
3. Nanofabrication
4. Experimental guided optics
5. Mechanics of nanoresonators
6. Optomechanical coupling
7. Experimental optomechanics
8. Conclusions/perspectives

Radiation pressure in a GaAs disk resonator

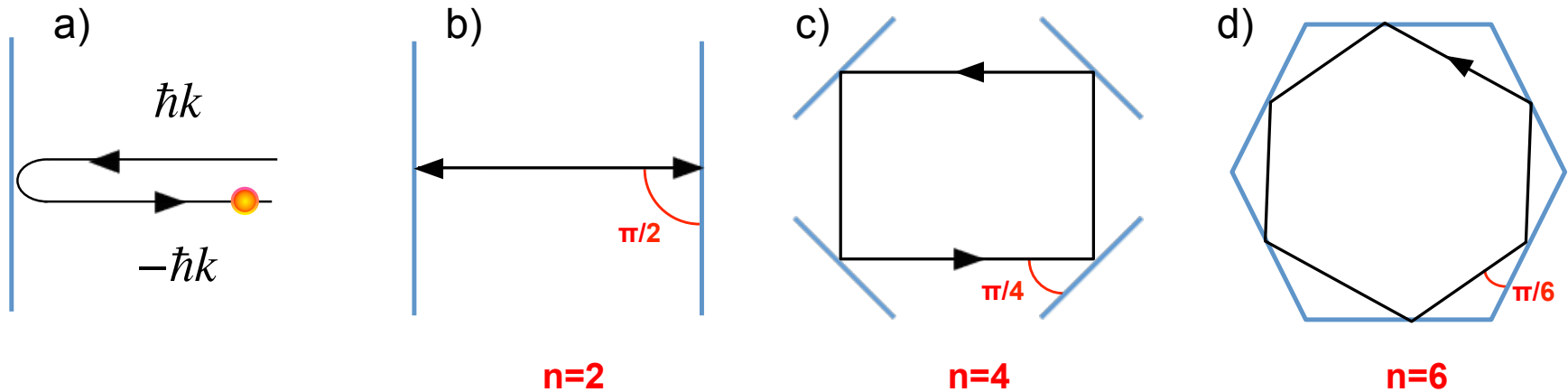

Momentum transfer per round trip in a circular cavity:

$$2\hbar k \lim_{n \rightarrow \infty} n \sin(\pi / n) = 2\pi\hbar k$$

$$F = \frac{dP}{dt} = \frac{2\pi\hbar k}{2\pi R n_{\text{eff}} / c} = \frac{\hbar\omega_0}{R} \approx 1.5 \times 10^{-13} \text{ N}$$

$$P = mg = 5.2 \times 10^{-14} \text{ N}$$

Radiation pressure force due to a single photon larger than the disk's weight !

Geometric optomechanical coupling in GaAs disks

$$2\pi nR \approx m\lambda_0$$

Mechanical deformation \rightarrow Change in cavity size \rightarrow shift in optical resonance frequency

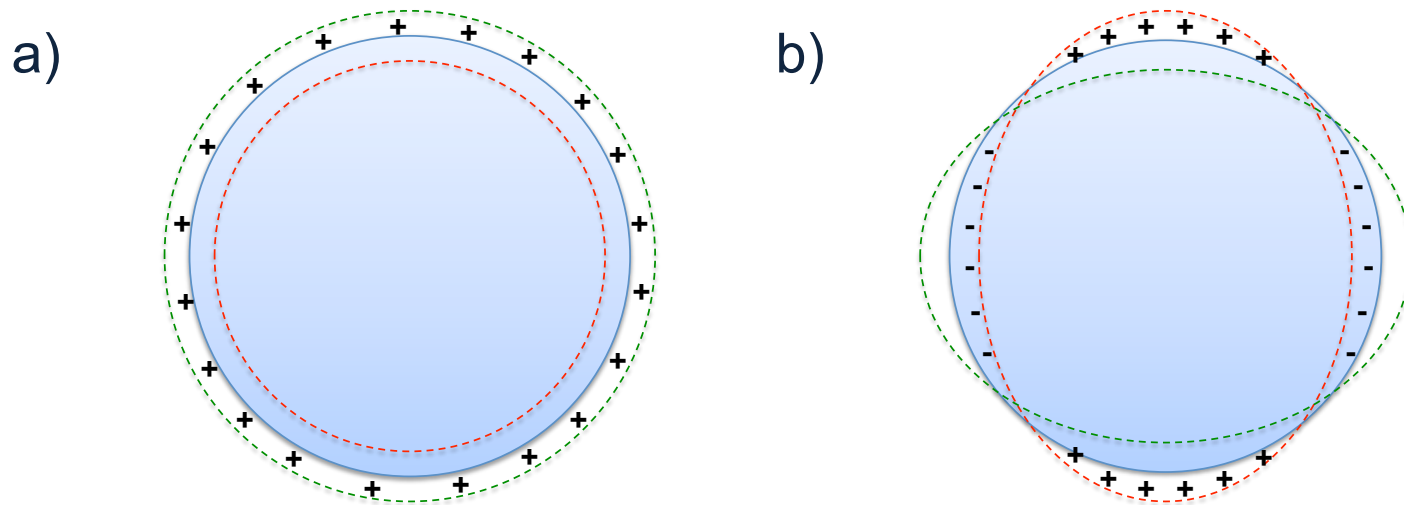

Selection rule: largest optomechanical coupling for modes with highest rotational symmetry

Calculations of g_0^{geo} in GaAs disks

For a 1 μm radius GaAs disk:

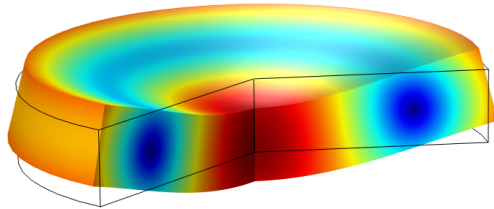

$$\Omega_M = 0.5 \text{ GHz},$$
$$g_0^{\text{geo}} = 0.32 \text{ kHz}$$

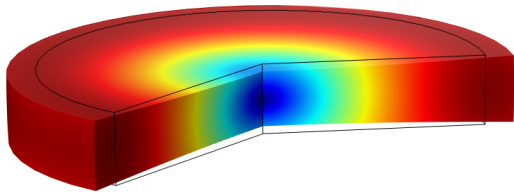

$$\Omega_M = 1.37 \text{ GHz},$$
$$g_0^{\text{geo}} = 1.3 \text{ MHz}$$

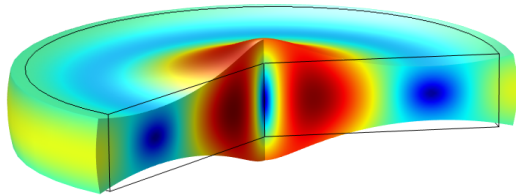

$$\Omega_M = 3.5 \text{ GHz},$$
$$g_0^{\text{geo}} = 0.5 \text{ MHz}$$

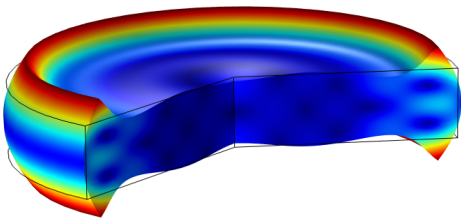

$$\Omega_M = 5.7 \text{ GHz},$$
$$g_0^{\text{geo}} = 0.18 \text{ MHz}$$

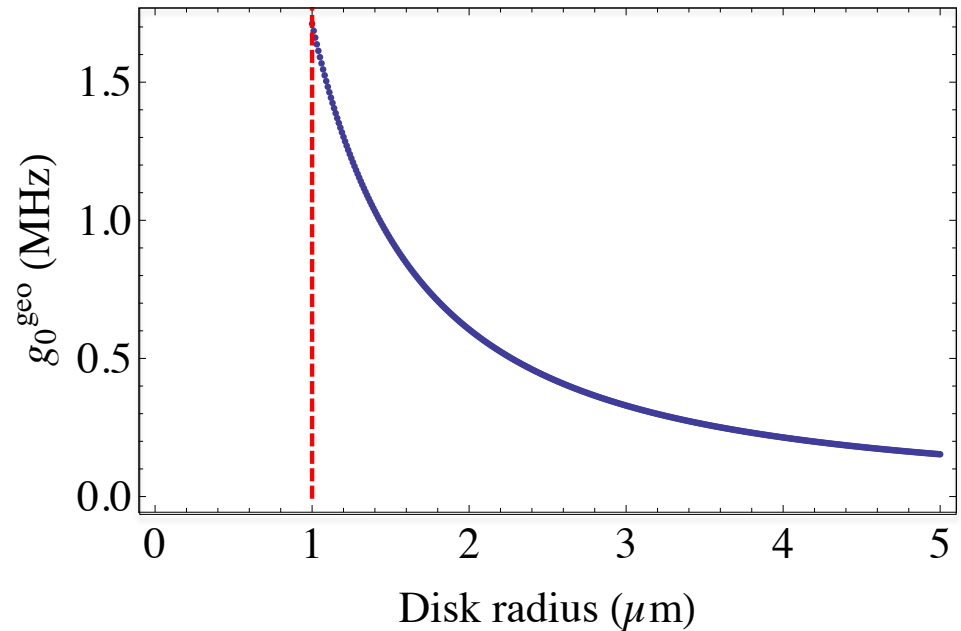

Semi-analytical derivation of g_0^{geo}

Photoelastic optomechanical coupling in GaAs disks

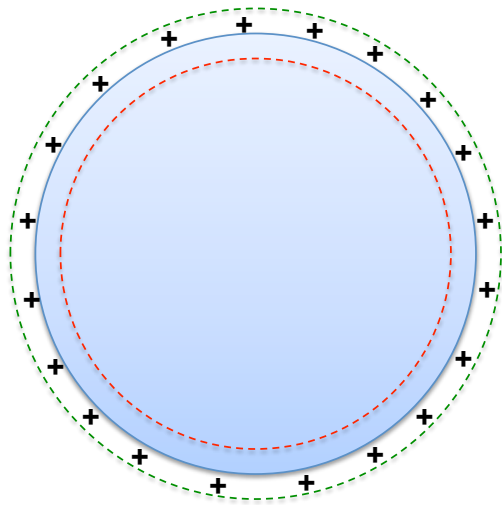

$$2\pi nR \approx m\lambda_0$$

$$\begin{pmatrix} \Delta(\epsilon_1^{-1}) \\ \Delta(\epsilon_2^{-1}) \\ \Delta(\epsilon_3^{-1}) \\ \Delta(\epsilon_4^{-1}) \\ \Delta(\epsilon_5^{-1}) \\ \Delta(\epsilon_6^{-1}) \end{pmatrix} = \underbrace{\begin{pmatrix} p_{11} & p_{12} & p_{12} & 0 & 0 & 0 \\ p_{12} & p_{11} & p_{12} & 0 & 0 & 0 \\ p_{12} & p_{12} & p_{11} & 0 & 0 & 0 \\ 0 & 0 & 0 & p_{44} & 0 & 0 \\ 0 & 0 & 0 & 0 & p_{44} & 0 \\ 0 & 0 & 0 & 0 & 0 & p_{44} \end{pmatrix}}_{\text{photoelastic tensor}} \begin{pmatrix} S_1 \\ S_2 \\ S_3 \\ S_4 \\ S_5 \\ S_6 \end{pmatrix}$$

Mechanical deformation \rightarrow deformed crystal lattice \rightarrow anisotropic *and* inhomogeneous dielectric permittivity

The p_{ij} are negative in GaAs \rightarrow geometric and photoelastic optomechanical coupling add constructively 😊

Strong photoelastic coupling in GaAs disks, $g_0^{\text{pe}} \sim 1\text{MHz}$ for the first RBM, comparable to g_0^{geo}

1st and 2nd RBM strain profile

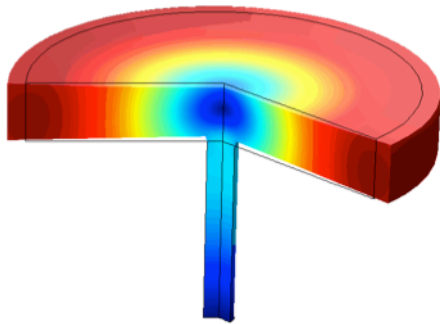

1st RBM displacement

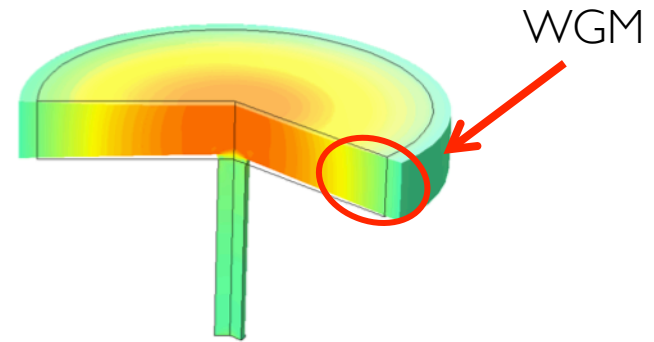

1st RBM radial strain

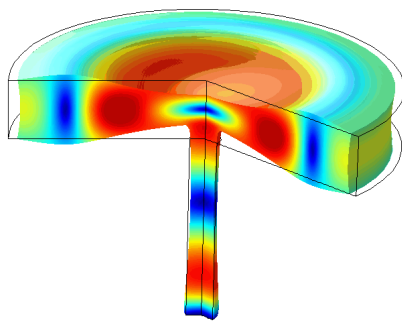

2nd RBM displacement

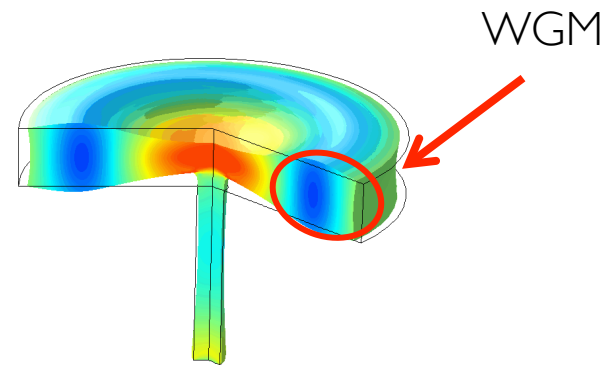

2nd RBM radial strain

$$g_0^{pe} \sim 2\text{MHz, at } 3.5 \text{ GHz}$$

C. Baker et al. *In preparation*

Outline

1. Introduction
2. Whispering gallery mode resonators
3. Nanofabrication
4. Experimental guided optics
5. Mechanics of nanoresonators
6. Optomechanical coupling
7. Experimental optomechanics
8. Conclusions/perspectives

Ultra-sensitive optical measurement of GaAs disk motion

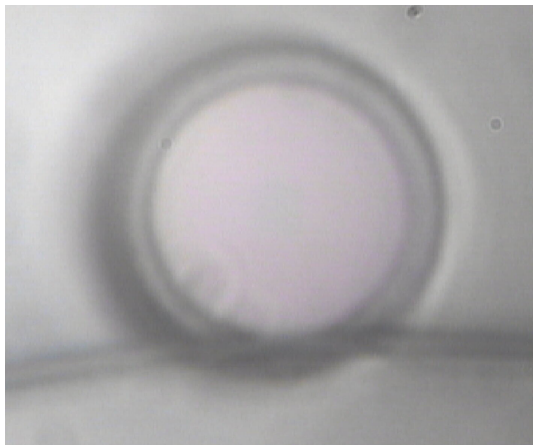

Fiber-coupled freestanding GaAs disk resonator

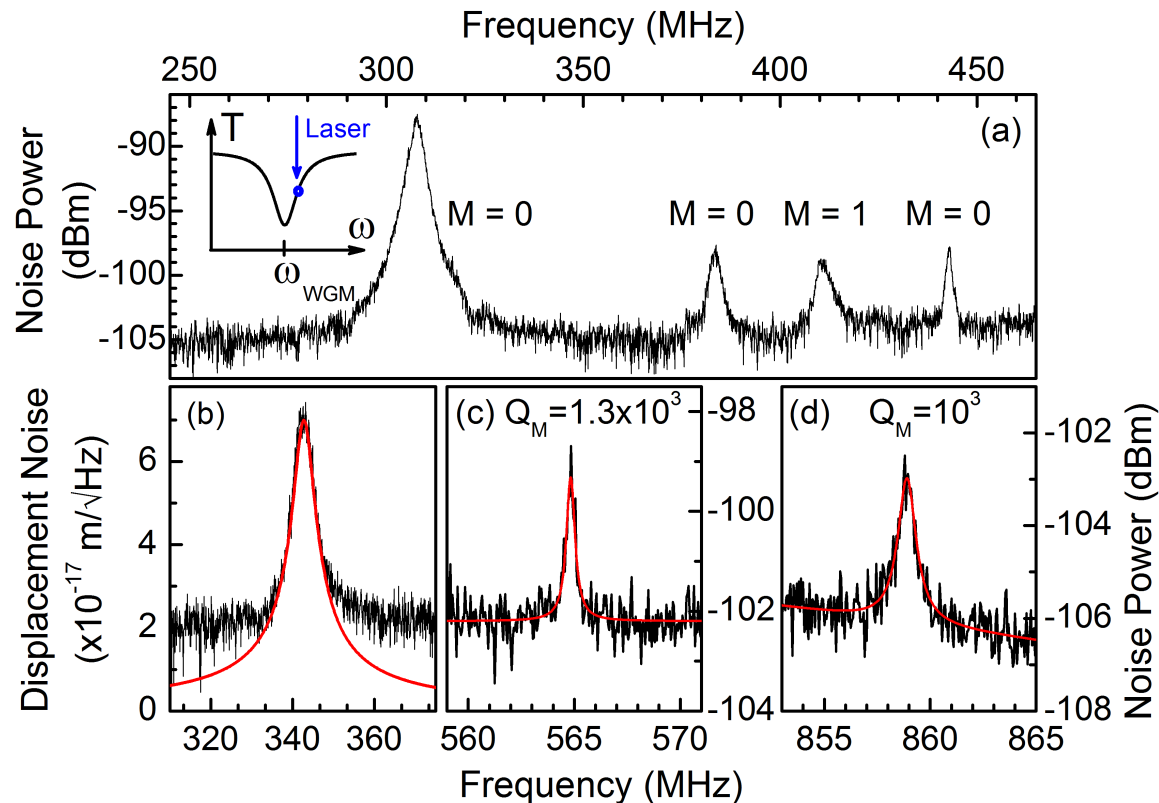
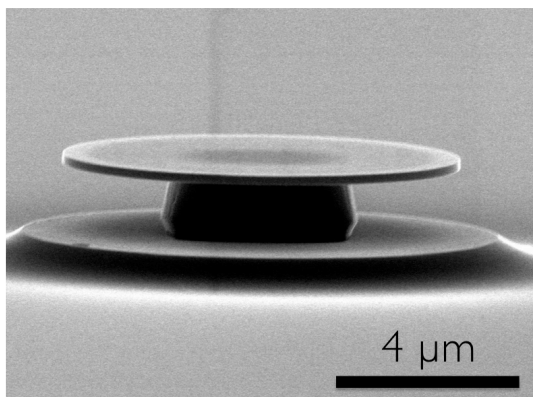

- Frequency of mechanical modes up to GHz
- In air, mechanical Q factor 50 to 10^3 ($Q \times f_M \sim 10^{11}$ in air)
- Sensitivity 10^{-17} m/ $\sqrt{\text{Hz}}$ (approaching the quantum limit)
- Optomechanical coupling $g_0 \sim 100$ kHz

L. Ding, C. Baker et al. *Physical Review Letters*, 105(26):263903, 2010.

GaAs Disk Mechanical modes above the GHz

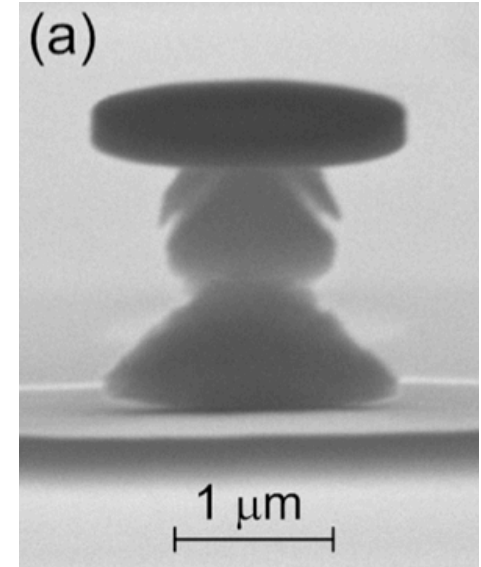
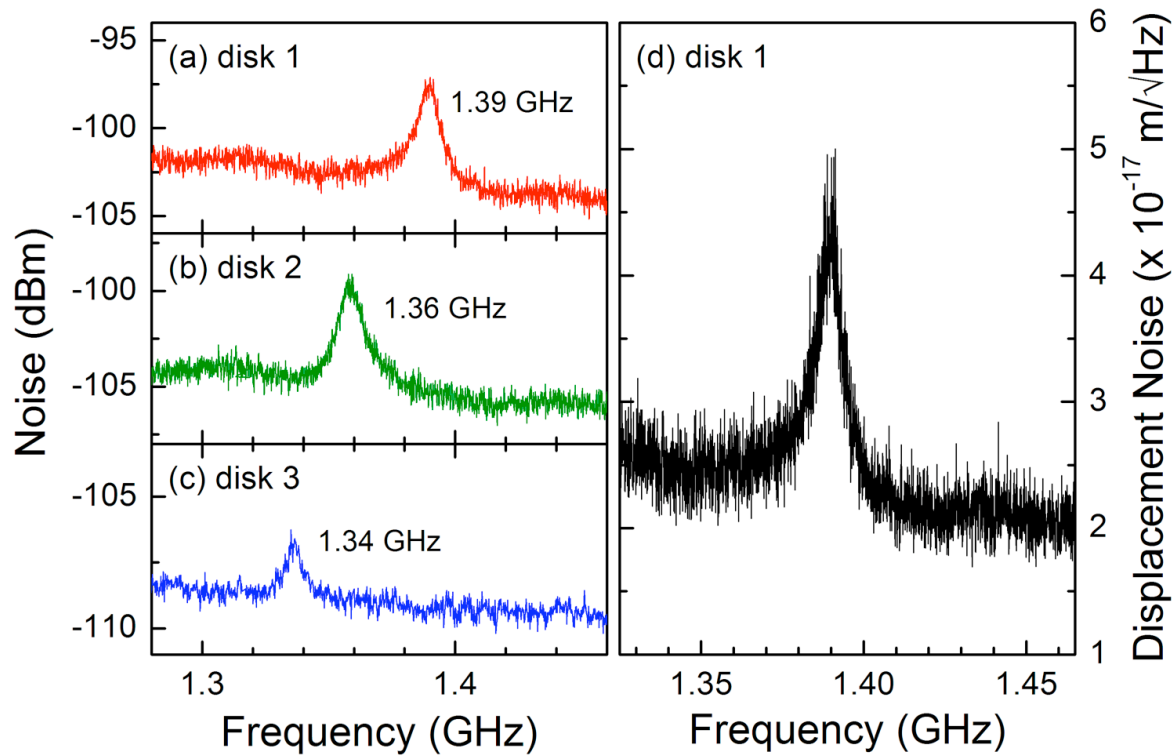

$$\text{Radius} = 1 \mu\text{m}, Q \times f_M \sim 10^{11}, g_0 \approx 1 \text{ MHz}$$

L. Ding, C. Baker et al. *Applied Physics Letters*, 98:113108, 2011.

Cryostat setup

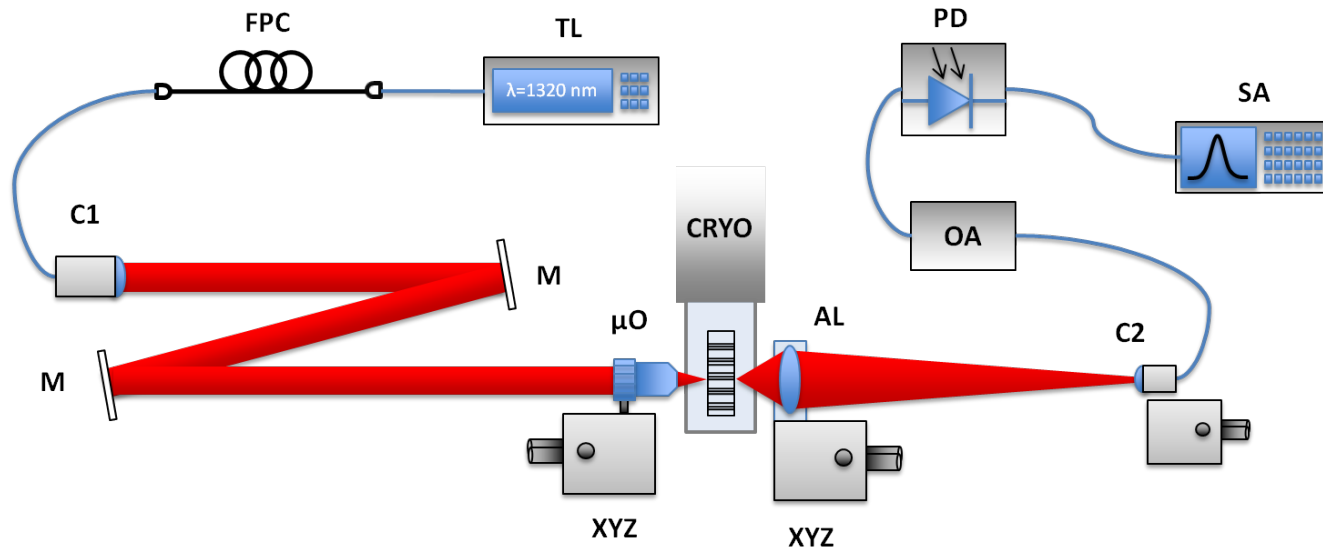
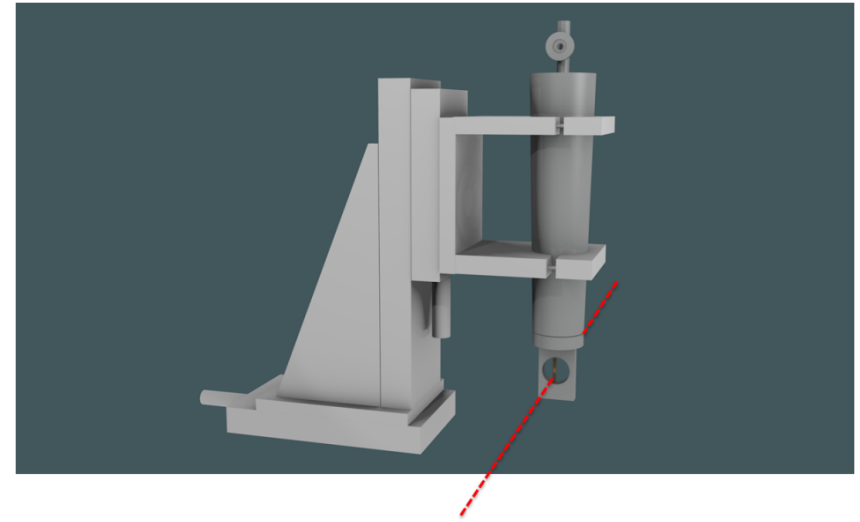
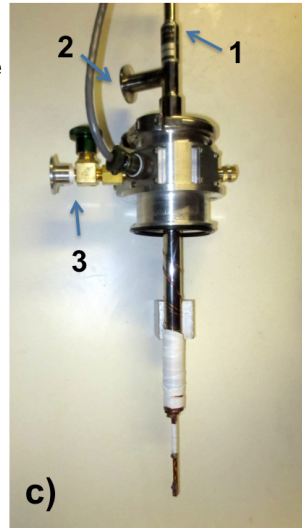
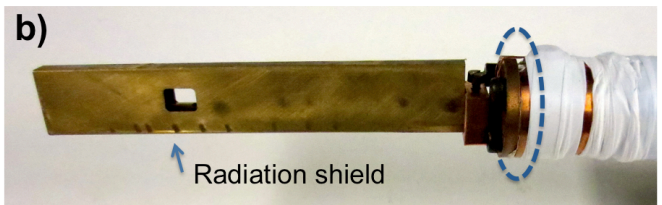
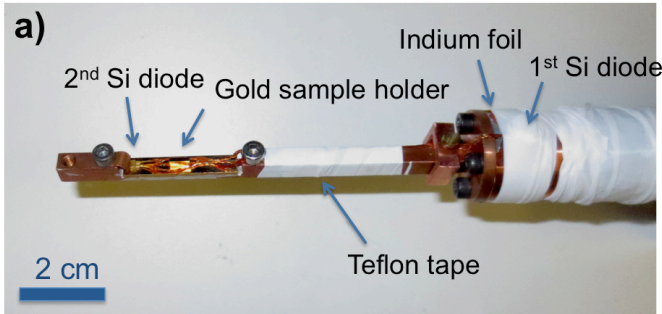

Measurements in cryostat

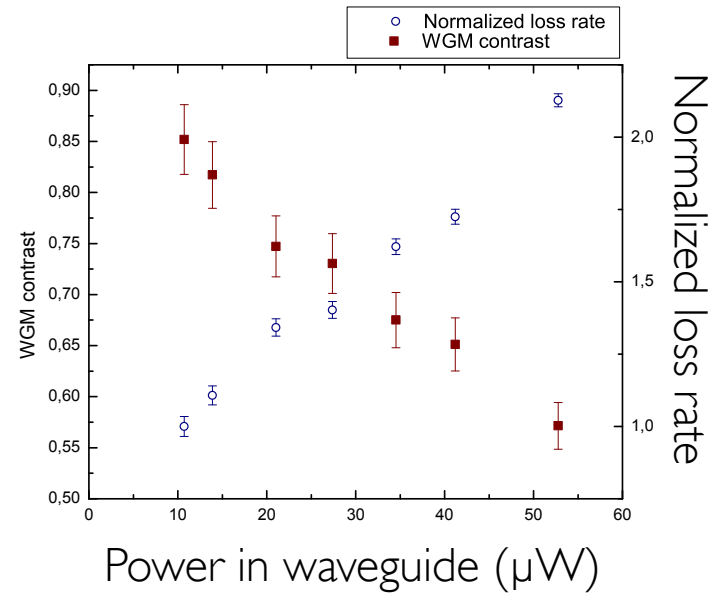
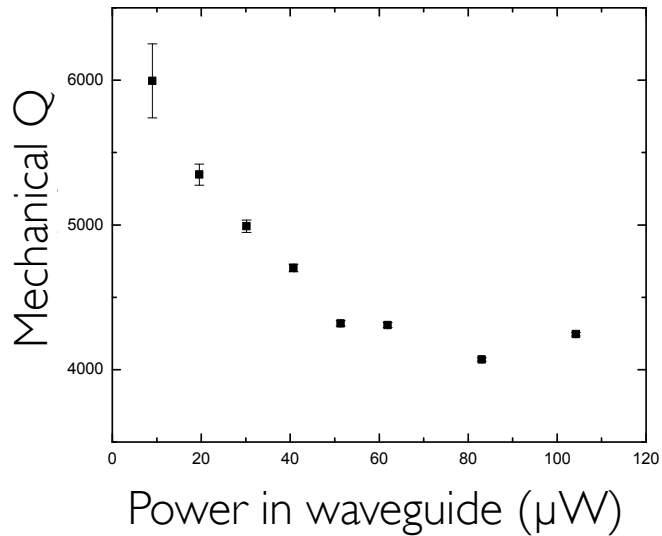
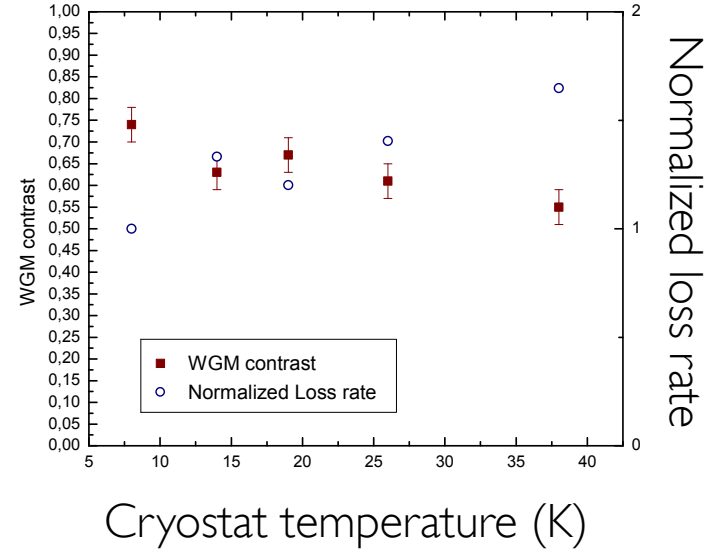
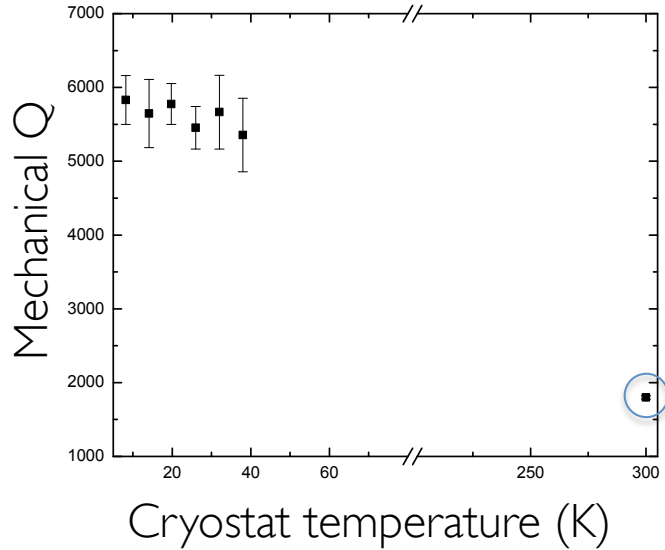

Experimental perspectives: towards quantum effects

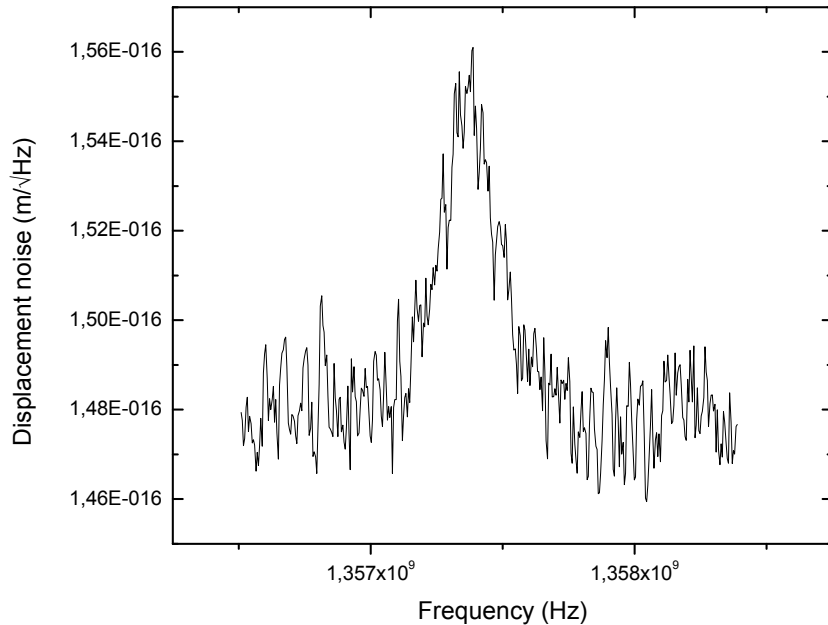

Measurement of mechanical mode thermalized at 12K:

$$n_{\text{th}} = \frac{k_B T}{\hbar \Omega_M} \sim 180 \text{ phonons}$$

$$\frac{4g_0^2 N_{\text{cav}}}{\kappa \Gamma_M}$$

- At 4K, thermal occupation $n_{\text{th}} \sim 60$ phonons
With current parameters, expect to cool by a factor ~ 100
Optomechanical cooling to quantum ground state feasible

Thanks

DON

I. Favero, G. Leo, S. Ducci, D. Parrain, D.-T. Nguyen, W. Hease, B. Guha, E. Gil-Santos, A. Andronico, A. Delga, M. Savanier, A. Orioux, S. Mariani, C. Ozanam, G. Boucher, A. Eckstein, F. Boitier, C. Autebert

LPN

P. Senellart, A. Lemaître, E. Galopin

LMU

E. Weig, S. Stapfner

MPQ

C. Sirtori, A. Servouze, C. Manquest,
P. Filloux, S. Suffit, J. Mercier,
J. Moreau, M. Apfel, P. Lepert

