



HAL
open science

Étude expérimentale de la variabilité posturale intra- et inter- individus pour la prédiction de la posture de conduite

Jeanne Bulle

► **To cite this version:**

Jeanne Bulle. Étude expérimentale de la variabilité posturale intra- et inter- individus pour la prédiction de la posture de conduite. Génie mécanique [physics.class-ph]. Université Claude Bernard - Lyon I, 2013. Français. NNT : 2013LYO10230 . tel-00948391v2

HAL Id: tel-00948391

<https://theses.hal.science/tel-00948391v2>

Submitted on 3 Oct 2014

HAL is a multi-disciplinary open access archive for the deposit and dissemination of scientific research documents, whether they are published or not. The documents may come from teaching and research institutions in France or abroad, or from public or private research centers.

L'archive ouverte pluridisciplinaire **HAL**, est destinée au dépôt et à la diffusion de documents scientifiques de niveau recherche, publiés ou non, émanant des établissements d'enseignement et de recherche français ou étrangers, des laboratoires publics ou privés.

THESE DE L'UNIVERSITE DE LYON

Présentée devant

L'UNIVERSITE CLAUDE BERNARD LYON 1

ECOLE DOCTORALE MEGA

Pour l'obtention du

DIPLOME DE DOCTORAT
(arrêté du 7 août 2006)

Spécialité : Génie Mécanique

Soutenue publiquement le 15 Novembre 2013

par

Jeanne BULLE

**Etude expérimentale de la variabilité posturale intra-
et inter- individus pour la prédiction de la posture de
conduite**

Directeur de thèse : Xuguang Wang, Ifsttar

JURY

S. Gomes	Professeur, UTBM	Rapporteur
P. Pudlo	Professeur, Université de Valenciennes	Rapporteur
L. Chèze	Professeur, UCBL	Examineur
G. Caccia Dominioni	Toyota Motor Europe	Examineur
X. Wang	Directeur de recherches, Ifsttar	Examineur
H. J. Wirsching	Human Solutions	Examineur

TITRE

Etude expérimentale de la variabilité posturale intra- et inter- individus pour la prédiction de la posture de conduite.

RESUME

Une prédiction réaliste de la posture de conduite est requise tant pour la protection individualisée des conducteurs que pour la conception de véhicules, tout particulièrement lorsque des mannequins numériques (DHM) sont utilisés dans les premières phases de développement. Des plages étendues de réglage du volant et du siège sont disponibles dans les véhicules actuels, offrant aux conducteurs de nombreuses postures de conduite possibles. Ce travail de thèse vise à quantifier la variabilité intra- (i.e. la variabilité posturale pour un même conducteur) et inter-individu (i.e. la variabilité entre différents conducteurs), ainsi qu'à développer un modèle statistique de prédiction de posture de conduite.

Les postures de conduite de 34 volontaires représentatifs de la population européenne ont été mesurées sur 5 véhicules différents. En faisant varier les ajustements initiaux du siège et du volant, une variabilité intra-individu de 22 ± 14 mm dans la direction longitudinale (x) et de 16 ± 12 mm dans la direction verticale (z) ont été observées pour la position du siège. En ce qui concerne la position du volant, une variabilité légèrement plus faible a été observée, 20 ± 15 mm en x et 13 ± 9 mm en z. La position du bassin dépend à la fois du type de véhicule et de l'anthropométrie du conducteur. Plus la hauteur d'assise du véhicule est basse, et plus le conducteur est grand, plus le siège est positionné bas et en arrière. Fait intéressant, l'angle du dossier par rapport à la verticale n'est affecté ni par l'anthropométrie du conducteur, ni par le type de véhicule.

Un modèle statistique pour la prédiction de la posture de conduite basé sur les données expérimentales est proposé et comparé à d'autres modèles prédictifs existant. Les postures de conduite recueillies expérimentalement sont aussi comparées aux prédictions obtenues avec le mannequin numérique RAMSIS. Si l'on se base sur les valeurs de variabilité intra-individu pour la position des yeux et du bassin comme critère d'évaluation des prédictions de RAMSIS, seulement 16% et 30% des prédictions peuvent être considérées comme correctes. Différentes solutions pour améliorer les prédictions sont proposées.

TITLE

Experimental investigation on intra- and inter-individual variability in automotive driving postures for their prediction using a digital human model

ABSTRACT

Realistic prediction of driving posture is required for both individualized protection and vehicle packaging especially when a digital human model (DHM) is used in early phase of a vehicle design. A large range of seat and steering wheel adjustments is available in today's vehicles, offering many possibilities in driving position. The present PhD thesis aims at quantifying intra- (i.e. postural variability for a same driver) and inter-individual (i.e. variability between different drivers) variability and developing a statistical driving posture prediction model.

Driving postures of 34 volunteers were recorded on 5 different vehicles, covering a large range of European drivers' anthropometry and vehicle types. By varying initial adjustments and comparing road and laboratory conditions, we observed an intra-individual variation in the seat position, 22 ± 14 mm in longitudinal (x) direction and 16 ± 12 mm in vertical (z) direction on average. For steering wheel position, slightly smaller variations were also observed, 20 ± 15 mm in x and 13 ± 9 mm in z directions. As expected, hip position was strongly affected by both vehicle and driver's anthropometry. Drivers sat lower and more backward for a taller driver and a higher seat. Interestingly, torso angle relative to the vertical direction was affected neither by vehicle nor by stature group.

A statistical driving posture prediction model based on collected data is proposed and compared with other existing statistical models. Collected driving postures were also compared with the predictions by the digital human software modeling package RAMSIS. If we refer to the range of intra-individual variation in hip and eye locations for assessing RAMSIS predictions, only 30% and 18% of the predictions can be considered as good. Solutions for improving predictions are suggested.

DISCIPLINE

Génie Mécanique – Option Biomécanique

MOTS-CLES

Ergonomie, Automobile, Posture de conduite, Mannequin numérique

INTITULE ET ADRESSE DE L'U.F.R. OU DU LABORATOIRE :

LBMC – Laboratoire de Biomécanique et Mécanique des Chocs (UMR – T 9406)
25, avenue François Mitterrand – Case 24
F-69675 Bron, France

Table of Contents

1	Introduction	11
2	Literature review	15
2.1	Experimental investigations on driving posture	17
2.2	Driving posture prediction models	22
2.3	Conclusion and research objectives	27
3	Experimental protocol and data processing	29
3.1	Introduction	30
3.2	Subjects	30
3.3	Vehicles	31
3.4	Experimental procedure and test conditions	34
3.4.1	Preparation of the experiments	34
3.4.2	Driving posture data collection	35
3.4.3	Questionnaire	36
3.5	Data processing	37
3.5.1	Common reference coordinate system between FARO and Vicon Data	37
3.5.2	Calculation of seat and steering wheel adjustments	37
3.5.3	Posture reconstruction	39
4	Statistical analysis of car interior adjustments and driving postures	43
4.1	Introduction	44
4.2	Data analysis methods	44
4.2.1	Questionnaire	44
4.2.2	Intra-individual variability	44
4.2.3	Effect of group of stature and vehicle package	45
4.2.4	Postural asymmetry	45
4.3	Results	45
4.3.1	General observations	45
4.3.2	Questionnaires analysis	45
4.3.3	Vehicle interior adjustments	49
4.3.4	Driving posture	51
4.4	Comparison with existing studies	55
4.4.1	Comparison with CPM model	55
4.4.2	Comparison with SAE standards	56
4.4.3	Preferred joint angles	57
4.5	Discussion	58
4.6	Conclusions	61

5	Driving posture prediction model	63
5.1	Introduction	64
5.2	General model formulation	64
5.2.1	Definition of model inputs	64
5.2.2	Definition of model outputs	65
5.3	Regression equations	65
5.4	Model assessment	67
5.4.1	Model assessment: original data	67
5.4.2	Model assessment: additional data	68
5.5	Restrictions and limitations	70
6	Comparison between RAMSIS driving posture predictions and experimental data	73
6.1	Introduction	74
6.2	Methods	74
6.2.1	RAMSIS posture simulation	74
6.2.2	Methods of comparison	75
6.3	Results	76
6.4	Discussion	78
6.5	Conclusion	79
7	Conclusion and perspectives	81
7.1	Summary of main findings	82
7.2	Principal limitations	83
7.3	Perspectives	84
8	Appendix	87
8.1	Literature review	88
8.1.1	Vehicle packaging terminology	88
8.1.2	SAE J941 – Motor vehicle drivers’ eye locations	89
8.1.3	CPM posture prediction model	91
8.2	Experimental protocol	93
8.2.1	Main anthropometric characteristics of participants	93
8.2.2	Correlation between main anthropometric dimensions	97
8.2.3	Vehicle measurements protocol	97
8.2.4	Main vehicle packaging measurements	100
8.2.5	Markers placement for driving posture data collecting	101
8.2.6	Questionnaire	102
8.2.7	RAMSIS Kinematic model	104
8.3	Vehicle adjustments and driving posture analysis	105
8.3.1	Correlation with main anthropometric dimensions	105
8.4	RAMSIS posture prediction - Parametric study	107
8.4.1	Objectives and methods	107
8.4.2	Results	110

8.4.3 Discussion	117
------------------------	-----

9 Synthèse 119

9.1 Introduction	120
9.2 Etat de l'art	121
9.2.1 Processus d'adaptation de la posture de conduite	121
9.2.2 Angles articulaires privilégiés	122
9.2.3 Modèles de prédiction de la posture de conduite	122
9.2.4 Conclusion et objectifs de recherche	126
9.3 Analyse statistique des réglages du poste de conduite et de la posture de conduite.....	126
9.3.1 Méthodes et procédures expérimentales.....	126
9.3.2 Variabilité intra-individu	129
9.3.3 Variabilité inter-individus	130
9.3.4 Comparaison avec les standards de la SAE	131
9.4 Modèle statistique de prédiction de la posture de conduite	133
9.4.1 Formulation du modèle.....	133
9.4.2 Validation du modèle.....	134
9.4.3 Limitations du modèle prédictif	135
9.5 Evaluation du modèle de prédiction de la posture de conduite de RAMSIS.....	136
9.6 Conclusion et perspectives.....	139

10 References 141

Remerciements

De nombreuses personnes ont contribué à l'aboutissement de ce travail, aussi je tiens à les remercier chaleureusement. « Faire une thèse » est une expérience qui n'est pas tous les jours facile, et qui nous met souvent à rude épreuve. Alors après plus de 3 ans d'efforts, laissons place à un peu de légèreté. Les paroles qui suivent ont été librement (et largement) adaptées de la chanson « Le trophée » de Pierre Perret (1992), et sont bien évidemment à prendre avec beaucoup d'humour et de deuxième degré.

Je viens ce soir pour ma récompense
J'avais dit-on des chances infimes
Modestement j'ai eu je le pense
Un coup d' génie en écrivant cette thèse
Je remercie l'équipe tout entière
Et l' directeur du laboratoire
Les techniciens, et les gars d'Unex
Et puis Brigitte, et bien sûr Geneviève
Je remercie Xuguang, Sabine et Giancarlo
Et mes parents qui m'ont fait si intelligente

Je n'oublie pas mes deux rapporteurs
Qui ont tout lu, jusqu'au dernier mot
Ni tous les autres membres du jury
Kawata-San, et l'équipe de TME
Tous les essais, avec les volontaires
Qui essayaient tout jusqu'à mon divan
Je remercie bien sur les stagiaires
Qui m'ont aidé pendant les manips
Je remercie Dorian, Anne-Laure et Clémentine
Doris, Sophie, Florence, Julien et Rominou

Je remercie les femmes de ménage
Qui m' dégottaient mes barbituriques
Et le jury qui trouvait dommage
Que les manips manquent de comique
Merci encore de l'aide si précieuse
De l'assistante qui gardait Paulo
Et du soutien dans les heures creuses
De Clémentine et de nos tasses de thé
Je remercie Ahmed, Naoual et les Juliens
Alex, Laurent, Jean-Mi, Sandra et Jérémie

Je remercie bien sûr ma famille
Celle qui est loin, et celle qui est tout près
Mes frères et sœurs, et mon petit Paul
Et puis Pablo qui me supporte tout l'temps
Je remercie l'équipe du Vercors
Et le public qui m'ont dit génial
Même le jury qui écrit sans tendresse
Que je s'rais mieux dans le rôle de l'assistante
Merci à Véronique, à l'équipe d'l'a cantine
Et puis à Mo qui m'app'lait toujours ma chérie

Ce beau trophée enfin je l'partage
Avec mon psy qui est mort d'épuis'ment
Mon co-bureau fumace qu'au final
J'ai fait une thèse meilleure que la sienne
Je s'rais ingrate d'en profiter seule
Et j'attribue leur part de gâteau
Aux doctorants qui font tous la gueule
Et aux sujets, qui sont à l'hosto
Je remercie encore Pablo et petit Paul
Et mes parents qui m'ont fait si intelligente

1 Introduction

The evolution of social demands, particularly in terms of personalized products, the increasing global trading and the need to reduce more and more the duration of design phase, among others, give an unquestionable place to ergonomics in the products' design process.

This work deals with the ergonomics of the passenger car, and more particularly with the interactions between the driver and the car cabin (i.e. the seat and the driving commands). Applied to car cabin design, computer-aided ergonomics (CAE) can assist manufacturers in improving their product in more effective and proactive ways. In the past, engineers mainly worked on physical mock-ups to optimize the driver cockpit configuration. They were therefore limited by the time and cost of fabrication of these mock-ups. More importantly, ergonomic assessment was made late in the design process. Nowadays, CAE makes it possible to shorten development time, and ergonomics evaluations can be done much earlier in the design process.

Digital Human Models (DHM) are now widely used in the ergonomics field, and allow designers to have a better knowledge of the interactions between future users and new product, and to assess the product ergonomics through virtual simulation. Each foreseen innovation can then be tested extensively in order to anticipate the consequences of any new technical solution, and this even before starting the production of the vehicle.

However, the use of DHM in early phase of vehicle design requires a realistic prediction of driving posture. A large range of seat and steering wheel adjustments is available in today's vehicle, offering many possibilities in driving position. Differently sized drivers adopt different driving positions. Even if the driving cockpit is a quite confined space, two drivers with similar body size can sit in different postures, and even a same driver can adopt different driving postures from time to time. Vehicle factors (e.g. vehicle class or interior geometry) have been demonstrated to also substantially affect driving posture (Chapter 1). How to correctly position a virtual mannequin within the environment is therefore a critical issue for vehicle packaging when a DHM is used.

An accurate prediction of driving posture is also required for individualized protection of drivers (e.g. deployment characteristics of the airbags). In case of frontal impact, the mass of the driver, as well as the distance between the steering wheel (location from which the airbag is deployed in case of frontal impact) and the driver are key factors in determining the nature and severity of injuries driver receives [1, 4] and [11]. For instance, a short driver, by sitting closer to the steering wheel, may suffer injuries by hitting the airbag in its deployment phase. On the contrary the distance between driver and steering wheel increases for tall drivers, and in some cases they can hit the airbag that has already started to deflate. This, coupled with an heavier body mass can make the driver go through the airbag and hit the steering wheel. Therefore, for safety purposes, it is of primary importance to be able to accurately predict driving posture (including distance from the driver to the steering wheel), as well as driver size.

In this context, the overall objective of the current work is therefore to better understand the driving posture selection. In spite of a large amount of experimental investigations on driving postures (see Chapter 2), very few have focused on the observation of intra- (i.e. variability for a same driver) and inter-individual (i.e. variability between different drivers) postural variabilities from real vehicles. In this work, we will study both intra- and inter-individual postural variabilities, and investigate the effects of driver's anthropometry and

vehicle design factors on the driving posture. As the intra-individual variability can be considered as the range of errors that a simulation should respect, currently existing driving posture methods including RAMSIS, a DHM tool largely used in automotive industry, will be assessed.

This dissertation is organized in six chapters.

The first chapter gives a state of the art of existing work on experimental investigation and on driving posture prediction, and identify the work hypothesis and objectives.

The experimental protocol and procedure used in this study as well as the data processing are presented in Chapter 2.

In the third chapter, the collected data is analyzed and intra-individual variability in both vehicle interior adjustments and posture is quantified. The influence of driver's anthropometry and vehicle package on driving posture is also presented in this chapter.

Based on the experimental data analysis, a statistical driving posture prediction model is developed and evaluated in Chapter 4.

In Chapter 5, the RAMSIS driving posture prediction tool is assessed by comparing RAMSIS predictions with driving postures observed experimentally.

Finally, the last chapter summarizes the main findings and limitations of this study, and presents recommendations for future work.

2 Literature review

In a given vehicle, a driver can adopt more than one driving posture thanks to multiple adjustments available.

These feasible postures must allow the driver to perform the following driving tasks:

- to manipulate the steering wheel,
- to manipulate the different pedals,
- to manipulate gearbox and other hand controls,
- to correctly see the road (visibility outside), and
- to correctly see internal displays (visibility inside)

These requirements lead to physical constraints (i.e. restrictions) on the location of several body parts of the driver, which reduces the range of possible driving postures that a driver can adopt. For example, the position of the steering wheel leads to a constraint on the position of driver's hand. Similarly, the position of pedals results in a constraint on the position of driver's feet. In addition, the vehicle layout represents another set of constraints on the posture due to limited ranges of seat and steering wheel adjustment. On the other hand, driver's anthropometry (e.g. stature) and physical limitations (e.g. joint range of motion) are also important parameters in the definition of the range of feasible driving postures. For instance, due to the length of his legs, a short driver will not be able to fully depress the pedals if the driver places the seat in a very backwards position.

The overall driving posture selection process must also deal with postural comfort. Indeed, it is likely that among the range of feasible driving postures, a driver will choose a comfortable one. At the same time, the selected driving posture is also influenced by psychological factors (e.g. training) and other factors such as driving duration.

The driving posture adaptation process deals with all these factors in a complex way (Figure 1), making the understanding of the posture selection process not so straightforward.

In what follows, both experimental investigation and modelling of driving postures will be reviewed.

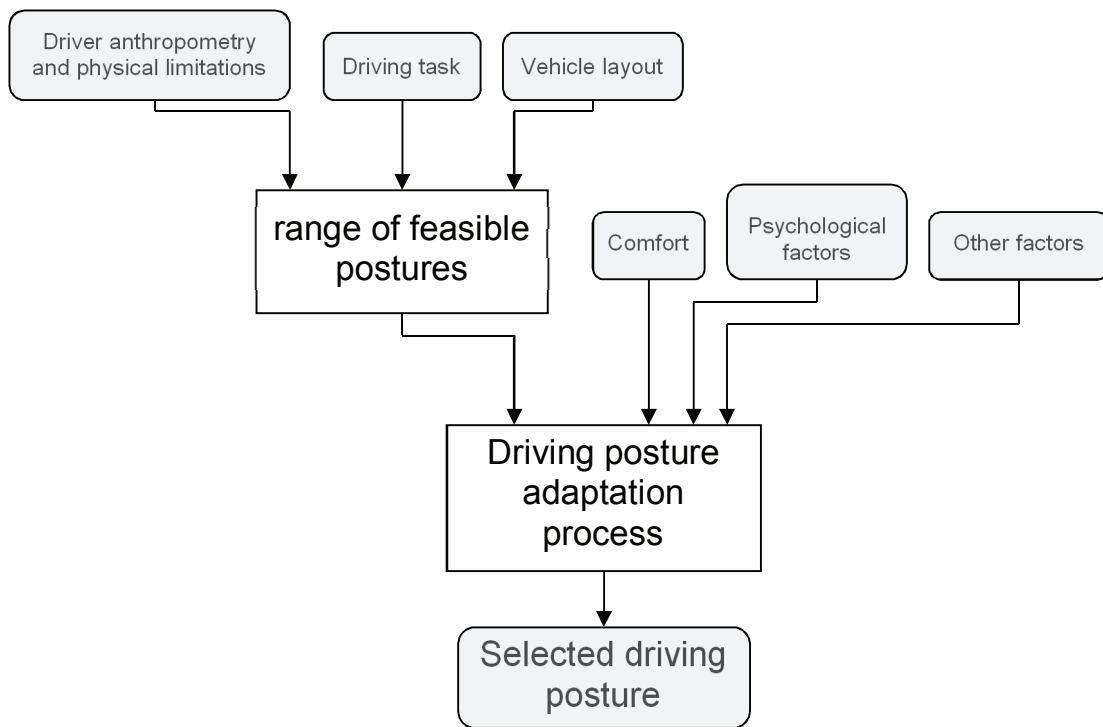

Figure 1: Driving posture adaptation process

2.1 Experimental investigations on driving posture

A large amount of experimental studies have already been carried out for the determination of preferred and/or optimum joint angles in automotive sitting posture. However, several factors such as the number of participants, driving venue, seat design, or vehicle class tested can differ from one study to another. Due to these differences, comparisons can sometimes be difficult. Table 1 summarizes the main results of most relevant studies found on the definition of preferred joint angle ranges [37]. Preferred joint angles are defined as follow:

- hip angle: angle between driver's thigh and the line passing through the hip point and the shoulder joint in the sagittal plane.
- elbow angle: angle between the arm and the forearm segments in the plane of the segments. Greater values correspond to more extended arm.
- knee angle: angle between thigh and leg segments in the plane of the segments. Greater values correspond to more extended leg.

Two categories of factors can have a significant influence on driving posture: human related factors (i.e. individual differences in anthropometry, age or gender), and vehicle factors (i.e. class of vehicle, differences in vehicle geometry or type of seat).

Regarding human related factors, several studies investigated the effect of gender on preferred driving posture [13, 17, 25, 26, 30]. Hanson et al. [13] found no significant differences between males and females, contrary to the four other studies. Park et al. performed two studies [25, 26] in which they investigated the effect of gender on driving posture. In the first one [26], they found significant gender differences in elbow, shoulder and foot-calf angles. However, in their second study [25], gender differences were found only for shoulder and elbow angle. Porter and Gyi [30] observed that males generally preferred a more "open"

posture (i.e. more extended elbow and trunk-thigh angles). Kyung and Nussbaum [17] also found gender differences at the left elbow in Sedan and for both elbows in SUV. However, in most of these studies gender is strongly linked to stature. For instance, in the study by Kyung and Nussbaum [17], short volunteers were almost all females, while tall volunteers were almost all males. Therefore, the effect of gender could be due to differences in stature.

Regarding the effect of stature on selected driving posture, Reed [32] found that stature is the primary determinant of driver's hip fore-aft position. He also observed that the ratio of sitting height to stature is an important predictor of hip-to-eye angle and elbow angle. Kyung and Nussbaum [17] also observed a significant effect of stature on left hip angle for both Sedan and SUV. Park et al. [26] observed that all angles except trunk-thigh angle had a "reducing tendency as the body sizes of the subjects increased". Hanson et al. [13] found that stature had a significant effect on preferred interior adjustments, however they found no differences in postural angles between short and tall drivers.

The age of the driver is also another factor that may influence driving posture [14]. Milne and Lauder [21] observed different forms of spinal curvature in the sixth decade of life. However, only few studies investigated the effect of age on preferred joint angles in the driving position. Kyung and Nussbaum [17] observed that 2 to 6 joint angles (depending on vehicle class) are smaller for subjects over 60 years old.

Few studies investigated the influence of vehicle factors on driving preferred joint angles. However they may influence driving posture. Preferred joint angles have been widely investigated for Sedan-type vehicles, but very few studies gave preferred joint angles for other vehicle classes (e.g. Sport Utility Vehicles (SUV)) [17, 48]. However, since vehicles may differ in package geometry and adjustment ranges (for example, sedans have 60 mm lower seat and 15 mm higher steering wheel center height on average than SUVs [18]), it is likely that different driving postures will be observed between vehicle classes. Diffrient et al. [8] defined different seat back rest angle for several vehicle classes, but they did not include other postural angles in their study. Kyung and Nussbaum [17] investigated comfortable joint angle ranges in both Sedan and SUV. They found that "a distinct set of recommended joint angles is need for each vehicle class".

Kyung and Nussbaum [17], and Oudenhuijzen et al. [23] also studied the influence of different seats on selected driving posture. Oubenhuijzen et al. [23] found differences in knee angles between two different seats (the first one was a medium soft seat while the second one was a firm seat). Kyung and Nussbaum [17] also tested two different seats (one with higher and one with lower comfort rate) in both Sedan and SUV. They found significant differences only in right hip angle for the Sedan, and in left hip and left knee angles for the SUV.

It is important to note that most of these studies present two principal limitations. The first one is that most of them were performed in laboratories, often allowing larger adjustable workspace than that offered by actual vehicles. Therefore, actual joint angles may differ from the ones observed in field-based studies. For instance, Kyung and Nussbaum [17] observed a significant effect of driving venue for Sedan. Moreover, a laboratory mock-up can hardly represent all the constraints linked to the driving task. However, a less constrained environment leads to a larger range of possible postures, and may lead volunteers to choose a driving posture that would not be possible in a real vehicle environment. Therefore it should be kept in mind

that the experimental determination of preferred driving posture is largely dependant on the experimental set-up.

The second main limitation is that most of the authors assumed driving posture to be symmetrical, because the pedals were not considered. Therefore only one side of the body was studied. However, Hanson et al. [13] and Kyung and Nussbaum [17] investigated postural differences between left and right sides. Hanson et al. [13] found differences in elbow, hip, shoulder and wrist angles, while Kyung and Nussbaum [17] highlighted differences in elbow, hip and knee angles for both Sedan and SUV, and also in shoulder and ankle angles in the SUV.

Table 1: Overview of most relevant studies on optimum and preferred joint angles for driving posture.

Reference	Method			Results		Additional		
	Subjects	Experimental environment	Measuring method	Vehicle class	Hip angle		Elbow angle	Knee angle
Seidl [38]	47 (23 males, 24 females)	Laboratory mock-up :	Driving posture measured with Vicon 3D measurement system.	n. s.	99	127	119	
		<ul style="list-style-type: none"> ▪ 3 directions adjustable steering wheel ▪ seat adjustable in fore/aft, height and backrest angle ▪ pedal adjustable in height Driving simulator (10 minutes test)						
Ribouchon [35]	45 (34 males, 11 females)	Laboratory mock-up:	16 reflective markers placed on anatomical landmarks on the right side of the driver.	n. s.	132.1 ± 13.0	138.5 ± 18.1	126.1 ± 10.2	
		<ul style="list-style-type: none"> ▪ steering wheel adjustable in fore/aft, height and tilt ▪ seat adjustable in height, backrest angle, cushion angle, lumbar support position ▪ position of foot rest adjustable in fore/aft and tilt angle 	Driving posture measured from 2 simultaneous photographs (right side view and ¾ front view) + dorsal profile given by 13 probes on the seat back. Mock-up adjustment levels measured from 12 potentiometers placed on the mock-up.					
Porter and Gyi [30]	55 (28 males, 27 females)	Laboratory mock-up :	Joint markers positioned on anatomical landmarks. Postural angles were recorded on subject's right-hand side with a goniometer (the average of 3 readings was recorded).	7 experimental seats with different foam density derived from the seat of a small family car.	90 - 115	86 - 164	99 - 138	
		<ul style="list-style-type: none"> ▪ floor, steering wheel and pedals adjustable around the seat ▪ seat adjustable in tilt, backrest angle and lumbar support ▪ pedals, gearbox and steering wheel incorporated some realistic force Driving simulator (2,5 hours test route)	Driving posture measured whilst semi-depressing the accelerator pedal, with hands on the steering wheel and looking ahead.				Gender difference	
Park et al. [26]	36 (20 males, 16 females) representative of the automotive driving population of Korea	Laboratory mock-up :	Driving posture measured with Vicon 140 motion analysis system. Seat adjustments levels measured with a Driving Posture Monitoring System. Body pressure distributions measured using Body Pressure Measurement System [27]	Seat selected as the most comfortable seat out of sixteen seats [27]	Mean ± SD (range) 115.8 ± 6.5 (101 – 127)	Mean ± SD (range) 111.5 ± 11.4 (88 – 137)	Mean ± SD (range) 132.7 ± 6.9 (120 – 151)	Gender difference

Reference	Subjects	Method Experimental environment	Measuring method	Vehicle class	Hip angle	Elbow angle	Knee angle	Additional
Park et al. [25]	43 (24 males, 19 females) representative of the automotive driving population of Korea	Laboratory mock-up : ▪ Seat mounted on a seat buck, equipped with a steering wheel and a "dead" pedal at a 60° angle for the right foot ▪ Available adjustments: front and back tilt function of cushion, reclining function of back, and sliding function	Driving posture measured with Vicon 140 motion analysis system. Seat adjustments levels measured with a Driving Posture Monitoring System.	n. s.	Mean ± SD (range) 117.4 ± 7.7 (103 – 131)	Mean ± SD (range) 113.0 ± 14.0 (86 – 144)	Mean ± SD (range) 133.7 ± 8.5 (120 – 152)	Gender difference
Hanson et al. [13]	38 (17 males and 21 females)	Laboratory mock-up : ▪ Flexible geometry: pedals, steering wheel and seat electrically adjustable in x (forward/backward) and z (up/down) directions. ▪ Angle of foot rest and depth of the seat manually adjustable ▪ Driving simulator	Driving posture recorded every 30 seconds with two synchronised cameras. Interior coordinates of heel point, steering wheel centre and hip point continuously measured during the tests with a position system.	non-brand specific except for the seat (Saab unique). Extended adjustment ranges compared to a normal vehicle.	Left 100 ± 4.4 Right 87 ± 6.3	Left 128 ± 16 Right 135 ± 15	Mean ± SD (range) 125 ± 9.3 (109 – 157)	Significant differences between the left and right side No significant gender difference
Kyung and Nussbaum [17]	38 (18 males, 20 females)	Two driving venues. ▪ Laboratory based: driving rig with adjustable seat and steering wheel ▪ Field In both cases driving was conducted for 20 minutes.	Surface landmarks measured with FARO arm digitizer.	Sedan and SUV with two different seats each	Sedan Left 79 – 87 (G1) 107 – 118 (G2) Right 83 - 92 (G1) 112 – 123 (G2) SUV Left 84 – 87 (G1) 119 – 126 (G2) Right 85 – 91 (G1) 120 – 130 (G2)	Sedan Left 85 - 120(G1) 146 - 165 (G2) Right 85 - 108 (G1) 133 - 167 (G2) SUV Left 84 – 116 (G1) 121 - 160 (G2) Right 84 – 109 (G1) 117 – 157 (G2)	Sedan Left 84 - 91 (G1) 118 - 129 (G2) Right 93 - 110 (G1) 123 - 142 (G2) SUV Left 95_ 105 (G1) 135 – 138 (G2) Right 97 - 111 (G1) 136 - 139 (G2)	Gender difference Significant differences between the left and right side

2.2 Driving posture prediction models

Three different categories of driving posture prediction models are reported in the literature: optimization based models, statistical regression models and hybrid models. Hybrid methods are a combination of both optimization-based and statistical regression models.

- Statistical regression models

The Society of Automotive Engineers (SAE) proposed a set of two-dimensional accommodation tools that are traditionally used for designing the cockpit, including recommended seat position, hand reach envelopes, head contours and eye ellipse [36]. Among them, the SAE J1517 (related to driver's hip position) [41] and SAE J941 (related to driver's eye location) [44] are of principal interest.

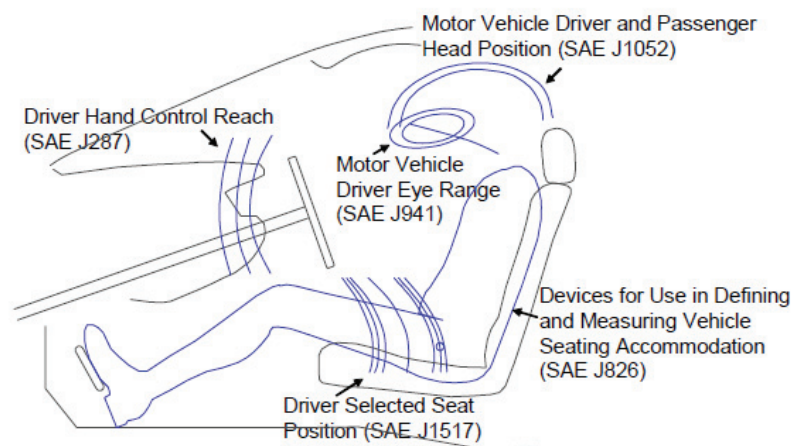

Figure 2: SAE accommodation design tools and recommended practices [16]

SAE J1517 provides a percentile accommodation method in the form of a set of 7 equations to describe driver selected seat position for certain percentages of drivers (E.1 to E.7). These equations describe the seat longitudinal position (X) in function of driver's seat height (z) for a mixed population (ratio male to female = 1:1).

$$X_{97.5} = 936.6 + 0.613879z - 0.00186247z^2 \quad (E.1)$$

$$X_{95} = 913.7 + 0.672316z - 0.00195530z^2 \quad (E.2)$$

$$X_{90} = 885 + 0.735374z - 0.00201650z^2 \quad (E.3)$$

$$X_{50} = 793.7 + 0.903387z - 0.00225518z^2 \quad (E.4)$$

$$X_{10} = 715.9 + 0.968793z - 0.00228674z^2 \quad (E.5)$$

$$X_5 = 692.6 + 0.961427z - 0.00226230z^2 \quad (E.6)$$

$$X_{2.5} = 687.1 + 0.895336z - 0.00210494z^2 \quad (E.7)$$

where X_i is the location in mm of the i th percentile H-point with respect to the ball of foot reference point (the H-point is the pivot center of the torso and thigh on the two- or three-dimensional devices used in defining

and measuring vehicle seating accommodation (see [43]), and z is the height of the H-point above the accelerator heel point (H30) in mm¹.

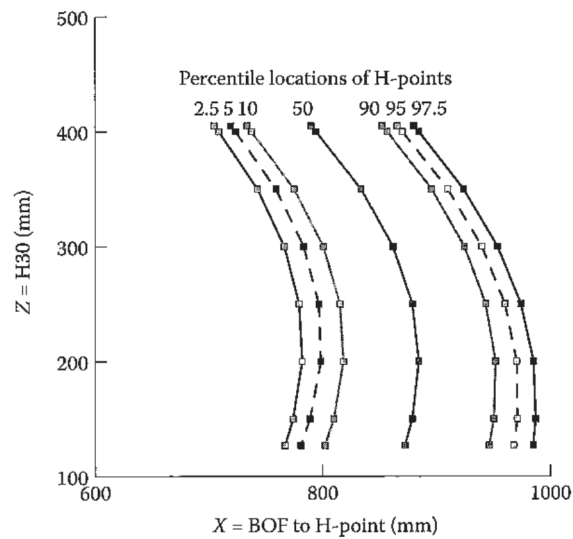

Figure 3: H-point location curves for 2.5 to 97.5 percentile H-points as functions of H30 for class A vehicles (reproduced from Ergonomics in the automotive design)

In addition, SAE J4004 [42] standard provides a seat position prediction model (E.8) based on work by Flannagan, Scheider and Manary [9, 10] for class A vehicles, in which individual seat position was found to be best predicted by stature, regardless of gender. It also takes into account the transmission type (presence or absence of clutch pedal).

$$X = 16.8 + 0.433(\text{stature in mm}) - 0.24(H30) - 2.19(A27) + 0.41(L6) - 18.2t \quad (E.8)$$

where:

- X is the seat longitudinal position (measured in mm aft of BOF)
- $H30$ is the seat height (in mm)
- $A27$ is the seat cushion angle (in degrees)
- $L6$ is the steering wheel center longitudinal position (measured in mm aft to BOF)
- t represents the transmission type: =1 if clutch pedal;; =0 if no clutch pedal

SAE standard J941 defines the 95th % tangent cutoff eyellipse, that is a statistical representation in three-dimensional space of the location of driver's eyes (Figure 4). The tangent cutoff principle (in which the definition of eyellipses is based) is that any tangent drawn to the ellipse (or any tangent plane to an ellipsoid in three dimensions) divides the population of eyes as follow: P percent of the population of eyes is below the tangent, and $(100 - P)$ percent of the population of eyes is above the tangent, P being the percentile value of the eyellipse (Figure 5). Sight lines are then defined as tangent to the ellipsoids for vision analysis.

¹ Ball of foot reference point and Accelerator heel point definitions are given in Appendix 8.1.1.

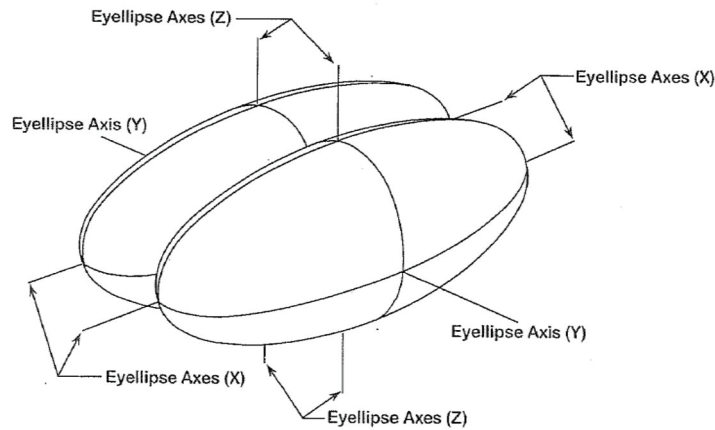

Figure 4: Three-dimensional tangent cutoff eyellipses for left and right eyes (reproduced from SAE J941 [44])

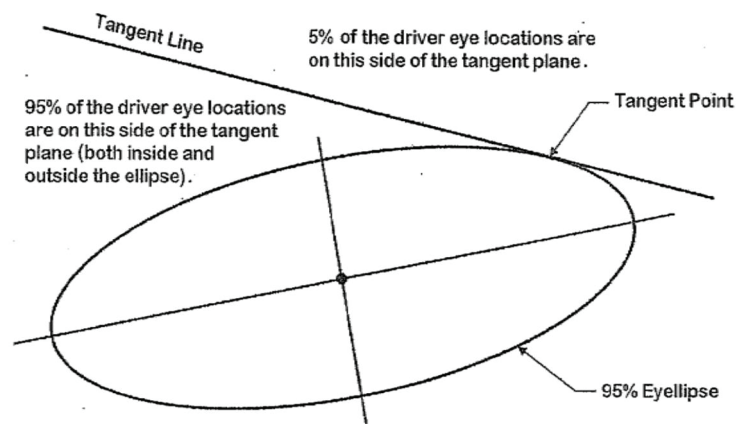

Figure 5: Two dimensional tangent cutoff description (reproduced from SAE J941 [44])

It should be noted that the 95th % eyellipse does not enclose 95% of the eye locations inside the ellipse, but only 74%. The equations for the location of eyellipses centroids and for the determination of the lengths of their axes are presented in appendix 8.1.2.

Eyellipses are based on data from American drivers for a 50/50 male/female gender mix. However, SAE J941 also provides equations for the definition of eyellipse for other populations (Japan and Netherlands), and for other stature distribution and gender mix.

Despite the fact that these SAE standards are widely used by car manufacturers, they have some limitations. First of all, the driver seat prediction model proposed in SAE J1517 is based on experimental data representative of the American population. However, different populations differ in main anthropometrical dimensions. Therefore, if a vehicle is designed for another target population, predictions might be less accurate. Because of secular change in anthropometry and continuous change of vehicle design with new technologies, there is also a constant need of updating the data from which the regression equations are derived.

Moreover, SAE J1517 and SAE J941 are percentile-accommodation methods, i.e. they describe the behaviour of several percentiles of a population but they do not give predictions for any individual within this population. Kyung [17] also found that SAE J1517 does not adequately consider the extremes of the population (i.e. 5th percentile female and 95th percentile male).

Finally, SAE J1517 and SAE J4004 only provide two-dimensional information on seat fore-aft position, and do not deal with potentially asymmetrical driving postures.

- Optimization-based models

In the case of optimization-based models, the driving posture prediction problem is treated as a multiple constraint optimization problem. The number of the geometric constraints imposed to a human model is often not high enough to result in a unique posture. Therefore, a reference posture, also called neutral posture, is needed. The selected solution will be the posture that deviates as least as possible from this reference posture. An optimization-based method is used in RAMSIS, the digital human modelling tool widely used in automotive industry. RAMSIS was initiated by the German car industry in the 1980s for developing a new tool that would provide German car engineers with an accurate, three-dimensional representation of the human body in their CAD environment [49]. The RAMSIS car driver posture prediction model (i.e. neutral posture) was based on the experimental observations by Seidl [38] from a laboratory study. 47 volunteers (23 males and 24 females) representative of the German population participated in the experiment. Their static driving postures were recorded in three simulated package configurations, one representing a sports car, one a sedan and one a minivan. Multi-dimensional probability distributions of joint angles were derived from experimental data (i.e. angle ranges that are most likely to be used were defined for each joint). Then, an optimization algorithm predicts a posture which tries to fulfill all the defined constraints, while keeping each joint angle as close as possible to the neutral posture (Figure 6).

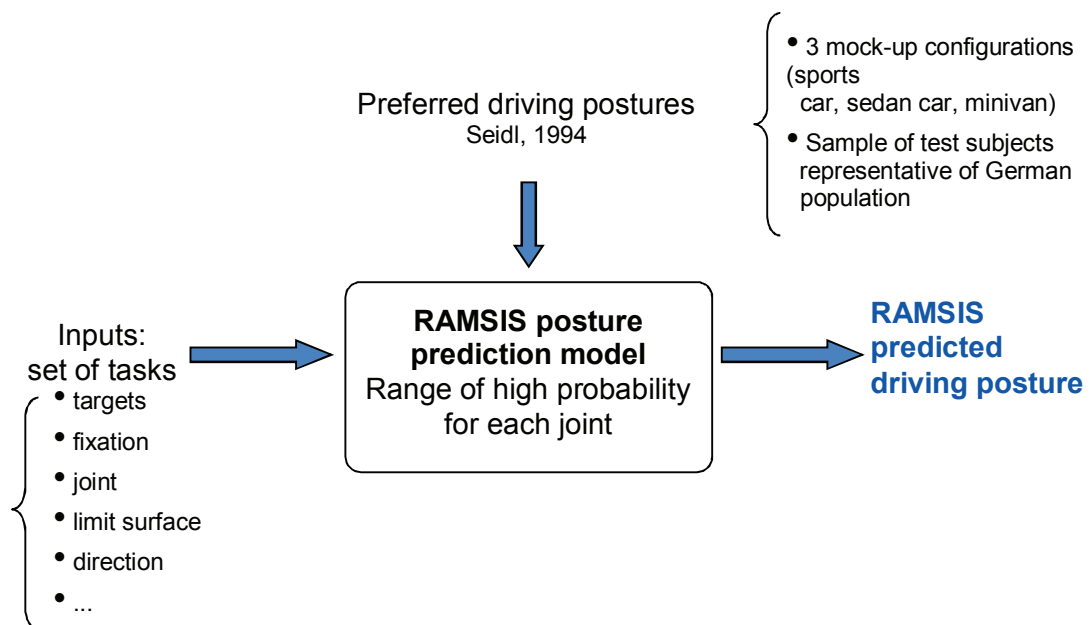

Figure 6: RAMSIS posture prediction model

Reed et al [33] also proposed an optimization prediction model similar to RAMSIS and compared it to their cascade posture prediction model. More recently, Gragg et al [12] applied the optimization-based method simulating seat adjustment range for three manikin generation approaches (boundary manikins, population sampling, special population).

Currently existing optimization-based prediction methods present some limitations. First of all, driving posture prediction strongly depends on the neutral posture. For RAMSIS, the neutral posture was defined based on experiments performed about 20 years ago. Population's anthropometry changes over time, as well as vehicle design. Therefore the data on which RAMSIS posture prediction model is based may not be representative of actual preferred driving postures. It is also difficult to formulate all constraints appropriately. For instance, a good road vision is probably the most important constraint for driving, but its formulation is not so straight forward. Thirdly, in case that all the geometric constraints imposed to a driver cannot be satisfied at the same time, the existing methods for driving posture prediction do not allow to specify the order of priority of the constraints. Recently, a priority optimization method was proposed by Peng et al [28] at IFSTTAR.

- Hybrid models

During his doctoral thesis, Reed developed the Cascade Prediction Model (CPM) [22]. This driving posture prediction model combines both statistical regression equations and optimization method, and emphasizes high importance on prediction accuracy for hip and eye locations.

This model is based on an experiment performed on 68 volunteers (1,5 m to 1,9 m tall) in 18 different vehicle package and seat conditions. Participants were asked to select their preferred driving posture in a vehicle mock-up representing a wide range of vehicle interior conditions. The driving posture of each participant was recorded for the 18 combinations of seat height, seat cushion angle and steering wheel fore-aft position. The steering wheel fore-aft position varied over a 200 mm range for seat heights of 180, 270 and 360 mm. The predictive model developed from the collected data was validated by comparison with the driving postures from a data base of 120 drivers in five vehicles.

The CPM model (Appendix 8.1.3) combines regression functions with inverse kinematics guided by additional information from the input data set:

- Step 1: prediction of fore-aft hip location (Hip_x reBOF) using regression functions (Table 39). The hip-to-H-point offset vector is then calculated using regression functions presented in Table 40.
- Step 2: prediction of eye location in relation to the regression functions in Table 39.
- Step 3: Use of a kinematics sub-model to fit the kinematic linkage representation of the torso to the predicted hip and eye locations.
- Step 4: calculation of upper-extremity posture using inverse kinematics and hand grip locations.
- Step 5: calculation of lower-extremity (thigh and leg segments) posture using an analogous process so it fits the predicted hip and ankle locations.

Although this model is based on a large amount of data, it has some limitations. The most important ones are that seat height and steering wheel longitudinal and vertical positions could not be adjusted by the participants, and the model assumes an automatic transmission, which is not representative of European market.

2.3 Conclusion and research objectives

The selection of a driving posture by a driver in a given vehicle is a complex process that must deal simultaneously with driver and vehicle factors among others. All these factors can be qualified as sources of variability in driving posture, and can be of three kinds:

- variability due to human related factors:
 - variability for a same driver (intra-individual variability), i.e. difference between driving postures adopted by a same driver in a same vehicle from time to time,
 - variability due to anthropometric factors (inter-individual variability). As an example, due to limited body segment lengths, a short driver will not be able to adopt the same driving posture as a tall driver,
- variability due to differences in vehicle package. A wide range of vehicles exists in the actual market, from small car to SUV. Of course available ranges of adjustments differ from a vehicle to another, as well as the relative position of the seat relative to the steering wheel and the pedals. In consequence driving postures may change depending on vehicle package,
- other variability: for a same vehicle, two drivers with similar anthropometry may adopt different driving postures. Psychological factors (stress, driving experience), driving field (highway or minor road), or driving duration among other factors can account for this variability.

Much research work has been already carried out on the understanding of the posture selection process. However, our literature review shows that the three sources of variability in driving posture were not always investigated. To our knowledge, the intra-individual variability was rarely investigated[15]. Regarding the influence of driving package, most of the experimental studies were performed on laboratory mock-up, which does not fully guarantee that recorded driving postures are realistic. Moreover, most of the studies are based on the assumption that driving posture is laterally symmetrical without considering pedals, but more recent studies showed that significant differences exist between left and right side at some joint angles [13, 17].

Therefore, the main objective of the current research work is to understand driver's sitting posture selection process within the range of existing in-vehicle adjustments. More specifically, the current research work is aimed to

- quantify both intra- and inter-individual variability and to understand the effects of vehicle package on driving posture,
- propose a driving posture prediction model from the observation of actual driving postures adopted in real passenger vehicles.

3 Experimental protocol and data processing

3.1 Introduction

In order to observe actual driving postures, an experiment was performed with a representative sample of European drivers testing 5 passenger vehicles with a large choice of seat and steering wheel adjustments. In this chapter, the detailed experimental protocol and data processing methods are presented.

3.2 Subjects

34 subjects, from 20 to 45 years old (25.9 ± 6.9 years old) participated in the study. They were recruited according to their stature and sitting height, in order to obtain a representative sample of the French driver population. The following groups were defined:

- short volunteers: stature ≤ 165 cm (mainly females)
- average volunteers: stature between 166 and 180 cm (males and females)
- tall volunteers: stature ≥ 180 cm (mainly males)

When possible, volunteers were selected in order to have a sitting height distribution as uniform as possible within the 3 groups:

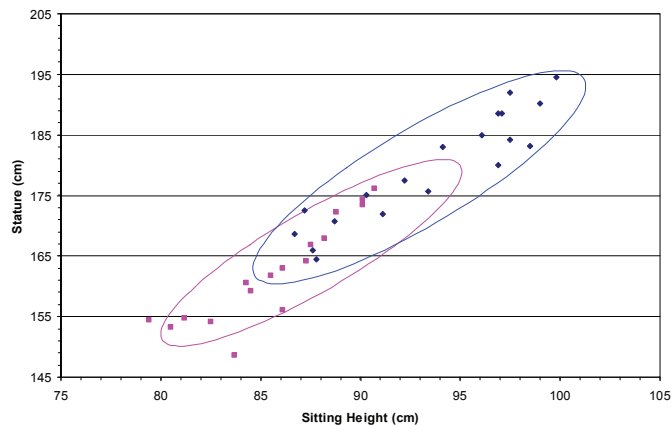

Figure 7: Distribution of participants (females in pink – males in blue) in function of stature and sitting height and 95% ellipses of Dutch and Italian populations (CEASAR 2000)

Table 2 summarizes the main characteristics of the participants by stature group. More anthropometric dimensions are given in Appendix 8.2 for each participant.

Table 2 : Main characteristics of the 3 groups of participants

Group of stature	Number of subjects	Stature (cm)	Stature min (cm)	Stature max (cm)	Age (years)	Weight (kg)
Short	12 (1M / 11F)	158 ± 5	149	164	27 ± 9	58 ± 7
Average	13 (8M / 5F)	172 ± 4	166	177	26 ± 6	64 ± 7
Tall	9 (9M / 0F)	187 ± 5	180	195	25 ± 6	80 ± 17
Total	34 (18M / 16F)	171 ± 12	149	195	26 ± 7	66 ± 14

Inclusion criteria:

- 50% male - 50% female,
- age ranging from 20 years old to 50 years old,
- the participant should own a driving license for at least one year and regularly drives cars,
- the participant should be socially insured or entitled.

Exclusion criteria:

- people who suffer any neurological or musculoskeletal disorders,
- pregnant woman.

The experimental protocol was approved by ethical committee of IFSTTAR

3.3 Vehicles

The vehicle dimensions are specified using standard reference points and dimensions definitions documented in SAE J1100 [40]:

- The H-point (for hip point) is a point relative to the seat that is measured with the SAE H-point machine (see SAE J826 [42]) and that represents the pivot center of the torso and thigh of the H-point machine. The H-point moves with the seat, and defines the seat travel path as the seat moves throughout its longitudinal and vertical ranges of adjustment.
- The Seating Reference Point (SgRP) corresponds to the predicted location of the hip-joint center of a driver seated at the 95th percentile seat position.
- The Seat Reference Point (SRP) is a particular point on the seat travel path that can be located in different ways depending on car manufacturers. In this study, SRP was defined as the H-point location when the seat is placed at its rearmost and mid-height position.
- The ball of foot reference point (BOFRP) is a point measured with the SAE H-point machine that defines a vertical plane to which horizontal measurements are referenced.
- The accelerator heel point (AHP) is a point on vehicle's floor measured with the SAE H-point machine that defines the horizontal plane from which vertical measurements are referenced.

Five vehicles were chosen mainly considering two parameters (Table 3): seat height (H30) and field of view. In order to obtain a vehicle with a medium H-point height, a 30 mm mat was added to the seat of the Vehicle 3.

Definition of vehicle package parameters is given in Table 4, and they are illustrated in Figure 8. Principal dimensions of the 5 tested vehicles are summarized in Table 5 (For definition of vehicle reference points and dimensions definition, refer to Appendix 8.2.2).

Table 3: Vehicles characteristics

H-point Height (H30)	Field of View		
	Good	Average	Limited
Low around 245 mm	Vehicle 1	-	Vehicle 2
Medium around 280 mm	-	Vehicle 3 + 30mm mat	-
High around 330 mm	Vehicle 4	-	Vehicle 5

Table 4: Definition of vehicle package parameters

Variable	Definition
SgRPx	Longitudinal distance between Seating Reference Point (SgRP) and Ball of Foot reference point (BOFRP)
H30	Vertical distance between Seating Reference Point (SgRP) and vehicle's floor
L6	Longitudinal distance between Steering Wheel Center at it's middle position in steering wheel travel path and Ball of Foot reference point (BOFRP)
H17	Vertical distance between Steering Wheel Center at it's middle position in steering wheel travel path and vehicle's floor

Table 5: principal dimensions of tested vehicles. Dimensions are given in the SAE coordinate system [40].

		Veh1	Veh2	Veh3	Veh4	Veh5
SgRPx (mm)		998	966	1015	958	915
H30 (mm)		241	252	298	324	362
L6 (mm)		541	532	549	471	452
H17 (mm)		631	645	654	721	754
BOFRP_Z (mm)		111	147	171	123	127
AHP_X (mm)		149	218	247	182	124
Seat adjustment	x	244.5	210.0	241.0	241.0	250.5
range length	z	59.0	51.0	47.5	67.5	67.5
(mm)						
SW adjustment	x	47.0	51.0	54.5	65.0	66.5
range length	z	49.5	53.5	59.0	64.0	59.5
(mm)						

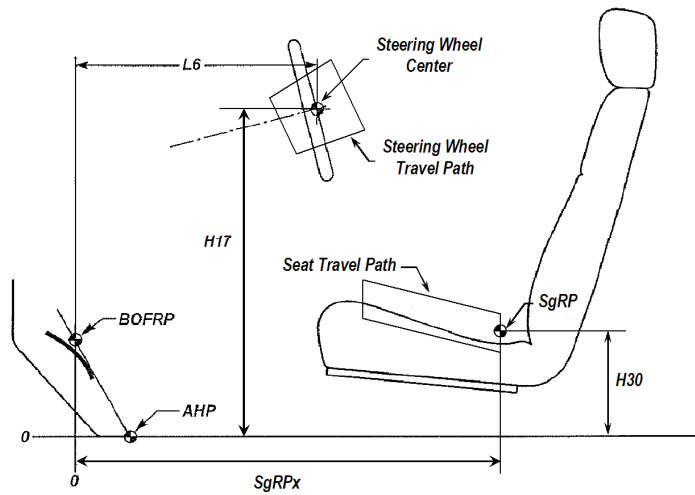

Figure 8 Vehicle package parameters (from SAE J4004 [42])

The field of view (FOV) is characterized by the distance between Seating Reference Point (SgRP) and ceramic point of the vehicle. The ceramic point of the vehicle corresponds to the intersection between the ceramic line of the windshield and the side view plane (Figure 9). For vehicles with similar Seat Reference Point, if ceramic point is higher or more forward, field of view gets more limited (Figure 10).

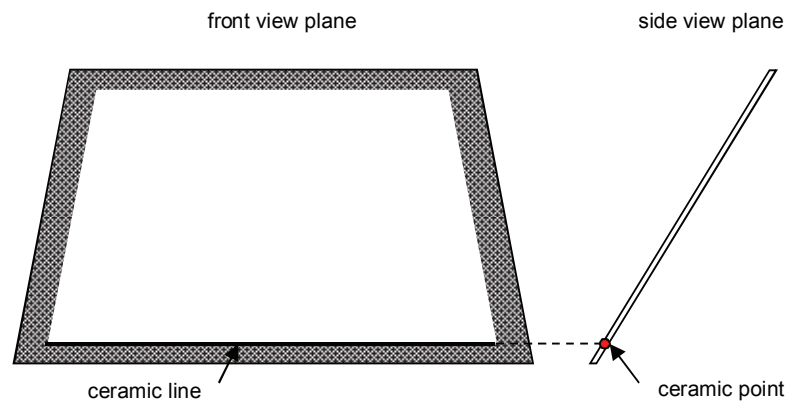

Figure 9: Front and side view planes of vehicle's windshield for the definition of vehicle ceramic point

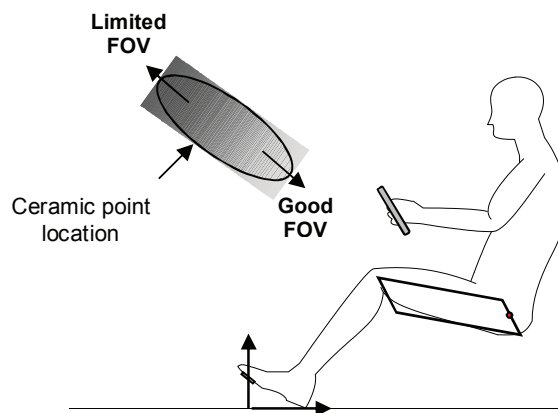

Figure 10: Field of view evaluation criterion used for the choice of vehicles to be used in the experiments, depending on ceramic point location

For each vehicle, the following adjustments were available:

- Seat vertical position
- Seat longitudinal position
- Seat back inclination
- Steering wheel vertical position
- Steering wheel longitudinal position

3.4 Experimental procedure and test conditions

The experiment was divided into 4 phases:

- Phase 1: Preparation phase. It included the preparation of vehicles (instrumentation and measurements), room instrumentation and volunteers preparation
- Phase 2: data collection for the estimation of hip joint center (HJC) location
- Phase 3: driving posture data collection
- Phase 4: filling questionnaires

3.4.1 Preparation of the experiments

(a) Room instrumentation

Ten motion capture cameras were used. Four cameras were placed on the wall of the experimental room, one in each corner of the experimental room, three on the driver side of the vehicle, and three on the passenger side of the vehicle. Prior to each experiment, the VICON device was calibrated.

(b) Vehicle instrumentation and measurements

A FARO arm device was used to measure vehicle geometry. A detailed protocol explains how the different data was measured in Appendix 8.2.3. The following data was collected:

- Vehicle Seat Reference Point (SRP)
- Seat cushion angle
- Ball of Foot point (BOF)
- Accelerator Heel Point (AHP)
- Seat travel path
- Steering wheel travel path

Measurements are given in Appendix 8.2.4 (Table 43). The locations of reflective markers placed on the driver and passenger door openings, and on vehicle's roof were also recorded. Finally, several reflective markers were placed on the steering wheel, seat cushion and seat back, in order to record the seat and the steering wheel adjustments (Appendix 8.2.3, Figure 28).

(c) Preparation of the volunteer

When the volunteer arrived, the experimenter explained him/her the general purpose of the experiments. Then the volunteer was asked to wear thigh fitting clothes provided by the experimenter: shorts for males and shorts and a sports bra for females.

(d) Anthropometric measurements

Anthropometers (bracket, meter tape and sliding calliper) were used to measure the classical anthropometric dimensions (e.g. age, weight, stature, circumferences, segments lengths, etc.) for each subject (Appendix 8.2).

(e) Placement of markers on the subject

65 reflective markers were placed on anatomical points of the subject in order to record his/her driving posture (Appendix 8.2.5). In addition, technical markers were placed on the subject to ensure the calculation of body segments' trajectories in case one marker was lost. Technical clusters were also placed on the pelvis and the left and right thighs of the volunteer for the estimation of HJC location.

(f) Volunteer's calibration

Once markers were well positioned, the subject was asked to sit in a stool placed between 4 calibration bars, with his/her arms placed as if he/she was grasping an imaginary steering wheel (Figure 11 (a)). A Vicon capture and 4 pictures of the subject (front, back and from both sides) were taken. The same operation was repeated with the volunteer standing between the 4 calibration bars (Figure 11 (b)).

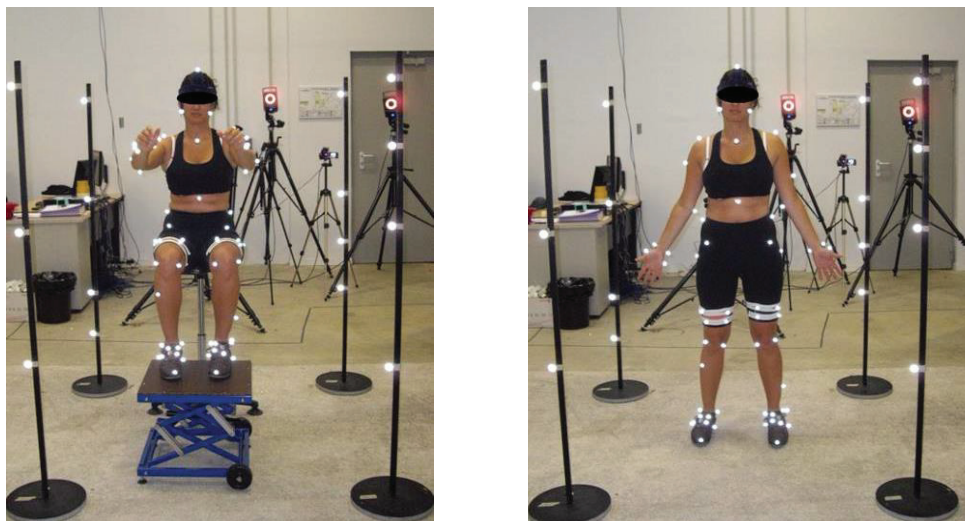

Figure 11: subject in the seated (a) and standing (b) calibration posture

3.4.2 Driving posture data collection

This part of the experiment aimed at collecting a data set of driving postures. To study the influence of initial adjustments on driving posture, 3 initial seat and steering wheel configurations were tested.

The seat and the steering wheel were successively adjusted in different initial configurations (Table 6). Configurations were tested in a random order.

For each configuration, participants were asked to adjust the seat and the steering wheel. They could take as long time as they needed to make these adjustments. Once the seat and the steering wheel were adjusted, subjects were asked to successively adopt a driving posture corresponding to the following 3 instructions:

- left foot on footrest + right foot on accelerator pedal (off) + hands on the steering wheel (10 O'clock and 2 O'clock positions)

- left foot on clutch pedal (off) + right foot on accelerator pedal (off) + hands on the steering wheel
- left foot on clutch pedal (on) + right foot on accelerator pedal (off) + hands on the steering wheel

Table 6: Initial seat and steering wheel configurations tested during the experiments

Adjustment	AR	DE	MI
Seat vertical position	lowest position	highest position	mid position
Seat longitudinal position	rearmost position	foremost position	mid position
Seatback recline	most reclined position	less reclined position	mid position
Steering wheel vertical position	lowest position	highest position	mid position
Steering wheel longitudinal position	rearmost position	foremost position	mid position

The subject was then asked to maintain the corresponding driving posture for each position, and this posture was recorded during 1 second, using a VICON optoelectronic system with ten MX40 cameras sampled a 100 Hz. The 3D location of reflective markers placed on the subject's skin and on the driving environment was recorded. Almost simultaneously, two pictures of the subject's driving posture were taken from both left and right sides of the subject.

Once the 3 initial configurations were tested, the subject was asked to drive the vehicle outside for approximately 5 minutes. During the driving session, the subject could re-adjust the seat and the steering wheel if necessary. After the driving session, the subject returned back to the experimental room and the three driving postures were recorded once more.

3.4.3 Questionnaire

In order to know how adjustments were used, participants were asked to fill-in a questionnaire after having tested each vehicle (Appendix 8.2.6). The questionnaire was divided into 3 parts:

- Part 1 aimed at knowing if subjects re-adjusted the seat and/or the steering wheel during the driving session, and the reason why they made these changes. The purpose of this item was to see if the adjustments made in a laboratory room are representative of adjustments in a real driving environment or not.
- Part 2 aimed at identifying if the range of adjustments was large enough, i.e. if a subject could adjust the seat or/and steering wheel as desired. If not, subjects had to indicate which adjustments were restricted, and in which direction.
- Part 3 was designed in order to know the importance of different criteria (vision of the road, accessibility of the commands, head clearance, etc.) when adjusting seat and steering wheel position.

3.5 Data processing

3.5.1 Common reference coordinate system between FARO and Vicon Data

The calculation of seat and steering wheel adjustments requires the location of several points previously recorded using the FARO arm device. However, driving postures were recorded in a Vicon local coordinate system. Therefore, in order to merge both FARO and Vicon data, it was necessary to create a common reference coordinate system between these two measurements.

For that purpose, 7 reflective markers were placed on the driver side door opening, 7 more on the passenger side door opening, and 4 on the vehicle roof (Appendix 8.2.3, Figure 28). The location of these markers was recorded in the vehicle measurement coordinate system with the FARO arm device. They were also recorded for each driving posture trial with the Vicon system, in the VICON local coordinate system. Using an algorithm based on the estimation of the translation and the rotation of a moving body from measurements of the spatial coordinates of at least 3 non-collinear markers [50], the coordinates of Vicon reflective markers were transformed in the vehicle measurement coordinate system. Several verifications were made in order to ensure the merging between Vion and Faro data was correct.

All Vicon and FARO data was expressed in the SgRP centered vehicle coordinate system (Figure 12) thanks to the common vehicle points at the left and right doorframes and the roof. The SgRP centered vehicle coordinate system is similar to vehicle measurement coordinate system, its axes remain the same, but the origin is moved to the vehicle Seating Reference Point (SgRP).

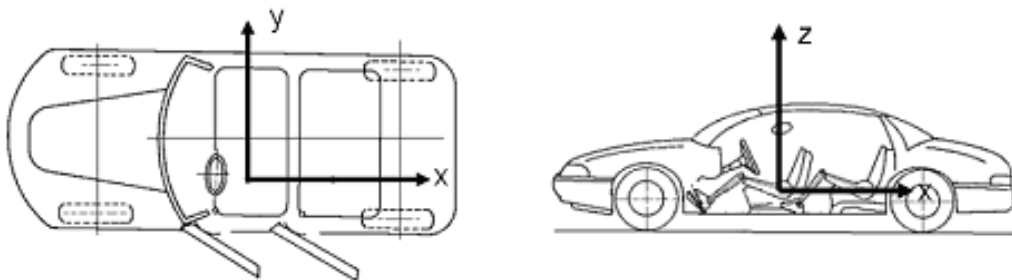

Figure 12: SgRP centered vehicle coordinate system - Axis are the same as defined in SAE J1100 [40]. The origin of the coordinate system is defined as being the middle position between left and right seat H-points measured with the SAE H-point machine

3.5.2 Calculation of seat and steering wheel adjustments

From VICON trials and FARO data, the vehicle adjustments presented in Table 7 were calculated for each driving posture measurement (Figure 13).

Table 7: calculated vehicle adjustments selected by drivers

Variable	Definition
Seat_X	Longitudinal distance between Seat H-point location (corresponding to seat chosen adjustment) and Ball of Foot reference point (BOFRP)
Seat_Z	Vertical distance between Seat H-point location (corresponding to seat chosen adjustment) and vehicle's floor
SWC_X	Longitudinal distance between Steering Wheel Center location (corresponding to steering wheel chosen adjustment) and Ball of Foot reference point (BOFRP)
SWC_Z	Vertical distance between Steering Wheel Center location (corresponding to steering wheel chosen adjustment) and vehicle's floor
SBA	Seat back angle (SBA) value (corresponding to seat back recline chosen adjustment) from vertical.

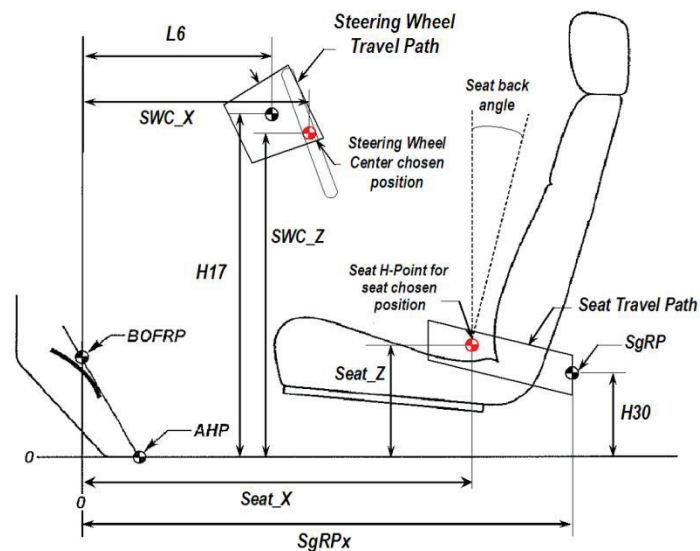

Figure 13: Vehicle package geometry

In order to calculate the longitudinal and vertical adjustments of the seat, it was necessary to calculate the location of the seat H-point in the configuration chosen by the volunteer. For that purpose, several reflective markers were placed on the left side of seat cushion (Appendix 8.2.3, Figure 29). When Seating Reference Point (SgRP) was measured, the coordinates of these markers were also measured. Assuming that the seat only moves in the plane (O,x,z), and that SgRP is fixed relative to seat cushion markers, then if at least two seat cushion markers are visible by VICON, the position of the seat H-point corresponding to the seat adjustments chosen by the volunteer can be calculated using Veldpaus algorithm [50] in the planar movement case.

The steering wheel centre position corresponding to steering wheel adjustments chosen by drivers is calculated the same way. This time, steering wheel centre position was estimated from 4 reflective markers placed on the steering wheel (Appendix 8.2.3, Figure 30).

Seat back angle (SBA) chosen by the volunteer (defined from the vertical) was also calculated the same way, using 8 reflective markers placed on both left and right sides of the seat back.

When volunteers did not change their adjustments during the driving session, two different measurements of the same adjustments were available: one before driving session (measurement 1) and one after driving session (measurement 2). Therefore, it was possible to estimate the precision of adjustments calculation by estimating the differences between measurements 1 and 2. Results are presented in Table 8.

Table 8: Mean and standard deviations of the differences between two measurements of the same vehicle adjustments

Variable	Number of observations	Mean \pm SD
Seat_X (mm)	96	0.6 \pm 2.2
Seat_Z (mm)	96	0.4 \pm 0.6
SWC_X (mm)	88	1.1 \pm 1.4
SWC_Z (mm)	88	1.5 \pm 1.9
SBA ($^{\circ}$)	85	0.6 \pm 1.1

3.5.3 Posture reconstruction

Postures were reconstructed using a tool developed by IFSTTAR, named RPx. Three steps are necessary [51]:

- creation of a personalized digital manikin,
- attachment of reflective markers,
- driving posture reconstruction

3.5.3.1 *Creation of personalized digital manikin and attachment of reflective markers*

From anthropometric measurements collected during the experiments, a digital manikin was created for each subject using the RAMSIS Body Builder module. The RAMSIS kinematic model is presented in Appendix 8.2.7. RAMSIS corresponding manikins were imported into the RPx software, a matlab customized motion analysis and simulation tool developed at IFSTTAR [52].

Using a static posture captured with the volunteer standing between 4 calibration bars, pictures of the volunteer taken at the same time were calibrated and the manikin was superimposed on these pictures by adjusting mannequin's joint angles (Figure 14). It was then also possible to verify that manikin dimensions correspond to real dimensions of the volunteer. If necessary, RPx allowed user to adjust manikin segments length.

Once the manikin was correctly superimposed on at least two pictures (taken with different viewpoints), each reflective marker was "numerically attached" to its corresponding segment for estimating the local coordinates of the markers in their respective body segment coordinate system.

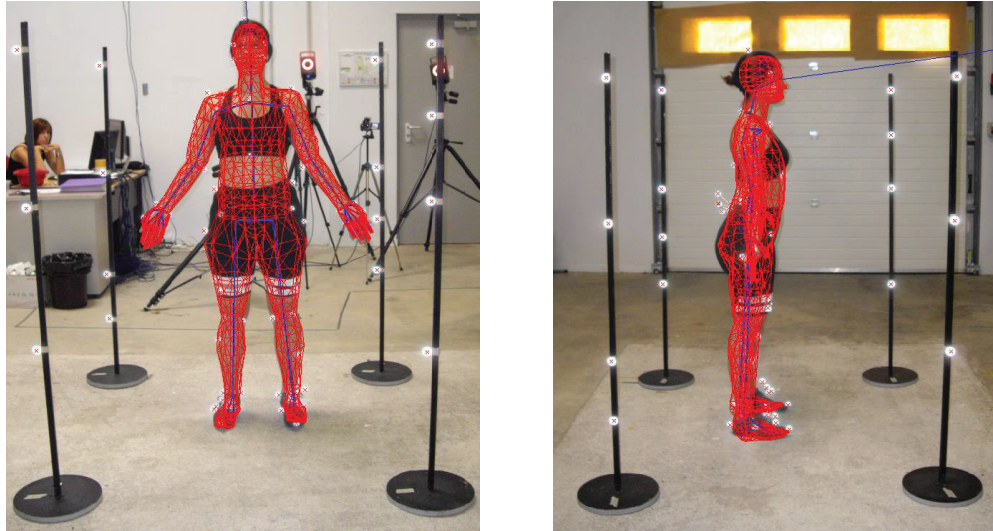

Figure 14: Superimposition of RPx manikin on pictures for attachment of reflective markers

3.5.3.2 *Driving posture reconstruction*

Driving postures of the volunteer could then be reconstructed from the trajectories of reflective markers placed on the volunteer's skin, using an inverse kinematics algorithm (Figure 15). The joint angles of the RAMSIS kinematic figure were calculated by minimizing the distance between the measured and model-based marker positions.

In order to assess posture reconstructions, the reconstruction residuals (i.e. the distance between the measured position of the marker and its reconstructed position) were calculated for each marker. The smaller the residual values are, the better is the posture reconstruction. Average values and standard deviations of residual for some markers of interest are presented in Table 9. The mean residual is lower than 10 mm for upper limb markers, except for the left acromion (LACR). This could be explained by the fact that during driving session, volunteers were asked to use the seat belt, which often made this marker move. For lower limb markers, mean residuals are a little bit higher (on average 18 mm). For the markers of the pelvis (LASI and RASI) and the two markers placed on the left and right great trochanters (LFTC and RFTC), high residuals were observed (from 18 to 34 mm). The main reason of these high errors is that these reflective markers were attached on the pair of shorts of the volunteers. When volunteers sit and get out of the vehicles, the shorts could move with respect to volunteer's skin in addition to large skin movement relative to the underlying bone. Lower weighting coefficients were used for these markers when performing posture reconstruction.

It is important to mention that difficulties were faced in accurately location the driver's hip joint center (HJC). Two classes of methods (regression equations [3, 7] and [39] or functional method [6, 19] and [29]) are commonly used for the estimation of HJC location, but the reliability of these methods was almost never investigated in the case of driving posture prediction. Prior to this experimental study, another experimental study was conducted on 10 volunteers in order to assess these methods in the case of driving posture [5]. However, results showed that both methods do not give satisfying results for the prediction of HJC location in a seated posture, and therefore none of the two methods was used for the driving posture reconstruction.

Table 9: Mean residuals (mm) and standard deviations (mm) of posture reconstruction for some markers of interest on each body segment. Mean values are calculated for all the trials recorded during the experiment. Marker acronym definitions are given in Appendix 1.

Segment	Marker acronym	mean residual and SD (mm)
Head	LHEA	3.4 ± 2.5
	RHEA	3.4 ± 3.0
Trunck	USTR	6.5 ± 3.8
	LACR	23.1 ± 14.0
	RACR	8.7 ± 5.7
Left arm	LELE	8.5 ± 4.6
	LWRE	6.0 ± 4.8
Right arm	RELE	10.6 ± 5.8
	RWRE	7.8 ± 5.3
Pelvis	LASI	17.8 ± 10.0
	RASI	21.4 ± 10.2
Left leg	LFTC	33.7 ± 16.7
	LKNE	15.2 ± 8.6
	LANE	12.8 ± 6.8
Right leg	RFTC	27.9 ± 22.3
	RKNE	16.9 ± 13.0
	RANE	19.7 ± 17.2



Figure 15: Reconstructed driving posture and recorded vehicle geometry. The markers attached to the body are also showed as well as their residual errors with respect to measured positions, characterized as a directed line from the center of each marker.

3.5.3.3 Driving posture variables

More than 100 angles are used for defining a whole body's posture. In order to reduce the number of postural parameters to analyze, a set of postural variables (Table 10) were calculated using joint centers from the reconstructed postures.

Table 10: Definition of driving posture variables

Variable	Definition
Hip_X	Longitudinal coordinate of driver hip point in the SgRP centered vehicle coordinate system
Hip_Z	Vertical coordinate of driver hip point in the SgRP centered vehicle coordinate system
Eye_X	Longitudinal coordinate of driver eye point in the SgRP centered vehicle coordinate system
Eye_Z	Vertical coordinate of driver eye point in the SgRP centered vehicle coordinate system
LELB (RELB)	Left (right) elbow angle. Angle between the left (right) arm and the left (right) forearm segments in the plane of the segments. Greater values correspond to more extended arm.
LKN (RKN)	Left (right) knee angle. Angle between the left (right) thigh and the left (right) leg segments in the plane of the segments. Greater values correspond to more extended leg.
LHIP (RHIP)	Left (right) hip angle. Angle between the left (right) thigh and the line passing through the hip point and the left (right) shoulder joint in the sagittal plane.
Torso	Torso angle. Angle between the vertical and the line passing through the hip point and the shoulder joint in the sagittal plane.

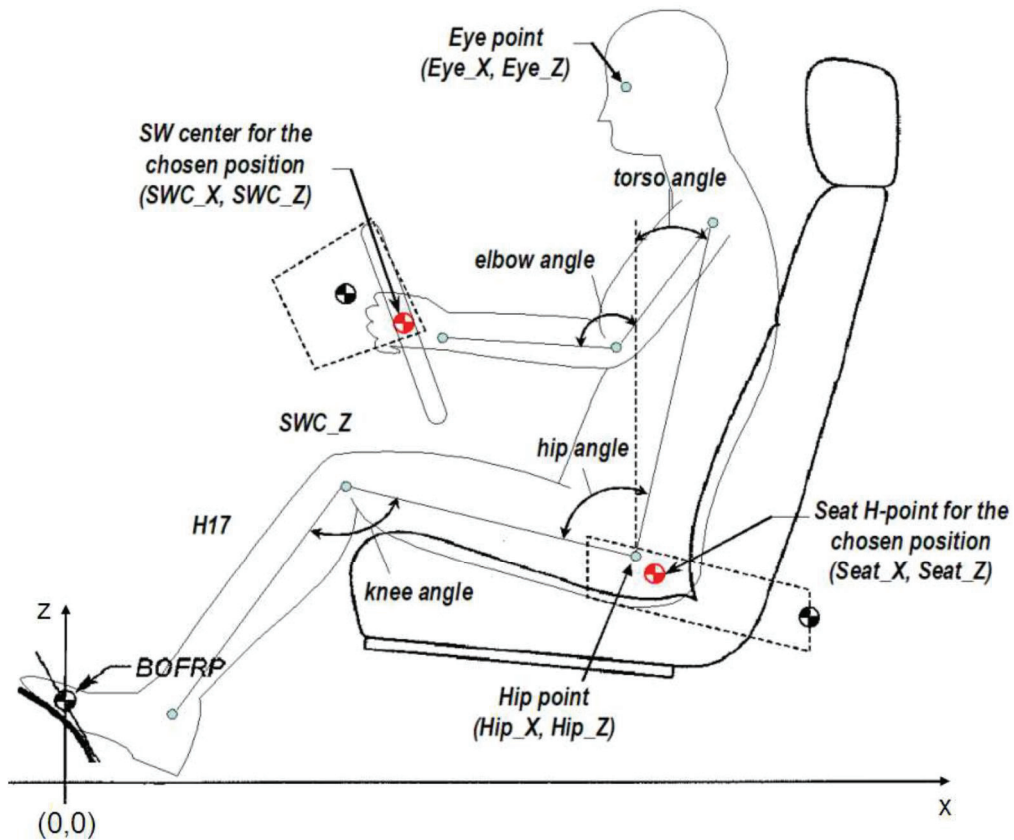

Figure 16: Illustration of driving posture variables

4 Statistical analysis of car interior adjustments and driving postures

4.1 Introduction

As introduced in Chapter 1, several factors can affect the driving posture selected by a driver in a given vehicle, such as anthropometric factors (e.g. stature) or vehicle package (Figure 1). Much work has been carried out on preferred joint angles, under a laboratory condition using a multiple-adjustable vehicle package. However, few studies investigated the influence of these factors on driving posture especially under real conditions. [13, 17, 26, 32, 34] and [42]. The aim of this chapter is therefore to analyze the collected data for a better understanding of the influence of stature and vehicle package on both vehicle adjustments and driving posture variables.

Thanks to multiple seat and steering-wheel adjustments, more than one driving posture can be adopted by a driver in a given vehicle. Intra-individual variability (i.e. difference between driving postures adopted by a same driver in a same vehicle) was also quantified, providing an estimation of the accuracy needed for driving posture predictions models.

It is likely that drivers with extreme body size (short or tall drivers) will have more limited range of feasible driving postures. For instance, due to shorter legs, short drivers will be restrained in their fore-aft seat position in order to be able to fully access the pedals. On the contrary, taller drivers may be limited in seat height in order to keep enough head clearance. Therefore, higher intra-individual variability values are expected for average drivers than for short and tall drivers. An effect of vehicle package on intra-individual variability can also be expected. Some vehicles may be more restrictive than others (e.g. a vehicle with no steering wheel adjustments), therefore, it can be expected to observe lower intra-individual variability values for more restrictive vehicles. Of course, variabilities in driving position between volunteers and between vehicles will also be analysed.

4.2 Data analysis methods

4.2.1 Questionnaire

Contingence tables of number of responses for each question crossing stature group and vehicle were calculated.

4.2.2 Intra-individual variability

For each vehicle, four test configurations (three initial adjustments and driving condition) were tested. The corresponding seat and steering wheel adjustments were calculated, and the corresponding driving postures were reconstructed by inverse kinematics. Intra-individual variability was quantified as being the maximal range of variation for each adjustment and for each driving posture variable between these four test configurations.

For each parameter (vehicle adjustments or driving posture variables), a general linear model (GLM) was used to describe the effects of Group of stature (G) and Vehicle (V) and their interaction (G*V). The level of statistical significance was set at $p = 0.05$.

4.2.3 Effect of group of stature and vehicle package

For each vehicle adjustment, and for each driving posture variable, average values and standard deviations were calculated. Average values were also calculated for each vehicle and each group of stature. A general linear model (GLM) was used to describe the effects of Group of stature (G) and Vehicle (V), and their interactions (G*V). The level of statistical significance was set at $p = 0.05$.

4.2.4 Postural asymmetry

In order to investigate possible differences between left and right angles, a paired t-test was used.

4.3 Results

4.3.1 General observations

As detailed in section 3, seat and steering wheel adjustments were calculated, as well as seat back angle (Figure 13). Figure 17 shows seat and steering wheel adjustments adopted by the drivers in the five tested vehicles. From this figure, we can observe that the entire range of both seat and steering wheel travel paths were used for the first three vehicles. For vehicles 4 and 5, the seat longitudinal range of adjustment seems unnecessarily too large, since none of the volunteers adjusted the seat in the front-most position. We can also clearly distinguish the seat adjustments of the 3 different groups of stature for seat longitudinal position, tall drivers placing the seat more backwards, while short drivers sit more forward. For steering wheel adjustments, no differences between the 3 groups of stature can be observed in this figure.

4.3.2 Questionnaires analysis

4.3.2.1 *Influence of driving session on selected adjustments*

This first part of the questionnaire aimed at knowing if a driver re-adjusted the seat and/or the steering wheel during the driving session, and the reason why he/she made these changes in case that he/she decided to readjust the seat and/or the steering wheel.

This question aimed at knowing if the adjustments made in the laboratory room are representative of adjustments in a real driving environment (with realistic constraint of vision) or not.

Compared to the first adjustments when the car is stationary, in the laboratory room, the constraints related to vision (road vision for instance) should be stronger. 47 over 175 volunteer-vehicle pairs (27%) made at least one change in the initial adjustments during the road driving session (Table 11), showing that a real road driving practice is necessary to ensure a realistic driving posture.

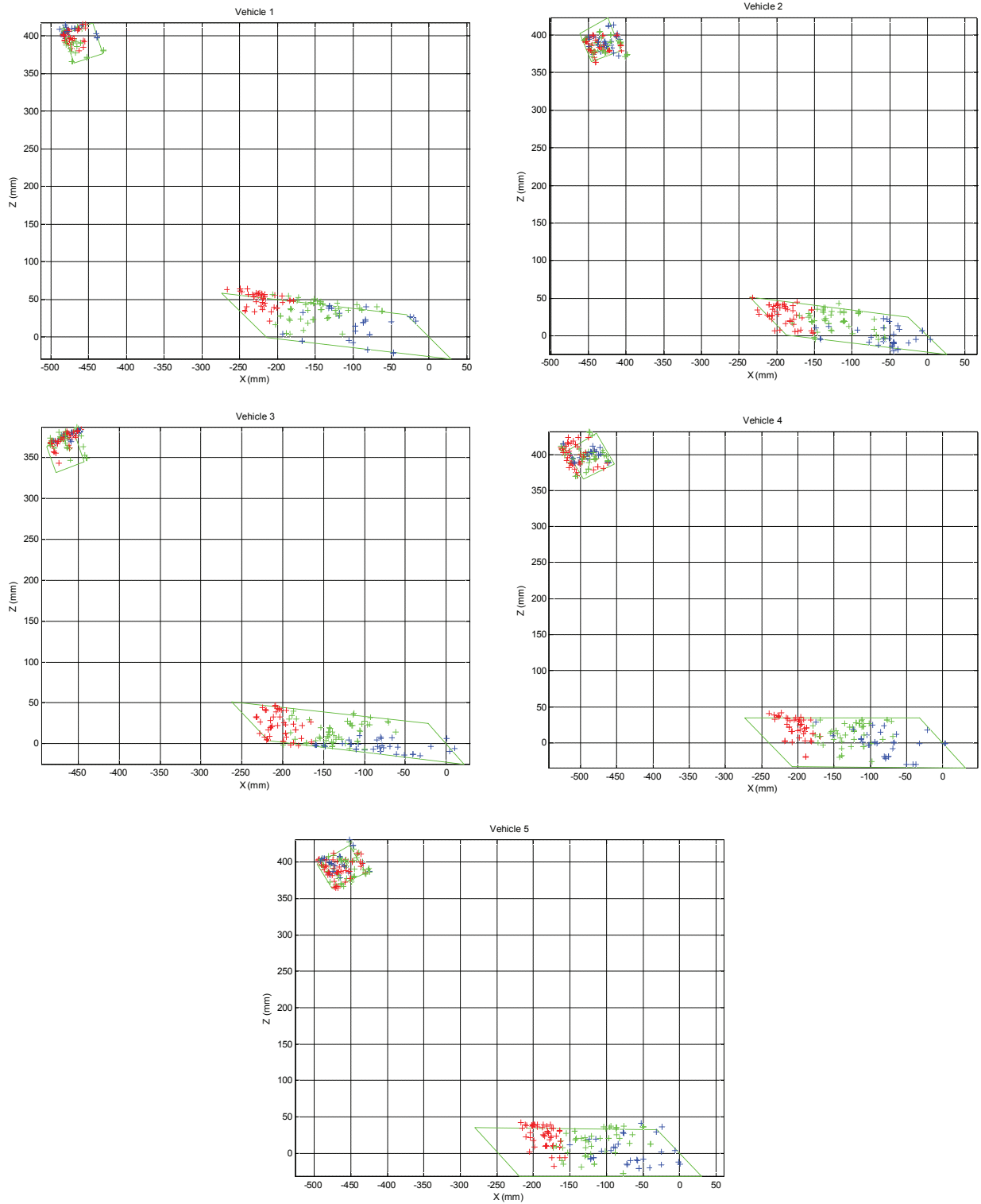

Figure 17: Calculated seat and steering wheel adjustments for the five tested vehicles and the 3 groups of stature (red for short drivers, green for average drivers and blue for tall drivers)

Table 11: number of times volunteers changed at least one of the seat or steering wheel adjustments. Results are presented by vehicle and group of stature

	Veh1	Veh2	Veh3	Veh4	Veh5	Total	Total (%)
Short	4	4	3	3	4	18	32.9
Average	4	6	6	3	4	23	30.0
Tall	1	2	3	0	0	6	13.3
Total	9	12	12	6	8	47	26.9

The need of re-adjustment mainly concerned seat position, 25 times for seat longitudinal position, 17 times for seat back inclination and 13 times for seat height over 175 trials in total, while steering wheel vertical and longitudinal position were only changed 3 and 4 times respectively (Table 12). For the steering wheel adjustments, it almost concerned two vehicles: Vehicle 1 and Vehicle 2. Vehicle 4 had the least number of re-adjustments. Proportionally, short and average volunteers needed more re-adjustments (Table 13).

Table 12: Number of times each adjustment was re-adjusted during the driving session for each group of stature

Group of stature	Seat height	Seat fore-aft	Seat back recline	SW height	SW fore-aft	Total
Short	5 (8.3%)	11 (18.3%)	8 (13.3%)	0	3 (5.0%)	27 (9.0%)
Average	7 (10.0%)	10 (14.3%)	8 (11.4%)	2 (2.8%)	1 (1.4%)	28 (8.0%)
Tall	1 (2.2%)	4 (8.9%)	1 (2.2%)	1 (2.2%)	0	7 (3.1%)
Total	13 (7.4%)	25 (14.3%)	17 (9.7%)	3 (1.7%)	4 (2.3%)	62 (7.1%)

Table 13: Number of times each adjustment was re-adjusted during the driving session for each vehicle

Vehicle	Seat height	Seat fore-aft	Seat back recline	SW height	SW fore-aft	Total
Veh1	3 (8.6%)	6 (17.1%)	3 (8.6%)	3 (8.6%)	0	15 (8.6%)
Veh2	4 (11.4%)	9 (25.7)	3 (8.6%)	0	0	16 (9.1%)
Veh3	1 (2.9%)	4 (11.4%)	5 (14.3%)	0	3 (8.6%)	13 (7.4%)
Veh4	2 (5.7%)	2 (5.7%)	3 (8.6%)	0	0	7 (4.0%)
Veh5	3 (8.6%)	4 (11.4%)	3 (8.6%)	0	1 (2.9%)	11 (6.3%)
Total	13 (7.4%)	25 (14.3%)	17 (9.7%)	3 (1.7%)	4 (2.3%)	62 (7.1%)

4.3.2.2 Seat and steering wheel travel path design

The second item of the questionnaire aimed at identifying if seat and steering wheel adjustment ranges fit all the volunteers. For that, volunteers were asked if they could adjust the seat and/or steering wheel as he/she wanted. If not, the volunteers had to indicate in which direction the adjustment was limited.

For 55 over 175 volunteers-vehicle pairs, (31.4%), at least one adjustment was judged too restrictive (Table 14). As expected, short volunteers complained more than others. For almost half of the short participants (48%), at least one adjustment was not satisfying, while for the average and tall volunteers, their proportions are 20% and 26.7% respectively.

When looking more in detail at the different adjustment ranges (Table 15, Table 16), seat height was reported too restrictive more frequently (17.1%), followed by steering wheel vertical and longitudinal adjustments. On the contrary, seat longitudinal range was almost always acceptable.

Regarding vehicles, ranges of adjustments for Vehicle 4 and Vehicle 5 were almost always satisfying, while participants complained more for Vehicle 3. This can be explained in part by the fact that a 30 mm foam was added on the seat without changing anything else. Therefore the maximum vertical space allowed between seat and steering wheel was reduced. This might have hindered volunteers to adjust the seat and/or the steering wheel as they wanted.

Table 14: number of times volunteers judged at least one of the seat and steering wheel adjustments too restrictive. Results are presented by vehicle and group of stature.

	Veh1	Veh2	Veh3	Veh4	Veh5	Total	Total (%)
Short	6	6	9	4	4	29	48.3
Average	5	1	5	2	1	14	20.0
Tall	2	3	5	0	2	12	26.7
Total	13	10	19	6	7	55	31.4

Table 15: Number of times an adjustment was judged too restrictive, for the 3 groups of stature.

Group of stature	Seat height	Seat fore-aft	Seat back recline	SW height	SW fore-aft	Total
Short	20 (33.3%)	2 (3.3%)	0	6 (10.0%)	13 (21.7%)	41 (13.7%)
Average	5 (7.1%)	1 (1.4%)	1 (1.4%)	6 (8.6%)	6 (8.6%)	19 (5.4%)
Tall	5 (11.1%)	3 (6.7%)	0	6 (13.3%)	5 (11.1%)	19 (8.4%)
Total	30 (17.1%)	6 (3.4%)	1 (0.6%)	18 (10.3%)	24 (13.7%)	79 (9.0%)

Table 16: Number of times that an adjustment was judged too restrictive, for the five tested vehicles.

Vehicle	Seat height	Seat fore-aft	Seat back recline	SW height	SW fore-aft	Total
Veh1	7 (20.0%)	2 (5.7%)	1 (2.9%)	6 (17.1%)	5 (14.3%)	21 (12.0%)
Veh2	6 (17.1%)	2 (5.7%)	0	5 (14.3%)	3 (8.6%)	16 (9.1%)
Veh3	10 (28.5%)	2 (5.7%)	0	3 (8.6%)	12 (34.3%)	27 (15.4%)
Veh4	3 (8.6%)	0	0	2 (5.7%)	2 (5.7%)	7 (4.0%)
Veh5	4 (11.4%)	0	0	2 (5.7%)	2 (5.7%)	8 (4.6%)
Total	30 (17.1%)	6 (3.4%)	1 (0.6%)	18 (10.3%)	24 (13.7%)	79 (9.0%)

4.3.2.3 Importance of factors that influence seat and steering wheel adjustments

The last question of the questionnaire was designed in order to know the order of importance of the six factors when adjusting the seat and steering-wheel position.

Results (Table 17) clearly show that for all volunteers, the most important factor for the adjustment of seat and steering wheel is the accessibility of the pedals (classified the most important in 76% of the cases). The second most important factor depends on group of stature: for short and average volunteers, visibility of the road was ranked as second most important factor, followed by the accessibility of the steering wheel, whereas for tall volunteers the accessibility of the steering wheel was classified as more important than visibility of the road that was ranked as the third most important factor. An interesting point is that for short and average volunteers there is a clear difference between the first ranked factor (accessibility of the pedals) and the second ranked factors (visibility of the road). However, for tall volunteers, the difference between first and second factors is not so clear.

Surprisingly, head clearance was ranked as the less important factor, even for tall volunteers. The visibility of control panel was also not considered as an important factor that influences adjustments for the volunteers.

Table 17: Cumulative percentages of the number of times one adjustment was classed (from 1 for the most important to 7 for the less important)

Group of stature	Factor	1	2	3	4	5	6	7
Short	Accessibility of the pedals	84.3	98.6	98.6	98.6	98.6	100.0	100.0
	Accessibility of steering wheel	0.0	40.0	90.0	92.9	92.9	100.0	100.0
	Accessibility of other controls	0.0	1.4	1.4	14.3	80.0	92.9	100.0
	Control panel visibility	0.0	0.0	8.6	75.7	85.7	98.6	100.0
	Road visibility	14.3	57.1	85.7	95.7	100.0	100.0	100.0
	Head clearance	1.4	1.4	7.1	14.3	34.3	92.9	100.0
	Average	Accessibility of the pedals	88.3	100.0	100.0	100.0	100.0	100.0
Accessibility of steering wheel		0.0	26.7	73.3	83.3	98.3	100.0	100.0
Accessibility of other controls		0.0	0.0	8.3	68.3	100.0	100.0	100.0
Control panel visibility		0.0	1.7	18.3	40.0	91.7	100.0	100.0
Road visibility		11.7	70.0	93.3	100.0	100.0	100.0	100.0
Head clearance		0.0	1.7	6.7	8.3	10.0	100.0	100.0
Tall		Accessibility of the pedals	46.7	82.2	88.9	91.1	93.3	100.0
	Accessibility of steering wheel	35.6	60.0	80.0	93.3	100.0	100.0	100.0
	Accessibility of other controls	0.0	13.3	26.7	57.8	84.4	100.0	100.0
	Control panel visibility	0.0	13.3	17.8	37.8	93.3	100.0	100.0
	Road visibility	15.6	26.7	68.9	97.8	100.0	100.0	100.0
	Head clearance	2.2	4.4	17.8	22.2	28.9	100.0	100.0
	All	Accessibility of the pedals	76.0	94.9	96.6	97.1	97.7	100.0
Accessibility of steering wheel		9.1	40.6	81.7	89.7	96.6	100.0	100.0
Accessibility of other controls		0.0	4.0	10.3	44.0	88.0	97.1	100.0
Control panel visibility		0.0	4.0	14.3	53.7	89.7	99.4	100.0
Road visibility		13.7	53.7	84.0	97.7	100.0	100.0	100.0
Head clearance		1.1	2.3	9.7	14.3	24.6	97.1	100.0

4.3.3 Vehicle interior adjustments

4.3.3.1 Correlations between vehicle interior adjustments

Table 18 presents the coefficient of correlation between seat and steering wheel selected adjustments. Steering wheel longitudinal and vertical adjustments are strongly correlated (-0.82). A negative correlation means that for lower positions of the steering wheel, drivers adjust the steering wheel in a more backward position. Seat vertical adjustment (Seat_Z) is strongly correlated to both longitudinal and vertical steering wheel adjustments (-0.74 and 0.88 respectively): when the seat is adjusted in a lower position, the steering wheel is moved lower and backwards. Seat longitudinal and vertical adjustments are also negatively correlated, but with a lower coefficient of correlation (-0.36). Finally, seat back angle is not correlated to any of the seat and steering wheel adjustments.

Since the 5 tested vehicles have different seat height, the correlations between seat vertical adjustments and steering wheel longitudinal and vertical adjustments suggest that the factor Vehicle will have a significant influence on the selected steering wheel adjustments. Similarly, we can expect that Vehicle will significantly affect the seat longitudinal adjustment. These hypotheses will be verified in next section.

Table 18: coefficient of correlation (from 0 for no correlation to ± 1 for 100% positive or negative correlation) between seat and steering wheel adjustments

	Seat_X	Seat_Z	SWC_X	SWC_Z	SBA
Seat_X		-0.36***	0.37***	-0.17***	-0.005
Seat_Z	-0.36***		-0.74***	0.88***	0.02
SWC_X	0.37***	-0.74***		-0.82***	-0.08
SWC_Z	-0.17***	0.88***	-0.82***		-0.03
SBA	-0.005	0.02	-0.08	-0.03	

*** $p < 0.001$

4.3.3.2 Intra-individual variability

Table 19: Means and standard deviations of the maximal range of variation between the 4 test configurations for the 5 vehicle adjustments.

	Seat_X_d (mm)	Seat_Z_d (mm)	SWC_X_d (mm)	SWC_Z_d (mm)	SeatTo SWC_X_d (mm)	SeatTo SWC_Z_d (mm)	SBA_d (°)
Veh1	24.8 ± 15.9	10.8 ± 8.7	12.2 ± 9.3	8.9 ± 5.9	27.9 ± 17.9	12.2 ± 8.4	3.7 ± 2.0
Veh2	20.4 ± 11.0	16.3 ± 10.0	21.0 ± 15.0	13.9 ± 8.0	28.3 ± 17.3	17.5 ± 8.7	3.5 ± 2.4
Veh3	24.0 ± 14.9	12.7 ± 9.4	15.0 ± 9.2	8.4 ± 4.7	28.1 ± 15.2	15.3 ± 10.1	4.0 ± 1.9
Veh4	18.9 ± 10.9	17.2 ± 12.3	23.2 ± 15.5	13.4 ± 10.1	31.5 ± 17.1	17.7 ± 13.3	4.5 ± 4.1
Veh5	23.5 ± 16.9	20.7 ± 15.3	26.0 ± 17.6	18.1 ± 11.3	33.4 ± 24.8	19.8 ± 12.4	4.8 ± 2.9
S	17.5 ± 10.2	12.8 ± 10.5	20.7 ± 14.1	13.5 ± 8.8	27.3 ± 14.9	16.6 ± 10.8	4.4 ± 3.4
A	24.9 ± 15.8	17.5 ± 11.6	22.5 ± 16.0	12.7 ± 9.4	34.4 ± 22.3	18.1 ± 11.1	4.0 ± 2.3
T	25.0 ± 14.7	16.5 ± 13.3	13.3 ± 10.8	11.0 ± 8.7	26.6 ± 16.1	13.9 ± 10.6	4.0 ± 2.5
All	22.3 ± 14.1 G**	15.6 ± 11.8 V**	19.5 ± 14.5 G**,V***	12.6 ± 9.0 V***	29.8 ± 18.7 G**	16.5 ± 10.9 V**	4.1 ± 2.8

* $p < 0.05$, ** $p < 0.01$, *** $p < 0.001$

Table 19 presents the intra-individual variability of seat adjustments (Seat_X_d and Seat_Z_d), steering wheel adjustments (SWC_X_d and SWC_Z_d) and seat back angle (SBA_d) for the 3 groups of stature and the 5 tested vehicles. The maximal variations in the seat longitudinal (Seat_X_d) and vertical (Seat_Z_d) adjustments between the four test configurations are $22.3 \text{ mm} \pm 14.1 \text{ mm}$, and $15.6 \pm 11.8 \text{ mm}$ on average respectively, representing about 10% and 25% of their adjustment range. For steering wheel longitudinal and vertical adjustments (SWC_X_d and SWC_Z_d), they are respectively 19.5 ± 14.5 and $12.6 \pm 9 \text{ mm}$ representing about 40% and 25% of their adjustment ranges. Group of stature significantly affected intra-individual variability in both seat and SW longitudinal adjustments. For seat longitudinal adjustment, intra-individual variability increased with stature. For steering wheel longitudinal adjustment, intra-individual variability was lower for tall drivers. If we accept the idea that a more restricted environment results in smaller postural variations, the five tested vehicles are more restrictive for shorter drivers in seat position and for tall drivers in steering wheel position.

Vehicle significantly affected intra-individual variability in the two steering wheel adjustments (SWC_X_d and SWC_Z_d) as well as in the seat vertical adjustment (Seat_X_d). For these three adjustments, intra-individual variability increased with seat height, except for Vehicle 3. Intra-individual variability in seat back angle (SBA_d) was neither affected by group of subjects nor by vehicle. No interaction between vehicle and group of subject was found for any of the vehicle adjustments.

4.3.3.3 Effect of group of stature and vehicle package

The means and standard deviations of the adjustments for the five vehicles and three stature groups are presented in Table 20.

Table 20: Means and standard deviations of the 5 vehicle adjustments. SeatToSWC_X is defined as the longitudinal distance between Seat position and steering wheel center (Seat_X – SCW_X), and SWCToSeat_Z is defined as the vertical distance between steering wheel center and seat reference point (SWC_Z – Seat_Z)

	Seat_X (mm)	Seat_Z (mm)	SWC_X (mm)	SWC_Z (mm)	SeatToSWC_X (mm)	SWCToSeat_Z (mm)	SBA (°)
Veh1	834.7 ± 59.1	276.1 ± 19.1	525.0 ± 11.6	639.0 ± 10.9	309.7 ± 58.9	362.9 ± 21.9	21.2 ± 3.6
Veh2	835.3 ± 59.9	270.1 ± 17.1	532.7 ± 15.2	639.9 ± 9.6	302.6 ± 59.0	369.8 ± 20.4	20.8 ± 3.3
Veh3	868.5 ± 58.7	311.3 ± 16.1	547.8 ± 12.3	671.0 ± 7.8	320.9 ± 58.3	359.7 ± 19.0	21.9 ± 3.2
Veh4	814.8 ± 56.9	336.7 ± 17.7	459.9 ± 18.5	722.7 ± 12.0	354.0 ± 54.7	386.4 ± 20.2	21.6 ± 4.0
Veh5	785.8 ± 56.5	376.5 ± 18.5	451.1 ± 18.2	755.1 ± 13.2	334.6 ± 57.6	378.6 ± 19.8	21.7 ± 4.0
S	769.3 ± 31.6	324.2 ± 40.5	500.7 ± 43.2	683.4 ± 46.7	268.8 ± 29.0	359.3 ± 20.5	20.3 ± 3.3
A	842.4 ± 41.7	314.6 ± 41.3	506.2 ± 40.6	683.5 ± 48.7	336.1 ± 43.2	368.9 ± 18.1	22.5 ± 3.7
T	894.9 ± 50.5	297.1 ± 44.3	508.3 ± 44.6	688.1 ± 45.9	387.3 ± 42.3	391.9 ± 16.2	21.6 ± 3.4
All	828.6 ± 64.3 V***,G***	313.8 ± 43.0 V***,G***	504.6 ± 42.6 V***,G***	684.6 ± 47.2 V***,G***	323.4 ± 61.5 V***,G***	371.1 ± 22.5 V***,G***	21.5 ± 3.6° G***

Group of stature was found to have a statistically significant effect on both seat longitudinal and vertical adjustments (Seat_X and Seat_Z). Big differences between the 3 groups of subjects are observed, with short drivers adjusting the seat more forward and higher, while tall drivers adopted more backward and lower seat positions. Group of stature also had a statistically significant influence on both longitudinal and vertical steering wheel adjustments, as well as on seat back angle. However differences between the mean values of the 3 groups of subjects are relatively small for these 3 adjustments (about 8 mm for SWC_X, 5 mm for SWC_Z and less than 3° for SBA).

Vehicle had a statistically significant effect on all adjustments, except for seat back angle. For both seat and steering wheel adjustments, the same tendency was observed: seat and steering wheel position are higher on more forward for vehicles with higher seat height.

In order to see if longitudinal and vertical distances between seat and steering wheel remain constant regardless of Vehicle package, the means and standard deviations of longitudinal and vertical distances between seat and steering wheel (SeatToSWC_X and SWCToSeat_Z) are also presented in Table 20. Results showed that they both increased with seat height (H30).

4.3.4 Driving posture

4.3.4.1 Correlations between driving posture variables

Coefficients of correlation between driving posture variables are presented in Table 21. Quite high correlations were found between hip (Hip_X and Hip_Z) and eye (Eye_X and Eye_Z) positions. Especially, eye longitudinal position is strongly correlated with seat longitudinal position (0.80). As expected, the variables of the right side are highly correlated with those corresponding to the left side. However, low coefficients of correlation were observed for other postural variables, except for left and right hip angles that are correlated with hip longitudinal and vertical positions, and with eye vertical position.

Table 21: coefficient of correlation (from 0 for no correlation to ± 1 for 100% positive or negative correlation) between driving posture variables. For LKN and LHIP, two values are presented. The first one corresponds to the driving posture for which the left foot is on the undepressed clutch pedal. values between brackets correspond to the driving posture for which the left foot is on the fully depressed clutch pedal.

	Hip_X	Hip_Z	Eye_X	Eye_Z	LELB	RELB	LKN	RKN	LHIP	RHIP
Hip_X		-0.58	0.80*	0.57*	0.19*	0.19*	-0.04 (-0.15*)	-0.07 ^a	-0.47* (-0.43*)	-0.50*
Hip_Z	-0.58*		-0.58*	-0.68*	0.07 ^a	0.08 ^a	-0.02 ^a (0.09 ^a)	0.14*	0.52* (0.38*)	0.44*
Eye_X	0.80*	-0.58*		0.51*	0.43*	0.40*	-0.23* (-0.23*)	-0.23*	-0.19* (-0.14*)	-0.17*
Eye_Z	0.57*	-0.68*	0.51*		-0.12*	-0.10*	-0.05 ^a (-0.13*)	-0.11*	-0.47* (-0.34*)	-0.41*
LELB	0.19*	0.07 ^a	0.43*	-0.12*		0.84*	-0.22* (-0.23*)	-0.19*	0.26* (0.17*)	0.20*
RELB	0.19*	0.08 ^a	0.40*	-0.10*	0.84*		-0.18* (-0.21*)	-0.18*	0.20* (0.13*)	0.26*
LKN	-0.04 ^a (-0.15*)	-0.02 ^a (0.09 ^a)	-0.23* (-0.23*)	-0.05 ^a (-0.13*)	-0.22* (-0.23*)	-0.18* (-0.21*)		0.70* (0.70*)	0.27* (0.60*)	0.26* (0.45*)
RKN	-0.07 ^a	0.14*	-0.23*	-0.11*	-0.19*	-0.18*	0.70* (0.70*)		0.30* (0.40*)	0.34*
LHIP	-0.47* (-0.43*)	0.52* (0.38*)	-0.19* (-0.14*)	-0.47* (-0.34*)	0.26* (0.17*)	0.20* (0.13*)	0.27* (0.60*)	0.30* (0.40*)		0.86* (0.85*)
RHIP	-0.50*	0.44*	-0.17*	-0.41*	0.20*	0.26*	0.26* (0.45*)	0.34*	0.86* (0.85*)	

^ap \geq 0.05,*p<0.01

4.3.4.2 Intra-individual variability

Similarly to vehicle adjustments, intra-individual variability was calculated for driving posture variables. Results are presented in Table 22.

Intra-individual variability in hip center positions were slightly higher than in seat adjustments (Table 19). Hip longitudinal and vertical intra-individual variabilities were significantly affected by Group of stature. Higher variations were found for tall drivers. Intra-individual variability in hip vertical position was also significantly affected by Vehicle, with higher values for higher seat height (H30).

Intra-individual variability for driver's eye position was found even higher than for hip position (38.6 ± 20.8 mm and 23.6 ± 10.4 mm on average for eye x and z positions respectively). Intra-individual variability in both longitudinal and vertical eye position were affected by vehicle (it increased with seat height (H30)). Intra-individual variability on vertical position was also affected by Group of stature: smaller values were found for short volunteers.

Quite small intra-individual variability values were found for left knee angle ($5.8 \pm 3.2^\circ$ and $7.3 \pm 4.8^\circ$ on average for clutch pedal undepressed and fully depressed postures respectively), left hip angle ($4.9 \pm 2.6^\circ$ and $5.2 \pm 2.5^\circ$ on average for clutch pedal undepressed and fully depressed postures respectively), and right hip angle ($7.7 \pm 3.8^\circ$ on average). Higher values were found for right knee angle ($12.8 \pm 6.4^\circ$ on average) and both left and right elbow angles ($16.0 \pm 8.6^\circ$ and $16.9 \pm 8.5^\circ$ respectively). None of the postural angles were affected by Vehicle nor by Group of stature.

No interaction between Vehicle and Group or stature was found for any of the driving posture variables.

4.3.4.3 *Effect of group of stature and vehicle package*

The means and standard deviations of the 10 driving postures are presented in Table 23.

- Effect of Group of stature

Group of stature had a statistically significant influence on driver's hip positions. Tall drivers sat lower and more backward, while short drivers adopted higher and more forward hip positions. Group of stature also significantly affected driver's eye position. Longitudinal and vertical position of driver's eyes from the pedals (Eye_X and Eye_Z) increased with stature.

For both left and right elbow angles, similar values were found for average and tall drivers, while short drivers showed smaller angle values. On the contrary, left and right knee angles as well as for left and right hip angles decreased with stature. Similar values were found for short and average drivers, while smaller values were observed for tall drivers. A statistically significant influence of group of stature on torso angle was observed, with lower values observed for short drivers. However, the differences between average values of the three groups of stature are very small (less than 1.5°).

- Effect of Vehicle package

Vehicle package had a strong influence on driver's hip and eye positions. Drivers adopted more forward and higher hip and eye positions in vehicles with higher seat height (H30).

Right elbow angle was only slightly affected by vehicle package (average value increased with seat height). The same tendency was observed for left elbow angle, but with higher differences between the five vehicles.

The statistical analysis of data also showed that vehicle package significantly affected both left and right knee angles, however, only slightly higher values were observed for Vehicle 1, while very similar angle values were found for the other 4 vehicles.

A statistically significant effect of vehicle package on left and right hip angles was found, however very small differences between the 5 vehicles are observed (5° on average). Finally, vehicle type was also found to have a statistically significant influence on torso angle. Higher values are observed for Vehicle 1 and Vehicle 3, while very similar values are observed for Vehicle 2, 4 and 5.

Table 22. Means and standard deviations of the maximal range of variation between the 4 test configurations for driving posture variables.

	Hip_X_d (mm)	Hip_Z_d (mm)	Eye_X_d (mm)	Eye_Z_d (mm)	LELB_d (°)	RELB_d (°)	LKN_d (°)	RKN_d (°)	LHIP_d (°)	RHIP_d (°)	Torso_d (°)		
					DE	FI	DE	FI	DE	FI			
Veh1	22.8 ± 11.6	17.2 ± 10.3	28.9 ± 16.8	21.4 ± 10.0	14.4 ± 6.3	15.8 ± 8.1	6.4 ± 3.2	7.4 ± 4.6	10.5 ± 6.0	4.4 ± 2.5	4.9 ± 2.2	7.9 ± 3.8	4.5 ± 1.9
Veh2	26.1 ± 10.5	22.0 ± 10.0	42.1 ± 21.9	27.5 ± 11.1	13.9 ± 6.1	16.3 ± 7.4	6.1 ± 3.3	6.7 ± 3.0	12.6 ± 5.5	4.6 ± 2.9	4.7 ± 1.9	7.9 ± 3.7	5.3 ± 2.6
Veh3	26.8 ± 12.2	16.3 ± 7.7	43.9 ± 18.5	24.9 ± 11.0	16.8 ± 8.4	17.3 ± 9.5	5.8 ± 3.5	7.7 ± 4.2	13.6 ± 6.5	4.6 ± 2.4	5.3 ± 2.5	8.2 ± 4.1	5.5 ± 2.3
Veh4	23.0 ± 11.2	25.4 ± 11.1	44.0 ± 25.3	28.6 ± 13.1	17.9 ± 9.1	17.9 ± 7.8	4.8 ± 2.6	6.4 ± 4.3	14.2 ± 5.5	4.5 ± 2.4	4.7 ± 1.9	7.4 ± 4.0	4.7 ± 2.4
Veh5	26.1 ± 11.7	26.0 ± 14.4	37.7 ± 14.2	26.4 ± 13.4	16.3 ± 7.9	17.6 ± 9.1	6.5 ± 3.2	8.4 ± 4.8	14.9 ± 7.4	4.6 ± 2.4	4.8 ± 1.9	6.7 ± 3.0	4.8 ± 2.1
S	24.0 ± 10.8	19.0 ± 12.3	36.6 ± 15.4	20.0 ± 8.8	16.9 ± 9.9	16.7 ± 7.7	5.9 ± 3.0	7.7 ± 5.7	14.6 ± 6.4	5.4 ± 2.7	5.3 ± 2.9	8.2 ± 4.6	5.5 ± 2.5
A	23.4 ± 10.3	21.7 ± 10.7	38.4 ± 21.4	28.7 ± 12.4	14.9 ± 7.3	16.2 ± 8.3	5.6 ± 3.2	7.1 ± 4.4	11.2 ± 6.1	4.6 ± 2.4	5.2 ± 2.0	7.5 ± 3.1	5.0 ± 2.0
T	29.8 ± 13.6	24.5 ± 11.3	45.6 ± 23.8	28.9 ± 12.2	16.7 ± 8.8	19.1 ± 9.8	6.0 ± 3.5	7.1 ± 3.9	14.9 ± 7.3	4.6 ± 2.7	4.9 ± 2.3	7.1 ± 3.5	4.1 ± 2.0
All	25.0 ± 11.4 G*	21.4 ± 11.5 V***, G*	38.6 ± 20.8 V**	23.6 ± 10.4 V*, G**	16.0 ± 8.6	16.9 ± 8.5	5.8 ± 3.2	7.3 ± 4.8	12.8 ± 6.4	4.9 ± 2.6	5.2 ± 2.5	7.7 ± 3.8	4.9 ± 2.3

Table 23. Means and standard deviations of the 10 driving posture variables. For left knee angle (LKN) and left hip angle (LHIP) the first value (DE) corresponds to the undepressed clutch pedal postures, while the second one (FI) corresponds to the fully depressed clutch pedal postures.

	Hip_X (mm)	Hip_Z (mm)	Eye_X (mm)	Eye_Z (mm)	LELB (°)	RELB (°)	LKN (°)	RKN (°)	LHIP (°)	RHIP (°)	Torso (°)		
					DE	FI	DE	FI	DE	FI			
Veh1	838.0 ± 48.8	278.7 ± 26.2	923.1 ± 70.4	904.3 ± 31.2	119.2 ± 16.1	113.6 ± 17.2	103.7 ± 8.3	133.4 ± 10.6	113.7 ± 9.8	87.5 ± 6.7	99.6 ± 7.4	93.6 ± 7.1	27.4 ± 5.0
Veh2	843.2 ± 56.8	285.2 ± 19.6	902.0 ± 72.8	906.0 ± 35.9	123.6 ± 16.0	120.9 ± 16.1	101.2 ± 7.3	128.5 ± 9.1	110.9 ± 8.6	87.8 ± 6.6	98.0 ± 7.2	91.5 ± 6.8	25.6 ± 5.4
Veh3	857.5 ± 49.9	312.3 ± 21.9	935.7 ± 68.8	923.7 ± 34.8	130.8 ± 15.2	122.5 ± 16.1	98.0 ± 7.3	128.1 ± 10.1	110.5 ± 8.2	90.0 ± 6.0	99.9 ± 6.7	93.9 ± 6.6	28.1 ± 4.0
Veh4	793.8 ± 52.0	350.8 ± 22.7	855.3 ± 67.3	974.3 ± 38.5	128.4 ± 15.2	123.4 ± 15.8	99.6 ± 7.4	127.7 ± 9.8	110.7 ± 8.3	92.0 ± 6.2	100.2 ± 6.3	95.3 ± 6.7	25.8 ± 4.0
Veh5	768.0 ± 55.7	385.5 ± 22.9	829.3 ± 62.1	1007.0 ± 40.1	129.1 ± 15.0	125.9 ± 15.9	98.4 ± 7.5	126.5 ± 10.3	111.1 ± 8.9	93.2 ± 6.3	101.2 ± 6.8	97.4 ± 6.8	25.8 ± 4.5
S	771.4 ± 43.1	333.1 ± 43.1	819.8 ± 62.0	914.9 ± 43.1	119.0 ± 18.1	112.9 ± 16.1	104.3 ± 6.5	134.5 ± 8.0	114.5 ± 8.3	92.2 ± 7.2	102.2 ± 7.2	96.5 ± 7.4	25.7 ± 5.2
A	831.4 ± 47.0	320.8 ± 46.0	910.5 ± 52.1	942.5 ± 51.3	130.1 ± 14.8	124.1 ± 16.6	100.4 ± 6.9	129.9 ± 8.5	112.7 ± 8.0	91.3 ± 5.5	101.7 ± 4.8	95.6 ± 5.8	27.3 ± 4.4
T	873.1 ± 55.3	307.1 ± 46.9	950.7 ± 69.9	984.1 ± 48.5	129.6 ± 10.9	128.2 ± 12.4	93.8 ± 6.9	118.6 ± 8.5	104.5 ± 7.5	84.7 ± 5.1	93.0 ± 5.3	89.0 ± 6.0	26.7 ± 4.2
All	820.5 ± 62.3 V***, G***	321.9 ± 46.3 V***, G***	889.3 ± 79.4 V***, G***	942.9 ± 54.4 V***, G***	126.2 ± 16.1 V***, G***	121.3 ± 16.7 V***, G***	100.2 ± 7.8 V***, G***	128.8 ± 10.2 V***, G***	111.4 ± 8.9 G***	90.1 ± 6.7 V***, G***	99.8 ± 6.9 G***	94.3 ± 7.1 V***, G***	26.5 ± 4.7 V***, G***

- Postural asymmetry

Instructions given to participants for left and right foot positions were not the same (right foot was placed on the accelerator pedal un-depressed, and left foot was placed either on the un-depressed or fully depressed clutch pedal), therefore significant differences between left and right hip angles were observed, as well as between left and right knee angles. Despite the fact that participants were asked to place their hands on the steering wheel in a symmetric posture (the 10 O'clock and 2 O'clock positions), significant differences were observed between left and right elbow angles, with an average difference of 5.0 ° (left – right).

4.4 Comparison with existing studies

4.4.1 Comparison with CPM model

Observed seat longitudinal position, and driver's hip and eye positions were compared with predictions given by the CPM model [34]. Average differences between observations and CPM predictions are presented in Table 24. Average negative differences are observed for seat and steering wheel positions (-10.6 ± 29.9 mm and -11.6 ± 46.3 mm respectively), indicating that the CPM model predicts more forward seat and driver's eye wheel positions. On average, the CPM model also predicts higher driver's eye positions (-19.6 ± 20.3 mm on average). Surprisingly, the opposite trends were observed for hip longitudinal and vertical positions. Results indicate that the CPM model predicts further forward and lower hip position (10.8 ± 35.6 mm and 7.6 ± 15.5 on average, respectively).

Both group of stature and vehicle type have a statistically significant influence on the differences between observations and CPM predictions. As expected, highest differences are almost always observed for extreme drivers (i.e. short or tall drivers). Regarding the effect of vehicle type, highest differences are almost always observed for Vehicle 5 (vehicle with highest seat height).

If we refer to intra-individual variability values (Table 19 and Table 22), average differences between observations and CPM predictions are within the range of intra-individual variability.

Table 24: Mean differences and standard deviations between CPM predictions and observations in seat longitudinal position (D_Seat_X), and hip longitudinal and vertical positions (D_Hip_X and D_Hip_Z).

	D_Seat_X (mm)	D_Hip_X (mm)	D_Hip_Z (mm)	D_Eye_X (mm)	D_Eye_Z (mm)
Veh1	11.7 ± 26.3	-14.7 ± 33.1	-1.9 ± 13.7	9.9 ± 45.4	16.7 ± 19.2
Veh2	4.9 ± 23.9	-15.6 ± 33.5	-11.3 ± 13.8	24.9 ± 47.7	14.0 ± 20.6
Veh3	-8.7 ± 24.6	-27.5 ± 33.0	5.1 ± 13.3	8.0 ± 46.5	27.0 ± 21.0
Veh4	6.3 ± 23.7	-6.8 ± 32.4	-18.3 ± 11.6	21.1 ± 45.3	13.1 ± 18.4
Veh5	40.9 ± 26.4	12.9 ± 33.2	-13.6 ± 12.1	29.0 ± 45.7	16.9 ± 19.3
S	11.8 ± 25.4	-27.6 ± 27.9	-7.4 ± 16.1	9.6 ± 40.7	22.0 ± 14.2
A	2.6 ± 33.9	-15.2 ± 32.5	-6.0 ± 13.9	-8.6 ± 38.1	24.9 ± 21.0
T	21.2 ± 25.6	20.6 ± 29.9	-10.5 ± 16.5	33.0 ± 46.1	12.2 ± 21.9
All	10.6 ± 29.9 V***, G***	-10.8 ± 35.6 V***, G***	-7.6 ± 15.5 V***, G***	11.6 ± 46.3 V***, G***	19.6 ± 20.3 V***, G***

4.4.2 Comparison with SAE standards

4.4.2.1 Seat longitudinal position (SAE J1517)

Observed seat longitudinal positions were also compared with SAE J1517 recommended practice [41] (Figure 18). Results of the comparison showed that the population accommodation is quite good for tall drivers, while short drivers often adjusted their seat in a more forward position than the recommended seat longitudinal for the 2.5th percentile of the population.

It should also be noted that for Vehicle 3 the opposite trend is observed. However, the seat travel path was initially designed for a lower seat height.

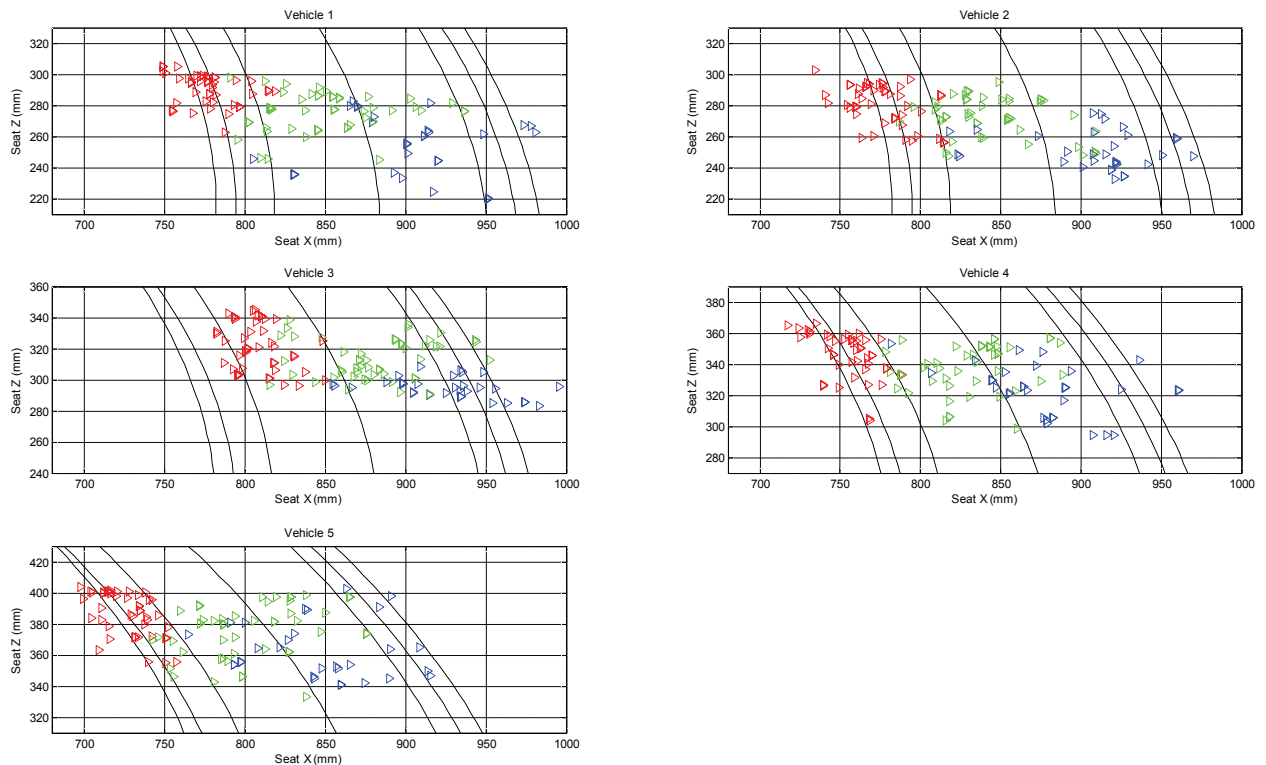

Figure 18: Comparison of driver's observed seat position with SAE recommendations [41] red for short drivers, green for average drivers and blue for tall drivers – dark lines correspond to SAE J1517 2.5th, 5th, 10th, 50th, 90th, 95th, and 97.5th percentile accommodation models (from left to right)

4.4.2.2 Eye location (SAE J941)

Observed driver's eye location were superimposed to 95% tangent cutoff eyellipse (SAE J941 [44]). Results are presented in Figure 19. The 95% inclusive ellipse from SAE J1517 and from experimental observations were also plotted and compared (Table 25). For Vehicles 1, 2, 4 and 5 axis lengths of 95% inclusive ellipse obtained from experimental observations are very similar to axes lengths of the 95% inclusive ellipse from SAE J1517, even if for ellipses obtained from experimental observations x axis' length tends to decrease with seat height, while z axis' length tends to increase. Ellipse tilt angle also increased with seat height. Vehicle 3 followed the opposite trends.

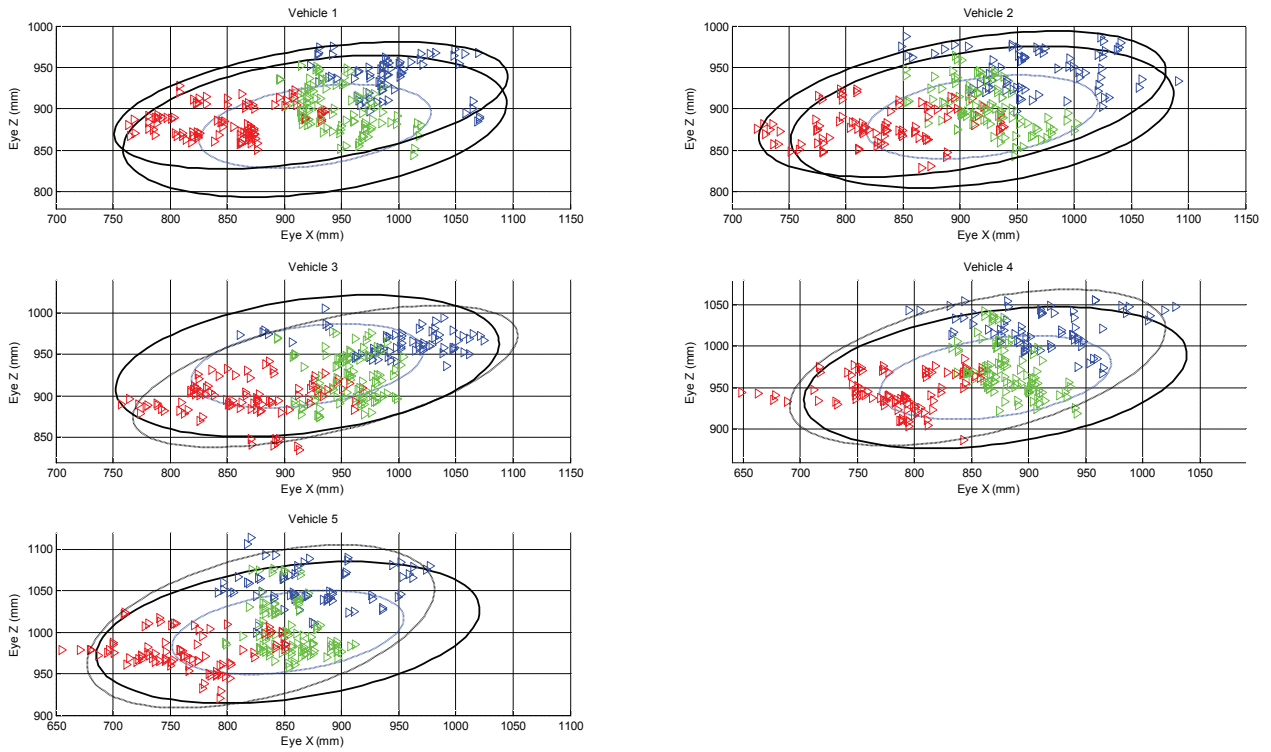

Figure 19: Comparison of driver's observed eye positions (red for short drivers, green for average drivers and blue for tall drivers) with SAE 95% tangent cutoff eyellipse (blue solid line) and 95% inclusive eyellipse (dark dotted line). [44]. The dark solid line ellipse correspond to the 95% confidence ellipse obtained from experimental observations.

Table 25: Comparison of 95% inclusive ellipse for eye position between SAE recommended practice J941 [44] and experimental observations

	SAE recommended practice J1517			Experimental observations						
	95% inclusive ellipse axis lengths (mm)		β ($^{\circ}$)	95% inclusive ellipse center (mm)		95% inclusive ellipse axis lengths (mm)		β ($^{\circ}$)	95% inclusive ellipse center (mm)	
	X	Z		X	Z	X	Z		X	Z
Veh1	170.65	79.35	12	926.7	879.2	176.2	66.7	13.2	923.2	905.0
Veh2	170.65	79.35	12	919.2	890.3	183.6	75.9	15.3	902.0	906.0
Veh3	170.65	79.35	12	920.0	936.6	176.7	66.2	19.3	935.7	923.7
Veh4	170.65	79.35	12	870.9	962.2	172.8	78.2	19.9	855.3	974.3
Veh5	170.65	79.35	12	853.1	999.7	160.9	82.6	22.6	829.3	1007.0

4.4.3 Preferred joint angles

Observed postural angles for hip, elbow and knee were compared to existing recommendations (Table 26). Ranges given for the actual study are calculated as being the angle average value \pm standard deviation. Observed postural angles from this study were within most of the previous recommended ranges.

Table 26: Comparison of observed postural angles with existing recommended joint angles

	Rebiffé [31]	Hanson et al. [13]	Andreoni [2]	Porter and Gyi [30]	Kyung MCMD1 [16]	Kyung MCMD2 [16]	Actual study	
							Left	Right
Hip angle (°)	95 – 120	68 – 109	83 – 105	90 – 115	79 – 92	107 – 123	83 – 97 (DE) 93 – 107 (FI)	87 – 101
Knee angle (°)	95 – 135	109 – 157	123 – 149	99 – 138	84 – 110	118 – 142	92 – 108 (DE) 119 – 139 (FI)	102 – 120
Elbow angle (°)	80 – 120	96 – 163	104 – 135	120 – 152	85 – 108	133 – 167	110 – 142	105 – 138

4.5 Discussion

In a first part, variability in vehicle adjustments was investigated. As expected, short drivers adopted more forward and higher seat positions, while tall drivers adjusted their seat in more backward and lower positions. The small differences observed between the three groups in steering wheel selected adjustments suggest that stature is not the principal predictor of steering wheel adjustments, and other factors, such as vision of control panel, may also influence the selected steering wheel position.

If we look at the position of seating reference point (SgRP) and steering wheel center (SWC) of the tested vehicles with respect to the pedals, we can clearly see that higher seats allows more forward seat positions, as well as more forward and higher steering wheel positions (Figure 20). Therefore, seat and steering wheel selected positions are highly dependent on vehicle package. The distance between SgRP and SWC was almost the same for the 5 tested vehicles, except for Vehicle 3 for which the vertical distance was slightly reduced since the seat height was lifted up due to the foam added on the seat (Table 27). However, if we look at the average longitudinal and vertical positions of the steering wheel with respect to the adjusted seat position (SeatToSWC_X and SWCToSeat_Z) (Table 20) we can see that they both increased with seat height (H30), suggesting that vehicle package had an influence on selected seat adjustments. This result also suggests that driving package may have a significant effect on postural angles, especially on elbow angle that should be greater (i.e. elbow should more extended) for vehicles with higher seat height (H30). Indeed, this hypothesis was confirmed by the results presented in Table 23, showing that both left and right elbow angles were bigger for the vehicles with a higher seat (H30). Higher differences were observed for left elbow angle.

Selected seat back angle was affected by both vehicle package and stature (Table 23), however, very small differences were observed between the 3 groups of stature or between the 5 vehicles. This agrees with results obtained by Reed [32], who observed that driver's torso posture remained largely unaffected by changes in driving package.

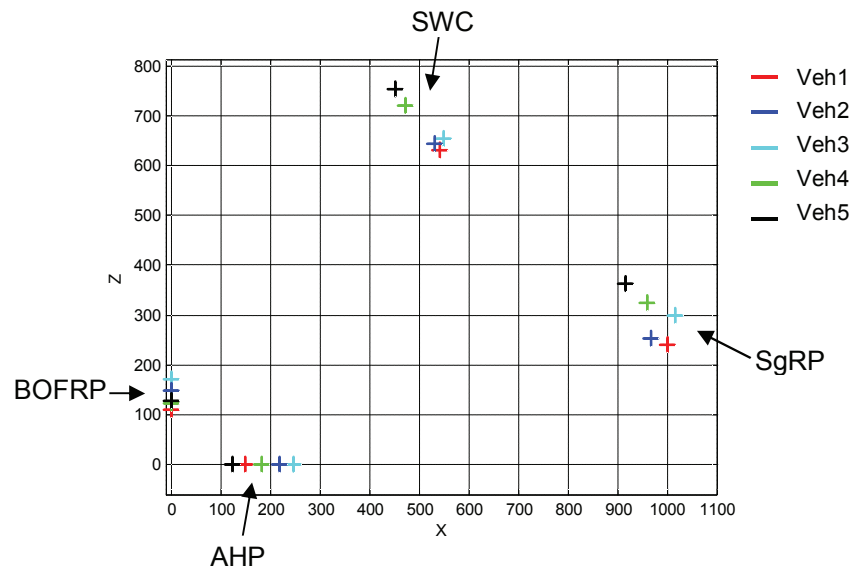

Figure 20: Position of seating reference point (SgRP) and steering wheel center (SWC) of the tested vehicles with respect to the pedals (BOFRP and AHP)

Table 27: longitudinal and vertical distances between seat reference point and steering wheel center for the 5 tested vehicles

	dx (mm)	dz (mm)
Veh1	457	390
Veh2	434	393
Veh3	466	356
Veh4	487	397
Veh5	463	392
All	461.4 ± 19.0	385.6 ± 16.7

As expected, average drivers almost always showed the highest intra-individual variability values, except for seat back angle, for which all three groups of stature showed similar values. If we look more in details at the questionnaire answers, for the 3 groups of stature the most important factor for vehicle interior adjustments was the accessibility of the pedals (Table 17). However, the second most important factor depended on stature group. Short drivers allowed more importance to the visibility of the road than tall drivers, and interestingly smallest intra-individual variability in seat vertical position was found for short drivers. Similarly, for tall drivers the accessibility of the steering wheel was ranked second most important factor, and smallest intra-individual variability in steering wheel adjustments was found for tall drivers.

For seat longitudinal adjustments, intra-individual variability was not affected by vehicle package, whereas for all the other adjustments intra-individual variability increased with seat height (H30). This suggests that vehicles with lower seat height are more restrictive in seat and steering wheel adjustments. It should also be noted that intra-individual values found for Vehicle 3 did not follow the observed trend, i.e. lower values were found for this vehicle, confirming that the foam added on the seat restricted the range of feasible postures. Indeed, by adding this foam, the distance between the seat and the steering wheel was reduced, and therefore the number of possible acceptable seat and steering wheel adjustments for a driver was also reduced. This can also be observed in Figure 17, in which we can clearly observe that for this vehicle, the

lowest part of the seat travel path is more often chosen, while the steering wheel has almost always been placed in the upper most position. This was also confirmed with the questionnaire analysis that showed that in almost 30% of cases seat and steering wheel vertical positions were judged as limited (Appendix 1.1.1).

If we refer to the 95% variation range (i.e. range for which 95% of the adjustments are within this range of variation), the repetibilities are given in Table 28. These results agree with 95% variation ranges found by Jonsson et al. [15] (49 mm for seat longitudinal adjustment, and 9° for seat back angle). Lower values were observed for seat vertical adjustment (22 and 15 mm for rear edge and front edge of seat cushion respectively). In four of the five tested vehicles (Vehicle 2 to Vehicle 5), the seat longitudinal position could not be adjusted continuously, but with discreet steps (notches). In actual vehicles, one step length is about 15 mm, which means that participants were able to reproduce their seat longitudinal adjustment within 3 steps.

Table 28: 95% confidence ranges for vehicle adjustments based on 4 repetitions by participant.

Adjustment	95% variation range
Seat_X	46 mm
Seat_Z	34 mm
SWC_X	43 mm
SWC_Z	26 mm
SBA	8°

In the current study, stature was found to significantly affect postural angles. Knee and hip angles were found to decrease with stature (i.e. more flexed knees and hips for taller drivers), which agrees with results found by Park et al. [26] and Ferhen et al. (2003). On the contrary, more extended elbows were observed for tall drivers.

Interestingly, only slightly more extended knees and hips were observed for lower seats (average differences between Vehicle 1 and Vehicle 5 lower than 5°). Intra-individual variability for these angles was also very small (from 4.9° to 7.7°) in comparison with intra-individual variability value found for elbow angles (16.5° on average). These observations suggest that drivers adapted their posture to changes in vehicle package by changes in elbow angle while hip and knee angles were less affected.

The comparison between left and right side was not possible for knee and hip angles, since constraints imposed on both left and right foot were not the same. Indeed, constraints imposed by the driving task are not the same between left foot (that can be on foot rest or on clutch pedal) and right foot (that is used for braking and accelerating). Regarding elbow angle, a significant difference was found between left and right side. Therefore, this suggests that driving postures should be described and predicted asymmetrically.

Observed driver's seat and eye positions were compared to CPM model predictions [34] and SAE recommended practices [41, 44]. Results show that the CPM model gives slightly more backward predictions (average differences between observations and CPM predictions were -10.6 ± 29.9 mm for seat longitudinal position and -11.6 ± 46.3 mm for eye longitudinal position). This is probably due to the fact that the CPM model was developed based on data collected on automatic vehicles. If we refer to the predictive equations given by SAE standards ([41] and [44]), the seat longitudinal position and the longitudinal position of the eyellipse center are predicted 12.5 mm further backward in case of no clutch pedal.

When comparing observations with SAE standards, it was found that driver's seat position is not well predicted for lower extremes of the population, which agrees with results found by Kyung [16] who observed that "SAE J1517 does not adequately consider extremes of a population". Regarding the prediction of eye location, the 95% tangent cutoff eyellipse was found to be very restrictive, whereas 95% inclusive ellipse obtained from experimental observation had always the same axis lengths than the 95% inclusive ellipse from SAE J941, suggesting that inclusive ellipses should be used instead of tangent cutoff eyellipse. Again, this result agrees with Kyung's observations [16]. However, in the actual study the orientation of the 95% inclusive ellipse was found to increase with seat height (from 13° to 22°), whereas Kyung found lower tilt angle for SUV (14.7° for Sedan and 12.5° for SUV).

Finally, observed postural angles were compared to existing recommendations, suggesting that actual vehicle interior design allow drivers to adopt driving postures close to their preferred ones.

4.6 Conclusions

Results from questionnaire analysis show that for almost 30% of all trials at least one adjustment range was judged too restrictive. This unsatisfying proportion is particularly high for short participants, suggesting that currently existing passenger vehicles are not well designed for them. In addition, for two of five tested vehicles, the seat longitudinal adjustment range was not fully used, suggesting that seat travel path may not be optimized.

Descriptions of vehicle adjustments and postural angles for five actual vehicles were obtained, and postural variability was investigated. The 95% confidence ranges of variation between two repetitions were 46 mm and 34 mm for seat longitudinal and vertical adjustments respectively. For steering wheel adjustment, very similar values were observed (43 mm in x and 26 mm in z directions). These values can be used as an indicator of the accuracy required for a driving posture prediction model.

The most important observation from the analysis of variability due to vehicle package is that drivers adapted their posture to changes in vehicle package by changes in elbow angles, while hip and knee angles remained almost unaffected. Variability in torso angle is not well explained by driver's anthropometry nor by vehicle factors.

The postural asymmetry identified in this work should also be considered when using DHMs for vehicle interior design, as well as postural variability due to driver anthropometry.

Interestingly, the position of the steering wheel with respect to the seat position was affected by vehicle, suggesting that other constraints such as visibility (outside and inside the vehicle) may influence steering wheel adjustments. This should be further investigated.

Finally, results show that the foam added on the seat of Vehicle 3 introduced a bias on selected vehicle adjustments and driving posture variables, that does not follow the general trends observed for other vehicles. Therefore, this vehicle will be removed of the data for further analysis.

5 Driving posture prediction model

5.1 Introduction

In this chapter, based on the driving posture and vehicle adjustments analysis (Chapter 4), a statistical driving posture prediction model is proposed, aiming at predicting vehicle adjustments (i.e. seat and steering wheel vertical and longitudinal positions, and seat back angle) and driving posture (mainly characterized by hip and eye position, elbow, knee and torso angles), for a given vehicle geometry and a given driver's anthropometry.

5.2 General model formulation

5.2.1 Definition of model inputs

Two types of inputs are used in this model: vehicle package parameters and driver anthropometric parameters. The definition of the four vehicle package parameters is given in Chapter 1 (Table 4 and Figure 8). The following 5 anthropometric parameters are also inputs of the model: stature (S), sitting height (SH), weight (W), lower limb length (LL) and upper limb length (UL). Sitting height is defined as being the difference between total height sitting and seat height, upper limb length is defined as the sum of upper arm length and forearm length and lower limb length as the sum of buttock-knee length and knee height sitting (Appendix 8.2). Since these anthropometric parameters are highly correlated (Table 41), the ratio of sitting height to stature (SH/S), the ratio of lower limb length to stature (LL/S), the ratio of upper limb length to stature (UL/S) and the body mass index (BMI) were used instead of sitting height, lower limb length, upper limb length and weight respectively.

The set of data used for the development of this posture prediction model comes from the data collected during the experimental study carried on 34 volunteers and 4 vehicles (data collected on Vehicle 3 were removed since the foam added on the seat cushion introduced a bias on selected adjustments). Since the questionnaire analysis showed that seat and/or steering wheel positions were readjusted during the driving session in about 30% of total cases, only postures and adjustments recorded after the driving session were used for the development of this predictive model. For each pair volunteer/vehicle, 3 driving postures were recorded after the driving session, with left foot on foot rest, left foot on un-depressed clutch pedal position and left foot on fully depressed clutch pedal position respectively. For the 3 recorded driving postures, the right foot was always placed on the un-depressed accelerator pedal and the two hands at 2- and 10-o'clock. The posture with left foot on foot rest allowed too much variability in left foot position, leading to high variability in left knee angle value. Therefore, only data from driving postures with left foot on un-depressed and fully depressed clutch pedal was used for the development of the model.

In order to also have data for the assessment of the model, recorded driving postures were divided into 2 homogeneous groups. The first one was used for the development of regression equations, and the second one for the assessment of the model (Table 29 and Table 30). The kinematic model of the human body used in this driving posture prediction model is the one used in RAMSIS (Appendix 8.2.7).

Table 29: Main characteristics of the 3 groups of subjects used for the development of regression equations

Groups of stature	Number of subjects	Stature (cm)	Stature min (cm)	Stature max (cm)
Short	7 (1M / 6F)	158 ± 6	149	164
Average	8 (6M / 2F)	172 ± 4	166	177
Tall	5 (5M / 0F)	187 ± 6	180	195
Total	20 (12M / 8F)	171 ± 12	149	195

Table 30: Main characteristics of the 3 groups of subjects used for the model assessment

Groups of stature	Number of subjects	Stature (cm)	Stature min (cm)	Stature max (cm)
Short	5 (0M / 5F)	157 ± 4	153	163
Average	5 (2M / 3F)	172 ± 4	167	175
Tall	4 (4M / 0F)	187 ± 4	183	192
Total	14 (6M / 8F)	171 ± 13	153	192

5.2.2 Definition of model outputs

Models outputs are of two kinds: vehicle adjustments and driving posture parameters. The definition of these outputs is given in Chapter 1 (Table 7 and Figure 13 for vehicle adjustments, and Table 10 and Figure 16 for driving posture parameters).

The model presented here starts with the prediction of vehicle adjustments. Driver's hip point location can be predicted in two different ways: directly predicted in the vehicle coordinate system i.e. with respect to the pedals (Hip_X and Hip_Z), or with respect to the seat position (Hip_X-Seat_X and Hip_Z-Seat_Z). This second method is probably less accurate, since a same driver can adopt different postures in a same seat, i.e. he/she can place his pelvis more forward or more backwards in the seat, but it may be less affected by vehicle type. Both methods are presented here, and will be further assessed.

5.3 Regression equations

As mentioned in 5.2.1, the data set used for the development of predictive regression equations is made of 160 observations corresponding to the data collected on 20 volunteers in 4 vehicles, after the driving session, with the left foot on undepressed and fully depressed clutch pedal.

In order to chose the predictors (i.e. the inputs of the model), a regression model selection procedure was used. This procedure fits regression models involving all combinations of given predictors. The different models are then compared based on the adjusted R² value, the Mallows' Cp and the mean squared error (MSE). The chosen model is the one that has a high adjusted R² value, while keeping a Mallow's Cp value close to the number of predictors of the model (a low Mallows' Cp value corresponds to a small residual sum of squares).

This procedure showed that UL/S (ratio of Upper Limb length to Stature) did not provide substantially better prediction for vehicle adjustments or driving posture variables. Therefore, it was not used as predictor for

vehicle adjustments. For almost all vehicle adjustments or driving posture variables, the cushion angle (CA) also did not provide substantially better predictions, except for the prediction of driver's hip vertical position with respect to the seat vertical position (Hip_Z-Seat_Z).

By examining the values presented in Table 31, we can observe that the seat longitudinal adjustment can be quite well predicted by the driver's anthropometric dimensions and vehicle geometry, with $R^2 = 83.3\%$. However it is important to notice that the root mean square error (RMSE) value is not so small (26.9), indicating that some variances are not taken into account in the regression equation. The vertical adjustment of seat H-point (Seat_Z) is also well predicted with $R^2 = 90.1\%$. The small RMSE value (15.6) reflects the good predictive ability of the model.

Similarly, steering wheel longitudinal and vertical adjustments (SWC_X and SWC_Z) appear to be well predicted, with R^2 values of 84.5 and 96.4 respectively. RMSE values are also quite small for both adjustments..

Two different models are proposed for the prediction of driver's hip position. The first model directly predicts hip position from vehicle package parameters and driver's main anthropometric dimensions. It seems to give quite good predictions ($R^2=82.5\%$ and 83.78% for Hip_X and Hip_Z respectively). The second model that predicts hip position with respect to seat position (H-point) shows relatively low R^2 values (38.2% and 33.5% for Hip_X-Seat_X and Hip_Z-Seat_Z respectively) showing that hip position with respect to the seat is moderately well predicted. This could be explained by the fact that for a same seat position, drivers can adopt different hip locations (i.e. they will sit more forwards or more backwards on the seat).

The eye location in the vehicle coordinate system is also well predicted by anthropometric dimensions and vehicle geometry ($R^2 = 76.2\%$ and 88.9% for eye longitudinal and vertical position respectively), but again the RMSE values are quite high, especially for eye longitudinal position (RMSE=41.0). Eye position is of course affected by selected seat position and torso angle. However, the analysis of driving postures showed that torso angle is not correlated to any of the driver's anthropometric dimensions nor to vehicle package parameters . Therefore this could partly explain the considerable remaining variance.

As expected, the lack of predictive ability for torso angle is observed in the low R^2 value (20.9%). Contrary to torso angle, stature was found to have a statistically significant effect on elbow and knee angles. This agrees with the slightly higher R^2 values observed for these two angles (31.7% and 33.6% for right elbow angle and right knee angle respectively).

Table 31: Adjusted Pearson correlation coefficient (R^2) and root mean square error (RMSE) for the prediction of driving posture variables. For Left knee angle, the first value corresponds to an undepressed clutch pedal while the value between brackets corresponds to the fully depressed clutch pedal.

Variable	R^2_{adj} (%)	RMSE
Seat_X (mm)	83.3	26.9
Seat_Z (mm)	90.1	15.6
SWC_X (mm)	84.5	16.6
SWC_Z (mm)	96.4	9.9
SBA (°)	14.8	4.0
Hip_X (mm)	82.5	26.5
Hip_Z (mm)	83.7	21.0
Hip_X-Seat_X (mm)	38.2	23.3
Hip_Z-Seat_Z (mm)	33.5	13.2
Eye_X (mm)	76.2	41.0
Eye_Z (mm)	88.9	18.6
Left Elbow angle (°)	25.4	15.4
Right Elbow angle (°)	31.7	15.8
Left Knee angle (°)	25.3 (37.4)	6.0 (8.3)
Right Knee angle (°)	33.6	7.2
Torso angle (°)	20.9	3.9

5.4 Model assessment

The model assessment can be of two kinds: first the ability of the model to fit the original data used to construct the model can be assessed. Then, the ability of the model to accurately predict driving posture can be assessed using new driving posture data.

5.4.1 Model assessment: original data

In order to study the ability of the model to fit the original data, experimental observations used for the development of regression equations are compared to predictions.

Table 32 presents the mean differences between predictions and observations (i.e. difference = prediction – observation) for seat adjustments and driver’s hip and eye positions. In order to see if stature and vehicle package has an influence on the model precision, results are also presented for the 3 groups of stature and for the 4 different vehicles. For each adjustment and driving posture variable a general linear model (GLM) was used to describe the effects of Group of stature (G) and Vehicle (V), and their interaction (G*V).

Neither Group of stature nor Vehicle had a statistically significant influence on differences between observations and predictions, except for the prediction of driver’s hip vertical position in the case that driver’s hip position is predicted with respect to the seat.

As expected, the model that predicts driver’s hip position directly in the vehicle coordinate system gives more accurate predictions than the model that predicts driver’s hip position with respect to the seat H-point position, especially for driver’s hip vertical position. This result suggests that driver’s hip position should be preferentially predicted directly with respect to the pedals.

Table 32: Mean differences and standard deviations between predictions and observations of seat adjustments and driver's hip and eye positions. Hip_X1 and Hip_Z1 correspond to driver's hip position directly predicted from vehicle package parameters and main anthropometric dimensions. Hip_X2 and Hip_Z2 correspond to driver's hip position predicted with respect to seat position.

	Seat_X (mm)	Seat_Z (mm)	Hip_X1 (mm)	Hip_Z1 (mm)	Hip_X2 (mm)	Hip_Z2 (mm)	Eye_X (mm)	Eye_Z (mm)
Veh1	-1.0 ± 27.3	5.5 ± 13.6	-3.9 ± 24.1	-0.8 ± 20.3	-5.1 ± 24.1	4.9 ± 18.3	3.8 ± 45.5	1.7 ± 20.1
Veh2	-0.5 ± 27.1	-5.9 ± 12.1	4.4 ± 26.0	0.9 ± 22.6	3.0 ± 26.0	-4.7 ± 21.8	-11.1 ± 41.7	-1.1 ± 17.4
Veh4	5.0 ± 26.9	0.9 ± 16.5	-0.6 ± 29.0	-0.1 ± 20.1	-2.6 ± 29.1	-16.9 ± 21.0	0.0 ± 38.0	-3.0 ± 18.6
Veh5	-3.1 ± 25.4	0.0 ± 17.2	0.0 ± 25.8	0.0 ± 20.5	1.3 ± 25.8	57.0 ± 19.4	-3.5 ± 41.1	1.9 ± 15.5
Short	-5.0 ± 23.8	0.3 ± 15.1	-1.9 ± 15.9	3.0 ± 18.0	-2.6 ± 15.7	9.1 ± 35.0	-5.5 ± 34.8	3.1 ± 15.9
Average	5.6 ± 27.1	-3.3 ± 14.0	1.0 ± 27.0	-3.0 ± 19.9	0.4 ± 27.1	12.1 ± 34.9	11.6 ± 31.0	-4.0 ± 18.5
Tall	-1.0 ± 28.7	4.4 ± 17.1	1.2 ± 35.6	0.1 ± 25.0	0.0 ± 35.7	7.7 ± 33.6	-8.9 ± 54.9	1.4 ± 20.9
All	0.0 ± 26.5	0.0 ± 17.2	0.0 ± 26.1	0.0 ± 20.7	-0.8 ± 26.1	9.8 ± 34.3 _{v**}	0.0 ± 40.4	0.0 ± 18.4

5.4.2 Model assessment: additional data

Another important point for the assessment of the driving posture prediction model performance is the comparison between the model predictions and additional recorded driving postures (that were not used for the development of the model). The data set used for the assessment of the predictive regression equations is made of 112 observations that correspond to the data collected on 14 volunteers (Table 30) in 4 vehicles, after the driving session, with the left foot on undepressed and fully depressed clutch pedal.

We focuss more particularly on the differences between observed and predicted driver's hip and eye positions. Mean differences between predictions and observations are presented in Table 33. In order to see if the prediction accuracy varies substantially with the inputs of the model, mean differences between predictions and observations are also presented for each vehicle and group of stature.

Results show that the proposed driving posture prediction model gives quite good predictions, with very small average errors (less than 8.5 mm on average). The values of standard deviation are very close to observed intra-individual variability values (22.3 ± 14.1 in x and 15.6 ± 11.8 in z for seat adjustments, 25.0 ± 11.4 mm in x direction and 21.4 ± 11.5 mm in z direction for hip position, and 38.6 ± 20.8 mm in x and 23.6 ± 10.4 mm in z direction for eye point position) (Table 19 and Table 22).

Interestingly, the group of stature was found to have a statistically significant effect on model errors for seat and eye longitudinal position. Table 33 shows that seat longitudinal position is well predicted for short and average drivers (average error lower than 2 mm) while more forward seat positions are predicted for tall drivers (average error of -16.7 ± 18.8 mm). The same results are observed for eye longitudinal position that is quite well predicted for Short and Average drivers (mean error lower than 10 mm), however it becomes higher for tall drivers, with an average error of -37.5 ± 38.7 mm. The group of stature was also found to have a statistically significant influence on seat vertical adjustment, that is predicted slightly higher than the observations for short drivers.

Finally, vehicle only had a statistically significant influence on model errors for the seat vertical adjustment. On average, higher seat positions are predicted for Vehicle 1 and Vehicle 4 while lower seat positions are predicted for Vehicle 2 and Vehicle 5. Interestingly, Vehicle 1 and Vehicle 4 were selected as vehicles with a

good field of view, and Vehicle 2 and Vehicle 5 were selected as vehicles with a limited field of view (Table 3). This suggests that other parameters related to vision may improve the predictions.

If we compare the error values presented in Table 33 with the mean differences between predictions given by the CPM model and observations from the data set used for the model assessment (

Table 34), we can see that average errors are almost always higher for the CPM model, especially for driver's hip and eye vertical positions. However, average errors from CPM predictions are still acceptable since they are close to observed intra-individual variability values. Note that CPM predicted a seat position more backward than observations. This could be explained by the presence of the clutch pedal in the current data while CPM was established from data of automatic transmission vehicles.

Table 33: Mean differences and standard deviations between observations and predictions of seat adjustments and driver's hip and eye positions. Hip_X1 and Hip_Z1 correspond to driver's hip position predicted with respect to the pedals

	Seat_X (mm)	Seat_Z (mm)	Hip_X1 (mm)	Hip_Z1 (mm)	Eye_X (mm)	Eye_Z (mm)
Veh1	-8.1 ± 30.5	11.7 ± 9.1	-12.9 ± 26.3	1.1 ± 20.9	-1.3 ± 38.7	10.7 ± 23.6
Veh2	-2.1 ± 19.0	-11.2 ± 13.2	1.2 ± 23.0	4.2 ± 19.7	-9.5 ± 49.2	-3.3 ± 25.0
Veh4	3.5 ± 17.7	2.5 ± 14.8	-7.7 ± 20.3	3.1 ± 22.6	-2.6 ± 38.3	7.4 ± 22.1
Veh5	-10.5 ± 28.3	-8.4 ± 14.7	-6.4 ± 24.6	-2.2 ± 23.3	-13.2 ± 53.6	0.5 ± 28.7
Short	-1.8 ± 17.2	7.2 ± 12.2	-8.2 ± 16.3	3.4 ± 21.1	5.3 ± 49.4	0.1 ± 22.8
Average	1.5 ± 31.4	-4.0 ± 18.7	-0.3 ± 25.6	1.1 ± 22.0	7.4 ± 39.4	5.9 ± 29.7
Tall	-16.7 ± 18.8	0.6 ± 13.2	-13.3 ± 26.9	-4.9 ± 19.6	-37.5 ± 38.7	0.0 ± 23.6
All	-4.4 ± 24.8 G*	-1.2 ± 15.9 V***, G**	-6.4 ± 23.8	0.2 ± 21.8	-5.6 ± 46.6 G***	2.4 ± 25.9

*p<0.05, **p<0.01, ***p<0.001

Table 34: Mean differences and standard deviations between observations and CPM predictions of seat longitudinal adjustment and driver's hip and eye positions.

	D_Seat_X (mm)	D_Hip_X (mm)	D_Hip_Z (mm)	D_Eye_X (mm)	D_Eye_Z (mm)
Veh1	12.9 ± 27.8	-18.9 ± 30.6	-3.5 ± 11.8	-8.6 ± 39.4	19.7 ± 19.5
Veh2	5.7 ± 24.7	-17.0 ± 29.3	-13.3 ± 12.4	9.4 ± 39.9	18.9 ± 19.9
Veh4	5.5 ± 23.9	-9.2 ± 32.0	-20.5 ± 11.5	8.7 ± 38.1	12.5 ± 20.0
Veh5	44.4 ± 24.9	10.8 ± 26.8	-15.7 ± 10.1	19.7 ± 41.8	19.0 ± 20.5
S	15.6 ± 25.5	-22.7 ± 27.5	-15.6 ± 13.7	0.4 ± 34.0	18.4 ± 13.6
A	13.3 ± 35.3	-16.4 ± 25.8	-12.6 ± 13.5	-8.2 ± 39.3	19.4 ± 22.0
T	24.0 ± 24.2	22.4 ± 24.9	-10.6 ± 10.7	32.2 ± 45.9	13.8 ± 20.0
All	16.7 ± 29.8 V***, G***	-8.9 ± 31.9 V***, G***	-13.2 ± 13.1 V***, G***	8.7 ± 44.8 V***, G***	16.5 ± 18.8 V***, G***

***p<0.001

5.5 Restrictions and limitations

Of course, the driving posture model developed in this work presents some restrictions and limitations. First of all, this model assumes a manual transmission, which is most representative of the European car market. In SAE seat longitudinal position prediction model, the presence or absence of clutch pedal is taken into account, adding 18.2 mm to the distance between seat H-point and ball of foot reference point when no clutch pedal. It can be assumed that the presence of clutch pedal makes drivers sit slightly further forward than in automatic transmission vehicles since they must be able to fully depress the clutch pedal. However, this added value is similar to intra-individual variability (22.3 ± 14.1 mm for Seat_X), suggesting that the presence of clutch pedal does not dramatically change driving posture.

The model also takes into account vehicle adjustments that are most commonly found in recent vehicles, i.e. independent seat and steering wheel vertical and longitudinal adjustments, and seat back recline. However, in some vehicles, other adjustments are also available and were not taken into account in this study, such as lumbar support, or seat cushion angle. Again, the global ranges of these adjustments are not very high (only few degrees of variation), and we can also assume that they will not significantly affect driving posture.

Driving postures used for this model were recorded after a short driving session, in normal driving conditions (i.e. looking forwards with the hands on the steering wheel). During this driving session, volunteers could re-adjust the seat and/or the steering wheel when necessary, which could ensure that the recorded postures were as realistic as possible. However, different studies showed that a longer driving session can have an influence on driving posture. Therefore the driving postures predicted by this model are not representative of long driving postures.

Another limitation of this model is that volunteers who participated in the study were quite young drivers, from 20 to 45 years old (25.9 ± 6.9 years old). One of the requirements to participate in the study was to own a driving license for at least one year and regularly drive cars. However, the driving posture might be different for other population segments, such as more experienced drivers, or very old drivers.

The presented model also does not take into account some important factors that can affect driving posture. The first of them is vision constraint, which is very difficult to characterize in a simple way. Recent studies showed that drivers want to be able to see the middle of the vehicle's hood. Therefore, they might adjust their seat in different ways depending on vehicle exterior design. The influence of vision of panel controls was also not included into the model, and may probably affect steering wheel adjustments. Also the effect of head room restriction was not taken into account in the proposed model.

Finally, an important limitation to this model is that it does not take into account the fact that the seat and steering wheel travel path of the real vehicles are not large enough, especially for extreme drivers. The analysis of the questionnaire given to participants showed that in about 30% of the cases at least one adjustment was judged too restrictive, and especially for about half of the short participants at least one adjustment was not satisfying. This suggests that these drivers had to adapt their seat and steering wheel adjustments in order to compensate these limitations. This has not been taken into account in this driving

posture prediction model, and in further studies it would be interesting to look at how drivers adapt their adjustments and their driving posture when the seat and/or steering wheel adjustments are limited.

6 Comparison between RAMSIS driving posture predictions and experimental data

6.1 Introduction

RAMSIS, a digital human modeling software package, is used for vehicle packaging by many car manufacturers including Toyota Motor Europe, who sponsored this work. One of key features required for car interior design is its capacity of driving posture prediction. RAMSIS was initiated by the German Forschungsverein für Automobiltechnik (FAT) in the 1980s for developing a new tool that would provide German car engineers with an accurate, three-dimensional representation of the human body in their CAD environment [49]. The RAMSIS posture prediction model was based on the experimental observations by Seidl [38] from a laboratory study. 47 volunteers (23 males and 24 females) participated in the experiment. Their static driving postures were recorded in three simulated package configurations, one representing a sports car, one a sedan and one a minivan. From experimental data, multi-dimensional probability distributions of joint angles were derived. They are used to predict a most probable posture, probably in a similar way as the optimization prediction model (OPM) described by Reed et al. [33].

However, very few validation studies have been performed with different real vehicles and differently sized drivers. Loczi et al. [20] tried to compare RAMSIS posture predictions with experimental observations from 30 subjects using only one vehicle. More recently, Park et al. [24] performed a laboratory study with 12 subjects using an experimental seating buck and assessed RAMSIS simulations. For both studies, driving postures were measured without real road driving. Possible effects of driver's anthropometry and vehicle type were not investigated. In addition, intra-individual variability in driving position was not studied, making it difficult to define a reliable criterion for assessing RAMSIS predictions.

In this chapter, we compare RAMSIS driving posture predictions with the experimental data collected in this PhD work.

6.2 Methods

6.2.1 RAMSIS posture simulation

RAMSIS driving posture prediction strongly depends on the chosen neutral posture and on the constraints (tasks) applied to the manikin. Constraints defined in the RAMSIS Application Guide [47] are the following (Figure 21):

- Pedal point of right shoe on accelerator pedal 1/2 depressed and heel point of right shoe to floor
- Heel point of left shoe on foot rest
- Hip point on seat travel path
- Hands grasping points on grasping surfaces (travel path of the steering wheel contact point)
- Top of head below the roof
- Eye of the manikin above lower vision bounding plane
- Tangent of vision line: downwards view angle of 6°
- Pelvis: lock "Tilt Sideways" and "Long axis rotation" at (0.0°, 0.0°)

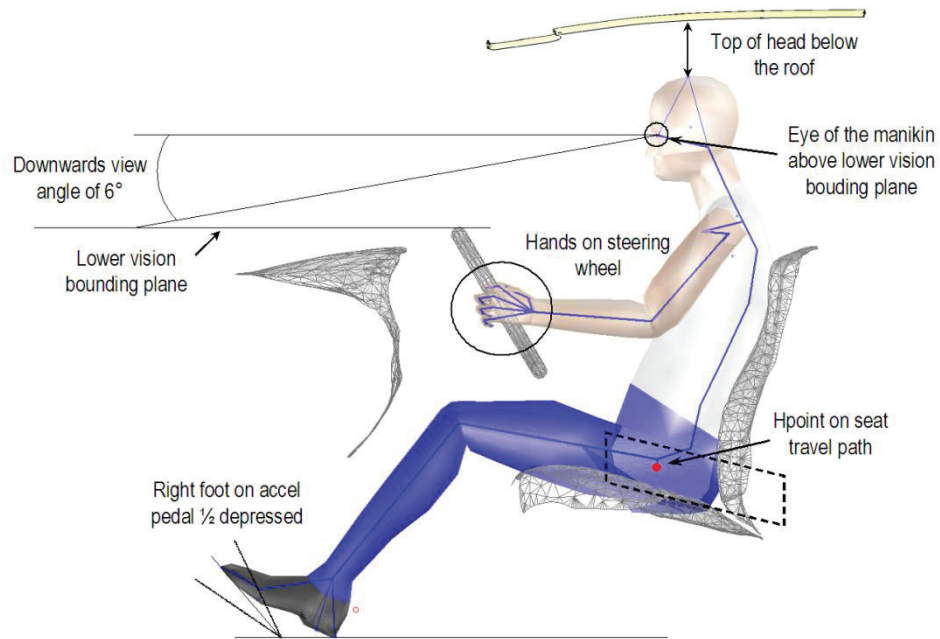

Figure 21: Set of constraints recommended in RAMSIS application guide for driving posture prediction

Then a neutral driving posture, called predictive model, has to be defined by users. Several posture models are proposed by RAMSIS specifically for car and truck, called Car and Truck posture models [46]. The H30 Posture Model [45] interpolates the Car Posture Model and the Truck Posture Model over the H30 parameter. In the current study, the Car Posture model was used. Once having specified the constraints and posture model, an optimization algorithm predicts a posture which tries to fulfill all the defined constraints, while keeping each joint angle as close as possible to the neutral posture.

Of course, the predicted driving posture depends on the constraints applied to the mannequin, as well as the neutral posture. Therefore, in order to better understand their influence on the RAMSIS driving posture prediction, a parametric study was performed (Appendix 8.4). Results showed that some constraints such as neutral posture or feet positions had a strong influence on RAMSIS prediction, suggesting that they should be carefully defined in order to ensure that the resulting posture reflects the reality.

6.2.2 Methods of comparison

In order to see if the set of constraints proposed in the RAMSIS Application Guide gives realistic predictions, the driving posture of the 34 volunteers who participated in the experimental study was predicted using this recommended set of constraints in the 4 tested vehicles (Vehicle 1, 2, 4 and 5). Then, the predicted postures were compared to the observed ones. To ensure correct comparisons, geometrical data recorded on the tested vehicles with FARO arm was used to reconstruct the same CAD vehicle geometry, especially the same seat and steering wheel travel paths, and the same pedal positions.

For each pair subject/vehicle the observed adjusted seat H-point was compared with the RAMSIS manikin H-point prediction (Hip_X and Hip_Z). Observed mid-eye point position (Eye_X and Eye_Z) was also compared with the predicted RAMSIS mannequin's mid-eye point.

As the clutch pedal position is not considered for constraints in RAMSIS predictions, only the rest postures from experimental observation were compared with RAMSIS prediction. For each participant, 4 rest driving postures were recorded for each vehicle (1 for each initial seat and steering wheel configurations, and one

after the driving session). Therefore for each pair participant/vehicle, 4 seat H-points were measured. The average position from these four conditions was calculated for each pair of participant/vehicle, and measured seat H-points were centered on their mean position. The same operation was done for all the volunteers, and then it was possible to superimpose the 4 seat H-points of each pair of volunteer/vehicle in a same graphic. The dispersion of these points represents the intra-individual variability (difference between different postures adopted for a same person and a same vehicle). Since the intra-individual variability was found to depend on stature and on vehicle type, one graphic was plotted for each group of stature and vehicle . For each graphic, the 95% confidence ellipse of the cloud of points was calculated, and the predicted RAMSIS mannequin's H-points were superimposed on the experimental data. The comparison criterion was then defined as follow:

- If RAMSIS prediction is inside the ellipse, the prediction is assumed to be "correct"
- If RAMSIS prediction is outside the ellipse, the prediction is assumed to be "incorrect".

The same operation was done for the comparison of mid-eye point position.

6.3 Results

For each test vehicle, four rest postures were measured for a participant: three different initial interior adjustment configurations without road driving and one in road driving. The average position from these four conditions was calculated for each pair of vehicle and participant. The standard deviations of their differences for the hip and eye locations are given in Table 35. Globally, the ranges of intra-individual variation of the hip were about 40 and 50 mm in longitudinal (x) and vertical (z) directions (see also Figure 22a). For the eye, much higher variation with a range of about 80 mm in x was observed. Vertical variation remained unchanged. Vehicle and participant group significantly affected the intra-individual variability in the hip and eye location.

Average differences between RAMSIS predictions and experimental observations in hip and eye positions are summarized in Table 36, and illustrated in Figure 22. The 95% confidence ellipses characterizing the intra-individual variability in hip and eye locations are also illustrated.

Results of the comparison of hip position showed average differences of -12.7 ± 34.3 mm and 0.3 ± 29.0 mm in longitudinal (x) and vertical (z) directions respectively. Higher differences are observed for eye position, -33.9 ± 48.5 mm in x direction and 13.2 ± 32.1 mm in z direction. If we refer to the comparison criterion defined in previous section, only 30% and 19.2% of predictions can be considered as correct for hip and eye position respectively (i.e. 30% of RAMSIS hip predictions and 19.2% of RAMSIS eye predictions are inside the 95% confidence ellipse).

Table 35: Standard deviations (mm) of the differences to the average position for the hip and eye location

	Hip_X	Hip_Z	Eye_X	Eye_Z
Veh1	8.5	8.5	13.3	7.7
Veh2	10.9	11.8	18.4	11.5
Veh4	8.6	11.6	17.6	12.1
Veh5	10.6	12.9	16.0	11.9
Short	9.2	11.2	15.0	8.4
Average	9.3	11.2	16.8	11.9
Tall	11.1	11.8	17.8	12.4
All	9.7 ^{G*,V*}	11.3 ^{V***}	16.4 ^{V***}	10.9 ^{G***,V***}

*p<0.05, ***p<0.001

Table 36: Means and standard deviations (mm) of the differences between RAMSIS simulations and experimental observations for the hip and eye location. %Hip and %Eye are the percentages of good RAMSIS predictions for hip and eye locations (see text for explanation).

	Hip			Eye		
	x	z	%	x	z	%
Veh1	2.8 ± 30.0	-12.3 ± 34.0	30.3	-10.0 ± 40.9	-8.4 ± 35.4	18.2
Veh2	-49.6 ± 26.8	5.5 ± 23.7	15.2	-41.9 ± 57.6	14.5 ± 28.8	15.2
Veh4	-5.3 ± 22.4	7.4 ± 28.1	28.1	-32.8 ± 48.8	23.7 ± 27.9	15.6
Veh5	2.1 ± 27.1	0.8 ± 26.2	46.9	-51.5 ± 39.1	23.6 ± 25.3	21.9
Short	-19.2 ± 27.3	-20.8 ± 24.6	33.3	-34.5 ± 45.6	-5.1 ± 28.4	18.8
Average	-20.3 ± 34.6	3.8 ± 19.8	30.0	-50.8 ± 47.7	17.1 ± 29.9	22.0
Tall	9.0 ± 35.0	26.6 ± 23.0	21.9	-6.6 ± 42.3	34.5 ± 25.4	25.0
All	-12.7 ± 34.3 G***,V***	0.3 ± 29.0 G***,V**	30.0	-33.9 ± 48.5 G***,V**	13.2 ± 32.1 G***,V***	19.2

p<0.01, *p<0.001

An ANOVA was performed to study the effect of group of stature (G) and vehicle (V) on differences between RAMSIS predictions and experimental observations. Significant effect of vehicle and group of stature were observed on difference for both eye and hip positions. RAMSIS tended to predict higher hip and eye positions for tall drivers (average differences of 26.6 mm and 34.5 mm respectively) while lower hip and eye predictions were observed for short drivers (-20.8 mm and -5.1 mm respectively). Surprisingly, longitudinal position of both hip and eye points is on average best predicted for tall drivers, while RAMSIS tends to predict too forward hip and eye positions for average and short drivers.

If we refer to average differences for the 4 vehicles, we can see that for Vehicle 2 RAMSIS almost always predicted a more forward hip position, with an average difference of -49.6 ± 26.8 mm, whereas for the 3 other vehicles average differences are smaller (from -5.3 mm to 2.8 mm). For Vehicle 1, RAMSIS almost always predicted lower hip and eye points (average differences of -12.3 ± 34.0 mm and -8.4 ± 35.4 mm respectively), whereas for the 3 other vehicles RAMSIS predicted higher hip and eye positions on average.

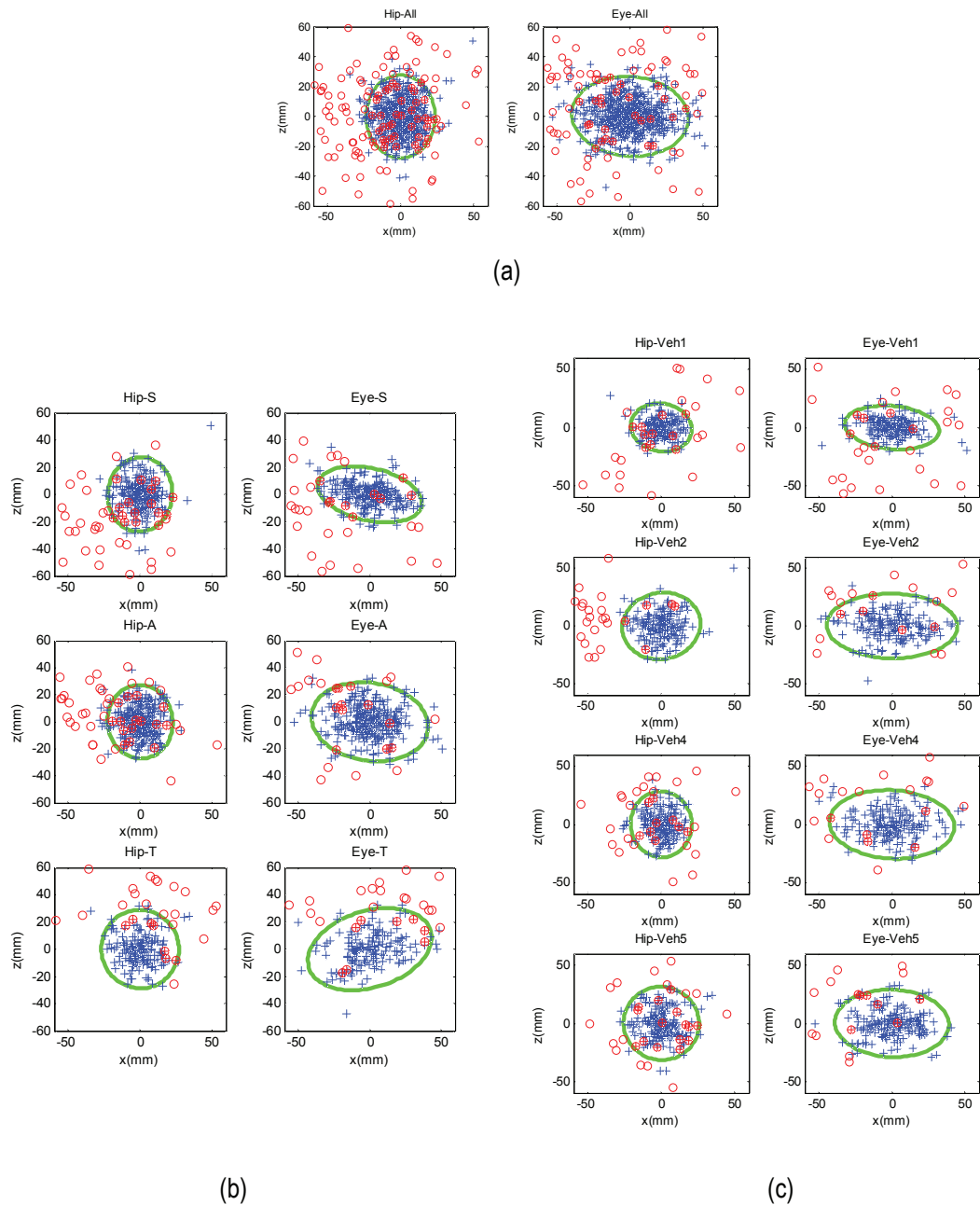

Figure 22: Differences in hip and eye locations between RAMSIS predictions (red circles) and the average positions from the four test conditions for each pair participant-vehicle experimental observations. Dispersions of the four test conditions for a same pair participant-vehicle (blue +) are also illustrated as well as the corresponding 95% confidence ellipses (green solid line). (a) all subjects and vehicles, (b) by group of stature, (c) by vehicle

6.4 Discussion

The comparison between RAMSIS predictions and experimental observations showed average differences of -12.7 ± 34.3 mm in x and 0.3 ± 29.0 mm in z direction for hip position. For the eye point, higher differences were observed, on average -33.9 ± 48.5 mm in x and 13.2 ± 32.1 mm in z direction. These global average differences appear to be quite small (especially for hip point), however, results also presented high dispersions according to group of stature and vehicle were observed. If we refer to the range of intra-individual variation in hip and eye locations for assessing RAMSIS predictions, only 30% of RAMSIS predictions of hip point can be considered as correct, and only 19% of eye point predictions. Driving posture predictions were significantly affected by group of stature, RAMSIS tending to predict a lower hip location for short drivers and a higher hip position for tall ones. RAMSIS prediction performances also depended on

vehicle. 47% of good predictions were obtained for the minivan (Vehicle 5), whereas only 15% were observed for the sedan-type vehicle (Vehicle 2). For this latest vehicle, a more forward hip position was systematically predicted. If we look at vehicle selection criteria, Vehicle 2 was considered as a vehicle with limited field of view (Table 3), suggesting that vision constraints were probably not appropriate for this vehicle.

The RAMSIS Car Driver posture prediction model used in this study is the same regardless of vehicle and driver. However, results show that RAMSIS prediction performance was significantly affected by vehicle and group of stature. This suggests that different set of constraints should be used depending on mannequin's anthropometry and vehicle type. A preliminary study showed that RAMSIS predictions are strongly dependent on the selected neutral posture, another alternative could also be to adapt neutral posture depending on manikin's anthropometry and/or vehicle type. Of course in the current study, only the recommended set of constraints was assessed. However, other set of constraints may give better results and should probably be tested, especially for vision constraints. For instance, instead of constraining mannequin's top of head (head clearance) and vision angle down, eye position could be constrained to stay in a defined area (e.g. SAE eyellipse [44]).

It should finally be noted that before performing RAMSIS simulations, CAD environments of the four tested vehicles were checked and corrected based on the geometries reconstructed from FARO arm digitizer measurements. However, RAMSIS predictions were compared to driving posture experimentally recorded, and reconstructed with help of body surface markers. Mean residual of posture reconstructions were quantified (Table 9), and may certainly lead to errors especially in the location of the pelvis (and thus hip position) [5].

6.5 Conclusion

To accurately predict a driving posture, it is of primary importance to be able to correctly define the constraints that reflect the driving task. Results of the current study show that RAMSIS prediction performance significantly depended on vehicle and subject group, suggesting different sets of constraints should be used depending vehicle type and stature group.

RAMSIS Car Driver posture prediction model used in this study does not adapt the effects of geometric constraints in function of anthropometry nor vehicle type. To take into account the effect of vehicle type, the H30 model was developed, with a neutral posture that changes with the vehicle's H30 value [45]. Unfortunately, due to license restrictions it was not possible to test this posture prediction model in this study. However it could be interesting to compare the experimental data to RAMSIS postures predicted with the H30 model, in order to see if it improves RAMSIS predictions. It could also be interesting to develop a new posture prediction model that also adapts the neutral posture depending on mannequin's anthropometry. With such model, it might be possible to define a single set of constraints for all drivers and vehicles, based on the experimental observations, and on results from the parametric study. In the case this is not possible, another alternative could also be to define different set of constraints depending on driver's anthropometry.

7 Conclusion and perspectives

7.1 Summary of main findings

The main objective of this research work is to better understand the driving posture selection process, and to develop a driving posture predictive model to be used for vehicle design. The literature review showed that the driving posture selection process is a quite complex problem, that must deal simultaneously with kinematic constraints imposed by the driving task (e. g. hands on the steering wheel), vehicle package, driver's anthropometric dimensions and physical limitations, and other factors such as comfort (Figure 1).

The first part of this work focussed more particularly on intra-individual variability, i.e. the differences between driving postures adopted by a same driver in a same vehicle from time to time, and on the effect of driver's anthropometry and vehicle layout on driving posture. From the collected experimental data, and based on driving posture analysis, a statistical prediction model was then developed. Finally, the driving posture predictions given by the RAMSIS digital human model were assessed by comparing them with experimental observations.

The study of intra-individual variability showed that drivers were able to reproduce their seat and steering wheel adjustments quite accurately (within 3 notches for seat longitudinal adjustment). Average drivers showed highest intra-individual variability values, in agreement with the hypothesis that drivers with extreme body size (i.e. very short or very tall drivers) have a more limited range of feasible driving postures. Higher intra-individual variability values were found for vehicles with higher seat height (H30), suggesting that vehicles with higher seat height offer a larger range of feasible driving postures.

Driving posture was affected by driver's anthropometry for a given vehicle. More flexed knees and hips, and more extended elbows were observed for tall drivers than for the two other groups. Interestingly, vehicle layout only slightly influenced knee and hip angles (average differences between the 5 tested vehicles are lower than 5°), while elbow angles increased with higher seat height, suggesting that drivers adapted their posture to changes in vehicle layout by changes in elbow angle, while lower limb posture remained almost unaffected. Of course, driver's elbow angle also depends on the position of the steering wheel. Interestingly, the position of the steering wheel selected by the drivers was hardly explained by driver anthropometry, suggesting that other constraints such as visibility (outside and inside the vehicle) may influence the steering wheel position. Experimental results also suggested that driving postures should be described asymmetrically.

SAE standards are traditionally used to design the vehicle interior. Experimental observations were compared to SAE predictions, and results showed that driver's seat position is not well predicted for short females (lower extreme of the population). Regarding the prediction of eye location, results suggested that 95% inclusive ellipses should be used instead of 95% tangent cutoff eyellipses, which were found too restrictive.

Based on these observations, a statistical driving posture prediction model was developed. This statistical model predicts both vehicle adjustments and driving posture variables.

Finally, the comparison between observations and RAMSIS predictions suggested that different set of constraints and/or neutral posture might be used depending on vehicle package and driver's stature group.

7.2 Principal limitations

The effect of driver's anthropometry was investigated by selecting 34 participants according to their stature and sitting height, in order to obtain a representative sample of the European driver population. The results obtained in this study may therefore not be applicable to other populations for which anthropometry substantially differs from the French population's one. Drivers who participated in the experimental study were also young drivers (from 20 to 45 years old), and driving posture might be different for older drivers.

The influence of vehicle layout was investigated by selecting and testing 5 actual vehicles with clutch pedal. Of course, results may not be applicable to vehicles with automatic transmission. Moreover, the influence of each vehicle package parameter (e.g. position of clutch pedal, or position of steering wheel) was not investigated. The influence of the seat itself (e.g. foam of the cushion, shape, etc...) was also not investigated.

Regarding the driving task, the constraint of vision was not investigated. However results of this study indicate that the constraint of vision may be an important parameter especially for the prediction of the steering wheel position.

The results presented in this study are based on driving postures recorded after a 5 minutes driving session. However, previous studies found that long duration driving may have an influence on the driving posture.

If we refer to Figure 1, it also clearly appears that the influence of comfort (e.g. foam of the seat, or lumbar support) and psychological factors (e.g. fatigue) was not investigated in this study, which should be done in order to completely understand the driving posture selection process.

Regarding methodological aspects, we faced difficulties for the data processing under Vicon Nexus system. This is due to the large number of reflective markers placed on volunteer's skin, and to the fact that the driving cockpit is a very constrained environment. Therefore, frequently a certain number of markers could not be captured by the Vicon system. Due to this marker missing problem, the marker labelling had to be done manually, which was a quite time consuming process. The second issue was linked to the correspondence between FARO and Vicon measurements. For the calculation of seat and steering wheel adjustments, and in order to reconstruct driving postures in the vehicle coordinate system, both FARO and Vicon measurements were necessary. Therefore, several verifications had to be done in order to ensure that both measurements could be expressed in the same coordinate system and superimposed. Again, this was a difficult step, since both measuring tools have their own accuracy (measurement errors), especially the FARO arm that had to be moved during the measurement of a same vehicle in order to measure both left and right sides of the vehicles. In some cases, it introduced some measurement errors that had to be corrected.

Finally, the pelvis, and in particular the hip joint center (HJC) is usually the root of DHM. Therefore, to avoid errors in positioning a digital mannequin in a seat, it is of primary importance to be able to accurately predict the HJC position in the seated position. In a previous experimental study, two methods currently used for the prediction of HJC in gait analysis (regression method and functional method) were assessed in order to estimate the uncertainty in HJC in the automotive driving position [5]. Unfortunately, both regression and functional methods did not give satisfying results, and they could not be used to improve the accuracy of the

driving posture reconstruction. Therefore, in this work, driver's HJC positions were first estimated by RAMSIS Bodybuilder tool when creating the virtual mannequin from anthropometric measurements, and then driver's pelvis position was estimated in the SgRP centered vehicle coordinate system using reflective markers placed on pelvis anatomical landmarks (antero-superior iliac spines and crest tubercles). However, the pelvis is a body area for which soft tissue artifacts are important, and the relative movement between the reflective markers and the underlying bone when changing posture could introduce errors in locating driver's pelvis.

7.3 Perspectives

The findings and limitations of this study suggest several areas for future investigations.

- **Investigation of the influence of each vehicle package factor on driving posture**

In this study, the influence of vehicle package was investigated by testing 5 actual vehicles, which corresponds to 5 pairs of seat and steering wheel positions relative to the pedals. It could also be interesting to study the influence of each vehicle parameter separately, e.g. by varying the seat reference point position, or by reducing driver's head clearance. Such results could give a better understanding of the role of each vehicle parameter on the driving posture selection.

- **Investigation of the role of discomfort on driving posture**

A study could be conducted to investigate the relationships between potential sources of discomfort (e.g. different seat foams), driver's perception of discomfort and selected driving posture.

- **Investigation of the influence of long-driving session on driving posture**

The driving postures collected in this study and used for the development of the predictive model were recorded after a short driving session, ensuring that recorded driving postures were as realistic as possible. However, a longer driving may substantially affect the driving posture. Driving postures were also recorded assuming normal driving conditions (i.e. with the hands on the steering wheel and looking forwards). In the context of safety and individualized protection of drivers, it could be interesting to also investigate changes in driving posture in other driving conditions (for example before a frontal impact).

- **Investigation of the perception of the importance of constraints depending on driver's anthropometry and vehicle layout**

In the current work, a questionnaire was filled out by the participants of the experimental study in order to investigate the importance of each constraint on the selected driving posture. The results of this questionnaire suggest that the importance of the constraints imposed by the driving task may vary depending on driver's anthropometry. It should be therefore interesting to further investigate this issue, in order to integrate the results in a new driving posture prediction model.

- **Investigation of the influence of the external body shape on the selected driving posture**

In this PhD thesis, only volunteers with normal BMI (from 18.5 to 25 kg/m²) participated in the experimental study. However, it can be assumed that drivers with high BMI may need to adjust their driving posture in a different way, in order to keep an acceptable clearance from the steering wheel.

- **Investigation of new techniques for the accurate estimation of hip joint center in an automotive driving position**

If a driving posture prediction model relies on experimental data for which the pelvis position was not reconstructed or measured properly, then it is likely that it will result in errors in predicting driving postures (and especially in pelvis location). Existing methods for the estimation of HJC were investigated in a seated position but results were not satisfactory. Therefore, new techniques should be further investigated in order to improve the accuracy of HJC estimation in an automotive driving position.

- **Development of a new driving posture prediction method**

Based on the result of the investigation on the perception of the importance of constraints linked to the driving task, order of priority or weighting factor should be defined for each constraint especially in case of conflicting constraints. A new optimization-based driving posture prediction model that can take into account weighting and priority order of constraints should be proposed.

8 Appendix

8.1 Literature review

8.1.1 Vehicle packaging terminology

This appendix aims at providing the basic terminology used in the automobile interior packaging field. This terminology has been established in standard practices developed by the Society of Automotive Engineers (SAE) [43, 40] and [42].

The H-point is the pivot center of the torso and thigh on the two- or three-dimensional devices used in defining and measuring vehicle seating accommodation.

The Seating Reference Point (SgRP), the Ball of Foot Reference Point (BOF) and the Accelerator Heel Point (AHPt) are defined and measured using the SAE H-point machine (a weighted manikin) and the measurement procedures described in SAE J826 [43]. According to SAE J1100 [40], the SgRP establishes the rearmost normal design driving position, but the location of this point depends on manufacturers. In this case, the SgRP is measured when the seat is at its rearmost position, at the middle seat height. Once the seat is placed in this reference position, the H-point machine, with 95th percentile legs, is placed in the seat. The left foot is placed on the un-depressed accelerator pedal, and the right foot is placed approximately opposite and symmetrical, approximately 254 mm apart. Once the installation of the H-point machine is completed, left and right H-points are measured, as well as BOF and AHPt (which are reference points of the manikin) (Figure 23 and Figure 24). The SgRP is defined as the mean point between left and right measured H-Points. The AHPt defines the horizontal plane from which vertical measurements are made, while BOF defines the vertical plane from which longitudinal measurements are made. Once these three points are defined, vehicle package parameters presented in Table 37 can be calculated.

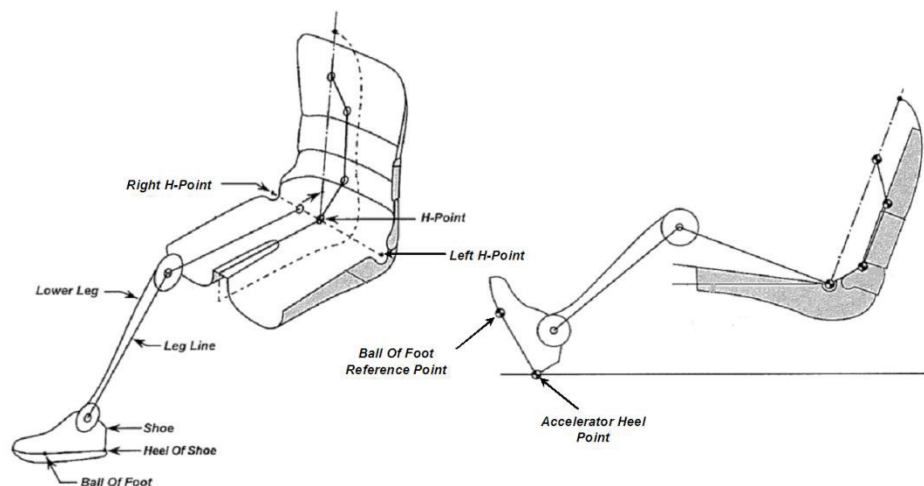

Figure 23: Reference points used for the definition of vehicle packaging [42][42][42]

Table 37: Definition of vehicle package parameters from SAE J4004

Variable	Definition
SgRPx	Longitudinal distance between Seating Reference Point (SgRP) and Ball of Foot reference point (BOFRP)
H30	Vertical distance between Seat Reference Point (SgRP) and vehicle's floor
L6	Longitudinal distance between Steering Wheel Center at it's middle position in steering wheel travel path and Ball of Foot reference point (BOFRP)
H17	Vertical distance between Steering Wheel Center at it's middle position in steering wheel travel path and vehicle's floor

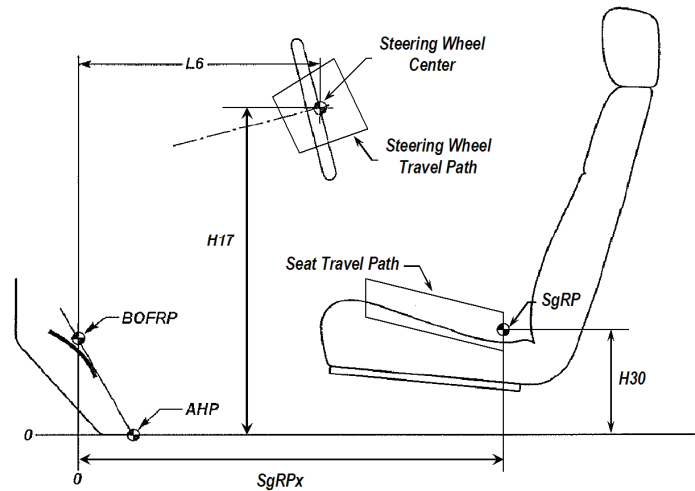

Figure 24: 25 Vehicle package parameters [42]

8.1.2 SAE J941 – Motor vehicle drivers' eye locations

The SAE recommended practice J941 [44] describes the eyellipse which is used for design and evaluation of vision in motor vehicles.

- Centroid locations

The centroid of the eyellipse is defined by the following equations:

$$X_c = L1 + 664 + 0.587(L6) - 0.176(H30) - 12.5t \quad (E.9)$$

$$Y_{cl} = W20 - 32.5 \quad (E.10)$$

$$Y_{cr} = W20 + 32.5 \quad (E.11)$$

$$Z_c = H8 + 638 + H30 \quad (E.12)$$

Where:

L1 is the BOFRP x coordinate

L6 is steering wheel center to BOFRPx

H30 is the z coordinate of the SgRP, measured vertically from AHP

T is transmission type (1 with clutch pedal, 0 without clutch pedal)

W20 is SgRP y coordinate and

H8 is AHP z coordinate

It must be noted that for seats with vertical adjustment, equations E.9 to E.12 were developed with SgRP positioned at the middle of the vertical adjustment range (the middle of the vertical adjustment range being an

H-point travel path that is midway between, and parallel to, the upper and lower for/aft H-point travel paths (Figure 26)).

In case the SgRP is not defined on this mid-height H-point travel path, the accuracy of predictions of the vertical position of the eyellipse will be reduced.

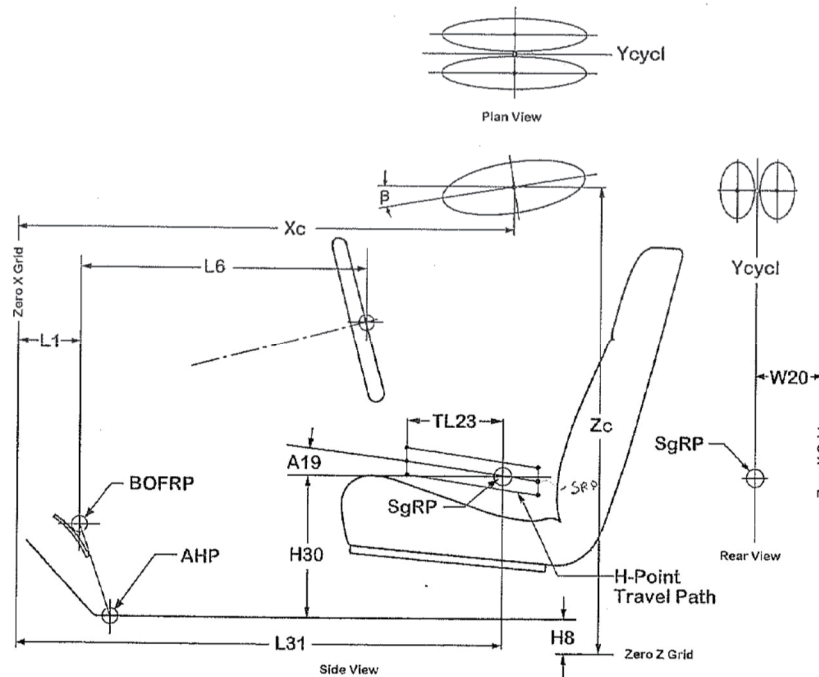

Figure 26: Eyellipse package factors, side view and axis angle, and centroid location (reproduced from SAE J941)

- Axis angles

The eyellipse is aligned with the vehicle axes in rear view (X-plane) and plane view (Z-plane). Eyellipse is tilted down at the front in side view (Y-plane). The tilt angle is defined as $\beta = 12.0^\circ$ (positive, tipped down at the front from horizontal).

- Axis lengths

Eyellipse axes length are given in Table 38.

Table 38: Left and right eyellipse axes lengths

Seat track travel (TL23)	Percentile	X axis length	Y axis length	Z axis length
> 133	95	206.4	60.3	93.4
	99	287.1	85.3	132.1
1 - 133	95	173.8	60.3	93.4
	99	242.1	85.3	132.1

8.1.3 CPM posture prediction model

Reed's Cascade Prediction Model (CPM) schema is presented in Figure 27. Regression equations of the model are summarized in Table 39 and Table 40.

Table 39: CPM regression models

Variable (mm or °)	Intercept	Stature (mm)	Sitting Height/ Stature	Seat Height (H30; mm)	SW to BOFx (L6; mm)	Cushion angle (L27;°)	R ² _{adj}	RMSE
Hipx reBOF	84.8	0.4659	-430.1	-0.1732	0.4479	-1.04	0.78	65.9
Hip-to-eye angle	-72.7	0.00642	115.7	—	0.0147	0.11	0.20	3.9
Eyez re BOF	-836.6	0.5842	916.6	-0.1559	0.6101	—	0.71	50.9
Eyez re AHP	-267.1	0.3122	679.9	1.0319	0.0292	—	0.89	21.8
Eyez reHip	-916.0	0.1187	1347.2	—	0.1563	1.15	0.23	41.7
Eyez reHip	-261.5	0.3336	675.8	—	-0.0544	—	0.72	22.9
Anklex reBOF	-300.2	0.0400	467.6	0.1746	0.1358	1.3	0.32	18.0
Anklex reAPedal	46.1	-0.0466	—	—	—	—	0.05	23.2
Anklez reAHP	8.4	0.0312	—	0.1236	—	0.55	0.25	13.1
Knee angle	69.1	-0.0071	61.3	-0.0321	0.0829	-0.59	0.44	7.7
Head angle	-156.2	0.00919	137.5	—	—	—	0.03	10.6
Neck angle	16.1	-0.01197	—	—	0.0109	—	0.04	7.7
Thorax angle	-42.7	0.00497	45.2	—	0.0128	—	0.03	6.1
Abdomen angle	-94.5	0.0109	184.5	—	0.0222	—	0.09	9.7
Pelvis angle	-16.3	0.0102	90.2	—	0.0177	0.39	0.04	10.0

Note: Linear model created by multiplying each term in the table by the value of the column variable and adding a constant intercept. BOF = ball of foot; AHP = accelerator heel point; APedal = accelerator pedal; SW = steering wheel.

Table 40: CPM Regression Models for H-Point Location

Variable	Intercept	Stature (mm)	Body Mass Index (kg/m ²)	Seat Height (H30; mm)	SW to BOFx (mm)	Cushion Angle (°)	R ² _{adj}	RMSE
Hipx re HPt	-131.5	0.0482	-2.677	—	—	5.00	0.34	27.6
Hipz re HPt	-143.4	—	2.009	0.0700	0.1375	0.49	0.40	13.7

Note: Linear model created by multiplying each term in the table by the value of the column variable and adding a constant intercept. SW = steering wheel; BOF = ball of foot; HPt = H point.

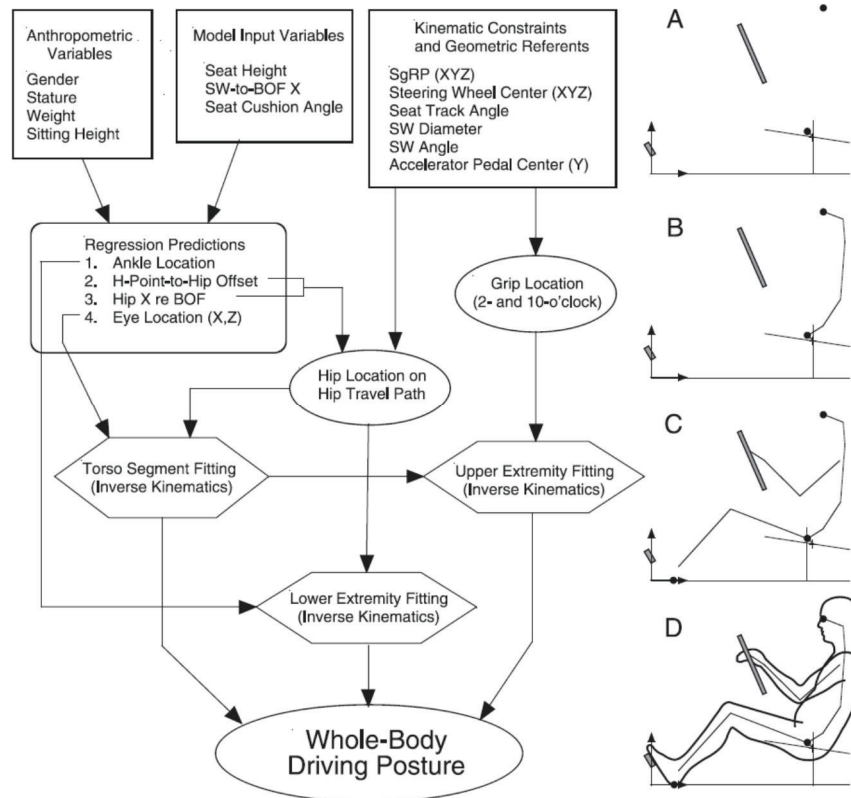
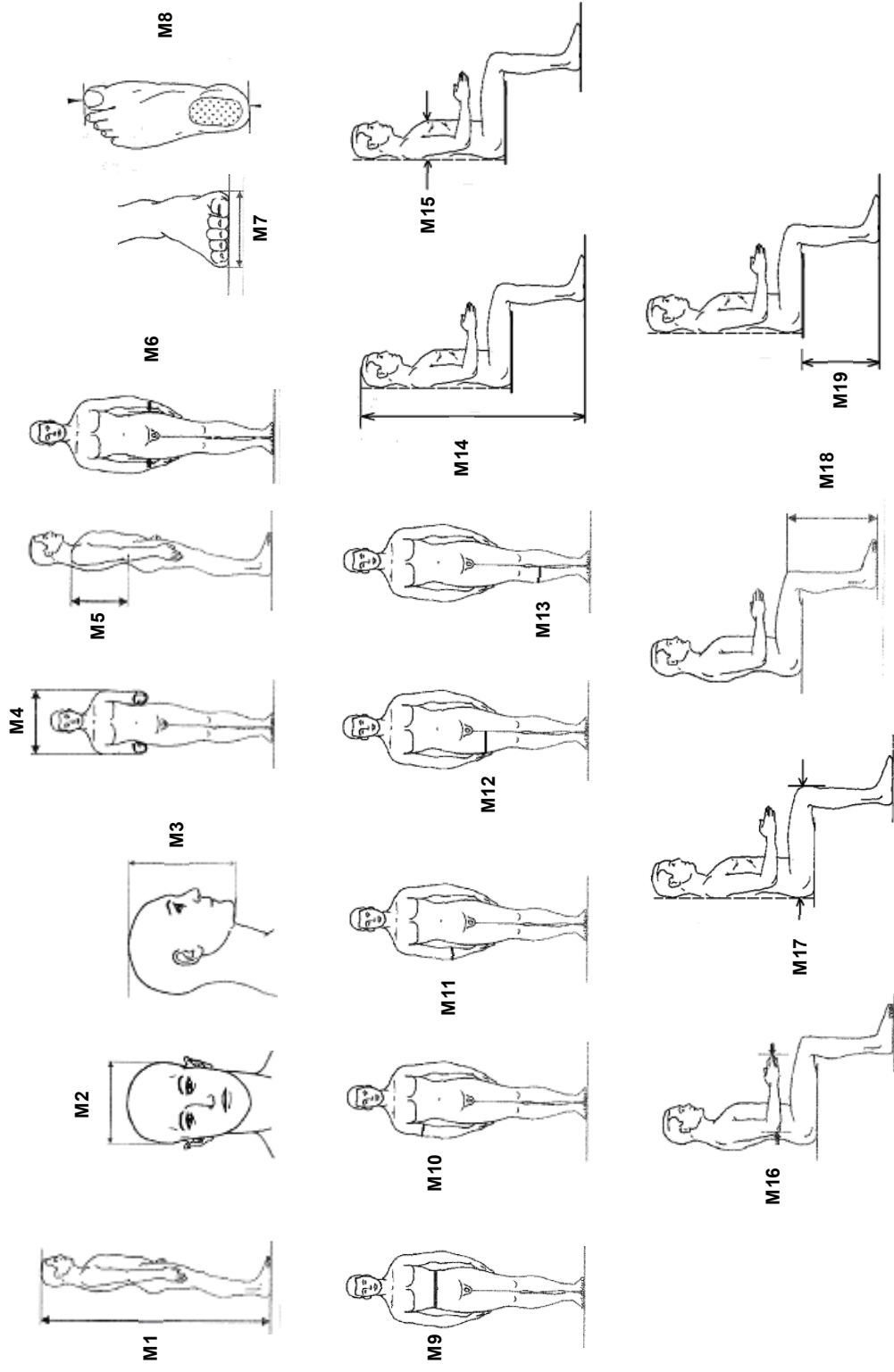

Figure 27: Information flow schematic of cascade prediction model (CPM) and step-by-step sequence. A: Predict hip and eye locations. B: fit torso segments by inverse kinematics using data-based motion distribution. C: Fit limb segments by inverse kinematics using slay data. D: Fit full 3-D model to kinematics linkage. SW = steering wheel, SgRP = seating reference point, BOF = ball of foot (reproduced from [32])

8.2 Experimental protocol

8.2.1 Main anthropometric characteristics of participants



Measurement	Unit	Id	01_DZ	02_FZ	03_MB	04_TS	05_ML	06_ML	08_CR	09_CH	10_AR	11_LB	12_MB	13_AB
Age	(years)		24	22	22	22	21	20	20	22	23	22	22	20
Gender			M	M	M	M	F	F	F	F	M	M	F	M
Stature	(mm)	M1	1902	1885	1920	1885	1618	1734	1642	1669	1756	1743	1548	1659
Stature with shoes on	(mm)		1910	1892	1940	1910	1639	1756	1662	1681	1768	1754	1569	1682
Head width	(mm)	M2	151	159	146	154	146	152	137	149	145	148	146	152
Head height	(mm)	M3	224	235	237	230	208	213	206	227	220	225	204	234
Bideltoid shoulder width	(mm)	M4	457	470	466	461	386	429	418	405	440	396	382	435
Upper arm length	(mm)	M5	333	358	361	354	297	327	317	307	349	329	298	309
Maximum hip width	(mm)	M6	359	340	340	310	309	352	364	381	317	369	324	311
Foot breadth	(mm)	M7	97	101	105	96	84	86	88	90	96	88	92	95
Foot breadth with shoes	(mm)		107	108	107	103	89	91	94	94	103	96	92	103
Foot length	(mm)	M8	273	286	281	273	230	236	234	240	258	259	235	266
Foot length with shoes	(mm)		314	304	296	296	249	256	262	267	291	280	261	290
Minimum waist circumference	(mm)	M9	878	828	819	814	746	765	826	837	742	784	716	778
Maximum upper arm circumference	(mm)	M10	325	291	302	288	255	265	288	321	254	266	255	285
Maximum forearm circumference	(mm)	M11	271	270	291	262	235	244	236	244	243	250	224	269
Maximum thigh circumference	(mm)	M12	584	532	571	490	536	564	589	661	520	567	507	514
Maximum lower leg circumference	(mm)	M13	391	374	369	348	338	353	359	408	348	398	345	351
Total sitting height	(mm)	M14	1454	1455	1450	1459	1266	1340	1275	1289	1372	1352	1200	1289
Sitting eye height	(mm)		1358	1361	1346	1355	1147	1247	1162	1170	1276	1239	1109	1213
Chest depth	(mm)	M15	231	203	185	225	169	194	219	242	209	231	215	198
Forearm length	(mm)	M16	504	514	518	499	422	454	431	444	475	464	422	466
Buttock-knee length	(mm)	M17	658	645	650	628	579	603	600	582	608	631	555	574
Knee height sitting	(mm)	M18	597	589	608	593	479	539	505	525	538	550	481	512
Seat height	(mm)	M19	464	484	475	490	411	439	402	414	438	451	388	413
Weight	(kg)		81	73	80	72	53	59	63	69	62	67	50	60
BMI	(kg/m ²)		22	21	22	20	20	20	23	25	20	22	21	22
Shoe size	Europe		45	45	45	44	37	38	39	40	42	41	39	43

Measurement	Unit	Id	14_CL	15_VA	16_LD	17_DS	18_IB	19_AD	20_MA	21_GH	22_JM	23_AC	24_AO	25_LA
Age	(years)		20	20	23	31	23	20	21	26	25	41	43	31
Gender			F	M	F	M	F	M	F	M	M	M	F	F
Stature	(mm)	M1	1533	1725	1545	1751	1761	1945	1592	1774	1686	1842	1486	1541
Stature with shoes on	(mm)		1558	1744	1570	1771	1781	1958	1608	1795	1708	1867	1511	1564
Head width	(mm)	M2	140	154	143	159	145	166	145	164	140	155	144	148
Head height	(mm)	M3	201	235	198	226	210	245	196	223	222	227	206	198
Bideltoid shoulder width	(mm)	M4	390	454	403	473	417	526	431	438	433	463	404	375
Upper arm length	(mm)	M5	300	322	294	355	324	386	291	349	343	366	270	290
Maximum hip width	(mm)	M6	320	353	381	363	324	394	375	330	339	377	340	366
Foot breadth	(mm)	M7	88	97	82	92	97	106	86	91	98	96	84	87
Foot breadth with shoes	(mm)		88	105	89	104	100	110	94	103	98	104	86	90
Foot length	(mm)	M8	233	264	221	265	259	293	228	260	265	271	206	232
Foot length with shoes	(mm)		254	294	247	294	285	308	261	290	292	303	241	249
Minimum waist circumference	(mm)	M9	739	845	766	872	786	1131	888	863	829	971	812	693
Maximum upper arm circumference	(mm)	M10	253	302	267	302	250	368	324	285	273	307	304	274
Maximum forearm circumference	(mm)	M11	215	282	245	271	235	340	269	267	265	273	250	221
Maximum thigh circumference	(mm)	M12	511	578	584	544	522	669	586	532	534	561	521	542
Maximum lower leg circumference	(mm)	M13	327	438	396	370	356	456	384	371	388	385	358	334
Total sitting height	(mm)	M14	1190	1291	1186	1350	1345	1479	1237	1359	1273	1416	1173	1183
Sitting eye height	(mm)		1073	1200	1091	1273	1230	1394	1140	1262	1205	1322	1070	1082
Chest depth	(mm)	M15	199	188	199	214	215	291	268	236	226	255	228	206
Forearm length	(mm)	M16	410	476	431	498	469	530	429	483	484	477	385	412
Buttock-knee length	(mm)	M17	552	617	567	613	606	697	567	629	612	653	544	556
Knee height sitting	(mm)	M18	481	537	500	556	553	633	509	552	539	565	445	471
Seat height	(mm)	M19	385	419	392	447	438	481	392	437	406	441	336	358
Weight	(kg)		47	72	58	75	59	122	71	70	69	84	59	54
BMI	(kg/m ²)		20	24	24	25	19	32	28	22	24	25	27	23
Shoe size	Europe		38	44	37	44	42	47	39	43	43	45	36	37

Measurement	Unit	Id	26_MD	27_JA	28_DV	29_SB	30_CH	31_SG	32_LB	33_MB	34_XW	35_SC	36_CP
Age	(years)		25	27	26	27	24	27	21	25	45	38	38
Gender			M	M	M	M	F	F	M	F	M	F	F
Stature	(mm)	M1	1719	1708	1800	1849	1630	1561	1830	1605	1644	1679	1722
Stature with shoes on	(mm)		1743	1727	1818	1875	1653	1581	1851	1628	1660	1701	1744
Head width	(mm)	M2	148	156	144	158	140	155	152	145	160	151	149
Head height	(mm)	M3	225	210	207	206	196	217	220	201	203	212	210
Bideloid shoulder width	(mm)	M4	436	437	451	352	411	409	451	415	433	396	328
Upper arm length	(mm)	M5	324	335	350	467	302	281	347	276	297	319	400
Maximum hip width	(mm)	M6	342	315	330	343	409	350	316	344	328	353	328
Foot breadth	(mm)	M7	99	101	101	100	82	95	94	85	91	94	88
Foot breadth with shoes	(mm)		105	96	106	105	89	92	102	89	96	92	91
Foot length	(mm)	M8	256	236	273	263	226	228	255	230	233	234	242
Foot length with shoes	(mm)		287	268	305	295	247	255	289	255	270	259	263
Minimum waist circumference	(mm)	M9	842	829	772	824	805	744	791	842	874	745	681
Maximum upper arm circumference	(mm)	M10	302	285	254	281	283	283	290	270	300	217	227
Maximum forearm circumference	(mm)	M11	267	263	246	279	236	241	272	220	263	206	209
Maximum thigh circumference	(mm)	M12	533	533	480	564	586	573	538	533	563	523	482
Maximum lower leg circumference	(mm)	M13	369	350	342	399	375	359	360	345	363	343	317
Total sitting height	(mm)	M14	1340	1310	1427	1400	1249	1227	1390	1231	1276	1323	1320
Sitting eye height	(mm)		1253	1202	1346	1301	1156	1118	1290	1146	1190	1218	1218
Chest depth	(mm)	M15	187	209	188	178	216	217	192	227	234	175	197
Forearm length	(mm)	M16	467	439	491	489	439	411	489	407	431	445	448
Buttock-knee length	(mm)	M17	589	600	585	624	604	548	627	567	572	566	593
Knee height sitting	(mm)	M18	632	533	552	582	492	478	577	496	495	531	532
Seat height	(mm)	M19	429	423	458	439	388	366	449	388	398	441	432
Weight	(kg)		69	65	61	74	64	59	72	56	67	55	49
BMI	(kg/m ²)		23	22	19	22	24	24	21	22	25	19	17
Shoe size	Europe		43	40	45	44	37	38	43	38	40	39	39

8.2.2 Correlation between main anthropometric dimensions

Table 41 presents the coefficients of correlation between main driver's anthropometric dimensions. Results show that main anthropometric dimensions are highly correlated, with coefficient values almost always higher than 0.90. Transformed anthropometric dimensions (ratio of main anthropometric dimensions to stature) are only moderately correlated with stature (Table 42).

Table 41: coefficients of correlation (from 0 for no correlation to ± 1 for 100% positive or negative correlation) between main anthropometric dimensions of the drivers who participated in the experimental study

	Stature	Sitting Height	Upper Limb length	Lower Limb length	Weight
Stature		0.96***	0.91***	0.95***	0.71***
Sitting Height	0.96***		0.85***	0.89***	0.70***
Upper Limb length	0.91***	0.85***		0.89***	0.64***
Lower Limb length	0.95***	0.89***	0.89***		0.80***
Weight	0.71***	0.70***	0.64***	0.80***	

***p<0.001

Table 42: coefficients of correlation (from 0 for no correlation to ± 1 for 100% positive or negative correlation) between transformed anthropometric dimensions of the drivers who participated in the experimental study. SH/S, UL/S and LL/S are the ratio of Sitting height, Upper Limb and Lower Limb to Stature respectively. Body Mass Index (BMI) is the ratio of Weight (kg) to Stature² (m²).

	Stature	SH/S	UL/S	LL/S	BMI
Stature		-0.57***	0.27 ^a	-0.25 ^a	-0.05
SH/S	-0.57***		-0.36*	-0.12 ^a	0.16 ^a
UL/S	0.27 ^a	-0.36*		0.06 ^a	-0.09 ^a
LL/S	-0.25 ^a	-0.12 ^a	0.06 ^a		0.51***
BMI	-0.05 ^a	0.16 ^a	-0.09 ^a	0.51***	

^ap>0.05, *p<0.05, ***p<0.01

8.2.3 Vehicle measurements protocol

This appendix describes the protocol used for vehicle measurements. All the measurements were performed using a FARO arm device.

a) Vehicle installation and definition of coordinate system

The vehicle was lifted with a lifting platform in order to enable the effect of suspensions. Then a FARO global coordinate system was defined and the vehicle CAD data was imported. Then 5 points available in vehicle CAD data were measured on the vehicle. Using these 5 points, the FARO coordinate system was overlaid to the CAD coordinate system, which is the one defined in the SAE recommended practice J1100. This step ensured that all measured data with the FARO arm was directly measured in the vehicle coordinate system.

b) Vehicle instrumentation

Several reflective markers were placed on the vehicle roof and door openings (Figure 28), seat (Figure 29) and steering wheel (Figure 30).

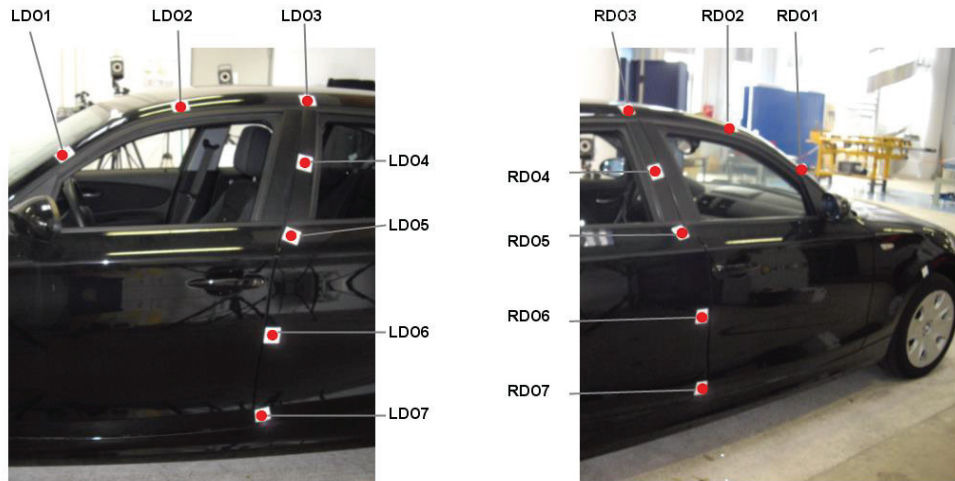

Figure 28: reflective markers placement on left and right door openings

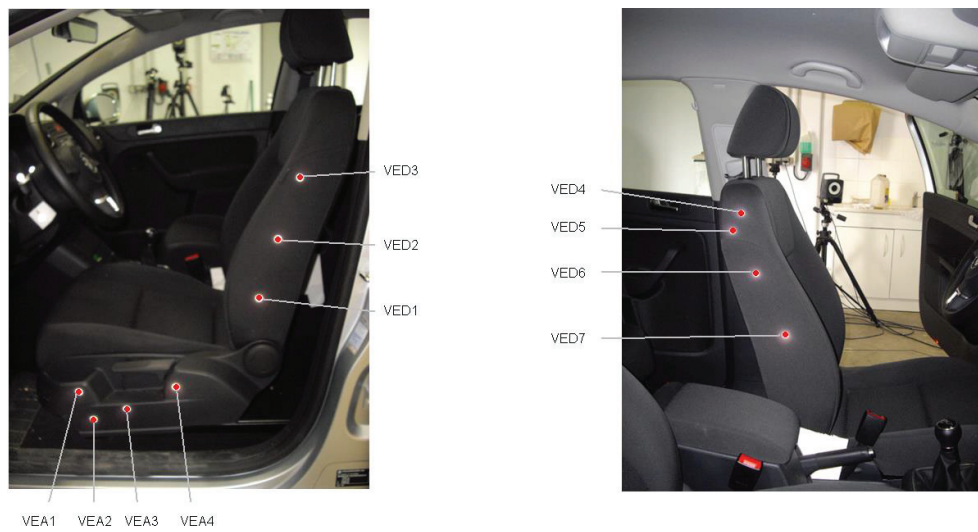

Figure 29: reflective markers placement on seat cushion (VEA) and seat backrest (VED)

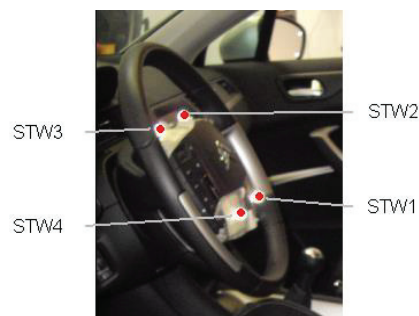

Figure 30: reflective markers placement on steering wheel

c) *Driver seat measurements with H-point machine*

Several points were measured using the SAE H-point machine (Figure 31). The seat was placed at the most rearward and mid position. Then the H-point machine was placed on the seat following the procedure described in SAE Standard J826.

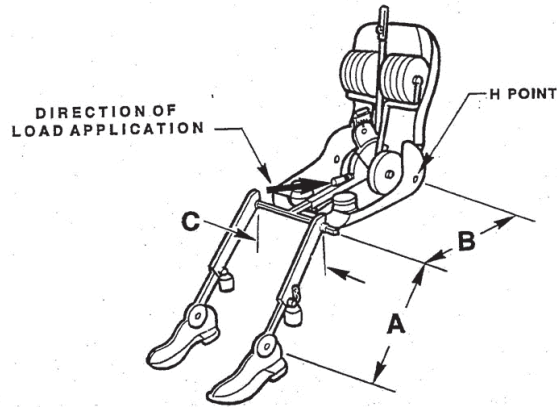

Figure 31: SAE H-point machine (SAE J826)

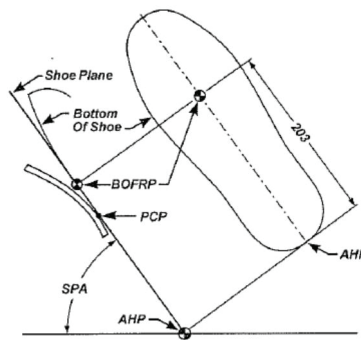

Figure 32: Driver shoe plane CAD tool [42][42][42]

Once the H-point machine was correctly placed on the seat, left and right H-point were measured, as well as Accelerator Heel Point and Ball of Foot (Figure 32). Measurements were repeated 3 times (H-point machine was removed and replaced on the seat each time), and the final value was calculated as the average of the 3 measurements. At the same time, the position of the seat cushion reflective markers was recorded.

The seat cushion angle was also determined following the procedure described in Appendix B of SAE Standard J826 [43].

The location of seat back reflective markers was recorded for different values of H-point machine torso angle (15°, 20°, 25° and 30°).

Finally, the seat travel path was determined by recording the location of seat reflective markers (Figure 29) in the 4 extreme positions of the seat (rearmost/uppermost, rearmost/full-down, frontmost/uppermost, frontmost/full-down).

d) *Steering wheel measurements*

The location of steering wheel center was recorded in the 4 extreme positions of the steering wheel. At the same time, the location of steering wheel reflective markers (Figure 30) was also recorded.

e) *Other measurements*

Scans of seat and instrument panel were also recorded (Figure 33).

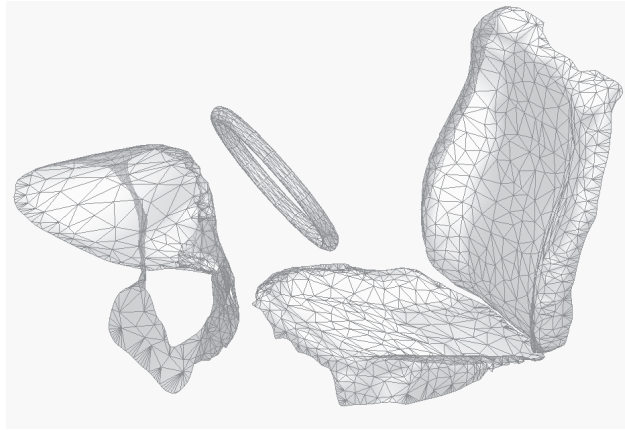

Figure 33: scans of seat and instrument panel

f) *Measurements for overlay with VICON data*

In order to be able to overlay VICON driving posture measurements with measurements of geometry, the location of the reflective markers placed on the door openings (Figure 28) of the vehicle was recorded.

8.2.4 Main vehicle packaging measurements

Table 43: Main vehicle packaging measurements. Values are given in the SAE vehicle coordinate system. For travel path measurements, 4 extreme points are given: RU (Rear most – Upper most), RL (Rear most – Lower most), FL (Front most – Lower most) and FU (Front most – Upper most).

		Vehicle 1		Vehicle 2		Vehicle 3		Vehicle 4		Vehicle 5	
		x	z	x	z	x	z	x	z	x	z
		(mm)	(mm)	(mm)	(mm)	(mm)	(mm)	(mm)	(mm)	(mm)	(mm)
BOFRP		0	110.6	0	146.6	0	170.5	0	123.2	0	126.8
AHP		149.3	0	218.0	0	246.9	0	181.7	0	123.7	0
SgRP		998.3	241.1	966.2	252.3	1014.7	298.2	957.2	324.1	914.9	361.7
SWC		541.2	631.0	531.7	644.7	548.9	653.9	471.0	720.8	451.9	753.9
Seat travel path	RU	968.5	270.6	991.8	227.3	993.0	323.5	989.0	289.4	945.1	329.8
	RL	1028.1	211.7	940.5	277.3	1036.3	272.9	925.4	358.8	884.8	393.5
	FL	784.5	240.2	730.7	304.1	796.8	302.2	684.2	358.9	634.4	396.9
	FU	724.0	299.1	778.5	253.1	752.0	349.5	749.6	291.4	695.9	329.6
Steering wheel travel path	RU	553.7	658.5	542.2	675.6	559.5	679.6	479.7	753.6	463.0	784.4
	RL	566.8	617.1	559.2	631.6	572.3	643.5	503.9	710.8	485.8	747.4
	FL	528.5	605.0	520.3	616.7	537.5	630.1	461.6	689.8	439.9	725.1
	FU	515.6	643.4	504.9	654.8	526.5	662.3	438.9	728.9	419.1	758.4

8.2.5 Markers placement for driving posture data collecting

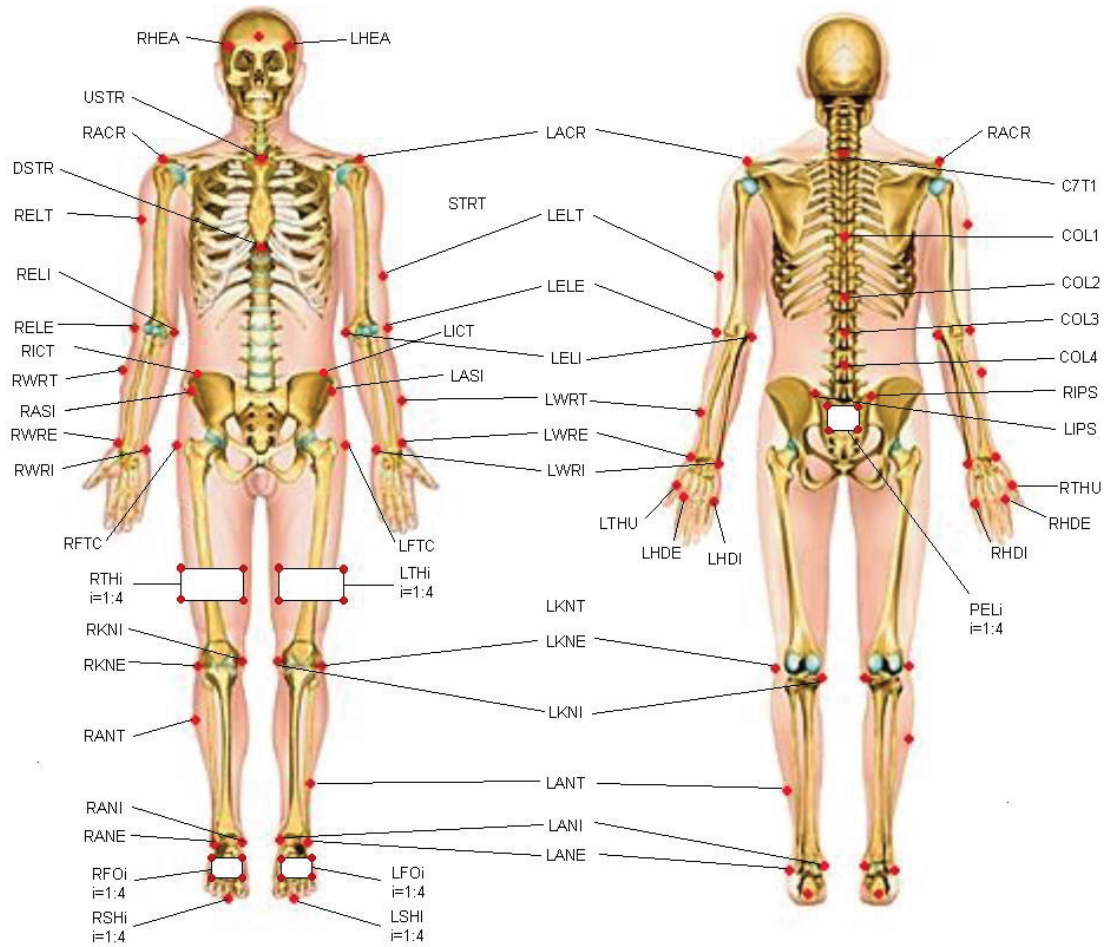

Figure 34: Markers placement for driving posture measurement

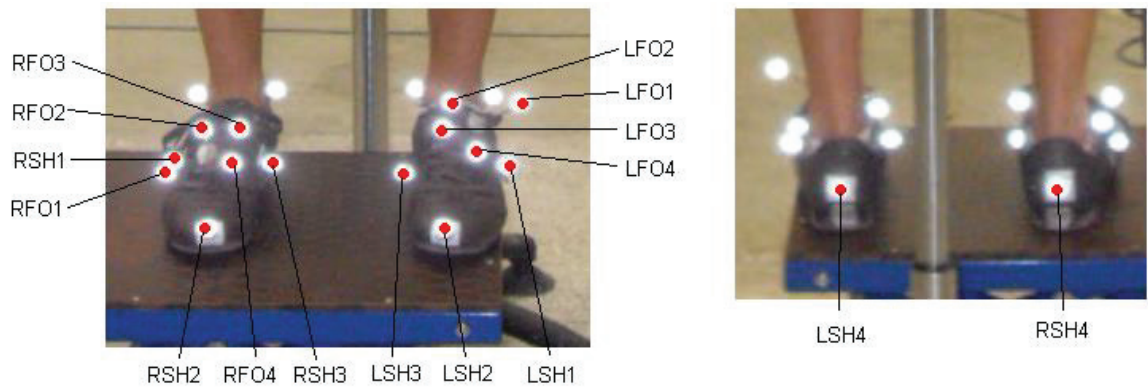
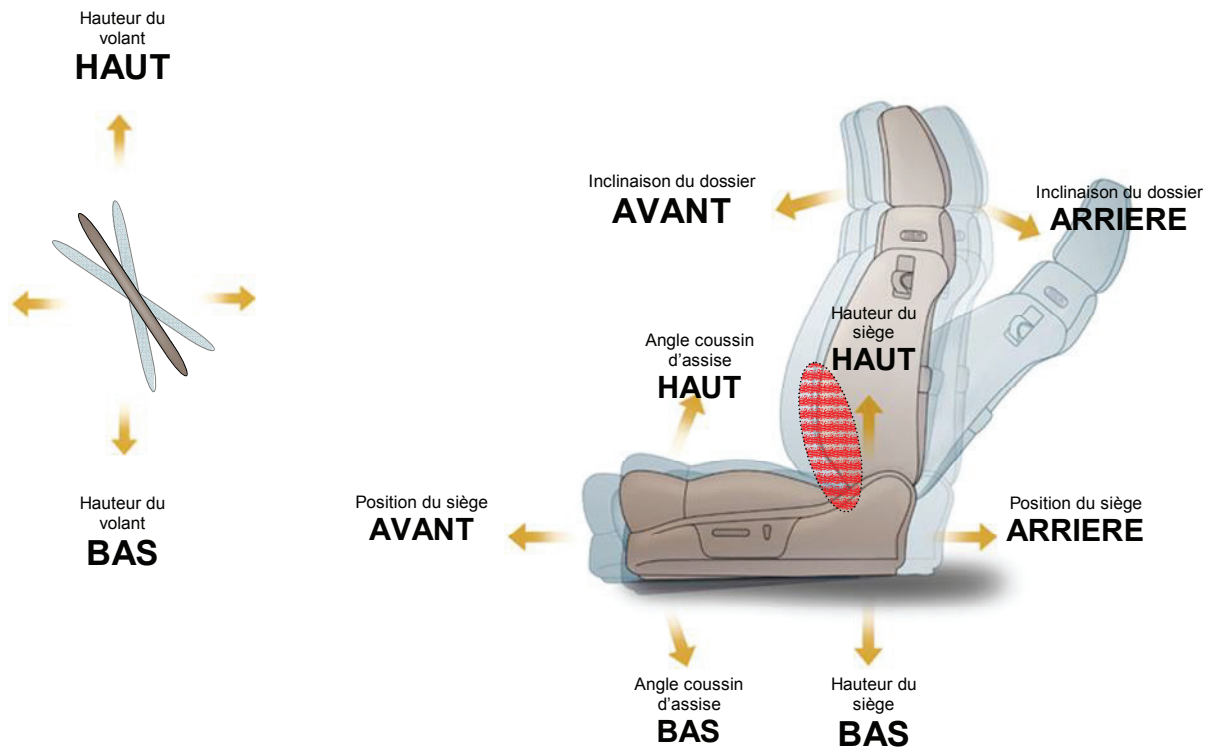

Figure 35: Marker placement in left and right feet

8.2.6 Questionnaire

Cadre à remplir par l'expérimentateur

IdSujet	_____	Véhicule	_____	Date	_____
---------	-------	----------	-------	------	-------



1. Parmi les réglages disponibles dans le véhicule, quels sont ceux que vous avez modifiés pendant la session de conduite? Expliquez pourquoi vous avez effectué ces changements.

Réglages	Modifié pendant la session de conduite?		Raison
	oui	non	
hauteur du siège	oui	non	
position avant/arrière du siège	oui	non	
inclinaison du dossier	oui	non	
hauteur du volant	oui	non	
position avant/arrière du volant	oui	non	
support lombaire (zone rouge)	oui	non	
autre:	-		

2. Parmi les réglages disponibles dans le véhicule, quels sont ceux qui ont un plage de réglage limitée (c'est à dire, qui ne vous permet pas d'adopter une position de conduite confortable)?

Réglages			Si oui, direction dans laquelle le réglage est limité	
	oui	non		
hauteur du siège	oui	non	vers le haut	vers le bas
position avant/arrière du siège	oui	non	vers l'avant	vers l'arrière
inclinaison du dossier	oui	non	vers l'avant	vers l'arrière
hauteur du volant	oui	non	vers le haut	vers le bas
position avant/arrière du volant	oui	non	vers l'avant	vers l'arrière
support lombaire (zone rouge)	oui	non	vers l'avant	vers l'arrière
autre:				

3. Classez les éléments listés ci-dessous par ordre de priorité lors du réglage du poste de conduite (1 pour le plus important, 6 pour le moins important):

accessibilité des pédales	
accessibilité du volant	
accessibilité des commandes	
visibilité du tableau de bord	
visibilité de la route	
espace libre entre votre tête et le toit	
autre (précisez)	

8.2.7 RAMSIS Kinematic model

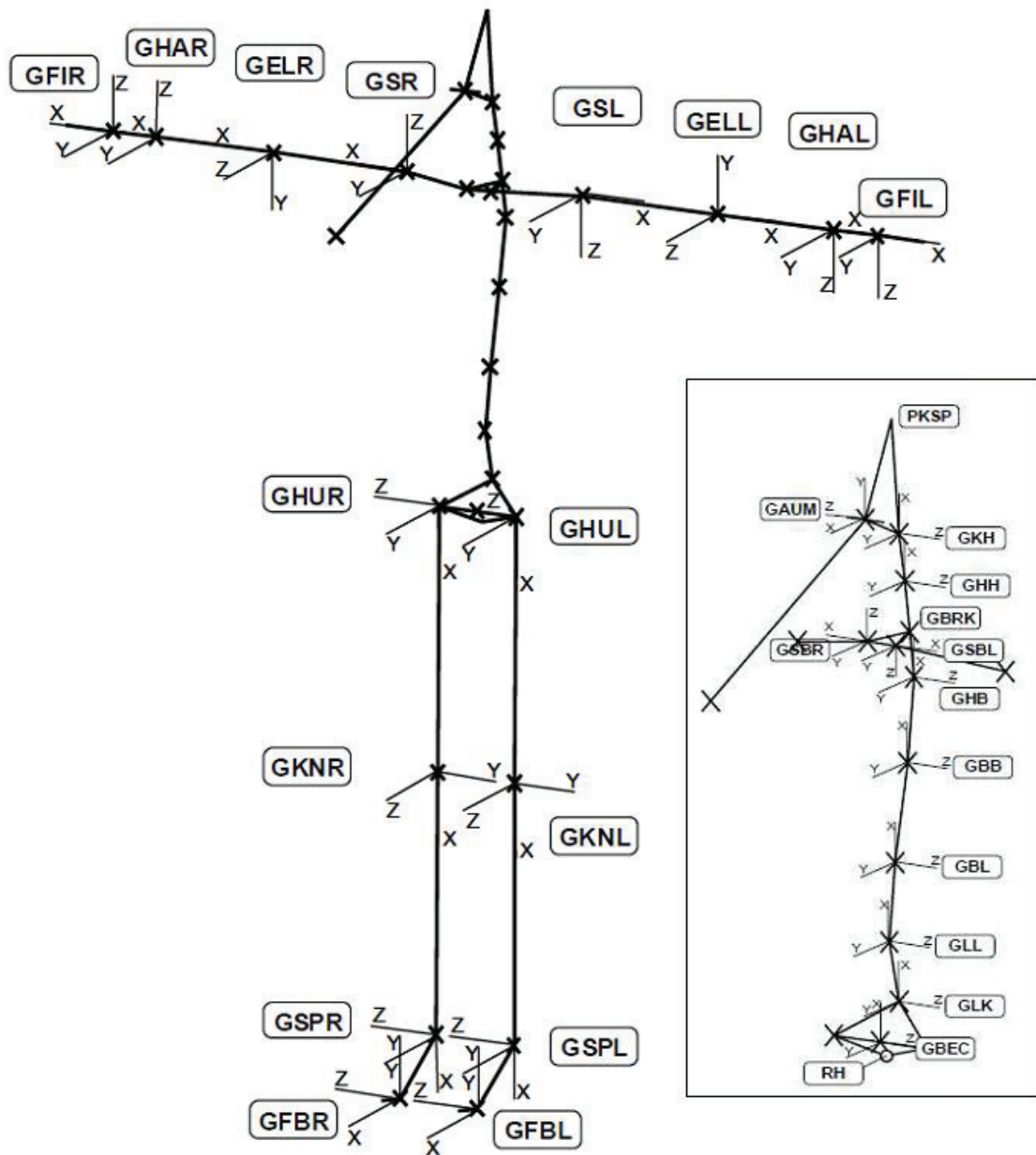

Figure 36: RAMSIS kinematic model – Definition of body joints

8.3 Vehicle adjustments and driving posture analysis

8.3.1 Correlation with main anthropometric dimensions

Table 44 gives the coefficients of correlation between adjustments and anthropometric dimensions, and between driving posture variables and main anthropometric characteristics. For vehicle adjustments, when possible, the correlation coefficients are also compared to correlation coefficients found in the literature [13, 30].

Results show that the most correlated adjustment with anthropometric dimensions is the seat longitudinal position, with a correlation coefficient of 0.80 with stature, in agreement with the results by Hanson et al. [13]. The seat vertical position is also correlated with driver's anthropometry, but with very lower correlation coefficients (-0.24 with stature).

Surprisingly, no significant correlation was found between steering wheel longitudinal position and anthropometric adjustments, not even with the upper limb length. Also no significant correlation was found between steering wheel vertical adjustment and driver's anthropometric dimensions in agreement with the results by Hanson et al. [13]. However, the position of steering wheel with respect to the seat is correlated with most of the main anthropometric dimensions of the drivers. The longitudinal and vertical distances between seat and steering wheel positions are strongly correlated with almost all main driver's anthropometric dimensions, except hip breadth. Similar results were found by Porter and Gyi [30], but in this case they found smaller correlation coefficients.

Statistically significant correlations were also found between both knee and elbow angles and main anthropometric dimensions of drivers, especially with stature, sitting height and upper limb length.

Finally, seat back angle and torso angle are only slightly correlated with driver's main anthropometric dimensions.

Table 44: coefficient of correlations between vehicle adjustments and mains driver's anthropometric dimensions. A grey cell correspond to unavailable data. For Porter et al results, the presented results are values for females (F) and males (M).

Adjustment	Study	Stature	Sitting Height	Hip breadth	Buttock-knee length	Upper limb length	Weight
Seat_X	actual study	0.80***	0.75***	0.07 ^a	0.78***	0.77***	0.64***
	Porter et al						
	Hanson et al	0.80	0.72		0.73		0.60
SWC_X	actual study	0.05 ^a	-0.06 ^a	0.00 ^a	0.04 ^a	0.05 ^a	0.04 ^a
	Porter et al						
	Hanson et al	—	—	—	0.45		—
Seat_X-SWC_X	actual study	0.79***	0.73***	0.07 ^a	0.78***	0.75***	0.63***
	Porter et al	0.56 (F) 0.54 (M)	0.52 (F) 0.47 (M)	—	0.56 (F) 0.57 (M)		0.38 (F) 0.64 (M)
	Hanson et al	0.61	0.55		0.46		—
Seat_Z	actual study	-0.25***	-0.26***	-0.07 ^a	-0.22***	-0.22***	-0.21***
	Porter et al						
	Hanson et al	—	—	—	—	—	—
SWC_Z	actual study	0.04 ^a	0.05 ^a	-0.00 ^a	0.04 ^a	0.02 ^a	0.03 ^a
	Porter et al						
	Hanson et al	—	—	—	—	—	—
SWC_Z-Seat_Z	actual study	0.57***	0.60***	0.13**	0.50***	0.47***	0.45***
	Porter et al	0.37 (F) 0.48 (M)	0.42 (F) 0.32 (M)	0.18 (F) 0.54 (M)	0.26 (F) 0.63 (M)		—
	Hanson et al						
SBA	actual study	0.16***	0.14***	-0.03 ^a	0.10*	0.11**	—
	Porter et al	0.18 (F) 0.10 (M)	0.27 (F) 0.18 (M)	0.25 (F) 0.44 (M)	0.13 (F) 0.29 (M)		0.10 (F) 0.51 (M)
	Hanson et al						
Hip_X		0.70***	0.61***	0.07**	0.70***	0.68***	0.57***
Hip_Z		-0.30***	-0.28***	-0.04 ^a	-0.25***	-0.26***	-0.19***
LKN		-0.62*** (-0.69***)	-0.62*** (-0.68***)	0.24*** (0.19***)	-0.50*** (-0.57***)	-0.55*** (-0.61***)	-0.30*** (-0.41***)
RKN		-0.48***	-0.50***	-0.15***	-0.38***	-0.43***	-0.25***
ELB		-0.39***	0.36***	0.04 ^a	0.40***	0.33***	0.32***
Torso Angle		0.08**	0.12***	-0.07*	0.03 ^a	0.05 ^a	0.01 ^a

^ap≥0.05, *p<0.05, **p<0.01, ***p<0.001

8.4 RAMSIS posture prediction - Parametric study

8.4.1 Objectives and methods

RAMSIS driving posture prediction strongly depends on the chosen neutral posture and on the constraints (tasks) applied to the manikin. In order to study the influence of each constraint and neutral posture on RAMSIS driving posture prediction, a parametric study was performed on 3 manikins representative of a very short female (5th percentile), an average male (50th percentile) and a very tall man (95th percentile). The Germany 2004 population anthropometric data base was used, for the year 2012. For the 3 selected manikins, medium waist circumference and sitting height type were selected.

Driving posture was first predicted using the set of constraints recommended in RAMSIS Application guide. Then, all the defined constraints were changed one by one, and the driving posture was re-calculated. Constraints were tested in 4 different vehicles.

Constraints defined in the RAMSIS Application Guide [47] are the following (Figure 21):

- Pedal point of right shoe on accelerator pedal 1/2 depressed and heel point of right shoe to floor
- Heel point of left shoe on foot rest
- Hip point on seat travel path
- Hands grasping points on grasping surfaces (travel path of the steering wheel contact point)
- Top of head below the roof
- Eye of the manikin above lower vision bounding plane
- Tangent of vision line: downwards view angle of 6°
- Pelvis: lock "Tilt Sideways" and "Long axis rotation" at $(0.0^\circ, 0.0^\circ)$

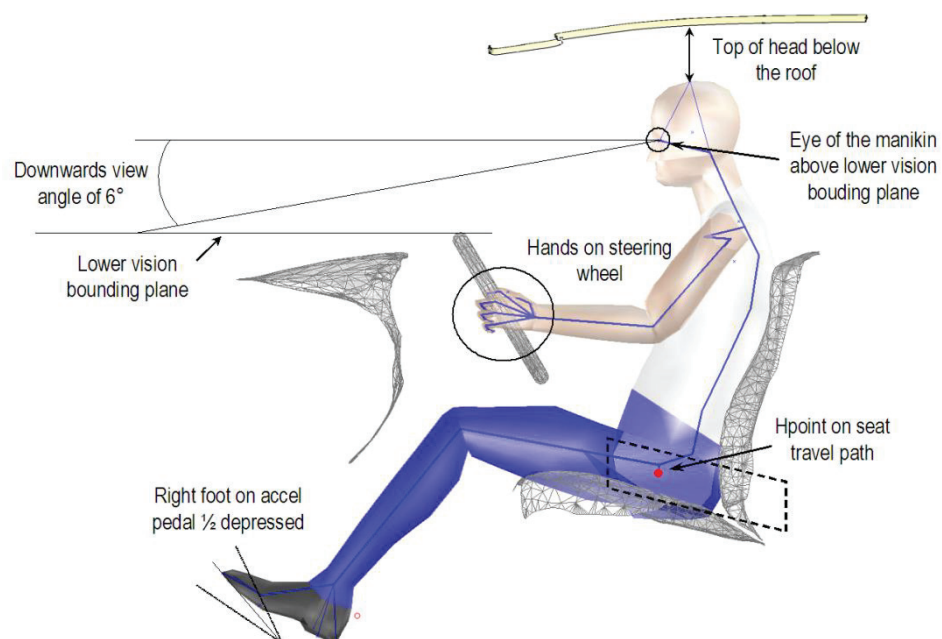

Figure 37: Set of constraints recommended in RAMSIS application guide for driving posture prediction

Table 45: Main anthropometric measurements of RAMSIS manikins

	5th percentile female	50th percentile male	95 th percentile male
Body Height (mm)	1552.7	1784.8	1904.8
Sitting Hight / Body Height	0.53	0.52	0.51
Waist Circumference (mm)	787.5	885.4	839.4

In a first step, the driving posture was predicted using the recommended set of constraints defined in [47]. The resulting predicted posture is referred as the recommended driving posture. Then, each constraint was modified (one by one), and the driving posture was recalculated. The modification of constraints is defined as follow:

- Neutral posture

For this study, only the Car Driver posture model was available. Therefore, in order to study the influence of neutral posture on driving posture prediction, 3 neutral postures were defined (Figure 38). The first one is the one corresponding to the Car Driver posture model (b). The second one corresponds to a more erect driver with more flexed legs (a), and the third one to a more reclined driver with more stretched legs (c).

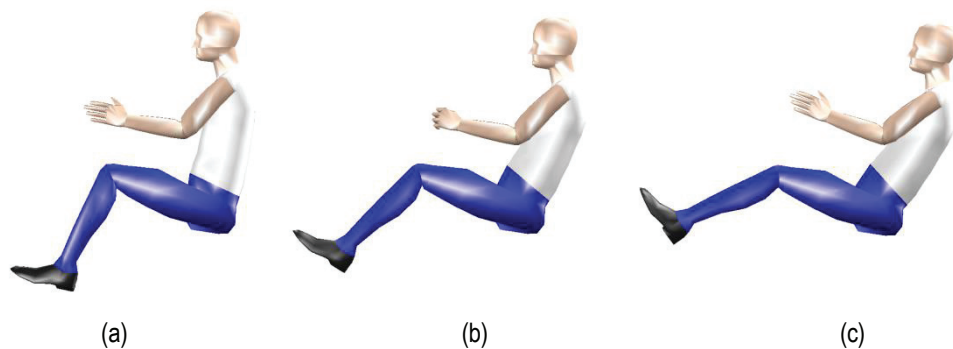

Figure 38: tested neutral postures: more erect posture (a), Car Driver neutral posture (b), more reclined posture (c)

- Right foot position

In the recommended set of constraints, mannequin's right foot is placed on the 1/2 depressed accelerator pedal. Two other alternatives were tested to see the influence of this task constraint on the predicted posture: right foot on undepressed accelerator pedal and right foot on fully depressed accelerator pedal.

- Left foot position

In RAMSIS Application Guide it is recommended to place the left foot of the manikin on the floor. Three other alternatives were tested to see the influence of this task constraint on the predicted posture: left foot on undepressed, half depressed and fully depressed clutch pedal respectively.

In this case, differences with recommended driving posture will depend on the initial position of the left foot for the recommended driving posture: the imposed constraint is that the heel point of left shoe should be in contact with the floor. However the floor is a quite large surface, and therefore the position of left foot will widely vary for different manikins when using the recommended set of constraints for posture prediction.

- View angle down

Vision field is a very important constraint for the driving task, since it is of primary importance to be able to correctly see the road while driving. However, it is also very difficult to characterize this constraint in a simple way. Different possibilities are offered in RAMSIS to define the constraint of vision (Figure 40), and one of them is to change the angle of vision line. It is also possible to constrain the point of vision, or to define a surface in which the mannequin's head or eye point must be.

In the RAMSIS Application Guide, it is recommended to set the vision line with a downward vision angle of 6° , without any constraint for the point of vision. In order to see the influence of this angle value on the predicted posture, the downward vision angle was set to three different values: 3° , 9° and 11° .

- Position of point of vision

As seen previously, it is also possible to add a constraint on the mannequin's point of vision. In this case, for a given downward view angle, the mannequin's head position is constrained to be on a line (Figure 41). This added constraint may then have a strong influence on the predicted driving posture, since the position of the mannequin's head is then strongly constrained. In order to see the effects of that kind of constraint on driving posture predictions, the position of the point of vision was imposed to be on the top of engine hood, and at the middle of engine hood respectively.

- Head clearance

For each manikin, the driving posture was first predicted with the constraint that the top of head should be below the roof (i.e. the minimum distance between top of head and vehicle's roof is equal to 0 mm). The position of the top of head for the corresponding driving posture was determined, and then the 2 following alternative constraints were tested (Figure 39):

- Top of head above the plane 1 defined by $z = \text{Predicted top of head } Z + 30 \text{ mm}$ (when possible)
- Top of head below the plane 2 defined by $z = \text{Predicted top of head } Z - 30 \text{ mm}$

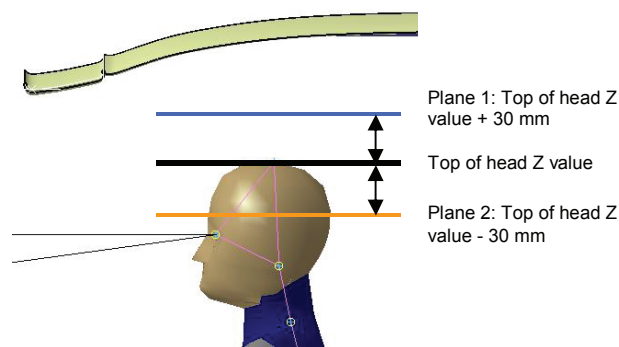

Figure 39: definition of two planes for the study of the influence of head clearance on predicted driving posture

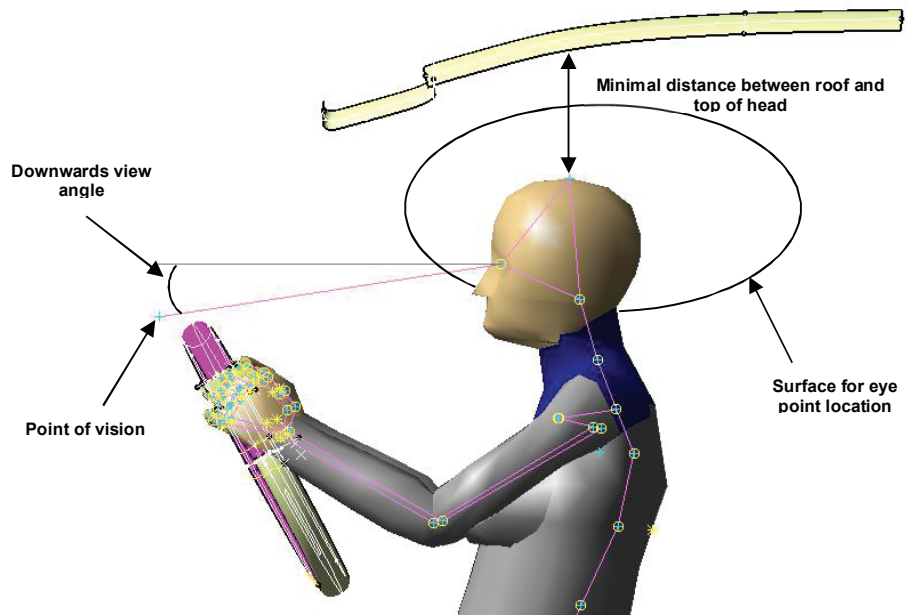

Figure 40: Illustration of possible constraints that influence driver's vision

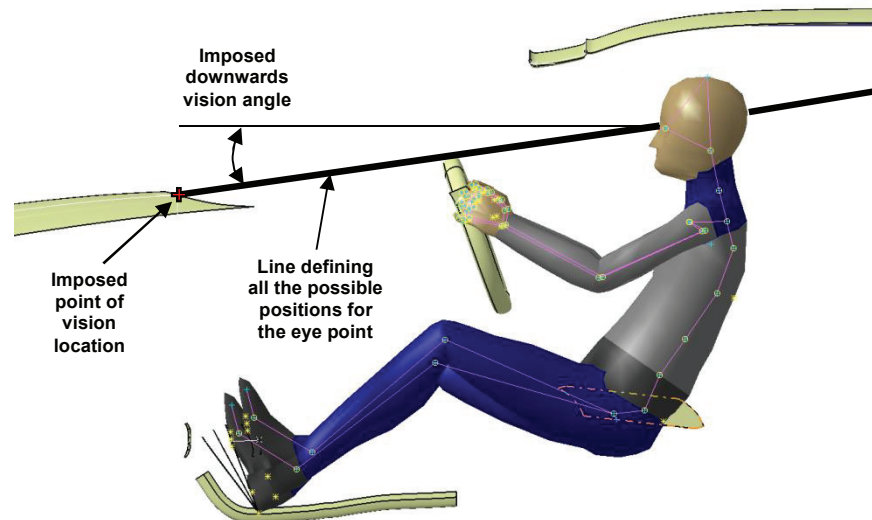

Figure 41: Point of vision and downwards view angle constraints for RAMSIS posture prediction

8.4.2 Results

summarizes the main effects of each constraint on driving posture prediction when varying constraints from their recommended value for mannequin's hip point, eye point and torso angle. Differences between recommended driving posture and postures obtained with modified constraints are given in Table 47 to Table 52.

Table 46: Main effects of geometrical constraints imposed on manikin on RAMSIS driving posture prediction.

Constraint	Variation	Main effects on predicted driving posture
Neutral posture	<ul style="list-style-type: none"> • More erect • Car driver • More reclined 	<p>When a more erect neutral posture is used, a higher and more forward hip position is predicted (average differences of -35mm in longitudinal direction (x) and -21 mm in vertical direction (z). On the contrary, RAMSIS gives more backward and lower hip predictions with a more reclined neutral posture.</p> <p>Differences can reach up to 100 mm in eye point longitudinal position and 75 mm in hip longitudinal position.</p> <p>Hip point longitudinal position is predicted slightly further forward when right foot is placed on fully depressed accelerator pedal (average difference of -10.9 ± 8.9 mm), and is predicted slightly more backward when right foot is placed on undepressed accelerator pedal (average difference of 5.0 ± 7.9 mm). Hip vertical position remains constant on average (3.1 ± 6.9 mm and -2.2 ± 5.0 mm respectively) .</p> <p>Similar tendencies are observed for manikin's eye point.</p> <p>Torso angle remains fairly constant ($0.0 \pm 1.2^\circ$ and $0.1 \pm 1.4^\circ$ respectively).</p>
Right foot position	<ul style="list-style-type: none"> • undepressed accelerator pedal • ½ depressed accelerator pedal • fully depressed accelerator pedal 	<p>On average, hip point longitudinal position is always predicted more forward when left foot is on clutch pedal (average absolute difference of 28.9 ± 28.0 mm). Higher differences are observed when left foot is placed on undepressed clutch (49.4 ± 22.5 mm on average).</p> <p>Eye longitudinal position follows the same trend (average absolute difference of 17.4 ± 25.5 mm).</p> <p>No influence on hip position (2.4 ± 6.2 mm and 1.7 ± 6.8 mm in longitudinal (x) and vertical (z) directions respectively).</p> <p>No influence on torso angle (-0.1 ± 0.8 mm on average).</p> <p>Small influence on eye position: slightly more backward for smaller view angle down value, and slightly more forward when view angle down value increases.</p>
Left foot position	<ul style="list-style-type: none"> • on floor • undepressed clutch pedal • ½ depressed clutch pedal • fully depressed clutch pedal 	<p>on average manikin's hip point is predicted more forward and lower (average differences of -33.6 ± 47.8 mm and -40.5 ± 15.5 mm in x and z directions respectively).</p> <p>High differences are observed in eye position predicted more backward and lower (68.5 ± 41.0 mm and -108.8 ± 53.1 mm in x and z directions respectively).</p> <p>High differences are also observed in torso angle ($13.1 \pm 8.5^\circ$ on average).</p> <p>Small changes in hip position are observed (average differences of 4.4 ± 9.6 mm in x and -6.1 ± 15.2 mm in z direction).</p> <p>Manikin's eye point position is predicted higher and more forward for smaller head clearance (average differences of -26.1 ± 21.8 mm in x and 19.6 ± 15.1 mm in z direction). On the contrary, eye point is predicted lower and more backward (28.0 ± 14.2 mm in x and -22.8 ± 6.4 mm in z direction) when minimum head clearance value is higher.</p> <p>In the first case a more erect torso posture is predicted (average difference of $-4.0 \pm 1.5^\circ$) while in the second case torso posture is predicted more reclined (average difference of $2.4 \pm 1.1^\circ$).</p>
View angle down	<ul style="list-style-type: none"> • 3° • 6° • 9° 	<p>on average manikin's hip point is predicted more forward and lower (average differences of -33.6 ± 47.8 mm and -40.5 ± 15.5 mm in x and z directions respectively).</p> <p>High differences are observed in eye position predicted more backward and lower (68.5 ± 41.0 mm and -108.8 ± 53.1 mm in x and z directions respectively).</p> <p>High differences are also observed in torso angle ($13.1 \pm 8.5^\circ$ on average).</p> <p>Small changes in hip position are observed (average differences of 4.4 ± 9.6 mm in x and -6.1 ± 15.2 mm in z direction).</p> <p>Manikin's eye point position is predicted higher and more forward for smaller head clearance (average differences of -26.1 ± 21.8 mm in x and 19.6 ± 15.1 mm in z direction). On the contrary, eye point is predicted lower and more backward (28.0 ± 14.2 mm in x and -22.8 ± 6.4 mm in z direction) when minimum head clearance value is higher.</p> <p>In the first case a more erect torso posture is predicted (average difference of $-4.0 \pm 1.5^\circ$) while in the second case torso posture is predicted more reclined (average difference of $2.4 \pm 1.1^\circ$).</p>
Position of point of vision	<ul style="list-style-type: none"> • unconstrained • on top of engine hood • at middle of engine hood 	<p>on average manikin's hip point is predicted more forward and lower (average differences of -33.6 ± 47.8 mm and -40.5 ± 15.5 mm in x and z directions respectively).</p> <p>High differences are observed in eye position predicted more backward and lower (68.5 ± 41.0 mm and -108.8 ± 53.1 mm in x and z directions respectively).</p> <p>High differences are also observed in torso angle ($13.1 \pm 8.5^\circ$ on average).</p> <p>Small changes in hip position are observed (average differences of 4.4 ± 9.6 mm in x and -6.1 ± 15.2 mm in z direction).</p> <p>Manikin's eye point position is predicted higher and more forward for smaller head clearance (average differences of -26.1 ± 21.8 mm in x and 19.6 ± 15.1 mm in z direction). On the contrary, eye point is predicted lower and more backward (28.0 ± 14.2 mm in x and -22.8 ± 6.4 mm in z direction) when minimum head clearance value is higher.</p> <p>In the first case a more erect torso posture is predicted (average difference of $-4.0 \pm 1.5^\circ$) while in the second case torso posture is predicted more reclined (average difference of $2.4 \pm 1.1^\circ$).</p>
Head clearance	<ul style="list-style-type: none"> • smaller minimum head clearance (top of head above plane 1) • 0 mm minimum • higher minimum head clearance (top of head below plane 2) 	<p>on average manikin's hip point is predicted more forward and lower (average differences of -33.6 ± 47.8 mm and -40.5 ± 15.5 mm in x and z directions respectively).</p> <p>High differences are observed in eye position predicted more backward and lower (68.5 ± 41.0 mm and -108.8 ± 53.1 mm in x and z directions respectively).</p> <p>High differences are also observed in torso angle ($13.1 \pm 8.5^\circ$ on average).</p> <p>Small changes in hip position are observed (average differences of 4.4 ± 9.6 mm in x and -6.1 ± 15.2 mm in z direction).</p> <p>Manikin's eye point position is predicted higher and more forward for smaller head clearance (average differences of -26.1 ± 21.8 mm in x and 19.6 ± 15.1 mm in z direction). On the contrary, eye point is predicted lower and more backward (28.0 ± 14.2 mm in x and -22.8 ± 6.4 mm in z direction) when minimum head clearance value is higher.</p> <p>In the first case a more erect torso posture is predicted (average difference of $-4.0 \pm 1.5^\circ$) while in the second case torso posture is predicted more reclined (average difference of $2.4 \pm 1.1^\circ$).</p>

Table 47: Differences (mm) between recommended driving posture and predicted driving postures. Influence of neutral posture.

Neutral posture	Stature	Vehicle	Hip Point		Eye Point		Torso angle (°)	
			x (mm)	z (mm)	x (mm)	z (mm)		
More erect	Short	Veh1	-4.3	-9.5	-4.8	6.4	-4.4	
		Veh2	-9.4	4.6	-21.8	20.5	-4.4	
		Veh4	-9.1	-18.6	11.8	-3.1	-1.2	
		Veh5	-23.8	-37.9	-24.7	-20.8	-3.7	
	Average	Veh1	-10.8	1.4	-12.0	9.9	-2.2	
		Veh2	-56.5	-19.1	-61.5	-9.1	-2.5	
		Veh4	-47.3	-38.4	-64.7	-24.7	-4.1	
		Veh5	-49.1	-55.3	-42.0	-39.5	-2.6	
	Tall	Veh1	-41.3	4.7	-42.4	5.7	-1.2	
		Veh2	-74.4	7.1	-102.4	18.7	-4.1	
		Veh4	-50.2	-41.4	-78.7	-28.2	-4.7	
		Veh5	-40.1	-53.8	-36.8	-33.6	-2.9	
	All		-34.7 ± 22.6	-21.4 ± 23.4	-40.0 ± 32.7	-8.2 ± 20.8	-3.2 ± 1.2	
	More reclined	Short	Veh1	24.7	2.2	42.2	8.5	0.1
			Veh2	38.7	2.1	44.5	7.9	0.1
			Veh4	27.0	9.9	51.4	15.7	1.9
Veh5			41.4	8.6	49.9	15.8	0.3	
Average		Veh1	51.7	-5.9	34.1	10.1	-2.7	
		Veh2	28.3	-2.7	47.7	1.1	1.2	
		Veh4	39.9	20.0	28.9	28.6	-1.4	
		Veh5	-38.3	3.6	32.2	1.1	6.1	
Tall		Veh1	43.6	-4.9	34.8	10.2	-1.9	
		Veh2	26.6	-2.5	36.4	1.7	0.5	
		Veh4	43.4	-0.1	27.6	12.0	-2.0	
		Veh5	-18.1	5.1	54.5	8.1	5.5	
All			25.7 ± 26.9	3.0 ± 7.3	40.4 ± 9.2	10.1 ± 7.7	0.6 ± 2.8	

Table 48: Differences (mm) between recommended driving posture and predicted driving postures. Influence of right foot position.

Right foot position	Stature	Vehicle	Hip Point		Eye Point		Torso angle (°)	
			x (mm)	z (mm)	x (mm)	z (mm)		
Undepressed accelerator pedal	Short	Veh1	0.0	-0.1	6.2	-0.7	0.6	
		Veh2	5.6	-3.6	0.7	-2.2	-0.6	
		Veh4	7.6	-5.3	4.8	-4.6	-0.4	
		Veh5	18.5	-13.8	28.9	-12.9	0.9	
	Average	Veh1	-5.9	2.8	-22.0	3.9	-2.0	
		Veh2	1.3	-0.3	15.4	-15.4	1.6	
		Veh4	5.4	-9.0	6.2	-10.1	0.2	
		Veh5	15.9	3.2	-2.8	4.4	-1.7	
	Tall	Veh1	1.1	0.0	10.5	-2.9	0.9	
		Veh2	-6.2	0.6	12.5	-6.3	1.9	
		Veh4	3.3	0.0	3.7	0.5	-0.1	
		Veh5	13.9	-1.4	3.3	-0.5	-0.9	
	All		5.0 ± 7.9	-2.2 ± 5.0	5.6 ± 12.0	-3.9 ± 6.3	0.0 ± 1.2	
	Fully depressed accelerator pedal	Short	Veh1	-31.7	3.0	-13.6	1.8	1.6
			Veh2	-11.3	6.8	-6.9	6.4	0.4
			Veh4	-12.2	-0.4	2.9	-2.1	1.6
Veh5			-13.0	0.1	-6.7	-0.6	0.7	
Average		Veh1	-6.6	-10.5	0.5	-12.1	0.7	
		Veh2	1.6	-0.1	-21.7	-1.3	-2.6	
		Veh4	-0.1	19.8	-23.6	22.6	-2.1	
		Veh5	-17.3	3.3	1.6	2.2	1.7	
Tall		Veh1	-7.5	1.0	-9.9	1.0	-0.1	
		Veh2	-15.9	1.5	-28.9	3.7	-1.1	
		Veh4	-2.9	0.0	-4.0	0.5	-0.2	
		Veh5	-13.5	1.1	-5.3	0.5	0.7	
All			-10.9 ± 8.9	3.1 ± 6.9	-9.6 ± 10.4	1.9 ± 7.9	0.1 ± 1.4	

Table 49: Differences (mm) between recommended driving posture and predicted driving postures. Influence of left foot position.

Left foot position	Stature	Vehicle	Hip Point		Eye Point		Torso angle (°)	
			x (mm)	z (mm)	x (mm)	z (mm)		
Undepressed clutch pedal	Short	Veh1	36.8	-4.3	1.1	8.6	-4.6	
		Veh2	57.3	-9.5	46.0	-8.7	-1.2	
		Veh4	55.4	7.9	43.1	9.8	-1.4	
		Veh5	21.5	-13.6	52.3	-14.7	3.0	
	Average	Veh1	85.8	18.0	59.2	24.3	-2.7	
		Veh2	55.1	-5.3	59.2	-15.1	0.3	
		Veh4	57.5	19.6	21.3	21.8	-3.1	
		Veh5	12.2	3.3	30.9	-1.4	2.0	
	Tall	Veh1	74.9	-8.4	38.0	2.3	-3.7	
		Veh2	49.9	-4.8	12.5	2.0	-3.3	
		Veh4	65.6	-0.3	7.7	7.1	-5.1	
		Veh5	21.0	3.6	34.5	1.0	1.2	
	All		49.4 ± 22.5	0.5 ± 10.5	33.8 ± 19.7	3.1 ± 12.4	-1.6 ± 2.7	
	1/2 depressed clutch pedal	Short	Veh1	5.3	-0.7	-26.8	11.6	-4.2
			Veh2	34.4	2.5	39.7	1.5	0.6
			Veh4	20.0	8.3	31.1	8.2	1.1
Veh5			4.8	-6.0	24.6	-7.5	2.0	
Average		Veh1	76.0	19.1	59.5	34.6	-1.8	
		Veh2	36.4	-3.5	37.7	-12.5	0.0	
		Veh4	48.4	19.6	-7.3	24.3	-4.9	
		Veh5	-0.4	3.4	8.5	0.6	1.0	
Tall		Veh1	46.1	-5.1	24.9	4.4	-2.4	
		Veh2	46.8	-4.5	0.6	5.2	-4.2	
		Veh4	46.4	-0.2	0.2	6.2	-4.1	
		Veh5	8.4	1.1	11.1	0.0	0.3	
All			31.1 ± 23.4	2.8 ± 8.7	17.0 ± 23.0	6.4 ± 12.8	-1.4 ± 2.5	
Fully depressed clutch pedal		Short	Veh1	-29.3	3.2	-62.7	17.9	-4.6
			Veh2	26.9	-21.4	29.6	-20.6	0.1
			Veh4	-12.1	12.9	5.8	9.6	2.0
	Veh5		-24.0	3.6	-3.8	1.4	2.2	
	Average	Veh1	25.4	24.9	20.2	32.7	-0.1	
		Veh2	10.0	-9.5	7.7	-18.3	-0.2	
		Veh4	16.6	17.9	-11.8	22.0	-2.6	
		Veh5	25.4	24.9	20.2	32.7	-0.1	
	Tall	Veh1	6.6	-0.6	9.9	-0.2	0.2	
		Veh2	8.9	-0.9	2.8	0.9	-0.6	
		Veh4	28.5	-0.1	-0.8	3.8	-2.6	
		Veh5	-8.6	1.5	-0.4	0.3	0.8	
	All		6.2 ± 20.3	4.7 ± 13.6	1.4 ± 23.3	6.9 ± 17.2	-0.5 ± 2.0	

Table 50: Differences (mm) between recommended driving posture and predicted driving postures. Influence of view angle down.

View angle down	Stature	Vehicle	Hip Point		Eye Point		Torso angle (°)	
			x (mm)	z (mm)	x (mm)	z (mm)		
3°	Short	Veh1	1.9	-0.2	15.2	1.3	0.9	
		Veh2	0.2	-0.4	53.0	1.0	0.1	
		Veh4	0.1	-0.3	2.9	2.0	0.1	
		Veh5	3.0	-6.5	14.8	-4.1	1.0	
	Average	Veh1	21.2	20.2	25.2	33.3	0.0	
		Veh2	-1.9	0.3	23.1	-5.2	1.5	
		Veh4	0.2	-0.4	0.9	0.7	0.0	
		Veh5	-0.6	0.3	4.1	2.7	0.3	
	Tall	Veh1	-0.1	0.1	11.5	3.4	0.5	
		Veh2	-0.1	0.0	4.4	1.7	0.2	
		Veh4	-0.4	0.0	1.5	1.6	0.0	
		Veh5	-0.2	-1.8	8.8	3.1	0.4	
	All		1.9 ± 6.2	0.9 ± 6.3	13.8 ± 14.8	3.5 ± 9.8	0.4 ± 0.5	
	9°	Short	Veh1	10.7	-1.1	-6.0	6.7	-2.2
			Veh2	0.4	1.7	-4.6	0.1	-0.3
			Veh4	-0.1	0.2	-31.4	-1.7	0.0
Veh5			1.8	-3.0	5.2	-4.8	0.4	
Average		Veh1	20.4	25.4	-5.1	33.3	-1.7	
		Veh2	2.3	-0.2	-15.0	-13.3	-1.0	
		Veh4	0.1	0.7	-7.9	-1.8	-0.4	
		Veh5	-0.5	3.4	-2.7	1.4	-0.1	
Tall		Veh1	0.1	0.1	-10.1	-2.7	-0.4	
		Veh2	0.0	0.0	-9.0	-2.5	-0.4	
		Veh4	-0.3	0.0	-4.4	-2.3	-0.2	
		Veh5	0.2	1.2	-6.7	-1.6	-0.4	
All			2.9 ± 6.3	2.4 ± 7.4	-8.1 ± 8.8	0.9 ± 11.2	-0.6 ± 0.7	

Table 51: Differences (mm) between recommended driving posture and predicted driving postures. Influence of position of point of vision.

Position of point of vision	Stature	Vehicle	Hip Point		Eye Point		Torso angle (°)	
			x (mm)	z (mm)	x (mm)	z (mm)		
On top of engine hood	Short	Veh1	-6.4	-15.8	27.4	-38.2	5.3	
		Veh2	5.0	-3.3	8.5	-12.5	1.3	
		Veh4	14.6	-46.0	42.6	-59.6	3.9	
		Veh5	5.1	-50.2	48.7	-59.6	4.9	
	Average	Veh1	16.3	-35.8	111.1	-70.0	10.7	
		Veh2	-21.3	-39.2	72.8	-88.9	10.2	
		Veh4	-23.5	-38.8	63.3	-114.4	12.9	
		Veh5	-79.5	-55.2	72.9	-136.2	18.6	
	Tall	Veh1	-50.7	-38.0	1.2	-145.9	12.3	
		Veh2	-26.5	-58.6	74.3	-129.4	12.5	
		Veh4	-47.0	-36.7	69.5	-97.7	13.0	
		Veh5	-51.0	-58.6	68.1	-163.3	16.7	
	All		-22.1 ± 30.3	-39.7 ± 16.6	55.0 ± 31.1	-93.0 ± 46.4	10.2 ± 5.3	
	At the middle of engine hood	Short	Veh1	-7.8	-18.7	29.9	-42.0	5.7
			Veh2	15.2	-10.7	9.7	-37.1	1.8
			Veh4	11.3	-46.0	60.9	-107.4	10.2
Veh5			5.1	-50.2	26.9	-110.3	7.2	
Average		Veh1	2.3	-34.2	134.7	-75.4	13.7	
		Veh2	-29.0	-38.4	81.1	-107.0	12.9	
		Veh4	-59.6	-38.7	105.8	-161.8	22.8	
		Veh5	-121.0	-54.9	136.3	-184.1	30.2	
Tall		Veh1	-27.2	-58.5	77.7	-131.5	12.9	
		Veh2	-48.1	-36.6	56.9	-120.9	14.0	
		Veh4	-115.5	-56.8	120.4	-206.4	27.9	
		Veh5	-166.9	-53.0	144.4	-202.3	33.2	
All			-45.1 ± 59.8	-41.4 ± 15.1	82.1 ± 46.4	-123.9 ± 56.7	16.0 ± 10.1	

Table 52: Differences (mm) between recommended driving posture and predicted driving postures. Influence of head clearance.

Head clearance	Stature	Vehicle	Hip Point		Eye Point		Torso angle (°)	
			x (mm)	z (mm)	x (mm)	z (mm)		
Top of head above plane 1	Short	Veh1	-6.5	0.7	-48.6	7.1	-4.6	
		Veh2	2.1	5.6	-21.8	5.8	-2.4	
		Veh4	-4.2	12.8	-32.8	15.0	-2.9	
		Veh5	2.2	8.9	-13.8	37.1	-4.8	
	Average	Veh1	20.3	25.5	6.6	36.8	-1.1	
		Veh2	2.6	-0.2	-46.7	-0.4	-5.0	
		Veh4	17.7	19.8	-15.6	24.9	-3.1	
		Veh5	11.6	3.3	4.8	43.2	-4.9	
	Tall	Veh1	-	-	-	-	-	
		Veh2	4.9	-0.5	-37.6	12.3	-4.6	
		Veh4	5.1	0.0	-55.8	13.8	-6.1	
		Veh5	-	-	-	-	-	
	All		5.6 ± 8.7	7.6 ± 9.1	-26.1 ± 21.8	19.6 ± 15.1	-4.0 ± 1.5	
	Top of head below plane 2	Short	Veh1	0.3	-0.1	49.4	-10.3	4.9
			Veh2	15.2	-11.1	45.6	-16.0	3.0
			Veh4	6.6	-18.0	29.7	-16.9	2.1
Veh5			6.6	-25.1	36.3	-28.1	3.0	
Average		Veh1	26.9	-22.4	47.9	-18.8	2.1	
		Veh2	1.7	-14.0	28.7	-29.7	2.5	
		Veh4	2.8	-21.0	20.1	-24.7	1.5	
		Veh5	-5.1	-24.9	5.8	-30.8	1.3	
Tall		Veh1	2.0	-20.3	19.5	-23.5	1.4	
		Veh2	-17.7	-9.8	16.7	-20.8	3.3	
		Veh4	0.4	-19.7	22.2	-24.5	1.8	
		Veh5	2.3	-24.7	13.6	-30.0	1.3	
All			3.5 ± 10.7	-17.6 ± 7.6	28.0 ± 14.2	-22.8 ± 6.4	2.4 ± 1.1	

8.4.3 Discussion

Results of the parametric study clearly show that some constraints have a very important influence on the RAMSIS prediction, especially the neutral posture. Regarding this input, the variation in longitudinal H-point position can reach 75 mm, and up to 100 mm for eye longitudinal position. This highly suggests that the selected neutral posture must be carefully selected and in adequacy with the task the user wants to simulate in order to ensure that the resulting posture reflects the reality. On the contrary, it is quite probable that the predicted posture will not be correct.

Other constraints were found to strongly influence the predicted posture, such as the constraint on the manikin's point of vision, or the minimal distance imposed between vehicle's roof and the manikin's top of head. Changes in these constraints can lead to significant changes in the predicted posture, and therefore these constraints should be used very carefully.

The other difficulty lies in the fact that several constraints can affect a same postural parameter. For example, right and left foot both affect the longitudinal position of the driver. Modifying the head clearance also influences the H-point longitudinal position. In this study, only the influence of each constraint separately was studied. However, it is possible that modifying several constraints at the same time can lead to additional errors in RAMSIS predictions, if not used properly. To better understand how driving posture is affected by

constraints, it could be interesting to look at how predictions are affected when modifying several constraints at the same time.

Another important constraint linked to the driving task is that a driver should have enough clearance between the abdomen and the steering wheel. With RAMSIS, it is possible to impose a minimal distance between a body part and any part of the vehicle geometry. Therefore, it should be possible to impose such a constraint to the manikin. However, as the position of the steering wheel is adjustable, its final position will depend on the predicted hand position. Then to take into account this abdomen clearance constraint, RAMSIS should be able to consider at the same time that driver's hands can move inside a surface corresponding to the steering wheel travel path while keeping a minimal distance between the abdomen and the steering wheel (i.e. for any steering wheel adjustment). However, RAMSIS is not able yet to consider both constraints at the same time, and therefore the posture prediction has to be done in two steps. In the first step, the posture is predicted with a constraint on the hands' position that should be inside the steering wheel travel path. Then, it is necessary to have a verification step, to ensure that the minimum clearance between the manikin's abdomen and the steering wheel is respected. The same issue occurs with the clearance between the thigh and the steering wheel..

9 Synthèse

9.1 Introduction

L'évolution des besoins auxquels doit répondre l'industrie, les exigences croissantes des utilisateurs ainsi que la nécessité de réduire de plus en plus la phase de développement d'un nouveau produit donne une place incontestable à l'ergonomie dans le processus de conception des produits.

Ce travail traite de l'ergonomie des véhicules, et plus particulièrement de l'interaction entre le conducteur et le poste de conduite (siège et commandes de conduite). Appliquée à la conception d'un poste de conduite automobile, l'ergonomie peut aider les concepteurs à améliorer leurs produits de façon efficace et proactive. Dans le passé, les concepteurs utilisaient principalement des maquettes physiques pour l'optimisation et la validation du poste de conduite. Les ergonomes étaient donc limités dans leur travail d'une part par le temps et le coût de fabrication de telles maquettes, mais aussi parce que les évaluations étaient réalisées à la fin du processus de conception. De nos jours, les outils de CAO permettent de réduire considérablement le temps de développement, et les évaluations ergonomiques peuvent être réalisées beaucoup plus tôt dans le processus de conception. Les mannequins numériques de l'homme (appelés en anglais Digital Human Models, ou DHM) sont maintenant largement utilisés dans le domaine de l'ergonomie, et permettent aux concepteurs d'avoir une meilleure connaissance du comportement humain dans son ensemble. En apportant une meilleure compréhension et des connaissances plus approfondies sur les interactions entre l'humain et la machine, l'utilisation des DHM permet l'optimisation de la conception des postes de conduite. Chaque nouvelle innovation peut ainsi être testée de manière à anticiper les conséquences d'une nouvelle solution technique, et ce avant même le lancement de la production du nouveau véhicule.

Cependant, l'utilisation des DHM en amont du développement d'un véhicule nécessite d'être capable de prédire de façon réaliste la posture de conduite adoptée par les automobilistes. De nombreux ajustements sont disponibles dans les véhicules actuels (tels que le réglage de la position du volant et/ou du siège), offrant aux conducteurs de nombreuses possibilités de positionnement. Même si l'habitacle est un espace très contraint, deux conducteurs d'anthropométries semblables peuvent adopter des postures de conduite très différentes. De même, un automobiliste peut lui-même adopter différentes postures de conduite dans un même véhicule. Différentes études [15, 25] ont montré que les facteurs liés au véhicule (par exemple la géométrie de l'habitacle, ou le segment auquel appartient le véhicule) influencent aussi la posture de conduite choisie par les automobilistes. Le positionnement correct d'un mannequin numérique dans son environnement de conduite virtuel est donc un problème complexe, et des erreurs dans son positionnement peuvent entraîner des erreurs sur les analyses qui en dérivent (par exemple l'analyse du champ de vision, du volume d'encombrement ou de l'inconfort résultant de l'exécution d'une tâche).

Une prédiction précise de la posture de conduite des automobilistes est aussi nécessaire dans le cas de la protection individualisée des conducteurs (par exemple pour la définition des caractéristiques de déploiement des airbags). En cas de choc frontal, la masse du conducteur ainsi que la distance entre le volant (emplacement à partir duquel l'airbag se déploie) et le conducteur sont des facteurs clés pour la détermination de la nature et de la gravité des blessures [6, 7, 11]. Par exemple, un petit conducteur, en s'asseyant près du volant, peut subir des blessures en heurtant l'airbag au cours de sa phase de déploiement. Au contraire, la distance entre le volant et le conducteur augmente avec la taille de ce dernier, et dans certains cas, les très

grands conducteurs peuvent heurter l'airbag alors qu'il a déjà commencé à se dégonfler. Ceci, couplé avec une masse corporelle souvent plus élevée, peut entraîner un choc entre le conducteur et le volant. Par conséquent, il est primordial de pouvoir prédire de façon précise la posture de conduite (y compris la distance entre le conducteur et le volant).

Dans ce contexte, l'objectif de ce travail de thèse consiste à mieux comprendre le processus de sélection de la posture de conduite, en étudiant et en quantifiant la variabilité intra- (i.e. la variabilité posturale pour un même conducteur) et inter-individu (i.e. la variabilité posturale entre plusieurs conducteurs), ainsi que l'influence des facteurs liés au véhicule sur la posture de conduite adoptée.

9.2 Etat de l'art

9.2.1 Processus d'adaptation de la posture de conduite

Dans un même véhicule, un conducteur peut adopter différentes postures de conduite. Ces postures doivent permettre au conducteur de réaliser différentes tâches de conduite (manipulation du volant, des pédales, des commandes, visibilité correcte de la route et du tableau de bord). Ceci se traduit par des contraintes physiques sur différentes parties du corps du conducteur (par exemple la position du volant introduit une contrainte sur la position des mains du conducteur), et réduit l'ensemble des postures possibles. Du fait de plages d'ajustements limitées pour la position du volant et du siège, la géométrie du véhicule restreint aussi l'ensemble des postures possibles. Enfin, l'anthropométrie du conducteur (par exemple sa stature) et ses limitations physiques (butées articulaires) limitent aussi l'ensemble des postures de conduite possibles.

D'autres paramètres sont aussi à prendre en compte, tels que le confort postural (il est probable qu'une posture très inconfortable ne sera pas choisie par le conducteur), ou encore d'autres facteurs tels que les facteurs psychologiques (par exemple la fatigue).

Le processus de sélection de la posture de conduite est donc un processus complexe, qui fait interagir tous ces facteurs les uns avec les autres (Figure 42).

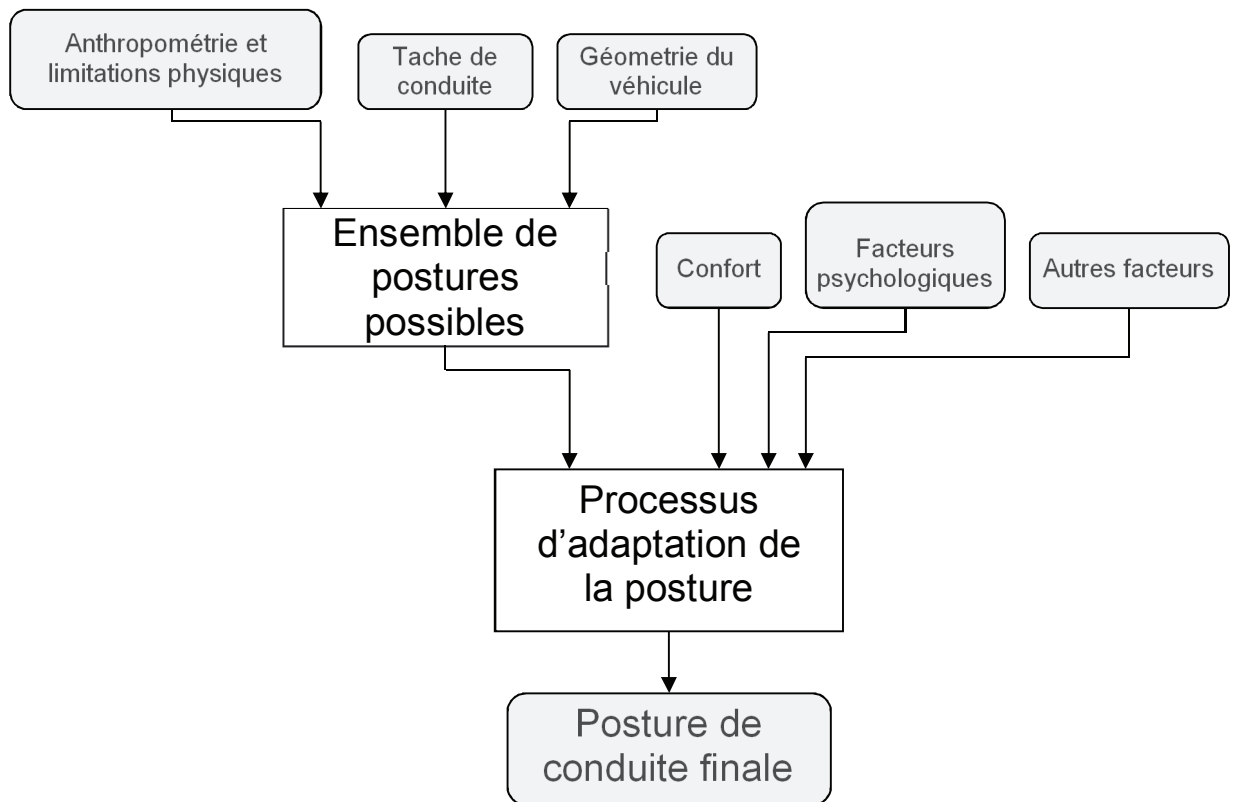

Figure 42: Processus d'adaptation de la posture de conduite

9.2.2 Angles articulaires privilégiés

De nombreuses études ont été réalisées pour la détermination des angles articulaires privilégiés par les conducteurs. Cependant, ces études ont été réalisées de manière parfois très différentes (études expérimentales ou observations théoriques, nombre de participants, type de véhicule etc...), rendant la comparaison entre elles peu aisée. Les études les plus pertinentes trouvées sur le sujet sont résumées dans le Tableau 1.

9.2.3 Modèles de prédiction de la posture de conduite

Trois catégories de modèles pour la prédiction de conduite sont recensés : les modèles basés sur l'optimisation, les modèles de régressions statistiques et les modèles hybrides, qui combinent les deux types de modèles précédents.

- Modèles de régressions statistiques

La Société des Ingénieurs Automobiles (SAE) a développé un ensemble d'outils de prédiction en deux dimensions qui sont traditionnellement utilisés par les constructeurs automobiles lors de la phase de conception de l'habitacle. Parmi ceux-ci, la SAE propose un outil permettant de déterminer la position recommandée du siège (SAE 1517), l'emplacement des yeux du conducteur (SAE J941).

Tableau 1: Overview of most relevant studies on optimum and preferred joint angles for driving posture.

Référence	Méthode		Résultats			Autre		
	Volontaires	Expérimentation	Méthode de mesure	Type de véhicule	Angle de la hanche (°)		Angle du coude (°)	Angle du genoux (°)
Seidl [38]	47 (23 hommes, 24 femmes)	<p>Maquette expérimentale :</p> <ul style="list-style-type: none"> Volant réglable dans les 3 directions Siège réglable d'avant n arrière et en hauteur Angle du dossier réglable pedales réglables en hauteur <p>Simulateur de conduite (session de 10 minutes)</p>	Posture de conduite mesurée à l'aide du système Vicon 3D.	n. s.	99	127	119	
Porter and Gyi [30]	55 (28 hommes, 27 femmes)	<p>Maquette expérimentale :</p> <ul style="list-style-type: none"> plancher, volant et pédales réglables autour de la position du siège inclinaison de l'assise du siège réglable, angle du dossier réglable et support lombaire réglable force réaliste intégrée au niveau des pédales, du levier de vitesse et du volant <p>Simulateur de conduite (session de 2h30)</p>	<p>Marqueurs placés sur les points anatomiques remarquables. Les angles posturaux ont été enregistrés sur le côté droit du conducteur à l'aide d'un goniomètre (la moyenne de 3 mesures est prise en compte).</p> <p>Lors de la mesure de la posture de conduite, le conducteur regarde droit devant, avec les mains sur le volant et la pédale d'accélérateur à demi-enfoncée.</p>	7 sièges testés avec différentes densités de mousse	90 - 115	86 - 164	99 - 138	Différences observées entre hommes et femmes
Park et al. [26]	36 (20 hommes, 16 femmes) représentatifs des conducteurs coréens	<p>Maquette expérimentale :</p> <ul style="list-style-type: none"> poste de conduite "hautement réglable" 	<p>La posture de conduite est mesurée à l'aide du système Vicon 140.</p> <p>Les réglages du siège ainsi que la distribution des pressions sur le siège sont mesurés à l'aide d'un système développé par les expérimentateurs (Driving Posture Monitoring System)</p> <p>[Erreur ! Source du renvoi introuvable.]</p>	Seat selected as the most comfortable seat out of sixteen seats [27]	Mean ± SD (range) 115.8 ± 6.5 (101 – 127)	Mean ± SD (range) 111.5 ± 11.4 (88 – 137)	Mean ± SD (range) 132.7 ± 6.9 (120 – 151)	Différences observées entre hommes et femmes

Référence	Méthode			Résultats		Autre		
	Volontaires	Expérimentation	Méthode de mesure	Type de véhicule	Angle de la hanche (°)		Angle du coude (°)	
Park et al. [25]	43 (24 hommes, 19 femmes) représentatifs des conducteurs coréens	Maquette expérimentale : <ul style="list-style-type: none"> Réglages disponibles : inclinaisons avant et arrière de l'assise du siège, inclinaison du dossier, position avant arrière du siège 	La posture de conduite est mesurée à l'aide du système Vicon 140. Les réglages du siège sont mesurés à l'aide d'un système développé par les expérimentateurs (Driving Posture Monitoring System).	n. s.	Moyenne ± ET (étendue) 117.4 ± 7.7 (103 – 131)	Moyenne ± ET (étendue) 113.0 ± 14.0 (86 – 144)	Moyenne ± ET (étendue) 133.7 ± 8.5 (120 – 152)	Différences observées entre hommes et femmes
Hanson et al. [13]	38 (17 hommes and 21 femmes)	Maquette expérimentale : <ul style="list-style-type: none"> Géométrie ajustable: pédales, volant et siège réglables (commande électrique) en x (avant/arrière) et en z (haut/bas). Régalge manuel possible du repose pied et de la profondeur du siège. Simulateur de conduite 	La posture de conduite est mesurée toutes les 30 secondes à l'aide de 2 caméras synchronisées. Les coordonnées du centre du volant, du centre des pédales et du siège sont mesurées de façon continue à l'aide d'un système de positionnement.	La maquette ne correspond à aucune marque de véhicule en particulier, excepté pour le siège (marque Saab). Les plages d'ajustement disponibles sont plus étendues que dans les véhicules réels.	Gauche 100 ± 4.4 Droite 87 ± 6.3	Gauche 128 ± 16 Droite 135 ± 15	125 ± 9.3 (109 – 157)	Différences observées entre le côté droit et le côté gauche pour les angles du coude et de la hanche. Aucunes différences observées entre hommes et femmes
Kyung and Nussbaum [17]	38 (18 hommes, 20 femmes)	Deux types d'expérimentations: <ul style="list-style-type: none"> Maquette expérimentales avec siège et volant ajustables Sur la route (véhicules réels) <p>Dans les deux cas, la conduite a été simulée (maquette expérimentale) ou effectuée (sur la route) ependant 20 minutes.</p>	Marqueurs placés sur la peau du conducteur, mesurés à l'aide d'un bras FARO.	Sedan et monospace. Chaque véhicule est testé avec deux sièges différents.	Sedan Gauche 79 – 87 (G1) 107 – 118 (G2) Droite 83 - 92 (G1) 112 – 123 (G2) Monospace Gauche 84 – 87 (G1) 119 – 126 (G2) Droite 85 – 91 (G1) 120 – 130 (G2)	Sedan Gauche 85 - 120(G1) 146 - 165 (G2) Droite 85 - 108 (G1) 133 - 167 (G2) Monospace Gauche 84 – 116 (G1) 121 - 160 (G2) Droite 84 – 109 (G1) 117 – 157 (G2)	Sedan Gauche 84 - 91 (G1) 118 - 129 (G2) Droite 93 - 110 (G1) 123 - 142 (G2) Monospace Gauche 95 – 105 (G1) 135 – 138 (G2) Droite 97 - 111 (G1) 136 - 139 (G2)	Différences observées entre hommes et femmes Différences observées entre le côté droit et le côté gauche

- Modèles basés sur l'optimisation

Dans ce cas, le problème de la prédiction de la posture de conduite est traité comme un problème d'optimisation multi-contraintes. Deux approches sont le plus souvent employées. La première consiste à minimiser l'erreur résiduelle globale (c'est-à-dire qu'aucune des contraintes n'est exactement atteinte). Dans ce cas, un poids peut être attribué à chaque contrainte de façon à contrôler la distribution de l'erreur résiduelle. Dans la seconde approche, les contraintes sont traitées par ordre de priorité. Dans ce cas, les contraintes les plus importantes sont entièrement satisfaites.

Le modèle d'optimisation le plus fréquemment utilisé est le modèle RAMSIS [34]. Le modèle prédictif de RAMSIS (appelé aussi posture neutre) est basé sur des données expérimentales recueillies lors d'une étude sur 47 volontaires représentatifs de la population allemande. Leur posture de conduite a été enregistrée dans trois configurations expérimentales correspondant à un véhicule de sport, une berline et un monospace. A partir de ces données expérimentales, des distributions de probabilités pour chaque angle articulaire ont été définies (c'est-à-dire les plages de valeurs qui sont les plus susceptibles d'être utilisées pour chaque angle articulaire). Un algorithme d'optimisation est ensuite utilisé pour prédire la posture de conduite de façon à satisfaire au mieux les contraintes appliquées au mannequin numérique (par exemple position des mains sur le volant), tout en gardant chaque angle articulaire aussi proche que possible de la posture neutre.

Ce modèle est largement utilisé par de nombreux constructeurs automobile, mais il présente néanmoins quelques limitations. Tout d'abord, les contraintes appliquées au mannequin numérique doivent pouvoir représenter de façon réaliste la tâche de conduite. Or certaines contraintes ne peuvent pas, à ce jour, être prises en compte de manière directe (par exemple la distance minimale entre le volant et l'abdomen). De plus, les prédictions obtenues à l'aide de RAMSIS dépendent fortement de la posture neutre, qui est basée sur des expérimentations réalisées il y a plus de 20 ans, et qui n'est peut-être plus représentatif des préférences actuelles des automobilistes.

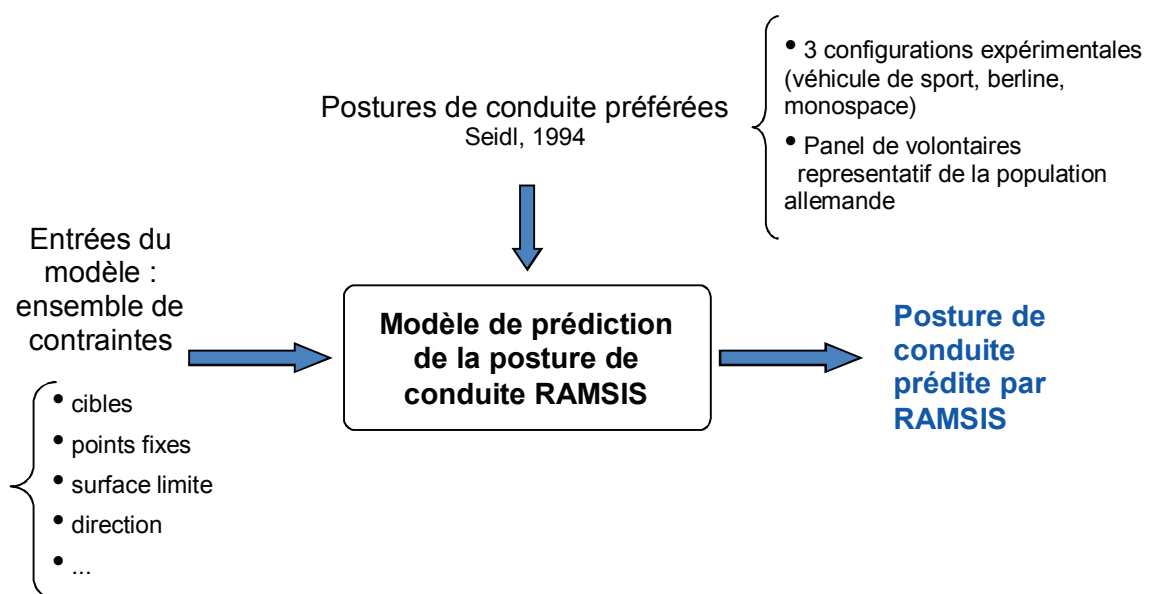

Figure 43: prédiction de la posture de conduite – Modèle RAMSIS

- Modèles hybrides

M. Reed a développé, au cours de sa thèse de doctorat, un modèle de prédiction hybride appelé le modèle de prédiction en cascade (ou CPM pour Cascade Prediction Model) [22]. Ce modèle combine des équations de régression pour la prédiction de la position du bassin et des yeux du conducteur, avec un modèle de cinématique inverse pour déterminer la posture du dos et membres supérieurs et inférieurs en fonction des contraintes données sur la position des pieds et des mains du conducteur (pour plus de détail sur ce modèle, se référer à l'annexe 8.1.3).

La principale limitation de ce modèle est qu'il a été développé à partir de données recueillies sur des véhicules à transmission automatique, ce qui n'est pas représentatif du marché européen. De plus, la hauteur du siège ainsi que la position du volant n'étaient pas réglables lors des expérimentations.

9.2.4 Conclusion et objectifs de recherche

Le but de cette étude est d'approfondir les connaissances existantes sur le processus de sélection de la posture de conduite. Pour cela, nous proposons dans cette étude de :

- Quantifier la variabilité posturale due aux facteurs anthropométriques, ainsi que celle due aux facteurs liés au véhicule (géométrie, segment etc...) ,
- Quantifier la variabilité posturale intra-individu. Ces résultats pourront être utilisés comme une spécification du niveau de précision que doivent avoir les modèles de prédiction de la posture de conduite.

En outre, ce travail propose l'évaluation du modèle prédictif RAMSIS en comparant les données expérimentales recueillies au cours de cette étude avec les postures de conduite obtenues avec RAMSIS.

9.3 Analyse statistique des réglages du poste de conduite et de la posture de conduite

9.3.1 Méthodes et procédures expérimentales

9.3.1.1 Mesures expérimentales

Une étude expérimentale a été menée afin d'enregistrer les postures de conduite de 34 volontaires (18 hommes et 16 femmes) dans 5 véhicules différents. Les volontaires ont été recrutés en fonction de leur stature et de leur hauteur d'assise, afin de représenter au mieux la population européenne. Les véhicules ont été sélectionnés selon deux critères : la visibilité (bonne ou limitée) et la hauteur d'assise.

Chaque volontaire a testé les 5 véhicules, dans trois configurations initiales (Tableau 2). Pour chaque couple volontaire/véhicule, et pour chaque configuration initiale, les 3 postures de conduite suivantes ont été enregistrées ;

- Pied gauche sur le repose pied + pied droit sur la pédale d'accélérateur non enfoncée + mains sur le volant
- Pied gauche sur la pédale d'embrayage non enfoncée + pied droit sur la pédale d'accélérateur non enfoncée + mains sur le volant

- Pied gauche sur la pédale d'embrayage enfoncée+ pied droit sur la pédale d'accélérateur non enfoncée + mains sur le volant

Afin que les postures enregistrées soient le plus réalistes possible, chaque participant a également conduit pendant environ 5 minutes, en extérieur. Pendant cette courte session de conduite, le participant pouvait, si nécessaire, ré-ajuster les réglages du siège et du volant.

Tableau 2: Configurations initiales du volant et du siège testées par les volontaires au cours de l'expérimentation

Réglage	AR	DE	MI
Position verticale du siège	position la plus basse	position la plus haute	position milieu
Position longitudinale du siège	position la plus en arrière	position la plus en avant	position milieu
Inclinaison du dossier	position la plus inclinée	position la moins inclinée	position milieu
Position verticale du volant	position la plus basse	position la plus haute	position milieu
Position longitudinale du volant	position la plus en arrière	position la plus en avant	position milieu

Au cours de cette expérimentation, plusieurs types de données ont été recueillies pour chaque participant et chaque véhicule:

- des données anthropométriques décrivant chaque participant
- la géométrie des véhicules mesurée à l'aide d'un bras FARO
- les positions des marqueurs réfléchissants placés sur le participant et sur le véhicule à l'aide du système optoélectronique VICON (utilisées pour reconstruire la posture de conduite)

Pour chaque véhicule, les participants ont également répondu à un questionnaire, afin de :

- savoir si le participant juge les plages de réglage limitées ou non, et si oui dans quelle direction,
- savoir si le participant a modifié les réglages du siège et/ou du volant au cours de la session de conduite, et si oui pourquoi,
- connaître l'ordre de priorité des contraintes lors du réglage pour chaque participant.

9.3.1.2 Traitement des données

A partir des données expérimentales, les réglages du véhicule présentés dans le Tableau 3 et illustrés sur la Figure 44 sont calculés.

A partir des dimensions anthropométriques collectées et du module BodyBuilder du logiciel RAMSIS, un mannequin numérique correspondant à chaque participant a été créé. Ce mannequin personnalisé a ensuite été exporté dans le logiciel RPx, et la position des marqueurs placés sur le participant a été définie dans le repère du segment auquel ils appartiennent. Cette étape est réalisée en superposant une représentation schématique du modèle sur différentes prises de vue de la posture du participant, dans un espace calibré.

Chaque posture de conduite a ensuite été reconstruite par cinématique inverse, à l'aide d'une méthode d'optimisation qui minimise les écarts entre la position des marqueurs mesurés (position réelle du marqueur) et la position du même marqueur lié au mannequin numérique (position virtuelle du marqueur).

Les variables posturales présentées dans le Tableau 4 et illustrées sur la Figure 45 sont calculées pour chaque posture.

Tableau 3: Définition des variables correspondant aux réglages d'un véhicule

Variable	Définition
Seat_X	Distance longitudinale entre le point H du siège correspondant au réglage choisi par le conducteur et le point de référence de la pédale d'accélération (BOFRP).
Seat_Z	Distance verticale entre le point H du siège correspondant au réglage choisi par le conducteur et le plancher du véhicule.
SWC_X	Distance longitudinale entre le centre du volant correspondant au réglage choisi par le conducteur et le point de référence de la pédale d'accélération (BOFRP).
SWC_Z	Distance verticale entre le centre du volant correspondant au réglage choisi par le conducteur et le plancher du véhicule.
SBA	Angle d'inclinaison du dossier correspondant au réglage choisi par le conducteur, mesuré par rapport à la verticale.

Tableau 4: Définition des variables posturale

Variable	Définition
Hip_X	Coordonnée longitudinale du centre des hanches du conducteur dans le système de coordonnées du véhicule.
Hip_Z	Coordonnée verticale du centre des hanches du conducteur dans le système de coordonnées du véhicule.
Eye_X	Coordonnée longitudinale des yeux du conducteur dans le système de coordonnées du véhicule.
Eye_Z	Coordonnée verticale des yeux du conducteur dans le système de coordonnées du véhicule.
LELB (RELB)	Angle gauche (droit) du coude. Angle entre le bras gauche (droit) et l'avant bras gauche (droit) calculé dans le plan défini par les deux segments. De plus petites valeurs correspondent à un bras plus fléchi.
LKN (RKN)	Angle gauche (droit) du genou. Angle entre la cuisse gauche (droite) et la jambe gauche (droite) calculé dans le plan défini par les deux segments. De plus petites valeurs correspondent à une jambe plus fléchie.
LHIP (RHIP)	Angle gauche (droit) de la hanche. Angle entre la cuisse gauche (droite) et la ligne passant par le centre de la hanche gauche (droite) et le centre articulaire de l'épaule gauche (droite) dans le plan sagittal. De plus petites valeurs correspondent à une hanche plus fléchie.
Torso angle	Angle entre la verticale et la ligne passant par le centre des hanches et le centre des épaules dans le plan sagittal.

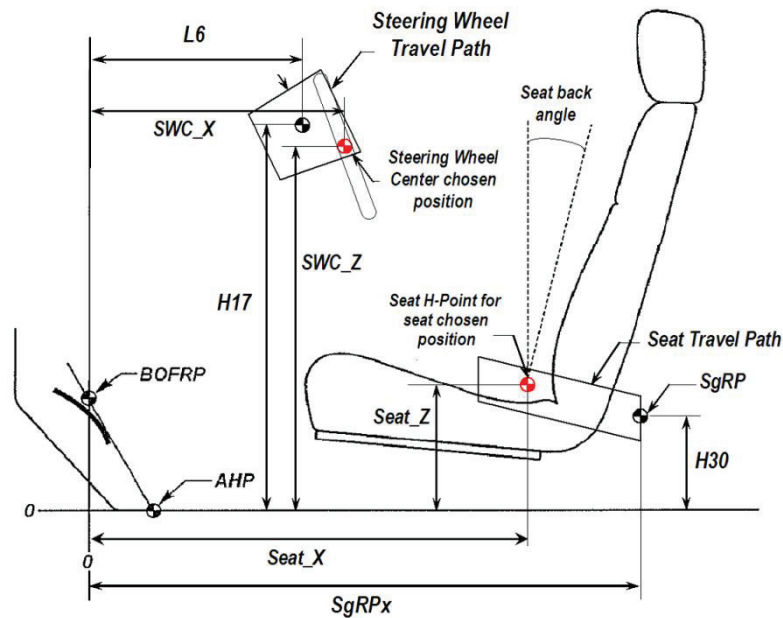

Figure 44: Réglages du poste de conduite

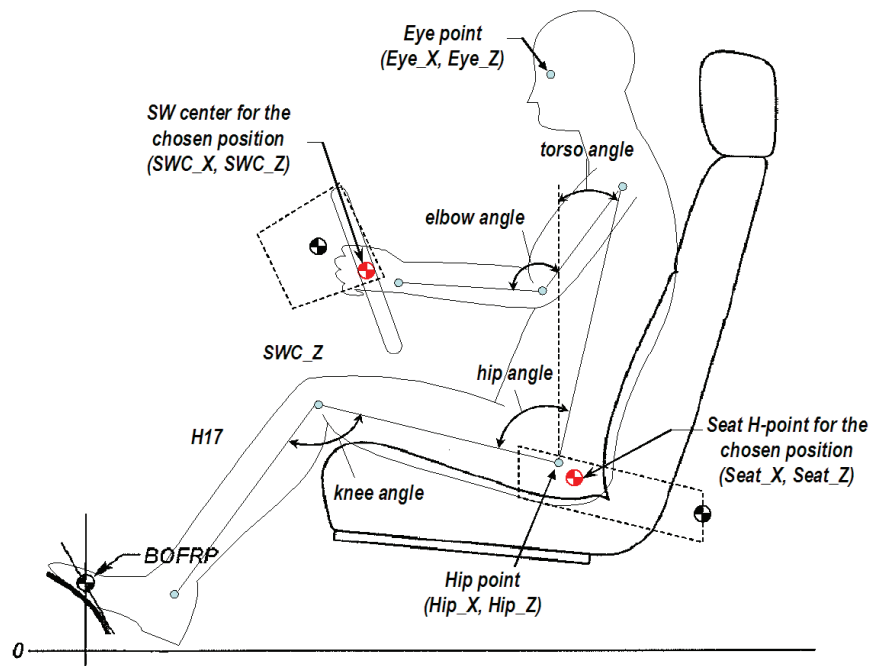

Figure 45: Variables posturales caractérisant une posture de conduite

9.3.2 Variabilité intra-individu

Les résultats obtenus à partir des données expérimentales montrent que les participants ont été capables de reproduire les mêmes réglages du siège et du volant de façon assez précise. Comme on pouvait s'y attendre, les participants de taille moyenne sont ceux qui présentent la plus grande variabilité intra-individu. Le type de véhicule influence aussi la variabilité intra-individu, et de plus grandes valeurs sont obtenues pour les véhicules ayant les plus hautes hauteurs d'assise, ce qui suggère que les véhicules à faible hauteur d'assise sont plus contraints que les autres véhicules. Si l'on se réfère à l'intervalle de confiance à 95% (c'est à dire à la plage de valeurs pour laquelle la probabilité que la différence entre deux ajustements se trouve dans cette plage soit de 95%), la répétabilité est donnée dans le Tableau 5. Ces résultats sont en accord avec ceux

trouvés par Jonsson et al (2008), qui a observé des valeurs de répétabilité de 49mm pour la position longitudinale du siège, et de 9° pour l'angle du dossier. Dans le cas de 4 véhicules sur les 5 testés, le réglage du siège ne peut pas être fait de façon continue, mais par pas discrets (ou encore appelés crans). Dans les véhicules actuels, un cran mesure 15 mm en moyenne, ce qui signifie que les participants ont été capables de reproduire le réglage longitudinal du siège à 3 crans près.

Tableau 5: Répétabilité des réglages (intervalle de confiance à 95%) calculée à partir de 4 répétitions du réglage du poste de conduite d'un même véhicule par un même participant.

Réglage	Répétabilité
Seat_X	46 mm
Seat_Z	34 mm
SWC_X	43 mm
SWC_Z	26 mm
SBA	8°

9.3.3 Variabilité inter-individus

En ce qui concerne les réglages du poste de conduite, l'anthropométrie du conducteur a une forte influence sur la position du siège. Les petits conducteurs positionnent le siège plus haut et plus en avant, tandis que les grands conducteurs ont tendance à reculer et baisser leur siège. En revanche, pour les réglages du volant, les faibles différences observées entre les différents groupes de stature suggèrent que la stature du conducteur n'est pas le principal facteur prédictif. D'autres facteurs, tels que la vision du tableau de bord, ont probablement une influence non négligeable sur la position choisie du volant.

Si l'on regarde la position du point de référence du siège (SgRP) et celle du centre du volant (SWC) par rapport à la position des pédales (BOFRP, AHP), on voit clairement que les véhicules qui ont une haute hauteur d'assise permettent aux conducteurs de se positionner plus en avant que dans les véhicules à faible hauteur d'assise (Figure 46). Il était donc attendu que le type de véhicule ait une forte influence sur la position longitudinale du siège.

En revanche, si l'on se réfère aux distances longitudinales et verticales entre le centre du volant et le point de référence du siège, on constate que plus la hauteur d'assise du véhicule est haute, plus ces distances augmentent, ce qui suggère que le type de véhicule a aussi une influence sur la posture de conduite, et plus particulièrement sur l'angle du coude qui devrait être plus élevé pour les véhicules à hauteur d'assise plus élevée. Cette hypothèse est effectivement vérifiée par les données expérimentales, bien que l'influence du type de véhicule soit plus marquée pour l'angle du coude gauche que pour l'angle du coude droit.

En ce qui concerne l'angle du dossier, il n'est affecté ni par l'anthropométrie du conducteur, ni par le type de véhicule. Ce résultat est en accord avec les résultats obtenus par Reed [32].

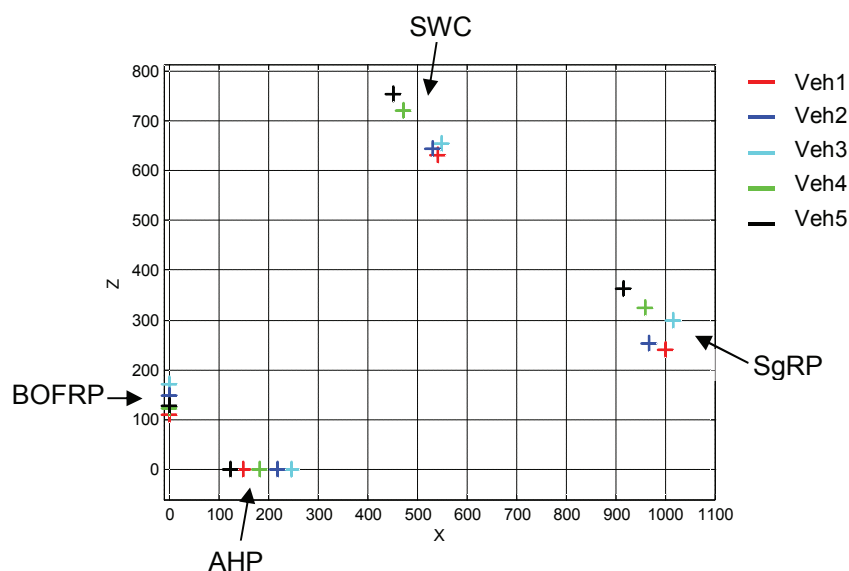

Figure 46: Position du point de référence du siège (SgRP) et du centre du volant (SWC) des 5 véhicules testés par rapport à la position des pédales (BOFRP et AHP)

Les résultats de cette étude montrent aussi que la stature du conducteur a un effet non négligeable sur les angles posturaux. Les angles de la hanche et du genou tendent à décroître lorsque la taille du conducteur augmente, alors qu'à l'inverse, les valeurs observées pour l'angle du coude augmentent avec la stature du conducteur. En revanche, le type de véhicule apparaît n'avoir qu'une faible influence sur les angles du genou et de la hanche, alors que l'angle du coude augmente lorsque la hauteur d'assise augmente. Ces observations suggèrent que les conducteurs s'adaptent aux différentes géométries de véhicule en adaptant la posture des membres supérieurs, alors que la posture des membres inférieurs reste quasiment inchangée.

Lors de cette étude, la symétrie de la posture de conduite n'a pas pu être étudiée pour les angles du genou et de la hanche, étant donné que les contraintes imposées sur les pieds gauche et droit du conducteur étaient différentes. En revanche, les résultats montrent qu'il existe une différence significative entre les angles gauche et droit du coude. Cette assymétrie posturale devrait être prise en compte pour la prédiction de la posture de conduite.

9.3.4 Comparaison avec les standards de la SAE

La position des yeux et du bassin des participants est également comparée aux recommandations de la SAE [41, 44]. Les résultats montrent que les recommandations concernant la position longitudinale du siège ne considèrent pas les petits conducteurs de façon adéquate (Figure 47). Ce résultat est en accord avec les observations de Kyung [16]. En ce qui concerne les recommandations de la SAE pour la position des yeux, les résultats montrent que l'utilisation de l'eyellipse est trop restrictive, et il serait plus approprié d'utiliser ellipse inclusive à 95% (Figure 48). L'inclinaison de l'ellipse à 95% obtenue à l'aide des données expérimentales est également légèrement plus élevée que celle préconisée par la SAE (de 13° à 22° pour les ellipses obtenues à partir des données expérimentales, contre 12° recommandés par la SAE).

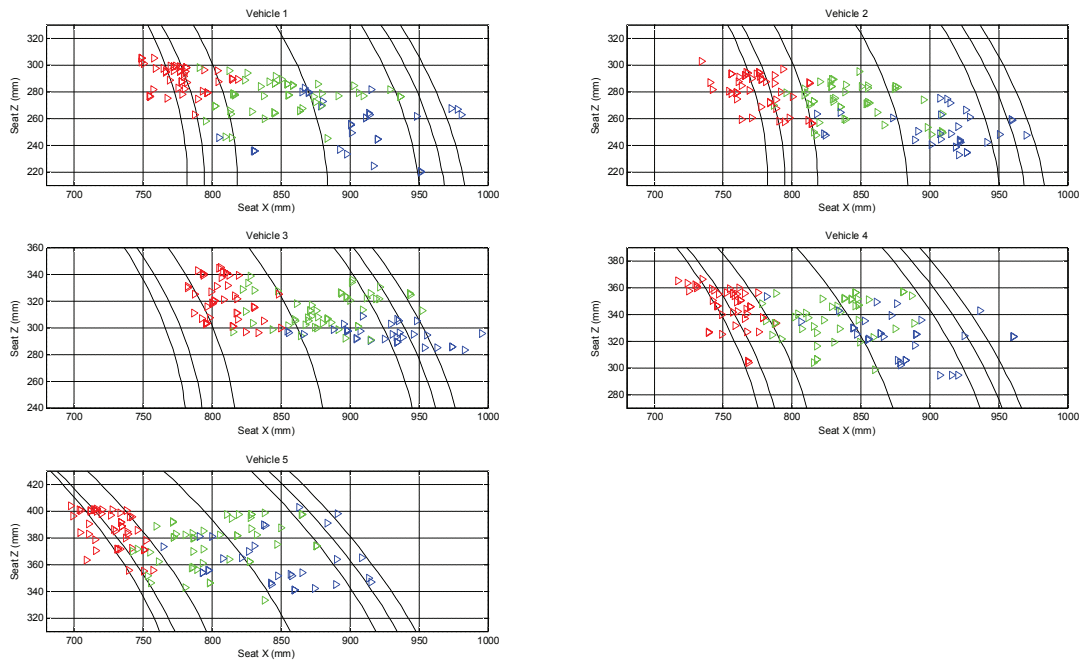

Figure 47: Comparaison de la position du siège des conducteurs avec les recommandations de la SAE [41] rouge pour les petits conducteurs, vert pour les conducteurs de stature moyenne, bleu pour les grands conducteurs les lignes noires correspondent aux modèles d'accommodation (du 2.5^{ème} centile à gauche au 97.5^{ème} centile à droite de la figure)

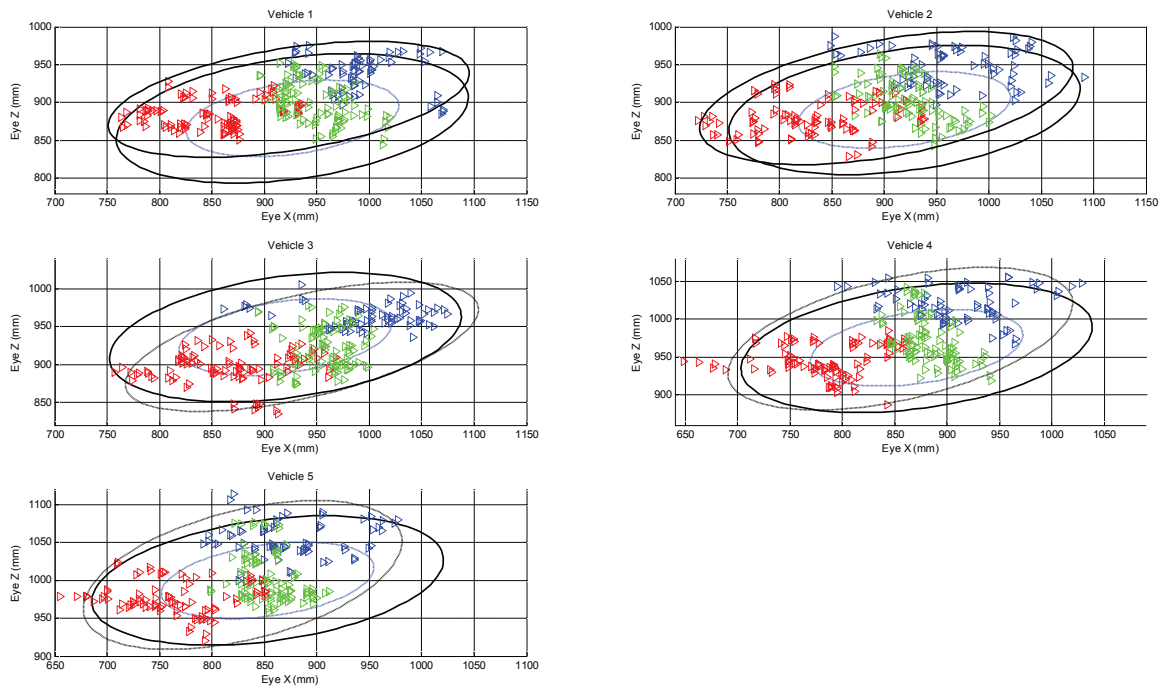

Figure 48: Comparaison de la position des yeux des conducteurs avec les recommandations de la SAE [41] rouge pour les petits conducteurs, vert pour les conducteurs de stature moyenne, bleu pour les grands conducteurs l'ellipse en trait plein bleu correspond à l'eyellipse à 95%, l'ellipse en trait pointillé noir correspond à l'ellipse à 95% obtenue à l'aide des recommandations de la SAE, l'ellipse en trait plein noire correspond à l'ellipse à 95% obtenue à l'aide des données expérimentales

9.4 Modèle statistique de prédiction de la posture de conduite

Basé sur les données expérimentales recueillies lors de cette étude, un modèle statistique de prédiction de la posture de conduite est proposé. Ce modèle donne à la fois une prédiction des réglages du poste de conduite, et une prédiction de la posture de conduite de l'automobiliste.

Afin de valider le modèle, les données expérimentales sont séparées en deux groupes homogènes (). Le premier jeu de données est utilisé pour établir les équations de régression, alors que le second jeu de données est utilisé pour valider le modèle développé.

Tableau 6: Principales caractéristiques des 3 groupes de volontaires utilisés pour le développement des équations de régression

Groups of stature	Number of subjects	Stature (cm)	Stature min (cm)	Stature max (cm)
Short	7 (1M / 6F)	158 ± 6	149	164
Average	8 (6M / 2F)	172 ± 4	166	177
Tall	5 (5M / 0F)	187 ± 6	180	195
Total	20 (12M / 8F)	171 ± 12	149	195

Tableau 7: Principales caractéristiques des 3 groupes de volontaires utilisés pour la validation du modèle

Groups of stature	Number of subjects	Stature (cm)	Stature min (cm)	Stature max (cm)
Short	5 (0M / 5F)	157 ± 4	153	163
Average	5 (2M / 3F)	172 ± 4	167	175
Tall	4 (4M / 0F)	187 ± 4	183	192
Total	14 (6M / 8F)	171 ± 13	153	192

9.4.1 Formulation du modèle

L'analyse des données expérimentales a montré que tant le type de véhicule que l'anthropométrie du conducteur ont une influence sur la posture de conduite et les réglages du poste de conduite. Ainsi, deux types d'entrée sont utilisés pour les équations de régression : les paramètres caractérisant la géométrie du véhicule d'un part, et l'anthropométrie du conducteur d'autre part. La définition des entrées du modèle portant sur la géométrie du véhicule est présentée dans le Tableau 8. Elles sont illustrées sur la Figure 49. En ce qui concerne l'anthropométrie, les 5 paramètres suivant sont définis comme entrées du modèle : la stature (S), le rapport de la hauteur d'assise (SH) sur la stature (SH/S), le ratio de la longueur des membres supérieurs (UL) sur la stature (UL/S), le ratio de la longueur des membres inférieurs (LL) sur la stature (LL/S) et l'indice de masse corporelle (BMI).

Les sorties du modèles sont définies dans les tableaux Tableau 3 Tableau 4, et illustrées sur les figures Figure 44 et Figure 45.

Tableau 8: Définition des paramètres caractérisant la géométrie du véhicule

Variable	Définition
SgRPx	Distance longitudinale entre le point de référence du siège (SgRP) et le point de référence de la pédale d'accélération (BOFRP).
H30	Distance verticale entre le point de référence du siège (SgRP) et le plancher du véhicule.
L6	Distance longitudinale entre le centre du volant dans sa position moyenne et le point de référence de la pédale d'accélération (BOFRP).
H17	Distance verticale entre le centre du volant dans sa position moyenne et le plancher du véhicule.

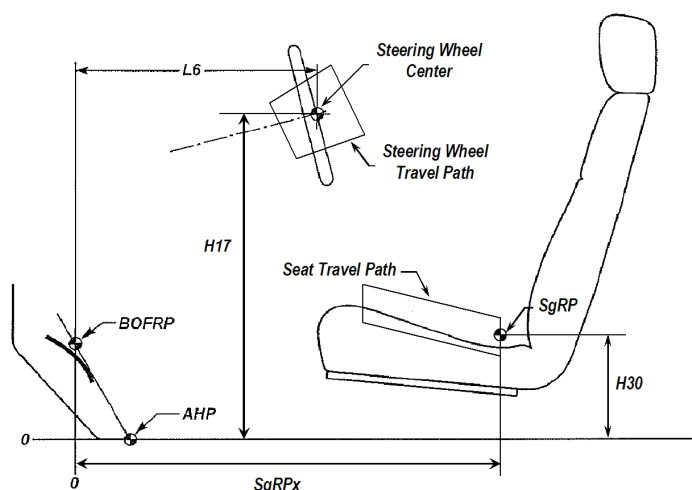

Figure 49: Paramètres caractérisant la géométrie du véhicule

9.4.2 Validation du modèle

La validation du modèle prédictif est effectuée en comparant les prédictions obtenues avec le deuxième jeu de données expérimentales. Ici, nous nous intéressons plus particulièrement à la prédiction de la position des yeux et du bassin. Les différences moyennes entre les prédictions et les données expérimentales sont très faibles (moins de 5 mm en moyenne). Les valeurs des écart-types sont aussi acceptables puisqu'elles sont de l'ordre des valeurs observées de variabilité intra-individu (25.0 ± 11.4 mm dans la direction longitudinale (x) et 21.4 ± 11.5 mm dans la direction verticale (z) pour le bassin, et 38.6 ± 20.8 mm en x et 23.6 ± 10.4 mm en z pour la position des yeux).

Le groupe de stature a une influence significative sur la précision de la prédiction de la position des yeux. La position des yeux est relativement bien prédite pour les petits conducteurs ainsi que pour les conducteurs de stature moyenne (erreur moyenne inférieure à 12 mm), en revanche elle devient plus importante pour les grands conducteurs, avec une erreur moyenne de 37.5 ± 38.7 mm.

Tableau 9: Différences moyennes et écart-types entre les données expérimentales et les prédictions de la position du bassin et des yeux du conducteur. (d_Hip_X1; d_Hip_Z1) and (d_Hip_X2; Hip_Z2) correspondent à la position du bassin prédite directement dans le repère véhicule, et par rapport à la position du siège respectivement.

	Seat_X (mm)	Seat_Z (mm)	Hip_X1 (mm)	Hip_Z1 (mm)	Eye_X (mm)	Eye_Z (mm)
Veh1	-8.1 ± 30.5	11.7 ± 9.1	-12.9 ± 26.3	1.1 ± 20.9	-1.3 ± 38.7	10.7 ± 23.6
Veh2	-2.1 ± 19.0	-11.2 ± 13.2	1.2 ± 23.0	4.2 ± 19.7	-9.5 ± 49.2	-3.3 ± 25.0
Veh4	3.5 ± 17.7	2.5 ± 14.8	-7.7 ± 20.3	3.1 ± 22.6	-2.6 ± 38.3	7.4 ± 22.1
Veh5	-10.5 ± 28.3	-8.4 ± 14.7	-6.4 ± 24.6	-2.2 ± 23.3	-13.2 ± 53.6	0.5 ± 28.7
Short	-1.8 ± 17.2	7.2 ± 12.2	-8.2 ± 16.3	3.4 ± 21.1	5.3 ± 49.4	0.1 ± 22.8
Average	1.5 ± 31.4	-4.0 ± 18.7	-0.3 ± 25.6	1.1 ± 22.0	7.4 ± 39.4	5.9 ± 29.7
Tall	-16.7 ± 18.8	0.6 ± 13.2	-13.3 ± 26.9	-4.9 ± 19.6	-37.5 ± 38.7	0.0 ± 23.6
All	-4.4 ± 24.8 G*	-1.2 ± 15.9 V***, G**	-6.4 ± 23.8	0.2 ± 21.8	-5.6 ± 46.6 G***	2.4 ± 25.9

9.4.3 Limitations du modèle prédictif

Le modèle prédictif proposé dans cette étude présente plusieurs limitations. Premièrement, ce modèle est basé sur des données recueillies sur des véhicules à transmission manuelle, mais ne peut pas être appliqué dans le cas de véhicules automatiques. Le modèle SAE donnant une prédiction de la position longitudinale du siège prend en compte ce paramètre, en ajoutant 18.2 mm à la distance longitudinale entre le point H du siège et le point de référence des pédales (BOFRP) dans le cas d'un véhicule automatique. Il est intéressant de constater que cette valeur est similaire à la valeur de la variabilité intra-individu (22.3 ± 14.1 mm), ce qui suggère que le type de transmission du véhicule n'affecte pas de façon importante la posture de conduite.

Le modèle prédictif présenté dans cette étude prend en compte les principaux ajustements que l'on peut trouver communément dans les véhicules récents. En revanche, dans certains véhicules, d'autres ajustements sont disponibles (comme par exemple le réglage du support lombaire), et ne sont pas pris en compte dans cette étude.

Les postures de conduites utilisées pour le développement de ce modèle prédictif ont été enregistrées après une courte session de conduite de 5 minutes. Pendant cette session de conduite, les participants pouvaient modifier les réglages du volant et du siège si nécessaire. De cette façon, nous nous assurons d'enregistrer des postures de conduite réalistes. En revanche, différentes études ont montré que des temps de conduite plus élevés pouvaient modifier la posture de conduite. Aussi, ce modèle n'est pas représentatif de la posture de conduite après un long trajet.

Une autre des limitations de ce modèle vient du fait que les participants, bien que possédant le permis de conduire depuis plus d'un an, étaient relativement jeunes (25.9 ± 6.9 ans en moyenne). Il est probable que la posture de conduite de conducteurs plus âgés diffère légèrement de celles recueillies dans cette étude.

Le modèle proposé ne prend pas non plus en compte certains facteurs qui peuvent avoir une forte influence sur la posture de conduite choisie par un conducteur. Parmi ces facteurs, nous pouvons citer la contrainte de vision (visibilité de la route, et visibilité du tableau de bord), ou encore l'influence d'un espace restreint entre la tête du conducteur et le toit du véhicule.

Enfin, une des limitations de ce modèle vient du fait qu'il ne prend pas en compte le fait que pour certains conducteurs, les plages de réglages disponibles peuvent être limitées. En effet, les résultats du questionnaire rempli par les participants à la fin de l'expérimentation montrent que dans 30% des cas, au moins un des réglages du véhicule a été jugé comme limité (c'est-à-dire que la plage de réglage disponible ne permettait pas au conducteur de régler le siège et/ou le volant comme il l'aurait souhaité). Or cela suppose que dans le cas où un des réglages a été jugé limité, le conducteur a dû adapter sa posture de conduite de façon à compenser cette limitation. Cette étape d'adaptation n'a pas été prise en compte dans le modèle actuel.

9.5 Evaluation du modèle de prédiction de la posture de conduite de RAMSIS

Lorsqu'on utilise un modèle d'optimisation pour la prédiction de la posture de conduite, il est important de s'assurer que les entrées du modèle sont définies de façon à représenter la tâche de conduite de manière réaliste. Pour conduire un véhicule, tous les automobilistes doivent être capables de voir correctement la route, d'actionner les différentes pédales et d'atteindre les différentes commandes nécessaires (levier de vitesse, volant, etc...), et cela indépendamment du véhicule conduit. Cela suppose que les contraintes imposées par la tâche de conduite doivent être les mêmes pour tous les véhicules. Cependant, la perception de l'importance de ces contraintes peut être différente d'un individu à l'autre. Les résultats du questionnaire ont en effet montré que les conducteurs de petite et moyenne taille accordent plus d'importance à la visibilité de la route que les grands conducteurs. Ainsi, un bon modèle de prédiction de la posture de conduite doit être capable de refléter ceci (c'est-à-dire qu'il doit être capable d'adapter les effets de chaque contrainte géométrique en fonction du véhicule et de l'anthropométrie du conducteur), tout en gardant le même jeu d'entrées du modèle.

Une analyse paramétrique de l'influence des contraintes sur les postures prédites par RAMSIS (Appendix 8.4) a montré que la posture de conduite prédite dépend fortement de la posture neutre, ainsi que de certaines contraintes (comme par exemple la distance minimum imposée entre la tête du conducteur et le toit du véhicule). Dans certains cas extrêmes, la variation de la position longitudinale du bassin du mannequin numérique obtenues à l'aide de deux postures neutres différentes peut atteindre 75 mm. Ces résultats montrent donc que la posture neutre doit être choisie précautionneusement afin d'obtenir des postures de conduite le plus réalistes possible.

Les postures de conduite correspondant aux 34 participants de l'étude expérimentale ont été simulées. Pour cela, le mannequin RAMSIS a tout d'abord été mis à la taille de chaque participant, à l'aide des différentes mesures anthropométriques recueillies lors des expérimentations. Le jeu de contraintes utilisé en entrée du modèle est celui proposé par Human Solutions [35]. Il est illustré sur la Figure 50.

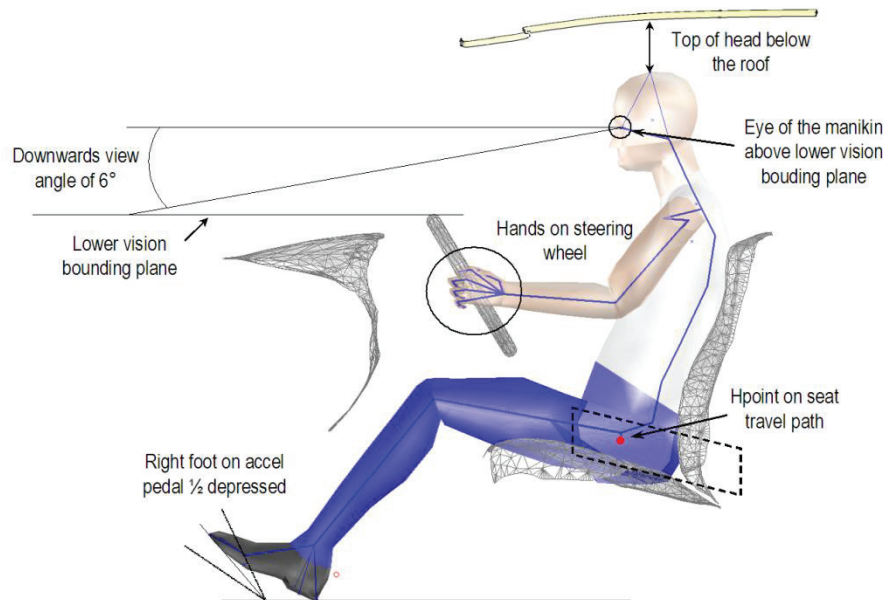

Figure 50: Jeu de contraintes recommandé pour la prédiction de la posture de conduite avec le logiciel RAMSIS

Les résultats de la comparaison pour la position du bassin et des yeux sont présentés sur la Figure 51. Ils montrent que le groupe de stature a un effet sur les prédictions de la posture de conduite. RAMSIS a tendance à prédire une position du bassin plus basse pour les petits conducteurs, et plus haute pour les grands conducteurs. De même, le type de véhicule semble avoir une influence sur les prédictions. Pour le véhicule 5, 47% des prédictions de RAMSIS se trouvent à l'intérieur de l'ellipse de confiance à 95%, alors que dans le cas du véhicule 2, ce les prédictions de RAMSIS se trouvent à l'intérieur de l'ellipse de confiance à 95% dans seulement 15% des cas.

Le modèle prédictif de RAMSIS utilisé dans cette étude ne permet pas d'adapter les effets de chaque contrainte sur la posture de conduite en fonction du type de véhicule et de l'anthropométrie du conducteur. Un modèle prédictif appelé le modèle H30 peut être utilisé par RAMSIS et permet d'adapter la posture neutre en fonction de la hauteur d'assise du véhicule. Malheureusement, en raison de restrictions de licence, il ne nous a pas été possible de tester un tel modèle. Toutefois, il pourrait être intéressant de comparer les postures expérimentales aux prédictions obtenues à l'aide de ce modèle, afin de voir si celui-ci améliore ou non les prédictions. Il pourrait aussi être intéressant de développer un nouveau modèle prédictif capable d'adapter l'effet de chaque contrainte sur la posture de conduite en fonction de l'anthropométrie du conducteur. Une autre alternative pourrait être de proposer un jeu de contraintes différent pour chaque groupe de stature.

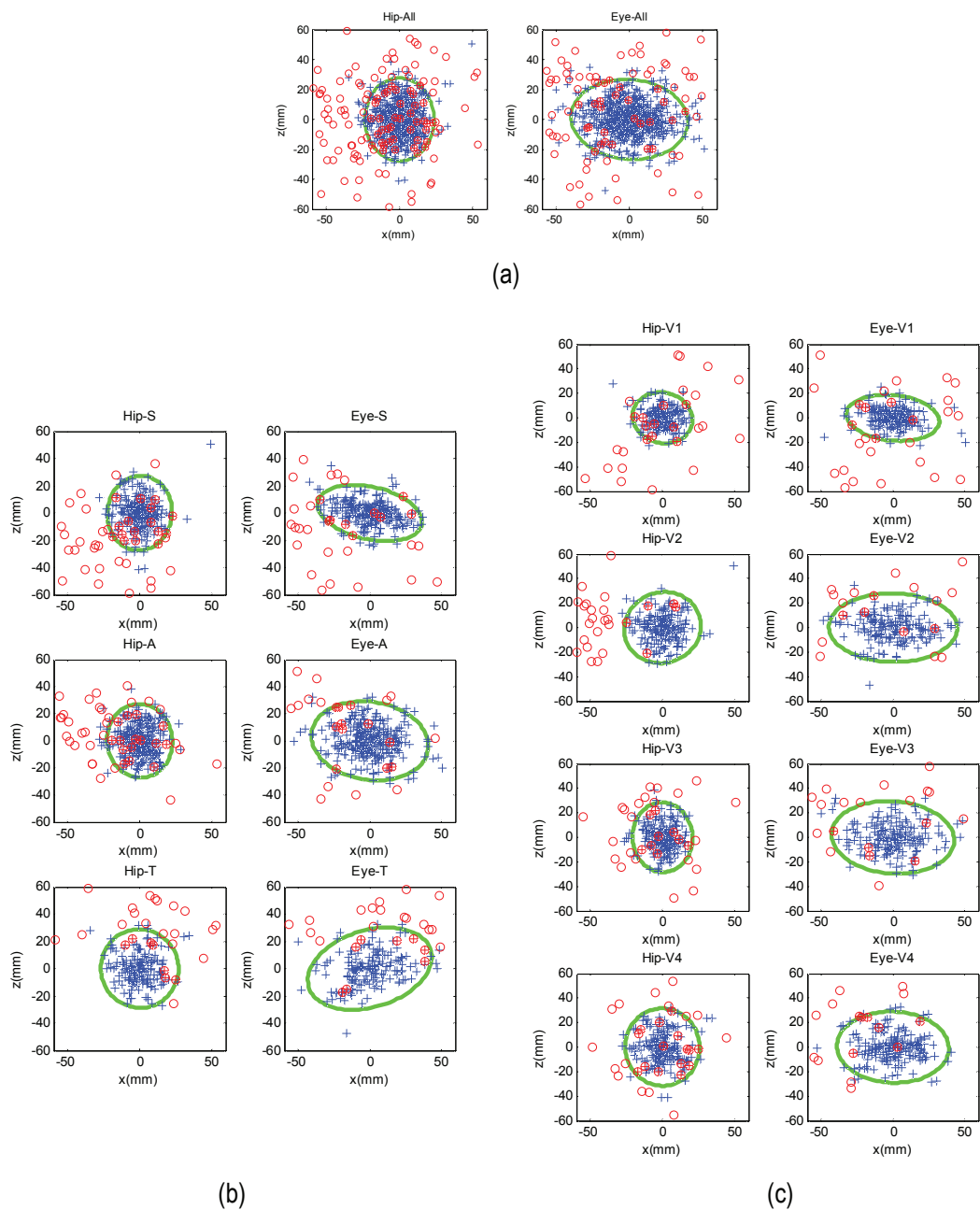

Figure 51: Différences entre les prédictions RAMSIS (cercles rouges) et les positions moyennes des observations expérimentales obtenues à partir des 4 configurations testées pour chaque couple participant-véhicule (croix bleues). La dispersion des 4 configuration testées pour chaque couple participant-véhicule est aussi illustrée par l'ellipse de confiance à 95% (trait continu vert).

(a) tous sujets et véhicules confondus, (b) par groupe de stature, (c) par véhicule

9.6 Conclusion et perspectives

L'objectif principal de ce travail de thèse est d'approfondir les connaissances sur le processus de sélection de la posture de conduite des automobilistes. Les principaux résultats sont résumés ci-après :

- La posture de conduite dépend de l'anthropométrie du conducteur. Les angles du genou et des hanches diminuent lorsque la stature augmente, alors que l'angle du coude a une tendance à augmenter chez les conducteurs de grande taille.
- Les conducteurs semblent s'adapter à des changements dans la géométrie du véhicule par une modification de l'angle du coude (celui-ci augmente lorsque la hauteur d'assise augmente), alors que les angles des genoux et des hanches restent sensiblement constants.
- La position du siège dépend de l'anthropométrie du conducteur. Les grands conducteurs ont tendance à placer leur siège plus bas et plus en arrière que les petits conducteurs qui, eux, choisiront plutôt une position haute et en avant du siège.
- La position du volant ne semble pas dépendre de l'anthropométrie du conducteur, ce qui suggère que d'autres facteurs tels que la visibilité du tableau de bord ont aussi une influence significative sur la position du volant.

Les principales limitations de cette étude sont les suivantes. Premièrement, les volontaires qui ont participé aux expérimentations ne sont représentatifs que de la population française, et d'une tranche d'âge relativement jeune. De plus, l'influence de la contrainte de vision sur la posture de conduite n'a pas été étudiée ici. Il est pourtant probable qu'elle joue un rôle important dans le processus de sélection. Enfin, d'autres facteurs tels que la sensation d'inconfort ou encore la fatigue n'ont pas été pris en compte dans cette étude.

Les résultats de cette étude suggèrent néanmoins plusieurs pistes de recherches futures :

- **L'influence de chaque paramètre du véhicule séparément sur la posture de conduite**

Dans cette étude, l'influence du type de véhicule a été étudiée en sélectionnant 5 véhicules différents, correspondant à 5 géométries différentes. En revanche, il pourrait être intéressant d'étudier l'influence de chaque paramètre séparément sur la posture de conduite, par exemple en gardant une même position du volant et des pédales et en faisant varier la position du siège, ou encore en gardant une même position du siège, du volant et des pédales et en faisant varier la hauteur du toit. Une telle étude pourrait permettre de mieux comprendre l'influence de chaque contrainte sur la posture de conduite.

- **La perception de l'inconfort dans le processus de sélection de la posture de conduite**

Il est probable qu'un conducteur ne choisira pas une posture de conduite très inconfortable. Ainsi, il pourrait être intéressant d'étudier les relations pouvant exister entre les sources potentielles d'inconfort (par exemple différents types de mousses pour l'assise du siège), les perceptions de l'inconfort du conducteur et la posture de conduite choisie.

- **L'influence d'une durée de conduite plus longue sur la posture de conduite finale**

Les postures de conduites recueillies dans cette étude ont été enregistrées après une session de conduite d'une durée de 5 minutes seulement. Cependant, certaines études ont montré qu'une durée de conduite plus longue pouvait entraîner des changements dans la posture de conduite. De plus, dans un contexte de sécurité et de protection individualisée des automobilistes, il pourrait être intéressant d'étudier la posture de conduite dans les conditions de conduites différentes (par exemple juste avant un impact frontal).

- **La perception de l'importance des contraintes en fonction de l'anthropométrie des conducteurs et du type de véhicule**

Les personnes ayant participé à l'expérimentation menée à bien au cours de ce travail de recherche ont rempli un questionnaire concernant l'importance de chaque contrainte sur le choix de la posture de conduite. Les résultats de ce questionnaire suggèrent que l'importance des contraintes peut varier en fonction des conducteurs. Il serait donc intéressant d'approfondir cette question, afin de mieux comprendre le degré d'importance de chaque contrainte sur le choix de la posture de conduite.

- **L'influence de l'enveloppe externe du conducteur sur sa posture de conduite**

Uniquement des personnes de corpulence « normale » (IMC compris entre 18.5 et 25 kg/m²) ont participé à cette étude. Cependant, il est possible d'imaginer qu'un conducteur avec un IMC plus élevé aura besoin de régler son poste de conduite de manière différente, de façon à garder un espace suffisant entre ses cuisses et son volant par exemple, ou bien entre son abdomen et son volant.

- **Recherche de nouvelles techniques pour une prédiction plus précise du centre des hanches dans une position de conduite automobile**

Différentes méthodes existantes et communément utilisées pour la prédiction de la position du centre des hanches en position debout ont été évaluées pour la prédiction du centre des hanches en position assise. Cependant, les résultats obtenus n'ont pas été satisfaisants, et il serait donc intéressant de développer de nouvelles techniques permettant d'améliorer la précision de ces méthodes permettant de déterminer la position du centre des hanches de l'automobiliste en position de conduite.

- **Développement d'un nouveau modèle de prédiction de posture de conduite**

L'étude de l'ordre d'importance de différents facteurs liés à la tâche de conduite, au cours du réglage du poste de conduite a montré que cet ordre peut varier selon les conducteurs (des différences entre conducteurs de petite taille et conducteurs de grande taille ont notamment été observées). En étudiant plus en détails cet ordre d'importance et les différences entre conducteurs, il serait envisageable de déterminer un ordre de priorité (ou des poids différents) des contraintes liées à la tâche de conduite. Ceci pourrait être utilisé notamment en cas de conflit entre plusieurs contraintes imposées au conducteur (contraintes ne pouvant pas être satisfaites en même temps).

A terme, tous ces résultats pourront être intégrés dans un modèle prédictif plus complet, capable d'adapter les effets de chaque contrainte en fonction du véhicule et du conducteur.

10 References

- [1] T. Aibe, K. Watanabe, T. Okamoto, and T. Nakamori. Influence of occupant seating posture and size on head and chest injuries in frontal collision. *SAE Paper*, (826032), 1982.
- [2] G. Andreoni, G.C. Santambrogio, M. Rabuffetti, and A. Pedotti. Method for the analysis of posture and interface pressure of car drivers. *Applied Ergonomics*, 33(6):511–522, 2002.
- [3] A.L. Bell, D.R. Pedersen, and R.A. Brand. A comparison of the accuracy of several hip center location prediction methods. *Journal of Biomechanics*, 23(6):617 – 621, 1990.
- [4] D. Bose, J.R. Crandall, C.D. Untaroiu, and E.H. Maslen. Influence of pre-collision occupant parameters on injury outcome in a frontal collision. *Accident Analysis & Prevention*, 42(4):1398–1407, 2010.
- [5] J. Bulle, G. Beurier, and S. Wang, X. nd Compigne. Comparing hip joint center location methods in an automotive driving position. *International Journal of Human Factors Modelling and Simulation*, 3:294 – 311, 2013.
- [6] A. Cappozzo, F. Catani, U. Della Croce, and A. Leardini. Position and orientation in space of bones during movement: anatomical frame definition and determination. *Clinical Biomechanics*, 10(4):171 – 178, 1995.
- [7] R.B. Davis, S. Ounpuu, D. Tyburski, and J. Gage. Agaitamethods data collection and reduction technique. *Human Movement Science*, 10:575 – 587, 1991.
- [8] N. Diffrient, A.R. Tilley, and J.C. Bardagjy. *Humanscale 1/2/3*, 1990. Cambridge, Mass. MIT Press.
- [9] C.A.C. Flannagan, M.A. Manary, L.W. Schneider, and M.P. Reed. An improved seating accommodation model with application to different user populations. *SAE transactions*, 107:1189–1197, 1999.
- [10] CC Flannagan, LW Schneider, and MA Manary. Development of a seating accommodation model, 1996.
- [11] M.D. Galer Flyte and M.F. Perchard. The prediction of car driver size and position to enhance safety in crashes. *Ergonomics*, 42(9):1149–1166, 1999.
- [12] J. Gragg, J. Yang, and B. Howard. Hybrid method for driver accommodation using optimization-based digital human models. *Computer-aided design*, 44:29–39, 2012.
- [13] L. Hanson, L. Sperling, and R. Akselsson. Preferred car driving posture using 3-d information. *International journal of vehicle design*, 42(1):154–169, 2006.
- [14] P. Herriotts. Identification of vehicle design requirements for older drivers. *Applied Ergonomics*, 36(3):255–262, 2005.
- [15] B. Jonsson, H. Stenlund, M.Y. Svensson, and U. Björnstig. Seat adjustment–capacity and repeatability among occupants in a modern car. *Ergonomics*, 51(2):232–241, 2008.
- [16] G. Kyung. *An integrated human factors approach to design and evaluation of the driver workspace and iinterface: driver perceptions, behaviors, and objective measures*. PhD thesis, Virginia Polytechnic Institute and Sate University, 2008.
- [17] G. Kyung and M.A. Nussbaum. Specifying comfortable driving postures for ergonomic design and evaluation of the driver workspace using digital human models. *Ergonomics*, 52(8):939–953, 2009.
- [18] G. Kyung and M.A. Nussbaum. Specifying comfortable driving postures for ergonomic design and evaluation of the driver workspace using digital human models. *Ergonomics*, 52(8):939–953, 2009.
- [19] A. Leardini, A. Cappozzo, F. Catani, S. Toksvig-Larsen, A. Petitto, V. Sforza, G. Cassanelli, and S. Gianninni. Validation of a functional method for the estimation of hip joint center location. *Journal of Biomechanics*, 32(1):99 – 103, 1999.
- [20] J. Loczi, M. Dietz, and G. Nielson. *Automotive Design*, chapter Validation and application of the 3D CAD manikin RAMSIS, pages 2307 – 2314. SAE Transactions, 1999.
- [21] J.S. Milne and I.J. Lauder. Age effects in kyphosis and lordosis in adults. *Annals of human biology*, 1(3):327–337, 1974.
- [22] Reed M.P. *Statistical and biomechanical prediction of automobile driving Posture*. PhD thesis, University of Michigan Transportation Research Institute, 1998.
- [23] A. Oudenhuijzen and K. Tan. The relationship between comfort and knee angles. 2004.

- [24] J. Park, K. Jung, J. Chang, J. Kwon, and H. You. Evalrams of driving posture prediction in digital human simulation using ramsis. *Proceedings of the Human Factors and Ergonomics Society Annual Meeting 2011*, 55:1711 – 1715.
- [25] S.J. Park, C.B. Kim, C.J. Kim, and J.W. Lee. Comfortable driving postures for koreans. *International journal of industrial ergonomics*, 26(4):489–497, 2000.
- [26] S.J. Park, J.W. Lee, K.S. Kwon, C.B. Kim, and H.K. Kim. Preferred driving posture and driver's physical dimension. In *Proceedings of the Human Factors and Ergonomics Society Annual Meeting*, volume 43, pages 742–746. SAGE Publications, 1999.
- [27] S.J. Park, Y.S. Lee, Y.E. Nahm, J.W. Lee, and J.S. Kim. Seating physical characteristics and subjective comfort: design considerations. *SAE Paper no. 980653*, 1998.
- [28] J. Peng, X. Wang, and L. Denninger. An iterative tasks-priority optimization-based method for predicting driving posture. In *2nd international Digital Human Modeling Symposium*, Ann Arbor, Michigan, 2013. University of Michigan Transportation Institute and Pennsylvania State University.
- [29] S.J. Piazza and P.R. Cavanagh. location of the functional method for hip joint center location: effects of limited motion and varied implementation. *Journal of Biomechanics*, 34(7):967 – 973, 2001.
- [30] J.M. Porter and D.E. Gyi. Exploring the optimum posture for driver comfort. *International Journal of Vehicle Design*, 19(3), 1998.
- [31] R. Rebiffé. Le siège du conducteur: Son adaptation aux exigences fonctionnelles et anthropométriques. *Ergonomics*, 12(2):246–261, 1969.
- [32] M.P. Reed and C.A.C. Flannagan. Anthropometric and postural variability: limitations of the boundary manikin approach. *SAE transactions*, 109(6):2247–2252, 2000.
- [33] M.P. Reed, M.A. Manary, C.A.C. Flannagan, and L.W. Schneider. Comparison of methods for predicting automobile driver posture. *SAE transactions*, 109(6):2279–2290, 2000.
- [34] M.P. Reed, M.A. Manary, C.A.C. Flannagan, and L.W. Schneider. A statistical method for predicting automobile driving posture. *Human Factors: The Journal of the Human Factors and Ergonomics Society*, 44(4):557–568, 2002.
- [35] S. Ribouchon. *Confort postural du conducteur assis: étude des situations de confort optimal et des situations observées sous contrainte de hauteur d'assise*. PhD thesis, Université Paris XI Orsay, 1991.
- [36] R.W. Roe. Occupant packaging. *Automotive ergonomics*, pages 11–42, 1993.
- [37] S. Schmidt, M. Amereller, M. Franz, R. Kaiser, and A. Schwirtz. A literature review on optimum and preferred joint angles in automotive sitting posture. *Applied ergonomics*, 2013.
- [38] A. Seidl. *Synthese und Simulation dreidimensionaler Körperhaltungen des Menschen*. PhD thesis, Dissertation, Lehrstuhl für Ergonomie, Technische Universität München, 1994.
- [39] G.K. Seidl, D.M. Marchinda, M. Dijkers, and R.W. Soutas-Little. Hip joint center location from palpable bony landmarks - a cadaver study. *Journal of Biomechanics*, 28(8):995 – 998, 1995.
- [40] J1100 Society of Automotive Engineers. Motor vehicle dimensions. *Warrendale, PA: Society of Automotive Engineers*, 1998.
- [41] J1517 Society of Automotive Engineers. Driver selected seat position. *Warrendale, PA: Society of Automotive Engineers*, 2009.
- [42] J4004 Society of Automotive Engineers. Positioning the h-point design tool - seaseat reference point and seat track length. *Warrendale, PA: Society of Automotive Engineers*, 2008.
- [43] J826 Society of Automotive Engineers. Devices for use in defining and measuring vehicle seating accommodation. *Warrendale, PA: Society of Automotive Engineers*, 1995.
- [44] J941 Society of Automotive Engineers. Motor vehicle drivers' eye location. *Warrendale, PA: Society of Automotive Engineers*, 2008.
- [45] H.J. Speyer. *RAMSIS H30 posture model*. Human Solutions GmbH, 2002.
- [46] H.J. Speyer. *RAMSIS Posture prediction models*. Human Solutions GmbH, 2005.

- [47] H.J. Speyer, C. Pruett, and H. Rothaug. *RAMSIS A step-by-step instruction guide for working on evaluation tasks*. Human Solutions GmbH, 2005.
- [48] A.R. Tilley and H. Dreyffus. *The Measure of Man and Woman: Human Factors in Design*. 2002.
- [49] P. van der Meulen and A. Seidl. Ramsis—the leading cad tool for ergonomic analysis of vehicles. In *Digital Human Modeling*, pages 1008–1017. Springer, 2007.
- [50] F.E. Veldpaus, H.J. Woltring, and J.M.G. Dortmans. Aleasposition algorithm for the equiform transformation from spatial marker co-ordinates. *Journal of Biomechanics*, 21(1):45 – 54, 1988.
- [51] X. Wang, N. Chevalot, G. Monnier, S. Ausejo, Suescun A., and J. Celigüeta. Validation of a model-based motion reconstruction method developed in the realman project. In *Transactions Journal of Passenger Cars - Electronic and Electrical Systems*, pages 873 – 880. Society of Automotive Engineers, New York, NY, USA, 2005.
- [52] X. Wang, G. Monnier, and J. Trasbot. *RPx, a motion simulation tool for car interior design*, pages 31.1 – 31.14. Taylor and Francis Group, 2009.