



HAL
open science

Metagenome-based study of quinolein degradation in soils

Jun Yuan

► **To cite this version:**

Jun Yuan. Metagenome-based study of quinolein degradation in soils. Other. Ecole Centrale de Lyon, 2012. English. NNT : 2012ECDL0067 . tel-00955925

HAL Id: tel-00955925

<https://theses.hal.science/tel-00955925>

Submitted on 5 Mar 2014

HAL is a multi-disciplinary open access archive for the deposit and dissemination of scientific research documents, whether they are published or not. The documents may come from teaching and research institutions in France or abroad, or from public or private research centers.

L'archive ouverte pluridisciplinaire **HAL**, est destinée au dépôt et à la diffusion de documents scientifiques de niveau recherche, publiés ou non, émanant des établissements d'enseignement et de recherche français ou étrangers, des laboratoires publics ou privés.

ECOLE CENTRALE DE LYON

THESE

pour obtenir le grade de

DOCTEUR

Spécialité : «Génomique microbienne environnementale»

préparée dans le laboratoire Ampère

dans le cadre de l'Ecole Doctorale «Électronique, Électrotechnique et Automatique»

par

Jun YUAN

**Approche métagénomique pour l'étude de la
dégradation de la quinoléine dans les sols.**

Soutenance prévue le 20 décembre 2012 devant la commission d'examen

JURY

Rapporteur	Jean Luc Pernodet	Directeur de Recherche CNRS-Université Paris-Sud
Rapporteur	Christine Cagnon	Maître de Conférences(HDR)-Université de Pau et des Pays de l'Adour
Examineur	Pascale Bauda	Professeur à l'Université de Lorraine
Encadrant	Laure Franqueville	Ingénieur de Recherche CNRS-Ecole Centrale de Lyon
Examineur	Timothy M. Vogel	Professeur -Université de Lyon
Directeur de thèse	Pascal Simonet	Directeur de Recherche CNRS-Ecole Centrale de Lyon

Acknowledgements

I am very glad to have this moment expressing my sincere thanks. First of all, I would like to thank the opportunity given by the Ecole centrale de Lyon and the China Scholarship Council who offered me the bursaries and enabled me to enroll for this degree.

I would like to thank my supervisors: Dr Pascal SIMONET, Research Director of Environmental Microbial Genomics Group in Laboratoire Ampère, UMR 5005 CNRS at the Ecole Centrale de Lyon and Dr Xiaojun ZHANG, Laboratory of Molecular Microbial Ecology and Ecogenomics, Shanghai Jiao Tong University. They awakened my interest in this topic and gave me continuous guidance, support, encouragement, and invaluable advices. I also would like to express my deepest gratitude to my co-supervisor, Dr Laure Franqueville, Environmental Microbial Genomics Group in Laboratoire Ampère, UMR 5005 CNRS at Ecole Centrale de Lyon who has provided me with valuable guidance in every stage of the writing of my thesis. Without her enlightening instruction, impressive kindness and patience, I could not have completed my thesis.

I appreciate the people from scientific comity: Jean Luc Pernodet, Christine Cagnon, and Pascale Bauda. Thanks for their time reading and evaluating my work.

During my Genefish project, I would like to thanks our group for their great contributions in this project including the former members: Laurent Philippot, Microbiologie des Sols-Géosols, UMRA111, CMSE, INRA, 21065 Dijon cedex, France and Jean-Claude Lazzaroni, Unité de Microbiologie, Adaptation et Pathogénie, UMR5240, Université de Lyon, 69622 Villeurbanne cedex, France. Nathalie Lombard, Laure Franqueville, Samuel Jacquiod, Aurelie Faugier. I also would like to thanks Sébastien Cécillon, for his help in data analysis and GC/MS manipulation.

In my daily work, I have been extremely lucky and blessed with many cheerful and friendly colleagues, friends and non-academic staff: Timothy M. Vogel, Elisabeth Navarro, Samuel Jacquiod, Tom O. Delmont, Laurine Blanchard, Alban Mathieu, Joseph Nesme, Lorrie Macario, Jérémy Reboulet, Sébastien Cecillon, Sandrine Demanèche, Richard Barthollet, Monique Lacroix, Jean-Michel Monier,. Here, I would like to express my special thanks to Samuel Jacquiod and Tom O. Delmont for their selfless help especially during the early days when I joined the group.

Table of content

Acknowledgements	1
Abbreviations and definitions	6
Résumé	8
Abstract	10
General introduction	12
Part I: quinoline biodegradation in soil microcosm	17
1. Bibliographical review of quinoline and its biodegradation	17
1.1 Quinoline biodegradation	18
1.1.1 <i>Pseudomonas</i> sp. for quinoline biodegradation	18
1.1.2 <i>Rhodococcus</i> sp. for quinoline biodegradation	20
1.1.3 <i>Comamonas</i> sp. for quinoline biodegradation.....	21
1.1.4 <i>Thauera.sp</i> for quinoline biodegradation	22
1.2 Metabolic quinoline pathway.....	24
1.2.1 Metabolic quinoline pathway by <i>Pseudomonas.sp</i>	24
1.2.2 Metabolic quinoline pathway by <i>Rhodococcus.sp</i>	25
1.2.3 Metabolic quinoline pathway under anaerobic/anoxic condition.....	25
1.3 Genes involved in the quinoline biodegradation.....	26
2. Materials and methods	30
2. 1 Quinoline microcosm.....	30
2.2 RISA (rRNA intergenic spacer analysis).....	31
2.3 GC/MS analysis for quinoline biodegradation.....	32
3. Results.....	33
3.1 Nucleotide BLAST of <i>bcr</i> operon in the Rothamsted metagenome.....	33

3.2 RISA results	34
3.3 Results of GC/MS analysis	40
4. Discussion and conclusion	42
PART II: <i>in vitro</i> development and use of Genefish to capture targeted DNA fragments	
1. Background	47
2. Bibliographical review of Lambda-Red homologous recombination and Genefish approach	48
2.1 Lambda-Red homologous recombination	48
2.1.1 Introduction	48
2.1.2. Lambda-Red recombination system	49
2.1.2.1 Overview of Lambda-Red recombination system	49
2.1.2.2 Different vectors for the Lambda-Red system	53
2.1.2.3 Substrates for the Lambda-Red system	56
2.1.2.3.1 Double-strand DNA recombination	57
2.1.2.3.2 Single-strand DNA recombination	59
2.2. The “Genefish” tool	62
2.2.1 General presentation of “Genefish”	62
2.2.2 The suicide cassette	63
2.2.3 Homologous recombination with Lambda-Red system	66
2.2.4 <i>bcr</i> operon	66
3. Genefish application using <i>bcr</i> operon	67
3.1. Capture plasmid and host strain construction	67
3.1.1 Materials:	67
3.1.2 Methods:	68
3.1.2.1 Highly conserved <i>bcr</i> fragment sequences determination	68

3.1.2.2 Capture plasmid construction	69
3.1.2.3 Host strain construction.....	69
3.1.2.4 Escape rate test.....	70
3.1.3 Results.....	71
3.1.3.1 Highly conserved <i>bcr</i> fragment selected for capture plasmid construction	71
3.1.3.2 Capture plasmid construction.....	74
3.1.3.3 Host strain construction and escape rate test.....	74
3.2. Genefish tool application	77
3.2.1 Materials.....	77
3.2.2 Methods:.....	78
3.2.2.1 Co-electroporation.....	78
3.2.2.2 Plasmid segregation.....	79
3.2.3 Results	80
3.2.3.1 Co-electroporation by using <i>bcr</i> c-d fragment.....	80
3.2.3.2 Plasmid segregation by using pBAD35K7toxN-bcrc-d	82
3.2.3.3 Plasmid segregation by using pBAD35K7toxN-bcrc-a	83
3.3. Genefish improvements	84
3.3.1. Materials.....	84
3.3.2 Methods:.....	85
3.3.2.1 Improvement of co-electroporation and plasmid segregation efficiency through culture time decrease	85
3.3.2.2 Single-copy plasmid construction	86

3.3.2.2.1 Classical digestion and ligation.....	87
3.3.2.2.2 In-Fusion HD Cloning Kit method.....	88
3.3.3 Results:.....	90
3.3.3.1 Improved co-electroporation	90
3.3.3.2 Improved plasmid segregation	91
3.3.3.3 single-copy capture plasmid construction	95
4. Conclusions and Discussion.....	96
5. Perspectives.....	101
References:	102
Annex 1: metagenomic DNA extraction	114
Annex 2: protocols for RISA analysis on Agilent 2100 bioanalyzer	116
Annex 3: Escape rate test.....	119
Annex 4: Protocol for the co-electroporation.....	123
Annex 5: Protocol for plasmid segregation	125

Abbreviations and definitions

- ***Ara***: Genotype of the bacteria means the bacteria lacks the gene *ara* and the function of arabinose metabolism. The gene in the chromosome of Genefish strain was deleted by genetic manipulation.
- **BAC**: Bacterial Artificial Chromosomes, BAC vectors were created from part of F' plasmid and also were developed to hold much larger pieces of DNA than a plasmid can.
- **BLAST**: Basic Local Alignment Search Tool, this tool can compare nucleotide or amino acid sequences to DNA or protein data bases thus find out the similarity between sequences.
- **Bp/kb**: base pairs/kilobase pairs, as the units to describe (calculating the base pairs (A-T, C-G)) the size of DNA.
- **BGA**: Between Group Analysis, a supervised method for sample discrimination and class prediction based on the PCA.
- **Cb**: Carbenicillin, a bacteriolytic antibiotic belonging to the carboxypenicillin subgroup of the penicillins. It was used to screen pSIM6 containing colony in this study.
- **CFU**: Colony-Forming Units. Transfer diluted bacterial culture into medium plates by spreading; the colonies were formed from a single bacterial cell.
- **Cm**: Chloramphenicol, a prototypical broad-spectrum antibiotic, against a wide variety of Gram-positive and Gram-negative bacteria. It was used to screen capture plasmid or recombinants containing colony in this study.
- **DNA**: Deoxyribonucleic acid (DNA) molecular, the carrier of genetic information is biological macromolecules consisting of four nucleotides: A, G, C, T and deoxyribose connected by Phosphodiester bond.
- **ER**: Escape Rate=number of survival colony/total cell number (probability that the host strain escape from death after the toxic cassette induction)
- **GC/MS**: Gas chromatography–mass spectrometry, a method that combines the features of gas-liquid chromatography and mass spectrometry to identify different substances in sample. In this study, it was used to analyze the quinoline degradation in the soil microcosm.
- **IPTG**: Isopropyl β -D-1-thiogalactopyranoside, IPTG is a stable and highly-inducing chemical agent. In this study, it was used to induce the *relF* gene in Genefish capture plasmid.

- **Kn:** Kanamycin, an aminoglycoside antibiotic, commonly used to treat a wide variety of infection. It was used to screen our host strain in this study
- **LB:** Luria-Bertani medium, a common medium for *E.coli*. Antibiotic can be added to select targeted bacteria.
- **mRNA:** messenger RNA, containing genetic information which also act as the template for protein synthesis.
- **PCA:** Principal Component Analysis, a mathematical procedure that converts a set of (possibly) correlated variables into a (smaller) number of uncorrelated variables called principal components. It can parse out the main factors from diverse system, simplify complex problems. In this study, PCA was used to analyze the main bacterial composition which responding to quinoline degradation.
- **PCR:** The polymerase chain reaction (PCR) is a rapid and specific *in vitro* technology for amplification of target DNA through several rounds of denaturation, annealing and extension. This technology is widely used in gene cloning, sequences analysis, regulation of gene expression and gene polymorphism studies.
- **RecBCD:** It is an enzyme complex (composed of three different sub-units RecB, C and D) of the *E.coli* bacterium that initiates *in vivo* homologous recombination.
- **RISA:** The rRNA intergenic spacer analysis (RISA) involves PCR amplification of the rRNA gene operon (the intergenic spacer region) between the small (16S rDNA) and large (23S rDNA) subunits which were used as bacterial species signature in phylogeny. These PCR products are compared through electrophoretic analysis for rapid examination of complex bacterial communities
- **rRNA:** Ribosomal ribonucleic acid (rRNA) is one kind of RNA that binds to ribosomal proteins thus form the ribosome which is the factory for protein synthesis in all living cells.
- **SOB:** Super Optimal Broth, nutrient rich medium for *E.coli* culture.
- **ssDNA/dsDNA:** single stranded DNA/ double stranded DNA. Most of the DNA exists in double-helical structure, but after heat or alkali treatment it becomes single-stranded structured.

Résumé

Grâce au développement des technologies de métagénomique au cours des dix dernières années, il a été constaté que les micro-organismes représentent la plus grande ressource de diversité métabolique et génétique sur Terre. En effet, un gramme de sol contient 10^9 cellules bactériennes et 10^3 - 10^4 différentes espèces bactériennes. Certaines sont en mesure de réaliser des réactions enzymatiques conduisant à la dégradation complète de certains polluants toxiques pour l'environnement comme les composés organiques tels que la quinoléine. Cependant, l'immense réservoir de molécules et enzymes microbiennes n'a pas encore été exploité, car plus de 99% d'entre elles ne sont, pour l'instant, pas cultivables *in vitro*.

Mon travail s'inscrit dans le cadre d'une collaboration entre l'Université SJTU (Shanghai Jiao Tong Université en Chine) et le groupe de G. M.E (Génomique Microbienne Environnementale) du laboratoire Ampère à l'Ecole Centrale de Lyon. Nos partenaires à l'Université SJTU ont construit un réacteur de dénitrification à l'échelle du laboratoire capable de dégrader la quinoléine en retirant la demande chimique en oxygène. Un nouvel outil appelé "Genefish" a été développé dans notre laboratoire comme une méthode alternative de la métagénomique pour aider à la découverte de nouveaux gènes d'intérêt industriel ou environnemental. A la suite des premiers travaux réalisés dans notre laboratoire, ma thèse présentée ici comporte deux parties.

Dans la première partie de ce travail, nous avons étudié le potentiel de dégradation de la quinoléine présente dans les bactéries d'un sol de référence largement étudié au laboratoire. Pour cela nous avons mis en place des expériences de microcosme qui visent à révéler la diversité potentielle des bactéries responsables de la dégradation de la quinoléine. Des analyses comparatives des profils RISA (Ribosomal Intergenic Spacer analysis) nous ont permis de mettre en évidence des changements dans la structure de la communauté des bactéries du sol incubé en conditions aérobie et anaérobie en présence de quinoléine. La dégradation de la quinoléine a été confirmée par technique de GC/MS (Gas Chromatography-Mass Spectrometry). Les travaux futurs seront de vérifier la communauté de bactéries responsables de la dégradation de quinoléine en utilisant la technique de NGS (Next Generation Sequencing).

Le deuxième objectif de ma thèse a été d'utiliser Genefish dont la finalité est de capturer des gènes ciblés (le gène *bcr* qui serait responsable de la dégradation de quinoléine dans le réacteur de

nos partenaires) dans l'ADN métagénomique extrait du sol. Genefish consiste à élaborer une souche d'*E.coli* incluant un plasmide de capture permettant de pêcher les gènes recherchés dans un échantillon d'ADN metagénomique par recombinaison homologue. Le plasmide de capture comprend une cassette de deux gènes toxiques pour la souche qui activés par induction chimique vont permettre la sélection positive directe des clones recombinants, et deux sites multiples de clonage dans lesquels sont insérées les zones de recombinaison qui vont jouer le rôle d'hameçons. Nous avons testé la capacité de Genefish à capturer des produits PCR du gène *bcr*, l'efficacité de recombinaison reste faible à cause de la persistance de plusieurs copies du plasmide suicide dans la cellule après l' événement de recombinaison. Par conséquent, trois stratégies ont été essayées pour améliorer l'efficacité: la co-électroporation, la ségrégation de plasmide et la construction de plasmide suicide en mono-copie. Finalement, la stratégie de la ségrégation plasmidique fonctionne mais l'efficacité de recombinaison est encore trop faible peut-être due à l'incertitude des modèles de recombinaison homologue. Les travaux futurs se concentreront sur l'amélioration des fréquences de recombinaison par transfert de fragments du plasmide de capture dans le chromosome de la souche Genefish.

Mots clés

Métagénomique, gène *bcr*, quinoléine, microcosme, communauté des bactéries, RISA, GC/MS
Genefish, Lambda Red, recombinaison homologue, cassette toxique, taux d'échappement,.

Abstract

As the development of metagenomic technologies in the past ten years, it is unquestioned that microorganisms encompass the largest resource of metabolic and genetic diversity in the world. Actually, one gramme of soil contains more than 10^9 bacteria and 10^3 - 10^4 species. Some of their members are able to carry out enzymatic reactions leading to the complete degradation of pollutants (such as quinoline). So, the biodegradation of some highly toxic or organic compounds by microorganisms will be a general trend for pollutant treatment. However, the huge reservoir of molecules and enzymes from microorganisms still need to be explored because more than 99% of microorganisms cannot be cultivated *in vitro*.

My work was based on collaboration between the University SJTU and Ecole Centrale de Lyon. Our partners at the University SJTU have built a laboratory scale denitrification reactor which was capable of degrading quinoline by removing the chemical oxygen demand. A new tool called "Genefish" has been developed in our laboratory as an alternative method for metagenomics which aims to discover novel industrial or environmental genes of interest. Following the early work in our laboratory, my thesis is presented here in two parts.

In the first part, we set up a quinoline microcosm experiment both under aerobic and anaerobic condition using reference soil extensively studied in the laboratory at Ecole Centrale de LYON. This work aimed to reveal the potential bacterial diversity and even genes responsible for quinoline degradation. We used RISA (Ribosomal intergenic Spacer analysis) to analyze the bacteria community structure changes and GC/MS (Gas Chromatography-Mass Spectrometry) was also used to detect the quinoline degradation and reveal potential quinoline metabolic pathways under aerobic and anaerobic condition. Results showed great bacteria community structure changes and high quinoline degradation activity after the quinoline addition under aerobic condition. The future work is to investigate the bacteria community which may be responsible for quinoline degradation using the technique of NGS (Next Generation Sequencing).

The second object of my thesis was to use the Genefish tool to capture targeted genes

(the *bcr* gene responsible for the quinoline degradation in the wastewater treatment bioreactor) from the soil metagenome. The aim was to construct an *E.coli* strain containing a capture plasmid and Red system for capturing targeted genes from metagenomic DNA by homologous recombination. The capture plasmid includes a toxic cassette consisting of two suicide genes which can be activated by chemical induction, finally support the positive recombinants selection. It also contains two multiply cloning sites in which highly conserved sequences were inserted and works as the bait during recombination. We have tested the capacity of Genefish to capture the PCR products of *bcr* gene; the efficiency was low because of the persistence of several copies of the capture plasmid into the Genefish strain after recombination events. So, three strategies were tried to improve the recombination efficiency: co-electroporation, plasmid segregation and mono-copy capture plasmid construction. Finally, the strategy of plasmid segregation works but the recombination efficiency was still low maybe caused by the uncertain model of homologous recombination. The further research will focus on the transfer of the toxic cassette and homologous arms into the host strain chromosome, this new strategy will exclude the bad effect of low copy number capture plasmid, uncertain model of λ Red induced homologous recombination and the homologous arms site in the capture plasmid which are the most important factors influencing the homologous recombination efficiency in Genefish.

Keywords

Metagenomics, *bcr* gene, quinoline, microcosm, bacteria community, RISA, GC/MS
Genefish, lambda Red, homologous recombination, toxic cassette, Escape rate

General introduction

Thousand years ago, human knew little about microorganisms but they already use them to produce wine, vinegar and preserve food through appropriate methods. Antoni van Leeuwenhoek (1632-1723), the “father” of microbiology was the first to observe and describe single cell organisms through his handcrafted microscopes. However, in that era, his discovery didn’t catch enough attention and people lack the technology to recognize the tiny microorganisms. Two centuries later, the microbiology researches entered into physiology stage. The French microbiologist Louis Pasteur (1822-1895) considered that fermentation is caused by microorganisms, and he also proposed the “Germ theory of disease” and invented vaccine to cure rabies and anthrax. His works in microbiology greatly improved the development of medicine and fermentation industry. Start from the 20th century, microbiology developed quickly. In 1928, Alexander Fleming discovered antibiotic substance called penicillin, afterwards, more and more antibiotics have been screened after his achievements. In 1953, James Watson and Francis Crick discovered the double helix molecular structure of DNA which promoted the development of modern microbiology. Because of the cooperation, mutual promotion and interpenetration between microbiology, biochemistry, biophysics and molecular biology, rapid development of microbiology has been achieved not only in fundamental research but also in other applications such as agriculture, food industries, clean bio-energy production, medical treatment, etc.

Microorganisms appear everywhere and can live as individuals or clusters in the environment. They are not only ubiquitous, but also essential for all life in the world, because they represent the primary source of nutrients, and the primary recyclers of dead matter back to available organic form (Wooley, Godzik et al. 2010). Microorganisms are considered as the oldest life forms on earth, some of them have existed for billion years (Benzerara, Menguy et al. 2006). Scientists found microbial community that can survive in marine sediments with low rates of metabolism in the deep North Pacific Gyre for million years (D'Hondt, Spivack et al. 2009). Microorganisms exist in mild habitats such as the water we drink, the air we breathe. They can grow in extreme environments such as hypersaline (Ollivier, Caumette et al. 1994), high temperature (Ranieri and Boor 2009), low oxygen (Mesbah and Wiegel 2008), alkaline (Grant and Heaphy 2010), high pressure (Kato and Qureshi 1999), polluted sites such as mineral

water(Uroz, Calvaruso et al. 2009), etc. Because of their incredible adaption capacity, microorganisms attract extensive attention and are studied worldwide. They are gradually applied in every aspect of our life such as health care (Bixquert Jimenez 2009), environmental protection (Jose, Giridhar et al. 2011; Sasaki, Morita et al. 2011), agriculture (Bossio, Scow et al. 1998), industrial production of enzymes (Yamabhai, Buranabanyat et al. 2011), even biomass electricity and fuel generation (Juang, Yang et al. 2011; Wei, Liang et al. 2011). Although we know microorganisms have played central roles in Earth's climatic, geological, geochemical and biological evolution (Xu 2006), but only a few of them can be cultivated *in vitro*.

One gram of soil may contain 10 billion microorganisms and thousands of species (Torsvik, Goksoyr et al. 1990), this makes soil the most biologically diverse ecosystem on Earth. The traditional culture-dependent approaches helped us to isolate some microorganisms but they cannot provide us the information on microbial communities of natural environments. These technical limitations block the people away from discovering the great amount and unknown reservoir of microbial resource. Over the last few decades, culture-independent approaches have significantly contributed to our understanding of microbial diversity and community composition in the environment (Zengler 2009). In order to exploit the huge genetic resource in uncultivable environmental bacteria, Handelsman et al (Handelsman, Rondon et al. 1998) proposed a novel method which is called metagenomics and it is now widely used. In this strategy, genomic DNA of microorganisms in environmental samples is extracted directly and cloned into plasmids or fosmids to form clone libraries (Fig.1). A clone library containing inserted heterologous genomic DNA then can be used to

- 1) Reveal microbial diversity (Handelsman 2004), gene diversity (Cowan, Meyer et al. 2005) in the environmental samples through high throughput sequencing.

- 2) Use fluorescence in situ hybridization (FISH) (Cottrell, Waidner et al. 2005; Ardura, Planes et al. 2011) to detect colonies containing target genes.

- 3) Select positive colonies possessing specific function (Uchiyama and Miyazaki 2009) according to their phenotypes-driven analysis.

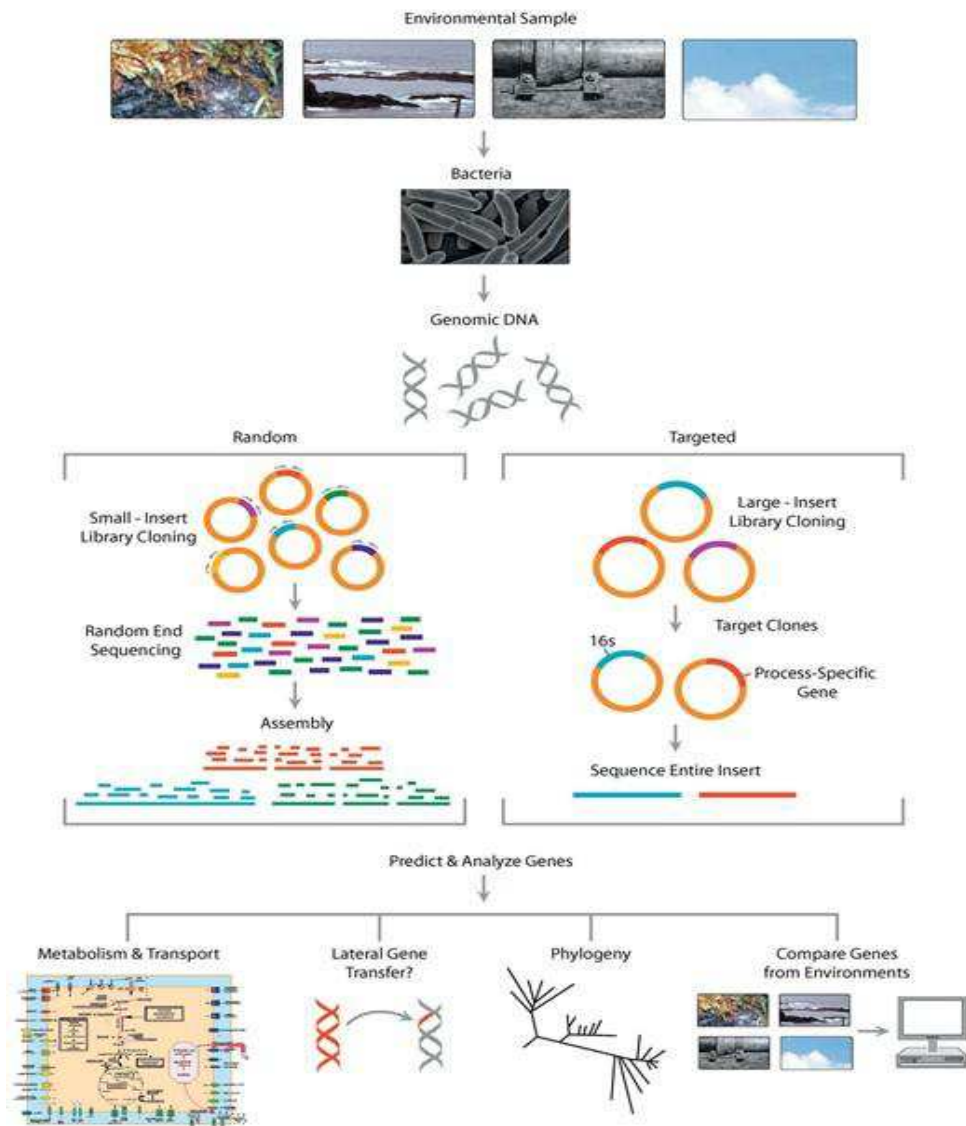

Fig.1: Principle of Metagenomic process: Genomic DNA extracted from soil or other environmental samples is cloned into plasmid such as fosmid thus forming the clone library. This clone library with inserted genomic DNA will be sequenced and analyzed for metabolism function, phylogeny and other researches.

However, metagenomic approaches still have a number of limitations that need to be resolved. The most difficult problem is the low resolution of microbial community when cloning environmental DNA samples of high complexity. Because of the fragments diversity, DNA from more dominant bacteria could be cloned and this usually causes difficulties in linking specific microbes (not predominant) to specific ecological functions, underestimating the real microbial diversity and even missing the rare community members (Warnecke and Hugenholtz 2007). According to the metagenomic process, the DNA fragments are digested and randomly cloned into vectors and this automatically decrease the opportunity to capture genes which are responsible for some specific functions. Even if metagenomic DNA libraries with million clones encompass the huge bacterial genomic diversity, this strategy still costs a lot and is not very flexible if we want to compare microbial community or specific genes in various environmental samples.

Coking wastewater has large amount of toxic refractory organic content and without dealing with this direct emissions, the waste cause great pollution to the environment and also direct threat to human health. Coking wastewater treatment process has been long-term studied and the use of microbial biodegradation is the main method. In order to reveal the bacterial community structure during the quinoline biodegradation, our partners in Shanghai Jiao Tong University monitored the wastewater treatment process and constructed a laboratory scale denitrifying reactor which was estimated to degrade quinoline and remove the chemical oxygen demand. They found *Thauera.sp* enriched with Benzoyl-coenzyme A reductases operon was abundant in the reactor and they may be involved in the quinoline degradation. In our lab, soil of Rothamsted located at the Rothamsted experimental station in England was used as the resource for studying natural selection, biodiversity and the project of Metasoil. A metagenomic database (fosmid library of two million clones, pyro-sequenced) was generated from the soil of Rothamsted by former PhD student Tom O. Delmont (Delmont, Prestat et al. 2012). *bcr* operon sequences (coding for Benzoyl-coenzyme A reductases (BCRs)) were also found existing in this metagenomic database. In order to benefit from this resource, the first part of my work mainly focuses on enrichment and identification of the potential quinoline degrading bacterial community from the Rothamsted soil. Find out whether the *bcr* operon is essential for quinoline degradation through microcosm and if there is *bcr* operon, we then can use traditional

metagenomic approach to capture relevant genes. Three objectives were included in this study:

1) Investigate the soil microbial community potential related to quinoline degradation under aerobic and anaerobic condition.

2) Compare the microbes responsible for quinoline degradation in this study with previous researches. This may help us to reveal the microbial diversity even new microbes related to quinoline degradation.

3) Find potential genes and even metabolic pathway of quinoline degradation under aerobic and anaerobic condition.

Overall, revealing the microbial diversity could lead to better understand the relationship between microorganisms and functions. Metagenomics is still a common tool to disclose the relationship between the genetic composition of environmental microorganisms and its community function. The function of interested genes in nature may help us to expand the capacity of wastes degradation and finally ameliorate the environment which has been increasingly polluted during the past decades. In order to capture target genes and fragments more efficiently and precisely from environmental metagenomes, a new tool “Genefish” was constructed in our group as a complementary method for metagenomics. Genefish is included in the European project Metaexplore which aims to discover and characterize new enzymes from environmental microbial community. The molecules of interest in this project are implicated in the biodegradation of recalcitrant (chitin, lignin) and xenobiotic halogenated compounds. In view of the initial results obtained in our group by Nathalie Lombard, Samuel Jacquiod and Laure Franqueville, the Genefish tool was constructed and presented promising performance.

The second part of this work was to develop and use the “Genefish” technology to capture *bcr* operon. This work was in co-tutorial with Shanghai Jiao Tong University and EMG (Environmental Microbial Genomics) group of the Ampère Lyon laboratory (Lyon University). Two objectives were included in this study:

1) Genefish experiments with the genes of interest

Genefish system including the toxic cassette, λ Red system and the host strain have been validated by Nathalie Lombard (Thesis 2007), Laure Franqueville and Samuel Jacquiod (Thesis 2012). Here, we use *bcr* operon as the target for Genefish application.

2) Genefish limitations and its improvements

Part I: quinoline biodegradation in soil microcosm

1. Bibliographical review of quinoline and its biodegradation

Quinoline (C₉H₇N) is an heterocyclic aromatic nitrogen organic compound with a double-ring structure that contains a benzene ring fused to pyridine at two adjacent carbon atoms which is usually found in coal tar, oil shale, chemical manufacturing plants and even groundwater near creosote wood preservation (Aislabie, Bej et al. 1990; Bai, Sun et al. 2010). Quinoline and its derivatives were widely used as some industrial intermediates, solvents, dyes, pharmaceuticals and pesticides (S.Fetzner 1998). Quinoline exhibits a particular chemical structure with a strong pharmacological property and is widely used as "parental" compounds to synthesize molecules with medical benefits, such as anti-malarial, antibiotics, anti-microbial, even anti-tumoral activities (Solomon and Lee 2011). Recently, Styrylquinoline derivatives have gained strong attention due to their activity as probable HIV integrase inhibitors (Normand-Bayle, Benard et al. 2005; Pommier, Johnson et al. 2005). Other studies show that some new 8-hydroxyquinoline derivatives possess antifungal and photosynthesis-inhibiting activity (Musiol, Jampilek et al. 2007; Musiol, Tabak et al. 2008).

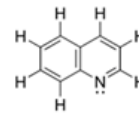

However, coking wastewater contains large amount of quinoline, and its waste cause great pollution to the environment and also direct threat to human health. Due to its carcinogenic and mutagenic toxicity as well as its strong odor (Hirao, Shinohara et al. 1976; Barrick, Furlong et al. 1984; LaVoie, Shigematsu et al. 1984), waste materials containing quinoline must be eliminated before discharge. Thereby, complete degradation of such xenobiotic molecules represents a big challenge for environment preservation. Physical and chemical treatments for the removal of nitrogen organic compounds are usually based on hydrodenitrogenation and hydrodesulfurization (Sugaya 2001). Many microscale/nanoscale catalysts like phase-pure TiO₂ (Mao, Zhang et al. 2010), doped TiO₂, and WO₃ (Rockafellow 2009) were studied, Mao and Zhang (Mao, Zhang et al. 2010) use and develop P25 film in a recirculation reactor to remove quinoline from synthetic wastewater. However, this physical and chemical methods for quinoline degradation should be processed under high-temperature and high-pressure conditions, this also requires special equipment, extra cost and the wastewater after the treatment still need following operations to degrade quinoline completely.(Yu 1989).

Studies also showed that quinoline can be biodegraded under aerobic or anaerobic conditions by microorganisms such as *Pseudomonas* (Carl and Fetzner 2005; Bai, Sun et al. 2010), *Rhodococcus* (O'Loughlin 1996), *Desulfobacterium* (Licht 1997), *Moraxella* (Crescitelli 1950), *Nocardia* (Shukla 1987), *Burkholderia* (Jianlong, Xiangchun et al. 2002; Wang, Wu et al. 2004), *Comamonas* (Chen, Cui et al. 2003; Cui 2004), white rot fungus (Zhang 2007), and *Thauera* (Mao, Zhang et al. 2010).

1.1 Quinoline biodegradation

Quinoline is stable and slightly soluble in water, it is difficult to be degraded in natural environments which will tend to accumulation. Since the study of Antranikian (Antranikian, Vorgias et al. 2005), microorganisms have been considered as a clean resource for the application in future biotechnological processes such as toxic aromatic compounds degradation. As microorganisms encompass the largest resource of metabolic and genetic diversity, some of their members are able to carry out enzymatic reactions leading to the complete degradation of organic pollutants from contaminated sites (Kahng, Kukor et al. 2000; Oie, Albaugh et al. 2007). Here, we summarize the information of microorganisms, metabolic pathways and expected genes involved in quinoline biodegradation.

1.1.1 *Pseudomonas* sp. for quinoline biodegradation

Pseudomonas was described as the dominant polycyclic aromatic hydrocarbon-degrading bacteria the first round by Shukla (Shukla 1986) from sewage by enrichment with 0.03% quinoline in a phosphate salt medium culture. They found that isolated *Pseudomonas* sp. played an important role in quinoline degradation. It rapidly grew with a quinoline concentration of 0.01 to 0.015% (w/w) while it grew with a time delay at 0.025 to 0.03 % (w/w). Higher concentrations of quinoline were toxic and completely abolished the growth of this strain (Shukla 1986). In another study, two strains of *P.aeruginosa* and *P.putida* were isolated from oil contaminated and a creosote contaminated soil respectively and using quinoline as a sole source of carbon and nitrogen (Bai, Sun et al. 2010). *P.aeruginosa* QP and *P.putida* QP completely degraded quinoline within 24 hours and 12 hours respectively when they inoculated in phosphate salts medium containing 2.5 mM quinoline. However, these strains only degrade quinoline under aerobic

conditions, no quinoline degradation activity was demonstrated under denitrifying conditions, because this strain could not utilize nitrate as the electron acceptor during respiration. Another bacterial strain, BW003, isolated and identified as *Pseudomonas* sp. by Qinghua Sun (Sun, Bai et al. 2009; Bai, Sun et al. 2010) This strain can degrade 192 to 911 mg/L of quinoline with a removal rates ranging from 96% to 98% in 3 to 8 hours under optimum conditions at 30°C with pH 8 (Fig.2). Moreover, quinoline and its metabolic by-products can be eliminated from wastewater by controlling the C/N ratio using BW003. They compared the concentration variation of ammonia-N transformed from quinoline by BW003 by using two different media: MSM (Mainstream media) and MSM+glucose. Results show ammonia-N was much lower than that in MSM alone media, the author suggested that the extra ammonia-N was not utilized by BW003 when the available carbon source (quinoline and its metabolic products) was exhausted. However, in the MSM+glucose media, glucose supplied the carbon and energy source when the available carbon source was used up while the bacteria continues the synthesis of ammonia-N into the cells of bacteria or the transformation of ammonia-N into NO_3^- -N. An immobilized cell bioreactor inoculated with *Pseudomonas* sp1 and *Pseudomonas* sp2 was successfully used to degrade benzene, naphthalene, phenanthrene, pyridine, quinoline, and isoquinoline in the wastewater discharging from a biomass gasification power-generation plant (Tian, Qian et al. 2006). After microbial adaptation phase, stable metabolic phase and high efficient reaction phase, the COD (chemical oxygen demand), and aromatic compounds in the bioreactor were removed efficiently.

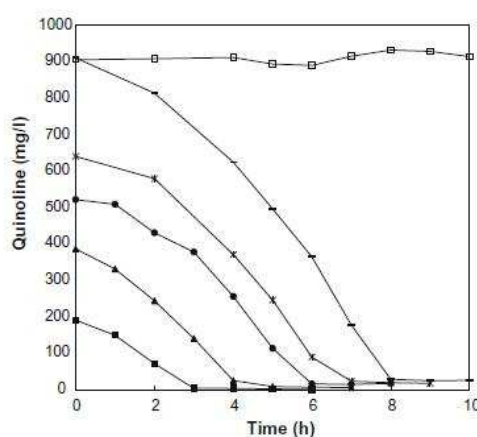

(□) Blank, (■) 192 mg/l, (▲) 387 mg/l, (●) 522 mg/l, (*) 641 mg/l, (-) 911 mg/l.

FIG.2: Biodegradation of quinoline in different initial concentrations by the strain *Pseudomonas* sp. BW003 (Sun, Bai et al. 2009).

1.1.2 *Rhodococcus* sp. for quinoline biodegradation

Two aerobic gram-positive bacteria strains identified as *Rhodococcus* sp. Q1 and *Rhodococcus* sp. QL2 which were capable of utilizing quinoline as the dominant carbon, nitrogen as source of energy were isolated from soil (O'Loughlin 1996) and from activated sludge of a coke plant wastewater treatment process (Sun, Bai et al. 2009). However, 3.88mM of quinoline was toxic to *Rhodococcus* sp. Q1. Results from Aislabie (Aislabie, Bej et al. 1990) indicated extra nitrogen sources like ammonium sulfate, potassium nitrate and potassium nitrite added to the substrate can stimulate the growth of *Rhodococcus* sp. Q1 and *Rhodococcus* sp. QL2. The efficiency of their promotional effects was as follows: $(\text{NH}_4)_2\text{SO}_4 > \text{NH}_4\text{NO}_3 > \text{NaNO}_3 > \text{Urea}$. Quinoline degradation by *Rhodococcus* sp. QL2 at different initial concentrations (37 °C, pH 8.0, and 150 rpm) is shown in Fig.3 (Zhu, Liu et al. 2008). *Rhodococcus* sp. QL has a strong degradation capacity of quinoline at low substrate concentration (60–120mg/L) within 5 and 7 h. 60–120mg/L was a quinoline concentration that detected in most contaminated soil and discharged wastewater(O'Loughlin 1996), so the strain has a great advantage of solving practical quinoline pollution. However, we still can see that *Pseudomonas* sp has a better capacity of quinoline degradation. Compared to *Rhodococcus* sp., *Pseudomonas* sp. BW003 can degrade quinoline at a concentration more than 900mg/L (Fig.2) while 680mg/L of the quinoline is toxic for *Rhodococcus* sp. (Fig.3).

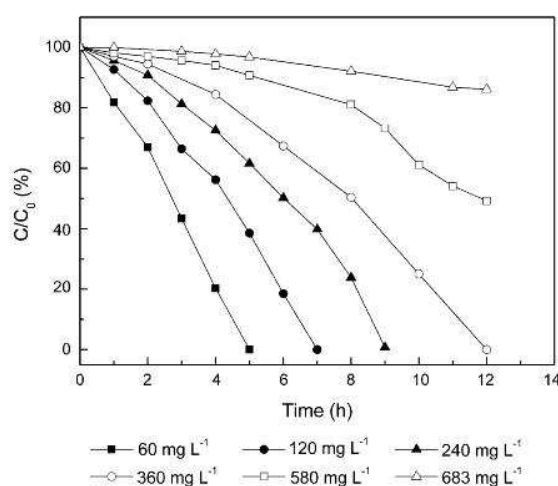

Fig.3: Different initial concentrations of quinoline were used to test the capacity of quinoline degradation by *Rhodococcus* sp. QL2. C is quinoline concentration in medium, and C₀ is initial quinoline concentration (Zhu, Liu et al. 2008).

1.1.3 *Comamonas* sp. for quinoline biodegradation

A *Comamonas* sp. has been isolated and identified as an aerobic strain which can degrade quinoline efficiently (Ulonska 1995; Sugaya 2001; Chen, Cui et al. 2003; Cui, Chen et al. 2003; Cui 2004). Sugaya (Sugaya 2001) used a strain *Comamonas* sp TKV3-2-1 to degrade quinoline in crude oil. Concentration changes of different nitrogen compounds (nitrogen concentration in quinoline, 2-Hydroxy-quinoline and ammonia) were recorded during the quinoline degradation process (Fig.4). Their results show that concentration of nitrogen derived from quinoline (CQn-N) in crude oil (7mM/L) disappeared within about 30 minutes and about 74% of the quinoline contained in crude oil was converted into 2-Hydroxy-quinoline. After 4 hours incubation, 2-Hydroxy-quinoline in water and crude oil were totally degraded; ammonia nitrogen concentration and total nitrogen concentration reached the highest level in the water phase. Over 90% of the quinoline metabolic products containing nitrogen were present as water-soluble substances and about 62% of them were accumulated as ammonia. Cui et al (Cui 2004) chose TOC (total organic carbon) to monitor the mineralization extent of quinoline by *Comamonas* sp. using quinoline as the sole carbon and energy resource. Fig 5 shows that the TOC decreased quickly at the beginning of quinoline degradation and nearly 70% of TOC was removed after 10 hour's culture. The author suggested that this residual TOC could probably correspond to some persistent metabolites, and maybe also included soluble polymers from the biomass.

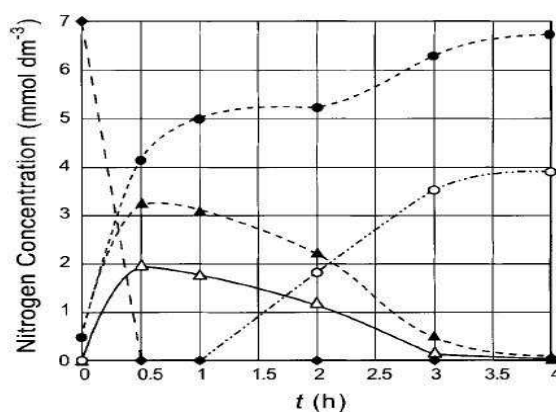

FIG.4 Concentration changes of nitrogen component during quinoline-degradation reaction by *Comamonas* sp TKV3-2-1 in crude oil (Sugaya 2001).

◆: Concentration of nitrogen derived from quinoline in crude oil (= CQn-N), △: concentration of nitrogen derived from 2-hydroxy-quinoline in crude oil [= (C2-OHQn-N) C], ▲: concentration of nitrogen derived from 2-hydroxy-quinoline in water phase [= (C2-OHQn-N) W], ○: ammonia nitrogen concentration in water phase (= CNH4-N), ●: Total nitrogen concentration in water phase (= CT-N).

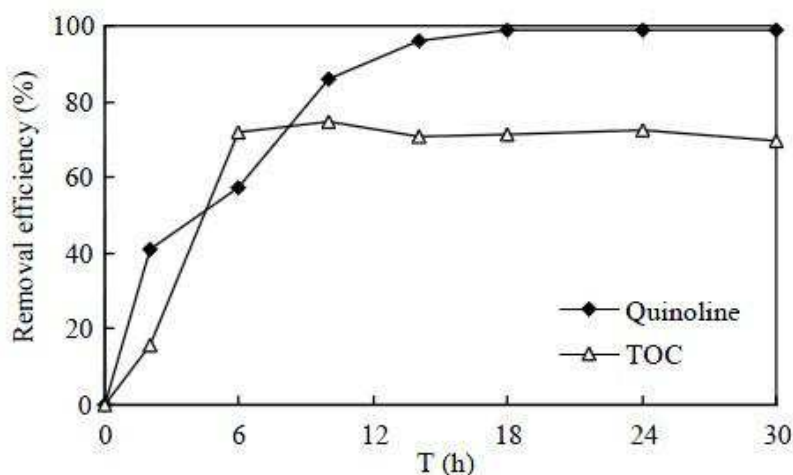

FIG.5 TOC(total organic carbon) removal during quinoline biodegradation by *Comamonas Q10* (Cui 2004). After 18 hours, quinoline was completely degraded and TOC also was removal with efficiency around 70%.

1.1.4 *Thauera.sp* for quinoline biodegradation

Thauera.sp was characterized by its ability to use aromatic hydrocarbons under anoxic conditions through a unique pathway. A laboratory-scale denitrifying reactor was adapted by using of seeding sludge of wastewater treatment plant and this reactor was estimated to degrade quinoline and remove the chemical oxygen demand (Bin Liu 2006). The reactor reached a steady state after a 6 weeks' adaptation and the removal efficiencies for quinoline and COD on five consecutive days are shown in Fig.6. DGGE (denaturing gradient gel electrophoresis) and Real Time-PCR results based on the sequences of 16s V3 region indicated that species of the genera *Thauera* and *Azoarcus* increased in abundance by about one order of magnitude during the period of adaptation. Microbial community of the reactor was dominated by *Thauera* related bacteria with an abundance of 74% and this suggested they might play an important role for quinoline and chemical oxygen demand removal under denitrifying conditions.

Three *thauera* strains *thauera* sp. 3-35, *thauera* sp.Q4 and *thauera* sp.Q20-C with identical 16S rRNA genes were isolated from a full-scale coking waste water treatment plant (Mao, Zhang et al. 2010). Their aromatic compound-degrading capacity was evaluated under both aerobic and anoxic conditions.

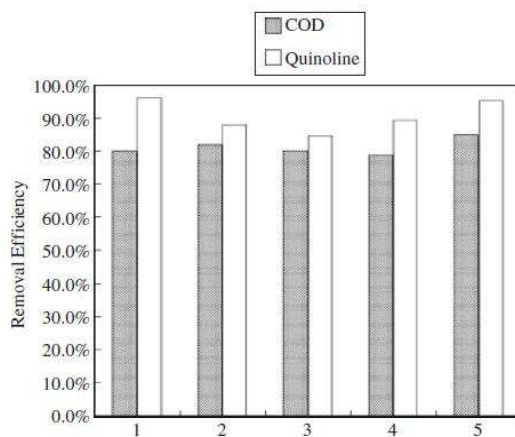

Fig.6. Quinoline and chemical oxygen demand removal efficiencies over 5 consecutive days monitoring (Bin Liu 2006). Results showed that quinoline and chemical oxygen demand were steady removed in the Lab-scale reactor.

After 4 days aerobic incubation with *Thauera* sp. 3-35, *Thauera* sp.Q4 and *Thauera* sp.Q20-C, except quinoline, almost all of the organic pollutants in the coking wastewater were completely degraded. This result demonstrated that these *Thauera* strains can degrade a wide spectrum of aromatic compounds under aerobic condition. However, they cannot degrade the same aromatic compounds under anoxic conditions. Comparing to aerobic conditions, most of the known *Thauera* species (including *T. aromatica* and *T. aminoaromatica* (Anders, Kaetzke et al. 1995; Mechichi, Stackebrandt et al. 2002) have more versatile aromatic compound-degrading ability under denitrification conditions. So, a denitrification condition seems to be necessary for the degradation of quinoline by *Thauera*.sp.

Strain	Condition	Quinoline Concentration	Time for completed degradation	Temperature	
<i>Pseudomonas</i> sp. (Shukla 1986)	Oxic	10-15mg/L	24h	30 °C	
		25-30 mg/L	Delay		
		30mg/L-	Toxic		
<i>Pseudomonas.aeruginosa</i> and <i>Pseudomonas.putida</i> (Aislabie, Bej et al. 1990)		320mg/L	24h	28 °C	
		320mg/L	12h		
<i>Pseudomonas</i> sp. BW003 (Bai, Sun et al. 2010)			192 to 911 mg/L	3-8h	30 °C
<i>Rhodococcus</i> sp. Q1 (O'Loughlin 1996)			60-120 mg/L	5-7h	35 °C
<i>Rhodococcus</i> sp. QL2 (Zhu, Liu et al. 2008)			360 mg/L	12h	37 °C
<i>Comamonas</i> sp TKV3-2-1(Sugaya 2001)			900mg/L	0.5h	30 °C
<i>Thauera</i> .sp(Bin Liu 2006)	Anoxic	40mg/L	6 weeks	30 °C	

Table1: Brief conclusion of quinoline biodegradation ability by different strain under different conditions. *Pseudomonas* sp. BW003 was the best strain to complete degradation of quinoline under oxic condition, while only *Thauera*.sp was reported to degrade quinoline under anoxic condition with a low efficiency.

1.2 Metabolic quinoline pathway

As we have mentioned before, microorganisms can degrade different kind of aromatic compounds that can be found in polluted wastes. Recently, two main possible pathways for the quinoline transformation were established from studies developed on *Pseudomonas* and *Rhodococcus* respectively. Grant and Al-Najjar (Grant and Al-Najjar 1976) suggested that the transformation starts with an hydroxylation at position 2 of the heterocyclic aromatic ring thus forming 2-hydroxyquinoline. Additional hydroxylation steps transform 2-hydroxyquinoline into 2, 6-dihydroxyquinoline and a trihydroxyquinoline. Based on this theory, other researches figured out the real pathway according to their experiments.

1.2.1 Metabolic quinoline pathway by *Pseudomonas.sp*

Aislabie et al (Aislabie, Bej et al. 1990) considered quinoline is first metabolized into 2-hydroxyquinoline by *Pseudomonas aeruginosa* QP and *P. putida* QP. Both strains cannot metabolize 2-methylquinoline because the methyl group at position 2 blocks the formation of hydroxyquinoline. Shukla et al (Shukla 1986) found that *Pseudomonas* sp. strain grown in quinoline media metabolized quinoline with a maximum accumulation of metabolites after 16 hours' of culture. Four metabolite products were identified as 2-hydroxyquinoline, 8-hydroxycoumarin, 2, 8-dihydroxyquinoline and 2, 3-dihydroxyphenylpropionic acid. 2, 8-dihydroxyquinoline was oxidized very slowly while further incubation resulted in the complete disappearance of other three substrates. This implicated 2-hydroxyquinoline, 8-hydroxycoumarin and 2, 3-dihydroxyphenylpropionic acid which might be the intermediate molecules during quinoline degradation. Bai (Bai, Sun et al. 2010) revealed that most of the quinoline is first transformed into 2-hydroxyquinoline then 2-hydroxyquinoline was converted into 2, 8-dihydroxyquinoline which was immediately and rapidly transformed into 8-hydroxycoumarin and ammonium. Furthermore, the quinoline nitrogen transformation was studied and they demonstrated that the final product containing nitrogen after quinoline biodegradation was mainly $\text{NH}_3\text{-N}$. Appropriate C/N ratio in medium could improve the efficiency of quinoline degradation and reduce the yield of $\text{NH}_3\text{-N}$ in substrates. So, a proposed pathway for the metabolism of quinoline by *Pseudomonas* sp. is presented in Fig. 7.

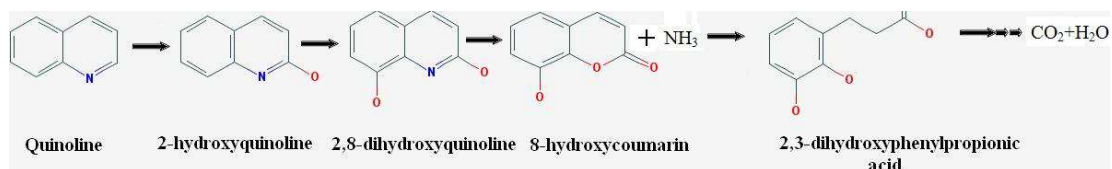

Fig.7. Transformation of quinoline by a *Pseudomonas* sp. (Shukla 1986; Kaiser, Feng et al. 1996; Bai, Sun et al. 2010).

1.2.2 Metabolic quinoline pathway by *Rhodococcus*.sp

Schwarz et al. (Schwarz, Bauder et al. 1989) used three bacterial strains to investigate the quinoline catabolism. They found 2-oxo-1, 2-dihydroquinoline, 8-hydroxy-2-oxo-1, 2-dihydroquinoline, 8-hydroxycoumarin, and 2, 3-dihydroxyphenylpropionic acid as intermediates of quinoline transformation conducted by *Pseudomonas fluorescens* 3 and *Pseudomonas putida* 86 which support the results of Shukla (Shukla 1986). However, other intermediates were found in the culture medium of a *Rhodococcus* strain B1, such as 2-oxo-1, 2-dihydroquinoline, 6-hydroxy-2-oxo-1, 2-dihydroquinoline, and 5-hydroxy-6-(3-carboxy-3-oxo propenyl)-1H-2-pyridone. Fig.8 shows the proposed pathway for the transformation of quinoline by *Rhodococcus* strain B1. Quinoline is degraded into 8-hydroxycoumarin and ammonia after the third step by *Pseudomonas* sp. While *Rhodococcus* strain B1 need more steps to eliminate the nitrogen atom of quinoline and its pathway is still unknown.

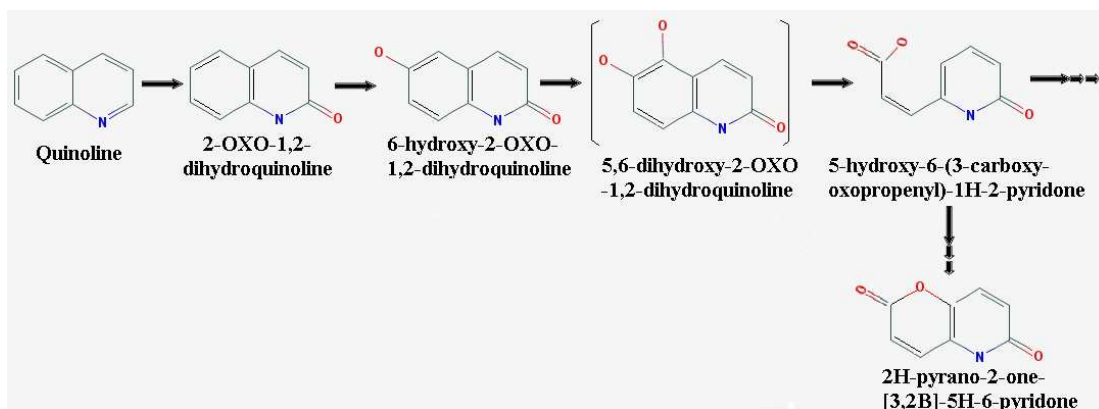

Fig.8. Transformation of quinoline by *Rhodococcus* strain B1 (Schwarz, Bauder et al. 1989).

1.2.3 Metabolic quinoline pathway under anaerobic/anoxic condition

Pereira et al. (Pereira 1987) studied the anaerobic transformation of quinoline in groundwater contaminated by wood-treatment chemicals under both field and laboratory conditions. Those groundwater samples contained quinoline, isoquinoline, methylquinolines, and acridines. The

results obtained illustrate the transformation of quinoline that occurred under anaerobic conditions starting with the hydroxylation at position 2 of the heterocyclic ring. This indicates that these anaerobic microorganisms use a similar quinoline transformation pathway than aerobic bacteria which has been described above. By using H_2O^{18} , their studies also showed that the oxygen required for the hydroxylation reaction is derived from water (Pereira 1988).

Wang et al. (Wang 1984; Wang, Suidan et al. 1984) acclimatized a methanogenic consortium with quinoline during 6 months under anaerobic conditions. They got 85% of the expected amount methane production, indicating that quinoline could be used as the sole resource under anaerobic conditions. However, no further intermediates were reported, and the pathway of quinoline metabolism under anaerobic conditions remains unknown. Brockman et al. (Brockman, Denovan et al. 1989) isolated two gram-negative bacteria from deep subsurface sediments. These two microorganisms mineralized quinoline under aerobic conditions and transformed quinoline to soluble intermediates under anaerobic conditions.

Liu et al. (Bin Liu 2006) used a laboratory-scale denitrifying reactor which was adapted from seeding sludge of wastewater treatment plant and was utilized to degrade quinoline and remove the chemical oxygen demand. After adaptation of *Thauera* and *Azoarcus* under anoxic and denitrifying conditions, quinoline and chemical oxygen demand removal was clearly noticeable suggesting that this consortium might play an important role.

1.3 Genes involved in the quinoline biodegradation

Microorganisms are able to transform or even mineralize many N-heterocyclic compounds of both natural and xenobiotic sources. Proposed pathways of bacterial quinoline degradation have been declared above. But so far, detailed knowledge of their gene organization and regulation is not yet available.

Pseudomonas putida 86 is able to utilize quinoline as sole source of carbon, nitrogen and energy; its degradation proceeds via the 8-hydroxycoumarin pathway (Aislabie, Bej et al. 1990). The first step of this pathway, quinoline 2-oxidoreductase (Qor), a molybdo-iron/sulfur-flavoprotein which belongs to the xanthine oxidase family of molybdenum enzymes catalyzes the formation of 2-hydroxyquinoline (Blase, Bruntner et al. 1996). In the

second step, 2-hydroxyquinoline is hydroxylated at position C-8 by 1H-2-oxoquinoline 8-monoxygenase (OxoOR), a two-component nonheme iron oxygenase that is encoded by *oxoO* (oxygenase component) and *oxoR* (reductase component). The *oxoO* gene is localized approximately 15 kb upstream of *oxoR* on the chromosome of strain *Pseudomonas putida* 86; the *qorMSL* genes coding for Qor are situated in between (Rosche, Tshisuaka et al. 1997). Further metabolites of the pathway such as 8-Hydroxycoumarin and 2, 3-dihydroxyphenylpropionic acid were identified but their related metabolic enzymes, genetic organization and regulation are still unknown. Carl et al. (Carl, Arnold et al. 2004) characterized a gene cluster involved in quinoline degradation in strain *Pseudomonas putida* 86. They located the gene upstream *oxoO* encoding the oxygenase component of OxoOR and the gene *oxoS* coding for a XylS-type protein (a transcriptional activator). Several putative ORFs on the 7.3kb DNA segment between *oxoO* and *qorMSL*, and the 3.3kb fragment between *qorL* and *oxoR* were also identified (Fig.9).

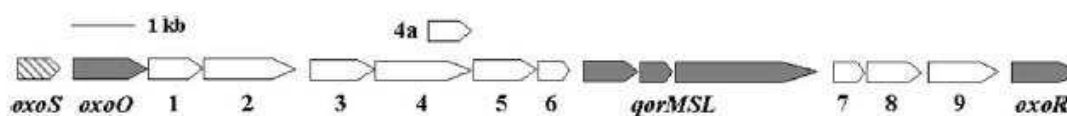

Fig.9. Genetic map of the *qor* region of *P.putida* 86(Carl, Arnold et al. 2004).

Dot blot analysis with RNA probes suggested that ORF1, ORF2, ORF7, ORF8 and ORF9, as well as *qorL*, *oxoO* and *oxoR* are specifically transcribed in the presence of quinoline or 2-hydroxyquinoline. Transcription of these genes also requires the presence of the *oxoS* gene product: OxoS, a XylS-type protein which acts as a quinoline-dependent transcriptional activator. They also found that ORFs7 to -9 can start the transcription weakly in the absence of quinoline, and even in an OxoS⁻ mutant strain. Low level expression of ORF7 to -9 that is independent of quinoline suggests that they might be essential for bacterial housekeeping functions. The gene cluster is probably transcribed from several promoters, resulting in multiple overlapping polycistronic mRNAs (Carl, Arnold et al. 2004).

Latest researches by Carl and Fetzner (Carl and Fetzner 2005) showed that the gene cluster of *P. putida* 86 involved in quinoline degradation is transcribed from several quinoline-dependent promoters (*PoxoO*, *Porf3*, *PqorM*, and *PoxoR*) in the presence of *oxoS* (Fig.10). Internal promoters like *Porf3*, *PqorM*, and *PoxoR* ensure adequate expression of distal genes of the operon in long and unstable transcripts, they also may provide differential expression of genes within an

operon in response to different physiological states or growth conditions (Kaebernick, Dittmann et al. 2002).

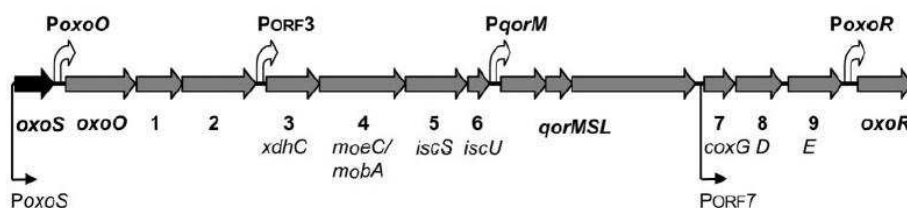

Fig.10. Genetic map of the qor region and the specific promoters of *P.putida* 86(Carl and Fetzner 2005).

As we described before, *T. aromatica* has been reported as a microorganism degrading quinoline and removing the chemical oxygen demand under anoxic conditions (Bin Liu 2006). However, the metabolic pathway and genetic regulations of quinoline degradation by *T. aromatica* is still unknown. Nevertheless, the author suggested that the *bcr* operons encoding for Benzoyl-coenzyme A reductases might be involved in the quinoline degradation.

Benzoyl-coenzyme A reductases (BCRs) are known as key enzymes in the anaerobic degradation of many aromatic compounds such as benzene, toluene. Benzoyl-CoA (BCoA) serves as the substrate for BCRs, which dearomatize the aromatic ring by reduction yielding to cyclohexa-1, 5-diene-1-carboxyl-CoA (dienoyl-CoA) (Löffler, Kuntze et al. 2011). There are two different classes of BCRs, while both of them yield the identical dienoyl-CoA product using different electron activation processes.

Genes coding for class I subunits of BCRs are present in the genome of denitrifying bacteria (*Thauera*, *Azoarcus*, *Magnetospirillum* species) or bacteria displaying an anoxygenic photosynthesis (*Rhodospseudomonas*, *Rhodomicrobium* species)(Boll 2005). A class I BCR enzyme has so far only been isolated and characterized in the denitrifying, facultative anaerobe *Thauera aromatica* strain K172 (Boll and Fuchs 1995). This enzyme is extremely oxygen-sensitive and composed of four genes as BcrABCD. The AD subunits bind to one ATP molecule each and are linked by a [4Fe-4S] cluster, whereas the BC subunits are proposed to bind two further [4Fe-4S] cluster and the benzoyl-CoA binding active site (Boll, Fuchs et al. 2000).

Recently, the class II BCRs was discovered in the obligate anaerobic Fe (III)-respiring *Geobacter.metallireducens* which uses low molecular aromatic growth substrates (Kung, Löffler et al. 2009). Different proteome analysis results suggested that a cluster of eight benzoate inducible genes coding for a class II BCRs complex referred to BamBCDEFGHI (Wischgoll,

Heintz et al. 2005; Heintz, Gallien et al. 2009). No ATP-binding motif was found in the BamB-I complex, suggesting that electron transfer to BCoA may be independent of ATP hydrolysis. Fig.11 shows the reaction of two different classes of BCRs that are involved in BCoA degradation. (A): Cluster of genes coding for BCR (bcrA-D) and other enzymes (had, oah, and dch) of the BCoA degradation pathway in *T. aromatica*. Note that BcrA-D couples ring reduction to a stoichiometric ATP hydrolysis (upper BCR reaction). (B): Cluster of genes coding for putative BCR (bamB-I) and another enzyme (bamA, a homolog for oah) involved in the BCoA degradation pathway in *G. metallireducens* and figure 12 shows the protein cluster structure of BCR (bcrA-D) and BCR (bamB-I) (Kung, Loffler et al. 2009).

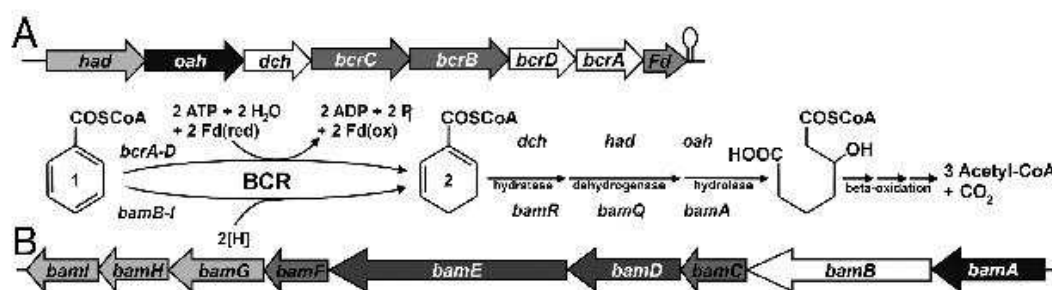

Fig.11. Enzymatic reactions of BCRs and organization of genes involved in BCoA degradation in *T. aromatica* and *G. metallireducens* (Kung, Loffler et al. 2009)

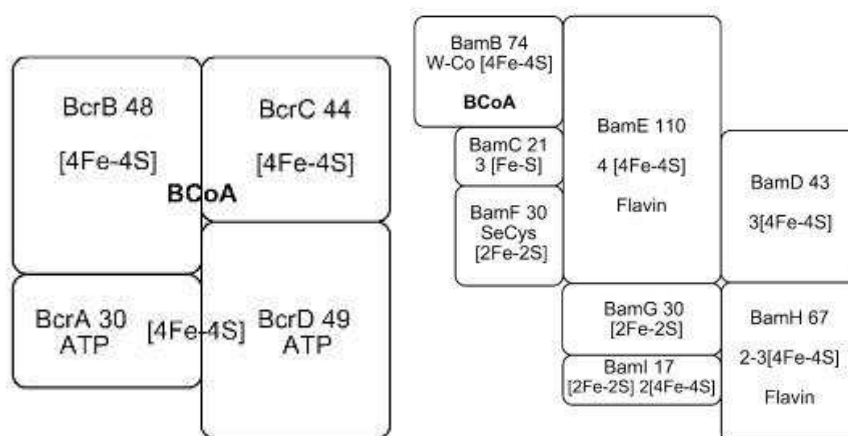

Fig.12. (Left): Composition of the class I BCR in the *T. aromatica* (Loffler, Kuntze et al. 2011) (Right): Putative composition of the class II BCR in *G. metallireducens* (Loffler, Kuntze et al. 2011)

2. Materials and methods

2.1 Quinoline microcosm

The soil for the microcosm was collected from an untreated control plot of Park Grass, Rothamsted, England, in June 2010. The Park Grass soil is an internationally recognized resource for about 150 years and has been designated as a reference soil for metagenomic studies (Delmont, Robe et al. 2011; Delmont, Robe et al. 2011; Delmont, Prestat et al. 2012). The quinoline microcosm under aerobic condition was performed at room temperature in a fume cupboard. 50g soil, 20ml double distilled H₂O and different dose of quinoline (0mg, 2mg, 10mg, 25mg and 50mg) were added into the microcosm bottles, each bottle was closed with cheese cloth. Each condition (for example 2mg quinoline added, aerobic condition), triplicates (three bottles of soil microcosm) were considered as a group and double distilled H₂O was replenished to its original content three days after the incubation and before sampling. One gram of quinoline microcosm samples from each bottle was collected and stored at -20°C for further use. Fig.13 shows the design and sampling time points of the aerobic quinoline microcosm. Samples collected before adding the quinoline (T0) are considered as the negative control.

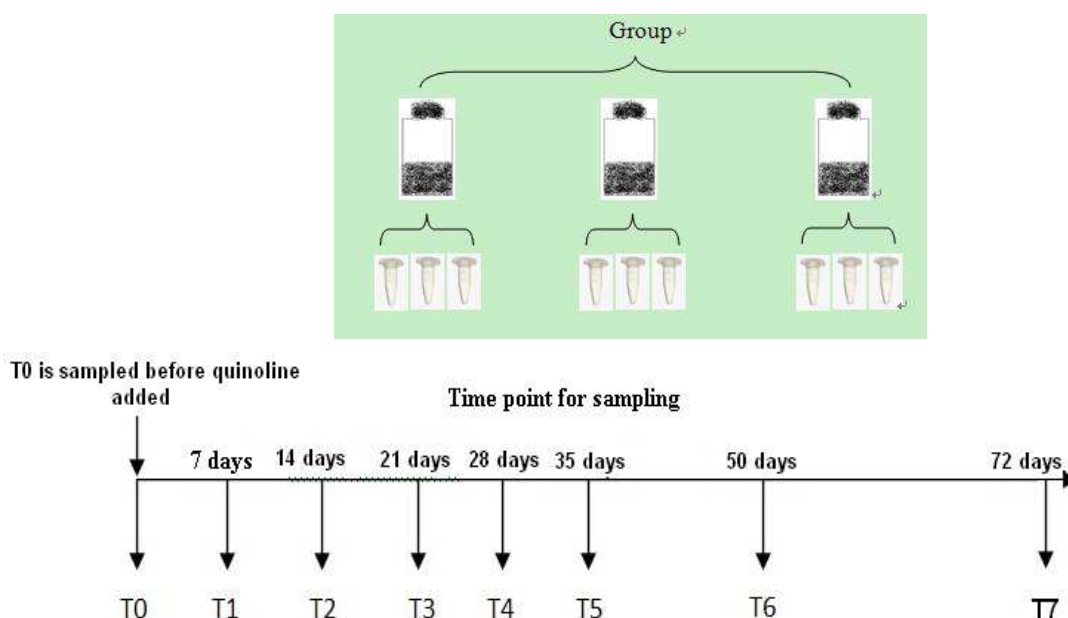

Fig.13: Quinoline soil microcosm under aerobic condition. The top diagram shows the microcosms group for each condition; triplicates for each condition and three samples are collected from each repeat. The bottom diagram shows the sampling time point of each condition. T0 is considered as the negative control which is collected before adding quinoline.

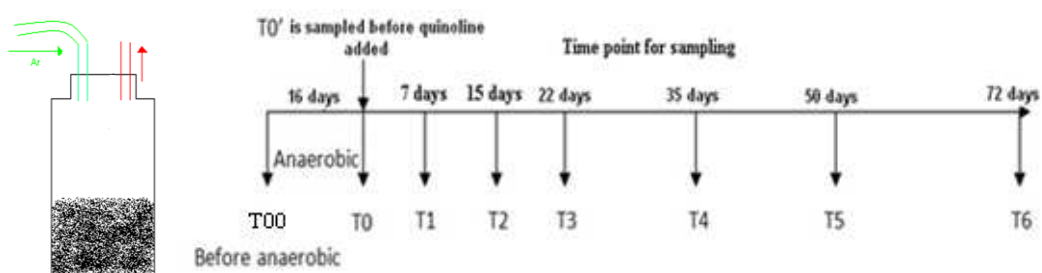

Fig.14: anaerobic condition of the quinoline soil microcosm. The left diagram shows the device used to generate anaerobic condition. Argon flow through the bottle and expel the air out. The right schema shows the sampling time points.

For anaerobic condition construction, argon (Linde France) was injected into the bottles with a pressure of 2 bars for 2 minutes. The bottles were previously closed with a rubber plug, and two syringes were inserted into the plug, one syringe for the argon injection into the bottle (green arrow), meanwhile the second one (red arrow) for air expelling out of the bottle. After the injection, syringes were pulled out and the bottles were stored at 22°C. But in this case, before adding quinoline, microcosm was maintained for a 16 days period under anaerobic condition for adaptation. After this period, soil was sampled (T0) and quinoline was added. Samples collected from natural soil (T00) are considered as the negative control and T0 are considered as the negative control under anaerobic condition. Fig.14 shows the design and sampling points of the anaerobic quinoline microcosms.

Metagenomic DNA from aerobic and anaerobic microcosms was extracted and purified for the further RISA analysis (Annex 1).

2.2 RISA (rRNA intergenic spacer analysis)

In this study, the intergenic spacer between the small (16S) and large (23S) subunit rRNA genes of microcosms' metagenomic DNA were amplified using primers (RISA-fw: 5'-TGCGGCTGGATCCCCTCCTT-3', RISA-rv: 5'-CCGGGTTTCCCCATTCGG-3')(Normand P. 1996). The amplified products then were loaded and migrated in gel by using Agilent DNA 1000 Kit to analyze the bacterial community changes. Principal Component Analysis (PCA) and Between Group Analysis (BGA) were used to reveal the internal structure of data extracted from the gel by the software R (Annex 2).

2.3 GC/MS analysis for quinoline biodegradation

Soil samples from aerobic quinoline microcosm (T0, T1, T2, T3, T4 and T5) and samples from anaerobic quinoline microcosm (T00, T1, T3, T5 and T6) were analyzed by GC/MS. Triplicated samples were extracted, filtered (Mao, Zhang et al. 2010) in CH₂Cl₂ (HPLC grade) and then analyzed by using Agilent 6850 equipped with a DB-5 column (30-m length, 0.25-mm inner diameter) and a flame ionization detector, using the following method: the injector temperature was 280°C; the column of the GC was retained at 70°C for 3 min, and then increased to 280°C with an increment of 5°C/min; the temperature for the MS ion source was 200°C and electron energy was 70 eV.

3. Results

3.1 Nucleotide BLAST of *bcr* operon in the Rothamsted metagenome

In order to investigate the existence of *bcr* operon in the soil microcosm, nucleotide BLAST using the Rothamsted metagenomic DNA database (Thesis Tom O. Delmont) and *bcr c*, *bcr a* and *bcr d* from *Thauera. aromatica* as the query sequences were done. Results are shown in table 2, sequences producing significant alignments in database then were taken as the query sequences to do a nucleotide BLAST in NCBI.

	reference	size	identities		Score(bits)	E value
<i>bcr c</i>	62468031 gb AY956871.1	929bp	229/267	85%	228	5e-58
			240/302	79%	100	4e-19
			117/140	83%	96	7e-18
			68/78	87%	76	6e-12
			52/57	91%	74	2e-11
<i>bcr a</i>	62468125 gb AY956856.1	1298bp	291/337	86%	287	1e-75
			262/314	83%	210	2e-52
			139/155	89%	180	2e-43
			215/257	83%	170	2e-40
			164/192	85%	159	6e-37
			216/266	81%	123	5e-26
<i>bcr d</i>	62468141 gb AY956864.1	799bp	308/362	85%	289	2e-76
			273/321	85%	256	3e-66
			118/137	86%	121	9e-26
			71/80	88%	88	2e-15
			58/63	92%	86	4e-15

Table 2: Nucleotide BLAST using *bcr c*, *bcr a* and *bcr d* gene as the query sequences and the metagenomic DNA from Rothamsted (60Gbp pyrosequencing) as the database.

All matched sequences (marked out in table 2) from the Rothamsted metagenomic DNA database were verified by nucleotide BLAST on NCBI. *Rhodopseudomonas.palustris* (9 sequences), *Magnetospirillum.sp* (5 sequences) and *Thauera.sp* (3 sequences) contain the target *bcr c* sequence. However, no target sequence matched with the sequence got from the Rothamsted database which has an E-value of 4e-19 compared to *bcr c* gene. BLAST using sequences that matched with *bcr a* gene also got target sequences from *Rhodopseudomonas.palustris* (13 sequences), *Magnetospirillum.sp* (11 sequences) and *Thauera.sp* (16 sequences). Other sequences from BLAST *ochloris.sp* (1 sequence), *Paracoccus.sp*

(3 sequences), *Bradyrhizobium.sp* (3 sequences), *Acidovorax.sp* (3sequences), *Pseudomonas.sp* (2 sequence), *Ensifer.sp* (1 sequence), and uncultured bacterium (8 sequences) were also detected. BLAST using sequences that matches with *bcr d* gene only got target sequences of *Rhodopseudomonas.palustris* (12 sequences) and *Thauera.sp* (13 sequences).

So far, in Rothamsted soil, *bcr* operon might primarily exist in *Rhodopseudomonas.palustris*, *Magnetospirillum.sp* and *Thauera.sp* as BLAST using *bcr c*, a fragments all showed positive hits in those strains and they were also reported to contain *bcr* type benzoyl-CoA reductase genes (Song and Ward 2005).

3.2 RISA results

rRNA intergenic spacer PCR products from each serie of quinoline soil microcosm samples (triplicates) were analyzed. Fig.15 shows the electrophoresis results of aerobic quinoline soil microcosm, repeats are not shown here but will be shown in Between Group Analysis.

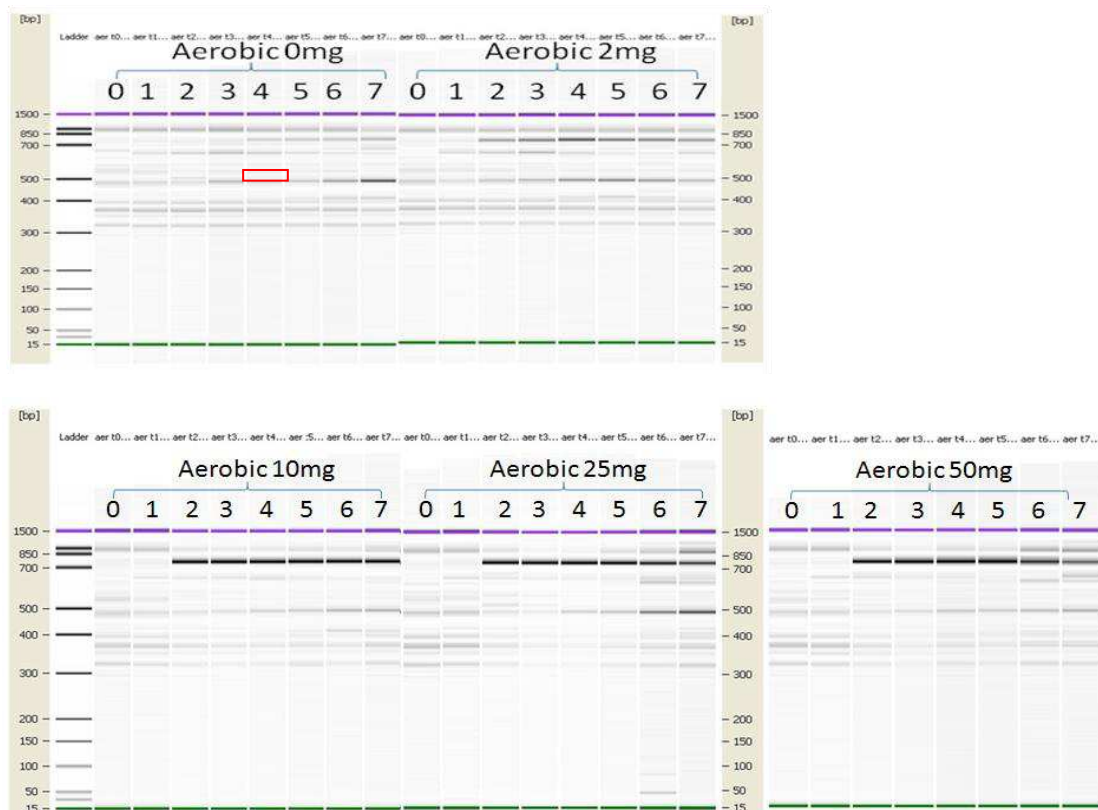

Fig.15: Electrophoresis results using rRNA intergenic spacer PCR products amplified from aerobic quinoline soil microcosm samples. The band in purple is the upper marker and the band in green is the lower marker. Lane 0-7 means the sampling time points already described above. T0 means the negative control of microcosm (original soil samples before adding quinoline).

The gel profile clearly shows the band variety between each time point and each condition: First, in the gel profile of 0mg quinoline aerobic microcosm, the band framed by red rectangle (size between 700-850 bp) became stronger at the time point T4. When quinoline was added into each soil microcosm, the same band appears earlier at time point T2. However, the band intensity increased in parallel to the quantity of quinoline present in the microcosm. Second, the band close to the upper marker exists in 0mg and 2mg quinoline microcosm while becomes unstable at the time points T2 to T5 of 10mg, 25mg and 50mg quinoline added microcosm. Third, compared with the negative control (0mg quinoline added), the profiles changed (band density) especially after 10 mg, 25mg and 50mg quinoline addition

Fig.16 shows the electrophoresis grams of anaerobic quinoline soil microcosm, repeats are not shown here but in Between Group Analysis later.

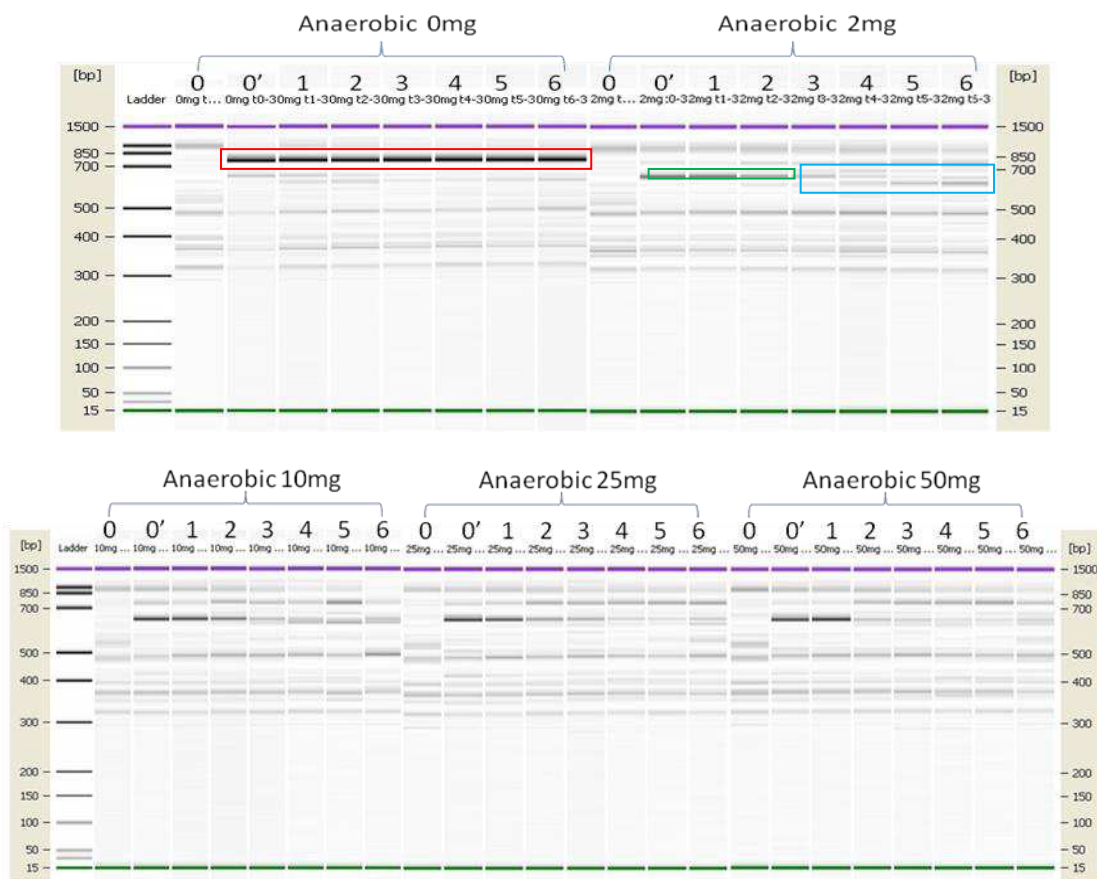

Fig.16: Electrophoresis results using rRNA intergenic spacer PCR products amplified from anaerobic quinoline soil microcosm samples. The band in purple is the upper marker and the band in green is the lower marker. Lane 0-6 means the sampling time points already described above. T0 and T0' means the negative control of microcosm (original soil samples before anaerobic condition and quinoline addition respectively).

From the gel of negative control (anaerobic 0mg), the band framed by red rectangle also appeared in the anaerobic condition. However, when quinoline was added into the microcosm, the band first faded and then strengthened at time point T2 (10, 25, 50mg). The band framed by green rectangle was stronger in quinoline added soil sample and faded gradually during incubation. Starting from the time point T3, new (bands framed by blue rectangle) bands arised in the quinoline added (especially with 2mg quinoline) samples. The band closed to the upper marker (around 1000bp) existing in quinoline added microcosm was stable while it disappeared in negative control samples.

Normalized location and intensity of each RISA band under aerobic and anaerobic condition were used in the PCA and BGA analysis. The BGA results (Fig.17) below shows the bacterial community movements between each groups during the microcosm experiments. Under anaerobic condition, plots cannot be separated clearly, while under aerobic condition, Group NQ0 (No quinoline added), group NQ2 (2mg quinoline added) and the rest groups were separated clearly. So, quinoline could be the factor influencing the microbial community under anaerobic condition. Under aerobic condition, we still can find out the tendency of the microbial community shifts through the BGA results. The aerobic and anaerobic condition seems to be the main factors that influence the microbial community changes rather than quinoline addition.

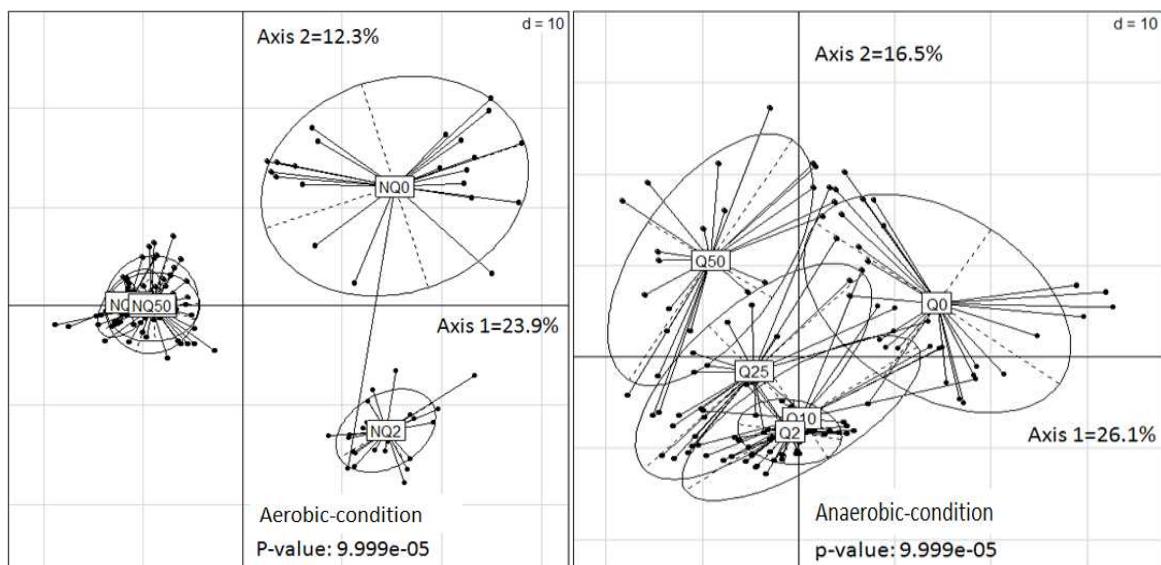
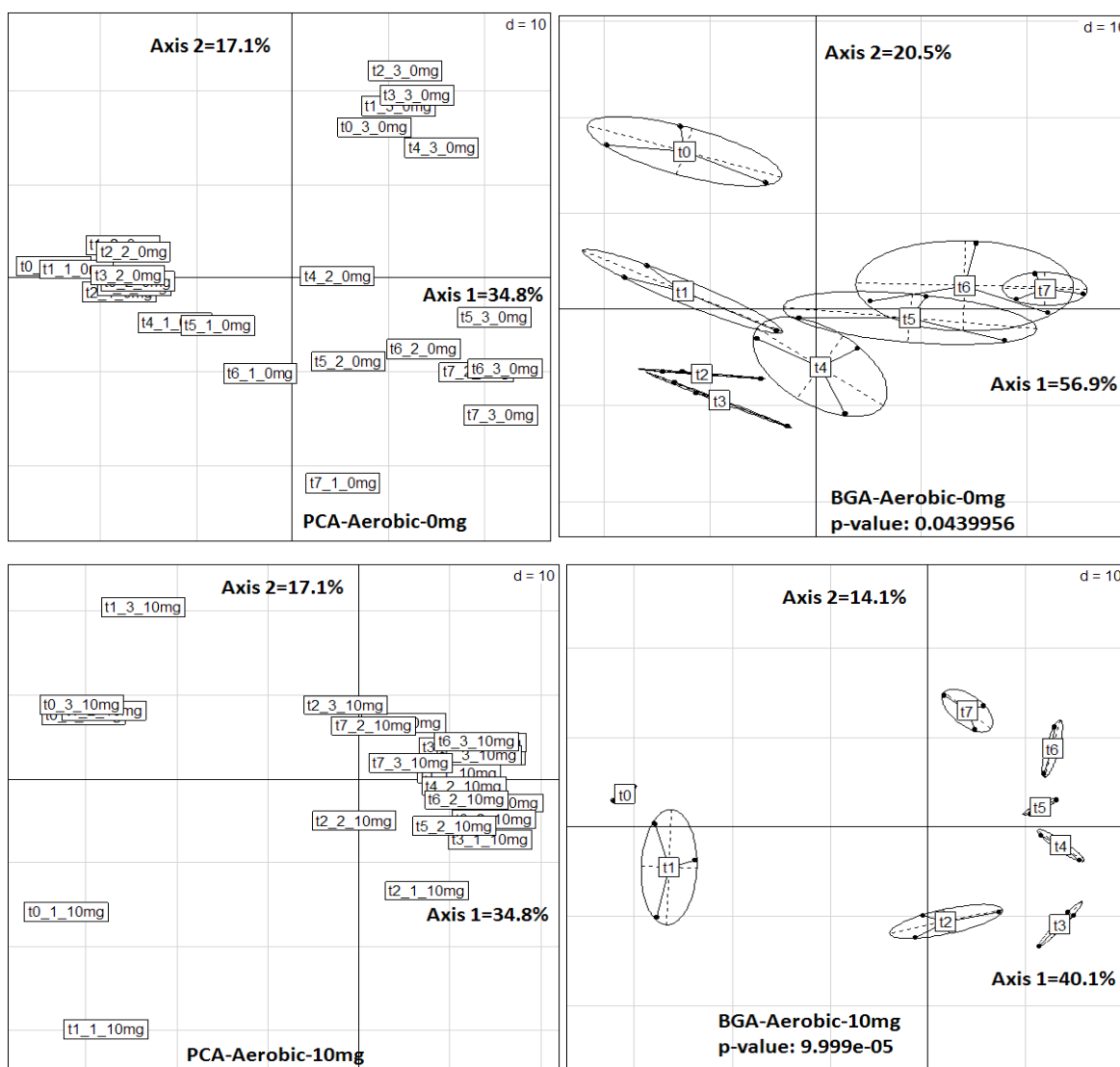

Fig.17: BGA analysis of aerobic and anaerobic microcosm. group Q0,Q2,Q10,Q25,Q50 under anaerobic condition; group NQ0,NQ2,NQ10,NQ25,NQ50 under aerobic condition. The number means dose of quinoline (mg) added, N stands for oxygen needed condition, Q stands for quinoline.

The PCA and BGA analysis results of each series are shown below (Fig18, 19): while in each series under aerobic condition, although the plot cannot be directly separated but the tendency is clear (plots in middle left move toward the lower right). When quinoline was added into the microcosm, the tendency is clearer, especially in aerobic 10mg, 25mg and 50mg conditions. Plots can be separated into two groups: one group containing the plots of T0 and T1, the other group containing the plots T2 to T7. The same results also appeared in the anaerobic condition. One group includes T00 and the other group includes T0 to T7. From BGA results, the important concentration of quinoline added (10mg) shapes the bacterial community distinctly under both aerobic and anaerobic conditions. The time point that starts the great changes is T2 under aerobic condition and T0 under anaerobic condition.



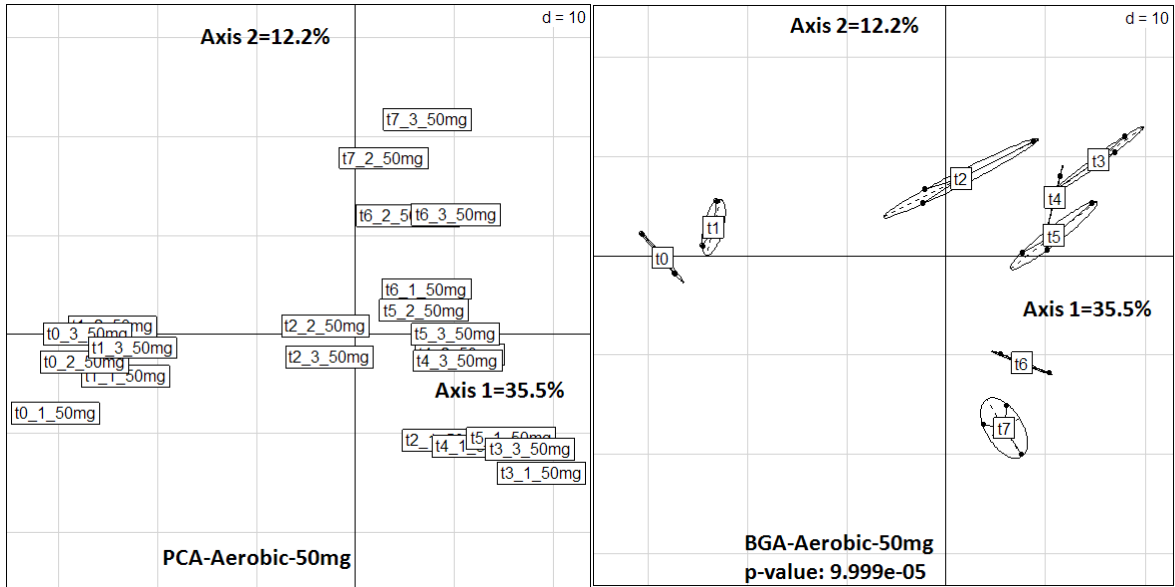
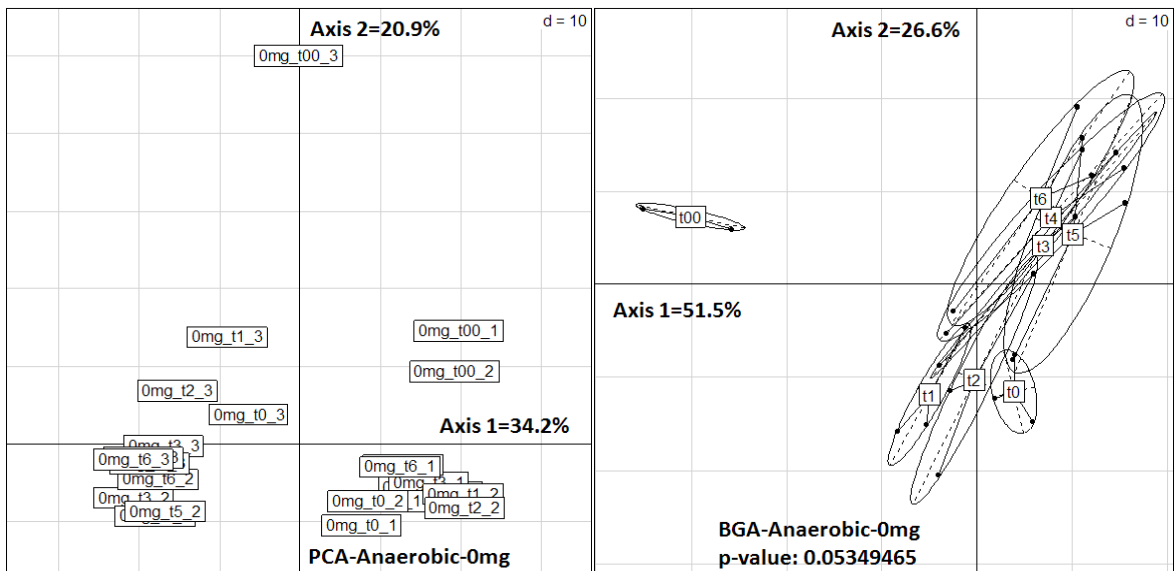

Fig.18: PCA and BGA analysis of bacterial community structure changes during the soil incubation with 0,10 and 50mg quinoline under aerobic condition.t0-t7 means sampling time point.



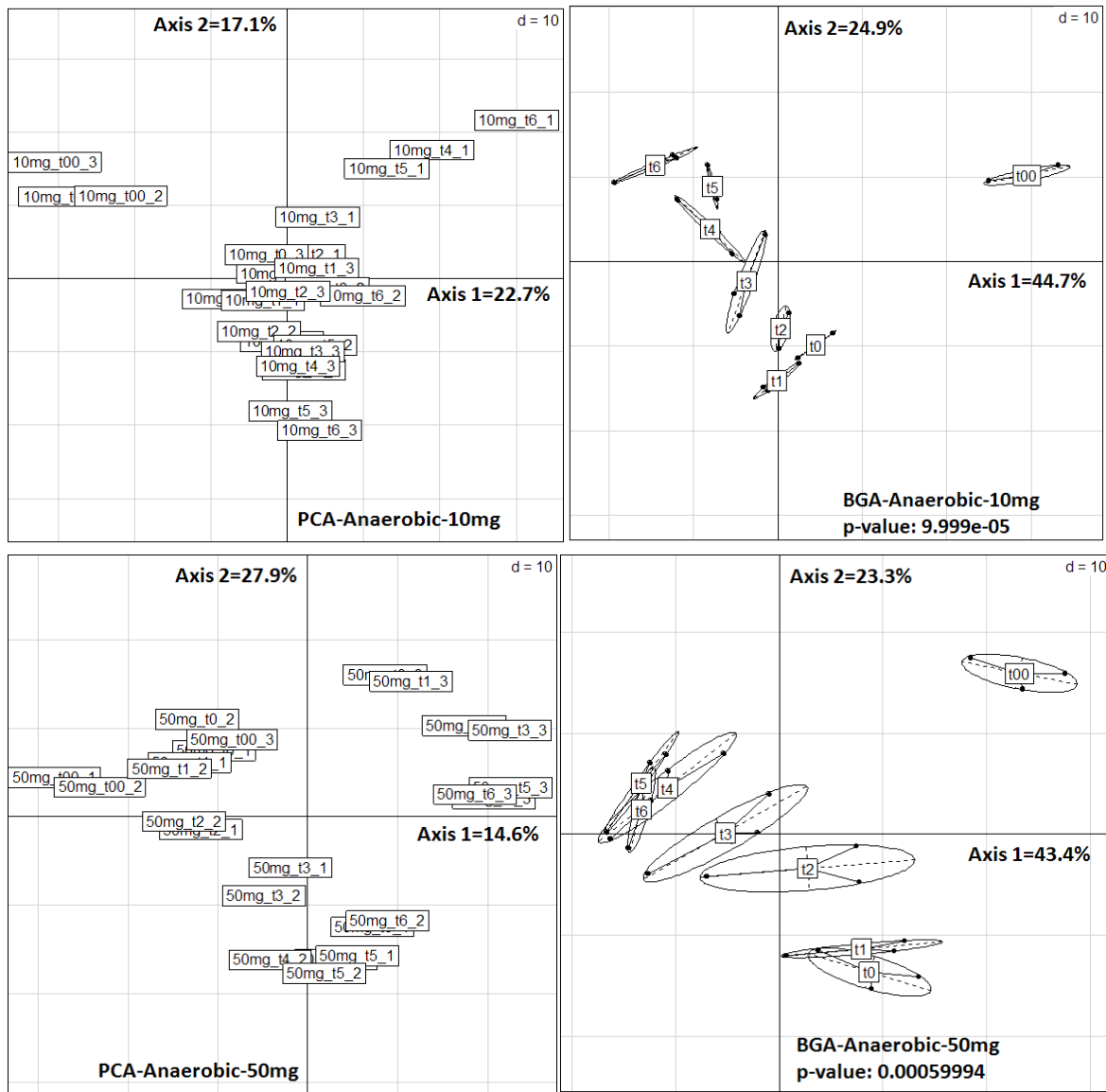

Fig.19: PCA and BGA analysis of community structure changes during the soil incubation with 0,10 and 50mg of quinoline under anaerobic condition. t0-t7 means sampling time point.

3.3 Results of GC/MS analysis

The figures below show results obtained from the GC/MS analysis. The pure quinoline in solvent was tested to confirm the retention time (Fig.20). From the GC/MS profile, a highly contaminated molecule (reagent dissolved in syringe by dichloromethane) emerged and was identified as butylated hydroxytoluene. Fig.21 shows the GC/MS profile and the composition of the aerobic T1 (10mg quinoline added) soil sample. Quinoline and butylated hydroxytoluene were predominant, while no related metabolites previously mentioned in the chapter “metabolic pathway of quinoline” were detected.

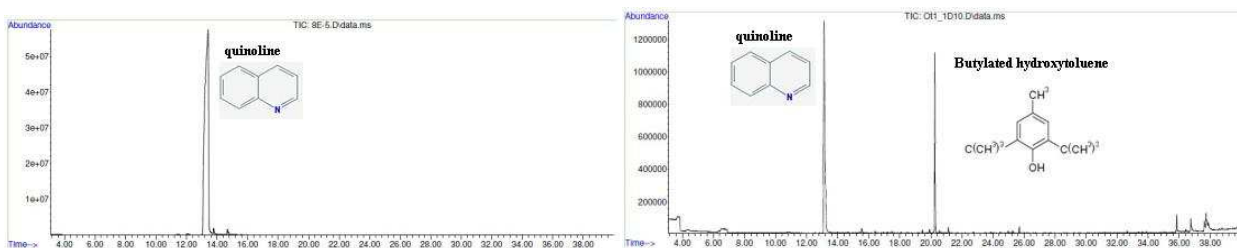

Fig.20: GC/MS results using quinoline with a dilution of 80 ppm. The peak appearing between 13-13.5 minutes is corresponding to quinoline and the peak appearing around 20-21minutes is considered as a contamination

PK#	RT	Area%	Library/ID	Ref#	CAS#	Qual	PK#	RT	Area%	Library/ID	Ref#	CAS#	Qual
1	6.521	2.11	C:\Database\NIST08.L trans-4-(2-(5-Nitro-2-furyl)vinyl)-2-quinolinamine	121738	000847-10-9	64	1	13.120	63.93	C:\Database\NIST08.L Quinoline	12934	000091-22-5	94
			Cyclohexasiloxane, dodecamethyl-	133887	000556-67-2	47				Quinoline	12933	000091-22-5	91
			7H-Dibenzo[b,g]carbazole, 7-methyl	122034	003557-49-1	43				Quinoline	12935	000091-22-5	91
2	15.552	2.16	C:\Database\NIST08.L Cyclohexasiloxane, dodecamethyl-	206263	000540-97-6	83	2	20.260	26.56	C:\Database\NIST08.L Butylated Hydroxytoluene	74768	000128-37-0	97
			Cyclohexasiloxane, dodecamethyl-	206262	000540-97-6	81				Butylated Hydroxytoluene	74766	000128-37-0	96
			Cyclohexasiloxane, dodecamethyl-	206261	000540-97-6	38				Butylated Hydroxytoluene	74767	000128-37-0	95
3	19.919	1.77	C:\Database\NIST08.L Cycloheptasiloxane, tetradecamethyl-	214563	000107-50-6	91	3	35.831	2.25	C:\Database\NIST08.L 9-Octadecenamide, (Z)-	121980	000301-02-0	95
			Hexasiloxane, 1,1,3,3,5,5,7,7,9,9,11,11-dodecamethyl-	203504	000995-82-4	53				9-Octadecenamide, (Z)-	121981	000301-02-0	91
			Cycloheptasiloxane, tetradecamethyl-	214562	000107-50-6	46				9-Octadecenamide, (Z)-	121982	000301-02-0	87
4	20.260	58.55	C:\Database\NIST08.L Butylated Hydroxytoluene	74767	000128-37-0	98	4	36.743	2.92	C:\Database\NIST08.L 1-benzylindole	64817	1000334-31-3	38
			Butylated Hydroxytoluene	74768	000128-37-0	97				Benzene, 1,1'-[1-(2,2-dimethyl-3-butenyl)-1,3-propanediyl]bis-	119894	061142-62-9	32
			Butylated Hydroxytoluene	74766	000128-37-0	95				Benzonitrile, n-phenethyl-	64826	034176-91-5	17
5	21.127	1.99	C:\Database\NIST08.L 1,5,9-Cyclododecatriene, 1,5,9-trimethyl-	62341	021064-19-7	46	5	37.610	2.14	C:\Database\NIST08.L 5-Methyl-2-phenylindolizine	64829	036944-99-7	53
			1,5,9-Cyclododecatriene, 1,5,9-trimethyl-	62339	021064-19-7	43				1H-Indole, 1-methyl-2-phenyl-	64833	003558-24-5	50
			5-Acetamido-4,7-dioxo-4,7-dihydrobenzofurazan	64922	153136-27-7	38				Benzo[h]quinoline, 2,4-dimethyl-	64840	000605-67-4	47
6	25.695	2.02	C:\Database\NIST08.L Cyclobutane, 1,2-diphenyl-	65741	003018-21-1	64	6	37.721	2.20	C:\Database\NIST08.L 5-Methyl-2-phenylindolizine	64829	036944-99-7	53
			Cyclobutane, 1,3-diphenyl-, trans-	65752	025558-23-0	58				1H-Indole, 1-methyl-2-phenyl-	64833	003558-24-5	52
			Benzene, 1,1'-(1,2-cyclobutanediyl)bis-, cis-	65772	007694-30-6	53				Methadone N-oxide	155135	1000120-80-7	45
7	35.008	1.84	C:\Database\NIST08.L Octasiloxane, 1,1,3,3,5,5,7,7,9,9,11,11,13,13,15,15-hexadecamethyl-	217228	019095-24-0	58							
			Cyclononasiloxane, octadecamethyl-	219101	000556-71-8	38							

Fig.21: GC/MS results using aerobic soil sample T0 (left). Fig.21 (Right) shows us the GC/MS result using aerobic soil samples T1. Quinoline is detected with a retention time of 13.12 minutes.

Here, we used 10mg quinoline added aerobic samples to find out the quinoline

biodegradation after GC/MS analysis. According to the GC/MS profile results, the quinoline peak area detected in each sample was automatically calculated. Results are shown below in tables 3 and 4, Fig 22 and 23. The histogram with error bar and P-value was drawn and calculated by using Microsoft Excel software. P-value below 0.05 means there are significant differences between each group and the P-value was also used for quinoline degradation analysis in this study.

Aerobic samples	Area	Area%	Start time(min)	End time(min)
T0-1	NA	NA	NA	NA
T0-2	NA	NA	NA	NA
T0-3	NA	NA	NA	NA
T1-1	7135575	63.93	13.045	13.409
T1-2	7452564	59.63	13.045	13.401
T1-3	5046638	51.11	13.053	13.409
T2-1	3357255	41	13.038	13.431
T2-2	3717641	44.6	13.053	13.401
T2-3	3270807	45.87	13.053	13.379
T3-1	744218	14.23	13.068	13.349
T3-2	1356890	16.1	13.060	13.416
T3-3	772650	11.54	13.075	13.334
T4-1	NA	NA	NA	NA
T4-2	NA	NA	NA	NA
T4-3	NA	NA	NA	NA
T5-1	NA	NA	NA	NA
T5-2	NA	NA	NA	NA
T5-3	NA	NA	NA	NA

Table 3: quinoline peak area values in aerobic 10mg quinoline added samples.

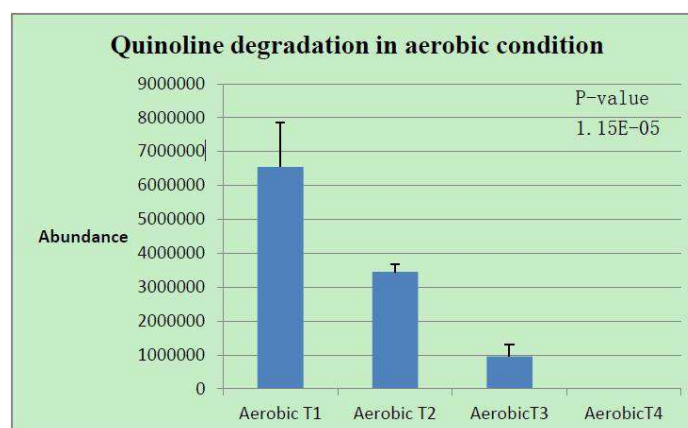

Fig.22: Quinoline degradation test: samples collected from aerobic condition microcosms. 10mg of quinoline was completely degraded after the time point T4 under aerobic condition.

Anaerobic samples	Area	Area%	Start time	End time
T1-1	3732024	47.82	13.045	13.460
T1-2	4313605	51.15	13.045	13.357
T1-3	6187714	70.56	13.038	13.357
T3-1	3702209	52.8	13.045	13.387
T3-2	3345472	49.9	13.053	13.401
T3-3	4293936	54.38	13.045	13.475
T5-1	4726012	58.87	13.053	13.446
T5-2	4940835	59.22	13.045	13.423
T5-3	5120902	53.68	13.053	13.386
T6-1	4135664	44.42	13.045	13.349
T6-2	3613608	42.47	13.053	13.379
T6-3	4122499	44.81	13.045	13.409

Table 4: quinoline peak area value in anaerobic 10mg quinoline added samples.

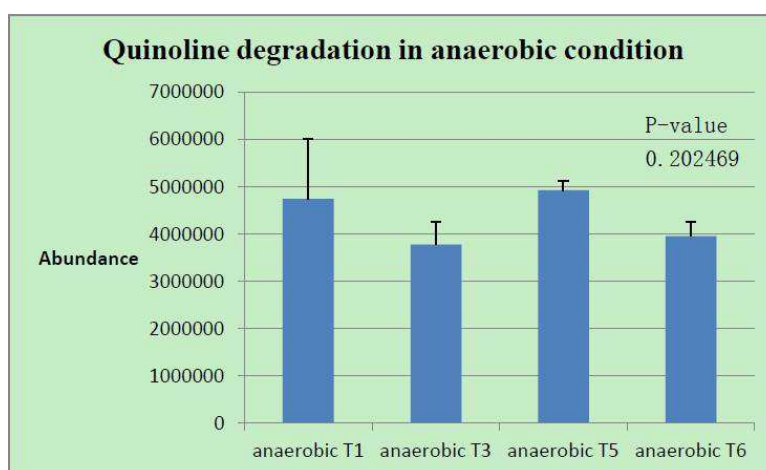

Fig.23: quinoline degradation test: samples collected from anaerobic condition microcosm. No significant (P -value: $0.2 > 0.05$) quinoline degradation was detected.

4. Discussion and conclusion

Coal tar remains the principal source of commercial quinoline (Gomtsyan, Bayburt et al. 2005), its waste materials containing quinoline does great damages to the environment and to humans. In order to find the quinoline degrading bacteria, former experiments usually incubate quinoline contaminated soil samples in quinoline containing phosphate salts medium (Shukla 1986).

To date, research has focused on the disclosing and recovery of microorganism community function in environmental samples because of its huge unrevealed genetic resources (Trevors, van Elsas et al. 1990; Eller, Kruger et al. 2005). Laboratory microcosms are commonly used to assess

potential ecological effects which may result from the introduction of a particular organism in a particular habitat by mimicking key field parameters in a laboratory situation (Bonkowski and Roy 2005). After a bio-adaptation strategy using contaminated soil, microcosms also can be applied to screen potential biodegradation microbial communities (Kools, Ferwerda et al. 2005).

The soil microorganism primarily consists of bacteria, actinomycetes, fungi, algae and protozoa. Currently, 16S rRNA gene sequence analysis and lots of technologies based on PCR such as random amplified polymorphic DNA (RAPD) (Mehta, Leite et al. 2001; Ponnusamy, Jose et al. 2011), amplified restriction fragment polymorphism (AFLP) (Duran, Gryzenhout et al. 2010; Ogunjobi, Fagade et al. 2010), restriction fragment length polymorphism (RFLP)(Tanti, Ray et al. 2011), terminal restriction fragment length polymorphism (T-RFLP)(Nithya and Pandian 2012), single-strand conformation polymorphism (SSCP) (Sen, Hamelin et al. 2008; Larentis and Alfreider 2011), denaturing gradient gel electrophoresis (DGGE) (Gillan, Speksnijder et al. 1998; Nicolaisen and Ramsing 2002) and temperature gradient gel electrophoresis (TGGE) (Gomez-Villalba, Calvo et al. 2006) have been widely applied to the study of microbial diversity.

The intergenic spacer region between the small (16S) and large (23S) rRNA genes were considered to be under less evolutionary selective pressure than the 16S and 23S rRNA coding genes and therefore provided an excellent tool for a finer identification at the species/strain level (Mora, Ricci et al. 2003; Panangala, van Santen et al. 2005). The rRNA intergenic spacer analysis (RISA) was used to study the genetic structure of the bacterial community pools from environment samples (Ranjard, Poly et al. 2000; Buchan, Alber et al. 2001). RISA is easy to perform, allows rapid examination at the composition of complex bacterial communities, and can also be performed without the use of specific and expensive equipment (Borneman and Triplett 1997; Acinas, Anton et al. 1999). Different fingerprints represent different genetic structures giving evidence that some populations are specific to a given location in addition to the common populations of all the microenvironments.

As described in the introduction, quinoline can be degraded under both aerobic and anaerobic condition. In this study, we used soil microcosm experiments which would give the opportunity to reveal the diversity of quinoline degrading bacteria and to investigate the presence of *bcr* operon containing bacteria. Meanwhile, if the *bcr* operon is enriched during soil

microcosm experiment, we can use the microcosm metagenomic DNA as substrate to test the capacity of the Genefish tool in capturing low percentage genes.

We used quinoline enriched microcosms under aerobic and anaerobic conditions to investigate the quinoline degrading bacterial diversity. After the RISA analysis, the community structure of quinoline microcosms changed after the quinoline was added. From the PCA and BGA results, addition of 2mg quinoline into the soil microcosm generates slight changes in bacterial community structure under anaerobic conditions while obvious changes under aerobic condition. 10mg, 25mg and 50mg of quinoline added in the soil sample shapes the community structure under aerobic condition. Nucleotide BLAST results showed that *bcr* type genes were related to *Rhodopseudomonas.palustris*, *Magnetospirillum.sp* and *Thauera.sp* in Rothamsted soil samples. *Rhodopseudomonas.palustris* is a purple photosynthetic bacterium widely distributed in nature such as swine waste lagoons, earthworm droppings, marine coastal sediments and pond water (Harwood 1992). It grows with or without oxygen and uses many alternative forms of inorganic electron donors, carbon and nitrogen. It degrades plant biomass and chlorinated pollutants and it generates hydrogen as a product of nitrogen fixation (Smith and Wilcox 1992; Roberts 2005). It is also reported to degrade p-coumarate under anaerobic condition (Yang, Horton et al. 2005), when growing photosynthetically in the absence of oxygen, *R. palustris* converts aromatic compounds to Ac-CoA, which is then used as carbon and energy source (Villa-Komaroff, Efstratiadis et al. 1978; Roberts and Burgess 2005). Pelletier and Harwood (Pelletier and Harwood 2000) have compared differences in the pathway of anaerobic benzoate degradation between *R. palustris* and *T. aromatica*. These two organisms have similar benzoyl-CoA reductase enzymes (BadDEFG in *R. palustris*(Egland and Harwood 1999)), but once benzoyl-CoA is reduced to a cyclohexadienecarboxyl-CoA intermediate, the next step in *T. aromatica* is an hydration of the ring, whereas the next probable step in *R. palustris* is a two-electron reduction to give cyclohex-1-ene-1-carboxyl-CoA as an intermediate (Song and Ward 2005). *Magnetospirillum* strains are microaerophiles thriving at the aerobic/anaerobic interface in natural ecosystems (Saari, Torma et al. 2011). Shinoda et al. (Shinoda, Akagi et al. 2005) isolated a phenol-degrading *Magnetospirillum* strain which represents a third denitrifying bacterial group capable of anaerobic utilization of aromatic compounds. In *Magnetospirillum* sp. strain TS-6, transcription of the *bcr* operons was observed in cells grown in aerobic condition on

benzoate, even though the Bcr is active only under anaerobic conditions (Kawaguchi, Shinoda et al. 2006).

Gas chromatography–mass spectrometry (GC/MS) is a method that combines the features of gas-liquid chromatography and mass spectrometry. It has been widely used in the separation and identification of complex components (Wittmann 2007), which have the high resolution of the GC and high sensitivity of the MS. It is a highly effective tool for the qualitative and quantitative analysis of drugs and metabolites in biological samples (Tuo, Yan et al. 2012). GC/MS analysis suggested the quinoline degradation in aerobic soil microcosms (10mg quinoline added) while no evident quinoline degradation functions were detected in anaerobic soil microcosms (10mg quinoline added). 10mg of quinoline were almost degraded after 28 days (T4) under aerobic condition. However, for the GC/MS results, we still need the negative control (sterilized soil sample with 10mg quinoline). Although there were slightly bacterial community structure changes (in RISA) under anaerobic adaptation but no quinoline was degraded after the GC/MS analysis. One hypothesis is: the anaerobic condition enriched the anaerobic bacteria and they grew using the nutrition (organic compounds, inorganic salts etc.) in the soil, finally leads to the community structure changes. Benzoyl-coenzyme A reductase was reported as an ATP dependence key enzyme of anaerobic aromatic metabolism (Boll and Fuchs 1995). So, for the quinoline degradation under anaerobic condition, bacteria usually need the energy captured from anaerobic respiration such as denitrification (Zumft 1997). The reason why no quinoline degradation was detected under anaerobic condition might be the lacking of nitrates in these soil microcosms. Adding extra nitrogen sources such as ammonium sulfate, potassium nitrate in soil microcosms may stimulate the growth of anaerobic bacteria and lead to quinoline degradation.

After the quinoline soil microcosm experiment in this study, it is confirmed that the soil microcosm strategy was a good method to analyze microbial diversity involved in contaminants biodegradation. Although quinoline degradation was detected under aerobic condition with the Rothamsted soil, but the principal bacterial responding community were still not yet confirmed. Further works should focus on 16S rRNA amplification, identification or even pyrosequencing of quinoline soil microcosm metagenome: this would help us to reveal (1) the relationship between quinoline degradation and relative microbial community (specific band shifts in the profile before and after quinoline addition into microcosms), (2) reveal the bacteria involved in quinoline

degradation and perhaps new bacteria not yet discovered through quinoline enrichment even in selective medium.

PART II: *in vitro* development and use of Genefish to capture targeted DNA fragments

1. Background

The “gene” was first considered as a crucial factor that causes an inheritable phenotype characteristic in organisms (Noble 2008). Since the development of molecular biology, a gene is defined as a region of genomic sequence, corresponding to a unit of inheritance, which is composed of regulatory regions, transcribed regions, and/or other functional sequence regions (Pearson 2006; Pennisi 2007). The genotype of an organism is the conclusive force to determine the phenotype of the organism. Because of the massive genotype diversity, our living world presents a colorful bio-ecology. Take microorganisms for example, they exist almost everywhere and some of them even can survive under extreme conditions such as hypersaline (Ollivier, Caumette et al. 1994), high temperature (Ranieri and Boor 2009), low oxygen (Mesbah and Wiegel 2008), alkaline (Grant and Heaphy 2010), high pressure (Kato and Qureshi 1999), polluted sites such as mineral water (Uroz, Calvaruso et al. 2009), etc. So, the specific genotype of those microorganisms raises high interest of scientists. However, relating genotypes to phenotypes of microorganisms is problematic because the interactions between genes, proteins and their physiological functions are extremely complex. Speculation indicated that only about 1% of microorganisms in nature can be cultured (Smith 1996) and the rest are still mysterious and needed to be revealed. As we mentioned in the general introduction, to date, metagenomic approaches afford to reveal the genetic diversity, bacterial diversity, and even some functional molecules responding to specific phenotypes. However, the defect of metagenomic approaches is also obvious, targeted genes or fragments were randomly captured which will dramatically decrease the capture efficiency. In order to capture target genes and fragments more efficiently and precisely from environmental metagenomes, a new tool “Genefish” was constructed in our group as a complementary method for metagenomics. The “Genefish” concept is based on the genetic recombination process catalyzed by the λ Red system and cloning of specific genes from a metagenome. Genefish is included in the European project Metaexplore which aims at

discovering and characterizing new enzymes from environmental microbial community. Interested enzymes encoding by new genes in this project are implicated in the biodegradation of recalcitrant (chitin, lignin) and xenobiotic halogenated compounds. Thanks to the effort of Nathalie Lombard, former PhD who built the capture-plasmid and counter-selection system, my assignment in this project was to continue the initial work achieved by Nathalie Lombard, Samuel Jacquiod and Laure Franqueville, to develop and to use the Genefish tool to capture relevant genes implicated in quinoline degradation.

2. Bibliographical review of Lambda-Red homologous recombination and Genefish approach

2.1 Lambda-Red homologous recombination

2.1.1 Introduction

Restriction enzymes and DNA ligases have been used as classical sub-cloning tools for more than 30 years (Arber and Linn 1969; Smith and Wilcox 1970; Roberts 1976; Kessler and Manta 1990) . This method enables to efficiently get small DNA fragments *in vitro* (Kelly and Smith 1970; Villa-Komaroff, Efstratiadis et al. 1992; Roberts 2005). However, some genetic modification including gene deletion, gene insertion and large fragment cloning are difficult and even impossible to succeed by using this classical tool. Recently, a new *in vitro* technology called recombineering (recombination-mediated genetic engineering) (Ellis, Yu et al. 2001) has emerged, and by using this technology, genetic engineering could greatly be improved, and simplified for plasmid and strain construction. (Bian, Huang et al. 2012; Cottingham 2012; Marinelli, Hatfull et al. 2012). Recombineering is based on homologous recombination that can occur between two short homologous sequences of recipient and target fragments. To date, this strategy is commonly applied in genetic modification such as gene point mutation, deletion, insertion without the use of restriction enzymes and DNA ligases (Bird, Erler et al. 2012; Chai, Shan et al. 2012; Dai, Kim et al. 2012). Actually, it is catalyzed by the bacteriophage-encoded homologous recombination functions, such as the coliphage λ Red system (Yu, Ellis et al. 2000; Song, Dong et al. 2010;

Tuntufye 2011) and the RecET system from the Rac prophage (Cobb and Zhao ; Zhang, Buchholz et al. 1998; Datta, Costantino et al. 2008; Swingle 2010; Cobb and Zhao 2012). Here, we are focusing on the λ Red system which is also applied in our study Genefish. The process of λ Red homologous recombination includes four steps: (1) Preparation of the host cells which contain the λ Red system (into their chromosome or on a plasmid). (2) Preparation of targeted exogenous linear DNA containing homologous sequences for recombineering. (3) Induction of λ Red system and electroporation of the target DNA into the host cells. (4) Selection or screening for the recombinants containing requested genetic changes. During the homologous recombination, nucleotide sequences are exchanged between two similar or identical DNA molecules resulting in new combinations of genetic material.

2.1.2. Lambda-Red recombination system

2.1.2.1 Overview of Lambda-Red recombination system

The Lambda-Red homologous recombination system primarily consists of three genes: *gam*, *exo* and *bet*. In general, linear DNA transformed into *E. coli* will be degraded by the powerful RecBCD nuclease (an exonuclease from *E. coli* that degrades ssDNA and dsDNA) (Dabert, Ehrlich et al. 1992; Boyd, Weiss et al. 2000; Singleton, Dillingham et al. 2004). However, the λ Gam protein encoded by the gene *gam* can inhibits the nuclease activities of RecBCD, preserving linear DNA and thereby allowing it to be taken as substrate for recombination (Karu, Sakaki et al. 1975; Murphy 1991). The λ Exo protein encoded by the gene *exo* is only required for dsDNA recombineering. It has a 5' to 3' exonuclease activity, Exo binds and remains bound to 5' ends of dsDNA and start the degradation in 5' to 3' direction (Carter and Radding 1971; Cassuto and Radding 1971). This process forms dsDNA with a 3' exposed dsDNA overhang where the Beta protein could further bind. The λ Beta protein encoded by the gene *bet* is a ssDNA binding protein that promotes annealing of two complementary DNA molecules. Beta binds to the 3' overhang of the exposed dsDNA and protects the DNA from single-strand nuclease attack (Muniyappa and Radding 1986; Karakousis, Ye et al. 1998; Desai and Shankar 2003). Recombineering with linear dsDNA require all these three proteins but Exo is not necessary for

ssDNA recombination (Yu, Ellis et al. 2000; Ellis, Yu et al. 2001). Fig.24 shows the overview of λ Red recombination system for dsDNA recombineering.

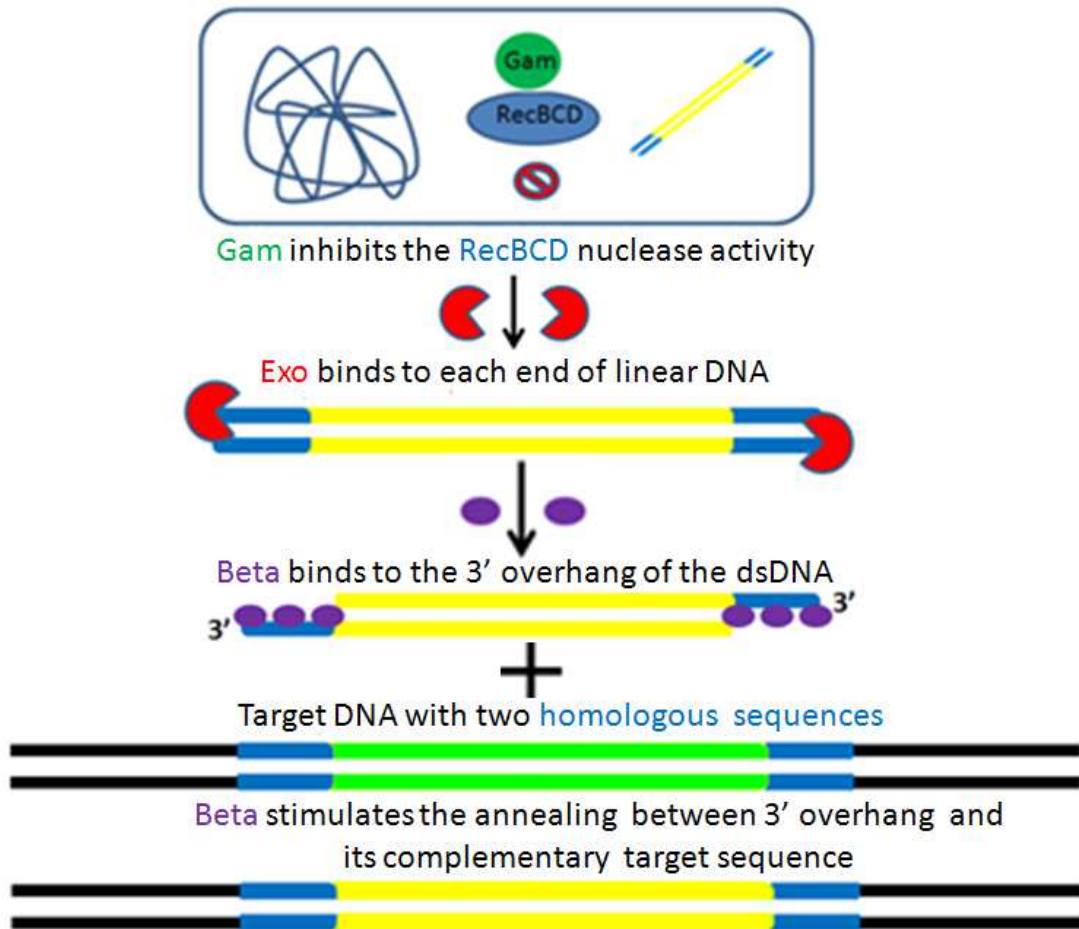
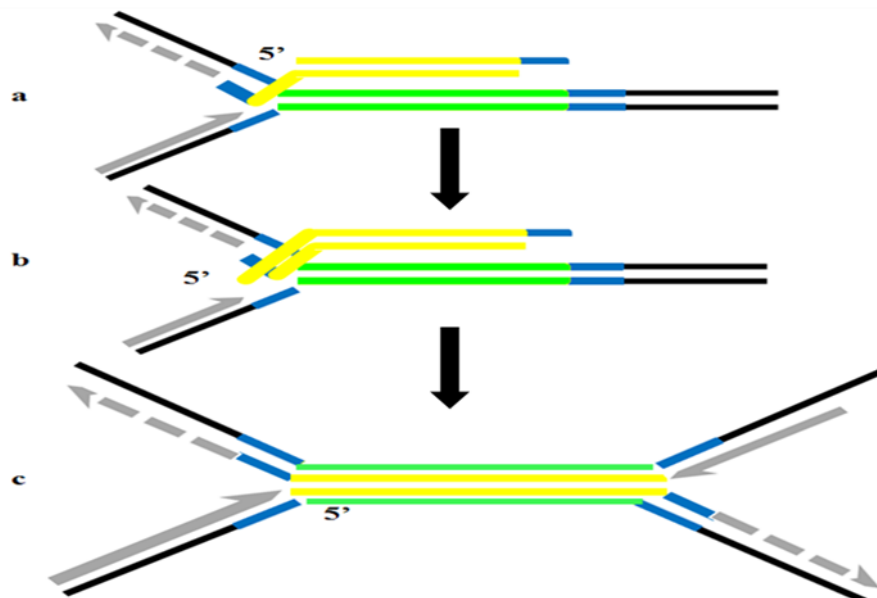

Fig.24: Process of λ Red recombination system used for recombineering.

The Gam protein inhibits the activity of the *E.coli*'s RecBCD nuclease thus allow the maintenance of the exogenous DNA after its transformation into the strain. Exo degrades dsDNA in 5' to 3' direction, leaving a 3' overhang ds DNA. Beta binds to the single-stranded regions produced by Exo and facilitates recombination by promoting annealing to the homologous genomic target site (Sawitzke, Thomason et al. 2007). Fragment in blue stands for highly conserved sequences; fragment in yellow stands for exogenous target sequences; fragments in green and black stand for recipient sequences in the host strain.

Although the lambda Red system was commonly used for genetic engineering (Brack, Eberle et al. 1976; Kopecka, Hillova et al. 1976; Pirrotta 1976; Martinsohn, Radman et al. 2008), the detailed mechanism by which lambda Red mediates double-stranded DNA recombination remains uncertain. Currently, three different Red-mediated dsDNA recombination mechanisms were proposed by Court et al (Court DL 2002), Poteete (Poteete 2008) and Mosberg et al (Mosberg, Lajoie et al. 2010) respectively.

The strand-annealing model for lambda Red-mediated dsDNA recombination proposed by Court et al. occurs during DNA replication (Fig.25). The 3' exposed end of dsDNA overhang anneals to its homologous target at the replication fork. This replication fork then backtracks and the former leading strand switches on to the degraded 5' end dsDNA. The heterologous dsDNA blocks further replication from this fork. The other replication fork processing in the opposite direction around the circular bacterial chromosome will finish the rest of the recombination task until the other 3' overhang of dsDNA anneals to its complementary region and thus forming a crossover structure. This crossover structure then is resolved by unspecified *E. coli* enzymes (Court DL 2002).



*Fig.25: Mechanism of strand-annealing model for lambda Red-mediated dsDNA recombination during DNA replication described by Court et al. Heterologous dsDNA is shown in yellow and homologous sequences are represented in blue at each end. (a) Beta promotes the annealing between the 3' overhang and the complementary sequence in the lagging strand. (b) The annealing reaction blocks the replication proceeding. (c) While the replication in opposite direction still progresses until the replication fork arrives at the other homologous recognition sites. This crossover structure is resolved by unspecified *E. coli* enzymes (Court DL 2002).*

Poteete et al (Poteete 2008) assume that the dsDNA recombination also occurs between target DNA (a lambda phage DNA they used) and a plasmid which does not have a second replication fork (plasmid replicate in one direction). In contrast to the Court mechanism, the two opposite direction replication forks are not formed in the mechanism proposed by Poteete. So, an alternate replisome invasion model was established by Poteete (Fig.26). The Exo 5' to 3' exonuclease activity degrades each end of the exogenous dsDNA homologous region into ssDNA overhangs. One of the 3' overhangs first anneals to its complementary sequence on the replication fork. Distinct from the mechanism put forward by Court, the leading strand switches to 3'overhang which already annealed with its complementary sequence and serves the 3'overhang as the new template for synthesis (Poteete 2008). So the replication will continue through the exogenous dsDNA, and release the original lagging strand template. The author indicated that a second strand-switching event might occur at the other end of the incoming dsDNA to complete the recombination. However, in this mechanism, no more information were given on the endonuclease which is responsible for resolving the structure after the first template switching event and the formation of the new replication fork.

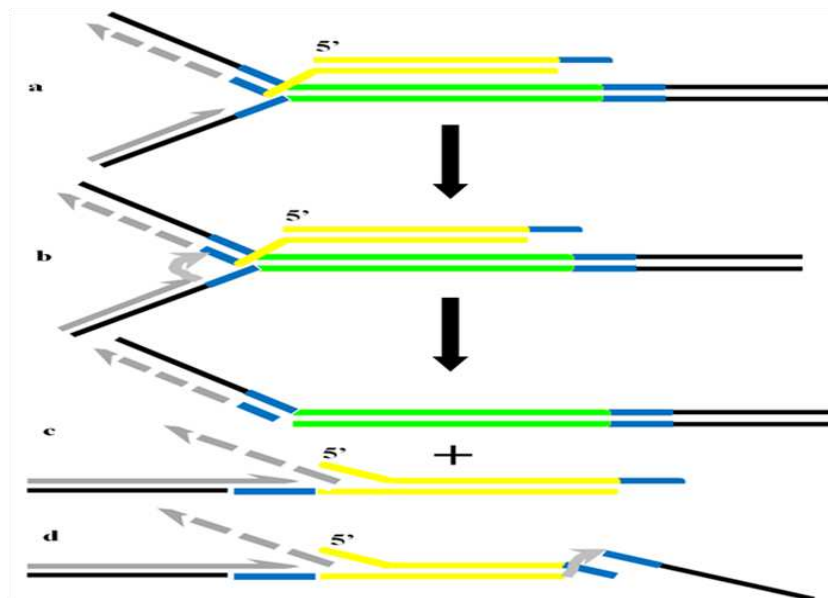

Fig.26: Replisome invasion model for lambda Red-mediated dsDNA recombination according to Poteete. Heterologous dsDNA of the plasmid is shown in yellow and homologous sequences are in blue at each ends. (a) Beta promotes the annealing between 3' overhang and its complementary sequence in the plasmid. (b) The leading strand switches to the 3' overhang of the Exo processed dsDNA and consider it as the new template for new synthesized strand. (c) The new replication fork travels through the heterologous dsDNA to continue the replication. (d) The replication fork arrives at the other homologous sequence site and the leading strand switches again on-to the original homologous sequence of the plasmid.

Mosberg et al (Mosberg, Lajoie et al. 2010) proposed a lambda Red mediated dsDNA recombination progression via a ssDNA intermediate. According to their theory, dsDNA molecules transformed into *E.coli* are completely dissociated to ssDNA by Exo. This dissociation starts at one end of the dsDNA and exposes two homologous regions. When the replication fork arrive at the homologous sequences, this ssDNA will anneals to its complementary targets and is inappropriately taken as part of the newly synthesized strand (Fig.27). No more information about the resolution of the mismatch structure between lagging strand and non-homologous sequences was mentioned by the authors.

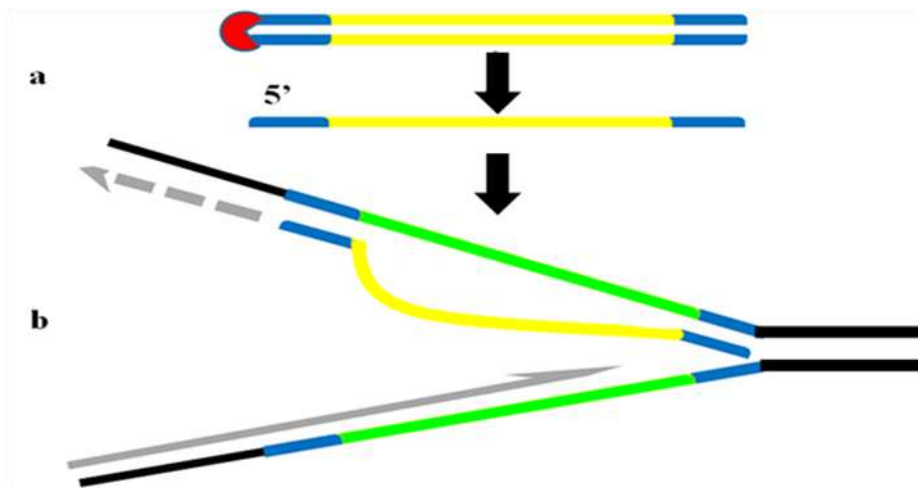

Fig.27: Mechanism of ssDNA intermediate model for lambda Red-mediated dsDNA recombination outlined by Mosberg et al (Mosberg, Lajoie et al. 2010). Heterologous dsDNA is represented in yellow and homologous sequences are represented in blue at each ends. (a) Exo completely dissociates the exogenous dsDNA and generates two ssDNA. (b) One ssDNA anneals to its complementary sequence at each end of the homologous sites. This ssDNA is inappropriately used as part of the newly synthesized strand.

2.1.2.2 Different vectors for the Lambda-Red system

For λ Red recombineering strategy, in order to obtain the highest recombineering efficiency, an appropriate expressed level of the λ Red recombination proteins is required. Limited expression of Gam protein couldn't inhibit the RecBCD nuclease activities completely (Sergueev, Yu et al. 2001), a high expression of Gam could also cause plasmid instability (Silberstein Z 1990; Murphy 1991) and even cell death (Kirill Sergueev 2001). The λ Red enzymes could be expressed under the control of their own promoter or under heterologous regulated promoters. While endogenous phage promoter leads to tight regulation and coordinates expression thus

leading to a higher recombination frequency (Court DL 2002). Court et al (Yu, Ellis et al. 2000; Ellis, Yu et al. 2001; Court DL 2002) have developed and utilized a λ prophage Red system on the *E.coli* chromosome for recombineering application. In this system, they do some genetic modification of λ prophage including the deletion of lysis, replication and structural genes thus inactivate the λ prophage infectious cycle. However, the critical functions such as transcriptional control of the Red are retained (Fig.28).

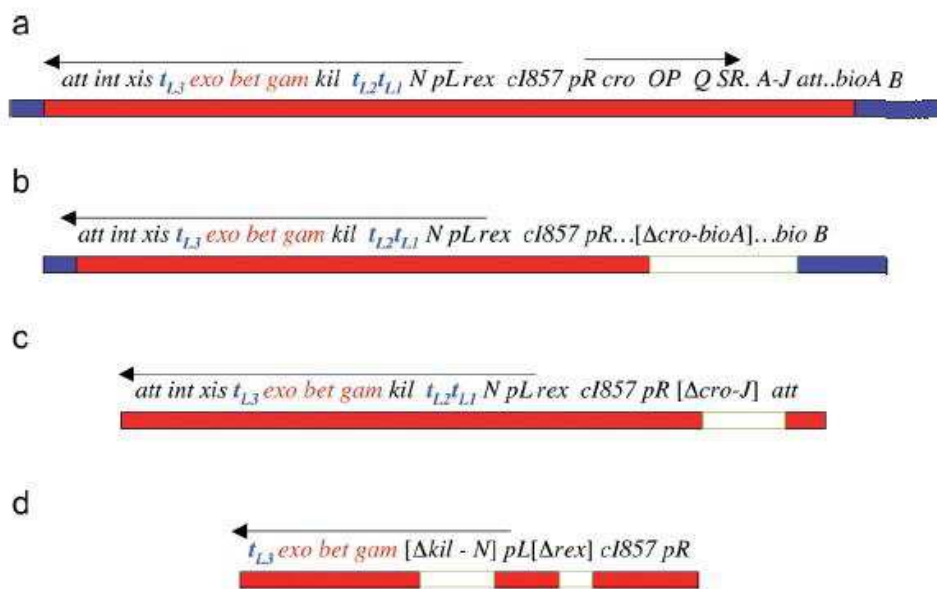

Fig.28: Schematic representation of λ phage constructs into *E.coli* chromosome used for recombineering (Sharan, Thomason et al. 2009)

Bacterial DNA is shown in blue bar, phage DNA in red bar and the region containing a deletion and/or a substitution is a white bar. (a) Genetic structure of λ prophage which is integrated into the bacterial chromosome: the complete λ prophage is flanked by its attachment site *att*, where integration with the bacterial chromosome occurred and is adjacent to the bacterial biotin genes, *bioAB*. The *int* and *xis* genes located in the *pL* operon and encode function products which can help phage DNA to integrate into or excise phage DNA out of the bacterial chromosome. There are two operons as shown with arrows and their promoters *pL* and *pR* in the prophage. The *exo*, *bet*, and *gam* genes are under the control of the temperature-sensitive repressor *CI857*. At temperatures less than 32°C (Yu, Ellis et al. 2000), *CI* repressor binds to the operators and prevents transcription of the *pL* operon and thereby the expression of Red. The expression of the Red system can be turned on easily at 42°C inducing the repressor *CI857* denaturation and as a consequence, allows the Red genes transcription. When shifting back to low temperature, *CI857* re-natures and recovers its initial

functions thus completely blocks the transcription of *pL*. When λ Red functions are turned on for a short time period, like 5 min, cells become more recombinogenic after linear DNA uptake (Yu, Ellis et al. 2000). The *N* gene encodes an anti-transcription terminator and prevents RNA polymerase termination of *pL* transcripts at terminators *tL1*, *tL2*, and *tL3*. The *kil* gene is adjacent to *gam* and when expressed for over 1 hour kills the host bacterial cell (Sergueev, Yu et al. 2001). The replication genes *O* and *P* of the λ prophage are in the *pR* operon. *Cro* functions as a partial repressor of the *pL* and *pR* operons when *CI* is inactive at 42°C. The lysis and structural genes, *SRA-J*, are shown located beyond their regulator *Q* (Sharan, Thomason et al. 2009).

(b) The defective prophages used for recombineering in *DY380*, *SW102*, and the *HME* strains (Lee, Yu et al. 2001; Warming S 2005): *cro* through the *bioA* prophage genes are deleted. The right *att* site is also deleted preventing any excision of the prophage. In *DY380* and *SW102* strains, those deleted genes are replaced by the tetracycline resistance cassette, *tetRA*.

(c) The mini- λ phage DNA (Court, Swaminathan et al. 2003) is shown with the lytic genes *cro* through *J* deletion. In different constructs of the mini λ , the *cro-J* region is replaced with various drug resistant cassettes. As we mentioned before in the genetic structure of λ prophage, mini- λ has kept *att* sites plus *int* and *xis*, allowing its integration and excision.

Recently, for the convenient use of λ Red systems, its critical elements were integrated into a set of different plasmids. For instance, Murphy et al (Murphy 1998; Murphy, Campellone et al. 2000) designed a plasmid possessing phage recombination functions under the control of an IPTG-inducible *lac* promoter. Later on, Datsenko (Datsenko and Wanner 2000) and Wang (Wang, Sarov et al. 2006) developed recombineering plasmids under the arabinose inducible *pBAD* promoter (Chao, Chiang et al. 2002; Terpe 2006). In this construction, the AraC protein is both a positive and a negative regulator (Yajima, Muto et al. 1993; Cobb and Zhao 2012). In the presence of arabinose, transcription from the *pBAD* promoter is turned on; in its absence, transcription occurs at very low levels (Lee, Francklyn et al. 1987). Other studies (Dodd, Shearwin et al. 2005; Donald L. Court 2006) show that the repression system of the λ Red machinery is strong exclusively under the controls of *pL* and *pR* promoters. So the ideal conditions is to ensure the presence of *pL* and *pR* promoters on all of the prophage constructs, whether carried on the bacterial chromosome, on low copy plasmids or under the control of a temperature sensitive gene such as *cI857*.

The pSIM vectors (Datta, Costantino et al. 2006) consist of the basic elements for its replication and other necessary elements for prophage induced homologous recombination. Fig.28 (d) shows the λ segment of the pSIM plasmids. The genes from *cro* to *att* and genes beyond *tL3* including *int* and *xis* were removed. The red genes were directly connected to *pL* by a deletion that removes *kil* through *N* genes. The drug resistance marker specific of each pSIM plasmid replaces the *rex* gene (inhibit cell function without phage superinfection (L snyder 1989)) adjacent to *cI857*. The basic features are conserved in all of these Red expression pSIM plasmids. This λ Red system was left under the control of native phage elements for optimal expression and regulation. The *pL* promoter drives gene expression and is controlled by the temperature sensitive but reversible λ *CI857* repressor. In all, the *cro* gene is inactive to maximize *pL* expression, and the replication genes are absent or inactive to prevent lethal effects on the cell.

2.1.2.3 Substrates for the Lambda-Red system

Based on the strategy of λ Red system, different DNA substrates could be used. Exogenous double or single-strand linear DNA both need to contain two regions homologous to their target sequences in any case. The inserted region between two highly conserved sequences could either be a selective marker or a non-selective DNA (Roberts 2005). Yu et al. (Yu, Ellis et al. 2000) demonstrated that 30- to 50-bp homologies are able to result in recombination *in vitro*. For those exogenous DNA substrates constructions, we only need to add homology sequences (30- to 50-bp) at each 5' end of PCR primers. These primers can amplify the exogenous DNA with highly homology conserved sequences easily at each end of PCR products and this PCR dependant DNA substrates preparation could substantially facilitates the λ Red system application because we can modify the homology sequences as we want.

2.1.2.3.1 Double-strand DNA recombination

ds DNA substrate can be generated by polymerase chain reaction (PCR) with a pair of primers containing homologous sequences to the target site (Arber and Linn 1969). Each primer, about 70 bases in length, contains 50 nucleotides at the 5' end corresponding to the homologous targeted region and around 20 nucleotides at its 3' end to amplify the exchanged sequences (Fig.29).

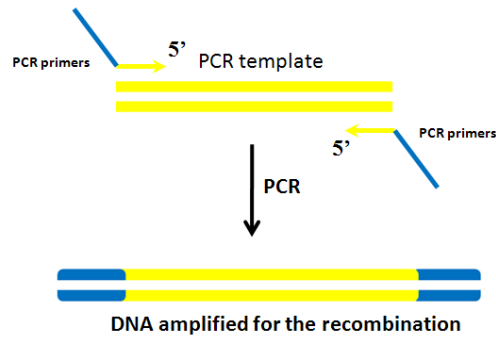

Fig.29: ds DNA substrates for recombination generated by PCR: homologous region (in blue bar) and non-homologous sequences which usually contain selective marker (usually antibiotic resistance gene).

When the ds DNA including selection marker is used (antibiotic resistance genes) for recombination, positive recombinants can easily be screened through the specific phenotype. However, not all exogenous ds DNA contain selective marker, for recombinants selection in this case, two steps counter-selection method or *loxP*, *FRT* (Flp recognition target) dependant method are helpful (Fig.30) (Tischer, Smith et al. 2010). In these two-steps counter-selection processes, two homologous recombination phases were performed consecutively. Two different types of ds DNA substrate containing identical highly conserved sequences are essential. The first recombination event occurs with ds DNA possessing a selection marker and positive recombinants can directly be screened. Then the selected recombinants are taken as objects to be replaced in the second round recombination using initial targeted but non selective marker ds DNA. The phenotype changes before and after recombination indicates the gene replacement in the targeted region.

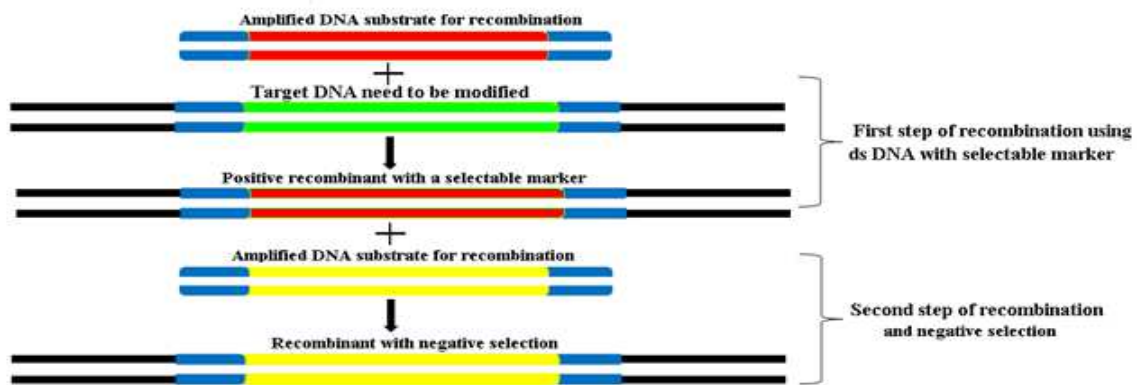

Fig.30 A two-step recombination process by using non-selective marker ds DNA. Green bar are target sequences to be replaced by non-selective marker ds DNA (yellow bar). In the first step, a selective marker containing fragment was inserted (red bar). In the second step, the target sequence of recombinants that was already selected after the first step recombination was replaced by the expected fragment (yellow bar). Positive recombinants can be screened by the counter-selection of the selective maker.

In another method (Datsenko and Wanner 2000), a selective marker flanked by two *loxP* or *FRT* sites at each end is linked to a non-selective DNA fragment which contains two homologous sequences corresponding to the target DNA site. The *loxP* and *FRT* sites are regions of 34 base pairs (bp) in length and consist of two 13 bp inverted repeats separated by an 8 bp spacer region (Hoess, Wierzbicki et al. 1986; Datsenko and Wanner 2000). The FLP recombinase binds to the palindromic sequences, whereas the 8 bp spacer corresponds to the site of DNA break, exchange and ligation (Lacroix, Giovannini et al. 2011). Target DNA deletion produced by Cre-lox or Flp-FRT recombination is determined by the orientation and location of flanking *loxP* or *FRT* sites. When the two *loxP* or *FRT* sites are in the same orientation, Cre or Flp recombinase protein expressed by the host strain can induce a site-specific recombination thus deleting the DNA sequences between two *loxP* or *FRT* sites respectively (Fig.31). However, after the deletion of the selective marker, a single *loxP* or *FRT* sites will remain.

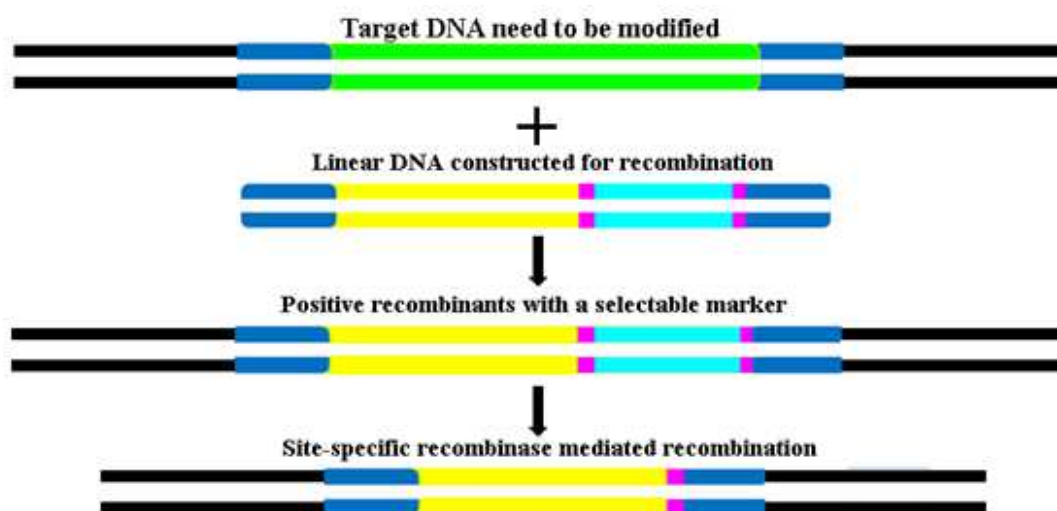

Fig.31: a site-specific dependent recombination system applied to modify targeted sequence by using the *loxP* or *FRT* sites. Green bars are the target sequences to be replaced by the non-selective marker ds DNA (yellow bar). The short bar in pink can be *loxP* or *FRT* sites which participate in the Cre-Lox or Flp-FRT recombination respectively.

2.1.2.3.2 Single-strand DNA recombination

Recombineering can also be performed using synthetic oligonucleotides or short denatured PCR products (Swaminathan S 2001; Costantino and Court 2003; Yang and Sharan 2003; Maresca, Erler et al. 2010). Single-strand DNA can be used to create point mutation through homologous recombination and this method is highly efficient and do not require any selection

step. In contrast, an optimal condition that primarily contains two variables can stimulate the process of recombination when using single-strand DNA. The first variable is the use of a “lagging-strand” oligo nucleotide, a single strand corresponding in sequence to the DNA chain that is replicated discontinuously (Kim, Dallmann et al. 1996; Ellis, Yu et al. 2001; Costantino and Court 2003). Ellis (Ellis, Yu et al. 2001) found a strand bias in recombination levels when using two complementary ss DNAs and a strand bias of 4 to 10 fold was seen in each of four independent experiments using lagging strand. The other important variable is to avoid the *E. coli* methyl-directed mismatch repair (MMR) system: preventing MMR increases recombination frequency about 100 fold (Li, Costantino et al. 2003). Yang and Sharan (Yang and Sharan 2003) developed a more generally useful “hit and fix” two-step recombineering approach which can be used to generate and find subtle changes in BAC DNA and, in this approach, recombinants can be screened by colony hybridization method (Fig.32). A set of long primers containing 80 bases of homologous and 20 bases of target site are used to generate the DNA substrates. This strategy consists of two steps called “hit” and “fix” respectively. “Hit” targeting DNA is first inserted into the wild type BAC. Recombinants can be identified by specific “hit” hybridization probe. Positive recombinants were used as the target to perform the “fix” step. “Fix” targeting DNA including a point mutation is recombined into the target sites thus generating recombinants with the expected point mutation.

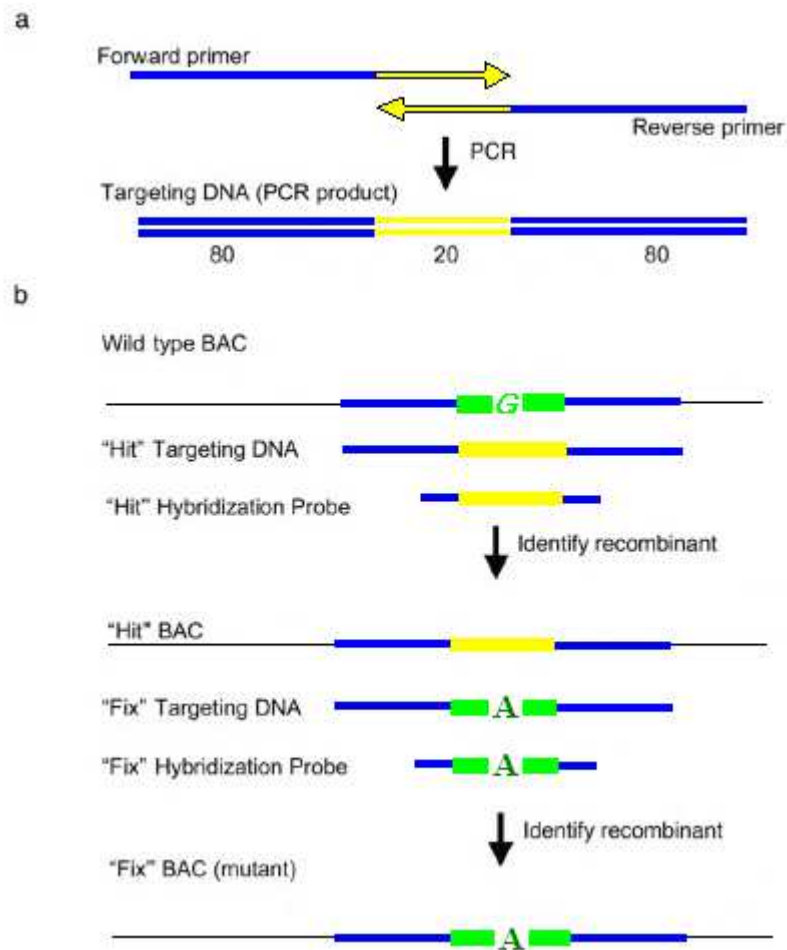

Fig.32: Two-step "hit & fix" method to create point mutations using single stranded short PCR product or oligonucleotides as targeting vector (Sharan, Thomason et al. 2009).

(a): 180 bases of PCR products containing 80 bases of homologous at each end and 20 unique bases in between. The 20 unique bases are used as the target to design probes for colony hybridization. The PCR products can be denatured to get single-stranded oligonucleotides used as targeting substrates.

(b): Process of point mutation (G to A) by using "hit & fix" method. Step 1: The "Hit" PCR amplified targeting DNA is used to replace 20 nucleotides (green bar) with 20 heterologous nucleotides (yellow bar). In step 2, the 20 nucleotides (yellow bar) are replaced by the "Fix" targeting DNA (green bar) except for the expected mutation. Recombinants can be identified by colony hybridization or PCR by using primers specific to the recombinant DNA.

2.2. The “Genefish” tool

2.2.1 General presentation of “Genefish”

The Genefish tool that we describe here can be considered as a complementary method for metagenomics. This approach aims to directly recover specific genes or DNA fragments from a metagenome. The “Genefish” project is based on the genetic recombination process catalyzed by the λ Red system as we described above and cloning of specific genes from the metagenome *in situ*. In order to achieve this objective, genetic engineered system has been constructed expanding the application of λ Red system. This new system called “Genefish” is composed of three molecular units. The first part consists in the capture plasmid which contains two short highly conserved DNA fragments cloned from the gene of interest (the specific gene we want to clone from a metagenome). This capture plasmid also encompasses a two suicide gene *relF* and *colE3* cassette allowing positive selection of the intended clones. The mechanism of this positive selection will be introduced in a latter chapter. The second part is made of the λ Red system as we described before, and in our project, the λ Red system is integrated in a plasmid pSIM6. The system is strictly controlled by the temperature sensitive promoter *cI857*. The third part corresponds to the host strain which was improved after genetic modification and is taken as recipient for Genefish process (Fig. 33).

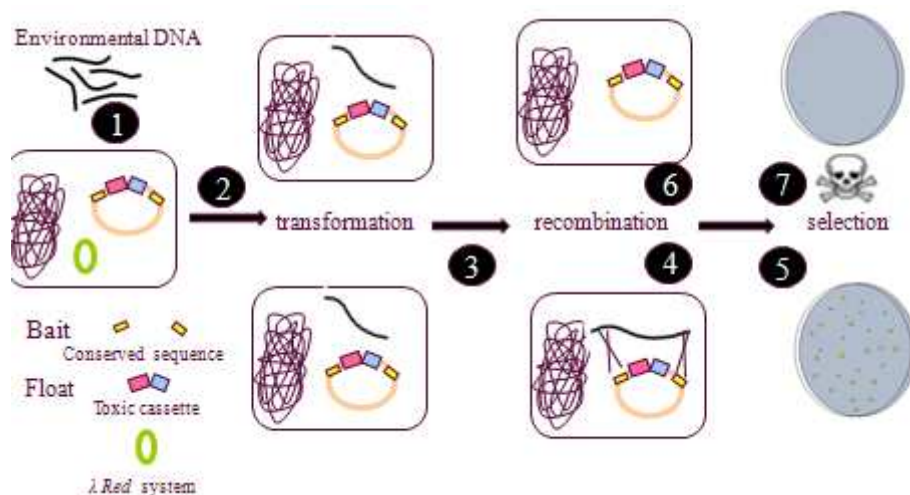

Fig.33: Principle of the Genefish strategy: An *E.coli* strain is engineered with a plasmid containing 2 target sequences flanking a cassette composed of 2 genes that express lethal functions(float) for the cell when induced (1).After transformation an environmental DNA fragment (2) can recombine by double crossover based on target sequences(bait) (3). The suicide cassette is then replaced(4)allowing the transformed cell to develop a colony on the growth medium containing the toxic genes inducers(5)while non recombinant cells(6)are killed (7).

2.2.2 The suicide cassette

The capture plasmid, called pBAD35K7toxN, contains a suicide cassette composed of two toxic genes. After their induction, genes *relF* and *colE3* express lethal proteins in the *E.coli* cell and lead to cell death (Fig. 34).

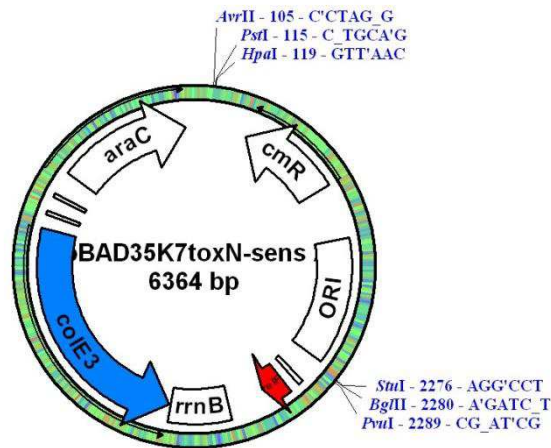

Fig.34: The plasmid pBAD35K7 tox: red arrow indicates *relF* gene, and blue arrow represents the *colE3* gene; the tick marks represent the 2 multi-cloning sites devoted to the insertion of the two short target sequences; *cmR* is Chloramphenicol resistance gene (Source: Lombard. N. Thesis 2007)

relF gene encodes a polypeptide of 51 amino acids which have 40% homology to the *hok* and *gef* gene products (Gerdes, Bech et al. 1986; Poulsen, Larsen et al. 1989). Induction of *relF* gene leads to the collapse of the cell membrane potential, arrest of respiration, changes in morphology and cause cell death (Gerdes, Bech et al. 1986; Gerdes, Poulsen et al. 1990). In our plasmid, *relF* is under the control of a synthetic *lac* promoter $P_{A1-03/04}$ (Jensen, Ramos et al. 1993). *lacIq* gene in the chromosome of our host strain is a mutation of *lacI* gene. The specific mutation on the promoter of *lacI* gene results in higher level expression of *lac* repressor (de Boer and Glickman 1998). The expressed repressor protein LacIq inhibits the promoter $P_{A1-03/04}$ thus shutting down the expression of the *relF* gene. However, LacIq can be blocked by the presence of IPTG at the final concentration of 500 $\mu\text{g/ml}$ (Knudsen, Saadbye et al. 1995), this will release the promoter $P_{A1-03/04}$ allowing the expression of the *relF* gene.

ColE3 gene encodes a RNase colicin E3 that specifically induces the cleavage of a single phosphodiester bond in the *E. coli* 16S ribosomal RNA (Zarivach, Ben-Zeev et al. 2002). This cleavage results in a complete inactivation of the ribosome and inhibition of the protein synthesis thus finally leading to cell death. The expression of *colE3* is under the control of P_{bad} promoter

which is regulated by the protein AraC, encoded by the *araC* gene. The AraC protein demonstrates both negative and positive regulations to *colE3* gene and this mechanism also called “the light switch mechanism” because the arms switch the system on and off (Harmer, Wu et al. 2001). In the absence of L (+) arabinose, the dimeric AraC protein binds to two sites (one is *araO*₂ site and the other is *araI*₁ site) near the promoter P_{bad} and forms a loop that prevents RNA polymerase binding to the *ara* operon promoter, and thereby blocks transcription (Guzman, Belin et al. 1995; Sa-Nogueira and Mota 1997). When arabinose is present, it breaks the *araO*₂-*araI*₁ loop and leads to occupancy at *araI*₁-*araI*₂ site. This process finally activates the P_{bad} promoter and the *ColE3* expression starts leading to the cell death (Lobell and Schleif 1990). Further researches showed that the P_{bad} promoter is highly induced by L (+) arabinose at a concentration of 1% (mass/volume) in the culture media (Qiu 2008). However, in the absence of L(+)-arabinose, the *colE3* gene still has a basal expression (Lee 1980; Lee, Francklyn et al. 1987). This low concentration of colicin still can kill a majority of cells and thus makes the system inefficient. So, in order to counteract the remaining colicine, genetic modification of the host strain was done. The gene *immE3* encoding the protein ImmE3 has been inserted into the host strain chromosome. This immunity E3 protein binds to colicin E3 and inhibits its RNase activity (Masaki and Ohta 1982; Lau, Rowsome et al. 1984; Yajima, Muto et al. 1993). ImmE3 expression is under the control of a constitutive promoter P_{bla}. In normal living cells, ImmE3 binds to the colicin molecules thus enables the cells growing. However, when *colE3* gene is induced by 1% (mass/volume) L (+) arabinose, a huge quantity of colicine is expressed. The quantity of ImmE3 is not sufficient to deactivate the toxic activity of colicin thus leading to cell death. The figure 35 and figure 36 show how these two toxic genes are processing in the host cell. These constructions were accomplished by former PhD student Nathalie Lombard (thesis 2007).

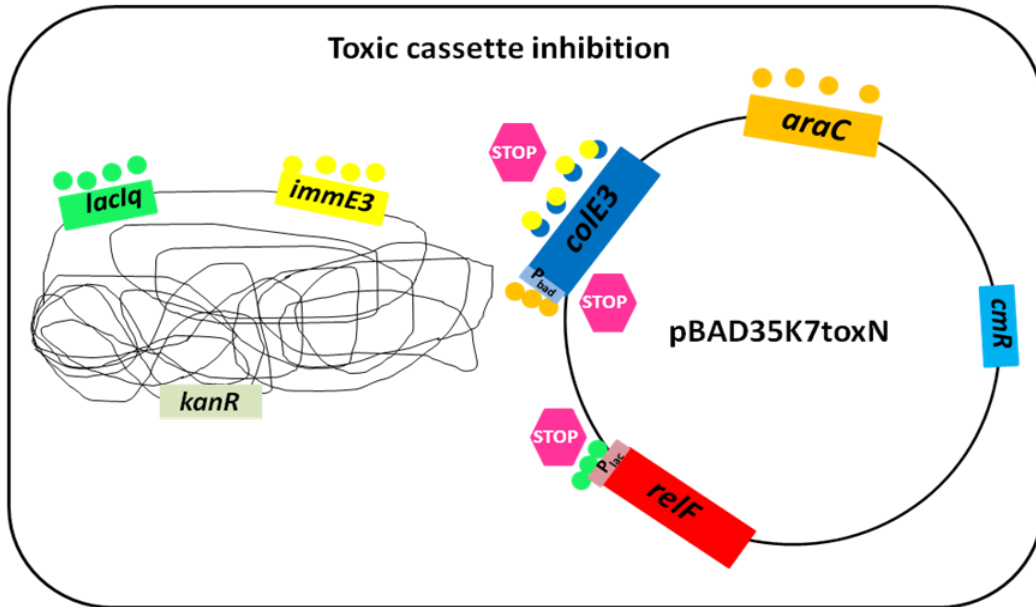

Fig. 35: Regulation of the toxic cassette on pBAD35K7tox plasmid before its induction. AraC protein (orange) binds the P_{bad} promoter of the *colE3* gene (dark blue) thus decreasing the amount of ColE3. Some of the ColE3 proteins that are expressed will be suppressed by ImmE3 (yellow). LacIq gene product (green) inhibits the P_{lac} promoter of *relF* gene.

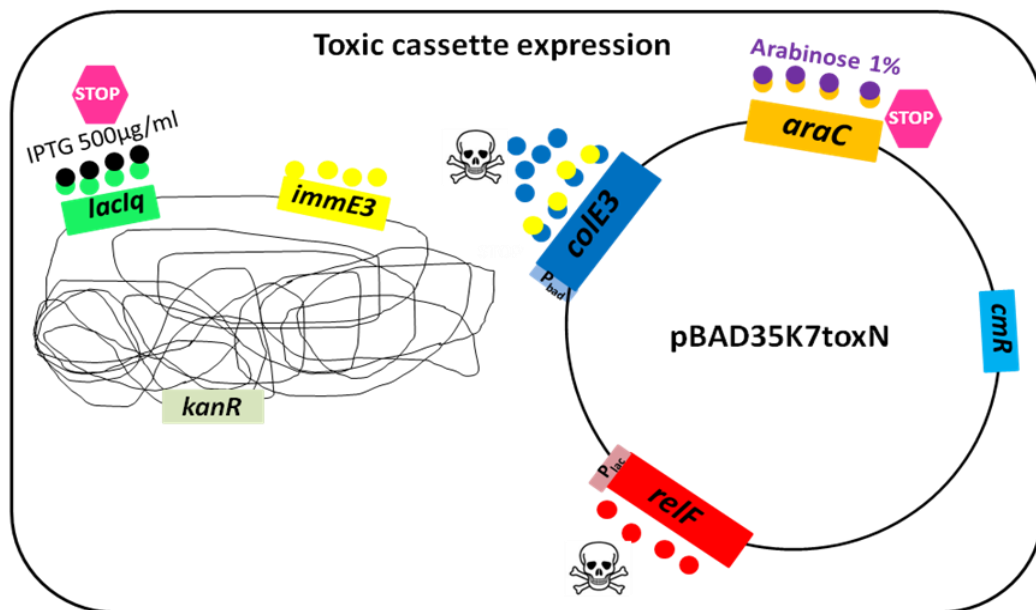

Fig. 36: Regulation of the toxic cassette on pBAD35K7tox plasmid after its induction. IPTG (black) inhibits LacIq thus releases the P_{lac} promoter of the *relF* gene leading to the cell death. L (+) arabinose (purple) at the concentration of 1% (mass/volume) greatly induces the *colE3* expression and also causes the cell death.

2.2.3 Homologous recombination with Lambda-Red system

Court et al (Datta, Costantino et al. 2006) created a low copy number, Red expression vector (pSIM6) with the DNA replication origin of pSC101. This plasmid contains an ampicillin resistance drug marker and occurs in 16 copies per cell (Hashimoto-Gotoh, Franklin et al. 1981) (Fig.37). Genes *gam*, *beta* and *exo* encode proteins Gamma, Beta and Exo respectively. These three genes are under the control of the temperature sensitive *ci857* repressor (Yu, Ellis et al. 2000). When temperature is increased up to 42°C, expression of these three genes starts and enhances the occurrence of homologous recombination. The temperature sensitive replicons of pSIM6 permits curing of plasmids by growing the host strains at 37°C once the expected recombination is confirmed (Datta, Costantino et al. 2006; Sharan, Thomason et al. 2009). It is preferable to use 37°C as the P_L operon remains mostly repressed by *CI857* at this temperature, blocking unwanted Red expression into the host strain (Datta, Costantino et al. 2006).

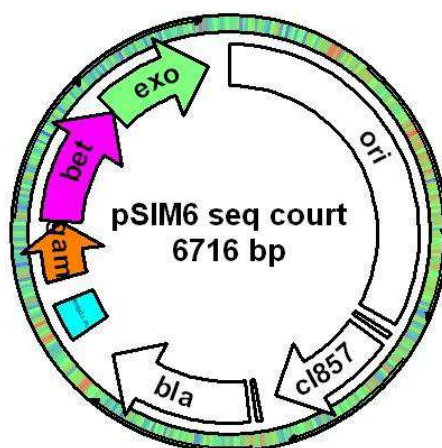

Fig.37: pSIM6 plasmid: three genes *gam*, *bet* and *exo* are under the control of the repressor *ci857*. When the temperature is increased up to 42°C, translation of these three genes will start and enhances the occurrence of homologous recombination.

Source: Datta, Court, Costantino (Datta, Costantino et al. 2006) and N.Lombard.

2.2.4 *bcr* operon

More and more man-made organic compounds and the associated aromatic molecules wastes cause great pressures for environmental conservation and health caring. Thereby, complete degradation of such xenobiotic molecules represents a big challenge. Benzoyl-coenzyme A is established as a central intermediate in the anaerobic biodegradation

pathway of many aromatic compounds such as benzene, toluene, benzoate, aniline and etc (Spormann and Widdel 2000; Carmona, Zamarro et al. 2009). Bacterial Benzoyl-coenzyme A reductases (BCRs) are described as key enzymes in the benzoyl-CoA degradation pathway. Genes coding for Bcr α , β , γ , δ subunits of BCRs are present in the genomes of denitrifying bacteria (*Thauera*, *Azoarcus*, *Magnetospirillum* species) or bacteria displaying an anoxygenic photosynthesis (*Rhodopseudomonas*, *Rhodomicrobium* species)(Boll 2005). However, this kind of BCR enzyme has so far, only been isolated and characterized in the denitrifying, facultative anaerobe *Thauera aromatic* strain K172(Boll and Fuchs 1995). So, *Thauera aromatic* strain could be taken as the model for *bcr* operon and support the Genefish application.

The *bcr* operon in *Thauera.sp* is composed of four genes *bcr c*, *bcr b*, *bcr a* and *bcr d* respectively (Fig.38). This *bcr* operon then was used as the template for for Genefish application.

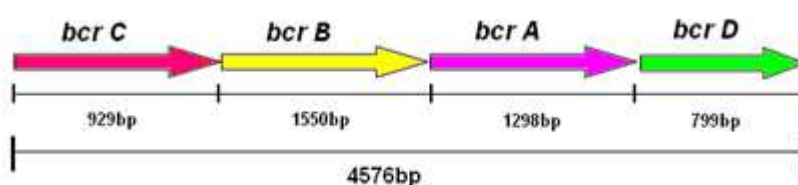

Fig.38: Structure of the *bcr* operon in *Thauera.sp*. Four genes *bcr c*, *b*, *a*, *d* are shown with different colors. The *bcr* operon (gi|19471177|emb|AJ224949.2) is 4576bp in length.

3. Genefish application using *bcr* operon

3.1. Capture plasmid and host strain construction

3.1.1 Materials:

Plasmid pBAD35K7toxN (constructed by Nathalie Lombard) was used for capture plasmid construction, the host strain *E.coli* 14102 (F-lac-3350, galT22, IN (rrnD-rrnE) 1, rpsL179 Δ trp:: [KnR-immE3_lacIq] Δ araBAD, Δ narGnarH) used in this study was constructed and supplied by our collaborator Jean-Claude Lazzaroni (Unité de Microbiologie, Adaptation et pathogénie, UMR5240, Université de LYON, 69622 Villeurbanne cedex, France). Metagenomic DNA from a quinoline degradation bioreactor (partner in Shanghai Jiao Tong University, China) was used as the template for highly conserved *bcr* fragment amplification. Table 5 and 6 present

primers (invitrogen) used for target fragment amplification.

Primer	Sequence of primer 5' to 3'	Tm(°C)	Length of PCR products
bcr c fw-BglIII	GAAGATCTTCGCCTACATGCCGGTAT	60.5	270bp
bcr c rv-PvuI	ATCGATCGGAACATCAGCTTCCACAT	60.4	
bcr a fw-AvrII	ATCCTAGGAAGTCGATCCGCATCAA	59.5	276bp
bcr a rv-HpaI	GCGTTAACATGTTGATCTGCACTTCG	59.5	
bcr d fw-AvrII	TCCTAGGTGACGATCACTGCAGGCAT	63.2	277bp
bcr d rv-HpaI	GCGTTAACATGCGTGGTCATCGAGTAGAA	62.2	
bcr c fw1	GCTTTACGAGGACCTTGATTTTC	53.9	4134bp
bcr d rv1	CATCTTGTAGGTTTCGACCTTG	53.5	
bcr fw s	CGCAAGGTTATCGCCTACAT	54.8	4084bp
bcr rv s	TGGCTGGTCATCTTGTAGGT	54.9	

Table.5: Primers designed to amplify highly conserved sequences of *bcr c*; *bcr a*; *bcr d*; whole *bcr* operon based on the sequence of AJ224949.2 (NCBI). Red bases are the restriction enzyme recognition sites and green bases are the protection bases added to improve the digestion efficiency. Primers for whole *bcr* operon amplification: Primer *bcr c fw1* and *bcr d rv1* are used to amplify the whole *bcr* operon from metagenomic DNA samples. Then primer *bcr fw s* and *bcr rv s* were used to amplify shorter *bcr* operon taking the amplified *bcr* operon as the template for Genefish application.

Primer	Sequence of primer 5' to 3'	Tm(°C)	Length of PCR products
r1 fw2	TGAATGATGTAGCCGTC AAG	52.3	523 bp
r1 rv1	CAGGGCAGGGTCGT TAAATA	53.9	
r2 fw2	AAGAGATTACGCGCAGACCA	56.1	415 bp
r2 rv1	CAGGGCAGGGTCGT TAAATA	56.5	

Table.6: Primers designed to amplify homologous sequences inserted into the capture plasmid. All these primers targeted on the capture plasmid.

3.1.2 Methods:

3.1.2.1 Highly conserved *bcr* fragment sequences determination

Here, we take *bcr c* and *bcr a* as a group, *bcr c* and *bcr d* as the other group (group as the bait for recombination) to construct the capture plasmid. In order to get homologous sequences of *bcr c*, *bcr a* and *bcr d* gene, all sequences from different species of *Thauera.sp* (genera *Thauera* was dominant in metagenomic DNA supplied by our partner in Shanghai) were collected from NCBI and were aligned using the software ClustalX. Selected highly conserved *bcr c*, *bcr a* and *bcr d* were amplified by PCR while adding specific restriction enzyme sites corresponding to the multi-cloning site on plasmid pBAD35K7toxN. The PCR thermal program was set as 95°C for 5 min, followed by 30 cycles at 95°C for 30 s, 60°C for 30 s, and 72°C for 30 s, followed by a final extension performed at 72°C for 5 min and then kept at 15°C. PCR products were verified,

digested by Bstz17I and StuI and purified by illustra GFX PCR DNA and Gel Band Purification Kit before the ligation step (GE Healthcare).

3.1.2.2 Capture plasmid construction

The first step of capture plasmid construction was a double enzyme digestion of *bcr c* fragment and pBAD35K7toxN by using *BglIII* and *PvuI* restriction enzyme (Fermentas). Conditions for *bcr c* and pBAD35K7toxN digestions were as followed: 50 μ l reaction in a DNase-free 500 μ l tube containing 1 μ l of BglII (10U/ μ l) and 1 μ l of PvuI (10U/ μ l), 5 μ l of purified *bcr c* fragment(63ng/ μ l) or 5 μ l of pBAD35K7toxN plasmid (supplied by Laure Franqueville,70ng/ μ l), 10 μ l of 10x Tango Buffer and 33 μ l of double distilled H₂O. The reaction was performed in a 37°C water bath and afterwards the enzymes inactivated at 80°C for 20min. After the digestion reaction, products were verified using agarose gel electrophoresis. The 6360bp fragment of digested capture plasmid then was cut out of the gel and purified for further ligation use. However, the *bcr c* fragment length was about 270 bp and there were no significant changes before and after the digestion. So, the digested *bcr c* fragments were used directly for the next step of ligation.

Ligation between the digested pBAD35K7toxN plasmid and *bcr c* fragment using T4 DNA ligase (Fermentas) was performed as followed: 25 μ l ligation reaction contains 50 ng of vector and a 3-fold molar excess of insert (6 ng), 2.5 μ l of 10-x concentrated ligase buffer, 1 μ l T4 DNA ligase (1U/ μ l), and double distilled H₂O. The ligation was performed at 22°C for 3 hours in water bath.

Then highly conserved sequence *bcr a* or *bcr d* fragment (flanked with restriction enzyme sites) was inserted into the upstream multiple cloning site of the plasmid pBAD35K7toxN-bcrc thus forming two capture plasmids called pBAD35K7toxN-bcrc-a and pBAD35K7toxN-bcrc-d.

3.1.2.3 Host strain construction

The λ Red system is indispensable for our Genefish strategy. In this study, we constructed two types of host strain: one contains plasmid pSIM6 and the other contains both capture plasmid and pSIM6. When we use the former for Genefish application, capture plasmid and target exogenous DNA should be transformed into the host strain together for controlling the copy number of capture plasmid. While only target exogenous DNA was electroporated into the latter host strain, this could simplify the Genefish process.

For the host strain containing plasmid pSIM6: plasmid pSIM6 was transformed into *E.coli* 14102 competent cells. We added carbenicillin (50µg/ml) in culture medium as the selection marker for the pSIM6transformants at 29°C.

For the host strain containing both capture plasmid and pSIM6: the constructed capture plasmid was transformed into pSIM6 containing host strain and the transformants were selected under the pressure of carbenicillin (50µg/ml) and chloramphenicol (50µg/ml).

3.1.2.4 Escape rate test

According to the Genefish design, only recombinants (in which toxic cassette has been replaced by targeted fragment) could survive and be screened. However, uncertain factors may cause mutation or deletion into the toxic gene plasmid sequences and this enable the strain escaping from death after induction. In the Genefish strategy, we define the escape rate as a probability of the host strain to escape from death after the toxic cassette induction. The relationship between total colony, escape rate and recombinant rate are shown in figure 39, by using the strain with a lower escape rate for Genefish application, higher recombinant ratio in survival colony would be screened.

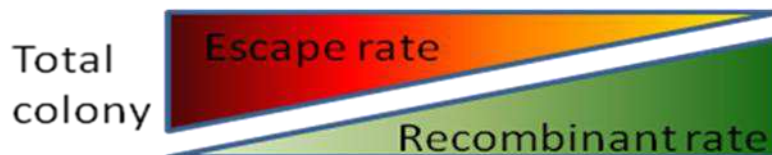

Fig.39: Relationship between total colonies, escape rate and recombinant rate. When the escape rate is high, false positive recombinants ratio in survival total colony would increase and this is undesirable results. Only when we use the strain that has the lowest escape rate, recombinants can predominant in total colony.

3.1.3 Results

3.1.3.1 Highly conserved *bcr* fragment selected for capture plasmid construction

Eight *bcr c* gene sequences were collected from NCBI and the alignment results (table 7, Fig.40) showed a high similarity with few bases difference between those sequences. As the *bcr c* gene has 929 bp in length, part of the alignment results are presented below. These alignment results showed a conserved *bcr c* gene between 6380 bp and 6740 bp of original sequence AJ224949.2.

Reference	Source
gi 62468033 gb AY946872.1	<i>Thauera selenatis</i> strain AX putative benzoyl-CoA reductase (<i>bcrC</i>) gene, partial cds
gi 62468031 gb AY946871.1	<i>Thauera aromatica</i> strain T1 putative benzoyl-CoA reductase (<i>bcrC</i>) gene, partial cds
gi 62468029 gb AY946870.1	<i>Thauera chlorobenzoica</i> strain 4FB2 putative benzoyl-CoA reductase (<i>bcrC</i>) gene, partial cds
gi 62468027 gb AY946869.1	<i>Thauera chlorobenzoica</i> strain 4FB1 putative benzoyl-CoA reductase (<i>bcrC</i>) gene, partial cds
gi 62468025 gb AY946868.1	<i>Thauera aromatica</i> strain 3CB3 putative benzoyl-CoA reductase (<i>bcrC</i>) gene, partial cds
gi 62468023 gb AY946867.1	<i>Thauera aromatica</i> strain 3CB2 putative benzoyl-CoA reductase (<i>bcrC</i>) gene, partial cds
gi 62468021 gb AY946866.1	<i>Thauera chlorobenzoica</i> strain 3CB1 putative benzoyl-CoA reductase (<i>bcrC</i>) gene, partial cds
gi 19471177 emb AJ224949.2	<i>Thauera aromatica</i> korB, korA, had, oah, dch, <i>bcrC</i> , <i>bcrB</i> , <i>bcrA</i> and <i>bcrD</i> genes and ORFs

Table 7: Eight sequences of *bcr c* gene got from NCBI. The last sequence with reference AJ224949.2 is a whole operon involved in the benzoyl-CoA degradation pathway.

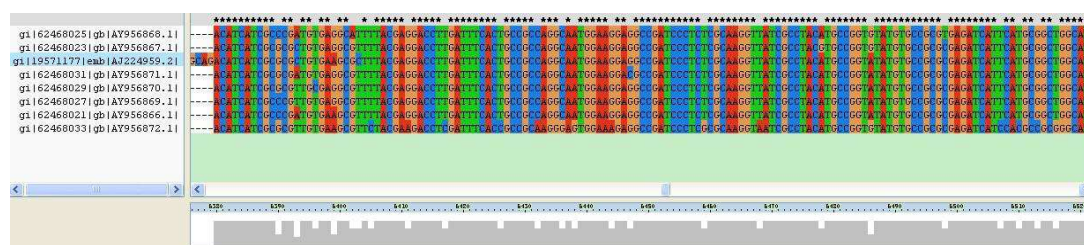

Fig.40: Alignment of the eight *bcr c* gene of *Thauera sp* collected in the table 7. The left titles are the reference of each sequence and the bases are in different colors. The homologous sequences of *bcr c* gene start from the 6380bp site of the sequence AJ224949.2.

For the *bcr a* gene, nine sequences were collected from NCBI and alignment results (table 8 and Fig.41) also showed that *bcr a* gene was highly conserved between 9770 bp and 10150 bp of original sequence AJ224949.2.

Reference	Source
gi 62468127 gb AY946857.1	<i>Thauera selenatis</i> strain AX putative benzoyl-CoA reductase (<i>bcrA</i>) gene, partial cds
gi 62468125 gb AY946856.1	<i>Thauera aromatica</i> putative benzoyl-CoA reductase (<i>bcrA</i>) gene, partial cds
gi 62468123 gb AY946855.1	<i>Thauera aromatica</i> strain AR1 putative benzoyl-CoA reductase (<i>bcrA</i>) gene, partial cds
gi 62468121 gb AY946854.1	<i>Thauera chlorobenzoica</i> strain 4FB2 putative benzoyl-CoA reductase (<i>bcrA</i>) gene, partial cds
gi 62468119 gb AY946853.1	<i>Thauera chlorobenzoica</i> strain 4FB1 putative benzoyl-CoA reductase (<i>bcrA</i>) gene, partial cds
gi 62468117 gb AY946852.1	<i>Thauera aromatica</i> strain 3CB3 putative benzoyl-CoA reductase (<i>bcrA</i>) gene, partial cds
gi 62468115 gb AY946851.1	<i>Thauera aromatica</i> strain 3CB2 putative benzoyl-CoA reductase (<i>bcrA</i>) gene, partial cds
gi 62468113 gb AY946850.1	<i>Thauera chlorobenzoica</i> strain 3CB1 putative benzoyl-CoA reductase (<i>bcrA</i>) gene, partial cds
gi 19471177 emb AJ224949.2	<i>Thauera aromatica</i> korB, korA, had, oah, dch, bcrC, bcrB, bcrA and bcrD genes and ORFs

Table 8: Nine sequences of *bcr a* gene get from NCBI. The last sequence with a reference AJ224949.2 is a whole operon involved in the benzoyl-CoA degradation pathway.

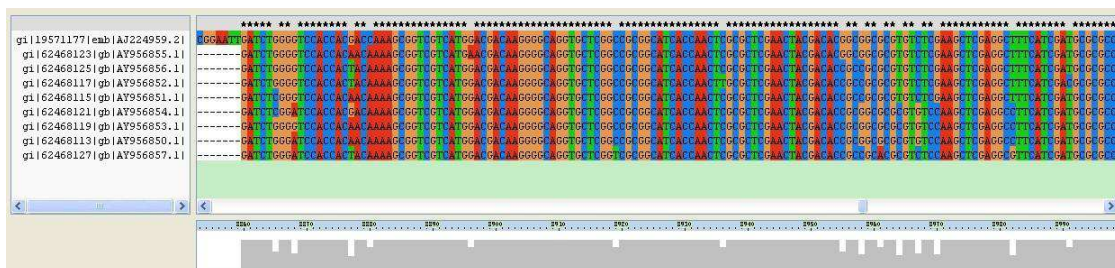

Fig.41: Alignment of the nine *bcr a* genes of *Thauera.sp* collected in the table 8. The left titles are the reference of each sequence and the bases are in different colors. The homologous sequences of *bcr a* gene start from the 8860bp site of the sequence AJ224949.2.

For the *bcr d* gene, nine sequences were collected from NCBI and alignment results (table 9 and Fig.42) also showed that *bcr d* gene was conserved between 10160 bp and 10520 bp of original sequence AJ224949.2.

Reference	Source
gi 62468143 gb AY946865.1	<i>Thauera selenatis</i> strain AX putative benzoyl-CoA reductase (<i>bcrD</i>) gene, partial cds
gi 62468141 gb AY946864.1	<i>Thauera aromatica</i> putative benzoyl-CoA reductase (<i>bcrD</i>) gene, partial cds
gi 62468139 gb AY946863.1	<i>Thauera aromatica</i> strain AR1 putative benzoyl-CoA reductase (<i>bcrD</i>) gene, partial cds
gi 62468137 gb AY946862.1	<i>Thauera chlorobenzoica</i> strain 4FB2 putative benzoyl-CoA reductase (<i>bcrD</i>) gene, partial cds
gi 62468135 gb AY946861.1	<i>Thauera chlorobenzoica</i> strain 4FB1 putative benzoyl-CoA reductase (<i>bcrD</i>) gene, partial cds
gi 62468133 gb AY946860.1	<i>Thauera aromatica</i> strain 3CB3 putative benzoyl-CoA reductase (<i>bcrD</i>) gene, partial cds
gi 62468131 gb AY946859.1	<i>Thauera aromatica</i> strain 3CB2 putative benzoyl-CoA reductase (<i>bcrD</i>) gene, partial cds
gi 62468129 gb AY946858.1	<i>Thauera chlorobenzoica</i> strain 3CB1 putative benzoyl-CoA reductase (<i>bcrD</i>) gene, partial cds
gi 19471177 emb AJ224949.2	<i>Thauera aromatica</i> korB, korA, had, oah, dch, <i>bcrC</i> , <i>bcrB</i> , <i>bcrA</i> and <i>bcrD</i> genes and ORFs

Table 9: Nine sequences of *bcr d* genes got from NCBI. The last sequence with a reference AJ224949.2 is a whole operon involved in the benzoyl-CoA degradation pathway.

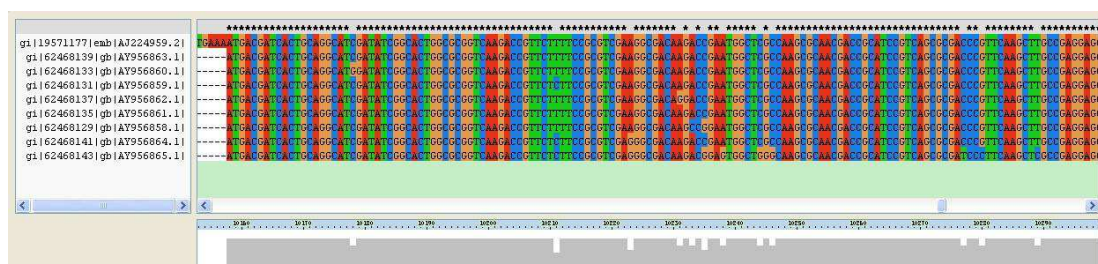

Fig.42: Alignment of the nine *bcr d* genes of *Thauera.sp* collected from table 9. The left titles are the reference of each sequence and the bases are in different colors. The homologous sequences of *bcr d* genes start from the 10160 bp site of the sequence AJ224949.2.

According to the alignment results, the most conserved sequences of *bcr c*, *bcr a* and *bcr d* genes from *Thauera sp.* were confirmed. Six restriction enzyme digestion sites in multi-cloning sites were screened on the conserved *bcr c*, *bcr a* and *bcr d* gene sequences. Results showed *bcr d* gene contains a *StuI* and two *PstI* restriction enzyme sites and conserved *bcr c* and *bcr a* do not

show those restriction enzyme sites mentioned above. Finally, BglII and PvuI restriction enzyme were chosen for the downstream multiple cloning site digestion. AvrII and HpaI restriction enzyme for the upstream multiple cloning site digestion. All sequences were amplified by PCR using primers described in table 5.

3.1.3.2 Capture plasmid construction

According to the capture plasmid construction method (Fig.43), two capture plasmids pBAD35K7toxN-bcra-a and pBAD35K7toxN-bcra-d were constructed and the inserted highly conserved sequences were verified by sequencing.

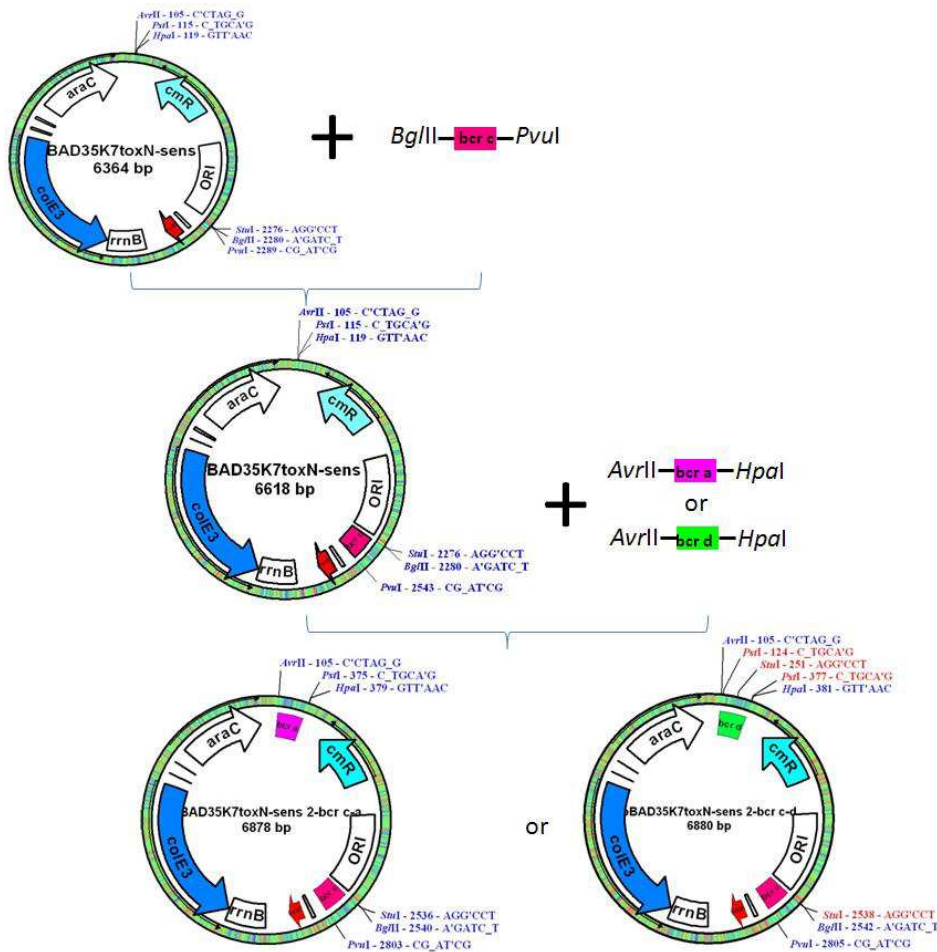

Fig.43: Overview of the capture plasmids construction. Our original plasmid pBAD35K7toxN was used as the substrate for capture plasmids construction. Highly conserved sequence *bcr c* was first inserted into the downstream multiple cloning site. The highly conserved sequence *bcr a* or *bcr d* then was inserted to the constructed plasmid pBAD35K7toxN-bcra respectively leading to the construction of two types of capture plasmid for Genefish application.

3.1.3.3 Host strain construction and escape rate test

Constructed capture plasmid were transformed into host strain *E.coli* 14102. Three colonies each of the constructed host strain *E.coli* 14102 pBAD35K7toxN-bcrc-a-9,-11,-13 and pBAD35K7toxN-bcrc-d-1,-3,-7 were selected for escape rate test (protocol see annex 3). According to the escape rate results, colony pBAD35K7toxN-bcrc-a-13 and pBAD35K7toxN-bcrc-d-7 were chosen as the best strain for further Genefish explorations.

ER Ara		ER Ara	
pBAD35K7toxN-bcrc-a-9	2.6E-07	pBAD35K7toxN-bcrc-d-1	8.5E-06
pBAD35K7toxN-bcrc-a-11	4.0E-07	pBAD35K7toxN-bcrc-d-3	1.9E-06
pBAD35K7toxN-bcrc-a-13	9.3E-07	pBAD35K7toxN-bcrc-d-7	2.6E-06
ER IPTG		ER IPTG	
pBAD35K7toxN-bcrc-a-9	9.5E-05	pBAD35K7toxN-bcrc-d-1	2.2E-03
pBAD35K7toxN-bcrc-a-11	1.3E-04	pBAD35K7toxN-bcrc-d-3	4.2E-03
pBAD35K7toxN-bcrc-a-13	6.7E-05	pBAD35K7toxN-bcrc-d-7	1.1E-03
ER Ara and IPTG		ER Ara and IPTG	
pBAD35K7toxN-bcrc-a-9	1.3E-08	pBAD35K7toxN-bcrc-d-1	4.2E-08
pBAD35K7toxN-bcrc-a-11	2.5E-09	pBAD35K7toxN-bcrc-d-3	9.8E-08
pBAD35K7toxN-bcrc-a-13	2.3E-08	pBAD35K7toxN-bcrc-d-7	3.3E-08

a

Total bacteria pBAD35K7toxN- bcr-a-9,-11,-13	Dilutions	-4	-5	-6	Dilutions	-4	-5	-6	Dilutions	-4	-5	-6
	9(CFU/plate)	740	77	58	11(CFU/plate)	3200	89	79	13(CFU/plate)	398	46	13
	1ml dilution 0	7.40E+07	7.70E+07	5.80E+08	1ml dilution 0	3.20E+08	8.90E+07	7.90E+08	1ml dilution 0	3.90E+07	4.60E+07	1.30E+08
	Mean			7.50E+07	Mean			4.00E+08	Mean			4.30E+07
Total bacteria pBAD35K7toxN- bcr-d-1,-3,-7	Dilutions	-4	-5	-6	Dilutions	-4	-5	-6	Dilutions	-4	-5	-6
	1(CFU/plate)	113	19	4	3(CFU/plate)	15	9	2	7(CFU/plate)	175	12	6
	1ml dilution 0	1.10E+07	1.90E+07	4.00E+07	1ml dilution 0	1.50E+06	9.00E+06	2.00E+07	1ml dilution 0	1.70E+07	1.20E+07	6.00E+07
	Mean			2.30E+07	Mean			1.00E+07	Mean			2.90E+07
Arabinose	Dilutions	0	-1	Dilutions	0	-1	Dilutions	0	-1			
	9(CFU/plate)	0	1	11(CFU/plate)		8	13(CFU/plate)	0	2			
	1ml dilution 0		2.00E+01	1ml dilution 0		1.60E+02	1ml dilution 0		4.00E+01			
	Mean		2.00E+01	Mean		1.60E+02	Mean		4.00E+01			
Arabinose	Dilutions	0	-1	Dilutions	0	-1	Dilutions	0	-1			
	1(CFU/plate)	0	10	3(CFU/plate)	0	1	7(CFU/plate)	0	4			
	1ml dilution 0		2.00E+02	1ml dilution 0		2.00E+01	1ml dilution 0		8.00E+01			
	Mean		2.00E+02	Mean		2.00E+01	Mean		8.00E+01			
IPTG	Dilutions	-1	-2	Dilutions	-1	-2	Dilutions	-1	-2			
	9(CFU/plate)	104	4	11(CFU/plate)	760	33	13(CFU/plate)	28	3			
	1ml dilution 0	1.00E+04	4.00E+03	1ml dilution 0	7.60E+04	3.30E+04	1ml dilution 0	2.80E+03	3.00E+03			
	Mean		7.20E+03	Mean		5.40E+04	Mean		2.90E+03			
IPTG	Dilutions	-1	-2	Dilutions	-1	-2	Dilutions	-1	-2			
	1(CFU/plate)	496	55	3(CFU/plate)	392	47	7(CFU/plate)	264	40			
	1ml dilution 0	4.90E+04	5.50E+04	1ml dilution 0	3.90E+04	4.70E+04	1ml dilution 0	2.60E+04	4.00E+04			
	Mean		5.20E+04	Mean		4.30E+04	Mean		3.30E+04			
Arabinose and IPTG	Dilutions	0	Dilutions	0	Dilutions	0						
	9(CFU/plate)	0	11(CFU/plate)	0	13(CFU/plate)	0						
	1ml dilution 0		1ml dilution 0		1ml dilution 0							
	Mean	1.00E+00	Mean	1.00E+00	Mean	1.00E+00						
Arabinose and IPTG	Dilutions	0	Dilutions	0	Dilutions	0						
	1(CFU/plate)	0	3(CFU/plate)	0	7(CFU/plate)	0						
	1ml dilution 0		1ml dilution 0		1ml dilution 0							
	Mean	1.00E+00	Mean	1.00E+00	Mean	1.00E+00						

Table 10: Escape rate (ER) results of *E.coli* strain 14102, pBAD35K7toxN-bcr-a-9,-11,-13 and pBAD35K7toxN-bcr-d-1,-3,-7 in table a; table below shows the counting results in the test.

3.2. Genefish tool application

3.2.1 Materials

E. coli 14102 pBAD35K7toxN-bcrc-a-13 and pBAD35K7toxN-bcrc-d-7 were chosen as the host strain for the Genefish application. Two different types of target *bcr* genes (*bcr c-a* 3617 bp and *bcr c-d* 4084 bp) were used as the donor of targeted fragments to test the Genefish capacity for capturing different length of target fragment. Primers R1rv1 (5'-CAGGGCAGGGTCGTTAAATA-3') and R2fw2 (5'-AAGAGATTACGCGCAGACCA-3') were used to verify positive recombinants. This pair of primers was used to amplify the region located between conserved targeted sequences of the capture plasmid. PCR products of positive recombinants and pBAD35K7toxN-bcrc-d were 4290 bp and 4945 bp in length respectively. In order to confirm the insertion of targeted exogenous fragment in the recombinants, seven groups of primers were designed targeted on the *bcr* operon (Table 11).

Region	Primers	Sequence of primer 5' to 3'	Annealing temperature(°C)
Zoom 1	rct fw 1-2	GCAGACCAAAAACGATCTCA	57.7
	rct rv 1-2	CCAGGTAGTCCTTCAGCATC	
Zoom 2	rct fw 2-2	GGTCGAAGAGCACAACCAG	57.9
	rct rv 2-2	TTGATGACTTCAGGGTTGGT	
Zoom 3	rct fw 3-2	TGCCCTACATCTCGTTCAA	57.4
	rct rv 3-2	CGCCGAGTTCCTTCAGGTATT	
Zoom 4	rct fw 4-2	CGCCACGAATACAAGTGC	58.6
	rct rv 4-2	CAAGGTCGGTCTCGATGAA	
Zoom 5	rct fw 5-2	CTCGATCAAGAGCTGCAACA	59.5
	rct rv 5-2	TTCACCGATCTGCATGAAGC	
Zoom 6	rct fw 6-2	GAAGAGGCGGACAAGCTTTT	59.5
	rct rv 6-2	TTGATGCGGATCGACTTGGT	
Zoom 7	rct fw 7-2	AACATGGGTCTGCACGAACT	58.7
	rct rv 7-2	TTGACTACCGAAGCAGTGT	

Table 11 and fig.44: PCR primers designed to confirm positive recombinants.

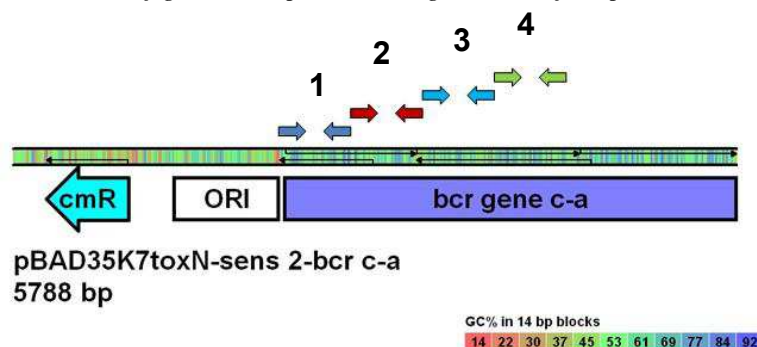

3.2.2 Methods:

According to the Genefish strategy, former PhD student Samuel Jacquiod did some tests (Thesis defence 11/2012). However, results showed recombinants cannot be easily screened (low number of recovered recombinants) because each cell contains 15-30 copies of capture plasmid. Because of this, only the host cell contains all recombinated capture plasmids can survive after the toxic cassette induction otherwise the toxicity expressed by non-recombined plasmid could still kill the cell. To deal with this situation is to strictly control the copy number between capture plasmid and host strain during the homologous recombination. Two methods called co-electroporation and plasmid segregation were used in this study.

3.2.2.1 Co-electroporation

The aim of this strategy was to simultaneously transform the capture plasmid and the target DNA fragment into pSIM6 containing host strain. During the transformation, mole ratio between capture plasmid and the host strain were strictly controlled as 1:1. Fig.45 shows the process of co-electroporation.

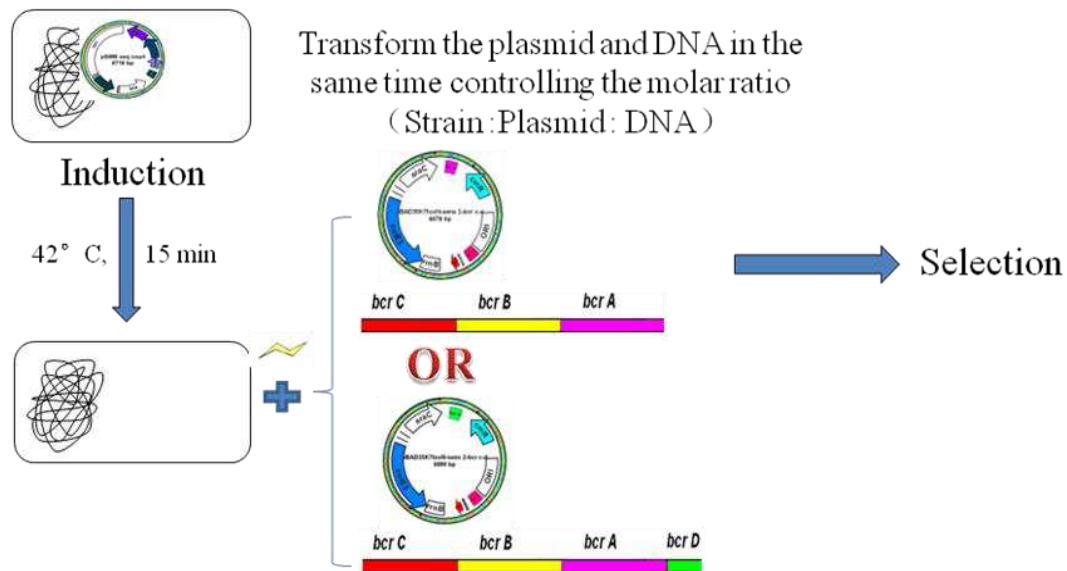

Fig.45: co-electroporation process used in our study. The host strain containing pSIM6 is induced at 42°C for 15min. Then, the mix of capture plasmid and target DNA is co-electroporated into the competent cells by controlling their mole ratio.

3.2.2.2 Plasmid segregation

Firstly, target DNA fragments were transformed into the host strain containing pSIM6 and the capture plasmid. Then, after the transformation, total plasmids (reservoir of recombined or non-recombined plasmids) were extracted. In the last step, plasmids mixture were transformed into plasmid-free host strain while controlling the molar ratio (1:1) between plasmid mixture (copy number) and competent cells (number) (Fig.46).

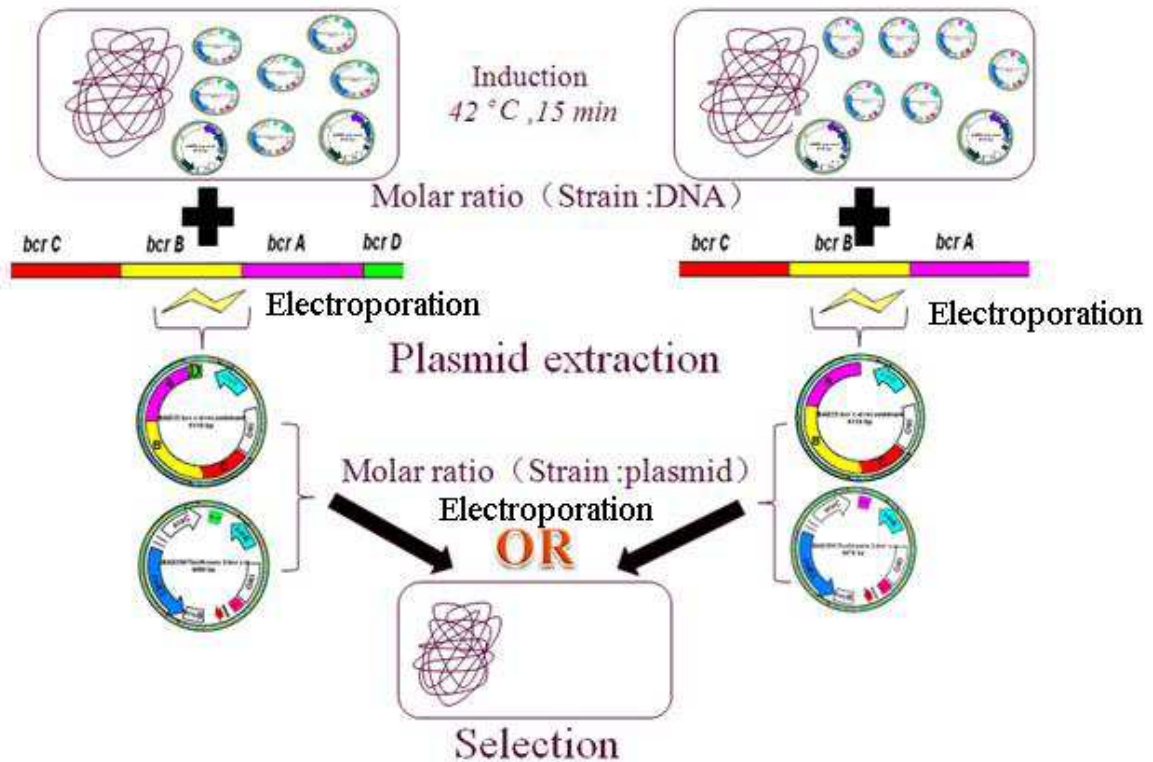

Fig.46: plasmid segregation process. Target DNA is electroporated into capture plasmid and pSIM6 containing competent cells. The plasmid pool of transformants are extracted and used as the substrate for a second run of electroporation.

3.2.3 Results.

3.2.3.1 Co-electroporation by using bcr c-d fragment

Results obtained with co-electroporation (annex 4) showed that the total number of colony including transformed plasmid decreased when more target DNA were used (table 12-a). In the dilution of 10^{-2} , only 16 colonies of ratio 1:1:5 grew in the CM containing medium. The total number of survival colony decrease when using the ratio 1:1:10 for co-electroporation (6 colonies and no colony grew in the dilution of 10^{-2} and 10^{-3}). So, decreasing the quantity of DNA fragment for the co-electroporation may generate more colonies and this will also eliminate the risk of electro sparks during the electroporation. Only one colony grew using the Lambda Red activated competent cells while there was also one colony growing in the negative control (table 12-b).

Further co-electroporation experiments using the ratio 1:1:0.5, 1:1:1, 1:1:2, 1:0.5:0.5, 1:0.5:1 and 1:0.5:2. Table 7 shows the recombination experiment results.

Mole ratio (strain:plasmid:DNA)	Total colony in each dilution			Mole ratio (strain:plasmid:DNA)	Recombinants	
	10^{-2}	10^{-3}	10^{-4}		42°C(activated)	29°C(inactivated)
1:1:0 (No CM, with Kn)	++	++	++	1:1:5(Cm+IPTG+Ara)	0	0
1:1:5 (No CM, with Kn)	++	++	++			
1:1:10 (No CM, with Kn)	++	++	++			
1:1:5 (CM with Kn)	16	5	0			
1:1:10 (CM with Kn)	6	0	0	1:1:10(Cm+IPTG+Ara)	1	1

a

b

Table 12: total number of colonies (a) and potential recombinants (b) after co-electroporation. Colony screened in the medium without CM stand for competent cells survival after electroporation. While colony screened with CM means capture plasmid was well transformed. However, among these colonies, only 1 colony may be recombinant (table b)

Copy control (cell: plasmid:DNA)	Total colony after toxic cassette induction		
	Repeat 1(colony)	Repeat 2(colony)	Repeat 3(colony)
1:1:5	0		
1:1:10	1		
1:1:0.5		1	0
1:1:1		9	5
1:1:2		7	4
1:0.5:0.5		3	13
1:0.5:1		0	10
1:0.5:2		6	5
Total colony	1	26	37

Table 13: co-electroporation results using bcr c-d fragments. All these transformants will be verified in the following step.

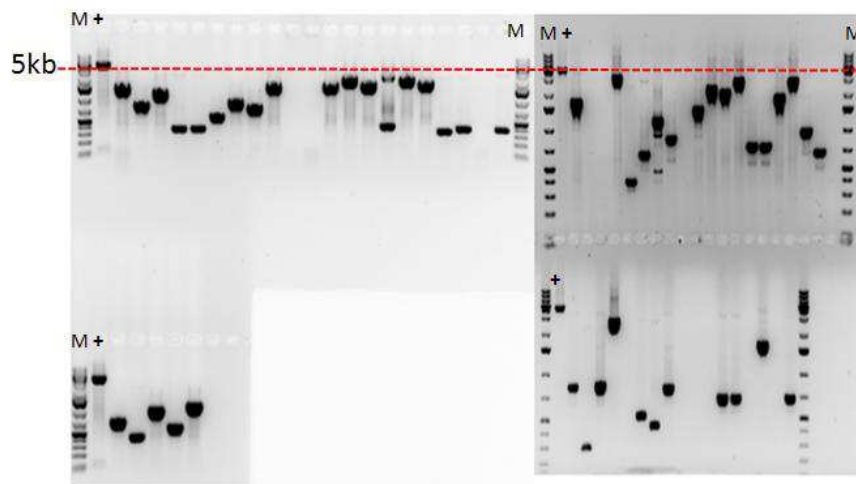

Fig.47 (left) and Fig.48 (right): Gel electrophoresis of colony PCR products screened after selection. M and + stand for 1kb plus DNA marker and positive control (PCR products of plasmid pBAD35K7toxN-bcr-c-d).

After PCR verification (Fig.47 and 48), none of grown colonies were positive recombinants. The size of PCR products showed multiple differences in length (table 14). As we have mentioned, the positive recombinants should have a PCR products around 4290bp long. These results told us that most of the capture plasmid deleted the toxic cassette to escape from the death thus generate the PCR products with different size.

Mole ratio (cell:plasmid:DNA)	No PCR products	PCR Products 1-1000bp	1000-2000bp	2000-3000bp	3000-4000bp	4000bp -	Total
1:1:5							0
1:1:10	1						1
co-electroporation with ratio 1:1:0.5, 1:1:1, 1:1:2, 1:0.5:0.5, 1:0.5:1, 1:0.5:2	3	13	7	3	1		26
	10	16	5	5			37

Table 14: distribution of PCR amplified fragments. Positive recombinants have a 4290bp PCR product while all those transformants have shorter PCR products patterns.

3.2.3.2 Plasmid segregation by using pBAD35K7toxN-bcrc-d

At last, more than 674 colonies (table 15) were obtained (annex 5) and the 94 colonies from mole ratio condition 1:0.5(1:2) and 1:0.5(1:4) were selected for recombinants verification using colony PCR (Fig 49). The mole ratio (1:2) means the strain: plasmid (extracted from condition of 1:0.5 in the first round electroporation). Mole ratio 1:0.5(1:2) contains two parts, the first part 1:0.5 means mole ratio between strain and plasmid. Then the plasmid was extracted and taken as the source of recombinant plasmid for the second round of electroporation.

Mole ratio (strain : DNA)	Mole ratio (strain : Plasmid)	colony
1:0.5	1:0.5	63
	1:1	++
1:1	1:0.5	49
	1:1	++
1:2	1:0.5	54
	1:1	207
1:4	1:0.5	40
	1:1	261
total		674++

Table 15: transformants screened using plasmid segregation protocol. More than 674 colonies were captured, + mean colonies contaminated. 94 colonies in green were selected for colony PCR verification.

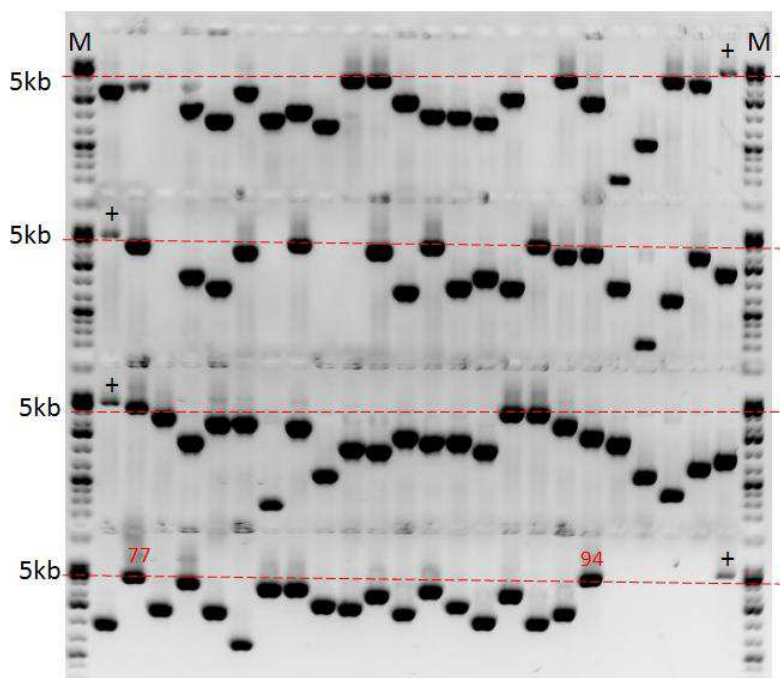

Fig. 49: Colony PCR products gel electrophoresis, M and + mean 1kb plus DNA marker and positive control (pBAD35K7toxN-bcrc-d) respectively. PCR products of positive recombinants and pBAD35K7toxN-bcrc-d were 4290 bp and 4945 bp in length.

Colonies 77 and 94 may be positive recombinants as their PCR products are close to the expected size. So far, the plasmid segregation seems to work better than co-electroporation because more transformants were screened and this gave more opportunity to screen positive recombinants. Primer group 1-4 (PCR products room 1-4, see Fig. 44) were used to amplify the target sequence in potential recombinants 77 and 94 (Fig.50).

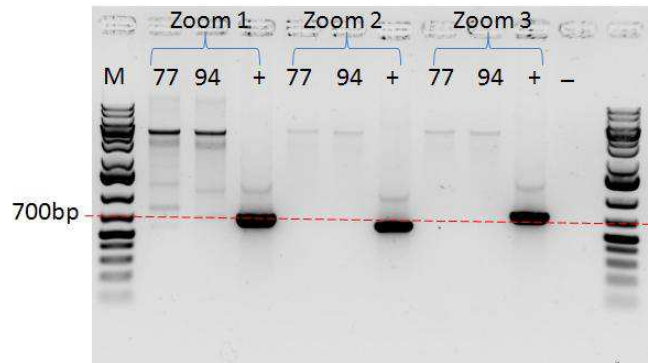

Fig.50: Specific PCR used to amplify captured bcr operon fragment. Three groups of primers were used and + stands for the positive PCR products size of captured colony pBAD35K7toxN-bcrc-a D8. 77 and 94 were supposed recombinants candidates. Lane M and – are 1kb plus DNA marker and negative control respectively. After the gel electrophoresis, colony 77 and 94 did not show predicted band signal.

Former colony PCR results showed colonies 77 and 94 have positive band signal and they were considered as positive recombinants, but no predicted band signal were detected using *bcr* operon targeted primers (group 1-4). Finally, colonies 77 and 94 were false positive recombinants.

3.2.3.3 Plasmid segregation by using pBAD35K7toxN-bcrc-a

330 transformants were screened (table 16) and these colonies were first verified by colony PCR.

Copy control (strain : DNA)	Copy control (strain :Plasmid)	colony
1:0.5	1:0.5	13
	1:1	47
1:1	1:0.5	37
	1:1	77
1:2	1:0.5	48
	1:1	76
1:4	1:0.5	13
	1:1	19
Total		330

Table 16: colonies screened after plasmid segregation using plasmid pBAD35K7toxN-bcrc-a.

Because too many colonies were verified by gel electrophoresis, only recombinant candidates were presented here in Fig 51.

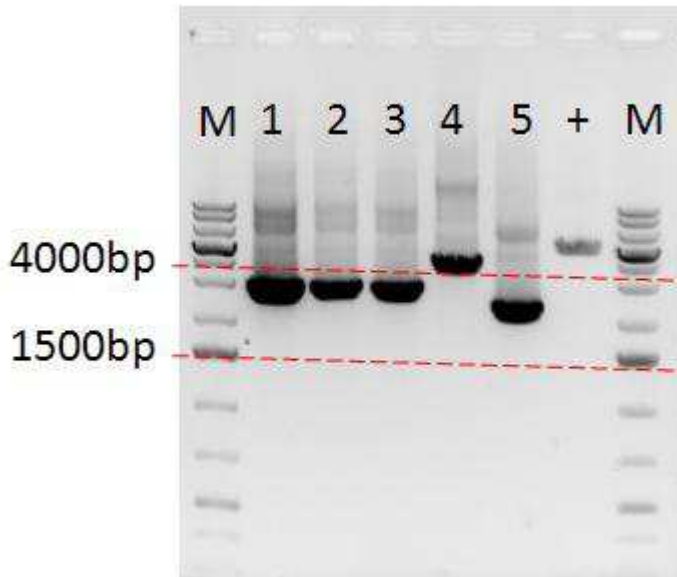

Fig.51: gel verification of colony PCR products. M and + mean the 1kb plus DNA marker and positive control pBAD35K7toxN-bcrc-a. From these five colonies (1-5) are colony D11, D12, G5, D8 and F9 respectively, colony D8 has the appropriate size of PCR product.

Colony D8 was chosen and verified by primers group 1-4(table 10). Results shown colony D8 has all positive signals in the agarose gel. All amplified four fragments were sequenced and compared with the whole *bcr* operon and the alignment results show they match 99.9%. There are few mismatches but this indicated colony D8 was a recombinant by using the new tool Genefish with pBAD35K7toxN-bcrc-a.

3.3. Genefish improvements

From the results of both co-electroporation and plasmid segregation, false positive recombinants account for a large proportion in survival total colony. All transformants captured using pBAD35K7toxN-bcrc-d were false positive and only one positive recombinant was captured in 330 transformants. Among those false positive recombinants, toxic cassette in capture plasmid was deleted in varying degrees which were testified by PCR products sequencing (thesis Samuel Jacquiod 11/2012). It is unusual to get so many false positive recombinants even if the strain we used has the lowest escape rate.

3.3.1. Materials

Capture plasmids pBAD35K7toxN-bcrc-a and pBAD35K7toxN-bcrc-d, host strain *E.coli* 14102 containing plasmid pSIM6 and In-Fusion HD Cloning Kit (Clontech) were used.

Single-copy number plasmid pJEL250 (Masai, Kaziro et al. 1983; Valentin-Hansen 1986) was supplied by Jean-Claude Lazzaroni (Fig.52). The pJEL250 contains the ORI region from plasmid R1, the gene encoding the replication initiation protein (repA1), genes parAB (Bagdasarian, Lurz et al. 1981) coding for ParA-ParB (partitioning proteins), and other copy number controlling genes copAE. All those genes are under the control of the thermosensitive CI857 repressor, each cell contains one copy of pJEL250 when the culture temperature is less than 37°C. Primer Bstz-pJEL250 fw: tgtatacGCTGCGGTAAGTCGCATAAA, StuI-pJEL250 rv: aaggcctAGATCGTTACCCGCCAA ACA were used for single copy number capture plasmid construction through classical digestion and ligation. Primer Infusion fw: TTGGAACCTCTTACGTGGCTGCGGTAAGTCGCATAAA and primer Infusion rv: GGCGAAGATCTAGGCCTAGATCGTTACCCGCCAAACA were used to amplify targeted sequences on plasmid pJEL250. Each 5' end of primer contains 15bp (underlined) homologous to one end of digested capture plasmid.

Fig.52: presentation of the single-copy number plasmid pJEL250. All copy number controlling genes are marked out in arrows (From Laure Franqueville).

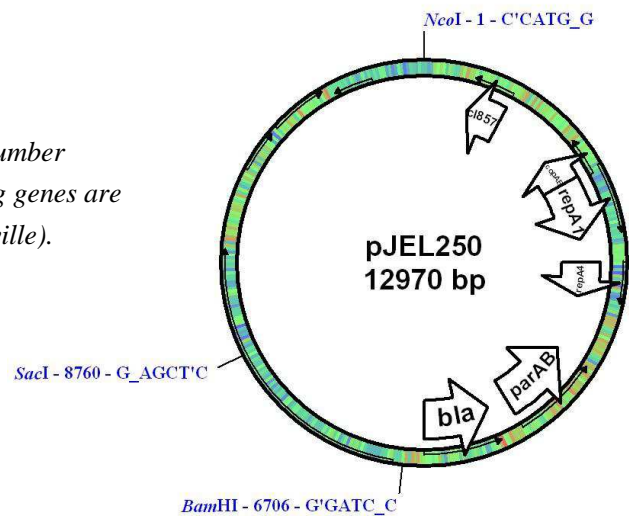

3.3.2 Methods:

3.3.2.1 Improvement of co-electroporation and plasmid segregation efficiency through culture time decrease

According to the process of co-electroporation and plasmid segregation (fig.53), long culture time of the host strain may be the factor causing the toxic cassette deletion. Especially during the process of large amount capture plasmid preparation. This is a key step because the prepared capture plasmid will be used as the substrate for co-electroporation and plasmid segregation. If

the capture plasmid delete toxic cassette during the culture, transformed plasmids will cause the emergence of false positive recombinants.

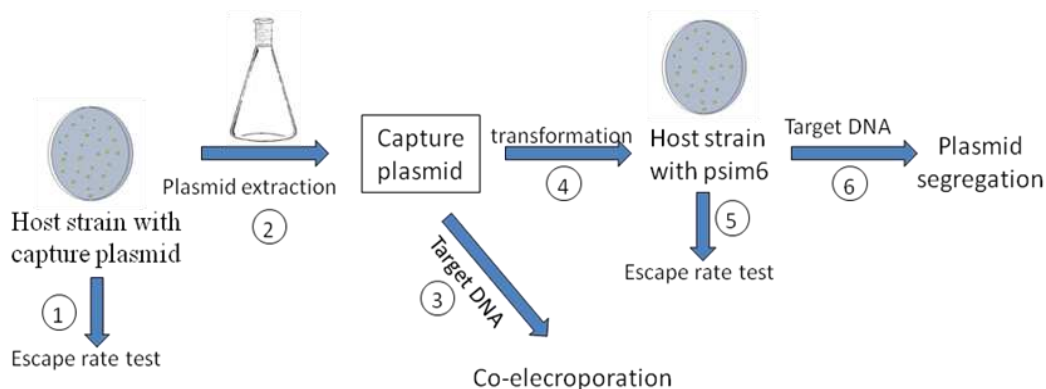

Fig.53: Over-view of the Genefish process in this study. Host strain with capture plasmid is chosen according to its low escape rate. Then this strain is cultivated more than 10 hours for plasmid extraction. The extracted capture plasmid (marked into square) will be used as the substrate for co-electroporation and plasmid segregation.

During plasmid preparation process, starter culture (overnight host strain pre-cultured) was taken as the inoculum for large scale culture of host strain as quick as possible. But after long time culture, cells consumed the nutrients from the medium and accumulated secondary metabolites especially in the starter culture. Moreover, toxic cassette has a basal expression and toxicity in the culture medium will accumulate during strain growth. In order to resolve this conflict, host strain needs to regulate the balance between growth and toxic protein accumulation. Thus deleting the toxic cassette of capture plasmid seems to be an effective strategy.

Decreasing the culture time may also decrease or even avoid the false positive recombinants in transformants. Starter culture step was canceled but enriched medium SOB was used to improve the growth of the host strain. Capture plasmids pBAD35K7toxN-bcrc-a and pBAD35K7toxN-bcrc-d were freshly prepared through this new strategy. The host strain was transformed again by using those freshly prepared capture plasmid to improved co-electroporation and plasmid segregation.

3.3.2.2 Single-copy plasmid construction

As described before, the capture plasmid in this study has 15-30 numbers of copies per cell. This argues the co-electroporation and plasmid segregation strategy. However, the fundamental solution would be to construct a single-copy capture plasmid. Single-copy capture plasmid could simplify the experiments and also increase the recombinant detection rate. In this single-copy

plasmid construction, the plasmid should contain the toxic cassette, the highly conserved sequences from capture plasmid and the system responding to single-copy number plasmid phenotype. In order to construct a single-copy plasmid, the ORI of our capture plasmid should be replaced by the single-copy regulation system including the ORI region from pJEL250 (Masai, Kaziro et al. 1983; Valentin-Hansen 1986). Finally, three strategies were employed to construct single-copy number capture plasmid.

3.3.2.2.1 Classical digestion and ligation

In this strategy, it is needed to construct the vector and PCR fragment with the same restriction enzyme sites at each end. As the plasmid pJEL250 contains the *BsaAI* restriction enzyme site in the expected PCR fragment (Fig.54). So, *Bstz17I* and *StuI* were chosen for restriction enzyme digestion. The double enzyme digestion of plasmid pBAD35K7toxN-bcrc-a was done by using *Bstz17I* and *StuI*. 50 μ l digestion reactor contains 0.5 μ l of *StuI* (10U/ μ l), 1 μ l of *Bstz17I* (5U/ μ l), 10 μ l of capture plasmid pBAD35K7toxN-bcrc-a (110ng/ μ l), 5 μ l of 10 \times NE buffer 4 (Biolabs) and 33.5 μ l of double distilled H₂O. The reaction was performed in a 37 $^{\circ}$ C water bath and inactivates the enzymes at 80 $^{\circ}$ C for 20min.

For PCR amplification of the expected fragment, primer Bstz17I-pJEL250 fw and primer stuI-pJEL250 rv were used. The PCR thermal program was set as 95 $^{\circ}$ C for 5 min, followed by 30 cycles at 95 $^{\circ}$ C for 30 s, 60 $^{\circ}$ C for 30 s, and 72 $^{\circ}$ C for 5min, followed by a final extension performed at 72 $^{\circ}$ C for 5 min and then kept at 15 $^{\circ}$ C. PCR products were verified, digested by *Bstz17I* and *StuI* and purified by illustra GFX PCR DNA and Gel Band Purification Kit (GE Healthcare) before the ligation step. 25 μ l ligation reaction system contains 5 μ l 5x ligation buffer, 4 μ l linearized vector (14.4ng/ μ l), 6.2 μ l PCR fragment (23.5ng/ μ l), 2 μ l T4 ligase enzyme (5U/ μ l), 2 μ l PEG4000 and 5.8 μ l double distilled H₂O. Chemical calcium chloride transformation method was tested.

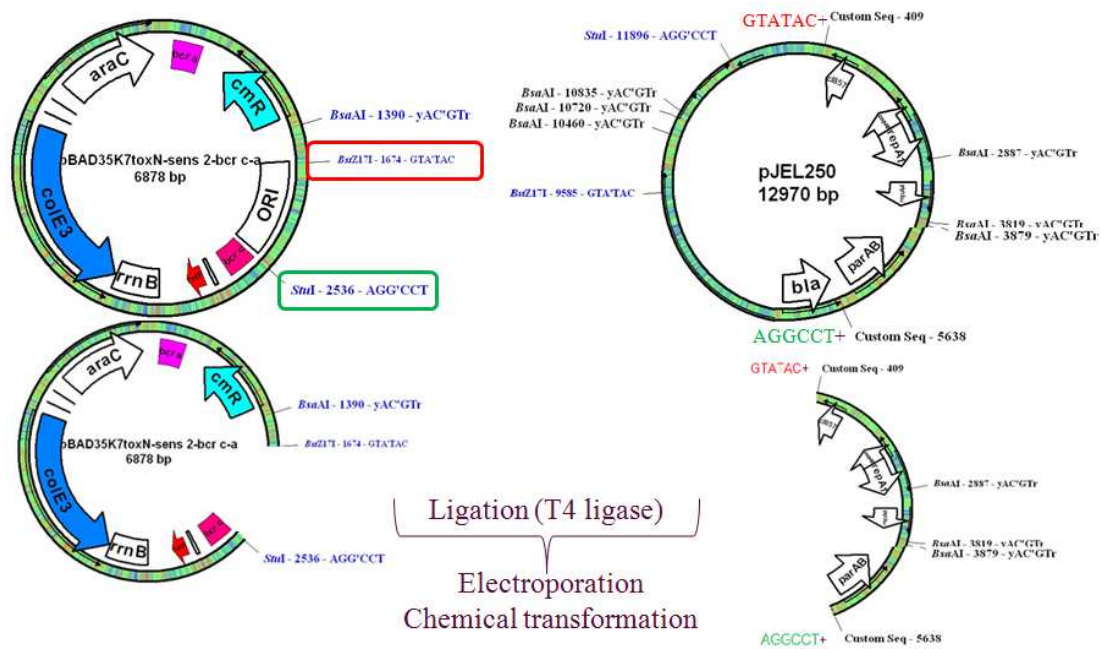

Fig.54: overview of classical digestion and ligation protocol for single copy Genefish plasmid.

3.3.2.2.2 In-Fusion HD Cloning Kit method

In-Fusion HD Cloning Kit (Clontech) was involved in this new capture plasmid construction (Fig.55). This kit is designed for fast, directional cloning of one or more fragments of DNA into a vector. The cornerstone of In-Fusion Cloning technology which is Clontech's proprietary In-Fusion Enzyme, which fuses DNA fragments e.g. PCR-generated sequences and linearized vectors, efficiently and precisely by recognizing a 15 bp overlap at their ends. This 15 bp overlap can be engineered by designing primers for amplification of the expected sequences. In-Fusion HD Kits offer increased cloning efficiency, especially for longer fragments, short oligonucleotides, and multiple fragments.

The double enzyme digestion of plasmid pBAD35K7toxN-bcr-c-a was done by using *BsaAI* and *StuI*. 50µl digestion reaction contains 0.5µl of *StuI* (10U/µl), 1µl of *BsaAI* (5U/µl), 10µl of capture plasmid pBAD35K7toxN-bcr-c-a (110ng/µl), 5µl of 10× NE buffer 4(Biolabs) and 33.5µl of double distilled H₂O. The reaction was performed in a 37°C water bath and enzymes were inactivated at 80°C for 20min. The digested products then were verified by agarose gel electrophoresis. The targeted digested fragments contained two fragments, one was about 1146bp and the other was about 5732bp. The 5732bp fragment then was extracted from agarose gel and purified by Nucleo Spin Extract II (Macherey N).

Primer Infu fw and Infu rv were used to amplify targeted pJEL250 fragment flanked by 15bp homologous sequences corresponding to the capture plasmid at each end. The PCR thermal program was set as follow: 95°C for 5 min, followed by 30 cycles at 95°C for 30 s, 60°C for 30 s, and 72°C for 5min, followed by a final extension performed at 72°C for 5 min and then kept at 15°C. Advantage HD Polymerase Mix (Clontech) was used for the PCR reaction. The PCR product were verified and purified by NucleoSpin Extract II kit (Macherey-Nagel). Concentration of purified PCR and capture plasmid products was tested by using Qubit dsDNA BR Assay Kit (Invitrogen). 25µl ligation reaction system contains 5 µl 5x ligation Buffer, 4 µl linearized vector (14.4ng/µl), 6.2 µl PCR fragment (23.5ng/µl), 2µl T4 ligase enzyme (5U/µl), 2µl PEG4000 and 5.8µl double distilled H₂O. Chemical calcium chloride transformation method was tested.

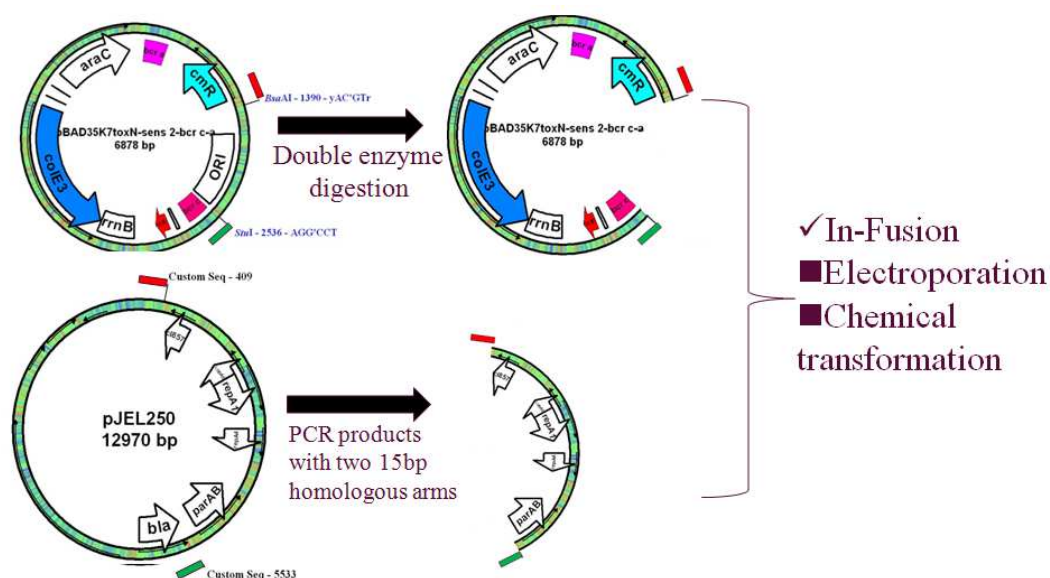

Fig.55: schema presenting the structure of capture plasmid pBAD35K7toxN-bcr c-a and pJEL250 and the In Fusion cloning. The sequences between cmR and bcr c gene contain three unique restriction enzyme digestion sites BsaAI, Bstz171 and StuI. While three BsaAI digestion sites exist in targeted fragment of pJEL250. So, Bstz171 and StuI sites were chosen for In-Fusion cloning method.

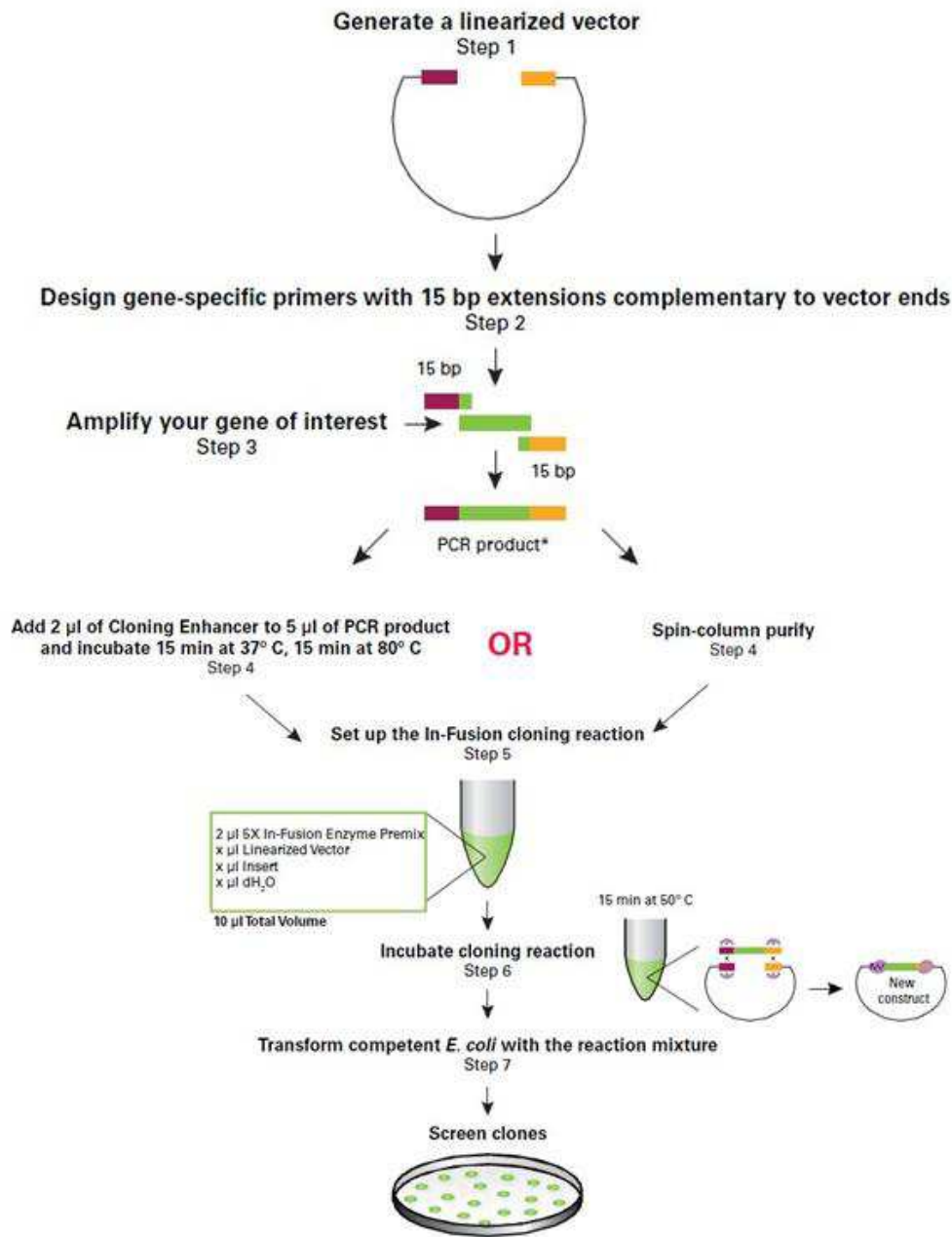

Fig.56: *In-Fusion HD* protocol overview used for single copy capture plasmid construction (from *In-Fusion Clontech*).

3.3.3 Results:

3.3.3.1 Improved co-electroporation

The results of improved co-electroporation are shown in table 17. The transformants containing capture plasmid pBAD35K7toxN-bcrc-a and pBAD35K7toxN-bcrc-d in the ratio of 1:1:1(strain: plasmid: DNA) was about 3.0×10^3 and 9.0×10^3 respectively. While in the control

condition 1:1(strain:plasmid), about 9.5×10^3 and 3.0×10^4 transformants containing capture plasmid pBAD35K7toxN-bcrc-a and pBAD35K7toxN-bcrc-d respectively were screened. Comparing the transformants screened by Cm (50 μ g/ml) between the condition 1:1 and 1:1:1, when exogenous DNA was added for recombination, 2/3 of transformants were lost. The total number of competent cells after the transformation was about 2.88×10^6 and 4.34×10^6 respectively. Although there was no colony growing in the plates after the induction of toxic genes, this strategy was a great improvement as it decreased the false positive recombinants proportion.

pBAD35K7toxN-bcrc-a						
Mole ratio	With Cm (50 μ g/ml)			With kn(25 μ g/ml)		
	10^{-2}	10^{-3}	10^{-4}	10^{-2}	10^{-3}	10^{-4}
1:1(strain: plasmid)	9	1	0	2891	316	26
1:1:1(strain: plasmid: DNA)	3	0	0			
pBAD35K7toxN-bcrc-d						
Mole ratio	With Cm (50 μ g/ml)			With kn(25 μ g/ml)		
	10^{-2}	10^{-3}	10^{-4}	10^{-2}	10^{-3}	10^{-4}
1:1(strain: plasmid)	21	4	0	4274	296	58
1:1:1(strain: plasmid: DNA)	8	1	0			

Table17: results of co-electroporation using improved pBAD35K7toxN-bcrc-a and pBAD35K7toxN-bcrc-d plasmid preparation.

3.3.3.2 Improved plasmid segregation

For the plasmid segregation, newly prepared capture plasmid was transformed into the host strain containing pSIM6. After the liquid activation and escape rate test, colony pBAD35K7toxN-bcrc-a a1 (escape rate 2.4E-08) and pBAD35K7toxN-bcrc-d b3 (escape rate 1.1E-09) were chosen for plasmid segregation.

The mole ratio (1:1, 1:2 and 1:4) between competent cells and targeted fragment were used in the first round electroporation, each condition repeated 4 times to enrich the plasmid. For the second round of electroporation, the plasmid mixture (both recombinants and non-recombinants) was transformed into *E.coli* 14102, host strain with a mole ratio 1:1 and 1:2(competent cells:

plasmid). Results are shown in table 18 and 54 colonies were obtained.

Mole ratio (strain : DNA)	Mole ratio (strain :Plasmid)	colony
1:1	1:1	19
	1:2	10
1:2	1:1	3
	1:2	6
1:4	1:1	8
	1:2	8
total		54

Table 18: results from improved plasmid segregation using *pBAD35K7toxN-bcrc-a*.

Condition 1:2:1 (green) was taken as the control for total transformants and total cells counting after the electroporation. For this condition, 2.3×10^7 cells were screened under kanamycine selection and only 600 transformants contained the capture plasmid (screened under chloramphenicol selection). Among those 600 transformants, only 3 colonies escaped from death after the induction of the toxic cassette with IPTG and arabinose.

All 54 transformants were verified by colony PCR, two colonies might be positive recombinants because they generated the same PCR products size comparing to recombinant D8 (sequenced positive recombinant). But after the specific PCR which aimed at amplifying recombined *bcr* fragment, they were found as cheaters (Fig.57). Similar results also obtained after improved plasmid segregation, 64 transformants were screened. Three colonies showed the same colony PCR products size comparing to the positive recombinant. But after PCR verification, none of them were recombinants (gel not shown).

PCR products zoom 1 of colony a2 and a3 were sent for sequencing. Sequences were aligned to the original capture plasmid *pBAD35K7toxN-bcrc-a*, and results showed that the sequences between 3000 bp and 3900 bp of the capture plasmid were deleted. This deleted region contains the *relF* and *rrnB* gene. After deletion, colony escaped from death and generated the similar positive colony PCR products size.

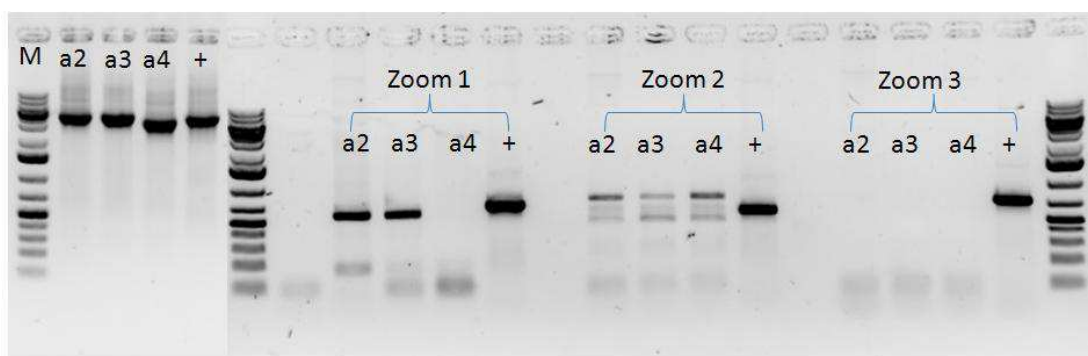

Fig.57: two colonies a2, a3 may be positive recombinants according to their colony PCR products (left), a4 is taken as a negative control. After the specific PCR which uses three group primers to amplify inserted *bcr* operon, none of them are positive recombinants. + is the positive control (*pBAD35K7toxN-bcrc-a* recombinant colony D8).

Because too much dsDNA transformed into competent cells usually cause sparks during electroporation and lead low survival rate of host strain. In previous electroporation, not too much target dsDNA was transformed for recombination, maximal dose was about 60ng. However, more dsDNA electroporated into the competent cells could increase the rate of recombination. So, when large amount dsDNA were used for electroporation, other cuvettes from cell projects were employed to avoid the sparks.

In the plasmid segregation experiments, 250 ng of target dsDNA *bcr-c-a* gene were transformed into its corresponding competent cells. Here, a negative control: electroporation without target dsDNA was done. Negative control plasmids were also transformed into *E.coli* competent cells during the second round of electroporation. After the selection, 29 colonies and 15 colonies grew in the selection plates respectively (table 19). 15 colonies obtained in the negative control, while no targeted fragments were transformed in this control which means those colonies contain capture plasmid deleted from their toxic cassette. This also indicated the culture time (around 10 hours) for capture plasmid and pSIM6 containing strain was still too long. The other 29 colonies were verified by colony PCR, and results showed that 2 positive recombinants were captured (Fig.58 and 59). *bcr c-d* gene was also taken as the substrates for plasmid segregation, but no recombinants were captured in 26 captured colonies.

Repeats	First	Second	Third	total
Plasmid segregation(colony)	12	12	5	29
Negative control(colony)	12	3	0	15

Table 19: colonies screened after the improved plasmid segregation using *pBAD35K7toxN-bcrc-a*

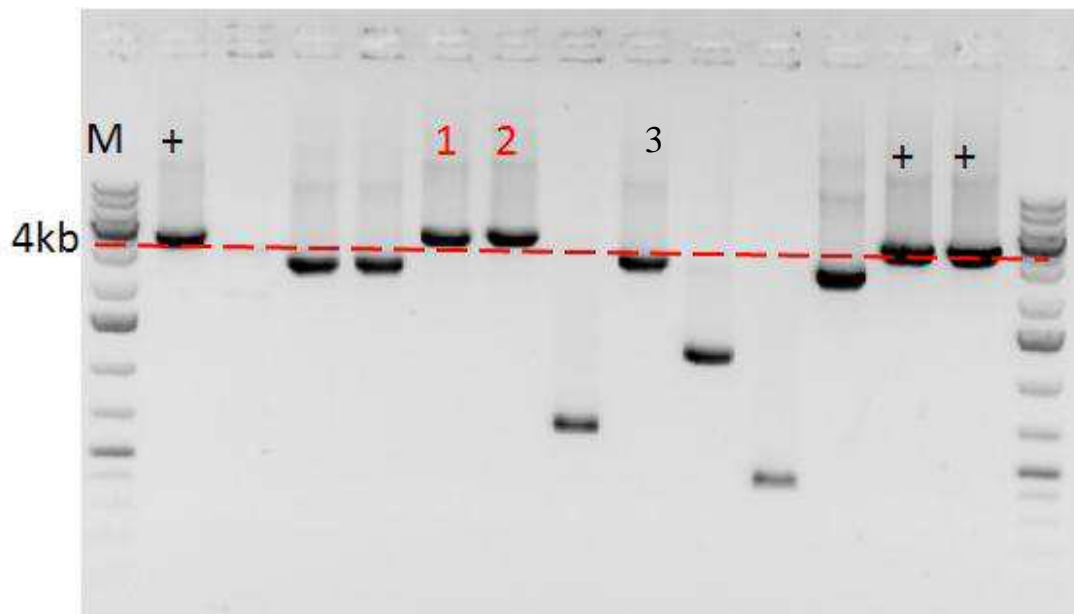

Fig.58: gel electrophoresis of colony PCR products using plasmid segregation. M and + mean the 1kb plus DNA marker and positive control (colony recombinant D8). 1 and 2 show the positive recombinants.

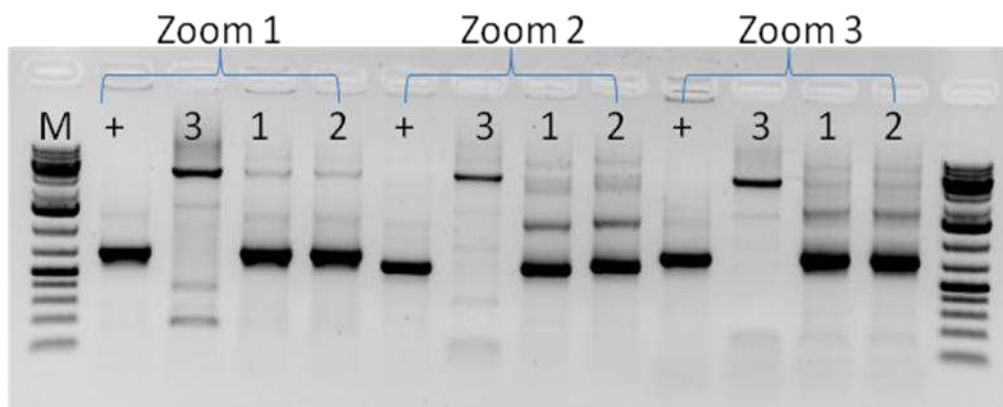

Fig.59: colonies verification by bcr operon specific PCR. Zoom 1, 2 and 3 are fragments amplified using group 1, 2 and 3 primers. After this verification, we can see colonies 1 and 2 are positive recombinants as they show the positive signal of bcr operon products.

3.3.3.3 single-copy capture plasmid construction

Classic ligation and In-Fusion method were tested to construct the single-copy plasmid

After three repeat, no expected colony grows in the plates using the In-Fusion and classical ligation samples (table 20).

	Positive control In-Fusion	Capture plasmid	Plasmid pJEL250	In-Fusion sample	In-Fusion sample	Classic ligation sample	Classic ligation sample
quantity	1µl	1ng	1ng	2µl	4µl	2µl	4µl
Colony (CFU)	92	124	106	--	--	--	--
	51	168	47	--	--	--	--
	72	127	68	--	--	--	--

Table 20: results of classical ligation and novel In-Fusion method after the chemical transformation.

Although the In-Fusion HD Cloning Kit enables us to fusion targeted linearized vectors and PCR products, but the In-Fusion Kit seems works not very well with our substrates. The reason might be the long target fragment used in this study. Long insert decreases the efficiency of ligation and might also decrease the efficiency of the In-Fusion process.

In order to explain this low In-Fusion efficiency, we tried to confirm the existence of expected single-copy plasmid in the In-Fusion products. The transformation efficiency of our host strain was also investigated. Primers R1fw2 (TGAATGATGTAGCCGTC AAG), R2rv1 (CAGGGCAGGGTCGTAAATA) were used to amplify the inserted target fragment of In-Fusion products. If there was expected single-copy plasmid, the PCR products should be longer than using template of pBAD35K7toxN-bcrc-a. But no PCR products were detected using In-Fusion products which mean the In-Fusion reaction didn't work. Transformation efficiency of our host strain was tested by using plasmid pBAD35K7toxN-bcrc-a, and the optimized efficiency was 10^6 cfu/µg. But the protocol of In-Fusion kit requires a transformation efficiency of at least 10^8 cfu/µg.

4. Conclusions and Discussion

Genefish tool aims to capture targeted gene or DNA fragment from metagenomic DNA. This tool depends on the λ Red recombination system and toxic cassette induction which will cause phenotype difference between recombinants and non-recombinant cells. In the frame of the development of Genefish, it is essential to test each unit involved in the tool such as (1) the genetic modification of host strain; (2) escape rate of the host strain containing capture plasmid; (3) efficiency of λ Red system inducing homologous recombination when using different sizes of targeted sequence or highly conserved sequences.

First studies developed by Nathalie Lombard during her PhD (Thesis 2007), were focused on the construction of the toxic cassette system which contains two suicide genes (*colE3* and *relF*) and the validation of host strain that already described above (section host strain construction and toxic cassette). Then Laure Franqueville tested the efficiency of λ Red system for homologous recombination: the pSIM6 was chosen to achieve chromosome recombination. The results showed homologous recombination efficiency was around 10^{-4} (recombinants/competent cell) (supplied by Laure Franqueville).

So, the Genefish system was established and the aim of my work was to test the capacity and limitations of Genefish. The capture plasmid containing two highly conserved sequences was constructed and transformed into the host strain containing the pSIM6 plasmid. Targeted exogenous DNA was transformed into the best host strain (with the lowest escape rate) containing both the capture plasmid and pSIM6. However, this direct transformation strategy (original Genefish strategy) was not suitable because the capture plasmid has about 15 copies in each cell and the λ Red system was not sufficient to recombine all plasmid. So, the residual capture plasmid in the transformants would lead to cell death after the toxic cassette induction. We finally lost the recombinants and also failed to capture the targeted fragments.

Strategy co-electroporation and plasmid segregation were applied to overcome this problem. However, only one recombinant in 330 obtained transformants was screened. The recombination efficiency was too low and there were too many false positive recombinants deleting their toxic cassette spontaneously. Analysis indicated the large number of false positive recombinants would be caused during the capture plasmid preparation.

New strategy was figured out to decrease the culture time at each culture step and the capture plasmid was re-extracted from the culture (culture time was decrease from 10 hours to 7 hours and 30 minutes). After the improvement, promising results after co-electroporation and plasmid segregation experiments showed that most of false positive recombinants were eliminated. No recombinant (either false positive or positive) grew using co-electroporation strategy. When using plasmid segregation strategy, less false positive recombinants grew but two recombinants in 29 obtained transformants were screened. The positive recombinant ratio was improved from $1/330 \approx 0.3\%$ to $2/29 \approx 7\%$ (positive recombinant/total transformants) after decreasing the culture time for the Genefish application.

Although positive recombinants rose by controlling mole ratio between cells and capture plasmids, but the process was too complicated to manage. Three strategies (classical digestion and ligation, In-Fusion, two In-Fusion steps), two transformation protocols (electroporation and chemical transformation) were applied to construct the single-copy number capture plasmid. However, no expected single-copy number capture plasmid was constructed. The reason might be the low transformation efficiency of our host strain, the optimized efficiency got was 10^6 cfu/ μ g; While the protocol of In-Fusion kit required a transformation efficiency at least 10^8 cfu/ μ g.

Anyway, Genefish system was constructed, and up to 7% (2 positive recombinnats in 29 total colonies) succeeds in capturing *bcr* c-a sequences *in vitro*. Positive recombinants ratio was increased by decreasing the culture time at each culture step, using co-electroporation and plasmid segregation. However, the homologous recombination efficiency is still too low (10^{-9}); only 2 recombinants were screened using about 10^9 competent cells. This recombinant's capture efficiency was still too low to capture targeted fragments in environment samples.

Why the homologous recombination efficiency is so low? This was caused by the low copy number capture plasmid. Although we counted the mole ratio between host strain and plasmid, but the number of strain cell cannot be precisely defined. We used empirical value 10^9 cells in 1ml (OD600=1) *E.coli* culture for Genefish application. Hence, inaccurate number of host strain cells may probably affects the Genefish efficiency. However, series of mole ratio tests showed no significant difference. So, three reasons could be summarized here: 1) the plasmid-plasmid system for homologous recombination, 2) uncertain model of λ Red homologous recombination, 3) inappropriate capture plasmid structure for recombination.

The λ Red homologous recombination system has been broadly used in bacterial genetic engineering, such as the chromosome modification (Mizoguchi, Tanaka-Masuda et al. 2007; Feher, Karcagi et al. 2008; Lesic 2008; Yamamoto, Izumiya et al. 2009), plasmid modification (Yosef, Bloushtain et al. 2004; Thomason, Costantino et al. 2007; Song, Dong et al. 2010), and bacterial artificial chromosome modification (Court, Swaminathan et al. 2003; Zhang and Huang 2003; Warming S 2005; Hollenback, Lyman et al. 2011). Two optimal λ Red system used for those modifications are summarized by Donald L.Court (Sharan, Thomason et al. 2009): For bacterial chromosome or BAC DNA modification, mobile recombineering systems like the pSIM vectors, mini- λ or the replication-defective λ phage (λ TetR) can be introduced into the bacterial cells to be engineered. When high or low copy plasmids have to be manipulated, bacterial strains containing the prophage recombination system on the chromosome (e.g DY380 and its derivatives like SW102) should be used. However, in this study, the mobile recombineering system pSIM6 was applied to modify the low copy capture plasmid. This plasmid-plasmid mode (recombination on plasmid and was induced by mobile recombineering systems pSIM6) maybe the reason caused low recombination efficiency. The recombination efficiency using pSIM6 plasmid to modify bacterial chromosome has been validated by Laure Franqueville already whiles the plasmid-plasmid recombination efficiency in this study remained too low. In order to exclude the effect of low copy capture plasmid in our toxic cassette system selection, a target fragment containing antibiotic resistance operon (like tetracycline) could be used to test the plasmid-plasmid recombination efficiency. During the recombinants selection step, two rounds selection could be used to confirm whether the low recombination results were caused by the plasmid-plasmid system or by the low copy number of capture plasmid. The first round selection: add tetracycline in mediums (only recombinants containing the *tet* gene can survive) to select recombinants. This would reveal the homologous recombination efficiency by using “plasmid-plasmid system”. Second round selection: re-select recombinants that have been captured during the first round by IPTG, Ara and tet containing mediums. If we get high efficiency after first round selection and low efficiency after the second round selection, this means toxic cassette selection system in plasmid-plasmid recombination system is not suitable and the single-copy number capture plasmid will be the potential solution. If we get low efficiency in first round selection, this means “plasmid-plasmid system” maybe not suitable for

our Genefish tool.

Although the λ Red recombination system is commonly used, the detailed mechanism by which lambda Red mediates double-stranded DNA recombination remains uncertain. The general theory of λ Red recombination occurs during the DNA replication. Because DNA polymerase is able to add free nucleotides only to the 3' end of the newly forming strand, this results in elongation of the new strand in a 5'-3' direction. The leading strand is the template strand for new complementary strand synthesis in 5' to 3' direction corresponding to the movement of the replication fork. The lagging strand is the complementary strand of leading strand in the original sequence, because the movement of replication fork is opposite to the working orientation of DNA polymerase, replication of the lagging strand is slower than that of the leading strand. On the lagging strand, primase "reads" the DNA and adds RNA to it in short, separated segments, RNA primers are removed by 5'-3' exonuclease activity of polymerase I and replaces the RNA nucleotides with DNA nucleotides (Nosikov, Braga et al. 1976). DNA ligase joins the fragments together at last, while the homologous recombination especially the 3' overhang of target dsDNA will invade the complementary site on lagging strand.

So far, there are three λ Red homologous recombination mechanisms which are already described in the introduction chapter. The Court mechanism (Fig.25) generates crossover junctions after the homologous recombination and this structure would be resolved by unspecified *E. coli* enzymes (Court DL 2002). Poteete et al (Poteete 2008) proposed another mechanism in which one recombinant DNA is generated but one copy of original chromosome or plasmid would remain (Fig.26). Recently, J.A.Mosberg et al (Mosberg, Lajoie et al. 2010) proposed a simpler λ Red homologous recombination mechanism, in which dsDNA recombination mediated by Lambda Red proceeds via a ssDNA intermediate (Fig.27). However, one original copy of chromosome or plasmid still remains. So, if the λ Red homologous recombination mechanism is exactly as Poteete or J.A.Mosberg said, original capture plasmid will be retained after recombination. After toxic cassette induction, transformants will be killed even if they recombined. This may be the critical reason of low homologous recombinants recovery. So, one copy of capture system (on the plasmid or chromosome) in each cell may solve the problem. But, construct a single copy plasmid containing capture plasmid in this study has been proved difficult (in chapter "Genefish improvements").

An other hypothesis could be considered: capture plasmid used in this study is 6880 bp taking pBAD35K7toxN-bcrc-d for example (Fig.60). The two highly conserved sequences *bcr c* and *bcr d* are closed to the ORI region of the plasmid. The *bcr c* fragment is just separated in few base pairs from the plasmid replication ORI site which means the replication fork will pass and finish the replication of the *bcr c* region within a short time. This inappropriate site of highly conserved sequences could decrease the invasion opportunities of exogenous DNA thus close the window for homologous recombination. The *bcr d* fragment is located upstream (2 kb away) *bcr c*, if homologous recombination occurs, the region containing *bcr c*, *ORI*, *cmR* and *bcr d* will be replicated while the rest (more than 4 kb) will be replaced by targeted sequence. This recombined capture plasmid may not be successfully resolved because of the instable capture plasmid structure (the size of the plasmid is about 6.9 kb while 4 kb need to be replaced).

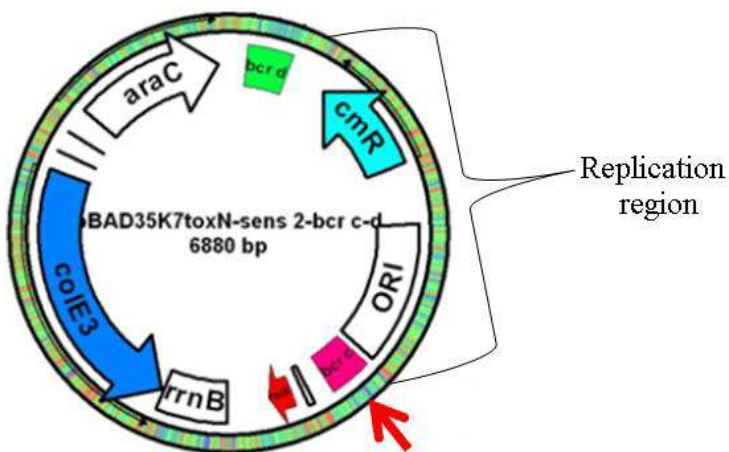

Fig.60: structure of capture plasmid pBAD35K7toxN-bcrc-d. Red arrow shows the location of high conserved sequence *bcr c* and the region marked in brackets is the replication region during homologous recombination

5. Perspectives

Although we have encountered some problems using the Genefish tool to capture targeted *bcr* fragments, but there are still some solutions. As mentioned during the discussion chapter, we can first test the plasmid-plasmid recombination efficiency using λ Red system. In any case, transfer the region containing highly conserved sequences and the toxic cassette of capture plasmid on the bacterial chromosome would solve many problems that we have encountered, such as the plasmid-plasmid recombination system, copy number of plasmid, highly conserved sequences too close to the ORI etc. So, the next step is to fix the toxic cassette on an appropriate bacterial chromosome region and test for chromosome recombination.

The ultimate aim of Genefish tool is to capture targeted fragment from metagenomic DNA, while in this study, we still cannot get enough recombinants using pure PCR target fragments. Even if we can reach the recombination efficiency at 10^{-4} using PCR products, we still need to pay attention on the accessibility of targeted fragment in metagenomic DNA. In metagenomic DNA, the targeted fragment may be diluted in million or even more times, and this could dramatically decrease the Genefish efficiency. During the metagenomic DNA extraction, genomes will be cut into 2-3 kb fragment randomly by bead beating and this will also decrease the percentage of optimized target fragment (two highly conserved sequences present at each end of fragment). Other conditions for Genefish application still need to be tested, such as the host strain improvements: knock out a set of exonucleases (RecJ, ExoI, ExoVII, ExoX, and Exo) genes which were already testified improving the homologous lambda Red recombineering (Mosberg, Gregg et al. 2012); recombination efficiency using different size of target fragments; optimize GC% of targeted sequences; size of highly conserved sequences; and similarity level between donor and recipient DNA etc.

References:

- Acinas, S. G., J. Anton, et al. (1999). "Diversity of free-living and attached bacteria in offshore Western Mediterranean waters as depicted by analysis of genes encoding 16S rRNA." Appl Environ Microbiol **65**(2): 514-522.
- Aislabie, J., A. K. Bej, et al. (1990). "Microbial degradation of quinoline and methylquinolines." Appl Environ Microbiol **56**(2): 345-351.
- Anders, H. J., A. Kaetzke, et al. (1995). "Taxonomic position of aromatic-degrading denitrifying pseudomonad strains K 172 and KB 740 and their description as new members of the genera *Thauera*, as *Thauera aromatica* sp. nov., and *Azoarcus*, as *Azoarcus evansii* sp. nov., respectively, members of the beta subclass of the Proteobacteria." Int J Syst Bacteriol **45**(2): 327-333.
- Antranikian, G., C. E. Vorgias, et al. (2005). "Extreme environments as a resource for microorganisms and novel biocatalysts." Adv Biochem Eng Biotechnol **96**: 219-262.
- Arber, W. and S. Linn (1969). "DNA modification and restriction." Annu Rev Biochem **38**: 467-500.
- Ardura, A., S. Planes, et al. (2011). "Beyond biodiversity: fish metagenomes." PLoS One **6**(8): e22592.
- Bagdasarian, M., R. Lurz, et al. (1981). "Specific-purpose plasmid cloning vectors. II. Broad host range, high copy number, RSF1010-derived vectors, and a host-vector system for gene cloning in *Pseudomonas*." Gene **16**(1-3): 237-247.
- Bai, Y., Q. Sun, et al. (2010). "Quinoline biodegradation and its nitrogen transformation pathway by a *Pseudomonas* sp. strain." Biodegradation **21**(3): 335-344.
- Barrick, R. C., E. T. Furlong, et al. (1984). "Hydrocarbon and azaarene markers of coal transport to aquatic sediments." Environ Sci Technol **18**(11): 846-854.
- Benzerara, K., N. Menguy, et al. (2006). "Nanoscale detection of organic signatures in carbonate microbialites." Proc Natl Acad Sci U S A **103**(25): 9440-9445.
- Bian, X., F. Huang, et al. (2012). "Direct cloning, genetic engineering, and heterologous expression of the syringolin biosynthetic gene cluster in *E. coli* through Red/ET recombineering." Chembiochem **13**(13): 1946-1952.
- Bin Liu, F. Z. (2006). "*Thauera* and *Azoarcus* as functionally important genera in a denitrifying quinoline-removal bioreactor as revealed by microbial community structure comparison." FEMS Microbiol Ecol **55**: 13.
- Bird, A. W., A. Erler, et al. (2012). "High-efficiency counterselection recombineering for site-directed mutagenesis in bacterial artificial chromosomes." Nat Methods **9**(1): 103-109.
- Bixquert Jimenez, M. (2009). "Treatment of irritable bowel syndrome with probiotics. An etiopathogenic approach at last?" Rev Esp Enferm Dig **101**(8): 553-564.
- Blase, M., C. Bruntner, et al. (1996). "Cloning, expression, and sequence analysis of the three genes encoding quinoline 2-oxidoreductase, a molybdenum-containing hydroxylase from *Pseudomonas putida* 86." J Biol Chem **271**(38): 23068-23079.
- Boll, M. (2005). "Dearomatizing benzene ring reductases." J Mol Microbiol Biotechnol **10**.
- Boll, M. and G. Fuchs (1995). "Benzoyl-coenzyme A reductase (dearomatizing), a key enzyme of anaerobic aromatic metabolism. ATP dependence of the reaction, purification and some properties of the enzyme from *Thauera aromatica* strain K172." Eur J Biochem **234**(3): 921-933.
- Boll, M., G. Fuchs, et al. (2000). "EPR and Mossbauer studies of benzoyl-CoA reductase." J Biol Chem **275**(41): 31857-31868.
- Bonkowski, M. and J. Roy (2005). "Soil microbial diversity and soil functioning affect competition among

- grasses in experimental microcosms." *Oecologia* **143**(2): 232-240.
- Borneman, J. and E. W. Triplett (1997). "Molecular microbial diversity in soils from eastern Amazonia: evidence for unusual microorganisms and microbial population shifts associated with deforestation." *Appl Environ Microbiol* **63**(7): 2647-2653.
- Bossio, D. A., K. M. Scow, et al. (1998). "Determinants of Soil Microbial Communities: Effects of Agricultural Management, Season, and Soil Type on Phospholipid Fatty Acid Profiles." *Microb Ecol* **36**(1): 1-12.
- Boyd, D., D. S. Weiss, et al. (2000). "Towards single-copy gene expression systems making gene cloning physiologically relevant: lambda InCh, a simple Escherichia coli plasmid-chromosome shuttle system." *J Bacteriol* **182**(3): 842-847.
- Brack, C., H. Eberle, et al. (1976). "A map of the sites on bacteriophage PM2 DNA for the restriction endonucleases HindIII and HpaII." *J Mol Biol* **104**(1): 305-309.
- Brockman, F. J., B. A. Denovan, et al. (1989). "Isolation and characterization of quinoline-degrading bacteria from subsurface sediments." *Appl Environ Microbiol* **55**(4): 1029-1032.
- Buchan, A., M. Alber, et al. (2001). "Strain-specific differentiation of environmental Escherichia coli isolates via denaturing gradient gel electrophoresis (DGGE) analysis of the 16S-23S intergenic spacer region." *FEMS Microbiol Ecol* **35**(3): 313-321.
- Carl, B., A. Arnold, et al. (2004). "Sequence and transcriptional analysis of a gene cluster of Pseudomonas putida 86 involved in quinoline degradation." *Gene* **331**: 177-188.
- Carl, B. and S. Fetzner (2005). "Transcriptional activation of quinoline degradation operons of Pseudomonas putida 86 by the AraC/XylS-type regulator OxoS and cross-regulation of the PqorM promoter by XylS." *Appl Environ Microbiol* **71**(12): 8618-8626.
- Carmona, M., M. T. Zamorro, et al. (2009). "Anaerobic catabolism of aromatic compounds: a genetic and genomic view." *Microbiol Mol Biol Rev* **73**(1): 71-133.
- Carter, D. M. and C. M. Radding (1971). "The role of exonuclease and beta protein of phage lambda in genetic recombination. II. Substrate specificity and the mode of action of lambda exonuclease." *J Biol Chem* **246**(8): 2502-2512.
- Cassuto, E. and C. M. Radding (1971). "Mechanism for the action of lambda exonuclease in genetic recombination." *Nat New Biol* **229**(1): 13-16.
- Chai, Y., S. Shan, et al. (2012). "Heterologous expression and genetic engineering of the tubulylin biosynthetic gene cluster using Red/ET recombineering and inactivation mutagenesis." *Chem Biol* **19**(3): 361-371.
- Chao, Y. P., C. J. Chiang, et al. (2002). "Stringent regulation and high-level expression of heterologous genes in Escherichia coli using T7 system controllable by the araBAD promoter." *Biotechnol Prog* **18**(2): 394-400.
- Chen, F., M. Cui, et al. (2003). "Biodegradation of quinoline by freely suspended and immobilized cells of Comamonas sp strain Q10." *J Gen Appl Microbiol* **49**(2): 123-128.
- Cobb, R. E. and H. Zhao "Direct cloning of large genomic sequences." *Nat Biotechnol* **30**(5): 405-406.
- Cobb, R. E. and H. Zhao (2012). "Direct cloning of large genomic sequences." *Nat Biotechnol* **30**(5): 405-406.
- Costantino, N. and D. L. Court (2003). "Enhanced levels of lambda Red-mediated recombinants in mismatch repair mutants." *Proc Natl Acad Sci U S A* **100**(26): 15748-15753.
- Cottingham, M. G. (2012). "Genetic manipulation of poxviruses using bacterial artificial chromosome recombineering." *Methods Mol Biol* **890**: 37-57.

- Cottrell, M. T., L. A. Waidner, et al. (2005). "Bacterial diversity of metagenomic and PCR libraries from the Delaware River." Environ Microbiol **7**(12): 1883-1895.
- Court DL, S. J., Thomason LC. (2002). "Genetic engineering using homologous recombination." Annual Review of Genetics **36**: 28.
- Court, D. L., S. Swaminathan, et al. (2003). "Mini-lambda: a tractable system for chromosome and BAC engineering." Gene **315**: 63-69.
- Cowan, D., Q. Meyer, et al. (2005). "Metagenomic gene discovery: past, present and future." Trends Biotechnol **23**(6): 321-329.
- Crescitelli, F. (1950). "Effects of oxine, carbostyryl and quinoline on frog nerve." Am J Physiol **163**(1): 197-200.
- Cui, M. (2004). "Microbial metabolism of quinoline by Comamonas sp." World Journal of Microbiology & Biotechnology **20**.
- Cui, M. (2004). "Microbial metabolism of quinoline by Comamonas sp. ." World Journal of Microbiology & Biotechnology **20**.
- Cui, M., F. Chen, et al. (2003). "Cometabolic biodegradation of quinoline's derivatives by a quinoline-degrading bacteria: Comamonas sp. strain Q10." J Gen Appl Microbiol **49**(6): 351-355.
- D'Hondt, S., A. J. Spivack, et al. (2009). "Subseafloor sedimentary life in the South Pacific Gyre." Proc Natl Acad Sci U S A **106**(28): 11651-11656.
- Dabert, P., S. D. Ehrlich, et al. (1992). "Chi sequence protects against RecBCD degradation of DNA in vivo." Proc Natl Acad Sci U S A **89**(24): 12073-12077.
- Dai, G., S. Kim, et al. (2012). "Development of a bacterial artificial chromosome (BAC) recombineering procedure using galK-untranslated region (UTR) for the mutation of diploid genes." J Virol Methods **182**(1-2): 18-26.
- Datsenko, K. A. and B. L. Wanner (2000). "One-step inactivation of chromosomal genes in Escherichia coli K-12 using PCR products." Proc Natl Acad Sci U S A **97**(12): 6640-6645.
- Datta, S., N. Costantino, et al. (2006). "A set of recombineering plasmids for gram-negative bacteria." Gene **379**: 109-115.
- Datta, S., N. Costantino, et al. (2008). "Identification and analysis of recombineering functions from Gram-negative and Gram-positive bacteria and their phages." Proc Natl Acad Sci U S A **105**(5): 1626-1631.
- de Boer, J. G. and B. W. Glickman (1998). "The lacI gene as a target for mutation in transgenic rodents and Escherichia coli." Genetics **148**(4): 1441-1451.
- Delmont, T. O., E. Prestat, et al. (2012). "Structure, fluctuation and magnitude of a natural grassland soil metagenome." ISME J **6**(9): 1677-1687.
- Delmont, T. O., P. Robe, et al. (2011). "Accessing the soil metagenome for studies of microbial diversity." Appl Environ Microbiol **77**(4): 1315-1324.
- Delmont, T. O., P. Robe, et al. (2011). "Metagenomic comparison of direct and indirect soil DNA extraction approaches." J Microbiol Methods **86**(3): 397-400.
- Desai, N. A. and V. Shankar (2003). "Single-strand-specific nucleases." FEMS Microbiol Rev **26**(5): 457-491.
- Dodd, I. B., K. E. Shearwin, et al. (2005). "Revisited gene regulation in bacteriophage lambda." Curr Opin Genet Dev **15**(2): 145-152.
- Donald L. Court, A. B. O., and Sankar L. Adhya (2006). "A New Look at Bacteriophage λ Genetic Networks." Journal of Bacteriology **189**(2): 7.
- Duran, A., M. Gryzenhout, et al. (2010). "AFLP analysis reveals a clonal population of Phytophthora pinifolia

- in Chile." Fungal Biol **114**(9): 746-752.
- Egland, P. G. and C. S. Harwood (1999). "BadR, a new MarR family member, regulates anaerobic benzoate degradation by *Rhodopseudomonas palustris* in concert with AadR, an Fnr family member." J Bacteriol **181**(7): 2102-2109.
- Eller, G., M. Kruger, et al. (2005). "Comparing field and microcosm experiments: a case study on methano- and methylo-trophic bacteria in paddy soil." FEMS Microbiol Ecol **51**(2): 279-291.
- Ellis, H. M., D. Yu, et al. (2001). "High efficiency mutagenesis, repair, and engineering of chromosomal DNA using single-stranded oligonucleotides." Proc Natl Acad Sci U S A **98**(12): 6742-6746.
- Feher, T., I. Karcagi, et al. (2008). "Scarless engineering of the *Escherichia coli* genome." Methods Mol Biol **416**: 251-259.
- Gerdes, K., F. W. Bech, et al. (1986). "Mechanism of postsegregational killing by the *hok* gene product of the *parB* system of plasmid R1 and its homology with the *relF* gene product of the *E. coli relB* operon." EMBO J **5**(8): 2023-2029.
- Gerdes, K., L. K. Poulsen, et al. (1990). "The *hok* killer gene family in gram-negative bacteria." New Biol **2**(11): 946-956.
- Gillan, D. C., A. G. Speksnijder, et al. (1998). "Genetic diversity of the biofilm covering *Montacuta ferruginosa* (Mollusca, bivalvia) as evaluated by denaturing gradient gel electrophoresis analysis and cloning of PCR-amplified gene fragments coding for 16S rRNA." Appl Environ Microbiol **64**(9): 3464-3472.
- Gomez-Villalba, B., C. Calvo, et al. (2006). "TGGE analysis of the diversity of ammonia-oxidizing and denitrifying bacteria in submerged filter biofilms for the treatment of urban wastewater." Appl Microbiol Biotechnol **72**(2): 393-400.
- Gomtsyan, A., E. K. Bayburt, et al. (2005). "Novel transient receptor potential vanilloid 1 receptor antagonists for the treatment of pain: structure-activity relationships for ureas with quinoline, isoquinoline, quinazoline, phthalazine, quinoxaline, and cinnoline moieties." J Med Chem **48**(3): 744-752.
- Grant, D. J. and T. R. Al-Najjar (1976). "Degradation of quinoline by a soil bacterium." Microbios **15**(61-62): 177-189.
- Grant, W. D. and S. Heaphy (2010). "Metagenomics and recovery of enzyme genes from alkaline saline environments." Environ Technol **31**(10): 1135-1143.
- Guzman, L. M., D. Belin, et al. (1995). "Tight regulation, modulation, and high-level expression by vectors containing the arabinose PBAD promoter." J Bacteriol **177**(14): 4121-4130.
- Handelsman, J. (2004). "Metagenomics: application of genomics to uncultured microorganisms." Microbiol Mol Biol Rev **68**(4): 669-685.
- Handelsman, J., M. R. Rondon, et al. (1998). "Molecular biological access to the chemistry of unknown soil microbes: a new frontier for natural products." Chem Biol **5**(10): R245-249.
- Harmer, T., M. Wu, et al. (2001). "The role of rigidity in DNA looping-unlooping by AraC." Proc Natl Acad Sci U S A **98**(2): 427-431.
- Harwood, C. R. (1992). "Bacillus subtilis and its relatives: molecular biological and industrial workhorses." Trends Biotechnol **10**(7): 247-256.
- Hashimoto-Gotoh, T., F. C. Franklin, et al. (1981). "Specific-purpose plasmid cloning vectors. I. Low copy number, temperature-sensitive, mobilization-defective pSC101-derived containment vectors." Gene **16**(1-3): 227-235.
- Heintz, D., S. Gallien, et al. (2009). "Differential membrane proteome analysis reveals novel proteins involved in the degradation of aromatic compounds in *Geobacter metallireducens*." Mol Cell

- Proteomics **8**(9): 2159-2169.
- Hirao, K., Y. Shinohara, et al. (1976). "Carcinogenic activity of quinoline on rat liver." Cancer Res **36**(2 Pt 1): 329.
- Hoess, R. H., A. Wierzbicki, et al. (1986). "The role of the loxP spacer region in P1 site-specific recombination." Nucleic Acids Res **14**(5): 2287-2300.
- Hollenback, S. M., S. Lyman, et al. (2011). "Recombineering-based procedure for creating BAC transgene constructs for animals and cell lines." Curr Protoc Mol Biol **Chapter 23**: Unit 23 14.
- Jensen, L. B., J. L. Ramos, et al. (1993). "A substrate-dependent biological containment system for *Pseudomonas putida* based on the *Escherichia coli* *gef* gene." Appl Environ Microbiol **59**(11): 3713-3717.
- Jianlong, W., Q. Xiangchun, et al. (2002). "Microbial degradation of quinoline by immobilized cells of *Burkholderia pickettii*." Water Res **36**(9): 2288-2296.
- Jose, J., R. Giridhar, et al. (2011). "Heavy metal pollution exerts reduction/adaptation in the diversity and enzyme expression profile of heterotrophic bacteria in Cochin estuary, India." Environ Pollut **159**(10): 2775-2780.
- Juang, D. F., P. C. Yang, et al. (2011). "Effects of microbial species, organic loading and substrate degradation rate on the power generation capability of microbial fuel cells." Biotechnol Lett **33**(11): 2147-2160.
- Kaebnick, M., E. Dittmann, et al. (2002). "Multiple alternate transcripts direct the biosynthesis of microcystin, a cyanobacterial nonribosomal peptide." Appl Environ Microbiol **68**(2): 449-455.
- Kahng, H. Y., J. J. Kukor, et al. (2000). "Characterization of strain HY99, a novel microorganism capable of aerobic and anaerobic degradation of aniline." FEMS Microbiol Lett **190**(2): 215-221.
- Kaiser, J. P., Y. Feng, et al. (1996). "Microbial metabolism of pyridine, quinoline, acridine, and their derivatives under aerobic and anaerobic conditions." Microbiol Rev **60**(3): 483-498.
- Karakousis, G., N. Ye, et al. (1998). "The beta protein of phage lambda binds preferentially to an intermediate in DNA renaturation." J Mol Biol **276**(4): 721-731.
- Karu, A. E., Y. Sakaki, et al. (1975). "The gamma protein specified by bacteriophage gamma. Structure and inhibitory activity for the *recBC* enzyme of *Escherichia coli*." J Biol Chem **250**(18): 7377-7387.
- Kato, C. and M. H. Qureshi (1999). "Pressure response in deep-sea piezophilic bacteria." J Mol Microbiol Biotechnol **1**(1): 87-92.
- Kawaguchi, K., Y. Shinoda, et al. (2006). "Purification and characterization of benzoate-CoA ligase from *Magnetospirillum* sp. strain TS-6 capable of aerobic and anaerobic degradation of aromatic compounds." FEMS Microbiol Lett **257**(2): 208-213.
- Kelly, T. J., Jr. and H. O. Smith (1970). "A restriction enzyme from *Hemophilus influenzae*. II." J Mol Biol **51**(2): 393-409.
- Kessler, C. and V. Manta (1990). "Specificity of restriction endonucleases and DNA modification methyltransferases a review (Edition 3)." Gene **92**(1-2): 1-248.
- Kim, S., H. G. Dallmann, et al. (1996). "tau couples the leading- and lagging-strand polymerases at the *Escherichia coli* DNA replication fork." J Biol Chem **271**(35): 21406-21412.
- Kirill Sergueev, D. Y., Stuart Austin, Donald Court (2001). "Cell toxicity caused by products of the pLoperon of bacteriophage lambda." Gene **272**(1-2): 9.
- Knudsen, S., P. Saadbye, et al. (1995). "Development and testing of improved suicide functions for biological containment of bacteria." Appl Environ Microbiol **61**(3): 985-991.
- Kools, S. A., B. Ferwerda, et al. (2005). "Microbial responses to zinc in soil microcosms with and without a natural assemblage of enchytraeids." Environ Toxicol Chem **24**(9): 2178-2184.

- Kopecka, H., J. Hillova, et al. (1976). "Effect of restriction endonucleases on infectivity of Rous sarcoma virus DNA." *Nature* **262**(5563): 72-74.
- Kung, J. W., C. Loffler, et al. (2009). "Identification and characterization of the tungsten-containing class of benzoyl-coenzyme A reductases." *Proc Natl Acad Sci U S A* **106**(42): 17687-17692.
- L Snyder, K. M. (1989). "The rex genes of bacteriophage lambda can inhibit cell function without phage superinfection." *Gene* **81**(1): 17-24.
- Lacroix, C., D. Giovannini, et al. (2011). "FLP/FRT-mediated conditional mutagenesis in pre-erythrocytic stages of *Plasmodium berghei*." *Nat Protoc* **6**(9): 1412-1428.
- Larentis, M. and A. Alfreider (2011). "Comparative evaluation of prokaryotic 16S rDNA clone libraries and SSCP in groundwater samples." *J Basic Microbiol* **51**(3): 330-335.
- Lau, P. C., R. W. Rowsome, et al. (1984). "Comparative nucleotide sequences encoding the immunity proteins and the carboxyl-terminal peptides of colicins E2 and E3." *Nucleic Acids Res* **12**(22): 8733-8745.
- LaVoie, E. J., A. Shigematsu, et al. (1984). "Tumor-initiating activity of quinoline and methylated quinolines on the skin of SENCAR mice." *Cancer Lett* **22**(3): 269-273.
- Lee, E. C., D. Yu, et al. (2001). "A highly efficient *Escherichia coli*-based chromosome engineering system adapted for recombinogenic targeting and subcloning of BAC DNA." *Genomics* **73**(1): 56-65.
- Lee, N. (1980). "Molecular aspects of ara regulation." 22.
- Lee, N., C. Francklyn, et al. (1987). "Arabinose-induced binding of AraC protein to araI2 activates the araBAD operon promoter." *Proc Natl Acad Sci U S A* **84**(24): 8814-8818.
- Lesic, B. (2008). "Use of the lambda Red recombinase system to rapidly generate mutants in *Pseudomonas aeruginosa*." *BMC Mol Biol* **9**.
- Li, X. T., N. Costantino, et al. (2003). "Identification of factors influencing strand bias in oligonucleotide-mediated recombination in *Escherichia coli*." *Nucleic Acids Res* **31**(22): 6674-6687.
- Licht, D. J. (1997). "Transformation of indole and quinoline by *Desulfobacterium indolicum*" *Applied Microbiology and Biotechnology* **42**(7).
- Lobell, R. B. and R. F. Schleif (1990). "DNA looping and unlooping by AraC protein." *Science* **250**(4980): 528-532.
- Loffler, C., K. Kuntze, et al. (2011). "Occurrence, genes and expression of the W/Se-containing class II benzoyl-coenzyme A reductases in anaerobic bacteria." *Environ Microbiol* **13**(3): 696-709.
- Mao, Y., X. Zhang, et al. (2010). "Versatile aromatic compound-degrading capacity and microdiversity of *Thauera* strains isolated from a coking wastewater treatment bioreactor." *J Ind Microbiol Biotechnol* **37**(9): 927-934.
- Maresca, M., A. Erler, et al. (2010). "Single-stranded heteroduplex intermediates in lambda Red homologous recombination." *BMC Mol Biol* **11**: 54.
- Marinelli, L. J., G. F. Hatfull, et al. (2012). "Recombineering: A powerful tool for modification of bacteriophage genomes." *Bacteriophage* **2**(1): 5-14.
- Martinsohn, J. T., M. Radman, et al. (2008). "The lambda red proteins promote efficient recombination between diverged sequences: implications for bacteriophage genome mosaicism." *PLoS Genet* **4**(5): e1000065.
- Masai, H., Y. Kaziro, et al. (1983). "Definition of oriR, the minimum DNA segment essential for initiation of R1 plasmid replication in vitro." *Proc Natl Acad Sci U S A* **80**(22): 6814-6818.
- Masaki, H. and T. Ohta (1982). "A plasmid region encoding the active fragment and the inhibitor protein of colicin E3--CA38." *FEBS Lett* **149**(1): 129-132.
- Mechichi, T., E. Stackebrandt, et al. (2002). "Phylogenetic and metabolic diversity of bacteria degrading

- aromatic compounds under denitrifying conditions, and description of *Thauera phenylacetica* sp. nov., *Thauera aminoaromatica* sp. nov., and *Azoarcus buckelii* sp. nov." Arch Microbiol **178**(1): 26-35.
- Mehta, A., R. P. Leite, Jr., et al. (2001). "Assessment of the genetic diversity of *Xylella fastidiosa* isolated from citrus in Brazil by PCR-RFLP of the 16S rDNA and 16S-23S intergenic spacer and rep-PCR fingerprinting." Antonie Van Leeuwenhoek **79**(1): 53-59.
- Mesbah, N. M. and J. Wiegel (2008). "Life at extreme limits: the anaerobic halophilic alkalithermophiles." Ann N Y Acad Sci **1125**: 44-57.
- Mizoguchi, H., K. Tanaka-Masuda, et al. (2007). "A simple method for multiple modification of the *Escherichia coli* K-12 chromosome." Biosci Biotechnol Biochem **71**(12): 2905-2911.
- Mora, D., G. Ricci, et al. (2003). "16S-23S rRNA intergenic spacer region sequence variation in *Streptococcus thermophilus* and related dairy streptococci and development of a multiplex ITS-SSCP analysis for their identification." Microbiology **149**(Pt 3): 807-813.
- Mosberg, J. A., C. J. Gregg, et al. (2012). "Improving lambda red genome engineering in *Escherichia coli* via rational removal of endogenous nucleases." PLoS One **7**(9): e44638.
- Mosberg, J. A., M. J. Lajoie, et al. (2010). "Lambda red recombineering in *Escherichia coli* occurs through a fully single-stranded intermediate." Genetics **186**(3): 791-799.
- Muniyappa, K. and C. M. Radding (1986). "The homologous recombination system of phage lambda. Pairing activities of beta protein." J Biol Chem **261**(16): 7472-7478.
- Murphy, K. C. (1991). "Lambda Gam protein inhibits the helicase and chi-stimulated recombination activities of *Escherichia coli* RecBCD enzyme." J Bacteriol **173**(18): 5808-5821.
- Murphy, K. C. (1998). "Use of bacteriophage lambda recombination functions to promote gene replacement in *Escherichia coli*." J Bacteriol **180**(8): 2063-2071.
- Murphy, K. C., K. G. Campellone, et al. (2000). "PCR-mediated gene replacement in *Escherichia coli*." Gene **246**(1-2): 321-330.
- Musiol, R., J. Jampilek, et al. (2007). "Investigating biological activity spectrum for novel quinoline analogues." Bioorg Med Chem **15**(3): 1280-1288.
- Musiol, R., D. Tabak, et al. (2008). "Investigating biological activity spectrum for novel quinoline analogues 2: hydroxyquinolinecarboxamides with photosynthesis-inhibiting activity." Bioorg Med Chem **16**(8): 4490-4499.
- Nicolaisen, M. H. and N. B. Ramsing (2002). "Denaturing gradient gel electrophoresis (DGGE) approaches to study the diversity of ammonia-oxidizing bacteria." J Microbiol Methods **50**(2): 189-203.
- Nithya, C. and S. K. Pandian (2012). "Evaluation of bacterial diversity in Palk Bay sediments using terminal-restriction fragment length polymorphisms (T-RFLP)." Appl Biochem Biotechnol **167**(6): 1763-1777.
- Noble, D. (2008). "Genes and causation." Philos Transact A Math Phys Eng Sci **366**(1878): 3001-3015.
- Normand-Bayle, M., C. Benard, et al. (2005). "New HIV-1 replication inhibitors of the styrylquinoline class bearing aroyl/acyl groups at the C-7 position: synthesis and biological activity." Bioorg Med Chem Lett **15**(18): 4019-4022.
- Normand P., P. C., Nesme X. (1996). "ITS analysis of prokaryotes." Molecular Microbial Ecology Manual **3**.
- Nosikov, V. V., E. A. Braga, et al. (1976). "Protection of particular cleavage sites of restriction endonucleases by distamycin A and actinomycin D." Nucleic Acids Res **3**(9): 2293-2301.
- O'Loughlin, E. J. (1996). "Isolation, characterization, and substrate utilization of a quinoline-degrading bacterium." International Biodeterioration & Biodegradation **38**(2).

- Ogunjobi, A. A., O. E. Fagade, et al. (2010). "Comparative analysis of genetic variation among *Xanthomonas axonopodis* pv *manihotis* isolated from the western states of Nigeria using RAPD and AFLP." Indian J Microbiol **50**(2): 132-138.
- Oie, C. S., C. E. Albaugh, et al. (2007). "Benzoate and salicylate degradation by *Halomonas campisalis*, an alkaliphilic and moderately halophilic microorganism." Water Res **41**(6): 1235-1242.
- Ollivier, B., P. Caumette, et al. (1994). "Anaerobic bacteria from hypersaline environments." Microbiol Rev **58**(1): 27-38.
- Panangala, V. S., V. L. van Santen, et al. (2005). "Analysis of 16S-23S intergenic spacer regions of the rRNA operons in *Edwardsiella ictaluri* and *Edwardsiella tarda* isolates from fish." J Appl Microbiol **99**(3): 657-669.
- Pearson, H. (2006). "Genetics: what is a gene?" Nature **441**(7092): 398-401.
- Pelletier, D. A. and C. S. Harwood (2000). "2-Hydroxycyclohexanecarboxyl coenzyme A dehydrogenase, an enzyme characteristic of the anaerobic benzoate degradation pathway used by *Rhodospseudomonas palustris*." J Bacteriol **182**(10): 2753-2760.
- Pennisi, E. (2007). "Genomics. DNA study forces rethink of what it means to be a gene." Science **316**(5831): 1556-1557.
- Pereira, W. E. (1987). "Fate and movement of azarenes in an aquifer contaminated by wood-treatment chemicals." Environmental Toxicology and Chemistry **6**.
- Pereira, W. E. (1988). "Microbial hydroxylation of quinoline in contaminated groundwater: evidence for incorporation of the oxygen atom of water." Appl Environ Microbiol **53**.
- Pirrota, V. (1976). "Two restriction endonucleases from *Bacillus globigii*." Nucleic Acids Res **3**(7): 1747-1760.
- Pommier, Y., A. A. Johnson, et al. (2005). "Integrase inhibitors to treat HIV/AIDS." Nat Rev Drug Discov **4**(3): 236-248.
- Ponnusamy, K., S. Jose, et al. (2011). "Genetic diversity study of *Chromobacterium violaceum* isolated from Kolli Hills by amplified ribosomal DNA restriction analysis (ARDRA) and random amplified polymorphic DNA (RAPD)." Lett Appl Microbiol **53**(3): 341-349.
- Poteete, A. R. (2008). "Involvement of DNA replication in phage lambda Red-mediated homologous recombination." Mol Microbiol **68**(1): 66-74.
- Poulsen, L. K., N. W. Larsen, et al. (1989). "A family of genes encoding a cell-killing function may be conserved in all gram-negative bacteria." Mol Microbiol **3**(11): 1463-1472.
- Qiu, D., et al. (2008). "PBAD-based shuttle vectors for functional analysis of toxic and highly regulated genes in *Pseudomonas* and *Burkholderia* spp. and other bacteria. ." Appl Environ Microbiol **74**.
- Ranieri, M. L. and K. J. Boor (2009). "Short communication: bacterial ecology of high-temperature, short-time pasteurized milk processed in the United States." J Dairy Sci **92**(10): 4833-4840.
- Ranjard, L., F. Poly, et al. (2000). "Heterogeneous Cell Density and Genetic Structure of Bacterial Pools Associated with Various Soil Microenvironments as Determined by Enumeration and DNA Fingerprinting Approach (RISA)." Microb Ecol **39**(4): 263-272.
- Roberts, A. J. (2005). "How restriction enzymes became the workhorses of molecular biology." Proc Natl Acad Sci U S A **102**.
- Roberts, R. J. (1976). "Restriction endonucleases." CRC Crit Rev Biochem **4**(2): 123-164.
- Roberts, R. J. (2005). "How restriction enzymes became the workhorses of molecular biology." Proc Natl Acad Sci U S A **102**(17): 5905-5908.
- Roberts, R. J. and I. F. Burgess (2005). "New head-lice treatments: hope or hype?" Lancet **365**(9453): 8-10.

- Rockafellow, E. M. (2009). "Is sulfur-doped TiO₂ an effective visible light photocatalyst for remediation?" Applied Catalysis B: Environmental **91**(1).
- Rosche, B., B. Tshisuaka, et al. (1997). "2-oxo-1,2-dihydroquinoline 8-monooxygenase: phylogenetic relationship to other multicomponent nonheme iron oxygenases." J Bacteriol **179**(11): 3549-3554.
- S.Fetzner (1998). "Bacterial degradation of pyridine, indole, quinoline, and their derivatives under different redox conditions." Appl Microbiol Biotechnol **49**.
- Sa-Nogueira, I. and L. J. Mota (1997). "Negative regulation of L-arabinose metabolism in *Bacillus subtilis*: characterization of the *araR* (*araC*) gene." J Bacteriol **179**(5): 1598-1608.
- Saari, R., J. C. Torma, et al. (2011). "Microwave-assisted synthesis of quinoline, isoquinoline, quinoxaline and quinazoline derivatives as CB₂ receptor agonists." Bioorg Med Chem **19**(2): 939-950.
- Sasaki, K., M. Morita, et al. (2011). "Syntrophic degradation of proteinaceous materials by the thermophilic strains *Coprothermobacter proteolyticus* and *Methanothermobacter thermautotrophicus*." J Biosci Bioeng **112**(5): 469-472.
- Sawitzke, J. A., L. C. Thomason, et al. (2007). "Recombineering: in vivo genetic engineering in *E. coli*, *S. enterica*, and beyond." Methods Enzymol **421**: 171-199.
- Schwarz, G., R. Bauder, et al. (1989). "Microbial metabolism of quinoline and related compounds. II. Degradation of quinoline by *Pseudomonas fluorescens* 3, *Pseudomonas putida* 86 and *Rhodococcus spec. B1*." Biol Chem Hoppe Seyler **370**(11): 1183-1189.
- Sen, B., J. Hamelin, et al. (2008). "Structural divergence of bacterial communities from functionally similar laboratory-scale vermicomposts assessed by PCR-CE-SSCP." J Appl Microbiol **105**(6): 2123-2132.
- Sergueev, K., D. Yu, et al. (2001). "Cell toxicity caused by products of the p(L) operon of bacteriophage lambda." Gene **272**(1-2): 227-235.
- Sharan, S. K., L. C. Thomason, et al. (2009). "Recombineering: a homologous recombination-based method of genetic engineering." Nat Protoc **4**(2): 206-223.
- Shinoda, Y., J. Akagi, et al. (2005). "Anaerobic degradation of aromatic compounds by magnetospirillum strains: isolation and degradation genes." Biosci Biotechnol Biochem **69**(8): 1483-1491.
- Shukla, O. P. (1986). "Microbial transformation of quinoline by a *Pseudomonas* sp." Appl Environ Microbiol **51**(6): 1332-1342.
- Shukla, P. (1987). "Microbiological transformation and biodegradation of quinoline isolation and characterization of quinoline-degrading bacteria and identification of early intermediates." Biology and Medicine **13**.
- Silberstein Z, M. S., Berger I, Cohen A. (1990). "Lambda Red-mediated synthesis of plasmid linear multimers in *Escherichia coli* K12." Molecular Genetics and Genomics **223**(3): 12.
- Singleton, M. R., M. S. Dillingham, et al. (2004). "Crystal structure of RecBCD enzyme reveals a machine for processing DNA breaks." Nature **432**(7014): 187-193.
- Smith, C. (1996). "The strange case of David Acer: myth and reality." CDS Rev **89**(2): 10-20.
- Smith, H. O. and K. W. Wilcox (1970). "A restriction enzyme from *Hemophilus influenzae*. I. Purification and general properties." J Mol Biol **51**(2): 379-391.
- Smith, H. O. and K. W. Wilcox (1992). "A restriction enzyme from *Hemophilus influenzae*. I. Purification and general properties. 1970." Biotechnology **24**: 38-50.
- Solomon, V. R. and H. Lee (2011). "Quinoline as a privileged scaffold in cancer drug discovery." Curr Med Chem **18**(10): 1488-1508.
- Song, B. and B. B. Ward (2005). "Genetic diversity of benzoyl coenzyme A reductase genes detected in denitrifying isolates and estuarine sediment communities." Appl Environ Microbiol **71**(4):

2036-2045.

- Song, J., H. Dong, et al. (2010). "Construction and functional characterization of an integrative form lambda Red recombineering Escherichia coli strain." FEMS Microbiol Lett **309**(2): 178-183.
- Spormann, A. M. and F. Widdel (2000). "Metabolism of alkylbenzenes, alkanes, and other hydrocarbons in anaerobic bacteria." Biodegradation **11**(2-3): 85-105.
- Sugaya, K. (2001). "Biodegradation of quinoline in crude oil." Journal of Chemical Technology and Biotechnology **76**(6).
- Sun, Q., Y. Bai, et al. (2009). "Aerobic biodegradation characteristics and metabolic products of quinoline by a Pseudomonas strain." Bioresour Technol **100**(21): 5030-5036.
- Swaminathan S, E. H., Waters LS, Yu D, Lee EC, Court DL, Sharan SK. (2001). "Rapid engineering of bacterial artificial chromosomes using oligonucleotides." Genesis **29**(1): 8.
- Swingle, B. (2010). "Recombineering using RecTE from Pseudomonas syringae." Appl Environ Microbiol **76**.
- Tanti, B., S. K. Ray, et al. (2011). "Differentiation of petroleum hydrocarbon-degrading Pseudomonas spp. based on PCR-RFLP of the 16S-23S rDNA intergenic spacer region." Folia Microbiol (Praha) **57**(1): 47-52.
- Terpe, K. (2006). "Overview of bacterial expression systems for heterologous protein production: from molecular and biochemical fundamentals to commercial systems." Appl Microbiol Biotechnol **72**(2): 211-222.
- Thomason, L. C., N. Costantino, et al. (2007). "Multicopy plasmid modification with phage lambda Red recombineering." Plasmid **58**(2): 148-158.
- Tian, S., C. Qian, et al. (2006). "Biodegradation of biomass gasification wastewater by two species of pseudomonas using immobilized cell reactor." Appl Biochem Biotechnol **128**(2): 141-148.
- Tischer, B. K., G. A. Smith, et al. (2010). "En passant mutagenesis: a two step markerless red recombination system." Methods Mol Biol **634**: 421-430.
- Torsvik, V., J. Goksoyr, et al. (1990). "High diversity in DNA of soil bacteria." Appl Environ Microbiol **56**(3): 782-787.
- Trevors, J. T., J. D. van Elsas, et al. (1990). "Transport of a genetically engineered Pseudomonas fluorescens strain through a soil microcosm." Appl Environ Microbiol **56**(2): 401-408.
- Tuntufye, H. N. (2011). "Use of lambda Red-mediated recombineering and Cre/lox for generation of markerless chromosomal deletions in avian pathogenic Escherichia coli." FEMS Microbiol Lett **325**.
- Tuo, B. H., J. B. Yan, et al. (2012). "Biodegradation characteristics and bioaugmentation potential of a novel quinoline-degrading strain of Bacillus sp. isolated from petroleum-contaminated soil." Bioresour Technol **107**: 55-60.
- Uchiyama, T. and K. Miyazaki (2009). "Functional metagenomics for enzyme discovery: challenges to efficient screening." Curr Opin Biotechnol **20**(6): 616-622.
- Ulonska, A. (1995). "Degradation of quinoline by immobilized Comamonas acidovorans in a three-phase airlift reactor." Biotechnol Bioeng **46**.
- Uroz, S., C. Calvaruso, et al. (2009). "Mineral weathering by bacteria: ecology, actors and mechanisms." Trends Microbiol **17**(8): 378-387.
- Valentin-Hansen, P. (1986). "DNA-protein recognition: demonstration of three genetically separated operator elements that are required for repression of the Escherichia coli deoCABD promoters by the DeoR repressor." EMBO J **5**.
- Villa-Komaroff, L., A. Efstratiadis, et al. (1978). "A bacterial clone synthesizing proinsulin." Proc Natl Acad

- Sci U S A **75**(8): 3727-3731.
- Villa-Komaroff, L., A. Efstratiadis, et al. (1992). "A bacterial clone synthesizing proinsulin. 1978." Biotechnology **24**: 316-320.
- Wang, J., M. Sarov, et al. (2006). "An improved recombineering approach by adding RecA to lambda Red recombination." Mol Biotechnol **32**(1): 43-53.
- Wang, J. L., W. Z. Wu, et al. (2004). "Microbial degradation of quinoline: kinetics study with *Burkholderia picekittii*." Biomed Environ Sci **17**(1): 21-26.
- Wang, Y.-T. (1984). "Anaerobic activated carbon filter for the degradation of polycyclic N-aromatic compounds." Water Pollution Control Federation **56**.
- Wang, Y. T., M. T. Suidan, et al. (1984). "Anaerobic biodegradation of indole to methane." Appl Environ Microbiol **48**(5): 1058-1060.
- Warming S, C. N., Court DL, Jenkins NA, Copeland NG. (2005). "Simple and highly efficient BAC recombineering using galK selection." Nucleic Acids Research **33**(4): 12.
- Warnecke, F. and P. Hugenholtz (2007). "Building on basic metagenomics with complementary technologies." Genome Biol **8**(12): 231.
- Wei, J., P. Liang, et al. (2011). "Recent progress in electrodes for microbial fuel cells." Bioresour Technol **102**(20): 9335-9344.
- Wischgoll, S., D. Heintz, et al. (2005). "Gene clusters involved in anaerobic benzoate degradation of *Geobacter metallireducens*." Mol Microbiol **58**(5): 1238-1252.
- Wittmann, C. (2007). "Fluxome analysis using GC-MS." Microb Cell Fact **6**.
- Wooley, J. C., A. Godzik, et al. (2010). "A primer on metagenomics." PLoS Comput Biol **6**(2): e1000667.
- Xu, J. (2006). "Microbial ecology in the age of genomics and metagenomics: concepts, tools, and recent advances." Mol Ecol **15**(7): 1713-1731.
- Yajima, S., Y. Muto, et al. (1993). "The three-dimensional structure of the colicin E3 immunity protein by distance geometry calculation." FEBS Lett **333**(3): 257-260.
- Yamabhai, M., B. Buranabanyat, et al. (2011). "Efficient *E. coli* expression systems for the production of recombinant beta-mannanases and other bacterial extracellular enzymes." Bioeng Bugs **2**(1): 45-49.
- Yamamoto, S., H. Izumiya, et al. (2009). "Application of lambda Red recombination system to *Vibrio cholerae* genetics: simple methods for inactivation and modification of chromosomal genes." Gene **438**(1-2): 57-64.
- Yang, Y. and S. K. Sharan (2003). "A simple two-step, 'hit and fix' method to generate subtle mutations in BACs using short denatured PCR fragments." Nucleic Acids Res **31**(15): e80.
- Yang, Z., J. R. Horton, et al. (2005). "Structure of HinPII endonuclease reveals a striking similarity to the monomeric restriction enzyme MspI." Nucleic Acids Res **33**(6): 1892-1901.
- Yosef, I., N. Bloushtain, et al. (2004). "Restoration of gene function by homologous recombination: from PCR to gene expression in one step." Appl Environ Microbiol **70**(12): 7156-7160.
- Yu, C. Y. (1989). "Hydrodenitrogenation of quinoline with Y-type zeolite." Industrial & Engineering Chemistry Research **28**(1).
- Yu, D., H. M. Ellis, et al. (2000). "An efficient recombination system for chromosome engineering in *Escherichia coli*." Proc Natl Acad Sci U S A **97**(11): 5978-5983.
- Zarivach, R., E. Ben-Zeev, et al. (2002). "On the interaction of colicin E3 with the ribosome." Biochimie **84**(5-6): 447-454.
- Zengler, K. (2009). "Central role of the cell in microbial ecology." Microbiol Mol Biol Rev **73**(4): 712-729.
- Zhang, X. M. and J. D. Huang (2003). "Combination of overlapping bacterial artificial chromosomes by a

- two-step recombinogenic engineering method." Nucleic Acids Res **31**(15): e81.
- Zhang, X. Y. (2007). "Studies on quinoline biodegradation by a white rot fungus (*Pleurotus ostreatus* BP) in liquid and solid state substrates." Fresenius Environmental Bulletin **16**(8).
- Zhang, Y., F. Buchholz, et al. (1998). "A new logic for DNA engineering using recombination in *Escherichia coli*." Nat Genet **20**(2): 123-128.
- Zhu, S. N., D. Q. Liu, et al. (2008). "Degradation of quinoline by *Rhodococcus* sp. QL2 isolated from activated sludge." J Hazard Mater **160**(2-3): 289-294.
- Zumft, W. G. (1997). "Cell biology and molecular basis of denitrification." Microbiol Mol Biol Rev **61**(4): 533-616.

Annex 1: metagenomic DNA extraction

Each aerobic and anaerobic microcosm was composed of 120 samples, and the protocols for DNA extraction are recorded as follow:

- ✓ Weight 0.3 g soil samples into 2ml lysing Matrix tubes, add 600µl extraction buffer (50% w/w solution of CTAB 10 % (w/w) and NaCl 0.7M, 50% (w/w) 240mM K₂HPO₄/KH₂PO₄ buffer) and 600µl Phenol: Chloroform: Isoamylalcohol (25:24:1Roth ref: A156.2) solution.
- ✓ Transfer those tubes into FastPrep-24 instrument (MP Biomedicals), Bead beating with a FastPrep speed of 5.5M for 30 seconds.
- ✓ Centrifuge at 4°C for 10 minutes at speed of 11,000 rpm.
- ✓ Transfer the supernatant into 2ml eppendorf tubes and add 500µl of Chloroform: Isoamylalcohol (24:1) solution. Vortex well and centrifuge them at 4°C for 5 minutes at speed of 11,000 rpm.
- ✓ Transfer the supernatant into 2ml eppendorf tubes, add 1/10 volume NaCl(5M) and 2 fold volume of 100% ethanol(-20°C). Then store tubes at 4°C overnight.
- ✓ Centrifuge at 4°C for 30 minutes at speed of 12,000 rpm, discard supernatant and add 100µl ethanol (70%).
- ✓ Centrifuge at 4°C for 5 minutes at speed of 12,000 rpm. Discard supernatant carefully and add 100µl ethanol (70%).
- ✓ Centrifuge at 4°C for 5 minutes at speed of 12,000 rpm. Discard supernatant carefully with pipette.
- ✓ Dry the DNA at room temperature for 15 minutes
- ✓ Add 50µl of ddH₂O to dissolve the pellet
- ✓ Purification with illustra GFX PCR DNA and Gel Band purification kit.
- ✓ Add 500µl of capture buffer type 3, mix thoroughly and transfer the mix to assembled GFX Microspin Column and collection tube.
- ✓ Centrifuge for 30 seconds at speed of 16,000 rpm, discard flow through and add 500µl of wash buffer type 1
- ✓ Centrifuge for 30 seconds at speed of 16,000 rpm. Discard collection tube and transfer GFX Microspin Column to a 1.5ml eppendorf tube.
- ✓ Add 50µl of elution buffer type 6, centrifuge for 60 seconds at speed of 16,000 rpm.

✓ Those extracted DNA can be stored at -20°C.

Concentrations of extracted DNA samples were quantified by Qubit® dsDNA BR Assay Kit.

Annex 2: protocols for RISA analysis on Agilent 2100 bioanalyzer

For RISA, Agilent DNA 1000 Kit was used. The relevant protocols are shown below:

1) Preparing the Gel-Dye Mix

- Allow the DNA dye concentrate (blue) and DNA gel matrix (red) to equilibrate to room temperature for 30 minutes.
- Vortex the blue-capped DNA dye concentrate (blue) for 10 seconds and spin down. Make sure the DMSO is completely thawed.
- Pipette 25µl of the blue capped dye concentrate (blue) into a red-capped DNA gel matrix vial (red). Store the dye concentrate at 4 °C in the dark again.
- Cap the tube, vortex for 10 seconds. Visually inspect proper mixing of gel and dye.
- Transfer the gel-dye mix to the top receptacle of a spin filter.
- Place the spin filter in a microcentrifuge and spin for 15 minutes at room temperature at 2240 g ± 20 % (for Eppendorf microcentrifuge, this corresponds to 6000 rpm).
- Discard the filter and put the mix at 4°C or for RISA use.

2) Setting up the Chip Priming Station

- Replace the syringe:
 - ✓ Unscrew the old syringe from the lid of the chip priming station.
 - ✓ Release the old syringe from the clip. Discard the old syringe.
 - ✓ Remove the plastic cap of the new syringe and insert it into the clip.
 - ✓ Slide it into the hole of the luer lock adapter and screw it tightly to the chip priming station.
- Adjust the base plate:
 - ✓ Open the chip priming station by pulling the latch.
 - ✓ Using a screwdriver, open the screw at the underside of the base plate.
 - ✓ Lift the base plate and insert it again in position C. Retighten the screw.
- Adjust the syringe clip:
 - ✓ Release the lever of the clip and slide it down to the lowest position.

3) Setting up the Bioanalyzer

- Adjust the chip selector:

✓ Open the lid of the bioanalyzer and make sure that the electrode cartridge is inserted in the instrument. If not, open the latch, remove the pressure cartridge and insert the electrode cartridge.

✓ Remove any remaining chip and adjust the chip selector to position (1).

4) Starting the 2100 Expert Software

➤ Go to desktop and double-click the following icon  .

➤ If more than one instrument is connected to the PC, select the instrument we want to use in the tree view.

5) Loading the Gel-Dye Mix

➤ Allow the gel-dye mix to equilibrate to room temperature for 30 minutes before use. Protect the gel-dye mix from light during this time.

➤ Take a new DNA chip out of its sealed bag and place the chip on the chip priming station.

➤ Pipette 9.0µl of the gel-dye mix at the bottom of the well marked .

➤ Set the timer to 60 seconds, make sure that the plunger is positioned at 1 ml and then close the chip priming station. The lock of the latch will click when the Priming Station is closed correctly.

➤ Press the plunger of the syringe down until it is held by the clip.

➤ Wait for exactly 60 seconds and then release the plunger with the clip release mechanism.

➤ Visually inspect that the plunger moves back at least to the 0.3 ml mark.

➤ Wait for 5 seconds, and then slowly pull back the plunger to the 1 ml position.

➤ Open the chip priming station.

➤ Pipette 9.0 µl of the gel-dye mix in each of the wells marked.

6) Loading the Marker

➤ Pipette 5 µl of green-capped DNA marker (green) into the well marked with the ladder symbol  and into each of the 12 sample wells.

7) Loading the Ladder and the Samples

➤ Pipette 1 µl of the yellow-capped DNA ladder (yellow) in the well marked with the ladder symbol .

➤ In each of the 12 sample wells pipette 1 µl of sample (used wells) or 1 µl of deionized water (unused wells).

8) Inserting a Chip in the Agilent 2100 Bioanalyzer

- Open the lid of the Agilent 2100 bioanalyzer.
- Check that the electrode cartridge is inserted properly and the chip selector is in position (1). Refer to “Setting up the Bioanalyzer” on page 8 for details.
- Place the chip carefully into the receptacle. The chip fits only one way.
- Carefully close the lid. The electrodes in the cartridge fit into the wells of the chip.
- The 2100 expert software screen shows that we have inserted a chip and closed the lid by displaying the chip icon at the top left of Instrument context.

9) Starting the Chip Run

- In the Instrument context, select the appropriate assay from the Assay menu.
- Accept the current File Prefix or modify it. Data will be saved automatically to a file with a name using the prefix we have just entered. At this time we can also customize the file storage location and the number of samples that will be analyzed.
- Click the Start button in the upper right of the window to start the chip run. The incoming raw signals are displayed in the Instrument context.
- To enter sample information like sample names and comments, select the Data File link that is highlighted in blue or go to the Assay context and select the Chip Summary tab. Complete the sample name table.
- To review the raw signal trace, return to the Instrument context
- After the chip run is finished, remove the chip from the receptacle of the bioanalyzer

10) Cleaning Electrodes after a DNA 1000 Chip Run.

- Slowly fill one of the wells of the electrode cleaner with 350 µl deionized analysis-grade water.
- Open the lid and place electrode cleaner in the Agilent 2100 bioanalyzer.
- Close the lid and leave it closed for about 10 seconds.
- Open the lid and remove the electrode cleaner.
- Wait another 10 seconds to allow the water on the electrodes to evaporate before closing the lid.

Annex 3: Escape rate test

Escape rate tests are process in two steps: first selection in liquid induction media and second selection in solid induction medium plates. The pre-selection process called liquid activation. Liquid activation was a preliminary selection of potential colonies for escape rate test while escape rate test was used to calculate the real strain escaping rate from death. This rate means the ratio of colonies in a total 10ml culture escaping from death. The CFU were recorded on plates with different types of medium which were already used in the liquid activation test.

Target strains were streak cultivated on plates containing 20ml LB agar and 20 μ l chloramphenicol (CM: 50mg/ml) at 37°C. At least 24 colonies of each target strains were chosen for the liquid activation. Those colonies were cultured under four different mediums in 96 well plates: medium (1) LB broth medium with chloramphenicol (50 μ g/ml), medium (2) LB broth medium containing 1% arabinose (w/v), medium (3) LB broth medium containing IPTG (500 μ g/ml), medium (4) LB broth medium containing 1% arabinose (w/v) and IPTG (500 μ g/ml) respectively. These four kinds of medium all contain 50 μ g/ml chloramphenicol .The protocol for liquid activation is described below:

- ✓ LB broth induction media preparation: calculate the total volume of medium for the culture, each well we need 100 μ l of medium. 47 total colonies means 48 well are needed and one well is the blank control. So, 6ml of each kind medium is enough: 6ml LB broth medium with 6 μ l chloramphenicol(CM:50mg/ml); 5.4ml LB broth medium with 6 μ l chloramphenicol(CM: 50mg/ml) and 600 μ l of arabinose(10%,w/v); 6ml LB broth medium with 6 μ l chloramphenicol(CM: 50mg/ml) and 15 μ l IPTG(200mg/ml); 5.4ml LB broth medium with 6 μ l chloramphenicol(CM:50mg/ml), 15 μ l IPTG(200mg/ml) and 600 μ l of arabinose(10%,w/v).
- ✓ Starter culture of target colony is inoculated in CM (50 μ g/ml) containing LB broth medium. 100 μ l of medium is transferred into each well from A1-to-D12 of the 96 well plates. 47 colonies are inoculated into each well respectively and the last well (D12) is the blank control. Incubate this 96 well plate on a shaker at 37°C and at speed of 150 rpm for about 2 hours until turbidity appears in each well.
- ✓ During this time, prepare two other 96 well plates for the liquid activation. A1 -D12 of the first plate containing 100 μ l LB broth medium (1) and E1-H12 containing 100 μ l LB broth

medium (2). A1-D12 of plate number 2 contains 100µl LB broth medium (3) and E1-H12 contains 100µl LB broth medium (4).

- ✓ Transfer the starter culture into the prepared 96 well plate 1 and 2 respectively. Make sure that each colony starter culture is accurately transferred into their corresponding wells. Incubate these two plates on a shaker at 37°C and at speed of 150 rpm for an overnight culture.
- ✓ Store the starter culture after 8 hours' culture: add 100µl of 50% glycerol (25% final concentration) into each well of starter culture, mix gently and store the plate at -20°C.

Results of liquid activation: Fig 61 shows the 96 well plates used for the liquid activation. Plate one (left) shows that colonies in wells A1 to D11 grow very well while no bacteria grows in the blank control well (D12). However, there were bacteria growing in wells F8 and G8, this means these two strains have escaped from death induced by 1% arabinose. In the same way, well A1-A3, A6, A7, B2, B4, B7, B10 and C5 of plate two have escaped from death induced by 200µg/ml IPTG. No colony can survive under the induction of both 1% arabinose and 200µg/ml IPTG (E1-H11 of plate 2). So, for the further escape rate test, those colonies mentioned above cannot be chosen although they cannot survive under both toxic genes induction. At last, three colonies of each strain, colony pBAD35K7toxN-bcrc-a-9,-11 and -13 (well B1) and pBAD35K7toxN-bcrc-d-1,-3 and -7 were selected for escape rate test.

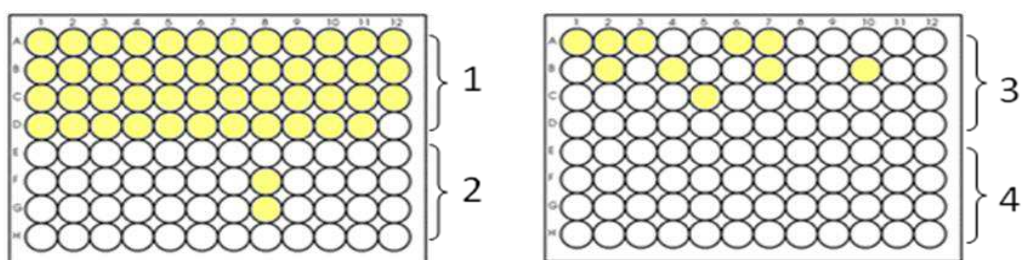

Fig.61: liquid activation results of strain 14102, pBAD35K7toxN-bcrc-a and pBAD35K7toxN-bcrc-d. Wells in yellow show growing strain; 1, 2, 3 and 4 means the type of culture medium used in those wells.

Second step of escape rate test for pBAD35K7toxN-bcrc-a and pBAD35K7toxN-bcrc-d: Three colonies of pBAD35K7toxN-bcrc-a-9,-11,-13 and other three colonies of pBAD35K7toxN-bcrc-d-1,-3,-7 were selected for escape rate test. Each of these 6 colonies was streak cultivated in plate containing 20ml LB agar and 20µl chloramphenicol (CM: 50mg/ml).

All plates were cultivated at 37°C for overnight, one single colony was picked up from each plate and cultivated in 50ml tube containing 15minl LB broth medium and 15µl chloramphenicol (CM: 50mg/ml). All tubes were fixed on a shaker at 37°C at speed of 200rpm for 7 hours culture.

LB agar medium preparation:

- a) For the total colony number counting in culture: 50ml LB agar medium with 50 μ l chloramphenicol (CM: 50mg/ml), mix well then pour into three 10cm Petri plates.
- b) For the colony number escaping from death (induced by arabinose): 27 ml LB agar medium with 30 μ l chloramphenicol (CM: 50mg/ml) and 3ml of filtered 10% arabinose (m/v). Mix well then pour into one 10cm Petri plates.
- c) For the number of colony escaping from death (induced by IPTG): 50ml LB agar medium with 50 μ l chloramphenicol (CM: 50mg/ml) and 125 μ l IPTG (200mg/ml). Mix well then pour into three 10cm Petri plates.
- d) For the number of colony escaping from death (induced both by IPTG and arabinose): 27 ml LB agar medium with 30 μ l chloramphenicol (CM: 50mg/ml), 3ml of filtered 10% arabinose (m/v) and 75 μ l IPTG (200mg/ml). Mix well then pour into two 15cm Petri plates.

Preparation of culture samples:

15minl culture was separated into two parts, one part contains 10ml culture for the escape rate test and the other part with 5ml culture is used for the strain storage. For the strain storage, protocol was described before and all these six strains were stored at -80°C.

Process for the escape rate test on 10ml culture: centrifuge at 4°C for 10min at speed of 4000g. Carefully discard the supernatant, add 800 μ l of 0.8 % (m/v) NaCl, mix well and transfer the solution into a DNase-free 1.5ml eppendorf tube. Adjust the volume of the solution to 1ml at last.

Serial 10-fold dilution of each solution: 10^{-6} dilution was used to calculate the total number of cells in original culture. For each diluted sample, 6 DNase-free 1.5ml eppendorf tubes were pre-filled with 900 μ l of 0.8 % (m/v) NaCl. This solution was considered as the original dilution (10^0). At each step, 100 μ l of the previous dilution is added to 900 μ l of 0.8 % (m/v) NaCl.

For the total colony number, pour 100 μ l of dilution 10^{-4} , 10^{-5} , 10^{-6} of each strain into three 10cm Petri plates containing medium (1).

Escape rate when using arabinose, pour 450 μ l of dilution 10^0 , 10^{-1} of each strain into two 10cm Petri plates containing medium (2).

Escape rate when using IPTG, pour 100 μ l of dilution 10^{-1} , 10^{-2} , 10^{-3} of each strain into three 10cm Petri plates containing medium (3).

Escape rate when using IPTG and arabinose, pour 450µl of dilution 10^0 of each strain into two 15cm Petri plates containing medium (4).

All plates were then transferred into incubator at 37°C for overnight culture.

Annex 4: Protocol for the co-electroporation

Lambda Red activation:

- ✓ Host strain (14102, *E.coli* with plasmid pSIM6) is streak cultivated in 20ml LB agar medium with 20µl carbenicillin (50mg/ml) at 29°C.
- ✓ Pick up a single colony and cultivate in 100ml LB broth medium with 100µl carbenicillin (50mg/ml) at 29°C at speed 200 rpm. Measure the OD600 from time to time.
- ✓ When the OD600 is between 0.4-0.6, warm up 50ml of culture into water bath at 42°C and the other half culture at 29°C at speed 100rpm for 15 minutes. This process at 42°C is used to activate the λ Red system and the culture at 29°C is taken as the negative control.

Competent cells preparation:

- ✓ The protocol for competent cells preparation is the same as before. At last, each 50ml culture is prepared at the end as 10 tubes of competent cells. This means each tube contains 4×10^9 cells.
- ✓ Calculation: calculate the quantity of capture plasmid needed for the recombination. The plasmid is 6880 bp long and the average molar mass of each base is 330, so the molar mass of capture plasmid pBAD35K7toxN-bcrc-d is 4540800. The formula to calculate the quantity of plasmid (ng): $(\text{Quantity (ng)} \times 10^{-9} \times 6.02 \times 10^{23}) / 4540800 = 4.0 \times 10^9 (\text{number of competent cells})$. According to this, 30ng of plasmid for the co-electroporation was enough. From the same calculation 18ng of *bcr operon* give the same copy number between the plasmid and the host strain.

Electroporation:

- ✓ Positive control: electroporate plasmid pBAD35K7toxN-bcrc-d alone into the lambda red activated competent cells with a ratio of 1:1. With this positive control, the quantity of competent cells was estimated. For the homologous recombination test, electroporate both plasmid and target *bcr operon* into the lambda red activated competent cells with the ratio 1:1:5 and 1:1:10. The negative control: electroporate both plasmid and target *bcr operon* into the non-activated lambda red competent cells with the ratio 1:1:5 and 1:1:10.

Plate preparation

- ✓ Two mediums were prepared to test the electroporation efficiency. LB agar medium with kanamycin (final concentration 25µg/ml) for the total number of cells after the electroporation and LB agar medium with CM (final concentration 50µg/ml) to calculate the total number of

pBAD35K7toxN-bcrc-d transformed cell. For the homologous recombinants detection, the LB agar medium contains CM, arabinose, IPTG with a final concentration of 50µg/ml, 1 %(m/m) and 500µg/ml respectively.

- ✓ After the transformation, all plates were cultivated at 37°C for overnight culture until the colonies were visible.

Annex 5: Protocol for plasmid segregation

First time electroporation:

Culture of host strains *E.coli* 14102 pBAD35K7toxN-bcrc-d+pSIM6 on 20ml LB agar medium with 20µl CM(50mg/ml) and 20µl carbenicillin (CB 50mg/ml) at 29°C for about 30 hours.

Liquid culture of the host strain: Pick up a single colony and do a starter culture with 10ml LB broth medium which contains 10µl CM and 10µl CB at 29°C and at speed 200rpm. After overnight culture, transfer 1ml of starter culture into 50ml LB broth medium which contains 50µl CM and 50µl CB and culture at 29°C at speed 200rpm. Measure the OD600 from time to time after 3 hours of culture until reaches OD600 of 0.4-0.6.

The protocol for host strain preparation was the same as before with a 42°C, 15min induction. 50ml culture was prepared as competent cells into 10 tubes.

The mole ratio between host strain and target DNA fragment for the first round electroporation were: 1:0.5, 1:1, 1:2 and 1:4. Two tubes of competent cells were used for each ratio condition. After the electroporation, 1ml of transformed cells was cultivated at 37°C for one hour.

NucleoSpin® Plasmid kit (Macherey Nagel) was used for the plasmid extraction.

The extracted plasmid mixture was quantified by using Qubit® dsDNA BR Assay Kit (Invitrogen). Finally, the plasmid mixture has a concentration of 40ng/µl for each ratio.

Second round of electroporation:

Host strain *E.coli* 14102, was streaked cultivated in 20ml LB agar medium with 10µl Kn (50mg/ml) at 37°C.

Pick up a single colony and cultivated in 50ml LB broth medium with 25µl Kn (50mg/ml) at 37°C and at speed of 200rpm. 50ml of this culture was then prepared as competent cells into 10 tubes. The ratio between host strain and plasmid mixture for the second round of electroporation were 1:0.5 and 1:1. For the condition 1:0.5, 20ng of plasmid mixture were used. All transformants were screened using the selective mediums which were already described before.