



HAL
open science

Solutions quasi-périodiques et solutions de quasi-collision du problème spatial des trois corps

Lei Zhao

► **To cite this version:**

Lei Zhao. Solutions quasi-périodiques et solutions de quasi-collision du problème spatial des trois corps. Systèmes dynamiques [math.DS]. Université Paris-Diderot - Paris VII, 2013. Français. NNT : . tel-00958727

HAL Id: tel-00958727

<https://theses.hal.science/tel-00958727>

Submitted on 13 Mar 2014

HAL is a multi-disciplinary open access archive for the deposit and dissemination of scientific research documents, whether they are published or not. The documents may come from teaching and research institutions in France or abroad, or from public or private research centers.

L'archive ouverte pluridisciplinaire **HAL**, est destinée au dépôt et à la diffusion de documents scientifiques de niveau recherche, publiés ou non, émanant des établissements d'enseignement et de recherche français ou étrangers, des laboratoires publics ou privés.

École Doctorale Paris Centre

THÈSE DE DOCTORAT

Discipline : Mathématiques

présentée par

Lei ZHAO

Solutions quasi-périodiques et solutions de quasi-collision du problème spatial des trois corps

dirigée par Alain CHENCINER et Jacques FÉJOZ

Soutenue le 31 mai 2013 devant le jury composé de :

M. Christian MARCHAL	ONERA
M. Alain CHENCINER	Université Paris Diderot
M. Jacques FÉJOZ	Université Paris Dauphine
M. Jacques LASKAR	CNRS
M. Jean-Pierre MARCO	Université Pierre et Marie Curie

Après les rapports de :

M. Christian MARCHAL	ONERA
M. Jesús PALACIAN	Université publique de Navarre

Institut de mécanique céleste et de calcul des éphémérides
77, Avenue Denfert-Rochereau
75 014 Paris

École doctorale Paris centre Case 188
4 place Jussieu
75 252 Paris cedex 05

*Marcher jusqu'au lieu où tarit la source,
Et attendre, assis, que se lèvent les
nuages.*

*Parfois, errant, je rencontre un ermite:
On parle, on rit, sans souci du retour.*

Mon refuge au pied du mont Chung-nan,
WANG Wei.
*Traduction en français par François
Cheng.*

Remerciements

Tout d'abord, je remercie profondément Alain Chenciner et Jacques Féjoz, mes directeurs de thèse : leur enthousiasme pour les mathématiques m'a inspiré constamment. C'est le temps qu'ils m'ont consacré, leur patience presque infinie pendant les discussions et la lecture des nombreuses versions préliminaires de mes travaux qui m'ont permis de mener à bien cette thèse sous sa forme actuelle.

Je remercie très sincèrement Christian Marchal et Jesús Palacian de m'avoir fait l'honneur d'être les rapporteurs de cette thèse, et Christian Marchal, Jacques Laskar, Jean-Pierre Marco d'avoir accepté d'être membres du jury.

Je tiens à remercier tous les membres de l'équipe *Astronomie et systèmes dynamiques*. Les bonnes conditions de travail et l'atmosphère très chaleureuse de l'équipe ont constamment soutenu ma recherche. Merci en particulier à Alain Albouy : sa connaissance profonde des mathématiques m'a toujours inspiré.

Merci également à l'*Institut de Mathématiques de Jussieu* et l'*Institut Henri Poincaré* où j'ai suivi des cours et participé à des séminaires et des colloques. Les trois écoles d'hiver organisées par le réseau dynamique espagnol DANCE m'ont beaucoup aidé et je les en remercie.

Je remercie sincèrement mes amis qui m'ont épaulé : à Nanjing, Chongqing Cheng, Yanning Fu, John Cui, Jian Cheng, Wei Cheng, Lin Wang, Min Zhou, Xingbo Xu, Jiacheng Liu, Kangmin Zhou et Xiangsheng Meng, et à Paris, Guan Huang, Kai Jiang, Shanna Li, Qiaoling Wei et Kunliang Yao.

Merci à Xian Liao, qui m'a encouragé constamment pendant ces années et m'a aidé à améliorer la rédaction de cette thèse.

Finalement, je remercie chaleureusement ma mère et toute ma famille.

Résumé

Résumé

Cette thèse généralise au problème spatial dans le cas lunaire les études sur diverses familles de mouvements quasi-périodiques dans le problème plan des trois corps.

En tronquant au premier ordre non trivial le développement en puissances du rapport des demi grands axes de la fonction perturbatrice moyennée sur les angles rapides, on obtient un système complètement intégrable qui peut servir de première approximation pour le système initial. C'est le système *quadripolaire*, découvert par Harrington. Dans un article classique, Lidov et Ziglin ont étudié la dynamique de ce système. Nous commençons par établir l'existence de solutions quasi-périodiques du problème spatial des trois corps en appliquant les théorèmes de KAM à ce système.

Nous montrons ensuite l'existence de familles de solutions que nous appelons *solutions quasi-périodiques de quasi-collision* : ce sont des solutions le long desquelles deux des corps deviennent arbitrairement proches l'un de l'autre sans toutefois avoir de collision : la limite inférieure de leur distance est nulle alors que la limite supérieure est strictement positive. Ces solutions sont quasi-périodiques dans un système régularisé à un changement de temps près. Des solutions de ce type ont été mises en évidence tout d'abord dans le problème restreint plan circulaire par Chenciner et Llibre puis, dans le problème plan des trois corps par Féjoz. Nous prouvons l'existence d'une mesure positive de ces solutions dans le problème spatial des trois corps. L'existence de ce type de solutions avait été prédit par Marchal dont nous confirmons rigoureusement le résultat. La démonstration consiste en l'application d'un théorème KAM équivariant dans une régularisation du problème, ici celle de Kustaanheimo-Stiefel, et par la compréhension, suivant Féjoz, de la relation entre régularisation et moyennisation.

Mots-clefs

problème des trois corps, système séculaire, système quadripolaire, régularisation de Kustaanheimo-Stiefel, orbite de quasi-collision

Quasi-periodic and Almost-collision Solutions of the Spatial Three-body Problem

Abstract

This thesis generalizes to the spatial three-body problem in the lunar case some studies about several families of quasiperiodic motions in the planar circular restricted three-body problem and in the planar three-body problem.

As discovered by Harrington, if we develop the perturbing function of the system averaged over the fast angles in the powers of the ratio of the semi major axes, then the truncation at the first non-trivial order is integrable. This is the *quadrupolar system*. In a classical article, Lidov and Ziglin studied the dynamics of this system. We start by proving the existence of some quasi-periodic solutions of the spatial three-body problem by applying KAM theorems to this system.

We then prove the existence of a family of *quasi-periodic almost-collision solutions*: These are solutions along which two bodies become arbitrarily close to one another but never collide: the lower limit of their distance is zero but the upper limit is strictly positive. After a change of time, these solutions are quasi-periodic in a regularized system. Such solutions were first discovered in the planar circular restricted three-body problem by Chenciner and Llibre, and afterwards, in the planar three-body problem by Féjoz. We show the existence of a positive measure of such solutions in the spatial three-body problem, which confirms rigorously a prediction of Marchal. The proof goes through the application of an equivariant KAM theorem to a regularization of the problem, here the Kustaanheimo-Stiefel regularization, and, as in Féjoz's work, it requires understanding the relation between the regularization and averaging.

Keywords

three-body problem, secular systems, quadrupolar system, Kustaanheimo-Stiefel regularization, almost-collision orbits

Contents

Introduction	11
0.1 Introduction (Français)	11
0.2 Introduction	14
Notations	27
1 Secular Spaces and Reductions	29
1.1 Basic Facts about the Three-Body Problem	29
1.2 Spaces of Spatial Ellipse Pairs	35
2 Quadrupolar Dynamics and Quasi-periodic Solutions	45
2.1 Secular and Secular-integrable Systems	45
2.2 Quadrupolar Dynamics	50
2.3 KAM Theorems and Applications	57
3 Regularization and Almost-collision orbits	67
3.1 Kustaanheimo-Stiefel Regularization	67
3.2 Quasi-periodic Almost-collision orbits	79
Appendices	93
A Estimates of the Perturbing Functions	93
B Analyticity of F_{quad} near Degenerate Inner Ellipses	95
C Singularities in the Quadrupolar System	96
D Non-degeneracy of the Quadrupolar Frequency Maps	98
Bibliography	103

Introduction

0.1 Introduction (Français)

L'étude du *problème des N -corps newtonien*, comme modèle central de la *mécanique céleste*, commence sa longue et passionnante histoire avec l'œuvre fondamentale de Sir Isaac Newton sur la "loi d'attraction universelle en inverse du carré de la distance", énoncée dans les *Principia* (publiés en 1687).

Après son succès dans la résolution du problème des deux corps, Newton a essayé de comprendre le cas de N corps de façon perturbative. Dans sa Proposition 65 [CW99], il écrivait:

More than two bodies whose forces decrease as the squares of the distances from their centers are able to move with respect to one another in ellipses and, by radii drawn to the foci, are able to describe areas proportional to the times very nearly.

Dans le formalisme hamiltonien, nous interprétons cette phrase de la manière suivante: Dans une certaine région (dépendant des masses) de l'espace des phases, il est possible de décomposer l'hamiltonien F du problème des trois corps en deux parties

$$F = F_{Kep} + F_{pert},$$

où F_{Kep} est la somme de deux hamiltoniens keplériens découplés, et F_{pert} est une petite perturbation. La dynamique de F peut alors être considérée approximativement comme celle de mouvements keplériens dont le faible couplage induit une évolution lente des éléments des ellipses keplériennes (les mouvements séculaires). Une telle décomposition n'est pas unique, et doit être choisie, en fonction de la situation étudiée, de façon à minimiser la norme de la fonction perturbatrice.

Après Newton, Euler, Clairaut, d'Alembert, Lagrange et Laplace donnèrent beaucoup de résultats importants sur ce sujet. Notamment, Laplace a donné le premier résultat de "stabilité" du système Soleil-Jupiter-Saturne. Les techniques développées à ce propos composent une partie essentielle de la théorie des perturbations et des systèmes dynamiques; plus généralement, elles ont eu une grande influence sur le développement des mathématiques.

Pour étudier la dynamique séculaire, on développe habituellement la *partie perturbative* F_{pert} en série de puissances de petites quantités (par exemple, les rapports de masse, les excentricités ou les rapports de demi grand axes), puis on tronque la série et on moyenne sur les angles rapides keplériens, *i.e.* les longitudes moyennes, (ou bien on fait ces opérations dans l'ordre inverse, comme dans l'étude du problème planétaire) pour obtenir un *système approché* qui est un système fermé en les *éléments séculaires*, c'est-à-dire en les éléments qui décrivent les formes et les positions instantanées des ellipses keplériennes. La *dégénérescence propre* de la partie képlérienne F_{Kep} empêche d'appliquer directement les techniques de la théorie des perturbations: l'hamiltonien d'un mouvement képlérien elliptique ne dépend en effet que de son demi grand axe et non des autres variables d'action qui

sont données par l'excentricité et l'inclinaison. Ce n'est donc qu'à partir de la dynamique du *système approché* évoqué ci-dessus que l'on peut appliquer les techniques de la théorie des perturbations pour obtenir des informations dynamiques sur le système complet.

La majorité des études séculaires ne concerne qu'une partie très particulière de l'espace des phases, qui correspond aux problèmes planétaires ou aux problèmes lunaires. Dans sa thèse [Féj99], J. Féjoz présente une étude plus globale de la dynamique séculaire du problème plan des trois corps. Il étudie en particulier la dynamique au voisinage de situations de collision double. Appliquant un théorème KAM bien adapté à ce système, il établit l'existence de plusieurs familles de tores invariants (correspondant à des solutions quasipériodiques), et celle de solutions de *quasi-collision* dans lesquelles deux des corps ont des rencontres de plus en plus proches sans avoir cependant de collision. L'existence de ce dernier type de solutions généralise le résultat de A. Chenciner et J. Llibre [CL88] sur l'existence de solutions de quasi-collision dans le problème réstreint plan circulaire des trois corps.

Contrairement à ce qui se passe pour le problème des trois corps dans le plan, dans le problème spatial des trois corps, les systèmes séculaires ne sont a priori pas intégrables. Toutefois, comme l'a d'abord observé Harrington [Har68], si on développe le système séculaire en puissances du rapport des demi grands axes, un heureux hasard fait que le premier terme non trivial est intégrable: c'est le *système quadripolaire*. Dans [LZ76], Lidov et Ziglin ont présenté une étude globale la dynamique quadripolaire. Néanmoins, leur étude au voisinage des collisions n'est pas complète. Après avoir justifié leur étude au voisinage des collisions en utilisant la technique de régularisation, nous montrons l'existence de certaines familles de solutions quasi-périodiques et également de familles de solutions de quasi-collision dans le problème spatial des trois corps. En fait, l'existence de solutions de quasi-collision avait déjà été prédite par C. Marchal dans [Mar78]. Notre étude constitue ainsi une confirmation rigoureuse de sa prédiction.

Le système étudié par Lidov et Ziglin vit naturellement dans l'espace séculaire réduit par les rotations dans l'espace et les rotations de l'ellipse extérieure dans son plan (qui forment un groupe $SO(3) \times SO(2)$). Or cet espace réduit est singulier lorsque l'ellipse intérieure dégénère tout en étant orthogonale au plan de l'ellipse extérieure. Au prix de la restriction à un sous-espace contenant les situations où l'ellipse intérieure dégénère et du passage à un revêtement à deux feuillets ramifié en ces points, nous pouvons continuer à utiliser certaines cordonnées de Delaunay et ainsi donner un sens au Hamiltonien de Lidov et Ziglin jusqu'aux collisions, ce qui est la clé pour prouver l'existence de solutions de quasi-collision.

L'une des subtilités de la régularisation est sa relation avec la moyennisation. Dans le cas du problème plan où la régularisation est celle de Levi-Civita, J. Féjoz avait remarqué que, si elles ne commutent pas, les deux opérations commutent "presque" dans un sens précis. La régularisation que nous utilisons, dans l'espace, est celle de Kustaanheimo-Stiefel; la notion de *plan de Levi-Civita* permet de faire le lien entre les deux régularisations et ainsi de généraliser au problème spatial le traitement de ce point délicat. En particulier, le système quadripolaire et le système régularisé quadripolaire sont orbitalement conjugués au prix d'un petit changement de la masse du corps extérieur.

Appliquant un théorème KAM iso-énergétique équivariant bien adapté à la dégénérescence propre du système (ou, ce qui est équivalent, en appliquant un théorème KAM iso-énergétique au système réduit), nous trouvons un ensemble de mesure positive de tores invariants sur le niveau d'énergie régularisé, rencontrant transversalement l'*ensemble de collision* que la régularisation a ajouté à l'espace des phases. En montrant l'existence d'un ensemble de mesure positive de sous-tores ergodiques qui rencontrent l'ensemble de

collision suivant des sous-variétés de codimension 3, nous concluons qu'il existe un ensemble de mesure positive de solutions de quasi-collisions dans le problème spatial des trois corps. Ces solutions sont quasi-périodiques dans le système régularisé, c'est-à-dire après changement de la loi du temps. Comme l'avait indiqué C. Marchal, ces solutions de quasi-collision donnent, dans la modèle idéal qui vient celle de Soleil-Terre-Lune, une probabilité positive des collisions de la lune avec la terre.

0.2 Introduction

0.2.1 A Short Historical Survey of Perturbative and Secular Studies of the N-Body Problem

Right after the fundamental work of Sir Issac Newton on the “inverse-square law” in his *Principia* (published in 1687), the study of the *Newtonian N-body problem*, as a central model of modern *celestial mechanics*, begins its long and exciting history.

After his success in solving the two-body problem, Newton began to study the case of N-bodies by what we call a *perturbative* viewpoint. In his Proposition 65 [CW99], he wrote

More than two bodies whose forces decrease as the squares of the distances from their centers are able to move with respect to one another in ellipses and, by radii drawn to the foci, are able to describe areas proportional to the times very nearly.

In Hamiltonian formalism, we may interpret this sentence in the following way: After fixing the center of mass, in some particular region of the phase space depending on the masses, it is possible to decompose the Hamiltonian F of the three-body problem into two parts

$$F = F_{Kep} + F_{pert},$$

where F_{Kep} is the sum of several uncoupled Keplerian Hamiltonians, and F_{pert} is significantly smaller than each of the Keplerian Hamiltonians in F_{Kep} . The dynamics of F can thus be described as uncoupled Keplerian motions with slow evolutions of the Keplerian orbits (the so-called secular motions).

In the proof, Newton pointed out two cases allowing the above.

The first case, the *planetary problem*, is that of several small bodies (the “planets”) moving around a significantly massive body (the “Sun”) with initially lower-bounded mutual distances. This case models the motion of the solar system in which the masses of the planets are very small compared to the mass of the Sun, and, their mutual interactions can thus be ignored in first approximation.

The second case is that either a planetary system or a two-body system is affected by another body far away. In the first approximation, the planetary system or the two-body system is not affected by the distant body, hence the system with all its mass considered as being concentrated at its center of mass and the distant body form a two-body system. The Earth-Moon-Sun system is an example, which explains that one speaks of the *lunar system*.

In his Proposition 66 and its twenty-two corollaries, Newton had made the first series of perturbative studies of the three-body problem. Notably, in the eleventh corollary, he studied the evolution of the node of the moon with the orbital plane of the sun in the lunar problem, and concluded that the node will either move retrogradely or stay stationary and is therefore carried backward at each revolution. As the node is an elliptical element which does not depend on the *fast Keplerian motion* (the movement of the moon on its elliptic orbit), this is also the first result concerning the *secular dynamics* of the three-body problem, that is, the dynamics of the slow evolutions of the Keplerian ellipses in the three-body problem.

After Newton, understanding the secular motions of the solar system became a topic of great interest in mathematico-astronomical research. The term “secular system”, which is the averaged system of F_{pert} over the fast angles, together with a series of important results on its dynamics, appeared already at the time of Lagrange (e.g. [Lag73], [Lag81], [Lag82]) and Laplace (e.g. [Lag83], [Lap72], [Lap84]). After the important contributions

of Euler, Clairaut, D'Alembert and Lagrange, Laplace proved the first order¹ secular invariance of the semi major axes in the Sun-Jupiter-Saturn system in [Lap73]². Later on, the secular evolution of the orbital elements was further studied by Lagrange, Laplace and their successors. Mathematically, these studies gave birth to many important ideas and phenomena of the *perturbation theory*, or more generally, the theory of *dynamical systems*: averaging method, periodic and quasi-periodic motions, effect of resonances, method of variation of constants, problem of stability and instability, and so on. The study of the secular dynamics was later continued by many mathematicians and astronomers, notably Cauchy, Le Verrier, Tisserand, Poincaré, Arnold, Moser, Lieberman, Lidov-Ziglin etc, up to nowadays, where the power of computers allows studying the dynamics on extremely long duration of time (See for example the works of Laskar [Las88], [Las90], [Las08]).

0.2.2 Some Methods of Secular Studies

To study the secular dynamics, one usually expands the *perturbing part* into a power series of some small quantities (e.g. the mass ratios, the eccentricities or ratios of the semi major axes), then truncates the series properly and averages over the fast Keplerian angles (or in the opposite order, as in the study of planetary problem) to get an *approximating system* (often called *secular system*), which is a closed system in the slow *secular elements*, *i.e.* the elements that describe the shapes and positions of the ellipses. Based on the dynamical knowledge of the approximating system, one can then apply techniques of perturbation theory to understand the dynamics of the full system.

In this strategy, the study boils down to finding a proper approximating system whose dynamics can be studied explicitly at least locally, and verify that the tools from perturbation theory can be applied. A particular problem encountered in applying techniques of perturbation theory is the *proper degeneracy* of the *Keplerian part*: Among the $3N - 3$ action variables, it only depends on $N - 1$ of them. One thus needs more informations about the *perturbing part*. In fact, if we can find an approximating system as mentioned above, then by putting it together with the Keplerian part, we get a Hamiltonian which will most probably depend non-trivially on more action variables (thus remove the proper degeneracy), and whose dynamics is equally known.

0.2.3 Local and Global Secular Studies

The approximating system need not be integrable. This fact often forces a local nature of study. Indeed, even if the approximating system is not integrable, one may possibly get an elliptic singularity (*i.e.* an elliptic equilibrium) from the symmetries and the Hamiltonian nature of the system. By building Birkhoff normal forms around this singularity, one obtains its nearby dynamics up to a sufficiently high order, which may enable us to apply perturbation theory. This analysis can only be carried out locally in the phase space, and was naturally called *local secular study*. See Jefferys-Moser [JM66], Lieberman [Lie71] and Laskar-Robutel [LR95], Robutel [Rob95], Féjóz [Féj04] for example.

On the other hand, if one has constructed an integrable approximating system, then it is possible to study its dynamics *globally*. For example, the *secular systems* of the planar three-body problem are integrable. In fact, the *first order secular system* (*i.e.* the *averaged system*, which is defined by the averaged Hamiltonian of the *perturbing part* over the two fast angles) has two degrees of freedom and is invariant under the Hamiltonian

¹The development was made for the eccentricities.

²Several years later, Lagrange has shown that if one expands the secular system in the power series of the eccentricities, then the semi major axes has also no secular evolution.

SO(2)-action of rotations in the plane. By fixing the angular momentum and reducing the system by the SO(2)-symmetry, we arrive at a Hamiltonian system with only one degree of freedom. For the same reason, if the two Keplerian frequencies are Diophantine, or if they do not appear at the same order of magnitude, then the higher order secular systems (which one gets from higher order averaging over the fast angles) remain integrable. In his thesis [Féj99] (see also [Féj02]), J.Féjóz studied the dynamical behaviors and bifurcations of the first order secular system in detail, especially in the neighborhood of a degenerate inner ellipse (which was not much studied before his work), and thus gave a global view of the first order secular dynamics of the planar three-body problem. As the smallness of the perturbing function is expressed by a relation involving the masses and semi major axes, this study remains valid in the *perturbing region* defined in [Féj02]. In particular it covers not only the traditional planetary and lunar regions but also other regions of the phase-parameter space in terms of the masses and the ratio of semi major axes α .

In the present study of the spatial three-body problem, the situation is different. The secular systems will in general have four degrees of freedom. They also possess the SO(3)-symmetry. Reduction by this SO(3)-symmetry will in general lead to systems with two degrees of freedom, which are *a priori* not integrable. However, as was first observed by Harrington [Har68] in 1968, if we expand the first order secular system in powers of the ratio α of the semi major axes, then luckily the first non-trivial term admits an additional SO(2)-symmetry. The presence of this unexpected symmetry implies the integrability of the truncated secular system reduced to this term, which is called the *quadrupolar system* and denoted by $\alpha^3 F_{quad}$. A global study of F_{quad} was carried out by Lidov and Ziglin [LZ76] and supplemented by Ferrer and Osacar [FO94]. We will further supplement the study of Lidov and Ziglin by a reformulation of their study in the neighborhood of a degenerate inner ellipse. As a result, we obtain a global view of the quadrupolar dynamics. A treatment of the quadrupolar dynamics with the restricted problem with an infinitesimal outer body was treated in [FL10].

As we require α to be small, we need to stick to the lunar case and cannot be more global in the phase space.

0.2.4 Lindstedt Series and Kolmogorov-Arnold-Moser Theorem

In the eighteenth century, the perturbative methods for secular study faced a serious problem: the existence of *secular terms* (*i.e.* those terms tending to infinity when time tends to infinity) in the expansion of the perturbing part along an invariant torus of an approximating system. A problem of working with such expansion is that the motions that its truncations describe do not fit well with the slow evolution of the secular dynamics: due to the existence of the secular terms, the truncated series in general determines a dynamics in which there are many escaping motions and the escaping velocity is polynomially in time. This is one of the main deficits of the *old method*.

The *new method* began its fast development from Poincaré's proof of the existence of *Lindstedt series*, which do not contain any secular term. In such series, the expansion is made with e.g. fixing frequencies³ at an invariant torus in an approximating system. A truncation at a right number of terms of such a series can therefore be taken as a good approximation of the full motion in which the terms do not blow up when the time goes to infinity. Poincaré's method was later brought by Von Zeipel to the situation that only some of the phases were eliminated, and thus well-suitable to the systems with proper degeneracy

³The frequencies are not the only quantities that one may to fix to obtain Lindstedt series. For example, one can equally fix the energy and the ratio of the frequencies instead.

and/or resonances. As noticed by Poincaré, such series depending on variable frequencies are in general divergent. The reason for the divergence are two folds: each term in the series is itself determined by some series, whose coefficients contain *small divisors*: the frequencies that are too close to resonance imply that infinitely many denominators of the terms of the expansion are “very small” compared to the corresponding numerators, which makes the series divergent in general. Even if all the terms of the series are convergent, the Lindstedt series (with variable frequencies, depending on some small parameter) itself may well be divergent, caused by the destruction of the resonant tori, as observed by Poincaré in [Poi92].

Nevertheless, are some of such series convergent? It was found that the convergence of the terms in the Lindstedt series are closely linked with the arithmetical property of its frequencies. The main breakthrough started in 1954, when A. Kolmogorov showed that a invariant torus with *Diophantine* frequencies of an analytic Hamiltonian system persists under small perturbations, provided some non-degeneracy condition on the frequency map is satisfied [Kol54]. After Siegel’s work on complex dynamics, this was the second important achievement on the small divisor problem. The degenerate case pertinent to the planetary problem was then treated by V. Arnold in 1963 [Arn63], which is also the first application of such techniques in celestial mechanics. These results, together with J. Moser’s similar results on smooth twist maps, gave birth to the celebrated *KAM* theory. The issue of convergence of the Lindstedt series was finally settled by Moser in [Mos67], in which he showed that the persisting invariant torus depends analytically on the small parameter of the Lindstedt series, and therefore the corresponding Lindstedt series with fixed Diophantine frequencies converge. With Jefferys, Moser also established the existence of quasi-periodic motions in the spatial three-body problem arising from a hyperbolic secular singularity in the planetary and the lunar cases in [JM66]. An application of KAM theorems to the planar three-body problem was done by Lieberman [Lie71].

As noticed by several authors, due to a surprising resonance of the linear part discovered by Herman, the original proof of Arnold on the stability of the planetary problem is only valid for the planetary system with two planets in the plane. The theorem is proven for the spatial three-body problem by F. Robutel in [Rob95], Following a manuscript of M. Herman, a complete proof of *Arnold’s theorem* concerning the stability of the planetary problem with many planets in \mathbb{R}^3 was carried out by J. Féjóz [Féj04]. Another proof of this result has been achieved by Chierchia and Pinzari [CP11b]. In the planetary three-body problem, some elliptic invariant 2-tori was shown to exist in [BCV06].

In his thesis [Féj99], based on the global study of the secular dynamics of the planar three-body problem, J.Féjóz has proved that there exists a set of positive measure of Lagrangian tori which arise from secular invariant tori, and a positive relative measure (the Lebesgue measure in some appropriate parameter space; this set of tori are lower dimensional, hence has zero measure in Π) of invariant isotropic tori that arise from the secular singularities in the planar three-body problem.

In the spatial three-body problem, based on Lidov-Ziglin’s study of the quadrupolar system, by applying KAM theorem, we prove

Theorem 0.1. *In the spatial three-body problem, after reduction of the $SO(3)$ -symmetry, there exists a set of positive measure of 4-dimensional invariant ergodic Lagrangian tori, which arise from 4-dimensional quadrupolar invariant tori, and a positive relative measure of 3-dimensional invariant isotropic ergodic tori which arise from the quadrupolar elliptic singularities. They give rise to 5-dimensional invariant tori and 4-dimensional invariant tori of the spatial three-body problem respectively.*

We already recalled that the persistence of a lower dimensional tori arising from the

hyperbolic secular singularity (which is present only for large enough mutual inclinations), is already shown by Jefferys and Moser [JM66]. Part of our results can be seen as a generalization of their result to elliptic secular singularities in the lunar case.

0.2.5 Quasi-periodic Almost Collision Orbits

In Chazy's classification of the seven possible final motions of the three-body problem (see [AKN06], P. 83), let us consider two particular kinds of possible motions: bounded motions and oscillating motions. Bounded motions are those motions such that the mutual distances remain bounded when time goes to infinity, while oscillating motions are those motions such that as time goes to infinity, the upper limit of the mutual distances goes to infinity, while the lower limit of the mutual distances remains finite. They are exactly the possible final motions for which Chazy has not classified the possible velocities. We know a number of bounded motions but still relatively few oscillating motions, with Sitnikov's model being one of the well-known example of the latter kind.

There is yet another possibility of oscillating motions, namely, if we replace the oscillation of mutual distances by the oscillation of relative velocities of the bodies. C. Marchal called such bounded motions with oscillating velocities "oscillating motions of the second kind". By consulting the criteria for velocities in Chazy's classification, we see that if such motions do exist and are not oscillating motions, then they must be bounded.

In [Mar78], by analyzing the quadrupolar dynamics near a degenerate inner ellipse, C. Marchal became aware of the existence of a positive measure of such motions in the spatial three-body problem. Having not applied rigorous perturbative tools, he nevertheless did mention in his study that the motions he had in mind

- are with incommensurable frequencies;
- arise from quadrupolar invariant tori;
- form a possibly nowhere dense set with small but positive measure in the phase space.

We shall investigate a particular kind of oscillating motions of the second kind: the *quasi-periodic almost-collision orbits*, which are, by definition, orbits along which two bodies get arbitrarily close to each other but never collide: the lower limit of their distance is zero but the upper limit is strictly positive, and they are quasi-periodic in a regularized system. More precisely, we shall show the existence of a set of positive measure of such orbits arising from the (regularized) quadrupolar invariant tori. These are the orbits predicted by C. Marchal.

The first rigorous mathematical study of quasi-periodic almost-collision orbits was achieved by A. Chenciner and J. Llibre in [CL88], where they considered the planar circular restricted three-body problem in a rotating frame with a large enough Jacobi constant which determines a Hill region with three connected components. After regularizing the dynamics near the double collision of the astroid with one of the primaries, they reduce the dynamical study to the study of the corresponding Poincaré map on an annulus of section in the regularized system. They showed that this is a twist map with a small twist perturbed by a much smaller perturbation, which makes it possible to apply Moser's theory to establish the persistence of a positive measure of invariant KAM tori. By adjusting the Jacobi constant, they showed that a positive measure of such invariant tori intersect transversally the codimension 2 *collision set* (the set in the regularized phase space corresponds to the double collision of the astroid with one of the primaries). Such

invariant tori were called invariant “punctured” tori because they are “punctured” by the collisions in the regularized phase space. As the flow is linear and ergodic on each punctured torus in the regularized system, most of the orbits will not pass through but will get arbitrary close to the collision set. These orbits correspond to a set of positive measure of quasi-periodic almost-collision orbits in the planar circular restricted three-body problem.

In his thesis [Féj99], J. Féjóz generalized the study of Chenciner-Llibre to the planar three-body problem. In his study, the inner double collisions were regularized by Levi-Civita regularization. The *secular regularized systems*, *i.e.* the normal forms one gets by averaging over the fast angles, can then be built with the same averaging method as the usual non-regularized ones. A careful analysis shows that the dynamics of the secular regularized system and the naturally extended (through degenerate inner ellipses) secular system are conjugate up to a modification of the mass of the third body which is far away from the inner pair. The global analysis of the secular dynamics then permitted him to verify the non-degeneracy conditions which are necessary to apply KAM theorem. The persistence of a set of positive measure of invariant tori is thus established. After verifying the transversality of the intersections between the KAM tori and the codimension 2 collision set, he concluded that as the frequencies of the KAM tori are irrational, most of the orbits will not pass through but will get arbitrary close to the collision set. These orbits give rise to quasi-periodic almost-collision orbits of the planar three-body problem.

In this thesis, we generalize the former works of Chenciner-Llibre and Féjóz to the spatial three-body problem. Simultaneously it gives a rigorous proof of Marchal’s prediction. More precisely, we shall prove the following theorem:

Theorem 0.2. *There exists a set of positive measure of quasi-periodic almost-collision orbits on each negative energy surface of the spatial three-body problem. They form a set of positive measure of quasi-periodic almost-collision orbits in the phase space of the spatial three-body problem.*

0.2.6 Other Types of Almost Collision Orbits

Aside from examples of, or related to, quasi-periodic almost-collision orbits cited above, we also know some other examples, which are closely related to the existence of non-collision singularities in the N -body problem for $N > 3$. Such solutions were constructed by Z. Xia [Xia92] in the spatial problem with $N = 5$, and by J. Gerver [Ger91] in the planar problem with N a large enough multiple of 3. The motions remain collisionless along these orbits, but some of the velocities and the size of the system goes to infinity. As the number of particles is finite, this can only happen when at least two particles get arbitrarily close to each other.

0.2.7 Variants of Secular Space and Lidov-Ziglin’s Study of the Quadrupolar System

As already mentioned above, the global secular dynamics of the lunar spatial three-body problem that we are going to describe is closely related to the dynamics of the *quadrupolar system* F_{quad} , which has an additional first integral: the norm of the outer angular momentum $|\vec{C}_2| = G_2$. It can then be further reduced to one degree of freedom, and hence is integrable.

After reduction to one degree of freedom, that is after fixing \vec{C} and G_2 to non-zero values and eliminating the conjugate angles, the quadrupolar system is well defined on the

2-dimensional reduced space, which is a smooth manifold except when $C := |\vec{C}| = G_2$, where the degenerate inner ellipses orthogonal to the Laplace plane give rise to two singular points, and possibly if $G_1 = L_1 = |C + G_2|$ which corresponds to a horizontal circular inner ellipse (see Figure 2.5).

When $C \neq G_2$, the functions $G_1 - |C - G_2|$ and g_1 become symplectic polar coordinates in the neighborhood of the unique point where G_1 attains its minimum value, that is when the inner and outer ellipses are coplanar.

When $C = G_2$, the reduced space is not smooth, and the secular Delaunay coordinates lose their regularity along the curve $G_1 = 0$. Nevertheless, in order to use Lidov and Ziglin's study when the inner ellipse degenerates, we find more convenient, rather than introducing new local coordinates, to continue using Delaunay/Deprit coordinates after having extended their validity on the branched double cover of this reduced space, defined as follows:

We first define the *modified secular space* by treating inner ellipses as *decorated*: A *decorated ellipse* is a pair consisting of a non-oriented plane and a possibly degenerate ellipse (oriented when the ellipse is non-degenerate) within this plane. This space is seen as the blow-up of the *secular space*, or *space of ellipse pairs* along degenerate inner ellipses. We then define the *critical quadrupolar space* as a particular *codimension 1* subspace of the modified secular space, which is invariant under the flow of the quadrupolar dynamics⁴ for $C = G_2$. We show that on a double cover of the critical quadrupolar space, the Delaunay and Deprit coordinates can be naturally extended by allowing the inner eccentricity e_1 to be negative, and that the extended coordinates become regular near a degenerate inner ellipse. The quadrupolar dynamics now becomes more transparent by lifting Lidov-Ziglin's formula for F_{quad} to this double cover of the critical quadrupolar space (See Figure 2.6).

0.2.8 Regularizations of the Kepler Problem

The presence of collisions makes the Keplerian flow incomplete. In order to make a perturbative study of the Kepler problem near collisions, it is necessary to regularize the system so as to get a smooth complete flow near collisions. Various methods are available with possibly different understandings of the word "regularization". In this thesis, we shall only consider the following type: A *regularization of the Kepler problem* on a negative energy surface consists in a compactification of the energy surface, and the extension of the flow after a change of time to the compactified energy surface such that the resulting flow is complete.

The first geometrical regularization of the planar Kepler Problem was constructed by Levi-Civita in [LC20], though we should note that the main ingredient of this method was already presented 31 years before by E. Goursat [Gou87]⁵.

For the spatial Kepler problem, two methods of regularizing the collisions are among the most widely used: the Moser regularization and the Kustaanheimo-Stiefel regularization. Moser's method transforms an energy level of the Kepler problem into a dense open subset of an energy level of the geodesic flow on S^3 which can be completed directly. Moser's method has the advantage that the underlying geometry, and in particular the $SO(4)$ -symmetry of the spatial Kepler problem, become evident; this method can be generalized directly to higher dimensional Kepler problem.

⁴This also holds for the secular-integrable dynamics, which one get by higher order eliminations of the angle conjugate to G_2 , see Subsection 2.1.3.

⁵This historical remark is due to A. Albouy. E. Goursat already defined the same symplectic transformation (as Levi-Civita) based on the complex square mapping to transform harmonic oscillators (resonant, with only one frequency) into Kepler problem.

Kustaanheimo-Stiefel regularization⁶ generalizes Levi-Civita regularization by transforming Kepler problem into a linear system of completely resonant harmonic oscillators. Compared to Moser’s regularization, this method has the advantage that the resulting dynamics is linear whose expression is easier to handle. The theory of this regularization (notably the related geometry), together with several theoretical applications, was presented in details in the book [SS71] of Stiefel and Scheifele. The relation between Moser’s regularization and Kustaanheimo-Stiefel regularizations is explored in [Kum82].

In Section 3.1, starting with a formula in [Mik], we have formulated the Kustaanheimo-Stiefel regularization in the language of quaternions. The benefit of such a formulation is that it leads to very compact formulæ. Another quaternionic formulation can be found in e.g. [Wal08]. The symplecticity of the Kustaanheimo-Stiefel regularization is established by means of a symplectic reduction procedure. Even if the regularized flow is directly related (via a change of time) to the Kepler flow only for a single value of the energy, for all values of the energy of the regularized system greater than a negative quantity depending only on the masses of the Kepler problem, we show that the corresponding trajectories in the physical space are ellipses. Following [SS71], a link between Levi-Civita regularization and Kustaanheimo-Stiefel regularization is presented in terms of the *Levi-Civita planes*. We then build several sets of coordinates in the regularized phase space Π_{reg} . Following a course of A. Chenciner [Che86], J. Féjóz has built a set of coordinates for the (Levi-Civita) regularized dynamics in the planar case in [Féj01] which we call *planar Chenciner-Féjóz coordinates*. A generalization of these coordinates in the spatial case is made, which, with proper justification, can be used to study the dynamics of the quadrupolar regularized system (*i.e.* the regularized counterpart of the quadrupolar system). Another set of action-angle coordinates (called *regularized coordinates*) is also introduced, which is regular near collision-ejection motions and allows the application of perturbative techniques.

0.2.9 Outlines of the Proofs

Outline of the proof of Theorem 0.1

We consider the lunar case, so that the third body stays far away from the other two. In Jacobi coordinates, we make the decomposition

$$F = F_{Kep} + F_{pert}.$$

By hypothesis, the two Keplerian frequencies do not appear at the same order of magnitude of α . Following Jefferys-Moser [JM66] and Féjóz [Féj02], we eliminate the fast angles from the perturbing part, up to a remainder of higher order of smallness (of α), by a change of coordinates close to identity, *without imposing further arithmetic conditions on the two Keplerian frequencies*, and obtain an approximation by the first-order secular system F_{sec}^1 . We build higher order secular systems F_{sec}^n with the same averaging method.

As we have said, an important difference with the planar case is the integrability of the secular systems. Integrable approximating systems in the spatial case are found by developing the secular systems in powers of α , the ratio of semi major axes a_1, a_2 , and truncating the series at the lowest non trivial term, which, by chance, is independent of the argument g_2 of the pericentre of the outer ellipse. We thus get the integrable *quadrupolar system* F_{quad} . Note that this term remains the same for all the higher order

⁶One uses also the word “regularization” for the Levi-Civita or Kustaanheimo-Stiefel constructions, though the actual regularization are only obtained after the reduction of some symmetry (respectively by $\mathbb{Z}/2\mathbb{Z}$ or S^1) coming from the construction.

secular systems F_{sec}^n . We then eliminate the angle g_2 , conjugate to G_2 , to get the higher order *secular-integrable systems* $F_{sec}^{n,n'}$, whose dynamics is only a small perturbation of the quadrupolar dynamics, and orbitally conjugated to it for a dense open set of parameters.

When C and G_2 are different, the triangle inequality implies that the angular momentum G_1 of the inner ellipse remains bounded away from zero (equivalently, the eccentricity e_1 of the inner ellipse is bounded away from 1). The required verification of iso-chronic non-degeneracy of the secular-integrable systems reduced by the $SO(3)$ -symmetry is done in Appendix D. It is based on Lidov-Ziglin's study of the quadrupolar dynamics which, together with the effective dependance of the Keplerian part on the semi major axes, allows us to apply the iso-chronic KAM theorem described in Corollary 2.1 and thus prove the theorem. Theorem 2.2 affirms that in the reduced system, there exists a family of periodic orbits of the reduced system accumulating every Lagrangian KAM torus.

Outline of the proof of Theorem 0.2

To prove Theorem 0.2, we first regularize the inner double collisions of the system on a negative energy surface $F = -f$, $f > 0$ by Kustaanheimo-Stiefel regularization and obtain a *regularized system* \mathcal{F} which is no longer singular on the set Col consisting of inner double collisions. Note that by construction, \mathcal{F} has an additional $SO(2)$ -symmetry, and that the actual regularization is obtained from \mathcal{F} by reduction of this symmetry. (Subsection 3.1.2, 3.2.2)

We decompose \mathcal{F} as

$$\mathcal{F} = \mathcal{F}_{kep} + \mathcal{F}_{pert}.$$

The Hamiltonian \mathcal{F}_{kep} describes the uncoupled motions of four harmonic oscillators in $1 : 1 : 1 : 1$ resonance (the regularized inner motion) and an outer Keplerian motion, and \mathcal{F}_{pert} is of smaller magnitude comparing to \mathcal{F}_{kep} . Again, \mathcal{F}_{kep} is properly degenerate (Subsection 3.2.2). In order to make perturbative studies, we need to study some integrable approximations of \mathcal{F}_{pert} .

Analogously as in the initial non-regularized case, we eliminate the fast angles in \mathcal{F}_{pert} by a change of coordinates close to identity, *without imposing further arithmetic conditions on the fast frequencies*, to get the n -th order *secular regularized systems* \mathcal{F}_{sec}^n . (Subsection 3.2.5)

As the secular systems F_{sec}^n , the secular regularized systems \mathcal{F}_{sec}^n are *a priori* not integrable. Nevertheless, if we expand \mathcal{F}_{sec}^n into the powers of α , then the truncation at the first non-trivial term is again integrable, since it is invariant under the $SO(3)$ -symmetry, and has an additional first integral G_2 . This term defines the *quadrupolar regularized system* \mathcal{F}_{quad} . We can then build the secular-integrable regularized systems $\overline{\mathcal{F}_{sec}^{n,n'}}$ by again eliminating g_2 . These systems remain integrable and their dynamics is only a small perturbation of \mathcal{F}_{quad} (Subsection 3.2.6). The function \mathcal{F}_{quad} descends to a function on the *regularized secular space*, a space which can be identified with the secular space. We study its dynamics in the neighborhood of degenerate inner ellipses in the critical quadrupolar space, on whose double cover Chenciner-Féjóz coordinates and the "Deprit-like coordinates" extend to regular coordinates. (Subsection 3.2.4, Subsection 3.2.3; see also Subsection 1.2.3, Subsection 3.1.6).

In order to understand the dynamics of \mathcal{F}_{quad} , especially in the neighborhood of the regularized critical quadrupolar space, we first establish its relation with F_{quad} . The regularization and averaging procedure do not commute.. Nevertheless, we show that after being symplectically reduced by the $SO(3)$ -symmetry, the dynamics of \mathcal{F}_{quad} is conjugate to the dynamics of F_{quad} , up to a modification of the mass m_2 of the non-fictitious outer

body and a (secular) constant factor (Proposition 3.2.4). This allows us to directly deduce the dynamics of \mathcal{F}_{quad} from the dynamics of F_{quad} , especially in the neighborhood of the critical quadrupolar space (Section 2.2). Moreover, up to a constant factor, the invariant tori in the corresponding quadrupolar system and the quadrupolar regularized system are conjugate. (Subsection 3.2.7) We then deduce the geometry of the invariant tori of $\mathcal{F}_{sec}^{n,n'}$ and the existence of their torsions from that of \mathcal{F}_{quad} , which in turn is deduced from that of F_{quad} . In particular, with our study of the quadrupolar system F_{quad} (Section 2.2), we immediately deduce the quadrupolar iso-chronous non-degeneracy in need from the quadrupolar iso-chronous non-degeneracy of F_{quad} , which holds in a dense open subset of the secular space for a dense open set of parameters. (Appendix D) The iso-energetical non-degeneracy of the regularized Keplerian part with respect to the action variables conjugate to the fast angles are verified directly (Subsection 3.2.8). Therefore we have obtained all the non-degeneracy conditions in need to apply the equivariant iso-energetic KAM theorem (Corollary 2.3) in Π'_{reg} .

By applying Corollary 2.3, we establish the existence of a positive measure of Lagrangian invariant tori on the regularized zero-energy surface for any negative energy of the non-regularized system (Subsection 3.2.8). We then show that the collision set intersects a positive measure of these invariant tori transversely (so that, in the original phase space, they give rise to invariant *punctured tori*, *i.e.* invariant tori punctured by the collisions). (Subsection 3.2.9)

Such an invariant Lagrangian torus, which intersect the collision set transversally, is foliated by lower dimensional ergodic subtori. These ergodic subtori are interchanged by the symmetries of the system. We use this fact to prove that these ergodic subtori intersect the collision set on codimension 3 submanifolds. As the flow is irrational on these tori, almost all the trajectories get arbitrarily close to Col , but never actually intersect it. As a result, for each negative value of the energy, there exists a set of positive measure of quasi-periodic almost-collision orbits on this energy surface, and hence there exists a set of positive measure of quasi-periodic almost-collision orbits in the original phase space Π , which proves the theorem. (Subsection 3.2.11)

Comparison between the planar and spatial cases

We explicitly list here some common points and differences between our study and the proof of the corresponding results in the planar case by Féjóz in [Féj02].

Common Features between the Planar and the Spatial Cases

- Jacobi coordinates;
- Proper degeneracy of the Keplerian part;
- Construction of secular systems by asynchronous elimination procedure;
- Existence of integrable approximating systems;
- Application of KAM theorems;
- Transversality of the invariant tori with the collision set;
- Existence of different types of KAM tori and existence of quasi-periodic (including quasi-periodic almost-collision) orbits.

Differences between the Planar and the Spatial Cases

	Planar case	Spatial case
Degrees of freedom (Before / after fixing center of mass)	6 / 4	9 / 6
Rotation Symmetry	SO(2)	SO(3)
Secular spaces	$S^2 \times S^2$	$(S^2 \times S^2) \times (S^2 \times S^2)$
Integrability of secular systems	Integrable	Not <i>a priori</i> integrable
Integrable approximations	Secular systems	Secular-integrable systems
Codimension of the inner collision set	2	3
Secular Delaunay elements of an ellipse Regularity at degenerate ellipse	L, G, g Regular	L, G, g, H, h Not regular
Regularization Additional symmetry	Levi-Civita $S^0 \cong Z_2$	Kustaanheimo-Stiefel S^1
Sets of regularized coordinates used	Chenciner-Féjóz + Poincaré	Chenciner-Féjóz+Delaunay Deprit-like Stiefel-Scheifele/regularized

Astronomical significance of the study

As remarked by C. Marchal [Mar78], our result concerning quasi-periodic almost-collision orbits leads to a better understanding of collision phenomena in the universe. As soon as the bodies occupy positive volumes, the existence of a set of positive measure of quasi-periodic almost-collision motions implies a positive probability of collisions in some triple star systems. The collision mechanism given by quasi-periodic almost-collision orbits is thus more important than the mechanism given by direct collisions in the particle model.

Structure of the thesis

In Section 1.1, we recall the Hamiltonian formulation of the spatial three-body problem, and the eliminations of the node of Jacobi and Deprit. We then introduce and analyze, in Section 1.2, the secular space and some of its modifications.

In Section 2.1, we present the asynchronous elimination procedure which, in the situation we consider, allows obtaining the secular systems by successive single frequency eliminations. By a new elimination, we obtain the secular-integrable systems which are integrable approximations, refining the so-called “quadrupolar system”; their dynamics is studied in Section 2.2. In Section 2.3, we recall how to deduce from an analytic “hypothetical conjugacy theorem” an iso-chronic and an iso-energetic KAM theorem adapted to the degeneracies of the problem and present some equivariant versions of them. By applications of the iso-chronic KAM theorem and a theorem of Pöschel, we establish the existence of several families of quasi-periodic solutions and periodic orbits accumulating them in the spatial three-body problem reduced by the SO(3)-symmetry.

In Section 3.1, we formulate the Kustaanheimo-Stiefel regularization of the Kepler problem in the language of quaternions. The planar Chenciner-Féjóz coordinates are recalled and generalized to the spatial case. In Section 3.2, we regularize the inner double collisions of the spatial three-body problem by Kustaanheimo-Stiefel regularization and explore in particular the relation between the quadrupolar regularized system and the quadrupolar system. An application of the equivariant iso-energetic KAM theorem ensures the existence of regularized invariant tori close to the collision set. We conclude by showing that a set of positive measure of invariant ergodic tori intersect the collision set transversely.

0.2.10 Some Further Questions

The present study raises several natural questions.

Question 0.1. Are there quasi-periodic almost-collision solutions which appear near a double collision in the planar and spatial N -body problem for $N \geq 4$?

The main difficulty toward this generalization is the lack of a global integrable approximating secular system, and the lack of local secular study near double collisions. On the other hand, regularization and application of KAM theorems might allow straightforward generalizations.

Question 0.2. Are there quasi-periodic almost-collision solutions for three-body problem in \mathbb{R}^4 ?

A possible approach would be to first regularize the inner double collision and then study the quadrupolar regularized system of the 4-dimensional three-body problem, and then proceed as in the previous study.

Question 0.3. Are there other types of almost-collision orbits near double inner collisions in the planar or spatial three-body problem?

The existence of non-quasi-periodic almost-collision orbits, which arise from the intersection of the collision set with the Mather sets that are not Lagrangian tori in the regularized system seems quite plausible. Comparing to the present study, the new difficulty arises from the understanding of invariant objects introduced by Mather in our given systems.

In order to gain some intuition about this problem, let us look at the simpler situation of the planar circular restricted three-body problem [CL88]. In this case, we need to understand the intersection of the collision set with the Cantor-like Aubry-Mather sets: Can these intersections be empty for all choice of parameters? If not, the motions corresponding to actual intersections is then not quasi-periodic but only *almost-automorphic* (See e.g. [Yi03]).

Question 0.4. Are there solutions of the three-body problem which are oscillating both in positions and in velocities?

The existence of such motions could be seen as a complement to Chazy's classification for the final evolution of velocities. Note that according to Xia [Xia92] and Gerver [Ger91] there are such motions respectively in the five-body problem and the $3N$ -body problem for N large, but their examples concern pseudo-collision orbits, which do not exist in the three-body problem (Painlevé [Pai97]).

Question 0.5. (E. Maderna) Are there collisionless solutions of the three-body problem along which two particles get infinitely close when the time $t \rightarrow +\infty$, but all the mutual distances are bounded from below by some positive quantity when $t \rightarrow -\infty$?

Notations

$(P_i, Q_i), i = 1, 2$	positions/momenta of the two fictitious bodies	29
F	Hamiltonian of the three-body problem	29
Π	phase space of the spatial three-body problem	29
m_0, m_1, m_2	masses of the three real bodies	29
p_0, p_1, p_2	momenta of the three real bodies	29
q_0, q_1, q_2	positions of the three real bodies	29
(L, l, G, g, H, h)	Delaunay coordinates for a general ellipse	30
$(L_i, l_i, G_i, g_i, H_i, h_i), i = 1, 2$	Delaunay coordinates for inner and outer ellipses	30
F_{Kep}	Keplerian part	30
F_{pert}	perturbing part	30
$\alpha = \frac{a_1}{a_2}$	ratio of the semi major axes	30
μ_1, μ_2, M_1, M_2	constants depending only on the masses	30
a_1, a_2	semi major axes of the inner and outer ellipses	30
e_1, e_2	eccentricities of the two ellipses	30
i_1, i_2	inclinations of the two ellipses	30
\vec{C}	total angular momentum	31
\vec{C}_1, \vec{C}_2	angular momenta of the two ellipses	31
$(L_1, l_1, L_2, l_2, G_1, \bar{g}_1, G_2, \bar{g}_2, \Phi_1, \varphi_1, \Phi_2, \varphi_2)$	Deprit coordinates	32
C, C_z	norm and vertical component of \vec{C}	32
Π'	subspace of Π with non-vertical fixed direction of the angular momentum	32
Π'_{vert}	vertical angular momentum subspace of Π	32
u_1	eccentric anomaly of the inner ellipse	33
\vec{h}_1	the direction defined by h_1	39
\mathcal{P}^*	region on which we proceed asynchronous elimination	45
\mathbb{T}^n	n -dimensional torus	46
ν_1, ν_2	the two Keplerian frequencies	46
ϕ^n	symplectic transformation for constructing n -th order secular systems	46
F_{sec}^n	n -th order secular system	47
F_{quad}	quadrupolar Hamiltonian	48
$\overline{F_{sec}^{n, n'}}$	(n, n') -th order secular-integrable system	49

$\psi^{n'}$	symplectic transformation for constructing (n, n') -th order secular-integrable system from the n -th order secular system	49
B_r^n	n -dimensional centered ball with radius r	57
$HD_{\bar{\gamma}, \bar{\tau}}$	set of $(\bar{\gamma}, \bar{\tau})$ -Diophantine frequencies	57
N'	perturbed Hamiltonian	57
N^o	unperturbed Hamiltonian	57
$\mathcal{H}(\cdot)$	Hessian	58
$\mathcal{H}^B(\cdot)$	Bordered Hessian	60
\bar{N}'	reduced perturbed Hamiltonian	61
\bar{N}^o	reduced unperturbed Hamiltonian	61
\hat{N}'	modified perturbed Hamiltonian	61
\hat{N}^o	modified unperturbed Hamiltonian	61
$\nu_{quad,1}, \nu_{quad,2}$	quadrupolar frequencies	64
$\bar{\mathcal{I}}_1$	action variable of F_{quad} in a certain region of the (G_1, \bar{g}_1) -space	64
$\bar{\mathcal{J}}_1$	action variable of $\overline{F_{sec}^{n,n'}}$ in a certain region of the (G_1, \bar{g}_1) -space	64
Σ	7-dimensional quadratic cone of $T^*\mathbb{H}$, defined by $BL(z, w) = 0$	68
$K.S.$	the Kustaanheimo-Stiefel mapping	69
V^0	quotient of Σ^0 by its characteristic foliation	69
V^1	quotient of Σ^1 by its characteristic foliation	69
$\Sigma^1 = \Sigma \setminus \{z = 0\}$		69
$\Sigma^0 := \Sigma \setminus \{(0, 0)\}$		69
ω_1	symplectic form on V^0 and V^1	69
ϑ	Kustaanheimo-Stiefel angle	69
$-f$	energy of the non-regularized system	71
$K(z, w)$	regularized Kepler Hamiltonian	71
$T(P, Q)$	Kepler Hamiltonian	71
ω	frequency of the harmonic oscillator	71
\tilde{f}	energy of the regularized system	74
$(\mathcal{L}, \delta, \mathcal{G}, \gamma, \mathcal{H}, \zeta)$	Chenciner-Féjóz coordinates	76
$(\mathcal{P}_0, \mathcal{P}_1, \mathcal{P}_2, \mathcal{P}_3, \vartheta_0, \vartheta_1, \vartheta_2, \vartheta_3)$	regularized coordinates	78
Π_{reg}	regularized phase space	80
$\mathcal{C}ol$	collision set in the regularized phase space	80
\mathcal{F}	regularized Hamiltonian of the three-body problem	80
\mathcal{F}_{sec}^n	n -th order secular regularized system	82
\mathcal{F}_{quad}	quadrupolar regularized system	84
$\overline{\mathcal{F}_{sec}^{n,n'}}$	(n, n') -th order secular-integrable regularized system	84
$\bar{\mathcal{I}}_1$	action variable of \mathcal{F}_{quad} in the $(\mathcal{G}_1, \gamma_1)$ -plane	86
\mathcal{J}_1	The area between the invariant curve and the point $\{\mathcal{G}_1 = \mathcal{G}_{1,min}\}$ in the completely reduced system $\mathcal{F}_{Kep} + \overline{\mathcal{F}_{sec}^{n,n'}}$	87

Chapter 1

Secular Spaces and Reductions

1.1 Basic Facts about the Three-Body Problem

1.1.1 The Hamiltonian of the Three-Body problem

We consider the classical Newtonian three-body problem. Let us formulate this problem in the Hamiltonian formalism.

We identify the three-dimensional space with \mathbb{R}^3 by choosing a Cartesian reference frame and endow the *phase space*

$$\Pi := \left\{ (p_j, q_j)_{j=0,1,2} \in (\mathbb{R}^3 \times \mathbb{R}^3)^3 \mid \forall 0 \leq j \neq k \leq 2, q_j \neq q_k \right\}$$

with the standard symplectic form

$$\sum_{j=0}^2 \sum_{l=0}^2 dp_j^l \wedge dq_j^l.$$

The *Hamiltonian* of the system is

$$F = \frac{1}{2} \sum_{0 \leq j \leq 2} \frac{\|p_j\|^2}{m_j} - G_{uni} \sum_{0 \leq j < k \leq 2} \frac{m_j m_k}{\|q_j - q_k\|},$$

in which q_0, q_1, q_2 denote the positions of the three particles, p_0, p_1, p_2 denote their conjugate momenta respectively, and $q_j = (q_j^0, q_j^1, q_j^2), p_j = (p_j^0, p_j^1, p_j^2), j = 0, 1, 2$. The Euclidean norm of a vector in \mathbb{R}^3 is denoted by $\|\cdot\|$. The masses of the particles are respectively m_0, m_1, m_2 . Thanks to the invariance of the Newton equation under the change of unit of time, we can set the gravitational constant G_{uni} to 1.

1.1.2 Jacobi Decomposition

The Hamiltonian F is invariant under translations and rotations. In order to reduce the system from the translation symmetry, we pass to the *Jacobi coordinates* $(P_i, Q_i), i = 0, 1, 2$, defined as

$$\begin{cases} P_0 = p_0 + p_1 + p_2 \\ P_1 = p_1 + \sigma_1 p_2 \\ P_2 = p_2 \end{cases} \quad \begin{cases} Q_0 = q_0 \\ Q_1 = q_1 - q_0 \\ Q_2 = q_2 - \sigma_0 q_0 - \sigma_1 q_1. \end{cases}$$

The Hamiltonian is thus independent of Q_0 in these coordinates. After setting $P_0 = 0$ and reduction by the translation symmetry with $P_0 = 0$, the (reduced) coordinates $(P_i, Q_i), i =$

1, 2 describe the motions of two fictitious particles. In these coordinates, we decompose the Hamiltonian F into two parts $F = F_{Kep} + F_{pert}$, where the *Keplerian part* F_{Kep} and the *perturbing part* F_{pert} are

$$F_{Kep} = \frac{\|P_1\|^2}{2\mu_1} + \frac{\|P_2\|^2}{2\mu_2} - \frac{\mu_1 M_1}{\|Q_1\|} - \frac{\mu_2 M_2}{\|Q_2\|},$$

$$F_{pert} = -\mu_1 m_2 \left[\frac{1}{\sigma_0} \left(\frac{1}{\|Q_2 - \sigma_0 Q_1\|} - \frac{1}{\|Q_2\|} \right) + \frac{1}{\sigma_1} \left(\frac{1}{\|Q_2 + \sigma_1 Q_1\|} - \frac{1}{\|Q_2\|} \right) \right],$$

with

$$\frac{1}{\mu_1} = \frac{1}{m_0} + \frac{1}{m_1}, \quad \frac{1}{\mu_2} = \frac{1}{m_0 + m_1} + \frac{1}{m_2},$$

$$\frac{1}{\sigma_0} = 1 + \frac{m_1}{m_0}, \quad \frac{1}{\sigma_1} = 1 + \frac{m_0}{m_1}, \quad M_1 = m_0 + m_1, \quad M_2 = m_0 + m_1 + m_2.$$

We have followed the notations in [Féj02].

We shall only be interested in the region of the phase space where $F = F_{Kep} + F_{pert}$ is a small perturbation of a pair of Keplerian elliptic motions.

1.1.3 Delaunay Coordinates

Let a_1, a_2 be the semi major axes of the inner and outer ellipses respectively. Denote the *ratio of the semi major axes* by $\alpha = \frac{a_1}{a_2}$, it will play the role of a small parameter in this study.

We shall first use the Delaunay coordinates

$$(L_i, l_i, G_i, g_i, H_i, h_i), i = 1, 2$$

for both ellipses. They are defined as the following:

$$\left\{ \begin{array}{ll} L_i = \mu_i \sqrt{M_i} \sqrt{a_i} & \text{circular angular momentum} \\ l_i & \text{mean anomaly} \\ G_i = L_i \sqrt{1 - e_i^2} & \text{angular momentum} \\ g_i & \text{argument of pericentre} \\ H_i = G_i \cos i_i & \text{vertical component of the angular momentum} \\ h_i & \text{longitude of the ascending node,} \end{array} \right.$$

in which e_1, e_2 are the eccentricities and i_1, i_2 are the inclinations of the two ellipses respectively. We shall write (L, l, G, g, H, h) to denote the Delaunay coordinates for a body moving on an general Keplerian elliptic orbit. From their definitions, we see that these coordinates are well-defined only when neither of the ellipses is circular, horizontal or rectilinear. We refer to [Poi07], [Che89] or the appendix A of [Féj10] for more detailed discussions of Delaunay coordinates.

In these coordinates, the Keplerian part F_{Kep} is in the action-angle form

$$F_{Kep} = -\frac{\mu_1^3 M_1^2}{2L_1^2} - \frac{\mu_2^3 M_2^2}{2L_2^2}.$$

The proper degeneracy of the Kepler problem can be seen by the fact that F_{Kep} depends only on two of the action variables out of six. Therefore, in order to study the dynamics of F , it is crucial to look at higher order effects arising from F_{pert} .

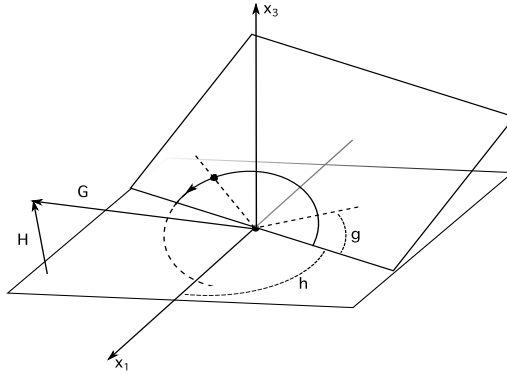

Figure 1.1: Some Delaunay Variables

The Delaunay coordinates are not always well-defined in the cases that we are interested in. For example they are not well-defined when the ellipse degenerates to a line segment. If we omit the fast motion on the ellipse for, fix L , and only consider the ellipse itself and the *secular Delaunay coordinates* which describes this ellipse. A difference between the planar and the spatial cases appears. The *planar secular Delaunay coordinates* G, g are regular coordinates in the neighborhood of rectilinear motions. In contrast to this, the spatial secular Delaunay coordinates G, g, H, h are not regular coordinates in the neighborhood of rectilinear motions, since there is no privileged plane associated to a degenerate ellipse (a line segment) in space. This is one of the practical difficulties we encounter when studying the secular dynamics near a degenerate ellipse in the spatial three-body problem.

1.1.4 Reduction of the SO(3)-Symmetry: Eliminations of the Nodes of Jacobi and Deprit

The group $SO(3)$ acts on Π by simultaneously rotating the positions Q_1, Q_2 and the momenta P_1, P_2 . This action is Hamiltonian for the standard symplectic form on Π and it leaves the Hamiltonian F invariant. Its moment map is the total angular momentum $\vec{C} = \vec{C}_1 + \vec{C}_2$, in which $\vec{C}_1 := Q_1 \times P_1$ and $\vec{C}_2 := Q_2 \times P_2$. To reduce F by this $SO(3)$ -symmetry, we fix \vec{C} (equivalently, the direction of \vec{C} and $C = \|\vec{C}\|$) to a regular value (*i.e.* $\vec{C} \neq \vec{0}$) and then reduce the system from the $SO(2)$ -symmetry around \vec{C} . As $SO(3)$ also acts on the space of directions of \vec{C} , the reduced system must be independent of the direction of \vec{C} . Finally, we obtain from F a Hamiltonian system with 4 degrees of freedom.

The plane perpendicular to the total angular momentum \vec{C} is invariant. It is called the *Laplace plane*. In practice, choosing it as the horizontal reference plane (*i.e.* fixing \vec{C} vertical) leads to Jacobi's reduction of the node. Nevertheless, we can also fix \vec{C} non-vertical, that is choose a horizontal reference plane different from the Laplace plane. The Deprit coordinates describe the reduction procedure in this case.

Jacobi's elimination of the node

Since the angular momenta \vec{C}_1, \vec{C}_2 of the two Keplerian motions and the total angular momentum $\vec{C} = \vec{C}_1 + \vec{C}_2$ must lie in the same plane, the node lines of the orbital planes of the two ellipses in the Laplace plane must coincide (*i.e.* $h_1 = h_2 + \pi$). Therefore, by fixing the Laplace plane as the reference plane, we can express H_1, H_2 as functions of $G_1,$

G_2 and $C := \|\vec{C}\|$:

$$H_1 = \frac{C^2 + G_1^2 - G_2^2}{2C}, H_2 = \frac{C^2 + G_2^2 - G_1^2}{2C},$$

and, since \vec{C} is vertical, $dH_1 \wedge dh_1 + dH_2 \wedge dh_2 = dC \wedge dh_1$.

We can then reduce the system by the $SO(2)$ -symmetry around the direction of \vec{C} . The number of degrees of freedom of the system is then reduced from 6 to 4.

This reduction procedure was first carried out by Jacobi and is thus called ‘‘Jacobi’s elimination of the node’’.

Remark 1.1.1. Denote by Π'_{vert} the subspace of the phase space Π one gets by assuming $C \neq 0$ and fixing the direction of \vec{C} to the vertical direction $(0, 0, 1)$. The space Π'_{vert} is an invariant *symplectic* submanifold of Π . Jacobi’s elimination of node implies that the coordinates

$$(L_1, l_1, G_1, g_1, L_2, l_2, G_2, g_2, C, h_1)$$

are Darboux coordinates on a dense open set¹ of Π'_{vert} .

Reduction in the Deprit variables

When the inner ellipse degenerates to a line segment, the outer ellipse is contained in the Laplace plane. In order to keep using Delaunay coordinates for the outer ellipse, we must suppose that the Laplace plane is different from reference horizontal plane and even that it makes a sufficiently large angle with the reference plane.

For \vec{C} non-vertical, the reduction procedure is conveniently understood in the *Deprit coordinates*²

$$(L_1, l_1, L_2, l_2, G_1, \bar{g}_1, G_2, \bar{g}_2, \Phi_1, \varphi_1, \Phi_2, \varphi_2),$$

defined as follows (see Figure 1.2): Let ν_L be the intersection line of the two orbital planes³, ν_T be the intersection of the Laplace plane with the horizontal reference plane. We orient ν_L by the ascending node of the inner ellipse, and choose any orientation for ν_T . Let

- \bar{g}_1, \bar{g}_2 denote the angles from ν_L ⁴ to the pericentres;
- φ_1 denotes the angle from ν_T to ν_L ;
- φ_2 denotes the angle from the first coordinate axis in the reference plane to ν_T ;
- $\Phi_1 = C = \|\vec{C}\|$, $\Phi_2 = C_z =$ the vertical component of \vec{C} .

Proposition 1.1.1. (*Chierchia-Pinzari [CP11a]*) *Deprit coordinates are Darboux coordinates. In the open dense subset of Π where all the Delaunay and Deprit variables are well-defined, we have:*

$$\begin{aligned} & dL_1 \wedge dl_1 + dG_1 \wedge dg_1 + dH_1 \wedge dh_1 + dL_2 \wedge dl_2 + dG_2 \wedge dg_2 + dH_2 \wedge dh_2 \\ &= dL_1 \wedge dl_1 + dG_1 \wedge d\bar{g}_1 + dL_2 \wedge dl_2 + dG_2 \wedge d\bar{g}_2 + d\Phi_1 \wedge d\varphi_1 + d\Phi_2 \wedge d\varphi_2. \end{aligned}$$

¹The set is defined such that on which all the variables are well-defined, *i.e.* the ellipse they describe are non-degenerate, non-circular, non-horizontal.

²The terminology follows from [CP11a].

³This is the common node line of the two planes in the Laplace plane.

⁴A conventional choice of orientation of the node line, is given by their ascending nodes, which leads to opposite orientations of ν_L in the definition of \bar{g}_1 and \bar{g}_2 .

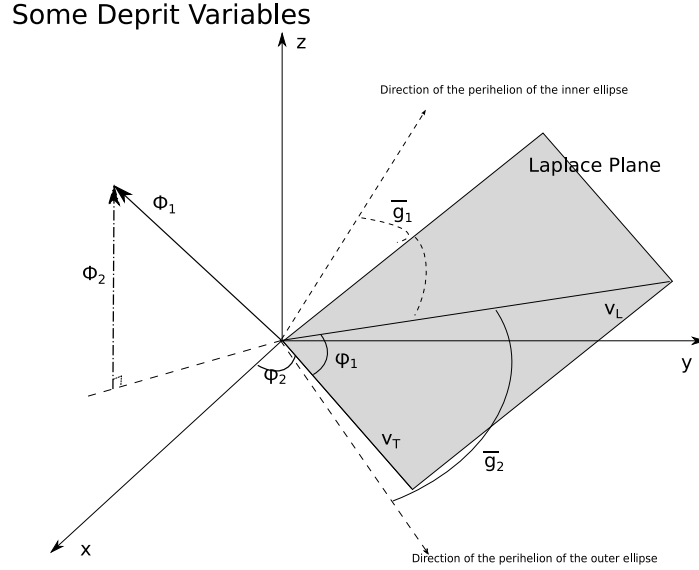

Figure 1.2: Some Deprit Variables

The coordinates $(L_1, l_1, L_2, l_2, G_1, \bar{g}_1, G_2, \bar{g}_2, \Phi_1, \varphi_1)$ are Darboux coordinates on a dense open set (on which all the variables are well-defined) of Π' , any of the subspace of Π one gets by fixing the direction of \vec{C} non-vertical. In these coordinates, the Hamiltonian can be written in closed form in the “planar variables” $(L_1, l_1, G_1, \bar{g}_1, L_2, l_2, G_2, \bar{g}_2)$ and C , *i.e.*

$$F = F(L_1, l_1, G_1, \bar{g}_1, L_2, l_2, G_2, \bar{g}_2, C),$$

which can be seen as a function defined in Π' . We can then fix C and reduce the system from the $SO(2)$ -symmetry around the direction of \vec{C} to complete the reduction procedure.

In [Dep83], Deprit established a set of coordinates closely related to the set of coordinates presented above. The actual form of our Deprit coordinates was first presented by Chierchia and Pinzari in [CP11a]. Note that in both of these references, Deprit coordinates are built for the general N -body problem, with the aim to generalize Jacobi’s elimination of node, or to conveniently reduce the $SO(3)$ -symmetry of the N -body problem for $N \geq 4$, which is of significant importance for the perturbative study of the N -body problem.

Remark 1.1.2. In Π'_{vert} , we have $\bar{g}_1 = g_1$, $\bar{g}_2 = g_2$ and $\Phi_1 = \Phi_2$. The angles ϕ_1 , ϕ_2 are not defined individually. Nevertheless, their sum $\phi_1 + \phi_2$ remains well defined. One can then recover Jacobi’s elimination of the node from the Deprit variables using a limit procedure, see [CP11a] for details.

Remark 1.1.3. We may slightly modify the coordinates $(L_1, l_1, G_1, \bar{g}_1, L_2, l_2, G_2, \bar{g}_2)$ to pairs of planar Poincaré coordinates⁵ to obtain regular coordinates near circular motions as well.

Nevertheless, the reduction procedure in Deprit coordinates still does not extend to degenerate inner ellipses for two reasons: The mean anomaly l_1 and the inner orbital plane are not defined. The first problem can be solved by changing the time (*i.e.* taking the *eccentric anomaly* u_1 instead of l_1 as part of the coordinates). To deal with the second problem, we shall show in Subsection 1.2.3 that on a well-chosen manifold, except for the fast angle l_1 , a natural extension of the set of Deprit coordinates (and the Delaunay coordinates) remains regular near a degenerate inner ellipse.

⁵See [Poi07] or [Féj99], among others, for the definitions of these coordinates.

1.1.5 A digression: Partial Reduction

This section dedicates to present a generalization of the partial reduction [MRL02], which simultaneously gives a conceptual way of understanding this procedure.

Let us start by present the partial reduction procedure. Fixing the direction of \vec{C} defines an invariant submanifold of the phase space Π . The dense open set of Π where $\vec{C} \neq 0$ is foliated by such invariant submanifolds. Each leaf is the image of any other one under some rotation. Since the standard symplectic form on Π is invariant under the $\text{SO}(3)$ -action, each leaf is an invariant symplectic submanifold of Π , on which the $\text{SO}(3)$ -symmetry of the system F reduces to a (Hamiltonian) $\text{SO}(2)$ -symmetry. The study of the dynamics of F could hence be restricted to any of the leaves. In [MRL02], this restriction is called the *partial reduction* (see Subsection 1.1.5 for a more general viewpoint).

Now let us generalize the idea of partial reduction. This generalized viewpoint also leads us to a more general version of equivariant KAM theorem (Subsection 2.3.3). In the rest of this subsection we shall use some basic notions in the theory of moment maps. We refer to the book [Aud04] about moment map, and the book [FH91] about representation theory.

Let \check{G} be a compact connected Lie group which acts Hamiltonianly on a connected symplectic manifold $(\check{M}, \check{\omega})$ and let $\check{\mu} : \check{M} \rightarrow \mathfrak{g}^*$ be the associated moment map, in which \mathfrak{g}^* is the dual of the Lie algebra \mathfrak{g} of \check{G} . For any fixed Cartan subalgebra $\mathfrak{h}^* \subset \mathfrak{g}^*$, denote by \check{T} the corresponding Cartan subgroup (*i.e.* a maximal torus) in \check{G} . Let us choose a (positive) Weyl chamber W_+ in \mathfrak{h}^* . It turns out that the pre-image $\check{\mu}^{-1}(W_+)$ of W_+ is a “symplectic cross-section” (in the words of [GS82]) of the \check{G} action on $(\check{M}, \check{\omega})$:

Theorem 1.1. (*Guillemin-Sternberg [GS82]*) $\check{\mu}^{-1}(W_+)$ is a \check{T} -invariant symplectic submanifold of $(\check{M}, \check{\omega})$. The restriction of the \check{G} action to $\check{\mu}^{-1}(W_+)$ is a Hamiltonian torus action of \check{T} . For any closed subgroup $\check{T}' \subset \check{T}$, the subset of $\check{\mu}^{-1}(W_+)$ consisting in \check{T}' -fixed points is a symplectic submanifold of $\check{\mu}^{-1}(W_+)$.

Since \check{G} is a compact connected Lie group, the Cartan subalgebras of \mathfrak{g}^* are conjugate to each other. As $\check{\mu}$ intertwines the \check{G} action on $(\check{M}, \check{\omega})$ and the coadjoint action of \check{G} on \mathfrak{g}^* , any two of these “symplectic cross-sections” are the image of each other under the \check{G} -action.

Remark 1.1.4. The original statement also requires that \check{M} be compact. However, in order to get the statements we cite here, this requirement is not used and this hypothesis is therefore unnecessary.

In the spatial three-body or N -body problems, the group $\text{SO}(3)$ acts Hamiltonianly on their phase spaces. Its associated moment map is just the total angular momentum vector \vec{C} . The algebra $\mathfrak{so}(3)^*$ is naturally identified with \mathbb{R}^3 . Now, any Cartan subalgebra (which is the algebra of infinitesimal generators of rotations with fixed rotation axis) is a 1-dimensional vector subspace (homeomorphic to \mathbb{R}) in \mathbb{R}^3 , and a positive Weyl chamber is therefore a connected component of this 1-dimensional vector subspace deprived of the origin, *i.e.* an open half line, consisting in infinitesimal generators of rotations around the fixed axis with some chosen orientation. The pre-image of this open half line is exactly the submanifold one gets by fixing the direction of \vec{C} . Theorem 1.1 shows that this submanifold is symplectic, and the restriction of the $\text{SO}(3)$ -action on this submanifold is the $\text{SO}(2)$ -action around the fixed direction of \vec{C} . This is exactly the “partial reduction” procedure of [MRL02].

1.2 Spaces of Spatial Ellipse Pairs

In this section, we shall introduce several spaces of spatial ellipse pairs. The first one is the *secular space*, or *space of ellipse pairs*, a natural space which carries the secular dynamics. Nevertheless, for the purpose of carrying out our study of the secular and secular-integrable dynamics (defined in Section 2.1) in the neighborhood of the degenerate inner ellipse, especially in order to use natural extensions of Delaunay and Deprit coordinates in this neighborhood, we shall blow up the degenerate inner ellipses in the secular space to obtain the *modified secular space*. Geometrically, the blowing-up means to replace each degenerate ellipse by the set of pairs of this ellipse and a non-oriented plane containing it. Moreover, as the set $\{C = G_2\}$ is invariant under the quadrupolar and the secular-integrable dynamics, we shall further investigate the *critical quadrupolar space* as a subset of the modified secular space, on which the secular-integrable dynamics with parameters satisfying $C = G_2$ naturally lies in, and show that on a double cover, Delaunay and Deprit coordinates can be extended to regular coordinates near a degenerate inner ellipse. In order to deal with circular or horizontal motions, we also define the *second kind decorated ellipse* and introduce the *second modified secular space*, on which the Delaunay/Deprit coordinates can also be extended to cover the circular or horizontal motions. These spaces serve as spaces which carry the (extended) secular/secular-integrable dynamics. The secular-integrable dynamics can be directly studied on the secular space, but these modifications of spaces allow us to keep using (extensions of) classical coordinates.

Let us first fix some settings. By “ellipse” we mean an ellipse with eccentricity e ranging from 0 (circle) to 1 (degenerate ellipse, that is a line segment). By “Keplerian ellipse” we mean an elliptic Keplerian orbit with fixed semi major axis, which has a focus at the origin and possesses an orientation as long as it is non-degenerate. The semi major axes a_1, a_2 of the two ellipses are conservative quantities for systems that does not depend on fast angles. We suppose that a_1, a_2 are fixed. The Delaunay/Deprit coordinates are considered only at the secular level, *i.e.* the fast angles l_1, l_2 are dropped, and their conjugate action variables L_1 and L_2 are fixed together with a_1 and a_2 .

1.2.1 Secular Space

The following construction shows that the space of Keplerian ellipses in the three-dimensional Euclidean space is homeomorphic to $S^2 \times S^2$ (See also [Pau26],[Sou70],[Alb02]).

We denote by $S_L^2 \in \mathbb{R}^3$ the sphere of radius \sqrt{L} . For each spatial ellipse with semi major axis a and circular angular momentum L (Subsection 1.1.3), we take its angular momentum \vec{C} and the vector \vec{T}_1 from the origin to its second focus (or the second endpoint), then calculate the *eccentricity vector*⁶ $\vec{T} = \frac{\vec{T}_1}{2a}$ and the *normalized angular momentum* $\vec{S} = \frac{\vec{C}}{L}$. They satisfy the relation $\|\vec{T}\|^2 + \|\vec{S}\|^2 = 1$. The two points $\sqrt{L}(\vec{T} + \vec{S})$ and $\sqrt{L}(\vec{T} - \vec{S})$ are exactly the two points on the sphere S_L^2 that we are looking for. This construction defines a map which sends a spatial ellipse to a point in $S_L^2 \times S_L^2$. One checks easily that this map is a bijection.

Let $\Omega_{S_L^2}$ be the area form on S_L^2 . The manifold $S_L^2 \times S_L^2$, equipped with the symplectic form $\Omega_{S_L^2} \otimes (-\Omega_{S_L^2})$ ⁷, is called the *Pauli-Souriau space*. One checks directly that, when all

⁶In this convention, the eccentricity vector points toward the direction of the apocentre rather than the direction of the pericentre. Note that the converse convention using the direction of the pericentre is also popular.

⁷The form $\Omega_{S_L^2} \otimes (-\Omega_{S_L^2})$ evaluate at a vector $(\tilde{v}_1, \tilde{v}_2) \in T_x S^2$ is equal to $\Omega_{S_L^2, x}(\tilde{v}_1) - \Omega_{S_L^2, x}(\tilde{v}_2)$

the Delaunay elements are well defined, the *Pauli-Souriau symplectic form* $\Omega_{S_L^2} \otimes (-\Omega_{S_L^2})$ agrees with $dG \wedge dg + dH \wedge dh$. Indeed this relation is easily seen in the case of planar ellipses, and one can then use the “Rotation Lemma” (Lemma 3.1.3) and carry out the calculation (direct but long) to conclude in the general case.

Another way to confirm this relation without much calculation is due to A. Albouy: In order to calculate the secular symplectic form of the Kepler problem on $S_L^2 \times S_L^2$ (which is equal to $dG \wedge dg + dH \wedge dh$, when all Delaunay elements are well-defined), one can use the $\text{SO}(4)$ -symmetry of the Kepler problem. The Lie algebra of $\text{SO}(4)$ is $\mathfrak{so}(4) = \mathfrak{so}(3) \times \mathfrak{so}(3)$. Each factor $\mathfrak{so}(3)$ acts on one of the components S^2 , which can be “integrated” into an action of $\text{SO}(3)$. Now the only closed 2-form on S_L^2 invariant under the action of $\text{SO}(3)$ is, up to a factor, the area form $\omega_{S_L^2}$. Therefore the symplectic form on $S_L^2 \times S_L^2$ we are looking for is a linear combination of the two area forms on the two S^2 -components. The coefficients of this linear combination can then be determined by considering the subspace formed by those ellipses lying in the horizontal plane (the space of such ellipses can be easily identified with the sphere S_L^2 , equipped with the symplectic form $\omega_{S_L^2}$), for which the coordinates (G, g) are just the symplectic cylindrical coordinates on the sphere S_L^2 . This simultaneously determines the coefficients of the linear combination.

The secular space is the space of spatial ellipse pairs, formed by an “inner” and an “outer” ellipse, thus homeomorphic to $(S^2 \times S^2) \times (S^2 \times S^2)$, which is a symplectic manifold if we equip it with the sum of Pauli-Souriau symplectic forms for each $S^2 \times S^2$ -factor. The group $\text{SO}(3)$ acts on the secular space by simultaneously rotating the pair of ellipses. If we suppose the outer ellipse is non-degenerate and non-circular, then the $\text{SO}(3)$ -action is always free, even if the inner ellipse degenerates or becomes circular.

1.2.2 Modified Secular Space

We define the *modified secular space* by replacing the inner ellipse by a pair consisting of a non-oriented plane and an oriented (if non-degenerate) ellipse in this plane (when it is non-degenerate, it gives the plane a *natural* orientation).

We call such a pair a *decorated ellipse*. A non-degenerate decorated ellipse can be identified with a non-degenerate ellipse, as the plane in the pair is just its orbital plane, but each degenerate ellipse corresponds to a \mathbf{P}^1 -family of degenerate decorated ellipses. Equivalently, the space of decorated ellipses is homeomorphic to the manifold one gets by blowing up the diagonal of $S^2 \times S^2$.

Let $\text{Gr}(2, 3)$ be the Grassmannian of non-oriented planes passing through origin in \mathbb{R}^3 . By consider the normal direction of each non-oriented plane, $\text{Gr}(2, 3)$ can be identified with \mathbf{P}^2 .

Lemma 1.2.1. The space of decorated ellipses is homeomorphic to $\mathbf{P}^2 \times S^2$.

Proof. We define a mapping $(\mathcal{P}, \vec{E}) \mapsto (\mathcal{P}, \mathcal{E}_p)$ from $\text{Gr}(2, 3) \times S^2 \cong \mathbf{P}^2 \times S^2$ to the space of decorated ellipses in the following way: Each element of $\mathbf{P}^2 \times S^2$ (in which S^2 is the unit sphere in \mathbb{R}^3) consists in a non-oriented plane \mathcal{P} and a unit vector \vec{E} . Decompose the unit vector \vec{E} into $\vec{E} = \vec{E}_1 + \vec{E}_2$ where \vec{E}_1 is the orthogonal projection of \vec{E} on \mathcal{P} , and \vec{E}_2 is orthogonal to \mathcal{P} . The ellipse \mathcal{E}_p given by \vec{E} in \mathcal{P} is the one with the eccentricity vector \vec{E}_1 and the normalized angular momentum vector \vec{E}_2 . One checks that this map is bijective. \square

We do not change the space $S^2 \times S^2$ of outer ellipses. As a result, the *modified secular space* is homeomorphic to $(\mathbf{P}^2 \times S^2) \times (S^2 \times S^2)$.

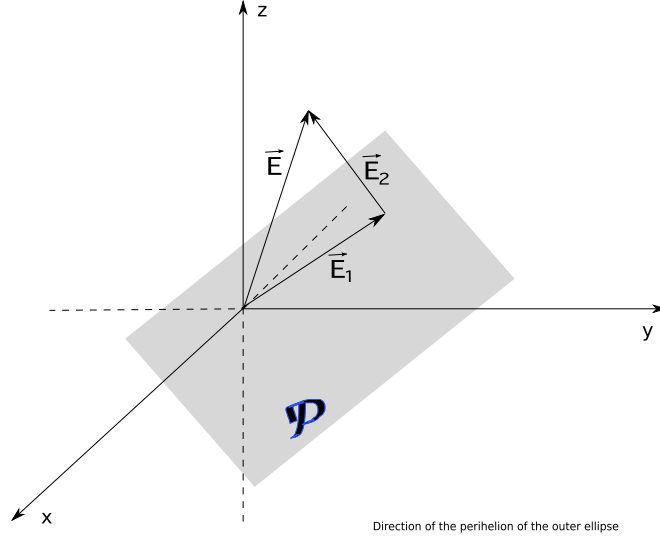

Figure 1.3: Construction of a decorated ellipse

Let us now consider the reduction procedure by the $SO(3)$ -symmetry of the modified secular space. After fixing $\vec{C} \neq 0$, the $SO(2)$ group action of rotations around the direction of \vec{C} induces the $SO(2)$ -action on $\mathbf{P}^2 \times S^2 \times (S^2 \times S^2)$:

$$R \cdot ((\mathcal{P}, \vec{E}), (\vec{E}_3, \vec{E}_4)) = (R \cdot \mathcal{P}, R \cdot \vec{E}, R \cdot \vec{E}_3, R \cdot \vec{E}_4),$$

where R is a rotation which fixes \vec{C} , $(\vec{E}_3, \vec{E}_4) \in S^2 \times S^2$. This action fixes only eight points:

$$\left(\text{plane orthogonal to } \vec{C}, \pm \frac{\vec{C}}{\|\vec{C}\|}, \pm \frac{\vec{C}}{\|\vec{C}\|}, \pm \frac{\vec{C}}{\|\vec{C}\|} \right).$$

They correspond either to circular inner and outer ellipses orthogonal to \vec{C} , or circular inner ellipses orthogonal to \vec{C} and degenerate outer ellipse parallel to \vec{C} . In particular, the action is free in a neighborhood of degenerate inner decorated ellipses parallel to \vec{C} , thanks to the blow up.

1.2.3 Critical Quadrupolar Space

In their study of the quadrupolar dynamics (defined in Subsection 2.1.3), Lidov and Ziglin [LZ76] have noticed several particular properties of this system (we shall recall part of their study in Section 2.2):

1) C and G_2 are commuting first integrals. The existence of the additional first integral G_2 makes it possible to reduce the system to one degree of freedom and implies integrability.

2) When the inner ellipse degenerates (this is possible only if $C = G_2$), its limit orbital plane contains \vec{C} . This implies that the indeterminacy of the orbital plane for the degenerate ellipse disappears as long as the degenerate ellipse is not parallel to \vec{C} .

Moreover, when $C = G_2$, if we naïvely allow G_1 to take negative values, and consider the evolution of G_1 instead of $\frac{G_1^2}{L_1^2}$ in the equation of quadrupolar motions in [LZ76], then in the (G_1, \bar{g}_1) -plane, \dot{G}_1 does not vanish at $G_1 = 0$ and G_1 changes its sign along generic phase portraits.

These properties roughly characterize the space on which the quadrupolar dynamics and higher order secular-integrable dynamics (will be defined in Subsection 2.1.3) naturally lies in, when the parameters satisfies $C = G_2$. These observations motivate the definition of the critical quadrupolar space, which is the key to understand the quadrupolar dynamics on $\{C = G_2\}$, and is important for the investigation of quasi-periodic almost-collision orbits.

Definition of the Critical Quadrupolar Space

Definition 1.2.1. In the subspace of the modified secular space where $C \neq 0$, the *critical quadrupolar space* is defined to be the closure of $((\mathbf{P}^2 \times S^2) \times (S^2 \times S^2 \setminus \text{Diagonal})) \cap \{G_1 \neq 0, C = G_2\}$.

The diagonal elements of $S^2 \times S^2$ correspond to degenerate outer ellipses, which must have $G_2 = \|\vec{C}_2\| = 0$ and are therefore excluded.

The condition $C = G_2$ implies that when the inner ellipse degenerates (*i.e.* when \vec{C}_1 tends to $\vec{0}$) the limiting direction of \vec{C}_1 must be perpendicular to \vec{C} . Therefore, taking the closure amounts to adding the degenerate decorated inner ellipses whose orbital planes contains \vec{C} to the space consisting of non-degenerate inner and outer ellipses. If the degenerate inner ellipse is not parallel to \vec{C} , such a plane is unique. If the degenerate inner ellipse is parallel to \vec{C} , then a \mathbf{P}^1 -family of non-oriented planes can be attached to it, and form a \mathbf{P}^1 -family of degenerate decorated inner ellipses.

Proposition 1.2.1. *If $L_1 \neq 2L_2$ (which, the masses being fixed, is always the case if α is small enough), the critical quadrupolar space is a smooth submanifold of the modified secular space.*

If $G_1 \neq 0$, we have

$$\begin{aligned} C - G_2 = 0 &\Leftrightarrow G_1(G_1 + 2G_2 \cos(i_1 - i_2)) = 0 \\ &\Leftrightarrow G_1 + 2G_2 \cos(i_1 - i_2) = 0. \end{aligned}$$

with the hypothesis $L_1 \neq 2L_2$, we thus deduce that 0 is a regular value of $C - G_2$ outside $\{G_1 = 0\}$. Therefore we only have to check the regularity of the critical quadrupolar space in a small neighborhood of degenerate decorated inner ellipses. We shall define a subspace \mathcal{D} of the critical quadrupolar space, such that on its double cover, defined by giving to each plane its two possible orientations, we can smoothly extend the Delaunay/Deprit coordinates through degenerate decorated inner ellipses. The smoothness of the critical quadrupolar space follows from the existence of such smooth coordinates.

Definition of the Subspace \mathcal{D}

Recall that i_1 and i_2 are the inclinations of the inner and outer orbital planes respectively. Let us define a subspace \mathcal{D} of the modified secular space by the following additional conditions (as the inner orbital plane is possibly not oriented, the angle $i_1 - i_2$ is defined modulo π) :

- $e_1 \neq 0, e_2 \neq 0, 1$;
- $C = \|\vec{C}_2\| > \frac{L_1}{2}$;
- $i_2 \neq 0 \pmod{\pi}$.

The second condition ensures that the inner orbital plane never lies in the Laplace plane. The third condition together with the first ensures that the Delaunay coordinates are regular for the outer ellipse⁸. Notice that being a subspace of the critical quadrupolar space implies the orthogonality of \vec{C}_1 and \vec{C}_2 at the limit when the inner ellipse degenerates, that is

$$\cos(i_1 - i_2)|_{e_1=1} = 0.$$

From the definition, we see that the subspace \mathcal{D} is open and dense in the critical quadrupolar space.

Coordinate Analysis

The restriction to \mathcal{D} allows the use of Delaunay/Deprit coordinates to make some further analysis. Seen as a function on the double cover of the modified space, G_1 may now become negative. More precisely, if we fix \vec{C} (which simultaneously gives the direction of \vec{C} and the value $C = G_2$) and only consider the inner orbital plane, then when $G_1 \neq 0$ and when the inner orbital plane is not horizontal, the oriented inner orbital plane can be defined uniquely by the pair $(|G_1|, h_1)$: The inclination \tilde{i}_1 of the plane with respect to the Laplace plane is determined by the formula $\cos \tilde{i}_1 = \frac{|G_1|}{2C}$. There exists a S^1 -family of planes with this inclination. Each of these planes is (co-)oriented by \vec{C}_1 , or equivalently by $\vec{C} - \vec{C}_p$, in which \vec{C}_p is the projection of \vec{C} in this plane, which is non-zero by hypothesis. For each plane with node line passing through $\vec{h}_1 = (\cos h_1, \sin h_1, 0)$ (there are actually two planes with the same $|G_1|$ and the same node line), we assign a (co-)orientation by the vector $\vec{h}_1 \times \vec{C}_p$. Let us call this orientation *h-orientation*. In this way, a pair $(|G_1|, h_1)$ gives h-orientations to two planes, while only for one of them its h-orientation agrees with its natural orientation.

We assign to the pair (G_1, h_1) the one of the two oriented planes defined by $(|G_1|, h_1)$, such that its h-orientation agrees with (resp. opposes to) its natural orientation when $G_1 > 0$ (resp. $G_1 < 0$). We note that when $G_1 \neq 0$, two pairs (G_1, h_1) and $(-G_1, h_1 + \pi)$ define the same oriented plane, whose orientation agrees with its natural orientation. In Deprit coordinates, the role of h_1 is played by ϕ_1 . We define the angle ϕ_1 to be the longitude of the node of the inner ellipse in the Laplace plane. This definition agrees with the usual one and remains valid for a degenerate inner ellipse (in this case the outer orbital plane is the Laplace plane).

Now let us consider those oriented planes containing \vec{C} , which correspond to a pair of the form $(G_1 = 0, h_1)$. They serve as orbital planes for degenerate decorated inner ellipses. There is no way to associate to each non-oriented plane containing \vec{C} a natural orientation, but as long as h_1 is given, the h-orientation of the inner orbital plane is also well-defined. We note that the pairs $(0, h_1)$ and $(0, h_1 + \pi)$ give the same non-oriented plane containing \vec{C} .

For given L_1 , the quotient space of the annulus $\{(G_1, h_1) \in \mathbb{R} \times \mathbb{T} : -L_1 < G_1 < L_1\}$ by the equivalence relation $(G_1, h_1) \sim (-G_1, h_1 + \pi)$ is an open Möbius band (with the open annulus $\{(G_1, h_1) \in \mathbb{R} \times \mathbb{T} : -L_1 < G_1 < L_1\}$ as its orientable double cover), each of its element determines a non-oriented inner orbital plane (with its natural orientation when $G_1 \neq 0$) and the eccentricity of the inner ellipse. By adding the angle g_1 , we find that the

⁸The conditions $e_2 \neq 0, i_2 \neq 0 \pmod{\pi}$ are non-essential. To drop these restrictions we just need to take any convenient coordinates in the neighborhood of circular/horizontal outer ellipses (e.g. the Poincaré coordinates, [Che89]). We keep these restrictions (unless in situation where it is necessary to drop them) so to handle the outer ellipse more easily.

space of inner ellipses is the quotient space of $\{(G_1, h_1, g_1) \in \mathbb{R} \times \mathbb{T}^2 : -L_1 < G_1 < L_1\}$ by the equivalence relation $(G_1, h_1, g_1) \sim (-G_1, h_1 + \pi, \pi - g_1)$, so that $\frac{|G_1|}{L_1}$ defines its eccentricity, (G_1, h_1) defines its h-oriented orbital plane, and g_1 gives its direction of the pericentre inside the h-oriented orbital plane. Similar discussion also holds for Deprit variables.

Extended Delaunay/Deprit coordinates

Let $\tilde{\mathcal{D}}$ be the orientable double cover of \mathcal{D} . The former discussion shows that the secular Delaunay coordinates and secular Deprit coordinates can be extended to $\tilde{\mathcal{D}}$ so as to let G_1 vary in the interval $(-L_1, L_1)$. We shall call them *extended Delaunay/Deprit coordinates*. They agree with the usual Delaunay/Deprit coordinates in the region $G_1 \in (0, L_1)$.

A remarkable phenomenon is that these coordinates can be extended smoothly through the subset $\{G_1 = 0\}$ in $\tilde{\mathcal{D}}$:

The coordinate G_1 can be regarded as a map $G_1 : \widetilde{\text{Gr}(2, 3)} \times S^2 \rightarrow \mathbb{R}$ on the double cover of the space of decorated ellipses by associating to each ellipse a pair (\mathcal{P}_+, \vec{E}) of an oriented plane and a vector of length L_1 the normal component of \vec{E} with respect to \mathcal{P}_+ . More precisely, if \vec{N} is the unit normal vector of \mathcal{P}_+ , then $G_1(\mathcal{P}_+, \vec{E}) = \vec{E} \cdot \vec{N}$. The map G_1 defined in this way is therefore a smooth function. Similarly, the element $H_1 = G_1 \cos i_1$ is also smooth. The element $h_1, \phi_1 : \widetilde{\text{Gr}(2, 3)} \rightarrow \mathbb{T}$ depends only on the oriented plane and therefore is smooth when it is defined. Now as g_1 and \bar{g}_1 are smooth functions of \mathcal{P}, \vec{E} , they are also smooth functions on $\widetilde{\text{Gr}(2, 3)} \times S^2$ as long as they are defined.

To define the full set of extended Deprit coordinates, we just have to take the same extension for G_1 , and redefine the angle ϕ_1 to be the longitude of the node of the inner orbital plane with the Laplace plane. The angle ϕ_1 plays the role in the extended Deprit coordinates as h_1 plays in the extended Delaunay coordinates: for each non-oriented plane, ϕ_1 gives it an orientation. The equivalence relation is $(G_1, \phi_1) \sim (-G_1, \phi_1 + \pi)$.

These discussions show that the extended Delaunay/Deprit coordinates are regular coordinates on $\tilde{\mathcal{D}}$. We can carry out our dynamical studies, in particular, part of the quadrupolar dynamical studies near a degenerate inner ellipse, in these coordinates.

Note that we have only defined a set of coordinates on the codimension 1 submanifold $\tilde{\mathcal{D}}$ of the modified secular space. In particular, the extended Delaunay/Deprit coordinates are not action-angle coordinates in the neighborhood (in the modified secular space) of any pair in $\tilde{\mathcal{D}}$ with a degenerate inner ellipse. If one wants to have a set of regular coordinates in such a neighborhood, a natural choice would be to replace H_1 by i_1 in the extended Delaunay coordinates. The defect for such a choice is that the resulting coordinates are not Darboux coordinates even outside degenerate inner ellipses.

Proof of Proposition 1.2.1

To prove Proposition 1.2.1, we only have to investigate the region of the critical quadrupolar space near degenerate inner (decorated) ellipses. As the outer ellipse might be circular, we need to temporarily extend the definition of \mathcal{D} and $\tilde{\mathcal{D}}$ to include such cases. We fix the direction of \vec{C} non-vertically and choose the neighborhood small enough, so that the extended Delaunay coordinates are well-defined and $i_2 \neq 0 \pmod{\pi}$ in this neighborhood, and use the extended Delaunay coordinates in the neighborhood of degenerate decorated inner ellipse in $\tilde{\mathcal{D}}$, so that the inner ellipses are decorated by h-oriented planes. We see from the discussions we have made that, this neighborhood is smoothly parametrized by the extended Delaunay coordinates (G_1, h_1, g_1) together with

- (G_2, g_2) when $G_2 < L_2$;
- $(\xi_1, \xi_2) \in \mathbb{R}^2$ satisfying $\xi_1^2 + \xi_2^2 < \frac{L_2}{2}$ and

$$(\xi_1, \xi_2) = (\sqrt{L_2 - G_2} \cos g_2, \sqrt{L_2 - G_2} \sin g_2)$$

when $(\xi_1, \xi_2) \neq (0, 0)$.

Therefore this neighborhood is smooth, which, by rotating the direction of \vec{C} , implies that $\tilde{\mathcal{D}}$ is smooth. Since the identification relation is induced by a free discrete group action on $\tilde{\mathcal{D}}$, the quotient space \mathcal{D} is smooth. Hence, the critical quadrupolar space is a smooth manifold.

Reduction by the SO(3) Symmetry in \mathcal{D} and $\tilde{\mathcal{D}}$

In the secular space, after fixing \vec{C} , when a degenerate inner ellipse is parallel to \vec{C} , its isotropy group is SO(2). As SO(2) acts in its secular deleted⁹ neighborhood freely, the reduced space of the secular neighborhood of a degenerate inner ellipse which is parallel to \vec{C} is not smooth.

The situation is a little different in the critical quadrupolar space. The SO(2)-action around \vec{C} is locally free¹⁰ in a small neighborhood of a degenerate decorated inner ellipse parallel to \vec{C} and is free in a small neighborhood of a degenerate decorated inner ellipse not parallel to \vec{C} . Even more, this action is free in the neighborhood of any degenerate decorated inner ellipse on the orientable double cover of the critical quadrupolar space. Therefore the reduced space of \mathcal{D} is not smooth, but the reduced space of $\tilde{\mathcal{D}}$ is a smooth manifold.

In the sequel, the study of the reduced quadrupolar dynamics lies naturally in the *reduced space* of \mathcal{D} by the symmetry $\text{SO}(3) \times \text{SO}(2)$, which can be naturally lifted to $\tilde{\mathcal{D}}$, on which we may take coordinates G_1 and \bar{g}_1 in $\{(G_1, \bar{g}_1) \in \mathbb{R} \times \mathbb{T} : -L_1 \leq G_1 \leq L_1\}$. In practice, the reduction procedure in the double cover of the critical quadrupolar space amounts to first fix \vec{C} and then ignore the inner orbital planes. In our coordinates, the reduction means to fix $C = G_2 \neq 0$ and ignore the variables h_1, ϕ_1, ϕ_2 . The equivalence relation is then $(G_1, \bar{g}_1) \sim (-G_1, \pi - \bar{g}_1)$. The quotient of the set $\{|G_1| < L_1\}$ is then smooth outside two singular points $(G_1 = 0, \bar{g}_1 = \pm \frac{\pi}{2})$. The boundary $\{G_1 = L_1\}$ corresponds to an inner circle and should be further identified to a point. This point is singular in the quotient if $C = G_2 = \frac{L_1}{2}$ and regular otherwise. Finally, the quotient space, or the *reduced critical quadrupolar space*, is a manifold outside two or three singularities (Figure 1.4). Moreover, in the reduction procedure, the group acts freely on the decorated degenerate ellipses non parallel to \vec{C} while the isotropy subgroup has 2 elements when the degenerate ellipse is parallel to \vec{C} ; hence, the reduced critical quadrupolar space and the quotient space of the set $\{C = G_2\}$ in the secular space are topologically the same, have the same singular points, and can thus be identified. When $G_1 = 0$, the angle \bar{g}_1 gives the “inclination” of a degenerate inner ellipse with respect to the Laplace plane.

1.2.4 A Summarizing Diagram

The following graph summarizes the discussions in this section. “MSS” denotes the modified secular space, “CQS” denotes the critical quadrupolar space (which is also denoted

⁹More precisely, ellipse pairs with degenerate inner ellipses parallel to \vec{C} are deleted.

¹⁰It has a discrete \mathbb{Z}_2 -symmetry at a degenerate decorated inner ellipse, and is free in the deleted neighborhood of the degenerate decorated inner ellipse.

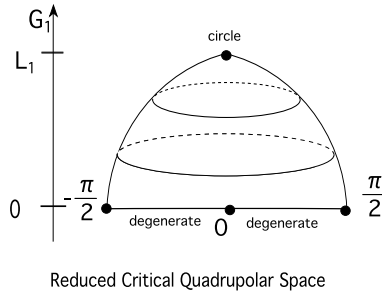

Figure 1.4: The reduced critical quadrupolar space

briefly by $\{C = G_2\}_{reg}$), “SS” denotes the secular space, and “D/D” denotes the extended Delaunay/Deprit coordinates:

$$\begin{array}{ccccc}
 (S^2 \times S^2) \times (S^2 \times S^2) & \longleftarrow & \widetilde{\{C = G_2\}_{reg}} & \longleftarrow & \widetilde{\mathcal{D}} \quad (\text{D/D}) \\
 \downarrow /2 & & \downarrow /2 & & \downarrow \\
 \text{MSS} : (\mathbf{P}^2 \times S^2) \times (S^2 \times S^2) & \longleftarrow & \text{CQS} : \{C = G_2\}_{reg} & \longleftarrow & \mathcal{D} \\
 \downarrow & & \downarrow & & \\
 \text{SS} : (S^2 \times S^2) \times (S^2 \times S^2) & \longleftarrow & \{C = G_2\} & &
 \end{array}$$

1.2.5 Another digression: The Second Kind Decorated Ellipses

In subsection 1.2.2, we have blown-up the diagonal of $S^2 \times S^2$ (homeomorphic to the secular space) to obtain the modified secular space, for the purpose of dealing with degenerate ellipses in the secular studies. This subsection is devoted to the treatment of circular or horizontal ellipses, again by blow-up techniques, to extend the validity of Delaunay coordinates to the secular neighborhood of these ellipses. This subsection is not used in the proofs of existence of invariant tori and almost-collision orbits.

Let us first fix a reference plane in the space. An ellipse is said to be horizontal if it lies in the reference plane, and is said to be non-horizontal if not. Remind that a direction is understood as oriented, therefore two vectors differ by an angle of π have opposite directions.

Definition 1.2.2. A *second kind decorated ellipse* consists in a triple of an oriented non-degenerate ellipse, a direction and a straight line: the direction is the direction of the pericentre when the ellipse is not circular, and any direction in its orbital plane if the ellipse is circular. The straight line lies in the intersection of the orbital plane of the ellipse and the horizontal plane.

We see that if a non-degenerate ellipse is non-circular and non-horizontal, then a second kind decorated ellipse can be identified with the ellipse itself. If the non-degenerate ellipse is circular but non-horizontal (resp. horizontal but non-circular), then a S^1 (resp. \mathbf{P}^1)-family of directions can be associated to it. When the non-degenerate ellipse is both

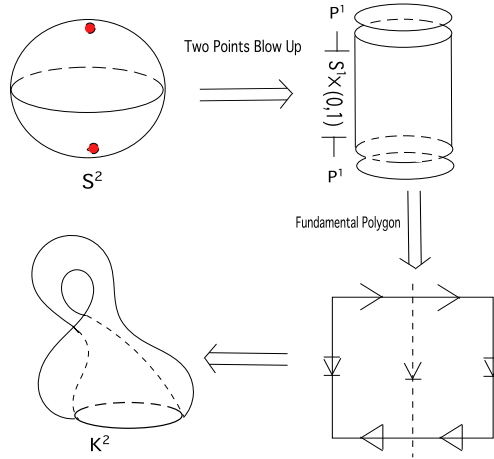

Figure 1.5: Blowing up two points on S^2 .

circular and planar, then a $S^2 \times \mathbf{P}^1$ -family of pairs of direction and straight line can be associated to it.

Lemma 1.2.2. The space of second kind decorated ellipses is homeomorphic to $(0, 1] \times S^1 \times \mathbf{K}^2$, in which \mathbf{K}^2 denotes the Klein bottle.

Proof. The space $\widetilde{\text{Gr}(2, 3)}$ of oriented 2-planes in \mathbb{R}^3 is homeomorphic to the sphere S^2 . We blow-up the two poles on the sphere, corresponding to the two horizontal planes by associate a straight line inside it to such a plane. We explain in Figure 1.5 that blowing up two points of S^2 results in \mathbf{K}^2 . In a given oriented plane, the non-degenerate ellipses with the same orientation as the plane are parametrized by the eccentricity and the argument of the pericentre, therefore they form an open disc. The oriented blow-up of a point inside the open disc, corresponds to associating all directions inside the plane passing through the origin to a circle, resulting in a cylinder homeomorphic to $(0, 1] \times S^1$. Therefore, the space of second kind decorated ellipses is homeomorphic to $(0, 1] \times S^1 \times \mathbf{K}^2$. \square

The Delaunay elements are then everywhere well-defined on the orientable double cover of the space of second kind decorated ellipses, homeomorphic to $\mathbb{R} \times S^1 \times \mathbb{T}^2$. Especially, they can be directly adapted to study the dynamics which preserves the boundary $\{L = G\}$, corresponding to circles.

To use the same idea to study secular dynamics of the three-body problem, we directly set the Laplace plane to be horizontal (*i.e.* consider only the space Π'_{vert}) in the forthcoming definition.

Definition 1.2.3. The *second modified secular space* is the space of pairs consisting of an (inner) second kind decorated ellipse and an outer ellipse, with $C \neq 0$ and horizontal Laplace plane. The outer ellipse is a pair of an ellipse and a direction, which is the direction of the pericentre when it is non-circular, and any direction in its orbital plane passing through the origin if it is circular.

When the inner and outer ellipses are both horizontal, the node line of the inner ellipse plays the role of the common node line. The Deprit elements $(G_1, \bar{g}_1, G_2, \bar{g}_2, C, \phi_1)$

are then everywhere well-defined on the orientable double cover of the second modified secular space, with the equivalence relation

$$(G_1, \bar{g}_1, G_2, \bar{g}_2, C, \phi_1) \sim (G_1, \pi - \bar{g}_1, G_2, \pi - \bar{g}_2, C, \phi_1 + \pi).$$

Especially, they can be directly adapted to study the dynamics of flows which preserves the boundary $\{G_i = |C - G_j|\} \cup \{G_i = \min\{L_i, |C - G_j|\}\}, i \neq j \in \{1, 2\}$ ¹¹.

The reduction by the $\text{SO}(2)$ -symmetry around the direction of \vec{C} in the second modified secular space takes a very simple form: one just needs to forget the direction of the inner node line. Note that this reduction procedure does not lead to an effective reduction procedure (of the $\text{SO}(2)$ -symmetry) for coplanar ellipse pairs in the secular space, since we have just ruled out the additional directions (of the node) which are added to coplanar ellipse pairs.

From the discussions of this section, we see that the classical Delaunay coordinates (as well as the Deprit coordinates) can be used more “globally”, thanks to proper modification of the secular space. In particular, these coordinates can be used to show that Lidov-Ziglin’s study of the quadrupolar dynamics [LZ76] is a global study in proper blow-ups of the secular spaces, up to circular or horizontal inner motions, and circular or horizontal outer motions. The quadrupolar dynamics on the secular spaces can be deduced directly.

¹¹This boundary is deduced from the triangular inequality and $G_i \leq L_i, i = 1, 2$

Chapter 2

Quadrupolar Dynamics and Quasi-periodic Solutions

2.1 Secular and Secular-integrable Systems

In the lunar case, the two Keplerian frequencies do not appear at the same magnitude of the small parameter α . This fact enables us to build normal forms up to any order, without necessarily considering the interaction between the two frequencies. This is the asynchronous elimination procedure that we are going to describe. In the literature, this particular elimination procedure is carried out by Jefferys and Moser in [JM66]. Another method of this elimination procedure is presented by Féjóz in [Féj02], in which the terminology *asynchronous region* is coined. In order to build integrable approximating systems, we shall further average over g_2 to obtain the secular-integrable systems by an additional single frequency averaging.

2.1.1 Definition of the Asynchronous Region

We fix the masses m_0, m_1, m_2 arbitrarily, and suppose that the eccentricities e_1 and e_2 are bounded away from 0, 1, so there exist positive real numbers $e_1^\vee, e_1^\wedge, e_2^\vee, e_2^\wedge$, such that

$$0 < e_1^\vee < e_1 < e_1^\wedge < 1, \quad 0 < e_2^\vee < e_2 < e_2^\wedge < 1.$$

Recall that $\alpha = \frac{a_1}{a_2}$ is the ratio of the semi major axes, which plays the role of a small parameter in this study. We suppose that $\alpha < \alpha^\wedge$ for

$$\alpha^\wedge := \min\left\{\frac{1 - e_2^\wedge}{80}, \frac{1 - e_2^\wedge}{2\sigma_0}, \frac{1 - e_2^\wedge}{2\sigma_1}\right\},$$

in which $\frac{1}{\sigma_0} = 1 + \frac{m_1}{m_0}$, $\frac{1}{\sigma_1} = 1 + \frac{m_0}{m_1}$ (see Appendix A for the choice of α^\wedge). In particular,

$$\max\{\sigma_0, \sigma_1\} \alpha \frac{1 + e_1}{1 - e_2} < 1,$$

i.e., the two ellipses are always bounded away from each other for all the time.

Without loss of generality, we fix two real numbers $a_1^\wedge > a_1^\vee > 0$, such that the relation $a_1^\vee < a_1 < a_1^\wedge$ holds for all time.

The subset of the phase space Π in which Delaunay coordinates for both ellipses are regular coordinates, and satisfy these restrictions is denoted by \mathcal{P}^* : it can thus be regarded

(by Delaunay coordinates) as a subset¹ of $\mathbb{T}^6 \times \mathbb{R}^6$. The function F_{pert} can thus be regarded as an analytic function on $\mathcal{P}^* \subset \mathbb{T}^6 \times \mathbb{R}^6$.

Let ν_1, ν_2 denote the two Keplerian frequencies: $\nu_i = \frac{\partial F_{Kep}}{\partial L_i} = \sqrt{\frac{M_i}{a_i^3}}, i = 1, 2$.

Let $T_{\mathbb{C}} = \mathbb{C}^6/\mathbb{Z}^6 \times \mathbb{C}^6$ and T_s be the s -neighborhood of $\mathbb{T}^6 \times \mathbb{R}^6 := \mathbb{R}^6/\mathbb{Z}^6 \times \mathbb{R}^6$ in $T_{\mathbb{C}}$. Let $T_{\mathbf{A},s}$ be the s -neighborhood of a set $\mathbf{A} \subset \mathbb{T}^6 \times \mathbb{R}^6$ in T_s .

The complex modulus of a transformation is the maximum of the complex moduli of its components. We use $|\cdot|$ to denote the modulus of either a function or a transformation.

Lemma A.3 states that there exists some small real number $s > 0$, such that in $T_{\mathcal{P}^*,s}$, $|F_{pert}| \leq \text{Cst} |\alpha|^3$, in which the constant Cst is independent of α .

2.1.2 Asynchronous Elimination of the Fast Angles

Proposition 2.1.1. *For any $n \in \mathbb{N}$, there exist an analytic Hamiltonian $F^n : \mathcal{P}^* \rightarrow \mathbb{R}$ independent of the fast angles l_1, l_2 , and an analytic symplectomorphism $\phi^n : \mathcal{P}^* \supset \tilde{\mathcal{P}} \rightarrow \phi^n(\tilde{\mathcal{P}})$, $|\alpha|^{\frac{3}{2}}$ -close to the identity, such that*

$$|F \circ \phi^n - F^n| \leq C_0 |\alpha|^{\frac{3(n+2)}{2}}$$

on $T_{\tilde{\mathcal{P}},s''}$ for some open set $\tilde{\mathcal{P}} \subset \mathcal{P}^*$, and some real number s'' with $0 < s'' < s$. Moreover, locally the density of $\tilde{\mathcal{P}}$ in \mathcal{P}^* tends to 1 when α tends to 0.

Proof. The strategy is to first eliminate l_1 up to sufficiently large order, and then eliminate l_2 to the desired order.

We describe the first step of eliminating l_1 . In order to eliminate the angle l_1 in the perturbing function F_{pert} , we look for an auxiliary analytic Hamiltonian \hat{H} , which is of order $O(\alpha^3)$. We denote its Hamiltonian vector field by $X_{\hat{H}}$ and its flow by ϕ_t . The symplectic coordinate transformation that we are looking for is given by the time-1 map ϕ_1 ($:= \phi_t|_{t=1}$) of $X_{\hat{H}}$.

Define the first order complementary part $F_{comp,1}^1$ by the equation

$$\phi_1^* F = F_{Kep} + (F_{pert} + X_{\hat{H}} \cdot F_{Kep}) + F_{comp,1}^1,$$

in which $X_{\hat{H}}$ is seen as a derivation operator. Let

$$\langle F_{pert} \rangle_1 = \frac{1}{2\pi} \int_0^{2\pi} F_{pert} dl_1$$

be the average of F_{pert} over l_1 , and $\tilde{F}_{pert,1} = F_{pert} - \langle F_{pert} \rangle_1$ be its zero-average part.

As the two Keplerian frequencies do not appear at the same magnitude of α , we do not need to ask \hat{H} to solve the (standard) cohomological equation:

$$\nu_1 \partial_{l_1} \hat{H} + \nu_2 \partial_{l_2} \hat{H} = \tilde{F}_{pert,1};$$

instead, we just need \hat{H} to solve the perturbed cohomological equation

$$\nu_1 \partial_{l_1} \hat{H} = \tilde{F}_{pert,1}.$$

¹The condition defining \mathcal{P}^* can be replaced by other conditions, e.g. by asking that the Deprit coordinates to be regular.

We thus set

$$\hat{H}(l_2) = \frac{1}{\nu_1} \int_0^{l_1} \tilde{F}_{pert,1} dl_1$$

as long as $\nu_1 \neq 0$. The last condition is indeed satisfied for any Keplerian frequency. This amounts to proceed with a single frequency elimination for l_1 . We have

$$|\hat{H}| \leq \text{Cst } |\alpha|^3 \text{ in } T_{\mathcal{P}^*,s}.$$

We obtain by Cauchy inequality that in $T_{\mathcal{P}^*,s-s_0}$, $|X_{\hat{H}}| \leq \text{Cst } |\hat{H}| \leq \text{Cst } |\alpha|^3$ for some $0 < s_0 < s/2$. Shrinking from $T_{\mathcal{P}^*,s-s_0}$ to $T_{\mathcal{P}^{**},s-s_0-s_1}$, where \mathcal{P}^{**} is an open subset of \mathcal{P}^* , so that $\phi_1(T_{\mathcal{P}^{**},s-s_0-s_1}) \subset T_{\mathcal{P}^*,s-s_0}$, with $s - s_0 - s_1 > 0$. The time-1 map ϕ_1 of X_H thus satisfies $|\phi_1 - Id| \leq \text{Cst } |\alpha|^3$ in $T_{\mathcal{P}^{**},s-s_0-s_1}$.

The function $\phi_1^* F$ is analytic in $T_{\mathcal{P}^{**},s-s_0-s_1}$. Now F is conjugate to

$$\phi_1^* F = F_{Kep} + \langle F_{pert} \rangle_1 + F_{comp,1}^1,$$

and $|F_{comp,1}^1|$ is of order $O(\alpha^{\frac{9}{2}})$: indeed, analogous to [Féj02], the complementary part

$$F_{comp,1}^1 = \int_0^1 (1-t) \phi_t^*(X_{\hat{H}}^2 \cdot F_{Kep}) dt + \int_0^1 \phi_t^*(X_{\hat{H}} \cdot F_{pert}) dt - \nu_2 \frac{\partial \hat{H}}{\partial l_2}$$

satisfies

$$|F_{comp,1}^1| \leq \text{Cst } |X_{\hat{H}}| (|\tilde{F}_{pert,1}| + |F_{pert}|) + \nu_2 |\hat{H}| \leq \text{Cst } |\alpha|^{\frac{9}{2}}.$$

The first order averaging with respect to l_1 is then accomplished. One proceeds analogously and eliminate the dependence of the Hamiltonian of l_1 up to order $O(\alpha^{\frac{3(n+2)}{2}})$ for any chosen $n \in \mathbb{Z}_+$. The Hamiltonian F is then analytically conjugate to

$$F_{Kep} + \langle F_{pert} \rangle_1 + \langle F_{comp,1}^1 \rangle_1 + \cdots + \langle F_{comp,n-1}^1 \rangle_1 + F_{comp,n}^1,$$

in which the expression $F_{Kep} + \langle F_{pert} \rangle_1 + \langle F_{comp,1}^1 \rangle_1 + \cdots + \langle F_{comp,n-1}^1 \rangle_1$ is independent of l_1 , and $F_{comp,n}^1$ is of order $O\left(\alpha^{\frac{3(n+2)}{2}}\right)$.

After this, we proceed by eliminating l_2 from

$$F_{Kep} + \langle F_{pert} \rangle_1 + \langle F_{comp,1}^1 \rangle_1 + \cdots + \langle F_{comp,n-1}^1 \rangle_1.$$

This is again a single frequency averaging and it can be carried out as long as $\nu_2 \neq 0$.

The Hamiltonian generating the transformation for the first step of averaging over l_2 is

$$\frac{1}{\nu_2} \int_0^{l_2} (\langle F_{pert} \rangle_1 - \langle F_{pert} \rangle) dl_2 \leq \text{Cst } |\alpha|^{\frac{3}{2}}.$$

The other steps are similar to the first step of eliminating l_1 .

By eliminating l_2 , the Hamiltonian F is conjugate to

$$F_{Kep} + \langle F_{pert} \rangle + \langle F_{comp,1} \rangle + \cdots + \langle F_{comp,n-1} \rangle + F_{comp,n},$$

in which the (first order) *secular system*

$$F_{sec}^1 = \langle F_{pert} \rangle := \frac{1}{4\pi^2} \int_0^{2\pi} \int_0^{2\pi} F_{pert} dl_1 dl_2$$

and the n -th order secular system

$$F_{sec}^n := \langle F_{pert} \rangle + \langle F_{comp,1} \rangle + \cdots + \langle F_{comp,n-1} \rangle$$

is independent of l_1, l_2 , with

$$\langle F_{comp,i} \rangle = O(\alpha^{\frac{3(i+2)}{2}}), \quad F_{comp,n} = O(\alpha^{\frac{3(n+2)}{2}})$$

in $T_{\tilde{\mathcal{P}},s''}$ for some open subset $\tilde{\mathcal{P}} \subset \mathcal{P}^*$ and some $0 < s'' < s$ both of which are obtained by finite steps of constructions analogously to that we have described for the first step elimination of l_1 . In particular, the set $\tilde{\mathcal{P}}$ is obtained by shrinking \mathcal{P}^* from its boundary by a distance of $O(\alpha^{\frac{3}{2}})$. We may thus set

$$F^n := F_{Kep} + F_{sec}^n.$$

□

The function F_{sec}^n is defined on a subset of the phase space Π . It does not depend on the fast Keplerian angles. To study its dynamics, we fix L_1 and L_2 , then quotient by the Keplerian \mathbb{T}^2 -symmetry. The resulting function is then defined on a subset of the secular space. We keep the same notation F_{sec}^n for the resulting function.

2.1.3 Secular-integrable Systems

Unlike the planar case, the spatial secular systems F_{sec}^n has two degrees of freedom after being reduced by the $SO(3)$ -symmetry, and therefore they are *a priori* not integrable. As a result, they cannot directly serve as an “integrable approximating system” for our study.

In \mathcal{P}^* , the function F_{sec}^1 is of order $O(\alpha^3)$, and the functions $F_{comp,n}$, $n \geq 2$ are of order $O(\alpha^{\frac{9}{2}})$.

We express F_{sec}^n as a function

$$F_{sec}^n(a_1, \alpha, e_1, e_2, g_1, g_2, h_1, h_2, i_1, i_2),$$

then expand it in powers of α :

$$F_{sec}^n = \sum_{i=0}^{\infty} F_{sec}^{n,i} \alpha^{i+1} = F_{sec}^{n,0} \alpha + F_{sec}^{n,1} \alpha^2 + \cdots.$$

As a consequence of Lemma A.1, we see that

$$\forall n \in \mathbb{N}_+, F_{sec}^{n,i} = 0, i = 0, 1.$$

Moreover, since $F_{comp,n}$, $n \geq 1$ is of order $O(\alpha^{\frac{9}{2}})$, therefore

$$F_{sec}^n - F_{sec}^1 = O(\alpha^{\frac{9}{2}}),$$

in particular, we have

$$F_{sec}^{n,2} = F_{sec}^{1,2}, F_{sec}^{n,3} = F_{sec}^{1,3}, \quad \forall n = 1, 2, 3, \dots$$

As noticed by Harrington in [Har68]², the term $F_{sec}^{1,2}$ is independent of g_2 , thus G_2 is an additional first integral of the system $F_{sec}^{1,2}$. The system $F_{sec}^{1,2}$ can then be reduced to one degree of freedom after reduction of the symmetries, hence it is integrable. We call $F_{quad} := F_{sec}^{1,2}$ the *quadrupolar system*.

The integrability of the quadrupolar Hamiltonian is, in Lidov and Ziglin's words, a "happy coincidence": it is due to the particular form of F_{pert} . Indeed, if one goes to even higher order expansion in powers of α , then in general the truncated Hamiltonian will no longer be independent of g_2 (resp. \bar{g}_2) (c.f. [LB10]).

In order to have better control of the perturbation so as to apply KAM theorems, we need to build higher order integrable approximations by eliminating g_2 in the secular systems F_{sec}^n . This is a single frequency elimination procedure and can be carried out everywhere as long as the frequency of g_2 is not zero.

Let $\nu_{quad,2}$ be the frequency of g_2 in the system F_{quad} . Since the analytic function F_{quad} depends non trivially on G_2 (See Section 2.2), For any ε small enough, we have $|\nu_{quad,2}| > \varepsilon$ on an open subset $\check{\mathcal{P}}$ of \mathcal{P}^* and locally the density of $\check{\mathcal{P}}$ in \mathcal{P}^* tends to 1 when ε tends to 0. For any fixed ε , analogous to Subsection 2.1.2, for small enough α , there exists an open subset $\hat{\mathcal{P}}$ in $\check{\mathcal{P}}$ with local density in $\check{\mathcal{P}}$ tending to 1 when α tends to 0, such that on $\hat{\mathcal{P}}$ we can conjugate our system up to small terms of higher orders to the normal form that one gets by the standard elimination procedure³ to eliminate g_2 .

More precisely, as the elimination of l_2 in the proof of Proposition 2.1.1, for the first step of elimination, we eliminate the angle g_2 in $F_{Kep} + \alpha^3(F_{quad} + \alpha F_{sec}^{1,3})$ by a symplectic transformation ψ^3 close to identity, which is the time-1 map of the Hamiltonian

$$\frac{\alpha}{\nu_{g_2}} \left(\int_0^{g_2} \left(F_{sec}^{1,3} - \frac{1}{2\pi} \int_0^{2\pi} F_{sec}^{1,3} dg_2 \right) dg_2 \right).$$

The transformation is then of order α . We proceed analogously for higher order eliminations. We denote by $\psi^{n'} : \hat{\mathcal{P}} \rightarrow \psi^{n'}(\hat{\mathcal{P}})$ the corresponding symplectic transformation, so that

$$\psi^{n'*} F_{sec}^n = \alpha^3 F_{quad} + \alpha^4 \widetilde{F_{sec}^{n,3}} + \dots + \alpha^{n'} \widetilde{F_{sec}^{n,n'}} + F_{secpert}^{n'+1},$$

in which $F_{secpert}^{n'+1} = O(\alpha^{n'+2})$ and $\widetilde{F_{sec}^{n,i}}, i = 1, 2, \dots$ are independent of g_2 .

Let

$$\overline{F_{sec}^{n,n'}} = \alpha^3 F_{quad} + \alpha^4 \widetilde{F_{sec}^{n,3}} + \dots + \alpha^{n'} \widetilde{F_{sec}^{n,n'}}$$

and call it the (n, n') -th order *secular-integrable system*. We have

$$\psi^{n'*} \phi^{n*} F = F_{Kep} + \overline{F_{sec}^{n,n'}} + F_{secpert}^{n'+1} + F_{comp}^n.$$

For α small enough, the latter two terms can be made arbitrarily small by choosing n, n' large enough. Since $F_{sec}^{n,3}$ depends non-trivially on g_2 (See e.g. [LB10]), the transformation ψ^3 (the transformation used to eliminate the dependence of g_2 in $F_{sec}^{n,3}$) is of order α , the transformation ϕ^n is of order $O(\alpha^{3/2})$, therefore the transformation $\phi^n \psi^{n'}$ is of order α , and is dominated by the transformation ψ^3 .

Remark 2.1.1. A Hamiltonian function does not depend on g_2 when it is expressed in Delaunay coordinates if and only if it does not depend on \bar{g}_2 when it is expressed in

²For the (inner) restricted spatial three-body problem, the integrability of the quadrupolar system has been discovered in 1961 by Lidov [Lid61] (see also Lidov [Lid62], Kozai [Koz62]). Its link with the non-restricted quadrupolar system has been discussed in [LZ76].

³The elimination method we use is the standard procedure described in [Arn83].

Deprit coordinates: this is because they are conjugate to the same action variable G_2 in different Darboux coordinates. Therefore it is equivalent to eliminate either of them in their corresponding coordinate systems.

2.2 Quadrupolar Dynamics

The secular-integrable systems $\overline{F_{sec}^{n,n'}}$ are $O(\alpha^4)$ perturbations⁴ of $\alpha^3 F_{quad}$, therefore for α small, the key to understand the dynamics of $\overline{F_{sec}^{n,n'}}$ is to understand the dynamics of F_{quad} (seen as a function defined on a subset of the secular space). In this section, we shall reproduce and reformulate some of the study of Lidov-Ziglin in [LZ76].

In Deprit coordinates, after reduction by the $SO(3)$ -symmetry, the quadrupolar Hamiltonian takes the form

$$F_{quad} = -\frac{\mu_{quad} L_2^3}{8a_1 G_2^3} \left\{ 3 \frac{G_1^2}{L_1^2} \left[1 + \frac{(C^2 - G_1^2 - G_2^2)^2}{4G_1^2 G_2^2} \right] + 15 \left(1 - \frac{G_1^2}{L_1^2} \right) \left[\cos^2 \bar{g}_1 + \sin^2 \bar{g}_1 \frac{(C^2 - G_1^2 - G_2^2)^2}{4G_1^2 G_2^2} \right] - 6 \left(1 - \frac{G_1^2}{L_1^2} \right) - 4 \right\},$$

where the constant $\mu_{quad} = \frac{m_0 m_1 m_2}{m_0 + m_1}$ only depends on the masses.

Notations: We separate the variables of the system and the parameters by a semicolon so as to make the difference between different reduced systems more apparent.

The functions L_1 , L_2 , C and G_2 are first integrals of $F_{quad}(G_1, \bar{g}_1, C, G_2, L_1, L_2)$. We fix the direction of \vec{C} and these first integrals, and reduce the system by the conjugate \mathbb{T}^4 -symmetry, so that C and G_2 are considered as parameters of the reduced system. The resulting system is thus written as $F_{quad}(G_1, \bar{g}_1; C, G_2, L_1, L_2)$.

By applying the triangular inequality to the vectors \vec{C} , \vec{C}_1 , \vec{C}_2 , we see that the parameters L_1 , C and G_2 must satisfy the condition

$$|C - G_2| \leq L_1.$$

This condition defines the region of admissible parameters in the (C, G_2) -parameter space. By triangular inequality and definition of G_1 , when C and G_2 are fixed, the quantity $|G_1|$ belongs to the interval $[G_{1,min}, G_{1,max}]$, where $G_{1,min} := |C - G_2|$, $G_{1,max} := \min\{L_1, C + G_2\}$.

Recall that after blow-up of the secular space, we may still use $(G_1, \bar{g}_1, G_2, \bar{g}_2)$ to study circular inner or outer ellipses or coplanar pairs of ellipses. In this section, we retain this convention unless otherwise stated. Note that the reduction procedure of the $SO(2)$ -symmetry around \vec{C} for coplanar pairs of ellipses after the blow-up procedure, however, does not lead to an effective reduction procedure in the secular space. See Subsection 1.2.5 for more details.

From its explicit expression, we see that the Hamiltonian F_{quad} is regular for $C \neq G_2$ for all $0 < G_1 < L_1$; it is also regular when $C = G_2$, since the factor G_1^2 in the denominator is cancelled out by G_1^4 appearing in the numerator. This phenomenon also holds for any $\overline{F_{sec}^{n,n'}}$.⁵ For $G_1 < G_{1,min}$, the dynamics determined by the above expression of F_{quad} is irrelevant to the real dynamics; nevertheless, the fact that the expression of F_{quad} is

⁴Actually $\overline{F_{sec}^{n,3}} = 0$ but $\overline{F_{sec}^{n,4}} \neq 0$, therefore $\overline{F_{sec}^{n,n'}} - \alpha^3 F_{quad}$ is of order $O(\alpha^5)$.

⁵Each $\overline{F_{sec}^{n,n'}}$ depends polynomially on $\cos(i_1 - i_2)$ (through Legendre polynomials), therefore it remains analytic in G_1 for $0 < G_1 < L_1$ if we substitute $\cos(i_1 - i_2)$ by $\frac{C^2 - G_1^2 - G_2^2}{2G_1 G_2}$.

analytic in G_1 for all $0 < G_1 < L_1$ enable us to develop F_{quad} into Taylor series of G_1 at $\{G_1 = G_{1,min}\}$ for $G_{1,min} > 0$. In Appendix D, this allows us to show the existence of torsion for those quadrupolar invariant tori near $\{G_1 = G_{1,min}\}$ with some simple calculations.

Now we may fix C and G_2 and reduce the system to one degree of freedom. When $C \neq G_2$, the (physically relevant) reduced quadrupolar dynamics lies in the cylinder defined by the condition $G_{1,min} \leq G_1 \leq G_{1,max}$. When $C = G_2$, the reduced quadrupolar dynamics naturally lies in the reduced critical quadrupolar space (Figure 1.4). The analysis of the quadrupolar dynamics in this space is the key for the proof of the existence of quasi-periodic almost-collision orbits (Section 3.2).

As is shown by Lidov-Ziglin, for fixed L_1 and L_2 , in different regions of the (C, G_2) -parameter space, the phase portraits in the (G_1, \bar{g}_1) -plane have periodic orbits, finitely many singularities and separatrices; the first two kinds give rise to invariant 2-tori and periodic orbits of the reduced system of F_{quad} by the $SO(3)$ -symmetry, and invariant 3-tori and 2-tori of the system F_{quad} (not being reduced by the $SO(3)$ -symmetry) in the secular space.

The quadrupolar phase portraits in the (G_1, \bar{g}_1) -space are invariant under the translations

$$(\bar{g}_1, G_1) \rightarrow (\bar{g}_1 + n\pi, G_1), n \in \mathbb{Z},$$

and the reflections

$$(\bar{g}_1, G_1) \rightarrow (-\bar{g}_1, G_1).$$

Therefore, without loss of generality, we can identify points obtained by reflexions and translations. In particular, we shall make this identification for the singularities.

Figure 2.1 and Figures 2.2, 2.3 are the parameter space and phase portraits of the quadrupolar system, which are slight modifications of the corresponding figures in [LZ76].

When $C \neq G_2$, the dynamics of F_{quad} can be easily deduced from [LZ76] by using the relations (ϵ, ω denote respectively the symbols ε, ω in [LZ76])

$$\epsilon = \frac{G_1^2}{L_1^2}, \quad \omega = g_2.$$

According to different choices of parameters, we list different quadrupolar phase portraits in the following:

1. $G_2 < C, 3G_2^2 + C^2 < L_1^2$.

In this case, there exists an elliptical singularity

$$B : (\bar{g}_1 = \frac{\pi}{2} \pmod{\pi}, G_1 = G_{1,B}),$$

where $G_{1,B}$ is determined by the equation

$$\frac{G_{1,B}^6}{L_1^6} - \left(\frac{G_2^2 + 2C^2}{2L_1^2} + \frac{5}{8} \right) \frac{G_{1,B}^4}{L_1^4} + \frac{5(C^2 - G_2^2)^2}{8L_1^4} = 0.$$

There also exists a hyperbolic singularity

$$A : \left(\bar{g}_1 = 0 \pmod{\pi}, G_1 = \sqrt{3G_2^2 + C^2} \right).$$

2. $G_2 + C < L_1, 0 < (G_2 - C)(G_2 + C)^2 < 5C(L_1^2 - (C + G_2)^2)$
or
 $G_2 + C > L_1, 0 < 2L_1^2(3G_2^2 + C^2 - L_1^2) < 5(4L_1^2G_2^2 - (C^2 - G_2^2 - L_1^2)^2).$

In this case, there exist two singularities: the elliptic singularity B , and a hyperbolic singularity E :

$$E : (\bar{g}_1 = \arcsin \sqrt{\frac{(G_2 - C)(G_2 + C)^2}{5C(L_1^2 - (G_2 + C)^2)}, G_1 = G_{1,max})$$

if $C + G_2 < L_1$, and

$$E : (\bar{g}_1 = \arcsin \sqrt{\frac{2L_1^2(3G_2^2 + C^2 - L_1^2)}{5(4L_1^2G_2^2 - (C^2 - G_2^2 - L_1^2)^2)}, G_1 = G_{1,max})$$

if $C + G_2 > L_1$.

3. $(C - G_2)^2 < \frac{2}{3}(\frac{G_2^2}{2} + C^2 + \frac{5L_1^2}{8}) < \min\{L_1^2, (C + G_2)^2\}$
 $L_1^2(C^2 + G_2^2)^2 < \frac{32}{135}(\frac{G_2^2}{2} + C^2 + \frac{5L_1^2}{8})^3$
 $5C(L_1^2 - (C + G_2)^2) < (G_2 - C)(G_2 + C)^2$, if $C + G_2 < 1$ and
 $5(4L_1^2G_2^2 - (C^2 - G_2^2 - L_1^2)^2) < 2L_1^2(3G_2^2 + C^2 - L_1^2)$, if $C + G_2 > 1$.

In this case, there exists an elliptic singularity B and a hyperbolic singularity A' on the line defined by $\bar{g}_1 = \frac{\pi}{2} \pmod{\pi}$. The ordinate of A' is determined by the same equation that defines the ordinate of B in the case (1).

4. The border cases of the above-listed choices of parameters. For such parameters, the corresponding phase portraits can be easily deduced by limiting procedures. We shall not list them in details, as we do not need them in this study.
5. There are no singularities for other choice of parameters.

When $C = G_2$ (Figure 2.3), the quadrupolar Hamiltonian F_{quad} defines a dynamical system on the dense open set $\tilde{\mathcal{D}}$ of the critical quadrupolar space, on whose double cover we can use the extended Deprit coordinates, which, after reduction by the $SO(3) \times SO(2)$ symmetry, give coordinates (G_1, \bar{g}_1) which are regular near degenerate inner ellipses on the branched double cover of the reduced critical quadrupolar space. The phase portraits of this system can be easily deduced from [LZ76]:

1. $C = G_2 \leq \frac{L_1}{2}$.

The expressions of the hyperbolic singularities A and E coincide, and give out one hyperbolic singularity $A = E$ at $(\bar{g}_1 = 0 \pmod{\pi}, G_1 = G_{1,max})$. There also exist two elliptic singularities: $(\bar{g}_1 = 0 \pmod{\pi}, G_1 = 0)$ and $(\bar{g}_1 = \frac{\pi}{2} \pmod{\pi}, G_1 = 0)$.

2. $C = G_2 > \frac{L_1}{2}$.

Only one hyperbolic singularity E exists, together with two elliptic singularities: $(\bar{g}_1 = 0 \pmod{\pi}, G_1 = 0)$ and $(\bar{g}_1 = \frac{\pi}{2}, \pmod{\pi}, G_1 = 0)$.

In either of the two cases, a dense open set of trajectories passes through the subset $\{G_1 = 0\}$, as indicated by the phase portraits. Remind that these are the phase portraits

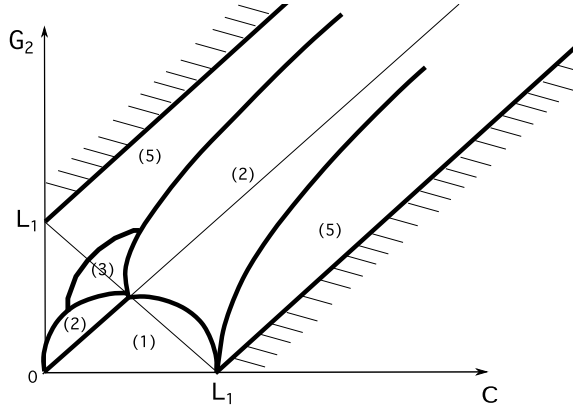

Figure 2.1: The parameter space of the quadrupolar system

on the branched double cover of the reduced critical quadrupolar space. To obtain the corresponding phase portraits on the reduced critical quadrupolar space, we have to reduce the system by the equivalence relation $(G_1, \bar{g}_1) \sim (-G_1, \pi - \bar{g}_1)$. The quotient space (a part of it is depicted in Figure 2.5) is then a disc⁶ with two singular points when $C = G_2 \geq \frac{L_1}{2}$. In particular, the frequency of a periodic orbit in the reduced critical quadrupolar space and its lift in the branched double cover winding around the singularity $(G_1 = 0, \bar{g}_1 = \frac{\pi}{2})$ are differed by a factor of 2, while for periodic orbits in the reduced critical quadrupolar space whose lift wind around the singularity $(G_1 = 0, \bar{g}_1 = 0)$, each of them has the same frequency as its lift.

In order to understand the phase portraits in and near the reduced critical quadrupolar space in the reduced secular space, we need to carry out the reduction procedure in the secular space but not in its blow-ups. If we fix the direction of \vec{C} and suppose that the outer ellipse is non-degenerate and non-circular, then the only points in the restriction of the secular space on which the action of $SO(2) \times SO(2)$ is not free are ellipse pairs containing degenerate inner ellipse parallel to \vec{C} or a circular inner ellipse perpendicular to \vec{C} (on which the isotropy group is $SO(2)$). Therefore the quotient is a smooth manifold outside these points. The reduction also leads into identifying the circles $\{G_1 = G_{1,min}\}$ and $\{G_1 = G_{1,max}\}$ to points (see Figure 2.5 for the resulting phase portraits near $\{G_1 = G_{1,min}\}$).

We summarize the relations between variants of the secular space and reductions in these space in Figure 2.6.

Remark 2.2.1. The use of non-symplectic coordinates $\epsilon = \frac{G_1^2}{L_1^2}, \omega = \bar{g}_1$ in [LZ76] calls for some comments. First, the reduced system is integrable and has only one degree of freedom, therefore the use of non-symplectic coordinates does not cause much inconvenience. Moreover, the choice of ϵ respects the symmetry $(G_1, \bar{g}_1) \rightarrow (-G_1, \bar{g}_1)$ of the quadrupolar system, and when $C \neq G_2$ the quadrupolar dynamics is naturally restricted to the subset of the phase space Π in which the transformation $(\epsilon, \omega) \rightarrow (G_1, \bar{g}_1)$ is regular. In the case when $C = G_2$, the formulation of the quadrupolar dynamics in coordinates (ϵ, ω) in the region $\epsilon > 0$ indicates that along a dense open set of trajectories, the eccentricity e_1 of

⁶In Figure 2.4, we further identify the set $\{G_1 = G_{1,max}\}$ to a point, while here we have not made this identification.

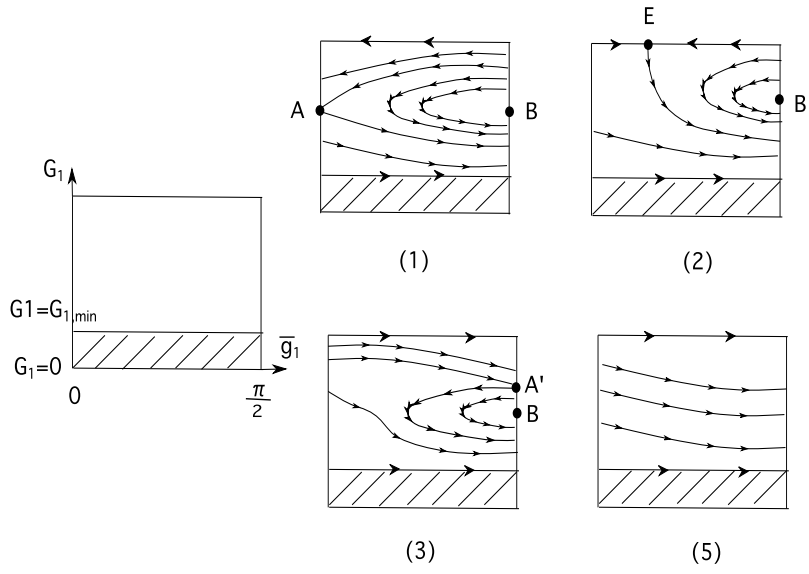

Figure 2.2: The phase portraits of the quadrupolar system for $C \neq C_2$.

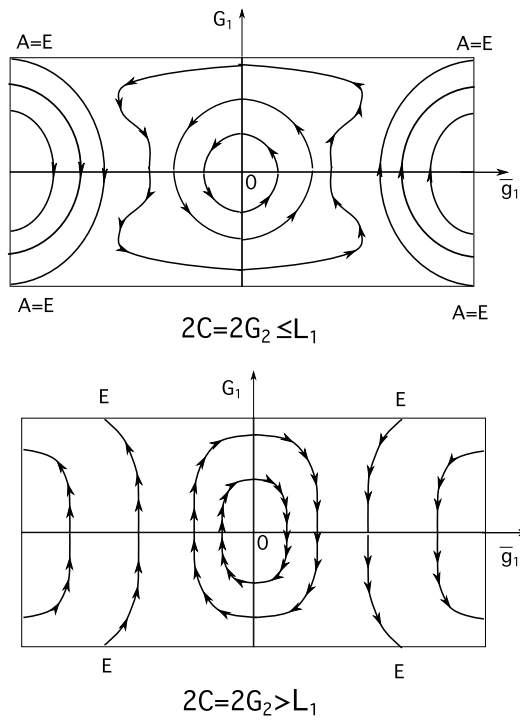

Figure 2.3: The G_1 - \bar{g}_1 phase portraits on the branched double cover of the reduced critical quadrupolar space, $\bar{g}_1 \in [-\frac{\pi}{2}, \frac{\pi}{2}]$.

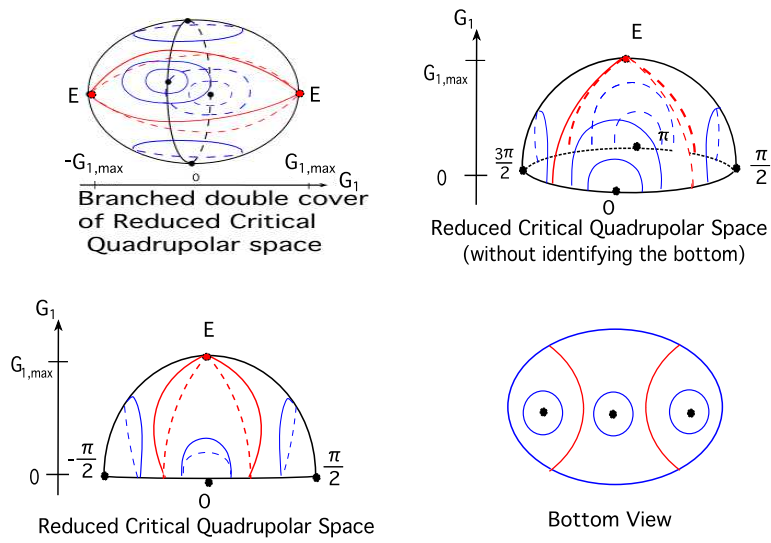

Figure 2.4: The flow foliation on the reduced critical quadrupolar space and its branched double cover.

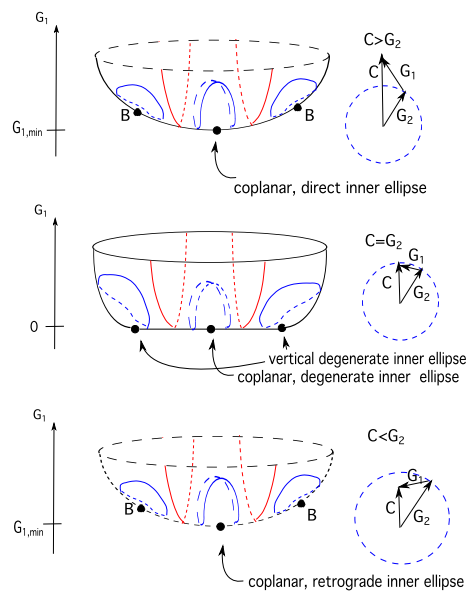

Figure 2.5: The reduced quadrupolar flow near the reduced critical quadrupolar space. Only the phase portraits near $G_1 = G_{1,min}$ are depicted.

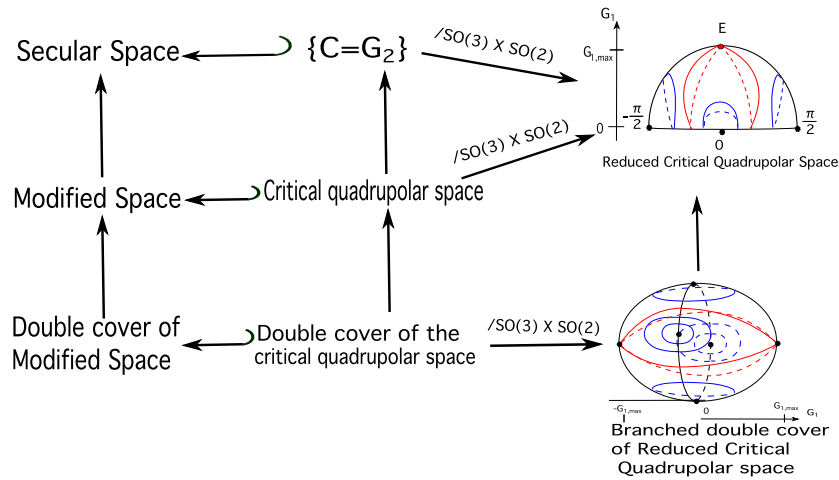

Figure 2.6: Variants of the secular spaces and reductions

the inner ellipse will tend and reach 1. This is well-adapted to their purpose, which is to generalize their former studies of the quadrupolar dynamics of the restricted spatial three-body problem to the (non-restricted) spatial three-body problem and to show that in this case, except for initial values lying in the subset $\{|G_1| = G_{1,max}\}$, even for initial value arbitrarily close to this subset, the inner orbital plane tends to be perpendicular to the Laplace plane, and the eccentricity e_1 of the inner ellipse tends to 1. If one considers the Earth-Moon-Astroid system, then regardless of whether one models the system by the spatial restricted three-body problem or the spatial three-body problem, then even if the astroid is released in an orbit very close to the orbital plane of the moon around the earth, the astroid will eventually have its orbital plane becoming perpendicular to the orbital plane of the moon, and its eccentricity tending to 1, which will finally end up in a collision with the Earth. Unfortunately, these informations are insufficient for our purpose, and further analysis is needed.

In the phase space Π , consider the system $F_{Kep} + \alpha^3 F_{quad}$ when $C = G_2$: each choice of the two Keplerian frequencies and the two secular frequencies gives rise to invariant 4-tori in the system reduced by the $SO(3)$ -symmetry. Moreover, if the two Keplerian frequencies and the two secular frequencies are not in resonance, then the flow is ergodic on such invariant 4-tori. Based on the quadrupolar dynamics, we see that the flow on such tori gives rise to a zero measure set of collision orbits and to a set of full measure of almost-collision orbits in $\{C = G_2\}$. These almost-collision orbits are, strictly speaking, not quasi-periodic, as we need to exclude the set of inner collisions from their closures.

For each pair (n, n') of positive integers, the higher order secular-integrable systems $\overline{F_{sec}^{n,n'}}$ has first integrals C and G_2 . As for F_{quad} , when $C \neq G_2$, the inner eccentricity e_1 is bounded away from 1. After fixing C and G_2 and reducing $\overline{F_{sec}^{n,n'}}$ by the $SO(2)$ -actions of their conjugate angles, the reduced dynamics of $\overline{F_{sec}^{n,n'}}$ is defined in the same space as that of F_{quad} for $C \neq G_2$. By analyticity of F_{quad} , we will show that for a dense open set of the parameter space, the singularities A, B, A', E are of Morse type (Proposition C.1). These Morse singularities persist under small perturbations (i.e. for small enough α) and

serve as singularities for $\overline{F_{sec}^{n,n'}}$. The phase portraits of $\overline{F_{sec}^{n,n'}}$ are just small perturbations of (and orbitally conjugate to) that of the quadrupolar system F_{quad} . To obtain the same result near the singularity $\{G_1 = G_{1,min}\}$, we do not need to verify if the singularity $\{G_1 = G_{1,min}\}$ is Morse or not (see Appendix C).

Lidov-Ziglin's study of the quadrupolar dynamics near the secular neighborhood of a circular inner ellipse may be understood more clearly by considering the quadrupolar dynamics in the second modified secular space (Definition 1.2.3), therefore Lidov-Ziglin's study can be regarded as valid up to circular inner ellipse after blowing-up the secular space as described in (Definition 1.2.3). In order to get the "real" quadrupolar dynamics in the secular space, it is enough to proceed with the corresponding blow-down procedure.

In [FO94], Ferrer and Osacar used regular coordinates in the neighborhood of a circular inner ellipse to supplement the study of the quadrupolar dynamics of Lidov-Ziglin. Near a degenerate inner ellipse, they have identified the line segment $\{G_1 = 0\}$ in the critical quadrupolar space to a single point, thus worked in a quotient of the actual reduced space.

2.3 KAM Theorems and Applications

We present some KAM results in this section. We first give an analytic version of a powerful "hypothetical conjugacy" theorem (see e.g. [Féj04]); this result does not depend on any non-degeneracy condition. We then discuss some classical (strong) non-degeneracy conditions which guarantee the existence of KAM tori. Some equivariant KAM theorems, applicable for systems which are invariant under a (free) Hamiltonian torus action are presented thereafter, as well as discussions about the case of more general symmetry of a compact connected Lie group. We also present a theorem of J.Pöschel, which shows the existence of families of periodic solutions accumulating KAM tori. Finally we apply the iso-chronic KAM theorem to obtain some invariant tori of the system F which are bounded away from inner collisions.

2.3.1 Hypothetical Conjugacy Theorem

For $p \geq 1$ and $q \geq 0$, consider the phase space $\mathbb{R}^p \times \mathbb{T}^p \times \mathbb{R}^q \times \mathbb{R}^q = \{(I, \theta, x, y)\}$ endowed with the standard symplectic form $dI \wedge d\theta + dx \wedge dy$. All mappings are assumed to be analytic except when explicitly mentioned otherwise.

Let $\delta > 0$, $q' \in \{0, \dots, q\}$, $q'' = q - q'$, $\varpi \in \mathbb{R}^p$, and $\beta \in \mathbb{R}^q$. Let B_δ^{p+2q} be the $(p+2q)$ -dimensional closed ball with radius δ centered at the origin in \mathbb{R}^{p+2q} , and $N_{\varpi,\beta} = N_{\varpi,\beta}(\delta, q')$ be the space of Hamiltonians $N \in C^\omega(\mathbb{T}^p \times B_\delta^{p+2q}, \mathbb{R})$ of the form

$$N = c + \langle \varpi, I \rangle + \sum_{j=1}^{q'} \beta_j (x_j^2 + y_j^2) + \sum_{j=q'+1}^q \beta_j (x_j^2 - y_j^2) + \langle A_1(\theta), I \otimes I \rangle + \langle A_2(\theta), I \otimes Z \rangle + O_3(I, Z),$$

with $c \in \mathbb{R}$, $A_1 \in C^\omega(\mathbb{T}^p, \mathbb{R}^p \otimes \mathbb{R}^p)$, $A_2 \in C^\omega(\mathbb{T}^p, \mathbb{R}^p \otimes \mathbb{R}^{2q})$ and $Z = (x, y)$; the isotropic torus $\mathbb{T}^p \times \{0\} \times \{0\}$ is an invariant ϖ -quasi-periodic torus of N , and its normal dynamics is elliptic, hyperbolic, or a mixture of both types, with Floquet exponents β . The definitions of tensor operations can be found in e.g. P. 62 [Féj04].

Let $\bar{\gamma} > 0$ and $\bar{\tau} > p - 1$, $|\cdot|$ be the ℓ^2 -norm on \mathbb{Z}^p . Let $HD_{\bar{\gamma}, \bar{\tau}} = HD_{\bar{\gamma}, \bar{\tau}}(p, q', q'')$ be the set of vectors (ϖ, β) satisfying the following homogeneous Diophantine conditions:

$$|k \cdot \varpi + l' \cdot \beta'| \geq \bar{\gamma} (|k|^{\bar{\tau}} + 1)^{-1}$$

for all $k \in \mathbb{Z}^p \setminus \{0\}$ and $l' \in \mathbb{Z}^{q'}$ such that $|l'_1| + \dots + |l'_{q'}| \leq 2$; we have denoted $\beta' = (\beta_1, \dots, \beta_{q'})$. Let $\|\cdot\|_s$ be the s -analytic norm of an analytic function, *i.e.*, the supremum norm of its analytic extension to the s -neighborhood of its (real) domain in the complexified space.

Theorem 2.1. *Let $(\varpi^o, \beta^o) \in HD_{\bar{\gamma}, \bar{\tau}}$ and $N^o \in N_{\varpi^o, \beta^o}$. For some $d > 0$ small enough, there exists $\varepsilon > 0$ such that for every Hamiltonian $N' \in C^\omega(\mathbb{T}^p \times B_\delta^{p+2q})$ such that*

$$\|N' - N^o\|_d \leq \varepsilon,$$

there exists a vector (ϖ, β) satisfying the following properties:

- *the map $N' \mapsto (\varpi, \beta)$ is of class C^∞ and is ε -close to (ϖ^o, β^o) in the C^∞ -topology;*
- *if $(\varpi, \beta) \in HD_{\bar{\gamma}, \bar{\tau}}$, N' is symplectically analytically conjugate to a Hamiltonian $N = c(N) + \langle \varpi, I \rangle + \dots \in N_{\varpi, \beta}$.*

Moreover, ε can be chosen of the form $Cst\bar{\gamma}^k$ (for some $Cst > 0$, $k \geq 1$) when $\bar{\gamma}$ is small.

This theorem is an analytic version of the C^∞ “hypothetical conjugacy theorem” of [Féj04]. Its complete proof will appear in the article [Féj13] of J. Féjóz. Since analytic functions are C^∞ , except for the analyticity of the conjugation, other statements of the theorem directly follow from the “hypothetical conjugacy theorem” of [Féj04].

2.3.2 Iso-chronic and Iso-energetic KAM theorems

We now assume that the Hamiltonians $N^o = N_\iota^o$ and $N' = N'_\iota$ depend analytically (C^1 -smoothly would suffice) on some parameter $\iota \in B_1^{p+q}$. Recall that, for each ι , N_ι^o is of the form

$$N_\iota^o = c_\iota^o + \langle \varpi_\iota^o, I \rangle + \sum_{j=1}^{q'} \beta_{\iota, j}^o (x_j^2 + y_j^2) + \sum_{j=q'+1}^q \beta_{\iota, j}^o (x_j^2 - y_j^2) + \langle A_{\iota, 1}(\theta), I \otimes I \rangle + \langle A_{\iota, 2}(\theta), I \otimes Z \rangle + O_3(I, Z).$$

Theorem 2.1 can be applied to N_ι^o and N'_ι for each ι . We will now add some classical non-degeneracy conditions to the hypotheses of the theorem, which ensure that the condition “ $(\varpi_\iota, \beta_\iota) \in HD_{\bar{\gamma}, \bar{\tau}}$ ” actually occurs often in the set of parameters.

Call

$$HD^o = \left\{ (\varpi_\iota^o, \beta_\iota^o) \in HD_{\bar{\gamma}, \bar{\tau}} : \iota \in B_{1/2}^{p+q} \right\}$$

the set of “accessible” $(\bar{\gamma}, \bar{\tau})$ -Diophantine unperturbed frequencies. The parameter is restricted to a smaller ball in order to avoid boundary problems.

Corollary 2.1 (Iso-chronic KAM theorem). *Assume the map*

$$B_1^{p+q} \rightarrow \mathbb{R}^{p+q}, \quad \iota \mapsto (\varpi_\iota^o, \beta_\iota^o)$$

is a diffeomorphism onto its image. If ε is small enough and if $\|N'_\iota - N_\iota^o\|_d < \varepsilon$ for each ι , the following holds:

For every $(\varpi, \beta) \in HD^o$ there exists a unique $\iota \in B_{1/2}^{p+q}$ such that N'_ι is symplectically conjugate to some $N \in N_{\varpi, \beta}$. Moreover, there exists $\bar{\gamma} > 0, \bar{\tau} > p - 1$, such that the set

$$\{\iota \in B_{1/2}^{p+q} : (\varpi_\iota, \beta_\iota) \in HD^o\}$$

has positive Lebesgue measure.

Proof. If ε is small, the map $\iota \mapsto (\varpi_\iota, \beta_\iota)$ is C^1 -close to the map $\iota \mapsto (\varpi_\iota^o, \beta_\iota^o)$ and is thus a diffeomorphism over $B_{2/3}^{p+q}$ onto its image, which contains the positive measure set HD^o for some $\bar{\gamma} > 0, \bar{\tau} \geq p - 1$. The first assertion then follows from Theorem 2.1. Since the inverse map $(\varpi, \beta) \mapsto \iota$ is smooth, it sends sets of positive measure onto sets of positive measure. \square

Example-Condition 2.1. When $N^o = N^o(I)$ is integrable, $q = 0$, we may set $N_\iota^o(I) := N^o(\iota + I)$. The iso-chronic non-degeneracy of N_ι^o is just the non-degeneracy of the Hessian $\mathcal{H}(N^o)(I)$ of N^o with respect to I :

$$|\mathcal{H}(N^o)(I)| \neq 0.$$

When this is satisfied, Corollary 2.1 asserts the persistence of a set of Lagrangian invariant tori of $N^o = N^o(I)$ parametrized by a positive measure set in the action space. By Fubini theorem, these invariant tori form a set of positive measure in the phase space.

If the system $N^o(I)$ is properly degenerate, say

$$I = (I^{(1)}, I^{(2)}, \dots, I^{(N)}),$$

and there exist real numbers

$$0 < d_1 < d_2 < \dots < d_N$$

such that

$$N^o(I) = N_1^o(I^{(1)}) + \epsilon^{d_1} N_2^o(I^{(1)}, I^{(2)}) + \dots + \epsilon^{d_N} N_N^o(I),$$

then,

$$|\mathcal{H}(N^o)(I)| \neq 0, \forall 0 < \epsilon \ll 1 \Leftrightarrow |\mathcal{H}(N_i^o)(I^{(i)})| \neq 0, \forall i = 1, 2, \dots, N.$$

i.e. the non-degeneracy of $N^o(I)$ can be verified separately at each scale.

Let us explain this fact by a simple example: Let $N^o(I_1, I_2) = N_1^o(I_1) + \epsilon N_2^o(I_1, I_2)$, then

$$|\mathcal{H}(N^o)(I_1, I_2)| = \epsilon \cdot \frac{d^2 N_1^o(I_1)}{dI_1^2} \cdot \frac{d^2 N_2^o(I_1, I_2)}{dI_2^2} + O(\epsilon^2).$$

Therefore for small enough ϵ , to have $|\mathcal{H}(N^o)(I_1, I_2)| \neq 0$ it suffices to have

$$\frac{d^2 N_1^o(I_1)}{dI_1^2} \neq 0, \frac{d^2 N_2^o(I_1, I_2)}{dI_2^2} \neq 0.$$

The smallest frequency of $N^o(I)$ is of order ϵ^{d_N} . if $N^o(I)$ is non-degenerate, then for any $0 < \epsilon \ll 1$, there exists a set of positive measure in the action space, such that under the frequency map, its image contains a set of positive measure of homogeneous Diophantine vectors in $HD_{\epsilon^{d_N} \bar{\gamma}, \bar{\tau}}$ whose measure is uniformly bounded from below for $0 < \epsilon \ll 1$. Actually, since for any vector $\nu' \in \mathbb{R}^{p+q}$,

$$\epsilon^{d_N} \nu' \in HD_{\epsilon^{d_N} \bar{\gamma}, \bar{\tau}} \Leftrightarrow \nu' \in HD_{\bar{\gamma}, \bar{\tau}},$$

the measure of Diophantine frequencies of $N^o(I)$ in $HD_{\epsilon^{d_N} \bar{\gamma}, \bar{\tau}}$ is at least the measure of Diophantine frequencies of

$$N_1^o(I^{(1)}) + N_2^o(I^{(1)}, I^{(2)}) + \dots + N_N^o(I)$$

in $HD_{\bar{\gamma}, \bar{\tau}}$, which is independent of ϵ .

Following Theorem 2.1, we may thus set $\varepsilon = \text{Cst} (\epsilon^{d_N} \bar{\gamma})^k$ for the size of allowed perturbations, for some positive constant Cst and some $k \geq 1$, provided $\bar{\gamma}$ is small.

We now characterize invariant tori in terms of their energy and of the projective class of their frequency. We denote by $[\cdot]$ the projective class of a vector. Let $c^o := c_0^o$, and

$$D^o = \left\{ (c_\iota^o, [\varpi_\iota^o, \beta_\iota^o]) : c_\iota^o = c^o, (\varpi_\iota^o, \beta_\iota^o) \in HD_{2\bar{\gamma}, \bar{\tau}}, \iota \in B_{1/2}^{p+q} \right\};$$

note that the factor 2 in the Diophantine constant $2\bar{\gamma}$, meant to take care of the fact that along a given projective class, locally the constant $\bar{\gamma}$ may worsen a little (we will apply Theorem 2.1 with Diophantine constants $(\bar{\gamma}, \bar{\tau})$).

Corollary 2.2 (Iso-energetic KAM theorem). *Assume that the map*

$$B_1^p \rightarrow \mathbb{R} \times \mathbf{P}(\mathbb{R}^p), \quad \iota \mapsto (c_\iota^o, [\varpi_\iota^o])$$

is a diffeomorphism onto its image. If ε is small enough and if for some $d > 0$, we have $\|N'_\iota - N_\iota^o\|_d < \varepsilon$ for each ι , and the following holds:

For every $(c^o, \nu) \in D^o$, there exists a smooth function c_ι which is C^1 -close to c_ι^o , and a unique $\iota \in B_{1/2}^{p+q}$ such that $(c_\iota, [\varpi_\iota]) = (c^o, \nu)$, and N'_ι is symplectically (analytically) conjugate to some $N_\iota \in N_{\varpi_\iota, \beta_\iota}$ of the form

$$N_\iota = c^o + \langle \varpi_\iota, I \rangle + \langle A_1(\theta), I \otimes I \rangle + O(|I|^3).$$

Moreover, there exists $\bar{\gamma} > 0, \bar{\tau} > p - 1$, such that the set

$$\{\iota \in B_{1/2}^{p+q} : c_\iota = c^o, \varpi_\iota \in HD^o\}$$

has positive $(p - 1)$ -dimensional Lebesgue measure.

Proof. From the hypothesis, the image of the restriction to $\{\iota : c_\iota^o = c^o\}$ of the mapping $\iota \mapsto \varpi_\iota^o$ is a $(p - 1)$ -dimensional smooth manifold, diffeomorphic to a subset of $\mathbf{P}(\mathbb{R}^p)$ with non-empty interior, hence it contains a positive measure set of Diophantine vectors. Therefore there exists $\bar{\gamma} > 0, \bar{\tau} > p - 1$, such that the set D^o has positive $(p - 1)$ -dimensional measure.

Moreover, $D^o \subset D' = \left\{ (c^o, [\varpi_\iota]) : \varpi_\iota \in HD_{\bar{\gamma}, \bar{\tau}}, \iota \in B_{2/3}^p \right\}$. Indeed, if $(c^o, [\varpi_\iota^o]) \in D^o, \iota^o \in B_{1/2}$, then there exists some $\iota' \in B_{2/3}$ such that $(c^o, [\varpi_\iota^o]) = (c^o, [\varpi_{\iota'}])$. If ε is small enough, $\varpi_{\iota'}$ is close enough to $\varpi_{\iota^o} \in HD_{2\bar{\gamma}, \bar{\tau}}$, hence belongs to $HD_{\bar{\gamma}, \bar{\tau}}$, and $(c^o, [\varpi_{\iota'}]) \in D'$.

In view of Theorem 2.1, we may set $c_\iota = c(N'_\iota)$ when $\varpi(N'_\iota) \in HD_{\bar{\gamma}, \bar{\tau}}$, which is C^1 -close to c_ι^o on $HD_{\bar{\gamma}, \bar{\tau}}$, and extend it to a smooth function C^1 -close to c_ι^o on $\iota \in B_{2/3}^p$.

If ε is small, the mapping $\iota \mapsto (c_\iota, [\varpi_\iota])$ is C^1 -close to $\iota \mapsto (c_\iota^o, [\varpi_\iota^o])$, hence it is a diffeomorphism, and the image of its restriction to $B_{2/3}^p$ contains the set D' .

The first assertion then follows from Theorem 2.1. Since the map $\iota \mapsto (c_\iota, [\varpi_\iota])$ is smooth, the pre-image of a set of positive $(p - 1)$ -Lebesgue measure has positive $(p - 1)$ -dimensional Lebesgue measure. \square

Example-Condition 2.2. When $N^o = N^o(I)$ is integrable, $q = 0$, we may set $N'_\iota(I) := N^o(\iota + I)$. The iso-energetic non-degeneracy of N'_ι is just the non-degeneracy of the bordered Hessian

$$\mathcal{H}^B(N^o)(I) = \begin{bmatrix} 0 & N^o{}'_{I_1} & \cdots & N^o{}'_{I_p} \\ N^o{}'_{I_1} & N^o{}''_{I_1, I_1} & \cdots & N^o{}''_{I_1, I_p} \\ \vdots & \vdots & \ddots & \vdots \\ N^o{}'_{I_p} & N^o{}''_{I_p, I_1} & \cdots & N^o{}''_{I_p, I_p} \end{bmatrix}$$

(in which $N'_{I_i} = \frac{\partial N^o}{\partial I_i}$, $N''_{I_i, I_j} = \frac{\partial^2 N^o}{\partial I_i \partial I_j}$) satisfying

$$|\mathcal{H}^B(N^o)(I)| \neq 0.$$

When this is satisfied, Corollary 2.2 asserts the persistence under sufficiently small perturbations of a set of Lagrangian invariant tori of $N^o = N^o(I)$ parametrized by a positive $(p-1)$ -Lebesgue measure set in the action space. By Fubini theorem, these invariant tori form a set of positive measure in the energy surface with energy c_0 .

If the system $N^o(I)$ is properly degenerate, say $I = (I^{(1)}, I^{(2)}, \dots, I^{(N)})$, $0 < d_1 < d_2, \dots, < d_N$ and

$$N^o(I) = N_1^o(I^{(1)}) + \epsilon^{d_1} N_2^o(I^{(1)}, I^{(2)}) + \dots + \epsilon^{d_N} N_N^o(I),$$

then,

$$|\mathcal{H}^B(N^o)(I)| \neq 0, \forall 0 < \epsilon < 1 \Leftrightarrow |\mathcal{H}^B(N_1^o)(I^{(1)})| \neq 0, |\mathcal{H}^B(N_i^o)(I^{(i)})| \neq 0, \forall i = 2, \dots, N.$$

2.3.3 Equivariant KAM theorems

In this subsection, we state some equivariant KAM theorems for Hamiltonian systems with Hamiltonian symmetries, which allow us to directly show the existence of Lagrangian invariant tori in such systems without passing to the quotient. These results are not new, but they make the applications of KAM theorems for symmetric systems more flexible. As an application, we shall apply the equivariant iso-energetic theorem in Section 3.2.

Hamiltonian torus symmetry

We suppose that both N^o and N' are invariant under the Hamiltonian action of a torus \mathbb{T}^m and let $\Gamma \in \mathbb{R}^m$ be the associated moment map. In this case, we may symplectically reduce the systems N^o and N' from the \mathbb{T}^m -symmetry. Denote by \bar{N}^o and \bar{N}' the reduced systems at a common moment level $\Gamma = \Gamma_0$ respectively. In order to apply KAM theorems to \bar{N}^o and \bar{N}' , we have to show that the frequency map

$$B_1^{p+q-m} \rightarrow \mathbb{R}^{p+q-m}, \bar{l} \mapsto (\varpi_{\bar{l}}^r, \beta_{\bar{l}}^r)$$

of \bar{N}^o is a diffeomorphism onto its image. As long as we know the existence of an invariant torus of \bar{N}' , we may recover an invariant torus of N from the action of the symmetric group \mathbb{T}^m .

Nevertheless, in some applications, the reduction procedure might be difficult to carry out explicitly in a simple way, hence the non-degeneracy of the frequency map

$$B_1^{p+q-m} \rightarrow \mathbb{R}^{p+q-m}, \bar{l} \mapsto (\varpi_{\bar{l}}^r, \beta_{\bar{l}}^r)$$

might be difficult to verify.

Let us present another approach without descending to the quotient. Following M. Herman (who attributed this method to Poincaré), we modify the Hamiltonians “in the directions of symmetry”: for $\iota' \in \mathbb{R}^m$, set

$$\hat{N}^o = N^o + \iota' \cdot \Gamma, \hat{N}' = N' + \iota' \cdot \Gamma.$$

From the hypothesis, the flows of \hat{N}' and N' commute.

Denote by ι_Γ the frequency of the angle conjugate to Γ . In proper coordinates, the frequency of \hat{N}^o is written as $(\iota_\Gamma + \iota', \varpi_\ell^r, \beta_\ell^r)$. By allowing ι' to take value in $(-1, 1)^m \subset \mathbb{R}^m$, we see that the mapping

$$B_1^{p+q-m} \rightarrow \mathbb{R}^{p+q-m}, \bar{\iota} \mapsto (\varpi_\ell^r, \beta_\ell^r)$$

is a diffeomorphism onto its image if and only if the mapping

$$B_1^{p+q-m} \times (-1, 1)^m \rightarrow \mathbb{R}^{p+q}, (\bar{\iota}, \iota') \mapsto (\iota_\Gamma + \iota', \varpi^r, \beta^r)$$

is a diffeomorphism onto its image.

Therefore, the non-degeneracy of \bar{N}^o with parameter $\bar{\iota}$ is equivalent to the non-degeneracy of \hat{N}^o with parameter $(\iota', \bar{\iota})$. When the non-degeneracy of \hat{N}^o is verified, we may apply Corollary 2.1 or Corollary 2.2 to find invariant KAM tori of \hat{N}' . If these tori are Lagrangian, then the following proposition assures that they are also invariant Lagrangian tori of N' . Note that since we have modified the frequency, we do not know if the flows of N' on these Lagrangian tori are ergodic or not.

Proposition 2.3.1. (*Herman*) *For fixed ι' , any invariant Lagrangian torus of \hat{N}' on which all the orbits are dense is also an Lagrangian invariant torus of N' .*

Proof. By Lagrangian intersection theory, an invariant Lagrangian torus of \hat{N}' must intersect its image under small Hamiltonian isotopy determined by the flow of N' . To see this, one uses Weinstein's Lagrangian neighborhood theorem (Theorem 3.33, [MS98]) to identify a small neighborhood of the torus with a small neighborhood of zero section in the cotangent bundle of the torus, and then apply the Lagrangian intersection theorem for cotangent bundle (Theorem 11.18, [MS98]). The commutativity of the two Hamiltonians implies that the \hat{N}' -orbit of an intersection point lies entirely in the intersection. Since all the orbits of \hat{N}' are dense on the invariant torus, so is the intersection. As a result, the torus necessarily agrees with its image under the time- t_0 map of N' . Therefore, this invariant Lagrangian torus is also invariant under the flow of N' . \square

Let us summarize the above discussions in the following corollaries:

Corollary 2.3 (Equivariant iso-chronic KAM theorem in the torus case). *Set $\iota = (\iota', \iota'')$. Assume the map*

$$B_1^{p+q} \rightarrow \mathbb{R}^{p+q}, \iota \mapsto (\varpi_\ell^o, \beta_\ell^o)$$

is a diffeomorphism onto its image. If ε is small enough and if $\|N'_\ell - N_\ell^o\|_d < \varepsilon$ for each ℓ , the following holds:

For every $(\varpi, \beta) \in HD^o$ there exists a unique $\iota \in B_1^{p+q}$ such that $\hat{N}'_\ell = N'_\ell + \iota' \cdot \Gamma$ is symplectically conjugate to some $N \in N_{\varpi, \beta}$.

In particular, there exists $\bar{\gamma} > 0, \bar{\tau} > p - 1$, such that the set

$$\{\iota \in B_{1/2}^{p+q}, (\varpi_\ell, \beta_\ell) \in HD^o\}$$

has positive Lebesgue measure.

Moreover, every invariant Lagrangian ergodic torus of \hat{N}' thus established is an invariant Lagrangian torus of N' .

Corollary 2.4 (Equivariant iso-energetic KAM theorem in the torus case). *Set $\iota = (\iota', \iota'')$. Assume that the map*

$$\phi : B_1^{p+q} \rightarrow \mathbb{R} \times \mathbf{P}(\mathbb{R}^{p+q}), \iota \mapsto (c_\ell + \iota' \cdot \Gamma, [\varpi_\ell^o, \beta_\ell^o])$$

is a diffeomorphism onto its image. If ε is small enough and if $\|N'_l - N_l^o\|_d < \varepsilon$ for each ι , the following holds:

For every $(c^o, \nu) \in D^o$, there exists a unique $\iota \in B_1^{p+q}$ such that $\hat{N}'_l = N'_l + \iota' \cdot \Gamma$ is symplectically conjugate to some $N_\iota \in N_{\varpi_\iota, \beta_\iota}$ with energy c^o , thus of the form

$$N_\iota = c^o + \langle \varpi_\iota, I \rangle + \sum_{j=1}^{q'} \beta_{\iota, j} (x_j^2 + y_j^2) + \sum_{j=q'+1}^q \beta_{\iota, j} (x_j^2 - y_j^2) + \langle A_{\iota, 1}(\theta), I \otimes I \rangle + \langle A_{\iota, 2}(\theta), I \otimes Z \rangle + O_3(I, Z).$$

Moreover, there exists $\bar{\gamma} > 0, \bar{\tau} > p - 1$, such that the set

$$\{\iota \in B_{1/2}^{p+q} : \hat{N}'_l = c^o, (\varpi_\iota, \beta_\iota) \in HD^o\}$$

has positive Lebesgue measure. Every invariant Lagrangian ergodic torus of \hat{N}'_l with energy $c + \iota' \cdot \Gamma$ thus established is an invariant Lagrangian torus of N' with energy c .

Hamiltonian symmetry of a connected compact group action

We have only presented equivariant KAM theorem for systems with (free) Hamiltonian torus symmetry, which seems to be a strict restriction. Nevertheless, we have seen in Subsection 1.1.5 that for the symmetry induced by the Hamiltonian action of a connected compact group, if we are only interested in the dynamics in the submanifold of the phase space where the image of the associated moment map intersects each Weyl chamber (and does not intersect the boundaries of the Weyl chamber), we may always restrict the system to a proper invariant symplectic submanifold of the phase space of the system, where the restriction of the symmetry is a Hamiltonian torus symmetry. The equivariant KAM theorems established above are therefore applicable to the restricted system. The exact statements are just a combination of Theorem 1.1 with Corollary 2.3 or Corollary 2.4 respectively. They shall not be used in the sequel and hence we omit their statements.

2.3.4 Periodic Solutions accumulating KAM tori

A theorem of J. Pöschel (the last statement of Theorem 2.1 in [Pös80]) permits us to show that there are families of periodic solutions accumulating the KAM Lagrangian tori. In our settings, this theorem can be stated in the following way:

Theorem 2.2. (Pöschel) *Under the hypothesis of Corollary 2.1, the Lagrangian KAM tori of the system N'_l lie in the closure of the set of its periodic orbits.*

2.3.5 Far from Collision Quasi-periodic Orbits of the Spatial Three-Body problem

Now let us consider the Hamiltonian $F_{Kep} + \overline{F_{sec}^{n, n'}} + F_{secpert}^{n'+1} + F_{comp}^n$, seen as a system reduced by the $SO(3)$ -symmetry by Jacobi's elimination of node. We now consider $\overline{F_{sec}^{n, n'}}$ as defined on a subset of the (reduced) phase space instead of the (reduced) secular space, which has 4 degrees of freedom. By assuming the Laplace plane to be horizontal, we have $\bar{g}_1 = g_1$.

To apply Corollary 2.1, we start by verifying the non-degeneracy conditions in the system $F_{Kep} + \overline{F_{sec}^{n, n'}}$. As noted in Condition-Example 2.1, due to the proper degeneracy of the system, we just have to verify the non-degeneracy conditions in different scales.

Let us first consider the Kepler part:

$$F_{Kep}(L_1, L_2) = -\frac{\mu_1^3 M_1^2}{2L_1^2} - \frac{\mu_2^3 M_2^2}{2L_2^2}.$$

Considered only as a function of L_1 and L_2 , it is iso-chronically non-degenerate with respect to (L_1, L_2) .

To obtain the secular non-degeneracies of the system $\overline{F_{sec}^{n,n'}}$, let us first consider the quadrupolar system F_{quad} . From Figure 2.2, we see that for $C \neq G_2$, in the (G_1, g_1) -space, three types of regions are foliated by four kinds of closed curves of $F_{quad}(G_1, g_1; C, G_2, L_1, L_2)$. They are regions around the elliptical singularities B inside the separatrix of A or A' , and the regions from $G_1 = G_{1,max}$ and $G_1 = G_{1,min}$ up to the nearest separatrix. These regions in turn correspond to three types of regions in the (G_1, g_1, G_2, g_2) -space, foliated by invariant two-tori of the system $F_{quad}(G_1, g_1, G_2; C, L_1, L_2)$. We build action-angle coordinates⁷, and let $\bar{\mathcal{I}}_1$ be an action variable in any one of these corresponding regions in the (G_1, g_1) -space. In Appendix D, we show that the quadrupolar frequency map is non-degenerate in a dense open set for almost all $\frac{C}{L_1}$ and $\frac{G_2}{L_1}$.

Finally, for any fixed $C \neq 0$, the frequency map

$$(L_1, L_2, \bar{\mathcal{I}}_1, G_2) \mapsto \left(\frac{\mu_1^3 M_1^2}{L_1^3}, \frac{\mu_2^3 M_2^2}{L_2^3}, \alpha^3 \nu_{quad,1}, \alpha^3 \nu_{quad,2} \right)$$

of $F_{Kep} + \alpha^3 F_{quad}$ is a local diffeomorphism in a dense open set Ω of the phase space Π symplectically reduced from the $SO(3)$ -symmetry, in which $\nu_{quad,i}, i = 1, 2$ are the two frequencies of the quadrupolar system $F_{quad}(G_1, g_1, G_2; C, L_1, L_2)$ in the (G_i, g_i) -plans respectively, which are independent of α .

For any (n, n') , the Lagrangian tori of the system $\overline{F_{sec}^{n,n'}}$ are $O(\alpha)$ -deformations of Lagrangian tori of $\alpha^3 F_{quad}$. The frequency map of $F_{Kep} + \overline{F_{sec}^{n,n'}}$ are of the form

$$(L_1, L_2, \bar{\mathcal{J}}_1, G_2) \mapsto \left(\frac{\mu_1^3 M_1^2}{L_1^3}, \frac{\mu_2^3 M_2^2}{L_2^3}, \alpha^3 \nu_{quad,1} + O(\alpha^4), \alpha^3 \nu_{quad,2} + O(\alpha^4) \right),$$

which is thus non-degenerate in an open subset Ω' of Π symplectically reduced from the $SO(3)$ -symmetry for any choice of n, n' , with the relative measure of Ω' in Ω tends to 1 when $\alpha \rightarrow 0$, in which $\bar{\mathcal{J}}_1$ is defined analogously in the system $\overline{F_{sec}^{n,n'}}$ as $\bar{\mathcal{I}}_1$ in F_{quad} . At the expense of restricting Ω' a little bit, we may further suppose that the transformation $\phi^n \psi^{n'}$ is well-defined. We fix α such that the set Ω' has sufficiently large measure in Ω .

In Ω' , there exist $\bar{\gamma} > 0, \bar{\tau} \geq 3$, such that the set of $(\alpha^3 \bar{\gamma}, \bar{\tau})$ -Diophantine invariant Lagrangian tori of $F_{Kep} + \overline{F_{sec}^{n,n'}}$ form a positive measure set whose measure is uniformly bounded for small α (Example-Condition 2.1). By definition of Ω' , near such a torus with action variables $(L_1^0, L_2^0, \bar{\mathcal{J}}_1^0, G_2^0)$, there exists a λ -neighborhood for some $\lambda > 0$, such that the torsions of the Lagrangian tori of $F_{Kep} + \overline{F_{sec}^{n,n'}}$ do not vanish in this neighborhood. Let

$$(L_1, L_2, \bar{\mathcal{J}}_1, G_2) = \underline{\phi}^\lambda(L_1^\lambda, L_2^\lambda, \bar{\mathcal{J}}_1^\lambda, G_2^\lambda) := (L_1^0 + \lambda L_1^\lambda, L_2^0 + \lambda L_2^\lambda, \bar{\mathcal{J}}_1^0 + \lambda \bar{\mathcal{J}}_1^\lambda, G_2^0 + \lambda G_2^\lambda).$$

Thus for any $(L_1^\lambda, L_2^\lambda, \bar{\mathcal{J}}_1^\lambda, G_2^\lambda) \in B_1^4$, and for any choice of n, n' , the frequency map of the Lagrangian torus of $F_{Kep} + \overline{F_{sec}^{n,n'}}$ corresponding to $(L_1^0 + \lambda L_1^\lambda, L_2^0 + \lambda L_2^\lambda, \bar{\mathcal{I}}_1^0 + \lambda \bar{\mathcal{I}}_1^\lambda, G_2^0 + \lambda G_2^\lambda)$ is non-degenerate. The existence of λ follows from the definition of Ω' .

⁷See [Arn89] for the method of building action-angle coordinates we use here.

We may now apply Corollary 2.1 for Lagrangian tori (*i.e.* $p = 4, q = 0$) near the torus of $F_{Kep} + \overline{F_{sec}^{n,n'}}$ with action variables $(L_1^0, L_2^0, \overline{\mathcal{J}}_1^0, G_2^0)$. We take $N' = \underline{\phi}^{\lambda^*} \psi^{n'^*} \phi^{n^*} F$ (See Section 2.1 for definition of ψ^n and $\phi^{n'}$), $N^o = \underline{\phi}^{\lambda^*} (F_{Kep}(L_1, L_2) + \overline{F_{sec}^{n,n'}}(L_1^\lambda, L_2^\lambda, \overline{\mathcal{J}}_1^\lambda, G_2^\lambda; C))$, with parameter $(L_1, L_2, \overline{\mathcal{J}}_1, G_2) \in B_1^4$ and perturbation $\underline{\phi}^{\lambda^*} (F_{secpert}^{n'+1} + F_{comp}^n)$, whose rate of smallness with respect to α can be made arbitrarily large by choosing large enough integers n and n' . Hence Corollary 2.1 is applicable when n and n' are large enough. This confirms the existence of invariant Lagrangian tori of $\underline{\phi}^{\lambda^*} \psi^{n'^*} \phi^{n^*} F$ (and thus of F) close to the Lagrangian torus of $F_{Kep} + \overline{F_{sec}^{n,n'}}$ with action variables $(L_1^0, L_2^0, \overline{\mathcal{J}}_1^0, G_2^0)$. We apply Corollary 2.1 near other $(\alpha^3 \bar{\gamma}, \bar{\tau})$ -Diophantine invariant Lagrangian tori of $F_{Kep} + \overline{F_{sec}^{n,n'}}$ in Ω' analogously.

We thus get a set of positive measure of Lagrangian tori in the perturbed system $N' = \underline{\phi}^{\lambda^*} \psi^{n'^*} \phi^{n^*} F$ (and thus of F) for any fixed $C > 0$. It remains to show that most of these Lagrangian tori stay away from the collision set. The transformations we have used to build the secular and secular-integrable systems are of order $O(\alpha)$, which shall bring an $O(\alpha)$ -deformation to the collision set. Therefore, for C and G_2 of order 1, most of these invariant Lagrangian tori stay away from the collision set, provided α is small enough.

Theorem 2.3. *For each fixed C , there exists a positive measure of 4-dimensional Lagrangian tori in the spatial three-body problem reduced by the $SO(3)$ -symmetry, which are small perturbations of the corresponding Lagrangian tori of the system $F_{Kep} + \alpha^3 F_{quad}$ reduced by the $SO(3)$ -symmetry. They give rise to a positive measure of 5-dimensional invariant tori in the lunar spatial three-body problem.*

We establish the following types of quasi-periodic motions in the spatial three-body problem (the required non-degeneracy conditions are presented in Appendix D):

- Motions along which g_1 librate around $\frac{\pi}{2}$, corresponds to the phase portraits around the elliptical singularity B ;
- Motions along which G_1 remains large (eventually near $\{G_1 = G_{1,max}\}$) while g_1 decreases;
- Motions along which G_1 remains large (eventually near $\{G_1 = G_{1,max}\}$) while g_1 increases;
- Motions along which G_1 remains small but bounded from zero, while g_1 increases.

From Theorem 2.2, we get

Theorem 2.4. *There exist periodic orbits accumulating each of the KAM tori in the spatial three-body problem reduced by the $SO(3)$ -symmetry.*

Let us now consider isotropic tori. We set $p = 3, q = 1$. The frequency of an elliptical isotropic torus with parameters (L_1, L_2, G_2, C) corresponds to the only elliptic quadrupolar singularity B in Figure 2.2 is of the form

$$\left(\frac{\mu_1^3 M_1^2}{L_1^3}, \frac{\mu_2^3 M_2^2}{L_2^3}, \alpha^3 \nu_{quad,2} + O(\alpha^4), \alpha^3 \nu_{quadn,G_2} + O(\alpha^4) \right),$$

in which ν_{quadn,G_2} denotes the normal quadrupolar frequency of the elliptical isotropic torus. We show in Appendix D that the quadrupolar frequency map

$$(G_2, C) \rightarrow (\nu_{quad,2}, \nu_{quadn,G_2})$$

is non-degenerate for almost all $\frac{C}{L_1}, \frac{G_2}{L_1}$. Set $C = C^0 + \lambda C^\lambda$. We may now apply Corollary 2.1 in the same way as for Lagrangian tori, with parameters $L_1^\lambda, L_2^\lambda, G_2^\lambda, C^\lambda$ to obtain a positive 4-dimensional Lebesgue measure set of 3-dimensional isotropic elliptic tori in the direct product of the phase space of the reduced system of the spatial three-body problem (by the $SO(3)$ -symmetry) with the space of parameters C . Let's call this 4-dimensional Lebesgue measure a "relative measure".

Theorem 2.5. *There exists a positive relative measure of 3-dimensional isotropic elliptic tori in the spatial three-body problem reduced by the $SO(3)$ -symmetry, which are small perturbations of the isotropic tori corresponding to the elliptic secular singularity of $F_{Kep} + \alpha^3 F_{quad}$ reduced by the $SO(3)$ -symmetry. They give rise to 4-dimensional isotropic tori of the spatial three-body problem.*

Chapter 3

Regularization and Almost-collision orbits

3.1 Kustaanheimo-Stiefel Regularization

In order to study the neighborhood of inner double collisions of the three-body problem, we shall first regularize the system so as to get a smooth complete flow in this neighborhood. The regularization we use is the Kustaanheimo-Stiefel regularization, which leads to compact formulæ. It also has a direct link with the Levi-Civita regularization of double collisions of the planar problem. This section is dedicated to presenting Kustaanheimo-Stiefel regularization and some further results that we are going to use in the next section.

3.1.1 Preliminary on Quaternions

A quaternion $z = z_0 + z_1i + z_2j + z_3k \in \mathbb{H}$ can be naturally identified with a point $(z_0, z_1, z_2, z_3) \in \mathbb{R}^4$. We denote by $Re\{z\}$ the real part z_0 of z , and by $Im\{z\}$ the imaginary part $z_1i + z_2j + z_3k$ of z . A quaternion of the form $z_1i + z_2j + z_3k$ (*i.e.* with vanishing real part) is called a purely imaginary quaternion, and can be identified with the vector (z_1, z_2, z_3) in \mathbb{R}^3 . Due to the identification, we can further take inner (“ \cdot ”) or vector product (“ \times ”) of two purely imaginary quaternions, which results in a real number or a purely imaginary quaternion respectively. The conjugation \bar{z} of z is defined by $\bar{z} = z_0 - z_1i - z_2j - z_3k$. The product of two quaternions is defined by

$$z \cdot w = Re\{z\}Re\{w\} - Im\{z\} \cdot Im\{w\} + Re\{z\}Im\{w\} + Re\{w\}Im\{z\} + Im\{z\} \times Im\{w\}.$$

A quaternion-valued mapping $f_{\mathbb{H}} : \mathbb{H} \rightarrow \mathbb{H}$ is called *differentiable* if it is differentiable when considered as a mapping from \mathbb{R}^4 to \mathbb{R}^4 . Its derivative $df_{\mathbb{H}} = \frac{\partial f_{\mathbb{H}}}{\partial z_0} dz_0 + \frac{\partial f_{\mathbb{H}}}{\partial z_1} dz_1 + \frac{\partial f_{\mathbb{H}}}{\partial z_2} dz_2 + \frac{\partial f_{\mathbb{H}}}{\partial z_3} dz_3$ is a 1-form with values in \mathbb{R}^4 which we shall consider as quaternion-valued 1-form on \mathbb{H} .

Following A. Sudbery [Sud79], the wedge product $\phi_{\mathbb{H}} \wedge \psi_{\mathbb{H}}$ of two quaternion-valued 1-forms $\phi_{\mathbb{H}}, \psi_{\mathbb{H}}$ is defined by:

$$\forall v_{\mathbb{H}}, w_{\mathbb{H}} \in \mathbb{H}, \phi_{\mathbb{H}} \wedge \psi_{\mathbb{H}}(v_{\mathbb{H}}, w_{\mathbb{H}}) = \phi_{\mathbb{H}}(v_{\mathbb{H}})\psi_{\mathbb{H}}(w_{\mathbb{H}}) - \phi_{\mathbb{H}}(w_{\mathbb{H}})\psi_{\mathbb{H}}(v_{\mathbb{H}}),$$

which is a quaternion-valued differential 2-form. The detailed discussions can be found in [Sud79]. Here, we shall only deal with quaternion-valued 1-forms and their wedge products.

Note that due to the non-commutativity of the quaternion algebra, the exterior product of two quaternion-valued 1-forms is not anti-symmetric in general. In particular, the exterior product of a quaternion-valued 1-form with itself need not be zero. By direct calculation, one finds

$$dz \wedge dz = 2(dz_2 \wedge dz_3)i + 2(dz_3 \wedge dz_1)j + 2(dz_1 \wedge dz_2)k.^1$$

Nevertheless, one directly verifies that the real part of the product of two quaternions is symmetric: it is independent of the order of the two quaternions involved. We define the inner product of two quaternions x, y to be

$$\langle x, y \rangle = \operatorname{Re}\{\bar{x}y\} = \operatorname{Re}\{\bar{y}x\}.$$

The inner product of two quaternionic 1-forms is defined similarly. The modulus $\sqrt{\langle x, x \rangle}$ of a quaternion x is denoted by $|x|$.

In such notations, the canonical symplectic form on $T^*\mathbb{H}$ can be written as

$$\operatorname{Re}\{d\bar{y} \wedge dx\} = -\operatorname{Re}\{d\bar{x} \wedge dy\},$$

in which $x \in \mathbb{H}$, $y \in T_x^*\mathbb{H} \cong \mathbb{H}$ are the natural coordinates on the cotangent bundle $T^*\mathbb{H}$.

Rotations in $\mathbb{R}^3 \cong \mathbb{IH} := \{z \in \mathbb{H} : \operatorname{Re}\{z\} = 0\}$ can be represented by unit quaternions in the following way: If ρ_1 is a purely imaginary quaternion and $\rho = \cos \frac{\theta_\rho}{2} + \operatorname{Im}\{\rho\}$ a unit quaternion, then $\bar{\rho}\rho_1\rho$ is the purely imaginary quaternion rotated from ρ_1 with rotation angle θ_ρ and rotation axis $\operatorname{Im}\{\rho\}$. Unit quaternions form a group $\operatorname{Spin}(3) \cong \operatorname{SU}(2)$, which is diffeomorphic to S^3 . Two unit quaternions ρ and $-\rho$ define the same rotation. This gives a two-to-one covering map between $\operatorname{Spin}(3)$ and $\operatorname{SO}(3)$.

3.1.2 Kustaanheimo-Stiefel Transformation

We identify \mathbb{R}^3 with $\mathbb{IH} := \{z \in \mathbb{H} : \operatorname{Re}(z) = 0\} \subset \mathbb{H}$, the space of purely imaginary quaternions, by

$$(z_1, z_2, z_3) \mapsto z_1i + z_2j + z_3k \in \mathbb{IH}.$$

Definition 3.1.1. We define the *Hopf map* by

$$\begin{aligned} \operatorname{Hopf} : \mathbb{H} \setminus \{0\} &\rightarrow \mathbb{IH} \setminus \{0\} \\ z &\mapsto Q = \bar{z}iz. \end{aligned}$$

The Hopf map is a fibration whose fibres are the circles $S_z = \{e^{i\vartheta}z, \vartheta \in \mathbb{R}/2\pi\mathbb{Z}\}$.

Let $z = z_0 + z_1i + z_2j + z_3k$, $w = w_0 + w_1i + w_2j + w_3k$ be two quaternions. Let

$$BL(z, w) := \operatorname{Re}\{\bar{z}iw\} = z_1w_0 - z_0w_1 + z_3w_2 - z_2w_3.$$

By identifying $T^*\mathbb{H}$ with $\mathbb{H} \times \mathbb{H}$ (the fibres in $T^*\mathbb{H}$ are identified with the second factor), we may consider $BL(z, w)$ as a function on $T^*\mathbb{H}$. Define the 7-dimensional quadratic cone Σ by the equation

$$BL(z, w) = 0.$$

This equation is the *bilinear relation* in [SS71]².

¹Note that our formula differs from Formula (2.35), [Sud79] by a factor of 2.

²If we identify \mathbb{H} with \mathbb{R}^4 and equip it with the standard symplectic form, any two linearly independent quaternions satisfy the bilinear relation if and only if they generate a Lagrangian plane.

Let $\Sigma^0 := \Sigma \setminus \{(0, 0)\}$, which is a 7-dimensional coisotropic submanifold in the 8-dimensional symplectic space $(T^*\mathbb{H}, \text{Re}\{d\bar{w} \wedge dz\})$. Since the condition $BL(z, w) = 0$ defines a quadratic cone in $T^*\mathbb{H}$ with index 4, Σ^0 is diffeomorphic to $S^3 \times S^3 \times \mathbb{R}$.

By standard symplectic reduction, the symplectic form $\text{Re}\{d\bar{w} \wedge dz\}$ determines a symplectic form ω_1 on the quotient V^0 of Σ^0 by its characteristic foliation. Since the circle action on S_z is free, the quotient V^0 is a smooth manifold.

We define $\Sigma^1 = \Sigma \setminus \{z = 0\}$ (diffeomorphic to $S^3 \times \mathbb{R}^3 \times \mathbb{R}$). This is a dense open subset of Σ^0 . By the same symplectic reduction procedure, we get another reduced symplectic manifold (V^1, ω_1) .

Definition 3.1.2. The *Kustaanheimo-Stiefel mapping* is defined as the following:

$$\begin{aligned} K.S. : T^*(\mathbb{H} \setminus \{0\}) &\rightarrow \mathbb{H} \times \mathbb{H} \\ (z, w) &\mapsto (Q = \bar{z}iz, P = \frac{\bar{z}iw}{2|z|^2}). \end{aligned}$$

The fibres of this mapping are the circles $S_{z,w} = \{(e^{i\vartheta}z, e^{i\vartheta}w), \vartheta \in \mathbb{R}/(2\pi\mathbb{Z})\}$. We call the angle ϑ the Kustaanheimo-Stiefel angle. The mapping $K.S.$ sends Σ^1 to $T^*(\mathbb{H} \setminus \{0\})$, and its fibres in Σ^1 coincide with the leaves of the characteristic foliation of Σ^1 (See also the proof of Proposition 3.1.1). Computing the derivative, we see that the mapping $K.S.$ induces a diffeomorphism from the quotient space V^1 to $T^*(\mathbb{H} \setminus \{0\})$.

Proposition 3.1.1. For any $F \in C^2(T^*\mathbb{H}, \mathbb{R})$, the space Σ^0 is invariant under the flow of $X_{K.S.*F}$.

Proof. The $\text{SO}(2)$ -action $\vartheta \cdot (z, w) \mapsto (e^{i\vartheta}z, e^{i\vartheta}w)$ of the Kustaanheimo-Stiefel angle on $T^*\mathbb{H} \setminus \{(0, 0)\}$ is generated by the vector field (iz, iw) , which is exactly the Hamiltonian vector field of $-BL$. In other words, this $\text{SO}(2)$ -action is Hamiltonian with moment map $-BL$. The function $K.S.*F$ is invariant under this $\text{SO}(2)$ -action, therefore the associated moment map $-BL$ (and thus BL) is a first integral of the system $K.S.*F$. Therefore the space Σ^0 is invariant under the flow of $X_{K.S.*F}$. \square

Proposition 3.1.2. $K.S.*\text{Re}\{d\bar{P} \wedge dQ\}|_{\Sigma^1} = \text{Re}\{d\bar{w} \wedge dz\}|_{\Sigma^1}$.

Proof. The relation $BL(z, w) = 0$ implies

$$\bar{z}iw = \bar{w}iz,$$

and equivalently

$$z^{-1}iw = \bar{w}i\bar{z}^{-1}.$$

By differentiating the last equality, we obtain

$$d(z^{-1})iw + \frac{\bar{z}idw}{|z|^2} = \frac{d\bar{w}iz}{|z|^2} + \bar{w}id(\bar{z}^{-1}).$$

From the relation

$$0 = d(z^{-1}z) = d(z^{-1})z + z^{-1}dz$$

we have

$$d(z^{-1}) = -z^{-1}(dz)z^{-1}.$$

Also, one checks directly that

$$\text{Im}(d\bar{z}i \wedge dz) = 0.$$

Our aim is to calculate the expression

$$\begin{aligned} K.S.*Re\{d\bar{P} \wedge dQ\} &= Re\{d(z^{-1}iw) \wedge d(\bar{z}iz)\} \\ &= -Re\left\{\left(\frac{1}{2}d(z^{-1})iw + \frac{\bar{z}idw}{2|z|^2}\right) \wedge (d\bar{z}iz + \bar{z}idz)\right\}. \end{aligned}$$

By the help of the relations deduced before, we have

$$\begin{aligned} Re\left\{\left(\frac{1}{2}d(z^{-1})iw + \frac{\bar{z}idw}{2|z|^2}\right) \wedge (d\bar{z}iz)\right\} &= -Re\left\{(d\bar{z}iz) \wedge \left(\frac{1}{2}d(z^{-1})iw + \frac{\bar{z}idw}{2|z|^2}\right)\right\} \\ &= Re\left\{\frac{1}{2}d\bar{z}iz \wedge z^{-1}dzz^{-1}iw - d\bar{z}iz \wedge \frac{\bar{z}idw}{2|z|^2}\right\} \\ &= -Re\left\{\frac{1}{2}d\bar{z}i \wedge dzz^{-1}iw\right\} - Re\left\{d\bar{z}iz \wedge \frac{\bar{z}idw}{2|z|^2}\right\} \\ &= \frac{1}{2}Re\{d\bar{z} \wedge dw\}. \end{aligned}$$

$$\begin{aligned} Re\left\{\left(\frac{1}{2}d(z^{-1})iw + \frac{\bar{z}idw}{2|z|^2}\right) \wedge (\bar{z}idz)\right\} &= Re\left\{\left(\frac{1}{2}\bar{w}id(\bar{z}^{-1}) + \frac{d\bar{w}iz}{2|z|^2}\right) \wedge (\bar{z}idz)\right\} \\ &= -Re\left\{\left(\frac{1}{2}\bar{w}i\bar{z}^{-1}d(\bar{z})\bar{z}^{-1} \wedge \bar{z}idz - \frac{d\bar{w}iz}{2|z|^2} \wedge \bar{z}idz\right)\right\} \\ &= -\frac{1}{2}Re\{d\bar{w} \wedge dz\} \\ &= \frac{1}{2}Re\{d\bar{z} \wedge dw\}. \end{aligned}$$

Therefore

$$\begin{aligned} K.S.*Re\{d\bar{P} \wedge dQ\} &= Re\left\{(d\bar{z}iz + \bar{z}idz) \wedge \left(\frac{1}{2}d(z^{-1})iw + \frac{\bar{z}idw}{2|z|^2}\right)\right\} \\ &= -\frac{1}{2}Re\{d\bar{z} \wedge dw\} - \frac{1}{2}Re\{d\bar{z} \wedge dw\} \\ &= Re\{d\bar{w} \wedge dz\}. \end{aligned}$$

□

The smooth 2-form $Re\{d\bar{w} \wedge dz\}$ on Σ^1 can be extended to a smooth 2-form on Σ^0 , which in turn induces a symplectic form on V^0 , whose restriction on V^1 is just ω_1 .

Proposition 3.1.3. *K.S. induces a symplectomorphism from (V^1, ω_1) to $(T^*(\mathbb{I}\mathbb{H} \setminus \{0\}), Re\{d\bar{P} \wedge dQ\})$.*

Proof. We have seen that $K.S.$ induces a diffeomorphism from (V^1, ω_1) to $(T^*\mathbb{I}\mathbb{H}, Re\{d\bar{P} \wedge dQ\})$. Moreover, we see from Proposition 3.1.2 that $K.S.$ induces a symplectomorphism. □

3.1.3 Regularization of the Spatial Kepler Problem

The Hamiltonian of the spatial Kepler problem with mass parameters (μ_0, M_0) is of the form

$$T(P, Q) = \frac{1}{2\mu_0} \|P\|^2 + \frac{\mu_0 M_0}{\|Q\|},$$

where $(P, Q) \in T^*(\mathbb{R}^3 \setminus \{0\}) \cong T^*(\mathbb{H} \setminus \{0\})$. All negative energy levels of $T(P, Q)$ are orbitally conjugate to each other. For any $f > 0$, we change the time from t to τ with $\|Q\| d\tau = dt$ on the negative energy surface $T + f = 0$. In the new time variable τ , the flow on $\{T + f = 0\}$ is given by the Hamiltonian $\|Q\|(T + f)$. We further assume that at $\tau = 0$ the particle stays at the pericentre of the corresponding Keplerian ellipse. In the system $\|Q\|(T + f)$, the velocities are bounded at $\|Q\| = 0$. Finally, we pull back the Hamiltonian $\|Q\|(T + f)$ by *K.S.* to obtain

$$K.S.*(\|Q\|(T + f)) = K(z, w) = |z|^2(T(P, Q) + f) = \frac{1}{8\mu_0}|w|^2 + f|z|^2 - \mu_0 M_0.$$

In the Hamiltonian system $K(z, w)$, the set³ $\{z = 0\} \subset T^*\mathbb{H} \setminus \{(0, 0)\}$ corresponding to the collisions of the Kepler problem defines a codimension 4 submanifold of $T^*\mathbb{H} \setminus \{(0, 0)\}$. It is contained in Σ^0 and has codimension 3 in Σ^0 , and is no longer singular in the system $K(z, w)$. By adding $\{z = 0\}$ to Σ^1 , we obtain Σ^0 . By extending K analytically near $\{z = 0\} \subset T^*(\mathbb{H} \setminus \{0\})$, we get a system regular at $\{z = 0\}$, which descends to a regular system on V^0 . The $SO(2)$ -fibre action of the Kustaanheimo-Stiefel angle acts freely on $\{z = 0\}$, hence this set reduced by the $SO(2)$ -action is a codimension 3 submanifold in V^0 .

Let us now consider the dynamics of $K(z, w)$. The function $K(z, w)$ is defined on the whole $T^*\mathbb{H}$, where it defines four harmonic oscillators in $(1, 1, 1, 1)$ -resonance. Let $\omega = \sqrt{8\mu_0 f}$. The Hamiltonian system defined by $K(z, w)$ can be solved explicitly as

$$\begin{cases} z = \bar{\alpha} \cos \omega\tau + \bar{\beta} \sin \omega\tau \\ w = -\omega\bar{\alpha} \sin \omega\tau + \omega\bar{\beta} \cos \omega\tau. \end{cases}$$

Note that it is only on Σ^0 defined by $BL(z, w) = 0$ that the dynamics of $K(z, w)$ extends the dynamics of the spatial Kepler problem that we intend to study. Being reduced by the additional symmetry associated to ϑ , the function $K(z, w)|_{\Sigma^0}$ descends to a function on V^0 . We call V^0 the *regularized phase space* of the regularized Kepler problem $K(z, w)$. This method of regularizing the collision of the spatial Kepler problem is called *Kustaanheimo-Stiefel regularization*.

Let us sum up these discussions by a diagram:

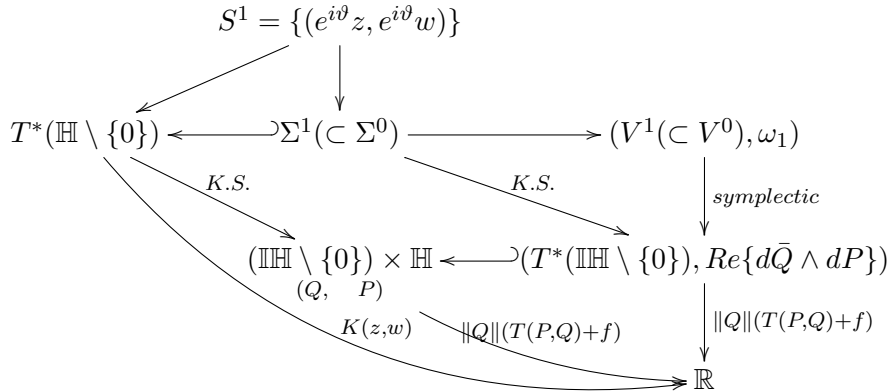

Corollary 3.1. *The compactification of the energy surface of the spatial Kepler problem determined by *K.S.* is homeomorphic to $S^3 \times S^2$.*

³We always remove the point $(0, 0)$ from $\{z = 0\}$. We keep the notation for its simplicity.

Proof. In Kustaanheimo-Stiefel regularization, the compactification of a negative-energy surface of T is the zero-energy surface of $K(z, w)$, which is

$$\{(z, w) \mid f|z|^2 + \frac{1}{8\mu_0}|w|^2 = \mu_0 M_0 > 0\},$$

diffeomorphic to S^7 . Since the quadratic cone $\Sigma = \{(z, w) : BL(z, w) = 0\}$ has index 4, its intersection with the set $\{(z, w) : f|z|^2 + \frac{1}{8\mu_0}|w|^2 = \text{Cst}\}$ is diffeomorphic to $S^3 \times S^3$. The group $\text{SO}(2)$ acts diagonally on this intersection by

$$\vartheta \cdot (x, y) = (e^{i\vartheta}x, e^{i\vartheta}y), \vartheta \in \mathbb{R}/2\pi\mathbb{Z}, (x, y) \in S^3 \times S^3 \subset \mathbb{H} \times \mathbb{H}.$$

In order to calculate the quotient of $S^3 \times S^3$ by this $\text{SO}(2)$ -action, we apply the diffeomorphism $(x, y) \rightarrow (x, x^{-1}y)$ from $S^3 \times S^3$ to itself. The diagonal $\text{SO}(2)$ -action on the source space $S^3 \times S^3$ induces an $\text{SO}(2)$ -action on the target space

$$\vartheta \cdot (x, y) \mapsto (e^{i\vartheta}x, y), \vartheta \in \mathbb{R}/2\pi\mathbb{Z}.$$

The quotient of the first factor S^3 by the Hopf S^1 -action being diffeomorphic to S^2 , the quotient of $S^3 \times S^3$ by the $\text{SO}(2)$ -action is $S^2 \times S^3$. \square

3.1.4 The Relations between Levi-Civita and Kustaanheimo-Stiefel Regularizations

Levi-Civita Planes

The orbits of the regularized Kepler problem lie in a particular kind of planes in \mathbb{H} : the *Levi-Civita* planes. Let us now characterize these planes.

Definition 3.1.3. The *Levi-Civita planes* are the planes spanned by two vectors $v_1, v_2 \in \mathbb{H}$ satisfying $BL(v_1, v_2) = 0$.

Lemma 3.1.1. For any $x, y \in \mathbb{H}$ satisfying $BL(x, y) = 0$, one has

$$|x|^2 \bar{y}iy + |y|^2 \bar{x}ix = \langle x, y \rangle (\bar{x}iy + \bar{y}ix).$$

Proof.

$$BL(x, y) = \text{Re}\{\bar{x}iy\} \bar{x}iy - \bar{y}ix = 0,$$

hence

$$(\bar{x}y - \bar{y}x)(\bar{x}iy - \bar{y}ix) = 0,$$

that is

$$\begin{aligned} |y|^2 \bar{x}ix + |x|^2 \bar{y}iy &= \bar{y}x\bar{y}ix + \bar{x}y\bar{x}iy, \\ 2|y|^2 \bar{x}ix + 2|x|^2 \bar{y}iy &= 2(\bar{y}x + \bar{x}y)(\bar{x}iy + \bar{y}ix), \end{aligned}$$

and finally

$$|y|^2 \bar{x}ix + |x|^2 \bar{y}iy = \langle x, y \rangle (\bar{x}iy + \bar{y}ix).$$

\square

Remark 3.1.1. (A. Chenciner) The more general equality holds:

$$|z_1|^2 \bar{z}_2 iz_2 + |z_2|^2 \bar{z}_1 iz_1 = 2\text{Re}\{\bar{z}_1 z_2\} \text{Im}\{\bar{z}_1 iz_2\} - 2\text{Re}\{\bar{z}_1 iz_2\} \text{Im}\{\bar{z}_1 z_2\}.$$

Corollary 3.2. *Suppose x and y are unit quaternions satisfying $BL(x, y) = 0$ and $\langle x, y \rangle = 0$, then*

- $\bar{x}ix = -\bar{y}iy$,
- $\frac{1}{2}(\bar{x}iy + \bar{y}ix) = \bar{x}iy$ is a unit quaternion and it is linearly independent of $\bar{x}ix = -\bar{y}iy$.

Proof. The first statement is a direct corollary of Lemma 3.1.1. It is thus clear that $\frac{1}{2}(\bar{x}iy + \bar{y}ix) = \bar{x}iy$ is unit. Since x and y are linearly independent and $\bar{x}i$ is non-zero, thus $\bar{x}ix$ and $\bar{x}iy$ are also linearly independent. \square

Corollary 3.3. *The Hopf map sends a Levi-Civita plane to a plane (containing the origin) in \mathbb{H} .*

On the other hand, we have

Proposition 3.1.4. *Any plane containing the origin in \mathbb{H} is exactly the image of a \mathbf{P}^1 -family of Levi-Civita planes.*

Proof. Let $\mathbf{e}_1, \mathbf{e}_2$ be an orthogonal basis of a plane in \mathbb{H} . There exists a rotation sending i to \mathbf{e}_1 , which determines a unit quaternion x such that $\mathbf{e}_1 = \bar{x}ix$. Then there exists another unit quaternion $y = -ix\mathbf{e}_2$ such that $\mathbf{e}_2 = \bar{x}iy$. Since \mathbf{e}_2 is purely imaginary, $Re\{\mathbf{e}_2\} = Re\{\bar{x}iy\} = BL(x, y) = 0$. We also have $0 = \langle \mathbf{e}_1, \mathbf{e}_2 \rangle = Re\{\bar{\mathbf{e}}_1\mathbf{e}_2\} = -Re\{\bar{x}ix\bar{x}iy\} = Re\{\bar{x}y\}$. Therefore the plane spanned by x and y is a Levi-Civita plane.

The family $(e^{i\vartheta}x, e^{i\vartheta}y), \vartheta \in \mathbb{R}/2\pi\mathbb{Z}$ corresponds to the same $(\mathbf{e}_1, \mathbf{e}_2)$. In such a family, $(e^{i\vartheta}x, e^{i\vartheta}y)$ and $(e^{i\vartheta+i\pi}x, e^{i\vartheta+i\pi}y)$ determine the same oriented Levi-Civita plane. Therefore for each oriented two-plane in \mathbb{H} passing through the origin, there exists a \mathbf{P}^1 -family of oriented Levi-Civita planes in its pre-image.

The fibres of the Hopf map are S^1 -circles. Each circle intersects a Levi-Civita plane in 0 or 2 points. As a result, the pre-image of any plane in \mathbb{H} consists in a \mathbf{P}^1 -family of Levi-Civita planes. \square

Definition 3.1.4. Let $z = c_1v_a + c_2v_b, w = c_3v_a + c_4v_b \in \mathbb{H}$, where $c_1, c_2, c_3, c_4 \in \mathbb{R}$, v_a, v_b are two unit orthogonal quaternions. We call the mapping

$$z \mapsto (c_1^2 - c_2^2)\bar{v}_aiv_a + 2c_1c_2\bar{v}_biv_b$$

the *square mapping*, the mapping

$$(z, w) \mapsto \left((c_1^2 - c_2^2)\bar{v}_aiv_a + 2c_1c_2\bar{v}_biv_b, \frac{(c_1c_3 + c_2c_4)\bar{v}_aiv_a + (c_1c_4 - c_2c_3)\bar{v}_biv_b}{2(c_1^2 + c_2^2)} \right)$$

is called *generalized Levi-Civita transformation*.

Remark 3.1.2. If one identifies v_a with \bar{v}_aiv_a , v_b with \bar{v}_biv_b , then the square mapping is just $z \mapsto z^2$, the generalized Levi-Civita transformation has the expression $(z, w) \mapsto (z^2, \frac{w}{2z})$, which is the same as the usual Levi-Civita transformation in the plane.

Remark 3.1.3. Restricted to a Levi-Civita plane, the Hopf map reduces to the square mapping. The Kustaanheimo-Stiefel transformation reduces to the generalized Levi-Civita transformation between the cotangent space of the Levi-Civita plane and its image under the Hopf map, hence Kustaanheimo-Stiefel regularization reduces to Levi-Civita regularization if one makes the identification as in Rem 3.1.2.

Proposition 3.1.5. *If a Keplerian orbit always lies in a particular plane in the physical space, then any corresponding (K.S.-) regularized orbit lies in a Levi-Civita plane determined by one of the corresponding initial conditions of the regularized system.*

Proof. Any initial value $(p_v, q_v) \in T^*\mathbb{H}$ of the Kepler problem corresponds, via K.S., to an S^1 -family of initial values $(z_v, w_v) \in T^*\mathbb{H}$ of the regularized system satisfying $BL(z_v, w_v) = 0$. Therefore, the orbit in the regularized system with initial value (z_v, w_v) lies in the Levi-Civita plane containing z_v and w_v . \square

3.1.5 Dynamics in the Physical Space

Lemma 3.1.2. For any regularized energy \tilde{f} satisfying $\tilde{f} > -\mu_0 M_0$, the projections of the orbits of the regularized Kepler flow in the physical space are ellipses.

Proof. The equation

$$K = \frac{|w|^2}{8\mu_0} + f|z|^2 - \mu_0 M_0 = \tilde{f}$$

is equivalent to

$$\|Q\| \left(\frac{\|P\|^2}{2\mu_0} - \frac{\mu_0 M_0 + \tilde{f}}{\|Q\|} + f \right) = 0,$$

that is

$$\frac{\|P\|^2}{2\mu_0} - \frac{\mu_0 M_0 + \tilde{f}}{\|Q\|} = -f.$$

By assumption $\mu_0 M_0 + \tilde{f} > 0$. The flows of this Hamiltonian and $T(P, Q)$ are the same up to time parametrization. Since the orbits of the Keplerian problem with negative energies are ellipses, the projections in the physical space of the orbits of the regularized Kepler flow are ellipses too. \square

We shall call these ellipses *physical ellipses*, and call the Keplerian ellipses of

$$T(P, Q) = \frac{\|P\|^2}{2\mu_0} - \frac{\mu_0 M_0}{\|Q\|}$$

initial ellipses. From Lemma 3.1.2, we see that for the same initial condition (P, Q) , the corresponding KS-ellipse is just the corresponding (initial) Keplerian ellipse, after changing the mass M_0 to $M_0 + \frac{\tilde{f}}{\mu_0}$.

As the regularized Kepler flow is, up to time parametrization, the same as the non-regularized Kepler flow, the following proposition is straightforward:

Remark 3.1.4. Let $(\hat{Q}_1, \hat{P}_1), (\hat{Q}_2, \hat{P}_2) \in T^*\mathbb{H}$. Suppose that $\text{span}\{\hat{Q}_1, \hat{P}_1\}$ and $\text{span}\{\hat{Q}_2, \hat{P}_2\}$ are both contained in the same plane, then the initial ellipse with initial value (\hat{Q}_1, \hat{P}_1) and the regularized ellipse with initial value (\hat{Q}_2, \hat{P}_2) are both contained in this plane.

3.1.6 Chenciner-Féjóz Coordinates

Remark 3.1.4 allows us to adapt the planar Chenciner-Féjóz Coordinates $(\mathcal{L}, \delta, \mathcal{G}, \gamma)$ (defined in [Féj01]), and extend them to the spatial Chenciner-Féjóz Coordinates by a ‘‘Reduction Lemma’’ (Lemma 3.1.3).

Levi-Civita Regularization and Planar Chenciner-Féjóz Coordinates

Let us first recall the Chenciner-Féjóz coordinates built in [Féj99] for the planar case, in which the double collision of the Kepler problem is regularized by Levi-Civita regularization. Following Remark 3.1.3, let us restrict $K.S.$ to one of the Levi-Civita planes, and identify this Levi-Civita plane together with its image with \mathbb{C} . The restricted mapping $L.C.$ can be expressed as

$$\begin{aligned} L.C. : T^*\mathbb{C} &\rightarrow T^*\mathbb{C} \\ (z, w) &\mapsto (Q = z^2, P = \frac{w}{2z}). \end{aligned}$$

It is direct to verify that

$$L.C.* Re(d\bar{P} \wedge dQ) = Re(d\bar{w} \wedge dz).$$

The function

$$T(P, Q) = \frac{1}{2\mu_0} \|P\|^2 + \frac{\mu_0 M_0}{\|Q\|}$$

is considered as defined on $T^*(\mathbb{C} \setminus \{0\})$. For $f > 0$, we change the time from t to τ as in Subsection 3.1.3 on the energy hypersurface

$$T(P, Q) + f = 0.$$

In the new time variable τ , the flow on this energy hypersurface is given by the Hamiltonian $\|Q\|(T(P, Q) + f)$.

The pull-back of $\|Q\|(T(P, Q) + f)$ by $L.C.$ is of the form

$$L.C.*(\|Q\|(T(P, Q) + f)) = \frac{1}{8\mu_0} |w|^2 + f|z|^2 - \mu_0 M_0,$$

which is the Hamiltonian of two harmonic oscillators in 1 : 1 resonance.

As in [Féj01], we switch to the symplectic coordinates

$$(W, Z) = \left(\frac{w}{\sqrt[4]{8\mu_0 f}}, \sqrt[4]{8\mu_0 f} z \right),$$

in which the function $K = K(Z, W)$ is of the form

$$K = \sqrt{\frac{f}{8\mu_1}} (|Z|^2 + |W|^2) - \mu_0 M_0.$$

We diagonalize the associated Hamiltonian vector field by posing

$$(W, Z) = \left(\frac{W' + \bar{Z}'}{\sqrt{2}}, \frac{W' - \bar{Z}'}{i\sqrt{2}} \right).$$

In (W', Z') coordinates

$$K = \sqrt{\frac{f}{8\mu_1}} (|Z'|^2 + |W'|^2) - \mu_0 M_0,$$

and the symplectic form is transformed to $\frac{i}{2}(dW' \wedge d\bar{W}' + dZ' \wedge d\bar{Z}')$.

We further switch to polar symplectic coordinates $(r_a, \theta_a, r_b, \theta_b)$ defined by

$$(Z', W') = (\sqrt{2r_a}e^{i\theta_a}, \sqrt{2r_b}e^{i\theta_b}).$$

In these coordinates,

$$K = \sqrt{\frac{f}{2\mu_1}}(r_a + r_b) - \mu_0 M_0.$$

Finally, we set

$$(\mathcal{L}, \delta, \mathcal{G}, \gamma) = \left(\frac{r_a + r_b}{2}, \theta_a + \theta_b, \frac{r_a - r_b}{2}, \theta_a - \theta_b + \pi\right).$$

In these coordinates, the Hamiltonian K is written as:

$$K = \mathcal{L} \sqrt{\frac{2f}{\mu_0}} - \mu_0 M_0,$$

and the symplectic form is transformed into the form $d\mathcal{L} \wedge d\delta + d\mathcal{G} \wedge d\gamma$. The translation by π in the definition of γ is due to the reason that one considers the argument of the pericentre of an ellipse rather than its apocentre.

The set of coordinates $(\mathcal{L}, \delta, \mathcal{G}, \gamma)$ originates in [Che86], and was called ‘‘Delaunay-like coordinates’’ in [Féj01]. We shall call this set of coordinates *planar Chenciner-Féjóz coordinates*.

Spatial Chenciner-Féjóz Coordinates

Now let us come back to the spatial case. Following [Féj99], since by Remark 3.1.4, $\text{span}(P, Q) = \text{span}(P', Q)$, we define the diffeomorphism k_f from V^0 to itself by the formula

$$k_f : (P, Q) \mapsto \left(P' = \frac{P}{\sqrt{2\mu_0 f L}}, Q\right)$$

such that the ellipse determined by (P, Q) in the physical space under the flow of the regularized Hamiltonian $K(z, w)$ coincides with the ellipse determined by (P', Q) under $T(P, Q)$. We note that in the above formula, somehow ambiguously, L is defined by the system $K(z, w)$ and its energy \tilde{f} . This corresponds to the modification of masses by \tilde{f} in the physical space (See the discussions below Lemma 3.1.2). In particular, $\sqrt{2\mu_0 f L} = 1$ only if $\tilde{f} = 0$.

The mapping k_f induces the identity from $S^2 \times S^2$ to itself, seen as two spaces of Keplerian ellipses with equally fixed semi major axis. Note that the mass parameters for this two spaces of Keplerian ellipses are not necessarily the same, therefore, the secular symplectic forms on the source and target space do not necessarily agree, hence the identity mapping of $S^2 \times S^2$ is not symplectic in general.

In terms of the Delaunay coordinates (L, l, G, g, H, h) and the diffeomorphism k_f , we define the *Chenciner-Féjóz Coordinates*, seen as coordinates on an open subset \tilde{V}^1 of the regularized phase space V^0 determined by the conditions that the corresponding physical

ellipse is non-degenerate, non-circular and non-horizontal, as the following:

$$\left\{ \begin{array}{l} \mathcal{L} = \frac{\sqrt{2f}L^2}{\mu_0^{3/2}M_0} \circ k_f \\ \delta = u \circ k_f \\ \mathcal{G} = \frac{\sqrt{2f}LG}{\mu_0^{3/2}M_0} \circ k_f \\ \gamma = g \circ k_f \\ \mathcal{H} = H \\ \zeta = h. \end{array} \right.$$

This set of coordinates is a direct extension of the planar Chenciner-Féjóz coordinates to the spatial case. On the energy surface $K(z, w) = 0$, we have $f = \frac{\mu_0^3 M_0^2}{2L^2}$, therefore k_f induces identity in terms of the Chenciner-Féjóz coordinates and Delaunay coordinates (except for the fast angle, which is the eccentricity anomaly u in Chenciner-Féjóz coordinates and l in Delaunay coordinates) as presented above.

In order to obtain a simple proof of the symplecticity of the Chenciner-Féjóz coordinates, let us first prove the following “Rotation Lemma”:

Let R_1^I be the simultaneous rotation in each factor of $\mathbb{R}^3 \times \mathbb{R}^3$ around the first axis with angle I , R_3^h be the simultaneous rotation in each factor of $\mathbb{R}^3 \times \mathbb{R}^3$ around the third (“vertical”) axis with angle h . Let

$$R_3^h \circ R_1^I(x_1, x_2, 0, y_1, y_2, 0) = (x'_1, x'_2, x'_3, y'_1, y'_2, y'_3).$$

Then

Lemma 3.1.3. (Rotation Lemma)

$$dy'_1 \wedge dx'_1 + dy'_2 \wedge dx'_2 + dy'_3 \wedge dx'_3 = dy_1 \wedge dx_1 + dy_2 \wedge dx_2 + d(x'_1 y'_2 - x'_2 y'_1) \wedge dh.$$

Proof. The rotation matrix of R_1^I , R_3^h and $R_3^h \circ R_1^I$ are respectively

$$\begin{bmatrix} 1 & 0 & 0 \\ 0 & \cos I & -\sin I \\ 0 & \sin I & \cos I \end{bmatrix}, \quad \begin{bmatrix} \cos h & -\sin h & 0 \\ \sin h & \cos h & 0 \\ 0 & 0 & 1 \end{bmatrix}, \quad \begin{bmatrix} \cos h & -\sin h \cos I & \sin h \sin I \\ \sin h & \cos h \cos I & -\cos h \sin I \\ 0 & \sin I & \cos I \end{bmatrix}.$$

Therefore

$$\left\{ \begin{array}{l} x'_1 = x_1 \cos h - x_2 \sin h \cos I \\ x'_2 = x_1 \sin h + x_2 \cos h \cos I \\ x'_3 = x_2 \sin I \\ y'_1 = y_1 \cos h - y_2 \sin h \cos I \\ y'_2 = y_1 \sin h + y_2 \cos h \cos I \\ y'_3 = y_2 \sin I. \end{array} \right.$$

An elementary calculation leads to

$$\begin{aligned} dx'_1 \wedge dy'_1 + dx'_2 \wedge dy'_2 + dx'_3 \wedge dy'_3 &= dx_1 \wedge dy_1 + dx_2 \wedge dy_2 + dh \wedge d((x_1 y_2 - x_2 y_1) \cdot \cos I) \\ &= dx_1 \wedge dy_1 + dx_2 \wedge dy_2 + dh \wedge d(x'_1 y'_2 - x'_2 y'_1). \end{aligned}$$

□

As a first application of this lemma, we can now easily deduce the spatial Delaunay coordinates (L, l, G, g, H, h) from the planar Delaunay coordinates (L, l, G, g) :

Corollary 3.4. *If (L, l, G, g) are Darboux coordinates on $T^*\mathbb{R}^2$ when they are well defined:*

$$dy_1 \wedge dx_1 + dy_2 \wedge dx_2 = dL \wedge dl + dG \wedge dg,$$

then $(L, l, G, g, H := x'_1 y'_2 - x'_2 y'_1, h)$ are Darboux coordinates on $T^\mathbb{R}^3$ when they are well defined, i.e.*

$$dy_1 \wedge dx_1 + dy_2 \wedge dx_2 + dy_3 \wedge dx_3 = dL \wedge dl + dG \wedge dg + dH \wedge dh.$$

The planar Chenciner-Féjóz Coordinates $(\mathcal{L}, \delta, \mathcal{G}, \gamma)$ are Darboux coordinates. As another corollary of Lemma 3.1.3 and Proposition 3.1.3, we deduce that the Chenciner-Féjóz Coordinates are also Darboux coordinates:

Proposition 3.1.6. *Chenciner-Féjóz coordinates are Darboux coordinates on \tilde{V}^1 .*

Note that while Chenciner-Féjóz coordinates are very helpful for our study due to their similarity with the Delaunay coordinates, they are not regular in the neighborhood of collision-ejection Keplerian motions, because there is no well-defined “orbital plane” for a degenerate ellipse. We shall discuss there extensions (similar to Subsection 1.2.3) in Subsection 3.2.4.

It is helpful to have Darboux coordinates which are regular in the neighborhood of collision-ejection Keplerian motions. We shall build such coordinates in the next subsection.

3.1.7 Regularized Coordinates

We now define a set of action-angle coordinates for the system of four harmonic oscillators in $1 : 1 : 1 : 1$ resonance. Recall that $\omega = \sqrt{8\mu_0 f}$. Let

$$\omega z_i = \sqrt{2I_i} \sin\left(\frac{\bar{u}}{2} - \phi_i\right), \quad w_i = \sqrt{2I_i} \cos\left(\frac{\bar{u}}{2} - \phi_i\right), \quad i = 0, 1, 2, 3.$$

We take

$$\left(\frac{I_i}{\omega}, \frac{\bar{u}}{2} - \phi_i\right) \mapsto (z_i, w_i), \quad i = 0, 1, 2, 3$$

and

$$\begin{aligned} \mathcal{P}_0 &= \frac{(I_0 + I_1 + I_2 + I_3)}{\omega}, \quad \vartheta_0 = \frac{\bar{u}}{2} - \phi_0, \\ \mathcal{P}_i &= \frac{I_i}{\omega}, \quad \vartheta_i = \phi_0 - \phi_i, \quad i = 1, 2, 3. \end{aligned}$$

The change of coordinates

$$(\mathcal{P}_0, \mathcal{P}_1, \mathcal{P}_2, \mathcal{P}_3, \vartheta_0, \vartheta_1, \vartheta_2, \vartheta_3) \mapsto (z_0, z_1, z_2, z_3, w_0, w_1, w_2, w_3)$$

satisfies

$$\mathcal{P}_0 \wedge \vartheta_0 + \mathcal{P}_1 \wedge \vartheta_1 + \mathcal{P}_2 \wedge \vartheta_2 + \mathcal{P}_3 \wedge \vartheta_3 = \operatorname{Re}\{d\bar{w} \wedge dz\}.$$

We shall call $(\mathcal{P}_0, \mathcal{P}_1, \mathcal{P}_2, \mathcal{P}_3, \vartheta_0, \vartheta_1, \vartheta_2, \vartheta_3)$ the *regularized coordinates*, which are well-defined as long as

$$\mathcal{P}_0 - \mathcal{P}_1 - \mathcal{P}_2 - \mathcal{P}_3 > 0, \mathcal{P}_1 > 0, \mathcal{P}_2 > 0, \mathcal{P}_3 > 0.$$

In these coordinates, the physical ellipse has

- semi major axis: $\frac{\mathcal{P}_0}{\omega}$;
- eccentricity⁴:

$$e = \mathcal{P}_0^{-1} \text{sqrt} \left\{ (\mathcal{P}_0 - \mathcal{P}_1 - \mathcal{P}_2 - \mathcal{P}_3 + \mathcal{P}_1 \cos(2\vartheta_1) + \mathcal{P}_2 \cos(2\vartheta_2) + \mathcal{P}_3 \cos(2\vartheta_3))^2 - (\mathcal{P}_1 \sin(2\vartheta_1) + \mathcal{P}_2 \sin(2\vartheta_2) + \mathcal{P}_3 \sin(2\vartheta_3))^2 \right\}.$$

In these coordinates, the Hamiltonian K takes the form

$$K = \frac{\mathcal{P}_0}{2} \sqrt{\frac{2f}{\mu_0}} - \mu_0 M_0.$$

In comparing with its expression in the Chenciner-Féjóz coordinates, we obtain $\mathcal{L} = \frac{\mathcal{P}_0}{2}$; in turn, if we consider ϑ_0 only as a function of δ , we have $d\delta = 2d\vartheta_0$.

These coordinates are regular Darboux coordinates in the neighborhood of the collision-ejection motions, thus they can be used in the perturbative study of these motions, which is essential for the elimination procedure of the fast angle in the regularized system. Nevertheless, the study of the secular (or quadrupolar) regularized dynamics in these coordinates leads to very complicated formulæ. For this purpose, we shall rather use coordinates closer to the ones we have used in the non-regularized phase space.

3.2 Quasi-periodic Almost-collision orbits

3.2.1 Outline of the Proof

We show the existence of a set of positive measure of quasi-periodic almost-collision solutions in the spatial three-body problem through the following steps:

1. Regularize the inner double collisions of F on the energy surface $F = -f < 0$ by Kustaanheimo-Stiefel regularization to obtain a Hamiltonian \mathcal{F} , which preserves the $\text{SO}(3) \times \text{SO}(2)$ -symmetry. It is only on the zero-energy surface that the dynamics of \mathcal{F} extends the dynamics of F (on the energy surface $F = -f, f > 0$).

2. Build the secular regularized systems \mathcal{F}_{sec}^n , the secular-integrable regularized systems $\overline{\mathcal{F}_{sec}^{n,n'}}$ and study their Lagrangian invariant tori near the collision set. This requires the study of the regularized quadrupolar system \mathcal{F}_{quad} for values $C - G_2$ close or equal to zero.

3. Apply the equivariant iso-energetic proper-degenerate KAM theorem to find a set of positive measure of invariant tori of \mathcal{F} on its zero-energy hypersurface.

4. Show that a set of positive measure of these invariant tori intersect the (inner) collision set transversally. Show that a set of positive measure of invariant ergodic subtori intersect the collision set in submanifolds of codimension at least 2. Conclude that there exists a set of positive measure of quasi-periodic almost-collision orbits in the energy surface $F = -f$. Finally, by varying f , show that these orbits also have positive measure in the phase space of F .

⁴*sqrt*{ } denotes the square root.

3.2.2 Regularization of the Inner Double Collisions in the Three-Body Problem

Let us regularize the inner double collision on the energy surface $F + f = 0$ for any fixed $f > 0$ by Kustaanheimo-Stiefel regularization. We change the time on this energy surface by multiplying $F + f$ by $\|Q_1\|$, and pull back the Hamiltonian $\|Q_1\|(F + f)$ by $K.S. \oplus Id$ (where Id is the identity mapping from $T^*(\mathbb{R}^3 \setminus \{0\})$, the phase space of the outer fictitious body, to itself). We nevertheless keep the same notation $K.S.$ for $K.S. \oplus Id$:

$$\begin{aligned} K.S. : \Sigma^1 \times T^*(\mathbb{R}^3 \setminus \{0\}) &\rightarrow T^*\mathbb{H} \times T^*(\mathbb{R}^3 \setminus \{0\}) \\ (z, w, Q_2, P_2) &\mapsto (Q_1 = \bar{z}iz, P_1 = \frac{\bar{z}iw}{2|z|^2}, Q_2, P_2), \end{aligned}$$

The *regularized Hamiltonian*

$$\mathcal{F} = K.S.*\left(\|Q_1\|(F_{Kep} + F_{pert} + f)\right) = \frac{|w|^2}{8\mu_1} + \left(f + \frac{\|P_2\|^2}{2\mu_2} - \frac{\mu_2 M_2}{\|Q_2\|}\right)|z|^2 - \mu_1 M_1 + K.S.*\left(\|Q_1\|F_{pert}\right)$$

is a function defined on $\Sigma^0 \times T^*(\mathbb{R}^3 \setminus \{0\})$. This function descends to the quotient space $\Pi_{reg} := V^0 \times T^*(\mathbb{R}^3 \setminus \{0\})$ and is no longer singular at the set $Col \subset \Pi_{reg}$ consisting of the pre-images of inner double collisions. We call Π_{reg} the *regularized phase space* of the three-body problem and consider \mathcal{F} as defined on Π_{reg} .

In practice, we shall also regard \mathcal{F} as a function (independent of the Kustaanheimo-Stiefel angle ϑ) on $\tilde{\Pi}_{reg} := T^*\mathbb{H} \setminus \{(0, 0)\} \times T^*(\mathbb{R}^3 \setminus \{0\})$. It is only on the zero-energy surface $\mathcal{F} = 0$, that the dynamics of \mathcal{F} extends the dynamics of F .

We write

$$\mathcal{F} = \mathcal{F}_{Kep} + \mathcal{F}_{pert},$$

where

$$\mathcal{F}_{Kep} = K.S.*\left(\|Q_1\|(F_{Kep} + f)\right) = \frac{|w|^2}{8\mu_1} + \left(f + \frac{\|P_2\|^2}{2\mu_2} - \frac{\mu_2 M_2}{\|Q_2\|}\right)|z|^2 - \mu_1 M_1$$

is the regularized Keplerian part, and

$$\mathcal{F}_{pert} = K.S.*\left(\|Q_1\|F_{pert}\right)$$

is the regularized perturbing part.

We use the Delaunay coordinates for the outer body. Following [Féj01], we set

$$f_1(L_2) = f + \frac{\|P_2\|^2}{2\mu_2} - \frac{\mu_2 M_2}{\|Q_2\|} = f - \frac{\mu_2^3 M_2^2}{2L_2^2}.$$

The regularized Keplerian Hamiltonian

$$\mathcal{F}_{Kep} = \frac{|w|^2}{8\mu_1} + f_1(L_2)|z|^2 - \mu_1 M_1$$

describes the dynamics of four harmonic oscillators in $1 : 1 : 1 : 1$ -resonance (the inner body), whose frequency is affected by the energy of the outer motion together with a Keplerian elliptic motion (the outer body) slowed down by the motion of the inner body. The slowing down of the outer Keplerian motion is due to the change of time of the regularization procedure. Comparing with the dynamics of F_{Kep} , we see that the dynamics of \mathcal{F}_{Kep} remains integrable, but the inner and outer motions are no longer uncoupled. The dynamics of \mathcal{F}_{Kep} is again properly-degenerate: it only admits invariant ergodic 2-tori in the 12-dimensional space Π_{reg} . We need to understand the secular dynamics of \mathcal{F}_{pert} in order to get rid of its degeneracy and apply KAM theorems to find invariant tori of \mathcal{F}_{pert} .

3.2.3 Chenciner-Féjóz and Deprit-like coordinates

The diffeomorphism k_f (defined in paragraph 3.1.6) can be directly extended to our present setting by only applying k_f to the inner motion and leaving the outer motion unchanged. We nevertheless keep the slightly abusive notation k_f to denote the extended diffeomorphism. In coordinates, we have

$$k_f : (P_1, Q_1, P_2, Q_2) \mapsto (P'_1, Q'_1, P_2, Q_2) = \left(\frac{P_1}{\sqrt{2\mu_1 f_1(L_2)} L_1}, Q_1, P_2, Q_2 \right).$$

We switch to the spatial Chenciner-Féjóz coordinates $(\mathcal{L}_1, \delta_1, \mathcal{G}_1, \gamma_1, \mathcal{H}_1, \zeta_1)$ for the inner physical ellipse. Explicitly, the expressions of these coordinates in terms of the Delaunay coordinates are:

$$\begin{cases} \mathcal{L}_1 = \frac{\sqrt{2f_1(L_2)}}{\mu_1^{\frac{3}{2}} M_1} L_1^2 \circ k_f \\ \delta_1 = u_1 \circ k_f \\ \mathcal{G}_1 = \frac{\sqrt{2f_1(L_2)} L_1}{\mu_1^{\frac{3}{2}} M_1} G_1 \circ k_f \\ \gamma_1 = g_1 \circ k_f \\ \mathcal{H}_1 = H_1 \\ \zeta_1 = h_1. \end{cases}$$

As in [Féj01], we have to modify l_2 to keep the symplectic form unchanged. In [Féj01], only the planar case was treated for the modification of l_2 . The spatial case can be treated in exactly the same way: the symplectic form remain unchanged if we modify l_2 properly by adding to it the function $\frac{f'_1(L_2)}{2f_1(L_2)} \sqrt{\mathcal{L}_1^2 - \mathcal{G}_1^2} \sin \delta_1$. We still denote this angle by the same symbol l_2 .

Again k_f induces identity between Delaunay coordinates and Chenciner-Féjóz coordinates on the energy level $\mathcal{F}_{Kep} = 0$ (“no modification of masses due to the regularized energy”) of the regularized Keplerian part \mathcal{F}_{Kep} , except for replacing l_1 by u_1 (u_1 is proportional to the new time) and slowing down l_2 (denoted by the same letter) so that it is proportional to the new time. From Proposition 3.1.6, we have

Proposition 3.2.1. *The Chenciner-Féjóz coordinates*

$$(\mathcal{L}_1, \delta_1, \mathcal{G}_1, \gamma_1, \mathcal{H}_1, \zeta_1, L_2, l_2, G_2, g_2, H_2, h_2)$$

are Darboux coordinates on a dense open set of Π_{reg} .

Likewise, we define the *Deprit-like coordinates*

$$(\mathcal{L}_1, \delta_1, \mathcal{G}_1, \bar{\gamma}_1 := \bar{g}_1 \circ k_f = \bar{g}_1, L_2, l_2, G_2, g_2, \Phi_1, \phi_1, \Phi_2, \phi_2).$$

The variables $(\Phi_1, \phi_1, \Phi_2, \phi_2)$ are defined in the same way as for Deprit coordinates. In the inner orbital plane with the direction of the ascending node playing the role of the first axis direction, the symplecticity of the planar Chenciner-Féjóz coordinates implies that

$$dL_1 \wedge dl_1 + dG_1 \wedge d\bar{g}_1 = d\mathcal{L}_1 \wedge d\delta_1 + d\mathcal{G}_1 \wedge d\bar{\gamma}_1,$$

which in turn implies that

Proposition 3.2.2. *The Deprit-like coordinates $(\mathcal{L}_1, \delta_1, \mathcal{G}_1, \bar{\gamma}_1, L_2, l_2, G_2, g_2, \Phi_1, \phi_1, \Phi_2, \phi_2)$ are Darboux coordinates on a dense open set of Π_{reg} .*

3.2.4 Secular Regularized Spaces

As in Section 1.2, we define the secular regularized space as:

Definition 3.2.1. The *secular regularized space* is the space of pairs (E_1, E_2) such that E_1 is the equivalent class of ellipses lying in a Levi-Civita plane in the 4-dimensional Euclidean space with fixed center at the origin and corresponding to the same physical Keplerian ellipse, and E_2 is an ellipse lying in the three-dimensional Euclidean space with fixed focus at the origin. Both semi major axes of the two Keplerian ellipses are fixed.

Since we have identified all the centered inner ellipses having the same image in the physical space under the Hopf map, the *secular regularized space* is homeomorphic to the secular space $S^2 \times S^2 \times S^2 \times S^2$. We therefore identify the secular regularized space with the secular space in the sequel. After fixing \mathcal{L}_1 and L_2 and dropping the fast angles, the rest of the Chenciner-Féjóz coordinates (for the inner ellipse) or the Deprit-like coordinates can be thus considered as defined on a dense open subset of the secular space. Moreover, we can then smoothly extend the Chenciner-Féjóz coordinates (for the inner ellipse) or the Deprit-like coordinates to a dense open subspace of the orientable double cover of the critical quadrupolar space, containing the degenerate inner ellipses, by allowing \mathcal{G}_1 to take values in $[-\mathcal{L}_1, \mathcal{L}_1]$. We call the resulting coordinates *extended Chenciner-Féjóz/Deprit like coordinates*.

3.2.5 Secular Regularized Systems

We choose a reference frame so that the regularized coordinates $(\mathcal{P}_i, \vartheta_i), i = 0, 1, 2, 3$ (defined in Subsection 3.1.7) for the inner ellipse and the Delaunay coordinates for the outer ellipse (note that the angle l_2 has changed in order to keep the symplectic form, see 3.2.3) are both well defined. In these coordinates, the fast angles are ϑ_0 and l_2 . In order to have consistent fast angles with Chenciner-Féjóz coordinates and Deprit-like coordinates, we shall take δ_1 and l_2 as fast angles, and take $\mathcal{L} = \frac{\mathcal{P}_0}{2}$ instead of \mathcal{P}_0 as the action variable conjugate to δ_1 . The regularized Hamiltonian reads

$$\mathcal{F} = \mathcal{F}(\mathcal{L}_1, \delta_1, \mathcal{P}_1, \vartheta_1, \mathcal{P}_2, \vartheta_2, \mathcal{P}_3, \vartheta_3, L_2, l_2, G_2, g_2, H_2, h_2).$$

For the regularized system, the asynchronous elimination procedure must be slightly modified. We only have to drop the requirement that e_1 cannot reach 1, and replace ν_1 by the regularized fast frequency $\frac{\partial \mathcal{F}_{Kep}}{\partial \mathcal{L}_1}$ of the inner ellipse. By the same elimination procedure as in Proposition 2.1.1, we obtain the transformations $\tilde{\phi}^n$ close to identity, such that

$$\tilde{\phi}^{n*} \mathcal{F} = \mathcal{F}_{Kep} + \mathcal{F}_{sec}^n + \mathcal{F}_{comp}^n,$$

in which the n -th order secular regularized system \mathcal{F}_{sec}^n is independent of u_1 and l_2 , and \mathcal{F}_{comp}^n is of order $O(\alpha^{\frac{3(n+2)}{2}})$. The transformation $\tilde{\phi}^n$ and the functions \mathcal{F}_{sec}^n and \mathcal{F}_{comp}^n are independent of the Kustaanheimo-Stiefel angle ϑ , therefore they are well defined on a subset of Π_{reg} . Moreover, \mathcal{P}_0 and L_2 being fixed, the function \mathcal{F}_{sec}^n descends to (a subset of) the secular space.

The first order secular regularized system \mathcal{F}_{sec}^1 equals to

$$\langle \mathcal{F}_{pert} \rangle = \frac{1}{4\pi^2} \int_{\mathbb{T}^2} \mathcal{F}_{pert} d\delta_1 dl_2.$$

Seen as a function on the secular space, it has a natural relation with

$$\langle F_{pert} \rangle = \frac{1}{4\pi^2} \int_{\mathbb{T}^2} F_{pert} dl_1 dl_2.$$

Proposition 3.2.3. *The initial and secular regularized Hamiltonians satisfy:*

$$\langle \mathcal{F}_{pert} \rangle = a_1 \cdot \langle F_{pert} \rangle \circ k_f.$$

Proof. This is a trivial generalization of Proposition 3.1 in [Féj01] to the spatial case and the proof is the same: Since the modification of l_2 does not change the form $d\delta_1 \wedge dl_2$, we have

$$\begin{aligned} \langle \mathcal{F}_{pert} \rangle &= \frac{1}{4\pi^2} \int_{\mathbb{T}^2} \mathcal{F}_{pert} d\delta_1 dl_2 \\ &= \frac{1}{4\pi^2} \int_{k_f(\mathbb{T}^2)} \mathcal{F}_{pert} \circ k_f^{-1} d(\delta_1 \circ k_f^{-1}) dl_2. \end{aligned}$$

Since the map k_f preserves the configuration coordinates (Q_1, Q_2) and $\mathcal{F}_{pert} = \|Q_1\| F_{pert}$ is only a function on the configuration space, $\mathcal{F}_{pert} = \|Q_1\| F_{pert}$ is invariant under k_f . Moreover, $\delta_1 \circ k_f^{-1} = u_1$, therefore

$$\begin{aligned} \langle \mathcal{F}_{pert} \rangle &= \frac{1}{4\pi^2} \int_{\mathbb{T}^2} \|Q_1\| F_{pert} du_1 dl_2 \\ &= \frac{a_1}{4\pi^2} \int_{\mathbb{T}^2} F_{pert} dl_1 dl_2. \end{aligned}$$

The last equality follows from the relation

$$\|Q_1\| du_1 = a_1 dl_1,$$

which is a direct consequence of Kepler's equation. \square

Since k_f preserves the semi major axes and induces the identity on the secular space, we obtain

Corollary 3.5. $\langle F_{pert} \rangle, F_{sec}^{1,2}, F_{sec}^{1,3}$ extend to analytic functions in the neighborhood of degenerate inner ellipses.

3.2.6 Secular-integrable Regularized Systems

Since k_f preserves the semi major axes, as a corollary of Proposition 3.2.3, we see that if we expand \mathcal{F}_{sec}^n into power series of α as for F_{sec}^n (Subsection 2.1.3)

$$\mathcal{F}_{sec}^n = \sum_{i=0}^{\infty} \mathcal{F}_{sec}^{n,i} \alpha^{i+1} = \mathcal{F}_{sec}^{n,0} \alpha + \mathcal{F}_{sec}^{n,1} \alpha^2 + \dots,$$

in which we regard $F_{sec}^{n,i}$ as a function in the phase space, and $\mathcal{F}_{sec}^{n,i} = K.S.*F_{sec}^{n,i}$ is a function in Π_{reg} after being reduced by the fibres of $K.S.$, then

- $\mathcal{F}_{sec}^{n,i} = 0, i = 0, 1;$

- $\mathcal{F}_{sec}^{n,2} = \mathcal{F}_{sec}^{1,2}$, $\mathcal{F}_{sec}^{n,3} = \mathcal{F}_{sec}^{1,3}$ for all $n \in \mathbb{N}_+$;
- the first non-trivial coefficient $\mathcal{F}_{sec}^{n,2} = \overline{\mathcal{F}_{sec}^{1,2}}$ does not depend on the angle \bar{g}_2 .

The system $\mathcal{F}_{sec}^{1,2}$ is again integrable. This is the *quadrupolar regularized system*. We denote it by \mathcal{F}_{quad} .

We then build the *secular-integrable regularized systems* $\overline{\mathcal{F}_{sec}^{n,n'}}$ by eliminating g_2 . As in Subsection 2.1.3, there exist transformations $\tilde{\psi}^{n'}$, dominated by the transformation $\tilde{\psi}^3$ of order α , such that

$$\tilde{\psi}^{n'*} \tilde{\phi}^{n*} \mathcal{F} = \mathcal{F}_{Kep} + \overline{\mathcal{F}_{sec}^{n,n'}} + \mathcal{F}_{secpert}^{n'+1} + \mathcal{F}_{comp}^n,$$

in which $\mathcal{F}_{secpert}^{n'+1} = O(\alpha^{n'+2})$. We shall describe these transformations more precisely when needed.

The transformation $\psi^{n'}$ and the systems $\overline{\mathcal{F}_{sec}^{n,n'}}$, $\mathcal{F}_{secpert}^{n'+1}$ descend to Π_{reg} . After fixing \mathcal{P}_0 and L_2 , the function $\overline{\mathcal{F}_{sec}^{n,n'}}$ descends further to the secular space, and is analytic near degenerate inner ellipses. For large enough integers n and n' , the Hamiltonian $\mathcal{F}_{Kep} + \overline{\mathcal{F}_{sec}^{n,n'}}$ plays the role of an integrable approximating system of \mathcal{F} .

In the quadrupolar regularized system \mathcal{F}_{quad} and the secular-integrable regularized system $\overline{\mathcal{F}_{sec}^{n,n'}}$, we have an additional first integral G_2 .

We shall not study the dynamics of \mathcal{F}_{quad} directly, but rather investigate the link between the dynamics of \mathcal{F}_{quad} and F_{quad} . From Proposition 3.2.3, we have

$$\mathcal{F}_{quad} = a_1 \cdot F_{quad} \circ k_f.$$

Since k_f is not symplectic for the symplectic structures involved, the dynamics of \mathcal{F}_{quad} is not directly equivalent to the one of F_{quad} . Nevertheless, we do have a simple relation between them.

Proposition 3.2.4. *For fixed masses m_0 , m_1 and m_2 , the semi major axes a_1 and a_2 , the energy $-f < 0$, and the angular momentum C , after full reduction by the $SO(3)$ -symmetry and the Keplerian \mathbb{T}^2 -action of the fast angles, there exists a fictitious value $m'_2 > 0$ of the outer mass, such that \mathcal{F}_{quad} is conjugated to $\frac{a_1 m_2}{m'_2} \cdot F_{quad}$, provided that m'_2 substitutes for m_2 in F_{quad} . In particular, the frequencies of the corresponding invariant tori are only differed by a factor $\frac{a_1 m_2}{m'_2}$.*

Note that the time scales of the two systems are different. The frequencies are determined with respect to their own time scales.

Proof. When $C \neq G_2$, we consider the system

$$F = F_{Kep} + F_{pert} = -\frac{\mu_1^3 M_1^2}{2L_1^2} - \frac{\mu_2^3 M_2^2}{2L_2^2} + F_{pert}$$

on the energy level

$$F = -f, \quad f > 0.$$

Since $|F_{pert}|$ is smaller than $\frac{\mu_2^3 M_2^2}{2L_2^2}$, we have that

$$\frac{\mu_1^3 M_1^2}{2L_1^2} < f.$$

Now as the mapping

$$m_2 \mapsto \mu_2^3 M_2^2 = \frac{(m_0 + m_1)^3 m_2^3}{m_0 + m_1 + m_2}$$

is a diffeomorphism from $(0, +\infty)$ to itself for any positive m_0, m_1 , there exists some $m'_2 > 0$, such that

$$f_1(L_2, m_0, m_1, m'_2) = f - \frac{\mu_2^3 M_2^2}{2L_2^2} = \frac{\mu_1^3 M_1^2}{2L_1^2}.$$

The composition of the mapping k_f with the mapping $m_2 \mapsto m'_2$ is just the identity between $(\mathcal{L}_1, \mathcal{G}_1, \bar{\gamma}_1, G_2, g_2)$ and $(L_1, G_1, \bar{g}_1, G_2, g_2)$ in the source and target spaces respectively. This means that the dynamical behaviors of the reduced quadrupolar regularized system

$$\mathcal{F}_{quad}(\mathcal{G}_1, \bar{\gamma}_1, G_2; \mathcal{L}_1, L_2, C, m_0, m_1, m_2) = \frac{m_2}{m'_2} \mathcal{F}_{quad}(\mathcal{G}_1, \bar{\gamma}_1, G_2; \mathcal{L}_1, L_2, C, m_0, m_1, m'_2)$$

is, up to a factor $\frac{m_2 a_1}{m'_2}$, the same as that of the non-regularized reduced quadrupolar system

$$F_{quad}(G_1, \bar{g}_1, G_2; L_1, L_2, C, m_0, m_1, m'_2).$$

In particular, the frequencies of the corresponding invariant tori in the two systems are the same up to a factor $\frac{m_2 a_1}{m'_2}$.

If $C = G_2$, we investigate the dynamics of \mathcal{F}_{quad} and F_{quad} in the critical quadrupolar space. The argument for the case $C = G_2$ are then the same as for the case $C \neq G_2$, by using extended Delaunay coordinates, or extended Deprit-like coordinates on the double cover of the critical quadrupolar space reduced by the $SO(3)$ -symmetry. \square

As a result, we deduce the dynamics of \mathcal{F}_{quad} immediately from the dynamics of F_{quad} , which we have presented in Section 2.2. Moreover, if we replace m_2 by a proper m'_2 in F_{quad} , then for the same parameter C , the dynamics of the quadrupolar and quadrupolar regularized systems is the same up to a constant factor. The quadrupolar regularized frequency map and its non-degeneracy are therefore directly deduced from F_{quad} .

3.2.7 Quadrupolar Regularized Dynamics

We omit to make a complete description of the dynamics of \mathcal{F}_{quad} , since by Proposition 3.2.4, they are essentially the same as those of F_{quad} .

We shall be mainly interested in the dynamics in or near $\{C = G_2\}$. When $C = G_2$, if we fully reduce the quadrupolar regularized system, then there exist periodic orbits of the system $\mathcal{F}_{quad}(\mathcal{G}_1, \bar{g}_1; C = G_2)$ around the elliptic singularities $\{\mathcal{G}_1 = 0, \bar{g}_1 = 0 \pmod{\frac{\pi}{2}}\}$, which correspond to invariant tori of $\mathcal{F}_{Kep} + \overline{\mathcal{F}_{sec}^{1,3}}$, and also give rise to invariant tori for \mathcal{F} via application of KAM techniques. These tori form a set of zero measure on the zero-energy surface of \mathcal{F} . A set of positive measure of nearby tori for which $C \neq G_2$ but $|C - G_2|$ is small enough (and $|\mathcal{G}_1|$ is close enough to the minimum of its allowed value $\mathcal{G}_{1,min}$) give rise to a set of positive measure of invariant punctured tori of \mathcal{F} , and quasi-periodic almost-collision orbits of F . We leave more discussions in the sequel.

The secular-integrable regularized systems $\overline{\mathcal{F}_{sec}^{n,n'}}$ are $O(\alpha^4)$ small perturbations of $\alpha^3 \mathcal{F}_{quad}$. We are only interested in their dynamics in $\{C = G_2\}$ and for $|C - G_2|$ small enough. The set $\{G_1 = G_{1,min}\}$ corresponds to coplanar pairs of ellipses in the physical space, thus it is also invariant for $\overline{\mathcal{F}_{sec}^{n,n'}}$. Moreover, after reduction by the $SO(3) \times SO(2)$ -symmetry, all the elliptic singularities of $\alpha^3 \mathcal{F}_{quad}$ in the branched double cover of $\{C = G_2\}$

are Morse singularities in the (G_1, \bar{g}_1) -space (Lemma C.1), hence $\overline{\mathcal{F}_{sec}^{n,n'}}$ is orbitally conjugate to \mathcal{F}_{quad} . (see Figure 2.5 for the dynamics of F_{quad} near $C = G_2$, and Appendix C for the analysis of singularities).

3.2.8 Application of the Equivariant KAM Theorem

After elimination of the fast angles and of g_2 up to order (n, n') , the regularized Hamiltonian \mathcal{F} is transformed into

$$\tilde{\psi}^{n'*} \tilde{\phi}^{n*} \mathcal{F} = \frac{1}{8\mu_1} |w|^2 + f_1(L_2) |z|^2 - \mu_1 M_1 + \overline{\mathcal{F}_{sec}^{n,n'}} + \mathcal{F}_{secpert}^{n'+1} + \mathcal{F}_{comp}^n,$$

which is regarded as a function on Π_{reg} . In the above expression, $\overline{\mathcal{F}_{sec}^{n,n'}}$ is the (n, n') -th order secular-integrable regularized Hamiltonian considered to be defined on a subset of Π_{reg} . The last two terms are defined in the regularized system in the same way as $F_{secpert}^{n'+1}$ and F_{comp}^n are defined in the non-regularized system. They are of higher order with respect to $\overline{\mathcal{F}_{sec}^{n,n'}}$ and can be made arbitrarily small by choosing n, n' large enough.

To directly obtain invariant Lagrangian tori of \mathcal{F} in Π_{reg} , we shall apply the equivariant iso-energetic KAM theorem (Corollary 2.4)⁵. Let us verify the non-degeneracy of the frequency map in need to apply Corollary 2.4, by verifying the non-degeneracy of the frequency maps of the system $\tilde{\psi}^{n'*} \tilde{\phi}^{n*} \mathcal{F}$ reduced from the $SO(3)$ -symmetry. As noted in Example-Condition 2.2, since $\tilde{\psi}^{n'*} \tilde{\phi}^{n*} \mathcal{F}$ is properly-degenerate, it is enough to verify the non-degeneracy conditions for different scales separately.

Partially iso-energetic non-degeneracy of the Keplerian part

In terms of $(\mathcal{L}_1, \delta_1, L_2, l_2)$, the function \mathcal{F}_{Kep} is expressed as

$$\mathcal{F}_{Kep} = \mathcal{L}_1 \sqrt{\frac{2f_1(L_2)}{\mu_1}} - \mu_1 M_1.$$

The regularized Keplerian frequencies are then

$$\left(\sqrt{\frac{2f_1(L_2)}{\mu_1}}, \frac{\mathcal{L}_1}{2\sqrt{2\mu_1 f_1(L_2)}} \right).$$

It is then direct to see that \mathcal{F}_{Kep} , seen as a function of \mathcal{L}_1 and L_2 , is iso-energetically non-degenerate with respect to \mathcal{L}_1 and L_2 .

Secular Non-degeneracy

By Proposition 3.2.4, When $C \neq G_2$, the non-degeneracy of the quadrupolar regularized frequency map is the same as the non-degeneracy of the quadrupolar frequency map, with respect to the parameters $(\mathcal{G}_1, \bar{\mathcal{I}}_1')$ and $(G_1, \bar{\mathcal{I}}_1)$ respectively, in which $\bar{\mathcal{I}}_1'$ denotes the corresponding action variable of \mathcal{F}_{quad} in the $(\mathcal{G}_1, \gamma_1)$ -plane (analogous to $\bar{\mathcal{I}}_1$ in F_{quad}). The non-degeneracy of the quadrupolar frequency maps is showed in Appendix D. In particular, the torsion does not vanish when $C - G_2 \rightarrow 0$. We thus obtain that after the reduction of the $SO(3)$ -symmetry, the quadrupolar regularized frequency map is non-degenerate on a dense open set in a neighborhood of $\{C = G_2\}$ in its phase space, for a dense open set

⁵Equivalently, we can also apply the iso-energetic KAM theorem (Corollary 2.2) in the quotient system and obtain the Lagrangian tori of \mathcal{F} in Π_{reg} by the symmetries.

of parameters. The frequency map of $\overline{\mathcal{F}_{sec}^{n,n'}}$ are $O(\alpha^4)$ perturbations of the quadrupolar regularized frequency map whose torsion is of order α^3 , thus these non-degeneracies also hold for their invariant tori near $\{\mathcal{G}_1 = \mathcal{G}_{1,min}\}$.

Thus for small enough α fixed, we deduce the existence of an open set $\Omega'' \in \Pi_{reg}$ containing a set of positive measure of degenerate inner ellipses, on which after symplectically reduced by the $SO(3)$ -symmetry, the frequency map of $\mathcal{F}_{Kep} + \overline{\mathcal{F}_{sec}^{n,n'}}$ is non-degenerate for any choice of n and n' . At the expense of restricting Ω'' a little bit, we may further suppose that the transformation $\tilde{\phi}^n \tilde{\psi}^{n'}$ is well-defined⁶.

Application of the Equivariant Iso-energetic KAM Theorem

After fixing C and being reduced by the $SO(3)$ -symmetry, the invariant tori of $\mathcal{F}_{Kep} + \overline{\mathcal{F}_{sec}^{n,n'}}$ near the point $\{\mathcal{G}_1 = \mathcal{G}_{1,min}\}$ are smoothly parametrized by $(\mathcal{L}_1, L_2, \mathcal{J}_1, G_2)$, in which for fixed $(\mathcal{L}_1, L_2, G_2)$, the variable \mathcal{J}_1 designates the area between the invariant curve (the invariant torus reduced by Keplerian \mathbb{T}^2 -symmetry and the symmetry of g_2) and the point $\{\mathcal{G}_1 = \mathcal{G}_{1,min}\}$ (See the discussions on P. 53 and Figure 2.5).

In Ω'' , for any fixed C and C_z , there exist $\bar{\gamma} > 0, \bar{\tau} \geq 5$, such that for a positive measure set of $(\mathcal{L}_1, L_2, \mathcal{J}_1, G_2, l'_1, l'_2)$, the corresponding Lagrangian torus of

$$F_{Kep} + \overline{F_{sec}^{n,n'}} + l'_1 C + l'_2 C_z$$

is $(\alpha^3 \bar{\gamma}, \bar{\tau})$ -Diophantine invariant Lagrangian tori of $F_{Kep} + \overline{F_{sec}^{n,n'}} + l'_1 C + l'_2 C_z$ form a set of positive measure whose measure is uniformly bounded for small α (Example-Condition 2.1). For any such torus with actions $(\mathcal{L}_1^0, L_2^0, \mathcal{J}_1^0, G_2^0)$ and parameters $l'_1 = l'_1{}^0, l'_2 = l'_2{}^0$, there exists $\lambda > 0$ independent of α , such that if we set

$$(\mathcal{L}_1, L_2, \mathcal{J}_1, G_2) = \underline{\tilde{\phi}}^\lambda(\mathcal{L}_1^\lambda, L_2^\lambda, \mathcal{J}_1^\lambda, G_2^\lambda) := (\mathcal{L}_1^0 + \lambda \mathcal{L}_1^\lambda, L_2^0 + \lambda L_2^\lambda, \mathcal{J}_1^0 + \lambda \mathcal{J}_1^\lambda, G_2^0 + \lambda G_2^\lambda),$$

and $l''_1 = l'_1 - l'_1{}^0, l''_2 = l'_2 - l'_2{}^0$, then for every $(\mathcal{L}_1^\lambda, L_2^\lambda, \mathcal{J}_1^\lambda, G_2^\lambda, l''_1, l''_2) \in B_1^6$, the frequency map of the torus of $\mathcal{F}_{Kep} + \overline{\mathcal{F}_{sec}^{n,n'}}$ with parameter $(\mathcal{L}_1^\lambda, L_2^\lambda, \mathcal{J}_1^\lambda, G_2^\lambda, l''_1, l''_2)$ is non-degenerate. Set

$$\begin{aligned} N^o &= \underline{\tilde{\phi}}^{\lambda*}(\mathcal{F}_{Kep} + \overline{\mathcal{F}_{sec}^{n,n'}}), \\ N^l &= \underline{\tilde{\phi}}^{\lambda*}(\mathcal{F}_{Kep} + \overline{\mathcal{F}_{sec}^{n,n'}} + \mathcal{F}_{secpert}^{n'+1} + \mathcal{F}_{comp}^n), \\ \hat{N}^o &= \underline{\tilde{\phi}}^{\lambda*}(\mathcal{F}_{Kep} + \overline{\mathcal{F}_{sec}^{n,n'}} + l'_1 C + l'_2 C_z), \\ \hat{N}^l &= \underline{\tilde{\phi}}^{\lambda*}(\mathcal{F}_{Kep} + \overline{\mathcal{F}_{sec}^{n,n'}} + l'_1 C + l'_2 C_z + \mathcal{F}_{secpert}^{n'+1} + \mathcal{F}_{comp}^n). \end{aligned}$$

We take $\iota = (\mathcal{L}_1^0, L_2^0, \mathcal{J}_1^0, G_2^0, l'_1{}^0, l'_2{}^0)$ as parameters. We apply Corollary 2.4 in this setting for any C, C_z satisfying $\{C/3 < C_z < 2C/3\}$ of Π_{reg} ⁷ (which implies in particular that for small enough α , the Delaunay elements of the outer ellipse are always well-defined).

By applying Corollary 2.4 and varying C and C_z , we get a set of positive measure of 6-dimensional invariant Lagrangian tori in Π_{reg} for which $|C - G_2|$ remain small⁸ on the zero-energy surface of $\underline{\tilde{\phi}}^{\lambda*} \tilde{\psi}^{n'*} \tilde{\phi}^{n*} \mathcal{F}$ (and hence of \mathcal{F}). The flow of \mathcal{F} on these invariant tori are, however, not ergodic: The frequency conjugate to C_z are always zero, and the

⁶Explicit expression of F_{quad} shows that this restriction does not avoid $\{C = G_2\}$ entirely.

⁷The restriction of the direction of \vec{C} is non-essential. We may recover other cases by rotations.

⁸The invariant tori of $\tilde{\psi}^{n'*} \tilde{\phi}^{n*} \mathcal{F}$ for which $|C - G_2|$ is large are not important for the existence of quasi-periodic almost-collision orbits.

frequency conjugate to C might be rationally dependent with other non-zero frequencies. The flow is therefore ergodic either on some 4-dimensional or 5-dimensional tori contained in these 6-dimensional tori, depending on whether the frequency of the rotation around the direction of \vec{C} is rationally dependent with the other four non-zero frequencies or not.

Theorem 3.1. *When the semi major axes ratio α is small, there exists a set of positive measure of 6-dimensional invariant Lagrangian tori on the zero-energy surface of the regularized system \mathcal{F} in Π_{reg} , which are small deformations of the invariant Lagrangian tori of $\mathcal{F}_{Kep} + \alpha^3 \mathcal{F}_{quad}$, and for which $|C - G_2|$ are small.*

3.2.9 Transversality of the Lagrangian Tori with the Collision Set

In this subsection, we make the conventions that transverse intersection always means non-empty transverse intersection, and all the invariant tori mentioned are invariant Lagrangian tori.

In the regularized phase space $\Pi_{reg} = V^0 \times T^*(\mathbb{R}^3 \setminus \{0\})$, the collision set $\mathcal{C}ol$ is a smooth codimension 3 submanifold (as seen on P. 71). The goal of this subsection is to show that there exists a set of positive measure of invariant tori of \mathcal{F} on its zero-energy hypersurface (obtained by equivariant KAM theorem) intersecting $\mathcal{C}ol$ in manifolds of codimension 3 in these tori.

We see from Subsection 3.2.6 that

$$\tilde{\psi}^{n'} * \tilde{\phi}^{n'} \mathcal{F} = \mathcal{F}_{Kep} + \overline{\mathcal{F}_{sec}^{n,n'}} + h.o.t..$$

As in Subsection 2.1.3 (P. 49), the transformation $\tilde{\phi}^{n'} \tilde{\psi}^{n'}$ is dominated by $\tilde{\psi}^3$, which is of order α .

To reach our goal of this subsection, it suffices to show that $\mathcal{C}ol' := (\tilde{\psi}^3)^{-1}(\mathcal{C}ol)$ intersects transversely an open set of invariant tori in the zero-energy hypersurface of an integrable approximating system $\mathcal{F}_{Kep} + \overline{\mathcal{F}_{sec}^{n,n'}}$ of $\tilde{\psi}^{n'} * \tilde{\phi}^{n'} \mathcal{F}$ in Π_{reg} , and that this transversality is preserved under perturbations.

For any $\tilde{C} > 0$, denote by $\Pi_{reg}^{\tilde{C}}$ the 11-dimensional subspace of Π_{reg} with $C = \tilde{C}$. We denote by $\underline{\mathcal{C}ol}$ the (transverse) intersection of $\mathcal{C}ol$ and $\Pi_{reg}^{\tilde{C}}$. The intersection of $\{C = G_2\}$ with $\Pi_{reg}^{\tilde{C}}$ is denoted by $\underline{\{C = G_2\}}$: it is the transverse intersection of $\{G_2 = \tilde{C}\}$ with $\{C = G_2\}$.

Lemma 3.2.1. For small enough α , any invariant torus of $\mathcal{F}_{Kep} + \overline{\mathcal{F}_{sec}^{n,n'}}$ for which $C = G_2 = \tilde{C}$ intersects $\underline{\mathcal{C}ol}$ transversely in $\underline{\{C = G_2\}}$.

Proof. In Section 2.2, we observed that in the submanifold of the secular space determined by $\{C = G_2\}$, after being symplectically reduced by the $SO(3) \times SO(2)$ -symmetry, any 1-dimensional periodic orbit of F_{quad} is transverse to the segment $\{e_1 = 1\}$ (or $\{G_1 = 0\}$) representing the degenerate ellipses (see Figure 2.5). By Proposition 3.2.4, the same phenomenon holds for the system \mathcal{F}_{quad} . Therefore, in $\underline{\{C = G_2\}} \subset \Pi_{reg}^{\tilde{C}}$, any invariant torus $\tilde{A}_{T,0}$ of $\mathcal{F}_{Kep} + \alpha^3 \mathcal{F}_{quad}$ must be transverse to the codimension 1 submanifold $\{e_1 = 1\}$ of $\underline{\{C = G_2\}}$. Indeed, if this is not the case, then at any intersection point \hat{p} , we must have $T_{\hat{p}} \tilde{A}_{T,0} \subset T_{\hat{p}} \{e_1 = 1\}$, which, after symplectic reduction by the \mathbb{T}^2 -symmetry of the Keplerian motions and the $SO(3) \times SO(2)$ -symmetry, implies that the tangent space of the resulting periodic orbit is contained in the tangent space of (the quotient of) $\{e_1 = 1\}$. Contradiction.

Moreover, the intersection of $\tilde{A}_{T,0}$ with $\{e_1 = 1\}$ is foliated by the S^1 -orbits of δ_1 (defined in Subsection 3.2.3). Hence, at any intersection point $\hat{p} \in \tilde{A}_{T,0} \cap \{e_1 = 1\}$,

removing the tangent direction of such an S^1 -orbit in $T_{\tilde{p}}\tilde{A}_{T,0}$ does not change the sum $T_{\tilde{p}}\tilde{A}_{T,0} + T_{\tilde{p}}\{e_1 = 1\} = T_{\tilde{p}}\{C = G_2\}$. In particular, $\tilde{A}_{T,0}$ is also transverse to the set $\underline{\mathcal{C}ol} = \{e_1 = 1\} \cap \{\delta_1 = 0\}$ in $\{C = G_2\}$.

In $\{C = G_2\}$, the invariant tori of $\mathcal{F}_{Kep} + \overline{\mathcal{F}_{sec}^{n,n'}}$ are just small enough deformations of the invariant tori of $\mathcal{F}_{Kep} + \alpha^3\mathcal{F}_{quad}$, therefore they are also transverse to the set $\underline{\mathcal{C}ol}$ in $\{C = G_2\}$. \square

However, since any of these invariant tori and $\underline{\mathcal{C}ol}$ lies in $\{C = G_2\}$, they are not transverse in $\Pi_{reg}^{\tilde{C}}$.

In Π_{reg} , we take Delaunay coordinates $(L_2, l_2, G_2, g_2, H_2, h_2)$ on $T^*(\mathbb{R}^3 \setminus \{0\})$, and take any convenient coordinates on V^0 in the neighborhood of $\mathcal{C}ol$.

At any intersection point \tilde{p}_0 of any invariant torus $A_{T,0}$ of $\mathcal{F}_{Kep} + \overline{\mathcal{F}_{sec}^{n,n'}}$ (in $C = \tilde{C}$) with $\underline{\mathcal{C}ol}$, we have the direct sum decomposition

$$T_{\tilde{p}_0}\Pi_{reg}^{\tilde{C}} = E^9 \oplus E_{G_2, g_2},$$

of the tangent space at \tilde{p}_0 to $\Pi_{reg}^{\tilde{C}}$, in which E^9 is the 9-dimensional subspace tangent to $\{C - G_2 = 0, g_2 = g_2(\tilde{p}_0)\}$, and E_{G_2, g_2} is the 2-dimensional subspace generated by $\frac{\partial}{\partial G_2}(\tilde{p}_0)$ and $\frac{\partial}{\partial g_2}(\tilde{p}_0)$. We observe the following facts:

- $E^9 \subset T_{\tilde{p}_0}\underline{\mathcal{C}ol} + T_{\tilde{p}_0}A_{T,0} = T_{\tilde{p}_0}\{C = G_2\}$, and
- $\frac{\partial}{\partial g_2}(\tilde{p}_0) \in T_{\tilde{p}_0}A_{T,0} \cap T_{\tilde{p}_0}\underline{\mathcal{C}ol}$.

The first assertion comes from the transversality of $A_{T,0}$ with $\underline{\mathcal{C}ol}$ in $\{C = G_2\}$, the second one comes from the fact that G_2 is a first integral of $\mathcal{F}_{Kep} + \overline{\mathcal{F}_{sec}^{n,n'}}$.

The transformation $\tilde{\psi}^3$ is the time 1-map of a function $\hat{\mathcal{H}}$ which satisfies the cohomological equation:

$$\tilde{\nu}_{g_2} \frac{\partial \hat{\mathcal{H}}}{\partial g_2} = \alpha(\mathcal{F}_{sec}^{1,3} - \frac{1}{2\pi} \int_0^{2\pi} \mathcal{F}_{sec}^{1,3} d\bar{g}_2),$$

in which $\tilde{\nu}_{g_2}$ denotes the frequency of g_2 in the system \mathcal{F}_{quad} .

Lemma 3.2.2. There exists a small real number $\tilde{\varepsilon}$ independent of α , and a non empty open subset $\underline{\mathcal{C}ol}_0$ of $\underline{\mathcal{C}ol}$ whose density tends to 1 locally in $\underline{\mathcal{C}ol}$ when $\tilde{\varepsilon} \rightarrow 1$, such that

$$\left| \frac{\partial^2 \hat{\mathcal{H}}}{\partial g_2^2} \Big|_{\underline{\mathcal{C}ol}_0} \right| > 2\alpha \cdot \tilde{\varepsilon}.$$

Proof. It suffices to show that the function $\frac{\partial \hat{\mathcal{H}}}{\partial g_2} \Big|_{\underline{\mathcal{C}ol}}$ depends non-trivially on g_2 . Indeed, if this is the case, then the analytic function $\frac{1}{\alpha} \frac{\partial^2 \hat{\mathcal{H}}}{\partial g_2^2}$ is not identically zero on $\underline{\mathcal{C}ol}$, and thus there exists $\tilde{\varepsilon}$ which bounds the absolute value of this function from below on a open set whose density tends to 1 locally in $\underline{\mathcal{C}ol}$ when $\tilde{\varepsilon} \rightarrow 0$.

To this end, we just have to show that the function $\mathcal{F}_{sec}^{1,3}|_{\underline{\mathcal{C}ol}} = K.S.*F_{sec}^{1,3}|_{\underline{\mathcal{C}ol}}$ depends non-trivially on g_2 . Moreover, since $K.S.$ does not change the orbital elements of the outer ellipse, we just have to verify that the analytic function $F_{sec}^{1,3}$ (Corollary 3.5 confirms that

it extends analytically to degenerate inner ellipses) restricted to $\underline{\mathcal{C}ol}$ depends non-trivially on g_2 .

When the elements i_1, \bar{g}_1 and \bar{g}_2 are well-defined, we see from [LB10] that,

$$\begin{aligned} F_{sec}^{1,3} = & -X_0^{3,1} X_0'^{-4,1} [(-\frac{3}{2}\underline{\mu} + \frac{15}{4}\underline{\nu}^2\underline{\mu} + \frac{15}{8}\underline{\mu}^3) \cos(\bar{g}_1 - \bar{g}_2) \\ & + (-\frac{3}{2}\underline{\nu} + \frac{15}{4}\underline{\mu}^2\underline{\nu} + \frac{15}{8}\underline{\nu}^3) \cos(\bar{g}_1 + \bar{g}_2)] \\ & - \frac{15}{8} X_0^{3,3} X_0'^{-4,1} (\underline{\nu}^2\underline{\mu} \cos(3\bar{g}_1 + \bar{g}_2) + \underline{\nu}\underline{\mu}^2 \cos(3\bar{g}_1 - \bar{g}_2)). \end{aligned}$$

In the above, $\underline{\mu} = \cos^2(\frac{i_1 - i_2}{2})$, $\underline{\nu} = \sin^2(\frac{i_1 - i_2}{2})$, $X_0^{3,1}, X_0^{3,3}$ are two Hansen coefficients depending of e_1 (both of them do not vanish at $e_1 = 1$) and $X_0'^{-4,1} \neq 0$ is a Hansen coefficient of e_2 .

Unfortunately, when the inner ellipse degenerates, $i_1, \bar{g}_1, \bar{g}_2$ are not well-defined. Nevertheless, we observe that if we restrict $F_{sec}^{1,3}$ to (direct) coplanar ellipse pairs, then $i_1 - i_2 = 0$ (and hence $\underline{\mu} = 1, \underline{\nu} = 0$) and $\bar{g}_2 - \bar{g}_1 = g_2 - g_1 + \pi$ with both angles g_1, g_2 are well-defined even the inner ellipse degenerates, and $F_{sec}^{1,3}$ is restricted to

$$F_{sec}^{1,3} = \frac{3}{8} X_0^{3,1} X_0'^{-4,1} \cos(g_1 - g_2).$$

This function depends non-trivially on g_2 when further restricted to $e_1 = 1$ and $C = \tilde{C}$. This implies that the analytic function $F_{sec}^{1,3}$ restricted to $\underline{\mathcal{C}ol}$ depends non-trivially on g_2 . \square

We now determine the transformation $\tilde{\phi}^3$ more precisely: we ask this transformation to preserve C . To this end, we only have to ask that $\hat{\mathcal{H}}$ is invariant under rotations. Notice that $\tilde{\nu}_{g_2}$ is invariant under the rotations. From [LB10], we see that on (a dense open subset of Π_{reg} , and thus on) Π_{reg} where the angle g_2 is well-defined, the function $F_{sec}^{1,3}(g_2)$ is a linear combination of $\cos g_2$ and $\sin g_2$, with coefficients independent of g_2 . Therefore, the same holds for the function $\mathcal{F}_{sec}^{1,3}(g_2)$. We thus set

$$\hat{\mathcal{H}} = -\frac{\alpha}{\tilde{\nu}_{g_2}} \mathcal{F}_{sec}^{1,3}(g_2 + \frac{\pi}{2}).$$

Let $\underline{\mathcal{C}ol}'_0 = (\tilde{\phi}^3)^{-1}(\underline{\mathcal{C}ol}_0)$. It is an open subset of $\underline{\mathcal{C}ol}' = (\tilde{\phi}^3)^{-1}(\underline{\mathcal{C}ol}) \subset \Pi_{reg}^{\tilde{C}}$.

Lemma 3.2.3. For small enough α , any invariant torus of $\mathcal{F}_{Kep} + \overline{\mathcal{F}_{sec}^{n,n'}}$ intersecting $\underline{\mathcal{C}ol}'_0$ is transverse to $\underline{\mathcal{C}ol}'$ in Π_{reg} .

Proof. Any $\tilde{p} \in \underline{\mathcal{C}ol}'_0$ can be written as $\tilde{p} = (\tilde{\phi}^3)^{-1}(\tilde{p}_0)$ for some $\tilde{p}_0 \in \underline{\mathcal{C}ol}_0$. Let \tilde{A} be the invariant torus which intersects $\underline{\mathcal{C}ol}'_0$ at \tilde{p} . We decompose $T_{\tilde{p}}\Pi_{reg}^{\tilde{C}}$ as

$$T_{\tilde{p}_0}\Pi_{reg}^{\tilde{C}} = (\tilde{\phi}^3)_*^{-1} E^9 \oplus E'_{G_2, g_2},$$

in which E'_{G_2, g_2} is the 2-dimensional space generated by $\frac{\partial}{\partial G_2}(\tilde{p})$ and $\frac{\partial}{\partial g_2}(\tilde{p})$. We choose a basis $(\mathbf{e}_1, \dots, \mathbf{e}_9)$ of $(\tilde{\phi}^3)_*^{-1} E^9$, each of which is $O(\alpha)$ -close to a vector in $T_{\tilde{p}}\underline{\mathcal{C}ol}' + T_{\tilde{p}}\tilde{A}$. In the basis $(\frac{\partial}{\partial g_2}(\tilde{p}), \frac{\partial}{\partial G_2}(\tilde{p}), \mathbf{e}_1, \dots, \mathbf{e}_9)$ of $T_{\tilde{p}}\Pi_{reg}^{\tilde{C}}$, we may write $\frac{\partial}{\partial g_2}(\tilde{p}) \in T_{\tilde{p}}\tilde{A}$ as $(1, 0, \dots, 0)$.

By Lemma 3.2.2, for α small enough, $\left| \frac{\partial^2 \tilde{\mathcal{H}}}{\partial \tilde{g}_2^2} \right| > \alpha \cdot \tilde{\varepsilon}$ in an $O(\alpha)$ -neighborhood of \tilde{p}_0 containing \tilde{p} . Hence we may write $(\tilde{\phi}^3)^{-1} \frac{\partial}{\partial g_2}(\tilde{p}) \in T_{\tilde{p}} \mathcal{C}ol'$ as $(1+O(\alpha), \tilde{\alpha}, O(\alpha), \dots, O(\alpha))$, in which $|\tilde{\alpha}| > \alpha \cdot \tilde{\varepsilon}$.

In such a way, we have obtained 11 vectors in $T_{\tilde{p}} \mathcal{C}ol' + T_{\tilde{p}} \tilde{A}$, which, written as row vectors, form a matrix of the form

$$\begin{pmatrix} 1 & 0 & \vec{0}_9 \\ 1+O(\alpha) & \tilde{\alpha} & O(\alpha)_9 \\ O(\alpha)_9^T & O(\alpha)_9^T & Id_{9,9} + O(\alpha)_{9,9} \end{pmatrix},$$

in which $\vec{0}_9$ is the 1×9 zero matrix, $O(\alpha)_9$ (resp. $O(\alpha)_{9,9}$) is a 1×9 (resp. 9×9) matrix with only $O(\alpha)$ entries, and $Id_{9,9}$ is the 9×9 identity matrix.

The determinant of this matrix is $\tilde{\alpha} + O(\alpha^2)$, which is non-zero provided α is small enough. This implies $T_{\tilde{p}} \mathcal{C}ol' + T_{\tilde{p}} \tilde{A} = T_{\tilde{p}} \Pi_{reg}^{\tilde{C}}$, *i.e.* $\mathcal{C}ol'$ is transverse to \tilde{A} at \tilde{p} in $\Pi_{reg}^{\tilde{C}}$.

The vector $\frac{\partial}{\partial G_2} = (0, 1, \vec{0}_9)$ is tangent to $\mathcal{C}ol$, thus $T_{\tilde{p}} \mathcal{C}ol'$ contains a vector of the form $(O(\alpha), 1+O(\alpha), O(\alpha)_9)$. Since $\frac{\partial}{\partial G_2}$ is transverse to $\Pi_{reg}^{\tilde{C}}$, any vector of the form $(O(\alpha), 1+O(\alpha), O(\alpha)_9)$ is transverse to $\Pi_{reg}^{\tilde{C}}$. Thus \tilde{A} is transverse to $\mathcal{C}ol'$ at \tilde{p} in Π_{reg} . \square

The action variables \mathcal{L}_1 and L_2 are first integrals of the system $\mathcal{F}_{Kep} + \overline{\mathcal{F}_{sec}^{n,n'}}$; moreover, they are invariant under $(\tilde{\phi}^3)^{-1}$. Therefore, the analysis in this subsection remains valid for any fixed \mathcal{L}_1 and L_2 (with α small enough), and in particular for those invariant tori for which \mathcal{L}_1 and L_2 satisfies $\mathcal{F}_{Kep}(\mathcal{L}_1, L_2) = 0$, thus $\mathcal{F}_{Kep} + \overline{\mathcal{F}_{sec}^{n,n'}} = O(\alpha^3)$. Since $(\tilde{\phi}^3)^{-1}$ preserves \mathcal{L}_1 and L_2 , it may only change the energy at order $O(\alpha^3)$. We may then make proper $O(\alpha^3)$ -modifications of \mathcal{L}_1 to obtain an open set of invariant tori on the zero-energy hypersurface of this system intersecting the set $\mathcal{C}ol'$ transversely.

Therefore, according to what we have said at the beginning of this subsection, after applying the equivariant iso-energetic KAM theorem (Subsection 3.2.8), a set of positive measure of invariant Lagrangian tori on the zero-energy surface of \mathcal{F} intersects $\mathcal{C}ol$ transversely.

3.2.10 Intersections of the Collision Set with Ergodic Tori

The transversality of a 6-dimensional Lagrangian torus of \mathcal{F} with $\mathcal{C}ol$ entails that all of its 4-dimensional or 5-dimensional ergodic tori must intersect $\mathcal{C}ol$. Indeed, in each 6-dimensional torus, any two of its lower dimensional ergodic tori can be transformed by a transformation in the group of symmetry \mathbb{T}^2 (conservations of C and C_z) of the system \mathcal{F} . The set $\mathcal{C}ol$ is also invariant under the action of \mathbb{T}^2 on Π_{reg} . Therefore if $\mathcal{C}ol$ does not intersect some ergodic torus, then it cannot intersect any, and consequently it cannot intersect this 6-dimensional torus. Note that $\mathcal{C}ol$ has codimension 3 in $\Pi_{reg}^{\tilde{C}}$, hence the intersection of the collision set with the 6-dimensional Lagrangian tori of \mathcal{F} is a 3-dimensional manifold.

Every such 6-dimensional Lagrangian torus is foliated by 5-dimensional invariant subtori each of which can be obtained from any other by a rotation around the direction of \vec{C} . The intersection of $\mathcal{C}ol$ with any such subtorus is therefore the intersection of $\mathcal{C}ol$ with the 6-dimensional Lagrangian torus reduced by the free $SO(2)$ -action conjugate to C_z , which is a 2-dimensional submanifold of the 5-dimensional subtorus. If this 5-dimensional

torus is not ergodic, then it is foliated by 4-dimensional ergodic subtori, each of which can be obtained from any other by a rotation around \vec{C} . This gives a free $SO(2)$ -action on the intersection of Col with the 5-dimensional tori, hence the intersection of Col with each 4-dimensional ergodic torus is a 1-dimensional manifold, which has codimension 3 in the ergodic torus. Therefore, the intersections of Col with any 4 or 5-dimensional ergodic subtorus has codimension 3 in the ergodic torus.

By a measure argument, we have the following lemma:

Lemma 3.2.4. Let \mathbb{T}^n be an n -dimensional torus and \mathbf{K} be a submanifold of \mathbb{T}^n whose codimension is at least 2. Let $\tilde{\theta} = (\tilde{\theta}_1, \dots, \tilde{\theta}_n)$ be the angular coordinates on \mathbb{T}^n ; then almost all the orbits of the linear flow $\frac{d}{dt}\tilde{\theta} = \tilde{v}$, $\tilde{v} \in \mathbb{R}^n$ do not intersect \mathbf{K} .

Proof. By Hypothesis, the set $\mathbf{K} \times \mathbb{R} \subset \mathbb{T}^n \times \mathbb{R}$ has Hausdorff dimension at most $n - 1$. The set \mathbf{K}' formed by orbits intersecting \mathbf{K} is the image of $\mathbf{K} \times \mathbb{R}$ under the smooth mapping

$$\mathbb{T}^n \times \mathbb{R} \rightarrow \mathbb{T}^n \quad (\tilde{\theta}(0), t) \mapsto \tilde{\theta}(t),$$

which has thus Hausdorff dimension at most $n - 1$. Therefore \mathbf{K}' has zero measure in \mathbb{T}^n . \square

3.2.11 Conclusion

We have thus proved the following theorem:

Theorem 3.2. *There exists a set of positive measure of quasi-periodic almost-collision orbits on each negative energy surface of the spatial three-body problem, which give rise to a set of positive measure of quasi-periodic almost-collision orbits in the phase space. Along such an orbit, the inner pair gets arbitrarily close to each other infinitely many times, but the motion remains collisionless.*

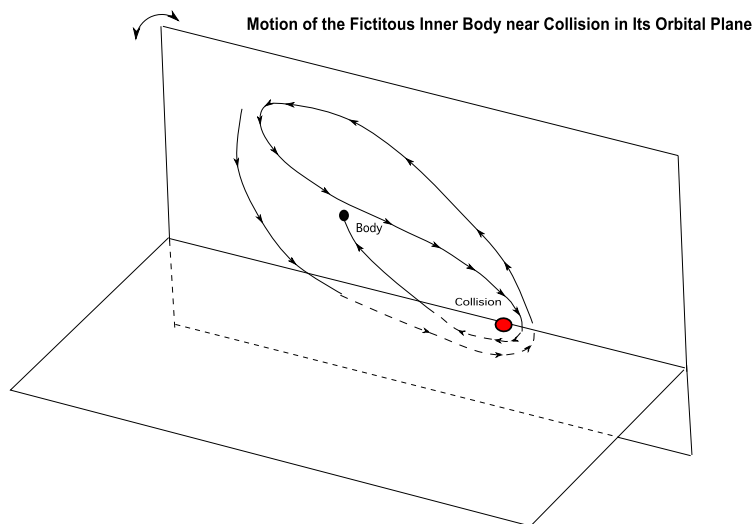

Figure 3.1: Motion of a fictitious inner body in an almost-collision orbit

Appendices

A Estimates of the Perturbing Functions

In this appendix, we present some estimates of the perturbing functions.

We first recall some hypothesis and notations from the beginning of Section 2.1:

- the masses m_0, m_1, m_2 are fixed arbitrarily;
- Let $e_1^\vee < e_1^\wedge, e_2^\vee < e_2^\wedge$ be positive numbers. We assume that

$$0 < e_1^\vee < e_1 < e_1^\wedge < 1, \quad 0 < e_2^\vee < e_2 < e_2^\wedge < 1;$$

The assumption that e_1 is bounded away from 1 will be dropped once we considers the regularized system.

- Let $a_1^\vee < a_1^\wedge$ be two positive real numbers. We assume that

$$a_1^\vee < a_1 < a_1^\wedge;$$

- $\alpha = \frac{a_1}{a_2} < \alpha^\wedge := \min\left\{\frac{1 - e_2^\wedge}{80}, \frac{1 - e_2^\wedge}{2\sigma_0}, \frac{1 - e_2^\wedge}{2\sigma_1}\right\};$

By the relations

$$a_i(1 - e_i) \leq \|Q_i\| \leq a_i(1 + e_i) \leq 2a_i,$$

we obtain in particular that $\frac{\|Q_1\|}{\|Q_2\|} \leq \frac{1}{\hat{\sigma}}$, for $\hat{\sigma} = \max\{\sigma_0, \sigma_1\}$.

Lemma A.1. (Lemma 1.1 in [Féj02]) The expansion

$$F_{pert} = -\mu_1 m_2 \sum_{n \geq 2} \sigma_n P_n(\cos \zeta) \frac{\|Q_1\|^n}{\|Q_2\|^{n+1}}$$

is convergent in $\frac{\|Q_1\|}{\|Q_2\|} \leq \frac{1}{\hat{\sigma}}$, (and therefore when $\alpha < \alpha^\wedge$) where P_n is the n-th Legendre polynomial, ζ is the angle between the two vectors Q_1 and Q_2 , $\hat{\sigma} = \max\{\sigma_0, \sigma_1\}$ and $\sigma_n = \sigma_0^{n-1} + (-1)^n \sigma_1^{n-1}$.

As in [Féj02], we have:

Lemma A.2.

$$\begin{aligned} |F_{pert}| &\leq \text{Cst} \alpha^3, \\ |\mathcal{F}_{pert}| &\leq \text{Cst}' \alpha^3, \end{aligned}$$

for some constant Cst only depending on $m_0, m_1, m_2, e_1^\vee, e_1^\wedge, e_2^\vee, e_2^\wedge$ and Cst' only depending on $m_0, m_1, m_2, e_1^\wedge, e_2^\vee, e_2^\wedge$.

Proof. Since ([Kel58], P. 129)

$$|P_n(\cos \zeta)| \leq (\sqrt{2} + 1)^n \leq 3^n,$$

and

$$\begin{aligned} |\sigma_n| &= |\sigma_0^{n-1} + (-1)^n \sigma_1^{n-1}| \\ &\leq |\sigma_0^{n-1}| + |\sigma_1^{n-1}| \\ &= \frac{m_0^{n-1}}{(m_0 + m_1)^{n-1}} + \frac{m_1^{n-1}}{(m_0 + m_1)^{n-1}} < 1, \end{aligned}$$

we obtain

$$\begin{aligned} |F_{pert}| &= \mu_1 m_2 \left| \sum_{n \geq 2} \sigma_n P_n(\cos \zeta) \frac{\|Q_1\|^n}{\|Q_2\|^{n+1}} \right| \\ &\leq \mu_1 m_2 \sum_{n \geq 2} 3^n \frac{\|Q_1\|^n}{\|Q_2\|^{n+1}} \\ &\leq \frac{\mu_1 m_2}{a_1^\vee 3(1 - e_1^\vee)} \sum_{n \geq 2} \frac{3^{n+1} \alpha^{n+1}}{(1 - e_2^\wedge)^{n+1}} \\ &\leq \frac{\mu_1 m_2}{a_1^\vee 3(1 - e_1^\vee)} \frac{3^3 \alpha^3}{(1 - e_2^\wedge)^2} \frac{1}{1 - e_2^\wedge - 3\alpha}. \end{aligned}$$

The conclusion thus follows when $\alpha < \frac{1 - e_2^\wedge}{6}$. In particular, the constant Cst is uniform in the region of the phase space given by the hypothesis in the beginning of this appendix.

The estimation on $\mathcal{F}_{pert} = K.S.*(\|Q_1\|F_{pert})$ is analogous. Note that the angle ζ is well-defined only on a dense open subset of the region. By continuity, the estimation extends even to the subset of the region where the angle is not well-defined. \square

In the following lemma, we regard F_{pert} as a function of Delaunay variables

$$(L_1, l_1, L_2, l_2, G_1, g_1, G_2, g_2, H_1, h_1, H_2, h_2) \in \mathcal{P}^* \subset \mathbb{T}^6 \times \mathbb{R}^6,$$

in which \mathcal{P}^* is defined, with the hypothesis of this appendix, by further asking that all the Delaunay variables are well defined; we regard \mathcal{F}_{pert} as a function of

$$(\mathcal{P}_0, \theta_0, \mathcal{P}_1, \theta_1, \mathcal{P}_2, \theta_2, \mathcal{P}_3, \theta_3, L_2, l_2, G_2, g_2, H_2, h_2) \in \mathcal{P}'^* \subset \mathbb{T}^7 \times \mathbb{R}^7.$$

in which \mathcal{P}'^* is defined by dropping the condition that e_1 is bounded from 1 in the hypothesis of this appendix, and further asking that all these variables are well defined. In the following lemma, all variables are considered as complex, thus \mathcal{P}^* (resp. \mathcal{P}'^*) is a subset of $T_{\mathbb{C}} = \mathbb{C}^6/\mathbb{Z}^6 \times \mathbb{C}^6$ (resp. $\mathbb{C}^7/\mathbb{Z}^7 \times \mathbb{C}^7$). The modulus of a complex number is denoted by $|\cdot|$.

Lemma A.3. There exists a positive number $s > 0$, such that $|F_{pert}| \leq \text{Cst} |\alpha|^3$ ($|\mathcal{F}_{pert}| \leq \text{Cst}' |\alpha|^3$) in the s -neighborhood $T_{\mathcal{P}^*,s}$ (resp. $T_{\mathcal{P}'^*,s}$) of \mathcal{P}^* (resp. \mathcal{P}'^*) for some constant Cst independent of α .

Proof. By continuity, there exists a positive number s , such that in $T_{\mathcal{P}^*,s}$, we have uniformly

$$|\cos \zeta| \leq 2; \quad \left| \frac{1}{\|Q_1\|} \right| \leq \frac{2}{a_1^\vee(1 - e^\vee)}; \quad \left| \frac{\|Q_1\|}{\|Q_2\|} \right| \leq \frac{4|\alpha|}{1 - e_2^\wedge}.$$

in which $\cos \zeta$, $\|Q_1\|$ and $\|Q_2\|$ are considered as the corresponding analytically extensions of the original functions.

Using Bonnet's recursion formula of Legendre polynomials

$$(n+1)P_{n+1}(\cos \zeta) = (2n+1) \cos \zeta P_n(\cos \zeta) - nP_{n-1}(\cos \zeta),$$

by induction on n , we obtain $|P_n(\cos \zeta)| \leq 5^n$.

Thus

$$\begin{aligned} |F_{pert}| &= \mu_1 m_2 \left| \sum_{n \geq 2} \sigma_n P_n(\cos \zeta) \frac{\|Q_1\|^n}{\|Q_2\|^{n+1}} \right| \\ &\leq \mu_1 m_2 \left| \frac{1}{\|Q_1\|} \right| \left| \sum_{n \geq 2} 5^n \left| \frac{\|Q_1\|}{\|Q_2\|} \right|^{n+1} \right| \\ &\leq \frac{\mu_1 m_2}{a_1^\vee 5(1-e_1^\vee)} \sum_{n \geq 2} \frac{5^{n+1} 4^{n+1} |\alpha|^{n+1}}{(1-e_2^\wedge)^{n+1}} \\ &\leq \frac{\mu_1 m_2}{a_1^\vee 5(1-e_1^\vee)} \frac{20^3 |\alpha|^3}{(1-e_2^\wedge)^2} \frac{1}{1-e_2^\wedge - 20|\alpha|}. \end{aligned}$$

It is then sufficient to impose $\alpha \leq \alpha^\wedge$ and s small enough to ensure that $|\alpha| \leq \frac{1-e_2^\wedge}{40}$.

The estimate of $\mathcal{F}_{pert} = K.S.^*(\|Q_1\|F_{pert})$ is obtained analogously, except for that we do not need to estimate $\left| \frac{1}{\|Q_1\|} \right|$. Again, the angle ζ is well-defined only on a dense open subset of the region. By continuity, the estimation extends even to the subset of the region where the angle is not well-defined. \square

B Analyticity of F_{quad} near Degenerate Inner Ellipses

In this appendix, we show by direct calculation that F_{quad} extends to an analytic function in the neighborhoods of degenerate inner ellipses. This fact is confirmed by Corollary 3.5. Nevertheless, an explicit formula is yet helpful to clarify the whole strategy.

The space of (inner) spatial Keplerian ellipse is homeomorphic to $S^2 \times S^2$, which is a symplectic manifold once equipped with half of the difference of the area forms of the two S^2 -components. The Pauli-Souriau coordinates for the inner spatial Keplerian ellipse $(A_1, A_2, A_3, B_1, B_2, B_3)$ satisfying $A_1^2 + A_2^2 + A_3^2 = B_1^2 + B_2^2 + B_3^2 = L_1$ are just the Descartes coordinates for two points on $S_{L_1}^2 \subset \mathbb{R}^3$ (we set the radius of the sphere $S_{L_1}^2$ to be $\sqrt{L_1}$). The angular momentum of the inner ellipse is then $\vec{C}_1 = (\frac{A_1-B_1}{2}, \frac{A_2-B_2}{2}, \frac{A_3-B_3}{3})$, the direction of the inner pericentre is the direction of $(-\frac{A_1+B_1}{2}, -\frac{A_2+B_2}{2}, -\frac{A_3+B_3}{3})$, and the direction of the inner ascending node is the direction of $(\frac{B_2-A_2}{2}, \frac{A_1-B_1}{2}, 0)$.

Following Lemma A.1, we expand F_{pert} as

$$F_{pert} = \frac{\mu_1 m_2}{2} \frac{\|Q_1\|^2}{\|Q_2\|^3} (3 \cos^2 \zeta - 1) + \frac{1}{\|Q_2\|} O\left(\frac{\|Q_1\|^3}{\|Q_2\|^3}\right).$$

A calculation leads to

$$F_{quad} = \frac{\mu_1 m_2}{2\alpha^3} \int_{\mathbb{T}^2} \frac{\|Q_1\|^2}{\|Q_2\|^3} (3 \cos^2 \zeta - 1) dl_1 d_2.$$

We take the Laplace plane to be the reference plane for simplicity. In terms of $(e_1, g_1, i_1, e_2, i_2)$ (for which let us restrict i_i to the interval $[0, \pi)$), this function takes the form

$$\begin{aligned} F_{quad} &= -\frac{\mu_1 m_2}{8a_1(1-e_2^2)^{\frac{3}{2}}} [3(1-e_1^2)(1+\cos^2(i_1-i_2)) + 15(\cos^2 g_1 + \cos^2(i_1-i_2)\sin^2 g_1) - 6e_1^2 - 4] \\ &= -\frac{\mu_1 m_2}{8a_1(1-e_2^2)^{\frac{3}{2}}} [-(3(1-e_1^2) + 15\sin^2 g_1)\sin^2(i_1-i_2) + 12(1-e_1^2) + 5]. \end{aligned}$$

We see from this expression that the analyticity of (the extension of) F_{quad} near degenerate inner ellipses directly follows from the analyticity of (the extensions of) the expressions $(1-e_1^2)\sin^2(i_1-i_2)$ and $\sin^2 g_1 \sin^2(i_1-i_2)$ near degenerate inner ellipses. In Pauli-Souriau coordinates and in terms of the normal vector of the outer ellipse $\vec{N}_2 = (N_1, N_2, N_3)$, these expressions can be written in the following form:

$$\begin{aligned} (1-e_1^2)\sin^2(i_1-i_2) &= \frac{1}{4L_1^2}(A_1-B_1)^2 + (A_2-B_2)^2 + (A_3-B_3)^2 \\ &\quad - \left((A_1-B_1)N_1 + (A_2-B_2)N_2 + (A_3-B_3)N_3 \right)^2, \\ \sin^2 g_1 \sin^2(i_1-i_2) &= \frac{((A_1+B_1)N_1 + (A_2+B_2)N_2 + (A_3+B_3)N_3)^2}{(A_1+B_1)^2 + (A_2+B_2)^2 + (A_3+B_3)^2}. \end{aligned}$$

Therefore they can be extended analytically to the set determined by the relation $(A_1, A_2, A_3) = (B_1, B_2, B_3)$, corresponding to degenerate inner ellipses. This shows that F_{quad} can be extended analytically to degenerate inner ellipses.

We provide a geometrical way to calculate the expression $\sin^2 g_1 \sin^2(i_1-i_2)$. Take any vector \vec{p} in the direction of the inner pericentre and its projection \vec{p}_1 in the outer orbital plane. Let \vec{p}_2 be the projection of \vec{p} to the direction of node. Then it is direct to verify that the direction of the node is perpendicular to $\vec{p}_1 - \vec{p}_2$. We have $\sin^2 g_1 = \frac{\|\vec{p} - \vec{p}_2\|^2}{\|\vec{p}\|^2}$ and $\sin^2(i_1-i_2) = \frac{\|\vec{p} - \vec{p}_1\|^2}{\|\vec{p} - \vec{p}_2\|^2}$, therefore $\sin^2 g_1 \sin^2(i_1-i_2) = \frac{\|\vec{p} - \vec{p}_1\|^2}{\|\vec{p}\|^2}$, a quantity only depend on the direction of the inner pericentre and the normal direction of the outer orbital plane, while both directions are well defined up to degenerate inner ellipses.

C Singularities in the Quadrupolar System

In this appendix, we show that, for a dense open set of values of parameters (G_2, C, L_1, L_2) , the singularities A, B, A', E of $F_{quad}(G_1, \bar{g}_1; G_2, C, L_1, L_2)$ are of Morse type in the (G_1, \bar{g}_1) -space.

In coordinates⁹ (G_1, \bar{g}_1) , the circle $\{G_1 = G_{1,min}\}$ corresponds to coplanar motions, and is therefore invariant under any system $F_{sec}^{n,n'}$. There are no other singularities near $\{G_1 = G_{1,min}\}$. Therefore, locally near the singularity $\{G_1 = G_{1,min}\}$ in the 2-dimensional reduced secular space, the flow of $F_{sec}^{n,n'}$ is orbitally conjugate to F_{quad} . We do not need to verify if this singularity is Morse or not.

Following [LZ76], we define the normalized variables¹⁰

$$\alpha = \frac{C}{L_1}, \beta = \frac{G_2}{L_1}, \delta = \frac{G_1}{L_1}, \omega = \bar{g}_1.$$

⁹Remind that these coordinates blows up the point $\{G_1 = G_{1,min}\}$ in the 2-dimensional reduced secular space into a circle

¹⁰in [LZ76], it is δ^2 (denoted by ε) which is taken as part of the coordinates.

From section 2.2, we deduce

$$F_{quad} = -\frac{k}{\beta^3}(\mathcal{W} + \frac{5}{3}),$$

in which

$$\mathcal{W}(\delta, \omega; \alpha, \beta) = -2\delta^2 + \frac{(\alpha^2 - \beta^2 - \delta^2)^2}{4\beta^2} + 5(1 - \delta^2) \sin^2(\omega) \left(\frac{(\alpha^2 - \beta^2 - \delta^2)^2}{4\beta^2\delta^2} - 1 \right).$$

The coefficient k is independent of δ and ω and α, β . This allows us working now with \mathcal{W} .

Lemma C.1. For a dense open set of values of the parameters (α, β) , all the singularities of the 1-degree of freedom Hamiltonian \mathcal{W} (seen as a function of (δ, ω)) are of Morse type. When $\alpha = \beta$ (*i.e.* $C = G_2$), and \mathcal{W} is considered as defined on the branched double cover of the reduced critical quadrupolar space, all its elliptic singularities are of Morse type.

Proof. A singularity is of Morse type if, by definition, the Hessian of \mathcal{W} at this point is non-degenerate. By evaluating the determinant of the Hessian of \mathcal{W} with respect to δ, ω at the corresponding singularity, we get an analytic function of α, β , hence we only need to show that this function is not identically zero. The following results were obtained using Maple 16.

Singularity A : The Determinant of the Hessian of W at this point is

$$\frac{20(\alpha^2 + 3\beta^2 - 1)(\alpha^2 - \beta^2)}{\beta^2} < 0.$$

Singularities B and A' : The squares δ_B^2 of the ordinates δ_B of B and A' are both determined by the same cubic equation

$$x^3 - \left(\frac{\beta^2}{2} + \alpha^2 + \frac{5}{8}\right)x^2 + \frac{5}{8}(\alpha^2 - \beta^2)^2 = 0. \quad (1)$$

In order to make the analysis simple, we set the ordinate of B to $\frac{\sqrt{2}}{2}$ and the ordinate of A' to $\frac{\sqrt{3}}{2}$. This leads to

$$\alpha = \sqrt{\frac{13}{60} - \frac{\sqrt{2}}{10}}, \quad \beta = \sqrt{\frac{13}{60} + \frac{\sqrt{2}}{10}},$$

which are in the allowable range of values (see condition (3) P. 52).

The determinants of the Hessian of W at $B : (\delta = \sqrt{2}/2, \omega = \pi/2)$ and $A' : (\delta = \sqrt{3}/2, \omega = \pi/2)$ are respectively $-\frac{51(30\sqrt{2}-5)}{8(13+12\sqrt{2})^2}$ and $-\frac{7(49560\sqrt{2}-61343)}{512(13+12\sqrt{2})^2}$.

Singularity $E(\alpha + \beta \leq 1)$: at $\beta = \alpha$, the determinant of the Hessian of W at this point is $-\frac{10(2\alpha - 1)^2(2\alpha - 3)}{\alpha^2}$.

Singularity $E(\alpha + \beta > 1)$: the determinant of the Hessian of W at this point is

$$-\frac{2(3\beta^2 - \alpha^2 - 1)(5\alpha^4 + 5\beta^4 - 10\alpha^2\beta^2 - 8\alpha^2 - 4\beta^2 + 3)}{\beta^4}.$$

□

In the case $\alpha = \beta$ ($C = G_2$), the Hamiltonian W is now of the form

$$\mathcal{W}' = -2\delta^2 + \frac{\delta^4}{4\beta^2} + 5(1 - \delta^2) \sin^2(\omega) \left(\frac{\delta^2}{4\beta^2} - 1 \right).$$

We find that at $(\delta = 0, \omega = 0)$, the determinant of the Hessian of W' is 40; at $(\delta = 0, \omega = \pi/2)$, it is $\frac{5(12\beta^2 + 5)}{\beta^2}$.

D Non-degeneracy of the Quadrupolar Frequency Maps

In this appendix, we verify the non-degeneracy of the frequency maps for the quadrupolar system $F_{quad}(G_1, \bar{g}_1, G_2; C, L_1, L_2)$ reduced by the $SO(3)$ -symmetry, but not by the $SO(2)$ -symmetry associated to the angle \bar{g}_2 . The calculations is assisted by Maple 16.

We still work in the normalized coordinates of [LZ76], described at the beginning of Appendix C, *i.e.* $\alpha = \frac{C}{L_1}$, $\beta = \frac{G_2}{L_1}$, $\delta = \frac{G_1}{L_1}$, $\omega = \bar{g}_1$. In these coordinates, we have

$$F_{quad} = \frac{k}{\beta^3}(\mathcal{W} + \frac{5}{3}), \text{ and}$$

$$\mathcal{W} = -2\delta^2 + \frac{(\alpha^2 - \beta^2 - \delta^2)^2}{4\beta^2} + 5(1 - \delta^2) \sin^2 \omega \left(\frac{(\alpha^2 - \beta^2 - \delta^2)^2}{4\beta^2 \delta^2} - 1 \right).$$

Let $\bar{\mathcal{W}}(\delta, \omega, \beta; \alpha) = \frac{\mathcal{W} + \frac{5}{3}}{\beta^3}$. This function is now considered as a two degrees of freedom Hamiltonian defined on the four-dimensional phase space, whose coordinates are $(\delta, \omega, \beta, \bar{g}_2)$, depending on the parameter α . We shall formulate our results in terms of $\bar{\mathcal{W}}$, from which the corresponding results for F_{quad} follow directly.

The main idea in the forthcoming proofs is to deduce the existence of torsion of $\bar{\mathcal{W}}$ from a local approximation system $\bar{\mathcal{W}}'(\delta, \omega, \beta; \alpha)$ whose flow, for fixed β , is linear in the (δ, ω) -plane. By analyticity, the torsion of $\bar{\mathcal{W}}$ is then non-zero almost everywhere in the corresponding region of the phase space foliated by the continuous family of the Lagrangian tori.

To obtain the approximating system $\bar{\mathcal{W}}'$, we consider the reduced system $\widetilde{\mathcal{W}}$ of $\bar{\mathcal{W}}$ by fixing β and reduced by the $SO(2)$ -action conjugate to β . We either develop $\widetilde{\mathcal{W}}$ into Taylor series of (δ, ω) at an elliptic singularity and truncate at the second order, or develop $\widetilde{\mathcal{W}}$ into Taylor series of δ at $\delta = \text{Cst}$ and truncate at the first order. In both cases, the torsion of the truncated system amounts to the non-trivial dependence of a certain function of the coefficients of the truncation with respect to β .

Lemma D.1. For a dense open set of values of α , the frequency mapping of the Lagrangian tori of $\bar{\mathcal{W}}$ is non-degenerate on a dense open subset of the phase space of $\bar{\mathcal{W}}$. Moreover, the torsion does not vanish when $\delta_{min} = \alpha - \beta \rightarrow 0$.

Proof. By analyticity of the system, we just have to verify the non-degeneracy in small neighborhoods of the singularity B and $\{\delta = \delta_{min}\}$ or $\{\delta = \delta_{max} = \max\{1, \alpha + \beta\}\}$ for the system $\widetilde{\mathcal{W}}$.

In a small neighborhood of B (whose δ -coordinate is denoted by δ_B), let $\delta_1 = \delta - \delta_B$, $\omega_1 = \omega - \frac{\pi}{2}$. We develop $\widetilde{\mathcal{W}}$ into Taylor series of δ_1 and ω_1 :

$$\widetilde{\mathcal{W}} = \Phi(\alpha, \beta) + \Xi(\alpha, \beta) \delta_1^2 + \Upsilon(\alpha, \beta) \omega_1^2 + O\left((|\delta_1|^2 + |\omega_1|^2)^{\frac{3}{2}}\right).$$

In which

$$\Xi(\alpha, \beta) = \frac{4\beta^2 \delta_B^4 - 24\delta_B^6 + 8\delta_B^4 \alpha^2 + 5\delta_B^4 + 15\alpha^4 - 30\alpha^2 \beta^2 + 15\beta^4}{4\beta^5 \delta_B^4};$$

$$\Upsilon(\alpha, \beta) = -\frac{5(\delta_B^2 - 1)((\alpha + \beta)^2 - \delta_B^2)((\alpha - \beta)^2 - \delta_B^2)}{4\beta^5 \delta_B^4}.$$

From Equation 1, we see that $\Upsilon(\alpha, \beta) \neq 0$. To show that $\Xi(\alpha, \beta) \neq 0$, we just need to use the identity (deduced from Equation 1)

$$15(\alpha^2 - \beta^2)^2 = 24\left(\frac{\beta^2}{2} + \alpha^2 + \frac{5}{8}\right)\delta_B^4 - 24\delta_B^6$$

to write $\Xi(\alpha, \beta)$ into the form

$$\Xi(\alpha, \beta) = \frac{4(\beta^2 + 2\alpha^2 + \frac{5}{4} - \delta_B^2)}{\beta^5}.$$

Since the singularity B is elliptic, we have $\Xi(\alpha, \beta)\Upsilon(\alpha, \beta) > 0$ for a dense open set of (α, β) . For f close to $\Phi(\alpha, \beta)$ when $\Xi > 0$ (resp. $\Xi < 0$), the equation $f = \Phi(\alpha, \beta) + \Xi(\alpha, \beta)\delta^2 + \Upsilon(\alpha, \beta)\omega^2$ defines an ellipse in the (ϵ, ω) -plane which bounds an area $\pi \frac{h - \Phi}{\sqrt{\Xi\Upsilon}}$, thus we may set $\bar{\mathcal{I}}_1 = \frac{f - \Phi}{2\sqrt{\Xi\Upsilon}}$, which is an action variable¹¹ for the truncating system of $\widetilde{\mathcal{W}}$ up to second order of δ_1 and ω_1 . Therefore $W' = \Phi + 2\sqrt{\Xi\Upsilon}\bar{\mathcal{I}}_1 + O(\bar{\mathcal{I}}_1^{\frac{3}{2}})$, where $O(\bar{\mathcal{I}}_1^{\frac{3}{2}})$ is a certain function of α, β and $\bar{\mathcal{I}}_1$, which goes to zero not slower than $\bar{\mathcal{I}}_1^{\frac{3}{2}} \rightarrow 0$.

We denote by $|\text{Det}|_{\mathcal{H}}(\mathfrak{F})$ the torsion of \mathfrak{F} *i.e.* the absolute value of the determinant of the Hessian matrix of a function $\mathfrak{F}(\bar{\mathcal{I}}_1, \beta)$, *i.e.*

$$|\text{Det}|_{\mathcal{H}}(\mathfrak{F}) \triangleq \left| \frac{\partial^2 \mathfrak{F}}{\partial \bar{\mathcal{I}}_1^2} \frac{\partial^2 \mathfrak{F}}{\partial \beta^2} - \left(\frac{\partial^2 \mathfrak{F}}{\partial \bar{\mathcal{I}}_1 \partial \beta} \right)^2 \right|.$$

It is direct to verify that

$$|\text{Det}|_{\mathcal{H}}(O(\bar{\mathcal{I}}_1^{\frac{3}{2}})) = O(\bar{\mathcal{I}}_1),$$

which is of at least the same order of smallness comparing to the quantity $f - \Phi$, which can be made arbitrarily small when restricted to small enough neighborhood of B , and

$$|\text{Det}|_{\mathcal{H}}(2\sqrt{\Xi\Upsilon}\bar{\mathcal{I}}_1) = 4\left(\frac{\partial\sqrt{\Xi\Upsilon}}{\partial\beta}\right)^2.$$

This is exactly the torsion of the system $2\sqrt{\Xi\Upsilon}\bar{\mathcal{I}}_1$ considered as a system of two degrees of freedom with coordinates $(\delta, \omega, \beta, \bar{g}_2)$.

Therefore in order to prove the statement, it is enough to show that $\frac{\partial(\sqrt{\Xi\Upsilon})}{\partial\beta} \neq 0$ for some α and β .

Suppose on the contrary that the function $\sqrt{\Xi\Upsilon}$ is independent of β , then the function $\Xi\Upsilon$ is also independent of β . In view of the expressions of Ξ and Υ , this can happen only if one of the following expressions is a non-zero multiple of $\beta^{\check{c}}$ for $\check{c} \geq 1$:

$$\delta_B^2 - 1, \quad \beta^2 + 2\alpha^2 + \frac{5}{4} - \delta_B^2, \quad \frac{1}{\delta_B^4}, \quad (\alpha + \beta)^2 - \delta_B^2, \quad (\alpha - \beta)^2 - \delta_B^2$$

Since δ_B^2 solves Equation 1, we substitute the particular form of δ_B^2 obtained in each case in Equation 1, thus exclude the first two by comparing the constant term, exclude the third by comparing the lowest order term of β , and exclude the last two by comparing the term only depend on α .

Therefore $\frac{\partial(\sqrt{\Xi\Upsilon})}{\partial\beta}$ is non-zero for a dense open set of values of (α, β) .

We now consider the torsion of the tori near the lower boundary $\{\delta = \delta_{min} = |\alpha - \beta| > 0\}$.

¹¹See [Arn89] for the method of building action-angle coordinates that we use here.

Recall that $\{\delta = \delta_{min}\}$ corresponds to coplanar ellipse pairs, that is to a point after full reduction (Figure 2.5). Nevertheless, it appears as a regular invariant curve of the system $\widetilde{\mathcal{W}}$ in coordinates δ, ω (Figure 2.2) after full reduction of the $SO(3) \times SO(2)$ symmetries of some blow-up of the secular space (See Subsection 1.2.5), and both $\widetilde{\mathcal{W}}$ and the coordinates δ, ω extend analytically to $\{0 < \delta < \delta_{min}\}$. We may then develop $\widetilde{\mathcal{W}}$ into Taylor series with respect to δ at $\delta = \delta_{min}$: set $\delta_1 = \delta - \delta_{min}$, we obtain

$$\widetilde{\mathcal{W}} = \bar{\Phi}(\alpha, \beta) + \bar{\Xi}(\alpha, \beta, \omega) \delta_1 + O(\delta_1^2),$$

in which

$$\bar{\Xi}(\alpha, \beta, \omega) = -\frac{2((9\alpha^2\beta - 6\alpha\beta^2 + \beta^3 - 4\alpha^3 + 5\alpha) + (-5\alpha + 5\alpha^3 - 10\alpha^2\beta + 5\alpha\beta^2)\cos^2\omega)}{\beta^4|\alpha - \beta|}.$$

We eliminate the dependence of ω in the linearized Hamiltonian $\bar{\Phi}(\alpha, \beta) + \bar{\Xi}(\alpha, \beta, \omega) \delta_1$ by computing action-angle coordinates. The value of the action variable $\bar{\mathcal{I}}_1$ on the level curve $E_f : \bar{\Phi}(\alpha, \beta) + \bar{\Xi}(\alpha, \beta, \omega) \delta_1 = f$ is computed from the area between this curve and $\delta_1 = 0$, that is

$$\bar{\mathcal{I}}_1 = \frac{1}{2\pi} \int_{E_f} \delta_1 d\omega = \frac{f - \bar{\Phi}(\alpha, \beta)}{2\pi} \int_0^{2\pi} \frac{1}{\bar{\Xi}(\alpha, \beta, \omega)} d\omega = \bar{\mathcal{I}}_1.$$

We have then

$$\widetilde{\mathcal{W}} = \bar{\Phi}(\alpha, \beta) + 2\pi \left(\int_0^{2\pi} \frac{1}{\bar{\Xi}(\alpha, \beta, \omega)} d\omega \right)^{-1} \bar{\mathcal{I}}_1 + O(\bar{\mathcal{I}}_1^2)$$

As in the proof of Lemma D.1, for $\bar{\mathcal{I}}_1$ small enough, the torsion of $\widetilde{\mathcal{W}}$ is dominated by the torsion of the term linear in $\bar{\mathcal{I}}_1$, which is

$$\left[2\pi \frac{d}{d\beta} \left(\int_0^{2\pi} \frac{1}{\bar{\Xi}(\alpha, \beta, \omega)} d\omega \right)^{-1} \right]^2$$

Using the formula

$$\int_0^{2\pi} \frac{d\omega}{a + b \cos \omega} = \frac{2\pi}{\sqrt{a^2 - b^2}}$$

we obtain

$$2\pi \left(\int_0^{2\pi} \frac{1}{\bar{\Xi}(\alpha, \beta, \omega)} d\omega \right)^{-1} = -\frac{2\sqrt{\alpha + \beta} \sqrt{9\alpha^2\beta - 6\alpha\beta^2 + \beta^3 - 4\alpha^3 + 5\alpha}}{\beta^4},$$

which depends non-trivially on β . Therefore the torsion of the system

$$2\pi \left(\int_0^{2\pi} \frac{1}{\bar{\Xi}(\alpha, \beta, \omega)} d\omega \right)^{-1} \bar{\mathcal{I}}_1$$

which is considered as a function of $\beta, \bar{\mathcal{I}}_1$, is not identically zero.

Moreover, at the limit $\alpha = \beta$, the limiting torsion of this system is $\frac{1125}{2\beta^8}$. By continuity¹², this proves the non-vanishing of the torsion in the critical quadrupolar space

¹²This is allowed because the secular space reduced by the $SO(3)$ -symmetry or even the $SO(3) \times SO(2)$ is smooth (as well as the reduced Hamiltonian) outside its singularities. See P. 53.

reduced by the $SO(3)$ -symmetry around $(\delta = 0, \omega = 0)$ in $\alpha = \beta$. In doing so, we avoid choosing coordinates near the reduced critical quadrupolar space.

In the case $\delta_{max}(= \min\{1, \alpha + \beta\}) = \alpha + \beta$, since $\overline{\mathcal{W}}$ is an odd function of β , we may simply replace β by $-\beta$ in the formula for tori near $\delta = \delta_{min}$ presented above. The required non-degeneracy follows directly.

In the case $\delta_{max}(= \min\{1, \alpha + \beta\}) = 1$, by the same method, we only have to notice that the function

$$\left(\beta^5 \int_0^{2\pi} \frac{d\omega}{(5\alpha^4 - 10\alpha^2\beta^2 - 10\beta^2 + 5 - 10\alpha^2 + 5\beta^4) \cos^2 \omega + (4\beta^2 + 8\alpha^2 - 3 - 5\alpha^4 + 10\alpha^2\beta^2 - 5\beta^4)} \right)^{-1} \\ = \frac{\sqrt{(6\beta^2 - 3\alpha^2 - 2 + 5\alpha^4)(\beta^2 + 8\alpha^2 - 3 - 5\alpha^4 + 10\alpha^2\beta^2)}}{\beta^5}$$

depends non-trivially on β . □

Lemma D.2. The frequency map of the elliptic isotropic tori corresponding to the secular singularity B is non-degenerate for a dense open set of values of (α, β) .

Proof. Following from the previous proof, we only need to note in addition that the secular frequency map of the elliptic isotropic tori corresponding to the secular singularity B is the limit of the secular frequency map of the Lagrangian tori around B : At the limit, the frequency of these tori with respect to $\overline{\mathcal{I}}_1$ becomes the normal frequency of the lower dimensional secular tori corresponds to B , and the frequency with respect to G_2 becomes the tangential frequency of the lower dimensional tori. We see that the frequency of the approximating Hamiltonian $2\sqrt{\Xi\Upsilon}\overline{\mathcal{I}}_1$ is independent of $\overline{\mathcal{I}}_1$, hence its frequency map for Lagrangian tori near the lower dimensional tori is the same the frequency map for the lower dimensional tori. Therefore by the same reasoning and calculations as in the proof of Lemma D.1, the non-degeneracy condition of the secular frequency holds for a dense open set in the (α, β) -space. □

Bibliography

- [AKN06] V.I. Arnold, V.V. Kozlov, and A.I. Neishtadt. *Mathematical aspects of classical and celestial mechanics*. Springer, 2006.
- [Alb02] A. Albouy. Lectures on the two-body problem. *Classical and Celestial Mechanics, The Recife Lectures*, pages 63–116, 2002.
- [Arn63] V.I. Arnold. Small denominators and problems of stability of motion in classical and celestial mechanics. *Russian Mathematical Survey 18 (1963)*, 18:85–191, 1963.
- [Arn83] V.I. Arnold. *Geometrical methods in the theory of ordinary differential equations*. Springer, 1983.
- [Arn89] V.I. Arnold. *Mathematical methods of classical mechanics*, volume 60. Springer Verlag, 1989.
- [Aud04] M. Audin. *Torus actions on symplectic manifolds*. Birkhauser, 2004.
- [BCV06] Luca Biasco, Luigi Chierchia, and Enrico Valdinoci. Elliptic two-dimensional invariant tori for the planetary three-body problem. *Archive for rational mechanics and analysis*, 170(2):91–135, 2003. corrigendum, 2006.
- [Che86] A. Chenciner. Le problème de la lune et la théorie des systèmes dynamiques (lecture notes, Paris 7 University). 1986.
- [Che89] A. Chenciner. Intégration du problème de Kepler par la méthode de Hamilton–Jacobi: coordonnées action-angles de Delaunay. *Notes scientifiques et techniques du Bureau des Longitudes*, S. 26, 1989.
- [CL88] A. Chenciner and J. Llibre. A note on the existence of invariant punctured tori in the planar circular restricted three-body problem. *Ergodic theory and Dynamical Systems*, 8:63–72, 1988.
- [CP11a] L. Chierchia and G. Pinzari. Deprit’s reduction of the nodes revisited. *Celestial Mechanics and Dynamical Astronomy*, pages 1–17, 2011.
- [CP11b] L. Chierchia and G. Pinzari. The planetary N-body problem: symplectic foliation, reductions and invariant tori. *Inventiones mathematicae*, 186(1):1–77, 2011.
- [CW99] I.B. Cohen and A. Whitman. *Isaac Newton: The Principia. Mathematical Principles of Natural Philosophy. A New Translation*. University of California Press, 1999.

- [Dep83] A. Deprit. Elimination of the nodes in problems of N-bodies. *Celestial Mechanics and Dynamical Astronomy*, 30(2):181–195, 1983.
- [Féj99] J. Féjóz. Dynamique séculaire globale du problème plan des trois corps et application à l’existence de mouvements quasipériodiques. *Thèse de l’université Paris 13*, 1999.
- [Féj01] J. Féjóz. Averaging the planar three-body problem in the neighborhood of double inner collisions. *Journal of Differential Equations*, 175(1):175–187, 2001.
- [Féj02] J. Féjóz. Quasiperiodic motions in the planar three-body problem. *Journal of Differential Equations*, 183(2):303–341, 2002.
- [Féj04] J. Féjóz. Démonstration du théorème d’Arnold sur la stabilité du système planétaire(d’après Herman)(revised version). *Ergodic Theory and Dynamical Systems*, 24(5):1521–1582, 2004.
- [Féj10] J. Féjóz. Periodic and quasi-periodic motions in the many-body problem, Mémoire d’Habilitation de l’Université Pierre & Marie Curie–Paris VI. 2010.
- [Féj13] J. Féjóz. The normal form of Moser and applications,. *preprint*, 2013.
- [FH91] W. Fulton and J. Harris. *Representation theory: a first course*. Springer, 1991.
- [FL10] F. Farago and J. Laskar. High-inclination orbits in the secular quadrupolar three-body problem. *Monthly Notices of the Royal Astronomical Society*, 401(2):1189–1198, 2010.
- [FO94] S. Ferrer and C. Osacár. Harrington’s Hamiltonian in the stellar problem of three bodies: Reductions, relative equilibria and bifurcations. *Celestial Mechanics and Dynamical Astronomy*, 58(3):245–275, 1994.
- [Ger91] J.L. Gerver. The existence of pseudocollisions in the plane. *Journal of Differential Equations*, 89(1):1–68, 1991.
- [Gou87] E. Goursat. Les transformations isogonales en mécanique. *Les Comptes Rendus de l’Académie des sciences*, 108:446–450, 1887.
- [GS82] V. Guillemin and S. Sternberg. Convexity properties of the moment mapping. *Inventiones mathematicae*, 67(3):491–513, 1982.
- [Har68] R.S. Harrington. Dynamical evolution of triple stars. *The Astronomical Journal*, 73:190–194, 1968.
- [JM66] W.H. Jefferys and J. Moser. Quasi-periodic solutions for the three-body problem. *The Astronomical Journal*, 71:568, 1966.
- [Kel58] Oliver. Kellogg. *Foundations of potential theory*, volume 31. Dover Publications, 1958.
- [Kol54] A. N. Kolmogorov. On conservation of conditionally periodic motions for a small change in hamilton’s function. In *Doklady Akademii Nauk SSSR (NS)*, volume 98, pages 527–530, 1954.
- [Koz62] Y. Kozai. Secular perturbations of asteroids with high inclination and eccentricity. *The Astronomical Journal*, 67:591–598, 1962.

- [Kum82] M. Kummer. On the regularization of the Kepler problem. *Communications in Mathematical Physics*, 84(1):133–152, 1982.
- [Lag73] J-L. Lagrange. Sur l'équation séculaire de la lune. *Mémoire de l'Académie royale des sciences de Paris*, 1773.
- [Lag81] J-L. Lagrange. Théorie des variations séculaires des éléments des planètes (première partie). *Memoirs of Berlin Academy*, 5:125–207, 1781.
- [Lag82] J-L. Lagrange. Théorie des variations séculaires des éléments des planètes (seconde partie). *Memoirs of Berlin Academy*, 5:211–344, 1782.
- [Lag83] J-L. Lagrange. Sur les variations séculaires des mouvements moyens des planètes. *Memoirs of Berlin Academy*, pages 381–414, 1783.
- [Lap72] P-S. Laplace. Mémoire sur les solutions particulières des équations différentielles et sur les inégalités séculaires des planètes. *Mémoire de l'Académie royale des sciences de Paris*, pages 325–366, 1772.
- [Lap73] P-S. Laplace. Sur le principe de la gravitation universelle et sur les inégalités séculaires des planètes, qui en dépendent. *Mémoire de l'Académie royale des sciences de Paris*, 8:199–275, 1773.
- [Lap84] P-S. Laplace. Mémoire sur les inégalités séculaires des planètes et des satellites. *Mémoire de l'Académie royale des sciences de Paris*, 1784.
- [Las88] J Laskar. Secular evolution of the solar system over 10 million years. *Astronomy and Astrophysics*, 198:341–362, 1988.
- [Las90] J. Laskar. The chaotic motion of the solar system: A numerical estimate of the size of the chaotic zones. *Icarus*, 88(2):266–291, 1990.
- [Las08] J. Laskar. Chaotic diffusion in the solar system. *Icarus*, 196(1):1–15, 2008.
- [LB10] J. Laskar and G. Boué. Explicit expansion of the three-body disturbing function for arbitrary eccentricities and inclinations. *Astronomy & Astrophysics*, 522, 2010.
- [LC20] T. Levi-Civita. Sur la régularisation du problème des trois corps. *Acta mathematica*, 42(1):99–144, 1920.
- [Lid61] ML Lidov. Evolyutsiya orbit iskusstvennykh sputnikov planet pod deistviem gravitatsionnykh vozmushchenii vneshnikh tel. *Iskusstvennye sputniki Zemli*, (8 S 5), 1961.
- [Lid62] M. Lidov. The evolution of orbits of artificial satellites of planets under the action of gravitational perturbations of external bodies. *Planetary and Space Science*, 9:719–759, 1962.
- [Lie71] B. Lieberman. Existence of quasi-periodic solutions to the three-body problem. *Celestial Mechanics and Dynamical Astronomy*, 3(4):408–426, 1971.
- [LR95] J. Laskar and P. Robutel. Stability of the planetary three-body problem. *Celestial Mechanics and Dynamical Astronomy*, 62(3):193–217, 1995.

- [LZ76] M. Lidov and S. Ziglin. Non-restricted double-averaged three body problem in Hill's case. *Celestial Mechanics and Dynamical Astronomy*, 13(4):471–489, 1976.
- [Mar78] C. Marchal. Collisions of stars by oscillating orbits of the second kind. *Acta Astronautica*, 5(10):745–764, 1978.
- [Mik] S Mikkola. A comparison of regularization methods for few-body interactions.
- [Mos67] J. Moser. Convergent series expansions for quasi-periodic motions. *Mathematische Annalen*, 169(1):136–176, 1967.
- [MRL02] F. Malige, P. Robutel, and J. Laskar. Partial reduction in the n-body planetary problem using the angular momentum integral. *Celestial Mechanics and Dynamical Astronomy*, 84(3):283–316, 2002.
- [MS98] D. McDuff and D. Salamon. *Introduction to symplectic topology*. Oxford Univ Press, USA, 1998.
- [Pai97] P. Painlevé. *Leçons sur la théorie analytique des équations différentielles: professées à Stockholm (septembre, octobre, novembre 1895) sur l'invitation du roi de Suède et de Norwège*. A. Hermann, 1897.
- [Pau26] W. Pauli. Über das Wasserstoffspektrum vom Standpunkt der neuen Quantenmechanik. *Zeitschrift für Physik A Hadrons and Nuclei*, 36(5):336–363, 1926.
- [Poi92] H. Poincaré. *Les méthodes nouvelles de la mécanique céleste*. Gauthier-Villars, Paris, 1892.
- [Poi07] H. Poincaré. *Leçons de mécanique céleste*, volume 1. Gauthier-Villars, 1905–1907.
- [Pös80] J. Pöschel. *Über invariante tori in differenzierbaren Hamiltonschen Systemen*. Mathematische Institut der Universität Bonn, 1980.
- [Rob95] P. Robutel. Stability of the planetary three-body problem. *Celestial Mechanics and Dynamical Astronomy*, 62(3):219–261, 1995.
- [Sou70] J.M. Souriau. *Structure des systemes dynamiques*. Dunod, 1970.
- [SS71] E. Stiefel and G. Scheifele. Linear and regular celestial mechanics. *Die Grundlehren der mathematischen Wissenschaften, Berlin: J. Springer, 1971*, 1, 1971.
- [Sud79] A. Sudbery. Quaternionic analysis. In *Mathematical Proceedings of the Cambridge Philosophical Society*, volume 85, pages 199–225. Cambridge Univ Press, 1979.
- [Wal08] J. Waldvogel. Quaternions for regularizing celestial mechanics: the right way. *Celestial Mechanics and Dynamical Astronomy*, 102(1):149–162, 2008.
- [Xia92] Z. Xia. The existence of noncollision singularities in Newtonian systems. *The Annals of Mathematics*, 135(3):411–468, 1992.
- [Yi03] Y. Yi. On almost automorphic oscillations. 2003.