



HAL
open science

Approximation and applications of distributed delay

Hao Lu

► **To cite this version:**

Hao Lu. Approximation and applications of distributed delay. Other. INSA de Lyon, 2013. English.
NNT: 2013ISAL0100 . tel-00961273

HAL Id: tel-00961273

<https://theses.hal.science/tel-00961273>

Submitted on 19 Mar 2014

HAL is a multi-disciplinary open access archive for the deposit and dissemination of scientific research documents, whether they are published or not. The documents may come from teaching and research institutions in France or abroad, or from public or private research centers.

L'archive ouverte pluridisciplinaire **HAL**, est destinée au dépôt et à la diffusion de documents scientifiques de niveau recherche, publiés ou non, émanant des établissements d'enseignement et de recherche français ou étrangers, des laboratoires publics ou privés.

UNIVERSITY OF LYON

Doctoral School : Electronics, Electrical, Automatic

P H D THESIS

to obtain the title of

Ph.D of Science

of the Institut National des Sciences Appliquées de Lyon-INSA Lyon

Speciality: Energy and systems

defended by

Hao LU

Approximation and Applications of Distributed Delay

Thesis Supervisors: Michaël DI LORETO and Eric BIDEAUX

prepared at

Laboratoire AMPÈRE (UMR CNRS 5005)

Département Méthodes pour l'Ingénierie des Systèmes

October 2013

Jury :

Reviewers:	Jean-Jacques LOISEAU	Ecole Centrale de Nantes (IRCCyN)
	Sabine MONDIÉ	CINVESTAV
Examinators:	Catherine BONNET	INRIA
	Alexandre SEURET	LAAS
Supervisors:	Michaël DI LORETO	INSA de Lyon (AMPÈRE)
	Eric BIDEAUX	INSA de Lyon (AMPÈRE)

Acknowledgements

Foremost, I would like to sincerely thank my supervisors Michaël Di Loreto and Eric Bideaux for providing me with the opportunity to do the PhD research in INSA de Lyon. I would like to thank them for their continued support and guidance along the course of this work. They have been actively interested in my work and have always been available to advise me. I am very grateful for their patience, motivation, enthusiasm, and immense knowledge in Control Theory that, taken together, make them great mentors.

My sincere thanks also go to Jean Jacques Loiseau for his help on the work of time-delay systems, Catherine Bonnet for her help on the study of stability control of infinite dimensional system, Alexandre Seuret for his advices on observer design, and Daniel Thomasset for his advices on stable inversion control.

I would also like to thank all my friends in Lyon and all members of Laboratory ampere, with whom I shared many good moments during my study here. I consider it an honor to be friends and work with them.

Last but not least, I would like to thank my parents Lijun Zhang and Mingyi Lu for giving birth and support to me, and my fiancée Wenjuan Deng for supporting me spiritually all the time.

Contents

Acknowledgements	iii
List of Figures	ix
Symbols	xiii
content of the thesis	xv
Introduction	xvii
1 INTRODUCTION	1
1.1 Introduction	1
1.2 Algebraic preliminaries	9
1.2.1 Convolution system	9
1.2.2 Algebra \mathcal{A}	10
1.2.3 Ring \mathcal{E}	10
1.2.4 Ring $\mathcal{P}_{\mathcal{E}}$	13
1.2.5 Euclidean algorithm	14
2 Distributed delay: Properties, Realization and Approximation	15
2.1 Definition and properties	18
2.1.1 Definitions	18
2.1.2 Properties	20
2.2 Approximation and implementation of distributed delay	22
2.2.1 Approximation problem	22
2.2.2 General solution of the approximation	23
2.2.2.1 Graph topology	23
2.2.2.2 Lumped approximation	26
2.2.2.3 Input-output approximation	27
2.2.2.4 Kernel approximation	31
2.2.2.5 Constructive implementation	37
2.2.2.6 Properties in time and frequency domains	40
2.2.3 Some solutions of the approximation problem	42
2.2.3.1 Methods with additional dynamics	43

2.2.3.2	Method by improved Newton-Cotes approximation	45
2.2.3.3	Method by rational approximation	47
2.3	Conclusion	49
3	Inversion and Model Matching	51
3.1	Inversion of linear systems	53
3.1.1	Preliminaries	53
3.1.2	Stable inversion problem	55
3.1.3	Some solutions in literature	57
3.1.4	Finite time stable inversion	63
3.1.4.1	Finite time stable inversion for SISO linear systems	63
3.1.4.2	Finite time stable inversion for MIMO linear systems	67
3.2	Model matching	71
3.2.1	Finite time model matching for SISO linear systems	72
3.2.2	Finite time model matching for MIMO linear systems	76
3.3	DC-motor example	81
3.4	Robustness under parameter uncertainties	83
3.5	Realization of control architecture	87
3.6	Conclusion	91
4	Stabilization and Observation Control	93
4.1	Stabilization and control of time-delay systems	94
4.1.1	Internal stabilization	94
4.1.2	Neutral time-delay systems	100
4.1.3	Smith predictor with distributed delay	112
4.2	Stabilization and control for fractional systems	116
4.2.1	Fractional systems	116
4.2.2	Finite spectrum assignment for fractional systems	120
4.3	Observer design for dynamical systems	122
4.3.1	Open-loop observer	123
4.3.2	Closed-loop observer	128
4.3.2.1	Scalar case	129
4.3.2.2	Multivariable case	131
4.3.2.3	Robustness under parameter uncertainty	137
4.4	Conclusion	141
5	Approximation of Distributed Parameter Systems	143
5.1	Approximation by lumped systems	144
5.2	Causality	146
5.3	Approximation by delay systems	148
5.3.1	Roesser model	151
5.3.2	Equivalence between Roesser model and neutral type time-delay	152
5.4	Conclusion	156

6 Conclusion and Future works	157
6.1 Conclusion	157
6.2 Future works	158
Reference	161

List of Figures

1	Réalisation d'un élément $\hat{\theta}_\lambda(s) \in \mathcal{K}_s(\mathbb{I}_{0,\vartheta})$, avec $\text{Re } \lambda < 0$	xxii
2	Diagramme de Bode en gain de $\hat{\theta}_1(s)$ et de son approximation obtenue par la un schéma d'intégration numérique trapézoïdal à 30 noeuds.	xxiii
3	Schéma bloc fonctionnel d'un contrôleur stabilisant pour l'Exemple 0.4.	xxiv
4	Réponse indicielle unitaire de la boucle fermée ($v = 5, h = 1$) pour l'Exemple 0.4.	xxv
5	Approximations du noyau $\theta_{1,\text{app}}(t)$ utilisant des fonctions exponentielles. Noyau $\theta_1(t)$ (continu), approximations d'ordre $n = 5$ (séparé) et $n = 10$ (pointillé).	xxvii
6	Diagramme de Bode de $\hat{\theta}_1(j\omega)$ et de son approximation $\hat{\theta}_{1,\text{app}}(j\omega)$, d'ordre $n = 5$	xxviii
7	Inversion stable à temps fini.	xxx
8	Evolution dans le domaine temporel de l'erreur d'inversion $e(t)$	xxx
9	Problème de poursuite de modèle.	xxxi
10	Erreur d'inversion en temps pour $\vartheta = 1$ (continu), $\vartheta = 0.5$ (séparé) et $\vartheta = 0.1$ (pointillé)(Exemple 0.5).	xxxii
11	Erreur de poursuite de modèle pour $\vartheta = 0.5$ (continu), $\vartheta = 1$ (pointillé), $\vartheta = 2$ (trait-mixte) (Exemple 0.6).	xxxiii
12	Simulation de l'observateur pour l'estimation de $x(t)$ (continu); l'état estimé est $\hat{x}(t)$ (pointillé $h = 0.5$, trait-mixte $h = 0.2$) (Exemple 0.7).	xxxviii
13	Simulation de l'observateur à convergence asymptotique de $x(t)$ (continu) ; estimation $\hat{x}(t)$ (pointillé $h = 0.5$, trait-mixte $h = 0.2$) (Exemple 0.7).	xxxviii
1.1	Closed-loop system for stabilization control.	6
2.1	Realization of an element $\hat{\theta}_\lambda(s) \in \mathcal{K}_s(\mathbb{I}_{0,\vartheta})$, with $\text{Re } \lambda < 0$	22
2.2	Feedback System.	24
2.3	Bode gain diagram of $\hat{\theta}_1(s)$ and its approximation based on integral approximation (trapezoidal Newton-Cotes method with 30 nodes).	29
2.4	Stabilizing control of Example 2.2	30
2.5	The step response (step value is 1) of the closed-loop system ($v = 5, h = 1$) in Example 2.2.	31
2.6	Continuous function $\psi_{c,0}(\rho)$	37

2.7	The continuous line is the kernel $\theta_0(t)$ ($\alpha = 1, \vartheta = 1$), the dash line is the approximation of θ_0 with $n = 5$. The dashdot line is the approximation with $n = 10$	39
2.8	Structure of the approximation distributed delay, $\gamma_i \in \mathbb{R}$	40
2.9	Kernel approximations $\theta_{1,\text{app}}(t)$ using exponentials in the time domain of the kernel $\theta_1(t)$ (continuous line), for orders $n = 5$ (dashed) and $n = 10$ (dot-dashed).	41
2.10	Representation of the norm error $\ \theta_1 - \theta_{1,n}\ _{\mathcal{L}}$ with respect to the order n of the approximation, for $\alpha = 1$ (star) and $\alpha = 1/5$ (circle).	41
2.11	Bode diagram of $\hat{\theta}_1(j\omega)$ and its kernel approximation $\hat{\theta}_{1,\text{app}}(j\omega)$, with order $n = 5$	43
2.12	The step response (step value is 1) of the closed-loop system, Improved Newton-Cotes approximation (dot-dashed, $\varepsilon = 1$), Low-pass filter approximation (dashed, $\gamma = 5$) and Stable finite exponential approximation (continuous), rational approximation (dot) (Example 2.3).	49
3.1	Exact stable inversion	55
3.2	Finite time stable inversion.	63
3.3	Time-domain evolution of the inverse error $e(t)$	64
3.4	Kernel of the inversion error in time for $\vartheta = 1$ (Example 3.2).	66
3.5	Kernel of the inversion error in time for $\vartheta = 1$ (continuous), $\vartheta = 0.5$ (dashed) and $\vartheta = 0.1$ (dashed-dot)(Example 3.3).	67
3.6	Kernel of the stable inversion error for $\vartheta = 0.5$ (continuous), $\vartheta = 1$ (dashed), $\vartheta = 2$ (dashed-dot) (Example 3.4).	69
3.7	Kernel of the stable inversion in time for $\vartheta = 1$ with approximated distributed delay (Example 3.5).	70
3.8	Model matching problem	72
3.9	Trajectory planning as a model matching problem.	75
3.10	Trajectory planning, for $\vartheta = 1$ (dot), $\vartheta = 0.5$ (dashed), and $\vartheta = 0.1$ (dashed-dot), with approximated distributed delay (Example 3.6).	76
3.11	Model matching error for $\vartheta = 0.5$ (continuous), $\vartheta = 1$ (dashed), $\vartheta = 2$ (dashed-dot) (Example 3.7).	80
3.12	DC-motor	81
3.13	Trajectory planning error, for $\vartheta_1 = \vartheta_2 = 0.5$ (dashed), $\vartheta_1 = \vartheta_2 = 1$ (continuous), and $\vartheta_1 = 0.2, \vartheta_2 = 0.3$ (dashed-dot) (Example DC-motor).	83
3.14	Trajectory planning, for model (continuous), $\vartheta_1 = \vartheta_2 = 0.5$ (dashed), $\vartheta_1 = \vartheta_1 = 1$ (dot), and $\vartheta_1 = 0.2, \vartheta_2 = 0.3$ (dashed-dot) (Example DC-motor).	84
3.15	Trajectory planning control, for $\vartheta_1 = \vartheta_2 = 0.5$ (dashed), $\vartheta_1 = \vartheta_1 = 1$ (continuous), and $\vartheta_1 = 0.2, \vartheta_2 = 0.3$ (dashed-dot) (Example DC-motor).	84
3.16	Model matching error with $\vartheta = 0.5$, for system $\Delta T_1(s)$ (continuous), $\Delta T_2(s)$ (dashed), $\Delta T_3(s)$ (dashed-dot) (Example 3.7 with uncertainty).	86

3.17	Stable inversion error for $\vartheta = 0.5$, system $\Delta T_1(s)$ (continuous), $\Delta T_2(s)$ (dashed), $\Delta T_3(s)$ (dashed-dot), (Example 3.4 with uncertainty)	86
4.1	Feedback System.	95
4.2	Step responses for the desired closed-loop (continuous line) and for the closed-loop system with approximation of distributed delay with 5th order (dash) and 3th order (dot-dash) (Example 4.2).	100
4.3	Step responses for the desired closed-loop with approximation of distributed delay with 5th order ((continuous line) and 2th order (dash) (Example 4.1).	101
4.4	Step responses for the desired closed-loop (continuous line) and for the closed-loop system with approximation of distributed delay with 5th order (dash) and 2rd order (dot-dash), (Example 4.3).	104
4.5	Step responses for the closed-loop system with initial condition $y(0) = 1$, (Example 4.4).	104
4.6	Step responses for the closed-loop system, (Example 4.5).	108
4.7	Block scheme of closed-loop system	110
4.8	Block scheme of the neutral time-delay system with elements proper.	110
4.9	Step response (step time at $t = 1$) of system without disturbance, (Example 4.6).	113
4.10	Feedback system for a plant with and without delay	113
4.11	Smith predictor implementation	115
4.12	Step response (step time at $t = 0$) of unstable system with modified Smith predictor (continuous), original Smith predictor (dash), (Example 4.7).	116
4.13	observer simulation with the state $x(t)$ (continuous) and the estimation of $\hat{x}(t)$ (dashed, with $h_1 = 1$, $h_2 = 0.5$) (dashed-dot, with $h_1 = 0.5$, $h_2 = 0.3$), the initial condition is $x_0(t) = [0 \ 1 \ 1]^T$, (Example 4.9).	128
4.14	observer simulation with the state $x(t)$ (continuous) and the estimation of $\hat{x}(t)$ (dashed $h = 1$, dashed-dot $h = 0.5$), $k = e^{-h}$ and the initial condition is $x_0 = 0.5$, (Example 4.10).	130
4.15	observer simulation with the state $x(t)$ (continuous) and the estimation of $\hat{x}(t)$ (dashed $k = 0.8$, dashed-dot $k = 0.5$), $h = 0.5$ and the initial condition is $x_0 = 0.5$, (Example 4.10).	131
4.16	observer simulation with the state $x(t)$ (continuous) and the estimation of $\hat{x}(t)$ (dashed $h = 0.5$, dashed-dot $h = 0.2$), the initial condition is $x_0 = [0.5 \ 0.5 \ 0.5]^T$, (Example 4.11).	137
4.17	observer simulation with the state $x(t)$ (continuous) and the estimation of $\hat{x}(t)$ (dashed $h = 0.5$, dashed-dot $h = 0.2$), the initial condition is $x_0 = [0.5 \ 0.5 \ 0.5]^T$, (Example 4.11).	138
4.18	observer simulation with the state $x(t)$ (continuous) and the estimation of $\hat{x}(t)$ ($\Delta h = 0.5$ (dash), $\Delta h = 1$ (dash-dot), $\Delta h = 1.5$ (dot)), the initial condition is $x_0 = [0.5 \ 0.5 \ 0.5]^T$, (Example 4.12).	141

5.1	The continuous line is $h(t)$, the dash line is the approximation of $h(t)$ (with $n = 10$), the dash-dot line is the approximation of $h(t)$ (with $n = 5$). (Example 5.1).	147
5.2	The continuous line is the step response of $P(s)$, the dash line is the step response of approximation plant with degree $n = 2$. (Example 5.2).	155
5.3	The error of step response of $P(s)$ and its approximation with degree $n = 2$. (Example 5.2).	155

Symbols

\mathbb{R}	set of real numbers
\mathbb{C}	set of complex numbers
\mathbb{N}	set of positive integers
\mathbb{Z}	set of integers
\mathbb{R}_+	set of real numbers positive or zero
Re	real part of the complex numbers
s	Laplace variable
\hat{x}	Laplace transform of x
\dot{x}	time derivative of x
e	exponential
\deg_s	degree in s
$\det A$	determinant of the square matrix A
$\operatorname{Rank}(A)$	rank of the matrix A
I_n	identity matrix ($n \times n$)
$\mathbb{R}[s]$	real rational polynomials in the variable s
$\mathbb{R}(s)$	set of rational fraction in the variable s
$\mathbb{R}[s, e^{-s}]$	the real polynomials in the variables s and e^{-s}
$\mathbb{R}(s, e^{-s})$	the set of rational fraction in the variables s and e^{-s}
\mathcal{G}	set of distributed delays
\mathcal{E}	set of pseudo-polynomials
$\mathcal{P}_{\mathcal{E}}$	set of pseudo-polynomials with degree non-positive.
L_1	L_1 linear space
$\ \cdot\ _{L_1}$	norm in L_1

\mathcal{A}	convolution algebra
$\ \cdot\ _{\mathcal{A}}$	norm in \mathcal{A}
$\mathbb{R}^{n \times m}$	set of real matrix ($n \times n$)
δ	dirac function

content of the thesis

The major two objectives of this manuscript are the study of distributed delay and its applications. In this manuscript, we first give the definition of distributed delay, analyse the properties of distributed delay and introduce a general method for the approximation of distributed delay. Then three applications of distributed delay are introduced, which is the second major objective of our research. The first application is stable inversion and model matching. The second is stabilization control and finite spectrum assignment for a class of infinite dimensional systems. And the last one is observer design. In addition to the two major objectives, we also introduce a new class of approximation for distributed parameter systems. Our work is mainly focused on the realization and representation of this class of approximation where distributed delay will appear explicitly. The manuscript is organized as follows.

Chapter 1: A general introduction to this manuscript and some algebraic preliminaries are given.

Chapter 2: Introduces the definition, properties and implementation of distributed delays.

Chapter 3: Presents the analysis of the stable inversion and model matching. Robustness under parameter uncertainties and state-space feedback realization of precompensator will also be discussed.

Chapter 4: The stability control and finite spectrum assignment control by using distributed delay are analysed. The observer design using distributed delay will be studied in the same chapter.

Chapter 5: Gives the description of the new class of approximation of distributed parameter systems.

Finally, Chapter 6 concludes the manuscript and presents perspectives.

Publications

M. Di Loreto, J-F. Lafay, and H. Lu. On the structure at infinity for linear time delay systems. 9th IFAC Workshop on Time Delay Systems, Prague (Czech Republic), 2010.

H. Lu and M. Di Loreto. On sable inversion for linear systems. 18th IFAC World Congress, Milan (Italy), Pages 6651-6656, 2011.

H. Lu and M. Di Loreto. Finite time model matching for multivariable linear systems, IFAC Workshop, Grenoble (France), Pages 66-71, 2013.

Submission of papers

H. Lu, M. Di Loreto, D. Eberard and J. P. Simon. Approximation of distributed delay. Submitted to *Systems & Control Letters*, 2013 (under review).

H. Lu, M. Di Loreto, Finite time model matching for linear systems (in preparation).

S. Damak, H. Lu and M. Di Loreto, Approximation of distributed parameter systems (in preparation).

Introduction

Cette thèse a pour objectif l'étude de l'opérateur de retard distribué, qui est un opérateur entrée-sortie de convolution décrit par

$$y(t) = (f * u)(t) = \int_{\vartheta_1}^{\vartheta_2} f(\tau)u(t - \tau)d\tau, \quad (1)$$

où $\vartheta_1, \vartheta_2 \in \mathbb{R}_+$ et $f(t)$ est une fonction continue, pour $t \in [\vartheta_1, \vartheta_2]$. La transformée de Laplace de cet opérateur s'écrit $\hat{y}(s) = \hat{f}(s)\hat{u}(s)$, où

$$\hat{f}(s) = \int_{\vartheta_1}^{\vartheta_2} f(\tau)e^{-s\tau}d\tau.$$

La motivation de l'étude de retards distribués est principalement liée à la commande de systèmes à retards, en particulier pour leur stabilisation. Cependant, ces opérateurs peuvent être utilisés dans d'autres problèmes classiques de l'Automatique, tels que le rejet de perturbation ou la poursuite de modèle, et pour une large classe de systèmes linéaires, qu'ils soient à retards, ou de dimension finie. L'objectif principal de ce travail de thèse est donc d'étudier la réalisation de tels opérateurs d'un point de vue numérique, et de montrer comment ces opérateurs permettent d'aborder et résoudre un certain nombre de problèmes.

Parcourons quelques exemples qui permettront de motiver notre étude.

L'un des problèmes fondamentaux en Automatique des systèmes linéaires est la synthèse de loi de commande stabilisante. L'intérêt dans l'utilisation de retards distribués pour la synthèse de loi de commande stabilisante de systèmes linéaires à retards a été souligné dans le travail précurseur de Olbrot [1, Olbrot (1978)]. La généralisation de méthodes algébriques pour la stabilisation, initialement développées pour les systèmes de dimension finie, aux systèmes à retards, a été introduite

par Kamen et al. [2, Kamen et al. (1986)], qui ont introduit un cadre mathématique pour une telle synthèse. Ces outils ont été formalisés dans les travaux de Brethé and Loiseau [3, Brethé and Loiseau (1996)] avec l'introduction de l'anneau de Bézout des pseudo-polynômes, ou avec une approche comportementale dans le travail de [4, Glüsing-Lüerßen (1997)]. Illustrons notre propos avec quelques exemples.

Exemple 0.1. *Considérons le système*

$$T_1(s) = \frac{1}{s-1}.$$

Un compensateur stabilisant est décrit par

$$C_1(s) = \frac{2 + (s-1) \cdot \frac{1-e^{-(s+1)}}{s+1}}{1 - \frac{1-e^{-(s+1)}}{s+1}}.$$

En boucle fermée, la fonction de transfert est

$$G_1(s) = \frac{T_1(s)C_1(s)}{1 + T_1(s)C_1(s)} = \frac{2 + (s-1) \cdot \frac{1-e^{-(s+1)}}{s+1}}{s+1},$$

qui est stable. On notera la présence d'un retard distribué dans le compensateur, à savoir $\hat{f}_1(s) = \frac{1-e^{-(s+1)}}{s+1}$, dont le noyau est $f_1(t) = e^{-t}$, $t \in [0, 1]$.

Exemple 0.2. *Considérons désormais le système instable à retard sur l'entrée*

$$T_2(s) = \frac{e^{-s}}{s-1}.$$

Un compensateur stabilisant est

$$C_2(s) = \frac{2e^1}{1 + 2\frac{1-e^{-(s-1)}}{s-1}}.$$

En boucle fermée, nous obtenons

$$G_2(s) = 2e^1 \frac{e^{-s}}{s+1},$$

qui est stable. De même que dans l'exemple précédent, un retard distribué a été utilisé dans la synthèse du contrôleur, $\hat{f}_2(s) = \frac{1-e^{-(s-1)}}{s-1}$, dont le noyau est $f_2(t) = e^t$, $t \in [0, 1]$.

De plus amples détails seront proposés dans le Chapitre 4 de ce manuscrit.

L'opérateur retard distribué est également utilisé pour le contrôle prédictif. Par exemple, prenons le système

$$\dot{x}(t) = Ax(t) + Bu(t - r). \quad (2)$$

Connaissant l'état $x(t_0)$ à l'instant t_0 et l'entrée de commande $u(t)$, l'unique solution de ce système est

$$x(t) = e^{A(t-t_0)}x(t_0) + \int_{t_0}^t e^{A(t-\tau)}Bu(\tau - r)d\tau, \quad t \geq t_0. \quad (3)$$

En prenant $t_0 = t - h$, $h < r$, nous obtenons

$$x(t + h) = e^{Ah}x(t) - e^{Ah} \int_{t+h}^t e^{A(t-\tau)}Bu(\tau - r)d\tau, \quad (4)$$

où $\int_{t+h}^t e^{A(t-\tau)}Bu(\tau - r)d\tau$ est un retard distribué. L'état du système à l'instant $t + h$ peut alors être estimé à partir de (4) en utilisant l'information passée sur le système. Le prédicteur de Smith [5, Smith (1959)] est fréquemment évoqué dans la synthèse de contrôle de systèmes à retards. Ce contrôleur permet de séparer la partie liée au retard sur l'entrée du reste du système, ce qui permet d'effectuer la synthèse d'un contrôleur sans retard. La principale limite de ce principe réside dans l'hypothèse que le système doit être stable en boucle ouverte. L'ajout d'un retard distribué dans le prédicteur de Smith permet d'éliminer cette limite [6, Michiels and Niculescu (2003)]. Voir également le Chapitre 4 (Section 4.1) de ce manuscrit.

Une troisième application du retard distribué réside dans la représentation des systèmes linéaires. A ce titre, considérons le système

$$\dot{x}(t) = Ax(t) + Bu(t). \quad (5)$$

La solution de (5) est

$$x(t) = e^{A(t-t_0)}x(t_0) + \int_{t_0}^t e^{A(t-\tau)}Bu(\tau)d\tau, \quad t \geq t_0. \quad (6)$$

Par le changement de variable $t_0 = t - h$, (6) s'écrit sous la forme

$$x(t) = e^{Ah}x(t-h) + \int_{t-h}^t e^{A(t-\tau)}Bu(\tau)d\tau, \quad t \geq h, \quad (7)$$

où $\int_{t-h}^t e^{A(t-\tau)}Bu(\tau)d\tau$ est un retard distribué. A partir de (7), la synthèse d'un observateur est également possible, observateur qui n'exploite que les informations passées sur le système [7, Medvedev and Toivonen (1994)] [8, Pourboghrat and Chyung (1984)].

L'opérateur retard distribué apparaît également dans la modélisation de systèmes physiques. Voir par exemple [9, Sinègre (2005)], [10, Kolmanovskii and Nosov (1986)], [11, Guardiola and Vecchio (2004)], [12, Jian et al. (2007)], etc.

Exemple 0.3. *Un modèle de la croissance d'une population a été proposé dans [10, Kolmanovskii and Nosov (1986)]. Soit $N(t)$ le nombre d'individus d'une population, supposée isolée, à l'instant t . La durée de vie est supposée égale à L . Le nombre de naissance par unité de temps est une fonction de $N(t)$, c'est-à-dire $g(N(t))$. Le nombre de morts par unité de temps est alors $g(N(t-L))$. Ainsi, la croissance de cette population est décrite par*

$$\dot{N}(t) = g(N(t)) - g(N(t-L)), \quad (8)$$

qui est une équation différentielle à retard. Afin de résoudre cette équation, le nombre d'individus sur un intervalle de temps passés doit être connu. Désormais, si nous introduisons $P(a)$ comme étant le taux de survie d'un individu à l'âge a et L la durée maximale de vie, la dynamique du nombre d'individus est gouvernée par

$$\dot{N}(t) = g(N(t)) + \int_0^L g(N(t-\tau))\dot{P}(\tau)d\tau, \quad (9)$$

où $\int_0^L g(N(t-\tau))\dot{P}(\tau)d\tau$ est un retard distribué.

Pour certains retards distribués, un problème de mise en œuvre numérique apparaît. Par exemple, si le noyau est $f(t) = 1$, $t \in [0, 1]$ dans le domaine temporel (ou de manière équivalente $\hat{f}(s) = \frac{1-e^{-s}}{s}$ dans le domaine fréquentiel), la fonction de transfert $\hat{f}(s)$ est stable (car $\hat{f}(0) = 1$). Cependant, il n'est pas possible de la réaliser numériquement avec stabilité, par suite de la présence de la singularité artificielle en 0. Afin de proposer une mise en œuvre numérique, il s'avère nécessaire d'effectuer une approximation du retard distribué. Cette question a été

soulevée dans les travaux de [13, Van Assche et al. (1999)], et a été largement traitée, comme par exemple dans [14, Zhong (2003)], [15, Mirkin (2004)], [16, Partingdon and Mäkilä]. Ces différentes méthodes seront détaillées dans le Chapitre 2. La résolution de ce problème de mise en œuvre numérique et la proposition d'un cadre général permettant d'englober l'ensemble des algorithmes proposés d'approximation est l'objectif principal de ce manuscrit.

Les objectifs secondaires de ce manuscrit sont alors de montrer l'intérêt de l'utilisation de l'opérateur retard distribué pour un certain nombre de problèmes de contrôle.

Commençons donc par introduire l'opérateur retard distribué et son approximation. Soit $\mathbb{I}_{a,b} = [a, b]$ un intervalle fermé borné de \mathbb{R}_+ , pour a et b des réels, $0 \leq a < b$. Nous notons de manière équivalente $\mathbb{I}_{0,\infty}$ ou \mathbb{R}_+ pour $[0, \infty]$. Nous définissons $\mathcal{K}(\mathbb{I}_{a,b})$ comme l'ensemble des fonctions complexes $g(\cdot)$ de la forme

$$g(t) = \begin{cases} g_{\mathbb{I}_{a,b}}(t), & t \in \mathbb{I}_{a,b} \\ 0, & \text{ailleurs} \end{cases} \quad (10)$$

où

$$g_{\mathbb{I}_{a,b}}(t) = \sum_{i \geq 0} \sum_{j \geq 0} c_{ij} t^j e^{\lambda_i t}, \quad (11)$$

pour certains c_{ij} et λ_i dans \mathbb{C} , les sommes étant finies.

Definition 0.1 (Retard distribué). Un retard distribué est un système causal de convolution, dont le noyau f appartient à $\mathcal{K}(\mathbb{I}_{\vartheta_1, \vartheta_2})$, pour des réels $0 \leq \vartheta_1 < \vartheta_2$.

En d'autres termes, un retard distribué peut être écrit comme un opérateur entrée-sortie de convolution sous la forme

$$y(t) = (f * u)(t) = \int_{\vartheta_1}^{\vartheta_2} f_{\mathbb{I}_{\vartheta_1, \vartheta_2}}(\tau) u(t - \tau) d\tau = \int_{t - \vartheta_1}^{t - \vartheta_2} f_{\mathbb{I}_{\vartheta_1, \vartheta_2}}(t - \tau) u(\tau) d\tau, \quad (12)$$

avec les notations introduites dans (11).

Definition 0.2 (Retard distribué élémentaire). Le retard distribué élémentaire est le retard distribué dont le noyau est $\theta_\lambda(\cdot) \in \mathcal{K}(\mathbb{I}_{0, \vartheta})$, pour $\lambda \in \mathbb{C}$ et $\vartheta > 0$, avec

$$\theta_\lambda(t) = \begin{cases} e^{\lambda t}, & t \in [0, \vartheta] \\ 0, & \text{ailleurs} \end{cases} \quad (13)$$

□

La transformée de Laplace de (13) est

$$\hat{\theta}_\lambda(s) = \frac{1 - e^{-(s-\lambda)\vartheta}}{s - \lambda}, \quad (14)$$

qui est une fonction entière, même pour $s = \lambda$ où $\hat{\theta}_\lambda(\lambda) = \vartheta$. Le retard distribué élémentaire se révèle fondamental par suite de la propriété ci-dessous.

Lemma 0.3. *Toute transformée de Laplace d'un retard distribué se décompose sous forme d'une somme finie des transformées de Laplace de retards distribués élémentaires et de leurs dérivées successives.*

A partir du Lemme 0.3 et des propriétés qui en découlent, l'analyse de l'approximation d'un retard distribué quelconque revient à l'approximation d'un retard distribué élémentaire. Pour cette raison, nous nous concentrons par la suite à la mise en œuvre numérique d'un retard distribué élémentaire. Nous définissons deux sous-espaces en somme directe dans $\mathcal{K}(\mathbb{I}_{\vartheta_1, \vartheta_2})$, notés respectivement $\mathcal{K}_s(\mathbb{I}_{\vartheta_1, \vartheta_2})$ et $\mathcal{K}_u(\mathbb{I}_{\vartheta_1, \vartheta_2})$. Ces sous-espaces contiennent des combinaisons linéaires de fonctions de type polynomial-exponentiel sur un intervalle fini comme dans (11), avec $\text{Re } \lambda_i < 0$ et $\text{Re } \lambda_i \geq 0$, respectivement, pour tout $i \geq 0$.

Tout élément de $\mathcal{K}_s(\mathbb{I}_{\vartheta_1, \vartheta_2})$ peut être réalisé numériquement avec stabilité, en utilisant des blocs élémentaires, comme illustré sur la Figure 1 pour $\theta_\lambda(t)$. Remarquons

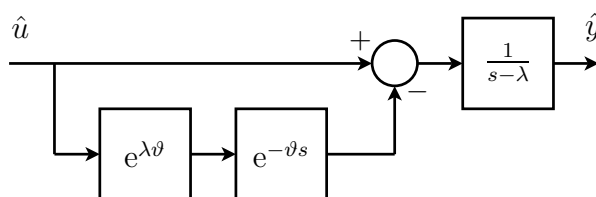

FIGURE 1: Réalisation d'un élément $\hat{\theta}_\lambda(s) \in \mathcal{K}_s(\mathbb{I}_{0, \vartheta})$, avec $\text{Re } \lambda < 0$.

qu'en pratique, puisque $\lambda \in \mathbb{C}$, cet élément nécessiterait pour sa mise en œuvre une décomposition réelle. L'approximation de la sous-classe de retards distribués $\mathcal{K}_s(\mathbb{I}_{\vartheta_1, \vartheta_2})$ n'est donc pas nécessaire, car ces éléments peuvent être réalisés numériquement avec stabilité, et ne nécessitent que deux retards ponctuels, c'est-à-dire 0 et ϑ . Cependant, cela n'est plus vrai pour les éléments dans $\mathcal{K}_u(\mathbb{I}_{\vartheta_1, \vartheta_2})$, où une réalisation numérique pour $\theta_\lambda(t)$ décrite sur la Figure 1 conduit à un opérateur instable, de part le fait de la non simplification numérique de la singularité

artificielle instable. Remarquons également qu'une autre réalisation pour $\hat{\theta}_\lambda(s)$ serait

$$\dot{x} = \lambda x(t) + u(t) - e^{\lambda\vartheta} u(t - \vartheta), \quad (15)$$

qui est également numériquement instable pour $\text{Re } \lambda \geq 0$.

La mise en œuvre numérique de l'opérateur retard distribué a été l'objet de nombreux travaux, dont l'objectif était principalement de proposer des algorithmes efficaces pour leur approximation et la synthèse de commande. Les premiers travaux sur ce sujet ont proposé une approximation d'un retard distribué à partir de l'approximation de l'intégrale par des schémas d'intégration numérique. Voir par exemple [13, Van Assche et al. (1999)]. L'approximation proposée s'écrit alors sous forme d'une convolution dont le noyau est une somme de distributions de Dirac retardées. Malheureusement, une telle approximation introduit des dynamiques additionnelles en boucle fermée et des phénomènes d'instabilité, liés à la sensibilité d'une telle approximation en hautes fréquences [14, Zhong (2003)], [17, Santos and Mondié (2000)]. Cette remarque est illustrée sur la Figure 2, où un diagramme fréquentiel de $\hat{\theta}_1(s)$ et une approximation entrée-sortie (obtenue par une approximation de Newton-Cotes trapézoïdale à 30 nœuds) est tracé, avec la notation $h(\omega) = 20 \cdot \log \left| \hat{\theta}_1(j\omega) \right|$. En boucle fermée, une telle approximation peut

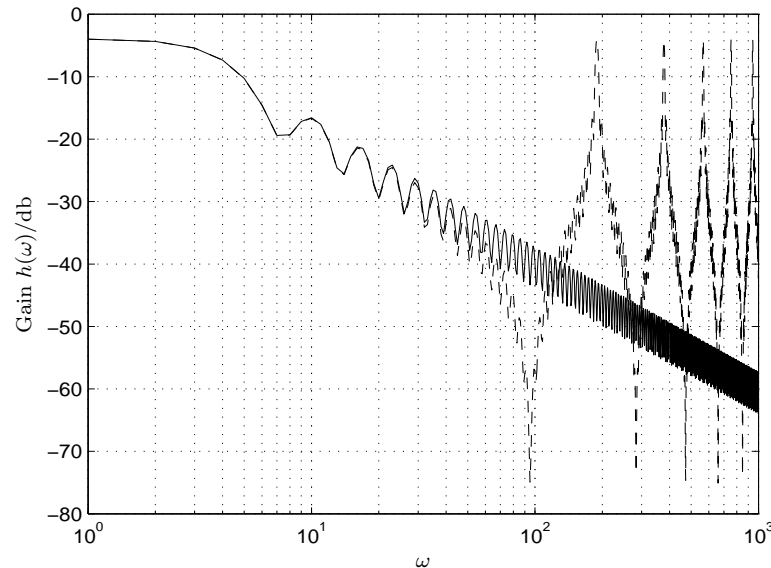

FIGURE 2: Diagramme de Bode en gain de $\hat{\theta}_1(s)$ et de son approximation obtenue par la un schéma d'intégration numérique trapézoïdal à 30 nœuds.

rendre le système instable, malgré le fait que le contrôleur avec retard distribué soit stabilisant.

Exemple 0.4. Soit

$$\hat{p}(s) = \frac{e^{-s}}{s-1}.$$

Un compensateur stabilisant est

$$\hat{c}(s) = \frac{2e}{1 + 2\frac{1-e^{-(s-1)}}{s-1}},$$

pour lequel le schéma de réalisation est tracé sur la Figure 3. Une réalisation en

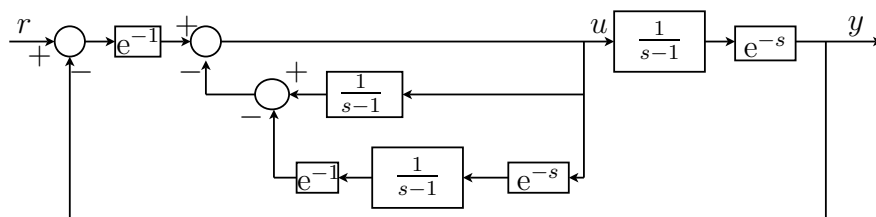

FIGURE 3: Schéma bloc fonctionnel d'un contrôleur stabilisant pour l'Exemple 0.4.

temps de ce contrôleur est

$$u(t) = -2e^1 y(t) - 2e^1 \int_{t-1}^t e^{t-\tau} u(\tau) d\tau + 2e^1 r(t)$$

où y est la sortie du système, u est l'entrée de commande, et r est une référence de la boucle fermée. En boucle fermée, la fonction de transfert entre r et y est $H(s) = 2\frac{e^{-(s-1)}}{s+1}$, qui est bien stable. Après mise en œuvre de la méthode d'approximation et simulation, une réponse instable du système est obtenue. Cette approximation est décrite par un schéma trapézoïdal d'intégration numérique

$$\begin{aligned} g_1(t) &= \int_{t-1}^t e^{t-\tau} u(\tau) d\tau \\ &\approx \frac{1}{v} \left[\frac{1}{2} u(t) + \sum_{i=1}^{v-1} e^{2\frac{i}{v}} u\left(t - 1\frac{i}{v}\right) + \frac{1}{2} e u(t-1) \right] = g_2(t) \end{aligned} \quad (16)$$

où $\frac{1}{v}$ ($v \in \mathbb{N}^+$) est le pas de discrétisation.

Les transformées de Laplace de $g_1(t)$ et $g_2(t)$ sont décrites par

$$\hat{g}_1(s) = \frac{1 - e^{-(s-1)}}{s-1}$$

$$\hat{g}_2(s) = \frac{1}{v} \left(\frac{1}{2} + \frac{1}{2} e^h e^{-s} + \sum_{i=1}^{v-1} e^{\frac{i-v}{v}} e^{-\frac{i}{v}s} \right).$$

Un résultat de simulation est tracé sur la Figure 4, après approximation. L'instabilité demeure même pour v très grand.

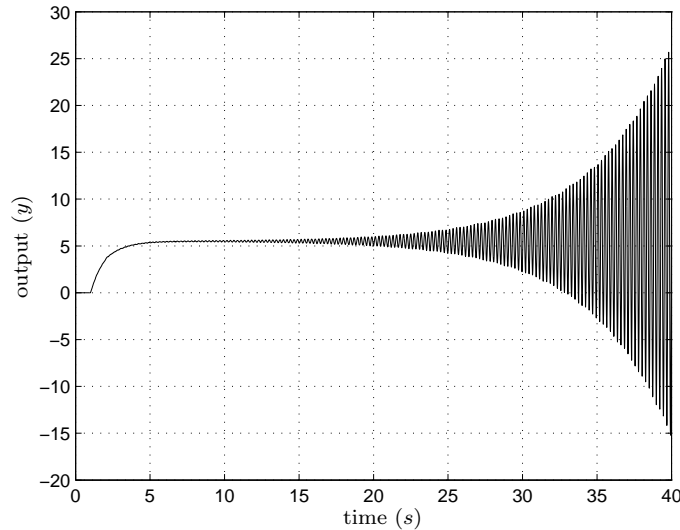

FIGURE 4: Réponse indicielle unitaire de la boucle fermée ($v = 5, h = 1$) pour l'Exemple 0.4.

Le polynôme caractéristique du système est

$$q(s) = (s - 1)(1 + 2\hat{g}_2(s)) + 2e^{-s}$$

qui admet des racines à partie réelle dans le semi-plan droit complexe (fermé).

Afin de contourner cette difficulté, plusieurs solutions ont été proposées dans la littérature. [15, Mirkin (2004)] a mis en évidence qu'une telle approximation possède une mauvaise précision et une grande sensibilité en hautes fréquences. Cet auteur a alors proposé l'ajout d'un filtre passe-bas dans cette approximation de l'intégrale. Une telle solution a aussi été proposée indépendamment par Mondié and Michiels [18, Mondié and Michiels (2003)]. D'autres techniques pour la mise en œuvre numérique ont été proposées par Zhong [19, Zhong (2005)], et Partington et Mäkilä [16, Partington and Mäkilä (2005)]. Ces différentes contributions répondent positivement au problème général de l'approximation numérique du retard distribué.

Nous proposons dans ce manuscrit une méthodologie générale pour la mise en œuvre numérique de retards distribués, qui permet de donner un cadre général de cette problématique pour des applications de commande de systèmes. La mise

en œuvre numérique d'un opérateur s'effectue en deux temps. La première phase consiste à définir un opérateur d'approximation continu en temps et une topologie pour cette approximation. La deuxième phase consiste à discrétiser en temps cet opérateur d'approximation.

Tout retard distribué est un opérateur de convolution BIBO-stable. Il est immédiat de vérifier qu'un système équivalent à temps échantillonné peut être obtenu par les outils habituels de discrétisation et échantillonnage. Un tel opérateur peut être mis sous forme d'une somme finie de distributions causales liées à l'opérateur retard échantillonné. En prenant convenablement une période d'échantillonnage, cet opérateur échantillonné est toujours BIBO-stable. La deuxième phase décrite ici pour la mise en œuvre ne présente donc pas de difficultés. Voir par exemple Zhong [20, Zhong (2004)] et les références associées. La première phase quant à elle présente les difficultés mentionnées ci-dessus. C'est donc cette partie qui est traitée dans le manuscrit.

Dans un premier temps, nous montrons qu'une approximation entrée-sortie d'un opérateur de convolution, classiquement réalisée par des schémas issus de l'analyse numérique, n'est pas satisfaisante en vue des propriétés obtenues pour le contrôle. Nous nous concentrerons alors à l'étude de l'approximation du noyau de convolution. Avec l'objectif permanent de remplacer un retard distribué par un système dynamique facilement implémentable, nous proposons d'utiliser les hypothèses de rationalité afin de définir deux classes d'approximation, à savoir les systèmes à paramètres localisés et une sous-classe de retards distribués. Munis des objectifs précédents, nous englobons le problème d'approximation dans l'algèbre de Wiener des systèmes BIBO-stables, en utilisant la topologie du graphe. Cette topologie correspond à la plus faible topologie pour laquelle la rétroaction est une propriété robuste. En outre, pour des systèmes stables, la topologie du graphe et la topologie associée à la norme sur cette algèbre sont les mêmes, ce qui permet de travailler directement sur la convergence de la norme de cette algèbre, qui est une algèbre de Banach. Ce contexte général a été défini et exploité dans [21, Vidyasagar and Anderson (1989)] pour l'approximation de systèmes à paramètres répartis par des systèmes à paramètres localisés. En d'autres termes, travailler sur l'approximation dans cette algèbre revient à réaliser une approximation du noyau de convolution sur l'algèbre de Banach $L_1(\mathbb{R}_+)$. On retrouve également cette idée dans [22, Ohta et al. (1992)], pour l'approximation de distributions de Dirac retardées qui apparaissent dans certains problèmes de commande optimale. Nous proposons ici une extension de la classe d'approximation, et nous montrons que dans ce cadre

général, l'approximation est valide aussi bien dans les domaines temporel que fréquentiel, pour une grande variété de signaux d'entrée. Nous montrons aussi que les propositions faites dans la littérature sur l'approximation de retards distribués, telles que [15, Mirkin (2004)] ou [18, Mondié and Michiels (2003)], sont des cas particuliers de ce cadre général d'approximation. A titre d'illustration, les Figure 5, 6 reportent des résultats de simulation d'une approximation d'un retard distribué, aussi bien en temps pour le noyau de convolution, que dans le domaine fréquentiel.

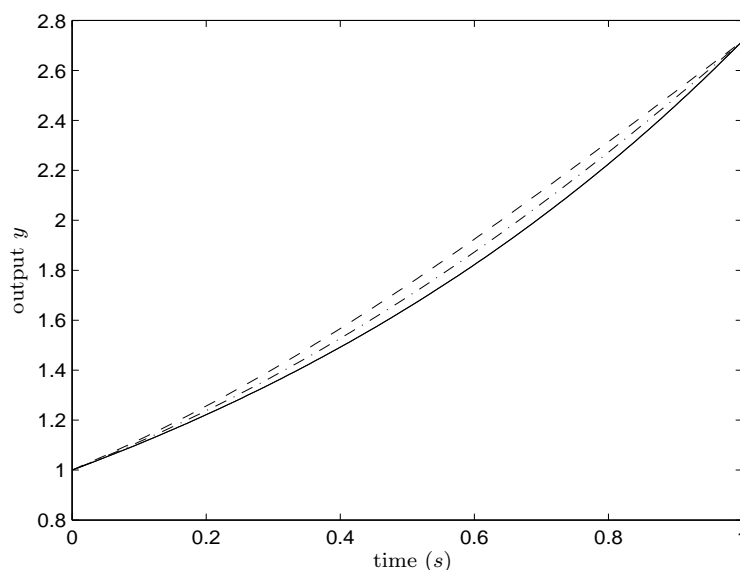

FIGURE 5: Approximations du noyau $\theta_{1,\text{app}}(t)$ utilisant des fonctions exponentielles. Noyau $\theta_1(t)$ (continu), approximations d'ordre $n = 5$ (séparé) et $n = 10$ (pointillé).

Nous analysons trois méthodes proposées dans la littérature. Dans [13, Van Assche et al. (1999)], l'approximation du retard distribué utilise une méthode d'intégration numérique, qui introduit en boucle fermée une instabilité, car cette méthode propose une approximation propre d'un opérateur strictement propre, et possède intrinsèquement une grande sensibilité en hautes fréquences, pour la boucle fermée. La première méthode analysée est celle proposée dans Mirkin [15, Mirkin (2004)], qui consiste à exploiter la même approximation que celle mentionnée ci-dessus, mais en y ajoutant un filtre passe-bas. La deuxième méthode étudiée a été proposée par Zhong [20, Zhong (2004)]. Nous montrons que ces deux méthodes sont en réalité des approximations du noyau de convolution pour la norme L_1 . La troisième méthode décrite est une approximation rationnelle proposée par Partington et Mäkilä [16, Partington and Mäkilä (2005)], où une approximation

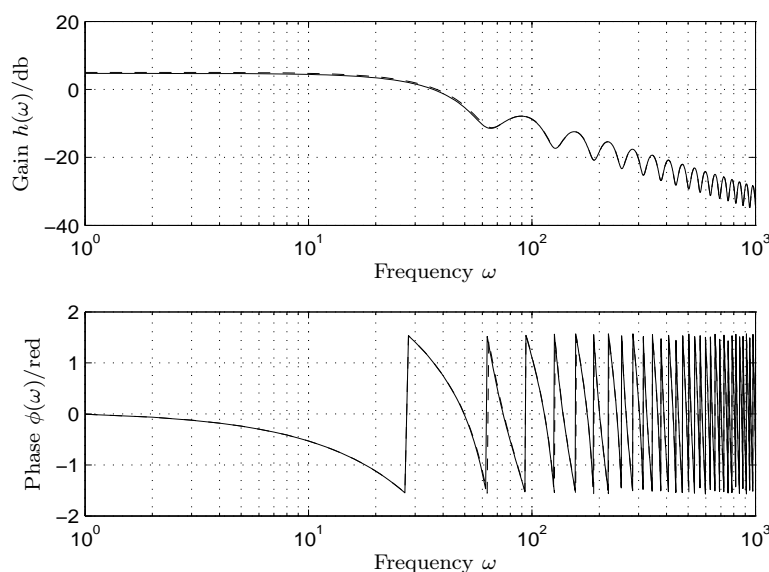

FIGURE 6: Diagramme de Bode de $\hat{\theta}_1(j\omega)$ et de son approximation $\hat{\theta}_{1,\text{app}}(j\omega)$, d'ordre $n = 5$.

de Padé a été utilisée pour garantir une convergence au sens de la norme sur H_∞ .

Après nous être intéressés à l'approximation de l'opérateur retard distribué, nous décrivons quelques applications dans lesquelles cet opérateur intervient. La première problématique à laquelle nous nous intéressons est le problème d'inversion et de poursuite de modèle.

Dans la théorie du contrôle, l'inversion d'un système dynamique est peut-être l'un des fondements communs à de nombreuses synthèses de contrôleurs. Son principe se retrouve ainsi dans la commande par anticipation (feedforward control), planification de trajectoire, dimensionnement de systèmes, découplage, ou encore rejet de perturbation. Pour un système donné de fonction de transfert $T(s)$, le problème classique d'inversion revient à déterminer $R(s)$ tel que $T(s)R(s) = I$. Pour l'inversion de systèmes SISO (Single Input-Single Output), un problème de stabilité de l'inverse apparaît lorsque le système est à non minimum de phase ou strictement propre. Par exemple, le système

$$T(s) = \frac{s - 1}{s + 1}$$

ne possède pas d'inverse stable, car le zéro instable $s_0 = +1$ conduit à un pôle instable de l'inverse. Pour les systèmes MIMO (Multivariable Input- Multivariable Output), des problèmes similaires pour l'obtention d'une inverse stable ou réalisable se généralisent à partir du cas SISO. L'une des questions auxquelles nous

nous sommes intéressés est donc de déterminer s'il est possible à partir de systèmes n'admettant pas d'inverse propre ou stable, de caractériser une inverse approchée, stable et réalisable au sens de la causalité. Ce travail s'insère dans les directions récentes de certains travaux sur ce sujet. A partir du travail précurseur de Silverman [23, Silverman (1969)], différentes extensions ont été proposées pour résoudre des extensions aux problème d'inversion avec stabilité. Parmi celles-ci, citons [24, Garcia et al. (1995)] où le problème de stabilité est étudié pour le problème de poursuite partiel de modèle, ou [25, Devasia et al. (1996)] où la précompensation stable et non-causale est étudiée pour des systèmes non linéaires. D'autres travaux ont étendu les résultats obtenus dans ce dernier papier, par exemple dans [26, Hunt et al. (1996)] où certaines contraintes sur les hypothèses ont été supprimées, ou encore [27, Sogo (2010)] où une équivalence entre l'inversion stable non-causale et l'utilisation de la transformée de Laplace bilatérale a été établie pour les systèmes linéaires. Pour d'autres classes de systèmes, des extensions ont également été proposées, comme par exemple pour les systèmes 2D [28, Loiseau and Brethé (1997)], ou [29, Di loreto (2006)] pour les systèmes à retards, ou encore [30, Goodwin et al. (2000)] pour l'utilisation de grands gains.

Dans ce manuscrit, notre contribution consiste à introduire un nouveau problème d'inversion, dont la solution est stable et causale. L'existence d'une solution est générique pour les systèmes linéaires. Le problème résolu est en réalité déterminé par un calcul approché de l'inverse. Plus précisément, cette inverse approché permet d'assurer que l'on obtient une inverse exacte après un temps fini $t = \vartheta$, où $\vartheta \in \mathbb{R}_+$ peut être choisi arbitrairement.

Ce problème d'inversion peut être formulé de la manière suivante pour les systèmes SISO. Soit $T(s)$ un système donné. On cherche à déterminer $R(s)$ tel que l'erreur d'inversion

$$\hat{e}(s) = 1 - T(s)R(s) \quad (17)$$

corresponde à la transformée de Laplace d'une fonction causale à support borné. Un tel précompensateur $R(s)$ est alors dit solution au problème d'inversion en temps fini, tandis que $\hat{e}(s)$ est l'erreur d'inversion. Ce problème est illustré sur la Figure 7 et sur la Figure 8.

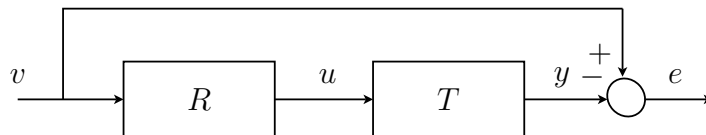

FIGURE 7: Inversion stable à temps fini.

Parmi les nombreux ensembles dans lesquels l'erreur d'inversion $\hat{e}(s)$ peut être définie, nous considérons ici la classe des éléments rationnels, au sens où des procédures algébriques peuvent être obtenues pour le calcul d'une solution au problème d'inversion en temps fini. Pour cela, nous imposons que l'erreur $e(t)$ soit définie sur l'ensemble \mathcal{P}_ϑ défini comme suit. Tout élément de \mathcal{P}_ϑ est de la forme

$$e(t) = g(t) + \sum_{k=0}^r e_k \delta(t - k\vartheta), \quad (18)$$

où $g \in \mathcal{G}$ est un retard distribué, et $e_k \in \mathbb{R}$, pour $k = 0, \dots, r$. Dans le domaine de Laplace, cela est équivalent à dire que tout élément $\hat{e}(s) \in \hat{\mathcal{P}}_\vartheta$ s'écrit sous la forme

$$\hat{e}(s) = \hat{g}(s) + \sum_{k=0}^r e_k e^{-k\vartheta s}. \quad (19)$$

Les éléments de $\hat{\mathcal{P}}_\vartheta$ sont propres, et BIBO-stables, car à support borné. Un schéma représentatif de l'erreur d'inversion est proposé sur la Figure 8, où les distributions de Dirac sont définies aux instants t_i , pour $i = 1, 2, 3$, qui correspondent à des multiples de $\vartheta > 0$. Après un temps fini $t_f \geq 0$, l'erreur d'inversion $e(t)$ est identiquement nulle. L'intervalle de temps $[0, t_f]$ contient le support de $e(t)$. La taille du support de l'erreur dépend donc de celle du retard distribué et de ϑ .

En utilisant cette classe, le problème d'inversion stable en temps fini revient à

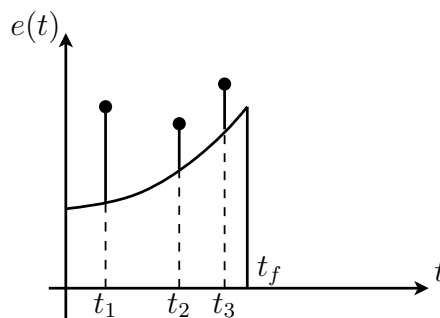
FIGURE 8: Evolution dans le domaine temporel de l'erreur d'inversion $e(t)$.

déterminer $R(s)$ tel que

$$\hat{e}(s) = 1 - T(s)R(s) \in \hat{\mathcal{P}}_\vartheta \quad (20)$$

Dans ce manuscrit, nous étudions ce problème d'inversion, pour des systèmes linéaires SISO et MIMO. Nous proposons également une extension de cette idée au problème de poursuite de modèle. Le problème de poursuite (exacte) de modèle consiste, étant donné un système $T(s)$ et un modèle $T_m(s)$, à déterminer un précompensateur $R(s)$, tel que la fonction de transfert $G(s) = T(s)R(s)$ corresponde à celle du modèle $T_m(s)$. En d'autres termes, on détermine dans ce problème un précompensateur $R(s)$ tel que l'erreur $e(t)$ soit identiquement nulle (voir Figure 9).

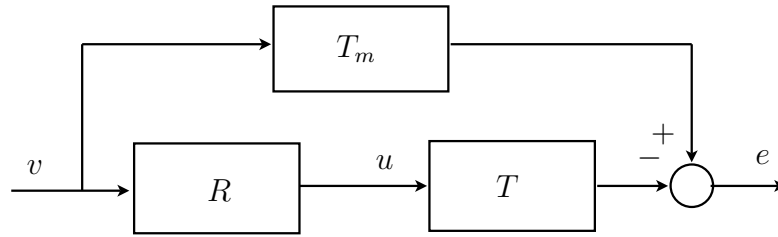

FIGURE 9: Problème de poursuite de modèle.

Cependant, les conditions d'existence d'une solution causale et stable à ce problème sont en général très conservatives. L'extension proposée consiste à définir une erreur de poursuite de modèle, qui n'est plus identiquement nulle,

$$E(s) = T_m(s) - T(s)R(s), \quad (21)$$

et qui est à support borné. Les conditions d'existence d'une solution $R(s)$ causale et stable sont génériques. Des algorithmes algébriques sont proposés pour le calcul d'une telle solution, dans le cas de systèmes linéaires SISO et MIMO. Nous effectuerons également quelques commentaires sur la réalisation de ce précompensateur par retour d'état, et sur la robustesse des propriétés inhérentes de la solution par rapport à des incertitudes paramétriques.

Illustrons notre propos par deux exemples, pour l'inversion et la poursuite de modèle.

Exemple 0.5. *Pour l'inversion stable en temps fini, considérons le système*

$$T(s) = \frac{1}{s+1}.$$

Notre procédure de calcul d'une solution fournit par exemple (solution non unique, voir Chapitre 3), le précompensateur propre et stable

$$R(s) = 1 - e^{-\vartheta(s+1)},$$

où l'erreur d'inversion est

$$\hat{e}(s) = 1 - \frac{1 - e^{-(s-1)\vartheta}}{s-1} \in \hat{\mathcal{P}}_{\mathcal{E}}.$$

Des résultats de simulation de cette erreur sont tracés sur la Figure 10, pour 3 valeurs de ϑ .

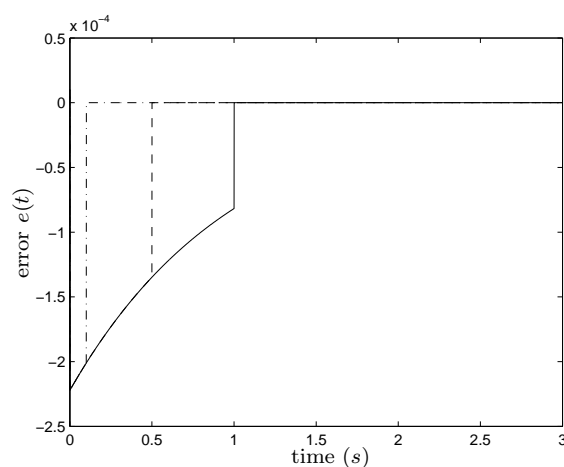

FIGURE 10: Erreur d'inversion en temps pour $\vartheta = 1$ (continu), $\vartheta = 0.5$ (séparé) et $\vartheta = 0.1$ (pointillé) (Exemple 0.5).

Exemple 0.6. *Considérons le système*

$$T(s) = \begin{bmatrix} \frac{s-1}{s+1} & \frac{1}{s+1} \end{bmatrix},$$

et le modèle $T_m(s) = \frac{s+2}{s+1}$. Un précompensateur solution du problème de poursuite de modèle en temps fini est (procédure décrite dans le Chapitre 3)

$$R(s) = \begin{bmatrix} 0 \\ e^{-(s+1)\vartheta} \end{bmatrix},$$

pour lequel l'erreur de poursuite de modèle est

$$E(s) = 1 + \frac{1 - e^{-(s+1)\vartheta}}{s+1}.$$

Dans le domaine temporel, cette erreur est

$$e(t) = \begin{cases} \delta(1) + e^{-t}, & t \in [0, \vartheta] \\ 0, & \text{sinon} \end{cases}.$$

Les résultats de simulation de cette solution sont tracés sur la Figure 11, pour 3 valeurs différentes de ϑ . Cette erreur s'annule après un temps fini.

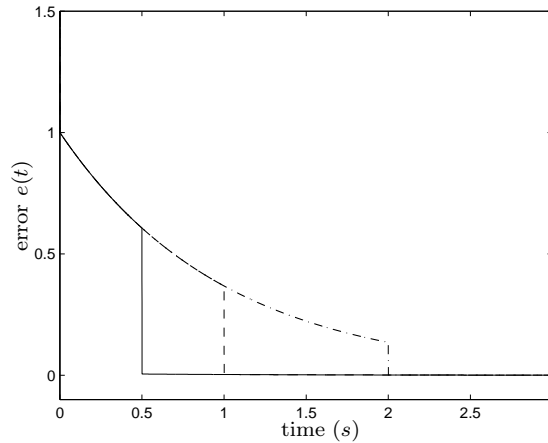

FIGURE 11: Erreur de poursuite de modèle pour $\vartheta = 0.5$ (continu), $\vartheta = 1$ (pointillé), $\vartheta = 2$ (trait-mixte) (Exemple 0.6).

La deuxième application étudiée dans ce manuscrit concerne la synthèse de commande stabilisante pour une certaine classe de systèmes de dimension infinie. Nous commençons par l'étude de systèmes à retards. Ces systèmes sont régis par des équations fonctionnelles, dans lesquelles interviennent des opérateurs de retards en temps. Ces systèmes ont fait l'objet de nombreux travaux, comme par exemple [31, Hale and Verduyn Lunel (1993)], [32, Conte and Perdon (2000)], [33, Kharitonov (2000)], [34, Niculescu (2001)], [35, Kolmanovskii et al. (1999)], [36, Loiseau (1998)], [28, Loiseau and Brethé (1997)], [37, Richard (1998)], [38, Richard (2003)] et [39, Watanabe et al. (1996)]. Nous étudions en particulier le problème de stabilisation de la classe de systèmes décrits par

$$\dot{x}(t) = \sum_{i=1}^k E_i \dot{x}(t - i\vartheta) + \sum_{i=0}^k A_i x(t - i\vartheta) + \sum_{i=0}^k B_i u(t - i\vartheta), \quad (22)$$

où A_i, B_i, E_i sont des matrices définies sur \mathbb{R} . Si $E_i = 0$, (4.1) est dit système à retard de type retardé. Si $E_i \neq 0$, le système (22) est dit de type neutre. Pour

la stabilisation de cette classe de systèmes, nous proposons d'appliquer l'approche par factorisation développée dans [40, Vidyasagar (1985)]. De manière générale, l'opérateur retard distribué apparaît lors de la synthèse d'une loi de commande stabilisante. Nous proposons donc des conditions sur l'ordre de l'approximation pour garantir une conservation des propriétés de stabilité de la boucle fermée en présence de cette approximation.

Pour les systèmes de type neutre, deux cas seront étudiés, à savoir, les systèmes neutres formellement stables, et ceux non formellement stables. Le système (22) est dit formellement stable si

$$\text{Rank}(I - \hat{E}(e^{-\theta s})) = n, \forall s \in \mathbb{C}, \text{Re}(s) \geq 0, \quad (23)$$

où

$$\hat{E}(e^{-\theta s}) = \sum_{i=1}^k E_i e^{-i\theta s}. \quad (24)$$

L'équation caractéristique de (22) est définie par

$$\Delta(s, e^{-\theta s}) = \det \left[s \left(I - \hat{E}(e^{-\theta s}) \right) - \hat{A}(e^{-\theta s}) \right] = 0, \quad (25)$$

où

$$\hat{A}(e^{-\theta s}) = \sum_{i=1}^k A_i e^{-i\theta s}. \quad (26)$$

Avec (23), le système (22) est formellement stable si et seulement si le terme principal de $\Delta(s, e^{-\theta s})$ est un polynôme de Hurwitz par rapport à la variable $e^{-\theta s}$. Pour les systèmes neutres formellement stables, la synthèse de commande stabilisante reste très proche de celle réalisée pour les systèmes de type retardé. Pour les systèmes neutres non formellement stables et strictement propres, il n'existe pas de compensateur stabilisant propre. Il est alors nécessaire afin de le stabiliser d'étendre la classe de retour d'état admissible, en utilisant des dérivées de l'état, c'est-à-dire,

$$\begin{aligned} u(t) &= \int_0^{\vartheta_1} f_1(\tau) u(t - \tau) d\tau + \int_0^{\vartheta_1} f_1(\tau) x(t - \tau) d\tau \\ &+ \int_0^{\vartheta_3} f_3(\tau) \dot{x}(t - \tau) d\tau + \dots \\ &+ \sum_{i=0}^k g_{1_i} x(t - i\vartheta) + \sum_{i=1}^k g_{2_i} \dot{x}(t - i\vartheta) + \dots \end{aligned} \quad (27)$$

La transformée de Laplace de (27) est

$$\hat{u}(s) = \hat{F}_1(s)\hat{u}(s) + \hat{F}_2(s)\hat{x}(s) \quad (28)$$

où $\hat{F}_1 \in \hat{\mathcal{G}}$, $\hat{F}_2 \in \hat{\mathcal{G}} + \mathbb{R}[s, e^{-\theta s}]$. La commande (27) conduit à une stabilité de la boucle fermée de type entrée-sortie, et non pas une stabilité interne de la boucle fermée, c'est-à-dire qu'une petite perturbation bornée peut rendre instable le système en boucle fermée, en général. Cette propriété est liée au fait que certaines expressions entrée-sortie de la boucle fermée ne sont pas propres. Pour palier cet inconvénient, nous proposons d'introduire des pondérations stables et strictement propres et précompensation, afin d'assurer une stabilité interne globale. La question de la réalisabilité d'un tel ajout de pondérations n'est cependant pas évoqué.

Notre analyse sera alors poursuivie par l'étude du problème de placement de spectre finie (FSA) pour une classe de systèmes de dimension infinie de type fractionnaire. Le problème consiste, par le biais d'un retour d'état, de placer n valeurs propres du système en boucle fermée à des valeurs arbitraires prédéfinies dans le plan complexe, tandis que les autres valeurs propres sont explicitement supprimées. Cela conduit alors à un système en boucle fermée qui ne possède qu'un nombre fini de modes. Cette méthode a été étudiée pour les systèmes à retards [41, Manitius and Olbrot (1979)], [42, Watanabe (1986)], [1, Olbrot (1978)], [43, Brethé and Loiseau (1998)]. Notre contribution consiste ici à appliquer cette technique de placement de pôles pour une classe de systèmes fractionnaires. Une condition nécessaire et suffisante pour l'existence d'une solution est décrite, et un algorithme pour le calcul de cette solution est proposée. Cependant, nous ne répondons pas au problème difficile de la mise en œuvre numérique des lois de commande obtenues.

La dernière application du retard distribué décrite dans ce manuscrit concerne la synthèse d'observateur pour les systèmes linéaires

$$\dot{x}(t) = Ax(t) + Bu(t) \quad (29)$$

$$y(t) = Cx(t) + Du(t) \quad (30)$$

avec la condition initiale $x(t_0) = x_0$, l'état $x \in \mathbb{R}^n$, l'entrée $u \in \mathbb{R}^m$ et la sortie $y \in \mathbb{R}^q$. La théorie des observateurs pour de tels systèmes, qui permettent de reconstruire l'état x à partir des mesures des entrées et sorties est bien établie et connue. L'erreur d'observation de l'état est synthétisée de manière à converger

vers zéro, soit asymptotiquement, soit en temps fini. Citons à ce titre les travaux de [44, Barnett (1975)], [45, Kailath (1980)], [46, O'Reilly (1983)], [47, Engel and Kreisselmeier (2002)], [48, Luenberger (1966)], [49, Pernebo (1981)]. Dans cette partie, notre contribution est de développer et analyser une nouvelle classe d'observateurs, dits observateurs à mémoire finie, initialement développés dans un cadre restreint par [7, Medvedev and Toivonen (1994)]. La synthèse de tels observateurs nécessite une reformulation du système, à travers laquelle l'observateur n'exploite plus que des mesures sur le système à des instants passés. Certaines mesures peuvent faire appel à des retards distribués, nécessitant par conséquent une connaissance continue en temps (passé) de l'état ou de l'entrée. Notre principale contribution consiste à développer les premiers résultats obtenus pour des observateurs dits en boucle ouverte (sans injection de sortie), en introduisant une injection de sortie et donc la possibilité de réglage de convergence des dynamiques de l'erreur d'estimation. Nous décrivons succinctement le principe des observateurs en boucle ouverte (et à mémoire finie), comme décrit par exemple dans [7, Medvedev and Toivonen (1994)], [50, Chyung (1984)], [51, Medvedev (1995)], puis proposerons une extension pour la synthèse d'observateur par injection de sortie. A ce titre, considérons l'observateur pour le système (29)-(30)

$$\begin{aligned}\hat{x}(t) &= e^{Ah}\hat{x}(t-h) + K[y(t-h) - \eta(t-h)] + \int_{t-h}^t e^{A(t-\tau)}Bu(\tau)d\tau, \quad t \geq h \\ \eta(t) &= C\hat{x}(t) + Du(t),\end{aligned}\tag{31}$$

où $K \in \mathbb{R}^{n \times m}$. L'erreur d'estimation $x(t) - \hat{x}(t)$ est régie par

$$\begin{aligned}e(t) &= x(t) - \hat{x}(t) \\ &= (e^{Ah} - KC)[x(t-h) - \hat{x}(t-h)] \\ &= (e^{Ah} - KC)e(t-h), \quad t \geq h\end{aligned}\tag{32}$$

L'équation (32) est une équation aux différences, où les coefficients h et K sont des paramètres de l'observateur. Il est donc possible, à travers ces paramètres, d'imposer des propriétés de convergence de l'erreur $e(t)$ vers zéro.

Exemple 0.7. *Considérons le système*

$$\begin{aligned}\dot{x}(t) &= \begin{bmatrix} -1 & 0 & 1 \\ 0 & -1 & 0 \\ 0 & 0 & -1 \end{bmatrix} x(t) + \begin{bmatrix} 1 \\ 1 \\ 0 \end{bmatrix} u(t) \\ y(t) &= \begin{bmatrix} 1 & 0 & 0 \\ 0 & 1 & 0 \end{bmatrix} x(t),\end{aligned}$$

où

$$A = \begin{bmatrix} -1 & 0 & 1 \\ 0 & -1 & 0 \\ 0 & 0 & -1 \end{bmatrix}, B = \begin{bmatrix} 1 \\ 1 \\ 0 \end{bmatrix}, C = \begin{bmatrix} 1 & 0 & 0 \\ 0 & 1 & 0 \end{bmatrix}.$$

Soit l'observateur

$$\begin{aligned}\hat{x}(t) &= e^{Ah}\hat{x}(t-h) + K[y(t-h) - \eta(t-h)] + \int_{t-h}^t e^{A(t-\tau)} Bu(\tau) d\tau \\ \eta(t) &= C\hat{x}(t).\end{aligned}$$

L'erreur d'estimation $e(t) = x(t) - \hat{x}(t)$ vérifie

$$e(t) = (e^{Ah} - KC)e(t-h).$$

Prenons $K = \begin{bmatrix} 2e^{-h} & 0 \\ 0 & e^{-h} \\ \frac{e^{-h}}{h} & 0 \end{bmatrix}$. Les valeurs propres de $(e^{Ah} - KC)$ sont identiquement nulles, garantissant ainsi une propriété de convergence en temps fini: $e(t)$

devient identiquement nulle à partir de $t = 2h$. La Figure 12 montre la réponse indicielle de l'état x_1, x_2, x_3 , et de ses estimées $\hat{x}_1, \hat{x}_2, \hat{x}_3$. La condition initiale de l'état est $x_0(t) = [0.5 \ 0.5 \ 0.5]^T$. Les tracés en pointillés sont obtenus pour $h = 0.5$. Pour le trait-mixte, les simulations ont été réalisées avec $h = 0.2$. On vérifie bien les propriétés de convergence en temps fini, de 1 s (pointillé) et 0.4 s (trait-mixte).

Si les pôles de la dynamique de l'erreur d'observation sont $\{0.1 \ 0.2 \ 0.3\}$, le gain

d'injection de sortie K est (le système étant observable) $K = \begin{bmatrix} 0.9131 & 0 \\ 0 & 0.3065 \\ 0.6790 & 0 \end{bmatrix}$.

L'estimée $\hat{x}(t)$ converge alors asymptotiquement vers $x(t)$. Une simulation est proposée sur la Figure 13.

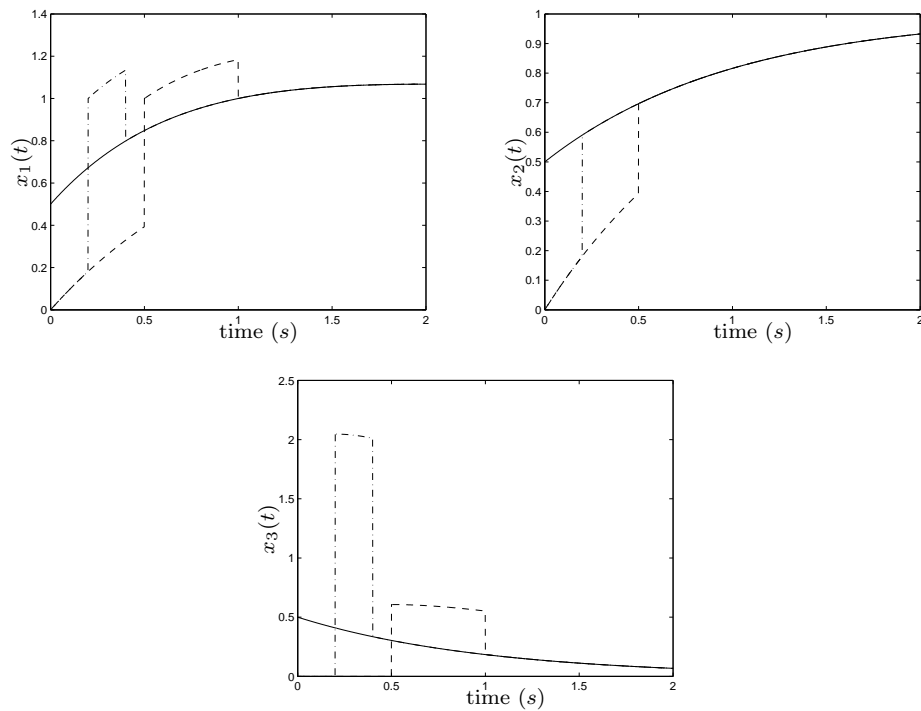

FIGURE 12: Simulation de l'observateur pour l'estimation de $x(t)$ (continu); l'état estimé est $\hat{x}(t)$ (pointillé $h = 0.5$, trait-mixte $h = 0.2$) (Exemple 0.7).

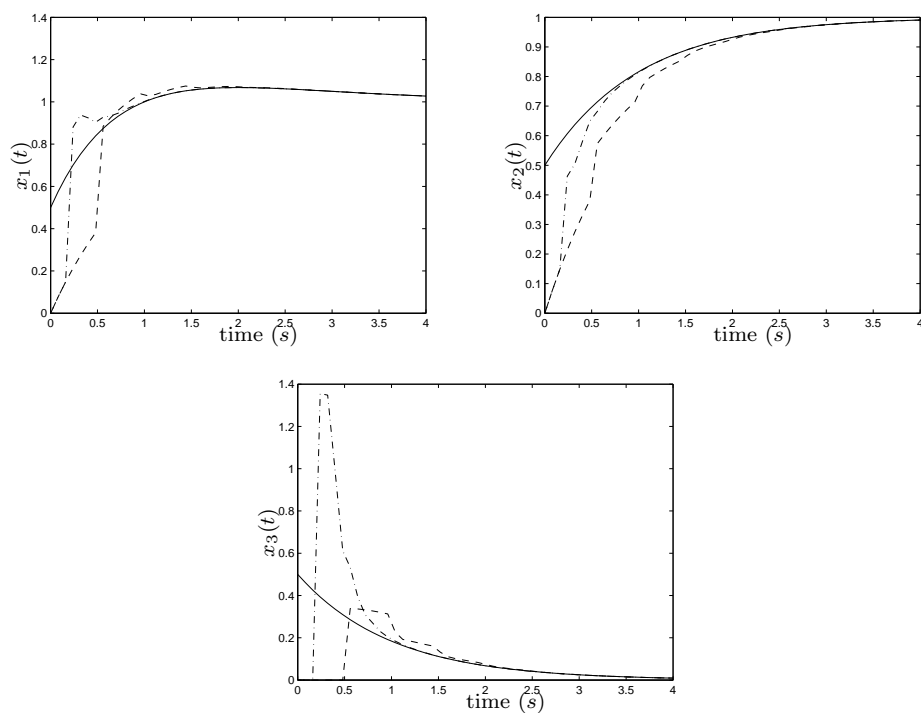

FIGURE 13: Simulation de l'observateur à convergence asymptotique de $x(t)$ (continu); estimation $\hat{x}(t)$ (pointillé $h = 0.5$, trait-mixte $h = 0.2$) (Exemple 0.7).

Le dernier chapitre de ce mémoire concerne l'analyse d'une nouvelle classe d'opérateurs d'approximation pour les systèmes à paramètres répartis. Ce dernier chapitre est davantage prospectif, et de taille réduite par rapport aux autres chapitres du mémoire. Les systèmes à paramètres répartis sont des systèmes de dimension infinie, qui peuvent être réalisés par des équations aux dérivées partielles. L'étude de l'approximation de systèmes à paramètres répartis est un très large domaine d'étude. Pour l'analyse des propriétés de contrôle de ces systèmes, une condition nécessaire et suffisante d'existence d'une approximation à paramètres localisés a été proposée dans [21, Vidyasagar and Anderson (1989)]. Cette condition est cependant très conservative, et non constructive. Concernant l'approximation par des systèmes à paramètres localisés, citons par exemple [52, Gu et al. (1989)], [53, Quarteroni and Valli (2008)], [54, Lavanya (2010)], [55, Grossmann et al. (2000)], [56, Strikwerda (2004)], [57, Partington (2004)], [58, Glover et al. (1988)], ou encore [59, Li (1996)], [60, Antoulas and Sorensen (2001)], [61, Antoulas (2005)].

Dans cette dernière partie, notre objectif n'est pas de proposer de nouvelles méthodes numériques d'approximation, mais de proposer une extension de la classe d'approximation, en effectuant une approximation d'un système à paramètres répartis par un système à retards. Nous montrons que sous certaines conditions non conservatives, une telle approximation existe toujours. La classe de systèmes à retards réalisant cette approximation est en réalité un système couplé d'équations différentielles et d'équations aux différences, dans lesquelles le retard distribué joue un rôle important. A partir de l'obtention du résultat central d'approximation, nous proposons d'étudier succinctement une équivalence entre plusieurs réalisations, à savoir sous forme de Roesser (issue des systèmes 2D), et sous forme d'un système à retards de type neutre. Cette dernière partie permet ainsi d'ouvrir un certain nombre de perspectives pour le contrôle frontière de systèmes régis par des équations aux dérivées partielles, à partir de la théorie et des outils développés pour les systèmes à retards.

Le manuscript est organisé comme suit. Le Chapitre 1 introduit quelques notations et outils algébriques utilisés dans le mémoire. L'analyse du retard distribué et son approximation sont étudiées dans le Chapitre 2. L'inversion stable en temps fini ainsi que le problème de poursuite de modèle en temps fini sont étudiés dans le Chapitre 3. Le Chapitre 4 concerne les applications du retard distribué pour la synthèse de contrôle stabilisant, et pour la synthèse d'observateur. Le Chapitre 5, plus court que les autres chapitres du mémoire, est consacré à l'étude de la nouvelle

classe d'approximation de systèmes à paramètres répartis, en utilisant des opérateurs à retards. Enfin, le Chapitre 6 confluera ce travail de thèse en mentionnant quelques perspectives.

Chapter 1

INTRODUCTION

1.1 Introduction

A distributed delay is a linear input-output operator of the form

$$y(t) = (f * u)(t) = \int_{\vartheta_1}^{\vartheta_2} f(\tau)u(t - \tau)d\tau, \quad (1.1)$$

where $\vartheta_1, \vartheta_2 \in \mathbb{R}_+$ and $f(t), t \in [\vartheta_1, \vartheta_2]$ is a continuous function. The Laplace transform of (1.1) is $\hat{y}(s) = \hat{f}(s)\hat{u}(s)$, where

$$\hat{f}(s) = \int_{\vartheta_1}^{\vartheta_2} f(\tau)e^{-s\tau}d\tau.$$

Distributed delays appears in many control applications. Its most well-known application is for the stabilizing control in linear systems. The interest for the use of distributed delays in the stabilization of time-delay systems comes from the pioneering work of Olbrot [1, Olbrot (1978)]. Kamen et al. [2, Kamen et al. (1986)] first introduce a general mathematical setting for the control to generalize algebraic methods issued from linear systems in finite dimensional spaces to time-delay systems, and in particular for the stabilization, of time-delay systems. This mathematical framework was formalized in Brethé and Loiseau [3, Brethé and Loiseau (1996)] by the introduction of the Bézout ring of pseudo-polynomials, or independently by [4, Glüsing-Lüerßen (1997)] with a behavioural approach. Beside of the stabilizing control, distributed delay also appears in predictive control [5,

Smith (1959)], [6, Michiels and Niculescu (2003)], representation of dynamical systems [7, Medvedev and Toivonen (1994)], [8, Pourboghrat and Chyung (1984)], in modeling [9, SinÁlgre (2005)], [12, Jian et al. (2007)], [62, Mukhopadhyay et al. (2004)], [63, Wolkowicz et al. (2007)], [64, Ruan and Wolkowicz (1996)].

In fact, for some distributed delays, a numerical implementation problem exists. For instance, if the kernel in (1.1) is $f(t) = 1$, for $t \in [0, 1]$ in the time-domain (or equivalently $\hat{f}(s) = \frac{1-e^{-s}}{s}$ in the frequency-domain), the transfer function $\hat{f}(s)$ is stable (since $\hat{f}(0) = 1$). But we can not directly implement it. So an approximation of the distributed delay is required for an effective numerical implementation. Such an implementation was early investigated. In the work of [13, Van Assche et al. (1999)], the authors propose a numerical integral approximation to realize an operator like (1.1). Such an approximation writes as a sum of lumped delayed distributions. Unfortunately, this approximation introduces additional closed-loop poles and instability phenomena (see, *e.g.* [14, Zhong (2003)], [17, Santos and Mondié (2000)], and the references therein). To overcome this problem, various solutions were proposed, such as [13, Van Assche et al. (1999)], [14, Zhong (2003)], [15, Mirkin (2004)], [16, Partington and Mäkilä (2005)]. The detail of these methods will be explained in Chapter 2. A proposition for an effective numerical implementation is the main objective of this manuscript.

The other objectives of this thesis are to show how to apply distributed delay in various control problems. Our work will focus on the general approximation, implementation of distributed delay and some new applications of it. So, we will start with a general definition of distributed delay, and the analysis of the properties of distributed delay. The implementation problem of distributed delays will be explained. Then approximation methods will be discussed. In particular, based on a kernel approximation, a new general class of realization will be given, in order to answer positively to the numerical implementation problem. The other parts of this manuscript will be devoted to applications of distributed delay in control problems.

The first application is the inversion and model matching for finite dimensional linear time-invariant systems. For a given plant $T(s)$, the inversion problem is to find a precompensator $R(s)$ such that $T(s)R(s) = I$. In fact, for some plant $T(s)$, there does not exist any stable and proper precompensator $R(s)$ such that $T(s)R(s) = I$ (for example, $T(s) = \frac{1}{s+1}$). Many works in the literature are devoted to solve this problem, such as [25, Devasia et al. (1996)], [26, Hunt et al. (1995)], [27, Sogo (2010)]. Unfortunately, the solution is always non proper, or

acausal. In this manuscript, we will propose a general solution for stable inversion problem. The precompensator $R(s)$ is not an exact inverse, but satisfies an identity of the form

$$E(s) = I - T(s)R(s), \quad (1.2)$$

where the error $E(s)$ is the Laplace transform of a function with finite time support. In our approach, we show that this approximated inverse always exists. Furthermore such solution can be computed through some algebraic algorithm. In these algorithm, the finite support time is a free parameter, and can be arbitrarily small, but strictly positive. Based on the technique of stable inversion, we extend this procedure to the model matching problem. For a given plant $T(s)$ and a given model $T_m(s)$ the model matching problem comes down to find a precompensator $R(s)$ such that $T(s)R(s) = T_m(s)$. This problem does not admit, in general, a stable and causal solution. For this, like in inversion, we introduce an approximated matching problem, called finite time matching, such that the error

$$E(s) = T(s)R(s) - T_m(s) \quad (1.3)$$

is the Laplace transform of a function with bounded support. Similarly to the inversion, a solution for this problem exists. We will describe algebraic procedures for the computation of such a solution for linear multivariable systems of finite dimension. It is noted that this solution is not unique.

Another application discussed in this manuscript is concerned with the stabilization of some classes of infinite dimensional systems. The first class of systems under consideration are time-delay systems. We will describe some basic tools for the stabilization of delay systems, then we will analyze the particular case of neutral delay systems of the form

$$\dot{x}(t) = \sum_{i=1}^k E_i \dot{x}(t - i\vartheta) + \sum_{i=0}^k A_i x(t - i\vartheta) + \sum_{i=0}^k B_i u(t - i\vartheta),$$

where A_i, B_i, E_i over \mathbb{R} . For these systems, distributed delays are used in the control law. Approximation of such a distributed delay is constrained to ensure stability of the closed-loop system. Hence conditions on the order of the approximation are proposed to guarantee such a goal. These conditions are strongly inspired from [40, Vidyasagar (1985)] and [65, Partington and Mäkilä].

We highlight the use of distributed delays in spectrum assignment problem, in

particular for the Finite Spectrum Assignment (FSA) introduced by [41, Manitius and Olbrot (1979)], [42, Watanabe (1986)], [1, Olbrot (1978)], [43, Brethé and Loiseau (1998)]. FSA is a static feedback control such that n eigenvalues of the corresponding closed-loop system are located at an arbitrarily preassigned set of points in the complex plant while the others are automatically eliminated. In this manuscript, an extension of FSA for a more general class of systems is proposed. These systems are fractional systems, of the form

$$T(s) = N(s)d^{-1}(s), \quad (1.4)$$

where $N(s) \in \mathbb{R}^{n \times 1}[s^{\frac{1}{\mu}}, e^{-s^{\frac{1}{\mu}}}]$, $d(s) \in \mathbb{R}[s^{\frac{1}{\mu}}, e^{-s^{\frac{1}{\mu}}}]$, $\mu \in \mathbb{N}_+$. A feedback control will be introduced for pole placement, and computational procedures will be described.

The last application of distributed delay that will be described is the observer design for state estimation. In this part, we will be concerned with only linear finite dimensional systems. An observer is a dynamical system which estimates the state or a partial state of a given plant. Among various classes of observers, we may find memoryless observers like those introduced in [7, Medvedev and Toivonen (1994)], [8, Pourboghrat and Chyung (1984)], [51, Medvedev (1995)]. These observers use past information on the system output to estimate the instantaneous state. This past information is obtained via delay operators, and in particular distributed delays. Open-loop memoryless observers will be introduced, following the works of [7, Medvedev and Toivonen (1994)], [51, Medvedev (1995)]. Our contribution is centered on closed-loop memoryless observers, with output injection. Asymptotic convergence, as well as finite time convergence of the estimation are analyzed. This gives a general framework for finite time convergence in estimation. Some robustness aspects are also discussed, depending on the times of measurements. Let us see the following linear finite dimensional system

$$\dot{x}(t) = Ax(t) + Bu(t), \quad x(t_0) = x_0.$$

The solution of the system is

$$x(t) = e^{A(t-t_0)}x(t_0) + \int_{t_0}^t e^{A(t-\tau)}Bu(\tau)d\tau, \quad t \geq t_0, \quad (1.5)$$

where $x(t_0)$ is the initial condition. Using $t_0 = t - h$, we can reformulate (1.5) into the following form

$$x(t) = e^{Ah}x(t-h) + \int_{t-h}^t e^{A(t-\tau)}Bu(\tau)d\tau, \quad t \geq h. \quad (1.6)$$

Note that there is a distributed delay $\int_{t-h}^t e^{A(t-\tau)}Bu(\tau)d\tau$ in (1.6). The observer synthesis will introduce an error $e(t) = x(t) - \hat{x}(t)$, with $\hat{x}(t)$ the state of the observer such that

$$e(t) = He(t-h), \quad t > h, \quad H \in \mathbb{R}^{n \times n}. \quad (1.7)$$

The equation (1.7) is a difference equation. We remark that $e(t)$ can be made identically zero after a finite time if and only if H is a nilpotent matrix, else the error will convergence to zero exponentially (if the matrix H is Hurwitz, in the sense of discrete-time systems).

The last part of this manuscript gives some prospective, and is devoted to a new class for approximation of distributed parameter systems. A distributed parameter system is an infinite dimensional system, which can be realized by partial differential equations. A large amount of works have been done to explore different approximations for distributed parameter systems. These approximations are, in general, realized by lumped systems. A powerful condition for approximation by lumped systems was proposed in [21, Vidyasagar and Anderson (1989)], [66, Anderson and Parks (1985)]. This condition is however too conservative, and not constructive, for the synthesis of a lumped approximation. A very large number of contributions addressed numerical approximation by lumped systems, using Fourier techniques [52, Gu et al. (1989)] [53, Quarteroni and Valli (2008)], discretization methods [54, Lavanya (2010)], [55, Grossmann et al. (2000)], [56, Strikwerda (2004)], spectral methods [57, Partington (2004)]. A general analysis of approximation for convolution systems was made in [58, Glover et al. (1988)], where Hankel operator and singular value decomposition were used. Other techniques include for instance [59, Li (1996)], [60, Antoulas and Sorensen (2001)], [61, Antoulas (2005)].

In this last part, we will not address numerical methods. The scope of this part is to reduce the conservatism of lumped approximation for control purposes. For this, we will introduce a new class of approximation, that are time-delay systems, for which effective methods exist for control synthesis. Working on the graph

topology, we will show that, under some weak assumptions, such an approximation can be realized. We will focus our work on realization and representation by neutral time-delay systems. Some comments on representation will be made, in particular with respect to 2-D Roesser models, or systems governed by difference equations where distributed delay appear. This contribution is a prospective work, so that this last chapter is shorter than the others.

Now let us see some examples where distributed delays appear. We start with an example of stabilizing control. The closed-loop system is reported in Figure 1.1, where T is the plant, C is the compensator, u is the control, v is reference input,

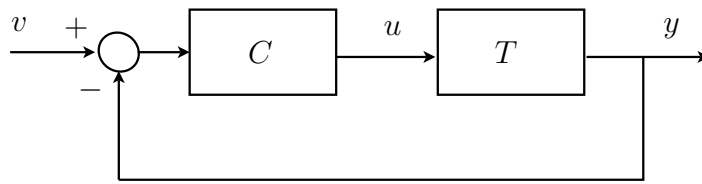

FIGURE 1.1: Closed-loop system for stabilization control.

y is output.

Example 1.1. *Let us consider the system*

$$T(s) = \frac{1}{s-1}.$$

A stabilizing compensator is

$$C(s) = \frac{2 + (s-1) \cdot \frac{1-e^{-(s+1)}}{s+1}}{1 - \frac{1-e^{-(s+1)}}{s+1}}.$$

Indeed, the closed-loop transfer function is

$$G(s) = \frac{T(s)C(s)}{1 + T(s)C(s)} = \frac{2 + (s-1) \cdot \frac{1-e^{-(s+1)}}{s+1}}{s+1},$$

which is stable. The controller include a distributed delay, which is $\hat{f}(s) = \frac{1-e^{-(s+1)}}{s+1}$, with kernel $f(t) = e^{-t}$, $t \in [0, 1]$.

Example 1.2. *We consider the input-delay system*

$$T(s) = \frac{e^{-s}}{s-1}.$$

A stabilizing controller is

$$C(s) = \frac{2e^1}{1 + 2\frac{1-e^{-(s-1)}}{s-1}},$$

where the closed-loop systems looks like

$$G(s) = 2e^1 \frac{e^{-s}}{s+1}.$$

The controller involves a distributed delay $\hat{f}(s) = \frac{1-e^{-(s-1)}}{s-1}$, with kernel $f(t) = e^t$, $t \in [0, 1]$. A time-domain realization of this controller is

$$u(t) = -2 \int_{t-1}^t e^{t-\tau} u(\tau) d\tau + 2e^1 \cdot (v(t) - y(t)).$$

Example 1.3. For the time-delay system

$$T(s) = \frac{e^{-s}}{s(1 - \frac{2}{1}e^{-s})}.$$

The stabilizing controller is given by

$$C(s) = \frac{1 - \frac{1}{2}e^{-s}}{2(1 + \frac{1-e^{-s}}{s})},$$

where the closed-loop systems is

$$G(s) = \frac{e^{-s}}{2(s+1)}.$$

The distributed delay $\hat{f}(s) = \frac{1-e^{-s}}{s}$, with the kernel $f(t) = 1$, $t \in [0, 1]$, is central for the stabilization of such system.

More details on the stabilization problem can be found in Chapter 4 (Section 4.1, 4.2) of this manuscript.

Distributed delays appear also in predictive control. For instance, consider the input-delay system

$$\dot{x}(t) = Ax(t) + Bu(t-r). \quad (1.8)$$

The solution of the system is

$$x(t) = e^{A(t-t_0)}x(t_0) + \int_{t_0}^t e^{A(t-\tau)}Bu(\tau-r)d\tau, \quad t \geq t_0. \quad (1.9)$$

In other words, for any $h > 0$,

$$x(t+h) = e^{Ah}x(t) + e^{Ah} \int_t^{t+h} e^{A(t-\tau)} Bu(\tau-r)d\tau, \quad t \geq 0 \quad (1.10)$$

where $\int_t^{t+h} e^{A(t-\tau)} Bu(\tau-r)d\tau$ is a distributed delay. Equation (1.10) tells us that the state of (1.8) can be predicted with time horizon h , using past information in time. The Smith predictor control [5, Smith (1959)] is famous in the control of time-delay systems. The predictor controller can separate the pure delay part of the transfer function from the remaining part. A limitation of this control is that the system must be stable. If we consider a distributed delay in the Smith predictor controller, we can remove this limitation. The main results on Smith predictor with distributed delay can be found in Chapter 4, Section 4.1.

Another application of distributed delay is state estimation. For instance, let us consider the system

$$\dot{x}(t) = Ax(t) + Bu(t), \quad x(0) = x_0. \quad (1.11)$$

The solution of the equation (1.11) is

$$x(t) = e^{A(t-t_0)}x(t_0) + \int_{t_0}^t e^{A(t-\tau)} Bu(\tau)d\tau, \quad t \geq t_0. \quad (1.12)$$

or equivalently

$$x(t) = e^{Ah}x(t-h) + \int_{t-h}^t e^{A(t-\tau)} Bu(\tau)d\tau, \quad t \geq h, \quad (1.13)$$

where $\int_{t-h}^t e^{A(t-\tau)} Bu(\tau)d\tau$ is a distributed delay. An observer control can be synthesized from the equation (1.13) as shown in [7, Medvedev and Toivonen (1994)] [8, Pourboghraat and Chyung (1984)].

Distributed delays also appear in modeling. In [9, Sinègre (2005)], or [67, Sinègre (2006)], a model for density wave dynamics in gas lifted wells was developed. In this model, the distributed delay represents the transport delay in the pipeline of the pressure wave. Another modeling with distributed delay comes from growth of a given population [11, Guardiola and Vecchio(2004)]. Many other models exist in the literature. See for instance, [12, Jian et al. (2007)], [62, Mukhopadhyay et al. (2004)], [34, Niculescu (2001)], [63, Wolkowicz et al. (1997)], [64, Ruan and

Wolkowicz (1996)] [11, Guardiola and Vecchio(2004)], [68, Guardiola and Vecchio(2003)].

This manuscript is organized as follows. Chapter 1 introduces some algebraic preliminaries and some notations. Chapter 2 introduces the definition, properties and implementation of distributed delay. In Chapter 3 we introduce the stable inversion and model matching. Robustness under parameter uncertainties and state-space feedback realization of precompensator will be also discussed in this chapter. In the Chapter 4 stabilization and finite spectrum assignment control by using distributed delay will be analyzed. The observer design using distributed delay will be also studied in this Chapter. Chapter 5 describes the new class of approximation of distributed parameter systems. The conclusion and perspectives will be given in Chapter 6.

1.2 Algebraic preliminaries

In this section we introduce some important sets which are used in this manuscript.

1.2.1 Convolution system

The distributed delay is an input-output convolution operator. An input-output causal convolution system is a dynamical system described by an equation of the form

$$y(t) = (f * u)(t) = \int_0^t f(\tau)u(t - \tau)d\tau, \quad t \neq 0, \quad (1.14)$$

where $y(\cdot)$, $u(\cdot)$ and $f(\cdot)$ are said to be the output, input and kernel of the map, respectively. Convolution systems are naturally defined over a commutative algebra. A general algebra of distributions which includes a wide class of convolution systems was introduced in [69, Callier and Desoer (1978)]. For our purpose, we consider a subalgebra of the Callier-Desoer algebra, and we denote it by \mathcal{A} . Before we define the algebra \mathcal{A} , we introduce the L_1 -norm.

Consider a Lebesgue measurable functions $f(t)$ in $L_1(\mathbb{R}_+)$. The L_1 -norm of $f(t)$ is

$$\|f(t)\|_{L_1} = \int_0^\infty |f(t)|dt. \quad (1.15)$$

The set of L_1 (or $L_1(\mathbb{R}_+)$) with norm $\|\cdot\|_{L_1}$ is a Banach algebra.

1.2.2 Algebra \mathcal{A}

An extension of L_1 was proposed in [69, Callier and Desoer (1978)]. This extension includes a generalization of the kernel in the convolution to contain distributions.

Definition 1.1 (The convolution algebra \mathcal{A}). We say that $f \in \mathcal{A}$ if

$$f(t) = \begin{cases} f_a(t) + f_{pa}(t), & t \geq 0 \\ 0, & t < 0 \end{cases} \quad (1.16)$$

where the complex-valued function $f_a(\cdot) \in L_1$, the complex-valued distribution $f_{pa}(\cdot)$ stands for the purely atomic part and writes

$$f_{pa}(t) = \sum_{n=0}^{\infty} f_n \delta(t - t_n), \quad (1.17)$$

with $f_n \in \mathbb{C}$, $n = 0, 1, \dots$, and $0 = t_0 < t_1 < t_2 < \dots$, $\delta(t - t_n)$ denotes the Dirac delta distribution centered in t_n , and $\sum_{n \geq 0} |f_n| < \infty$. \square

As done in Desoer and Vidyasagar [70, Desoer and Vidyasagar (1975)], Curtain [71, Curtain and Zwart (1995)], or Hille and Phillips [72, Hille and Phillips (1957)], it is well known that \mathcal{A} is a commutative convolution Banach algebra with norm defined by

$$\|f\|_{\mathcal{A}} = \|f_a\|_{L_1} + \sum_{n=0}^{\infty} |f_n|, \quad (1.18)$$

and with unit element the Dirac delta distribution δ . Denoting \hat{f} the Laplace transform of f , $\hat{\mathcal{A}}$ denotes the set of Laplace transforms of elements in \mathcal{A} (in this manuscript $(\hat{\cdot})$ denotes the Laplace transform). The set $\hat{\mathcal{A}}$ is also a commutative Banach algebra with unit element under pointwise addition and multiplication, for the norm

$$\|\hat{f}\|_{\hat{\mathcal{A}}} = \|f\|_{\mathcal{A}}, \quad \forall f \in \mathcal{A}. \quad (1.19)$$

Definition 1.2. A convolution system of the form (1.14) is said to be BIBO (Bounded-Input Bounded-Output) stable if $f \in \mathcal{A}$. \square

1.2.3 Ring \mathcal{E}

Let $\mathbb{R}[s]$ denote the real polynomials in the variable s , and $\mathbb{R}[s, e^{-\vartheta s}]$ denote the real polynomials in the variables s and $e^{-\vartheta s}$, with $\vartheta > 0$. The set $\mathbb{R}(s)$ is the set

of rational functions. We also use $\mathbb{R}^{m \times n}[s]$ to denote the set of $m \times n$ matrices whose entries are polynomials. The set of distributed delays is denoted by \mathcal{G} .

Definition 1.3 (Quasi-polynomials). Quasi-polynomials in $\mathbb{R}[s, e^{-\vartheta s}]$ are elements of the form

$$N(s) = \sum_{i=0}^p \sum_{j=0}^q N_{ij} s^i e^{-j\vartheta s}, \quad (1.20)$$

where coefficients N_{ij} lie in \mathbb{R} . The degree with respect to s of $N(s)$ is $\deg_s N(s) = p$. \square

The quasi-polynomial $N(s)$ is said to be monic if its leading coefficient in s is 1, that is $\sum_{j=0}^q N_{pj} e^{-j\vartheta s} = 1$. The zeros of $N(s)$ are the complex numbers s_0 such that $N(s_0) = 0$.

According to [73, Pontryagin (1955)], we say that $N(s)$ in $\mathbb{R}[s, e^{-\vartheta s}]$ is stable (exponent stable) if there exists $\varepsilon < 0$ such that for all $s \in \mathbb{C}$, with $\operatorname{Re} s \geq \varepsilon$, $N(s) \neq 0$.

Actually, operations defined over \mathcal{G} (the set of distributed delays) and $\mathbb{R}[s, e^{-\vartheta s}]$ include distributed delays, lumped delays, scalar multiplication and successive derivatives. In order to get a closed ring under these operations, and following [74, Brethé and Loiseau (1997)], we have the following definition.

Definition 1.4 (pseudo-polynomials, Ring $\hat{\mathcal{E}}$).

$$\hat{\mathcal{E}} = \mathcal{G} + \mathbb{R}[s, e^{-\vartheta s}]. \quad (1.21)$$

Elements in $\hat{\mathcal{E}}$ are called pseudo-polynomials. \square

For instance, the element

$$p(s) = s + 1 + e^{-s} + \frac{1 - e^{-s}}{s} \quad (1.22)$$

is the sum of a quasi-polynomial and a distributed delay therefore it belongs to $\hat{\mathcal{E}}$.

Using common multiple denominator in (1.21), any pseudo-polynomial $P(s) \in \hat{\mathcal{E}}$ can be written in the form

$$P(s) = N(s)D^{-1}(s) \quad (1.23)$$

where $N(s) \in \mathbb{R}[s, e^{-\vartheta s}]$, and $D(s) \in \mathbb{R}[s]$.

Remark 1.5. The element $P(s)$ has no pole, since the distributed delay has no pole. The degree of a pseudo-polynomial is defined by $\deg_s P(s) = \deg_s N(s) - \deg_s D(s)$, and can be either positive or negative. \square

The ring of pseudo-polynomials is a Bézout ring. Coprimeness of pseudo-polynomials is also well defined, in the sense of 2D-coprimeness. Then, we say that $N(s)$ and $D(s)$ in $\hat{\mathcal{E}}$ are coprime if they have no nontrivial common factor. This comes down, in fact, to the existence of $X(s)$ and $Y(s)$ in $\hat{\mathcal{E}}$ such that

$$X(s)N(s) + Y(s)D(s) = 1. \quad (1.24)$$

For the matrix case over $\hat{\mathcal{E}}$, let $A(s)$ and $B(s)$ be two matrices over $\hat{\mathcal{E}}$. If $Q(s)$ over $\hat{\mathcal{E}}$ is such that $B(s) = Q(s)A(s)$, then $A(s)$ is said to be a right divisor of $B(s)$. If $A(s) = A_1(s)D(s)$ and $B(s) = B_1(s)D(s)$ for some matrices A_1, B_1 and $D(s)$ over $\hat{\mathcal{E}}$, then $D(s)$ is a common right divisor of $A(s)$ and $B(s)$. Two matrices $A(s)$ and $B(s)$ are right coprime if all their common right divisors are invertible over $\hat{\mathcal{E}}$ [74, Brethé (1997)], [36, Loiseau (1998)]. If $A(s) \in \hat{\mathcal{E}}^{n \times m}$, $B(s) \in \hat{\mathcal{E}}^{p \times m}$ are right coprime, then there exists $P(s) \in \hat{\mathcal{E}}^{n \times (n+p-m)}$, $Q \in \hat{\mathcal{E}}^{p \times (n+p-m)}$, such that

$$\begin{bmatrix} A(s) & P(s) \\ B(s) & Q(s) \end{bmatrix}$$

is unimodular. If $A(s) \in \hat{\mathcal{E}}^{m \times m}$, $\text{Rank } A(s) = m$, and $\det A(s)$ is monic in s , then $A(s)$ and $B(s)$ are coprime if and only if

$$\text{Rank} \begin{bmatrix} A(s) \\ B(s) \end{bmatrix} = m, \quad \forall s \in \mathbb{C}.$$

A matrix $M(s) \in \mathbb{R}^{p \times m}(s, e^{-\vartheta s})$ can be factorized as $M(s) = N(s)D^{-1}(s)$, where $N(s)$ and $D(s)$ are right coprime. It is said that $N(s), D(s)$ is a right coprime factorization of $M(s)$. All these concepts are easily translated in terms of left coprimeness.

Theorem 1.6 ([28] Loiseau et al. (1997)). *Suppose that matrices $N(s) \in \hat{\mathcal{E}}^{n \times m}$, $D(s) \in \hat{\mathcal{E}}^{n \times p}$ are left coprime. Then there exist $X(s) \in \hat{\mathcal{E}}^{m \times n}$, $Y(s) \in \hat{\mathcal{E}}^{p \times n}$ such that*

$$N(s)X(s) + D(s)Y(s) = I_n. \quad (1.25)$$

Similarly right coprimeness of $N(s) \in \hat{\mathcal{E}}^{n \times m}$, $D(s) \in \hat{\mathcal{E}}^{p \times m}$ imply that there exist $\tilde{X}(s) \in \hat{\mathcal{E}}^{m \times n}$, $\tilde{Y}(s) \in \hat{\mathcal{E}}^{m \times p}$ such that

$$\tilde{X}(s)N(s) + \tilde{Y}(s)D(s) = I_m. \quad (1.26)$$

The realization of a fraction of pseudo-polynomials by a quadruple of matrices (A, B, C, D) , defined as convolution operators with Laplace transforms in $\hat{\mathcal{G}} + \mathbb{R}[e^{-\vartheta s}]$, is equivalent to require an input-output proper transfer function in the following sense.

Definition 1.7 (proper and strictly proper). A rational fraction

$$T(s) = N(s)D^{-1}(s),$$

where $N(s), D(s) \in \hat{\mathcal{E}}$, is said to be proper if the denominator $D(s)$ is monic, and the degree condition

$$\deg_s D(s) \geq \deg_s N(s) \quad (1.27)$$

holds. If $\deg_s D(s) > \deg_s N(s)$, we say that $N(s)$ and $D(s)$ are strictly proper. If $T(s)$ is matrix, the transfer function matrix $T(s)$ is said to be proper if the degree of any entry of $T(s)$ is non-positive, and strictly proper if all entries of $T(s)$ are strictly proper. \square

1.2.4 Ring $\mathcal{P}_{\mathcal{E}}$

In this manuscript, we are also interested in another ring denoted by $\mathcal{P}_{\mathcal{E}}$, which will be used in the Chapter 3 (inversion and model matching).

Definition 1.8 (Ring $\mathcal{P}_{\mathcal{E}}$). The set $\mathcal{P}_{\mathcal{E}}$ is defined by

$$\mathcal{P}_{\mathcal{E}} = \mathcal{G} + \mathcal{D}, \quad (1.28)$$

where \mathcal{D} is the set of elements of the form

$$d(t) = \sum_{k=0}^r d_k \delta(t - k\vartheta), \quad (1.29)$$

where $d_k \in \mathbb{R}$, $r \in \mathbb{N}$ is finite, and $\delta(t)$ denotes the Dirac distribution at time t . \square

In other words, the ring $\mathcal{P}_{\mathcal{G}}$ is the set of pseudo-polynomials in \mathcal{G} with degree less than zero. Elements in $\mathcal{P}_{\mathcal{G}}$ have no pole, since they are pseudo-polynomials. They are proper in the sense of Definition 1.7. They correspond in the time-domain to the truncation over a finite-time interval of rational elements in the convolution algebra \mathcal{A} . More detail of this ring will be introduced in Chapter 3.

1.2.5 Euclidean algorithm

Let $X(s) \in \mathbb{R}^{m \times p}[s, e^{-s\vartheta}]$, $D(s) \in \mathbb{R}^{m \times m}[s, e^{-s\vartheta}]$. If the term of the highest degree of each column of $D(s)$ is monic (or $\det D(s)$ is monic), there exist $Q(s) \in \mathbb{R}^{m \times p}[s, e^{-s\vartheta}]$, $R(s) \in \mathbb{R}^{m \times p}[s, e^{-s\vartheta}]$ such that

$$X(s) = D(s)Q(s) + R(s), \quad (1.30)$$

where $R(s)D^{-1}(s)$ is strictly proper.

Let $X(s) \in \mathbb{R}[s, e^{-s\vartheta}]$, $D(s) \in \mathbb{R}[s, e^{-s\vartheta}]$. If $D(s) = \sum_{i=0}^n d_i(e^{-s})s^i$ is not monic, there exist $Q(s), R(s) \in \mathbb{R}(s, e^{-s})$ such that equation (1.30) holds. But

$$Q(s) = \frac{q_0(e^{-s})}{p_0(e^{-s})}s^m + \dots + \frac{q_m(e^{-s})}{p_m(e^{-s})}s^0,$$

and $\deg_s R(s) < \deg_s D(s)$. In order to renormalize Euclidean division into quasi-polynomial representation, we multiply equation (1.30) by $e(s)$, where

$$e(s) = LCM [p_0(e^{-s}), \dots, p_m(e^{-s})], \quad m \in \mathbb{N}_+,$$

the Least Common Multiple of all the $p_i(e^{-s})$, ($i = 0, 1, \dots, m$). So the equation (1.30) can be renormalized into

$$X(s)E(s) = D(s)Q_e(s) + R_e(s), \quad (1.31)$$

where $E(s) = e(s) \in \mathbb{R}[e^{-s, \vartheta}]$, $Q_e(s) = \frac{Q(s)}{e(s)}$ and $R_e(s) = E(s)R(s)$ [75, Morf and Lévy (1977)].

Chapter 2

Distributed delay: Properties, Realization and Approximation

In this chapter we will introduce a class of infinite dimensional systems called distributed delays which plays a central role in this manuscript. The general definition of distributed delay will be given and the numerical implementation of distributed delay will be introduced. The applications of distributed delay will be also discussed for solving control problems (Inversion and model matching in Chapter 3; stabilization, finite spectrum assignment and observation in Chapter 4; approximation of distributed parameter systems in Chapter 5).

The interest for the use of distributed delays in the stabilization of time-delay systems appears in the pioneering work of Olbrot [1, Olbrot (1978)]. To generalize algebraic methods issued from linear systems in finite dimensional spaces to time-delay systems, Kamen et al. [2, Kamen et al. (1986)] first introduce a general mathematical setting for the control, and in particular for the stabilization, of time-delay systems. This mathematical framework was formalized in Brethé and Loiseau [3, Brethé and Loiseau (1996)] by the introduction of the Bézout ring of pseudo-polynomials, or independently by [4, Glüsing-Lüerßen (1997)] with a behavioural approach. These works were mainly focused on stabilization. More generally, one can be interested in spectrum assignment by feedback. For linear time-delay systems, a necessary and sufficient condition to achieve spectrum assignment is the spectral controllability for which we refer to [41, Manitius and Olbrot (1979)] or [42, Watanabe (1986)]. Finite spectrum assignment generalizes the principle of Smith's predictor for dead-time systems [5, Smith (1959)]

to general systems with delays, which can be stable or unstable. Distributed delays appear also in the characterization of equivalence transformation [76, Artstein (1982)]. Robustness issues and optimization [77, Dym et al. (1995)], robustness for input-delay systems [78, Mondié et al. (2001)], finite time control [29, Di Loreto (2006)] or model for dynamics systems [9, Sinègre and Petit (2005)] are other topics where distributed delays play a central role.

A distributed delay is a linear input-output convolution operator of the form

$$y(t) = (f * u)(t) = \int_0^{\vartheta} f(\tau)u(t - \tau)d\tau, \quad (2.1)$$

where ϑ is a strictly positive and finite real, and kernel $f(\cdot)$ is a continuous function with support $[0, \vartheta]$. Numerical implementation of distributed delay was early investigated, to propose effective algorithms for control. Such an implementation was the starting point of a research activity. A first proposition approximation with finite dimensional systems was proposed in [79, Kamen et al. (1985)]. Reduction and approximation of delay systems, involving lumped delays, were also investigated in [57, Partington (2004)]. In the work of [13, Van Assche et al. (1999)], the authors propose a numerical integral approximation to realize an operator like in (2.1). Such an approximation writes as a sum of lumped delayed distributions. Unfortunately, this approximation introduces additional closed-loop poles and instability phenomena (see, *e.g.* [14, Zhong (2003)], [17, Santos and Mondié (2000)], and references therein). To overcome this problem, various solutions were proposed. In [15, Mirkin (2004)], it was outlined that such an approximation has a poor accuracy and an high sensitivity for high frequencies. Hence, the author proposed to add a low-pass filter in the integral approximation. Such a solution was also proposed independently by Mondié and Michiels [18, Mondié and Michiels (2003)]. Further implementation improvements were proposed in Zhong [19, Zhong (2005)] and Partington and Mäkilä [16, Partington and Mäkilä (2005)], with rational approximation and extension of bilinear transformations. These last papers give positive answers to the open problem of general approximation of distributed delay, outlined in Richard [38, Richard (2003)].

We propose here a general methodology for numerical implementation of distributed delays. The numerical implementation of an operator exhibit two sides. The first one involves time discretization of the input-output behaviour of the operator. Any distributed delay is a BIBO-stable (Bounded-Input Bounded-Output stable) operator. It is immediate to verify that an equivalent discrete-time system

can be obtained by usual sampling tools, and that this system can be put into a sum of causal lumped distributions. Taking an appropriate sampling period, this equivalent discrete-time system is always BIBO-stable. Hence, this first part presents no difficulty. We refer for instance to Zhong [20, Zhong (2004)] and to references therein for more details on this part. The second part involves the approximation problem in continuous time of such an operator. This is the part we mainly address in this manuscript.

In this chapter, we will explain the implementation problem of distributed delay and give a general method for approximation of distributed delay. We show that input-output approximation is not suitable for approximation of distributed delays, and we will then focus on kernel approximation. With the objective to substitute the distributed delay by a more tractable systems, highlighting rational assumptions, we propose two classes to realize approximation, namely lumped systems and a subclass of distributed delays. With previous objectives, we enclose the approximation problem into the Wiener algebra of BIBO-stable systems, using the graph topology. This corresponds to the weakest topology where feedback is a robust property. Moreover, for stable systems, graph topology and norm topology being the same, we work on norm convergence over this algebra, which is a Banach algebra. So the graph topology will also be introduced before the general method. This general framework was used first in [21, Vidyasagar and Anderson (1989)] for approximation of distributed parameter systems by lumped systems. Roughly speaking, working over this algebra, an approximation comes down to realize approximation of the kernel over the Banach algebra $L_1(\mathbb{R}_+)$. This idea also grew in [22, Ohta et al. (1992)], for the approximation of lumped delayed distributions which appear in optimal control. Here, we propose an extension of the classes of approximation, and we show that working in this general setting yields an approximation of a distributed delays in both time and frequency domains, for large classes of input signals. We also propose to highlight the propositions made in [18, Mondié and Michiels (2003)] or [15, Mirkin (2004)], and to bring a mathematical foundation for this solution. In the remaining of this chapter, we introduce three approximation methods of distributed delay in the literatures. First we introduce the method that was proposed in Mirkin [15, Mirkin (2004)]. In [13, Van Assche et al. (1999)], the authors point that for the approximation of distributed delay the Newton-Cotes method will lead to instability phenomena in closed-loop system, since this method will let the strictly proper distributed delay become proper and produce a high sensitive in high frequencies. Mirkin considers to add a

low-pass filter in the approximation to overcome the problem. The second method which we will introduce was proposed by Zhong [20, Zhong (2004)]. A modified Newton-Cotes approximation was considered to overcome the instability problem. We will prove that both of them are L_1 -approximation. The third method is the rational approximation method that was proposed by Partington and Mäkilä [16, Partington and Mäkilä (2005)], where Padé approximation was considered to solve the problem and this approximation is in the H_∞ norm.

2.1 Definition and properties

2.1.1 Definitions

We define and fully characterize the main properties, in both time and frequency domains, of distributed delays. We characterize in particular a general decomposition of distributed delays on the so-called elementary distributed delays. The algebra \mathcal{A} which was introduced in Chapter 1 gives a general mathematical framework for the analysis of distributed delays.

Let $\mathbb{I}_{a,b} = [a, b]$ be the bounded closed interval in \mathbb{R}_+ , for some reals a and b , $0 \leq a < b$. Notations $\mathbb{I}_{0,\infty}$ or \mathbb{R}_+ stand for $[0, \infty]$. We define $\mathcal{K}(\mathbb{I}_{a,b})$ as the set of complex valued functions $g(\cdot)$ of the form

$$g(t) = \begin{cases} g_{\mathbb{I}_{a,b}}(t), & t \in \mathbb{I}_{a,b} \\ 0, & \text{elsewhere} \end{cases} \quad (2.2)$$

where

$$g_{\mathbb{I}_{a,b}}(t) = \sum_{i \geq 0} \sum_{j \geq 0} c_{ij} t^j e^{\lambda_i t}, \quad (2.3)$$

for some c_{ij} and λ_i in \mathbb{C} , and the sums are finite. In other words, $g_{\mathbb{I}_{a,b}}$ is a finite linear combination of exponential-polynomials type functions, and it is in particular a continuous function. For any real valued function in $\mathcal{K}(\mathbb{I}_{a,b})$, if some $\lambda_i \in \mathbb{C}$ appears in the sum, then so does its conjugate $\bar{\lambda}_i$, and the associated coefficient c_{ij} are complex conjugates. Hence, any real valued function in $\mathcal{K}(\mathbb{I}_{a,b})$ is a function generated by real linear combinations of $t^j e^{\sigma_i t}$, $t^j e^{\sigma_i t} \sin(\beta_k t)$ and $t^j e^{\sigma_i t} \cos(\beta_k t)$, for some real number σ_i, β_k , the sums being finite. The formal definition of distributed delays is made below.

Definition 2.1 (Distributed delay). A distributed delay is a causal convolution system, with kernel f in $\mathcal{K}(\mathbb{I}_{\vartheta_1, \vartheta_2})$, for some bounded real numbers $0 \leq \vartheta_1 < \vartheta_2$.

In other words, a distributed delay can be written like an input-output convolution operator of the form

$$y(t) = (f * u)(t) = \int_{\vartheta_1}^{\vartheta_2} f_{\mathbb{I}_{\vartheta_1, \vartheta_2}}(\tau) u(t - \tau) d\tau = \int_{t - \vartheta_1}^{t - \vartheta_2} f_{\mathbb{I}_{\vartheta_1, \vartheta_2}}(t - \tau) u(\tau) d\tau, \quad (2.4)$$

with notation introduced in (2.3). The set of distributed delays, denoted by \mathcal{G} , is a ring. Obviously, for real valued signals, the kernel $f(\cdot)$ will be a real valued function in $\mathcal{K}(\mathbb{I}_{\vartheta_1, \vartheta_2})$. In the previous definition, we restrict ourselves to define a distributed delay like a convolution operator with kernel in $\mathcal{K}(\mathbb{I}_{\vartheta_1, \vartheta_2})$. This restriction is not conservative as we will show in Section 2.2.2.4. Actually, all distributed delays which appeared in the literature are particular cases of this definition. This definition is based on a rational construction, as this appears explicitly using Laplace transform. Any distributed delay \mathcal{G} admits a Laplace transform, corresponding to the finite Laplace transform of its kernel $f \in \mathcal{K}(\mathbb{I}_{\vartheta_1, \vartheta_2})$,

$$\hat{y}(s) = \hat{f}(s) \hat{u}(s), \quad \hat{f}(s) = \int_{\vartheta_1}^{\vartheta_2} f_{\mathbb{I}_{\vartheta_1, \vartheta_2}}(\tau) e^{-s\tau} d\tau, \quad (2.5)$$

where $\hat{f} \in \hat{\mathcal{G}}$ is an entire function, *i.e.* holomorphic on the whole complex plane.

We next introduce the notion of elementary distributed delay, that, as we will show below, will greatly simplify the approximation problem.

Definition 2.2 (Elementary distributed delay). Let us define the complex valued function $\theta_\lambda(\cdot) \in \mathcal{K}(\mathbb{I}_{0, \vartheta})$, for some $\lambda \in \mathbb{C}$ and $\vartheta > 0$, by

$$\theta_\lambda(t) = \begin{cases} e^{\lambda t}, & t \in [0, \vartheta] \\ 0, & \text{elsewhere} \end{cases} \quad (2.6)$$

□

The Laplace transform of equation (2.6) is

$$\hat{\theta}_\lambda(s) = \frac{1 - e^{-(s-\lambda)\vartheta}}{s - \lambda}, \quad (2.7)$$

which is an entire function even in $s = \lambda$ where $\hat{\theta}_\lambda(\lambda) = \vartheta$. In other words, λ is a removable singularity, and consequently $\hat{\theta}_\lambda(s)$ has no pole. The distributed delay whose kernel is θ_λ is called an elementary distributed delay.

The k th derivative $\hat{\theta}_\lambda^{(k)}(s)$ of $\hat{\theta}_\lambda(s)$ yields

$$\hat{\theta}_\lambda^{(k)}(s) = \int_0^\vartheta (-\tau)^k e^{-(s-\lambda)\tau} d\tau, \quad (2.8)$$

which is still in $\hat{\mathcal{G}}$, and corresponds to the Laplace transform of the function $\theta_\lambda^k = (-t)^k e^{\lambda t}$ for $t \in [0, \vartheta]$, and 0, elsewhere.

2.1.2 Properties

From previous definitions, we can state the following lemma, which also appeared in Brethé and Loiseau [74, Brethé and Loiseau (1997)] using 2D-polynomials, and which will play a central role for approximation.

Lemma 2.3. *Any element in $\hat{\mathcal{G}}$ can be decomposed into a finite sum of Laplace transforms of elementary distributed delays and its successive derivatives.*

Proof. Take any element in $\hat{\mathcal{G}}$. Its kernel $g(\cdot)$ lies in $\mathcal{K}(\mathbb{I}_{\vartheta_1, \vartheta_2})$, and writes as in (2.3). By time translation corresponding to the lumped delay ϑ_1 , it is readily a linear finite combination of elementary distributed delay $\theta_\lambda(t)$ and of the functions $\theta_\lambda^k(t)$, as defined in (2.6) and (2.8), with $\vartheta = \vartheta_2 - \vartheta_1$. \square

In other terms, previous result tells us that for any $\hat{g} \in \hat{\mathcal{G}}$, there exist complex polynomials $\hat{g}_{ik} \in \mathbb{C}[e^{-\vartheta s}]$ with respect to the variable $e^{-\vartheta s}$ and $\lambda_i \in \mathbb{C}$, in finite number, such that

$$\hat{g}(s) = \sum_{i,k} \hat{g}_{ik} (e^{-\vartheta s}) \hat{\theta}_{\lambda_i}^{(k)}(s), \quad (2.9)$$

where successive derivatives are iteratively computed by

$$\hat{\theta}_{\lambda_i}^{(k)} = (-1)^k k! \frac{1 - e^{-(s-\lambda_i)\vartheta} - \sum_{n=1}^k \frac{\vartheta^n}{n!} e^{-(s-\lambda_i)\vartheta} (s - \lambda_i)^n}{(s - \lambda_i)^{k+1}}, \quad (2.10)$$

and $\hat{\theta}_{\lambda_i}^{(k)}(s)$ are still entire functions, since $\hat{\theta}_{\lambda_i}^{(k)}(\lambda_i) = \frac{(-1)^k \vartheta^{k+1}}{k!}$, for any $k \geq 1$.

From (2.9) and taking into account that practical distributed delay is a real valued

operator, we see that any element $\hat{g} \in \hat{\mathcal{G}}$ can be put into the form, grouping the terms via least common multiple, as a fraction

$$\hat{g}(s) = \frac{n(s, e^{-\vartheta s})}{d(s)}, \quad (2.11)$$

where $n(s, e^{-\vartheta s}) \in \mathbb{R}[s, e^{-\vartheta s}]$ is a real quasi-polynomial with respect to the algebraically independent variables s and $e^{-\vartheta s}$, and $d(s) \in \mathbb{R}[s]$. Any element in the right hand side of (2.9) being an entire function, $\hat{g}(s)$ is also an entire function. Hence, any zero of $d(s)$ is also a zero of $n(s, e^{-\vartheta s})$. Furthermore, the degree with respect to s of $\hat{\theta}_\lambda^{(k)}(s)$ in (2.7) and (2.10), for any k , being strictly negative, the degree with respect to s of $\hat{g}(s)$ satisfies $\deg_s n < \deg_s d$, so that its Laplace transform is strictly proper. As in [3, Brethé and Loiseau (1996)], the ring $\hat{\mathcal{G}}$ is the ring of those Laplace transforms of distributed delays that are rational in the variable s and $e^{-\vartheta s}$, which are entire and strictly proper (with respect to s). This result comes from the assumption on rational kernels in (2.3). The kernel of any element in \mathcal{G} is obviously in $L_1(\mathbb{R}_+)$, so that from (1.4) and the definition of \mathcal{A} , any distributed delay is BIBO stable. Convolution of two kernels with finite support yields another kernel with finite support, and since exponential-polynomials type functions are closed under classical product, we have in fact that \mathcal{G} is a normed subalgebra of \mathcal{A} for the $\|\cdot\|_{\mathcal{A}}$ -norm.

The contributions of this chapter includes that the general definition of the distributed delays, the properties of the distributed delays. The lumped approximation for distributed delay is introduced. We compare the input-output approximation and kernel approximation. A new construction of approximation of distributed delay is proposed. Analysis of this approximation in time-domain and frequency-domain are given.

2.2 Approximation and implementation of distributed delay

2.2.1 Approximation problem

Now we formulate the approximation problem of distributed delays. For this purpose, we define two subspaces in direct sum in $\mathcal{K}(\mathbb{I}_{\vartheta_1, \vartheta_2})$, denoted respectively $\mathcal{K}_s(\mathbb{I}_{\vartheta_1, \vartheta_2})$ and $\mathcal{K}_u(\mathbb{I}_{\vartheta_1, \vartheta_2})$, consisting of linear combinations of exponential-polynomials type functions on some finite interval as in (2.3), with $\text{Re } \lambda_i < 0$ and $\text{Re } \lambda_i \geq 0$, respectively, for all $i \geq 0$.

From Lemma 2.3 and (2.9) we know that any element $g \in \mathcal{K}_s(\mathbb{I}_{\vartheta_1, \vartheta_2})$ is a linear combination of elements $\theta_{\lambda_i}^k$ in $\mathcal{K}_s(\mathbb{I}_{\vartheta_1, \vartheta_2})$, for which $\text{Re } \lambda_i < 0$. Hence, any elements in $\mathcal{K}_s(\mathbb{I}_{\vartheta_1, \vartheta_2})$ can be numerically implemented with stability blocks, as illustrated in Figure 2.1 for $\theta_\lambda(t)$. Note that in practice, since $\lambda \in \mathbb{C}$, we should im-

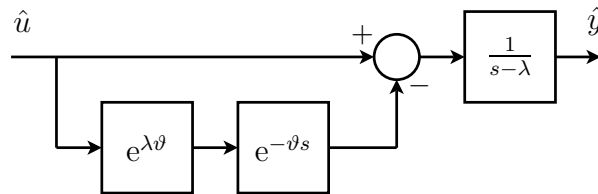

FIGURE 2.1: Realization of an element $\hat{\theta}_\lambda(s) \in \mathcal{K}_s(\mathbb{I}_{0, \vartheta})$, with $\text{Re } \lambda < 0$.

plement it using a real decomposition. Approximation for the subclass $\mathcal{K}_s(\mathbb{I}_{\vartheta_1, \vartheta_2})$ of distributed delays is not required, since this implementation is realized with stability, and requires, from an implementation point of view, only two point-wise delay, namely 0 and ϑ . However, this is no more true for elements in $\mathcal{K}_u(\mathbb{I}_{\vartheta_1, \vartheta_2})$, where numerical realization for $\theta_\lambda(t)$ as in Figure 2.1 yields an unstable system. Note that another realization for $\hat{\theta}_\lambda(s)$ may be

$$\dot{x} = \lambda x(t) + u(t) - e^{\lambda \vartheta} u(t - \vartheta), \quad (2.12)$$

which is however still numerically unstable for $\text{Re } \lambda \geq 0$. Intuitively, this instability is a consequence of a non exact numerical cancellation of the removable singularity $s = \lambda$ of $\hat{\theta}_\lambda(s)$. Therefore, we will mainly focus our attention on distributed delays with kernel in $\mathcal{K}_u(\mathbb{I}_{\vartheta_1, \vartheta_2})$.

The question can now be stated as follows: How to define a continuous time approximation of a distributed delay whose kernel lies in $\mathcal{K}_u(\mathbb{I}_{\vartheta_1, \vartheta_2})$? We give complete answers to this question in the subsections 2.2.2. Before this we introduce some particular solutions of this problem.

2.2.2 General solution of the approximation

For solving the approximation problem, we analyze the problem into the Wiener algebra of BIBO stable systems by using graph topology which is the weakest topology such that feedback stability is a robust property. The lumped approximation will be introduced for distributed delay, since the lumped system is the rational transfer functions which is easy to realize, implement and control. After that, we will explain that the input-output approximation is not a good approximation for distributed delay and that is the intrinsic problem when using Newton-Cotes approximation. We move to another class of approximation, using a sub class of distributed delay, easy to implement with stability. A general framework will be proposed for this approximation of distributed delay in graph topology by kernel approximation. Effective implementation and their construction are given. Properties of this approximation in time and frequency domains are also introduced. Simulations will show the effectiveness of the method.

2.2.2.1 Graph topology

Let us consider the standard feedback systems shown in Figure 2.2, and suppose the compensator $C \in \mathbb{R}^{n \times q}[s, e^{-s}]$ stabilizes the plant $P \in \mathbb{R}^{m \times n}[s, e^{-s}]$, *i.e.*, that the closed-loop transfer matrix

$$H(P, C) = \begin{bmatrix} (I + PC)^{-1} & -P(I + CP)^{-1} \\ C(I + PC)^{-1} & (I + CP)^{-1} \end{bmatrix} \quad (2.13)$$

belongs to $\mathcal{A}^{m \times q}$ (The stabilization will be discussed in more details in Chapter 4). Suppose that the plant uncertainty can be modelled by a family of plants P_Δ , where the uncertainty parameter Δ assumes values in some topological space Δ . Typically Δ represents some physical parameters of the plant, such as component values, and the function $\lambda \rightarrow P_\Delta$ captures the manner in which this uncertainty in the physical parameters is reflected in the plant description. Let P_{Δ_0} be the

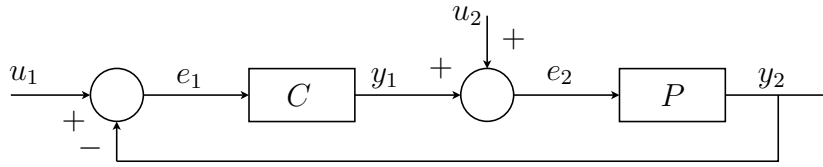

FIGURE 2.2: Feedback System.

nominal plant description on which the compensator design is based. In this section we will study the following question: When does there exist a robustly stabilizing compensator for a given family P_Δ of plants? The answer involves the introduction of an appropriate topology on the set $\mathbb{R}^{m \times n}(s, e^{-s})$ of possibly unstable plants, called graph topology [40, Vidyasagar (1985)]. In terms of the graph topology, the answer to the above question turns out to be exceedingly simple and satisfactory: Robust stabilization is possible if and only if the function $\Delta \rightarrow P_\Delta$ is continuous in the graph topology at $\Delta = \Delta_0$. In other words, robust stabilization is possible if and only if any variations in the parameter Δ from its nominal value Δ_0 affect the plant description in a continuous way, where the continuity of P_Δ is judged in the context of the graph topology.

As the name implies, the graph topology has to do with the graph of a plant, and we begin with this notion. Suppose $P \in \mathbb{R}^{m \times n}(s, e^{-s})$. The graph of a plant P is the set of bounded input-output pairs corresponding to P . More precisely, if $P \in \mathbb{R}^{m \times n}(s, e^{-s})$, then

$$\mathbb{G}_{\mathcal{A}}(P) = \{(u, y) \in \mathcal{A}^{m \times n} : y = Pu\} \quad (2.14)$$

is the graph of P with respect to \mathcal{A} .

Lemma 2.4. *Suppose $P \in \mathbb{R}^{m \times n}(s, e^{-s})$, and let (N, D) be any right coprime factorization of P in $\hat{\mathcal{A}}$. Then*

$$\mathbb{G}_{\mathcal{A}}(P) = \{(Dz, Nz) : z \in \mathcal{A}^n\} \quad (2.15)$$

Proof. See the proof of Lemma 2 in [40, Vidyasagar (1985)] Section 7.2. \square

This lemma shows that the graph of a plant P can be simply parametrized in terms of any right-coprime factorization (N, D) of P over $\hat{\mathcal{A}}$.

Now we can define the graph topology. Suppose (N, D) is a right-coprime pair over $\hat{\mathcal{A}}$, and that $|D| \neq 0$. Then there exists a constant $\mu = \mu(N, D)$ such that (N_1, D_1)

is also a right-coprime pair and $|D_1| \neq 0$ whenever $\|[(N_1 - N)^T (D_1 - D)^T]^T\|_{\hat{\mathcal{A}}} < \mu(N, D)$. Given a plant $P \in \mathbb{R}(s, e^{-s})^{m \times n}$, a basic neighbourhood of P is defined as following: Let (N, D) be any right-coprime factorization of P over $\hat{\mathcal{A}}$, and let ε be any positive number less than $\mu(N, D)$. Then the set

$$\mathcal{B}(N, D, \varepsilon) = \left\{ P_1 = N_1 D_1^{-1} : \left\| \begin{bmatrix} N_1 - N \\ D_1 - D \end{bmatrix} \right\|_{\hat{\mathcal{A}}} < \varepsilon \right\} \quad (2.16)$$

is a basic neighbourhood of P . Thus a basic neighbourhood of P merely consists of all plants P_1 which have a right-coprime factorization (N_1, D_1) that is "close" to a right-coprime factorization of P over $\hat{\mathcal{A}}$. For $P \in \mathcal{A}^{m \times n}$ a basic neighborhood of P will be also denoted by

$$\mathcal{B}(P, \varepsilon) = \{ P_\Delta \in \mathcal{A}^{m \times n} : \|P - P_\Delta\|_{\mathcal{A}} \leq \varepsilon \}. \quad (2.17)$$

The topology on $\mathbb{R}^{m \times n}(s, e^{-s})$ defined by the collection of sets of the form (2.16) as basis is called the graph topology. Two plants P_1 and P_2 are "close" if they have right-coprime factorizations $(N_1, D_1), (N_2, D_2)$ such that

$$\|[(N_1 - N)^T (D_1 - D)^T]^T\|_{\hat{\mathcal{A}}}$$

is "small". In view of Lemma 2.4, this means that P_1 and P_2 are "close" if their graphs are "close". For the graph topology, we have the following theorem.

Theorem 2.5 (Vidyasagar (1985)[40]). *Suppose $\Delta \rightarrow P_\Delta, \Delta \rightarrow C_\Delta$ are functions mapping on a first countable topological space Λ ¹ into $\mathbb{R}^{m \times n}(s, e^{-s})$, and suppose that the pair $(P_{\Delta_0}, C_{\Delta_0})$ is stable.*

- *Suppose the functions $\Delta \rightarrow P_\Delta, \Delta \rightarrow C_\Delta$ are continuous at $\Delta = \Delta_0$ in the graph topology. Then there exists a neighbourhood $\mathcal{B}(P_\Delta, C_\Delta, \varepsilon)$ of Δ_0 such that (P_Δ, C_Δ) is stable for all $\Delta \in \mathcal{B}(P_\Delta, C_\Delta, \varepsilon)$, and in addition $H(P_\Delta, C_\Delta)$ is continuous at $\Delta = \Delta_0$ in the norm topology on $\hat{\mathcal{A}}^{m \times n}$.*
- *Conversely, suppose there is a neighbourhood $\mathcal{B}(P_\Delta, C_\Delta, \varepsilon)$ of Δ_0 such that (P_Δ, C_Δ) is stable for all $\Delta \in \mathcal{B}(P_\Delta, C_\Delta, \varepsilon)$, and such that $H(P_\Delta, C_\Delta)$ is continuous at $\Delta = \Delta_0$ in the norm topology on $\mathcal{A}^{n \times m}$. Then the function $\Delta \rightarrow P_\Delta, \Delta \rightarrow C_\Delta$ are continuous at $\Delta = \Delta_0$ in the graph topology.*

¹A first countable topological space is a topological space in which every point has a countable number of open neighborhoods so that any neighborhood of this point contains one of these.

Proof. See the proof of Theorem 38 in [40, Vidyasagar (1985)] Chapter 7 or [80, Cantoni and Vinnicombe]. \square

From Theorem 2.5 we know that if there exist a neighbourhood $\mathcal{B}(P_\Delta, C_\Delta, \varepsilon)$ and a family $\{C_\Delta, \Delta \in \mathcal{B}(P_\Delta, C_\Delta, \varepsilon)\} \in \mathbb{R}^{n \times q}(s, e^{-s})$ of compensator such that (P_Δ, C_Δ) is stable for all $\Delta \in \mathcal{B}(P_\Delta, C_\Delta, \varepsilon)$ and such that $H(P_\Delta, C_\Delta)$ in equation (2.13) is continuous at $\Delta = \Delta_0$, then there exists a $C \in \mathbb{R}^{n \times q}(s, e^{-s})$ and a neighbourhood $\mathcal{B}(P_\Delta, C_\Delta, \varepsilon)$ of Δ_0 such that (P_Δ, C) is stable for all $\Delta \in \mathcal{B}(P_\Delta, C_\Delta, \varepsilon)$ and $H(P_\Delta, C)$ is continuous at $\Delta = \Delta_0$.

Example 2.1. Consider the plant $P = \frac{1}{s-1}$. A stable compensator can be chosen as $C = 2$. The transfer function of the closed-loop system is $H(s) = \frac{2}{s+1}$. Take the plant with uncertainty ε such that $P_\varepsilon = \frac{1}{s-1+\varepsilon}$. The transfer function of the closed-loop system will become $H_\varepsilon(s) = \frac{2}{s+1+\varepsilon}$. So the system will be stable if $|\varepsilon| < 1$.

The preceding results show that the graph topology is of fundamental importance in the study of robustness in feedback stability. More properties can be found in [40, Vidyasagar (1985)] or [80, Cantoni and Vinnicombe].

2.2.2.2 Lumped approximation

Consider a distribution p with a coprime factorization (n, d) in \mathcal{A} , that is $\hat{p} = \hat{n}\hat{d}^{-1}$, and such that there exist x and y in \mathcal{A} satisfying

$$n * x + d * y = \delta, \quad (2.18)$$

or in the Laplace domain

$$\hat{n}\hat{x} + \hat{d}\hat{y} = 1, \quad \forall s \in \mathbb{C}, \quad \text{Re } s \geq 0. \quad (2.19)$$

A neighbourhood of p in the graph topology is the set of all plants of the form $n_\Delta d_\Delta^{-1}$ where (n_Δ, d_Δ) belongs to some ball in \mathcal{A} centered at (n, d) . In [40, Vidyasagar (1985)], it was shown that the graph topology is the weakest topology in which feedback stability is a robust property. Graph topology being metrizable and hence first-countable, for BIBO-stable systems, norm topology and graph topology are the same. Let ϵ be a given suitable small positive number. Hence we

say that a distribution p_ε in \mathcal{A} is an approximation of p in the graph topology if the element p_ε is close to p , that is $p_\varepsilon \in \mathcal{B}(p, \varepsilon)$, or equivalently $\|p - p_\varepsilon\|_{\mathcal{A}} \leq \varepsilon$. This property can be related to convergence in \mathcal{A} , but we need first to define the class of operator that will approximate p in the graph topology. The most commonly used class is the so-called class of lumped systems, which consists in convolution operators whose kernels lie in the set \mathcal{Q} , defined by

$$\mathcal{Q} = \{g \in \mathcal{A} : g(t) = g_0\delta(t) + g_a(t), \quad g_0 \in \mathbb{C}, \quad g_a \in \mathcal{K}(\mathbb{I}_{0,\infty})\}. \quad (2.20)$$

From the work of Vidyasagar and Anderson in [21], we know that any plant p with coprime factorization (n, d) over \mathcal{A} can be approximated by a lumped plant in the graph topology if and only if there exists a real constant matrix M of rank 1 such that

$$MS_{pa} = 0, \quad \text{where} \quad S_{pa} = \begin{bmatrix} n_{pa} \\ d_{pa} \end{bmatrix}, \quad (2.21)$$

where $(\cdot)_{pa}$ denotes the purely atomic part. From this we can deduce the following result, that can be seen as a particular case of the above given condition (2.21).

Theorem 2.6. *Any plant in $L_1(\mathbb{R}_+)$ can be approximated by a lumped system in the graph topology.*

Proof. Let f be an element in $L_1(\mathbb{R}_+)$. A coprime factorization of f over \mathcal{A} is $n = f$ and $d = \delta$. Since $n_{pa} = 0$, any real constant matrix $M = [\star \ 0]$, (\star) denoting an arbitrary real number, satisfies (2.21). Hence from [21, Vidyasagar (1989)] Theorem 4.1, f can be approximated by a lumped system in the graph topology. \square

2.2.2.3 Input-output approximation

Any distributed delay with kernel $f \in \mathcal{K}(\mathbb{I}_{\vartheta_1, \vartheta_2})$ is a convolution operator. Its L_1 -induced norm is

$$\|f\|_{\mathcal{A}} = \|f\|_{L_1}. \quad (2.22)$$

A natural metric is then obtained from the \mathcal{A} -norm, which in turn can be enclosed in the graph topology.

Some approximation classes can be used to numerically realize a distributed delay.

In the literature, appears a method based on a numerical integral approximation, but such a method was shown to be at the core of various undesired results, like instability or numerical sensitivity. Let us briefly make some considerations on such approximations, introducing what we call input-output approximation, and let us show why such approximations are not suitable for our problem.

For any distributed delay $y(t) = (f * u)(t)$, we say that y_{app} is an L_1 input-output approximation of y , if for some arbitrarily $\varepsilon > 0$, $\|y - y_{\text{app}}\|_{L_1} \leq \varepsilon$ holds. For instance, consider the L_1 input-output approximation based on integral approximation, like Newton-Cotes quadrature methods, which leads to an approximation $y_{\text{app}}(t)$ of the form

$$y_{\text{app}}(t) = \sum_{k=0}^q c_k f(\tau_k) u(t - \tau_k), \quad (2.23)$$

where reals c_k and τ_k depend on the applied method [81, Ralston and Rabinowitz (2001)], [13, Van Assche et al. (1999)]. Various problems arise with this kind of approximation. First note that such an approximation is made for a given $u(\cdot)$. Hence, if such an input changes, the properties of this approximation failed, in general. Note also that, as mentioned by [15, Mirkin (2004)], the Laplace transform of (2.23) yields an input-output approximation transfer function that is proper, since it contains only pointwise delays. From (2.9) and (2.11), a distributed delay having a strictly proper transfer function, this approximation has a poor accuracy for high frequencies, which will have as consequence a high sensitivity to high frequency plant uncertainties, in particular for the closed-loop systems. This fact is illustrated in Figure 2.3, where a frequency diagram of $\hat{\theta}_\lambda(s)$ and an input-output approximation is plotted, $h(\omega) = 20 \cdot \log \left| \hat{\theta}_\lambda(j\omega) \right|$. This negative result is directly interpretable in the graph topology by the following result.

Theorem 2.7. *A distributed delay can not be approximated in the graph topology by a purely atomic distribution.*

Proof. Consider an element in \mathcal{G} with kernel g . Then $g \in L_1(\mathbb{R}_+)$. Consider any purely atomic distribution with pointwise delays of the form

$$p(t) = \sum_{i \geq 0} p_i \delta(t - t_i) \quad (2.24)$$

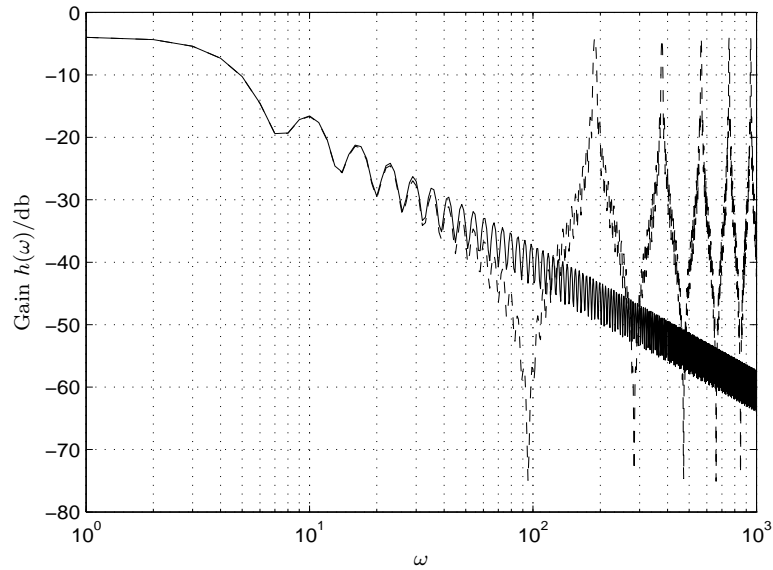

FIGURE 2.3: Bode gain diagram of $\hat{\theta}_1(s)$ and its approximation based on integral approximation (trapezoidal Newton-Cotes method with 30 nodes).

where $\sum_{i \geq 0} |p_i| < \infty$. Such a distribution corresponds to the kernel of the approximation using numerical integral approximation like in (2.23). Then

$$\|g - p\|_{\mathcal{A}} = \|g\|_{L_1} + \sum_{i \geq 0} |p_i|. \quad (2.25)$$

Hence $\|g - p\|_{\mathcal{A}} \geq \|g\|_{L_1}$, and consequently p can not approximate g in the graph topology. \square

Let us take an example to illustrate this theorem clearly.

Example 2.2. Consider the plant

$$\hat{p}(s) = \frac{e^{-s}}{s-1}.$$

Given the stabilizing compensator

$$\hat{c}(s) = \frac{2e}{1 + 2 \frac{1-e^{-(s-1)}}{s-1}},$$

the feedback system shown in figure 2.4 will be stable.

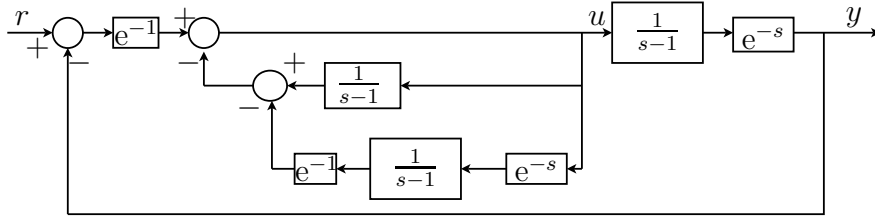

FIGURE 2.4: Stabilizing control of Example 2.2

The control law is

$$u(t) = -2e^1 y(t) - 2e^1 \int_{t-1}^t e^{t-\tau} u(\tau) d\tau + 2e^1 r(t)$$

where y is the plant output, u is the control input, and r is a reference signal. The closed loop transfer function is $H(s) = 2\frac{e^{-(s-1)}}{s+1}$, which is stable. But when we simulate the system, an unstable response appears. We consider implementation by numerical integral approximation. Using the trapezoidal integration rule to implement the distributed delay,

$$\begin{aligned} g_1(t) &= \int_{t-1}^t e^{t-\tau} u(\tau) d\tau \\ &\approx \frac{1}{v} \left[\frac{1}{2} u(t) + \sum_{i=1}^{v-1} e^{2\frac{i}{v}} u\left(t - 1\frac{i}{v}\right) + \frac{1}{2} e u(t-1) \right] = g_2(t) \end{aligned} \quad (2.26)$$

where $\frac{1}{v}$ ($v \in \mathbb{N}^+$) is the discretization step.

From the Laplace transform of $g_1(t)$ and $g_2(t)$ we obtain

$$\begin{aligned} \hat{h}(s) &= \frac{g_1(s)}{u(s)} = \frac{1 - e^{-(s-1)}}{s-1} \\ \tilde{h}(s) &= \frac{g_2(s)}{u(s)} = \frac{1}{v} \left(\frac{1}{2} + \frac{1}{2} e^h e^{-s} + \sum_{i=1}^{v-1} e^{\frac{i-v}{v}} e^{-\frac{i}{v}s} \right) \end{aligned}$$

this is the input-output approximation. As showing Figure 2.5, after using the approximation of the distributed delay the closed-loop system is still unstable, no matter how large v is.

The characteristic polynomial of the system is

$$q(s) = (s-1)(1 + 2\tilde{h}(s)) + 2e e^{-s}$$

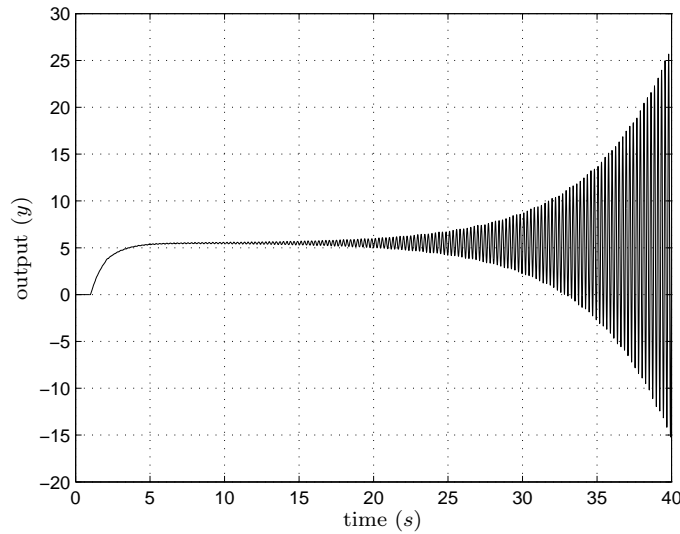

FIGURE 2.5: The step response (step value is 1) of the closed-loop system ($v = 5, h = 1$) in Example 2.2.

and would rise to unstable closed-loop response.

It is clear that input-output approximation is not suitable for numerical implementation. This was illustrated in [13, Van Assche et al. (1999)], [17, Santos and Mondié (2000)] or [14, Zhong (2003)]. Hence we focus our attention to the notion of approximation defined in the graph topology. This approximation is equivalent to realize an approximation of the kernel of the convolution, so we may also call it kernel approximation, to discern it with respect to input-output approximation.

2.2.2.4 Kernel approximation

Distributed delays having strictly proper transfer functions, we are also interested for approximation by the class of strictly proper lumped systems, denoted \mathcal{Q}_s , that is by elements in $\mathcal{K}_s(\mathbb{I}_{0,\infty})$. Such elements satisfy ordinary differential equations, and are easily simulated. From [82, Kammler (1976)], we know that the closure of \mathcal{Q}_s is $L_1(\mathbb{R}_+)$, since every function in $L_1(\mathbb{R}_+)$ can be approximated by a sum of exponentials.

Note that if the element f in $\mathcal{Q}_s \subset L_1(\mathbb{R}_+)$ is strictly proper, then an approximation in the graph topology realized by a lumped system will be in fact in the set \mathcal{Q}_s . Theorem 2.6 can also be seen as a direct consequence of approximation results in [82, Kammler (1976)] or [83, Pinkus (2005)], where it is shown that $\mathcal{K}_s(\mathbb{I}_{0,\infty})$ is

dense in $L_1(\mathbb{R}_+)$. Any convolution system whose kernel lies in $L_1(\mathbb{R}_+)$ can be approximated by a lumped system. Roughly speaking, since any distributed delay is a strictly proper fraction and is BIBO-stable, we know that it can be approximated in the graph topology by a strictly proper lumped system.

Corollary 2.8. *Any distributed delay can be approximated by a lumped system in the graph topology.*

Proof. Obvious from Theorem 2.6. □

Now we analyze the kernel approximation of a distributed delay. Approximation in the graph topology for an element f in $\mathcal{K}_s(\mathbb{I}_{\vartheta_1, \vartheta_2})$ requires to find, for some given $\varepsilon > 0$, an element f_{app} , defined in general in \mathcal{A} , such that $f_{\text{app}} \in \mathcal{B}(f, \varepsilon)$. Element f being in particular in $L_1(\mathbb{R}_+)$, adding purely atomic part in approximation can not improve approximation, so we realize it over the Banach algebra $L_1(\mathbb{R}_+)$. Indeed, if an approximation writes

$$f_{\text{app}} = f_a^{\text{app}} + f_{pa}^{\text{app}}, \quad (2.27)$$

where f_a^{app} and f_{pa}^{app} stand for the atomic and purely atomic parts of f_{app} , respectively, the following decomposition holds

$$\|f - f_{\text{app}}\|_{\mathcal{A}} = \|f - f_a^{\text{app}}\|_{\mathcal{A}} + \|f_{pa}^{\text{app}}\|_{\mathcal{A}}. \quad (2.28)$$

The purely atomic part of the approximation is in an independent sum, and can then be reduced to zero to reduce the approximation error. We have seen that an approximation can be obtained by lumped systems, with rational and stable transfer functions. Since we want to obtain an approximation which is global with respect to the time, we are interested in uniform convergent sequence of functions in $L_1(\mathbb{R}_+)$ to f .

Definition 2.9 (kernel approximation). Consider a sequence f_n of functions which uniformly converges to f , that is, for any $\varepsilon > 0$, there exists n in \mathbb{N} such that for any $k \geq n$, $\|f - f_k\|_{\mathcal{A}} \leq \varepsilon$. So, for any $k \geq n$, f_k is a kernel approximation of f in the graph topology. □

We propose next a method to approximate an element in $\mathcal{K}_u(\mathbb{I}_{\vartheta_1, \vartheta_2})$ by elements in $\mathcal{K}_s(\mathbb{I}_{\vartheta_1, \vartheta_2})$. Since these last element are easily implementable, this will give us

an effective approximation. We start by considering the case of an elementary distributed delay.

Lemma 2.10. *Any distributed delay with kernel $\theta_\lambda(\cdot)$ in $\mathcal{K}_u(\mathbb{I}_{0,\vartheta})$ can be approximated by distributed delays with kernels in $\mathcal{K}_s(\mathbb{I}_{0,\vartheta})$ for the graph topology.*

Proof. Let $\theta_\lambda(\cdot)$ be the kernel of an elementary distributed delay, with $\operatorname{Re} \lambda \geq 0$. Let $\mu \in \mathbb{C}$ such that $\operatorname{Re} \mu = \alpha < 0$. We define the transform

$$\Theta_\lambda(s) = (\alpha s)^{-1} \theta_\lambda(-\alpha^{-1} \ln s), \quad e^{-\vartheta\alpha} \leq s \leq 1. \quad (2.29)$$

The function $\Theta(\cdot)$ is continuous over $[e^{-\vartheta\alpha}, 1]$, and we have

$$\|\Theta_\lambda\|_{L_1} = \|\theta_\lambda\|_{\mathcal{A}}. \quad (2.30)$$

By Müntz-Szász Theorem [84, Cheney (1982)], we see that $\Theta_\lambda(\cdot)$ can be approximated with respect to L_1 -norm, as closed as desired, by a function of the form

$$\Theta_{\lambda,\text{app}}(s) = (\alpha s)^{-1} \Psi_{\lambda,\text{app}}(s), \quad (2.31)$$

where $\Psi_{\lambda,\text{app}}$ is a polynomial in s . Since norms are preserved in (2.30), we see that we can approximate θ_λ as closely as we please, using inverse transform of (2.30), by a sum of exponentials of the form

$$\psi_{\lambda,\text{app}}(t) = \Psi_{\lambda,\text{app}}(e^{-\alpha t}), \quad (2.32)$$

which is clearly an element in $\mathcal{K}_s(\mathbb{I}(0, \vartheta))$. □

In other words, an approximation of θ_λ in \mathcal{A} can be a function of the form

$$\psi_{\lambda,n}(t) = \sum_{i=1}^n \gamma_{i,n} \theta_{\alpha_i}(t), \quad (2.33)$$

with $\alpha_i \in \mathbb{C}$, $\operatorname{Re} \alpha_i < 0$ some arbitrarily complex numbers, and $\gamma_{i,n}$ some suitable constants. The order of the approximation n describes the number of parallel distributed elements to be added, to get the desired approximation accuracy. Such an approximation does not increase the degree (in the sense of Definition 1.5) of the elementary distributed, since it is a sum of distributed delays which are strictly proper and have same degree than $\hat{\theta}_\lambda(s)$. From the synthesis of an approximation

for the elementary distributed delay, we show in the next two results that it allows to construct an explicit approximation for any distributed delay.

Lemma 2.11. *Let $\psi_{\lambda,n}$ be an element in $\mathcal{K}_s(\mathbb{I}_{0,\vartheta}) \cap \mathcal{B}(\theta_\lambda, \varepsilon)$, for a given $\varepsilon > 0$, and k in \mathbb{N} . Then $\psi_{\lambda,n}^k \in \mathcal{K}_s(\mathbb{I}_{0,\vartheta}) \cap \mathcal{B}(\theta_\lambda^k, \vartheta^k \varepsilon)$, where*

$$\psi_{\lambda,n}^k(t) = \begin{cases} (-t)^k \psi_{\lambda,n}(t), & t \in [0, \vartheta] \\ 0, & \text{elsewhere} \end{cases}. \quad (2.34)$$

Proof. Let $\varepsilon > 0$, and take $\psi_{\lambda,n}$ an element in $\mathcal{K}_s(\mathbb{I}_{0,\vartheta}) \cap \mathcal{B}(\theta_\lambda, \varepsilon)$, that is

$$\psi_{\lambda,n}(t) = \sum_{i=1}^n \gamma_{i,n} \theta_{\alpha_i}(t), \quad (2.35)$$

with $\gamma_{i,n}$ in \mathbb{C} , and $\|\theta_\lambda - \psi_{\lambda,n}\|_{\mathcal{A}} \leq \varepsilon$. By Laplace transform and k th order differentiation, we get

$$\hat{\psi}_{\lambda,n}^{(k)}(s) = \sum_{i=1}^n \gamma_{i,n} \hat{\theta}_{\alpha_i}^{(k)}(s). \quad (2.36)$$

In the time domain, this last identity corresponds to

$$\psi_{\lambda,n}^k(t) = \sum_{i=1}^n \gamma_{i,n} \theta_{\alpha_i}^k(t) = (-t)^k \psi_{\lambda,n}(t). \quad (2.37)$$

Clearly $\psi_{\lambda,n}^k \in \mathcal{K}_s(\mathbb{I}_{0,\vartheta})$. Hence, it remains to show that $\psi_{\lambda,n}^k \in \mathcal{B}(\theta_\lambda^k, \vartheta^k \varepsilon)$. But $\psi_{\lambda,n} \in \mathcal{B}(\theta_\lambda, \varepsilon)$, so we have

$$\begin{aligned} \|\theta_\lambda^k - \psi_{\lambda,n}^k\|_{\mathcal{A}} &= \int_0^{\vartheta} |(-t)^k (\theta_\lambda(t) - \psi_{\lambda,n}(t))| dt \\ &\leq \vartheta^k \|\theta_\lambda - \psi_{\lambda,n}\|_{\mathcal{A}} \leq \vartheta^k \varepsilon \end{aligned} \quad (2.38)$$

which completes the proof. \square

For any distributed delay, we have the following general result.

Theorem 2.12. *Let $\hat{g} \in \hat{\mathcal{G}}$ be an arbitrary distributed delay, of the form*

$$\hat{g}(s) = \sum_{i,k} \hat{g}_{ik} (e^{-\vartheta s}) \hat{\theta}_{\lambda_i}^{(k)}(s), \quad (2.39)$$

and let ε_i be given positive real numbers. For any elements $\psi_{\lambda_i, n}$ in $\mathcal{K}_s(\mathbb{I}_{0, \vartheta}) \cap \mathcal{B}(\theta_{\lambda_i}, \varepsilon_i)$, we define

$$\hat{g}_{\text{app}}(s) = \sum_{i,k} \hat{g}_{ik}(e^{-\vartheta s}) \hat{\psi}_{\lambda_i, n}^{(k)}(s). \quad (2.40)$$

Then g_{app} lies in $\mathcal{K}_s(\mathbb{I}_{0, \vartheta}) \cap \mathcal{B}(g, \tilde{\varepsilon})$, where $\tilde{\varepsilon} = M \cdot \max_i \varepsilon_i$ for some positive constant M

Proof. Let g be the kernel of a distributed delay. According to (2.9), we decompose it as a linear combination of elementary distributed delays and their successive derivatives. From the definition of g_{app} , which is clearly in \mathcal{G} , we have

$$\begin{aligned} \|g - g_{\text{app}}\|_{\mathcal{A}} &= \left\| \sum_{i,k} \hat{g}_{ik}(e^{-\vartheta s}) \left(\hat{\theta}_{\lambda_i}^{(k)}(s) - \hat{\psi}_{\lambda_i, n}^{(k)}(s) \right) \right\|_{\mathcal{A}} \\ &\leq \sum_{i,k} \|\hat{g}_{i,k}(e^{-\vartheta s})\|_{\mathcal{A}} \left\| \hat{\theta}_{\lambda_i}^{(k)}(s) - \hat{\psi}_{\lambda_i, n}^{(k)}(s) \right\|_{\mathcal{A}}. \end{aligned} \quad (2.41)$$

Since, for any i , $\psi_{\lambda_i, n}$ are in $\mathcal{B}(\theta_{\lambda_i}, \varepsilon_i)$, using Lemma 2.11, we get

$$\begin{aligned} \|g - g_{\text{app}}\|_{\mathcal{A}} &\leq \sum_{i,k} \vartheta^k \|\hat{g}_{ik}(e^{-\vartheta s})\|_{\mathcal{A}} \left\| \hat{\theta}_{\lambda_i}(s) - \hat{\psi}_{\lambda_i, n}(s) \right\|_{\mathcal{A}} \\ &\leq \sum_{i,k} \vartheta^k \varepsilon_i \|\hat{g}_{ik}(e^{-\vartheta s})\|_{\mathcal{A}}. \end{aligned} \quad (2.42)$$

Denote the positive bounded constant $M = \sum_{i,k} \vartheta^k \|\hat{g}_{ik}(e^{-\vartheta s})\|_{\mathcal{A}}$. Hence

$$\|g - g_{\text{app}}\|_{\mathcal{A}} \leq \tilde{\varepsilon} = M \cdot \max_i \varepsilon_i, \quad (2.43)$$

That is g_{app} lies in $\mathcal{B}(g, \tilde{\varepsilon})$. □

By suitable choices for ε_i , the upper bound $\tilde{\varepsilon}$ can be reduced arbitrarily, so that we can find g_{app} as close as we please of g . Note that we particularize the proofs of previous results with approximations with kernels in $\mathcal{K}_s(\mathbb{I}_{0, \vartheta})$, but they can be trivially extended to others approximations over \mathcal{A} . Previous results state that from the approximation of the elementary distributed delays, we can realize a kernel approximation in the graph topology for any distributed delay in \mathcal{G} . Previous results state that, for any $f \in \mathcal{K}(\mathbb{I}_{\vartheta_1, \vartheta_2})$ and $\varepsilon > 0$, there exists an element $f_{\text{app}} \in \mathcal{K}_s(\mathbb{I}_{\vartheta_1, \vartheta_2})$ such that

$$\|f - f_{\text{app}}\|_{\mathcal{A}} \leq \varepsilon. \quad (2.44)$$

Said differently, we have the following corollary.

Corollary 2.13. *The set $\mathcal{K}_s(\mathbb{I}_{\vartheta_1, \vartheta_2})$ is dense in $\mathcal{K}(\mathbb{I}_{\vartheta_1, \vartheta_2})$ for the graph topology.*

Proof. Obvious from Lemma 2.3 and Theorem 2.12. \square

In the proof of Lemma 2.10, convergence of polynomial approximation is uniform, so we get here a uniform convergence of this approximation. The assumption that kernel of distributed delay lie in $\mathcal{K}(\mathbb{I}_{\vartheta_1, \vartheta_2})$ is not restrictive. Indeed, if this is not the case, any continuous function g in $[\vartheta_1, \vartheta_2]$ can be approximated with respect to L_1 -norm as close as we please by a function in $\mathcal{K}(\mathbb{I}_{\vartheta_1, \vartheta_2})$. Previous results addressed the approximation of distributed delays using kernels in $\mathcal{K}_s(\mathbb{I}_{\vartheta_1, \vartheta_2})$, which is based on uniform convergence of polynomials to any continuous function over $\mathbb{I}_{\vartheta_1, \vartheta_2}$. Other approximation can be proposed. Indeed, any elements f in $\mathcal{K}(\mathbb{I}_{\vartheta_1, \vartheta_2})$ can also be uniformly approximated by stepwise continuous functions in $L_1(\mathbb{I}_{0, \infty})$. This can be seen as a particular case of the previous approximation. For this, consider

$$\theta_{\lambda, \text{app}}(t) = \sum_{i=0}^n \gamma_i \psi(t - t_i), \quad (2.45)$$

where $t_i = \frac{i\vartheta}{n}$, and $\psi(\cdot)$ is a function in $\mathcal{K}_s(\mathbb{I}_{0, \vartheta})$. Then

$$\begin{aligned} \|\theta_\lambda - \theta_{\lambda, \text{app}}\|_{\mathcal{A}} &= \int_0^{\vartheta} |\theta_\lambda(t) - \theta_{\lambda, \text{app}}(t)| dt + \int_{\vartheta}^{\infty} |\theta_{\lambda, \text{app}}(t)| dt \\ &= \sum_{k=0}^{n-1} \int_{k\frac{\vartheta}{n}}^{(k+1)\frac{\vartheta}{n}} \left| \theta_\lambda(t) - \sum_{i=0}^k \gamma_i \psi(t - t_i) \right| dt + \int_{\vartheta}^{\infty} |\theta_{\lambda, \text{app}}(t)| dt. \end{aligned} \quad (2.46)$$

From Lemma 2.10, we see that approximation (2.45) uniformly converges to $\theta_\lambda(\cdot)$ in the graph topology by a suitable choice of coefficients γ_i . Taking $\psi(t) = e^{-\alpha t} h(t)$, where $\alpha > 0$ and $h(\cdot)$ stands for the Heaviside function, we obtain as a particular case the result obtained in [15, Mirkin (2004)], and separately in [18, Mondié and Michiels (2003)], where a low pass filter is added in the integral approximation with lumped delays distributions. Indeed, Laplace transform of (2.45) is of the required form

$$\hat{\theta}_{\lambda, \text{app}}(s) = \frac{1}{s + a} \sum_{i=0}^n \gamma_i e^{-st_i}, \quad (2.47)$$

for $a > 0$. Coefficients γ_i can be obtained for instance from some numerical integral approximation, to guarantee approximation over \mathcal{A} , or equivalently over $L_1(\mathbb{I}_{0, \infty})$. Note that approximation for the discrete-time case presents no difficulty, since it

is easy to show that, by taking a sufficiently small sampling period, a BIBO-stable discrete-time realization of a distributed delay comes down to define a kernel like a finite sum of lumped delayed distributions.

2.2.2.5 Constructive implementation

We particularize in this section a proposal of approximation, and we analyze the main properties of the error in the time and frequency domains. These properties will be still valid for any other approximation in the graph topology over \mathcal{A} . We propose here an effective and constructive approximation using elements in $\mathcal{K}_s(\mathbb{I}_{\vartheta_1, \vartheta_2})$. We start this proposal by the particular case of $\theta_0(\cdot)$. We denote $C_n^k = \frac{n!}{k!(n-k)!}$, $\psi_0(\xi) = \theta_0(-\alpha^{-1} \ln \xi)$, for $\xi \in (0, 1]$, and $\psi_0(0) = 0$.

Lemma 2.14. *Consider the sequence $\theta_{0,n}(\cdot)$ in $\mathcal{K}_s(\mathbb{I}_{0, \vartheta})$ described by*

$$\theta_{0,n}(t) = \sum_{k=0}^n C_n^k \psi_0\left(\frac{k}{n}\right) e^{-\alpha k t} (1 - e^{-\alpha t})^{n-k}, \quad t \in \mathbb{I}_{0, \vartheta} \quad (2.48)$$

and 0 elsewhere. Then $\theta_{0,n}(\cdot)$ is a kernel approximation of $\theta_0(\cdot)$ in the \mathcal{A} -norm.

Proof. Define

$$\psi_0(\varrho) = \theta_0(-\alpha^{-1} \ln \varrho), \quad \varrho \in (0, 1], \quad (2.49)$$

and $\psi_0(0) = 0$. The function $\psi_0(\cdot)$ has a bounded step discontinuity for $\varrho = e^{-\alpha \vartheta}$. Since $e^{-\alpha \vartheta}$ is irrational, there exists k in $0, 1, \dots, n-1$ such that $\frac{k}{n} < e^{-\alpha \vartheta} < \frac{k+1}{n}$.

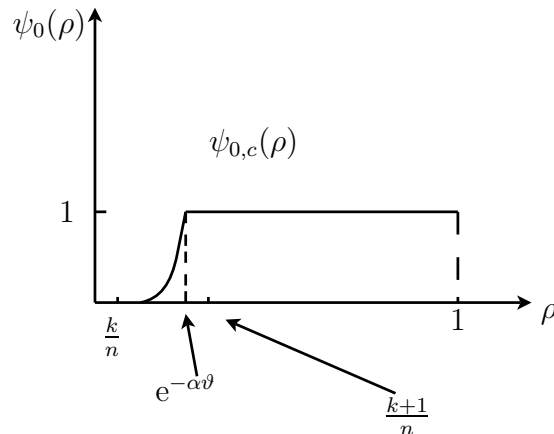

FIGURE 2.6: Continuous function $\psi_{c,0}(\rho)$

We take $\psi_{0,c}(\cdot)$ any continuous function over $[0, 1]$ satisfying

$$\psi_{0,c}(\varrho) = \psi_0(\varrho), \quad \varrho \in \left[0, \frac{k}{n}\right] \cup \left[\frac{k+1}{n}, 1\right], \quad (2.50)$$

that will remove this discontinuity and will be close as desired to $\psi_0(\cdot)$ for the $L_1(\mathbb{I}_{0,1})$ -norm (see Figure 2.6.). In particular $\psi_{0,c}(\cdot)$ will satisfy

$$\psi_{0,c}\left(\frac{k}{n}\right) = \psi_0\left(\frac{k}{n}\right), \quad k = 0, 1, \dots, n. \quad (2.51)$$

We now approximate as closed as we please the function $\psi_{0,c}$ (or equivalently ψ_0) by Bernstein polynomials

$$\psi_{0,\text{app}}(\varrho) = \sum_{k=0}^n C_n^k \psi_0\left(\frac{k}{n}\right) \varrho^k (1-\varrho)^{n-k}. \quad (2.52)$$

By the inverse transform of (2.49), we obtain

$$\theta_{0,n}(t) = \psi_{0,\text{app}}(e^{-\alpha t}), \quad (2.53)$$

which is in $\mathcal{K}(\mathbb{I}_{0,\vartheta})$ since $\psi_0(0) = 0$. Furthermore, from Lemma 2.10, we know that $\theta_{0,n}(\cdot)$ converges uniformly, by construction, to $\theta_0(\cdot)$. \square

The Figure 2.7 shows an example of approximation for $\theta_0(\cdot)$. Previous lemma gives an approximation of θ_0 in $\mathcal{B}(\theta_0, \varepsilon_n)$, where positive upper bound ε_n can be reduced arbitrarily when n increases. This algorithm can be easily generalized to approximations in $\mathcal{K}(\mathbb{I}_{0,\infty})$ or of the form (2.45), by modifying the domain of definition for (2.49). For the more general case of $\theta_\lambda(\cdot)$, we propose the following constructive solution.

Lemma 2.15. *The sequence of functions defined over $\mathcal{K}_s(\mathbb{I}_{0,\vartheta})$ by*

$$\theta_{\lambda,n}(t) = \frac{1}{(1 - e^{-\alpha\vartheta})^n} \sum_{k=0}^n C_n^k \Phi_\lambda\left(\frac{k}{n}\right) (e^{-\alpha t} - e^{-\alpha\vartheta})^k (1 - e^{-\alpha t})^{n-k}, \quad (2.54)$$

for $t \in \mathbb{I}_{0,\vartheta}$, with

$$\Phi_\lambda(\mu) = \theta_\lambda\left(-\alpha^{-1} \ln\left((1 - e^{-\alpha\vartheta})\mu + e^{-\alpha\vartheta}\right)\right), \quad \mu \in [0, 1], \quad (2.55)$$

is a kernel approximation of $\theta_\lambda(\cdot)$.

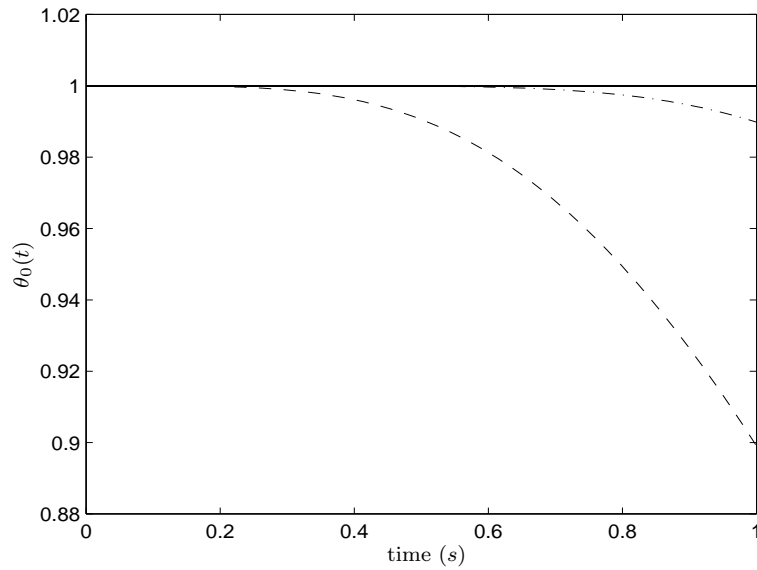

FIGURE 2.7: The continuous line is the kernel $\theta_0(t)$ ($\alpha = 1, \vartheta = 1$), the dash line is the approximation of θ_0 with $n = 5$. The dashdot line is the approximation with $n = 10$.

Proof. From Lemma 2.10, define

$$\Phi_\mu = \theta_\lambda \left(-\alpha^{-1} \ln \left((1 - e^{-\alpha\vartheta})\mu + e^{-\alpha\vartheta} \right) \right) \quad (2.56)$$

with $\mu \in [0, 1]$. Polynomial approximation $\Phi_{\lambda, \text{app}}(\cdot)$ can be obtained from Bernstein polynomials, that is

$$\Phi_{\lambda, \text{app}}(\mu) = \sum_{k=0}^n C_n^k \Phi_\lambda \left(\frac{k}{n} \right) \mu^k (1 - \mu)^{n-k}. \quad (2.57)$$

The inverse transformation for $\Phi_{\lambda, \text{app}}$ yields

$$\theta_{\lambda, n}(t) = \frac{1}{(1 - e^{-\alpha\vartheta})^n} \sum_{k=0}^n C_n^k \Phi_\lambda \left(\frac{k}{n} \right) (e^{-\alpha t} - e^{-\alpha\vartheta})^k (1 - e^{-\alpha t})^{n-k} \quad (2.58)$$

which uniformly converges to $\theta_\lambda(\cdot)$. \square

This approximation writes like a sum of elements in $\mathcal{K}_s(\mathbb{I}_{0, \vartheta})$ and $\theta_0(\cdot)$. With Lemma 2.15 and approximation of $\theta_0(\cdot)$, such an approximation is defined over $\mathcal{K}_s(\mathbb{I}_{0, \vartheta})$, and writes like in (2.33). The structure can be described in Figure 2.8.

Some basic considerations can be made on the order of this approximation. We know from [85, Achieser (1956)] or [84, Cheney (1982)] that, given $\varepsilon > 0$, there

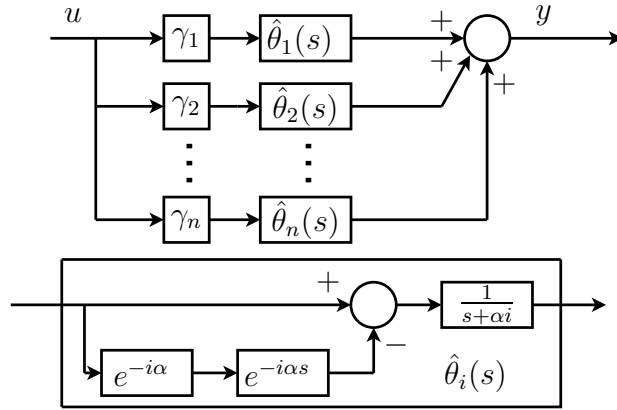
 FIGURE 2.8: Structure of the approximation distributed delay, $\gamma_i \in \mathbb{R}$.

exists η such that for any $\mu_1, \mu_2 \in [0, 1]$, $|\mu_1 - \mu_2| \leq \eta$ implies $|\Phi_\lambda(\mu_1) - \Phi_\lambda(\mu_2)| \leq \frac{\varepsilon}{2\vartheta}$, and that

$$|\Phi_\lambda(\mu) - \Phi_{\lambda, \text{app}}(\mu)| \leq \frac{\varepsilon}{2\vartheta} + \frac{\|\Phi_\lambda\|_{L^\infty}}{2\vartheta\eta^2 n}. \quad (2.59)$$

There exists β a positive bounded real number, such that $|\mu_1^{\frac{\lambda}{\alpha}} - \mu_2^{\frac{\lambda}{\alpha}}| \leq \beta |\mu_1 - \mu_2|$, with for instance $\beta \geq \frac{e^{\lambda\vartheta} - 1}{1 - e^{-\alpha\vartheta}}$. This in turn implies that

$$\eta \leq \frac{\varepsilon}{2\vartheta\beta} e^{-2\lambda\vartheta}. \quad (2.60)$$

Taking the maximal admissible value for η , we finally obtain that the approximation order n satisfies

$$n \geq \frac{4\vartheta^3 \beta^2}{\varepsilon^3} e^{5\lambda\vartheta}. \quad (2.61)$$

From this simple consideration coming from the use of Bernstein polynomials, we obtain, to guarantee a norm upper bound for the error, a condition on the order of the approximation. This condition is however quite conservative, and in practice, the order can be chosen iteratively, as illustrated in Figure 2.9 and Figure 2.10.

2.2.2.6 Properties in time and frequency domains

Let f_{app} be a kernel approximation in $\mathcal{B}(f, \varepsilon)$, for a given $\varepsilon > 0$ and $f \in \mathcal{K}(\mathbb{I}_{\vartheta_1, \vartheta_2})$. The corresponding output is $y_{\text{app}} = (f_{\text{app}} * u)(t)$. From (1.4), for any $1 \leq p \leq \infty$ and $u \in L_p(\mathbb{R}_+)$,

$$\|y - y_{\text{app}}\|_{L_p} \leq \varepsilon \|u\|_{L_p}. \quad (2.62)$$

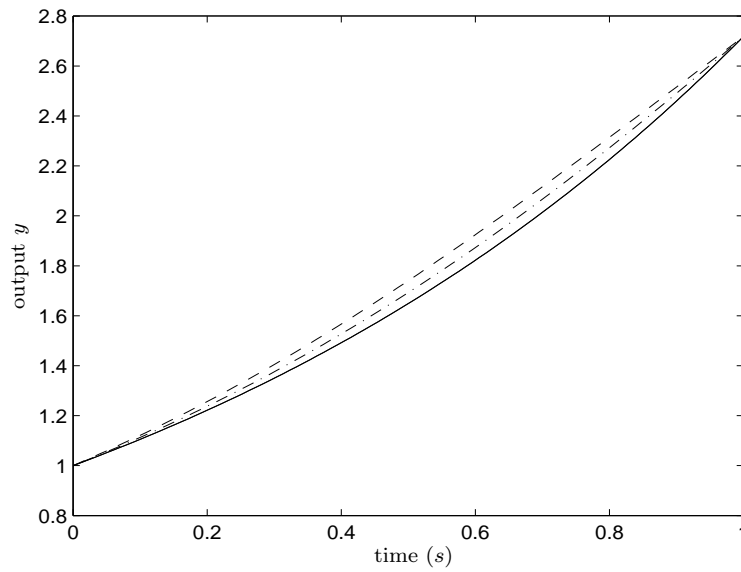

FIGURE 2.9: Kernel approximations $\theta_{1,\text{app}}(t)$ using exponentials in the time domain of the kernel $\theta_1(t)$ (continuous line), for orders $n = 5$ (dashed) and $n = 10$ (dot-dashed).

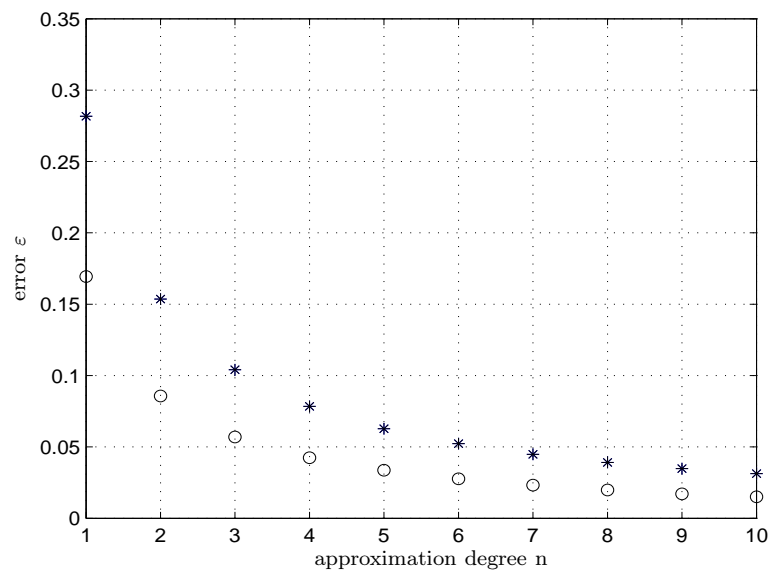

FIGURE 2.10: Representation of the norm error $\|\theta_1 - \theta_{1,n}\|_{\mathcal{A}}$ with respect to the order n of the approximation, for $\alpha = 1$ (star) and $\alpha = 1/5$ (circle).

In other words, the output error $e(t) = y(t) - y_{\text{app}}(t)$ can be made arbitrarily small for the L_p -norm by suitable choice of the arbitrary bound ε . Such a property includes the case of persistent input in $L_1(\mathbb{R}_+)$. The \mathcal{A} -norm is an upper bound of all induced L_p -norms. For the particular case $p = 2$, we have the following result.

Theorem 2.16. *Let $f \in \mathcal{G}$ be a given distribution, and f_{app} an approximation in $\mathcal{B}(f, \varepsilon)$, for some small $\varepsilon > 0$. Then*

$$\left\| \hat{f} - \hat{f}_{\text{app}} \right\|_{H_\infty} = \sup_{\omega \in \mathbb{R}} \left| \hat{f}(j\omega) - \hat{f}_{\text{app}}(j\omega) \right| \leq \varepsilon, \quad (2.63)$$

and for all ω in \mathbb{R} ,

$$\left| \arg(\hat{f}(j\omega)) - \arg(\hat{f}_{\text{app}}(j\omega)) \right| \leq \varepsilon. \quad (2.64)$$

Proof. Since $f_{\text{app}} \in \mathcal{B}(f, \varepsilon)$, we have

$$\sup_{\text{Re } s \geq 0} \left| \hat{f}(s) - \hat{f}_{\text{app}}(s) \right| = \sup_{\omega \in \mathbb{R}} \left| \hat{f}(j\omega) - \hat{f}_{\text{app}}(j\omega) \right| \leq \varepsilon. \quad (2.65)$$

To show that approximation holds also for the phase angle, remark that (2.65) implies that $\text{Re}(\hat{f}_{\text{app}}(j\omega))$ and $\text{Im}(\hat{f}_{\text{app}}(j\omega))$ pointwise converge to $\text{Re}(\hat{f}(j\omega))$ and $\text{Im}(\hat{f}(j\omega))$, respectively. Hence for any ω such that $\text{Re}(\hat{f}(j\omega)) \neq 0$, $\arctan\left(\frac{\text{Im}(\hat{f}_{\text{app}})}{\text{Re}(\hat{f}_{\text{app}})}\right)$ pointwise converges to $\arctan\left(\frac{\text{Im}(\hat{f})}{\text{Re}(\hat{f})}\right)$. \square

This frequency property is illustrated in Figure 2.11, where an approximation with order $n = 5$ in $\mathcal{X}_s(\mathbb{I}_{0,1})$ of $\hat{\theta}_1(j\omega)$ is plotted (where $h(\omega) = 20 \cdot \log \left| \hat{\theta}_1(j\omega) \right|$, $\phi(\omega) = \arctan\left(\frac{\text{Im}(\hat{\theta}_1(j\omega))}{\text{Re}(\hat{\theta}_1(j\omega))}\right)$). The approximation of distributed delay in the graph topology over \mathcal{A} yields an approximation in both time and frequency domains. This is a strong property, that turns to be central in control problems.

2.2.3 Some solutions of the approximation problem

In this section we will introduce three methods to approximate the elementary distributed delay which appear in the literature. From Lemma 2.3, we focus on the analysis of the elementary distributed delay. The first and second methods which will be introduced were proposed by Mirkin [15, Mirkin (2004)] and [20, Zhong (2004)] respectively. Both two methods are based on Newton-Cotes approximation

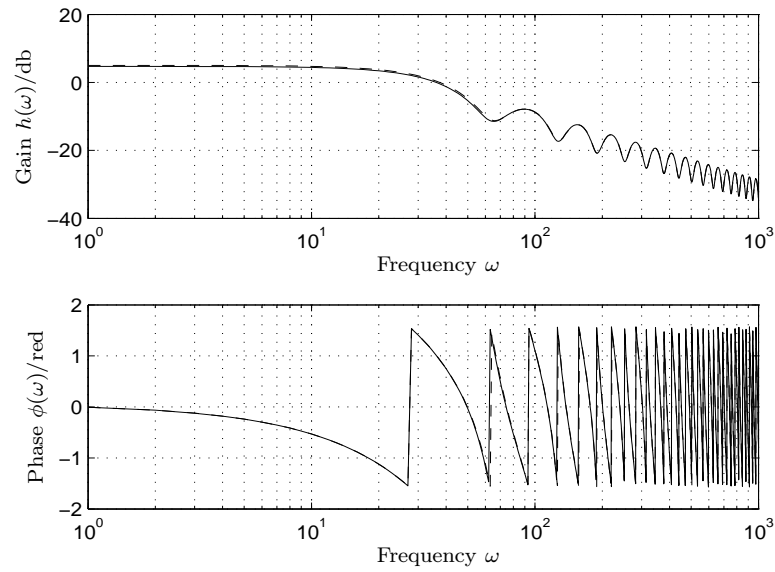

FIGURE 2.11: Bode diagram of $\hat{\theta}_1(j\omega)$ and its kernel approximation $\hat{\theta}_{1,\text{app}}(j\omega)$, with order $n = 5$.

(Trapezoidal rule). Mirkin adds a low-pass filter to change the degree of the approximation and Zhong uses Newton-Cotes approximation and Taylor truncation. The third method was proposed in [16, Partington and Makila (2005)]. The author considers the shift-based methods for rational approximation. In other words, the author approximates the delay e^{-s} by padé approximation. We will show that the first and second methods are L_1 -approximation. In third approximation the error is bounded in the H_∞ -norm.

2.2.3.1 Methods with additional dynamics

In this subsection, the method which we will introduce for distributed delay approximation was proposed in [15, Mirkin (2004)] and [18, Mondié and Michiels (2003)] [13, Van Assche (1999)], etc. The authors analyze the instability problem by using the Newton-Cotes approximation (Trapezoidal rule) in the closed-loop stability control. They found that this approximation has a high sensitivity in high frequency domains for distributed delay. To overcome this problem they propose to add a stable low-pass filter in the global closed-loop system. Here we introduce this method and directly add the low-pass filter in the distributed delay approximation. This approximation also leads to the same degree of the distributed delay (strictly proper).

Let us recall the elementary distributed delay and Newton-Cotes approximation (Trapezoidal rule). The elementary distributed delay convolution operator is of the form

$$\eta_\lambda(t) = \theta_\lambda(t) * u(t) = \int_0^\vartheta e^{\lambda\tau} u(t - \tau) d\tau. \quad (2.66)$$

Its Newton-Cotes approximation (Trapezoidal rule) is

$$\eta_\lambda(t) \approx \frac{\vartheta}{n} \left(\frac{u(t) + e^{\lambda\vartheta} u(t - \vartheta)}{2} + \sum_{k=1}^{n-1} e^{(k\frac{\vartheta}{n})\lambda} u\left(t - k\frac{\vartheta}{n}\right) \right) \quad (2.67)$$

where $a, b \in \mathbb{R}$. Now we can see the following lemma.

Lemma 2.17. *Let*

$$\hat{\xi}_n(s) = \frac{\gamma}{s + \gamma} \frac{\vartheta}{2n} \left(1 + e^{\lambda\vartheta} e^{-\vartheta s} + 2 \sum_{i=1}^{n-1} e^{i\frac{\lambda\vartheta}{n}} e^{-i\frac{\vartheta}{n}s} \right),$$

where $\gamma \in \mathbb{R}_+$. The element $\xi_n(\cdot)$ is an L_1 -approximation of $\theta_\lambda(\cdot)$.

Proof. In time-domain, since the Newton-Cotes approximation is an input-output approximation, by using the equation (2.23) we can represent the low-pass filter approximation by

$$\xi_n(t) = \sum_{i=0}^n \beta_i e^{-\gamma(t-t_i)} \mathbf{1}(t - t_i), \quad (2.68)$$

where $t_i = \frac{i\vartheta}{n}$, β_i are the coefficients that depend on the approximation approach, and $\mathbf{1}(\cdot)$ is the unit Heaviside function. The L_1 -norm of the error is

$$\begin{aligned} \|\theta_\lambda(t) - \xi_n(t)\|_{L_1} &= \int_0^\vartheta |\theta_\lambda(t) - \xi_n(t)| dt + \int_\vartheta^\infty |\xi_n(t)| dt \\ &= \sum_{k=0}^{n-1} \int_{k\frac{\vartheta}{n}}^{(k+1)\frac{\vartheta}{n}} \left| \theta_\lambda(t) - \sum_{i=0}^k \beta_i e^{-\gamma(t-t_i)} \mathbf{1}(t - t_i) \right| dt + \int_\vartheta^\infty |\xi_n(t)| dt. \end{aligned} \quad (2.69)$$

It is obvious that the first term on the right hand side of (2.69) is bounded, and since

$$\int_\vartheta^\infty |\xi_n(t)| dt = \sum_{i=0}^n \beta_i \frac{e^{-\gamma\vartheta}}{\gamma} < \infty,$$

so $\|\theta_\lambda(t) - \xi_n(t)\|_{L_1}$ is bounded. This approximation lies in L_1 . When $\gamma \rightarrow +\infty$, $\int_0^\infty |\xi_n(t)| dt$ goes to 0. Furthermore, there always exists $\gamma \in \mathbb{R}_+$ such that

$$\begin{aligned} & \int_0^\vartheta |\theta_\lambda(t) - \xi_n(t)| dt \\ &= \frac{2n}{\vartheta}(1 + e^{2\lambda\vartheta}) + \frac{n}{\vartheta}e^{\frac{\vartheta}{n}\gamma} \cdot \frac{1 - e^{\vartheta(\lambda+\gamma)}}{1 - e^{\frac{n}{\vartheta}(\lambda+\gamma)}} \\ &\xrightarrow{n \rightarrow \infty} \frac{e^{\vartheta(\lambda+\gamma)} - 1}{\lambda + \gamma} - \frac{e^{\vartheta\lambda} - 1}{\lambda} \end{aligned} \quad (2.70)$$

which converges to 0 when $\gamma \rightarrow 0$. We conclude that $\xi_n(\cdot)$ is an L_1 -approximation of $\theta_\lambda(\cdot)$. \square

2.2.3.2 Method by improved Newton-Cotes approximation

Another method was proposed in [20, Zhong (2004)]. The idea of the approximation is similar to Newton-Cotes approximation. It needs two steps to do this approximation. The first step, the author divides the interval $[0, \vartheta]$ into small subintervals, and approximate the function $\theta_\lambda(\cdot)$ in each subinterval by a constant. Combined with the Taylor expansion, we will get the approximation (see the Lemma 2.18). After the first approximation, it still has a distributed delay $\theta_0(\cdot)$ in the approximation. In the second step, the author considers using the truncation of Taylor expansion to approximate $\theta_0(\cdot)$ (see the Lemma 2.19). Now we see the first Lemma.

Lemma 2.18 (Zhong (2004) [20]). *Let*

$$\hat{\xi}_{\lambda,n}(s) = \frac{1 - e^{-s\frac{\vartheta}{n}}}{s} \cdot \sum_{i=0}^{n-1} e^{-i\frac{\vartheta}{n}(s-\lambda)}.$$

The elements $\xi_{\lambda,n}(\cdot)$ define from an L_1 -approximation of $\theta_\lambda(\cdot)$.

Proof. Let us consider (2.66), and divide the interval $[0, \vartheta]$ into n subintervals $\left[\frac{i\vartheta}{n}, \frac{(i+1)\vartheta}{n}\right]$, $i = 0, 1, \dots, n-1$. The output $\eta_\lambda(t)$ in (2.66) can be rewritten as

$$\eta_\lambda(t) = \sum_{i=0}^{n-1} \int_{\frac{i\vartheta}{n}}^{\frac{(i+1)\vartheta}{n}} e^{\lambda\tau} u(t - \tau) d\tau. \quad (2.71)$$

When n is chosen to be large enough, $e^{\lambda\tau}$ can be approximated by a constant $e^{i\lambda\frac{\vartheta}{n}}$ in $[i\frac{\vartheta}{n}, (i+1)\frac{\vartheta}{n}]$. This yields

$$\eta_\lambda(t) \approx \eta_{\lambda,n}(t) = \sum_{i=0}^{n-1} e^{i\lambda\frac{\vartheta}{n}} \int_0^{\frac{\vartheta}{n}} u\left(t - i\frac{\vartheta}{n} - \tau\right) d\tau. \quad (2.72)$$

Denote the causal truncated Heaviside function by

$$\mathbb{1}_{\frac{\vartheta}{n}}(t-h) = \begin{cases} 1, & h < t < h + \frac{\vartheta}{n} \\ 0, & \text{elsewhere} \end{cases}.$$

The inverse Laplace transform of $\hat{\xi}_{\lambda,n}(s)$ is

$$\xi_{\lambda,n}(t) = \sum_{i=0}^{n-1} e^{i\frac{\vartheta}{n}\lambda} \mathbb{1}_{\frac{\vartheta}{n}}\left(t - i\frac{\vartheta}{n}\right), \quad (2.73)$$

for $t \in [0, \vartheta]$. Since $\xi_{\lambda,n}(t)$ is a function with finite time support and pointwise continuous by step, $\xi_{\lambda,n}(t) \in L_1$. The error $e_{\lambda,n} = \theta_\lambda(t) - \xi_{\lambda,n}(t)$ lies in L_1 and its norm

$$\begin{aligned} \|e_{\lambda,n}\|_{L_1} &= \sum_{i=0}^{n-1} \int_{i\frac{\vartheta}{n}}^{(i+1)\frac{\vartheta}{n}} \left| e^{\lambda t} - i\lambda \frac{\vartheta}{n} \right| dt \\ &= \sum_{i=0}^{n-1} e^{i\lambda\frac{\vartheta}{n}} \left(\frac{e^{\lambda\frac{\vartheta}{n}} - 1}{\lambda} - \frac{\vartheta}{n} \right) \\ &= \frac{1 - e^{\lambda\vartheta}}{1 - e^{\lambda\frac{\vartheta}{n}}} \left[\frac{e^{\lambda\frac{\vartheta}{n}} - 1}{\lambda} - \frac{\vartheta}{n} \right] \end{aligned} \quad (2.74)$$

which converges to zero when $n \rightarrow \infty$. □

Since in Lemma 2.18, $\frac{1-e^{-s\frac{\vartheta}{n}}}{s}$ is still infeasible for stable implementation, the author consider to approximate it using a zero order truncated Taylor expansion, like in [20, Zhong (2004)].

Lemma 2.19 (Zhong (2004) [20]). *Let $\hat{\theta}_0(s) = \frac{1-e^{-s\frac{\vartheta}{n}}}{s}$ and*

$$\hat{\xi}_0(s) = \frac{1 - e^{-\frac{\vartheta}{n}(s+\varepsilon)}}{s + \varepsilon} \frac{\frac{\vartheta}{n}\varepsilon}{1 - e^{-\varepsilon\frac{\vartheta}{n}}}.$$

The element $\xi_0(\cdot)$ is an L_1 -approximation of $\theta_0(\cdot)$.

Proof. From the Taylor expansion of $\hat{\theta}_0(s)$, we have

$$\frac{1 - e^{-\frac{h}{N}s}}{s} = \frac{1 - e^{-\frac{h}{N}(s+\varepsilon)}}{s + \varepsilon} + \frac{1 - e^{-\frac{h}{N}(s+\varepsilon)} - \frac{h}{N}(s + \varepsilon)e^{-\frac{h}{N}(s+\varepsilon)}}{s + \varepsilon} + \dots,$$

for $\varepsilon > 0$. Take the first term of this equation we can obtain

$$\frac{1 - e^{-\frac{h}{N}s}}{s} \approx \frac{1 - e^{-\frac{h}{N}(s+\varepsilon)}}{s + \varepsilon}$$

Considering a static gain condition, we obtain

$$\hat{\theta}_0(s) = \frac{1 - e^{-\frac{h}{N}s}}{s} \approx \frac{1 - e^{-\frac{\vartheta}{n}(s+\varepsilon)}}{s + \varepsilon} \frac{\frac{\vartheta}{n}\varepsilon}{1 - e^{-\varepsilon\frac{\vartheta}{n}}}.$$

Since $\hat{\xi}_0(s) \in \hat{\mathcal{G}}$, the approximation error $e_0 = \xi_0 - \theta_0 \in L_1$, and

$$\lim_{n \rightarrow +\infty} \|e_0\|_{L_1} = \lim_{n \rightarrow +\infty} \int_0^{\frac{\vartheta}{n}} \left| 1 - \frac{\frac{\vartheta}{n}\varepsilon}{1 - e^{-\varepsilon\frac{\vartheta}{n}}} e^{-\varepsilon t} \right| dt = 0$$

So $\xi_0(\cdot)$ is an L_1 -approximation of $\theta_0(\cdot)$. \square

Using these two preliminary results, we obtain the following approximation scheme.

Lemma 2.20. *Let*

$$\hat{\xi}_n(s) = \frac{1 - e^{-\frac{\vartheta}{n}(s+\varepsilon)}}{1 - e^{-\varepsilon\frac{\vartheta}{n}}} \frac{e^{\frac{\vartheta}{n}\lambda} - 1}{\frac{s}{\varepsilon} + 1} \lambda^{-1} \cdot \sum_{i=0}^{n-1} e^{-i\frac{\vartheta}{n}(s-\lambda)}.$$

The element $\xi_n(\cdot)$ is an L_1 -approximation of $\theta_\lambda(\cdot)$.

Proof. Comes directly from Lemma 2.18 and Lemma 2.19. \square

2.2.3.3 Method by rational approximation

The third method was proposed by [16, Partington and Mäkilä (2005)] in which a detailed analysis of a class of shift operator based methods for rational approximation of certain distributed delay controllers has been presented. The idea of this method from Mäkilä and Partington (1999a,b) [86, Mäkilä and Partington (1999a)] [Mäkilä and Partington (1999b)][87], which takes as their starting point

the well-known padé approximation

$$e^{-z} \approx \left(\frac{1 - \frac{z}{2n}}{1 + \frac{z}{2n}} \right)^n. \quad (2.75)$$

Theorem 2.21 (Partington and Mäkilä (2005)[16]). *Let $p(z) = 1 + \frac{z}{2}$, and $z \in \mathbb{C}$ with $z > -\lambda\vartheta$. Then for $n > \lambda\vartheta$, we have*

$$\left| \frac{\vartheta(1 - u_n(s))}{s} - \frac{\vartheta(1 - e^{-s})}{s} \right| \leq 2\vartheta \times 3^{\lambda\vartheta} n^{-\frac{2}{3}},$$

where $u_n(s) = \left(\frac{p(-\frac{s}{n})}{p(\frac{s}{n})} \right)^n$. Then

$$\begin{aligned} \left\| \frac{1 - u_n((s - \lambda)\vartheta)}{s - \lambda} - \frac{1 - e^{-(s - \lambda)\vartheta}}{s - \lambda} \right\|_{H_\infty} &= \sup_{s \in \mathbb{C}_+} \left| \frac{1 - u_n((s - \lambda)\vartheta)}{s - \lambda} - \frac{1 - e^{-(s - \lambda)\vartheta}}{s - \lambda} \right| \\ &\leq 2\vartheta \times 3^{\lambda\vartheta} n^{-\frac{2}{3}}. \end{aligned}$$

The approximation $\frac{1 - u_n((s - \lambda)\vartheta)}{s - \lambda}$ is strictly proper, and the poles are at the points $s = \lambda - \frac{2n}{\vartheta}$. Thus $\frac{1 - u_n((s - \lambda)\vartheta)}{s - \lambda}$ is stable for $n > \frac{\lambda\vartheta}{2}$. The authors also consider by taking $p(z) = 1 + \frac{z}{2} + \frac{z^2}{12}$ instead of $p(z) = 1 + \frac{z}{2}$ which can obtain the similar results. The detail please refer[16, Partington and Mäkilä (2005)].

The simulation of the approximation of distributed delay using the four methods which are proposed in this chapter can be saw in the following example.

Example 2.3. *Consider the plant $\hat{p}(s) = \frac{e^{-s}}{1 - e^{-2s}}$, and we choose stabilizing compensator of the following form*

$$\hat{c}(s) = \frac{\hat{n}_c}{\hat{d}_c} = \frac{e^{-s} - \frac{1}{2} + (1 - e^{-2s}) \cdot \frac{1 - e^{-(s-1)}}{s-1}}{1 - \frac{1 - e^{-(s-1)}}{s-1} \cdot e^{-s}}.$$

A time realization of this compensator is

$$\begin{aligned} u(t) &= \frac{1}{2}r(t) + \frac{1}{2}y(t) + r(t - 1) + y(t - 1) + \int_0^1 e^\tau r(t - \tau) d\tau - \int_0^1 e^\tau y(t - \tau) d\tau \\ &+ \int_0^1 e^\tau y(t - \tau - 1) d\tau - \int_0^1 e^\tau r(t - \tau - 2) d\tau + \int_0^1 e^\tau y(t - \tau - 2) d\tau. \end{aligned}$$

And the closed-loop system transform function from \hat{r} to \hat{y} is

$$H(s) = \frac{e^{-s}(e^{-s} - \frac{1}{2}) + e^{-s}(1 - e^{-2s}) \cdot \frac{1 - e^{-(s-1)}}{s-1}}{1 - \frac{1}{2}e^{-s}}.$$

It is obvious that $H(s)$ is stable. Now we use the four methods which we introduced in this chapter to implement the distributed delay in the compensator, and use the same approximation degree $n = 2$. Give the step input in the system, the output response can be saw in Figure 2.12.

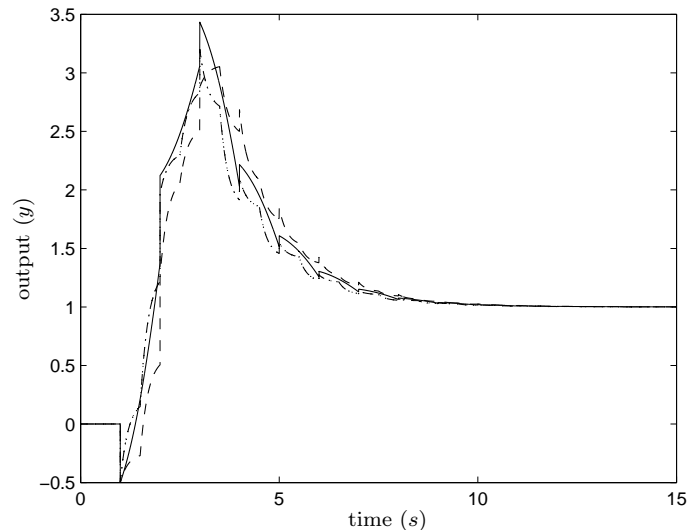

FIGURE 2.12: The step response (step value is 1) of the closed-loop system, Improved Newton-Cotes approximation (dot-dashed, $\varepsilon = 1$), Low-pass filter approximation (dashed, $\gamma = 5$) and Stable finite exponential approximation (continuous), rational approximation (dot) (Example 2.3).

2.3 Conclusion

In this chapter, we give the general definition of distributed delays. We introduced the properties of the distributed delays. The lumped approximation for distributed delay was introduced. We compare the input-output approximation and kernel approximation. A new construction of approximation of distributed delay was proposed. Analysis of this approximation in time-domain and frequency domain are given. These are the contributions of this chapter. We also introduce some approximation methods in the literature and convergence properties were analyzed.

Chapter 3

Inversion and Model Matching

In this chapter, we will introduce a new class of stable inversion for any finite dimensional linear time-invariant systems. A further introduction of the model matching will be given for such systems. Here the stable inversion (or model matching) is a kind of approximation inversion (or matching). Actually we obtain the exact inversion (or model matching) after a time $t = \vartheta$, where $\vartheta \in \mathbb{R}_+$ can be chosen arbitrarily. The precompensators which are introduced in this chapter are always proper and causal (in the sense of Definition 1.7 (in Chapter 1)).

In control theory, inversion of dynamics is perhaps one of the most common idea to design and synthesize controllers. Inversion principles can be found in feed-forward control, trajectory planning, sizing of dynamical systems, decoupling, or disturbance rejection. For a given plant $T(s)$, the basic inversion problem aims at finding $R(s)$ such that $T(s)R(s) = I$. For SISO (Signal Input- Signal Output) system inversion, the stability problem appears for nonminimum phase or strictly proper systems. For instance the plant

$$T(s) = \frac{s - 1}{s + 1}$$

does not have a stable inverse, since the unstable zero $s_0 = +1$ yields an unstable inverse $R(s)$. For MIMO (Multivariable Input- Multivariable Output) system inversion, a similar problems occurs, if some entries of the transfer function matrix are nonminimum phase or strictly proper. So we are interested in finding a stable inverse $R(s)$ such that $T(s)R(s) = I$.

From the earliest work of Silverman [23, Silverman (1969)], various extensions were proposed to address this stability problem. Among others, we can cite [24,

Garcia et al. (1995)] where the stability problem on partial model matching was addressed or [25, Devasia et al. (1996)] where stable non-causal feed-forward was studied for nonlinear systems. Based on this last paper, some extensions for the considered stability were also proposed in [26, Hunt et al. (1996)]. It was more recently pointed out the equivalence of such noncausal solution with the two-side Laplace transform for linear systems in [27, Sogo (2010)]. Other attempts were done for 2D systems in [28, Loiseau and Brethé (1997)], in [29, Di loreto (2006)] for model matching of time-delay systems, or in [30, Goodwin et al. (2000)] using high gain feedback.

In this chapter we address a BIBO-stable inversion for a linear systems. The inverse $R(s)$ we define is not an exact inverse, but satisfies an identity of the form

$$E(s) = I - T(s)R(s) \quad (3.1)$$

where the inverse error has a finite time support. This inverse ensures an exact inversion after a finite time. Such an inverse is causal and proper, in the sense that we can realize it using elementary operations, namely integration, addition, scalar multiplication and delay. The solution for this approximated inversion always exists, giving us a generic solution to many control problems. Constructive methods for the computation of such a solution are described, and some examples with numerical simulations will illustrate the results. The key tools for stable inversion are distributed delays. Since the algorithm of finding the stable inversion precompensator are different between SISO systems and MIMO systems, we will introduce these as two parts separately in this chapter.

Based on the technique of stable inversion, we extend this procedure to the model matching problem. For a given plant $T(s)$ and a given model $T_m(s)$ we want to find a precompensator $R(s)$ such that

$$T(s)R(s) = T_m(s). \quad (3.2)$$

In control theory, model matching is commonly used in many control applications, such as stable inversion, disturbance rejection, the design of desired closed-loop dynamics, tracking, and sensitivity minimization for linear systems ([88, Morse (1973)], [89, Wang et al. (1972)], [90, Kučera (1991)], [91, Šebek (1983)], [28, Loiseau et al. (1997)], [92, Picard et al. (1998)]).

Like the stable inversion, an exact matching is often difficult to achieve. In this

chapter, advanced investigation has been made to the problem of finite time model matching for SISO and MIMO linear time invariant systems. Roughly speaking, we wish to make vanish the impulse response of the matching error in a finite time which is parameter of precompensator. The interest to obtain a matching error with finite support comes from L_1 -optimization [93, Dahleh et al. (1986)], for which the optimal solution is a finite impulse response, from the regulation problem in systems with delayed inputs [94, Di Loreto et al. (2008)], or from real-time matching specifications, where the matching trajectory is specified over some finite time interval.

3.1 Inversion of linear systems

3.1.1 Preliminaries

Before we introduce the stable inversion, let us see some preliminaries.

Definition 3.1 (Unimodular matrix). A square polynomial matrix $U(s) \in \mathbb{R}^{n \times n}[s]$ is called unimodular if

$$\det U(s) \neq 0 \quad \text{for all } s \in \mathbb{C}$$

□

A rational polynomial $N(s) \in \mathbb{R}[s]$ can be decomposed into a product of irreducible factors. In particular $N(s)$ can be decomposed in a unique way by

$$N(s) = N_s(s)N_u(s) \tag{3.3}$$

where $N_s(s)$ is stable and monic, while no nontrivial factor of $N_u(s)$ is stable. Similarly, every nonzero matrix $H(s) \in \mathbb{R}^{m \times n}[s]$ can be decomposed into a product of irreducible factors. Using canonical Smith form, any matrix $H(s) \in \mathbb{R}^{m \times n}[s]$ can be decomposed into

$$H(s) = P(s)\Lambda(s)Q(s), \tag{3.4}$$

where $P(s) \in \mathbb{R}^{m \times m}[s]$ and $Q(s) \in \mathbb{R}^{n \times n}[s]$ are unimodular elements (a polynomial matrix $Q(s)$ is unimodular if and only if its inverse $Q^{-1}(s)$ is also polynomial),

and

$$\Lambda(s) = \left[\begin{array}{ccc|c} \lambda_1 & & & \mathbb{O} \\ & \ddots & & \\ & & \lambda_r & \\ \hline & & & \mathbb{O} \\ \hline & & & \mathbb{O} \end{array} \right]_{m \times n},$$

$\lambda_i \in \mathbb{R}[s]$ are unique. We say that λ_i has a stable (resp. unstable) zero s_0 , if $\lambda_i(s_0) = 0$ with $\operatorname{Re}(s_0) < 0$ (resp. $\operatorname{Re}(s_0) \geq 0$). This matrix $\Lambda(s)$ can be decomposed into

$$\Lambda(s) = \Lambda_u(s)\Lambda_s(s), \quad (3.5)$$

where $\Lambda_u \in \mathbb{R}^{m \times m}[s]$ has only unstable zeros, and $\Lambda_s(s) \in \mathbb{R}^{m \times n}[s]$ has stable zeros. This decomposition is of course non unique. For instance,

$$\begin{aligned} \begin{bmatrix} (s-1)(s+1) & 0 \\ 0 & 0 \end{bmatrix} &= \begin{bmatrix} (s-1) & 0 \\ 0 & 0 \end{bmatrix} \begin{bmatrix} (s+1) & 0 \\ 0 & 1 \end{bmatrix} \\ &= \begin{bmatrix} (s-1) & 0 \\ 0 & 0 \end{bmatrix} \begin{bmatrix} (s+1) & 0 \\ 0 & 2 \end{bmatrix}. \end{aligned}$$

Suppose $M \in \mathbb{R}^{p \times q}[s]$, and normal rank $M = r$. There exist square unimodular matrices L and R such that

$$LMR = \left[\begin{array}{ccc|c} \lambda_1 & & & \\ & \ddots & & \\ & & \lambda_r & \\ \hline & & & 0 \\ \hline \end{array} \right],$$

where $\lambda_i \in \mathbb{R}[s]$ are monic, and λ_i is divided by λ_{i+1} . Hence L is $p \times p$ and R is $q \times q$, so that zero block in the bottom right corner of the matrix LMR is $(p-r) \times (q-r)$.

The λ_i are called the invariant polynomials of M . They are uniquely defined by M , in particular

$$\lambda_i = \frac{\Delta_i}{\Delta_{i-1}}$$

where $\Delta_0 = 1$ and Δ_i is monic GCD (greatest common divisor) of $i \times i$ minors.

3.1.2 Stable inversion problem

To address stable inversion, we need first to recall the stability we consider, namely stability in the sense of Bounded Input-Bounded Output, defined in Definition 1.2. For linear systems, and more generally for proper fraction, BIBO-stability is equivalent to require that all the poles of the plant are in the open left-half complex plane. Hence it corresponds to the stability notion introduced for quasi-polynomials in Chapter 1.

Exact stable inversion can be stated as follows. Let $T(s)$ be a transfer function of a given linear plant. Such a plant admits a coprime factorization over $\mathbb{R}[s]$, say (N, D) , such that

$$T(s) = N(s)D^{-1}(s), \quad (3.6)$$

and that verify a Bézout type identity, that is there exist $X(s), Y(s)$ over $\mathbb{R}[s]$ such that $X(s)N(s) + Y(s)D(s) = I$. Exact stable inversion is a control problem which aims at finding a plant $R(s)$, which is stable such that

$$T(s)R(s) = I. \quad (3.7)$$

This problem is illustrated in Figure 3.1. In other words, if $\hat{y}(s) = T(s)\hat{u}(s)$,

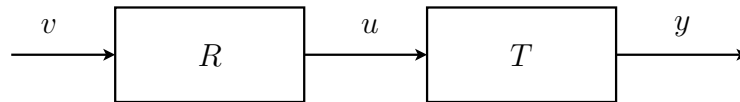

FIGURE 3.1: Exact stable inversion

this problem is equivalent to find a stable precompensator $R(s)$ such that $\hat{u}(s) = R(s)\hat{v}(s)$, where v corresponds, if a stable solution exists, to y . From Definition 1.2, stability means that for any bounded function $y(t), t \geq 0$, the output function $u(t)$ is also bounded. Actually, in this chapter, we want to find a proper solution. In other words, we want to find a precompensator $R(s)$ such that the exact stable inversion can be obtained after an arbitrary finite time.

Let us state the analysis of exact stable inversion SISO case. The main constraint for the existence of a solution comes from the stability condition. Such a constraint is synthesized in the following obvious result, noting that any element in \mathcal{A} is in fact proper in the sense of Definition 1.7.

Theorem 3.2 ([28] Loiseau and Brethé (1997)). *There exists a solution to the exact stable inversion if and only if $T(s)$ has no unstable zeros, and*

$$\deg_s N(s) = \deg_s D(s). \quad (3.8)$$

For instance, the plants

$$\frac{s-1}{s+1}, \quad \frac{1}{s-1}$$

have no solution to the exact stable inversion problem, since for the first one there is an unstable zero, while for the second the inverse is not proper. From Theorem 3.2, it appears that exact stable inversion is too restrictive. For MIMO systems the problem is similar in some plants although the condition for exact stable inversion is not too restrictive. For example the plant

$$T(s) = \begin{bmatrix} 1 & s-2 \\ s-3 & s+3 \end{bmatrix},$$

has an exact stable inversion proper and causal

$$R(s) = \begin{bmatrix} 5\frac{s-3}{s+3} \\ 1 \end{bmatrix},$$

where $R(s)$ is not unique. But the plant

$$T(s) = \begin{bmatrix} \frac{1}{s-1} & \frac{1}{s-2} \\ \frac{1}{s-3} & \frac{1}{s-4} \end{bmatrix}$$

has not proper inverse, since $R(s) = T^{-1}(s)$ is not proper. Among possible extensions, we may define an approximation of the inverse. The key idea is to find a solution such that, in the time-domain, after a finite time, this approximated inversion coincides with the exact inverse. This approximation needs to be characterized by a stable and proper pre-compensator. Unstable dynamics are constrained to lie only in this finite time interval, the other dynamics being stable. This will give us a BIBO-stable solution. In other words, exact stable inverse is obtained after a finite time interval. This problem, called hereafter the finite time stable inversion, is defined and solved in subsection 3.1.4. Before this, let us recall some other solutions for inversion, using non proper or non causal precompensator.

3.1.3 Some solutions in literature

The first solution was proposed in [25, Decasia et al. (1996)], using non causal precompensator. A link about the existence of such a solution and algebraic tools, issued from the use of the two-sided Laplace transform, was proposed in [27, Sogo (2010)]. Here we report the main results.

Let us consider a non-minimum phase system

$$G(s) = \frac{c_0 s^m + \dots + c_{m-1} s + c_m}{s^n + a_1 s^{n-1} + \dots + a_{n-1} s + a_n}, \quad n \geq m \quad (3.9)$$

with the state-space representation

$$\begin{cases} \dot{x} &= Ax + Bu \\ y &= Cx \end{cases} \quad (3.10)$$

We assume that the plant $G(s)$ is stable. Then the inversion of the transfer function (3.9) is

$$\begin{aligned} \frac{1}{G(s)} &= \frac{s^n + a_1 s^{n-1} + \dots + a_{n-1} s + a_n}{c_0 s^m + \dots + c_{m-1} s + c_m} \\ &= \frac{s^{m-n} + \bar{a}_1 s^{n-m-1} + \dots + \bar{a}_{n-m}}{c_0} + \frac{\bar{a}_{n-m+1} s^{m-1} + \dots + \bar{a}}{c_0 s^m + \dots + c_m}, \end{aligned} \quad (3.11)$$

which has the state-space representation

$$\dot{\xi} = \phi \xi + \Lambda \eta \quad (3.12)$$

$$u = \Gamma \xi + \Delta \eta \quad (3.13)$$

with state $\xi = (x_{n-m+1}, \dots, x_n)^T$ and input $\eta = (y^{(n-m)}, \dots, y^{(1)}, y)^T$, where $y^{(k)} = \frac{d^k y}{dt^k}$ and $\Delta = \begin{bmatrix} \frac{1}{c_0} & \frac{\bar{a}_1}{c_0} & \dots & \frac{\bar{a}_{n-m}}{c_0} \end{bmatrix}$. (ϕ, Λ, Γ) are the matrices of the controllable canonical form of the last term of (3.11). If $G(s)$ is a non-minimum phase system, ϕ has eigenvalues in the right half plane and the solution of the initial value problem of (3.12) is unbounded. This implies that the input to achieve perfect tracking to an output trajectory y_d is unbounded in the causal framework. However, if the constraint of causality is not imposed on (3.12), there exists a bounded input to achieve perfect tracking for a class of output trajectories. Let us see the following proposition.

Proposition 3.3 (Devasia et al., (1996)[25], Hunt et al.,(1996)[26]). *Assume that $y_d^{(i)} \in L_1 \cap L_\infty (i = 0, 1, \dots, n - m)$ and that $G(s)$ has no zero on the imaginary axis. Then, there exist bounded $x_d(t)$ and $u_d(t)$ such that*

$$\dot{x}_d = Ax_d + Bu_d \quad (3.14)$$

$$y_d = Cx_d \quad (3.15)$$

and

$$u_d(t) \rightarrow 0, \quad x_d \rightarrow 0 \quad \text{as } t \rightarrow \pm\infty. \quad (3.16)$$

□

Under the boundary condition (3.16), one can obtain the $x_d(t)$ and u_d in Proposition 3.3 by solving the differential equation (3.12). The solution is equivalent to the one that can be obtained by a change of state coordinates in (3.12) and a convolution calculation as follows [25, Devasia et al. (1996)]; Take the state coordinates $L\bar{\xi} = \xi$ such that

$$\bar{\phi} = L^{-1}\phi L = \begin{bmatrix} \bar{\phi}_- & 0 \\ 0 & \bar{\phi}_+ \end{bmatrix} \quad (3.17)$$

where the eigenvalues of $\bar{\phi}_-$ and $\bar{\phi}_+$ are in the left and right half planes, respectively. Then the solution is given by

$$x_d(t) = \int_{-\infty}^{+\infty} \phi(t - \tau) \bar{\Lambda} \begin{bmatrix} y^{(n-m)}(\tau) & \dots & y^{(1)}(\tau) & y(\tau) \end{bmatrix}^T d\tau, \quad (3.18)$$

where

$$\phi(t) = \begin{bmatrix} \mathbf{1}(t)e^{\bar{\phi}_- t} & 0 \\ 0 & -\mathbf{1}(-t)e^{\bar{\phi}_+ t} \end{bmatrix} \quad (3.19)$$

In [27, Sogo (2010)], the author shows that the inverse transfer function (3.11) in itself actually represents the stable inversion defined in Proposition 3.3 if we consider the transfer function as being defined by the two-sided Laplace transform function [95, Van der pol and Bremmer (1987)] [96, Papoulis (1962)]. For a function $g(t)$ defined on the infinite time horizon, the two-side Laplace transform is defined as

$$\mathcal{L}[g(t)](s) = G(s) := \int_{-\infty}^{+\infty} e^{-st} g(t) dt \quad (3.20)$$

where the region of convergence is characterized by the existence of γ_1, γ_2 in \mathbb{R} such that $\{s; \gamma_1 < \operatorname{Re}(s) < \gamma_2\}$. And the inversion transform can be expressed as

$$\begin{aligned} \mathcal{L}^{-1}[G(s)](t) &= g(t) = \frac{1}{2\pi j} \int_{\alpha-j\infty}^{\alpha+j\infty} e^{st} G(s) ds \\ &= \begin{cases} \sum_{\operatorname{Re}(p_n) < \alpha} \operatorname{Res}(e^{st} G(s), p_n) & t \geq 0 \\ \sum_{\operatorname{Re}(p_n) > \alpha} \operatorname{Res}(-e^{st} G(s), p_n) & t < 0 \end{cases}, \end{aligned}$$

where $\operatorname{Res}(H(s), p)$ denotes the residue of $H(s)$ at p and $\{p_n\}, \{p_m\}$ are the sets of poles of $G(s)$ that are in the left and right half planes of the vertical line $s = \alpha$ ($\alpha \in (\gamma_1, \gamma_2)$), respectively. The following Theorem and Corollary will give the solution of the inversion problem.

Theorem 3.4 (Sogo (2010)[27]). *Assume that $y_d^{(i)} \in L_1 \cap L_\infty (i = 0, \dots, n - m)$ and $G(s)$ has no zero on the imaginary axis. Functions u_d and x_d satisfying (3.14)-(3.15) can be defined by*

$$u_d(t) = \mathcal{L}^{-1}\left[\frac{1}{G(s)} \cdot Y_d(s)\right] \quad (3.21)$$

$$x_d(t) = \mathcal{L}^{-1}[(sI - A)^{-1} B U_d(s)], \quad (3.22)$$

where $Y_d(s) = \mathcal{L}[y_d](\cdot)$ and $U_d(s) = \mathcal{L}[u_d](\cdot)$.

Corollary 3.5 (Sogo (2010)[27]). *Assume the same conditions on $y_d^{(i)}$ and $G(s)$ as for Theorem 3.4. Let the last term in (3.11) be expressed as*

$$\frac{\bar{a}_{n-m+1}s^{m-1} + \dots + \bar{a}_n}{c_0 s^m + c_1 s^{m-1} + \dots + c_m} = F_l(s) \cdot F_r(s), \quad (3.23)$$

where $F_l(s)$ and $F_r(s)$ are proper transfer functions that have all poles in the left and right half planes, respectively, and let $f_l(t)$ and $f_r(t)$ be the bounded functions that are transformed into $F_l(s)$ and $F_r(-s)$ by the standard one-sided Laplace transform, respectively, i.e. $F_l(s) = \int_0^{+\infty} e^{-st} f_l(t) dt$ and $F_r(-s) = \int_0^{+\infty} e^{-st} f_r(t) dt$. Then the bounded $u_d(t)$ defined by (3.21) can be expressed as

$$\begin{aligned} u_d(t) &= \frac{y_d^{n-m}(t) + \bar{a}_1 y_d^{n-m-1}(t) + \dots + \bar{a}_{n-m} y_d(t)}{c_0} \\ &+ \int_{-\infty}^t f_l(t - \tau) v(\tau) d\tau \end{aligned} \quad (3.24)$$

$$v(t) = \int_{-\infty}^{\delta} f_r(\delta - \tau) y_d(-\tau) d\tau \Big|_{\delta=-t}. \quad (3.25)$$

The Theorem 3.4 and Corollary 3.5 show that stable inversion can be obtained by cascaded convolutions that correspond to the stable and antistable components of the transfer function. However, the solution is non-causal.

Example 3.1. *Consider a non-minimum phase system*

$$G(s) = \frac{(s+4)(3-s)}{s^3 + 2s^2 + 3s + 4} \quad (3.26)$$

and let us obtain the stable inversion for a desired output trajectory $y_d(t)$. Firstly, we express the inverse of (3.26) as $\frac{1}{G(s)} = -s - 1 + F_l(s) \cdot F_r(s)$ where

$$F_l(s) = \frac{14s + 16}{s + 4} = -\frac{40}{s + 4} + 14, \quad F_r(-s) = \frac{1}{s + 3}. \quad (3.27)$$

From (3.24) and (3.25), we have the bounded input:

$$u_d(t) = -\dot{y}_d(t) - y_d + \int_{-\infty}^t (-40e^{-4(t-\tau)})v(\tau)d\tau + 14v(t) \quad (3.28)$$

$$v(t) = \int_{-\infty}^{\delta} e^{-3(\delta-\tau)}y_d(-\tau)d\tau|_{\delta=-t}. \quad (3.29)$$

For numerical computation of $u_d(t)$, it is not necessary to calculate the closed forms of the inverse Laplace transforms. We can compute the convolutions numerically by the state-space representation for $F_l(s)$ and $F_r(-s)$ with time reversals, namely

$$\dot{x}_1(t) = -4x_1(t) + v(t) \quad (3.30)$$

$$u_d(t) = -40x_1 + 14v(t) - \dot{y}_d(t) - y_d(t) \quad (3.31)$$

and

$$\dot{x}_2(t) = -3x_2(t) + y_d(-t) \quad (3.32)$$

$$v(-t) = x_2(t). \quad (3.33)$$

The second method which we will introduce is the feedback control for tracking the trajectory by using the canonical form of Brunovsky [97, Brunovsky (1970)]. We want to determine a static state feedback control such that the system output to follow a desired output as asymptotic.

Consider the SISO system in the state space representation

$$\dot{x}(t) = Ax + Bu. \quad (3.34)$$

We suppose the system (3.34) is controllable. There exists a canonical form of the controllable pairs. That is to say, there exist appropriate unimodular matrix P such that

$$P^{-1}AP = \begin{bmatrix} 0 & 1 & 0 & \cdots & 0 \\ 0 & 0 & 1 & \cdots & 0 \\ \vdots & \vdots & \vdots & & \vdots \\ 0 & 0 & 0 & \cdots & 1 \\ -a_0 & -a_1 & -a_2 & \cdots & -a_{n-1} \end{bmatrix},$$

$$P^{-1}BP = \begin{bmatrix} 0 \\ 0 \\ \vdots \\ 0 \\ 1 \end{bmatrix}.$$

where $a_1, \dots, a_{n-1} \in \mathbb{R}$. And the canonical form of the Brunovsky can be obtained by change the variable $Pz(t) = x(t)$. That is

$$\dot{z}(t) = A_c z(t) + B_c u(t), \quad (3.35)$$

where $A_c = P^{-1}AP$, $B_c = P^{-1}BP$. The companion form is written

$$\begin{aligned} \dot{z}_1(t) &= z_2(t) \\ &\vdots \\ \dot{z}_{n-1}(t) &= z_n(t) \\ \dot{z}_n(t) &= -a_0 z_1(t) - a_1 z_2(t) - \cdots - a_{n-1} z_n(t) + u(t). \end{aligned} \quad (3.36)$$

Taking $\dot{z}_n(t) = v(t)$, we have the following form

$$\begin{aligned} \dot{z}_1(t) &= z_2(t) \\ &\vdots \\ \dot{z}_{n-1}(t) &= z_n(t) \\ \dot{z}_n(t) &= v(t) \end{aligned} \quad (3.37)$$

which is called the canonical form of Brunovsky [97, Brunovsky (1970)]. Since $v(t) = \dot{z}_n(t)$, we have

$$v(t) = -a_0 z_1(t) - a_1 z_2(t) - \cdots - a_{n-1} z_n(t) + u(t) \quad (3.38)$$

It is a closed-loop by static state feedback. More precisely, we have

$$u(t) = a^T z(t) + v(t), \quad (3.39)$$

with $\begin{bmatrix} a_0 & a_1 & \cdots & a_{n-1} \end{bmatrix}^T$. Taking into account the transformation $Pz(t) = x(t)$, we have

$$u(t) = f x(t) + v(t), \quad f = a^T P^{-1}. \quad (3.40)$$

this static state feedback leads to the canonical form of Brunovsky. The form (3.37) simplifies the control of trajectory tracking. Denote $y_d(t)$ is the desire output. Let

$$y^{(n)}(t) = v(t). \quad (3.41)$$

We define the error of trajectory tracking which is $\varepsilon(t) = y(t) - y_d(t)$, and choose the Hurwitz polynomial

$$\varepsilon^{(n)}(t) + k_{l-1} \varepsilon^{(n-1)}(t) + \cdots + k_0 \varepsilon(t) = 0, \quad (3.42)$$

to ensure that the error asymptotically goes to 0. The coefficients k_0, \dots, k_{n-1} are chosen to provide dynamic performance tracking the output $y_d(t)$. Decomposing $\varepsilon^{(n)}(t)$ and using equation (3.42), we obtain

$$v(t) = y_d^{(n)}(t) - [k_{l-1} \varepsilon^{(n-1)}(t) + \cdots + k_0 \varepsilon(t)]. \quad (3.43)$$

This identity can be written as

$$v(t) = v_d(t) - k^T z, \quad (3.44)$$

where $k = \begin{bmatrix} k_0 & k_1 & \cdots & k_{n-1} \end{bmatrix}^T$, and $v_d(t) = y_d^{(n)} + k_{n-1} y_d^{(n-1)} + \cdots + k_0 y_d$. This is a simple static feedback state on the canonical form of Brunovsky with a new input $v_d(t)$. Taking equation(3.44) into (3.39) we can obtain the general form of the control

$$u(t) = (a^T - k^T) z(t) + v_d. \quad (3.45)$$

From the form of the new input $v_d(t)$ we know that this control is non proper.

3.1.4 Finite time stable inversion

In this section we will introduce our contribution called the finite time stable inversion for SISO and MIMO systems.

3.1.4.1 Finite time stable inversion for SISO linear systems

First we define the finite time stable inversion for SISO linear systems and propose a general procedure for the computation of a pre-compensator solution.

This inverse problem can be stated as follows. Let $T(s)$ be a given plant. Find a stable pre-compensator $R(s)$ such that the error of inversion

$$\hat{e}(s) = 1 - T(s)R(s) \quad (3.46)$$

is the Laplace transform of a causal function with finite support. Such a pre-compensator $R(s)$ is said to be a solution to the finite time stable inversion problem, while $\hat{e}(s)$ is called the inversion error. This problem is illustrated in Figure 3.2 and Figure 3.3.

Among numerous classes where the inversion error $\hat{e}(s)$ may be defined, we con-

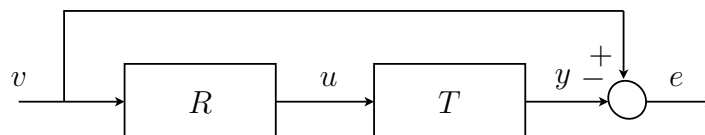

FIGURE 3.2: Finite time stable inversion.

sider only a class of rational elements, in the sense that algebraic procedures can be handled out for its computation. For this, we impose that $e(t)$ be in the set \mathcal{P}_ε defined in Definition 1.8. Any element in \mathcal{P}_ε is of the form

$$e(t) = g(t) + \sum_{k=0}^r e_k \delta(t - k\vartheta), \quad (3.47)$$

where $g \in \mathcal{G}$ is a distributed delay, $\vartheta \in \mathbb{R}_+$, and $e_k \in \mathbb{R}$, for $k = 0, \dots, r$. In the Laplace domain, this is equivalent to say that any $\hat{e}(s) \in \hat{\mathcal{P}}_{\mathcal{G}}$ can be written like

$$\hat{e}(s) = \hat{g}(s) + \sum_{k=0}^r e_k e^{-k\vartheta s}. \quad (3.48)$$

Elements in $\hat{\mathcal{P}}_{\mathcal{G}}$ are proper, and BIBO-stable, since they have a finite support. An illustration is made in Figure 3.3, where delayed Dirac distributions arise at time t_i , for $i = 1, 2, 3$, which correspond to multiple commensurate delays of $\vartheta > 0$. After a finite time $t_f \geq 0$, the inversion error $e(t)$ will be identically zero. The time interval $[0, t_f]$ enclose the support of $e(t)$. Its length is related to the support of the distributed delay $g(t)$ and $r\vartheta$.

Using this class, finite time stable inversion comes down to find a stable and

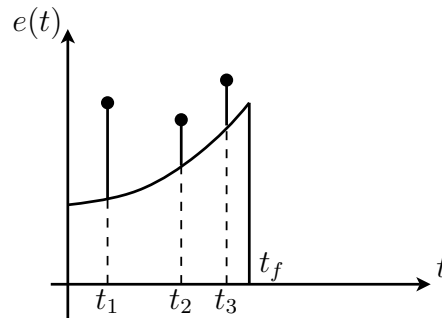

FIGURE 3.3: Time-domain evolution of the inverse error $e(t)$.

proper pre-compensator $R(s)$ such that

$$\hat{e}(s) = 1 - T(s)R(s) \in \hat{\mathcal{P}}_{\mathcal{G}} \quad (3.49)$$

We give next a complete characterization of a solution to the above problem, with a constructive proof.

Theorem 3.6 (Lu and Di Loreto (2011) [98]). *The problem of finite time stable inversion always admits a proper and stable solution.*

Proof. The proof is by construction. Take any coprime, factorization (N, D) of $T(s)$ in $\mathbb{R}[s]$. We first decompose $N(s)$ into a stable-unstable factorization, like in (3.3), that is

$$N(s) = N_s(s)N_u(s), \quad (3.50)$$

where N_s is monic and has stable zeros, while N_u has only unstable zeros.

The second step is a particular decomposition of identity I . Take any arbitrary element $Q(s) \in \hat{\mathcal{P}}_{\mathcal{E}}$, satisfying

$$\deg_s Q(s) \leq \min(\deg_s N_s(s) - \deg_s D(s), N_u). \quad (3.51)$$

Define $X(s) = Q(s)$ and $Y(s) = 1 - Q(s)N_u(s)$. Then we have

$$X(s)N_u(s) + Y(s) = 1. \quad (3.52)$$

This means that $N_u(s)$ and 1 are obviously coprime over $\hat{\mathcal{E}}$.

The third and last step is the construction of the pre-compensator. For this, define

$$R(s) = D(s)N_s^{-1}X(s). \quad (3.53)$$

From (3.51), we see that $R(s)$ is proper. Since $N_s^{-1}(s)$ is stable and $X(s) \in \hat{\mathcal{P}}_{\mathcal{E}}$, we see that $R(s)$ is stable. Furthermore, using (3.52) and (3.53), the inversion error

$$\begin{aligned} \hat{e}(s) &= 1 - T(s)R(s) \\ &= X(s)N_u(s) + Y(s) - T(s)R(s) \\ &= Y(s). \end{aligned} \quad (3.54)$$

The inversion error is $Y(s) = 1 - X(s)N_u(s)$, and using (3.51), we see that such a solution satisfies

$$\text{des}_s Y(s) \leq 0, \quad (3.55)$$

and is in $\hat{\mathcal{E}}$. Hence $e(t) \in \mathcal{P}_{\mathcal{E}}$, which completes the proof. \square

The above theorem gives a complete answer to the finite time stable inversion for a linear plant, for which a solution always exists and can be algebraically computed. Obviously, such a solution is highly non unique, from the free parameter $Q(s)$ in $\hat{\mathcal{P}}_{\mathcal{E}}$. Note also that the plant $T(s)$ can be stable or unstable, as proper or strictly proper. In practice, if there is at least one unstable zero in the plant, $Q(s)$ will be a distributed delay, with a negative degree given by (3.51).

Example 3.2. Consider the plant

$$T(s) = \frac{s-1}{s+1}, \quad (3.56)$$

where $N_u(s) = s - 1$, $N_s(s) = 1$ and $D(s) = s + 1$. Take for instance

$$X(s) = \frac{1 - e^{-(s-1)\vartheta}}{s - 1} \in \hat{\mathcal{G}}, \text{ where } \vartheta > 0.$$

A pre-compensator that solves the finite time stable inversion is

$$R(s) = (s + 1) \frac{1 - e^{-(s-1)\vartheta}}{s - 1},$$

since the inversion error is $\hat{e}(s) = Y(s) = e^{-(s-1)\vartheta}$. Note that there is no unstable pole-zero cancellation, since $+1$ is not a pole of $X(s)$. In the time domain, this inverse error is

$$e(t) = e^\vartheta \delta(t - \vartheta),$$

i. e. the error is a delayed Dirac at time $t_f = \vartheta$. Obviously, other choices for $X(s)$ are possible, leading to another inverse error with finite time support. A simulation is shown in Figure 3.4, where the inversion error is plotted with $\vartheta = 1$.

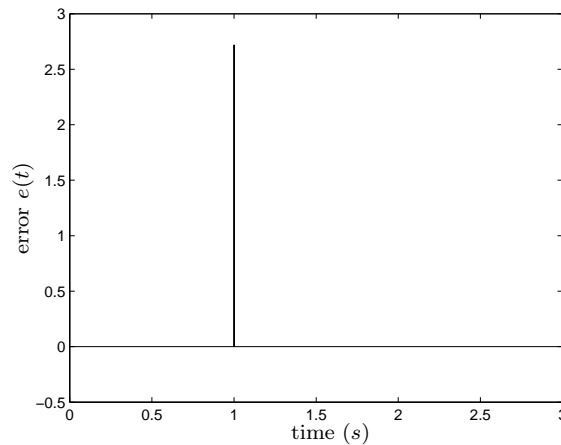

FIGURE 3.4: Kernel of the inversion error in time for $\vartheta = 1$ (Example 3.2).

Example 3.3. Let $T(s)$ be the stable strictly proper plant

$$T(s) = \frac{1}{s + 1}, \quad (3.57)$$

with $N_u(s) = 1$, $N_s(s) = 1$ and $D(s) = s + 1$. Take

$$X(s) = \frac{1 - e^{-(s-1)\vartheta}}{s - 1} \in \hat{\mathcal{G}}.$$

Using the proper and stable pre-compensator $R(s) = 1 - e^{-\vartheta(s+1)}$, the inversion error is

$$\hat{e}(s) = 1 - \frac{1 - e^{-(s-1)\vartheta}}{s-1} \in \hat{\mathcal{P}}_{\vartheta}.$$

In the time domain the error is

$$e(t) = \delta(t) - e^1, \quad t \in [0, \vartheta].$$

Simulation results of the inversion error in time are shown in Figure 3.5, for three different values of ϑ .

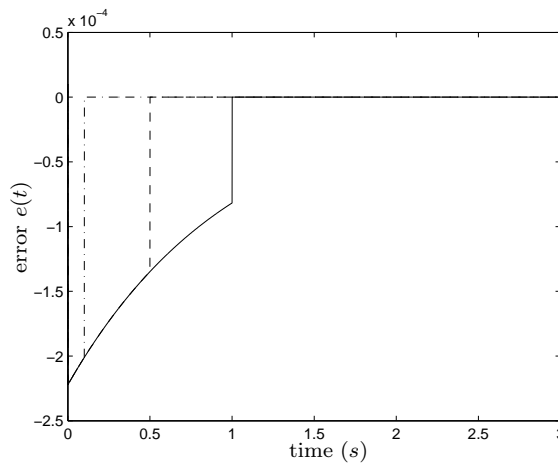

FIGURE 3.5: Kernel of the inversion error in time for $\vartheta = 1$ (continuous), $\vartheta = 0.5$ (dashed) and $\vartheta = 0.1$ (dashed-dot)(Example 3.3).

3.1.4.2 Finite time stable inversion for MIMO linear systems

For MIMO linear systems, the finite time stable inversion problem can be stated as follows: Given a plant $T(s) \in \mathbb{R}^{m \times n}(s)$, we want to find a stable pre-compensator $R(s) \in \mathbb{R}^{n \times m}(s)$ so that the error of the stable inversion

$$E(s) = I_m - T(s)R(s) \quad (3.58)$$

has finite support. In other words, a stable pre-compensator $R(s)$ is expected, so that the exact inversion can be obtained after a finite time (we want the error $E(s)$ in $\hat{\mathcal{P}}_{\vartheta}^{m \times m}$, that is to say all entries in $E(s)$ are in $\hat{\mathcal{P}}_{\vartheta}$). We have the following result.

Theorem 3.7 (Lu and Di Loreto (2013) [99]). *The stable inversion of the multi-variable linear system in (3.58) always admits a proper and stable solution.*

Proof. The first step, take coprime factorization (N, d) of $T(s)$ such that $T(s) = \frac{N(s)}{d(s)}$ where $T(s) \in \mathbb{R}^{m \times n}[s]$, $N(s) \in \mathbb{R}^{m \times n}[s]$ and $d \in \mathbb{R}[s]$. We decompose $N(s)$ into its Smith form $N(s) = U_1(s)\Lambda(s)U_2(s)$ (where $U_1(s) \in \mathbb{R}^{m \times m}[s]$, $U_2(s) \in \mathbb{R}^{n \times n}[s]$, are unimodular matrixs and $\Lambda(s) \in \mathbb{R}^{m \times n}[s]$ is a diagonal matrix). We decomposed $\Lambda(s)$ like in (3.5), $\Lambda(s) = \Lambda_u(s)\Lambda_s(s)$ where $\Lambda_u(s) \in \mathbb{R}^{m \times n}[s]$ has only unstable zeros, and $\Lambda_s(s) \in \mathbb{R}^{n \times n}[s]$ has stable zeros.

The second step, we take any arbitrary element $X(s) \in \hat{\mathcal{P}}_{\mathcal{E}}^{n \times m}$ such that

$$d(s)(\Lambda_s(s)U_2(s))^{-1}X(s) \text{ is proper} \quad (3.59)$$

Define $Y(s) = I_m - V(s)X(s)$ where $V(s) = U_1(s)\Lambda_u(s)$, then we have

$$V(s)X(s) + Y(s) = I_m. \quad (3.60)$$

It means that $V(s) \in \hat{\mathcal{E}}^{m \times n}$ and I_m are left coprime.

Define the precompensator

$$R(s) = d(s)(\Lambda_s(s)U_2(s))^{-1}X(s). \quad (3.61)$$

From (3.59) we know that $R^{n \times m}(s)$ is proper and the inversion error is

$$E(s) = I_m - T(s)R(s) = Y(s). \quad (3.62)$$

Since $R(s)$ is proper, the error $E(s) = Y(s)$ is proper. Since $Y(s) \in \hat{\mathcal{E}}^{m \times m}$ and proper, we can deduce that $E(s) \in \hat{\mathcal{P}}_{\mathcal{E}}^{m \times m}$ \square

Example 3.4. *Take*

$$T(s) = \begin{bmatrix} \frac{s-1}{s+1} & \frac{1}{s+1} \end{bmatrix}, \quad (3.63)$$

where $N(s) = [s-1 \quad 1]$, $d(s) = s+1$. We decompose $N(s) = U_1(s)\Lambda_u(s)\Lambda_s(s)U_2(s)$, where $U_1(s) = I$, $U_2(s) = \begin{bmatrix} s-1 & 1 \\ 1 & 0 \end{bmatrix}$, $\Lambda_u(s) = [1 \quad 0]$, $\Lambda_s(s) = \begin{bmatrix} 1 & 0 \\ 0 & 1 \end{bmatrix}$. Take for instance

$$X(s) = \begin{bmatrix} \frac{1-e^{-(s+1)\vartheta}}{s+1} \\ 0 \end{bmatrix} \in \hat{\mathcal{P}}_{\mathcal{E}}.$$

The pre-compensator

$$R(s) = d(s) [\Lambda_s(s)U_2(s)]^{-1} X(s) = \begin{bmatrix} 0 \\ 1 - e^{-(s+1)\vartheta} \end{bmatrix}$$

is stable and proper. The stable inversion error is

$$E(s) = Y(s) = 1 - \frac{1 - e^{-(s-1)\vartheta}}{s+1}.$$

In time domain this error writes as

$$e(t) = \begin{cases} \delta(t) - e^{-t}, & t \in [0, \vartheta] \\ 0, & \text{elsewhere} \end{cases}.$$

Simulation results are shown in Figure 3.6 for three different ϑ .

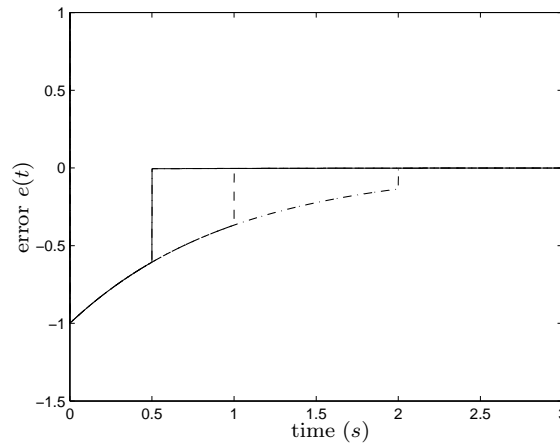

FIGURE 3.6: Kernel of the stable inversion error for $\vartheta = 0.5$ (continuous), $\vartheta = 1$ (dashed), $\vartheta = 2$ (dashed-dot) (Example 3.4).

Example 3.5. Let us consider the plant

$$T(s) = \begin{bmatrix} \frac{s-1}{s+1} \\ \frac{1}{s+1} \end{bmatrix}, \quad (3.64)$$

with $N(s) = \begin{bmatrix} s-1 \\ 1 \end{bmatrix}$, $d(s) = s+1$. $d(s) = s+1$. Decompose $N(s) =$

$U_1(s)\Lambda_u(s)\Lambda_s(s)U_2(s)$ we have $U_1(s) = \begin{bmatrix} s-1 & 1 \\ 1 & 0 \end{bmatrix}$, $U_2 = I_2$, $\Lambda_u(s) = \begin{bmatrix} 1 \\ 0 \end{bmatrix}$,

$$\Lambda_s(s) = \begin{bmatrix} 1 & 0 \\ 0 & 1 \end{bmatrix}, \text{ and } V(s) = \begin{bmatrix} s-1 \\ 1 \end{bmatrix}. \text{ Take}$$

$$X(s) = \begin{bmatrix} \frac{1 - e^{-(s-1)\vartheta}}{s-1} & 0 \end{bmatrix} \in \hat{\mathcal{P}}_{\mathcal{L}}^{1 \times 2}.$$

The proper and stable pre-compensator

$$R(s) = \begin{bmatrix} (s+1) \frac{1 - e^{-(s-1)\vartheta}}{s-1} & 0 \end{bmatrix} \in \hat{\mathcal{C}}^{1 \times 2},$$

and the inversion error is

$$E(s) = \begin{bmatrix} e^{-(s-1)\vartheta} & 1 \\ 1 - \frac{1 - e^{-(s-1)\vartheta}}{s-1} & 1 \end{bmatrix} \in \hat{\mathcal{P}}_{\mathcal{L}}^{2 \times 2}.$$

In the time domain the error is

$$E(t) = \begin{bmatrix} e^{\vartheta} \delta(t-1) & \delta(t) \\ \delta(t) - e^1 & \delta(t) \end{bmatrix}, \quad t \in [0, \vartheta].$$

Simulation results are reported in Figure 3.7.

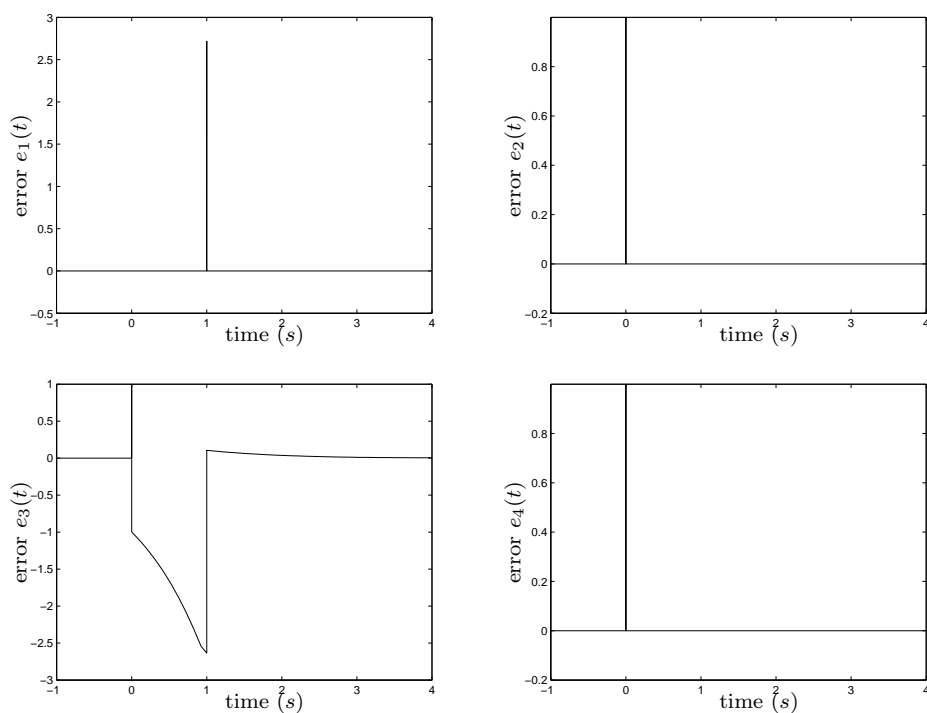

FIGURE 3.7: Kernel of the stable inversion in time for $\vartheta = 1$ with approximated distributed delay (Example 3.5).

Remark 3.8. In general, there are distributed delays in the pre-compensator. For this implementation an approximation is used (we introduced in Chapter 2). That is why in the lower left picture of Figure 3.7, the error of the stable inversion $e_3(t)$ asymptotically goes to 0 after the time 1s. But this error is very small and can be Negligible (for instance, in Example 3.5 the error is less than 10^{-5}). And the higher the accuracy of the distributed delay approximation is, the smaller the error is. \square

Remark 3.9. Note that we can not choose the coefficient $\vartheta = 0$. If we choose $\vartheta = 0$ we will lose the stability of the compensator (see Example 3.2, 3.3, 3.5) or lose the finite time convergence property of error (see Example 3.4). \square

Previous results on stable inversion give generic solution, and are concerned with the stable inversion of the convolution kernel, or in other words, for a Dirac distribution input. The inversion error kernel is defined to have a finite time support. When another arbitrary bounded input is taken, the output error will be only bounded, but has no particular property in the time-domain, except the case when this input has a finite support, in which case the output will still have finite support. For instance, for any constant persistent input, an inversion error in \mathcal{G} goes to a finite constant value.

In practice, inversion is understood from an input-output point of view. So we may have some arbitrary input, and we shall obtain an inversion error with finite support. This aim, of course, comes down to take into account the exogenous model on the input signal into the plant $T(s)$. Actually, this can be considered as an application of model matching. So, in the next section, we address and illustrate the model matching for SISO and MIMO linear systems.

3.2 Model matching

The problem of exact model matching can be stated as below: Given a plant $T(s)$ and a matching model $T_m(s)$, we want to find a pre-compensator $R(s)$, such that the transfer function of the resulting system $G(s) = T(s)R(s)$ has a prespecified model $T_m(s)$. In other words, we want to find the pre-compensator $R(s)$, so that the error $e(t)$ should be zeros, as shown in Figure 3.8. However, conditions for the existence of a causal and stable solution are too conservative. Hence, we are interested in the extension of the exact model matching. Namely, the tracking

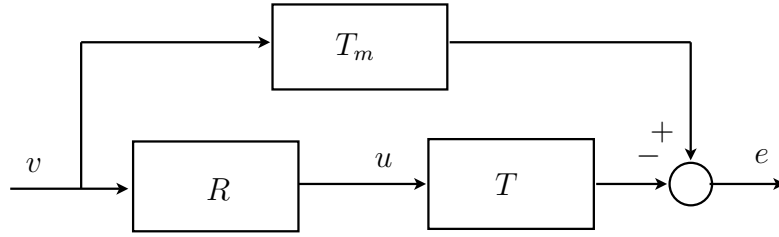

FIGURE 3.8: Model matching problem

error is not identically zero, but we have

$$E(s) = T_m(s) - T(s)R(s), \quad (3.65)$$

where the model matching error has a finite time support. The impulse response of the model matching error is expected to vanish in a finite time. In this problem, it should be noticed that the pre-compensator $R(s)$ is required to be BIBO-stable and causal, in order to apply it for real-time applications.

3.2.1 Finite time model matching for SISO linear systems

In this section we will propose a general procedure for the computation of a pre-compensator solution. We will introduce the trajectory planning by using model matching problem.

Theorem 3.10 (Lu and Di Loreto (2011) [98]). *The model matching problem in (3.65) always admits a proper and stable solution.*

Proof. To solve this problem, following [29, Di Loreto (2006)], we denote $T(s) = N(s)D^{-1}(s)$, $T_m(s) = N_m(s)D_m^{-1}(s)$, where the pairs (N, D) and (N_m, D_m) are coprime and defined over $\mathbb{R}[s]$. As in (3.3), we factorize the stable and unstable parts of $N(s)$ like

$$N(s) = N_s(s)N_u(s). \quad (3.66)$$

if $N_u(s)$ and $D_m(s)$ are coprime, there exist $X(s)$ and $Y(s)$ in \mathcal{E} such that

$$X(s)N_u(s) + Y(s)D_m(s) = 1. \quad (3.67)$$

If this is not the case, we can divide by the common factor and will work on the quotients. So there is no restriction in this assumption. The model $T_m(s)$ being

proper, $D_m(s)$ is monic. We can divide $X(s)N_m(s)$ by $D_m(s)$. We see that there exists $Q(s), P(s) \in \hat{\mathcal{E}}$, with $\deg_s P(s) < \deg_s D_m(s)$ such that

$$X(s)N_m(s) = Q(s)D_m(s) + P(s). \quad (3.68)$$

Since $P(s)$ is non unique in this division, we can take it with arbitrary negative degree (see remark 3.11). Define

$$R(s) = D(s)N_s^{-1}(s)P(s)D_m^{-1}(s). \quad (3.69)$$

This element is proper, and stable if $D_m(s)$ is stable (this precisely the trajectory we are planning). With this pre-compensator, the finite time model matching error will be

$$\hat{e}(s) = T_m(s) - T_e(s)C(s) = Y(s)N_m(s) + N_u(s)Q(s). \quad (3.70)$$

This error is in $\hat{\mathcal{E}}$. Since $\hat{e}(s) = T_m(s) - T(s)R(s)$, and the right-hand side is proper, we deduce that $\hat{e}(s)$ is proper. So it is in $\hat{\mathcal{D}}_{\mathcal{E}}$, which concludes the proof. \square

Remark 3.11. Let λ_i $i = 1, \dots, q$, denote the zeros of $D_m(s)$. From (3.68), we have

$$X(\lambda_i)N_m(\lambda_i) - P(\lambda_i) = 0,$$

and we assume first that all the zeros λ_i of D_m are different. Take $P(s) \in \hat{\mathcal{E}}$ with $\deg_s P(s) < -k$ for some given $k > 0$, and

$$P(\lambda_i) = X(\lambda_i)N_m(\lambda_i), \quad (3.71)$$

if $P(\lambda_i) = \alpha_i \in \mathbb{R}$ $i = 1, \dots, q$, we can deduce the form of $P(s)$ as follows,

$$P(s) = \sum_{i=1}^n \left[\prod_{j=1, (j \neq i)}^n \frac{s - \lambda_j}{\lambda_i - \lambda_j} g_i(s) \frac{\alpha_i}{g_i(\lambda_i)} \right], \quad (3.72)$$

where $g_i(\lambda_i) \neq 0$, and $g_i(s) \in \hat{\mathcal{E}}$ such that $\deg_s P(s) < -k$. Now the matrix $Q(s)$ in the equation (3.68). Since the degree of $P(s)$ can be chosen arbitrarily, the degree of $Q(s)$ is non positive. Since $D_m(s) = \prod_{i=1}^q (s - \lambda_i)$, we have $D_m^{-1}(s) = \sum_{i=1}^q \frac{\beta_i}{s - \lambda_i}$,

$\beta_i \in \mathbb{R}$. From (3.68), we have

$$\begin{aligned}
Q(s) &= (X(s)N_m(s) - P(s)) \sum_{i=1}^q \frac{\beta_i}{s - \lambda_i} \\
&= \sum_{i=1}^q \frac{\beta_i(X(s)N_m(s) - P(s))}{s - \lambda_i} \\
&\xrightarrow{s \rightarrow \lambda_i} \beta_i \frac{d[X(s)N_m(s) - P(s)]}{ds} \Big|_{s=\lambda_i}, \tag{3.73}
\end{aligned}$$

where $i = 0, 1, \dots, q$. So $Q(s) \in \hat{\mathcal{E}}$.

Note that if $D_m(s)$ have zeros with multiplicity greater than 1, the condition (3.71) is not enough. Let λ_k , $k \in \{1, \dots, q\}$ be a zero of multiplicity, $m_k \in \mathbb{N}$ with $m_k \geq 2$ be the number of the multiplicity zero λ_k . Additionally to (3.71) we should consider the following conditions,

$$\begin{aligned}
\frac{dP(\lambda)}{d\lambda} \Big|_{\lambda=\lambda_k} &= \frac{d(X(\lambda)N_m(\lambda))}{d\lambda} \Big|_{\lambda=\lambda_k} \\
\frac{d^2P(\lambda)}{d\lambda^2} \Big|_{\lambda=\lambda_k} &= \frac{d^2(X(\lambda)N_m(\lambda))}{d\lambda^2} \Big|_{\lambda=\lambda_k} \\
&\vdots \\
\frac{d^{m_k-1}P(\lambda)}{d\lambda^{m_k-1}} \Big|_{\lambda=\lambda_k} &= \frac{d^{m_k-1}(X(\lambda)N_m(\lambda))}{d\lambda^{m_k-1}} \Big|_{\lambda=\lambda_k}. \tag{3.74}
\end{aligned}$$

Now let us consider the trajectory planning by using Theorem 3.10. Let be a given bounded desired trajectory $y_d(t)$, $t \geq 0$. We want to find, with stability, an input $u_d(t)$, $t \geq 0$, such that $y_d(t) = T(t) * u_d(t)$, where $T(t)$ denotes the impulse response of $T(s)$. Following the case of kernel model matching, we propose here to solve the following less restrictive problem.

We may find a proper and stable pre-compensator $R(s)$, such that the output of the plant $y(t)$ satisfies, for some $t_f \geq 0$,

$$y(t) = y_d(t), \quad \forall t \geq t_f. \tag{3.75}$$

For this, take $v(t) = y_d(t)$, $t \geq 0$. The inversion error is

$$e(t) = y_d(t) - y(t), \quad t \geq 0, \tag{3.76}$$

where

$$y(t) = T(t) * R(t) * y_d(t), \quad t \geq 0. \tag{3.77}$$

In the Laplace domain, this identity is of the form

$$\hat{e}(s) = T_m(s) - T_e(s)R(s), \quad (3.78)$$

where $T_m(s) = \hat{y}_d(s)$, and $T_e(s) = T(s)\hat{y}_d(s)$.

This is a precisely a matching problem, where $T_m(s)$ is the given model we try to realize using a feed forward control. The stable trajectory planning (3.75) is then equivalent to require that $\hat{e}(s)$ be in $\hat{\mathcal{P}}_\varepsilon$, as for the finite time stable inversion. This problem is illustrated in Figure 3.9, where v denotes a Dirac distribution input at time $t = 0$.

The trajectory planning problem is similar to the kernel inversion problem. We

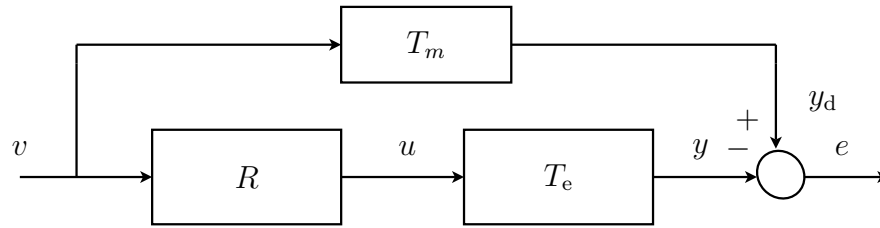

FIGURE 3.9: Trajectory planning as a model matching problem.

include in the plant the exogenous model of the desired output. In practice, this model will be incorporated into the proper pre-compensator $R(s)$. This form is strongly related to the internal model principle.

Example 3.6. *Take*

$$T(s) = \frac{s-1}{s+1}, \quad (3.79)$$

and consider a desired output $y_d(t) = 1, t \geq 0$. We have $T_m(s) = s^{-1}$, $T_e(s) = \frac{s-1}{s(s+1)}$, that is

$$N_s = 1, N_m(s) = 1, N_u(s) = s-1, D = s(s+1), D_m(s) = s.$$

Take

$$X(s) = \frac{1}{1-e^\vartheta} \left[\frac{1-e^{-(s-1)\vartheta}}{s-1} \right], Y(s) = \frac{-e^\vartheta}{1-e^\vartheta} \left[\frac{1-e^{-s\vartheta}}{s} \right]$$

that satisfy $X(s)N_u(s) + Y(s)D_m = 1$. Division (3.68) yields $Q = 0$ and $P(s) = \frac{1}{1-e^\vartheta} \left[\frac{1-e^{-(s-1)\vartheta}}{s-1} \right]$. A precompensator takes the form

$$R(s) = \frac{1}{1-e^\vartheta} (s+1) \left(\frac{1-e^{-(s-1)\vartheta}}{s-1} \right),$$

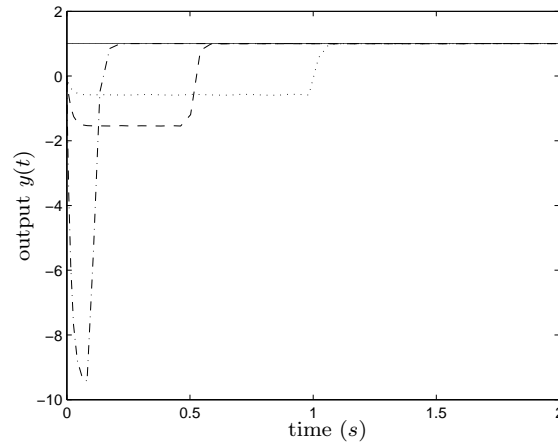

FIGURE 3.10: Trajectory planning, for $\vartheta = 1$ (dot), $\vartheta = 0.5$ (dashed), and $\vartheta = 0.1$ (dashed-dot), with approximated distributed delay (Example 3.6).

while the tracking error is

$$\hat{e}(s) = \frac{-e^{\vartheta}}{1 - e^{\vartheta}} \left[\frac{1 - e^{-s\vartheta}}{s} \right].$$

In the time domain, this error is

$$e(t) = \begin{cases} \frac{-e^{\vartheta}}{1 - e^{\vartheta}} & , \quad t \in [0, \vartheta] \\ 0 & , \quad \text{elsewhere} \end{cases}.$$

After a time $t_f = \vartheta$, we have $y(t) = y_d(t)$, using a precompensator $R(s)$ which is stable and proper. Simulation results are shown in Figure. 3.10.

3.2.2 Finite time model matching for MIMO linear systems

The model matching problem can be stated as below: Given a $m \times n$ plant $T(s)$ in $\mathbb{R}(s)$, the ring of fractions of $\mathbb{R}[s]$, and a $m \times q$ mode $T_m(s)$ in $\mathbb{R}(s)$, we want to find a $n \times q$ stable pre-compensator $R(s)$ in $\mathbb{R}(s, e^{-\vartheta s})$ such that the error of the system

$$E(s) = T_m(s) - T(s)R(s) \quad (3.80)$$

is the Laplace transform of a causal function with finite support. That is, the error has Laplace transform in the ring $E(s) \in \hat{\mathcal{P}}_e^{m \times p}$. So our model matching problem can be formulated as follows: find a pre-compensator $R(s) \in \mathbb{R}^{n \times q}(s, e^{-\vartheta s})$, stable and proper (in the sense that it is stable, admits a state-space realizations and its

solution is causal) such that the error of the system

$$E(s) = T_m(s) - T(s)R(s) \in \hat{\mathcal{P}}_{\mathcal{E}}^{m \times p}. \quad (3.81)$$

Now we give the following result.

Theorem 3.12 (Lu and Di Loreto (2013) [99]). *The problem of model matching for multivariable linear system, admits a proper and stable solution.*

Proof. Given a plant $T(s) \in \mathbb{R}^{m \times n}(s)$ and model $T_m(s) \in \mathbb{R}^{m \times q}(s)$. Take coprime factorization (N, d) of $T(s)$ and (N_m, d_m) of $T_m(s)$ such that $T(s) = \frac{N(s)}{d(s)}$, $T_m(s) = \frac{N_m(s)}{d_m(s)}$ where $d(s), d_m(s) \in \mathbb{R}[s]$, $N(s) \in \mathbb{R}^{m \times n}[s]$, $N_m(s) \in \mathbb{R}^{m \times q}[s]$.

Take the smith form of the matrix $N(s)$. We have $N(s) = U_1(s)\Lambda(s)U_2(s)$ where $U_1(s) \in \mathbb{R}^{m \times m}[s]$, $U_2(s) \in \mathbb{R}^{n \times m}[s]$ are unimodular matrices. The matrix $\Lambda(s)$ is the unique diagonal matrix in $\mathbb{R}^{m \times n}[s]$ of the form ([45, Kailath (1980)])

$$\Lambda(s) = \left[\begin{array}{ccc|c} \lambda_1 & & & \mathbb{O} \\ & \ddots & & \\ & & \lambda_r & \\ \hline & & & \mathbb{O} \end{array} \right]_{m \times n}.$$

We decompose Λ by $\Lambda = \Lambda_u \Lambda_s$, where

$$\Lambda_u(s) = \left[\begin{array}{ccc|c} \lambda_{1u} & & & \mathbb{O} \\ & \ddots & & \\ & & \lambda_{ru} & \\ \hline & & & \mathbb{O} \end{array} \right]_{m \times n},$$

$$\Lambda_s(s) = \left[\begin{array}{ccc|c} \lambda_{1s} & & & \mathbb{O} \\ & \ddots & & \\ & & \lambda_{rs} & \\ \hline & & & R(s) \end{array} \right]_{n \times n}.$$

The elements $\lambda_{1u}, \dots, \lambda_{ru}$ in $\Lambda_u(s)$, like in (3.5), have only unstable zeros, while elements $\lambda_{1s}, \dots, \lambda_{rs}$ in $\Lambda_s(s)$ have stable zeros, λ_{iu} and λ_{is} are respectively the unstable and stable parts (by factorizations) of λ_i . $R(s)$ is any stable polynomial

$(n - r) \times (n - r)$ matrix. Then the matrix $N(s)$ can be written as

$$N(s) = U_1(s)\Lambda_u(s)\Lambda_s(s)U_2(s). \quad (3.82)$$

Let $V(s) = U_1(s)\Lambda_u(s)$, $D_m(s) = d_m(s) \cdot I_m$. If $V(s)$ and $D_m(s)$ are not left coprime, there exist $\tilde{V}(s) \in \mathbb{R}^{m \times n}[s]$ and $F(s) \in \mathbb{R}^{n \times n}[s]$ such that $V(s) = \tilde{V}(s)F(s)$, and $D_m(s)$ and $\tilde{V}(s)$ are left coprime. If $V(s)$ and $D_m(s)$ are left coprime, then $F(s) = I_n$. Since the ring $\mathbb{R}[s]$ is a subring of $\hat{\mathcal{E}}$, we can extend the elements in $\hat{\mathcal{E}}$. Then from Theorem 1.6, there exist $X(s) \in \hat{\mathcal{E}}^{n \times m}$, $Y(s) \in \hat{\mathcal{E}}^{m \times m}$ such that

$$\tilde{V}(s)X(s) + D_m(s)Y(s) = I_m. \quad (3.83)$$

Now we divide $X(s)N_m(s)$ by $d_m(s) \cdot I_q$. We see that there exist $Q(s)$ and $P(s)$ in $\hat{\mathcal{E}}^{n \times q}$ such that

$$X(s)N_m(s) = Q(s)d_m(s) \cdot I_q + P(s), \quad (3.84)$$

with $P \cdot d_m^{-1}$ a strictly proper matrix. We know that in (3.84) $P(s) \in \hat{\mathcal{E}}^{n \times q}$ is not unique, since the degree of pseudo-polynomials can be negative (see remark 3.13).

We define

$$R(s) = d(s) [\Lambda_s(s)U_2(s)]^{-1} F^{-1}(s)P(s)d_m^{-1}(s). \quad (3.85)$$

Since the degree of $P(s)$ can be chosen arbitrarily, we can take $P(s)$ such that $R(s)$ is always proper. Then element $R(s)$ is proper and stable if $d_m^{-1}(s)$ is stable (this is precisely the model that we are planning to match, and $d_m^{-1}(s)$ stable implies that F^{-1} is stable). With this pre-compensator, the finite time model matching error will be

$$E(s) = T_m(s) - T(s)R(s) = Y(s)N_m(s) + \tilde{V}(s)Q(s), \quad (3.86)$$

so $E(s) \in \hat{\mathcal{E}}^{m \times q}$. Since $T(s)$ and T_m are proper or strictly proper, and $E(s)$ is proper. So we deduce that $E(s)$ lies in $\hat{\mathcal{P}}_{\mathcal{E}}^{m \times q}$. \square

Remark 3.13. Like the Remark 3.11. Let λ_i , $i = 1, \dots, q$ denote the different zeros of $d_m(s)$. The degree of entries in $P(s)$ can be arbitrary if $P(s) \in \hat{\mathcal{E}}^{n \times q}$,

$$X(\lambda_i)N_m(\lambda_i) = P(\lambda_i). \quad (3.87)$$

And

$$Q(s) = \frac{X(s)N_m(s) - P(s)}{d_m(s)} \in \hat{\mathcal{E}}^{n \times q}. \quad (3.88)$$

If $d_m(s)$ have zeros λ_k , $k \in \{1, \dots, q\}$ with multiplicity greater than 1, we should still need to consider the condition

$$\begin{aligned} \frac{dP(\lambda)}{d\lambda} \Big|_{\lambda=\lambda_k} &= \frac{d(X(\lambda)N_m(\lambda))}{d\lambda} \Big|_{\lambda=\lambda_k} \\ \frac{d^2P(\lambda)}{d\lambda^2} \Big|_{\lambda=\lambda_k} &= \frac{d^2(X(\lambda)N_m(\lambda))}{d\lambda^2} \Big|_{\lambda=\lambda_k} \\ &\vdots \\ \frac{d^{m_k-1}P(\lambda)}{d\lambda^{m_k-1}} \Big|_{\lambda=\lambda_k} &= \frac{d^{m_k-1}(X(\lambda)N_m(\lambda))}{d\lambda^{m_k-1}} \Big|_{\lambda=\lambda_k}, \end{aligned} \quad (3.89)$$

where m_k is the number of the zeros λ_k .

Example 3.7. Consider the plant

$$T(s) = \begin{bmatrix} \frac{s-1}{s+1} & \frac{1}{s+1} \end{bmatrix}, \quad (3.90)$$

and the model $T_m(s) = \frac{s+2}{s+1}$. We have

$$\begin{aligned} N(s) &= [s-1 \ 1], & d(s) &= s+1, \\ N_m(s) &= s+2, & d_m(s) &= s+1. \end{aligned}$$

We decompose

$$N(s) = U_1(s)\Lambda_u(s)\Lambda_s(s)U_2(s),$$

where $U_1(s) = I$, $U_2(s) = \begin{bmatrix} s-1 & 1 \\ 1 & 0 \end{bmatrix}$, $\Lambda_u(s) = [1 \ 0]$, $\Lambda_s(s) = I_2$. Take

$$X(s) = \begin{bmatrix} e^{-(s+1)\vartheta} \\ 0 \end{bmatrix} \quad Y(s) = \frac{1 - e^{-(s+1)\vartheta}}{s+1},$$

such that $V(s)X(s) + D_m(s)Y(s) = I$, where $V(s) = U_1(s)\Lambda_u(s)$. Division (3.84) yields

$$Q(s) = \begin{bmatrix} e^{-(s+1)\vartheta} \\ 0 \end{bmatrix}, \quad P(s) = \begin{bmatrix} e^{-(s+1)\vartheta} \\ 0 \end{bmatrix}.$$

The pre-compensator is of the form

$$R(s) = \begin{bmatrix} 0 \\ e^{-(s+1)\vartheta} \end{bmatrix},$$

and the model matching error is

$$E(s) = 1 + \frac{1 - e^{-(s+1)\vartheta}}{s + 1}.$$

In the time domain the error is

$$e(t) = \begin{cases} \delta(t) + e^{-t}, & t \in [0, \vartheta] \\ 0, & \text{elsewhere} \end{cases}.$$

Simulation results of the model matching error in time are shown in Figure. 3.11, for three different values of ϑ . The error vanishes after a finite time.

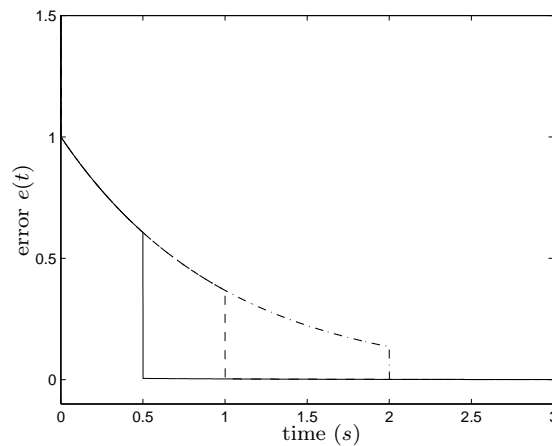

FIGURE 3.11: Model matching error for $\vartheta = 0.5$ (continuous), $\vartheta = 1$ (dashed), $\vartheta = 2$ (dashed-dot) (Example 3.7).

As the same with the stable inversion, we can not choose the coefficient $\vartheta = 0$, else we will lose the stability of the compensator or finite time convergence property of the model matching error.

Like the stable inversion, the results on model matching give generic solutions, and are concerned with the convolution kernel of the model matching error. The model matching error kernel is defined to have a finite time support. For any bounded input, the output error will be only bounded, but will not have any

particular property in the time domain. If the input vanishes asymptotically, then the output error will convergence asymptotically to zero. In practice, model matching is understood from an input-output point of view. For any bounded input, if the aim is to obtain a finite time error on the output, a model of this input can be included into the pant, in such a way that the previous problem can be applied.

3.3 DC-motor example

In this section let us see an application of model matching in DC-motor (Direct Current motor). The model is shown in Figure 3.12.

The dynamic equations of the circuit can be written

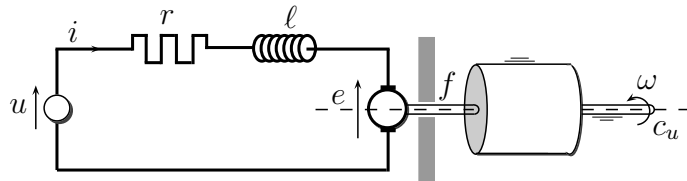

FIGURE 3.12: DC-motor

$$\left\{ \begin{array}{l} u = ri + \ell \frac{di}{dt} + e \\ J_c \ddot{\theta} = c_{em} - c_f - c_u \\ c_f = f \dot{\theta} = f \omega \\ c_{em} = k_{em} i \\ e = k_{em} \omega = k_{em} \dot{\theta}, \end{array} \right. \quad (3.91)$$

where u is the voltage of the source, J_c is the moment of inertia of load, c_u is the torque, c_f is the friction torque, f is the coefficient of friction, r is the resistance of the circuit and ℓ is the inductance of the circuit, k_{em} (constant) is the coefficient of the electromagnetic motor (which depends on the excitation flux), c_{em} is the torque of the motor, ω is the speed of rotation of the axle, θ is the angular position and i is the current flowing in the circuit (see Figure 3.12).

We can simplify the system by letting $\ell = 0$, and neglecting the torque of load ($c_u = 0$). From the equation (3.91), the system can be described by

$$J_c \ddot{\theta} = \frac{k_{em}}{r} u - \left(\frac{k_{em}^2}{r} - f \right) \omega. \quad (3.92)$$

So the transform function from u to v is

$$P(s) = \frac{\hat{\theta}(s)}{u(s)} = \frac{K}{s(1+sT)}, \quad (3.93)$$

where $K = \frac{k_{em}}{J_c r}$, $T = \frac{f}{J_c} + \frac{k_{em}^2}{r J_c}$. Our control objective is to track a unit step for the angular position. So the model of this matching problem is $T_m = \frac{1}{s}$. From Section 3.2 we have

$$N(s) = \frac{K}{T}, \quad N_u(s) = 1, \quad N_s(s) = \frac{K}{T},$$

$$D(s) = s^2 s \left(s + \frac{1}{T} \right), \quad N_m(s) = 1, \quad D_m(s) = s$$

Take

$$X(s) = 2k_1 \left(\vartheta_1 \frac{e^{-s\vartheta_1}}{s} - \frac{1 - e^{-s\vartheta_1}}{s^2} \right),$$

$$Y(s) = \frac{1 - e^{-s\vartheta}}{s} + k_1 \left(-\vartheta_1^2 \frac{e^{-s\vartheta_1}}{s} - 2\vartheta_1 \frac{e^{-s\vartheta_1}}{s^2} + 2 \frac{e^{1-e^{-s\vartheta_1}}}{s^3} \right),$$

where $k_1 = -\frac{1}{\vartheta_1^2}$, that satisfy $X(s)N_u(s) + Y(s)D_m(s) = 1$. The diversion (3.68) yields

$$Q(s) = 2k_1 \left(\vartheta_1 \frac{e^{-s\vartheta_1}}{s} - \frac{1 - e^{-s\vartheta_1}}{s^2} \right) \left[\frac{1 - e^{-s\vartheta_2}}{s} + k_2 \left(\vartheta_2 \frac{e^{-s\vartheta_2}}{s} - \frac{1 - e^{-s\vartheta_2}}{s^2} \right) \right] \quad (3.94)$$

where $k_2 = \frac{1}{\vartheta_2}$, and

$$P(s) = 2k_1 k_2 \left(\vartheta_1 \frac{e^{-s\vartheta_1}}{s} - \frac{1 - e^{-s\vartheta_1}}{s^2} \right) \frac{1 - e^{-s\vartheta_2}}{s}.$$

The precompensator can be obtained using (3.85),

$$C(s) = -\frac{2T}{\vartheta_1^2 \vartheta_2 K} \left(\vartheta_1 e^{-s\vartheta_1} - \frac{1 - e^{-s\vartheta_1}}{s} \right) \left(1 - e^{-s\vartheta_2} + \frac{1 - e^{-s\vartheta_2}}{Ts} \right),$$

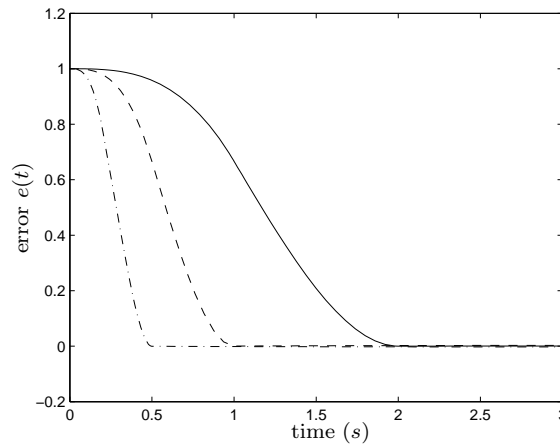

FIGURE 3.13: Trajectory planning error, for $\vartheta_1 = \vartheta_2 = 0.5$ (dashed), $\vartheta_1 = \vartheta_2 = 1$ (continuous), and $\vartheta_1 = 0.2$, $\vartheta_2 = 0.3$ (dashed-dot) (Example DC-motor).

while the tracking error is

$$\begin{aligned} \hat{e}(s) &= \frac{1 - e^{-s\vartheta_1}}{s} + k_1 \frac{d^2 \left(\frac{1 - e^{-s\vartheta_1}}{s^2} \right)}{ds} \\ &+ 2k_1 \left(\frac{1 - e^{-s\vartheta_2}}{s} \right) \frac{d \left(\frac{1 - e^{-s\vartheta_1}}{s} \right)}{ds} \\ &+ 2k_1 k_2 \left(\frac{d \left(\frac{1 - e^{-s\vartheta_1}}{s} \right)}{ds} \right) \left(\frac{d \left(\frac{1 - e^{-s\vartheta_2}}{s} \right)}{ds} \right). \end{aligned}$$

So the finite time equals $t_f = \vartheta_1 + \vartheta_2$. Simulation results of trajectory planning error are shown in Figure.3.13. Trajectory planning are shown in Figure.3.14, and the control of trajectory are shown in Figure.3.15

3.4 Robustness under parameter uncertainties

If the plant is exactly known and the controller is exactly implemented, then the results in section 3.1 and section 3.2 hold. But if any uncertainty occurs, what will happen? To address this robustness issue, we analyse the properties of the model matching error with respect to uncertainties.

We assume that the given plant $T(s)$ is always stable. That is to say, $T(s)$ is always stable (if $T(s)$ is not stable, the stabilization for the system should be done

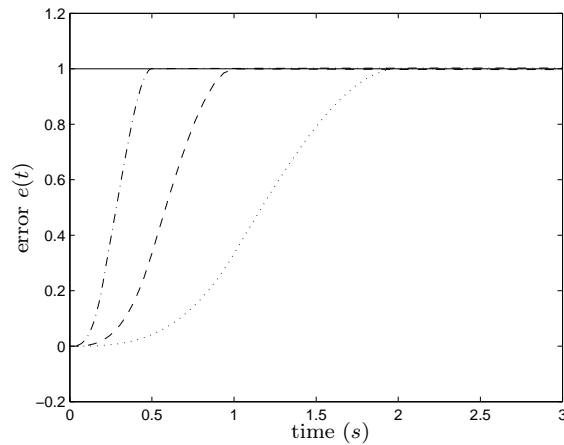

FIGURE 3.14: Trajectory planning, for model (continuous), $\vartheta_1 = \vartheta_2 = 0.5$ (dashed), $\vartheta_1 = \vartheta_2 = 1$ (dot), and $\vartheta_1 = 0.2, \vartheta_2 = 0.3$ (dashed-dot) (Example DC-motor).

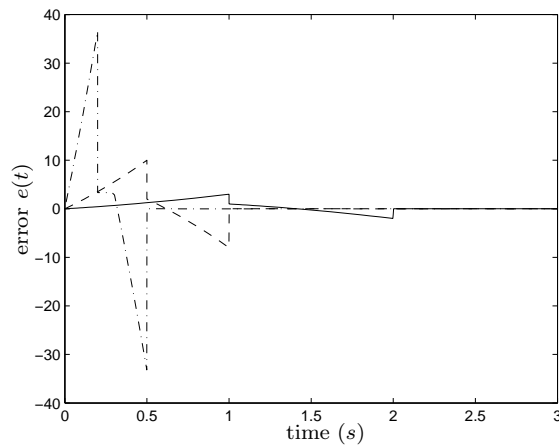

FIGURE 3.15: Trajectory planning control, for $\vartheta_1 = \vartheta_2 = 0.5$ (dashed), $\vartheta_1 = \vartheta_2 = 1$ (continuous), and $\vartheta_1 = 0.2, \vartheta_2 = 0.3$ (dashed-dot) (Example DC-motor).

first). It is also assumed that the model that we want to match is always stable ($T_m(s)$ is stable). If there is any uncertainty, the real system is defined as

$$T_{\Delta}(s) = [N(s) + \Delta N(s)] [d(s) + \Delta d(s)]^{-1}, \quad (3.95)$$

where the factorization $(N(s) + \Delta N(s), d(s) + \Delta d(s))$ of $T_{\Delta}(s)$ is $N(s) \in \mathbb{R}^{m \times n}[s]$, $\Delta N(s) \in \mathbb{R}^{m \times n}[s]$, $d(s) \in \mathbb{R}[s]$, $\Delta d(s) \in \mathbb{R}[s]$.

If $[d(s) + \Delta d(s)]^{-1}$ has no unstable pole, the plant $T_{\Delta}(s)$ is stable. We also do the synthesis of an open-loop controller $R(s)$ from the nominal plant, which is exactly known. The nominal system corresponds to $T(s) = N(s)d^{-1}(s)$. Since the model

matching pre-compensator $R(s)$ in (3.85) is certain and stable, the open-loop system $T(s)R(s)$ is stable.

We consider the uncertain system (3.95) with $(d(s) + \Delta d(s))^{-1}$ stable. For pre-compensator $R(s)$ in (3.85) the error of the model matching problem can be obtained using

$$E_{\Delta}(s) = E(s) + \delta_1(s)[T_m(s) - E(s)] + \delta_2(s)R(s), \quad (3.96)$$

where the $E(s) = T_m(s) - T(s)R(s)$ is the error without uncertain factor, $\delta_1(s) = \frac{\Delta d(s)}{d(s) + \Delta d(s)}$, $\delta_2(s) = \frac{\Delta N(s)}{d(s) + \Delta d(s)}$. Evidently, $E_{\Delta}(s)$ is not in the set $\hat{\mathcal{P}}^{m \times q}$, so the error $E_{\Delta}(s)$ is stable but has no finite time support. The error between $E_{\Delta}(s)$ and $E(s)$ is

$$\Delta E(s) = E_{\Delta}(s) - E(s) = \delta_1(s)[T_m(s) - E(s)] + \delta_2(s)R(s). \quad (3.97)$$

We can see that $\Delta E(s)$ is proper (or strictly proper) and stable. For any asymptotically vanishing input, the error $\Delta e(t)$ will asymptotically goes to zero. Evaluating the error $\Delta E(s)$ using $\hat{\mathcal{A}}$ norm, we have

$$\|\Delta E(s)\|_{\hat{\mathcal{A}}} \leq \|\delta_1(s)\|_{\hat{\mathcal{A}}} \| [T_m(s) - E(s)] \|_{\hat{\mathcal{A}}} + \|\delta_2(s)\|_{\hat{\mathcal{A}}} \|R(s)\|_{\hat{\mathcal{A}}}, \quad (3.98)$$

and

$$\|\Delta E(s)\|_{\hat{\mathcal{A}}} \geq \|\delta_2(s)R(s)\|_{\hat{\mathcal{A}}} - \|\delta_1(s)\|_{\hat{\mathcal{A}}} \| [T_m(s) - E(s)] \|_{\hat{\mathcal{A}}}. \quad (3.99)$$

Let $\| [T_m(s) - E(s)] \|_{\hat{\mathcal{A}}} = K_1$, $\|R(s)\|_{\hat{\mathcal{A}}} = K_2$ we have

$$\|\delta_2(s)R(s)\|_{\hat{\mathcal{A}}} - \|\delta_1(s)\|_{\hat{\mathcal{A}}} K_1 \leq \|\Delta E(s)\|_{\hat{\mathcal{A}}} \leq \|\delta_2(s)\|_{\hat{\mathcal{A}}} K_2 + \|\delta_1(s)\|_{\hat{\mathcal{A}}} K_1. \quad (3.100)$$

If the uncertainties on the plant are close to zero, that is to say $\|\delta_1(s)\|_{\hat{\mathcal{A}}}$ and $\|\delta_2(s)\|_{\hat{\mathcal{A}}}$ close to zero, we can deduce that $\Delta E(s)$ will be close to zero.

For the stable inversion problem, we can achieve the similar result, and the error $\Delta E(s)$ always asymptotically goes to zero.

Example 3.7 with uncertainty is used to simulate our uncertain system, as shown in Figure 3.16

$$\Delta T_i(s) = \begin{bmatrix} \frac{s-1}{s+1} & \frac{1 + \Delta N_i}{s+1 + \Delta d_i} \end{bmatrix}$$

where for $i = \{1, 2, 3\}$, $\Delta N_i = \{0.2, 0.2, 0\}$, $\Delta d_i = \{0.1, 0, 0.1\}$.

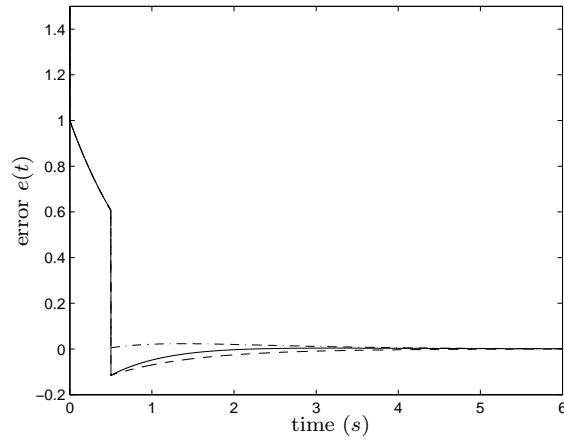

FIGURE 3.16: Model matching error with $\vartheta = 0.5$, for system $\Delta T_1(s)$ (continuous), $\Delta T_2(s)$ (dashed), $\Delta T_3(s)$ (dashed-dot) (Example 3.7 with uncertainty).

The simulation for the stable inversion using Example 3.4 is shown in Figure 3.17, where

$$\Delta T_i(s) = \begin{bmatrix} \frac{s-1}{s+1} \\ \frac{1+\Delta N_i}{s+1+\Delta d_i} \end{bmatrix}.$$

for $i = \{1, 2, 3\}$, $\Delta N_i = \{0.2, 0.2, 0\}$, $\Delta d_i = \{0.1, 0, 0.1\}$.

If parameter uncertainties are on compensator $R(s)$, we have similar properties.

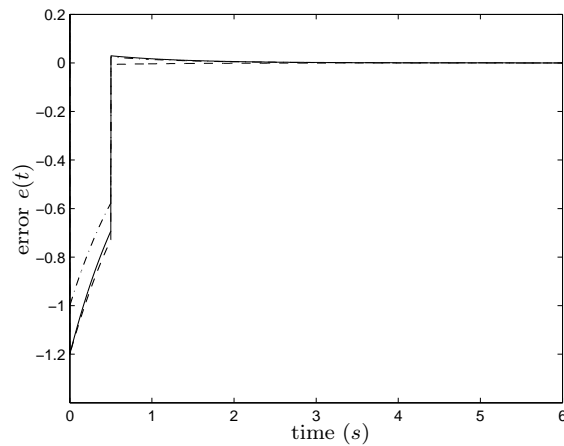

FIGURE 3.17: Stable inversion error for $\vartheta = 0.5$, system $\Delta T_1(s)$ (continuous), $\Delta T_2(s)$ (dashed), $\Delta T_3(s)$ (dashed-dot), (Example 3.4 with uncertainty)

If the uncertainties are on the coefficient ϑ (finite time of kernel of distributed

delay) of distributed delay, we only change the time convergence to zero. The distributed delay ensured that the response converge asymptotically to zero.

3.5 Realization of control architecture

In this section we will introduce the realization of the precompensator by using the feedback closed-loop control with internal stability (more detail of internal stability will be introduced in Chapter 4). First we introduce a realization of the rational fraction in \mathcal{P}_ε .

Definition 3.14. A fraction $T(s) = N(s)D^{-1}(s)$ (where $N(s) \in \mathbb{R}^{m \times n}[s, e^{-s}]$ and $D(s) \in \mathbb{R}^{n \times n}[s, e^{-s}]$) is realizable if there exist an integer m and matrices $A(e^{-s}) \in \hat{\mathcal{P}}_\varepsilon^{m \times m}$, $B(e^{-s}) \in \hat{\mathcal{P}}_\varepsilon^{m \times n}$, $C(e^{-s}) \in \hat{\mathcal{P}}_\varepsilon^{n \times m}$, $D(e^{-s}) \in \hat{\mathcal{P}}_\varepsilon^{m \times n}$ such that

$$C(e^{-s})(sI_n - A(e^{-s}))B(e^{-s}) + D(e^{-s}) = N(s)D^{-1}(s). \quad (3.101)$$

□

The system

$$\begin{cases} s\hat{x}(s) = A(e^{-s})\hat{x}(s) + B(e^{-s})\hat{u}(s) \\ \hat{y}(s) = C(e^{-s})\hat{x}(s) + D(e^{-s})\hat{u}(s) \end{cases} \quad (3.102)$$

is called a realization of $T(s)$, which, in turn, is termed the transfer of the system.

Writing

$$A(e^{-s}) = A_g(e^{-s}) + \sum_{i=0}^k A_i e^{-i\vartheta s}, \quad B(e^{-s}) = B_g(e^{-s}) + \sum_{i=0}^k B_i e^{-i\vartheta s},$$

$$C(e^{-s}) = C_g(e^{-s}) + \sum_{i=0}^k C_i e^{-i\vartheta s}, \quad D(e^{-s}) = D_g(e^{-s}) + \sum_{i=0}^k D_i e^{-i\vartheta s},$$

where $A_g(e^{-s}), B_g(e^{-s}), C_g(e^{-s}), D_g(e^{-s})$ are matrices over $\hat{\mathcal{G}}$, and A_i, B_i, C_i, D_i , $i = 0, \dots, k$ have real coefficients, and if $f_A(\tau), f_B(\tau), f_C(\tau), f_D(\tau)$ respectively denote the kernels of the distributed delays that have transfer $A_g(e^{-s}), B_g(e^{-s}),$

$C_g(e^{-s})$, $D_g(e^{-s})$, it appears that a system over $\hat{\mathcal{P}}_{\mathcal{E}}$ is actually a set of integro-differential equations of the forms

$$\begin{aligned}\dot{x}(t) &= \sum_{i=0}^k A_i x(t-i\vartheta) + \int_0^{k\vartheta} f_A(\tau) x(t-\tau) d\tau + \sum_{i=0}^k B_i u(t-i\vartheta) + \int_0^{k\vartheta} f_B(\tau) u(t-\tau) d\tau, \\ y(t) &= \sum_{i=0}^k C_i x(t-i\vartheta) + \int_0^{k\vartheta} f_C(\tau) x(t-\tau) d\tau + \sum_{i=0}^k D_i u(t-i\vartheta) + \int_0^{k\vartheta} f_D(\tau) u(t-\tau) d\tau.\end{aligned}$$

These equations have a unique solution provided that the initial conditions are well-chosen and the input $u(t)$ is known [100, Hale (1977)]. If the system $T(s) \in \mathbb{R}(s)$, the coefficients A, B, C, D of state-space representation are constant.

Theorem 3.15 (Loiseau and Brethé (1997) [28]). *A fraction $N(s)D^{-1}(s)$ of elements of \mathcal{E} is realizable if and only if it is proper.*

We consider the following general control law

$$\hat{u}(s) = H(s)\hat{u}(s) + F(s)\hat{x}(s) + G(s)\hat{v}(s) \quad (3.103)$$

where v is some external input, that can be a reference signal, a measured disturbance etc.... Assuming that $H(s)$ lies in $\hat{\mathcal{G}}^{n \times n}$, and that $F(s) \in \hat{\mathcal{P}}_{\mathcal{E}}^{n \times m}$, $G(s) \in \hat{\mathcal{P}}_{\mathcal{E}}^{n \times q}$ are proper matrices ensures that such a control law can be realized, (3.103) is a Volterra type equation. This control law leads to the closed-loop system (since the considering plant $T(s) \in \mathbb{R}^{m \times n}(s)$, the coefficients A, B, C, D of state-space representation are constant)

$$\begin{aligned}x(s) &= [sI_n - A - B(I_n - H(s))^{-1}F(s)]^{-1}B(I_n - H(s))^{-1}G(s)v(s) \\ &= (sI_n - A)^{-1}B[I_n - H(s) - F(s)(sI_m - A)^{-1}B]^{-1}G(s)v(s)\end{aligned}$$

It is therefore equivalent, from the input-output point of view, to the action of a precompensator

$$R(s) = [I_n - H(s) - F(s)(sI_m - A)^{-1}B]^{-1}G(s). \quad (3.104)$$

conversely, a precompensator $R(s)$ being given, it is of interest to test whether or not there exist matrices $F(s) \in \hat{\mathcal{P}}_{\mathcal{E}}^{n \times m}$, $G(s) \in \hat{\mathcal{P}}_{\mathcal{E}}^{n \times q}$ and $H(s) \in \hat{\mathcal{G}}^{n \times n}$, such that (3.104) holds. We shall then say that $F(s), G(s)$ and $H(s)$ define a state feedback realization of $R(s) \in \hat{\mathcal{P}}_{\mathcal{E}}^{n \times q}$.

Now we introduce more detail of the stable realization of precompensator which also give the procedure to find the state feedback realization. Writing

$$D^{-1}(s)R(s) = Q^{-1}(s)P(s), \quad (3.105)$$

where $D(s) \in \mathbb{R}^{n \times n}[s]$, $Q(s) \in \mathbb{R}^{n \times n}[s]$, $P(s) \in \hat{\mathcal{P}}_{\mathcal{E}}^{n \times q}$ and

$$N(s)D^{-1}(s) = (sI_m - A)^{-1}B, \quad N(s) \in \mathbb{R}^{m \times n}[s], \quad (3.106)$$

it appears that there exists a matrix $M(s) \in \hat{\mathcal{E}}^{n \times n}$, such that

$$M(s)P(s) = G(s) \in \hat{\mathcal{P}}_{\mathcal{E}}^{n \times q}, \quad (3.107)$$

$$M(s)Q(s) = (I_n - H(s))D(s) - F(s)N(s), \quad (3.108)$$

where $H(s) \in \hat{\mathcal{G}}^{n \times n}$, $F(s) \in \hat{\mathcal{P}}_{\mathcal{E}}^{n \times m}$. Hence, the product $M(s)Q(s)$ is column reduced, with the same column degrees and highest degree coefficient submatrix as $D(s)$.

Reversely, if there exists a matrix $M(s) \in \hat{\mathcal{E}}^{n \times n}$ such that the product $M(s)Q(s)$ is column reduced, with the same column degree and highest degree coefficient submatrix as $D(s)$, then there exist matrices $F(s) \in \hat{\mathcal{P}}_{\mathcal{E}}^{n \times m}$ and $H(s) \in \hat{\mathcal{G}}^{n \times n}$ such that (3.108) holds. Defining now $G(s)$ by (3.107), one can see that (3.104) holds, and check that

$$M(s)P(s) = [I_m - H(s) - F(s)N(s)D^{-1}(s)]R(s),$$

hence $G(s) \in \hat{\mathcal{E}}^{n \times q}$ that is proper, *i.e.* a matrix over $\hat{\mathcal{P}}_{\mathcal{E}}^{n \times q}$, if $C(s)$ is proper, and $F(s), G(s)$ and $H(s)$ define a state feedback realization of $R(s)$.

It should be clear from the developments above that $R(s)$ is realizable by static state feedback if and only if the matrix $M(s)Q(s)$ is column reduced, with the same column degrees and highest degree coefficient submatrix as $D(s)$. In addition, the closed-loop system is internally stable if and only if the matrix

$$\begin{bmatrix} sI_n - A & -B \\ F(s) & I_n - H(s) \end{bmatrix}$$

is stable, *i.e.*, the product $M(s)Q(s)$ is stable, and the pair (A, B) is stabilizable. The conclusion follows from the following technical result.

Lemma 3.16 (Loiseau and Brethé (1997) [28]). *There exists a matrix $M(s)$ such that the product $M(s)Q(s)$ is stable and column reduced, with the same column degrees and highest degree coefficient submatrix as $D(s)$ if and only if $Q(s)$ is stable.*

Theorem 3.17 (Loiseau and Brethé (1997) [28]). *Every proper compensator $R(s)$ is realizable by a feedback (3.103). In addition, it is realizable with internal stability if and only if the system is stabilizable and the denominator $Q(s)$ defined by (3.105) and (3.106) has no unstable zero.*

Example 3.8. *We consider the feedback realization of example 3.7. The plant $T(s)$ can be described by state-space representation*

$$\begin{cases} \dot{x} &= Ax + Bu \\ y &= Cx + Du \end{cases},$$

where $A = \begin{bmatrix} -1 & 0 \\ 0 & -1 \end{bmatrix}$, $B = \begin{bmatrix} -1 & 0 \\ 0 & -1 \end{bmatrix}$, $C = [-2 \ 1]$, $D = [1 \ 0]$, and pre-compensator $R(s) = \begin{bmatrix} 0 \\ e^{-(s+1)\vartheta} \end{bmatrix}$. From Equation (3.106) we can obtain $D(s) = \begin{bmatrix} s+1 & 0 \\ 0 & s+1 \end{bmatrix}$, $N(s) = I$, $Q(s) = D(s)$, $P(s) = R(s)$. So from Equations (3.107), (3.108), we can obtain

$$G(s) = \begin{bmatrix} 0 \\ e^{-(s+1)\vartheta} \end{bmatrix} \in \hat{\mathcal{P}}_{\mathcal{E}}, \quad H(s) = \begin{bmatrix} \frac{1-e^{-(s+1)\beta_1}}{s+1} & 0 \\ 0 & \frac{1-e^{-(s+1)\beta_2}}{s+1} \end{bmatrix} \in \hat{\mathcal{E}},$$

$$F(s) = - \begin{bmatrix} 1 - e^{-(s+1)\beta_1} & 0 \\ 0 & 1 - e^{-(s+1)\beta_2} \end{bmatrix} \in \hat{\mathcal{P}}_{\mathcal{E}},$$

So the feedback realization is

$$\hat{u}(s) = H(s)\hat{u}(s) + F(s)\hat{x}(s) + G(s)\hat{v}(s).$$

The simulation results are reported in Figure 3.11 (Example 3.7).

3.6 Conclusion

The contribution of this chapter include the definition and solution of approximation problem on inversion and model matching for linear systems, for which the inversion error and model matching error are required to be found over a finite time support. These give us a stable and proper solution to realize practical inversion and model matching. Solutions are causal and are easily simulated. Besides, the robustness analysis has been made on the system with uncertainty. State-space feedback realization was also introduced.

Chapter 4

Stabilization and Observation Control

In this chapter, we will address the stabilization of time-delay systems (TDS), Finite Spectrum Assignment (FSA) for fractional systems, and the design of observers for linear time-invariant systems by using distributed delays.

Time-delay systems are also called systems with aftereffect or dead-time, hereditary systems, equations with deviating argument or differential difference equations. They belong to the class of functional differential equations which are infinite dimensional, as opposed to ordinary differential equations. Many literatures are devoted to analysis of time-delay systems, such as [31, Hale and Verduyn Lunel (1993)], [32, Conte and Perdon (2000)], [33, Kharitonov (2000)], [34, Niculescu (2001)], [35, Kolmanovskii et al. (1999)], [36, Loiseau (1998)], [28, Loiseau and Brethé (1997)], [37, Richard (1998)], [38, Richard (2003)] and [39, Watanabe et al. (1996)] [101, Di Loreto et al. (2010)]. Here we focus on the stabilization control of time-delay systems with the following form

$$\dot{x}(t) = \sum_{i=1}^k E_i \dot{x}(t - i\vartheta) + \sum_{i=0}^k A_i x(t - i\vartheta) + \sum_{i=0}^k B_i u(t - i\vartheta), \quad (4.1)$$

where A_i, B_i, E_i over \mathbb{R} . If $E_i = 0$, (4.1) is called a retarded time-delay system. If $E_i \neq 0$, the system (4.1) is called a neutral time-delay system. We will introduce the factorization approach for the stabilizing control which was proposed in [40, Vidyasagar (1985)]. We will also introduce the modified Smith predictor control scheme for time-delay systems. Generally, distributed delay will appear in the

stabilization control of time-delay systems. So we will analyze stability conditions with approximation of distributed delays.

Further analysis will be done for Finite Spectrum Assignment (FSA) for a class of infinite dimensional systems. FSA is a static feedback control such that n eigenvalues of the corresponding closed-loop system are located at an arbitrarily preassigned set of points in the complex plane while the others are automatically eliminated. For many different control problems concerning infinite dimensional systems, such as optimal control and trajectory planning, FSA seems to be an effective method. This method was first developed by [41, Manitius and Olbrot (1979)]. Further developments of this method include the works of [42, Watanabe (1986)], [1, Olbrot (1978)], [43, Brethé and Loiseau (1998)]. We will recall some basic facts about FSA for time-delay systems. An extension for a particular class of fractional systems of the form $T(s) = N(s)D^{-1}(s)$ will be done. This type of systems can be easily found in distribution systems, for instance, the model of heat conduction [102, Necati Ozisik (1980)], or in wave propagation. Necessary and sufficient conditions for the FSA will be given, and an algorithm for the design of FSA compensator is described.

The last part of this chapter addresses the design of observers for linear systems. The open-loop observer will be recalled [8, Pourboughrat and Chyung (1984)] [7, Medvedev and Toivonen (1994)] and a new class of closed-loop observers will be introduced.

4.1 Stabilization and control of time-delay systems

First we will introduce the internal stabilization using a factorization approach. Usually, there is a distributed delay in the controller.

4.1.1 Internal stabilization

Consider the feedback system shown in Figure 4.1, where $P \in \mathbb{R}^{m \times n}(s, e^{-s})$ represents the plant and $C \in \mathbb{R}^{n \times q}(s, e^{-s})$ the compensator. u_1, u_2 denote the externally applied inputs, e_1, e_2 denote the inputs of the compensator and plant respectively, and y_1, y_2 denote the outputs of the compensator and plant respectively. The

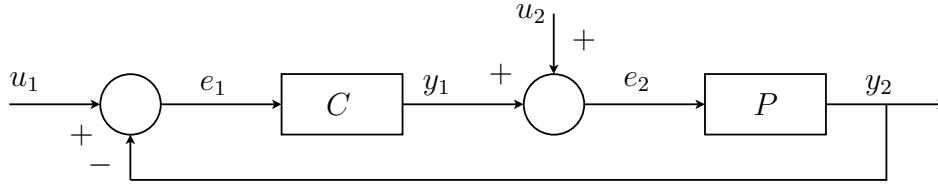

FIGURE 4.1: Feedback System.

closed-loop system can be described by

$$\begin{bmatrix} y_1 \\ y_2 \end{bmatrix} = H(P, C) \begin{bmatrix} u_1 \\ u_2 \end{bmatrix}, \quad H(P, C) = \begin{bmatrix} C[I + PC]^{-1} & -C[I + PC]^{-1}P \\ [I + PC]^{-1}PC & [I + PC]^{-1}P \end{bmatrix}, \quad (4.2)$$

or

$$\begin{bmatrix} e_1 \\ e_2 \end{bmatrix} = H_e(P, C) \begin{bmatrix} u_1 \\ u_2 \end{bmatrix}, \quad H_e(P, C) = \begin{bmatrix} [I + PC]^{-1} & -[I + PC]^{-1}P \\ C[I + PC]^{-1} & I - C[I + PC]^{-1}P \end{bmatrix}. \quad (4.3)$$

The system (4.2) is equivalent to system (4.3) in the sense of stability. It is stable if the transfer matrix $H(P, C)$ lies in \mathcal{A} . That is to say, if the system (4.2) is stable, all elements in matrix $H(P, C)$ are proper and stable. More generally, we give the following definition for proper and stable fraction.

Definition 4.1. The set of proper and stable fractions over \mathcal{E} , denoted by \mathcal{P} , is

$$\mathcal{P} = \left\{ \frac{n}{d} : n \in \mathcal{E}, d \in \mathcal{U}, \deg_s n \leq \deg_s d \right\}$$

where \mathcal{U} is the set of pseudo-polynomials which are monic in the variable s , and all the zeros lie in the left half-plane.

So if the system (4.2) is stable, $H(P, C) \in \mathcal{P}^{m \times q}$.

In the stabilization problem, we determine a control law of a given plant, such that the closed-loop system is stable. For this, we consider a distribution P with a left (or right) coprime factorization (N, D) proper and stable, and define the closed-loop system described in Figure 4.1, with a compensator C defined over $\mathcal{P}^{m \times q}$. We say that C stabilizes P , or the pair (P, C) is stable, if the matrix $H(P, C)$ is a fraction proper and stable. All internal signals in the closed-loop are bounded for any bounded exogenous inputs u_1 and u_2 . Before we introduce the stabilization condition of system (4.1), let us first consider the following definition.

Definition 4.2 (Vidyasagar (1985) [40]). Suppose P, C are proper and stable fractions. Let $(N, D), (\tilde{N}, \tilde{D})$ be any r.c.f. (right coprime factorization) proper and stable and any l.c.f. (left coprime factorization) proper and stable, and let $(N_c, D_c), (\tilde{N}_c, \tilde{D}_c)$ be any r.c.f. and l.c.f. of C proper and stable. Under these conditions, define

$$\Delta(P, C) = \tilde{N}_c N + \tilde{D}_c D, \quad \tilde{\Delta}(P, C) = \tilde{N} N_c + \tilde{D} D_c. \quad (4.4)$$

Then both $\det[\Delta(P, C)]$ and $\det[\tilde{\Delta}(P, C)]$ are characteristic determinants of $H(P, C)$

From the Definition 4.2 we can give the necessary and sufficient condition for (P, C) to be stable.

Theorem 4.3 (Di Loreto (2006) [103], Brethé (1997) [74], Vidyasagar (1985) [40]). *Let all symbols be as in Definition 4.2 The following are equivalent:*

- *The pair (P, C) is stable.*
- *The matrix $\tilde{N}_c N + \tilde{D}_c D$ is unimodular over \mathcal{P} .*
- *The matrix $\tilde{N} N_c + \tilde{D} D_c$ is unimodular over \mathcal{P} .*

The following corollary can be easily deduced from Theorem 4.3.

Corollary 4.4 (Di Loreto (2006) [103], Brethé (1997) [74], Vidyasagar (1985) [40]). *Suppose (N, D) and (\tilde{N}, \tilde{D}) be any r.c.f. over \mathcal{P} and any l.c.f. over \mathcal{P} of P . Then the following are equivalent:*

- *C stabilizes P*
- *C has an l.c.f. proper and stable $(\tilde{N}_c, \tilde{D}_c)$ such that $\tilde{N}_c N + \tilde{D}_c D = I$.*
- *C has an r.c.f. proper and stable (N_c, D_c) such that $\tilde{N} N_c + \tilde{D} D_c = I$.*

For the stabilization, we have the following theorem.

Theorem 4.5 (Loiseau and Brethé (1997) [28]). *All the transfer matrices $T(s, e^{-s}) \in \mathbb{R}^{m \times n}(s, e^{-s})$, with monic denominator, admit a right coprime factorization ND^{-1} proper and stable. And there exist XY^{-1} over \mathcal{P} such that*

$$XN + YD = I.$$

We can deduce the set of the stabilizing compensator. See the following theorem

Theorem 4.6 (Di Loreto (2006) [103], Brethé (1997) [74], Vidyasagar (1985) [40]). *Let (N, D) , (\tilde{N}, \tilde{D}) be any r.c.f. and l.c.f. proper and stable of P . Select matrix $X, Y, \tilde{X}, \tilde{Y}$ proper and stable such that $XN + YD = I$, $\tilde{N}\tilde{X} + \tilde{D}\tilde{Y} = I$. Then*

$$\begin{aligned} C_p &= \left\{ (Y - R\tilde{N})^{-1}(X + R\tilde{D}) : R \text{ is a matrix over } \mathcal{P}, |Y - R\tilde{N}| \neq 0 \right\} \\ &= \left\{ (\tilde{X} + DS)(\tilde{Y} - NS)^{-1} : S \text{ is a matrix over } \mathcal{P}, |\tilde{Y} - NS| \neq 0 \right\} \end{aligned} \quad (4.5)$$

The set C_p is the set of compensators that stabilize the plant P .

Example 4.1. *Consider the following system*

$$\dot{x}(t) = x(t-1) + u(t-1).$$

The transfer function from x to u is

$$\hat{p}(s) = \frac{\hat{x}(s)}{\hat{u}(s)} = \frac{e^{-s}}{s - e^{-s}}.$$

A coprime factorization of $\hat{p}(s)$ is $\hat{n}(s) = \frac{e^{-s}}{s+1}$, $\hat{d}(s) = \frac{s-e^{-s}}{s+1}$. Since there exists

$$\hat{n}_c(s) = \frac{3 + e^{-s} + \frac{1-e^{-s}}{s}}{s+1}, \quad \hat{d}_c(s) = \frac{s + e^{-s} + 2 + \frac{1-e^{-s}}{s}}{s+1},$$

such that

$$\hat{n}(s)\hat{n}_c(s) + \hat{d}(s)\hat{d}_c(s) = 1,$$

a stabilizing compensator is

$$\hat{c}(s) = \frac{3 + e^{-s} + \frac{1-e^{-s}}{s}}{s + e^{-s} + 2 + \frac{1-e^{-s}}{s}}.$$

And the transfer function of the closed-loop system is

$$G(s) = \frac{e^{-s}(3 + e^s + \frac{1-e^{-s}}{s+1})}{(s+1)^2}.$$

Let us analyze the properties of the stabilization compensator with approximation. Consider the following general time-delay system

$$\dot{x}(t) = \sum_{i=0}^k A_i x(t - h_i) + \sum_{i=0}^k B_i u(t - h_i), \quad h_i \geq 0. \quad (4.6)$$

For the system (4.6), there is no difficulty to find a stabilizing compensator using Theorem 4.3 and Corollary 4.4. Let us see the following example.

Example 4.2. Consider the plant $\hat{y}(s) = \hat{p}(s)\hat{u}(s)$, where

$$\hat{p}(s) = \frac{e^{-s}}{s-1}. \quad (4.7)$$

A proper and stable coprime factorization can be written as $\hat{n} = \frac{e^{-s}}{s+1}$, $\hat{d} = \frac{s-1}{s+1}$, since

$$\hat{n}(s) 2e^1 + \hat{d}(s) \left(1 + 2\hat{\theta}_1(s)\right) = 1. \quad (4.8)$$

where $\hat{\theta}_1(s) = \frac{1-e^{(s-1)\vartheta}}{s-1}$. Hence, a stabilizing compensator for (4.7) is

$$\hat{c}(s) = \frac{2e^1}{1 + 2\hat{\theta}_1(s)}.$$

In the time domain, the control is equivalent to

$$u(t) = -2(\theta_1 * u)(t) + 2e^1 y(t). \quad (4.9)$$

The transfer function of the closed-loop system is

$$G(s) = 2e^1 \frac{e^{-s}}{s+1}. \quad (4.10)$$

In general, a coprime factorization (N_c, D_c) over \mathcal{P} of a stabilizing compensator for P , includes some distributed delays, as shown in the Example 4.2. Approximating such a compensator as described in Chapter 2 yields the approximated controller C_{app} with factorization $(N_{c,\text{app}}, D_{c,\text{app}})$, where $N_{c,\text{app}} \in \mathcal{B}(n_c, \varepsilon_n)$, and $D_{c,\text{app}} \in \mathcal{B}(d_c, \varepsilon_d)$, for some given ε_n and ε_d . Applying this approximation in the control, we would know the conditions on C_{app} , such that the pair (P, C_{app}) is stable. The positive answer comes from a direct application of the small gain theorem for BIBO-stability.

Lemma 4.7. *The pair (P, C_{app}) is stable if*

$$\max(\varepsilon_n, \varepsilon_d) < \left\| \begin{pmatrix} N & D \end{pmatrix} \right\|_{\mathcal{A}}^{-1}. \quad (4.11)$$

Proof. Let (N_c, D_c) be a coprime factorization over \mathcal{P} of a stabilizing controller. Since $\mathcal{P} \subset \mathcal{A}$, from Theorem 4.3, we have

$$N * N_c + D * D_c = \delta, \quad (4.12)$$

where δ is a unit in \mathcal{A} . The approximated controller C_{app} with factorization $(N_{c,\text{app}}, D_{c,\text{app}})$ yields, in closed-loop, to the return equation

$$N * N_{c,\text{app}} + D * D_{c,\text{app}} = \delta - \begin{pmatrix} N & D \end{pmatrix} * \begin{pmatrix} N_c - N_{c,\text{app}} \\ D_c - D_{c,\text{app}} \end{pmatrix}. \quad (4.13)$$

The approximated controller will stabilize the plant P if and only if the right hand side in (4.13) is a unit over \mathcal{A} . Since \mathcal{A} is a Banach algebra, a sufficient condition is

$$\left\| \begin{pmatrix} N & D \end{pmatrix} * \begin{pmatrix} N_c - N_{c,\text{app}} \\ D_c - D_{c,\text{app}} \end{pmatrix} \right\|_{\mathcal{A}} < 1. \quad (4.14)$$

Via approximations, $N_{c,\text{app}} \in \mathcal{B}(N_c, \varepsilon_n)$ and $D_{c,\text{app}} \in \mathcal{B}(D_c, \varepsilon_d)$, so that the above inequality yields the sufficient condition

$$\left\| \begin{pmatrix} N & D \end{pmatrix} \right\|_{\mathcal{A}} \max(\varepsilon_n, \varepsilon_d) < 1. \quad (4.15)$$

□

Actually it is always possible to determine an approximation C_{app} such that (P, C_{app}) is stable. The counterpart will be in the order of approximation, that will increase when the required accuracy vanishes. Small gain theorem, which is still valid over any Banach algebra, gives us a sufficient condition on the approximation accuracy to guarantee robust stability. This condition helps us determine the order of the approximation. Note that from [105, Dahleh and Otha (1988)] where the conservativeness of the small gain theorem for BIBO-stability was studied, a converse statement for Lemma 4.7 holds, in line the \mathcal{H}_∞ case. This highlights the weak conservation of such a condition for robust stabilization. For this we can also refer [65, Partington and Mäkilä (1994)], [106, Partington and Bonnet (1994)], [107, Bonnet and Partington (2007)].

Hence, in the Example 4.2, follows from Lemma 4.7, a sufficient condition for robust stability with approximation of θ_1 is that $\varepsilon_d \leq \frac{1}{3}$. From Figure 2.10, we see that a first order may be sufficient for stability purpose. In practice, a sufficient accuracy is obtained for a 3th order approximation and 5th order approximation over $\mathcal{K}_s(\mathbb{I}_{0,1})$, as can be seen in Figure 4.2, where step responses in closed-loop are plotted.

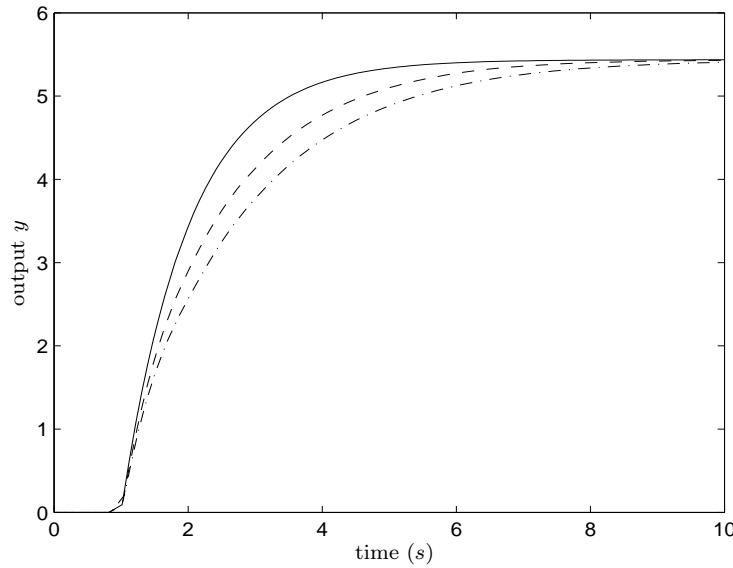

FIGURE 4.2: Step responses for the desired closed-loop (continuous line) and for the closed-loop system with approximation of distributed delay with 5th order (dash) and 3th order (dot-dash) (Example 4.2).

Similarly, in Example 4.1 we can calculate the sufficient condition for robust stability with approximation, which is $\max\{\varepsilon_n, \varepsilon_d\} < \frac{1}{2}$. For the approximation of the distributed delay $\frac{1-e^{-s}}{s}$, the sufficient condition for the degree is $n \geq 2$. In practice, for a sufficient accuracy we choose 2th-order and 5th-order approximation over $\mathcal{K}_s(\mathbb{I}_{0,1})$, as shown in Figure 4.3.

4.1.2 Neutral time-delay systems

The neutral time-delay system with commensurate pointwise delays has the following form:

$$\dot{x}(t) = \sum_{i=1}^k E_i \dot{x}(t - i\vartheta) + \sum_{i=0}^k A_i x(t - i\vartheta) + \sum_{i=0}^k B_i u(t - i\vartheta) \quad (4.16)$$

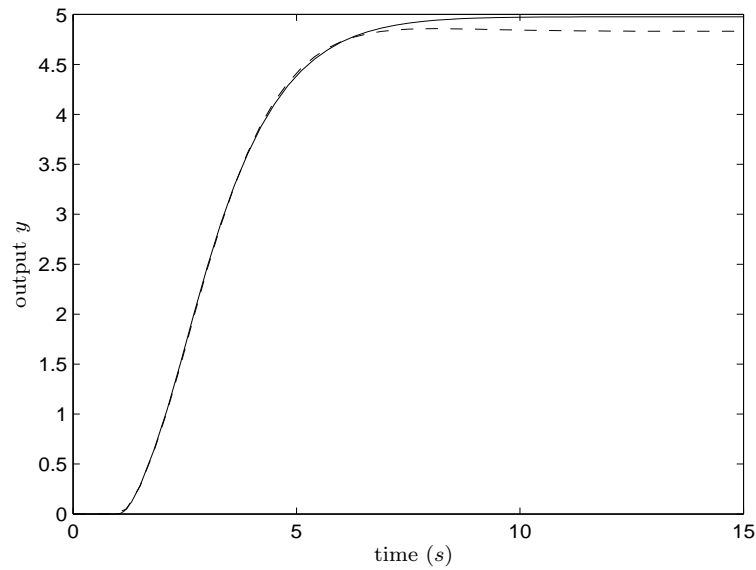

FIGURE 4.3: Step responses for the desired closed-loop with approximation of distributed delay with 5th order (continuous line) and 2th order (dash) (Example 4.1).

where $x(t) \in \mathbb{R}^n$ is the instantaneous state, $u(t) \in \mathbb{R}^m$ is the control input. The matrices A_i, B_i, E_i are real with adequate dimensions, and $E_i \neq 0$. All delays are commensurable to $\vartheta > 0$. This type of system arises in the boundary control of certain hyperbolic partial differential equations, such as in the study of lumped parameter networks or circuits interconnected by transmission line [108, Brayton (1968)] [109, Youla (1968)] [110, Hale (1972)], and in control problem for retarded delay system [111, Byrnes et al. (1984)].

The neutral time-delay system is a recurrent topic of control research, and many stabilization analysis were presented in the literature. Earlier works include [112, Bellman and Cooke (1963)], where various approaches were given. In [113, Pandolfi (1976)] [111, Byrnes et al. (1984)] [114, Emre and Knowles (1984)], a sufficient condition is established for the stabilization by an algebraic approach. In [115, O'Connor and Tarn (1983)], the authors introduce a functional approach to the stabilization problem.

To analyze the stability of neutral type time-delay systems, let us recall some basic facts. According to [111, Byrnes et al. (1984)], the system (4.16) is said to be formally stable, if

$$\text{Rank}(I - \hat{E}(e^{-\vartheta s})) = n, \quad \forall s \in \mathbb{C}, \text{Re}(s) \geq 0, \quad (4.17)$$

where

$$\hat{E}(e^{-\vartheta s}) = \sum_{i=1}^k E_i e^{-i\vartheta s}.$$

The open-loop characteristic equation associated with (4.16) is defined by

$$\Delta(s, e^{-\vartheta s}) = \det \left[s \left(I - \hat{E}(e^{-\vartheta s}) \right) - \hat{A}(e^{-\vartheta s}) \right] = 0, \quad (4.18)$$

where

$$\hat{A}(e^{-\vartheta s}) = \sum_{i=1}^k A_i e^{-i\vartheta s}.$$

Developing the determinant in (4.18), $\Delta(s, e^{-\vartheta s})$ is of the general form

$$\Delta(s, e^{-\vartheta s}) = \sum_{i=0}^q \sum_{k=0}^r \Delta_{ik} s^i e^{-k\vartheta s}, \quad (4.19)$$

with $\Delta_{ik} \in \mathbb{R}$, for $i = 0, \dots, q$ and $k = 0, \dots, r$, for some integers $q, r \in \mathbb{N}$. In fact, $\Delta(s, e^{-\vartheta s})$ is quasi-polynomials. From (4.18) we know that, in general, the neutral type time-delay system has an infinite number of roots.

Definition 4.8 (Pontryagin (1955)[73]). The system (4.16) is said to be stable if there exists $\delta < 0$, such that

$$\Delta(s, e^{-\vartheta s}) \neq 0, \quad \forall s \in \mathbb{C}, \operatorname{Re}(s) \geq \delta. \quad (4.20)$$

□

If the system (4.16) is formally stable, $\Delta(s, e^{-\vartheta s}) = 0$ has only a finite number of zeros in the closed right half complex plane [73, Pontryagin (1955)]. According to (4.17), the system (4.16) is formally stable if and only if the principal part of $\Delta(s, e^{-\vartheta s})$ is a stable polynomial in $e^{-\vartheta s}$.

In this section, we will mainly discuss the SISO case. The transfer function of system (4.16) from x to u is

$$T(s) = \frac{\hat{x}}{\hat{u}} = \frac{\hat{B}(e^{-\vartheta s})}{s(1 - \hat{E}(e^{-\vartheta s})) - \hat{A}(e^{-\vartheta s})}, \quad (4.21)$$

where $\hat{A}(e^{-\vartheta s}) = \sum_{i=0}^k A_i e^{-i\vartheta s}$, $\hat{B}(e^{-\vartheta s}) = \sum_{i=0}^k B_i e^{-i\vartheta s}$, $\hat{E}(e^{-\vartheta s}) = \sum_{i=1}^k E_i e^{-i\vartheta s}$ and $A_i, B_i, C_i \in \mathbb{R}$. From [116, Di Loreto et al. (2009)] we know that for strictly

proper and non-formally stable neutral systems, there does not exist, in general, a proper and stable coprime factorization. For instance, there does not exist a coprime factorization of $T(s) = \frac{1}{s(1-e^{-s})}$ over \mathcal{P} .

As a particular case, we have the following stabilization theorem.

Theorem 4.9. *Any formally stable SISO neutral time-delay system admits a proper and stable stabilization compensator.*

Proof. From Theorem 1 in [116, Di Loreto et al. (2009)] and its proof we know that any formally stable neutral time-delay system admits a coprime factorization (n, d) over \mathcal{P} and n_c, d_c over \mathcal{P} , such that $\hat{n}\hat{n}_c + \hat{d}\hat{d}_c = 1$. With Corollary 4.4 we can obtain the result. \square

Example 4.3. *Consider the system*

$$T(s) = \frac{e^{-s}}{s(1 - \frac{1}{2}e^{-s})}.$$

Factorize $T(s)$ as $\hat{n}(s) = \frac{e^{-s}}{s+1}$, $\hat{d}(s) = \frac{s(1-\frac{1}{2}e^{-s})}{s+1}$. There exists $\hat{x}(s) = 1$, $\hat{y}(s) = \frac{1}{1-\frac{1}{2}e^{-s}}(\frac{1-e^{-s}}{s} + 1)$ such that $\hat{x}(s)\hat{n}(s) + \hat{y}(s)\hat{d}(s) = 1$. So a stabilizing compensator is

$$\hat{c}(s) = \frac{1 - \frac{1}{2}e^{-s}}{(1 + \frac{1-e^{-s}}{s})},$$

and the closed-loop transfer function of the system is $G(s) = \frac{e^{-s}}{(s+1)}$. The simulation of the step response of the system is shown in Figure 4.4.

Example 4.4. *Consider the system*

$$T(s) = \frac{2e^{-s}}{1 + e^{-2s}}.$$

The poles of the system are $\lambda_k = j\frac{(2k+1)\pi}{2}$, with $k \in \mathbb{Z}$. A coprime factorization of $T(s)$, is $N(s) = e^{-s}$, $D(s) = 1 + e^{-2s}$. There exists $X(s) = -\frac{1}{2}e^{-s}$, $Y(s) = 1$ such that $X(s)N(s) + Y(s)D(s) = 1$. The compensator

$$C(s) = -\frac{1}{2}e^{-s}$$

stabilizes $T(s)$. The closed-loop transfer function of the system is $G(s) = -e^{-2s}$. The simulation of the step response of the system is shown in Figure 4.5.

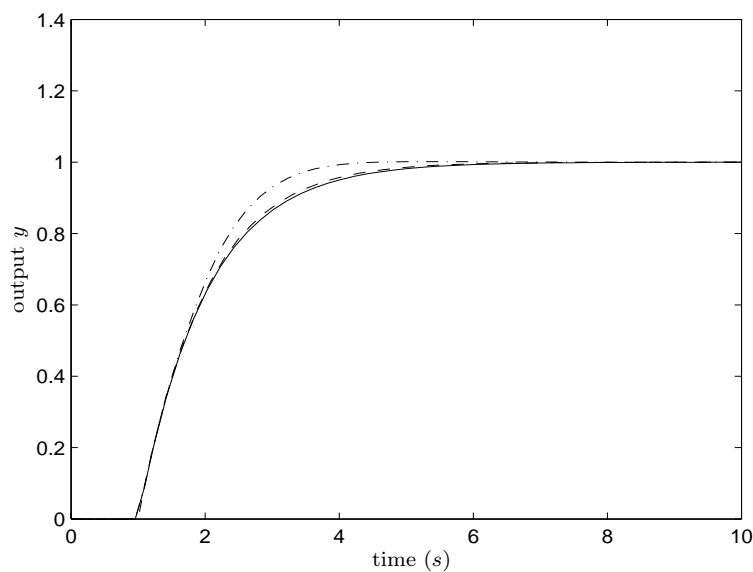

FIGURE 4.4: Step responses for the desired closed-loop (continuous line) and for the closed-loop system with approximation of distributed delay with 5th order (dash) and 2nd order (dot-dash), (Example 4.3).

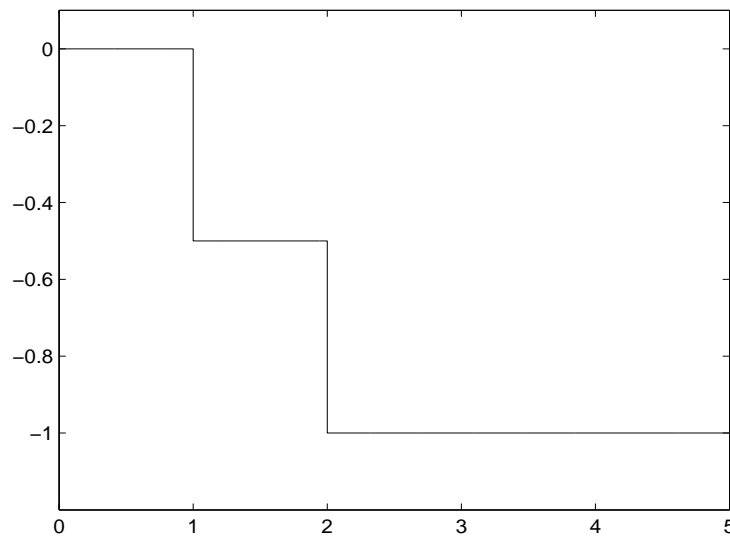

FIGURE 4.5: Step responses for the closed-loop system with initial condition $y(0) = 1$, (Example 4.4).

For the extension, let us consider the FSA problem for the SISO time-delay systems. Consider now the control law

$$\hat{u}(s) = \hat{F}_1(s)\hat{u}(s) + \hat{F}_2(s)\hat{x}(s),$$

where $\hat{F}_1 \in \mathbb{R}(s, e^{-s})$ with $\deg_s \hat{F}_1(s) < 1$ and without a constant term, and $\hat{F}_2 \in \mathbb{R}(s, e^{-s})$ with $\deg_s \hat{F}_2(s) < 1$. In other way $\hat{F}_1(s)$, $\hat{F}_2(s)$ should be proper and stable and \hat{F}_1 without a constant term.

Now we are ready to give the definition of the finite spectrum assignability in terms of the characteristic polynomial of the closed-loop system.

Definition 4.10. The system (4.16) is said to be finite spectrum assignable if there exist $\hat{F}_1 \in \mathbb{R}(s, e^{-s})$ with $\deg_s \hat{F}_1(s) < 1$ and without constant term, and $\hat{F}_2 \in \mathbb{R}(s, e^{-s})$ with $\deg_s \hat{F}_2(s) \leq 0$, such that

$$\det \begin{bmatrix} s(1 - \hat{E}) - \hat{A} & -\hat{B} \\ -\hat{F}_2 & 1 - \hat{F}_1 \end{bmatrix} = s + \alpha,$$

where $\alpha \in \mathbb{R}_+$, $\hat{E} = \sum_{i=1}^k E_i e^{-i\vartheta s}$, $\hat{A} = \sum_{i=0}^k A_i e^{-i\vartheta s}$, $\hat{B} = \sum_{i=1}^k B_i e^{-i\vartheta s}$.

For the FSA result, we have the following theorem.

Theorem 4.11. Assume that (4.16) is formally stable. The SISO system (4.16) is finite spectrum assignable if and only if

$$\text{Rank}[s(1 - \hat{E}) - \hat{A} \quad \hat{B}] = n, \quad \forall s \in \mathbb{C}.$$

where $\alpha \in \mathbb{R}_+$, $\hat{E} = \sum_{i=1}^k E_i e^{-i\vartheta s}$, $\hat{A} = \sum_{i=0}^k A_i e^{-i\vartheta s}$, $\hat{B} = \sum_{i=1}^k B_i e^{-i\vartheta s}$.

Proof. Since $\text{Rank}[s(1 - \hat{E}) - \hat{A} \quad \hat{B}] = n$, $s(1 - \hat{E}) - \hat{A}$ and \hat{B} are coprime. Let $\hat{n} = \hat{B}$, $\hat{d} = s(1 - \hat{E}) - \hat{A}$. There exist $\hat{x}, \hat{y} \in \hat{\mathcal{E}}$ such that

$$\hat{n}\hat{x} + \hat{d}\hat{y} = 1.$$

Let $\alpha \in \mathbb{R}_+$. Divide $\hat{x}(s + \alpha)$ by \hat{d} , there exist $\hat{T} \in \mathcal{E}$, $\hat{F}_3 \in \hat{\mathcal{P}}_{\mathcal{E}}$ and $\hat{E}_s \in \hat{\mathcal{P}}_{\mathcal{E}}$ (where \hat{E}_s has non unstable zeros) such that

$$\hat{E}_s \hat{x}(s + \alpha) = \hat{T}\hat{d} - \hat{F}_3.$$

Let $H = \hat{y}(s + \alpha) + \frac{\hat{T}}{1 - \hat{E}}\hat{n}$. We can check that \hat{H} and \hat{F}_3 satisfy

$$\hat{H}\hat{d} - \frac{\hat{F}_3}{\hat{E}_s}\hat{n} = s + \alpha.$$

Looking at the degrees of this equation, it appears that $\hat{H} = 1 - \hat{F}_1$, where \hat{F}_1 is proper and without coefficient constant. Let $\hat{F}_2 = \frac{\hat{F}_3}{\hat{E}s}$. Since the system (4.16) is formally stable, \hat{F}_1, \hat{F}_2 have no unstable poles. Now the feedback control law is

$$u(\cdot) = \left(\mathcal{L}^{-1}(\hat{F}_1 \hat{u}) \right) (\cdot) + \left(\mathcal{L}^{-1}(\hat{F}_2 \hat{x}) \right) (\cdot).$$

The characteristic polynomial of the closed-loop system is

$$\Psi_{bf}(s) = \det \begin{pmatrix} s[1 - \hat{E}] - \hat{A} & -\hat{B} \\ -\hat{F}_2 & 1 - \hat{F}_1 \end{pmatrix}. \quad (4.22)$$

Let $V_1 \in \mathbb{R}[s, e^{-s\theta}]$, $V_2 \in \mathbb{R}[s, e^{-s\theta}]$, and $\begin{bmatrix} s[1 - \hat{E}] - \hat{A} & -\hat{B} \end{bmatrix} V_1 - \hat{B}V_2 = 1$, satisfy that $V_1 - ND^{-1}V_2 = V_1 - \begin{bmatrix} s[1 - \hat{E}] - \hat{A} \end{bmatrix}^{-1} \hat{B}V_2 = \begin{bmatrix} s[1 - \hat{A}] - \hat{E} \end{bmatrix}^{-1}$. Thus

$$\begin{aligned} \det \begin{bmatrix} V_1 & \hat{n} \\ V_2 & \hat{d} \end{bmatrix} &= \det \left\{ \begin{bmatrix} 1 & W \\ 0 & 1 \end{bmatrix} \begin{bmatrix} V_1 & \hat{n} \\ V_2 & \hat{d} \end{bmatrix} \right\} \\ &= \det \begin{bmatrix} V_1 + WV_2 & \hat{n} + W\hat{d} \\ V_2 & \hat{d} \end{bmatrix} \end{aligned}$$

where W is a nonzero constant. Let $\hat{n} + W\hat{d} = 0$ we have $W = -\hat{n}\hat{d}^{-1}$. Then we have

$$\det \begin{bmatrix} V_1 & \hat{n} \\ V_2 & \hat{d} \end{bmatrix} = d \cdot (V_1 - \hat{n}\hat{d}^{-1}V_2) = 1,$$

since $\hat{d} = \begin{bmatrix} s[1 - \hat{A}] - \hat{E} \end{bmatrix}$. Therefore

$$\begin{aligned} \Psi_{bf}(s) &= \det \left\{ \begin{bmatrix} s[1 - \hat{A}] - \hat{E} & -\hat{B} \\ -\hat{F}_2 & H \end{bmatrix} \begin{bmatrix} V_1 & \hat{n} \\ V_2 & \hat{d} \end{bmatrix} \right\} \\ &= \det \begin{pmatrix} 1 & 0 \\ -\hat{F}_2 V_1 + HV_2 & s + \alpha \end{pmatrix} \end{aligned} \quad (4.23)$$

which gives $\Psi_{bf}(s) = s + \alpha$. □

Example 4.5. *Let us consider the simple example*

$$\dot{x} = \frac{1}{2}\dot{x}(t-1) + u(t).$$

The transfer function is

$$P(s) = \frac{1}{s(1 - \frac{1}{2}e^{-s})}.$$

Let $\hat{n}(s) = 1$, $\hat{d}(s) = s(1 - \frac{1}{2}e^{-s})$. Since $\hat{n}(s)$ and $\hat{d}(s)$ are coprime factors of $P(s)$, there exist $\hat{x}(s) = \frac{3}{2}e^{-s} - \frac{1}{2}e^{-2s}$, $\hat{y}(s) = \frac{1-e^{-s}}{s}$ such that $\hat{n}(s)\hat{x}(s) + \hat{d}(s)\hat{y}(s) = 1$. If we desire to obtain the pole in closed-loop in $s = -1$, we have $\Psi_{bf}(s) = s + 1$. Divide $\hat{x}\Psi_{bf}$ by $\hat{d}(s)$, to get

$$\hat{E}_s(e^{-s})\hat{x}(s+1) = \hat{T}(s)\hat{d}(s) - \hat{F}_3(s),$$

where $\hat{T}(s) = \frac{3}{2}e^{-s} - \frac{1}{2}e^{-2s}$, $\hat{F}_3(s) = -(\frac{3}{2}e^{-s} - \frac{1}{2}e^{-2s})(1 - \frac{1}{2}e^{-s})$, $\hat{E}_s = 1 - \frac{1}{2}e^{-s}$. Thus the feedback law which assigns the poles of the system at -1 is

$$\hat{u}(s) = \hat{F}_1(s)\hat{u}(s) + \hat{F}_2(s)\hat{x}(s),$$

where

$$\hat{F}_1(s) = e^{-s} - \frac{1 - e^{-s}}{s} - \frac{\frac{3}{2}e^{-s} - \frac{1}{2}e^{-2s}}{(1 - \frac{1}{2}e^{-s})},$$

$$\hat{F}_2(s) = -\frac{3}{2}e^{-s} - \frac{1}{2}e^{-2s}.$$

In the time domain the control law is

$$u(t) = \int_0^1 u(t - \tau - 1)d\tau + \frac{5}{2}u(t-1) - u(t-2) + \frac{3}{2}x(t-1) - \frac{1}{2}x(t-2).$$

The simulation results are reported in Figure 4.6.

Remark 4.12. For the stabilizing control of the formally stable MIMO neutral time-delay system, please refer to [117, Brethé]. Here we only show the following theorem.

Theorem 4.13 (Brethé [117]). *The MIMO system*

$$\begin{cases} \dot{x}(t) = Ax(t) + Ex(t-h) + Bu(t) \\ y(t) = Cx(t) + Du(t) \end{cases} \quad \text{for } t > 0$$

$$x(t) = \phi(t) \quad \text{for } t \leq 0,$$

where $x \in \mathbb{R}^n$, $y \in \mathbb{R}^p$, $u \in \mathbb{R}^m$, A, B, C, D and E are matrices over $\mathbb{R}[e^{-s}]$ of appropriate size, which is formally stable and is stabilizable by dynamic state

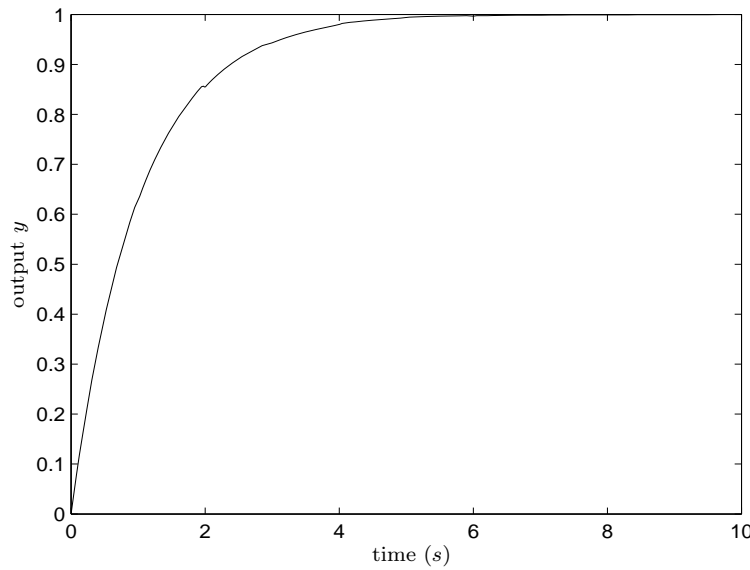

FIGURE 4.6: Step responses for the closed-loop system, (Example 4.5).

feedback

$$\begin{cases} \dot{x}_c(t) = A_c x_c(t) + E_c \dot{x}(t-h) + B_c x(t) \\ u(t) = -C_c x_c(t) - D_c x(t) + v(t) \end{cases},$$

where u , x and x_c are respectively the output, the input and the state of the compensator, and where v is the new input, if and only if there exists $\alpha > 0$ such that

$$\text{rank}[sI_n - A - se^{-sh}E, B] = n, \quad \forall s \in \mathbb{C}, \quad \text{Re } s \geq -\alpha.$$

After the introduction to the stabilizing control of the formally stable neutral time-delay system, now we introduce the stabilizing control for the non-formally stable neutral time-delay system. We still focus on the SISO system. Let us consider the following control

$$\begin{aligned} u(t) &= \int_0^{\vartheta_1} f_1(\tau)u(t-\tau)d\tau + \int_0^{\vartheta_1} f_1(\tau)x(t-\tau)d\tau \\ &+ \int_0^{\vartheta_3} f_3(\tau)\dot{x}(t-\tau)d\tau + \dots \\ &+ \sum_{i=0}^k p_i u(t-i\vartheta) + \sum_{i=0}^k g_{1i}x(t-i\vartheta) + \sum_{i=1}^k g_{2i}\dot{x}(t-i\vartheta) + \dots \end{aligned} \quad (4.24)$$

where $f_1, f_2, \dots \in \mathcal{G}$, $p_i, g_{1_i}, g_{2_i}, \dots \in \mathbb{R}$, $i = 1, 2, \dots, k$. The Laplace transform of the control (4.24) is

$$\hat{u}(s) = \hat{F}_1(s)\hat{u}(s) + \hat{F}_2(s)\hat{x}(s) + \hat{v}(s) \quad (4.25)$$

where $\hat{F}_1 \in \hat{\mathcal{G}}$, $\hat{F}_2 \in \hat{\mathcal{G}} + \mathbb{R}[s, e^{-\vartheta s}]$, $\hat{v}(s)$ is the reference input. The characteristic polynomial of the system (4.16) with the control (4.25) can be given as follows:

$$\Psi_{bf}(s) = \det \begin{bmatrix} s(1 - \hat{E}) - \hat{A} & -\hat{B} \\ -\hat{F}_2 & 1 - \hat{F}_1 \end{bmatrix}. \quad (4.26)$$

where $\hat{A}(e^{-\vartheta s}) = \sum_{i=0}^k A_i e^{-i\vartheta s}$, $\hat{B}(e^{-\vartheta s}) = \sum_{i=0}^k B_i e^{-i\vartheta s}$, $\hat{F}_1 \in \hat{\mathcal{G}}$, $\hat{F}_2 \in \hat{\mathcal{G}} + \mathbb{R}[s, e^{-\vartheta s}]$. If we can determine $\hat{F}_1 \in \hat{\mathcal{G}}$, $\hat{F}_2 \in \hat{\mathcal{G}} + \mathbb{R}[s, e^{-\vartheta s}]$, such that

$$\Psi_{bf}(s) = s + \alpha, \quad \alpha \in \mathbb{R}_+,$$

then we have the stabilization for the non-formally stable neutral time-delay system. The block scheme of the closed-loop system can be shown in Figure 4.7(a). For analyzing the internal stability, we add the reference input v_2, v_3 to the system (see Figure 4.7(b)).

The transfer function from $(\hat{v}_1 \hat{v}_2 \hat{v}_3)$ to the $(\hat{e}_1 \hat{e}_2 \hat{e}_3)$ is

$$\begin{bmatrix} \hat{e}_1 \\ \hat{e}_2 \\ \hat{e}_3 \end{bmatrix} = \frac{1}{1 - \hat{F}_1 - T\hat{F}_2} \begin{bmatrix} 1 & \hat{F}_1 & \hat{F}_2 \\ 1 & 1 - T\hat{F}_2 & \hat{F}_2 \\ 1 & T\hat{F}_1 & 1 - \hat{F}_1 \end{bmatrix} \begin{bmatrix} \hat{v}_1 \\ \hat{v}_2 \\ \hat{v}_3 \end{bmatrix}. \quad (4.27)$$

From the equation (4.27), we can find that the elements $\frac{\hat{F}_2}{1 - \hat{F}_1 - T\hat{F}_2}$ is not proper. So the system is not the internal stabilization. To overcome this problem, we consider to add a stable and strictly proper weight function $\hat{F}_3(s) \in \mathbb{R}(s)$ to the system. The new block scheme of the system can be found in Figure 4.8. Now the transfer function from $(\hat{v}_1 \hat{v}_2 \hat{v}_3)$ to the $(\hat{e}_1 \hat{e}_2 \hat{e}_3)$ is

$$\begin{bmatrix} \hat{e}_1 \\ \hat{e}_2 \\ \hat{e}_3 \end{bmatrix} = \hat{H} \begin{bmatrix} \hat{v}_1 \\ \hat{v}_2 \\ \hat{v}_3 \end{bmatrix}, \quad (4.28)$$

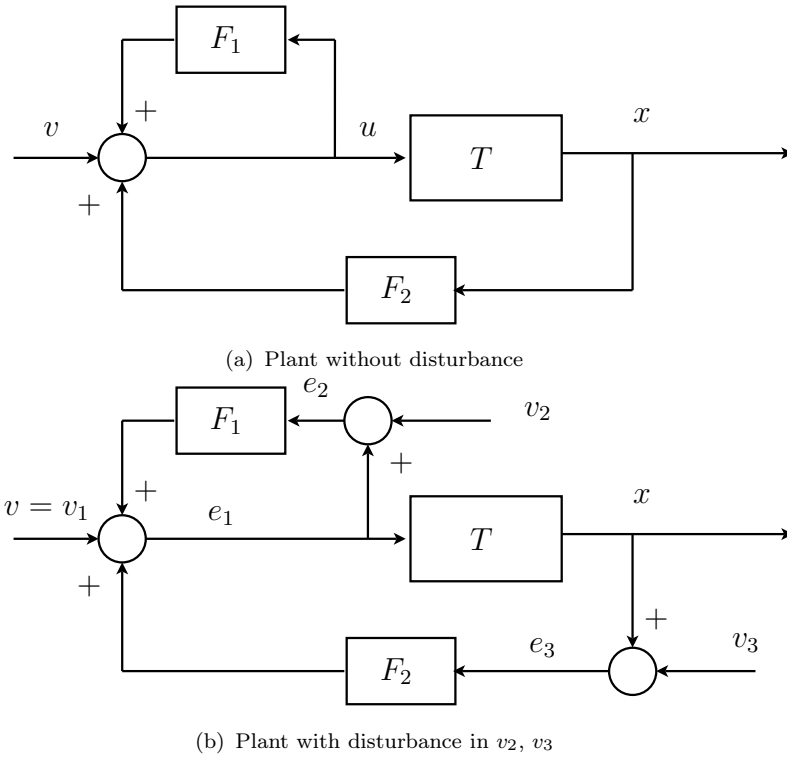

FIGURE 4.7: Block scheme of closed-loop system

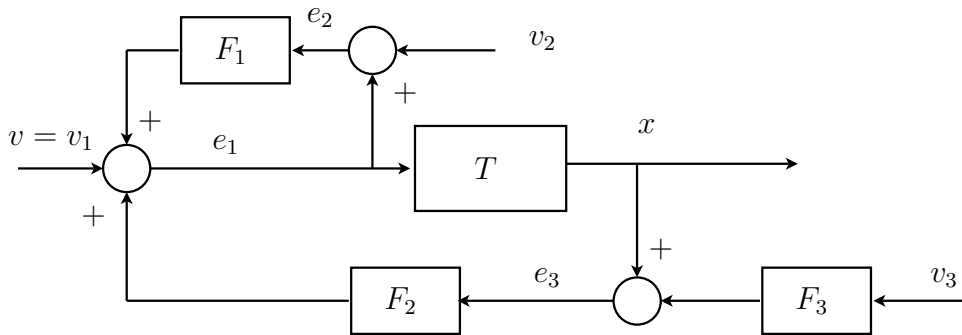

FIGURE 4.8: Block scheme of the neutral time-delay system with elements proper.

where

$$\hat{H} = \frac{1}{1 - \hat{F}_1 - T\hat{F}_2} \begin{bmatrix} 1 & \hat{F}_1 & \hat{F}_2\hat{F}_3 \\ 1 & 1 - T\hat{F}_2 & \hat{F}_2\hat{F}_3 \\ 1 & T\hat{F}_1 & (1 - \hat{F}_1)\hat{F}_3 \end{bmatrix}.$$

Since the $\hat{F}_3(s)$ is stable and the degree can be chosen negative arbitrarily, all the entries in \hat{H} are stable and proper. For multivariable systems, the idea is exactly the same. We have the following theorem.

Theorem 4.14. *The non formally stable SISO neutral time-delay system (4.16) admits an internal stabilizing control if and only if*

$$\text{rank}[s(I - \hat{E}(e^{-s\vartheta})) - \hat{A}(e^{-s\vartheta}), \hat{B}(e^{-s\vartheta})] = n, \quad \forall s \in \mathbb{C},$$

$$\text{where } \hat{E}(e^{-s\vartheta}) = \sum_{i=0}^k E_i e^{-i\vartheta s}, \quad \hat{A}(e^{-s\vartheta}) = \sum_{i=0}^k A_i e^{-i\vartheta s}, \quad \hat{B}(e^{-s\vartheta}) = \sum_{i=0}^k B_i e^{-i\vartheta s}.$$

Proof. Since $s(1 - \hat{E}) - \hat{A}$ and \hat{B} are coprime, let $\hat{n} = \hat{B}$, $\hat{d} = s(1 - \hat{E}) - \hat{A}$. There exist $\hat{x}, \hat{y} \in \hat{\mathcal{E}}$ such that

$$\hat{n}\hat{x} + \hat{d}\hat{y} = 1.$$

Let $\alpha \in \mathbb{R}_+$. Divide $\hat{x}(s + \alpha)$ by \hat{d} , there exist $\hat{T} \in \mathbb{R}[e^{-s}]$ and $\hat{F}_2 \in \hat{\mathcal{E}}$ such that

$$\hat{x}(s + \alpha) = \hat{T}\hat{d} - \hat{F}_2.$$

Note that in this division, F_2 is not proper but \hat{T} can be proper. Let $H = \hat{y}(s + \alpha) + \hat{T}\hat{n}$. We can check that \hat{H} and \hat{F}_3 satisfy

$$\hat{H}\hat{d} - \hat{F}_2\hat{n} = s + \alpha.$$

Looking at the degrees of this equation, it appears that $\hat{H} = 1 - \hat{F}_1$, where \hat{F}_1 is proper and without constant coefficient. Now the feedback control law is

$$u(\cdot) = \left(\mathcal{L}^{-1}(\hat{F}_1 \hat{u}) \right) (\cdot) + \left(\mathcal{L}^{-1}(\hat{F}_2 \hat{x}) \right) (\cdot).$$

The characteristic polynomial of the closed-loop system is

$$\Psi_{bf}(s) = \det \begin{pmatrix} s[1 - \hat{E}] - \hat{A} & -B \\ -\hat{F}_2 & 1 - \hat{F}_1 \end{pmatrix}.$$

The proof of the fact that $\Psi_{bf}(s) = s + \alpha$, is the same as the proof of Theorem 4.11. \square

Example 4.6. *Take the plant*

$$\begin{cases} \dot{x}(t) = \dot{x}(t-1) + u(t) \\ y(t) = x(t) \end{cases}$$

We have $\hat{A} = 0, \hat{B} = 1, \hat{C} = 1, \hat{D} = 0, \hat{E} = e^{-s}$, and $[s(I - \hat{E}) - \hat{A}] = s(1 - e^{-s})$. Since $\text{Rank} [s(I - \hat{E}) - \hat{A}, \hat{B}] = 1 = n$, there exists $N = 1, D = s(1 - e^{-s})$ which

satisfies

$$[s(I - \hat{E}) - \hat{A}]^{-1} \hat{B} = N \cdot D^{-1}.$$

And there exists $X = \frac{1-e^{-s}}{s}$, $Y = 2e^{-s} - e^{-2s}$ such that

$$X \cdot D + Y \cdot N = I.$$

Let $C = s + 1$, divide $[s(I - \hat{E}) - \hat{A}]$ by CY , there exist $T = 2e^{-s} - e^{-2s}$, $F = 2e^{-s} - e^{-2s} + se^{-s}(2e^{-s} - e^{-2s})$ such that

$$(s + 1) \cdot (2e^{-s} - e^{-2s}) = T \cdot [s(1 - e^{-s})] + F.$$

So we can obtain that $F_1 = 1 - (CX + TB) = 1 - (s + 1)\frac{1-e^{-s}}{s} - (2e^{-s} - e^{-2s})$, $F_2 = -(2e^{-s} - e^{-2s})(se^{-s} + 1)$, and the control of the system is

$$\begin{aligned} u(t) &= -u(t-1) + u(t-2) - \int_0^1 u(t-\tau) d\tau \\ &\quad - 2x(t-1) + x(t-2) - 2\dot{x}(t-2) + \dot{x}(t-3) + v(t). \end{aligned}$$

where $v(t)$ is the reference input. The simulation block is shown in Figure 4.7. The simulation of the step response of the system without disturbance in v_2, v_3 ($v_2 = v_3 = 0$) is shown in Figure 4.9.

4.1.3 Smith predictor with distributed delay

Predictive control which rely on dynamic models of the process is an advanced method of process control. It estimates the process output and based on this the actuation signal is chosen such that the output is made equal to the desired value. Clearly, this approach relies upon a process model to predict the future value of the controlled variable and uses this value as the input to the controller. This technique can be used in many control problems to preventing violations of input and output constraints, driving some output variables to their optimal set points, while maintaining other outputs within specified ranges, preventing excessive movement of the input variables. The best known compensation technique for time-delay (or dead-time) systems is the Smith predictor.

The Smith predictor proposed in [5, Smith (1959)] is a type of predictive controller for systems with pure input-delay. The principle of the Smith predictor can be developed by considering feedback arrangements, as shown in Figure 4.10, where

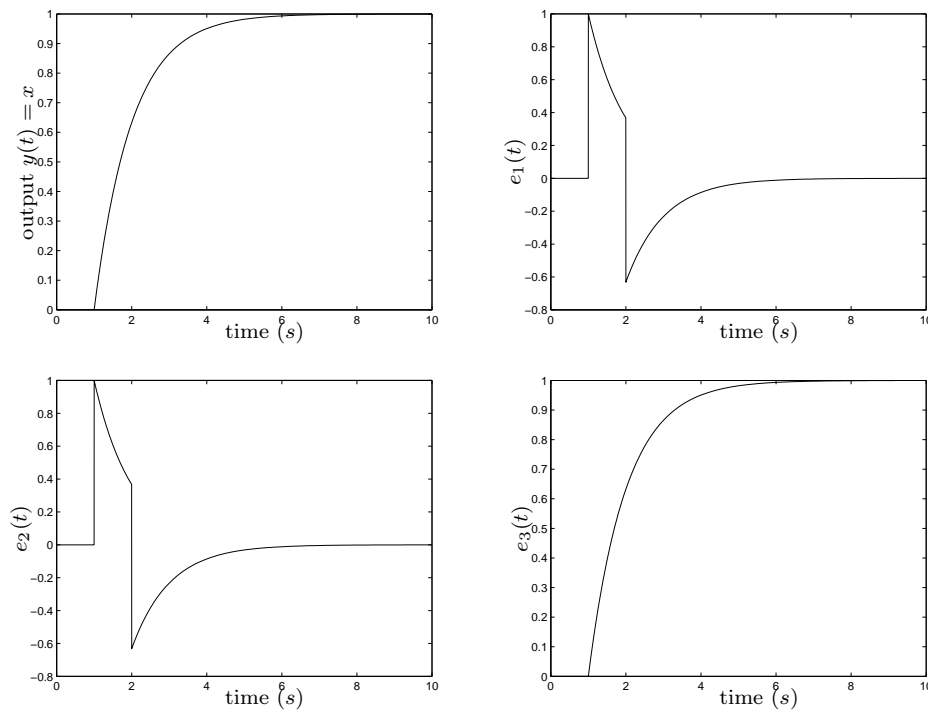

FIGURE 4.9: Step response (step time at $t = 1$) of system without disturbance, (Example 4.6).

T is the given plant without delay, $e^{-\vartheta s}$ is the delay with the delay time ϑ , C and C^* are compensators of the closed-loop system. In Figure 4.10(a), for the feedback

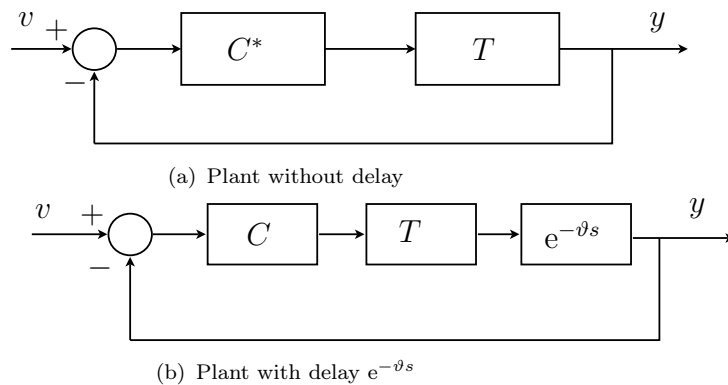

FIGURE 4.10: Feedback system for a plant with and without delay

block diagram without delay, the closed loop transfer function is:

$$G^*(s) = \frac{C^*(s)T(s)}{1 + C^*(s)T(s)}, \quad (4.29)$$

while with delay (Figure 4.10(b)):

$$G(s) = \frac{C(s)T(s)e^{-\vartheta s}}{1 + C(s)T(s)e^{-\vartheta s}}. \quad (4.30)$$

The objective is to design a controller $C(s)$ so that

$$G(s) = G^*(s)e^{-\vartheta s}. \quad (4.31)$$

Conceptually, this can be seen as designing the controller so that the time delay of the process is put outside the main feedback loop.

It follows from equation (4.29) (4.30) and (4.31) that

$$G(s) = \frac{C(s)T(s)e^{-\vartheta s}}{1 + C(s)T(s)e^{-\vartheta s}} = \frac{C^*(s)T(s)}{1 + C^*(s)T(s)}e^{-\vartheta s}, \quad (4.32)$$

which gives,

$$C(s) = \frac{C^*(s)}{1 + C^*(s)T(s)(1 - e^{-\vartheta s})}. \quad (4.33)$$

This transfer function can be represented by the feedback configuration shown in Figure 4.11(a), which is the form normally used for computer implementation. In order to appreciate the inherent structure of this controller the block diagram is redrawn to the one shown in Figure 4.11(b). This arrangement reveals that although the process variable y_p is unaccessible for measurement, an estimate \hat{y}_p is obtained from the model. It can be seen that $T(s)$ in the control receives the same actuation signal as the plant, and predicts the undelayed plant output, which is used as the feedback signal to form the error. Due to modelling errors or load disturbances, the estimate \hat{y}_p will not always accurately reflect the variable y_p , and so to compensate these errors, a second feedback loop is implemented using the error signal e_m . An alternative way to look at this implementation (Figure 4.11(b)) is that the delayed plant output is cancelled with that of the model prediction and without this cancellation the loop would become unstable. The Smith predictor cannot be applied to unstable systems since the compensator C will be unstable (in other words that in such applications it performs unstable pole-zero cancellation). To overcome this problem, The Smith predictor block can be replaced by a modified Smith predictor by using distributed delay [15, Mirkin (2004)].

Actually the Smith predictor includes an infinite-dimensional internal feedback of the form $T(1 - e^{-\vartheta s})$. If T is unstable, we consider replacing it by $T - T_a e^{-\vartheta s}$ such

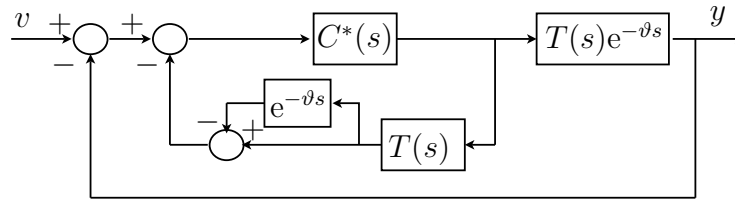

(a) Smith predictor implementation

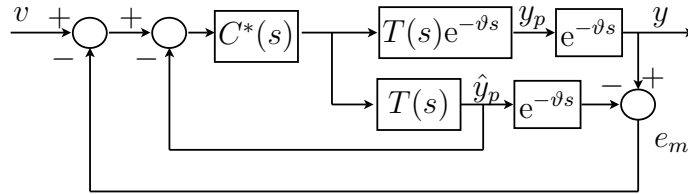

(b) Smith predictor implementation- redrawn

FIGURE 4.11: Smith predictor implementation

that $T - T_a e^{-\vartheta s} \in \hat{\mathcal{G}}$. So $T - T_a e^{-\vartheta s}$ will be stable, and there will be no pole-zero cancellation of the system. We illustrate it by an example

Example 4.7. Consider an unstable plant $P(s) = T(s) * e^{-s} = \frac{e^{-s}}{s-1}$. It is easy to find the original Smith predictor

$$C(s) = \frac{2}{1 + 2\frac{1}{s-1}(1 - e^{-s})}, \quad (4.34)$$

where the infinite-dimensional part is $\frac{1}{s-1}(1 - e^{-s})$. Although the transfer function of the closed-loop system is $G(s) = \frac{2e^{-s}}{s+1}$, the system is still unstable since C is unstable. The simulation can be found in Figure 4.12. Now we replace $\frac{1}{s-1}(1 - e^{-s})$ by

$$\frac{1}{s-1} - \frac{1}{s-1}e^{-(s-1)} = \frac{1 - e^{-(s-1)}}{s-1},$$

and we choose the controller

$$C_a = \frac{2e^1}{1 + 2\frac{1 - e^{-(s-1)}}{s-1}}. \quad (4.35)$$

Then the system is stable and the transfer function of the closed-loop system is $G(s) = \frac{2e^1 e^{-s}}{s+1}$. The step response of the system can be found in Figure 4.12.

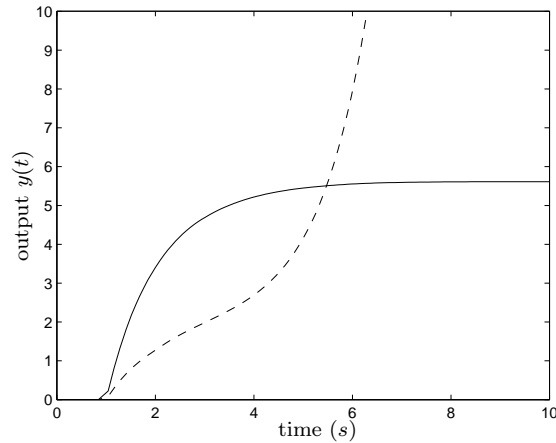

FIGURE 4.12: Step response (step time at $t = 0$) of unstable system with modified Smith predictor (continuous), original Smith predictor (dash), (Example 4.7).

4.2 Stabilization and control for fractional systems

Finite Spectrum Assignment (FSA) is a static feedback control, such that n eigenvalues of the corresponding closed-loop system are located at an arbitrarily pre-assigned set of points in the complex plane, while the others are automatically eliminated. This section is concerned with the FSA for a particular class of infinite dimensional systems with single input

$$T(s) = N(s)d^{-1}(s), \quad (4.36)$$

where $N(s) \in \mathbb{R}^{n \times 1}[s^{\frac{1}{\mu}}, e^{-s^{\frac{1}{\mu}}}]$, $d(s) \in \mathbb{R}[s^{\frac{1}{\mu}}, e^{-s^{\frac{1}{\mu}}}]$, $\mu \in \mathbb{N}_+$.

4.2.1 Fractional systems

Before we introduce the system, let us see some examples. In the one dimensional model of heat equation [118, Curtain and Morris (2009)], we are interested in the temperature profile in a rod, and the model can be described by a partial differential equation

$$\frac{\partial^2 w(x, t)}{\partial x^2} = \frac{\partial w(x, t)}{\partial t}, \quad 0 < x < L, t > 0, \quad (4.37)$$

where $w(x, t)$ is the temperature at time t at position x of the rod (length L). We use the Neumann boundary control

$$\begin{cases} \frac{\partial w(0,t)}{\partial x} = 0 \\ \frac{\partial w(L,t)}{\partial x} = u(t) \end{cases}, \quad (4.38)$$

where $u(t)$ is the rate of heat flow into the rod. Let the initial condition $w(\cdot, 0) = 0$, and measure the temperature at point $x = 0$. Then the transfer function from input (control $u(t)$) to the output ($y(t) = w(0, t)$) is

$$T(s) = \frac{\hat{y}(s)}{\hat{u}(s)} = \frac{2e^{-L\sqrt{s}}}{\sqrt{s}(1 - e^{-2L\sqrt{s}})}. \quad (4.39)$$

And the poles of the system are $p_k = \left(\frac{k\pi}{L}\right)^2$, $k \in \mathbb{Z}$.

In the model of the transmission line, we analyze the coaxial line (length $L = 1$) without losses [119, Lumbroso (1995)]. For the voltage we have

$$\frac{\partial^2 v}{\partial x^2} = \alpha \frac{\partial^2 v}{\partial t^2} + \beta \frac{\partial v}{\partial t} + \gamma v, \quad (4.40)$$

where the coefficient α, β, γ depend on the resistance, inductance, and capacity in the transmission line system. If we neglect the resistance in the transmission line we have the model

$$\frac{\partial^2 v}{\partial x^2} = \alpha \frac{\partial^2 v}{\partial t^2} \quad (4.41)$$

Considering the boundary conditions

$$\begin{cases} \hat{v}(0, s) = 0 \\ \hat{v}(1, s) = \hat{u}(s) \end{cases}, \quad (4.42)$$

the transfer function from control $\hat{u}(s)$ to the voltage $\hat{v}(x, s)$ is

$$T(s) = \frac{\hat{v}(x, s)}{\hat{u}(s)} = \frac{\sinh(x\alpha s)}{\sinh(\alpha s)}. \quad (4.43)$$

In the model of beam vibrations, we consider the classic Euler-Bernoulli beam model for the deflection $w(x, t)$

$$\frac{\partial^2 w(x, t)}{\partial t^2} + EI \frac{\partial^4 w(x, t)}{\partial x^4} = 0, \quad (4.44)$$

where E, I are material constants [118, Curtain and Morris (2009)]. Assume that the beam is clamped at $x = 0$ and free at the tip $x = L$, with control of the shear force at the tip. The boundary conditions are

$$w(0, t) = 0, \quad \frac{\partial w}{\partial x}(0, t) = 0, \quad (4.45)$$

$$\frac{\partial^2 w}{\partial x^2}(L, t) = 0, \quad -EI \frac{\partial^3 w}{\partial x^3}(L, t) = u(t) \quad (4.46)$$

where $u(t)$ represents an applied force at the tip, with positive direction the same as the positive direction for the deflection w . If we measure the tip velocity, we have the observation

$$y(t) = \frac{\partial w}{\partial t}(L, t). \quad (4.47)$$

Then the transfer function is

$$T(s) = \frac{L^3 s [\cosh(m(s))\sin(m(s)) - \sinh(m(s))\cos(m(s))]}{EI m^3(s) [1 + \cosh(m(s))\cos(m(s))]} \quad (4.48)$$

with

$$m(s) = L \left(\frac{-s^2}{EI} \right)^{\frac{1}{4}}.$$

Now let us consider the transfer function

$$T(s) = N(s)d^{-1}(s) \quad (4.49)$$

with $N(s) \in \mathbb{R}^{n \times 1}[s^{\frac{1}{\mu}}, e^{-s^{\frac{1}{\mu}}}]$, $d(s) \in \mathbb{R}[s^{\frac{1}{\mu}}, e^{-s^{\frac{1}{\mu}}}]$, and $\mu \in \mathbb{N}_+$. To present the properties of the system more clearly, we consider changing the variable by $z = s^{\frac{1}{\mu}}$. Then the system becomes

$$T(z) = N(z)d^{-1}(z) \quad (4.50)$$

$$\text{with } N(z) \in \mathbb{R}^{n \times 1}[z, e^{-z}], \quad d(z) \in \mathbb{R}[z, e^{-z}].$$

We denote the system (4.49) by \mathfrak{L} , while (4.50) is denoted by \mathfrak{L}_z . After that, if we consider z to be the Laplace transform operator, we can reformulate an abstract system into state-space representation. For this, we can divide the system into three cases.

1. The first case, $d(z) \in \mathbb{R}[z, e^{-z}]$ is monic. For example

$$d(z) = z^2 + 2ze^{-2z} + 1.$$

2. The second case, $d(z) \in \mathbb{R}[s, e^{-s}]$ is not monic. For example

$$d(z) = e^{-2z}z^2 + 2z + 1.$$

3. the third case, $d(s) \in \mathbb{R}[e^{-s}]$. For example

$$d(z) = e^{-2z} + 1.$$

In the first case, the system can be reformulated into the following state-space representation [45, Kailath (1980)].

$$\dot{x}(t) = \sum_{i=0}^r A_i x(t - i\vartheta) + \sum_{i=0}^r B_i u(t - i\vartheta), \quad (4.51)$$

where $x \in \mathbb{R}^n$, $u \in \mathbb{R}$, $\forall i \in \{0, \dots, r\}$, $A_i \in \mathbb{R}^{n \times n}$ and $B_i \in \mathbb{R}^n$, $h \in \mathbb{R}_+$. In this manuscript we will only introduce the FSA for the first case. The reader can refer to Section 4.1.2 for the second case, which is a neutral time-delay systems (SISO). As introduced in Section 4.1.2, FSA problem can be stated as follows.

Definition 4.15 (problem). Given a system (4.51), does there exist a feedback control

$$\hat{F}_1(z)\hat{u}(z) = \hat{F}_2(z)\hat{x}(z) \quad (4.52)$$

where $\hat{F}_1(z, e^{-z}) \in \mathbb{R}[z]$, $\hat{F}_2(z) \in \mathbb{R}^{1 \times n}[z, e^{-z}]$, $\hat{F}_2(z, e^{-z})\hat{F}_1^{-1}(z, e^{-z})$ is proper such that the closed-loop system has only a finite number of poles?

With the control (4.52) the characteristic polynomial of the closed-loop system is

$$\Psi_{bf} = \det \begin{pmatrix} zI_n - \hat{A} & -\hat{B} \\ -\hat{F}_2 & \hat{F}_1 \end{pmatrix}. \quad (4.53)$$

So the finite spectrum assignment problem is equivalent to determine \hat{F}_1, \hat{F}_2 , such that

$$\Psi_{bf}(z) = \prod_{i=1}^n (z^{\mu} - \alpha_i), \quad \alpha \in \mathbb{C}.$$

4.2.2 Finite spectrum assignment for fractional systems

Definition 4.16 (Spong and Tarn (1981) [120]). The system (4.51) is said spectrally controllable if

$$\text{rank} \left[zI_n - \hat{A}(e^{-\vartheta z}), \hat{B}(e^{-\vartheta z}) \right] = n, \quad \forall z \in \mathbb{C} \quad (4.54)$$

where $\hat{A}(e^{-\vartheta z}) = \sum_{i=0}^r A_i e^{-i\vartheta z}$, $\hat{B}(e^{-\vartheta z}) = \sum_{i=0}^r B_i e^{-i\vartheta z}$.

With this definition, we have the following theorem.

Theorem 4.17 (Brethé and Loiseau (1998) [43]). *FSA problem for the system (4.51) admits a solution if and only if*

$$\text{rank} \left[zI_n - \hat{A}(e^{-\vartheta z}), \hat{B}(e^{-\vartheta z}) \right] = n, \quad \forall z \in \mathbb{C} \quad (4.55)$$

where $\hat{A}(e^{-\vartheta z}) = \sum_{i=0}^r A_i e^{-i\vartheta z}$, $\hat{B}(e^{-\vartheta z}) = \sum_{i=0}^r B_i e^{-i\vartheta z}$.

Proof. Necessity of the condition comes from [41, Manitius and Olbrot (1979)] or [120, Spong and Tarn (1981)]

Sufficiency:

Under spectral controllability, $zI_n - \hat{A}(e^{-\vartheta z})$ and $\hat{B}(e^{-\vartheta z})$ are left factor coprime. Moreover, there exist $\hat{N}(z) \in \mathbb{R}^{n \times 1}[z, e^{-z}]$ and $\hat{d}(z) \in \mathbb{R}[z, e^{-z}]$ such that

$$\left[zI_n - \hat{A}(e^{-\vartheta z}) \right]^{-1} \cdot \hat{B}(e^{-\vartheta z}) = \hat{N}(z) \cdot \hat{d}^{-1}(z),$$

$\hat{N}(z)$ and $\hat{d}(z)$ being right coprime factors. Moreover $\hat{d}(z) = \det(zI_n - A)$ and $\hat{d}(z)$ is monic in z . We also have $\deg_z \hat{N}(z) < \deg_z \hat{d}(z)$ since $\left[zI_n - \hat{A}(e^{-\vartheta z}) \right]^{-1} \hat{B}(e^{-\vartheta z})$ is a strictly proper transfer matrix. Since $\text{rank} \left[zI_n - \hat{A}(e^{-\vartheta z}), \hat{B}(e^{-\vartheta z}) \right] = n$, $z \in \mathbb{C}$, it implies $\text{rank} \left[\hat{d}(z), \hat{N}^T(z) \right]^T = 1$, $\forall z \in \mathbb{C}$. Hence there exist $\hat{x}(z)$ and $\hat{y}(z)$ such that

$$\hat{x}(z)\hat{N}(z) + \hat{y}(z)\hat{d}(z) = 1.$$

Let $\Psi_{bf}(z) \in \mathbb{R}[z]$ defined as $\Psi_{bf}(z) = \prod_{i=1}^n (z - \alpha_i)$. Therefore $\Psi_{bf}(z)\hat{x}(z)\hat{N}(z) + \Psi_{bf}(z)\hat{y}(z)\hat{d}(z) = \Psi_{bf}(z)$. Divide $\hat{x}(z)\Psi_{bf}(z)$ by $\left[zI_n - \hat{A}(e^{-\vartheta z}) \right]$ on the left. There

exist $\hat{T}(z) \in \mathbb{R}^{1 \times n}[z]$ and $\hat{F}_2 \in \mathbb{R}^{1 \times n}[z]$ such that

$$\hat{x}(z)\Psi_{bf}(z) = \hat{T}(z) \left[zI_n - \hat{A}(e^{-\vartheta z}) \right] - \hat{F}_2(z),$$

where $\deg_z \hat{F}_2(z) < \deg_z \left[zI_n - \hat{A}(e^{-\vartheta z}) \right] = 1$. Let $\hat{H}(z) = \hat{y}(z)\Psi_{bf}(z) + \hat{T}(z)\hat{B}(e^{-\vartheta z})$. We can check that $\hat{H}(z)$ and $\hat{F}_2(z)$ satisfy

$$\hat{H}(z) \cdot \hat{d}(z) - \hat{F}_2(z) \cdot \hat{N}(z) = \Psi_{bf}(z).$$

Looking at the degree and at the highest degree coefficients in this equation, it appears that $\hat{H}(z) = \hat{F}_1(z)$ with $\deg_z \hat{F}_1(z) > 1$. Now we can give the feedback control law

$$\hat{F}_1(z)\hat{u}(z) = \hat{F}_2(z)\hat{x}(z).$$

We can verify that the characteristic polynomial of the closed-loop system is

$$\Psi_{bf}(z) = \det \begin{pmatrix} zI_n - \hat{A} & -\hat{B} \\ -\hat{F}_2 & \hat{F}_1 \end{pmatrix} = \prod_{i=1}^n (z^\mu - \alpha_i).$$

□

Since we change the variable $s^{\frac{1}{\mu}} = z$, for the realization the control law should be

$$\hat{F}_1(s^{\frac{1}{\mu}})\hat{u}(s) = \hat{F}_2(s^{\frac{1}{\mu}})\hat{x}(s),$$

and the poles of the system are α_1^μ .

Example 4.8. *Let us consider the plant*

$$T(s) = \frac{e^{-\sqrt{s}}}{\sqrt{s} + 1}$$

Change the variable \sqrt{s} by z ,

$$T(z) = \frac{e^{-z}}{z + 1}.$$

The state space representation of this abstract system is

$$\dot{x}(t) = -x(t) + u(t - 1) \tag{4.56}$$

Since $\text{rank}[zI - \hat{A}(e^{-z}), \hat{B}(-z)] = 1$, $\hat{n}(z) = e^{-z}$ and $\hat{d}(z) = z + 1$ are coprime, there exist $\hat{x}(z) = e^{-1}$, $\hat{y}(z) = \frac{1 - e^{-(z+1)}}{z+1}$ such that

$$\hat{x}(z)\hat{n}(z) + \hat{y}(z)\hat{d}(z) = 1$$

If we want to have the pole in closed-loop in $s = -1$, we get $\Psi_{bf}(z) = z^2 + 1$. Then there exist $\hat{T}(z) = e^{-1}(z - 1)$, $\hat{F}_2(z) = 2e^{-1}$ such that

$$\hat{x}(z)\Psi_{bf}(z) = \hat{T}(z)[zI - \hat{A}(e^{-s})] - \hat{F}_2(z)$$

We obtain $\hat{F}_1 = \hat{y}(z)\Psi_{bf}(z) + \hat{T}(z)\hat{B}(e^{-s}) = \frac{1 - e^{-(z+1)}}{z+1}(z + 1) + e^{-1}(z - 1)e^z$. The control of the system (for variable s) is

$$\frac{\hat{u}(s)}{\hat{x}(s)} = \frac{2e^{-1}}{\frac{1 - e^{-(\sqrt{s}+1)}}{\sqrt{s}+1}(\sqrt{s}^2 + 1) + e^{-1}(\sqrt{s} - 1)e^{-\sqrt{s}}}$$

The transfer function of the closed-loop system will be

$$G(s) = \frac{2e^{-(1+\sqrt{s})}}{s + 1}$$

There are still many works to be considered, such as FSA for MIMO fraction system, and realization of the control. For realizing the control, we consider using approximation based method such that the control can be implemented. These will be included in the future works.

4.3 Observer design for dynamical systems

Let us consider the following linear time invariant system

$$\dot{x}(t) = Ax(t) + Bu(t) \quad (4.57)$$

$$y(t) = Cx(t) + Du(t) \quad (4.58)$$

with some initial condition $x(t_0) = x_0$, the state $x \in \mathbb{R}^n$, input $u \in \mathbb{R}^m$ and output $y \in \mathbb{R}^q$. The theory of observers for such systems, which reconstruct the state x from measurements of the input and output, is well established. That is to say that we estimate the error of the state which can vanish after a finite

time or asymptotically goes to zero, see, e.g., [44, Barnett (1975)], [45, Kailath (1980)], [46, O'Reilly (1983)], [47, Engel and Kreisselmeier (2002)], [48, Luenberger (1966)], [49, Pernebo (1981)]. In this section, a new class of observers is developed and analysed for the linear-invariant systems. This is a closed-loop observer which includes a distributed delay. The synthesis of such observer requires only past measures and inputs. First let us see the open-loop observer by using distributed delay. The Similar results can be found in [7, Medvedev and Toivonen (1994)], [50, Chyung (1984)], [51, Medvedev (1995)]. Then we will introduce the closed-loop observer. This gives a general framework for the asymptotical convergence or finite time convergence of the estimation.

4.3.1 Open-loop observer

Let us consider the system (4.57)-(4.58). The general solution of (4.57) is given by

$$x(t) = e^{A(t-t_0)}x(t_0) + \int_{t_0}^t e^{A(t-\tau)}Bu(\tau) d\tau, \quad t \geq t_0. \quad (4.59)$$

At any time $t \geq t_0$, the state of the system is dependent from its past evolution. To make explicit this dependence from past state values, we reformulate (4.59) into the following form. For any fixed $h > 0$, the state $x(t)$ is described by

$$x(t) = e^{Ah}x(t-h) + \int_{t-h}^t e^{A(t-\tau)}Bu(\tau) d\tau, \quad t \geq h. \quad (4.60)$$

In (4.60), the second term in the right-hand side is a distributed delay with input $u(t)$. The support of its kernel is in $[0, h]$.

Multiplying this equation on the left by e^{-Ah} , we see that

$$e^{-Ah}x(t) = x(t-h) + \int_{t-h}^t e^{A(t-\tau-h)}Bu(\tau) d\tau, \quad t \geq h. \quad (4.61)$$

Using (4.61) and (4.58), we obtain that

$$Ce^{-Ah}x(t) = y(t-h) + \phi_h u(t), \quad t \geq h, \quad (4.62)$$

where

$$\phi_h u(t) = \int_{t-h}^t Ce^{A(t-\tau-h)}Bu(\tau) d\tau - Du(t-h) \quad (4.63)$$

is a convolution operator with input u , and $\int_{t-h}^t Ce^{A(t-\tau-h)}Bu(\tau) d\tau$ is the distributed delay. Its kernel lies actually in the ring of proper fractions of the ring of pseudo-polynomials.

The relationship (4.62) relates known signals, which are u and y , to the state x . Such a relation involves only delay operators, that is past information on measured signals. However, such a relation does not determine in a unique way, in general, the state x . Let us take $\{h_i, i = 1, \dots, n\}$ ordered positive reals such that $0 < h_1 < \dots < h_n$. Applying the procedure described previously for each h_i , $i = 1, \dots, n$, we obtain the linear system

$$\begin{aligned} Ce^{-Ah_1}x(t) &= y(t-h_1) + \phi_{h_1}u(t), \quad t \geq h_1 \\ Ce^{-Ah_2}x(t) &= y(t-h_2) + \phi_{h_2}u(t), \quad t \geq h_2 \\ &\vdots \\ Ce^{-Ah_n}x(t) &= y(t-h_n) + \phi_{h_n}u(t), \quad t \geq h_n. \end{aligned}$$

This system can be put into the matrix form

$$M_h x(t) = Y_h(t) + \Phi_h u(t) \quad (4.64)$$

where

$$M_h = \begin{bmatrix} Ce^{-Ah_1} \\ \vdots \\ Ce^{-Ah_n} \end{bmatrix}, \quad Y_h(t) = \begin{bmatrix} y(t-h_1) \\ \vdots \\ y(t-h_n) \end{bmatrix}, \quad \Phi_h u(t) = \begin{bmatrix} \phi_{h_1}u(t) \\ \vdots \\ \phi_{h_n}u(t) \end{bmatrix}.$$

To solve the $x(t)$ in equation (4.64), we need to know whether or not M_h is invertible. For this let us see the following Theorem.

Theorem 4.18. *If the system (4.57)-(4.58) is observable, for any $H > 0$, there exist h_1, \dots, h_n in $[0, H]$ such that*

$$\text{rank} \begin{bmatrix} Ce^{-Ah_1} \\ \vdots \\ Ce^{-Ah_n} \end{bmatrix} = n \quad (4.65)$$

Before proving this theorem, let us consider the following lemma.

Lemma 4.19 (Gohberg et al. (1986) [121]). *Assume that $p(s)$ is an analytic function in a neighborhood of each eigenvalue $\lambda_1, \dots, \lambda_r$ of A ($\lambda_1, \dots, \lambda_r$ are assumed to be distinct). Then $p(A)$ has exactly the same invariant subspaces as A if and only if the following conditions hold:*

- (i) $p(\lambda_i) \neq p(\lambda_j)$ if $\lambda_i \neq \lambda_j$
- (ii) $\frac{dp(s)}{ds}|_{s=\lambda_i} \neq 0$ for every eigenvalue λ_i with height of the Jordan block greater than 1.

Proof. See Theorem 2.11.3 in [121, Gohberg et al. (1986)] □

Now we can prove Theorem 4.18 by using Lemma 4.19 and the properties of the invariant subspace.

Proof. Define the observable space of the pair (A, C) as

$$\mathcal{N}_1 = \bigcap_{i=1}^n \ker(CA^{i-1}), \quad (4.66)$$

and the space

$$\mathcal{N}_2 = \bigcap_{i=1}^n \ker(Ce^{-Ah_i}). \quad (4.67)$$

It is obviously that $\mathcal{N}_1 = \emptyset$. Since $Ax = 0 \in \ker A$ for any $x \in \ker A$, the subspace $\ker A$ is A invariant. This implies that \mathcal{N}_1 is an invariant subspace of A . If \mathcal{N}_1 and \mathcal{N}_2 are exactly the same invariant subspaces of A , we will have the following equation:

$$\text{rank} \begin{bmatrix} Ce^{-Ah_1} \\ \vdots \\ Ce^{-Ah_n} \end{bmatrix} = \text{rank} \begin{bmatrix} C \\ \vdots \\ CA^{n-1} \end{bmatrix} \quad (4.68)$$

Lemma 4.19 stipulates two necessary and sufficient conditions for preserving invariant subspaces of a matrix under a functional transformation. Now we verify that the equality $\mathcal{N}_1 = \mathcal{N}_2$ hold. Let $p(s) = e^{-sh_i}$, $i = 1, \dots, n$. The condition (i) yields

$$e^{h\lambda_i}(1 - e^{h(\lambda_j - \lambda_i)}) \neq 0 \quad (4.69)$$

for all $h \in \{h_1, \dots, h_n\}$ and all $\lambda_i, \lambda_j \in \{\lambda_1, \dots, \lambda_r\}$. Since an exponential is never equal to zero, $h \in \mathbb{R}$, the condition (i) is always true. Obviously, (ii) is always true for the function in question. So we have $\mathcal{N}_1 = \mathcal{N}_2$. Since the pair (A, C) is observable, that is to say $\mathcal{N} = \emptyset$, we obtain

$$\bigcap_{i=1}^n \ker(CA^{i-1}) = \bigcap_{i=1}^n \ker(Ce^{-Ah_i}) = \emptyset, \quad (4.70)$$

which implies

$$\text{rank} \begin{bmatrix} C \\ \vdots \\ CA^{n-1} \end{bmatrix} = \text{rank} \begin{bmatrix} Ce^{-Ah_1} \\ \vdots \\ Ce^{-Ah_n} \end{bmatrix} = n \quad (4.71)$$

□

From Theorem 4.18, and equation (4.64), we can deduce the following equations

$$(M_h)^T M_h x(t) = (M_h)^T Y_h(t) + (M_h)^T \Phi_h u(t). \quad (4.72)$$

If the system is observable, $\det[(M_h)^T M_h] \neq 0$, where $r = n$ in the matrix M_h , we have

$$x(t) = [(M_h)^T M_h]^{-1} (M_h)^T Y_h(t) + [(M_h)^T M_h]^{-1} (M_h)^T \Phi_h u(t), \quad (4.73)$$

with $t > t_0$. So we can define our open-loop observer for system (4.57)-(4.58) is

$$\hat{x}(t) = [(M_h)^T M_h]^{-1} (M_h)^T Y_h(t) + [(M_h)^T M_h]^{-1} (M_h)^T \Phi_h u(t). \quad (4.74)$$

with $t \in [h, \infty)$, $h = \max\{h_1, \dots, h_n\}$. Then we have

$$\hat{x}(t) = x(t), \quad t \in [h, \infty), \quad h = \max\{h_1, \dots, h_n\}. \quad (4.75)$$

Remark 4.20. From Theorem 4.18 we know that if the pair (A, C) is observable, there exists M_h such that $\det[(M_h)^T M_h] \neq 0$, and there will be a solution for equation (4.72). But this is not the unique solution for the observer $\hat{x}(t)$. If the pair (A, C) is observable and there exist h_1, \dots, h_r , $r \leq n$ such that $\det[(M_h)^T M_h] \neq 0$

where

$$M_h = \begin{bmatrix} Ce^{-Ah_1} \\ \vdots \\ Ce^{-Ah_r} \end{bmatrix}.$$

we also have the observer $\hat{x}(t)$. We can see the Example 4.9.

Example 4.9. Consider the system

$$\begin{aligned} \dot{x}(t) &= \begin{bmatrix} -1 & 0 & 1 \\ 0 & -1 & 0 \\ 0 & 0 & -1 \end{bmatrix} x(t) + \begin{bmatrix} 1 \\ 1 \\ 0 \end{bmatrix} u(t) \\ y(t) &= \begin{bmatrix} 1 & 0 & 0 \\ 0 & 1 & 0 \end{bmatrix} x(t), \end{aligned}$$

where

$$A = \begin{bmatrix} -1 & 0 & 1 \\ 0 & -1 & 0 \\ 0 & 0 & -1 \end{bmatrix}, B = \begin{bmatrix} 1 \\ 1 \\ 0 \end{bmatrix}, C = \begin{bmatrix} 1 & 0 & 0 \\ 0 & 1 & 0 \end{bmatrix}.$$

If we choose $h_1 = 1$ and $h_2 = 0.5$, we can verify that

$$M_h = \begin{bmatrix} Ce^{-Ah_1} \\ Ce^{-Ah_2} \end{bmatrix}, \text{ and } \det [(M_h)^T M_h] = 50.75 \neq 0.$$

We can obtain

$$\hat{x}(t) = [M_h^T M_h]^{-1} M_h^T \begin{bmatrix} y(t - h_1) \\ y(t - h_2) \end{bmatrix} + [M_h^T M_h]^{-1} M_h^T \begin{bmatrix} Ce^{-Ah_1} \Phi_1(u)(t) \\ Ce^{-Ah_2} \Phi_2(u)(t) \end{bmatrix}.$$

The simulation results can be seen in Figure 4.13. In Figure 4.13, the u-left figure shows the step response of the state x_1 (continuous line) with initial condition $x_0 = [0 \ 1 \ 1]^T$. The dashed line show the observation value \hat{x}_1 of the state x_1 , where $h_1 = 1$, $h_2 = 0.5$. The dashed-dot line shows the observation value \hat{x}_2 with $h_1 = 0.5$, $h_2 = 0.3$. The other figures in Figure 4.13 show the simulation of state x_2 , \hat{x}_2 and x_3 , \hat{x}_3 , respectively. We can see that when the time $t \geq \max\{h_1, h_2\}$, $\hat{x}_1 = x_1$.

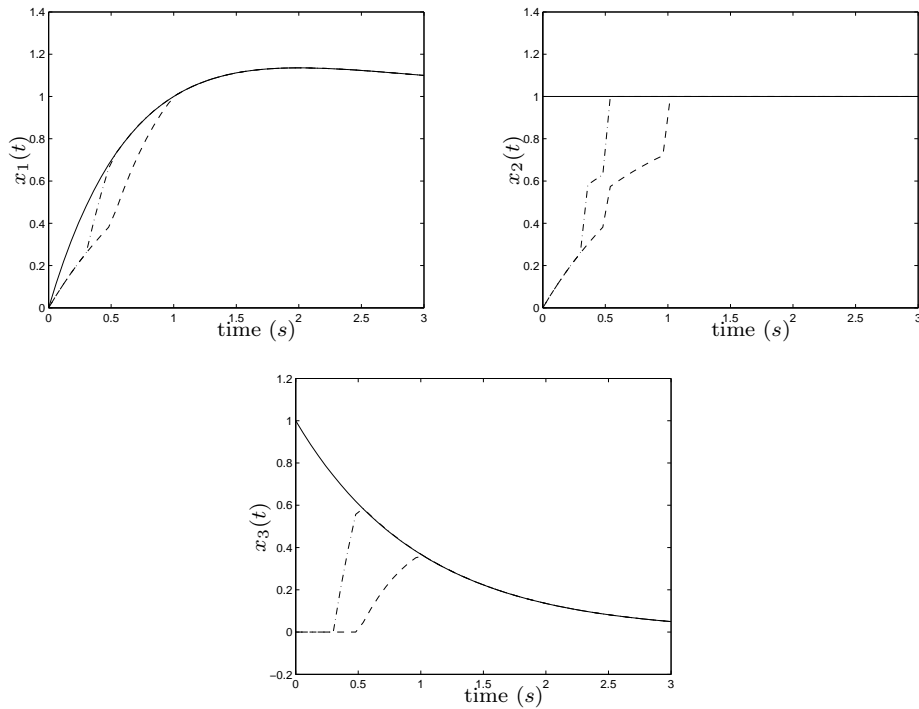

FIGURE 4.13: observer simulation with the state $x(t)$ (continuous) and the estimation of $\hat{x}(t)$ (dashed, with $h_1 = 1$, $h_2 = 0.5$) (dashed-dot, with $h_1 = 0.5$, $h_2 = 0.3$), the initial condition is $x_0(t) = [0 \ 1 \ 1]^T$, (Example 4.9).

4.3.2 Closed-loop observer

Now we introduce a new class of the closed-loop observer by using the distributed delay. Let us consider the following observer

$$\begin{cases} \hat{x}(t) = e^{Ah}\hat{x}(t-h) + K[y(t-h) - \eta(t-h)] + \int_{t-h}^t e^{A(t-\tau)}Bu(\tau)d\tau, & t \geq h \\ \eta(t) = C\hat{x}(t) + Du(t), \end{cases} \quad (4.76)$$

where $K \in \mathbb{R}^{n \times m}$. We estimate the state $x(t) - \hat{x}(t)$ that is

$$\begin{aligned} e(t) &= x(t) - \hat{x}(t) \\ &= (e^{Ah} - KC)[x(t-h) - \hat{x}(t-h)] \\ &= (e^{Ah} - KC)e(t-h), \quad t \geq h. \end{aligned} \quad (4.77)$$

Remark 4.21. We can also consider a more general observer having the following form

$$\begin{aligned}\hat{x}(t) &= e^{Ah}\hat{x}(t-h) + \sum_{i=1}^n K_i[y(t-h_i) - \eta(t-h_i)] + \int_{t-h}^t e^{A(t-\tau)}Bu(\tau)d\tau, \quad t \geq h \\ \eta(t) &= C\hat{x}(t) + Du(t).\end{aligned}\tag{4.78}$$

Where $K_i \in \mathbb{R}$, $h_i > 0$. The error of the estimate the state $x(t) - \hat{x}(t)$ is

$$e(t) = x(t) - \hat{x}(t) = e^{Ah}e(t-h) - \sum_{i=1}^n K_i C e(t-h_i),\tag{4.79}$$

which is a difference equation.

In this section, for the sake of simplicity, we only discuss about the observer with the form (4.76). We will show that the exact observer can be obtained by choosing appropriate coefficients h and K .

4.3.2.1 Scalar case

Let us see the scalar system first. In the scalar system, the solution of (4.77) is

$$e(t) = (e^{ah} - kc)^{\frac{t}{h}}\phi(t)\tag{4.80}$$

where $h \in \mathbb{R}_+$ and $\phi(t) \in \mathbb{R}[t]$, $t \in [-h, 0]$ which are bounded and depend on the initial condition of system (4.77). So if $|(e^{ah} - kc)| < 1$ the solution $e(t)$ will stable and convergence to zeros. If $|(e^{ah} - kc)| = 0$, we have $e(t) = 0$, $t \geq h$. So in the scalar system the convergence of the state observation to zero is always in the finite time h if $k = \frac{c}{e^{ah}}$. The convergence rate can be assigned by suitably choosing the gain k . In other words, we can choose the finite time by defining the parameter h in the observer.

Example 4.10. Consider the system

$$\begin{aligned}\dot{x}(t) &= -x(t) + u(t) \\ y(t) &= x(t),\end{aligned}$$

so

$$x(t) = e^{-h}x(t-h) + \int_{t-h}^t e^{-(t-\tau)}u(\tau)d\tau,$$

and the observer

$$\begin{aligned}\hat{x}(t) &= e^{-h}\hat{x}(t-h) + k[y(t-h) - \eta(t-h)] + \int_{t-h}^t e^{-(t-\tau)}u(\tau)d\tau \\ \eta(t) &= \hat{x}(t).\end{aligned}$$

The error $e(t) = x(t) - \hat{x}(t)$ is

$$e(t) = (e^{-h} - k)e(t-h).$$

The Figure 4.14 shows the exact observation of the state x . The continuous line is the step response of the state $x(t)$ with initial condition $x_0 = 0.5$. The dashed line is the estimation of \hat{x}_1 for $h = 1$. We can see that the exact observer can be obtained at time $t = h$. The dashed-dot line shows the simulation of the estimation of \hat{x}_1 with $h = 0.5$.

Figure 4.15 shows the convergence observation of the state x . The continuous line is the step response of the state $x(t)$ with initial condition $x_0 = 0.5$. The dashed and dashed-dot line is the estimation of \hat{x} with $h = 1$ and $h = 0.5$, respectively, which converges to the state $x(t)$.

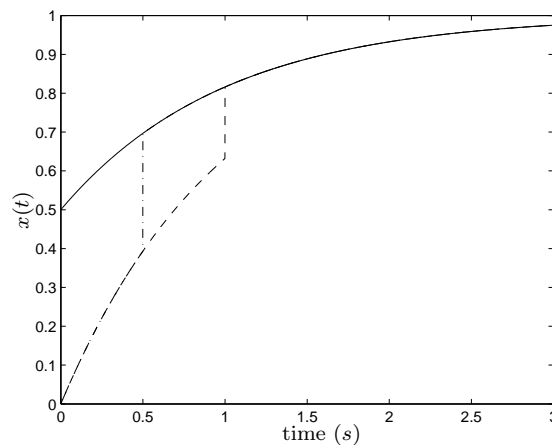

FIGURE 4.14: observer simulation with the state $x(t)$ (continuous) and the estimation of $\hat{x}(t)$ (dashed $h = 1$, dashed-dot $h = 0.5$), $k = e^{-h}$ and the initial condition is $x_0 = 0.5$, (Example 4.10).

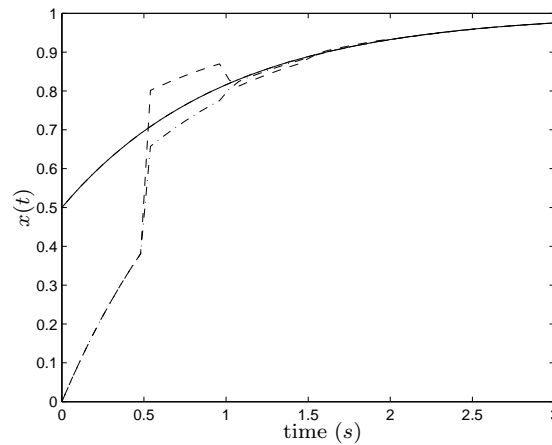

FIGURE 4.15: observer simulation with the state $x(t)$ (continuous) and the estimation of $\hat{x}(t)$ (dashed $k = 0.8$, dashed-dot $k = 0.5$), $h = 0.5$ and the initial condition is $x_0 = 0.5$, (Example 4.10).

4.3.2.2 Multivariable case

In the multivariable case, we denote

$$\rho(A) = \max \{ |\lambda| : \lambda \text{ is an eigenvalue of } A \}$$

The necessary and sufficient condition for the asymptotical stability of (4.77) is $\rho(e^{Ah} - KC) < 1$, [Damak et al 2013]. If the difference equation (4.77) is stable for any bounded initial condition,

$$\lim_{t \rightarrow \infty} e(t) = 0. \quad (4.81)$$

Now we decompose system (4.77) into its Jordan reduced form

$$z(t) = Jz(t - h), \quad t \geq h, \quad (4.82)$$

with $A = PJP^{-1}$, P is a unimodular transformation, $z(t) = Pe(t)$, and $J = \text{block diag}(J_1, J_2, \dots, J_l)$ for $l \leq n$, and where J_k stands for the $q_k \times q_k$ matrix (q_k

is the number of the same eigenvalues of λ_k)

$$J_k = \begin{bmatrix} \lambda_k & 1 & \cdots & 0 \\ & \lambda_k & \ddots & \\ & & \ddots & 1 \\ & & & \lambda_k \end{bmatrix}. \quad (4.83)$$

The elements λ_k , for $k = 1, \dots, l$, are the eigenvalues of A . Then there exist $t \in [nh, (n+1)h]$ such that

$$z(t) = J^{n+1}\phi(t - (n+1)h), \quad (4.84)$$

where $\phi(t)$ is the initial condition for the equation (4.82). If $J^\eta = 0$ for $\eta \in \mathbb{N}$, $z(t) = 0$ for any $t \in [kh, (k+1)h]$, $k \geq \eta - 1$ and $k \in \mathbb{N}$. That is to say if $J^\eta = 0$, $e(t) = P^{-1}z(t) = 0$ for any $t \in [kh, (k+1)h]$ where $k \geq \eta - 1$. So the condition for $e(t) = 0$ is $J^\eta = 0$ for $\eta \in \mathbb{N}$. In other words, the matrix J should be the nilpotent matrix. And $e(t) = 0$ at $t \in [(\eta - 1)h, \infty]$.

Remark 4.22. For choosing the coefficient K and h such that the matrix J is matrix nilpotent, we give the following procedure. Let us see the SISO system first.

If the system (4.57)-(4.58) is observable, from Theorem 4.18 we know that the pair (e^{Ah}, C) is observable. Then there exists an unimodular matrix Q such that

$$Q^{-1}e^{Ah}Q = A_e = \begin{bmatrix} 0 & 0 & \cdots & 0 & a_1 \\ 1 & 0 & \cdots & 0 & a_2 \\ 0 & 1 & \cdots & 0 & a_3 \\ \vdots & \vdots & \ddots & \vdots & \vdots \\ 0 & 0 & \cdots & 1 & a_n \end{bmatrix} \quad (4.85)$$

and

$$CQ = C_e = \begin{bmatrix} 0 & \cdots & 0 & 1 \end{bmatrix}. \quad (4.86)$$

where A_e and C_e are the observable canonical form. Since the matrix $(e^{Ah} - KC)$ and $Q^{-1}[e^{Ah} - KC]Q$ are matrix similarity, we can focus on calculating the

eigenvalues of matrix $Q^{-1}[e^{Ah} - KC]Q$. Let

$$Q^{-1}K = Ke = \begin{bmatrix} k_1 \\ \vdots \\ k_n \end{bmatrix}$$

we have

$$\begin{aligned} Q^{-1}[e^{Ah} - KC]Q &= A_e - K_e C_e \\ &= \begin{bmatrix} 0 & 0 & \cdots & 0 & a_1 - k_1 \\ 1 & 0 & \cdots & 0 & a_2 - k_2 \\ 0 & 1 & \cdots & 0 & a_3 - k_3 \\ \vdots & \vdots & \ddots & \vdots & \vdots \\ 0 & 0 & \cdots & 1 & a_n - k_n \end{bmatrix} \end{aligned} \quad (4.87)$$

The characteristic polynomial of $A_e - K_e C_e$ is

$$p(\lambda) = (a_1 - k_1) + (a_2 - k_2)(-\lambda) + \cdots + (-\lambda)^n \quad (4.88)$$

If all the eigenvalues equal zero, we can deduce $a_i = k_i$, $i = 1, \dots, n$.

Now we see the MIMO systems. Like the SISO system. If the system (4.57)-(4.58) is observable, from Theorem 4.18 we know that the pair (e^{Ah}, C) is observable. Then there exist an unimodular matrix Q such that

$$\begin{aligned}
A_e &= Q^{-1}e^{Ah}Q \\
&= \begin{bmatrix}
0 & \cdots & 0 & \times & 0 & \cdots & 0 & \times & & 0 & \cdots & 0 & \times & \uparrow \\
1 & & & \times & \vdots & & \vdots & \vdots & \cdots & \vdots & & \vdots & & q_1 \\
& & \ddots & \ddots & \vdots & & & \vdots & & & & & \vdots & \\
& & & 1 & \times & 0 & \cdots & 0 & \times & & 0 & \cdots & 0 & \times & \downarrow \\
0 & \cdots & 0 & \times & 0 & \cdots & 0 & \times & & 0 & \cdots & 0 & \times & \uparrow \\
\vdots & & \vdots & \vdots & 1 & 0 & & \times & & \vdots & & \vdots & \times & q_2 \\
& & & \vdots & & \ddots & \ddots & \vdots & \cdots & & & & \vdots & \\
0 & \cdots & 0 & \times & & & 1 & \times & & 0 & \cdots & 0 & \times & \downarrow \\
& & \vdots & & & \vdots & & & \ddots & & & & \vdots & \\
0 & \cdots & 0 & \times & 0 & \cdots & 0 & \times & & 0 & \cdots & 0 & \times & \uparrow \\
\vdots & & \vdots & \vdots & \vdots & & \vdots & \vdots & \cdots & 1 & 0 & & \times & q_l \\
& & & \vdots & & & \vdots & & & & \ddots & \ddots & & \\
0 & \cdots & 0 & \times & 0 & \cdots & 0 & \times & & & & 1 & \times & \downarrow \\
\leftarrow q_1 & & \rightarrow & \leftarrow q_2 & \rightarrow & & \leftarrow q_l & \rightarrow & & & & & &
\end{bmatrix}
\end{aligned}$$

and

$$\begin{aligned}
C_e &= CQ \\
&= \begin{bmatrix}
& & 1 & & 0 & & & 0 \\
& & 0 & & 1 & & \vdots & 0 \\
\mathbf{0} & & 0 & & \mathbf{0} & 0 & \cdots & \mathbf{0} & \vdots \\
& & \vdots & & \vdots & & & 0 \\
& & 0 & & 0 & & & 1 \\
\leftarrow q_1 & \rightarrow & \leftarrow q_2 & \rightarrow & & \leftarrow q_l & \rightarrow &
\end{bmatrix}
\end{aligned}$$

where A_e and C_e are the observable canonical form. Let $K_e = Q^{-1}K$,

$$K_e = \begin{bmatrix} k_{1,1} & \cdots & k_{1,m} \\ \vdots & & \vdots \\ k_{n,1} & \cdots & k_{n,m} \end{bmatrix}. \quad (4.89)$$

The matrix $Q^{-1}[e^{Ah} - KC]Q = A_e - K_e C_e$ has the same eigenvalue with $e^{Ah} - KC$.
The matrix $A_e - K_e C_e$ has the following form

$$\begin{aligned}
 & A_e - K_e C_e = \\
 = & \left[\begin{array}{cccccccc}
 0 & & \times - k_{1,1} & & \times - k_{2,1} & & & \times - k_{1,m} & \uparrow \\
 1 & 0 & \times - k_{1,2} & & \vdots & \dots & & & v_1 \\
 & \ddots & \ddots & \vdots & \vdots & & & \vdots & \\
 & & 1 & & & & & & \downarrow \\
 & & & 0 & & & & & \uparrow \\
 & & & \vdots & 1 & 0 & & & v_2 \\
 & & & \vdots & \ddots & \ddots & \vdots & \dots & \vdots \\
 & & & & & 1 & & & \downarrow \\
 & \vdots & & \vdots & & & & & \vdots \\
 & & & & & & & 0 & \uparrow \\
 & & & \vdots & & \vdots & \dots & 1 & 0 & v_l \\
 & & & \vdots & & \vdots & & & \ddots & \ddots \\
 & & \times - k_{n,1} & & \times - k_{n,2} & & & 1 & \times - k_{n,m} & \downarrow \\
 \leftarrow q_1 & & \rightarrow & \leftarrow q_2 & \rightarrow & & \leftarrow q_l & & \rightarrow &
 \end{array} \right].
 \end{aligned}$$

If any element $\times - k_{i,j} = 0$, $i = 1, \dots, n$, $j = 1, \dots, m$, the matrix $A_e - K_e C_e$ will be

$$A_e - K_e C_e = \begin{bmatrix} 0 & & & \\ 1 & 0 & & \\ & \ddots & \ddots & \\ & & 1 & 0 \end{bmatrix}. \quad (4.90)$$

That is to say all the eigenvalues of matrix are equal to zero.

Example 4.11. Consider the system

$$\begin{aligned}
 \dot{x}(t) &= \begin{bmatrix} -1 & 0 & 1 \\ 0 & -1 & 0 \\ 0 & 0 & -1 \end{bmatrix} x(t) + \begin{bmatrix} 1 \\ 1 \\ 0 \end{bmatrix} u(t) \\
 y(t) &= \begin{bmatrix} 1 & 0 & 0 \\ 0 & 1 & 0 \end{bmatrix} x(t),
 \end{aligned}$$

where

$$A = \begin{bmatrix} -1 & 0 & 1 \\ 0 & -1 & 0 \\ 0 & 0 & -1 \end{bmatrix}, B = \begin{bmatrix} 1 \\ 1 \\ 0 \end{bmatrix}, C = \begin{bmatrix} 1 & 0 & 0 \\ 0 & 1 & 0 \end{bmatrix}.$$

The observer

$$\begin{aligned} \hat{x}(t) &= e^{Ah}\hat{x}(t-h) + K[y(t-h) - \eta(t-h)] + \int_{t-h}^t e^{A(t-\tau)}Bu(\tau)d\tau \\ \eta(t) &= C\hat{x}(t). \end{aligned}$$

The error $e(t) = x(t) - \hat{x}(t)$ is

$$e(t) = (e^{Ah} - KC)e(t-h).$$

If we choose $K = \begin{bmatrix} 2e^{-h} & 0 \\ 0 & e^{-h} \\ \frac{e^{-h}}{h} & 0 \end{bmatrix}$, the eigenvalues of $(e^{Ah} - KC)$ are equal to zero

and the error $e(t)$ will vanish at $t = 2h$. Figure 4.16 shows the step response of the state x_1, x_2, x_3 and the estimation of $\hat{x}_1, \hat{x}_2, \hat{x}_3$. In the upper-left figure of Figure 4.16, the continuous line is the step response of the state x_1 with initial condition $x_0(t) = [0.5 \ 0.5 \ 0.5]^T$. The dashed line is the exact estimation of \hat{x}_1 with the coefficient $h = 0.5$. So we have $x_1(t) = \hat{x}_1(t)$, $t \geq 1$. The dashed-dot line is the simulation of \hat{x}_1 with $h = 0.2$. So we obtain $x_1(t) = \hat{x}_1(t)$, $t \geq 0.4$. The other figures in Figure 4.16 show the observation simulation of $x_2(t)$ and $x_3(t)$ respectively.

If we choose the poles of the error system to be $\{0.1 \ 0.2 \ 0.3\}$, the parameter K

can be obtained by calculation, that is $K = \begin{bmatrix} 0.9131 & 0 \\ 0 & 0.3065 \\ 0.6790 & 0 \end{bmatrix}$. So the estimate

$\hat{x}(t)$ will converge to the state $x(t)$. The simulation result can be seen in Figure 4.17. In the Figure 4.17, the continuous line is the step response of the state $x(t)$ with initial condition $x_0(t) = [0.5 \ 0.5 \ 0.5]^T$. The dashed line is the estimation of $\hat{x}(t)$ with coefficient $h = 0.5$. We can see that the estimation of $\hat{x}(t)$ converges to the state $\hat{x}(t)$. The dashed-dot line is the estimation of $\hat{x}(t)$ with the coefficient $h = 0.2$.

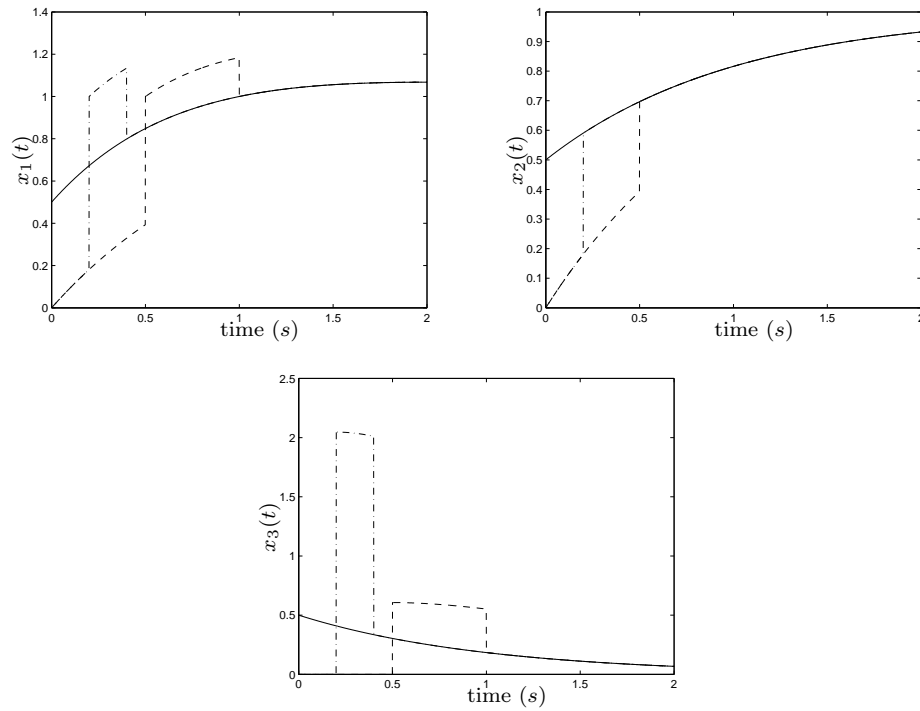

FIGURE 4.16: observer simulation with the state $x(t)$ (continuous) and the estimation of $\hat{x}(t)$ (dashed $h = 0.5$, dashed-dot $h = 0.2$), the initial condition is $x_0 = [0.5 \ 0.5 \ 0.5]^T$, (Example 4.11).

4.3.2.3 Robustness under parameter uncertainty

In this subsection we consider that some uncertainties occur in the observer parameter h . Let $h = h_0 + \Delta h$, h_0 is know while $\Delta h > -h_0$ is some uncertainties. The error of the observer can be defined as

$$e(t) = [e^{A(h_0+\Delta h)} - KC]e(t-h). \quad (4.91)$$

where the parameters h_0 , K are given and satisfy $\rho(e^{A(h_0)} - KC) < 1$. So the necessary and sufficient condition of asymptotical stability for the equation (4.91) is

$$\rho(e^{A(h_0+\Delta h)} - KC) < 1. \quad (4.92)$$

In the scalar case, the inequality (4.92) reduces to

$$(KC - 1)e^{-Ah_0} < e^{A\Delta h} < (KC + 1)e^{-Ah_0}. \quad (4.93)$$

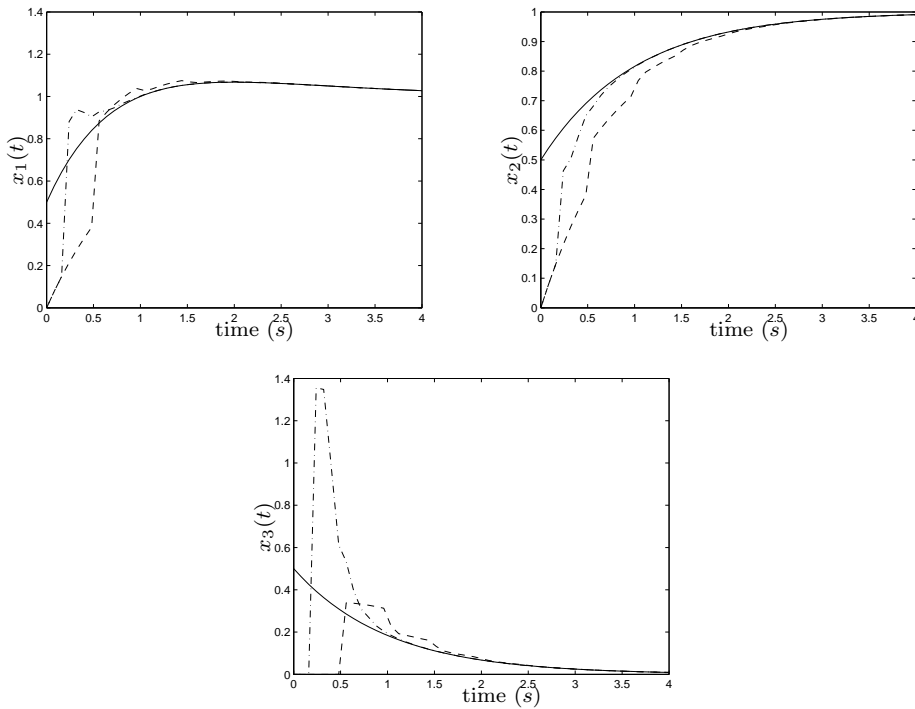

FIGURE 4.17: observer simulation with the state $x(t)$ (continuous) and the estimation of $\hat{x}(t)$ (dashed $h = 0.5$, dashed-dot $h = 0.2$), the initial condition is $x_0 = [0.5 \ 0.5 \ 0.5]^T$, (Example 4.11).

In the multivariable case, for any matrix $M \in \mathbb{R}^{n \times n}$, we denote $|M|$ the matrix with entries $|m_{ij}|$, $i, j = 1, 2, \dots, n$, where m_{ij} are the entries of M . And for the two matrix $M, N \in \mathbb{R}^{n \times n}$, the inequality $M < N$ stands for any corresponding entries of matrix M, N , we have $m_{ij} < n_{ij}$. If there exist matrix $A, B \in \mathbb{R}^{n \times n}$ such that $A < |A| < |B|$, we have the following inequality

$$\rho(A) < \rho(|A|) < \rho(|B|).$$

So we can obtain the following inequality

$$\rho(e^{A(h_0+\Delta h)} - KC) \leq \rho(|e^{A(h_0+\Delta h)}| + |KC|). \quad (4.94)$$

Then the sufficient condition of the asymptotically stable of the observation can be deduced as $\rho(|e^{A(h_0+\Delta h)}| + |KC|) < 1$. We know the exact value of $|KC|$. For the part $|e^{A(h_0+\Delta h)}|$, we decompose it into its Jordan form. In other words there

exist a unimodular matrix P such that

$$e^{A(h_0+\Delta h)} = P e^{J(h_0+\Delta h)} P^{-1} \quad (\text{or } A = PJP^{-1}), \quad (4.95)$$

where

$$J = \begin{bmatrix} J_1 & & \\ & \ddots & \\ & & J_q \end{bmatrix}, \quad J_i = \begin{bmatrix} \lambda_i & 1 & & \\ & \lambda_i & \ddots & \\ & & \ddots & 1 \\ & & & \lambda_i \end{bmatrix}_{l_i \times l_i}, \quad (4.96)$$

where λ_i for $i = 1, 2, \dots, q$ are the eigenvalues of A , l_i is the number of the same eigenvalues of λ_i . Since

$$J_i = \lambda_i I_{l_i} + N_i \quad (4.97)$$

where

$$N_i = \begin{bmatrix} 0 & 1 & & \\ & 0 & \ddots & \\ & & \ddots & 1 \\ & & & 0 \end{bmatrix}_{l_i \times l_i}$$

is the nilpotent matrix, we have

$$\begin{aligned} e^{J_i(h_0+\Delta h)} &= e^{(\lambda_i I_{l_i} + N_i)(h_0+\Delta h)} = e^{\lambda_i(h_0+\Delta h)} e^{N_i(h_0+\Delta h)} \\ &= e^{\lambda_i(h_0+\Delta h)} \sum_{k=0}^{l_i-1} \frac{N_i^k (h_0 + \Delta h)^k}{k!}. \end{aligned} \quad (4.98)$$

In other words

$$e^{J_i(h_0+\Delta h)} = e^{\lambda_i(h_0+\Delta h)} \begin{bmatrix} 1 & h_0 + \Delta h & \frac{(h_0+\Delta h)^2}{2!} & \cdots & \frac{(h_0+\Delta h)^{l_i-1}}{(l_i-1)!} \\ & 1 & h_0 + \Delta h & \ddots & \vdots \\ & & 1 & \ddots & \frac{(h_0+\Delta h)^2}{2!} \\ & & & \ddots & h_0 + \Delta h \\ & & & & 1 \end{bmatrix}. \quad (4.99)$$

So we have

$$e^{A(h_0+\Delta h)} = P e^{J(h_0+\Delta h)} P^{-1} = P \left[\text{block diag} \{ e^{J_1(h_0+\Delta h)}, \dots, e^{J_q(h_0+\Delta h)} \} \right] P^{-1}. \quad (4.100)$$

So if

$$\rho(|P [\text{block diag } \{e^{J_1(h_0+\Delta h)}, \dots, e^{J_q(h_0+\Delta h)}\}] P^{-1}| + |KC|) < 1, \quad (4.101)$$

the system still is stable. From inequality (4.101) we can find the bound (denoted by h_{min}, h_{max}) on the uncertainty Δh . So the robust stability condition for the uncertainty Δh is

$$\max\{-h_0, h_{min}\} < \Delta h < h_{max}.$$

Example 4.12. *Let us consider the Example 4.11. We choose*

$$h_0 = 0.5, \quad K = \begin{bmatrix} 0.9131 & 0 \\ 0 & 0.3065 \\ 0.6790 & 0 \end{bmatrix}, \quad C = \begin{bmatrix} 1 & 0 & 0 \\ 0 & 1 & 0 \end{bmatrix},$$

and

$$e^{A(h_0+\Delta h)} = e^{-(h_0+\Delta h)} \left(I + \begin{bmatrix} 0 & 0 & h_0 + \Delta h \\ 0 & 0 & 0 \\ 0 & 0 & 0 \end{bmatrix} \right)$$

From inequality (4.94) we have

$$\rho(e^{A(h_0+\Delta h)} - KC) < \rho(|e^{A(h_0+\Delta h)}| + |KC|). \quad (4.102)$$

where

$$|e^{A(h_0+\Delta h)}| + |KC| = \begin{bmatrix} e^{-h_0-\Delta h} + 0.9131 & 0 & h_0 + \Delta h \\ 0 & e^{-h_0-\Delta h} + 0.3065 & 0 \\ 0.6790 & 0 & e^{-h_0-\Delta h} \end{bmatrix}.$$

We can obtain $\rho(|e^{A(h_0+\Delta h)}| + |KC|) = 0.3679 + e^{-h-\Delta h}$. If the system (4.91) is stable, $\rho(|e^{A(h_0+\Delta h)}| + |KC|) = 0.3065 + e^{-h_0-\Delta h} < 1$. That is to say $\Delta h > \max\{0.3621 - h_0, -h_0\} = 0.3621 - h_0$. For example, let us choose $h_0 = 0.5$ (see Example 4.10), then $\Delta h > -0.1379$. For $\Delta h = \{0.5, 1, 1.5\}$, the step response of the state x and estimation of \hat{x} are shown in Figure 4.18.

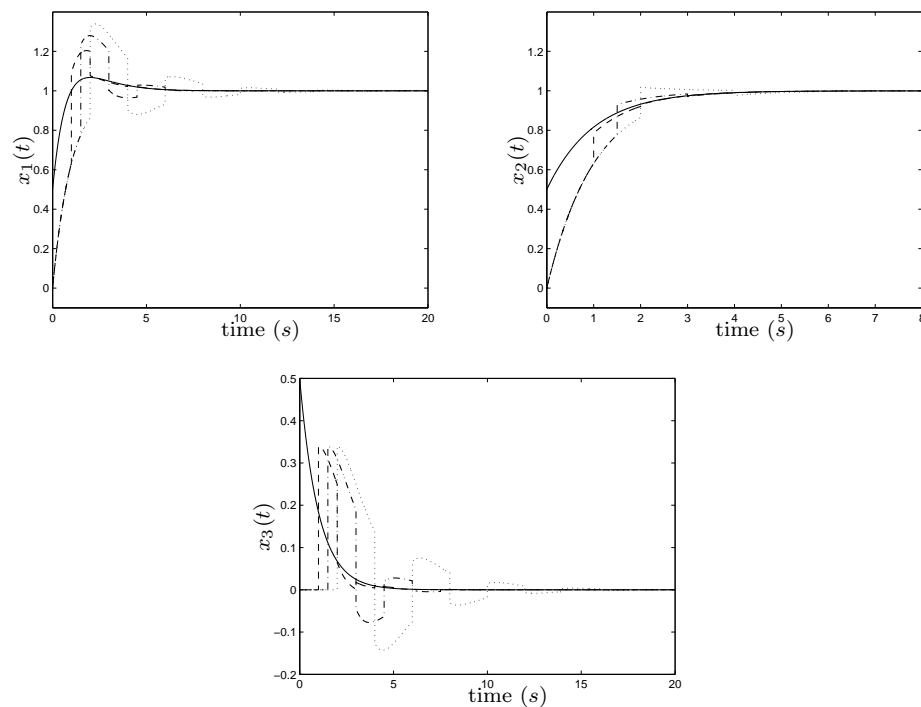

FIGURE 4.18: observer simulation with the state $x(t)$ (continuous) and the estimation of $\hat{x}(t)$ ($\Delta h = 0.5$ (dash), $\Delta h = 1$ (dash-dot), $\Delta h = 1.5$ (dot)), the initial condition is $x_0 = [0.5 \ 0.5 \ 0.5]^T$, (Example 4.12).

4.4 Conclusion

The first contribution of this chapter is the stabilization and FSA for SISO neutral time-delay systems. We presented an the algebraic algorithm to find the stabilizing control law. More generally, we introduced the FSA for a class of infinite dimensional systems. The necessary and sufficient condition for FSA were given and the procedure for finding the state feedback control was presented. The other contribution of this chapter is the observer synthesis for estimation or output control. We focused on the closed-loop memoryless observers by output injection. Asymptotic convergence, as well as finite time convergence of the estimation are analyzed by output injection. Some robustness aspects are also discussed, depending on the time of measurements.

Chapter 5

Approximation of Distributed Parameter Systems

In this chapter we study the approximation problem for linear distributed parameter systems. A distributed parameter system is an infinite dimensional system, which can be realized by partial differential equations. We are interested in the definition of a new class of approximation which we will introduce here. Such a new class of approximation is introduced to address the conservatism of conditions for approximation by lumped systems. Furthermore, such an approximation is defined in the graph topology, which will ensure that for control purpose, the properties obtained in closed-loop on the approximation are close to those of the finite dimensional plant.

From an input-output approach, working on approximation means to find a more tractable model with respect to specifications, like control, simulation, inversion, or model analysis. In other words, an approximation problem can be decomposed into two steps. The first one consists, from specifications, to define the class of operators used in the approximated model as well as the topology. The second step is the development of theoretical and numerical methods to determine an operator in the previous class which is close to the system. In this chapter, we will introduce a new class of approximation, that will include time-delay operators. Working on the graph topology, we will show that, under some weak assumptions, such an approximation can always be realized. We will focus our work on the realization and the representation of this approximation by Roesser model where distributed delay will appear explicitly. An equivalence between Roesser model

and neutral time-delay system is also commented in this chapter. This part contains more prospective works, and will open new motivations for the control theory on time-delay systems and the use of distributed delay.

5.1 Approximation by lumped systems

Let us recall first some facts on approximation by lumped systems. Most of the works in the literature on approximation are focused on approximation operators defined by lumped systems. Lumped systems were already presented in Chapter 2. Let us recall the basic and central result in approximation by lumped systems.

Theorem 5.1 (Vidyasagar and Anderson (1989) [21]). *Suppose a plant P has dimensions $l \times m$ and has an right coprime factorization (N, D) , where naturally $N \in \mathcal{A}^{l \times m}$ and $D \in \mathcal{A}^{m \times m}$. Then P can be approximated by a lumped plant in the graph topology if and only if there exists a constant matrix $M \in \mathbb{R}^{l \times (m+l)}$ of rank l such that*

$$MA_{pa} = 0 \quad \text{where} \quad A = \begin{bmatrix} N \\ D \end{bmatrix}, \quad (5.1)$$

and $(\cdot)_{pa}$ denotes the purely atomic part.

The necessary and sufficient condition proposed in Theorem 5.1 is strongly conservative. For example, for the plant

$$T(s) = \frac{2e^{-s}}{1 + e^{-2s}},$$

which can be obtained by some propagation phenomena, we have $N(s) = 2e^{-s}$, $D(s) = 1 + e^{-2s}$. These factors are coprime over \mathcal{A} since

$$-\frac{1}{2}e^{-s} \cdot N(s) + 1 \cdot D(s) = 1.$$

Now, using Theorem 5.1, we can show that $T(s)$ cannot be approximated in the sense of the graph topology by any lumped system. From Theorem 5.1, we have

$$A_{pa} = \begin{bmatrix} 2e^{-s} \\ 1 + e^{-2s} \end{bmatrix},$$

and the condition (5.1) is not satisfied. Indeed, for $M = [m_1, m_2]$, $m_1, m_2 \in \mathbb{R}$, we should obtain

$$2e^{-s}m_1 + (1 + e^{-2s})m_2 = 0.$$

This would imply $m_1 = m_2 = 0$, so that the rank condition on M can not be satisfied. From this example, presented in this chapter the central role that the purely atomic part plays in approximation is readily verified. This fact will be at the core of the new class of approximation.

Numerical methods for approximation by lumped systems can be found in many works, such as [122, Powell (1981)], [52, Gu et al. (1989)], [53, Quarteroni and Valli (2008)], [58, Glover et al. (1988)], [123, Morris and Navasca (2010)], [59, Li (1996)] etc. We have seen in Chapter 2 that plants defined over $L_1(\mathbb{R}_+)$ can be approximated in the graph topology by lumped systems. We will present here a numerical method proposed by [59, Li (1996)]. This method is based on Laguerre series expansion. Laguerre polynomials are defined by

$$L_n(t) := \sum_{k=0}^n \frac{n!}{k!(n-k)!} \frac{(-t)^k}{k!}, \quad n \geq 0, \quad t \geq 0. \quad (5.2)$$

and have been well studied in the literature (for instance in [124, Mäkilä (1990)]). The elements $g_n(t) = L_n(t)e^{-\frac{t}{2}}$, for $n \geq 0$, form an orthonormal Hilbert basis of $L_2(\mathbb{R}_+)$, and any function $h(t) \in L_2(\mathbb{R}_+)$ can be uniquely expanded as

$$h(t) = \sum_{n=0}^{\infty} c_n(h)g_n(t), \quad (5.3)$$

where $c_n(h) = \langle h, g_n \rangle = \int_0^{\infty} h(t)g_n(t)dt$, $n \geq 0$, are called the Laguerre coefficients of $h(t)$ relative to g_n . Using the Laguerre series expansion, we get the following result on L_1 - approximation.

Theorem 5.2 (Li (1996) [59]). *Suppose that there exists α_0 , such that $h(t)e^{\alpha_0 t} \in L_2(\mathbb{R}_+)$, and $h(t) \in L_1(\mathbb{R}_+)$. For any $\alpha \in]0, \alpha_0[$ define*

$$h_{n,\alpha}(t) = \sum_{k=0}^n c_{k,\alpha} L_k(t) e^{-(\frac{1}{2}+\alpha)t}, \quad (5.4)$$

where $c_{k,\alpha} = \langle h(t)e^{\alpha t}, g_k(t) \rangle$, $k \geq 0$. Then $h_{n,\alpha}(t)$ converges to $h(t)$ in L_1 , namely

$$\lim_{n \rightarrow \infty} \|h(t) - h_{n,\alpha}(t)\|_{L_1} = 0.$$

Let us illustrate such an approximation on a simple example, related to heat conduction.

Example 5.1. Consider the plant [118, Curtain and Morris (2009)]

$$\hat{h}(s) = \frac{\sinh(\sqrt{\frac{s}{2}})}{\sinh(2\sqrt{\frac{s}{2}})}.$$

The poles of the system are $-(k\pi)^2$, $k = 1, 2, \dots$, and the plant is strictly proper, and stable. The inverse Laplace transform of $\hat{h}(s)$ is

$$h(t) = \sum_{n=1}^{\infty} e^{-\frac{n^2}{2}\pi^2 t} n\pi \sin\left(\frac{n}{2}\pi\right), \quad t > 0. \quad (5.5)$$

We can verify that $h(t) \in L_1(\mathbb{R}_+)$ and for $\alpha_0 < \frac{\pi^2}{2}$, $h(t)e^{\alpha_0 t} \in L_2(\mathbb{R}_+)$. Applying Theorem 5.2 with any $\alpha \in (0, \alpha_0)$ an L_1 -approximation of $h(t)$ is

$$h_{app}(t) = \sum_{k=0}^n c_{k,\alpha} L_k(t) e^{-\frac{1}{2}t} e^{-\alpha t},$$

where

$$\begin{aligned} c_{k,\alpha} &= \int_0^{\infty} h(t) e^{\alpha t} L_k(t) e^{-\frac{1}{2}t} dt \\ &= \sum_{j=0}^k \left[C_k^{k-j} \frac{1}{j!} \sum_{q=1}^{\infty} (-1)^q \frac{j! \cdot (2q+1)\pi}{\left(\frac{(2q+1)^2}{2}\pi^2 + \frac{1}{2} - \alpha\right)^{(j+1)}} \right]. \end{aligned} \quad (5.6)$$

In Figure 5.1, a simulation result of $h(t)$ is reported. This approximated solution is compared to a truncation of the exact solution $h(t)$ in (5.5) where only the first 21 terms were taken into account.

5.2 Causality

Approximation is required to be causal. A plant P is said to be causal if the value of the output $(Pu)(t)$ at any time t depends only on the values of the input up to time t . Define \mathcal{P}_T as

$$\mathcal{P}_T(u)(t) = \begin{cases} u(t), & t \leq T \\ 0, & \text{elsewhere} \end{cases}. \quad (5.7)$$

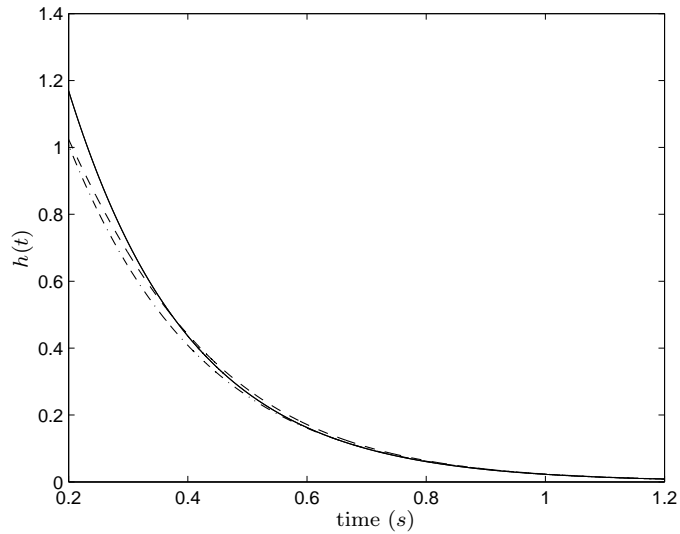

FIGURE 5.1: The continuous line is $h(t)$, the dash line is the approximation of $h(t)$ (with $n = 10$), the dash-dot line is the approximation of $h(t)$ (with $n = 5$). (Example 5.1).

The plant P is causal if and only if [125, Willems (1969)]

$$\mathcal{P}_T P \mathcal{P}_T = \mathcal{P}_T P. \quad (5.8)$$

The set of causal plants forms an algebra.

Lemma 5.3. *Let P be a $p \times m$ plant, and assume that P admits an rcf (N, D) , with $N \in \mathcal{A}^{p \times m}$ and $D \in \mathcal{A}^{m \times m}$. Then P is causal if and only if D^{-1} is causal.*

Proof. Assume that P is causal. Since (N, D) is an rcf, there exist $X \in \mathcal{A}^{m \times p}$ and $Y \in \mathcal{A}^{m \times m}$ such that $XN + YD = I_m$. Hence $XP + Y = D^{-1}$. Since the elements in \mathcal{A} are causal, $XP + Y$ is causal, and so is D^{-1} . The converse is obvious. \square

Any causal plant can be decomposed as

$$P = P_p + P_{sp}, \quad (5.9)$$

where P_p is proper, while P_{sp} is strictly proper in the sense of Definition 1.7.

Lemma 5.4. *Let D be in $\mathcal{A}^{m \times m}$. Then D is bicausal if and if D_0 is a nonsingular matrix in $\mathbb{R}^{m \times m}$, where*

$$D = \sum_{i \geq 0} D_i e^{-st_i}. \quad (5.10)$$

Proof. Assume that D is bicausal. Then D can be decomposed as $D = D_0 + \sum_{i \geq 0} D_i e^{-st_i} + D_r$, and

$$D^{-1} = Q_0 + Q_{sp}, \quad (5.11)$$

where Q_{sp} is strictly proper. Hence,

$$I_m = DD^{-1} = D_0 Q_0 + S, \quad (5.12)$$

where S is strictly proper. We conclude that the inversion of D_0 is Q_0 , so D_0 is nonsingular.

Conversely, assume that D_0 is nonsingular. Then

$$D^{-1} = (I_m + D_{sp})^{-1} D_0^{-1}, \quad (5.13)$$

where D_{sp} is strictly proper. Since strictly proper systems form a radical of the algebra of causal plants, we conclude that D^{-1} is causal. \square

In other words, for any plant P with an rcf (N, D) , the plant P is causal if and only if D_0 is nonsingular.

5.3 Approximation by delay systems

In this section, we show that under weak conditions, any distributed parameter plant can be approximated by a time-delay plant of neutral type.

The central result of this section is given below.

Theorem 5.5. *Let P be a $p \times m$ causal plant, and assume that P admits an rcf (N, D) , with $N \in \mathcal{A}^{p \times m}$ and $D \in \mathcal{A}^{m \times m}$. Then P can be approximated in the graph topology by a delay plant.*

Before we prove this theorem, let us introduce the following Lemma.

Lemma 5.6. *Let $N \in \mathcal{A}^{p \times m}$ and assume that $N = N_{pa}$. Then N can be approximated in the graph topology by an input-delay system.*

Proof. From assumption $N = N_{pa}$, it follows readily that

$$N = \sum_{i \geq 0} N_i \delta(t - t_i).$$

Since N_i is an $l_1^{p \times m}$ -convergent sequence, for any $\varepsilon > 0$, there exists $q \in \mathbb{N}$ such that $N_{T(q)} \in \mathcal{B}(N, \varepsilon)$, where $N_{T(q)}$ is the truncation of the first q -elements in N , that is $N_{T(q)} = \sum_{i=0}^q N_i \delta(t - t_i)$. It follows that a realization of this approximation is

$$y_q(t) = N_0 u(t) + N_1 u(t - t_1) + \dots + N_q u(t - t_q),$$

which is an input-delay system, where $y_q(t)$ is the output, and $u(t)$ is the input. \square

Now we can prove Theorem 5.5 by using Lemma 5.6.

Proof. Let $y = Pu$, and introduce the partial state ξ such that

$$\begin{aligned} u &= D\xi \\ y &= N\xi \end{aligned}$$

Since P is causal, D_0 is nonsingular, so that

$$I_m \xi + \left(\sum_{i \geq 1} D_0^{-1} D_i e^{-st_i} + D_0^{-1} D_r \right) \xi = u. \quad (5.14)$$

Since $D_0^{-1} D_r$ is strictly proper, it can be approximated by a lumped system in the graph topology. It follows that there exist real matrices (C, F, G) such that $C(sI_n - F)^{-1} G$ realizes a lumped approximation of $D_0^{-1} D_r$. Then, using the truncation proposed in Lemma 5.6, an approximation in the graph topology of $u = D\xi$ is given by

$$\begin{cases} \xi(t) = \sum_{i=1}^r A_i \xi(t - t_i) + Bz(t) + Cu(t) \\ \dot{z}(t) = Dz(t) + E\xi(t) \end{cases}. \quad (5.15)$$

The relationship $y = N\xi$ can be approximated by

$$\begin{cases} \dot{\omega}(t) = H\omega(t) + K\xi(t) \\ y(t) = \sum_i N_i \xi(t - t_i) + L\omega(t) \end{cases}. \quad (5.16)$$

□

From Theorem 5.5, we know that the causal plant (with coprime factorization over \mathcal{A}) can be approximated in a delay plant which has the following form

$$\begin{cases} x(t) = \sum_{i=1}^r A_i x(t - i\vartheta) + Bz(t) + Cu(t) \\ \dot{z}(t) = Dz(t) + Ex(t) \end{cases}, \quad \vartheta \in \mathbb{R}_+. \quad (5.17)$$

The equations (5.17) involve two linear operators, and we can also realize such approximation using only delay operators with pointwise and distributed delays. For this, just note that the solution of the ODE (Ordinary Differential Equation) in equations (5.17) is described by

$$z(t) = e^{D\vartheta} z(t - \vartheta) + \int_0^{\vartheta} e^{D\tau} Ex(t - \tau) d\tau, \quad t \neq \vartheta, \quad (5.18)$$

with

$$z(t) = e^{Dt} z(0) + \int_0^t e^{D(t-\tau)} Ex(t - \tau) d\tau, \quad t \in [0, \vartheta].$$

Hence (5.17) is equivalent to

$$\begin{cases} x(t) = \sum_{i=1}^r A_i x(t - i\vartheta) + Bz(t) + Cu(t) \\ z(t) = e^{D\vartheta} z(t - \vartheta) + \int_0^{\vartheta} e^{D\tau} Ex(t - \tau) d\tau \end{cases}, \quad \vartheta \in \mathbb{R}_+. \quad (5.19)$$

If the system has only one delay, the system can be rewritten into the canonical form of a Roesser-model. Consider the following system

$$\begin{cases} x(t) = Ax(t - \vartheta) + Bz(t) + Cu(t) \\ \dot{z}(t) = Dz(t) + Ex(t) \end{cases}, \quad \vartheta \in \mathbb{R}_+. \quad (5.20)$$

Let $\phi(t) = x(t) - Bz(t) - Cu(t) = Ax(t - \vartheta)$, the system (5.20) can be reformulated into

$$\begin{cases} \phi(t + \vartheta) = A_1 \phi(t) + A_2 z(t) + A_3 u(t) \\ \dot{z}(t) = A_4 z(t) + A_5 x(t) \end{cases}, \quad \vartheta \in \mathbb{R}_+, \quad (5.21)$$

where $A_1 = A$, $A_2 = AB$, $A_3 = AC$, $A_4 = D$, $A_5 = E$, and (5.20), (5.21) are the canonical form of a Roesser-model. The system (5.21) can be realized by delay

operators and distributed delay which has the following form

$$X(t) = \begin{bmatrix} A_1 & A_2 \\ 0 & e^{A_4 \vartheta} \end{bmatrix} X(t - \vartheta) + \int_{t-\vartheta}^t \begin{bmatrix} 0 & 0 \\ 0 & e^{A_4(t-\tau)} A_5 \end{bmatrix} X(\tau) d\tau, \quad (5.22)$$

where

$$X(t) = \begin{bmatrix} \phi(t) \\ z(t) \end{bmatrix}, \quad t > 0.$$

The initial condition are denoted by $\phi(t) = \Phi(t)$, $t \in [-\vartheta, 0]$, and $z(t) = \Psi(t)$, $t \in [-\vartheta, 0]$.

In this chapter, we mainly focus on the delay system with only one delay which is a Roesser-model. So in the following subsection, we will introduce the Roesser-model and the equivalence between Roesser-model and neutral time-delay system. The analysis of delay systems with finite number delay is left for future work.

5.3.1 Roesser model

We consider a Roesser model, that is a 2-D state-space realization

$$\begin{cases} qx & = A_1x + A_2z + B_1u \\ wz & = A_3x + A_4z + B_2u \\ y & = C_1x + C_2z + Du \end{cases} \quad (5.23)$$

where $x \in \mathbb{R}^n$, $z \in \mathbb{R}^s$, $y \in \mathbb{R}^p$, q and w are linear operators which represent the derivative and forward delay.

We can associate to system (5.23) in a unique way the rational $p \times m$ matrix $T(q, w)$ over $\mathbb{R}(q, w)$

$$T(q, w) = D + [C_1 \ C_2] \begin{bmatrix} qI_n - A_1 & -A_2 \\ -A_3 & wI_s - A_4 \end{bmatrix}^{-1} \begin{bmatrix} B_1 \\ B_2 \end{bmatrix}. \quad (5.24)$$

$T(q, w)$ is called the transfer of the system (5.23). Conversely, given a $p \times m$ matrix $T(q, w)$ in $\mathbb{R}(q, w)$ of the form (5.24), we say that (5.23) is a realization for $T(q, w)$.

The entries of the transfer matrix $T(q, w)$ are fractions of 2D-polynomials, that is

polynomials in the variables q and w . These elements are of the form $\frac{n(q,w)}{d(q,w)}$, where

$$n(q, w) = \sum_{i=0}^{r_q} \sum_{j=0}^{r_w} n_{ij} q^i w^j, \quad d(q, w) = \sum_{i=0}^{r_q} \sum_{j=0}^{r_w} d_{ij} q^i w^j, \quad (5.25)$$

and $d_{00} = 1$ is called the principal term of $d(q, w)$.

5.3.2 Equivalence between Roesser model and neutral type time-delay

For the equivalence between Roesser model and neutral time-delay we have the following theorem.

Theorem 5.7 (Brethé and Loiseau (1997) [126]). *A Roesser model can represent a time-delay of retarded type if and only if A_4 in (5.23) is nilpotent matrix.*

Proof. First we prove that any time-delay of neutral type can be realized by a Roesser model. We consider the system

$$\dot{x}(t) = \sum_{i=1}^N E_i \dot{x}(t - ih) + \sum_{i=0}^N A_i x(t - ih) + B_0 u(t) \quad (5.26)$$

and

$$y(t) = \sum_{i=0}^N C_i x(t - ih) + D_i u(t - ih), \quad (5.27)$$

where $A_i, E_i \in \mathbb{R}^{n \times n}$, $B_i \in \mathbb{R}^{n \times m}$, $C_i \in \mathbb{R}^{p \times n}$ and $D_i \in \mathbb{R}^{p \times m}$.

We introduce the variables $z_i(t) = x(t - ih)$ and w the linear forward operator on the finite horizon h . Hence $wz_i(t) = z_{i-1}(t)$, and $z_0(t) = x(t)$. Define the state-space vector of dimensions $(2N + 1)n$

$$\xi = (\xi_1^T \quad \xi_2^T)^T, \quad (5.28)$$

where

$$\xi_1 = (z_0^T \quad z_1^T \quad \cdots \quad z_N^T)^T, \quad \xi_2 = (z_1^T \quad \cdots \quad z_N^T)^T. \quad (5.29)$$

We deduce that (5.26) admits the Roesser state-space representation

$$\begin{aligned} & \begin{pmatrix} I_n & -E_1 & \cdots & -E_n & 0 \\ 0 & \cdots & \cdots & 0 & I_{nN} \end{pmatrix} \begin{pmatrix} q\xi_1 \\ w\xi_2 \end{pmatrix} \\ &= \begin{pmatrix} A_0 & A_1 & \cdots & A_N & 0 & \cdots & 0 \\ & & & I_{nN} & 0 & \cdots & 0 \end{pmatrix} \begin{pmatrix} \xi_1 \\ \xi_2 \end{pmatrix} + \begin{pmatrix} B_0 \\ 0 \end{pmatrix} u \end{aligned} \quad (5.30)$$

The matrix

$$E = \begin{pmatrix} I_n & -E_1 & \cdots & -E_N & 0 \\ 0 & \cdots & \cdots & 0 & I_{nN} \end{pmatrix} \quad (5.31)$$

admits a right inverse matrix

$$E^{-1} = \begin{pmatrix} I_n & 0_{n \times nN} \\ 0_{nN \times n} & 0_{nN \times nN} \\ 0_{nN \times n} & I_{nN} \end{pmatrix}, \quad (5.32)$$

with dimensions $n(2N + 1) \times n(N + 1)$. We obtain a Roesser state-space model of the form

$$\begin{pmatrix} q\xi_1 \\ w\xi_2 \end{pmatrix} = \begin{pmatrix} A_1 & A_2 \\ A_3 & A_4 \end{pmatrix} \begin{pmatrix} \xi_1 \\ \xi_2 \end{pmatrix} + \begin{pmatrix} B \\ 0 \end{pmatrix} u \quad (5.33)$$

The converse of this result holds. Let be given a Roesser model in the two operators (q, w) which represent the derivative and the forward delay. Then it can be realized by a neutral delay system.

From the Roesser model (5.23), the second equation gives

$$z = (wI_s - A_4)^{-1}(A_3x + B_2u). \quad (5.34)$$

Substituting this expression into the first equation of (5.23) yields

$$qx = [A_1 + A_2(wI_s - A_4)^{-1}A_3]x + [B_1 + A_2(wI_s - A_4)^{-1}B_2]u. \quad (5.35)$$

Multiply the two sides by $\det(wI_s - A_4)$ and w^{-s} to get the result. \square

Remark 5.8. We can deduce that the delay system with a finite number of delays can be realized by a neutral time-delay system, using arguments results to those in the proof of Theorem 5.7.

Finally, let us introduce an example using this class of approximation.

Example 5.2. Consider the causal plant

$$P(s) = \frac{\sinh\sqrt{\frac{s}{2}}}{(1 - \frac{1}{2}e^{-s})\sinh 2\sqrt{\frac{s}{2}} + \sinh\sqrt{\frac{s}{2}}}.$$

There exists

$$N(s) = \frac{\sinh(\sqrt{\frac{s}{2}})}{\sinh(2\sqrt{\frac{s}{2}})},$$

and

$$D(s) = 1 - \frac{1}{2}e^{-s} + \frac{\sinh(\sqrt{\frac{s}{2}})}{\sinh(2\sqrt{\frac{s}{2}})},$$

such that $N(s), D(s) \in \hat{\mathcal{A}}$, and $N(s), D(s)$ are coprime factors of $P(s)$ in $\hat{\mathcal{A}}$. Indeed, there exist $X(s) = -\frac{1}{1-\frac{1}{2}e^{-s}} \in \hat{\mathcal{A}}$, $Y(s) = \frac{1}{1-\frac{1}{2}e^{-s}} \in \hat{\mathcal{A}}$ such that

$$X(s)N(s) + Y(s)D(s) = 1.$$

Since $\frac{\sinh(\sqrt{\frac{s}{2}})}{\sinh(2\sqrt{\frac{s}{2}})}$ is strictly proper (in the sense of Definition B.1 in [118, Curtain and Morris (2009)]), it can be approximated by a lumped system (see Example 5.1). Let $y = Pu$ and introduce the partial state ξ such that $y = N\xi$, $u = D\xi$. Using the lumped approximation for $\frac{\sinh(\sqrt{\frac{s}{2}})}{\sinh(2\sqrt{\frac{s}{2}})}$ which is introduced in Example 5.1, we have the following approximation

$$\begin{cases} \xi(t) = \frac{1}{2}\xi(t-1) + Bz(t) + u(t) \\ \dot{z}(t) = Dz(t) + E\xi(t) \end{cases}, \quad (5.36)$$

$$\begin{cases} y(t) = L\omega(t) \\ \dot{\omega}(t) = H\omega(t) + K\xi(t) \end{cases}, \quad (5.37)$$

where B, D, E, L, H, K are real matrices and the value depend on the approximation degree. If we choose the lumped approximation degree $n = 2$, we have

$$B = -L = [-2.5594 \quad -26.0942 \quad -66.4427],$$

$$D = H = \begin{bmatrix} -15 & 75 & -125 \\ 1 & 0 & 0 \\ 0 & 1 & 0 \end{bmatrix},$$

$$E = K = \begin{bmatrix} 1 \\ 0 \\ 0 \end{bmatrix}.$$

For finding the state space representation, the reader is referred to [45, Kailath (1980)] or use matlab. The simulation of the step response of the plant and its approximation can be found in Figure 5.2, Figure 5.3.

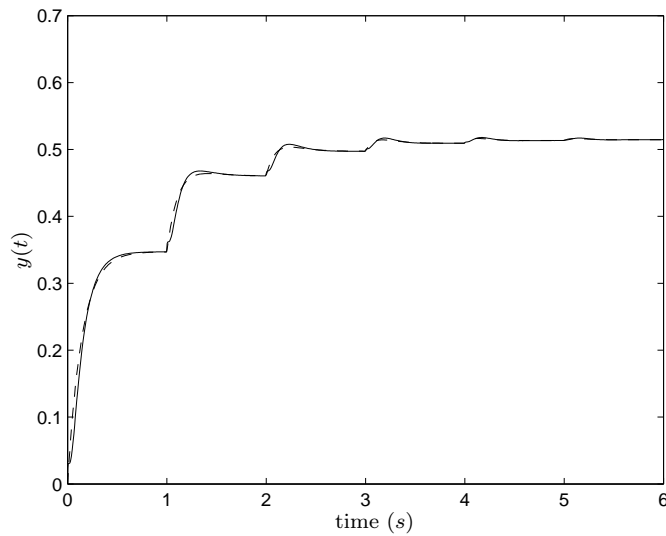

FIGURE 5.2: The continuous line is the step response of $P(s)$, the dash line is the step response of approximation plant with degree $n = 2$. (Example 5.2).

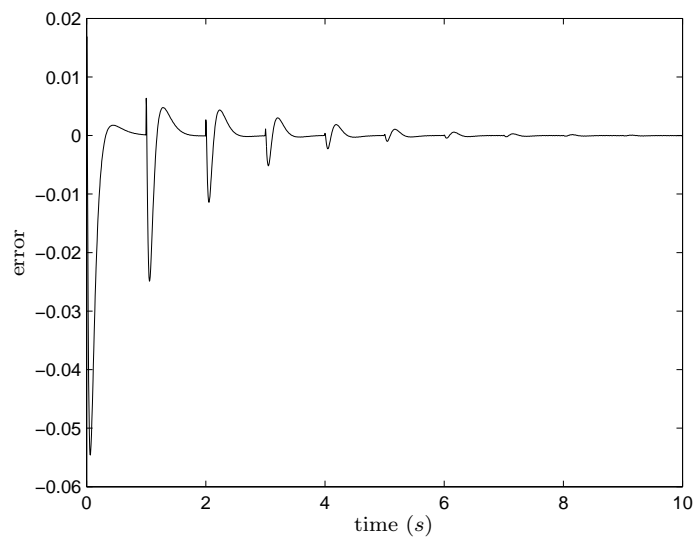

FIGURE 5.3: The error of step response of $P(s)$ and its approximation with degree $n = 2$. (Example 5.2).

5.4 Conclusion

In this chapter, we introduced a new class of approximation for distributed parameter systems, that are delay systems. We made some comments on equivalent realization about Roesser model representation. We also introduced the equivalence between Roesser model and neutral time-delay systems. Problem of interest in their own right such as realizing the delay system with finite number of delays by Roesser model, stabilization of such delay system, will be studied in the future.

Chapter 6

Conclusion and Future works

6.1 Conclusion

This manuscript investigates some applications of distributed delay with a particular emphasis on its approximation for numerical implementation. We define the distributed delay, and study its properties. The implementation problem of distributed delay is explained and a general method for its approximation of distributed delay is given. We compare the input-output approximation and kernel approximation, and show that input-output approximation is not suitable for distributed delay approximation. Then we focus on kernel approximation. With this objective, we propose two classes of systems to realize approximations which are lumped systems and a subclass of distributed delays in the graph topology. For the approximation with the subclass of distributed delay, we give an algebraic algorithm to calculate the approximation and we show that it works well in the time and frequency domains.

After that, we focus on three applications where distributed delays appear. We address first the stable inversion and model matching. For finite dimension linear systems, we define a new class of inversion problem, which consists in some sense to approximate the inverse of a given system. In practice, we have an exact inverse after a finite time $t = \vartheta$, where $\vartheta \in \mathbb{R}_+$ can be taken arbitrarily and where the solution is required to be stable and causal. We present a general procedure to determine the precompensator of the stable inversion, which is always proper and stable. We also analyze the model matching problem. Like the stable inversion, we define an approximation model matching problem, where exact matching is

reached after a finite time. State feedback realization of the precompensator is discussed and robustness analysis with respect to uncertainties in the systems parameters shows the effectiveness of our solution.

The second application is concerned with stabilizing control and finite spectrum assignment of infinite dimensional systems. In this manuscript, we discuss on stabilization for time-delay systems and neutral time-delay systems. A non formally stable neutral time-delay systems is analyzed and a kind of stabilization control is proposed. We also analyze finite spectrum assignment for a class of fractional infinite dimensional systems. In this application, there are still many open questions that need to be addressed.

The last application of distributed delay is concerned with the observer synthesis for estimation or output control. In this part we focus on linear finite dimensional systems. We define a closed-loop memoryless observer by input injection where distributed delay plays a central role. Asymptotic convergence as well as finite time convergence of the estimation are analyzed by output injection and input information via distributed delay. This gives a general framework for finite time convergence in estimation. Some robustness aspects are also discussed, depending on the delays parameters in measurements.

At last, we introduce a new class for approximation of distributed parameter systems. We work on the graph topology, and show that under some weak assumptions, such an approximation can be realized. We focus our work on realization and representation by neutral or Roesser models where distributed delay appears explicitly. These results deserve future analysis and developments.

6.2 Future works

For the prospectives of this work, there are still many open problems that need to be solved. For the approximation of distributed delay, here, we based our analysis on Bernstein polynomials. Other polynomials from L_2 -approximation theory may be used to improve the precision of our method.

For the stable inversion and model matching, our solution is expressed as a precompensator controller. State feedback control as well as output feedback should require some new insights.

In the stabilization of neutral time-delay systems, we only focus on SISO systems.

We may be also interested within MIMO systems. Similarly, in the finite spectrum assignment problem, we only work on single input time-delay systems. Addressing such a problem for MIMO is another issue, as well as output feedback. The realization and implementation of the controller for fractional systems should be also studied in the future. In order to give an effective methodology for the control of such a class of systems.

In the approximation of distributed parameter systems, the representation of delay systems with a finite number of delays in the Roesser model should also be addressed.

Reference

- [1] A. W. Olbrot. Stabilizability, detectability, and spectrum assignment for linear autonomous systems with general time delays. *IEEE Trans. on Autom. Contr.*, 23:887–890, 1978.
- [2] E. W. Kamen, P. P. Khargonekar, and A. Tannenbaum. Proper stable bezout factorizations and feedback control of linear time-delay systems. *Int. J. Contr.*, 43:837–857, 1986.
- [3] D. Brethé and J. J. Loiseau. A result that could bear fruit for the control of delay-differential systems. *4th IEEE Mediteranean Symp. Control and automation, Chania, Greece*, pages 168–172, 1996.
- [4] H. Glüsing-Lüerßen. A behavioral approach to delay-differential systems. *SIAM Journal on Control and Optimization*, 35:480–499, 1997.
- [5] O. J. M. Smith. A controller to overcome dead time. *Inst. Soc. Amer. J*, 6: 28–33, 1959.
- [6] W. Michiels and S. Niculescu. On the delay sensitivity of smith predictors. *International journal of systems science*, 34(8-9):543–551, 2003.
- [7] A. V. Medvedev and H. T. Toivonen. Feedforward time-delay structures in state estimation: finite memory smoothing and continuous deadbeat observers. *IEE Proc. Control Theory Appl.*, 141(2):121–129, 1994.
- [8] F. Pourboghrat and D. H. Chyung. State variable reconstruction of dealy systems. *Proceedings of 23rd conference on Decision and Control*, 23:869–870, 1984.
- [9] L. SinÁlgre, N. Petit, and P. Ménégatti. Distributed delay model for density wave dynamics in gas lifted wells. *44th IEEE Conference on Decision and*

- Control, and The European Control Conference, Seville, Spain*, pages 7390–7397, 2005.
- [10] V. B. Kolmanovskii and V. R. Nosov. Stability of functional differential equations. *Academic press*, 1986.
- [11] J. Guardiola and A. Vecchio. A distributed delay model of viral dynamics. *WSEAS transaction on biology and biomedicine*, 2:36–42, 2005.
- [12] N. D. G. White F. Jian, D. S. Jayas and P. G. Fields. A distributed-delay model to predict ageing and survival rates of adults of cryptolestes ferrugineus (stephens) (coleoptera: Laemophloeidae) in granaries filled with wheat. *Ecological Modelling*, 200:412–420, 2007.
- [13] V. Van Assche, M. Dambrine, J.-F. Lafay, and J.-P. Richard. Some problems arising in the implementation of distributed delay control laws. *Decision and Control, 1999. Proceedings of the 38th IEEE Conference*, 5:4668–4672, 1999.
- [14] Q. C. Zhong. Robust control of systems with delays. *Ph.D. Thesis. Imperial College London*, 2003.
- [15] L. Mirkin. On the approximation of distributed-delay control laws. *Systems & Control Letters*, 51:331–342, 2004.
- [16] J. R. Partington and P. M. Mäkilä. Rational approximation of distributed delay controllers. *Int. J. Control*, 78(16):1295–1301, 2005.
- [17] O. Santos and S. Mondié. Control laws involving distributed time delays: Robustness of the implementation. *American Control Conference*, 4:2479–2480, 2000.
- [18] S. Mondié and W. Michiels. Finite spectrum assignment of unstable time-delay systems with a safe implementation. *IEEE Trans. on Autom. Contr.*, 48:2207–2212, 2003.
- [19] Q.-C. Zhong. Rational implementation of ditributed delay using extended bilinear transformations. *Proc. of the 16th IFAC World Congr., Prague, Czech Republic*, 2005.
- [20] Q.-C. Zhong. On ditributed delay in linear control laws. part I: Discrete-delay implementation. *IEEE Trans. on Autom. Contr.*, 49:2074–2080, 2004.

- [21] M. Vidyasagar and B. D. O. Anderson. Approximation and stabilization of distributed systems by lumped systems. *Systems & Control Letters*, 12: 95–101, 1989.
- [22] Y. Ohta, H. Maeda, and S. Kodama. Rational approximation of l_1 optimal controllers for siso systems. *IEEE Trans. on Autom. Contr.*, 37:1683–1691, 1992.
- [23] L. M. Silverman. Inversion of multivariable linear systems. *IEEE Trans. on Autom. Contr.*, 14:270–276, 1969.
- [24] J. Garcia, M. Malabre, and V. Kučera. The partial model matching problem with stability. *Systems & Control Letters*, 24:61–74, 1995.
- [25] S. Devasia, D. Chen, and B. Paden. Nonlinear inversion-based output tracking. *IEEE Trans. on Autom. Contr.*, 41:930–943, 1996.
- [26] L. R. Hunt, G. Meyer, and R. Su. Noncausal inverses for linear systems. *IEEE Trans. on Autom. Contr.*, 41(4):608–611, 1996.
- [27] T. Sogo. On the equivalence between stable inversion for nonminimum phase systems and reciprocal transfer functions defined by the two-sided laplace transform. *Automatica*, 46:122–126, 2010.
- [28] J. J. Loiseau and D. Brethé. 2-d exact model matching with stability: The structural approach. *Bull. Polish Acad. of Science, Tech. Sciences*, 45(2): 309–317, 1997.
- [29] M. Di Loreto. Finite time model matching for time-delay systems. *6th IFAC Workshop on Time Delay Systems, Italy*, 2006.
- [30] G. Goodwin, S. F. Graebe, and M. E. Salgado. Control system design. *Prentice Hall, Chile*, 2000.
- [31] J. K. Hale and S. M. Verduyn Lunel. Introduction to functional differential equations. *Springer-verlag, New-York*, 1993.
- [32] G. Conte and A. M. Perdon. Geometric systems over ring: Theory and applications. *Annual Reviews in Control*, 24:113–124, 2000.
- [33] V. Kharitonov. Robust stability analysis of time delay systems: A survey. *Annual Reviews in Control*, 23:185–196, 2000.

- [34] S. I. Niculescu. Delay effects on stability: A robust control approach. *Springer: Heidelberg, LNCIS*, 2001.
- [35] V. B. Kolmanovskii, S. I. Niculescu, and K. Gu. Delay effects on stability: A survey. *Decision and Control, proceedings of the 38th IEEE conference*, 2: 1993–1998, 1999.
- [36] J. J. Loiseau. Algebraic tools for the control and stabilization of time-delay systems. *Annual Reviews in Control*, 24:235–249, 1998.
- [37] J. P. Richard. Some trends and tools for the study of time delay systems. *In second conferene IMACS-IEEE CESA, computational engineering in systems applications, Tunisia*, 39:27–43, 1998.
- [38] J. P. Richard. Time delay sysetms: An overview of some recent advances and open problems. *Automatica*, 39:1667–1694, 2003.
- [39] K. Watanabe, E. Nobuyama, and K. Kojima. Recent advances in control of time-delay systems a tutorial review. *Decision and Control, proceedings of the 35th IEEE conference*, pages 2083–2089, 1996.
- [40] M. Vidyasagar. Control system synthesis. a factorization approach. *MIT Press, Cambridge, Massachusetts*, 1985.
- [41] A. Z. Manitius and A. W. Olbrot. Finite spectrum assignment problem for systems with delays. *IEEE Trans. on Autom. Contr.*, 24:541–553, 1979.
- [42] K. Watanabe. Finite spectrum assignment and observer for multivariable systems with commensurate delays. *IEEE Trans. on Autom. Contr.*, 31: 543–550, 1986.
- [43] D. Brethé and J. J. Loiseau. An effective algorithm for finite spectrum assignment of single-input systems with delay. *Mathematics and Computers in Simulation*, 45:339–348, 1998.
- [44] S. Barnett. Introduction to mathematical control theory. *Clarendon, Oxford, U.K.*, 1975.
- [45] T. Kailath. Linear systems. *Prentice Hall, INC., Englewood Cliffs, N.J.*, 1980.
- [46] J. O'Reilly. Observers for linear systems. *Academic, New York*, 1983.

- [47] R. Engel and G. Kreisselmeier. A continuous-time observer which converges in finite time. *IEEE Trans. On Autom. Contr.*, 47(7):1202–1204, 2002.
- [48] D. G. Luenberger. Observers for multivariable systems. *IEEE Trans. on Autom. Contr.*, (11):190–197, 1966.
- [49] L. Pernebo. An algebraic theory for the design of controllers for linear multivariable systems part ii: Feedback realization and feedback design. *IEEE Trans. on Autom. Contr.*, 26(1):183–194, 1981.
- [50] D. H. Chyung. State variable reconstruction. *International Journal of Control*, 40:955–963, 1984.
- [51] A. V. Medvedev. Continuous least-squares observers with applications. *Proceedings of the 34th Conference on Decision and Control, New Orleans, LA*, pages 321–326, 1995.
- [52] G. X. Gu, P. P. Khargonekar, and E. B. Lee. Approximation of infinite-dimensional systems. *IEEE Trans. on Autom. Contr.*, 34:610–618, 1989.
- [53] A. Quarteroni and A. Valli. Numerical approximation of partial differential equation. *Springer, Berlin Heidelberg*, 2008.
- [54] R. Lavanya. Controllability and influence of the spatial discretization of the beam equation. *Nonlinear Analysis: Hybrid Systems*, 4(3):381–388, 2010.
- [55] C. Grossmann, H-G. Roos, and M. Stynes. Numerical treatment of partial differential equations. *Springer*, 2000.
- [56] J. C. Strikwerda. Finite difference schemes and partial differential equations. *Second Edition, Siam*, 2004.
- [57] J. R. Partington. Some frequency-domain approaches to the model reduction of delay systems. *Annual Reviews in Control*, 28:65–73, 2004.
- [58] K. Glover, R. F. Curtain, and J. R. Partington. Realisation and approximation of linear infinite-dimensional systems with error bounds. *SIAM J. Control and Optimization*, 26:863–898, 1988.
- [59] X. Li. l_1 approximation of a certain class of infinite dimensional systems in time-domain. *IEEE Trans. On circuits and systems*, 43(5):381–388, 1996.

- [60] A. C. Antoulas and D. C. Sorensen. Approximqtion of large-scale dynamical systems: an overview. *Int. J. Appl. Math. Comput. Sci.*, 11(5):1093–1121, 2001.
- [61] A. C. Antoulas. An overview of approximation methods for large-scale dynamical systems. *Annual Reviews in Control*, 29:181–190, 2005.
- [62] A. De Gaetano A. Mukhopadhyay and O. Arino. Linear partial differential equations for scientists and engineers. *Discrete and continuous dynamical systems-series B*, 4(2):407–417, 2004.
- [63] H. Xia G. S. K. Wolkowicz and S. Ruan. Competition in the chemostat: a distributed delay model and its global asymptotic behavior. *SIAM J. Appl. Math.*, 57(5):1281–1380, 1997.
- [64] S. Ruan and G. S. K. Wolkowicz. Bifurcation analysis of a chemostat model with a distributed delay. *Journal of mathematical analysis and applications*, 204:786–812, 1996.
- [65] J. R. Partington and P. M. Mäkilä. Worst-case analysis of identification-bibo robustness for closed-loop data. *IEEE Trans. on Autom. Contr.*, 39(10):2171–2176, 1994.
- [66] B. O. D. Anderson and P. C. Parks. Lumped approximation of distributed systems ans controllability questions. *Control Theory and Applicqtions, IEE Proceedings*, 132:89–94, 1985.
- [67] L. Sinègre. Etude des instabilités dans les puits activés par gas-lift. *PhD thesis, l'Ecole des Mines de Paris*, 2006.
- [68] J. Guardiola and A. Vecchio. Simulating the effect of vaccine-induced immune response on hiv infection. *Human Immunol*, (64):425–444, 2003.
- [69] F. M. Callier and C. A. Desoer. An algebra of transfer functions for distributed linear time-invariant systems. *IEEE Transactions on Circuits and Systems*, 25:651–662, 1978.
- [70] C. A. Desoer and M. Vidyasagar. Feedback systems: input-output properties. *Academic, New York*, 1975.
- [71] R. F. Curtain and H. J. Zwart. An introduction to infinite-dimensional linear systems theory. *Springer-Verlag, New York*, 1995.

- [72] E. Hille and R. S. Phillips. Functional analysis and semi-groups. *Amer. Math. Soc. Collec. Publ.*, 31, 1957.
- [73] L. S. Pontryagin. On the zeros of some elementary transcendental functions. *Amer. Math. Soc. Transi.*, 2(1):95–110, 1955.
- [74] D. Brethé. Contribution à l'étude de la stabilisation des systèmes linéaires à retards. *Thèse de Doctorat, École Centrale de Nantes-Université de Nantes*, 1997.
- [75] M. Morf, B. C. Lévy, and S. Y. Kung. New results in 2-d sysetms theory, part I: 2-d polynomial matrices, factorization, and comprimeness. *Proceeding of the IEEE*, 65:861–872, 1977.
- [76] Z. Artstein. Linear systems with delayed controls: a reduction. *IEEE Trans. on Autom. Contr.*, 27:869–879, 1982.
- [77] H. Dym, T. T. Georgiou, and M. C. Smith. Explicit formulas for optimally robust controllers for delay systems. *IEEE Trans. on Autom. Contr.*, 40: 656–669, 1995.
- [78] S. Mondié, S. Niculescu, and J. J. Loiseau. Delay robustness of closed loop finite assignment for input delay system. *In IFAC Workshop on Time-delay Systems, Santa-Fe, NM, USA*, 2001.
- [79] E. W. Kamen, P. P. Khargonekar, and A. Tannenbaum. Stabilization of time-delay systems using finite-dimensional compensators. *IEEE Trans. on Autom. Contr.*, 30:75–78, 1985.
- [80] M. Cantoni and G. Vinnicombe. Linear feedback systems and the graph topology. *IEEE Trans. On Autom. Contr.*, 47:710–719, 2002.
- [81] A. Ralston and P. Rabinowitz. A first course in numerical analysis. *Dover Publications, 2nd Ed., New York*, 2001.
- [82] D. W. Kammler. Approximation with sums of exponentials in $l_p[0, \infty)$. *Journal of Approximation Theory*, 16:384–408, 1976.
- [83] A. Pinkus. Density in approximation theory. *Surveys in Approximation Theory*, 1:1–45, 2005.
- [84] E. W. Cheney. Introduction on approximation theory. *AMS, 2nd Ed., Chelsea*, 1982.

- [85] N. I. Achieser. Theory of approximation. *Frederick Ungar Publishing Corp, New York*, 1956.
- [86] P. M. Mäkilä and J. P. Partington. Laguerre and kautz shift approximations of delay systems. *Internat. J. Control*, 72:932–946, 1999.
- [87] P. M. Mäkilä and J. P. Partington. Shift operator induced approximations of delay systems. *SIAM J. Control Optim.*, 37:1897–1912, 1999.
- [88] A. S. Morse. Structure and design of linear model following systems. *IEEE Trans. on Autom. Contr.*, 18(4):346–354, 1973.
- [89] S. H. Wang and C. A. Desoer. The exact model matching of linear multi-variable systems. *IEEE Trans. on Autom. Contr.*, 17:347–349, 1972.
- [90] V. Kučera. Analysis and design of discrete linear control systems. *Prentice Hall, London*, 1991.
- [91] M. Šebek. 2-d exact model matching. *IEEE Trans. on Autom. Contr.*, 27:215–217, 1983.
- [92] P. Picard, J. F. Lafay, and V. kučera. Model matching for linear systems with delays and 2d sysetms. *Automatica*, 34:183–191, 1998.
- [93] M. A. Dahleh and J. B. Pearson. l_1 -optimal compensators for continuous-time systems. *Decision and control, 25th IEEE conference*, 25:1826–1828, 1986.
- [94] M. Di Loreto, J. J. Loiseau, and J. F. Lafay. Distrubance attenuation by dynamic output feedback for input-delay systems. *Automatica*, 44(8):2202–2206, 2008.
- [95] B. Van Der Pol and H. Bremmer. Operational calculus based on the two-sided laplace integral. *Chelsea Pubilishing Company*, 1987.
- [96] A. Papoulis. The fourier integral and its applications. *McGraw-Hill*, 1962.
- [97] P. Brunovsky. A classification of linear controllable systems. *Kybernetika*, 6:173–188, 1970.
- [98] H. Lu and M. Di Loreto. On stable inversion for linear systems. *18th IFAC World Congress, Milano, Italy*, 18:6651–6656, 2011.

- [99] H. Lu and M. Di Loreto. Finite time model matching for multivariable linear systems. *5th Symposium on System Structure and Control, Grenoble, France*, 5:66–71, 2013.
- [100] J. K. Hale. Theory of functional differential equation. *Springer-verlag, New-York*, 1977.
- [101] M. Di Loreto, J-F. Lafay, and H. Lu. On the structure at infinity for linear time delay systems. *9th IFAC Workshop on time delay systems, Prague, Czech Republic*, 2010.
- [102] M. Necati Ozisik. Heat conduction. *A Wiley-Interscience publication, New York*, 1980.
- [103] M. Di Loreto. Méthodologie pour l’analyse et la commande des systèmes à retards. *Thèse de Doctorat, École Centrale de Nantes-Université de Nantes*, 2006.
- [104] D. Brethé and J. J. Loiseau. Proper stable factorization for time-delay systems: the multivariable case. *IFAC Time-delay systems, Grenoble*, 1998.
- [105] M. A. Dahleh and Y. Ohta. A necessary and sufficient condition for robust bibo stability. *System & Control Letters*, 11:271–275, 1988.
- [106] J. R. Partington and C. Bonnet. h_∞ and bibo stabilization of delay systems of neutral type. *Systems and Control Letters*, 52:283–288, 1994.
- [107] C. Bonnet and J. R. Partington. Stabilization of some fractional delay systems of neutral type. *Automatica*, 43:2047–2053, 2007.
- [108] R. K. Brayton. Small signal stability criterion for electrical networks containing lossless transmission line. *IBM J. Res. and Development*, 12:431–440, 1968.
- [109] D. Youla. The synthesis of networks containing lumped and distributed parameters. *Network and switching theory II*, 49:73–133, 1968.
- [110] J. K. Hale. Functional differential equations. *Springer-verlag, New-York*, 1972.
- [111] C. I. Byrnes, M. W. Spong, and T. J. Tarn. A several complex variables approach to feedback stabilization of neutral delay-differential equations. *Math. Systems Theory*, 17:73–133, 1984.

- [112] R. Bellman and K. L. Cooke. Differential-difference equations. *Academic Press New York*, 1963.
- [113] L. Pandolfi. Stabilization of neutral functional differential equations. *J. Optim. Theory Appl.*, 20:191–204, 1976.
- [114] E. Emre and G. J. Knowles. Control of linear systems with fixed noncommensurate point delays. *IEEE Trans. On Autom. Contr.*, 29(12):1083–1090, 1984.
- [115] D. O’Connor and T. J. Tarn. On stabilization by state feedback for neutral differential difference equations. *IEEE. Trans. On Autom. Contr.*, 29(12):1083–1090, 1983.
- [116] M. Di Loreto, C. Bonnet, and J. J. Loiseau. Stabilization of neutral time-delay systems. *Lecture Notes in Control and Information Sciences*, 2009.
- [117] D. Brethé. Stabilization and observation of neutral-type delay systems. *IFAC, Workshop on Time Delay Systems*, 1997.
- [118] R. F. Curtain and K. Morris. Transfer functions of distributed parameter systems: A tutorial. *Automatica*, 45:1101–1116, 2009.
- [119] H. Lumbroso. Electrocinétique. *Dunod, Paris*, 1995.
- [120] M. W. Spong and T. J. Tarn. On the spectral controllability of delay-differential equations. *Automatic Control, IEEE Transaction on*, 26:527–528, 1981.
- [121] I. Gohberg, P. Lancaster, and L. Rodman. Invariant subspaces of matrices with applications. *Wiley & Sons, Inc, New York*, 1986.
- [122] M. J. D. Powell. Approximation theory and methods. *Cambridge University Press*, 1981.
- [123] K.A. Morris and C. Navasca. Approximation of linear quadratic feedback control for partial differential equations. *Computational Optimization and Applications*, 46:93–111, 2010.
- [124] P. M. Mäkilä. Laguerre series approximation of infinite dimensional system. *Automatica*, 26(6):985–994, 1990.

-
- [125] J. C. Willems. Recent advances in control of time-delay systems a tutorial review. *SIAM J. CONTROL*, 7(4):645–671, 1969.
- [126] D. Brethé and J. J. Loiseau. The use of 2d systems theory for the control of time-delay systems. *Journal Europeen des Systemes Automatisés*, 31(6): 1043–1058, 1997.