



HAL
open science

Bio-methanation tests and mathematical modelling to assess the role of moisture content on anaerobic digestion of organic waste

Flavia Liotta

► **To cite this version:**

Flavia Liotta. Bio-methanation tests and mathematical modelling to assess the role of moisture content on anaerobic digestion of organic waste. Earth Sciences. Université Paris-Est, 2013. English. NNT : 2013PEST1177 . tel-00967951

HAL Id: tel-00967951

<https://theses.hal.science/tel-00967951>

Submitted on 31 Mar 2014

HAL is a multi-disciplinary open access archive for the deposit and dissemination of scientific research documents, whether they are published or not. The documents may come from teaching and research institutions in France or abroad, or from public or private research centers.

L'archive ouverte pluridisciplinaire **HAL**, est destinée au dépôt et à la diffusion de documents scientifiques de niveau recherche, publiés ou non, émanant des établissements d'enseignement et de recherche français ou étrangers, des laboratoires publics ou privés.

Joint PhD degree in Environmental Technology

UNIVERSITÉ
— PARIS-EST

Docteur de l'Université Paris-Est
Spécialité: Science et Technique de l'Environnement



Dottore di Ricerca in Tecnologie Ambientali

UNESCO-IHE
Institute for Water Education



Degree of Doctor in Environmental Technology

Thèse – Tesi di Dottorato – PhD thesis

Flavia Liotta

Bio-Methanation tests and Mathematical Models to assess the effect of moisture content
on anaerobic digestion of complex organic substrates

Defended 12/12/2013

In front of the PhD committee

Dr. Renaud Escudiè **Reviewer**
Prof. Francesca Malpei **Reviewer**
Dr. Hab.E.D. Eric van Hullebusch **Co-Promotor**
Prof. dr.ir. Piet N.L. Lens **Co-Promotor**
Dr. Giovanni Esposito **Promotor**
Prof. Massimiliano Fabbricino **Co-Promotor**



Erasmus Joint doctorate programme in Environmental Technology for Contaminated Solids, Soils and Sediments
(ETeCoS³)



“Love the truth, show yourself as you are, without claim, without fears and cares. And if the truth costs you persecution, accept it, and if the torment, bear it. And if for the truth you have to sacrifice yourself and your life, be strong in your sacrifice”.

San Giuseppe Moscati

To my family, my beloved husband Claudio and
my son Carlo who is still in my belly.

Acknowledgment

I would like to thank the European Commission for providing financial support through the Erasmus Mundus Joint Doctorate Programme ETeCoS³(Environmental Technologies for Contaminated Solids, Soils and Sediments under the EU grant agreement FPA No 2010-0009 and the French Ministry of Foreign Affairs in the framework of MOY Programme under Moy Grant N°2010/038/01.

My gratitude also to the committee members, Dr. Renaud Escudiè and Prof. Francesca Malpei for their helpful comments, constructive criticisms and valuable discussions.

I also would like to thank my PhD Supervisors, Prof. Giovanni Esposito and Prof. Massimiliano Fabbicino for their invaluable suggestions, patient advices and continuous encouragement extended throughout three years of this research. My special thanks go also to Prof. Francesco Pirozzi, Prof. Piet Lens, Prof. Eric van Hullebusch and Prof. Patrice Chatellier for supporting my during my PhD mobility and for scientific contribution on my research.

Special thanks to all friends, MariaRosaria, Jaka, Alberto, Stefano, Antonio, Anish, Rosita and Mario, who were working with me in DIGA Department of University Federico II of Napoli and in DIMSAT Department of University of Cassino and Lazio Meridionale.

Special thanks also to Ludovico, the head of the LARA (Laboratory of Environmental analysis and research) for helping me with patience and enthusiasm in sample analysis and equipment operation.

I also would like to thank Luigi for all useful suggestions for the research and his help on mathematical modelling and paper writing.

I can not forget all my international friends, in particular Rohan, Anna, Wendy, Alexandra and Mani, who I met during my mobility period in UNESCO-IHE and in University of Paris Est, with whom I shared my research and moments of fun!

To conclude, tanks to my parents, my sister and Claudio for supporting and encouraging my during my PhD studies.

I would like also to express my thank to God for giving me the inspiration, courage and the patience during the course of these three years and the little Carlo, who still has to born but accompanied me on the last months of my PhD studies. So small, but he already gave to me the power for a brilliant final defence and the hope for a prosperous and smiley future.

PhD Thesis Index

Abstract	1
Sommario	2
Resumè	4
Samenvatting	5
Chapter 1. Introduction	7
1.1 Problem Description	8
1.2. Objectives of the Study	9
Chapter 2. Effect of moisture content on wet anaerobic digestion of complex organic substrates	12
2.1 Introduction	13
2.2. Materials and Methods	15
2.2.1 Digester set-up and analytical measurements.....	15
2.2.2 Preliminary tests: Drying procedure.....	15
2.2.3 Effect of particle size on AD.....	17
2.2.4 Effect of moisture content on AD.....	19
2.2.5 Mathematical model.....	19
2.3. Results and discussions	21
2.3.1 Effect of particle size on AD performance.....	21
2.3.2. Effect of TS content on AD performances.....	23
2.4. Modelling results	24
2.4.1. Modelling the effect of particle size on AD.....	24
2.4.2. Modelling the effect of TS on AD.....	27
2.5 Conclusion	30
Chapter 3. Effect of moisture content on anaerobic digestion of food waste	32
3.1. Introduction	33
3.2. Materials and Methods	34
3.2.1 Experimental set-up.....	34
3.2.2. Substrate and inoculum preparation.....	35
3.2.3. Analytical methods.....	36
3.2.3.1 Methane production.....	36
3.2.3.2 VFAs analysis.....	36
3.2.3.3 Other parameters.....	37
3.3. Results and Discussion	37
3.3.1 Bio-methane production.....	37
3.3.2 VFAs production.....	39
3.4 Conclusions	44
Chapter 4. Effect of moisture content on anaerobic digestion of rice straw.	45
4.1 Introduction	46
4.2. Material Methods	47
4.2.1 Experimental set-up.....	47
4.2.2. Substrate and inoculum preparation.....	47
4.2.3. Analytical methods.....	48
4.2.3.1 Methane production, COD, TS, VS.....	48

4.2.3.2 VFAs and phenols analysis	48
4.3. Results and Discussion.....	49
4.3.1 Methane production	49
4.3.2 Analysis of process intermediates.....	51
4.4 Comparative process efficiency	55
4.5. Conclusions	55
Chapter 5. Modified ADM1 for dry and semi-dry anaerobic digestion of solid organic waste.....	57
5.1 Introduction.....	58
5.2 Model description.....	59
5.3 Model calibration	63
5.4. Results and discussion	68
5.5 Conclusion.....	71
Chapter 6. Literature Review	72
6.1 Mathematical modelling of aerobic plug flow reactor and non-ideal flow reactor	73
6.1.1 Introduction.....	73
6.1.2. Design models and performance-prediction models.....	74
6.1.3 Modeling approaches	76
6.1.4. Mathematical modeling of Activated Sludge plug flow reactors	79
6.1.4.1 Process description.....	79
6.1.5. Model development.....	80
6.1.5.1 Ideal PFR and CSTR in series.....	80
6.1.5.2 Non ideal flow reactor models.....	82
6.1.5.3 Computational fluid dynamics model development	84
6.1.5.4 Models comparisons	86
6.1.6. Mathematical modeling of fluidized bed reactors.....	86
6.1.6.1 Process description.....	86
6.1.6.2 Model development.....	87
6.1.6.2.1 Ideal flow reactor models.....	87
6.1.6.2.2 Non ideal flow reactor models	88
6.1.6.2.3 Models comparisons	90
6.1.7 Mathematical modeling of biofilter reactors.....	90
6.1.7.1 Process description.....	90
6.1.7.2 Model development.....	91
6.1.7.2.1 Ideal flow reactor model	91
6.1.7.2.2 Non-ideal flow reactor model	92
6.1.7.2.3 Models comparisons	95
6.1.8 Model comparisons and validation and calibration	96
6.1.8.1 Models comparisons	96
6.1.8.2 Activated sludge reactor.....	98
6.1.8.2.1 Ideal PFR and CSTR in series.....	98
6.1.8.2.2 Non ideal flow reactor models.....	99
6.1.8.3 Fluidized Bed Reactors	100
6.1.8.4 Biofilter reactors	101
6.2 Mathematical modelling of anaerobic plug flow reactor and non-ideal flow reactor	104
6.2.1 Introduction.....	104
6.2.2 Mathematical modelling of UASB Reactors	104
6.2.2.1 Hydrodynamic based models	106

6.2.2.2 Models coupling hydrodynamic with anaerobic digestion conversions	111
6.2.2.3 Models comparisons	112
6.2.3. Mathematical modelling of Anaerobic Biofilters	113
6.2.3.2 Models comparisons	116
6.2.4 Mathematical modeling of Anaerobic Biological Fluidized Bed Reactors	116
6.2.4.1 Models comparisons	118
6.2.5. Mathematical modeling of wet and dry digesters treating bio-solids	119
6.2.5.1 Models comparisons	123
6.2.6. Model comparisons and validation and calibration	123
6.2.6.1 Models comparisons	123
6.2.6.2 UASB reactor model validation and calibration	123
6.2.6.3 Anaerobic Biofilters model validation and calibration	125
6.2.6.4 Anaerobic Fluidized Bed Reactor model validation and calibration	127
6.2.6.5 Wet and dry digesters model validation and calibration	128
6.2.7. Conclusion	129
Chapter 7. Discussion and Conclusions	130
References	135

Abstract

Dry Anaerobic Digestion (AD) presents different advantages if compared to wet AD, i.e. smaller reactor size, lesser water addition, digestate production and pretreatment needed, although several studies have demonstrated that water promotes substrate hydrolysis and enables the transfer of process intermediates and nutrients to bacterial sites.

To better understand the role of water on AD, dry and semidry digestion tests of selected complex organic substrates (food waste, rice straw, carrot waste), with various TS contents of the treated biomass have been carried out in the present study. The results confirm that water plays an essential role on the specific methane production rate, final methane yield and Volatile Solids (VS) degradation. The final methane yield in semi-dry and dry conditions was 51% and 59% lower for rice straw and 4% and 41% lower for food waste, respectively, if compared with wet conditions.

Inhibition tests, based on Volatile Fatty Acid (VFA) analysis, were carried out to investigate the specific inhibition processes that take place with the selected substrates at different TS contents. In wet AD of carrot waste no VFA accumulation was found, and all VFA concentrations were lower than the inhibition limits. A direct correlation between TS content and total VFA (TVFA) concentration was noticed for rice straw and food waste AD. For rice straw a maximum TVFA concentration of 2.1 g/kg was found in dry condition, 1 g/kg in semidry conditions and 0.2 g/kg in wet conditions, whereas for food waste the TVFA concentration was 10 g/kg in dry condition, 9 g/kg in semidry conditions and 3 g/kg in wet conditions.

A Mathematical model of complex organic substrate AD in dry and semidry conditions has been proposed to simulate the effect of TS content on the process. The data obtained from batch experiments, in terms of methane production and VFA concentrations, were used to calibrate the proposed model. The kinetic parameters of VFA production and degradation, calibrated using the experimental data, resulted highly dependent on the TS content and different from wet AD literature values. This is due to VFA accumulation in dry conditions, which implies lower values of the kinetic constants function of the TS content introduced in the model.

Finally, as dry AD takes usually place in Plug Flow (PF) reactors, an historical and critical review on the role of hydrodynamics in PF bioreactors has been carried out.

Sommario

La digestione anaerobica (DA) a secco presenta diversi vantaggi rispetto a quella ad umido legati alla riduzione delle dimensioni del reattore, al minore consumo di acqua, alla più facile gestione del digestato prodotto, e alla mancata richiesta di pretrattamenti. Al contempo, tuttavia, il minor contenuto di umidità può comportare dei problemi nello svolgimento delle reazioni di trasformazione, giacché l'acqua promuove l'idrolisi dei substrati in trattamento, ha una azione di diluizione nei confronti di eventuali intermedi di processo che potrebbero inibire il metabolismo microbico, e permette il passaggio dei nutrienti e dei metaboliti attraverso il protoplasma cellulare.

Per meglio comprendere il ruolo dell'acqua sulla DA sono state effettuate prove di digestione batch a secco, semi-secco, ed umido, adoperando tre substrati diversi, vale a dire: scarti alimentari misti, paglia di riso e carote. Ai substrati è stato aggiunto un inoculo pre-digerito, il cui contenuto di solidi sospesi è stato opportunamente variato attraverso un processo di disidratazione. I risultati ottenuti hanno confermato che l'acqua svolge un ruolo fondamentale nello sviluppo del processo, influenzando sia il tasso di produzione specifica di metano che la produzione complessiva di quest'ultimo, oltre che le cinetiche di degradazione del substrato, e quindi il rendimento di riduzione dei Solidi Volatili.

Nello specifico, prendendo a riferimento la produzione complessiva di metano ottenuta nel processo ad umido, adoperando come substrato la paglia di riso i valori sono risultati ridotti di circa il 50% nella digestione a semi-secco, e di circa il 60% nella digestione a secco. La riduzione è risultata meno sensibile nel trattamento degli scarti alimentari misti, per i quali si è avuta un decremento del 4% nel corso del processo a semi-secco, e di poco più del 40% nel corso del processo a secco.

Il monitoraggio della concentrazione degli acidi grassi volatili (AGV) nel corso delle prove ha consentito di evidenziare gli eventuali accumuli di composti inibitori in funzione del substrato trattato e della concentrazione di solidi totali (ST). A riguardo si è osservato che nel caso della DA ad umido delle carote, non si è avuto alcun accumulo di AGV e tutte le concentrazioni misurate sono risultate sempre inferiori al valore limite d'inibizione. Nel caso della DA della paglia di riso e del rifiuto alimentare, è stata invece individuata una relazione lineare tra il contenuto di ST e la concentrazione di AGV. Più in dettaglio per la paglia di riso è stato trovato un valore di concentrazione massimo degli AGV pari a $2,1 \text{ g}\cdot\text{kg}^{-1}$ nel processo a secco, ed un valore minimo di $0,2 \text{ g}\cdot\text{kg}^{-1}$ nel processo ad umido,

mentre nel processo a semi-secco la concentrazione si è attestata su un valore intermedio, pari ad $1 \text{ g}\cdot\text{kg}^{-1}$. Nel caso della paglia di riso le concentrazioni rilevate sono state di $10 \text{ g}\cdot\text{kg}^{-1}$ nella digestione a secco, di $9 \text{ g}\cdot\text{kg}^{-1}$ nella digestione a semi-secco, e di $3 \text{ g}\cdot\text{kg}^{-1}$ nel processo ad umido.

I risultati ottenuti nel corso delle prove sperimentali sono stati interpretati alla luce di un modello matematico all'uopo sviluppato, in grado di simulare il processo di digestione di substrati organici complessi, tenendo conto del diverso contenuto dei ST che caratterizzano i processi a secco, semi-secco ed umido. La calibrazione del modello, effettuata sulla base di valori misurati relativi alla produzione di metano ed alla concentrazione degli AGV, ha consentito di verificare come i parametri cinetici relativi alla produzione ed alla degradazione di tali acidi siano fortemente dipendenti dal contenuto di ST, e, nel caso dei processi a basso contenuto di umidità, notevolmente diversi dai dati proposti in letteratura per la DA ad umido. Questo risultato è legato all'accumulo di acidi che comporta una riduzione delle cinetiche di degradazione dei substrati organici complessi di partenza e dei successivi intermedi delle trasformazioni in fase acquosa. Considerato che la DA a secco viene solitamente sviluppata in reattori con flusso a pistone, la parte conclusiva del lavoro è stata infine dedicata all'analisi storico-critica dei lavori presenti in letteratura relativi alla modellazione idrodinamica dei processi biologici, ed al ruolo che le diverse configurazioni reattoristiche possono avere nello sviluppo delle cinetiche di trasformazione, nell'ottica di porre le basi per una modellazione completa della digestione a secco, comprensiva sia della parte idrodinamica che di quella biochimica.

Resumé

La méthanisation par voie sèche possède différents avantages par rapport à la méthanisation par voie humide. Les réacteurs sont plus petits, les besoins en eau sont moindres, la production de digestat et le prétraitement nécessaire sont également moins importants. Cependant, plusieurs études ont démontré que l'eau favorise l'hydrolyse du substrat et permet le transport des sous-produits d'hydrolyse et des nutriments vers les bactéries.

Pour mieux comprendre le rôle de l'eau lors de la méthanisation, des tests de digestion sèche et semi-sèche à partir de substrats organiques complexes (déchets alimentaires, paille de riz, déchets de carotte), avec différentes teneurs en matière sèche de substrat traité ont été réalisées. Les résultats confirment que l'eau joue un rôle essentiel sur le taux de production spécifique de méthane, le rendement final de méthane généré et la dégradation de la matière volatile sèche (MVS). Le rendement final de méthane produit dans des conditions semi-sèches et sèches est respectivement de 51% et de 59% inférieur avec la paille de riz et 4% et 41% de moins pour les déchets alimentaires en comparaison avec des conditions humides.

Des tests d'inhibition basés sur l'analyse des acides gras volatils (AGV) ont été menés pour étudier les processus d'inhibition spécifiques qui ont lieu avec les substrats sélectionnés à différentes teneurs en matière sèche. Pour le cas de la méthanisation par voie humide des déchets de carotte, aucune accumulation d'AGV a été trouvée, et toutes les concentrations d'AGV étaient inférieures aux seuils d'inhibition. Une corrélation directe entre la teneur en matière sèche et la concentration totale d'AGV (AGV_{tot}) a été mise en évidence pour la paille de riz et les déchets alimentaires. Pour la paille de riz, une concentration d'AGV_{tot} maximale de 2,1 g / kg a été trouvée pour la voie sèche, 1 g / kg dans les conditions semi-sèche et 0,2 g / kg dans les conditions humides, alors que pour les déchets alimentaires la concentration d'AGV_{tot} était de 10 g / kg à l'état sec, 9 g / kg dans les conditions semi-sèche et 3 g / kg dans les conditions humides.

Un modèle mathématique de la méthanisation de substrats organiques complexes dans des conditions sèches et semi-sèche a été proposé pour simuler l'effet de la teneur en matière sèche sur le processus. Les données obtenues à partir d'expériences en mode batch, en termes de production de méthane et de concentration d'AGV, ont été utilisées pour calibrer le modèle proposé. Les paramètres cinétiques de production et d'élimination d'AGV ont été calibrés à l'aide des données expérimentales, et il a été montré qu'ils sont fortement dépendants de la teneur en matière sèche et différent des valeurs de la

littérature concernant la méthanisation par voie humide. Cela est dû à l'accumulation d'AGV dans les conditions sèches, ce qui implique d'utiliser des valeurs plus réduites concernant les constantes d'inhibition introduites dans le modèle.

Enfin, comme la méthanisation par voie sèche a généralement lieu dans des réacteurs à écoulement piston, une étude historique et critique de la littérature concernant la compréhension du rôle de l'hydrodynamique dans des bioréacteurs à écoulement piston a été réalisée.

Samenvatting

Droge Anaërobe Vergisting (AD) biedt verschillende voordelen in vergelijking met natte AD: kleinere reactorvolumes, minder water toevoeging, lagere digestaat productie en minder voorbehandeling nodig, ondanks dat verscheidene studies hebben aangetoond dat water de substraat hydrolyse en de uitwisseling van tussenproducten en nutriënten van en naar de bacteriële sites bevordert.

Om de rol van het water in AD beter te begrijpen, zijn in deze studie droge en halfdroge afbraaktests uitgevoerd met geselecteerde complexe organische substraten (voedselafval, rijststro en wortelafval), met verschillende Totale Vaste Stof (TS) gehalten van de behandelde biomassa. De resultaten bevestigen dat water een essentiële rol speelt in de specifieke methaan productiesnelheid, de uiteindelijke methaanopbrengst en de afbraak van de organische stof (VS). De uiteindelijke methaanopbrengst onder semi-droge en droge omstandigheden was, respectievelijk, 51% en 59% lager voor rijststro en 4% en 41% lager voor voedselafval in vergelijking met natte omstandigheden.

Remmingsproeven, gebaseerd op vluchtige vetzuren (VFA) analyses, werden uitgevoerd om de specifieke remming van de geselecteerde substraten bij verschillende TS concentraties te onderzoeken. Gedurende de natte AD van wortelafval werd geen VFA accumulatie gevonden, en de VFA concentraties bleven lager dan de inhibitiewaarden. Bij de AD van rijststro en voedselafval werd een direct verband tussen het TS gehalte en de totale VFA concentratie gevonden. De maximale totale VFA concentratie bedroeg 2,1 g/kg voor rijststro bij droge, 1 g/kg bij halfdroge en 0,2 g/kg bij natte AD, terwijl voor voedselafval de totale VFA concentratie 10 g/kg bij droge, 9 g/kg bij halfdroge en 3 g/kg bij natte AD bedroeg.

Een wiskundig model voor de AD van complexe organische substraten onder droge en halfdroge condities werd ontwikkeld om het effect van de TS concentratie te simuleren. De data van batchexperimenten, met name methaanproductie en VFA concentraties, werden gebruikt om het

ontwikkelde model te kalibreren. De kinetische parameters van VFA productie en afbraak, gekalibreerd met experimentele data, bleken sterk afhankelijk van de TS concentratie en verschilden aanzienlijk van de natte AD literatuurwaarden. Dit komt door de VFA accumulatie onder droge omstandigheden, dit leidt tot lagere inhibitiewaarden die in het model zijn opgenomen.

Ten slotte, omdat droge AD gewoonlijk plaats vindt in Plug Flow (PF) reactoren, werd een overzicht van de geschiedenis van dit reactortype gemaakt en de rol van de hydrodynamica in deze PF bioreactoren kritisch geëvalueerd.

CHAPTER 1

Introduction

1.1 Problem Description

Anaerobic Digestion (AD) is a biological process historically applied to wastewater treatment sludge, that reduces Chemical Oxygen Demand (COD) of complex organic substrate and converts it into a gas, which is mainly composed by methane and carbon dioxide. During this process organic matter is progressively converted into simpler and smaller sized organic compounds obtaining biogas and digestate as final products. This digestate is rich in nutrients and microelements and it is suitable for utilization in agricultural contexts (Esposito et al. 2012a,b). Nowadays there is a pressing need to manage correctly bio-waste from its generation stage to its safe disposal and to reduce its impact on the environment. Therefore AD can be used as biological treatment as it is one of the best option to achieve at the same time the objectives of the Kyoto Protocol and the EU Policies concerning renewable energy and organic waste disposal.

Based on the solid content of the influent bio-waste, AD can be defined dry, semidry and wet. In dry AD (high-solids digestion), the feedstock to be digested has a Total Solids (TS) content higher than 15%. In semidry AD the solid substrate to be digested has a TS content ranging between 10%-15%. In contrast, wet AD (low-solids digestion) deals with diluted feedstock having a TS content lower than 10% (Li et al. 2011; Zeshan and Annachatre, 2012). In the last decades, dry AD has got much attention due to its many advantages: smaller reactor volume, reduced amount of water addition, easier handling of digested residues, minimal nutrient loss (Karthikeyan and Visvanathan, 2012; Zeshan and Annachatre, 2012) and simplified pre-treatments compared to wet systems. The only pre-treatment which is necessary before feeding the wastes into a dry AD reactor is the removal of coarse materials larger than 40 mm (Vandevivere 1999). Because of the high viscosity of the treated bio-waste, in dry AD, the substrate moves via plug flow inside the reactor. Plug flow conditions within the reactor offer the advantage of technical simplicity. They leave however the problem of mixing, which is crucial to guarantee adequate inoculation and reduce acidification problems.

The economical differences between wet and dry systems are small, both in terms of investment and operational costs. The differences between those systems are more substantial in terms of environmental issues. For instance, while wet systems typically consume one m³ of fresh water per ton of treated Organic Fraction of Municipal Solid Waste (OFMSW), the water consumption of their dry counterparts is ten-fold less. As a consequence, the volume of wastewater to be discharged is

CHAPTER 1 - INTRODUCTION

several-fold less for dry systems (Vendevivere 1999).

Despite the listed advantages, this high solid contents determine also several technical disadvantages in terms of transport, handling and mixing compared to wet processes (Lissens et al. 2001; De Baere et al. 2010; Bollon et al. 2013). Moreover the low amount of water affects the process development. The water content in fact is a key parameter of dry AD as several studies have demonstrated that water promotes substrate hydrolysis and enables the transfer of process intermediates and ease the bacterial community access to nutrients (Lay et al. 1997a, b; Mora-Naranjo et al. 2004; Pommier et al. 2007; Bollon et al. 2013).

The present study is aimed at better understanding the role of water on AD, discussing in detail the experimental data obtained during dry and semidry digestion tests of selected complex organic substrates by varying the TS percentages of the treated biomass. Obtained data are used to model the effect of water content during dry AD. Moreover, considering, as mentioned previously, that AD takes usually place in Plug Flow reactors, this study analyses also in detail the hydrodynamic conditions of different bioreactors through an historical and critical literature review of the role of the hydrodynamic behaviour on biological processes. This review was done to create the premises for the development of a mathematical model able to simulate the dry AD in real biological reactor.

1.2. Objectives of the Study

The main objective of this research is to investigate the process performances of AD reactors, studying the effect of moisture content on process development. The research was carried out at lab-scale in batch reactor on the following substrates: rice straw and food waste. These two substrates were selected because food waste is representative of readily biodegradable bio-waste, while rice straw is representative of slowly biodegradable ones. Moreover both of them are produced in large amount and there is a practical need to define a proper treatment for them. Further investigations are conducted on carrot waste to study the effect of moisture content also in the case of wet AD and to analyse the effect of particle size on methane production. This substrate was selected because it presents a shape and a consistency that can be easily modelled. Mathematical modelling aimed at upgrading the Anaerobic Digestion Model n. 1 (ADM1) proposed by Batstone et al. 2002 by considering the effect of moisture on the process performances is also an objective of this thesis. The experimental data obtained during batch studies were used to calibrate the proposed model. The specific objectives of the research are

CHAPTER 1 - INTRODUCTION

listed below:

- Assess the effect of moisture content on semidry and dry AD of a selected easily biodegradable substrate (i.e. food waste);
- Model the dry AD of food waste and determine the kinetic parameters of the model by considering the effect of moisture content;
- Assess the effect of moisture content on semidry and dry AD of slowly biodegradable substrate, i.e. rice-straw;
- Model the dry AD of rice straw and determine the kinetic parameters of the model by considering the effect of moisture content;
- Assess the effect of moisture content on wet AD of carrot waste;
- Model the wet AD of carrot waste and determine the kinetic parameters of the model by considering the effect of moisture content;
- Individuate possible process inhibitions that could occur in dry anaerobic conditions by studying process intermediates, such as VFAs and model these parameters varying TS content.
- Review the hydrodynamic models described in literature for aerobic and anaerobic treatment of wastewater to give the premises for the development of a coupled model able to simulate the dry anaerobic digestion process, considering both the effect of the hydrodynamic conditions.

The specific objectives are addressed in the following chapters of this thesis. In chapter 2 are described the experimental and modelling results obtained on carrot waste wet AD. The batch tests results are used to discuss the effect of different particle size and moisture content on methane production. In chapter 3, the experimental results obtained on wet, semidry and dry AD of food waste are described. The effect of different moisture contents on methane production, VFA concentration and anaerobic degradation in terms of VS and COD is discussed. In chapter 4, the experimental results obtained on wet, semidry and dry AD of rice straw are described and discussed following the same approach used in chapter 3 for food waste. In chapter 5, an up-graded version of the ADM1 model for dry and semidry anaerobic digestion is proposed. Model

CHAPTER 1 - INTRODUCTION

calibration is performed by fitting the experimental data (methane production and VFA concentrations obtained during the batch tests described in chapter 3 and 4) on food waste and rice straw in wet, semidry and dry AD conditions. In chapter 6 are reviewed mathematical models of anaerobic and aerobic non-ideal flow reactor in wastewater treatment are reviewed. Finally, in chapter 7 an overall discussion and conclusion of the results is reported.

CHAPTER 2

Effect of moisture content on wet anaerobic digestion of complex organic substrates

This chapter has been published as:

Liotta, F., d'Antonio, G., Esposito, G., Fabbricino, M., Frunzo, L., van Hullebusch, E. D., Lens, N.L. and Pirozzi, F. (2014). Effect of moisture on disintegration kinetics during anaerobic digestion of complex organic substrates. **Waste Manage. Res.** 32, 40-48.

CHAPTER 3 - EFFECT OF MOISTURE CONTENT ON ANAEROBIC DIGESTION OF FOOD WASTE

2.1 Introduction

Anaerobic digestion is a multi-step process, that involves several micro-organisms: hydrolytic, fermentative, acetogenic and methanogenic bacteria. The limiting step of the AD process can not be unequivocally defined. Acetogenesis (Hills and Robert 1981; Bryers 1985; Costello et al. 1991a, b; Siegrist et al. 1993) and methanogenesis (Graef and Andrews 1974; Moletta et al. 1986; Smith et al. 1988), as well as hydrolysis (Vavilin et al. 2001) and disintegration (ADM1, Batstone et al. 2002, Esposito et al. 2008, 2011a,b, 2012a,b), can constitute the rate-determining steps.

When considering complex organic matter, the hydrolysis of complex polymeric substances becomes the rate-limiting step and modelling of this process has to be improved (Pavlostathis and Giraldo-Gomez 1991; Vavilin et al. 1996b, 1997, 1999; Batstone et al. 2002). In particular, several models showed that the presence of OFMSW particles can be better described with the introduction of a disintegration step. This step individuates the physical break and transformation of the complex organic matter in soluble particulate organics, and represents the rate-limiting step of the process (Hills and Nakano 1984; Sharma et al. 1988; Esposito et al. 2008, 2011a, 2012a; Batstone et al. 2002).

Several authors investigated the rate of hydrolysis and disintegration as a function of different parameters such as pH, temperature, hydrolytic biomass concentration, type of particulate organic matter and particle size (Pavlostathis and Giraldo-Gomez, 1991; Veeken et al. 1999; Hill and Nakano 1984; Esposito et al. 2008; Sharma et al. 1988; Sanders et al. 2000). However, it is less understood how the TS content can affect hydrolysis and in particular the disintegration step of complex organic substrate. There are several attempts in the literature to model the effect of moisture content on dry and semi-dry AD process. In particular in their work, Abbassi-Guendouz et al. (2012), by the application of ADM1 model, found a decreasing first-order hydrolysis rate constant for carbohydrates by increasing TS content. This constant was calibrated using batch experimental data with cardboard as initial substrate and imposing the TS content in the range of 15-30%. This finding is in agreement with results presented by Bollon et al. (2011). There are also several attempts in literature to investigate the effect of TS content on methane production by operating Specific Methanogenic Activity (SMA) tests and by simulating experimental data by using the Gompertz model (Le Hyaric et al. 2011; Le Hyaric et al. 2012; Lay et al. 1997a, 1997b, 1998). These authors suggested also that high TS content could reduce substrate degradation, resulting in a lower methanogenic activity. These

CHAPTER 2 - EFFECT OF MOISTURE CONTENT ON WET ANAEROBIC DIGESTION OF COMPLEX ORGANIC SUBSTRATES

results are consistent with several studies performed by Qu et al. (2009), Fernández et al. (2010), Forster-Carneiro et al. (2008), Pommier et al. (2007), who found a reduction of methane production with higher TS. All these studies showed that the moisture content plays an essential role in the biogas formation as the nutrients and substrates for the microorganisms must dissolve in water phase prior they can be assimilated. Furthermore, the moisture content is an important factor also in the low-solids (wet) anaerobic digestion because it supports the bacterial movement and helps substrate and product diffusion through the porous medium (solid waste) to bacterial cell membrane (Lay et al. 1997a; Lay et al. 1997b; Mora Naranjo et al. 2004; Le Hyaric et al. 2012; Pommier et al. 2007).

The aim of this chapter is, therefore, to assess the impact of the moisture content on wet anaerobic digestion of a selected complex organic substrate. To better evaluate the impact of the water content on the AD performances, computer solution using a new version of the ADM1 of complex organic substrate, proposed by Esposito et al. (2008, 2011a,b) is applied. The model is used to describe the experimental data and to define the dependence of the disintegration kinetic parameter on the particle size and moisture content.

More in detail, this chapter includes the following objectives:

- propose an experimental procedure for obtaining an inoculum at different moisture contents;
- investigate the effect of PS effect on the disintegration step of AD process of complex organic matter, i.e. greengrocery waste (carrot waste);
- investigate the TS effect on methane production;
- propose a new mathematical modelling approach to describe the effect of TS on the disintegration step of AD by using a new version of ADM1 model proposed by Esposito et al. (2008, 2011a, b).
- determine the surface based kinetic constant for the cited selected substrate, using the model proposed by Esposito et al. (2008).

CHAPTER 2 - EFFECT OF MOISTURE CONTENT ON WET ANAEROBIC DIGESTION OF COMPLEX ORGANIC SUBSTRATES

2.2. Materials and Methods

2.2.1 Digester set-up and analytical measurements

Biomethanation Tests (BMTs) were performed on a small scale under controlled and reproducible conditions in a 1000 mL glass bottle GL 45 (Schott Duran, Germany). Small amounts of Na_2CO_3 powder were also added to control pH value. Each bottle was sealed with a 5 mm silicone disc that was held tightly to the bottle head by a plastic screw cap punched in the middle (Schott Duran, Germany). All digesters were immersed up to half of their height in hot water kept at a constant temperature of 308.15 K by 200 W A-763 submersible heaters (Hagen, Germany). Once a day, each digester was connected by a capillary tube to an inverted 1000 mL glass bottle containing an alkaline solution (2% NaOH). The inverted 1000 mL glass bottle was sealed in the same way as the digesters. To enable gas transfer through the two connected bottles, the capillary tube was equipped on both ends with a needle sharp enough to pierce the silicone disc. The weight, TS and VS concentration of the anaerobic sludge as well as the dry matter, moisture organic matter and ash content of substrate were determined according to Standard Methods (APHA/AWWA/WEF, 1998). Temperature and pH of all mixtures investigated were monitored for at least once a day with a TFK 325 thermometer (WTW, Germany) and a pH meter (Carlo Erba, Italy), respectively (Esposito et al. 2012a).

2.2.2 Preliminary tests: Drying procedure

In order to evaluate the effect of different moisture contents during AD, experiments at different TS contents are necessary. With the objective to evaluate only the effect of moisture content, these experiments must be conducted using the same inoculum, at the same operational conditions, varying only the TS content. Therefore fresh digestate was collected from a mesophilic AD of a buffalo farm and stored in 10 L buckets at 4°C and used as inoculum source. The initial inoculum characteristics in terms of TS, VS, carbohydrates fraction (Ch), proteins fraction (Pr) and lipids fraction (Li) are shown in Table 1.

CHAPTER 2 - EFFECT OF MOISTURE CONTENT ON WET ANAEROBIC DIGESTION OF COMPLEX ORGANIC SUBSTRATES

Table 1. Main characteristics of Anaerobic Sludge

	Initial	Initial	Ch	Pr	Li
	TS [%]	VS [%]	[%]	[%]	[%]
Wet anaerobic sludge	2	1.2	2.1	56	41.9

The inoculum was dried by testing three different procedures: overnight drying of fresh digestate at 50°C until constant weight, centrifugation with 6000 rpm, 10 min and membrane filtration with a Kubota 203 microfiltration module. The selected drying procedures were aimed at removing water from inoculum, obtaining a final value of 4% TS.

In order to evaluate the effects of different drying treatments, the concentrated inoculum was reported at the initial TS content of 2% adding distilled water and was compared with the untreated inoculum in terms of biomethane potential. The aim of these tests was to individuate the drying procedure that does not modify the inoculum characteristics in terms of biomass activity and methane production. Therefore the inoculum obtained from each adopted drying procedure was used to carry out BMTs. These experiments were performed using pasta and cheese with known carbohydrate, protein and lipid concentrations (Table 2). The choice of the substrates was aimed at balancing the quantity of carbohydrates, proteins and lipids in the digester influent. The selected substrate allows the development of all microbial species involved in degradation of carbohydrates, proteins and lipids in order to evaluate the pre-treatment effect on all these species.

Table 2. Mass composition of organic substrate

Pasta [g]	Cheese [g]	Anaerobic Sludge [g]	Na₂CO₃ [g]
2.63	5.24	500	0.32

The methane production is expressed under standard conditions and takes into account the gas content variation in the headspace of the reactor. The calculated methane production accounts for the global methane production without the residual endogenous methane production measured with the blank assay, which represent the reactor filled only with digestate without substrate addition.

CHAPTER 2 - EFFECT OF MOISTURE CONTENT ON WET ANAEROBIC DIGESTION OF COMPLEX ORGANIC SUBSTRATES

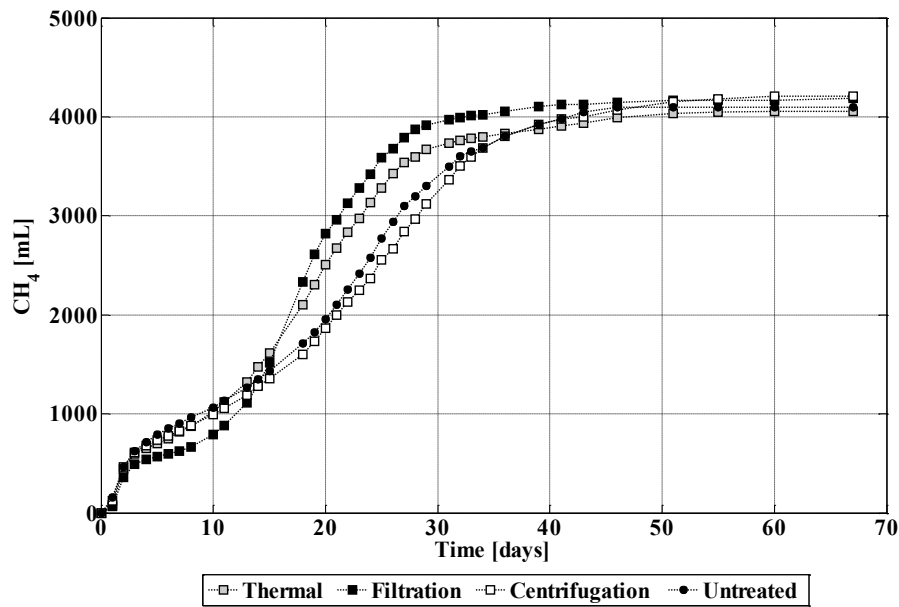

Figure 1. Cumulative methane production of different tests.

Figure 1 shows the cumulative methane production obtained using the different inoculums resulting from the different drying procedures and the untreated inoculum. The Bio-methanation Potential (BMP) is the same for all tests, but only adopting the centrifugation it is possible to observe a similar trend as for the untreated digestate. These results indicate that all the tested methods are suitable drying procedures that do not change the inoculum characteristics. For the following experiments, centrifugation was selected as drying procedure because it gives the minimum alteration of the inoculum and it is the most simple and cheaper method to apply in the laboratory.

2.2.3 Effect of particle size on AD

Bio-methanation experiments were performed using as initial substrate a selected greengrocery waste, (i.e. carrot waste) as initial substrate with the chemical composition in terms of TS, VS and concentrations of carbohydrates, proteins and lipids reported in Table 3. This substrate was selected for modelling purposes, due to the ease to obtain a cylindrical shape (Fig. 2). That shape was obtained by using cylindrical steel tube with a selected diameter. For each particle the same diameter and height was imposed in order to obtain a ratio between area and mass equal to a particle with spherical shape. The tests were conducted using four different PS: 0.25 mm, 4 mm, 9 mm, 15 mm (Table 4).

CHAPTER 2 - EFFECT OF MOISTURE CONTENT ON WET ANAEROBIC DIGESTION OF COMPLEX ORGANIC SUBSTRATES

The selected ratio between organic matter and anaerobic sludge was 0.5 organic matter/anaerobic sludge (i.e. Food/Mass ratio (F/M)). The selected digestate was collected from a mesophilic AD of a farm treating buffalo manure. The mass composition adopted for all tests is described in Table 4. BMTs were operated in triplicate and a blank assay was also carried out. In total 15 BMTs were performed.

Table 3. Substrate characteristics.

	Initial [%]	TS	Initial VS [%]	Ch [%]	Pr [%]	Li [%]
Carrot	12.7		11.4	0.121*	0.025*	0.006*

*Buffière et al. (2006).

Table 4. Composition of the organic mixture in terms of F/M ratio, PS, input substrate and inoculum for the experiments T1-T4

Tests	F/M	Initial [mm]	radius	Carrots [g]	Anaerobic sludge [g]	Na ₂ CO ₃ [g]
T1	0.5	15		48.2 (±0.5)	500 (±1)	0.30-0.40 (±0.001)
T2	0.5	9		48.2 (±0.5)	500 (±1)	0.30-0.40 (±0.001)
T3	0.5	4		48.2 (±0.5)	500 (±1)	0.30-0.40 (±0.001)
T4	0.5	0.25		48.2 (±0.5)	500 (±1)	0.30-0.40 (±0.001)

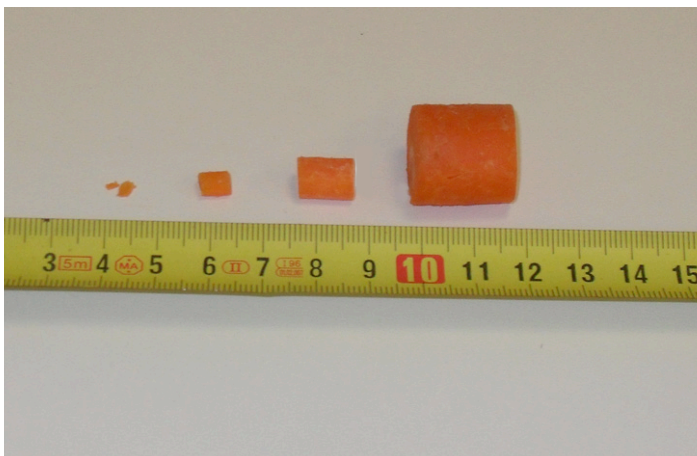

Figure 2. Different PS of Carrots with cylindrical shape.

CHAPTER 2 - EFFECT OF MOISTURE CONTENT ON WET ANAEROBIC DIGESTION OF COMPLEX ORGANIC SUBSTRATES

2.2.4 Effect of moisture content on AD

BMTs were performed using carrot with a cylindrical shape and buffalo manure anaerobic digestate. A specific value of PS = 15 mm was selected in order to get the disintegration step as rate limiting step.

The initial TS content of the fresh digestate was 2%, that was dried by operating centrifugation in order to obtain the desired moisture contents. A fixed substrate amount of substrate was defined and only the digestate volume was changed to obtain different moisture contents. All the tests were performed imposing a selected ratio between organic matter and anaerobic sludge of 0.5 organic matter/inoculum. All the tests were conducted in triplicate. A total of nine bottles were operated with three TS contents: 4.98%, 7.5%, 11.3%. The mixture composition of each BMT test is reported in Table 5.

Nine further tests were conducted using only anaerobic sludge as substrate to estimate the volume of methane resulting from the fermentation of the organics contained in the anaerobic sludge. Totally 18 tests were performed.

Table 5. Mixture composition

Test	TS mixture [%]	VS mixture [%]	Carrot amount [g]	Dried Anaerobic sludge [g]
T5	11.3	8.57	40	120
T6	7.5	4.6	40	245
T7	4.98	3.7	40	320

2.2.5 Mathematical model

For better understanding the effect of TS and PS on the anaerobic degradation of complex organic substrates, the anaerobic co-digestion model for complex organic substrates proposed by Esposito et al. (2011a,b) was used. The model was calibrated with the experimental data of the batch experiments to estimate the kinetic constant of the surface based disintegration process, K_{sbk} ($ML^{-2}T^{-1}$). The differential mass balance equations and the process kinetics and stoichiometry, described in detail in Esposito et al. (2011a,b), are based on the ADM1 approach.

The disintegration kinetic is based on the surface-based kinetic expression proposed by Sanders et al.

CHAPTER 2 - EFFECT OF MOISTURE CONTENT ON WET ANAEROBIC DIGESTION OF COMPLEX ORGANIC SUBSTRATES

(2000) and reformulated by Esposito et al. (2008, 2011a,b) by including a^* , which characterize the disintegration process:

$$a^* = \frac{A}{M} \quad (1)$$

$$\frac{dC}{dt} = -K_{sbk} \cdot a^* \cdot C \quad (2)$$

where:

C = concentration of the complex organic substrate in the digester [ML^{-3}];

A = disintegration surface area [L^2];

M = complex organic substrate mass [M].

Assuming that all the organic solid particles have the same initial size and cylindrical shape with $h = 2R$, that they are progressively and uniformly degraded, a^* equation is given by the following equation:

$$a^* = \frac{\sum_{i=1}^n A_i}{\sum_{i=1}^n M_i} = \frac{nA_i}{nM_i} = \frac{3}{\delta R} \quad (3)$$

where:

A_i = disintegration surface area of the organic solid particle i [L^2];

M_i = mass of the organic solid particle i [M];

n = total number of organic solid particles [ad.];

δ = complex organic substrate density [ML^{-3}];

R = organic solid particles radius [L], assumed to be time dependent according to the following expression proposed by Sanders et al. (2000):

$$R = R_0 - K_{sbk} \frac{t}{\delta} \quad (4)$$

where:

R_0 = initial organic solid particle radius [L], specified as the initial condition for model application.

CHAPTER 2 - EFFECT OF MOISTURE CONTENT ON WET ANAEROBIC DIGESTION OF COMPLEX ORGANIC SUBSTRATES

The a^* coefficient is different than the one proposed by Esposito et al. (2011a,b) as the solid particle present cylindrical instead of spherical shape.

Integration of the differential algebraic equations is performed using a multi-step solution algorithm based on the numerical differentiation formulas in the software tool MATLAB[®].

Model calibration and validation was also performed to estimate K_{sbk} ($ML^{-2}T^{-1}$) constant, the surface constant of the surface-based disintegration process.

Calibration was performed by comparing model results with experimental data of cumulative methane production for a selected particle size and define the unknown parameter by fitting experimental data with model results.

The calibration and validation procedure proposed by Esposito et al. (2011a,b) was performed. A comparison between experimental data and model results was performed by applying the Root Mean Square Error (RMSE) (Esposito et al. 2012a,b; Janssen and Heuberger 1995).

2.3. Results and discussions

2.3.1 Effect of particle size on AD performance

Figure 3 shows the cumulated methane production for the reactors operated at four different PS during the whole experiments. Each curve represents the average of three replicates. The results clearly show a different initial trend for the four curves indicating a cumulative methane production rate inversely proportional to the PS. The cumulative methane production rate was inversely proportional to the PS. The methane yield of all curves is in the range of 460(\pm 30) mL/gVS. There are no large differences as all reactors were filled with the same substrate amount (Fig. 3).

CHAPTER 2 - EFFECT OF MOISTURE CONTENT ON WET ANAEROBIC DIGESTION OF COMPLEX ORGANIC SUBSTRATES

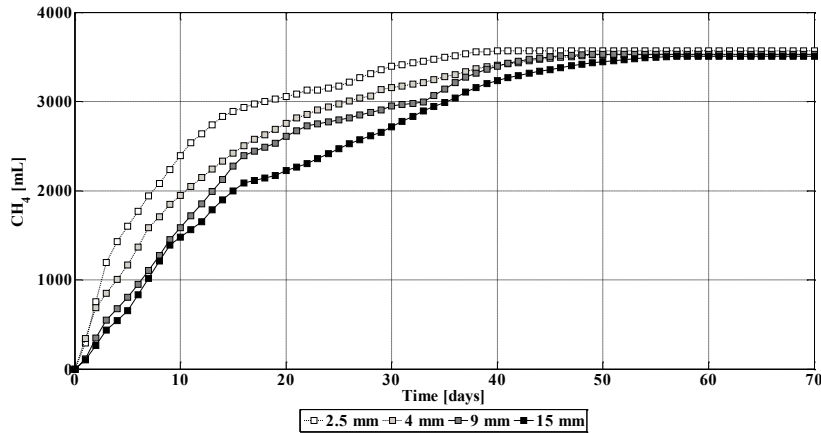

Figure 3. Effect of PS on the cumulative methane production

Figure 4 shows a logarithm relationship between PS and initial methane production rate for the substrate added, evaluated by dividing the specific net methane production by the number of days (3 days) from the start of the experiment. The Figure 4 indicates a strong impact of the PS on the kinetic rates and individuates the disintegration process as the rate-limiting step for methane production. These results are consistent with the findings of previous studies (Hills and Nakano 1984; Sharma et al. 1988; Esposito et al. 2008, 2011a,b). Hills and Nakano, (1984) plotting the methane gas production relative to the parameter $1/\Phi_s D_m$ (where Φ_s represent the sphericity of the particles and D_m the average particle diameter) found a linear correlation between these parameters. The similar correlation was implicitly considered in the model proposed by Esposito et al. (2008, 2011a).

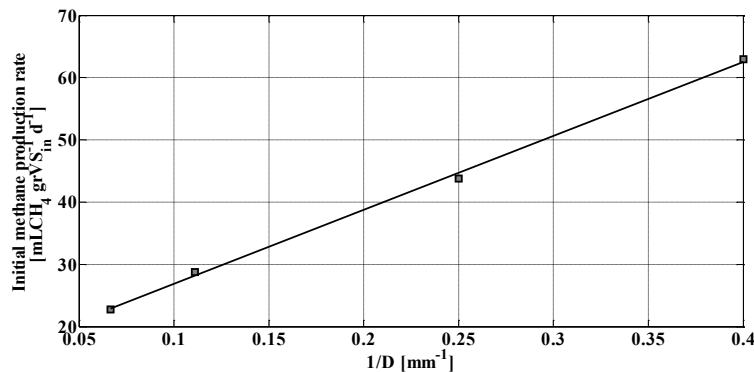

Figure 4. Influence of particle size on initial methane production rate.

2.3.2. Effect of TS content on AD performances

Figure 5 shows the cumulated methane production for the reactors operated at 3 different TS contents during the whole experiments. Each curve represents the average of 3 replicates. Lag-phase and the initial methane production rate, resulted inversely proportional to the TS content. These results are consistent with previous studies performed by Lay et al. (1997a,b), who made batch tests in mesophilic digesters at different pH values by testing the effect of moisture content in the range of wet digestion. The final methane yield, measured at the end of each experiment can be assumed for all tests coincident and equal to the mean value of 450 mL/gVS with a standard deviation of 14.23 (Table 6). This is apparently not in agreement with the findings of Abbassi-Guendouz et al. (2012), Fernández et al. (2008) and Dong et al. (2010), who found higher methane yields with lower TS in the range of dry and semidry AD. The difference is due to the different moisture content range investigated, as the present experiments were carried out in wet conditions. The conversion of acids to methane by methanogenic bacteria can thus be influenced by the lack of water (Lay et al. 1997b; Ghosh 1985) that can occur with higher TS content in the range of dry and semidry digestion (Abbassi-Guendouz et al. 2012; Fernández et al. 2008; Dong et al. 2010).

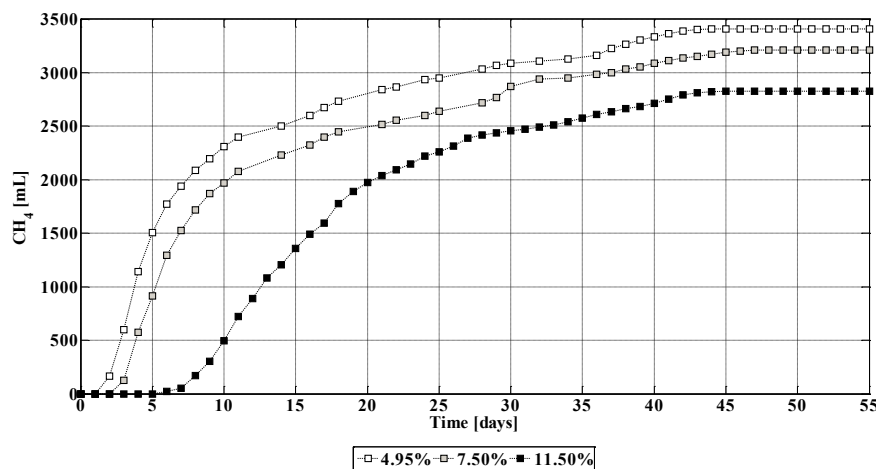

Figure 5. Effect of TS on the cumulated methane production from anaerobic digestion of carrots waste.

Figure 6 indicates a linear relationship between TS content and initial methane production rate. Such linear relationship was observed also by Lay et al. (1997b) on AD of selected dry organic waste (e.g. sludge cake, meat, carrot, rice, potato and cabbage), Le Hyaric et al. (2012) on AD of cellulose,

CHAPTER 2 - EFFECT OF MOISTURE CONTENT ON WET ANAEROBIC DIGESTION OF COMPLEX ORGANIC SUBSTRATES

Abbassi-Guendouz et al. (2012) on AD of cardboard, Mora-Naranjo et al. (2004) for waste samples excavated from landfill and Pommier et al. (2007) for paper waste. The presented results confirm that the TS content, also in wet AD, has a strong effect on the kinetic rates. In particular, at lower TS, due to the increasing water content and better transport and mass transfer conditions, it seems to be plausible that the microorganisms are better sustained with soluble substrates (Mora-Naranjo et al. 2004).

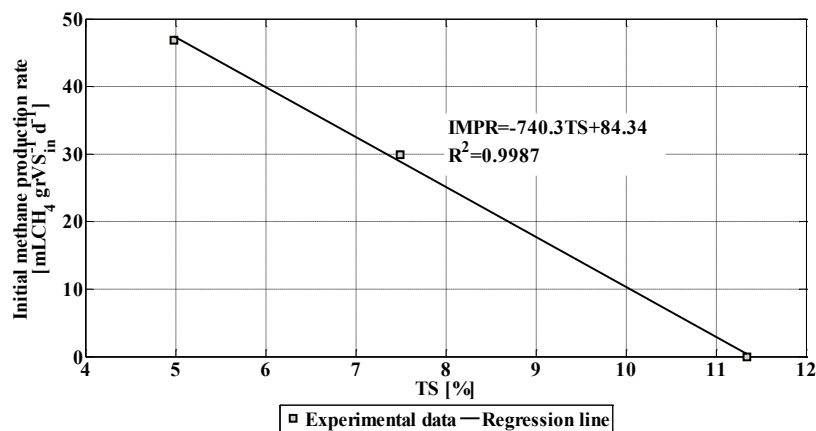

Figure 6. Influence of the TS on initial methane production rate.

Table 6. Cumulative methane production.

TS mixture [%]	4.98	7.5	11.3
Cumulative methane production [mL]	3410	3210	2830
Cumulative methane production of blank [mL]	1340	1230	725
Net cumulative methane production [mL]	2070	1980	2105
Specific Final Methane Yield [mL/gVSfeed]	455	430	460

2.4. Modelling results

2.4.1. Modelling the effect of particle size on AD

Model calibration was used to estimate the kinetic constant of the surface based disintegration process, K_{sbk} ($M L^{-2}T^{-1}$). Calibration was performed by comparing model results with experimental measurements of methane production and adjusting the unknown parameters until the model results adequately fit the experimental observations. The measured data of experiment T1 (Table 7) were

CHAPTER 2 - EFFECT OF MOISTURE CONTENT ON WET ANAEROBIC DIGESTION OF COMPLEX ORGANIC SUBSTRATES

used, and a calibration procedure introduced by Esposito et al. (2011a,b) was applied. Using the previously calibrated K_{sbk} model, validation was performed by calculating RMSE for T2, T3 and T4 experiments.

The model calibration performed resulted in setting the kinetic constant K_{sbk} equal to $0.28 \text{ kg m}^{-2}\text{s}^{-1}$. K_{sbk} was the value that minimizes RMSE (Fig. 7), that show a single monotone reversal trend that proves the existence of one and only one solution to the specific optimization problem.

In Figure 8A a good overlap between the simulated and model data is shown. A small shift between experimental data and model results was observed.

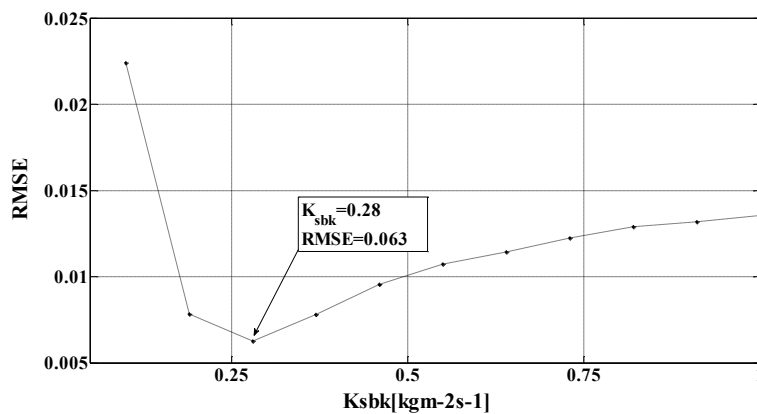

Figure 7. Calibration procedure for PS = 15 mm: dependence of RMSE on K_{sbk} .

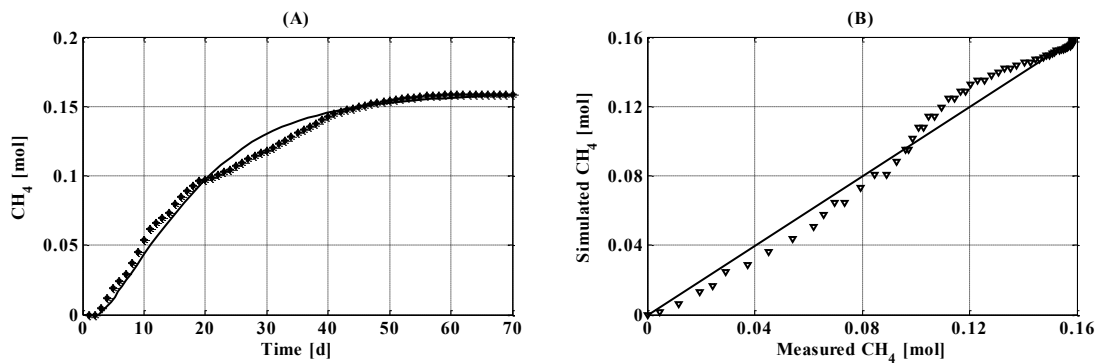

Figure 8. Comparison of measured and simulated cumulative methane production for experiments with PS = 15 mm: overlapping between measured and simulated data (a); comparison between simulated and experimental data with line of perfect fit (b).

The results of experiments T2, T3 and T4 were used to validate the mathematical model, assessing the agreement between simulated and observed data for the cumulative methane production with the

CHAPTER 2 - EFFECT OF MOISTURE CONTENT ON WET ANAEROBIC DIGESTION OF COMPLEX ORGANIC SUBSTRATES

parameter RMSE. Figures 9, 10 and 11 show a very good agreement between the simulated and experimental data. This agreement is confirmed in Table 8, where the values of a^* constant evaluated for different PS are also reported.

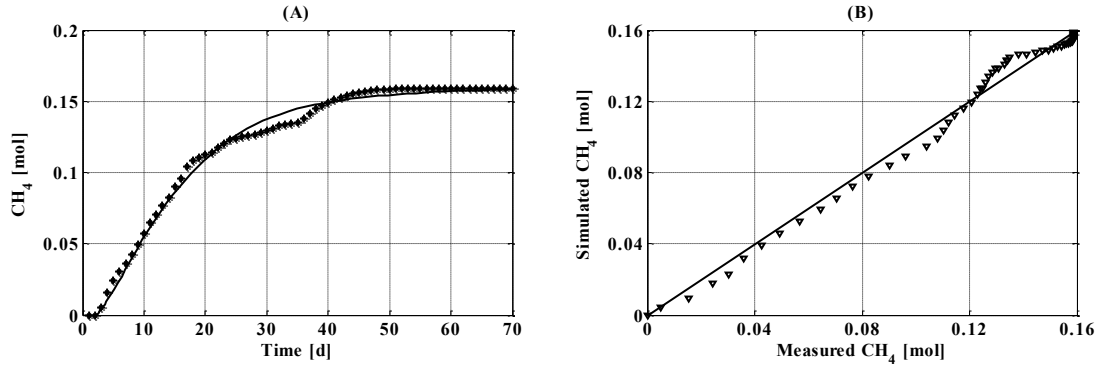

Figure 9. Comparison of measured and simulated by cumulative methane production for experiments with PS = 9 mm: overlapping between measured and simulated data (a); comparison between simulated and experimental data with line of perfect fit (b).

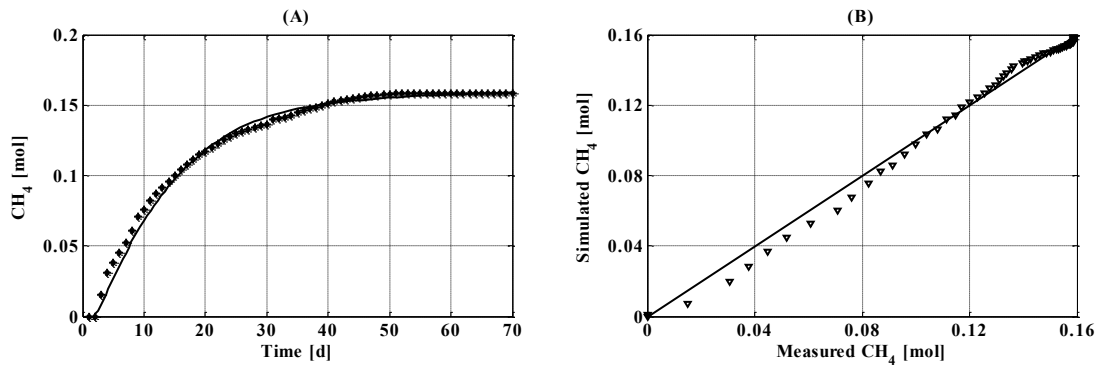

Figure 10. Comparison of measured and simulated cumulative methane production for experiments with PS = 4 mm: overlapping between measured and simulated data (a); comparison between simulated and experimental data with line of perfect fit (b).

CHAPTER 2 - EFFECT OF MOISTURE CONTENT ON WET ANAEROBIC DIGESTION OF COMPLEX ORGANIC SUBSTRATES

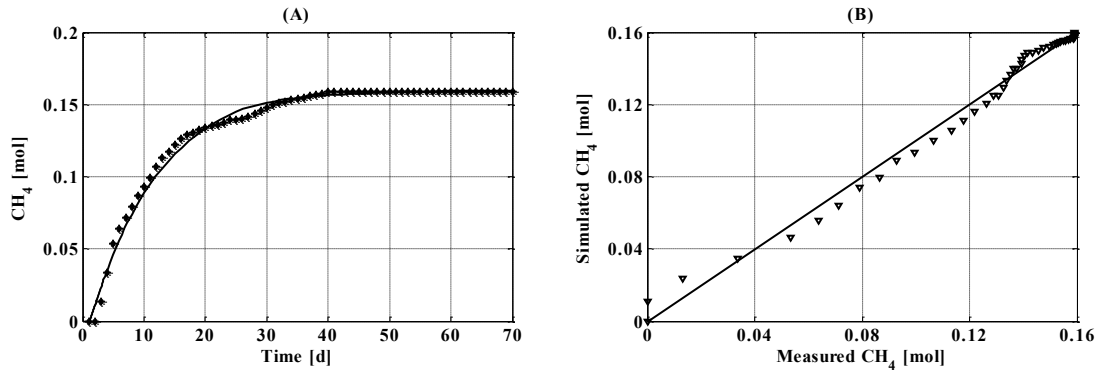

Figure 11. Comparison of measured and simulated cumulative methane production for experiments with PS = 0.25 mm: overlapping between measured and simulated data (a); comparison between simulated and experimental data with line of perfect fit (b).

Table 7. Results of the model calibration procedure.

Test	PS [mm]	a^* [m^2kg^{-1}]	K_{sbk} [$\text{kg m}^{-2}\text{s}^{-1}$]	RMSE
T1	15	0.561	0.28	0.083

Table 8. Results of the model validation procedure.

Test	PS [mm]	a^* [m^2kg^{-1}]	K_{sbk} [$\text{kg m}^{-2}\text{s}^{-1}$]	RMSE
T2	0.25	12.632	0.28	0.063
T3	4.0	1.579	0.28	0.0627
T4	9.0	0.702	0.28	0.067

2.4.2. Modelling the effect of TS on AD

The mathematical model proposed by Esposito et al. (2008, 2011a,b) was calibrated to set different values of the kinetic disintegration constant $K_{\text{dis}}[\text{T}^{-1}] = K_{\text{sbk}} a^*$, for different TS contents. For a selected PS = 15 mm, the value of a^* constant was $0.561 \text{ m}^2\text{kg}^{-1}$. The measured data of experiment (Table 4) were used, a calibration procedure introduced by Esposito et al. (2011a,b) was applied and RMSE for T5, T6 and T7 experiments were evaluated.

The results (Fig. 12-14) show a good agreement between the simulated and experimental data; this

CHAPTER 2 - EFFECT OF MOISTURE CONTENT ON WET ANAEROBIC DIGESTION OF COMPLEX ORGANIC SUBSTRATES

agreement is confirmed in Table 9, where the values of the K_{dis} constant, evaluated for different TS, are also reported. In particular the good fitting between simulated and experimental concentrations shows the capability of the model to simulate the AD process of substrates with different initial TS.

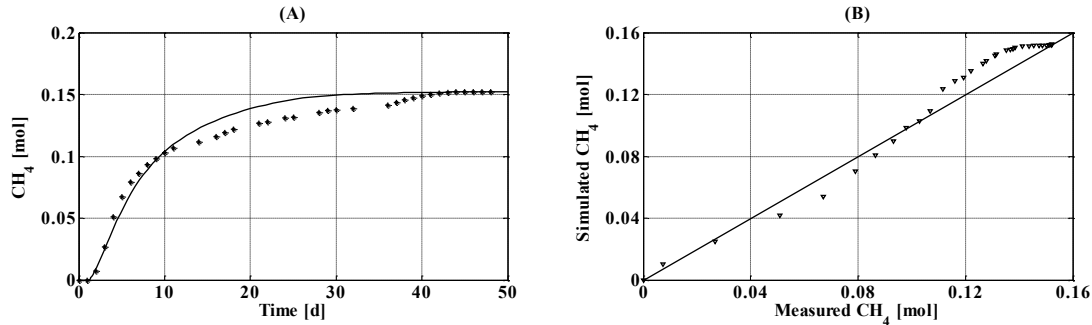

Figure 12. Comparison of measured and simulated by proposed model cumulative methane production for experiments with PS=15 mm and TS= 4.98%:overlapping between measured and simulated data (a); comparison between simulated and experimental data with line of perfect fit (b).

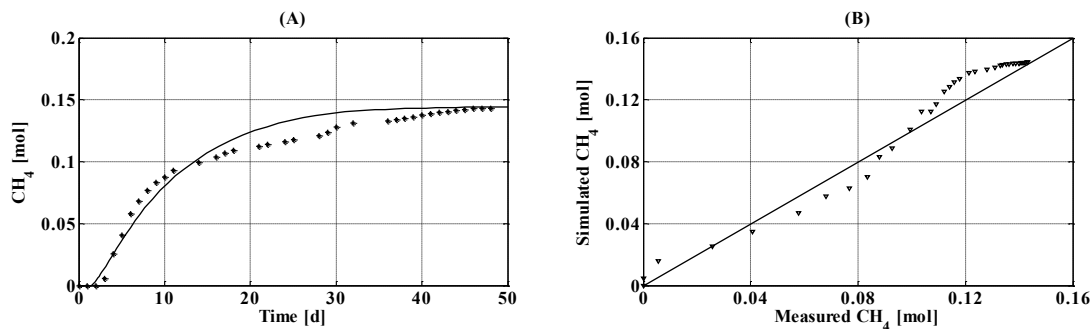

Figure 13. Comparison of measured and simulated by proposed model cumulative methane production for experiments with PS = 15 mm and TS= 7.48%: overlapping between measured and simulated data (a); comparison between simulated and experimental data with line of perfect fit (b).

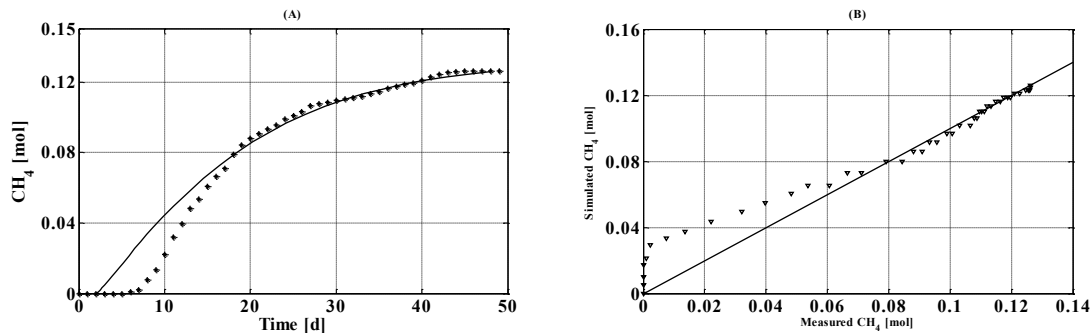

Figure 14. Comparison of measured and simulated by proposed model cumulative methane production for experiments with PS= 15 mm and TS= 11.34%:overlapping between measured and simulated data (a); comparison between simulated and experimental data with line of perfect fit (b).

CHAPTER 2 - EFFECT OF MOISTURE CONTENT ON WET ANAEROBIC DIGESTION OF COMPLEX ORGANIC SUBSTRATES

Table 9. Disintegration constant and RMSE for different TS.

Test	a* [m ² kg ⁻¹]	K _{dis} [s ⁻¹]	RMSE
T5	0.561	0.1	0.0084
T6	0.561	0.3	0.0088
T7	0.561	0.55	0.0087

Figure 15 indicates a linear relationship between TS and the disintegration kinetic constant obtained with the model proposed by Esposito et al. (2008, 2011a,b) implementation:

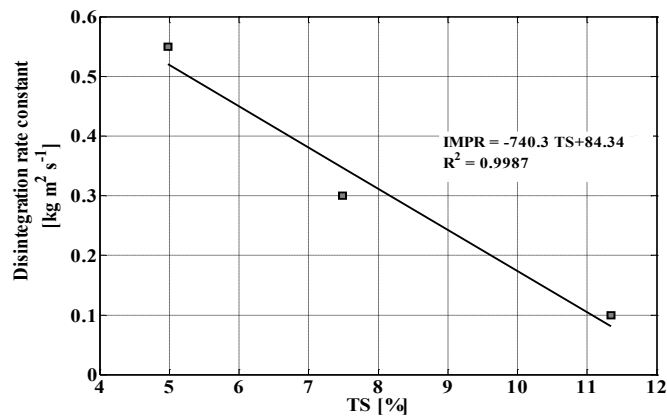

Figure 15. Correlation between TS content and disintegration rate constant.

The linear correlation represented in Figure 15 can be expressed using the following linear equation:

$$\frac{d[CH_4]_0}{dt} = -740.3 \cdot (TS\%) + 84.34 \quad (5)$$

By considering the presence of a limiting step (i.e. disintegration process) the rate of the overall AD process can be modelled by one equation. If first order kinetics is assumed for the disintegration process, the methane production rate can be expressed by equation (6):

$$\frac{d[CH]_d}{dt} = K_{dis}[C] \quad (6)$$

where:

[C] = substrate concentration [ML⁻³].

By including the following two parameters:

CHAPTER 2 - EFFECT OF MOISTURE CONTENT ON WET ANAEROBIC DIGESTION OF COMPLEX ORGANIC SUBSTRATES

$l =$ angular coefficient of the interpolation line (-2961.2)

$f =$ intercept value of the interpolation line on the axis of the initial methane production rate (337.36)

and integrating and making simplifications it is possible to obtain the following equation:

$$K_{dis} = \frac{\ln(l \cdot (TS\%) + f) \cdot t}{C_0} \quad (7)$$

where:

$t =$ integration time for the initial bio-methane production rate evaluation [T];

$C_0 =$ initial substrate concentration [ML⁻³].

Table 10. Disintegration kinetic constants obtained with equation (7) and with the mathematical model.

Test	K_{dis} [s ⁻¹]	K_{dis} [s ⁻¹]
	[with Esposito et al., 2011a,b)]	[with eq. (7)]
T5	0.1	0.19
T6	0.3	0.22
T7	0.55	0.55

In Table 10 the values of the disintegration constant, obtained with equation (7) and with the mathematical model proposed by Esposito et al. (2008, 2011a,b) are reported, showing a good agreement of the results of the two methods. This confirms that a simplified model (i.e. a one equation model) can approximate the results of a full model when a rate-limiting step of the biological process is clearly present.

2.5 Conclusion

This chapter focused on the effect of TS content and PS on anaerobic digestion of complex organic substrates. A linear correlation between initial methane production rate and TS content was individuated. An inverse correlation between the Particle Size and the specific methane production was found and also a linear relationship between 1/PS and initial methane production rate for the substrate added were found. These results underline a strong impact of the PS on the kinetic rates and individuating the disintegration process as the rate-limiting step for methane production. The surface-

CHAPTER 2 - EFFECT OF MOISTURE CONTENT ON WET ANAEROBIC DIGESTION OF COMPLEX ORGANIC SUBSTRATES

based kinetic constant K_{sbk} for the disintegration equation of carrot waste was determined. Also the values of the disintegration constant for different TS content were assessed. Finally a simple equation correlating TS and the disintegration constant was proposed, that showed a good agreement with the results of new version of ADM1 of complex organic substrate proposed by Esposito et al. (2008, 2011a,b).

CHAPTER 3

Effect of moisture content on anaerobic digestion of food waste

This chapter is the modified version of the article “**Effect of total solids content on methane and VFA production in anaerobic digestion of food waste**” submitted to the Journal Waste Management and Research (under revision).

3.1. Introduction

The environmental challenges related to the global population growth and the global energy demand are continuously promoting research efforts to develop innovative technologies aimed at producing energy from non-conventional sources (Lay et al. 1997a, b; Mora-Naranjo et al. 2004; Pommier et al. 2007; Bollon et al. 2013). The Kyoto Protocol imposed to the major EU industrial countries to reduce their total Greenhouse Gas (GHG) emissions by 8% from the 1990 level by the end of 2012 (Kyoto, 1997). To achieve this, the EU policies have set forward the task of supplying 5% of the European energy demands from Anaerobic Digestion (AD) biogas by the year 2020 (Kim and Oh 2011).

AD is a biological process for degradation of organic substrates under anaerobic conditions (Esposito et al., 2012a; Esposito et al., 2008) Based on the TS of waste used in the process, three types of AD can be distinguished: dry AD, characterized by a TS above 15%, semi-dry AD with a TS ranging between 15% and 10%, and wet digestion with a TS lower than 10% (Li et al., 2011; Liotta, 2014; Zeshan and Annachatre, 2012). The dry and semi-dry systems most widely applied at industrial scale are Valorga, Dranco, Kompogas and Bekon (Reith et al., 2003), but further applications have also been tested at pilot and farm-scale (Lianhua et al. 2010; Mussoline 2012; Mussoline et al. 2013; Zhang and Zhang 1999).

The key parameter of the dry AD process is the water content, that is essential for the biological process as water promotes substrate hydrolysis and enables the transfer of process intermediates and nutrients to the bacteria (Bollon et al., 2013; De Baere et al., 2010; Lissens et al., 2001). Hence, the first aim of this paper is to investigate the effect of TS on the AD of Food Waste (FW) under mesophilic conditions in batch reactors. BMTs were performed to compare methane yield, methane production rate, COD, VS and TS degradation in wet, semi-dry and dry conditions. In particular, VFAs composition and concentrations were also investigated as a useful indicator of process stress and instability (Ahring et al. 1995). VFAs are also valuable products that can be used as carbon source in biological processes (Elefsiniotis et al. 2004). However, the role of these parameters on the process development remains still little studied. Therefore, the second aim and main novelty of this chapter is to assess the TS effect on VFAs production from FW, and the VFAs effect on the process evolution.

CHAPTER 3 - EFFECT OF MOISTURE CONTENT ON ANAEROBIC DIGESTION OF FOOD WASTE

3.2. Materials and Methods

3.2.1 Experimental set-up

BMTs were performed at laboratory scale under controlled and reproducible conditions (Esposito et al. 2012b; Esposito et al. 2011a, b; Esposito et al. 2012c) using 2000 mL glass bottles GL 45 (Schott Duran, Germany). Each bottle was sealed with a 5 mm silicone disc, held tightly to the bottle head by a plastic screw cap punched in the middle (Schott Duran, Germany). A plastic tube hermetically closed to the top was inserted in the plastic screw cap to permit sample withdrawing. All digesters were immersed up to half of their height in hot water kept at a constant temperature of 308.15 K by 200 WA-763 submersible heaters (Hagen, Germany). Small amounts of Na_2CO_3 powder were also added to control the pH and alkalinity values (Esposito et al. 2012b,c).

CHAPTER 3 - EFFECT OF MOISTURE CONTENT ON ANAEROBIC DIGESTION OF FOOD WASTE

3.2.2. Substrate and inoculum preparation

BMTs were conducted in triplicate using FW and Buffalo Manure (BM) anaerobic digestate as inoculum. The FW was prepared according to Valorgas report (Valorgas, 2012) as indicated in Table 11.

Table 11. Food waste composition of the synthetic substrate used.

Food type	Amount (gr wet)
Potatoes	200
Tomatoes	170
Eggplants	170
Salad leaves	180
Broccoli	180
Carrots	140
Apples	150
Tangerines	170
Banana	150
Chicken	70
Pork	70
Fish	70
Cheese	20
Milk	20
Bread	70
Biscuits	70
Rice	50
Pasta	50

Particles size smaller than 0.5 mm were obtained by grinding the FW substrate before starting the experimental tests. The BM digestate, sampled from a mesophilic anaerobic digester, was dehydrated by filtration to obtain a final TS content of 17.82%. BMTs were carried out in wet (TS = 4.52%), semi-dry (TS= 12.87%) and dry (TS = 19.02%) conditions as indicated in Table 12. The different TS contents of the mixture were obtained by adding 500 g of inoculum, differently diluted with distilled water and varying the amount of the substrate calculated in order to keep the ratio between organic matter and anaerobic sludge equal to 1:2. Blank BMTs were also conducted on BM without addition of substrate to estimate, as a control, the volume of methane resulting from the fermentation of the inoculum. Table 12 gives the mixture composition of each BMTs and reports the BM and substrate

CHAPTER 3 - EFFECT OF MOISTURE CONTENT ON ANAEROBIC DIGESTION OF FOOD WASTE

amount as well as the TS and VS concentration of the substrate mixture.

Table 12. Composition of inoculum and FW substrate in BMT.

Tests	Inoculum [g]	TS inoculum [%]	Substrate amount [g]	TS substrate [%]	TS mixture [%]	VS Mixture [%]
T1	500 (± 1)	3.45	27.26	24.21	4.52	3.61
T2	500 (± 1)	10.88	87.80	24.21	12.87	10.45
T3	500 (± 1)	17.82	139.10	24.21	19.02	15.25

3.2.3. Analytical methods

3.2.3.1 Methane production

Volumetric methane production was measured once a day, by connecting each digester by a small pipe to an inverted 1000 mL glass bottle containing a strong alkaline solution (12% NaOH). The inverted 1000 mL glass bottle was sealed in the same way as the digesters. The adopted procedure is described in detail in the Chapter 2.

3.2.3.2 VFAs analysis

VFAs concentration and speciation were monitored throughout the process. VFAs were analysed collecting 100 mg of digestate sampled from each reactor and diluted with ultrapure water. The samples were vigorously stirred for three minutes and centrifuged at 8000 rpm for 5 min. VFAs were extracted from the supernatant by SPME prior to GC-MS injection following the procedure proposed by Ábalos et al. (2000). 50 μ L of a 2,2 dimethyl butanoic acid solution was added as internal standard. 85 μ m polyacrilate coated fibers from SUPELCO were used for the extraction and analysed after thermal desorption by an Agilent 6850 GC coupled with a 5973 Network MSD detector.

CHAPTER 3 - EFFECT OF MOISTURE CONTENT ON ANAEROBIC DIGESTION OF FOOD WASTE

3.2.3.3 Other parameters

The weight, TS and VS concentration of the anaerobic sludge were determined by gravimetry according to EPA Standard Method 1684 (U.S.E.P.A, 2001). Temperature of all mixtures investigated was monitored for at least once a day with a TFK 325 thermometer (WTW, Germany). COD was determined by the closed reflux method, followed by photometric determination according to APHA standard method 5220D (APHA, 1998) and by applying the method proposed Zupančič & Roš (2012). The photometer used was a WTW Photolab Spektral visible spectrophotometer.

3.3. Results and Discussion

3.3.1 Bio-methane production

Results of BMTs are summarized in Figures 16-18. Figure 16 reports the specific cumulative methane production versus time in reactors operated with different TS content. Each curve represents the average of 3 replicates (max standard deviation = 4%). The specific cumulative methane production was obtained dividing the cumulative methane production of each test by the initial substrate-inoculum VS mixture. Figure 17 reports the final specific methane yield, measured at the end of each experiment, as a function of the TS content and subtracted of the respective blank production. Finally Figure 18 illustrates the initial methane production rate versus the TS content, evaluated by dividing the specific net methane production by the number of days (3 days) from the start of the experiment.

A lower TS content favours both the cumulative methane production and the final methane yield. Such a result is consistent with previous findings (Abbassi-Guendouz et al. 2012; Fernández et al. 2008; Le Hyaric et al. 2012; Li et al. 2011; Liotta et al. 2014) obtained using different biodegradable substrates (Table 13), and confirms that the conversion of acids to methane by methanogenic bacteria can be negatively influenced by the lack of water (Lay et al. 1997a; Lay et al. 1997b). It is worth noting that the initial methane production rate is linearly and negatively correlated with the TS percentage (Fig. 18), as already observed during the AD of other organic wastes more or less rapidly biodegradable: dehydrated sludge mixed with dry kitchen waste (Lay et al. 1997a), waste excavated from a sanitary landfill (Mora-Naranjo et al. 2004), paper waste (Pommier et al. 2007), cellulose (Le Hyaric et al. 2012) and cardboard (Abbassi-Guendouz et al. 2012). At lower TS concentration, due to the increasing water content and to the more favourable transport and mass transfer conditions, it

CHAPTER 3 - EFFECT OF MOISTURE CONTENT ON ANAEROBIC DIGESTION OF FOOD WASTE

seems plausible that the microorganisms are better sustained with soluble substrates (Mora-Naranjo et al. 2004), so that the process takes place more rapidly.

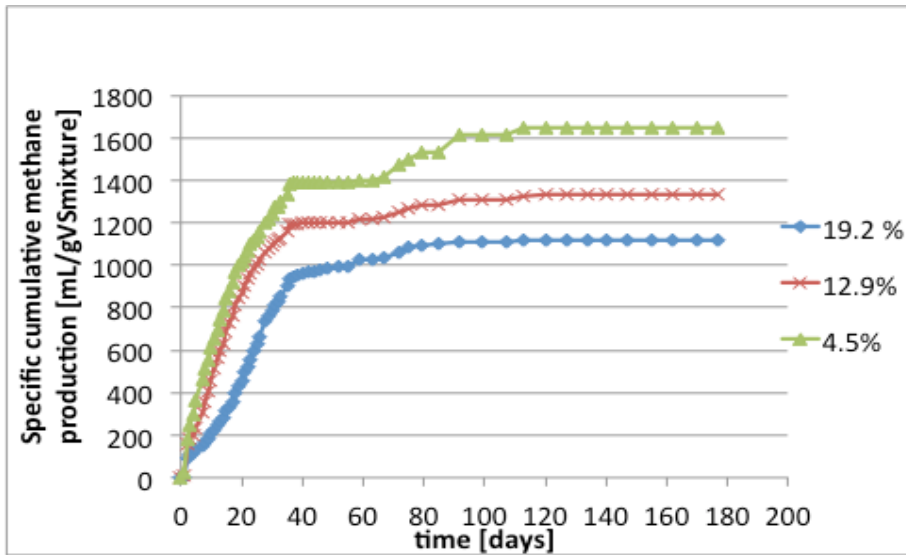

Figure 16. Specific cumulative methane production of FW at different TS content (Tests T1-T3).

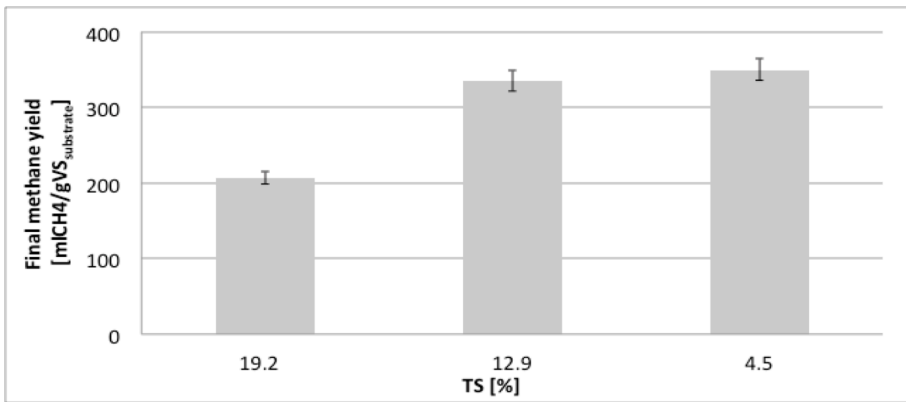

Figure 17. Final methane yield of FW with different TS content

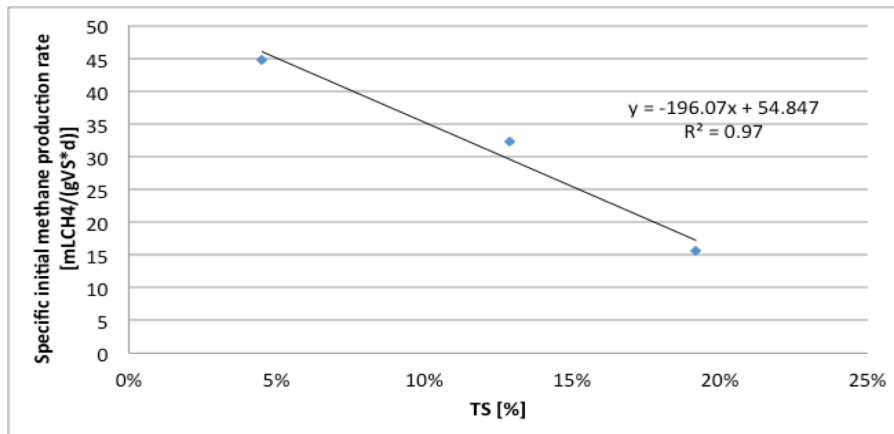

Figure 18. Linear correlation between the specific initial methane production rate and the TS content of FW.

CHAPTER 3 - EFFECT OF MOISTURE CONTENT ON ANAEROBIC DIGESTION OF FOOD WASTE

Table 13. Final methane yields improvement in wet conditions compared with semi-dry and dry conditions.

Substrates used in BMTs	Final methane yield improvement with lower TS content [%]	TS and Temperature	References
FW	57	TS = 30%, 20%; T=35°C	Fernández et al. (2008)
Water sorted organic fraction of municipal solid waste	15	TS = 16%, 11%; T=30 °C	Dong. et al. (2010)
Cellulose	11.6	TS = 25%, 18%; T=35°C	Abbassi-Guendouz et al. (2012)
Cardboard	24	TS = 30%, 10% T = 35 °C	Le Hyaric et al. (2012)
Carrot Waste	1	TS =11.3%, TS = 5% T =35°C	Liotta et al.2014
FW	69	TS=19.2 %, 4.5%;T= 35°C	This study

3.3.2 VFAs production

A deeper understanding of the TS effect on process development can be obtained by comparing the trend of daily methane production (Fig. 19) and the corresponding concentration and speciation of VFAs (Fig. 20). A first peak of methane production can be detected in all reactors on the second day (Fig. 19). This peak, most likely due to the degradation of fast biodegradable compounds, corresponds to the peak of Total Volatile Fatty Acids (TVFAs) related to acid accumulation at the start-up of the process (Fig. 20). This means that the methanization is the rate-limiting step at the beginning of the process.

Once the methanization has begun, the rate-limiting step becomes the hydrolysis process, and the TVFAs concentration slowly decreases. Two more peaks of methane production can be observed on day 15 and day 36. This finding is in agreement with Charles et al. 2009 and Dong et al. 2010 who

CHAPTER 3 - EFFECT OF MOISTURE CONTENT ON ANAEROBIC DIGESTION OF FOOD WASTE

found two peaks of methane production during anaerobic digestion of organic fraction of municipal solid waste. Dong et al. 2010 correlated this finding to the inhibitory effect of an elevated H_2 partial pressure on the acetoclastic methanogenesis. It is likely that the two peaks correspond to the degradation of easily and slowly biodegradable compounds contained in the FW.

The maximum TVFAs concentration found in the case of 12.9% and 19.2% were respectively 127 mmol/kg and 135 mmol/kg (Fig. 20): in these cases TVFAs concentrations exceed the threshold values reported by Karthikeyan and Visvanathan, 2012 over that a sensible reduction of process kinetics occurs. The same occurs for the concentration of acetic acid, which reaches values higher than 33 mmol/L. The lower specific methane yield detected at the higher TS content can be correlated to acid inhibition during the process, which is more important for TS 12.9% and 19.2%. Indeed, high TVFAs concentrations induce acidification of the medium, leading to the presence of TVFAs in their un-dissociated forms, which are more toxic for microorganisms (Amani et al. 2010). A lower water content in the fermenting mixture makes the TVFAs concentration higher due to a lack of solvent. Therefore, even if the amount of produced TVFAs is the same, their concentration in the reactor will be much higher in dry AD.

It has to be stressed that because of the lack of the mixing device inside the reactor higher TS concentrations imply higher heterogeneities and possible accumulation of inhibitory compounds inside specific reactor zones is likely to occur. Furthermore, at the highest TS concentrations investigated, environmental conditions do not allow the growth of acetoclastic, methanogens or acetate-oxidizing bacteria because of too high VFA concentrations and too low pH values (Abbassi-Guendouz et al. 2012). During the first stage (0-4 days), acetic acid accumulation occurs (Fig. 21a) because hydrolysis and acidogenesis take place and the easy biodegradable fraction of FW is converted to TVFAs. During the second stage (5-35 days), acetoclastic methanogens are in the exponential growth phase and the acetic acid consumption rate is higher than its generation rate (Dong et al. 2010). Therefore, hydrolysis and acidogenesis become the rate-limiting steps and the produced acids are consumed to produce methane (Dong et al. 2010).

CHAPTER 3 - EFFECT OF MOISTURE CONTENT ON ANAEROBIC DIGESTION OF FOOD WASTE

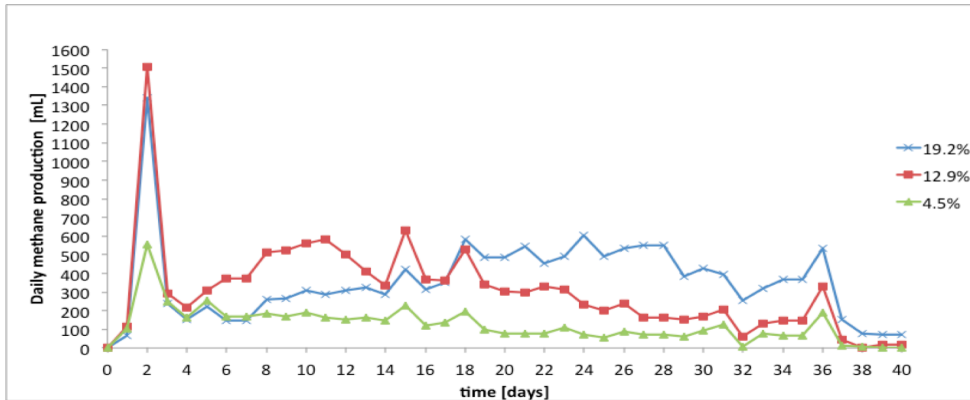

Figure 19. Daily methane production of FW at different TS content

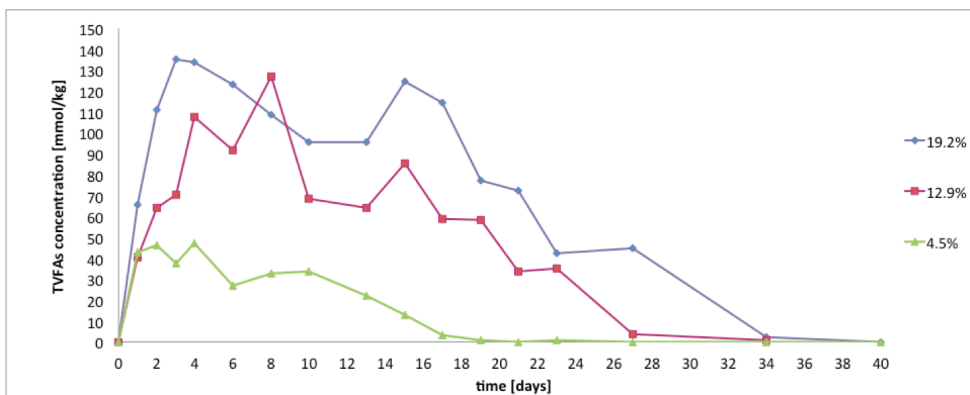
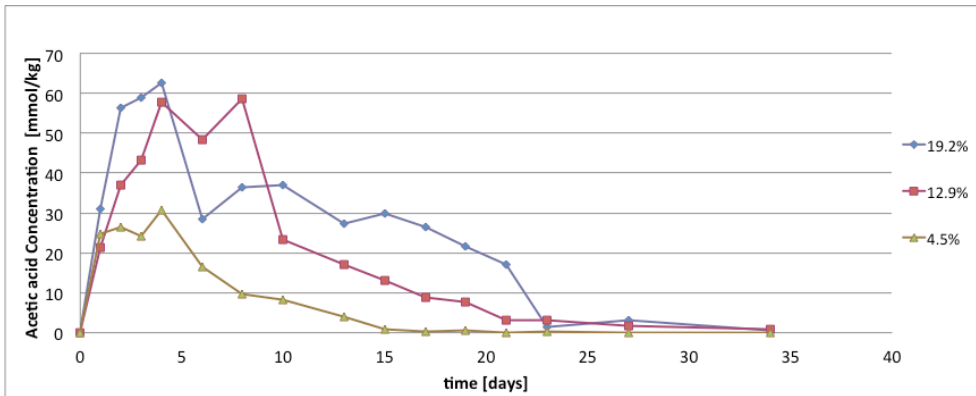

Figure 20. Evolution of TVFAs concentration in AD of FW at different TS contents

The maximum concentration of propionic acid (Fig. 21b) occurs sooner for lower TS concentrations (day 13) and later for higher TS concentrations (day 17). This accumulation, common also to formic acid (Fig. 21e), can be correlated to the limited transformation of propionate to other VFAs as pointed out also by Hanaki et al. 1994. Also butyrate and valeric acid isomers present higher values with higher TS (Fig. 21c and 21d), probably a consequence of the process instability occurring during the acid production, which determines the formation of isomeric compounds. About the propionic acid, although an accumulation (8-12 days) can also be seen for TS = 4.5% during days 7-12, in this case the concentration starts immediately to decrease and drops regularly to zero (Fig. 21b). Such behavior can be attributed to the fact that the concentration of propionate is directly related to that of acetate in the reactor and the lowest acetate accumulation occurs during test T1 (TS = 4.5%) (Fig. 21a). During tests T2 and T3 the concentration of acetate is twice higher and lasts for about 5 days longer. This leads to an accumulation of propionate that is contemporary to the accumulation of acetate. A long acetate and propionate accumulation is instead not present in the reactor with TS content of 4.5%. The accumulation of butyric and propionic acid that takes place only in the dry and semidry reactors might

CHAPTER 3 - EFFECT OF MOISTURE CONTENT ON ANAEROBIC DIGESTION OF FOOD WASTE

be attributed to the co-presence of alternative fermentation pathways, that yield to butyric acid accumulation. This pathway is alternative to the acetic fermentation and can have different process kinetics.



a) Acetic acid

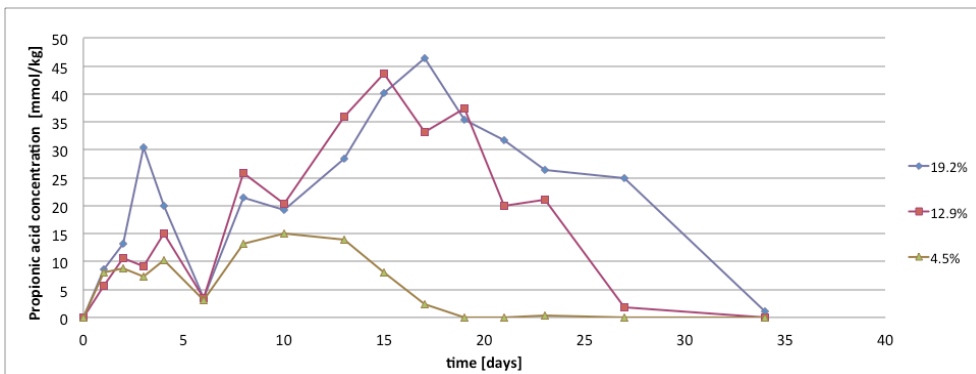

b) Propionic acid

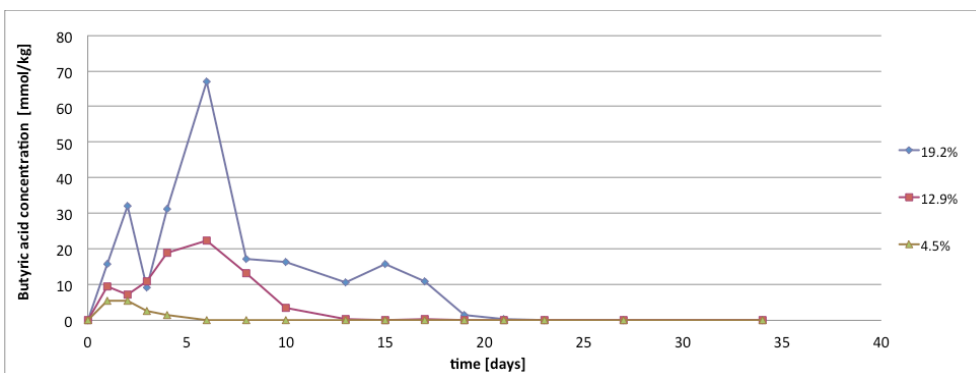

c) Butyric acid

CHAPTER 3 - EFFECT OF MOISTURE CONTENT ON ANAEROBIC DIGESTION OF FOOD WASTE

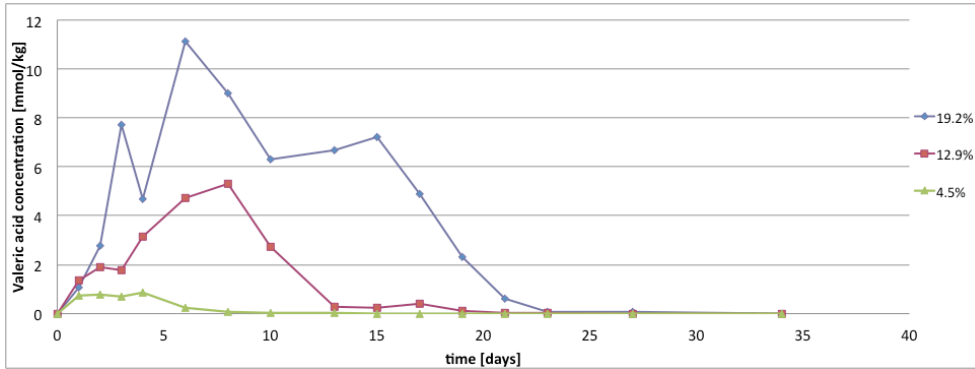

d) Valeric acid

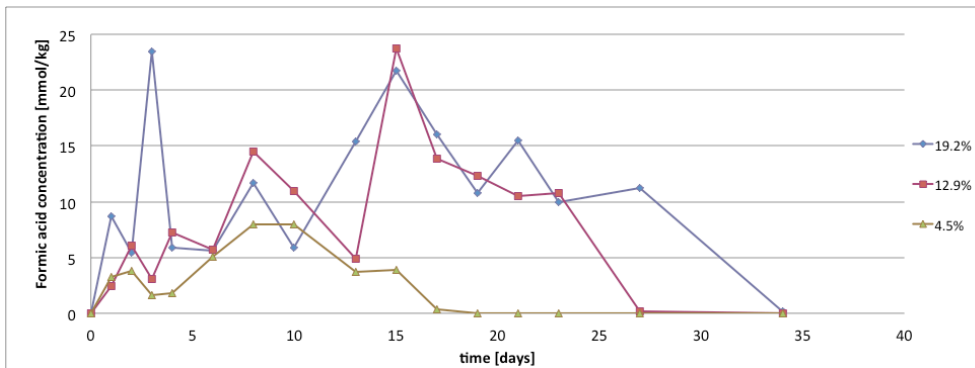

e) Formic acid

Figure 21. Evolution of the VFAs concentration of FW AD: a) acetic acid; b) propionic acid; c) butyric acid; d) valeric acid; e) formic acid.

The Total COD concentration in the reactor at different initial TS concentrations was also investigated. As expected, the COD degradation decreased under all TS conditions. The COD values at the end of the experiment were higher for higher TS content as COD removal decreased from $74 \pm 6\%$ (TS = 4.5%) to $62 \pm 8\%$ (TS = 12.9%), down to $56 \pm 7\%$ (TS = 19.2%), confirming the slowdown of process kinetics taking place at higher TS content due to high VFA concentration (Figs. 20 and 21).

CHAPTER 3 - EFFECT OF MOISTURE CONTENT ON ANAEROBIC DIGESTION OF FOOD WASTE

3.4 Conclusions

This chapter focused on the effect of the TS content on the anaerobic digestion of FW. The experimental results show a decrease of the specific final methane yield of 4.3% and 40.8% in semi-dry and dry conditions, respectively, compared to wet conditions. A higher specific cumulative methane production rate and better process performance in terms of COD reduction were also achieved at lower TS content. A linear correlation between the initial methane production rate and the TS content was observed. High TVFA concentrations of 135 mmol/kg and 127 mmol/kg were found in dry and semidry conditions, respectively, resulting in a slowdown of process kinetics

CHAPTER 4

Effect of moisture content on anaerobic digestion of rice straw.

CHAPTER 4- EFFECT OF MOISTURE CONTENT ON ANAEROBIC DIGESTION OF RICE STRAW

4.1 Introduction

Rice straw is one of the most abundant residues and is a potential renewable source for energy generation. AD may offer a promising alternative to solve imminent rice straw disposal problems in rice production regions (Zhang and Zhang 1999). Different advantages are connected to the AD of rice straw. This substrate is a very common agricultural waste and the biogas production potential is appealing to both developed and developing countries (Mussoline et al. 2013). However, one of the main disadvantages is related to the ligno-cellulosic structure of rice straw that is well attested to be difficult to biologically degrade (Sambusiti, 2013). Rice straw as lignocellulosic material is thus mainly composed as follow: cellulose (37.4%), hemi-cellulose (44.9%), lignin (4.9%) and silicon ash (13%) (Hills and Robert 1981).

Dry AD is well suited to handle lingo-cellulosic biomass and provides a reduction of problems encountered in liquid, such as floating and stratification of solids. Dry AD of rice straw received much attention due to the high TS content of rice straw, that requires less sludge addition and smaller reactor volumes and pre-treatment. However, such high solid contents involve several technical disadvantages in terms of transport, handling and mixing to those encountered in wet processes (De Baere et al. 2010). The key parameter of dry AD processes is the water content, that is essential for the biological organic waste conversion. Water promotes substrate hydrolysis and enables the transfer of process intermediates and nutrients to bacterial sites (Lay et al. 1997a,b; Mora-Naranjo et al. 2004; Pommier et al. 2007).

The aim of this chapter is to investigate the effect of the moisture content relating the AD performance to the process parameters monitored during the rice straw degradation. More in detail, by varying the TS in the range of 4.85-23.41% TS, the final specific methane production yield, VS, COD, VFA and total and soluble phenols concentration were analysed. In particular, this chapter focuses on inhibition problems and final methane yield reduction that occurs at elevated TS concentrations caused by VFAs and high concentration of soluble phenolic compounds.

CHAPTER 4- EFFECT OF MOISTURE CONTENT ON ANAEROBIC DIGESTION OF RICE STRAW

4.2. Material Methods

4.2.1 Experimental set-up

During the biogas production, samples were taken from the reactor, where pH, COD, VFAs and phenols concentrations were monitored. BMT were performed on a small scale under controlled and reproducible conditions in a 2000 mL glass bottle GL 45 (Schott Duran, Germany). Each bottle was sealed with a 5 mm silicone disc that was held tightly to the bottle head by a plastic screw cap punched in the middle (Schott Duran, Germany). A plastic tube hermetically closed at the top was inserted in the plastic screw cap to permit sampling. All digesters were immersed up to half of their height in hot water kept at a constant temperature of 308 +/- 1 K by 200 WA-763 submersible heaters (Hagen, Germany). Small amounts of Na₂CO₃ powder were also added to the medium to control pH values (Esposito et al., 2012a,b).

4.2.2. Substrate and inoculum preparation

BMTs were performed using rice straw and the anaerobic digestate of BM. The value of particle size smaller than 0.5 mm was obtained by grinding the rice straw prior to starting experimental tests.

The initial TS content of the fresh digestate was 10.88%, this high value is related to the nature of the digestate, that is an effluent of the dewatering system of a mesophilic Anaerobic Reactor. To increase the TS content, the digestate was dewatered by filtration to obtain a final TS content of 17.20%. Then, the sample was diluted with water to obtain the designed moisture content for batch tests with lower TS content (Table 14). A fixed amount of BM digestate equal to 500 g was defined for each batch test and only the amount of substrate was changed to obtain different moisture contents. All the tests were performed imposing a selected organic matter/inoculum ratio of 0.5 and conducted in triplicate. A total of nine bottles were operated with a final TS content of the mixture: 4.84%, 14.86%, 23.40%, which represents, respectively, wet, semi-dry and dry conditions. Table 14 gives the mixture composition of each BMT test.

Nine further tests were conducted using only BM as the substrate to estimate the volume of methane resulting from the fermentation of the organics contained in the anaerobic sludge. Totally 18 tests

CHAPTER 4- EFFECT OF MOISTURE CONTENT ON ANAEROBIC DIGESTION OF RICE STRAW

were performed.

Table 14. Inoculum and substrate characteristics.

Tests	Anaerobic sludge [g]	TS inoculum [%]	Substrate amount [g]	TS substrate [%]	TS mixture [%]	VS Mixture [%]
T1	500(±1)	3.45	8.09	91.00	4.85	3.75
T2	500(±1)	10.88	26.05	91.00	14.86	11.68
T3	500(±1)	17.82	41.27	91.00	23.41	17.98

4.2.3. Analytical methods

4.2.3.1 Methane production, COD, TS, VS.

Volumetric methane production was measured once a day, by connecting each digester by a capillary tube to an inverted 1000 mL glass bottle containing an alkaline solution (12% NaOH). The inverted 1000 mL glass bottle was sealed in the same way as the digesters. To enable gas transfer through the two connected bottles, the capillary tube was equipped on both ends with a needle sharp enough to pierce the silicone disc.

The weight, TS and VS concentration of the anaerobic sludge as well as the dry matter, moisture organic matter and ash content of the substrate were determined by gravimetry according to Standard Methods (APHA, 1998). Temperature of all mixtures investigated was monitored for at least once a day with a TFK 325 thermometer (WTW, Germany). COD was determined by the closed reflux method, followed by photometric determination using a WTW Photolab Spektral visible spectrophotometer according to the APHA standard method 5220D and by applying the method proposed by Zupančič and Roš (2012).

4.2.3.2 VFAs and phenols analysis

VFAs concentration and speciation were monitored throughout the process. VFAs were analysed collecting 100 mg of digestate sampled from each reactor and diluted with ultrapure water. The samples were vigorously stirred for three minutes and centrifuged at 8000 rpm for 5 min. VFAs were

CHAPTER 4- EFFECT OF MOISTURE CONTENT ON ANAEROBIC DIGESTION OF RICE STRAW

extracted from the supernatant by SPME prior to GC-MS injection following the procedure proposed by Ábalos et al. (2000). 50 μL of a 2,2 dimethyl butanoic acid solution were added as internal standard. 85 μm polyacrilate coated fibers from SUPELCO were used for the extraction and analysed after thermal desorption by an Agilent 6850 GC coupled with a 5973 Network MSD detector.

Total Phenols determination is according to APHA standard method 5550 B (APHA, 1998), by the use of the Folin reagent. The method is sensitive for any compound containing aromatic hydroxyl group. The calibration curve was built preparing standards at increasing concentration of phenol ($\text{C}_6\text{H}_5\text{OH}$).

4.3. Results and Discussion

4.3.1 Methane production

Results of BMTs are summarized in Figures 22-24. Figure 22 reports the specific cumulative methane production versus time in reactors operated with different TS content. Each curve represents the average of 3 replicates (max standard deviation = 3%). The specific cumulative methane production was obtained dividing the cumulative methane production of each test by the initial substrate-inoculum VS mixture. Figure 23 reports the final specific methane yield, measured at the end of each experiment, as a function of the TS content and subtracted of the respective blank production.

Figures 22-23 show that the lower TS content was favourable for improving the cumulative methane production and the final methane production yield.

Figure 24 illustrates the daily methane production during the first 60 days. One initial peak of methane production was detected in all reactors. This peak is connected to the anaerobic degradation of biodegradable substrates, corresponding to the TVFA (Fig. 26) peak related to acid accumulation at the start-up of the process. This means that the hydrolysis is the rate-limiting step of the process. The results obtained with the final methane yield for different TS are consistent with previous studies operated with different types of substrate performed by Lay et al. (1997a, b), Abbassi-Guendouz et al. (2012), Fernández et al. (2008), Dong et al. (2010), Le Hyaric et al. (2012) and Shi et al. (2014). All authors do agree that higher methane yields can be obtained with a lower TS. Thus, the conversion of acids to methane by methanogenic bacteria might be influenced by the lack of the free water (Lay et al. 1997b; Ghosh 1985) that can occur with a higher TS content in the range of dry and semidry

CHAPTER 4- EFFECT OF MOISTURE CONTENT ON ANAEROBIC DIGESTION OF RICE STRAW

digestion (Abbassi-Guendouz et al. 2012; Fernández et al. 2008; Li et al. 2011). Figure 25 indicates a non-linear relationship between TS content and initial methane production rate. This behaviour is not in agreement with several author findings, who found a linear relationship between the two parameters (Lay et al. 1997b; Le Hyaric et al. 2012; Abbassi-Guendouz et al. 2012; Mora-Naranjo et al. 2004; Pommier et al. 2007). The different behaviour can be explained because of the different substrate composition, the complex nature of lingo-cellulosic compounds, the low bio-availability of cellulose, the substrate crystalline structure and the presence of hemicellulose.

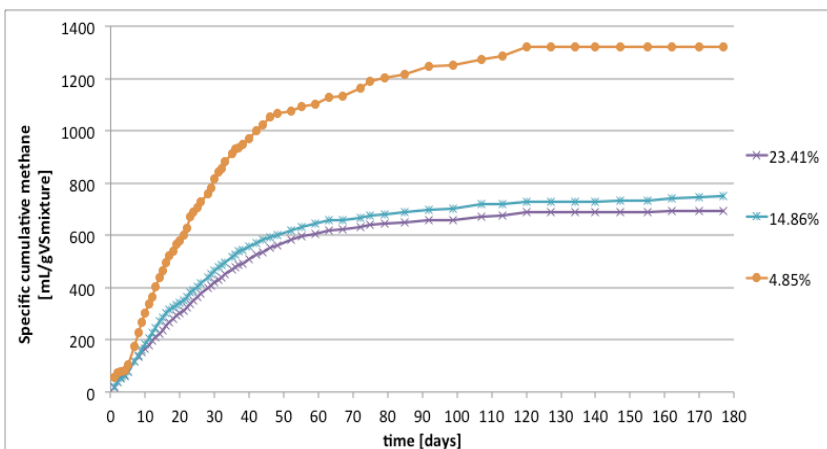

Figure 22. Specific cumulative methane production of rice straw in mesophilic conditions at different TS content.

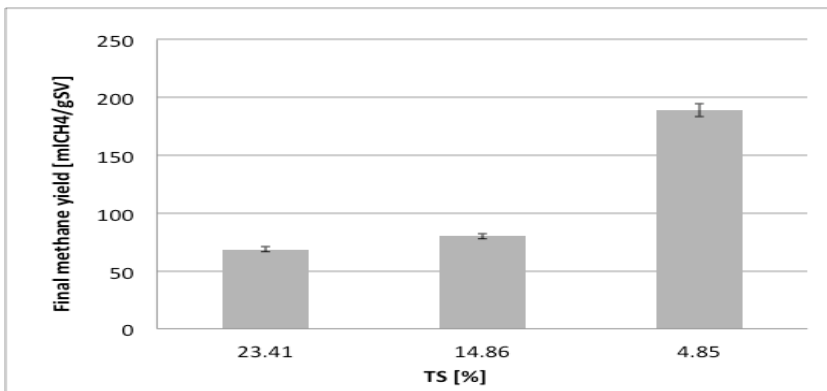

Figure 23. Final methane yield of rice straw AD at different TS content.

CHAPTER 4- EFFECT OF MOISTURE CONTENT ON ANAEROBIC DIGESTION OF RICE STRAW

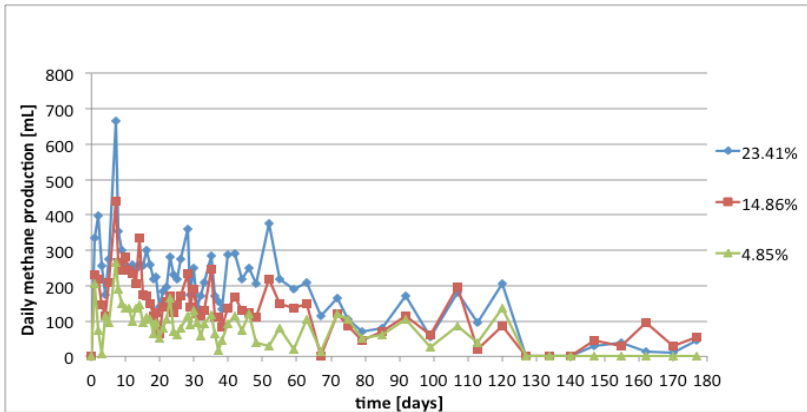

Figure 24. Daily methane production of rice straw anaerobic digestion at different TS content.

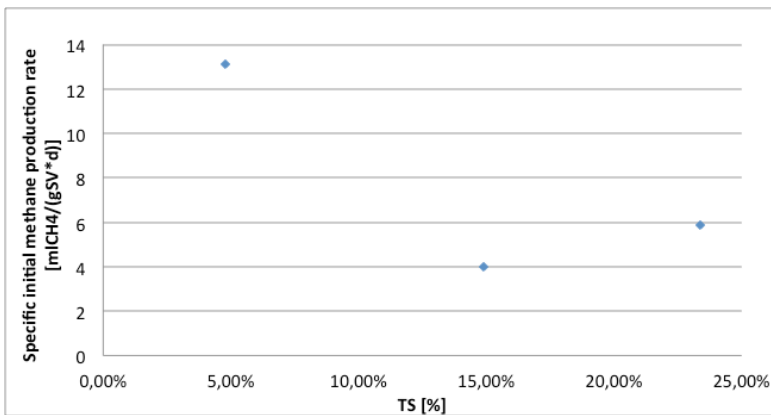

Figure 25. Not linear correlation between specific methane production and TS content.

4.3.2 Analysis of process intermediates

To explain the obtained results it was monitored the concentration of VFAs, that is considered an useful indicator of process stress and instability (Ahring et al. 1995). Figure 26 illustrates the temporal evolution of selected VFAs (acetate, butyrate, propionate, valerate and formic acid) for the three TS concentrations investigated. The lower methane yield detected with a higher TS content corresponded to an higher concentration of acids. The highest concentrations were observed at TS = 23.41%, with maximum values of 8.73 mmol acetic acid/kg on the 2nd day, 9.52 mmol formic acid/kg on the 8th day, 19.18 mg propionic acid/kg on the 2nd day and 2.02 mmol butyric acid/kg on the 8th day were found. In the case of TS = 14.86%, the maximum values of 5.16 mmol acetic acid/kg on the 8th day, 2.57 mmol formic acid/kg on the 8th day, 6.82 mg propionic acid/kg on the 8th day and 0.43 mmol butyric acid/kg on the 9th day were found. For a TS content of 4.85% the maximum values of 2.56 mmol

CHAPTER 4- EFFECT OF MOISTURE CONTENT ON ANAEROBIC DIGESTION OF RICE STRAW

acetic acid/kg on the 3rd day, 0.4 mmol formic acid/kg on the 1st day, 1.57 mmol propionic acid/kg on the 8th day and 0.21 mmol butyric acid/kg on the 3rd day were found.

An insufficient amount of methanogenic archaea may be the cause of such high concentrations of VFAs. Indeed, high VFA concentrations induce acidification of the medium, and result in the presence of VFAs in their un-dissociated form which is more toxic for microorganisms (Amani et al. 2010). Furthermore, at the highest TS concentrations, environmental conditions did not allow the growth of acetoclastic methanogens or acetate-oxidizing bacteria on account of high VFA concentrations and low pH values (Abbassi-Guendouz et al. 2012). Also during the first days, acid accumulation occurred (Fig. 27a-e), because the hydrolysis and acidogenesis took place and the easy biodegradable fraction of rice straw was converted to VFAs. During the second stage, acetoclastic methanogens were in the exponential growth phase and the acetic acid consumption rate exceeded its generation rate, also if the hydrolysis and acidogenesis were still going on. In the final stage, the balance between the hydrolysis/acidogenesis and methanogenesis was formed and the produced acids were consumed to produce methane (Dong et al. 2010).

It is finally possible to notice how the accumulation of butyric and formic acids takes place only in the dry and semidry reactors and lasts until the 8th day, while both these acids concentrations are close to zero during almost the whole experiment. This might be attributed to the co-presence of an alternative fermentation pathway, that brings to the formation of butyric acid. This pathway is alternative to the acetic fermentation and determines different process kinetics. This indicates that in the studied reactors the border conditions are different for the fermenting microorganisms, probably originating bacterial growths with different distributions and degradation pathways.

CHAPTER 4- EFFECT OF MOISTURE CONTENT ON ANAEROBIC DIGESTION OF RICE STRAW

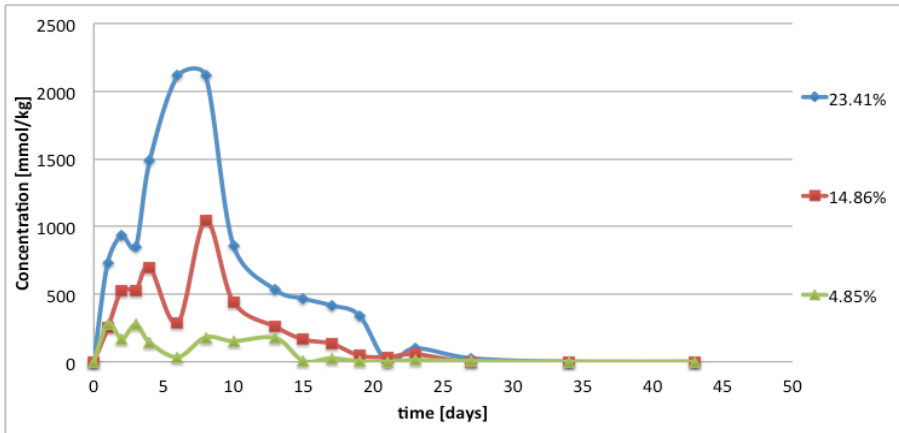
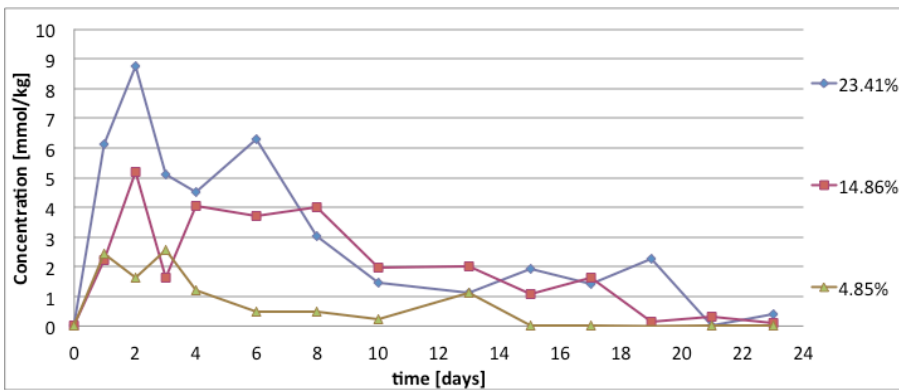
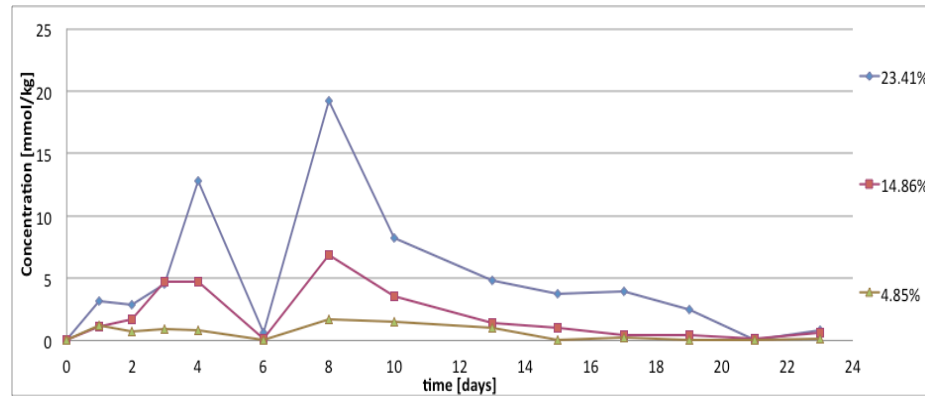

Figure 26. Evolution of TVFA concentration of rice straw at different TS content.



a) Acetic acid



b) Propionic acid

CHAPTER 4- EFFECT OF MOISTURE CONTENT ON ANAEROBIC DIGESTION OF RICE STRAW

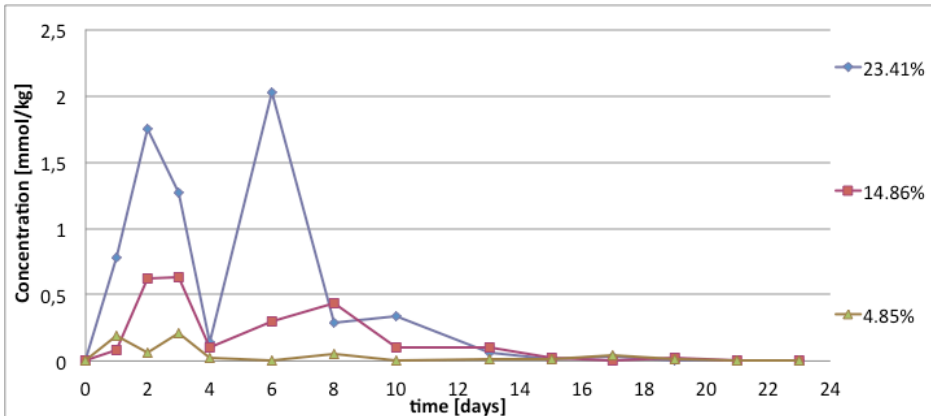

c) Butyric acid

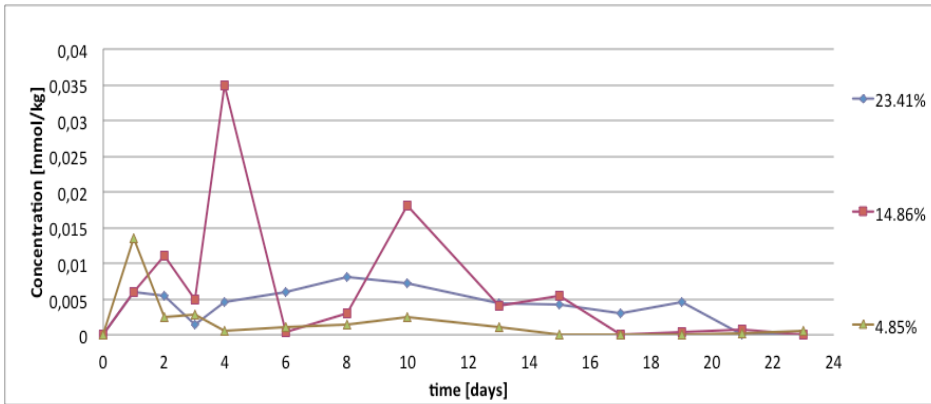

d) Valeric acid

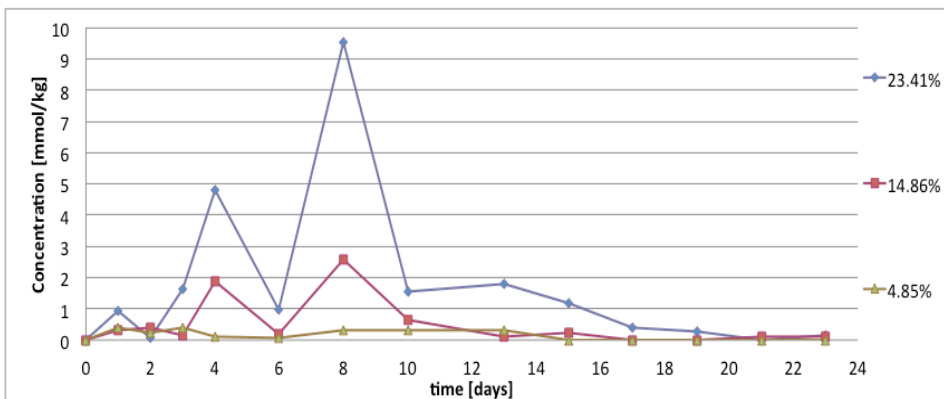

e) Formic acid

Figure 27. Evolution of VFA concentration of rice straw anaerobic digestion with different TS content: a) Acetic acid; b) propionic acid; c) butyric acid; d) valeric acid; e) formic acid.

Despite the observed differences among the three TS concentrations, each detected VFA concentrations never reached the inhibition limit (Fig. 27). The maximum TVFA concentrations were

CHAPTER 4- EFFECT OF MOISTURE CONTENT ON ANAEROBIC DIGESTION OF RICE STRAW

3 mmol/kg, 15 mmol/kg and 33 mmol/kg, respectively, i.e. much lower respect to the threshold value indicated by Karthikeyan and Visvanathan, 2012. It was therefore supposed that the inhibition occurred because of higher total phenols content at higher TS concentration (Fig. 28).

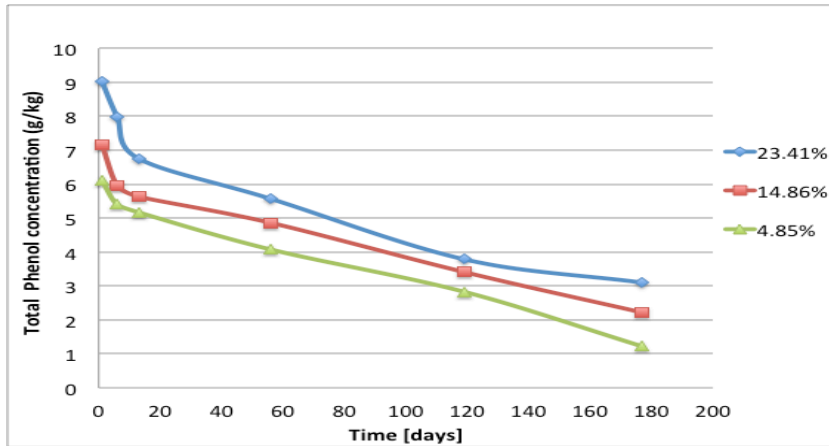

Figure 28. Total phenol degradation in anaerobic digestion of rice straw for different TS.

4.4 Comparative process efficiency

The reactor performances are reported for all TS concentrations in terms of VS reduction, evolution of COD removal and specific final methane production yield. In terms of VS removal efficiency, the better performances were observed at a lower TS content. This finding is in agreement with the measured final methane production yield.

The COD values at the end of the experiment were higher for higher TS content as COD removal decreased from $63 \pm 6\%$ (TS = 4.85%) to $59 \pm 8\%$ (TS = 14.86%), down to $48 \pm 7\%$ (TS = 23.4%), confirming the slowdown of process kinetics taking place at higher TS content due to high VFA concentration.

4.5. Conclusions

This chapter focuses on the effect of the moisture content on the anaerobic digestion of rice straw. A higher specific methane production yield and process performance in terms of VS and COD reductions were achieved at a lower TS content. This suggests that a wet anaerobic digestion gives

CHAPTER 4- EFFECT OF MOISTURE CONTENT ON ANAEROBIC DIGESTION OF RICE STRAW

better performances compared with dry processes. An inhibition correlated to the TVFA accumulation was found at higher TS content. In fact maximum TVFA concentration of 2.1 g/kg was found in dry condition, 1 g/kg in semidry conditions and 0.2 g/kg in wet conditions. Higher total phenol concentration was also found at higher TS content. This could determine inhibition phenomena and reduction of methane production.

CHAPTER 5

Modified ADM1 for dry and semi-dry anaerobic digestion of solid organic waste

This chapter is the modified version of the article “Modified ADM1 for dry and semi-dry anaerobic digestion of solid organic waste” submitted to Bioresource Technology Journal (under revision).

5.1 Introduction

Experimental research carried out in recent years on AD have definitely established that the TS content plays an important role on process development (Dong et al. 2010; Brown and Yebo 2013; Fernández et al. 2008; Forster-Carneiro et al. 2007; Forster-Carneiro et al. 2008; Le Hyaric et al. 2012; Lü et al. 2012; Jha et al. 2013; Wang et al. 2013; Xu and Li 2012; Liotta et al. 2014; Shi et al. 2014; Zhu et al. 2014). As a consequence, several studies have been lead recently to adapt and calibrate the existing mathematical models to take into account the effect of the TS content (Lay et al. 1997a, 1997b; Fdez-Güelfo et al. 2012; Brown et al. 2012; Le Hyaric et al. 2012; Motte et al. 2013). Le Hyaric et al. (2012) and Lay et al. (1997a, 1997b) applying the Gompertz model to simulate the results of Specific Methanogenic Activity test, found that a high TS content (15%-25%) reduces substrate degradation because of water and nutrients limitation, resulting in a lower methanogenic activity. Brown et al. (2012) used the first-order kinetic models to characterize the methane production of lignocellulosic biomass and found a linear relationship between logarithmic methane production and reaction time in both in wet and dry anaerobic digestion of switchgrass, corn stover, wheat straw, leaves, yard waste and maple. Dry anaerobic digestion generally exhibits a poor start-up performance, thus several models assume the hydrolysis as the rate-limiting step of the process (Jha et al. 2013). In particular, Abbassi-Guendouz et al. (2012), applying the ADM1 (Batstone et al. 2002) to cardboard treatment, found a decreasing first-order hydrolysis rate constant for carbohydrates degradation when increasing the TS content between 15-30%. Liotta et al. (2014) also found a decreasing disintegration rate when increasing the TS content in the range of wet digestion. Bollon et al. (2011) found a similar result using municipal solid waste digestate.

Moreover recent studies demonstrated the important role of the mechanisms associated to VFAs uptake on process performances (Ward et al., 2008, Bolzonella et al., 2003, Dai et al., 2013, Jha et al., 2013, Pohl et al., 2013). As intermediate products, VFAs have been treated as an indicator of the digestion efficiency, but high concentrations of VFAs can determine a decrease of pH leading to performance failure of the digester (Gerardi, 2003, Jha et al., 2013, Motte et al., 2013, Vavilin et al., 1996a).

An attempt to model dry anaerobic digestion considering also the role of VFA uptake was done by Guendouz et al. (2010), who found a transitory accumulation of VFA during the batch tests indicating that not only the hydrolysis is the rate-limiting step during dry anaerobic digestion of the solid wastes. Motte et al. (2013) proposed a quadratic model able to descript dynamically the effect of TS, PS and substrate/inoculum ratio on methane production, pH and VFA concentration. The model resulted

CHAPTER 5 - ADM1 FOR DRY AND SEMI-DRY ANAEROBIC DIGESTION OF SOLID ORGANIC WASTE

highly significant (p -value < 0.05) and the coefficient of determination reach also 80%, however the authors have not implemented a complete model, like ADM1, and have not calibrated any kinetic constant varying TS content.

The aim of the present chapter is to develop a kinetic model that can specifically characterize the disintegration, the acetogenesis and methanogenesis steps of selected complex organic substrates as a function of TS content in order to obtain a model able to predict and interpret results from anaerobic digesters in wet, semi-dry and dry AD. In the following section, an overview of the model structure, assumptions and main model parameters is presented. The proposed model is based on the cited ADM1 model (Batstone et al., 2002) as modified by Esposito et al. (2008, 2011a,b, 2012a,b) for complex organic substrates (modified ADM1). The kinetic equations are reformulated to consider the direct effect of TS content and the effect of the intermediate compounds, which can affect, as a function of the TS content, the whole process development. The dynamics of acetate, propionate and methane production presented in Chapter 3 and 4 and obtained from two different series of batch anaerobic digestion of food waste and rice straw were used to calibrate the proposed model. Food waste was selected as representative of easily, highly biodegradable and heterogeneous substrates (Zhang et al. 2007), while rice straw as representative of slowly biodegradable and model of lignocellulosic residues.

5.2 Model description

The proposed model is based on the Modified ADM1 (MADM1), extended to take into account the presence of complex organic substrates in the feedstock, and the operation of the digester in semi-dry and dry conditions. It is applied for Completely Stirred Tank Reactor (CSTR) and batch systems. The MADM1 is a structured biological model that simulates the major conversion mechanisms of organic substrates into biogas and the degradation of by-products. It assumes that composite materials are converted into carbohydrates, proteins and lipids by a disintegration step (Esposito et al. 2012a,b). These components are further hydrolysed into simple sugars, amino acids and long chain fatty acids. Then, during the acidogenic step, fermentative micro-organisms convert these products into acetic, propionic, butyric and valeric acids, hydrogen and carbon dioxide. The uptake of fatty acids yields acetate (acetogenic step), which is converted into methane by methanogens.

The disintegration and hydrolysis steps are modelled by first-order kinetics. The disintegration used surface based kinetic, while hydrolysis step a classical first order kinetic. All the other

CHAPTER 5 - ADM1 FOR DRY AND SEMI-DRY ANAEROBIC DIGESTION OF SOLID ORGANIC WASTE

transformations are classical biochemical transformations performed by specific bacterial groups, and are described by a Monod-type equation, where the substrate uptake is associated to the microbial growth. The kinetics of microbial growth and decay are also included in the model.

The overall model consists of 28 mass balance equations (Batstone et al. 2002) applied to the 28 state variables (13 substrates and 15 biomasses) summarized in Tables 15-16. The kinetic constants and processes of the modelled substrates in the MADM1 are listed in Table 17. It is worth noting that, according to the MADM1, only the parameter K_{sbk} , not included in the original version of the ADM1, is function of the substrate intrinsic characteristics and therefore depends also on the TS content of the substrate (Liotta et al. 2014).

Table 15. Substrate variables in the MADM1 model.

Substrate variables [ML⁻³]	Symbol
Initial Substrate	C
Soluble Inert	S_i
Total Propionate	S_{pro}
Total Acetate	S_{ac}
Total Butyrate	S_b
Total Valerate	S_v
Gaseous Hydrogen	S_{hg}
Gaseous Methane	S_{hm}
Inorganic carbon	S_c
Nitrogen	S_N
LCFA	S_{LCFA}
Sugar	S_s
Amino acids	S_{am}

CHAPTER 5 - ADM1 FOR DRY AND SEMI-DRY ANAEROBIC DIGESTION OF SOLID ORGANIC WASTE

Table 16. Biomass variables in the MADM1 model

Biomass variables [ML⁻³]	Symbol
Particulate inert	X_i
Propionate degraders	X_{pro}
Acetate Degraders	X_{ac}
Butyrate and Valerate degraders	$X_{b/v}$
Hydrogen degraders	X_h
Readily and slowly degradable carbohydrates	X_{cb-S}/X_{cb-R}
Readily and slowly degradable lipids	X_{l-S}/X_{l-R}
Readily and slowly degradable protein	X_{p-S}/X_{p-R}
LCFA Degraders	X_{LCFA}
Sugar Degraders	X_s
Amminoacids Degraders	X_{am}
Sludge concentration	X_{sl}

Table 17. Kinetic constants of the MADM1 model.

Substrate	Kinetic constants [T ⁻¹]*	Kinetic Process (ρ _j)
Complex Organic Substrate	K _{sbk}	Disintegration of complex organic matter
Propionate	K _{pro}	Uptake of Propionate
Acetate	K _{ac}	Uptake of acetate
Total Valerate and Butyrate	K _{c4}	Uptake of Valerate and Butyrate
Hydrogen	K _h	Uptake of hydrogen
Methane	K _m	
Carbohydrate (slowly and readily biodegradable)	K _{c-S} /K _{c-R}	Hydrolysis of carbohydrates
Lipids (slowly and readily biodegradable)	K _{L-S} /K _{L-R}	Hydrolysis of lipids
Proteins (slowly and readily biodegradable)	K _{p-S} /K _{L-R}	Hydrolysis of proteins
LCFA	K _{LCFA}	Uptake of LCFA
Sugars	K _s	Uptake of Sugars
Amino acids	K _{am}	Uptake of amino acids

*only in the case of K_{sbk} constant dimension is [ML⁻²T⁻¹].

With respect to the MADM1, the proposed model modifies some of the kinetic equations listed in Esposito et al. (2011a,b). Each kinetic constant (K_{sbk}, K_{ac} and K_{pro}) is expressed as function of the TS content in order to take into account the reduction of intermediate process kinetic on the following processes: the initial substrate disintegration, the acetate and the propionate up-take. More precisely assuming CSTR conditions and a constant reactor Volume (V), for each state variable (C_i), the mass balance has the following form:

$$\frac{dC_i}{dt} = \frac{qC_{i-in}}{V} - \frac{qC_{i-out}}{V} + \sum_{j=i-23} v_{ij}\rho_j \quad (8)$$

where:

CHAPTER 5 - ADM1 FOR DRY AND SEMI-DRY ANAEROBIC DIGESTION OF SOLID ORGANIC WASTE

the term $\frac{qC_{i-in}}{V} - \frac{qC_{i-out}}{V} = 0$ in batch conditions, where the flow rate (q) is assumed to be zero, and

the term $\sum_{j=i-23} v_{ij}\rho_j$ is the overall reaction term expressed as a sum of specific kinetic rate for the process j (ρ_j) multiplied by the stoichiometric coefficients (v_{ij}) that describe the influence of the specific process j on the individual component i.

The specific kinetic rates and the stoichiometric coefficients used in the present model are strictly equivalent to those present in the MADM1.

The main difference of the proposed model compared to the MADM1 is the capability to consider the variation of the kinetic constants K_{sbk} , K_{ac} and K_{pro} with the TS content. These constants are involved in the following specific kinetic rates:

$$\rho_{i,1} = K_{sbk} \cdot C \cdot a^* \quad (9)$$

$$\rho_{i,13} = K_{pro} \cdot \frac{S_{pro}}{K_s + S_{bu}} \cdot X_{pro} \cdot I_2 \quad (10)$$

$$\rho_{i,14} = K_{ac} \cdot \frac{S_{ac}}{K_s + S_{ac}} \cdot X_{ac} \cdot I_3 \quad (11)$$

These equations have been reformulated by substituting the kinetic constants K_{sbk} , K_{ac} and K_{pro} with the following functions:

$$K_{sbk}(TS) = a \cdot TS + b \quad (12)$$

$$K_{ac,pro}(TS) = c \cdot TS + d \quad (13)$$

where the new parameters a, b, c and d need to be calibrated depending on the substrate type (in this study rice straw and food waste) and the specific experimental conditions such as temperature, pressure, pH, retention time and mixing conditions (Liotta et al. 2014).

5.3 Model calibration

The proposed model was calibrated using the experimental data obtained during anaerobic digestion of food waste and rice straw. The experimental tests were conducted in batch, at 32°C, using two liter reactors. The following TS concentrations were tested 4.2%, 12.8% and 19.2% for the food waste,

CHAPTER 5 - ADM1 FOR DRY AND SEMI-DRY ANAEROBIC DIGESTION OF SOLID ORGANIC WASTE

and 4.85%, 14.86% and 23.40% for the rice straw. The experimental procedures and the obtained results are reported in Chapters 3-4.

The calibration was performed in two steps. In the first step, the simulated curves were plotted for each value of K_{ac} , K_{pro} and K_{sbk} , and the simulated results were compared with experimental data by applying the RMSE method, as usually done for the model calibration process (Janssen and Heuberger 1995; Esposito et al. 2011a, b). In the second step, the values of each K_{ac} , K_{pro} , K_{sbk} associated to the lower RMSE that better fit the proposed equations (12, 13), were introduced in the model to perform a second set of simulations. These modelling results were again compared with experimental data by individuating the final RMSE values for each K_{ac} , K_{pro} and K_{sbk} value. The final results of calibration procedure are summarized in Figures 29-31 and Table 18. In particular the experimental data were used for both substrates to calibrate the disintegration kinetic constants K_{dis} of the ADM1, assuming it coincides with the constant K_{sbk} of the MADM1, as the specific surface did not varied in the different tests. Acetic and propionic acid productions were used to calibrate the constants K_{ac} and K_{pro} . All the other constants and parameters were set from literature data (Batstone et al. 2002; Esposito et al. 2008, 2011a, b).

CHAPTER 5 - ADM1 FOR DRY AND SEMI-DRY ANAEROBIC DIGESTION OF SOLID ORGANIC WASTE

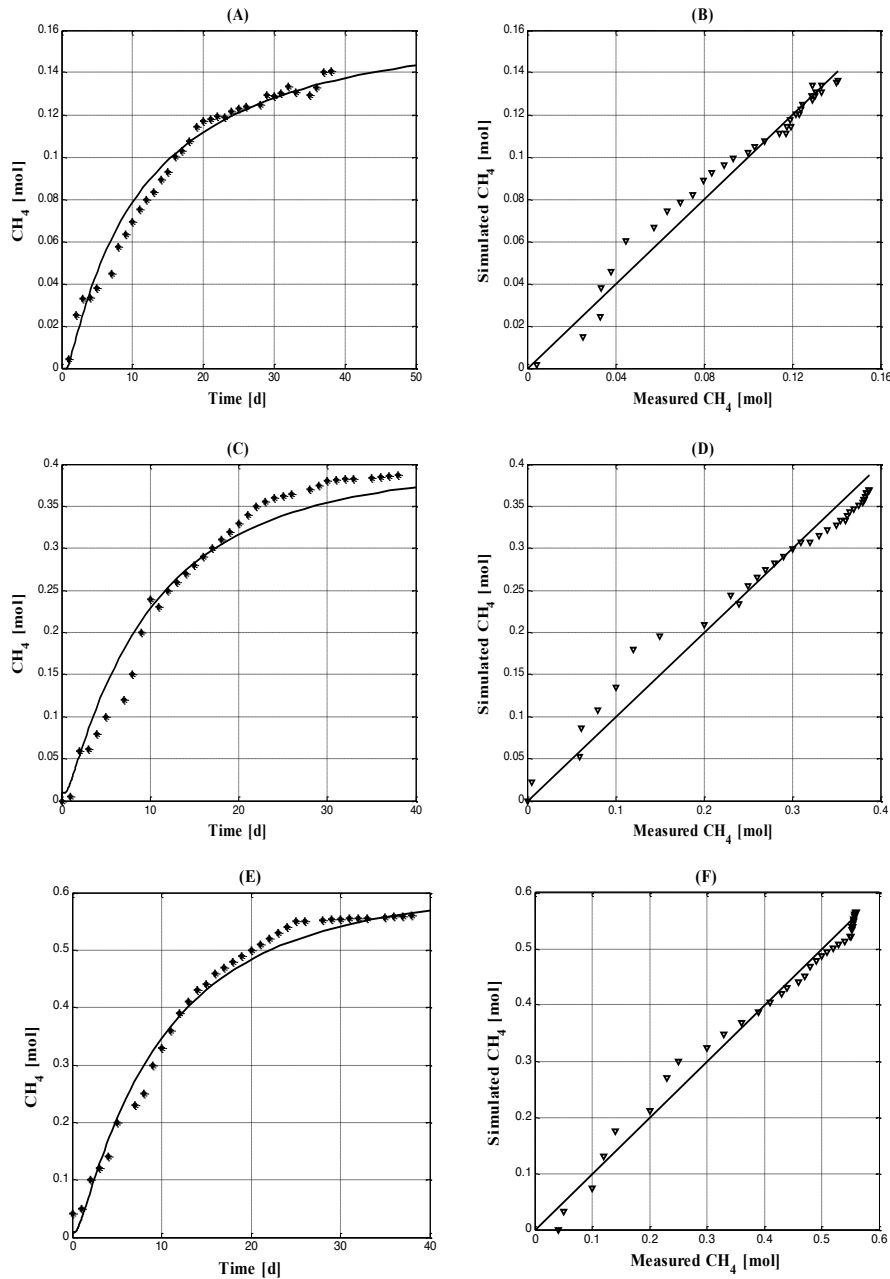

Figure 29. Comparison of measured (points) and simulated (continuous line) data of cumulative methane production for experiments with food waste at A, B) TS = 4.52%; C, D) TS = 12.87%; E, F) TS = 19.02%.

CHAPTER 5 - ADM1 FOR DRY AND SEMI-DRY ANAEROBIC DIGESTION OF SOLID ORGANIC WASTE

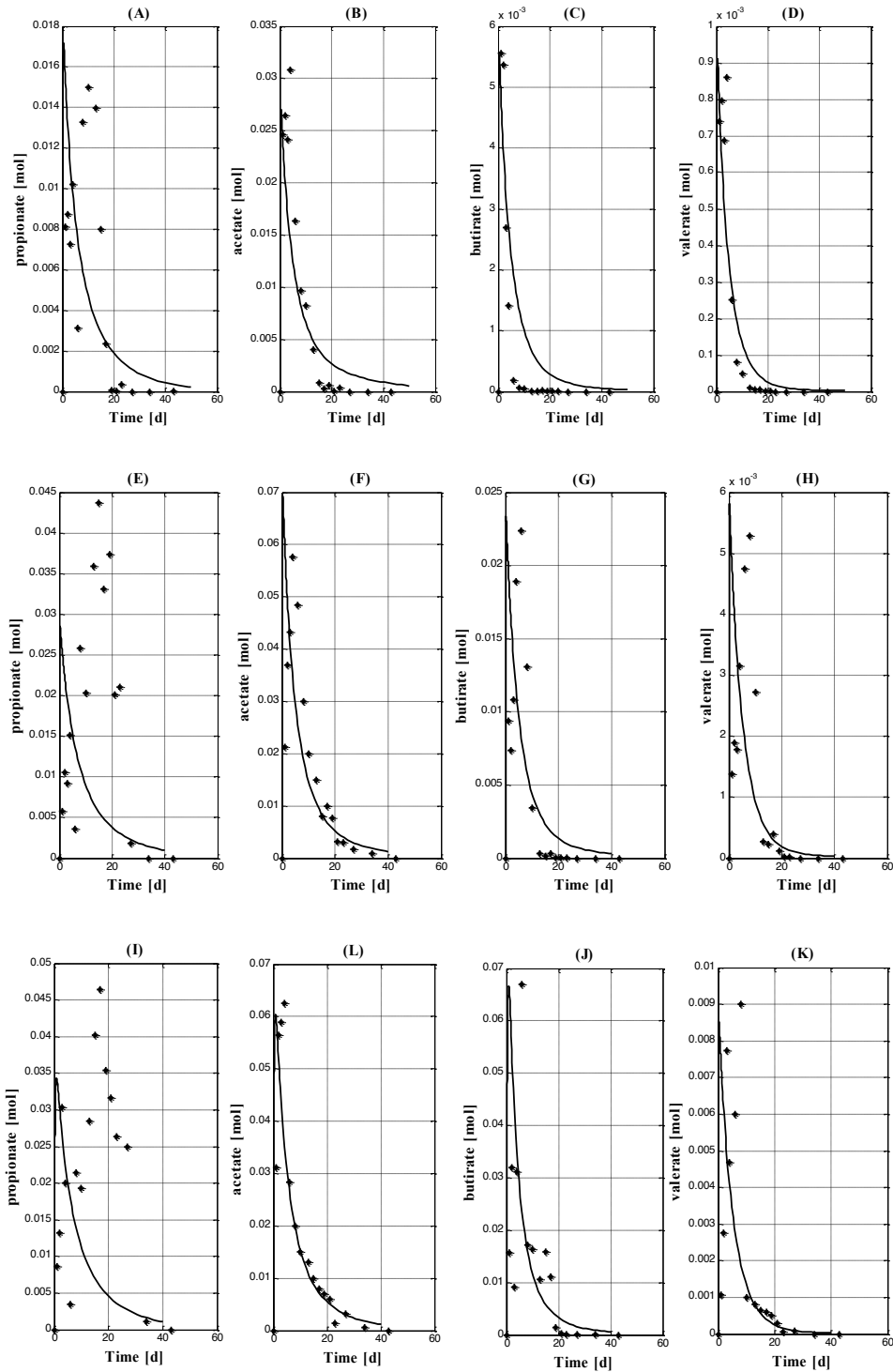

Figure 30. Comparison of measured (points) and simulated (continuous line) data for experiments with food waste: A-D) TS = 4.52%; E-H) TS = 12.92% and I-K) TS = 19.02%.

CHAPTER 5 - ADM1 FOR DRY AND SEMI-DRY ANAEROBIC DIGESTION OF SOLID ORGANIC WASTE

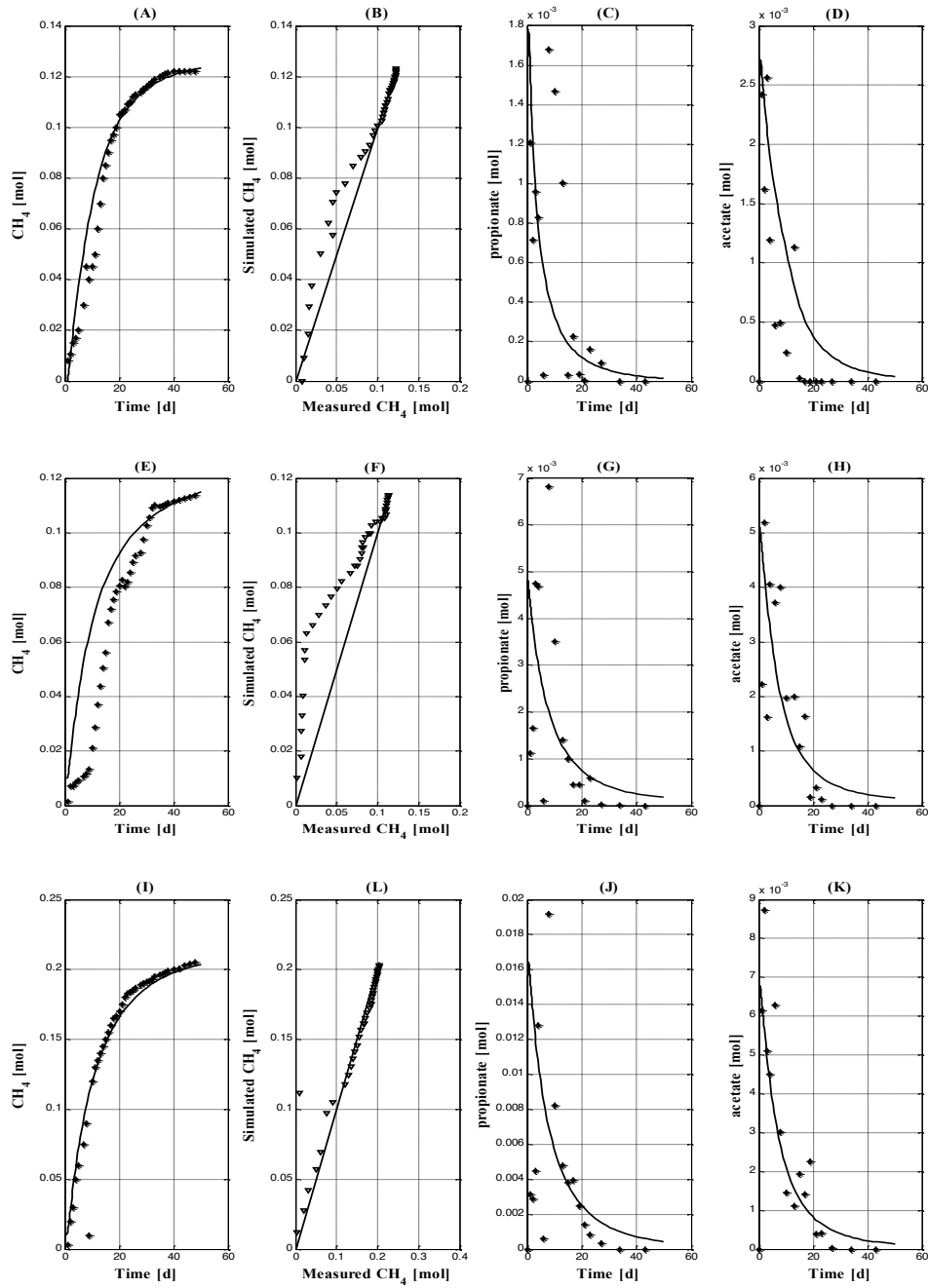

Figure 31. Comparison of measured (points) and simulated (continuous line) data for experiments with rice straw: A-D) TS = 4.85%; E-H) TS = 14.86%; I-K) TS = 23.4%.

CHAPTER 5 - ADM1 FOR DRY AND SEMI-DRY ANAEROBIC DIGESTION OF SOLID ORGANIC WASTE

Table 18. Kinetic constant for disintegration and VFA at different TS concentrations for food waste and rice straw.

Substrate	TS [%]	K_{dis} [d^{-1}]	RMSE	K_{ac} [d^{-1}]	RMSE	K_{pro} [d^{-1}]	RMSE
Food Waste	4.52	6.5	0.0072	8.47	0.0076	8.47	0.0052
	12.8	4	0.01	5.08	0.019	5.08	0.019
	19.02	2	0.0065	2.46	0.011	2.46	0.021
Rice Straw	4.85	2.5	0.01	8.79	0.005	8.79	0.005
	14.86	1.25	0.009	5.94	0.001	5.94	0.0019
	23.40	0.65	0.0073	3.51	0.001	3.51	0.0055

5.4. Results and discussion

Table 18 and Figure 32 show that for both substrates the calibrated disintegration rate constant linearly decreased with increasing TS concentration for both substrates. The linear function (12) can be expressed in this case as follow:

$$\text{For food waste: } K_{dis} = -0.31 \cdot TS + 7.9 \quad \text{with } r^2 = 0.99 \quad (14)$$

$$\text{For rice straw: } K_{dis} = -0.1 \cdot TS + 2.9 \quad \text{with } r^2 = 0.97 \quad (15)$$

Where K_{dis} is assumed to be coincident with K_{sbk} .

The values of parameters a, b are different for the two tested substrates because of the specific characteristic of the initial substrate to be hydrolysed. In fact food waste is a more easily biodegradable substrate compared to rice straw that is a complex lignocellulosic structure more difficult to be disintegrated. In fact, the structure of rice straw consists of different types of polymers that are difficult to degrade such as: cellulose (37.4%), hemi-cellulose (44.9%), lignin (4.9%) and silicon ash (13%) (Hills and Robert 1981; Mussoline et al. 2013). Thus for each TS the rice straw disintegration rate constant (and the values a, b) are lower than the one of food waste. These results are consistent with results previously presented by Liotta et al. (2014), where a linear correlation with $r^2 = 0.99$ was found between the carrot waste disintegration rate constant and TS in the range of wet conditions.

CHAPTER 5 - ADM1 FOR DRY AND SEMI-DRY ANAEROBIC DIGESTION OF SOLID ORGANIC WASTE

The linear correlations (14, 15) describe the slowing-down of the disintegration process with higher values of the TS content caused by the lack of water and the limited transfer of hydrolysis products (and other intermediates) to bacterial sites (Lay et al. 1997a, 1997b; Mora-Naranjo et al. 2004; Pommier et al. 2007). This is in agreement with results presented by Abbassi Guendouz et al. (2012), Pommier et al. (2007) and Liotta et al. (2014), who observed a strong impact of the TS content on biodegradation kinetic rates and maximum methane production in anaerobic digestion of different substrates.

Figure 33 shows that for both substrates, a linear and inverse correlation exist between the values of the propionate and acetate kinetic constants and the TS content. In this case, a unique linear function, as reported in (13), can be expressed for acetate and propionate as follows:

$$\text{For food waste: } K_{ac/pro} = -0.41 \cdot TS + 10.35 \text{ with } r^2 > 0.99 \quad (16)$$

$$\text{For rice straw: } K_{ac/pro} = -0.28 \cdot TS + 10.71 \text{ with } r^2 > 0.97 \quad (17)$$

The values of parameters b, c in equation (16, 17) are the same for acetate and propionate. This means that the kinetic rate constants for acetate and propionate are equal for each TS content. Thus, it can be concluded that the effect of the water content on propionate and acetate up-take is equal.

Also in this case the parameters c, d differ on the base initial substrate type because of different experimental conditions and biomass involved in the anaerobic degradation of food waste and rice straw. Additionally there are larger differences between the values of $K_{ac/pro}$ for rice straw and food waste with higher TS. Thus, the intrinsic characteristics of the substrate type are more influent on the process development and biomass selection with a lack of water.

This study show that with a higher TS content lower values of $K_{ac/pro}$ are obtained, that determine higher concentrations of acetate and propionate during the whole process (Figures 30-31). This means that a higher TS content can lead to process inhibition due to VFA accumulation, implying lower process efficiency in terms of VS degradation, final methane yield and specific methane production rate. Indeed, Figures 30-31 show a lower level of inhibition for the experiments under wet digestion conditions (TS = 4.52% for the food waste and TS = 4.85% for the rice straw), compared to the experiments under semi-dry (TS = 12.87% and TS = 14.86%) or dry (TS = 19.2% and TS = 23.4%) anaerobic conditions. This is probably due to a reduction of the water content that implies a lower nutrient content in the media and TVFAs accumulation.

Despite the good fitting between simulated and experimental concentrations, showing the capability of the model to simulate the AD process of the two substrates with different initial TS, it is worth

CHAPTER 5 - ADM1 FOR DRY AND SEMI-DRY ANAEROBIC DIGESTION OF SOLID ORGANIC WASTE

noting that the model fitting is of higher quality for the data obtained during rice straw digestion. For food waste, Figures 31,e and 31, i show that some points could not be fitted by the simulated curves. This means that an inhibition phenomenon, related to the difficult degradation of propionic acid and consequent formation of propionate isomers during the process not taken into account in the simulation, should be considered in the further development of the kinetic equations of the model. This different behaviour can be related to the nature of the substrate type. Food waste is of complex nature and contains many different compounds that have different degradation kinetics. In contrast, a unique substrate like rice straw, presents a kinetic behaviour easier to be modelled.

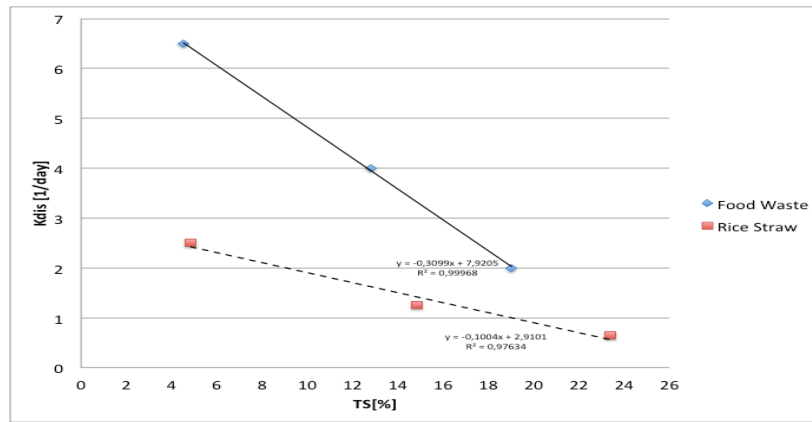

Figure 32. Linear correlation between disintegration kinetic constant and TS for rice straw and food waste.

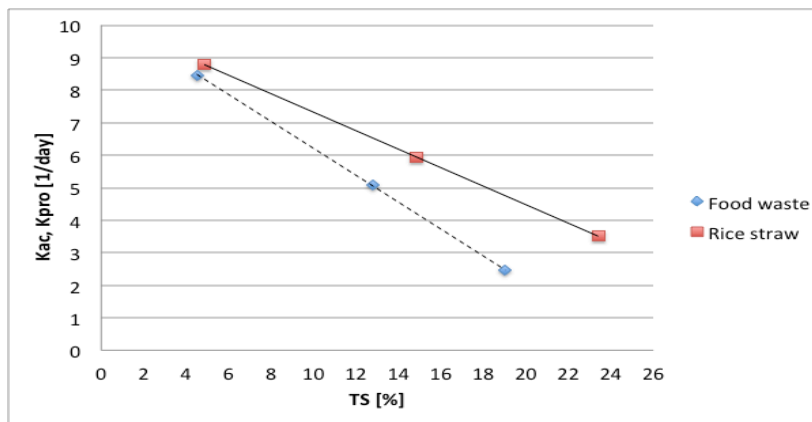

Figure 33. Linear correlation between propionate and acetate kinetic constants and TS content for rice straw and food waste.

5.5 Conclusion

- A mathematical model capable to simulate dry anaerobic digestion of selected complex organic substrates such as rice straw and food waste is proposed.
- Model calibration resulted in the determination of the disintegration and VFA kinetic constants for different TS contents in the range of 4.5%-23%.
- The good fitting of the bio-methanation tests data with the model simulation results for both methane production and VFA concentrations confirms the suitability of the model.
- A linear equation that correlate the TS content with the disintegration kinetic constant was proposed and included in the model MADM1.
- A linear equation that correlate the TS content with the acetate and propionate kinetic constants was proposed and included in the model MADM1.

CHAPTER 6

Literature Review

The paragraph 6.1 is the modified version of the article:

Flavia Liotta, Patrice Chatellier, Giovanni Esposito, Massimiliano Fabbri, Eric D. van Hullebusch & Piet N. L. Lens. (2014). Hydrodynamic mathematical modeling of aerobic plug flow and non-ideal flow reactors: a review, *Crit. Rev. Env. Technol.* **DOI:**10.1080/10643389.2013.829768

The paragraph 6.2 is the modified version of the article:

Flavia Liotta, Patrice Chatellier, Giovanni Esposito, Massimiliano Fabbri, Eric D. van Hullebusch & Piet N. L. Lens. Current views on hydrodynamic models of non-ideal flow anaerobic reactors, submitted to *Crit. Rev. Env. Technol.* **(under review)**.

6.1 Mathematical modelling of aerobic plug flow reactor and non-ideal flow reactor

6.1.1 Introduction

Mathematical modelling and dynamic simulation have become important tools for design and operation of wastewater and solid waste treatment plants. However, semi-empiric methods and mathematical models based on ideal assumptions are still used for routine reactor design and operation. For instance, biochemical models for the evaluation of the bioconversion processes prevailing in CSTR, such as the IAWPRC Activated Sludge Model (ASM1) (Henze et al. 1987) and modelling tools to evaluate system design and upgrade options, such as the ATV models (ATV 1991; Benedetti et al. 2008) are widely applied. However, these models do not include the hydrodynamics of the bioreactor. This is a limitation for the model suitability as many authors claim that the efficiency of the pollution removal process depends also on the reactor hydrodynamics (Levin and Gealt 1993; Le Moullec et al. 2008; Makinia and Wells 1999).

Several authors in the presented models couple the hydrodynamic processes with biochemical processes and consider in the model the effect of one process on another. In particular the biochemical process can be affected by the reactor flow conditions because the biomass, substrates and inhibiting compounds can be distributed in different reactor zones. This implies that the biochemical process can occur with different kinetics depending on hydrodynamic condition. Inhibition could also happen due to the accumulation of some inhibitory compounds in specific reactor zones. In parallel, the biomass type developing in the reactor influences the viscosity of the mixed liquor and thus the hydrodynamics of the reactor. The objective of this literature review is, therefore, to review mathematical models of aerobic reactors going beyond the hypothesis of complete mixing conditions and focusing only on hydrodynamic aspects and on the role of reactor configuration on the process performances. The present research also analyses and compares performance-prediction models referring to the most common aerobic bioreactors configurations, i.e. Activated Sludge Reactors (AS), Fluidized Bed Reactors (FBR), Biofilters (BF) and Trickle Filters (TF), and addresses both plug flow reactors and non-ideal flow reactors. Finally, the chapter illustrates more in details the differences among the proposed approaches, indicates the adopted solving algorithms and discusses the capacity of the models to fit the experimental data.

6.1.2. Design models and performance-prediction models

A design model is a model capable of predicting the reactor volume when the desired treatment efficiency and the operational conditions are set. It is typically based on simplified assumptions aiming to make the model easy to apply. For instance, steady-state instead of dynamic conditions are assumed. In the literature, there are few attempts to use steady-state mathematical models to design PFR and non-ideal flow reactors (San 1994) (Table 19). They are often simply modelled in terms of design graph or charts (San 1994). These steady-state models are however beyond the scope of this chapter. In contrast, a performance-prediction model is typically a dynamic model that simulates most of the physical, chemical and biological processes taking place in the reactor. It is aiming to predict the effluent concentrations once the bioreactor volume is known and the operational conditions are set. Table 20 gives some performance-prediction models published in the literature. They are reviewed in details in this chapter, after a short description of the fundamentals of the adopted approaches. The attempts made by the authors to calibrate or validate these models are described as well.

Table 19. Design model of Activated Sludge and Fluidized Bed Reactor

Reactor	References
Activated Sludge	San (1994); Muslu (2000)
Fluidized Bed Reactor	Shieh et al. (1982)

CHAPTER 6 – LITERATURE REVIEW

Table 20. Performance prediction mathematical models

PFR	Activated Sludge	San (1989); San (1992); Lawrence and McCarty (1980); Olsson and Andrews (1978);
	Fluidized Bed	Shieh et al. (1982);
	Biofilter and Trickling Filters	Meunier and Williamson (1981); Baquerizo et al. (2005); Jacob et al. (1996);
TIS/TIS derived	Activated Sludge	Milbury et al. (1965); Braha and Hafner (1985); Muslu (2000a,b).
	Fluidized Bed	Yu et al. (1999)
	Biofilter and Trickling Filters	Fdz-Polanco et al. (1994);
Dispersion	Activated Sludge	Martinov et al. (2010); Mezaoui (1979); Nyadziehe (1980); Sant'Anna (1985); De Clercq et al. (1999); Turian et al. (1975); Lee et al. (1999a,b); Olsson and Andrews (1978); Makinia and Wells (2000);
	Fluidized Bed	El-Temtamy et al. (1979a,b); Muroyama and Fan (1985); Davidson et al. (1985); Lin (1991); Kim and Kang (1997); Michelsen and Østergaard (1970).
	Biofilter and Trickling Filters	Froment and Bischoff 1990; Séguret and Racault (1998); Muslu (1990); Muslu (1984); Muslu and San 1990; Séguret et al. (2000)
CFD	Activated Sludge	Le Moullec et al. (2010a,b); Glover (2006)
	Fluidized Bed	
	Biofilter and Trickling Filters	Iliuta and Larachi (2005)

6.1.3 Modeling approaches

Hydrodynamic models can be generally divided into two different groups: ideal models, referring to CSTR and PFR conditions, and non ideal models, taking into account the effect of longitudinal mixing neglected by ideal models (Table 21). In the CSTR model, the inlet reactant is assumed to be completely mixed in the reactor so that concentrations are homogeneous in the vessel.

The mass-balance equation for a non-reactive tracer in a CSTR is:

$$\frac{dC_{ex}}{dt} V = Q \cdot C_{in} - Q \cdot C_{ex} \quad (18)$$

where:

t = time [T];

V = reactor control volume [L³];

Q = volumetric flow rate [L³T⁻¹];

C = reactant concentration [ML⁻³];

in = subscript denoting influent;

ex = subscript denoting effluent;

In the PFR, it is assumed that no longitudinal mixing occurs between adjacent elements of the fluid and each element of the influent reactant remains in the reactor for a time equal to the hydraulic retention time (HRT).

The mass-balance for a non-reactive tracer is:

$$\frac{\partial C}{\partial t} dV = Q \cdot C - Q \cdot \left(C + \frac{\partial C}{\partial x} dx \right) \quad (19)$$

where:

x = spatial variable in the flow direction [L].

Under un-steady state conditions, equation (11) may be written as:

$$\frac{\partial C}{\partial t} = -v \cdot \frac{\partial C}{\partial x} \quad (20)$$

where:

v = flow velocity [LT⁻¹].

Among non-ideal models, a prominent role is played by the tank-in-series (TIS) model. This model is used to describe the dispersion in PFR. The TIS model describes the flow in a reactor system considering it can be discretized into a series of equal-sized hypothetical CSTRs. This modeling

CHAPTER 6 – LITERATURE REVIEW

approach was introduced for tracer analyses and one of the earliest descriptions of this theory was given by MacMullin and Weber (1935).

If a tracer is distributed uniformly throughout all the compartments of the vessel and then diluted out at a constant rate, the effluent tracer concentration C_{ex} as a function of time is given by (Martin, 2000):

$$\frac{C_{ex}}{C_{in}} = \frac{N^N}{(N-1)!} \left(\frac{t}{\tau}\right)^{N-1} e^{-\frac{N}{\tau}t} \quad (21)$$

where:

N = number of reactor in series.

Levenspiel (1972) related the number of reactors in series to the variance number with the following expression:

$$\sigma^2 = \frac{1}{N} \quad (22)$$

where:

σ^2 = variance of Residence Time Distribution (RTD) curve from a pulse tracer input.

Generally, $N = 1$ represents a CSTR, whereas $N = \infty$ means a PFR.

With respect to the previous approach, the extended tank-in series model (ETIS) (Murphy and Timpany 1967) presents a small difference, as it introduces the concept of non-integer number of hypothetical tanks in series to remove the quantization problem which occurs as N tends to 1. The ETIS model defines the exit age distribution function, $E(t)$, through the following equations:

$$E(t) = \frac{C_{ex}}{C_{in}} = \frac{N^N}{\Gamma(N)} \left(\frac{t}{\tau}\right)^{N-1} e^{-\frac{N}{\tau}t} \quad (23)$$

$$\Gamma(N) = \int_0^{\infty} e^{-v} \cdot v^{(N-1)} dv \quad (24)$$

Consequently, the N parameter loses its physical meaning as a number (positive) of tanks in the ETIS model, but the model acquires a continuous distribution of flow-rate. The ETIS model coincides with the TIS model when the parameter N is an integer number. This model is particularly useful when N is small and a large number of discontinuities occurs in the TIS model due to the discrete nature of the parameter N . A further variation of the TIS model consists in fractionating the reactor in different sections, e.g. a CSTR section, a PFR section and a dead section with by-pass flows or back-mixing flows between the zones. With tracer tests and considering different liquid and gas flow rates, it is possible to define the values of bypass flows and dead sections.

CHAPTER 6 – LITERATURE REVIEW

Apart from the TIS and TIS-derived models, other approaches have been followed to describe the dispersion effect. One of the pioneering and most complete studies on longitudinal mixing in aeration tanks was published by Thomas and McKee (1944). They demonstrated that longitudinal mixing is the effect of various factors as the degree of turbulence, the flow rate, the length of the tank and the number of baffles. The authors set up the dispersion model introducing the differential equation for a tubular reactor with longitudinal diffusion as well as flow (changes in volume were assumed not to occur, so that the mean longitudinal velocity is the same at all cross-sections). The resulting equation is:

$$\frac{\partial C}{\partial t} = D \frac{\partial^2 C}{\partial x^2} - v \frac{\partial C}{\partial x} \quad (25)$$

where:

D = dispersion number [L^2T^{-1}].

Equation (17) was solved considering as initial boundary conditions that the concentration gradient was equal to the initial concentration and by assuming that the exit gradient was equal to zero at the end of the reactor.

The authors calculated the dispersion coefficient as:

$$\bar{D} = L^2 \frac{180}{\pi^2 \cdot t_{90}} \quad (26)$$

where:

L = reactor length [L];

t_{90} = time required for the effluent concentration to attain 90% of its ultimate value [T].

The dispersion number, D is defined as:

$$D = \frac{\bar{D}}{v \cdot L} \quad (27)$$

D has an important role to indicate which of the ideal flow models is approached. When D is higher than 0.5-4, completely mixing can be assumed (Khudenko and Shpirt 1986; U.S. EPA 1993; Makinia and Wells 1999). Long and narrow tanks, with a dispersion number lower than 0.05-0.2 (Khudenko and Shpirt 1986; U.S. EPA 1993; Eckenfelder et al. 1985; Makinia and Wells 1999) are considered an approximation of plug flow. Typical dispersion numbers in wastewater treatment units are in the range between 0.1 and 4, which suggests that the existing deviations from ideal flow have to be taken into consideration (Makinia and Wells 2005; Makinia and Wells 1999).

CHAPTER 6 – LITERATURE REVIEW

With regard to the integration of the equations an algebraic solution is possible for simple models based on CSTR or CSTR in series configurations, whereas finite difference techniques or Computational Fluid Dynamics (CFD).

Table 21 Modelling approach: PFR, CSTR, TIS, Dispersion model, CFD basic concept and equation

Modelling approach	Basic concept	Equation
Ideal PFR	No longitudinal mixing occurs between adjacent elements of fluid.	$\frac{\partial C}{\partial t} = -v \cdot \frac{\partial C}{\partial x}$
Ideal CSTR	The concentration is assumed to be homogeneous in the reactor.	$\frac{C_{ex}}{C_{in}} = e^{-\frac{t}{\tau}}$
TIS	The flow is discretized into a series of hypothetical CSTRs.	$\frac{C_{ex}}{C_{in}} = \frac{N^N}{(N-1)!} \left(\frac{t}{\tau}\right)^{N-1} e^{-\frac{Nt}{\tau}}$
Dispersion model	The Differential equation that include longitudinal diffusion and advection term.	$\frac{\partial C}{\partial t} = D \frac{\partial^2 C}{\partial x^2} - v \frac{\partial C}{\partial x}$
CFD	Is a techniques applied to solve fluid dynamics models on digital computers.	Discretizes the reactor using a computational grid and include fundamental mass, momentum and energy conservation equation.

6.1.4. Mathematical modeling of Activated Sludge plug flow reactors

6.1.4.1 Process description

The activated sludge process is used for the biological treatment of municipal and industrial wastewaters. The basic activated sludge treatment process (Fig. 34A) consists of the following three components: i) a flocculant slurry of mixed liquor suspended solids (MLSS) utilized in the bioreactor

to remove soluble and particulate organic matter from the influent waste stream; ii) a sedimentation tank to separate the MLSS from the treated water and iii) a recycle system to return solids removed from the liquid-solids separation unit back to the bioreactor.

The MLSS containing bioreactor is commonly called an aeration basin. It is an open tank equipped with a system to transfer oxygen into solution to provide mixing energy to guarantee suspension of the MLSS. Models taking into account the hydrodynamics of the plug flow aeration basin, that could affect key parameters of the process such as treatment efficiency or settling properties of the activated sludge, are described below.

6.1.5. Model development

6.1.5.1 Ideal PFR and CSTR in series

The ideal plug-flow model has been frequently applied to plug flow activated sludge systems (Fig. 34B). Lawrence and McCarty (1970), assuming steady-state conditions, proposed the following equation for processes that occur in the aeration basin based on the hypothesis of constant biomass concentration in the reactor, valid as long as the SRT/HRT ratio is higher than 5:

$$\frac{dC}{dt} = -\mu \cdot \frac{C \cdot \bar{X}}{k_s + C} \quad (28)$$

\bar{X} = time averaged biomass concentration [ML⁻³];

k_s = saturation coefficient [ML⁻³];

μ = maximum specific growth rate [T⁻¹].

San (1989, 1992) considered the same mass balance equation proposed by Lawrence and McCarty (1970) for the reactant at steady-state conditions. Taking also into account the time variation of the biomass concentration in the reactor and introducing the settler in the process configuration, they obtained the following differential equations:

$$\frac{dC}{dt} = -\mu \cdot \frac{1}{Y} \cdot \frac{C \cdot X}{k_s + C} \left(\frac{1}{1 + R} \right) \quad (29)$$

$$-\frac{dX}{dt} = Y \cdot \frac{dC}{dt} + \frac{k_d \cdot X}{1 + R} \quad (30)$$

where:

X = biomass concentration [ML⁻³];

CHAPTER 6 – LITERATURE REVIEW

k_s = saturation coefficient [ML^{-3}];

R = sludge recycle ratio;

μ = maximum specific growth rate [T^{-1}];

Y = yield coefficient;

k_d = decay coefficient [T^{-1}].

Equations (21) and (22) were solved by San (1989, 1992) using the following boundaries conditions, obtained from the mass balances of substrate and biomass concentration at the mixing point of fresh feed and recycled flow (Fig. 34B), also proposed by Tuček et al. (1971):

$$C_{mix} = \frac{C_{in} + R \cdot C}{1 + R} \quad (31)$$

$$X_{mix} = \frac{X_{in} + R \cdot X_r}{1 + R} \quad (32)$$

where:

r = subscript denoting the return flow;

mix = subscript denoting the combined flow entering in aeration basin;

in = subscript denoting the inlet flow in the activated sludge system constituted of aeration basin and settler.

Another attempt to use the ideal plug flow approach for activated sludge plug flow reactors, was done by Olsson and Andrews (1978) who proposed a model that simulates the substrate, biomass and oxygen concentrations as a function of time and the spatial variable.

To the best of our knowledge, one of the first attempts to model a plug flow reactor with a tank in series configuration was done by Milbury et al. (1965). Following this work also Murphy and Timpany (1967); Braha and Hafner (1985) and Muslu (2000a,b) modeled the plug flow reactor as a multiple tanks in series configuration. In particular Muslu (2000a,b) applied the old work of Milbury et al. (1965), removing some hypotheses of their proposed model. In particular they changed the biochemical model and proposed a new modeling approach where the axial change in biomass concentration is considered by writing two mass balance equations for biomass and reactant and considering a series of equal-sized, completely mixed reactors (Fig. 34 C) to represent the PFR reactor.

A steady state mass balance is considered for the biomass and substrate. The resulting equations that represent the effluent concentration of substrate and biomass from each reactor in dimensionless form are:

$$\bar{C}_{ex} = \frac{C_{ex}}{k_s} = \frac{1 + \frac{k_d \cdot \tau}{N} - \frac{\bar{X}_{in}}{X_{ex}}}{\frac{(\mu - k_d) \cdot \tau}{N} - 1 + \frac{\bar{X}_{in}}{X_{ex}}} \quad (33)$$

$$\bar{X}_{ex} = \frac{X_{ex}}{Y \cdot k_s} = \frac{\bar{X}_{in} + \bar{C}_{in} - \bar{C}_{ex}}{\left(1 + \frac{k_d \cdot \tau}{N}\right)} \quad (34)$$

These equations have to be solved using trial and error procedures.

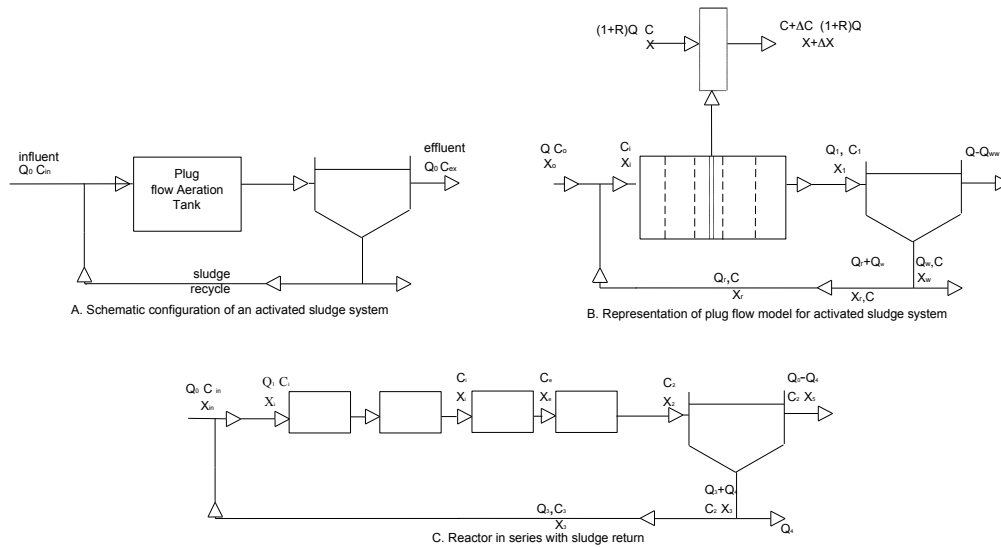

Figure 34. Schematic representation of activated sludge reactor.

6.1.5.2 Non ideal flow reactor models

In the plug flow aeration basin of activated sludge process can cause high transverse axial mixing and high aeration rate, high traverse velocities and irregular air distribution. Therefore, it is not possible to describe the process with ideal plug flow equations. Thus several authors (San 1989; Lee et al. 1999a; Wehner and Wilhelm 1956) described non-ideal conditions, caused by axial mixing, with the following advective-diffusive equation including a reaction term:

$$\frac{\partial C}{\partial t} + \frac{\partial(v \cdot C)}{\partial x} = \frac{\partial}{\partial x} \left(D \frac{\partial C}{\partial x} \right) + R_C \quad (34)$$

CHAPTER 6 – LITERATURE REVIEW

where:

R_C = reaction term [$\text{ML}^{-3}\text{T}^{-1}$].

In particular, Khudenko and Shpirt (1986) did not introduce the reaction term in the equation (34), but coupled this equation to the oxygen mass transfer equation to find the optimal sizes to the aeration tank and aeration system.

San (1992) developed an analytical solution for the differential equations of dispersed plug flow systems in steady-state conditions, including a reaction term based on Monod kinetics. Lately the same author (San 1994) introduced the following differential equations to simulate the effect of feed and outlet channels:

$$\frac{1}{Pe} \frac{d^2C}{dx^2} - \frac{dC}{dx} = 0 \quad x \notin [0,1] \quad (35)$$

$$\frac{1}{Pe} \frac{d^2C}{dx^2} - \frac{dC}{dx} - \frac{\tau \cdot \mu \cdot X}{Y \cdot k_s} \frac{1}{1+C} = 0 \quad x \in [0,1] \quad (36)$$

where:

Pe = Peclet number.

Equations (35) and (36) were solved using boundary conditions introduced by Wehner and Wilhelm (1956), resulting from the conservation of reactants at the exit and entrance of the reactor, taking into account flow and diffusion, and from the intuitive argument that the concentrations should be continuous between the reactor entrance and exit sections in steady-state conditions.

Turian et al. (1975), Lee et al. (1999a, 1999b) and Makinia and Wells (2000a,b) incorporated a more comprehensive chain of biological reactions into the dispersion flow reactor model in unsteady state conditions. Olivet et al. (2005) proposed tanks in series model to simulate the hydrodynamic behaviour of a full scale plant. In particular a four tank in series model was developed. The authors also included a dead zone to simulate the reactor zone with diffusers. Furthermore, the hydraulic model includes the external recycle from the secondary settler. RTD tests were done to find the model that better describes the reactor hydraulic behaviour. Also Potier et al. (2005) simulated full scale aerated channels treating wastewater by applying a tanks in series model with back-mixing. The authors considered in the model the variations of the wastewater characteristics (concentration and composition of polluted influent, flow-rate, etc.). They also demonstrated that it is possible to simulate easily the variations of the axial dispersion coefficient with the flow-rate through this model with a maximal fixed number of mixing cells and a variable backflow rate. The authors also found several

correlations of the dispersion coefficient with reactor width, reactor length and gas flow-rate as reported below:

$$D = 0.2032 \cdot H \cdot \left(\frac{Q_G}{L} \right)^{0.5} \quad (37)$$

where:

Q_G = gas flow-rate [ML^{-3}].

In another paper, Fall and Loaiza-Navia (2007) modelled with AQUASIM Software a full-scale activated sludge reactor by applying the CSTR in series model. The authors also validated the model by operating tracer tests. Lately, Ramin et al. (2011) modelled the activated sludge reactor also including a settling tank. The authors also performed a sensitivity analysis with the Monte Carlo method and uncertainty method and applied the convection-dispersion model.

6.1.5.3 Computational fluid dynamics model development

All the models described above are called “systemic models”, because they emphasize the functional aspects of the reactor, without detailing the localization of the phenomena inside the reactor. Thus, they give quite rapidly and with moderate efforts a first approximation of the reactor behavior. These models have a good robustness in the range of experimental and size conditions for which they have been developed (Le Moullec 2010b). However, they could remain unsatisfactory to consider local phenomena and to model the influence of the reactor geometry (length/width ratio, presence of baffles, effluent inlet device), the aeration process (sparging device, gas fraction field) and the resulting local mixing (Le Moullec 2010a).

In the last few years some attempts were made to model the activated sludge reactor using a new approach: a Computational Fluid Dynamics (CFD) model. It is a powerful tool which allows studying the influences of the operating parameters and the hydrodynamic phenomena at local scale (Le Moullec 2010b). With a structural approach a CFD model discretizes the reactor using a computational grid, formulates and solves the fundamental mass, momentum, and energy conservation equations in space (Huang et al. 2005). CFD simulations can define the flow patterns and the retention time distribution to characterize the reactor hydraulic behavior. This information provides a hint to the role of possible hydraulic problems related to the bad plant performance.

CHAPTER 6 – LITERATURE REVIEW

Alex et al. (2002) were among the first authors in the literature to use the CFD approach to generate an appropriate model structure to simulate the biological processes in CSTR activated sludge compartments. The first authors who implemented the ASM1 into the CFD code through the use of classical convective scalar transport equations were Glover et al. (2006). The obtained model, subsequently called CFD-ASM1, was then analysed at different levels and was validated with an experimental study and two numerical studies of an SBR-oxidation ditch (Vermande 2005). Glover et al. (2006) demonstrated that the classical biological modeling can take advantages of CFD results in order to obtain the local oxygen concentration and transfer and the hydraulic structure (recycling rate and number of perfect mixed reactors) of the system.

However, despite numerous developments and improvements, this approach still remains difficult to handle for reactors involving complex and coupled local hydrodynamics, heat and mass transfer and chemical reactions because of the high computational requirements.

Le Moullec et al. (2011) coupled CFD with the ASM model and compartmental approach. The authors considered also the dispersion model and found a correlation between the axial dispersion coefficient, the gas and liquid flow-rates and the reactor geometry. Such studies should allow to improve the detailed design of aerated reactors in wastewater treatment plants (gas distribution system, baffles location). In another study, Zima et al. (2009) proposed CFD for predicting the behaviour of reactive pollutants in the aerobic zone of a full scale bioreactor. The one-dimensional advection-dispersion equation was combined with simple biokinetic models incorporating the Monod-type expressions.

Even in single-phase reactors, chemical reactions are described by non-linear terms that often cause numerical instabilities. The high data quantity required is often prohibitive, while the complexity of the problems that arises from coupling the fluid dynamics with the bio-chemical phenomena means that the systems has be treated with attention for case (Rigopoulos and Jones 2003). In fact a lot of parameters are involved in both the biochemical (kinetic and stoichiometric) and hydrodynamic (dispersion) models. Furthermore is difficult to solve together two systems of linear and non-linear equations represented by Navier-Stocks equations and differential equations. These models also assume that the bio-chemical model does not impact on the hydrodynamic model and vice versa. This assumption is possible by neglecting the effect of biochemical processes on hydrodynamics but it is a big assumption for the effect of hydrodynamic conditions on biochemical processes. In fact the biochemical process can be affected by the reactor flow conditions because, the biomass, substrates

CHAPTER 6 – LITERATURE REVIEW

and inhibiting compounds can be distributed in different reactor zones. This implies that the biochemical process can occur at a different kinetic in function of the hydrodynamic condition. Recently, “hybrid” approaches have emerged as an alternative. In these cases CFD is employed only for the hydrodynamic simulations, while the bio-chemical phenomena are resolved with compartmental modeling (Rigopoulos and Jones 2003). The latter describes the reactor as a network of functional compartments spatially localized. It is based on CFD and on the determination of volumes in which physico-chemical processes occur.

6.1.5.4 Models comparisons

The model proposed by Lawrence and McCarty (1970), San (1989, 1992) and Milbury (1965) are old and simple to apply but the results can present a big degree of uncertainty. More complete models taking into account the dispersion related to reactor configuration and aeration are the ones proposed by Khudenko and Shpirt (1986) and San (1992). But the best models are those proposed by Turian et al. (1975), Lee et al. (1999a, 1999b), Olivet et al. (2005), Potier et al. (2005) and Makinia and Wells (2000a,b) who considered biochemical reactions and dispersion flow are the ones. Finally it is also useful to apply CFD models that are more complex than the previous models but describe the hydrodynamic phenomena more in detail, considering the local process that happens in the reactor.

6.1.6. Mathematical modeling of fluidized bed reactors

6.1.6.1 Process description

In biological Fluidized Bed Reactors (FBR), the liquid to be treated is pumped through a bed of inert particles (sand, pumice, activated coal) at a velocity sufficient to cause fluidization. Particles in a fluidized state provide a large specific area for attached biomass growth; this feature enables long solids residence times and low suspended solid concentrations. Usually aeration occurs through the liquid recirculation from the reactor to an oxygenator in which air or oxygen is bubbled (Fig. 35). It is also possible to have a three-phase fluidized bed reactor, by insufflating the oxygen directly into the reactor (Wisecaver and Fan 1989; Hirata et al. 1986; Trinet et al. 1991; Fan et al. 1987).

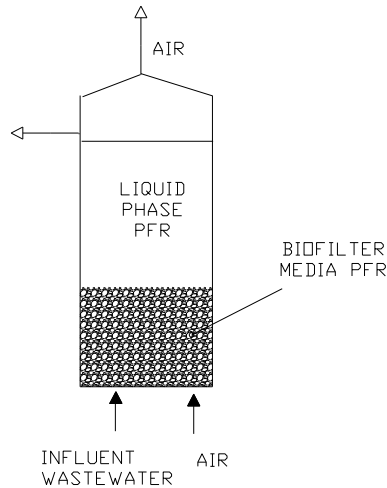

Figure 35. Schematic representation of fluidized bed reactor.

6.1.6.2 Model development

6.1.6.2.1 Ideal flow reactor models

The liquid phase transport of a reactant through an FBR encompasses molecular diffusion, turbulent diffusion, and convective diffusion caused by a non-uniform velocity distribution; the axial dispersion is insignificant under normal operating conditions. Thus, FBRs have usually been modeled using ideal flow patterns, such as CSTR or PFR (Shieh et al. 1982; Mulcahy et al. 1980; Mulcahy et al. 1981; Rittmann 1982; Park et al. 1984) conditions. Due to the high recirculation rates many mathematical models that were developed, as CSTRs did not consider the spatial gradients of the substrates and products along the height of the reactor.

Rittmann (1982) stated that FBR can achieve a better performance compared to complete-mix because the biofilm is evenly distributed throughout the reactor while the liquid regime is still “plug flow”. Adding an effluent recycle, making the liquid phase more homogeneous, can change this hydrodynamic behaviour. That dilutes the feed and makes the performance approaching a complete mixing unit, which implies a lower removal efficiency than under plug-flow conditions (Rittmann 1982). Shieh et al. (1982) tried to apply the PFR model to an FBR assuming that macroscopic radial

gradients do not occur inside the reactor and pseudo-steady-state conditions prevail. The adopted continuity plug flow equation is:

$$u \frac{dC}{dx} + R_v = 0 \quad (38)$$

where:

u = superficial velocity [ML⁻¹];

R_v = reactant conversion rate per unit fluidized bed volume [ML⁻³T⁻¹].

The authors included the following elements in their model: i) external and internal biofilm mass transfer; ii) reactant consumption within the biofilm; and iii) a degree of bed expansion and an expanded bed height under a given set of operating conditions such as flow rate, biofilm thickness, media size, and density. As a result, a general model of an FBR reactor was obtained by combining equation (38) with the reactant conversion rate expression and integrating the resulting equation subject to boundary conditions that considers a bulk-liquid reactant concentration equal to the inlet reactant concentration. The resulting equation describing the reactant concentration profile through the FBR is:

$$C^{0.55} = C_{in}^{0.55} - \frac{x}{v} \cdot 0.6162 \left[\frac{3 \cdot r_p^2}{\rho \cdot (r_p^3 - r_m^3)} \cdot 0.5 \right]^{0.9} k_0^{0.55} \cdot D^{0.45} \cdot x \quad \Phi_{0,m} \geq 1.15 \quad (39)$$

where:

k_0 = intrinsic zero order rate constant [T⁻¹];

r_m = media radius [L];

r_p = bioparticle radius [L];

r = biofilm dry density [ML⁻³];

$\Phi_{0,m}$ = Thiele modulus.

6.1.6.2.2 Non ideal flow reactor models

A three-phase fluidized bed reactor cannot always be described using simple models such as ideal plug flow, because appreciable back-mixing may occur in the liquid phase (Muroyama and Fan 1985). This back-mixing is caused by the rising of coalesced gas bubbles, in particular for beds of fine particles (Muroyama and Fan 1985). Thus, Yu et al. (1999) proposed a tank-in-series model, applying equation (13), to describe the flow pattern of an FBR that considers the reactor to be a combination of

CHAPTER 6 – LITERATURE REVIEW

two ideal CSTR reactors. Many other investigations on the flow pattern in an FBR suggest that an axial dispersed plug flow model can also be used to simulate the hydrodynamics of the process (Østergaard 1968; El-Temtamy et al. 1979a; Muroyama and Fan 1985; Davidson et al. 1985; Lin 1991; Kim and Kang 1997; Michelsen and Østergaard 1970; El-Temtamy 1979b).

Additionally, many authors studied the effect of gas production on the hydrodynamics for the design and scale-up of three-phase fluidized bed reactors. El-Temtamy et al. (1979a,b) described the flow of the gaseous and liquid phases in a three-phase FBR by introducing a radial dispersion coefficient inside the following axially dispersed plug flow equation:

$$\frac{\partial C}{\partial t} + \frac{u}{\varepsilon} \cdot \frac{\partial C}{\partial t} = D \frac{\partial^2 C}{\partial x^2} + D_r \left(\frac{\partial^2 C}{\partial r^2} + \frac{1}{r} \cdot \frac{\partial C}{\partial r} \right) + R_C \quad (40)$$

where:

ε = fluidized bed porosity;

r = relative radial position [L];

D_r = radial dispersion coefficient [L^2T^{-1}].

The authors solved equation (33) using boundary equations proposed by Danckwert (1953).

The authors also identified an indirect correlation between the Peclet number based on the particle diameter and the gas flow rate and a correlation between axial mixing in the liquid phase, the presence and motion of bubbles and the radial velocity profile (El-Temtamy et al. 1979a; Mulcahy and La Motta 1978).

Lin (1991) applied an axial dispersion model for the bulk phase considering reactant diffusion and consumption inside the biofilm and imposing Danckwerts (1953) boundary conditions to solve the proposed equations. Additionally, the author compared the experimental data obtained by Mulcahy and La Motta (1978) and Jeris (1977) with the model results and a high value of the Peclet number was also found that enables a simplification based on plug flow conditions. Thus, neglecting the dispersion term, the substrate in the bulk phase was modelled using the axial dispersion equation:

$$\frac{\partial C}{\partial t} = - \frac{\partial C}{\partial x} - \frac{A_b \cdot k_s \cdot H}{\varepsilon \cdot u} \cdot \left(\frac{C}{C_{in}} - \frac{C_f}{C_{in}} \right) \quad (41)$$

where:

C_f = reactant concentration in the biofilm phase [ML^{-3}];

A_b = specific surface area of coated particle [L^2];

H = height of fluidized bed [L].

CHAPTER 6 – LITERATURE REVIEW

In this case, the authors imposed an initial boundary condition for the value of the initial reactant concentration in the bulk phase.

6.1.6.2.3 Models comparisons

The models proposed by Ritmann (1982) and Schieh et al. (1982) are plug flow and steady-state models, that are easy to apply but their results not are accurate. Instead more accurate models consider also the effect of gas production on hydrodynamic behaviour (Lin et al. 1991; El-Temtamy 1979a,b).

6.1.7 Mathematical modeling of biofilter reactors

6.1.7.1 Process description

Aerobic biofilters (Fig. 36) are rectangular or circular packed beds used for the bio-oxidation of domestic or industrial wastewater. It is possible to schematize the reactors as a three-phase system where the liquid phase passes through the bed in contact with both the microbial film and a counter-current air stream rising by natural convection. Trickling filters have characteristics similar to biological aerated filters, except they are not submerged.

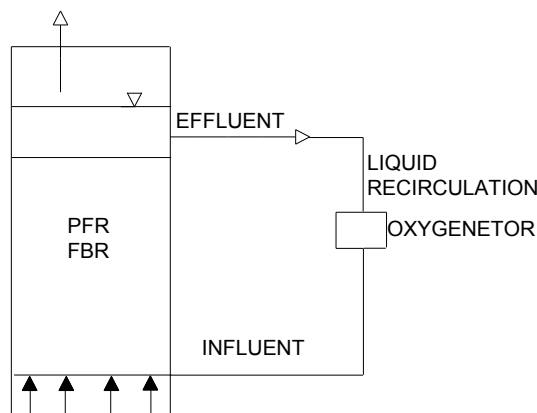

Figure 36. Schematic representation of up-flow biofilter reactor design.

6.1.7.2 Model development

6.1.7.2.1 Ideal flow reactor model

Many models assume ideal plug flow conditions in biofilter; however, non-ideal conditions may occur with increased mixing and dispersion at a high flow rate. Rittmann (1982), Chang and Rittmann (1987), Oleszkiewicz (1981), Costa Reis and Sant'Anna (1985) proposed a complete bioreactor model that includes the biofilm and CSTR flow for the liquid phase.

In particular, Rittmann (1982) stated that the biofilter hydrodynamics are related to the recycle ratio, in fact the reactor can achieve complete mixing conditions when the recycle ratio exceeds 10. Although some researchers have found that aerobic biofilters act as plug flow systems due to either channelling or backmixing (Särner 1978; Gray and Learner 1984; Vandevenne 1986; Muslu 1986; Meunier and Williamson 1981). In particular, Meunier and Williamson (1981) modelled the reactor considering a plug flow regime but neglected the back-mixing effect from rising bubbles of biogas. Baquerizo et al. (2005) proposed a mathematical model for the biofilter based on the mass balance equations, and considering four phases in the system: gas, liquid, biofilm, and solid. A plug flow pattern is considered for both the liquid and gas phases, resulting in the proposed equations:

$$\frac{\partial C_g}{\partial t} = -\bar{v}_g \cdot \frac{\partial C_g}{\partial x} - \frac{a_b}{\varepsilon} \cdot F_{g-l} \quad (42)$$

$$\frac{\partial C_l}{\partial t} = \bar{v}_l \cdot \frac{\partial C_l}{\partial x} + \frac{a_b}{h} \cdot F_{g-l} - \frac{a_b}{h} F_{l-b} \quad (43)$$

where:

g = subscript referred to the gas phase;

l = subscript referred to the liquid phase;

\bar{v} = interstitial velocity [LT^{-1}];

a_b = biofilm surface area per unit volume of biofilter bed [L^2L^{-3}];

F_{g-l} = mass flux from the gas phase to the liquid phase [$ML^{-2}T^{-1}$];

F_{l-b} = mass flux from the liquid phase to the biofilm phase [$ML^{-2}T^{-1}$];

h = dynamic hold-up coefficient [ad.].

In addition to the presented equations, the authors proposed a mass balance for the biofilm and the solid phase. Jacob et al. (1996) developed a complete dynamic model and applied it to an aerobic

biofilter assuming ideal plug flow conditions. The authors accounted for filter clogging and described a progressive reduction of the liquid space caused by biomass growth and suspended particle retention.

6.1.7.2.2 Non-ideal flow reactor model

Fdz-Polanco et al. (1994) performed a tracer test at a pilot scale plant and obtained different hydraulic reactor models by fitting experimental data with the theoretical model. These authors achieved a Standard Relative Deviation (SRD) value below of 20% only applying a CSTR reactor and a dead zone model. They also performed tracer tests for several design parameters (the length/particle diameter ratio and the porosity) and operational parameters (liquid and gas superficial velocity). These tests approached the plug flow for porous bed reactors, low bed porosity, low liquid and/or gas velocity. However, different authors demonstrated that back-mixing could occur in such reactors depending on the bed length, size of the packing particles and liquid phase velocity (Martinov et al. 2010; Froment and Bischoff 1990). Martinov et al. (2010) modelled a fibrous fixed bed reactor using recycle with a tank-in-series model, which is advantageous since it can model the large void fraction of the fixed bed and it is independent of the boundary conditions. Furthermore to account for a deviation from ideal flow, they proposed a schematic model with recirculation.

Sanchez et al. (2005) proposed a model based on two-mixed reactors of different sizes and included in the model the biofilm and gas liquid transfer. The proposed equations that describe the two mixed reactors of different size are reported below in dimensionless form:

$$E'(\theta') = \frac{\exp\left(-\frac{\theta'}{a} - \exp\left(\frac{\theta'}{1-a}\right)\right)}{2 \cdot a - 1} \quad (44)$$

$$a = \frac{V_{R2}}{V_{R1} + V_{R2}} \quad (45)$$

where:

V_{R1} = volume of the first reactor [L^3];

V_{R2} = volume of the second reactor [L^3];

E' = dimensionless residence time distribution function [ad.];

θ' = dimensionless time [ad.].

CHAPTER 6 – LITERATURE REVIEW

Also Perez et al. (2005) proposed a model based on the tanks in series model for nitrifying fixed bed bioreactors. This model was used to provide a detailed description of the biomass, ammonium, nitrite and nitrate concentrations along the reactor vertical axis. This flow model is useful to describe in a simple way the biofilm thickness gradient along the bed as experimentally observed.

The tanks in series description were complemented with a back-mixing flow-rate to describe the effect of the aeration flow-rate on the liquid phase mixing. Physically, raising gas bubbles generate a liquid down-flow, which is taken into account in the mathematical description of the flow model.

The reactor was then divided into three parts: the bottom represented by one stirred tank, the fixed bed represented by 5 identical stirred tanks in series, and the top represented by one stirred tank. To complete the hydrodynamic equations, a gas-liquid mass transfer term and a liquid-biofilm transfer term were added.

Froment and Bischoff (1990) focused on packed bed axial dispersion, using a low Reynolds number range (between 1 and 10) and the axial dispersion model. They demonstrated that the Peclet number of non-aerated granular beds varies within the range 1.4-2. Similar studies in a 0.2 m diameter packed bed bubble column with high porosity packing and a vertical co-current up-flow of gas and liquid have been reported by Bhatia et al. (2004). Séguret and Racault (1998) applied the residence time distribution method to define the effect of the mixing pattern on the process performance in a full-scale nitrifying biofilter. They demonstrated that the floating filter bed itself behaves as a dispersed plug flow reactor. Additionally, they identified a direct correlation between the dispersion and the flow rate, and a variation of the dispersion coefficient and the residence time distribution along the reactor height. They also applied a theoretical nitrifying model that accounts for the observed hydrodynamic behavior. One limit of the mechanistic models is the large number of variables requiring experimental confirmation. Thus, empirical models that are simpler to implement and solve are of interest, such as the model proposed by Mann and Stephenson (1997).

With regard to Trickling filters (TF), many authors studied residence time distribution in TFs (Sinkoff et al. 1959; Kshirsagar et al. 1972; Tariq 1975; Särner 1978; Gray and Learner 1984; Vandevenne 1986). In most works on the hydrodynamic behavior of TF, the RTD profile is a function of the media used, the hydraulic loading, and the amount of biomass. TF are modeled in most studies as a series of perfect mixers with a dead zone (Mezaoui 1979; Nyadziehe 1980; Sant' Anna 1980). While in the model proposed by De Clercq et al. (1999) the influence of the heterogeneous film structure was

CHAPTER 6 – LITERATURE REVIEW

considered, which consisted of a biofilm, a free flowing and a captured liquid film. The authors modelled the diffusion effect with the tanks in a parallel configuration and the free flowing liquid with CSTR series configuration linked to the diffusion block (De Clercq et al. 1999). Other model approaches are also described in the literature, such as the axial dispersed plug flow model proposed by Séguret and Racault (1998). The authors proposed a bio-diffusion model which considers the TF as a vertical tube that includes the reactor filling, an immobile phase, and a liquid film. The flow in the liquid is postulated to be an axially dispersed plug flow, and the governing equation is:

$$\frac{\partial C}{\partial t} = D \cdot \frac{\partial^2 C}{\partial x^2} - u \cdot \frac{\partial C}{\partial x} + a_e \cdot \frac{1}{\varepsilon \beta_m} J_E(x) \quad (46)$$

where:

a_e = specific surface area available for exchange per volume of filter [L^2L^{-3}];

b_m = mobile volume fraction;

$J_E(X)$ = flux of reactant at the interface between the main flow and the immobile phase [$ML^{-2}T^{-1}$].

To solve this equation, the authors applied Danckwerts boundary conditions for the dispersion of flow at the flow entrance, and the cessation of dispersion at the output (Séguret et al. 2000). In the immobile zone it is assumed that the tracer is subject to diffusion. One particular case of equation (46) is when a slice dz is considered to be perpendicular to the flow direction, in this case the mass balance becomes:

$$\frac{\partial C}{\partial t} = D_m \cdot \frac{\partial^2 C}{\partial x^2} \quad (47)$$

where:

D_m = molecular diffusion coefficient of reactant inside the biomass in the immobile phase [L^2T^{-1}].

Additionally the following boundary conditions at the liquid/biomass interface are also defined:

$$C(z = 0) = C(X) \quad (48)$$

$$\left(\frac{\partial C}{\partial z} \right)_{z=e} = 0 \quad (49)$$

where:

e = thickness of biomass [L].

Muslu (1990, 1984), Muslu and San (1990) conducted a tracer test on inclined plane trickling filters. The result was used to determine the following expression that correlates the dispersion coefficient for conserved tracer substances in flow over porous media and the flow rate:

$$D = \frac{\phi}{L} q^{4/3} \quad (50)$$

where:

ϕ = coefficient function of viscosity, molecular diffusion, localization of the flow path [ad.];

q = flow rate per unit of width [ML^{-2}];

L = length of axial travel in the reactor [L].

The authors identified the hydraulic reactor model considering different flow patterns that could occur inside the reactor. With high hydraulic loadings the flow pattern is a dispersed plug flow, thus the authors applied the axial dispersion equation. While with lower hydraulic loading rates the authors assumed a complete mix flow pattern. A transition zone in the flow regime indicates other mixing conditions.

Iliuta and Larachi (2005) modelled TF reactors using a two-dimensional two-fluid dynamic model. The complete model describes two-phase flow and the space-time evolution of biological clogging and physical plugging. It is based on the macroscopic volume-averaged mass and momentum balance equations, the continuity equation for the solid phase, the species balance equation for the fine particles and the volume-averaged species balance equations at the reactor level. The model is coupled with the simultaneous transport and consumption of phenol and oxygen within the biofilm and the simultaneous diffusion of both phenol and oxygen and the adsorption of phenol within the activated carbon particles. Using equations that account for the reactor hydrodynamics, the authors applied the axial dispersion model to describe the species balance in the fluid phase for oxygen and the substrate, while plug flow was assumed in the gas phase.

6.1.7.2.3 Models comparisons

Meunier and Williamson (1981), Baquerizo et al. (2005) and Jacob et al. (1996) proposed a plug flow model neglecting the back-mixing effect. Others models proposed by Fdz-Polanco et al. (1994), Martinov et al. (2010), Pérez et al. (2005) and Sanchez et al. (2005) included also the back-mixing conditions with tank in series configurations. Also Séguret and Racault (1998), Froment and Bischoff (1990), Muslu (1984, 1990), Muslu and San (1990) considered in the model the effect of dispersion by applying dispersion equation obtaining a more detailed model. Lately, CFD model was proposed by Iliuta and Larachi (2005). This is the most complete model because it describes a two-phase flow and the space-time evolution of physical and biological phenomena

6.1.8 Model comparisons and validation and calibration

6.1.8.1 Models comparisons

The models presented above for activated sludge reactor, fluidized bed reactor and biofilter reactor have different advantages and disadvantages. Furthermore there are some models which can be useful in some situation and not in others. Table 22 lists all the models reported indicating for each one the advantages and disadvantages and when can be utilize.

CHAPTER 6 – LITERATURE REVIEW

Table 22. Models comparisons

Author	Advantages	Disadvantages	When can be used
Van der Meer and Heertjes, 1983; Bolle et al., 1986a,b; Costello et al.,1991a,b, Ojha and Singh (2002) and Singh (2005). UASB	Introduce the model of CSTR in series model for UASB reactor	Without calibration and validation, simple model with a lot of assumption	For initial simulation to understand the general reactor behaviour
Wu and Hickey (1997), Singhal (1998) and Zang et al. (2005). But the best models are those proposed by Kalyuzhnyi et al., (2006), Batstone et al. (2005), Mu et al. (2008) and Penã et al. (2006). UASB	Consider dispersion in the reactor	Without calibration and validation, simple model with a lot of assumption	For initial simulation to understand the general reactor behaviour
Ren et al. (2009). UASB	Use the CFD model, describe the process with local phenomena	Without calibration and validation	To study the process in detail and focalize also on local phenomena in the reactor
Young and McCarty (1968), Young and Young (1988). AFBR	Apply the simple model of CSTR in series in AFBR reactor	Do not model the gas phase in the reactor	For initial simulation to understand the general reactor behaviour
Escudié et al. (2005), Huang and Jih (1997) and Smith (1996). AFBR	Consider the presence of biofilm	Without calibration and validation	For initial simulation and to understand the biofilm growth
Bonnet et al. (1997) BAF	Introduce the model of plug flow.	Without calibration and validation, simple model with a lot of assumption	For initial simulation to understand the general reactor behaviour
Seok and Komisar (2003), Otton et al.(2000), Buffière et al. (1998a,b), Schwarz et al.(1996-1997) and Diez and Blanco (1995). BAF	Consider dispersion in the reactor	Without calibration and validation, simple model with a lot of assumption	For initial simulation to understand the general reactor behaviour
Buffière et al. (1998a,b). BAF	Apply the dispersion model and consider also the gas-phase behaviour	Without calibration and validation	For initial simulation to understand the general reactor behaviour
Monteith and Stephenson (1981), Mendoza and Sharratt (1998, 1999), Smith et al. (1993) and Keshtkar et al. (2003). CSTR	Apply the simple model of CSTR in series in AFBR reactor	Do not model the gas phase in the reactor	For initial simulation to understand the general reactor behaviour
Vavilin et al. (2001, 2003). CSTR	Consider dispersion in the reactor	Without calibration and validation, simple model with a lot of assumption	For initial simulation to understand the general reactor behaviour

6.1.8.2 Activated sludge reactor

6.1.8.2.1 Ideal PFR and CSTR in series

Lawrence and McCarty (1970) first solved the proposed differential equations and obtained an algebraic solution. This solution was approximate because they assumed that the biomass concentration in the reactor remains nearly constant at least as long as the ratio of the solid retention time to the hydraulic retention time (SRT/HRT) exceeded 5. With this assumption, they demonstrated that the difference between PFR and CSTR is not too significant with regard to the evaluation of the biomass concentration. San (1989) solved the same equations with a finite difference method, avoiding any assumptions that could become restrictive in the case of wastewater with high solids concentrations. The author described a numerical method to determine the mean residence time and the effect of the kinetic coefficients on the mean solids residence times, but did not calibrate and validate the model with experimental data for the field conditions.

As a first attempt to model a plug flow reactor with a CSTR in series model, Milbury et al. (1965) defined the effective number of compartments for different detention times. Therefore they compared the effluent tracer concentration of a rectangular laboratory aeration vessel with the model results. Another model was developed by Muslu (2000a) and compared to the CSTR model results obtained with the approximate model developed by Lawrence and McCarty (1970). Experimental data reported by Lovett et al. (1984) were used to validate the model. The author obtained larger differences between the real and simulated data when the mean solids residence times were small. In particular for some industrial wastewater applications, there may be a considerable difference between the results of the Muslu model and the approximate analytical solution of Lawrence and McCarty that neglects the existence of a longitudinal biomass concentration gradient.

Among the models cited above only San (1989, 1992) solved the proposed equations using finite difference technique, the other authors (Lawrence and McCarty 1990; Milbury et al. 1965) proposed algebraic solutions of the equations introducing some simplifications.

Many authors performed tracer experiments that estimate the hydraulic parameters and characterize the hydraulic reactor model. These parameters include the real HRT value, the dispersion coefficient (for a dispersion model), the number of reactors in series (for a tank-in-series model), and back-mixing flows or dead zone volume. It is possible to obtain these parameters from the RTD curve that describes the exit concentration with time. The AWWA guide (Teefy 1996) gives several advices

regarding the achievement of tracer tests in water and wastewater treatment plants particularly with respect to the selection of suitable tracer. Murphy and Timpany (1967) made a comparison between reactor model and lab-scale reactor hydrodynamics using experimental points obtained from a tracer test conducted with a laboratory tank. The authors showed that the two extremes of PFR and CSTR are inadequate and that the dispersion model fits the experimental data significantly better than equal size CSTRs in series or the unequal size CSTR in series model.

6.1.8.2.2 Non ideal flow reactor models

San (1994) compared his method with a method using the same boundary conditions (Wehner and Wilhelm 1956) but with a first order reaction instead of a Monod type reaction. The author implemented the proposed equation and obtained a graph that can be used to design a plug flow reactor, in particular it gives a correlation between reaction rate, Peclet number and biological efficiency. Makinia and Wells (2000b) verified the flow pattern effects of their model on the one-dimensional unsteady advection-dispersion equation using data from a full-scale plant and introducing the model parameters developed from previous experiments (Makinia and Wells (2000a) and data from the literature. With dynamic conditions, the authors compared the predicted concentration of ammonia nitrogen and dissolved oxygen with the experimental data, and showed that, in all cases, the errors between the model predictions and the data were lower for the advection-dispersion model than for the tank-in-series model. In fact, even in the case of five mixed zones of equal size that was found as the best fitting tank-in-series model, the predicted peak concentrations were lower by approximately 12–17% and delayed by approximately 30–60 min compared with the actual peaks. The dispersion model was solved in unsteady conditions with a computational algorithm proposed by Lee et al. (1999a, 1999b). The results were compared with results obtained by the proposed model-collocation with a tank-in-series model using experimental data (Lee et al. 1999b). The authors applied the model to pilot-scale activated sludge process data presented in a previous study (Nogita et al. 1983), and showed that with simulated dynamics of the reactant at the outlet of the pilot plant, the proposed algorithm provides a superior prediction than the tank-in-series model. They demonstrated the feasibility of improving the accuracy of the results by optimizing the Peclet number.

Lee et al. (1999a) also validated the model using different numerical techniques - the orthogonal collocation method (MOC), the line method (ML), and the internal collocation and four elements

method (OCFE) and experimental data related to the hydraulics of a Surface Flow System (SSF) constructed wetland process presented by King and Forster (1990).

For all of these methods there is a good agreement between the experimental data and the model results, but these validations suggest that the OCFE technique is superior to ML and MOC in terms of numerical stability and the accuracy of the solution. Furthermore, all simulated RTD curves show a slower rise time and a faster tail than the experimental data, which indicates a plant-model mismatch. It is important to note that the experimental tracer curves at various points across the gravel bed of the SSF describe different peak concentrations and response times, which implies that there is a channelling phenomenon to a certain extent which is not accounted for in the axial dispersion model. The authors also calibrated the model with simulations using different values of the Peclet number, and they demonstrated that with an appropriate value it is possible to predict the process time delay using either technique (preferably OCFE or ML).

Glover et al. (2006) calibrated and validated a CFD-ASM1 model using experimental data from a laboratory scale reactor. Le Moullec et al. (2010b) applied a CFD model to an activated sludge reactor and compared systemic, CFD, and compartmental models for a biological reactor used in wastewater treatment in a theoretical case, without reference to experiments. In this model, the author considered a gas-liquid reactor with oxygen transfer and complex kinetics and showed that all three models follow the same main trends; in particular, the compartmental model provided results very similar to the CFD model. A discrepancy was observed between the CFD and compartmental models due to the more realistic introduction of effluent in the CFD model. In the case of a particulate biodegradable substrate, significant differences are noted between a systemic model and a CFD-based model (Le Moullec et al. 2010b) this is due to the calculated hydrolysis process, which is affected by the in-homogeneity of the particulate compounds concentration on a section of the reactor (Le Moullec et al. 2010b). This in-homogeneity is not taken into account in systemic models.

6.1.8.3 Fluidized Bed Reactors

Shieh et al. (1982) performed a sensitivity analysis of the proposed model parameters using reported numerical values. These authors studied the effects of media size and biofilm thickness on FBR performance in terms of the reactant conversion rate and biomass concentration. They found that these are two most important parameters that affect the FBR performance, but they did not include the

effects of the hydrodynamic parameters on the process. The authors additionally proposed an iterative procedure that is applied to the model for design purposes.

Yu et al. (1999) performed tracer experiments using a laboratory scale fluidized bed reactor to study the mixing and flow patterns of tap water. The author introduced a pulse input of a dye solution and demonstrated that the flow pattern can be described with a model of two CSTRs in series. This result was obtained by calculating, from the tracer concentration, the residence time distribution curves and their variance correlated to the number of CSTR reactors. The author also demonstrated that this approach improved the fit to the experimental data at low gas velocities and was equivalent to the axially dispersed plug flow model at higher gas velocities. Lin (1991) presented graphs that compared experimental data from the literature for biological fluidized bed de-nitrification and predicted values of the model. The graphs only enable qualitative agreement to be observed between experimental data and model predictions. El-Temtamy et al. (1979b) performed tracer tests on a laboratory scale reactor and correlated the radial concentration profile to the radius by varying the superficial gas velocity. The authors obtained different values of the radial dispersion coefficient and found that this parameter does not change with particle size as the fluid flow rates vary.

6.1.8.4 Biofilter reactors

Considering the ideal reactor model previously proposed, Jacob et al. (1996) solved the proposed system of eight differential equations, using two methods to reduce the distributed parameter model to a differential algebraic equation (DAE) system: the method of lines and orthogonal collocation. The experiments were performed on synthetic wastewater to simulate the nitrification and denitrification process. In the nitrification process, the experimental data was compared for nitrites and carbon concentrations, and a very good agreement was found between the experimental and the model results. In the denitrification process, the nitrate, nitrite, and carbon concentration were compared to the experimental data and found to be in good agreement. It should be emphasized that the simulations were performed without a real estimation of all parameters involved; in fact most of the parameters were taken from the literature or measured experimentally. Thus, this model lacks a rigorous parameters estimation procedure. De Clercq et al. (1999) performed a tracer test using a full-scale reactor and obtained improved fitting of the model performance to the measured lithium effluent concentration with a two-tank-in-series configuration. This did not include the diffusion effect as they

stated that this phenomenon does not influence the residence time distribution. Séguret and Racault (1998) performed a tracer test in order to obtain an experimental RTD curve and to estimate the immobile and mobile volume and the first moment of the proposed bio-diffusion model. The mobile volume from the bio-diffusion model and the first order moment were compared to the free draining volume and the mean retention time obtained experimentally. The authors determined that the mean residence time is overestimated compared with the first order of the bio-diffusion model. The reason may be an inaccurate fit of a decreasing exponential used to extend the RTD towards the infinite. It should be noted that the authors proposed to implement the hydrodynamic model using a kinetic biofilm model but did not demonstrate its applicability. To determine the range of validity of their models, Muslu (1990) performed some experiments using a data collected by Lamb and Owen (1970). In particular, the predicted and measured reactant removal efficiency, defined using the measured inlet and outlet COD concentrations, were compared to flow rate values. Good agreement was found between the experimental data and model results, with a determination coefficient equal to 0.98. Baquerizo et al. (2005) performed a sensitivity analysis of the model parameters and a model validation that compared the model results and experimental data referring only to the ammonia concentration along the reactor height. They only reported graphs to describe the gas concentration profiles along the biofilter bed for a low and a high ammonia inlet concentration, without giving a correlation index. Iliuta and Larachi (2005) performed a parameter estimation and model validation using experimental data, but they did not estimate the dispersion number because the extent of back-mixing in the liquid phase was quantified by a comprehensive Bodenstein number correlation (Piché et al. 2002). Additionally, the authors found good correspondence between the model results and the experimental data reported in the literature (Wisecaver and Fan 1989; Hirata et al. 1986). This agreement reflects the validity of the model over a wide range of biofilm thicknesses and ascertains the contribution of biological clogging in the hydrodynamic model. In Table 23 are listed all models previously described and are compared the calibration and validation procedures adopted for each.

CHAPTER 6 – LITERATURE REVIEW

Table 23. Model Calibration (C) and Validation (V): AS, FBR, BF, AF estimated parameters

Reactor	C	V	Estimated Parameters	Authors
	-	-	-	Lawrence and McCarty (1980);
	-	-	-	San (1989);
	X	X	Kinetic parameters	Muslu (2000a);
	-	-	-	San (1992);
	-	-	-	
AS	X	X	Dispersion coefficient, kinetic and stoichiometric parameters	Makinia and Wells (2000a,b)
	X	X	Peclet number	Lee et al. (1999a,b)
	X	X	Kinetic parameters (m, Y)	Glover et al. (2006)
	-	-	-	Le Moullec et al. (2010a,b)
FBR	-	-	-	Shieh et al. (1982)
	-	-	-	El-Temtamy et al. (1979a,b)
	X	X	Kinetic parameters, external mass transfer coefficient, dispersion number	Lin (1991)
	-	X	-	Jacob (1996)
	X	-	Number of reactor in series	Fdz-Polanco (1994)
BF/TF	X	X	Kinetic parameters	Muslu (1990)
	X	X	Kinetic and stoichiometric parameters	Baquerizo et al. (2005)
	-	X		Iliuta and Larachi (2005)

6.2 Mathematical modelling of anaerobic plug flow reactor and non-ideal flow reactor

6.2.1 Introduction

Anaerobic biological processes are widely applied for wastewater and organic waste treatment. Pioneering applications, not yet abandoned, were mainly based on low rate reactors using non-attached growth (McCarty and Smith; 1986). More recently, high rate anaerobic reactors using biofilms and bioflocs to increase the mean cell residence time, have been also proposed and successfully applied (Annachhatre, 1996). The growing interest towards anaerobic treatments can be explained considering the advantages of these processes, which can be summarized as: i) positive energy balance due to methane production; ii) no energy spending for aeration; iii) low biomass yield, leading to reduced sludge production; iv) reduced requirement of nutrients, which allows the treatment of many different substrates; v) low maintenance costs and little or no odour problems. Of course the process has also some disadvantages such as the long start-up time, the sensitivity to toxic compounds, the need to control alkalinity conditions and higher investments costs (Tchobanoglous et al. 2003; Gavrilescu 2000). To study the sensitivity of anaerobic processes to various operational conditions and to optimize the design of anaerobic reactors, several performance-prediction models have been proposed, dealing with kinetic expressions that describe the degradation and the production of organic and inorganic substrates inside the reactor. In some cases, these models have been coupled with the hydrodynamic description of the process to take into account the variability existing among the various configurations that certainly affect the overall performances of the treatment (Levin and Gealt 1993; Le Moullec et al. 2008).

6.2.2 Mathematical modelling of UASB Reactors

UASB reactors were developed in the late 1970s in the Netherlands by Lettinga et al. (1980) and are still widely used for wastewater treatment. The process is based on the development of a sludge bed, localized at the bottom of the reactor, formed by the natural self-immobilization of anaerobic bacteria. Above that bed a zone of finely suspended particles called sludge blanket is formed. A clear zone over the sludge blanket constitutes the settling zone. The influent wastewater is distributed at the bottom of the reactor and flows upward (Fig. 37a).

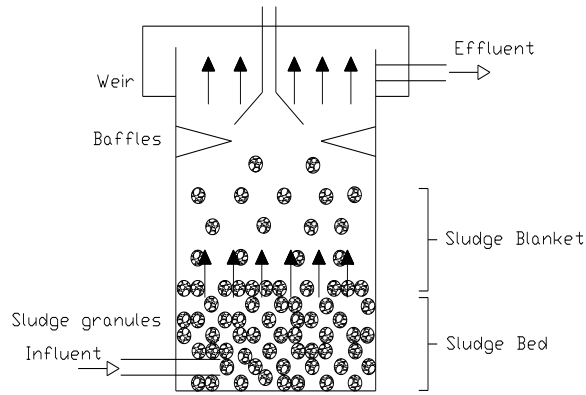

a) UASB reactor

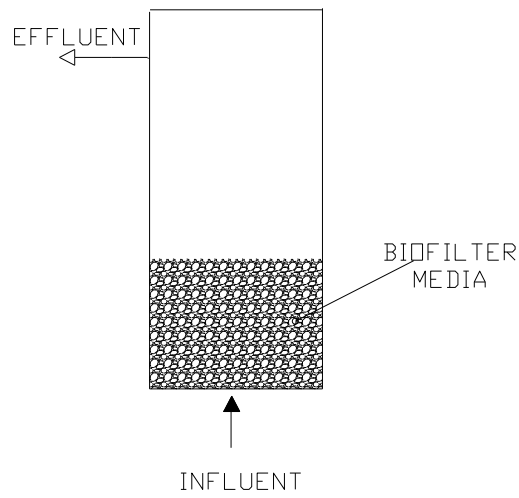

b) Anaerobic biofilter reactor

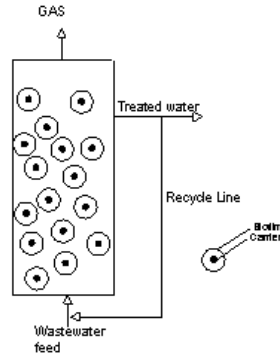

c) Anaerobic Fluidized Bed Reactor

Figure 37. Schematic representation of a) UASB reactor, b) Anaerobic Biofilter, c) Anaerobic Fluidized Bed Reactor

6.2.2.1 Hydrodynamic based models

Mathematical models of UASB reactors generally distinguish the three over mentioned zones and the reactor is described by Tank in Series derived models, usually named multi-compartment models (Van der Meer and Heertjes, 1983; Bolle et al. 1986a,b; Costello et al. 1991a,b; Wu and Hickey, 1997; Narnoli and Indu, 1997).

Both Heertjes et al. (1978, 1982) and Bolle et al. (1986a,b) divided the reactor into three compartments simulating the hydrodynamic conditions in the sludge bed and in the sludge blanket using a CSTR model, and the hydrodynamic conditions in the settling zone using a PFR model. Particularly Heertjes et al. (1978) assumed a by-pass flow between the inlet section and the second reactor, a dead zone in the first reactor, and a return flow between the second and the first reactor (Fig. 38a), obtaining the following equation set:

$$V_1 \frac{dC_1}{dt} = Q_0 C_0 + Q_2 \cdot C_2 - Q_1 \cdot C_1 \quad (51)$$

$$V_2 \frac{dC_2}{dt} = Q_1 C_1 + Q_k \cdot C_0 - Q_2 \cdot C_2 - Q \cdot C_2 \quad (52)$$

with:

CHAPTER 6 – LITERATURE REVIEW

$$Q = Q_k + Q_0 \quad (53)$$

$$Q_1 = Q_0 + Q_2 \quad (54)$$

$$V = V_1 + V_2 + V_3 + V_d \quad (55)$$

where:

Q = influent flow [L^3T^{-1}];

Q_k = by-pass flow [L^3T^{-1}];

Q_0 = flow entering the sludge bed [L^3T^{-1}];

Q_1 = flow entering the sludge blanket [L^3T^{-1}];

Q_2 = return flow [L^3T^{-1}];

V_1 = ideally mixed region in the sludge bed volume [L^3];

V_d = dead space volume [L^3];

V_2 = sludge blanket volume [L^3];

V_3 = plug-flow region volume [L^3];

C_1 = substrate concentration in the sludge bed [ML^{-3}];

C_2 = substrate concentration in the sludge blanket [ML^{-3}].

Bolle et al. (1986 a, b) introduced two main variations to the configuration assumed by the multi-compartment model proposed by Heertjes et al. (1978). He neglected the return flow between the first and the second reactor, and added a by-pass between the inlet section and the third reactor (Fig. 38b).

The resulting equation set obtained by Bolle et al. (1986a) is therefore:

$$V_1 \frac{dC_1}{dt} = (1 - SF_1) \cdot Q \cdot C_0 - (1 - SF_1) \cdot Q \cdot C_1 \quad (56)$$

$$V_2 \frac{dC_2}{dt} = (1 - SF_1) \cdot Q \cdot C_1 - (SF_1 - SF_2) \cdot Q \cdot C_0 - (1 - SF_2) \cdot Q \cdot C_2 \quad (57)$$

where:

SF_1 = fraction of flow by-passing the sludge bed;

SF_2 = fraction of flow by-passing the sludge blanket.



a. Block diagram proposed by Heertjes et al. 1978a, b. b. Block diagram proposed by Bolle et al.1986a,b

Figure 38. Block diagram proposed by Heertjes et al. (1978 a,b) and Bolle et al. (1986a,b).

Ojha and Singh (2002) completed the previous models by developing and testing a theory based on the flow resistance. They found that increasing the flow resistance in the reactor increases the magnitude of short-circuiting flows in the sludge bed. Successively, assuming the same schematization proposed by the previous authors, Singh et al. (2006) calculated the by-pass flow and the dead-zone in steady-state conditions, using the following mass-balance equation:

$$\frac{C_e}{C_i} = \left[1 - r_e e^{-(r_e Q_i / f_e (V_r + V_d)) t} \right] \quad (58)$$

where:

C_e = the exit concentration [ML⁻³];

r_e = the effective fraction of flow expressed as $r_e = 1 - (Q_b / Q_i)$;

Q_b = the by-pass flow [L³T⁻¹];

Q_i = the influent flow [L³T⁻¹];

f_e = the active space for flow expressed as $f_e = (I - V_d) / (V_d + V_r)$.

Wu and Hickey (1997), instead, modeled the sludge bed and the sludge blanket as a CSTR with a dead volume, and the settling zone as a PFR with lateral dispersion (Fig. 39a), developing the following equations:

$$V \frac{dC}{dt} = V \cdot C_0(t) - Q \cdot C(t) \quad (59)$$

CHAPTER 6 – LITERATURE REVIEW

$$\frac{\partial C}{\partial t} = \frac{D}{L} \frac{\partial^2 C}{\partial z^2} - \frac{u}{L} \frac{\partial C}{\partial z} \quad (60)$$

where:

V = CSTR working volume [L^3];

$C_0(t)$ = influent concentration [ML^{-3}];

Q = flow entering the working volume [L^3T^{-1}];

z = axial coordinate [L];

u = flow velocity within the PFR [LT^{-1}];

L = reactor length [L].

Assumed initial and boundary conditions were:

$$C(0,t) = C(t) \quad (61.a)$$

$$C(z,0) = C_0 \quad (61.b)$$

To avoid the need to evaluate too many parameters, Singhal et al. (1998) developed a simpler block diagram to simulate the reactor, composed by two reactors in series, each characterized by an axial dispersion (D_1, D_2), assuming that part of the liquid flow by-passes the first zone and enters directly into the second one (Fig. 39b). The authors applied the following dispersion equation in dimensionless form to both model's compartments.

$$\frac{\partial G}{\partial \theta} = \frac{\partial^2 G}{\partial \eta^2} \frac{1}{Pe} - \frac{\partial G}{\partial \eta} \quad (62)$$

where:

$q = t/t$, dimensionless time;

$h = z/L$, dimensionless axial coordinate;

Pe = Peclet number;

$G = C/C_0$, dimensionless concentration.

CHAPTER 6 – LITERATURE REVIEW

Assumed initial condition for the first reactor was:

$$C = 0 \text{ for } h > 0 \quad (62)$$

For the first zone of the model the equation (62) was solved analytically following the procedure proposed by Smith (1981). The response of the second zone was evaluated by using the Crank-Nicholson method and applying the following boundary conditions:

$$-\frac{1}{Pe} \left(\frac{\partial C}{\partial \eta} \right)_{\eta=0} + (C)_{\eta=0} = \frac{S + QC_1(\theta)}{(S + Q)} \quad \eta = 0, \theta \geq 0 \quad (63.a)$$

$$\left(\frac{\partial C}{\partial \eta} \right)_{\eta=1} = 0 \quad \eta = 1, \theta \geq 0 \quad (63.b)$$

The model proposed by Wu and Hickey (1997) was later reconsidered by Zeng et al. (2005). The authors added to the previous equations the following expression of the dispersion coefficient, obtained from a non reactive tracer test:

$$D = D_0 + u^a + b^u \quad (64)$$

where:

a, b and D_0 = empirical parameters;

u = flow velocity [LT^{-1}].

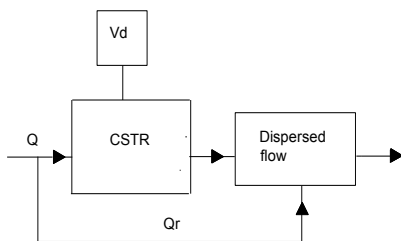

a) Wu and Hickey (1997)

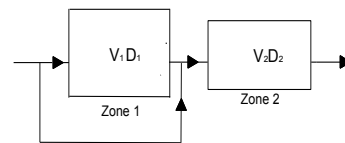

b) Singhal et al. (1998)

Figure 39. Block diagrams of UASB reactor proposed by Wu and Hickey (1997), b) Singhal et al. (1998).

6.2.2.2 Models coupling hydrodynamic with anaerobic digestion conversions

In the literature there are also several attempts to model these reactors considering both the hydraulic and biochemical behavior. One attempt was done by Batstone et al. (2005) and Mu et al. (2008), who introduced reaction terms into dispersion equation using the biochemical model ADM1 proposed by Anaerobic digestion I.W.A. working group (Batstone et al. 2002). Similarly Kalyuzhnyi et al. (1997, 1998) introduced the following equation to simulate the biochemical process, that was solved under steady-state conditions, using the Danckwert boundary conditions:

$$\frac{\partial C(z,t)}{\partial t} = \frac{\partial}{\partial z} \left[D(z,t) \cdot \frac{\partial C(z,t)}{\partial z} \right] - \frac{\partial}{\partial z} [u(z,t) \cdot C(z,t)] + r(z,t) - M(z,t) \quad (65)$$

where:

$r(z,t)$ = reaction term;

$M(z,t)$ = gas transfer coefficient.

Later the authors developed a more complete model combining the granular sludge dynamics, the solid-liquid-gas interactions, hydrodynamics with the biological conversions and the liquid phase equilibrium chemistry (Kalyuzhnyi et al., 2006). They introduced the following expression for the vertical velocity of sludge aggregates:

$$u(z,t) = \frac{V_R}{T \cdot C_S} - W_S \quad (66)$$

where:

V_R = the reactor liquid volume [L^3];

T = the retention time [T];

C_S = the reactor cross section [L];

W_S = the settling velocity for sludge solids [LT^{-1}].

They also used the dispersion coefficient expression for sludge aggregates, developed by Narnoli and Indu (1997):

$$D(z,t) = A_2 \cdot \left[q(z,t) \cdot \left(1 - \exp\left(\frac{-A_3}{q(z,t)} \right) \right) \right]^2 \quad (67)$$

where:

A_2, A_3 = empirical parameters [ad.];

$q(z, t)$ = surface gas production [L^3T^{-1}].

The resulting equation system was solved under unsteady-state conditions. Danckwert boundary conditions were used only for the soluble substrates while, for the biomass, the authors took into account the wash-out in the last compartment, assumed to be equal to the upward liquid velocity:

$$u(0) \cdot X_i(0, t) = D(0, t) \frac{dX_i(0, t)}{dz} \quad z = 0 \quad (68.a)$$

$$u(H) \cdot X_i(H, t) = D(H, t) \frac{dX_i(H, t)}{dz} \quad z = H \quad (68.b)$$

where:

$X_i(0, t)$ = biomass concentration at reactor inlet [ML^{-3}];

$X_i(H, t)$ = biomass concentration at reactor outlet [ML^{-3}].

Batstone et al. (2005) and Penã et al. (2006) used only one advective-diffusive equation to describe the entire reactor. Particularly the model proposed by Batstone et al. (2005) combines the internal recycle proposed by Bolle et al. (1986a,b) with the internal bypass proposed by Singhal et al. (1998). The authors considered the internal flow bidirectional, assuming either a recycle flow from the beginning of the second half of the reactor length to the influent section, or a by-pass from the influent section to the second half of the reactor length. Finally, Ren et al. (2009) developed the first 3-D transient CFD model to elucidate the hydrodynamics of the three-phase (gas-liquid-solid) UASB reactor. In the CFD simulation, a multiphase control volume, composed of one continuous (wastewater) and two dispersed (gas bubbles and microbial granules) phases, were analysed with the Eulerian-model (Diez et al. 2007).

6.2.2.3 Models comparisons

The models proposed by Van der Meer and Heertjes, 1983, Bolle et al. 1986a, b, Costello et al. 1991a, b, Ojha and Singh (2002) and Singh (2005) are CSTR in series models and present a lot of assumptions but are simple to apply; the results can present a big degree of uncertainty. More complete models taking into account the dispersion related to reactor configuration are the ones proposed by Wu and Hickey (1997), Singhal (1998) and Zang et al. (2005). But the best models are those proposed by Kalyuzhnyi et al. (2006), Batstone et al. (2005), Mu et al. (2008) and Penã et al.

(2006), who considered biochemical reactions and dispersion flow integrating in dispersion model also ADM1 model. Finally it is also useful to apply CFD models that are more complex than the previous models but describe the hydrodynamic phenomena more in detail, considering the local process that happens in the reactor, one attempt was done by Ren et al. (2009).

6.2.3. Mathematical modelling of Anaerobic Biofilters

ABFs are anaerobic packed-bed reactors, characterized by the formation of a biofilm responsible for the development of the anaerobic degradation of the influent substrate (Fig. 37 b). The influent flow can travel along the reactor both in the upflow mode (UAF configuration) or in the downflow mode (DAF configuration), although the first configuration is most widely applied (Fig. 37 b). The advantages of ABFs are the operational simplicity, elimination of mixing devices, better capability to withstand large toxic shock loads and the absence of a secondary clarifier. The major disadvantages are related to the cost of the packing material and to the possibility of packing clogging caused by the solids and biomass accumulation in the packing media (Gavrilescu, 2000; Rajeshwari et al., 2000).

To define the hydraulic behavior of ABFs it is important to take into account: i) the nature of the anaerobic processes occurring within the reactor; ii) the production of biogas and iii) the accumulation of biological solids.

One of the earliest attempts to model hydraulic behavior of such reactors was done by Young and McCarty (1968) who proposed one of the first models for ABFs, based on reactors in series. They developed a model of the process based on the premises of an ideal plug flow condition, making some adjustments to take into account the effect of solids accumulation, the consequence of mixing due to gas production and the existence of a diffusion gradient between the bulk liquid and the biological solids surfaces. Young and Young (1988) proposed a new model as a combination of ideal systems, composed by: a first CSTR, representing the inlet zone; an ideal plug-flow reactor with a dead zone, representing the central part of the reactor and a second CSTR representing the outlet zone (Fig. 40a). The dead-space region was introduced to take into account the physical configuration of the vessel, the formation of stagnant eddies near the discontinuities such as corners, baffles and contact points of the packing material, and the formation of stagnant areas adjacent to the surface.

Escudié et al. (2005) modeled the reactor considering two interconnected regions: a completely mixed one representing the mixed liquid and a dead zone representing the biofilm (Fig. 40b). The resulting mass balances were:

CHAPTER 6 – LITERATURE REVIEW

$$V_1 C_1 = (Q_1 \cdot C_{in} + Q_2 \cdot C_2) - (Q_1 \cdot C_1 + Q_2 \cdot C_1) \quad (69)$$

$$V_2 C_2 = (Q_2 \cdot C_1 - Q_2 \cdot C_2) \quad (70)$$

where:

V_1 = ideal Continuous Stirred Tank Reactor (“CSTR₁”), which represents the easily mixed liquid in the reactor [L^3]; V_2 = ideal Continuous Stirred Tank Reactor (“CSTR₂”), which represents the biofilm zone [L^3]; C_2 = the tracer concentration within the biofilm [ML^{-3}]; C_1 = the tracer concentration within the CSTR₁ [ML^{-3}]; C_{in} = inlet tracer concentration [ML^{-3}]; Q_1 = inlet liquid flow rate [L^3T^{-1}]; Q_2 = liquid flow rate between the two theoretical CSTRs [L^3T^{-1}].

Assuming:

$$C_1(0) = \frac{M}{V} \quad (71)$$

$$C_2(0) = 0 \quad (72)$$

A different configuration, composed by a CSTR with a dead zone, followed by a plug flow reactor, and including a by-pass of the first reactor (Fig. 40c) was proposed by Smith et al. (1996). The authors assumed that the flow through the mixed zone and the plug flow zones was sequential and localized in correspondence of the biofilter bed, while the dead zone (V_d) was assumed to be parallel to the mixed zone with a transfer flow between them, characterized by a transfer rate proportional to the difference in concentration between the two zones.

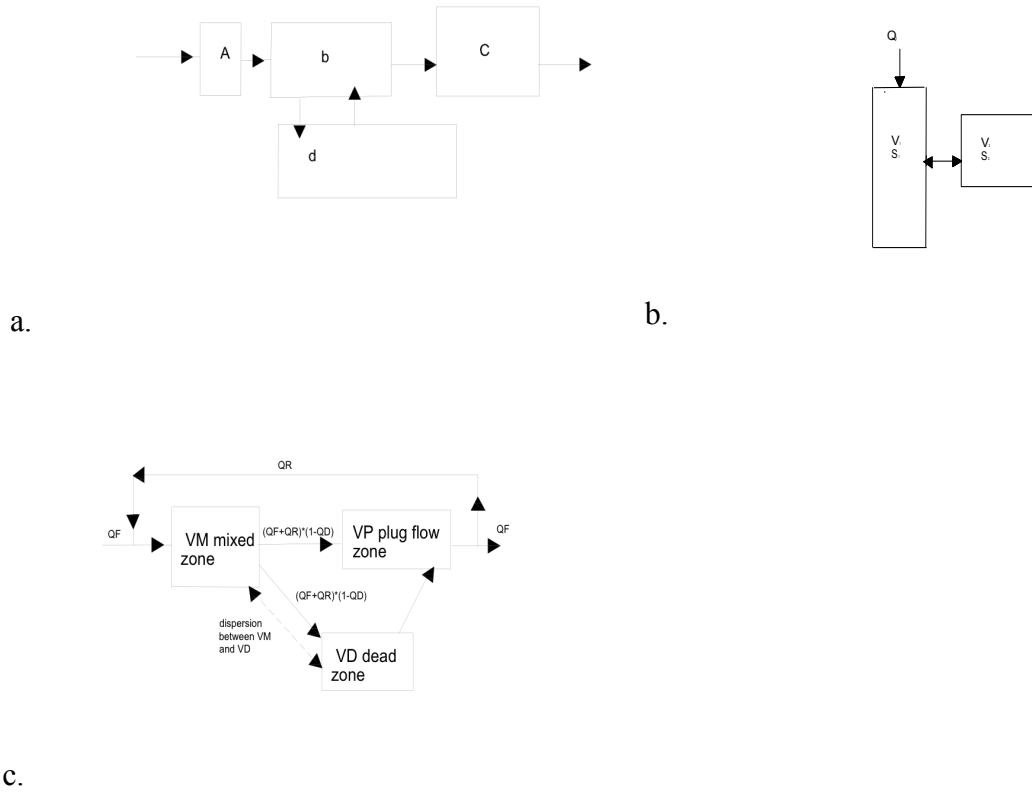

Figure 40. Modelling schemes of anaerobic biofilters proposed by a)Young and Young (1988), b) Escudié et al. (2005) and c) Smith et al. (1996).

Finally Huang and Jih (1997) coupled a dispersion model with a deep-biofilm kinetic neglecting the radial dispersion and the substrate removed by dispersed cells. They obtained the following equation:

$$\varepsilon \frac{\partial S}{\partial t} + u \frac{\partial S}{\partial Y} = D \left(\frac{\partial^2 S}{\partial Y^2} \right) - aJ \quad (73)$$

where:

S = the substrate concentration in the bulk liquid [ML^{-3}];

Y = the spatial distance [L];

a = the specific biofilm surface area [L];

ε = the fraction of reactor volume;

J = the substrate flux at biofilm surface [$\text{ML}^{-2}\text{T}^{-1}$], assumed equal to:

$$J = \beta \frac{\partial S}{\partial t} \quad (74)$$

where:

β = partition coefficient.

Equation (74) was solved considering steady-state conditions and applying the Dirichlet boundary conditions. The authors additionally manipulated the equation normalizing it with reactor height and obtaining the following expression:

$$\theta \frac{\partial S}{\partial t} + \frac{\partial S}{\partial Y^*} = \frac{1}{Pe} \left(\frac{\partial^2 S}{\partial Y^{*2}} \right) \quad (75)$$

where:

$$Y^* = \frac{Y}{H};$$

$$\theta = \frac{H(\varepsilon + \beta \cdot \varepsilon)}{u} = \text{estimated HRT} .$$

6.2.3.2 Models comparisons

The models proposed by Young and McCarty (1968), Young and Young (1988) are CSTR in series models old, simple to apply and the results can present a big degree of uncertainty. More complete models taking into account the dispersion related to reactor configuration are the ones proposed by Escudié et al. (2005), Huang and Jih (1997) and Smith (1996), who introduced a more complete model considering also the effect of biofilm growth.

6.2.4 Mathematical modeling of Anaerobic Biological Fluidized Bed Reactors

An AFBR is a vertical bed of inert particles (sand, pumice, activated coal) that serve as carrier material for the biofilm development. The liquid to be treated is pumped through the bed at a sufficient velocity to cause fluidization (Fig. 37c). In the fluidized state the carrier material provide a large specific surface for attached biomass growth. This feature permits to attain a long solids residence time for the development of the biological reactions and a low concentration of suspended solids. Mathematical reactor models for AFBRs have been developed as CSTR (Worden and Donaldson 1987) or PFR (Bonnet et al. 1997). Models for AFBRs generally consist of three parts

CHAPTER 6 – LITERATURE REVIEW

(Saravanan and Sreekrishnan, 2006): i) a bed fluidization model which describes the effect and the feature of inert particles; ii) a biofilm model which describes the rate of substrate conversion per individual granule and iii) a reactor flow model, which links the biofilm and the bed fluidization models to yield the substrate concentration as a function of the axial position within the AFBR.

Many investigations suggested also that an axial dispersed plug flow model can be successfully used to simulate the hydrodynamic process is occurring in AFBRs (Seok and Komisar 2003; Otton et al. 2000; Buffière et al. 1998 a, b; Schwarz et al. 1996-1997; Diez and Blanco 1995).

Bonnet et al. (1997) assumed that no dispersion occurs in AFBR reactors. The authors extended the PFR model considering un-steady state conditions and taking into account many components involved in the process such as: organic matter, VFA, methane, carbon dioxide, acidogenic and methanogenic bacteria. The dynamic model was developed considering the liquid and solid phase separately to compute the mass balance for all the process components and the momentum equation to link the solid and the liquid velocities. The authors used the model to study the effect of different parameters, including hydraulic and biological variables.

Buffière et al. (1998a, b) stated that the liquid mixing is well represented by an axially dispersed PFR model. Studying the effect of gas production on the hydrodynamic behavior of an AFBR, the authors demonstrated that this production is able to modify the axial mixing degree, which is responsible for the establishment of a concentration gradient in the reactor. In contrast Diez and Blanco (1995) stated that it is possible to study the AFBR as a solid-liquid fluidized bed neglecting the effect of biogas on the hydrodynamic behavior. The authors also described the important role of the biofilm growth on the hydrodynamic behavior showing that the biofilm produces significant effects on the relationship between the up-flow velocity and the bed expansion.

Turan and Ozturk (1996) studied the effect of the anaerobic biomass concentration on the hydraulic retention time and the dispersion coefficient. The authors applied the axial dispersion equation and defined the values of the Peclet number using the equation proposed by Van der Laan et al. (1957):

$$\sigma^2(\theta) = 2Pe^{-1} - 2Pe^{-2}[1 - \exp(-Pe)] \quad (76)$$

where:

$\sigma^2(\theta)$ = the variance of the theoretical response curve for closed reactor.

Similarly, Seok and Komisar (2003) developed an axial-dispersion model to simulate the behaviour of AFBRs, neglecting the effect of the gas formation on the hydrodynamic behaviour. They applied their model to quasi-steady state conditions, considering no external mass transfer resistance due to good

local mixing and small external boundary layers (Buffière et al. 1998c; Schwarz et al. 1996), obtaining the following mass balance equation:

$$\frac{\partial C_i(z,t)}{\partial t} = -\frac{u}{\varepsilon} \frac{\partial C_i(z,t)}{\partial z} + D \frac{\partial^2 C_i(z,t)}{\partial z^2} + \Pi_i(z,t) + M_{w,i} C_i(z,t) \quad (77)$$

$$\frac{\partial C_j(z,t)}{\partial t} = -\frac{u}{\varepsilon} \frac{\partial C_j(z,t)}{\partial z} + D \frac{\partial^2 C_j(z,t)}{\partial z^2} + \Pi_j(z,t) + r_{w,j}(z,t) + T_j(z,t) \quad (78)$$

where:

C_i = concentration of the suspended microbial species i in the bulk liquid [ML^{-3}];

C_j = concentration of substrate j in the bulk liquid [ML^{-3}];

u = superficial liquid velocity [LT^{-1}];

ε = bed porosity;

D = axial dispersion coefficient [L^2T^{-1}];

Π_j = exchange rate of microbial species i between bulk liquid and bio-particle [$\text{ML}^{-3}\text{T}^{-1}$];

$M_{w,i}$ = net growth rate of microbial species i in the bulk liquid [T^{-1}];

Π_j = transport rate of substrate j from the bulk liquid into the biofilm [$\text{ML}^{-3}\text{T}^{-1}$];

$r_{w,j}$ = net formation rate of substrate j in the bulk liquid [$\text{ML}^{-3}\text{T}^{-1}$].

The authors rearranged equations (77-78) introducing moving boundaries conditions and a system of normalized time-dependent spatial coordinates to simulate the bed expansion, the segregation along the reactor height and the microbial population distribution both along the reactor height and inside the biofilm. They paid particular attention to the bio-particle segregation phenomena associated with the biofilm exchange processes observed in the experimental study, but they partly neglected the theoretical interpretation of the hydrodynamics.

6.2.4.1 Models comparisons

The model proposed by Bonnet et al. (1997) is plug-flow model, simple to apply but the results can present a big degree of uncertainty. More complete models taking into account the dispersion related to reactor configuration are the ones proposed by Seok and Komisar (2003), Otton et al. (2000), Buffière et al. (1998 a, b), Schwarz et al. (1996-1997) and Diez and Blanco (1995). More complete models are the ones where also the gas production is taken into account, such as the models proposed by Buffière et al. (1998a, b).

6.2.5. Mathematical modeling of wet and dry digesters treating bio-solids

The term digester is usually referred as anaerobic reactors used for the treatment of OFMSW or sewage sludge. The process is termed low-solids, or wet, whenever the TS in the feed below 10%, and high-solids, or dry, whenever the TS is higher than 20%. Wet processes take place in closed reactors equipped with mixing systems aimed at minimizing the in-homogeneities in the treated fluid. Nonetheless RTD studies carried out on full-scale digesters have shown that actively mixed volumes are generally as low as 23% of the total volume Monteith and Stephenson (1981), and therefore, together with traditional models assuming CSTR conditions, different approaches able to take into account the effect of non-ideal mixing conditions have also been proposed. Dry processes, instead, take place in different reactors working in batch or continuous conditions. They have been rarely modelled in terms of hydrodynamic conditions. One attempt was done by Zaher and Chen (2006) who built mathematical models for industrial scale plug flow reactors (Dranco, Kompogas and Valorga designs). The authors used both ADM1 and Aquasim[®] software (Reichert, 1998) as a simulation platform. All different designs were modelled imposing CSTR in series configuration and introducing bifurcations to take into account recycling effects. One of the earliest attempts to model non-ideal mixing conditions of wet digesters was done by Smith et al. (1993). The authors proposed the same approach used to model the ABFs, considering three zones: a small initial mixed zone, a large main mixed zone and a dead zone. A dispersion coefficient was also used to describe the cross boundary movement of the substrate from the mixed zones into the dead zone. Mendoza and Sharratt (1999) proposed a compartment model with a confined-gas mixing (Fig. 41). The authors assumed that the circulation around the uptake tube can be represented by an ideally mixed compartment. Moreover they assumed that the fluid circulation, down the tank and back to the draft tube inlet, can be represented by a number of equally sized tanks-in-series (Fig. 41). The mass balances resulted in the following set of linear first-order ordinary differential equations:

$$\frac{dC_m}{dt} = \left(\frac{C_{1,1} - C_m}{\alpha_r} \right) + \frac{C_b - C_m}{\alpha_c} \quad (79)$$

$$\frac{dC_{1,1}}{dt} = \frac{N(C_0 - C_{1,1})}{(1-\alpha)t_r} + \frac{N(C_m - C_{1,1})}{2(1-\alpha)t_c} \quad (80)$$

$$\frac{dC_{1,3}}{dt} = \frac{N(C_{1,1} - C_{1,2})}{2(1-\alpha)t_c} \quad (81)$$

CHAPTER 6 – LITERATURE REVIEW

$$\frac{dC_b}{dt} = \frac{N(C_{1,3} - C_b)}{2(1-\alpha)t_r} + \frac{N(C_{2,3} - C_b)}{2(1-\alpha)t_c} \quad (82)$$

where:

C = non-reactive substrate concentration [ML³];

m = index of components inside mixed volume V_m ;

b = index of components inside mixed volume V_b ;

$1, 2, 3$ = index of components inside mixed volumes V_1, V_2, V_3 respectively;

t_r = the mean retention time in the vessel [T];

t_c = the circulation time [T];

N = the number of reactors in series;

α = the ratio of ideally mixed volume to the total liquid volume.

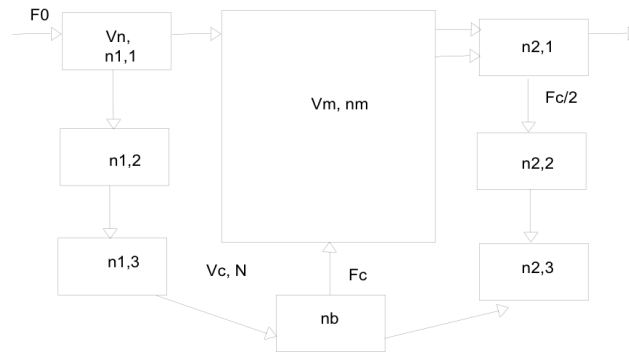

Figure 41. Flow reactor scheme of anaerobic digester proposed by Mendoza and Sharratt (1999), where m = index of components inside mixed volume V_m , n = the number of reactors in series, Q = flow-rate.

Another simple two region model was proposed by Mendoza and Sharratt (1998) (Fig.42). This model assumes that the whole volume can be divided into two sections, called, respectively, flow-through region and retention region. Both regions are assumed to be perfectly mixed but the transfer of material between them is limited, as the retention region behaves like a stagnant zone. Different levels of mixing are accomplished by adjusting the relative volume of the flow-through region and the exchange rate between regions expressed as the turnover time of material in the vessel. The mass

CHAPTER 6 – LITERATURE REVIEW

balance for a generic component j (Fig. 42) yields to a set of ordinary differential equations which can be summarized:

$$\frac{dC_{1,j}}{dt} = \frac{C_{0,j} - C_{1,j}}{\alpha\tau} + \frac{C_{2,j} - C_{1,j}}{\alpha\theta} \pm R(C_{1,j}) \quad (83)$$

$$\frac{dC_{2,j}}{dt} = \frac{C_{2,j} - C_{1,j}}{(1-\alpha)\theta} \pm R(C_{1,j}) \quad (84)$$

where:

j = index of different components involved in mass balance: degradable portion of viable activated sludge microorganism, particulate solids requiring hydrolysis, soluble substrates for acid formers, degradable portion of acidogenic biomass, VFA for methanogens, methanogenic biomass, methane;

$t = V/Q_{\text{exch}}$, is the turnover time [T];

Q_{exch} = flow exchange between zones [L^3T^{-1}];

α = ratio of the volume in flow-through region to the total reactor volume [ad.];

$(1-\alpha)$ = relative volume of the retention region [ad.].

In the set of the presented equations, equation (83) with odd numbers, applies to the flow-through zone whereas equation (84), with even numbers, applies to the retention zone.

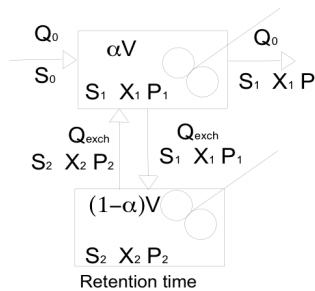

Figure 42. Reactor flow model of anaerobic digesters proposed by Mendoza and Sharratt (1998), where the subscript: 1= flow-through region; 2 = retention region; exch = exchange between zones; α = ratio of the volume in flow-through region to the total reactor volume; S_1 , S_2 = soluble substrate COD concentration; P_1 , P_2 = degradable particulate COD concentration; X_1 , X_2 = biomass concentration.

Later, Keshtkar et al. (2003) proposed the same mathematical model as Mendoza and Sharratt (1998) combining the two-region mixing model with a proper structured kinetic model.

CHAPTER 6 – LITERATURE REVIEW

Vavilin et al. (2001, 2003) introduced a system of parabolic partial differential equations in a 2D reactor imposing cylindrical symmetry. The proposed system describes the VFA and methanogenic biomass concentration profiles along the reactor height at different times. More in detail, the authors tried to simulate anaerobic reactor which treat solid waste by applying distributed model that includes diffusion and advection of VFA and methanogenic biomass.

Vesvikar and Al-Dahhan (2005) carried out 3-D steady-state Computational Fluid Dynamics (CFD) simulations of anaerobic digesters to visualize the flow patterns, obtaining the hydrodynamic parameters of the reactors. Another attempt to develop a mathematical model with CFD simulations was done by Wu and Chen (2008) who conducted a numerical simulation of the flow field to qualitatively and quantitatively characterize the mixing and dead zones. The CFD model developed was based on continuity and momentum equations and on the standard semi-empirical turbulence model proposed by Launder and Spalding (1974).

Terashima et al. (2009) proposed a homogeneous single-phase, laminar flow CFD model and selected a momentum equation for simulating the flow patterns in the digester. The authors introduced the following Uniformity Index (UI), using as statistical parameter Relative Mean Deviation (RMD), that characterizes the mixing inside the anaerobic reactor:

$$V = \sum_{i=1}^m V_i \quad (85)$$

$$C = \frac{\sum_{i=1}^m C_i \cdot V_i}{V} \quad (86)$$

$$UI = \frac{\sum_{i=1}^m [C_i - C] \cdot V_i}{V \cdot C} \quad (87)$$

where:

V = the volume of digester [L^3];

V_i = the partial volume for numerical calculation [L^3];

C_i = the local tracer substrate concentration [ML^{-3}];

C' = the average tracer concentration in the digester [ML^{-3}].

6.2.5.1 Models comparisons

The model proposed by Monteith and Stephenson (1981), Mendoza and Sharratt (1998, 1999), Smith et al. (1993) and Keshtkar et al. (2003) are CSTR in series models, simple to apply but the results can present a big degree of uncertainty. More complete models taking into account the dispersion related to reactor configuration are the ones proposed by Vavilin et al. (2001, 2003). Finally it is also useful to apply CFD models that are more complex than the previous models but describe the hydrodynamic phenomena more in detail, considering the local process that happens in the reactor, these attempts were done by Terashima et al. (2009), Wu and Chen (2008) and Vesvikar and Al-Dahhan (2005).

6.2.6. Model comparisons and validation and calibration

6.2.6.1 Models comparisons

The models presented above for UASB, fluidized bed reactor, biofilter reactor and anaerobic digester treating bio-solids have different advantages and disadvantages. Furthermore there are some models which can be useful in some situation and not in others.

6.2.6.2 UASB reactor model validation and calibration

Tracer experiments (performed with non reactive substrate) were carried out to validate the multi-compartment models proposed for UASB reactors (Ojha and Singh, 2002; Bolle et al. 1986a,b; Wu and Hickey, 1997). Some of them were used to calibrate the model's parameters. Ojha and Singh (2002) estimated each of the hydraulic parameters of the models proposed by Bolle et al. (1986a,b) and Wu and Hickey (1997), obtaining always good values of the determination coefficient, defined as:

$$R^2 = \sqrt{\frac{\sum_{i=1}^n (x_i - \bar{x})^2}{n}}$$

Batstone et al. (2005) compared the multi-compartment models with the axial-dispersion model and obtained the best fitting between the experimental data of tracer tests operated at laboratory scale and the model's results in case of a multi-compartment model with eight tanks. The authors also, used lab-scale experimental data to calibrate their model, estimating the dispersion number as well as the

CHAPTER 6 – LITERATURE REVIEW

governing biochemical kinetic parameters such as the maximum uptake rate and the half-saturation concentration.

The CSTR model proposed by Singh et al. (2006) was tested at different temperatures, fixing the HRT = 10 hours. Data fitting resulted to be satisfying for temperature values higher than 22°C, with a determination coefficient varying between 0.98 and 0.94, supporting the assumption that a complete mix flow pattern exists inside the reactor at elevated temperatures. At lower temperatures, instead, the model was proven to be inadequate to describe the data sets, probably because of the reduced biogas production.

Because of the important role of biogas production on the reactor hydrodynamic behavior Wu and Hickey (1997) carried out a calibration of their model at bench scale, varying the gas production rate. Lately Singhal et al. (1998) demonstrated that a simple two-compartment axial-dispersion model was adequate to explain the fluid flow characteristics without sacrificing the accuracy of the predictions. They found a good fitting between the model predictions and the response of an UASB reactor to an impulsive input of a non-reactive tracer. Zeng et al. (2005) developed a parameter estimation procedure to yield acceptable agreement between measured and calculated tracer trajectories and obtained a correlation between the dispersion number and the up-flow velocity for different reactor heights. Wu and Hickey (1997) observed the responses of an UASB reactor to an influent step increase, predicting the working volume, the dead volume and the plug-flow reactor volume which resulted in a close agreement with the total reactor volume. The authors performed also a sensitivity analysis on the major factors influencing the reactor performances and found that the distribution of the tracer within the reactor was largely dependent on diffusion processes. Kalyuzhnyi et al. (1997,1998) made a comparison between the experimental data of Alphenaar et al. (1993) and the model predictions, obtaining a determination coefficient >0.99 . The authors demonstrated that the dispersed plug-flow model was able to describe adequately a sufficiently big pool of experimental data but revealed also the same deficiencies in its conceptual structure. In particular they showed that the model overestimates the effluent substrate concentration and the amount of volatile suspended solids in the reactor. Lately Kalyuzhnyi et al. (2006) compared model's predictions and experimental data recorded by Yan et al. (1989, 1993). Although they did not report the obtained values of the determination coefficient or any other statistical index, it is possible from represented the diagrams to appreciate a close trend between the experimental data and the simulated ones, especially in terms of COD reduction.

Mu et al. (2008) used the ADM1 as a basis for the development of a comprehensive distributed parameter model, named ADM1d, that used a hyperbolic tangent function to describe the biomass distribution within a one compartment model. The authors made a comparison of ADM1 and ADM1d outputs and showed that ADM1d was better suited for modeling anaerobic reactors with limited mixing and high organic load, such as UASB reactors. The model was also validated by Tartakovsky et al. (2008), using the experimental results obtained at laboratory scale. They found that ADM1d gives a good description of biogas flow rates, methane concentration, COD effluent concentrations and VFA under different organic loads and recirculation rates. Additionally the authors demonstrated that the model was able to simulate COD and VFA gradients along the reactor height. Batstone et al. (2005) performed also tracer tests at full scale and demonstrated that the best fitting of experimental tracer tests was achieved with the two-CSTR model. Penã et al. (2006) and Penã (2002) demonstrated that the ideal flow pattern occurs only when the operational conditions are close to the design scenario, with a particular reference to the HRT design value. They showed that when the reactor is under-loaded, there is a hydrodynamically dispersed flow pattern with the coexistence of a well-mixed fraction, stagnant zones and short-circuiting flows. The authors obtained a correlation between the dispersion number, the effluent concentrations of COD and the effluent concentration of total suspended solids revealing that the optimal hydrodynamic condition occurs somewhere in between the two ideal flow extremes (i.e., plug flow and complete mixing). Ren et al. (2009) performed a 3-D unsteady CFD model to visualize the phase holdup and obtained their flow patterns in a UASB reactor. The simulation results further confirmed the discontinuity in the mixing behavior throughout the UASB reactor and the key role of the dispersion coefficient, that decreases along the axis of the reactor. In order to better describe the hydrodynamic behavior of the reactor they successfully introduced the Increasing-sized CSTRs (ISC) model and made a comparison with a CSTR in series model demonstrating that the results of the first one match the measured non-reactive substrate trajectories better than the results of the second one.

6.2.6.3 Anaerobic Biofilters model validation and calibration

Young and Young (1988) performed tracer experiments in order to define the dead space volume and the mixing ratio as a function of Reynolds number for the model proposed to simulate ABFs hydraulic behavior. The authors demonstrated that the plug flow and the dead space increase with the specific

CHAPTER 6 – LITERATURE REVIEW

surface area of the media. Although the authors recognized the interference between the hydrodynamic and the biological process they did not present a complete model to simulate both.

Escudié et al. (2005) validated the proposed model and estimated the following key parameters from a tracer curve analysis: the volume of the first theoretical CSTR, the volume of the dead zone and the value of the exchange flow between the two reactors. The values were obtained by minimizing the difference between the experimental data and the model results.

Smith et al. (1993) carried out hydrodynamic studies to define scale-up strategies, obtaining a correlation between laboratory scale reactor tracer tests and the volume of plug flow and mixed zone of full-scale reactors. Varying the impeller power, the authors defined with tracer tests and computational methods, the values of the dispersion coefficients, the volumes of the dead zone, the initial mixed zone and the large main zone. The authors also investigated through tracer studies the effect of liquid up-flow velocity and biogas production on the degree of reactor mixing. Thus they obtained different values of hydrodynamic parameters with different operating conditions and media types inside the reactor.

Tay et al. (1996) performed tracer tests to define the hydraulic characteristics of ABFs. The study revealed that the behavior of ABF reactors reflects more closely a plug-flow system with a certain degree of dispersion: this is clearly shown by the obtained values of the dispersion number, ranging from 0.0022 to 0.0045 for an HRT varying from 24 h to 6 h. Additionally the study demonstrated that the hydrodynamics and the extent of mixing can regulate the mass transfer and can have an important influence on the degree of contacts between the substrate and the bacteria, therefore affecting the whole ABF efficiency. In a second study, Tay and Show (1998) performed tracer tests considering dirty-bed and clean-bed conditions. They observed with clean bed conditions hydraulic flow patterns closer to a plug-flow system with a relatively large amount of dispersion, while in the case of dirty-bed conditions the flow pattern was found to be more similar to completely mixed flow conditions with high value of the dead-space (from 43-51%).

Huang and Jih (1997) made tracer experiments with a laboratory scale reactor to study the diffusion inside the reactor and thus defining the value of the Peclet number. Estimated values ranged from 0.01 to 1.5, reflecting that back-mixing occurs in biofilters due to the rising bubbles of biogas. Additionally the authors compared the experimental data and simulation results with reference to COD removal efficiency, obtaining a standard deviation of +/- 5%. The calculated COD removal efficiency using the CSTR model was found to be close to or lower than that using the axial dispersion model. They also

studied the VFA profile along the reactor and claimed that the flow pattern in the liquid phase was completely mixed.

6.2.6.4 Anaerobic Fluidized Bed Reactor model validation and calibration

Buffière et al. (1996) performed tracer experiments on an AFBR at very low gas flow rates and observed that the axially dispersed plug-flow model was not accurate enough to simulate the experimental data. In fact the tracer response curves were characterized by secondary peaks, suggesting the presence of an internal recycle current. The tank in series model led to a better fitting of the experimental data at low gas velocities. However, the model performance was equivalent to the performance of the axially dispersed plug flow model at higher gas velocities. The authors Buffière et al. (1998a,b) correlated the degree of mixing in the bioreactor to the Peclet number, showing that the mixing conditions of the liquid phase have a slight influence on the reactor performances.

Buffière et al. (1998a,b) stated that for modeling purpose of AFBRs it is necessary to know the variations of the Peclet number and of the axial dispersion coefficient. The authors tested several correlations to fit the experimental determination of the dispersion number, and found that the most appropriate one was the expression proposed by Muroyama and Fan (1985), which corresponds to the expression of a modified Peclet number, calculated with the column diameter as space length parameter:

$$\frac{D_c U_1}{\varepsilon \cdot z} = 1.01 U_1^{0.738} U_g^{-0.167} D_c^{-0.583} \quad (88)$$

where:

U_1 = liquid velocities [LT^{-1}];

U_g = gas velocities [LT^{-1}];

D_c = column diameter [L^2];

z = column length [L].

Turan and Ozturk (1996) obtained a correlation between the biological growth concentration and the ratio between Peclet and Reynolds numbers with a determination coefficient equal to 0.569. Assuming clean media, they also obtained a correlation between the HRT, Peclet and Reynolds numbers ratio:

$$t = 26.6 \left(\frac{Pe}{Re} \right)^{0.312} \quad r^2 = 0.54 \quad (89)$$

Otton et al. (2000) performed tracer tests using a simple tubular reactor to calibrate and validate the proposed hydrodynamic model. They quantified the recycling effect as a plug flow with a variable delay and the fluidization effect as an axial dispersion phenomenon. The authors only qualitatively discussed the validation; the presented graphs indicate a satisfactory agreement between all experimental data and the model simulation, but the model could not describe small variations of the operating parameters that occurred inside the reactor.

6.2.6.5 Wet and dry digesters model validation and calibration

Mendoza and Sharratt (1999) carried out tracer experiments at different flow rates to define the number of tanks-in series able to better simulate non-ideal flow in wet digesters. The authors obtained experimental results making tracer tests and demonstrated a good fitting between compartment model results and experimental tests. In the previous work, Mendoza and Sharratt (1998) did not performed any model calibration and validation but made an evaluation of the impact of the mixing parameters and showed that the relative volume of the flow-through region has a more significant effect than the turnover time (θ). The authors demonstrated that the degree of the liquid mixing affects the residence time distribution and the distribution of the components inside the reactor, influencing the kinetic rates of the anaerobic process.

Keshtkar et al. (2003) compared preliminary simulations with sequencing batch experimental runs, measuring methane yield at various organic loading rates for an HRT = 3 days, to determine the most appropriate set of mixing model parameters.

In the context of CFD models, Wu and Chen (2008) operated model's validation by comparing the predicted velocities with the experimental data proposed by Pinho and Whitelaw (1990). Finally, Terashima et al. (2009) made a comparison between experimental and CFD tracer response curve, finding a reasonably good fitting and analyzed the progress of mixing in the digester by defining a new parameter of uniformity index (UI). The developed model could be a usefull tool to define the required time for complete mixing in a full-scale digester at different solid concentrations and different mixing rate. Also Vesvikar and Al-Dahhan (2005) carried out 3D steady-state CFD simulations considering different digester configurations. The authors performed CFD simulation in terms of overall flow pattern, location of circulation cells and stagnant regions, trends of liquid

velocity profiles, and volume of dead zones. The results showed good qualitative comparison with the experimental data in terms of flow pattern, location of dead zones and trends in velocity profile.

6.2.7. Conclusion

Development of high-rate reactors has made anaerobic treatment an attractive option to treat wastewaters and bio-solids. In this chapter, mathematical models to simulate plug flow and dispersed plug flow of four specific anaerobic bioreactor configurations, i.e. Upflow Anaerobic Sludge Blanket Reactors, Anaerobic Fluidized Bed Reactors, Anaerobic Biofilters, wet and dry Digesters are reviewed. This review details the effect of hydrodynamics/flow pattern on the reactor performance. Most models are based on CSTR in series and axial dispersion equations to simulate the hydrodynamics of plug flow reactors. They mainly differ by the numerical techniques and the boundary conditions used to solve the mathematical equations. Model calibration is often aimed at assessing the key hydrodynamic parameters, i.e. the dispersion number or the Peclet number, by operating tracer test. When the model includes both a hydrodynamic module of the reactor and a biochemical module to simulate the biochemical reactions, model calibration is also aimed at assessing the kinetic constants. The research also describes the attempts to validate the proposed models, illustrating the models capability to fit the experimental data. In all reported models reasonably good fitting was found between model results and experimental data.

Most of the models described in this chapter are useful tools for operational optimization of waste and wastewater treatment plants but there are still only few attempts to apply the proposed models for optimum design and scale-up of these bioreactors. This indicates that further research efforts should be focused on such design models to provide a mathematical tool for bioreactor sizing purposes

CHAPTER 7

Discussion and Conclusions

7.1 Discussion and Conclusions

In the present research, the effect of TS content on dry and wet AD of different complex organic substrates was studied. The results indicate that water plays in both conditions an essential role on the specific methane production rate and VS degradation. In terms of final methane production yield, a different behaviour between wet and dry AD conditions was found. In particular in wet AD of carrot waste the same value of the final methane production yield, i.e. 450 mL/gVS with a standard deviation of 14.23 was found. This is not in agreement with the results obtained in both dry and semidry conditions with both rice straw and food waste. In these cases a higher final methane production yield was found with lower TS values. This last finding is in agreement with previous tests performed by Abbassi-Guendouz et al. (2012), Fernández et al. (2008) and Dong et al. (2010).

It is worth mentioning the existence of a linear relationship obtained in the case of carrot waste and food waste between TS content and initial methane production rate (Fig. 43). Such relationship was also observed by Lay et al. (1997b) on AD of selected dry organic waste (e.g. sludge cake, meat, carrot, rice, potato and cabbage), Le Hyaric et al. (2012) on AD of cellulose, Abbassi-Guendouz et al. (2012) on AD of cardboard, Mora-Naranjo et al. (2004) for waste samples excavated from landfill and Pommier et al. (2007) for paper waste. The presented results confirm that the TS content, also in wet AD, has a strong effect on the kinetic rates. At lower TS, due to the increasing water content and better transport and mass transfer conditions, it seems to be plausible that the microorganisms are better sustained with soluble substrates (Mora-Naranjo et al. 2004). This was not confirmed by the tests carried out on rice straw (Fig. 43). This can be due to the different substrate composition and to the complex nature of lignocellulosic compounds and difficult bio-availability of cellulose (Sambusiti, 2013). Further tests have to be done to explain this behaviour in detail. In particular a larger range of TS have to be investigated to understand in detail the correlation between TS content and initial methane production rate.

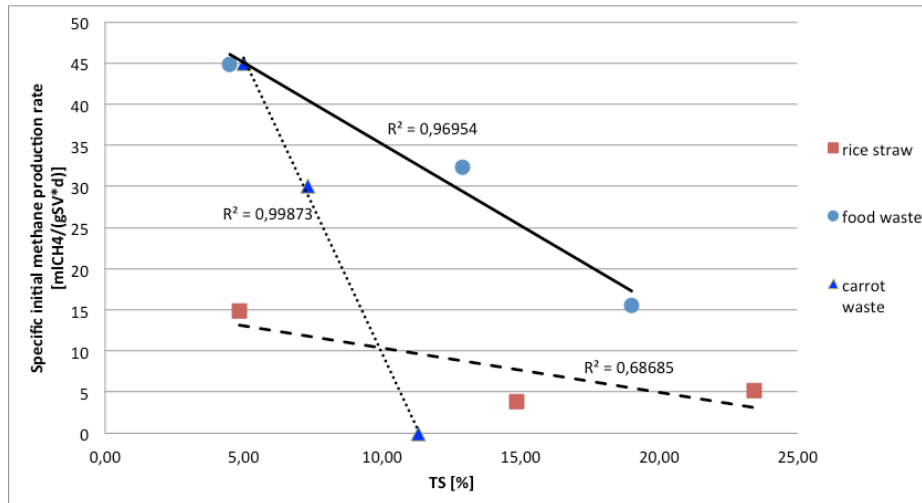

Figure 43. Linear correlation between initial methane production rate and TS for anaerobic digestion of carrot waste, food waste and rice straw.

Inhibition tests were carried out to investigate the specific inhibition processes that take place with complex organic compounds. A different behaviour in terms of VFAs concentration was found. In wet AD of carrot waste no VFAs accumulation was observed, and all the concentrations were lower than the inhibition threshold values, while in dry and semidry digestion acid accumulation was found. This means that inhibition occurs with lack of water and this inhibition is the cause of the lower final methane production yield with higher TS contents. However, in the specific case of rice straw, it was noticed a similar value of the final specific methane production yield in the case of dry and semi-dry conditions but a significant difference in terms of VFAs concentrations between these two different tests. This might be due to another inhibition mechanism that occurs beyond a threshold value of TS content, that can explain the similar value of final methane production at different TS contents. Thus, the soluble phenols was analysed to understand better the process inhibition with higher TS content. An accumulation of free phenolic compounds in the liquid bulk of the digesting mixture was found and can explain the inhibition problems observed over TS content of 15%. This can be related to the effect of the hydrolysis of lignocellulosic material that is composing the rice straw. Thus, there is a transfer of phenolic matter from the solid matrix of the digestate to the liquid matrix. In reactors with TS content of 23.4 %, due the lack of water, at parity of phenolics release, the hydrolysis brings to higher concentrations that are probably above the methanation inhibition limit. This could explain the specific methane production kinetics as well as the VFA accumulation due to the inhibition of the methanogenesis step.

CHAPTER 7– DISCUSSION AND CONCLUSIONS

Further studies were also done to compare the process performances also in terms of VS and COD degradation. For both substrates, rice straw and food waste, the better performances were observed at a lower TS content. This finding is in agreement with the measured final methane production yield.

It has to be stressed that the higher TS content in the batch reactor without mixing implies heterogeneous conditions inside the reactor and possible accumulations of inhibitory compounds inside specific reactor zones are likely to occur. In full-scale reactor the accumulation of inhibitory compound in a specific reactor zone could imply operating problems and reactor acidification. Thus it is important for each specific reactor configuration to monitor the process and identify specific conditions that could determine such inhibition problems.

In particular, further studies have to be done to individuate the highest TS content that can be accepted in an anaerobic reactor over that acidification phenomena occur, i.e. the maximum TS value before a complete process inhibition. On this topic, only one work has been already done by Abbassi-Guendoz et al. (2012), who found a threshold concentration of 30% TS that determine an inhibitory effect in high solids anaerobic digestion. This threshold could correspond to an inhibition of anaerobic digestion at high solids content due to accumulation of metabolic by-products, such as volatile fatty acids.

Moreover further research is needed to define the optimal TS of anaerobic digestion of food waste and rice straw. In the present work the wet digestion was individuated as the best option to maximize the specific final methane yield, but there is a need to make also an economical balance taking into account different process costs. In particular for a specific full-scale reactor, it has to be done a balance between the economical return related to higher specific methane production and the additional costs of water use, digestate production and pre-treatments needed. However this study is beyond the scope of this research and it has to be treated case by case considering a specific reactor configuration and waste type to be treated.

Another instrument useful for full-scale reactor operation can be a complete mathematical model of the anaerobic digestion process considering dry and wet conditions. This model can simulate the effect of TS content on the process performances. In this thesis a mathematical model was proposed and the model calibration was done only using the data obtained from batch experiments. The proposed model can be applied to simulate full-scale application, and also can be calibrated by using the data of full-scale plant considering the nature and quantity of the substrate to be treated and the specific reactor configuration.

CHAPTER 7– DISCUSSION AND CONCLUSIONS

Considering all the results obtained in the present work, still a lot of efforts have to be done yet to understand in deep the dry anaerobic digestion process, in particular the following research gaps and needs should be considered:

- increase the understanding of the effect of the reactor configuration, optimizing the operating conditions;
- increase the understanding of the dry anaerobic digestion processes through the comprehensive analysis of the roles of phase separation, microbial community distribution patterns, hydrogen ion partial pressure and accumulation of toxic compounds;
- understand the different effect of specific process inhibitors such as (Heavy Metals) HMs on different TS anaerobic digestion processes;
- define optimized reactor configurations in terms of mixing conditions for different TS contents in the reactor. This can be addressed performing hydrodynamic tests aimed at assessing the mixing effect and the degree of dispersion in the reactor in order to define a configuration capable to reduce the dispersion and short-circuiting problems.

Hydrodynamic experiments on plug flow laboratory scale reactor can be conducted with water and tracer, to understand how the hydrodynamic is influenced by flow-rate variations and reactor configurations (length, diameter, presence of impellers) and individuate the degree of dispersion with different flow-rate values. Hydrodynamic experiments should be conducted also in anaerobic conditions with inoculum and substrate to assess the effect of the substrate amount in the reactor and TS content on the degree of dispersion. Further efforts have to be done also to study full-scale reactor hydrodynamics and to model the AD process considering dispersion conditions.

REFERENCES

References

Ábalos, M., Bayona, J., Pawliszyn, J., (2000). Development of a headspace solid-phase microextraction procedure. for the determination of free volatile fatty acids in waste waters. *J. of Chromatogr A*, 873, 107-115.

Abbassi-Guendouz, A., Brockmann, D., Trably, E., Dumas, C., Delgenès, J.P., Steyer, J.-P. & Escudie R. (2012) Total solids content drives high solid anaerobic digestion via mass transfer limitation. *Bioresour. Technol.*, 111, 55–61.

Ahring, B.K., Sandberg, M., Angelidaki, I., (1995). Volatile fatty acids as indicators of process imbalance in anaerobic digestors. *Appl. Microbiol. Biot.*, 43, 559-565.

Alex, J., Kolisch, G., and Krause, K. (2002). Model structure identification for wastewater treatment simulation based on computational fluid dynamics. *Water Sci. Technol.* 45(4-5), 325-334.

Alphenaar, P.A., Visser, A. and Lettinga, G. (1993). The effect of liquid upward velocity and hydraulic retention time on granulation in UASB reactors treating waste water with a high sulphate content. *Bioresour. Technol.*, 43, 249–258.

Amani, T., Nosrati, M., Sreerishnan, T.R., (2010). Anaerobic digestion from the viewpoint of microbiological, chemical, and operational aspects - a review. *Environ. Rev.* 18, 255–278.

Annachhatre, A.P. (1996). Anaerobic treatment of industrial wastewaters. *Resour. Conserv. Recycl.*, 16, 161-66.

REFERENCES

APHA. (1998) Standards Methods for the Examination of Water and Wastewater, 20th ed., United Book Press, Inc., Baltimore, Maryland.

ATV. (1991). Bemessung von einstufigen Belebungsanlagen ab 5000 Einwohnerwerten. Arbeitsblatt A 131, ATV, St. Augustin, BRD.

Baquerizo, G., Maestre, J.P., Sakuma, T., Deshusses, M.A., Gamisans, X., Gabriel, D. and Lafuente, J.A. (2005). Detailed model of a biofilter for ammonia removal: model parameters analysis and model validation. *Chem. Eng. J.* 113 (2-3), 205-214.

Batstone, D.J., Hernandez, J.L.A. and Schmidt, J.E. (2005). Hydraulics of laboratory and full-scale upflow anaerobic sludge blanket (UASB) reactors. *Biotech. and Bioeng.* 91 (3), 387–391.

Batstone, D. J., Keller, J., Angelidaki, I., Kalyuzhnyi, S.V., Pavlostathis, S.V., Rozzi, A., Sanders, W.T.M., Siegrist, H. & Vavilin, V.A. (2002) Anaerobic digestion model no.1. *Sci. Tech. Rep. No. 13*, IWA Publishing, London.

Benedetti, L., Bixio, D., Claeys, F. and Vanrolleghem, P.A. (2008). Tools to support a model-based methodology for emission/immission and benefit/cost/risk analysis of wastewater systems that considers uncertainties. *Environ. Modell. Softw.* 23(8), 1082-1091.

Bhatia, B., Nigam, K.D.P., Auban, D. and Hebrard, G. (2004). Effect of a new high porosity packing on hydrodynamics and mass transfer in bubble columns. *Chem. Eng. Process.* 43 (11), 1371-1380.

Bolle, W.L., van Breugel, J., van Eybergen, G.C., Kossen, N.W.F., van Gils, W. (1986a). An integral dynamic model for the UASB reactor. *Biotechnol. Bioeng.* 28(11), 1621-1636.

Bolle, W.L., van Breugel, J., van Eybergen, G.C., Kossen, N.W.F., Zoetemeyer, R.J. (1986b). Modeling the liquid flow in up-flow anaerobic sludge blanket reactors. *Biotechnol. Bioeng.* 28(11), 1615-1620.

REFERENCES

- Bollon, J., Le-Hyariç, R., Benbelkacem, H., Buffière, P., (2011). Development of a kinetic model for anaerobic dry digestion processes: Focus on acetate degradation and moisture content. *Biochem. Eng. J.* 56, 212-218.
- Bollon, J., Benbelkacem, H., Gourdon, R., Buffière, P., (2013) Measurement of diffusion coefficients in dry anaerobic digestion media. *Chemical Engineering Science*, 89, 115-119
- Bolzonella, D., Innocenti, L., Pavan, P., Traverso, P., Cecchi, F. (2003). Semi-dry thermophilic anaerobic digestion of the organic fraction of municipal solid waste: focusing on the start-up phase. *Bioresour. Technol.* 86, 123-129.
- Bonnet, B., Dochain, D., Steyer, JP.(1997). Dynamical modelling of an anaerobic digestion fluidized bed reactor. *Water Sci Technol.*, 36, 285–292
- Braha, A. and Hafner, F. (1985). Use of Monod kinetics on multi stage bio reactors. *Water Res.* 19, 1217-1227.
- Brown, D., Shi, J., Li, Y. (2012). Comparison of solid-state to liquid anaerobic digestion of lignocellulosic feedstocks for biogas production. *Bioresour. Technol.* 124, 379–386.
- Brown, D. and Yebo, L. (2013). Solid state anaerobic co-digestion of yard waste and food waste for biogas production. *Bioresour. Technol.* 127, 275-280.
- Bryers, J.D. (1985) Structured modelling of the anaerobic digestion of biomass particulates. *Biotechnol. Bioeng.* 27, 638–649
- Buffière, P. (1996). Modeling and experiments on the influence of hydrodynamics on the performance of an anaerobic fluidized bed reactor, Ph.D Thesis, INSA Toulouse No. 410.

REFERENCES

- Buffière, P., Fonade, C. and Moletta, R.. (1998a). Liquid mixing and phase hold-ups in gas producing fluidized bed bioreactors. *Chem. Eng. Sci.* 53 (4), 617-627.
- Buffière, P., Fonade, C. and Moletta, R. (1998b). Mixing and phase hold-ups variations due to gas production in anaerobic fluidized-bed digesters: Influence on reactor performance. *Biotechnol. Bioeng.* 60(1), 36-43.
- Buffière, P., Steyer, J., Fonade, C and Moletta, R. (1998c). Modeling and experiments on the influence of biofilm size and mass transfer in a fluidized bed reactor for anaerobic digestion. *Water Res.*, 32(3), 657–668.
- Buffière, P., Loisel, D., Bernet, N. & Delgenes, J.P. (2006). Towards new indicators for the prediction of solid waste anaerobic digestion properties. *Water Sci. Technol.*, 53, 233-241
- Chang, H.T. and Rittmann, B.E. (1987). Mathematical modeling of biofilm on activated carbon. *Environ Sci. Technol.* 21(3), 273-280.
- Charles, W., Walker, L., & Cord-Ruwisch, R. (2009). Effect of pre-aeration and inoculum on the start-up of batch thermophilic anaerobic digestion of municipal solid waste. *Bioresour. Technol.*, 100, 2329-2335.
- Costa Reis, L.G and Sant'Anna, G.L. (1985). Aerobic treatment of concentrated wastewater in a submerged bed reactor. *Water Res.*, 19, 1341-1345.
- Costello, D.J., Greenfield, P.F., Lee, P.L. (1991a). Dynamic modelling of a single-stage high-rate anaerobic reactor-I. Model Derivation. *Water Res.* 25, 847-858.

REFERENCES

- Costello, D.J., Greenfield, P.F., Lee, P.L. (1991b). Dynamic modelling of a single-stage high-rate anaerobic reactor-II. Model verification. *Water Res.*, 25, 859-871
- Dai, X., Duan, N., Dong, B., Dai, L. (2013). High-solids anaerobic co-digestion of sewage sludge and food waste in comparison with mono digestions: Stability and performance. *Waste Manage.*, 33, 308-316.
- Danckwerts, P.V. (1953) Continuous flow systems, distributions of residence times. *Chem. Eng. Sci.* 2,1-13.
- Davidson, J. F., Clift, R. and Harrison, D. (1985) *Fluidization*. Pergamon Press. Oxford.
- De Baere, L., Mattheeuws, B., Velghe, F. (2010). State of the art of anaerobic digestion in Europe, In: Twelfth International Congress on Anaerobic Digestion. IWA, Guadalajara, Mexico.
- De Clercq, B., Coen, F., Vanderhaegen, B. and Vanrolleghem, P.A. (1999). Calibrating simple models for mixing and flow propagation in wastewater treatment plants. *Water. Sci. Technol.*, 39, 61-69.
- Diez-Blanco, R., Garcia-Encina, V., Fernandez-Polanco, P.A., (1995). Effect of biofilm growth, gas and liquid upflow velocities on the expansion of an anaerobic fluidized bed reactor (AFBR). *Water Res.*, 29, 1649–1654.
- Diez, L., Zima, B.E., Kowalczyk, W., Delgado, A. (2007). Investigation of multi- phase flow in sequencing batch reactor (SBR) by means of hybrid methods. *Chem. Eng. Sci.* 62,1803-1813.
- Dong, L., Zhenhong, Y. & Yongming, S. (2010) Semi-dry mesophilic anaerobic digestion of water sorted organic fraction of municipal solid waste (WS-OFMSW). *Bioresour. Technol.*,101, 2722-2728.
- Edelmann, W. (2003) Biomethanization of the Organic Fraction of Municipal Solid Wastes. In: Mata-Alvarez, J. (Ed.). IWA Publishing, London, 265–301.

REFERENCES

- Elefsiniotis, P., Wareham, D., Smith, M. (2004). Use of volatile fatty acids from an acid-phase digester for denitrification. *J. of Biotechnol.*, 114, 289-297
- Escudié, T., Conte, J.P., Steyer, J.P., Delgenès. (2005). Hydrodynamic and biokinetic models of an anaerobic fixed-bed reactor. *Proc. Bioch.* 40, 2311-2323.
- Esposito, G., Frunzo, L., Panico, A., d'Antonio, G. (2008). Mathematical modelling of disintegration – limited co-digestion of OFMSW and sewage sludge. *Water Sci. Technol.* 58, 1513–1519.
- Esposito, G., Frunzo, L., Panico, A., Pirozzi, F. (2011a). Modelling the effect of the OLR and OFMSW particle size on the performances of an anaerobic co-digestion reactor. *Process Biochem.* 46, 557–565.
- Esposito, G., Frunzo, L., Panico, A., Pirozzi F. (2011b). Model calibration and validation for OFMSW and sewage sludge co-digestion reactors. *Waste Manage.* 31, 2527–2535.
- Esposito, G., Frunzo, L., Liotta F., Panico, A., Pirozzi, F. (2012a). Bio-methane potential tests to measure the biogas production from the digestion and co-digestion of complex organic substrates. *Open Environ. Engine J.* 5, 1–8.
- Esposito, G., Frunzo, L., Giordano, A., Liotta, F., Panico, A., Pirozzi, F. (2012b). Anaerobic co-digestion of organic wastes. *Rev. Environ. Sci. Biotechnol.* 11, 325–341.
- Esposito, G., Frunzo, L., Panico, A., Pirozzi, F. (2012c). Enhanced bio-methane production from co-digestion of different organic wastes. *Env. Technol.*, 33, 2733-2740
- Eckenfelder, W.W., Goronszy, M.C. and Watkin, A.T. (1985). Comprehensive Activated Sludge Design. *Developments in Environmental Modeling No. 7 Mathematical Models in Biological Waste Water Treatment*, S.E. Jorgensen and M.J. Gromiec, eds. Amsterdam, 95-132.

REFERENCES

- El-Temtamy, S.A., El-Sharnoub, Y.D. and El Halwagi, M.M. (1979a). Liquid dispersion in gas-liquid fluidized beds: Part I: Axial and radial dispersion. The dispersed plug-flow model. *Chem. Eng. J.* 18, 161-168.
- El-Temtamy, S.A., El-Sharnoub, Y.D. and El Halwagi, M.M. (1979b). Liquid dispersion in gas-liquid fluidized beds: Part II: Axial dispersion. The axially dispersed plug-flow model. *Chem. Eng. J.* 18, 151-159.
- Esposito, G., Fabbicino, M., & Pirozzi, F. (2003). Four-substrate design model for single sludge predenitrification system. *J. of Env. Eng.*, 129, 394-401.
- Fall, C. and Loaiza-Navia, J.L. (2007). Design of a tracer test experience and dynamic calibration of the hydraulic model for a full-scale wastewater treatment plant by use of AQUASIM. *Water. Env. Res.*, 79, 893-900
- Fan, L.S., Kigie, K., Long, T.R. and Tang, W.T. (1987). Characteristics of a draft-tube gas-liquid solid fluidized bed reactor for phenol-degradation. *Biotechnol. Bioeng.* 30, 498-504.
- Fernández, J., Perez, M., Romero, L. (2008). Effect of substrate concentration on dry mesophilic anaerobic digestion of organic fraction of municipal solid waste (OFMSW). *Bioresour. Technol.* 99, 6075–6080.
- Fernández, J., Pérez, M., Romero, L.I. (2010). Kinetics of mesophilic anaerobic digestion of the organic fraction of municipal solid waste: Influence of initial total solid concentration. *Bioresour. Technol.*, 101, 6322–6328.
- Fdez-Güelfo, L. A., Álvarez-Gallego, C., Sales, D. and Romero García, L.I. (2012). Dry-thermophilic anaerobic digestion of organic fraction of municipal solid waste: Methane production modeling. *Waste Manage.* 32, 382-388.
- Fdz-Polanco, F., García, P. and Santiago, V. (1994). Influence of Design and Operation Parameters on the Flow Pattern of Submerged Filters. *J. Chem. Technol. Biot.* 61, 153-158.

REFERENCES

- Forster-Carneiro, T., Pérez, M., Romero, L.I. and Sales, D. (2007). Dry-thermophilic anaerobic digestion of organic fraction of the municipal solid waste: focusing on the inoculum sources. *Bioresour. Technol.* 98, 3195–3203.
- Forster-Carneiro, T., Pérez, M., Romero, L. (2008). Influence of total solid and inoculum contents on performance of anaerobic reactors treating food waste. *Bioresour. Technol.* 99, 6994–7002.
- Froment, G.F., Bischoff, K.B. (1990). *Chemical Reactor Analysis and Design*, 2nd ed. John Wiley & Sons, New York.
- Gavrilescu, M. 2002. Engineering concerns and new developments in anaerobic waste-water treatment. *Clean. Technol. Envir.* 3, 346-362.
- Gerardi, M.H. (2003). *The Microbiology of Anaerobic Digesters*. Wiley, John & Sons, New York.
- Ghosh, S. (1985). Solid-phase methane fermentation of solid waste. *J. of Ener. Res. Technol.*, 107, 402-405.
- Glover, G.C., Printemps, C., Essemiani, K. and Meinhold, J. (2006). Modelling of wastewater treatment plants - How far shall we go with sophisticated modelling tools? *Water Sci. Technol.* 53, 79-89.
- Graef, S.P. and Andrews, J.F. (1974). Stability and control of anaerobic digestion. *J. of Water Poll. Cont. Fed.*, 666-683.
- Gray, N.F., Learner, MA. (1984). Comparative pilot scale investigation into upgrading the performance of percolating filters by partial medium replacement. *Water Res.*, 18, 409-422.
- Guendouz, J., Buffière, P., Cacho, J., Carrere, M., Delgenes, J.P. (2010). Dry anaerobic digestion in

REFERENCES

batch mode: design and operation of a laboratory-scale, completely mixed reactor. *Waste Manag.* 30, 1768–1771.

Gustavsson, J., Cederberg, C., Sonesson, U., van Otterdijk, R., Meybeck, A. (2011). *Global food losses and food waste*. Rome: Food and Agriculture Organization of the United Nations (FAO).

Hanaki, K., Hirunmasuwan, S., & Matsuo, T. (1994). Selective use of microorganisms in anaerobic treatment processes by application of immobilization. *Water Res.* 28, 993-996.

Henze, M., Grady, C. P.L., Gujer, W., Marais, G.V.R., Matsuo, T. (1987). *Activated Sludge Model No. 1*. Scientific and Technical Report No. 1, IAWQ, London.

Heertjes, P.M. and Van Der Meer, R.R. (1978). Dynamics of liquid flow in an up-flow reactor-used for anaerobic treatment of wastewater. *Biotechnol. Bioeng.*, 20, 1577-1594.

Heertjes, P.M., Kujivenhoven, L.I and van der Meer, R.R. (1982). Fluid flow pattern in upflow reactors for anaerobic treatment of beet sugar factory wastewater. *Biotechnol. Bioeng.*, 24, 443-459.

Hill, D.T. (1982). A comprehensive dynamic model for animal waste methanogenesis. *Trans. ASAE* 25, 1374–1380

Hills, D.J. and Nakano, K. (1984). Effects of particle size on anaerobic digestion of tomato solid wastes. *Agricul. Wastes*, 10, 285–295

Hills, D. J. and Roberts, D.W. (1981). Anaerobic digestion of dairy manure and field crop residues. *Agri. Wastes*, 3, 179-89.

REFERENCES

- Hirata, A., Hosaka, Y. and Umezawa, H. (1986). Biological treatment of water and wastewater in three-phase fluidized bed. Proc. of the Third World Congress in Chemical Engineering, vol. III, Tokyo, 3, 556.
- Huang, J-S. and Jih, C-G. (1997). Deep- Biofilm kinetics of substrate utilization in anaerobic filters. Wat. Res. 31, 2309-2317.
- Huang, W., Wu, C., Xia, B. and Xia, W. (2005). Computational Fluid Dynamic Approach for Biological System Modeling. arXiv:q-bio/0508006v1[q-bio.QM].
- Jacob, J., Pingaud, H., Le Lann, J.M., Bourrel, S., Babary, J.P. and Capdeville, B. (1996). Dynamic simulation of biofilters. Simulat. Pract. Theory. 4, 335-348.
- Janssen, P.H.M. and Heuberger, P.S.C. (1995). Calibration of process-oriented models. Ecol. Model. 83, 55–66.
- Jha, A. K., Li, J., Nies, L. and Zhang, L. (2013). Research advances in dry anaerobic digestion process of solid organic wastes. Afr. J. Biotechnol., 10, 14242-14253.
- Jeris J.S. (1977). Biological fluidized bed for BOD and nitrogen removal. J. Water Pollut. Control Fed. 49, 816-831.
- Jin, B., Wilén, B. M. and Lant, P., (2004). Impacts of morphological, physical and chemical properties of sludge flocs on dewaterability of activated sludge. Chem. Eng. J., 98, 115-126.
- Kalyunzhnyi, S., Federovich, V., Lens, P., Pol, H. and Lettinga, G. (1998). Mathematical modelling as a tool to study population dynamics between sulfate reducing and methanogenic bacteria. Biodegradation. 9, 187-199.

REFERENCES

Kalyunzhnyi, S., Federovich, V. (1997). Integrated Mathematical Model of UASB Reactor for Competition between sulphate reduction and methanogenesis. *Wat. Sci. Tech.*, 36, 201-208.

Kalyunzhnyi, S., Vyacheslav, V., Federovich, V. and Lens, P. (2006). Dispersed plug flow model for upflow anaerobic sludge bed reactors with focus on granular sludge dynamics. *J. Ind. Microbiol. Biot.* 33, 221-237.

Karthikeyan, O.P. and Visvanathan, C., (2012). Bio-energy recovery from high-solid organic substrates by dry anaerobic bio-conversion processes: a review. *Rev. Env. Sci. Biotechnol.*, 12, 257-284.

Keshtkar, A. B. Meysami, G. Abolhamd, H. Ghaforian, M. Khalagi Asadi. (2003). Mathematical modeling of non-ideal mixing continuous flow reactors for anaerobic digestion of cattle manure. *Bioresour. Technol.* 87, 113-124.

Khudenko, B.M. and Shpirt, E. (1986). Hydrodynamic parameters of diffused air systems. *Water Res.* 20, 905-915.

Kim, S.D. and Kang, Y. (1997). Heat and Mass transfer in three-phase fluidized bed reactors-an overview. *Chem. Eng. Sci.* 52, 3639-3660.

Kim, D.-H. and Oh, S.E., (2011). Continuous high-solids anaerobic co-digestion of organic solid wastes under mesophilic conditions. *Waste Manage.*, 31, 1943-1948.

King, R.O. and Forster, C.F. (1990). Effects of sonication on activated sludge. *Enzyme Microb. Tech.* 12, 109-115.

Kshirsagar, S.R., Phadke, N.S. and Tipnis, S.S. (1972). Detention time studies in trickling filter. *Indian J. Environ. Hlth.* 14, 95-104.

REFERENCES

- Kyoto, P., (1997). United Nations framework convention on climate change. Kyoto Protocol, Kyoto.
- Iliuta, I. and Larachi, F. (2005). Modeling simultaneous biological clogging and physical plugging in trickle-bed bioreactors for wastewater treatment. *Chem. Eng. Sci.* 60, 1477-1489.
- Lamb, R. and Owen, S.G.H. (1970). A suggested formula for the process of biological filtration. *Water Pollut. Control.*, 69, 209-220.
- Lauder B.E. and Spalding, B.P. (1974). The numerical computation of turbulent flows. *Comput. Method Appl. M.* 3, 269-289.
- Lawrence, A.W. and McCarty, P.L. (1970). Unified basis for biological treatment design and operation. *J. San. Eng.*, 96, 757-778.
- Lay, JJ., Li YY. & Noike, T. (1997a) Influences of pH and moisture content on the methane production in high-solids sludge digestion. *Water Res.*, 31, 1518–1524
- Lay, JJ., Li, YY., Noike, T., Endo, J. and Ishimoto, S. (1997b) Analysis of environmental factors affecting methane production from high-solids organic waste. *Water Sci. Technol.*, 36, 493-500.
- Lay JJ., Li YY., Noike, T. (1998) Developments of bacterial population and methanogenic activity in a laboratory-scale landfill bioreactor. *Water Res.* 32, 3673–3679
- Lee, T.T., Wang, F. Y., Newell, R.B. (1999a). Dynamic modelling and simulation of activated sludge process using orthogonal collocation approach. *Water Res.* 33, 73-86.
- Lee, T.T., Wang, F.Y., Newell, R.B. (1999b). Dynamic simulation of bioreactor systems using orthogonal collocation on finite elements. *Comp. Chem. Eng.*, 23, 1247-1262.
- Le Hyaric, R., Chardin, C., Benbelkacem, H., Bollon, J., Bayard, R., Escudié, R. and Buffière, P.

REFERENCES

- (2011). Influence of substrate concentration and moisture content on the specific methanogenic activity of dry mesophilic municipal solid waste digestate spiked with propionate. *Bioresour. Technol.* 102, 822–827.
- Le Hyaric, R., Benbelkacem, H., Bollon, J., Bayard, R., Escudiè, R. and Buffière, P. (2012). Influence of moisture content on the specific methanogenic activity of dry mesophilic municipal solid waste digestate. *J. of Chem. Techn. Biotechnol.*, 87, 1032-1035.
- Le Moullec, Y., Potier O., Gentric, C. and Leclerc, J.P. (2008). Flow field and residence time distribution simulation of a cross-flow gas–liquid wastewater treatment reactor using CFD. *Chem. Eng. Sci.*, 63, 2436-2449.
- Le Moullec, Y., Gentric, C., Potier, O. and Leclerc, J.P. (2010a). CFD simulation of the hydrodynamics and reactions in an activated sludge channel reactor of wastewater treatment. *Chem. Eng. Sci.*, 65, 492-498.
- Le Moullec, Y., Gentric, C., Potier, O., Leclerc, J.P. (2010b). Comparison of systemic, compartmental and CFD modelling approaches: application to the simulation of a biological reactor of wastewater treatment. *Chem. Eng. Sci.*, 65, 343-350.
- Le Moullec, Y., Potier, O., Gentric, C., & Leclerc, J. P. (2011). Activated sludge pilot plant: Comparison between experimental and predicted concentration profiles using three different modelling approaches. *Water Res.*, 45, 3085-3097.
- Levin, M.A. and Gealt M.A. (1993). Overview of biotreatment practices and promises. Levin M.A. and Gealt M.A, eds. *Biotreatment of industrial and hazardous waste*. McGraw-Hill, Philadelphia (PA), 71-72.
- Li, Y., Park, S.Y., Zhu, J. (2011). Solid-state anaerobic digestion for methane production from organic waste. *Renew. Sust. Energ. Rev.*, 15, 821-826.

REFERENCES

- Liotta, F., d'Antonio, G., Esposito, G., Fabbicino, M., Frunzo, L., van Hullebusch, E. D., Lens, N.L. and Pirozzi, F. (2014). Effect of moisture on disintegration kinetics during anaerobic digestion of complex organic substrates. *Waste Manage. Res.* 32, 40-48.
- Lianhua, L., Dong, L., Yongming, S., Longlong, M., Zhenhong, Y., Xiaoying, K. (2010). Effect of temperature and solid concentration on anaerobic digestion of rice straw in South China. *Int. J. Hydrogen. Energ.*, 35, 7261-7266.
- Lin S.H. (1991). A mathematical model for a biological fluidized bed reactor. *J. Chem. Technol. Biot.*, 51, 473-482.
- Lissens, G., Vandevivere, P., De Baere, L., Biey, E., Verstraete, W. (2001). Solid waste digestors: process performance and practice for municipal solid waste digestion. *Water Sci. Technol.*, 44, 91-102
- Lovett, D.A., Travers S.M. and Davey K.R. (1984). Activated sludge treatment of abattoir wastewater-I: Influence of sludge age and feeding pattern. *Water Res.*, 18, 429-434.
- Lü, F., Hao, L., Zhu, M., Shao, L., He, P. (2012). Initiating methanogenesis of vegetable waste at low inoculum-to-substrate ratio: importance of spatial separation. *Bioresour. Technol.* 105, 169–173.
- Makinia, J. and Wells, S.A. (1999). Improvements in modeling dissolved oxygen in activated sludge systems. *Proc. of the 8th IAWQ Conference on Design, Operation and Economics of Large Wastewater Treatment Plants, Budapest*, 518-525.
- Makinia, J. and Wells, S.A. (2000a). A general model of the activated sludge reactor with dispersive flow-I. model development and parameter estimation. *Water. Res.*, 34, 3987-3996.
- Makinia, J. and Wells, S.A. (2000b). A general model of the activated sludge reactor with dispersive flow-II. Model verification and application. *Water Res.*, 34, 3997-4006.
- Makinia, J. and Wells, S.A. (2005). Evaluation of empirical formulae for estimation of the longitudinal dispersion in activated sludge reactors. *Water Res.*, 39, 1533-1542.

REFERENCES

- Mann, A.T., Stephenson, T. (1997). Modeling biological Aerated Filters for Wastewater Treatment. *Water Res.*, 31, 2443-2448.
- Martin AD. (2000). Interpretation of residence time distribution data. *Chem. Eng. Sci.*, 55, 5907-5917.
- Martinov, M., Hadjiev, D. and Vlaev, S.D. (2010). Liquid flow residence time in a fibrous fixed bed reactor with recycle. *Bioresour. Technol.*, 101, 1300-1304.
- Mata-Alvarez J., Mace, S. and Llabres, P. (2000). Anaerobic digestion of organic solid wastes. An overview of research achievements and perspectives. *Bioresour. Technol.* 74, 3–16.
- Mendoza R.B. and Sharratt, P.N. (1998). Modelling the effects of imperfect mixing on the performance of anaerobic reactors for sewage sludge treatment. *J. Chem. Tech. and Biotech.* 71, 121–130.
- Mendoza R.B. and Sharratt, P.N. (1999). Analysis of retention time distribution (RTD) curves in an anaerobic digester with confined-gas mixing using a compartment model. *Wat. Sci. Techn.* 40, 49-56.
- Meunier, A.D. and Williamson, K.J. (1981). Packed bed reactors: simplified model. *J. Environ. Eng.*, 107, 303-317.
- Mezaoui, A. (1979). Etude de l'épuration biologique sur lits bactériens à remplissage plastique. Ph.D. thesis, University of Montpellier, Montpellier, France.
- Michelsen, M.L. and Østergaard K. (1970). Hold-up and fluid mixing in gas-liquid fluidised beds. *Chem. Eng. J.*, 1, 37-46.
- Milbury, W.F., Pipes, W.O. and Grieves, R.B. (1965). Compartmentalization of aeration tanks. *J. San. Eng.*, 91 (SA3), 45-61.
- Moletta, R., Verrier, D. and Albagnac, G. (1986). Dynamic modelling of anaerobic digestion. *Water Res.* 20, 427–434.

REFERENCES

- Monteith, H. D. and Stephenson, J.P. (1981). Mixing efficiencies in full-scale anaerobic digesters by tracer methods. *J. WPCF*, 53, 78-84.
- Mora-Naranjo N., Meima J.A., Haarstrick A. & Hempel DC. (2004). Modelling and experimental investigation of environmental influences on the acetate and methane formation in solid waste. *Waste Manage.*, 24, 763–773.
- Motte, J. C., Escudié, R., Bernet, N., Delgenes, J. P., Steyer, J. P., Dumas, C. (2013). Dynamic effect of total solid content, low substrate/inoculum ratio and particle size on solid-state anaerobic digestion. *Bioresour. Technol.*, 144, 141-148.
- Mulcahy, L.T. and La Motta, E.J. (1978). Mathematical model of the fluidized bed biofilm reactor. Proc. of 51st Annual Conference, Water Pollution Control Federation, Anaheim, CA;
- Mulcahy, L.T., Shieh W.K., LaMotta, E.J. (1980). Kinetic model of biological denitrification in a fluidized bed biofilm reactor (FBBR). *Progr. Water. Technol.*, 12, 143-157.
- Mulcahy, L.T., Shieh, W.K. and LaMotta, E.J. (1981). Simplified Mathematic Models for a Fluidized-Bed Biofilm Reactor. *AICHe Symp. Boston, Portland; Chicago*, 273-285.
- Muroyama, K. and Fan, LS. (1985). Fundamentals of gas–liquid–solid fluidization. *AICHe Journal.*, 31, 1-34.
- Muslu, Y. (1984). Dispersion in granular media trickling filters. *J. Environ. Eng. ASCE*, 110, 961-976.
- Muslu, Y. (1986). Distribution of retention times in model biological filters containing packed spheres. *Water Res.*, 20, 259-265.
- Muslu, Y. (1990). Use of dispersed flow models in design of biofilm reactors. *Water Air Soil Poll.*, 53, 297-314.

REFERENCES

- Muslu, Y. and San, A.H. (1990). Mixing characteristics of suspended growth systems. Part 1. The mathematical model. *J. Disper. Sci. Technol.*, 11, 363-378.
- Muslu, Y. (2000a). Numerical approach to plug-flow activated sludge reactor kinetics. *Comput. Biol. Med.*, 30, 207-223.
- Muslu, Y. (2000b). Application of Monod kinetics on cascade reactors-in series. *J. Chem. Technol. Biot.*, 75, 1151-1159.
- Mussoline, W. (2013). Enhanced Methane Production from Pilot-Scale Anaerobic Digester Loaded with Rice Straw. *Open Env. Eng. J.*, 6, 32-39
- Mussoline, W., Esposito, G., Lens, P., Garuti, G., Giordano, A. (2012). Design considerations for a farm-scale biogas plant based on pilot-scale anaerobic digesters loaded with rice straw and piggery wastewater. *Biomass. Bioenerg.*, 46, 469-478
- Nogita, S., Saito, Y. and Kuge, T. (1983). A new indicator of the activated sludge process: Nitrous oxide. *Water Sci. Technol.*, 13, 199-204.
- Nyadziehe, K.T. (1980). Réacteur biologique à ruissellement sur garnissage plastique. Ph.D. thesis, University of Montpellier, Montpellier, France.
- Oleszkiewicz, J.A. (1981). Aerobic and anaerobic biofiltration of agricultural effluents. *Agric. Wastes.*, 3, 285-296.
- Olivet, D., Valls, J., Gordillo, M., Freixo, A. and Sanchez, A. (2005). Application of residence time distribution technique to the study of the hydrodynamic behaviour of a full-scale wastewater treatment plant plug-flow bioreactor. *J. Chem. Technol. and Biotech.*, 80, 425-432.
- Olsson, G. and Andrews, J.F. (1978). The dissolved oxygen profile-A valuable tool for control of the activated sludge process. *Water Res.*, 12, 985-1004.

REFERENCES

- Ojha, C., Singh, R. (2002). Flow distribution Parameters in Relation to Flow Resistance in an UpFlow Anaerobic Reactor System. *J. Environ. Eng.*, 128, 196-200.
- Otton, V., Hihn, J.Y., Béteau, J.F., Delpech, F. and Chérury, A. (2000). Axial dispersion of liquid in fluidisedbed with external recycling: two dynamic modelling approaches with a view to control. *Biochem. Eng. J.*, 4, 129-136.
- Park, Y., Davis, M.E. and Wallis, D.A. (1984). Analysis of a Continuous, Aerobic Fixed-Film Bioreactor. I. Steady-State Behavior. *Biotechnol. Bioeng.*, 26, 457-467.
- Pavlostathis, S.G. and Giraldo-Gomez, E. (1991). Kinetics of anaerobic treatment: a critical review. *Crit. Rev. Env. Technol.*, 21, 411-490
- Penã, M.R. (2002). Advanced primary treatment of domestic waste-water in tropical countries: development of high-rate anaerobic ponds. Ph.D. Thesis, University of Leeds, Leeds, England.
- Penã, M.R., Mara, D.D. and Avella, G.P. (2006). Dispersion and treatment performance analysis of an UASB reactor under different hydraulic loading rates. *Water Res.*, 40, 445-452.
- Pérez, J., Poughon, L., Dussap, C. G., Montesinos, J. L. and Gòdia, F. (2005). Dynamics and steady state operation of a nitrifying fixed bed biofilm reactor: mathematical model based description. *Pro. Biochem.*, 40, 2359-2369.
- Piché, S., Larachi, F., Iliuta, I. and Grandjean, B.P.A. (2002). Improving predictions of liquid back-mixing in trickle-bed reactors using a neural network approach. *J. Chem. Tech. Biotech.*, 77, 989-998.

REFERENCES

- Pinho, F.T. and Whitelaw, J.H. (1990). Flow of non-Newtonian fluids in a pipe. *J. Non-Newtonian Fluid Mech.* 34, 129–144.
- Pohl, M., Heeg, K., Mumme, J. (2013). Anaerobic digestion of wheat straw–Performance of continuous solid-state digestion. *Bioresour. Technol.* 146, 408-415.
- Pommier, S., Chenu, D., Quintard, M. and Lefebvre, X. (2007). A logistic model for the prediction of the influence of water on the solid waste methanization in landfills. *Biotechnol. Bioeng.*, 97, 473-482.
- Potier, O., Leclerc, J.P. and Pons, M.N. (2005). Influence of geometrical and operational parameters on the axial dispersion in an aerated channel reactor. *Water Res.*, 39, 4454-4462.
- Qu, X., Vavilin, V. A., Mazéas, L., Lemunier, M., Duquennoi, C., He, P. J. and Bouchez, T. (2009). Anaerobic biodegradation of cellulosic material: Batch experiments and modelling based on isotopic data and focusing on aceticlastic and non-aceticlastic methanogenesis. *Waste Manage.*, 29, 1828-1837.
- Ramin, E., Sin, G., Mikkelsen, P. S. and Plósz, B. (2011). Significance of uncertainties derived from settling tank model structure and parameters on predicting WWTP performance-A global sensitivity analysis study. 8th IWA Symposium on Systems Analysis and Integrated Assessment. *Watermax*, 476-483.
- Ratkocivh, N., Horn, W., Helmus, F.P., Rosenberger, S., Naessens, W., Nopens, I., Bentzen, T.R. (2013). Activated sludge rheology: A critical review on data collection and modelling. *Water Res.*, 42, 463-482.
- Reith, J.H., Wijffels, R.H., Barten, H. (2003). *Bio-methane and Bio-hydrogen: Status and Perspectives of Biological Methane and Hydrogen Production*. Dutch Biological Hydrogen Foundation, Petten, Netherlands.

REFERENCES

- Rigopoulos, S. and Jones, A. (2003). A hybrid CFD–reaction-engineering framework for multiphase reactor modeling: basic concept and application to bubble column reactors. *Chem. Eng. Sci.*, 58, 3077-3089.
- Rittmann, B.E. (1982). Comparative Performance of Biofilm Reactor. *Biotechnol. Bioeng.*, 24, 1341-1370.
- Ren, T.T, Mu, Y.H., Harada B.J., Yu H.Q. (2009). Hydrodynamics of upflow anaerobic sludge blanket reactors. *Aiche J.*, 55, 516-528.
- Reichert, P. (1998). User manual of AQUASIM 2.0 for the identification and simulation of aquatic systems, Swiss Federal Institute for Environmental Science and Technology, Dübendorf, Switzerland
- Sambusiti, C. (2013). Physical, chemical and biological pretreatments to enhance biogas production from lignocellulosic substrates. PhD thesis, Politecnico di Milano, Milano, Italy.
- San, H.A. (1989). A kinetic model for ideal plug-flow reactors. *Water Res.*, 23, 647-654.
- San, H.A. (1992). Mechanism of biological treatment in plug flow or batch systems. *J. Env. Eng. Proc.*, 118, 614-628.
- San, H.A. (1994). Impact of dispersion and reaction kinetics on performance of biological reactors solution by “S” series. *Water Res.*, 28, 1639-1651.
- Sánchez, O., Michaud, S., Escudié, R., Delgenès, J. P., & Bernet, N. (2005). Liquid mixing and gas–liquid mass transfer in a three-phase inverse turbulent bed reactor. *Chem. Eng. J.*, 114, 1-7.
- Sanders, W.T.M., Geerink M., Zeeman G. & Lettinga G. (2000). Anaerobic hydrolysis kinetics of particulate substrates. *Water Sci. Technol.*, 41, 17-24.

REFERENCES

Sant'Anna, J.R. (1980). Contribution à l'étude de l'hydrodynamique des réacteurs biologiques utilisés en traitement des eaux usées. Ph.D. thesis, INSA Toulouse, Toulouse, France.

Saravanan, V. and Sreekrishnan, T.R. (2006). Modelling anaerobic biofilm reactors-a review. *J. Environ. Man.*, 81, 1-18.

Särner E. (1978). Plastic-packed trickling filters, Bulletin Series Va, No. 21. Lund Institute of Technology, University of Lund, Lund, Sweden.

Schwarz, A., Yahyavi, B., Mosche, M., Burkhardt, C., Jordening, H-J, Buchholz, K., Reuss, M. (1996). Mathematical modelling for supporting scale up of anaerobic wastewater treatment in a fluidized bed reactor. *Water. Sci. Technol.* 34, 501-508.

Schwarz, A., Yahyavi, B., Mosche, M., Burkhardt, C., Jordening, H-J, Buchholz, K., Reuss, M.(1997). Mathematical modelling and simulation of an industrial scale fluidized bed reactor for anaerobic wastewater treatment-scale-up effect on pH-gradients. *Water Sci. Technol.* 36, 219-227

Séguret, F. and Racault, Y. (1998). Hydrodynamic behaviour of full-scale submerged biofilter and its possible influence on performances. *Wat. Sci. Tech.*, 38, 249-256.

Séguret, F., Racault, Y. and Sardin, M. (2000). Hydrodynamic behavior of full-scale trickling filters. *Water Res.*, 34, 1551-1558.

Seok, J. and Komisar, S. (2003). Integrated Modeling of Anaerobic Fluidized Bed Bioreactor for Deicing Waste Treatment. I.: Model Derivation. *J. Environ. Eng.* 129,100-109.

Service B.I., Preparatory Study on Food Waste across E.U.-27 for the European Commission, 2010, p. 14, http://ec.europa.eu/environment/eussd/pdf/bio_foodwaste_report.pdf, accessed 6 July 2012.

Sharma, S.K., Mishra, I.M., Sharma, M.P. and Saini, J.S. (1988). Effect of particle size on biogas

REFERENCES

generation from biomass residues. *Biomass*. 17, 251–263.

Shi, L.J., Huang, M., Zhang, W.Y. and Liu, H.F. (2013). Effect of Dry Matter Concentration on Dry Anaerobic Digestion of Animal Manure and Straw. *Appl. Mech. and Mat.*, 253, 897-902.

Shi, J., Xu, F., Wang, Z., Stiverson, J. A., Yu, Z. and Li, Y. (2014). Effects of microbial and non-microbial factors of liquid anaerobic digestion effluent as inoculum for solid-state anaerobic digestion of corn stover. *Bioresour. Technol.* 157, 188-196.

Shieh, W., Mulcahy, L.T. and LaMotta, E.J. (1982). Mathematical model for the fluidized bed biofilm reactor. *Enzyme Microb. Tech.*, 4, 269-276.

Siegrist, H., Renggli, D. and Gujer, W. (1993). Mathematical modelling of anaerobic mesophilic sewage sludge treatment. *Water Sci. Technol.* 27, 25–36.

Singh, K., Viraraghavan, T., Bhattacharyya, D. (2006). Sludge Blanket Height and Flow Pattern in UASB Reactor: Temperature effects. *J. Environ. Eng.* 132, 895-900.

Singhal, A., Gomes, J., Praveen, V.V., Ramachandran, K.B. (1998). Axial Dispersion Model for Upflow Anaerobic Sludge Blanket Reactors. *Biotechnol. Prog.* 14, 645-648.

Smith, J.M. (1981). *Chemical Engineering Kinetics*, 3rd ed., McGraw Hill Inc., New York.

Smith, L.C., Elliot, D.J., James, A. (1993). Characterisation of mixing patterns in an anaerobic digester by means of tracer curve analysis. *Ecol. Model.* 69, 267-285.

Smith, L.C., Elliot, D.J., James, A. (1996). Mixing in upflow anaerobic filters and its influence on performance and scale-up. *Water Res.* 30, 3061-3073.

REFERENCES

Smith, P.H., Bordeaux, F. M., Goto, M., Shiralipour, A., Wilkie, A., Andrews, J.F., Ide, S.M. and Barnett, W. (1988). Biological production of methane from biomass. In *Methane From Biomass: A Systems Approach*, 291-255. Elsevier Applied Science, London.

Tariq M.N. (1975). Retention time in trickling filters. *Progr. Water. Technol.*, 7, 225-234.

Tartakovsky, B., Mu, S.J., Zeng, Y., Lou, S.J., Guiot, S.R. and Wu, P. (2008). Anaerobic digestion model No.1 –based distributed parameter model of an anaerobic reactor: II. Model validation. *Bioresour. Technol.* 99, 3676-3684.

Tay, J.H., Show, K.Y. and Jeyaseelan, S. (1996). Effects of media characteristics on the performance of upflow anaerobic packed-bed reactors. *J. Envir. Engrg. Div., ASCE.* 122, 469-476.

Tay, J.H. and Show, K.Y. (1998). Media-Induced Hydraulic Behavior and Performance of Upflow Biofilters. *J. Envir. Engrg. Div. ASCE.* 124, 720-729.

Tchobanoglous, G., Burton F.L., Stensel, H.D. 2003. *Wastewater Engineering Treatment and Reuse*, 4th Edn. Metcalf and Eddy. *Inc.* McGraw-Hill Company.

Teefy, S. (1996). *Tracer studies in water treatment facilities: A protocol and case studies.* AWWA Research Foundation and American Water Works Association, Denver, CO.

Terashima, M., Goel, R., Komatsu, K., Yasui, H., Takahashi, H., Li, Y.Y. and Noike, T. (2009). CFD simulation of mixing in anaerobic digesters. *Bioresour. Technol.*, 100, 2228-2233.

Trinet, F., Heim, R., Amar, D., Chang, H.T. and Rittmann, B.E. (1991). Study of biofilm and fluidization of bioparticles in a three-phase fluidized-bed reactor. *Water Sci. Technol.*, 23, 1347-1354.

REFERENCES

Tuček, F., Chudoba, J. and Maděra, V. (1971). Unified basis for design of biological aerobic treatment processes. *Water Res.*, 5, 647-680.

Turan, M. and Ozturk, I. (1996). Longitudinal Dispersion and biomass hold-up of anaerobic fluidized bed reactor. *Water. Sci. Technol.*, 43, 461-468.

Turian, R.M., Fox, G.E. and Rice, R.A. (1975). The dispersed flow model for a biological reactor as applied to the activated sludge process. *Can. J. Chem. Eng.*, 53, 431-437.

U.S.E.P.A., (1993). EPA/625/R-93/010. United States Environmental protection Agency Office of Research and Development, Washington, DC.

U.S.E.P.A., (2001). METHOD 1684 Total, Fixed, and Volatile Solids in Water, Solids, and Biosolids, in: (4303), E.a.A.D. (Ed.), Washington, DC 20460.

Valorgas (2012). Seventh Framework Programme Theme Energy.2009.3.2.2.Biowaste as feedstocel for a 2nd generation. University of Southampton (Soton).

Van der Laan (1957). Notes on the diffusion-type model for the longitudinal mixing in flow. *Chem. Eng. Sci.*, 6, 187-191.

Van Der Meer, R.R., Heertjes, P.M. (1983). Mathematical description of anaerobic treatment of wastewater in upflow reactors. *Biotechnol. Bioeng.*, 25, 2531-2556.

Vandevenne, L. (1986). Epuration secondaire par lits bactériens. Final Report, CEBEDEAU-A.S.B.L, Liège, Belgium.

REFERENCES

- Vandevivere, P. (1999). New and broader applications of anaerobic digestion. *Critical Rev. Env. Sci. and Technol.*, 29, 151-173.
- Vavilin, V.A., Lokshina, L.Y., Rytov, S.V., Kotsyurbenko, O.R., Nozhevnikova, A.N. and Parshina, S.N. (1997). Modelling methanogenesis during anaerobic conversion of complex organic matter at low temperatures. *Water Sci. Technol.*, 36, 531–538
- Vavilin, V.A., Lokshina, L.Y. (1996a). Modeling of volatile fatty acids degradation kinetics and evaluation of microorganism activity. *Bioresour. Technol.* 57, 69–80.
- Vavilin, V.A., Rytov, S.V., Lokshina, L.Y. (1996b). A description of hydrolysis kinetics in anaerobic degradation of particulate organic matter. *Bioresour. Technol.*, 56, 229–237
- Vavilin, V.A., Rytov, S.V., Lokshina, L.Y., Pavlostathis, S.G. and Barlaz, M.A. (2003). Distributed model of solid waste anaerobic digestion: Effects of leachate recirculation and pH adjustment. *Biotechnol. Bioeng.* 81, 66-73
- Vavilin, V.A., Rytov, S.V., Lokshina, L.Ya. and Rintala, J.A. (1999). Description of hydrolysis and acetoclastic methanogenesis as the rate-limiting steps during anaerobic conversion of solid waste into methane. In: Mata-Alvarez, J., Tilche, A., Cecchi, F. (Eds.), *Proceedings of the Second International Symposium on Anaerobic Digestion of Solid Wastes, Barcelona, 1-4 June, 15-18, Barcelona, SP* .
- Vavilin, V.A., Rytov, S.V., Lokshina, L.Y., Rintala, J. A. and Lyberatos, G. (2001). Simplified hydrolysis models for the optimal design of two-stage anaerobic digestion. *Water Res.*, 35, 4247-4251
- Veeken, A. and Hamelers B. (1999). Effect of temperature on hydrolysis rates of selected biowaste components. *Bioresour. Technol.*, 69, 249-254.

REFERENCES

- Vermande, S. (2005). Hydraulics and biological modelling of activated sludge basins. PhD thesis, INSA Toulouse, Toulouse, France.
- Vesvikar, M.S. and Al-Dahhan, M. (2005). Flow pattern visualization in a mimic anaerobic digester using CFD. *Biotechnol. Bioeng.*, 89, 719–732.
- Wang, Z., Xu, F., Li, Y. (2013). Effects of total ammonia nitrogen concentration on solid-state anaerobic digestion of corn stover. *Bioresour. Technol.* 144, 281–287.
- Ward, A. J., Hobbs, P. J., Holliman, P. J., Jones, D.L. (2008). Optimisation of the anaerobic digestion of agricultural resources. *Bioresour. Technol.* 99, 7928-7940.
- Wisecaver, K.D. and Fan, L.S. (1989). Biological phenol degradation in a gas-liquid-solid fluidized bed reactor. *Biotechnol. Bioeng.*, 33,1029-1038.
- Wehner, J.F. and Wilhelm, R.H. (1956). Boundary conditions of flow reactor. *Chem. Eng. Sci.*, 6, 89-93.
- Worden RM and Donaldson TL. (1987). Dynamics of a biological fixed film for phenol degradation in a fluidized bed reactor. *Biotechnol. Bioeng.*, 30, 398-405.
- Wu, M.M. and Hickey, R.F. (1997). Dynamic model for UASB reactor including reactor hydraulics, reaction, and diffusion. *J. Environ. Eng.* 123, 244–252.
- Wu, B. and Chen, S. (2008). CFD simulation of non-Newtonian fluid flow in anaerobic digesters. *Biotechnol. Bioeng.*, 99, 700-711.
- Xu, F., Li, Y. (2012). Solid-state co-digestion of expired dog food and corn stover for methane production. *Bioresour. Technol.* 118, 219–226.

REFERENCES

- Yan, J.Q., Lo, K.V., Liao, P.H. (1989). Anaerobic digestion of cheese whey using up-flow anaerobic sludge blanket reactor. *Biol. Wastes.* 27, 289–305.
- Yan, J.Q., Lo, K.V., Pinder, K.L. (1993). Instability caused by high strength of cheese whey in a UASB reactor. *Biotechnol. Bioeng.* 41, 700–706.
- Young, J. C, and McCarty, P. L. (1968). The anaerobic filter for waste treatment. Tech. Report No. 87, Dept. of Civ. Engrg., Stanford Univ., Stanford, Calif.
- Yu, J. (1999). A three-phase fluidized bed reactor in the combined anaerobic/aerobic treatment of wastewater. *J. Chem. Technol. Biot.*, 74, 619-62.
- Zaher, U. and Chen, S., (2006). Interfacing the IWA anaerobic digestion model no1 (ADM1) with manure and solid waste characteristics. Proc. 79th Annual WEF Conference and Exposition (WEFTEC), October 21–25, Dallas, USA.
- Zeng, Y., Mu, S.J., Lou, S.J., Tartakovsky, B., Guiot, S.R. and Wu, P. (2005). Hydraulic modeling and axial dispersion analysis of UASB reactor. *Biochem. Eng. J.* 25, 113-123.
- Zeshan and Annachatre, A.P. (2012). Dry anaerobic digestion of municipal solid waste and digestate management strategies. Asian Institute of Technology.
- Zhang, R., El-Mashad, H. M., Hartman, K., Wang, F., Liu, G., Choate, C., Gamble, P. (2007). Characterization of food waste as feedstock for anaerobic digestion. *Bioresour. Technol.* 98, 929-935.
- Zhang, R. and Zhang, Z. (1999). Biogasification of rice straw with an anaerobic-phased solids digester system. *Bioresour. Technol.* 68, 235-245.

REFERENCES

Zhu, J., Zheng, Y., Xu, F., Li, Y. (2014). Solid-state anaerobic co-digestion of hay and soybean processing waste for biogas production. *Bioresour. Technol.* 154, 240-247.

Zima, P., Makinia, J., Swinarski, M., & Czerwionka, K. (2009). Combining computational fluid dynamics with a biokinetic model for predicting ammonia and phosphate behavior in aeration tanks. *Water Env. Res.*, 81, 2353-2362.

Zupančič, G.D. and Roš, M. (2012). Determination of Chemical Oxygen Demand in Substrates from Anaerobic Treatment of Solid Organic Waste. *Waste and Biom. Valor.*, 3, 89-98.