



**HAL**  
open science

## Graphs, games and propagation

Paul Dorbec

► **To cite this version:**

Paul Dorbec. Graphs, games and propagation. Discrete Mathematics [cs.DM]. Université Sciences et Technologies - Bordeaux I, 2013. tel-00975898

**HAL Id: tel-00975898**

**<https://theses.hal.science/tel-00975898v1>**

Submitted on 10 Apr 2014

**HAL** is a multi-disciplinary open access archive for the deposit and dissemination of scientific research documents, whether they are published or not. The documents may come from teaching and research institutions in France or abroad, or from public or private research centers.

L'archive ouverte pluridisciplinaire **HAL**, est destinée au dépôt et à la diffusion de documents scientifiques de niveau recherche, publiés ou non, émanant des établissements d'enseignement et de recherche français ou étrangers, des laboratoires publics ou privés.

**Université de Bordeaux I**  
Laboratoire Bordelais de Recherche en Informatique

## **HABILITATION À DIRIGER DES RECHERCHES**

*au titre de l'école doctorale de Mathématiques et Informatique de Bordeaux*

*soutenue et présentée publiquement le 1er juillet 2013*

par Monsieur Paul DORBEC

<b>Graphs, games and propagation</b>
--------------------------------------

### Rapporteurs

Monsieur Gary MacGillivray	Professeur à l'université de Victoria, Canada
Monsieur Richard Nowakowski	Professeur à l'université de Dalhousie, Canada
Monsieur Dieter Rautenbach	Professeur à l'université de Ulm, Allemagne

### Membres du Jury

Monsieur Sylvain Gravier	Directeur de recherches au CNRS
Monsieur Gary MacGillivray	Professeur à l'université de Victoria, Canada
Monsieur Richard Nowakowski	Professeur à l'université de Dalhousie, Canada
Monsieur André Raspaud	Professeur émérite à l'université de Bordeaux
Monsieur Dieter Rautenbach	Professeur à l'université de Ulm, Allemagne
Monsieur Éric Sopena	Professeur à l'université de Bordeaux



## RÉSUMÉ

Ce manuscrit d'Habilitation à diriger des recherches décrit mes travaux de recherche récents en théorie des graphes et en théorie des jeux combinatoires. Une première partie est consacrée à l'étude de paramètres de graphes en s'intéressant particulièrement aux contraintes structurelles qui permettent d'améliorer les bornes connues. Dans cette partie, nous traitons notamment la paire-domination, la domination indépendante mais aussi les partitions en cographes et les colorations quasi propres. Une deuxième partie traite de la domination de puissance, une forme itérative de la domination au sujet de laquelle nous proposons un début de synthèse des résultats existants. Enfin, une troisième partie parle de jeux. Nous y traitons d'abord le travail réalisé sur quelques conjectures portant sur un jeu de domino, puis au sujet des jeux en version misère. Nous y parlons enfin du jeu de domination, qui est à l'interface entre le paramètre de graphe et le jeu combinatoire.

## MOTS-CLÉS

Domination, power domination, coloration, partition, jeux combinatoires, convention misère.

## CLASSIFICATION MATHÉMATIQUE

05B40, 05C69, 05C70, 94B05.



## **ABSTRACT**

In this thesis for Habilitation à diriger des recherches, we describe our recent work on graph theory and combinatorial game theory. A first chapter is dealing with graph parameters, especially on the structural constraints that permit to give better general bounds. We consider in particular paired domination, independent domination but also cograph partitions and near colorings. In a second chapter, we propose a tentative survey of the known results on power domination, an iterated variation of domination. Finally, the third chapter is about games. We first present our recent results about some conjectures on a domino game, TOPPLING DOMINOES, and then about misère games. We finally discuss a domination game, which is a graph parameter based on a game.

## **KEY-WORDS**

Domination, power domination, colorings, partitions, combinatorial games, misère play, domination game.

## **MATHEMATICAL CLASSIFICATION**

05B40, 05C69, 05C70, 94B05.



# Contents

<b>1</b>	<b>Graph parameters</b>	<b>3</b>
1.1	Domination . . . . .	4
1.1.1	Paired domination . . . . .	4
1.1.2	Independent domination . . . . .	11
1.1.3	Conclusion . . . . .	14
1.2	Colorings . . . . .	15
1.2.1	Cograph partitions . . . . .	15
1.2.2	Near colorings . . . . .	18
<b>2</b>	<b>Power domination</b>	<b>23</b>
2.1	Definition . . . . .	23
2.2	Algorithmic aspects . . . . .	25
2.2.1	Complexity . . . . .	25
2.2.2	Algorithms . . . . .	26
2.3	Bounds for the power domination number . . . . .	26
2.3.1	General graphs . . . . .	26
2.3.2	Regular graphs . . . . .	28
2.4	Power domination in graph products . . . . .	30
2.4.1	Graph products definitions . . . . .	30
2.4.2	Product of paths . . . . .	31
2.4.3	General framework . . . . .	33
2.5	Conclusion . . . . .	34
<b>3</b>	<b>Games and graphs</b>	<b>35</b>
3.1	Definitions . . . . .	35
3.2	Toppling dominoes . . . . .	38
3.3	Taxonomic ranking for misère games . . . . .	40
3.3.1	A canonical form for dicots . . . . .	41
3.3.2	Counting the dicots . . . . .	43
3.3.3	Sums of dicots can have any outcome . . . . .	43
3.4	Domination game . . . . .	44
3.4.1	Effect of edge or vertex removal . . . . .	46
3.4.2	Sums of domination games . . . . .	47



3.5 Conclusion . . . . . 49

# Introduction

This document gives an overview of my researches since my PhD in 2007. Most of my contributions are dealing with graph parameters, such as domination and colorings, domination in particular being in a direct continuation of my PhD researches. I got interested in colorings mainly because of my integration of the LaBRI in 2009, whose historical specialty in graph theory is colorings. Another field I got involved in since my arrival in Bordeaux is combinatorial games theory, on which topic we have been supervising G. Renault's PhD with É. Sopena. Though it is still early for me to claim many results in the topic, and therefore a little daring to have included it in this document, I wanted to present the topic here as it is a new fascinating field of exploration for me. Also, one of my objectives in this document being to describe some of the research tracks I am willing to follow in future researches, it naturally has its place here. This is also the reason for which a whole chapter of this document is dedicated to power domination. Though it is a variation of domination that could have been treated along with the others in Chapter 1, I wanted to give a more extensive survey on the topic. It actually is to my opinion an important source of open problems for future researches. I already have a master student, N. Gillet, working on the topic and I am sure there is more than enough material for a PhD in the questions arising from power domination.

Note that some results and research tracks are willingly omitted in this document, often to keep some unity. Moreover, one of the blatant missing topic in this document is Vizing's conjecture. In 2008, I was invited by D.F. Rall to take part in a workshop on Vizing's conjecture in South Carolina. I was delighted with the opportunity I was given to cooperate with this small group of six people, all renowned researchers on domination in graphs. I thereafter took part in the writing of a survey on Vizing's conjecture [16] that is not included here since it is not my own writing, though I invite the reader to see it as the *lost chapter* of this document.

The document is divided into three chapters. First note that it does not come with a definitions section, and some concepts might as well not be defined thoroughly. We assume that the reader is at least a little familiar with graph theory, yet we still try to give most of the definitions along

with the writing, that the reader should be able to find through the index. Note also that there are basically no proof in the document. Most results described here are the object of a journal publication where the detailed proofs can be found.

The first chapter deals with graph parameters such as domination, colorings, and their variations. General bounds on these parameters can often be given, but are usually not very helpful because they are too close to a trivial answer. We present in this chapter better bounds that we can obtain on the parameter thanks to structural properties of graphs that allow the exclusion of the few cases that made the bound not practical.

The second chapter is about power domination, a recent variation of domination with an added propagation possibility. We here try to survey thoroughly the results on that topic. Many research tracks are open in that chapter, especially in relation with a recent generalization that we proposed for power domination.

Finally, the third chapter is about games. A first half really deals with combinatorial game theory, an elegant tool for deciding pure strategy games outcomes. Continuing to settle this theory is a very challenging task that is undertaken by a small but increasing group of (not necessarily academic) researchers. One of the main current topic is about misère games, on which we give some tentative improved framework. The other half is about a domination parameter defined as a game, the domination game number. Though this parameter does not really enter the combinatorial game theory settings, it is interesting to approach it with these settings in mind as we explain there. Note that the domination game is also a very recent but promising problem on which many questions should be considered.

# Chapter 1

## Graph parameters with structural properties

In graph theory, there are two main optimization problems, namely coloring and domination. A *proper coloring* is a partition of the vertices of a graph into sets of independent vertices (which are given a same color). You may see this as the problem of assigning jobs to parallel processors, or frequencies to communicating devices, or classes to teachers, etc... The objective in these settings is to determine the minimum number of independent sets/colors for which this is possible, i.e. the *chromatic number* of the graph, denoted  $\chi(G)$ . The coloring problem got very famous with the four color saga, this long story of the question whether four colors suffice to proper color any planar graph. A computer based proof exists now, but some people are still trying to simplify it. Other fascinating stories relate to that topic, e.g. on perfect graphs or on the Shannon capacity of a graph.

Graphs domination is less advertized, probably because there is no such nice stories yet, but it is still a very interesting problem. A subset of vertices in a graph is a dominating set if its neighborhood covers the whole graph. You can see this as choosing places for some devices such as cameras, sensors, intrusion detection system, or fire stations in a network. So as to monitor/protect each places of the network, you want that every vertex not equipped by a device is protected by a neighboring equipped vertex. In this setting, we try to determine the minimum number of vertices required to dominate the whole graph, called the *domination number* of the graph, and denoted  $\gamma(G)$ . Currently, the most challenging conjecture on domination was proposed fifty years ago by Vizing [76]. The conjecture states that the domination number of the Cartesian product of graphs should be proven to be no less than the product of the domination number of the factors. How little about this conjecture we have been able to prove until now is very surprising, the reader may refer to our survey on the topic [16].

In this chapter, we consider variations of these optimization problems,

starting with domination in Section 1.1, and then continuing in Section 1.2 with colorings.

## 1.1 Domination

In many variations of the domination problem, we look for a dominating set which satisfies some structural properties. This is a very natural way of generalizing the problem, often motivated by applied situations. For example, you may require that a dominating set be connected, so that the devices that are monitoring the network be able to communicate together. In this section, we study two other variations of domination with a restriction on the internal structure of the dominating set, namely paired and independent domination.

### 1.1.1 Paired domination

Among the variations of domination, one of the most natural is total domination. Total domination addresses the situation when each device does not protect the vertex on which it is situated. That may happen because what the network should be protected from may disrupt the device, or simply because of the setting of the device. Anyway, in that case we want that both the selected and non selected vertices be dominated by another vertex, and such a set is called a *total dominating set*. By definition, in a total dominating set, every vertex has at least one neighbor in the set, maybe more. In best cases, when there is no redundancy (called efficient total domination), the vertices in the total dominating set form an independent set of  $K_2$ . This is probably what drove Haynes and Slater [53, 54] to introduce paired-domination in graphs, presented as a way of assigning backups to guards for security purpose.

A *paired-dominating set* of a graph is a dominating set  $S$  whose induced subgraph  $G[S]$  has a perfect matching, i.e. a set of disjoint edges covering the vertices. Note that the matching is not necessarily induced, and thus that even if a paired dominating set is necessarily a total dominating set, it may not be an efficient one. Actually, every graph without isolated vertices has a paired dominating set, since the end-vertices of any maximal matching dominate the graph. The *paired-domination number* of  $G$ , denoted by  $\gamma_{\text{pr}}(G)$ , is the minimum cardinality of a paired dominating set.

In the following, we first describe how we concluded a search for good bounds for paired domination that we initiated during my PhD. We then describe some results on upper paired domination, based on the minimum degree of claw-free graphs. We finally present some bounds relating paired and double domination.

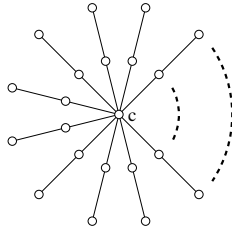

Figure 1.1: The shame of paired domination: a subdivided star

### In subdivided star-free graphs

Haynes and Slater, when they introduced paired domination, gave the following tight upper bound for paired domination in graphs :

**Theorem 1.1.1 (Haynes, Slater [53])** *If  $G$  is a connected graph of order  $n \geq 3$ , then  $\gamma_{\text{pr}}(G) \leq n - 1$  with equality if and only if  $G$  is  $C_3$ ,  $C_5$  or a subdivided star.*

In many aspects, this upper bound is the worst bound we could expect. When the number of vertices  $n$  in the graph is odd, the bound is trivial, and when it is even, it is not very difficult to find a basis for a paired dominating set that isolates one or two vertices so that they do not require to be added to the set. However, the bound is tight for an infinite family of graphs, namely subdivided stars. A subdivided star is a star of which every edge is subdivided once (see Figure 1.1).

The small cycles on 3 and 5 vertices ( $C_3$  and  $C_5$ ) in the theorem are not really a concern, because they are graphs of bounded order. Frequently, bounds for a parameter can be true only for graphs of large enough order. However, the subdivided stars form an infinite family of unbounded order. To improve the general bound, we thus have to eliminate the graphs with big subdivided stars at least as components. In *claw-free* graphs, the star with 3 rays  $K_{1,3}$  is forbidden as an induced subgraph. Considering claw-free graphs and thus excluding most subdivided stars, Favaron and Henning were able to propose a much better bound for cubic graphs:

**Theorem 1.1.2 (Favaron, Henning [42])** *If  $G$  is a connected claw-free cubic graph of order  $n$ , then  $\gamma_{\text{pr}}(G) \leq \frac{n}{2}$ .*

This study was continued in cite [29] by excluding a generalization of claw-free graphs, and dropping the regularity assumption. We have:

**Theorem 1.1.3 ([29])** *For  $a > 0$  an integer, if  $G$  is a connected  $K_{1,a+2}$ -free graph of order  $n \geq 2$ ,  $\gamma_{\text{pr}}(G) \leq \frac{2(an+1)}{2a+1}$  and this bound is sharp.*

Note that this result does not generalize the result of Favaron and Henning, since for claw-free graphs we get  $\gamma_{\text{pr}}(G) \leq \frac{2(n+1)}{3}$ , but dropping the regularity condition still makes this result tight.

Considering claw-free or star-free graphs, we avoid the critical cases of subdivided stars. However, just a claw or a star does not imply a large paired-domination number for a graph. Moreover, the examples for which the bound is tight in the above result are precisely the subdivided stars. These observations made us go on with the problem and try to obtain similar bounds for subdivided star-free graphs. The smallest subdivided star that is interesting as a forbidden subgraph is  $P_5$  the path on 5 vertices (the path  $P_3$  on 3 vertices can be seen as a subdivided trivial star, but a  $P_3$ -free graph is a complete graph). In [27], it is proved:

**Theorem 1.1.4 ([27])** *Let  $G$  be a connected graph of order  $n \geq 2$ . If  $G$  is not  $C_5$  and does not contain an induced  $P_5$ , then*

$$\gamma_{\text{pr}}(G) \leq \frac{n}{2} + 1,$$

*and this bound is sharp.*

The sharpness of the bound is attained by the corona of a complete graph of odd order: take a complete graph and attach a degree 1 vertex to each of its vertices. The graph is  $P_5$ -free since any path on 5 vertices in this graph contains three vertices in the complete subgraph, thus it is not induced.

Finally, the result that we wanted to present here is the following [28].

**Theorem 1.1.5** *Let  $G$  be a connected graph of order  $n \geq 3$ . If  $G$  contains no induced subdivided stars on  $a + 2$  rays for some  $a \geq 1$ , then we have*

$$\gamma_{\text{pr}}(G) \leq \frac{2(an + 1)}{2a + 1} \tag{1.1}$$

*and this bound is sharp.*

The proof of this theorem is based on the nonexistence of a minimum counterexample. We suppose there exists a minimum counterexample, we find a large subdivided star in it and remove its center. Then using a trick on the parity of the paired dominating sets, we prove that one of the resulting components is necessarily a counterexample too, contradicting the minimality of our counterexample. The sharpness of the bound for a given  $a$  is reached by the subdivided star with  $a + 1$  rays, so we cannot hope to keep the same bound for larger excluded subgraph. The bound is also reached on arbitrarily large graphs obtained by the following construction: take any number  $p$  of subdivided stars on  $a$  rays, and form a complete subgraph with the centers. Add a vertex to the clique and attach a degree one vertex to

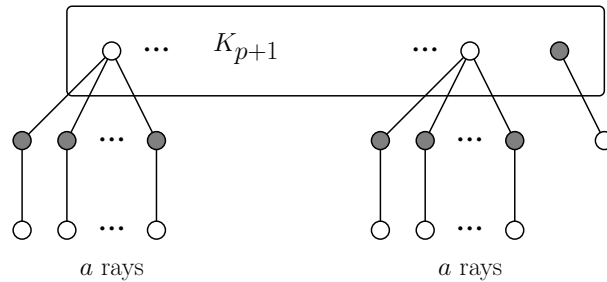

Figure 1.2: A construction of graphs reaching the bound of Theorem 1.1.5

it (see Figure 1.2). The set of gray vertices in the Figure is a subset of any total dominating set thus of any paired dominating set, and since it is independent, the paired domination number of the graph is at least twice its order.

Note that the bound obtained in this theorem is the same as in Theorem 1.1.3. This means that excluding subdivided stars is as efficient as excluding stars, though subdivided stars are much larger and more restricted subgraphs. This somehow confirms our intuition that subdivided stars are really the right subgraph for this study. Also, it should be noticed that the result gives a very general bound. For any graph (with maximum degree  $\Delta$ ), there exist some  $a \leq \Delta + 2$  such that the graph does not contain an induced subdivided star with  $a + 2$  rays. However, there is no lower bound implied by the existence of an induced subgraph isomorphic to a subdivided star.

### Upper paired domination

In the previous section, we described the research for a good lower bound on the cardinality of a minimal paired dominating set. Of course, it also seems interesting to find a good upper bound on the cardinality of a (inclusion-wise) minimal paired dominating set. The maximum size of a minimal paired dominating set of a graph is called its *upper-paired domination number* and denoted  $\Gamma_{\text{pr}}(G)$ . Upper domination parameters are defined similarly for most domination parameters. The upper-paired domination number can also be seen as the worst result that a greedy algorithm proceeding by exclusion of vertices to form a paired dominating set would return.

From Theorem 1.1.1, we know that there is again no better bound on the upper-paired domination number of a graph than its order minus one in the general case. To propose better bounds on the upper paired domination number, we tried to consider the case when the minimum degree of the graph is bounded. We first proved the following in [31]:



**Theorem 1.1.6** *If  $G$  is a connected graph of order  $n \geq 3$ , then  $\Gamma_{\text{pr}}(G) \leq n-1$ . Furthermore, if  $G$  has minimum degree  $\delta \geq 2$ , then  $\Gamma_{\text{pr}}(G) \leq n-\delta+1$ , and this bound is sharp.*

This theorem brings in view that no degree condition can efficiently decrease the upper paired domination number of graphs in general. To see that this bound is sharp, you may just consider the graph  $G_{\Gamma_{\text{pr}}}$  obtained as follows: take  $G_1$  a union of at least  $\frac{\delta}{2}$   $K_2$  and  $G_2$  any graph on  $\delta-1$  vertices, and add all possible edges between  $G_1$  and  $G_2$  (see Figure 1.3). Then  $G_1$  is a minimal paired dominating set of the graph of size  $n-\delta+1$ . Note that when taking for  $G_1$  a complete graph,  $G_{\Gamma_{\text{pr}}}$  does not contain an induced  $P_5$ , but it does contain a large star.

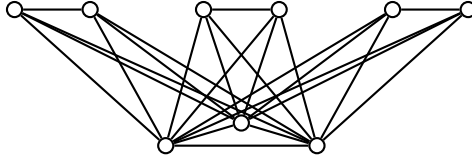

Figure 1.3: A graph  $G_{\Gamma_{\text{pr}}}$  with  $\Gamma_{\text{pr}}(G_{\Gamma_{\text{pr}}}) = n - \delta + 1$  for  $\delta = 4$

As a way to get rid of the cases with such large minimal paired dominating sets, we consider graphs with no induced claw. In claw-free graphs, we could prove that there exist no minimal paired-dominating sets on more than  $\frac{4n}{5}$  vertices. Actually, we managed to give better bounds for larger minimum degrees, and we got the following theorem.

**Theorem 1.1.7** *If  $G$  is a connected claw-free graph of order  $n$  and minimum degree  $\delta$ , then*

$$\Gamma_{\text{pr}}(G) \leq \begin{cases} \frac{4}{5}n & \text{if } \delta = 1 \text{ and } n \geq 3 \\ \frac{3}{4}n & \text{if } \delta = 2 \text{ and } n \geq 6 \\ \frac{2}{3}n & \text{if } \delta \geq 3. \end{cases}$$

*and these bounds are tight.*

The proof of this theorem strongly relies on a technical lemma that shows that given a graph  $G$  and a minimal paired dominating set  $D$ , every component of  $G[D]$  can be associated almost as many private-neighbors than half its order. This naturally brings you to a bound of about  $\frac{2}{3}$  the order of the graph.

When the minimum degree of the graph is larger, we found some nice constructions that we expect to reach the worst ratio (*upper-paired domination number*)/order. This ratio for our family goes to a half when the minimum degree goes to infinity, but we did not manage yet to prove that our construction indeed reach the worst case. It is still an open problem that we expect should be solvable.

Also, in a similar way as the previous section, we notice that the claw is an artificially chosen subgraph to avoid the worst cases. It seems that the actual subgraphs that should have been considered are in fact the graphs obtained by taking  $k$  copies of  $K_2$  and adding a vertex adjacent to at least one vertex of each  $K_2$ . Let  $\mathcal{G}_k$  denote this family. One may improve the bound by excluding this family instead.

**Question 1.1.8** *Is there a good bound on  $\Gamma_{\text{pr}}(G)$  when  $G$  does not contain an induced subgraph in  $\mathcal{G}_k$ ?*

Inspired by what was done on paired domination, a wild guess would be that is  $G$  does not contain a subgraph in  $\mathcal{G}_k$ , then  $\Gamma_{\text{pr}}(G) \leq \frac{2k-2}{2k-1}n$ .

### Paired versus double domination

In the study of domination, many variations were introduced. It is often difficult to give nice relationships between the various parameters, though it is very instructive. In some recent collaboration, we got interested in the relationship between paired domination and double domination. A subset of vertices in a graph is a *double dominating set* if every vertex is dominated twice, i.e. every vertex not in the set has two neighbors in the set and every vertex in the set has one. Double domination is a special case of  $k$ -tuple domination (where we require that every vertex be dominated  $k$  times). The minimum cardinality of a double dominating set of the graph is the double domination number, denoted  $\gamma_{\times 2}(G)$ .

Chellali and Haynes [23] were the first to study the relationship between paired and double domination in graphs. They observed the following.

**Observation 1.1.9 (Chellali, Haynes, [23])** *In general, paired and double domination numbers are incomparable.*

This observation is based on the following examples (given in [23]). For  $k \geq 1$ , let  $G_k$  be the graph obtained from  $k$  disjoint 6-cycles by adding a new vertex and joining it to an independent set of three vertices in each 6-cycle (see Figure 1.4). The resulting graph  $G_k$  is a bipartite graph satisfying  $\gamma_{\text{pr}}(G_k) = 4k$ , while  $\gamma_{\times 2}(G_k) = 3k + 1$ . The second example is the corona of the complete graph  $K_{2k}$ : for  $k \geq 1$ , let  $H_k$  be obtained from a complete graph  $K_{2k}$  on  $2k$  vertices by adding a pendant edge to each vertex of the complete graph. Then  $\gamma_{\text{pr}}(H_k) = 2k$ , while  $\gamma_{\times 2}(H_k) = 4k$ .

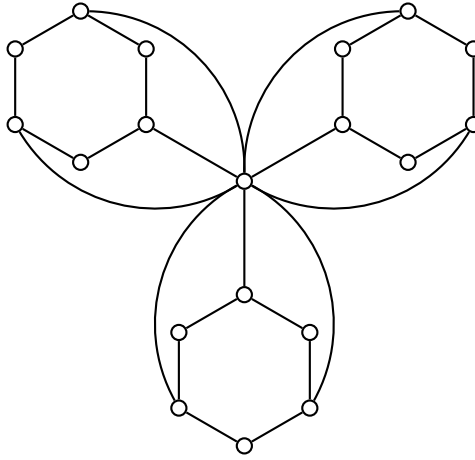
Figure 1.4: The graph  $G_k$  for  $k = 3$ 

Despite this observation, in various cases, a relation can be established between the paired and the double domination of two graphs. As an example, Blidia, Chellali, and Haynes [10] showed that for every tree  $T$  on at least two vertices,  $\gamma_{\text{pr}}(T) \leq \gamma_{\times 2}(T)$ , and they characterized the extremal trees. Chellali and Haynes [23] also showed the following bound on claw-free graphs:

**Theorem 1.1.10 (Chellali, Haynes [23])** *If  $G$  is a claw-free graph with no isolated vertex, then  $\gamma_{\text{pr}}(G) \leq \gamma_{\times 2}(G)$ .*

We managed to extend this bound by generalizing it to star-free graphs.

**Theorem 1.1.11** *For  $r \geq 2$ , if  $G$  is a  $K_{1,r}$ -free graph with no isolated vertex, then*

$$\gamma_{\text{pr}}(G) \leq \left( \frac{2r^2 - 6r + 6}{r(r-1)} \right) \gamma_{\times 2}(G),$$

*and this bound is asymptotically best possible.*

We prove this theorem in [30] by constructing a paired dominating set of appropriate order from a minimum double dominating of the graph. We first select a maximum matching in the double dominating set, and then extend this matching to get a dominating set. The star-free condition allows us to give a bound on the number of edges added to the set. Note that this proof is constructive and a polynomial time algorithm can be proposed naturally following the proof. The theorem directly extend Chellali and Haynes' result on claw-free graphs when we set  $r = 3$ . When  $r > 3$ , the graph for which this bound is closest to be tight to our knowledge is the following.

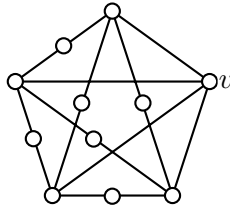
Figure 1.5: The graph  $F_5$ .

For  $r \geq 4$ , let  $F_r$  be the graph obtained from a complete graph  $K_r$  as follows: select an arbitrary vertex  $v$  and subdivide all edges not incident with  $v$ . Equivalently,  $F_r$  is obtained from a complete graph  $K_{r-1}$  by subdividing every edge once and then adding a new vertex  $v$  and joining  $v$  to every vertex of the original complete graph  $K_{r-1}$ . The graph  $F_5$ , for example, is illustrated in Figure 1.5. The graph  $F_r$  is  $K_{1,r}$ -free of order  $r + \binom{r-1}{2}$ . The minimum double dominating set of  $F_r$  is of size  $r$ , and it can be formed by the  $r$  vertices of degree more than 2. However, to get a paired dominating set one need to take  $2(r-2)$  vertices. Therefore, this graphs satisfies the following equality, which is very close from our proof:

$$\gamma_{\text{pr}}(F_r) = \left( \frac{2r^2 - 6r + 4}{r(r-1)} \right) \gamma_{\times 2}(F_r).$$

We expect that the upper bound can actually be improved to attain this value. There might be some clue in our proof related to the selection of the matching. Maybe a more careful choice than simply a maximal matching would close the gap, though it is difficult to verify.

### 1.1.2 Independent domination

The last topic on domination in this chapter is on independent domination. A dominating set of a graph is an *independent dominating set* if the subgraph induced by the set contains no edges, that is if the set is also an independent set. The minimum size of an independent dominating set is the *independent domination number*, denoted  $i(G)$ . Since any maximal independent set in a graph is also a dominating set, this parameter can also be seen as the minimum size of a maximal independent set in the graph (with a similar approach as upper domination, but for *lower independence*).

The question of best possible bounds on the independent domination number of a connected cubic graph remains unresolved. Recall that a graph is cubic (or 3-regular) if all its vertices are of degree 3, and subcubic if it is of maximum degree 3. Lam, Shiu, and Sun [63] established the following upper bound on the independent domination number of a connected cubic graph.

**Theorem 1.1.12 (Lam, Shiu, Sun [63])** *For a connected cubic graph  $G$  on  $n$  vertices,  $i(G) \leq 2n/5$  except for  $K_{3,3}$ .*

Equality in Theorem 1.1.12 holds for the prism  $C_5 \square K_2$ . It is conjectured in [46] that the graphs  $K_{3,3}$  and  $C_5 \square K_2$  (drawn in Figure 1.6) are the only exception for an upper bound of  $3n/8$ .

**Conjecture 1.1.13 (Goddard, Henning [46])** *If  $G \notin \{K_{3,3}, C_5 \square K_2\}$  is a connected cubic graph on  $n$  vertices, then  $i(G) \leq 3n/8$ .*

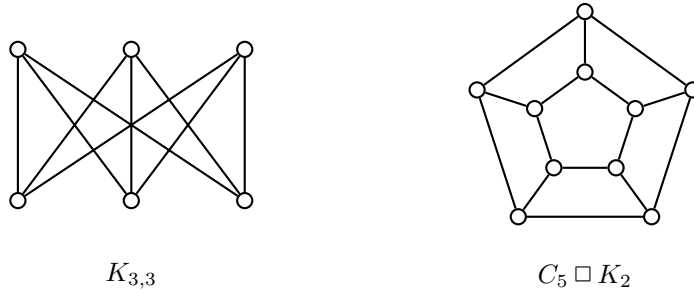

Figure 1.6: The graphs  $K_{3,3}$  and  $C_5 \square K_2$ .

As a comparison, the same bound is true for the domination number: Reed proved in [74] that cubic graphs of order  $n$  have domination number at most  $\frac{3n}{8}$ . He also conjectured that maybe a better bound of  $\lceil \frac{n}{3} \rceil$  could be proven. This was disproved by Kostochka and Stodolsky [61], who suggested that the bound might hold for 2-connected cubic graphs. That second suggestion was itself disproved by Kelmans [56], who conjectured that the bound should hold for 3-connected cubic graphs. We don't know of any result proving or disproving that conjecture yet.

In the meanwhile, Kostochka and Stocker gave a better upper bound for the domination number of connected cubic graphs. To summarize, if  $\mathcal{G}_{\text{cubic}}^n$  denotes the family of all connected cubic graphs of order  $n$ , then the following is known ([56, 62]).

$$0.35 = \frac{1}{3} + \frac{1}{60} \leq \sup_{G \in \mathcal{G}_{\text{cubic}}^n} \left( \lim_{n \rightarrow \infty} \frac{\gamma(G)}{n(G)} \right) \leq \frac{1}{3} + \frac{1}{42} \approx 0.35714.$$

In the following, we give a partial proof of Conjecture 1.1.13 for independent domination. Note that a better bound than  $i(G) \leq \frac{3n}{8}$  should not be expected. Indeed, two infinite families  $\mathcal{G}_{\text{cubic}}$  and  $\mathcal{H}_{\text{cubic}}$  of connected cubic graphs with independent domination number three-eighths their orders were proposed by Goddard, Henning, Lyle and Southey in [47].

**Property 1.1.14 ([47])** *If  $G \in \mathcal{G}_{\text{cubic}} \cup \mathcal{H}_{\text{cubic}}$  has order  $n$ , then  $i(G) = 3n/8$ .*

Graphs in the families  $\mathcal{G}_{\text{cubic}}$  and  $\mathcal{H}_{\text{cubic}}$  are illustrated in Figure 1.7. It is remarked in [46] that “perhaps it is even true that for  $n > 10$ ,  $i(G) \leq 3n/8$  with equality if and only if  $G \in \mathcal{G}_{\text{cubic}} \cup \mathcal{H}_{\text{cubic}}$ . We remark that computer search has confirmed this is true when  $n \leq 20$ .”

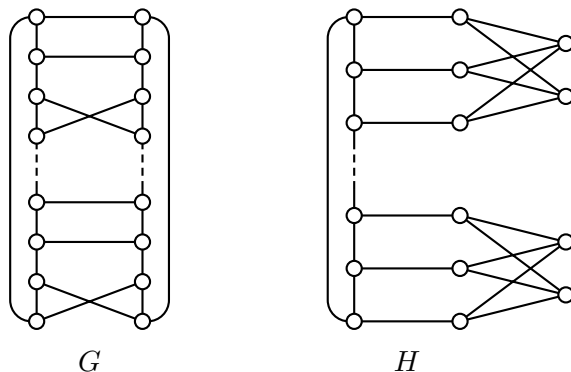

Figure 1.7: Graphs  $G \in \mathcal{G}_{\text{cubic}}$  and  $H \in \mathcal{H}_{\text{cubic}}$  of order  $n$  with  $i(G) = i(H) = 3n/8$ .

We prove in [33] the following:

**Theorem 1.1.15** *If  $G$  is a subcubic graph that does not have a subgraph isomorphic to  $K_{2,3}$  and which has no  $(C_5 \square K_2)$ -component, then*

$$8i(G) \leq 8n_0(G) + 5n_1(G) + 4n_2(G) + 3n_3(G).$$

The proof is based on the nonexistence of a minimum counterexample. Considering such a minimum counterexample, we show a series of lemmas of type: if the graph contains such a structure, then we can remove some subgraph, find a small enough independent dominating set on the subgraph we got, and extend it to the whole graph. We show this way first that a minimum counterexample should be 3-regular, then we work on the small cycles until we prove the graph has girth at least 8, which allows us to conclude the proof.

For this result, we require that there is no  $K_{2,3}$ -subgraph in  $G$ . However, we believe that the assertion should be dropped and replaced by  $G \neq K_{3,3}$ . This is still an open question. It is not an easy thing to do, but maybe starting on the same basis, and adding some clever argument to replace  $K_{2,3}$  by another subgraph, we could solve this other problem.

It should be noted that completing the same proof, we obtain the following theorem:

**Theorem 1.1.16** *If  $G$  is a subcubic graph, then*

$$8\gamma(G) \leq 8n_0(G) + 5n_1(G) + 4n_2(G) + 3n_3(G).$$

This theorem is not new, but it implies Reed's result [74] evoked earlier and is a new proof of the result proved independently by Fischer, Fraughnaugh, Seager [44], and Rautenbach [73] on the domination number of sub-cubic graphs.

### 1.1.3 Conclusion

In this section on domination, different results on domination are presented that all share a common approach. The very first step of the research process is looking for the worst cases for our parameter. We identify a few examples or a small family of examples that reaches the worst bound, which may usually be known. What we then prove is that this small family contains the only few graphs forcing the bound, and we then prove a better bound. In paired domination, this small family contains the subdivided stars; in upper paired domination, we got rid of the graphs with claws to exclude the graph  $G_{\Gamma_{\text{pr}}}$  (in Figure 1.3) or maybe simply the family  $\mathcal{G}_k$ ; for comparing paired and double domination, we excluded the graphs in Figure 1.4 by excluding induced stars; and for independent domination, the family contained just two graphs:  $K_{3,3}$  and  $C_5 \square K_2$ .

This really gives the feeling that for many problems, there are very few graphs that are difficult to deal with, and the vast majority of graphs are rather gentle. This idea is also supported by the very strong results that can be obtained for almost all graphs by probabilistic arguments, even though it is known that there are examples of graphs very far from the *almost sure* bound.

On the other hand, this is an interesting general approach for these graph parameters. Sometimes, like in paired domination and independent domination, we could give a better bound by excluding precisely the graphs known to be the worst cases. Such results are somehow more satisfying since they are precise. This can be seen as a general question:

**Problem 1.1.17 (General framework)** *Given a graph parameter  $\gamma^*$  for which we have a general bound and a family  $\mathcal{F}$  of graphs reaching this bound, can we improve the bound by excluding the family  $\mathcal{F}$ ?*

Note that this is an auto-regenerating problem, since when you get a new bound, you get a new graph for which it is tight and a new problem. However, we can reach rather satisfying general family of bounds for that problem, like what we got for paired domination in Theorem 1.1.5.

## 1.2 Colorings

In this second part of the chapter, we study problems of colorings, that is partitioning the vertices of a graph so that the vertices of a same color induce a subgraph with a given property. The most frequent coloring problems require for the parts to induce an independent set. We here study coloring problem with different restrictions. In section 1.2.1, we require that the parts induce a cograph. In section 1.2.2, we instead simply fix the maximum degree of the subgraph induced by each part.

### 1.2.1 Cograph partitions

In this section we focus on vertex-partitions such that each part induces a cograph. Cographs form the minimal family of graphs containing  $K_1$  that is closed under complement and disjoint union. Cographs are also characterized as the graphs containing no induced copy of the path  $P_4$  (see [75]). A simple example of a cograph is the star  $K_{1,n}$ . In the following, we get interested in both cograph partition and star partition.

A *cograph  $k$ -partition* (resp. *star  $k$ -partition*) of  $G$  is a vertex-partition of  $G$  in  $k$  sets  $V_1, \dots, V_k$  such that the graph induced by each  $V_i$  is a cograph (resp. a star forest). Moreover we call a  *$d$ -star  $k$ -partition* a star  $k$ -partition whose every induced component has order at most  $d$ . Note that a 1-star  $k$ -partition is a proper  $k$ -coloring, and that any star-partition is a cograph partition.

The first question we got focused on about cograph partition is the complexity of the problem. Deciding whether a graph is cograph  $k$ -partitionable is known to be linear time solvable when  $k = 1$  [25] and NP-complete for  $k \geq 2$  [3]. In [45] Gimbel and Nešetřil focused on planar graphs and proved:

**Theorem 1.2.1 (Gimbel, Nešetřil [45])**

1. *Deciding whether a planar graph is cograph 3-partitionable is NP-complete.*
2. *Deciding whether a planar graph with maximum degree at most 6 is cograph 2-partitionable is NP-complete.*

In the same paper, they implicitly raise the following question:

**Question 1.2.2 (Gimbel, Nešetřil [45])** *Does there exist a triangle-free planar graph that is not cograph 2-partitionable? If the answer is yes, what is the complexity of the associated decision problem?*

In [37], we provide an example of a triangle-free planar graph not partitionable into two cographs, and manage to prove that the corresponding decision problem is NP-complete, answering Question 1.2.2. In fact, we

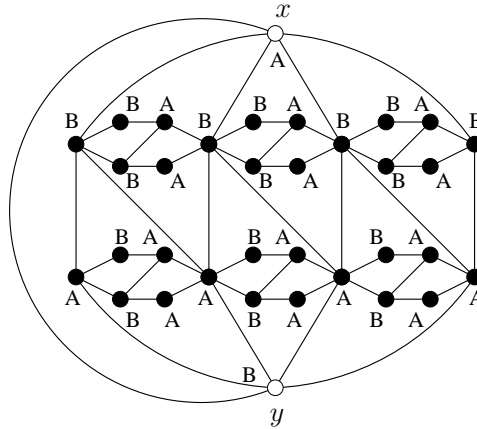

Figure 1.8: A triangle-free *edge widget* for NP-reduction

prove a stronger result. Let  $\overline{\mathcal{C}}_{\text{cograph}}$  be the class of graphs admitting no vertex-partition into two cographs, and let  $\mathcal{C}_{3\text{-star}}$  be the class of graphs admitting a 3-star 2-partition. Since a star is a cograph, these families of graphs are disjoint:  $\mathcal{C}_{3\text{-star}} \cap \overline{\mathcal{C}}_{\text{cograph}} = \emptyset$ .

### Theorem 1.2.3

1. It is NP-complete to determine whether a triangle-free planar graph in  $\mathcal{C}_{3\text{-star}} \cup \overline{\mathcal{C}}_{\text{cograph}}$  belongs to  $\mathcal{C}_{3\text{-star}}$ , i.e. is 3-star 2-partitionable.
2. It is NP-complete to determine whether a planar graph with no 4-cycle and with maximum degree 4 in  $\mathcal{C}_{3\text{-star}} \cup \overline{\mathcal{C}}_{\text{cograph}}$  belongs to  $\mathcal{C}_{3\text{-star}}$ .

This shows that we cannot decide whether a graph is cograph partitionable in polynomial time (unless  $P=NP$ ) even if we know that if the graph admits a cograph partition, then it is a *simple* one, that is a partition into 3-stars forests. The proof is based on a reduction from the problem of deciding whether a 3-uniform hypergraph is 2-colorable. We simply provide some appropriate sets of widgets, one triangle-free, the second of maximum degree 4 with no 4-cycles.

For example in the widget of Figure 1.8, we proved that it is not possible to find a cograph 2-partition where the two end-vertices  $x$  and  $y$  are in the same part. On the other hand, the labels A and B describe a 3-star 2-partition where these vertices are in different parts. To find a triangle-free planar graph not cograph 2-partitionable, one may simply replace the five edges of a cycle of length 5 by this widget, seen as the edge  $xy$ . Since the 5-cycle is not 2-colorable, there is no cograph 2-partition of the resulting graph.

Note that besides answering Question 1.2.2, this result also improves the second point of Theorem 1.2.1, reducing the maximum degree from 6 to 4. We observe that the maximum degree cannot be reduced further, with the following observation:

**Observation 1.2.4** *All subcubic graphs admit a vertex-partition into two subgraphs of maximum degree 1.*

To see this, consider a coloring  $\phi$  of the vertices of a subcubic graph with two colors that minimize the number of edges with the same color at both ends, called monochromatic edges. Suppose there is a vertex  $u$  with the same color than at least two of its neighbors in  $\phi$ . The vertex  $u$  is of degree at most 3 so recoloring  $u$ , we replace two monochromatic edges by at most one, contradicting our choice of  $\phi$ . Thus, this coloring partitions the vertices in two sets each inducing a graph of maximum degree one.

A very common proof technique for proving bounds on the coloring numbers of graphs is the so-called *discharging procedure*. Due to the nature of this technique, many studies on vertex partitions use the *maximum average degree* of a graph as a parameter. The maximum average degree of a graph  $G$ , denoted  $\text{mad}(G)$ , is the maximum of the average degrees of all subgraphs of  $G$ , that is: :

$$\text{mad}(G) = \max_{H \subseteq G} \left\{ \frac{2|E(H)|}{|V(H)|} \right\}$$

Note that due to Euler's formula, the maximum average degree of a planar graph is related to its girth  $g$ , i.e. to the length of a shortest cycle in the graph, by the relation  $(g - 2)\text{mad}(G) < 2g$ .

In this context, a general question for star-partitions is the following:

**Problem 1.2.5** *Given an integer  $k \geq 1$ , does there exist  $f(k)$  such that every graph with  $\text{mad}(G) < f(k)$  is  $k$ -star 2-partitionable?*

For  $k = 1$ , a 1-star 2-partition is exactly a 2-coloring, and the best general possible bound on the  $\text{mad}$  for a graph to be 2-colorable is  $\text{mad}(G) < 2$ , which correspond to trees. An odd cycle has average degree 2 and is not 2-colorable. Havet and Sereni [50] proved that every graph with  $\text{mad}(G) < \frac{8}{3}$  is 2-star 2-partitionable. Studying list strong linear 2-arboricity of sparse graphs, Borodin and Ivanova [11] proved that every graph with  $\text{mad}(G) < \frac{14}{5}$  and girth at least 7 is 3-star 2-partitionable. They added to their result the following comment:

*This could be weakened to  $g(G) \geq 6$ , say, but at price of some tedious case analysis.*

In [37], we prove that we can completely drop the assumption on the girth and obtain:

**Theorem 1.2.6** *Every graph  $G$  with  $\text{mad}(G) < \frac{14}{5}$  is 3-star 2-partitionable.*

The proof of this result begins by following the discharging procedure scheme. We show that a graph either has  $\text{mad}$  at least  $\frac{14}{5}$ , or contains one of a special family of subgraphs. Since  $\frac{14}{5} < 3$ , we know that the graph contains a vertex of degree at most 3 and we can find our family of subgraphs by generating the possible neighborhoods of this vertex. The girth assumption in [11] is a frequently used way to restrict the number of subgraphs generated that way. The originality of our proof resides in the fact that we do not describe explicitly all the subgraphs we study, and therefore avoid the “tedious case analysis” Borodin and Ivanova announced. We describe the possible configurations as a family of trees, and then prove the result for any embedding of these configurations in a graph. To do so, we identify in the configurations some vertices whose color can be chosen quite freely. We color greedily the other vertices, choosing any color if they have no colored neighbors, and then have few simple rules for choosing the color of the remaining vertices.

For  $k \geq 4$ , Problem 1.2.5 remains open. By [11], every planar graph of girth at least 7 is 3-star 2-partitionable. Moreover, there exist triangle-free planar graphs which are not cograph 2-partitionable, and therefore planar graphs with girth 4 not  $k$ -star 2-partitionable for any  $k$ . The existence of star 2-partitions or even of cograph 2-partitions for planar graphs of girth 5 and 6 remains an open question.

## 1.2.2 Near colorings

In this section, we consider partitioning the graph in subsets with a bounded maximum degree. A graph  $G$  is  $(d_1, \dots, d_k)$ -colorable if the vertex set of  $G$  can be partitioned into subsets  $V_1, \dots, V_k$  such that the graph  $G[V_i]$  induced by the vertices of  $V_i$  has maximum degree at most  $d_i$  for all  $1 \leq i \leq k$ . When all the  $d_i$  are equal to 0, this defines proper coloring on  $k$  colors, whereas if all  $d_i$  equal to a same positive integer  $d$ , then this defines  $d$ -improper coloring. For example, planar graphs are known to be  $(0, 0, 0, 0)$ -colorable [6] and  $(2, 2, 2)$ -colorable [26].

An interesting result for our following study is due to Havet and Sereni [50].

**Theorem 1.2.7 (Havet and Sereni [50])** *Every graph  $G$  with  $\text{mad}(G) < k + \frac{kd}{k+d}$  is  $d$ -improper  $k$ -colorable (in fact,  $d$ -improper  $k$ -choosable), i.e.  $(d, \dots, d)$ -colorable (where the tuple is of size  $k$ ).*

Moreover the bound they propose here on the maximum average degree is asymptotically sharp:

**Theorem 1.2.8 (Havet and Sereni [50])** *There exists a non  $d$ -improper  $k$ -colorable graph whose maximum average degree tends to  $2k$  when  $d$  goes to infinity.*

Until now, most studies on  $(d_1, \dots, d_k)$ -colorable graphs with  $d_i$  taking different values were just for  $(d_1, d_2)$ -colorings. After various weaker results on the topic, Borodin and Kostochka [15] showed that every graph  $G$  with  $\text{mad}(G) \leq \frac{12}{5}$  is  $(1, 0)$ -colorable, implying that every planar graph with girth at least 12 is  $(1, 0)$ -colorable. They also proved that their bound on the  $\text{mad}$  is best possible by constructing graphs  $G$  with  $\text{mad}(G)$  arbitrarily close (from above) to  $\frac{12}{5}$  that are not  $(1, 0)$ -colorable. Note that the largest known girth for a planar graph non  $(1, 0)$ -colorable is due to Esperet *et al.* [41] that found a planar graph non  $(1, 0)$ -colorable with girth 9; yet whether planar graphs with girth 10 or 11 are  $(1, 0)$ -colorable remains an open question.

More general problems on  $(d_1, \dots, d_k)$ -colorings were also studied. For this study, the most interesting one is the following:

**Theorem 1.2.9 (Borodin *et al.* [12])** *Let  $d \geq 2$  be an integer. Every graph  $G$  with  $\text{mad}(G) < \frac{3d+4}{d+2}$  is  $(d, 0)$ -colorable. Moreover there exists a non  $(d, 0)$ -colorable graph  $G$  with  $\text{mad}(G) = \frac{3d+4}{d+2} + \frac{1}{d+3}$ .*

Other results give some bounds on the  $\text{mad}$  for being  $(d, 1)$ -colorable [14] or general conditions on the graph density for being  $(d_1, d_2)$ -colorable [13].

We here consider the case where each graph  $G[V_i]$  ( $1 \leq i \leq k$ ) is either a subgraph with maximum degree at most  $d$ , or an edgeless graph, that is  $(d, \dots, d, 0, \dots, 0)$ -colorings. In particular, we prove that having for  $G[V_i]$  a subgraph with maximum degree at most  $d$  even for a large degree  $d$  is no more powerful (in terms of  $\text{mad}$ ) than having two edgeless graphs.

Let  $d, a, b$  be non-negative integers, with  $d > 0$ . A graph  $G$  is  $(d, a, b)^*$ -colorable if the vertex set of  $G$  can be partitioned into subsets  $D_1, \dots, D_a$  and  $O_1, \dots, O_b$  such that the graph  $G[D_i]$  induced by the vertices of  $D_i$  ( $1 \leq i \leq a$ ) has maximum degree at most  $d$ , while the graph  $G[O_j]$  induced by the vertices of  $O_j$  ( $1 \leq j \leq b$ ) is an edgeless graph. A  $(d, a, b)^*$ -coloring can be looked at as a  $(d, \dots, d, 0, \dots, 0)$ -coloring with  $a$  occurrences of the value  $d$  corresponding to colors of type  $D_i$  and  $b$  occurrences of value 0, colors of type  $O_j$ . We prove in [34]:

**Theorem 1.2.10** *Let  $a, b, d$  be integers with  $a + b > 0$  and  $d > 0$ . Every graph  $G$  with  $\text{mad}(G) < \mathfrak{f}(d, a, b)$  is  $(d, a, b)^*$ -colorable, where*

$$\mathfrak{f}(d, a, b) = a + b + \frac{da(a+1)}{(a+d+1)(a+1) + ab}.$$

This property of graphs with small maximum average degree is proved by a single general discharging procedure based on the degrees of the vertices.

It has only two discharging rules and does not make any special cases related to the values of  $a$ ,  $b$  or  $d$ . The bound can probably be improved for precise values of  $a$ ,  $b$  or  $d$  by a dedicated proof. The second result we prove in [34] shows that the bound is asymptotically tight.

**Theorem 1.2.11** *For any positive integers  $d, a, b$ , there exists a graph  $G_{d,a,b}$  which is not  $(d, a, b)^*$ -colorable but is  $(d, 0, a + b + 1)^*$ -colorable, and has maximum average degree  $\mathfrak{g}(d, a, b)$ , where*

$$\mathfrak{g}(d, a, b) = 2a + b - \frac{2}{(d+1)(b+1) - 1} + \frac{2a+2}{(d+1)^{a+1}(b+1)^{a+1} - 1}.$$

This theorem is simply proved by constructing a general family  $G_{d,a,b}$  of non  $(d, a, b)^*$ -colorable graphs that reach that bound, by recursion on  $a$ . For  $a = 0$ , we define  $G_{d,0,b} = K_{b+1}$ , the complete graph on  $b + 1$  vertices. Suppose now  $a \geq 1$ . We first define a graph  $F_x$  (called the fan on  $x$ ) as follows : take  $d + 1$  disjoint copies of  $G_{d,a-1,b}$  (denoted  $H_1, \dots, H_{d+1}$ ), and add a vertex  $x$  adjacent to all the vertices of every copy. To form  $G_{d,a,b}$ , now take  $b + 1$  fans  $F_{x_1}, \dots, F_{x_{b+1}}$ , and form a complete graph on  $x_1, \dots, x_{b+1}$ . The construction principle of the graph  $G_{d,a,b}$  is depicted in Figure 1.9.

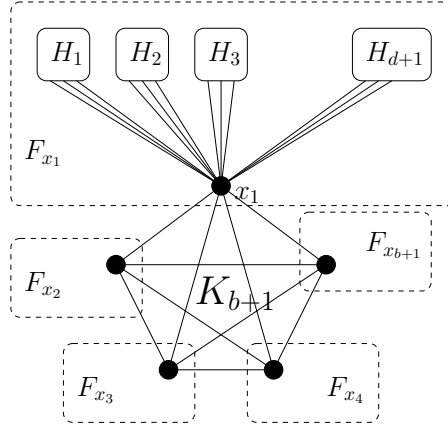

Figure 1.9: The graph  $G_{d,a,b}$ .

Then, proving the non  $(d, a, b)^*$ -colorability and the  $(d, 0, a + b + 1)^*$ -colorability is rather easy. However, computing the mad of the graph is a non trivial technical proof.

Interestingly, both functions  $\mathfrak{f}$  and  $\mathfrak{g}$  tend to  $2a + b$  when  $d$  tends to infinity, showing that asymptotically, we obtain a tight bound of  $2a + b$ . On the one hand, this bound confirms the intuition given by the bound of Havet and Sereni corresponding to the case  $b = 0$ , where the maximum average degree tends to  $2a$  when  $d$  goes to infinity. On the other hand, it also gives

a better perspective of the work of Borodin *et al.* [12] corresponding to the case  $a = 1$  and  $b = 1$ , where the maximum average degree tends to 3 when  $d$  goes to infinity. However our results do not imply these two results. For these cases, their results are sharper in the sense that (1) the upper bound on the maximum average degree that guarantees the existence of a  $(d, a, b)^*$ -coloring (for  $b = 0$  and  $a = 1, b = 1$ ) is higher, and (2) the convergence toward  $2a + b$  (for  $b = 0$  and  $a = 1, b = 1$ ) given by their constructions is quicker.

A question naturally arises from this study. We got that when  $d$  goes to infinity, a color whose induce subgraph have maximum degree  $d$  behaves in terms of maximum average degree similarly to two colors whose induced subgraph are independent. Is it possible that we can simply model the problem by giving a color of degree  $d$  for any  $d$  some *share* being simply a function of  $d$  lying between 1 and 2?

**Question 1.2.12** *Is there some function  $f$  such that any graph with maximum average degree less than  $\sum_{i=1}^k f(d_i)$  is  $(d_1, \dots, d_k)$ -colorable and this bound is tight?*

The result on  $(d, 0)$ -coloring in [12] together with our results suggest that  $f(d)$  should lie between  $1 + \frac{d}{d+2}$  and  $1 + \frac{d}{d+2} + \frac{1}{d+3}$ . It should be noticed that  $a(1 + \frac{d}{d+2}) + b$  lies nicely between  $\mathfrak{f}(d, a, b)$  and  $\mathfrak{g}(d, a, b)$ .



## Chapter 2

# Power domination

In this chapter, we are interested in power domination in graphs. Power domination is a variation of domination introduced to address a physical problem of monitoring a network with phasor measurement units. It is somehow a very singular variation of domination since it implies some possibility of propagation, the set of vertices monitored by an initial set has to be computed with an iterative process.

I got interested in this problem quite early, and I have followed carefully the different progresses on the topic. In 2010, during a visit in Taiwan, we proposed a generalized version which reveals a nice common behavior of power domination and domination. Since, I have often thought that this problem was really accurate for a student to work on. I currently supervise a master student working on this topic, especially on power domination in graph products. He would like to continue on a PhD if he gets some funding. Hopefully, he will have the opportunity to continue on power domination, which I am convinced is an appropriate topic.

In this chapter, we propose a tentative survey of the known results on power domination. After retracing the evolution of the definition of the problem in Section 2.1, we quickly describe the progress made on its algorithmic complexity in Section 2.2. Then, Section 2.3 is dedicated to the search for bounds on the power domination number of graphs, depending on the structural properties of the graph. This is the only section where we present some of our recent new results. Section 2.4 recalls the different studies on power domination in graph products, lattices and other families of graphs. This is mostly interesting for the wide research tracks this offers.

### 2.1 Definition

Power domination was introduced by Baldwin et al. in [7], then described as a graph theoretical problem by Haynes et al. in [51]. The problem is motivated by the requirement for constant monitoring of power systems by



placing a minimum number of phasor measurement units (PMU) in the network. A PMU placed at a bus measures the voltage of the bus plus the current phasors at that bus. Using Ohm and Kirchhoff current laws, it is then possible to infer from initial knowledge of the status of some part of the network the status of new branches or buses.

In [7], the following definitions are proposed:

A *measurement-assigned subgraph*, called for short a measurement subgraph, is a subgraph which has a current measurement assigned to each of its branches. These are either actual measurement or calculated pseudo-measurement deduced from Kirchhoff's and Ohm's laws. [...]

The *coverage* of a placement set of PMU's is the maximal spanning measurement subgraph that can be formed by this set, that is, the maximal observable sub-network that can be built from them.

They introduced the following formal definition of the spanning measurement subgraph:

**Definition 2.1.1 ([7])** A spanning measurement subgraph is constructed throughout the network on the grounds of the following rules:

- Rule 1: Assign a current phasor measurement to each branch incident to a bus provided with a PMU;
- Rule 2: Assign a pseudo-current measurement to each branch connecting two buses with known voltage;
- Rule 3: Assign a pseudo-current measurement to a branch whose current can be inferred by using Kirchhoff's current law.

In terms of graphs, where buses are vertices and connecting branches are edges, we can describe the observability rules of a network with the following definition:

**Definition 2.1.2 ([51])** Initially, set as monitored any vertex with a PMU and all edges incident to it. Then, expand iteratively the set of monitored edges and vertices with the following rules :

1. set as monitored any vertex incident to a monitored edge whose other end is monitored;
2. set as monitored any edge joining two monitored vertices;
3. if a vertex has all its incident edges monitored except one, set this one edge as monitored.

It was noticed in [40] and later in [36] that the power domination problem can be studied considering only vertices (from then said *monitored vertices*). The coverage of a placement set  $S$  of PMU is then simply the induced subgraph on the final set of monitored vertices,  $G[M(S)]$ . Recall that we denote by  $N(S)$  the *open neighborhood* of the vertices of  $S$ , that is  $N(S) = \{v \mid uv \in E, v \in S\}$ , and by  $N[S] = N(S) \cup S$  its *closed neighborhood*.

**Definition 2.1.3** ([40, 36]) Let  $G$  be a graph and  $S$  a subset of its vertices. The set  $M(S)$  of vertices monitored by  $S$  is defined algorithmically by:

1. (*domination*)  

$$M(S) \leftarrow S \cup N(S)$$
2. (*propagation*)  
 As long as there exists  $v \in M(S)$  such that  

$$N(v) \cap (V(G) - M(S)) = \{w\}$$
 set  $M(S) \leftarrow M(S) \cup \{w\}$ .

Finally, this latter definition was formally described with the following sets definition, where  $\mathcal{P}_1^i$  is the set of vertices monitored after  $i$  propagation rounds. This definition was first introduced by Aazami in [1] and we generalized this definition in [22] to introduced  $k$  power-domination. The corresponding definition for monitored set is obtained by replacing  $k$  by 1 in the following:

**Definition 2.1.4** ([22]) Let  $G$  be a graph,  $S \subseteq V(G)$  and  $k$  a non-negative integer. We define the sets  $(\mathcal{P}_k^i(S))_{i \geq 0}$  of vertices monitored by  $S$  at step  $i$  by the following rules.

- $\mathcal{P}_k^0(S) = N[S]$ .
- $\mathcal{P}_k^{i+1}(S) = \bigcup N[v]$ ,  $v \in \mathcal{P}_k^i(S)$  such that  $|N[v] \setminus \mathcal{P}_k^i(S)| \leq k$ .

It should be noticed that necessarily from this definition, for any  $i \geq 0$ ,  $\mathcal{P}_k^i(S) \subseteq \mathcal{P}_k^{i+1}(S)$ . Indeed, there exist some set  $S'$  (equal to  $S$  when  $i$  is 0) such that  $\mathcal{P}_k^i(S) = N[S']$ . Any vertex  $v$  in  $S'$  satisfies that  $|N[v] \setminus \mathcal{P}_k^i(S)| = 0 \leq k$ , and thus  $N[S'] \subseteq \mathcal{P}_k^{i+1}(S)$ . It should also be noticed that when  $k = 0$ , the definition corresponds to the normal domination parameter.

## 2.2 Algorithmic aspects

### 2.2.1 Complexity

The first question that arises with a new problem like this is whether it is NP-complete. Clearly, the problem is in NP because the computation of the monitored set from a vertex is polynomial. In [51], Haynes et al. proved

that deciding if a graph has power domination at most  $n$  is NP-complete even restricted to bipartite or chordal graphs. They used a similar reduction from 3-SAT than is used for domination. Guo, Niedermeyer and Raible then proved that power domination is also NP-complete for planar graphs, which was then restricted to planar bipartite graphs by Brueni and Heith [18].

### 2.2.2 Algorithms

While the problem is shown to be NP-complete for bipartite and chordal graphs, it can be polynomial in any classes not containing one of these. Indeed, Haynes et al. [51] proposed a linear algorithm for trees based on the recognition of spiders in the tree, a spider being any subdivision of a star. Guo et al. [48] proposed an other linear algorithm for trees using a technique more similar to the labelling algorithm that became classical for domination. We generalized this algorithm to  $k$ -power domination in [22]. This technique can also be extended to propose a *fixed parameter tractable (FPT)* algorithm for graphs with bounded tree-width. In fact, the existence of a FPT algorithm for power-domination was already proved for (1-)power domination by Kneis et al. [59] who used an expression of power domination in monadic second order logic. Then Guo, Niedermeyer and Raible [48] gave a direct linear algorithm for fixed parameter tractability for (1-)power domination in graphs with bounded tree-width.

Linear algorithms for block-cactus graphs were also proposed by Hon et al. [55], and for interval graphs and circular arc graphs by Liao and Lee in [64, 65].

## 2.3 Bounds for the power domination number

In this section, we recall bounds proven on the power domination number of a graph under certain restrictions.

### 2.3.1 General graphs

The first easy and general bound is due to Haynes et al. [51]. They note that the power domination number of a graph is always at least one, and that a dominating set of a graph is always also power dominating. We thus get

$$1 \leq \gamma_P(G) \leq \gamma(G).$$

The upper bound is obvious, yet Haynes et al. proved that there is no forbidden subgraph characterization of the graphs reaching the bound. This inequality can be easily extended to generalized power domination, as we noticed in [22]. Actually, we noticed that the obvious chain of inequality

$$\gamma(G) \geq \gamma_P(G) \geq \gamma_{P,2}(G) \geq \gamma_{P,3}(G) \geq \dots \geq 1 \quad (2.1)$$

cannot be improved.

**Observation 2.3.1** *If  $(x_k)_{0 \leq k \leq n}$  is a finite non-increasing sequence of positive integers, then there exists a graph  $G$  such that  $\gamma_{P,k}(G) = x_k$  for  $0 \leq k \leq n$ .*

Such a graph can be obtained by the following construction : for  $0 \leq k \leq n$ , take  $x_k - x_{k+1}$  copies of the star  $K_{1,k+1}$ , where  $x_{n+1}$  is set as 0, and form a complete subgraph on the centres of all these stars. An example of such a graph for the sequence  $(7, 5, 5, 3, 2)$  is depicted in Figure 2.1.

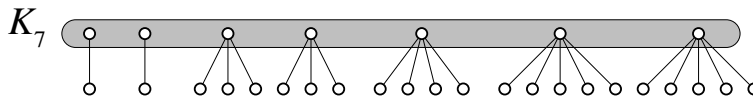

Figure 2.1: The graph for the  $k$ -power domination number sequence  $(7, 5, 5, 3, 2)$ .

This statement brings in the following open problem:

**Question 2.3.2** *Can one find some characterization of the graphs such that  $\gamma_{P,k}(G) = \gamma_{P,k+1}(G)$  for some  $k$ ?*

This question for  $k = 0$  is implicit in [51] Note that with a similar argument than for  $k = 0$ , one can prove that there is no forbidden subgraph such characterization.

Another interesting easy remark is that if a graph is connected and has maximum degree at most  $k + 1$ , then its  $k$ -power domination number is 1. Going further with this remark, we could infer that a minimum  $k$ -power dominating set of a graph of maximum degree at least  $k + 2$  can be formed taking only vertices of degree at least  $k + 2$ . A few more details and we got the following result (in [22]):

**Theorem 2.3.3** *If  $G$  is a connected graph of order  $n \geq k + 2$ , then*

$$\gamma_{P,k}(G) \leq \frac{n}{k+2}$$

*and this bound is best possible.*

Note that the result for (1-)power domination was already observed by Zhao, Kang and Chang in [79]. That the bound is tight is rather easy to observe. Take any graph  $G_0$  of order  $x$  with vertex set  $u_1, \dots, u_x$ , any family of  $x$  graphs  $H_1, \dots, H_x$  of order  $k+1$  and make each vertex  $u_i$  of  $G_0$  universal to the graph  $H_i$ , that is adjacent to all of  $H_i$ 's vertices. Then any  $k$  power dominating set has to contain at least one vertex in each of  $\{u_i\} \cup V(H_i)$ .

**Graphs with bounded diameter** A natural question that arises is whether one can bound the power domination number of a graph with some condition on the *diameter*, that is the maximum distance between two vertices of the graph. In [78], Zhao and Kang gave some result on (1-)power domination in graphs with bounded diameter. In particular, they give some general bounds for the power domination number of planar graphs with diameter 2 or 3. They showed that in outerplanar graphs, if the diameter is at most 2, then the graph admits a power dominating set of size one, while if the diameter is 4 or more, the power domination number can be arbitrarily large.

In [22], we consider the general case for  $k$ -power domination, and we prove that there exist graphs with diameter 2 and arbitrarily large  $k$ -power domination number. The family of graphs is based on the projective plane. Given a projective plane of order  $n$ , with  $P$  a set of  $n^2 + n + 1$  points and  $L$  a set of  $n^2 + n + 1$  lines, take the graph whose vertex set is  $P \cup L$  and where there is an edge between a line and all the  $n + 1$  points it contains as well as between any two lines. We proved in [22] that this graph is of diameter 2 and has  $k$ -power domination number  $n + 1 - k$ . Therefore, bounding the diameter by itself is not sufficient to give a general bound for the power domination number.

### 2.3.2 Regular graphs

For regular graphs, it seems that better bounds can be proved. The first results in that sense are using as an additional condition that the graph is claw-free.

**Theorem 2.3.4 (Zhao, Kang, Chang [79])** *If  $G$  is a connected claw-free cubic graph on  $n$  vertices, then  $\gamma_P(G) \leq \frac{n}{4}$ .*

Moreover, they characterize the graphs for which the bound is tight. This is actually a simple family: you take an even cycle and you replace every second edge by a  $K_4$  minus an edge, using the degree 2 vertices of  $K_4 - e$  as end vertices of the edge.

In [22], we generalized this result to  $k$ -power domination, with the following result:

**Theorem 2.3.5** *If  $G$  is a connected claw-free  $k + 2$ -regular graph on  $n$  vertices, then  $\gamma_{P,k}(G) \leq \frac{n}{k+3}$ .*

We also characterized the family of graphs reaching the bound, which is similar. The same construction replacing edges by a  $K_{k+3}$  minus an edge forms the whole family of such graphs (see Figure 2.3.2). The proof of this result strongly relies on the claw-freeness of the graph. For a claw-free cubic graph, we consider a minimum  $k$ -power dominating set  $S$  such that  $G[S]$  has as few edges as possible and  $|N[S]|$  is as large as possible. In that setting, we gradually describe better the graph around that set and deduce the theorem.

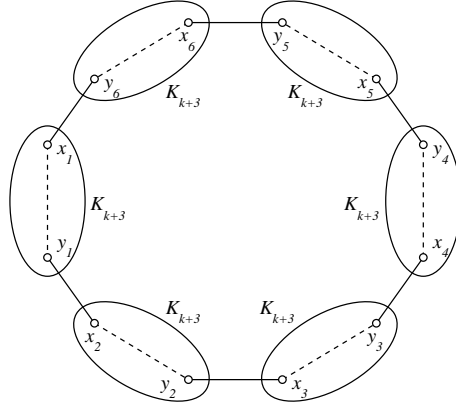

Figure 2.2: The family of graphs reaching the bounds of Theorems 2.3.4 and 2.3.5.

We recently improved this result by dropping the condition of claw-freeness. In [32], we showed

**Theorem 2.3.6** *If  $G$  is a connected  $k+2$ -regular graph on  $n$  vertices, then either  $G = K_{k+2, k+2}$  or  $\gamma_{P, k}(G) \leq \frac{n}{k+3}$ .*

Note that the  $k$  power domination number of  $K_{k+2, k+2}$  is  $2 = \frac{n+2}{k+3}$ . The proof of the theorem is based on the following ideas. Consider a maximum packing in the graph  $G$ . Suppose it does not propagate to the whole graph. This means that at some stage, all monitored vertices that are adjacent to a vertex not monitored are adjacent to at least  $k+1$  such. In that case, we may find some vertex that when added to our initial packing newly monitors at least  $k+3$  vertices. Otherwise, we describe precisely the settings of the vertices, and call it an  $(A, B)$ -configuration. The difficulty of the description is in fact that we do not want the description to rely on the current set of monitored vertices. We then prove that  $(A, B)$  configurations cannot intersect in too many ways, and then describe some way of choosing the initial packing so that no  $(A, B)$  configuration remain non monitored. This leads us to the result.

An interesting continuation of this study would be to drop the relation between the parameter  $k$  of the power domination and the regularity of the graph. We could propose the following question:

**Question 2.3.7** *Let  $r \geq 3$  and  $G$  be a connected  $r$ -regular graph of order  $n$  non isomorphic to  $K_{r, r}$ . What is the smallest positive value  $k_{\min}(r)$  such that  $\gamma_{P, k_{\min}(r)}(G) \leq n/(r+1)$ ?*

Notice that by the Inequality 2.1, the  $k$ -power domination number of a graph increases when  $k$  decreases, so  $k_{\min}(r)$  exists. Note also that when

$k \geq r-1$ ,  $\gamma_{P,k}(G) = 1 \leq n/(r+1)$  and thus clearly,  $k_{\min}(r) \leq r-1$ . Actually, we obtain from Theorem 2.3.6 that  $k_{\min}(r) \leq r-2$ . When  $k \leq r-3$ , the question remains open. In fact, we even conjecture that in general, it should be true that for all  $r$ ,  $k_{\min}(r)$  is 1:

**Conjecture 2.3.8** *For  $k \geq 1$  and  $r \geq 3$ , if  $G \neq K_{r,r}$  is a connected  $r$ -regular graph of order  $n$ , then  $\gamma_{P,k}(G) \leq n/(r+1)$ .*

## 2.4 Power domination in graph products

Another track which was well studied and sounds interesting is to try to determine the  $k$ -power domination number of graph products or on other frequent families of graphs. This topic is not much studied, or rather not many exact results were found on that setting. However, many interesting questions can be raised here.

### 2.4.1 Graph products definitions

There are four classical graph products, namely the Cartesian, the direct, the strong and the lexicographic products. Note that the direct product also carry many other names, such as the cross product or the Kronecker product. For any of these products, the product of two graphs  $G$  and  $H$  has vertex set  $V(G) \times V(H)$ , only the rules for obtaining the edges differ. For details on graph products and related topics, see [49].

The *Cartesian product* of  $G$  and  $H$  is denoted  $G \square H$  and two vertices  $(u, x)$  and  $(v, y)$  are adjacent in  $G \square H$  if either  $u = v$  and  $xy$  is an edge of  $H$  or  $uv$  is an edge of  $G$  and  $x = y$ . If you consider the subgraph of  $G \square H$  induced by all the vertices sharing some coordinate, say in  $G$ , then you have a copy of  $H$ , and vice versa. In particular, the Cartesian product of two paths is a grid.

The *direct product*  $G \times H$  has for edges the product of the edge sets of  $G$  and  $H$ , i.e. two vertices are adjacent if their first coordinates are adjacent in  $G$  and their second adjacent in  $H$ . Note that the direct product of two bipartite graphs is not connected.

The *strong product*  $G \boxtimes H$  has for edge set the union of the edge sets of  $G \square H$  and of  $G \times H$ . As a corollary, the closed neighborhood of a vertex in  $G \boxtimes H$  is the product of the closed neighborhoods of its coordinates in the factors. The strong product of two paths is sometimes also called the king grid.

The *lexicographic product*  $G \circ H$  is non symmetric. Vertices of  $G \circ H$  are adjacent if either their  $G$  coordinates are adjacent, or their  $G$  coordinates are equal and their  $H$  coordinates are adjacent.

### 2.4.2 Product of paths

Power domination in product of paths were among the first topic to be studied on power domination. Dorfling and Henning [40] studied the Cartesian product of two paths, i.e. the usual grid.

**Theorem 2.4.1 (Dorfling, Henning [40])** *The power domination number of the  $n \times m$  grid  $P_n \square P_m$  for  $m \geq n \geq 1$  is*

$$\gamma_{\mathcal{P}}(P_n \square P_m) = \begin{cases} \lceil \frac{n+1}{4} \rceil & \text{if } n \equiv 4 \pmod{8}, \\ \lceil \frac{n}{4} \rceil & \text{otherwise.} \end{cases}$$

In their proof, they explicitly describe the shape of the vertex set monitored by any set of vertices in the grid. However, their proof also relies on a study on the cylinder using the number of ‘columns’ as an invariant. Though, the use of an invariant is not explicit and cannot be transposed easily in other situations. The question on the cylinder (i.e. the product of a path and a cycle) was also studied later by Barrera and Ferraro [8]. They gave some upper bounds for these products, though they did not propose any lower bounds, which is in fact the difficult part of the study.

In [36], this study on the products of paths is continued with the three other products mentioned earlier. For the direct product (which has two connected components), the bound obtained can be synthesized as follows:

**Theorem 2.4.2 ([36])** *The power domination number of the product  $P_n \times P_m$  for  $m \geq n \geq 1$  is*

$$\gamma_{\mathcal{P}}(P_n \times P_m) = \begin{cases} 2\lceil \frac{n}{4} \rceil & \text{if } n \text{ is even,} \\ 2\lceil \frac{m}{4} \rceil & \text{if } n \text{ is odd and } m \text{ even,} \end{cases}$$

*If both  $m$  and  $n$  are odd,*

$$\gamma_{\mathcal{P}}(P_n \times P_m) \leq \max \left\{ \left\lceil \frac{m}{4} \right\rceil + \left\lceil \frac{m-2}{4} \right\rceil, \left\lceil \frac{m+n}{6} \right\rceil + \left\lceil \frac{m+n-2}{6} \right\rceil \right\}$$

Actually, the result in [36] gives more information for the odd by odd case. It is proved that one component as power domination number exactly  $\max \left\{ \left\lceil \frac{m}{4} \right\rceil, \left\lceil \frac{m+n}{6} \right\rceil \right\}$  whereas for the other component, the only lower bound proved is  $\frac{n}{4}$ . The technique for proving the  $\frac{m+n}{6}$  lower bound for the first component is somewhat surprising, since it first uses a transposition to another (popularization) problem then the known bound for that problem, which itself is related to an invariant. For the second component, this technique cannot be used, and it would be very interesting to see what technique can be used in that problem, also because it would transpose to many situations.

The situation for the strong product is a little simpler, though not completely solved either.



**Theorem 2.4.3** ([36]) *Let  $m \geq n \geq 2$ . Then*

$$\gamma_{\mathbb{P}}(P_m \boxtimes P_n) = \max \left\{ \left\lceil \frac{m}{3} \right\rceil, \left\lceil \frac{m+n-2}{4} \right\rceil \right\}$$

*unless  $3n - m - 6 \equiv 4 \pmod{8}$  in which case*

$$\max \left\{ \left\lceil \frac{m}{3} \right\rceil, \left\lceil \frac{m+n-2}{4} \right\rceil \right\} \leq \gamma_{\mathbb{P}}(P_m \boxtimes P_n) \leq \max \left\{ \left\lceil \frac{m}{3} \right\rceil, \left\lceil \frac{m+n-2}{4} \right\rceil + 1 \right\}.$$

In this theorem, the value is precisely given except when  $3n - m - 6 \equiv 4 \pmod{8}$  in which case a gap of one may happen. Again, we think that this gap is due to a too small lower bound, and we conjecture that the upper bound should be proven to be optimal. Note that similarly to the end of the previous case, these bounds are expressed as the maximum of two values. When one factor is much larger than the other, the optimal power dominating sets are of different shapes than when both factors are of similar length.

Note that the proofs of the lower bounds in this theorem again relies on an invariant. The invariant is counting the vertices not surrounded by power dominated vertices. Whenever there is some propagation in (1-)power domination, the vertex from which the propagation is made gets surrounded, and at most one new vertex may be added to the set of surrounded vertices. In the case of the strong product of two paths, one can consider the set of vertices on the border as non surrounded (and prove that any propagation that would start on one of these vertices could have been made from another vertex too). This invariant allows to prove the lower bound here.

The case of the lexicographic product is easier, since the role of the graph  $G$  is much more important than the role of  $H$  in  $G \circ H$ . Actually, unless the power domination number of  $H$  is one, it is as good to totally dominate  $G \circ H$  than to use propagation.

**Theorem 2.4.4** ([36]) *For any nontrivial graphs  $G$  and  $H$ , if  $G$  has no isolated vertices, then*

$$\gamma_{\mathbb{P}}(G \circ H) = \begin{cases} \gamma(G); & \gamma_{\mathbb{P}}(H) = 1, \\ \gamma_t(G); & \gamma_{\mathbb{P}}(H) > 1. \end{cases}$$

With N. Gillet, a master student in Bordeaux, we are currently working on the question of the power domination number of the product of graphs. We started to consider the following question, which seems interesting.

**Question 2.4.5** *Consider the (Cartesian-direct-strong) product of  $d$  paths. For which  $j, k$  does the  $k$ -power domination number of the product depend only of the length of the  $j$  shortest paths?*

For example, in the Cartesian product of two paths  $P_n \square P_m$ , the (1-)power domination number does not depend on the length of the longest path. The 2-power domination number of  $P_n \square P_m$  is one, and does not depend on the length of any factor. The (0-power) domination number of  $P_n \square P_m$  does depend on the length of both paths. For the strong product, what we got earlier that for  $k \leq 1$ ,  $\gamma_{P,k}(P_n \boxtimes P_m)$  depends on both  $m$  and  $n$ , and one can easily check that when  $k \geq 2$ , it does not depend on any of  $m$  and  $n$ . On larger dimensions, things are not so easy though.

### 2.4.3 General framework

During a conference in Bled (2011), we raised the following question as a general framework for studies in that direction:

**Question 2.4.6** *For some product  $\otimes$ , can we find some non trivial way to relate  $\gamma_{P,k}(G)$ ,  $\gamma_{P,\ell}(H)$  and some  $\gamma_{P,f(k,\ell)}(G \otimes H)$ ?*

Many things can be considered following this framework. First, one could ask whether Vizing's conjecture is still likely, that is if for all graphs  $G$  and  $H$

$$\gamma_{P,k}(G \square H) \geq \gamma_{P,k}(G)\gamma_{P,k}(H) ?$$

Note that  $\gamma_{P,k+1}(G \square H)$  can be less than  $\gamma_{P,k}(G)\gamma_{P,k}(H)$ , at least for  $k = 0$  and the product of two paths as seen earlier.

Another natural question in that framework is whether something nice can be said on the hypercube. A natural guess would be that

$$\gamma_{P,k+1}(Q_{i+1}) = \gamma_{P,k}(Q_i) \quad ( = \gamma(Q_{i-k}) \text{ if } i \geq k ).$$

Actually this is not true for  $k = 1$ . Pai and Chiu [69] showed that  $\gamma(Q_5) = 7$  while  $\gamma_P(Q_5) = 4$ , disproving the previous inequality. Though, there are no examples disproving the inequality for larger  $k$ . So the following question remains open:

**Question 2.4.7** *Is it true that for  $k \geq 1$ ,  $\gamma_{P,k+1}(Q_{i+1}) = \gamma_{P,k}(Q_i)$ ? And if not, what is the first counterexample for a given  $k$ ?*

Finally, if we consider other families of graphs, many problems sound interesting even if they may not be easy. Barrera and Ferrero started the study of generalized Petersen graphs in [8], which are also studied by Xu and Kang in [77]. However, again it is more difficult to prove some lower bound on the power domination, and their studies are rather unfinished. In [8], they suggest a more general study on Cayley graphs as a continuation.

## 2.5 Conclusion

We have seen in this chapter that power domination and its generalization is a topic on which there are many open problems. The main difficulty of the topic is to find lower bounds on the parameter, when we know that one vertex may dominate any number of vertices even in a graph of small degree. This tentative survey indeed shows that many more upper bounds are known than lower bounds. A few lower bounds were proposed on graph products, using invariants or similar techniques, but not much more. Note that the invariants proposed for power domination are not even useful when considering the generalized power domination problem, since they use the fact that a vertex propagate to at most one new vertex, thus creating at most one new vertex with the possibility to propagate further. This is no more true in generalized power domination.

Some other studies suggest some strengthening or other generalization of the problem, such as considering only a bounded number of propagation steps. This is probably a good way to make finding lower bounds easier, and there should be much more results to be found on families of graphs. Another interesting question we thought about in a currently going research with Klavžar is to characterize the power domination radius of a graph, i.e. the minimum number of steps a minimum power dominating set needs for monitoring the whole graph. We are studying this on the family of Sierpinski graphs but it is a first step initiating the study.

## Chapter 3

# Games and graphs

For a few years, I got interested in another field of discrete mathematics, namely combinatorial game theory. In this chapter we first recall the main concepts of this theory that are necessary later on, and then describe our recent results mostly with G. Renault and É. Sopena. These are on the one hand some results on the normal version in a domino game called toppling dominoes, in Section 3.2, and on the other hand some general study of misère games in Section 3.3. Finally, we describe in Section 3.4 a problem of different flavour, that is in between combinatorial game theory and graph parameters, the domination game.

### 3.1 Definitions

A combinatorial game is a finite two-player game with no chance and perfect information. The players, called Left and Right, alternate moves until one player has no available move. Under the normal convention, the last player to move wins the game while under the misère convention, that player loses the game. The misère version of a game is reputedly more difficult than its normal version. For notations and definitions, we generally follow [4], yet we recall basic concepts.

A game can be defined recursively by its sets of options  $G = \{G^L|G^R\}$ , where  $G^L$  is the set of games reachable in one move by Left (called Left options), and  $G^R$  the set of games reachable in one move by Right (called Right options). We note  $G^L$  for the typical option of  $G^L$ , and  $G^R$  for the typical option of  $G^R$ . Moreover, we allow ourselves to use an operation on these sets while it should be used on elements of these sets only, meaning that we apply the operation to all elements of the set. The zero game  $0 = \{\cdot|\cdot\}$ , is the game with no options. The birthday of a game is defined recursively as one plus the maximum birthday of its options, with 0 being the only game with birthday 0. We say a game  $G$  is born *on day*  $n$  if its birthday is  $n$  and that it is born *by day*  $n$  if its birthday is at most  $n$ . The games born on day

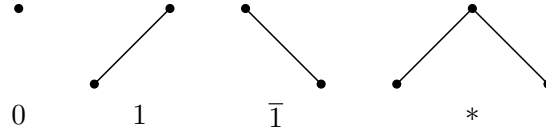

Figure 3.1: Game trees of games born by day 1.

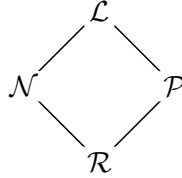

Figure 3.2: Partial ordering of outcomes

1 are  $\{0|\cdot\} = 1$ ,  $\{\cdot|0\} = \bar{1}$  and  $\{0|0\} = *$ .

A game can also be depicted by its game tree, where the game trees of its options are linked to the root by downward edges, left-slanted for Left options and right-slanted for Right options. For instance, the game trees of games born by day 1 are depicted on Figure 3.1.

Given two games  $G = \{G^L|G^R\}$  and  $H = \{H^L|H^R\}$ , the (disjunctive) *sum* of  $G$  and  $H$  is recursively defined as  $G + H = \{G^L + H, G + H^L|G^R + H, G + H^R\}$  (where  $G^L + H$  is the set of sums of  $H$  with an element of  $G^L$ ), i.e. the game where each player chooses on his turn which one of  $G$  or  $H$  to play on. The *conjugate*  $\bar{G}$  of a game  $G = \{G^L|G^R\}$  is recursively defined by  $\bar{G} = \{\bar{G}^R|\bar{G}^L\}$  (where  $\bar{G}^R$  is the set of conjugates of elements of  $G^R$ ). In normal convention, the conjugate of a game is also its opposite, and denoted  $-G$ .

One of the main objectives of combinatorial game theory is to determine for a game  $G$  the outcome of its sum with any other game. Under both conventions, there are four possible outcomes for a game. Games for which Left player has a winning strategy whatever Right does have outcome  $\mathcal{L}$  (for *left*). Similarly,  $\mathcal{N}$ ,  $\mathcal{P}$  and  $\mathcal{R}$  (for *next*, *previous* and *right*) denote respectively the outcomes of games for which the first player, the second player, and Right has a winning strategy. We note  $o^+(G)$  the normal outcome of a game  $G$ , i.e. its outcome under the normal convention, and  $o^-(G)$  the misère outcome of  $G$ . Outcomes are partially ordered according to Figure 3.2, with greater games being more advantageous for Left. Note that there is no general relationship between the normal outcome and the misère outcome of a game.

Given two games  $G$  and  $H$ , we say that  $G$  is greater than or equal to  $H$  whenever Left prefers the game  $G$  rather than the game  $H$ , that is  $G \geq^+ H$  if for every game  $X$ ,  $o^+(G + X) \geq o^+(H + X)$  in normal play, and  $G \geq^- H$  if for every game  $X$ ,  $o^-(G + X) \geq o^-(H + X)$  in misère play. Note that the relationship between two games is not necessarily the same under normal and

misère convention. We say that  $G$  and  $H$  are equivalent, denoted  $G \equiv^+ H$  (resp.  $G \equiv^- H$ ), when for every game  $X$ ,  $o^+(G + X) = o^+(H + X)$  (resp.  $o^-(G + X) = o^-(H + X)$ ). If  $G \geq^+ H$  and  $H \geq^+ G$ , then  $G \equiv^+ H$  and similarly in misère play.

While the equivalence of two games is well understood under normal convention, it is very limited in misère play, as we discuss in Section 3.3. There are therefore many interesting notations and corresponding properties under normal convention, a few of which we partially present here.

First of all, in normal convention, for any game  $G$ , we have the following:

$$\begin{aligned} G \geq^+ 0 &\iff o^+(G) \geq \mathcal{P} \\ G \leq^+ 0 &\iff o^+(G) \leq \mathcal{P} \end{aligned}$$

As a corollary, we have  $G \equiv^+ 0 \iff o^+(G) = \mathcal{P}$ , which is a characterization of the equivalence class of 0 in normal play. We also can write  $G >^+ 0$  for games with outcome  $\mathcal{L}$  and  $G <^+ 0$  for games with outcome  $\mathcal{R}$ . Games with outcome  $\mathcal{N}$  are called *fuzzy*. Note that this gives a second way to compare two games  $G$  and  $H$ , namely by computing the outcome of  $G - H$ . In particular, we mentioned earlier that the conjugate of a game was seen as its opposite, and it is indeed easy to prove that  $o^+(G + \overline{G}) = \mathcal{P}$  by describing for the second player a mimicking strategy.

Recall that the game  $\{0|\cdot\}$  is denoted 1. In normal play, note that  $\{1|\cdot\}$  has the same options than  $1 + 1$ . We thus denote  $2 = \{1|\cdot\}$  and similarly,  $n = \{n - 1|\cdot\}$ , and therefore,  $-n = \{\cdot|n - 1\}$ . All these number notations make perfectly sense with comparison, sums, and outcomes. Proofs of these statements are given in [4]. Now, interestingly enough one can prove that the game  $\{0|1\}$  satisfies  $\{0|1\} + \{0|1\} \equiv^+ 1$ . This is how  $\frac{1}{2}$  is defined. More generally, for  $m$  odd,  $\frac{m}{2j}$  is defined as the game  $\{\frac{m-1}{2j}|\frac{m+1}{2j}\}$ . All numbers can then be obtained as games, and we say a game is a *number* if it is equivalent to a number. Note that all games are not numbers, for example  $*$  =  $\{0|0\}$  is not. Actually, the outcome of a number may only be  $\mathcal{P}$ ,  $\mathcal{R}$  or  $\mathcal{L}$ . In the following, when a game is a number, say  $x$ , we usually denote  $x$  for the game value and  $X$  for the game itself.

An interesting characterization of numbers is the following :

**Theorem 3.1.1** *Let  $G$  be any game. If there exists a number  $x$  and its game  $X$  such that for all Left options  $G^L$ ,  $o^+(G^L - X) \leq \mathcal{N}$  and for all Right options  $G^R$ ,  $o^+(G^R - X) \geq \mathcal{N}$ , then  $G$  is a number.*

Note also that impartial games are represented by values of type  $*m$  where  $*1 = * = \{0|0\}$  and  $*m = \{0, *1, *2, \dots, *(m - 1)|0, *1, *2, \dots, *(m - 1)\}$ . These values correspond to the Grundy values of games.

We now should have enough basic concepts for discussing TOPPLING DOMINOES.

## 3.2 Toppling dominoes

The game TOPPLING DOMINOES was introduced by Albert et al. in [4]. The game is played on rows of dominoes that can take three colors: black, white and gray. Left may at his turn topple any black or gray domino in a row, either leftward or rightward, and remove all fallen dominoes (that is all dominoes on the left of the leftward toppled domino or on the right of the rightward toppled domino). Right then take his turn toppling similarly a white or gray domino, and the two players alternate turns until there is no dominoes left. In this section, we are interested in the game under normal convention, so where the last player to move wins.

To describe a one row TOPPLING DOMINOES game, we just give the word formed by the colors of its dominoes read from left to right. The black, white and gray dominoes are also symbolized respectively by a  $L$  (for Left or bLack),  $R$  (for Right) and a  $E$  (for either). For example,  $LLERR$  represents a TOPPLING DOMINOES game with two black dominoes followed by a gray then two white dominoes. We use the language notations for defining general words, and mean for example by  $(LR)^4$  the game  $LRLRLRLR$ .

A first easy observation on TOPPLING DOMINOES is that the only game on one row that has outcome  $\mathcal{P}$  is the empty row. Indeed, if there is at least one domino, any player who can play a domino at one end of the line can win playing first. So if both extremities of the game are black, the game has outcome  $\mathcal{L}$  (is positive), if both are white, the game has outcome  $\mathcal{R}$  (is negative), otherwise the game has outcome  $\mathcal{N}$  (is fuzzy). This uniqueness of the 0 game is rather unusual, and a natural question that arises is the following :

**Question 3.2.1** *In the game TOPPLING DOMINOES, are there many equivalence classes with a unique element consisting in only one row? Or are there many games with few representations in a single row?*

Some initial study of this question was given by Fink et al. in [43]. They gave much credit to this question with the following result:

**Theorem 3.2.2 (Fink et al. [43])** *All numbers appear uniquely in TOPPLING DOMINOES, i.e. if two games  $G \equiv^+ G'$  are numbers, then they are identical.*

A nice corollary of this result is that numbers in TOPPLING DOMINOES are necessarily palindromes, since they equal their reversal. Another result in the sense of this question is for  $LR$ -TOPPLING DOMINOES.

A TOPPLING DOMINOES game is  $LR$ -TOPPLING DOMINOES if it does not use the color gray ( $E$ ). Fink et al. proved that there are exactly  $2m$   $LR$ -TOPPLING DOMINOES games with value  $*m$ .

**Theorem 3.2.3 (Fink et al. [43])** *The LR-TOPPLING DOMINOES game  $G$  is equivalent to  $*m$  if and only if it is of the form  $(LR)^k(RL)^m(LR)^k$  for some  $0 \leq k < m$ .*

Recall that  $*m$  corresponds to the nim stack on  $m$  matches, and could obviously have also been represented by  $E^m$  in TOPPLING DOMINOES. There are possibly many other games with value  $*m$  in TOPPLING DOMINOES, but how many remains an open question.

We call a TOPPLING DOMINOES-number  $x$  a TOPPLING DOMINOES game which is equivalent to a number  $x$ . Fink et al. conclude [43] with a series of conjectures, some of which are inspired by Theorem 3.2.2. They reformulate Theorem 3.2.2 as follows, explicitly describing for a number  $x$  the unique TOPPLING DOMINOES games equivalent to  $x$ .

**Theorem 3.2.4 (Fink et al. [43])** *If a game  $G$  has value a number in canonical form  $\{a|b\}$ , then  $G$  is the TOPPLING DOMINOES game  $aLRb$ .*

Their first conjecture was that a similar result is also true when  $a$  and  $b$  are numbers but not the resulting game:

**Conjecture 3.2.5 (Fink et al. [43])** *Let  $a$  and  $b$  be numbers with  $a \geq b$ , the game  $\{a|b\}$  is given (uniquely) by the TOPPLING DOMINOES game  $aLRb$ .*

In recent yet unpolished work [39], we solve that conjecture. We first prove that the game  $aLRb$  is indeed the game  $\{a|b\}$ , but we then show that  $aEb$  also has value  $\{a|b\}$ . However, we proved that there are no other TOPPLING DOMINOES games with that value, namely:

**Theorem 3.2.6** *Let  $a \geq b$  be numbers and  $G$  be a TOPPLING DOMINOES game. The value of  $G$  is  $\{a|b\}$  if and only if  $G$  is  $aLRb$ ,  $aEb$  or one of their reversal.*

Fink et al. proposed two similar conjectures in [43], for the games  $\{a|\{b|c\}\}$  and  $\{\{a|b\}||\{c|d\}\}$ .

**Conjecture 3.2.7 (Fink et al. [43])** *Let  $a, b$  and  $c$  be numbers with  $a \geq b \geq c$ . The game  $\{a|\{b|c\}\}$  is given (uniquely) by the TOPPLING DOMINOES game  $aLRcRLb$ .*

**Conjecture 3.2.8 (Fink et al. [43])** *Let  $a, b$  and  $c$  be numbers with  $a \geq b \geq c \geq d$ . The game  $\{\{a|b\}||\{c|d\}\}$  is given (uniquely) by the TOPPLING DOMINOES game  $bRLaLRdRLc$ .*

We propose the following result to settle the conjectures.



**Theorem 3.2.9** *If  $a \geq b \geq c$  are numbers, then  $aLRcRLb \equiv^+ \{a||\{b|c\}\}$ . Moreover, if  $a > b$  are numbers, then  $aEcRLb$  also is equivalent to  $\{a||\{b|c\}\}$ . If  $a \geq b > c \geq d$  are numbers, then both  $bRLaLRdRLc$  and  $bRLaEdRLc$  are equivalent to  $\{\{a|b\}||\{c|d\}\}$ .*

Note also that Conjecture 3.2.8 is not true when  $b = c$ . Indeed, the game  $\{\{a|b\}||\{b|d\}\}$  has value  $b$ , and therefore has a unique representation by Theorem 3.2.2. However, for these two conjectures, the question of the uniqueness remains open. This raises the following questions, ordered by increasing generality:

**Question 3.2.10** *For numbers  $a \geq b \geq c \geq d$ ,*

1. *can we characterize all the LR-TOPPLING DOMINOES games that have value  $\{a||\{b|c\}\}$  and  $\{\{a|b\}||\{c|d\}\}$ ?*
2. *is  $aLRcRLa$  the unique TOPPLING DOMINOES game with value  $\{a||\{a|c\}\}$ ?*
3. *can we characterize all the TOPPLING DOMINOES games that have value  $\{a||\{b|c\}\}$  and  $\{\{a|b\}||\{c|d\}\}$ ?*

Note that  $a$  and  $c$  being numbers and thus palindromes, the second question here is related to another conjecture of [43], namely:

**Conjecture 3.2.11 (Fink et al. [43])** *In LR-TOPPLING DOMINOES, if  $G$  is a palindrome then  $G$ 's value appears uniquely.*

Remark that in [43], many other questions and conjectures are raised, and many research tracks exist about the apparently simple game TOPPLING DOMINOES.

### 3.3 Taxonomic ranking for misère games

We now consider misère games, a family of games generally considered more difficult than normal games. Indeed, as mentioned in this chapter's introduction, general equivalence and comparison of games are very limited in misère play (see [66, 72]). In particular, in misère games, no game with any option is equivalent to the game 0. A solution to handle this situation is to try to consider the games we study in special circumstances. This is probably why Plambeck and Siegel defined in [70, 71] an equivalence relationship under restricted universes, leading to a breakthrough in the study of misère play games.

**Definition 3.3.1 ([70, 71])** Let  $\mathcal{U}$  be a universe of games,  $G$  and  $H$  two games (not necessarily in  $\mathcal{U}$ ). We say  $G$  is greater than or equal to  $H$  modulo  $\mathcal{U}$  in misère play and write  $G \geq^- H \pmod{\mathcal{U}}$  if  $o^-(G + X) \geq o^-(H + X)$  for every  $X \in \mathcal{U}$ . We say  $G$  is equivalent to  $H$  modulo  $\mathcal{U}$  in misère play and write  $G \equiv^- H \pmod{\mathcal{U}}$  if  $G \geq^- H \pmod{\mathcal{U}}$  and  $H \geq^- G \pmod{\mathcal{U}}$ .

For instance, Plambeck and Siegel [70, 71] considered the universe of all positions of given games, especially octal games. Other universes have been considered, including the universes of impartial games  $\mathcal{I}$  [9, 24], dicot games  $\mathcal{D}$  [5, 67], dead-ending games  $\mathcal{E}$  [68], and all games  $\mathcal{G}$  [72]. Briefly, impartial games are games where Left and Right always have the same options, dicot games are defined below, and dead ending games are such that if a game has no Left (resp. Right) option, so do its options. These classes are ordered (ranked) by inclusion as follows:

$$\mathcal{I} \subset \mathcal{D} \subset \mathcal{E} \subset \mathcal{G}.$$

To simplify notation, we use from now on  $\geq_{\mathcal{U}}^-$  and  $\equiv_{\mathcal{U}}^-$  to denote superiority and equivalence modulo the universe  $\mathcal{U}$ . Note that the symbol  $=$  is reserved for equality between game trees. Observe also that if  $\mathcal{U}$  and  $\mathcal{U}'$  are two universes with  $\mathcal{U} \subseteq \mathcal{U}'$ , then for any two games  $G$  and  $H$ ,  $G \leq_{\mathcal{U}}^- H$  whenever  $G \leq_{\mathcal{U}'}^- H$ .

The canonical form of a game is the simplest game of its equivalence class. It is therefore natural to consider canonical forms modulo a given universe. In normal play, impartial games have the same canonical form when considered modulo the universe of impartial games or modulo the universe of all games. In misère play, the corresponding canonical forms are different.

### 3.3.1 A canonical form for dicots

In the following, we focus on the universe of dicots. A game is said to be a dicot either if it is 0 or if it has both Left and Right options which then are all dicots. Note that the universe of dicots, denoted  $\mathcal{D}$  is closed under conjugate, sum of games and taking option. Our first result is to provide a canonical form for dicots modulo the universe  $\mathcal{D}$  of dicots.

To obtain the canonical form of a game, we generally remove or bypass options that are not relevant. These options are of two types: dominated options can be removed because another option is always a better move for the player, and reversible options are bypassed since the answer of the opponent is ‘predictible’. Under normal play, simply removing dominated options and bypassing reversible options is sufficient to obtain a canonical form. Under misère play, things are more complicated. Mesdal and Ottaway [66] proposed definitions of dominated and reversible options under misère play in the universe  $\mathcal{G}$  of all games, then Siegel [72] proved that deleting dominated options and bypassing reversible options actually defines a canonical form in the universe  $\mathcal{G}$ . However, modulo smaller universes, games with different canonical forms may be equivalent. In the following, we adapt the definition of dominated and reversible options to restricted universes of games.

#### Definition 3.3.2 ( $\mathcal{U}$ -dominated and reversible options)

Let  $G$  be a game,  $\mathcal{U}$  a universe of games.

- (a) A Left option  $G^L$  is  $\mathcal{U}$ -dominated by some other Left option  $G^{L'}$  if  $G^{L'} \geq_{\mathcal{U}}^- G^L$ .
- (b) A Right option  $G^R$  is  $\mathcal{U}$ -dominated by some other Right option  $G^{R'}$  if  $G^{R'} \leq_{\mathcal{U}}^- G^R$ .
- (c) A Left option  $G^L$  is  $\mathcal{U}$ -reversible through some Right option  $G^{LR}$  if  $G^{LR} \leq_{\mathcal{U}}^- G$ .
- (d) A Right option  $G^R$  is  $\mathcal{U}$ -reversible through some Left option  $G^{RL}$  if  $G^{RL} \geq_{\mathcal{U}}^- G$ .

To obtain the known canonical forms for the universe  $\mathcal{G}$  of all games [72] but also for the universe  $\mathcal{I}$  of impartial games [24], one may just remove dominated and bypass reversible options such defined. The natural question that arises is whether a similar process gives canonical forms in other universes. Indeed, it is remarkable that in all universes closed by taking options, dominated options can be ignored, as shown by the following lemma.

**Lemma 3.3.3** *Let  $G$  be a game and let  $\mathcal{U}$  be a universe of games closed by taking option of games. Suppose  $G^{L_1}$  is  $\mathcal{U}$ -dominated by  $G^{L_2}$ , and let  $G'$  be the game obtained by removing  $G^{L_1}$  from  $G^L$ . Then  $G \equiv_{\mathcal{U}}^- G'$ .*

Unfortunately, the case involving reversible options is more complex. We managed to prove in the special case of dicots that we can bypass reversible options that are different from  $*$ , and even bypass  $*$  when another option is winning for the corresponding player.

We obtain the following reduced form in [38]:

**Definition 3.3.4 (Reduced form)** Let  $G$  be a dicot. We say  $G$  is in *reduced form* if:

- (i) it is not  $\{*\mid*\}$ ,
- (ii) it contains no dominated option,
- (iii) if Left has a reversible option, it is  $*$  and no other Left option has outcome  $\mathcal{P}$  or  $\mathcal{L}$ ,
- (iv) if Right has a reversible option, it is  $*$  and no other Right option has outcome  $\mathcal{P}$  or  $\mathcal{R}$ ,
- (v) all its options are in reduced form.

**Theorem 3.3.5** *Let  $G$  be a dicot, there exists a game  $G'$  in reduced form that is equivalent to  $G$  modulo the universe of dicots  $\mathcal{D}$ ; i.e.  $G' \equiv_{\mathcal{D}}^- G$ .*

Once we know that every game has a reduced form, to prove that this reduced form can be considered as a canonical form, we prove that any two equivalent games in reduced form are identical, namely:

**Theorem 3.3.6** *Consider two dicots  $G$  and  $H$ . If  $G \equiv_{\mathcal{D}}^- H$  and both are in reduced form, then  $G = H$ .*

Remark also that as it was proved by Siegel in [72], we can prove that if two games are equivalent modulo the dicot universe, so are they in normal play. This is simply a corollary of the following result we proved in [38]:

**Theorem 3.3.7** *Let  $G$  and  $H$  be any games. If  $G \geq_{\mathcal{D}}^- H$ , then  $G \geq^+ H$ .*

In particular, thanks to this result, we get that any non equivalent games in normal version are also non equivalent in misère modulo the dicot universe. Moreover, the same things hold for any universe containing the universe of dicots, such as the universe  $\mathcal{G}$  of all game (implying the result of [72]) and for the universe  $\mathcal{E}$  of dead-ending games (studied in [68]).

### 3.3.2 Counting the dicots

Thanks to this result, we can count the number of dicots born by day 3. Beforehand, note that there are 10 dicots born by day 2 of which only 2 are equivalent modulo the universe  $\mathcal{D}$  of dicots, namely 0 and  $\{*\}$ . We thus get nine games. To count the dicots born by day 3, we thus just have to count the number of distinct games in reduced form that can be obtained with only options born by day 2.

We obtain the following result:

**Theorem 3.3.8** *There are 1268 dicots non equivalent modulo the universe  $\mathcal{D}$  of dicots born by day 3, of which 64 have outcome  $\mathcal{P}$ , 201 have outcome  $\mathcal{L}$ , 201 have outcome  $\mathcal{R}$  and 802 have outcome  $\mathcal{N}$ .*

That makes 1, 3, 9 and 1268 dicots born by day 0, 1, 2 and 3 respectively. As a comparison, recall that the number of impartial misère games distinguishable modulo the universe  $\mathcal{I}$  of impartial games that are born by day 0, 1, 2, 3 and 4 are respectively 1, 2, 3, 5 and 22 (see [24]). Siegel [72] proved that the number of misère games distinguishable modulo the universe  $\mathcal{G}$  of all games that are born by day 0, 1 and 2 is respectively 1, 4 and 256, while the number of distinguishable misère games born by day 3 is at most  $2^{183}$ .

### 3.3.3 Sums of dicots can have any outcome

Another property of the normal convention that makes it easier to study is that in normal play, summing a game  $G$  with another game  $H$  whose

outcome is  $\mathcal{P}$  does not change the outcome, namely  $o^+(G + H) = o^+(G)$  whenever  $o^+(H) = \mathcal{P}$ . This is in fact just a corollary of the fact that all games with outcome  $\mathcal{P}$  are equivalent to 0 in normal play. Such a property is not true in misère version in general, and not even if we restrict ourselves to the universe to dicots, as we show in [38].

**Theorem 3.3.9** *Let  $\mathcal{A}, \mathcal{B}$  and  $\mathcal{C}$  be any outcome in  $\{\mathcal{P}, \mathcal{L}, \mathcal{R}, \mathcal{N}\}$ . On the one hand, there exists a dicot  $G$  with normal outcome  $o^+(G) = \mathcal{A}$  and misère outcome  $o^-(G) = \mathcal{B}$ , and on the other hand, there exist two dicots  $G_1$  and  $G_2$  such that  $o^-(G_1) = \mathcal{A}$ ,  $o^-(G_2) = \mathcal{B}$  and  $o^-(G_1 + G_2) = \mathcal{C}$ .*

This result is somehow still a very bad news for the study of games under misère version. It would really be very useful to be able to at least partially characterize the outcomes of sums of games in terms of the outcomes of the operands, as is possible in normal play. One could thus consider the following questions, even though they seem very difficult. It is anyway perhaps the underlying hope of many studies of misère games in restricted universes.

**Question 3.3.10** *Is there some family such that there could be a better relationship between the normal and misère outcome? Is there some family where the outcome of the sum can be partly deduced from the outcomes of the operands? Can we find a more precise partition of the games to have such properties?*

### 3.4 Game as a graph parameter: the domination game

We now study a game of very different flavor, since what we are interested in is not the winner anymore but the final number of moves if both players play optimally. Therefore, this study does not fit into combinatorial game theory. However, it seems that some parallels with this theory can be enlightening.

The domination game was introduced by Brešar, Klavžar and Rall in [19]. It is played on a finite graph  $G$  by two players, *Dominator* and *Staller*. They alternate turns in choosing a vertex that dominates at least one new vertex. The game ends when there are no more possible moves, that is when the chosen vertices form a dominating set of the whole graph. Dominator's goal is that the game finishes in as few moves as possible while Staller tries to keep the game going as long as she can. There are two possible variants of the game, depending on who starts the game. In Game 1, Dominator starts, while in Game 2, Staller starts. The game domination number, denoted by  $\gamma_g(G)$ , is the total number of chosen vertices in Game 1 when both players play optimally. Similarly, the Staller-start game domination number  $\gamma'_g(G)$  is the total number of moves in Game 2 when both players play optimally.

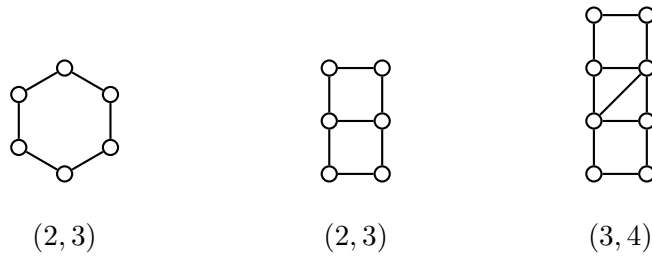

Figure 3.3: Some MINUS graphs.

Despite the fact that  $\gamma(G) \leq \gamma_g(G) \leq 2\gamma(G) - 1$  holds for any graph  $G$  (see [19]), the game domination number is essentially different from the domination number. First of all,  $\gamma_g(G)$  is generally much more difficult to determine than  $\gamma(G)$ . Even on simple graphs such as paths and cycles, the problem of determining  $\gamma_g$  is nontrivial [58].

As proved in [19, 57], the game domination number and the Staller-start game domination number can differ by at most 1:

**Theorem 3.4.1** ([19, 57]) *If  $G$  is any graph, then  $|\gamma_g(G) - \gamma'_g(G)| \leq 1$ .*

Call a pair  $(k, \ell)$  of integers *realizable* if there exists a graph  $G$  with  $\gamma_g(G) = k$  and  $\gamma'_g(G) = \ell$ . For the complete answer that all pairs that are potentially realizable can be realized (with relatively simple families of graphs) see [60].

Whereas it seems rather natural that the Staller-start game domination number  $\gamma'_g(G)$  may be larger than the game domination number  $\gamma_g(G)$ , it is not so obvious that the other way around can happen. We later call graphs  $G$  with  $\gamma'_g(G) = \gamma_g(G) - 1$  MINUS, and examples of small MINUS graphs are depicted on Figure 3.3.

Kinnersley, West, and Zamani [57] conjectured that if  $G$  is an isolate-free forest of order  $n$  or an isolate-free graph of order  $n$ , then  $\gamma_g(G) \leq 3n/5$ . Actually they posed two conjectures, because while the truth for isolate-free graphs clearly implies the truth for isolate-free forests, it is not known whether the converse implication holds. These conjectures are known as 3/5-conjectures. A progress on them has been made by Brešar et al. in [21] by constructing large families of trees that attain the conjectured 3/5-bound and by finding all extremal trees on up to 20 vertices; in particular, there are exactly ten trees  $T$  on 20 vertices with  $\gamma_g(T) = 12$ .

For a vertex subset  $D$  of a graph  $G$ , let  $G|D$  denote the graph  $G$  in which vertices from  $D$  are considered to be dominated. One of the most useful result on the domination game was proved by Kinnersley, West, and Zamani [57] and is known as the continuation principle:

**Theorem 3.4.2** ([57, Lemma 2.1] - Continuation Principle) *Let  $G$  be a graph and  $A, B \subseteq V(G)$ . If  $B \subseteq A$ , then  $\gamma_g(G|A) \leq \gamma_g(G|B)$  and  $\gamma'_g(G|A) \leq \gamma'_g(G|B)$ .*

### 3.4.1 Effect of edge or vertex removal

Clearly, removing an edge from a graph can only increase its domination number, that is,  $\gamma(G - e) \geq \gamma(G)$ . On the other hand, it was proved in [20] that for any integer  $\ell \geq 1$ , there exists a graph  $G$  and its spanning tree  $T$  such that  $\gamma_g(T) \leq \gamma_g(G) - \ell$ . One of our recent contribution on the domination game is to solve the question how much  $\gamma_g(G)$  and  $\gamma'_g(G)$  can change if an edge is removed from  $G$  as well as the analogous question for vertex-removal. In [17], we prove the following:

**Theorem 3.4.3** *If  $G$  is a graph and  $e \in E(G)$ , then*

$$|\gamma_g(G) - \gamma_g(G - e)| \leq 2 \quad \text{and} \quad |\gamma'_g(G) - \gamma'_g(G - e)| \leq 2.$$

This result is quite surprising. The possibility of modifying the domination game number by 1 in any direction is quite intuitive: the edge can make a move legal or illegal, so could allow Staller one extra move to postpone the issue of the game. But this extra move might also be played by Staller just before starting to play in a MINUS for which  $\gamma_g = \gamma'_g + 1$ . In such a situation, Staller would increase the number of moves in the game by 2.

The proof of our result is made by proposing a strategy for both players that guarantees no more moves than our bounds. It uses both the imagination strategy (one player mimic on the real game his optimal strategy for an imagined game) and the continuation principle. We also accompany this result with series of graphs that realize all possible pairs of values for the (Staller-start) domination game numbers of  $G$  and of  $G - e$ .

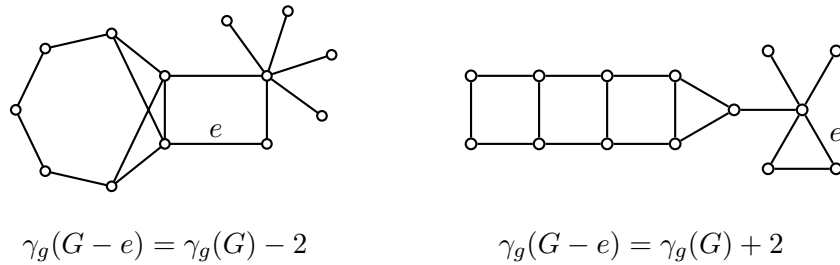

Figure 3.4: Graphs with  $|\gamma_g(G - e) - \gamma_g(G)| = 2$

We also got similar results for the removal of a vertex of the graph. Note that the domination number of a graph can increase arbitrarily with the removal of a vertex and so does the domination game number, e.g. when the vertex is the center of a large induced star. However, while the removal of a vertex could decrease the domination number by at most one, it can decrease the domination game number by up to two:

**Theorem 3.4.4** *If  $G$  is a graph and  $v \in V(G)$ , then*

$$\gamma_g(G) - \gamma_g(G - v) \leq 2 \quad \text{and} \quad \gamma'_g(G) - \gamma'_g(G - v) \leq 2.$$

Again, we propose in [17] families of graphs that realize the possible values that we proved above. Coming back to the edge deletion problem, we wondered first whether it was possible to successively decrease the game domination number by 2 by choosing different edges. We raise the following problem:

**Question 3.4.5** *Given a positive integer  $k$ , can one find a general upper and lower bound for  $\gamma_g(G) - \gamma_g(G_k)$  where  $G_k$  is obtained from a graph  $G$  by the deletion of  $k$  edges from  $G$ ? In particular, when two edges  $e$  and  $e'$  of a graph  $G$  are deleted, can  $|\gamma_g(G) - \gamma_g(G - e - e')|$  be more than 3?*

Another question is whether it is possible to have in a same graph an edge whose removal decreases the game domination number by two and an edge whose removal increases it by two. In general we have the following question:

**Question 3.4.6** *Which of the subsets of  $\{-2, -1, 0, 1, 2\}$  can be realized as*

$$\{\gamma_g(G) - \gamma_g(G - e) : e \in E(G)\}$$

*within the family of all (respectively connected) graphs  $G$ ? In particular, does there exist a graph  $G$  with edges denoted by  $e_{-2}, e_{-1}, e_0, e_1, e_2$  such that  $\gamma_g(G) - \gamma_g(G - e_i) = i$  for all  $i$ ?*

In addition, one can ask for a characterization of certain subfamilies of graphs with respect to the above properties. For instance, following domination terminology, a possible question is to characterize the graphs that are game domination edge-critical. That is, for which  $G$  we have  $\{\gamma_g(G) - \gamma_g(G - e) : e \in E(G)\} \subseteq \{-2, -1\}$ ?

### 3.4.2 Sums of domination games: the game played on the disjoint union

Another study we made on the domination game is more related to combinatorial games, as it tries to characterize the possible types of the disjoint union of two games.

Recall that since  $|\gamma_g(G) - \gamma'_g(G)| \leq 1$  for any graph  $G$ , realizable pairs for  $(\gamma_g(G), \gamma'_g(G))$  are precisely of the form  $(k, k + 1)$ ,  $(k, k)$  and  $(k, k - 1)$ . We say a partially dominated graph  $G$  is a  $(k, +)$  (resp.  $(k, =)$ ,  $(k, -)$ ) if  $k = \gamma_g(G) = \gamma'_g(G) - 1$  (resp.  $k = \gamma_g(G) = \gamma'_g(G)$ ,  $k = \gamma_g(G) = \gamma'_g(G) + 1$ ). Additionally, we say that a graph  $G$  is a PLUS (resp. EQUAL, MINUS) if  $G$  is



$(k, +)$  (resp.  $(k, =)$ ,  $(k, -)$ ) for some  $k \geq 1$ . Examples of known MINUS are drawn in Figure 3.3.

This classification is interesting in the sense that players want to be first to move on a PLUS, but would rather let the other player start on a MINUS, in a similar way to what happen in games with outcome  $\mathcal{N}$  and outcome  $\mathcal{P}$  in impartial combinatorial games. We thus wondered whether we could describe the games behavior better by partitioning the games into PLUS and MINUS as they can be partitioned according to their outcome in combinatorial game theory. We proved in [35] that things are still not simple, except when we consider graphs in a special family, that we call no-minus graphs. We say that a graph  $G$  is a *no-minus graph* if for any subset of vertices  $S$ ,  $\gamma_g(G|S) \leq \gamma'_g(G|S)$ . It is known from Kinnersley et al. [57] that forests are no-minus graphs.

In [35], we prove that two families of graphs are no-minus graphs. The first one is the family of *tri-split graphs*, a generalization of split graphs. A graph is tri-split if its vertex set can be partitioned into three sets  $A$ ,  $B$  and  $C$  such that:

- (i)  $A$  is non empty and  $G[A]$  is complete
- (ii)  $B$  is an independent set
- (iii) vertices in  $C$  are adjacent to all vertices in  $A$  and to no vertices in  $B$ .

**Theorem 3.4.7** *Connected tri-split graphs are no-minus graphs.*

The second family of no-minus graphs is the family of dually chordal graphs. A vertex  $u$  in the neighborhood  $N(v)$  is a maximum neighbor of  $v$  if for all  $w \in N[v]$ ,  $N[w] \subseteq N[u]$ , i.e. every vertex at distance at most 2 from  $v$  is a neighbor of  $u$ . A vertex ordering  $v_1, \dots, v_n$  is a maximum neighborhood ordering if for each  $i < n$ ,  $v_i$  has a maximum neighbor in  $G[1, \dots, i]$ . A graph is dually chordal if it has a maximum neighborhood ordering. We prove in [35] the following.

**Theorem 3.4.8** *Dually chordal graphs are no-minus graphs.*

The proof of this theorem follows similar ideas than the proof for forests in [57]. Note that forests, interval graphs and strongly chordal graphs are all subclasses of dually chordal graphs, and therefore also are no-minus graphs as a corollary of our result. We now describe the possible effects of the disjoint union of no-minus graphs.

**Theorem 3.4.9** *Let  $G_1|S_1$  and  $G_2|S_2$  be partially dominated graphs,  $S_1$  and  $S_2$  being possibly empty. If  $G_1$  and  $G_2$  are no-minus, then their disjoint union  $G_1 \cup G_2|S_1 \cup S_2$  is also a no-minus. Moreover,*

- if  $G_1|S_1$  is  $(k, =)$  and  $G_2|S_2$  is  $(\ell, =)$ , then  $G_1 \cup G_2|S_1 \cup S_2$  is  $(k + \ell, =)$
- if  $G_1|S_1$  is  $(k, =)$  and  $G_2|S_2$  is  $(\ell, +)$ , then  $G_1 \cup G_2|S_1 \cup S_2$  is  $(k + \ell, +)$
- if  $G_1|S_1$  is  $(k, +)$  and  $G_2|S_2$  is  $(\ell, +)$ , then  $G_1 \cup G_2|S_1 \cup S_2$  is either  $(k + \ell, +)$ ,  $(k + \ell + 1, =)$  or  $(k + \ell + 1, +)$ .

This theorem describes an easy situation, where the union of the graphs can take few values. Note that all the values can be reached by some union of trees. When we consider general graphs, things are more complicated. First, useful information to be added into the study is whether  $\gamma_g(G)$  is even or odd. Indeed, if  $\gamma_g(G)$  is even, then if Dominator plays first on  $G + H$  by a move from  $G$ , Staller may force him to play first on  $H$  too. Choosing for each graph whether it is a  $(k, -)$ , a  $(k, =)$  or a  $(k, +)$  and considering the cases whether  $k$  is even or odd, we got 21 different cases to study. We solved most of them, meaning that we got bounds and examples of unions reaching the bounds. In one case, when both operands are PLUS, one with odd game domination number and the other with even game domination number, tight bounds are at distance 3, i.e. there are graphs where the bound is  $k + \ell - 1$  and others where it is  $k + \ell + 2$ , but this is the unique case for such a distance. For 6 out of the 42 bounds, we did not find an example matching the bound yet, though it is likely that some examples reaching the current bounds exist (rather than we can improve the bound).

Two things remain on that study. First, many of our examples are artificially built by taking union of appropriate graphs. First, can we reach the bounds with connected graph? Or better, can we find a graph operation creating connected graphs equivalent to the disjoint union? The second problem is motivated by how our study shows that no-minus graphs form a rather predictable family in regards of the domination game. This motivates the following question:

**Question 3.4.10** *Can we characterize the family of no-minus graphs? Or can we simply propose more families of no-minus graphs?*

One could start by trying to prove that chordal graphs are no-minus. They are indeed a common generalization of split graphs, interval graphs and forests, though we have no idea whether this family is no-minus.

### 3.5 Conclusion

In this chapter, we studied games with two very different settings: on the one hand combinatorial games, where the only real concern is the possibility to compute the outcome of a game as easily as possible and to find the next optimal move, and on the other hand the domination game where what we really want to know is what happened during the game, and which set of

vertices was chosen. However, in both games we have to think on strategies: the proofs mostly relies on the description of a good strategy, often described by following another (sometimes hypothetical) strategy that we know is optimal in a different situation. For this reason, the problem still are closely related, even though they are described differently.

Both topics contain many open problems, generally related to one game or one situation. However, what we are really looking for is always a better way to describe the game so that the solution is inherent to the description. This is a difficult task but easier results may be found by restricting our study to some subfamilies of games, such as no-minus graphs for the domination games or dicots for combinatorial games as we did. Already trying to properly define things in these situation gives a frame for generalizing the idea to other families.

# Bibliography

- [1] A.Azami, Domination in graphs with bounded propagation: algorithms, formulations and hardness results. *J. Comb. Optim.* 19 (2010), no. 4, 429–456.
- [2] A. Aazami, M.D. Stulp, Approximation algorithms and hardness for domination with propagation, *SIAM J. Discrete Math.* 23 (2009), no. 3, 1382–1399.
- [3] D. Achlioptas. The complexity of  $g$ -free colourability. *Discrete Math.* 165–166 (1997), 21–30.
- [4] M.H. Albert, R.J. Nowakowski, D. Wolfe, *Lessons in Play*, 2007, A K Peters Ltd.
- [5] M.R. Allen. An Investigation of Misère Partizan Games. PhD thesis, Dalhousie University, 2009.
- [6] K. Appel and W. Haken. Every planar map is four colorable. Part I. Discharging. *and* Part II. Reducibility *Illinois J. Math.* 21 (1977), 429–490 *and* 491–567.
- [7] T.L. Baldwin, L. Mili, M.B. Boisen Jr, R. Adapa, Power system observability with minimal phasor measurement placement, *IEEE Trans. Power Systems* 8 (1993), no. 2, 707–715.
- [8] R. Barrera, D. Ferrero, Power domination in cylinders, tori, and generalized Petersen graphs. *Networks* 58 (2011), no. 1, 43–49.
- [9] E.R. Berlekamp, J.H. Conway, R.K. Guy, *Winning ways for your mathematical plays*. Vol. 1, (2nd edition) 2001, A K Peters Ltd.
- [10] M. Blidia, M. Chellali, and T.W. Haynes, Characterizations of trees with equal paired and double domination numbers. *Discrete Math.* 306 (2006), no. 16, 1840–1845.
- [11] O.V. Borodin and A.O. Ivanova. List strong linear 2-arboricity of sparse graphs. *J. Graph Theory* 67, no 2 (2011) 83–90.

- [12] O.V. Borodin, A.O. Ivanova, M. Montassier, P. Ochem, and A. Raspaud. Vertex decompositions of sparse graphs into an edgeless subgraph and a subgraph of maximum degree at most  $k$ . *J. Graph Theor.* 65 (2010) no 2, 83–93.
- [13] O.V. Borodin, A.O. Ivanova, M. Montassier, and A. Raspaud.  $(k, j)$ -coloring of sparse graphs. *Discrete Appl. Math.* 159 (2011), no 17, 1947–1953.
- [14] O.V. Borodin, A.O. Ivanova, M. Montassier, and A. Raspaud.  $(k, 1)$ -coloring of sparse graphs. *Discrete Math.* 312 (2012), no 6, 1128–1135.
- [15] O.V. Borodin and A.V. Kostochka. Vertex partitions of sparse graphs into an independent vertex set and subgraph of maximum degree at most one. *Sibirsk. Mat. Zh.* 52 (2011), no 5, 1004–1010.
- [16] B. Brešar, P. Dorbec, W. Goddard, B.L. Hartnell, M.A. Henning, S. Klavžar, D.F. Rall, Vizing’s conjecture: a survey and recent results. *J. Graph Theory* 69 (2012), no. 1, 46–76.
- [17] B. Brešar, P. Dorbec, S. Klavžar and G. Košmrlj Effect of edge-removal and vertex-removal on domination game. Manuscript.
- [18] D.J. Brueni, L.S. Heath, The PMU placement problem, *SIAM J. Discrete Math.* 19 (2005), no. 3, 744–761.
- [19] B. Brešar, S. Klavžar, D. F. Rall, Domination game and an imagination strategy, *SIAM J. Discrete Math.* 24 (2010) 979–991.
- [20] B. Brešar, S. Klavžar, D. F. Rall, Domination game played on trees and spanning subgraphs, *Discrete Math.* 313 (2013) 915–923.
- [21] B. Brešar, S. Klavžar, G. Košmrlj, D. F. Rall, Domination game: extremal families of graphs for the  $3/5$ -conjectures, *Discrete Appl. Math.* 161 (2013) 1308–1316.
- [22] J.G. Chang, P. Dorbec, M. Montassier and A. Raspaud, Generalized power domination of graphs. *Discrete Appl. Math.* 160 (2012), no. 12, 1691–1698.
- [23] M. Chellali and T.W. Haynes, On paired and double domination in graphs. *Util. Math.* 67 (2005), 161–171.
- [24] J.H. Conway, *On Numbers and Games*, (2nd edition), 2001, A K Peters Ltd.
- [25] D.G. Corneil, Y. Perl and L. Stewart, A linear recognition algorithm for cographs, *SIAM J. Computing* 14 (1985), 926–934.

- [26] L.J. Cowen, R.H. Cowen, and D.R. Woodall. Defective colorings of graphs in surfaces: partitions into subgraphs of bounded valency. *J. Graph Theor.* 10 (1986) no 2, 187–195.
- [27] P. Dorbec and S. Gravier, Paired-domination in  $P_5$ -free graphs. *Graphs Combin.* 24 (2008), no. 4, 303–308.
- [28] P. Dorbec and S. Gravier, Paired-domination in subdivided star-free graphs. *Graphs Combin.* 26 (2010), no. 1, 43–49.
- [29] P. Dorbec, S. Gravier and M.A. Henning, Paired-domination in generalized claw-free graphs. *J. Comb. Optim.* 14 (2007), no. 1, 1–7.
- [30] P. Dorbec, B. Hartnell and M.A. Henning, Paired versus Double Domination in  $K_{1,r}$ -free Graphs, To appear in *J. Comb. Optim.*
- [31] P. Dorbec and M.A. Henning, Upper paired-domination in claw-free graphs. *J. Comb. Optim.* 22 (2011), no. 2, 235–251.
- [32] P. Dorbec, M.A. Henning, C. Löwenstein, M. Montassier and A. Raspaud, Generalized Power Domination in Regular Graphs. Manuscript (2013).
- [33] P. Dorbec, M.A. Henning, M. Montassier, J. Southey, Independent domination in Cubic Graphs. Manuscript (2013).
- [34] P. Dorbec, T. Kaiser, M. Montassier, A. Raspaud, Limits of Near-Coloring of Sparse Graphs. To appear in *J. Graph Theory* (2013), 10.1002/jgt.21731.
- [35] P. Dorbec, G.Košmrlj and G. Renault, The domination game played on unions of graphs. Submitted
- [36] P. Dorbec, M. Mollard, S. Klavžar, S. Špacapan, Power domination in product graphs. *SIAM J. Discrete Math.* 22 (2008), no. 2, 554–567.
- [37] P. Dorbec, M. Montassier, P. Ochem, Vertex-partitions of graphs into cographs and stars. *J. Graph Theory*, 75(1)(2014), 75–90.
- [38] P. Dorbec, G. Renault, A. Siegel, E. Sopena, Dicots, and a taxonomic ranking for misère games. Submitted.
- [39] P. Dorbec, G. Renault, E. Sopena, Toppling switches. Manuscript.
- [40] M. Dorfling and M. A. Henning, A note on power domination in grid graphs, *Discrete Appl. Math.* 154 (2006), no. 6, 1023–1027.
- [41] L. Esperet, M. Montassier, P. Ochem, and A. Pinlou. A complexity dichotomy for the coloring of sparse graphs. To appear in *J. Graph Theor.*, 2012.

- [42] O. Favaron and M.A. Henning, Paired-domination in claw-free cubic graphs. *Graphs Combin.* 20 (2004), no. 4, 447–456.
- [43] A. Fink, R.J. Nowakowski, A. Siegel, D. Wolf, *Toppling Conjectures*, (2008).
- [44] D. C. Fischer, K. Fraughnaugh, and S. M. Seager, Domination in graphs with maximum degree three. *Proceedings of the Eight Quadrennial International Conference of Graph Theory, Combinatorics, Algorithms, and Applications*. Ed. Y. Alavi, D. R. Lick, and A. Schwenk (1999), 411–421.
- [45] J. Gimbel and J. Nešetřil. Partitions of graphs into cographs. *Discrete Math.* 310 (2010), 3437–3445.
- [46] W. Goddard and M.A. Henning, Independent domination in graphs: A survey and recent results. *Discrete Math.* 313 (2013), no. 7, 839–854.
- [47] W. Goddard, M. A. Henning, J. Lyle, and J. Southey, On the independent domination number of regular graphs. *Annals Combi.* 16 (2012), 719–732.
- [48] J. Guo, R. Niedermeier, D. Raible, Improved algorithms and complexity results for power domination in graphs, *Algorithmica* 52 (2008), no. 2, 177–202.
- [49] R. Hammack, W. Imrich, S. Klavžar, *Handbook of product graphs*, second edition. CRC Press (2011).
- [50] F. Havet and J.-S. Sereni. Improper choosability of graphs and maximum average degree. *J. Graph Theory* 52 (2006), 181–199.
- [51] T.W. Haynes, S.M. Hedetniemi, S.T. Hedetniemi and M.A. Henning, Domination in graphs applied to electric power networks. *SIAM J. Discrete Math.* 15 (2002), no. 4, 519–529.
- [52] T. W. Haynes, S. T. Hedetniemi, P. J. Slater, *Fundamentals of Domination in Graphs*, Marcel Dekker, New York, 1998.
- [53] T.W. Haynes and P.J. Slater, Paired-domination and the paired-domomatic number. *Congr. Numer.* 109 (1995), 65–72.
- [54] T.W. Haynes and P.J. Slater, Paired-domination in graphs. *Networks* 32 (1998), no. 3, 199–206.
- [55] W-K. Hon , C-S. Liu, S-L. Peng, C.Y. Tang, Power Domination on Block-cactus Graphs. *The 24th Workshop on Combinatorial Mathematics and Computation Theory*

- [56] A. Kelmans, Counterexamples to the cubic graph domination conjecture, arXiv:math.CO/0607512 v1 20 July 2006.
- [57] W. B. Kinnersley, D. B. West, R. Zamani, Extremal problems for game domination number, manuscript, 2012.
- [58] W. B. Kinnersley, D. B. West, R. Zamani, Game domination for grid-like graphs, manuscript, 2012.
- [59] J. Kneis, D. Mölle, S. Richter, P. Rossmanith, Parameterized power domination complexity, *Inform. Process. Letters* 98 (2006), no. 4, 145–149.
- [60] G. Košmrlj, Realizations of the game domination number, to appear in *J. Comb. Optim.*, DOI: 10.1007/s10878-012-9572-x.
- [61] A.V. Kostochka and B.V. Stodolsky, On domination in graphs with minimum degree two, *Discrete Mathematics* 304 (2005) 749–762.
- [62] A.V. Kostochka and C. Stocker, A new bound on the domination number of connected cubic graphs. *Sib. Elektron. Mat. Izv.* 6 (2009), 465–504.
- [63] P.C.B. Lam, W.C. Shiu and L. Sun, On independent domination number of regular graphs. *Discrete Math.* 202 (1999), no. 1-3, 135–144.
- [64] C-S. Liao, D-T Lee, Power Domination Problem in graphs Proc. 11th Int. Comput. Combin. Conference (2005), 818–828.
- [65] C-S. Liao, D-T Lee, Power Domination in Circular-Arc Graphs. *Algorithmica* 65 (2013), no. 2, 443–466.
- [66] G.A. Mesdal and P. Ottaway. Simplification of partizan games in misère play. *INTEGERS*, 7:#G06, 2007. G.A. Mesdal is comprised of M. Allen, J.P. Grossman, A. Hill, N.A. McKay, R.J. Nowakowski, T. Plambeck, A.A. Siegel, D. Wolfe.
- [67] R. Milley. Restricted Universes of Partizan Misère Games, PhD thesis, Dalhousie University, 2013.
- [68] R. Milley and G. Renault. Dead ends in misère play: the misère monoid of canonical numbers. To appear in *Disc. Math.* (2013), available at arxiv 1212.6435.
- [69] K-J. Pai, W-J. Chiu, A Note on “on The Power Dominating Sets of Hypercubes”. 29th Workshop on Combinatorial Mathematics and Computation Theory, Taipei, 2012.



- [70] T.E. Plambeck. Taming the wild in impartial combinatorial games. *INTEGERS*, 5:#G5 (2005), Comb. Games Sect., 36pp..
- [71] T.E. Plambeck and A.N. Siegel. Misere quotients for impartial games. *J. Combin. Theory A*, 115 (2008) no 4:593 – 622.
- [72] A.N. Siegel. Misère canonical forms of partizan games. arxiv preprint math/0703565.
- [73] D. Rautenbach, A linear Vizing-like relation between the size and the domination number of a graph. *J. Graph Theory* 31 (1999), 297–302.
- [74] B.A. Reed, Paths, stars and the number three. *Combin. Probab. Comput.* 5 (1996), 277–295.
- [75] D. Seinsche, On a property of the class of  $n$ -colorable graphs. *J. Combin. Theory Ser. B* 16 (1974), 191–193.
- [76] V.G. Vizing, The Cartesian product of graphs. *Vychisl. Sistemy* No. 9 (1963), 30–43
- [77] G. Xu, L. Kang On the power domination number of the generalized Petersen graphs, *J. Comb. Optim.* 22 (2011), no. 2, 282–291
- [78] M. Zhao and L. Kang, Power domination in planar graphs with small diameter. *J. Shanghai University* 11 (2007), no. 3, 218–222
- [79] M. Zhao, L. Kang and G. J. Chang, Power domination in graphs, *Discrete Math.* 306 (2006), 1812–1816.

# Index

- birthday, **35**
- Cartesian product, **30**
- chromatic number, **3**
- claw-free, **5, 8, 10**
- closed neighborhood, **25**
- cograph, **15**
- cograph partition, **15**
- $(d, a, b)$ -coloring, **19**
- combinatorial game, **35**
- complement, **15**
- conjugate, **36**
- corona, **9**
- cubic, **5, 11**
  
- diameter, **28**
- direct product, **30**
- domination game, **44**
- domination number, **3**
- double domination, **9**
- $k$ -tuple domination, **9**
- dually chordal graph, **48**
  
- game tree, **36**
- girth, **13, 17**
  
- improper coloring, **18**
- independent domination, **11**
- independent set, **3, 9, 11**
- induced subgraph, **4**
  
- lexicographic product, **30**
  
- maximum average degree, **17**
- misère convention, **35**
  
- normal convention, **35**
- number, **37**
  
- open neighborhood, **25**
- open problems, **9, 13, 14, 17–19, 21, 27, 29, 31, 38, 40, 45, 47, 49**
  
- paired domination, **4**
- perfect matching, **4**
- planar graph, **15**
- private neighbor, **8**
- proper coloring, **3**
  
- realizable pair, **45**
  
- star partition, **15**
- strong product, **30**
- subdivided star, **5**
- sums of games, **36**
  
- TOPPLING DOMINOES, **38**
- total domination, **4**
- tri-split graph, **48**
  
- universal vertex, **27**
- upper-paired domination, **7**
  
- Vizing’s conjecture, **3, 33**



# List of symbols

FPT	Fixed Parameter Tractable
$C_n$	cycle on $n$ vertices
$\{G^L \mid G^R\}$	a typical combinatorial game
$G[S]$	subgraph induced by $S$ in $G$
$G \square H$	Cartesian product of $G$ and $H$
$G \mid D$	A graph $G$ with a set of dominated vertices $D$
$\gamma(G)$	domination number of $G$
$\gamma_{\times 2}(G)$	double domination number
$\gamma_g$	Domination game number
$\gamma'_g$	Staller-start domination game number
$\gamma_{\text{pr}}(G)$	paired domination number of $G$
$\Gamma_{\text{pr}}(G)$	upper-paired domination number
$i(G)$	independent domination number
$K_{i,j}$	bipartite complete graph with parts of size $i$ and $j$
$K_n$	complete graph on $n$ vertices
mad	maximum average degree
$N(S)$	open neighborhood
$N[S]$	closed neighborhood
$P_n$	path on $n$ vertices
$\chi(G)$	Chromatic number