



**HAL**  
open science

# Optical frequency combs and optical frequency measurements

Yann Le Coq

► **To cite this version:**

Yann Le Coq. Optical frequency combs and optical frequency measurements. Optics [physics.optics]. Université Pierre et Marie Curie - Paris VI, 2014. tel-00989992

**HAL Id: tel-00989992**

**<https://theses.hal.science/tel-00989992>**

Submitted on 12 May 2014

**HAL** is a multi-disciplinary open access archive for the deposit and dissemination of scientific research documents, whether they are published or not. The documents may come from teaching and research institutions in France or abroad, or from public or private research centers.

L'archive ouverte pluridisciplinaire **HAL**, est destinée au dépôt et à la diffusion de documents scientifiques de niveau recherche, publiés ou non, émanant des établissements d'enseignement et de recherche français ou étrangers, des laboratoires publics ou privés.

Université Pierre et Marie Curie, discipline : physique

---

# Peignes de fréquences et mesures de fréquences optiques

---

## HABILITATION À DIRIGER DES RECHERCHES

Soutenue le 28 janvier 2014

par

**Yann LE COQ**

Composition du jury :

Pr. Patrick Gill (NPL)	Rapporteur
Dr. Vincent Giordano (FEMTO-ST)	Rapporteur
Dr. Martina Knoop (PIIM)	Rapporteur
Dr. Christophe Salomon (LKB)	Examineur
Dr. Daniele Romanini (LiPhy)	Examineur

---

Travail de recherche présenté effectué à

LNE-SYRTE, UMR8630 CNRS/UPMC/Observatoire de Paris  
Paris, France

National Institute of Standards and Technology, Time and Frequency Division,  
Boulder, CO, USA.



---

# Acknowledgments

---

I am grateful to Martina Knoop, Vincent Giordano and Patrick Gill to have accepted to act as reviewers on my "Habilitation". They were willing to take some time from their busy schedule to read this manuscript and provide the report, as well as useful comments and advice for improvement and I appreciate their time and efforts. Christophe Salomon was kind enough to preside the defense jury and I am thankful for that as well as to Daniele Romanini who also accepted to be part of my jury.

## Institut d'Optique Graduate School

Although not much is said in this manuscript about my first post-doctoral experience at Institut d'Optique, I spent 2 great years there, interacting with several people of which I have many fond memories. Alain Aspect and Philippe Bouyer kindly offered me to stay working with them after my doctorate and to entrust me with the many technical and management aspects of the construction of the second Rubidium BEC apparatus. Many a thing I know today (both technical and human), which make me the scientist I am, owe a lot to their patronage at that time, and I thank them for it. We started the adventure of the second Rb BEC apparatus with an empty room and a lot of enthusiasm with Marie Fauquemberg, who was then starting her PhD and, for a while, the help of Effrossini Tsoushnika and, briefly, Signe Seidelin, as interns. We were joined later by Jean-Félix Riou and, at the end of my postdoc, by William Guerrin and were helped for a while by Karsten Van Nielsen as a visiting PhD student. I have strongly appreciated interacting with them. Facing together with them the ups and downs of the construction from scratch of a complex scientific apparatus was definitely a great experience. Despite the difficulties and the high workload, we never stopped enjoying ourselves at work together and manage to operate as a team both efficient and fun to be a part of. At the end of my postdoc at Institut d'Optique, I was also interacting regularly with the people in charge of building what was to become the ICE experiment (an atom interferometry experiment that flew in the zero-gravity aircraft). I enjoyed very much working with Robert Nyman and Gael Varoquaux at that time. During all my stay in the Atom Optics group at Institut d'Optique, I really enjoyed the strong and efficient technical support that Frederic Moron and André Villing were providing in electronics. Michel Lécrivain from ENS Cachan played a major role in the design and realization of the Rb atom trapping electro-magnet and our interactions were very productive and interesting. After I moved to Boulder, I kept working for a while, on the side, with William and Jean-Félix, with extra help from Francois Impens and Christian Bordé on theoretical aspects of atom laser propagation. These were some very stimulating interactions which resulted in my only purely theoretical paper so far. This

was definitely an enriching experience that I am very happy about. I particularly enjoyed our way of using the time difference between Boulder and Orsay to provide an almost constant flow of new ideas, tests, simulations and calculus on atom laser propagation.

## **NIST, Boulder, Colorado, USA**

Although I had no prior experience on time and frequency metrology, Leo Hollberg and Chris Oates were kind enough to hire me as a guest researcher at NIST in Boulder, for which I am truly grateful. I also interacted scientifically with the comb part of the group which was under supervision of Scott Diddams with whom I was very glad to work. Leo, Chris and Scott were leading scientific teams which they managed to make both extremely high level, among the best in the world, and very friendly and human. I strongly appreciate this aspect of their leadership. My stay there introduced me to the arcane of optical frequency metrology which became the core of my current activity and the present manuscript. I feel very lucky to have been in Boulder at this time, one of the best places in the world for this reasearch topic. I often interacted at NIST with Tara Fortier and Jason Stalnaker through the use of the optical frequency comb and learned many a useful thing on these devices from them. Working with them was both extremely enriching and very fun. I also worked with Davy Ortega, who was spending a part of his time as a PhD Student at NIST, and I particularly enjoyed his enthusiasm and energy. I shared many interesting discussions and good meals with many members of the optical frequency metrology group at NIST, including, in addition to previously mentioned people Qudsia Quraishi, Vela M'bele, Mat Kirchner, John Kitching, Svenja Knappe, Elizabeth Donley with occasional participation of Tom Heavner from the atomic fountain group. As a part of the Time and frequency division, we were also in regular scientific and friendly interaction with people from other parts of the building. I want to give a special recognition to Jim Bergquist, whose help in difficult situations, both in science and life has been a great source of inspiration. I am also indebted to the scientific collaboration with Nathan Newbury and Ian Coddington on Fiber-based femtosecond lasers which has been very productive and enriching. Through Signe, I was in frequent connection with people from the ion storage group, both for fun and science and I thank them for their help and friendship. I also owe a lot to our colleagues at JILA in the Jun Ye's group Strontium clock team whose collaboration and efficiency on the Strontium-Calcium experiment was paramount.

## **LNE-SYRTE, Paris, France**

Pierre Lemonde was the leader of the Optical frequency metrology group at LNE-SYRTE in Paris when he asked me to join, in order to work on the optical frequency combs there. I am very grateful for the opportunity he gave me then and his support and help for getting the permanent position I currently hold. Philipp Tuckey and Noel Dimarcq have been the directors and vice-directors of LNE-SYRTE and SYRTE (in this or that order) over the years I have spent in this laboratory so far, and I thank them for their hard and difficult work and their constant support over the years. I have had

---

a particularly strong and efficient collaboration during most of my stay at LNE-SYRTE with Giorgio Santarelli on the femtosecond laser activity and most particularly on low phase noise microwave generation. Giorgio has taught me many of the black magic behind microwave phase noise and it has always been extremely thrilling to discuss new ideas and strategies with him. Now that he has left SYRTE for new challenges at LP2N in Bordeaux, I hope the best for him there and hope our friendship and collaboration will keep enduring. Sebastien Bize is the current group leader of the optical frequency group after Pierre left for other horizons in 2010. It has been a real pleasure to work with Sebastien ever since the first day I arrived at LNE-SYRTE and it is now a privilege to be part of the research team he leads. His friendship, advice and support have been a constant guidance in science and work-ethics throughout these years and I am grateful for it. Michel Lours, as manager of the electronic technical support service has constantly been an amazing source of help with many of the hard-core technical aspects of low noise and large bandwidth electronics. I have many times relied on his vast knowledge of techniques and components and have much enjoyed working with him along these years. As the person in charge of the femtosecond laser activity, I have had the great opportunity to interact with the various optical clocks people: Sebastien Bize, Jerome Lodewyck and, more recently, Rodolphe Le Targat and Luigi de Sarlo for the permanent staff, as well as other permanent members of the optical frequency group and microwave primary frequency references team (Paul-Eric Pottie, Ouali Acef, Peter Wolf, Michel Abgrall, Daniele Rovera, Phillipe Laurent, Peter Rosenbusch, Jocelyn Guéna). Such interactions have always been a great source of learning and progress in our common metrologic goals. My research activity owes a great deal to the interns, PhD students and post-doc I have had the opportunity to work closely with over the years at LNE-SYRTE. Jacques Millo, Elizabeth English, Wei Zhang, Daniele Nicolodi, Bérangère Argence, Adil Haboucha, Tang Li, Sylvain DiManno and Catxere Andrade Casacio on the frequency comb activity and low-noise microwave generation, as well as Katharina Predehl and Olivier Gobron on the more recent spectral-hole burning-stabilized laser activity. Wei and Daniele's work in particular have been central for pushing the comb's performance to the next level. I have shared many interesting discussions, scientific or not, with the various members, permanent and not permanent, scientific, technical or administrative, of the optical frequency group and the whole SYRTE laboratory in general. A full list is impossible to fit in here, but may they all be thanked collectively for the good spirit they manage to keep, despite the very demanding workload. The work on low-noise microwave generation with optical frequency comb has been done in part in collaboration with the "Franche-Comté Electronique, Mécanique, Thermique et Optique - Sciences et Technologies" (FEMTO-ST) institute from Besançon who dedicated their own frequency comb to this project for more than 1 year. The main FEMTO-ST people involved in this collaboration were Yann Kersalé, Rodolphe Boudot and Zenyu Xu. Andre Luiten was a visiting scientist from University of Western Australia during the time of this LNE-SYRTE/FEMTO-ST collaboration and I have had the great pleasure to work with him. The frequency comb referencing part of the long-distance telecom fiber optical link project lead me to interact closely with the "Métrologie, Molécules et Tests Fondamentaux" group at Laboratoire de Physique des Laser (LPL) at Villetaneuse. We have been interacting with Anne Amy-Klein, Christian Chardonnet and Benoit Darquié

in this collaboration and will continue doing so, especially with the development of the REFIMEVE+ project (distribution over the telecom network of optical frequency metrologic reference on the national and european level), jointly managed by LNE-SYRTE and LPL (and Laboratoire de Photonique, numérique et Nano-science"-LP2N, now that Giorgio has moved to this newly created laboratory), for which the frequency comb activity will be closely integrated. I hope this long standing collaboration will be rich and productive.

As a final word, I want to thank Signe for her constant help, support and encouragement throughout the years without which nothing would have been possible.

---

# Contents

---

<b>Introduction and work presentation</b>	<b>9</b>
<b>1 Optical frequency measurements</b>	<b>13</b>
1.1 Optical frequency comb principles . . . . .	14
1.2 Optical frequency combs at LNE-SYRTE . . . . .	17
1.2.1 Titanium-sapphire based system . . . . .	17
1.2.1.1 Description of the laser . . . . .	17
1.2.1.2 Phase-locking of the comb onto a 1062.5 nm cw laser, narrow linewidth regime . . . . .	18
1.2.2 Erbium-doped fiber based systems . . . . .	20
1.2.2.1 Description of the lasers . . . . .	20
1.2.2.2 Phase-locking the comb onto a 1.5 $\mu$ m cw laser in the narrow-linewidth regime . . . . .	21
1.2.3 Measuring the repetition rate . . . . .	22
1.2.4 Determining the index of the comb mode . . . . .	23
1.3 Overview of my work on optical frequency measurements . . . . .	25
1.4 Personal publications relevant to this chapter . . . . .	30
<b>2 New applications of frequency combs in the microwave domain</b>	<b>33</b>
2.1 Phase and amplitude noise of an oscillator, mathematical definitions, properties and measurement in the microwave domain . . . . .	34
2.2 Low phase noise microwave sources and optical frequency combs . . . . .	36
2.3 Application to fountain clocks and first experiments . . . . .	38
2.4 Copying the cw laser spectral property on a large Fourier frequency range	40
2.4.1 Feed-forward technique . . . . .	40
2.4.2 Intra-cavity EOM . . . . .	40
2.5 Limiting the effect of amplitude phase conversion . . . . .	41
2.5.1 Active stabilization . . . . .	41
2.5.2 “Magic points” of the photo-diode . . . . .	43
2.6 Increasing the signal to-noise ratio . . . . .	44
2.6.1 High linearity photo-diodes . . . . .	46
2.6.2 Repetition rate multiplication . . . . .	47
2.6.3 dual-photo-detector combined with repetition rate multiplication .	48
2.7 Chapter conclusion . . . . .	49
2.8 Personal publications relevant to this chapter . . . . .	51



<b>3</b>	<b>New applications of Frequency combs in the optics domain</b>	<b>53</b>
3.1	Direct frequency comb spectroscopy . . . . .	54
3.2	Multiple frequencies optical network over 100's of meters and 100's of Tera-Hertz . . . . .	57
3.3	Transfer of spectral purity between wavelengths at the $10^{-18}$ level . . . .	57
3.4	Remote spectroscopy in the mid-IR . . . . .	60
3.5	Personal publications relevant to this chapter . . . . .	62
	<b>Conclusion and perspectives</b>	<b>63</b>
	<b>Bibliography</b>	<b>74</b>

---

# Introduction and Outline

---

[...] εἰ τότε κοῦρος ἔα νῦν αὐτέ με γῆρας ὀπάζει.  
Ἄλλὰ καὶ ὧς ἵππεῦσι μετέσσομαι ἠδὲ κελεύσω  
βουλῇ καὶ μύθοισι· τὸ γὰρ γέρας ἐστὶ γερόντων.  
Αἰχμᾶς δ' αἰχμᾶσσοῦσι νεώτεροι, οἳ περ ἐμεῖο  
ὀπλότεροι γεγάασι πεποιθασίν τε βίηφιν.

As I was then a youth, so now doth old age attend me. Yet even so will I abide among the charioteers and urge them on by counsel and by words; for that is the office of elders. Spears shall the young men wield who are more youthful than I and have confidence in their strength.

*Homer, Iliad, book IV, verses 321-325 (Translation by A. T. Murray, PhD)*

Atomic clocks that work in the micro-wave domain (*i.e.* at a frequency of a few GHz) are currently at the base of the realization of the SI second and the “Temps Atomique International” (TAI) - atomic international time. They are progressively reaching their intrinsic limit, and systems that operate in the optics domain (*i.e.* at a frequency of a few hundred THz) are expected to progressively replace them in the next few decades.

These systems in the optics domain operate by probing an ultra-narrow atomic transition with a cw laser of extremely high stability and spectral purity (usually less than 1 Hz linewidth). By locking the laser’s frequency to the resonance of the probed optical transition, one realizes an optical frequency standard<sup>1</sup>. The short term frequency stability of such standards (currently a few  $10^{-15}$  at 1s) greatly surpasses that of microwave frequency standards (based on Cesium or Rubidium), which is, in itself, a strong motivation for developing them. Furthermore, a better stability also provides an easier, faster and more convenient characterization of systematic bias that may impact the frequency standard. In term of accuracy, many effects are insensitive to the reference frequency (Zeeman effect, density shift, for exemple), and therefore become relatively smaller when compared to an optical frequency than to a microwave frequency. The effects related to the movement of the atoms (Doppler effect, recoil effect) are the only ones which induce shifts proportional to the frequency, but this particular point has been solved for optical clocks either by confining the atoms in an optical lattice (neutral atoms), or in an ion

---

<sup>1</sup>the terms “optical frequency standard” and “optical clock” are used very often, somewhat abusively, to describe the same kind of setup. Rigorously, a frequency standard produces an oscillating signal which is frequency stable and absolutely referenced to primary standards. A clock includes a frequency standard, but also the surrounding systems that allow to use it to actually measure the passing of time.

trap (charged particles).

The advantage of using optical frequency standards is therefore particularly clear. The inconvenient lies in the fact that the actual signal produced by such frequency standard is an electro-magnetic field in the optical frequency domain, which exhibits an oscillation frequency of several hundreds of THz: no electronic system is fast enough to count it or compare it to other frequency standards, either optical (operating at other wavelength) or microwave.

Before the invention of optical frequency combs, the only possibility to realize optical frequency measurements were involving extremely complex frequency multiplication chains, with tens of lasers, and very manpower consuming. Only a handful of laboratories worldwide had access to such technology. Optical frequency combs, based on self-referenced femtosecond lasers [1, 2], allow such measurement with a simple, compact (approx. 1 m<sup>2</sup> of optical table), reliable and, nowadays, commercially available device.

Optical frequency chains of old time were, on the contrary, extremely complicated apparatuses, designed for a single very specific wavelength measurement, and requiring half a dozen of highly trained specialists to operate (and even then, only so rarely, a few times a year at best in the handful of institution that sheltered them). Optical frequency combs are now ubiquitous tools which have revolutionized the domain of optical frequency metrology by providing a phase coherent link over the optics and microwave domain, thereby covering hundreds of THz of spectrum with a single device of moderate complexity.

Their relative simplicity of operation, wide optical spectrum and high performance have also allowed the blooming of a very rich domain of applications, where they have shown their usefulness beyond the relatively narrow circle of highest-performance optical clocks community. Research with optical frequency combs includes, nowadays, application in the microwave domain (sources for radar and telecommunication), tera-Hertz (as sources of radiation and frequency control), mid-infrared, optical and VUV-XUV range. Scientific communities as various as radio-astronomers, optical domain astronomers, particle accelerator operators, free electron lasers researchers and, of course spectroscopists with various fields of interest are showing interest for these tools.

My working in the field of optical frequency combs and optical frequency measurements started at the National Institute for Standards and Technology (NIST) in Boulder, Colorado, USA, during my stay as a guest researcher in 2004-2007. My original field of research was Bose-Einstein condensation of laser-cooled neutral atoms []. After a PhD thesis in this field, under the supervision of Alain Aspect and Philippe Bouyer at Institut d'Optique, I pursued working in this group where I, along with three undergraduate students and various interns, had the opportunity to build from zero a high performance Rubidium Bose-Einstein condensation experimental apparatus. This two-year long post doc position led me to publish several papers in the field of atom laser realization and analysis [3, 4, 5, 6], as well as precision measurement using Bose-Einstein condensation [7]. The present manuscript doesn't describe these experimental and theoretical contributions, as I preferred keeping the scope of this manuscript to one single field. a list of the papers in peer-reviewed international journals that were published in relation with this work is given at the end of the introduction.

After leaving Institut d'Optique, I was employed as a guest researcher at NIST,

Boulder, in the group of Leo Hollberg, where I was working on a cold neutral calcium optical atomic clock and with optical frequency combs in 2005-2007. After this stay abroad, I was recruited at LNE-SYRTE in Paris Observatory to take in charge the optical frequency comb activities in the optical frequency measurement group. I have been doing research in this institution since then.

In the present manuscript, I have divided my various research projects at NIST and LNE-SYRTE along three main themes. The first chapter describes the realizations that I was a part of in the domain of optical frequency measurements. This includes detailed description of how to actually measure the signal from an optical clock with a frequency comb and a description of the results of the various measurement campaigns that I was involved in over the years. The second chapter describes my work in the field of ultra-low phase noise microwave signal generation with optical frequency combs. The third chapter describes various experiments I have worked on, which demonstrate new utilization possibilities of frequency combs in the optics domain. The first and third chapter mix work that was realized at NIST and LNE-SYRTE, while the second chapter covers a research program that I worked on exclusively at LNE-SYRTE.

The separation in three chapters is, of course, somewhat arbitrary, as many technical and fundamental problems were found indiscriminately in the three lines of research, and solving them in one context benefited the others greatly. For example, generating low noise microwave signal with a frequency comb renders the absolute frequency measurement of an optical clock against a primary frequency reference much more efficient. To be capable of quasi-autonomous operation of combs for hours and days, as is required for optical frequency measurement, makes the study of transfer of spectral purity between optical wavelengths and between optics and microwave much more convenient as one can rely on robust and reliable apparatus, *etc.*

As a general rule of research in the field of metrology, the real progress in the long run can only be obtained from a highly advanced, yet reliable technology. Indeed, at NIST and LNE-SYRTE, which are both National Metrology Institutes, researchers are strongly encouraged to design reliable and autonomous experiments, as, in the long run, they are supposed to be operated continuously with minimal human intervention. Whereas this could be considered a burden, this is also a strength as they then provide a reliable and solid ground on which to build highly ambitious research programs. This is a strong specificity of experimental research in National Metrology Institutes that cannot be emphasized enough.

## Personal publications relevant to my post-doctoral work at Institut d'Optique on Bose-Einstein condensation and atom lasers

*Partially ferromagnetic electromagnet for trapping and cooling neutral atoms to quantum degeneracy*

M. Fauquembergue, J.F. Riou, W. Guerin, S. Rangwala, F. Moron, A. Villing, Y. Le Coq, M. Lécivain, P. Bouyer and A. Aspect  
Rev. Sci. Instrum. 76, 103104 (2005)

*Beam Quality of a Non-ideal Atom Laser*

J.-F. Riou, W. Guerin, Y. Le Coq, M. Fauquembergue, V. Josse, P. Bouyer, and A. Aspect  
Phys. Rev. Lett., 96, 070404 (2006)

*Coherent matter wave inertial sensors for precision measurements in space*

Y. Le Coq, J. A. Retter, S. Richard, A. Aspect and P. Bouyer  
App. Phys. B, 84, 627-632 (2006)

*Tapered-amplified AR-coated laser diodes for Potassium and Rubidium atomic-physics experiments*

R. A. Nyman, G. Varoquaux, B. Villier, D. Sacchet, F. Moron, Y. Le Coq, P. Bouyer and A. Aspect  
Rev. Scient. Instrum., 77, 033105 (2006)

*Theoretical tools for atom-laser-beam propagation*

J.-F. Riou, Y. Le Coq, F. Impens, W. Guerin, C. J. Bordé, A. Aspect and P. Bouyer  
Phys. Rev. A., 77, 033630 (2008)

---

# Optical frequency measurements

One should avoid carrying out an experiment  
requiring more than 10 per cent accuracy.

*Walther Nernst (1864-1941), physicist and chemist. Quoted in [8].*

The optical frequency measurement is the prime application of frequency combs and historically the most developed worldwide. I describe in this chapter the work I have realized in connexion with optical frequency measurements at LNE-SYRTE and NIST.

At NIST, I was working primarily on a simple and robust cold atom optical frequency standard based on neutral Calcium that served as a high long term stability reference, allowing the full characterization of systematic errors of a state-of-the-art neutral Strontium lattice clock at JILA [9]. The measurement campaigns were realized thanks to an optical fiber link between the two institutions (distant by 3km), and optical frequency combs at each end of this link to connect it to the wavelength of operation of the Strontium and the Calcium clocks.

My work at LNE-SYRTE is mostly centered on the comb part, in strong interaction with the people working on the optical frequency standards *per se*. This includes many measurement campaigns of the two Strontium lattice clocks [10, 11, 12], the one neutral mercury clock of the laboratory [13, 14, 15, 16, 17, 18], as well as some long-distance measurement of the CO<sub>2</sub>/OsO<sub>4</sub> mid-infrared frequency standard located at Laboratoire de Physique des Lasers (LPL) in Villestaneuse, *via* an optical fiber link between this laboratory and LNE-SYRTE [19].

I begin with a general introduction to the concepts and techniques related to optical frequency combs. This can be considered a short “technical-tutorial-like” introduction to the subject, presenting concepts that are fundamental for the rest of the manuscript.

I proceed with a description of the system, techniques and setups used nowadays at LNE-SYRTE for optical frequency measurements. This description gives an overview of present day state-of-the-art fiber-based frequency comb system. Although not exactly equivalent to the systems used at NIST and JILA while I was there (Titanium-sapphire based systems with phase-locking of both  $f_0$  and  $f_{\text{rep}}$  were, and are still, the technique of choice there<sup>1</sup>), the system I describe can be considered as a good example of a reliable device that allows measuring any present-day optical frequency standards without degradation in terms of stability or accuracy.

I finish by giving an overview of the various experiments that I participated in over the years which relate to optical frequency measurements.

---

<sup>1</sup>The definition of the parameter  $f_0$  and  $f_{\text{rep}}$  will be given in the following paragraphs

## 1.1 Optical frequency comb principles

The electromagnetic field emitted by a mode-locked femto-second laser is composed, in the frequency domain, of a series of modes, regularly spaced in frequency, and phase coherent with each other. The frequency of each mode thus follows the relation

$$\nu_N = N \times f_{\text{rep}} + f_0 \quad (1.1)$$

where  $f_{\text{rep}}$  is the repetition rate (typically radio-frequency) of the laser pulses,  $\nu_N$  is the optical frequency of the considered mode,  $N$  a large integer (typically of the order of  $10^6$ ), and  $f_0$  is a global shift frequency called “carrier-envelope offset frequency”. This last term is related to the difference between the phase velocity and group velocity in the laser oscillator. It corresponds, in the time domain, to the fact that the electric field is not strictly identical from one pulse to the next, but exhibits a phase shift with reference to the time envelop of the pulse (see figure 1.1)

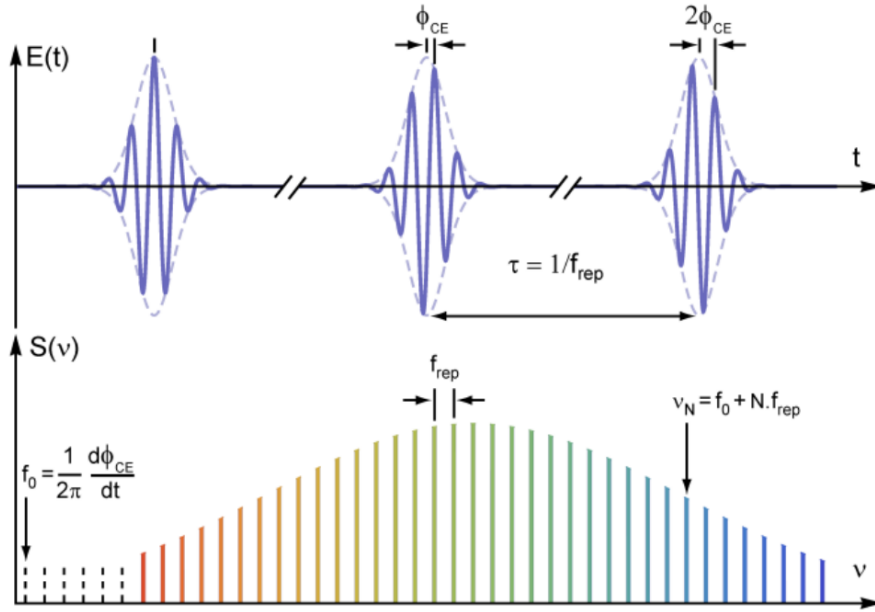

Figure 1.1: Correspondence between the time (successive pulses) and frequency domains (regularly spaced modes) for the electromagnetic fields generated by a mode-locked femto-second laser of repetition rate  $f_{\text{rep}}$ . The dephasing  $\Phi_{\text{CE}}$  between the envelop and the optical carrier that arise between two successive pulses corresponds, in the frequency domain, to a global shift of the frequency of the modes by a offset  $f_0 = \frac{1}{2\pi} \frac{d\Phi_{\text{CE}}}{dt} = \frac{\Phi_{\text{CE}}}{2\pi} f_{\text{rep}}$ .

By mixing (on a partially reflecting mirror or a fibered beam-combiner) the electromagnetic fields generated by a femtosecond laser and a cw laser whose frequency  $\nu_{\text{cw}}$  needs to be measured, and detecting the result with a fast photo-diode (of which the bandwidth will be denoted  $f_{\text{BW}}$ ), one gets a radio-frequency signal whose spectrum is composed of, for one part, harmonics of the repetition rate  $f_{\text{rep}}$ , and, for another part, different optical beat-notes with frequencies  $f_{\text{b},N} = |\nu_{\text{cw}} - N \times f_{\text{rep}} - f_0|$ , with the integer

$N$  taking all the values such that  $f_{b,N} < f_{BW}$ . One can then easily isolate from this complex signal, using a sufficiently narrow radio-frequency band-path filter, one of the  $f_{b,N_{cw}}$  components which provides the frequency shift of the cw laser with one on the modes of the femtosecond laser, indexed by the integer  $N_{cw}$ .

Likewise, with another narrow band-path filter, one can isolate one of the harmonics of  $f_{rep}$ , which provides access to this value. In practice, it's however common to physically split the measurement of  $f_{rep}$  and  $f_{b,N}$  on two different photo-diodes, so as to optimize the detection for these two signals separately. For example, optimizing the signal-to-noise ratio of the beat-note  $f_{b,N_{cw}}$  normally requires to limit the spectrum of the femtosecond laser that illuminates the photo-diode to a narrow spectral width around the optical frequency  $\nu_{cw}$ . Otherwise, using the full spectrum of the femtosecond laser would produce a very large number of components with frequencies  $f_{b,N}$  higher than  $f_{BW}$ , which produce shot-noise without producing a useful signal. To decrease as much as possible this added shot-noise by filtering the spectrum around its “useful domain” can therefore greatly increase the signal-to-noise ratio of the beat-note at frequency  $f_{b,N_{cw}}$ . This is typically done with a narrow interferometric filter with a spectral bandwidth of 1 nm or below. In contrast, the optimal detection of  $f_{rep}$  requires to use the maximum available optical power (within the limit imposed by the photo-diode saturation), so as to maximize the detection signal-to-noise ratio. Furthermore, in this case, we have shown how some specific operation regime can greatly reduce the residual measurement noise of  $f_{rep}$ , and therefore enables the use of the detected signal, for instance, as an ultra-low phase-noise microwave source (see chapter 2). These solutions, at the current stage of our research, can only be used reliably when a specific photo-diode is dedicated to the sole detection of  $f_{rep}$  (or of one of its harmonics).

If the integer  $N_{cw}$  is known, or at least easy to determine (for example in the case where the frequency  $\nu_{cw}$  is already known with a better accuracy than the repetition rate  $f_{rep}$ ),  $f_0$  is the only remaining frequency to determine for completely defining the equations, and therefore measuring absolutely the optical frequency  $\nu_{cw}$ . The measurement of  $f_0$  is realized by the self-referencing technique, which requires the femtosecond laser to exhibit a spectrum that spans at least one octave (*i.e.* from one optical frequency to its double for the so-called f-2f technique<sup>2</sup>). In practice, very few lasers exhibit such a wide spectrum “naturally” (so far, only ultra-short pulses Titanium-Sapphire based lasers with pulse duration of 3 to 5 fs approximately have been shown to exhibit such a wide spectrum, see for examples [21, 22, 23, 24]). Nevertheless, using a piece of highly non-linear fiber allows to broaden the spectrum of a few types of short pulses femtosecond lasers, sufficiently to reach the octave spanning condition while maintaining the phase coherence condition between modes that is necessary for the operation of the self-referencing technique<sup>3</sup>. These highly non-linear fibers are engineered so as to exhibit a quasi-vanishing chromatic dispersion near the central wavelength of the

<sup>2</sup>Some self-referencing experiments have been realized with spectrum covering only two third of an octave, see for example [20]. They require an even higher level of sophistication and are not widely used nowadays

<sup>3</sup>Many lasers can reach an octave spanning spectrum by propagating in a long enough dispersion-managed non-linear fiber, provided they can reach a high enough peak intensity. One can buy, nowadays, such “white light lasers” from various providers. However, maintaining the coherence between the two sides of the octave spanning spectrum is an entirely different business.



femtosecond laser. This allow the pulses to propagate in them while keeping a short duration and therefore keep a high peak intensity along the propagation, which in turns provide the requirement for high non-linear effects. By successive 4-wave mixing processes (both degenerate or non-degenerate for the various possible mode combination) between the various modes that compose the femtosecond laser spectrum, the non-linear fiber progressively broadens the spectrum until there is a factor equal or higher than two between its low and high frequency sides, which the a prerequisite for the self-referencing technique. Thus, it appears in the spectrum a component at optical frequency  $\nu_N = N \times f_{\text{rep}} + f_0$  and another one, at the other end of the spectrum of frequency  $\nu_{2N} = 2N \times f_{\text{rep}} + f_0$ . By doubling the frequency of the component  $\nu_N$  in a non-linear crystal, and detecting the optical beat-note between this signal of frequency  $2 \times \nu_N$  and the mode of frequency  $\nu_{2N}$  with a fast photo-diode, one gets a signal at frequency  $|2N \times f_{\text{rep}} + 2f_0 - 2N \times f_{\text{rep}} - f_0| = f_0$ . The frequency doubling acts on several optical modes at the same time. The final signal therefore contains, in addition, harmonics of the repetition rate  $f_{\text{rep}}$ , but also components at frequencies  $M \times f_{\text{rep}} \pm f_0$  with  $M$  an integer. It is however easy to remove those components with sufficiently narrow radio-frequency bandpass filters. It is important to notice that the participation of a large number of pair of modes of frequencies  $2\nu_N$  and  $\nu_{2N}$  to the signal is actually favorable, since several pairs will produce beat-notes that may add coherently to produce a signal of much larger amplitude than would be produced by a single pair. As the typical optical power per mode is of the order of a few pW, this coherent build up is actually essential to the detection. However, it can only happen if every pair produces a signal of frequency  $f_0$  with identical phase as the others, which requires a fine tuning of the global dispersion of the optical systems that realize this f-2f interferometer (the optical path for components of frequency  $\nu_{2N}$  and for components of frequency  $\nu_N$  before, while and after the frequency doubling must be identical). This phase matching condition is actually equivalent, in the time domain picture, to ensure that the parts of the pulse which have been frequency doubled, and that which haven't, reach the photo-diode at the same moment. This condition can for example, simply be realized with an adjustable delay line that acts only on part of the optical spectrum (before the frequency doubling stage), or with *ad hoc* fixed dispersion elements (glass plate or negative dispersion mirrors) added in the optical path.

The set of radio-frequency signals  $f_{b,N_{cw}}$ ,  $f_{\text{rep}}$  and  $f_0$  gives all the parameters that completely define the system of equations, and therefore provides a mean to compare optical to microwave frequencies. Furthermore, when using several beat-notes between the optical frequency comb and several cw lasers (operating at different wavelengths),  $f_{b,N_{cw}^{(1)}}$ ,  $f_{b,N_{cw}^{(2)}}$ ,  $f_{b,N_{cw}^{(3)}}$ , etc. one can compare simultaneously several optical frequencies, without necessarily using the intermediate of the micro-wave domain.

Nevertheless, these measurements assume that the mode indices  $N_{cw}^{(i)}$  are previously known. The easiest way to determine those is when the optical frequency to measure is known beforehand with an accuracy better than the comb's repetition rate. Indeed, in this case, it's easy to locate the mode closest to  $\nu_{cw}$ . In the particular case of optical clock transitions whose frequency is known with a very large accuracy (for the "classic" clock transitions like for neutral Strontium for example), this condition is naturally fulfilled. For non-absolute optical frequency standards, like a high-finesse Fabry-Perot cavity not

in relation with an atomic transition, or an atomic clock transition that hasn't been measured previously (as was the case for the first neutral mercury experiments at LNE-SYRTE), this previous knowledge of the optical frequency is normally not sufficient as the best commercially available wavemeters don't provide, in general, an absolute accuracy of a few MHz or tens of MHz, as required, for an arbitrary wavelength (in the best case, such accuracy is only available a few nm away from a fixed calibration wavelength). Realizing several measurements using different repetition rates of the comb, assuming the optical frequency to determine doesn't change too fast in-between the measurements, and the measurements themselves are realized with a sufficiently high resolution, one can however deduce the integer indexes of modes with basic mathematics. If one has access to two working combs, one can even make the measurement with the two combs (operating at different repetition rates) simultaneously (or, even better, synchronously) [25, 26], thereby greatly relaxing the necessity for the optical frequency which is measured to exhibit small fluctuations, as well as the necessity of high resolution measurement.

## 1.2 Optical frequency combs at LNE-SYRTE

The LNE-SYRTE owns several optical frequency combs based on two different technologies. The combs based on Titanium-sapphire femtosecond lasers appeared in the year 2000 and allowed the measurement of many optical frequencies in the visible domain and the near infra-red. Their operation for more than a few hours or a day is generally still a challenge for the high repetition rate lasers that are preferred for metrology applications. A new generation of comb, based on fiber lasers, that we started working on in 2009 at SYRTE, are progressively replacing the Titanium-Sapphire based systems for operational level measurement tools. Our work in collaboration with our industrial partner (MenloSystems GmbH) has allowed these fiber-based optical frequency combs to reach the current state-of-the-art and these devices are progressively taking over for measurement campaigns at LNE-SYRTE.

### 1.2.1 Titanium-sapphire based system

#### 1.2.1.1 Description of the laser

The first generation of optical frequency combs at LNE-SYRTE uses, as a femtosecond laser oscillator, a titanium ion-doped sapphire crystal in a free-space resonant cavity. This system is pumped by a continuous 8 W commercial laser at 532 nm, based on intra-cavity frequency doubling of a neodymium YAG laser. The mode-locked pulsed operation is realized by Kerr-lens effect in the Titanium-Sapphire crystal itself. The repetition rate is close to 767 MHz, finely tunable with a piezo-electric actuator mounted on one of the mirrors of the cavity. The pump beam, before reaching the laser oscillator, is passing through an acousto-optic modulator (AOM), used in the 0<sup>th</sup> order, which allows fine tuning of the effective pumping power. This fast actuator allows typically to provide feed-back with a bandwidth near 400 kHz, and acts both on the frequency  $f_0$  and the repetition rate  $f_{\text{rep}}$ , by modifying the index of refraction and the dispersion seen by the femtosecond laser in the titanium-doped crystal. A motorized glass wedge also allows a coarse adjustment of the  $f_0$  frequency, by adding or removing a dispersive

glass thickness in the laser cavity. The pulses that are produced by this laser, typically 30 fs in our case, are sent, in parallel, on a fast GaAs photoconductor (to detect  $f_{\text{rep}}$  and its harmonics up to 14 GHz), and on a 20 cm non-linear photonic crystal fiber which produces at its output a quasi-continuum that covers more than one octave of spectral bandwidth (from 520 nm to 1100 nm approximately). Several free-space optical elements allow to generate from this wide spectrum the self-referencing  $f_0$  signal and the optical beat-notes between the comb and several cw lasers to measure at LNE-SYRTE: clock (698nm) and trapping (813 nm) lasers of the Strontium optical frequency standards, clock (1062.5 nm before frequency quadrupling for interrogation of atoms at 265.6 nm) laser of the neutral mercury optical frequency standard and an iodine-stabilized laser (1064 nm). The general setup schematic for the Titanium-Sapphire optical frequency comb at LNE-SYRTE is represented on figure 1.2.

### 1.2.1.2 Phase-locking of the comb onto a 1062.5 nm cw laser, narrow linewidth regime

The beat-note signal at  $\lambda_{cw} = 1062.5$  nm exhibits a large signal to noise ratio ( $>50$ dB in a 500kHz bandwidth). We use this property to phase-lock the comb to the ultra-stable laser at this wavelength with a large ( $>400$ kHz) feed-back bandwidth<sup>4</sup>. This beat-note signal is, like any other optical beat-note amplified and mixed with the  $f_0$  signal. After this mixing, we obtain mainly two components at frequencies  $\nu_{cw} - N_{cw}f_{\text{rep}} - f_0 + f_0$  and  $\nu_{cw} - N_{cw}f_{\text{rep}} - f_0 - f_0$ , but only the first is independent of  $f_0$  and its fluctuations. We isolate this radio-frequency component with a narrow band-pass filter and divide its frequency by 8. This digital division step is used to increase the phase-lock loop reliability by decreasing the probability of cycle-slips occurrence. We beat the result against a fixed frequency reference made with a synthesizers referenced to the primary standards of the laboratory. After low-pass filtering, the error signal obtained is processed in an analog corrector, implementing proportional gain plus multiple integrators, which acts, for high Fourier frequencies to the optical pump power (via the 0 order AOM at 532 nm) and for low Fourier frequencies ( $<1$  kHz) on the piezo-electric actuator that tunes the length of the femtosecond laser cavity. This realizes a phase-lock loop which connects the repetition rate of the pulsed laser with the optical frequency of the cw laser via the relation:

$$\frac{\nu_{cw} - N_{cw}f_{\text{rep}}}{8} = f_{\text{REF}} \quad (1.2)$$

In practice, we do not necessarily use the comb mode nearest to  $\nu_{cw}$ , but choose a beat-note at a frequency sufficiently far from spurious or unwanted beat-notes to facilitate its isolation from the rest of the signal. Because of this phase-lock loop, we therefore connect two frequency domain of the electromagnetic spectrum separated by more than 5 orders of magnitude (radio-frequencies and optical frequencies), via an integer division factor  $N_{cw}$  and a fixed frequency shift  $f_{\text{REF}}$ .

It's not necessary to precisely know  $f_0$ , as this quantity is removed from the beat-notes by RF mixing. It is sufficient to ensure that the relative electronic and propagation

<sup>4</sup>The rule a thumb for phase lock-loops is that the signal-to-noise ratio of the beat-note used to generate the error signal must be higher than  $\approx 23$ -30 dB in a given bandwidth  $B$  to be able to phase-lock with a unitary gain bandwidth of approximately  $B$ .



of  $f_{\text{ref}}$  and its harmonics) of very low phase noise, that can be compared against the laboratory's primary reference with very high stability and accuracy. The final optical frequency measurement is therefore of much better quality.

## 1.2.2 Erbium-doped fiber based systems

### 1.2.2.1 Description of the lasers

The second generation of optical frequency combs at LNE-SYRTE uses a technology mostly based of fiber optics with Erbium doping as an active medium. The core of the systems is commercial-based, with heavy modifications by the LNE-SYRTE team to make them reach the current state-of-the-art performance.

The mode-locked laser uses the non-linear polarization effect, thanks to which a convenient choice of orientation for birefringent intra-cavity wave-plates strongly favors a pulsed mode operation. Although mostly fibered, over a few centimeters the laser cavity is realized in free-space, which is used to setup several actuators. Adjustment of the optical path length of the cavity, and therefore the repetition rate  $f_{\text{rep}}$  can be realized coarsely with a motorized translation stage, finely with a piezo-electric ceramic, both acting on the position of a mirror of the cavity, and very finely (but with a very large feed-back bandwidth capability) with an intra-cavity electro-optic modulator that acts as a voltage-tunable group delay. A coarse adjustment of  $f_0$  is also possible via a motorized glass wedge in the cavity. This oscillator is pumped by high power diode lasers at 980 nm, which are powered by constant current low-noise power supplies. The femtosecond lasers produce pulses of 300 fs with a repetition rate of 250 MHz and an average optical power of 200 mW (at the available output) [27].

The main advantage of these setups is a much improved reliability and long-term maintenance-free operation. A mode-locked operation is typically obtained without interruption or operator intervention for 3 to 6 months. Historically, such technology had the disadvantage of a large noise in free-running operation (both amplitude and phase noise), typically larger than Titanium-Sapphire based systems, mostly due the high power pump diode lasers, relatively noisy compared to commercial solid-states 532 nm pump lasers typically used for pumping Titanium-Sapphire lasers. Furthermore, the relaxation times of the relevant transitions and gain saturation dynamics in the Erbium-fiber medium are quite long, which prevent acting on the system with a large feed-back bandwidth by modulating the pump power. A feed-back bandwidth of a few tens of kHz is typically the maximum achievable (even with a carefully designed electronic phase compensator), which normally prevents reaching the narrow-linewidth regime (of which I have described the advantages for the Titanium-Sapphire systems).

We have resolved this issue by the addition of an intra-cavity electro-optic modulator in the femtosecond laser cavity which produces a variable group delay that can be adjusted via the control voltage. This actuator is an efficient way to provide feed-back onto the repetition rate of the laser with a large bandwidth, typically larger than 1.4 MHz, which has proven sufficient to reach the narrow-linewidth regime. We have realized a detailed study of the effect of this actuator, in particular regarding the unavoidable cross-talks to the power or the  $f_0$  frequency of the femtosecond laser [28], which demonstrated the strong potential of this technique. Thanks to our partnership

with the industry, this technology is now commercially available [27].

### 1.2.2.2 Phase-locking the comb onto a $1.54 \mu\text{m}$ cw laser in the narrow-linewidth regime

The phase locking and absolute frequency measurement chain of the fiber-based optical frequency comb are described in Fig. 1.3. Part of the optical power from the femtosecond laser is filtered with an Optical Add and Drop Module (OADM - an interferometric narrow-band filter from the optical telecommunication technology) centered at  $1.54 \mu\text{m}$ . The narrow band-passed component is combined with an ultra-stable laser at the same wavelength (which is the reference oscillator for the LNE-SYRTE/LPL long distance frequency reference transfer via optical link [29]). After RF filtering, frequency division by a factor 8, and mixing with a fixed frequency reference (generated by a computer controlled DDS - Direct Digital synthesizer), the beat-note signal provides the error signal of the optical frequency comb phase-locking process. With a proportional plus multiple cascaded integrator corrector, this signal is applied to the intra-cavity electro-optic crystal of the femtosecond laser (for Fourier frequencies  $>5 \text{ kHz}$ ) and the piezoelectric actuator that tunes its cavity length (Fourier frequencies  $<5 \text{ kHz}$ ). When the loop is on, the optical frequency comb is phase-locked to the  $1.54 \mu\text{m}$  reference and reaches the narrow-linewidth regime. The part of the spectrum that is not filtered by the OADM (approx.  $70 \text{ mW}$ ) is fully used to illuminate a fast and highly linear InGaAs photo-detector (DSC40S HLPD by Discovery Semiconductor Inc.) which generates RF components at the repetition rate and its harmonics.

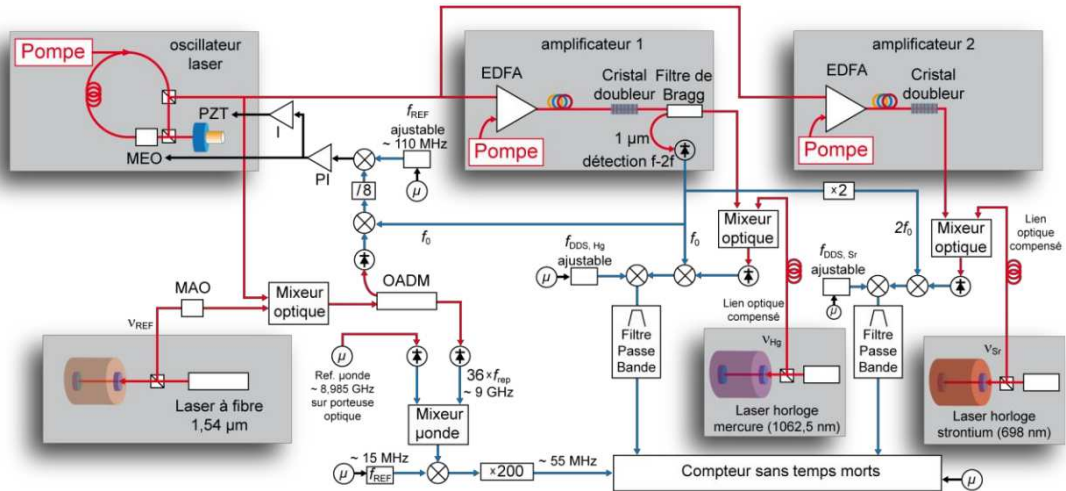

Figure 1.3: Schematics of the setup of the Er-doped fiber based optical frequency comb currently used at LNE-SYRTE for optical frequency measurements.

Another part of the femtosecond laser output is sent to an Erbium-doped Fiber Amplifier (EDFA) followed by a Highly Non Linear Fiber (HNLF) which broadens the spectrum to one octave (from  $1 \mu\text{m}$  to  $2 \mu\text{m}$ ). A Periodically Poled Lithium Niobate

(PPLN) doubling Crystal in waveguide geometry, followed by a photodetection of the beatnote between the part of the spectrum near  $2\mu\text{m}$  that is frequency doubled and that near  $1\mu\text{m}$ . This beatnote gives the  $f_0$  signal. Furthermore, part of the light obtained near  $1\mu\text{m}$  is also used to generate the optical beat-note of the comb with the  $1062.5\text{ nm}$  ultra-stable laser which, after frequency quadrupling, is used to probe the clock transition of the neutral mercury optical frequency standard experiment. Finally, a part of the femtosecond laser output is sent to a second EDFA followed by a highly non-linear fiber and a frequency doubler that provides some comb modes near  $698\text{ nm}$ . This last system allows the generation of an optical beatnote with the  $698\text{ nm}$  ultra-stable laser that is the probe for the clock transition on the two Strontium optical frequency standards developed at LNE-SYRTE. After removing the  $f_0$  signal (or  $2 \times f_0$  in the case of the  $698\text{ nm}$  beat-note), the  $1062.5\text{ nm}$  and  $698\text{ nm}$  signals are narrow-linewidth (typically  $<1\text{ Hz}$ ) and are therefore easily filtered and subsequently amplified to have their frequencies measured with a dead-time-free, synchronous multi channel RF frequency counter <sup>5</sup>, referenced to the primary frequency standards of the laboratory. The general setup schematics for the Er-doped fiber-based optical frequency comb at LNE-SYRTE which is used primarily for optical frequency measurement is represented on figure 1.3

### 1.2.3 Measuring the repetition rate

It is, of course, necessary to measure accurately and continuously the repetition rate of the optical frequency comb against primary frequency standards. This allows to deduce from the various frequencies of the optical beat-notes the absolute optical frequencies being measured, as well as that of the optical frequency reference onto which the comb is phase-locked. To do so, we use the higher harmonics of  $f_{\text{rep}}$  that are produced by the fast InGaAs or GaAs photo-detector (depending on the laser, Er-doped fiber in the first case and Titanium sapphire in the second case). With narrow microwave bandpass filters, we isolate, for the Titanium Sapphire based system, the twelfth harmonic of  $f_{\text{rep}}$  whose frequency is close to  $9.2\text{ GHz}$  and mix it with an exact microwave reference at  $9.185\text{ GHz}$  derived from the primary frequency reference of the laboratory. The resulting beat-note, whose frequency is close to  $15\text{ MHz}$ , is then mixed with a RF signal that is also exact (*i.e.* derived from primary frequency references) but tunable (it is produced with a computer controlled DDS), so as to obtain a frequency very close to  $275\text{ kHz}$  (to within  $1\text{ Hz}$ ). This signal near  $275\text{ kHz}$  is then multiplied by 200 to reach a frequency of approximately  $55\text{ MHz}$  which is measured by the dead-time-free synchronous multi-channel RF frequency counter. The frequency multiplication step is necessary in order to use the counter as best as its performance allows. As a matter of fact, this device exhibits a frequency resolution of  $1\text{ mHz}$  at  $1\text{ s}$  measuring time which would correspond to a resolution of only  $10^{-13}$  on the measurement of the harmonic  $12 \times f_{\text{rep}}$ , which is much less than the available stability of the frequency reference available at LNE-SYRTE. The multiplication step allows to measure in  $1\text{ s}$  the  $55\text{ MHz}$  frequency signal with a  $1\text{ mHz}$  resolution, which is equivalent to measuring the  $275\text{ kHz}$  signal with a “virtual” resolution of  $5\mu\text{Hz}$  (at  $1\text{ s}$  measuring time). Compared to the carrier at  $9.2\text{ GHz}$ , this

<sup>5</sup>FXE from Kramers-Klische company

corresponds to a resolution of  $5.4 \times 10^{-16}$  which is compatible with the stability of the 9.185 GHz microwave reference. Indeed, this resolution is better than the expected stability (at a few  $10^{-15}$ ) of the microwave reference that is distributed throughout the LNE-SYRTE laboratory and therefore doesn't represent a limitation to the optics-to-microwave frequency comparison in the laboratory. For the Er-doped fiber -based optical frequency combs, the setup is similar, except that the thirty-sixth harmonic of  $f_{\text{rep}}$  is used, and that the mixing is realized with first a fixed and exact reference at 8.985 GHz then a tunable (and exact) reference near 15 MHz to obtain a signal with a frequency very close to 275 kHz

#### 1.2.4 Determining the index of the comb mode

In order to measure the absolute optical frequency, one needs also to identify unequivocally the index  $N$  of the optical frequency comb that realizes the beat-note with the cw laser to measure, as well as the various signs + or - in the arithmetic formulas that gives the optical frequency  $\nu_{\text{cw}}$  from the beat-note frequency and the repetition rate frequency. The frequency of the optical carrier  $\nu_{\text{REF}}$  onto which the comb is phase-locked is given by the relationship:

$$\nu_{\text{REF}} = N_{\text{REF}} \times f_{\text{rep}} + 8 \times \text{sign}_{\text{REF}} \times f_{\text{REF}} \quad (1.3)$$

Thus phase-locked to an optical cw reference, the comb allows to also measure other optical frequency references  $\nu_{\text{cw}}^{(i)}$  by isolating their beat-note signals against the nearest mode of the comb, and then mix it with  $f_0$  to remove this parameter from the equations:

$$\nu_{\text{cw}}^{(i)} = N_{\text{cw}}^{(i)} f_{\text{rep}} + \text{sign}^{(i)} \times f_{\text{beat}}^{(i)} \quad (1.4)$$

(note that equation 1.4 also holds for  $\nu_{\text{REF}} = \nu_{\text{cw}}^{(0)}$  by defining  $f_{\text{beat}}^{(0)} = 8 \times f_{\text{REF}}$  and  $\text{sign}^{(0)} = \text{sign}_{\text{REF}}$ ).

Three complementary methods allow to determine the  $N_{\text{cw}}^{(i)}$  integers and the  $\text{sign}^{(i)}$  quantities if the optical and microwave reference that are compared are sufficiently stable and/or previously known.

If the optical frequency to measure is known beforehand with an inaccuracy sufficiently small compared to the repetition rate  $f_{\text{rep}}$ , the first method simply consists in direct identification. Indeed, in this case, a single integer  $N_{\text{cw}}^{(i)}$ , and only one sign before  $f_{\text{beat}}^{(i)}$  are compatible with the equation 1.4, which naturally solves the indetermination. This is the case, for example for the ultra-stable lasers at 698 nm and 1062.5 nm at LNE-SYRTE (after their respective frequencies have been determined with other methods at least once), whose frequencies do not change by more than 1.5 MHz per year, *i.e.* more than two orders of magnitude lower than the repetition rate of the Titanium-Sapphire-based (approx. 767 MHz) and Erbium-doped fiber-based (approx. 250 MHz) optical frequency combs.

The optical frequency drifts or the experimental tunability of other lasers in the laboratory can make the *a priori* uncertainty of the optical frequency too large, in which case other methods need to be used. First, the quantities  $\text{sign}^{(i)}$  are generally quite easy to determine by opening the phase-lock loop which sets up equation 1.3 and scanning



slightly  $f_{\text{REF}}$  while observing the direction in which the corresponding  $f_{\text{beat}}^{(i)}$  signals are moving. To determine  $N_{\text{cw}}^{(i)}$ , a possible method consists in realizing two successive comparisons between the optical frequency to determine and the microwave reference by using two different repetition rates  $f_{\text{rep},1}$  and  $f_{\text{rep},2}$ . By measuring the frequency of the beat-note between  $\nu_{\text{cw}}^{(i)}$  and the mode  $N_{\text{cw}}^{(i)}$  of the comb, and then with the mode  $N_{\text{cw}}^{(i)} + M$ , where  $M$  is an integer easily deduced from the scrolling of the spectral lines when going from  $f_{\text{rep},1}$  to  $f_{\text{rep},2}$ . Thus, we can get  $N_{\text{cw}}^{(i)}$  from the relationship:

$$N = M \frac{f_{\text{rep},1}}{f_{\text{rep},2} - f_{\text{rep},1}} + \frac{\text{sign}_2^{(i)} \times f_{\text{beat},2}^{(i)} - \text{sign}_1^{(i)} \times f_{\text{beat},1}^{(i)}}{f_{\text{rep},2} - f_{\text{rep},1}} \quad (1.5)$$

In most cases, the stability of these two measurements (limited by that of the optical and microwave frequency reference), leads to an uncertainty much lower than 1 in 1.5 (note that increasing  $M$  reduces proportionally the stability requirement). The only hypothesis necessary for this method to succeed is that the drift of the optical frequency to determine is much smaller than  $f_{\text{rep},2} - f_{\text{rep},1}$ . This condition is easily fulfilled in the laboratory, where the frequency drifts of the laser to measure rarely exceed a few tens Hz per second.

Finally, by looking at equations 1.3 and 1.4, one can see that the factors  $N$  can be interpreted as the sensitivity of the relevant optical frequency to changes in  $f_{\text{rep}}$ . The third method, that we use regularly and have completely automatized, consists in inducing voluntarily a change in  $f_{\text{rep}}$  while keeping the phase-lock loop that imposes relation 1.3 closed. This is done by shifting by  $\Delta$  the value of  $f_{\text{REF}}$  slightly ( $\Delta=1.8$  MHz in practice, a value limited essentially by two fixed narrow-band filters used to isolate the various beat-notes), which must be done by ramping it continuously (to prevent failure of the phase-lock-loop 1.3, the ramping needs to be slow compared to the bandwidth of the phase-lock loop). By averaging (after the ramping) for a certain time, we obtain a repetition rate frequency value  $f_{\text{rep},+}$  with a given resolution. If  $f_{\text{REF}}$  and  $f_{\text{rep}}$  vary in the same direction, then  $\text{sign}_{\text{REF}} = -1$  (and  $+1$  in the other case). A second ramping of  $f_{\text{REF}}$  down by  $-2\Delta$  and second averaging provides a symmetric measurement of  $f_{\text{rep},-}$ . The value of  $N_{\text{REF}}$  is obtained by the relation:

$$N_{\text{REF}} = \left\lfloor \frac{\text{sign}_{\text{REF}} \times 2 \times 8 \times \Delta}{f_{\text{rep},+} - f_{\text{rep},-}} \right\rfloor \quad (1.6)$$

where the  $\lfloor \cdot \rfloor$  operator denotes the ‘‘round to nearest integer’’ function.

For  $\Delta=1.8$  MHz,  $f_{\text{rep}} \simeq 250$  MHz, and  $N_{\text{REF}} \simeq 8 \times 10^5$  (hence  $\nu_{\text{REF}} \simeq 200$  THz, *ie*  $1.5 \mu\text{m}$  wavelength), a stability at the  $10^{-15}$  level for the measurement of  $f_{\text{rep},+}$  and  $f_{\text{rep},-}$  is sufficient to reach a resolution much better than 1 on  $N_{\text{REF}}$  (as calculated by equation 1.6). At LNE-SYRTE, the very high stability of the microwave frequency reference distribution system allow this level to be reached in typically 8 s averaging, provided that the measurement at 8 s is dominated by, at most, flicker frequency noise process and not higher order processes which would prevent the Allan deviation of the measurement to average down (with longer averaging times) like, in particular, linear drifts.

In practice, it is very often the case that optical frequency references exhibit linear drifts of a few Hz per second that may prevent reaching a sufficiently high resolution on the measurement of the repetition rate. This issue is however easily solved, as this linear drift is not a stochastic process on the considered time scale, by measuring this drift and modifying equation 1.6 to take it into account. Specifically, if during the two averaging periods, both the average values of  $f_{\text{rep},+}$  and  $f_{\text{rep},-}$  are measured, but also their first derivative with time  $f'_{\text{rep},+}$  and  $f'_{\text{rep},-}$  and the average time of the two measurements  $t_+$  and  $t_-$ , the equation 1.6 is modified into :

$$N_{\text{REF}} = \left\lceil \frac{\text{sign}_{\text{REF}} \times 2 \times 8 \times \Delta}{(f_{\text{rep},+} - f_{\text{rep},-}) - (t_+ - t_-) \times (f'_{\text{rep},+} + f'_{\text{rep},-})/2} \right\rceil \quad (1.7)$$

Such a way of taking linear drift into account could be further pushed to higher order non-stochastic drifts (quadratic drifts and so on), but we have never experienced the necessity for it at LNE-SYRTE.

The main advantage of this third method is that it can be easily automatized as it doesn't require the opening and closing of the comb's phase-lock-loop. However, as the value of the frequency shift  $\Delta$  that can be achieved is limited to a couple of MHz, this method requires to be able to realize an optics-to-microwave frequency comparison with a resolution of a few  $10^{-15}$  in a time over which the frequency drifts remains predictable (as for linear drift for example), *ie* a few seconds or minutes. This method is easy to implement only in an institution where microwave frequency reference with an intrinsic stability in the  $10^{-15}$  range over these time constant is available (a cryogenic sapphire oscillator frequency locked on a H-maser for example).

Finally, this last method is also applicable for determining the integers  $N_{\text{cw}}^{(i)}$ , as a shift in the repetition rate  $\Delta f_{\text{rep}}$  induces a shift of  $f_{\text{beat}}^{(i)}$  whose sign and amplitude allow to determine  $\text{sign}^{(i)}$  and  $N_{\text{cw}}^{(i)}$ .

### 1.3 Overview of my work on optical frequency measurements

At NIST, I was involved in the work that led to the first demonstration of a neutral atom optical clock with an accuracy near  $1 \times 10^{-16}$  in the context of a collaboration between the team at JILA lead by Jun Ye and the team at NIST led by Leo Hollberg, Chris Oates and Scott Diddams. My central contribution was on the development of a robust atomic frequency standard based on neutral Calcium using a Ramsey-Bordé interferometric interrogation scheme. Although this frequency standard setup is relatively old in its design, and its performance in absolute accuracy is modest, its most prominent quality is its robustness, ease-of-use, and good short term (up to a few hundred seconds) stability. Typically, after my few years at NIST, this setup was able to operate continuously for days and weeks with minimal human supervision and provide long term stability as low as  $3 \times 10^{-16}$  at 200s averaging time.

The robustness of the Ca clock comes primarily from the low number of lasers used to operate it as only two lasers systems are used. One ultra-stable laser at 657 nm

is used to probe the clock transition  $^1S_0(4s^2)(m = 0) - ^3P_1(4s4p)(m = 0)$  transition of cold Ca atoms. The natural linewidth of this transition is 400 Hz, which is quite large compared to modern state-of-the-art optical lattice clocks (which typically use effective linewidths about 1 Hz), but sufficient to provide a stability of the clock near  $2 \times 10^{-15} \times \tau^{-1/2}$  where  $\tau$  is the integrating time. This laser is an extended cavity diode laser frequency locked, with the Pound-Drever-Hall (PDH) technique on a high finesse ultra-stable Fabry-Perot cavity. The phase sidebands for realizing the PDH are realized with an EOM (finely aligned to minimize residual amplitude modulation). This master clock laser injection locks a similar diode laser (although not in an extended cavity configuration) that provides (after switching and frequency shifting AOMs) 10 mW of power on the atoms. A second laser is used for laser cooling (Zeeman slower and magneto-optical trap) the atoms down to 1 mK temperature, using the  $^1S_0(4s^2) - ^1P_1(4s4p)$  transition at 423 nm. This cooling transition has a natural linewidth of 34 MHz, which, combined with the absence of sub-Doppler cooling effect due to lack of fine structure, prevents reaching sub-mK temperatures but still allows very fast and efficient cooling. This laser is a 846 nm extended cavity diode laser frequency locked (PDH) on a highly stable Fabry-Pérot cavity and frequency doubled in a periodically-poled lithium niobate (PPLN) crystal in a resonant bow-tie cavity (also frequency locked to the input laser with the PDH technique). As these frequency locks have much less stringent requirements than that of the clock laser, the PDH sidebands (identical for both locks) are simply realized by modulating the current driving the diode laser (which has the drawback of producing substantial residual amplitude modulation -RAM-, whose effect on the lock is, however, much smaller than the natural linewidth of the cooling transition). All lasers can be switched by single-pass AOMs before reaching the atoms, and the offset between the part of the 657 nm laser that probes the atoms and that which is used to frequency-lock in on the reference cavity is controlled by a DDS. The clock transition probing uses the Ramsey-Bordé method on the freely expanding atoms. The complete laser cooling cycle and frequency-lock loop is controlled by a micro-controller which drives the switches and DDS necessary to operate the full system. The full cycle duration is 5 ms, including 3 ms laser cooling (MOT) of the atoms. An important aspect of the Ca clock is that its cycle is very short, which actually allows recapturing of the atoms from the previous cycle during the laser cooling phase. This is an essential process for allowing such a small cooling cycle (90 percent of the atoms are actually recycled for the next cycle, the Zeeman-slowed newly captured atoms making the extra 10 percent in a stable cyclo-stationary regime). A total of  $6 \times 10^7$  atoms are laser cooled in the MOT, over which only 20 percent are used in the Ramsey-Bordé interferometric process to produce a clock error signal. This loss of efficient atoms is due to the finite available optical power at 657 nm, as the duration of the  $\pi$  and  $\pi/2$  pulses in the Ramsey-Bordé interferometer is inversely proportional to the light intensity and the width of the velocity class that is resonant with these pulses is inversely proportional to this duration. In practice the parameters of the Ca clock were all optimized for the highest stability and not for absolute accuracy. In particular, the width of the Ramsey-Bordé beams are identical to that of the MOT, which maximizes the amplitude of the clock signal for a given optical power but renders the experiment more sensitive to residual wavefront curvatures and drifts in the atomic velocity and density distributions.

This device was used as a reference oscillator to evaluate the systematic errors of a state-of-the-art lattice-trapped neutral Strontium clock at JILA, by use of a 4-km long optical fiber link operating at 1064 nm wavelength and two optical frequency combs (one at JILA and one at NIST) connecting this optical fiber link to the 657 nm (Ca clock at NIST) and 698 nm (Sr clock at JILA) ultra-stable clock lasers (see figure 1.4). By averaging many data points, each of them corresponding to an integration over 100 s

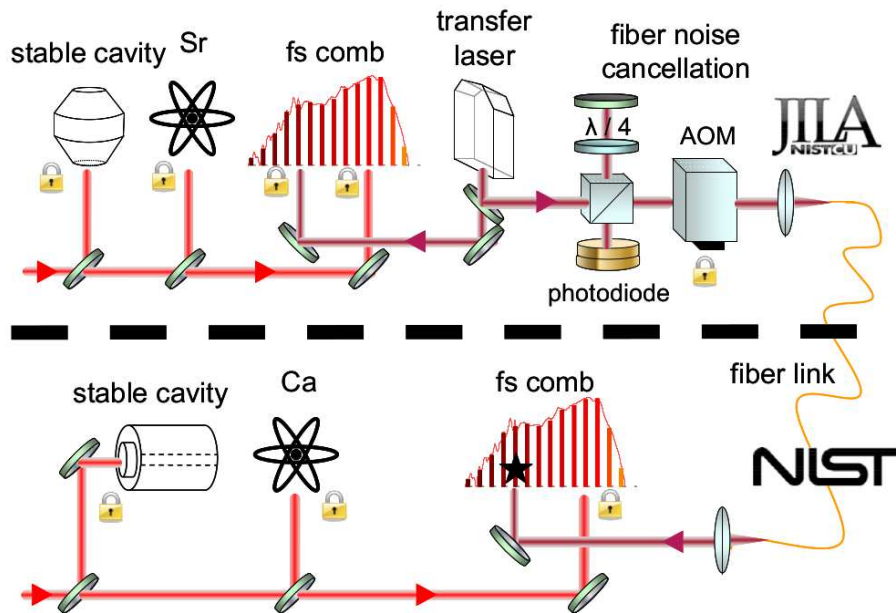

Figure 1.4: Schematic of the setup for the comparison between the neutral calcium clock at NIST at the lattice-trapped neutral. The robustness and ease-of-use of the Ca clock allows to use it as a local oscillator of high stability to evaluate the systematic errors of the remote Sr clock.

(corresponding to a  $\simeq 3 \times 10^{-16}$  stability of the comparison between the JILA Sr clock and the NIST Ca clock), the various systematic errors of the Sr optical lattice clock were studied with a resolution below  $1 \times 10^{-16}$ , leading to a total budget uncertainty of  $1.5 \times 10^{-16}$ , *i.e.* lower than the best existing microwave fountain clocks. This experiment was reported in Science [9].

Although these NIST/JILA experiments demonstrated for the first time absolute accuracy of an optical lattice clock near  $10^{-16}$ , they didn't provide an actual optical frequency measurement of the Strontium clock transition at this level and didn't realize a link to primary frequency standards. At LNE-SYRTE a few years later, I was took part in such an experiment, which was involving the absolute frequency comparison between two Strontium optical lattice clocks and the three atomic fountain clocks of the laboratory (see fig 1.5). This absolute frequency measurement campaign built upon the collective work of many LNE-SYRTE projects over decades, and provides a firmly established link between optical clocks and microwave clocks that enables a future redefinition of the SI second in terms of optical frequency cycles, (instead of the current microwave based definition). This work was recently reported in Nature Communications [12]. It

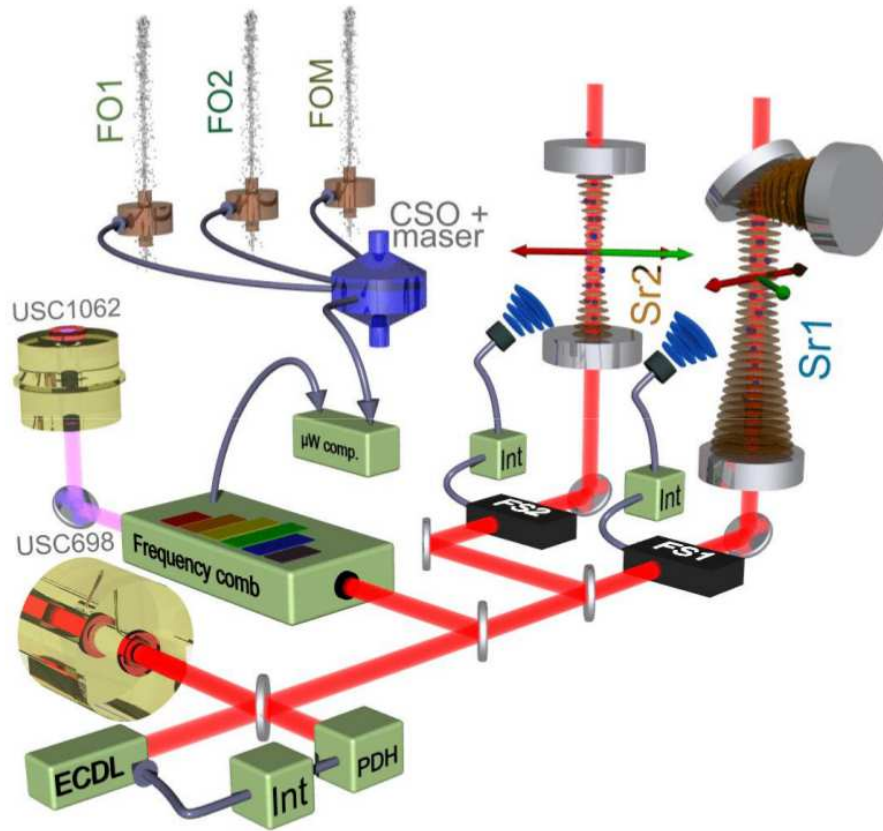

Figure 1.5: Schematics of the setup for the absolute frequency measurement of the Strontium lattice clocks at LNE-SYRTE vs. the laboratory's primary frequency references (fountain clocks).

exhibits a total accuracy budget for the Strontium clocks of  $1.1 \times 10^{-16}$ , and an accuracy of the Sr clock transition measurement set by that of the combined microwave fountain clocks at  $3.1 \times 10^{-16}$ .

The dominant term of the accuracy budgets of these two optical clocks is the so-called black-body radiation shift. This effect arises from the emission of incoherent radiation from the atoms' experimental environment (which is near room temperature). Indeed, the blackbody radiation spectrum at 300 K is broadband and centered at  $9.7 \mu\text{m}$  (as is well known from the Wien law). This radiation couples to the atomic transitions to shift the energy levels, including the ground and excited state of the clock transition. This results in a fixed frequency offset between the zero-temperature frequency and the measured frequency, which depends on the actual temperature environment experienced by the atoms. The temperature of the apparatus surrounding the atoms, and most particularly the gradients are difficult to know with an accuracy much better than a degree, which produces an accuracy limit of the black-body radiation correction (near  $0.8 \times 10^{-16}$  for JILA and SYRTE Sr clocks). To decrease this effect, a possibility is to design carefully controlled thermal enclosures for the atoms, or even cryogenic environ-

ments. An alternative (or complementary) route is to use atoms with lower sensitivity to the black-body radiation shift. Along these lines, a neutral mercury experiment is being designed at LNE-SYRTE, for which several measurement campaigns have been realized with the optical frequency combs. The idea behind using the mercury atom is that the clock ground and excited states are less coupled to the 300 K blackbody radiation than in the case of Strontium. In a nutshell, this is due to the fact that the strongly allowed (electric dipole) transitions from these levels are all in the UV domain, while many are in the visible domain for Strontium and therefore are coupled more strongly to the  $9.7 \mu\text{m}$  radiation from the environment. The drawback of using such an atomic species is that its laser-cooling transitions are also in the UV range which makes the laser-cooling and trapping challenging. Therefore, only a couple of groups in the world currently develop such an optical clock.

The group at LNE-SYRTE has pioneered work using this atom for optical clock application, which has led to the first observation and measurement of the clock transition (reported in Physical Review Letters [13]) in freely expanding laser cooled atoms, the first realization of a lattice trapping and subsequent accurate determination of the clock transition in neutral mercury (reported in Physical Review Letters [15]). The current apparatus realizes a frequency stability of  $5.4 \times 10^{-15}/\tau^{-1/2}$  [18] and an absolute accuracy at  $5.7 \times 10^{-15}$  [17]. The currently limiting contribution to the accuracy budget is the precise determination of the magic wavelength (*i.e.* the lattice trapping wavelength which doesn't perturb the clock transition) for the mercury atom, which should improve in the future with larger available lattice trapping potential depth. The current blackbody radiation shift component of the accuracy budget is not a limiting factor to the current evaluation ( $1.6 \times 10^{-16}$ ), and, in any case, has yet a lot of margin for improvement.

The current capability of the comb to measure optical frequencies, in stability or accuracy largely exceeds any current and future requirement of optical and microwave clocks. In this context, the future evolution of the research on the optical frequency comb measurement capability will be to go towards the "operational" level, by which I mean a stand-alone operation without human supervision for long periods of time (weeks, months, at least). This capability will be important in the future, where the optical clocks are expected to replace the microwave fountain as primary frequency standard and, therefore, be at the heart of national and international timescales. In such configurations, operation of the optical clocks and the frequency comb that tends progressively to 24/24 h, 7/7 d all year long will become a stringent technical requirement that will need to be addressed. In this context, the expertise and extensive use of fiber-based frequency combs, that can typically operate in mode-lock regime for months without human supervision, is a strong asset of the LNE-SYRTE laboratory.

## 1.4 Personal publications relevant to this chapter

*Accuracy Evaluation of an Optical Lattice Clock with Bosonic Atoms*

X. Baillard, M. Fouché, R. Le Targat, P. G. Westergaard, A. Lecallier, Y. Le Coq, G. D. Rovera, S. Bize and P. Lemonde  
Optics Letters **32**, 1812 (2007)

*Sr lattice clock at  $1 \times 10^{-16}$  fractional uncertainty by remote optical evaluation with a Ca clock*

A. D. Ludlow, T. Zelevinsky, G. K. Campbell, S. Blatt, M. M. Boyd, M. H. G. de Miranda, M. J. Martin, J. W. Thomsen, S. M. Foreman, Jun Ye, T. M. Fortier, J. E. Stalnaker, S. A. Diddams, Y. Le Coq, Z. W. Barber, N. Poli, N. D. Lemke, K. M. Beck and C. W. Oates  
Science **319**, 5871 (2008)

*Doppler-Free Spectroscopy of the  $^1S_0 - ^3P_0$  Optical Clock Transition in Laser-Cooled Fermionic Isotopes of Neutral Mercury*

M. Petersen, R. Chicireanu, S.T. Dawkins, D. V. Magalhães, C. Mandache, Y. Le Coq, A. Clairon and S. Bize  
Physical Review Letters **101**, 183004 (2008)

*An ultra-stable referenced interrogation system in the deep ultraviolet for a mercury optical lattice clock*

S. Dawkins, R. Chicireanu, M. Petersen, J. Millo, D. Magalhaes, C. Mandache, Y. Le Coq and S. Bize  
Applied Physics B **99**, 41 (2010)

*Optical Lattice Trapping of  $^{199}\text{Hg}$  and Determination of the Magic Wavelength for the Ultraviolet  $^1S_0 - ^3P_0$  Clock Transition*

L. Yi, S. Mejri, J.J. McFerran, Y. Le Coq and S. Bize  
Physical Review Letters **106**, 073005 (2011)

*Ultraviolet laser spectroscopy of neutral mercury in a one-dimensional optical lattice*

S. Mejri, J.J. McFerran, L. Yi, Y. Le Coq and S. Bize  
Phys. Rev. A **84**, 032507 (2011)

*Neutral Atom Frequency Reference in the Deep Ultraviolet with Fractional Uncertainty  $5.7 \times 10^{-15}$*

J.J. McFerran, L. Yi, S. Mejri, S. Di Manno, W. Zhang, J. Guéna, Y. Le Coq and S. Bize  
Physical Review Letters **108**, 183004 (2012)

*Laser locking to the  $^{199}\text{Hg}$   $^1S_0 - ^3P_0$  clock transition with  $5.4 \times 10^{-15}/\sqrt{\tau}$  fractional frequency instability*

J.J. McFerran, D.V. Magalhaes, C. Mandache, J. Millo, W. Zhang, Y. Le Coq, G.

Santarelli and S. Bize  
Optics Letters **37**, 3477 (2012)

*Optical lattice clocks as candidates for a possible redefinition of the SI second*  
M. Gurov, J.J. McFerran, B. Nagorny, R. Tyumenev, Z. Xu, Y. Le Coq, R. Le Targat,  
P. Lemonde, J. Lodewyck and S. Bize  
IEEE Transactions on instrumentation and measurement **62**, 1568 (2013)

*Experimenting an optical second with strontium lattice clocks*  
R. Le Targat, L. Lorini, Y. Le Coq, M. Zawada, J. Guéna, M. Abgrall, M. Gurov, P.  
Rosenbusch, D. G. Rovera, B. Nagórny, R. Gartman, P. G. Westergaard, M. E. Tobar,  
M. Lours, G. Santarelli, A. Clairon, S. Bize, P. Laurent, P. Lemonde and J. Lodewyck  
Nature Communication **4**, 2109 (2013)





# New applications of frequency combs in the microwave domain

Dear lord, thank You for this microwave bounty  
even though we don't deserve it

*Dan Castellaneta (1957-), American actor, voice actor (Homer Simpson),  
comedian, singer and screen writer, in "The Simpsons" season 1 episode 4*

Optical frequency combs realize a phase coherent link between the optics domain and the microwave domain [30, 31]. As such, they generate microwave signals the performance of which, in term of noise, can be, in principle, serious competitors for the existing purely microwave technology. Although the science of low-noise microwave is quite ancient (it stems mostly from the development of RADAR applications during the second world war...), it's still attracting attention and research efforts nowadays, due to the numerous domains of applications requiring high performance microwave sources and processing tools. This chapter describes the several years research efforts that we have conducted at LNE-SYRTE in this domain.

The original interest for this topic at LNE-SYRTE came from the microwave frequency metrology research, where the Laboratory's primary standards (atomic fountain clocks) are using a cryogenic sapphire oscillator [32] based system to probe the atoms [33, 34]. As this cryogenic system is very high cost of operation and maintenance consuming, it appears, in the context of ever increasing operational requirements, that developing an alternative microwave source from opto-electronic technology is an important goal, in order to increase redundancy and cost-effectiveness. The first section of the chapter describes the experiment we have carried out to demonstrate this capability.

Beyond their applications for primary microwave frequency standards, low phase-noise microwave sources can have a wide range of applications in scientific, civil and military fields. For example, they can provide ultra-low timing jitter synchronization capabilities for particle accelerators, Very Long Baseline Interferometry (VLBI) radio-astronomy facilities and be used in deep-space navigation networks. They are raising interest in the telecommunication industry for higher transfer rates and time-stamping accuracy. The civil and military RADAR companies are also in the search for alternatives or better microwave sources to improve the directivity in noisy multi-echo environments. I begin this chapter with a general overview on phase noise and present a few different techniques to measure it. I proceed by describing the results that we have obtained so far for very high performance low-phase noise comb-based systems.

## 2.1 Phase and amplitude noise of an oscillator, mathematical definitions, properties and measurement in the microwave domain

A real-world oscillator produces a quasi-periodic signal  $s(t)$  that can be described by the equation

$$s(t) = A_0 \cdot [1 + \alpha(t)] \cdot \cos[2\pi\nu t + \phi_0 + \phi(t)] \quad (2.1)$$

where  $t$  is the time,  $\nu$  the carrier frequency,  $A_0$  and  $\phi_0$  the “static” amplitude and phase, while  $\alpha(t)$  and  $\phi(t)$  are stochastic functions representing, respectively, amplitude and phase fluctuations.

The phase noise power spectral density  $S_\phi(f)$  is defined, mathematically, as

$$\forall f \in \mathbb{R}, S_\phi(f) \triangleq \lim_{T \rightarrow \infty} \frac{E[|\Phi_T(f)|^2]}{2T} \quad (2.2)$$

where  $E[\cdot]$  is the statistical expectation value operator and the  $\Phi_T(f)$  are the Fourier transforms of the truncated functions  $\phi_T$  defined as

$$\forall f \in \mathbb{R}, \phi_T(t) \triangleq \begin{cases} x(t) & \text{for } |t| \leq T \\ 0 & \text{for } |t| > T \end{cases} \quad (2.3)$$

which are square-integrable (and therefore *do* have a Fourier transforms  $\Phi_T(f)$ )

$$\forall f \in \mathbb{R}, \Phi_T(f) = \int_{-\infty}^{+\infty} \phi_T(t) \cdot \exp(2\pi ft) dt \quad (2.4)$$

As  $\phi(t)$  is expressed in [rad],  $S_\phi(f)$  is expressed in [rad<sup>2</sup>/Hz] (and  $\Phi_T(f)$  in [rad.s]). For  $\phi(t)$  a stochastic *stationary* function of time (*i.e.* its self-correlation  $R(\tau) = E[\phi(t) \cdot \phi(t + \tau)]$  doesn't depend on the time  $t$ , only on the time difference  $\tau$ ), the Wiener-Khinchine theorem states that, equivalently,  $S_\phi(f) = \int_{-\infty}^{+\infty} R(\tau) \cdot \exp[2\pi f\tau]$ . In this case, as  $\phi(t)$  is real,  $R(\tau)$  is real and of even parity, thus  $S_\phi(f)$  is real, positive and of even parity. Without loss of information, in the literature, the one-sided power spectral density  $S_\phi^{\text{OS}}(f)$  is therefore rather used. This quantity is defined as

$$\forall f \in \mathbb{R}^+, S_\phi^{\text{OS}}(f) = 2 \cdot S_\phi(f) \quad (2.5)$$

Without further precision, in the rest of the manuscript, all power spectral densities of phase must be understood as one-sided. A further concept, widely used in the literature (and *de-facto* standard for manufacturers specifications), is the single-side-band (SSB) power spectral density  $\mathcal{L}(f)$ , defined as  $\mathcal{L}(f) = S_\phi^{\text{OS}}(f)/2$ . Note the term “single-side-band” should not be confused with the term “one-sided”. This concept arises from early (obsolete) definitions, based on measurement of  $s(t)$  (understood here as a signal of electrical nature) on a spectrum analyzer with resolution bandwidth  $f_{\text{RBW}}$ . In the case of negligible amplitude noise ( $\alpha(t) \simeq 0$ ) and sufficiently low excursion of phase  $\phi(t)$ <sup>1</sup>, the phase noise  $S_\phi^{\text{OS}}(f)$  appears, in such a measurement and for  $\nu \gg f \gg f_{\text{RBW}}$  as

<sup>1</sup>The “sufficiently low” condition is mathematically expressed here as  $\int_f^\infty S_\phi^{\text{OS}}(f) df < 0.1 \text{ rad}^2$

two symmetric components at frequencies  $\nu + f$  and  $\nu - f$  around the carrier peak (of which the central frequency is of course  $\nu$ ). A single one of these two components (for instance at  $\nu + f$ ), normalized by the power in the carrier peak (at  $\nu$ ) and the RBW  $f_{\text{RBW}}$  corresponds to  $\mathcal{L}(f)$  while the sum of them corresponds to  $S_{\phi}^{\text{OS}}(f)$ . In logarithmic units (which is the most usual representation of noise power spectral densities), the (one-sided) phase noise PSD  $S_{\phi}(f)$  is expressed in dB(rad<sup>2</sup>)/Hz (this unit being the result of the mathematical expression  $10 \cdot \log_{10}[S_{\phi}^{\text{OS}}(f)]$ ), while the SSB phase noise PSD is expressed in dBc/Hz (this unit being the result of the mathematical expression  $10 \cdot \log_{10}[S_{\phi}^{\text{OS}}(f)] - 3\text{dB}$ ).

Similarly, with the same notation conventions, the amplitude noise power spectral density  $S_{\alpha}(f)$  is defined as

$$\forall f \in \mathbb{R}, S_{\alpha}(f) \triangleq \lim_{T \rightarrow \infty} \frac{E[|A_T(f)|^2]}{2T} \quad (2.6)$$

where the  $A_T(f)$  are the Fourier transforms of the truncated functions  $\alpha_T(t)$ . The one-sided amplitude noise power spectral density  $S_{\alpha}^{\text{OS}}(f)$ , and the SSB amplitude noise (expressed, in logarithmic unit, in dBc/Hz) are defined similarly to that of phase noise. The use of the same unit to describe SSB amplitude and phase noise power spectral density is not accidental. It arises from the observation of the power spectrum of  $s(t)$  on a spectrum analyzer (with  $s(t)$  a signal of electrical nature). For a signal  $s(t)$  with negligible amplitude noise the sidebands from the carrier directly represent phase noise components. For a signal  $s(t)$  with negligible phase noise, they represent amplitude noise components. For a signal where neither amplitude nor phase noise is negligible, the sidebands are the sum of these two noise components (which may add incoherently or even coherently if there is a non-vanishing correlation between  $\phi(t)$  and  $\alpha(t)$ , in which case the right and left sidebands become asymmetric). Building a measuring device solely sensitive to amplitude or phase noise can be non-trivial in this general case and great care must be taken to realize a meaningful measurement.

In the microwave (or radio-frequency) domain, the most standard way of measuring the relative phase noise [35] between two oscillators is to set them at the exact same frequency and in quadrature phase, and mix them on a double-balanced microwave mixer with the input powers according to the mixer specification (typically 7 dBm on the “local oscillator” -LO- port and 0 dBm to 7 dBm on the “radio-frequency” -RF- port for a typical mixer, said to be of “level 7”). In this configuration, the voltage noise at the output is proportional to the relative phase noise between the oscillators. If the two signals are set in phase, the output voltage fluctuations are proportional to the amplitude fluctuations of the signal applied to the RF port. In phase detection configuration, the proportionality coefficient depends on the actual microwave powers on the mixer input ports (LO and RF) and is easily calibrated by setting two oscillators on the LO and RF ports with identical powers to that used in the real measurement, but operating at slightly different frequencies and measuring the slope of the resulting beat note when it crosses 0 (*i.e.* at quadrature). The unavoidable small mismatch between the fast diodes that compose the mixer are responsible for an input-amplitude-dependent offset in the output voltage that causes a small amplitude noise to phase noise conversion process [36]. For typical double-balanced mixers, this technique is, however, relatively

insensitive to amplitude noise as it provides typically 20-30 dB isolation from it. For microwave sources with amplitude noise 20 dB or more over their phase noise, this point must be carefully considered<sup>2</sup>.

Any microwave device exhibiting non-linearities (like a double-balanced mixer, or an amplifier working at an output power not negligible compared to its 3 dB compression point) exhibits 1/f flicker phase noise which is an important part of its specifications when one has to make a choice for a specific application. For measuring phase noise close to the carrier, this flicker phase excess noise can be a strong limitation. One solution to get rid of it is to realize a carrier suppression scheme [37, 38]. The idea is to set the two microwave sources to be compared at exactly the same frequency and send them at the two input ports of a hybrid junction (the microwave equivalent of a 50/50 beam splitter in optics). Fine tuning of the amplitudes and phases provides exact cancellation of the signal at one of the outputs of the hybrid junction (carrier suppression) except for the very small fluctuations arising from amplitude and phase noise of the sources. Subsequent amplification and demodulation of these small fluctuations using a mixer provides a measurement devoid of the 1/f excess noise limitations (since the amplifier and mixer operate with powers much smaller than their compression points). To realize phase detection, the demodulation is realized with the mixer fed on its LO port with a signal at the carrier frequency of normal amplitude (7 dBm for a level 7 mixer) and phase quadrature (with reference to one of the sources to measure), while the small fluctuations (carrier suppressed) signal to demodulate is applied on its RF port. Note that the intrinsic phase noise of this demodulating signal at the LO port doesn't perturb the measurement, as it's in common mode between the two sources at the input of the hybrid junction. Usually, this demodulating signal is conveniently obtained from the second output of the hybrid junction (where the two sources do not cancel each other but build up coherently) suitably amplified and phase-tuned.

Other advanced techniques exist for measuring phase noise in the microwave domain<sup>3</sup>, but the two described here were sufficient for the several experiments that we have realized at LNE-SYRTE with optical frequency combs as low phase-noise microwave sources over the last few years.

## 2.2 Low phase noise microwave sources and optical frequency combs

The idea behind obtaining a very low phase-noise microwave source from an optical frequency comb is quite simple. When phase-locked to a state-of-the-art cw optical reference, as that realized by a laser frequency locked on a high-finesse ultra-stable Fabry-Perot cavity, the repetition rate of the femtosecond laser is a down-converted

<sup>2</sup>Some solution still exist, as there are - normally slightly away from quadrature - phase difference points where the mixer provides infinite rejection of amplitude noise. Using the mixer near these points therefore allows good phase noise sensitivity with very low amplitude noise sensitivity. As these "magic" points are device-specific and extremely input microwave power dependent, using them should be considered a last resort solution, to be implemented only by experienced microwave metrologists.

<sup>3</sup>In particular, the cross-correlation technique [36] is likely to be used in our future experiments when very low white noise floor measurement capability (beyond our current capabilities) will be required.

image of the optical frequency of the cw laser. Mathematically, the phase noise of a source is decreased in frequency division process. More precisely, if the frequency is divided by  $N$ , the phase noise (in logarithmic units) is decreased by  $-20 \cdot \log(N)$ . This is because the *time jitter* is identical, whereas the carrier period is decreased, hence the mathematically decreasing phase noise. The frequency division process from the optical domain (near, for instance 200 THz for a  $1.5\mu\text{m}$  cw laser) and the microwave domain (near, for instance 10 GHz for the 40<sup>th</sup> harmonics of a 250 MHz repetition rate Er-doped-fiber comb of the kind described in chapter 1), provides a division by  $N \simeq 20000$ , *i.e.* a mathematical reduction of the phase noise by 86 dB ! A state-of-the-art cw optical reference using a high-finesse ultra-stable Fabry-Perot cavity [39, 40, 41, 42, 43, 44] exhibits low phase noise in the 0.1 Hz to 100 kHz Fourier frequency range and beyond, which, once mathematically frequency divided by 20000, can be as low as -105 dBc/Hz at 1 Hz and -175 dBc/Hz at 10 kHz from a 10 GHz carrier (see typical exemple in fig 2.1). This compares favorably with any existing microwave source existing to-date from other technologies ([45, 46, 47, 48, 49]).

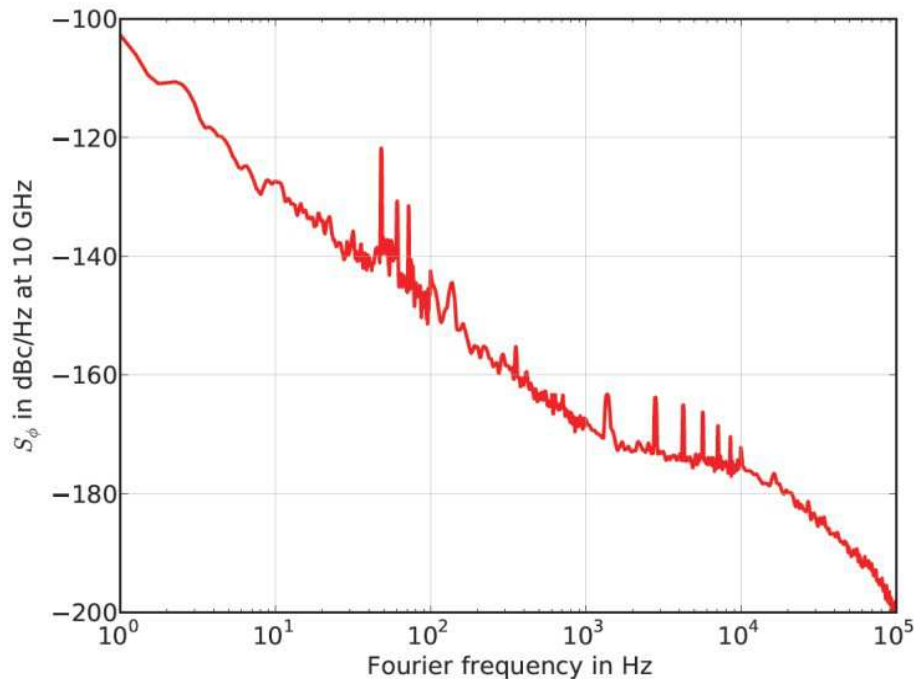

Figure 2.1: The phase noise power spectral density of a typical Fabry-Perot stabilized ultra-stable laser at  $1.5\mu\text{m}$  wavelength, *mathematically* divided to a carrier frequency of 10 GHz. The actual frequency comb that is making the “real-world” division process is adding extra phase noise to this mathematical limit that needs to be minimized.

Close to the carrier, the best microwave sources to-date are cryogenic sapphire oscillators (of the kind currently used at LNE-SYRTE for the microwave fountain clocks, or using a close-cycle cryogenic system for lower operation cost [45, 46]) that exhibit phase noise at 1 Hz from a 10 GHz carrier of -100 dBc/Hz comparable with the performance of our opto-electronic system. Further from the carrier, cryogenic sapphire oscillators

suffer from reduced microwave power in the resonator, and room temperature sapphire oscillators exhibit lower phase noise, although their close-to carrier performance is rather poor (typically -60 dBc/Hz at 1 Hz). The availability and price of both these technologies are however highly problematic for the application that require them<sup>4</sup>. The last existing technology for low-noise microwave source is the opto-electronic oscillator (OEO) [49], which is commercially available with a very low footprint (approximately 1 liter) and exhibits a phase noise about -160 dBc/Hz in the 1 kHz-10 kHz Fourier frequency range from a 10 GHz carrier, which is particularly important in radar applications. Their close-to carrier performance (about -40dBc/Hz at 1Hz) is however quite poor and they exhibit strong phase noise resonant harmonics in the 10kHz-1MHz Fourier frequency range, at best reaching -40dBc/Hz, that can be the source of serious complication for many application. Comb-based systems, on the other hand, have the capability to offer both close-to-the-carrier and far-from-the-carrier extreme performance with one single device with a system that, we believe, can be reasonably robust and industrially packaged in a volume of a few liters.

Of course, in practice, the frequency division process that generates microwave signals from optical reference with a comb is not perfect and produces additive phase noise. We have worked extensively over the years to reduce this to a minimum, which requires a good understanding of the physics behind this process.

## 2.3 Application to fountain clocks and first experiments

Our primary goal when beginning to explore this technology was based on the fact that using such advanced devices proved necessary to reach the Quantum Projection Noise (QPN) limit of these frequency standards, *i.e.* a regime where the stability performance is solely imposed by the number of probed atoms, and not by the phase noise of the microwave source used to probe the atoms. Our first experiments trying to generate a microwave signal from an optical frequency comb phase-locked to an ultra-stable cw laser already produced signals with sufficient low phase noise for this application. These experiments are reported in [50]. See also [51] for comparable work performed at the PTB in Germany. Briefly, an Erbium-doped fiber-based optical frequency comb is phase locked to a 1542 nm ultra-stable cw laser. The repetition rate of the femto-second laser was tuned such that the 48<sup>th</sup> harmonics is close to 11.932 GHz. This frequency was chosen because it corresponds to that of the free-running Cryogenic Sapphire Oscillator of the laboratory ( that is used normally as the source of the frequency chain that probes the atoms in the fountain clocks at LNE-SYRTE). The direct photo-detection of the pulse train, microwave narrow-band filtering near 11.932 GHz and transfer over the few hundred meters between the different laboratories via an amplitude-modulated optical carrier fiber link similar to that described in [52] provided a microwave signal directly suitable to replace the cryogenic sapphire oscillator (CSO) in the frequency chain. We demonstrated that this very first proof-of-principle experiment was indeed providing a microwave source with sufficiently low phase-noise to operate the fountain clocks in

<sup>4</sup>Although companies now exist that sell each of these two technologies, one for each [47, 48], the price of a single device is in the 300 k€ range in 2013, and the room temperature Sapphire systems are now produced, to our knowledge, exclusively for Raytheon integrated radar systems

the QPN limit, therefore providing a suitable and credible alternative microwave source for this application. The project of making these systems sufficiently reliable for an operational task requiring near to continuous autonomous operation over months with minimal intervention is still under process, but should lead to the replacement of the CSO as the core of the atomic primary frequency standards microwave chain in the next few years.

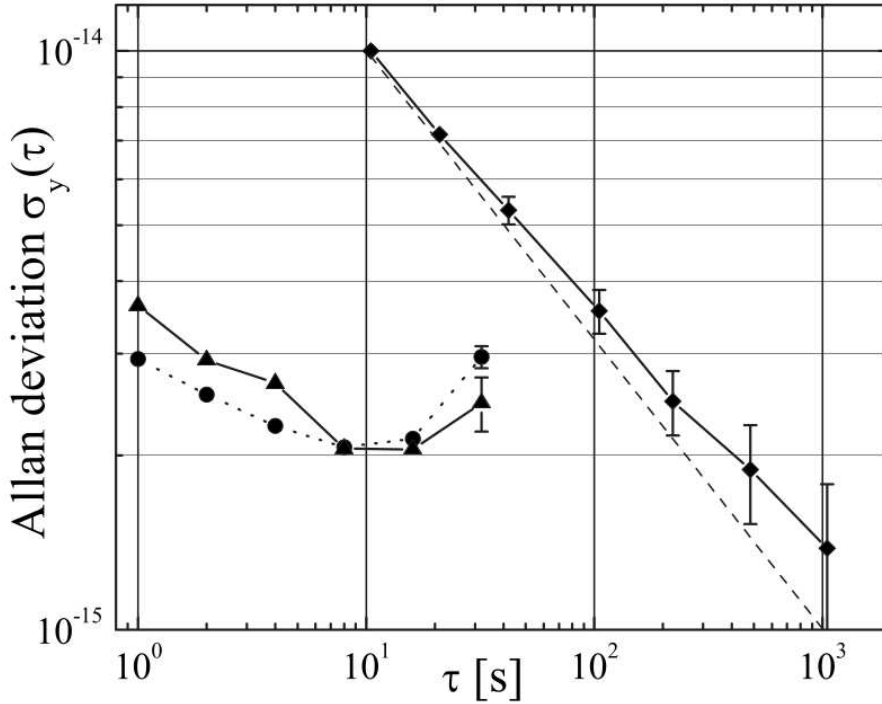

Figure 2.2: Circles: Fractional frequency instability (Allan standard deviation) vs integration time of the microwave signal generated by the fiber-based optical frequency comb (FOFC) against the cryogenic Sapphire oscillator (CSO) at 11.932 GHz. Triangles: FOFC vs titanium Sapphire based optical frequency comb(TSOFC). Diamonds: FOFC locked onto the FO2 atomic signal, compared against the CSO, quadratic drift removed. The latter instability scales as  $3.5 \times 10^{-14} \tau^{-1/2}$  (dashed line).

To evaluate the intrinsic limit of our comb system without the possible limitation from the cw laser itself (or the microwave fiber transfer used in the previous experiment), we have realized a differential measurement, in collaboration with the FEMTO-ST laboratory (Besançon, France), where two quasi identical combs were phase locked on the same cw reference (and with the same mode index, therefore producing two identical frequencies microwave signals). A microwave phase noise measurement system based on a simple double balanced mixer set at quadrature, assuming equal contribution of the two combs, allowed characterization of the additive phase noise produced by our comb-photo-detection system. The result were published in [53] and were exhibiting differential microwave phase noise of -105 dBc/Hz at 1Hz from the 11.55 GHz carrier. The carrier frequency was chosen here only for narrow microwave filter immediate avail-



ability, and other similar frequencies would lead to similar results. Note that the phase noise far from the carrier (in the 100 Hz-100 kHz range) was, at that time, limited by the lack of fast actuators on the repetition rate, as the intra-cavity EOM technology was not yet developed.

## 2.4 Copying the cw laser spectral property on a large Fourier frequency range

Even though the first experiment we realized did exhibit very low phase-noise close to the carrier, the performance above 10 kHz of Fourier frequencies was limited by the low feed-back bandwidth achievable with piezo and/or pump diode current modulation actuators on the repetition rate of the femtosecond laser. We have developed two techniques to overcome this limitation.

### 2.4.1 Feed-forward technique

In the first technique, developed before we implemented intra-cavity EOM with high feed-back bandwidth capability, we were using a voltage-controlled phase shifter (VCPS) on the generated microwave source. The idea is that even though the feed-back bandwidth achievable at that time was limited, the measured error signal of the phase-lock loop contains the information about how much residual phase error *should* have been corrected, had the feed-back bandwidth been larger. Multiplying this in-loop phase error by the suitable factor and applying it to the VCPS, the residual phase error is “post-corrected”. This method proved useful to reduce the microwave phase noise in the 100 Hz-100 kHz Fourier frequency range to below -130 dBc/Hz [54]. This “post-correction” technique is not a feed-back process, in that its effect depends directly on the exact value of the multiplying factor (and the phase of the correction signal), while, for a feed-back process the exact value of the gain of the loop is, up to a certain point, not an essential parameter. As the multiplication factor was realized with analog electronics and pre-determined via calibration of the radian-volts correspondence of the VCPS and the phase detector of the combs phase-lock loop, it was difficult to realize an accuracy much better than 10 percent on the multiplication factor, implying a reduction of in-loop phase noise by 20 dB at best.

### 2.4.2 Intra-cavity EOM

In a second time, along with our collaborators at MenloSystems GmbH, we implemented an intra-cavity EOM, which acts as a voltage-controlled group delay actuator thereby allowing fast feed-back bandwidth on the repetition rate of the femtosecond laser. We were able to realize unitary gain bandwidths of more than 1 MHz with this system. At such large bandwidths, great care must be taken with the electronics of the phase-lock loop. In particular, the narrow band-path filters used to isolate the various beatnotes from the neighboring peaks must be set as large as possible to keep the corresponding group delay of the filter as low as possible. Also, carefully designed electronics using

very high gain-bandwidth products and low group delay operational amplifiers must be used.

A particular concern that arises with the introduction of an intra-cavity EOM is that of cross talk to other parameters of the comb than its repetition rate, which must be reduced ideally to minimum, and at least, at a level where it doesn't impact the microwave generation. We have characterized these cross talk coefficients thoroughly and showed that it will not be a limitation to microwave generation down to a very low level (see [28]). In particular, the small action of the EOM actuator to the laser output power may lead, through amplitude-phase conversion process in the photo-detection, to additional microwave phase-noise and this cross-talk must therefore be verified to be small. Another effect is the small coupling of the EOM to the  $f_0$  carrier-envelope offset frequency of the comb. Whereas the  $f_0$  signal is removed from the beat-note with the reference cw laser before producing the error signal of the comb phase-lock-loop, a particularly subtle effect arise if the *dynamics* of the EOM to  $f_{\text{rep}}$  and EOM to  $f_0$  action are substantially different (which is indeed often observed to be the case, the coupling to  $f_0$  being typically mediated via polarization/amplitude and therefore limited by the relaxation dynamics of the laser exhibiting low-pass behavior with bandwidths of a few tens of kHz). In such a case, the coupling of the EOM to  $f_0$  must be significantly smaller than that of the EOM to  $N \times f_{\text{rep}}$  ( $N$  being the index of the comb mode which is locked to the cw reference), otherwise, at Fourier frequencies where  $f_0$  and  $N \times f_{\text{rep}}$  have different response dynamics, the response of the comb to EOM actuation is a complex combination of that of  $f_0$  and  $f_{\text{rep}}$ , which we observed to produce a strong decrease in the achievable phase-lock-loop bandwidth. A careful alignment of the EOM crystal principal axis on the incident polarization is however sufficient to reduce these cross-coupling effects to a low enough level.

## 2.5 Limiting the effect of amplitude phase conversion

One effect that we, as well as colleagues at NIST, identified early as a strong limitation to the phase noise performance achievable, at least close to the carrier, is the conversion of amplitude noise of the femtosecond laser into microwave phase noise that occurs in the photodetection process. We have successfully implemented two techniques to reduce the impact of this effect.

### 2.5.1 Active stabilization

We have successfully demonstrated the strong gain achievable, close to the carrier, by implementing an amplitude servo-locking of the optical power impinging the pulse-train detection photo-diode. We have implemented an amplitude stabilization by measuring the DC output of the microwave signal generating diode. The feed-back was applied either on a zero-order fibered AOM set as a controllable amplitude modulator in front of the microwave-generating photo-diode, or directly on the driving current of the pump diode laser of the femto-second oscillator. In collaboration with FEMTO-ST, we have realized a differential measurement to characterize the achieved reduction in microwave phase noise. The results were reported in [54], where we demonstrated a record low

phase noise of  $-120$  dBc/Hz at 1 Hz from a 11.55 GHz carrier sufficiently low to transfer any present-day cw ultra-stable reference into the microwave domain. Measuring such a low level of phase noise close to the carrier required developing and implementing a microwave carrier suppression scheme adapted to the pulsed nature of the microwave signal that is produced immediately after the photo-diode.

Interestingly, we have observed that, for time scales longer than 1 s (which are traditionally characterized by the Allan standard deviation rather than the phase noise, as this metric requires substantially less time to evaluate with a small error bar), the results we obtained were better in the case where the active power stabilization was acting on the pump of the oscillator than on an AOM before the photo-detection process. Indeed, the differential Allan variance typically exhibits a plateau between 1 Hz and 10 Hz (while a  $\tau^{-1}$  behavior is expected for a flicker-phase noise dominated measurement). Although we haven't yet pursued the detailed study of this phenomenon, we can speculate that the reduction of pump power noise that is likely to occur in the second technique (as this noise correlates strongly to the laser's output amplitude noise) makes the spectral phase properties of the femto-second laser pulses more stable in time, which may impact the optical-microwave phase relation imposed by the comb main servo-loop. Expressing the stability of the microwave generation process in terms of time deviation, this second technique implies a synchronization stability between the optical and microwave domain significantly below the 100 as level for time scales between 1 s and 1000 s.

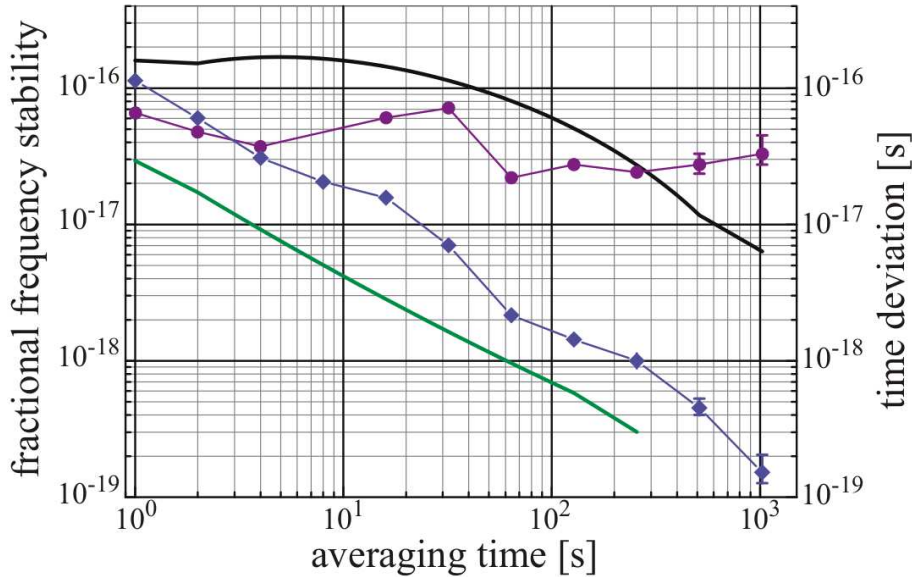

Figure 2.3: Fractional frequency stability (FFS) measured by Allan standard deviation (left scale) and time deviation (TDEV, right scale) for a single optics-to-microwave fiber-based optical frequency comb system. Top solid line: FFS with power stabilization on acousto-optic modulator; diamonds and circles, respectively, FFS and TDEV with power stabilization on pump current control; bottom continuous line: FFS floor of the measurement system. The error bars, when not visible, are smaller than the size of the marker.

### 2.5.2 “Magic points” of the photo-diode

Although the active stabilization technique proved very efficient to reduce phase noise close to the carrier, the limited achievable feed-back bandwidth (both with the AOM technique or the pump diode feed-back) makes it quite inefficient for Fourier frequencies larger than a few tens of kHz. Fortunately, a careful study of the photo-detection process that generated the microwave signal led us to discover the existence of “magic points”: experimental conditions for which the amplitude-phase conversion process was exactly vanishing for a given harmonics of the photo-detected repetition rate. The experimental and simple theoretical analysis of this effect is reported in [55]. Work along the same line, carried out by our colleagues at NIST, is reported in [56].

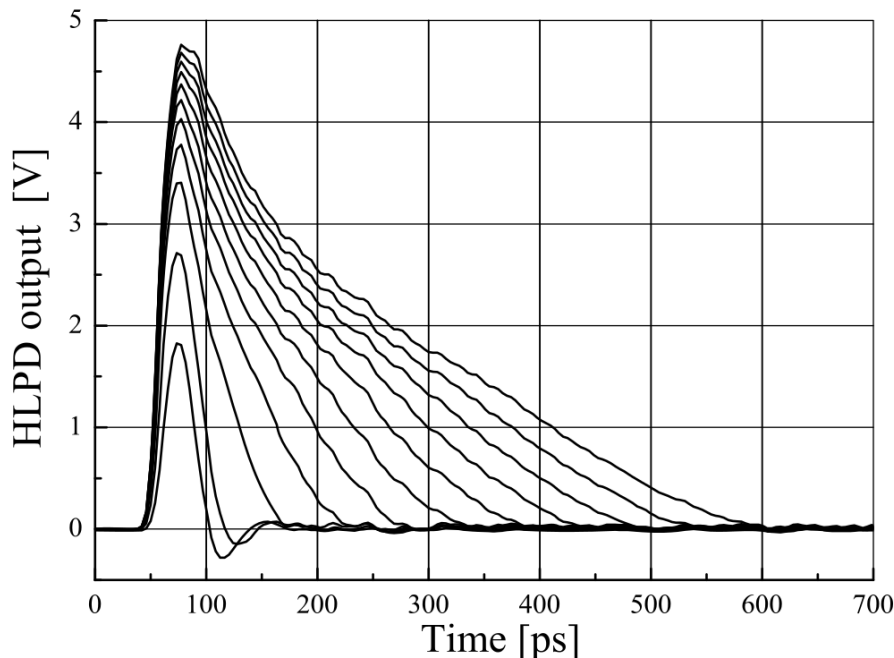

Figure 2.4: Time response of photo-diode HLPD from Discovery semiconductor for various optical energies per pulse (from bottom to top: 3.2, 6.4, 12.8, 19.2, 25.6, 32, 38.4, 44.8, 51.2, 57.6 and 64 pJ/pulse)

Briefly, when reaching the onset of saturation in a pin photo-diode, the space charge screening effect is responsible for a decreasing of the velocity of carriers in the intrinsic part of the pin junction. When the photo-diode is illuminated with pulses from a femtosecond laser (therefore much shorter in time than the inverse of the bandwidth of the photo-detector), at low energy per pulse, the space-charge screening is negligible and the resulting electrical pulses are narrow peaks, of which the duration is imposed by the bandwidth of the photo-diode. When the energy per pulse is getting closer to saturation, the electric response becomes asymmetric, with a fast rising followed by a slower decrease to zero. This asymmetry is responsible for the amplitude phase conversion effect. However, for higher harmonics of the repetition rate, this non-linear effect makes the amplitude-phase conversion factor alternate between positive and negative values for

increasing energy per pulse. Therefore, for specific combinations of optical energy per pulse, temperature and bias voltage, one gets annihilation of the amplitude-phase conversion effect which is of strong interest for low phase noise microwave generation. Most particularly, this annihilation is valid for any Fourier frequency. Using such “magic points” is therefore a more powerful technique than an active stabilization of power, which is necessarily realized over a limited bandwidth. The microwave amplitude noise, however, is not removed by this technique, which may be troublesome for some applications, and should be considered when measuring the phase noise with a technique that exhibits a finite rejection of the amplitude noise.

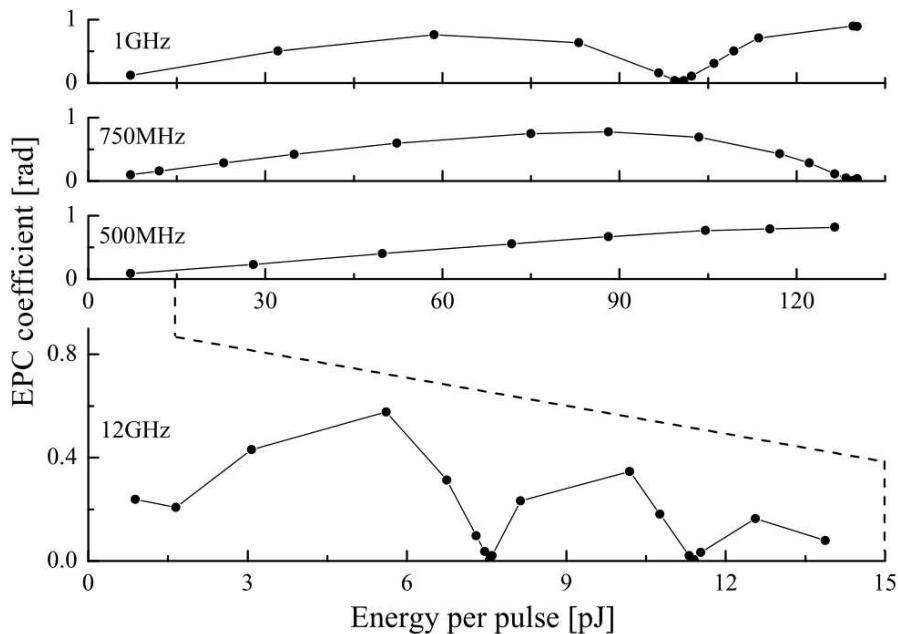

Figure 2.5: Amplitude to phase conversion coefficients obtained for the HLPD photodiode at various carrier frequencies. Only the absolute value of the coefficient is plotted. The temperature is servo-ed at 19 °C and the bias voltage at 9 V

## 2.6 Increasing the signal to-noise ratio

The ultimate limit of low phase noise generation at Fourier frequencies where the flicker limit is no longer an issue is the white phase-noise plateau arising from the limited signal-to-noise ratio of the microwave signal. The signal level is imposed by the optical power impinging the photo-diode, the quantum efficiency of the detector and the saturation effect which limits the microwave power even for increasingly large illumination. The white microwave noise background comes from two possible sources:

The thermal noise (or Johnson-Nyquist noise) is due to the finite temperature of resistors in the electric circuit which implies a random movement of the electrons that produce a “white” voltage noise of variance  $v_B^2 = 4k_BTR\Delta f$ , with  $R$  the resistance

(in Ohm),  $T$  the temperature (in Kelvin),  $\Delta f$  the measurement bandwidth and  $k_B$  the Boltzman constant. This voltage noise is normally considered to be shared equally between amplitude noise and phase noise. For an matched impedance source/load pair at room temperature, the thermal noise has a power spectral density of -174 dBm/Hz (independent of the actual impedance), which induces an additive phase noise on the microwave signal of -177 dBm/Hz. The calculated thermally-induced noise must be normalized by the carrier microwave power to give the corresponding phase noise limit (removing 3 dB to get the  $\mathcal{L}(f)$  single side-band limit in dBc/Hz). In other words, a 0 dBm microwave signal in an impedance matched circuit cannot possibly have a phase noise lower than -180 dBc/Hz at room temperature. In practice, all microwave devices (amplifiers and mixers in particular) are characterized by a “noise figure” which gives the excess white phase noise plateau that arises on top of the mathematically calculated thermal noise from the particular implementation of the device (a few dB typically for a good amplifier). The cumulated noise figures of the equipment rapidly increase over this “mathematical” limitation. Increasing the signal’s amplitude of the source (without using amplifiers, which also amplify the noise...) is the best way to decrease this white phase noise limit.

The second source of white phase noise is the shot noise, arising from the finite number of electrons transporting the signal and their associated Poissonian statistics. For a long time, the community has used the stationary shot-noise expression, obtained for a cw light illumination, as an estimation of the shot-noise limit for the microwave generation with a femtosecond laser. This leads to an estimation of the shot-noise limited phase noise power spectral density of

$$\mathcal{L}(f) = \frac{eI_{\text{avg}}R}{8P_{nf_{\text{rep}}}} \quad (2.7)$$

where  $e$  is the electron charge,  $I_{\text{avg}}$  the average photo-current,  $R$  the impedance of the circuit (typically 50 Ohms) and  $P_{nf_{\text{rep}}}$  the measured microwave power at the desired harmonics. However, very recently our colleagues at NIST pointed out that the real shot-noise limit to be considered was different (and possibly much lower), due to the cyclo-stationary nature of the photo-current and the corresponding correlations in the statistics [57, 58]. In the case of a gaussian pulses with duration  $\tau_G$  (half width at 1/e from maximum) much smaller than the detector’s bandwidth, the shot-noise-induced photo-detection phase noise power spectral density is expressed as [58]:

$$\mathcal{L}(f) = \frac{e}{2I_{\text{avg}}} (2\pi n f_{\text{rep}} \tau_G)^2 \quad (2.8)$$

with  $f_{\text{rep}}$  the repetition rate and  $n$  the order of the considered harmonics ( $n f_{\text{rep}}$  is the frequency of the microwave carrier). The corresponding jitter on the arrival time of the pulses on the photo-detector is

$$\sigma_t = \sqrt{\frac{e}{2I_{\text{avg}}}} f_{\text{rep}} \cdot \tau_G = \sqrt{\frac{h\nu}{2\eta E_p}} \tau_G \quad (2.9)$$

with  $E_p$  the energy per pulse and  $\eta$  the photo-electric quantum efficiency. In other words, the pulse arrival time can be detected with a resolution at best equal to the *optical* pulse

width<sup>5</sup> divided by the square root of the number of photo-electrons<sup>6</sup>. Interestingly, this limit can be set arbitrarily low for extremely short optical pulses. This recent development sheds a new light on the shot noise issue and will certainly lead us to minimize the optical pulse duration on the photo-detector in the future (whereas, until now, we were simply making sure that it was much smaller than the inverse of the photo-detector's bandwidth).

To reduce the white noise plateau limitation, we have used two complementary approaches detailed in the following.

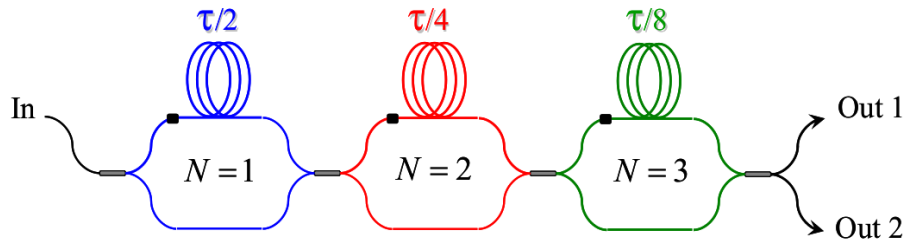

Figure 2.6: An illustration of the cascaded Mach-Zehnder interferometer (MZI) scheme used to achieve a pulse rate multiplication.

### 2.6.1 High linearity photo-diodes

The saturation effect of the photo-diode, due to space-charge screening, is responsible for limiting the microwave power in a given harmonics of the repetition rate when the impinging optical power is increased. To get the maximum possible microwave power from a 250MHz repetition rate Er-doped fiber based femtosecond laser with typically 70mW available at the output (or even several hundreds mW if one uses an EDFA), it's paramount to use specially designed photo-diodes which exhibit a linear behavior on a very large range of impinging optical power. We have focused primarily on the high linearity photo-diode (HLPD) from Discovery semiconductor based on the pin technology. We have thoroughly characterized it for our application [55]. Further development will be undertaken by Discovery semiconductor to reach even larger linearity without reducing the bandwidth of the photodiodes.

An alternative technology which is now becoming available is the uni-traveling carrier (UTC) photo-diode, in which only the electrons are carrying the signal (while for pin photo-diodes, both electrons and holes are). As electrons have a much larger velocity than holes, the space-charge screening effect is much reduced for this technology, which is very promising for our application. For the same reason, the achievable bandwidth can be much larger than for pin photo-diodes (hundreds of GHz) for the same junction size. We do not yet have easy access to well packaged UTC diodes, but if such were

<sup>5</sup>It's indeed the optical pulse width that matters, not the electrical pulse width (the later being imposed by the finite bandwidth of the photo-detector.). This surprising feature is due to the fact that the process which transforms the photo-generated electron pulse into a bandwidth limited pulse is not random, but perfectly predictable.

<sup>6</sup>The similarity with the quantum projection noise effect for atomic clocks is particularly striking here.

to become accessible, these devices would be very interesting to try for our application [59].

### 2.6.2 Repetition rate multiplication

In our low-phase noise microwave generation scheme, we produce on the photo-diode all the harmonics of the repetition rate (250MHz for our Er-doped fiber systems) within the bandwidth of the photo-diode. The one harmonic of interest among those (typically around 10 GHz) is then narrow-bandpass filtered to obtain the single frequency microwave source of subsequent use. The energy from all the unwanted harmonics is therefore lost. In the context of signal-to-noise-limited phase noise at high Fourier frequency, it is therefore desirable to multiply the repetition rate of the femtosecond laser. As higher repetition rate Er-doped comb systems are not commercially available, a possible alternative is to externally multiply the repetition rate, for example by using a filtering Fabry-Perot cavity.

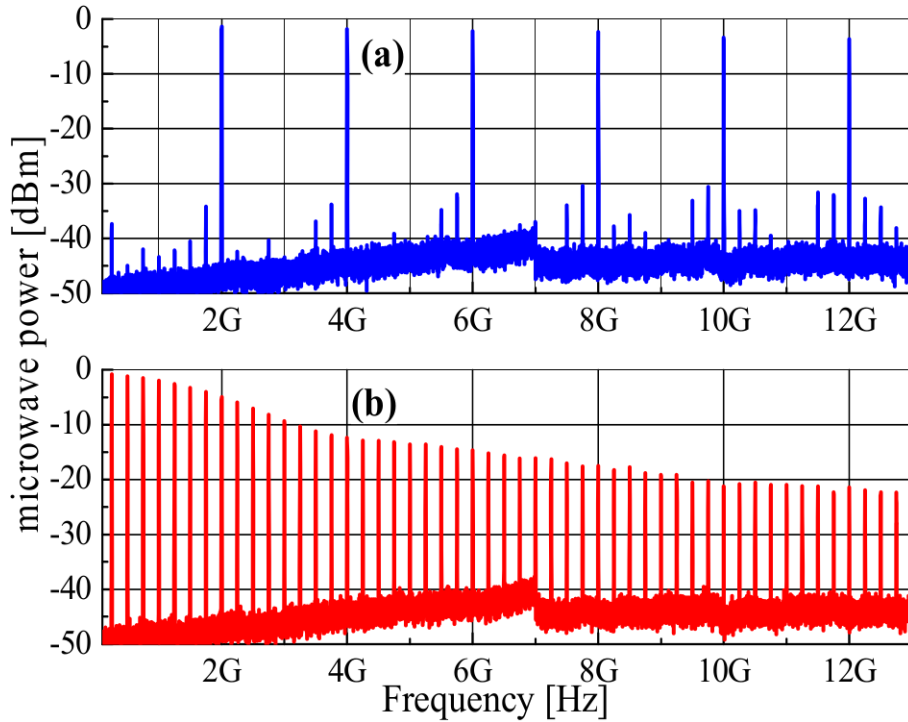

Figure 2.7: Photodiode (HLPD from Discovery semiconductors) output spectrum driven with 10 mW optical power. Plot (a) after repetition rate multiplication  $\times 8$  with cascaded Mach-Zehnder interferometer. Plot (b) driven by the un-multiplied output of the frequency comb.

We have implemented an external repetition rate multiplier based on cascaded Mach-Zehnder interferometers [60] that present the strong advantage over a filtering FP cavity of not losing the optical power from the undesired repetition rate. The implementation is illustrated in fig 2.6. We were able to obtain microwave powers at 10 GHz near 0 dBm.



This led to the demonstration of differential phase noise of the microwave extraction process (one cw laser and 1 comb in common mode) as low as  $-165$  dBc/Hz at 10 MHz from a 10 GHz carrier. For differential microwave generation process (1 common mode cw laser and 2 combs) there is excess phase noise of undetermined origin that still needs to be investigated. However, at 10 MHz from the carrier, the phase noise is below  $-160$  dBc/Hz and substantially below  $-150$  dBc/Hz for Fourier frequencies above 1 kHz.

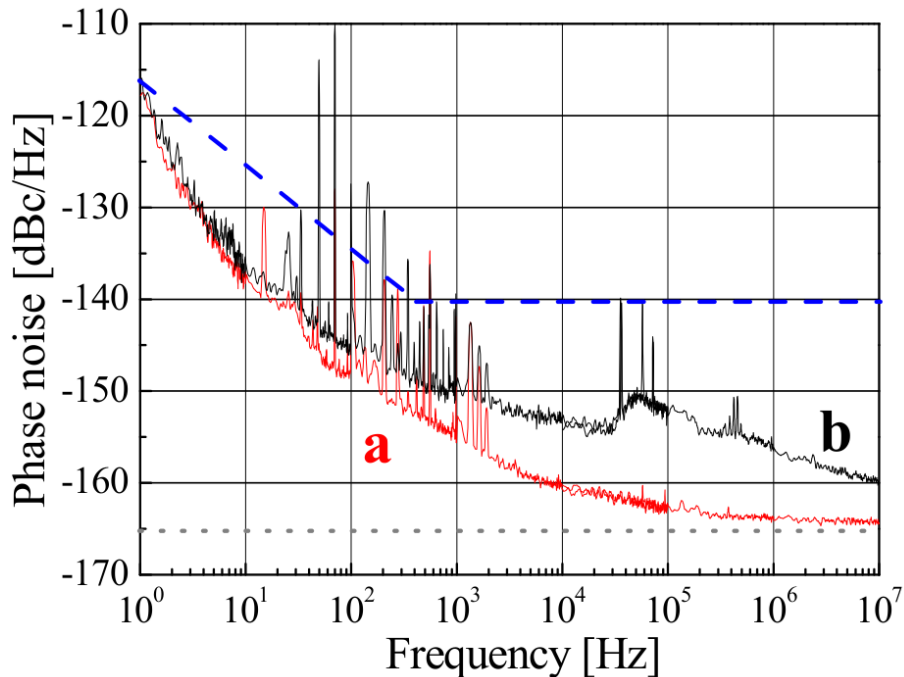

Figure 2.8: Plot (a) Residual phase noise for a single repetition rate multiplier system (measured with a common fiber-based optical frequency comb). The dotted line estimates the shot-noise limit for these conditions ( 11 mW optical power, 8 mA photocurrent). Plot (b) Residual phase noise for a single complete optical-to-microwave system i.e. a frequency comb followed by a repetition rate multiplier and high linearity photo-detector (measured with two independent systems). The dashed line represents the typical phase noise level that would be achievable without the repetition rate multiplier.

### 2.6.3 dual-photo-detector combined with repetition rate multiplication

The repetition rate multiplier topology we use exhibits two outputs, of which only one was used previously for low noise microwave generation. In a later work, we used a combination of repetition rate multiplier with dual photo-detectors (at the two outputs) whose microwave signals are combined coherently to provide an increased signal to noise ratio. Furthermore, by carefully tuning the bias voltage of each photo-detector, it is possible to operate one and the first zero amplitude-phase conversion point, while the other operate at the second vanishing point. As the first and second point exhibit

opposite slope of amplitude-phase conversion factor with reference to impinging optical power, the combined dual-photo-detector scheme exhibits a much reduced dependence of the global microwave phase noise sensitivity to the laser power fluctuations [61]. Such a multi-detector coherent combination technique will be subject to further investigation in the future. In particular, as it allows to reach higher coherently combined signals (up to 6 dB) than a single photo-detector, it is likely to lead a substantial improvement of the microwave signal-to-noise ratio and hence, the high Fourier frequency white phase noise plateau, at least in the context of ultra-short pulses where the high Fourier frequency noise is imposed solely by thermal noise whereas shot-noise is considered negligible.

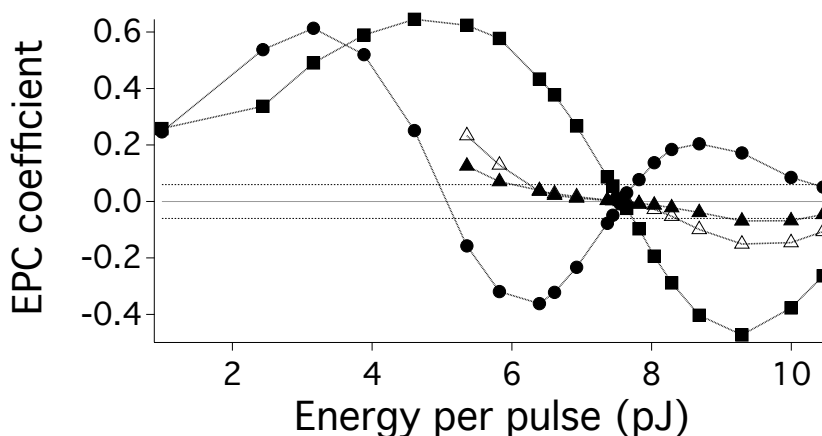

Figure 2.9: Energy to phase conversion factor (EPC, in rad) vs energy per pulse (in pJ) for various phot-detectors. Squares: first high linearity photo-diode (HLPD) with 9V bias voltage. Dots: second HLPD with 7.36V bias voltage. This second bias voltage was chosen so that the second zero of the EPC curve matches the first zero of the previous curve. Triangles: combined system where the microwave fields from the two previous photo-detectors are coherently combined. Open triangles: simple model for the curve in filled-triangles, where the average of the dots and square curves is considered a first order approximation of the expected experimental data.

## 2.7 Chapter conclusion

The research on low phase noise microwave signal generation by photo-detecting the pulse train of a fs laser phase locked to a cw ultra-stable reference is currently very active and progressing fast. With the emergence of new photo-diode technology, and the development of high repetition rate lasers, either by direct increasing of the repetition rate or external multiplication, it seems within reach to achieve extremely competitive systems with phase noise below -100 dBc/Hz at 1 Hz from a 10 GHz carrier and about -170 dBc/Hz at 10 kHz and above. Such systems would be unprecedented in performance by any competitive technology and raise strong interest, for example in radar applications. Although I have focused here on our work at LNE-SYRTE on this topic which, as

well as those at NIST [62], utilize the photodetection technique, another promising technology has been developed at MIT in F. Kartner's group for synchronizing microwave signal with the repetition rate of a fs laser [63, 64, 65, 66]. This technique is based on Sagnac loops with an Electro-optic transducer in the loop that couples microwave signals with the balancing condition of the Sagnac loop. The full capability of such technique still needs to be fully investigated and several groups worldwide are investing research time on it.

## 2.8 Personal publications relevant to this chapter

*Ultra-low noise microwave generation with fiber-based optical frequency comb and application to atomic fountain clock*

J. Millo, M. Abgrall, M. Lours, E.M.L. English, H. Jiang, J. Guena, M.E. Tobar, A. Clairon, S. Bize, Y. Le Coq and G. Santarelli  
App. Phys. Lett., 94, 141105 (2009)

*Ultrastable lasers based on vibration insensitive cavities*

J. Millo, D. V. Magalhaes, C. Mandache, Y. Le Coq, E. M. L. English, P. G. Westergaard, J. Lodewyck, S. Bize, P. Lemonde and G. Santarelli  
Phys. Rev. A 79, 053829 (2009)

*Ultra-Low Noise Microwave Extraction from Fiber-Based Optical Frequency Comb*

J. Millo, R. Boudot, M. Lours, P. Y. Bourgeois, A. N. Luiten, Y. Le Coq, Y. Kersalé and G. Santarelli  
Opt. Lett., 34, 3707 (2009)

*Sub-100 attoseconds stability optics-to-microwave synchronization*

W. Zhang, Z. Xu, M. Lours, R. Boudot, Y. Kersalé, G. Santarelli and Y. Le Coq  
App. Phys. Lett., 96, 211105 (2010)

*Advanced noise reduction techniques for ultra-low phase noise optical-to-microwave division with femtosecond fiber combs*

W. Zhang, Z. Xu, M. Lours, R. Boudot, Y. Kersale, A.N. Luiten, Y. Le Coq and G. Santarelli  
IEEE Transactions on Ultrasonics, Ferroelectrics, and Frequency Control 58, 900 (2011)

*An Optical Fibre Pulse Rate Multiplier for Ultra-low Phase-noise Signal Generation*

A. Haboucha, W. Zhang, T. Li, M Lours, A. N. Luiten, Y. Le Coq and G. Santarelli  
Optics Letters 36, 3654 (2011)

*Amplitude to phase conversion of InGaAs pin photo-diodes for femtosecond lasers microwave signal generation*

W. Zhang, T. Li, M. Lours, S. Seidelin, G. Santarelli and Y. Le Coq  
Applied Physics B 106, 301 (2012)

*Characterizing a fiber-based frequency comb with electro-optic modulator*

W. Zhang, M. Lours, M. Fischer, R. Holzwarth, G. Santarelli and Y. Le Coq  
IEEE Transactions on Ultrasonics, Ferroelectrics, and Frequency Control 59, 432 (2012)

*Dual photo-detector system for low phase noise microwave generation with femtosecond lasers*

W. Zhang, S. Seidelin, A. Joshi, S. Datta, G. Santarelli and Y. Le Coq  
Optics Letters 39, 1204 (2014)



# New applications of Frequency combs in the optics domain

The most exciting phrase to hear in science, the one that heralds new discoveries, is not 'Eureka!' (I found it!) but 'That's funny ...'

*Isaac Asimov (1920 - 1992)*

Beyond the original application of optical frequency combs in optical frequency measurement, and their application to low noise microwave signal generation, another variety of applications has appeared, which use the coherence properties of the combs in the optics domain itself. Examples of such applications include, for example, extension to deep UV by high harmonic generation for spectroscopy and UV frequency metrology [67], dual-comb spectroscopy [25, 26, 68], calibration of spectrometers for astrophysics [69, 70, 71], gas trace detection by cavity enhanced absorption spectroscopy [68] or molecular fingerprinting [72]. The range of applications is ever increasing and, no doubt, new utilities will keep being invented in the future for the ubiquitous optical frequency comb.

The main properties of optical frequency combs that are used in these applications are:

- the phase coherence between the various optical modes that compose the comb
- the large span of frequencies available in parallel
- the large optical peak power, enabling strong non-linear effects (in particular for high harmonic generation applications)

My research activities at NIST and LNE-SYRTE have led me to carry out several proof-of-principle experiments that explored new applications of frequency combs, and this chapter will summarize the various publications that stemmed from this research.

### 3.1 Direct frequency comb spectroscopy

For some spectroscopy applications, the lack of reliable and high performance cw lasers at the required wavelength can be problematic. Furthermore, for very high resolution spectroscopy, as that realized in an optical clock, the development of an ultra-stable cavity stabilized laser at the required wavelength can be time consuming and costly. An optical frequency comb phase-locked to an ultra-stable cw optical reference is spectrally composed of a very large number of modes spanning over one octave of spectrum, each of them having the same spectral purity and stability of the cw laser that the comb is phase-locked to. It is therefore tempting to use the photons in one of these many modes to directly realize the spectroscopy of the atomic (or molecular) transition that is under consideration. The problem is that the available optical power per mode of the comb is very small (typically in the micro-watt range, or even lower) making the detection of a spectroscopic signal challenging.

During my stay at NIST, we have realized high resolution Direct Frequency Comb Spectroscopy (DFCS) of two spectral absorption lines in a cold (2 mK) sample of neutral Calcium atoms utilizing new original techniques to circumvent the low available optical power per mode. These proof-of-principle experiments have been realized with the cold Ca atomic clock which was described briefly in chapter 1 and an octave spanning Titanium-Sapphire based frequency comb in the next door room. The comb's light was brought to the Ca clock experiment with a 20m long polarization maintaining single mode optical fiber.

In a first experiment, the mode of the comb closest to the "clock transition" between the  $4s^2\ ^1S_0(m=0)$  and  $4s4p\ ^3P_1(m=0)$  levels of  $^{40}\text{Ca}$  is scanned through the resonance by acting on the reference synthesizer that controls the phase-lock loop of the comb to an ultra-stable 1068 nm fiber laser. The light of the comb is filtered around 657 nm by a ruled grating before injection to the fiber that guides it to the Calcium clock experiment. To compensate for the various losses in the fiber and grating, the output of the fiber is amplified in a anti-reflection coated semiconductor diode laser (operated below the self-lasing threshold driving current) that acts as a gain chip to provide approximately 8 times amplification to a  $3\ \mu\text{W}$  per mode power at 657 nm. The cold sample of atoms is probed by this light with  $100\ \mu\text{s}$  pulses and the resulting depletion from the ground state is detected by the standard shelving technique. We were able to get down to a resolution of 5.9 kHz enabling the observation of the recoil doublet of cold Ca (for which the recoil splitting value is 23.1 kHz). As the recoil doublet is a saturated absorption feature, further improvement in resolution was limited by the low percentage of atoms that are, at such high resolution, within the resonant velocity class. For a 2 mK sample of atoms, the Doppler width is about 3 MHz. Hence, at 5.9 kHz resolution, only about 0.1 percent of the atoms ( $\sim 6000$  atoms) participate in the spectroscopic feature

In a second experiment, although the implementation is quite similar, we changed completely the semi-conductor amplification regime by setting the driving current above the self-lasing threshold. In such regime, the effect of the input comb mode is that of an injection locking, by which the free-running lasing optical frequency is forced to equate that of the seed laser. In such regime, the phase locking bandwidth (and the capture range) is proportional to the seed optical power. For such low optical power (about

400 nW per mode), the injection range is small, and actually smaller than the 1 GHz spacing between two consecutive modes of the comb. As a result, a single mode of the comb is preferably amplified by the injection locked semiconductor laser, leading to optical power as large as  $800 \mu\text{W}$  at resonance with the Ca clock transition. The amplified power was experimentally asserted by measuring the power broadening of the transition line spectroscopy. For such power, it is feasible to realize Ramsey-Bordé interferometry, which allows high resolution spectroscopy with a participation of a substantial portion of the thermal distribution. In practice,  $\sim 3$  percent of the atoms are used in the Ramsey-Bordé interferometer, leading to a signal to noise ratio of the fringes of the order of 4 after 150 ms averaging for a resolution of 1.2 kHz.

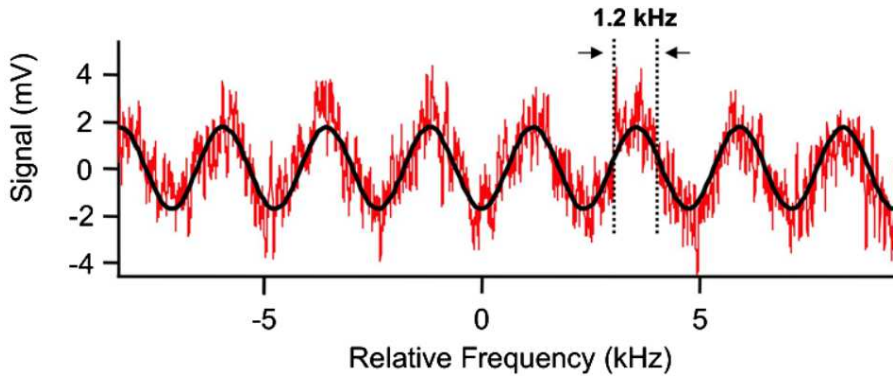

Figure 3.1: Time-resolved optical Ramsey-Bordé fringes for pulse lengths of  $7 \mu\text{s}$ , separated by  $203 \mu\text{s}$ . Each point in the plot is the result of 150 ms of averaging. On the vertical axis, 1 mV corresponds to 600 atoms.

These techniques could be used for high-resolution absolute measurement of the line center because the weak dipole coupling of the clock transition yields a negligible ac Stark shift due to other comb components. Even for the unlikely case of a completely asymmetric distribution of comb lines with equal amplitudes, we estimate this shift to be  $< 1 \text{ mHz}$ . These proof-of-principle experiments were reported in Physical Review Letters [73].

In a third experiment, we used the standard 657 nm clock high-finesse diode lasers to pump the atoms in the  $4s4p \ ^3P_1$  state from which we excited the metastable atoms to the  $4s5s \ ^3S_1$  state thanks to direct frequency comb spectroscopy using a single tooth of the optical frequency comb (filtered by a grating around 612 nm). The resonance was detected by its effect on the depletion of the ground state ( $4s^2 \ ^1S_0$ ) while cycling the experiment continuously. Indeed, the atoms pumped in the  $4s5s \ ^3S_1$  state are “lost” and cannot be re-captured in the next cycle, contrary to the majority of atoms in the  $4s^2 \ ^1S_0$  (ground) state or those in the  $4s4p \ ^3P_1$  which decay back to the ground state in a few milli-seconds after excitation. To reach the required level of sensitivity in the detection, we used a combination of an optical chopper on the comb beam and a lock-in amplifier to realize a lock-in detection scheme at 10 Hz. The modulation frequency was chosen to be sufficiently slow so that the 612 nm light leak mechanism would yield the necessary depletion of the steady-state number of atoms, while still providing sufficient suppression



of low-frequency noise. This experiment led to a determination of the absolute frequency of the  ${}^3P_1$ - ${}^3S_1$  optical transition with an accuracy of 56 kHz, nearly three orders of magnitude better than previously reported. In a fourth experiment, we realized the

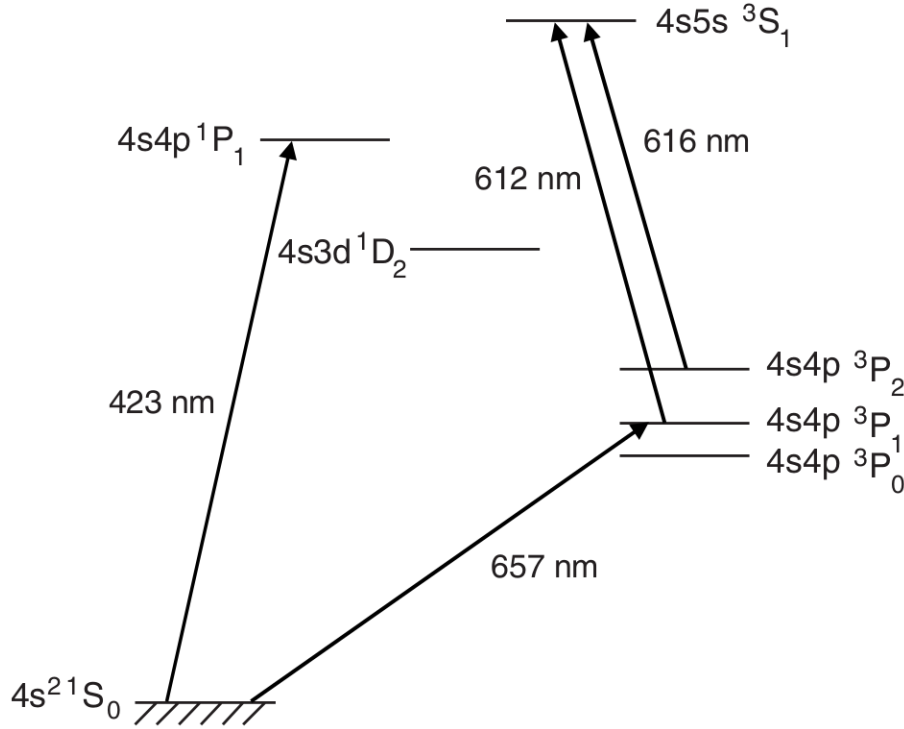

Figure 3.2: Low-lying energy levels of Ca. The 423 nm transition is used for laser cooling (and atom number detection). The 657 nm transition is the clock transition.

direct frequency comb spectroscopy of the  $4s4p {}^3P_2$  -  $4s5s {}^3S_1$  transition at 616 nm. Probing this excited transition was possible due to some specificities of the experimental apparatus. The cooling transition for neutral Ca atoms is the  $4s^2 {}^1S_0$  to  $4s4p {}^1P_1$  at 423 nm. From the  $4s4p {}^1P_1$  state, the atoms have a small ( $\approx 10^{-5}$ ) probability to decay in the  $4s3d {}^1D_2$  state, from which they further decay predominantly into the  $4s4p {}^3P$  states. Atoms that decay to the  ${}^3P_2$  state can be magnetically trapped in the magnetic-field gradient due to the magneto-optical trap coils. By exciting these atoms on the  $4s4p {}^3P_2$  to  $4s5s {}^3S_1$  transition at 616 nm we were able to create a re-pumping mechanism that increases the number of atoms in the ground state, as some of the atoms decay from the  ${}^3S_1$  state to the  ${}^3P_1$  state and then back to the ground state. The same lock-in scheme, with chopping the optical frequency comb beam at 10 Hz, allows observation of this small re-pumping mechanism effect, leading to an absolute measurement of the  $4s4p {}^3P_2$  -  $4s5s {}^3S_1$  transition at 616 nm with an accuracy of 9 MHz, a 50 times improvement over the previously reported value. These last two experiments were reported in Physical Review A [74].

The four DFCS experiments reported here represent interesting examples of techniques that can be implemented to allow probing an atomic transition in a sample of

cold atoms with a single tooth of the frequency comb, despite the low optical power available in the said tooth. With such methods, the large spectrum covered by the optical frequency comb demonstrates its full potential in enabling, the probing of any atomic transition within its spectrum, typically covering a full octave in the visible to near infrared range.

### **3.2 Multiple frequencies optical network over 100's of meters and 100's of Tera-Hertz**

While at NIST, I took part in an other proof-of-principle experiment involving optical frequency combs and ultra-stable lasers that demonstrated coherent transfer of optical spectral purity and stability across different locations and at various optical frequencies. This experiment was involving two optical frequency combs, one based on Ti:Sapphire femtosecond laser (covering a spectrum from  $\approx 550$  nm to  $\approx 1200$  nm), the other on Er-doped fibre laser (covering a spectrum from  $\approx 1000$  nm to  $\approx 2000$  nm), and 4 ultra-stable cw lasers (operating at 657 nm, 767 nm, 1126 nm and 1535 nm). We demonstrated full coherence of optical frequency transfer across buildings (over a few 100s of meters of fibre-optics) and across the various wavelengths at stake in the network. Such a complex network, involving many different experiments and laser technologies is an important step toward a complex integrated system at the scale of a metrology institute. As the development of ultra-stable lasers are increasingly expensive and time consuming as time passes by and the required performance increases, developing in such institution the capability of distributing one or more references among different experiments that may require its high spectral purity (although at a different wavelength and relatively remote location) will become more and more important in the future.

These first experiments at NIST demonstrated a coherent phase link between optical frequencies in different locations with an excess degradation in stability as low as  $6.7 \times 10^{-17}$  at one second integrating time, with an accuracy budget at the  $5.3 \times 10^{-19}$  level reached after 5 hours of data accumulation (obtained in different runs). These results were reported in Nature Photonics [75].

### **3.3 Transfer of spectral purity between wavelengths at the $10^{-18}$ level**

Furthering the line of research discussed in the previous section, we recently realized at LNE-SYRTE an experiment demonstrating the actual transfer of spectral purity from a master laser at 1062 nm to a slave laser at 1542 nm via a fiber-based optical frequency comb. The master laser exhibits a stability at 1 s of  $4.5 \times 10^{-16}$  (independently characterized). The slave laser by itself has a 1 s stability of a few  $10^{-15}$  which, after applying our spectral purity transfer technique becomes equal to that of the master laser (as was independently demonstrated with the help of an extra high quality reference laser at 1542 nm). The setup is depicted in figure 3.3

The level of degradation in the spectral purity transfer was experimentally demonstrated (by differential measurement involving two quasi identical frequency comb-based

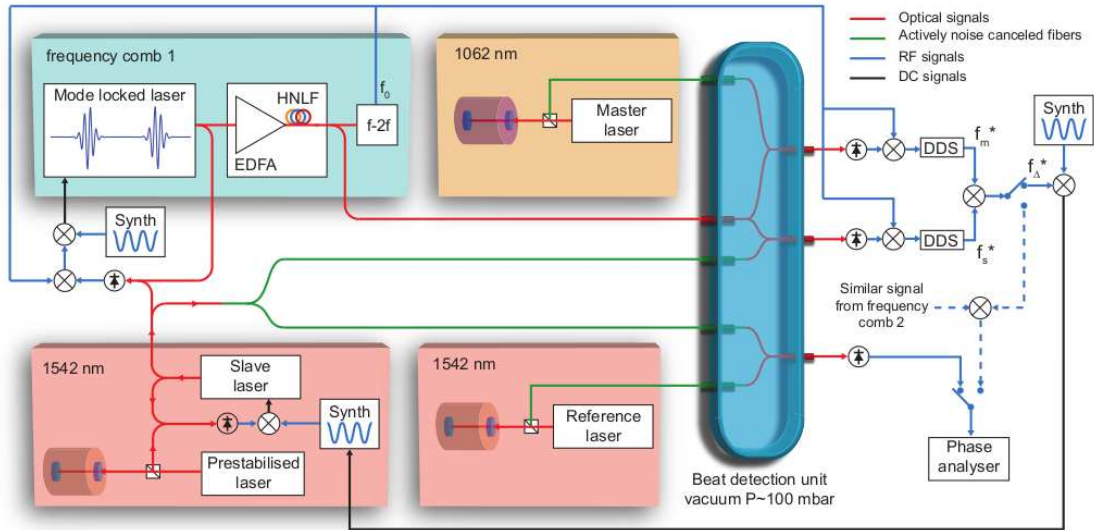

Figure 3.3: Experimental setup. AOM: acousto-optic modulator; EDFA: Erbium-doped fiber amplifier; HNLF: highly non-linear fiber; Synth: radio-frequency synthesizer. This setup is used for transferring the spectral purity from the master laser at 1062 nm wavelength to the slave laser at 1542 nm wavelength with a heterodyne phase-locking technique. To demonstrate the stability improvement, the resulting oscillator is characterized against the 1542 nm reference laser with a phase noise analyzer. To characterize the limit of the system, we compare two such comb-based systems and compare their results with the phase noise analyzer, with a setup illustrated by the dashed lines.

spectral purity transfer systems and one single pair of master/slave lasers) to be equal to  $3 \times 10^{-18}$  at 1 s, reaching a stability of  $2 \times 10^{-20}$  at 1000 s integrating time [76, 77]. This is a factor 20 to 100 lower in stability than the best previously reported results [78, 79, 75, 80, 81]. Very importantly, this level is more than an order of magnitude lower than the best ultra-stable laser demonstrated to-date [44] and compatible with the requirements for operating the current optical lattice clocks at the quantum projection noise limit.

To achieve this level of performance, it was necessary to realize the various phase comparisons of the comb teeth with the cw lasers, as well as the comb's self-referencing at the output of a single branch, *i.e.* after a single Erbium-doped fiber amplifier (EDFA) and highly non linear fiber (HNLF). As a matter of fact, when comparing the optical phases obtained from different EDFA+HNLF branches, the extra differential noise in-between branches can typically limit the stability at 1 s near the  $1 \times 10^{-16}$  level. The inconvenient is that, without a proper optimization of a branch specifically designed for obtaining one large “good” beat-note signal at a given optical frequency, it is highly unlikely to get good signal to noise ratios (SNR) of the various RF signals. Indeed, we typically obtain SNRs of at best 10 dB in 1 MHz bandwidth for beat-note signals with cw lasers at 1062 nm and 1542 nm obtained from the  $f_0$  measuring branch of or Er-doped fiber based optical frequency combs. The multi-frequency phase comparison system make use of the “transfer oscillator technique” [82, 83] where the RF beat-note

signals to compare are digitally divided each by a specific scaling factor that allows direct comparison of the output phases. The digital frequency divisions are realized with DDSs for which clock signals are the RF signals to divide and programed in a way to make the output frequencies equal to that of the clocks divided by a fixed factor specific for each beat-note. Such systems require clean (high SNR) clock signals to operate, which seems incompatible with our application. However, by operating the comb in the narrow linewidth regime, the RF beat-note signals have line-width of a few Hertz at most (depending on the quality of the cw lasers to compare and of the cw laser on which the comb is phase-locked to). This allows narrow-band filtering of the RF signal to “clean” them, up to a level sufficient to drive the clock inputs of the frequency dividing DDSs. As a minimal  $\approx 30$  dB SNR is required for driving digital electronics, by filtering the RF beat-note signals in tracking oscillator filters with bandwidths about 2-10kHz, sufficient quality DDS clocking signals are therefore recovered. This essential step is only possible due to the narrow linewidths of the beat-notes as otherwise such narrow bandpass filtering wouldn’t be possible.

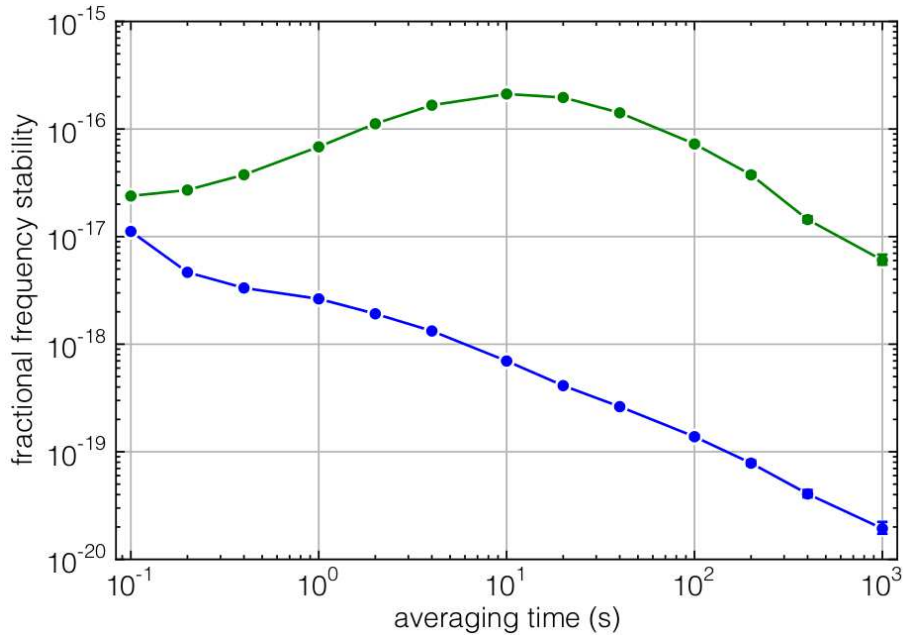

Figure 3.4: Frequency stability limit (modified Allan deviation) of the spectral purity transfer setup obtained by differential measurement between two identical setups, assuming uncorrelated systems. Green: typical result obtained in a multi-branch configuration. Blue: result obtained in the phase noise canceling transfer oscillator technique configuration. Error bars, when invisible, are smaller than the graphical size of the markers.

The advantage of using a single branch to generate  $f_0$  and the different beat-note signals between the comb’s teeth and the cw lasers, combined with the “transfer oscillator technique” is that all excess spectral phase fluctuations that may appear in, either the femtosecond laser itself or the EDFA+HNLF system, and that scale up to linear order

with the optical frequency are common mode and therefore rejected from the phase comparison.

This technique and its demonstrated lower limit are readily applicable to transfer the spectral purity between lasers in the  $1\ \mu\text{m}$ - $2\ \mu\text{m}$  spectral range where self-referenced Er-doped fiber based optical frequency combs have a non-negligible output optical power. With proper use of second harmonic generation, extension to the visible and near-UV domain is also possible. The bandwidth over which the master laser's phase noise is copied onto that of the slave laser is solely limited by the lowest of the ensemble of tracking filter bandwidths, which are themselves set by the RF beat-note signals detection SNRs. In the example that we realized, we transferred the spectral purity of a 1062 nm laser to a 1542 nm laser that is also used to lock the comb with large feedback bandwidth and set it in the narrow linewidth regime. Note that the slave laser doesn't necessarily have to be the one used for prestabilizing the comb, nor to be operating at a wavelength compatible with large SNR (and hence large feed-back bandwidth) with the comb. However, in this case, as the comb itself is also locked to the slave laser, when the setup is running, the transfer of spectral purity applies both to the slave laser and the frequency comb itself. This could have useful applications, for example with low phase noise microwave generation by photodetection of the femtosecond laser's pulse train (which is the subject of chapter 2). Indeed, in this particular application, the lowest absolute phase noise generation reported close to the carrier is still limited by the spectral purity of the cw laser to which the comb is phase-locked [62]. Transferring the spectral purity of an excellent quality master laser operating at a wavelength different than the one required for large feed-back bandwidth phase-locking of the comb would therefore improve the cw reference, and hence the microwave phase noise (close to the carrier).

The most straightforward application that we will be targeting in the near future is to transfer the spectral purity of an excellent quality cw laser to the wavelength of the clock transitions in the Hg and Sr optical frequency standard experiment. In these experiments, so far, the laser that realizes the spectroscopy of the clock transition is limiting the frequency standard stability due to the so-called Dick effect [84]. Realizing a new cw laser with a spectral purity sufficiently high so as not to impact the stability (*i.e.* operating the clock at the quantum projection noise limit - QPN) is a formidable task that has yet to be demonstrated in the metrology community. However, once this is realized, our spectral purity transfer, with its  $3 \times 10^{-18}$  level stability near 1 s does have now the capability to transfer it to the clock transition wavelength of the LNE-SYRTE lattice clocks and operate them at the QPN limit.

### 3.4 Remote spectroscopy in the mid-IR

In the context of the long-standing collaboration between LNE-SYRTE and the Laboratoire de Physique des Lasers (LPL, CNRS/Université Paris XIII Villetaneuse), some experiments involving the optical fiber-link between the two laboratories have been carried on for several years [85, 86, 87, 52, 88] transmitting a radio-frequency reference on an optical carrier *via* this link. Recently, the research has turned to directly transmitting the frequency of the optical carrier itself [29, 89, 90]. The optical link uses telecom

fibers to transmit a cw ultra-stable laser at  $1.5\ \mu\text{m}$  wavelength over 43 km from the LNE-SYRTE laboratory to the LPL, with noise-compensation phase lock loops to reduce the effect of perturbations that arise along the fiber.

We realized recently an experiment that involved optical frequency combs in both laboratories, both phase-locked to the  $1.5\ \mu\text{m}$  optical link laser. At LNE-SYRTE the frequency comb was used to generate a microwave signal of which the frequency was monitored against the laboratory primary reference. At LPL the comb was used to generate, via non-linear fiber and sum frequency mixing a coherent mid-infrared domain signal, used to monitor the frequency of a  $\text{OsO}_4$ -stabilized  $\text{CO}_2$  laser. Effectively, this whole experiment was realizing a coherent network of various electro-magnetic signals spanning from the RF and microwave to the mid and near infrared, and that over a distance of 43 km.

As a proof-of-principle, an absolute MIR frequency measurement of the  $\text{OsO}_4$  stabilized  $\text{CO}_2$  laser was realized, with an accuracy of  $8.4 \times 10^{-13}$  dominated by the reproducibility of the  $\text{OsO}_4$ -stabilized laser. In principle, with this network, the stability and accuracy performance of the LNE-SYRTE atomic fountain become achievable for distant institutions connected to the LNE-SYRTE via optical link and equipped with a state-of-the-art optical frequency comb<sup>1</sup>. As was demonstrated in this experiment, the wavelength of interest for the remote institution doesn't have to be in the visible range as non linear-optics combined with frequency comb can transfer the measurement capability of the comb to the MIR range. This experiment was reported in *New Journal of Physics* [19].

---

<sup>1</sup>The REFIMEVE+ “equipex” project, jointly managed by LNE-SYRTE and the Laboratoire de Physique des Lasers aims at realizing a network of such optical links, using the standard RENATER telecommunication infrastructure, connecting at the beginning a dozen of institutions throughout France to the LNE-SYRTE optical frequency reference, with planned extensions to other European institutions

### 3.5 Personal publications relevant to this chapter

*Kiloherz-resolution spectroscopy of cold atoms with an optical frequency comb*

T.M. Fortier, Y. Le Coq, J.E. Stalnaker, D. Ortega, S.A. Diddams, C.W. Oates and L. Hollberg

Phys. Rev. Lett., 97, 163905 (2006)

*Measurement of excited-state transitions in cold calcium atoms by direct femtosecond frequency-comb spectroscopy*

J.E. Stalnaker, Y. Le Coq, T. Fortier, S.A. Diddams, C.W. Oates, and L. Hollberg

Phys. Rev. A (rapid comm.), 75, 040502 (2007)

Also selected for Virtual Journal of Ultrafast Science, Volume 6, Issue 5 (May 2007)

*Coherent optical link over 100's of meters and 100's of terahertz with sub-femtosecond timing jitter*

I. Coddington, W.C. Swann, L. Lorini, J.C. Bergquist, K. Feder, Y. Le Coq, J. Nicholson, C.W. Oates, Q. Quraishi, P. Westbrook, S.A. Diddams and N.R. Newbury

Nature Photonics 1, 283 (2007)

*Mid-infrared laser phase-locking to a remote near-infrared frequency reference for high precision molecular spectroscopy*

B. Chanteau, O. Lopez, W. Zhang, D. Nicolodi, B. Argence, F. Auguste, M. Abgrall, C. Chardonnet, G. Santarelli, B. Darquié, Y. Le Coq and A Amy-Klein

New Journal of Physics 15, 073003 (2013)

*Spectral purity transfer between optical wavelengths at the  $10^{-18}$  level*

D. Nicolodi, B. Argence, W. Zhang, R. Le Targat, G. Santarelli and Y. Le Coq

Nature Photonics 8, 219 (2014)

*Pure transfer*

Y. Le Coq

Nature Photonics 8, 264 (2014)

---

# Conclusion and perspective

---

無為而無不為

When nothing is done, nothing is left undone

*Lao-Tzu (老子), Dao De Jing (道德經), book 48 (trans. by S. Mitchell)*

I have presented here some of the research that I have worked on involving optical frequency combs and optical frequency measurements over the last decade. This is of course but a glimpse of a very active field in which new applications are born every year. In the context of the optical frequency standards developed at LNE-SYRTE and other National Metrology Institutes worldwide, the performance that we reached for optical frequency measurement greatly exceeds the one required for the foreseeable next several years of progress in frequency standards. Beyond this core application, the search for new applications of self-referenced optical frequency combs has been quite successful and full of promises for the future. I have presented several of such new applications in this manuscript.

In the next several years, part of my research activity will be an extension of my current work on the generation of low phase noise microwave signals with optical frequency combs. In particular, working in close collaboration with two industrial partners, one from Germany (MenloSystems GmbH, specialized in optical frequency combs) and the other from the USA (Discovery semiconductor Inc., specialized in high performance high speed photo-diodes), I am planning to further the performance of our systems by studying the potentiality, in particular, of new fibre-comb technologies (solitonic regime vs stretched pulse fiber lasers,...) and higher power handling photo-detectors. It will also be interesting to experiment with micro-resonator-based optical frequency combs for the generation of low-noise microwave signals with ultra-compact systems. A collaboration with the group of Pr. Tobias Kippenberg at the Ecole Polytechnique Fédérale de Lausanne (EPFL) has been initiated for this specific topic. A European Union based research program (in the Eurostar framework) between MenloSystems, LNE-SYRTE and the Laboratoire Photonique, Numérique et Nanoscience (LP2N) is currently starting and formalizes these collaborations with the industry. A DARPA-funded research program between LNE-SYRTE, LP2N, MenloSystems, Discovery Semiconductor and EPFL is currently in the negotiation phase to further formalize (and fund) this academic/industry collaborative project for the next 2 to 5 years (depending on progress).

In the absolute frequency measurement part of my research work LNE-SYRTE, which is an essential part of the development of optical clocks, a strong emphasis will be put in the next few years on automatizing the measurement process and render it as



maintenance-free as possible. Although mostly technological, this aspect of research is essential in the context of a National Metrology Institute like LNE-SYRTE. Indeed, such institution has a strong requirement to, progressively, go beyond the “proof-of-principle” and “demonstration of pure performance” experiments and make its state-of-the-art developments available to the operational-level tasks of the laboratory. Fundings for this part of my work are and will mainly be provided by the LNE, the ANR (LIOM) and the Refimeve+ Equipex.

In parallel and in synergy with my optical frequency comb activity, I have recently started a new research project aiming at producing ultra-stable cw lasers of a new generation. This project needs to be contextualized to the current state of research in optical frequency standards. In these frequency standards, a narrow (highly forbidden) optical transition in cold atoms is probed with a cw laser whose frequency is maintained at resonance via a locking scheme. The most fundamental limitation of atomic clocks in term of short term stability is set by the quantum projection noise limit (QPNL) which, very schematically, gives a stability which, for an ideal probe laser, is proportional to atomic transition linewidth divided by the square root of the number of probed atoms. Unfortunately, for non-ideal cw probe lasers, the overall performance of the frequency standards is degraded. The current state-of-the-art probe lasers are based on ultra-high finesse Fabry-Pérot cavity in highly controlled environments. These systems nowadays reach their own fundamental limits (at a few  $10^{-16}$  short term stability), set by the thermal agitation of their composing atoms at room temperature. The stability corresponding to this limit is not sufficient to allow the neutral atoms lattice optical frequency standards developed worldwide to reach their fundamental quantum projection noise limit. Four possibilities are currently explored in the optical frequency metrology worldwide community to circumvent this limitation.

The first is to develop longer and larger high finesse Fabry-Perot cavities, with optimized high-reflection coatings, as the thermal noise agitation effects are averaged over the size of the cavity and therefore reduced for larger devices. A development in this direction is currently underway in the optical frequency group at LNE-SYRTE, led by another permanent member of the group.

A second possibility is to set the whole Fabry-Perot cavity device at cryogenic temperature [44]. As the temperature is lowered, the thermal agitation of the atoms is reduced, which, in turn, decreases the thermal fluctuations of the length of the cavity. At LNE-SYRTE, a collaboration with the team of Pr. Kersalé at FEMTO-ST institute (Besançon) is being developed in this direction, where my contribution will focus on the application to optical frequency standards *via* optical frequency combs.

A third possibility, currently explored at room temperature but which could be adapted to cryogenic temperatures in parallel to the previously discussed route, is to use crystalline ultra-high reflection coatings [91]. As a matter of facts, at room temperature, a study of the various sources of thermal noise for an ultra-stable high finesse Fabry-Perot cavity shows that the dominant effect comes from the high reflection coatings themselves. This comes from the fact that the thin layer materials in use for standard high reflection coatings are not chosen normally for their very high mechanical quality factor and their small size doesn't allow for large averaging of the thermally-induced atomic mechanical vibrations. The use of special dielectric coating realized with crys-

talline materials (which therefore require special fabrication and deposition techniques) therefore permits reducing this contribution by several orders of magnitude. These special coatings are now in the process of becoming commercially available.

The fourth possibility is the one in which I am starting a new research program at LNE-SYRTE, with main fundings, so far, from the LNE, a CNRS/PSL\* PEPS, the Ville de Paris (Emergences program), the Région Ile-de-France (DIM nano-K), the FIRST-TF Labex, the Observatoire de Paris and the Humboldt foundation. It consists in changing paradigm and, rather than stabilizing a laser to a macroscopic Fabry-Perot cavity, stabilizes it to a narrow spectral structure realized in a few mm 3 rare-earth doped crystals (REDC) at cryogenic temperature. Such structures can be realized by spectral hole burning (a few hundred Hz linewidth has been obtained in  $\text{Eu}^{3+}:\text{Y}_2\text{SiO}_5$  crystals near 4K). As the crystal is small (much smaller than a Fabry-Perot cavity in particular), it is comparatively easy to cool it down to a few Kelvin and keep it in a very low perturbation environment (in term of temperature, pressure and vibrations in particular). Preliminary experiments realized at NIST (Boulder USA) have demonstrated a stability of such a laser at  $6 \times 10^{-16}$  at 2s, comparable to the best Fabry-Perot stabilized lasers, with much room for improvements [92].

These new systems have a large potentiality for extremely high short term stability cw laser realization, as the spectral reference is operating at cryogenic temperature and therefore is expected to have very low thermal-agitation-induced limit. However, strong challenges will have to be overcome to realize the full potential of these systems. Among them the sensitivity to (dynamic) external perturbations on the crystalline matrix is one of the most important ones to assess and control. My work (and that of co-workers at LNE-SYRTE, including 1 post-doc and 1 PhD student both full time on the project under my supervision) on this topic will be realized in collaboration with the team led by Dr. Philippe Goldner at Laboratoire de Chimie de la Matière Condensée de Paris (LCMCP) for the chemistry of solid and crystal growth, the team led by Dr. Thierry Chanelière and Dr. Jean-Louis Legouët at Laboratoire Aimé Cotton (LAC) for the physics and spectroscopy of spectral hole burning structures, and the team led by Dr. Vincent Giordano and Pr. Yann Kersalé at FEMTO-ST for the realization of extremely low perturbation cryogenic environments. Promising routes to explore are, in particular: the use of isotopically pure doping of samples, which may decrease the homogeneous linewidth achievable; high symmetry matrices which may exhibit lower sensitivity to pressure and residual acceleration (forces); and development of novel spectroscopic methods to use the maximum number of rare-earth ions in the probing, thereby increasing signal-to-noise ratio and lowering the shot-noise limit on short term stability.

As the laser that we will be developing will be complex and intrinsically wavelength specific, an important aspect of my future work will be to develop techniques to transfer the spectral purity that will be achieved by such technique at one given wavelength to the other wavelengths of metrological interest *via* an optical frequency comb. As an example (and first foreseen realization), we will realize the spectral purity transfer between a  $\text{Eu}^{3+}:\text{Y}_2\text{SiO}_5$  stabilized laser at 580 nm and a 698 nm laser used to probe the clock transition of neutral Strontium atoms (one of the lattice atomic clocks developed at LNE-SYRTE). Currently, 1 post-doc is working full time on this project under my supervision. This will allow to use the quality of the rare earth doped crystal (REDC)

stabilized laser to actual improvement of the performance of an existing optical clock. The long term goal will be, of course, to reach the QPNL for the optical lattice clocks developed at LNE-SYRTE thanks to the REDC stabilized laser technology. Realizing this spectral purity transfer without degradation at the  $10^{-17}$  level in a robust and reliable way is a challenge that we have already started to address (see part 3.3 of this manuscript). Extending this technique to other wavelengths, including some which require the use of multi-branch fiber-based frequency combs will be explored. Beyond the primary use in optical frequency metrology, and on a longer timescale, my research activity in this field may have impact on the development of highly sensitive pressure, force, or electric field sensors based on REDC systems, for example by realizing micro or nano resonator systems in such materials, where externally applied strain or stress could be detected via the frequency shift of extremely narrow linewidth spectral structures. This may open fruitful collaboration with the nano-opto-mechanics community in the future.

---

# Bibliography

---

- [1] T. HÄNSCH, “Nobel Lecture: passion for precision”, *Review of Modern Physics* **12**, 1297 (2006).
- [2] J. HALL, “Nobel Lecture: defining and measuring optical frequencies”, *Review of Modern Physics* **78**, 1279 (2006).
- [3] M. FAUQUEMBERGUE, J. RIOU, W. GUERIN, S. RANGWALA, F. MORON, A. VILLING, Y. LE COQ, M. LÉCRIVAIN, P. BOUYER, and A. ASPECT, “Partially ferromagnetic electromagnet for trapping and cooling neutral atoms to quantum degeneracy”, *Review of Scientific Instruments* **76**, 103104 (2005).
- [4] J.-F. RIOU, W. GUERIN, Y. LE COQ, M. FAUQUEMBERGUE, V. JOSSE, P. BOUYER, and A. ASPECT, “Beam Quality of a Non-ideal Atom Laser”, *Physical Review Letters* **96**, 070404 (2006).
- [5] R. A. NYMAN, G. VAROQUAUX, B. VILLIER, D. SACCHET, F. MORON, Y. LE COQ, P. BOUYER, and A. ASPECT, “Tapered-amplified AR-coated laser diodes for Potassium and Rubidium atomic-physics experiments”, *Review of Scientific Instruments* **77**, 033105 (2006).
- [6] J.-F. RIOU, Y. LE COQ, F. IMPENS, W. GUERIN, C. J. BORDÉ, A. ASPECT, and P. BOUYER, “Theoretical tools for atom-laser-beam propagation”, *Physical Review A* **77**, 033630 (2008).
- [7] Y. LE COQ, J. A. RETTER, S. RICHARD, A. ASPECT, and P. BOUYER, “Coherent matter wave inertial sensors for precision measurements in space”, *Applied Physics B* **84**, 627 (2006).
- [8] W. JOST, “45 Years of Physical Chemistry in Germany”, *Annual Review of Physical Chemistry* **17**, 9 (1966).
- [9] A. LUDLOW, T. ZELEVINSKY, G. CAMPBELL, S. BLATT, M. BOYD, M. DE MIRANDA, M. MARTIN, J. THOMSEN, S. FOREMAN, J. YE, T. FORTIER, J. STALNAKER, S. DIDDAMS, Y. LE COQ, Z. BARBER, N. POLI, N. LEMKE, K. BECK, and C. OATES, “Sr lattice clock at  $1 \times 10^{-16}$  fractional uncertainty by remote optical evaluation with a Ca clock”, *Science* **319**, 5871 (2008).
- [10] X. BAILLARD, M. FOUCHÉ, R. LE TARGAT, P. WESTERGAARD, A. LECALLIER, Y. LE COQ, G. ROVERA, S. BIZE, and P. LEMONDE, “Accuracy Evaluation of an Optical Lattice Clock with Bosonic Atoms”, *Optics Letters* **32**, 1812 (2007).

- 
- [11] M. GUROV, J. MCFERRAN, B. NAGORNY, R. TYUMENEV, Z. XU, Y. LE COQ, R. LE TARGAT, P. LEMONDE, L. J., and B. S., “Ultraviolet laser spectroscopy of neutral mercury in a one-dimensional optical lattice Optical lattice clocks as candidates for a possible redefinition of the SI second”, *IEEE Transactions on Instrumentation and Measurement* **62**, 1568 (2013).
- [12] R. LE TARGAT, L. LORINI, Y. LE COQ, M. ZAWADA, J. GUÉNA, M. ABGRALL, M. GUROV, P. ROSENBUSCH, D. ROVERA, B. NAGO’RNY, R. GARTMAN, P. WESTERGAARD, M. TOBAR, M. LOURS, G. SANTARELLI, A. CLAIRON, S. BIZE, P. LAURENT, P. LEMONDE, and J. LODEWYCK, “Experimental realization of an optical second with strontium lattice clocks”, *Nature Communication* **4**, 2109 (2013).
- [13] M. PETERSEN, R. CHICIREANU, S. DAWKINS, D. MAGALHÃES, C. MANDACHE, Y. LE COQ, A. CLAIRON, and S. BIZE, “Doppler-Free Spectroscopy of the  $^1S_0-^3P_0$  Optical Clock Transition in Laser-Cooled Fermionic Isotopes of Neutral Mercury”, *Physical Review Letters* **101**, 183004 (2008).
- [14] S. DAWKINS, R. CHICIREANU, M. PETERSEN, J. MILLO, D. MAGALHAES, C. MANDACHE, Y. LE COQ, and S. BIZE, “Doppler-Free Spectroscopy of the  $^1S_0-^3P_0$  Optical Clock Transition in Laser-Cooled Fermionic Isotopes of Neutral Mercury”, *Applied Physics B* **99**, 41 (2010).
- [15] L. YI, S. MEJRI, J. MCFERRAN, Y. LE COQ, and S. BIZE, “Optical lattice trapping of 199Hg and determination of the magic wavelength for the ultraviolet  $^1S_0-^3P_0$  clock transition”, *Physical Review Letters* **106**, 073005 (2011).
- [16] S. MEJRI, J. MCFERRAN, L. YI, L. C. Y., and B. S., “Ultraviolet laser spectroscopy of neutral mercury in a one-dimensional optical lattice”, *Physical Review A* **84**, 032507 (2011).
- [17] J. MCFERRAN, L. YI, S. MEJRI, S. DI MANNO, W. ZHANG, J. GUÉNA, Y. LE COQ, and S. BIZE, “Neutral atom frequency reference in the deep ultraviolet with fractional uncertainty  $5.7 \times 10^{-15}$ ”, *Physical Review Letters* **108**, 183004 (2012).
- [18] D. MCFERRAN, J.J. MAGALHAES, C. MANDACHE, J. MILLO, W. ZHANG, Y. LE COQ, G. SANTARELLI, and S. BIZE, “Laser locking to the Hg-199  $^1S_0-^3P_0$  clock transition with  $5.4 \times 10^{-15}/\sqrt{\tau}$  fractional frequency instability”, *Optics Letters* **37**, 3477 (2012).
- [19] B. CHANTEAU, O. LOPEZ, W. ZHANG, D. NICOLODI, B. ARGENCE, F. AUGUSTE, M. ABGRALL, C. CHARDONNET, G. SANTARELLI, B. DARQUIÉ, Y. LE COQ, and A. AMY-KLEIN, “Mid-infrared laser phase-locking to a remote near-infrared frequency reference for high precision molecular spectroscopy”, *New Journal of Physics* **15**, 073003 (2013).
- [20] A. BARTELS and H. KURZ, “Generation of a broadband continuum by a Ti:sapphire femtosecond oscillator with a 1-GHz repetition rate”, *Optics Letters* **27**, 1839 (2002).

- [21] R. ELL, U. MORGNER, F. KAERTNER, J. FUJIMOTO, E. IPPEN, V. SCHEUER, G. ANGELOW, T. TSCHUDI, M. LEDERER, A. BOIKO, and B. LUTHER-DAVIES, “Octave-spanning Ti:sapphire laser with a repetition rate  $>1$  GHz for optical frequency measurements and comparisons”, *Optics Letters* **31**, 1011 (2006).
- [22] L. MATOS, D. KLEPPNER, O. KUZUCU, T. SCHIBLI, J. KIM, E. IPPEN, and F. KAERTNER, “Direct frequency comb generation from an octave-spanning, prismless Ti:sapphire laser”, *Optics Letters* **29**, 1683 (2006).
- [23] T. FORTIER, A. BARTELS, and S. DIDDAMS, “Octave-spanning Ti:sapphire laser with a repetition rate  $>1$  GHz for optical frequency measurements and comparisons”, *Optics Letters* **31**, 1011 (2006).
- [24] O. l. w. G. r. r. IdeestaQE, website, consulté en 2014, <http://www.idestaqe.com/products/ultrafast-laser/octavius-1g/>.
- [25] I. CODDINGTON, W. SWANN, and N. NEWBURY, “Coherent multiheterodyne spectroscopy using stabilized optical frequency combs”, *Physical Review Letters* **101**, 049901 (2008).
- [26] F. GIORGETTA, I. CODDINGTON, E. BAUMAN, W. SWANN, and N. NEWBURY, “Fast high-resolution spectroscopy of dynamic continuous-wave laser sources”, *Nature Photonics* **4**, 853 (2010).
- [27] M. GmbH, website, consulté en 2014, <http://www.menlosystems.com/products/optical-frequency-combs/fc1500-250-wg/>.
- [28] W. ZHANG, M. LOURS, M. FISCHER, R. HOLZWARTH, G. SANTARELLI, and Y. LE COQ, “Characterizing a fiber-based frequency comb with electro-optic modulator”, *IEEE Transactions on Ultrasonics, Ferroelectrics and Frequency Control* **59**, 432 (2012).
- [29] H. JIANG, F. KÉFÉLIAN, S. CRANE, O. LOPEZ, M. LOURS, J. MILLO, D. HOLLEVILLE, P. LEMONDE, C. CHARDONNET, A. AMY-KLEIN, and G. SANTARELLI, “Long-distance frequency transfer over an urban fiber link using optical phase stabilization”, *Journal of the Optical Society of America B - Optical Physics* **25**, 2029 (2008).
- [30] S. DIDDAMS, D. JONES, J. YE, S. CUNDIFF, J. HALL, J. RANKA, R. WINDELER, R. HOLZWARTH, T. UDEM, and T. HÄNSCH, “Direct link between microwave and optical frequencies with a 300 THz femtosecond laser comb”, *Physical Review Letters* **84**, 5102 (2000).
- [31] T. RAMOND, S. DIDDAMS, L. HOLLBERG, and A. BARTELS, “Phase coherent link from optical to microwave frequencies by means of the broadband continuum from a 1-GHz Ti:sapphire femtosecond oscillator”, *Optics Letters* **27**, 1842 (2002).
- [32] A. LUITEN, A. MANN, M. COSTA, and D. BLAIR, “Power stabilized cryogenic sapphire oscillator”, *IEEE Transactions on Instrumentation and Measurements* **44**, 132 (1995).

- 
- [33] G. SANTARELLI, P. LAURENT, P. LEMONDE, A. CLAIRON, A. MANN, S. CHAN, A. LUITEN, and C. SALOMON, “Quantum projection noise in atomic fountain: a high stability cesium frequency standard”, *Physical Review Letters* **82**, 4619 (1999).
- [34] J. GUÉNA, M. ABGRALL, D. ROVERA, P. LAURENT, B. CHUPIN, M. LOURS, G. SANTARELLI, P. ROSENBUSCH, M. TOBAR, R. LI, K. GIBBLE, A. CLAIRON, and S. BIZE, “Progress in atomic fountains at LNE-SYRTE”, *IEEE Transactions on Ultra-sonic, Ferromagnetic and Frequency Control* **59**, 391 (2012).
- [35] R. BOUDOT and E. RUBIOLA, “Phase noise in RF and microwave amplifiers”, *IEEE Transactions on Ultra-sonic, Ferromagnetic and Frequency Control* **59**, 2613 (2012).
- [36] R. BOUDOT and E. RUBIOLA, “The effect of AM noise on correlation phase noise measurement”, *IEEE Transactions on Ultra-sonic, Ferromagnetic and Frequency Control* **54**, 926 (2007).
- [37] E. IVANOV, M. TOBAR, and W. R.A., “Microwave interferometry: application to precision measurement and noise reduction techniques”, *IEEE Transactions on Ultra-sonic, Ferromagnetic and Frequency Control* **45**, 1526 (1998).
- [38] E. RUBIOLA, V. GIORDANO, and J. GROSLAMBERT, “Very high frequency and microwave interferometric PM and AM noise measurement”, *Review on Scientific Instruments* **70**, 220 (1999).
- [39] B. YOUNG, F. CRUZ, W. ITANO, and J. BERGQUIST, “Visible lasers with subhertz linewidths”, *Physical Review Letters* **82**, 3799 (1999).
- [40] T. NAZAROVA, F. RIEHLE, and U. STERR, “Vibration-insensitive reference cavity for an ultra-narrow-linewidth laser”, *Applied Physics B - Lasers and Optics* **83**, 531 (2006).
- [41] A. LUDLOW, X. HUANG, M. NOTCUTT, T. ZANON-WILLETTE, S. FOREMAN, M. BOYD, S. BLATT, and J. YE, “Compact, thermal-noise-limited optical cavity for diode laser stabilization at  $1 \times 10^{-15}$ ”, *Optics Letters* **32**, 641 (2007).
- [42] S. WEBSTER, M. OXBORROW, and P. GILL, “Vibration insensitive optical cavity”, *Physical Review A* **75**, 011801 (2007).
- [43] J. MILLO, D. MAGALHAES, C. MANDACHE, Y. LE COQ, E. ENGLISH, P. WESTERGAARD, J. LODEWYCK, S. BIZE, P. LEMONDE, and G. SANTARELLI, “Ultra-stable lasers based on vibration insensitive cavities”, *Physical Review A* **79**, 053829 (2009).
- [44] T. KESSLER, C. HAGEMANN, C. GREBING, T. LEGERO, U. STERR, F. RIEHLE, M. MARTIN, L. CHEN, and J. YE, “A sub-40-mHz-linewidth laser based on a silicon single-crystal optical cavity”, *Nature Photonics* **6**, 687 (2012).
- [45] J. HARTNETT, N. NAND, C. WANG, and J.-M. LE FLOCH, “Cryogenic sapphire oscillator using a low-vibration design pulse-tube cryocooler: first results”, *IEEE Transactions on Ultra-sonic, Ferromagnetic and Frequency Control* **57**, 1034 (2010).

- [46] S. GROP, P. BOURGEOIS, R. BOUDOT, Y. KERSALÉ, E. RUBIOLA, and V. GIORDANO, “10 GHz cryocooled sapphire oscillator with extremely low phase noise”, *Electronic Letters* **46**, 420 (2010).
- [47] ULISS-ST, website, consulté en 2013, <http://www.uliss-st.com/>.
- [48] Raytheon, Poseidon Scientific Instruments department website, consulté en 2013, [http://www.raytheon.com.au/businesses/integrated\\_solutions/capabilities/psi\\_program/index.html](http://www.raytheon.com.au/businesses/integrated_solutions/capabilities/psi_program/index.html).
- [49] OEwaves, website, consulté en 2013, <http://www.oewaves.com/>.
- [50] J. MILLO, M. ABGRALL, M. LOURS, E. ENGLISH, H. JIANG, J. GUÉNA, A. CLAIRON, M. TOBAR, S. BIZE, Y. LE COQ, and G. SANTARELLI, “Ultralow noise microwave generation with fiber-based optical frequency comb and application to atomic fountain clock”, *Applied Physics Letters* **94**, 141105 (2009).
- [51] S. WEYERS, B. LIPPHARDT, and H. SCHNATZ, “The Stability of an Optical Clock Laser Transferred to the Interrogation Oscillator for a Cs Fountain”, *Physical Review A* **79**, 031803R (2009).
- [52] O. LOPEZ, A. AMY-KLEIN, C. DAUSSY, C. CHARDONNET, F. NARBONNEAU, M. LOURS, and G. SANTARELLI, “86-km optical link with a resolution of  $2 \times 10^{-18}$  for RF frequency transfer”, *European Physical Journal D* **48**, 35 (2008).
- [53] J. MILLO, R. BOUDOT, M. LOURS, P. BOURGEOIS, A. LUITEN, Y. LE COQ, Y. KERSALÉ, and G. SANTARELLI, “Ultra-Low Noise Microwave Extraction from Fiber-Based Optical Frequency Comb”, *Optics Letters* **34**, 3707 (2009).
- [54] W. ZHANG, Z. XU, M. LOURS, R. BOUDOT, Y. KERSALÉ, G. SANTARELLI, and Y. LE COQ, “Sub-100 attoseconds stability optics to microwave synchronization”, *Applied Physics Letters* **96**, 211105 (2010).
- [55] W. ZHANG, T. LI, M. LOURS, S. SEIDELIN, G. SANTARELLI, and Y. LE COQ, “Amplitude to phase conversion of InGaAs PIN photodiodes for femtosecond lasers microwave signal generation”, *Applied Physics B lasers and Optics* **106**, 301 (2012).
- [56] J. TAYLOR, S. DATTA, A. HATI, C. NELSON, F. QUINLAN, A. JOSHI, and S. DIDDAMS, “Characterization of power-to-phase conversion in high-speed P-I-N photodiodes”, *IEEE Photonics Journal* **3**, 140 (2011).
- [57] F. QUINLA, T. FORTIER, H. JIANG, A. HATI, C. NELSON, Y. FU, J. CAMPBELL, and S. DIDDAMS, “Exploiting shot noise correlations in the photodetection of ultrashort optical pulse trains”, *Nature Photonics* **7**, 290 (2013).
- [58] F. QUINLAN, T. FORTIER, H. JIANG, and S. DIDDAMS, “Analysis of shot noise in the detection of ultrashort optical pulse trains”, *Journal of the Optical Society of America* **30**, 1775 (2013).



- 
- [59] T. FORTIER, F. QUINLAN, A. HATI, C. NELSON, J. TAYLOR, Y. FU, J. CAMPBELL, and S. DIDDAMS, “Photonic microwave generation with high-power photodiodes”, *Optics Letters* **38**, 1712 (2013).
- [60] A. HABOUCHA, W. ZHANG, T. LI, M. LOURS, A. LUITEN, Y. LE COQ, and G. SANTARELLI, “Optical-Fiber Pulse Rate Multiplier for Ultra-low Phase-noise Signal Generation”, *Optics Letters* **36**, 3654 (2011).
- [61] W. ZHANG, S. SEIDELIN, A. JOSHI, S. DATTA, G. SANTARELLI, and Y. LE COQ, “Dual photo-detector system for low phase noise microwave generation with femtosecond lasers”, *Optics Letters* **39**, 1204 (2014).
- [62] T. FORTIER, M. KIRCHNER, F. QUINLAN, J. TAYLOR, J. BERGQUIST, T. ROSEN BAND, N. LEMKE, A. LUDLOW, Y. JIANG, C. OATES, and S. DIDDAMS, “Generation of ultrastable microwaves via optical frequency division”, *Nature Photonics* **5**, 425 (2011).
- [63] J. KIM, F. KARTNER, and F. LUDWIG, “Balanced optical-microwave phase detectors for optoelectronic phase-locked loops”, *Optics Letters* **31**, 3659 (2006).
- [64] J. KIM, F. LUDWIG, M. FELBER, and F. KARTNER, “Long-term stable microwave signal extraction from mode-locked lasers”, *Optics Express* **15**, 8951 (2007).
- [65] J. KIM, J. COX, J. CHEN, and F. KARTNER, “Drift-free femtosecond timing synchronization of remote optical and microwave sources”, *Nature Photonics* **2**, 733 (2008).
- [66] J. KIM and F. KARTNER, “Microwave signal extraction from femtosecond mode-locked lasers with attosecond relative timing drift”, *Optics Letters* **35**, 2022 (2010).
- [67] A. CINGÖZ, D. YOST, T. ALLISON, A. RUEHL, M. FERMAN, I. HARTL, and J. YE, “Direct frequency comb spectroscopy in the extreme ultraviolet”, *Nature* **482**, 68 (2012).
- [68] B. BERNHARDT, A. OZAWA, P. JACQUET, M. JACKY, Y. KOBAYASHI, T. UDEM, R. HOLZWARH, G. GUELACHVILI, T. HANSCH, and N. PICQUÉ, “Cavity-enhanced dual-comb spectroscopy”, *Nature Photonics* **4**, 55 (2010).
- [69] C. LI, A. BENEDICK, P. FENDEL, G. A.G., F. KARTNER, D. PHILLIPS, D. SASSELOV, A. SZENTGYORGYI, and R. WALSWORTH, “A laser frequency comb that enables radial velocity measurements with a precision of  $1\text{ cm}\cdot\text{s}^{-1}$ ”, *Nature* **452**, 610 (2008).
- [70] T. STEINMETZ, T. WILKEN, C. ARAUJO-HAUCK, R. HOLZWARH, T. W. HAENSCH, L. PASQUINI, A. MANESCAU, S. D’ODORICO, M. MURPHY, T. KENTISCHER, W. SCHMIDT, and T. UDEM, “Laser Frequency Combs for Astronomical Observations”, *Science* **321**, 1335 (2008).

- [71] T. WILKEN, G. LO CURTO, R. PROBST, T. STEINMETZ, A. MANESCAU, L. PASQUINI, J. GONZÁLEZ HERNÁNDEZ, R. REBOLO, T. HAENSCH, T. UDEM, and R. HOLZWARH, “A spectrograph for exoplanet observations calibrated at the centimetre-per-second level”, *Nature* **485**, 611 (2012).
- [72] S. DIDDAMS, S. HOLLBERG, and V. MBELE, “Molecular fingerprinting with the resolved modes of a femtosecond laser frequency comb”, *Nature* **445**, 627 (2007).
- [73] T. FORTIER, Y. LE COQ, J. STALNAKER, D. ORTEGA, S. DIDDAMS, C. OATES, and L. HOLLBERG, “Kiloherz-resolution spectroscopy of cold atoms with an optical frequency comb”, *Physical Review Letters* **97**, 163905 (2006).
- [74] J. STALNAKER, Y. LE COQ, T. FORTIER, S. DIDDAMS, C. OATES, and L. HOLLBERG, “Measurement of excited-state transitions in cold calcium atoms by direct femtosecond frequency-comb spectroscopy”, *Physical Review A (Rapid Communication)*, Also selected for *Virtual Journal of Ultrafast Science, Volume 6, Issue 5 (May 2007)* **75**, 040502 (2007).
- [75] I. CODDINGTON, W. SWANN, L. LORINI, J. BERGQUIST, K. FEDER, Y. LE COQ, J. NICHOLSON, C. OATES, Q. QURAIISHI, P. WESTBROOK, S. DIDDAMS, and N. NEWBURY, “Coherent optical link over 100’s of meters and 100’s of terahertz with sub-femtosecond timing jitter”, *Nature Photonics* **1**, 283 (2007).
- [76] D. NICOLODI, B. ARGENCE, W. ZHANG, R. LE TARGAT, G. SANTARELLI, and Y. LE COQ, “Spectral purity transfer between optical wavelengths at the  $10^{-18}$  level”, *Nature Photonics* **8**, 219 (2014).
- [77] Y. LE COQ, “Pure Transfer”, *Nature Photonics* **8**, 264 (2014).
- [78] L.-S. MA, Z. BI, A. BARTELS, L. ROBERTSSON, M. ZUCCO, R. WINDELER, G. WILPERS, C. OATES, L. HOLLBERG, and S. DIDDAMS, “Optical frequency synthesis and comparison with uncertainty at the  $10^{-19}$  level”, *Science* **303**, 1843 (2004).
- [79] L.-S. MA, Z. BI, A. BARTELS, K. KIM, L. ROBERTSSON, M. ZUCCO, R. WINDELER, G. WILPERS, C. OATES, L. HOLLBERG, and S. DIDDAMS, “Frequency uncertainty for optically referenced femtosecond laser frequency combs”, *IEEE Journal of Quantum Electronics* **43**, 139 (2007).
- [80] Y. NAKAJIMA, H. INABA, K. HOSAKA, K. MINOSHIMA, A. ONAE, M. YASUDA, T. KOHNO, S. KAWATO, T. KOBAYASHI, T. KATSUYAMA, and F.-L. HONG, “A multi-branch, fiber-based frequency comb with millihertz- level relative linewidths using an intra-cavity electro-optic modulator”, *Optics Express* **18**, 1667 (2010).
- [81] C. HAGEMANN, C. HAGEMANN, C. GREBING, T. KESSLER, S. FALKE, N. LEMKE, C. LISDAT, H. SCHNATZ, F. RIEHLE, and U. STERR, “Providing  $10^{-16}$  short-term stability of a 1.5 mm laser to optical clocks”, *IEEE Transactions on Instrumentation and Measurement* **62**, 1556 (2013).

- 
- [82] H. TELLE, B. LIPPHARDT, and J. STENGER, “Kerr-lens, mode-locked lasers as transfer oscillators for optical frequency measurements”, *Applied Physics B - Lasers and Optics* **74**, 1 (2002).
- [83] E. BENKLER, H. TELLE, A. ZACH, and F. TAUSER, “Circumvention of noise contributions in fiber laser based frequency combs”, *Optics Express* **13**, 5662 (2005).
- [84] J. LODEWYCK, P. WESTERGAARD, A. LECALLIER, L. LORINI, and P. LEMONDE, “Frequency stability of optical lattice clocks”, *New Journal of Physics* **12**, 065026 (2010).
- [85] A. AMY-KLEIN, A. GONCHAROV, C. DAUSSY, C. GRAIN, O. LOPEZ, G. SANTARELLI, and C. CHARDONNET, “Absolute frequency measurement in the 28-THz spectral region with a femtosecond laser comb and a long distance optical link to a primary standard”, *Applied Physics B - Lasers and Optics* **78**, 25 (2004).
- [86] C. DAUSSY, O. LOPEZ, A. AMY-KLEIN, A. GONCHAROV, M. GUINET, C. CHARDONNET, F. NARBONNEAU, M. LOURS, D. CHAMBON, S. BIZE, A. CLAIRON, G. SANTARELLI, M. TOBAR, and A. LUITEN, “Long-distance frequency dissemination with a resolution of  $10^{-17}$ ”, *Physical Review Letters* **94**, 203904 (2005).
- [87] F. NARBONNEAU, M. LOURS, S. BIZE, A. CLAIRON, G. SANTARELLI, O. LOPEZ, C. DAUSSY, A. AMY-KLEIN, and C. CHARDONNET, “High resolution frequency standard dissemination via optical fiber metropolitan network”, *Review of Scientific Instruments* **77**, 064701 (2006).
- [88] O. LOPEZ, A. AMY-KLEIN, M. LOURS, C. CHARDONNET, and G. SANTARELLI, “High-resolution microwave frequency dissemination on an 86-km urban link”, *Applied Physics B - Lasers and Optics* **98**, 723 (2010).
- [89] F. KÉFÉLIAN, O. LOPEZ, H. JIANG, C. CHARDONNET, A. AMY-KLEIN, and G. SANTARELLI, “High resolution optical frequency dissemination on a telecommunication network with data traffic”, *Optics Letters* **34**, 1573 (2009).
- [90] O. LOPEZ, A. HABOUCHA, H. KÉFÉLIAN, F. ANDJIANG, V. CHANTEAU, B. ANF RONCIN, C. CHARDONNET, A. AMY-KLEIN, and G. SANTARELLI, “Cascaded multiplexed optical link on a telecommunication network for frequency dissemination”, *Optics Express* **18**, 16849 (2010).
- [91] G. COLE, W. ZHANG, M. MARTIN, J. YE, and M. ASPELMEYER, “Tenfold reduction of Brownian noise in high-reflectivity optical coatings”, *Nature Photonics* **7**, 644 (2013).
- [92] M. THORPE, L. RIPPE, T. FORTIER, M. KIRCHNER, and T. ROSEN BAND, “Frequency stabilization to  $6 \times 10^{-16}$  via spectral hole burning”, *Nature Photonics* **5**, 689 (2011).