



**HAL**  
open science

# Étude de l'efficacité énergétique des navires : développement et application d'une méthode d'analyse

Pierre Marty

► **To cite this version:**

Pierre Marty. Étude de l'efficacité énergétique des navires : développement et application d'une méthode d'analyse. Thermique [physics.class-ph]. Ecole Centrale de Nantes (ECN), 2014. Français. NNT : . tel-01001539

**HAL Id: tel-01001539**

**<https://theses.hal.science/tel-01001539>**

Submitted on 4 Jun 2014

**HAL** is a multi-disciplinary open access archive for the deposit and dissemination of scientific research documents, whether they are published or not. The documents may come from teaching and research institutions in France or abroad, or from public or private research centers.

L'archive ouverte pluridisciplinaire **HAL**, est destinée au dépôt et à la diffusion de documents scientifiques de niveau recherche, publiés ou non, émanant des établissements d'enseignement et de recherche français ou étrangers, des laboratoires publics ou privés.

# Thèse de Doctorat

Pierre MARTY

*Mémoire présenté en vue de l'obtention du  
grade de Docteur de l'École Centrale de Nantes  
sous le label de L'Université Nantes Angers Le Mans*

École Doctorale : Sciences Pour l'Ingénieur Géosciences et Architecture

Discipline : Énergétique, Thermique et Combustion

Unité de recherche : *Laboratoire de recherche en Hydrodynamique, Énergétique et Environnement Atmosphérique*

Soutenue le 16 mai 2014

## Ship energy efficiency study: development and application of an analysis method

---

## *Étude de l'efficacité énergétique des navires : développement et application d'une méthode d'analyse*

### JURY

Président :	Jean-Yves BILLARD, Professeur des Universités, École Navale
Rapporteurs :	Georges DESCOMBES, Professeur des Universités, Conservatoire National des Arts et Métiers Patrick SÉBASTIAN, Maître de Conférences HDR, Université de Bordeaux
Examineurs :	Philippe CORRIGNAN, Docteur, Bureau Veritas Raphaël CHENOUEAU, Maître de Conférences, École Centrale de Nantes
Invité(s) :	Pierre-Yves LARRIEU, Professeur de l'Enseignement Maritime
Directeur de Thèse :	Jean-François HÉTET, Professeur des Universités, École Centrale de Nantes



## Abstract

The shipping industry is facing three major challenges: climate change, increasing bunker fuel price and tightening international rules on pollution and CO<sub>2</sub> emissions. All these challenges can be met by reducing fuel consumption. The energy efficiency of shipping is already very good in comparison with other means of transportation but can still be and must be improved. There exist many technical and operational solutions to that extent. But assessing their true and final impact on fuel consumption is far from easy as ships are complex systems. A first holistic and energetic modelling approach tries to deal with this issue. Based on the first law of thermodynamics, it has made it possible to model a complete and modern cruise carrier. Its fuel consumption and corresponding atmospheric emissions were calculated with a good level of accuracy. The model has also proven to very useful at comparing design alternatives hence showing its capacity to evaluate energy efficiency solutions. A second approach completes the first one. Based this time on the second law, including the concept of exergy, it offers a more detailed and physical description of ships. It can precisely assess energy savings, including the part of thermal energy convertible into work. This innovative approach has required new model developments, including a new model of diesel engine, based on the mean value approach, capable of calculating the complete thermal balance for any engine operating point.

Keywords: Shipping; Energy modelling; Exergy; Modelica; Energy efficiency, Diesel engine modelling



## Résumé

*Le transport maritime fait face à trois défis majeurs : le dérèglement climatique, l'augmentation du cours du baril et le durcissement des normes internationales en termes de pollutions et d'émissions de CO<sub>2</sub>. Ce triple challenge peut être relevé en réduisant la consommation de fioul. L'efficacité énergétique des navires est déjà très bonne en comparaison avec les autres moyens de transport mais elle peut et doit encore progresser. Il existe à cet effet de multiples solutions techniques et opérationnelles. Mais évaluer leur impact réel sur les économies finales n'est pas toujours chose aisée étant donné la complexité des navires. Une première approche globale de modélisation énergétique du navire tente de répondre à cette problématique. Basée sur le premier principe de la thermodynamique, cette approche a permis de modéliser un paquebot. La consommation de fioul et les émissions associées ont été calculées avec un niveau d'exactitude satisfaisant. Le modèle s'est de plus montré très utile dans la comparaison d'alternatives de conception, illustrant ainsi sa capacité à évaluer les solutions d'économie d'énergie. Une deuxième approche vient compléter la première. Basée cette fois-ci sur le second principe et notamment sur le concept d'exergie, cette approche propose une description plus détaillée et physique du navire. Elle permet d'évaluer précisément les gains d'énergie possibles et en particulier la part convertible en travail mécanique. Cette approche novatrice a nécessité le développement de nouveaux modèles et notamment un nouveau modèle de moteur diesel basé sur l'approche moyenne et qui permet de calculer la balance thermique complète et ce sur tout le champ moteur.*

*Mots clés : Transport maritime ; Modélisation énergétique ; Exergie ; Modelica ; Efficacité énergétique ; Modélisation moteur diesel*



# ACKNOWLEDGMENTS

---

This doctorate degree started in May 2011 and finished in May 2014. It took place in Nantes (France) where I divided my time between my company, Bureau Veritas and my laboratories at the École Centrale de Nantes. I could not have achieved this work without the help of people from both these two organizations.

First of all, I would like to express my deepest gratitude to Doctor Philippe Corrigan, who offered me this thesis work. Thank you for your careful attention, your professional skills and challenging remarks. Thank you also for providing me with such fantastic working conditions.

I am also extremely grateful towards Professor Jean-François Hétet, my supervisor. Thank you for your kind patience and sorry for being so “tenacious”.

Very big thanks also to Professor Raphaël Chenouard, my co-supervisor, who patiently explained to me systemics and modelling theories.

I also owe a great debt of gratitude to Professor Pierre-Yves Larrieu for sharing with me his immense and gripping knowledge on ships.

I would like to thank also Professor Jean-Yves Billard, Professor Georges Descombes and Professor Patrick Sébastian for carefully reading my thesis and doing me the honour of being members of my jury.

My special thanks go to Antoine Rogeau, engineer student at the École Centrale de Nantes, who offered me his help when I needed it most.

I am also very grateful to Antoine Gondet, from STX France, for his collaboration in the IMDC paper and cruise ship modelling.

I also would like to thank Pierre Madoz for kindly sharing his knowledge on electrical networks with me.

I wish to thank Cédric Brun, for his help on Python.

I would like to express my many thanks towards all my colleagues at Bureau Veritas and Centrale Nantes for their help, kindness and friendship.

Finally, I wish to thank my family and my lovely wife for their unconditional support and encouragement throughout my study.





# TABLE OF CONTENTS

---

<b>ACKNOWLEDGMENTS</b> .....	<b>5</b>
<b>TABLE OF CONTENTS</b> .....	<b>7</b>
<b>LIST OF FIGURES</b> .....	<b>9</b>
<b>LIST OF TABLES</b> .....	<b>13</b>
<b>NOMENCLATURE</b> .....	<b>15</b>
<b>THESIS ORGANISATION</b> .....	<b>21</b>
<b>INTRODUCTION</b> .....	<b>23</b>
ENVIRONMENTAL CONTEXT.....	24
ECONOMIC CONTEXT.....	28
REGULATORY CONTEXT .....	29
DOCTORATE OBJECTIVES .....	31
<b>CHAPTER 1 SHIP ENERGY EFFICIENCY</b> .....	<b>35</b>
1.1 ENERGY AND EXERGY FUNDAMENTALS .....	36
1.2 ENERGETIC AND EXERGETIC ANALYSIS.....	44
<b>CHAPTER 2 SHIP ENERGY MODELLING</b> .....	<b>51</b>
2.1 SYSTEMIC APPROACH.....	53
2.2 ENERGY MODELLING METHOD .....	64
2.3 AN ENERGY MODELLING TOOL: MODELICA.....	67
2.4 CONCLUSIONS.....	72
<b>CHAPTER 3 HOLISTIC MODELLING</b> .....	<b>73</b>
3.1 SEECAT.....	74
3.2 APPLICATION TO A REAL SHIP .....	75
3.3 MODELLING THE COMPONENTS.....	77
3.4 RESULTS ANALYSIS .....	88
3.5 DESIGN ALTERNATIVES .....	99
3.6 CONCLUSIONS.....	104
<b>CHAPTER 4 ENGINE MODELLING</b> .....	<b>107</b>
4.1 DATA AVAILABLE.....	110
4.2 MODELLING DIESEL ENGINES .....	111
4.3 THE MEAN VALUE APPROACH.....	116
4.4 DATA ANALYSIS.....	117
4.5 PRESENTATION OF THE MODEL.....	123
4.6 CONCLUSION .....	145

<b>CHAPTER 5 FLUID CIRCUIT &amp; EXERGY MODELLING</b> .....	<b>149</b>
5.1    FLUID CIRCUIT MODELLING .....	151
5.2    EXERGY ANALYSIS.....	154
5.3    RESULTS.....	156
5.4    ENERGY PERFORMANCE IMPROVEMENTS .....	164
5.5    CONCLUSION .....	166
<b>CONCLUSION</b> .....	<b>167</b>
<b>APPENDICES</b> .....	<b>171</b>
<b>APPENDIX A SHIP DESCRIPTION</b> .....	<b>175</b>
A.1    PROPULSION .....	177
A.2    ELECTRICITY PRODUCTION .....	182
A.3    ELECTRICITY DISTRIBUTION .....	187
A.4    SEA WATER CIRCUIT .....	191
A.5    FRESH WATER PRODUCTION.....	192
A.6    WATER COOLING CIRCUIT .....	197
A.7    FUEL CIRCUIT .....	199
A.8    STEAM PRODUCTION AND DISTRIBUTION .....	201
A.9    HEATING, VENTILATION AND AIR CONDITIONING.....	208
<b>APPENDIX B DIESEL ENGINE FUNDAMENTALS</b> .....	<b>211</b>
<b>APPENDIX C HEATING VENTILATION &amp; AIR CONDITIONING</b> .....	<b>217</b>
C.1    HEAT PUMPS, AIR-CONDITIONING AND COLD PRODUCTION .....	218
<b>LIST OF PUBLICATIONS</b> .....	<b>221</b>
<b>BIBLIOGRAPHY</b> .....	<b>223</b>

# LIST OF FIGURES

---

Figure 1: Atmospheric carbon dioxide concentrations .....	24
Figure 2: Global average temperature change .....	25
Figure 3: Emissions of CO <sub>2</sub> from shipping compared with global total emissions .....	26
Figure 4: Typical range of CO <sub>2</sub> efficiencies of ships compared with rail and road transport.....	26
Figure 5: Trajectories of the CO <sub>2</sub> emissions from international shipping .....	27
Figure 6: Crude oil prices trends since 1860 .....	28
Figure 7: Oil consumption in thousand barrels per day since 1965 .....	29
Figure 1.1: Illustration of reversible and irreversible processes .....	39
Figure 1.2: Schematic diagram showing energy, exergy and anergy flows through a closed system transformation .....	40
Figure 1.3. Exergetic content of thermal heat .....	43
Figure 1.4: Schematic diagram of 66 MW unit of Zarqua's (Jordan) power plant.....	45
Figure 1.5: Sankey diagram representing the energetic (a) and exergetic (b) balance of the coal-fired Nanticoke Generating Station in Ontario .....	47
Figure 2.1: Basic example of code structure in Modelica.....	68
Figure 2.2: Block architecture of Modelica .....	70
Figure 2.3: Translation stages from Modelica code to executing simulation.....	70
Figure 3.1: SEECAT's diagram view of the modelled cruise vessel.....	77
Figure 3.2: Black-box type representation of a diesel engine .....	78
Figure 3.3: BSFC map and curve of a Wärtsilä 46 engine .....	79
Figure 3.4: Black-box type representation of an electric motor or alternator .....	80
Figure 3.5: Black-box type representation of a waste heat recovery boiler.....	82
Figure 3.6: Black-box type representation of an oil-fired boiler.....	82
Figure 3.7: Black-box type representation of a distiller.....	83
Figure 3.8: Black-box type representation of a reverse osmosis fresh water production unit.....	85
Figure 3.9: Black-box type representation of a conditioning system .....	86
Figure 3.10: Black-box type representation of the ship's hydrodynamics.....	87
Figure 3.11: Map presenting the route followed by the ship during the four cruises .....	89
Figure 3.12: Total instantaneous fuel consumption during the first cruise.....	91
Figure 3.13: Total instantaneous electrical production during the first cruise .....	92
Figure 3.14: Instantaneous electrical consumption by propulsion motors during the first cruise .....	92
Figure 3.15: Instantaneous electrical consumption by other electrical consumers during the first cruise.....	94
Figure 3.16: Electrical balance for cruise 1 according to simulation.....	95
Figure 3.17: Fuel consumption comparison between the four cruises .....	96
Figure 3.18: ASFC comparison between the four cruises.....	97
Figure 3.19: Electrical consumption comparison between the four cruises .....	97
Figure 3.20: Speed profile of a typical 7 days cruise .....	99
Figure 3.21: Ship's thermal balance, in winter conditions, without AHRP system .....	102
Figure 3.22: Ship's thermal balance, in winter conditions, with AHRP system .....	102
Figure 4.1: CPP and FPP curves for engine A .....	110
Figure 4.2: Example of a brake specific fuel consumption map of a diesel engine.....	112

Figure 4.3: Diesel engine thermal balance presentation, displaying energy inputs and outputs.....	118
Figure 4.4 : Global architecture of the Diesel engine mean value model.....	123
Figure 4.5: 3D visualization and contour visualisation of mass flow interpolation.....	131
Figure 4.6: 3D visualisation and contour visualisation of efficiency interpolation.....	133
Figure 4.7: 3D visualisation and contour visualisation of water cooling power interpolation.....	134
Figure 4.8: 3D visualisation and contour visualisation of lubrication oil cooling power interpolation.....	136
Figure 4.9: Graphical interface of the SEECAT mean value model of engine A.....	138
Figure 4.10: Brake specific fuel consumption values along the propeller curve.....	139
Figure 4.11: Engine combustion heat values along the propeller curve.....	139
Figure 4.12: Engine jacket water cooling heat values along the propeller curve.....	139
Figure 4.13: Engine lubrication oil cooling heat values along the propeller curve.....	139
Figure 4.14: Scavenge air cooling heat values along the propeller curve.....	140
Figure 4.15: Exhaust gas heat (after turbine) values along the propeller curve.....	140
Figure 4.16: Exhaust mass flow values along the propeller curve.....	141
Figure 4.17: Exhaust gas (after turbine) temperature values along the propeller curve.....	141
Figure 4.18: Engine operating diagram.....	142
Figure 4.19: BSFC map built using the sensitivity analysis data.....	143
Figure 4.20: Scavenge air cooling heat map built using the sensitivity analysis data.....	143
Figure 4.21: Engine lubrication oil cooling heat map built using the sensitivity analysis data.....	143
Figure 4.22: Engine jacket water cooling heat map built using the sensitivity analysis data.....	143
Figure 4.23: Exhaust mass flow map built using the sensitivity analysis data.....	144
Figure 4.24: Exhaust gas temperature map built using the sensitivity analysis data.....	144
Figure 5.1: Schematic representation of an engine cooling system under the new "fluid circuit" approach.....	152
Figure 5.2 Schematic representation of an engine cooling system under the previous "energy flow" approach.....	152
Figure 5.3: Absolute output energy balance of engine A.....	157
Figure 5.4: Relative output energy balance of engine A.....	157
Figure 5.5: Absolute output exergy balance of engine A.....	158
Figure 5.6: Relative output exergy balance of engine A.....	158
Figure 5.7: SEECAT model of engine A and its cooling and WHR circuit.....	159
Figure 5.8: Energy (a) and exergy (b) Sankey diagrams of engine A with its cooling and exhaust circuits.....	163
Figure A.1: Ship diagram legend.....	176
Figure A.2: Main engine fuel oil supply diagram.....	177
Figure A.3: Main engine lubrication circuit diagram.....	179
Figure A.4: Main engine exhaust and inlet circuits.....	181
Figure A.5: Diesel generator diagram.....	182
Figure A.6: Shaft generator diagram.....	184
Figure A.7: Steam turbo-alternator diagram.....	185
Figure A.8: Gas turbine diagram.....	187
Figure A.9: Electric distribution diagram.....	188
Figure A.10: Sea water circuit diagram.....	191
Figure A.11: Fresh water generator diagram.....	193
Figure A.12: Reverse osmosis unit diagram.....	195
Figure A.13: Fresh water distribution circuit.....	196
Figure A.14: Fresh Water Cooling System diagram.....	198
Figure A.15: Fuel circuit diagram.....	199
Figure A.16: Fuel separator detail diagram.....	200

Figure A.17: Oil-fired boiler and steam circuit diagram.....	202
Figure A.18: Oil-fired and waste heat recovery boilers diagram.....	204
Figure A.19: Condenser diagram .....	205
Figure A.20: Oil-fired boiler burners diagram .....	207
Figure A.21: HVAC system diagram.....	208
Figure B.1: (PV) and (TS) diagrams of the Diesel cycle.....	211
Figure B.2: Typical cycle for a real diesel engine.....	212
Figure C.1: Idealized vapour compression refrigeration cycle .....	219



# LIST OF TABLES

---

Table 1: Assessment of potential reductions of CO <sub>2</sub> emissions from shipping by using known technology and practices, according to IMO [6].....	32
Table 1.1: Comparison of energy and exergy.....	42
Table 1.2: Exergy analysis of Zarqua's power plant .....	46
Table 2.1: Comparison between a complicated and a complex problem.....	54
Table 2.2: Comparison between analytical and systemic approach.....	56
Table 2.3: Comparison between analytical and empirical approach.....	59
Table 2.4: Comparison between causal and acausal models.....	60
Table 2.5: Comparison between the "Energy flow" approach and the "Fluid circuit" approach .....	66
Table 2.6: Potential and flow variables for different physical fields in Modelica.....	69
Table 2.7: Content of Modelica Standard Library.....	71
Table 3.1: Main characteristics of cruises selected for verification .....	89
Table 3.2: STX and SEECAT data comparison for the first cruise.....	90
Table 3.3: Design alternatives' fuel consumption comparison in summer conditions .....	100
Table 3.4: Design alternatives' emissions comparison in summer conditions .....	100
Table 3.5: Design alternatives' fuel consumption comparison in winter conditions.....	100
Table 3.6: Design alternatives' emissions comparison in winter conditions.....	101
Table 4.1: Comparison of specifications and requirements among various diesel engines modelling approaches.....	115
Table 4.2: Engine thermal balance: list of output and input power flows and corresponding equations.....	118
Table 4.3: Comparison between two complete thermal balances of engine A.....	121
Table 4.4: Distribution of heat losses (except radiation) for thermal balances A1 and A2.....	122
Table 5.1: Energetic and exergetic content of engine A output power.....	156
Table 5.2: Standard simulation parameters.....	160
Table 5.3: Energy and exergy flows for engine A with cooling and exhaust system.....	162





# NOMENCLATURE

---

$An$	Energy production or exergy destruction	[J]
$an$	Specific energy	[J/kg]
$C$	Heat capacity	[J·K <sup>-1</sup> ]
$c$	Specific heat capacity	[J·K <sup>-1</sup> ·kg <sup>-1</sup> ]
$Ex$	Exergy	[J]
$ex$	Specific exergy	[J/kg]
$H$	Enthalpy	[J]
$h$	Specific enthalpy	[J/kg]
$\dot{m}$	Mass flow	[kg/s]
$n$	Number	-
$P$	Power	[W]
$p$	Pressure	[Pa]
$pr$	Pressure ratio	-
$Q$	Heat	[J]
$\dot{Q}$	Heat transfer rate	[W]
$r$	Specific perfect gas constant	[J·K <sup>-1</sup> ·kg <sup>-1</sup> ]
$S$	Entropy	[J·K <sup>-1</sup> ]
$s$	Specific entropy (J·K <sup>-1</sup> ·kg <sup>-1</sup> )	[J·K <sup>-1</sup> ·kg <sup>-1</sup> ]
$T$	Temperature (K)	[K]
$V$	Volume	[m <sup>3</sup> ]
$W$	Work	[J]
$\dot{W}$	Work rate	[W]

▪ **Greek letters:**

$\gamma$	Adiabatic index	-
$\underline{\Delta}k^0$	Specific chemical exergy of a fuel	[J/kg]
$\varepsilon$	Effectiveness	-
$\eta$	Efficiency	-
$\theta$	Carnot factor ( $1-T_a/T$ )	-
$\lambda$	Air-fuel equivalence ratio or air excess ratio	-
$\tau$	Torque	[N · m]
$\omega$	Rotary velocity	[rad/s]
$\phi$	Fuel-air equivalence ratio	-

▪ **Subscript:**

<i>a</i>	Ambient
<i>b</i>	Brake
<i>cal</i>	Calorific
<i>ch</i>	Chemical
<i>cs</i>	Cycle per second
<i>D</i>	Delivered
<i>e</i>	Output quantity across port e
<i>elec</i>	Electric
<i>en</i>	Energy
<i>ER</i>	Exhaust receiver
<i>ex</i>	Exergy
<i>exh</i>	Exhaust
<i>ext</i>	External
<i>frigo</i>	Frigorific
<i>fw</i>	Fresh water
<i>i</i>	Input quantity across port i – Indicted
<i>int</i>	Internal
<i>mech</i>	Mechanical
<i>p</i>	At constant pressure
<i>PC</i>	Post-combustion
<i>prop</i>	Propeller
<i>ref</i>	Reference
<i>s</i>	Isentropic
<i>stoich</i>	Stoichiometric
<i>sw</i>	Sea water
<i>t</i>	Total
<i>th</i>	Thermomechanical / thermal

▪ **Acronyms and abbreviations:**

AHRP	Advanced Heat Recovery Plant
ASFC	Average Specific Fuel Consumption
BMEP	Brake mean effective pressure (Pa)
BSFC	Brake specific fuel consumption (g/kWh)
CFD	Computational Fluid Dynamic
COP	Coefficient Of Performance
CPP	Controllable pitch propeller
CR	Compression ratio
DG	Diesel Generator
DO	Diesel oil
EEDI	Energy Efficiency Design Index
EEOI	Energy Efficiency Operational Index
FLT	First law of thermodynamics
FMEP	Friction mean effective pressure (Pa)
FO	Fuel oil
FPP	Fixed pitch propeller
FWG	Fresh Water Generator
GDP	Gross domestic product
GHG	Greenhouse gases
HFO	Heavy fuel oil
HHV	Higher heating value (J/kg)
HT	High Temperature
HVAC	Heating Ventilation and Air Conditioning
IMEP	Indicated mean effective pressure (Pa)
IMO	International Maritime Organization
IPCC	Intergovernmental Panel on Climate Change
LFO	Light fuel oil
LHV	Lower heating value (J/kg)
LNG	Liquefied natural gas
LO	Lubrication oil
LT	Low Temperature
Lub.	Lubricating
MCR	Maximum continuous rating (engine power)
MDO	Marine Diesel oil
MVEM	Mean Value Engine Model
NO <sub>x</sub>	Nitrogen oxides: NO and NO <sub>2</sub>

OECD	Organisation for Economic Co-operation and Development
OFB	Oil Fired Boiler
ORC	Organic Rankine Cycle
PMS	Power management system of the ship's electrical power plant
RCP	Representative Concentration Pathways
ROPU	Reverse osmosis production unit
SAC	Scavenge air cooler
SEECAT	Ship Energy Efficiency Calculation and Analysis Tool
SEEMP	Ship Energy Efficiency Management Plan
SLT	Second law of thermodynamics
SO <sub>x</sub>	Sulphur oxides
SRES	Special Report on Emissions Scenarios
WHR	Waste Heat Recovery



# THESIS ORGANISATION

---

The present document is mainly composed of an introduction, five chapters, a general conclusion and appendices. The two first chapters are bibliographic reviews and theoretical presentations concerning respectively the concept of exergy and modelling techniques applied to energetic systems. The last three present the development work.

The **Introduction** presents the environmental, economic and regulatory context and defines the study objectives.

**Chapter 1 “Ship Energy Efficiency”** starts by presenting the fundamental definitions, equations and notions relative to Energy and Exergy. A bibliographic review of energy and exergy analysis methods is then presented.

In **Chapter 2 “Ship Energy Modelling”**, a first part presents the theory of systemics. It is followed by a presentation of an energy modelling method and the Modelica modelling language.

**Chapter 3 “Holistic Modelling”** presents a first ship energy modelling approach based on power conversion. This approach is then applied to a real ship for which sea measurement data were available. The model produced is presented and its validation discussed. The use of this model is finally illustrated by comparing different ship design alternatives.

In **Chapter 4 “Engine Modelling”**, a limitation of the first ship energy modelling approach is answered by developing a new engine model. The objectives and constraints of the model are first discussed. The data available is then presented. The best suited modelling approach is selected based on a bibliographic review. The data available is then analysed and cleaned. The structure of the model and its equations are presented. Finally, the validity of the model is discussed.

**Chapter 5 “Fluid Circuit & Exergy Modelling”** introduces a second level approach called “circuit fluid” approach. This approach makes it possible to use the exergy analysis. It is applied to a ship main engine and its cooling and exhausts circuits. A set of ideas for energy and exergy saving is proposed.

A general **Conclusion** closes the main corpus of the thesis and proposes new work perspectives.

The **Appendices** contain in particular an extensive description of all the main energy circuits on board ships.





# INTRODUCTION

---

*“There is too much fossil energy on this planet to count on its limitation to save the climate but there is not enough of it to count on its abundance to restart the European economy”*

Jean Marc Jancovici [1]

<b>INTRODUCTION .....</b>	<b>23</b>
ENVIRONMENTAL CONTEXT.....	24
ECONOMIC CONTEXT .....	28
REGULATORY CONTEXT .....	29
DOCTORATE OBJECTIVES .....	31

## ENVIRONMENTAL CONTEXT

In September 2013, the Intergovernmental Panel on Climate Change (IPCC) has released the first part of its fifth assessment report, *The Physical Science Basis* [2]. This report, written by more than two hundred authors\*, reviewed by over a thousand experts compiles and synthesises† peer reviewed publications of thousands of scientists around the world‡. It offers the latest state of the art knowledge on climate change. This report is accompanied by a 33 pages long summary for policymakers [3]. This summary highlights the main conclusions of the full report. The most relevant conclusions of this report are presented below.

This report reminds us that climate change is a reality and that its consequences are already measurable:

*“Warming of the climate system is unequivocal, and since the 1950s, many of the observed changes are unprecedented over decades to millennia. The atmosphere and ocean have warmed, the amounts of snow and ice have diminished, sea level has risen, and the concentrations of greenhouse gases have increased.”*

Furthermore, this report leaves almost no doubt possible concerning the origin of climate change:

*“Human influence on the climate system is clear.[...] It is extremely likely§ that human influence has been the dominant cause of the observed warming since the mid-20th century.”*

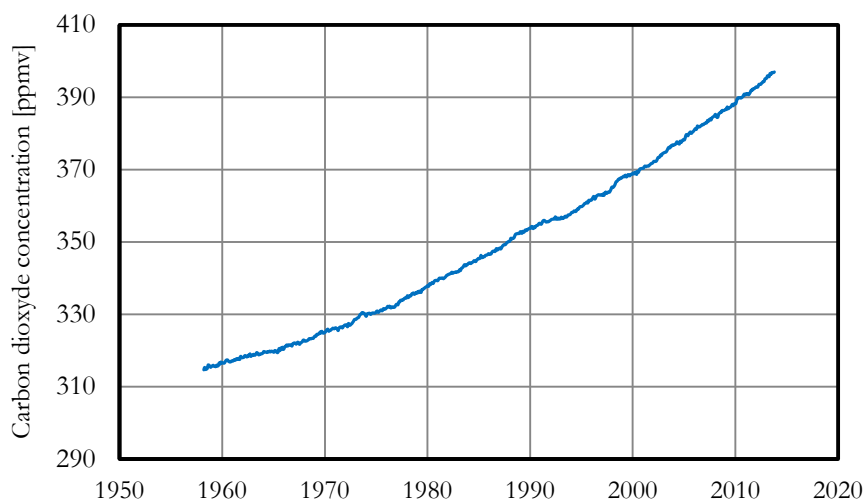

Figure 1: Atmospheric carbon dioxide concentrations measured at the Mauna Loa observatory in ppmv (part per million by volume)

The clearest sign of this “human influence” is the strong increase in carbon dioxide atmospheric concentration which is due mainly to fossil fuel combustion. The Mauna Loa observatory (Hawaii, USA) has continually recorded atmospheric CO<sub>2</sub> levels since 1956. Its data is publically available and serves as a reference in the scientific world. Between 1956 and 2012, atmospheric CO<sub>2</sub> concentration has increased

\* 209 lead authors, 50 review editors and over 600 hundred contributing authors

† The report is nevertheless more 2000 pages long

‡ Over 2 million gigabytes of numerical data from climate model simulations and over 9200 scientific publications cited

§ 95–100% probability

by over 25%. This increase is continuous and getting stronger with time (see Figure 1). More globally, the IPCC reports that:

*“The atmospheric concentrations of carbon dioxide, methane, and nitrous oxide have increased to levels unprecedented in at least the last 800,000 years. Carbon dioxide concentrations have increased by 40% since pre-industrial times, primarily from fossil fuel emissions and secondarily from net land use change emissions. The ocean has absorbed about 30% of the emitted anthropogenic carbon dioxide, causing ocean acidification”*

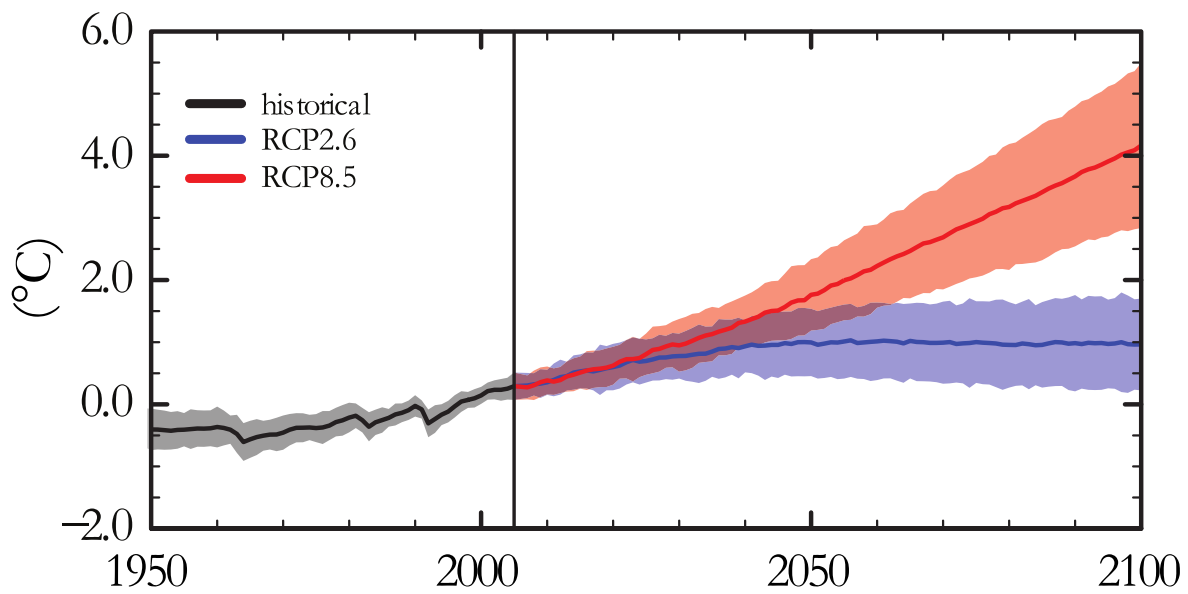

Figure 2: Global average temperature change. The black curve corresponds to the modelled historical temperature, the red one corresponds to scenario RCP8.5 and the blue one to scenario RCP2.6. These curves are obtained by averaging results of various models (more than 30 each). The shadings are a measure of uncertainty [3].

Historical emissions of greenhouse gases (GHG) have already modified the climate and will continue to do so for decades even if these emissions were to stop completely tomorrow. The damages done is almost irreversible but may still be manageable. Nevertheless, GHG emissions are due to continue and hence climate change worsen. The future evolution of the climate has been assessed by Van Vuuren et al [4] according to different scenarios. These scenarios are based on different hypothesis such as world population growth, world GDP\* growth, energy consumption growth and the evolution of the type of energy consumed (solar, wind, geothermal, hydraulic, bio-fuels, nuclear, gas, oil or coal). Climate models are used to evaluate the increase of global temperature following these different scenarios. Four scenarios called RCP, for Representative Concentration Pathways, were built. The future evolution of global average temperature is presented following two of these scenarios: the most optimistic and the most pessimistic ones (see Figure 2). For the sake of brevity, only the evolution of temperature is presented, nevertheless, global change is not limited to temperature change. The evolution of global ocean surface pH, sea levels, sea ice extent, levels of precipitation are other crucial points. For more details, interested readers can refer to the work already cited.

Scenario RCP2.6 is an optimistic scenario. The global mean temperature increase in 2081-2100 compared to 1986-2005 is likely to be in a range of “only” 0.3 °C to 1.7 °C. The temperature should settle down and

\* GDP: Growth Domestic Product

even decrease a little by 2100. Following this path would require great emission reduction efforts. On the other hand, scenario RCP8.5 is a pessimistic scenario in which emissions are not handled and continue to increase strongly. In such case, the temperature increase would be in a range of 2.6 °C to 4.8 °C. Moreover, the temperature would tend to continue increasing.

If these variations can seem small, it must be reminded that an average surface temperature difference of only 5 °C separates us from the previous glacial age and that the temperature evolution since 1950 is the fastest ever recorded [5]. The consequences on the environment and hence humanity could be dramatic.

Following either of these two paths is of crucial importance. It is a choice that belongs to every government, company and citizen.

The shipping industry can be seen as a small contributor to climate change. In 2009, the IMO\* published a report where the contribution of the total shipping industry† to the world global emissions was assessed to correspond to “only” 3.3% (see Figure 3) [6]. The figure is quite impressive bearing in mind that shipping is responsible for the transportation of 80% in volume of total merchandise [7]. Shipping is in fact a very efficient means of transportation. When the CO<sub>2</sub> emissions are related to the tonne of merchandise and the distance travelled, shipping is found to be more efficient than road transport in every case and more efficient than rail transport in a majority of cases (see Figure 4).

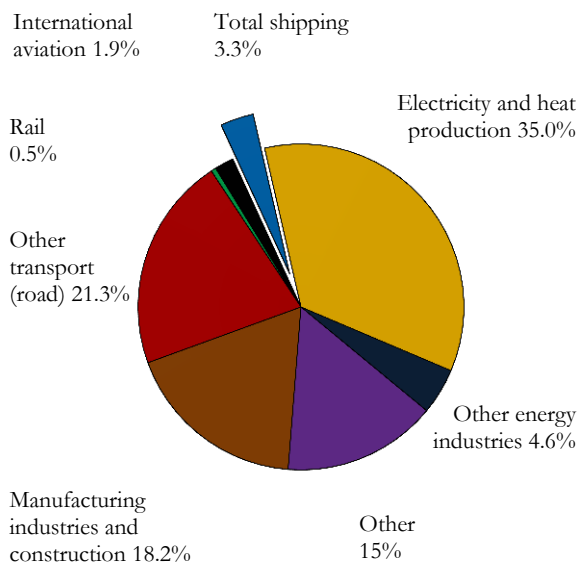

**Figure 3: Emissions of CO<sub>2</sub> from shipping compared with global total emissions. Shipping is estimated to have emitted 1,046 million tonnes of CO<sub>2</sub> in 2007, which corresponds to 3.3% of the global emissions during 2007 [6].**

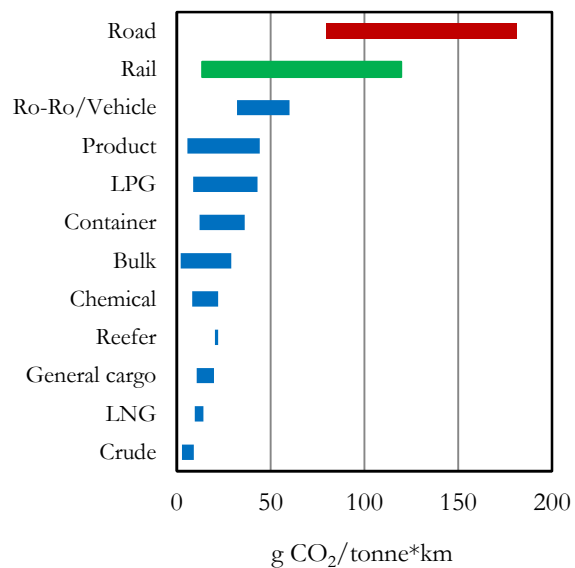

**Figure 4: Typical range of CO<sub>2</sub> efficiencies of ships compared with rail and road transport. Air freight is not presented on this figure but its CO<sub>2</sub> efficiency has been calculated to be in a range of 435 to 1800 g CO<sub>2</sub>/tonne\*km [6].**

\* International Maritime Organization: <http://www.imo.org/>

† International shipping plus domestic shipping and fishing

Nevertheless, efforts must be made to reduce CO<sub>2</sub> emissions. Historically, there always has been a strong link between economic growth and seaborne trade. Yet the world GDP growth was of 3.2% in 2012, 2.9% in 2013 and it is projected to be of 3.6% in 2014 [8]. If the world economy increases at a rate of 3% for the next 25 years then the world GDP will have more than doubled. GHG emissions due to shipping could hence increase in similar proportions. The future evolution of CO<sub>2</sub> emissions from international shipping has been assessed by the IMO based on SRES\* scenarios from the 2007 IPCC report [5]. The results are presented in Figure 5.

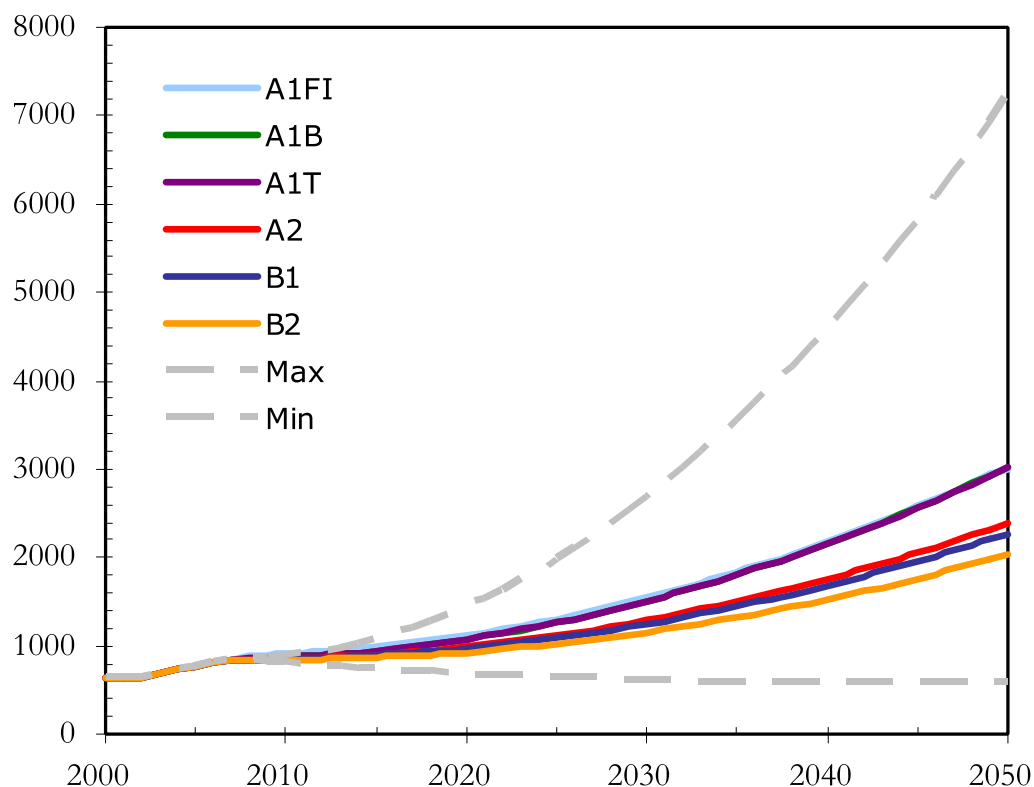

Figure 5: Trajectories of the CO<sub>2</sub> emissions from international shipping (million tonnes CO<sub>2</sub>/year). The coloured lines correspond to mean evolution according to IPCC 2007 report SRES scenarios [5]. The dashed lines correspond to the most optimistic and pessimistic scenarios [6].

The calculated emissions from shipping in 2050 vary over a wide range: from a multiplication by more than 7 in the worst case scenario to a small decrease in the best one. Nevertheless, the mean values of each scenario follow similar trends (indicating by the way a good reliability) were carbon dioxide emissions may grow by a factor 2 to 3 by 2050.

Proactive actions must be taken to avoid this foreseeable future. Such actions already exist or are in development. The IMO has estimated that technical and operational measures could possibly reduce GHG emissions by 25% to 75% compared to current levels (see section “Doctorate objectives” below). Some of these measures are cost-effective; others are not and will have to be supported by new binding policies to be put in place. Assessing accurately the fuel reduction and hence GHG emissions reduction of any measure is therefore essential for ship owners who will have to choose the best solution for the least investment. This is especially true given the constraint of high fuel prices.

\* Special Report on Emissions Scenarios

## ECONOMIC CONTEXT

The maritime industry is very dependent on fuel price. The overwhelming majority of commercial ships use fossil fuel energy to navigate (heavy fuel oil and diesel oil in vast majority and a bit of gas or coal) and fuel cost has become the second or first item in operational expenditures. This situation is not on the verge of changing favourably, as fuel prices have historically almost always increased (see Figure 6) and are physically bound to continue. The main reasons for that are:

- The limited resource: even if new stocks are discovered frequently the resource is physically limited. Certain regions have certainly already reached or passed their pick oil such as northern Europe.
- The increasing difficulty to extract oil: oil companies have to dig deeper and deeper to extract oil, increasing further the price in addition to increasing the risk of environmental pollutions.
- The decreasing quality of the extracted oil: as conventional oils become less available, oil companies have invested in the production of oil from new sources such as oil sands, oil shale and heavy crude oil. These unconventional sources require more energy and therefore more money to extract and transform.
- The increasing demand: even if the oil consumption of OECD\* countries has settled down or even decreased over the last decade, the world demand continues to increase strongly, mainly due to the increasing world population and its increasing living standard. This is particularly true for Asia with China and India (see Figure 7).

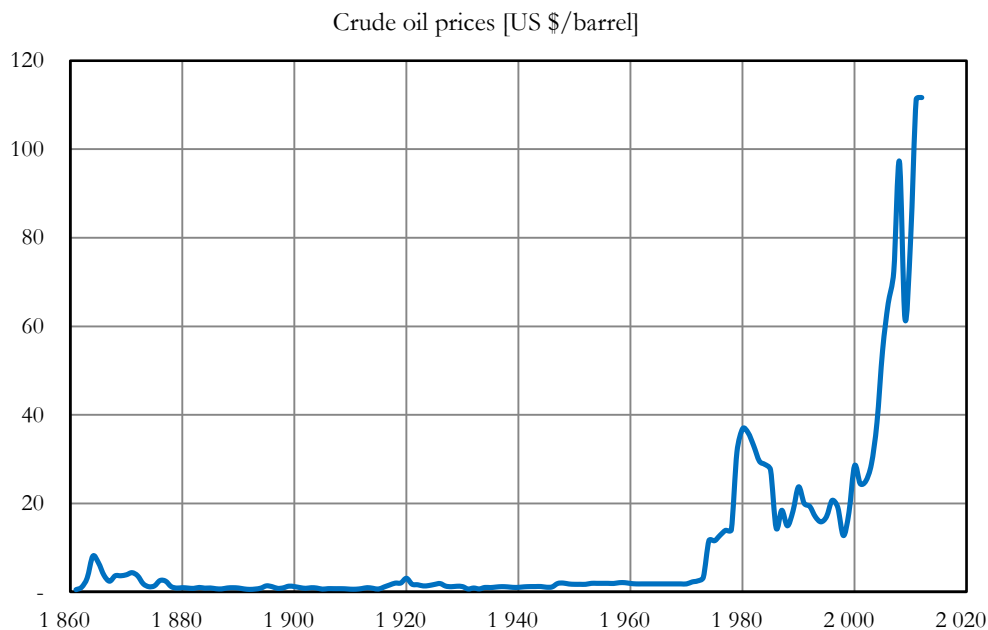

Figure 6: Crude oil prices trends since 1860 [9]

This long term trend towards high fuel prices is certainly a strong incentive to fuel consumption reduction. But it is not strong enough to guarantee the best fuel consumption reduction possible. Additional regulatory constraints are therefore necessary.

---

\* Organisation for Economic Co-operation and Development: list of 34 “developed” countries mainly including UE countries, North America countries, Turkey, Chili, Australia, New-Zealand, Japan and South-Korea.

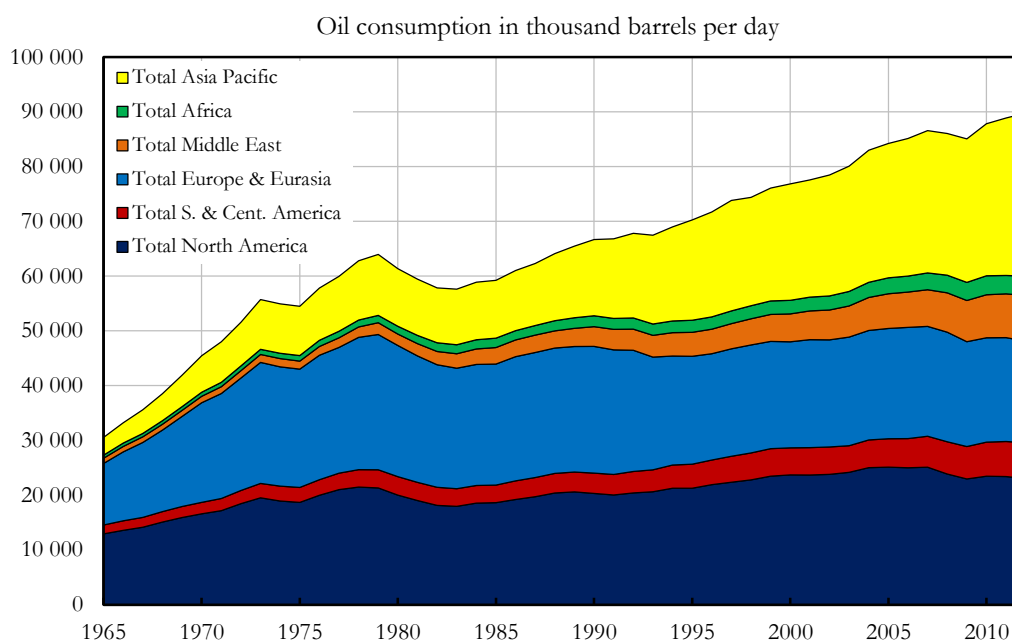

Figure 7: Oil consumption in thousand barrels per day since 1965 [9]

## REGULATORY CONTEXT

The strong scientific evidence for climate change and its major contributor, anthropogenic emissions, have led policy makers to take direct actions to reduce CO<sub>2</sub> emissions in the recent years: Kyoto protocol (1997), European Union reduction plan by 2020. Despite the fact that maritime transportation is the most carbon efficient way of motorized transportation, seaborne emission regulations have not been overlooked. The IMO has strengthened its regulations on NO<sub>x</sub> and SO<sub>x</sub> emissions and introduced CO<sub>2</sub> regulation with tools such as EEDI, EEOI and SEEMP.

### ▪ Energy Efficiency Design Index (EEDI)

The EEDI assesses the CO<sub>2</sub> performance of the ship design. It is evaluated at building stage and verified during sea trials [10]. The EEDI expresses a ratio between the environmental impact of shipping and the benefit enjoyed by the community from shipping. Equation (1) presents a simplified version of EEDI.

$$EEDI = \frac{\text{Impact to environment}}{\text{Benefit to society}} = \frac{\text{Power} \times \text{Fuel consumption} \times \text{CO}_2 \text{ emission factor}}{\text{Capacity} \times \text{Ship speed}} \quad (1)$$

The real equation of EEDI is rather complicated and takes into account energy consumers as well as specific features or needs such as energy recovery systems, the use of low-carbon fuels, the performance of ship in waves or the need for ice strengthening [11]. The EEDI is expressed in grams of CO<sub>2</sub> per capacity-mile, where “capacity” refers to the type of cargo the ship is designed to carry. For most ships, the “capacity” is expressed in deadweight tonnage\*.

---

\* The Deadweight tonnage is a measure (in tonnes) of how much weight a ship can safely carry. It is the sum of the weights of cargo, fuel, fresh water, ballast water, provisions, passengers, and crew.



The EEDI resolution [12] came into force on the 1<sup>st</sup> of January 2013. It applies to most ships types (bulk carrier, gas tanker, tanker, container ship, general cargo ship, refrigerated cargo, ro-ros, passenger ships) with the exception of working ships (offshore vessels, dredgers, supply vessels, tugs) and ships with specific propulsion systems (diesel-electric, turbine, hybrid). Ship with a gross tonnage\* lower than 400 are also exempted. All new ships concerned by the resolution must show an EEDI value lower than a regulatory baseline, otherwise the ship will not be allowed to navigate. The baseline depends on the ship type and is a decreasing function of the ship size. Moreover, this baseline is planned to reduce over the years, therefore increasing the incentive for energy efficient ship designs.

EEDI is a fixed performance indicator calculated for one operating point. It is not suited for energy efficiency monitoring in service. EEOI is more adapted for that purpose.

#### ▪ Energy Efficiency Operational Index (EEOI)

The basic principle of EEOI is similar to EEDI, it assesses the CO<sub>2</sub> performance of a ship. But unlike EEDI, EEOI is calculated for each leg of a voyage using the following formula [13]:

$$EEOI = \frac{\sum_j FC_j \times C_{F_j}}{m_{cargo} \times D} \quad (2)$$

Where:

- $j$  is the fuel type;
- $FC_j$  is the mass of consumed fuel  $j$ ;
- $C_{F_j}$  is the fuel mass to CO<sub>2</sub> mass conversion factor for fuel  $j$ ;
- $m_{cargo}$  is the cargo carried (tonnes) or work done (number of TEU<sup>†</sup> or passengers) or gross tonnes for passenger ships; and
- $D$  is the distance in nautical miles corresponding to the cargo carried or the work done.

The EEOI is expressed in the same unit as EEDI, that is to say in grams of CO<sub>2</sub> per capacity-mile. It also measures the ship energy efficiency in service.

For the moment EEOI monitoring is not mandatory. But it can be used, on a voluntary basis, to build the SEEMP.

#### ▪ Ship Energy Efficiency Management Plan (SEEMP)

To help shipping companies manage the CO<sub>2</sub> efficiency of their fleet, the IMO has developed and defined a new tool: the SEEMP [14]. This tool is put into practice by following four phases that form a cycle:

- **Planning:** in this phase, the main actions of the SEEMP are to assess current ship energy usage, to identify energy-saving measures that have already been implemented and evaluate their effectiveness and to list future potential improvements. Of course, these measures depend on the ship type, size and operation. To insure the best implementation possible, several additional actions are recommended:

---

\* Gross tonnage is a unitless index related to a ship's overall internal volume. It is not a physical measure but rather an administrative one. It is used notably for ship's manning regulations, safety rules, registration fees, and port dues.

† Twenty-foot Equivalent Unit (TEU): unit used to describe the capacity of container ships based on the volume of a 20-foot-long (6.1 m) intermodal container.

involve all ship stakeholders (ship repair yards, ship-owners, operators, charterers, cargo owners, ports and traffic management services), provide crew training and set emission reduction goals.

- **Implementation:** the actions identified in the previous phase are implemented.
- **Monitoring:** the efficiency of these actions should be monitored quantitatively (this can be done using EEOI).
- **Self-evaluation and improvement:** in this final phase, a critical review of the first three phases is made. The effectiveness of the actions implemented and their implementation are self-evaluated in order to produce relevant feedback for the following improvement cycle.

In the end the SEEMP takes the form of a document. Whilst the presence of this document on board of every ship is mandatory, for now the content of it is overlooked.

The three tools, EEDI, EEOI and SEEMP have been implemented in the MARPOL Annex 6 [15] which is the IMO convention for the Prevention of Pollution From Ships. They constitute a first regulatory step towards increasing ship energy efficiency.

## DOCTORATE OBJECTIVES

The maritime industry is hence facing three challenges: environmental - due to the greenhouse effect and climate change as well as pollutant emissions, economic - due to increasing bunker fuel price, and regulatory - with new laws. All three challenges can be met through one single measure: reducing fuel consumption.

This can be achieved through various measures (see Table 1), such as optimizing hull shape and propeller design to ensure lower propulsion power or improving the efficiency of machinery equipment or systems (for example diesel engines, electrical motors, alternators, boilers, distillers, pumps, turbines, etc.). Reducing fuel consumption can also be achieved by changing the operational cycle such as adopting ship speed reduction (slow steaming). A combination of these techniques and often all of them together are used in new ship design. A new ship may boast a new engine that effectively consumes 5% less fuel. It may also have a new hull that presents 5% less hydrodynamic resistance. But in the end the ship may not consume 9.75%\* less fuel. This is to do with the complexity of a ship. A ship is composed of many devices producing and consuming energy and there are many interactions amongst them. For instance reducing speed or hydrodynamic resistance leads to lower mechanical power requirement and hence lower fuel consumption. But it also leads to less thermal energy loss which is often recovered on board for various purposes (for example bunker fuel heating, cabin heating, fresh water production using distillers, sanitary water heating, steam production, etc.). Less thermal energy may lead in certain cases to starting an oil fired boiler and hence increase fuel consumption. This simple theoretical example illustrates the complexity of ships and the fact that calculating energy consumption is neither direct nor obvious.

This thesis offers to meet this complexity and will provide methods and tools to assess correctly means of fuel reduction. In particular, a simulation platform, called SEECAT, will be developed for that goal. The systems approach will help grasp the complex nature of ships and help define the best modelling approach. The exergy concept will allow a better understanding of the different energetic processes at stake as well as determining more accurately the true energy saving potentialities.

---

\*  $1 - 0.95^2 = 0.0975$

Moreover, holistic ship energy and exergy modelling are growing topics in the maritime industry and academic world. They nevertheless suffer from a limited literature background. And to that extent, this thesis should constitute an innovative work.

**Table 1: Assessment of potential reductions of CO<sub>2</sub> emissions from shipping by using known technology and practices, according to IMO [6]**

	Saving of CO <sub>2</sub> /tonne-mile	Combined	Combined
<b>DESIGN (New ships)</b>			
Concept, speed and capability	2% to 50%*		
Hull and superstructure	2% to 20%		
Power and propulsion systems	5% to 15%		
Low-carbon fuels	5% to 15%†	10% to 50%*	
Renewable energy	1% to 10%		25% to 75%*
Exhaust gas CO <sub>2</sub> reduction	0%		
<b>OPERATION (All ships)</b>			
Fleet management, logistics & incentives	5% to 50%*		
Voyage optimization	1% to 10%	10% to 50%*	
Energy management	1% to 10%		

† CO<sub>2</sub> equivalent, based on the use of LNG

\* Reductions at this level would require reductions of operational speed

### Objectifs de la thèse

L'industrie maritime fait donc face à trois défis : le défi environnemental dû aux gaz à effet de serre et au dérèglement climatique, le défi économique dû à l'augmentation continue du prix du fioul et le défi réglementaire dû aux nouvelles lois. C'est trois défis peuvent être relevés grâce à une unique mesure : la réduction de la consommation de fioul.

Cette réduction de consommation peut être obtenue de plusieurs manières (voir tableau 2), telle que l'optimisation de la forme de la carène et des hélices afin de diminuer la puissance propulsive ou l'amélioration du rendement des différents systèmes à bord (par exemple les moteurs diesel, les moteurs électriques, les alternateurs, les chaudières, les bouilleurs, les pompes, les turbines, etc.). La réduction de la consommation peut également être obtenue en agissant sur le profil opérationnel en réduisant par exemple la vitesse. Une combinaison de ces méthodes et souvent toutes ces méthodes à la fois sont utilisées lors de la conception de nouveaux navires. Un nouveau navire peut par exemple avoir des moteurs diesel consommant 5 % de fioul en moins, ainsi qu'une coque réduisant la résistance hydrodynamique de 5 %. Mais à la fin, l'ensemble ne consommera pas nécessairement 9.75 %\* de fioul en moins. Ceci est dû à la complexité des navires. Les navires sont composés de multiples machines produisant et consommant de l'énergie et il peut y avoir des nombreuses interactions entre ces machines. Par exemple, réduire la vitesse du navire ou sa résistance hydrodynamique aura pour effet une moindre demande de puissance mécanique et donc une moindre consommation de fioul des moteurs. Mais cette baisse de la consommation aura pour effet direct une baisse de la puissance thermique disponible, puissance thermique qui est souvent récupérée et qui assure de multiples

\*  $1 - 0.95^2 = 0.0975$

besoins (par exemple le chauffage des soutes à combustible pour les tankers et plus généralement le chauffage des cabines, la production d'eau douce grâce aux bouilleurs, la production d'eau chaude sanitaire, la production de vapeur, etc.). Cette baisse de la consommation de fioul des moteurs pourrait ainsi, dans certains cas, entraîner un démarrage des chaudières à bruleurs pour pallier ce manque de puissance thermique et ainsi ré-augmenter la consommation globale de fioul du navire. Ce simple exemple théorique permet d'illustrer la complexité des navires et montre comment le calcul de la consommation énergétique d'un navire n'est ni direct ni évident.

Cette thèse aborde cette complexité et propose des méthodes et des outils afin d'évaluer correctement des solutions pour réduire la consommation des navires. Une plateforme de simulation, appelée SEECAT, sera notamment développée à cet effet. L'approche système permettra de gérer la nature complexe des navires et aidera à définir la meilleure approche de modélisation à suivre. Le concept d'exergie permettra une meilleure compréhension des différents processus énergétiques à l'œuvre et une meilleure évaluation des gains énergétiques potentiels.

De plus, la modélisation énergétique et exergetique globale des navires est un sujet émergent dans le monde de l'industrie maritime et le monde académique. Ce sujet est malheureusement mal documenté dans la littérature spécialisée. Cette thèse se veut donc être une contribution innovante à ce sujet.

**Tableau 2: Évaluation des réductions potentielles d'émissions de CO<sub>2</sub> du transport maritime en ayant recours à des pratiques et des technologies connues (selon l'Organisation Maritime Internationale [6])**

	Économie de CO <sub>2</sub> /tonne-mile	Combinées	Combinées
<b>CONCEPTION (bateau neuf)</b>			
Conception, vitesse et capacité	2 % à 50 %*		
Coque et superstructure	2 % à 20 %		
Puissance et systèmes propulsifs	5 % à 15 %	10 % à 50 %*	
Carburant à faible teneur en carbone	5 % à 15 %†		
Énergies renouvelables	1 % à 10 %		25 % à 75 %*
Réduction de CO <sub>2</sub> des gaz d'échappement	0 %		
<b>OPÉRATION (tous navires)</b>			
Gestion de la flotte, logistique et incitations	5 % à 50 %*		
Optimisation du routage	1 % à 10 %	10 % à 50 %*	
Gestion de l'énergie	1 % à 10 %		

† En équivalent CO<sub>2</sub>, basé sur l'usage de gaz naturel liquéfié

\* Des réductions à ce niveau nécessitent une baisse de la vitesse de croisière



# CHAPTER 1

## SHIP ENERGY EFFICIENCY

---

<b>CHAPTER 1 SHIP ENERGY EFFICIENCY.....</b>	<b>35</b>
1.1 ENERGY AND EXERGY FUNDAMENTALS.....	36
1.1.1 Energy.....	36
1.1.1.1 First law of thermodynamics.....	37
1.1.1.2 Second law of thermodynamics.....	38
1.1.2 Exergy.....	40
1.1.2.1 Definition of exergy.....	40
1.1.2.2 Properties of exergy.....	41
1.1.2.3 Reference environment.....	42
1.1.2.4 Exergy of thermal heat.....	42
1.1.2.5 Exergy loss and exergy destruction.....	43
1.1.2.6 Conclusion concerning exergy.....	44
1.2 ENERGETIC AND EXERGETIC ANALYSIS.....	44
1.2.1 <i>Application to thermal power plant</i> .....	44

Saving energy is the most straightforward and efficient way of reducing carbon dioxide emissions and it can possibly save money. But in order to save energy, it is essential to correctly assess it. That is especially the case for complex systems such as ships where energy exists in many forms (thermal - steam, cooling water or lubrication oil, mechanical - engine shaft rotation or propeller thrust, chemical - fuel and electricity) and undergoes many transformations (combustion, expansion, compression, heating, cooling, etc.). Correctly understanding and representing the complete set of energy flows and transformations on board ships is the first step towards energy saving. To that extent, the concept of exergy will help understanding the different energy processes at stake and the different energy saving potentialities.

In this chapter, the theory fundamentals of energy and exergy will be presented. It will be followed by the presentation of energy and exergy analysis applied to power plants.

*Les économies d'énergie sont le moyen le plus simple et le plus direct de réduire les émissions de dioxyde de carbone et permettent éventuellement d'économiser de l'argent. Mais afin d'économiser de l'énergie, il est au préalable nécessaire de correctement la quantifier. Ceci est d'autant plus vrai pour les systèmes complexes tels que les navires où l'énergie existe sous plusieurs formes (sous forme thermique avec la vapeur, l'eau de refroidissement des moteurs et l'huile de lubrification, sous forme mécanique avec le travail de l'arbre moteur ou la poussée de l'hélice, sous forme chimique avec les différents combustibles ou encore sous forme électrique) et subissent de multiples transformations (combustion, détente, compression, chauffage, refroidissement, etc.). Correctement comprendre et représenter ces ensembles de flux d'énergie et de transformations est la première étape vers d'éventuelles économies d'énergie. À cet égard, le concept d'exergie permettra de mieux comprendre les différents processus énergétiques à l'œuvre et de mieux évaluer les possibilités d'économies d'énergie.*

*Dans ce chapitre, les fondamentaux théoriques de l'énergie et de l'exergie seront présentés. Ils seront suivis d'une présentation sur l'analyse énergétique et exergétique appliquée aux centrales électriques.*

## 1.1 ENERGY AND EXERGY FUNDAMENTALS

Exergy is a concept that stems from thermodynamics; it is also a physical quantity, similar to energy, measured in Joules or its derivatives. The term was first introduced by a Slovenian scientist, Zoran Rant in 1956 [16]. It is also synonymous with: availability, available energy, exergic energy, essergy, utilizable energy, available useful work, maximum (or minimum) work, maximum (or minimum) work content, reversible work, and ideal work.

To fully understand the concept of exergy, it is necessary to first present the basic rules of thermodynamics. Thermodynamic is the science of energy transfers. It is mainly ruled by two laws: the first law of thermodynamic that states that for any energetic process (except nuclear reactions) energy is conserved; and the second law of thermodynamic that states that not all energetic processes are possible.

### 1.1.1 Energy

Energy is a physical quantity measured in Joules or its derivatives. It exists in various forms:

- Mechanical energy: it can take several forms, the energy associated with the motion of an object is called kinetic energy, the energy associated with the position of an object is called gravitational potential energy and the energy associated with the force that causes the motion of an object is called work.
- Electrical energy: the potential energy linked to an electrical charge into an electrical field
- Magnetic energy: the potential energy linked to a magnet into a magnetic field

- Radiant energy: it is a combination of the two preceding energies, it is the energy of electromagnetic waves or particle. The most common form of radiant energy is the energy of the sun light. X-rays,  $\gamma$ -rays, ultraviolet and infrared light and also radio and microwaves have radiant energy.
- Chemical energy: potential energy linked to the electronic structure of molecules. Chemical energy is released or gained through chemical reactions. Combustion is a chemical reaction where energy is released, the process of charging a battery is a chemical reaction that consumes energy.
- Nuclear energy: potential energy linked to the cohesion of the nucleons inside an atom's nucleus. This energy can be released via nuclear reactions such as fission and fusion.
- Heat energy: the energy transferred from a body to another via a thermal process (convection, conduction or radiation)

In thermodynamics, these different forms of energy can be classified into two groups: macroscopic and microscopic energy. Macroscopic forms of energy are linked to the overall system such as the kinetic and potential energy of the system. The microscopic form of energy is the energy linked to the molecular structure inside the system. The molecules inside the system have also kinetic and potential energy. The microscopic kinetic energy is due to the motion of each particle inside the system (translation, rotation, vibration). The microscopic potential energy includes chemical, nuclear, electric, magnetic and gravitational potential energy. The sum of all microscopic energies is called **internal energy**.

Therefore, all systems have multiple forms of energy and measuring or calculating each one of them can be very difficult and time consuming. Assessing the absolute energy of a system is therefore almost impossible. On the contrary, energy variations through transformations are much easier to access. Here is a list of transformation examples:

- A combustion process transforms the chemical energy of fuel into heat
- A heat engine transforms heat into mechanical force
- A wind turbine transforms the kinetic energy of wind into mechanical energy
- An alternator transforms mechanical energy into electricity
- An electrical engine transforms electricity into mechanical energy
- A solar panel transforms solar energy (electromagnetic energy of the sun light) into electricity
- A power dam transforms the potential energy of water into mechanical energy
- A electrical battery can transform chemical energy into electricity and vice versa
- The photosynthesis process is used by plants to convert the light's energy into chemical energy

### **1.1.1.1** *First law of thermodynamics*

The first law of thermodynamics states that energy can neither be created, nor destroyed, but can only change form. This law is the **law of the conservation of energy**. An equivalent statement is that the energy of an isolated system is constant.

It is necessary to introduce the following definitions:

- Open system: a system which can exchange energy and matter with its surrounding, e.g., turbines, pumps, internal combustion engines.
- Closed system: a system which can exchange only energy (no matter) with its surrounding, e.g., cooling loops, refrigerating circuit, water circuits in Rankine cycles.
- Isolated system: a system which cannot exchange, neither energy nor matter with its surrounding. The only true isolated system known is the universe as a whole.



Given the following variables:

- $W$ : work exchanged between the system and its surrounding,
- $Q$ : thermal energy (or heat) exchanged between the system and its surrounding,
- $e$ : electrical energy exchanged between the system and its surrounding,
- $\Delta U$ : internal energy variation,
- $\Delta E_p$ : external potential energy variation,
- $\Delta E_c$ : external kinetic energy variation,
- $\Delta E_e$ : electric energy variation,

the first law of thermodynamics can be written as:

$$W + Q + e + \dots = \Delta U + \Delta E_p + \Delta E_c + \Delta E_e + \dots \quad (1.1)$$

The left part of equation (1.1) corresponds to energy exchanged between the system and the environment. The right part corresponds to energy variation in the system itself. Both parts of the equation provide space for possible additional energies such as light, nuclear or chemical energies. For a thermomechanical system, that is to say a system where only mechanical and thermal energy variations and exchange occur, equation (1.1) can be simplified into:

$$W + Q = \Delta U + \Delta E_p + \Delta E_c \quad (1.2)$$

If a motionless system is considered:  $\Delta E_p = 0$  and  $\Delta E_c = 0$  and therefore, equation (1.2) becomes:

$$W + Q = \Delta U \quad (1.3)$$

The first law of thermodynamics is the law of energy equivalence or energy conservation. According to this law, energy must be conserved throughout any energetic process. Spontaneous (natural) processes have a preferred direction of evolution. For example heat always flows from hot to cold reservoirs and never the opposite unless work is provided\*. This restriction is due to the second law of thermodynamics.

### 1.1.1.2 Second law of thermodynamics

Sadi Carnot is credited to be the first to formulate the second law of thermodynamics. Modern statements of the second law use the concept of **entropy**  $S$ . Entropy is a state function which expresses a measure of disorder or randomness and has for unit Joules per Kelvin (J/K). The entropy of a thermodynamic system can change under the influence of internal entropy creation ( $\delta S_{int}$ ) and entropy exchange with the surrounding ( $\delta S_{ext}$ ):

$$dS_{system} = \delta S_{int} + \delta S_{ext} \quad (1.4)$$

---

\* According to the first law only, exotic energetic process could occur: a ship could for example cool down the sea to navigate, which is of course impossible

Each time the system receives or gives away heat to its surrounding (environment or thermal sources) it receives or gives away entropy:

$$\delta S_{ext} = \frac{\delta Q}{T} \quad (1.5)$$

Where  $T$  is the temperature of the surrounding.

The creation of internal entropy depends on the quality of the transformation:

- $\delta S_{int} = 0$  for a reversible process (ideal process)
- $\delta S_{int} > 0$  for an irreversible process (real process)
- $\delta S_{int} < 0$  impossible (nonphysical process)

This definition highlights the notions of reversible and irreversible processes. A thermodynamic transformation that brings a system X from state A to state B requiring (or producing) an amount of energy  $E$  is said to be **reversible** if its inverse transformation (going from state B to state A) produces (or requires) the same amount of energy  $E$  (see Figure 1.1). Reversible transformations are ideal transformations that can only be approached in laboratories. In the real world all transformations are irreversible. Known sources of irreversibilities are dissipative work (fluid and solid friction), non-isothermal heat transfers (as a matter of fact all useful heat transfers), mixing of matter at different temperatures and spontaneous chemical reactions (for example combustion).

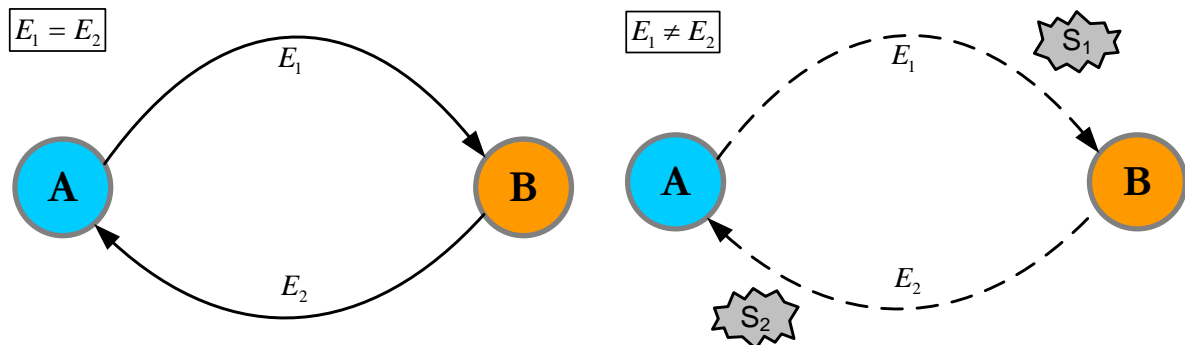

(a) Reversible process: going from state A to state B and back requires or produces the same energy  $E = E_1 = E_2$  (b) Irreversible process: each transformation creates entropy, and  $E_1 \neq E_2$

**Figure 1.1: Illustration of reversible and irreversible processes**

The entropy function can be difficult to understand, because:

- it is measured in J/K, which is a non-intuitive unit;
- it is a “pessimist” function, as it increases with imperfection.

These two limitations explain why entropy is a difficult concept to comprehend and manipulate. The concept of **exergy** takes into account irreversibilities in a manner which is more comprehensible than entropy. In fact the second law of thermodynamics can be redefined as the principle of exergy destruction linked to irreversibilities [17].

**Note:** For more details about the nature of energy and the first and second law of thermodynamics, readers can refer to the book of Michel Feidt : *Energétique : Concepts et applications - Cours et exercices corrigés* [18].

## 1.1.2 Exergy

**Exergy** ( $Ex$ ) and its counterpart **anergy** ( $An$ ) are physical quantities similar to energy and are measured in Joules (J). The concept of exergy tries to unify the first and the second law of thermodynamics: exergy is conserved through reversible processes but is destroyed when irreversibilities occur (2<sup>nd</sup> law) – the destruction of exergy is compensated for by the creation of anergy as the sum of exergy and anergy of a system remains constant (1<sup>st</sup> law) (see Figure 1.2).

**Note:** In this document, the quantity of exergy will alternatively be expressed as simple exergy, noted  $Ex$  in Joules (J), as specific exergy, noted  $ex$ , in Joules per kilogram (J/kg) or as exergy flow, noted  $\dot{Ex}$  in Watts (W) and therefore similar to power.

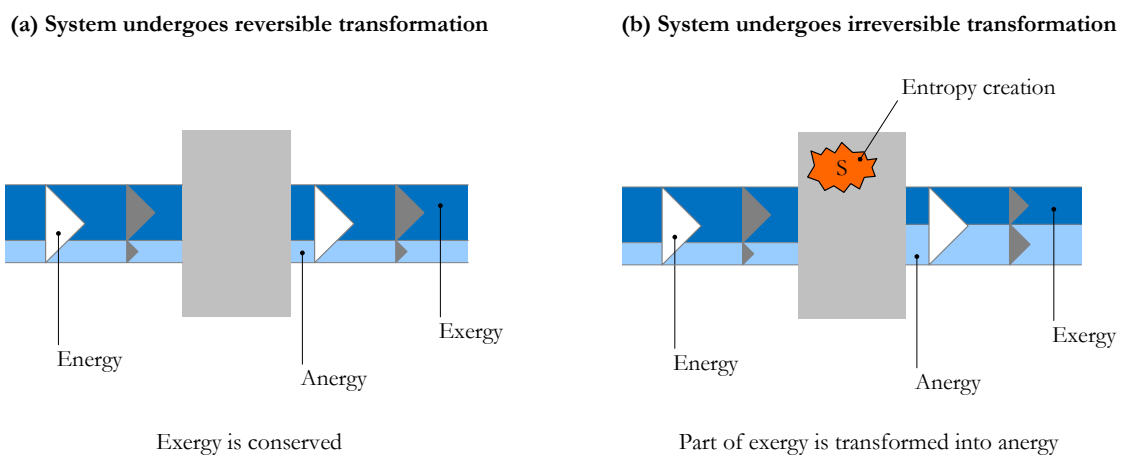

Figure 1.2: Schematic diagram showing energy, exergy and anergy flows through a closed system transformation, source A. Lallemand [17]

### 1.1.2.1 Definition of exergy

Dincer and Rosen give a short definition of exergy [19]:

The exergy of a system is defined as the maximum shaft work that can be done by the composite of the system and a specified reference environment

The specific exergy of a fluid is the addition of its thermomechanical and chemical exergy [20]:

$$ex = ex_{th} + ex_{ch} \quad (1.6)$$

The chemical exergy of a system is defined as the exergy of this system when the system is in thermal and mechanical equilibrium with its environment, that is to say, when the system has the same pressure and temperature as its environment. Applied to fuels, the chemical exergy of a system is the maximum work associated with its combustion at ambient pressure and temperature [21]. The calculation of the chemical exergy of a system is a delicate matter which is out of the scope of this thesis. Interested readers can refer to the book “Thermodynamique et Énergétique” from Borel et Favrat [22]. Nevertheless, for practical reasons, in this thesis, the exergy of fuels will be considered as equal to their lower heating value  $LHV$ :

$$Ex_{ch_{fuel}} = LHV \quad (1.7)$$

The thermomechanical exergy of a system is the counterpart of its chemical exergy. It corresponds to the maximum theoretical work achievable for a fluid evolving between any state in chemical equilibrium with the environment and a state of equilibrium with the environment. The following mathematical definition of thermomechanical exergy is given for open systems:

$$ex_{th} = h_t - h_{T_a} - T_a(s - s_a) \quad (1.8)$$

Where:

- $T_a$  is the temperature of the reference environment (K);
- $h_t$  is the total specific enthalpy\* of the fluid (J/kg);
- $h_{T_a}$  is the total specific enthalpy of the fluid at the temperature  $T_a$  (J/kg);
- $s$  is the specific entropy of the fluid (J/K.kg);
- and  $s_a$  is the specific entropy of the fluid at the temperature  $T_a$  (J/K.kg).

The counterpart of exergy, anergy  $an$  is defined as:

$$an = T_a(s - s_a) \quad (1.9)$$

And hence:

$$h_t - h_{T_a} = ex_{th} + an \quad (1.10)$$

Enthalpy and entropy are state functions and therefore their values are defined to within a constant. If the total specific enthalpy and specific entropy of the fluid at ambient temperature are set to 0, then equation (1.10) becomes:

$$h_t = ex_{th} + an \quad (1.11)$$

**N.B.:** For the rest of this document, when not explicitly specified, the notation " $ex$ " will apply to thermomechanical exergy and not total exergy (see equation (1.6))

### 1.1.2.2 Properties of exergy

Exergy has the following characteristics [19]:

- A system in complete equilibrium with its environment (same temperature, pressure, concentration) has no exergy
- The more a system deviates from its environment, the more exergy it has

---

\* The enthalpy  $H$  of a thermodynamic system is the sum of its internal energy  $U$  and its energy  $PV$  it has used to occupy the volume  $V$  under the pressure  $P$ :  $H = U + PV$

- Exergy is conserved through reversible processes and destroyed through irreversible ones
- The exergy content of a system cannot exceed its energy content, at best it can only equalize it
- Mechanical, electrical, electromagnetic and chemical energies are composed of pure exergy [17]
- The exergy content of thermal power depends on the ratio between its own temperature and the environment's temperature

The main advantage of the exergy concept is to fill in the gaps left by the concept of energy as it provides a more thorough indication of thermal efficiencies and irreversibilities location. The two concepts are compared in the following table:

**Table 1.1: Comparison of energy and exergy (source: Dincer and Rosen 2007 [19])**

<b>Energy</b>	<b>Exergy</b>
Dependent on properties of only matter or energy flow, and independent of environment properties	Dependent on properties of both a matter or energy flow and the environment
Has values different from zero when in equilibrium with the environment (including being equal to $mc^2$ in accordance with Einstein's equation)	Equal to zero when in the dead state by virtue of being in complete equilibrium with the environment
Conserved for all processes, based on the first law of thermodynamics	Conserved for reversible processes and not conserved for real processes (where it is partly or completely destroyed due to irreversibilities), based on the second law of thermodynamics
Can be neither destroyed nor produced	Can be neither destroyed nor produced in a reversible process, but is always destroyed (consumed) in an irreversible process
Appears in many forms (e.g., kinetic energy, potential energy, work, heat) and is measured in that form	Appears in many forms (e.g., kinetic exergy, potential exergy, work, thermal exergy), and is measured on the basis of work or ability to produce work
A measure of quantity only	A measure of quantity and quality

### **1.1.2.3 Reference environment**

As shown in equation (1.8) the value of exergy depends on the reference environment. The reference environment has then to be specified prior to any exergy calculation. When calculating the thermomechanical exergy only, the only information required concerning the environment is its temperature.

### **1.1.2.4 Exergy of thermal heat**

Thermal heat occupies a special place in the exergy theory as it is the only form of energy containing anergy; all the other forms of energy are pure exergy. The ratio of energy and anergy contained in thermal energy depends only on its temperature and the temperature of the environment. The best theoretical device to convert heat into work is the Carnot engine. The Carnot engine is an ideal thermal engine based

on a fully reversible thermodynamic cycle\*. The work produced by the Carnot engine is given by the following relation:

$$W = \theta \delta Q = \left(1 - \frac{T_a}{T}\right) \delta Q \stackrel{\text{def}}{=} Ex \quad (1.12)$$

Where  $\theta$  is the Carnot factor. The work produced by this engine is the maximum theoretical work extractible from a thermal source, given a reference environment. Hence, this work corresponds to the exergetic part of the thermal source (see Figure 1.3). Equation (1.12) shows that the higher the temperature of the thermal source is or the lower the temperature of the environment is, the higher the work produced by the Carnot engine will be, or in other words, the higher the exergetic content of the thermal source will be.

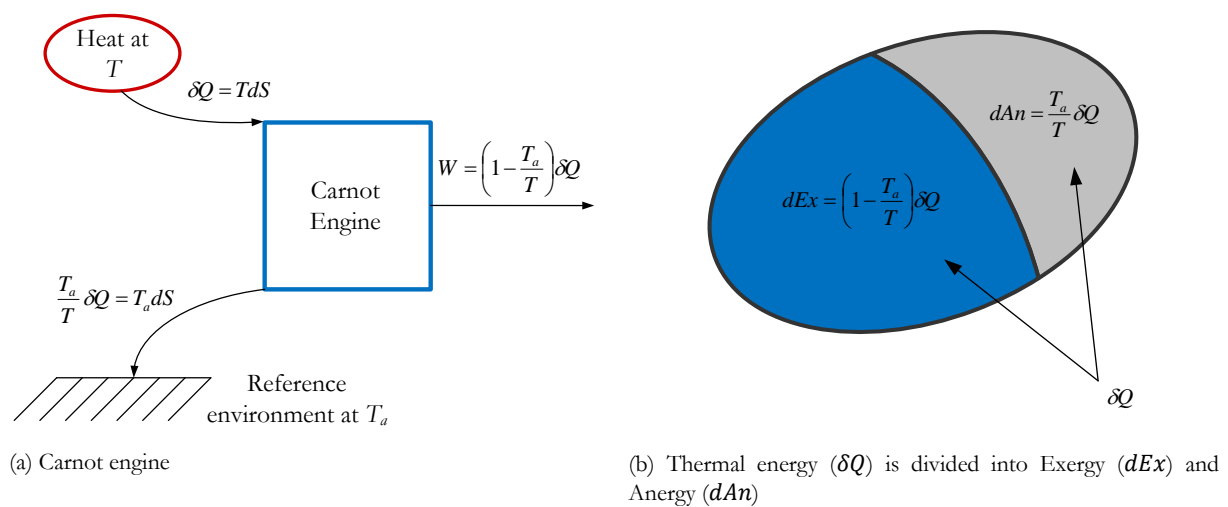

Figure 1.3. Exergetic content of thermal heat, source A. Lallemand [17]

### 1.1.2.5 Exergy loss and exergy destruction

A clear distinction must be made between exergy destruction and exergy loss. Exergy is destroyed through irreversible processes such as friction or heat transfers or in other words exergy is destroyed when internal entropy is created. The destruction of a certain amount of exergy results in the creation of the same amount of anergy. The term “destruction” highlights the fact that the exergy disappears for ever and cannot be recovered. On the other hand, lost exergy can be recovered. For example, the exhaust gas stream out of a ship contains exergy and anergy, as it is thermal energy. As long as these gases remain hot, their exergetic content can be recovered (for example through a combination of a waste heat recovery boiler and a steam turbine). If nothing is done, these gases will cool down and their exergy will be finally destroyed.

\* The Carnot cycle is composed of four reversible transformations: a reversible isothermal expansion, a reversible adiabatic expansion, a reversible isothermal compression and a reversible adiabatic compression.

### 1.1.2.6 Conclusion concerning exergy

Exergy is a concept that unifies the two laws of thermodynamics in a comprehensible and useful manner. It makes it possible to detect sources of irreversibilities as well as evaluating the quality of thermal energies. When comparing several sources of heat, the exergy analysis will determine which ones are more suitable for heating (exergy destruction) or work production (recovering lost exergy). But in any case the exergy analysis will provide a turnkey solution on how to save this energy. The method for exergy analysis applied to thermal power plants is presented in section 1.2.

## 1.2 ENERGETIC AND EXERGETIC ANALYSIS

Energy analysis is crucial for engineers to understand and optimize thermodynamic systems. Classical energy analyses often focus on the energy efficiency which can be misleading. Exergetic analysis, on the contrary, can distinguish clearly between energy losses to the environment and irreversibilities. For this reason exergetic analysis often completes energy analysis. As a matter of fact, exergetic analysis has become a popular tool in the last decades and is now applies to a very wide range of subjects: from traditional energetic matters such as heat pumps, frigorific installations, internal combustion engines, fuel cells, pumps and turbines or boilers to more complex systems such as power plants, aircraft and ships and even human systems such as cities, regions, countries or economic sectors. Exergy analysis is also popular in ecology and sustainable development fields where it participates in life cycle assessments and renewable energy systems evaluation [23].

To the best of the author's knowledge, only very few exergetic analysis have been carried out for entire ships. It is nevertheless an emerging topic. Baldi has performed one on a chemical carrier [24]. He insisted on the help exergy analysis brought in understanding energy flows and in pinpointing the sources of irreversibilities. He also indicated that the greatest potential for exergy recovery lied in exhaust gases and evaluated possible gains using ORC\* and WHR† systems or by adapting operational profile. Dimopoulos et al also applied exergy analysis to shipping and particularly for the optimization of WHR systems [25]. If literature is rather limited concerning exergy analysis applied to shipping, it is rich in papers concerning parts of ships (such as diesel engines, turbines, heat exchangers, etc.) or complex systems such power plants which can be favourably compared to ships.

### 1.2.1 Application to thermal power plant

Many authors have applied the concept of exergy to thermal power plant analysis. Dincer and Rosen presented a general methodology for exergy analysis of steam power plants in their book *"Exergy: Energy, Environment and Sustainable Development"* [26]. Aljundi produced an energy and exergy analysis of a heavy fuel oil steam power plant in Jordan. Rosen [27] compared coal-fired and nuclear power plants with energy and exergy analysis. Koroneos et al [28], [29] used exergy analysis to compare alternatives of power plant designs. Kaushik et al [30] carried out a detailed bibliographic review of papers regarding this matter in order to compare energy and exergy analysis.

---

\* Organic Rankine Cycle

† Waste Heat Recovery





Table 1.2: Exergy analysis of Zarqua's power plant when  $T_0 = 298.15$  K and  $p_0 = 101.3$  kPa, with  $ex$  the specific exergy and  $\dot{E}x$  the total exergy rate

Point	$T$ [K]	$p$ [MPa]	$\dot{m}$ [ton/h]	$h$ [kJ/kg]	$s$ [kJ/kg·K]	$ex$ [kJ/kg]	$\dot{E}x$ [MW]
1	618.55	2.4231	17.80	3 118.1	6.8419	1 082.748	5.354
2	547.85	1.3244	14.92	2 986.9	6.8835	939.145	3.892
3	463.65	0.5690	16.40	2 831.4	6.9511	7 630.490	3.478
4	394.35	0.2060	13.96	2 707.7	7.1173	590.238	2.289
5	360.45	0.0628	6.39	2 655.2	7.5169	418.597	0.743
6	343.15	0.0272	204.90	2 626.9	7.8193	300.136	17.083
7	339.75	0.0272	204.90	279.66	0.9159	11.151	0.635
8	339.75	0.0270	226.00	278.82	0.9134	11.045	0.693
9	341.15	1.3734	226.00	285.79	0.9299	13.113	0.823
10	337.60	0.0245	21.10	269.81	0.8868	9.959	0.058
11	356.15	0.0536	226.00	347.61	1.1111	20.896	1.312
12	362.45	0.0687	13.96	374.09	1.1848	25.403	0.099
13	390.15	0.1815	226.00	491.08	1.4954	49.787	3.126
14	428.15	0.6867	275.00	653.88	1.8922	94.281	7.202
15	430.15	12.2630	275.00	669.49	1.8991	107.834	8.237
16	436.15	0.6671	32.70	688.52	1.9725	104.980	0.954
17	461.45	10.7910	275.00	804.43	2.2056	151.391	11.565
18	466.15	2.3544	17.80	821.28	2.2626	151.246	0.748
19	494.15	10.3010	275.00	950.46	2.5124	205.949	15.732
20	793.15	9.1233	275.00	3 436.3	6.7168	1 438.247	109.866
Input Air	298.15	0.1013	23 900	424.54	3.8814	0.000	0.000
Output air	318.15	0.1013	23 900	444.68	3.9468	0.647	4.294
Dead state	298.15	0.1013	-	104.92	0.3672	0.000	-

In order to calculate heat and work inputs and outputs as well as irreversibilities and energy and exergy efficiencies, the respective balance equations for heat, energy and exergy are used\* [26]:

$$\sum_i \dot{m}_i = \sum_e \dot{m}_e \quad (1.13)$$

$$\sum_i \dot{m}_i h_i + \dot{Q} = \sum_e \dot{m}_e h_e + \dot{W} \quad (1.14)$$

$$\sum_i \dot{E}x_i + \sum_j \left[ 1 - \frac{T_0}{T_j} \right] \dot{Q}_j = \sum_e \dot{E}x_e + \dot{W} + \dot{A}n \quad (1.15)$$

\* These three balance equations are valid for steady-state processes where potential and kinetic energies of the fluid are neglected. In this convention, input and output flows are both counted as positive.

These balances are declined for each component. The energy and exergy efficiencies are then calculated for each component and for the global installation using the following equations [30]:

$$\eta_{en} = \frac{\text{Energy output}}{\text{Energy input}} = 1 - \frac{\text{Energy loss}}{\text{Energy input}} \quad (1.16)$$

$$\eta_{ex} = \frac{\text{Exergy output}}{\text{Exergy input}} \quad (1.17)$$

Finally, once all these calculations are done, results can be displayed in tables, graphs or even Sankey diagrams. Figure 1.5 illustrates one of the greatest aspect of exergy analysis, as according to S.C. Kauskik et al authors [30]: “*The exergetic performance analysis can not only determine magnitudes, location and causes of irreversibilities in the plants, but also provides more meaningful assessment of plant individual components efficiency*”. A simple energetic analysis of a power plant (see Figure 1.5 (a)) indicates that the maximum energy losses are found in the condenser and conversely, energy losses in the boiler are very limited. These facts can be misleading as they suggest that further improvements should be concentrated on the condenser and not in the boiler. On the contrary, the exergetic analysis (see Figure 1.5 (b)) pinpoints the greatest sources of irreversibilities (exergy destruction) as the boiler and turbine. In actual fact, the energy lost through the condenser has very little exergetic content (poor quality), in relative term, its loss is relatively not important. On the opposite, the boiler destroys a significant part of the exergy of the coal (659 MW in this example, which represents 46% of coal’s exergy input). Thermodynamic optimization should then concentrate on the boiler and turbine even if at this point in time, considering the present state of actual development, not all irreversibilities can be reduced.

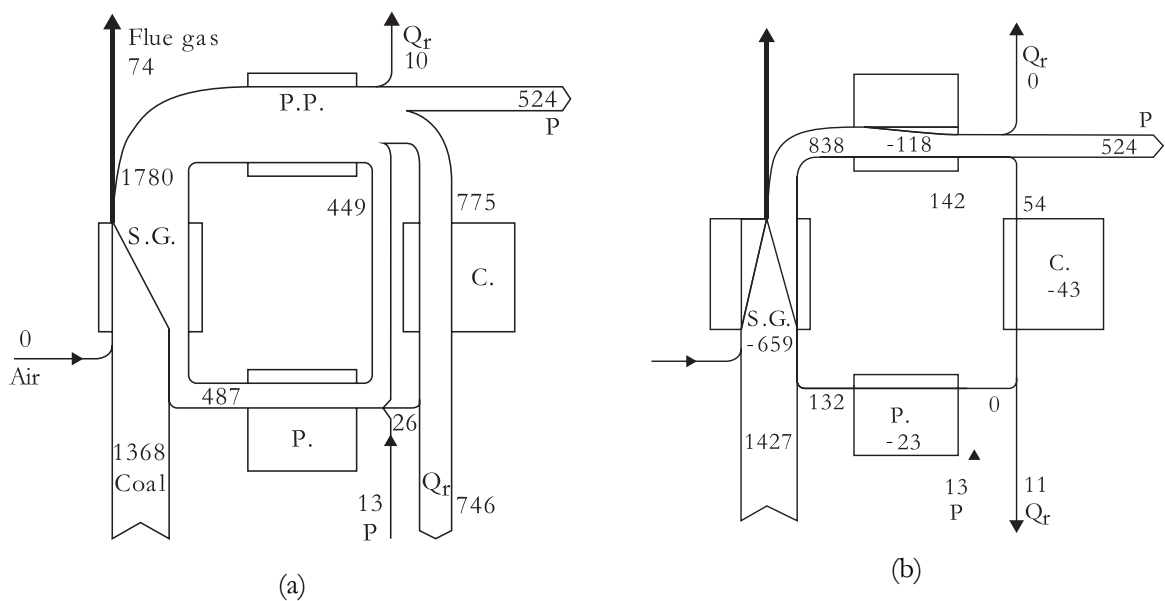

Figure 1.5: Sankey diagram representing the energetic (a) and exergetic (b) balance of the coal-fired Nanticoke Generating Station in Ontario, Canada. The different values indicate the net energy and exergy flow rates (MW). Components represented are steam generator (S.G.), power production, i.e. turbine plus alternator (P.P.), condenser (C.) and preheater (P.). Flows represented are power ( $P$ ), heat input ( $Q$ ) and heat rejected ( $Q_r$ ) [27].

## ▪ Discussion

Several observations can be made:

- The definition of the exergetic efficiency can appear unsatisfying when applied to the overall power plant, as its value is very close to the energetic efficiency. Aljundi calculated the overall energetic and exergetic efficiencies of Zarqua's power plant and found respectively 26% and 25% [31]. Rosen found the efficiencies to be of 37% and 36% for the coal-fired Nanticoke Generating Station in Ontario, Canada [27]. And Koroneos et al found the energetic and exergetic efficiencies of Linoperamata's (Crete) power plant to be approximately the same: 34% [28]. The definitions of the energetic and exergetic efficiencies explain why (see equations (1.16) and (1.17)). The output of power plants is electricity and as a matter of fact electricity is pure exergy and hence Energy output = Exergy output. Similarly, the input of power plants is fuel (gas, fuel oil, coal, etc.) and the chemical energy of fuel is considered to be pure exergy. Therefore Energy input = Exergy input. And so:  $\eta_{en} = \eta_{ex}$ . The small differences calculated by Aljundi and Rosen come from the fact that the lower heating value (LHV) of fuels is lower than their exergetic content (see next point). But globally, the energetic and exergetic efficiencies of thermal power plants are the same and hence the exergetic efficiency gives no additional information. New definitions of exergetic efficiency can be imagined to fill this gap (see section 5.2).
- As mentioned above, the specific chemical exergy of a fuel is different from its LHV. The energetic or exergetic content of a fuel corresponds to the energy one can retrieve from a complete combustion. The calculation of this energy is a delicate matter and depends on conventions (the reference environment, the state, pressure and temperature of the reagents, the state of the water after combustion, etc.). The presentation of these different definitions is outside the scope of this thesis. Nevertheless the following relations given by Borel et Favrat can be used:

$$\underline{\Delta k}^0 \cong LHV \quad (1.18)$$

$$\underline{\Delta k}^0 \cong \frac{LHV + HHV}{2} \quad (1.19)$$

Where  $\underline{\Delta k}^0$  is the chemical exergy of fuel and  $HHV$  its higher heating value. Relation (1.18) applies to solid and liquid fuels, whereas (1.19) is valid for gas fuels. The calculation of the chemical exergy of fuels is debatable and different authors use different relations. For more details concerning this matter, readers can refer to Borel and Favrat's book "Thermodynamique et Énergétique" [22]. For specific definition of chemical exergy for coal based-fuels, readers can refer to Bilgen and Kayguzuz paper [32]. And for a general definition applied to liquid hydrocarbon fuels readers can refer to Rakopoulos and Giakoumis paper [33].

- The authors use a single reference environment, either a source of water or the ambient air. On board ships there are two reference environments: the sea and the ambient air. Moreover, these reference environments change with time. How to deal with these specificities is one of the challenges of this thesis (see section 5.2).
- All of the studies presented in this section are carried out at a nominal point. On board ships, the power production and demand vary frequently. Studying the exergetic balance of the ship in non-stationary conditions is another interesting aspect of this thesis (see section 5.3.1).

In the end, the authors mentioned above often share the same general conclusion concerning exergetic analysis: it makes it possible to pinpoint more accurately the origin of irreversibilities and hence indicate where the efforts to improve efficiency should focus. In thermal power plants, the main source of irreversibilities is combustion.



# CHAPTER 2

## SHIP ENERGY MODELLING

---

<b>CHAPTER 2 SHIP ENERGY MODELLING .....</b>	<b>51</b>
2.1 SYSTEMIC APPROACH.....	53
2.1.1 <i>The theory of systemics</i> .....	53
2.1.2 <i>The practice of systemics</i> .....	56
2.1.3 <i>Conclusion concerning the systemic approach</i> .....	63
2.2 ENERGY MODELLING METHOD .....	64
2.2.1 <i>Modelling the overall system</i> .....	65
2.2.2 <i>Modelling the components</i> .....	65
2.2.3 <i>A dual modelling approach</i> .....	66
2.3 AN ENERGY MODELLING TOOL: MODELICA.....	67
2.3.1 <i>Introduction</i> .....	67
2.3.2 <i>The model and connector concepts</i> .....	69
2.3.3 <i>Modelica compiler</i> .....	70
2.3.4 <i>Libraries</i> .....	71
2.4 CONCLUSIONS.....	72

One of the purposes of the thesis is to develop an exhaustive energy model of a ship in order to evaluate, study and possibly optimize her energy efficiency. To the best of the author's knowledge, this has rarely been done.

The shipping industry has a long history in modelling. The hydrodynamic resistance of hulls has been studied by naval architects since William Froude's time (1810 - 1879). Two hundred years ago and up until quite recently, models were only physical (scaled models), but now, the development of computers and more particularly personal computers has enabled the use of numerical models. Nowadays, almost all the key aspects of shipping are numerically modelled: from fluid-structure interactions to fire safety and evacuation, including hydrodynamic resistance, stability, manoeuvrability, structure resistance, mooring, collision, machinery, etc. All these items, even if very complicated, have benefited from modelling and simulation and are now well understood. Despite increasing economic and environmental pressure over the past forty years, global energy and modelling has not enjoyed the same level of attention. To estimate the overall fuel consumption, shipyards still mainly rely on static energy balances and worst case scenarios. Moreover, the process of selection of the main prime-movers is rather based on past experience (crew familiarity and training, spare part inventories, service support, etc.) and economic considerations (fuel type specifications, installation and maintenance cost, etc.) than on energy efficiency [34]. This fact can mainly be explained by the great complexity that ship energy systems represent. Ships contain multiple energy devices which rely on multiple physical fields and operate in multiple environmental conditions. Besides, each device has its own specific set of experts: experts of device A have only limited knowledge of device B. This fragmented approach can result in a non-optimum energy design.

The systemic approach is meant to answer this complexity issue. This discipline is presented in this chapter. This presentation will be followed by the presentation of modelling methods and tools applied to complex energy systems.

*L'un des objectifs de cette thèse est de développer un modèle énergétique complet et exhaustif d'un navire afin d'en évaluer et si possible d'en optimiser son efficacité énergétique. À la connaissance des auteurs, ceci a rarement été fait.*

*L'industrie du transport maritime a une longue expérience de la modélisation. La résistance hydrodynamique des coques est notamment étudiée par les architectes navals depuis l'époque de William Froude (1810 – 1879). Depuis ce temps et jusqu'à une période relativement proche, les modèles des navires existaient seulement sous la forme de maquettes. Mais aujourd'hui, l'avènement de l'informatique et particulièrement des ordinateurs personnels ont permis l'utilisation de modèles numériques. Aujourd'hui, tous les aspects essentiels de la conception d'un navire sont modélisés numériquement : de l'interaction fluide structure à la protection incendie et l'évacuation en passant par la résistance hydrodynamique, la stabilité, la manoeuvrabilité, la résistance des matériaux, l'ancrage, la collision, la machinerie, etc. Tous ces aspects, même si parfois très compliqués ont largement bénéficié de la modélisation et de la simulation numérique et sont maintenant bien compris. Malgré une augmentation forte du prix des carburants et des contraintes environnementales, la modélisation énergétique globale des navires n'a pas bénéficié du même niveau d'attention. Pour estimer la consommation globale de combustible, les chantiers navals s'appuient encore sur des balances énergétiques statiques utilisant des valeurs de dimensionnement. De plus, le choix des moteurs et systèmes propulseurs est le plus souvent fonction de traditions (expérience et formation de l'équipage, inventaire de pièces de rechange, service après-vente, etc.) ou de raisons économiques (type de fioul, coûts d'installation et de maintenance, etc.) plutôt que de considérations énergétiques ou environnementales [34]. Ceci peut notamment être expliqué par la grande complexité des systèmes énergétique à bord des navires. Les navires possèdent de multiples systèmes énergétiques apparentés à différents domaines de la physique et ils opèrent dans des environnements changeants. Chaque équipement possède ses propres experts et chaque expert possède des connaissances limitées des autres équipements. Cette approche fragmentée peut résulter en une conception non optimale d'un point de vue énergétique.*

*L'approche systémique est pensée pour ce genre de problème. Cette discipline est présentée dans ce chapitre. Cette présentation sera suivie d'une présentation sur les outils et les concepts de modélisation appliqués aux systèmes énergétiques complexes.*

## 2.1 SYSTEMIC APPROACH

Systemics or systems theory embraces concepts and terms such as systems analysis, systems approach, systems thinking, systems engineering and cybernetics\*. According to Gicquel [35] “*the systemic approach is the best theoretical basis available to apprehend devices including several components, each of them relatively complex, linked together by a complex relation network, organised around a purpose and in such a way that the behaviour of each component apparently does not answer to simple rules and can only be explained in the light of the overall system*”. However, systemics is a relatively new discipline, appeared in the 1950’s, which is still evolving and lacks a universal, clear and definite theory. Adding to that the fact that systemics covers a large and eclectic range of applications (such as: natural and engineering sciences, geography, economy, sociology or even human behaviour) and that it is at the border of science, technology and philosophy, therefore giving a precise presentation of this discipline is not an easy task. For the sake of clarity and coherence this short presentation will then globally follow the one given by the AFSCET† group: “Systemic approach: what about it ?” [36]. Readers which would like a complete overview of the systemic approach can read the book of Jean de Rosnay “Le Macroscopie” (The Macroscopie) [37] and for a more detailed presentation focused on systemic modelling, readers can refer to the book of Le Moigne “La théorie du système général” (The general system theory) [38].

This presentation is divided in two parts: the theory and the practice of systemics and starts by the definition of systemics according to the AFSCET [36]:

New discipline which covers theoretical, practical and methodological approach related to the study of subjects recognized to be too complex to be reduced, and which raises issues linked to the system’s border, internal and external relations, structure, laws or emerging properties or problems of method of observation, representation, modelling or simulation of a complex totality.

### 2.1.1 The theory of systemics

This definition highlights the four main concepts of the systemics theory: the system, the complexity, the totality and the interaction.

#### ▪ The system

The Oxford dictionaries give the following definition of a system [39]:

A set of things working together as parts of a mechanism or an interconnecting network; a complex whole

De Rosnay gives a different definition in his book “Le Macroscopie” (The Macroscopie‡) [37]:

---

\* According to the Oxford dictionaries, the word systemic means “*relating to a system, especially as opposed to a particular part*”.

† “Association Française de Science des Systèmes Cybernétiques, Cognitifs Et Techniques – Science of cybernetics, cognitive and technical systems French association.

‡ In the same way that the microscope is a mean to observe the infinitely small and the telescope the infinitely great, de Rosnay defines the macroscopie as a tool to observe the infinitely complex [37]



■ A system is a set of elements in dynamic interaction, organized for a goal

This last definition focuses on one of the key aspects of systemics: the purpose of the system. However, whilst the finality of man-made systems can be quite obvious, what is the purpose of a cell or an ecosystem? De Rosnay answers this question: their purpose is, in the first case (cell) to maintain its structure and replicate and for the second (ecosystem), to maintain its equilibrium and permit the development of life. The traditional Cartesian approach relies on the analytical description of phenomenological laws whereas the systemic approach emphasizes the finality of each component of the system. This functional approach requires less detail than the analytical one: a black-box model can often suffice [35].

A system can be qualified as:

- closed or open towards its environment;
- natural, artificial or social;
- organised hierarchically or in networks.

#### ■ The complexity

The complexity of a system encompasses:

- a great number of elements, each one of them having a specific purpose;
- a high level of organization;
- a great number of internal and external interactions some of which being non-linear;
- a lack of information which leads to an incomplete understanding.

French and English dictionaries tend to consider the terms complex and complicated as synonyms, but some authors see semantic nuances between them. Glouberman and Ziemmerman take the problems of sending a rocket to the moon and raising a child as examples of respectively a complicated and a complex problem [40]:

**Table 2.1: Comparison between a complicated and a complex problem [40]**

<b>Sending a rocket to the moon</b>	<b>Raising a child</b>
Formulae are critical and necessary	Formulae have a limited application
Sending one rocket increases assurance that the next one will succeed	Raising one child provides experience but no assurance of success with the next one
High levels of expertise in a variety of fields are necessary for success	Expertise can contribute but is neither necessary nor sufficient to assure success
Rockets are similar in critical ways	Every child is unique and must be understood as an individual
There is a high degree of certainty of outcome	Uncertainty of outcome remains

#### ■ The totality

The totality or globality is a characteristic of a complex system which makes it impossible to understand one part of it without considering the overall system. It can be summed up by the saying: “*the whole is greater than the sum of its parts*”. This totality expresses the interdependency of the components as well as the

overall coherence of the system [36]. To apprehend a complex system it is necessary to adopt a global or holistic point of view.

#### ▪ **The interactions**

Interactions or interrelations are key concepts of systemics: systems are said to be complex because of the nonlinear relations between their components and with the environment. From this characteristic stems the concepts of feedback.

The previous four notions presented are necessary to understand the theory of systemics but not sufficient. The following section gives a short definition of additional concepts applicable to ships.

#### ▪ **Information**

After energy and mass, information is the third fundamental flow inside a system.

#### ▪ **The purpose**

Presented in the definition of a system by de Rosnay (see previous section above), the purpose of a system is a key aspect of systemics. The systemic modeller will first answer the question of what the system is meant to do, before answering the question of how it works.

#### ▪ **Feedback**

A feedback occurs each time the output of a system influences its input. There exists two types of feedbacks:

- positive feedback where a small disturbance of the input induces a great perturbation at the output (A increases B which in return increases A);
- negative feedback where the output is regulated via the control of the input.

Positive feedbacks are explosive (snowball effect) whereas negative feedback allows stabilization of the system.

#### ▪ **Regulation**

Negative feedback allows regulation of the system. Controlling this feedbacks makes it possible to adapt the system to its environment and operating condition. Cybernetics is the part of systemics which focuses on the control and regulation of complex systems [37].

#### ▪ **Structure**

The structure of the system must be described by taking into account the following items:

- the inner components: one must evaluate their number, nature and function;
- the border: open or closed;
- the interactions: the nature of the different flows between the component and with the environment (energy, mass and information) as well as the possible feedbacks;
- and the possible storage of energy, mass or information.

#### ▪ **Open/Closed**

In the same manner as defined in thermodynamics, systems can either be closed or open. According to the second law of thermodynamics an open system can maintain its level of organization and even

increase its order whereas a closed system can only maintain or decrease its order (see section 1.1.1.2 “Second law of thermodynamics”). In fact all systems, except the universe, are open systems.

- **Black-box/White-box**

A black-box approach only considers the inputs and outputs of the system, not its constituents, whereas a white-box approach does.

## 2.1.2 The practice of systemics

Systems with limited number of variables can be modelled with an analytical approach. That is what all students learn to do when they calculate the trajectory of a body or the efficiency of a thermodynamic cycle. The mathematical formulae of the physical laws are applied to idealized systems (for example, the body is considered as a particle and friction is often neglected). This approach remains very powerful as long as the system does not deviate too much from its model and the number of variables remain low. Solving the equations can be very complicated but the problem is not complex. When the number of variables and interactions is too great, the system becomes complex and systemic approach must be used. De Rosnay compares the two approaches in the following table (see Table 2.2).

**Table 2.2: Comparison between analytical and systemic approach [37]**

Analytical Approach	Systemic Approach
Isolates, then concentrates on the elements	Unifies and concentrates on the interaction between elements
Studies the nature of interaction	Studies the effects of interactions
Emphasizes the precision of details	Emphasizes global perception
Modifies one variable at a time	Modifies groups of variables simultaneously
Validates facts by means of experimental proof within the body of a theory	Validates facts through comparison of the behaviour of the model with reality
Uses precise and detailed models that are less useful in actual operation (example: econometric models)	Uses models that are insufficiently rigorous to be used as bases of knowledge but are useful in decision and action (example: models of the Club of Rome*)
Has an efficient approach when interactions are linear and weak	Has an efficient approach when interactions are nonlinear and strong
Leads to discipline-oriented (juxtadisciplinary) education	Leads to multidisciplinary education
Leads to action programmed in detail	Leads to action through objectives
Possesses knowledge of details, poorly defined goals	Possesses knowledge of goals, fuzzy details

\* The Club of Rome is an international think tank, founded in 1968, “interested in contributing in a systemic interdisciplinary and holistic manner to a better world. The Club of Rome members share a common concern for the future of humanity and the planet”. <http://www.clubofrome.org/>

The author mentions that this table is “*a caricature of reality*” and “*excessively dualist*” but it has the merit of existing and presenting the two approaches in a simple and useful comparison. He also adds that these two approaches are in facts much more “*complementary than opposed*”.

The systemic approach practice is composed of four fundamental steps: 1. the analysis of the system, its components and interactions; 2. the building of a model; 3. the simulation and 4. the validation of the model. These four steps are sequential and must be repeated until satisfaction and compliance with expectations. A first simple model is built and simulations are run; the results of the simulation are compared with reality and therefore the model is refined, the simulation is re-run and the results re-compared, etc. Several iterations can be necessary.

### 2.1.2.1 *Analysis and synthesis*

The systems analysis must specify its borders, its main components and interactions between them, its flow variables and state variables, its feedbacks (positive and negative), as well as its possible delays, stock, sources and sinks. This step must produce a coherent and synthetic description of the system. The right level of detail must be found. Too much detail will produce an unusable model whereas not enough detail will produce a false model, or to be more exact, an inaccurate model. Two types of analysis will help in this task: functional and structural analysis.

#### ▪ **Structural analysis**

The structural analysis aims at describing the structure of the system. In this regard, the systemic approach is similar to the analytical one, with one subtle difference: the focus is put on the relationship between components much more than on the components themselves.

The structural analysis shall reference:

- the system’s constituents, their number and nature;
- the system’s border which separates the totality of the constituents from the environment, this border is always more or less permeable;
- the interactions between the constituents, which will be a flow of mass, energy or information;
- the stocks of mass, energy and information.

The breakdown of the system into its constituents is relatively subjective and arbitrary. This system breakdown should rather identify subsystems associated with functionalities rather than physical components. These subsystems should then also be described according to structural and functional analysis. The number of levels of breakdown shall depend on the available amount of information and on the importance of the subsystem. Main subsystems shall be broken down more than secondary ones. This level of description will also depend on constraints such as money, computing power as well as development and computational time.

#### ▪ **Functional analysis**

The functional analysis completes the structural analysis and is much more specific to systemics analysis than structural analysis is. It is meant to answer questions such as: what is it meant to do? Rather than: how does it work? Or questions such as: how does it interact with its environment?

The functional analysis shall reference:

- the flows of energy, mass and information between the subsystems and with the environment;
- the sources and sinks of these flows;
- the controllers that regulate the flows and stock levels;
- the feedback loops;
- and the possible delays.

Several methods can be used to perform a system functional analysis such as the APTE method [41], the FAST diagrams [42] and the SADT diagrams [43]. These kinds of methods offer graphical descriptions of the system which is good for rapid and global understanding.

### 2.1.2.2 Modelling

Modelling is the art of creating an abstract representation of a concrete reality, or in other words: a model. Models are built in order to represent, understand and simulate the behaviour of a system. Non complex systems (yet possibly complicated) can be represented by physical models (prototypes, scaled models). For example, ship models are built and tested in towing and wave tanks to study their hull resistance and dynamic response to waves. Car and plane models are tested in wind tunnels to evaluate their aerodynamic resistance. Using these physical models, even today, presents many advantages, since their computer counterparts, for instance based on Computational Fluid Dynamics calculation, can be more expensive and not necessarily more accurate (computer calculations are nevertheless becoming more and more efficient thanks to increasing computer power and new models). The physical approach still works as long as the system represented remains “simple”. A scale model of a ship with its hull and including all its main prime-movers along with all the steam, fuel, cooling water, exhaust gas circuits would be almost as big as the original ship and extremely expensive; not to mention scaling issues. In fact, as the number of variables and interactions increases, the use of computer models becomes more and more necessary.

Computer models are based on the data collected during system analysis and synthesis. The different subsystems, connections and interactions are represented by equations in the adequate programming language. There are many ways of modelling systems: different approaches, different time and space dimensions and different levels of details.

#### 2.1.2.2.1 Different modelling approaches

##### ▪ Analytical/empirical

Models are said to be **analytical** (or phenomenological) when they are based on physical equations. Conversely, models based on measurements are said to be **empirical**. For example, a scientist interested in calculating the speed of a falling object in a vacuum could either solve the equation of Newton’s second law of motion ( $\sum_i \vec{F}_i = m \cdot \vec{a}$ ) or perform an experiment using a vacuum tube and a speed measurement device. The first approach would be qualified as analytical and would provide very accurate results (accuracy of the calculator). The second approach would be described as empirical and would give correct accuracy at the measurement points, depending on the measuring instrument. The scientist would have to interpolate between these points to obtain the speed at each instant, and could even extrapolate to access the speed outside the measuring range. Nevertheless, the scientist would have to carry out a second experiment to understand that the mass has no influence on the speed of the object, whereas solving Newton’s equation gives this indication directly ( $\vec{g} = \vec{a}$ ). This advantage of the analytic approach is even more convincing when imagining the case where the scientist would want to study the influence of gravity on the speed of the object. Knowing the value of the gravity on Mars or Pluto, Newton’s equation makes it possible to calculate the speed of the object on these planets whereas the empirical approach would

require installing the experiment on these planets. This simple example allows to draw a first comparison between these two modelling approaches:

**Table 2.3: Comparison between analytical and empirical approach**

Analytical	Empirical
Based on laws of physics	Based on measurement tables
Requires mathematical competence	Requires measurements
Very predictive	Limited predictive capacity
Adaptable	Single case application

As the previous example might suggest, the analytical approach is generally more accurate for simple and theoretical models. But this is not necessarily true for more complex and realistic models. In fact, with the exception of a limited range of theoretical cases, the laws of physics are rarely as “elegant”. Taking into account the inevitable irreversible processes such as friction requires introducing empirical coefficients. Moreover, as phenomena get more and more complex, the physical laws need to be simplified (approximated) to be usable. In fact, for a given application, an empirical model might be as accurate, or even more accurate than an analytical one [44].

Empirical models are based on measurements and regression equations and contrary to analytical models, they do not give insight into how the model works: they are purely descriptive. In this respect they cannot be used to design or improve systems. But they can be used to study, simulate and control the system.

Inside an analytical model, all the parameters and variables have a physical meaning and might have units. This is not necessarily the case in empirical models which can contain tuning parameters with no physical meaning.

Models are rarely completely analytical or empirical and actually are often a combination of physical and empirical parameters, variables and equations. Such models might be called hybrid models.

#### ▪ **White box/black box**

Models are said to be of **black-box** type when they can be represented only by their inputs and outputs and a transfer function between them, without any understanding of their internal workings. On the other hand, a **white-box** model is a model where all the equations, knowledge and internal workings are accessible. These concepts stem from a systemic approach [36] and control engineering. There is no clear and definite definition of these concepts. Some authors, such as Gicquel [35] identify black-box models with empirical models, and hence, white-box models to analytical ones. Whereas Gaaloul Chouikh [44] approaches these concepts more in terms of confidentiality issues.

#### ▪ **Causal/acausal**

**Causal** models are based on assignment statements: a series of explicit equations connect the input variables to the output variables (result). The causality of the model, that is to say the data flow is specified and fixed. Equations are solved in a specified order. Traditional programming languages such as C, C++, Java, Fortran, MATLAB, etc. are based on causal models. They use algorithms to indicate the computational procedure to the compiler.

On the other hand, according to Jardin [45], **acausal** models consist in a series of non-ordered implicit equations where the input and output variables are not specified. These models are said to have a declarative notation. The causality of the model is unspecified and fixed only when solving the equations.

Modelica is for example a modelling language based on acausal models. The equations are written in a straightforward manner. It is the program and not the user that will rewrite the equations in a causal way depending on the overall system. This possibility of writing the equations directly as they are, allows Fritzson [46] to characterize this approach of *physical modelling*.

The following table draws a comparison between causal and acausal models.

**Table 2.4: Comparison between causal and acausal models (Source [46] [47] [48])**

Causal approach	Acausal approach
Fixed data flow	Reversible data flow
Difficult to build and extremely difficult to modify	Easy to build and modify
Hard to reuse	Reusable
Generally don't require sophisticated tools to handle them efficiently	Require highly elaborated tools to handle them efficiently
Computer code is a computation procedure	Computer code is closer to equations
Easier to debug	Harder to debug

#### 2.1.2.2.2 Different time models

##### ▪ Dynamic/static models

According to Fritzson [46], all systems, natural or man-made are dynamic in the sense that they exist in the real world which evolves over time. Nevertheless, systems which do not depend on time can be approximated as static models. The following definition can be given:

- A model is said to be **dynamic** when it includes time in the model, either directly as a variable in its equations or indirectly through the time derivative of a variable.
- A model is said to be **static** when it does not include time in the model.

For example, the fuel consumption of a diesel engine is a dynamic process. Even at nominal temperature, the fuel consumption will “oscillate” after a change in torque: there is a delay before the fuel consumption reaches its equilibrium value and stays constant (or to be more precise the variations of the fuel consumption are undetectable or negligible). However, if this time delay is much smaller than the desired computer step and that the influence of these dynamic processes is negligible over the overall performance, the engine can be represented by a quasi-static model. A **quasi-static** model is a static model fed with time dependent variables.

##### ▪ Continuous/discrete time models

Dynamic models can be continuous-time or discrete-time models:

- Models are said to be **continuous-time** models if their mathematical expression includes continuous time dependent functions, often written  $f(t)$ .
- Models are said to be **discrete-time** models if their output value varies at discrete points in time. These models often include difference equations (e.g.  $x(t + 1) = 2x(t) + 1$ ) or events linked to conditional statements such as “if” and “when”.

Models can include continuous and discrete-time sub-models. For example, a model that would represent the level of water in a tank would include a continuous-time sub-model for the water level and discrete-time sub-model for the control of the filling and emptying valves (open or closed).

### 2.1.2.2.3 Different spatial dimensions

In the same way as all real systems should be represented by dynamic models, all real systems with geometric dimensions should be represented by **three-dimensional** (3D) models. However, 3D models are complicated and expensive and hence often reduced when possible. Models can be first simplified thanks to the possible properties of symmetry and invariance of the studied variable inside the system; for example, the radiative power of the sun depends only on one dimension: the distance to its centre. In such cases, there is no loss of accuracy. However several approximations can also simplify the model: a thin parallelepiped rectangle (3D) can be represented by a rectangle (2D) or a thin tube (3D) by a line (1D). Systems can even be represented by **zero-dimensional** models (0D). A lot of diesel engine models consider for example 0D models of the combustion cylinder; the temperature and pressure inside are then considered isotropic (see section 4.2.1.4 “Zero-dimensional models”).

#### ▪ Single/multi-zone

Zero-dimensional models can nevertheless be divided into multiple zones. For example, the gases inside the combustion cylinder can be represented by a single zone, in which case its temperature and pressure will be uniform, or by two zones, one for the fresh gases and one for burnt ones, in which case there will be two different temperatures and pressures inside the cylinder.

#### ▪ Multi-dimensional models

Complex dimensional models (1D, 2D or 3D) can be discretized by a set of finite parts connected together by nodes, forming a mesh. The equations of the system are then discretized into partial differential equations. The equations are solved from one part to the other, starting from the boundaries where initial values are defined. Different methods exist for representing and evaluating partial differential equations, such as the finite element method, the finite volume method and the finite difference method. These modelling techniques are amongst the most expensive and time consuming, and are limited to microscopic approach (see next section). These finite methods can be applied to fluids, in which case one would talk of computational fluid dynamics (CFD – see section 4.2.1.5).

### 2.1.2.2.4 Different levels of detail

Depending on what is of key interest, the overall system or a specific part of the system, the model will use different levels of detail:

- a **macroscopic** approach will concentrate on the overall system and will not require a accurate model; an empirical model will often suffice;
- a **microscopic** approach will concentrate on very few elements of the system and will require a very accurate analytical model; finite element methods will often be used;
- for an intermediate approach, where the different elements of the system, and their interactions are represented, one will talk of **mesoscopic** approach.



### 2.1.2.2.5 Conclusion concerning model heterogeneity

These different modelling approaches, time and spatial dimension, answer the different needs and constraints of modellers, but result nevertheless in a great heterogeneity. This heterogeneity can raise simulation issues when one wants to:

- use the models for different applications than designed for;
- use the models in different programming languages than written for;
- connect models with different modelling approaches, time and spatial dimension together.

These issues multiply with the number of subsystems and can thus become very important when modelling complex system. They require time to adapt and rewrite the different models. To answer these issues, Gaaloul Chouikh recommends adopting interoperability solutions which would guarantee easy adaptation and transformation of models as well as high compatibility between different simulation software [44].

The Modelica modelling language will be chosen in this respect (see section 2.3).

### 2.1.2.3 Simulation

■ A simulation is an experiment performed on a model [46]

Computers have a great advantage over the human brain: they can do parallel computing, and hence compute several variables simultaneously, which is essential for simulating complex systems.

Once the complex system model is finalized and all the initial parameters fixed, the simulation can start. The operator then has access to a very powerful experimentation tool: the model can run under a very wide range of operating conditions in a limited time and for a limited cost.

These great assets should not hide the limitations of simulation. Models and thus simulation results will never be exact; they can only try to reach the highest level of accuracy and precision as possible. There is nevertheless a general tendency: the more a model is detailed and based on analytical laws or accurate empirical laws, the closer the simulation results will get to reality, but in the same time the model will become more costly in both time and money and more specialized (less reusable) [49]. In fact, some authors even describe an optimum in the accuracy function of the level of detail curve: after a certain point, increasing the number of details can be counterproductive, as each new subsystem introduced in the model contains its share of error and might increase the global model error [49]. Moreover, the ability to change easily the operating conditions can lead to dangerous conclusions as all the physical and technological limitations may not be represented. For example, increasing the output temperature of a diesel engine might be interesting from a thermodynamic point of view (as the exergetic content of the heat released would be higher), but is in reality limited to the manufacturer's prescription for technological reasons.

The modeller must keep these limitations in mind when testing different hypotheses.

### 2.1.2.4 Validation

To be usable, a model must first be validated. To verify and validate a general model (not necessarily a complex one) several steps can be followed [46]:

- the modeller can first critically review the different assumptions and approximations;
- he can then check the internal consistency of the model;
- perform a sensitivity analysis, that is to say study how sensitive the model is to small variations of the operating conditions (a high sensitivity can indicate a source of error);
- and compare simplified variants of the model to analytical solutions.

But when modelling complex systems, the only way to acceptably validate a model is to compare the simulation results with measurement results. The modeller will judge if the discrepancies are acceptable or not. If not, the model will be changed or tuned. If considered acceptable, the model will be considered valid, but only for operating conditions close to those used for validation. Interpolation between, and extrapolation outside measurement operating conditions is of course possible (it is in fact the whole point of modelling) but must remain limited.

## 2.1.3 Conclusion concerning the systemic approach

To sum up this presentation, one can say that the systemic approach complements the traditional analytical approach. An analytical approach cannot cope with the great number of variables and interactions that characterize complex systems: the systemic approach can. Thanks to a systems analysis which focuses more on the function of subsystems than on their behaviour and through modelling and simulation, systemic approach is the most appropriate tool to study complex systems.

It is adapted to exploring systems such as living cells, the human body, businesses, the economy, society and complex engineering facilities.

Ships can be considered as complex systems because:

- they contain a great number of subsystems (propulsion systems, water production systems, steam production systems, electricity distribution system, etc. (see section Appendix A);
- they have a complex border in contact with two different environments (sea and air), each of them evolving in time and space;
- there are a great number of interactions between the different subsystems;
- a great number of mass, energy and information flows connect the different subsystems (fuel, lubrication oil, fresh water, sea water, electricity, air, exhaust gas, steam, refrigerants, mechanical thrust, command and measurement signals);
- there are several types of stocks such as fuel and water tanks;
- there are several regulation loops (water levels, cooling water temperature, steam pressure, engine speed, etc.);
- they possess a dynamic behaviour;
- and require a very wide range of disciplines and techniques to build.

More generally, the systemic approach is well adapted to study complex energy systems.

## 2.2 ENERGY MODELLING METHOD

**N.B.:** This section follows the energy modelling method proposed by Gicquel [35]. This method focuses on thermal energy and thermodynamic transformations. Nevertheless, this method will be adapted to all ship energy media and transformations.

Complex energy systems are complex systems, such as defined previously, but with one of their main functions being energy transformation. Such systems are cars, trains, planes, building, ships, etc. but mostly industrial, chemical or electrical power plants.

Modelling energy systems relies on two pillars: the modelling of the thermodynamic fluid and the modelling of their thermodynamic transformations.

### ▪ Thermodynamic fluids

Thermodynamic fluids, such as water, refrigerant, exhaust gas, etc. can be completely characterized thanks to three values: their enthalpy, pressure and mass flow. Given this information, and with the appropriate thermodynamic tables and formulas, one can calculate the fluid's temperature, phase, density, entropy, heat capacity, exergy, etc.

### ▪ Thermodynamic transformations

Thermodynamic transformations are of four types: compression, expansion, heating and cooling. These transformations can follow different paths, they are then characterized by the following adjectives: isochoric, adiabatic, isotherm, isobaric and more generally polytropic. They can also be of different quality, they are then reversible or irreversible. All reversible transformations are characterized by equations which determine the thermodynamic state of the fluid at the output, knowing the input state and one additional indication, which is the compression ratio for compressions and expansions or the heat exchanged for heating and cooling transformations. In reality, there are no reversible transformations, only irreversible ones. Irreversible transformations are characterized by an efficiency relative to a corresponding reversible transformation. For example, one talks of the isentropic efficiency of a compression. This efficiency compares the work required by a real pump to compress a gas from a pressure  $p_1$  to a pressure  $p$ , to the theoretical work required by a reversible pump to compress the gas between the same pressures  $p_1$  and  $p_2$ . One talks also similarly of isothermic and polytropic efficiencies\*. Finally, knowing:

- the transformation efficiency;
- the input state;
- the compression ratio or the heat exchanged;

means one can determine the thermodynamic state of a fluid after a real thermodynamic transformation.

Therefore, a complex energetic system can be represented by a set of components operating thermodynamic transformations, and connected by thermodynamic fluids. Gicquel [35] considers that an energy modelling platform should combine:

- an analytical approach to represent the components by their main variables, parameters and equations;
- and a systemic approach to represent the global architecture of the system (choice of subsystems and description of interactions).

---

\* For a complete presentation concerning this matter, francophone readers can refer to Lallemand's article: "Compression et détente des gaz ou des vapeurs" (Compression or expansion of gas or steam) [50]

## 2.2.1 Modelling the overall system

The modelling of the overall system follows the systemic approach. Gicquel considers four fundamental steps [35]:

- the analysis of the system structure and functions which will define the main subsystems and their interactions. At this stage the subsystems are empty boxes, but their input and output connection ports are specified (type of flow, name, variables, quantity, units). A clear and coherent definition of the connection ports makes the structure independent of the level of detail of each subsystem;
- for each subsystem, the **identification of the thermodynamic fluids** (type of flow, name, variables, quantity, units). These fluids will enter and exit the subsystem through the connection ports. They will not necessarily exit the subsystem in the same form as they entered (for example, a diesel engine consumes air and fuel and rejects burned gases). On a graphical representation, subsystems will be connected via links, these links will then carry the fluid (similarly as a pipe or electric wire). The state of the fluid will be considered constant through a link;
- for each subsystem, the **definition of the thermodynamic transformation** that the fluid undergoes from the input port to the output port. The thermodynamic transformations are represented by a set of equations, either empirical or analytical or both.
- the subsystems are connected together and the overall model assembled. The parameters of the operating conditions are set. The global energy balance is calculated.

## 2.2.2 Modelling the components

Once the overall structure of the system is defined, the subsystems' empty boxes must be filled in. Subsystem models contain connection ports, variables, parameters and equations. A distinction is made between parameters and variables [46]:

- variables can change value during simulation;
- parameters cannot change value during simulation and are defined by the operator before simulation.

Equations permits the calculation of the output port values based on the input port and parameters values. The variables are used as calculation intermediates.

As mentioned previously, the equations can either be analytical or empirical or both. The level of detail in the model will depend on several criteria:

- the modeller's knowledge, that is to say his competence and his access to information;
- the desired output accuracy;
- the desired level of reusability of the model [49];
- the importance of the subsystem inside the system;
- the time and money allocated;
- and the computational power.

The final model will be a compromise between all these criteria. Nevertheless, when modelling complex systems, most of the time, the main interest will focus on the overall behaviour than on specific subsystems' behaviour. Hence, models that give the global performance of a subsystem rather than detailed internal models will often suffice.

## 2.2.3 A dual modelling approach

Along this thesis two complementary methods will be used to build energetic models of ships and their subsystems. The first one, named “fluid circuit” approach, based on the method presented above, is well suited for describing energetic processes involving thermal energy flows. Nevertheless, ship energetic processes cannot be reduced to a set of transformations involving thermal energy flows. Other types of energetic transformations take place in ships, such as electromagnetic transformations. And other type of energy flows take place such as mechanic, electric and chemical energy flows. A second approach, simpler, will be used to describe these transformations and flows. The reason for this dual approach can be explained by the concept of exergy. As mentioned previously, electric, mechanic and chemical energies are made of pure exergy. Therefore, as their quality is never deteriorated by any process (except energetic transformations involving thermal energy) only one variable is necessary to assess the exergetic content of these energies: the energy itself. On the contrary, thermal energy is composed of both exergy and energy. And as shown in the definition of exergy (see equation 1.8), at least two variables are necessary to assess the exergetic content of thermal energy: enthalpy and entropy. These two approaches are compared in Table 2.5.

**Table 2.5: Comparison between the "Energy flow" approach and the "Fluid circuit" approach**

“Energy flow” approach	“Fluid circuit” approach
First level approach	Second level approach
Based on the first law of thermodynamics	Based on the first and second law of thermodynamics
Allows energy analysis	Allows energy and exergy analysis
Based on energy flows	Based on at least three variables, typically mass flow, pressure and specific enthalpy*
Well adapted to describing electric, mechanic and chemical energy flows. Less adapted for thermal energy flows.†	Well adapted to describing thermal energy flows
Well adapted to describing energetic transformations not involving thermal energy. Less adapted to describe energetic transformations involving thermal energy†.	Well adapted to describing energetic transformations involving thermal energy
Easier to model	Requires more elaborate models (for example diesel engine, pumps, heat exchangers, fluid mixers, etc.)
Faster to compute	Longer to compute

It is reminded that these two approaches are complementary. In fact all ship models will be, at least partly, built using the “Energy flow” approach. In Chapter 3 (“Holistic Modelling”) an entire cruise ship will be modelled using this first approach. The “Fluid circuit” approach will be used as an additional layer to describe subsystems of key interest such as the diesel engines in Chapter 4 (“Engine Modelling”) as well as engine cooling and exhaust systems in Chapter 5 (“Fluid Circuit & Exergy Modelling”).

\* The entropy and temperature can be deduced from these three variables, either using thermodynamics equations or using thermodynamics fluid property tables.

† Describing thermal energy flows and thermodynamics transformations is still possible as long as not too many details are expected.

The following method will be used to model ships:

1. The ship is first divided into the main energy and control subsystems. These systems can correspond to real equipment (boilers, diesel engine, etc.), producers and consumers network (electric system, fresh water system, cooling system, steam system, etc.) or functions (hydrodynamic resistance, navigation, etc.). From the author's experience, how these divisions are made is not essential. The key point is that all energy producers and consumers are taken into account.
2. Then all energy flows between these subsystems are listed.
3. At this point a first level of modelling can be done. Each subsystem can be coded as a black-box model where every energy flow going in and out of these systems will be declared as input and output variables.
4. Depending on their importance, on the level of detail desired and on the data available, subsystems can be further broken down into sub-subsystems. Step 1, 2 and 3 are hence repeated as much as desired and possible.
5. Once the overall structure of the ship has been finalised, modelling can continue:
  - a. For each thermodynamic fluid listed, a "connector" is created (see section 2.3.2). Connectors are also coded for command signals.
  - b. The equations of every model are coded. They must link input variables to output variables, possibly in the most direct way. These equations can either be empirical or physical. The structure of these models is built in order to guarantee maximum reusability. Parameters are defined adequately in order to do so.
  - c. Input and output variables are connected to their respective connectors.
  - d. Models are linked to each other using the corresponding connectors.
6. The operational profile is defined and coded inside a "command model". It will usually define the ship's speed profile, electricity and water consumption and the environmental conditions met. The operational profile is connected to the rest of the ship model.

Once all these steps completed, simulations can start.

The method proposed above relies on the breakdown of the system into models, connectors and links. The Modelica modelling language is well suited to such a structure.

## 2.3 AN ENERGY MODELLING TOOL: MODELICA

### 2.3.1 Introduction

The Modelica association gives the following presentation of their modelling language [51]:

Modelica is a freely available, object-oriented language for modelling of large, complex, and heterogeneous physical systems

This short presentation highlights partially the main characteristics and assets of Modelica [46]-[52]:

- Modelica allows acausal modelling: the language is hence rather based on equations than on assignment statements. Acausal modelling is better suited for physical modelling and permits better reuse of models since the equations do not specify the data flow;

- Modelica is adapted to multi-physical modelling thanks to the concepts of models and connectors and thanks to a wide range of libraries covering multiple domains such as electricity, mechanics, thermodynamics, hydraulics, biology, control applications, etc.;
- Modelica is an object-oriented language (likewise Java or C++) which uses concepts of “class” and “inheritance”. This simplifies the evolution and reuse of models. It also makes Modelica a perfect tool to describe and structure complex physical systems;
- Modelica benefits from a large community of users, building, testing and providing free and open source libraries.

For all the reasons, the Modelica language is well adapted for the energy modelling of ships.

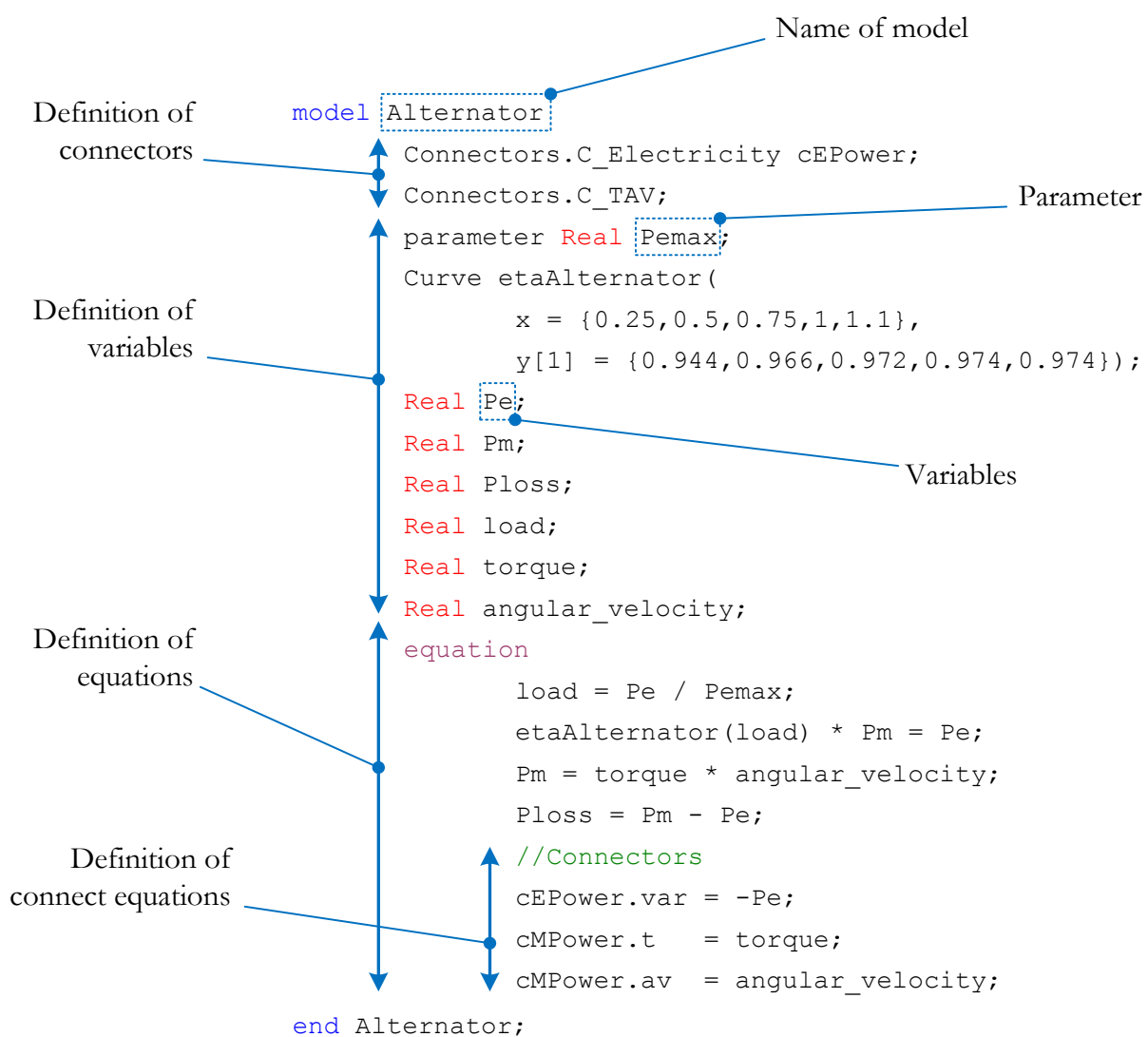

Figure 2.1: Basic example of code structure in Modelica

## 2.3.2 The model and connector concepts

As mentioned above, among the greatest assets of Modelica are the concepts of “models” and “connectors”.

The philosophy of Modelica relies on a modular approach. Big and complex systems can be divided into smaller subsystems based on any approach which is best suited (functional, structural, etc.). Each subsystem will then be represented by a Modelica **model**, which is a piece of computer code containing the definitions and declarations of the required variables, equations, algorithm and functions. In Modelica, a “model” is a generic term that covers many types of models. This presentation will focus on the two main types of models: “**components**” and “**connectors**”.

### ▪ Component models

Component models are the most important models in a Modelica program. They are the ones that represent the behaviour of a subsystem. For example, if the overall system is an electrical circuit, there will be component models for the resistors and capacitors. Likewise, a mechanical system may integrate component models for springs and dampers. The structure of a component model is composed of the definition of the model and its possible inheritance, the definition of the different connectors, parameters and variables and the definition of the different equations, functions and algorithms. An example of a simplified component model code (without inheritance) is described in Figure 2.1. Component models can exchange information between each other using connectors and connect equations.

### ▪ Connectors

Connectors are small Modelica models which are instantiated into component models. Models sharing same connectors can exchange variables amongst each other. Connectors can carry one or several variables at a time. These variables can be of various types (boolean, integer, real, vector, text) and nature (signal or physical flow). In Modelica, physical flows are generally represented as a couple of a **potential** and a **flow** variable (see Table 2.6). Variables that are declared as “potential” or “flow” type will automatically obey to respectively Kirchhoff’s voltage law and Kirchhoff’s current law.

**Table 2.6: Potential and flow variables for different physical fields in Modelica**

Fields	Potential variable	Flow variables
Electricity	Tension	Current
Mechanical (translation)	Speed	Force
Mechanical (rotational)	Angular velocity	Torque
Hydraulics	Pressure	Volumetric flow
Thermodynamics	Temperature	Enthalpy flow

### ▪ Graphical user interface

Most of the simulation platforms using the Modelica language offer a graphical user interface allowing the developer to assemble his component models by creating virtual links between identical connectors (see Figure 2.2). Adding to that the fact that Kirchhoff’s law are automatically applied to connectors, makes assembling the complete system an effective and simple task.



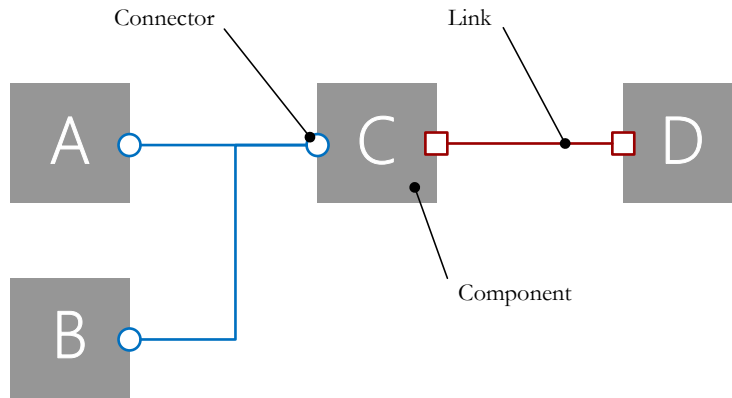

Figure 2.2: Block architecture of Modelica

Although easy to use, this approach does have some drawbacks. The consequence of this “block architecture” is that the code is written with no specific or intuitive order. Moreover Modelica handles acausal modelling, meaning that the developer can directly write implicit\* equations, leaving it to the solver to restate the equation into an explicit form. This restatement is not always the best possible. These two facts make Modelica programs quite difficult to debug, often more difficult than traditional imperative† language.

### 2.3.3 Modelica compiler

Modelica is a high-level modelling language and therefore needs to be transformed in order to be executed by a computer. The different steps required are presented in Figure 2.3. First, the Modelica source code (typically contained in a .mo file) is transformed into a “flat model” via a translator. This step means that one can analyse the models for type checking, to translate all connections into the equivalent equations and to instantiate all inherited objects. The equations of this flat model are then sorted out and optimized through an analyser and an optimizer before C code can be generated. This C code is finally compiled into an executable machine code ready for simulation [44], [53].

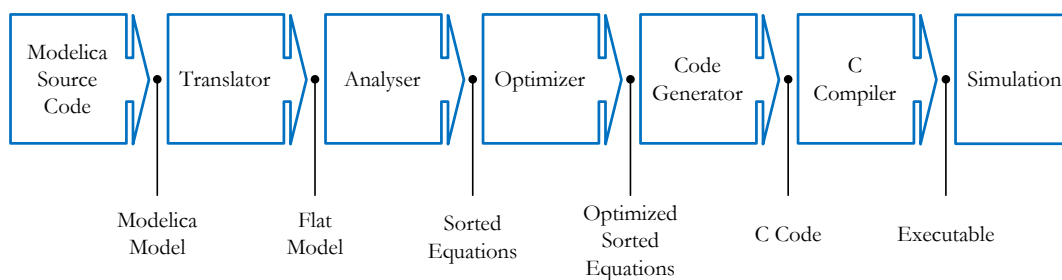

Figure 2.3: Translation stages from Modelica code to executing simulation [53]

\* Explicit equation are written under the form  $y = f(x)$ , whereas implicit equations are written under the form  $f(x, y) = 0$ . For example, the function  $y = 5x - 9$  is an explicit function whereas  $5x - y = 9$  is an implicit function. In this example, the implicit function can easily be restated into an explicit form. Nevertheless it is not always as straightforward or even possible. For example, the function  $x^2 + y^2 = 25$  must be restated into two explicit functions:  $y = +\sqrt{25 - x^2}$  and  $y = -\sqrt{25 - x^2}$ .

† An imperative language is a programming language that describes the different operations in terms of command sequences. C, Pascal and FORTRAN are examples of imperative programming languages.

Modelica is only a modelling language and therefore needs to be associated to a software to achieve the different steps described above. There are different simulation platforms (free and open source or commercial) based on the Modelica language, such as: CATIA Systems, CyModelica, Dymola, LMS AMESim, JModelica.org, MapleSim, OpenModelica, SCICOS, SimulationX, Vertex and Wolfram SystemModeler.

## 2.3.4 Libraries

The Modelica association develops and maintains the Modelica language. It also provides the Modelica Standard Library which is composed of the several sublibraries (see Table 2.7). These libraries can be completed by other accessible libraries. SEECAT is an example of Modelica library which will be presented in section Chapter 3.

**Table 2.7: Content of Modelica Standard Library (version 3.2) [54]**

<b>Blocks</b>	Continuous, discrete and logical input/output blocks (Continuous, Discrete, Logical, Math, Nonlinear, Routing, Sources, Tables)
<b>Constants</b>	Mathematical and physical constants (pi, eps, h, ...)
<b>Electrical</b>	Electric and electronic components (Analog, Digital, Machines, MultiPhase)
<b>Fluid</b>	Components to model 1-dim. thermo-fluid flow in networks of vessels, pipes, fluid machines, valves and fittings.
<b>Icons</b>	Icon definitions
<b>Magnetic.FluxTubes</b>	Components to model magnetic devices based on the magnetic flux tubes concepts.
<b>Maths</b>	Mathematical functions for scalars and matrices (such as sin, cos, solve, eigenValues, singular values)
<b>Mechanics</b>	Mechanical components (Rotational, Translational, MultiBody)
<b>Media</b>	Media models for liquids and gases (about 1250 media, including highly accurate water model)
<b>SIunits</b>	SI-unit type definitions (such as Voltage, Torque)
<b>StateGraph</b>	Hierarchical state machines (similar power as Statecharts)
<b>Thermal</b>	Thermal components (FluidHeatFlow, HeatTransfer)
<b>Utilities</b>	Utility functions especially for scripting (Files, Streams, Strings, System)
<b>ModelicaServices</b>	New top level package that shall contain functions and models to be used in the Modelica Standard Library that requires a tool specific implementation.

## 2.4 CONCLUSIONS

Ships are complex systems. Handling their complexity is not necessarily easy. This chapter has presented a complementary method to the traditional analytical approach: the systemic approach. This approach is meant to represent complex systems. Such systems are divided into subsystems linked together. The subsystems are no longer exclusively described analytically (how does it work?) but rather functionally (what does it do?). They can then be represented by relatively simple models, even black-boxes, where the inputs are linked to the outputs in the most straightforward way. The overall complexity will arise as the number of models and connexions between these models increases. Of course there is no unique way of describing complex systems. A method specific to energetic systems is presented, relying on connectors and energetic transformations. This method is based on a dual approach. Two complementary levels of modelling will be used in the rest of this thesis. A first approach, based on energy flows will be applied in the following chapter. A second approach, based on exergy, will be applied in Chapter 4 and Chapter 5. The Modelica modelling language is finally presented. This tool is well adapted to complex systems modelling and multi-physical modelling and is used in the rest of this thesis.

*Les navires sont des systèmes complexes. Gérer cette complexité n'est pas forcément aisé. Ce chapitre propose une méthode complémentaire à la traditionnelle méthode analytique : l'approche systémique. Cette approche est pensée pour représenter les systèmes complexes. De tels systèmes sont alors divisés en sous-systèmes reliés les uns aux autres. Chaque sous-système n'est plus alors représenté seulement de manière analytique (comment ça marche ?) mais aussi de manière fonctionnelle (à quoi sert le système ?). Ils peuvent alors être décrit à l'aide de modèles très simples, voir même de boîtes noires où les variables de sorties sont reliées aux variables d'entrées de la manière la plus directe qui soit. La complexité du modèle global apparaîtra alors au fur et à mesure que le nombre de sous modèles et leurs connexions associées augmentent. Une méthode spécifique aux systèmes complexes de nature énergétique est également présentée. Cette méthode est basée sur une double approche. Deux niveaux de modélisation complémentaires vont être utilisés dans le reste de cette thèse. Un premier niveau de modélisation, basé sur les flux d'énergie sera appliqué au chapitre suivant. Le deuxième niveau de modélisation, basé sur l'exergie, sera utilisé dans les chapitres 4 et 5. Le langage de programmation Modelica est finalement présenté. Cet outil est bien adapté à la modélisation de systèmes complexes et multi-physiques et sera utilisé dans la suite de cette thèse.*

# CHAPTER 3

## HOLISTIC MODELLING

---

<b>CHAPTER 3 HOLISTIC MODELLING.....</b>	<b>73</b>
3.1 SEECAT.....	74
3.2 APPLICATION TO A REAL SHIP .....	75
3.2.1 <i>The Ship Architecture</i> .....	75
3.2.2 <i>The Ship Model</i> .....	76
3.2.3 <i>Operational Profile</i> .....	76
3.3 MODELLING THE COMPONENTS.....	77
3.3.1 <i>Connectors</i> .....	78
3.3.2 <i>Diesel engines</i> .....	78
3.3.3 <i>Electric motor and alternator</i> .....	80
3.3.4 <i>Waste Heat Recovery Boiler</i> .....	81
3.3.5 <i>Oil-Fired Boiler</i> .....	82
3.3.6 <i>Fresh Water Generator</i> .....	83
3.3.7 <i>Reverse Osmosis Production Unit</i> .....	84
3.3.8 <i>Air Conditioning and Chiller Systems</i> .....	86
3.3.9 <i>Hydrodynamics</i> .....	87
3.3.10 <i>Conclusion concerning the models</i> .....	88
3.4 RESULTS ANALYSIS .....	88
3.4.1 <i>Verification Method</i> .....	88
3.4.2 <i>First cruise analysis: from Miami to Saint-Martin</i> .....	90
3.4.3 <i>Comparisons with the three other cruises</i> .....	96
3.4.4 <i>Conclusion of the analysis of results</i> .....	98
3.5 DESIGN ALTERNATIVES .....	99
3.6 CONCLUSIONS.....	104

Chapter 1 and Chapter 2 have paved the way towards a ship holistic energy modelling. In this chapter an initial, straightforward yet efficient method is used. The method is based on the systems approach and focuses on energy flows. It constitutes a first level approach in this thesis and is based on the first law of thermodynamics only. It therefore does not allow exergy analysis, but it will nevertheless prove to be accurate and fast to compute. The different models used are described. These models are coded in the Modelica language and a library of components, called SEECAT is created. The general method is presented and applied to a real case. A cruise ship, built and monitored by STX France, has been modelled. The simulation results are compared to measurements and the validity of the model is discussed. Finally, SEECAT is used to compare different design alternatives, illustrating its capacity to assess energy saving solutions.

*Les chapitres 1 et 2 ont jeté les bases de la modélisation énergétique globale des navires. Dans ce chapitre une première méthode, simple et efficace est utilisée. Cette méthode est basée sur l'analyse systémique et se concentre sur les flux d'énergie. Elle constitue un premier niveau d'approche basée sur le premier principe de la thermodynamique. Elle ne permet donc pas l'analyse exergétique mais elle se montrera néanmoins précise et rapide à calculer. Les différents modèles utilisés sont décrits. Ces modèles sont codés en langage Modelica et une bibliothèque de composant appelée SEECAT est créée. La méthode générale est présentée et appliquée à un cas réel. Un paquebot, construit et instrumenté par STX France a été modélisé. Les résultats des simulations sont comparés aux signaux de mesure et la validité du modèle est discutée. Finalement, SEECAT modèle est utilisé pour comparer différentes alternatives de conception, illustrant ainsi sa capacité à évaluer des solutions d'économie d'énergie.*

## 3.1 SEECAT

The SEECAT\* ship modelling platform has been developed in order to assess the global energy efficiency of ships, or ship systems, for realistic operational profiles. More specifically, it makes it possible to:

- evaluate the efficiency of the different energy consumers on board in order to estimate the potential of recoverable energy;
- predict fuel consumption and associated air emissions;
- compare impacts of alternative machinery systems or architectures, or strategies of operation in order to optimize or validate future designs or optimize existing systems operation.

SEECAT consists of two layers.

The first layer of SEECAT is for developers, the second is accessible to non-developer users.

The first layer is a library of models coded in the Modelica language. The SEECAT library developed contains over 40 models which simulate the energetic behaviour of marine devices such as: hydrodynamic resistance modules, alternators, electrical motors, diesel engines, power management systems, waste heat recovery boilers (WHR boiler), oil fired boilers, distillers, HVAC† systems, etc.

The second layer of SEECAT consists of the ITI SimulationX‡ software. This software offers a human computer interface which will create the models, organize them into a library and assemble them into a ship model. SimulationX can then compile the ship model and perform a time domain simulation. The

---

\* SEECAT stands for Ship Energy Efficiency Calculation and Analysis Tool

† Heating Ventilation and Air Conditioning. HVAC systems on board ships are presented in appendix A.9. The theory is presented in Appendix C

‡ <http://www.simulationx.com/>

software then makes it possible to visualize and save the results of simulations as time series. It also offers the possibility of linking the parameters of a model to different types of databases.

SEECAT's modelling method is based on a holistic approach, that is to say a global approach where all energy producers and consumers are taken into account. Thus the interactions amongst the following energy vectors are correctly described:

- chemical energy, from fuel;
- mechanical energy, for example propeller shaft power;
- electricity;
- heat, for example steam, cooling water and exhaust gases.

This holistic approach and the acausal and object-oriented properties of Modelica make SEECAT a very modular tool capable of modelling any kind of marine propulsion architecture.

In the present state, SEECAT models are mostly quasi-static which is sufficient for the current application cases. Nevertheless, the development of dynamic models is possible.

## 3.2 APPLICATION TO A REAL SHIP

In order to validate the ship modelling platform, the model of an existing ship was built and simulation results were compared with sea measurement data. As part of the collaboration between Bureau Veritas and STX France, a modern large cruise vessel designed by STX and for which three measurement campaigns had been carried out has been chosen. Cruise vessels are one of the most, if not the most complex ships from an energetic point of view. This is due to the great variety of energy producers and consumers, to the number of energy networks and the interactions amongst these networks and the behaviour of passengers.

### 3.2.1 The Ship Architecture

The selected ship presents the following main characteristics:

- Shipyard: STX France
- Length overall: 330 m
- Tonnage: 153,000 GT\*
- Maximum speed: 22 knots
- Propulsion type: Diesel-electric
- Propulsion power: 2 x 24 MW AC motors on two propeller shafts
- Electrical power: 6 diesel engines
- Steam production: 6 waste heat recovery boilers and 2 oil-fired boilers
- Fresh water production: 3 reverse osmosis production units (hereafter referred to as "ROPU") and 2 distillers
- Cold production: 5 chiller plants

---

\* Gross tonnage (GT) is a unitless index related to a ship's overall internal volume. It is not a physical measure but rather an administrative one. It is used notably for ship's manning regulations, safety rules, registration fees, and port dues.

This ship integrates a system that has been developed by STX France and called Advanced Heat Recovery Plant (AHRP) [55]. This AHRP system recovers the heat dissipated in both high and low temperature diesel engines cooling circuits, whereas traditional systems usually neglect the low temperature circuit. This system is said to be able to save up to about 90% of the oil-fired boilers' fuel consumption.

### 3.2.2 The Ship Model

The ship model, as presented on Figure 3.1 is an assemblage of subcomponent models taken from the SEECAT library. The parameters of these subcomponent models have been set based on data provided by the shipyard and equipment manufacturers. The ship mainly includes models of energy producers and consumers such as:

- Diesel generators (DG)
- Waste heat recovery (WHR) boilers
- Oil-fired boilers (OFB)
- Electrical motors
- HVAC systems
- Distillers
- ROPU
- Various electricity, steam and heat consumers

The ship model also includes a model that simulates the hydrodynamic behaviour of the ship. This model is based on a speed power curve to convert the speed signal command into power to the electrical motors. These models are completed by controller and indicator models which respectively specify input data and monitor output data. These are listed in the following section.

### 3.2.3 Operational Profile

The ship's operational profile is defined by inputting the timewise description of the following data:

- Ship's speed
- Instantaneous fresh water consumption
- Type of fuel consumed in boilers and diesel engines
- Navigation mode (at berth, manoeuvring, sailing)
- Sea water temperature
- Outside air temperature

The main output data calculated are:

- Fuel mass flow and total consumption, per fuel type
- CO<sub>2</sub> mass flow and total emission
- NO<sub>x</sub> mass flow and total emission
- SO<sub>x</sub> mass flow and total emission
- Level in fresh water tanks
- Wasted energy rejected to the sea and the atmosphere

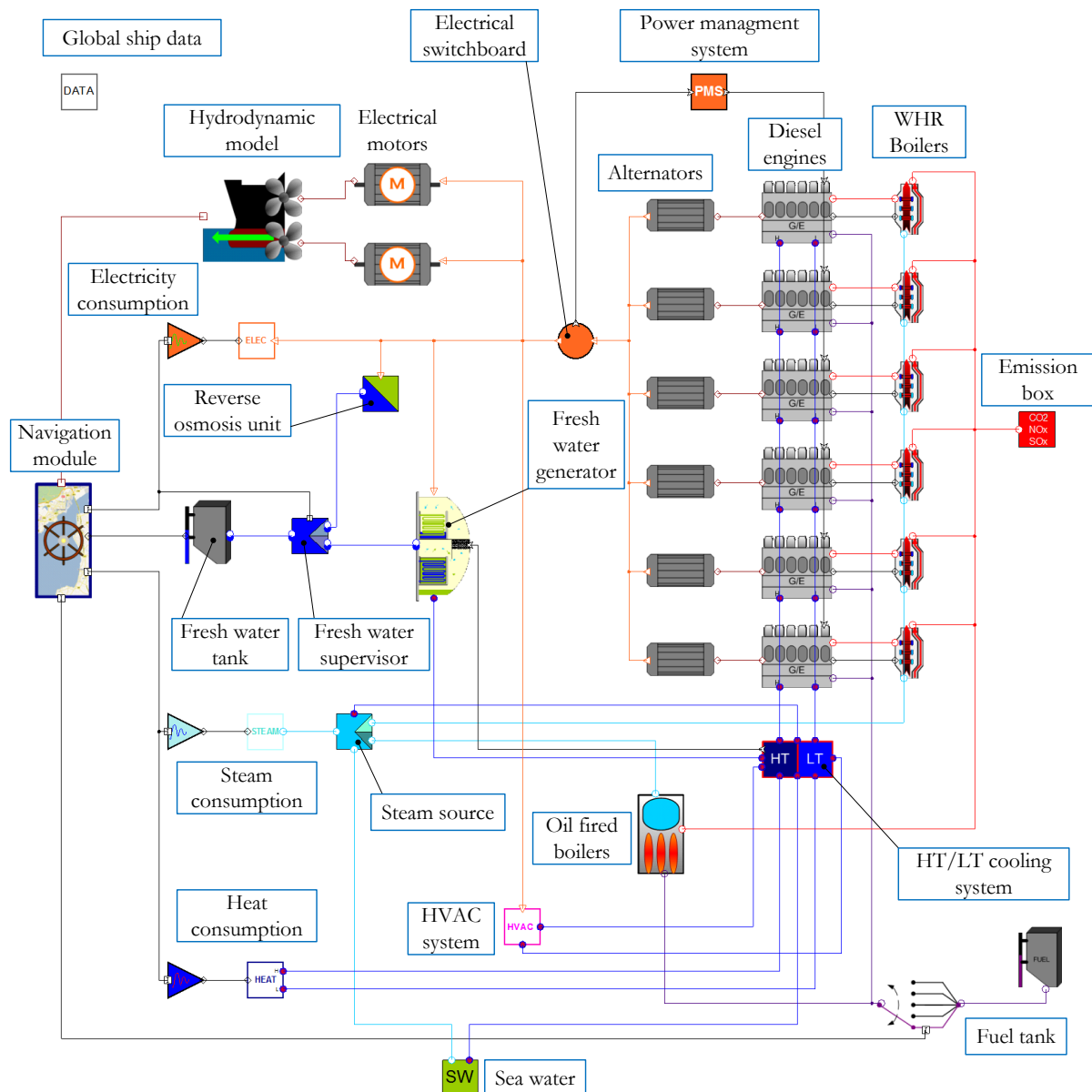

Figure 3.1: SEECAT's diagram view of the modelled cruise vessel

### 3.3 MODELLING THE COMPONENTS

The description of the main components is given below. The focus is placed on energy (or power) and how this energy changes from one side of the component to the other. Because the energy must be conserved, the energy balance must be equilibrated. The main equations that determine the output variables in function of the inputs are given. As the main focus is energy, models will sometimes exclude variables which do not influence the energy balance, even if these variables are essential to the physical functioning of the device. For example, sea water, or air at ambient temperature are not represented as they have no exergy.

It must be remembered that the models alone are not of key interest, it is their interactions with the other models, and the behaviour of the overall model which are essential.



### 3.3.1 Connectors

Almost every model has connectors. Connectors of the same type can be connected together via a link. These links can transit matter, energy or information. There are connectors for almost every input and output of a model. Building a standardized library of connectors has guaranteed compatibility between models. Connectors can carry multiple variables. These variables are either of type potential or flow, thus obeying respectively to Kirchhoff's voltage law, or Kirchhoff's current law.

There are connectors for electricity, cooling water, fresh water, steam, fuel, exhaust gas, mechanical force, control signal, etc.

### 3.3.2 Diesel engines

The function of a diesel engine is to provide mechanical power. From a black-box point of view, an engine can be represented as a mass and energy converter where fuel and air are the inputs and exhaust gases, mechanical power and heat are the outputs (see Figure 3.2).

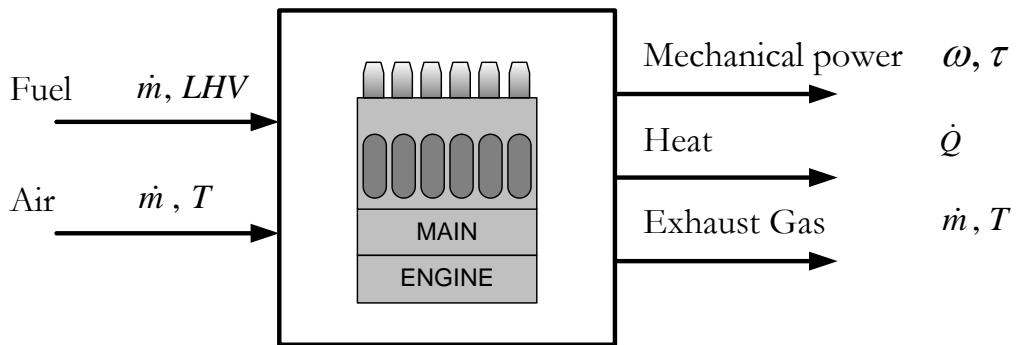

Figure 3.2: Black-box type representation of a diesel engine

The main equations that link the inputs to the outputs are the following:

- **Conservation of energy**

The calorific power of the fuel is converted into mechanical power and heat:

$$P_{combustion} = P_{crankshaft} + \dot{Q}_{loss} \quad (3.1)$$

Where:

- $P_{combustion}$  is the calorific power of the fuel:  $P_{combustion} = \dot{m}_{fuel} \cdot LHV$ ;
- $P_{crankshaft}$  is the effective output power of the engine:  $P_{crankshaft} = \tau \cdot \omega$ ;
- and  $\dot{Q}_{loss}$  is the heat lost.

The global engine efficiency provides a ratio between the calorific power of the fuel and the effective mechanical power output:

$$\eta_{global} = \frac{P_{crankshaft}}{P_{combustion}} \quad (3.2)$$

In stationary conditions, the global efficiency only depends on the engine load and speed. Manufacturers do not directly provide the efficiency but the brake specific fuel consumption (BSFC):

$$BSFC = \frac{\dot{m}_{hc}}{P_b} = \frac{3\,600\,000}{\eta_{global} \cdot LHV} \quad (3.3)$$

Where  $\dot{m}_{hc}$  is the fuel mass consumption per hour (g/h). For engines working at variable speeds, the BSFC must be given as a map (see for example Figure 4.2 or Figure 3.3). For engines working at constant speed, such as generators, BSFC can be given as a simple curve function of the load (see Figure 3.3).

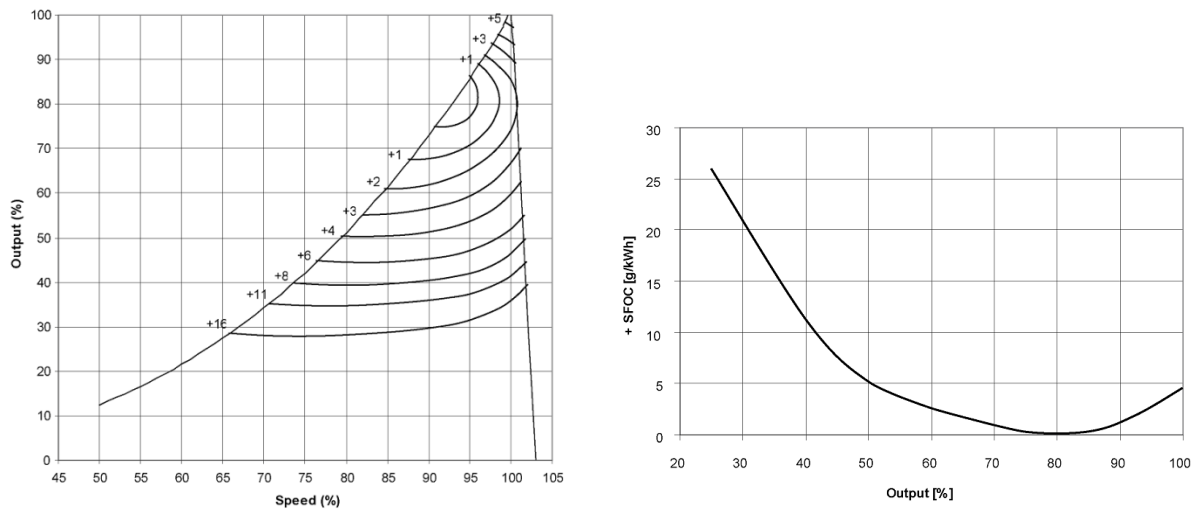

BSFC map of a Wärtsilä 46 diesel engine. Output power and speed are given as a percentage of power and speed at MCR\*.

BSFC curve of a Wärtsilä 46 diesel engine at a constant speed of 500 or 540 rpm

**Figure 3.3: BSFC map and curve of a Wärtsilä 46 engine [56]. BSFC values are relative to the best BSFC achieved for a specific engine, for example, 170 g/kWh for the Wärtsilä 12V46**

The heat lost is dissipated through radiation, cooling (water or oil circulation) and exhaust gas:

$$\dot{Q}_{loss} = \dot{Q}_{radiation} + \dot{Q}_{cooling} + \dot{Q}_{exhaust} \quad (3.4)$$

The distribution of these heat losses is not constant and will vary with engine load and speed. Manufacturers may provide technical data which give  $\dot{Q}_{cooling}$  and  $\dot{Q}_{exhaust}$ .  $\dot{Q}_{radiation}$  is then calculated as the remaining part of the total heat losses (they represent usually under 5% of  $P_{combustion}$  [57]). Nevertheless, to the best of the author's knowledge, manufacturers only provide heat losses at constant speed. This is not a problem as long as these engines are generators (the ship described in section

\* Maximum Continuous Rating : maximum output power an engine is capable of producing continuously under normal conditions

3.2 is a diesel electric propulsion ship) but is troublesome for variable speed engines. This reason, amongst others, has led to the development of a more detailed engine model.

#### ▪ Conservation of mass

The mass flow of exhaust gas is equal to the sum of the fuel mass flow and air mass flow:

$$\dot{m}_{air} + \dot{m}_{fuel} = \dot{m}_{exhaust} \quad (3.5)$$

The mass of carbon, hydrogen and oxygen remains constant. The combustion undergoes the following generic chemical equation:

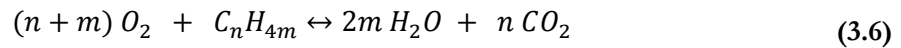

Where  $n$  and  $m$  are integers. Equations (3.5) and (3.6) calculate the  $CO_2$  mass flow. The  $SO_x$  mass flow is calculated thanks to the sulphuric content of the fuel. The  $NO_x$  production is not yet modelled as it depends on the temperature of the combustion, which is not modelled. This last point is another reason for developing a more detailed engine model (see next chapter).

The equations presented above are the main equations used in this preliminary SEECAT engine model. This preliminary engine model has been used successfully in the following sections but its limitations have motivated the decision to develop a more physical engine model.

In a complete SEECAT ship model, the diesel engine is connected to:

- A fuel supply: fuel tank or fuel switch
- An exhaust circuit: waste heat recovery boilers or directly the atmosphere
- The high and low temperature cooling circuit
- The power management system
- A mechanical device: alternator, propeller, clutch or gearbox

### 3.3.3 Electric motor and alternator

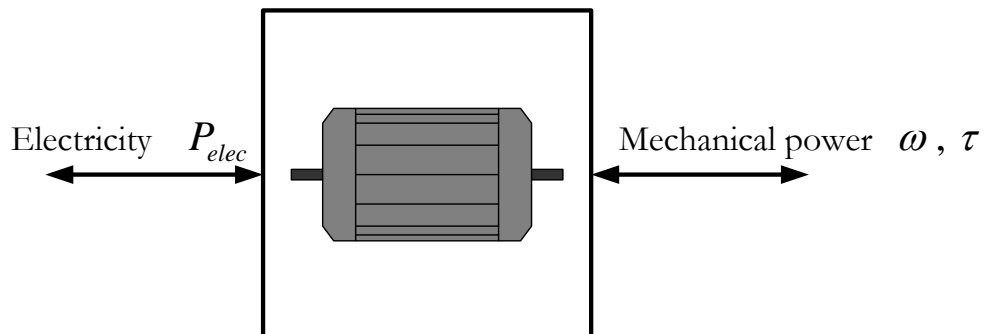

Figure 3.4: Black-box type representation of an electric motor or alternator

The function of an electric motor is to produce mechanical power. The function of an alternator is to produce electricity. An electric motor is a reversible machine which can work as an alternator. The modelling of such a device therefore benefits of the acausal property of Modelica. From a black-box point of view, an electric motor (or alternator) is a machine that converts electricity (or mechanical power) into mechanical power (or electricity) (see Figure 3.4).

The equations that link the input to the output are:

$$\eta_{motor} = \frac{P_{mech}}{P_{elec}} \qquad \eta_{alternator} = \frac{P_{elec}}{P_{mech}} \qquad (3.7)$$

Where:

- $\eta_{motor}$  is the efficiency of the electric machine working as a motor;
- $\eta_{alternator}$  is the efficiency of the electric machine working as an alternator;
- $P_{mech}$  is the mechanical power (W);
- $P_{elec}$  is the electrical power (W).

The efficiencies are usually high (around 95%) but depend on the electric machine load and the electric circuit power factor. The efficiency curves  $\eta = f(load)$  are usually provided by the manufacturer.

### 3.3.4 Waste Heat Recovery Boiler

The function of a waste heat recovery (WHR) boiler is to produce steam. It is basically a heat exchanger: it uses the heat of the diesel engines and oil-fired boilers (OFB) exhaust gases to heat up water and produce steam. Depending on the quantity of heat produced by the engines, the WHR boiler can work independently or associated to OFB. For more details concerning the steam production, readers can refer to the appendices (A.8 Steam production and distribution).

A black-box type representation of a WHR is given in Figure 3.5.

The inputs of the WHR boiler are the exhaust gas and the feed water, and the outputs are the exhaust gas and the steam. The water and steam are characterized by their mass flow, pressure and enthalpy; the exhaust gas by its mass flow and thermal power. The boiler is considered to work in stationary conditions and the mass flow of water and exhaust gas are considered to be conserved:

$$\dot{m}_{in} = \dot{m}_{out} \qquad (3.8)$$

Moreover, the power lost by the exhaust gases is considered to be fully transferred to the water:

$$P_{th.exh.in} - P_{th.exh.out} = \dot{Q}_{exh} = \dot{m}_{steam} \cdot (h_{steam.out} - h_{steam.in}) \qquad (3.9)$$

Where:

- $P_{th.exh.in}$  and  $P_{th.exh.out}$  are the thermal power of exhaust gases in and out of the boiler (W);
- $\dot{Q}_{exh}$  is the thermal power lost by the exhaust gases (W);
- $\dot{m}_{steam}$  is the steam (or feed water) mass flow (kg/s);
- and  $h_{steam.out}$  and  $h_{steam.in}$  are the specific enthalpy of the steam (or feed water) in and out of the boiler (J/kg).

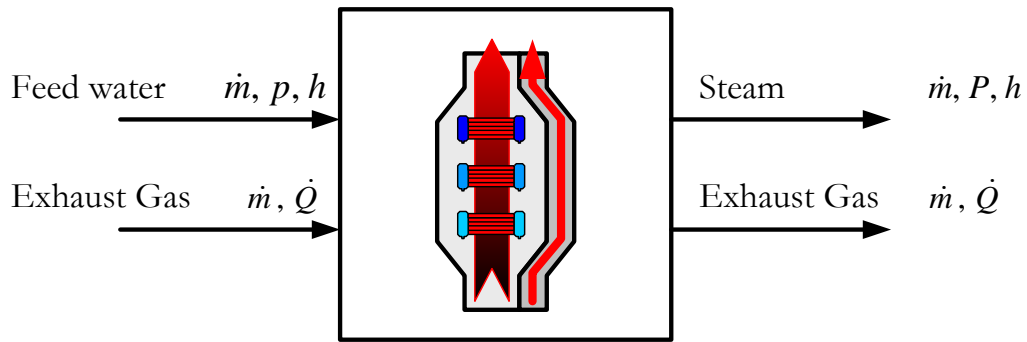

Figure 3.5: Black-box type representation of a waste heat recovery boiler

In a first approach, and considering the specific ship modelled in the previous section (3.2), the flow of feed water is not represented and the mass flow of steam produced is calculated thanks to manufacturer's data and depends on the diesel engine load.

The WHR boiler model is connected to the emission box\*, the steam network and the diesel engines models.

### 3.3.5 Oil-Fired Boiler

The function of an oil-fired boiler (OFB) is to produce steam. From a black-box type point of view, the OFB is considered to have fuel and feed water as inputs and exhaust gas and steam as outputs (see Figure 3.6). The fuel is characterized by its mass flow and lower heating value, the feed water and steam by their mass flow, pressure and specific enthalpy, and the exhaust gas, by its mass flow and thermal power.

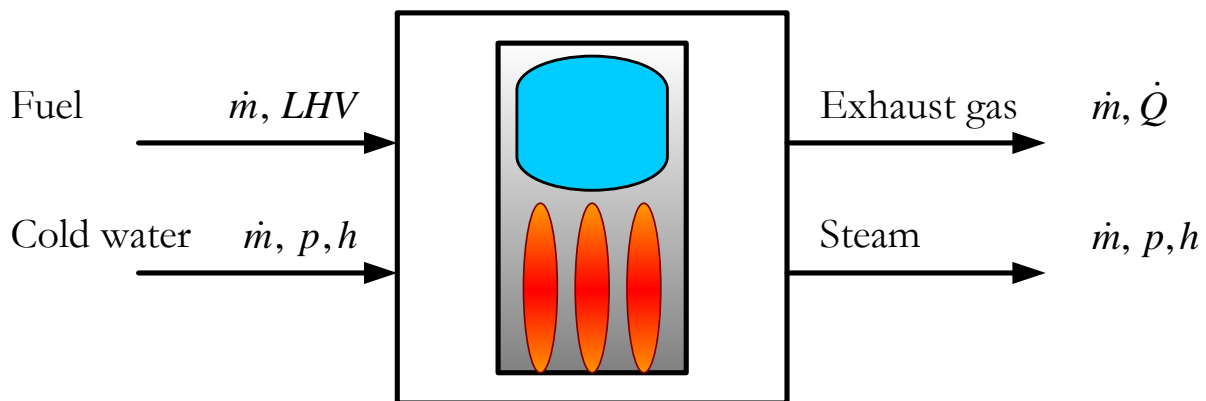

Figure 3.6: Black-box type representation of an oil-fired boiler

\* The emission box model represents the atmosphere and calculates the values of CO<sub>2</sub>, NO<sub>x</sub>, and SO<sub>x</sub> mass emitted as well as the thermal energy released through exhaust over the full simulation.

In a first approach, the OFB can be represented by its two main physical phenomena: the combustion and the heat transfer. The combustion transforms the fuel and air into exhaust gases, releasing heat in the meantime:

$$P_{fuel} = \dot{m}_{fuel} \cdot LHV \quad (3.10)$$

With  $P_{fuel}$  the calorific power of the fuel. This power is partially transferred to the water:

$$P_{fuel} \cdot \eta_{OFB} = P_{steam} = \dot{m}_{steam} \cdot (h_{steam.out} - h_{steam.in}) \quad (3.11)$$

Where:

- $\eta_{OFB}$  is the efficiency of the boiler;
- and  $P_{steam}$  is the power transferred to the water (W).

The efficiency of the OFB is a manufacturer's data. It depends on the boiler's load.

The emissions of CO<sub>2</sub> and SO<sub>x</sub> are calculated similarly to the diesel engine. The mass flow of CO<sub>2</sub> is directly proportional to the fuel mass flow. The mass flow of SO<sub>x</sub> is also directly proportional to the fuel mass flow and depends on the sulphuric content of the fuel.

In a first approach the feed water is not represented.

The OFB model is connected to the emission box, the fuel tank (or fuel switch) and the steam network.

### 3.3.6 Fresh Water Generator

Fresh water generators (FWG), also called distillers, produce fresh water from sea water. The basic principle of FWG is to boil up and evaporate sea water to get rid of its salt. The heat used to boil up the sea water usually comes from the cooling of the diesel engines or steam from the OFB. The main phenomenon that takes place is hence heat transfer. Readers can refer to appendix A.5.1.

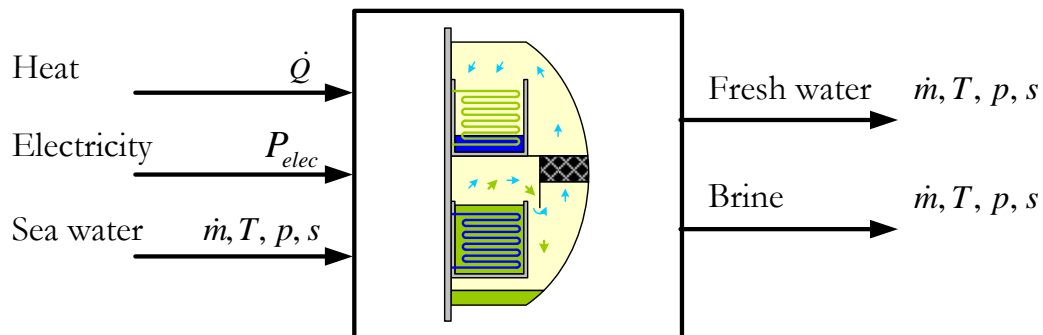

Figure 3.7: Black-box type representation of a distiller

From a black-box point of view (see Figure 3.7), the FWG is considered to have electricity, heat and sea water as inputs and fresh water and brine\* as outputs. The electricity is characterized by its power and is used to supply the various pumps. In a first approach, the electric demand is modelled by a manufacturer's data and is considered constant. In fact, the FWGs modelled for this specific ship have an "all or nothing" type behaviour. The amount of heat provided by the high temperature cooling circuit, for a one stage FWG, can be calculated using the following expression:

$$\dot{Q}_{cooling} = \dot{m}_{fw} \cdot (h_{sw.out} - h_{sw.in}) \quad (3.12)$$

Where:

- $\dot{Q}_{cooling}$  is the heat extracted from the high temperature cooling circuit to evaporate the sea water (W);
- $\dot{m}_{fw}$  is the fresh water produced mass flow (kg/s);
- $h_{sw.out}$  is the specific enthalpy of the sea water at saturation point and under reduced pressure (J/kg), it is a parameter of the model;
- $h_{sw.in}$  is the specific enthalpy of the sea water at ambient temperature and under reduced pressure (J/kg).

To make evaporation possible at a temperature around 80 °C, the pressure inside the chamber is reduced.

Most of today's FWGs are multi-stage, the sea water is heated up in a first stage through the condensation phase before entering a second stage in the boiling phase.

In a first approach, the FWG is considered to be a single stage one, the sea water input and the brine output are not represented, and the electricity consumption is a tabulated value function of the fresh water mass flow.

In this particular ship application, the FWG model represents two fresh water generators. The model is connected to the fresh water network, the electric network and the cooling system model.

### 3.3.7 Reverse Osmosis Production Unit

The function of a reverse osmosis production unit (ROPU) is to produce fresh water. It is based on the filtration of salt through osmotic membranes. From an energetic point of view, these membranes are passive: they do not use or produce energy. The only energy required is for putting the sea water under high pressure (around 60 bars). Part of this energy can be saved using a turbine on the brine output flow.

From a black-box type point of view, the ROPU is considered to have electricity and sea water as inputs and fresh water and brine as outputs (see Figure 3.8).

The sea water, the fresh water and the brine are characterized by their mass flow, temperature, pressure and salinity. The mass flow is conserved through the ROPU:

$$\dot{m}_{sw} = \dot{m}_{fw} + \dot{m}_{brine} \quad (3.13)$$

Where  $\dot{m}_{fw}$  is the fresh water mass flow.

---

\* Water saturated or strongly impregnated with salt

The power provided to the pump is:

$$P_{elec} \cdot \eta_g = \dot{V} \cdot \Delta P \quad (3.14)$$

Where:

- $P_{elec}$  is the electric power delivered to the pump (W);
- $\eta_g$  is the global efficiency of the pump;
- $\dot{V}$  is the volume flow through the pump (m<sup>3</sup>/s);
- $\Delta P$  is the pressure difference between the output and input of the pump.

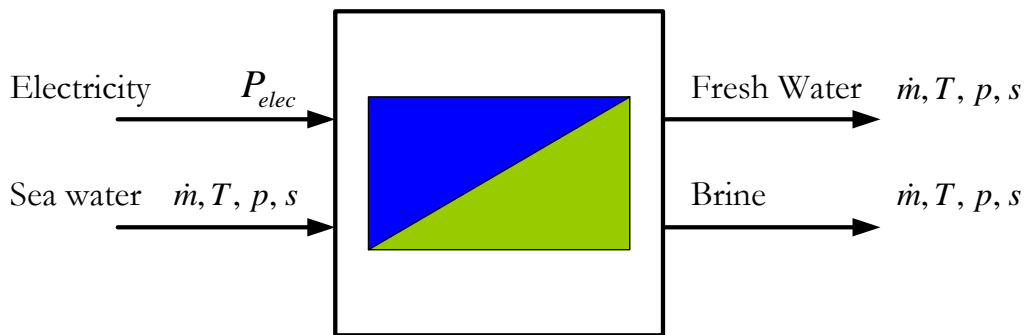

Figure 3.8: Black-box type representation of a reverse osmosis fresh water production unit

The ROPU can be considered, from an energetic point of view as a partial pressure loss. The 60 bars of pressure or so are used to activate the reverse osmosis process, but part of this pressure is lost. Nevertheless, most of it can be saved by using a turbine:

$$P_{turbine} = \dot{V} \cdot \Delta P \cdot \eta_g \quad (3.15)$$

Solving this set of equations requires in-depth knowledge of the ROPU behaviour: how the sea water flow is distributed between fresh water and brine, the pump and turbine efficiencies and characteristic curves ( $\Delta P = f(\dot{V})$ ), the pressure loss of the osmotic membranes and how it changes with sea water temperature, etc.

As a matter of fact, ROPUs often work in an “all or nothing” manner. And the manufacturer provides the fresh water mass flow, the ROPU electric consumption, and how it changes with sea water temperature. In a first approach, the sea water and brine flow were not modelled, and the electric consumption and fresh water flow calculation relied on manufacturer’s data.

The ROPU model is connected to the fresh water and electric network.



### 3.3.8 Air Conditioning and Chiller Systems

**Note:** In this section the term chiller will refer to water conditioning systems. The generic term conditioning systems or conditioners will refer to either air conditioners or chillers.

The main function of a conditioning system is to cool down a stream of air or water (when cooling down air, a second function is to control the level of humidity). The calories taken from the stream of water or air are rejected back to the environment. A detailed description of such systems is given in section Appendix C and appendix A.9.

From a black-box type point of view, conditioning systems have electricity and hot water or air as inputs and cool water or air as output (see Figure 3.9). The environment is not represented in a first approach.

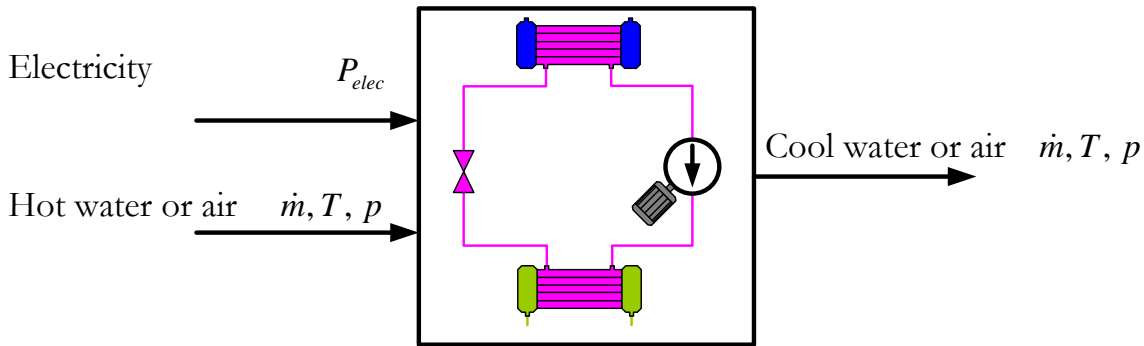

Figure 3.9: Black-box type representation of a conditioning system

The electricity consumed by a conditioning system is mainly due to the compressor and the potential evaporator and condenser fans. This electric power is calculated by the coefficient of performance (COP):

$$COP = \frac{\dot{Q}_{frigo}}{P_{elec}} \quad (3.16)$$

Where  $\dot{Q}_{frigo}$  is the heat flow extracted from the fluid (or frigorific power). The frigorific power is calculated by the following expression:

$$\dot{Q}_{frigo} = \dot{m}_{stream} \cdot (h_{stream.out} - h_{stream.in}) \quad (3.17)$$

Where:

- $\dot{m}_{stream}$  is the stream (air or water) mass flow (kg/s);
- and  $h_{stream.out}$  and  $h_{stream.in}$  are the specific enthalpy of the stream out and in of the conditioning system (J/kg).

If the cooling demand is known, the electric consumption can be quite simple to approximate. Nevertheless, obtaining such information is very complex as it depends on many parameters: sea and air temperature, sun radiation, thermal inertia and resistance of the ship, heat dissipation inside the ship, regulation, etc. Each of these parameters also depends on other parameters.

Conditioning systems are part of HVAC systems. The ship builder has provided average electric consumption values for the complete HVAC system.

The HVAC model is connected to the hot and cold water cooling circuit and the electric network.

### 3.3.9 Hydrodynamics

The hydrodynamic model represents the hull and propeller from an energetic point of view. From this point of view, the function of the propeller is to provide thrust to compensate for the hydrodynamic resistance of the ship. From a black-box type point of view, the model is considered to have the ship's speed and the sea state as inputs and the propeller torque and rotational speed as outputs (see Figure 3.10). The ship's draft also influences the hydrodynamic resistance, but in this particular case (the STX cruise vessel), the draft was kept almost constant thanks to water ballast. Therefore, the draft is considered constant.

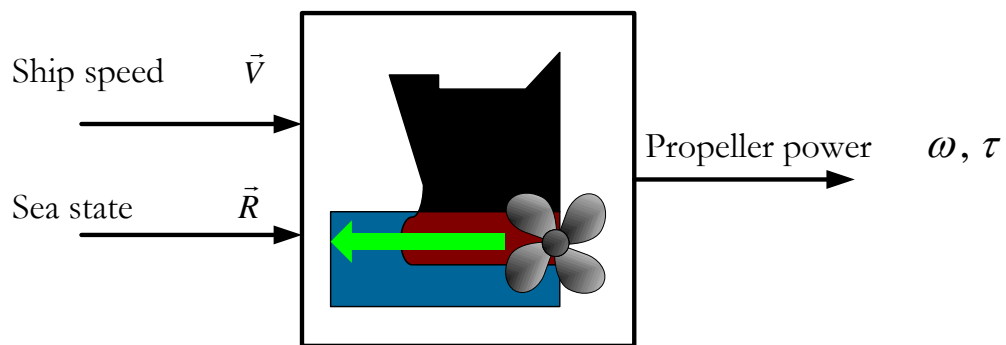

Figure 3.10: Black-box type representation of the ship's hydrodynamics

The model developed is quasi-static, therefore the operating conditions are considered stationary and hence, the propeller thrust  $\vec{T}$  always compensates for the ship towing resistance  $\vec{R}_t$  (frictional, residual and air resistance) and thrust deduction fraction  $\vec{F}^*$ :

$$\vec{T} = -\vec{R}_t - \vec{F}^* \quad (3.18)$$

---

\* The thrust reduction factor is due to the rotation of the propeller which “sucks” back the water at the front creating an extra resistance [58]-[59].

The power delivered to the propeller can be calculated with the following expression:

$$P_D = \frac{\|\vec{T}\| \cdot \|\vec{V}\|}{\eta_{prop}} = \frac{P_T}{\eta_{prop}} \quad (3.19)$$

With:

- $P_D$  the power delivered to the propeller;
- $P_T$  the power delivered by the propeller to water;
- $\vec{V}$  the ship speed;
- and  $\eta_{prop}$  the propeller efficiency (behind hull).

The power delivered to the propeller can be directly related to the ship's speed thanks to sea trials (calm sea, no wind and no current conditions) and measurement data. Sea measurements were provided by the ship builder and analysed. With correct filtering and data processing it has been possible to plot the curve  $P_D = f(V)$ ; with  $V$  the ship speed. An interpolation function has been calculated from this curve and used in the model. The curve obtained very closely matched the one derived by STX during their propulsion sea trials.

Sea state (waves, current, wind) can be taken into account via an additional resistance factor. The determination of this factor is nevertheless tricky.

Other models can be used instead of this power-speed curve, for example an Holtrop and Mennen model [60]-[61] can be used for the towing resistance calculation and associated to a propeller model. These models nevertheless require extensive sets of data, particularly geometric dimensions and coefficients, which are not necessarily available. But these models will not be necessarily more accurate.

The hydrodynamic model is connected to the navigation module (which defines the ship's speed) and a mechanical power (electric motor, engine shaft).

### 3.3.10 Conclusion concerning the models

The models created in SEECAT are "energy oriented". The energy conversions that occur in each model are characterized by equations, either empirical or physical, depending on the data available, but most of the time hybrid. Connecting all these models together has made it possible to build a complete quasi-static, acausal and continuous time ship model.

## 3.4 RESULTS ANALYSIS

### 3.4.1 Verification Method

The verification exercise consisted in using measured values for the operational profile parameters, and comparing the calculated output with the corresponding sea data.

The sea data have been collected by STX during three different one month duration measurement campaigns. The vessel sailed in the Caribbean and Mediterranean regions and performed a transatlantic crossing during the months of January, May and August. More than 250 data sample were recorded, including ship speed, wind speed, draft, latitude and longitude, the boilers' and diesel engine's fuel consumption, electrical power consumption of various devices, thermal power consumption, ambient air

temperature, sea water temperature, cooling loop temperature and mass flow, fresh water consumption, etc. The sampling rate was one point every ten minutes.

To verify the modelling methodology, simulations were run over four cruises. They took place over the month of January in the eastern Caribbean's. Their main characteristics are presented in Table 3.1.

**Table 3.1: Main characteristics of cruises selected for verification**

		<b>Cruise 1:</b>	<b>Cruise 2:</b>	<b>Cruise 3:</b>	<b>Cruise 4:</b>
		Miami to St-Martin	St-Martin to St-Thomas	St-Thomas to Nassau	Nassau to Miami
<b>Total duration</b>	[h]	71	24	53	20
<b>Time at port</b>	[h]	8	10	8	7
<b>Time at sea</b>	[h]	63	14	45	13
<b>Average speed at sea</b>	[Knots]	17.98	9.77	19.58	16.23
<b>Distance travelled</b>	[NM]*	1133	137	881	211
<b>Average Beaufort</b>	-	6	3	6	6

The route followed by the four cruises is presented in the Figure 3.11.

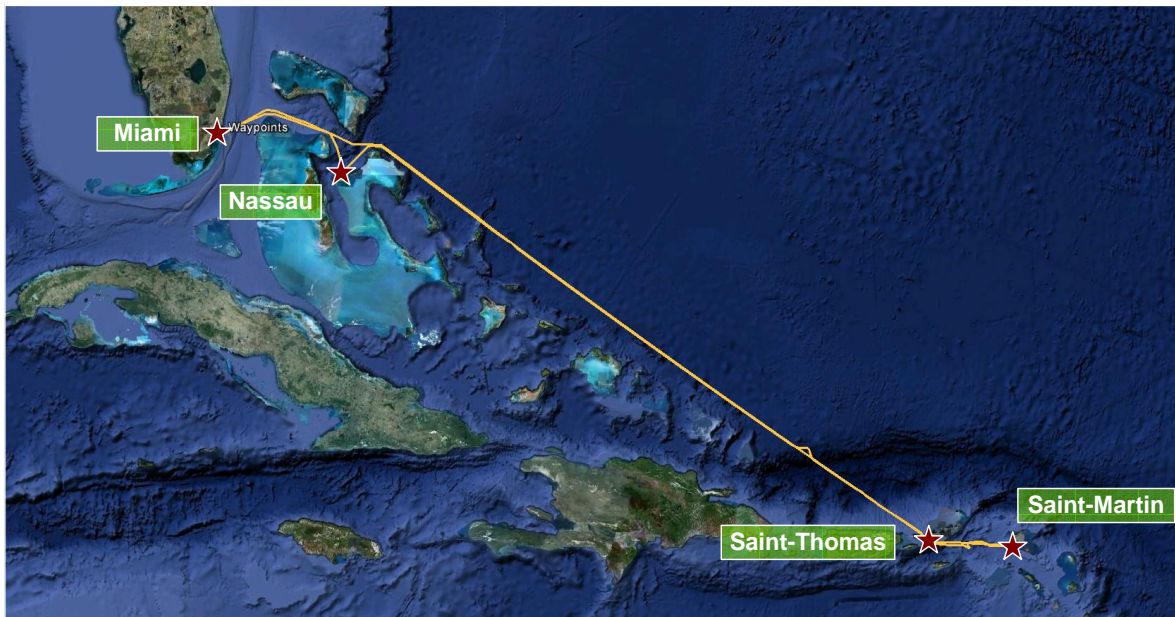

**Figure 3.11: Map presenting the route followed by the ship during the four cruises**

All simulations were run with the same machinery parameters. During the four cruises the ship only consumed HFO. For the simulations, a cruise from port X to port Y is considered to start when the ship arrives at port X and to finish when she arrives at port Y.

The comparison between simulations and measurements are made for fuel and electricity consumptions. CO<sub>2</sub>, NO<sub>x</sub> and SO<sub>x</sub> emissions are not compared because no measurements data were available.

\* 1 nautical mile (NM) = 1,852.00 m

### 3.4.2 First cruise analysis: from Miami to Saint-Martin

The main results are presented in Table 3.2 below:

Table 3.2: STX and SEECAT data comparison for the first cruise

MIAMI TO SAINT-MARTIN	unit	Measurements	Simulation	Ratio*
<b>Total fuel consumption</b>	tonnes <sup>†</sup>	613.91	514.47	-16.2%
<b>DG<sup>‡</sup>'s fuel consumption</b>	tonnes	609.29	514.47	-15.6%
<b>Boiler's fuel consumption</b>	tonnes	4.62	0.00	-100.0%
<b>Total electrical production</b>	MWh <sup>§</sup>	2 523.01	2 568.25	1.8%
<b>Propulsion motors' electrical consumption</b>	MWh	1 627.01	1 519.58	-6.6%
<b>Other electrical consumption</b>	MWh	896.00	1 048.66	17.0%
<b>Average DG's specific fuel consumption</b>	g/KWh <sub>elec</sub>	241.49	200.32	-17.0%

#### ▪ Fuel consumption analysis

It can be observed that simulations underestimate the total fuel consumption of the ship with a relative difference of -16.2%. 0.75% comes from the fact that, in simulations, the steam production does not require the oil-fired boilers whereas according to the measurements, oil-fired boilers are used in ports. The boilers are required mainly at port when only one or two diesel generators are on and thus steam production from WHR boilers is not sufficient. The difference is due to the fact that simulations slightly underestimate the thermal energy demand (cooling heat or steam) in port. The reason for this difference has not yet been clearly identified and would require further investigation. Nevertheless the gap is small.

The total measured and calculated instantaneous fuel consumptions are presented in Figure 3.12.

The relative difference observed on the total fuel consumption is also visible on the instantaneous consumptions. The calculated consumption is almost constantly below the measured ones, although the tendency is correctly simulated. From the start to the 8<sup>th</sup> hour the ship is at port, thereafter she is navigating and slows down back to port from the 69<sup>th</sup> hour to the end.

A slot of almost constant fuel consumption can be noticed on the measurement time trace, between the 33<sup>rd</sup> hour and 47<sup>th</sup> hour. During this same time slot the simulation signal presents many variations. This difference can be explained by the two ways the ship can be operated:

- either on autopilot, and the propulsion motors are then controlled by the speed command. For a constant speed command, the power consumed by the propulsion and hence the fuel consumption depends on the sea state;
- or, on a constant propulsion power mode. Here, the power transmitted to the propellers is constant and the ship goes as fast as she can, depending on the wind and sea state.

\* Ratio = (Simulation – Measurements) / Measurements

† The fuel consumed is HFO, its density is considered to be of 991 kg/m<sup>3</sup>

‡ DG : diesel generator

§ 1 MWh = 3.6 x 10<sup>9</sup> J

It seems that during this specific time slot the ship was operated in this latter mode, with speed variations due to the types of wind, waves and current encountered. The simulations are performed with a speed command, without adding time varying ship resistance due to waves, current or wind, hence the variations in the simulation results. This is confirmed by the analysis of the propulsion engine electrical consumption presented hereafter.

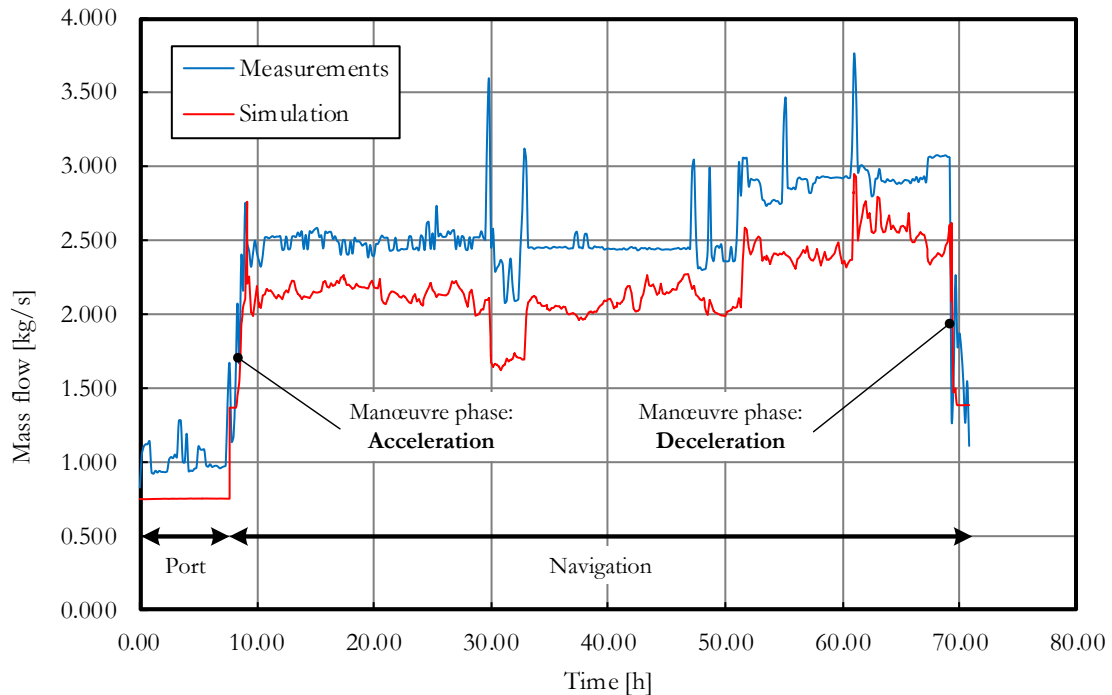

Figure 3.12: Total instantaneous fuel consumption during the first cruise

#### ▪ Electrical production and consumption

The measured and calculated electrical productions shown in Table 3.2 present a very close match. Nevertheless a closer analysis shows that the simulation underestimates the electrical consumption of propulsion motors (the difference is of -6.6%) and overestimates the electrical consumption of other consumers (the difference is of 17%).

The instantaneous total electricity production, the instantaneous propulsion motors' electricity consumption and the instantaneous other electricity consumption are respectively presented in Figure 3.13, Figure 3.14 and Figure 3.15.

#### ▪ Total electricity production analysis

The analysis of Figure 3.13 shows that measurement and simulation curves globally match. The measurement curve is mainly composed of different plateaus whereas the simulation curve presents more variations. These variations are linked to variations of the ship's speed and the sea's state. This seems to be confirmed by the analysis of Figure 3.14.

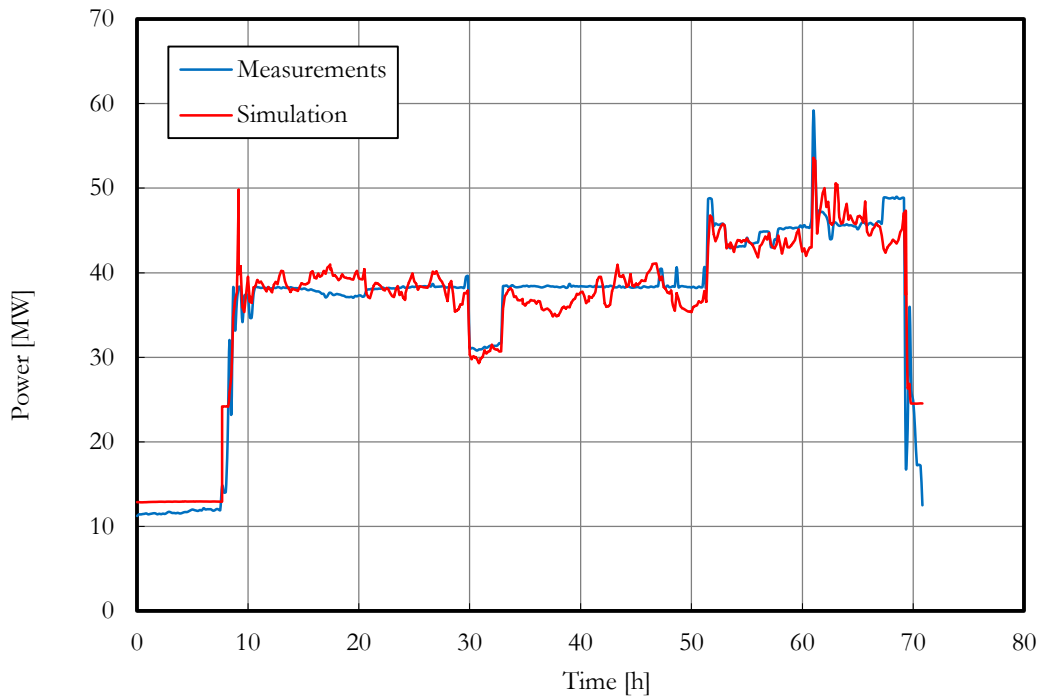

Figure 3.13: Total instantaneous electrical production during the first cruise

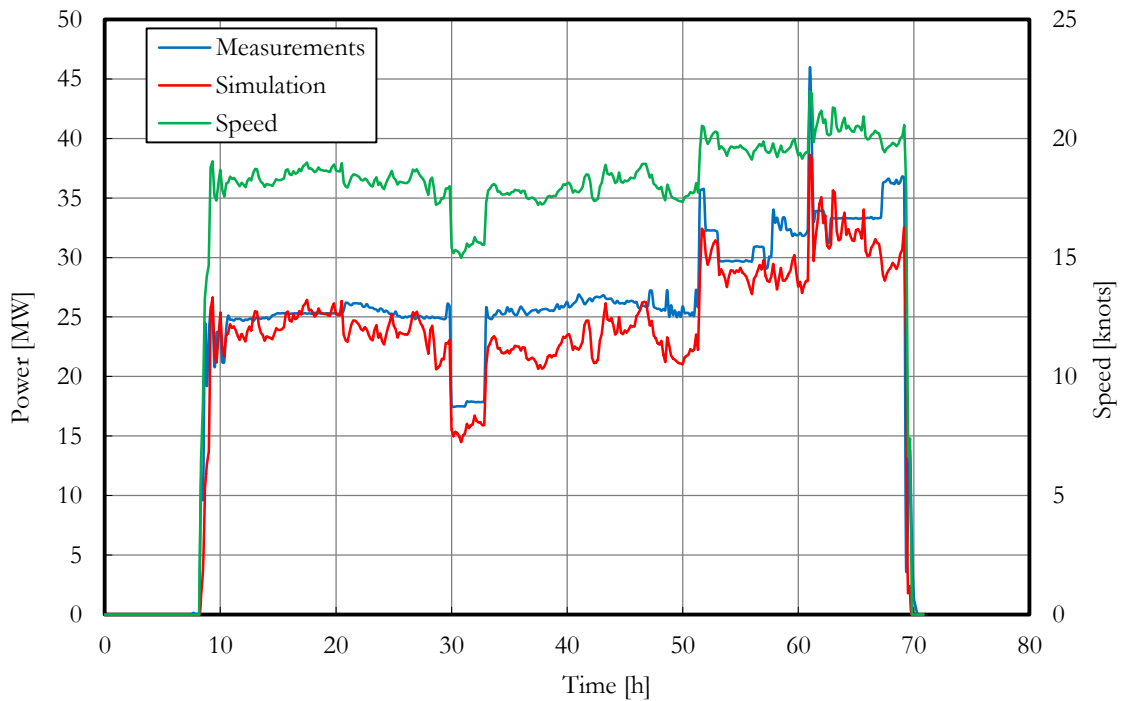

Figure 3.14: Instantaneous electrical consumption by propulsion motors during the first cruise

#### ▪ Propulsion motors electricity consumption analysis

Figure 3.14 presents the instantaneous electrical consumption of electrical motors according to STX's measurements and SEECAT's simulations. These curves are compared to the speed curve.

For different time slots the measured electrical consumption curve is almost constant, whereas the speed curve is not. If the propulsion motors consume a constant electrical power they must deliver a constant mechanical power to the propellers. The fact that for a constant propeller power the speed varies can only mean that the environmental conditions (waves, wind or current) are changing. The variation in time of waves and current were not measured, and their influence on the ship's resistance is difficult to assess. This influence is classically accounted for by applying a constant average correction factor (sea margin) to the ship's resistance. Applying a 6.6% sea margin on this first cruise, which is in the range of sea margin values classically applied by ship designers, would cancel the mean difference between measured and simulated propulsion engine electrical consumption.

#### ▪ Other electrical consumers' analysis

Figure 3.15 presents the instantaneous electrical consumption of other electrical consumers. These consumers include a large variety of devices such as:

- Propulsion auxiliaries
- Air compressors
- Fans
- Navigation systems
- Thrusters
- HVAC systems
- Lights
- Various pumps
- Galley and pantry equipment
- Fresh water production systems
- etc.

These devices operate according to many different profiles. Some have almost constant electricity consumptions such as air compressors, lights or fans. Others depend greatly on outside conditions such as speed for propulsion auxiliaries, air temperature for HVAC systems or fresh water consumption for ROPU and distillers.

The measurement signal presents two peaks corresponding to manoeuvring phases when the thrusters are engaged. Since the manoeuvring phase is unsteady, and due to the under-sampling effect, the measured power signal cannot be correctly read, and hence modelled during these phases. Apart from these two peaks the signal is close to a sinusoid with a time period of 24 hours. The values vary between 11,500 kW and 13,500 kW. The electrical consumption in port is close to that at sea. This is due to the fact that on a very large cruise vessel, the electrical consumption of propulsion auxiliaries is quite low compared with the "hotel" consumption (HVAC system, lighting, general services, etc.).

The simulation curve also presents the two peaks corresponding to the manoeuvring phases. However, the model considers that thrusters are used at their maximum capacity during manoeuvres. Apart from manoeuvres, the simulation curve is composed of plateaus. This is explained by the fact that the majority of the electrical consumers are modelled as variables whose values only depend on the navigation mode.

The steps between plateaus on Figure 3.15 mainly come from the activation and deactivation of the ROPU and distillers. In the simulation model, the activation and deactivation of these devices is ruled by a



command law that seeks to emulate the behaviour of the chief engineer in charge of water production. The command law could be tuned to get as close as possible to the engineer's behaviour, but this operation would have to be done for almost every new cruise.

The variations observed on each plateau in the simulation curve are due to the HVAC system electricity consumption which depends on the air temperature, which itself slightly varies during the cruise.

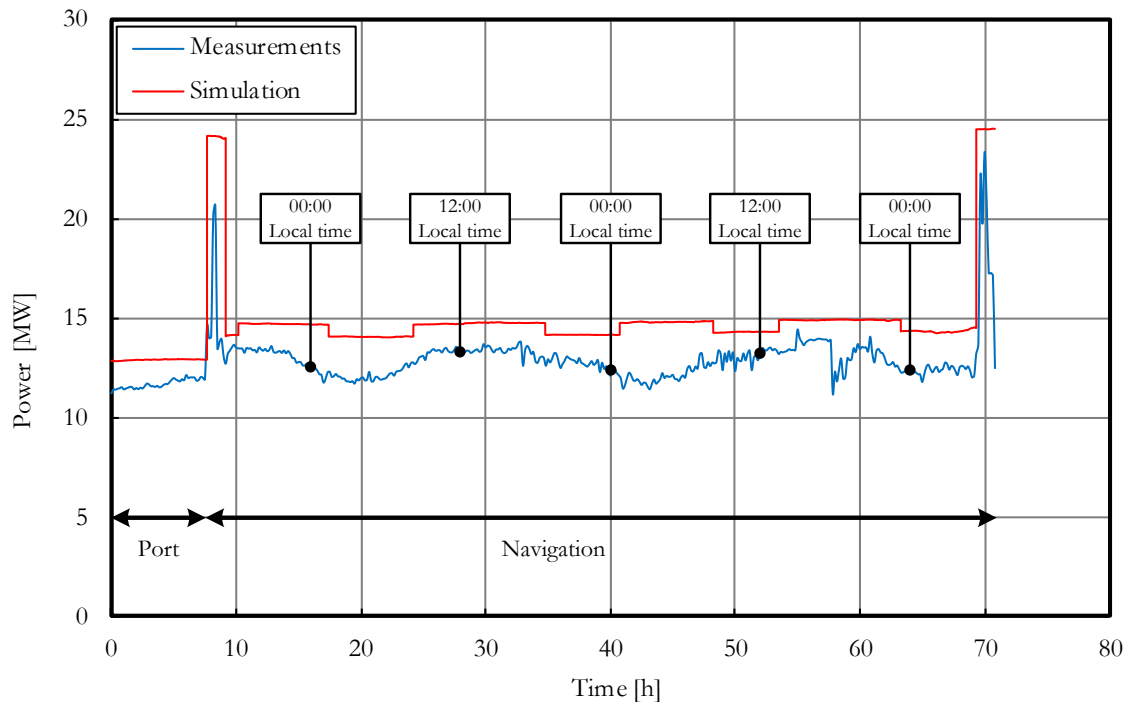

Figure 3.15: Instantaneous electrical consumption by other electrical consumers during the first cruise

Globally, it is observed that simulations overestimate the consumption of other electrical consumers. This is to do with the fact that the models of most of these consumers are built on the shipyard's electrical balance, which in turn, is based on maximum consumptions for critical external conditions (tropical conditions and cold winter conditions). Analysis of measurements over the long term could better identify the usage factors of these consumers, and thus give a better match between simulations and measurements.

#### ▪ Conclusion on the analysis of the first cruise

The electrical consumption of propulsion motors is underestimated, mainly because of the influence of environmental conditions (waves, wind and current), but the trends are correctly predicted. The application of a reasonable sea margin to the ship resistance model would lead to a very close match.

The consumption of other electrical consumers is overestimated, mainly because of conservative assumptions related to the usage of thrusters and non-propulsion related parameters. Again, the application of correction factors, to be identified from the analysis of measurement in the long term, would give closer agreement.

Nevertheless there is a notable difference between the total fuel consumption according to the measurements and the simulations (-16.2%).

This difference is explained by the last row of Table 3.2. The DG's average specific fuel consumption (ASFC) can be calculated as follows:

$$ASFC = \frac{\text{Total DG's fuel consumption}}{\text{Total electricity produced}} \quad (3.20)$$

The relative difference (-17%) between measured ASFC (241.5 g/kWh<sub>elec</sub>) and the one obtained from simulations (200.3 g/kWh<sub>elec</sub>) clearly indicates that either the model is incorrect or the fuel consumption measurements are biased.

In fact both hypotheses are valid. The simulations are performed using specific fuel consumption curves issued from the DGs' factory acceptance tests. Indeed these tests are performed in standard ISO conditions, and do not take into account engine-driven pumps which can increase BSFC\* by 5%. Moreover the fuel flow sensors are not fully reliable and may lead to bias.

#### ▪ Distribution of electricity consumption

The distribution of electricity consumption according to simulations is presented in Figure 3.16.

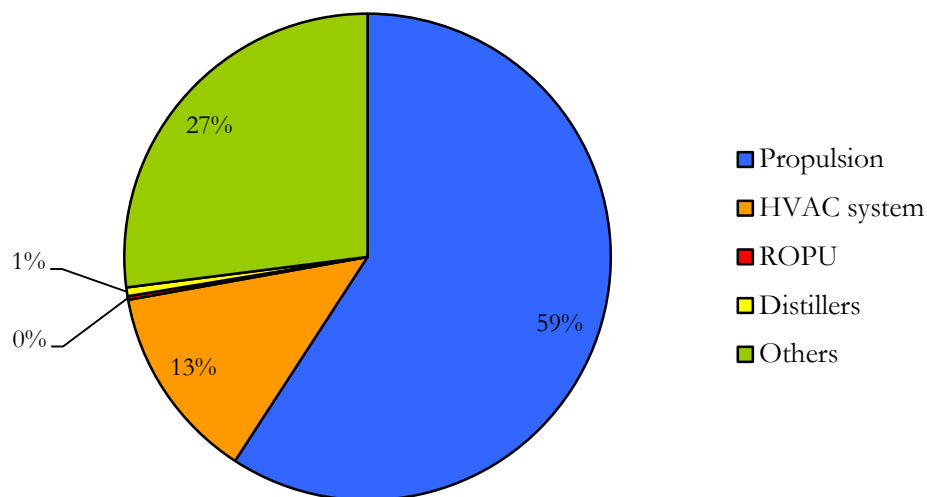

Figure 3.16: Electrical balance for cruise 1 according to simulation

As expected, propulsion is the major electrical consumption item. The relative importance of this item naturally changes with navigation speed and duration, and may, in certain particular cruises, represent less than 50% of total electrical consumption (see following section).

Figure 3.16 outlines the importance of HVAC and other consumers' consumption. On the other hand, one can observe that the total energy consumed by fresh water producers (ROPU and distillers) represents less than 1% of the electrical balance.

---

\* Brake specific fuel consumption

### 3.4.3 Comparisons with the three other cruises

Figure 3.17 presents the total fuel consumption, the DG's fuel consumption and the boiler's fuel consumption, according to measurements and simulation, for each cruise listed in Table 3.1.

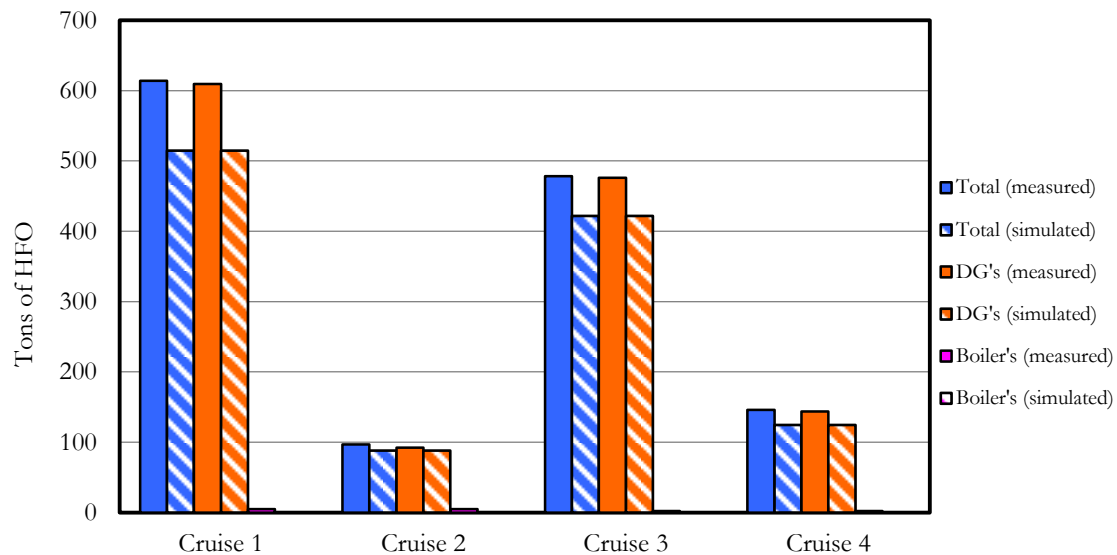

Figure 3.17: Fuel consumption comparison between the four cruises

Figure 3.17 highlights the fact that practically all of the fuel is consumed by the diesel generators. The boilers' consumption is very small but would have been higher in true winter conditions. As a matter of fact, although the four cruises occur during the month of January, temperatures are closer to summer conditions (air temperature between 20 and 30 °C and sea water temperature close to 25 °C in the Caribbean's area). In the four simulations there is no boiler consumption.

This figure also confirms that simulations underestimate the fuel consumption, as explained above for cruise 1.

Each time the simulations tend to underestimate the total fuel consumption, and one of the reasons for this is the difference between specific fuel consumptions.

The average specific fuel consumptions derived for the four cruises, both from measurements and simulations as explained before, are presented on Figure 3.18.

This figure first confirms that the ASFC based on measurements is always larger than the one based on simulations. It is also noticeable that both measurement-based and simulation-based ASFC are almost constant for all four cruises. This tends to confirm the existence of a bias that is deemed to stem from diesel generators' model parameters and fuel consumption measurements as explained previously (see cruise 1 analysis).

The total electrical consumption, the propulsion engines electrical consumption and the other consumers' electrical consumption, according to measurements and simulations, for each cruise, are presented in Figure 3.19.



Figure 3.18: ASFC comparison between the four cruises

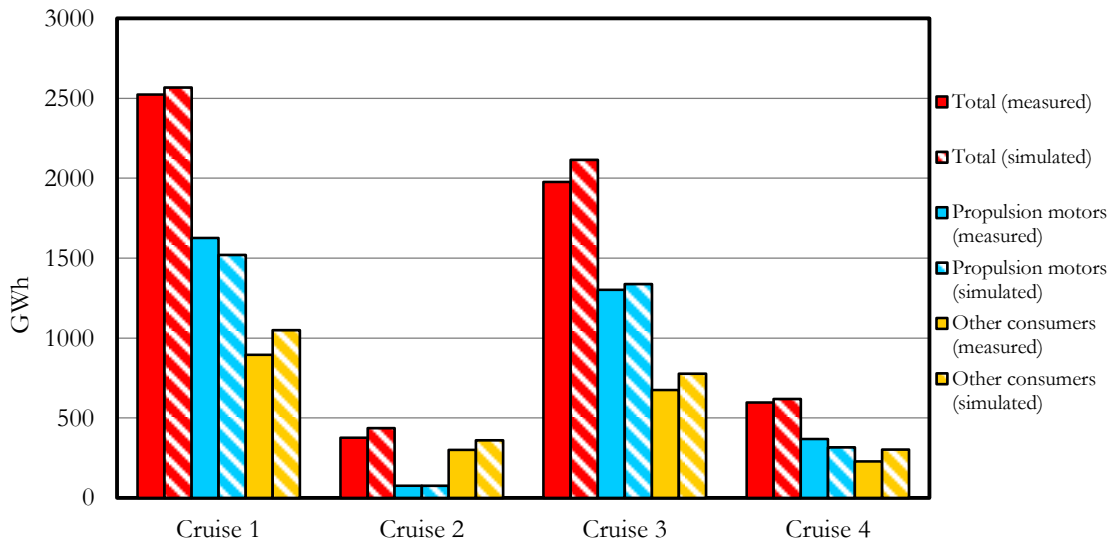

Figure 3.19: Electrical consumption comparison between the four cruises

This figure confirms that propulsion motors and other consumers' electrical consumption are of high importance in the total electrical balance. Globally propulsion is the major electrical item. It may be almost equal or even lower than the other consumers' item, as in the second cruise where propulsion accounts for only 20% of the measured electrical consumption. This is due to a short navigation time in comparison to time at port (respectively 14 and 10 hours) and to a slow navigation speed (average speed of 9.8 knots, see Table 3.1).

As described in the analysis of cruise 1 one observes that:

- globally, the propulsion power is reasonably well predicted by simulations. It is generally underestimated due to weather conditions, as explained for cruise 1, except for cruise 3. The overestimation for this cruise needs to be further investigated;
- on the contrary, simulations constantly overestimate other consumers' electrical consumption;
- overall, total electrical consumptions predictions are conservative with differences ranging from 2 to 16%.

### 3.4.4 Conclusion of the analysis of results

Globally the simulator overestimates all other consumers' electrical consumption. This is due to the fact that the models are based on values extracted from the electrical balance. The models' equations can be tuned to reduce this gap.

On the contrary SEECAT tends to underestimate the propulsion motors' consumption. This is because the propulsion power is calculated directly from the speed thanks to a speed-power curve, and this curve has been calculated for a calm sea with no wind. A sea margin correction factor would take into account the sea state and hence reduce the difference between measurements and simulation. Calculating this correction factor is tricky but could be done by analysing the sea data measurements.

On the four cruises considered for this analysis, the ASFC based on onboard measurements are systematically higher than the one based on the simulations (approximately and respectively 240 g/kWh<sub>elec</sub> and 200 g/kWh<sub>elec</sub>). This discrepancy certainly comes from both a bias in fuel consumption measurements and on the specific fuel consumption curves used to model the DGs, but this would need to be further confirmed.

The comparison of simulations with onboard measurements for four typical cruises shows that SEECAT provides reasonable absolute estimates of the cruise vessel fuel consumption. Improving the modelling of some consumers, and in particular of the ship's added resistance due to waves, wind and current, and of some electrical consumer items, would lead to even better results, although requiring a finer description of the operational profile (e.g. sea state, wave and wind direction, etc.). In addition, these improvements are not important when using SEECAT for making design or operational alternatives comparisons, as long as these alternatives do not concern the items which require better modelling.

## 3.5 DESIGN ALTERNATIVES

In this section SEECAT is used to compare two design alternatives of the STX cruise vessel: with STX’s “Advanced Heat Recovery Plant” system (AHRP) [55], that is the current ship design as modelled in the previous sections, and without this system. Before this system was designed, consumers such as sanitary water heating, HVAC heating and swimming pools heating were heated up thanks to steam only. Steam was either produced by the oil-fired boilers or the WHR boilers. With the AHRP system these consumers are directly heated up by the diesel engines low and high temperature cooling loops.

The two alternatives are compared on a typical 7 day cruise profile. The ship will navigate 6 times for different durations and at different speeds, as presented in Figure 3.20. She consumes only HFO\*.

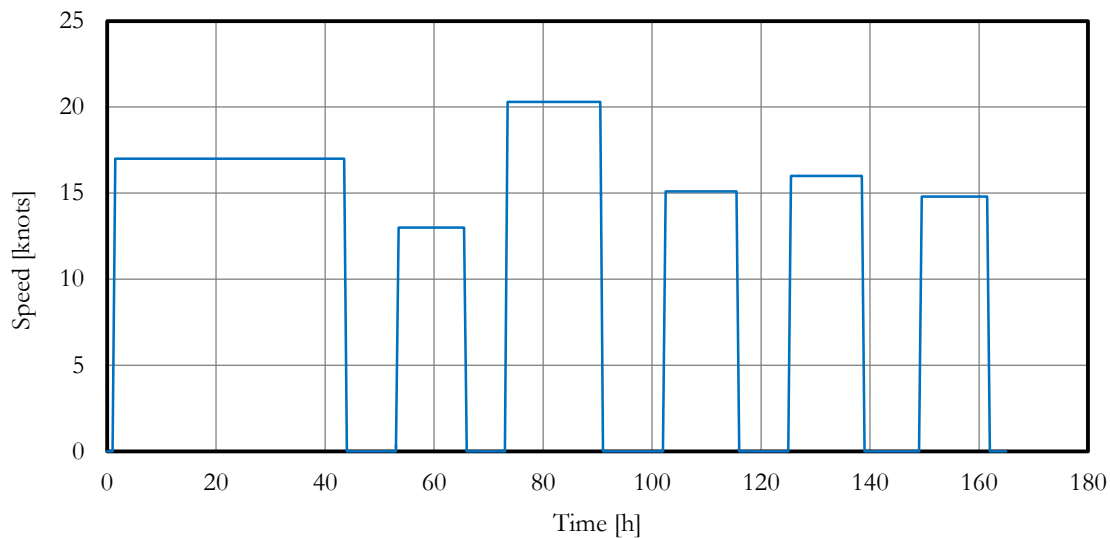

Figure 3.20: Speed profile of a typical 7 days cruise

This speed profile will be run twice for each design, once in summer conditions (constant 20 °C air and sea water temperature) and once in winter conditions (constant 0 °C air temperature and constant 5 °C sea water temperature).

### ▪ Design alternatives comparison in summer conditions

The main simulation results are presented in Table 3.3.

In summer conditions, on this test cruise, the boiler’s fuel consumption represents 4.2% of total fuel consumption without the AHRP system. Adding this system reduces the boiler’s fuel consumption by 99.5%, with a remaining consumption of 0.21 ton of HFO.

The DG’s fuel consumption is slightly increased when adding the AHRP system (+ 0.2%). Since more calories are taken from the engine’s cooling loops, fewer are available for the distillers that consequently produce less fresh water. Therefore the ROPUs are switched on slightly more often. The total fuel consumption is nevertheless reduced by 4%.

---

\* This HFO is considered to have a sulphur content of 2.7% of mass

Table 3.3: Design alternatives' fuel consumption comparison in summer conditions

SUMMER CONDITIONS	unit	Without AHRP system	With AHRP system	Relative difference*
<b>Total fuel consumption</b>	tonnes	937.80	900.50	-4.0%
<b>DG's fuel consumption</b>	tonnes	898.65	900.29	0.2%
<b>Boiler's fuel consumption</b>	tonnes	39.15	0.21	-99.5%

The reduction in total fuel consumption is logically reproduced on simulated CO<sub>2</sub> and SO<sub>x</sub> emissions (see Table 3.4). NO<sub>x</sub> emissions are not calculated because NO<sub>x</sub> emission factors were not available for the ship's engines.

Table 3.4: Design alternatives' emissions comparison in summer conditions

SUMMER CONDITIONS	unit	Without AHRP system	With AHRP system	Relative difference
<b>CO<sub>2</sub></b>	tonnes	2 922.15	2 804.16	-4.0%
<b>SO<sub>x</sub></b>	tonnes	50.64	48.63	-4.0%

#### ▪ Design alternatives comparison in winter conditions

The main simulation results are presented in Table 3.5.

Table 3.5: Design alternatives' fuel consumption comparison in winter conditions

WINTER CONDITIONS	unit	Without AHRP system	With AHRP system	Relative difference†
<b>Total fuel consumption</b>	tonnes	984.72	862.16	-12.4%
<b>DG's fuel consumption</b>	tonnes	835.85	838.00	0.3%
<b>Boiler's fuel consumption</b>	tonnes	148.87	24.16	-83.8%

In winter conditions the boiler's fuel consumption now represents over 15% of total fuel consumption. In fact, on the one hand the heating demand is higher in winter than in summer, and, on the other hand, the DGs load is lower (chillers are off) so the recoverable energy from DGs cooling loops is lower. Both events combine, with as a result, a greater use of oil-fired boilers. Adding the AHRP system helps reduce the boiler's consumption by 83.8%, bringing it down to 24.16 tonnes of HFO.

As for the summer-time scenario, adding the AHRP system in fact slightly increases the DG's fuel consumption.

The reduction on total fuel consumption is once again reproduced in CO<sub>2</sub> and SO<sub>x</sub> emissions (see Table 3.6).

---

\* (with-without)/without

† (with-without)/without

Table 3.6: Design alternatives' emissions comparison in winter conditions

WINTER CONDITIONS	unit	Without AHRP system	With AHRP system	Relative difference
CO <sub>2</sub>	tonnes	3 066.42	2 685.76	-12.4%
SO <sub>x</sub>	tonnes	53.17	46.56	-12.4%

#### ▪ Thermal balance analysis

The analysis of the ship's thermal power balance provides a better understanding of how the AHRP system works. Figure 3.21 and Figure 3.22 represent these balances for the ship respectively without and with the AHRP system. Both analyses were done for winter conditions as thermal consumption is stronger and hence the AHRP's effect more visible. Nevertheless the following conclusions are identical in summer conditions.

**Attention: please note that for both figures, the time scale is not linear; because of the way these graphs were built, transient phases are exaggerated whereas stationary phases are dwarfed. That explains why these figures seem distorted compared to the speed profile in Figure 3.20. Nevertheless, this has no consequence on further observations and conclusions.**

Both figures present:

- the thermal power of the steam produced by WHR boilers;
- the thermal power of the steam produced by oil-fired boilers;
- the thermal power produced by diesel engines' high and low temperature cooling loop;
- the power consumed by thermal consumers.

The thermal consumers' item includes all steam and heat consumers including distillers. Distillers produce fresh water by making sea water boil, which requires heat coming from the engine's high temperature cooling loop. Traditionally, if the engine's cooling heat is not sufficient, OFBs are started to compensate the missing thermal power. On this ship, distillers can be switched to an energy-saving mode which prevents starting-up OFBs. Therefore, distillers take only available thermal power.

On both figures, there are two red curves. The thick one represents the thermal consumption of all consumers except distillers. The thin one represents the thermal consumption of all consumers, including distillers. Therefore the difference between both curves represents the distillers' consumption.

On both figures, one can observe that the DGs' cooling power evolves between high and low thermal power levels which correspond to respectively phases where the ship is at port and phases where she is navigating at cruise speed. The WHR boilers' power production follows the same pattern. The peaks observed on both curves, surrounding port phases, correspond to manoeuvring phases when thrusters are switched on. The peaks observed during acceleration and deceleration phases reflect the power management system switching between DGs' combinations.

Both figures illustrate what could be qualified as "free thermal power". All the power in green (DG's cooling power) which is above the thick red line (all consumers except distillers' thermal consumption) can be considered as free, because it comes from the DG's cooling loop and if not used by the distillers, it would be wasted. Both figures highlight the fact that distillers use only "free thermal power".



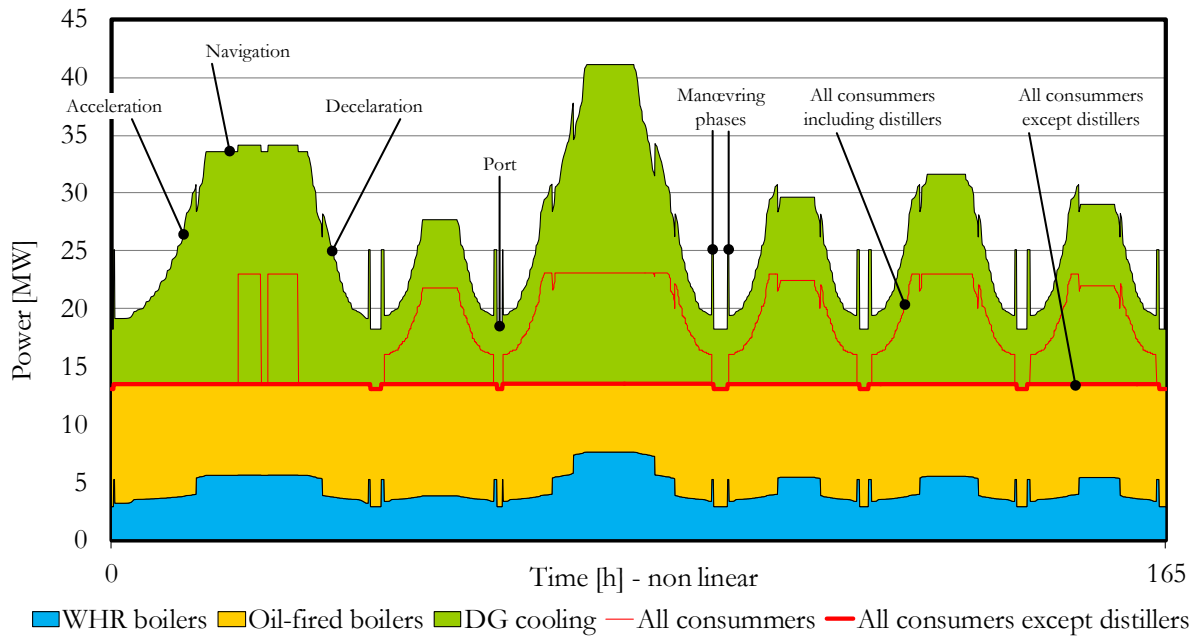

Figure 3.21: Ship's thermal balance, in winter conditions, without AHRP system

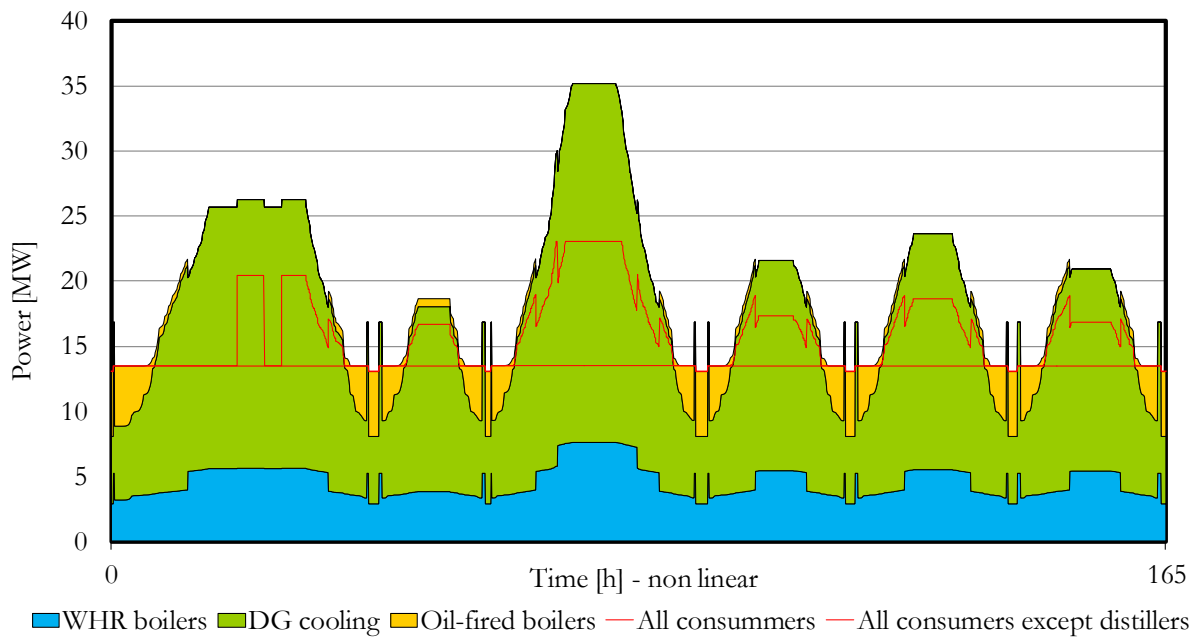

Figure 3.22: Ship's thermal balance, in winter conditions, with AHRP system

Without the AHRP system, all thermal consumers except distillers require steam only. If the steam provided by WHR boilers is not sufficient, OFBs are started. Figure 3.21 illustrates that. Thermal consumption is continuously above WHR boiler capacity and OFBs have to compensate to meet demand. The cooling power produced by DGs remains exclusively available to distillers.

However, with the AHRP system, DG's cooling power is available to other thermal consumers. Hence, as Figure 3.22 illustrates, the OFBs are mainly switched on when the power produced by both WHR boilers and DG's cooling loop are not sufficient to meet demand. One can see that even when there is sufficient thermal power, a small amount of remaining OFBs' thermal production subsists. This production guarantees the supply of consumers which accept steam only, such as:

- HFO and diesel oil purifying systems
- Fuel oil preparation units
- Lubricating oil purifying systems
- Tank heating systems
- Galleys
- Laundry equipment
- Bio dryers
- etc.

#### ▪ **Design alternative comparison observations**

Simulations with SEECAT indicate that the benefit of using STX's Advanced Heat Recovery Plant (AHRP) represent a fuel consumption reduction of 4% in the summer case-scenario, and 12% in the winter case-scenario which is in line with STX's own calculations. This indicates the good accuracy of the model when used for relative comparison and the strength of this design alternative comparison method. The model being highly modular and generic, new alternative models can be built and simulated very quickly. SEECAT therefore proves to be a powerful tool for assessing energy saving solutions, even when based on this first energy approach.

## 3.6 CONCLUSIONS

In this chapter, component models were built and assembled in a complete energetic ship model. This model has been used to simulate the behaviour of a very large cruise vessel over four typical cruises. The comparison between simulations and measurements shows that SEECAT provides reasonable absolute estimates of the cruise vessel fuel consumption. Although part of the discrepancies observed are deemed to come from measurement and manufacturer's data biases, potential sources of modelling improvements have been identified for some energy consumers (for example the influence of the environment on ship resistance, HVAC electrical and thermal power consumption) and will be considered for future developments. However, it should be noted that refining these models will also require the user to provide a finer and more complete description of the ship's operational profile.

Another interesting application of such a simulation tool is the comparison of the energy efficiency of design or operational alternatives, where relative values are more important than absolute values.

The development of the component models and the modelling approach has globally proved to be fruitful. In addition to being relatively accurate, it is worth mentioning that the model is fast to compute. The Miami to St-Martin cruise, that lasted just under three days (254 988 s) takes only 22 s to compute\*. It nevertheless has some limits.

First of all, the "energy oriented" modelling approach shows some limitations: it does not account for energy quality (or exergy). In order to take account of the quality of energy, fluids should no longer be characterized only by their energy (or power), but by their pressure, mass flow and specific enthalpy. Using these three variables, it becomes possible to totally characterize the thermodynamic state of a fluid, and therefore calculate its exergy.

This approach would require "fluid circuit" models, where pumps, pressure loss and heat exchangers are represented. The new level of detail would provide a better insight into the true energy saving potentialities.

Secondly, this "energy approach" is not exhaustive. Some energetic media are neglected a priori, because they are considered as waste, such as the hot brine rejected by distillers. A complete and accurate energy balance is therefore not possible. A "fluid circuit" modelling of the distillers could solve this problem.

Finally, a lot of the component models depend greatly on manufacturer's data. When these data are available and reliable, using them for modelling can be quite an effective method. And it has proven it in this case. But this approach has disadvantages other than depending on the manufacturer's good will. The data are often given with a limited precision and for a limited range of operating conditions. This is particularly sensitive for the diesel engines which are the main energy converters on board ships. For example, the BSFC curves and maps of the Wärtsilä 46 engine are truncated (see Figure 3.3). And the cooling power is given only for a fixed speed. Moreover, these data give no insight into the behaviour of the engine or its internal energy balance. Accessing energy transfers would make it possible, for example, to calculate the amount of energy available thanks to admission air cooling. Using "fluid circuit" models of the components could mean being less dependent on manufacturer's data and could provide greater understanding of the energy flow networks. Building a mean value or zero-dimensional model of the engine would moreover permit to consider the internal energy balance.

"Fluid circuit" modelling and more detailed engine models are two major aspects of this thesis and are presented in the following chapters.

---

\* On a laptop running on windows 7 64 bits, equipped with 4 GB of RAM and an Intel Core i5-3360M processor running at 2.80 GHz.

*Dans ce chapitre, des modèles de composants ont été codés et assemblés en un modèle énergétique complet de navire. Ce modèle a été utilisé pour simuler le comportement d'un très grand paquebot sur quatre profils de croisières différents. La comparaison entre les résultats de simulations et les mesures montre que SEECAT fournit de bonnes estimations de la consommation de fioul. Si une part des écarts constatés provient certainement des incertitudes de mesures, une autre provient des modèles et notamment des modèles des consommateurs d'énergie et leur amélioration est envisagée lors de futurs développements (par exemple l'influence de l'environnement sur la résistance hydrodynamique, ou la consommation thermique et électrique des systèmes de chauffage, ventilation et conditionnement d'air).*

*Un autre intérêt majeur de cette plateforme de simulation est la possibilité de comparer l'efficacité énergétique de différentes alternatives de conception ou de profil opérationnel, là où justement les grandeurs relatives sont plus importantes que les grandeurs absolues.*

*Globalement, le développement des modèles de composant et de l'approche de simulation s'est montré fructueux. En plus d'être relativement précis, le modèle est notablement rapide à exécuter. La croisière de Miami à St-Martin, qui prend un peu moins de trois jours (254 988 s) nécessite seulement 22 s pour être simulée\*. Le modèle possède néanmoins quelques limitations.*

*Premièrement, l'approche orientée énergie ne permet pas de prendre en compte la qualité de l'énergie (ou autrement dit son exergy). Pour résoudre ce problème, il faudrait alors caractériser les fluides, non plus par leur seule énergie (ou puissance) mais par leur débit massique, enthalpie spécifique et pression. Utiliser ces trois variables permettra alors de déterminer complètement l'état thermodynamique du fluide et ainsi de calculer son exergie.*

*Cette nouvelle manière de représenter le fluide nécessiterait alors une modélisation de type « circuit fluide » où les pompes, pertes de charges et échangeurs thermiques seraient modélisés. Ce niveau de détail supplémentaire permettrait alors une meilleure évaluation des économies d'énergie possibles.*

*Deuxièmement, cette approche orientée énergie n'est pas exhaustive. Certains fluides énergétiques sont négligés a priori, du fait qu'ils soient généralement considérés comme des pertes, tel que la saumure rejetée par les bouilleurs. Une évaluation complète et précise de la balance énergétique du navire est donc impossible. Une approche de type « circuit fluide » appliquée aux bouilleurs permettra de résoudre ce problème.*

*Finalement, une dernière limite notable du modèle est sa dépendance vis à vis des données constructeurs. Quand ces données sont accessibles et fiables, les utiliser s'avère être très efficace. Mais cette approche rend tributaire de la bonne volonté des constructeurs. Les données qu'ils fournissent sont malheureusement souvent parcellaires et d'une précision limitée. Cela peut être particulièrement délicat quand il s'agit des moteurs diesels qui sont les principaux convertisseurs d'énergie à bord des navires. À titre d'exemple, les courbes et cartes de consommation spécifique du moteur Wärtsilä 46 sont tronquées (voir Figure 3.3). Et la puissance thermique dissipée par refroidissement est fournie seulement pour une vitesse donnée. De plus, ces données ne fournissent aucune indication sur le fonctionnement interne du moteur ou sa balance thermique. Connaître par exemple la valeur des transferts thermiques permettrait de calculer l'énergie dissipée par le refroidissement de l'air d'admission. Utiliser une nouvelle approche de type « circuit fluide » permettrait d'être moins dépendant des données constructeurs et permettrait une meilleure compréhension des transferts énergétiques. Construire un modèle de type « valeur moyenne » ou suivant une approche « zéro-dimensionnelle » permettra en plus de calculer la balance thermique du moteur.*

*Développer une approche de type « circuit fluide » et un modèle plus détaillé du moteur sont deux aspects majeurs de cette thèse et sont présentés dans les chapitres suivants.*

---

\* Sur un ordinateur portable sous windows 7 64 bits et équipé de 4 GB de RAM et d'un processeur Intel Core i5-3360M cadencé à 2.80 GHz



# CHAPTER 4

## ENGINE MODELLING

---

<b>CHAPTER 4 ENGINE MODELLING .....</b>	<b>107</b>
4.1 DATA AVAILABLE .....	110
4.2 MODELLING DIESEL ENGINES .....	111
4.2.1 <i>Modelling methods</i> .....	111
4.2.1.1 Performance maps.....	112
4.2.1.2 Transfer function models .....	113
4.2.1.3 Mean value models.....	113
4.2.1.4 Zero-dimensional models .....	113
4.2.1.5 Multi-dimensional models .....	114
4.2.1.6 Comparison between modelling techniques .....	115
4.3 THE MEAN VALUE APPROACH.....	116
4.4 DATA ANALYSIS.....	117
4.4.1 <i>Engine thermal balance</i> .....	117
4.4.2 <i>Specific engine data analysis and cleaning</i> .....	120
4.5 PRESENTATION OF THE MODEL.....	123
4.5.1 <i>Global model architecture</i> .....	123
4.5.2 <i>Equations</i> .....	125
4.5.2.1 Generic equations.....	125
4.5.2.2 Turbocharger.....	127
4.5.2.2.1 Turbocharger rotor shaft.....	127
4.5.2.2.2 Compressor.....	128
4.5.2.2.3 Turbine.....	128
4.5.2.3 Scavenge air cooler.....	129
4.5.2.4 Engine cylinders.....	130
4.5.2.4.1 Air mass flow equation.....	130
4.5.2.4.2 Efficiency equation.....	132
4.5.2.4.3 Water and lubrication oil cooling equations .....	133
4.5.2.4.4 First law of thermodynamics equation .....	136
4.5.3 <i>The SEECAT Model</i> .....	137
4.5.4 <i>Results and validation</i> .....	138
4.6 CONCLUSION .....	145

The previous chapter pointed out the importance of the diesel engine model – diesel engines are the main energy converter on board ships – but it also showed how dependent the SEECAT model is on manufacturers' data. Moreover, the ship that was modelled used diesel electric propulsion. As a matter of fact these engines, as they operate at constant speed, are relatively easy to model or at least easier than traditional main engines. If the same approach was used for a main engine, the model usage would be limited to the propeller curve. Finally, the exergy analysis of the previous engine model was not possible. To avoid these limitations an entirely new model has been developed.

The purpose of this model is to represent the behaviour of two or four stroke marine diesel engines. This model will be written in the Modelica language using the simulation software SimulationX. And it will be integrated in the SEECAT library. This means that the model must be fast, robust and accurate. It also implies that this new diesel engine model will be connected to the rest of the ship model in a similar way to the previous model is and will be controlled by only the engine load and speed. It must be able to return the fuel consumption and associated atmospheric emissions as well as the complete thermal balance all over the engine's operational field.

This model will be calibrated using only public data, that is to say, mainly data provided by engine manufacturers on their websites. However, most of the time these data are provided only along the propeller curve. This propeller curve corresponds to heavy conditions (fouled hull, nominal displacement, heavy seas). However, the SEECAT modelling platform must be able to represent real-life conditions, with variable hull fouling, non-nominal displacement and variable sea state conditions. Moreover, SEECAT must be able to model variable pitch propellers and even investigate the energy saving potentiality of replacing the propeller. Real-life conditions, variable pitch propellers and changing the propeller implies different propeller curves and hence different engine operating points outside the "ideal propeller curve". The main goal of this engine model is therefore to extrapolate outside this propeller curve.

A second goal of this model is to provide a modular approach, that is to say, an approach where each module (for instance the cylinders, the compressor, the turbine, the scavenge air cooler, etc.) is represented separately and can be changed independently from the others. This would make it possible to study the potentiality of changing one component, for example the turbocharger.

This chapter starts by reviewing the data available. Then the different modelling approaches are presented and compared. It will be explained why a mean value approach was preferred. Then, the data available for one specific engine is analysed and "cleaned up". After that, the model equations and structure are presented and finally results are presented and validation is discussed.

*Le chapitre précédent a mis en avant l'importance de bien modéliser les moteurs diesel (ils sont les principaux convertisseurs d'énergie à bord des navires), mais a aussi montré la dépendance du modèle SEECAT vis-à-vis des données constructeurs. De plus les moteurs modélisés étaient utilisés dans le cadre d'une propulsion électrique. De fait, ces moteurs sont relativement faciles à modéliser, ou du moins plus faciles à modéliser que les moteurs de propulsion, car ils opèrent à vitesse constante. Si la même approche de modélisation était appliquée à un moteur de propulsion, le modèle résultant serait limité à la courbe hélice. Finalement, l'approche de modélisation précédente ne permettait pas de développer une analyse exergetique. Afin de contourner ces limitations, un tout nouveau modèle de moteur a été développé.*

*L'objectif de ce nouveau modèle est donc de représenter le comportement de moteur diesel marins deux-temps ou quatre-temps. Ce modèle sera codé en langage Modelica et fonctionnera avec la plateforme de simulation SimulationX. Le modèle devra s'intégrer à la bibliothèque SEECAT. Cela signifie notamment que le modèle devra être robuste, précis et rapide à exécuter. Cela impliquera également que le nouveau modèle s'interface avec le reste du navire de manière similaire à l'ancien modèle ; il sera ainsi contrôlé uniquement par la charge et la vitesse moteur. Le modèle devra pouvoir calculer la consommation de fioul ainsi que la balance thermique complète sur l'ensemble du champ moteur.*

*Le modèle sera calibré en ayant recours seulement aux données librement accessibles, c'est-à-dire, principalement des données fournies par les constructeurs sur leurs sites internet. Malheureusement, ces données sont fournies la plus part du temps le long de la courbe hélice. Or cette courbe correspond à des conditions bien spécifiques (coque sale, déplacement nominal, mer agitée). Et la plateforme de simulation SEECAT doit permettre de représenter n'importe quelles conditions d'opération, avec une coque de salissure variable, un déplacement non nominal et des états de mer changeants. De plus SEECAT doit permettre de modéliser des hélices à pas variables et d'étudier les économies d'énergie réalisables en changeant d'hélices. Toutes ces raisons font que se restreindre à une loi hélice unique n'est pas envisageable. Un des objectifs premiers de ce nouveau modèle de moteur est donc de pouvoir extrapoler en dehors de cette courbe hélice.*

*Un deuxième objectif de ce modèle est de permettre une approche modulaire, c'est-à-dire, une approche où chaque module (par exemple les cylindres, le compresseur, la turbine, le refroidisseur d'air de suralimentation, etc.) est représenté séparément et peut être changé indépendamment des autres modèles. Cela permettra d'étudier la possibilité de changer certains composants comme le turbocompresseur.*

*Ce chapitre commence par étudier les données classiquement disponibles auprès des constructeurs. Puis, différentes approches de modélisation seront comparées. Il sera expliqué pourquoi une approche par valeur moyenne a été privilégiée. Ensuite, les données disponibles pour un moteur spécifique seront analysées et « nettoyées ». Puis, la structure du modèle et ses équations seront détaillées. Et finalement, des résultats de simulations seront présentés et comparés aux données constructeurs pour validation du modèle.*



**N.B.:** In this chapter, the method and the equations presented are generic: they can be applied to any marine turbocharged diesel engine. Nevertheless a specific engine has been chosen for modelling, it will be called *engine A*. This engine is a very large, two-stroke, slow speed, turbocharged, marine diesel engine. All numerical values produced below apply to this particular engine. Moreover the fundamental laws governing Diesel engines are recalled in Appendix B.

## 4.1 DATA AVAILABLE

The two main marine engine manufacturers, Wärtsilä and MAN Diesel & Turbo (hereinafter referred to as MAN), both provide a webtool to access their public engine data (respectively netGTD\* [62] and CEAS-ERD† [63]). Both tools are similar, allowing the user to choose an engine, a number of cylinders, a desired speed and power at MCR‡ point, the turbocharger, the environmental operating conditions (ambient air and scavenge air coolant temperature) as well as other diverse parameters. These tools finally offer the possibility of downloading a report containing their public data. A typical set of data contains:

- Specific fuel consumption
- Exhaust gas mass flow
- Exhaust gas temperature after turbine
- Scavenge air mass flow
- Scavenge air pressure
- Scavenge air temperature after and before scavenge air cooler (SAC)
- SAC heat
- Jacket water cooler heat
- Main lubrication oil heat

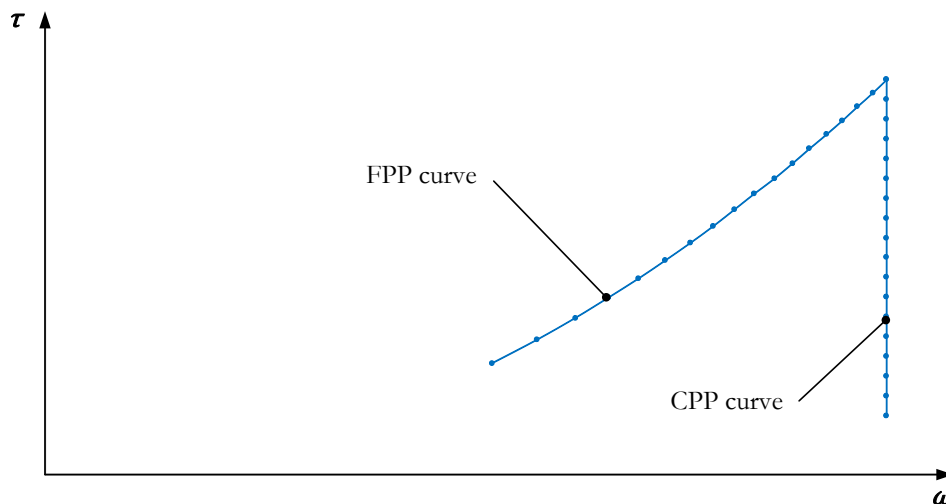

Figure 4.1: CPP and FPP curves for engine A

\* General Technical Data

† Computerised Engine Application System – Engine Room Dimensioning

‡ Maximum continuous rating: maximum output power an engine is capable of producing continuously under normal conditions

As mentioned previously, this set of data is usually given along the propeller curve. For engine A, when using the manufacturer's webtool, it is possible to choose between a fixed pitch propeller (FPP) and controllable pitch propeller (CPP). When choosing a FPP configuration, the data is plotted along the propeller curve, whereas when choosing a CPP configuration, the data is plotted along a constant speed curve (see Figure 4.1). Therefore, two sets of data are available for engine A. These two sets will be used for interpolation.

In addition to these "internet report" data, similar and complementary information can be found in another document (also provided by the manufacturer and also available on the internet) called the engine "project guide".

## 4.2 MODELLING DIESEL ENGINES

Modelling turbocharged compression ignition (diesel) engines is of great scientific and industrial interest as today these engines are one of the preferred prime movers for medium and large scale applications such as cars, lorries, trains, ships and electrical power plants. Diesel engines are successful because of their reliability and efficiency, which can reach 50% for large slow-speed two-stroke engines [64]. Regulatory, market and societal pressure encourage developments and innovation to further increase this efficiency and hence lead on to developments in simulation techniques. One can distinguish two objectives for engine simulation which correspond to two types of models:

- descriptive models, which help understanding and analysing the engine as well as assessing its performance;
- predictive models, suitable for more parametric studies and developing new engine designs. Predictive models will tend to be more complex than descriptive ones.

This section will present the different engine modelling methods as well as their pros and cons. The fundamental equations that govern the behaviour of a diesel engine are recalled in Appendix B.

### 4.2.1 Modelling methods

There are many ways to simulate the behaviour of diesel engines: the model can either be empirical or phenomenological (also called analytical or physical); it can operate under static or transient conditions; phenomenological models can either be zero-dimensional or multi-dimensional; multi-dimensional can be of one, two or three dimensions and zero-dimensional models can be single or multi-zone. In fact, it is very difficult to sort engine models into distinct categories. Most of the engine models found in public literature are hybrid models:

- Models said to be phenomenological are almost never purely phenomenological as they often include empirical or semi-empirical submodels and components. For instance, the SELENDIA code, developed by Hétét et al [65] uses zero-dimensional models (based on the filling and emptying method) for the combustion chamber, inlet and exhaust manifolds and pipes but manufacturer's maps for the turbine and compressor. Moreover, the model used to simulate combustion heat release, the widely used Wiebe's functions, is also semi-empirical [64]-[66]. Phenomenological models are in addition often compared to measurements and tuned with correction factors.
- Phenomenological models can also be developed with different dimensions for different parts of the engine. The MERLIN code, developed by the Lloyd's Register is a hybrid zero/one dimension simulation program [67]. It is based on a zero-dimension approach but represents pipes with a one-dimension approach to take into account the evolution of the pressure from one end to the other.

- The same logic applies for models under static or transient conditions. Rakopoulos et Giakoumis produced an extensive review of thermodynamic diesel engine simulations techniques under transient operating conditions [64] and explain that such simulation codes often include non “true transient submodels”.

These hybrid approaches are necessary for reasons of time, effort and cost. In fact depending on what is of key interest - the behaviour of an overall system including a diesel engine, or the diesel engine itself, or even a part of the diesel engine - the complexity of the model will vary from static performance maps, to transient non-linear multi-dimensional models, throughout a whole range of hybrid models. Choosing between these different methods will be a compromise between expectations (accuracy, speed, results, etc.) and constraints (time, cost, effort, data availability, etc.).

The different modelling techniques will be presented in order of increasing complexity.

#### 4.2.1.1 Performance maps

When the diesel engine is part of an overall complex system, the models to simulate their behaviour tend to be simple in order to keep computing time within reasonable limits. For example, for most current hybrid vehicles simulations, the engine (not necessary of diesel type) is represented by a map obtained on a bench test through experimentation [68]. Figure 4.2 is an example of a brake specific fuel consumption map of a diesel engine. Given the torque and the rotational speed of the engine, one can find the corresponding brake specific fuel consumption (BSFC) on the map and hence the engine efficiency.

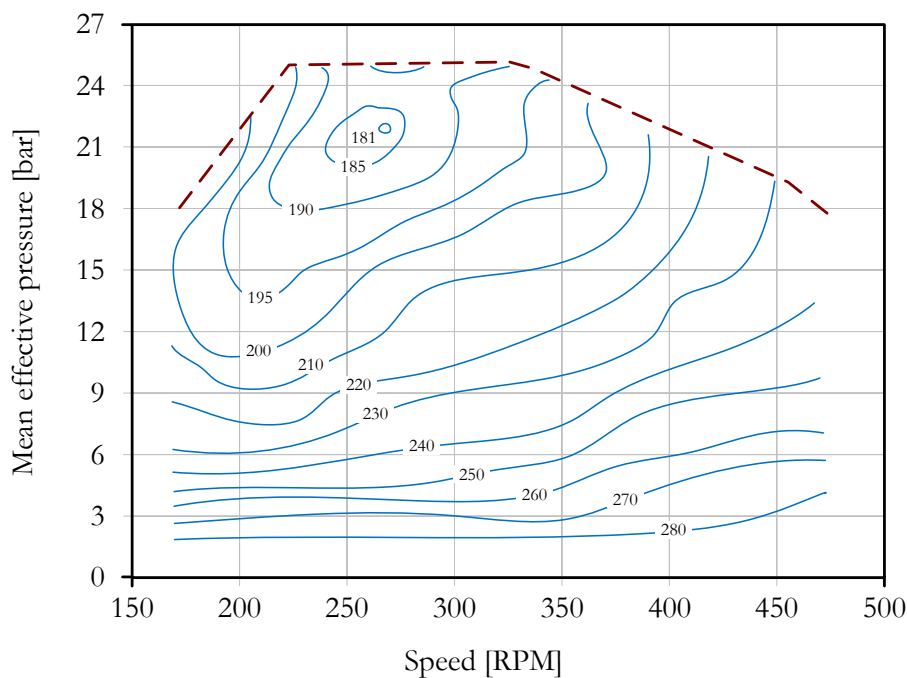

Figure 4.2: Example of a brake specific fuel consumption map of a diesel engine (in g/kWh). The axes are horizontally the rotational speed, in rpm and vertically the mean effective pressure (bar)\*.

\* In the marine industry, most diesel engine performance maps plot the specific fuel consumption in function of the engine speed (X-axis) and the engine load (Y-axis).

If digitized, BSFC maps can provide simple yet efficient quasi-static models of the engine. These kinds of maps present the following drawbacks:

- these maps rarely cover the entire operating range, for example, the map of Figure 4.2 starts at 150 RPM; extrapolating is moreover very tricky;
- these maps do not give access to the thermodynamic properties of the fluid;
- these maps are obtained for a given reference fuel with given reference environmental conditions;
- these maps are purely descriptive and cannot be applied to a different engine;

Similar performance maps can give the output temperature or pressure of the exhaust gas as a function of the engine torque and rotational speed or also the behaviour of the turbine and compressor.

The engine model of Chapter 3 was a performance map.

#### **4.2.1.2** *Transfer function models*

Transfer function models are mathematical models based on sampled data analyses that can provide an accurate method for determining a diesel engine's transient response. These kind of models do not give any insight into the properties of the gas (black box type) but only the response of the engine to an input signal, for example the engine speed in relation to the fuel rack position. Most of the models are used for governor control as they are quite simple and fast to compute [64].

#### **4.2.1.3** *Mean value models*

Mean value models (also known as quasi linear models) are intermediate models between transfer function models and zero-dimensional models. Basically they are simplified zero-dimensional models, the cylinders are described using the energy and mass conservation equations, but complicated phenomena such as combustion and heat transfer are described using empirical equations. Moreover, the temperature, pressure and mass flows variations are averaged over the cycle (hence the “mean value” name). Mean value models tend to represent the engine behaviour with a maximum number of physics' equations possible given the “black-box” type representation of the cylinders. They allow for greater speed and compactness while still delivering relatively good insight and accuracy [69].

The mean value modelling approach will be more extensively presented in section 4.3.

#### **4.2.1.4** *Zero-dimensional models*

Zero-dimensional models are phenomenological models based on energy and mass conservation equations (also known as “high frequency” models or “filling and emptying” models). They are called “zero-dimensional” in opposition as opposed to dimensional models in the sense that they do not involve any consideration of the flow field dimensions [70]. A diesel engine zero-dimensional model is divided into several submodels:

- Combustion cylinder
- Inlet and exhaust manifolds
- Turbocharger
- Fuel pumps
- Governor
- Engine dynamics

Inside the combustion model, the engine cycle is computed. The thermodynamic properties of the gas (pressure and temperature) are known for each computational step (often one degree of crank angle or even less). The combustion cylinder model is further divided into submodels:

- Combustion heat release such as Wiebe's functions [71]-[66]
- Heat transfer such as Wochni's model [72]
- Fluid flow such as Barré de Saint-Venant's law [73]
- Pressure drops and leaks
- Thermodynamic properties of gas such as Keenan & Kaye's function [74]
- Turbulence
- Friction losses such as Chen & Flynn's model [75]
- Exhaust emissions
- Piston head displacement

The main differences between diesel engine models found in specialist publications lies in the different submodels choice. As mentioned previously, these submodels are rarely all of the same complexity. Inside the same diesel engine simulation code, one will find empirical and phenomenological models as well as transient and quasi-static models. Building a "coherent" diesel engine model, made up entirely of "pure" transient and phenomenological models for all of the models and submodels detailed above would considerably increase computation time, cost and effort [70].

Zero-dimensional models of diesel engines rely on the "filling and emptying approach". According to Rakopoulos et Giakoumis [64], this approach "*has proven to be the best approach to adequately shed light into the engine processes during transient*". This approach considers the engine and its subsystems as a succession of control volumes linked together by valves or orifices that interchange mass, heat and work. The working fluid is approximated to an ideal gas to which the laws of energy and mass conservation apply. The simulation consists in resolving a series of first order differential equations. The cylinder control volume is often represented by a single zone, which means that the gas composition, temperature and pressure will be considered uniform [65], [70], [76]. Two zone models often consider one zone for the unburnt gases and one for the burnt ones. Increasing the number of zones poses no theoretical problems and provides better modelling of the process inside the chamber, in particular the combustion. Multi-zone models are a good compromise between single-zone models and multi-dimensional models which involve resolving Navier-Stokes equations [76]. Of course, increasing the number of zones implies increasing computation time in an almost proportional way. Nowadays transient diesel engine simulation codes based on the filling and emptying approach are almost exclusively single zone ones. Multi-zone models have encountered only moderate success [64].

#### **4.2.1.5 Multi-dimensional models**

Multi-dimensional models are based on Computational Fluid Dynamic (CFD) calculations. CFD methods are used to solve fluid dynamics problems inside given accurate geometry and are based on the Navier-Stokes equations. Building a diesel engine CFD model always follows the same basic procedure:

- first a pre-processing phase, where:
  - the geometry of the engine is defined,
  - the gas is discretized (mesh),
  - the equations are defined (for example: mass conservation, energy conservation, etc.),
  - finally the boundary conditions and initial conditions are defined;
- then the simulation is run by solving the equation iteratively;
- finally, a post-processing phase where the results are displayed and analysed.

Multi-dimensional models provide a very detailed description of the gas dynamics and combustion but are very complicated and slow in terms of computation time.

#### 4.2.1.6 Comparison between modelling techniques

Table 4.1 presents the different diesel engine simulation techniques along with their pros and cons.

**Table 4.1: Comparison of specifications and requirements among various diesel engines modelling approaches. The “insight” criterion represents the model’s capacity to give adequate understanding of the various engine processes by identifying the effect of key operating parameters. The “adaptability” criterion represents the model’s capacity to easily adapt to different engines/operating conditions. This table is adapted from Rakopoulos et Giakoumis [64].**

	Performance map	Transfer function	Mean Value	Filling & Emptying	Multi-dimensional
<b>Linear</b>	Yes	Yes	Quasi	No	No
<b>Transient</b>	Quasi-static	Quasi-static	Quasi-static*	Dynamic	Dynamic
<b>Mathematical Complexity</b>	Very Low	Very Low	Low	High	Very High
<b>Insight</b>	Very Low	Very Low	Low	Medium	High
<b>Computer time</b>	Negligible	Negligible	Negligible	Limited	Very large
<b>Adaptability</b>	Very Low	Medium	Low	Medium	Low

Given the objectives and constraints of the model, a mean value approach has been chosen as it seemed the best solution. The limited data excluded a filling and emptying approach. Transfer function models would not have been able to extrapolate outside the propeller curve. And finally performance maps are simply not available. Mean value approach is hence the only approach possible given the data set available. But even with all the desired data available, the mean value approach would have remained a good choice as its time scale (several engine cycles) is well suited to holistic ship energy modelling.

\* Can nevertheless contain some dynamic equations

## 4.3 THE MEAN VALUE APPROACH

The development of mean value engine models started in the late 80's with the work of a Danish research team led by E. Hendricks. Their work initially focused on large turbocharged two-stroke diesel engines [77]. But the scope of their work rapidly spread out to all kind of internal combustion engines [78]. At that time, researchers and engineers had to choose between “very large and complex or very small and simplistic” [77] models. The large models were very accurate but required powerful and expensive “mainframe” computers, “long computing time” and “large numbers of fitting parameters”. On the other hand, small models relied almost exclusively on empirical data and suffered from inaccuracies. The author gives an explanation for this limited number of models:

*“The reason that mostly these two classes of model are found is that engines are rightly thought of as being composed of a number of very complex subsystems and are thus thought to be extremely complex as a whole. While the first conclusion is obviously true, the second is misleading. Though the overall system is complex, it does not necessarily follow that there are no underlying physical principles which can give a simple overall picture of engine operation.” [77]*

Hendricks answers this complexity issue using time scale considerations. Because very short time variations are not of his interest, he decides to simplify a “large model” by transforming differential equations (which correctly represent the dynamic of the associated process) into analytical ones. But he does this only for short-time processes, the ones which take place inside the cylinder. The cyclic nature of the engine is therefore no longer represented and only long time dynamic remains. Reducing the number of differential equations reduces the mathematical complexity and the computer time. He keeps the differential equations for the “long time” processes such as engine speed and the turbocharger speed. More simplifications are made but will not be presented here.

In the end, Hendricks managed to produce a model which provided good performance in terms of accuracy and computational time and at the same time guaranteed a minimum level of physical coherence.

Since then, this modelling approach has been largely used and computer performances have skyrocketed. Nowadays, mean value models remain popular and are used in a variety of applications such as engine control systems [79]-[80]-[81]-[82]-[83], on board diagnostics [84], real-time modelling, “hardware in the loop”, overall vehicle modelling [79] and even crew training simulation software [85]. In fact no mean value models were found in the literature with the purpose of calculating the thermal balance.

Of course there is a great variety of mean value models. Depending on the objectives and constraints of each developer, the model will include varying numbers of differential equations. Theotokatos [86] compared two mean value approaches of different complexity for representing the transient behaviour of a MAN B&W large two-stroke marine diesel engine. He concluded that the two models were valid but not intended to achieve the same goals. The first model is simpler, faster and accurate enough for “engine speed control design process”. Whereas the second model is more complex, slower, but gives better predictions, especially for fast transient behaviours and hence is “more appropriate for advanced engine control system design studies”.

But finally, the philosophy and modelling architecture of all mean value models remains similar. They try to simplify to a maximum a zero-dimensional model while still conserving sufficient accuracy. Ultimately, a mean value model can be seen as a zero-dimensional model where the cylinder sub-models are replaced by a black-box. This black-box cylinder nevertheless contains the basic but essential thermodynamic equations: the conservation of mass and energy.

## 4.4 DATA ANALYSIS

The mean value model presented in this chapter relies solely on the manufacturer's data. Unfortunately the data available is sparse and its reliability, questionable. Some data pre-processing is essential to guarantee good polynomial identifications in section 4.5.

### 4.4.1 Engine thermal balance

As any other thermodynamic system, the diesel engine must respect the first law and therefore present a complete thermal balance: the sum of all input energies must be equal to the sum of all output energies.

First of all, it is reminded that the variation of enthalpy of a fluid which undergoes any thermodynamic transformation under constant pressure is equal to the heat received:

$$\Delta H = Q \quad (4.1)$$

Where  $\Delta H$  is enthalpy variation and  $Q$  the heat received (both in J ). For a perfect gas, the variation of enthalpy only depends on the variation of temperature:

$$\Delta H = C_p \cdot \Delta T \quad (4.2)$$

Where  $C_p$  is the perfect gas heat capacity under constant pressure (in J.K<sup>-1</sup>). For liquids, in a first approximation (incompressible fluid), the variation of enthalpy is:

$$\Delta H = C \cdot \Delta T \quad (4.3)$$

Where  $C$  is the liquid heat capacity (in J.K<sup>-1</sup>).

The absolute value of a fluid enthalpy cannot be measured or calculated, only the variations of enthalpy are accessible. Calculating the thermal energy of a fluid requires defining a reference state. The thermal energy of the fluid in state A is defined as the heat that the fluid would exchange if it went from state A to the reference state. As for ideal liquids and perfect gases the variation of enthalpy only depends on the variation of its temperature, the reference state is defined only by a **reference temperature**.

The reference temperature must be defined carefully and definitively. Obviously, the reference temperature must be the same for all fluids. The ambient air temperature would have been a good choice for the reference temperature, as this way, the engine air admission (before air filter and compressor) would have been considered as having no thermal energy, which corresponds to intuition. Nevertheless, in the case of holistic ship energy modelling, the ambient air temperature changes continually, which complicates the thermal balance analysis. Moreover, for ships, there are two environmental temperatures: the air temperature and the sea water temperature, which makes the thermal balance analysis even more confusing. **Therefore, an arbitrary reference temperature will have to be defined for all fluids and under all environmental conditions, prior to any analysis.**

In addition to choosing the adequate reference temperature, one must define carefully the **system boundary** in order to build a coherent and complete thermal balance. The boundary chosen by D. Bichat-Gobard [57] is presented below for illustration purposes.



The system includes the engine, the turbocharger and the scavenge air cooler (hereafter referred to as ‘‘SAC’’). But the system does not include the complete engine installation, and therefore, fuel, lubricating oil and cooling water heater, preheater and pumps are not included (see Figure 4.3).

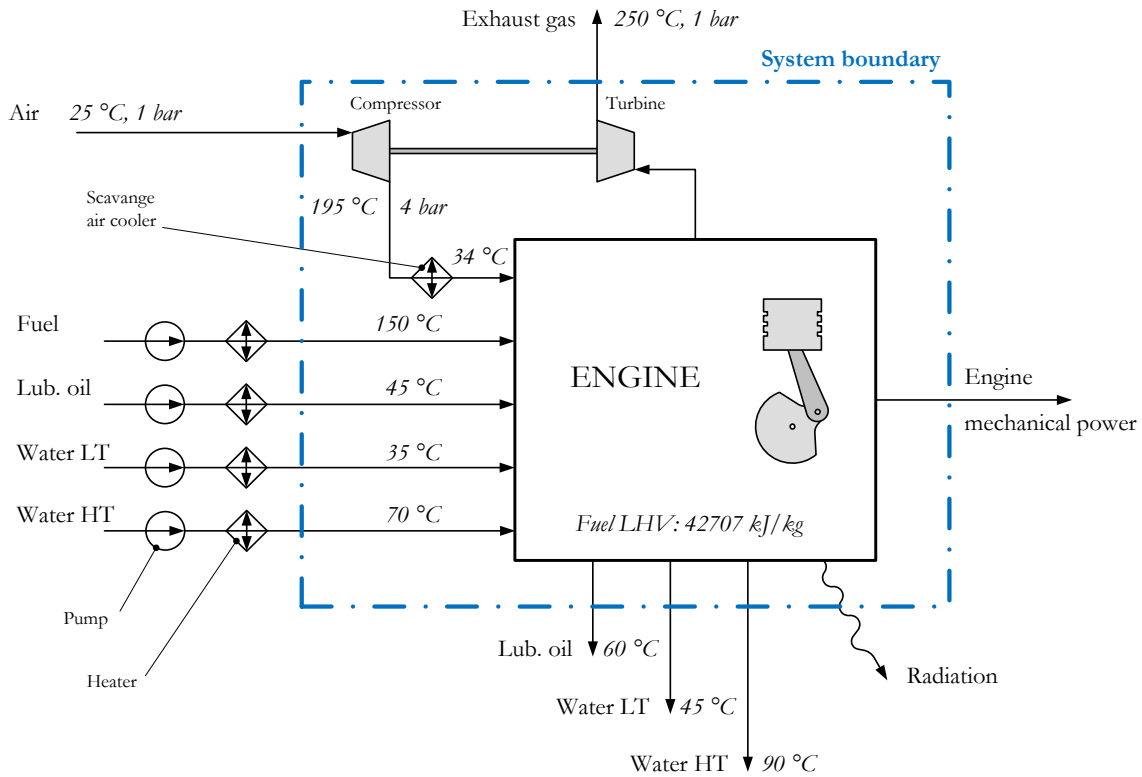

Figure 4.3: Diesel engine thermal balance presentation, displaying energy inputs and outputs. Source [57]. Figures for illustration purposes only (do not apply to engine A)

Table 4.2: Engine thermal balance: list of output and input power flows and corresponding equations. Source [57]

$P$  is power,  $\dot{Q}$  is thermal power,  $\dot{m}$  is mass flow,  $h$  is specific enthalpy (in J/kg),  $c_p$  is specific heat capacity at constant pressure (in  $\text{J}\cdot\text{kg}^{-1}\cdot\text{K}^{-1}$ ),  $T$  is temperature,  $c$  is specific liquid heat capacity (in  $\text{J}\cdot\text{kg}^{-1}\cdot\text{K}^{-1}$ ) and LHV is lower heating value (J/kg).

Input powers	Output powers
$P_{\text{combustion}} = \dot{m}_{\text{fuel}} \cdot \text{LHV}$	$P_{\text{crankshaft}}$
$\dot{Q}_{\text{air}} = \dot{m}_{\text{air}} \cdot \Delta h_{\text{air}} = \dot{m}_{\text{air}} \cdot c_{p\text{air}} \cdot \Delta T_{\text{air}}$	$\dot{Q}_{\text{SAC}} = \dot{m}_{\text{air}} \cdot \Delta h_{\text{air}} = \dot{m}_{\text{air}} \cdot c_{p\text{air}} \cdot \Delta T_{\text{air}}$
$\dot{Q}_{\text{fuel}} = \dot{m}_{\text{fuel}} \cdot \Delta h_{\text{fuel}} = \dot{m}_{\text{fuel}} \cdot c_{\text{fuel}} \cdot \Delta T_{\text{fuel}}$	$\dot{Q}_{\text{exhaust}} = (\dot{m}_{\text{air}} + \dot{m}_{\text{fuel}}) \cdot \Delta h_{\text{exhaust}}$
	$\dot{Q}_{\text{exhaust}} = (\dot{m}_{\text{exhaust}}) \cdot c_{p\text{exhaust}} \cdot \Delta T_{\text{exhaust}}$
$\dot{Q}_{\text{water}_{\text{in}}} = \dot{m}_{\text{water}} \cdot c_{\text{water}} \cdot (T_{\text{water}_{\text{in}}} - T_{\text{ref}})$	$\dot{Q}_{\text{water}_{\text{out}}} = \dot{m}_{\text{water}} \cdot c_{\text{water}} \cdot (T_{\text{water}_{\text{out}}} - T_{\text{ref}})$
$\dot{Q}_{\text{oil}_{\text{in}}} = \dot{m}_{\text{oil}} \cdot c_{\text{oil}} \cdot (T_{\text{oil}_{\text{in}}} - T_{\text{ref}})$	$\dot{Q}_{\text{oil}_{\text{out}}} = \dot{m}_{\text{oil}} \cdot c_{\text{oil}} \cdot (T_{\text{oil}_{\text{out}}} - T_{\text{ref}})$
	$\dot{Q}_{\text{radiation}}$

Alternatively, the system can be considered as a black-box. No physical insight is required to build the thermal balance. The only knowledge necessary is the energy flows which cross the system boundary. For

instance, the energy saved by the turbine and sent to the compressor is not taken into account, as it stays inside the system.

All the energy flows entering or leaving the system, and their corresponding equations are listed in Table 4.2. These energy flows are recorded over a period of one second and therefore calculated as powers.

▪ **Observations:**

The calculation method presented above is a good estimation of the engine thermal balance. It nevertheless contains several approximations:

- The term  $P_{combustion}$  represents the power contained in the fuel which can be potentially recovered through combustion. All this theoretical chemical power may not be fully transformed into heat if the combustion is not perfect (see the definition of the combustion efficiency: eq.(B.15)). In practice, both two-stroke and four-stroke modern marine diesel engines have combustion efficiencies very close to 100%. In a first approximation, the combustion is considered perfect.
- The combustion of the cylinders lubricating oil is neglected. The lubricating oil specific consumption is usually around 2 or 3 g/kWh [87].
- The thermal power dissipated through heat radiation is difficult to assess [76]. It can be calculated using the Stefan–Boltzmann law for “grey bodies”:

$$\dot{Q}_{radiation} = \varepsilon \cdot \sigma \cdot S \cdot T^4 \quad (4.4)$$

Where  $T$  is the temperature of the engine,  $S$  its surface,  $\sigma$  the Stefan–Boltzmann constant\* and  $\varepsilon$  the emissivity factor of the engine. The emissivity factor and the surface of the engine are quite complex to estimate and not accessible to the author. Whilst some manufacturers directly provide an estimation of  $P_{radiation}$  others do not. Values provided by the manufacturers, as well as values found in the literature are usually under 5% of the combustion power [88].

- The thermal power dissipated by the engine through convection to the engine room air and conduction to the ship structure is neglected in a first approach.
- As mentioned previously, fluids are considered either as perfect gases or ideal liquid, thus neglecting the energy contained in pressure variations. The kinetic and potential energies of the fluids are also neglected.
- Because the fresh air and the exhaust gases are considered as perfect gases, their specific heat capacity only depends on the temperature and is calculated with the Keenan and Kaye empirical formulae (see section 4.5.2.1).

All these approximations can lead to small discrepancies between the total input and output power of the engine. Further discrepancies can potentially be explained by the uncertainties contained in the manufacturer’s data. These uncertainties can come directly from the values. Manufacturers usually associate large tolerances with their data, sometimes over 10% uncertainties.

---

\*  $\sigma = 5.670 \times 10^{-8} \text{ W} \cdot \text{m}^{-2} \cdot \text{K}^{-4}$

Further uncertainties can result from an erroneous interpretation of the data. Here is a non-exhaustive list of possible misinterpretations:

- The lower heating value (LHV) of the fuel used by the manufacturers for their measurements is most of the time provided but not defined. And small differences can be found in the literature between definitions [22]. Moreover, the LHV is always defined according to a reference temperature, which is not stated by the manufacturer. Changing the reference temperature (from 0 to 25 °C) leads to a different thermal balance. Nevertheless, the discrepancies induced remain small (less than 0.5% of the combustion power according to the author's calculation).
- The biggest source of uncertainty due to incorrect interpretation might come from the definition of the “cooling items”. Main manufacturers state items such as “Jacket water cooler heat” and “Main lubrication oil heat”, or simply “Cylinder” and “Lub. oil”, without specifying the exact content of these items. For instance, most manufacturers do not specify whether the “Main lubrication oil heat” (or “Lub. oil”) item includes the heat released by the lubrication of the turbocharger. And this heat represents approximately 1% of the combustion power according to the author's calculation (assuming a turbocharger efficiency of 95%).
- The BSFC value can also be a source of error. The brake specific fuel consumption value depends on the calculation method and perimeter. For instance it depends on whether the lubricating oil and cooling water pumps are electrically or mechanically driven (approximately 1 or 2 g/kWh for each mechanical pump\*). It also depends on the exhaust gas back pressure after turbine. Of course it also depends on the ambient temperature and pressure, on the charge air pressure, on the relative humidity and on the fuel LHV, but these values are usually specified by the manufacturers.
- Finally, the use of exhaust gas and admission air by-passes, power turbine, turbo-compounds, waste heat recovery boilers or other appendices significantly increase the number of misinterpretations.

In the end and despite the numerous possible errors and approximations, the thermal balance analysis presented in this section is a powerful method to verify the coherence of manufacturer's data.

## 4.4.2 Specific engine data analysis and cleaning

Several engines, a part from engine A have been studied. Most of these engines showed small yet significant discrepancies between the values provided in their “internet reports” and in their “project guides”, particularly concerning exhaust gas temperature (outlet from turbocharger) and specific fuel consumption. Moreover all the engines studied showed inconsistent thermal balance. Most of the time the output power calculated thanks to the method presented in the previous section was higher than the input power. The difference could reach more than 15% of the mechanical power. The manufacturer states clearly that these data are to be used for guidance only and are associated with measurement tolerances (not specified but higher for loads below 35%). If the precision of these data can obviously be brought into question in the absence of additional information, it is impossible to pinpoint the exact source of the errors. Nevertheless the thermal balance needs to be corrected before using these data. This work has been done for the engine A.

For engine A, the data found in the internet report is coherent with the data found in the project guide. And the thermal balance study showed limited error: the output power exceeds the input power by 11.7%

---

\* For example: +0.6 g/kWh for each mechanical cooling water pump and +1.9 g/kWh for each mechanical lubricating oil pump for the MAN four stroke engine 48/60CR TierII at 85% load [89].

of the mechanical power at 100% load. To cancel this error, a first approach could have consisted in simply reducing each output power of the same factor. This approach would have guaranteed a consistent thermal balance but not necessarily a good distribution of the powers.

Instead the data was “cleaned” using a third source of information. The manufacturer has published a document on waste heat recovery systems. In this document, a Sankey diagram\* presents the thermal balance of engine A at 100% load. This thermal balance will serve as a reference to clean up the data of the internet report. The two thermal balances are compared in the following table:

**Table 4.3: Comparison between two complete thermal balances of engine A**

Thermal balance A1 corresponds to the data set from the document on waste heat recovery systems. Thermal balance A2 corresponds to the data set from the internet report. The “variation” column indicates the relative difference between A2 and A1 ( $\text{Variation} = (A2 - A1) / A1$ ). Both thermal balances correspond to 100% load operation under ISO conditions (25 °C and 1 bar).

Unit	Thermal balance A1 %	Thermal balance A2 %	Variation %
Fuel	100.00	100.00	-
Shaft	49.30	50.78	3.00
Lubrication oil	2.90	3.56	22.81
Jacket Water	5.20	6.17	18.64
Exhaust gas	25.50	25.37	- 0.52
Air cooler	16.50	19.45	17.86
Heat radiation	0.60	0.62	3.18
<b>Total output</b>	<b>100.00</b>	<b>105.94</b>	<b>5.94</b>

A few observations are made:

- The thermal balance A1 considers only the fuel as input energy (the reference temperature must have been chosen at 25 °C and the thermal power of the fuel must have been neglected). The thermal balance A2 was modified in consequence, the reference temperature set to 25 °C and the thermal power of the fuel neglected (anyhow below 0.1 % of combustion power).
- The total output power is higher in A2 than in A1. This illustrates the non-consistency of the A2 thermal balance. It is the result of several discrepancies that are listed below.
- The “Shaft” line indicates the engine global efficiency. And for a specific fuel, this efficiency is directly inversely proportional to the BSFC (see equation (B.12) in Appendix B). The internet report indicates a BSFC of 166 g/kWh and the document on waste heat recovery systems a BSFC of 167 g/kWh. This small difference is considered as unimportant; this gap can be due to fuel pumps or cooling pumps. However, with a fuel LHV of 42 700 kJ/kg, as indicated in the internet report, a BSFC of 167 g/kWh should give an efficiency of 50.5% instead of 49.3%. This small difference is not explained (perhaps a different fuel is used) and considered negligible in a first approach.

\* A Sankey diagram is a particular type of flow diagram in which the flow arrow width is proportional to the flow value.

- The heat dissipated via the lubrication oil is higher in thermal balance A2 than A1. The absolute difference is small but the relative difference is the highest of all the powers. The source of this error is unknown but a correction will have to be made to the A2 data set values.
- A similar observation applies to the heat dissipated via jacket water. The “jacket water” values of data set A2 will have to be corrected too.
- The thermal power of the exhaust gases is calculated in the thermal balance A2 (not directly provided by the engine manufacturer). Even though the absolute values are similar, the data set A2 will have to be corrected as the total power dissipated is higher in A2 than in A1.
- The heat dissipated in the air cooler is higher in A2 than in A1. The absolute and relative difference is important and will have to be corrected. This error may come from an after cooler scavenge air temperature reported too low in the internet report data set.
- The heat dissipated via thermal radiations is very close in both cases and represents approximately 0.6% of the combustion power. No correction will be made to this item as the absolute value and the relative differences are small.

Four items will be corrected: the lubrication oil, the jacket water, the exhaust gas and the air cooler. The correction will be made in two steps:

- a first step to correct the distribution of the different heat dissipations in order to correspond to the reference thermal balance A1;
- and a second step to correct the total amount of heat dissipation in order to respect the first law of thermodynamics.

The following Table 4.4 compares the two thermal balances. The analysis is this time restricted to the four heat dissipations.

**Table 4.4: Distribution of heat losses (except radiation) for thermal balances A1 and A2**

The ratio column is the ratio between A2 and A1:  $\text{ratio} = A2 / A1$ . The correction factor of a specific power is the ratio between the specific Ratio and the Ratio of totals:  $\text{Correction factor} = \text{Ratio} / \text{Total Ratio}^*$ .

Unit	Thermal balance A1 %	Thermal balance A2 %	Ratio -	Correction factor -
Lubrication oil	5.79	7.33	1.27	1.13
Jacket Water	10.38	12.69	1.22	1.09
Exhaust gas	50.90	52.19	1.03	0.91
Air cooler	32.93	40.01	1.21	1.08
<b>Total</b>	<b>100.00</b>	<b>112.23</b>	<b>1.12</b>	<b>1.00</b>

The first correction stage is to divide the values of lubrication, jacket water, exhaust gas and air cooler found in the internet report by their respective correction factors. Without any further information concerning the source of these errors, the same correction factor is applied to all engine operating points. For example, it is considered that if the power dissipated via lubricating oil is overestimated by 27% at 100% load, it is overestimated by 27% for all operating points. The distribution of heat losses at 100%

\* For example, the ratio for the lubrication oil is:  $1.27 = 7.33 / 5.79$ . And its correction factor is:  $1.13 = 1.27 / 1.12$ .

load will be therefore the same as in thermal balance A1 but not for other operating points. This correction will not change the total of these four items but their distribution.

Once the distribution of heat losses is rectified, several other corrections are applied to make sure that the thermal and mass balances are consistent. For the sake of clarity and simplicity, these corrections will not be detailed.

Finally, once the data has been cleaned and verified, the values can be used for interpolation in order to build the mean value model of engine A. In the end, the following sets of data were corrected: the exhaust gas temperature (after turbine), the scavenge air temperature after cooler, the scavenge air cooler heat, the jacket water cooler heat, the lubrication oil heat, the air mass flow and hence the exhaust gas mass flow.

## 4.5 PRESENTATION OF THE MODEL

The model presented below is a mean value model. It combines physics equations with empirical ones in order to describe as accurately as possible the behaviour of a marine diesel engine given the available data.

### 4.5.1 Global model architecture

From a Modelica, or more generally speaking, from an object-oriented modelling language point of view, a marine diesel engine mean value model is composed of four main components: the compressor, the scavenge air cooler, the cylinders and the exhaust gas turbine. Each of these components will be represented by its own model, with their own equations and connected to the other ones via connectors and links (see Figure 4.4).

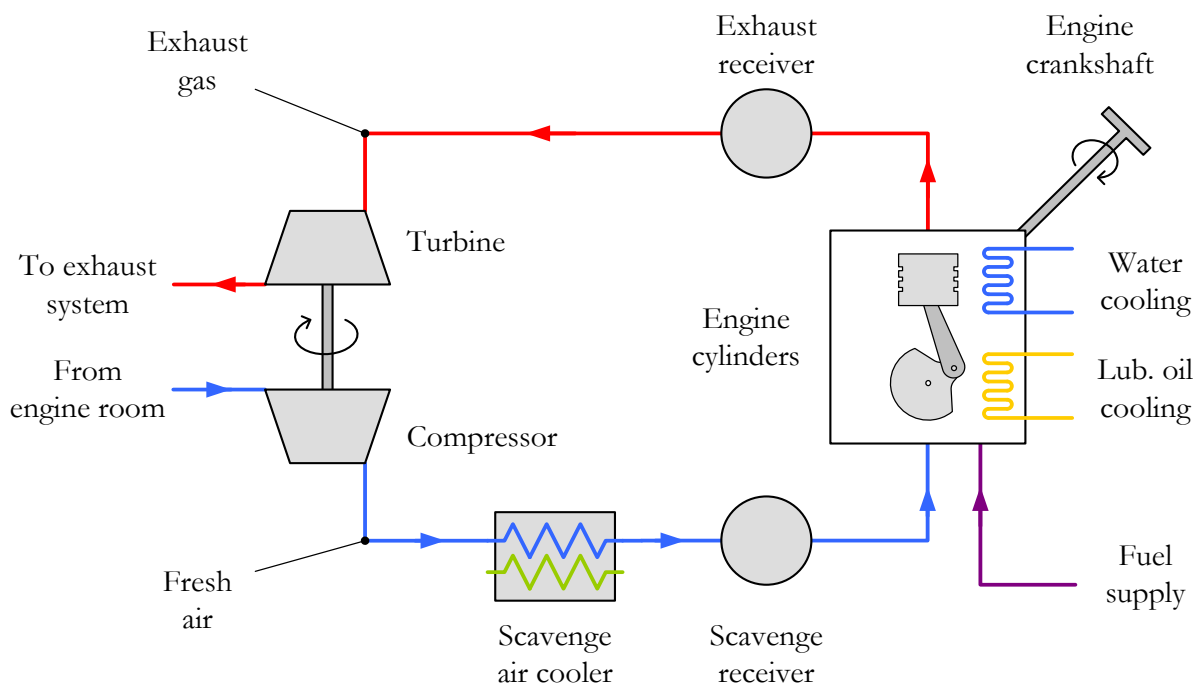

Figure 4.4 : Global architecture of the Diesel engine mean value model

### ▪ Connectors

The mean value model will integrate several connectors, basically one for each energy flow (engine and turbocharger work, fuel flow, cooling water flow, lubricating oil water flow). But the connector of main interest will be the one carrying the air and exhaust gas thermodynamic information. The variables that this connector shall carry must be chosen with care. The best set of variables for mean value modelling with Modelica have been discussed in previous work [90] [83] and vary between  $\{p, \dot{m}, T\}$ ,  $\{p, \dot{m}, h\}$  and  $\{p, \dot{m}, T, h\}$ \*. Under the perfect gas hypothesis  $\Delta h = c_p \cdot \Delta T$ . Moreover, the heat capacity is often considered as constant for fresh air and exhaust gases. Therefore the temperature is proportional to the enthalpy and hence all three sets of variables can be considered as equivalent in terms of level of information. Nevertheless, in this model, the heat capacity is not considered as constant and is recalculated at each connector using the Keenan and Kaye empirical formulas (see section 4.5.2.1). These formulae consider as inputs the temperature of the gas as well as its composition, represented here by the excess air ratio  $\lambda$ . And the gas composition changes throughout the engine (basically in the cylinder because of the combustion, but can also change in the induction system in the presence of exhaust gas recirculation). Therefore the following set of variables has been chosen for the gas connector model:  $\{p, \dot{m}, T, \lambda\}$ .

Moreover, it is reminded that links between connectors are “perfect” (that is how Modelica is built). They transport information with no loss and can be seen as “zero length pipes”. Therefore, the transport of information from component A to B is assumed to be lossless, and in particular, there is no loss of mass, pressure or temperature [83].

### ▪ Compressor

The compressor is powered by the turbine. It extracts air from the engine room and blows it into the induction system. In a first approach, all compressors and all stages of each compressor are represented as a single compressor.

### ▪ Scavenge air cooler

The scavenge air cooler cools down the air from the compressor in order to increase its density. The SAC is either cooled down by sea water or fresh water. In a first approach, all engine SAC and all SAC stages are represented as a single SAC.

### ▪ Engine cylinders

The main engine body (cylinders, piston, crankshaft, lubricating oil circuit, cooling water circuit, fuel injectors, exhaust valves, air admission ports/valves, etc.) is represented by a single model and can be seen as a black-box. The engine receives fuel from the fuel supply model and fresh air from the SAC model. And it provides work to the crankshaft, exhaust gases to the turbine and heat to the high and low temperature cooling systems. In a mean value approach the cyclical nature of the engine behaviour is neglected and only averaged values over one or several engine cycles are calculated. Moreover in a initial approach, all engine cylinders are represented as a single one.

---

\* With  $p$  the absolute pressure [bar],  $\dot{m}$  the mass flow [kg/s],  $T$  the temperature [°C] and  $h$  the specific enthalpy [kJ/kg].

- **Turbine**

The turbine is fed by the engine exhaust gases. Its output is either connected to a waste heat recovery system or directly to the exhaust circuit. The power saved by the turbine drives the compressor. In a first approach, all turbines and all turbine stages are represented as a single one.

- **Scavenge and exhaust receivers**

The scavenge and exhaust receivers are not modelled. In stationary operation, they don't have much influence. Nevertheless, in this mean value model, fresh air cylinder input variables and exhaust gas cylinder output variables correspond to the ones in the scavenge and exhaust receivers.

## 4.5.2 Equations

This section presents the general method and all the necessary equations to model a marine diesel engine. The generic equations and physics equations can be applied to all marine engines. The empirical ones are "fitted" to engine A and will have to be re-adapted to all new engines. Most mean value models contain one or two differential equations to typically calculate the dynamic behaviour of the engine shaft and the turbocharger shaft. Modelling the inertia of the turbocharger and engine shaft is necessary when the engine control is the object of the mean value model. Moreover in the automotive industry, it is a well-established fact that instationary operations contribute much more to the total amount of emissions than the stationary ones [64]. But this is not necessarily the case for the maritime industry. Ships travel most of the time at their nominal speed. In addition, the purpose of the modelling is not engine control but thermal balance prediction. A larger time-scale can suffice. Moreover, ships equipped with measurement systems often record points with very low frequency (the order of magnitude is often one point per minute or even one point per hour). Such data acquisition frequencies are inadequate for correct transient modelling. Therefore the model presented below is purely quasi-static, it contains no differential equations.

### 4.5.2.1 *Generic equations*

The global diesel engine model is controlled by an engine shaft speed and torque signal delivered by the rest of the SEECAT ship model (either by an alternator model controlled by a power management system or directly by a propeller model). Given these two signals, the new mean value model will calculate its complete mass and heat balance. In order to do so, several hypotheses were made.

- **Mass conservation**

As a consequence of the quasi-static modelling approach, the mass is perfectly conserved at each instant for every model, and therefore:

$$\dot{m}_{in} = \dot{m}_{out} \quad (4.5)$$

Where  $\dot{m}_{in}$  and  $\dot{m}_{out}$  are respectively the instantaneous mass flow entering and leaving the component.



### ▪ Perfect gas hypothesis

Moreover it is must be reminded that component models are connected to each other via connectors which perfectly conserve mass, energy, pressure and gas composition. Furthermore, apart from inside the cylinders, air and exhaust gases are considered as **perfect gases** and therefore:

$$\Delta h = c_p \cdot \Delta T = c_p \cdot (T - T_{ref}) \quad (4.6)$$

If the specific enthalpy is considered null at reference temperature, a common approximation is then to write:

$$h = c_p \cdot \Delta T = c_p \cdot (T - T_{ref}) \quad (4.7)$$

### ▪ Specific heat capacity calculation

Values of specific heat capacity at constant pressure for fresh air and exhaust gases are calculated thanks to the empirical formulas of Keenan and Kaye [74] [91]. These equations depend on the temperature (**in Celsius degrees**) and the air-fuel equivalence ratio (see section Appendix B):

- For  $T \geq 326.85$  °C:

$$c_p = \left(166.3 + \frac{24.5}{\lambda}\right) \cdot \log\left(T - 70 - \frac{120}{\lambda}\right) \quad (4.8)$$

- For  $T < 326.85$  °C, two possible cases:
- if  $\lambda < 8$ , then:

$$c_p = (975.5 + 0.28 \cdot T) - \log(\lambda) \cdot (11.92 + 0.06 \cdot T) \quad (4.9)$$

- else:

$$c_p = 1000 + 2.85 \cdot e^{0.0088 \cdot (T - 273.15)} \quad (4.10)$$

These curves do not perfectly "join" at 326.85 °C and therefore a linear interpolation, between 226.85 °C and 426.85 °C, has been added in the Modelica code of the Keenan and Kaye function.

### ▪ Adiabatic gas constant calculation

The adiabatic gas constant  $\gamma$  used in the compressor and turbine equations is calculated thanks to the specific heat capacity using the following thermodynamic equation:

$$\gamma = \frac{c_p}{c_v} = \frac{c_p}{c_p + r} \quad (4.11)$$

With  $c_v$  the specific heat capacity at constant volume (in J.K<sup>-1</sup>.kg<sup>-1</sup>) and  $r$  the specific perfect gas constant which for dry air equals  $r = 287$  J.K<sup>-1</sup>.kg<sup>-1</sup> (used also for exhaust gases in a first approximation).

### ▪ Pressure ratio definition

As a convention, the pressure is defined identically for the compressor, the cylinders and the turbine:

$$pr = \frac{p_{out}}{p_{in}} \quad (4.12)$$

Where  $p_{in}$  and  $p_{out}$  are respectively the component inlet and outlet pressure.

## 4.5.2.2 Turbocharger

In mean value models and zero-dimensional models the turbocharger is often represented by compressor and turbine maps. These maps can be provided by the turbocharger manufacturer and give the efficiency and pressure ratio as a function of the rotational speed and the mass flow. Moreover, in dynamic models, the speed of the turbocharger is calculated thanks to Newton's second law for rotation. This law requires the knowledge of the shaft inertia, which is not available and of limited interest in this case. The turbine and compressor maps are also not available for engine A. Therefore a simpler approach is adopted.

### 4.5.2.2.1 Turbocharger rotor shaft

The turbine drives the compressor via a rotor shaft. This rotor usually rotates on lubricated journal bearings to limit friction. Some residual friction remains nonetheless and therefore the turbine power is not transmitted integrally. The turbocharger mechanical efficiency is defined by the following relationship:

$$\eta = \frac{P_{compressor}}{P_{turbine}} \quad (4.13)$$

This efficiency can be determined with the manufacturer's data. The thermal power dissipated by the turbocharger lubrication  $\dot{Q}_{loss}$  is provided and corresponds approximately to the difference between the turbine power and the compressor power:

$$P_{compressor} \approx P_{turbine} - \dot{Q}_{loss} \quad (4.14)$$

The compressor power can be determined thanks to the manufacturer's data and equation (4.15) (see next section). Hence the turbocharger mechanical efficiency can be determined. Experimental data were found to vary between 95% and 99% for engine loads above 30%, with a mean value of 98%. For the sake of simplicity a constant efficiency has been chosen for the model.

Finally, the turbocharger rotor shaft is represented thanks to two physics equations and one parameter  $\eta$  has been identified thanks to the manufacturer's data.

#### 4.5.2.2.2 Compressor

The compressor compresses the engine room air (25 °C and 1 bar in standard ISO conditions) and sends it to the cylinders. The compression is considered **adiabatic** and therefore the relationship between the mechanical power received from the turbocharger shaft  $W$  and the variation of specific enthalpy of the scavenge air  $\Delta h$  is:

$$P_{compressor} = \dot{m} \times \Delta h = \dot{m} \times c_p \times \Delta T \quad (4.15)$$

The quality of the compression is characterized by its isentropic efficiency  $\eta$ :

$$\eta = \frac{T_{in}}{T_{out} - T_{in}} \cdot \left( pr^{\frac{\gamma-1}{\gamma}} - 1 \right) \quad (4.16)$$

The engine manufacturer provides the compressor input and output temperature, as well as the pressure ratio along the propeller curve. It is therefore possible to calculate the isentropic efficiency. The values are found to vary between 80.1% and 81.6% for loads higher than 30%. Given this narrow range of variation and the lack of further information concerning the compressor, based on the work of Hendricks [77] and Jankovic [92], it has been decided to consider a constant compressor efficiency throughout the engine operational range. The mean value of 81% has been chosen.

The compressor pressure ratio usually varies with the air mass flow and speed. The speed is not available and therefore a polynomial law, depending on the mass flow only, has been identified with the manufacturer's data:

$$pr = c_1 \cdot \dot{m}^2 + c_2 \cdot \dot{m} + c_3 \quad (4.17)$$

This polynomial law is an approximation of reality which remains correct as long as the engine stays "close" to the propeller and CPP curves. The errors induced by this approximation are limited as they have limited influence on the behaviour of the engine cylinders model.

The air mass flow is determined in the engine cylinders model. Therefore, knowing the air mass flow, and the input temperature, equations (4.16) and (4.17) gives the possibility to calculate the output temperature:

$$T_{out} = T_{in} \cdot \left( 1 + \frac{pr^{\frac{\gamma-1}{\gamma}} - 1}{\eta} \right) \quad (4.18)$$

In the end, the compressor is modelled thanks to two physics equations and one empirical equation. Four parameters ( $\eta$ ,  $c_1$ ,  $c_2$  and  $c_3$ ) are identified thanks to the manufacturers data.

#### 4.5.2.2.3 Turbine

The turbine provides mechanical power to the compressor by expanding the hot and pressurized exhaust gases from the engine (approximately 4 bars and 390 °C) to the atmosphere (considered at 1 bar). The expansion is considered adiabatic and because of the lack of data, its isentropic efficiency is considered equal to the compressor. The output temperature is calculated with the following relationship:

$$T_{out} = T_{in} \cdot \left( 1 - \eta \cdot \left( 1 - pr^{\frac{\gamma-1}{\gamma}} \right) \right) \quad (4.19)$$

The difference of temperature induces a difference of enthalpy and hence power:

$$P_{turbine} = \dot{m} \times \Delta h = \dot{m} \times \Delta T \quad (4.20)$$

The turbine is finally modelled thanks to two physics equation and one parameter: the efficiency.

### 4.5.2.3 Scavenge air cooler

The scavenge air cooler is basically a heat exchanger. It is there to cool down the air from the compressor (from approximately 210 °C to 65 °C at 100% load). This operation increases the air density and hence gives the possibility to the engine to admit more air and inject more fuel at each cycle, thus increasing the combustion power.

The air cooler can be modelled as an intermediate volume. This approach would permit to calculate the pressure drop but would add a differential equation. The effect of the pressure drop on the air density is nevertheless negligible compared to the effect of the temperature drop and is therefore considered null [79]. Considering the SAC as dimensionless is therefore sufficient and saves one state variable and hence computer time.

The energy efficiency of the SAC is considered perfect (100%), that is to say that all the energy lost by the air is transferred to the coolant. Hence, the following relation is considered:

$$\dot{Q}_{SAC} = \dot{m} \times \Delta h \quad (4.21)$$

Where  $\dot{Q}_{SAC}$  is the heat rate (in W) lost or received by either one of the fluids.

The temperature at the output of the SAC (and hence the actual heat transfer) is calculated thanks to the SAC effectiveness  $\varepsilon$ :

$$\varepsilon = \frac{T_{out} - T_{in}}{T_{coolant} - T_{in}} \quad (4.22)$$

For engine A, the SAC inlet and outlet temperature (respectively  $T_{in}$  and  $T_{out}$ ), as well as the inlet coolant temperature ( $T_{coolant}$ ) are given following the propeller curve and the CPP curve. For loads between 40 and 100%, the effectiveness is found to decrease from 95% to 83%. The effectiveness usually varies with the temperature difference and the mass flows [79]. In a first approach, the effectiveness will be estimated by a linear function of the air mass flow:

$$\varepsilon = s_1 \times \dot{m}_{air} + s_2 \quad (4.23)$$

For loads below 40%, the effectiveness will be considered constant at 95%. If the characteristics of the heat exchanger are well known (area of heat transfer and heat transfer coefficient), the Number of Transfer Units (NTU) method can be used to calculate the effectiveness value.

In the end, the SAC is represented thanks to two physics equations. Its effectiveness is calculated thanks to an empirical equation where the coefficients are determined using the manufacturers' data.

#### 4.5.2.4 *Engine cylinders*

**N.B.:** As mentioned previously, the following description of this model applies to the main engine body (cylinders, piston, crankshaft, lubricating oil circuit, cooling water circuit, fuel injectors, exhaust valves, air admission ports/valves, etc.) but not the full engine (turbocharger, exhaust and scavenge circuits, etc.)

The engine cylinders are the most important parts of the engine but at the same time are the most complicated ones to model because of physical phenomena such as combustion and heat transfer.

So far the behaviour of the compressor, the SAC, the turbine and the turbocharger shaft have been modelled. The compressor model needs the air mass to work and the turbine needs the exhaust receiver gas temperature. Overall, this engine cylinders model will have to contain several equations:

- a first equation to determine the scavenge air mass flow; this equation will allow the compressor model to work and in the end calculate the pressure and temperature in the scavenge receiver and hence the thermal power of the air entering the cylinders;
- a second equation to determine the efficiency of the engine; this equation will calculate the fuel mass flow and hence the combustion power; it will also calculate the air-fuel equivalence ratio  $\lambda$  and the fuel thermal power;
- two more equations will be necessary to calculate the water and the lubrication oil cooling;
- knowing the combustion power, the input air and fuel thermal power, the mechanical work, the radiation heat loss and the cooling power makes it possible to determine the exhaust power thanks to the first law and hence the exhaust temperature.

The first four equations are empirical ones. They will be determined by interpolation between the corrected propeller and CPP curves. All the interpolations are made thanks to the MATLAB software. The interpolations are of polynomial type, based on two variables: engine speed and torque. The structures and the value of the interpolation coefficient of these polynomials are relevant for engine A only and may vary for other engines. Moreover, the values of the coefficients are determined for specific environmental conditions and overall engine structure. They should be recalculated each time environmental conditions or engine structure changes. Some new empirical laws taking into account the influence of the environmental conditions could partly solve this issue.

##### 4.5.2.4.1 *Air mass flow equation*

Assessing the air mass flow is essential to the thermal balance calculation and to the model functioning. The value calculated in the engine cylinders models will be applied to the complete scavenge line as the modelling is of quasi-static type. Several mean value models use fluid flow equations such as the equation of Barré de Saint-Venant [83]-[86] to determine the air mass flow. This approach is similar to zero-dimensional models [65]. Others rely more deeply on measurement values as they use volumetric efficiency tables [77]-[93]. The first approach considers the cylinders as an expansion valves [73] but requires geometric dimensions which are not available. The second approach relies on extensive measurement campaigns.

For engine A, the air mass flow has been found to be mainly a function of torque and engine speed. The following interpolation has been found to fit correctly the corrected manufacturer's points:

$$\dot{m}_{air} = a_1 + a_2 \cdot \omega + a_3 \cdot \tau + a_4 \cdot \omega \cdot \tau + a_5 \cdot \tau^2 \quad (4.24)$$

With  $a_1$ ,  $a_2$ ,  $a_3$ ,  $a_4$ , and  $a_5$  the interpolation coefficients. The interpolation curves are presented in Figure 4.5.

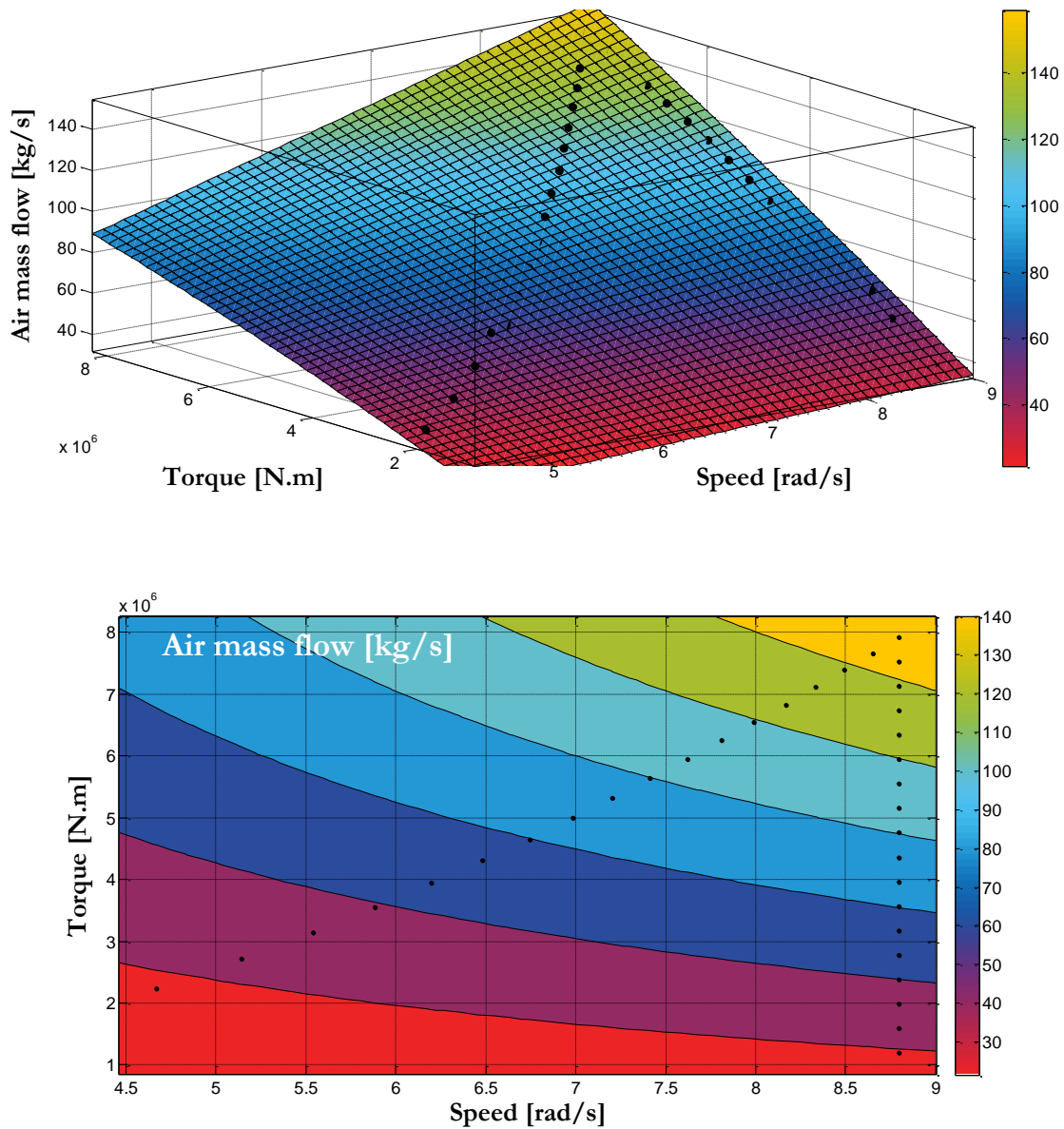

Figure 4.5: 3D visualization and contour visualisation of mass flow interpolation

For engine A, in ISO conditions, the air mass flow interpolation showed a R-square coefficient of 0.9969, indicating a very good level of interpolation.

Finally, the air mass flow is determined thanks to an empirical equation fitted to the corrected manufacturer's points. For this engine, five empirical coefficients have been identified.

#### 4.5.2.4.2 Efficiency equation

In zero-dimensional models, the engine efficiency is determined thanks to several complicated sub-models such as convective heat transfer model, fluid flow model, ignition delay model, combustion heat release model, valve discharge model, etc. In a mean value approach, this method is not possible as the cyclical behaviour of the engine cylinders is overlooked. All mean value models found in the literature use empirical equations to assess the global engine efficiency. Hendricks points out that the efficiency equation “*is one of the few purely empirical functions used in the model but it cannot be avoided here*” [77]. In his model, the efficiency is found to be a function of the sole air-fuel equivalence ratio. The models of Kao and Moskwa [94] and Omran [80] consider the efficiency to be a function of the air-fuel equivalence ratio and the engine speed. Yet all these functions have been tested for engine A without success. Unfortunately, following the propeller curve, the air-fuel equivalence ratio has been found to be a non-bijective function of speed, making interpolations very difficult. Instead, the efficiency has been found to be a polynomial function of engine speed and torque:

$$\eta_{global} = b_1 + b_2 \cdot \omega + b_3 \cdot \tau + b_4 \cdot \omega^2 + b_5 \cdot \omega \cdot \tau + b_6 \cdot \tau^2 \quad (4.25)$$

The empirical coefficients  $b_1, b_2, b_3, b_4, b_5$  and  $b_6$  have been fitted to the manufacturer’s data. It must be noted that the variations of efficiency are small along the propeller curve and CPP curve (efficiencies range between 48.90% and 52.03% for loads higher than 35%), making the interpolations very sensitive to data accuracy and correction. The interpolations curves are presented in Figure 4.6.

For engine A, in ISO conditions, the engine overall efficiency interpolation showed a R-square coefficient of 0.9778, indicating a good level of interpolation.

The efficiency is used to calculate the fuel mass flow:

$$\eta_{global} = \frac{P_{crankshaft}}{\dot{m}_f \cdot LHV} \quad (4.26)$$

The fuel mass flow is used to calculate the associated CO<sub>2</sub> and SO<sub>x</sub> emissions. The calculation of NO<sub>x</sub> emissions is not yet possible. New developments will have to be considered to answer this limitation. In the meantime, the engine NO<sub>x</sub> certificates can provide a maximum value of emissions.

The fuel mass flow also calculates the air-fuel equivalence ratio, which is used for heat capacity calculations:

$$\lambda = \frac{\dot{m}_a}{\dot{m}_f \cdot C_{stoich}} \quad (4.27)$$

Finally, the engine efficiency is calculated thanks to an empirical equation. And for engine A, six polynomial coefficients are identified using the manufacturer’s data.

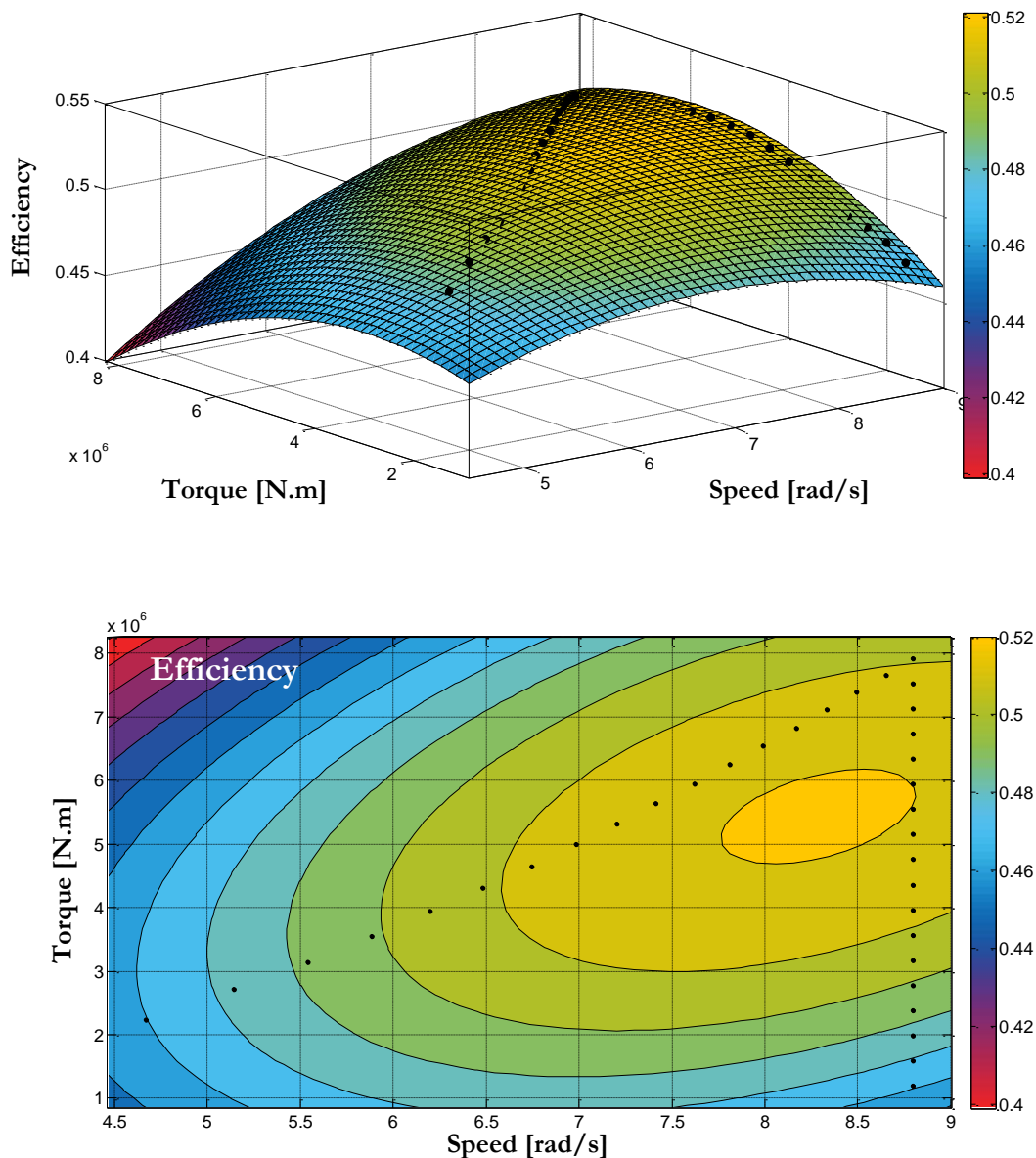

Figure 4.6: 3D visualisation and contour visualisation of efficiency interpolation

#### 4.5.2.4.3 Water and lubrication oil cooling equations

The temperature inside the cylinders of a diesel engine easily reaches 1 800 °C. To maintain the strength of the materials as well as good lubrication\*, it is essential to cool down the engine. Refrigeration is done by circulation of the cooling liquid and lubrication of the moving parts. The cylinders are cooled down by a closed circuit circulation of fresh water flowing through water passages in the jacket. The piston head is cooled down by a closed circuit circulation of fresh water or lubrication oil. The injectors are either cooled down by lubrication oil or fuel oil directly.

\* Lubrication oil can deteriorate at temperatures above 70-80 °C



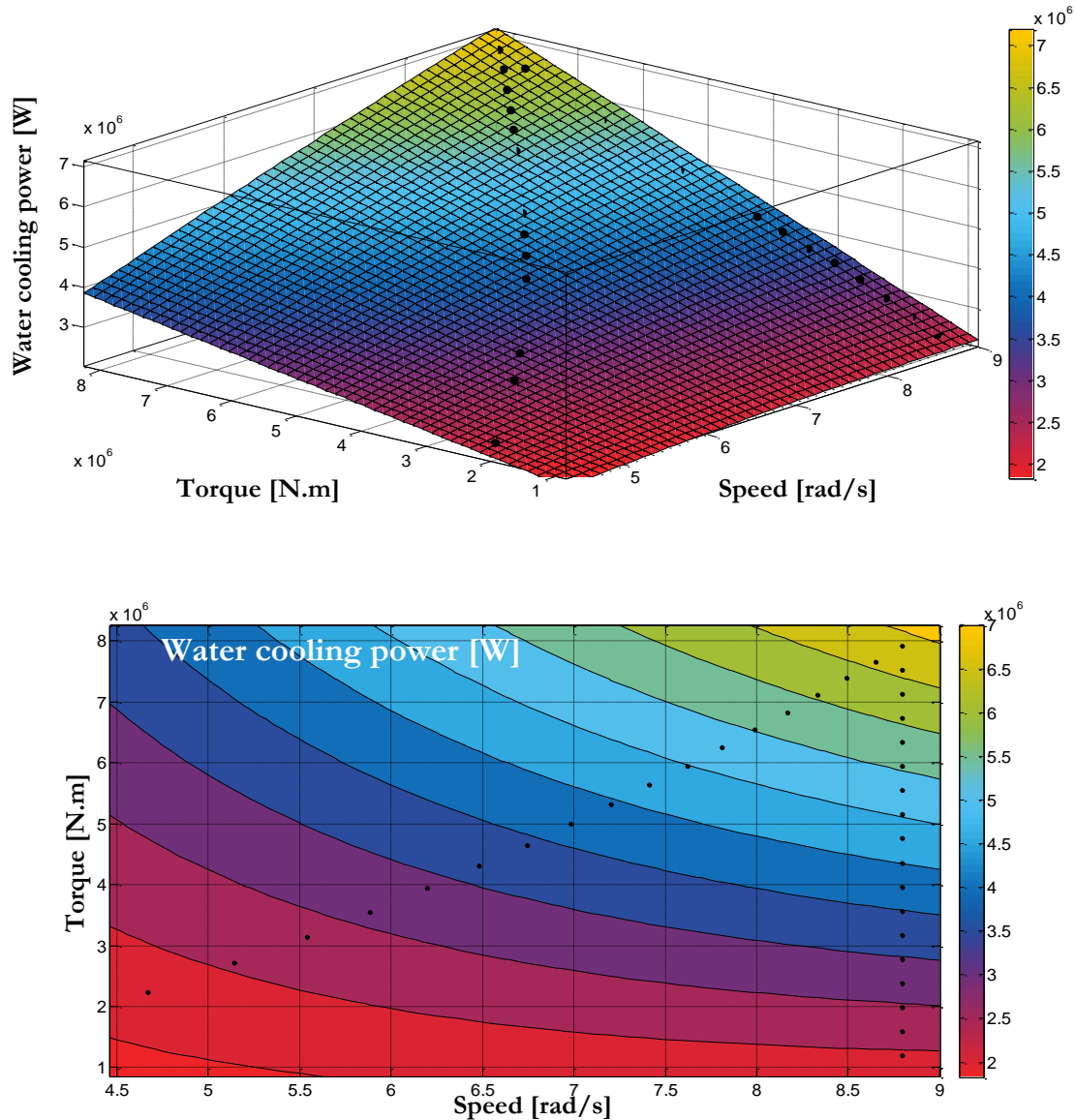

Figure 4.7: 3D visualisation and contour visualisation of water cooling power interpolation

In the end, a significant part of the engine combustion power is dissipated through water cooling and lubrication oil (respectively approximately 6.2% and 3.6% at 100% load, for engine A). Evaluating this power is rather complicated.

Most mean value models do not calculate the heat dissipated through cooling water and lubrication oil [77]-[83]-[84]-[86]-[93]. In fact, even zero-dimensional models rarely calculate the power dissipated through water cooling and lubrication oil but rather convective heat transfers and friction losses [65]-[67].

Heat transfers between the cylinders gases and cylinder walls are traditionally modelled using Newton's law. It requires knowledge of the gas temperature, the wall temperature, the wall surface and the heat transfer coefficient. The gas and wall temperature vary with each engine crank angle and can be assessed only by using an elaborate combustion heat release model. And the heat transfer coefficient is assessed using complicated models such as Woschni's heat transfer model which itself relies on the cylinder instantaneous gas temperature, pressure and velocity [95]. In the end, it seems that the mean value approach is not compatible with traditional heat transfer calculations.

Friction losses can be assessed using Chen & Flynn's model [75]. The model relies on cylinder maximum pressure and mean piston speed. These variables are compatible with a mean value approach, but to build this model, extensive measurement must be done to identify the empirical coefficients.

In any case, even if heat transfers and frictions losses could be correctly assessed in a mean value approach, it is the final destination of these powers which are of interest in this work. And if in a first approximation, one can associate heat transfers to water cooling and friction losses to lubrication oil, it is not entirely exact. Cylinder friction creates heat which can be dissipated by the water circulation [96] and the lubrication oil can be used to cool down engine parts, such as the piston head.

In the end, empirical polynomial interpolations were used to evaluate heat dissipated via the cooling water and the lubrication oil.

#### ▪ Water cooling

For engine A, a polynomial with engine speed to the power two and engine torque to the power one was found to fit best the corrected manufacturer's data:

$$\dot{Q}_{water} = c_1 + c_2 \cdot \omega + c_3 \cdot \tau + c_4 \cdot \omega^2 + c_5 \cdot \omega \cdot \tau \quad (4.28)$$

With  $c_1$ ,  $c_2$ ,  $c_3$ ,  $c_4$  and  $c_5$  the constant polynomial coefficients. The interpolation curves are presented in Figure 4.7.

For engine A, in ISO conditions, the water cooling power interpolation showed a R-square coefficient of 0.999, indicating a very good level of interpolation.

Finally, the heat dissipated via the cooling water is assessed using a polynomial interpolation. For engine A, five parameters have to be identified using the corrected manufacturer's data.

#### ▪ Lubrication oil cooling

For engine A, in ISO conditions, the lub. oil cooling power interpolation showed a R-square coefficient of 0.9969, indicating a very good level of interpolation.

The heat dissipated via lubrication oil is determined using a polynomial interpolation. In a first approximation, this interpolation could be fitted to Chen & Flynn's model. This model considers that friction can be represented as a polynomial of the maximum cylinder pressure and the mean piston speed to the power two. The maximal cylinder pressure is not available in a mean value approach, but it is an image of torque. And the mean piston speed is proportional to the engine speed. Therefore a polynomial interpolation using the torque to the power one and the engine speed to the power two has been tested but without success. For engine A, a polynomial with engine speed and torque to the power two has been found to best fit the corrected manufacturer's data:

$$\dot{Q}_{oil} = d_1 + d_2 \cdot \omega + d_3 \cdot \tau + d_4 \cdot \omega^2 + d_5 \cdot \omega \cdot \tau + d_6 \cdot \tau^2 \quad (4.29)$$

With  $d_1$ ,  $d_2$ ,  $d_3$ ,  $d_4$ ,  $d_5$  and  $d_6$  empirical coefficients. The interpolations curves are presented in Figure 4.8.

Finally, the heat dissipated via the lubrication oil is modelled using an empirical equation. Six polynomial coefficients have to be identified using the manufacturer's data.

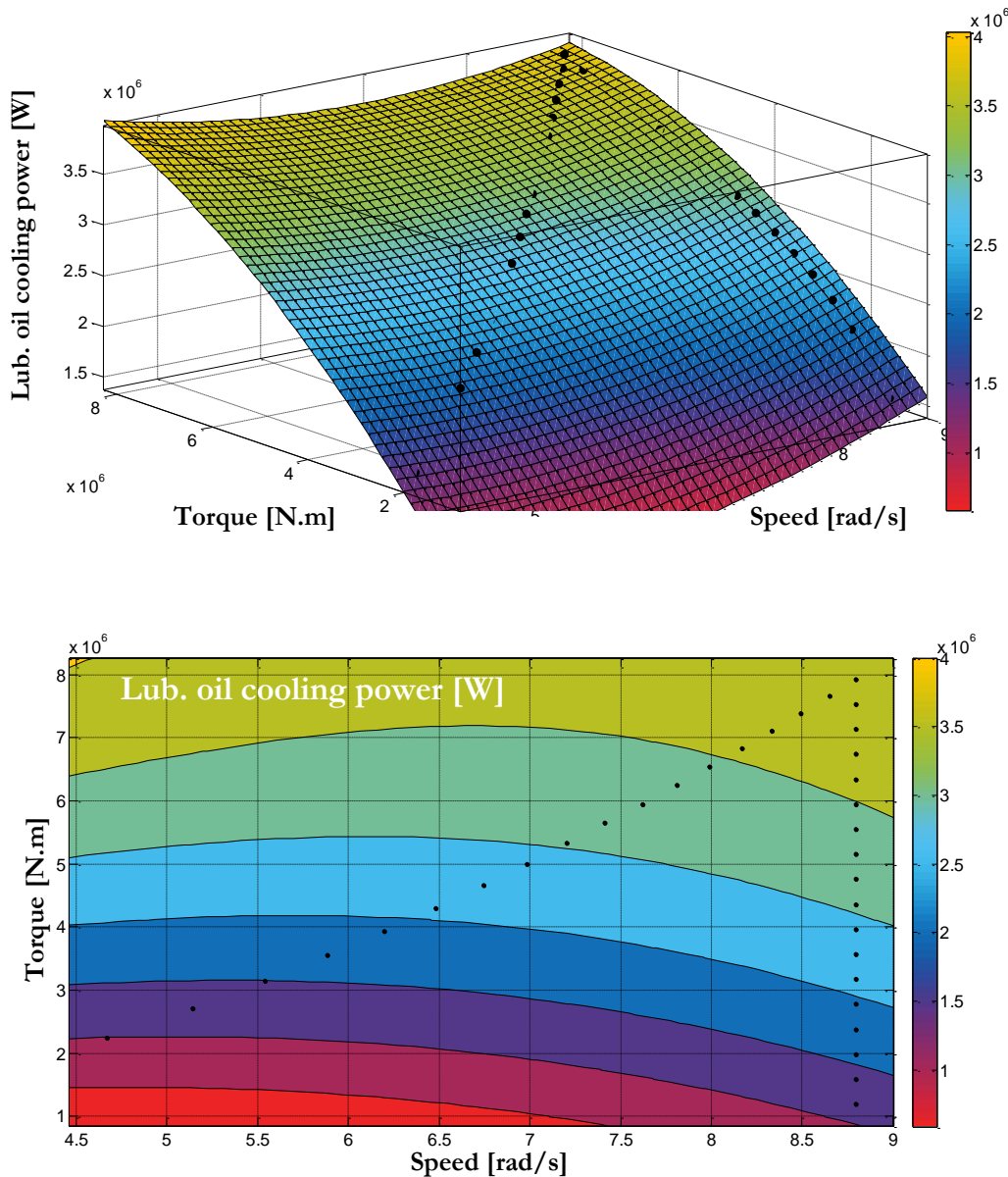

Figure 4.8: 3D visualisation and contour visualisation of lubrication oil cooling power interpolation

#### 4.5.2.4.4 First law of thermodynamics equation

The thermal power of the exhaust gases is calculated at the end, deduced from the thermal balance. But first the heat dissipated via thermal radiations must be assessed. The manufacturer does not provide any value for this power. A value found for a similar engine from a different engine manufacturer has been chosen. This value, of 850 kW, represents 0.6 % of the combustion power, which is consistent with the thermal balance A1 (see section 4.4.2). Because thermal radiation depends on the temperature of the engine, and since this temperature is regulated to be approximately constant over the entire engine operating range\*, thermal radiation is considered constant.

\* The engine temperature is usually regulated by a circulation of cooling water and a three port valve (for more details see appendix A.6 Water cooling circuit)

Finally, knowing the thermal radiation power and all other powers, the exhaust gas thermal power  $P_{exh}$  can be calculated thanks to the first law in the same manner as in section 4.4.1 (Engine thermal balance), but this time, restraining the system boundary to the cylinders. Therefore, the exhaust thermal power calculated corresponds to the thermal power available before the turbine, in the exhaust receiver and the thermal power of the air is considered after the SAC, in the scavenge receiver:

$$P_{combustion} + \dot{Q}_{fuel} + \dot{Q}_{air} = P_{crankshaft} + \dot{Q}_{cooling} + \dot{Q}_{exhaust} + \dot{Q}_{radiation} \quad (4.30)$$

Moreover, following the mass conservation law, the mean exhaust mass flow  $\dot{m}_{exh}$  is equal to:

$$\dot{m}_{exhaust} = \dot{m}_{air} + \dot{m}_{fuel} \quad (4.31)$$

Finally, the exhaust receiver temperature  $T_{ER}$  is deduced from the exhaust gas thermal power, as:

$$\dot{Q}_{exhaust} = \dot{m}_{exhaust} \cdot c_p \cdot \Delta T = \dot{m}_{exhaust} \cdot c_p \cdot (T_{ER} - T_{ref}) \quad (4.32)$$

Finally, three physics equations are used to calculate the exhaust gas mass flow, temperature and thermal power.

### 4.5.3 The SEECAT Model

The method and the equations described above are used to build the mean value model of engine A in SEECAT (see Figure 4.9). The compressor, the air cooler, the engine cylinders and the turbine component model compose the complete engine model. The compressor is connected to the “ambient air” model which specifies the pressure and temperature ambient conditions in the engine room. The scavenge air cooler is connected to a source and a sink of cooling fresh water. The engine cylinders model is connected to: a fuel tank for fuel supply; a shaft model which represents the mechanical load connected to the engine (either a propeller directly, an alternator or a gearbox); a control box which sets the engine speed and torque; two sources of cooling fresh water, one at low temperature ( $\sim 35$  °C) for the lubrication oil system and one at high temperature ( $\sim 80$  °C) for the jacket cooling system; a fresh water sink for the high temperature cooling system; to the turbocharger cooling system. Finally, the turbine is connected to an “exhaust” model where the atmospheric pressure is specified and to the low temperature cooling network via the engine cylinders model and a sink model.

The model alone is time efficient. On a laptop running on a 2.80 GHz dual core processor\*, calculating 120 engine operating points along the propeller curve takes approximately 1 second. It requires four state variables† which the simulator chooses itself and are in this case the turbine output temperature, the turbine pressure ratio, the exhaust receiver temperature and the compressor output temperature. All the other variables are either deduced from these four state variables or from other input parameters. The model runs smoothly all over the operating range, with the exception of very low loads ( $< 5\%$  MCR power) where it can no longer converge.

---

\* Laptop running on windows 7 64 bits, equipped with 4 GB of RAM and an Intel Core i5-3360M processor running at 2.80GHz.

† The state variables are the variables used in the Jacobian matrix that the simulator builds to solve the implicit equations of the problem

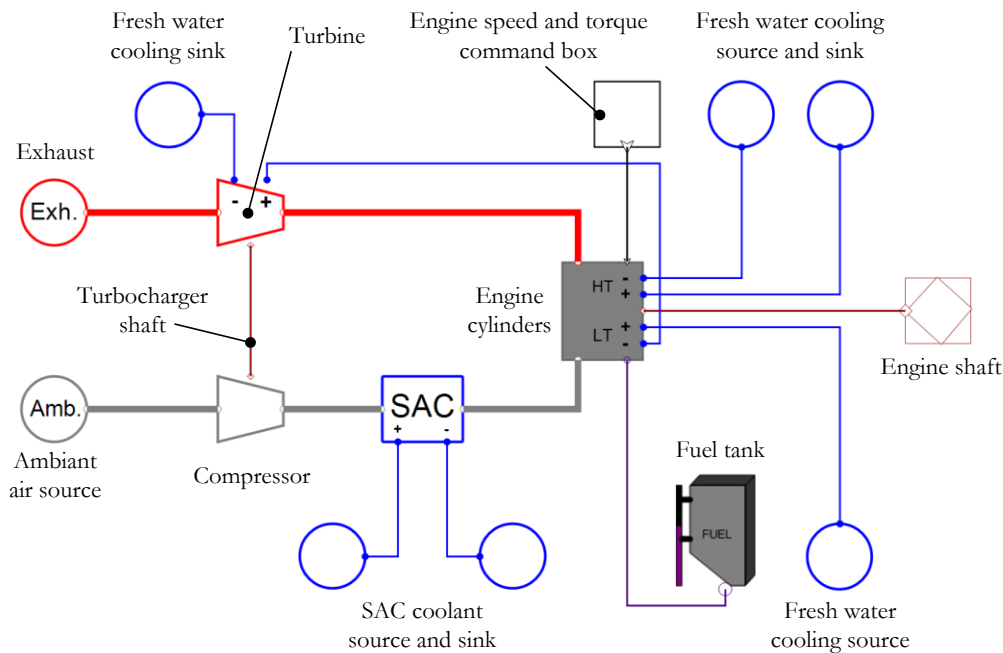

Figure 4.9: Graphical interface of the SEECAT mean value model of engine A

## 4.5.4 Results and validation

In this section simulation results are presented and the validity of the model is discussed. To begin with, simulation results will be compared against the corrected manufacturer's data set to make sure interpolations are good enough. Secondly, a more qualitative validation will be undertaken in order to grow confidence in the model results outside the propeller and CPP curves.

### ▪ Validation along the propeller curve

**Before starting it will be noted that engine A manufacturer mentions that: "loads below 35% are associated with larger tolerances". This should be kept in mind as results are analysed.**

The model is delicate to validate. The only data available for validation are those used to calibrate the model. Therefore, it is no surprise that most of the points calculated along the propeller and the CPP curves are very close to the corrected set of data.

This is particularly true for the specific fuel consumption (see Figure 4.10). If the model is not able to represent the second order variations, the main tendency is correctly simulated. Moreover the errors remain small: less than 1%. No corrections were made on the manufacturer's BSFC data, therefore the two curves are superimposed.

The heat produced by the combustion of the fuel is directly related to the BSFC. Hence, the "Manufacturer's data", "Corrected data" and the "Model results" curves match almost perfectly (see Figure 4.11).

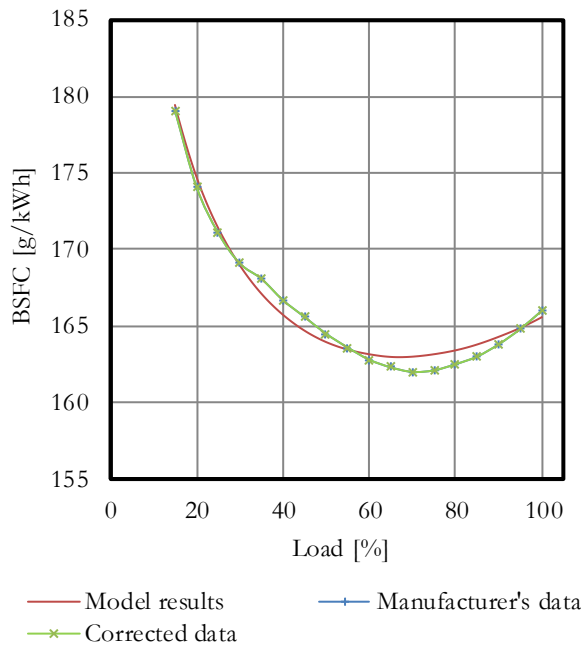

Figure 4.10: Brake specific fuel consumption values along the propeller curve. Comparison between the manufacturer's data, the corrected data and the SEECAT model.

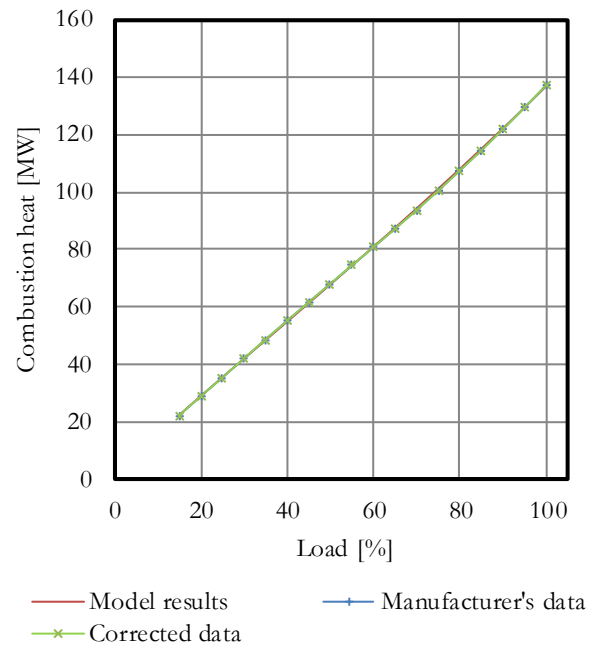

Figure 4.11: Engine combustion heat values along the propeller curve. Comparison between the manufacturer's data, the corrected data and the SEECAT model.

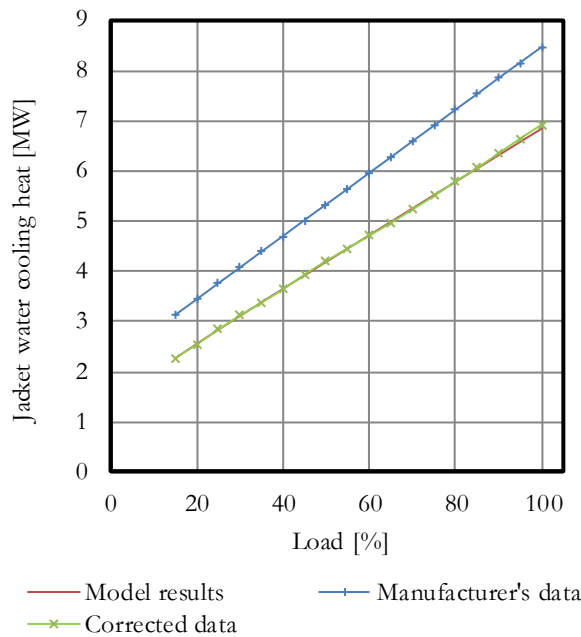

Figure 4.12: Engine jacket water cooling heat values along the propeller curve. Comparison between the manufacturer's data, the corrected data and the SEECAT model.

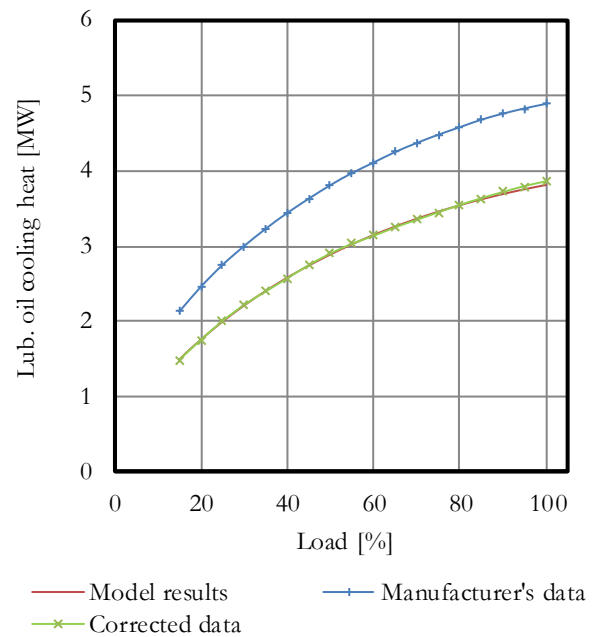

Figure 4.13: Engine lubrication oil cooling heat values along the propeller curve. Comparison between the manufacturer's data, the corrected data and the SEECAT model.

The heat produced by the engine jacket water cooling system and lubrication oil cooling system are calculated using interpolation equations. Along the propeller curve, the simulations results fit very closely

the corrected data set (see Figure 4.12 and Figure 4.13). Significant corrections were made on the manufacturer's data set for both measurements. Reduction factors of respectively 22%\* and 24%\* were applied.

The calculation of the scavenge air cooling heat depends on many parameters and variables such as ambient air temperature, compressor work and efficiency, heat exchanger effectiveness and cooling water temperature. In the end, the values predicted by the model are very close to the manufacturer's corrected data (see Figure 4.14). The errors remain small, below 750 kW along the propeller curve and below 4% relative difference at 100% load. These errors could be reduced by fine tuning the different parameters mentioned above. The gap between the manufacturer's raw data and the corrected data is due to the reduction factor applied: approximately 21%\*.

The exhaust gas thermal heat power is calculated in the SEECAT model by deduction from the rest of the thermal balance. The accuracy of the calculation therefore depends on the accuracy of the other forms of power calculated previously (combustion power, engine cooling power, SAC cooling power, etc.). The comparison with the manufacturer's corrected data set (Figure 4.15) shows good results. The trend is correctly followed and errors remain small: less than 1 MW difference along the majority of the propeller curve and 2 MW at 100% load, which represents a relative difference of 5%. A small reduction factor of approximately 6%\* was applied to the raw manufacturer's data.

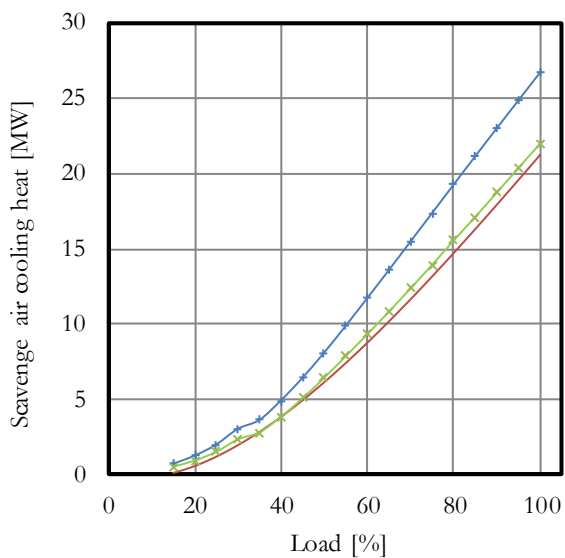

— Model results      —+— Manufacturer's data  
—\*— Corrected data

**Figure 4.14:** Scavenge air cooling heat values along the propeller curve. Comparison between the manufacturer's data, the corrected data and the SEECAT model.

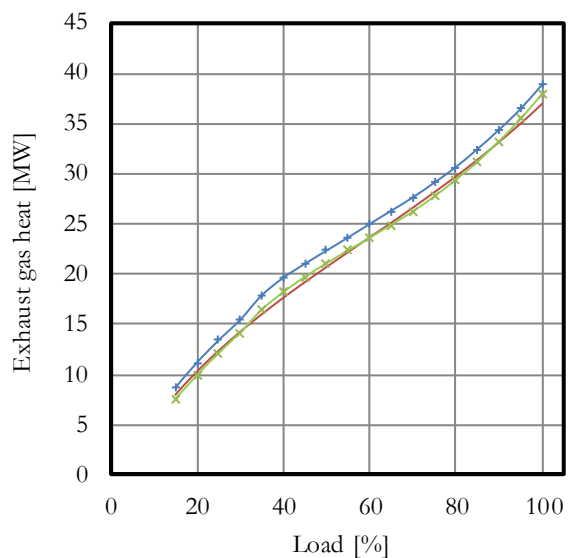

— Model results      —+— Manufacturer's data  
—\*— Corrected data

**Figure 4.15:** Exhaust gas heat (after turbine) values along the propeller curve. Comparison between the manufacturer's data, the corrected data and the SEECAT model.

The exhaust mass flow is the addition of the air mass flow, which is calculated using interpolation equations and the fuel mass flow, which is deduced from the BSFC which is also calculated using interpolation equations. The model results are very close to the corrected data (see Figure 4.16). For loads above 50% the relative difference remains smaller than 2%. Around 30% load, a bump can be observed on the manufacturer's curves. This irregularity corresponds to the starting of auxiliary blowers. These

\* Average value along the propeller curve

blowers, which are electrically driven, support the turbocharger whenever the cylinder inlet pressure drops below a pre-set pressure corresponding approximately to 25-35% load. As the model does not take into account these auxiliary blowers, this bump is not modelled. Nevertheless, the error due to this bump is less than 5% relative difference. Finally, the small difference observed between the manufacturer's data and the corrected data set is certainly due to rounding off errors from the manufacturer.

The exhaust gas temperature (after turbine) is calculated by the turbine model and therefore depends on input turbine temperature and thermal power as well as on the exhaust gas flow and the compressor work. The values from the manufacturer's data have a shape which is difficult to explain (see Figure 4.17). The values above 50% load remain relatively constant with a local minimum around 70% load certainly corresponding to the BSFC minimum observed on Figure 4.10. Below 50% load, the curve is more irregular and presents notably a steep increase between 30% and 35% load. This increase is not perfectly understood but could correspond to auxiliary blowers getting into action. The model does not manage to represent all the variations in the manufacturer's data. Nevertheless, for loads above 50%, the average temperature calculated by the model, 225.5 °C, is very close to the corrected data set, 222.3 °C and the maximum error is under 8 °C. For loads under 50%, discrepancies are higher but remain under 22 °C. Finally, the differences between the two manufacturer's curves are due to the thermal balance corrections.

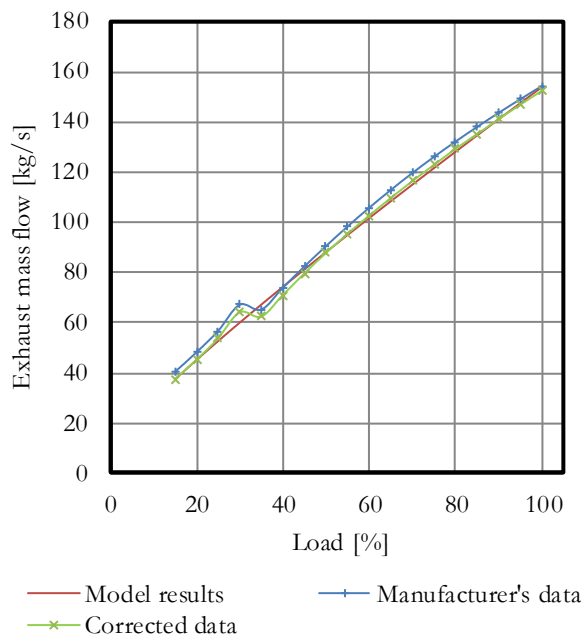

Figure 4.16: Exhaust mass flow values along the propeller curve. Comparison between the manufacturer's data, the corrected data and the SEECAT model.

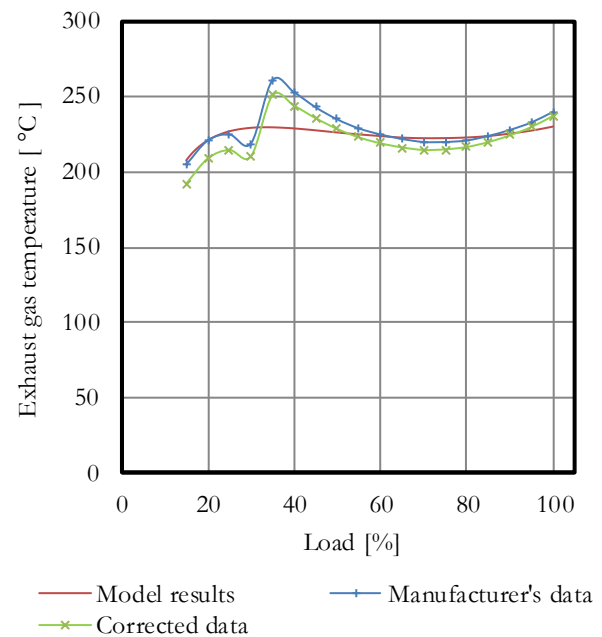

Figure 4.17: Exhaust gas (after turbine) temperature values along the propeller curve. Comparison between the manufacturer's data, the corrected data and the SEECAT model.

In the end, the overall accuracy of the model along the propeller curve is considered as good. In detail the accuracy varies from correct to almost perfect. Considering the limited data and knowledge available this is considered as an important achievement. That is all the more true as ships operate most of the time near the propeller curve. The same analysis has been made along the controllable pitch propeller curve and has led to similar conclusions. The good model accuracy along the propeller and the CPP curve increases confidence for values between and outside these two curves.



### ▪ Sensitivity analysis

Of course, a definitive validation of the model for values outside the propeller and the CPP curves is impossible without reference data. Nevertheless a sensitivity analysis can be made and has been carried out in order to generally study the response of the model to a variation of its inputs and notably assess its robustness and check for “strange” values and variations. 17 simulations were run at constant speed, from 110% of MCR speed to 30%. For each simulation, the engine load was changed, from a maximum value on the “overload curve”\* (see Figure 4.18) down to 5% load (below the model usually stops converging)†. In the end more than 1 400 engine operating points were simulated.

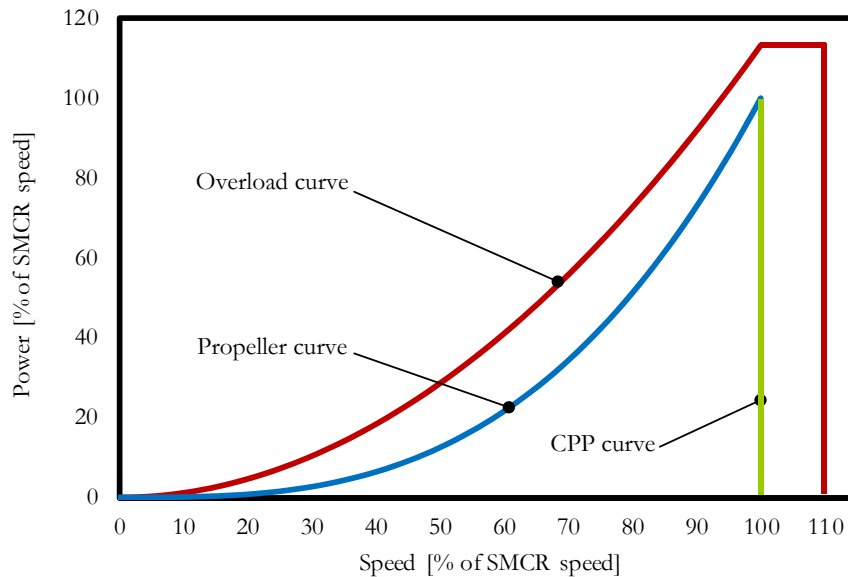

Figure 4.18: Engine operating diagram

For each point, the brake specific fuel consumption, the air cooler heat, the engine jacket and lubrication oil cooling heat as well as the exhaust mass flow and temperature, were recorded. These values are presented as contour maps in the figures below.

The brake specific fuel consumption values range from 161.8 to 214.5 g/kWh. The best consumption achieved is located at approximately 70% load and 90% speed which is very close to the propeller curve (Figure 4.19). It of course almost identical to Figure 4.6 (3D visualisation and contour visualisation of efficiency interpolation) as BSFC is an inverse function of efficiency. Nevertheless, the global shape of the map is similar to maps found in the literature (see Figure 3.3) which increases confidence in the model.

\* The overload curve corresponds to a technical limitation for engine damage prevention. Engines cannot exceed this limit.

† It is recalled that the model is “fixed”. It has been built for the parameters and environmental conditions that the manufacturer provides. It is therefore not possible to calculate correctly engine outputs for a different engine configuration (different turbocharger or different scavenge air cooler) or in a different environment (different ambient air temperature). The only input parameters which are “allowed” to change are the engine power and speed.

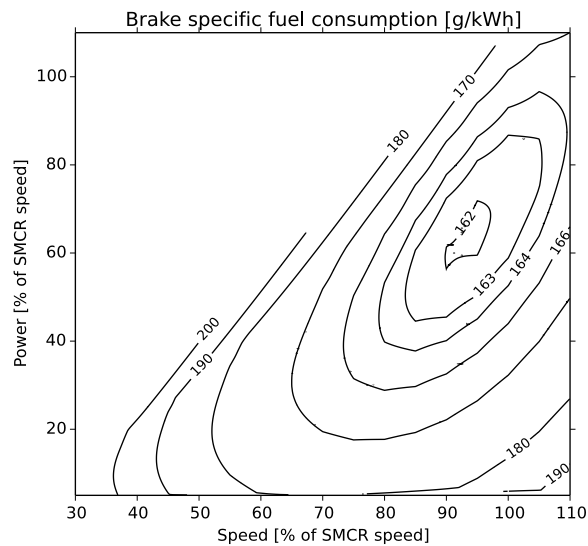

Figure 4.19: BSFC map built using the sensitivity analysis data

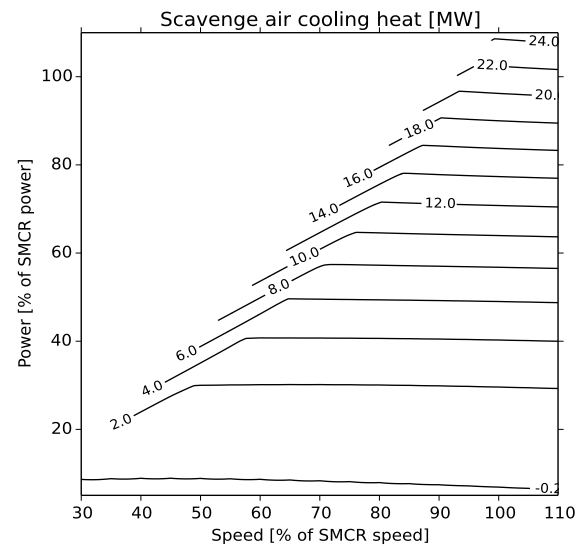

Figure 4.20: Scavenge air cooling heat map built using the sensitivity analysis data

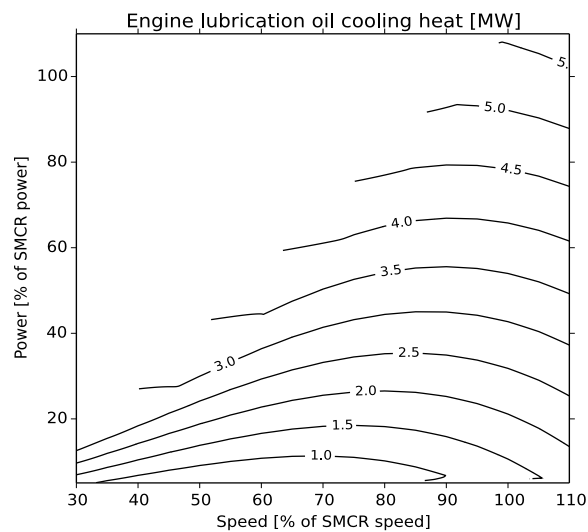

Figure 4.21: Engine lubrication oil cooling heat map built using the sensitivity analysis data

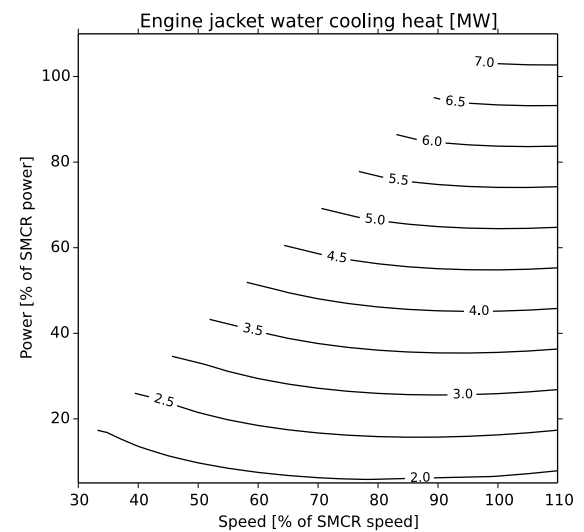

Figure 4.22: Engine jacket water cooling heat map built using the sensitivity analysis data

Concerning the scavenge air cooling heat, the values range from -278 kW to 24 774 kW. The negative values appear at very low load where the compressor output temperature is below the SAC coolant temperature. In this case, the SAC no longer cools down the scavenge air but instead heats it up. The map shows that the SAC cooling heat is mainly a function of the engine power (see Figure 4.20). This seems sensible as the air cooling power mainly depends on the compressor work which is known to mainly depend on the engine load.

The engine lubrication oil cooling heat values range from 528 kW to 5 738 kW. The map shows that cooling is mainly a function of power (see Figure 4.21). At constant speed, cooling is a strictly increasing

function of power which seems logical. Moreover, this map is almost identical to Figure 4.8\* as the lub. oil cooling depends directly on the interpolation equation (4.29).

The same observations can be made for the engine jacket water cooling system. These cooling values range from 1 511 to 7 385 kW. The cooling also appears to be mainly a function of power and at constant speed it is a strictly increasing function of power, which also seems logical (see Figure 4.22). This map is necessarily almost identical to Figure 4.7† as the jacket cooling is directly determined using the interpolation equation (4.28).

The exhaust mass flow values range from 21 to 167 kg/s. The exhaust mass flow is the addition of the air mass flow and the fuel mass flow, both of which are determined by empirical interpolation equations ((4.24)(4.25)). Therefore, the exhaust mass flow map (Figure 4.23) is very similar to the fresh air mass flow interpolation map Figure 4.5 (3D visualization and contour visualisation of mass flow interpolation). The mass flow appears to be mainly a function of the engine power.

The exhaust gas temperature (after turbine) values range from 64 °C to 291 °C. The temperatures appear to be a complex function of both speed and power (Figure 4.24). Nevertheless, most of the domain corresponds to temperatures between 200 °C and 240 °C. Moreover, at constant speed, the temperature appears to be mainly increasing with power which is sensible. The highest temperatures achievable are found for low speeds and high loads.

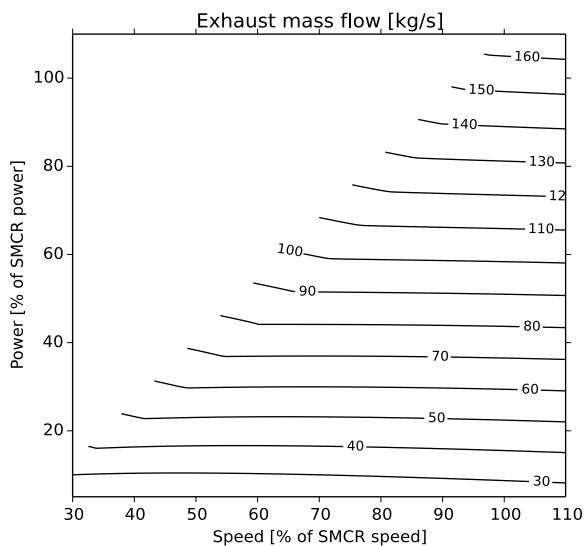

Figure 4.23: Exhaust mass flow map built using the sensitivity analysis data

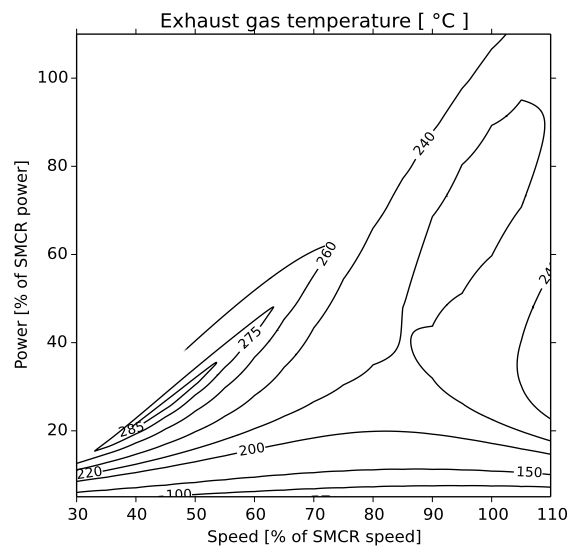

Figure 4.24: Exhaust gas temperature map built using the sensitivity analysis data

Finally, no signal showed extreme values or “strange” variations in the sensitivity analysis range. On this basis, and given the purpose of this model, the model can be considered as robust. The validity of the points outside the two curves only depend on the structure and the quality of the interpolation equations as well as on the pertinence of the different assumptions (e.g.: perfect gas hypothesis, quasi-static approach, etc.). Most assumptions are traditional assumptions in mean value and zero dimensional modelling and their pertinence has already been discussed above. Concerning interpolations, their

\* 3D visualisation and contour visualisation of lubrication oil cooling power interpolation, page 134.

† 3D visualisation and contour visualisation of water cooling power interpolation, page 133.

structure have been chosen to fit best physics or literature equations and manufacturer's data. The quality of these interpolations has been assessed using statistics coefficients.

In the end, if the mean value model of engine A has not been validated quantitatively, it is nevertheless considered valid qualitatively. This model will be used in the next chapter and more generally this modelling approach will be used for future work.

The energetic and exergetic balance of engine A are presented in the next chapter.

## 4.6 CONCLUSION

In this chapter, a computer model for marine diesel engines has been presented. The modelling approach is based on mean value models. Physical and empirical equations are used to describe the behaviour of the engine. The empirical equations are calibrated with manufacturer's data available for a specific engine. But the data is first "cleaned" through a thorough analysis mainly based on the first law. In the end a new model is added to the SEECAT library which can compute the complete thermal balance of an engine for any engine operating point. Several observations can be made:

- The mean value approach is not initially meant for thermal balance calculations. In fact, all modelling approach included, only very few papers were found in the literature for thermal balance calculations. The rare papers found were fairly simple and relied heavily on empirical data [97]. The mean value approach introduces more physical insight and more flexibility (possible modularity) than the previous approach used in Chapter 3.
- This model is fast to execute and its equations remain accessible.
- It is reminded that given the quantity and quality of the data available, the mean value modelling is considered by the author as the best possible approach. If more data were available (for example turbocharger maps), the components could easily be changed, keeping the same structure but modifying the equations, hence producing a more complicated but more accurate model.

The model possesses nevertheless some limitations:

- The model does not yet take into account variations of ambient air temperature. The model is hence fixed for now to the reference temperature of the manufacturer's data (20 °C for engine A). Nevertheless, engine manufacturers often provide the possibility to select a specific ambient air temperature on their webtools. Studying the influence of the different engine variables according to air temperature could reveal an empirical law, which could then be coded in the model.
- The model contains physical and empirical equations. The latter rely completely on the manufacturer's data which are often sparse and incoherent. From a certain point of view, the model could be seen as an empirical model in which physical equations are added for consistency.
- A propeller *and* a CPP curve are necessary to build most of the empirical equations. The CPP curve is not always available freely.
- The accuracy of the model remains questionable as the results have not been quantitatively validated. However, as long as the engine is operated "close" to the propeller and CPP curve, the errors should remain limited. Moreover the variations between the two curves are small, hence reducing further the risk of error. Finally, the output values calculated are coherent with literature and common knowledge.
- The model contains no differential equations and is therefore not a "true" dynamic model. It is nevertheless a quasi-static model. This limitation should have minor consequences as long as the ship

speed variations remain limited. This limitation should nevertheless be kept in mind when writing a ship operational profile model.

- One of the initial objectives of the model was to have a modular approach in which each component (turbine, compressor, cylinders, SAC) could be changed independently from the other. This objective has not yet been fully met. This is due to the four interpolations in the engine cylinders model (global efficiency, air mass flow, water cooling and lubrication oil cooling) which depend only on global variables: engine speed and torque. And therefore, these empirical laws cannot take into account any modification in the engine architecture. For example, modifying the compressor in the present model will have no effect on the global efficiency, which is of course in contradiction with reality. Therefore the model is fixed and remains as the engine manufacturer has described it. No modifications can yet be correctly assessed. To make the model modular, the four interpolation equations of the engine cylinders models will have to be replaced by new ones. These new equations shall rely on input variables alone such as scavenge receiver pressure or fuel mass flow.

Once the precedent limitations fixed, several further modifications can be considered such as the development of:

- by-passes (around the turbine, the compressor or the SAC);
- exhaust gas recirculation system [98];
- power turbines;
- auxiliary blowers;
- turbo-compound [99];
- dual-fuel and gas engines;
- NO<sub>x</sub> emissions calculation.

Finally, over and above the technical aspects, the work done in this chapter illustrates a powerful approach for modelling diesel engines with the purpose of predicting thermal balance. Its adaptability to holistic ship energy modelling is presented in the next chapter.

*Dans ce chapitre, un modèle numérique de moteur marin fut présenté. Ce modèle est basé sur l'approche par valeurs moyennes. Un ensemble d'équations empiriques et physiques est utilisé pour représenter le comportement du moteur. Les équations empiriques sont calibrées à l'aide des données fournies par les constructeurs. Mais ces données ont d'abord nécessité un long travail d'analyse et de « nettoyage » en se basant notamment sur le premier principe de la thermodynamique. Finalement, un nouveau modèle est ajouté à la librairie SEECAT. Ce modèle permet de calculer la balance thermique complète d'un moteur et ce pour n'importe quel point de fonctionnement. Plusieurs observations peuvent être faites :*

- *L'approche par valeur moyenne n'a pas été initialement pensée pour le calcul de balance thermique. En réalité, toutes approches de modélisation confondues, très peu de papiers dont l'intention est de calculer la balance thermique furent trouvés [97]. L'approche par valeurs moyennes permet plus de flexibilité (possible modularité) et un fonctionnement plus physique que l'approche utilisée dans le chapitre 3.*
- *Le modèle reste néanmoins rapide à exécuter et ses équations accessibles*
- *Il est rappelé qu'étant donné la qualité et la quantité d'information disponible, l'approche par valeurs moyennes est considérée par l'auteur comme la plus adaptée. Si plus d'information était disponible (par exemple les cartes des turbocompresseurs), les composants concernés pourraient être facilement changés, leurs équations modifiées mais leur structure conservée, rendant ainsi le modèle global plus précis même si toutefois plus compliqué.*

*Le modèle possède néanmoins quelques limites:*

- *Le modèle ne tient pas encore compte des variations de température ambiante. Le modèle est donc fixé, pour l'heure, à la température de référence mentionnée par le constructeur (20 °C pour le moteur spécifiquement étudié). Néanmoins, les constructeurs offrent généralement la possibilité de changer cette température dans leurs outils en ligne. Étudier l'influence de cette température sur les différentes variables du moteur permettra peut-être de déterminer une loi empirique, loi qui serait alors codée dans le modèle.*
- *Le modèle contient à la fois des équations de la physique et des équations empiriques. Ces dernières reposent entièrement sur les données constructeurs qui sont malheureusement souvent parcellaires et incohérentes. D'un certain point de vue, le modèle peut être vu comme un modèle empirique étayé par des équations de la physique pour plus de cohérence.*
- *Une courbe d'hélice classique ainsi que courbe d'hélice à pas variable sont nécessaires pour calibrer un grand nombre d'équations empiriques de ce modèle. Malheureusement, les courbes d'hélices à pas variable sont moins fréquentes que les courbes d'hélices classiques.*
- *La précision du modèle reste discutable du fait qu'il n'a pas été proprement validé de manière qualitative. Néanmoins, du moment que le moteur opère « près » de la courbe d'hélice classique ou la courbe d'hélice à pas variable, les erreurs devraient rester limitées. De plus, les variations entre ces deux courbes sont faibles, réduisant d'autant plus le risque d'erreur. En outre, les résultats des simulations sont cohérents avec les valeurs issues de la littérature et la pratique.*
- *Le modèle ne contient pas d'équations différentielles et ne peut donc pas, à ce titre, être qualifié de modèle dynamique à proprement parler. Il est néanmoins de type quasi-statique. Cette limite ne devrait donc avoir que des conséquences mineures, du moment que les variations de vitesse du navire restent faibles. Cette limite devra néanmoins être gardée à l'esprit lorsqu'il s'agira de définir le profil opérationnel du navire.*
- *L'un des objectifs initiaux était de permettre une approche modulaire où chaque composant (turbine, compresseur, cylindres, refroidisseur d'air de suralimentation) peut être changé indépendamment des autres. Cet objectif n'a pas encore été rempli. Ceci est dû principalement au fait que les quatre interpolations décrivant le fonctionnement des cylindres (rendement global, débit d'air, refroidissement par eau et refroidissement par huile) ne dépendent que de paramètres globaux, à savoir la vitesse et le couple moteur. Et ainsi, ces équations empiriques ne permettent pas de tenir compte d'éventuelles modifications du moteur. Par exemple, modifier le compresseur dans le modèle actuel n'aura pas d'influence sur le rendement global, ce qui est évidemment contraire à la réalité. Le modèle est donc fixe et doit rester dans la configuration détaillée par le constructeur. Aucune modification ne peut être pour l'heure correctement évaluée. Afin de rendre ce modèle plus modulable, il faudrait changer ces quatre équations d'interpolation. Les nouvelles équations devront alors se baser sur des variables locales telles que la pression de suralimentation ou le débit de fioul.*

*Une fois les précédentes limites contournées, plusieurs nouveaux développements seront envisagés tels que la modélisation de :*

- *systèmes de by-pass (autour de la turbine, du compresseur ou du refroidisseur d'air de suralimentation) ;*
- *systèmes de recirculation des gaz d'échappement [98] ;*
- *turbines de puissance ;*
- *soufflantes auxiliaires ;*
- *système dit de « turbo-compound » [99] ;*
- *moteurs « dual fuel » et moteurs à gaz ;*
- *des émissions de NO<sub>x</sub>.*

*Finalement, au-delà des considérations techniques, le travail réalisé pour ce chapitre illustre une puissante approche de modélisation des moteurs diesel dans le but de calculer leur balance thermique. L'intégration de ce modèle dans un modèle plus global est détaillée dans le chapitre suivant.*



# CHAPTER 5

## FLUID CIRCUIT & EXERGY MODELLING

---

<b>CHAPTER 5 FLUID CIRCUIT &amp; EXERGY MODELLING .....</b>	<b>149</b>
5.1 FLUID CIRCUIT MODELLING.....	151
5.1.1 <i>A new structure</i> .....	151
5.1.2 <i>Equations</i> .....	153
5.2 EXERGY ANALYSIS .....	154
5.3 RESULTS .....	156
5.3.1 <i>Engine energetic and exergetic balance</i> .....	156
5.3.2 <i>Engine cooling and exhaust circuit: energetic and exergetic balance</i> .....	158
5.4 ENERGY PERFORMANCE IMPROVEMENTS.....	164
5.4.1 <i>Design</i> .....	164
5.4.2 <i>Retrofit</i> .....	165
5.4.3 <i>Operation</i> .....	165
5.5 CONCLUSION .....	166



In Chapter 3 Holistic Modelling, an initial modelling approach was developed and presented. This method has proven to be effective and accurate. But this approach was based on the transport and conversion of energy flows only. The engine cooling, for example, was described by a single value, its thermal power in kW. Chapter 1 has explained how this was not sufficient. A single value approach only assess the quantity of energy but not its quality. In order to do so, it is necessary to describe the fluid using at least two values, typically, the fluids mass flow and the temperature. Doing so will allow exergetic analysis and thus provide better understanding of the energetic transformations at stake and better assessment of the true energy saving potentialities. This new approach will be named the “Fluid Circuit” approach as opposed to the previous “Energy flow” approach. It will nevertheless require important modifications in the models. These modifications will be presented in the first part of this chapter. After that, new considerations concerning exergy will be discussed. Then a theoretical model of engine A and its cooling and exhaust circuits will be presented. Simulation results will be presented along with exergy analysis. Finally, solutions for energy and exergy saving will be proposed.

*Dans le chapitre 3, une première approche de modélisation a été développée et présentée. Cette méthode s’est montrée être à la fois efficace et précise. Mais cette approche est basée sur les transferts et conversion d’énergie seulement. La puissance dissipée par le refroidissement du moteur est, par exemple, décrite par une seule valeur, à savoir sa puissance thermique en kW. Or le chapitre 1 nous a montré en quoi cela n’était pas satisfaisant. Une approche qui représente les fluides énergétiques à l’aide d’une seule valeur ne permet qu’une description quantitative du fluide et non qualitative. Une approche qualitative nécessite de décrire le fluide à l’aide d’au moins deux valeurs, classiquement le débit massique et la température. Faire ainsi permettra de développer une analyse exergetique et donc de fournir une meilleure compréhension des transformations énergétiques à l’œuvre et une meilleure évaluation des économies d’énergie réalisables. Cette nouvelle approche sera nommée « circuit fluide » en opposition à la précédente approche par « flux d’énergie ». Cette nouvelle approche requiert néanmoins de nombreuses modifications du modèle. Ces modifications sont présentées dans la première partie de ce chapitre. À la suite de quoi, des considérations sur l’exergie seront discutées. Ensuite, un modèle théorique du moteur modélisé dans le chapitre précédent et ces circuits de refroidissement et d’échappement sera détaillé. Des résultats de simulations seront présentés accompagnés d’une analyse exergetique. Finalement, des solutions pour économiser l’énergie et l’exergie seront discutées.*

## 5.1 FLUID CIRCUIT MODELLING

A new modelling approach is presented in this section. This approach is similar to the one used in Chapter 4 for the diesel engine model.

### 5.1.1 A new structure

Describing the ship energy flows using several variables instead of one implies significant modifications to the model. The modifications are illustrated by comparing Figure 5.1 and Figure 5.2. The first figure shows a schematic model of an engine cooling system under the “fluid circuit” approach. The structure of the new model is much closer to technical blue prints used in the marine industry. Pumps, heat exchanger and valves are now represented. And links could almost be directly associated to water pipes. The second figure shows the same system but with the previous “energy flow” approach. The network structure has disappeared, the engine high temperature (HT) and low temperature (LT) cooling powers now flow directly to the sea, feeding on their way possible heat consumers. The black-box approach is here evident. It is therefore obvious that on the one hand, the new approach will require more models, more state variables and therefore more computer time. But on the other hand it will describe with more details essential systems such engine cooling networks, waste heat recovery boilers, steam circuits and HVAC\* systems. It will also enable the representation of new systems such as power turbines or ORC† systems. It will finally permit exergy analysis.

The new approach requires in the first place a new connector to transport the fluid information. The reasoning about which variables are best suited to describe the fluid is similar to that undertaken for the mean value engine model. In the MVEM, the connectors carried the following set of variables:  $\{p, \dot{m}, T, \lambda\}$ . The fluids described in this chapter will mainly be fresh water (liquid or vapour), but they could also be sea water or lubrication oil. The air mass fuel equivalence ratio  $\lambda$  is therefore no longer useful. And because the fluids may change phase, the specific enthalpy will be preferred to the temperature. Finally, fluids will be described with the following set of variables:  $\{p, \dot{m}, h\}$ . For fresh water, the temperature and the entropy of the fluid are calculated thanks to its specific enthalpy and pressure using the water tables IF97 [102].

The new approach also requires new models such as pumps, heat exchangers and valves. The equations for these models are presented in the next section.

The increasing number of models implies more links and connexions and also more fluid junctions and separations. To that extent, the inherent characteristics of the Modelica language are very valuable. As mentioned in Chapter 2, Modelica integrates natively the Kirchhoff’s current and voltage laws which have proven to be very useful.

The SEECAT model presented in section 5.3.2 also integrates several proportional integral controllers for temperature regulation. From an “energetic” or “fluid circuit” modelling approach, these regulators are not justified as their energy consumption is negligible. Nevertheless, they are useful for modelling purposes as they avoid having to laboriously declare start values variable and allow computation even when temperature setpoints are not achievable: they allow more simulation flexibility. Of course, their counterpart is an increasing number of state variables and thus more computer time.

---

\* Heating Ventilation and Air Conditioning. HVAC systems on board ships are presented in appendix A.9. The theory is presented in Appendix C.

† Organic Rankine Cycle [100]-[101]

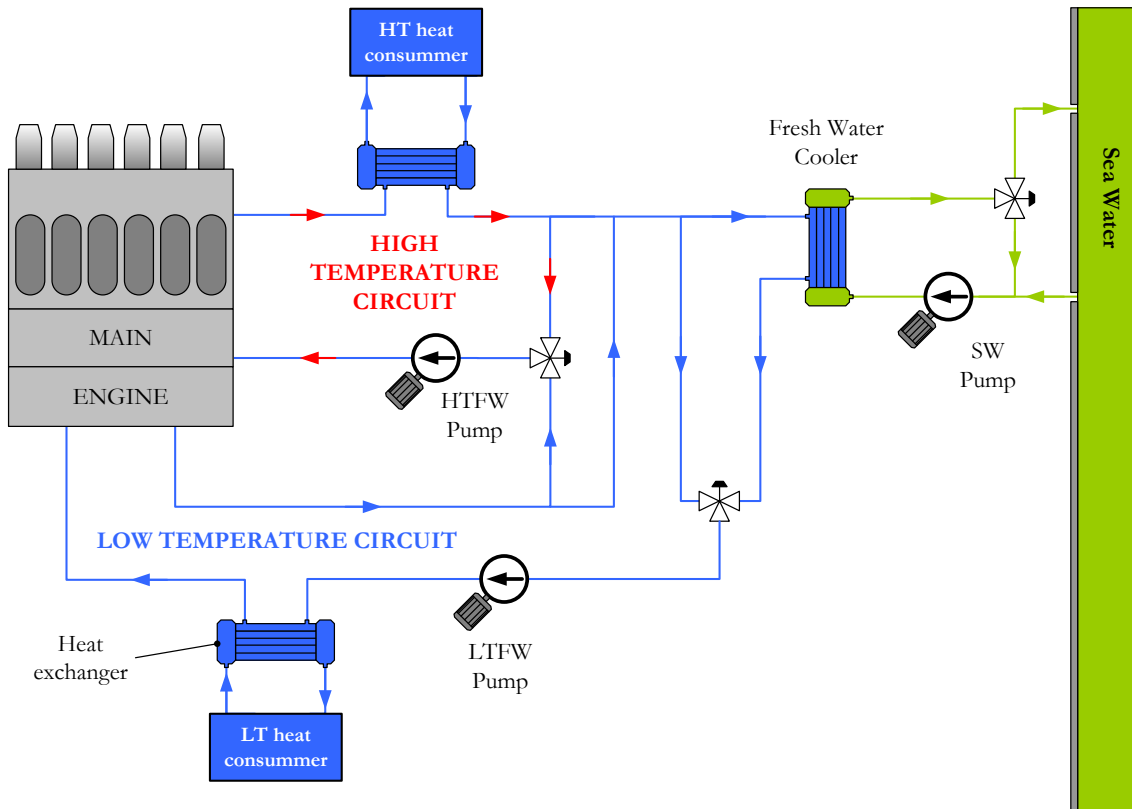

Figure 5.1: Schematic representation of an engine cooling system under the new "fluid circuit" approach

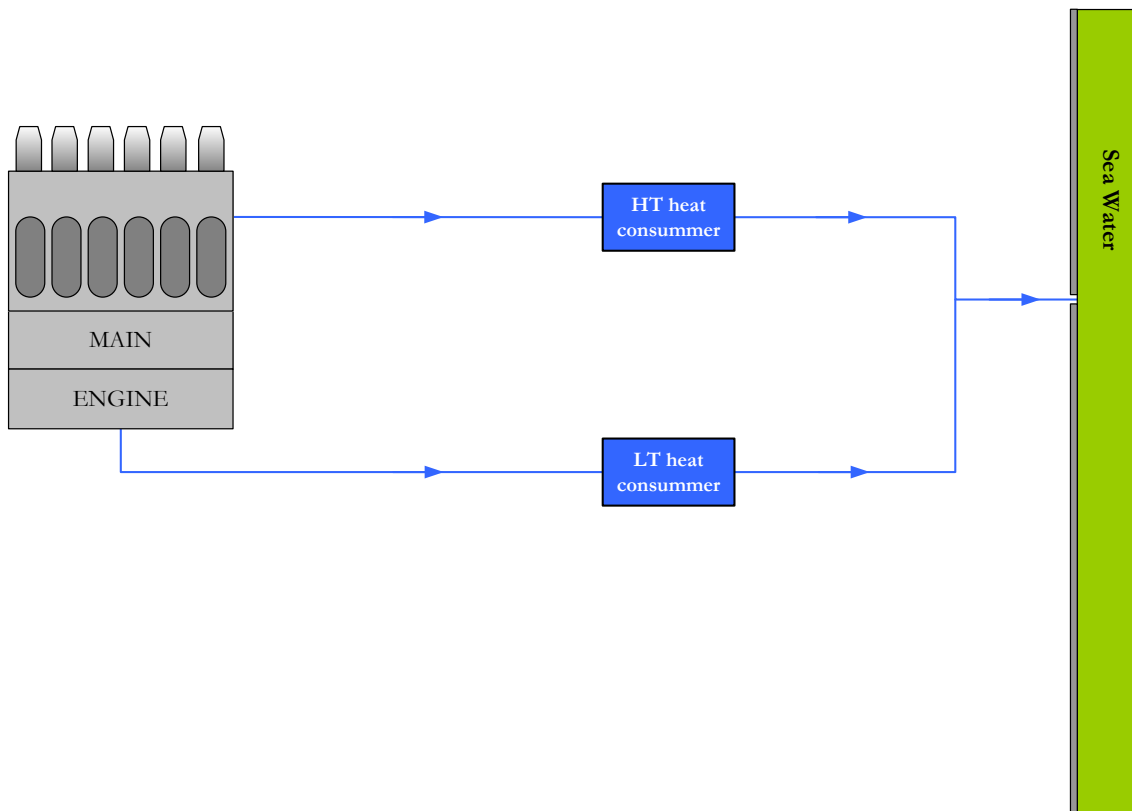

Figure 5.2 Schematic representation of an engine cooling system under the previous "energy flow" approach

## 5.1.2 Equations

The fluid circuit approach has a similar modelling approach to the one developed in Chapter 4 for the mean value engine model. Except for regulators, there are no differential equations and the model can be qualified as quasi-static. Moreover, links are ideal and have no length, they conserve perfectly mass, energy and pressure. Finally, multiple components are represented as one, for example, two pumps working in parallel are represented by a single equivalent pump model.

### ▪ Pumps

All pumps, whatever the technology they rely on, are represented in the same way. The water pump behaviour is mainly represented by its isentropic efficiency  $\eta_s$ :

$$\eta_s = \frac{h_s - h_{in}}{h_{out} - h_{in}} \quad (5.1)$$

Where:

- $h_{in}$  is the specific enthalpy of the fluid at input flange (J/kg);
- $h_{out}$  is the specific enthalpy of the fluid at output flange (J/kg);
- and  $h_s$  is the enthalpy of the fluid at output flange if the pump were ideal and therefore the compression adiabatic and reversible, hence isentropic. It corresponds to the enthalpy of a fluid at output pressure and input entropy.

In a first approach, the model will only represent fixed flow pumps. Because these pumps only work around a nominal point (fixed flow, fixed pressure drop) the isentropic efficiency will be considered constant.

Moreover, the compression is considered as adiabatic and therefore:

$$\dot{W} = \dot{m} \cdot (h_{out} - h_{in}) \cdot \eta_{mech} \quad (5.2)$$

For the same reasons mentioned previously, the mechanical efficiency will be also considered constant.

### ▪ Heat exchangers

Heat exchangers are mainly described by their effectiveness  $\varepsilon$  which is the ratio between the real heat transfer  $\dot{Q}$  (W) and the maximum heat transfer  $\dot{Q}_{max}$  (W):

$$\varepsilon = \frac{\dot{Q}}{\dot{Q}_{max}} \quad (5.3)$$

Heat exchangers are considered perfectly insulated and therefore the thermal power lost by the hot fluid is entirely transferred to the cold fluid:

$$\dot{Q} = \dot{m}_{hot} \cdot c_{p_{hot}} \cdot \Delta T_{hot} = \dot{m}_{cold} \cdot c_{p_{cold}} \cdot \Delta T_{cold} \quad (5.4)$$

The maximum heat transfer achievable is defined as follow:

$$\dot{Q}_{max} = C_{min} \cdot (T_{hot\,in} - T_{cold\,out}) \quad (5.5)$$

With  $C_{min}$  is the minimum value between the hot fluid and the cold fluid heat capacity rates (W/K):

$$C_{min} = \text{minimum}(\dot{m}_{cold} \cdot c_{p\,cold}, \dot{m}_{hot} \cdot c_{p\,hot}) \quad (5.6)$$

In a first approximation the heat exchanger effectiveness is considered constant and set as an input parameter. If additional data is available, the effectiveness can be determined using the Number of Transfer Units (NTU) method.

#### ▪ Fluid mixer

As mentioned previously, Modelica integrates natively the Kirchhoff's current and voltage laws. These laws are useful for fluid separations: the mass flow is divided and the pressure and specific enthalpy is conserved automatically. Nevertheless, for fluid junctions this is not possible. A model has to specify the output pressure. For the rest, the mass flow is conserved and the output specific enthalpy is the weighted average of the inputs:

$$h_{out} = \frac{\dot{m}_{in1} \cdot h_{in1} + \dot{m}_{in2} \cdot h_{in2}}{\dot{m}_{out}} \quad (5.7)$$

Finally, the “fluid circuit” approach is put into practice and illustrated in section 5.3.2.

## 5.2 EXERGY ANALYSIS

Nowadays, modern ships already meet nearly all their needs in thermal power thanks to energy recovery systems. New research and developments should then focus on increasing the mechanical power. Exergy analysis is very useful to that extent.

First of all, it is recalled that the exergy of a fluid represents the maximum work extractable from an ideal machine; it is expressed as:

$$ex = h_t - h_{T_a} - T_a(s - s_a) \quad (5.8)$$

And the counterpart of exergy, anergy  $an$  is defined as:

$$an = T_a s \quad (5.9)$$

And hence\*:

---

\* Simplifications are made. See section 1.1.2.1 “Definition of exergy” for more details

$$h_t = ex_{th} + an \quad (5.10)$$

Finally, it is recalled that the exergetic efficiency is defined as follow:

$$\eta_{ex} = \frac{\text{Exergy output}}{\text{Exergy input}} \quad (5.11)$$

At the end of Chapter 1, it was pointed out that this definition of exergetic efficiency was to some extent unsatisfying. According to this definition, the exergetic efficiency of a thermodynamic device that converts fuel into work is equal to its energetic efficiency:

$$\eta_{ex} = \frac{\text{Exergy output}}{\text{Exergy input}} = \frac{\text{Work}}{\text{Fuel chemical energy}} = \frac{\text{Energy output}}{\text{Energy input}} = \eta_{en} \quad (5.12)$$

For example, the energy efficiency of engine A (engine modelled in Chapter 4) is of 51.7% at 70% load. Its exergy efficiency is also of 51.7%. A new exergy efficiency definition, no longer considering the exergy input as the fuel chemical energy but instead, the fuel combustion exergy, could be more satisfying. This efficiency could be called “post-combustion exergy efficiency”:

$$\eta_{exPC} = \frac{\text{Exergy output}}{\text{Combustion thermal exergy}} \quad (5.13)$$

The combustion thermal exergy is the exergy of the combustion thermal power. Of course, in most cases, the combustion thermal energy would be very close to the fuel chemical energy. The difference between them is the combustion efficiency, which is usually very high in modern engines and boilers (more than 95%). But this combustion thermal energy would be associated with a finite combustion temperature and therefore anergy. Going back to engine A, a traditional combustion temperature for this kind of engine is 1 800 °C. For an ambient temperature of 25 °C, the combustion thermal exergy would be:

$$\begin{aligned} \text{Combustion thermal exergy} &= \text{Fuel chemical energy} \cdot \left(1 - \frac{T_{\text{ambient}}}{T_{\text{combustion}}}\right) \\ &= 94.36 \text{ MW} \times \left(1 - \frac{25 \text{ °C} + 273.15}{1\,800 \text{ °C} + 273.15}\right) \\ &= 80.79 \text{ MW} \end{aligned} \quad (5.14)$$

The engine “post-combustion exergy efficiency” would then be:

$$\eta_{exPC} = \frac{\text{Work}}{\text{Combustion thermal exergy}} = \frac{48.80}{80.79} = 60.4\% \quad (5.15)$$

This new efficiency of 60.4% shows how close to ideality the engine is when considering a combustion temperature of 1 800 °C and an ambient temperature of 25 °C. The previous efficiency of 51.7% showed how close the engine was to ideality too but when considering an infinite combustion temperature.

In Chapter 1, the issue of dual environment temperatures was also raised. As a matter of fact, exergy is defined for a given environment temperature. In the case of ships, there are two possible environment temperatures: the sea water and the ambient air. Traditionally, most systems are cooled down ultimately by sea water. Nevertheless, this is not necessarily ideal and it has been decided that the environment chosen for exergy calculation would be the one with the lowest temperature. And hence, if ambient air has a lower temperature than the sea, it will be chosen for exergy calculation.

Finally the difference between exergy loss and destruction is recalled. Exergy destruction is exergy converted into anergy: the process is irreversible. Exergy loss is thermal exergy on the way to destruction but which could be converted into work if an ideal engine was used. For example, the combustion of fuel at a finite temperature in the engine destroys exergy: part of the fuel chemical exergy is transformed into anergy. Whereas the exergy of the engine exhaust gases is lost and will ultimately be destroyed as it cools down in contact with atmosphere. But it could be partly saved if an energy saving device is used such as a waste heat recovery (WHR) boiler.

## 5.3 RESULTS

This new approach is illustrated by theoretical models and simulation results.

### 5.3.1 Engine energetic and exergetic balance

An exergetic analysis has been carried out for engine A. The energetic and exergetic balance of its output power when operating at 70% load are presented in Table 5.1.

**Table 5.1: Energetic and exergetic content of engine A output power (engine operating at 70% load)**

	Energy	Exergy	Ratio*
	MW	MW	%
Mechanical power	48.80	48.80	100.00
Exhaust thermal power	26.62	6.83	25.64
Scavenge air cooler thermal power	11.64	1.14	9.83
High temperature engine cooling thermal power	5.25	0.99	18.87
Low temperature engine cooling thermal power	3.36	0.38	11.43
Radiation	0.85	0.17	19.82
<b>Total</b>	<b>96.53</b>	<b>58.32</b>	<b>60.41</b>

Table 5.1 illustrates clearly the difference between energy and exergy. Considering the “Mechanical power” line, one observes that mechanical shaft has the same energy and exergy content. That is of course in accordance with theory. But considering now the other lines of the table, one observes that energy and exergy content now differ. Thermal exhaust power, for example, has an energy content of 26.62 MW and an exergy content of 6.83 MW. That means that only 25.64% of this thermal power could be converted into mechanical power, if an ideal Carnot machine were used. And hence, 74.36% of this exhaust power is

\* Exergy content over energy content

energy and doomed to stay as thermal power. The exergy content ratio, which is the ratio between the exergy and energy contents of a thermal fluid, depends on its temperature. The higher the temperature, the higher the ratio. In the end, the total exergy content of the engine climbs to 58.32 MW which represents 60.41% of the total input power (mainly composed of the fuel chemical power). 48.8 MW are directly converted into mechanical work, and hence 9.52 MW remain to be converted. If these 9.52 MW of exergy were converted to work, engine A would have a brake specific fuel consumption (BSFC) of only 136 g/kWh, which is 16% less than current value.

The energetic and exergetic balance of engine A over the complete propeller curve are presented in Figure 5.3, Figure 5.4, Figure 5.5 and Figure 5.6. The first figure shows how all energy outputs increase with engine load. The second one shows how the energy distribution changes with engine load. If the mechanical part stays roughly constant, all other energy outputs, except SAC cooling, have their distribution reduced with load. The predominance of exhaust heat among “waste” energies is nevertheless clear. The third figure, using the same scale as the first one, illustrates clearly how most “waste” energies are mainly composed of energy. Their exergy content is relatively small due to low output temperatures. Nevertheless, the fourth figure shows that mechanical energy represents “only” approximately 82% of the total exergy output and that 18% remain to be saved. These proportions are roughly constant along the propeller curve. Exhaust gases represent the major part of these remaining 18%.

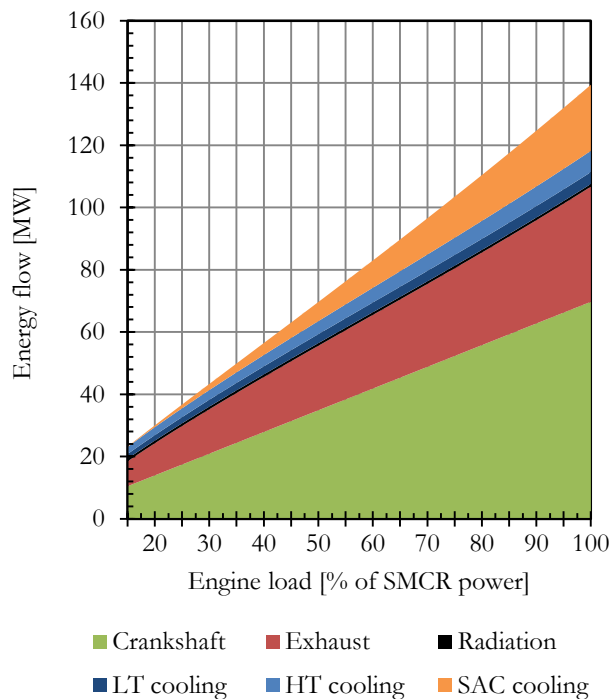

Figure 5.3: Absolute output energy balance of engine A

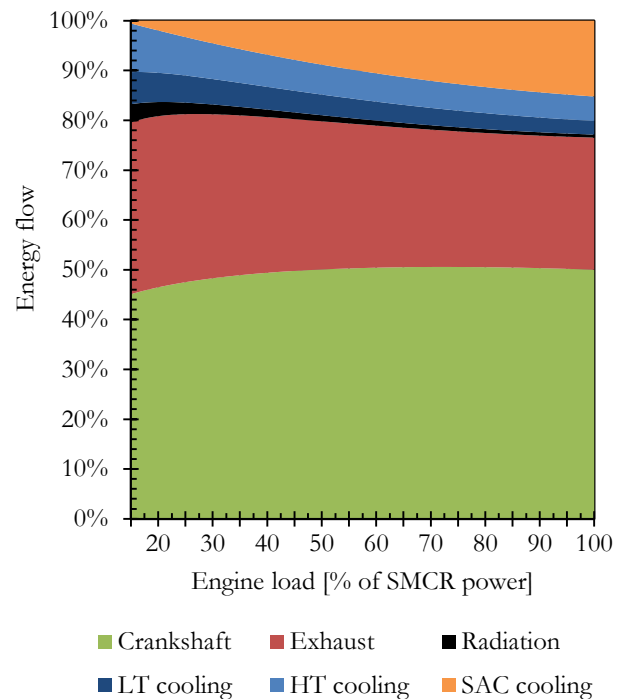

Figure 5.4: Relative output energy balance of engine A



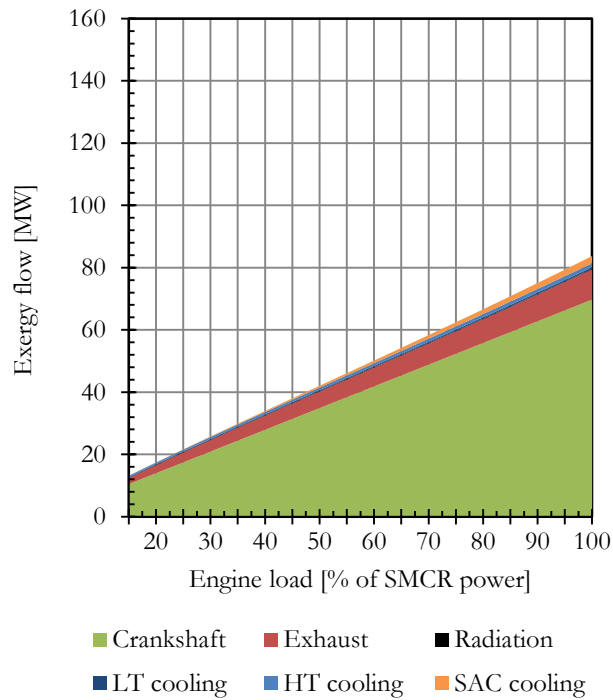

Figure 5.5: Absolute output exergy balance of engine A

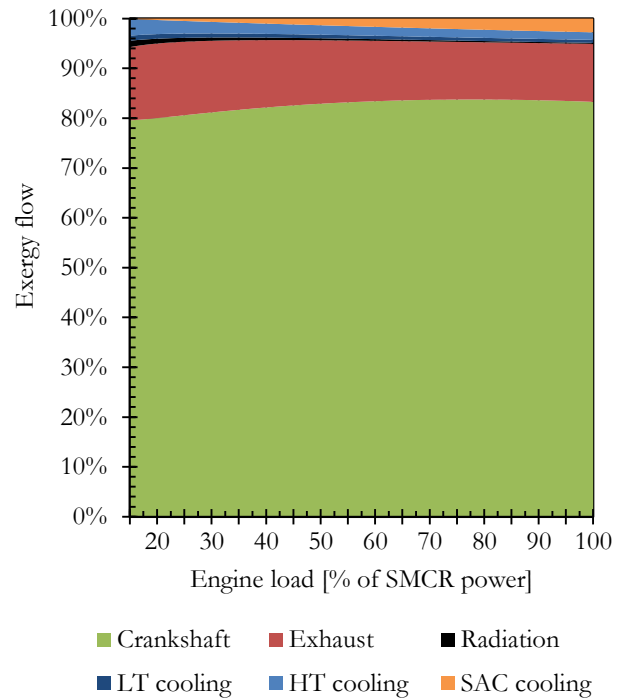

Figure 5.6: Relative output exergy balance of engine A

The next section will explain how this waste exergy is either lost or destroyed and how it could be saved or even increased.

### 5.3.2 Engine cooling and exhaust circuit: energetic and exergetic balance

In this section, the engine is now represented with its cooling and exhaust circuits. The structure and the values of the circuits are based on a theoretical ship whose purpose is to illustrate the strengths and possibilities of the exergy analysis.

#### ▪ Presentation

The SEECAT diagram of engine A and its cooling and WHR circuit is represented in Figure 5.7. The engine is symbolised by the grey rectangle with “MVEM” written in it. In the top left corner, the exhaust circuit and WHR system are represented. Distilled water is brought up to 22 bars by a pump and sent to the economizer and evaporator where it turns into steam (8 bar). This steam is then overheated in the superheater and expanded in the turbine where it produces work. It finally goes to the condenser and back to the pump. A three port valve regulation controls the water flow in the WHR boiler to avoid exhaust gases cooling down under 170 °C (under 140 °C the sulphuric acid contained in the exhaust gases could condensate and corrode exhaust pipes)\*. Everything on the right side of the engine represents the engine cooling system. The light red zone represents the high temperature fresh water cooling circuit; the light blue zone represents the low temperature fresh water cooling circuit and the green zone represents the sea water cooling circuit. The HT circuit cools down the engine jacket. A three port valve controls the engine

\* For more details on WHR boilers and circuits, please refer to appendix A.8

output temperature and maintains it at around 80 °C. The HT circuit is cooled down by the LT circuit which itself cools down the engine lubrication oil system and the scavenge air cooler. The temperature in the LT circuit is regulated by a three port valve, the temperature set point is traditionally around 36 °C\*. The LT is finally cooled down by the sea water circuit whose temperature is also regulated by a three port valve to a temperature around 25 °C†.

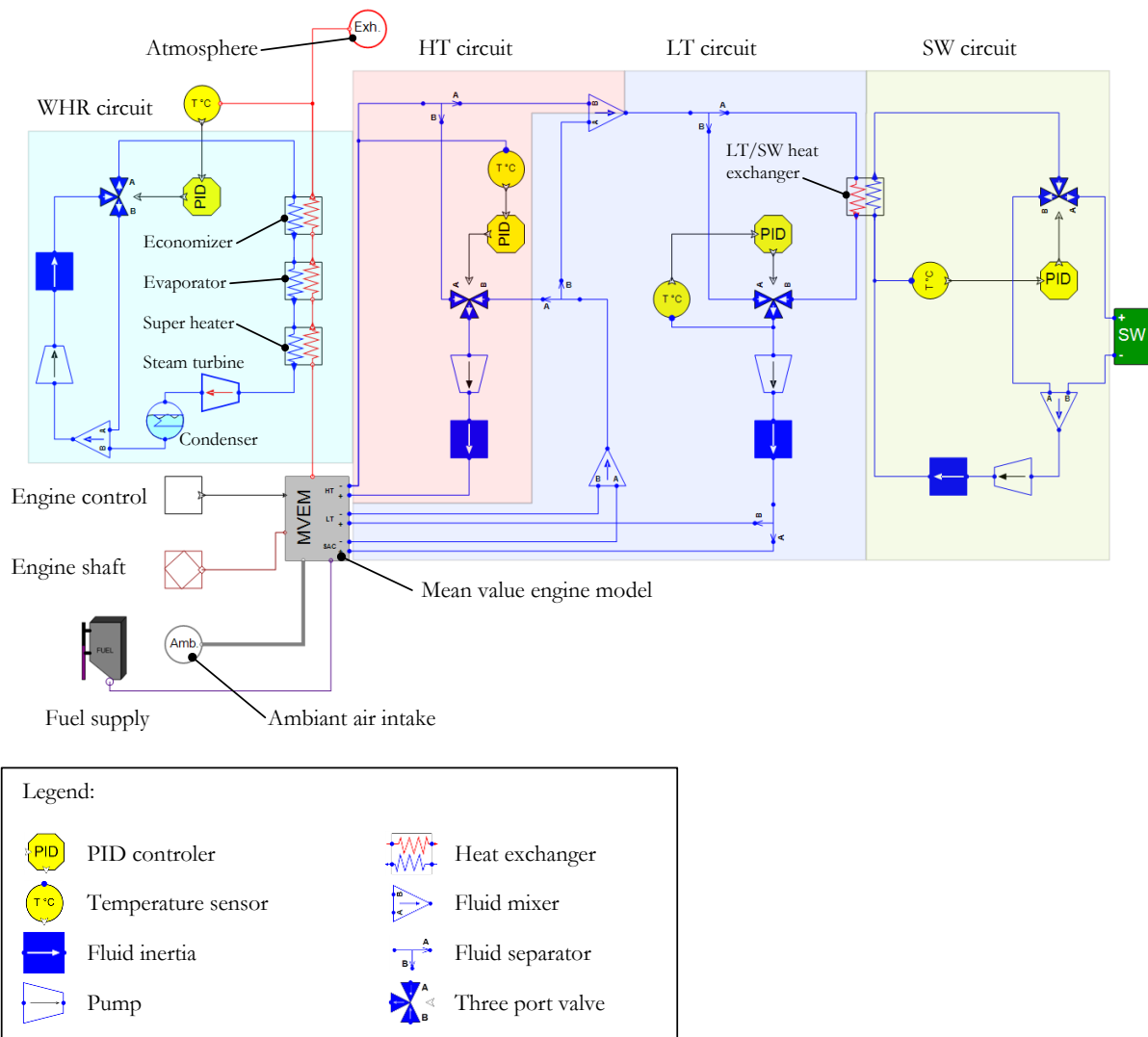

Figure 5.7: SEECAT model of engine A and its cooling and WHR circuit

\* For more details on engine cooling circuits, please refer to appendix A.6

† For more details on sea water cooling circuits, please refer to appendix 0

If not mentioned otherwise, the simulation will be run with the following parameters:

**Table 5.2: Standard simulation parameters**

Standard conditions			
Atmospheric pressure:	1 bar	Reference temperature:	0 °C
Air temperature:	25 °C	High temperature engine cooling circuit regulation temperature:	80 °C
Sea water temperature:	10 °C	Low temperature engine cooling circuit regulation temperature:	36 °C
Exergy temperature:	10 °C	Sea water cooling circuit regulation temperature:	25 °C

The exergy temperature represents the lower of the two environment temperatures, in this case the sea water temperature. The reference temperature represents the temperature used for enthalpy, entropy and thermal power calculations. Enthalpy, entropy and thermal power of a fluid are considered null at reference temperature.

#### ▪ Simulation results

A simulation was run with the engine load at 70%. In the previous section, the engine exergy balance was presented. It was found that “waste” energy contained 9 345 kW of exergy:

- 6 826 kW in the exhaust gases;
- 1 144 kW in the LT circuit due to SAC cooling;
- 991 kW in the HT circuit due to engine jacket cooling;
- and 385 kW in the LT circuit due to engine lubrication oil cooling.

In most cases, this exergy is not converted into work and is hence either destroyed or lost. Table 5.3 lists all energy and exergy flows in and out of the main components of the engine cooling and exhaust circuits. This table makes it possible to track down exergy and find out where it is lost or destroyed. The Sankey diagrams in Figure 5.8 are based on the same results and represent the net flows of energy and exergy. Comparing the two diagrams highlights the average low quality of exergy and indicates clearly the sources of irreversibilities.

In the cooling circuits, exergy is provided by the engine and the pumps. The exergy gain brought by the pumps is almost entirely destroyed by the pressure drops inside the circuit. Concerning the exergy provided by the engine cooling, it is eventually entirely destroyed or lost. The exergy gains on the cooling circuits total 2 854 kW. 1 769 kW are destroyed in the pressure drops, heat exchangers, three port valves and fluid mixers. It is interesting to notice that heat exchangers, three port valves and fluid mixers have perfect energy efficiencies: the heat flowing in is entirely transferred to the output. As for the fluid mixers and three port valves, the process of mixing fluids - for instance a hotter one with a colder one, is known to be highly irreversible. Concerning heat exchangers, exergy can be conserved provided there is perfect effectiveness, equal mass flow and equal heat capacity. These conditions are of course ideal and present moreover no industrial interest. In practise, heat exchangers are always sources of irreversibilities and hence destroy exergy. Concerning pressure drop, the exergy destruction is due to the friction between the fluid and the pipes. Finally, friction, heat exchange and fluid mixing are responsible for the entire exergy destruction in the cooling circuits. The remaining 825 kW of exergy are lost in the sea but could be saved.

The exhaust circuit is where most of the exergy lies: 6 826 kW released by the engine. It represents 73.0% of the waste exergy produced by the engine whereas it contains “only” 55.8% of the waste energy. This clearly indicates where the priority lies. It is a well-known practice to add a waste heat recovery boiler to

the exhaust circuit in order to produce steam. But this steam is not always used to produce work and is often used only for heating and cleaning purposes, which is total destruction of exergy. Adding a power turbine will help save part of this exergy. In the simulation made, 2 kg/s (7 200 t/h) of steam at 8 bars\* are produced by the WHR boiler and expanded in the turbine. The turbine which has an isentropic efficiency of 70% then produces 522 kW of work for 691 kW of exergy consumed. The rest of the exergy is either destroyed or lost. The condenser destroys up to 1 142 kW, the boiler heat exchangers destroy 615 kW and 5 485 kW are lost in the atmosphere.

The relative importance of the condenser in the destruction of exergy is contrary to the conclusions of Rosen presented in Chapter 1 [27]. Rosen had shown that condensers, even if they dissipated a lot of energy, did not destroy much exergy as the energy flow entering the condenser was of poor quality (low pressure and low temperature). The conclusion nevertheless applied to thermal power plants where the steam turbines operate at very high pressure and temperature (typically 160 bar and 540 °C). In such conditions, turbines are able to operate a greater enthalpy variation and hence send the fluid to the condenser with less exergy. But in any case, the exergy destruction in the condenser is not the “responsibility” of the condenser but rather the responsibility of the rest of the circuit.

Concerning the exergy lost in the atmosphere, it has already been said that the WHR system can be regulated to stop exhaust gases cooling down to below 150 °C, thus avoiding the condensation of sulphuric acid. If exhaust gases could be cooled down to lower temperatures, it would allow more steam production, at higher temperatures and hence more exergy saving.

In the end, the WHR boiler and turbine system have an exergetic efficiency of 7.6 %, that is to say, 7.6 % of the exergy entering the system is converted into work. This small figure indicates that the system is far from ideal and that there is a considerable scope for improvements, which is, from a certain perspective, very encouraging. It means that there is no theoretical limit to a big increase in work production. Nevertheless, there are, as mentioned above, some technological limitations. If the temperature of 150 °C for exhaust gases was an absolute technological limitation (which is not the case by the way) it would be possible to define a new concept based on exergy that would measure the maximum work producible given this temperature limitation. This work would be calculated using a Carnot machine working between the fluid temperature and the temperature limitation (instead of the environment temperature as in exergy). In the present case, this work would be:

$$\begin{aligned}\dot{W}_{150\text{ }^{\circ}\text{C}} &= \dot{Q}_{\text{exhaust}} \cdot \left(1 - \frac{T_{\text{limitation}}}{T_{\text{exhaust}}}\right) \\ &= 26\,618\text{ kW} \cdot \left(1 - \frac{150\text{ }^{\circ}\text{C} + 273.15}{223\text{ }^{\circ}\text{C} + 273.15}\right) \\ &= 3\,916\text{ kW}\end{aligned}\tag{5.16}$$

That means, that if ship designers do not want to cool down exhaust gases under 150 °C, there is still 3 916 kW energy convertible into work. Of course, a new efficiency could be associated to this new concept, which would measure the ratio between the work really achieved and the best theoretical work achievable given the temperature limitation. In this case this efficiency would be of 522 / 3 916 kW = 13.3 %. The figure still indicates a great potential for exergy saving.

---

\* These values are very close to the ones indicated by engine A manufacturer in his project guide

Table 5.3: Energy and exergy flows for engine A with cooling and exhaust system [kW]

	$\dot{H}_{in}$	$\dot{H}_{out}$	$\Delta\dot{H}$	$\dot{W}$	$\dot{E}x_{in}$	$\dot{E}x_{out}$	$\dot{E}x_{dest}$	$\dot{E}x_{loss}$	$\dot{E}x_{gain}$
<b>HT cooling circuit</b>									
Jacket cooling	44 986	50 237	5 251	-	3 686	4 677	-	-	991
Pump	44 951	44 986	34	34	3 677	3 706	-	-	29
Pressure drop	44 986	44 986	-	-	3 706	3 686	-20	-	-
HT-LT three port valve	44 951	44 951	-	-	3 857	3 677	-180	-	-
HT-LT mixer	93 773	93 773	-	-	4 587	4 361	-227	-	-
<b>LT cooling circuit</b>									
Engine lub. oil cooling	26 904	31 037	4 133	-	837	1 222	-	-	385
SAC cooling	45 809	57 451	11 642	-	1 425	2 570	-	-	1 144
LT-SAC mixer	88 488	88 488	-	-	3 781	3 770	-11	-	-
Pump	72 501	72 713	213	213	2 234	2 381	-	-	148
Pressure drop	72 713	72 713	-	-	2 381	2 262	-119	-	-
Three port valve	72 501	72 501	-	-	2 583	2 234	-349	-	-
LT-SW exchanger	112 256	112 256	-	-	3 128	2 695	-433	-	-
<b>SW circuit</b>									
Pump	66 009	66 271	262	262	977	1 134	-	-	157
Pressure drop	66 271	66 271	-	-	1 134	990	-144	-	-
Mixer	26 635	26 635	-	-	1 491	977	-514	-	-
SW	30 944	9 410	-21 534	-	825	-	-	-857	-
<b>Exhaust circuit</b>									
Engine exhaust	-	26 618	26 618	-	-	6 826	-	-	6 826
WHR boiler	26 917	26 917	-	-	7 943	7 328	-615	-	-
Power turbine	5 734	5 212	-522	-522	1 842	1 151	-	-	-
Condenser	5 212	293	-4 919	-	1 151	8	-1 142	-	-
Mixer	293	293	-	-	9	9	-	-	-
Pump	293	299	5	5	9	13	-	-	4
Atmosphere	21 183	-	-21 183	-	5 485	-	-	-5 485	-

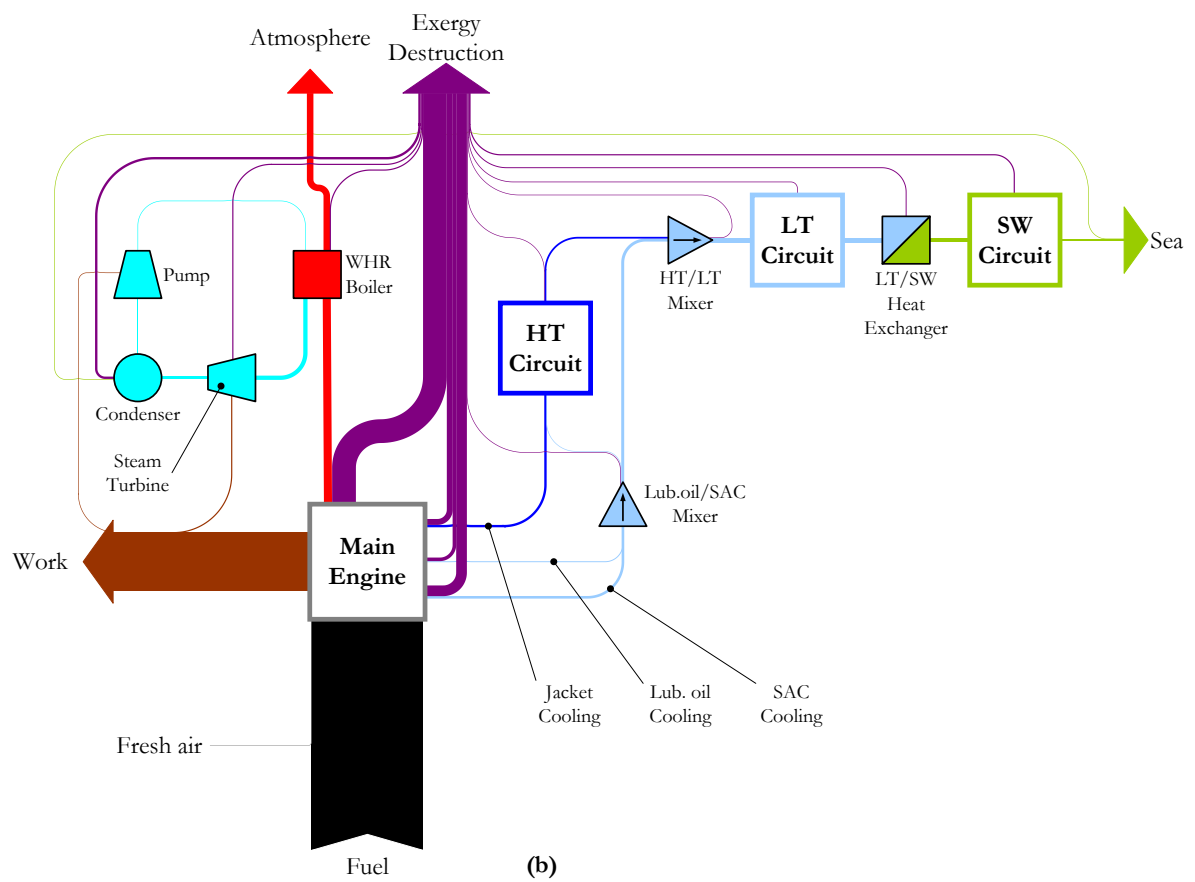
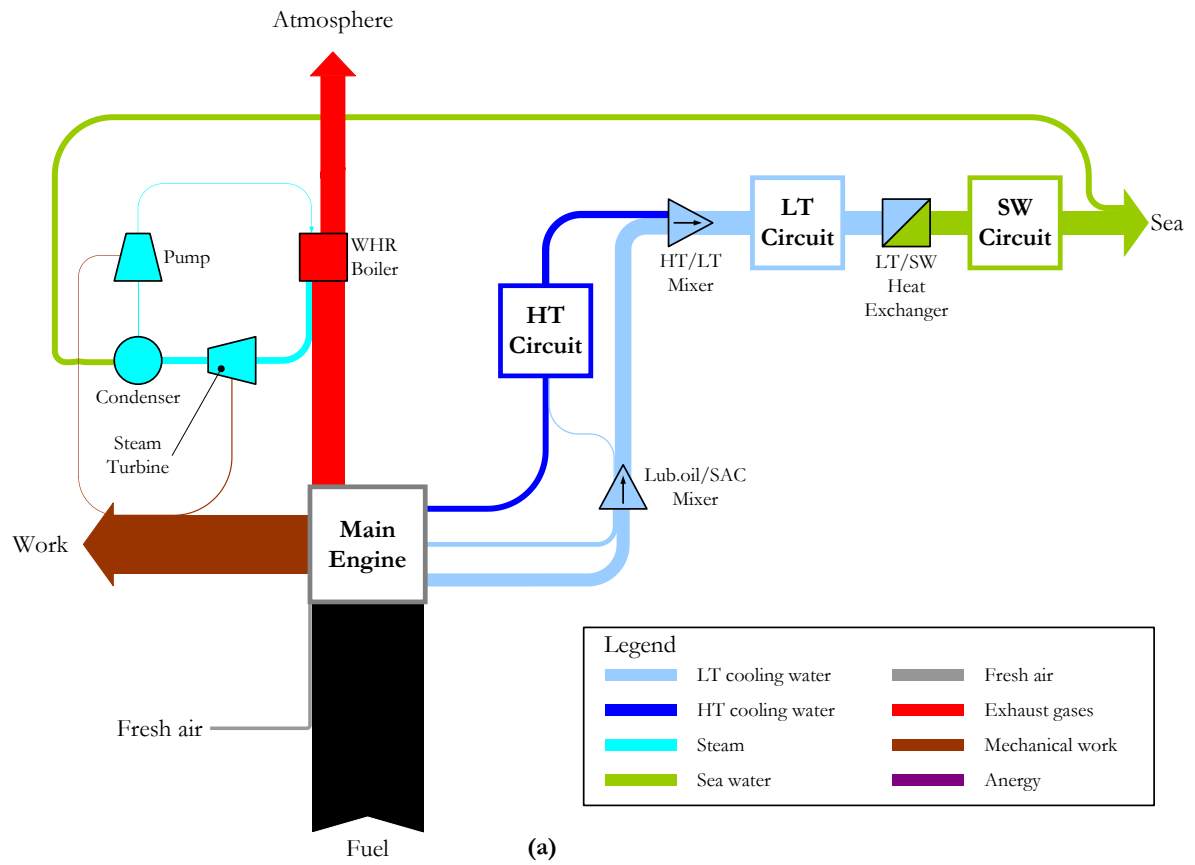

Figure 5.8: Energy (a) and exergy (b) Sankey diagrams of engine A with its cooling and exhaust circuits

## 5.4 ENERGY PERFORMANCE IMPROVEMENTS

This section presents a set of solutions for energy performance improvements. Some of these solutions are “old” ones that have already been imagined and tested in other fields, others are recent ones just emerging and some are new. As mentioned previously, modern ships already meet their needs in thermal power thanks to energy saving. Today, new developments should focus on exergy saving. The solutions presented in this section are theoretical solutions that “work on paper”. Some of these solutions might not be economically interesting or comply with regulations. Others might be opposed to “traditional construction rules” or not even be technically feasible. It is nevertheless the role of engineers and researchers to sometimes emancipate themselves from these limitations and imagine new and bold solutions. Restarting from scratch is often salutary, and for complex problems requesting holistic approaches such as energy efficiency it is almost essential.

The solutions proposed in this section are divided in three parts: design, retrofit and operation.

### 5.4.1 Design

Diesel engines are traditionally seen as work producers. This should no longer be the case. They should at least be seen as work and heat producers or better as exergy and energy producers. And to that extent engine design should focus on maximizing the production of exergy.

Today, engine cooling thermal powers have poor exergy content. The only way to increase their exergy content is to increase the engine cooling temperatures. Engines are cooled down to limit material fatigue and guarantee good lubrication (lubrication oils work best at a certain temperature). But if the jacket cooling water is maintained at temperatures around 80 °C, this also serves to avoid evaporation. If engines were cooled down by thermal oil, the engine could be kept at a higher temperatures without risking evaporation. In the case of engine A, if it was cooled down by oil at 110 °C instead of water at 80 °C, the exergy production of the HT cooling circuit would increase from 991 kW up to 1 370 kW. In the same way, if new lubrication oils, working best at higher temperatures were used, the exergy production could be significantly increased. For example, with lubrication oil working at 80 °C instead of 36 °C, the exergy production of the LT cooling circuit would increase from 385 kW up to 820 kW. Applying the same logic to scavenge air cooling will not be necessarily advantageous. Increasing the temperature of the SAC cooling would mean increasing the cylinder air input temperature which would degrade the engine volumetric efficiency. Finding an optimum balance between exergy production and engine efficiency would be an interesting study to carry out. Finally, the same logic could also be applied to the sea water cooling circuit. The temperature of the sea water cooling circuit is regulated to avoid salt precipitation which fouls the heat exchanger. This precipitation occurs around 35 °C. It could be avoided by using another fluid for cooling such as the fuel in fuel tankers. It could also be, not avoided, but ignored if the heat exchange between the LT circuit and sea water was not made through a heat exchanger but directly through the hull plating. In this case, the sea water circuit would be replaced by a fresh water circuit or simply deleted.

The exergy analysis of engine A and its cooling circuit has also highlighted the necessity to avoid as best as possible heat exchangers and fluid mixers. New designs requiring fewer heat exchangers and fluid mixers are preferable.

All these means of increasing exergy production and avoiding exergy destruction are only good if this exergy can be converted into work. A solution would be to use the HT and LT power to heat up a working fluid. For example, the HT circuit is often used for fresh water production thanks to distillers. But today, reverse osmosis water production units have shown themselves to be more efficient. The HT thermal power could then be entirely used to heat up the water used in the WHR boiler. It would then

serve as a “pre-economizer” instead of being cooled down by the LT circuit. The LT heat could also serve as a “pre-pre-economizer”. The WHR boiler could then increase the steam produced and its temperature, hence increasing the work producible by the turbine. A second way of saving the cooling circuit exergy would be to use organic Rankine cycle systems (ORC) [100]-[101]. These systems convert heat into work in a similar way as the WHR boiler and steam turbine do, but instead of using water they use organic fluids (such as n-pentane or toluene). These fluids present the advantage of evaporating at lower temperatures than water but still have low efficiencies.

The analysis of engine A thermal and exergy balance has shown that the major part of “waste” energy was made up of exhaust heat and that exhaust heat had the highest exergy content ratio because of its high temperature. Exhaust gases are in fact the best exergy vectors and new engine designs should try to increase even further the proportion of exhaust gases in waste energy (by mainly increasing output temperature if possible). A possible way to do that would be to insulate the engine. Research into this concept has already been carried out. The primary objective was to increase engine efficiency by reducing heat loss. Results were never conclusive in that regard as it was observed that the heat saved by insulating the engine was mainly transferred to the exhaust gases [103]. This solution could then be successfully applied to diesel engines.

In order to save as much exergy as possible from the exhaust gases, the steam should be produced at the highest pressure possible. 15 bars could be feasible as then water boils at around 200 °C. Moreover, it should be possible to cool down exhaust gases below 150 °C by using new materials that resist to sulphuric acid corrosion. This is already done in domestic condensing boilers. These two measures should allow more steam to be produced at a higher pressure and hence more work production.

## 5.4.2 Retrofit

Several of the solutions proposed above could also be used in retrofitting. Nevertheless, it would certainly be more costly and complicated. An interesting solution that would be relatively easy to retrofit is variable flow pumps. Most ships today use three-port valves for temperature regulation. This implies a fixed flow pump which consumes a constant quantity of work whatever the cooling needs are. Using variable flow pumps instead is a simple method to reduce this work demand and hence exergy consumption. Of course, there are many factors to consider. Fixed flow pumps are often more efficient than variable flow pumps and are less expensive. The profitability of such an operation will also depend greatly on the ship average operational profile. Correctly assessing the possible gains is now made possible thanks to the “fluid circuit” approach.

## 5.4.3 Operation

The Carnot efficiency indicates that operating under cold environmental conditions is favourable. The concept of exergy easily explains this: as the environment temperature goes down, the enthalpy difference between the fluid in its current state and the fluid at environment temperature increases and more work is producible. This theory is verified in practice. Engine A manufacturer provides its data sheet for different environment temperatures and indicates a gain of almost 2 g/kWh in cold conditions (10 °C ambient air and sea) compared to ISO conditions (25 °C ambient air and sea). These gains should be added to possible gains in the exhaust WHR system. This energy gain could be taken into account when planning routes. When faced with two similar alternatives, the route presenting the lowest predicted sea and air temperature should be favoured.



## 5.5 CONCLUSION

The model developed in Chapter 3 presented some limitations. It was based only on the first law of thermodynamics and can be described now as a first level approach. This chapter moved up to a second level where the second law of thermodynamics, through the concept of exergy, is now taken into account. This new approach required more detailed and complicated modelling but using it made it possible to pinpoint precisely sources of irreversibility and potential work production. It globally provided a better understanding and more physical representation of complex systems such engine cooling and exhaust circuits. And it opened up a vast field of energy and exergy saving solutions, solutions that will require new models and simulations. But this new approach also calls for a new level of modelling. As the exergy concept introduced physical limitations to the first law of thermodynamics, technology introduces limitations to the second law of thermodynamics. The concept of exergy works in an ideal world. The real one implies friction, finite dimensions and material corrosion or fatigue. Taking into account these limitations is essential if one wants to correctly assess possible energy and exergy gains.

Finally, this new “fluid circuit” approach will be very useful to model, understand and improve new systems such as HVAC.

*Le modèle développé dans le chapitre 3 présentait quelques limites. Il était basé sur le premier principe de la thermodynamique seulement et constituait alors, ce que l'on peut décrire maintenant comme une première approche de modélisation. Ce chapitre a proposé un deuxième niveau d'approche, prenant cette fois-ci en compte le deuxième principe de la thermodynamique à travers notamment le concept d'exergie. Cette nouvelle approche requiert une modélisation plus précise et compliquée mais permet en contrepartie de localiser précisément les sources d'irréversibilités et de connaître la quantité d'énergie thermique théoriquement convertible en travail mécanique. Cette nouvelle approche permet globalement une meilleure compréhension et description des systèmes énergétiques complexes et prend tout son sens dans l'étude des systèmes de refroidissement et d'échappement du moteur. Elle a également ouvert la possibilité d'évaluer un vaste ensemble de solutions d'économie d'énergie et d'exergie, solutions qui nécessiteront néanmoins de nouvelles modélisations et simulations. Mais cette nouvelle approche en appelle une autre. De la même manière que le concept d'exergie a introduit les limitations physiques au premier principe de la thermodynamique, les contraintes technologiques introduisent des limitations au second principe de la thermodynamique. Le concept d'exergie fonctionne dans un monde idéal. Le monde réel implique des frottements, des dimensions finies et des problèmes de fatigue et de corrosion des matériaux. Prendre en compte ces limites est essentiel pour quiconque souhaite correctement évaluer les gains potentiels d'énergie ou d'exergie d'une nouvelle solution.*

*Enfin, cette nouvelle approche, dite de « circuit fluide » sera très utile pour la modélisation, la compréhension et l'amélioration de nouveaux systèmes comme les systèmes de chauffage, de ventilation et d'air conditionné.*

# CONCLUSION

---

This thesis presents the research and development work done over the past three years. The main contributions of this thesis can be summarized in the following points:

- The Chapter 1 and 2 have presented the essential concepts of exergy and systemic approach used in this thesis. In Chapter 2, a general method for modelling ships, in the purpose of assessing their energetic efficiency is proposed. It is based on a dual approach:
  - a first approach, called “energy flow” approach, which is based on the first law of thermodynamics and makes energy analysis possible;
  - and a second approach, called “fluid circuit” approach, which is based on the second law of thermodynamics and makes exergy analysis possible.

These two approaches are complementary and have been developed, presented and validated in the rest of this thesis.

- In Chapter 3, the ship energy simulation platform tool SEECAT, written in the Modelica language and built from scratch has been presented. This tool is initially based on the “energy flow” approach. It makes it possible to model all the main energy flows inside a ship and it calculates her energy consumption. The tool has been tested for a real modern cruise ship and simulation results were compared to measurements. SEECAT showed good agreement with measurements and also proved to be very interesting and useful for comparing design and operational profiles alternatives.
- In Chapter 4, a new diesel engine model has been developed to answer the needs for a more detailed, physical and modular model. The mean value modelling approach has been chosen in that extent. A model of an existing engine has been created using only publicly available data. This model calculates the complete thermal balance at any operating point. It is fast to compute and has proved to provide a high level of accuracy when compared to manufacturer’s data.
- In Chapter 5, the second level approach for energy modelling has been developed and presented. This new “fluid circuit” approach relies on the second law of thermodynamics and requires more models and more information about these models. Thermodynamic fluids are no longer represented only by their energetic content, but, at the very least, by their mass flow and specific enthalpy. This new approach makes exergy calculations possible. Simulations based on a theoretical model of a main engine and its cooling and exhaust circuits were run. The results illustrated the strengths of the exergy analysis: the sources of irreversibilities as well as the potentialities for work production were located. This exergy analysis finally stimulated a reflection on how to save more energy and exergy on ships.

Several observations can be made concerning this work:

- Even if the second approach provides significant improvements in terms of understanding, accuracy and simulation possibilities, the first level approach will not be put aside. Depending on the needs, it may very well be preferred to the second approach as it is simpler to build and faster to compute. It also requires less data. In fact, models will often be a hybrid solution, mixing both first and second level approach; the first level approach being preferred for the general arrangement of the model and the second level approach being used for key components and circuits.
- Chapter 4 and Chapter 5, but particularly Chapter 4 have shown how difficult it could be to go from one level of modelling approach to the other. Mean value engine models are not famous for their complexity, nevertheless developing such a model with the limited data and knowledge available represented one of the main challenges of this thesis. Applying the same level of detail to other ships components is hence not necessarily possible nor desirable. The decision to do so should be taken with care and fully justified.
- Finally, the modelling approaches developed could be adapted to many kinds of complex energetic systems such as power plants, cars, planes, etc. It would be particularly well suited for cogeneration applications.

Finally, this thesis calls for new developments:

- The fluid circuit approach should be implemented for other systems such as oil-fired boilers and HVAC\* systems where significant energy and exergy gains should be possible. HVAC systems are very good examples of complex systems. Their power demand depend on a great variety of factors such as sun radiation, ambient air temperature and humidity, wind, ship thermal inertia, heat dissipation, occupation, etc. Knowledge of HVAC systems for land buildings is still progressing but benefits of a large experience. Applied to shipping, the study of HVAC systems presents new challenges linked to the variety of operational profiles and environmental conditions met. This topic could be covered by a completely new thesis.
- Time and data available did not allow the author to apply the new mean value engine model and “fluid circuit” approach to a complete ship model. The author and his team are strongly motivated to collaborate with shipyards or ship owners in order to do so. A large database containing energy and exergy analyses of ships of different types, with different operational profiles, sailing in different environmental conditions should be built. It would constitute a great achievement and a big contribution to the shipping community. On top of being very interesting from a scientific point of view, it would certainly drive prolific new research and developments towards more efficient ships.
- The energy and exergy solutions proposed in Chapter 5 should be simulated.
- Finally it must be pointed out that one of the main purposes of all this research is to help reduce CO<sub>2</sub> emissions (another one is to save money) and to that extent, life cycle assessment can be a useful ally. Life cycle assessment is an environmental impact study that takes into account all the life phases of a product, from cradle to grave according to the formula. It should be used for comparing design or operational profile alternatives. For example a new propulsion system could provide a fuel consumption reduction of 1%, but if its energy cost at building and recycling phases is too high, it could eventually lead to higher global CO<sub>2</sub> emissions over the entire ship life. Not taking into account all the life phases of a system can lead to erroneous conclusions.

---

\* Heating, Ventilation and Air Conditioning

*Cette thèse présente les travaux de recherche et de développement réalisés pendant ces trois dernières années. Les principales contributions de ces travaux peuvent être résumées par les points suivants :*

- *Les chapitres 1 et 2 ont présentés les concepts essentiels d'exergie et d'approche systémique utilisés dans cette thèse. Dans le chapitre 2, une méthode générale de modélisation des navires, en vue d'évaluer leurs efficacités énergétiques, est proposée. Elle est basée sur une approche à double niveaux :*
  - *une première approche, appelée « flux d'énergie », basée sur le premier principe de la thermodynamique, qui permet de réaliser des analyses énergétiques ;*
  - *et une deuxième approche, appelée « circuit fluide », basée sur le deuxième principe de la thermodynamique, qui permet de réaliser des analyses exergetiques.*

*Ces deux approches sont complémentaires et ont été développées, présentées et validées dans le reste de la thèse.*

- *Dans le chapitre 3, la plateforme de simulation énergétique de navire SEECAT a été présentée. Codée en langage Modelica, elle a été entièrement développée par le doctorant et son équipe. Cet outil est initialement basé sur l'approche par « flux d'énergie ». La plateforme permet de modéliser tous les principaux flux d'énergie à bord des navires et permet de calculer leur consommation globale. Elle a été testée sur un paquebot moderne existant et les résultats de simulation furent comparés aux mesures. SEECAT a montré une bonne exactitude des résultats et s'est montré très utile et intéressant pour comparer des alternatives de design ou profil opérationnel.*
- *Dans le chapitre 4, un nouveau modèle de moteur, plus précis, plus physique et plus modulaire a été développé et présenté. Ce modèle se base sur l'approche par « valeurs moyennes ». Un modèle d'un moteur existant a été créé en n'utilisant que des données librement disponibles. Ce modèle permet de calculer la balance thermique complète et ce sur l'ensemble du champ moteur. Il est, de plus, rapide à exécuter et s'est montré d'un haut niveau de justesse quand comparé aux données du constructeur.*
- *Dans le chapitre 5, un deuxième niveau de modélisation énergétique a été développé et présenté. La nouvelle approche de modélisation, appelée « circuit fluide » s'appuie sur le second principe de la thermodynamique. Cette nouvelle approche requiert de nouveaux modèles et des modèles plus détaillés. Les fluides thermodynamiques ne sont plus représentés uniquement par leur contenu énergétique mais dorénavant par au moins leur débit massique et leur enthalpie spécifique. Ce niveau de détail supplémentaire a permis de développer des analyses exergetiques. Des simulations ont été réalisées sur un modèle théorique d'un moteur avec ses systèmes de refroidissement et d'échappement. Les résultats ont illustré les avantages de l'analyse exergetique : il a ainsi été possible de localiser précisément les sources d'irréversibilité et d'évaluer la quantité théorique de chaleur convertible en travail. L'analyse exergetique a également permis de stimuler une réflexion nouvelle sur des moyens d'économie d'énergie et d'exergie à bord des navires.*

*Plusieurs observations peuvent être faites sur cette thèse :*

- *Même si la seconde approche de modélisation apporte des améliorations significatives en termes de compréhension, de précision de possibilités de simulation, la première approche n'est pas pour autant écartée. En fonction des besoins, la première approche pourra tout à fait être préférée dans la mesure où elle est plus simple et plus rapide à exécuter. Elle possède de plus l'avantage de nécessiter moins d'informations sur les systèmes. En réalité, les modèles de navires seront souvent hybrides, mélangeant les deux approches, la première approche étant préférée pour la structure énergétique générale du navire et la seconde approche réservée aux composants et circuits les plus importants ou les plus intéressants.*
- *Les chapitres 4 et 5, mais surtout le chapitre 4 ont montré à quel point il peut être difficile de passer d'un niveau de modélisation à l'autre. L'approche par valeur moyenne n'est pas réputée pour sa complexité, mais le développement d'un nouveau modèle de moteur basé sur cette approche aura représenté un des grands challenges de cette thèse. Appliquer un tel niveau de modélisation à l'ensemble du navire n'est ni forcément souhaitable ni forcément possible. La décision de faire ainsi devra être murement réfléchie.*

- *Finally, it is interesting to note that the approach developed for ships could be applied to all types of complex energy systems such as for example power plants, cars, planes, etc. This method should be particularly adapted to the modeling of cogeneration systems.*

*This thesis calls for new developments :*

- *The approach by « fluid circuit » must be implemented to other systems such as boilers and burners and HVAC systems where important energy and exergy savings should be possible. HVAC systems are very good examples of complex systems. Their energy consumption depends on a very large number of factors such as solar radiation, temperature and ambient humidity, wind, thermal inertia of the ship, energy dissipation, occupancy, etc. HVAC knowledge in terrestrial buildings is progressing continuously but benefits from a long experience. Applied to maritime transport, the study of HVAC systems presents new challenges linked to the variety of operational profiles and environmental conditions encountered. This subject could be covered by a new thesis.*
- *The time available and the data available did not allow applying the new engine model and the approach by « fluid circuit » to a complete ship. The doctor and his team are very motivated to collaborate with shipyards or shipowners for this purpose. It would be possible to build a large database containing energy and exergy analyses of ships of various types, with various operational profiles and navigating in all environmental conditions. This would be an important achievement and a major contribution to the maritime community. In addition to being very interesting from a scientific point of view, this would stimulate new research and developments to make ships even more efficient.*
- *The energy and exergy saving solutions presented in chapter 5 should be modeled and simulated.*
- *Finally, it is not vain to remind that one of the major interests of this research work is to reduce CO<sub>2</sub> emissions from ships (another major interest is to save money) and that, in this regard, life cycle analysis can be very useful. Life cycle analysis evaluates the environmental impact of a system by considering its entire life cycle, from construction to recycling, or according to the well-known formula, from the cradle to the grave. They should be used to compare design or usage alternatives. A new propulsion system can for example allow a 1% reduction in fuel consumption. But if the construction and recycling of the new system consume a lot of energy, the global consumption of the ship over its entire life cycle could be higher than that of the old propulsion system. Not taking into account the entire life cycle of the ship can lead to poor decisions.*

# APPENDICES



# TABLE OF CONTENT

<b>APPENDIX A SHIP DESCRIPTION.....</b>	<b>175</b>
A.1 PROPULSION.....	177
<i>A.1.1 Main engine cooling.....</i>	<i>177</i>
<i>A.1.2 Fuel oil supply.....</i>	<i>177</i>
<i>A.1.3 Main engine lubrication.....</i>	<i>178</i>
<i>A.1.4 Air intake, exhaust gas and turbocharging.....</i>	<i>180</i>
A.2 ELECTRICITY PRODUCTION .....	182
<i>A.2.1 Diesel generator.....</i>	<i>182</i>
<i>A.2.2 Shaft generator.....</i>	<i>184</i>
<i>A.2.3 Turbo-alternator.....</i>	<i>185</i>
<i>A.2.4 Gas turbine.....</i>	<i>186</i>
A.3 ELECTRICITY DISTRIBUTION.....	187
A.4 SEA WATER CIRCUIT.....	191
A.5 FRESH WATER PRODUCTION .....	192
<i>A.5.1 Fresh water generator.....</i>	<i>193</i>
<i>A.5.2 Reverse osmosis unit.....</i>	<i>194</i>
<i>A.5.3 Fresh water distribution circuit.....</i>	<i>196</i>
A.6 WATER COOLING CIRCUIT.....	197
A.7 FUEL CIRCUIT.....	199
A.8 STEAM PRODUCTION AND DISTRIBUTION.....	201
<i>A.8.1 Oil-fired boilers and steam circuit.....</i>	<i>201</i>
<i>A.8.2 Oil-fired boilers and waste heat recovery boilers.....</i>	<i>203</i>
<i>A.8.3 Condenser.....</i>	<i>205</i>
<i>A.8.4 Boiler combustion.....</i>	<i>206</i>
A.9 HEATING, VENTILATION AND AIR CONDITIONING .....	208
<b>APPENDIX B DIESEL ENGINE FUNDAMENTALS.....</b>	<b>211</b>
<b>APPENDIX C HEATING VENTILATION &amp; AIR CONDITIONING .....</b>	<b>217</b>
C.1 HEAT PUMPS, AIR-CONDITIONING AND COLD PRODUCTION.....	218





# APPENDIX A

## SHIP DESCRIPTION

---

The great majority of modern large ships are propelled by propellers. Older ships used wheel paddles. Wind, paddles or less frequently animal traction are still used for smaller ships. Hydrojet systems can be found on water scooters, high-speed ferries or certain military vessels. Hydrojet systems are based on jet-propulsion: water is pumped under the hull and expelled at high speed and pressure at the back of the hull. They can offer better performances than propeller-propulsion systems at high speed (above 25 knots). Since the 1960's the potentialities of magneto-hydrodynamic propulsion were explored. Its basic principle relies on electromagnetism: sea water inside a duct is electrified and put to motion under the magnetic field of a permanent coil on board the ship, hence creating a water flow. This propulsion technique has not yet met success [104].

Historically, ships were powered by steam engines. Today, steam engines are still used on LNG ships, where they burn the LNG boil-off, but even in this particular case, they tend to be replaced by dual-fuel diesel engines. Steam engines are also used in naval ships, ice-breakers or rare commercial ships associated with nuclear reactors. Nowadays, the great majority of modern large ships, propelled by propellers, are powered by diesel engines as they have proven to be reliable and efficient. Traditionally, the rotating crank shaft of the diesel engine is directly coupled to the propeller. However, for ships with variable velocity operation profiles such as cruise liners, supply vessels or naval ships, the previous propulsion architecture can be advantageously replaced by electric propulsion. The propeller is then coupled to an electric motor powered by a diesel power plant. According to Hansen et al [105] these architectures can provide improved availability (less risk of complete blackout and loss of propulsion), better manoeuvrability when using azimuth thrusters, higher flexibility in terms of room arrangement, simplified maintenance and for vessels with large variation in operative conditions reduced fuel consumption. The environmental constraint and regulations tend to support development of dual fuel diesel engine (fuel oil and gas) since gas has a lower carbon factor than fuel oil. High speed vessels such as frigates and ferries may also rely on gas-turbines as prime movers as they can offer greater power for reduced size.

Diesel engines, electric motors, steam turbines and gas turbines are the main propulsion prime movers. They can be arranged in a great variety of combinations. To simplify the following presentation, the descriptions of the ship's main energy networks and systems are based on the architecture of a very large crude carrier\* powered by a slow two-stroke diesel engine† with a controllable pitch propeller (exceptions are mentioned). The diagrams are inspired of the Kongsberg Neptune engine room simulator found at the Ecole Nationale de Marine Marchande de Nantes‡. These diagrams have been made generic enough to approximately correspond to a great majority of ships. The colour and pictograms convention used is described in Figure A.1.

Simplifications were brought in order to keep the diagrams readable, therefore certain equipments, which were not of key interest from an energetic point of view, were never or not systematically represented, such as: valves, steam vents, drains, filters, purging and filling circuits, connections, expansion tanks, sensors or redundant machinery. Moreover the electric network is only represented for producers. Hydraulic and pneumatic are not represented.

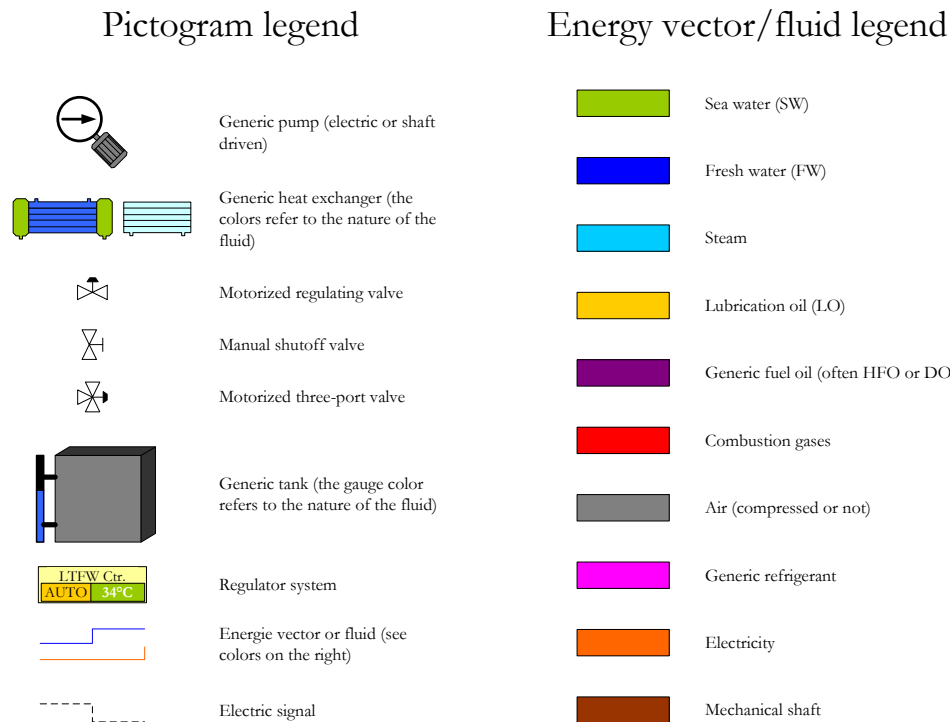

Figure A.1: Ship diagram legend

\* Overall length: 305 m; breadth moulded: 47 m; depth moulded: 30.4 m; dead-weight: 187 997 tonnes; speed: 14 knots

† Type: MAN B&W 5L90MC; MCR: 17400 kW; specific fuel consumption: 168 g/kwh

‡ National Merchant Marine School in Nantes, France

## A.1 PROPULSION

### A.1.1 Main engine cooling

The description of how the main engine is cooled down is given in section A.6 “Water cooling circuit”.

### A.1.2 Fuel oil supply

Two-stroke and four-stroke marine diesel engines are traditionally fuelled with DO and HFO. Some ships can use MDO which does not need to be heat up before injection. Dual fuels engine can use both liquid fuel and gas fuel. The following description is given for DO and HFO fuelled engines.

- **Main objective, function**

Supply the main engine with the correct fuel, at the correct viscosity.

- **Diagram**

See Figure A.2:

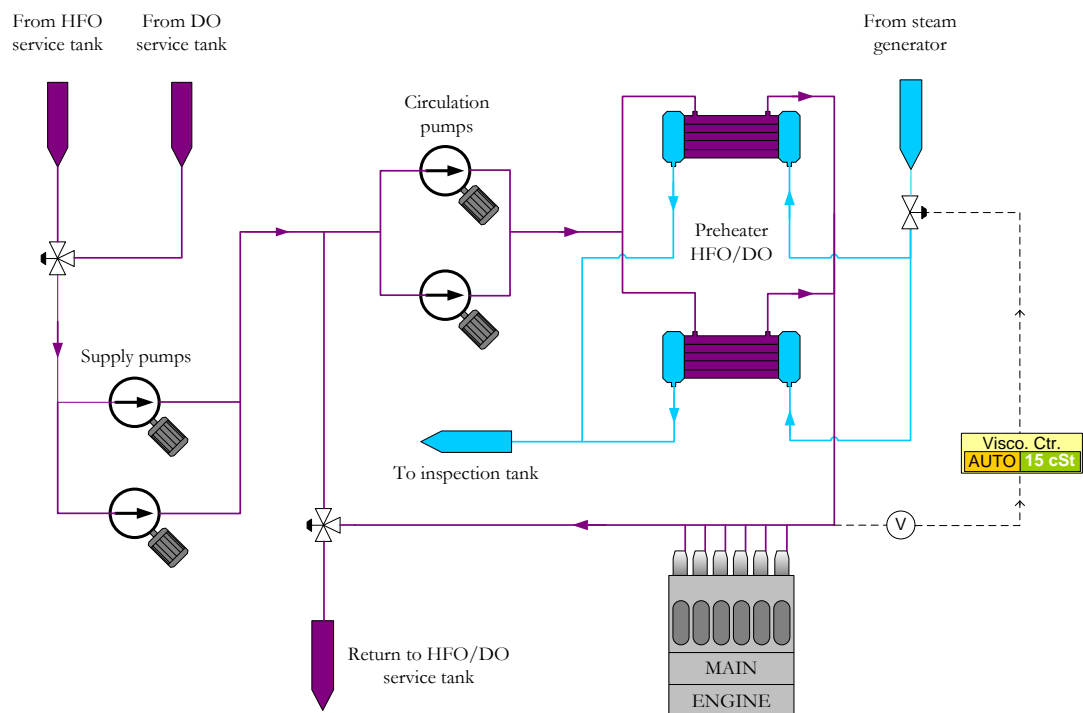

Figure A.2: Main engine fuel oil supply diagram

#### ▪ **Interaction with other circuits**

The main engine fuel supply system is linked to:

- The fuel storage, purification and transfer circuit
- The steam circuit.

#### ▪ **Main components**

The main engine fuel oil supply system is composed of the following elements:

- The main engine
- A pre-selection three-port valve
- A re-circulation three-port valve
- A viscometer
- A fuel viscosity regulator
- A steam/fuel heat exchanger
- Circulation and feed pumps

#### ▪ **Working principle**

A three-port valve allows the selection between HFO and DO which depends on pollution regulation (DO has lower sulphur content). The selected fuel is then pumped into the main engine fuel supply loop. The viscosity of the fuel is controlled by a viscosity regulator. Depending on the desired viscosity, the regulator will open or close the steam inlet valve, allowing the fuel to be more or less heated up through the heat exchangers. Once the right viscosity reached, the injectors may work.

### A.1.3 Main engine lubrication

#### ▪ **Main objective, function**

Lubrication guaranties a good operation of the main engine by limiting friction between mechanical parts and hence improving efficiency and engine lifetime. Lubrication also takes part in the engine cooling.

#### ▪ **Diagram**

See Figure A.3.

#### ▪ **Interaction with other circuits**

The main engine lubrication circuit is connected to the fresh water cooling circuit.



### ▪ Working principle

- Cylinder liner lubrication circuit working principle:

The cylinder lubrication oil daily tank is fed from the cylinder lubrication oil storage tank via a feed pump. The daily tank feeds the cylinder liner lubrication nozzles, lubrication oil enters the cylinder and is burned during combustion.

- Camshaft lubrication circuit working principle:

The camshaft lubrication circuit is a closed one. The circulation of the oil is guaranteed by two parallel pumps. The oil enters the main engine to lubricate the camshaft; it then returns back to the storage tank. The temperature of the oil is regulated before it enters the engine by a regulator and a three-port valve which can bypass the cooler. The cooler is fed by fresh water.

- Main lubrication circuit working principle:

The sump tank feeds the main engine lubrication system. It self is fed by a make-up pump connected to the general lubrication oil circuit and the main engine internal sump output. The sump oil is cleaned by a separator. It then supplies the engine where it lubricates the crankshaft bearings. The distribution of the oil is guaranteed by two circulation pumps. The oil temperature is controlled by a regulator and two coolers.

## A.1.4 Air intake, exhaust gas and turbocharging

**Note: The following presentation is given for the turbocharging of the main engine but applies also to diesel generators.**

### ▪ Main objective, function

Most of today's marine diesel engines are turbocharged. Turbocharging is a mean of forced induction, it allows higher admission pressure, hence better air/fuel mixture cylinder filling and hence greater power delivered by the cylinder. As the turbocharger is powered by the otherwise lost exhaust gas kinetics, it increases efficiency.

### ▪ Diagram

See Figure A.4:

### ▪ Interaction with other circuits

The air admission circuit is connected to the fresh water cooler circuit.

The exhaust gas circuit is connected to the waste heat recovery boilers if present.

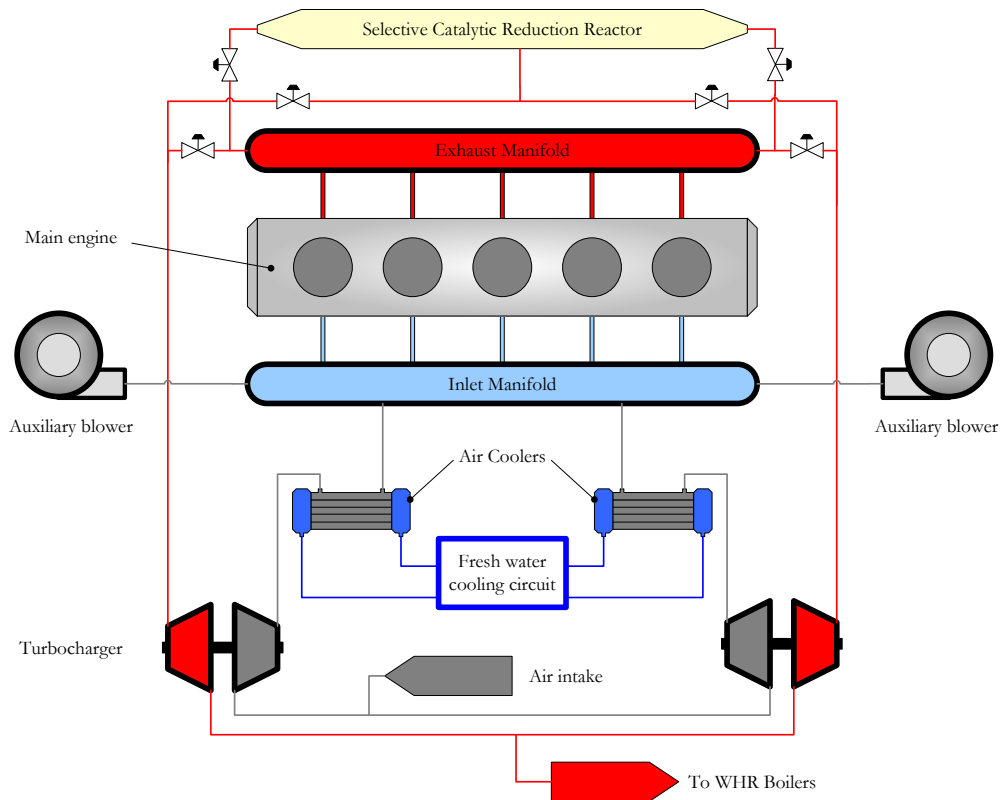

Figure A.4: Main engine exhaust and inlet circuits

#### ▪ Main components

The turbocharging system is composed of:

- Turbochargers
- A charge air cooler
- An inlet manifold
- An exhaust manifold
- The main engine
- An exhaust gas NO<sub>x</sub> reduction device
- Auxiliary blowers

#### ▪ Working principle

Fresh air is taken from the engine room. It is compressed through the turbochargers then cooled down through the charge air coolers and send in the inlet manifold where its typical pressure and temperature are around 1.8 bar and 45 °C. The air coolers is fed by the fresh water cooling circuit and aim at increasing the density of the admission air and hence increasing filling efficiency.

The air is then admitted into the cylinder.

The exhaust gases are then collected into the exhaust manifold where their typical pressure and temperature are around 1.5 bar and 350 °C.

The hot exhaust gases then go through the turbine where it yields part of its energy. The remaining energy then goes to the exhaust system. The turbine powers the compressor.



Before that, depending on the pollution regulation, the gases can be chemically cleaned to reduce their  $\text{NO}_x$  quantity. The hot gases then go through a selective catalytic reduction (SCR) reactor. The exhaust gas stream mixed with a reducing agent (ammonia or urea) transforms the nitrogen oxides ( $\text{NO}_x$ ) into diatomic nitrogen ( $\text{N}_2$ ) water and carbon dioxide ( $\text{CO}_2$ , only when using urea) with the help of a catalyst.

Auxiliary blowers will help admission air compression when the turbochargers are not operational (when the engine is started).

## A.2 ELECTRICITY PRODUCTION

There are three major means of electricity production on board ships:

- Diesel generators
- Shaft generators
- Turbo-alternators

The electricity produced is alternating current, generally around 50-60 Hz.

All these means of production can be combined into one power plant. Such a power plant is generally automated by a power management system (PMS) which controls the starting and stopping of each electricity producer depending on demand.

### A.2.1 Diesel generator

#### ▪ Main objective, function

Diesel generators provide electricity when the main engine is not started or not available. They are necessary to start the main engine which needs compressed air and hence a compressor to start. On diesel-electric propulsion ships, diesel generators provide electricity to the propulsion electrical motors.

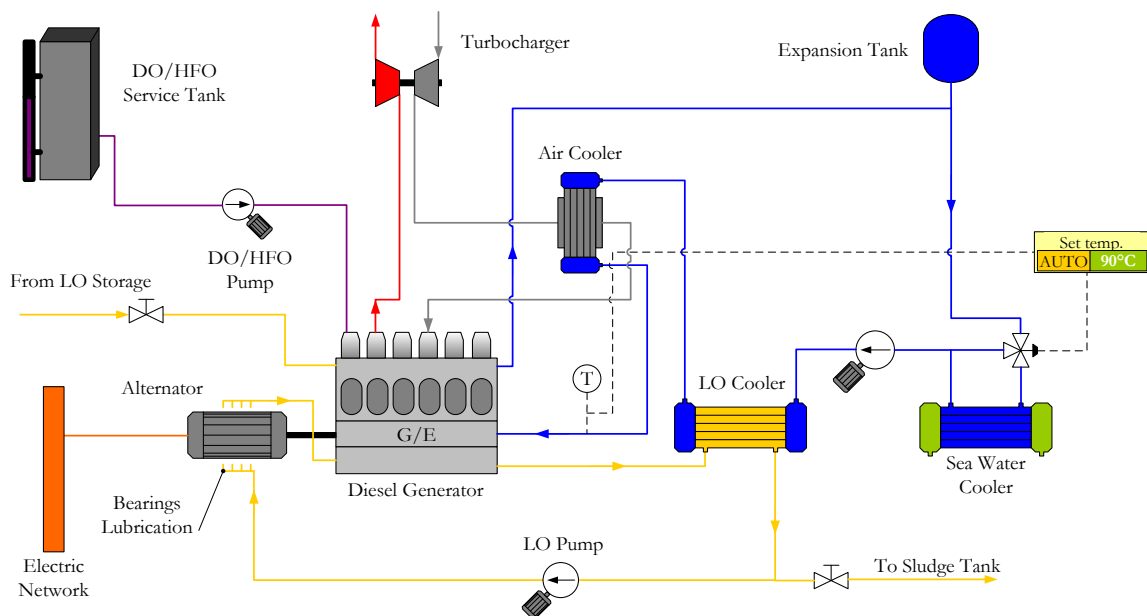

Figure A.5: Diesel generator diagram

**▪ Diagram**

See Figure A.5.

**▪ Interaction with other circuits**

The diesel generators electricity production system is linked to the following circuits/networks:

- The electric network
- The fuel supply circuit
- The lubrication oil circuit
- The fresh water cooling circuit
- The power management system (not represented)

**▪ Main components**

The main components of the diesel generator system are:

- A diesel generator, itself composed of:
  - An alternator
  - A diesel engine, traditionally a medium speed four stroke engine
  - A turbocharger
  - A cooling circuit
  - A three-port valve for temperature regulation
  - A temperature regulator
  - A lubrication system
  - A fuel supply system

**▪ Working principle**

The alternator is driven by the diesel engine via the shaft line. The alternator delivers electricity to the main switchboard.

The diesel engine is supplied in HFO or DO from the service tanks.

The engine cylinder, camshaft and crankshaft bearings as well as the alternator bearings are lubricated thanks to a circulation of lubrication oil. The circulation of oil is guaranteed by a circulation pump and the circuit is fed from the lubrication oil storage tank.

Most of marine diesel engines are turbocharged. The admission air is compressed by the compressor before entering the combustion chamber. The compressor is driven by the turbine which recovers part of the exhaust gas energy. For more details see section A.1.4 “Air intake, exhaust gas and turbocharging”.

The lubrication oil circuit, the charged admission air as well as the engine cylinder jackets are cooled down by a fresh water circuit. This circuit is itself cooled down by sea water. The circulation of the fresh water is guaranteed by a circulation pump. The temperature of the circuit is controlled by a regulator which commands a three port valve; a typical temperature command is around 80-90 °C. The density variations of the water induced by the temperature variations are absorbed by an expansion tank.

## A.2.2 Shaft generator

### ▪ Main objective, function

Shaft generators are alternators driven by the propeller shaft. They provide electricity.

### ▪ Diagram

See Figure A.6.

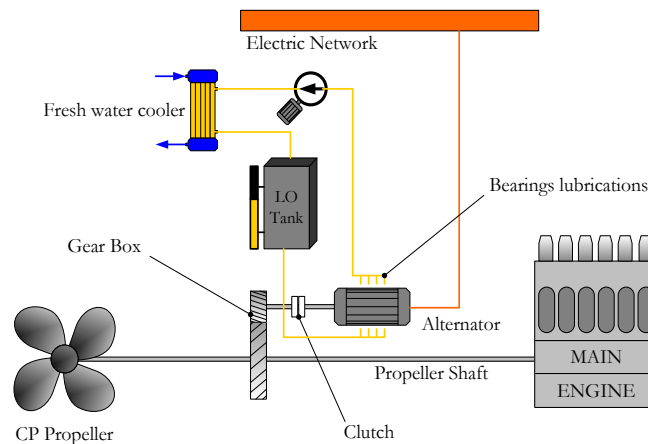

Figure A.6: Shaft generator diagram

### ▪ Interaction with other circuits

The shaft generator electricity production system is linked to the following circuits/networks:

- Electric network
- The fresh water cooling system
- The main engine

### ▪ Main components

The main components of the shaft generator electricity production system are:

- The main engine
- The propeller shaft
- A gear box
- A clutch
- A lubrication system

### ▪ Working principle

The propeller shaft is equipped with a gear box which drives an alternator. A clutch allows to disconnect the alternator. The alternator provides electricity to the main switchboard. The alternator bearings are lubricated. The lubrication oil is cooled down by a fresh water cooler.

In order to deliver electricity to the electric network, the main engine rotation speed must remain constant, therefore requiring a propeller of controllable pitch type.

## A.2.3 Turbo-alternator

### ▪ Main objective, function

Turbo-alternators are alternators driven by a turbine. They provide electricity.

Usually, the turbines are powered by high pressure superheated steam; this configuration is particularly interesting when the steam is produced for free by the waste heat recovery boilers. The turbine can also be powered by fuel (see next section) but this presentation is given for steam turbines

### ▪ Diagram

See Figure A.7.

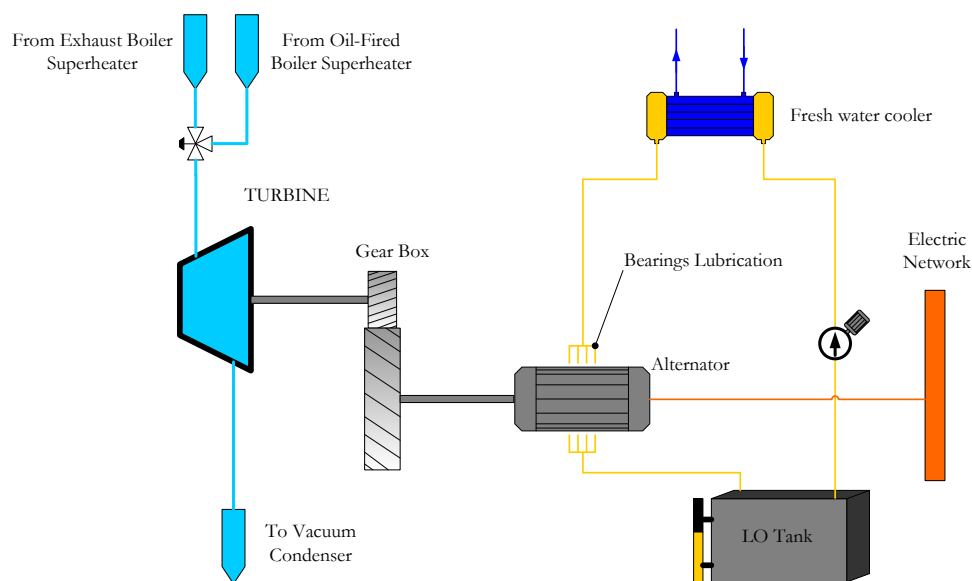

Figure A.7: Steam turbo-alternator diagram

### ▪ Interaction with other circuits

The turbo-alternator electricity production system is linked to:

- A steam production, which can either be:
- An oil-fired boiler
- A waste heat recovery boiler
- A condenser
- A fresh water cooling circuit
- An electric network

### ▪ **Main components**

The turbo-alternator electricity production system main components are:

- A steam turbine
- An alternator
- A steam inlet connected to a three-port valve
- A steam outlet towards the condenser
- A lubrication system
- A gear box

### ▪ **Working principle**

A three-port valve allows selecting between two steam sources: from the waste heat recovery boiler or the oil-fired boiler. The steam expands through the turbine and returns to the condenser. The turbine drives the alternator which provides electricity to the electric network. The wright alternator rotational speed is selected via the gear box. The alternator bearings are lubricated. The lubrication oil is cooled down with a fresh water cooler.

## A.2.4 Gas turbine

### ▪ **Main objective, function**

A gas turbine is an internal combustion engine which provides mechanical power. This power can be used for propulsion or electricity generation. The latter case is presented below.

### ▪ **Diagram**

See Figure A.8.

### ▪ **Interaction with other circuits**

A gas turbine electricity production system is linked to the following circuits/networks:

- A fresh water cooling circuit
- An electric network
- An exhaust gas circuit
- A fuel and air supply circuit
- A lubrication circuit

### ▪ **Main components**

The gas turbine electricity production system main components are:

- A gas turbine and an alternator placed together inside a shielded casing
- A lubrication system
- A fuel supply system
- A gear box

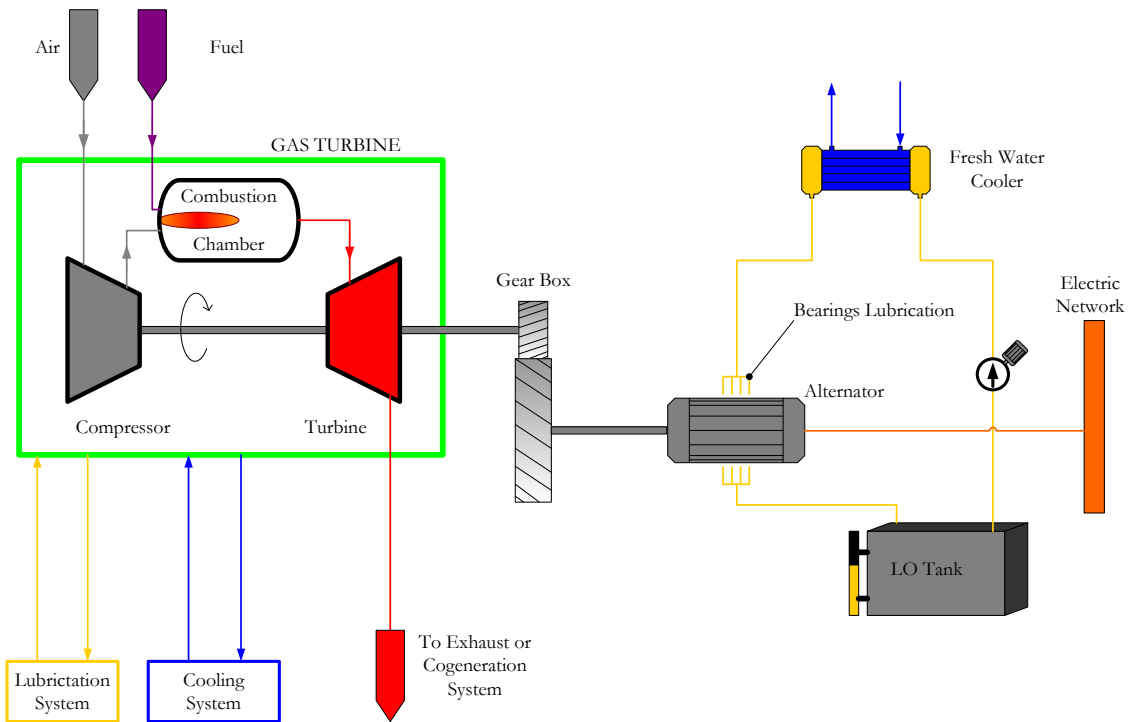

Figure A.8: Gas turbine diagram

#### ▪ Working principle

The general working principle is similar to the turbo-alternator's one (see previous section).

The compressor, driven by the turbine, feeds the combustion chamber with high pressure fresh air. Fuel is also fed to the combustion chamber where it is mixed with the air and ignited. The flue gas then expands through the turbine which drives the alternator which then provides electricity to the electric network. The exhaust gases are sent to the atmosphere or a cogeneration system (waste heat recovery boilers for example). The right alternator rotational speed is selected via the gear box. The alternator bearings are lubricated. The lubrication oil is cooled down with a fresh water cooler.

## A.3 ELECTRICITY DISTRIBUTION

**N.B.:** The current values below are given for example and can vary depending on the ship

#### ▪ Main objective, function

The electricity distribution system's function is to link the different electricity producers and consumers, ensuring that the total electricity production and consumption are always equal (in order to avoid overloading or blackouts).

#### ▪ Diagram

See Figure A.9.

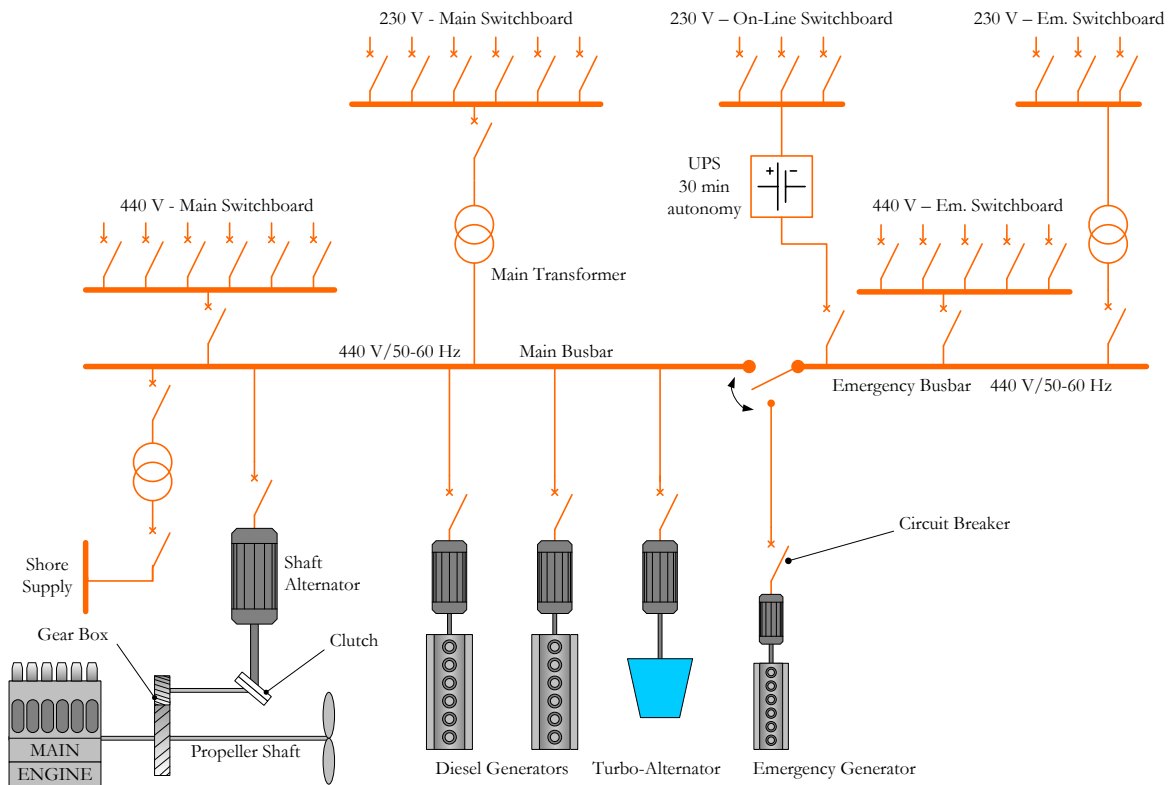

Figure A.9: Electric distribution diagram

#### ▪ Interaction with other circuits

The electricity distribution network is connected to any device that requires or produces electricity.

#### ▪ Main components

The main components of a marine electric network are:

- Electric cables each one of them equipped with a breaker
- Transformers
- Several switchboards:
  - A main busbar (440 V/50-60 Hz)
  - An emergency busbar (440 V/50-60 Hz)
  - A 440 V main switchboard
  - A 440 V emergency switchboard
  - A 230 V main switchboard
  - A 230 V on-line switchboard
  - A 230 V emergency switchboard
- Switches
- An UPS (uninterruptable power supply) device
- Several power supplies:
  - Shaft alternator
  - Diesel generator

- Turbo-alternator
- Emergency alternator
- A power management system (not represented)

▪ **Working principle**

The power management system will start, control the power output and shut down the different electricity generators, ensuring that at each instant the total electric power produced equals the total electric power absorbed. Each alternator must turn at the same fixed speed (50 or 60 Hz generally) and be synchronized in terms of voltage (440 V generally) and current offset. In diesel electric ship architectures, the power management system controls usually around five or six diesel generators. It then has to optimize the number of diesel generators running, in order to make them run at their best possible efficiency.

The electricity produced by the alternators is directly sent to the main busbar via electric cables. Every electric cable is protected by a circuit breaker to avoid fire and protect electrical installations. The electricity from the main busbar is sent to the 440 V main switchboard and the 230 V main switchboard via a transformer.

The 440 V main switchboard supplies strong power devices such as:

- Emergency busbar
- Air fans
- Fuel, lubrication oil, water pumps
- Air compressors
- Fire pumps
- Boiler fuel feed pumps
- Diesel engine fuel feed pumps
- Bow thrusters
- Deck machinery
- Steering gear
- Air conditioning plant
- Refrigeration plant
- Incineration plant
- Fresh water generator and reverse osmosis units
- HFO/DO/LO purifying systems
- Cargo and ballast systems
- Accommodations heating and conking systems
- Etc.

The 230 V main busbar supplies lower power devices such as:

- Light panels
- Accommodations minor panels
- Etc.



In normal operation (no failure) the main busbar supplies the emergency busbar. After a serious electricity generation failure or during cold start the emergency busbar is supplied by an emergency diesel generator. This generator can be started manually and requires neither preheating nor compressed air or electricity supply. It can only supply the emergency busbar, not the main busbar. The emergency busbar supplies a 440 V emergency switchboard, a 230 V on-line switchboard via an UPS device and a 230 V emergency switchboard via a transformer.

The 440 V emergency switchboard supplies strong power devices such as:

- Steering gear
- Emergency fire pumps
- Emergency air compressor
- Lifeboats winch
- Diesel generators LO/DO/HFO pumps
- Air fans
- Cooling water pumps
- Elevator system
- Etc.

The 230 V emergency switchboard supplies lower power devices such as:

- Light panels
- Nautical instruments
- Radar system
- Radio system
- Lifeboat battery charger
- Etc.

The 230 V on-line switchboard supplies power to essential emergency devices and sensitive electronic devices that need constant power supply (the UPS device integrates a transformer, a charger, a 30 minute autonomy battery and an inverter):

- Nautical instruments
- Engines remote control
- Elevator control
- Fire alarm
- DC 24 V emergency lighting

When at port, the main busbar can be connected to the shore supply via a transformer.

## A.4 SEA WATER CIRCUIT

### ▪ Main objective, function

Because of its unlimited availability, its temperature between 0 °C and 30 °C and its high heat capacity, sea water is the perfect coolant. Indirectly but ultimately, almost all on board installations are cooled down by sea water. Indirectly, because sea water has a strong corrosion and sooting potential and therefore most of installations are cooled down by fresh water; and the fresh water is then cooled down by sea water; this in order to limit the length of pipes and number of heat exchangers in contact with sea water.

Sea water is also used for fire fighting, ballast tank filling and fresh water production.

### ▪ Diagram

See Figure A.10.

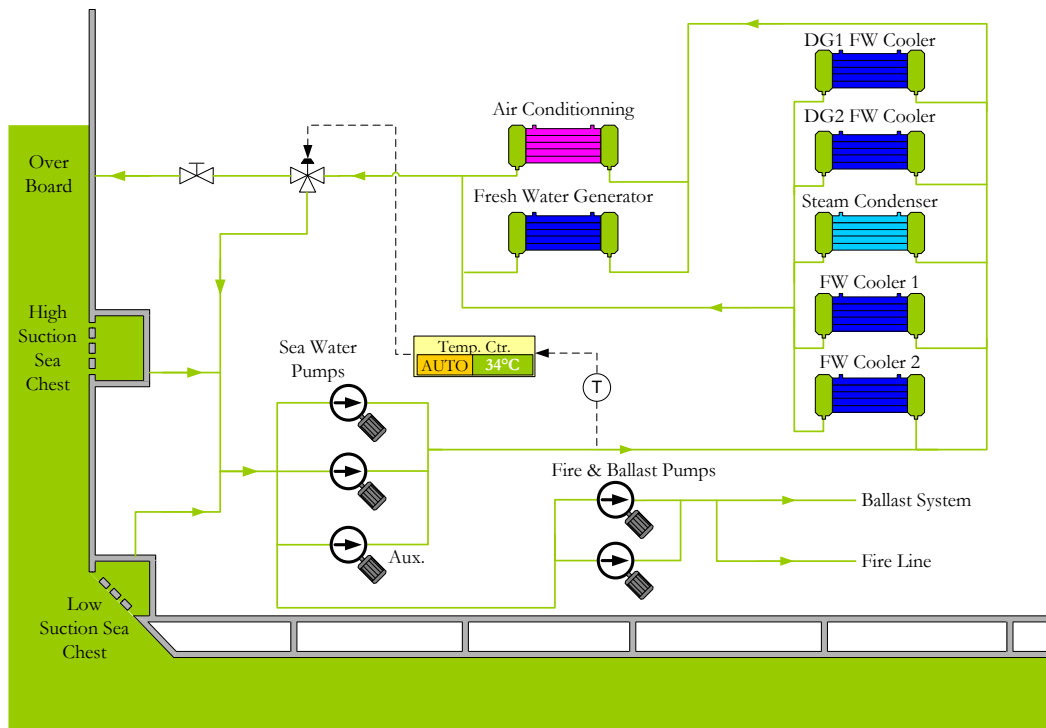

Figure A.10: Sea water circuit diagram

### ▪ Interaction with other circuits

The sea water circuit is linked to the following circuits/networks:

- The diesel generator cooling circuit
- The condenser cooling circuit
- The fresh water cooling circuit (high and low temperature)
- The fresh water generator
- The air conditioning condenser cooling circuit

The sea water also feeds the ballast system and fire line.

#### ▪ **Main components**

The sea water circuit is composed of the following main components:

- Circulations pumps
- Heat exchangers
- Suction sea chests
- A three-port valve
- A temperature regulator

#### ▪ **Working principle**

Sea water is pumped from suction sea chests (high or low depending on the position of the ship: at sea or docked) into the circuit. It then passes through series of heat exchangers where its temperature increases:

- the diesel generators fresh water coolers;
- the steam condenser;
- the main fresh water coolers which cool down, amongst other installations, the main engine;
- the fresh water generator which produces fresh water;
- the air conditioning system where it condensates the refrigerant fluid.

A regulator controls the temperature of the sea water. Depending on the temperature of the water before entering the different heat exchangers, the controller will allow more or less sea water recirculation through the activation of a three port valve. When the water is too hot, most of the water will be sent over board.

## A.5 FRESH WATER PRODUCTION

Fresh water is used on board for many purposes:

- Installations cooling or heating
- Steam production
- HFO/DO/LO cleaning
- Fuel emulsion
- Drinking

Concerning cooling, heating, and steam production, these applications require only very few input water as they work almost in closed loops. For the other applications, fresh water has to be produced or supplied at shore and stored. Fresh water is produced from sea water either by fresh water generator or reverse osmosis units.

## A.5.1 Fresh water generator

**Note:** Fresh water generators are also called distillers or evaporators

### ▪ Main objective, function

Produce fresh water. Unlike reverse osmosis units, fresh water generators produce distilled fresh water usable by boilers.

### ▪ Diagram

See Figure A.11.

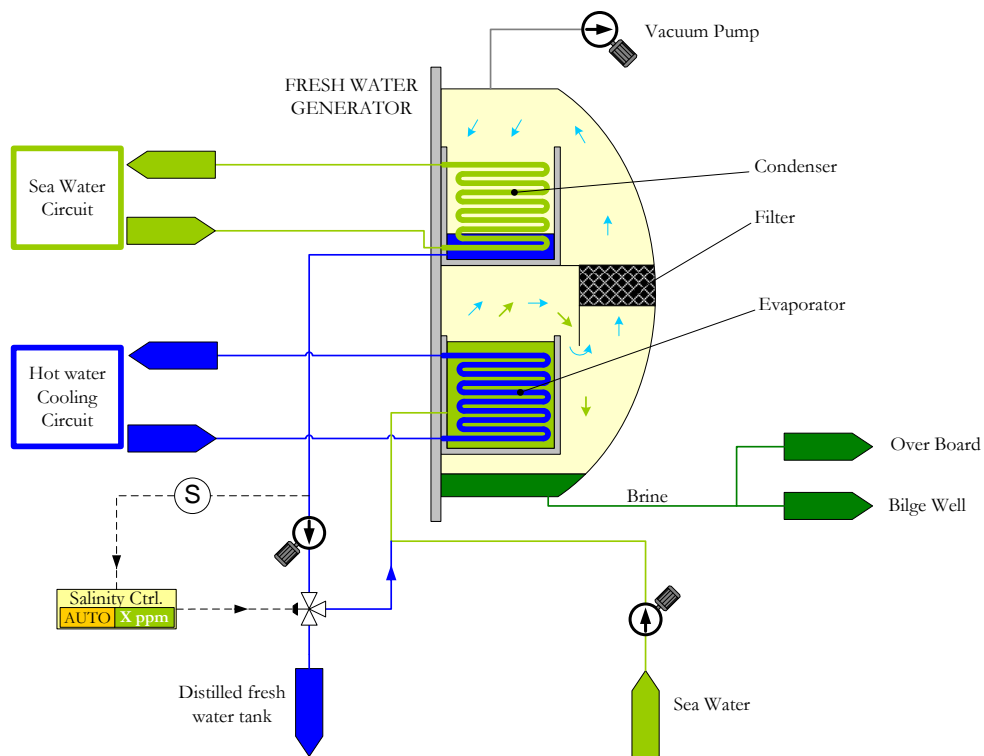

Figure A.11: Fresh water generator diagram

### ▪ Interaction with other circuits

Fresh water generators are linked to the following circuits:

- Sea water circuit
- High temperature fresh water cooling circuit

### ▪ **Main components**

The fresh water generator system is composed of the following main components:

- The fresh water generator, itself composed of:
  - An evaporator
  - A condenser
  - Filters
  - A vacuum pump
  - A salinity regulator
  - Circulation pumps

### ▪ **Working principle**

The purpose of the fresh water generator is to get the sea water rid of its salt. To do so, sea water is pumped into the evaporator section where it boils in contact of the hot water cooling circuit (the one that, amongst other installations, cools down the main engine). The evaporation is made possible by a vacuum pump which lowers the pressure (at around 0.1 bar) inside the fresh water generator, allowing the sea water to boil at around 60 °C. Once evaporated, the water is filtered and condensed in the condenser which is cooled down by sea water. The condensed desalinated water can then be sent to the distilled fresh water tanks. If its salinity is too high it recirculates in the fresh water generator.

The evaporator section collects the brine which expelled over board.

If the temperature of the hot water cooling circuit is too low, a steam “booster heater” (heat exchanger) can provide the missing calories.

Modern fresh water generators use multi-stage flash distillation process to increase efficiency. The cold sea water will cross each stage condenser and gain the latent heat of condensation. Once arrived at the end of the stages, its temperature will be near boiling point. It will then flow back through the different stage but this time in the evaporator section where it will evaporate.

## A.5.2 Reverse osmosis unit

### ▪ **Main objective, function**

Reverse osmosis units rely on reverse osmosis process to produce fresh water.

### ▪ **Diagram**

See Figure A.12.

### ▪ **Interaction with other circuits**

The reverse osmosis unit system is linked to the sea water and fresh water circuit.

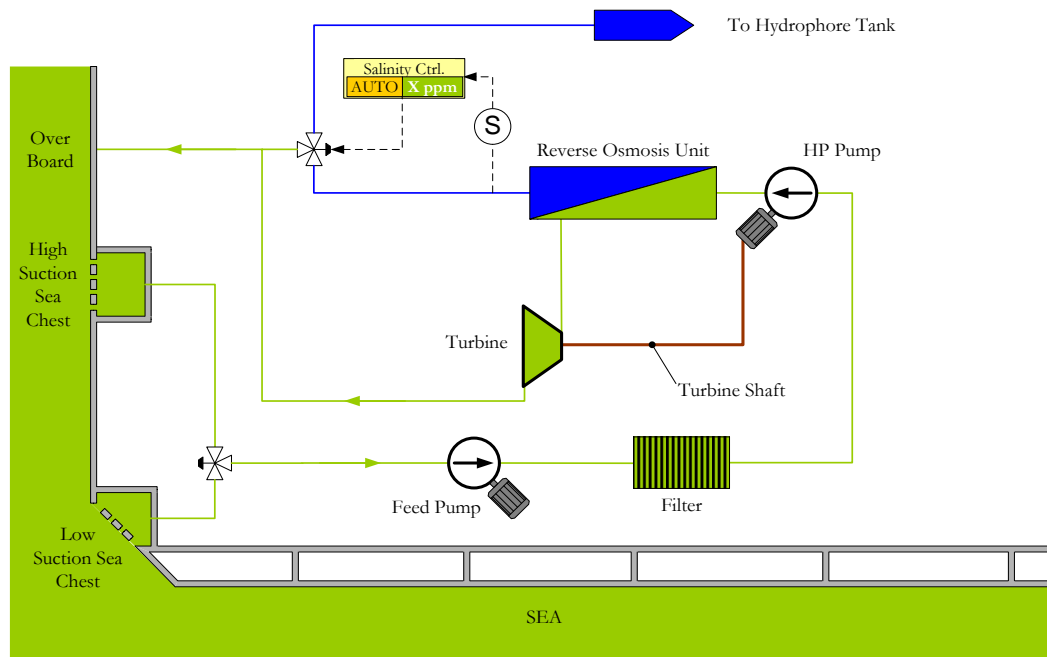

Figure A.12: Reverse osmosis unit diagram

#### ▪ Main components

The reverse osmosis unit system is composed of the following main components:

- Suction sea chests
- A feed pump
- A high pressure pump
- Filters
- A reverse osmosis unit
- A salinity regulator
- A turbine

#### ▪ Working principle

Sea water is pumped from the sea chests. It is first cleaned through filters and then sucked up a high pressure pump and delivered to the reverse osmosis unit at a pressure around 60 bars. The reverse osmosis unit contains semipermeable membranes that filter salt, letting go through the fresh water and retaining the brine. The brine is then sent back to the sea. The brine leaving the reverse osmosis unit can be expanded through a turbine that would then drive the high pressure pump, hence saving energy. The salinity of the fresh water produced is controlled by a regulator. If salinity level does not comply with the setpoint, the water is sent back to the circuit. The fresh water is sent to the hydrophore tank (see next section).

Reverse osmosis unit are today more energy efficient than fresh water generators even when the latter only uses “free” thermal energy to evaporate the sea water.

### A.5.3 Fresh water distribution circuit

▪ **Main objective, function**

Provide passengers and machinery with fresh water

▪ **Diagram**

See Figure A.13.

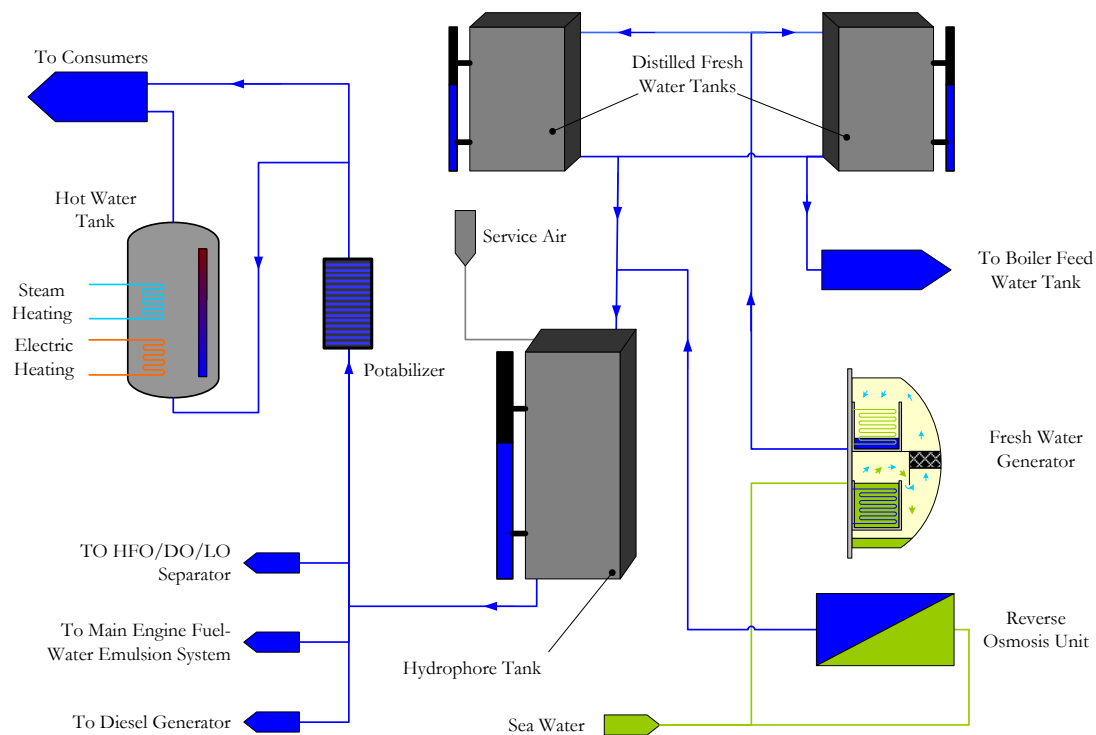

Figure A.13: Fresh water distribution circuit

▪ **Interaction with other circuits**

The fresh water distribution circuit is linked to the following circuits/networks/systems:

- The electric network
- The steam circuit
- The sea water circuit
- The compressed air network
- HFO/DO/LO separators
- Fuel water emulsion system
- To diesel generators fresh water cooling circuit fill-up input

### ▪ **Main components**

The main components of the fresh water distribution system are:

- The fresh water generator
- The reverse osmosis unit
- Distilled fresh water tanks
- The Hydrophore Tank
- A potabilizer
- The hot water tank

### ▪ **Working principle**

The water produced by the fresh water generator is stored in distilled fresh water tanks where it can then be used to supply the boiler feed water tank or the hydrophore tank. The water produced by the reverse osmosis unit feeds directly the hydrophore tank as its salinity is often not suitable for steam production. The hydrophore tank is pressurized with the service air to work as a water tower. The water from the hydrophore tank can then either be used directly by machinery such as:

- HFO/DO/LO separators where it is used to clean the oil/fuel;
- water/fuel emulsion system for the main engine use (water/fuel emulsions allow better fuel viscosity and hence lower heating necessary as well as lower combustion temperature for NO<sub>x</sub> emissions reduction);
- diesel generator fresh water cooling system where it is used to fill up the circuit in case of low water level.

When cleaned through a potabilizer, the water can be used by the passengers and crew members for drinking, showering, cooking, etc. Hot water is produced and stored in a hot water tank powered by the electrical network or the steam circuit.

## A.6 WATER COOLING CIRCUIT

### ▪ **Main objective, function**

The fresh water cooling circuit aim at cooling down different pieces of machinery. There exist different fresh water cooling circuits:

- the high temperature circuit, which cools down the main engine;
- the low temperature circuit, linked to the high temperature circuit, which cools down a variety of machinery;
- the diesel generators cooling circuit.

The diesel generator cooling circuit is presented in section A.2.1 “Diesel generator”.

### ▪ **Diagram**

See Figure A.14.



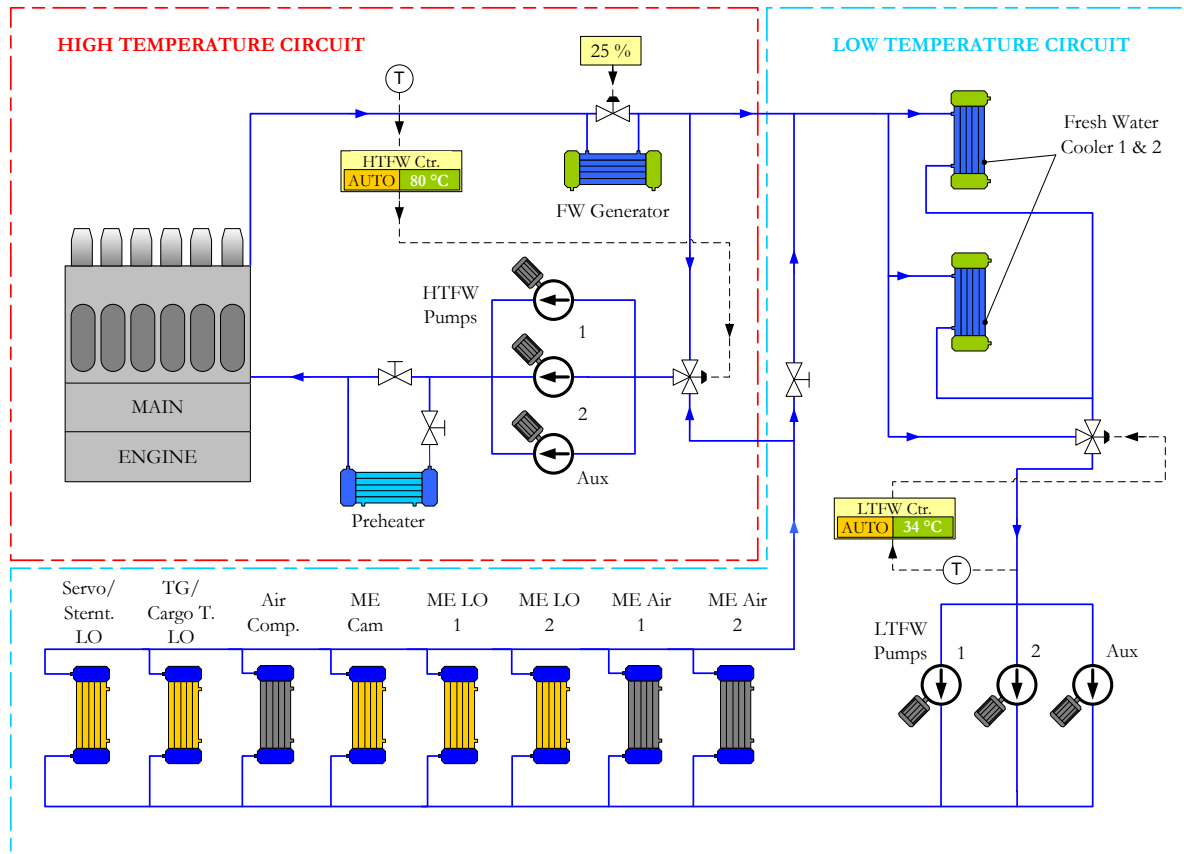

Figure A.14: Fresh Water Cooling System diagram

#### ▪ Interaction with other circuits

The high and low temperature fresh water circuits are linked to the following circuits/networks:

- The sea water circuit
- The fresh water generator
- The main engine air admission circuit
- The main engine lubrication circuit
- The compressed air network
- The turbo-alternators and cargo pumps (for oil tankers) lubrication circuit
- The propeller shaft lubrication circuit
- The propeller servo oil circuit
- The stern tube lubrication oil circuit

#### ▪ Main components

The main components of the high and low temperature fresh water circuits are:

- The main engine
- Several heat exchangers
- Several circulation pumps
- Two three-port valves
- A temperature regulator

### ▪ Working principle

The fresh water of the low temperature circuit cools down a series of heat exchangers:

- The main engine charged air cooler (ME Air 1 & 2)
- The main engine lubrication oil cooler (ME LO 1 & 2)
- The main engine camshaft lubrication cooler (ME Cam)
- The service air and main engine start air coolers (Air Comp.)
- The turbo-alternators and turbo-pumps lubrication oil cooler (TG/Cargo T. LO)
- The stern tube lubrication oil cooler and the propeller servo oil cooler (Servo/Stern t. LO)

The fresh water of the low temperature circuit is itself cooled down by the sea water through the fresh water coolers. The circulation of the water is guaranteed by the low temperature fresh water pumps (LTFW). Its temperature is controlled by a regulator, which activates a three-port valve, which allows to shortcut the fresh water coolers if temperature is under the setpoint (generally around 35 °C).

The high temperature circuit cools down the main engine. The engine output cooling water can be used by the fresh water generator. The water of the high temperature circuit is itself cooled down by the low temperature circuit. Its temperature is controlled by a regulator, which activates a three port valve, which allows the engine output cooling water to directly re-enter the engine cooling system, if its temperature is below a setpoint (usually around 80-90 °C). The circulation of the engine cooling water is guaranteed by several pumps. Before starting, the engine is heated up by a steam preheater.

## A.7 FUEL CIRCUIT

**Note 1:** The following presentation and diagrams are given for HFO. For DO, the working principle is very similar. Differences are explained at the end of this section.

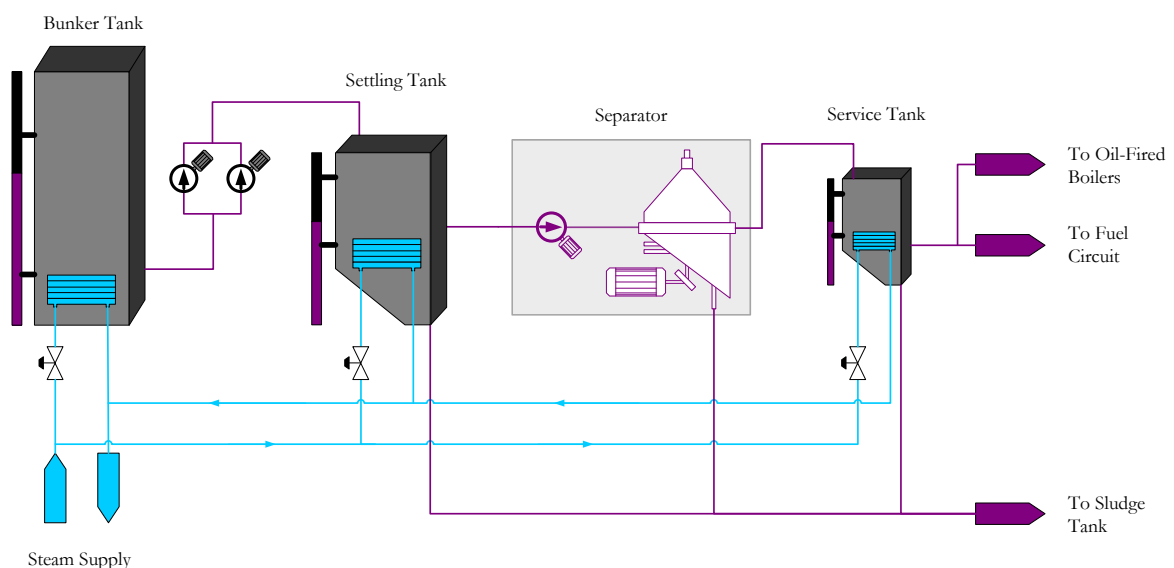

Figure A.15: Fuel circuit diagram

▪ **Main objective, function**

Store, prepare and transfer the fuel.

▪ **Diagram**

See Figure A.15 and Figure A.16.

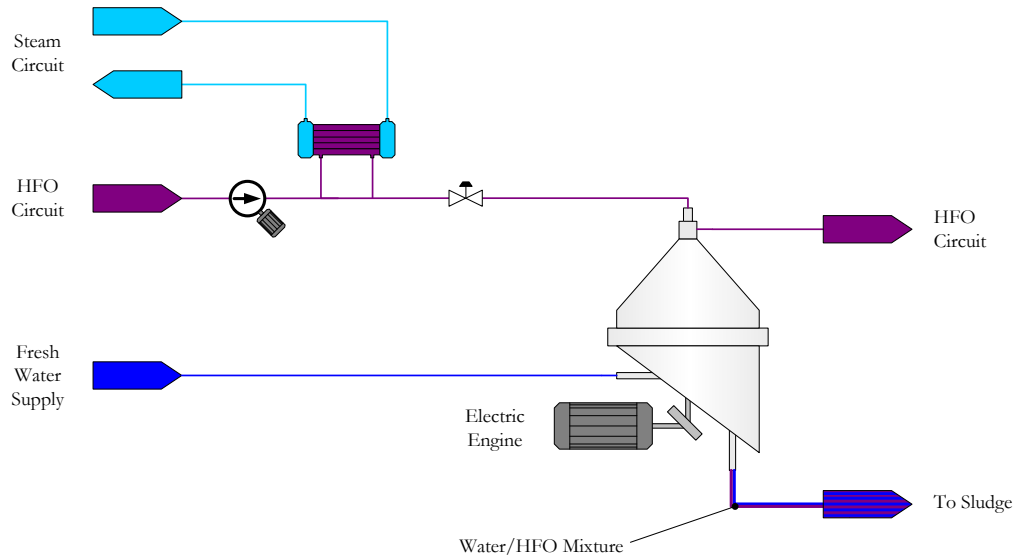

Figure A.16: Fuel separator detail diagram

▪ **Interaction with other circuits**

The fuel circuit is connected to the steam and the fresh water circuits.

▪ **Main components**

The main components of the fuel circuit are:

- Bunker tanks
- Settling tanks
- Service tanks
- Fuel purifying systems composed of:
  - A separator driven by an electric engine
  - A feed pump
  - A steam heat exchanger
  - A sludge drain pipe
  - A fresh water connection
- Feed pumps

### ▪ Working principle

The fuel used for the ship's own consumption is first stored in bunker tanks.

Depending on the consumption, the fuel is pumped into settling tanks where it can be decanted: the heavy fraction is then sent to the sludge tank, and the light fraction sent to the purifying system.

Before entering the separator, the fuel is warmed up through a steam heat exchanger to guarantee the right viscosity. Separators are based on the centrifugation principle. As the separator turns, the heavier fractions are pushed towards the exterior of the separator bowl and washed out with fresh water and sent to the sludge tank.

Once cleaned, the fuel is sent to the service tanks and then to the diesel engines and boilers.

To maintain, the right viscosity, all tanks used to store HFO are heated by steam heat exchangers.

**Note: Diesel oil (DO) is a light fuel which does not need to decant. DO is therefore directly sent from the storage tanks, to the service tanks; there are no settling tanks. Moreover, DO is much less viscous than HFO and needs less heating. Therefore, the DO storage tanks and separators do not require steam heating.**

## A.8 STEAM PRODUCTION AND DISTRIBUTION

### ▪ Main objective, function

Steam is produced by oil-fired boilers and waste heat recovery (WHR) boilers. If today, most of ships do not use steam for propulsion, it is still useful for heating and electricity production mainly. Moreover, it is a strong mean of energy saving when produced by WHR boilers. The presentation of the steam production and distribution systems is divided in four parts.

### A.8.1 Oil-fired boilers and steam circuit

#### ▪ Main objective, function

Produce steam at the desired pressure and temperature for the circuit (around 8 bars and 180 °C) by burning fuel.

#### ▪ Diagram

See Figure A.17.

#### ▪ Interaction with other circuits/systems:

The oil-fired boiler is linked to the following circuits:

- The fuel supply circuit (not represented – see Figure A.15)
- The fresh water circuit (not represented – see Figure A.13)
- The exhaust gas system
- The WHR boilers evaporator
- The steam circuit

The steam circuit supplies several installations:

- Turbo-alternators and turbo-pumps
- The WHR boiler superheater
- The condenser for steam dumping
- The boiler feed water tanks
- The bunker tanks heaters
- The settling tanks heaters
- The service tanks heaters
- The main engine fuel line heaters
- The suction sea chest blowers
- The boiler burners steam atomizers
- The boiler fuel line heaters
- The main engine fuel heaters
- The main engine water cooling preheater
- General accommodations
- The HFO/DO/LO separators
- HVAC heaters

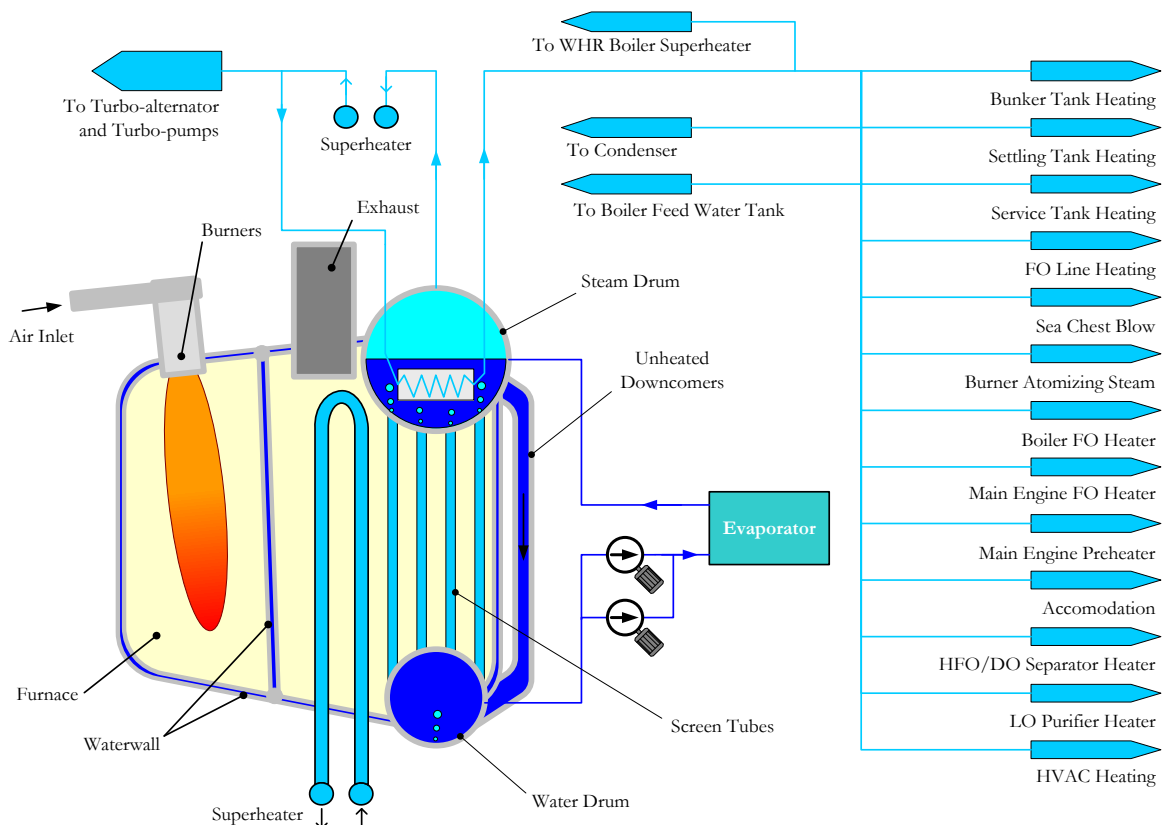

Figure A.17: Oil-fired boiler and steam circuit diagram

### ▪ **Main components**

The oil-fired boiler is composed of the following main components:

- A burner with an air input
- A furnace
- A superheater
- A steam drum
- A water drum
- Screen tubes
- Unheated downcomers
- An exhaust pipe
- Waterwalls

### ▪ **Working principle**

The burners ignite the air and fuel mixture producing a flame that heats up the pipes inside the boiler: waterwalls, superheaters, screen tubes. The steam generated is stored inside the steam drum. The water drum contains liquid water.

A natural water circulation operates between the two drums: the liquid water of the steam drum flows down into the water drum where it boils up and evaporates to the steam drum. On the way down, the water is cooled by the unheated downcomers and on the way up, the steam is heated up through the screen tubes.

As the boiler heats up, the pressure and temperature inside the steam drum rises. Once the temperature and pressure have reached the setpoints, the steam can be sent to the circuit.

The steam sent to the turbo-alternators and turbo-pumps is heated up once again via the superheater, its temperature rises and therefore increases the turbines efficiencies.

When the main engine is started, the WHR boilers can be used in parallel. The WHR boiler evaporator can be used to heat up the water from the water drum to the steam drum, and the superheater instead of the oil-fired boiler superheater.

## A.8.2 Oil-fired boilers and waste heat recovery boilers

### ▪ **Main objective, function**

Produce steam at the desired pressure and temperature for the circuit by recovering heat from the exhaust gas.

### ▪ **Diagram**

See Figure A.18.

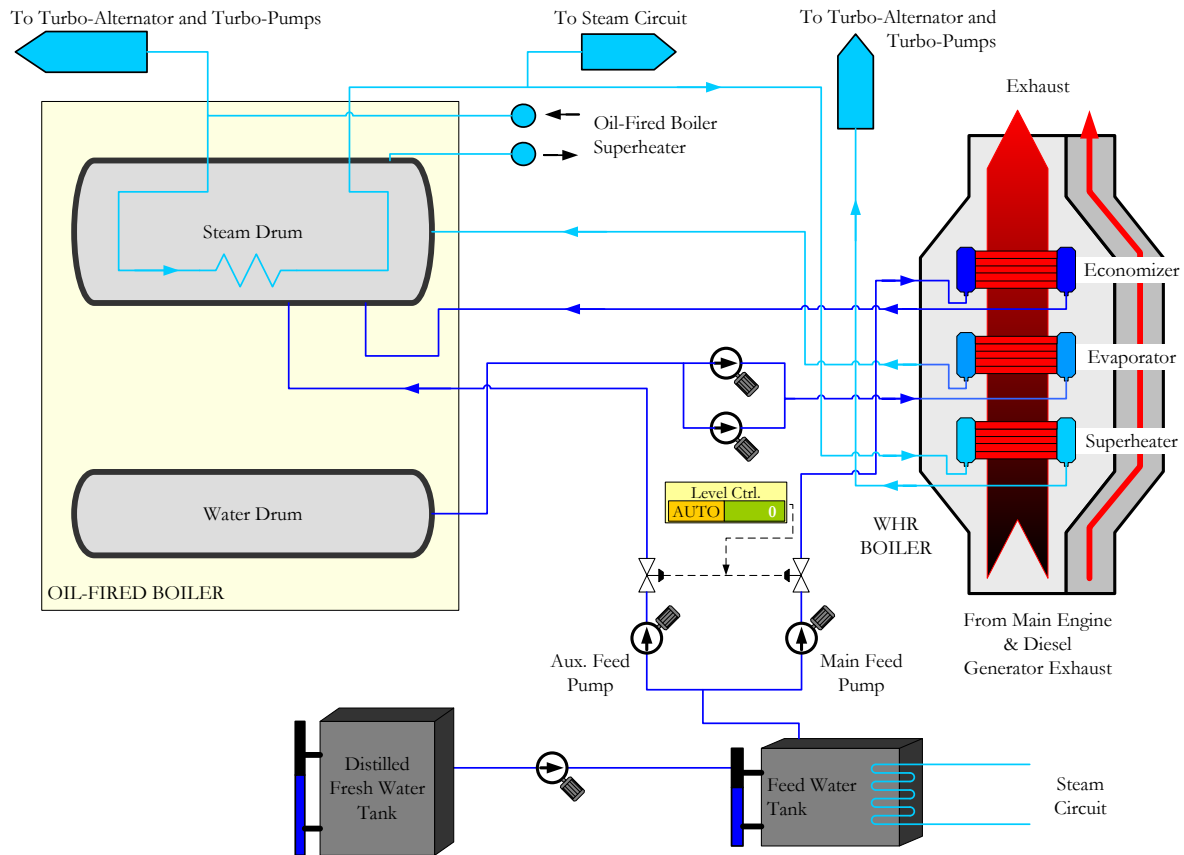

Figure A.18: Oil-fired and waste heat recovery boilers diagram

#### ▪ Interaction with other circuits

The WHR boiler and oil-fired boiler are linked to the following circuits/system:

- The fresh water production system
- The main engine exhaust gas circuit
- The steam circuit and its sub-circuits
- The fuel supply circuit (not represented – see Figure A.15)

#### ▪ Main components

The diagram of Figure A.18 main components are:

- A distilled fresh water tank
- A boiler feed water tank
- The oil-fired boiler (for more details see previous section)
- The waste heat recovery boiler
- A water level regulator
- Several circulation and feed pumps

### ▪ Working principle

The WHR boiler is composed of two chimney sections: an exhaust damper channel which goes straight to the exterior environment and the recovery channel equipped with a series of heat exchangers: the superheater (closest to the engine exhaust), the evaporator and the economizer (closest to the exit). Valves at the exit of the WHR boiler (not represented) allow to deviate the exhaust stream from one channel to the other.

The feed water tank, supplies distilled water to the steam drum via feed pumps; either directly or through the WHR economizer (if it is hot enough). A regulator controls the water level inside the steam drum.

The water from the water drum can be evaporated in the WHR boiler evaporator (if it is hot enough); the steam produced goes to the steam drum.

The steam from the steam drum can be superheated through the WHR boiler superheater (if it is hot enough) before being sent to the turbo-alternators and turbo-pumps.

## A.8.3 Condenser

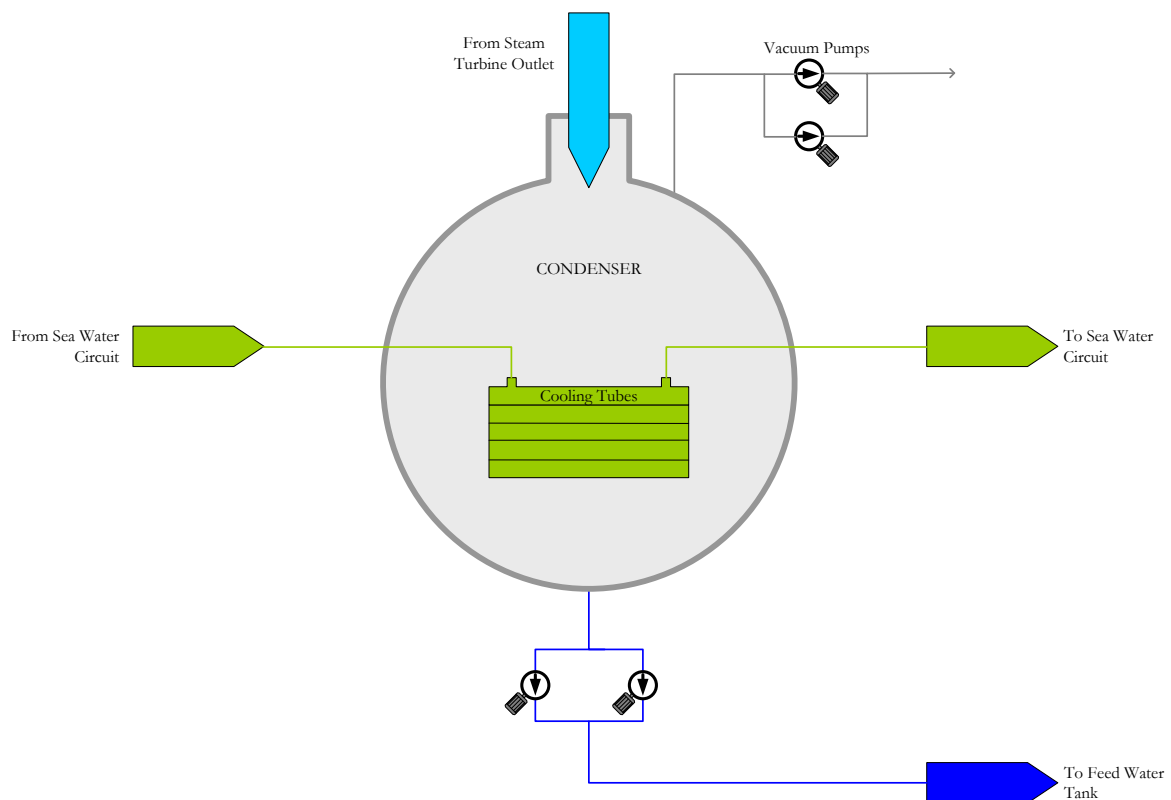

Figure A.19: Condenser diagram



### ▪ **Main objective, function**

The condenser is essential to guarantee the proper functioning of the turbine. A turbine power depends on its compression ratio, hence the lower the pressure at the turbine outlet, the greater the power. Condensing the steam also allows easier pumping afterwards.

### ▪ **Diagram**

See Figure A.19.

### ▪ **Interaction with other circuits**

The condenser is linked to the following circuits:

- The turbo-alternators outlets
- The sea water circuit
- The boilers feed water circuit

### ▪ **Main components**

The main components of the condenser system are:

- The condenser body
- A sea water cooler
- A vacuum pump
- Circulation pumps

### ▪ **Working principle**

The condenser body is maintained at low temperature, thanks to the sea water exchanger, and at low pressure (around 0.1 bar) thanks to the vacuum pump. The steam from the turbine condenses inside and is collected in the hotwell (not represented). The condensates are pumped back to the boiler feed water tank.

## A.8.4 Boiler combustion

### ▪ **Main objective, function**

Guarantee a good combustion of the fuel/air mixture inside the boiler.

### ▪ **Diagram**

See Figure A.20.

### ▪ **Interaction with other circuits**

The boiler combustion system is connected to the following circuits:

- The fuel supply circuit
- The steam circuit

### ▪ Main components

The boiler combustion system is composed of the following main components:

- A burner manifold
- A fan
- A fuel supply circuit
- An HFO steam reheater
- A steam or compressed air atomizer
- A combustion regulator (MASTER Control on the diagram)

### ▪ Working principle

The fuel is supplied to the burners via feed pumps. The HFO first heats up through a steam reheater (if steam is not available, the burner are first fed with DO).

A fan supplies fresh air.

The fuel can be atomized with high pressure steam or compressed air for better combustion and heat transfer.

The combustion regulator commands the fuel and air flow in order to control:

- the steam pressure inside the steam drum;
- the steam flow;
- the oxygen rate inside the exhaust gases.

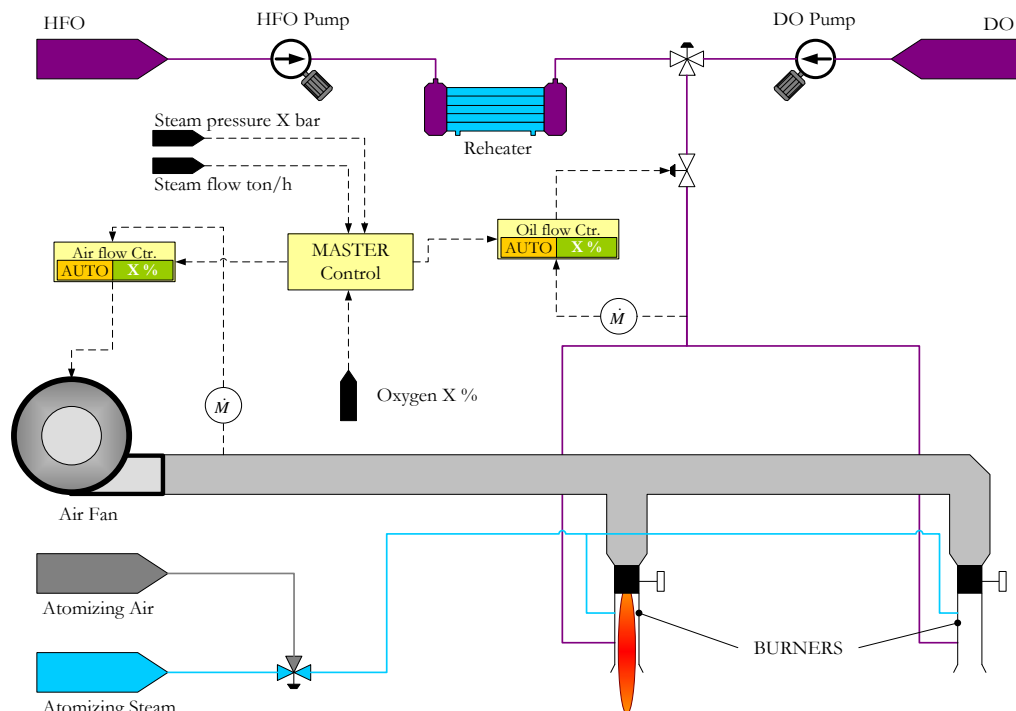

Figure A.20: Oil-fired boiler burners diagram

## A.9 HEATING, VENTILATION AND AIR CONDITIONING

**Note:** the heating, ventilation and air conditioning (HVAC) system presented in the following section is inspired of a cruise ship. Non-passenger ships tend to not have such complex systems.

### ▪ Main objective, function

The HVAC system ensures air recycling, living rooms heating and air conditioning as well as hygrometry regulation.

### ▪ Diagram

See Figure A.21.

### ▪ Interaction with other circuits

The HVAC system is connected to the following circuits:

- The steam circuit
- The sea water circuit

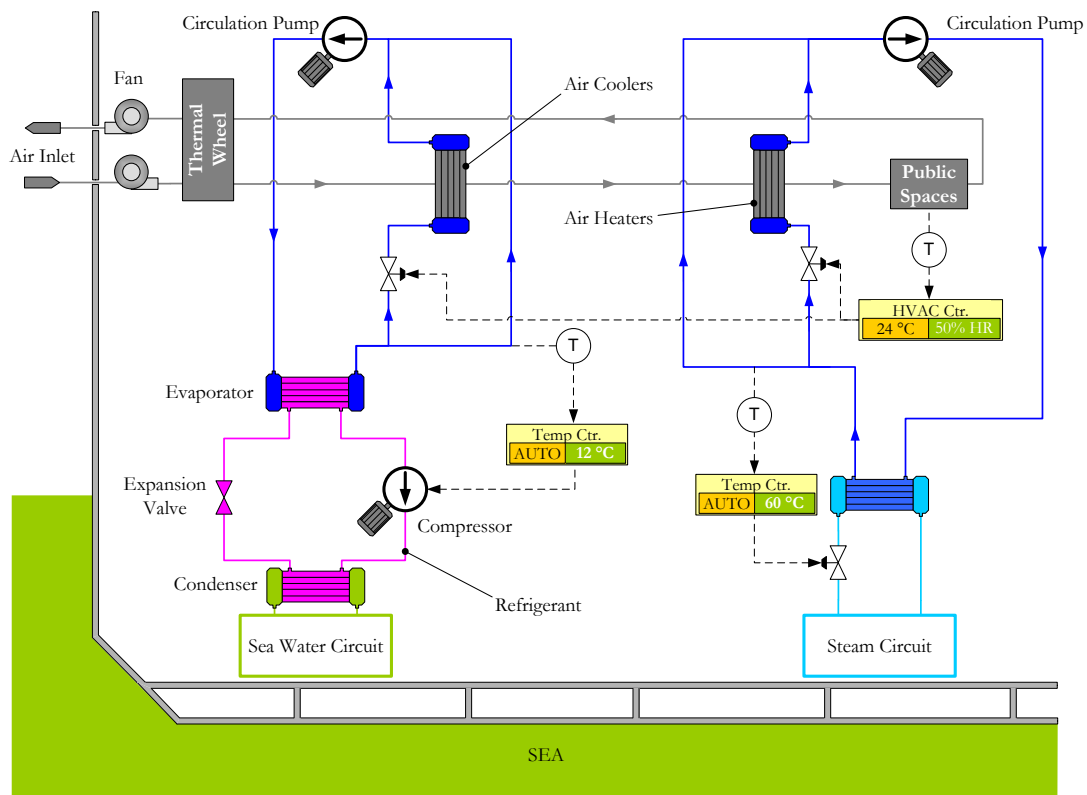

Figure A.21: HVAC system diagram

### ▪ **Main components**

The main components of an HVAC system are:

- Fans
- Thermal wheels
- An air conditioning plant or chiller composed of
  - An evaporator
  - A compressor
  - A sea water condenser
  - An Expansion valve
- A refrigerant circuit
- Air coolers
- Air heaters
- A steam exchanger
- Circulation pumps
- Temperature regulators

### ▪ **Working principle**

The air recycling function is ensured by fans that blow fresh air inside the public spaces and extract fouled air. This function can be constant or regulated thanks to CO<sub>2</sub> sensors. The fouled air can exchange its calories with the input fresh air through a rotary air heat exchanger or thermal wheel. In winter, the hot fouled air will preheat the cold fresh air.

The heating is ensured by a steam heat exchanger that heats up a fresh water loop. This hot water loop then heats up the air heaters. The water flow is ensured by a circulation and its temperature is controlled by a regulator.

The air conditioning is ensured by a chiller that cools down a fresh water loop. Inside the chiller, a refrigerant undergoes four thermodynamic transformations:

- the refrigerant starts in a gaseous state and is compressed at a high pressure in the compressor, it is now at a relative high pressure and temperature;
- the refrigerant is then condensed in the condenser where it loses its energy to the sea water, it is now in a liquid state, at relative low temperature and high pressure;
- the refrigerant is then expanded through an expansion valve, it is now at relative low temperature and pressure
- At this temperature and pressure, the refrigerant can then be evaporated at ambient temperature; it is therefore evaporated through the evaporator where it gives its energy to the cold fresh water loop; the refrigerant is now at relative low pressure and high temperature and can re-enter the compressor.

The flow of the cold fresh water loop is ensured by circulation pumps. Its temperature is controlled by a regulator.

The hygrometry is controlled by the combination of air cooling and heating. In a hot and humid environment, the air will first be cooled down at a temperature below dew point (around 8 °C) where its water will be condensed, collected and extracted, and then reheated at a warmer temperature (around 15 °C) before entering living rooms.



# APPENDIX B

## DIESEL ENGINE FUNDAMENTALS

---

The Diesel cycle is composed of four phases (see Figure B.1):

- 1 – 2: isentropic compression of the fluid by the piston;
- 2 – 3: reversible isobaric heating by the fluid's combustion;
- 3 – 4: isentropic expansion of the fluid on to the piston;
- 4 – 1: reversible isochoric cooling of the fluid.

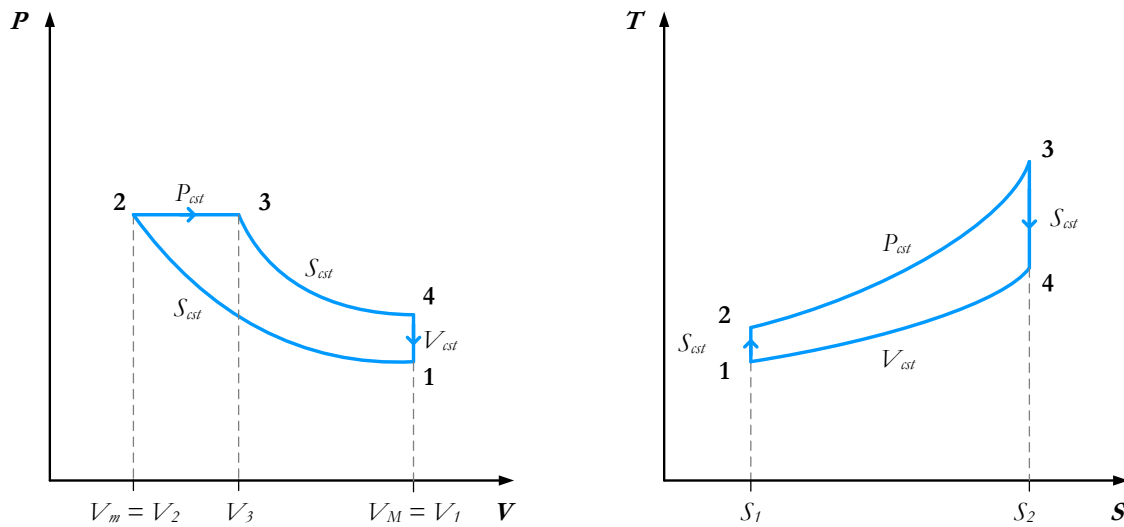

Figure B.1: (PV) and (TS) diagrams of the Diesel cycle.  $V_M$  is the maximum volume of the chamber and  $V_m$  is the minimum volume of the chamber.

The efficiency of the Diesel cycle is:

$$\eta_{th \cdot th} = 1 - \frac{|Q_{41}|}{Q_{23}} \quad (\text{B.1})$$

Where  $Q_{41}$  is the heat exchanged during phase 4 – 1 and  $Q_{23}$ , the heat exchanged during phase 2 – 3.

Given the following definitions:

- the compression ratio:  $CR = V_M/V_m$  ;
- the compression ratio for the isobaric combustion (2 – 3):  $CR_p = V_3/V_m = T_3/T_2$  ;

then the equation (B.1) can be rewritten into [76]:

$$\eta_{th\cdot th} = 1 - \frac{1}{CR^{\gamma-1}} \frac{CR_p^{\gamma} - 1}{\gamma \cdot (CR_p - 1)} \quad (\text{B.2})$$

Where  $\gamma$  is the adiabatic index. The efficiency increases with increasing  $CR$  and decreasing  $CR_p$ .

Theoretical cycles are relatively simple to simulate as they are only composed of reference thermodynamic transformations which are moreover often reversible. Unfortunately the real diesel engine cycle is quite different from the theoretical one (see Figure B.2).

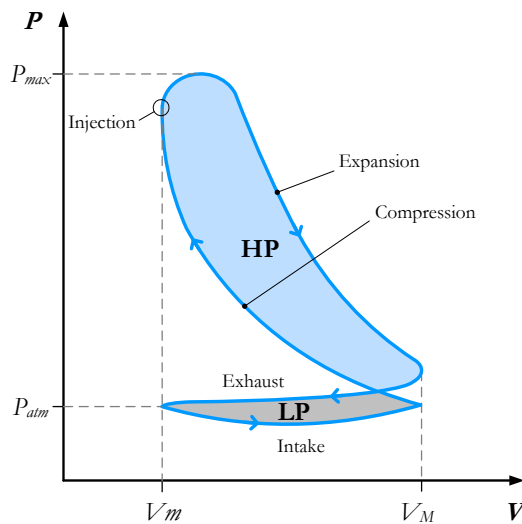

The real cycle of a diesel engine consists of two loops:

- the high pressure loop (HP) which corresponds to the compression and expansion phases; this loop globally provides work and one shall try to maximize its area;
- the low pressure loop (LP) which corresponds to the phases with open valves, that is to say exhaust and intake phases; this loop globally requires work due to pumping losses and one shall try to minimize its area.

**Figure B.2:** Typical cycle for a real diesel engine. Evolution of the pressure in function of the volume of the combustion chamber.

Every diesel engine model has to be compared to experimental values, whether it is for building an empirical model entirely based on measurements or for tuning a complex multi-dimensional model. These values are obtained through measure on an engine bench test. To assess the performance of a diesel engine, the minimum measurements required are [76]:

- the rotation speed;
- the brake torque;
- the fuel mass flow;
- the air mass flow;
- the average pressure and temperature at exhaust;
- the average pressure and temperature at admission;
- the pressure and temperature of the environment.

Moreover, when interested in gas emissions, one should measure CO<sub>2</sub>, CO, HC, NO<sub>x</sub>, O<sub>2</sub>, H<sub>2</sub>O, N<sub>2</sub> and particulates.

These measurements allow characterizing the evolution of the fluid and calculating important global parameters such as work, power or efficiency. The following parameters definitions are given.

▪ **Indicated work, indicated power**

The indicated work  $W_i$  (in J) is obtained by integration of the pressure curve over the entire cycle in the ( $PV$ ) diagram:

$$W_i = \oint -PdV \quad (\text{B.3})$$

The indicated work is given for one cycle. The indicated power  $P_i$  (in W) is obtained by multiplying by the number of cycles per second  $n_{cs}$ :

$$P_i = W_i \cdot n_{cs} \quad (\text{B.4})$$

▪ **Brake power**

The brake power  $P_b$  (in W) is the power available on the engine shaft:

$$P_b = \tau \cdot \omega \quad (\text{B.5})$$

Where:

- $\tau$  is the engine torque (N · m);
- and  $\omega$  is the engine rotation speed (rd/s).

The brake power will depend on whether the engine auxiliaries are taken into account or not and on the atmospheric conditions.

▪ **Power lost through friction**

The difference between indicated and brake power is the power lost through friction  $P_f$  (in W):

$$P_f = P_i - P_b \quad (\text{B.6})$$

The parameter  $P_f$  includes all power lost through friction inside the engine and the power absorbed by the engine auxiliaries (pump, ignition, injection, etc.).

▪ **Indicated, brake and friction mean effective pressure**

The indicated mean effective pressure  $IMEP$  (in Pa) is the theoretical average pressure inside the combustion chamber over one cycle:

$$IMEP = \frac{W_i}{V_M - V_m} \quad (\text{B.7})$$



The brake mean effective pressure  $BMEP$  (in Pa) is the mean effective pressure associated with the brake power:

$$BMEP = \frac{4\pi \cdot \tau}{(V_M - V_m)} = \frac{4\pi \cdot P_b}{\omega \cdot (V_M - V_m)} \quad (\text{B.8})$$

The equation (B.8) is valid for four stroke engine. For two stroke engine, the term  $4\pi$  is replaced by  $2\pi$ .

Just as  $P_f = P_i - P_b$ , one can write about the friction mean effective pressure  $FMEP$  (in Pa):

$$FMEP = IMEP - BMEP \quad (\text{B.9})$$

#### ▪ Fuel-Air equivalence ratio

The mass ratio of fuel over air before combustion characterizes the mixture. But this ratio allows to compare mixtures only when the same fuel is used as the stoichiometry of the combustion depends on the fuel used. To avoid this limitation, the following fuel-air equivalence ratio  $\phi$  is defined:

$$\phi = \frac{\left(\frac{m_{fuel}}{m_{air}}\right)_{real}}{\left(\frac{m_{fuel}}{m_{air}}\right)_{stoich}} \quad (\text{B.10})$$

Therefore:

- $\phi = 1$ : stoichiometric mixture;
- $\phi < 1$ : lean mixture or air excess;
- $\phi > 1$ : rich mixture or fuel excess that will necessarily lead to incomplete mixture.

The air-fuel equivalence ratio or excess air ratio  $\lambda$  is the inverse of the fuel-air equivalence ratio:  $\lambda = \phi^{-1}$ .

#### ▪ Effective efficiency

The engine effective efficiency (or global efficiency) is defined as the ratio of effective output power over the calorific power of the fuel  $P_{cal}$  (in W):

$$\eta_g = \frac{P_b}{P_{cal}} \quad (\text{B.11})$$

Where:  $P_{cal} = \dot{m}_{fuel} \cdot LHV$

#### ▪ Brake specific fuel consumption

The brake specific fuel consumption  $BSFC$  (in g/kWh) defines the mass of fuel consumed by the engine for a kWh of energy produced. The  $BSFC$  is proportional to the inverse of the global efficiency:

$$BSFC = \frac{\dot{m}_{hc}}{P_b} = \frac{3\,600\,000}{\eta_g \cdot LHV} \quad (\text{B.12})$$

To correctly calculate the engine BSFC, one must use the exact units specified below:

- $\dot{m}_{hc}$  the fuel mass consumption per hour (g/h)
- $P_b$  the effective power or brake power (kW)
- $LHV$  the lower heating value (kJ/kg)

▪ **Other efficiencies**

The organic efficiency  $\eta_{org}$  is the ratio of effective power over indicated power. It expresses the mechanical losses due to friction and auxiliaries work:

$$\eta_{org} = \frac{P_b}{P_i} \quad (\text{B.13})$$

The thermal efficiency  $\eta_{th}$  is the ratio of indicated power over the power released by the combustion  $P_{comb}$  (in W). It reflects the efficiency of the engine cycle:

$$\eta_{th} = \frac{P_i}{P_{comb}} \quad (\text{B.14})$$

The combustion efficiency  $\eta_{comb}$  is the ratio of combustion power over the calorific power of the fuel. It represents the quality of the combustion:

$$\eta_{comb} = \frac{P_{comb}}{P_{cal}} \quad (\text{B.15})$$

The theoretical thermodynamic efficiency  $\eta_{th \cdot th}$  is the ratio of the indicated power through the theoretical thermodynamic cycle over calorific power of the fuel. It reflects the quality of the theoretical engine cycle:

$$\eta_{th \cdot th} = \frac{P_{indicated \text{ over theoretical cycle}}}{P_{comb}} \quad (\text{B.16})$$

This efficiency can be compared to ideal engine efficiency such as the Carnot efficiency.

The cycle efficiency is the ratio of the indicated power over the indicated power over a theoretical cycle. It compares the performance of the engine cycle to the theoretical one:

$$\eta_{cycle} = \frac{P_i}{P_{indicated \text{ over theoretical cycle}}} \quad (\text{B.17})$$



# APPENDIX C

## HEATING VENTILATION & AIR CONDITIONING

---

**Note:** For a short technical description of HVAC systems please see section A.9.

HVAC systems can be very different from one ship to the other. The heating function can be fulfilled by simple electric radiators, heat pumps or hot water circuits. The ventilation can be single or dual flow\*. The air conditioning can be air to air, water to water or water to air†. Public spaces might be or not air-conditioned. And reefer ships keep their cargo refrigerated. HVAC systems may also be used to control humidity level in public spaces as explained in section A.9.

Calculating the energy consumption of HVAC systems depends on many factors:

- Sea and air temperature
- Air humidity
- Sunlight, which itself depends on:
  - Day of the year
  - Time of the day
  - Ship position on the globe
  - Ship azimuth
- The thermal inertia of the ship which itself depends on:
  - Ship structure
  - Space arrangement
  - Insulation
  - Window surface
  - Thermal bridges
  - Mass repartition
  - etc.

---

\* In single flow ventilation, ventilators put the ship in depression. The fouled air is extracted through suction nozzles present in humid rooms. Fresh air is naturally aspirated from the outside through nozzles in the hull. In dual flow ventilation, fresh air is no more aspirated but blown into the ship. Heat exchangers allow to heat up the fresh air in contact with the fouled air.

† The air conditioning system is said to be water to air when its condenser is cooled down by water and its evaporator heated up by air.

- Heat dissipation on board ship which itself depends on:
  - Machinery
  - Electrical devices (lighting, etc.)
  - Humans
  - Ventilation
  - Temperature and humidity regulation
  - etc.

Moreover most of these parameters will depend on time and space. In this respect, calculating the energy consumption of HVAC systems on board ships can be considered as a complex problem. As a matter of fact, to the best of the author's knowledge, there is no fully dedicated software available to meet this issue. In fact, most shipyards and design offices use spreadsheet programs based on worst case scenarios to choose equipments. These programs will overestimate the real energy consumption. For research applications, some shipyards and design offices start using more accurate programs. They may use dynamic energy analysis simulation programs such as TRNSYS, Pléiades-Comfie or EnergyPlus, which are designed for buildings but can be adapted to ships. Or they can use simulation platforms such as Modelica or Matlab Simulink where they can build their own models.

## C.1 HEAT PUMPS, AIR-CONDITIONING AND COLD PRODUCTION

Heat pumps, air-conditioners, freezers and refrigerators, all work according to the same principle: heat is extracted from a cold source and rejected to a hot one. They globally try to follow the reverse Carnot cycle, that is to say the Carnot cycle operated in the reverse way. Naturally, heat flows from the hot source to the cold one. A Carnot engine converts part of this heat flow into mechanical work. A frigorific cycle operates in the reverse way. The heat flows from the cold source to the hot one with the help of a mechanical force.

### ▪ Thermodynamic cycle

A practical yet still theoretical vapour compression refrigeration cycle is presented below on a Mollier diagram (Pressure – specific enthalpy) (see Figure C.1):

The key principle of refrigeration cycles (which allows to go against the naturel heat flow) is to condense a fluid (refrigerant) at a higher temperature than it will evaporate. This can only be achieved if condensation operates at a higher pressure than evaporation and hence requires a compressor. The different phases of a vapour compression refrigeration cycle are:

- 1 to 2: Liquid and vapour mixture is converted to all vapour through the evaporator
- 2 to 3: Vapour is overheated to avoid liquid entering the compressor
- 3 to 4: Vapour is compressed through the compressor
- 4 to 5: Vapour is fully converted into liquid through condenser
- 5 to 6: Liquid is cooled down through condenser
- 6 to 1: High pressure liquid is expanded through expansion valve and partially evaporates

Heat is transferred from the cold source to the refrigerant in the evaporator. Work is delivered to the compressor to compress the refrigerant from a low pressure (*LP*) to a high pressure (*HP*). Heat is transferred from the refrigerant to the hot source in the condenser.

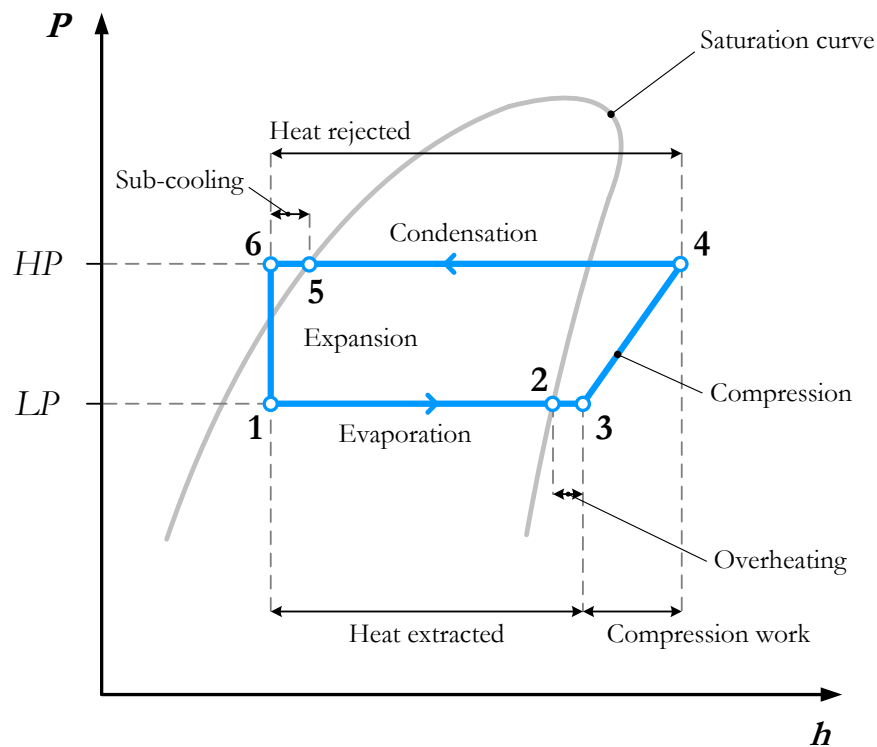

Figure C.1: Idealized vapour compression refrigeration cycle

#### ▪ Efficiencies

The difference between heat pumps and cold production units (air conditioning, refrigerators or freezers) is the desired output. For heat pumps the desired output is the heat rejected during condensation. This energy will heat up the equipped room while the heat extracted during evaporation will be taken from the environment. Therefore, the cold environment will be cooled down and the hot living room will be warmed up. For cold production units, the desired output is the heat extracted in the evaporator. In fact, to extract heat is synonym of producing cold. The evaporator will be placed inside the refrigerator or freezer or inside a living room for air conditioning purposes, while the condenser will release the extracted calories to the environment. For both heat and cold production, the input is the compressor work.

The general and theoretical expression of vapour compression refrigeration cycles efficiency is:

$$\eta_{th} = \frac{\text{Energy output}}{\text{Energy input}} = \frac{\text{Energy output}}{\text{Compressor work}} \quad (\text{C.1})$$

Applied to heat pumps, this expression becomes:

$$\eta_{th \text{ calorific}} = \frac{\text{Heat rejected}}{\text{Compressor work}} = \frac{h_4 - h_6}{h_4 - h_3} \quad (\text{C.2})$$

And for cold production units:

$$\eta_{th\ frigorific} = \frac{\text{Heat extracted}}{\text{Compressor work}} = \frac{h_3 - h_1}{h_4 - h_3} \quad (\text{C.3})$$

**Note: Because these efficiencies can be, and often are above 100%, one often talks of “coefficient of performance” (COP)**

These efficiencies are only theoretical. In fact, the compression is never isentropic and the compressor must compensate the pressure drop inside the refrigerant circuit. Moreover one should consider the mechanical work required by the evaporators and condensers fans and pumps. These factors lead to an increase of the overall required work by the installation and therefore a degradation of the efficiency.

# LIST OF PUBLICATIONS

---

P. Marty, P. Corrigan, A. Gondet, R. Chenouard, and J.-F. Hétet, “Modelling of energy flows and fuel consumption on board ships: application to a large modern cruise vessel and comparison with sea monitoring data,” presented at the 11th International Marine Design Conference, University of Strathclyde, Glasgow, Scotland, 2012, vol. 3, pp. 545–563.

P. Marty, P. Corrigan, and J.-F. Hétet, “Development of a Marine Diesel Engine Mean-Value Model for Holistic Ship Energy Modelling,” presented at the COFRET’14 - Colloque FRancophone en Énergie, Environnement, Économie et Thermodynamique, Paris, 2014.





# BIBLIOGRAPHY

---

- [1] *Hearing of Jean-Marc Janconvici at the French National Assembly concerning Climate Change*. French National Assembly, 2013.
- [2] Intergovernmental Panel on Climate Change, *Working Group I contribution to the IPCC 5th Assessment Report "Climate Change 2013: The Physical Science Basis". Final Draft Underlying Scientific-Technical Assessment*, Cambridge University Press. S. Joussaume, J. Penner, F. Tangang, 2013.
- [3] *IPCC, 2013: Summary for Policymakers. In: Climate Change 2013: The Physical Science Basis. Contribution of Working Group I to the Fifth Assessment Report of the Intergovernmental Panel on Climate Change*, Cambridge University Press, Cambridge, United Kingdom and New York, NY, USA. T. F. Stocker, D. Qin, G.-K. Plattner, M. Tignor, S. K. Allen, J. Boschung, A. Nauels, Y. Xia, V. Bex and P.M. Midgley (eds.), 2013.
- [4] D. P. van Vuuren, J. Edmonds, M. Kainuma, K. Riahi, A. Thomson, K. Hibbard, G. C. Hurtt, T. Kram, V. Krey, J.-F. Lamarque, T. Masui, M. Meinshausen, N. Nakicenovic, S. J. Smith, and S. K. Rose, "The representative concentration pathways: an overview," *Climatic Change*, vol. 109, no. 1–2, pp. 5–31, Nov. 2011.
- [5] Intergovernmental Panel on Climate Change, *Climate change 2007: the physical science basis: contribution of Working Group I to the Fourth Assessment Report of the Intergovernmental Panel on Climate Change*, Cambridge University Press. Cambridge, United Kingdom and New York, NY, USA: Solomon, S., D. Qin, M. Manning, Z. Chen, M. Marquis, K.B. Averyt, M. Tignor and H.L. Miller (eds.), 2007.
- [6] Ø. Buhaug, J. J. Corbett, Ø. Endresen, V. Eyring, J. Faber, S. Hanayama, D. S. Lee, D. Lee, H. Lindstad, and A. Z. Markowska, "Second IMO GHG Study 2009," International Maritime Organization, London (UK), 2009.
- [7] United Nations Conference on Trade and Development, *Review of maritime transport 2011*. New York: United Nations, 2011.
- [8] *World Economic Outlook 2013 Transition and Tensions*. International Monetary Fund, 2013.
- [9] BP p.l.c., "BP Statistical Review of World Energy 2013," London (UK), Jun. 2013.
- [10] International Maritime Organization, *MEPC.1/Circ.682 Interim Guidelines For Voluntary Verification Of The Energy Efficiency Design Index*. 2009.
- [11] International Maritime Organization, *MEPC.1/Circ.681 Interim Guidelines On The Method of Calculation Of The Energy Efficiency Design Index For New Ships*. 2009.
- [12] International Maritime Organization, *Resolution MEPC.203(62) Amendments to the Annex of the Protocol of 1997 to Amend the International Convention for the Prevention of Pollution from Ships, 1973, as Modified by the Protocol of 1978 Relating thereto*. 2011.
- [13] International Maritime Organization, *MEPC.1/Circ.684 Guidelines for voluntary use of the ship Energy Efficiency Operational Indicator (EEOI)*. 2009.

- [14] International Maritime Organization, *MEPC.1/Circ.683 Guidance for the development of a Ship Energy Efficiency Management Plan (SEEMP)*. 2009.
- [15] International Maritime Organization, *MARPOL: articles, protocols, annexes, unified interpretations of the International Convention for the Prevention of Pollution from Ships, 1973, as modified by the 1978 and 1997 protocols*, Consolidated ed. 2011, 5th ed. London: IMO, 2011.
- [16] Z. Rant, "Exergie, ein neues Wort für technische Arbeitsfähigkeit," *Gebiet des Ingenieurwesens*, no. 22, pp. 36–37, 1956.
- [17] A. Lallemand, "Thermodynamique appliquée Bilans entropiques et exergetiques," *Techniques de l'ingénieur Thermodynamique et énergétique*, vol. TIB216DUO, no. be8008, 2014.
- [18] M. Feidt, *Energétique : Concepts et applications Cours et exercices corrigés*. Dunod, 2006.
- [19] I. Dincer and M. A. Rosen, "Chapter 1 - Thermodynamic Fundamentals," in *Exergy (Second Edition)*, I. Dincer and M. A. Rosen, Eds. Elsevier, 2013, pp. 1–20.
- [20] C. Sayin, M. Hosoz, M. Canakci, and I. Kilicaslan, "Energy and exergy analyses of a gasoline engine," *International Journal of Energy Research*, vol. 31, no. 3, pp. 259–273, 2007.
- [21] M. Feidt, R. Benelmir, and A. Lallemand, "Analyse exergetique," *Techniques de l'ingénieur Thermodynamique et énergétique*, vol. TIB216DUO., no. be8015, 2014.
- [22] L. Borel and D. Favrat, *Thermodynamique et énergétique*. PPUR presses polytechniques, 2005.
- [23] I. Dincer and M. A. Rosen, *Exergy: Energy, Environment and Sustainable Development*. Elsevier, 2007.
- [24] F. Baldi, "Improving Ship Energy Efficiency through a Systems Perspective," Licentiate thesis, Chalmers University of Technology. Department of Shipping and Marine Technology, Gothenburg, Sweden, 2013.
- [25] G. G. Dimopoulos, C. A. Georgopoulou, and N. M. P. Kakalis, "The introduction of exergy analysis to the thermo-economic modelling and optimisation of a marine combined cycle system," in *The 25th International Conference on Efficiency, Cost, Optimization and Simulation of Energy Conversion Systems and Processes*, Perugia (Italy), 2012.
- [26] I. Dincer and M. A. Rosen, "Chapter 12 - Exergy Analysis of Steam Power Plants," in *Exergy (Second Edition)*, I. Dincer and M. A. Rosen, Eds. Elsevier, 2013, pp. 261–284.
- [27] M. A. Rosen, "Energy- and exergy-based comparison of coal-fired and nuclear steam power plants," *Exergy, An International Journal*, vol. 1, no. 3, pp. 180–192, 2001.
- [28] C. Koroneos, I. Haritakis, K. Michaloglou, and N. Moussiopoulos, "Exergy Analysis for Power Plant Alternative Designs, Part I," *Energy Sources*, vol. 26, no. 13, pp. 1277–1285, 2004.
- [29] C. Koroneos, I. Haritakis, K. Michaloglou, and N. Moussiopoulos, "Exergy Analysis for Power Plant Alternative Designs, Part II," *Energy Sources*, vol. 26, no. 13, pp. 1287–1295, 2004.
- [30] S. C. Kaushik, V. S. Reddy, and S. K. Tyagi, "Energy and exergy analyses of thermal power plants: A review," *Renewable and Sustainable Energy Reviews*, vol. 15, no. 4, pp. 1857–1872, May 2011.
- [31] I. H. Aljundi, "Energy and exergy analysis of a steam power plant in Jordan," *Applied Thermal Engineering*, vol. 29, no. 2–3, pp. 324–328, Feb. 2009.

- [32] S. Bilgen and K. Kaygusuz, "The calculation of the chemical exergies of coal-based fuels by using the higher heating values," *Applied Energy*, vol. 85, no. 8, pp. 776–785, Aug. 2008.
- [33] C. D. Rakopoulos and E. G. Giakoumis, "Second-Law Analysis of Indirect Injection Turbocharged Diesel Engine Operation Under Steady State and Transient Conditions," 2005.
- [34] D. V. D Mermiris, "Dynamic Energy Modeling – A New Approach To Energy Efficiency And Cost Effectiveness In Shipping Operations," presented at the Low Carbon Shipping, Glasgow, 2011.
- [35] R. Gicquel, *Systèmes énergétiques: Volume 1, Méthodologie d'analyse, bases de thermodynamique, composants, Thermoptim*. Presses des MINES, 2009.
- [36] G. Donnadieu, D. Durand, D. Neel, E. Nunez, and L. Saint-Paul, "L'approche systémique : de quoi s'agit-il ?," presented at the Diffusion de la pensée systémique.
- [37] J. de Rosnay, *Le macroscope - Vers une vision globale*. Seuil, 1977.
- [38] J.-L. L. Moigne, *La théorie du système général*, 3e éd. mise à jour. Presses Universitaires de France (PUF), 1990.
- [39] "System," *Oxford Dictionaries*. Oxford University Press, Apr-2010.
- [40] S. Glouberman and B. Zimmerman, "Complicated and complex systems: what would successful reform of Medicare look like?," *Changing Health Care in Canada: The Romanow Papers*, vol. 2, pp. 21–53, 2002.
- [41] B. de la Bretesche, *La méthode APTE : analyse de la valeur, analyse fonctionnelle*. Paris: Ed. Pétrele, 2000.
- [42] J. J. Kaufman and R. Woodhead, *Stimulating Innovation in Products and Services : Function Analysis and Function Mapping*, 1st ed. Wiley-Interscience, 2006.
- [43] D. T. Ross, "Structured Analysis (SA): A Language for Communicating Ideas," *IEEE Transactions on Software Engineering*, vol. SE-3, no. 1, pp. 16–34, Jan. 1977.
- [44] S. Gaaloul, "Interopérabilité basée sur les standards Modelica et composant logiciel pour la simulation énergétique des systèmes de bâtiment," Ph.D. dissertation, Université de Grenoble, 2012.
- [45] A. Jardin, "Contribution à une méthodologie de dimensionnement des systèmes mécatroniques : analyse structurelle et couplage à l'optimisation dynamique," Ph.D. dissertation, INSA de Lyon, 2010.
- [46] P. Fritzson, *Principles of Object-Oriented Modeling and Simulation with Modelica 2.1*. John Wiley & Sons, 2004.
- [47] S. Furic, "Hybrid acausal modeling using Modelica Presentation of Modelica," presented at the Journées Outils, INSA Lyon, 2007.
- [48] J. Kofránek, M. Mateják, P. Privitzer, and M. Tribula, "Causal or acausal modeling: labour for humans or labour for machines," *Technical Computing Prague*, pp. 1–16, 2008.
- [49] Yoann VERNAT, "Formalisation et qualification de modèles par contraintes en conception préliminaire," Ph.D. dissertation, École Nationale Supérieure d'Arts et Métiers - Centre de Bordeaux, 2004.

- [50] A. Lallemand, "Compression et détente des gaz ou des vapeurs," *Techniques de l'ingénieur Thermodynamique et énergétique*, vol. TIB216DUO., no. be8013, 2014.
- [51] "Modelica® - A Unified Object-Oriented Language for Systems Modeling - Language Specification - Version 3.3." Modelica Association, 09-May-2012.
- [52] R. Renier and R. Chenouard, "De SYSML à Modelica : Aide à la formalisation de modèles de simulation en conception préliminaire," in *12ème Colloque National AIP PRIMECA*, 2011.
- [53] P. Fritzson, A. Pop, P. Aronsson, D. Akhvlediani, B. Bachmann, V. Baluta, S. Björklén, M. Blom, D. Broman, and H. Eriksson, "OpenModelica System Documentation - Preliminary Draft, 2007-11-08 for OpenModelica 1.4.3." 2007.
- [54] Modelica association, "Modelica Standard Library," *Modelica*. [Online]. Available: <https://www.modelica.org/libraries/Modelica>. [Accessed: 01-Apr-2013].
- [55] S. Berger and M. Lorang, "Navire pourvu de moyens de récupération d'énergie thermique et procédé correspondant," EP2106999 B129-Dec-2010.
- [56] Wärtsilä Finland, "Project Guide - Wärtsilä 46." Mar-2007.
- [57] D. Bichat-Gobard, *Thermodynamique : Les Principes et leurs Applications*. InfoMer, 2002.
- [58] "Basic Principles of Ship Propulsion." MAN Diesel & Turbo, 2012.
- [59] D. Paulet and D. Presles, *Architecture navale: connaissance et pratique*. Paris: Ed. La Villette, 1998.
- [60] J. Holtrop and G. G. J. Mennen, "A Statistical Power Prediction Method," *International Shipbuilding Progress*, vol. 25, no. 290, Oct. 1978.
- [61] J. Holtrop and G. G. Mennen, "An approximate power prediction method," 1982.
- [62] "Wärtsilä netGTD." [Online]. Available: <http://www.wartsila.com/en/marine-solutions/products/netGTD>. [Accessed: 17-Oct-2013].
- [63] "MAN Diesel & Turbo - CEAS-ERD." [Online]. Available: <http://www.mandieselturbo.com/ceas/index.html>. [Accessed: 17-Oct-2013].
- [64] C. D. Rakopoulos and E. G. Giakoumis, "Review of thermodynamic diesel engine simulations under transient operating conditions," *SAE Paper*, no. 2006-01, p. 0884, 2006.
- [65] J. F. Hétet, B. Inozu, P. Roy, X. Tauzia, and P. Chessé, "Performance simulation of marine diesel engines with SELENDIA," *Journal of ship research*, vol. 43, no. 4, pp. 201-207, 1999.
- [66] T. Jaine and P. Higelin, "Modélisation du cycle moteur Moteur à allumage par compression," *Techniques de l'ingénieur Combustion dans les moteurs thermiques et environnement*, vol. base documentaire : TIB166DUO., no. ref. article : bm2516, 2013.
- [67] K. Banisoleiman, L. A. Smith, Z. Bazari, and N. Mathieson, "Computer simulation of Diesel engine performance," 1992.
- [68] Rémi Dubouil, "Etude par simulation des transferts thermiques dans un groupe motopropulseur hybride électrique automobile," Ph.D. dissertation, Ecole Centrale de Nantes, Nantes, 2012.

- [69] C. D. Rakopoulos, C. N. Michos, and E. G. Giakoumis, "Study of the transient behavior of turbocharged diesel engines including compressor surging using a linearized quasi-steady analysis," *SAE Paper No. 2005-01*, vol. 225, 2005.
- [70] C. D. Rakopoulos and E. G. Giakoumis, *Diesel Engine Transient Operation: Principles of Operation and Simulation Analysis*. Springer, 2009.
- [71] I. Wiebe, *Halbempirische formel für die verbrennungsgeschwindigkeit*, Verlag der Akademie der Wissenschaft der VDSSR. Moscow, 1967.
- [72] G. Woschni, "A Universally Applicable Equation for the Instantaneous Heat Transfer Coefficient in the Internal Combustion Engine," SAE International, Warrendale, PA, SAE Technical Paper 670931, Feb. 1967.
- [73] N. A. Watson and M. S. Janota, *Turbocharging: The Internal Combustion Engine*. Macmillan Publishers Limited, 1982.
- [74] J. H. Keenan and J. Kaye, *Gas tables: thermodynamic properties of air products of combustion and component gases comprehensive flow functions*. New York, N.Y.: J. Wiley and Sons, 1948.
- [75] S. K. Chen and P. F. Flynn, "Development of a Single Cylinder Compression Ignition Research Engine," SAE International, Warrendale, PA, SAE Technical Paper 650733, Feb. 1965.
- [76] P. GUIBERT, "Modélisation du cycle moteur Approche zérodimensionnelle," *Techniques de l'ingénieur Combustion dans les moteurs thermiques et environnement*, vol. base documentaire : TIB166DUO., no. ref. article : bm2510, 2005.
- [77] E. Hendricks, "Mean Value Modelling of Large Turbocharged Two-Stroke Diesel Engines," SAE International, Warrendale, PA, SAE Technical Paper 890564, Feb. 1989.
- [78] E. Hendricks and S. C. Sorenson, "Mean Value Modelling of Spark Ignition Engines," SAE International, Warrendale, PA, SAE Technical Paper 900616, Feb. 1990.
- [79] O. Grondin, "Modélisation du moteur à allumage par compression dans la perspective du contrôle et du diagnostic," Ph.D. dissertation, Université de Rouen, Rouen, 2004.
- [80] R. Omran, "Modélisation du moteur diesel, en vue de sa commande dynamique par réseaux de neurones pour minimiser les émissions," Ph.D. dissertation, Ecole Centrale de Lyon, 2007.
- [81] D. R. Rajamani, "Mean Value Modeling of SI and Diesel Engines," in *Vehicle Dynamics and Control*, Springer US, 2012, pp. 241–265.
- [82] J. Karlsson and J. Fredriksson, "Cylinder-by-Cylinder Engine Models Vs Mean Value Engine Models for Use in Powertrain Control Applications," SAE International, Warrendale, PA, SAE Technical Paper 1999-01-0906, Mar. 1999.
- [83] D. Silverlind, "Mean value engine modeling with modelica," Master's thesis, Linköping, Sweden, 2001.
- [84] J. Biteus, "Mean Value Engine Model of a Heavy Duty Diesel Engine," Master's thesis, Linköping, Sweden, 2002.

- [85] P. Chesse, D. Chalet, X. Tauzia, J. F. Hetet, and B. Inozu, "Real-Time Performance Simulation of Marine Diesel Engines for the Training of Navy Crews," *Marine Technology*, vol. 41, no. 3, pp. 95–101, Jul. 2004.
- [86] G. P. Theotokatos, "A Comparative Study on Mean Value Modelling of Two-Stroke Marine Diesel Engine," in *WSEAS International Conference on Maritime and Naval Science and Engineering*, 2009, pp. 24–26.
- [87] D. Woodyard, "Chapter Four - Fuels and Lubes: Chemistry and Treatment," in *Pounder's Marine Diesel Engines and Gas Turbines (Ninth Edition)*, D. Woodyard, Ed. Oxford: Butterworth-Heinemann, 2009, pp. 87–142.
- [88] D. Woodyard, "Chapter One - Theory and General Principles," in *Pounder's Marine Diesel Engines and Gas Turbines (Ninth Edition)*, D. Woodyard, Ed. Oxford: Butterworth-Heinemann, 2009, pp. 1–40.
- [89] MAN Diesel & Turbo, "48/60CR Project Guide - Marine. Four-stroke diesel engines compliant with IMO Tier II," 2.13, May 2011.
- [90] A. Stankovic, "Modelling of air flows in automotive engines using Modelica," Master's thesis, Linköping, Sweden, 2000.
- [91] J. F. Hétet, "Établissement d'un programme de simulation du fonctionnement de moteurs diesel suralimentés par deux étages de turbo-compresseurs en série. Application à la recherche des limites d'exploitation en relation avec le phénomène de pompage dans les compresseurs," Ph.D. dissertation, ENSM Nantes, Nantes, 1989.
- [92] M. Jankovic and I. Kolmanovsky, "Robust nonlinear controller for turbocharged diesel engines," in *American Control Conference proceedings*, Philadelphia, PA, 1998, vol. 3, pp. 1389–1394.
- [93] D. N. Malkhede, B. Seth, and H. C. Dhariwal, "Mean Value Model and Control of a Marine Turbocharged Diesel Engine," SAE International, Warrendale, PA, SAE Technical Paper 2005-01-3889, Oct. 2005.
- [94] M. Kao and J. J. Moskwa, "Turbocharged diesel engine modeling for nonlinear engine control and state estimation," *Journal of dynamic systems, measurement, and control*, vol. 117, no. 1, pp. 20–30.
- [95] T. F. Yusaf, S. F. Fong, M. Z. Yusoff, and I. Hussein, "Modeling of transient heat flux in spark ignition engine during combustion and comparisons with experiments," *American Journal of Applied Sciences*, vol. 2, no. 10, pp. 1438–1444, Oct. 2005.
- [96] L. Tomaselli and A. Alexandre, "Analyse des transferts énergétiques dans les moteurs automobiles," *Techniques de l'ingénieur Combustion dans les moteurs thermiques et environnement*, vol. TIB166DUO., no. bm2900, 2014.
- [97] R. W. Cruz, S. A. Nebra, and E. F. Cartaxo, "A Simple Simulation Technique For Energy Balance Of Internal Combustion Engines Under Variable Load," presented at the ECOS 2005 - 18th International Conference on Efficiency, Cost, Optimization, Simulation and Environmental Impact of Energy Systems, Trondheim, Norway, 2005, pp. 1353–1358.
- [98] M. Zheng, G. T. Reader, and J. G. Hawley, "Diesel engine exhaust gas recirculation—a review on advanced and novel concepts," *Energy Conversion and Management*, vol. 45, no. 6, pp. 883–900, Apr. 2004.

- [99] O. Flårdh and M. Gustafson, “Mean value modelling of a diesel engine with turbo compound,” Master’s thesis, Linköping, 2003.
- [100] U. Larsen, L. Pierobon, F. Haglind, and C. Gabriellini, “Design and optimisation of organic Rankine cycles for waste heat recovery in marine applications using the principles of natural selection,” *Energy*, vol. 55, pp. 803–812, Jun. 2013.
- [101] G. Shu, Y. Liang, H. Wei, H. Tian, J. Zhao, and L. Liu, “A review of waste heat recovery on two-stroke IC engine aboard ships,” *Renewable and Sustainable Energy Reviews*, vol. 19, pp. 385–401, Mar. 2013.
- [102] The International Association for the Properties of Water and Steam, “Revised Release on the IAPWS Industrial Formulation 1997 for the Thermodynamic Properties of Water and Steam.” Aug-2007.
- [103] G. Descombes, F. Maroteaux, and M. Feidt, “Study of the interaction between mechanical energy and heat exchanges applied to IC engines,” *Applied Thermal Engineering*, vol. 23, no. 16, pp. 2061–2078, Nov. 2003.
- [104] Anthony F. Molland, Ed., *The Maritime Engineering Reference Book*. Oxford: Butterworth-Heinemann, 2008.
- [105] J. F. Hansen, A. K. Ådnanes, and T. I. Fossen, “Mathematical Modelling of Diesel-Electric Propulsion Systems for Marine Vessels,” *Mathematical and Computer Modelling of Dynamical Systems*, vol. 7, no. 3, pp. 323–355, 2001.



# Thèse de Doctorat

Pierre MARTY

**Title: Ship energy efficiency study: development and application of an analysis method**

**Titre : Étude de l'efficacité énergétique des navires : développement et application d'une méthode d'analyse**

## Abstract

The shipping industry is facing three major challenges: climate change, increasing bunker fuel price and tightening international rules on pollution and CO<sub>2</sub> emissions. All these challenges can be met by reducing fuel consumption. The energy efficiency of shipping is already very good in comparison with other means of transportation but can still be and must be improved. There exist many technical and operational solutions to that extent. But assessing their true and final impact on fuel consumption is far from easy as ships are complex systems. A first holistic and energetic modelling approach tries to deal with this issue. Based on the first law of thermodynamics, it has made it possible to model a complete and modern cruise carrier. Its fuel consumption and corresponding atmospheric emissions were calculated with a good level of accuracy. The model has also proven to be very useful at comparing design alternatives hence showing its capacity to evaluate energy efficiency solutions. A second approach completes the first one. Based this time on the second law, including the concept of exergy, it offers a more detailed and physical description of ships. It can precisely assess energy savings, including the part of thermal energy convertible into work. This innovative approach has required new model developments, including a new model of diesel engine, based on the mean value approach, capable of calculating the complete thermal balance for any engine operating point.

**Key Words: Shipping; Energy modelling; Exergy; Modelica; Energy efficiency, Diesel engine modelling**

## Résumé

Le transport maritime fait face à trois défis majeurs : le dérèglement climatique, l'augmentation du cours du baril et le durcissement des normes internationales en termes de pollution et d'émission de CO<sub>2</sub>. Ce triple challenge peut être relevé en réduisant la consommation de fioul. L'efficacité énergétique des navires est déjà très bonne en comparaison des autres moyens de transport mais elle peut et doit encore progresser. Il existe à cet effet de multiples solutions techniques et opérationnelles. Mais évaluer leur impact réel sur les économies finales n'est pas toujours chose aisée étant donnée la complexité des navires. Une première approche globale de modélisation énergétique du navire tente de répondre à cette problématique. Basée sur le premier principe de la thermodynamique, cette approche a permis de modéliser un paquebot. La consommation de fioul et les émissions associées ont été calculées avec un niveau d'exactitude satisfaisant. Le modèle s'est de plus montré très utile dans la comparaison d'alternatives de conception, illustrant ainsi sa capacité à évaluer les solutions d'économie d'énergie. Une deuxième approche vient compléter la première. Basée cette fois-ci sur le second principe et notamment sur le concept d'exergie, cette approche propose une description plus détaillée et physique du navire. Elle permet d'évaluer précisément les gains d'énergie possibles et en particulier la part convertible en travail mécanique. Cette approche novatrice a nécessité le développement de nouveaux modèles et notamment un nouveau modèle de moteur diesel basé sur l'approche moyenne et qui permet de calculer la balance thermique complète et ce sur tout le champ moteur.

**Mots clés : Transport maritime ; Modélisation énergétique ; Exergie ; Modelica ; Efficacité énergétique ; Modélisation moteur diesel**